

# Electronic Design 24

VOL. 15 NO.

FOR ENGINEERS AND ENGINEERING MANAGERS.

NOV. 22, 1967

**Perform 4500 tests in minutes.** Also, check data from thousands of test points in just seconds. Such tasks are assigned to 125 computers in the NASA Apollo

program, the most complicated use so far of automatic checkout equipment. Advances in displays and sensors are also contributing to rapid testing. See page 49.



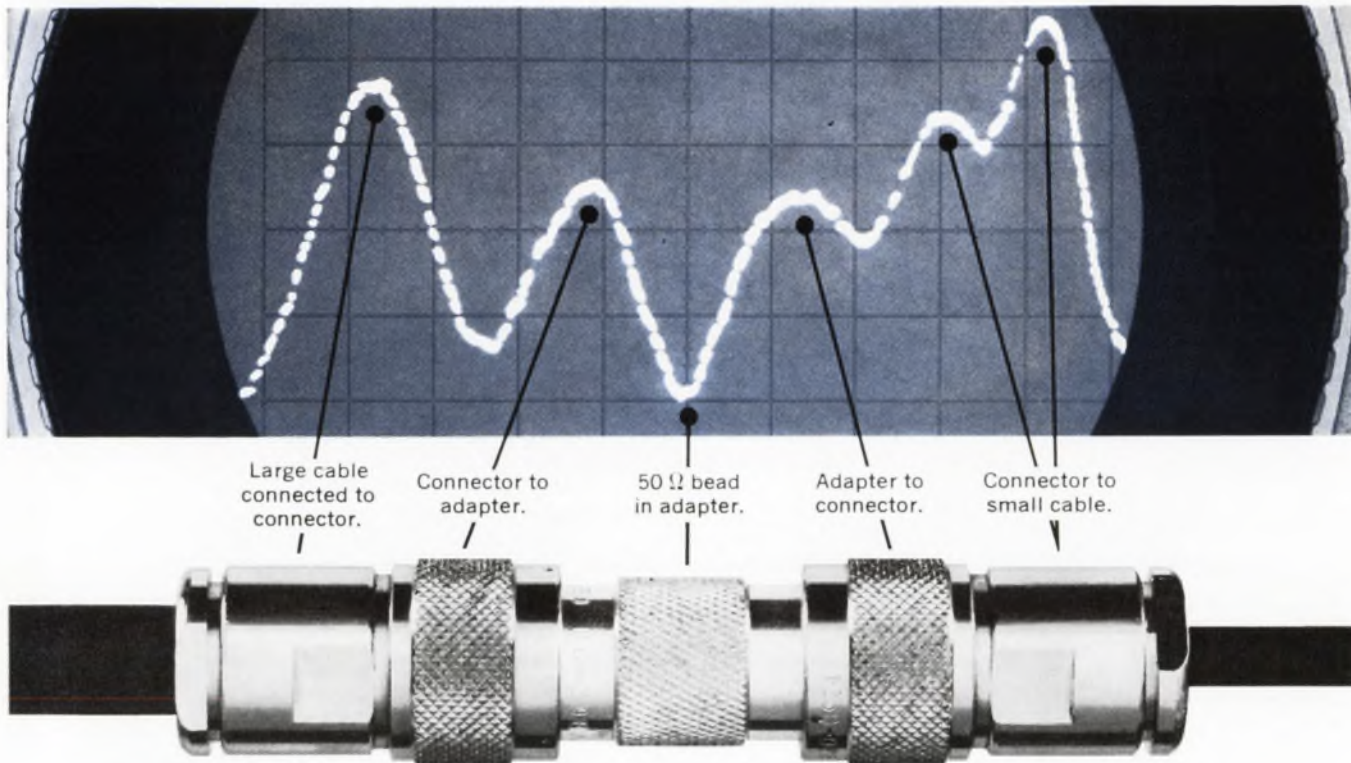

## Here's a measurement you've never seen before!

*40 ps TDR resolves and locates discontinuities to a half centimeter in systems through X band.*

Minute discontinuities mean reflections and trouble at GHz frequencies. They are also the ones almost impossible to discern in slower TDR systems.

With 40 ps TDR, you can pinpoint fault locations down to within 0.4 cm in polyethylene, 0.6 cm in air. This is four times the resolution you have had up to now. (Reflection coefficient sensitivity extends to 0.002/cm.)

You not only have precision location, but you can clearly identify high frequency transmission line reflections—inductive discontinuities down to 0.01 nH, and capacitive discontinuities down to 0.004 pF.

If you design or build in the GHz region, here is an essential instrument for quickly checking and correcting attenuators, delay lines, distributed deflection plates, strip lines, switches and connectors.

If you already have a new hp 28 ps Sampling System, add the hp 1105/1106A Fast Rise Pulser (\$750) and you have a 40 ps TDR System. 28 ps Sampling System: 140A Oscilloscope Mainframe, \$595 (or 141A Variable Persistence and Storage Oscilloscope Mainframe, \$1395); 1424A Time Base, \$1200 (or 1425A Time Base, \$1600); 1411A Vertical Amplifier, \$700; 1430A 28 ps Remote Sampling Head, \$3,000.

Ask your hp field engineer for the complete story on

hp TDR systems. Or, write to Hewlett-Packard, Palo Alto, California 94304. Europe: 54 Route des Acacias, Geneva.

### hp 140 — The Scope System that gives you



**20 MHz Wideband · High-Sensitivity, no drift · 40 or 150 ps TDR  
12.4 GHz Sampling · Variable Persistence and Storage**

081106

**HEWLETT  PACKARD**

**OSCILLOSCOPE SYSTEMS**

ON READER SERVICE CARD CIRCLE 242



- 1309-A . . . \$325\*
- 10 Hz to 100 kHz, sine or square waves
  - Distortion < 0.05%
  - Output flat  $\pm 2\%$  over entire range; 5-V open-circuit output
  - 60-dB attenuator (20 dB/step)



- 1311-A . . . \$225\*
- 50 Hz to 10 kHz in 11 fixed steps
  - Distortion < 0.5%
  - 100-V open-circuit output, 4 A short circuit



- 1312-A . . . \$295\*
- 2 Hz to 2 MHz
  - Distortion <  $\pm 0.5\%$  (even with output shorted)
  - 20-V open-circuit output



- 1313-A . . . \$325\*
- 10 Hz to 50 kHz in one range
  - sine or square wave
  - Distortion < 0.5%
  - Output flat to  $\pm 2\%$  over entire range; 5-V open-circuit output.
  - 60-dB attenuator (20 dB/step)



\*Prices apply only in U.S.A.

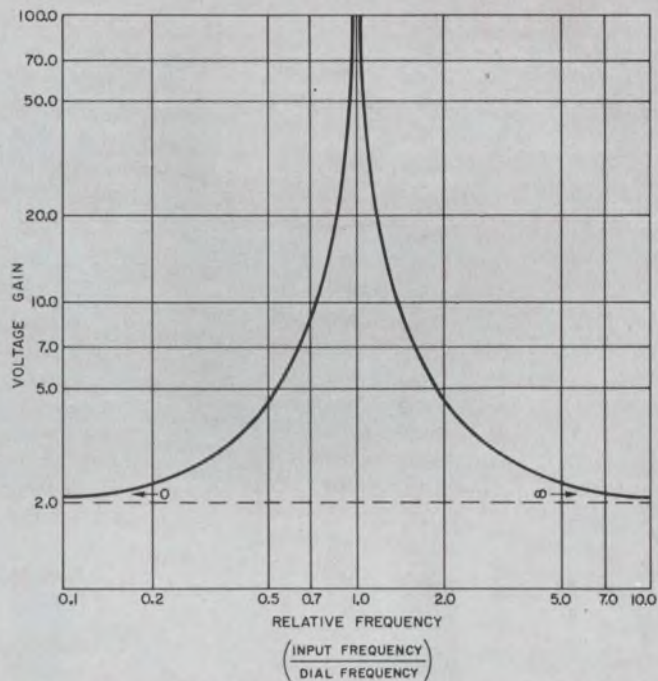

## These oscillators function as high-Q filters

While oscillating, three of them can function as tunable narrow-band filters . . . hence they can be used at a variety of frequencies to reduce fm and jitter.

They can also serve as frequency-selective amplifiers with a voltage gain of greater than 100 and with effective rejection of noise and harmonics.

They can be locked to a frequency standard for use as high-stability signal sources at test stations. Or, they can be used as frequency multipliers because they can be locked onto a harmonic as easily as they can be locked to a fundamental. They can also furnish sync signals to other instruments.

How can an oscillator do all this? No big secret . . . these RC oscillators are all equipped with a handy "synchronizing jack" . . . another GR first in oscillator design. Put a signal in (1 volt will do) and out comes the same frequency all cleaned up and amplified; or take out the sync signal and use it to trigger a counter or a scope or even another GR RC oscillator. One other thing — they're great when used as just oscillators.

**GENERAL RADIO**

ON READER-SERVICE CARD CIRCLE 3

# If you buy HP counters, we have news for you.

**Systron-Donner makes advanced counter instrumentation that has no equivalent in the HP catalog. That's why it pays to check with Systron-Donner before you buy. You'll find equipment with unique capability like:**

1. A plug-in that will extend your counter's frequency range to 15 GHz – measuring FM and pulsed RF as well as CW and AM. The only way to get the full dc to 15 GHz range in one cabinet. No calculations. Displays final answer.



3. "Thin Line" counters that take only 1 3/4" of rack space. Built with ultra-reliable integrated circuits to give you automatic frequency measurements – dc to 100 MHz or 0.3 to 12.4 GHz.

These are the highlights of expandable systems that will make just about any measurement possible with counters. The accuracy of our basic 50 MHz and 100 MHz counters is unsurpassed. (Time base aging rate is only 5 parts in 10<sup>10</sup> per 24 hrs.) All devices to extend the range or add functions are convenient plug-ins – not rack mounts. The newest are a prescaler to extend counter range to 350 MHz and a heterodyne converter to measure noisy signals in the 0.2 to 5 GHz range.

Are you surprised that Systron-Donner is a step ahead of HP in counter technology? How else could we stay in business?

Systron-Donner Corporation, 888 Galindo Street, Concord, California 94520

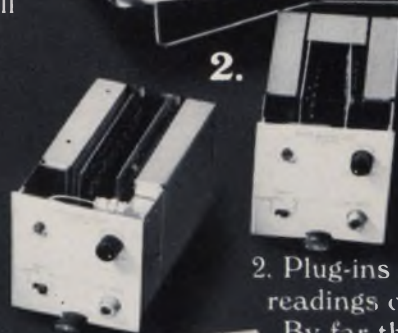

2. Plug-ins that produce automatic readings of microwave frequencies. By far the most compact and economical equipment for producing automatic readings in the 0.3 to 3 GHz band or the 5 to 12.4 GHz band.



**Send for catalog.**



**SYSTRON  DONNER**

---

## NEWS

- 13 News Scope
- 17 The Dolby black box opens. . .just a little  
Audio device divides spectrum, boosts low-level signals to mask noise.
- 20 In the LSI era, extra circuits may lower cost
- 22 Faraday effect gives new twist to laser memory
- 24 Go West, young man, but buy a round-trip ticket
- 29 Washington Report
- 38 Letters
- 40 Test Instrument Directory Errata
- 42 Sidelights of the Issue
- 45 **Editorial:** One person can count, but why not an engineer?

---

## TECHNOLOGY

- 49 **Special Report: ACE—The ultimate in failure detection**
- 50 Computers point the way to more versatile ACE
- 52 Automatic checkout heads for an era of growth
- 60 Better displays emerging as data volume mounts
- 64 **Passive sensors needed for ACE of the future**
- 70 **Build a fast, wide-range agc system** with a 'vario-losser' attenuator. The circuit has few ICs and discrete components, no transformers.
- 75 **Simulate ICs with analog black boxes** by using the ECAP digital computer program and basic circuit-building blocks.
- 81 **Regulate voltages with varistors.** Their symmetrical response to voltage changes makes them suitable for dc and ac regulation.
- 88 **Good budgeting can boost profits.** Learn the fiscal fundamentals, and you'll know how management plans profits by controlling costs.
- 94 NASA Tech Briefs
- 98 Ideas for Design

---

## PRODUCTS

- 108 **Materials:** 70 million lb/in.<sup>2</sup> elasticity in single-crystal sapphire.
- 120 **Systems:** Penciled records enter EDP systems.
- 112 Microwaves
- 116 Components
- 118 Semiconductors
- 119 Production Equipment

---

## Departments

- 96 Book Reviews
- 124 Design Aids
- 125 Application Notes
- 126 New Literature
- 130 Reprints
- 132 Advertisers' Index
- 134 About the Magazine
- 135 Designer's Datebook

Reader Service card inside back cover

# The newest look in a new look at

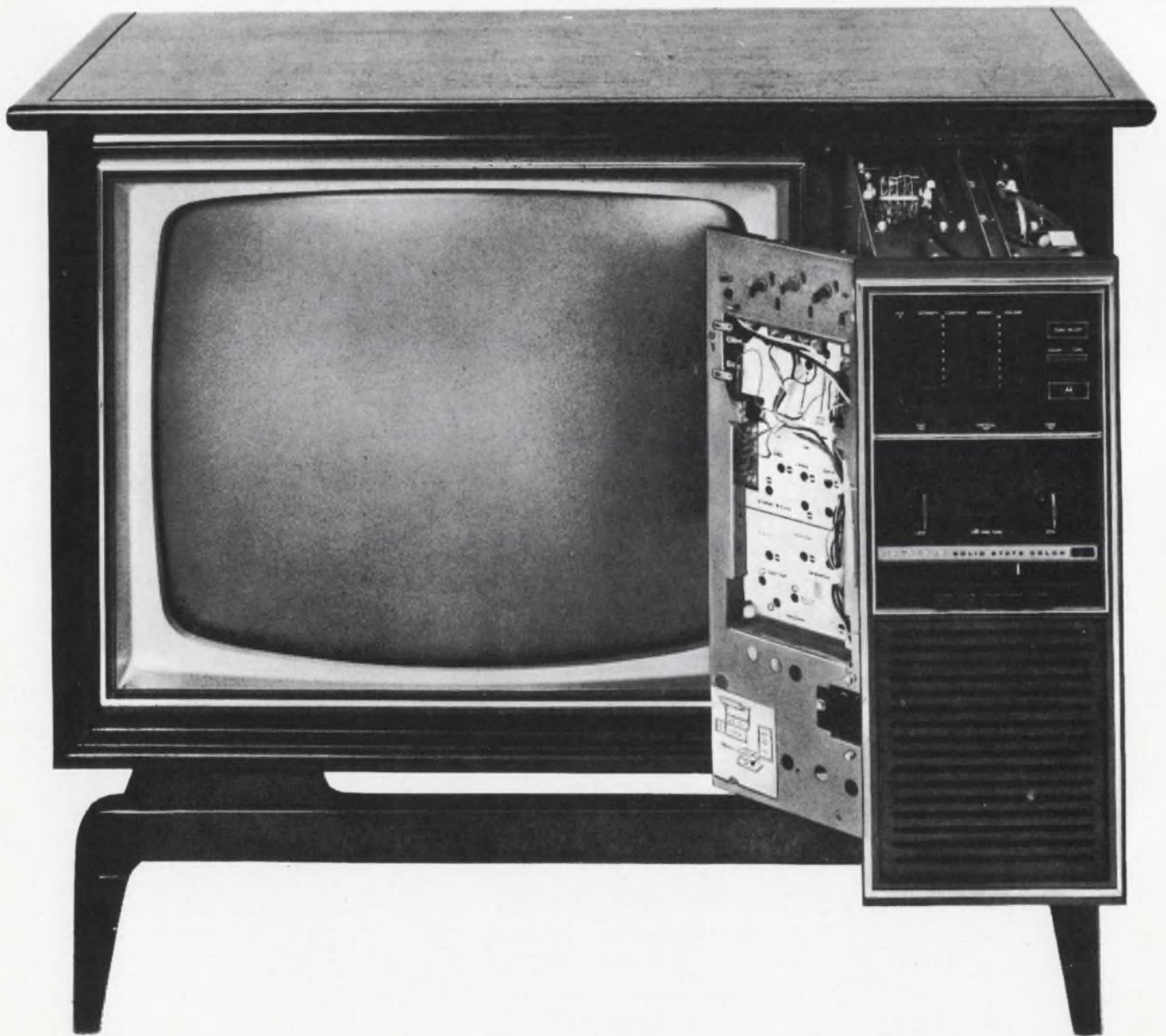

ON READER-SERVICE CARD CIRCLE 5

# color TV requires interconnections.

Major innovation from Motorola: ten pluggable solid-state modules in one solid-state color TV. All with AMPMODU\* Interconnection products. Why? Reliability. Economy. Serviceability. The AMPMODU System: a post and a double-spring receptacle. For hand or automated wiring. Infinite variety of modular combinations. Joins circuits electrically. And mechanically. So all circuits can be assembled or replaced in minutes. Joining circuitry? Investigate AMP's Interconnection ideas now.

\*Trademark of AMP Incorporated

PUT YOUR IDEAS INTO ACTION WITH THE HELP OF AMP ENGINEERING... WORLDWIDE.

## AMP

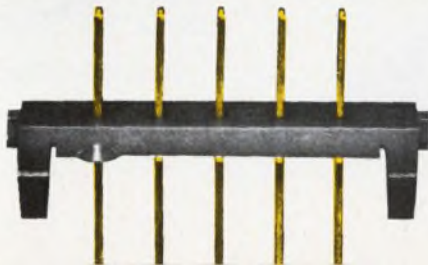
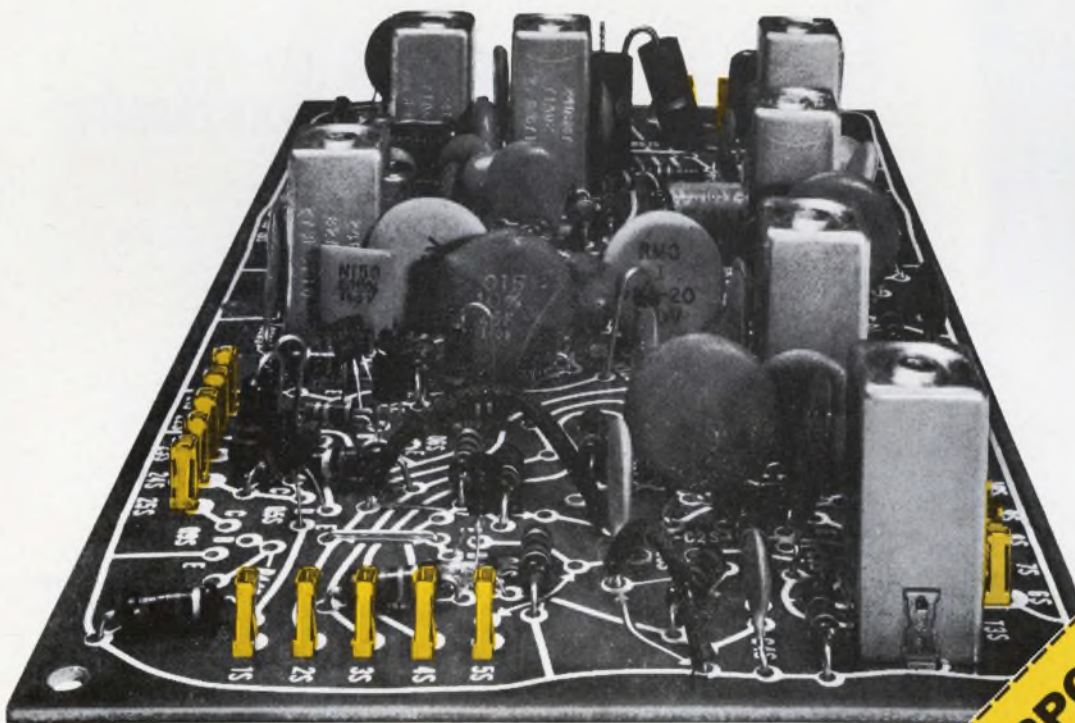

**AMP INCORPORATED**  
Harrisburg, Pa. 17105

Send data on AMPMODU Interconnection Products to me fast.

NAME \_\_\_\_\_  
COMPANY \_\_\_\_\_  
ADDRESS \_\_\_\_\_  
CITY \_\_\_\_\_ STATE \_\_\_\_\_ ZIP \_\_\_\_\_

# COMPARE RCL's 1/2" ROTARY SWITCHES



**4 SERIES TO FIT  
EVERY REQUIREMENT  
PLUS  
INDUSTRY'S  
BEST DELIVERY!**

- ★ Shorting AND non-shortng poles may be grouped on one deck in any combination.
- ★ Up to 12 positions per deck shorting or ■ non-shortng.
- ★ Life expectancy 200,000 mechanical operations.

*Write For Free Engineering Catalog*

**RCL**  
ELECTRONICS, INC.

700 South 21st Street, Irvington, N. J. 07111

ON READER-SERVICE CARD CIRCLE 6



# IN THE LATEST INDUSTRY SURVEY\* YOU NAMED MOTOROLA No. 1 IN RECTIFIERS



## WE'RE TRYING.

We don't think you've moved us up from fourth place to first in just four years simply because Motorola produces nearly 40 million rectifiers annually for the auto industry, nor because the mil-type Surmetic<sup>†</sup> introduced the industry to a new high standard of performance in low-cost rectifiers. Actually, we feel it's because Motorola's line is so broad and manufacturing quality so uniformly high that you've found us to be a certain source for just about any device—and you know you can have confidence in every one you use.

If you'd like a complete look at our full line, send for the Motorola Rectifier Selector Guide — key to some 1,200 different types. (Box 955, Phoenix, Arizona 85001.)

Then, buy with confidence.

<sup>†</sup> Trademark of Motorola Inc.

*-where the priceless ingredient is care!*



**MOTOROLA**  
**Semiconductors**

\*SOURCE FURNISHED ON REQUEST.

ON READER-SERVICE CARD CIRCLE 7

# PROBLEM: YOUR CIRCUITS NEED THE LOW COST OF HIGH VOLTAGE.

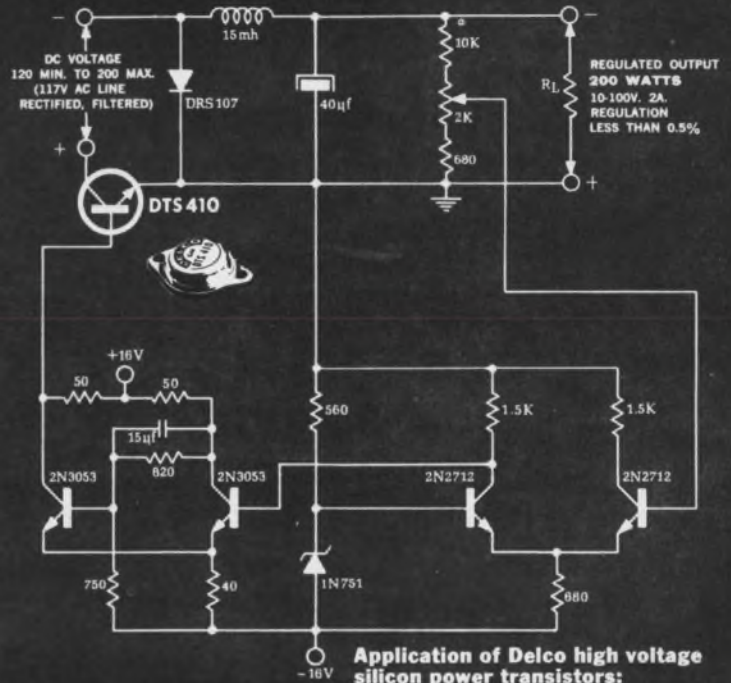

# SOLUTION: DELCO SILICON POWER.

Application of Delco high voltage silicon power transistors: the switching regulator.

Delco high voltage silicon power transistors provide high energy capability at the lowest possible cost. Take the applications pictured above: switching regulators, DC to DC convertors and DC voltage regulators. Unit prices? Just \$1.70 for the DTS-410\*, \$4.95 for the DTS-423\* and \$3.95 for the DTS-413\*.

There are other cost cutting advantages to our high voltage silicon power transistors. You can reduce the number and complexity of input-output and filtering components, which means more compact circuitry. Greater reliability. Lower assembly costs.

Other high energy circuits where Delco silicon power transistors have proved capabilities include: ultrasonic power supplies, VLF class C amplifiers, off-line class A audio output, and magnetic CRT deflection (several major TV manufacturers are using them in big screen horizontal and vertical sweep circuits).

They're available in production quantities. For prices, delivery, data, or applications information, just give us a call. Or call your local Delco distributor.

With Delco silicon power transistors, everything's high powered but the price.

\*When purchased in quantities of 1,000 and up. Prices subject to change without notice.

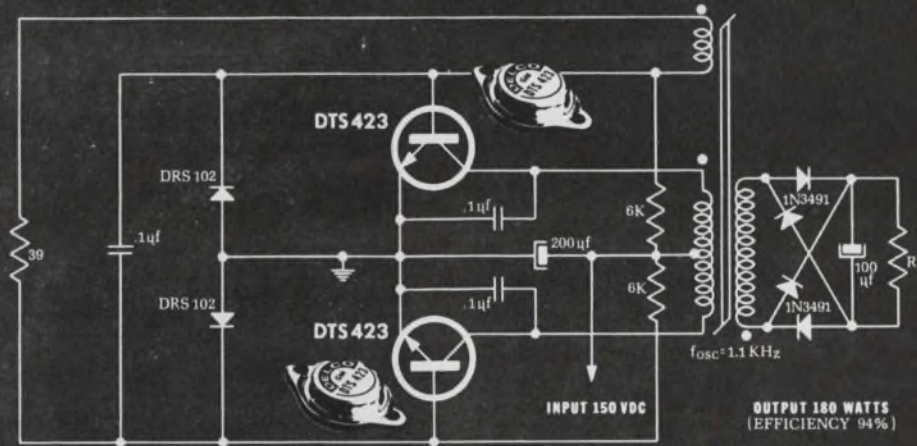

Application of Delco high voltage silicon power transistors: the DC to DC Converter.

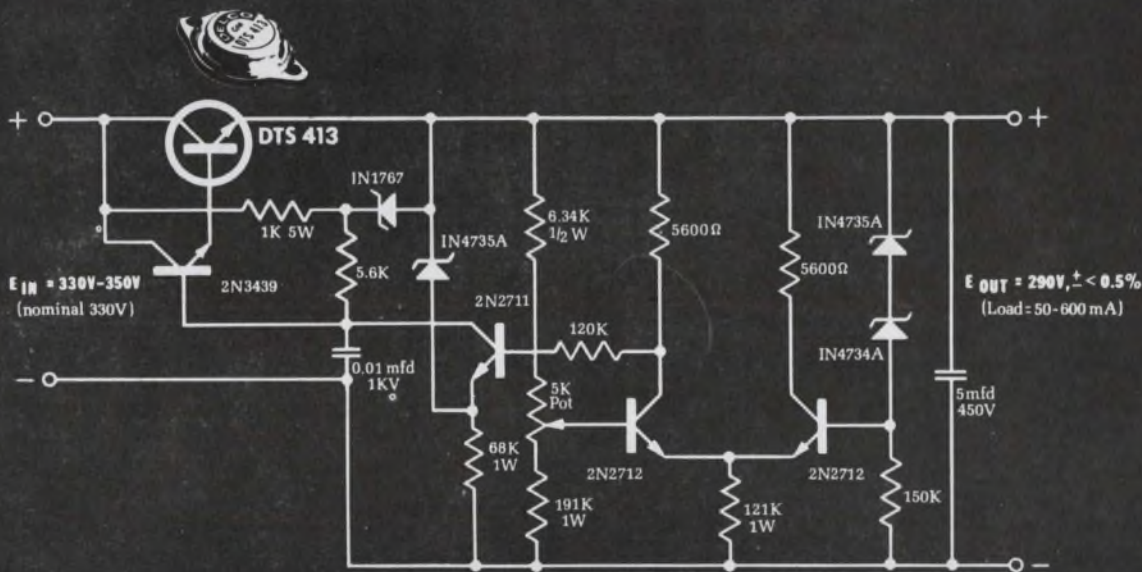

Application of Delco high voltage silicon power transistors: a DC voltage regulator.

TYPE	V <sub>CEX</sub>	V <sub>CEO</sub> (SUS) min.	I <sub>C</sub> max.	h <sub>FE</sub> min. V <sub>CE</sub> =5 V @ I <sub>C</sub>	P <sub>D</sub> max.	PRICE 1000-and-up QUANTITIES
DTS-410	200V	200V	3.5A	10 @ 2.5A	80W	\$1.70
DTS-411	300V	300V	3.5A	10 @ 2.5A	100W	\$2.20
DTS-413	400V	325V	2.0A	15 @ 1.0A	75W	\$3.95
DTS-423	400V	325V	3.5A	10 @ 2.5A	100W	\$4.95
DTS-424	700V	350V	3.5A	10 @ 2.5A	100W	\$7.00
DTS-425	700V	400V	3.5A	10 @ 2.5A	100W	\$10.00
DTS-430	400V	300V	5.0A	10 @ 3.5A	125W	\$12.00
DTS-431	400V	325V	5.0A	10 @ 3.5A	125W	\$18.00

NPN silicon transistors packaged in solid copper TO-3 case.



**DELCO RADIO**

Division of General Motors, Kokomo, Indiana

Field Sales Offices  
Union, New Jersey\* 07083  
Box 1018 Chestnut Station  
(201) 687-3770

Detroit, Michigan 48202  
57 Harper Avenue  
(313) 873-6560

Syracuse, New York 13203  
1054 James Street  
(315) 472-2668

Chicago, Illinois\* 60656  
5151 N. Harlem Avenue  
(312) 775-5411

Santa Monica, Calif.\* 90401  
726 Santa Monica Blvd.  
(213) 870-8807

General Sales Office:  
700 E. Firmin, Kokomo, Ind. 46901  
(317) 459-2175

\*Office includes field lab and resident engineer for applications assistance.

ON READER-SERVICE CARD CIRCLE 8

# Did You Know Sprague Makes 51 Types of Foil and Wet Tantalum Capacitors?

## FOIL-TYPE RECTANGULAR TANTALEX® CAPACITORS



Type 300D polarized plain-foil  
Type 301D non-polarized plain-foil  
Type 302D polarized etched-foil  
Type 303D non-polarized etched-foil

ASK FOR BULLETIN 3650

ON READER-SERVICE CARD CIRCLE 162

## FOIL-TYPE TANTALUM CAPACITORS TO MIL-C-3965C

CL20, CL21 tubular 125 C polarized etched-foil  
CL22, CL23 tubular 125 C non-polar etched-foil  
CL24, CL25 tubular 85 C polarized etched-foil  
CL26, CL27 tubular 85 C non-polar etched-foil  
CL30, CL31 tubular 125 C polarized plain-foil  
CL32, CL33 tubular 125 C non-polar plain-foil  
CL34, CL35 tubular 85 C polarized plain-foil  
CL36, CL37 tubular 85 C non-polar plain-foil  
CL51 rectangular 85 C polarized plain-foil  
CL52 rectangular 85 C non-polar plain-foil  
CL53 rectangular 85 C polarized etched-foil  
CL54 rectangular 85 C non-polar etched-foil

ON READER-SERVICE CARD CIRCLE 163

## 125 C FOIL-TYPE TUBULAR TANTALEX® CAPACITORS



Type 120D polarized plain-foil  
Type 121D non-polarized plain-foil  
Type 122D polarized etched-foil  
Type 123D non-polarized etched-foil

ASK FOR BULLETIN 3602C

ON READER-SERVICE CARD CIRCLE 161

## 85 C FOIL-TYPE TUBULAR TANTALEX® CAPACITORS



Type 110D polarized plain-foil  
Type 111D non-polarized plain-foil  
Type 112D polarized etched-foil  
Type 113D non-polarized etched-foil

ASK FOR BULLETIN 3601C

ON READER-SERVICE CARD CIRCLE 164

## SINTERED-ANODE TUBULAR TANTALEX® CAPACITORS



Type 109D elastomer seal 85 C  
Type 130D elastomer seal 125 C  
Type 137D hermetic seal 125 C

ASK FOR BULLETINS 3700F, 3701B, 3703

ON READER-SERVICE CARD CIRCLE 165

## SINTERED-ANODE CUP STYLE TANTALEX® CAPACITORS



Type 131D 85 C industrial-type  
Type 132D 85 C vibration-proof  
Type 133D 125 C vibration-proof

ASK FOR BULLETINS 3710B, 3711

ON READER-SERVICE CARD CIRCLE 166

## SINTERED-ANODE CYLINDRICAL TANTALEX® CAPACITORS



Type 140D  
up to 175 C operation,  
3/8" diam.  
Type 141D  
up to 175 C operation,  
1/2" diam.

ASK FOR BULLETIN 3800

ON READER-SERVICE CARD CIRCLE 167

## SINTERED-ANODE RECTANGULAR TANTALEX® CAPACITORS



Type 200D negative terminal grounded  
Type 202D both terminals insulated

ASK FOR BULLETIN 3705B

ON READER-SERVICE CARD CIRCLE 168

## SINTERED-ANODE TANTALUM CAPACITORS TO MIL-C-3965C

CL14 cylindrical, 3/8" diam.  
CL16 cylindrical, 3/8" diam., threaded neck  
CL17 cylindrical, 1 1/8" diam.  
CL18 cylindrical, 1 1/8" diam., threaded neck  
CL44 cup style, uninsulated  
CL45 cup style, insulated  
CL55 rectangular, both terminals insulated  
CL64 tubular, uninsulated  
CL65 tubular, insulated

ON READER-SERVICE CARD CIRCLE 169

For comprehensive engineering bulletins on the capacitor types in which you are interested, write to:  
Technical Literature Service  
Sprague Electric Company  
347 Marshall Street  
North Adams, Mass. 01248

48C-515BR2

**SPRAGUE**  
THE MARK OF RELIABILITY

Sprague and (S) are registered trademarks of the Sprague Electric Co.

# News

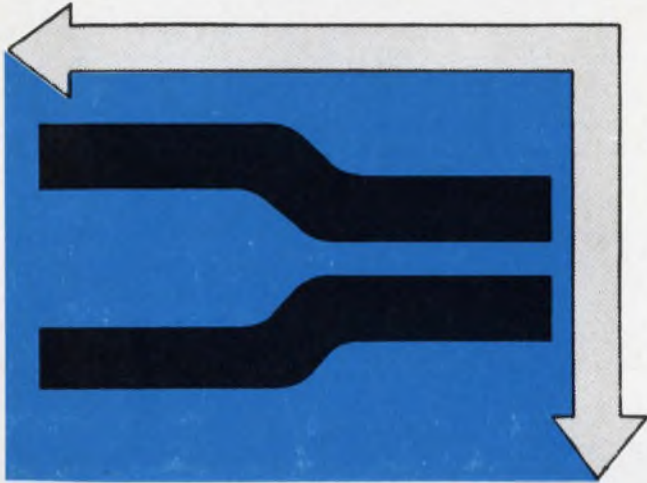

**Dolby system masks noise selectively** so as to clean up master audio tapes. Page 17



**Low-power laser-beam memory** may read out at the rate of 100 million b/s. Page 22



**Survey of engineering salaries** indicates that those with less than seven years of ex-

perience earn most in the West and those with more get better pay in the East. Page 24

## Also in this section:

**'Add circuits and save money'** will be theme of LSI era. Page 20

**'Write your own IC masks** in real time with light pen. Page 36

**News Scope**, Page 13. . . **Washington Report**, Page 29. . . **Editorial**, Page 45

# THE connector THING

A periodical periodical designed to further the sales of Microdot Inc. connectors and cables. Published entirely in the interest of profit.

## Everybody wins! Play Microdot Historical

In the words of Virginia Woolf, it's time for fun and games.

For this new national pastime, you simply need a smattering of history, mythology and current events. And some information about Microdot's cable products. We'll supply you with the latter. For the rest, go listen to Walter Cronkite.

We got started on this activity while we were sitting around one evening with a bottle of Slivovitz (we ran out of Scotch), trying to think of memorable ways to remind you of the various unique features of Microdot cables. Like —

Like our Mini-Noise cable — reduces noise voltage from shock and vibration by a factor of more than 100 to 1 compared to untreated cable. This makes possible the transmission of extremely faint signals through coax cable without audio frequency noise. Off-the-shelf.

Like our microminiature coax cable — uses a fine silver-plated copper steel-covered wire. You get 50 ohm impedance, and even with the addition of dielectric, outer shield and protective jacket, the nominal O.D. does not exceed .080". And we can get that O.D. down to .025" in a range of hundreds of different cables.

Like our new complete in-house capability to produce precision quality multi-conductor cables, which includes twisting, extruding, shielding and jacketing — the whole deal. All under one roof. And we can cable hundreds of conductors into one unit.

Like we're the only one to produce a high temperature, low weight, low capacitance coax cable through the use of a cellular Teflon dielectric. Especially suited to the requirements of video tape recorders.

Like Microdot's Twinaxial cable — to be used when you need to send two signals from a single source which must both terminate at the same point. No need to use two coax cables; therefore lower cost and greater flexibility.

Now when you think of cables, you think of cablegrams. And when you drink a lot of Slivovitz, it sort of takes you back through time and you come up with stuff like this:



WIN  
YOUR  
OWN  
CABLE  
FORK

**Low noise Spaghetti-Gram:**  
"You lose. Signed, Calvin Coolidge"

**High temperature Spaghetti-Gram:**  
"Julius, honey, ain't nobody home tonight but me. Signed, Cleopatra"

**Miniature size Spaghetti-Gram:**  
"Cancel that order for bras.  
Signed, Twiggy"

**Dual shield Spaghetti-Gram:**  
"I can lick any guy in the joint.  
Signed, Brunhilde"

**Large size multiconductor Spaghetti-Gram:**  
"Send more elephants.  
Signed, Hannibal"

Get the idea. You can use any of the features of any of our cable products, such as low noise (Mini-Noise), special requirements (Multiconductors), high temperature, low weight, and, of course, small size. You don't really need the Slivovitz. It works well even with Sanka.

### About the fork

No, Melvin, we won't explain the relationship between cable and spaghetti. We call

it a cable fork, and if you don't want to use it for eating cables that's your problem. The manufacturer describes this

handy gadget as a "revolutionary breakthrough that leaps forward from antiquated hand labor to the modern machine age!" We won't try to top that. We'll just explain that you stick it into the pasta and then turn the little handle to save getting spaghetti all over your celluloid collar.

Want one for your very own? Okay. Just send us a Microdot Spaghetti-Gram scribbled on company stationery and taking off from any of the product features we've discussed. We'll send you a beautiful cable fork along with more literature on our cable products than we care to mention.

But hurry. We've already run out of Slivovitz. It won't be long before we run out of cable forks. (That means offer is limited.)



**MICRODOT  
INC.** 220 Pasadena Avenue  
South Pasadena, Calif. 91030.

Mini-Noise is a registered trade-mark of  
Microdot Inc. Cable Fork is open to question.



ON READER-SERVICE CARD CIRCLE 9

## Saturn test spurs hope for manned flight in '68

On ignition, the giant metallic cylinder shuddered atop an inferno, like a skyscraper straining to rise off its foundations. Then, ever so slowly, it began its record-shattering flight. Three miles away, viewers were physically shaken by its power, assaulted by over 120 dB of rumbling din. Eight hours and 37 minutes later, the National Aeronautics and Space Administration pronounced the first flight of its Saturn V lunar booster rocket a resounding success.

The unmanned test from the Kennedy Space Center in Florida on Nov. 9 so exceeded the usual expectations of cautious scientists that the nation's first manned Apollo flight may be moved up from some time in 1969 to late next year.

The nearly perfect countdown and on-time launching of the world's largest booster vehicle, the payload injection into orbit, its later firing into a long, elliptical Earth-interception path, and the subsequent re-

covery at sea of the Apollo command module demonstrated that mission planning was flawless—despite odds estimated at 30 to 1. Success hinged on the vehicle propulsion systems and on the most complex ground-flight electronics ever combined for a single operation.

If the second unmanned Apollo/Saturn mission proves equally successful, a manned flight may be held in October or November of 1968, according to NASA.

The Apollo 4 flight called for a 7 a.m. liftoff, insertion of the Apollo and the S-IVB third stage into a 117-mile circular "parking" orbit for two Earth revolutions, refiring of the S-IVB to achieve an elliptical orbit with a 10,800-mile apogee, separation of the S-IVB, and firing of the Apollo service propulsion system to raise the apogee to 11,400 miles. On the return path toward the Earth, the service propulsion engine was again to be fired to boost velocity and ensure reentry at about 25,000 mi/h. Prior to reentry the Apollo service module was to be separated from the conical command module. Splashdown and recovery was planned at a point 622 miles northwest of Hawaii at 8 hours 41 minutes after liftoff.

The entire flight was well within these tolerances. Liftoff occurred at 7:01.4 a.m. An almost circular orbit was achieved, with early measurements indicating 117.9 miles by 114.7 miles. The apogee achieved late in the elliptical orbit was roughly 11,330 miles, and the reentry velocity was slightly above the planned 25,000 mi/h. The splashdown was 18,500 yards west of the aiming point at 8 hours 37 minutes after liftoff.

There were a few minor problems but none, according to George M. Low, the Apollo spacecraft program

office manager, that would in any way have endangered a crew member had the vehicle been manned.

Some interruptions were encountered with S-band telemetry, probably caused by improper spacecraft antenna patterns with respect to ground stations, one official said, but more will be known after final data reduction.

At one point the ground station at Carnarvon, Australia, had difficulty in updating the spacecraft guidance system, but this was later accomplished successfully. Out of several thousand data channels used during the test, only seven are known to have failed, and none of these was apparently critical. A problem with a hydrogen-vent valve on the S-IVB stage, in flight also proved to be noncritical.

For old hands watching the launching, Apollo 4 was an unforgettable experience. Even Dr. Wernher von Braun, who promoted the Saturn V concept and has directed its development, said that he found the initial lift-off "the longest 10 seconds of my life."

### 'Caissons rolling along'—now guided by Tacfire

A contract is expected to be awarded next month to the Data Systems Div. of Litton Industries, Van Nuys, Calif., for the development of the Tactical Fire Direction System (Tacfire). Tacfire is the major element in the Army's program to modernize the use of artillery in the field by introducing advanced computers and display techniques. Litton, winner of the contract definition phase in competition with IBM and Burroughs Corp., is virtually assured of the procurement, which is estimated to be worth more than \$50 million over several years.

In operation, forward artillery spotters will supply information to a central Tacfire computer, which will process targeting information and feed it to Army units from corps headquarters and so on down to the artillery crew level. It is expected to facilitate the planning of barrages, the massing of artillery firepower, the selection of targets, the monitoring of ammunition inventories, the computing of survey data and the distribution of meteor-



Saturn V, off on a record hop.

ological information. At present, all operations except the calculation of artillery ballistics and impact area are performed manually. It will also be used in the firing of tactical ground-to-ground missiles. The system, to become operational in the 1970s, is expected to provide greater accuracy of fire and speedier response—up to 30 times faster, according to a Litton spokesman.

Litton says its Tacfire system includes one computer installation in each artillery battalion's fire direction center. This computer will control three firing batteries. It is linked to a digital message entry device at each forward observer's station and a digital display at each firing battery.

Litton will supply the microminiaturized general-purpose computer and a digital message entry device that permits transmission of data in instantaneous bursts. Teamed with the Data Systems Div. are the Communication Div. of Radio Corp. of America, Stanford Research Institute and Litton's Datalog Div.

Tacfire is part of an over-all Army effort to exploit the technologies of microminiaturization and data processing and to have an integrated automatic data system within the Army in the field (ADSAF) during the next decade.

This is the first major Army project contract due to be awarded under the Defense Dept.'s total package procurement concept. Under this, contractors will be responsible for the complete program of development, production and field support.

## Bell Labs study group rethinks transmission

A group has been formed at Bell Telephone Laboratories, Holmdel, N.J., to appraise future public needs for transmission technology.

Bell Telephone engineers, for instance, have already held informal meetings with doctors on the need for early warning of when patients go into shock, so that prompt and possibly life-saving treatment may

be given. The signals would have to be monitored, then transmitted to a remote station where a nurse could oversee several patients.

While Bell Laboratories is prohibited by its charter from producing medical electronics, it would cooperate with designers of monitoring equipment to arrive at the best format and configuration for transmission of data, according to Courtney Pratt, head of the Mechanics Research Dept.

"Maybe we aren't offering the right things now because we don't know what people really want," says Pratt. "If so, we intend to find out." "Our philosophy is one of sympathetic and positively encouraging reaction," he added.

The group is also studying how best to apply some of Bell Telephone's research results. For example, a novel approach has been discovered for optimizing communication with a particular person in a group. It involves not only suppressing (lowering the intensity of) unwanted sounds, but also garbling them to make it easier for the listener to concentrate on the sounds of interest. Pratt says that noise is particularly distracting if it contains some sort of intelligence—snatches of conversation, for example. Hence the garbling.

## Troposcatter radar to face Soviet FOBS

In announcing that the U.S. was developing an over-the-horizon radar to warn of nuclear attack, Defense Secretary Robert S. McNamara declined to give details. It is believed, however, to be the AN/FPS/95 troposcatter radar now under development at Radio Corp. of America's Missile and Surface Radar Div., Moorestown, N.J. This is thought to be an advanced version of the ballistic missile early warning system (BMEWS).

McNamara made his announcement as he reported that the Soviet Union was working on a fractional orbiting bombardment system (FOBS). The over-the-horizon radar would give 15 minutes' warning of an attack; without it, the U.S. would have only about 3 minutes' warning as a nuclear payload left orbit and plummeted toward earth. Present BMEWS would be

ineffective in detecting FOBS because of their relatively low (100-mile) orbit.

The RCA troposcatter radar operates in the high-frequency range (25 to 60 MHz) and by means of multibounce techniques obtains from the ionosphere a backscatter indication of the booster plume of a launching. Resolution is reported to be poor and only a rough trajectory can be determined, but it is presumed that the launching and the site of it can be located with reasonable accuracy.

These data, combined with those from such intelligence sources as the Samos reconnaissance satellites, could detect impending danger and alert more conventional radars in time to obtain more accurate target information.

## Domestic comsats face tough price competition

The use of communications satellites for domestic transmissions may be far less economically attractive in the U. S. than elsewhere, according to James D. O'Connell, White House director of telecommunications management.

Why? The U. S. already has a complex and sophisticated communications network that efficiently reaches every corner of the nation. Many underdeveloped countries, on the other hand, have relatively primitive transmission systems that satellites could profitably supplement.

O'Connell pointed out at the Northeast Electronics Research and Engineering Meeting in Boston that the growth of technology is rapidly reducing the cost of expanding the U.S. domestic ground-based telephone net. Over the past 20 years the capital cost of ground transmission in the U.S. has come down from \$225 to \$4 per voice-channel-circuit mile. And even then, only about 20% of the cost of a call derives from the long-haul transmission.

In the area of radio and television broadcasting, one satellite enables the entire country to be covered simultaneously, O'Connell conceded. But the whole structure of the broadcasting industry would have to be altered to adjust to this new form of transmission. And again, distance accounts for only about 20% of the cost of nationwide broadcasting.



# New Generation

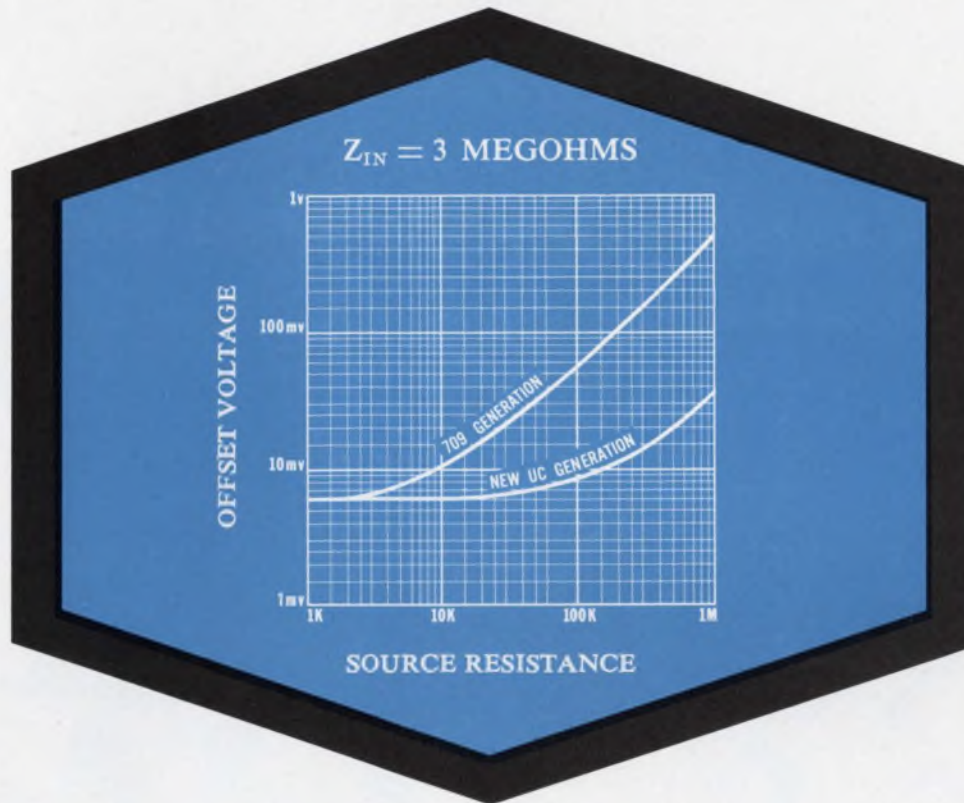

## in IC op amps!



UC709/ $\pm 15\text{V}$  POWER SUPPLY



UC4200/ $\pm 24\text{V}$  POWER SUPPLY

- High Input Impedance: 3 megohms (typ)
- Output is short circuit proof
- Low power dissipation
- Balanced supply current
- Temperature coefficient:  $6\mu\text{V}/^\circ\text{C}$  (typ)
- Output Swing:  $\pm 10\text{V}$  (UC709);  $\pm 20\text{V}$  (UC4200)
- Gain: 25K min (UC709); 50K min (UC4200)
- Output current: 5 mA min (UC709); 4 mA min (UC4200)
- Operating Temperature:  $-55^\circ\text{C}$  to  $+125^\circ\text{C}$
- Package: 8-lead JEDEC TO-99

Applications: Ideal for airframe and aerospace use • Infrared sensors  
PM sensors • Piezoelectric transducers • Ionization gauges • EEG and EKG pre amps  
Analog integrators and electrometric type voltage followers.



ELECTRONICS

Semiconductor Department/365 Middlefield Road, Mountain View, California 94040, (415) 961-3300

ON READER-SERVICE CARD CIRCLE 10

# RCA Announces two important new test instruments for service, industrial and lab applications.



## All solid-state battery operated VOLTOHMYST® WV-500A

Eliminate warm-up time! Eliminate zero-shift that can occur in tube-operated voltmeters! RCA's new WV-500A VoltOhmyst is an all solid-state, battery operated, completely portable voltmeter that is ideal for service, industrial and lab applications. Seven overlapping resistance ranges measure from 0.2 ohm to 1000 megohms. Eight overlapping dc-voltage ranges measure from 0.02 volt to 1500 volts (including special 0.5 dc volt range), ac peak-to-peak voltages of complex waveforms from 0.5 volts to 4200 volts, and ac (rms) voltages from 0.1 to 1500 volts. Input impedance of all dc ranges is 11 megohms.

All measurements are made with a sturdy, wired-in single-unit probe with fully shielded input cable. The probe is quickly adapted to either dc measurement or ac and resistance measurement by a convenient built-in switch. And an accessory slip-on high voltage probe is also available to make possible measurements up to 50,000 dc volts.

Solid-state reliability and convenience for only \$75.00\*

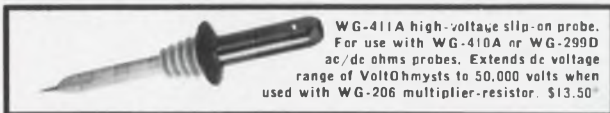

WG-411A high-voltage slip-on probe. For use with WG-410A or WG-299D ac/dc ohms probes. Extends dc voltage range of VoltOhmysts to 50,000 volts when used with WG-206 multiplier-resistor. \$13.50\*



## In-circuit / out-of-circuit TRANSISTOR TESTER WT-501A

Completely portable and requiring no external power source, RCA's new WT-501A tests transistors both in-circuit and out-of-circuit, tests both low and high power transistors, and has both NPN and PNP sockets to allow convenient transistor matching for complementary symmetry applications. The instrument tests out-of-circuit transistors for dc beta from 1 to 1000, collector-to-base leakage as low as 2 microamperes, and collector-to-emitter leakage from 20 microamperes to 1 ampere. Special low impedance circuitry assures reliable in-circuit testing.

Collector current is adjustable from 20 microamperes to 1 ampere in four ranges, permitting most transistors to be tested at rated current level. A complete DC Forward Current Transfer Ratio Curve can be plotted. The three color-coded test leads are provided for in-circuit testing, and for out-of-circuit testing of those transistors that will not fit into the panel socket.

Extra features... RCA reliability... for only \$66.75\*

\*Optional Distributor resale price. All prices subject to change without notice. Prices may be slightly higher in Alaska, Hawaii and the West.

Ask to see them at your Authorized RCA Test Equipment Distributor, or write RCA Commercial Engineering Department K18W-4 415 South Fifth Street, Harrison, N.J.



RCA Electronic Components and Devices, Harrison, N.J.

The Most Trusted Name in Electronics

# The Dolby black box opens... just a little

## Audio noise-reduction device divides spectrum; only low-level signals are boosted to mask noise

Richard N. Einhorn  
News Editor

In the recorded-music industry the most talked-about development of the last year has been the Dolby A-301 audio noise reduction system. Orders have been taken for about 125 units, and the first Dolby-process discs are already on the market, but little circuit information has been released about the highly publicized black box that scrubs the musical content of magnetic tapes clean of noise and distortion during the dubbing (rerecording) process.

Up to now the recording engineer using conventional noise-reduction techniques has faced a dilemma: Should he record everything at such a high level that he masks the background noise completely, though risking overload distortion? Or should he hold back, so that the louder climaxes are either passed or clipped cleanly, though the softer passages are lost in a hash of background from the tape recorder?

The usual solution has been compromise: pass the loud passages cleanly and boost the low ones to mask noise. It works—at a price. Since the lowest levels are raised and the higher ones are not, the dynamic range (difference in dB between the highest and lowest levels) is compressed. The result is disappointing to the music lover (the buyer of the disc)—those soft, delicate passages for which his favorite pianist is noted sound little less loud than medium passages. In this fashion, electronic distortion gives way to musical distortion, which may be even worse.

Now Dolby has come along to remedy that. The system passes high-level signals essentially with unity gain. So far so good, since there is no compression at the top. But in soft passages, the system raises the signal level just prior to recording, then pares the amplified signals back to the original level during

playback. In the process, noise that has been added during recording is reduced by the same amount.

This means that soft passages are no longer lost in rumble, pops, clicks and hiss. Nor does the technique incur the cost of permanently compressed dynamic range, for signals above the threshold amplitude pass through unmodified. Recently Dr. Ray M. Dolby, the expatriate American who heads Dolby Laboratories in London, was in town to make arrangements for distribution in the United States. He offered some enlightenment to *ELECTRONIC DESIGN*—more than has been published previously, but not enough to stop tantalizing the designer.

Basically, his system divides the audio spectrum into four separate frequency bands (Fig. 1) and reduces noise as follows:

- Band 1 covers the hum and rumble frequency range and uses an 80-Hz low-pass filter.

- Band 2 covers the middle range, where broad-band noise, crosstalk and tape print-through are common, and uses an 80- to 3000-Hz band-pass filter.

- Band 3 covers the moderately high frequencies and some of the tape-hiss frequencies with a 3000-Hz high-pass filter.

- Band 4 covers the high frequencies and the major hiss region with a 9000-Hz high-pass filter.

The system selectively compresses and expands each band to arrive at an over-all improvement in signal-

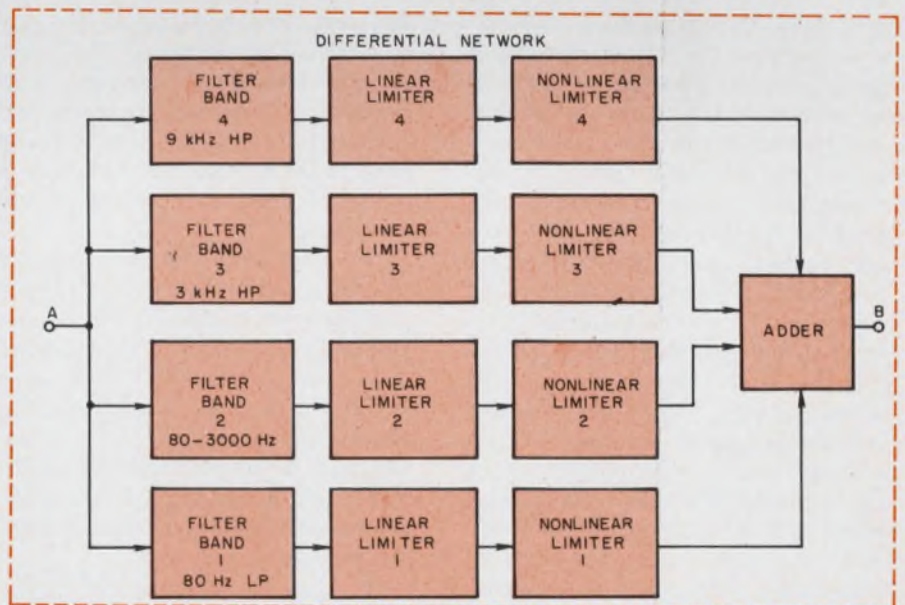
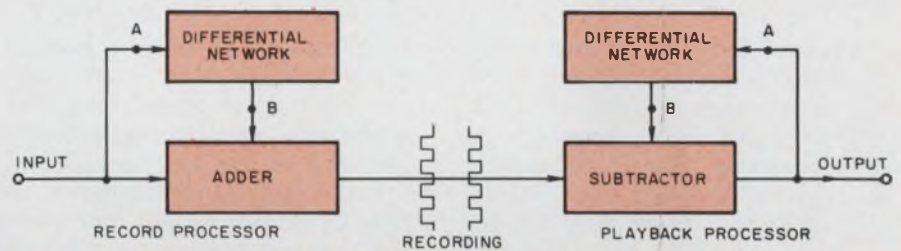

1. Dolby noise-reduction system masks audio-tape noise by selective filtering. Signals in each of four frequency bands are boosted when they are below a preset threshold, passed through with unity gain when above that threshold. Differential networks in record and playback channels are identical.

(Dolby, *continued*)

to-noise ratio of 10 dB. The compression threshold in each band is 40 dB below peak levels (Fig. 2). The outputs of all the filters are combined with the main signal flow so that the ultimate record processor output is 10 dB higher than the input signal. (Actually, in band 4, the noise reduction is set at 15 dB because on the average, musical sounds in the region from 9 to 15 kHz are at a generally lower level than in other bands.)

In theory, the audio spectrum should be split into a far greater number of bands, but this is impractical: the device already contains something like 99 silicon planar transistors and 163 semiconductor diodes and costs \$1960 without accessories. Dolby believes that four bands are a suitable compromise that will satisfactorily cope with tape hiss, the chief offender.

### Identical networks are used

Identical networks are used in the recording and playback portions of the unit to ensure that the output signals are equal to the input signals. The differential networks (operators) are signal multipliers controlled by the amplitudes, frequencies and dynamic properties of the signals fed into them. During playback, the network samples the output signal and feeds low-level components assumed to be noise back to the subtractor, which partially cancels these components in the main signal flow. In the process of reducing noise, the differential network and the subtractor also partially cancel low-level signal components. To compensate for this cancellation, the differential network in the recording portion, which has the same characteristics as the other network, adds an identical component prior to recording.

Dolby stresses the importance of the differential scheme. He says it eliminates the tracking problem, which has been "painfully evident" for systems in which the whole signal content—loud, soft, and medium—is treated.

The compression and expansion components are synthesized by the

addition and subtraction networks. These networks contain precision resistors; power to the entire unit is furnished by a regulated supply. As a result, in production units, deviation from the 10-dB value has been on the order of  $\pm 0.1$  dB.

Dolby points out that since there is some gain at low levels and unity gain at amplitudes exceeding the threshold, the transfer characteristic must be linear up to the compression threshold, rise slightly with increasing input and decrease with larger inputs. The Dolby system copes with a recurrent problem of dynamics: overshoots due to control-circuit time lags. These overshoots are exactly equal to the amount of compression. If passed linearly, they waste the dynamic range of the recording system audio channel; if clipped, various side effects can be created—blocking of amplifiers, breakthrough from groove to groove on the discs, and interference with other channels.

The usual solution has been to make the attack time as short as possible to avoid these effects. (In compressors, attack time is the time required for stabilization when an overshoot, say, from -10 vU to 0 vU is introduced following a no-signal input condition.) The resultant rapid changes in gain produce significant modulation products, which may or may not be canceled subsequently.

Dolby has found it possible not only to limit overshoots, but also to use relatively long attack times and so limit intermodulation. He has done this by following the linear limiters (compressor circuits) with nonlinear limiters (conventional symmetrical clippers). The clipping level is set so that the overshoot is limited to 2 dB with peak-amplitude step inputs.

The addition of the low-amplitude clipped signal to the high-amplitude unclipped main signal leads to momentary distortion, but so small and brief (1 ms or less) that it is masked by transients in the input signal and attenuated subjectively by the human ear. In practice, the clipper circuit rarely is called upon; the compressor operates linearly except with, say, percussive transients.

The use of long attack times, Dolby says, not only reduces modulation distortion, but also tends to improve the noise reduction. Overshoots may be produced, but they are

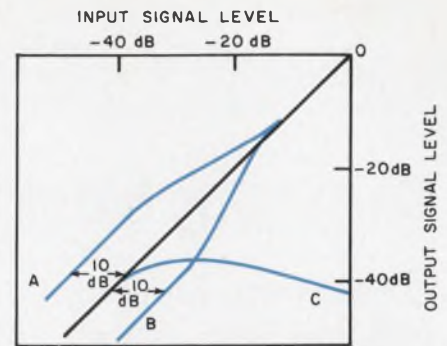

2. **Input-output transfer curves** include compression (A), expansion (B) and differential components (C). Characteristic (a) is formed by adding (C) to the input signal. Characteristic (B) is formed by subtracting (C) from the recorded signal by means of negative feedback.

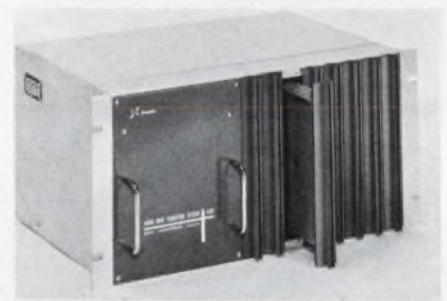

**Dolby unit has no operating controls.** Only the connections between it and the tape recorder can be varied.

low compared with peak levels.

While the use of long attack times is the most important part of the system dynamics, the decay or recovery time is the most important part of noise reduction. The use of short recovery times in ordinary compressors results in distortion at the low frequencies and in intermodulation. Dolby claims to have overcome this by using a variable time constant for smoothing: a long time constant under steady-state conditions, a short one for sharp reductions in signal amplitude. He says recovery is thus fast enough to avoid intermodulation effects after high-amplitude signals, yet long enough to avoid distorted low frequencies.

Dolby says he has received 125 orders for this, his first product, from record companies and broadcast studios around the world.

One licensed manufacturer, KLH Research & Development, Cambridge, Mass., is said to be readying for the home entertainment market a stereo tape recorder with a simplified noise-reduction circuit. ■ ■

The Model 335A measures and supplies DC voltages from 0 to 1100 volts with an output of 0 to 50 milliamperes. As a source and as a differential voltmeter, absolute accuracy is within 0.003% of setting. Resolution for any voltage range is 0.1 ppm. Only 7 inches high, the compact functionally styled solid state Model 335A needs no fan for cooling. □ Stability of the Model 335A is  $\pm(0.0025\%$  of setting + 10  $\mu\text{V}$ ) per six months. Overcurrent protection automatically limits output current at any preset level between 1 ma and 60 ma. Any voltage within the range of the instrument can be selected as an overvoltage trip point. Ripple and noise are less than 40  $\mu\text{V}$  rms on the 1000 v range. □ The null detector, which can be used at the same time the Model 335A is being used as a voltage source, offers an accuracy of 3% of end scale on all ranges. An output meter allows the operator to read voltage or current at a glance. Now if you can find any comparable device at any price (let alone the modest \$2,485 we'll let you have the Model 335A for), **buy** it. We **remain** confident. So, when you want a demonstration or more information, please call your full service Fluke sales engineer (listed in EEM) or write directly to us at the factory if you prefer.

## Multi-function instruments

aren't new. But multi-function instruments  
in which no single function degrades  
the others are! Sounds suspiciously like a  
description of the new Fluke Model 335A DC Voltage  
Calibrator, Differential Voltmeter  
and Null Detector.  
Elementary. . .



Fluke: Box 7428, Seattle, Washington 98133. Phone: (206) 774-2211 • TWX: (910) 449-2850  
In Europe, address Fluke International Corporation, P.O. Box 5053,  
Ledeboerstraat 27, Tilburg, Holland. Telex: 844-50237.



# In the LSI era, extra circuits may lower cost

What sort of design trade-offs will the engineer face when he deals with LSI (large-scale integration) problems?

Some of the ground rules for partitioning large circuit arrays were spelled out by Dr. Harlow Freitag, manager of a design information group at IBM during the Northeast Electronics Research & Engineering Meeting (Nerem) in Boston.

Advances in integrated-circuit design also reported at the meeting included:

- A 150-GHz gain-bandwidth monolithic amplifier.
- An integrated operational amplifier with FET inputs achieving subnanoampere input currents.

Instead of partitioning according to circuit functions, Dr. Freitag believes, a designer will more likely look at his entire system and cut across functional lines to produce a minimum set of chips with the least possible pin count. Since fabrication costs are on a per-chip rather than a per-circuit basis, it may be wise in many cases to increase the number of circuits on a chip to lower the pin count.

## Add circuits, save dollars

An example of such an approach is shown in the table. Adding 84 redundant circuits allowed the elimination of one complete chip, thus saving an eighth of the cost.

After partitioning is completed each chip will likely be different. At this point a cost-conscious user, according to Dr. Freitag, will probably go back to see if he can add extra circuits in some cases to generate some identical chip types.

The designer will then have to cal-

## Design LSI-style

	Case I (No redundancy)	Case II (Redundancy added)
Circuits	656	740
Chips	8	7
Total pins	309	255
Pins/chip	39	36
Circuits/pin	2.1	2.9

culate whether he has left enough area for interconnections on the chip. If he hasn't, he will have to remove some of the circuits from that chip and repartition again.

## Analog IC's advance

The 150-GHz gain-bandwidth monolithic amplifier was designed by a group from Philco-Ford Corp., Blue Bell, Pa., and reported by A. McKelvey. The circuit makes use of a recursive, common-emitter, single-transistor gain stage. It combines a low-parasitic-capacitance transistor with tantalum thin-film resistors, p- and n-type diffused resistors and anodically formed SiO<sub>2</sub> capacitors. The construction produced a circuit with a bandwidth essentially determined by the RC product of the load resistor and the collector-substrate (ground) capacitance of the transistors.

The operational amplifier, described by J.E. Thompson of Motorola, Inc., Phoenix, Ariz., has p-channel junction field-effect transistors cascaded with an npn differential amplifier. High gain (55,000) is achieved in only two stages by use of current-source loading on the FETs and a Darlington input connection for the differential amplifier.

At present the circuit is being built on two chips, one for the FETs and one for the rest of the circuitry.

A fully monolithic approach has been developed and will be described in three or four months, Thompson said.

The use of FET inputs allows input bias currents several orders of magnitude less than those with conventional bipolars (0.8 nA in the circuit cited).

The basic circuit, left in the diagram, requires three current sources. Source I<sub>1</sub> supplies the required common-mode rejection, and the two I<sub>2</sub> sources provide the high load impedance for the drain circuits needed for high voltage gain.

The I<sub>2</sub> sources are easily made with npn transistors. But the I<sub>1</sub> source requires a pnp device because of the polarity, and these are difficult to realize in integrated form. A lateral pnp was used to solve the problem even though betas are close to one. A possible circuit configuration which is independent of later β, if β ≥ I<sub>1</sub>/I<sub>3</sub>, is shown in the diagram at right.

The operational amplifier provides offset of less than 15 mV with 68-mW power dissipation and 92-dB common-mode rejection with a common-mode input range of +13 and -10 volts. It supplies a maximum +11-volt output into 1 kΩ, Class B.

The *Nerem Record*, containing digests of the papers, is available for \$7.50 from the Boston Section of the IEEE, 31 Channing Street, Newton, Mass. 02158. The meeting was held in Boston, Nov. 1-3 ■■

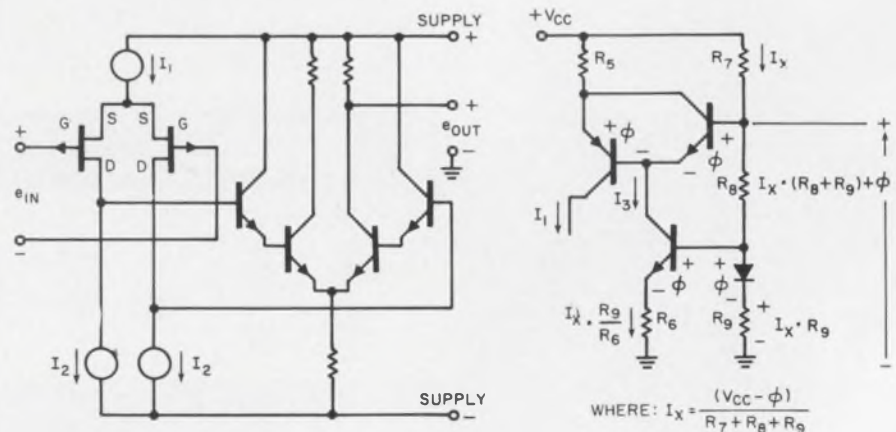

**Input FETs lower input currents** to the subnanoampere range in this operational-amplifier configuration (left). By compensating the stage with two pole-splitting capacitors of 5 pF, the amplifier achieved a gain-bandwidth product of 10 MHz. The current source I<sub>1</sub> (right) requires difficult-to-integrate pnp transistors. Lateral devices are used.



## Now...a custom IC counter-timer at a standard price!

### FEATURES

- 100% IC ■ DC to 3MHz ■ 0.1 volt sensitivity ■
- ±300 volt input overload protection ■ Automatic decimal point ■ Designed for maximum systems flexibility ■ Low cost

Computer Logic Corporation offers, for the first time, a complete line of 100% integrated circuit counter-timers that can be easily adapted to practically any system, O.E.M., or special application—and at prices that compare with competitive *standard* counters!

All standard options are provided in CLC's basic PC boards. The many options available can be added either at the time of purchase or at a later date. Thus, CLC's counter-timers can be continually up-dated as new requirements arise.

Need a special-purpose counter-timer? No problem! All CLC PC boards are designed to be readily adaptable for special-purpose use. Where other companies won't even *talk* specials, CLC will *deliver* them to your specifications.

The CLC 600, 700, and 800 counter-timers represent the ultimate in third-generation IC instrumentation. In addition to the obvious advantages—small size, light weight, and low power consumption—CLC's counters offer *eight to ten times* the life expectancy over discrete devices.

Computer Logic Corporation leads the field in the design and development of IC logic cards, and is a major supplier of these cards. The Series 600, 700, and 800 counter-timers are a natural progression from our years of IC experience and know-how.

Write or call now for our new four-page, two-color brochure, and find out how you can put a custom counter-timer to work for you at a price that you can afford!

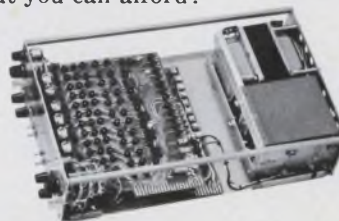

Internal view of CLC Model 816 with all options added. Display board and control board are plug-in types, easily removed.



**COMPUTER LOGIC CORP.**

1528 20TH ST., SANTA MONICA, CALIF. 90404 / TELEPHONE (213) 451-9754

ON READER-SERVICE CARD CIRCLE 12

# Faraday effect gives new twist to laser memory

## Thin-film magneto-optic system may be 100 times faster and store 30 times more than present units

Jeffrey N. Bairstow  
Computer Editor

An optical memory system that makes use of the Faraday effect would store over two million bits on a surface the size of a dime. The magneto-optical store, with laser reading and writing, would be able to store 30 times more data and read the data out up to 100 times faster than present disk memories.

Describing his research, Dr. Donald Blue, head of solid-state physics at the Honeywell, Inc., corporate research center in Minneapolis, called the company's proposed mass storage system a beam-addressable, beam-alterable optical memory.

The actual storage element is a ferromagnetic film that exhibits the Faraday magneto-optical effect. This means it is capable of rotating polarized light according to previously stored magnetization directions (Fig. 1). The information is addressable by scanning with a laser beam and alterable by heating with the laser beam to change the direction of magnetization of tiny areas of the film. Because the storage causes the alignment of several magnetic domains, the recording density is not

limited by grain size, as with a photographic emulsion.

### Evaporated films used

In Dr. Blue's experimental setup (Fig. 2), the memory plane is a glass or mica substrate with an evaporated film of manganese bismuth about  $1000\text{ \AA}$  thick, or approximately 1000 times thinner than a human hair. Such MnBi films are ferromagnetic—that is to say, they have a relative permeability or greater than unity, and their magnetization is dependent on the strength of the applied field—as with iron, cobalt and nickel, for tals formed of alternate close-packed hexagonal plates of manganese and bismuth atoms. It is possible to prepare the films so that the hexagonal planes are parallel to the substrate, with the result that the magnetization lies normal to the substrate.

Before an attempt is made to store bit patterns in the film, the whole film is uniformly magnetized to represent the storage of zeros over the entire area of the film. To store information, a laser beam is focused onto a small area of the film to heat that area momentarily above the Curie

temperature, which is  $360^\circ\text{C}$  for MnBi. Since MnBi loses its ferromagnetism very sharply at  $360^\circ\text{C}$ , the magnetization of the heated area will be destroyed. As the spot cools, a properly applied magnetic field will cause the reversal of the previous direction of magnetization to represent the storage of a one. Thus areas with the original direction of magnetization will indicate the storage of a zero, and those with a reversed direction of magnetization will indicate the storage of a one. Dr. Blue calls this the Curie point writing technique.

### Minimum spot size nears limit

Heating might be expected to be a slow process, but in fact even a laser of a few milliwatts of continuous power can deliver tens of thousands of watts per square inch of radiant flux density. Commercial lasers of these powers are now available. Dr. Blue noted. In addition it should be possible to focus the narrowly divergent beam of a laser to an area limited only by diffraction effects. In practice, Dr. Blue has found that, due to lens aberrations and heat diffusion, a practical spot size is 3 microns in diameter—about three times larger than the theoretical limit. A 1-microsecond pulse is sufficient to raise the temperature of the spot from  $0^\circ\text{C}$  to  $360^\circ\text{C}$ . After another microsecond, the tem-

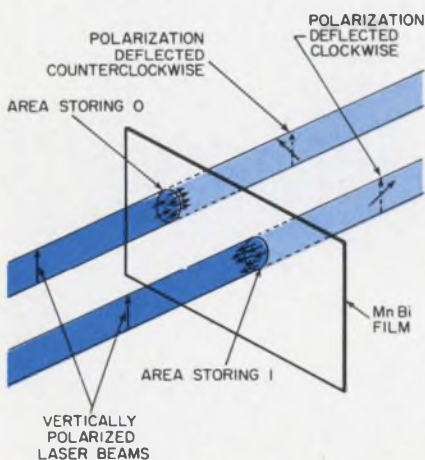

1. Faraday effect in a manganese bismuth film causes opposite rotations of a vertically polarized laser beam for stored ones and zeros.

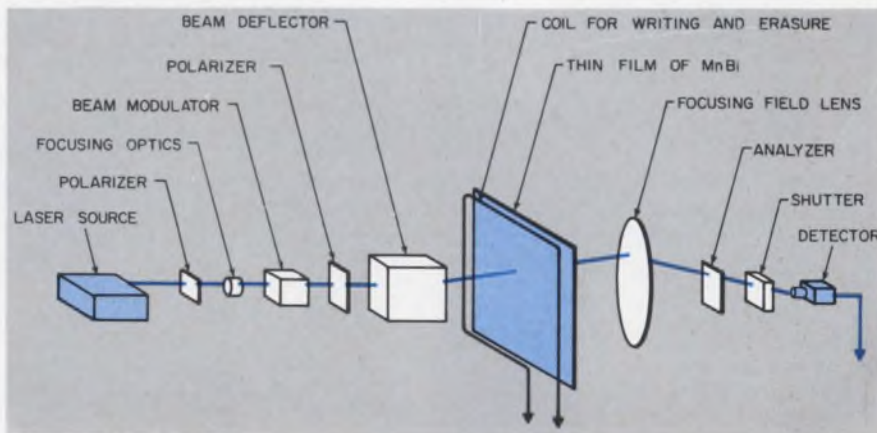

2. Proposed beam alterable and addressable memory uses a laser as the light source for scanning and as a source of heat for altering the directions of magnetization. Differing directions of magnetization cause opposite changes in the plane of polarization that can be detected by the analyzer and a photodiode.



perature at the center of the spot will have decreased to 100°C.

Thus megahertz writing rates are possible at present. To prevent diffusion heating effects, Dr. Blue proposes that the 3-micron spots be spaced by 10 microns, thereby giving a packing density of 6.5 million bits per square inch. Dr. Blue expects that this density will be improved as experience is gained with the films.

### Beam polarization changes

To read information, the beam is scanned by a polarized laser beam (Fig. 2). The deflection system is likely to be a form of electro-optic switch (see ED 23, Nov. 8, p. 38). The light beam will experience a Faraday rotation as it passes through the film, depending on the thickness of the film. In the example shown in Fig. 1 a clockwise rotation will represent a zero and a counterclockwise rotation a one. At a wavelength of 6328 Å, the wavelength of the NeHe laser line, the Faraday rotation of MnBi is  $5 \times 10^5$  degrees per centimeter at room temperature. Thus for a 1000-Å film the rotation will be 5°, giving a 10° differential between the planes of polarization for ones and zeros. The difference is readily detectable with a polarization analyzer and a photomultiplier or a photodiode detector.

Greater rotation could be obtained by the use of a thicker film, but with an increase in the amount of light absorbed. This would result in a poorer signal-to-noise ratio. Even the 1000-Å film absorbs 99% of the incident beam, but since a 1-milliwatt laser emits  $10^{15}$  photons/s, of which 90% are absorbed by the focussing optics,  $10^{12}$  photons/ will be available at the detector. If the noise level of commercially available detectors is assumed to be about  $10^{11}$  photons/s at  $10^4$  Hz, a signal-to-noise ratio of about 100 to 1 results. Thus Dr. Blue's proposed memory will have a readout rate of 100 MHz, about 10 times faster than the writing speed. Higher readout rates could be achieved at the expense of signal-to-noise ratio, said Dr. Blue, who expects that rates of one billion bits per second will be feasible.

### Low power needed

Power requirements for the optical memory will be quite modest. Dr. Blue believes, citing 100 watts for a 10-milliwatt laser and an estimate of less than 200 watts for the modulator and deflection system. ■ ■

# 1970

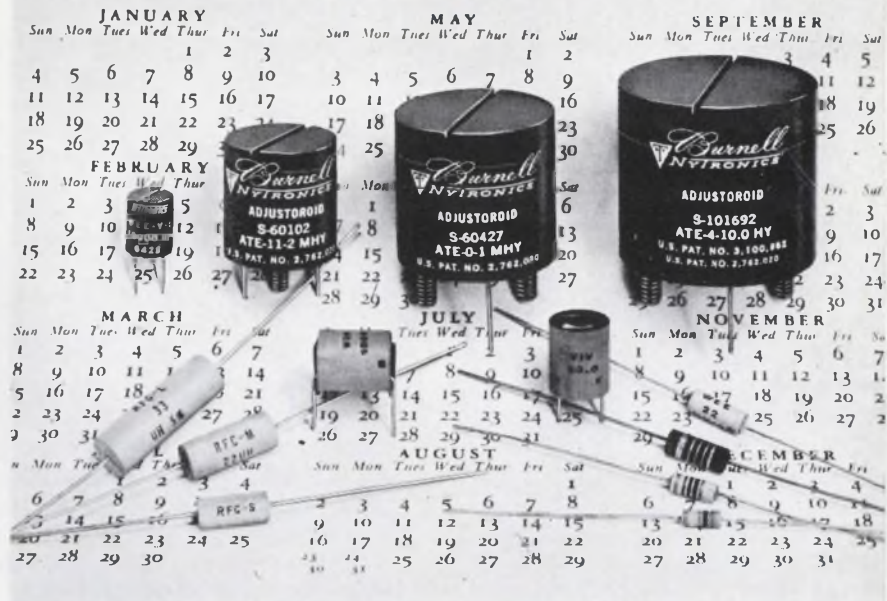

## Nytronics Inductors are ahead of their time!

Nytronics continuous research and development have produced standardized quality inductors with the superb precision and stability to meet the demanding requirements of tomorrow's circuitry. Yours today — delivered off the shelf from a large inventory. Pioneering is a Nytronics speciality!

**WEE-DUCTOR** — Magnetically shielded with inductance range 0.1 to 180,000uH, designed to MIL-C-15305, Grade 1, Class B. Encapsulated Envelope: 0.157" diameter x .450" length.

**SUPER WEE-DUCTOR/90537 TYPE** — Manufactured in accordance with MS90537, Molded Magnetically shielded with inductance range 0.1 to 100,000uH  $\pm 10\%$  tolerance. Molded Envelope: 0.163" diameter x 0.410" length.

**WEE WEE-DUCTOR** — Magnetically shielded with inductance range 0.1 to 10,000uH. Designed to MIL-C-15305. Encapsulated Envelope: 0.125" diameter x 0.335" length.

**DECIDUCTOR** — Subminiature with inductance range 0.1 to 1000uH. Designed to MIL-C-15305, Grade 1, Class B. Molded Envelope: 0.100" diameter x 0.250" length.

**S-M-L INDUCTORS** — Non-shielded with inductance range 0.1 to 10,000uH. Designed to MIL-C-15305, Grade 1, Class B. Molded Envelope: "S" Type — 0.188" diameter x 0.44" length, "M" Type — 0.25" diameter x 0.60" length, "L" Type — 0.31" diameter x 0.90" length.

**VARIABLE INDUCTOR** — Unshielded with adjustable range 0.1 to 4700uH. Designed to meet MIL-C-15305, Grade 1, Class B. Encapsulated Envelope: 0.400" diameter x 0.500" length. Vertical or Horizontal mounting.

**WEE V-L** — Magnetically shielded adjustable range 0.1 to 100,000uH. Designed to MIL-C-15305, Grade 1, Class B. Epoxy Molded 0.300" diameter x 0.400" length.

**ADJUSTOROID** — Adjustable toroid available in nominal values from 0.01Hy to 12Hy. This unit provides stepless adjustment in a completely hermetically sealed package.

Nytronics off-the-shelf inventory also includes a wide range of capacitors, delay lines, and resistors. Write today for complete engineering data.



## NYTRONICS®

...for Precision Electronic Components

550 Springfield Ave., Berkeley Heights, N.J. 07922 ■ (201) 464-9300 ■ TWX: 710-984-7977

ON READER-SERVICE CARD CIRCLE 13

# Go West, young man, but buy a round-trip ticket

## Salary survey shows pay for beginners is highest in West Coast area, but better in East after 7 years

**Howard S. Ravis**  
Management and Careers Editor

If you want to earn a top engineering salary, work for a large electronics company on the West Coast the first seven years of your career. After that, try New York, New Jersey or Pennsylvania.

That, at least, is one way to interpret the most recent salary findings of the Engineering Manpower Commission of the Engineers Joint Council.

A commission survey has found that the median salaries paid in 1966 to engineers with up to seven years' experience were highest in the Pacific States (Alaska, California, Hawaii, Oregon and Washington). The next highest starting engineering salaries in the country were paid in the Middle Atlantic States (New York, New Jersey and Pennsylvania). The Midwest, the commission survey shows, tends to pay the lowest salaries.

For the engineer with zero to seven years' experience, the median Pacific salary, according to the survey, is \$8550 to \$12,350. The same engineer was found to earn \$8300 to \$12,250 in the Middle Atlantic States. In the

Midwest the figures are \$7850 to \$11,350.

But for the engineer with eight to 35 years' experience, the median salary ranges are as follows:

Mid-Atlantic — \$12,700 to \$16,150.

Pacific — \$12,600 to \$14,000.

Midwest — \$10,500 to \$14,550.

(See chart on p. 26 for breakdown of median salaries by areas for engineers with up to 35 years' experience.)

Interestingly, Texas is in one of the low salary areas in the survey. Since other recent surveys show Texas as the fastest-growing area for electronics, salaries apparently had not caught up with the growth, as of 1966.

Engineers are reminded that the states paying the highest salaries also have the highest costs of living, according to available data. This would tend, from a practical standpoint, to narrow the salary gaps.

The commission survey also shows that the salary differential between high-paying and low-paying areas widens as the engineer gains experience (see table below).

The survey recognizes two types of large companies that employ engi-

neers: "Large Employers, Advanced Technology" and "Large Employers, General." The former are those with heavy commitment to electrical and electronic technology. The latter include chemical and petroleum companies and all others with engineers.

For survey purposes, a large company is considered to be one employing at least 2000 engineers.

### Large companies pay more

The commission has found that large companies, especially the "advanced technology" ones, pay considerably higher salaries than comparable small ones. See Figure.

According to the survey, an engineer with such a large electrical or electronic company can expect to earn between 5 and 13.5 per cent more from his sixth through 22nd year of experience than an engineer with the small company. The median salary of an engineer in a large electrical or electronic company peaks at \$16,800 after 22 years of experience. The median salary for an engineer with a small company reaches \$14,800 after the same 22 years.

Engineers with other large companies—those classified as "general"

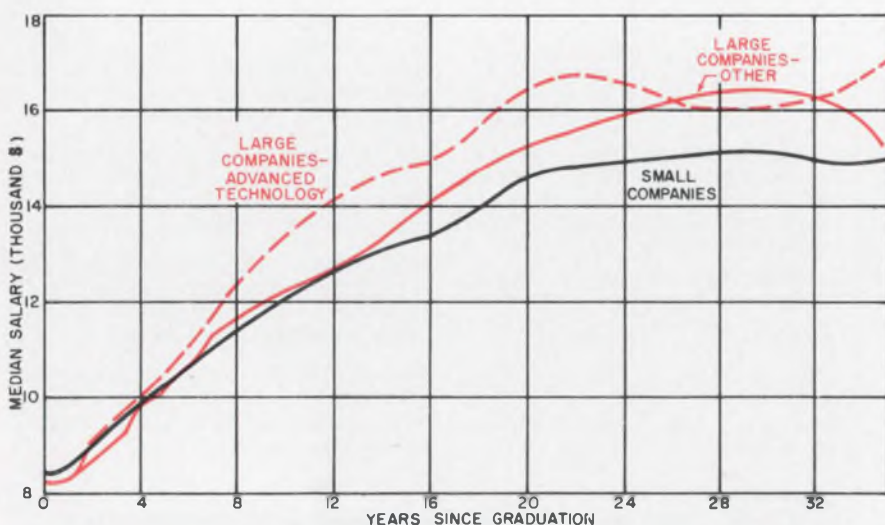

Separated by company size and involvement in electronics are the median salaries paid engineers in 1966, according to a survey by the Engineering Manpower Commission of the Engineers Joint Council. In the survey, a company employing at least 2000 engineers was considered large. The "advanced technology" category denotes those companies which have a heavy commitment in the areas of electrical and electronic technology.

### Range of salary differential

Years Since Grad.	High	Low	Diff.
0	\$8,550	\$7,850	\$750
1	8,900	8,200	700
2	9,450	8,650	800
3	10,150	9,300	850
4	10,550	9,400	1,150
5	11,000	9,600	1,500
6	11,650	9,700	1,950
7	12,350	10,050	2,300
8	12,700	10,500	2,200
9-11	13,550	11,200	2,350
12-14	14,700	11,750	2,950
15-17	15,550	12,350	3,200
18-20	15,750	13,550	2,200
21-23	16,100	13,900	2,200
24-26	16,500	13,850	2,650
27-29	16,100	13,900	2,200
30-34	16,500	13,050	3,450
35	16,150	12,450	3,700



## RE SERIES POWER SUPPLIES

**HIGH PERFORMANCE — LOW COST POWER SUPPLY**  
 ... for system and laboratory applications

The Rowan RE series is designed for both precise laboratory and systems applications. The units are convection cooled and use all silicon semi-conductors throughout. The RE series can be operated in either a constant voltage mode or a constant current mode and features circuitry providing automatic crossover to either mode.

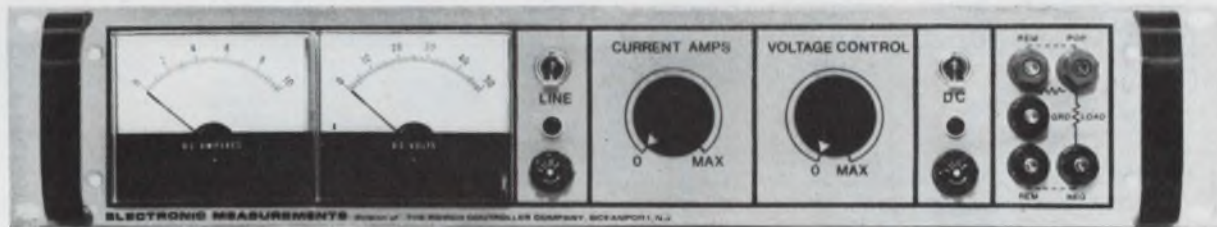

RE 40 - 5ML

### FEATURES:

- All silicon semi-conductors
- Convection cooled
- Automatic E/I crossover
- Constant voltage/constant current operation
- Series master-slave operation
- Remote sensing
- Remote programming
- Single knob voltage control with dual knob resolution

### RE SERIES SPECIFICATION TABLE

Model	Output volts	Output amps	Regulation line or load %*	Ripple MV RMS	Meters Ammeter Voltmeter	Terminals F - front R - rear	Size 19" panel	Weight	Price
RE 40 — 5	0 - 40	5	.01 or 2 MV	0.5	No	R	3½ H x 17¼ D	36#	\$290.00
RE 40 — 5M	0 - 40	5	.01 or 2 MV	0.5	Yes	R	3½ H x 17¼ D	36#	315.00
RE 40 — 5ML	0 - 40	5	.01 or 2 MV	0.5	Yes	F & R	3½ H x 17¼ D	36#	320.00
RE 60 — 2.5	0 - 60	2.5	.01 or 2 MV	0.5	No	R	3½ H x 17¼ D	36#	290.00
RE 60 — 2.5M	0 - 60	2.5	.01 or 2 MV	0.5	Yes	R	3½ H x 17¼ D	36#	315.00
RE 60 — 2.5ML	0 - 60	2.5	.01 or 2 MV	0.5	Yes	F & R	3½ H x 17¼ D	36#	320.00

\*whichever is greater. Input for all models 105-125, 50-63 HZ

## ELECTRONIC MEASUREMENTS

division of THE ROWAN CONTROLLER CO. | 2 CRESCENT PLACE | OCEANPORT, N.J. 07757

ON READER-SERVICE CARD CIRCLE 14

(salary survey, *continued*)

companies—also were found to earn more than engineers employed with small companies.

An interesting finding is the diversity of the salary curves. Engineers with large electrical and electronic companies reach a salary peak after 22 years, drop and then hit a new peak at 35 years. Engineers with other large companies peak at 32 years, while those with small firms experience only a slight decline after 28 years. ■ ■

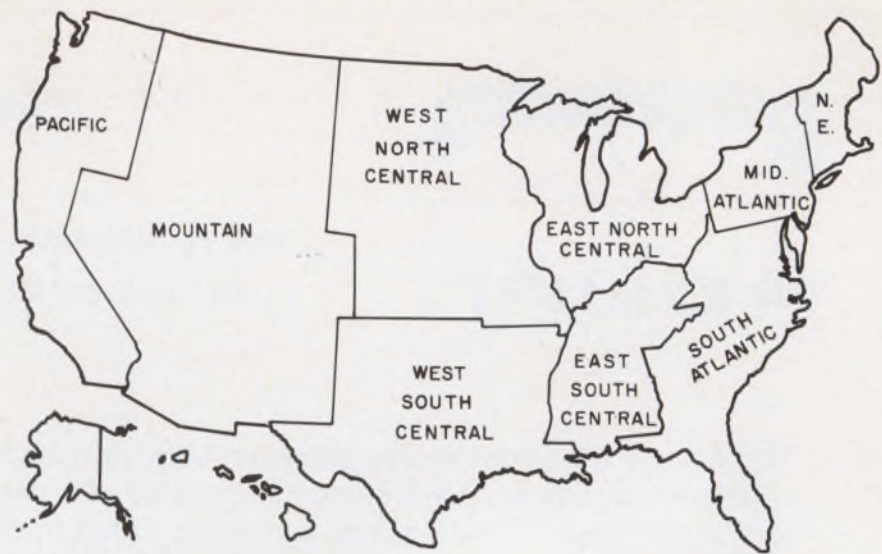

### Median salaries of engineers by geographic areas

Years Since Graduation	New England	Middle Atlantic	South Atlantic	East North Central	East South Central	West North Central	West South Central	Mountain	Pacific
0	\$ 8050	\$ 8300	\$ 8100	\$ 8000	\$ 7850	\$ 8400	\$ 8350	\$ 7800	\$ 8550
1	8500	8600	8550	8600	8200	8600	8700	8600	8900
2	8950	9400	8850	9000	8650	9150	9050	9300	9450
3	9450	9950	9450	9400	9400	9350	9300	10,150	9800
4	10,000	10,500	9850	9700	9550	10,000	9400	10,300	10,550
5	10,400	10,900	10,300	10,100	10,150	10,100	9600	9800	11,000
6	10,600	11,650	10,700	10,350	10,600	10,800	9700	10,900	11,500
7	11,250	12,250	11,350	10,650	10,900	11,350	10,050	10,900	12,350
8	11,600	12,700	11,700	11,000	11,250	11,600	10,500	12,150	12,600
9-11	12,300	13,550	12,450	11,650	11,650	12,450	11,200	12,450	13,500
12-14	13,000	14,700	13,200	12,400	12,400	12,800	11,750	13,000	13,950
15-17	13,750	15,550	13,850	13,250	13,300	13,700	12,350	13,550	14,750
18-20	14,400	15,750	14,650	13,950	13,750	14,400	13,600	13,550	15,350
21-23	14,050	16,100	15,600	14,150	15,000	14,250	14,700	13,900	15,950
24-26	14,200	16,500	16,050	14,350	14,850	14,300	14,850	13,850	16,150
27-29	14,400	16,050	16,100	14,600	15,350	14,300	15,500	13,200	15,900
30-34	13,450	15,850	16,500	14,500	14,650	13,050	15,550	13,150	15,600
35	13,050	16,150	15,200	14,550	14,800	12,850	15,850	12,450	14,000

**Legend:** Colored boxes are areas paying the highest median salaries; gray boxes, the lowest.

# ADVANCE

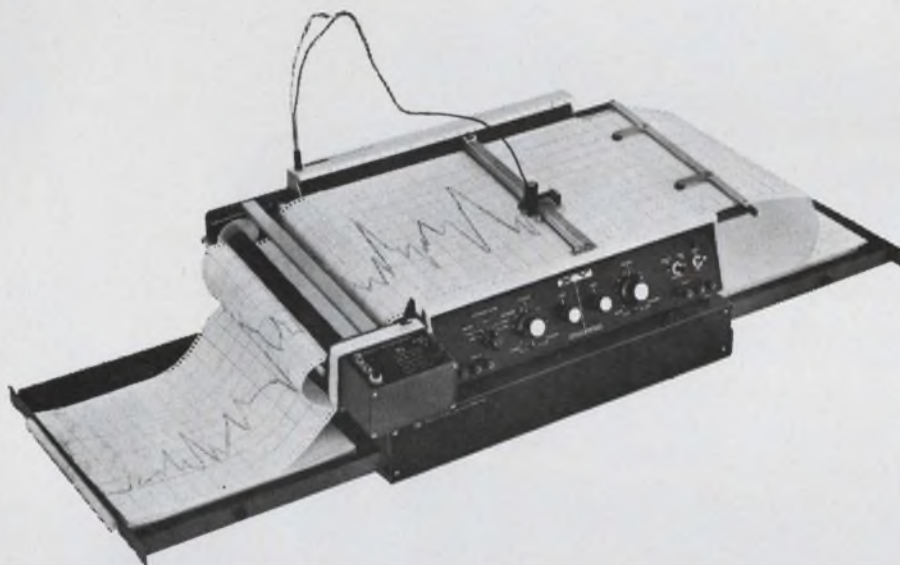

new X-Y  
accessory  
offers  
unique  
recorder  
flexibility

The new 17005A Incremental Chart Advance turns your Moseley X-Y recorder into a more flexible lab and production tool. It provides this added versatility and high performance by converting your X-Y into a strip-chart recorder. It offers incremental advance for multi-channel pulse height analysis with resolution between channels—and accepts both positive- and negative-going signals to advance the appropriate increment in the advance mode.

Designed for remote control operation. Will adapt to most 11x17 Moseley Recorders. Powered by the recorder itself. Uses roll chart or Z-fold paper. Price: Model 17005A, \$895.

For complete information, contact your local HP field engineer, or write Hewlett-Packard, Palo Alto, California 94304; Europe: 54 Route des Acacias, Geneva.

#### SPECIFICATIONS:

##### *Incremental advance mode*

Plot density (plots/inch):

200, 100, 50, 20, 10

Increment size (in./advance):

0.005", 0.01", 0.02",  
0.05", 0.10"

##### *Frame advance mode*

Advance distance: 24"

Accuracy:

$\pm 0.005$ " (non-accumulative)

Advance time: <20 sec.

##### *Time base mode*

Chart speeds:

1, 5, 10, 50, 100 sec/in.

Accuracy:  $\pm 2\%$

##### *Major division advance mode*

Advance distance:

Major divs. in 3" increments

Accuracy:

$\pm 0.005$ " (non-accumulative)

Advance time: 2½ sec.

Other advance increments available

HEWLETT  PACKARD

GRAPHIC RECORDERS

11701

ON READER-SERVICE CARD CIRCLE 15

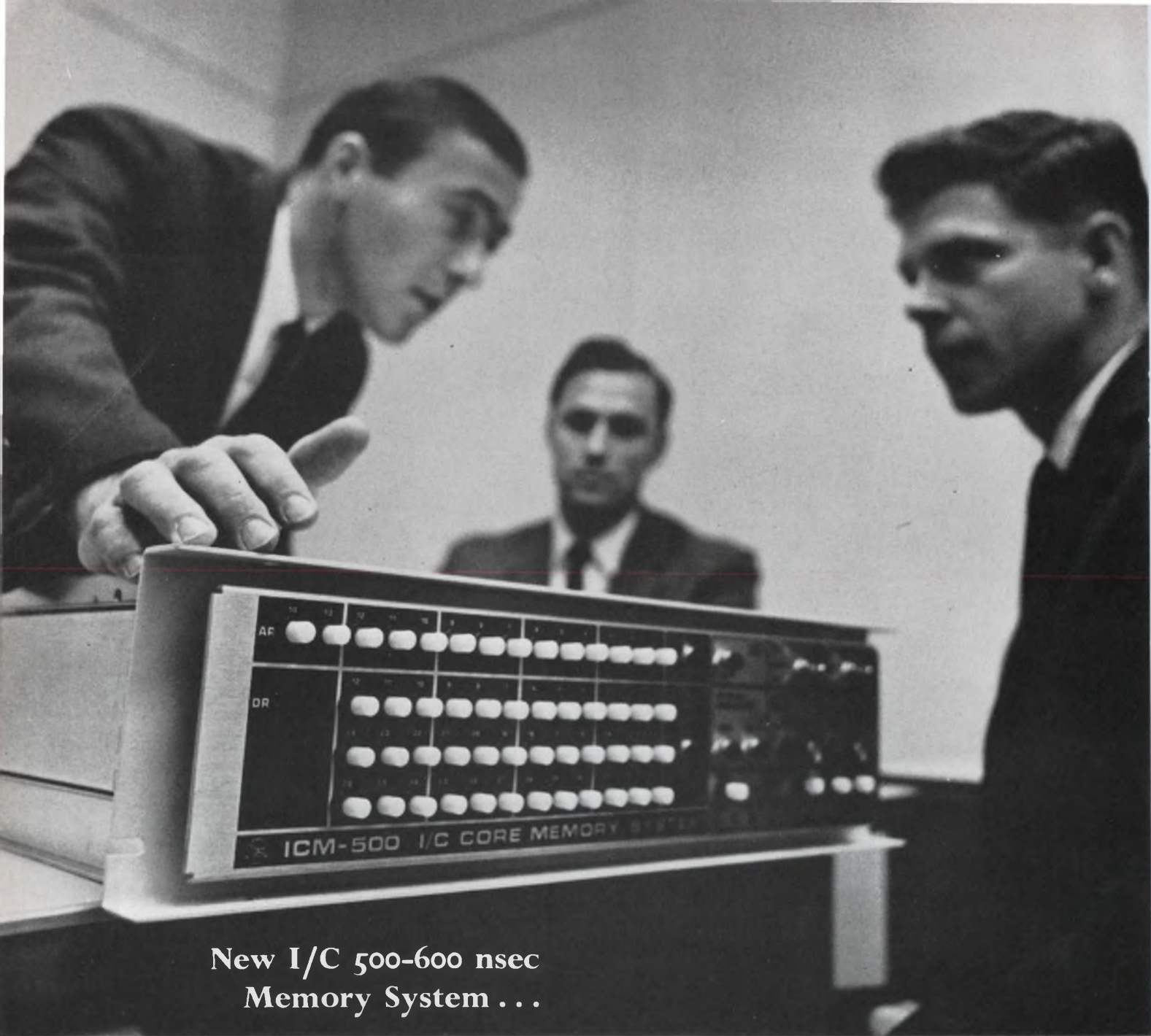

**New I/C 500-600 nsec  
Memory System . . .**

**. . . Stores 1/4 million bits in  
single 5-1/4" high unit, features  
MTBF of 12 years under normal  
40-hour week operation**

Now you can get the new  $\mu$ -STORE ICM-500 in standard systems: 600 nanoseconds full cycle time. Special systems: cycle times as low as 500 nanoseconds. Up to 16,384 words with 54 bits/word; or up to 4096 words with 72 bits/word. (Over 3/4 of a million bits in little more than 15" of vertical rack space — including power supply). You also get I/C construction for all major functions including X-Y current drivers plus a choice of mechanical packaging.

Get the full story. And take advantage of our eight years' experience in solving core memory problems. Write today for our new brochure. Honeywell, Computer Control Division, Old Connecticut Path, Framingham, Massachusetts 01701.

\*Patent applied for.

**Honeywell**

 **COMPUTER CONTROL  
DIVISION**

DOD space spending to triple by 1976.



## Peace not so bad after all

Looking ahead to the effects on the electronics industry should the Viet Nam conflict end by the 1969-70 period, the Electronic Industries Association forecasts continued growth in the Defense Dept. and a reduction in NASA expenditures. EIA's reasoning is as follows. The level of the space agency's appropriations will rise or fall in accordance with the success of the Apollo program. Following completion of the currently planned program, however, its funds may be cut in the absence of a firm, approved follow-on national space goal. The EIA also feels that the viability of NASA programs depends on the length and cost of the Vietnamese conflict. Thus EIA experts conservatively predict that three years after peace NASA expenditures may level at \$3.2 billion and electronics outlays at roughly half the 1966 level.

The EIA experts predict on the other hand a steady increase in DOD space programs to a point where 1976 expenditures will be thrice those of 1966. The association foresees that despite a cut in DOD spending following a cessation of hostilities electronics expenditures should be 60% higher in the 1972-74 period than in 1966.

EIA, nevertheless anticipates postwar economic problems for many firms. These will be chiefly associated with over-capacity, excess personnel, diversification, skills transfer and securing investment capital for new ventures.

## FAA funds survive Congress

Despite efforts by members of the House to hold Federal Aviation Administration 1968 appropriations to a minimum, the will of the Senate won out and funds for new electronic systems were retained in the Department of transportation appropriation bill. The result then is that \$54.0 million will remain in the bill as a compromise. The rough breakdown is as follows:

# Washington Report

CHARLES D. LAFOND  
WASHINGTON BUREAU

- \$16 million—air route traffic control centers (long-range radars, automation equipment, and other center facilities).
- \$17.5 million—air traffic control towers (terminal area radars and automation plus other tower facilities).
- \$15.2 million—air navigation facilities (VORTAC, 1f and mf radio facilities, instrument landing systems, and visual aids).
- \$4.2 million—miscellaneous equipment and R&D facilities.

The original request for funds amounted to \$35.4 million. The compromise increased this amount by \$18.6 million and will permit the purchase of airport surveillance radars for eight locations (\$4.8 million), instrument landing systems for 80 locations, approach lights for 76 locations (\$11.7 million), and direct beacon code identification and altitude readout for 23 locations (\$2.1 million).

## Navy confirms SABMIS award

As reported earlier in this column (ED 21, Oct. 11, 1967, p. 29), the Navy has confirmed the award of a six-month feasibility study for a sea-based antiballistic missile intercept system (SABMIS) to Hughes Aircraft Co., Redondo Beach, Calif. Under the \$720,000 contract, Hughes will work with Lockheed Missiles and Space Co., Sunnyvale, Calif., and Newport News Shipbuilding and Drydock Co., Va. Hughes will perform total system concept and design studies, Lockheed will concentrate on the missile portion and Newport News S&D will determine ship design and special structural problems.

Informants now state that only portions of the Nike-X missile site radar (see "Nike-X: A merger of radars and computers," ED 22, Oct. 25, 1967, pp. 17-24) will be applicable to the system—principally in the transmitter portion—but it can use the same frequency. Radars will use phased arrays. As far as possible, elements of the existing Naval tactical data system will be used and the AN/YUK-7 computer will be employed for

data-processing and data transmission between radar ships. The use of submarines is reported no longer under consideration. It is expected, however, that at least initially the long-range Spartan ABM will be considered for the sea-launch system, rather than a new missile.

Initial track prediction for ABM launch will be necessarily short, further complicating the intercept problem. Contrary to what was believed earlier, intercept will occur as close as possible to that point in the trajectory of the attacking ICBM after multiple warhead separation has occurred. The cloud of warheads and decoys will then still be contained in a relatively small volume.

## Panel wants funds for electric car

Government sponsorship of an R&D program to develop electrically powered vehicles has been recommended by panel set up by the Dept. of Commerce. The group, headed by Richard S. Morse of MIT, included eminent industrial, academic, and technical experts. It studied the very critical problems of automotive air pollution in an attempt to find some method of practical control, and has presented its initial findings in a recently published report, *The Automobile and Air Pollution—A Program for Progress—Part I*.

The panel proposed a five-year, \$60-million program to study vehicle pollution problems, set up suitable emission standards and support continued research. The report stressed the need to investigate alternative energy sources for vehicles, emission control devices, and special-purpose urban cars. It suggested that the Federal Government should use its procurements to stimulate the development and use of devices and vehicles that would emit fewer atmospheric pollutants.

## Comsat opposes ATT cable proposal

The Communications Satellite Corp., in a 92-page response to a Federal Communications Commission request, has stated its objections to the installation of any new transatlantic telecommunications cable. Comsat's chief argument is that such a cable "would impede the development at a critical time of economical satellite communications to serve developing and developed nations alike." It further argued that

versatile, high-capacity communications satellites planned for the early 1970s will more than meet demands for high-quality communications across the Atlantic.

The Comsat announcement of its response to the FCC followed close on the heels of statements by ATT Vice President Richard R. Hough, who has urged construction of a \$70.4 million high-volume cable between the U.S. and Southern Europe. The cable system, said Hough, would make a nearly even balance of capacity between cable and satellite communications across the Atlantic by 1970. In arguing the ATT case, Hough stated that such a cable/satellite capability would reduce the impact should catastrophic failure befall either system.

In its proposal, ATT suggested a land connection on the Iberian Peninsula to serve an area now reached only by long overland circuits connecting with four northern European telephone cables. Hough also pointed out the distinct advantage in providing additional back-up for U.S. military and government communications.

In arguing the case for satellites, Comsat's chairman, James McCormack, declared that the principal issue is whether or not the satellite system of the 1970s will be permitted to realize its potential through optimum utilization. He indicated that diversion of traffic at that time to "an unneeded cable" could seriously limit the space communications system during its critical period of growth.

## Dept. of Communications next?

It is possible that a solution to many of today's problems in a national and international telecommunications may be found with the establishment someday of a new Dept. of Communications or Communications Agency evolving from the existing Office of Telecommunications Management, according to Rep. Torbert H. Macdonald (D-Mass.). The chairman of the Communications and Power Subcommittee of the House Interstate and Foreign Congress Committee has suggested that a Federal agency may be required to handle radio-frequency allocations in the future.

The emergency of satellite communications, he said, adds to the expanding problems. Although the spectrum is crowded, the Congressman said, no one appears to know whether or not all the available frequencies are actually being used. "There is a great amount of speculation that many frequencies now are not in fact being used, and this is particularly true of frequencies assigned to the Department of Defense."





## **ELECTRONIC DESIGN IS ON THE UP AND UP AND UP...**

**Up in ad pages: 262 page gain 1st 9 months 1967**

**Up in editorial awards: four received in 1967**

**Up in new advertisers: 149 first nine months 1967 or 38%**

**Up in subscribers: 62,000 in November. Up 6,000 from June 1967**

**Up in editorial staff: three more full time editors added in 1967**

**Up in inquiries: a gain of 304,629 or 76% more than 1966-January through June**

**Up in tell-all/catalog-type inserts: a 25% gain**

**Up in 4-color pages: 102 pages or a 52% gain**

**Up in readership "wins": 5 new "wins" to be published this month**

**Up in subscription renewals: an all-time high of 94.4%**

**UP WITH THE LARGEST ADVERTISING PAGE GAIN OF ANY ELECTRONICS PUBLICATION IN 1967.**

**ELECTRONIC DESIGN'S EDITORIAL AUTHORITY, VERVE AND  
BALANCE KEEP IT ROLLING #1 WITH ENGINEERS AND ENGINEERING MANAGERS—  
THE MEN WHO SPECIFY IN THE 22 BILLION DOLLAR ELECTRONIC INDUSTRY.**

**WE HAVE A BALL PRODUCING THE INDUSTRY'S FINEST PUBLICATION.**

when Westinghouse selected us to build this **ANTENNA FEED ARRAY** for their AN/TPS-43 tactical radar systems... their engineers re-wrote the book on critical specifications.

1. We were presented with a very stringent set of electrical phase parameters over which we had to maintain close mechanical control. Otherwise, the system would not meet the necessary pattern requirements and phase distribution specification.
2. Weight limitations required the removal of .030 inches of material from each broad wall surface to an accuracy of plus or minus .003" over 12 feet of length.
3. Positioning and rigidity specifications demanded that we maintain  $\pm .003"$  for horn openings along with  $\pm 10$  min perpendicularity on each individual horn. This meant that all detail part tolerances had to conform to  $\pm .001$  inch.
4. Angularity tolerances over entire 10 ft. Array from flange faces to focal axis was  $\pm 5$  min. Perpendicularity from flange to faces to horn array was  $\pm 5$  min.
5. The bending of waveguides was a critical area . . . minor deviations in the array. Bend locations in the 6061 alloy aluminum waveguide were held to  $\pm .010$  inches while locating flange centers to within  $\pm .005$  inches.

To accomplish all this, a bit of Waveline ingenuity had to be applied. One thing we did was to perform a sequence of dip brazing operations which, up to then, were considered beyond the state of the art. We constructed a 4 ft. x 12 ft. precision fixture for the purpose of accurately gaging the entire final assembly.

The Westinghouse AN/TPS-43 will operate as part of the 407-L Tactical Air Control System of the Electronic Systems Division, USAF Systems Command—and we're proud of the role Waveline will play in helping to maintain our nation's defense system.

Where will our next highly challenging assignment come from? How about you?

Waveline Inc., P.O. Box 718, West Caldwell, New Jersey,  
Phone: (201) 226-9100, TWX (201) 226-5558

ON READER-SERVICE CARD CIRCLE 18



approx. 36" x 120" at a weight of less than 90 lbs.

**WAVELINE** INC.

NEWS

**Laser beam shifted  $\pm 45$  GHz by crystal**

The ability to tune lasers over a wide range of optical frequencies may one day be useful in a multiplexing system for laser communications. In this context, scientists of Bell Telephone Laboratories, Murray Hill, N. J., have succeeded in producing Doppler shifts of  $\pm 45$  GHz in a continuously operating laser. Not only is this the largest frequency shift achieved with electro-optical means, but it is also reported to be stable and precisely controllable.

M. A. Duguay and J. W. Hansen, in a paper presented at the 1967 International Electron Devices Meeting in Washington, D.C., said they had produced a Doppler shift in the output of a helium-neon laser by rapidly changing the refractive index of a stationary crystal. Frequency is proportional to the rate of change, they said, because changing the index is equivalent to changing the optical path length.

The mode-locked output of the He-Ne laser was passed through a lithium niobate crystal outside the laser cavity, and modulated by a 100-MHz rf signal locked in phase with the optical pulse train input. Each laser pulse had a 0.5-ns duration, and pulses arrived at 10-ns intervals. These pulses were described as a packet of some 25 optical frequencies, uniformly separated by 100 MHz and centered about 474 THz ( $4.74 \times 10^6$  GHz).

Synchronization of the rf signal with the light output is said to have produced the same effect as if the laser itself had been moved. ■ ■

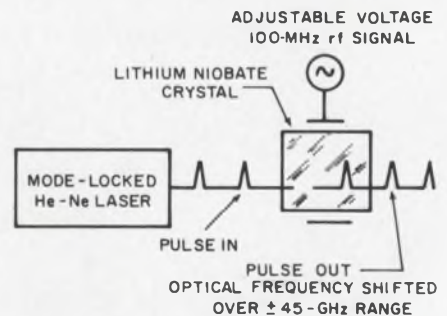

**Laser output is shifted  $\pm 45$  GHz** by directing it into electro-optical crystal. Applied rf field locks in phase with optical pulses and changes refractive index of crystal. This in effect varies the optical path length.

# IDEAS

from SYLVANIA

## INFORMATION DISPLAY

### Think how much more useful this display would be in 2 colors

It IS 2 colors—red and green...

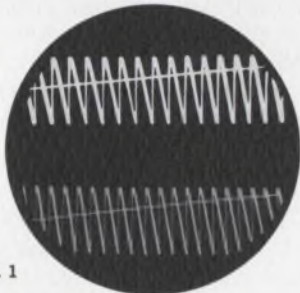

Fig. 1

... and it's not a split screen. Both colors are available—visually simultaneously—over the entire raster area. Thus Sylvania's new 2-color CRTs can display two entirely different sets of information with complete visual distinction between each.

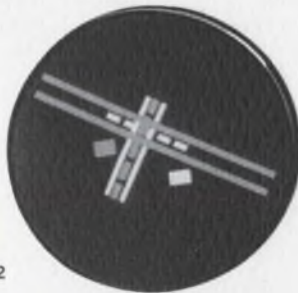

Fig. 2

Air-traffic control display. Here east-west airplanes and aircraft can be shown in red (lighter lines), while north-south information is shown in green (darker lines). This is typical of information-display versatility of our new one-gun, two-color CRTs.

CRT employs only one electron gun, with two layers of phosphor (red and green). Low voltage electron beam actuates the red phosphor; high voltage activates the green. By rapid switching from high to low voltage, red and green information appears visually simultaneously over full screen. And there is no shadow mask to reduce brightness or resolution.

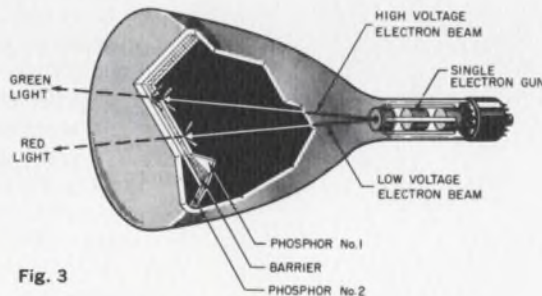

Fig. 3



Fig. 4

Tubes are currently being produced in 5" size (SC-4689, left, with electrostatic focusing and deflection) and a new 10" size (SC-4827, right, with electromagnetic focusing and deflection). On special order we can make them in any size from 1" screen diameter to 27".

Here, we think, is one of the most versatile information display concepts ever devised: an industrial/military-quality CRT that presents information simultaneously in two colors. Two types are available: a 5" size with electrostatic focusing and deflection, and the new 10" size shown, with electromagnetic focusing and deflection.

Extra two guns and three-dot phosphor used in conventional color CRTs aren't needed in our one-gun tube. This eliminates the precise shadow-mask control and alignment procedures normally used in color CRTs. And because dots of three different phosphors are no longer required for each information point, the new tube has very high resolution. This means more information can be displayed in a given area, increasing display space efficiency.

(Continued on next page)

## This issue in capsule

**Integrated Circuits** — A TTL binary-to-decimal averager with SUHL™ circuits and functional arrays

**Readouts** — Random-access EL panels provide alphanumeric or pictorial information displays

**Microwave Components** — Schottky diodes lower 1/F noise and microphonics in doppler radars

**Manager's Corner**—Advancing the state-of-the-art in industrial and military cathode ray tubes

**Diodes** — Voltage-variable capacitors for automatic frequency control systems

**Television** — New lighter weight, lower cost color picture tube in 22" rectangular size

Elimination of the three-dot phosphors means there's no chance of misalignment which can cause the wrong phosphor to be activated by the wrong gun.

Our tube, on the other hand—using a red-and-green multi-layer phosphor combination and no shadow mask—provides the brightness, resolution and image quality of a monochrome tube...but in two separate and distinct colors. It's a 2-color image display in green and red (or other color combination) from a single gun, with the gun producing red from low voltage and green from high voltage.

These tubes are available in 5" and 10" round-face diameters (see Fig. 4), but other faces can be designed on special order. Both use a bright green and Sylvania's "rare earth" europium-activated red phosphor selected for contrast and high light output.

We recommend them for:

- Air traffic control systems
- Military identification systems
- Bio-medical equipment
- Stock market quotation units
- Teaching machines
- Electronic test equipment
- Computer displays

- Airline and other transportation-status boards
- Any application requiring discrete-color information display.

In air-traffic control displays, for example, these CRTs could be used to provide quick and positive information on different altitudes or stacked aircraft problems. Different colors could be used to indicate various runways, holding patterns or air traffic lanes (see Fig. 2).

In computer displays, color can be used to indicate particularly significant data or newly changed, added or deleted data. For alphanumeric stock quotation displays, red could be used to indicate a stock which has declined since the last quotation, and green a stock which has gone up.

#### Switching requirements and circuits

The speed at which color selection is required determines the type of switching circuits needed. System requirements should be analyzed to determine if field sequential rates satisfy the ultimate need. For example, all information to be displayed in one color may be presented, the voltage switched, and all information of the

second color presented. Such an arrangement may help to reduce transients and the need for extremely rapid switching.

#### 5" electrostatically deflected CRT

Relatively fast switching speeds can be achieved with the basic circuit shown in Fig. A. This mode of operation is typical for our 5" electrostatically deflected CRTs. The second anode is at ground potential and the cathode is operated below ground by 6 KV. It is only necessary to switch the final anode between ground and +6 KV to select color.

With  $V_1$  conducting, essentially the entire 6 KV is dropped across  $R_1$ . The speed at which it is dropped is determined by  $C_x$  and the parallel resistance of  $R_1$  and  $R_p$  of  $V_1$ . When  $V_1$  is cut off, the capacitance  $C_x$  charges through  $R_1$ . For rapid switching, the RC product of  $C_x R_1$  should be as small as possible, consistent with the available power source. The values shown are typical.

Since the time constant is considerably different from one state to the other, switching in one direction is considerably faster than in the other. Consideration should be given to the addition of shunt or series "peaking" to increase the charging speed of  $C_x$  through  $R_1$ .

It should also be noted that, since the final anode of the CRT is changing potential, its effect on other parameters must also be considered. For example, the deflection sensitivity or deflection factor is different under the two modes of operation and, therefore, should be altered at the same time the final anode is switched. It may be advantageous to increase the beam current at the time the anode is switched to the lower voltage in order to maintain relatively constant brightness under the two operating conditions.

#### 10" electromagnetically deflected CRT

The switching circuit for our 10" tube (Fig. B) operates with the cathode at ground potential. The final anode is switched over a range of from +6,000 volts to +12,000 volts. In this circuit arrangement, the 6BK4 stands off the entire anode voltage. During the interval that the 6BK4 is nonconducting, the anode of the cathode ray tubes is essentially at the supply potential.

During the time that the 6BK4 is conducting through  $R_1$ , the final anode of the CRT is reduced in potential to a value whose product is equal to  $R_1 I_p$ . The maximum  $I_p$  is limited to a value which is adjustable by the bias applied to diode  $D_1$ .

#### Fast-switching requirement for 10" CRT

Fig. C illustrates the basic circuit for a fast-switching requirement. This shunt-series control arrangement virtually eliminates the  $R_1 C_x$  time constant associated with Figs. A and B.

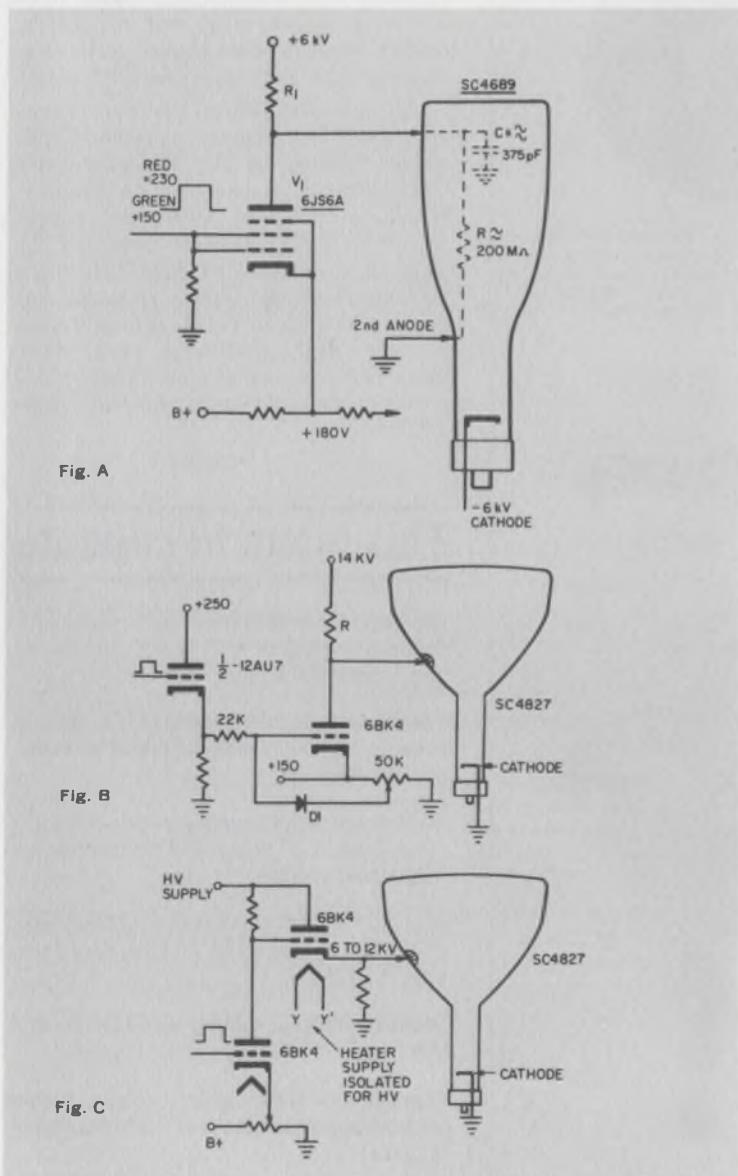

# High-speed TTL binary-to-decimal averager using SUHL™ and functional arrays

This binary decimal averaging converter, designed by Sylvania for a specific customer application, illustrates again the range, capability and versatility of Sylvania integrated circuits. It also demonstrates the complete compatibility of Sylvania's SUHL line of TTL integrated circuits; here four different IC types work together in a TTL system with absolutely no special interfacing required.

This custom-designed circuit simultaneously accepts an 8-bit binary addend, an 8-bit binary augend, adds and averages them and provides an output coded for all forms of visual readout. And this system is open ended: by adding IC packages, larger numbers can be easily processed.

### How it works

The system shown employs four SM-60 4-bit storage registers to accept addend and augend information; eight SM-10 full adders in an 8-stage parallel adder; four SG-140 NAND/NOR gates, and seven SF-50 J-K flip-flops in a shift-left register that feeds into a binary to BCD converter made up of standard SUHL gates and flip-flops.

The SM-60 storage registers and the SM-10 full adders require true input only, thereby simplifying wiring requirements. But where necessary, an internal inverter in each SM-10 provides inverted output, which in this case the SF-50's require. By using these internal gates, only four SG-140 NAND/NOR gates are needed.

Addend and augend data are entered in the A and B registers simultaneously. An enable pulse gates the contents of the A and B register simultaneously into the 8-stage parallel adder, which then computes the sum.

A Logic # 1 on the inhibit line permits the sum to be asynchronously

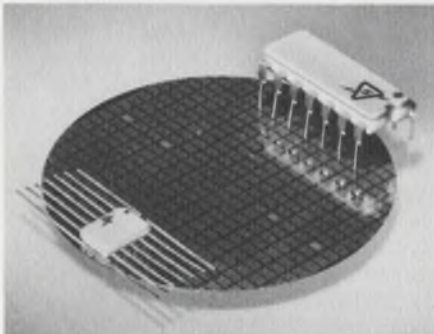

Fig. 1. Sylvania ceramic-packaged TTL SUHL integrated circuits used in binary-to-decimal averaging converter. System employs SM-60 four-bit storage registers, SM-10 full adders, SG-140 dual 4-input NAND/NOR gates and SF-50 AND-input J-K flip-flops. All are available either in Sylvania's 14-lead dual in-line plug-in package or TO-85 flat pack.

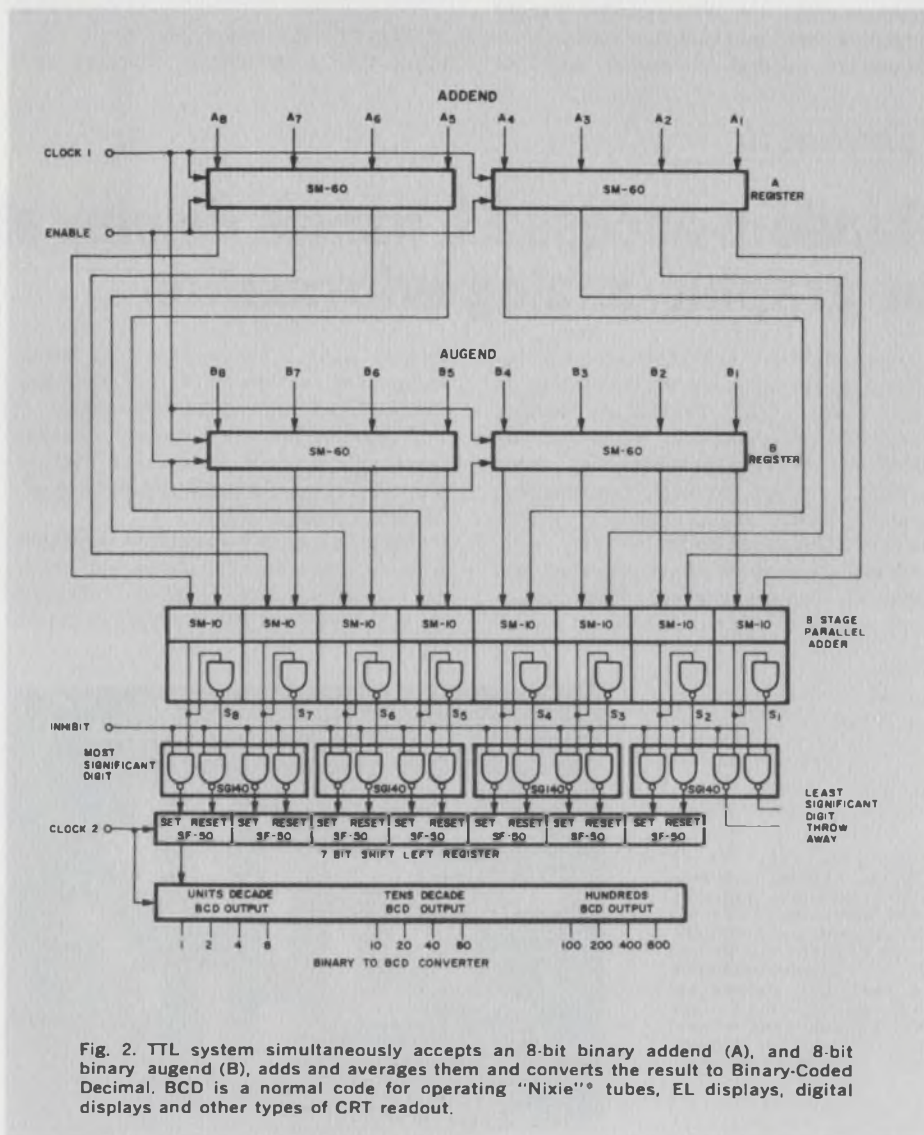

Fig. 2. TTL system simultaneously accepts an 8-bit binary addend (A), and 8-bit binary augend (B), adds and averages them and converts the result to Binary-Coded Decimal. BCD is a normal code for operating "Nixie" tubes, EL displays, digital displays and other types of CRT readout.

\*Registered Trademark, Burroughs Corp.

entered through the inverting gates into a 7-bit shift-left register. Since the most significant 7 bits from the parallel adder are entered in the shift register, with the least significant digit being dropped, the sum is effectively divided in half to provide the average. The average is accurate to  $\pm 1$  binary bit; higher accuracy can be obtained if the least significant digit is used.

After 7 pulses on the Clock #2 line, the information in the shift register is entered in the binary to BCD converter. Total time from parallel input to BCD output: approx. 1.5  $\mu$ s based on a 5 MHz clock rate. You have to take it from there, depending on your system requirements.

### Component Characteristics

The ICs used in this system are Sylvania's Monolithic Digital Func-

tional Arrays (SM-10, SM-60) and SUHL gates and flip-flops (SG-140, SF-50). These quality ICs offer complete compatibility, high noise immunity, high logic levels, proven reliability with low power consumption, and operations over both military and industrial temperature ranges.

SM-60 storage registers, one of the Monolithic Digital Functional Arrays, are saturated logic devices providing high-output drive capability from a single 5-volt power supply. It stores a "1" in 20 ns, a "0" in 25 ns, with 4-bit parallel read-in and read-out. Output current is 20 ma noise immunity  $\pm 1$  v, with a power drain of 30 mw/bit.

SM-10 full adders, also one of the Monolithic Digital Functional Arrays, are recommended for ripple-carry adder subsystems. This array will sum 2 digits in 25 ns and provide a carry in 13 ns. Only one package is

(Continued on next page)

required per stage, thereby reducing interconnections. A 64-stage ripple-carry adder subsystem built with SM-10s can add two 64-digit numbers in less than a microsecond.

Each SG-140 NAND/NOR gate contains four gates consisting of a 2-input AND gate followed by an inverting amplifier. They are extremely useful where multiple inverting functions are needed, or where multiple

drivers with fan-out capability of up to 15 are required as in clock distribution systems. The SG-140 series features high-capacitance drive (up to 600 pF), high logic swing ("0" = 0.26 v typ., "1" = 3.3 v typ.), low power consumption, and integral short-circuit protection.

The SF-50 J-K flip-flop is designed to implement high-speed logic systems with a minimum of gates and

interconnections. Three J and three K data-input connections provide the AND function right in the flip-flop, assuring high speed and reduction in system package counts. And the unit is raceless; the inhibiting action of the clock input also directly inhibits the J and K terminals to prevent any internal racing problem. And they're all designed to work together in one big compatible SUHL family.

CIRCLE NUMBER 301

## EL READOUTS

# Random-access EL panels display alphanumeric or graphic/analog information

*How many different types of information display systems are available to you today? CRT digital or analog readouts and printouts, neon-bulb indicators, charts, pen-and-ink paper graphs, fast-switching bar graphs, meters, ticker tape, computer printouts... the mind boggles.*

*Here we plan to show you that our new electroluminescent random-access panels might provide more useful*

*output than other systems in many industrial, commercial and military applications and—hopefully—why.*

Everyone has seen moving character displays such as the sign around the old Times Tower Building in New York's Times Square.

Now Sylvania has applied the same principle to electroluminescent readout systems—but with all the inherent superiority that EL displays provide.

Such as: light weight... ruggedness... low power drain... flat configuration... wide viewing angle... compactness... and those all-important Sylvania exclusives: hermetically sealed all-glass construction, high contrast, and high luminosity (to 15 fL, so the display is readily visible even in high ambient-light conditions).

Depending on switching circuitry, units can be made bi-stable or mono-stable. In bi-stable units, any "on" remains "on" till pulsed "off"; in mono-stable units, an "on" remains "on" so long as actuating current is applied. Using Sylvania computer technology, our engineers will help you achieve optimum switching design.

Each square on the grid is essentially a flat capacitor containing the EL phosphor material in a dielectric sandwich between two conductors, one electrode being common to all capacitors. Squares are switched "on" or "off" by solid-state digital integrated or magnetic circuitry for trouble-free operation and long life.

Squares can be switched in any combination or sequence to present letters, numbers, curves, maps, symbols... or moving displays such as air-traffic patterns.

As in the air traffic pattern at left (Fig. 2.), different shapes and symbols may be used to differentiate between aircraft. Direction of flight travel or wind direction may be indicated by arrows or other appropriate symbols. An aircraft symbol may be accompanied by a numeric readout to indicate flight number and altitude as well as position. There's literally no limit to what you can do.

These flat, compact, wall-type units are ideal for spacecraft, aircraft, submarine, shipborne or industrial instrumentation, meeting or exceeding military specifications. With versatility virtually unlimited, we consider them one of the most advanced concepts for visual information display available today.

We'll be glad to custom design our EL readout panels to meet your specific needs.

CIRCLE NUMBER 302

Fig. 1. Typical Sylvania high-brightness, high-contrast random-access electroluminescent panel element. Panel consists of a grid of EL squares with resolution as fine as 10 squares per inch. Any pattern of squares may be illuminated at random to produce alphanumeric or analog readout.

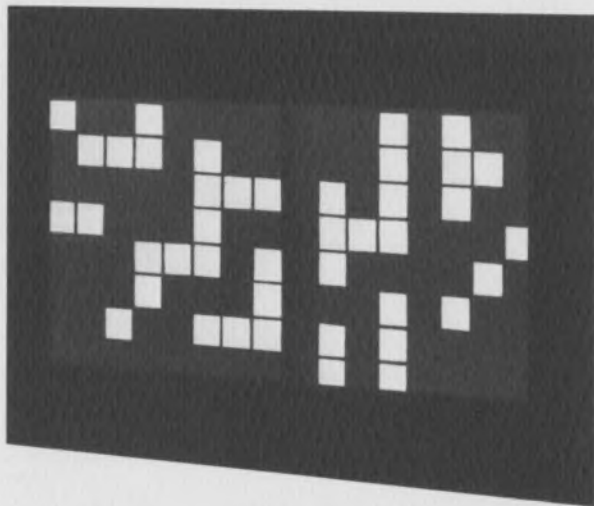
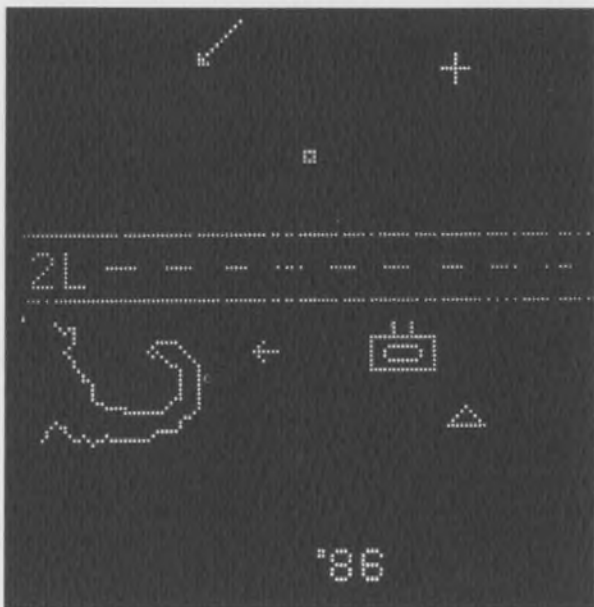

Fig. 2. Any number of elements may be combined into an uninterrupted large-board display like this air-traffic control pattern of an area of the Atlantic Ocean just east of Cape Cod. The outline of the Cape, airplanes and various aircraft in the vicinity are readily visible.



# How to lower 1/F noise and microphonics in doppler radar systems

Traditionally, microwave mixer diodes used in cw doppler radar systems employing audio-range i-f frequencies have been of the point-contact type. But in point-contact diodes, 1/F noise levels and microphonics can cause spurious responses and excessive noise in the doppler radar receiver. Now Sylvania has developed Schottky barrier diodes for microwave mixer applications with 1/F noise levels as much as 12 dB less than levels obtained with conventional point-contact diodes. And they cover the entire microwave spectrum from L through Ka-bands.

### The Noise Problem

Unwanted audio noise is generated in a diode due to the local oscillator action, or by outside disturbances such as shock.

The reduction of af noise that can be realized when using a Schottky rather than a point-contact diode is demonstrated in Fig. 1.

### The Microphonics Problem

Microphonics — noise generated by mechanical motion of internal parts within a device—can also be a problem in doppler systems using low frequency i-fs. Figure 2 shows comparative microphonics output of a typical point-contact diode when subjected to shock, and a Sylvania Schottky diode when subjected to an equivalent shock. The figure speaks for itself: essentially no microphonics with the Schottky diode.

### MQM Construction

Only Sylvania offers Schottky barrier diodes in the low-capacitance MQM package. The MQM package (only 0.08" x 0.20" overall) utilizes a low dielectric glass body hermetically sealed to precision mounting pins, providing a package capacitance of only 0.08 pF. This construction is ideal for broadband systems.

### Beam-lead Construction

Beam-lead Schottky barrier diodes are bonded directly onto a non-conductive ceramic substrate which provides a convenient mount for use in stripline or microcircuits. This configuration provides an extremely strong, stable and vibration-resistant component.

### Full Microwave Spectrum Coverage

Sylvania Schottky barrier diodes in the MQM package cover the microwave spectrum as follows (see Fig. 4) :

D5503	L to S bands
D5506	X-band
D5507	Ku-band
D5509	K through Ka bands

As an example of performance ca-

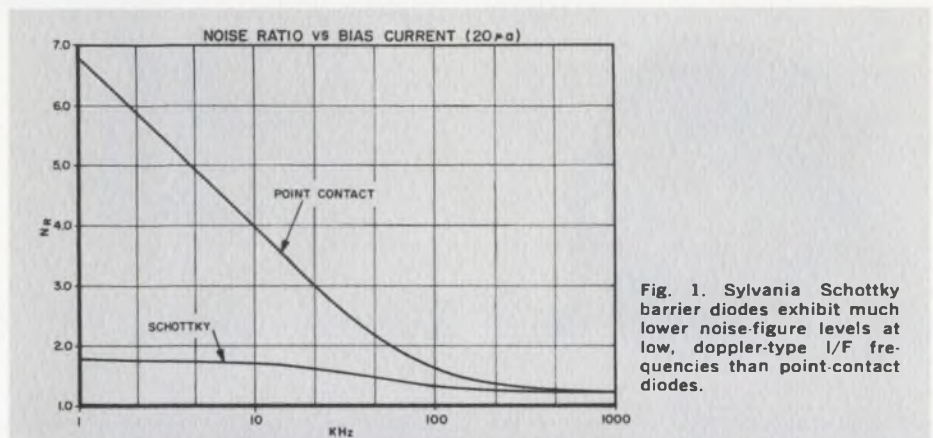

Fig. 1. Sylvania Schottky barrier diodes exhibit much lower noise-figure levels at low, doppler-type 1/F frequencies than point-contact diodes.

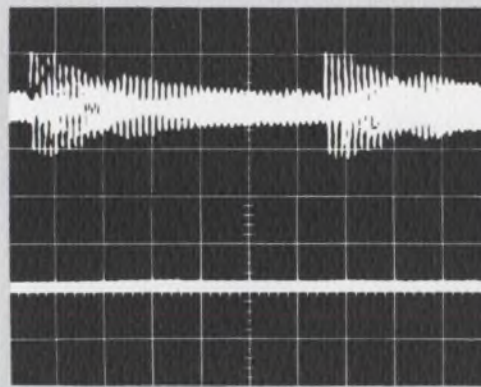

Fig. 2. Sylvania Schottky barrier diodes exhibit much lower microphonics than point-contact diodes. Upper trace is microphonic response of a point-contact diode when subjected to a shock; lower trace shows the lack of microphonic response of a Sylvania Schottky D5503 when subjected to the same shock.

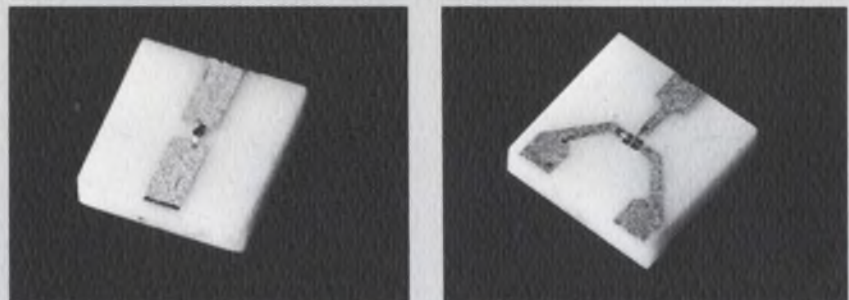

Fig. 3. Beam-lead construction. Beam-lead diodes are bonded directly to ceramic substrate.

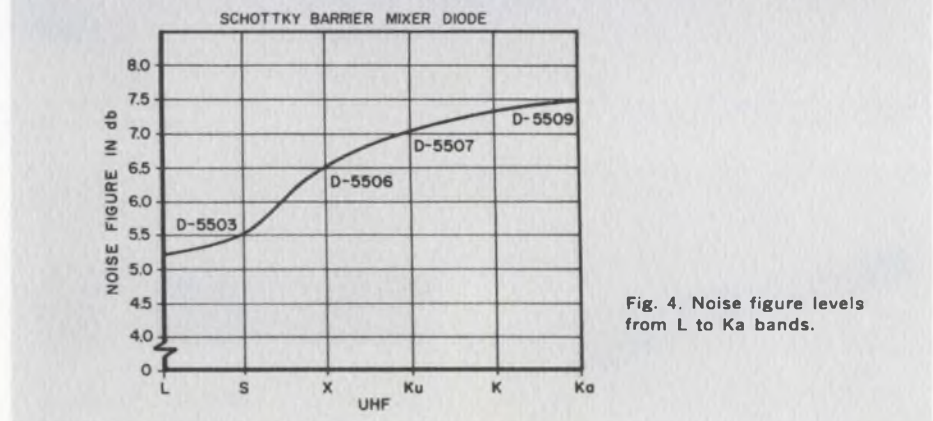

Fig. 4. Noise figure levels from L to Ka bands.

pability, our millimeter D5509C exhibits an overall noise figure of 8 dB. This low noise figure results from the low series resistance of the diode, which is achieved by keeping the epitaxial layer extremely thin, on the order of 1 micron.

Doppler radar systems will benefit from the use of Schottky diodes because of the inherently low 1/F noise. Prime examples of such systems are DME, altimeters, proximity fuses and police radars.

CIRCLE NUMBER 303

# "A million of those, and half a dozen of these"

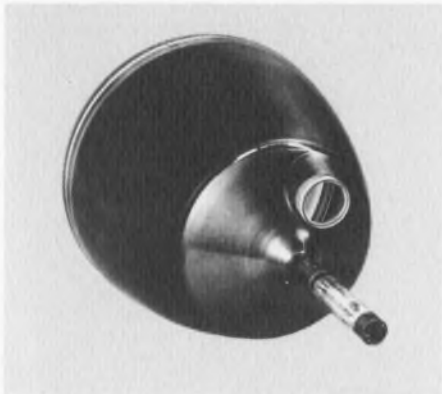

**SC3875** — A rear ported CRT, 19" in diameter, allowing full optical access to the rear of the phosphor display . . . either to photograph the electronic image or to superimpose optical information with the electronics.

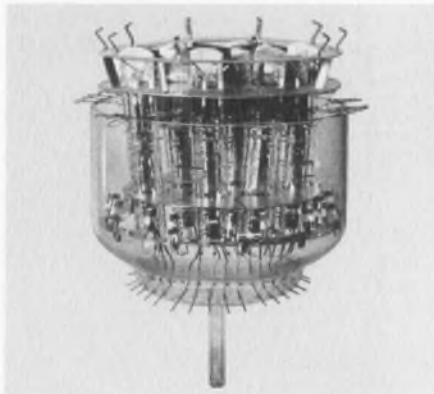

**SC3814** — 6-gun tube assembly providing tremendous versatility in spectrum analyzer applications.

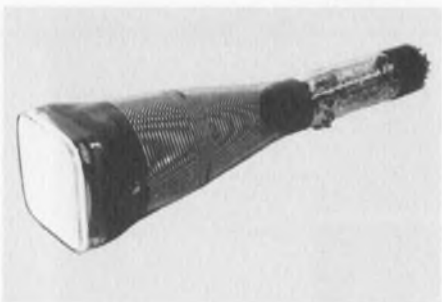

**SC3511** — One of several CRTs which incorporate the exclusive low power heater cathode . . . If you have to carry around a battery for your portable displays, you should use a heater/cathode design that uses only 0.22 watts, rather than commonly used 4-watt units.



**SC4649** — Developed to display 1000 lines at 1000 fL of brightness . . . for sophisticated cockpit displays in fighter aircraft.



**SC4082** — A new fiber optics tube with a full 3"x 5" face . . . the largest fiber optics tube being made in quantity.

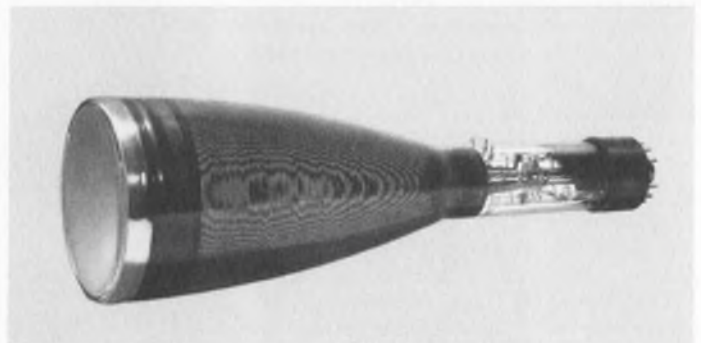

**SC4689** — Provides, for the first time, a practical 2-color display capability to the display systems engineer.

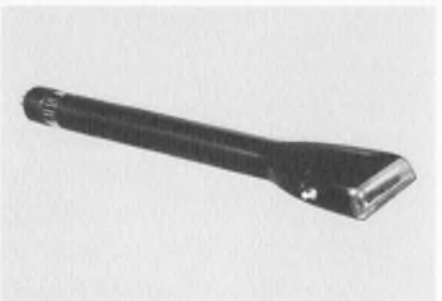

**SC2795** — 3" electrostatic charge printing tube, allowing publisher to print address labels at the rate of over 120,000 per hour. Tubes are also in use with 5" and 8" matrix for very fast recording on hard copy.

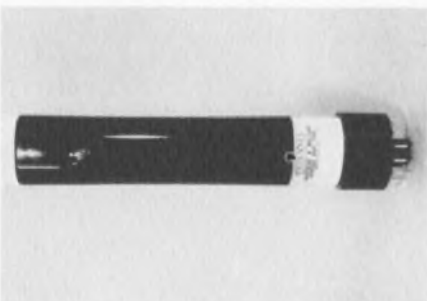

**SC4648** — Monoscope with a library of 64 characters affording one of the lowest cost methods of character generation.

Most of our production facilities at Sylvania are geared to volume production . . . the manufacture of a broad line of electron tubes, semiconductors, phosphors, plastic parts, lighting products in the millions.

But in the midst of all this mass-production activity is Sylvania's Industrial and Military Cathode Ray Tube Department. Here an order for a half dozen tubes can be of major significance.

The purpose of this department is to design and build specialized cathode ray tubes. In most cases they are built to special order because they don't exist at the time. Our job is to make them exist. This requires a close relationship among customer, sales engineer and the tube design engineer.

That's how our Sylvania I and M CRT department can prototype a device which, someday, may be moved into mass production. Yet even in this prototyping operation, the foremost experts in glass, ceramics, heater and cathode processing from our Division Engineering Organization are available to solve problems.

Since we are primarily a prototype department, one of our jobs is to advance the state-of-the-art. That's why an order for even a half dozen tubes can be important . . . to you, to us and to the industry.

The types shown here give you an idea of our department's contributions . . . plus an indication of ways in which we might help you in the future.

These I and M CRTs are but a few of our designs . . . but none were developed just to put a new tube on the market. Sylvania designed them to meet specific display system needs.

ALFRED D. JOHNSON  
MANAGER,  
INDUSTRIAL AND MILITARY CATHODE RAY TUBES

If you **don't** need any of the display devices shown here, by all means call Sylvania. We'll help you develop the one you **do** need.



# VVC's for automatic frequency control

Voltage-variable capacitance diodes offer designers an attractive alternative to mechanically restrictive methods of tuning. With these new solid-state devices, designers can now integrate the tuning function where it can best serve the electrical performance considerations, and exploit the new freedom from mechanical linkages to improve styling. Sylvania has just introduced the first of a line of voltage-variable capacitance diodes to reduce frequency control problems in automatic fine tuning adjustments in color and monochrome television, and fm receivers.

Sylvania's new D6743 voltage-variable capacitance (VVC) diode simplifies the design of automatic frequency control into electronic equipment. Utilizing the dynamic relationship of diode capacitance to applied voltage,

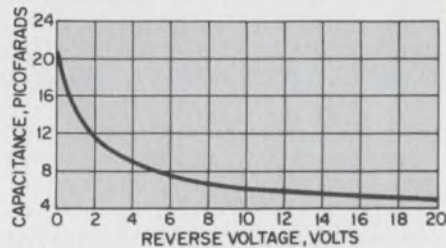

Capacitance vs  $V_R$

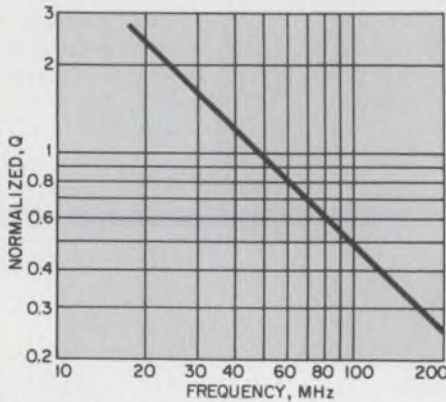

Normalized Q vs Frequency

## D6743 RATINGS AND CHARACTERISTICS

### ABSOLUTE MAXIMUM RATINGS AT 25°C:

Reverse Voltage, $V_R$	20 volts
Power Dissipation, $P_T$	250 mW
Operating Temperature, $T_{oper}$	-65°C to +175°C
Storage Temperature, $T_{stg}$	-65°C to +200°C

### ELECTRICAL CHARACTERISTICS AT 25°C (except as noted)

	Conditions	Min	Max	Units
Breakdown Voltage, $V_{BR}$	$I_R = 1 \mu A$	20		V
Reverse Current, $I_R$	$V_R = 10 V$		50	nA
Capacitance, $C_{SH}$	$V_R = 4 V$ $f = 50 MHz$	7.0	11.0	pF
Capacitance Change Ratio, C	$V_R = 4V/10V$ $f = 50 MHz$	1.25		
Quality Factor, Q	$V_R = 4 V$ $f = 50 MHz$	200		
Temperature Coefficient, $T_C$	$V_R = 4 V$ $f = 50 MHz$	140	260	ppm/°C

these devices permit precise electronic tuning for automatic frequency control as desired in applications such as automatic fine tuning in color television sets. This effect can also be used advantageously in modulators for fm equipment, voltage-variable oscillators and sweep generators.

The VVC diode offers the physical advantages of small size, light weight, absence of microphonics, and inherently high reliability for electronically fine tuning with no necessity for additional mechanical complexity. Accordingly, these devices complement traditional, manual tuning methods to open new opportunities for remote tuning concepts.

The Quality Factor (Q) of the D6743 is greater than 200 at 50 MHz and with a reverse bias of four volts. Typical capacitance at these conditions is nine picofarads. The minimum capacitance change ratio is 1.25 over

an operating bias of four to ten volts. Operable over the temperature extremes of -65 to +175°C, these new units are rated to dissipate 250mW, and handle reverse voltages to 20 volts.

The Sylvania D6743 unit is designed to minimize circuit complexities arising from series lead inductance. Featuring whiskerless construction, the DO-35 package retains wire-in flexibility, and still permits a low series inductance of 1.5 nanohenries.

The D6743 device, the first unit of Sylvania's line of voltage-variable capacitance diodes, is to be followed by the D6750 VVC diode for tuning the fm band. More sophisticated devices suitable for performing the total tuning functions in equipment designed for frequencies from uhf television through the a-m broadcast band are now in development.

CIRCLE NUMBER 304



Use Sylvania's "Hot Line" inquiry service, especially if you require full particulars on any item in a hurry. It's easy and it's free. Circle the reader service number(s) you're most interested in; then fill in your name, title, company and address. We'll do the rest and see you get further information by return mail.

## BUSINESS REPLY MAIL

No Postage Stamp Necessary if Mailed in the United States

POSTAGE WILL BE PAID BY

Sylvania Electric Products Inc.  
Sylvania Electronic Components  
1100 Main Street  
Buffalo, New York 14209

Dept. B999

FIRST CLASS  
Permit No. 2833  
Buffalo, N. Y.

# Lighter weight, lower cost **color bright 85** picture tubes in 22" rectangular size.

Sylvania has expanded its line of color bright 85 color picture tubes with the new integral tension-band and rim implosion protection system to include 22" types: the RE-ST4570 and the RE-ST4563A. This brings to three the sizes we offer with this new, improved system: a 15" size (T-Brand), a 19" size (Kimcode) and the 22" size (Kimcode). Both Kimcode construction sizes may be provided with optional mounting lugs on the tension band to simplify mounting the tube in the set by eliminating

harnesses and similar devices. Our new 22" Kimcode-protected color picture tubes are shadow-mask rectangular types with almost straight sides, 90° diagonal deflection angle, employing Sylvania-developed rare-earth red phosphors to produce pictures of maximum brightness. They are lighter than bonded tubes of the same size, cost less, and—with optional integral mounting lugs (Type RE-ST4570) — can cut time and cost of set assembly. The new tubes have a minimum

FEATURES	
Implosion protection.....	Kimcode
Minimum useful screen dimension .....	17.466" x 13.640"
Minimum useful screen area .....	227 sq. in.
Overall length .....	19.012 ± .375"
Neck length .....	6.693 ± .188"
Weight (approximate) .....	29 pounds
Deflection angle (diagonal) .....	90 degrees
Anode voltage (max) .....	27,500V
Phosphor .....	Includes Sylvania rare-earth Europium red

useful screen dimension of 17.466" by 13.640", producing a minimum projected area of 227 square inches. They are to be used in sets marketed as 20" units. They are electrically interchangeable with our familiar and popular RE-22KP22 (non-bonded) and our RE-22JP22 and RE-22LP22 types which have an integral protective window bonded directly to the faceplate. Each features a spherical, dark-tint, 42%-transmission faceplate, aluminized screen, electrostatic focus, magnetic convergence and deflection. Electron guns, spaced 120° apart, have axes tilted toward the tube axis to facilitate convergence of the three beams at the shadow mask. Internal magnetic pole pieces are provided for individual radial convergence control of each beam. Masks and face panels of each tube are aligned automatically by a computerized process which precisely establishes an optimized relationship.

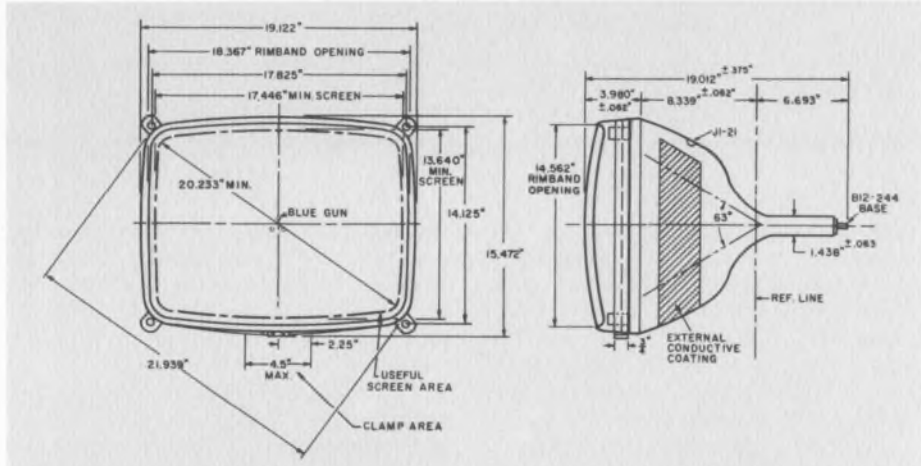

New Sylvania 22" color bright 85 color picture tube with integral Kimcode tension-band and rim-type implosion protection. Tension band may be provided with integral mounting lugs as shown (Type RE-ST4570) to speed and simplify set assembly . . . or without (as Type RE-ST4563A). It's the first domestically produced 22" color picture tube with rim and tension-band protection system and integral mounting lugs.

\*Registered Trademark, Sylvania Electronic Products

CIRCLE NUMBER 305

This information in Sylvania Ideas is furnished without assuming any obligations.

# SYLVANIA

A SUBSIDIARY OF  
GENERAL TELEPHONE & ELECTRONICS

NEW CAPABILITIES IN: ELECTRONIC TUBES • SEMICONDUCTORS • MICROWAVE DEVICES • SPECIAL COMPONENTS • DISPLAY DEVICES

NAME \_\_\_\_\_

TITLE \_\_\_\_\_

COMPANY \_\_\_\_\_

ADDRESS \_\_\_\_\_

CITY \_\_\_\_\_ STATE \_\_\_\_\_



## HOT LINE INQUIRY SERVICE

Need information in a hurry? Clip the card and mail it. Be sure to fill in all information requested. We'll rush you full particulars on any item indicated.

You can also get information using the publication's card elsewhere in this issue. Use of the card shown here will simplify handling and save time.

Circle Numbers Corresponding to Product Item

300	301	302	303	304
305				

Please have a Sales Engineer call

## 40-khz inverter uses mini-filters

A new type of power inverter circuit that achieves higher efficiency with less weight than conventional units has been announced by Westinghouse Research Laboratories, Pittsburgh. According to a company spokesman, the circuit is expected to be applicable to high power military and industrial systems, such as the conversion of power from fuel cells or thermoelectric generators from dc to ac to meet the power needs of large spacecraft.

In the new concept, known as staggered phase carrier cancellation, a number of pulse-width-modulated waveforms with the same low-frequency modulation but different carrier time phases are combined to synthesize a desired low-frequency waveform. By multiplying the carrier frequency by a factor of four in effect, the technique permits a reduction in the output filter's size and weight.

Conventional inverters that pulse-width-modulate the carrier are limited in frequency to about 10 kHz by the inadequate switching speed of power transistors. The cutoff frequency of the output filter must therefore lie just below 10 kHz, making size and weight excessive for certain applications.

The new technique achieves a 40-kHz carrier frequency by canceling the original 10-kHz carrier as well as the 20-kHz (second) and 30-kHz (third) harmonics by means of the displacement of four carrier waveforms 90 degrees in phase. At 40 kHz, a smaller, lighter output filter can be used—about one-fourth the value at 10 kHz, since size is inversely proportional to frequency. The smaller filter also reduces output impedance and phase shift, so simplifying the parallel use of inverters.

Richard J. Ravas, supervisor of new semiconductor applications, points out that the efficiency of the new technique "makes it practical for use at power levels where losses have been economically prohibitive."

Other uses forecast are in power amplifiers operating in the kilowatt range. Typical applications are public address systems, sonar systems, and sonic machines that are used in stress analyses of aerospace vehicles. that are used in stress analyses of aerospace vehicles. ■ ■

# Only from Sprague!

## DIGITAL-TO-ANALOG HYBRID D to A CIRCUITS

with precision components not found in monolithic integrated microcircuits

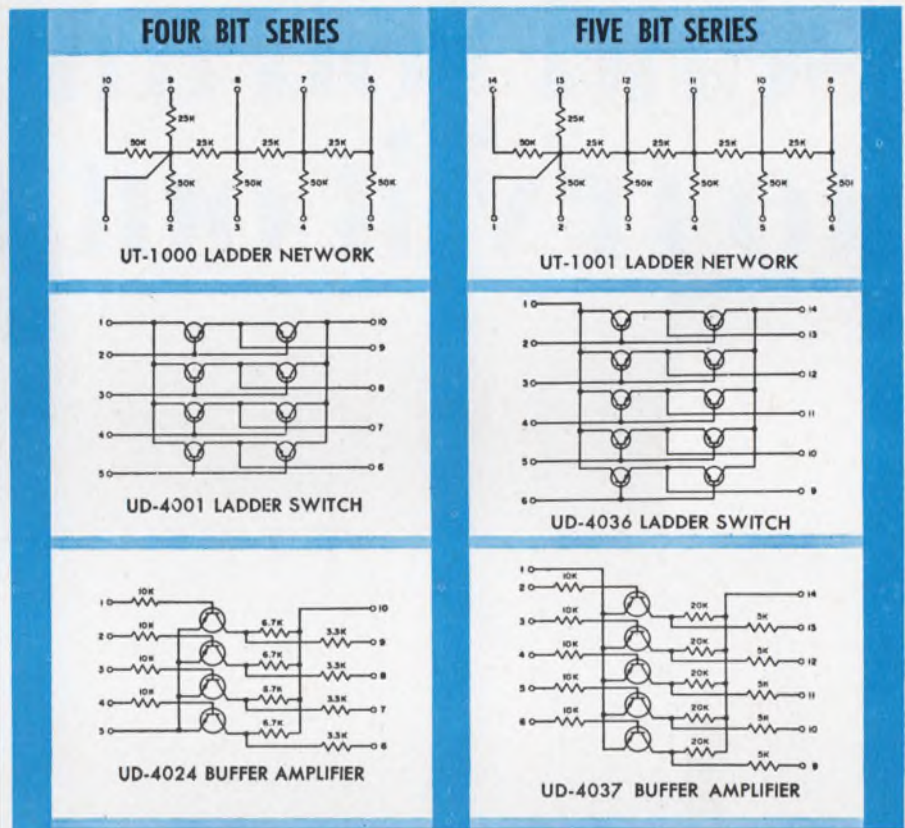

### Up to 12 bits with less than 1/2 bit error!

Improved tracking over temperature range of  $-55^{\circ}\text{C}$  to  $+125^{\circ}\text{C}$ .

3 to 1 size reduction over conventional converters using discrete components.

Reduced handling of components . . . fewer external connections . . . lower assembly costs.

Silicon-base hybrid microcircuits in hermetically-sealed flat packs.

4-bit series expandable to 8 or 12 bits . . . 5-bit series expandable to 10 bits.

Combination of precision thin-film tantalum nitride resistors, nickel-chromium resistors, and active devices of planar construction.

Packaged for compatibility with monolithic circuits.

For complete technical data on D-to-A microcircuits, write to Technical Literature Service, Sprague Electric Company, 347 Marshall St., North Adams, Mass. 01247.

#### SPRAGUE COMPONENTS

THIN-FILM MICROCIRCUITS  
INTEGRATED CIRCUITS  
TRANSISTORS  
CAPACITORS  
RESISTORS  
PULSE TRANSFORMERS  
459-7141

INTERFERENCE FILTERS  
PACKAGED COMPONENT ASSEMBLIES  
FUNCTIONAL DIGITAL CIRCUITS  
MAGNETIC COMPONENTS  
CERAMIC-BASE PRINTED NETWORKS  
PULSE-FORMING NETWORKS



Sprague and 'S' are registered trademarks of the Sprague Electric Co.

ON READER-SERVICE CARD CIRCLE 19

# Send us a new LM 100 application send you an LM 100 to try it out on.

Here's the LM 100:

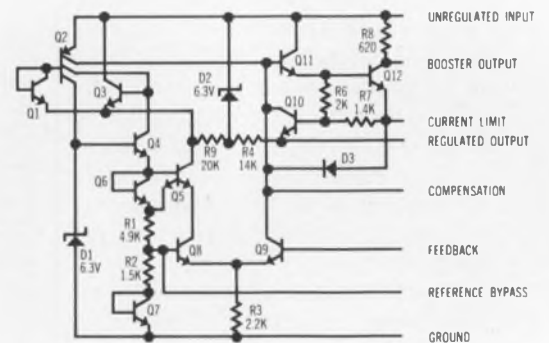

- Output Voltage: Adjustable from 2V to 30V
- Load and Line Regulation: 1%
- Operating Junction Temperature Range:  $-55^{\circ}\text{C}$  to  $+150^{\circ}\text{C}$
- Power Dissipation: 500mW
- Temperature Stability: 1%
- Output Currents:  $>5\text{A}$  with External Transistors

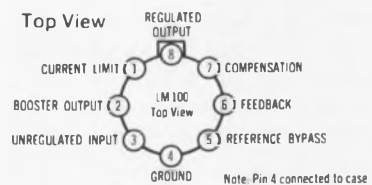

# and we'll

And here are a few applications to start you thinking.

2A Regulator with Foldback Current Limiting

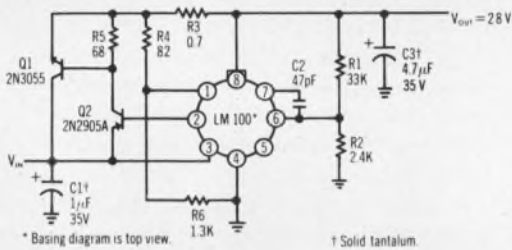

4A Switching Regulator

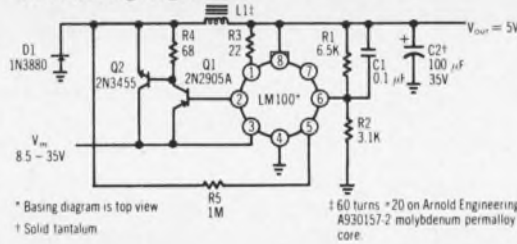

Basic Regulator Circuit

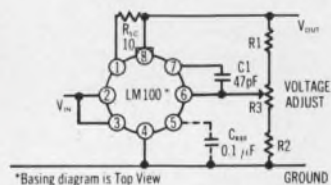

200mA Regulator

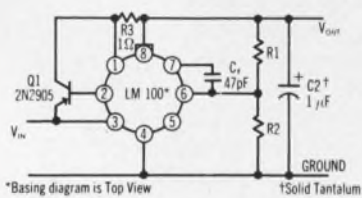

Your application goes here

Mail your drawings to Regis McKenna. (Isn't that a good name to mail things to?) He'll send you the 100, then review your drawing with Bob Widlar, the guy who invented the 100. They'll arbitrarily decide on the best one. (All entries must arrive by January 1.) We'll send a nice little portable color TV (brand undecided, but a good value) to the winner. A modest prize we agree, but then it's a modest contest.\*

If you need more information before you can think up an application, write us at National Semiconductor, 2975 San Ysidro Way, Santa Clara, California 95051, and request our bulletin SC100.

\*Contest void where prohibited by law.

## National Semiconductor

ON READER-SERVICE CARD CIRCLE 20

# 25 AMPS OF REGULATED DC FOR INTEGRATED CIRCUITS

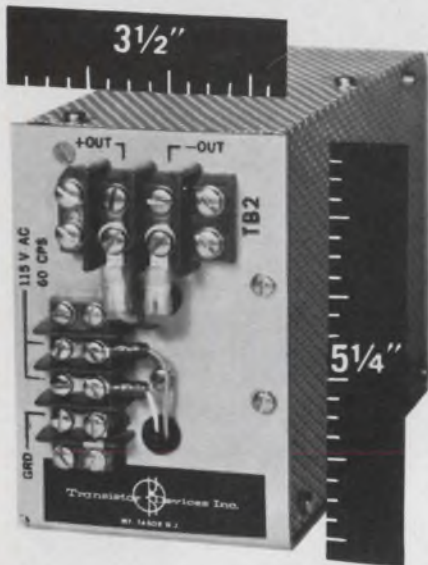

**INPUT:** 105-120 VAC at 50, 60 or 400 Hz  
**WEIGHT:** Only six pounds

Here's a new series of high efficiency power supplies specifically designed to meet the regulation, ripple, noise and RFI requirements of all commonly available integrated circuits, and deliver more watts of regulated power per cubic inch than previously available from any module of its size.

For example, Model IC5-25 measuring only 5 1/4" x 3 1/2" x 7 1/2" and weighing only six pounds, delivers 5 VDC at 25 AMPS with regulation of 125 MV and RMS ripple of 15 MV.

This high efficiency and package density creates new design flexibility and capability for applications where space is at a premium, or power distribution a problem. Low RFI and noise add to the suitability of this series for Integrated Circuits and similar applications.

All models have full isolation between line and load, automatic short circuit protection and operate in ambient temperatures between 0 and 55°C. Higher temperature operation is available with forced air cooling or derating. Military Grade and other units are available on special order.

Model	Output Adj. Range	Load Current	Regulation Line & Load	Ripple RMS
1C4-25	3-4 V	0-25 A	± 125 MV	15 MV
1C5-25	4-5 V	0-25 A	± 125 MV	15 MV
1C6-20	5-6 V	0-20 A	± 125 MV	15 MV
1C10-13	6-10 V	0-13 A	± 200 MV	20 MV

For complete technical data write to:

**Transistor  
Devices Inc.**

ROUTE 53, MT. TABOR, N. J. 07878  
TELEPHONE (201) 625-0250  
ON READER-SERVICE CARD CIRCLE 21

## NEWS

### Write your own IC masks with light pen

Using a light pen, a cathode-ray-tube display and a digital computer, an engineer can design integrated circuits in real time. By the time he gets up from the keyboard, a mask for his circuit is on the way to etching.

The device that makes this possible is the Series 9000 modular display console developed by Tasker Industries of Van Nuys, Calif. According to E.M. Forgey, product manager for Tasker, the designer enters circuit symbols on a 24-inch-diameter cathode-ray tube. A 14-by-14-inch square inscribed within the 24-inch circle is the actual design area; the remainder serves as a "menu" from which such circuit elements as resistors and capacitors can be drawn by a touch of the light pen.

The designer can transfer any menu item to the "breadboard" by touching, first, the symbol and then the x-y coordinate where it is to be entered. Numerical values are entered at the keyboard.

The designer can interrogate the computer to obtain the transfer function for a circuit, or the calculated voltage level at a particular junction. Under user control, the computer can juggle values for the desired results.

Assuming that the first component is a resistor (see figure) and the next is to be a diode, the designer enters it with the light pen, and connects it to the resistor. In this way he can trace an entire circuit and commit it to

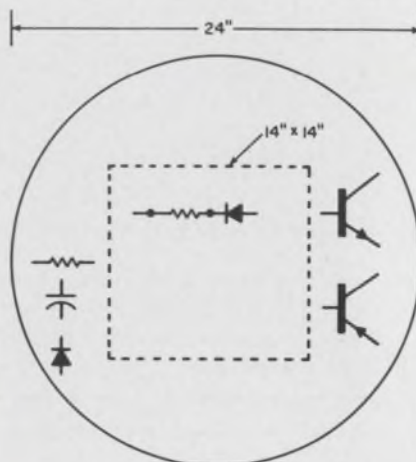

**IC designer selects components** from "menu" on periphery of CRT display to breadboard his circuit mask. Light pen transfers symbols.

memory in the computer. Any portion can be erased or changed in value from the keyboard.

To make a mask, the designer simply overlays each successive stage over the previous one. When he presses a button, the final circuit mask goes directly to etching.

At least one major semiconductor manufacturer is said to be producing integrated circuits in this fashion.

According to Forgey, the advances that make the Tasker system work are these:

- A bandwidth above 2 MHz—remarkable for an electromechanical device. Since the device does not operate on an electrostatic principle, there is no deflection circuit. Forgey says that the Tasker system is not troubled by the resonance of coils.

- Rapid writing and higher reliabilities, achieved through the use of high voltage and low current, instead of low voltage and high current.

The system has also been used by Douglas Aircraft for simulated stress tests and wind-tunnel studies, Forgey says. It is more convenient than conventional computer simulation.

A novel application is the speedy preparation of technical manuals. The engineers store all pertinent technical thoughts in the computer memory by punching in words on the keyboard and making sketches with the light pen. They can return to the machine at any time and add new material, while the previously written material is displayed simultaneously on a split screen.

If three different engineers are responsible for the electronic, hydraulic and mechanical sections of the manual, say, each writer can see how his section relates to the others, by retrieving any portion from storage.

Once this has been done, a typist and a format editor can go to work, again using the split-screen display. Eventually the typed text goes into the machine on tape. The sequence then is from the tape deck to the automatic printer to the bound manual.

Editing of the text is done directly on the cathode-ray tube with an editing key. The entire paragraph can be typographically justified (set with even margins) when individual words are changed. ■ ■

# FLUX'EM, SOAK'EM, CLEAN'EM



## BOURNS 3 NEW COMMERCIAL MODELS TAKE IT!

. . . that's right because the new E-Z-TRIM® potentiometers have been designed and built to meet today's production requirements. Sealed to prevent damage from fluxing, soldering and cleaning, the new Models 3005, 3065 and 3066 are available in two sizes . . . with wirewound or non-wirewound elements . . . yet the unit price is less than competitive models with lower specs.

Don't live with unnecessary production problems . . . when your design and production needs call for sealed, low-cost potentiometers, specify these E-Z-TRIM units . . . they're big in everything but size and price!

Write today for complete data or contact your nearest Bourns office or representative.



	Model 3005 Wirewound Element	Model 3065 Wirewound Element	Model 3066 Carbon Element
Size (L, W, H)	.75 x .14 x .31	1 x .29 x .36	1 x .29 x .36
Standard Resistance Range	10Ω to 25K	50Ω to 20K	20K to 1 Meg
Resistance Tolerance (Standard)	±10%	±10%	±20%
Resolution	0.2 to 1.6%	0.32 to 1.39%	Infinite
Power Rating	1 watt	0.5 watt	0.2 watt
Temperature Range	-65°C to +125°C	-55°C to +85°C	-55°C to +85°C
Seal	Immersion Proof	Immersion Proof	Immersion Proof
Price (500 piece)	\$1.45	\$1.44	\$1.44



BOURNS, INC., TRIMPOT DIVISION • 1200 COLUMBIA AVE., RIVERSIDE, CALIF.  
TELEPHONE (714) 684-1700 • TWX: 910 332-1252 • CABLE: BOURNSINC.

# Specify New Oscillators and Power Modules from Austron!



## CRYSTAL OSCILLATORS

Output frequencies from 50 Hz to 10 MHz. Stabilities from  $1 \times 10^{-6}$  to  $1$  to  $10^{-10}$  per day. High frequency stability over operating ranges as great as  $-55^{\circ}\text{C}$  to  $+85^{\circ}\text{C}$ .

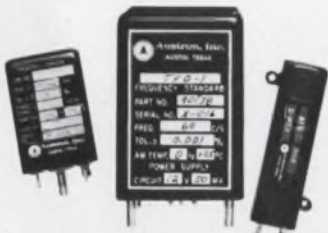

## TUNING-FORK OSCILLATORS

Packaged units include basic resonators or complete oscillator units. Range of frequencies, stabilities and mechanical configurations available.



## POWER MODULES

5 VA to 1 KVA, AC output with AC or DC input, square or sine-wave output, 50 Hz to 5 kHz, frequency tolerances to  $\pm 0.00005\%$ , output regulation to  $\pm 2\%$ .

Write today for data sheets on these, and other Austron components.



**AUSTRON INC.**

10214 NORTH INTERREGIONAL HIGHWAY,  
AUSTIN, TEXAS 78753  
TELEPHONE (512) 454-2581

ON READER-SERVICE CARD CIRCLE 23

# Letters

## Generator can be built with just 1-1/4 packages

Sir:

Once again, a three-pulse clock generator. The designs previously submitted (ED 8, April 12, 1967, p. 106; ED 12, June 7, p. 48; ED 20, Sept. 27, p. 40) all required two and a half or three IC packages.

The design in Fig. a takes only one and a quarter packages—FF1 and FF2 are two halves of a SN 7473 and A is a quarter SN 7402. The following table shows that it does not lock up in the unused state (00):

Present state		Flip-flop inputs				Next state	
Q <sub>1</sub>	Q <sub>2</sub>	J <sub>1</sub>	K <sub>1</sub>	J <sub>2</sub>	K <sub>2</sub>	Q <sub>1</sub>	Q <sub>2</sub>
0	0	1	0	0	1	1	0
1	0	0	0	1	0	1	1
1	1	0	1	1	0	0	1
0	1	1	1	0	1	1	0

A. Goldberger

Staff Specialist

TRG Div.

Control Data Corp.

Melville, N. Y.

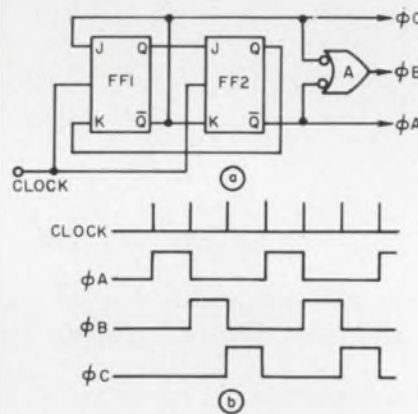

One and 1/4 IC packages suffice for a three-phase square-wave generator (a). Waveforms appear in (b).

## Costs may sway choice of generator design

Sir:

ELECTRONIC DESIGN's Sept. 27 issue shows a circuit in the Letters column for the design of a three-phase square-wave generator ["Three-phase gen-

erator made with 2 flip-flops." ED 20, p. 40].

Engineers interested in this controversy might compare the price of three DT  $\mu$ L 946s as opposed to the price of two or more DT  $\mu$ L 945s.

John L. Nichols

Systems Engineer

Fairchild Semiconductor

Mountain View, Calif.

(Mr. Nichols, whose original Idea for Design published in ED 8, April 12, 1967, p. 106 triggered the suggestions and countersuggestions that have appeared in our Letters column, has a point. The current list price in quantities from 24 to 99 of commercial-grade DT  $\mu$ L 945s is \$4.20 each; that of DT  $\mu$ L 946s is \$2.90.—Ed.)

## Output waves affect design choice, too . . .

Sir:

ELECTRONIC DESIGN's Sept. 27 issue shows a circuit from E.G. Holm in the Letters column [ED 20, p. 40] for the design of a three-phase square-wave generator. The circuit is indeed a three-phase generator, but the outputs,  $\phi A$ ,  $\phi B$  and  $\phi C$ , do not produce square waves.

If a non-square-wave generator is desired, it could be built with only two 945 flip-flops (see schematic) on the basis of Orville Lykins's Idea for Design ["Five-bit counter saves a package"] in ED 14, July 5, 1967, p. 112.

R. B. Derickson III

Systems Engineer

Fairchild Semiconductor

Mountain View, Calif.

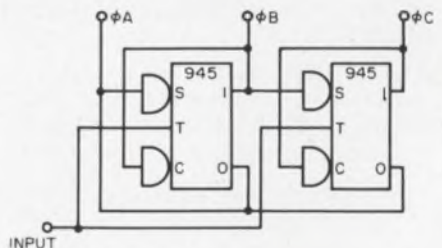

Three-phase generator for non-square waves is built with two flip-flops. O outputs are wired to eliminate gating.



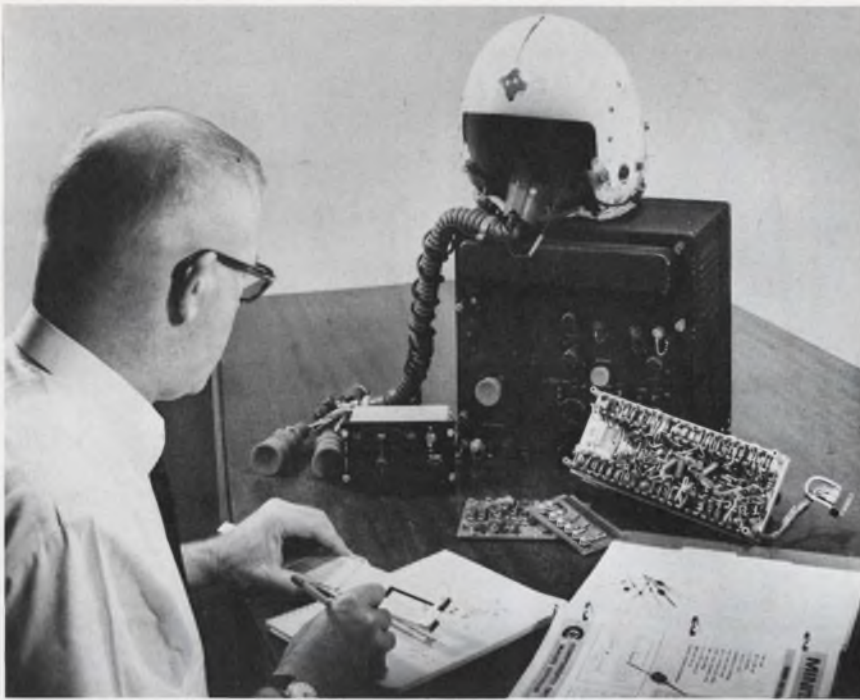

## *how to save space in avionics black boxes...*

**Application:** Fire control system on our latest tactical fighter.

**Problem:** How to fit an analog/digital data processor, two servo systems, and a power supply into a 10" x 8" x 6" box and still not sacrifice reliability.

**Solution:** Thick film substrates utilizing Minitan solid tantalum capacitors.

Minitan subminiature solid tantalums are up to 75% smaller than equivalent CS13 styles — at no sacrifice in performance. That's why Minitans are specified on Poseidon, HARP, F-111, Apollo, Saturn V and dozens of other airborne and space systems.

Minitans operate reliably to 125°C, handle 130% voltage surges, and withstand Method 106 moisture testing. Standard tolerances are  $\pm 20\%$ ,  $\pm 10\%$ , and  $\pm 5\%$ . DC leakage is typi-

cally less than .01  $\mu\text{A}$  per mfd-volt. Impedance is below 10 ohms between 1MHz and 10MHz.

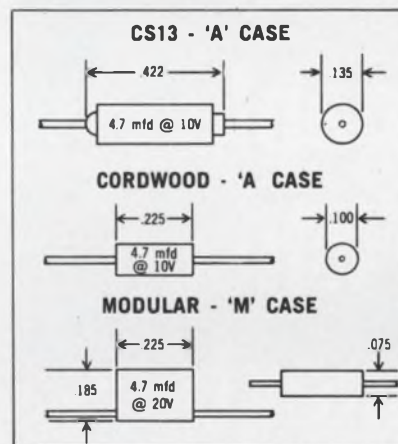

Not only are Minitans substantially smaller than CS13s, they come in both rectangular and tubular styles with either radial or axial leads. For maximum IC compatibility, gold plated ribbon leads are a standard option.

Minitan subminiatures are available in 11 case sizes, working

voltages to 35 volts, and capacitance values from .001 to 220 mfd. A full line of non-polar styles is offered for severe reverse DC bias applications.

Components, Inc. offers more subminiature case styles and ratings than anyone else. Our products are designed in, not added on. So we welcome requests for samples, performance and reliability data, and applications aid. Almost every catalog part can be shipped in prototype quantities within 24 hours.

*... with  
**Minitan<sup>®</sup>**  
solid tantalum  
capacitors.*

**COMPONENTS, INC.**  
**MAINE DIVISION**  
SMITH ST. BIDDEFORD, MAINE 04005 TEL: 207-284-5956 TWX-710-229-1559

ON READER-SERVICE CARD CIRCLE 24

# No.



## You cannot pull the cable out of our Micon Emlock<sup>®</sup> connectors.

No tricks. Our claim is that it is impossible to pull the cable out of one of our Emlock<sup>®</sup> compression fit, miniature connectors. Disengagement will be caused only by failure of the braid, not pullout of the compression. We believe this extraordinary capability beats crimped type connectors all hollow. Yes, and competitive compression types, too.

Prove it to yourself. Have one of our Technical Representatives call on you. He'll attach any one of our stock Emlock<sup>®</sup> connectors to a section of braided cable. Then, as he holds the connector body with a pliers, he'll hand you the chain nose, and you pull! The assembly will break away,

of course. He will then disassemble the connector and show you that there is still enough wire trapped to prove that Emlock<sup>®</sup> compression held and the braid failed!

Here's your chance to gain a new concept in miniature connector reliability. Remember, only Emlock<sup>®</sup> connectors offer this basic capability and only we have Emlock<sup>®</sup>.

Write for the name of our Technical Representative in your territory. He'll phone for an appointment and give you a chance to prove it to yourself. *While you are about it, why don't you ask for Bulletin MMC, Issue 1 describing the complete line of Emlock<sup>®</sup> connectors?*

Micon is now a part of

**PHELPS DODGE** ELECTRONIC PRODUCTS  
NORTH HAVEN, CONNECTICUT



ON READER-SERVICE CARD CIRCLE 25

## 99.99% accuracy won't do in Test Instrument Insert

Less than a dozen corrections for over 40,000 data entries may sound darn good for 100 pages of specifications for over 2500 instruments. But we're not pleased at all. We don't want our readers to be biased by incorrect information when they make selections—only 100% accuracy is acceptable in a directory listing.

So we urge you to take a few minutes of your time and correct the Sept. 27 Test Instrument Directory as follows:

### 1. Ballantine Laboratories, Inc.

*Model 303* (p. T74, V10) is not limited to 0.006 kHz... its maximum frequency extends to 6000 kHz. The meter scale is log. lin. and meter calibration should read V, dB. Misc. features include f, k, q, r and s.

*Model 323* (p. T74, V10) is a true rms voltmeter with a maximum frequency of 20,000 kHz, not 0.20 kHz. Meter scale is log. lin. Misc. features include f, k, r and x.

*Model 350* (p. T74, V12) costs \$720, not \$1200, and misc. features include k and x. A rack-mounted model, 350-s/2, is available at \$740.

*Model 355* (add to p. T51, D31) is an ac digital voltmeter with a frequency range of 30 Hz to 250 kHz, voltage range of 10 mV to 1000 V with 0.25% accuracy, six ranges, in-line (X) readout, 2-M $\Omega$  input impedance, cabinet model, misc. features j and x, with a \$620 price tag.

### 2. Lampkin Laboratories, Inc.

*Model 103-BMFM and 105-BMFM* (p. T84, T2) have 0.001% accuracy, not 0.02%. The manufacturer's correct address is 8400 Ninth Ave. N. W., Bradenton, Fla. 33505.

### 3. Anadex Instruments, Inc.

*Model 350 and CF-503-6R* (p. T100, F2 and F3) have an input sensitivity of 10 mV, not 100 mV.

### 4. California Instrument Corp.

*Model 7000* (p. T24, S8) costs \$3150, for a complete bay of seven oscilloscopes.

### 5. Trymetrics Corp.

*Model 4100-500A* (p. T44, D3) is priced at \$1120, not \$7120.

### 6. Sell-Tronic Products

Cross Index (p. T86). Change address to 1056 Boynton Ave., Bronx, N. Y. 10472.

ON READER-SERVICE CARD CIRCLE 26

# Giant Killers

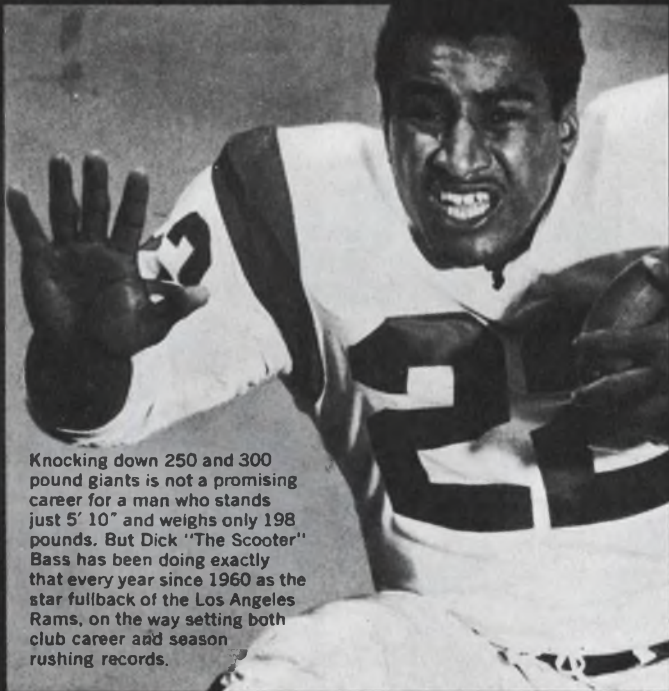

Knocking down 250 and 300 pound giants is not a promising career for a man who stands just 5' 10" and weighs only 198 pounds. But Dick "The Scooter" Bass has been doing exactly that every year since 1960 as the star fullback of the Los Angeles Rams, on the way setting both club career and season rushing records.

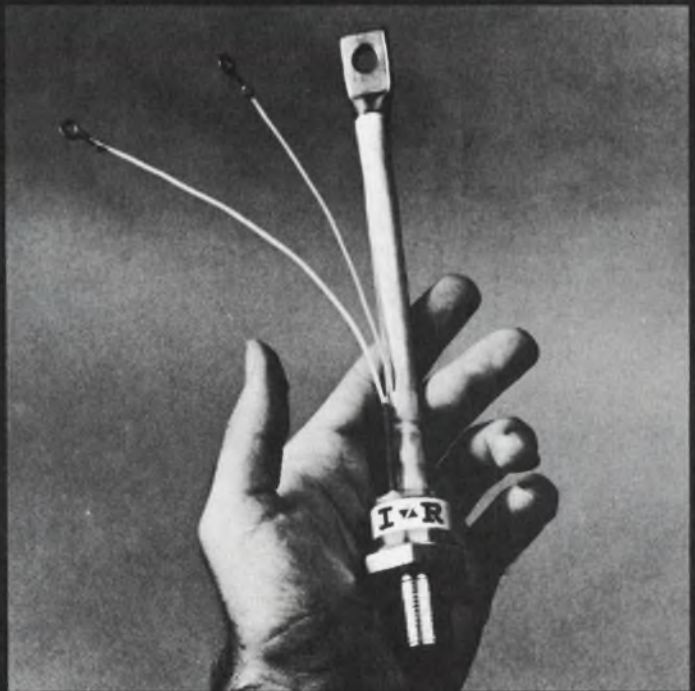

When we broke the news of our logic-triac to the world last September, we suspect that we upset some of the giant names in industry who also dabble in rectifiers. □ Our triac is the world's most powerful (200 Amps, 400-1000 Volts), made possible by our exclusive epitaxial process. Where ordinary triacs are limited to say household appliances, our logic-triac can handle enough power to run a freight elevator. □ The "logic" capability means you can control both AC and DC, since the device has selective gate characteristics. Therefore the same freight elevator with a three phase induction motor will be controlled by IOR logic-triacs to go up or down, slow or fast, and accomplish dynamic braking more easily by imposing a DC current through the triacs to the motor. □ Our complete technical and application data on logic-triac can make you master of this giant killer. Ask for it.

INTERNATIONAL RECTIFIER



Semiconductor Division, 233 Kansas Street, El Segundo, California 90245, Phone (213) 678-6281  
Field offices and distributors in major cities around the world

# GIANNINI

## on inter- valometers

*"Our programmable intervalometers can handle just about any sequencing operation you can think of, where precise timing is required. They're probably the most versatile gadgets of their type available."*



The unit shown above, for example, is programmable in both time and mode. We make others where the sequence, too, can be programmed from the face of the unit. You can select the time interval, with 5% accuracy, from 100 milliseconds to 9.99 seconds, in 0.01 second increments. They are simple to operate, and extremely reliable.

These are the first programmable intervalometers, to be specifically designed for military airborne use. They meet the environmental requirements of MIL-STD-810. All the armature and stepping relays are manufactured by us, and conform to MIL-R-6106.

If you have any kind of sequence switching requirement where precise timing is a factor, let us show you how we can adapt these little devices to your exact needs.

*Gianni M. Giannini*

## Giannini

P.O. Box A-A, Irvine, Calif. 90664 • (714) 540-9010  
Plants in Whittier, Costa Mesa and San Diego

ON READER-SERVICE CARD CIRCLE 27

## SIDELIGHTS OF THE ISSUE

### It's back to school for ED news editor

Ralph Dobriner, *ELECTRONIC DESIGN's* chief news editor, has a high ICQ (intelligent curiosity quotient). It helps explain why he enjoys covering news for the magazine. And it explains, too, why last July 24, a perspiry, lackluster day in New York, Dobriner went to school instead of to work.

The school was the United Engineering Center at 345 E. 47 St., and the course director was David M. Goodman, senior research scientist at the New York University School of Engineering and Science.

For four and a half days, the 194 students—scientists, engineers, and a lone chief news editor—learned about the latest techniques in automatic checkout equipment. The course was called "Built-In Test Equipment for the Maintenance of Complex Electronic Systems."

"How was school?" Editor Howard Bierman asked Dobriner when Ralph returned to the office.

"Not bad," Dobriner assured him. "I was in the dark a good part of the time."

Translation: The auditorium at the United Engineering Center was darkened, because there was heavy reliance on audio-visual techniques. Fortunately Bierman is an old lecture-attender himself and he understood this.

After completing the course (and collecting a diploma), Dobriner felt ready to begin an investigation of automatic checkout equipment for *ELECTRONIC DESIGN*. The results are summarized in the Special Report starting on p. 49.



**Student** Ralph Dobriner (left) and **teacher** David M. Goodman at the United Engineering Center, New York City.

### About the cover photo:

Paul Sepp of PRD Electronics demonstrates testing "by the numbers" as he mans the data transfer unit in the Navy's VAST automatic checkout system, now under development. When ready by 1970, VAST (Versatile Avionic Ship Test) will troubleshoot about 85 per cent of electronic gear on carrier aircraft and will reduce the number of technicians needed by 25 per cent.

# Small wonder:



Our new "4th-generation" 12.5 MHz universal counter/timer. Wonderful versatility in a wonderfully small package — at an even more wonderfully small price.

With the new Model 100A you can measure average frequency, frequency ratio, single period or time interval, or count total events. It has a crystal-controlled clock, Monsanto integrated circuit construction, and built-in compatibility with a rapidly growing assemblage of accessory modules.

With its \$575\* price tag (accessory modules are pegged at comparably modest rates) you can have big-league counter/timer performance at

costs never before possible. Small wonder we are selling (and delivering) Model 100A's just as fast as we can build them.

Call your local Monsanto field engineering representative for full technical details, or contact us directly at: Monsanto Electronics Technical Ctr., 620 Passaic Avenue, West Caldwell, New Jersey 07006. Phone (201) 228-3800; TWX 710-734-4334.

\*U.S. Price, FOB West Caldwell, New Jersey.

**Monsanto**  
**ELECTRONICS**

For Airborne Military and Space Memory Systems

# RCA's high-density memory stacks are tested and proved to military specifications

These military-type high-density stacks are available in various capacities up to 4k x 32...operating temperature range from -55°C to +125°C. And we can provide fast delivery of most configurations...just let us know your requirements!

Other sizes available where requirements warrant it.

RCA "building-block" construction provides wide flexibility of electrical capacities, ruggedized construction, improved reliability and faster delivery.

Greater reliability is assured because core mats are continuously wound—solder joints are kept to a bare minimum. Fewer frames result in smaller size, lighter weight, tighter, more compact package. The RCA 30/18 lithium ferrite cores provide wide-temperature operation. The complete package withstands vibrations up to 15G's.

Backed by more than two years of manufacturing experience and strict quality control, these RCA High-Density stacks are proved to MIL specs before you

order them. In many cases we can make initial deliveries in eight to ten weeks.

May we have one of our salesmen arrange for a demonstration for your specific military applications? Contact your RCA Field Representatives for details and availability for your requirements. Or call Marketing Dept. (617-444-7200), RCA Memory Products Division, Needham Heights, Mass. 02194. For Technical Bulletin MP317, write RCA Commercial Engineering, Section FG11-3, Harrison, N.J. 07029.

Designed to meet requirements of MIL Specifications MIL-E-5400, MIL-T-5422

30/18 High-Density Stack	
Capacity: 4096 words 25 bits	Shock: 50g
Temp. Range: -55°C to +125°C	Altitude: 0 to 70,000 ft.
Vibration: 10-500 cps 15g	Humidity: 10 days

4k x 16  
4k x 15  
4k x 14

4k x 17  
4k x 18  
4k x 19

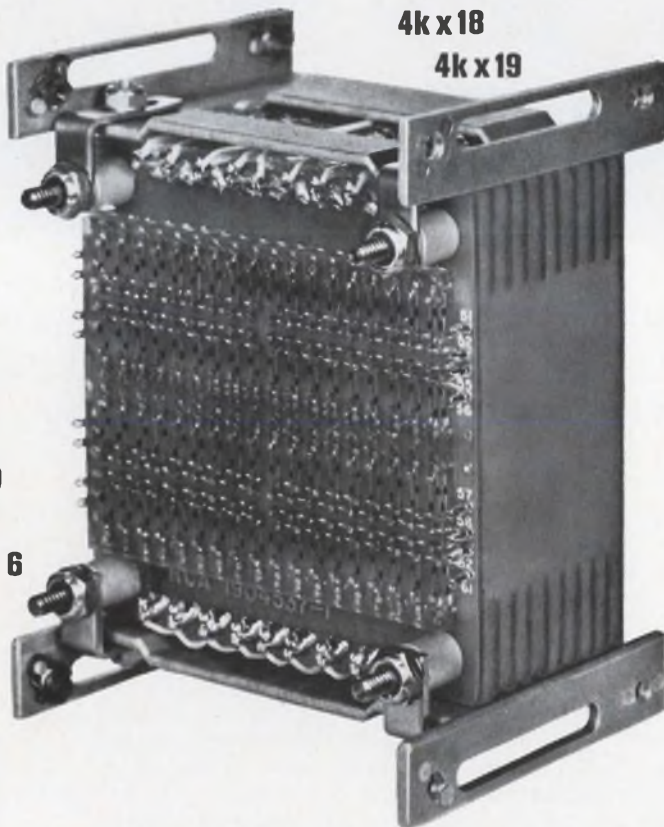

4k x 20  
4k x 23  
4k x 24  
4k x 25

4k x 10  
4k x 9  
4k x 8  
4k x 6

4k x 26  
4k x 32



RCA Electronics Components and Devices

THE MOST TRUSTED NAME IN ELECTRONICS

ON READER-SERVICE CARD CIRCLE 29

**Co-Publishers**

James S. Mulholland, Jr.  
Hugh R. Roome

**Editor**

Howard Bierman

**Managing Editor**

Robert C. Haavind

**Technical Editors**

Jeffrey N. Birstow  
Peter N. Budzilovich  
Roger K. Field  
David H. Surgan

**Management and Careers Editor**

Howard S. Ravis

**News Editors**

Ralph Dobriner, Chief  
Richard N. Einhorn

**Washington News Bureau**

Charles D. LaFond, Chief

**East Coast Editor**

Neil Sclater

**West Coast Editor**

Ron Gechman

**New Products Editor**

Steven B. Futterman

**Copy Editor**

Peter Beales

**Editorial Production**

Dollie S. Viebig  
Marian Arkin

**Art Director**

Clifford M. Gardiner

**Art Assistant**

William Kelly

**Technical Illustrators**

Cheh Nam Low  
Sheila F. Ward  
William Alvarez

**Production Manager**

Thomas V. Sedita

**Asst. Production Manager**

Helen De Polo

**Production Assistants**

Bernard Wolinsky  
Gregory A. Bannon

**Circulation Manager**

Nancy L. Merritt

**Reader Service**

Diane Mandell

## EDITORIAL



## One person can count, but why not an engineer?

The drug industry is still under strong pressure from Congress to improve its methods, as was recommended some years back by a committee under Senator Estes Kefauver.

The chemical industry was spurred into making tremendous efforts to alter its image by *Silent Spring*. In that book Rachel Carson, a biologist with a gift for gathering facts and presenting them in beautiful, flowing prose, described the damage done to the balance of nature by the misuse of overpowerful insecticides.

More recently, the automobile industry has been forced to design safety as well as looks into its new cars. This was due in large measure to Ralph Nader, whose book *Unsafe at Any Speed*, detailed faults in automobile design.

The television industry is now under fire because of intense X-radiation that resulted from improper shielding of a tube in General Electric color sets. Nader has joined others in calling for standards for X-ray emission as more and more powerful electronic equipment is introduced into our society.

Where are the engineers to compare with these crusaders? *ELECTRONIC DESIGN* has run articles and editorials citing such hazards as poorly designed medical electronic systems, noxious fumes and chemicals used in component manufacturing with no proper precautions to ensure workers' safety, noise pollution in our cities, and featherbedding in defense and space contracts. Yet in our investigations we have seldom come across engineers campaigning strongly to right the wrongs.

There is a tendency today, as society grows more complex, for people to say: "What can one person do?" Either he becomes an "organization man" and goes along with management without question or he "freaks out."

The fact is that one person *can* count. Kefauver, Miss Carson and Nader are individuals whose names have become bywords for searching out facts and then presenting powerful evidence to support what they thought was right. Engineers can count too, even if they don't earn the renown that these crusaders achieved.

Safety hazards, poor design or faulty manufacturing should be a constant concern of engineers. If study is necessary to determine the extent of a suspected hazard, these studies should either be undertaken or recommended. Engineers can learn a lesson from these crusaders' successes. Gather the facts and make a really strong case. Management, like the public, needs to be convinced of the urgency of a potential hazard, to be shaken out of its apathy.

As technology evolves, engineers will be called to account for what they have designed. Where do you stand?

ROBERT HAAVIND

evaluating  
semiconductors?

# use one of these Tektronix transistor curve tracers to meet your needs

The performance range of the Type 575 enables you to evaluate the dynamic characteristics of most semiconductor devices.

Several transistor characteristic curves may be displayed including the collector family of NPN or PNP devices in a common base or a common emitter configuration with forward or reverse biasing. The Type 575 features collector sweep supply ranges continuously variable from 0 to 20 V at 10 A, or 0-200 V at 1 A. A base or emitter step generator, operating at either 2 or 4 times the line frequency, provides 4 to 12 steps per family of characteristic curves in single or repetitive display modes. The step generator provides voltage increments from .01 V/step to 0.2 V/step or current increments from .001 mA/step to 200 mA/step.

Choose the Type 575 MOD 122C transistor curve tracer for evaluating higher voltage devices.

The Type 575 MOD 122C has the same features of the Type 575 plus the capability of diode breakdown test voltage variable from 0 to 1500 V at 1 mA and a much higher collector supply voltage of up to 400 V at 0.5 A.

For a demonstration, contact your nearby Tektronix field engineer or write: Tektronix, Inc., P. O. Box 500, Beaverton, Oregon 97005.

For evaluating high current semiconductors, add the Type 175 High Current Adapter to either of these curve tracers.

The Type 175 features collector sweep supply ranges of 0-200 A at 0-20 V and 0-40 A at 0-100 V. The Type 175 step generator provides current ranges from 1 mA/step to 1000 mA/step and voltage steps from 0.5 to 10 V/step with driving resistance selectable from 11 values ranging from 0.5 ohms to 1 k ohm. Other resistance values may be added externally.

- Type 575 Transistor Curve Tracer (including accessories) . . . . . \$1100
- Type 575 Transistor Curve Tracer MOD 122C (including accessories) . . . . . \$1365
- Type 175 High Current Adapter (including accessories) . . . . . \$1570

U. S. Sales Prices, f.o.b. Beaverton, Oregon

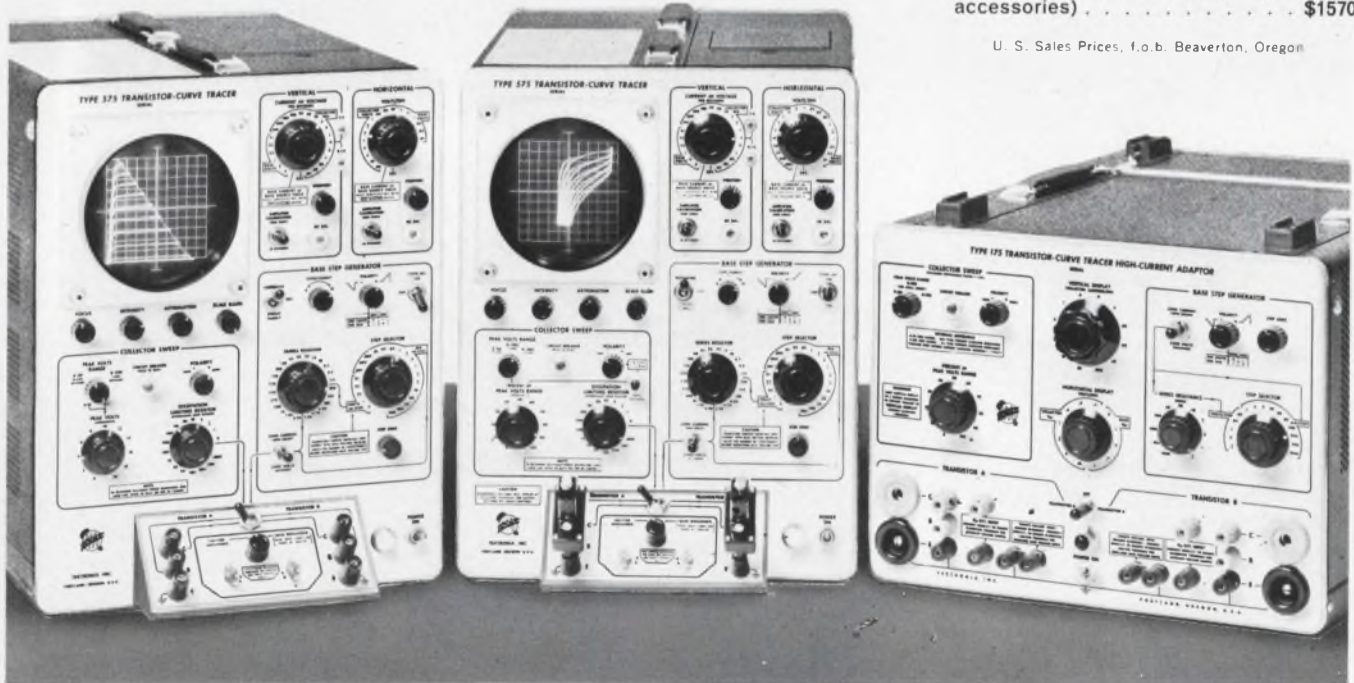

Worldwide operations  
serving customers  
in more than 50 countries



... part of the Tektronix commitment  
to continuing customer service

ON READER-SERVICE CARD CIRCLE 30





## New miniature PC Correeds

Here's the pee wee edition of our famous dry-reed switches. Same efficient magnetic shielding as their big brothers. Same soggy-proof bobbins—made of glass-reinforced nylon.

All this with a low, low silhouette (just 0.350 inch above mounting surface).

MPC Correeds measure as small as  $\frac{1}{32}$  by 1.350 inch. We located the terminals on 0.050 inch centers to match your board grids. You can stack them tightly in your racks—without magnetic interaction.



These space-saving little switches are perfect for high-speed applications. They're readily driven from transistors (their self-inductance is lower than their profiles). They give you an ideal interface between electronic and electromechanical circuitry.

Want some helpful new technical information? Just write to the Director, Electronic Control Equipment Sales, Automatic Electric, Northlake, Illinois 60164.

***AUTOMATIC ELECTRIC***

SUBSIDIARY OF GENERAL TELEPHONE & ELECTRONICS

ON READER-SERVICE CARD CIRCLE 31

# ACE: The ultimate in failure detection

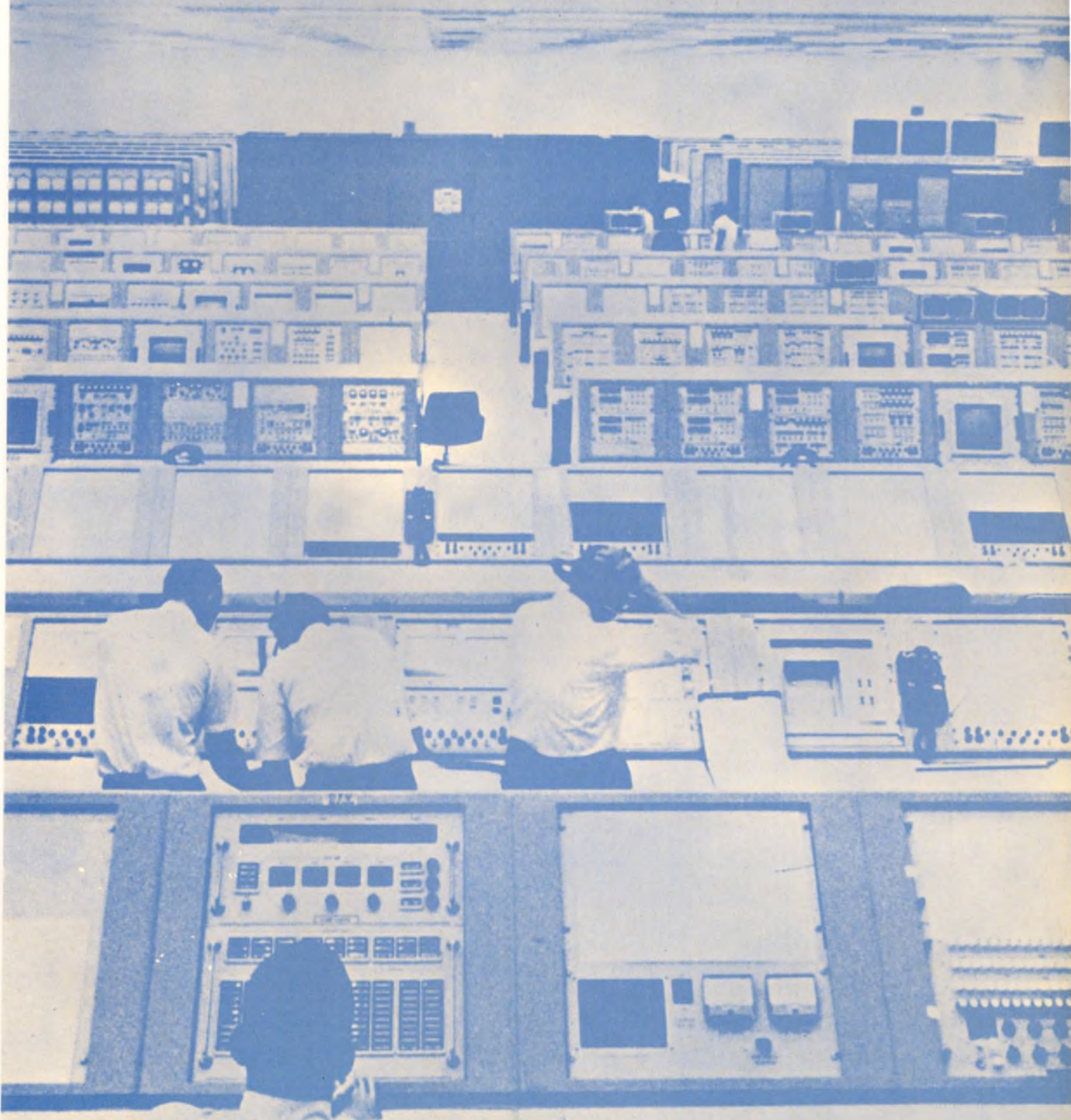

An ELECTRONIC DESIGN Special Report

By Ralph Dobriner, Chief News Editor

# Automatic checkout heads for an era of growth



**Self-checkout capability of Minuteman** ICBM makes possible this dramatic double launching.

It's called ACE—for automatic checkout equipment. And it's fast becoming a leading card in the electronics industry with multimillion-dollar stakes.

Fifteen years ago the first ACE—a sequentially programmed tester—was developed for the Navy's Terrier missile. Today it is estimated that more than 150 types of automatic and semiautomatic checkout systems are in use.

The military and NASA are the biggest users. But ACE is turning up with increasing frequency in commercial aviation.

Why all the interest? For the user who wants to know if his equipment is in working order, either before or while he uses it, the reasons are almost self-evident. ACE can do all of these things, and more:

- Monitor, reduce and display great gobs of data, and analyze the failure trends.
- Eliminate the error-producing interferences of human emotions, fatigue and distraction, by providing for automatic corrective action and by doing it faster than any human operator could respond.

ACE systems of the future, specialists in the field say, will be able to isolate faults in the tiniest removable assemblies or modules in complex electronic networks. When this goal is achieved, semiskilled technicians will be able to monitor the equipment and to replace defective units, thereby reducing "down time" tremendously. In this connection, Herbert Brockman, project engineer at the Radio Corp. of America's Missile and Surface Radar Div., Moorestown, N.J., reminds designers:

- Automatic fault detection and isolation of small removable assemblies can be done most economically in large systems by using a central control computer to evaluate the test results.

- To be effective, checkout and monitoring functions must be designed into a system when the system itself is developed.

When designed properly, the hardware for the system's ACE can cost less than 10 per cent of the expense for the full system, Brockman indicates.

At present ACE is playing a vital role in keeping B-58 and F-111 military aircraft in the air instead of in repair depots on the ground. Many leading electronic manufacturers—including Bendix, Motorola, Sperry, Emerson Electric, General Electric, Autonetics—are sharing in these efforts.

Earlier this year RCA's Depot Installed Maintenance ACE was delivered to the Army, a computer-controlled setup that can check military equipment ranging from relatively simple walkie-talkies to complex communications systems.

A test evaluation and monitoring system under development by Northrup Nortronics for the Navy's Knox-class of destroyer escorts will check out the ships' sonar, fire-control radar, navigation radar, air-search radar—up to 5000 test points. This Northrop ACE will scan the critical points of each electronic system in a ship every 15 minutes.

Last month the Navy briefed industry on contract-

ing opportunities worth about \$300 million for its VAST (Versatile Avionic Shop Test) program—a computer system for shipboard testing of aircraft electronics. It is expected to be in operation by 1970 on carriers and at supporting shore installations.

Missile programs are heavily committed to ACE. One by Autonetics for the Minuteman II has a, microminiaturized on-board guidance computer that also checks out the missile in the silo. A Lockheed test system is being used with the Polaris missile.

But the leader in the field today, the ace of ACEs, is the checkout system for NASA's Project Apollo. A total of 125 computers of 30 different types are supporting the automatic checkout features of the nation's Moon program. It is estimated that by 1970 some \$1.5 billion will have been spent on this.

Meanwhile the airlines are taking advantage of the growing technology. American, Trans World and Eastern—all are pressing the use of automatic checkout in jet engines to detect unseen turbine cracks and other flaws before they become serious enough to ground an airliner.

Interest in ACE is so high that estimates of how much is being spent by buyers vary widely in the industry. Some say the market will top \$1 billion by 1970. The Federal Government is more conservative. This year some \$350 million will be spent on electronic checkout equipment of all types, according to the Federal Business and Defense Services Administration. Surprisingly, spending for ACE has dropped in the last two years, the federal agency says; it was \$386 million in 1964 and \$368 million in 1965. The decline is attributed to two prime reasons: a gradual decrease in outlays by the National Aeronautics and Space Administration (probably because most of the major equipment purchases for the Apollo program have already been completed) and across-the-board economies in Government programs not directly concerned with the war in Vietnam.

Problems with ACE? The usual electronic growing pains. A big one is that primary equipment is not being designed for automatic checkout. There is a need for readily accessible test points in equipment. Programming is another sore point.

New types of sensors are being developed to overcome still another problem—the need to replace active sensors with passive ones. Sensors that must be joined physically to a circuit to be tested have limitations with the increasing use of microcircuitry. Among the new techniques being explored are infrared and rf sensors.

Displays are becoming more sophisticated, to handle the inundation of data in modern ACE systems. Four new methods are being investigated: cathode-ray matrix tubes, deflection modulation, thermoplastic and magneto-optic.

Beyond these advances, ACE designers look toward the ultimate in convenience and efficiency: a built-in ACE in every electronic system or complicated piece of equipment.

# Computers point the way to more versatile ACE

What are the major trends in automatic checkout equipment? Here are some:

- A gradual shift from sequentially programmed systems to fully computer-controlled ACE.
- Greater use of checkout equipment that is built in as part of a primary system when the latter is first developed.
- Increasing use of telemetry instead of hardline data transmission.
- Development of automatic checkout systems that will alert users to failures before they occur, even at the component level.

In the meantime, what is being used today? There are still many programmed machines, as typified by the Air Force's AN/GJQ-9 programmer-comparator. Made by Bendix at Teterboro, N.J., the units have been used since 1961 to verify the operational readiness of aircraft and missiles. Most of the Navy's equipment is still tape-programmed. Extensive use is being made of BACE (Basic Automatic Checkout Equipment), a family of mobile programmer-comparators developed by Autonetics to check the A-6A, A-5C, and E-2A aircraft, as well as the F-111. DATICO (Digital Automatic Tape Intelligence Checkout) a tape-controlled tester, supplied by Northrop Nortronics, Palos Verdes, Calif., is being used to check most of the individual packages that go into the Polaris missile. The B-58 supersonic bomber makes extensive use of tape-programmed machines to check its flight control, fire control, air-to-ground identification and the bombing and navigation equipment.

Why the trend to computer-controlled checkout? For one thing, sequential programmers are relatively limited machines. With a punch paper-tape or punch card, they merely check out a series of select test points for malfunctions. The more versatile computer can not only measure many more test points, it can do it faster and more efficiently. In addition it indicates the exact cause of the fault and provides a print-out of the component to be replaced or repaired, with specific repair instructions.

Within 18 months, for example, the Navy will seek bids on equipment for a computer-controlled ACE program called VAST (AN/USM-247). It is to mon-

itor most electronic gear on carrier aircraft. VAST, which stands for Versatile Avionic Shop Test system, was developed by PRD Electronics, Inc., Westbury, N. Y., a subsidiary of the Harris-Intertype Corp. The program is designed to test and troubleshoot automatically about 85 per cent of existing and projected carrier-based avionic systems, including that on the Navy's F-111B. It will replace dozens of special testers, each tailored to an individual aircraft and now stocked aboard aircraft carriers. Both the Integrated Light Attack Avionic System (ILAAS) and the Integrated Helicopter Avionic System (IHAS), which is scheduled to become operational next year, will be compatible with VAST.

VAST is expected to reduce the number of technicians aboard aircraft carriers by about 25 per cent. A typical attack-carrier air wing requires 145 men to operate the avionic shops. Capt. Arthur Stanziano, former director of the Avionics Div. of the Naval Air Systems Command cites this added advantage: "Training requirements will be radically reduced, because it will no longer be necessary to train technicians in the use of the new special-support equipment which is being provided with almost each new avionic system."

Capt. Stanziano, like many other military leaders, notes the almost exponential rate at which electronic equipment is being added to aircraft. The Navy's E-2A, for example, which carries more than five tons of electronic equipment, contains 18,000 separate active components.

The introduction of microelectronics techniques, according to an industry spokesman, has produced packing densities so high that it is virtually impossible to test isolated circuits manually. In such cases, the only method of testing is automatically, with the test points provided in the original design.

Only computers can cope with such checkout needs.

The heart of VAST is a general-purpose digital computer, the Sperry Rand Univac 1218. The Navy envisions that each carrier installation will ultimately have six test stations, arranged in two groups of three, with each group controlled by a computer. Each of the computers will be time-shared.

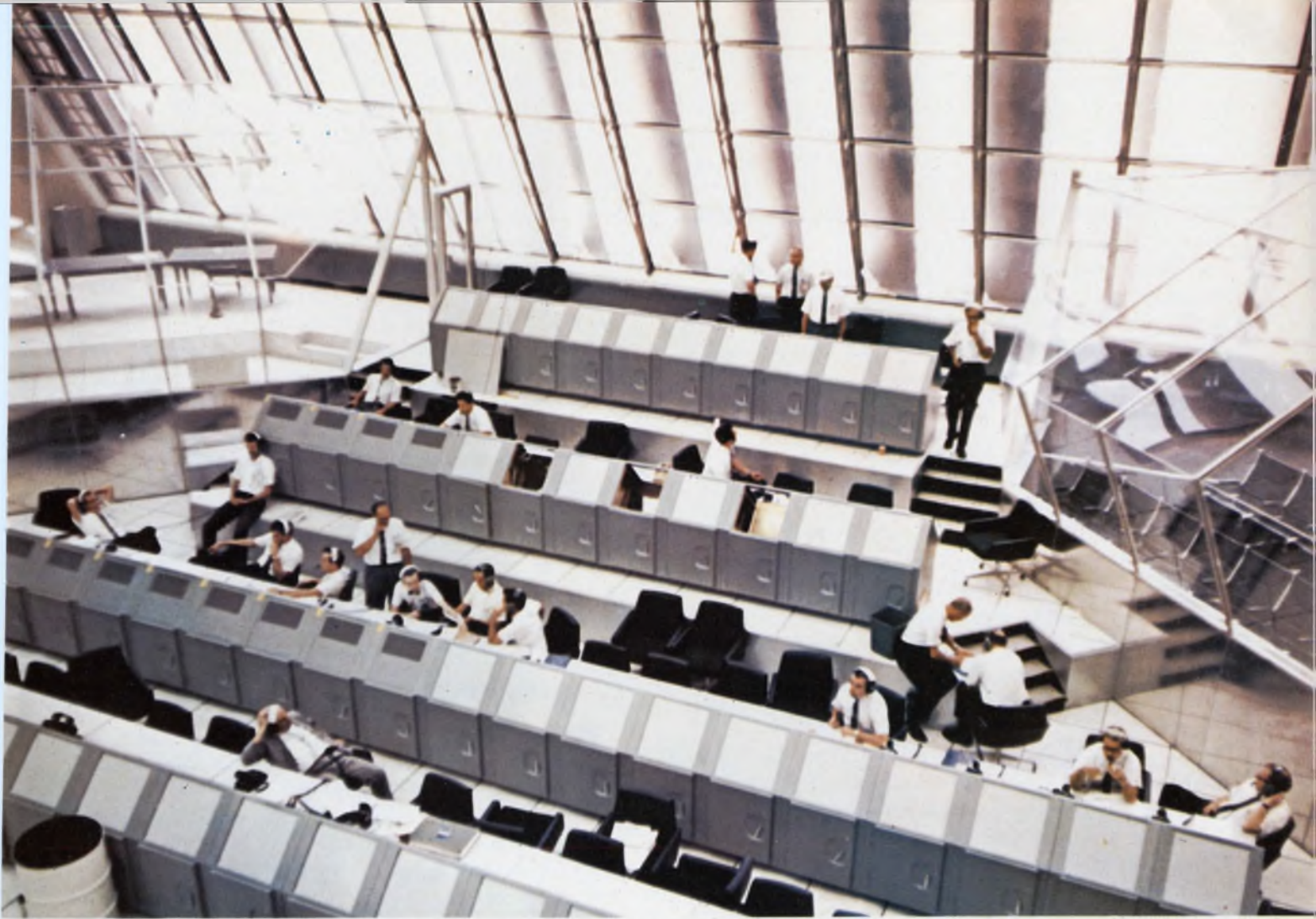

**Automatic checkout control room** at the Cape Kennedy Manned Spacecraft Operations building shows the com-

plexity of equipment needed to monitor and check out the Saturn Apollo spacecraft and rocket.



**Saturn V checkout** is done by these RCA 110A computers at Cape Kennedy. About 4500 different measurements are monitored by similar computers in the Apollo program.



**ACE generates a lot of data.** How best to display this information is testing the ingenuity of designers of checkout equipment.

Each test station will consist of a Data Transfer Unit, consisting of a keyboard and console and a Stimulus and Measurement Section. The latter section will be composed of a combination of modular, programmable stimulus generators and response monitors. The Data Transfer Unit will be the buffer between the computer station and the Stimulus and Measurement Section.

Communication between the computer and each test station will take place over two cables, one for instructions originating at the computer and one for data sent back to the computer from the stations.

About 55 independent programmable building-block modules will be available for use in the Stimulus and Measurement Section. The modules will break down this way: 17 basic signal generators, 16 response monitors, six power supplies, four test-point switches and 12 miscellaneous, or service, units. The building blocks can be connected and re-configured to provide a variety of signal measurement capabilities for many test requirements.

The NAVY will be able to accommodate changes in aircraft on a carrier by merely substituting new test programs and test cables.

Two other major computer-controlled test systems belong to the Army. One is MAIDS (Multi-purpose Automatic Inspection and Diagnostic System), used at the Frankford Arsenal in Philadelphia to check a variety of military equipment, including hydraulic and electric systems. The other is DIMATE (Depot-Installed Maintenance Automatic Test Equipment), recently installed at the Army Depot in Sacramento, Calif. It can check a walkie-talkie as well as a complex communications system.

MAIDS makes use of a drum-programmed computer, the Librascope LGP-30, which is really a revamped field-artillery digital computer. One unit with two test stations is in use at the Letterkenny Army Depot, Chambersburg, Pa., for testing tank engines. Another is used at Frankford Arsenal to test jeep engines. A mobile version is called READY-MAIDS. For versatility, there are several MAIDS subsets, used for checking equipment ranging from electronic to automotive and hydraulic-pneumatic systems.

DIMATE is a modular test system that is capable of automatic, semiautomatic and manual modes of operation. Developed by RCA's Aerospace Systems Div. at Burlington, Mass., it automatically detects malfunctions and pinpoints faulty modules or circuit boards in Army electronics, including radio, radar, surveillance-detection, computer and other avionic and navigation systems.

In a typical operation, a DIMATE operator connects equipment to the test set and selects the program specified for that piece of equipment. The computer-controlled test set then automatically checks the components and identifies trouble spots. A printed message is recorded—for example, "Circuit xy faulty—replace."

Other computer-controlled ACE systems being used by the military include VATE (Versatile Automatic Test Equipment system) and ACRE (Automatic Checkout and Readiness Equipment). They are important because both use computers that have been specifically designed for checkout functions. Most computer-controlled systems today employ general-purpose processors that have been redesigned for checkout tasks.

VATE has been in use at the Air Force Station in Newark, Ohio, to check advanced ICBM guidance systems. It can detect and isolate faults down to the plug-in-card or inertial-component level. It can also be used for acceptance testing of missile guidance systems. Like Vast, it is an example of a central control system that can concurrently and independently monitor several test stations by operating one computer on a rapid time-sharing basis.

ACRE contains a transistorized, magnetic-drum, digital computer developed by Lockheed Aircraft, of Sunnyvale, Calif. It performs final systems tests on the Polaris missile.

### Many computers check out Apollo

The most highly automated checkout program devised so far is employed in NASA's Apollo space program. The use of a ground computer to test systems in the first stage of the Saturn I launching vehicle started in 1962. Since that time automatic testing has been gradually introduced to all stages and at all test sites, until today ground computers participate in practically all checkout phases of the Saturn V program. It has been estimated that about 125 computers of 30 different types are being used to check the Apollo launching vehicle and spacecraft.

But according to Charles Brooks, Jr., project engineer at the George C. Marshall Space Flight Center, not every Apollo test can be automated at present. "There are numerous tests, especially those involving mechanical systems, that can be performed more reliably and more economically by manual operations", he says, "usually because the state of the art in hardware has not progressed sufficiently to permit fully automated tests."

However, the trend, Brooks concedes, is to automate even those hazardous operations that are performed manually at present.

An indication of the need for automatic testing is readily seen in the fact that whereas some 200 measurements were needed to check the operational readiness of the early Mercury spacecraft, something on the order of 4500 are needed in the Apollo program.

Installed Apollo computers include 26 CDC 160G digital computers at spacecraft test sites; seven Packard-Bell PB-250s, 16 CDC 924s and 11 CDC 8090 digital computers for stage checkout, and 28 RCA-110s for launching-vehicle checkout at static test stands and launching sites. Numerous other



smaller computers are used as central data processors to ease the workload of the checkout computers.

Essentially the same type of checkout stations are used at the factory, the launching sites for the spacecraft, the static test stands and the launching sites for the launching vehicle, according to Richard Diller, NASA project officer. "This is to ensure that essentially the same test equipment and procedures are used," he explains, "so that we can correlate measurements from the factory to the launch site and have a good base in pinpointing discrepancies."

Probably no more than 50 per cent of the Apollo checkout parameters have been automated, Diller says, "Most of our systems are currently set up and being operated as initiation of an individual test command, which may throw a series of relays or institute a test voltage to a certain device," he explains. "This is then relayed to the spacecraft or launch vehicle, and the output is processed by the computer, compared with tolerances, and presented as a complete event."

The electronic areas and some of the electrical ones are fairly easy to automate, Diller notes. However, he adds, NASA still has not come up with a good automatic method of rf checkout, either in the vhf or radar bands. Consequently a mixture of automatic and manual equipment is used here, Diller says.

So far NASA has pressed for only a minimum of automation in mechanical equipment. As Diller notes: "Those who have tried to automate the closure of a protective cover, the movement of a service arm from an umbilical tower, and so on, know that these areas are often better operated with somebody looking at a manual activated light."

### Telemetry vs hard line

Increased use is being made of telemetry instead of hard line coaxial cables to check out space vehicles and test missiles. The Apollo space program is particularly dependent on telemetry links. Hard line is usually employed more for early prelaunching check-out, to avoid radio-interference problems, but radiated signals may be used after the umbilicals are released or carry-on equipment is removed.

Most designers prefer to use cable links for check-out because it is more reliable, but for space missions, it is obviously impractical.

Several systems today besides Apollo are oriented entirely toward the use of telemetered data. One of these is the Vandenberg Automatic Data Evaluation, used during prelaunching checkout of the Agena satellite vehicle.

### The goal: Built-in ACE

It would be ideal if every electronic system or complex piece of equipment could troubleshoot itself with its own built-in ACE. And some designers believe the goal is not as impractical as it might seem



**SAC missile team monitors Minuteman launch** from Vandenberg AFB. On-board guidance computer continuously reports on the ICBM's status. If a fault is detected, the missile control center, some miles away, is alerted automatically.

at first glance.

"Every system built today is being designed with built-in checkout in mind," Robert Kirkman, engineer at TRW's Space Technology Laboratory in Redondo Beach, Calif., says optimistically.

But Kirkman also knows that having something "in mind" is not always the same as doing it. There is resistance to employing built-in ACE for all equipment, he concedes. In the aerospace field alone, he says, some designers question whether it is not illogical and expensive "to fly the test equipment" when the same functions can be performed better by ground ACE. Kirkman believes, however, that the trends favor the optimists. Inevitably, he says, the practice of building self-testing features into electronic equipment will prevail, especially where complex space missions or critical military systems are involved.

Built-in checkout equipment is now frequently linked to a computer that has a primary function other than checkout—for example, navigation in the Minuteman II missile.

In its unattended silo, Minuteman II undergoes remote checkout with the help of the missile's digital guidance and control computer. Some tests are conducted continuously, others periodically. The 38-pound computer, which employs integrated circuitry extensively, has a rotating-disk memory with a capacity of 7222 words. Information is stored on both sides of the disk.

The computer operates under control of a program

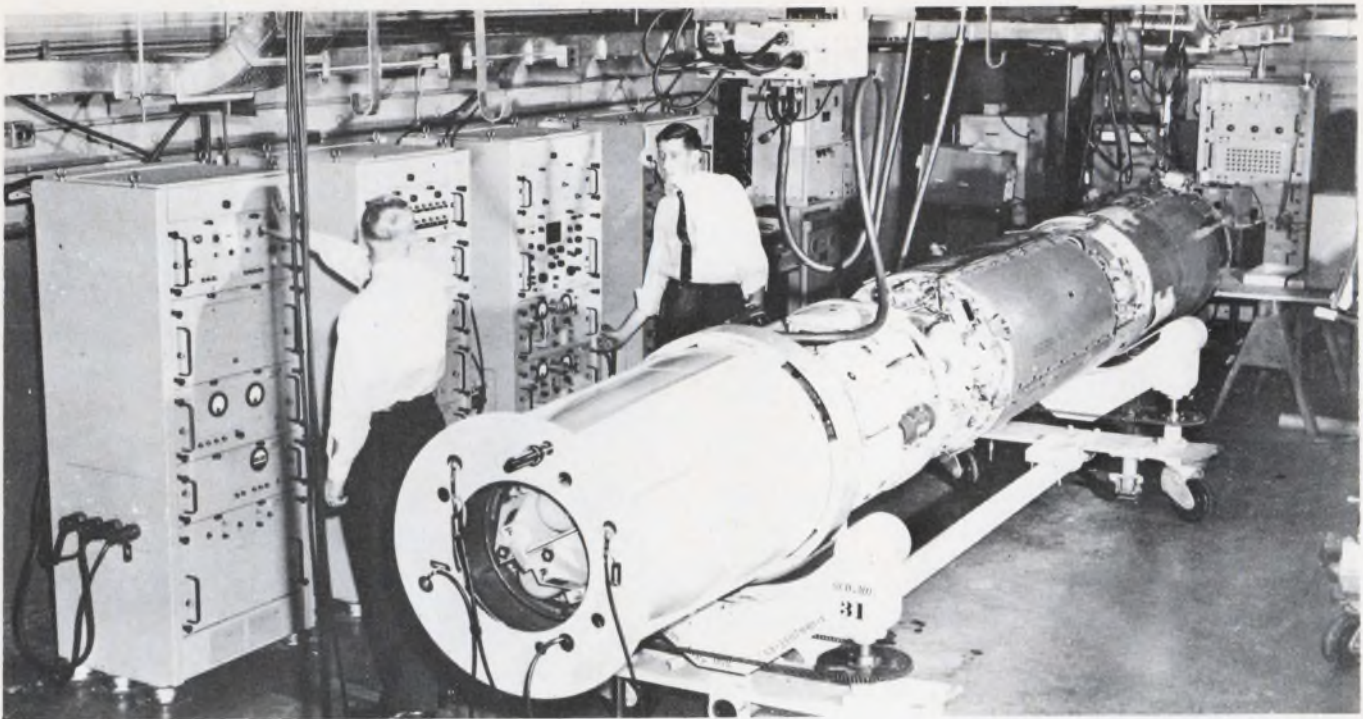

**TALOS missile gets shipboard checkout** with Navy's AN/DSM-60 tactical test equipment. Malfunctions in missile

are shown by simple go/no-go indication. Fault isolation goes down to the level of a replaceable subassembly.

## A typical ACE: how it works

Here is how ACE might work in a computer-setup as shown below:

Digital command data goes to the test system and controls all checkout and monitoring functions in the same way that command data to the radar controls its functions. Command data to the test system may contain the following information:

- The radar mode of operation.
- The location of the signal to be selected for monitoring.
- The location and type of test signal stimulus required for monitoring.
- The target parameters for simulated check-out target signals.

Using such data, the test system selects a particular point to be monitored, generates test signals,

stimulates the circuit and processes the monitored signal, so that the results can be fed back to the computer for evaluation. Monitored signals are usually processed by converting the signal to a dc or video amplitude, normalizing the signal amplitude, converting the signal to digital form in an analog-to-digital converter, and transmitting the signal to the computer over the output data bus. This technique lends itself to sequential monitoring of many points in the system.

Simulated checkout target signals, generated from target parameters in the command data, are fed into the front end of the radar. Realistic dynamic targets can be generated by using prerecorded magnetic tape in conjunction with the computer to simulate various targets.

The results obtained from the test system by the computer are compared with expected values stored either directly in the computer memory or in some external memory device (such as a magnetic tape or a drum) accessible to the computer. The deviation of the measured value from the expected value is compared with preset limits to establish a go or no-go condition. When several signals having the same characteristic are monitored, it is often desirable to compare the measured value of each signal with the average of all the measured values, to establish an out-of-tolerance condition. In this case the computer performs an additional function, by computing the average and storing it in the memory as the expected value. When the computer determines that a no-go condition exists on any signal monitored, the location of the fault is determined and displayed on a visual readout, such as a hard-copy printer.

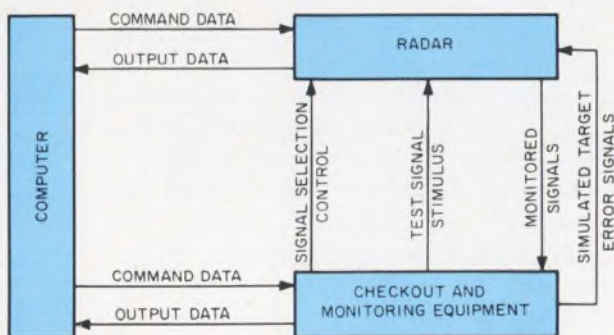

that is stored internally on tape. The memory stores a complete ground and operational program, including all target data required for guidance to one of a number of stored targets. In addition the computer continually monitors and reports missile and support equipment on a go/no-go status. If a fault is detected, the missile control center, some miles away, is alerted automatically.

The remote automatic checkout of the missile in its silo is thorough, and there is no other scheduled maintenance.

### The black-box system

Another built-in ACE, the Mark 2 in the F-111 aircraft, is said to be the most advanced in avionics. Most of the electronics are microminiaturized and packaged in removable black boxes.

The F-111 avionics system is designed to operate with virtually no external ground checkout. Before takeoff and during missions, the on-board ACE continuously monitors the status of all boxes. Unlike comparable built-in aircraft systems, the Mark 2 not only indicates a general failure but also points to the specific module that has failed. Thus, upon landing, the pilot can direct the removal of a faulty module and its replacement with another. The new module is plugged in, and aircraft "down time" is reduced drastically.

Until recently the use of built-in test equipment in aircraft, missiles or space vehicles was limited by the equipment's relatively large size and weight, and low reliability. Now, with microelectronics, built-in testing can be added on a modular basis, or it can be completely integrated with the primary electronics equipment.

"The next two years will see tremendous advances in the use of microelectronics in both built-in and ground checkout equipment," according to Frank DeArmond, project engineer at North American-Rockwell's Autonetics Div. in Downey, Calif.

He believes that the miniaturized D-37 computer in the Minuteman II has demonstrated the effectiveness of integrated circuits in automatic checkout equipment. In addition to size and weight savings, DeArmond foresees two major trends resulting from the use of microelectronics:

- The high cost of current checkout systems will be drastically reduced.
- Portable checkout equipment will be developed, with a test capability equivalent to that found in today's "shop" systems.

Aside from such outstanding examples as the Minuteman II and F-111, most automatic checkout equipment in use today is rather bulky, with little use of modules or miniaturization. The checkout equipment in the Apollo program, for example, employs a mix of hybrid, transistor and integrated circuits with few integrated circuits.

Another identifiable trend is the integration of



Apollo spacecraft systems are checked out with Motorola's Digital Test Command System.

ACE into the primary equipment. Built-in systems are of two types:

- Systems in which separate packages are added on to the primary equipment.
- Systems in which all or some of the components are individually integrated into the primary equipment. The guidance computer aboard the Minuteman II and the Mark 2 avionics system on the F-111 fall into the second category.

A major advantage of integrated built-in test equipment, especially in missiles and space vehicles is that the system can check itself out at one site—the factory, say—and serve as its own launching-control system at the launching site. But despite its advantages, integrated built-in testing does increase the complexity of the primary equipment and add weight.

Test equipment today tells what has failed—at the present moment. Designers agree, however, that future automatic test equipment will probably detect incipient failures, possibly down to the component level. Such systems would analyze inputs from primary equipment and tell how much longer the system or component could be expected to perform dependably.

But such advances will encounter many roadblocks. Future equipment will be more miniaturized and will use integrated circuits widely; the detection of incipient failures on the chip level will be a major problem, says TRW's Kirkman.

"Comprehensive testing is based on failure-mode analysis and detecting failure mechanisms in progress. This has not been thoroughly exploited even in

components such as resistors, capacitors and vacuum tubes," he notes.

### Commercial airlines check ACE

For the past few years, several major U.S. airlines, including American, Eastern and Trans World, have been investigating the advantages of automatic testing. They are primarily interested in ACE as a means of reducing engine overhaul time to help lower over-all aircraft operating costs.

Reasons for their snail's-pace adoption of ACE have been the high cost of equipment and the lack of information on what equipment to use, and what parameters to measure. The cost factor, however, is paramount. As one airline spokesman observed: "If we commit ourselves to spend a million dollars on an automatic checkout system, we've got to save a million and a half dollars on operating costs."

Extensive on-board checkout systems are planned for the future supersonic transport, and the C-5A and 747 "jumbo jets." These systems will not only monitor performance but also continuously check all electronics systems aboard the aircraft.

ACE systems for today's commercial aircraft primarily monitor engine performance. The main objective is to spot flaws before extensive maintenance is required.

Earlier this year, American Airlines began to equip its commercial fleet with an airborne recording system developed by the Air Research Division of Garrett Corp. It collects data on such flight characteristics, as start of takeoff roll and gear retraction as a means of evaluating pilot performance. A continuous tally is also kept of 47 critical engine parameters—such as blade vibration, exhaust temperature, oil pressure—and 44 flight characteristics (events). In one hour the system records about 82,000 parameter values and 158,400 events. At the end of each day's flying, the tapes are removed and sent to computers for processing and evaluation.

According to an American Airlines spokesman, preliminary estimates are that the ACE system will reduce maintenance cost per engine operating hour by about 40 per cent.

As a result of the use of in-flight engine monitoring, the Federal Aviation Agency has already given American permission to more than double the time between overhauls on certain types of engines. For example, the time between overhauls on Rolls Royce engines used on the BAC-111 was extended from 1200 hours to 3500 hours. An airline spokesman said this may be extended to 10,000 hours in the near future. Ultimately, in-flight monitoring may completely eliminate the need for any engine overhaul, since parts that are worn or functioning improperly will be adjusted or replaced as needed, he said.

A similar in-flight recording concept is employed by Trans-World Airlines on its DC-9 aircraft. Instead of continuous recording, 50 engine parameters are recorded three times per flight; there are plans to expand the system eventually to measure 500 parameters at sampling rates of 100 per second.

For the past two years, Eastern Air Lines has been flying an experimental digital airborne maintenance recording system aboard a Boeing 727. According to a company spokesman, however, it has taken longer than anticipated to have the system functioning properly. "Matching the right equipment for the right job turned out to be a much more detailed and time-consuming effort than we originally estimated," he noted.

The system now under test consists of an IBM integrated-circuit digital computer, which monitors some 200 key airframe, engine and subsystem parameters. Real-time information is channeled to the crew during flight and also recorded on magnetic tape, which is later processed by an IBM 7074 ground computer.

The system was slated for fleet installation earlier this year, but has now been indefinitely postponed, according to Eastern.

## Barriers to automatic checkout

A standard complaint of automatic checkout equipment engineers is that the designers of primary electronic equipment tend to ignore the need for maintenance in their designs.

Among the complaints are these:

- Packaging schemes split circuits at points that make fault isolation to the replaceable element difficult. There is a lack of functional packaging.
- Circuit sharing reduces the cost of the prime equipment by 1 per cent, but it increases troubleshooting difficulties and cost 100 per cent.

Perhaps the leading complaint of test-equipment users involves the inaccessibility of test points. Test points in primary equipment must be externally accessible and in sufficient number.

For automatic testing, the points must be carried to multicontact connectors, and they must be able to stand the relatively large capacitance loading of the test equipment and its cabling. Or they must be internally conditioned and multiplexed. In addition they must be chosen so that normal circuit operation is not affected when the test equipment is connected, even at the cost of installing built-in isolation amplifiers or networks.

In addition to measurement points, it may be necessary to install switching to permit setting up test conditions under external control. Over-all, it may be less expensive to install a test relay in the primary equipment than to bring more wires to the connectors or remove operational input-output con-

nectors and replace them with test connectors every time the device is tested.

In addition, primary equipment may need special built-in test transducers and signal sources. For example, devices containing displacement or rate gyros are often "tested" by replacing the gyro with an electrical signal simulating gyro output, if the gyro has no provision for controlled torquing. The resulting cost of unscheduled failures and haphazard repairs may be considerably greater than the cost of adding torquing provisions to the gyro.

If access to test points is suitable, programing fault-isolation tests can be very simple. If access is not suitable, fault isolation and even end-to-end testing may require complex and subtle chains of programed logic, based perhaps on tenuously justified assumptions. It may even not be possible at all.

The original primary-equipment designer may find it advisable to consult test and programing experts, to help him arrive at the most useful arrangements for testing access.

### Programing a big problem

Another stumbling-block to the wider use of ACE is its high cost, especially that of programing.

Addressing a symposium on computer systems, Col. Paul Galentine of Mitre Corp., Bedford, Mass., said: "In the design and production of a software system, we stand today at a point analagous to the state of hardware production 200 years ago. At that time all production was dependent on the efforts of a limited number of skilled craftsmen. Until the process of producing goods was freed from the artisans, supply was doomed to fall further behind the demand of an expanding population.

"In my opinion, conventional programing techniques, although now refined and sophisticated in many respects, cannot hope to keep pace with requirements.

"What is needed today is a sort of industrial revolution in software production. We can no longer afford to be limited by the laborious manual efforts of a few software artisans. Rather tools must be provided that will permit the semiskilled, nonprograming specialist to produce software systems."

David M. Goodman, senior research scientist with the New York University School of Engineering and director of its Project SETE, has listed the following problem areas in ACE programing:

- Engineers who understand automatic-test programing are scarce.
- The programing process is difficult and expensive, both to prepare and maintain. It is often not realized that the cost of programing may exceed hardware costs.
- The effect of input-output and other peripheral equipment on programing requirements are grossly underestimated in real-time systems.
- There is failure to distinguish between com-

mand, control, fault detection and fault isolation, which, in that order, impose increasing difficulties in the programing process.

- The capabilities of both computers and programing have been oversold. There is a preoccupation, a fascination with computer technology at the expense of system and subsystem development.

- There is excessive dependence on "quick fixes." Programing languages are aids, not a programing solution.

- The limitations in today's computer technology are not appreciated. The magnitude of effort required to develop such scientific programs as Fortran is largely ignored.

- The development of an automatic test program is often not closely coordinated with the prime-equipment design and with plans for the test system's ultimate use.

Goodman concludes: "One transducer, well-placed, can eliminate hundreds of computer instructions. One display, suitably designed, can eliminate hundreds of computer instructions."

### 3 types of checkout equipment

The Government and industry recognize three main categories of checkout equipment:

**Manual checkout equipment**—Includes standard, commercial or common test equipment, and special (custom) test equipment.

**Semi-automatic checkout equipment**—Hybrid systems or manual and automatic procedures.

**Automatic checkout equipment**—Includes all classes of equipment that all but eliminate the need for an human operator. This usually refers to the employment of sequentially or internally programed or computer-controlled equipment.



A hundred and fifty miles of wiring for electrical and electronic systems will go into this BAC/Sud supersonic Concorde jet-liner, now under construction, and therein lies a problem: how to make convenient test points accessible for automated checkout.

# Better displays emerging as data volume mounts

With the trend to ever greater automation of the testing of complex electronic systems, the engineer will have to analyze an increasing volume of data, often at high sampling rates. He has to be aware of current status, of how the test has progressed, and of what new information he must anticipate. "What to show" and "how to display these data" are a growing challenge to the ingenuity of designers of automatic checkout equipment.

Countless shapes, sizes and types of display are available. For example, the Apollo ACE uses four different types: simple go/no-go indicators, analog meters, cathode-ray tubes and graphic recorders.

It is worth noting that displays are ordinarily grouped in two categories. The first consists of those used by engineers and scientists to monitor and check out complex systems, such as in the Apollo program. The second category is simple indicator lamps for maintenance checkout in the field.

Few improvements have yet been made in easing the presentation of complex data.

Here are some advanced types of displays being investigated that promise to overcome the information "bottleneck."

## CRT matrix registers faults

A CRT display in which any drift, intermittence or failure in an assembly shows up as a "color flag" in a matrix of white dots has been proposed by Dave Goodman, of Project SETE.

As shown on page 62, a matrix of 8 by 12—96 data points—corresponding to 96 components critical to equipment performance appears in real time on a color cathode-ray tube. Ninety-four of the test points in the assembly are within tolerance and the corresponding data points on the matrix appear white. One of the test points is above tolerance and the corresponding data point shows red. Another registers a low value and shines green.

The sketch in the corner of the figure shows in greater detail the vertical line structure of the target screen on which the colors are produced. An optical port, shown at the rear of the CRT envelope, is where a camera may be positioned to take color photo-

graphs of the back of the target screen. This makes the system self-programing, and so overcomes a major obstacle in presently conceived test systems.

To determine the significance of the "flats," the observer may rely on his memory, may refer to his handbook for predicted failure patterns of multiple malfunctions, or may read the information from the display screen itself.

## Display gives 3-D view

One novel approach to the interpretation of data is the deflection-modulation (DM) cathode-ray tube, which has been under investigation at the University of California at Berkeley.<sup>3</sup>

The DM display differs from normal TV displays in that video signals are presented on the CRT in three-dimensional form. They thus contain more information.

The TV display shown in photo 1 and the DM display in photo 2 were generated by equivalent video signals and represent the base current induced in an npn transistor. Where the TV display is black ( $E$ ), the lines on the DM display are horizontal; the brighter the area ( $o$ ) of the TV display, the greater is the vertical deflection on the DM display. Where the annular region ( $A1$ ) appears almost uniformly gray on the TV display, appreciable structure exists on the lines in the corresponding region of the DM display, which therefore has higher information content in this region. There are certain regions, however, where the lines overlap, and the information content of the DM display may be more confusing than that of the TV display.

The brightness of photo 1 and the apparent height of photo 2 are both proportional to the current induced into the transistor base area by a 15-kV electron beam of submicron diameter. This beam was scanned over the transistor in synchronism with the CRT beam which produced the upper photo. The larger the deflection in the DM display, the larger the induced base current.

The difference in brightness of the three annular regions of the transistor base area in the upper photo corresponds to the amount of current induced

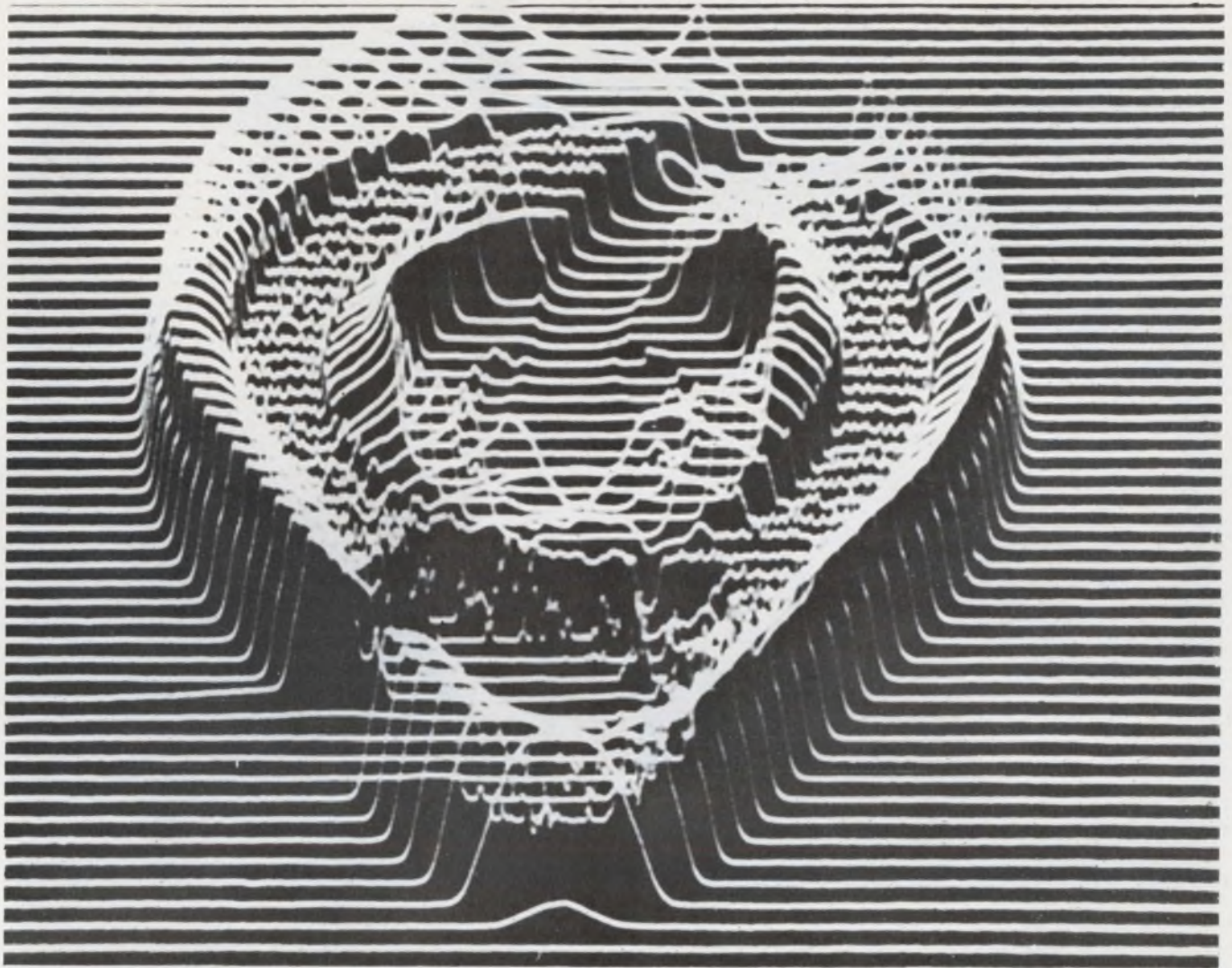

1. **Deflection-modulation CRT display** of transistor base current contains more information than conventional TV display in photo below. The three bright annular regions,

A1, o, B, correspond to different levels of induced base current. The larger the vertical deflections in the DM display the greater the current.

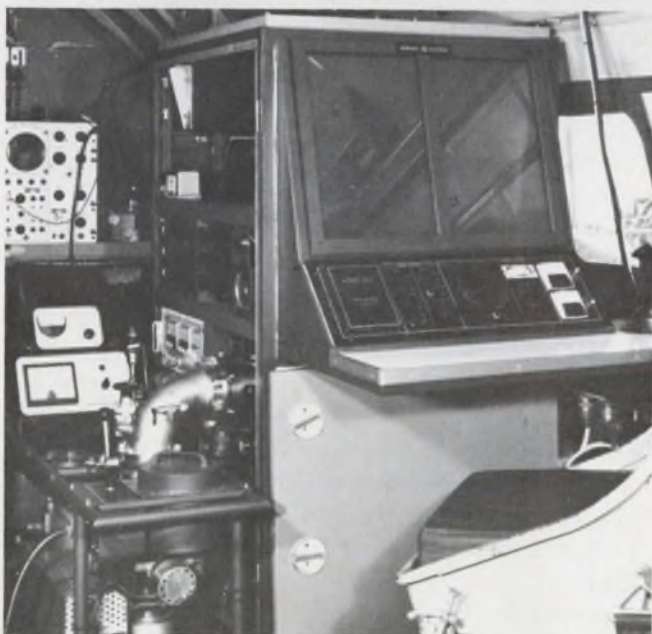

**Thermoplastic recording display** is being used by the Air Force for aerial reconnaissance.

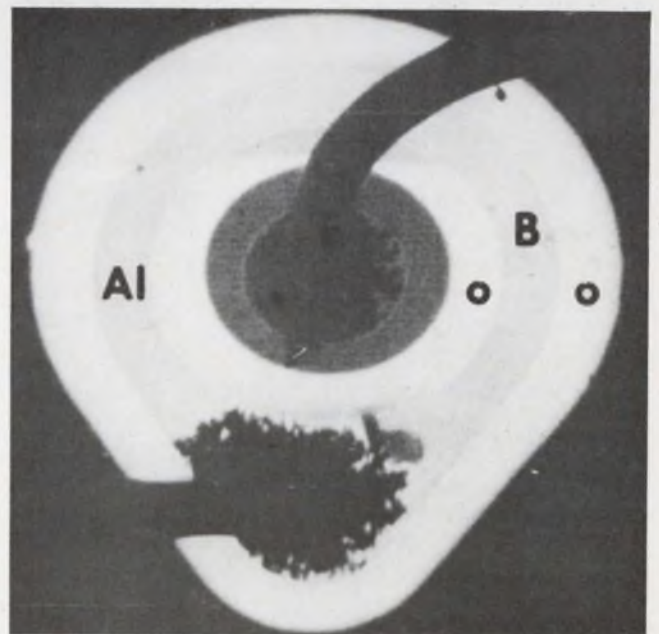

2. **Television display** of the base current induced in an npn transistor by a 15-kV scanning electron beam.

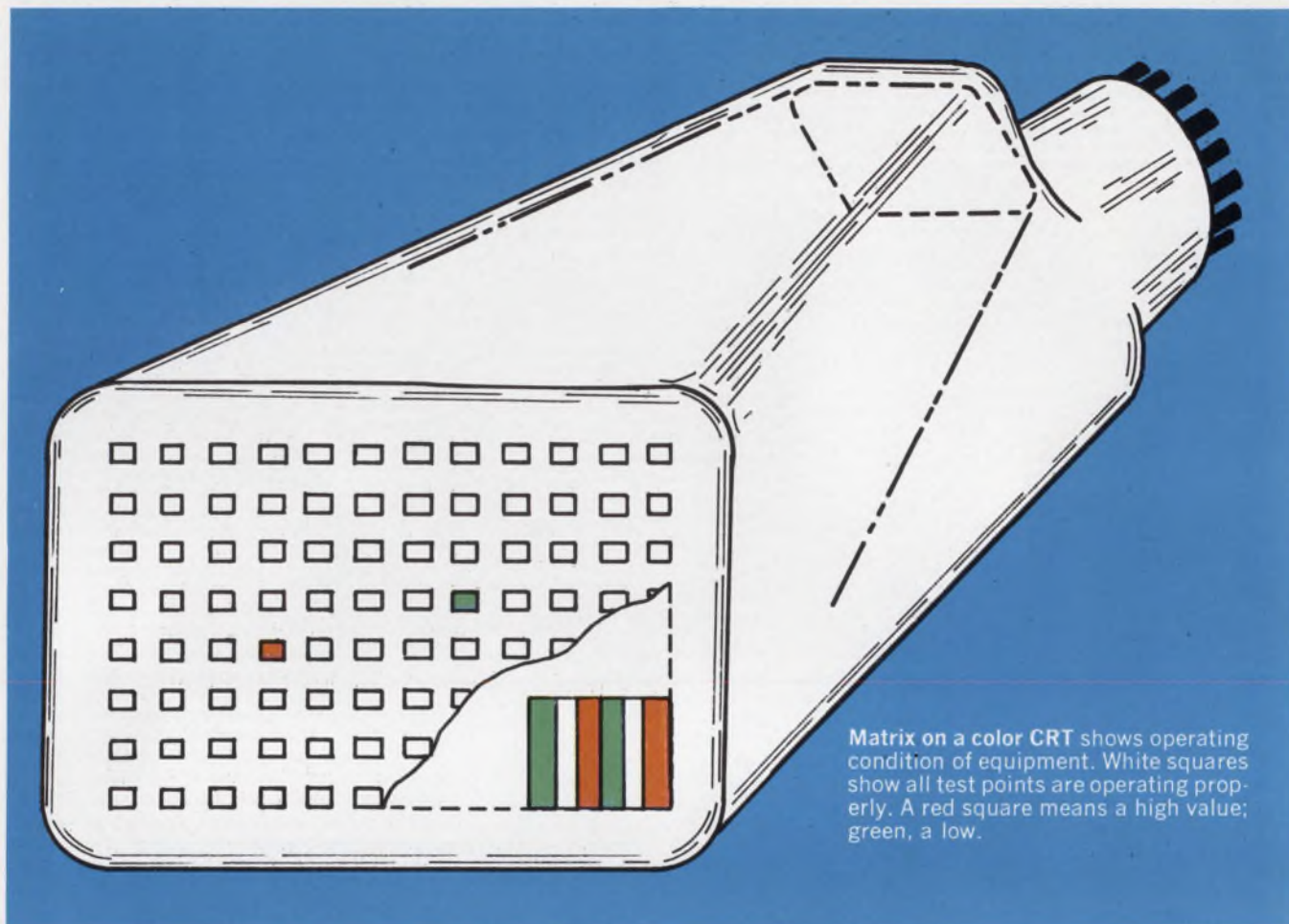

Matrix on a color CRT shows operating condition of equipment. White squares show all test points are operating properly. A red square means a high value; green, a low.

into the transistor base region. For example, the two brighter annular regions marked *o* correspond to the base covered with a passivating layer of oxide. The annular region marked *Al* corresponds to the aluminum base contact, which absorbs some of the electron beam energy, and reduces the electron beam induced current. Very little signal is produced in the center dark emitter region *E*, because the beam does not penetrate to the planar emitter base junction, and the minority carrier diffusion length in the heavily doped emitter is short.

The three-dimensional effect and hence the information content of a DM display can be increased by:

- Adding more lines to the raster (photo 1 has a 64-line raster).
- Increasing the energy level of the scanning electron beam.

The higher-energy beam penetrates more deeply into those regions where it is difficult to induce a base current, that is, regions *E* and *Al* in photo 2. The perspective of the display can also be altered by rotating the direction of scan of the electron beam (this corresponds to rotating the negative in a flying-spot scanner).

The DM technique has also been suggested as a means of altering color on a multicolor display, to produce a color-coded contour map.

The emitter connection is a thermal compression bonded gold lead (crossing all regions). The base connection is a similar lead connected to the evaporated aluminum base contact, *Al*, toward the bottom of the two photos.

The contrast produced in a DM display can be understood as follows: The light intensity of a CRT is proportional to the CRT beam current and inversely proportional to the CRT beam scanning velocity. In a TV display, the CRT beam current is modulated by the video signal to produce the picture, while in the DM display, the CRT scanning velocity is increased by changes in video signal, producing darker regions in the display. Brighter regions are produced by overlapping lines.

### Thermoplastic display has high resolution

For some years, General Electric Co. has been working on advanced display concepts that exploit thermoplastic recording techniques. This is said to offer higher resolution and wider dynamic range than current cathode-ray-tube photographic film displays.

A recorder display console employing this technique was delivered to the Air Force earlier this year for use in a real-time aerial reconnaissance system,



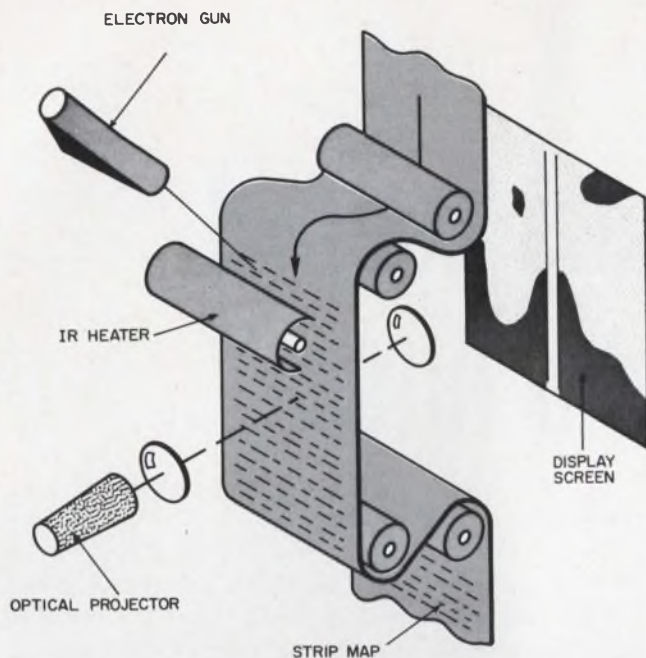

**Thermoplastic layer of recording tape** is scanned by a modulated electron beam. The infrared heater softens the layer and grooves are formed by the beam. The information is displayed on a screen by an optical projection system. Developed at General Electric's Electronics Laboratory in Syracuse, N.Y., the advanced display concept is reported to be superior to CRT displays in that information is displayed and permanently recorded at the same time. The tape can be reused by simply reheating the thermoplastic layer. The process from writing to readout can be accomplished in milliseconds, making it a real-time display.

(see "Airborne system forms instant maps," ED 16, Aug. 2, 1967, p. 33).

The display portion of the system is applicable to any number of equipment checkout setups, according to G.J. Chafaris of GE's Electronics Laboratory in Syracuse, N.Y. It is superior to a CRT display, he said, in that information is displayed and permanently recorded at the same time.

Thermoplastic recording is analogous to photographic film, except that it is developed by non-chemical methods.

The recording film is made of three layers: a base film, a conductive coating and a surface film of thermoplastic material. In recording, a modulated and scanned electron beam deposits amplitude-modulated line charges on the thermoplastic surface. Other forms of modulation can also produce a charge density modulation along each scan line.

Grooves varying in depth and slope are formed by the action of the modulated electron beam as an infrared heater liquefies the surface of the moving tape. As the tape cools, the grooves solidify in the tape surface, and the information is available for readout. The process from writing to readout can be accomplished in milliseconds, making it practically a real-time display. After readout, the tape can be reheated to a higher temperature and the recorded information erased. Readout can be accomplished

by schlieren optics or a flying-spot scanner.

### Magneto-optic devices store and display

In recent years, a class of magneto-optic devices has stirred considerable interest for information recording, processing and display applications. These devices can perform many of the functions that are associated with memory arrays. The state of an element in the array can also be sensed optically.

With a magneto-optic display, information can be read out in real time, data can be altered by means of a magnetic pen and—like a thin-film memory—information can be stored for later readout. In fact, such a display could double as a general-purpose thin-film memory when it is not being used as a read-out device.

Because memory is essentially built into the magneto-optic display, stored data does not have to be updated constantly, as is the case in CRT displays in use today.

General Electric, Sylvania, and Laboratory For Electronics in Boston are some of the companies that have been developing such displays but, except for a number of experimental arrays, none is yet operational.

A magneto-optic display essentially consists of fine iron particles suspended in a water solution and applied to a nickel-iron film surface. Magnetic particles in the solution are attached to the film by a localized magnetic field caused by striped domains (a fine line change in a magnetic field gradient normal to the plane of the magnetic film). The frequency of the striped domains is of such order that an optical grating is obtained in the visible region. Diffracted light is observed when the incident light is shone perpendicularly onto the grating. No diffracted light is observed when the grating is parallel to the incident light beam.

### Three-color display is predicted

An x-y matrix, wire loop or magnetic recording head can be used to rotate the optical grating in the desired direction, permitting the diffraction or reflection of light through the display. A two-color display is achieved by varying the thickness of the nickel-iron film.

Scientists at GE's Electronics Laboratory in Syracuse, N.Y., have built an experimental magneto-optic array consisting of a matrix of 2500 elements driven at computer rates by a solid-state driver.

GE is working on methods of reading out electronically, instead of optically, the state of magnetization of an element in the matrix display. Techniques for generating three-color displays and 3-D displays operating on the panoramic parallax stereogram principles are also being explored, according to a GE spokesman.

# Passive sensors needed for ACE of the future

Designers of built-in ACE are taking a close look at entirely new families of passive sensors<sup>1</sup> that differ drastically from today's conventional transducers such as strain gauges and thermocouples. Practically all sensors used today are physically "wired-in" to the primary equipment under test. This is considered undesirable, especially for critical military and space applications, since failure of the sensor could affect the outcome of the mission.

By breaking the connector system and inserting a variety of sensors, a technician can change the characteristics of a circuit as well as mismatching the line. Also cables may be incorrectly reconnected. Finally, with increased use of microcircuits in built-in equipment, it will become increasingly difficult to attach sensors to selected portions of the circuitry.

To overcome such problems, designers have begun to investigate passive, or indirect, sensing techniques that include infrared, electromagnetic, light, radio frequency, acoustical and radioactive sensors. So far, few if any of these have been used in operational systems, but they are expected to find increased application in future checkout systems.

## Infrared checks component flaws

Infrared sensing techniques have been used for some time, mainly in the laboratory, to spot defects in printed-circuit boards and components.

This technique has also been found useful for detecting temperature fluctuations among components in electronic equipment. A key problem has been how to obtain line-of-sight access into packaged equipment.

One approach under investigation at the Illinois Institute of Technology Research Institute (IITRI) makes use of fiber optic bundles to transmit infrared emanations to an exterior display. By spreading the fiber optic bundle at the sensing end, access to all interior areas of the package is possible.

One problem in using this scheme is that infrared transmission through the fibers is reliable only for a distance of about 1 meter. Another problem concerns emissivity variations of the different components in a given cluster. This could make it difficult to obtain

correct temperature readings.

To get around the latter problem, scientists at IITRI are attempting to develop a coating that will standardize the emissivity of all the components to some given level. In some instances, the emissivity would even be increased, according to an IITRI spokesman.

IITRI scientists have devised a number of other passive sensing techniques using fiber optic bundles. One approach employs a thermosensitive phosphor, which is deposited on a component. This eliminates the emissivity problem by causing the phosphor temperature to be that of the component itself. As shown on p. 65, lower photo, ultra-violet light derived from a source built into the prime equipment would be piped to the component by means of a quartz fiber-optic bundle. The thermo-sensitive phosphor gives off visible light which is a function of the temperature of the phosphor. The light is then piped, again by fiber optics, to an external display panel.

Finally, IITRI scientists have proposed a wide-band fiber optic telemetry system that, they say, could reduce the amount of hard-wire in missile umbilical cables. This would minimize potential rf interaction problems and permit additional test points to be monitored.

As shown in drawing on p. 66 outputs from several sensors are sent to a multiplexer. Various types of multiplexing methods, such as sequential sampling or frequency multiplex (different signals occupy different regions of the spectrum), can be used. The modulator transforms the signals from the multiplexer to a current of sufficiently high power level to modulate a noncoherent laser diode, which produces an infrared output at about 9000 Å. The laser beam is piped through fiber optics to a photodiode and then to a remote readout display. For long-distance transmission, a photomultiplier can be added to the photodiode. Its output is coupled to either a cathode or emitter follower, which effectively isolates the photomultiplier output from changing load conditions.

According to an IITRI scientist the telemetry system is capable of transmitting signals up to about 1 MHz over fiber optic links of about 40 feet.

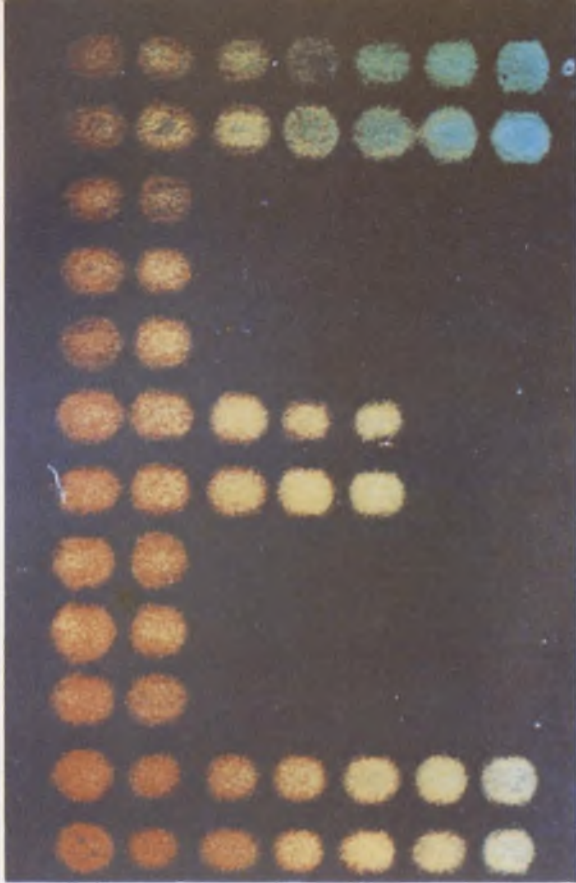

**Two-color alphanumeric character** in magneto-optic display was written with a 50 line/inch current matrix on a 100-line/inch nickel-iron film.

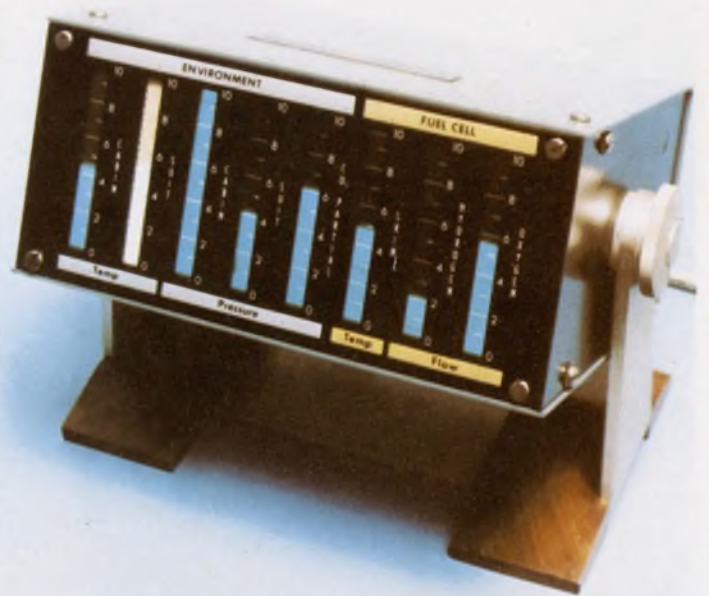

**Electroluminescent bar-graph display**, developed at GE's Electronics Laboratory, permits quick visual check of eight typical spacecraft conditions.

**Thermosensitive phosphor coatings** on IC flat packs fluoresce when exposed to ultraviolet light to indicate a rise in surface temperature. The tube is a fiber optic bundle that

pipes the visible light to remote monitoring points. The phosphor is under investigation at the IIT Research Institute in Chicago.



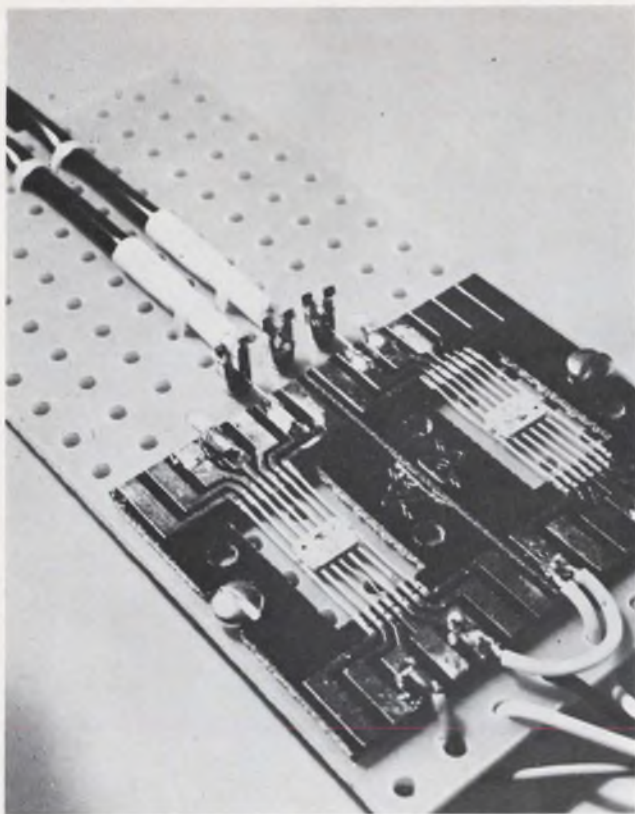

For a long time electromagnetic sensing has been used with clip-on ammeters. In this case, the magnetic field established by a current in a conductor couples with the clip-on loop to provide an indication on the meter.

The use of solid-state Hall-effect devices looks promising for this purpose. Satisfactory output signals, of almost constant level, in a frequency range from about 5 Hz to 5 MHz have been reported from such devices manufactured at Ohio Semitronics, Inc., Columbus, Ohio.

For moving parts, work has also been done to install small permanent-magnet sources at strategic locations on the parts and then to sense the magnetic field of these magnets to indicate such parameters as motion, relative motion, speed, etc.

A simple noncontact device, called a ferrite core indicator, which shows promise for indicating dc current flow in electronic circuits, has been developed by IITRI scientists. The indicator can be built directly into connector assemblies or employed on printed-circuit boards.

As shown in the diagram on the opposite page, when an ac signal is applied to the primary windings on the ferrite core, an output signal appears across the secondary windings which varies in proportion to the magnitude of the dc current in the wire through the center of the core. By monitoring the output signal across the secondary windings, the amount of dc current in a circuit wire can be determined.

An appreciable change in the output wave form occurs for dc currents from about 5 to 300 mA. This range includes a large percentage of present day

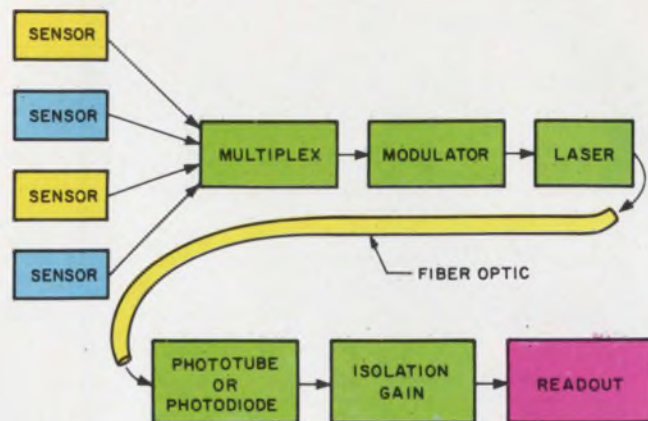

**Wide-band fiber optic telemetry system** employs laser beam modulated with signals from variety of sensors. The beam is piped through fiber optics, for up to 40 feet, to an external display.

**Tiny glow of a "grain-of-wheat" lamp** wired into an integrated circuit, signals an overload in the circuit. Fiber optic bundles pipe the warning light to a remote monitoring location.

transistor circuits. The polarity of the dc current can be determined by the phase of the output waveform.

The output oscilloscope could be replaced with a peak-to-peak detector and a dc voltmeter which would permit a dc voltage to be proportional to the dc circuit current.

### Diodes, lasers as light sensors

The use of light is another attractive possibility for circuits where no coupling with the device being measured is desired. It is possible, for example, to use a light-emitting diode so that the diode switches on when a signal is present. This is particularly useful when a discrete on-off condition is to be sensed, and where problems of interference by outside light can be avoided with an enclosure. General Electric has developed a connector which uses light for coupling between the two sides of the connector.

Lasers also offer possibilities for the future, although currently there are many problems associated with them, particularly in the area of modulation and sources.

### Interference may prove useful

Radio-frequency interference is usually considered a nuisance. Someday, however, these spurious signals may be used to indicate an existing or incipient failure in operational systems.

The Boeing Co. has developed a mathematical computer model<sup>6</sup> that may make it possible to predict sources of rf interference and susceptibility.

Honeywell scientists, for example, have found that

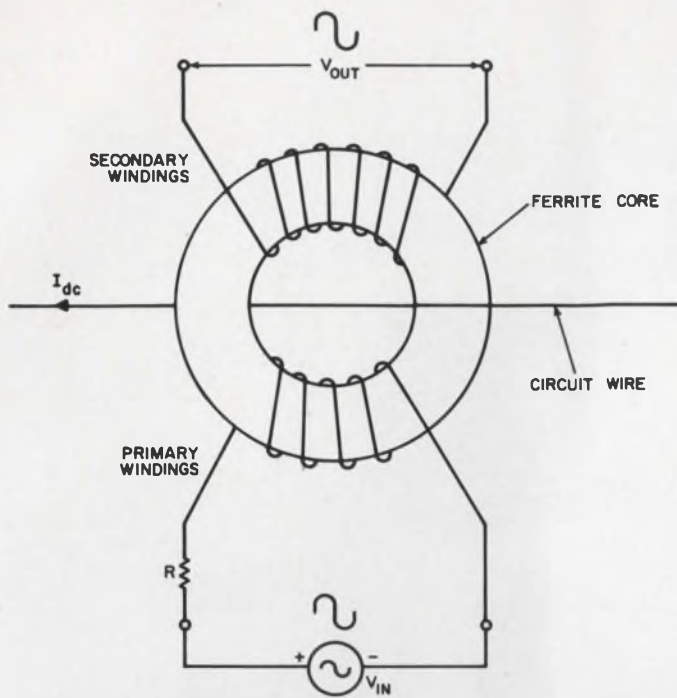

**Ferrite core indicator** detects dc current flow in a wire. When an ac signal is applied to the primary, the output signal across the secondary varies with the magnitude of the dc current.

by mechanically stimulating certain electronic devices, a predictable range of noise around 27 MHz can be obtained. Other investigations are under way on adaptive networks and self-repairing control systems.

Much work still remains to be done to simplify pattern recognition techniques in order to take advantage of these methods.

### Acoustics determines device performance

Another source of information on device performance is the output of acoustical energy. This is applicable only where the device includes a moving part: Valves of all types and gyros (here the problem is considerably more subtle) for instance.

The Army has worked on acoustical monitoring, particularly of tank engines that need repair. A computer diagnoses the acoustical energy received and defines the repair required—a logical extension of use of the trained ear of a good mechanic.

The major technical problem encountered in acoustical techniques, aside from the pattern recognition problem, is that of isolating the desired signal from other extraneous noise. Location of pickups with a hard mount immediately adjacent to or on the device to be sensed gives the best signal-to-noise ratio. Filtering and other pattern recognition approaches are also useful, if the sensed information frequency bands are convenient. Repetitive testing of a large, representative sample of the components to obtain information on good and bad characteristics is the first step in pattern recognition.

Radioactive isotope tracers have been used for several years to determine whether leaks exist in hermetically sealed electronic components. The component is placed in a container and gas containing tracers is used to pressurize the container for a given time. The component is then removed and scintillation counters are used to detect gas inside the component. In the same manner, it is possible to inject known quantities of a tracer gas, such as krypton 85, along with the normal pressurizing medium into a pneumatic system. Leaks then become a point source of radioactivity which can be detected by standard means.

Although this method may be useful in the future, much groundwork remains to be done before a practical application can be made. A follow-on application would be to use tracers soluble in cryogenic liquids, which can then be detected to indicate a propellant leak in missile systems. ■ ■

### References:

1. Bradford T. Joyce and Eugene M. Stockton, "Computer-Controlled Automatic Testing—A Review," *RCA Engineer*, X, No. 5 (March 1965), 8-11.
2. David M. Goodman, *Problems and Pitfalls in Automatic Test Computer Programming* (New York: N.Y. University School of Engineering and Science Report No. SETE 210/86, May 1965).
3. Thomas E. Everhart, "Deflection-Modulation CRT Display," *Proc. IEEE (Correspondence)*, LIV, No. 10 (Oct. 1966), 1480-1482.
4. H.S. Dordick and J.W. Ranftl, *Advanced Sensing Techniques for Automatic Checkout* (Santa Monica, Calif.: Rand Corp. Report No. RM-4937-NASA, March 1966).
5. *Research on Passive Instrumentation and Stimuli Generation for Saturn 1B Equipment Checkout* (Seattle: Boeing Co. Summary Report No. D5-13268-1, May 1966).
6. *Establishment of Broad-Band, Near-Field EMI Prediction Techniques: Final Report* (Seattle: Boeing Co., Nov. 1964).

### Bibliography:

- Brockman, Herbert P. "Automatic Checkout and Monitoring of Large Complex Systems," *RCA Engineer*, July 1966, 72-75.
- Chester, L., and Turn, R. *The Monitoring Task in Automated Checkout of Space Vehicles*. Santa Monica, Calif.: Rand Corp. Report No. RM-4678-NASA, Sept., 1965.
- Danheiser, E.L., and Korsen, M. "Integrated, Adaptable Automatic Checkout and Simulation," *RCA Engineer*, VIII, No. 2 (Sept. 1962).
- Goodman, David M. "A Self-Programming Automatic Electronic Test System with Pattern Recognition Displays," *IEEE Trans. on Aerospace*, Vol. AS-2, No. 4 (Oct. 1965).
- A Review of the State of the Art in Automatic Electronic Test Equipment*. New York: IEEE 1966 International Convention Preprint Paper No. 389, 1966. Abstract printed in 1966 *IEEE International Convention Record*, XIV, Part 4, 80.
- Kirkman, Robert A. "The Use of Automation in the Checkout of Aircraft, Spacecraft, and Missile Systems," Paper No. 64-250 delivered to 1st AIAA Annual Meeting, Washington, D.C., 1964.
- Moon, Warren D. "Predicting System Checkout Errors," *RCA Engineer*, X, No. 5 (March 1965).
- Schermerhorn, C. "Development, Design and Application of Pre-flight Test Equipment for Aircraft Fire Control Systems," *Proc. of 2nd Annual Joint Military and Industrial Electronic Test Equipment Symposium*, 1958.
- Smith, Robert L., Jr. "Technical Problems in On-Board Checkout Systems," in Goodman, David M. (ed.), *Automation in Electronic Test Equipment*, IV ("Built-In Test and Continuous Monitoring") (New York: N.Y. University, 1967), p. 1-23.

### Free Reprint

A copy of this report, "ACE: The ultimate in failure detection," will be sent free of charge to readers who circle Reader-Service number 250.



# energetic,

Clare Stepping Switches are kept busy counting, totalizing, scanning, sequencing, monitoring in countless operations . . . and stand ready to take your most advanced mass sequential switching needs in stride!

Design around new *plug-in* simplicity with the exclusive Clare Quick-Mount . . . and the proven long-life, low maintenance operation of Clare's spring-driven, cam, and direct-drive models. There's no "make-do" ever! You match your needs exactly. There's a wide variety of options in standard models . . . capacities up to 624 contact points . . . operating voltages, 6-110 vdc . . . speeds up to 60 steps/sec. Hermetically-sealed and dust cover models further broaden the range of application. All are engineered to provide more levels in less space . . . millions of steps with minimum maintenance. For complex problems, let Clare provide special modifications or functional assemblies.

For complete product information, circle Reader Service Number, or ask Clare for Stepping Switch Manuals 601 and 602, and Quick-Mount Data Sheet 651-3 . . . write Group 11A6.



C. P. Clare & Co., Chicago, Illinois 60645

a GENERAL INSTRUMENT company

---

**New Clare Quick-Mount** combines the speed and ease of plug-in mounting with the proven long-life service of Clare spring-driven switches . . . makes mass sequential switching more economical . . . easier to use. Ideal for fast unit-for-unit replacement in continuous service operations, and for advanced pcb applications.

---

## *CLARE STEPPING SWITCHES*

for mass sequential switching in commercial, industrial, and military control systems

ON READER-SERVICE CARD CIRCLE 32

# Build a fast, wide-range agc system

with a 'vario-losser' attenuator. The circuit has few ICs and discrete components, no transformers.

Fast and stable automatic-gain-control (agc) systems can be obtained by replacing conventional agc schemes<sup>1-5</sup> with a "vario-losser" attenuator.

The vario-losser<sup>6</sup> is a varistor-bridge shunt whose impedance can be varied by changing the agc control voltage (see Fig. 1). Its advantages include low distortion over a wide control range and inherent stability in systems with rapid response times.

The circuit, using integrated circuits and no transformers, can reduce input signal-level variations as high as 54 dB to approximately 2 dB at the output (see box). The maximum fade rate that the system can correct for is approximately 100 cycles per second for a carrier of 360 Hz. This feature depends on the low-pass filter within the control-loop and may be varied, as required, for a particular application, as will be shown.

## A simple system results

The system ( Fig. 2) consists of a variable gain pre-amplifier, the vario-losser, an output amplifier, a buffer, and the feedback control loop. The feedback loop consists of an amplifier, a full-wave rectifier, a low-pass filter and a control amplifier.

A variable-gain preamplifier, which provides as much as 20 dB of voltage gain, permits adjustment of the system to the average input signal level of the particular installation. The system can then correct for signal changes of 54 dB from the nominal level. The preamplifier serves two other useful functions: It acts as an impedance buffer and as a source of a push-pull signal, thus eliminating the need for transformer coupling. The designer can vary the input impedance to suit his requirements. However, a maximum base termination of approximately 15 k ohms for the integrated circuit used is recommended for optimum temperature stability. If a higher input impedance is desired, an integrated circuit such as the RCA CA-3000 may be used.

The fact that this system can correct a 54-dB input signal level change with only a 2-dB error means that the vario-losser can be controlled. It is at the output of the vario-losser that the signal is kept con-

stant ( within 2 dB). This is accomplished and may be best understood by considering the vario-losser as a simulated balanced L-pad.

Referring to Fig. 3a we see that one L-pad is formed by resistors *R5* and *R7* acting as the series arm of the L-pad, with diodes *CR1* and *CR4* forming the shunt arm. The other L-pad is formed by *R6*, *R8*, *CR2* and *CR3* (Fig. 3b). Diodes *CR1* and *CR4* act in parallel with the ac signal, as do diodes *CR2* and *CR3*. When the dc current through the diodes is varied, the impedance is varied and the voltage divider formed with the series resistance is changed. This, in a nutshell, is the vario-losser action.

There are several reasons for resorting to a *balanced* L-pad to form the vario-losser. Diodes *CR1* and *CR4* (and *CR2* and *CR3*) must act in parallel for ac signals. If a single L-pad were used, large capacitors would have to be placed from the negative and positive terminals (Fig. 3a) to accomplish this, and long-time constants would result, precluding a rapidly acting system. Furthermore, to produce a system that will introduce little or no distortion, the amount of signal handled by each diode must be minimized. All these requirements are met by the use of a balanced L-pad arrangement.

When a push-pull signal is placed across the input, points A and B (Fig. 3b) become nulled by the opposite polarity signals and, as such, are effectively at ac ground. In this way no large capacitors are required and a fast-acting agc system is possible. For the same reason, each half of the balanced L-pad is only required to operate on half of the sinusoidal carrier at a time. This minimizes the distortion.

A change in the current through the bridge, changes operating point on the volt-ampere characteristics of the diodes. As a result the static and dynamic resistances of the diodes are altered. The greater the dc current through the diodes, the lower is their effective impedance, and this, in turn, causes signal attenuation. Figure 4 shows the relationship between the bridge impedance and the dc current through it. Figure 5 shows the relationship between input signal level and the current that must flow in the bridge to cause the vario-losser to attenuate the correct amount to maintain an essentially constant signal.

The bridge current is varied by the control amplifier ( Fig. 2), which consists of transistors *Q4* and

---

Salvatore A. Romano Jr., Consultant, Brooklyn, N. Y.



Q5 in a Darlington configuration ( Fig. 6). A Darlington circuit is used here so that a linear relationship between the Q4 base voltage—the control-voltage—and the bridge-current (Q4, Q5 collector current) is obtained (Fig. 7). This feature, while not necessary in most agc systems, facilitates metering of the control voltage, which then may be scaled to the actual input signal level. This relationship is shown by the curve in Fig. 8.

### Handling the vario-losser output

If we refer back to Fig. 2, we see that the twofold purpose of the integrated circuit amplifier, IC-2, is to provide a high-impedance termination for the vario-losser while contributing voltage gain. This unit has an emitter-follower input, and the circuit permits the use of 47 K-ohm base terminating resistors while maintaining good temperature stability. A high-impedance termination of the vario-losser is required so the diode bridge is the major portion of the shunt impedance of the balanced L-pads. This is necessary if the vario-losser is to have its maximum possible correction range.

Since integrated-circuit amplifier IC-2 has a different input, no coupling transformer is needed. This is an important benefit, because a transformer at this low point would have to be extremely well shielded, both internally and externally. No collector resistors are required for IC-2, since they are internally provided in the unit.

Output signal-level requirements, isolation and necessary controls dictate the remaining in-line stages of the system. Note that while a certain output signal level may be required to achieve system "stiffness," it is not important whether gain is placed in the circuitry following the vario-losser or the feedback control loop that encloses it. (Stiffness

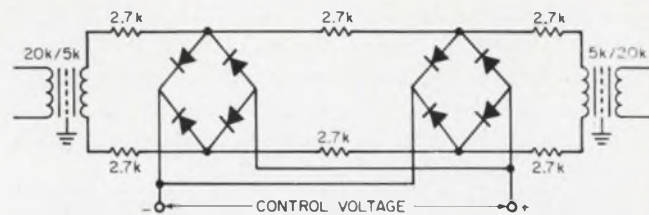

1. **40-dB input signal change can be reduced to 1 dB** in the output variation with this typical two-stage video-losser network<sup>h</sup>. Varistors are used in the bridges. While this circuit uses transformers, the circuit described in the article is transformerless.

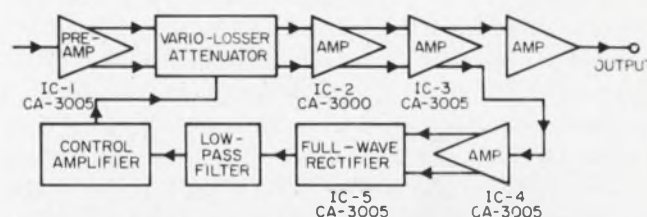

2. **Commercially available integrated circuits** are used with the vario-losser attenuator in an agc system. (See box for the specifications.) No transformers are used thus simplifying the system.

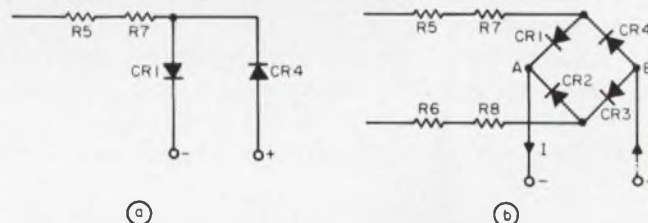

3. **One L-pad (a) constitutes half of the vario-losser bridge (b)**. Two such balanced L-pads assure fast response, since no capacitors are required. The impedance of the bridge is controlled by a small dc current, I, applied to the negative and positive terminals. This, in turn, alternates the signal.

### Agc circuit specifications:

Power required: (unit)	± 6.8 volts, ≈ 14 mA from each supply
(bridge)	± 6.8 volts, ≈ 3.8 mA
Input impedance:	600 ohms, single-ended
Output impedance:	50 ohms, approx. min.
Input level:	-70 dBm, min.
Output level:	0.25 V rms, min.
Frequency response:	120 Hz to 40 kHz, ± 2 dB
Harmonic distortion:	2nd-0.75% @ 467 Hz fund. 3rd-0.5% @ 425 Hz fund.
Max. ambient temp.:	60 °C
Correction:	54 dB with an error of -2dB
Response time:	30 ms approx. min.
Voltage gain:	90 dB approx. max.

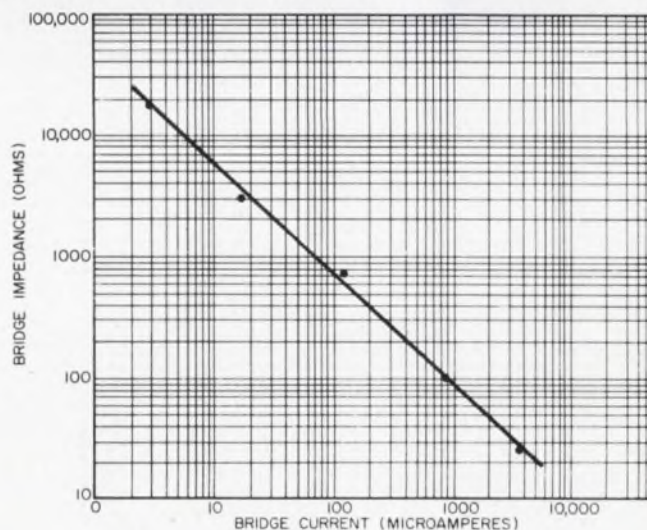

4. **Vario-losser action** is apparent from the plot of its impedance vs dc control current. Note the wide attenuation range possible.

is a measure of the maximum error resulting in the output for the maximum system correction. The stiffness is usually expressed as a ratio of output signal change to input signal change. It is 1 to 25 for this circuit. (A change of 54 dB of the input signal is corrected to a 2-dB change at the output).

Another important concept in the design of an agc system is evident from this ratio. It is this 2-dB error at the output that—after amplification, rectification and filtering in the feedback control loop—produces all the control voltage change needed by the vario-losser to correct a 54-dB input signal variation. IC-4 and associated circuitry couple a portion of the output signal to the full-wave rectifier, IC-5. The circuit permits single-ended control of the signal fed back and isolation of any loading effects that might distort the output signal. The differential output of IC-4 obviates the need for a transformer to drive the full-wave rectifier, which, is obtained from the proper connection of integrated circuit IC-5. The latter is essentially a common-collector, common-emitter, power rectifier. This type of full-wave rectifier contributes voltage gain to the system.

After rectification and filtering, a positive control voltage proportional to the output signal is obtained. This voltage is used to vary the conduction of the control-amplifier and thereby change the current in the vario-losser.

The low-pass filter is a very important part of the over-all system. The response time and the stability of the system are controlled by its over-all time constant and its configuration, respectively. This

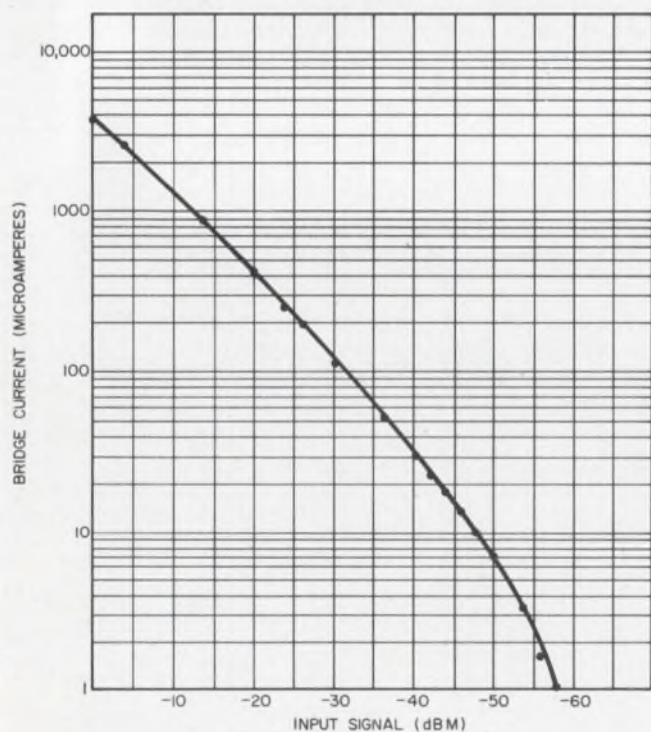

5. **Agc control current** can be related directly to the input signal attenuation possible with the vario-losser bridge.

filter enables the system to respond to input signal variations — carrier fades — of approximately 100 cycles/second with carrier frequencies of as low as 360 Hz. With variations in the design of the filter, this system can be adapted to applications requiring many different responses.

To understand the operation of the entire system, consider what happens when the input signal suddenly decreases by 40 or 50 dB. Instantaneously a change of equal magnitude takes place at the output because of the time delay of the system in responding to and changing the attenuation of the vario-losser. This time delay is determined by the discharge time of the filter, the output of which, is a voltage proportional to the output signal.

When the output signal suddenly decreases, the agc voltage from the filter begins to decrease. This causes the control amplifier to conduct less, reducing the current through the diode bridge of the vario-losser. This in turn raises the impedance of the bridge, so that the vario-losser attenuates less of the input signal. The net result is that the output signal is finally increased back almost to normal. The error that remains creates all the decrease in the agc voltage needed to cause this action to take place. ■ ■

#### References:

1. David N. Leonard, "Improve FM Performance With FETs." *ELECTRONIC DESIGN* 5, March 1, 1967, pp. 63-67.
2. Ernest Klein, "Y-Parameters Simplify Mixer Design." *ELECTRONIC DESIGN* 7, April 1, 1967, pp. 68-74.
3. Brent Welling, "Stagger-Tune the IC Amplifier Stages." *ELECTRONIC DESIGN* 9, April 26, 1967, pp. 236-239.
4. Charles L. Farrell, "FETs Can Improve AGC Performance." *ELECTRONIC DESIGN* 18, Sept. 1, 1967, pp. 66-71.
5. "Swamp Out Distortion in Wide-Range AGC Systems." *ELECTRONIC DESIGN* p. 72, Vol. 14, No. 8, April 12, 1966.
6. Telegraph Terminal AN/FGC-29, Dept. of Army Technical Manual TM 11-2245.
7. RCA Linear Integrated Circuit Fundamentals Technical Series IC-40.
8. RCA Application Notes for CA-3000 and CA-3005 Integrated Circuits.

#### Test your retention

Here are questions based on the main points of this article. They are to help you see if you have overlooked any important ideas. You'll find the answers in the article.

1. What makes the "vario-losser" tick?
2. What are some vario-losser advantages, compared with conventional agc systems? Disadvantages?
3. In what kind of impedance should the vario-losser be terminated?
4. What is system "stiffness"?
5. What determines the system response to the input signal variations?

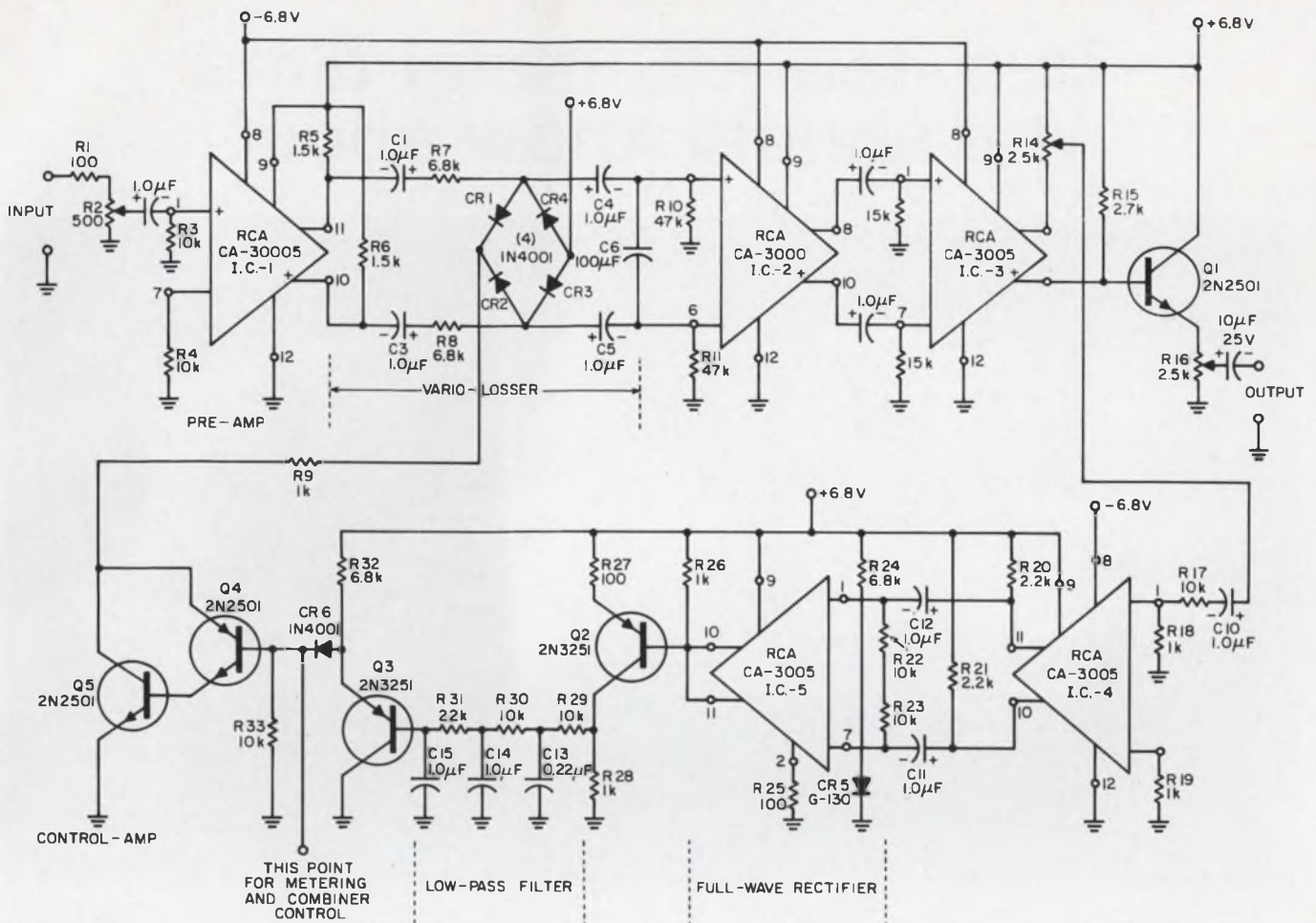

6. **54-dB changes in the input level produce only 2-dB variations in the output with the agc circuit.** The heart of the system is the vario-losser, the

impedance of which is controlled by varying the dc current through it. This current is supplied by the control amplifiers, Q4 and Q5. (See box.)

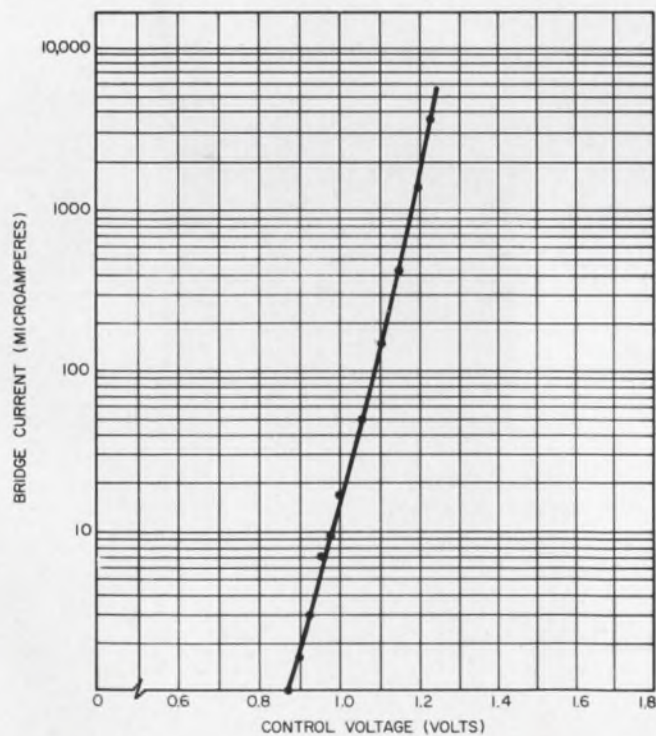

7. **Only small control voltage variations** are required to change the vario-losser bridge current for the full range of 54 dB.

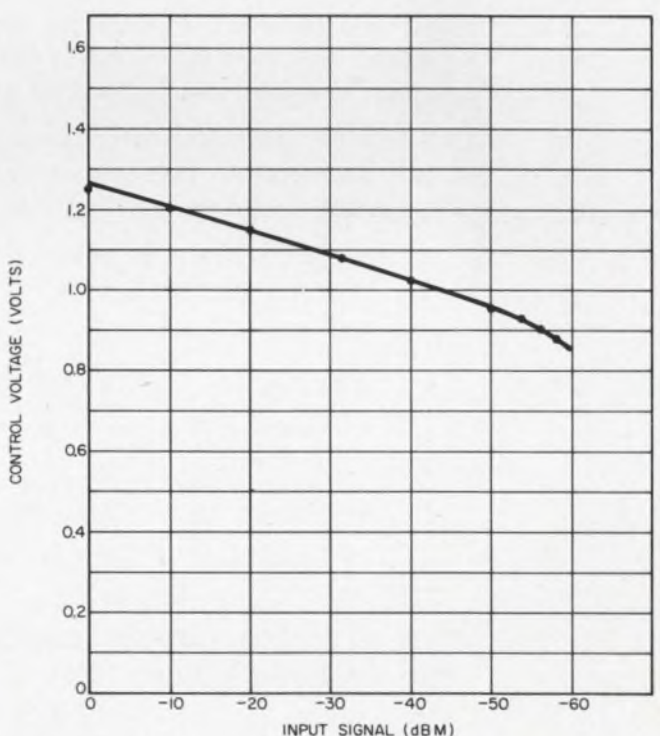

8. **Input signal range** can be referred directly to the control voltage required to operate the vario-losser. (Also see Figs. 4, 5 and 7.)

# Two new IRC metal films you should know about

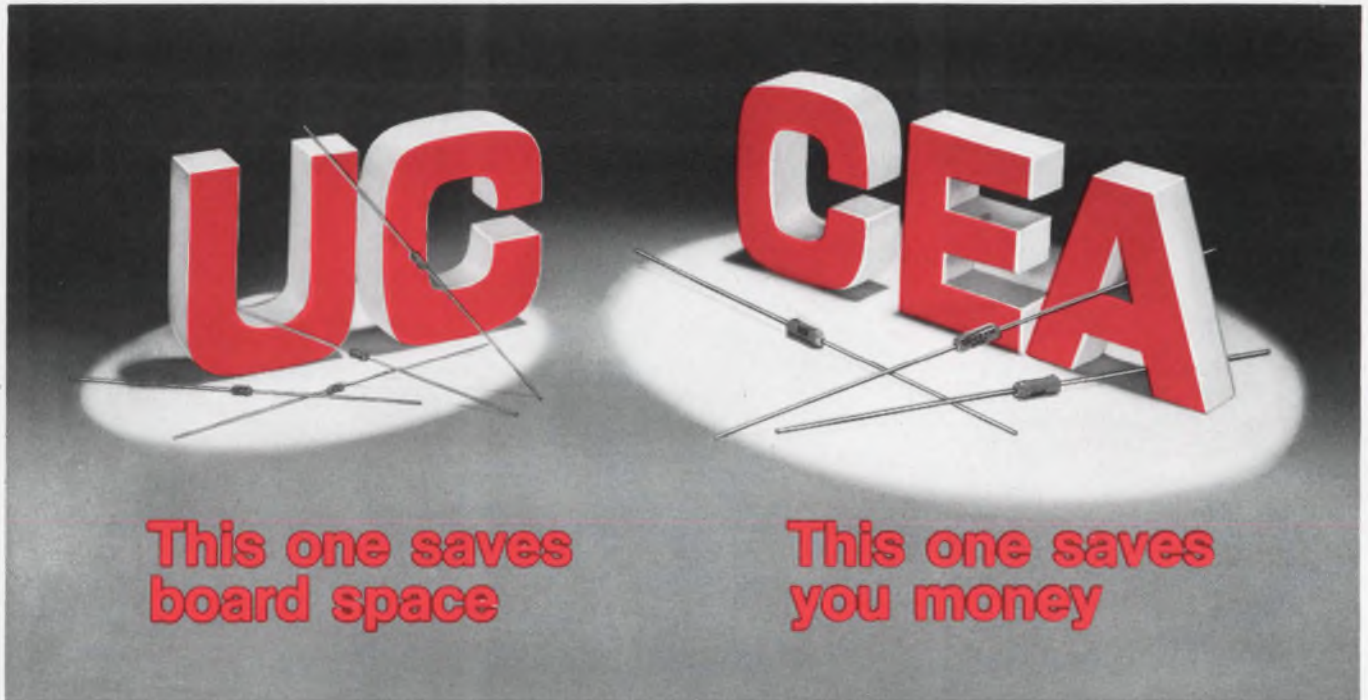

These new IRC metal film resistors can solve many of your space and cost problems. Both offer IRC's superior metal film performance. Both meet or exceed the requirements of MIL-R-10509.

**TYPE UC.** An ultra-miniature unit that fills the gap between discrete resistors and microcircuits. It has stability and reliability of higher rated units, and a tolerance that most microcircuits can't match. Gold dumet leads, reliable high alumina substrate and rugged end cap termination.

**TYPE CEA.** Handles four different power ratings. You can combine your metal film needs to save money and simplify stocking.  $\Delta R$ 's are all well within MIL limits. Rugged end cap termination.

$\frac{1}{2}W @ 70^{\circ}C$  1%  $\Delta R$   
 $\frac{1}{4}W @ 125^{\circ}C$  1%  $\Delta R$

$\frac{1}{4}W @ 70^{\circ}C$  .5%  $\Delta R$   
 $\frac{1}{8}W @ 125^{\circ}C$  .5%  $\Delta R$

## CAPSULE SPECIFICATIONS

	Type UC	Type CEA
Resistance:	50 $\Omega$ to 10K	10 $\Omega$ to 1.5 meg.
Tolerances:	$\pm 1, 2, 5\%$	$\pm 1\%$
Temp. Coeff.:	$\pm 50, 100ppm/^{\circ}C$	$\pm 100ppm/^{\circ}C$
Power:	1/20W @ 100 $^{\circ}C$	$\frac{1}{2}$ and $\frac{1}{4}W @ 70^{\circ}C$ $\frac{1}{4}$ and $\frac{1}{8}W @ 125^{\circ}C$
Body Size:	.145" x .057" dia. max.	.281" x .100" dia. max.

Write for complete data and evaluation sample. IRC, Inc., 401 N. Broad St., Philadelphia, Pennsylvania 19108.



ON READER-SERVICE CARD CIRCLE 33

# Simulate ICs with analog black boxes

by using the ECAP digital computer program and basic circuit building blocks.

Don't forget those analog-computer methods when using digital computers to model ICs. Many widely used programs<sup>1,2,3,4</sup> are set up by defining discrete component parameters. But in an integrated circuit, individual components merge into one physical entity. The only parameters available may be the overall circuit input-output characteristics. Then the IC can be treated as a black box and the boxes tied together as in an analog-computer simulation.

Here are the basic techniques involved in setting up the black-box models and some examples of their application to linear and nonlinear circuits. The basic idea is applicable to several commonly available circuit analysis programs, but that to be used here is the widely circulated Electronic Circuit Analysis Program (ECAP).<sup>5</sup> Although previous experience with ECAP is not necessary in order to understand the basic method, Wall and Falk<sup>5</sup> and an ECAP manual (available from IBM) will be required reading before putting the method into use.

It is worth noting that this idea is not limited to IC's. Discrete circuits and servo systems could also be simulated in the same way. For additional ideas try any good text on analog computation.<sup>6</sup>

## The basic black-box is a simple amplifier

A very basic black-box building block is the simple amplifier circuit (Fig. 1a). This circuit has an input impedance,  $R_{in}$ , an output impedance,  $R_{out}$ , and a voltage gain equal to  $g_m R_{out}$ . The sign of the voltage gain is determined by the sign of the transconductance,  $g_m$ , or the direction in which the  $R_{out}$  branch is defined; positive gain is shown.

For many analyses, the circuit of Fig. 1b may be sufficient to simulate the significant properties, input and output impedances and voltage gain of a linear integrated circuit. However, two undesirable

features are apparent:

- The simulation of frequency characteristics is not provided
- Gain and output impedance are not independent.

Both these disadvantages can be eliminated by isolating the input and output circuits of the model through use of a frequency-compensated operational-amplifier equivalent circuit.

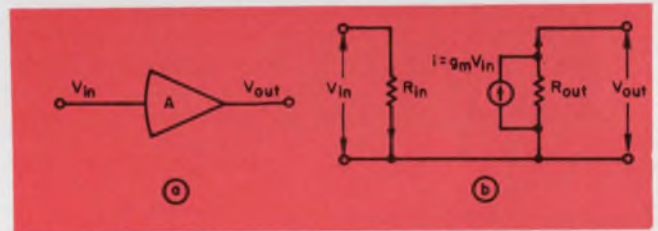

1. **Three parameters.**  $g_m$ ,  $R_{in}$  and  $R_{out}$ , define the simplest building block (b). This simple amplifier may be regarded as a basic computing amplifier without summing and feedback impedances. (a).

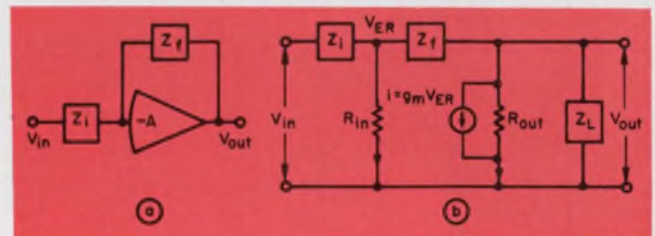

2. **Independence of gain and output impedance** are characteristic of an analog operational amplifier (a) when used with a computing network. The impedances of the network  $Z_i$  and  $Z_f$  complete the equivalent circuit of the operational amplifier (b).

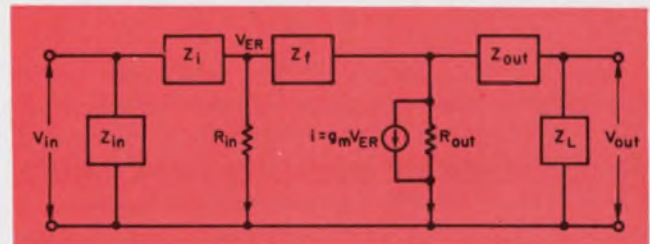

3. **The four basic amplifier parameters,**  $Z_i$ ,  $Z_f$ ,  $Z_{in}$  and  $Z_{out}$ , are independently simulated by adding both an input and an output impedance to the operational-amplifier equivalent circuit.

\*ECAP (Electronic Circuit Analysis Program) is available from International Business Machines Corp., Greenbelt Space Flight Center, Greenbelt, Md. (contact Roger Cliff).

Donald B. Herbert, Reliability Engineer, General Dynamics, Pomona Div., Pomona, Calif.

## Integrated-circuit simulation— the linear case

As an illustration of integrated-circuit simulation, consider a high-input-impedance differential amplifier (Fig. 4). The emitter-follower inputs are used to obtain higher input impedances and lower offset currents than would be possible with a Fairchild  $\mu A702A$  integrated amplifier alone. For optimum results the transistors should be matched; or even better, a dual differential transistor of another

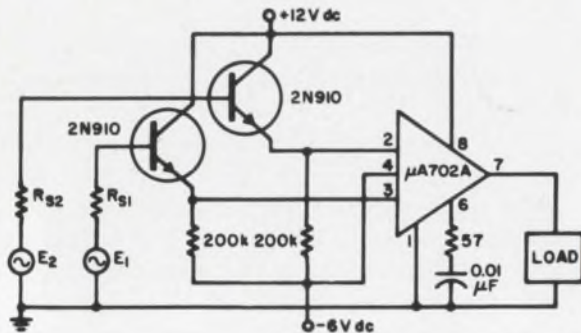

4. **No circuit measurements are needed** to obtain parameters for this high-input-impedance differential-amplifier circuit. A dc solution may be obtained by inspection and the transistor parameters may be found from the manufacturer's data sheets.

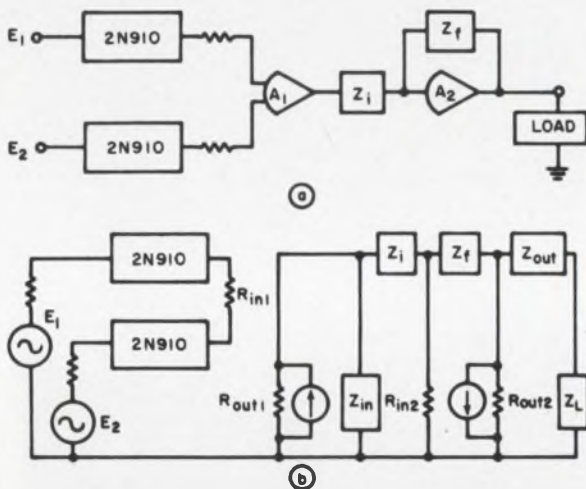

5. **The differential amplifier** is represented by a simple amplifier and an operational amplifier in cascade (a). The differential inputs to the  $\mu A702A$  result in a modified equivalent circuit (b).

An ideal operational-amplifier equivalent circuit should have infinite input impedance, infinite open-loop negative gain, infinite open-loop bandwidth, and zero output impedance. The simple amplifier circuit (Fig. 1b) will approximate these characteristics if  $R_{in}$  and  $g_m$  are made large and  $R_{out}$  approaches zero. This open-loop amplifier can be used to simulate a linear IC amplifier by converting it into a closed-loop amplifier with the addition of a feedback impedance,  $Z_f$ , and a summing imped-

type may be used.

The 200-kohm emitter-circuit resistors are used to reduce the output offset voltage, to bias the transistors and the  $\mu A702A$ , and to provide almost unity transistor gain.

The input circuit is relatively simple, and a nominal solution for the dc currents and voltages can be obtained by inspection. The 2N910 parameters used in the analysis were obtained from the manufacturer's data sheet for a quiescent collector current of 30  $\mu A$ . This current level allows nominal 4- $\mu A$  input currents to the  $\mu A702A$  and 26  $\mu A$  through the 200-k $\Omega$  resistors.

The black-box model (Fig. 5a) of the  $\mu A702A$  is developed by means of the circuit of Fig. 1b in cascade with the circuit of Fig. 2b. Since both inputs to the  $\mu A702A$  are being driven, it is necessary to simulate differential action by using amplifier  $A_1$  as a high-gain differential amplifier feeding amplifier  $A_2$ . This can be translated into the schematic of Fig. 5b and finally into the full equivalent circuit (Fig. 6). The two transistors are represented by the normal ECAP model.<sup>9</sup>

The nominal low-frequency differential gain of the  $\mu A702A$  and the model is given by:

$$A = 2600 R_{in} / (R_{in} + 2R_s), \quad (5)$$

where  $R_{in}$  is the input resistance measured with one input terminal grounded,  $R_s$  is the matched external source resistances, and 2600 is the magnitude of the gain (nominal value) when  $R_s$  is zero.  $R_s$  in this circuit configuration is equal to the output resistance of each transistor in parallel with the 200-k $\Omega$  resistors. The transconductance and resistance in branch 18 set the gain of the circuit:

$$g_m R_{B18} = 2600.$$

The operational amplifier stage of the equivalent circuit simulates the approximate low frequency response characteristics of the  $\mu A702A$ , that is:

$$Z_f/Z_i = 1 / \left[ 1 + s/25,100 \right] \left[ 1 + s/(28.2 \times 10^6) \right].$$

The time constants are derived from the manufacturer's published specifications. In accordance with the ECAP coding for the equivalent circuit, each branch and node is labeled (Fig. 7). The results of the computer ac analysis solution for node voltage and branch currents are presented in Fig. 8 for a frequency of 1 kHz. The computer used for this analysis was a CDC3400.

ance  $Z_i$  (Fig. 2b). Again this circuit has the same features as an analog computer amplifier with feedback and summing impedances (Fig 2a). The transfer function for the circuit is given by:

$$\frac{V_{out}}{V_{in}} = \left( -\frac{Z_f}{Z_i} \right) \left[ 1 + \frac{Z_f^2}{g_m Z_f - 1} \left( \frac{1}{R_{out}} + \frac{1}{Z_L} + \frac{1}{Z_f} \right) \left( \frac{1}{Z_i} + \frac{1}{R_{in}} + \frac{1}{Z_f} \right) \right] \quad (1)$$



## Integrated-circuit simulation—the nonlinear case.

Nonlinear circuits may be given a similar treatment. For example, take a nonlinear circuit with a Fairchild  $\mu A710$  as an integrated level detector (Fig. 9a). The  $\mu A710$  in this application serves as a voltage limiter. The resistor-capacitor network at the noninverting input (pin 2) serves two functions: ac coupling and voltage attenuation. Attenuation is required to prevent the input signal amplitude from exceeding the specified maximum input voltage of the device. The 10-k $\Omega$  resistor from the inverting input (pin 3) to ground minimizes the quiescent output-voltage offset. The output (pin 7) is ac-coupled to the 2-k $\Omega$  load.

An equivalent circuit is shown in Fig. 9b, which models the essential characteristics of the limiter. An operational amplifier model again serves as the basic building block for the simulation of the  $\mu A710$  black-box parameters. Parameters and branches are listed in Fig. 10.

In the operation of the model, the input voltage

to the  $\mu A710$  from  $B1$  is developed across the 10-k $\Omega$  resistor in  $B8$ , which is in parallel with the series combination of the  $\mu A710$  input resistance and the 10-k $\Omega$  resistor from the noninverting input and ground. The voltage developed across  $B8$  is sensed and multiplied by the transconductance in  $B5$  developed across the 1-ohm resistor (the small-gain degradation due to the resistance in branch 2 can be neglected). From this point, the bandwidth of the  $\mu A710$  is simulated by the summing impedance of the operational amplifier mode. In the range of output voltages,  $0.5 \leq V_6 \leq 2.8$ , the dc gain of the circuit,  $V_4$  to  $V_6$  is 1500. This represents the nominal gain of the  $\mu A710$  in the linear region as estimated from the manufacturer's voltage transfer characteristic.

In the region of output voltage,  $2.8 \leq V_6 \leq 3.1$ , the transconductance in  $B5$  is reduced to 225 by switch 3. Limiting is simulated by the switching circuits in branches 12 and 13. The quiescent output

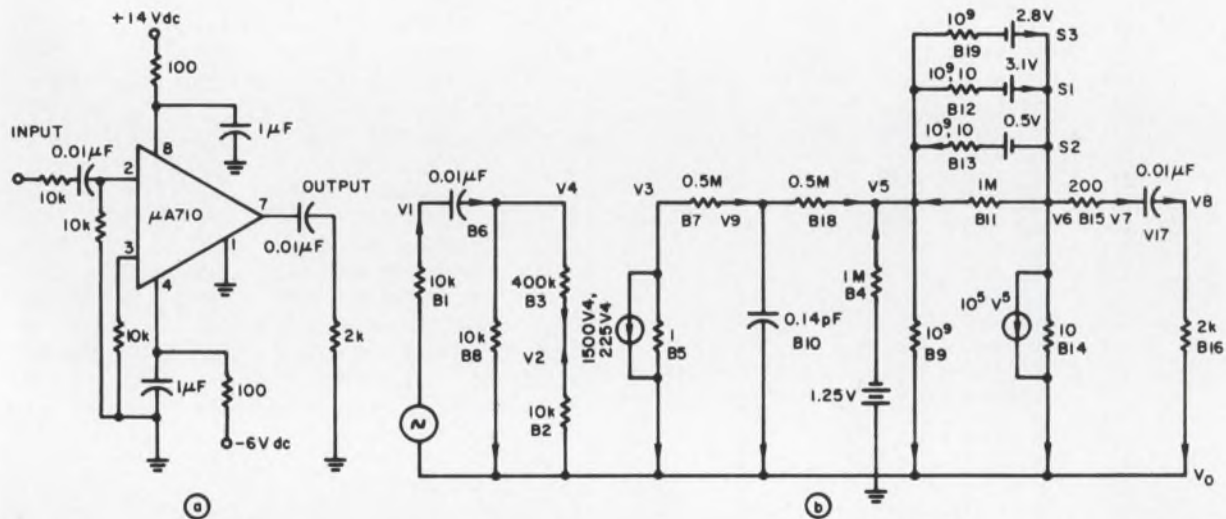

9. Nonlinear circuit simulation (a) uses the operational amplifier as its basic block (b). The limiting

action of the  $\mu A710$  level detector is simulated by the switching action of branches 12 and 13.

output impedance, gain and frequency response. This circuit makes use of the operational-amplifier model for the basic building block (Fig. 3). Impedance  $Z_i$  must be selected such that the input impedance  $Z_{in}$  is not appreciably loaded. The bandwidth and no-load gain of the operational amplifier are determined by the impedance ratio  $Z_f/Z_i$ . Therefore the approximate transfer function for the over-all model is given by:

$$V_{out}/V_{in} \approx (-Z_f/Z_i) \left[ Z_i / (Z_i + Z_{out}) \right] \quad (4)$$

### Linear and nonlinear simulation

Transfer function generation is the key to the black-box simulation of integrated circuits for im-

plementing bandwidth and/or time response characteristics. Many linear relationships can be formed simply by choosing the correct elements for  $Z_i$  and  $Z_f$ . Complicated linear voltage transfer functions can be constructed by the proper combination of resistor, capacitor and inductor elements.<sup>7</sup>

The elements used in the impedances  $Z_i$  and  $Z_f$  need not be linear. Switch-type techniques are available to model nonlinear integrated circuits with ECAP. Simple switching circuits in the input and/or feedback circuits of the operational-amplifier model can be used to simulate the characteristics of saturation, threshold, hysteresis, ON-OFF devices, limits, comparators, and many other nonlinear characteristics.<sup>8</sup> ■ ■



voltage is set by the 1.25-volt battery in B4.

As in the case of the ac analysis, the input to ECAP for transient analysis consists of specifying each branch and control statement based on the desired output and time step. ECAP assumes initial conditions of capacitor voltages and inductor currents to be zero unless otherwise specified.

Comparing plots of the computer solution and the breadboarded circuit response to an input level of 1 volt rms at 800 kHz shows the responses

of the model and the hardware to be quite similar; however, two notable differences exist:

- The hardware limited at a higher level than the model (the magnitude of the model saturation levels can be easily modified for any desired levels).

- The positive hardware limit was a "soft" limit as indicated by the overshoots in the response. Such a characteristic would be difficult, but not impossible, to simulate in the model.

```

TRANSIENT ANALYSIS
B1  N(0.1) , R = 1E4
B2  N(0.2) , R = 1E4
B3  N(4.2) , R = 40E4
B4  N(0.5) , R = 1E6, E = -1.25
B5  N(3.0) , R = 1
B6  N(1.4) , C = .01E-6
B7  N(3.9) , R = 0.5E6
B8  N(4.0) , R = 1E4
B9  N(5.0) , R = 1E9
B10 N(9.0) , C = .1400E-12
B11 N(6.5) , R = 1E6
B12 N(5.6) , R = (1E9, 10) , E = 3.1
B13 N(6.5) , R = (1E9, 10) , E = 0.5
B14 N(6.0) , R = 10
B15 N(6.7) , R = 200
B16 N(8.0) , R = 2E3
B17 N(7.8) , C = .01E-6, E0 = -1.25
B18 N(9.5) , R = 0.5E6
B19 N(5.6) , R = 1E9, E = 2.8
T1  B(8.5) , GM = (1500, 225)
T2  B(9.14) , GM = 1E5
S1  B = 12 (12), ON
S2  B = 13 (13), ON
S3  B = 19 (5.3), ON
E1  SIN(2.275E-6) , 1.414, 0, 0
TIME STEP = .0354E-6
OUTPUT INTERVAL = 2
FINISH TIME = 5E-6
PRINT, VOLTAGE, CURRENTS
PLOT (V1, V3, V4, V7, V8)
EXECUTE

```

10. Transient analysis initial conditions are assumed to be zero by ECAP unless specified. For example branch 17 (0.01- $\mu$ F capacitor) has an initial voltage of -1.25.

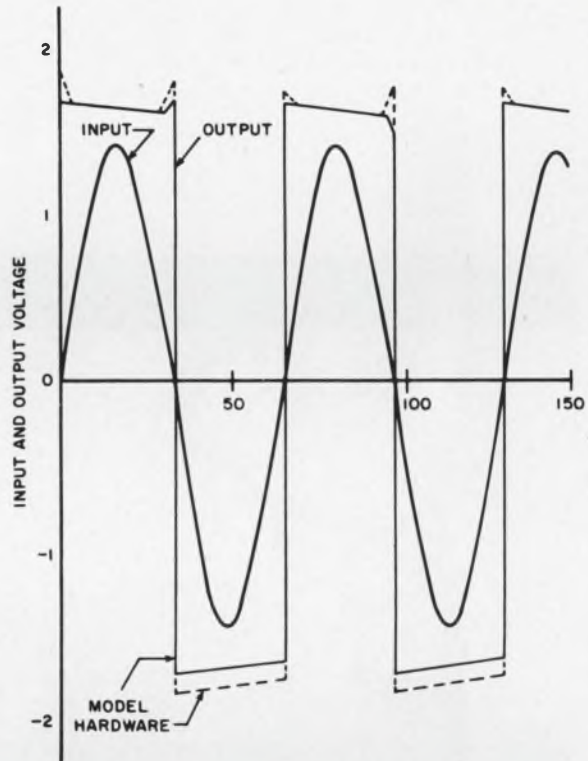

11. Hardware and model plots show close agreement except in the limiting levels for negative inputs and the soft characteristic of the hardware. The limits can easily be reset by the program but soft limiting would be difficult to reproduce.

**References:**

1. Stephen R. Sedore, "SCEPTRE Gives Designers New Power," *ELECTRONIC DESIGN*, XV, No. 6 (March 15, 1967), 230-234.
2. N.O. Sokal et al, "Use a good switching transistor for model," *ELECTRONIC DESIGN*, XV, No. 12 (June 7, 1967), 54-59.
3. —, "Assign the proper numerical values," *ibid.*, No. 13 (June 21, 1967), 60-66.
2. Herbert Wall and Howard Falk, "Circuit Analysis by Computer," *Electro-Technology*, LXXVIII, No. 5 (Nov. 1966), 50-56.
5. *Ibid.*
6. Albert S. Jackson, *Analog Computation* (New York: McGraw-Hill Book Co., 1965).
7. D.B. Herbert, "The Black Box Simulation of Microelectronic Devices Using Digital Computer Aided Circuit Analysis Techniques," General Dynamics Pomona Div. Engineering Research Report ERR-PO-310-3, Jan. 1967.
8. Jackson, *op. cit.*
9. Herbert, *op. cit.*

**Test your retention**

Here are questions based on the main points of this article. They are to help you see if you have overlooked any important ideas. You'll find the answers in the article.

1. What four characteristics are desirable for an operational-amplifier model? Why?
2. How can ECAP be used to simulate nonlinear circuits?
3. How are the initial conditions specified for ECAP transient analysis?

# Comar doesn't shy away from the tough one's



Anyone can handle the easy relay applications, but it takes a company with engineering knowhow, manufacturing superiority and just plain "guts" to take on the tough one's.

The engineers at Comar have an enviable record of rolling up their sleeves and burning the midnight oil to meet stringent relay specifications . . . shock, vibration, miss testing, humidity, special operating characteristics.

The next time someone tells you "it can't be done," call Comar. No miracles, just technical experience and the finest relay test laboratory in the world!



## Comar electric company

3349 Addison Street  
Chicago, Illinois 60618

TELEPHONE TYPE RELAYS • SUBMINIATURE RELAYS •  
RELAY ASSEMBLIES • SOLENOIDS • SOLENOID ASSEMBLIES



ON READER-SERVICE CARD CIRCLE 34

# Regulate voltages with varistors

Their symmetrical response to voltage changes suits them to dc and ac regulation.

Silicon carbide varistors excel as voltage regulators, whether applied to an ac or a dc source. These varistors (voltage-variable resistors)<sup>1</sup> change their resistance with voltage in a symmetrical but slightly nonlinear fashion. The symmetry enables them to be used with ac sources, and the nonlinearity is small enough to permit approximations that simplify design equations.

Two equations to be developed (they appear in box rules later) enable the designer to decide if he can use varistors at all; and if the answer is yes, to pick the optimum device from the manufacturer's specifications without a complex circuit analysis.

## What you should know of SiC varistors

Symmetrical, or nonrectifying, varistors are made of sintered silicon carbide (SiC). They are little affected by temperature and can handle appreciable power levels, as the following typical values illustrate. The temperature coefficient of their voltages at a constant current is approximately  $-0.1\%/^{\circ}\text{C}$ . The temperature coefficient of their currents at a constant voltage is  $+0.1\%/^{\circ}\text{C}$  to  $+0.6\%/^{\circ}\text{C}$ , depending on the slope of the  $I$ - $V$  curve. To some extent, both temperature coefficients depend on the material and the processing of the varistor, as well as its operating condition.

Power ratings depend on the mounting and heat dissipation of a specific unit. A continuous rating of  $0.25\text{ W/in.}^2$  of varistor surface is adequate for individual units mounted vertically in still air at  $25^{\circ}\text{C}$ . This rating may be increased by cooling, such as forced air, oil immersion, or the use of radiating fins.

The effect of humidity on SiC varistors may be minimized by silicone impregnating fluids. The effectiveness of the impregnant and long-term stability requirements limit these varistors' operating temperature to  $110^{\circ}\text{C}$  for continuous use and  $150^{\circ}\text{C}$  for intermittent use.

## Varistor characteristics are nearly linear

The voltage-current characteristics of typical varistors are plotted in Fig. 1 on log-log paper. The

curves are nearly linear over a relatively wide range. The voltage-current characteristic may be expressed mathematically as:

$$\log I_v = n \log E_v + K, \quad (1)$$

where  $n$  is the slope of the linear portion of the curve. The voltage-current characteristic of a SiC varistor may therefore be represented, over a relatively wide range, by the equation:

$$I_v = K E_v^n, \quad (2)$$

where  $I_v$  and  $E_v$  are the instantaneous varistor current and voltage, respectively,  $K$  is a constant (amperes at 1 volt), and  $n$  is an exponent with values between 1 and about 6. Both  $K$  and  $n$  depend on the material, geometry and processing of the varistor. A graphite additive can raise the value of  $K$  and lower that of  $n$ , the degree of nonlinearity. Increasing the sintering temperature has a comparable effect.

Another frequently used form of the voltage-current characteristic is:

$$E_v = C I_v^{1-a}, \quad (3)$$

where  $C = (1/K)^{1/n}$  and  $a = 1 - (1/n)$ . This form is simply a rephrasing of Eq. 2, with the varistor's voltage,  $E_v$ , as the independent variable.

## Graphical solution for the operating point

The commonest shunt regulator circuit in which a SiC varistor is used is shown in Fig. 2. It is identical in form to the classic Zener diode shunt regulator.<sup>2</sup> Since the Zener diode is not symmetrical, however, it may be used only for dc regulation; the SiC varistor, on the other hand, may be used with either ac or dc source voltages.

The Thévenin equivalent circuit of the regulator is shown in Fig. 2b. The relationship between the varistor's voltage,  $E_v$ , and its current,  $I_v$ , is:

$$E_s R_L / (R_s + R_L) = E_v + [I_v R_s R_L / (R_s + R_L)]. \quad (4)$$

where  $E_s$  is the source voltage,  $R_s$  is the source resistance and  $R_L$  is the load resistance.

Equation 4 expresses a linear relationship between  $E_v$  and  $I_v$ , and so may be plotted as a straight line on linear, rectangular coordinates. This line, commonly referred to as a "load line," intercepts the varistor voltage ordinate at the point  $E_v = E_s R_L / (R_s + R_L)$  and has a slope equal to  $-R_s R_L / (R_s + R_L)$ , as shown by the line in color in Fig. 3.

The operating point of the varistor can be found

**Meyer Sapoff**, Vice President, Victory Engineering Corp., Springfield, N. J.

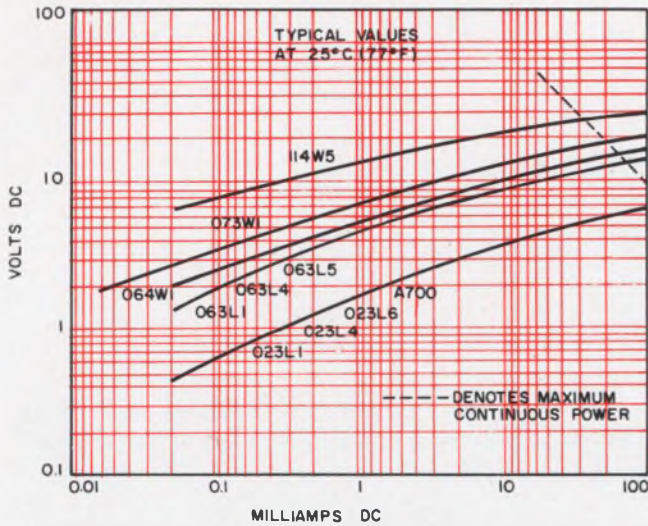

1. Voltage-current characteristics of varistors appear to be nearly linear over a fairly wide range, when plotted on a log-log scale. Their resistance changes symmetrically with voltage, so they can be used to regulate ac sources.

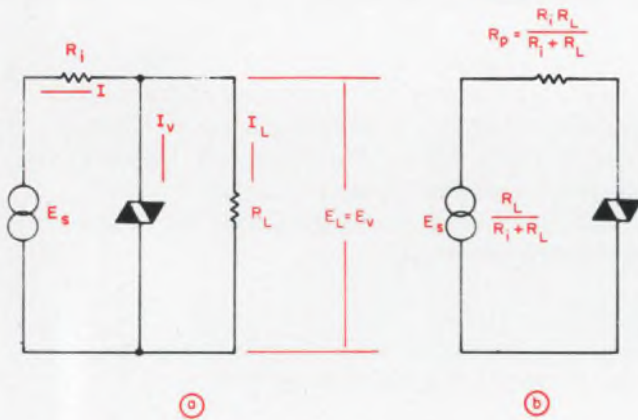

2. Typical shunt regulator circuit with a varistor is identical in form (a) with the classic Zener-diode regulator, but the SiC varistor can be used with ac or dc sources. The Thévenin equivalent circuit (b) helps in the analysis.

Table: Error vs ratio of  $R_s/R_p$

$R_s/R_p$	$\Delta E_L/E_L$	% error
0.1	0.0265	1.6
0.2	0.0276	7.3
0.3	0.0289	11.5
0.4	0.0306	16.3
0.5	0.0320	20.0
0.6	0.0333	23.2
0.7	0.0346	25.9
0.8	0.0358	28.4
0.9	0.0369	30.7
1.0	0.0380	32.6

with the aid of Fig. 3 and the curves in Fig. 1, which depict the inherent behavior of the device. Simply superimpose the voltage-current characteristic curve on the load line; their intersection yields the operating point. Figure 3 also shows the shift of the load line that results when the source voltage changes (dashed line), as derived below.

Limits of voltage regulation

In a specific system, the first point to be clarified is the amount of regulation possible with a given varistor.

The varistor's static resistance,  $R_s$ , is defined as the steady-state value at the operating point, and the varistor's dynamic resistance,  $R_D$ , as the rate of change of the varistor voltage with respect to the varistor current. With the aid of Fig. 3 and Eq. 2 these parameters can be expressed in terms of the circuit variables:

$$R_s = E_v/I_v = E_c/KE_v^{n-1} = 1/KE_v^{n-1}, \quad (5)$$

$$R_D = \Delta E_v / \Delta I_v = a/c, \quad (6)$$

where  $a = \Delta E_v$  and  $c = \Delta I_v$ , as shown in Fig. 3. Other useful relationships that can be obtained from Fig. 3 include the value of the Thévenin equivalent resistance of  $R_L$  and  $R_i$ , and its relation to the dynamic resistance of the varistor:

$$R_{Th} = R_p = b/c = R_i R_L / (R_i + R_L), \quad (7)$$

where  $b = [R_L \Delta E_s / (R_i + R_L)] - \Delta E_v$ , and  $c = \Delta I_v$  (from Fig. 3) and:

$$R_D/R_p = a/b = \Delta E_v / \left\{ [R_L \Delta E_s / (R_i + R_L)] - \Delta E_v \right\}. \quad (8)$$

Rearrangement of the terms in Eq. 8 yields:

$$\Delta E_v = [R_D/R_p] [R_L \Delta E_s / (R_i + R_L)] / [1 + (R_D/R_p)]. \quad (9)$$

To determine the effect of variations in the source voltage, consider an incremental change,  $\Delta E_s$ , in  $E_s$ . This change results in a vertical translation of the load line by an amount,  $\Delta E_s R_L / (R_i + R_L)$  (see Fig. 3). The displacement of the load line modifies Eq. 4 to:

$$\left[ \frac{R_L}{R_i + R_L} \right] [E_s + \Delta E_s] = E_c + \Delta E_c + [R_p (I_c + \Delta I_c)]. \quad (10)$$

Subtract Eq. 4 from Eq. 10:

$$\Delta E_s R_L / (R_i + R_L) = \Delta E_c + R_p \Delta I_c. \quad (11)$$

If it is assumed that an incremental change in varistor current,  $\Delta I_v$ , results from the incremental change in source voltage,  $\Delta E_s$ , then  $\Delta I_c$  can be eliminated from Eq. 11 with the aid of Eq. 2:

$$I_v + \Delta I_v = K(E_v + \Delta E_v)^n = K E_v^n (1 + \Delta E_v/E_v)^n. \quad (12)$$

Subtract  $I_v = K E_v^n$  from both sides of Eq. 12:

$$\Delta I_v = K E_v^n \left[ (1 + \Delta E_v/E_v)^n - 1 \right]. \quad (13)$$

The circuit of Fig. 2a shows that:

$$E_L = E_v. \quad (14)$$

Equations 13 and 14 are substituted into Eq. 11 to relate the incremental change in load voltage that results from a specified incremental change in source voltage:

$$\Delta E_s R_L / (R_i + R_L) = \Delta E_L + R_p K E_L^n \left[ (1 + \Delta E_L/E_L)^n - 1 \right]. \quad (15)$$

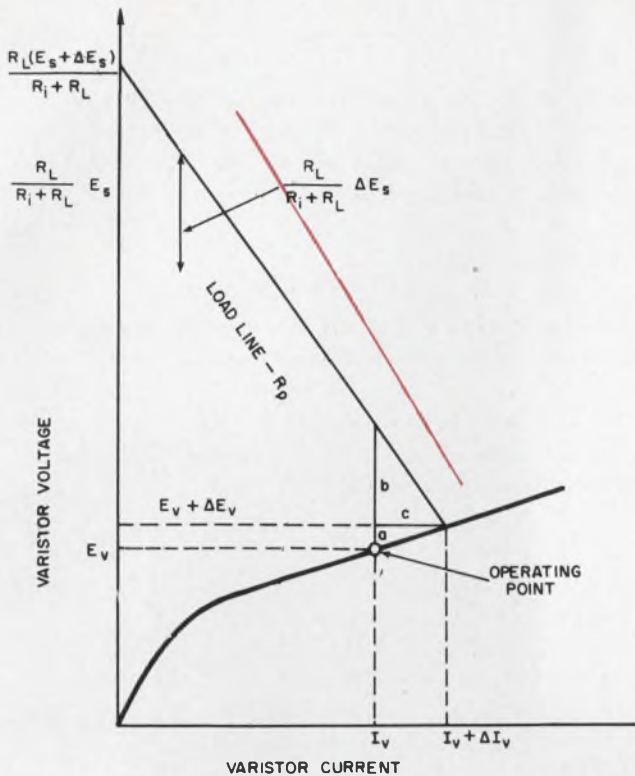

3. **Operating curve of a varistor** (heavy black line) intersects the load line of the shunt regulator circuit at the operating point. A change in the source voltage shifts the load line into a new position (line in color).

The coefficient of  $\Delta E_s$  can be expressed in terms of the load and source voltages by substituting Eqs. 2 and 14 into Eq. 4:

$$R_L / (R_i + R_L) = (E_L + R_p K E_L^n) / E_s \quad (16)$$

Substitute Eq. 16 into Eq. 15:

$$\frac{\Delta E_s}{E_s} = \frac{(\Delta E_L / E_L) + R_p K E_L^{n-1} [(1 + \Delta E_L / E_L)^n - 1]}{1 + R_p K E_L^{n-1}} \quad (17)$$

which with the substitution of Eq. 5 may be reduced to:

$$\frac{\Delta E_s}{E_s} = \frac{\Delta E_L / E_L + (R_p / R_s) [(1 + \Delta E_L / E_L)^n - 1]}{1 + R_p / R_s} \quad (18)$$

### Source voltage variation with load voltage

Although Eq. 18 provides an accurate means for determining the maximum allowable percentage change in source voltage for a specified maximum change in load voltage, it is cumbersome and difficult to evaluate.

Take a look at Eq. 9. It is clear that optimum regulation is obtained when  $R_p \rightarrow \infty$ . So if it is assumed that  $R_p \gg R_s$  and 1 is added to both sides of Eq. 18, the outcome is the simplified form:

$$1 + \Delta E_s / E_s \approx (1 + \Delta E_L / E_L)^n \quad (19)$$

For most practical applications:

$$\Delta E_L / E_L \ll 1 \quad (20)$$

Equation 19 may thus be expanded as an infinite

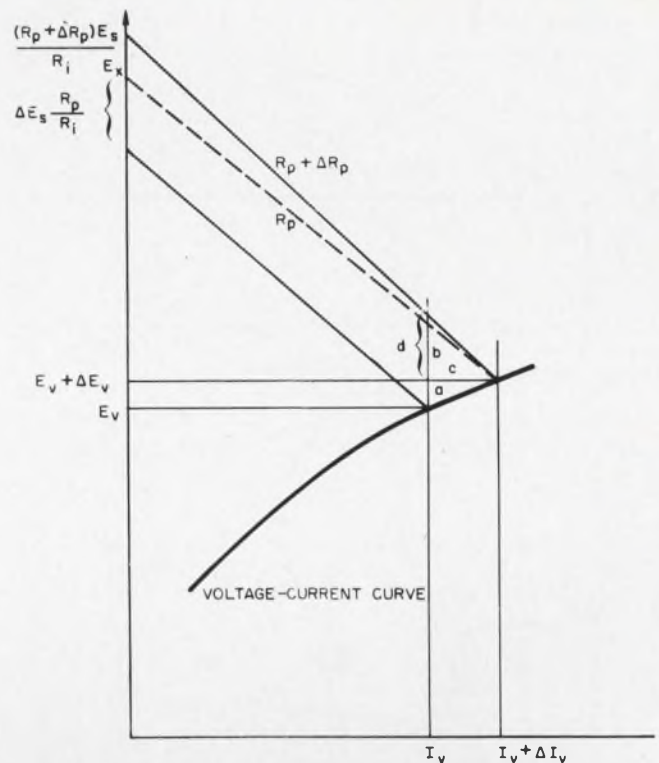

4. **Variations in load current displace and rotate the load line.** The vertical displacement is given by a + B (just as in Fig. 3). The variations in load current also rotate the load line resulting in a final varistor voltage of E<sub>s</sub>.

series and, by neglecting higher-order terms in  $\Delta E_L / E_L$ , can be reduced to:

$$1 + \Delta E_s / E_s \approx 1 + n \Delta E_L / E_L \quad (21)$$

or:

$$\boxed{(\Delta E_s / E_s) / (\Delta E_L / E_L) \approx n} \quad (22)$$

Equation 22 is a figure of merit for the regulator circuit. It also affords an approximate solution for the percentage change in output voltage resulting from a specified variation in source voltage, and ties all these to the critical parameter of the varistor. So once the designer knows the needed regulation, he can check immediately whether the varistor can do the job. The approximation of Eq. 22 is valid until  $R_s$  approaches  $R_p$ . It can also always be used as an upper limit for regulation.

A more exact solution can be obtained by multiplying both sides of Eq. 9 by  $E_s / E_v$  and rearranging terms:

$$(\Delta E_L / E_L) / (\Delta E_s / E_s) = R_p E_s / R_i E_L (1 + R_p / R_s) \quad (22a)$$

### Check load current variations

Changes in the load current affect the load voltage. To determine the extent of variation, assume an incremental change,  $\Delta R_L$ , in the load resistance,  $R_L$ . The first change occurs in the load line: it is rotated around the operating point by an amount  $\Delta R_p$ , which may be expressed in terms of the circuit components:

$$\Delta R_p = \frac{R_i (R_L + \Delta R_L)}{R_i + R_L + \Delta R_L} - \frac{R_i R_L}{R_i + R_L} \quad (23)$$

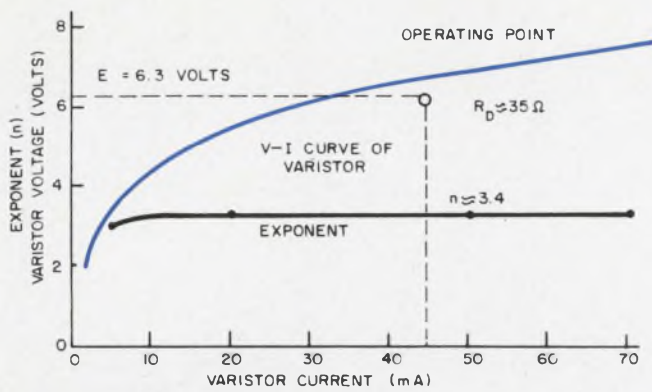

5. Plots of the exponent,  $n$ , and the V-I curve for the selected varistor help determine shunt regulator circuit components and effects of source and load changes.

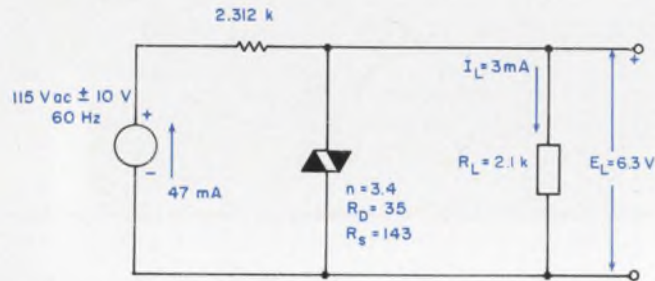

6. Designed shunt regulator uses a varistor with an exponent of 3.4 ( $n=3.4$ ) for active regulation within 3%. The varistor currents will be 44 mA and the open circuit voltage 54.7 V.

The second change occurs in the open-circuit (or Thévenin equivalent) voltage:

$$\Delta E_{Th} = \Delta R_p E_s / R_i$$

$$= \left[ \frac{R_L + \Delta R_L}{R_i + R_L + \Delta R_L} - \frac{R_L}{R_i + R_L} \right] E_s \quad (24)$$

Equation 24 may be simplified to:

$$\Delta E_{Th} \approx R_i \Delta R_L E_s / (R_i + R_L)^2 \quad (25)$$

while Eq. 23 may be simplified to:

$$\Delta R_p \approx R_i^2 \Delta R_L / (R_i + R_L)^2$$

$$= (\Delta R_L / R_L) (R_p^2 / R_L) \quad (26)$$

It is imperative that the designer knows the percentage of regulation that is required for a given change in the load. With the aid of the regulator circuit in Fig. 2 and the graph of the effects of load current variations in Fig. 4, this relationship can be derived straightforwardly. From Fig. 4:

$$R_p + \Delta R_p = d/c$$

$$R_d = a/c$$

$$R_s = b/c$$

where  $a = \Delta E_s$

$$b = \left[ R_L \Delta E_s / (R_i + R_L) \right] - \Delta E_c$$

$$c = \Delta I_L$$

The percentage change of  $R_p$  (the equivalent Thévenin resistance in Fig. 2b) can be expressed in terms of the varistor voltage,  $E_c$ :

$$\frac{R_p + \Delta R_p}{R_p} = \frac{[(R_p + \Delta R_p)/R_i] / E_c - (E_c + \Delta E_c)}{E_c - (E_c + \Delta E_c)} \quad (27)$$

where  $E_c$  is the Thévenin voltage resulting from a change in the source,  $\Delta E_s$ , and is equal to  $R_p(E_s + \Delta E_s)/R_i$ . The change in the varistor voltage is related to the change in source voltage by Eq. 9:

$$R_p \Delta E_s / R_i = \Delta E_c (1 + R_p / R_D) \quad (28)$$

Therefore  $E_c$  becomes:

$$E_c = (R_p / R_i) E_s + (1 + R_p / R_D) \Delta E_c \quad (29)$$

The substitution of Eq. 29 into Eq. 27, cross-multiplication and simplifications yield:

$$\Delta E_c (R_p + \Delta R_p) (1 + R_p / R_D) = \Delta R_p (E_c + \Delta E_c) \quad (30)$$

On the basis of practical experience, the following assumptions may be made

$$R_p \gg \Delta R_p$$

$$R_p \gg R_D$$

$$E_c \gg \Delta E_c$$

(31)

Then:

$$(R_p + \Delta R_p) / R_p \approx 1$$

$$1 + R_p / R_D \approx R_p / R_D$$

$$\Delta E_c / (E_c + \Delta E_c) \approx \Delta E_c / E_c \quad (32)$$

These approximations modify Eq. 30 to:

$$(\Delta R_p / R_p) / (\Delta E_c / E_c) = (\Delta R_p / R_p) / (\Delta E_L / E_L)$$

$$\approx R_p / R_D \quad (33)$$

By substituting for  $\Delta R_p / R_p$  from Eq. 26, the final form of Eq. 33 becomes:

$$\boxed{(\Delta R_L / R_L) / (\Delta E_L / E_L) = R_L / R_D} \quad (34)$$

or:

$$\Delta E_L / E_L = (\Delta R_L / R_L) (R_D / R_L) \quad (35)$$

These last two equations relate the changes in the load to a varistor parameter that may be obtained from manufacturers' curves.

### The proof is in the circuit

To see how these equations work, consider a case history. The situation involves regulating a resistive load of 3mA at 6.3 volts, 60 Hz, to within  $\pm 3\%$ . First, it has to be determined whether a silicon carbide varistor can be used; then if so, a specific varistor has to be recommended.

Assume that the line voltage varies between 105 and 125 volts ac. Hence,  $E_s = 115 \pm 10$  V ac and  $\Delta E / E_s = \pm 8.7\%$ . The exponents for the curves in Fig. 1 vary between 3 and 5 in the range defined by the load values. The variations in the source voltage and the needed regulation define the exponent (Eq. 22) as:  $n \geq 8.7/3 = 2.9$ . Hence the use of a varistor appears to be feasible.

Since the characteristic curve of the 023L series in Fig. 1 is in the correct voltage range, it has been replotted on linear, rectangular coordinates in Fig. 5. For the purposes of analysis, the exponent has also been plotted. The required circuit with the calculated values is shown in Fig. 6.

The intersection of the  $V-I$  curve and the specified load voltage yields the operating point in Fig. 5. The projection of this point to the horizontal axis yields a varistor current of 44 mA. Current  $I$  therefore is  $(44+3)$ , or 47, mA.

The resistances in the circuit can be easily found:  
 $R_i = (E_s - E_v)/I = (115 - 6.3)/47 \times 10^{-3} = 2.313 \text{ k}\Omega$ ,  
 $R_L = E_L/I_L = 6.3/3 \times 10^{-3} = 2.1 \text{ k}\Omega$  (since  $E_L = E_v$ ),  
 $R_s = E_v/I_c = 6.3/44 \times 10^{-3} = 143 \Omega$ .

The equivalent Thévenin resistance,  $R_p$ , is:  
 $R_p = R_i R_L / (R_i + R_L) = 2.1 \times 2.313 / 4.412 = 1.1 \text{ k}\Omega$ .

The open-circuit voltage for the varistor is:  
 $E_{Th} = (R_L / (R_i + R_L)) E_s = (115)(2100)/(4412) = 54.7 \text{ V}$ .

The values of the exponent and of  $R_D$  can be read off from Fig. 5 at the operating point:  $n \approx 3.4$  and  $R_D \approx 40 \text{ ohms}$ .

### Check the error due to the approximations

The error introduced by the approximations that lead to Eq. 22 can be checked with ease. The exact solution may be obtained by taking Eq. 9, multiplying both sides by  $E_v/E_L$  and plugging in the values:

$$\Delta E_L/E_L = 0.0265.$$

The approximate solution from Eq. 22 yields:

$$\Delta E_L/E_L = (10/115)/3.4 = 0.0256.$$

Equation 22 is therefore accurate to within 3.4% for this specific case ( $R_i/R_p \leq 0.13$ ).

It is interesting to examine the error as the ratio,  $R_i/R_p$ , varies. This is shown in the table. The tabulated values show that the approximation leading to Eq. 22 is valid until  $R_p$  approaches  $R_i$ .

The regulation for changes in  $R_L$  is good, too, since  $R_D/R_L$  is  $40/2100 = 0.019$ . ■ ■

### References:

1. "Varistor Definitions and Test Methods" in *Standards Proposal No. 912* (New York: Electronic Industries Association, Feb. 28, 1966).
2. *Zener Diode Handbook* (El Segundo, Calif.: International Rectifier Corp., 1960), Chap. 2, "Silicon Zener Diode Regulators," p. 23.

### Test your retention

Here are questions based on the main points of this article. They are to help you see if you have overlooked any important ideas. You'll find the answers in the article.

1. What is the basic difference between varistors and Zener diodes?
2. How can you find the operating point quickly?
3. What is the significance of the figure of merit?
4. How does the change in load current affect the load line?

# now in production

## HIGH RF VOLTAGE PISTON TRIMMER CAPACITORS

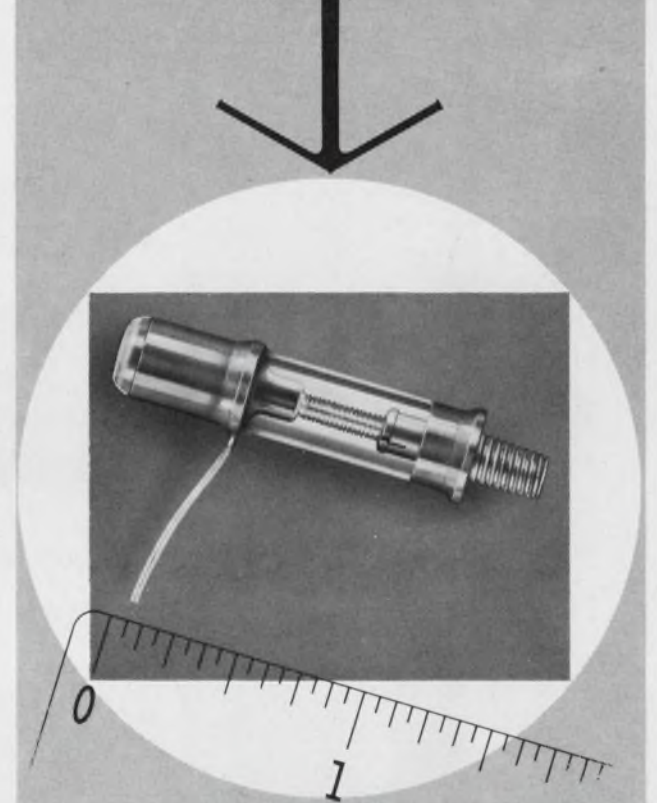

A new High RF Voltage Piston Trimmer Capacitor featuring high stability and small size is now available from JFD. The VCJ1616D is applicable in communications equipment and wherever a small trimmer capacitor is needed to handle large voltage peaks and high power at elevated temperatures. It operates over a frequency range of from 1 to 30 MHz.

This trimmer has an especially designed fused-quartz cylinder which yields an extremely low dissipation factor and temperature coefficient.

The operating RF voltage level of this unit is 3100 Volts peak at +25°C derated to 2500 Volts peak at +200°C. Its capacitance is variable from 0.5 to 5 pf, and its operating temperature range is from -55°C to +200°C. Its turning torque is 1-10 inch ounces in accordance with the Mil Spec.

The unit is furnished for panel mounting. It is 1 3/8" long and 3/16" in diameter.

Bulletin Hi RFV-67 will give you additional information. Write for your copy today.

**JFD** "TODAY'S COMPONENTS BUILT FOR TOMORROW'S CHALLENGES"

JFD ELECTRONICS CO. / COMPONENTS DIVISION 15th Avenue at 62nd Street  
 Brooklyn, New York 11219 / Phone 212-331-1000  
 Offices and subsidiaries in principal cities, world-wide.  
**ON READER-SERVICE CARD CIRCLE 35**

# What Kind of Panel Meter Do You Need ?



## crisp, classic Horizon Line?



## trim, built-in Horizon Line?

Built-in or front-mounted, General Electric HORIZON LINE® panel meters add quiet sophistication that accents, never dominates your electronic equipment. Check these distinctive HORIZON LINE features: smart, low-profile; clean, soft line; fine-precision markings. All ratings are available in 2½", 3½", and 4½".

## distinctive Big Look?



Add bold, exciting, truly distinctive styling to your electronic equipment with General Electric BIG LOOK® panel meters. Panelboards take on added flair with such BIG LOOK features as . . . big, bold numerals, uncluttered display, tapered pointer, stylish shape, plus many others. All ratings are available in 1½", 2½", 3½", 4½".



Besides saving you valuable panel space, General Electric slim-line Type 185 EDGEWISE panel meters add exceptional styling and readability to your electronic equipment. These 2¼" Type 185 EDGEWISE panel meters can be mounted individually or in space-saving clusters of two, three, or more. All ratings are available for vertical or horizontal mounting, with or without bezels.

## smart, slim edgewise?

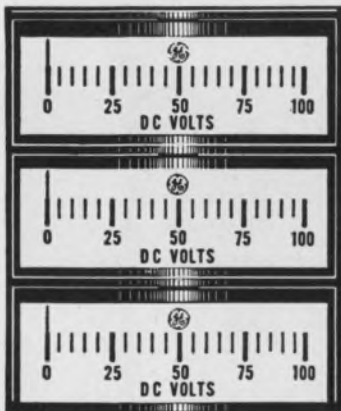

## style-matched time meters?



Distinctive BIG LOOK styling is yours with General Electric BIG LOOK elapsed time meters. These "look-alike" time meters combine to give your equipment uniformity and beauty. G-E elapsed time meters measure either hours or minutes with or without a reset knob. All ratings are available in 2½" and 3½".

## bright, bold meter relay?



Add years ahead BIG LOOK styling to your equipment with General Electric Type 195 contactless meter relays, featuring a totally new, solid-state, light-sensitive switch for the ultimate in control simplicity and readability. "Piggyback" control modules make for faster, easier installation. Companion pyrometers are also offered. All ratings are available in three sizes (2½", 3½", 4½") with single or double setpoints.

## You can get it...from General Electric's full line

And, of course, General Electric's full line of panel meters is unmatched for accuracy and reliability. They're as near as your dependable G-E electronic distributor or sales office. You get fast delivery, too. For free descriptive bulletins describing G.E.'s full line of panel meters, write General Electric Co., Section 592-25A, Schenectady, New York 12305.

**GENERAL ELECTRIC**

ON READER-SERVICE CARD CIRCLE 36

# Good budgeting can boost profits

Learn the fiscal fundamentals and you'll know how management plans profits by controlling costs.

*Part 2 of a three-part series*

Budgets are two-faced!

But, unlike the colloquial two-faced person, each face of the budget complements the other.

One face is a *control*. A budget provides the mechanism for predicting income and costs, and then comparing them against ensuing actual company performance to achieve control over that performance.

The other face is a *profit plan*. Laying down a projection of income goals and cost restraints is an act of management that is clearly also a plan for the company's future.

Put the two faces together and a budget is seen to be a realistic statement of objectives, a plan, against which actual performance is matched so that control can be achieved.

Experience shows that budgeting is the single most effective way to control costs and so make profits.

## What type is best?

There are two types of budgets, *fixed* and *flexible*.

When sales are relatively stable month by month, it is often entirely practical to project a budget month by month. Then in the course of that fiscal year, actual sales and expenses are simply compared with the budget. The comparisons made are:

Budgeted sales	vs	Actual sales
	and	

Budgeted expenses	vs	Actual expenses
at budgeted sales		at actual sales

This is called fixed budgeting and has these advantages:

- It is simple and relatively easy to understand.
- It involves a minimum amount of effort and expense, because there is no need to analyze costs to determine their variable element for such interim periods as a month.
- It is easier to apply because budgeted allowances are calculated once a year and are not ad-

justed to actual month-by-month activity.

In reality, however, actual sales almost never equal budgeted sales, so you should want to compare actual costs with budgeted costs.

Fixed budgeting does not allow for this comparison because it does not show the budgeted expense of the actual activity. As a result there is no standard against which to compare actual expenses, and thus no controls.

A more meaningful control is the flexible operating budget, under which variable expenses are identified, and budgeted allowances can be revised to a more realistic allowance based on actual activity.

Under flexible operating budgets, the sales comparison is still the same as under fixed budgets:

Budgeted sales	vs	Actual sales
----------------	----	--------------

The comparison for expenses, however, is now:

Budgeted expenses	vs	Actual expenses
at actual sales		at actual sales

Now what was actually spent can be compared with what you believe should have been spent at the given actual volume. And with these data, operating costs can be controlled.

Budgets should be both a control and a plan. Only flexible budgets meet both these requirements. Fixed budgets fall short in the control category.

## Start with the basics

If budgets are to be effective, three basics, which comprise the foundation of a budget, must first be established:

1. *Cost centers*—sometimes called work and/or profit centers—must be established to reflect how the operation is actually set up, so that responsibility for budget performance can be pinpointed. In an electronics firm, cost centers might be manufacturing, sales, research and development, adminis-

---

**Lawrence M. Matthews**, Vice President, Stevenson, Jordan and Harrison Management Consultants, Inc., New York.

---

Robert Benjamin (center), director of engineering, Atlantic Research Missile Systems Division, Costa Mesa, Calif., discusses the division's proposed budget with his engineering managers.

AVIANTIC RESEARCH  
MISSILE SYSTEMS DIVISION  
21 SEP 67

## MISSILE SYSTEMS DIVISION PROPOSAL BUDGET

ANALYSIS

TOTAL BUDGET	275,832
COMMITTED	193,839
UNCOMMITTED BAL	81,993
ACTUAL EXPENDED	176,822
BUDGET BALANCE	99,010

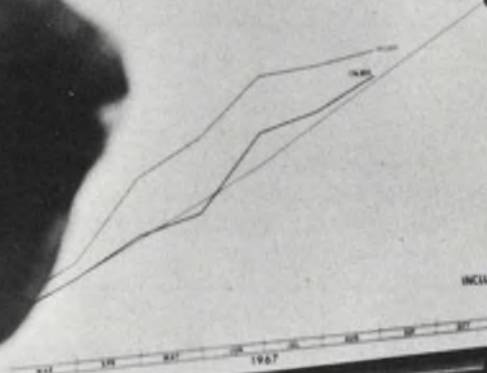

**“A budget is the single most effective way to control costs, and thus attain or increase profits.”**

## Glossary of terms

*Activity measure*—This is the specific yardstick that is felt accurately reflects or measures the level of activity of a cost center. It is against this activity measure that costs in the center will be matched, to predict how these same costs may act in the future months.

*Actual expense*—The dollars actually spent by the cost center in a budget period for a given cost item.

*Budget allowance*—The dollars allowed by the budget for a budget period for a given cost item in a specific cost center.

*Budget period*—The segment of a full year for which budget and actual expenses are compared and variances developed, usually monthly.

*Budget year*—The twelve months of the fiscal year, which may or may not coincide with the calendar year.

*Chart of accounts*—A list by name and code number of cost, asset, liability and capital money items, needed to apply standard accounting practice to the financial and operating affairs of an enterprise and to produce meaningful statements in both

financial and operating departments.

*Cost and variance statement*—The enumeration for a budget period of all the budget allowances, actual expenses, and variances for a given cost center.

*Cost center*—A segment of the enterprise under the direction of a specified member of management who is responsible for the effective operation of that segment. A typical example of a cost center in a capacitor plant would be electrolytic capacitor winding, which is under a specific foreman. When a given cost center is very large or involves great amounts of money, sub-divisions of the center, called subcenters, may be used.

*Variance*—The difference between the budget allowance and the actual expense for a given cost item in a specific cost center for a particular budget period. Where actual expenses are less than the budget allowance, the variance is called "favorable" and is most commonly printed in black. Where actual expenses exceed the budget allowance, the variance is called "unfavorable" and is most commonly printed in red or within brackets.

tration, etc. It is often advisable to subdivide these centers. In manufacturing, for example, such subdivisions might be individual production departments, shipping, stock room, etc.

2. A *chart of accounts* must be drawn. It should be complete and well-defined and fit the needs of both accounting and operating departments. Budgets are operating controls and must reflect actual operating conditions, not artificial accounting classifications. The accounting classifications (chart of accounts) must therefore reflect the operating requirements of the plant and its cost centers.

3. *Cost charging (or distribution) procedures* that are well-understood and disciplined must be used in day-to-day operations, so that all operating costs (labor, supplies, etc.) are properly identified and charged to the cost center or centers that use them.

### Develop your budget

A flexible operating budget passes through three phases:

*Predictive*—a forecast of future performance (that is, the actual preparation of the budget).

*Comparison*—actual performance related to the budget's predicted performance.

*Followup*—constructive action on the findings of the comparison between predicted and actual, rewarding good performances and correcting bad.

With the basics established, the actual budget can be prepared:

1. Begin with a sales projection—an estimate of income for the budget year. Sales forecasting usually is the function of the sales or marketing department, which should provide this information.

2. Break down the sales forecast into product lines and quantities of units; then into activity measures for each cost center involved in making the products. If this type of detailed breakdown is impossible, then the budgeting department must translate the dollars of forecasted sales into some form of activity measures for individual cost centers. Such measures could be direct labor hours, engineer's salaries, materials used, machine hours, units produced, etc. It is important that the activity measure chosen charts and reflects changes in production activity and production costs during the budget year.

3. Determine the following for each cost center:

- What specific items of cost must be budgeted for the cost center?

- How much has been spent in the past for these items of cost?

- How are these costs identified? Are they fixed, variable or mixed? (See "Profit by learning cost analysis", ED 23, Nov. 8, 1967, pp. 96-101).

- How much should be allowed or budgeted for

## R&D budgeting is a greater challenge

Developing a budget for research and development is a greater challenge than other budgeting. It is less susceptible to close prediction: it is difficult to measure progress in clear-cut and objective terms. As a result, it can be difficult to measure performance at specific intervals within the budget year.

R&D budgeting must include the following steps:

1. Top management must determine what percentage of forecast income will be allocated to R&D.

2. Once the R&D allocation is roughed out, the available funds must be spread among the research functions or projects. How the monies will specifically be budgeted depends on how the R&D effort is organized—that is, by functions, by projects or by a combination of the two. This step of dividing the total R&D allocation requires the efforts of three management areas:

- Research—to propose specific areas of promise worthy of effort and expenditure of company funds.

- Marketing—to propose specific product developments needed to maintain and increase the company's share of the market.

- Top management—to weigh alternatives and reconcile differences.

This step implies the existence of company policies and long-range plans that will provide the basis for decisions on the potential of each R&D program. Without such long-range plans, decisions can only be made in the light of current conditions. Such decisions are more prone to change than those based on long-term plans. This in turn increases the danger and frequency of misallocations of R&D funds.

Long range plans become particularly important when a total program, or programs, require more funds than are allocated. Then it will be necessary to evaluate and compare programs and select those that offer the greatest potential from available funds.

3. Budgets or planned cost estimates are then laid out to control the flow of money to specific programs.

4. Finally there must be periodic progress reviews to decide whether to continue programs, rechannel funds or terminate programs.

Though this final step implies the ability to measure objectively the progress of R&D programs and to establish and define stages of progress, there are times when progress can only be stated in subjective terms. Regardless, the important point is that an attempt to measure progress in the best available terms should be made.

each cost at various levels of predicted activity? This is the actual establishment of budgeted costs which will be based on past history, personal judgment or both.)

Don't hesitate to use historical costs as the basis for developing budget allowances. They have the following advantages:

- They provide the needed starting point.

- The data are needed to help identify the nature of each cost (fixed, variable or mixed) as it actually reacts to volume changes.

- They are the data most readily available.

- They provide standards that will be beaten if your budgets are effective.

4. Establish a complete record for each cost item in each cost center by using a budget data sheet (Fig. 1). Once these are included in a budget data book, you have a record of how you reach your specific budget decision, as well as a starting point for next year's budget.

5. Summarize, on one sheet for each cost center and subcenter, the budget allowances at normal or average activity for all costs incurred in that cost center. These summary sheets (Fig. 2) can be tied into the profit plan calculations.

6. Review in detail with each department head or foreman all the budget allowances for each cost item in his department. If possible, have him work with

you in the development of his allowances. He must have the opportunity to make a complete review and express his views on each item.

Be alert in the course of the budget review to whether unrealistic goals have been established. Oddly enough, the most common fault in preparing budgets is to set budget goals that are too high to be realistic and cannot be met. In such circumstances, the experienced budget man advocates looser or lower standards. They may be higher than yet attained, but still are reachable.

### Follow up your budget

The followup is most important because it is the payoff of all the budget effort.

The first step in budget followup is periodic reporting, usually monthly, of actual performance to budget. These reports are commonly called cost and variance statements (Fig. 3). One such report is issued for each cost center and subcenter with summary reports for major departmental groupings and for the business as a whole. The cost and variance report for any cost center shows the following for each item of cost:

- What dollar amount was budgeted at the actual activity level.

- What was actually spent.

## BUDGET DATA SHEET

DATE	COMPILED	ACCT. CLASS	COST CENTER NAME	COST CENTER NO.
DATE	ACCEPTED	PERIOD	ACCOUNT NAME	ACCOUNT NO.
DATE	APPROVED	UNIT	UNITS IN PERIOD	
DATE	REASON FOR REVISION OF BUDGET		AMOUNT	TOTAL REVISION
			\$	\$
			\$	\$
			\$	\$
			\$	\$
THIS ACCOUNT IS CHARGED WITH:				
BUDGET WAS DETERMINED AS FOLLOWS:			TOTAL	CONSTANT

Figure 1

## BUDGET SUMMARY SHEET

COST CENTER NO.	COST CENTER NAME		COMPILED	DATE			
			ACCEPTED	DATE			
UNITS IN PERIOD	PERIOD	UNIT	APPROVED	DATE			
ACCOUNTS		TYPE OF COST	STANDARD BUDGET			RATE PER UNIT	
NO.	NAME		TOTAL	VARIABLE	CONSTANT		VARIABLE

Figure 2

## MANUFACTURING COST AND VARIANCE STATEMENT

DEPARTMENT \_\_\_\_\_

MONTH OF: \_\_\_\_\_

YEAR TO DATE: \_\_\_\_\_

EXPENSE ANALYSIS						
VARIANCE (BAD IN RED)	ACTUAL	STANDARD OR BUDGET	ACCOUNT		ACTUAL	VARIANCE
			NO.	TITLE		

Figure 3

■ What the difference or variance between the two was.

Again note that in flexible budgets the budgeted amount listed on the cost and variance statement is for the actual activity for the budget period, not the activity originally forecast for the period.

These reports should be issued within 10 days after the budget period ends.

To ensure meaningful reporting, make sure of the following:

■ That accounting clerks, receiving clerks, storeroom men, purchasing people, and others involved understand what cost items are charged to what account. Put the account definitions in writing.

■ That too many diverse items of cost are not lumped into one account. Each major item of expense should have its own account. When several such items are lumped in one account, gains in one item may disguise over-budget costs in others.

■ That purchasing and the storeroom are not charging several months of costs to one operating period. If a number of months' needs are purchased for delivery at one time, the item should be doled out in monthly quantities and not charged in its entirety in the month received. The latter practice distorts all the months affected, overcharging the month received and undercharging subsequent months.

At the start of a new budget or budget revitalization program, large variances are frequently encountered. The cause of these variances must be investigated at once. If they are caused by procedural or clerical errors, correct them immediately. If poor operating performance is the cause, the variances obviously cannot easily be changed immediately. Further performance analysis or supervisory correction will be needed.

The final followup step is the establishment of a fairly rigid program of checking with cost center supervisors on their performance to budget. This step is vital because it provides supervisors with the opportunity to ask questions and obtain answers, and it affords budgeting personnel the chance to detect areas of potential cost reduction.

There are three other follow-up guidelines:

1. Do not depend solely on the cost and variance statements for all cost control. Recognize that there are certain costs that involve so much money that they warrant weekly and even daily reports. Direct labor and direct material are two examples of costs that commonly need more than monthly control.

2. Alert top management to the fact that department managers can go only so far in improvement efforts, because of time, experience and training limitations. After that they need staff assistance from industrial engineering, product engineering, plant engineering, etc.

3. Keep a continuing critical eye on the budgeting program:

■ Set up quantitative measures of budget results

by, for example, continuing comparisons between current and past actual costs.

■ Set up qualitative measures such as the way department heads and foremen react to their budgets, how actively they follow them up and, most important, what action they take as the result of their budgets.

If the budget installation and followup actions are effective, costs will be reduced and favorable variances generated. In subsequent budget years, the allowances will be reduced to reflect the improved performance. However, you must be realistic when raising budget standards so that the new standards can be attained.

## Measure the results

Effective budgets always yield a dollar return that is many times their cost. A common and readily understood measure is a comparison of the most important costs for three months before budget versus three months after budget, with production activity equalized for both periods. Another measure is the tracing of cost improvements directly into the monthly profit and loss statement.

This measure leads us into the subject of the third and final article of this series, profit/volume analysis—a technique for evaluating and measuring the effects of improvement in fixed and variable costs, which is one of the chief aims of budgeting. This will appear in the next issue. ■ ■

### Test your retention

Here are two problems based on the main points of this article. They are to help you see if you have overlooked any important ideas. You'll find the answers on p. 130.

You are given the following information:

Plant produces two products, A and B.

A single shift consists of one supervisor (at \$130 a week, exempt from overtime) and six workers (at \$100 each for a 40-hour week, time-and-a-half for overtime). Two crews are employed.

A crew can produce 1000 units of A or 2000 of B in an eight-hour shift.

Rent is fixed at \$1000 a month.

Electricity costs \$10 per 1000 units of A and \$5 per 1000 units of B.

Material costs \$100 per 1000 units of A and \$60 per 1000 units of B. Both A and B are reduced by 5% for units used in excess of 20,000 for A and/or 40,000 of B for the month.

Assuming that no other outside factors will affect the data given, budget for the following two mixtures of product production for a four-week month:

(1) 20,000 units of A, 40,000 units of B.

(2) 21,000 units of A, 45,000 units of B.

**SENIOR PHYSICIST**

Excellent opportunity in our thin film development laboratory for the qualified physicist to initiate aging studies of plated wire memory elements.

This is a top-level position and requires experience in film or magnetic materials.

In addition to an excellent starting salary, fringe benefits, etc., we are sure you will find the responsibilities involved are both challenging and rewarding.

For further information, please send resume in confidence to Mr. A. J. Petit, 6201 E. Randolph Street, Los Angeles, California 90022. Or call (213) 722-6810. An equal opportunity employer.

**LOCKHEED ELECTRONICS COMPANY**

A Division of Lockheed Aircraft Corporation  
ON CAREER-INQUIRY FORM CIRCLE 901

**Hybrid solid-state switch replaces power types**

**Problem:** Replace existing motor-driven power switches used on spacecraft. They are heavy, large, costly and produce a stray external field.

**Solution:** A hybrid solid-state switch that uses a transistor circuit and relay contacts.

The transistor circuit handles the turn-on and turn-off transients and allows only 3 V or less to appear across an associated pair of relay contacts during contact transfer. If we limit the open circuit voltage to this small amount during transfer, unusually high transient currents at reasonable cycle life can be handled by a small relay contact. After transfer, the open circuit voltage may be increased; this is limited only by the contact insulation. The relay contacts are closed for the steady-state load and provide a minimum voltage drop.

To eliminate battery current drain, the associated logic circuitry is completely disconnected during the steady-state on or off periods. Ground (or remote) hard-line commands bring this circuitry into action only during transfer to on or off. A single rotary stepping relay that has rolling contacts does the switching. This relay is the electrical equivalent of a four-pole mechanical latching relay. The relay has provisions for make-before-break and make-after-break contact arrangements and is capable of performing certain time-dependent logic functions, which are primarily of a switching nature.

To reduce weight, much of the logic circuitry is placed at the remote command site. A differential amplifier measures the voltage across the switch contacts that are to handle the full load current. When 3 V or less appears, a signal is sent to the remote logic to step the relay that will close the contacts. On opening, the circuitry maintains a maximum of 3 V across the load-current contacts until the contacts are fully open, whereupon the voltage may then rise to its full open circuit value.

The hybrid solid-state switch has been breadboarded, and satisfactory test results have been obtained at  $-10^{\circ}$ ,  $25^{\circ}$  and  $75^{\circ}$  C. With small relay contacts, this switch could be used for high-current switching and at high voltages when a compact, reliable device is needed. It could be used, for example, for heavy-duty motors when large starting currents are required as in the pumps of washing machines and oil burners.

*Inquiries concerning this invention may be directed to: Technology Utilization Officer, Jet Propulsion Laboratory, 4800 Oak Grove Drive, Pasadena, Calif., 91103. Reference: B67-10165.*

A dynamic and aggressive Regional Sales Engineer is needed for our modern Central New Jersey Office.

Position requires a technical degree and a minimum of 5 years experience in Sales or Engineering.

Our Bailiwick is the suppressing of EMI/RFI with electro/mechanical components. Your work will entail administrating and operating a territory on a Sales and engineering level with our Field Representatives. Up to 30% travel is required.

We offer Excellent salary and expenses plus profit sharing and benefits.

If you have the initiative, intelligence and interest to grow with us, please write outlining your experience or call collect:

Mr. Ed. Steel 201-272-5500

**TECKNIT - EASTERN DIVISION**  
129 Dermody St., Cranford, N.J. 07016

An equal opportunity employer.

 **TECKNIT - EASTERN DIVISION**

*Technical Wire Products Inc.*

ON CAREER-INQUIRY FORM CIRCLE 902

**REGIONAL  
SALES  
ENGINEER**



# Free Career Inquiry Service

## Absolutely Confidential

Respond to the career opportunities advertised in this issue. Fill out and send us this handy resume. **Electronic Design** will do the rest – neatly typed copies of this form will be mailed to the companies of your choice, indicated by the circled Career Inquiry Numbers at the bottom of this page.

# 24

<b>Name</b>				<b>Home Phone</b>	
<b>Home Address (Street)</b>			<b>City</b>	<b>State</b>	<b>ZIP Code</b>
<b>Age</b>	<b>U.S. Citizen</b> <input type="checkbox"/> Yes <input type="checkbox"/> No		<b>Security Clearance</b>		
<b>Prime Experience</b>			<b>Secondary Experience</b>		
<b>Desired Salary</b>			<b>Availability Date</b>		
<b>Employment History – present and previous employers</b>					
<b>Company</b>					
<b>City, State</b>					
<b>Dates</b>	to		to		to
<b>Title</b>					
<b>Specialty</b>					
<b>Education – indicate major if degree is not self-explanatory</b>					
<b>Degree</b>					
<b>College</b>					
<b>City, State</b>					
<b>Dates</b>	to		to		to
<b>Additional Training – non-degree, industry, military, etc.</b>					
<b>Professional Societies</b>					
<b>Published Articles</b>					

**Career Inquiry Numbers:**

- |     |     |     |     |     |     |     |     |     |     |
|-----|-----|-----|-----|-----|-----|-----|-----|-----|-----|
| 900 | 901 | 902 | 903 | 904 | 905 | 906 | 907 | 908 | 909 |
| 910 | 911 | 912 | 913 | 914 | 915 | 916 | 917 | 918 | 919 |

**ELECTRONIC DESIGN**  
 850 Third Avenue  
 New York, New York 10022

## Why Make Trade-offs in Your Career?

You make trade-offs all the time in engineering—giving up cost advantages, say, for miniaturization and light weight. But are you making trade-offs with your personal career, too? Giving up a pleasant place to live for a good salary? Or submerging yourself in a mammoth engineering staff so you can work on big aerospace projects? You don't have to, you know! Look into L.S.I. We design and produce advanced flight reference, navigation, communication and display systems. As a result, we have a team of 450 crack engineers making important contributions to every major aerospace program. They've gained recognition—and are well rewarded, too—because everybody here knows that our engineers are the backbone of the company. And our men live in a pleasant, medium-size city just minutes from the office and high-rated schools, in the heart of Michigan's year 'round vacationland. If you'd like to have your cake and eat it too, write in confidence to L. A. Mellinger, Professional Employment Manager. Some of the many opportunities now available include these disciplines:

COMMUNICATION SYSTEMS  
RECEIVER SYSTEMS  
NAVIGATION SYSTEMS

CIRCUIT DESIGN  
ELECTRONIC PACKAGING  
SYSTEMS ANALYSIS

LEAR SIEGLER, INC.



AN EQUAL OPPORTUNITY EMPLOYER

INSTRUMENT DIVISION  
4141 EASTERN AVE., S. E., GRAND RAPIDS, MICHIGAN 49508

ON CAREER-INQUIRY FORM CIRCLE 903

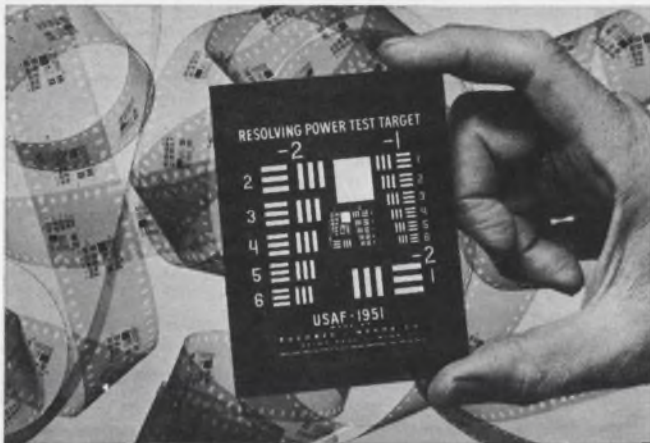

## RESOLVING POWER TEST TARGETS

Resolving Power Test Targets have been designed and produced for U.S.A.F. under contract, for American Standards Association Resolution Chart and National Bureau of Standards Microcopy Resolution Test Chart . . . High and low resolution targets are available — low targets in high, medium and low contrast. Special Resolution Chart Targets are made on 35 mm film in 20 foot rolls. Specialized targets to custom specification. Send us your requirements in sketch or blue print — we will rush quote.

BUCKBEE/MEARS  
COMPANY  
245 E. 6th ST./SAINT PAUL, MINN.



ON READER-SERVICE CARD CIRCLE 37

## Book Reviews

### RESULTS MANAGEMENT IN ACTION

by  
BURT K. SCANLAN

MANAGEMENT CENTER OF CAMBRIDGE

### Guide for Management

*Results Management in Action.* Burt K. Scanlan (Management Center in Cambridge, Cambridge, Mass.), 132 pp. \$7.95.

The author, a professor at the University of Wisconsin Management Institute, has written terse, practical advise. His book is crammed with helpful suggestions for all levels of management. Dr. Scanlan's motto seems to be, "Why use 10 words when one will suffice." And it pays off.

Howard S. Ravis

### Analog Computation

*Basic Analog Computation,* Gerald R. Peterson (The Macmillan Company, New York), 124 pp. \$3.95.

This book offers a simplified explanation of the basics of analog computation. The author comments in his preface that while such a book has long been available on digital computation, analog computation has remained a specialized topic for the electrical engineer. The book is written in the belief that all engineering students should be trained in the use of the analog computer as soon as they have the proper mathematical background.

# EE openings on SRAM, Minuteman and other Boeing programs

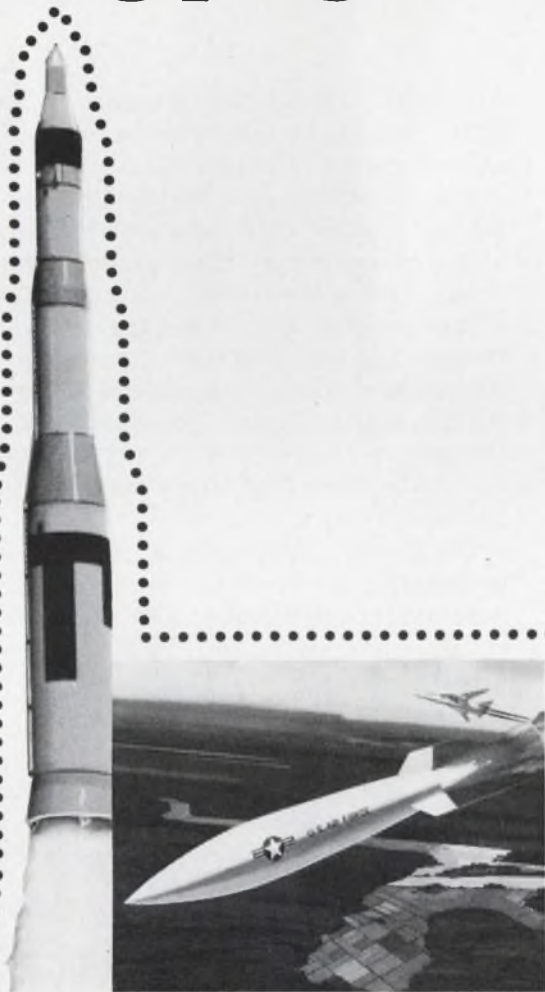

*I'm interested in a Boeing career; please contact me with details.*

Name \_\_\_\_\_

Address \_\_\_\_\_

Phone (incl. area code) \_\_\_\_\_

City \_\_\_\_\_ State \_\_\_\_\_ Zip \_\_\_\_\_

I'm usually home between \_\_\_\_\_ and \_\_\_\_\_ (hours) on \_\_\_\_\_ (days)

Degree Field of Interest \_\_\_\_\_

*Please mail to the location of your choice and qualifications: SEATTLE: Mr. J. I. Cartwright, The Boeing Company, P.O. Box 3999-EDH, Seattle, Washington 98124. HUNTSVILLE: Mr. Lee Batt, The Boeing Company, P.O. Box 1680-EDH, Huntsville, Alabama 35807. KENNEDY SPACE CENTER: Mr. G. S. McDaniel, The Boeing Company, P.O. Box 1698-EDH, Cocoa Beach, Florida 32931.*

Boeing's deep involvement with the nation's major missile and space programs provides immediate career opportunities for electrical/electronic engineers at Seattle, Huntsville, and Kennedy Space Center.

Boeing is system integration contractor for SRAM, the U.S. Air Force's new Short-Range Attack Missile. The company also is weapon system integrator for the USAF advanced Minuteman II ICBM. In space, Boeing is prime contractor for the National Aeronautics and Space Administration's Lunar Orbiter, the moon-circling spacecraft which is helping NASA scientists select the best landing sites for Apollo astronauts. In addition, Boeing is a major mission-support contractor to NASA on the Apollo/Saturn V program, and is building the first stage of the Saturn V launch vehicle.

Immediate openings exist at Seattle on the SRAM, Minuteman and Lunar Orbiter programs. Assignments in test technology include data systems and instrumentation and test data handling and processing. Qualifications include a B.S. or M.S. in electrical engineering and two to five years applicable experience. Flight technology positions are available in flight control and flight mechanics. Qualifications include a B.S. or M.S. in electrical engineering with two to five years experience.

Additional Seattle openings exist in developmental design and electronic packaging. Design assignments are in airborne control systems, ground system electrical power systems, and environmental control, and require a B.S. degree in an applicable discipline plus related experience. Electronic packaging qualifications include a B.S. in electrical engineering plus applicable experience.

A number of openings also exist on the Apollo/Saturn V program. At Huntsville, assignments in flight mechanics and flight evaluation include operational trajectories, mission analysis, trajectory analysis, post-flight trajectories, flight simulation development, and flight dynamics. Qualifications include a B.S., M.S. or Ph.D. in electrical engineering. Openings also exist for electrical/electronic engineers at Kennedy Space Center.

Salaries are commensurate with experience and educational background. Moving and travel allowances are paid to newly employed personnel. Boeing is an equal opportunity employer.

Please fill in and mail the coupon to the location of your choice and qualifications. A Boeing representative will get in touch with you.

## **BOEING**

MISSILE & INFORMATION SYSTEMS DIVISION  
SPACE DIVISION

Other Divisions: Commercial Airplane • Vertol • Wichita  
Also, Boeing Scientific Research Laboratories

# Go/no-go short detector for printed circuits is simple and reliable

A shorts sense amplifier (SSA) can be used to detect solder bridges across printed circuit lines. The SSA provides an up level (0 V) when a resistance of less than 15  $\Omega$  is connected across its input terminals A and B (see schematic) and a down level (-6 V) when a resistance greater than 15  $\Omega$  is connected across them.

Current flowing through the three series-connected germanium diodes, CR1, CR2 and CR3, develops a voltage. This is applied through emitter-follower Q1 to a voltage divider comprising R<sub>2</sub>, R<sub>1</sub> and the external resistance under test. The voltage at the base of Q2 varies as the external resistance under test is varied. A small voltage variation at the base of Q2 is amplified by Q2, Q3, Q4 and Q5 to cause a large voltage change at the SSA output.

To calibrate the SSA, a 15- $\Omega$  resistor is connected across SSA input pins A and B and the 100- $\Omega$  trimpot, R<sub>2</sub>, is turned clockwise until a transition from -6V to 0 V is noted at output pin C. With R<sub>2</sub> at this setting, a 0.1- $\Omega$  change above or below 15  $\Omega$  is sufficient to cause a full swing from 0 to -6 V at the output.

When the external resistance becomes greater than 15  $\Omega$ , the voltage at the base of Q2 increases, causing Q2 collector voltage to decrease. This lower-

ed voltage is transmitted by emitter-follower Q3 and voltage divider R8 and R9 to the base of Q4, causing Q4 to come out of conduction. Current through R12 is now released to flow through R13 and CR7. The current through CR7 generates a positive voltage which reverse-biases the base-to-emitter junction of Q5, turning it off. With Q5 cut off, the collector voltage drops to -6 V. When the external resistance becomes less than 15  $\Omega$  the voltage at the collector of Q2 increases. This is transmitted to the base of Q4, putting that transistor into conduction. Q4 draws current out of the base of Q5, putting that transistor into conduction. This causes the output to swing to ground.

The base-to-emitter turn-on potential for Q2 has a temperature coefficient of -1.9 mV/ $^{\circ}$ C. Because of the temperature coefficient of CR1, CR2 and CR3, the voltage at the emitter of Q1 has a temperature coefficient of -2.4 mV/ $^{\circ}$ C. This is reduced by voltage-



**VOTE!** Go through all Idea-for-Design entries, select the best, and circle the appropriate number on the Reader-Service-Card.

**SEND US YOUR IDEAS FOR DESIGN.** You may win a grand total of \$1050 (cash)! Here's how. Submit your IFD describing a new or important circuit or design technique, the clever use of a new component or test equipment, packaging tips, cost-saving ideas to our Ideas-for-Design editor. You will receive \$20 for each accepted idea, \$30 more if it is voted best-of-issue by our readers. The best-of-issue winners become eligible for the Idea Of the Year award of \$1000.

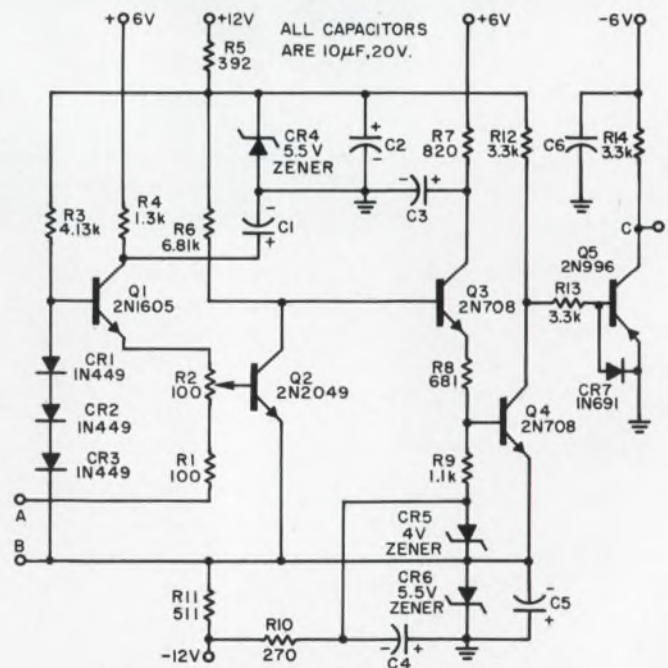

**Shorts, or any resistance less than 15  $\Omega$ ,** are detected, when connected across A and B, by putting out zero volts at C. For higher resistance values, the output will be -6V. Threshold accuracy is better than 0.5 $\Omega$ .

# Even if it weren't the lowest-cost digital translator-display the new Sigma 7 would be a bargain.

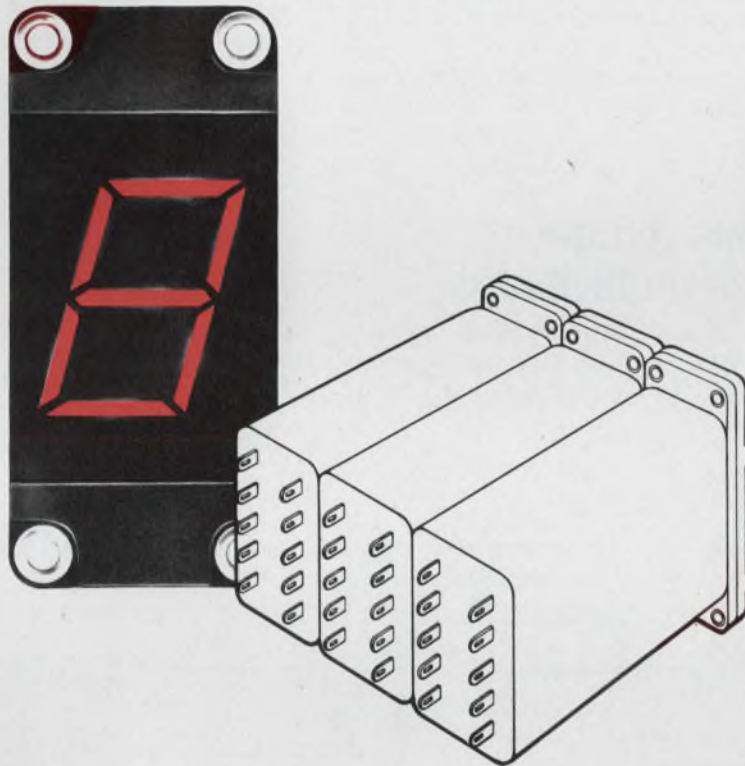

The new Sigma 7 is available in quantity at under \$15 with all of these advantages:

Combines code translation and numerical display in a compact opto-electronic module.

Eliminates need for high voltage switching transistors and separate high-voltage supply.

Accepts binary-coded decimal input at low voltage levels of either polarity.

Inputs interface directly with integrated circuit or transistor levels of 6, 12, or 24 VDC or 115 VAC.

Generates decimal output, 0 through 9, on an integral 7-bar neon display that lights directly from 115 VAC, 60 Hz.

Modules may be grouped for high visibility, single plane, multidigit display.

Translator utilizes Sigma's unique solid-state Datacel<sup>®</sup>, the opto-electronic switching device that provides input-output isolation and rugged long life.

Drive module available separately. Memory optional.

Sigma 7 is applicable in automatic test equipment, computers and peripheral equipment, digital process control indicators, laboratory instruments and read-out display boards.

Want more information—or a sample Sigma 7? Contact us or your Sigma representative today.



**SIGMA INSTRUMENTS INC**

*Assured Reliability With Advanced Design / Braintree, Mass. 02185*

*Sigma Instruments (Canada) Ltd., P.O. Box 43, Toronto 18*

ON READER-SERVICE CARD CIRCLE 38

divider action to be equal to  $-1.9 \text{ mV}/^\circ\text{C}$  at the base of  $Q2$ , so providing temperature compensation for the SSA.

Because of small individual variations among components, one should by trial and error select the value of  $R3$  that gives the best temperature compensation. The SSA will hold its  $15 \Omega$  threshold to within  $\pm 0.5 \Omega$  from  $0^\circ\text{C}$  to  $+40^\circ\text{C}$ .

To improve the temperature transient response, diodes  $CR1$ ,  $CR2$  and  $CR3$  and transistors  $Q1$  and  $Q2$  are mounted inside a small copper block. The high thermal conductivity of the copper ensures that these components share the same temperature.

*C.H. Ristad, Senior Associate Engineer, IBM, Components Div., Endicott, N. Y.*

NOTE FOR 110

## Circuit permits remote programming of multivibrator

A simple control circuit allows one to program a multivibrator remotely with several feet of cable and the help of a program board, switch or comparable arrangement.

Ordinarily if the frequency controls of a conventional multivibrator are placed several feet away from the circuit, the output waveform characteristics will be affected. Two frequency-control resistors are usually required. The amount of frequency change per control is ordinarily no more than 15:1, because, as the control resistors are increased in value to lower the frequency, the base currents of the transistors are also reduced, and this in turn will eventually stop the multivibrator from oscillating. The period does not have a linear relationship to the control resistors because of the nonlinear discharge of the timing capacitors. Also, only a square-wave output is available.

Figure 1 shows a multivibrator whose frequency can be varied a minimum of 50:1 from a remote location of at least four feet with one resistor,  $R_p$ . The high frequency ratio is the result of keeping the discharge path for  $C_{1a}$  and the hold-on base current,  $I_{b3}$ , for  $Q3$  independent of each other. (The same can be said for  $C_{1b}$  and  $Q2$ .) Because  $C_{1a}$  and  $C_{1b}$  alternately discharge through a constant-current source,  $Q5$ , time vs resistance,  $R_p$ , has a linear relationship. A linear sawtooth output is available at the collector of  $Q5$ , because

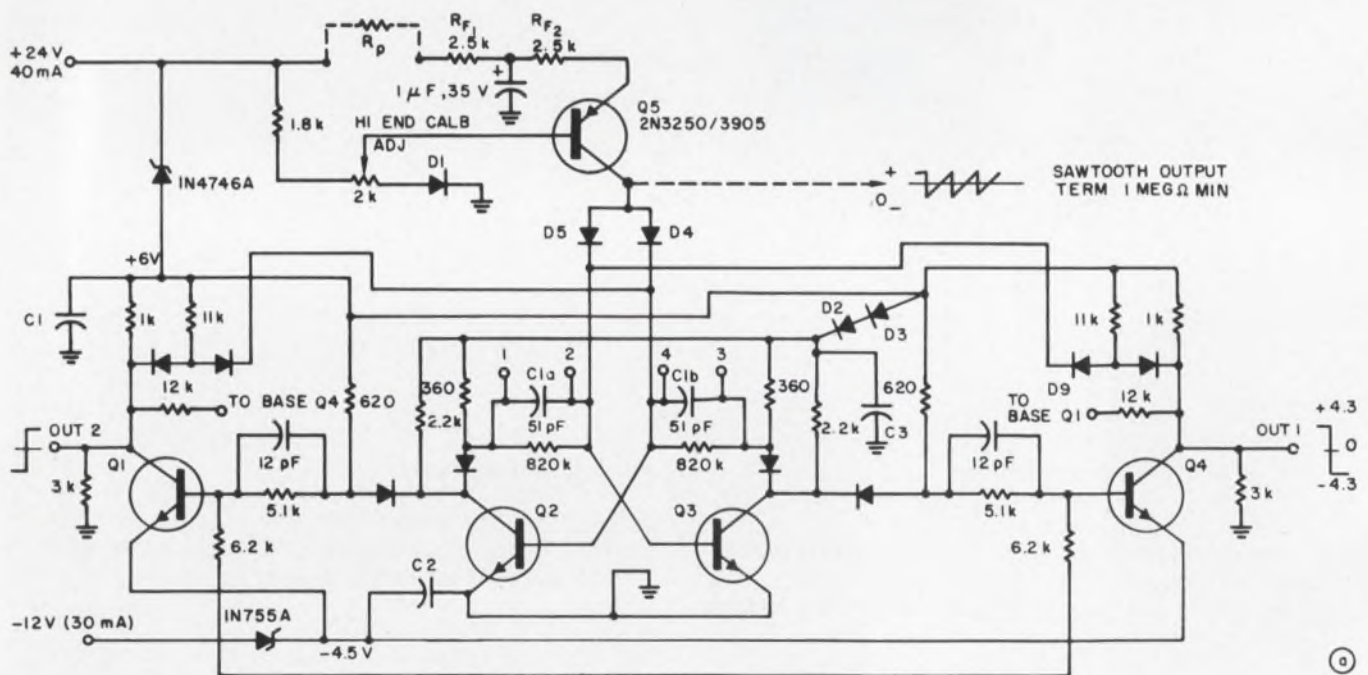

D1 TO D3 IN458  
 C1 TO C3 0.1 μF  
 ALL OTHER DIODES, EXCEPT AS SHOWN,  
 ARE IN3063 OR IN916  
 Q1 TO Q4 ARE 2N709 OR 2N2784  
 RES ± 5% 1/4 W  
 $R_{F1} + R_{F2} = R_F = 5k$

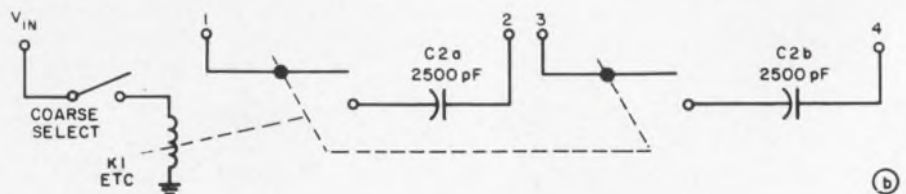

10-MHz-to-1-MHz multivibrator frequency can be adjusted remotely without affecting the output waveform.

# This integrating DVM *still* offers better performance than any other of its kind.

Measure low-level signals even in the presence of extreme noise with Hewlett-Packard's 2401C Integrating Digital Voltmeter. It has a floating and guarded input for minimizing the effects of common mode noise; and integration averages out all noise superimposed on the signal.

But the 2401 DVM could do that when it was first introduced. Since then there have been two new models and many additional features to keep the 2401 the industry's most useful bench and system DVM.

Here's why:

5 ranges, 100 mV, 1 V and the 3 usuals; 300% over-ranging on the 4 most sensitive ranges, 6th digit for overrange display; integration through zero; full programmability; BCD output for systems use; independent internal calibrate source stable to 0.006% / 6 mo.; 300 kHz frequency counting ability; optional autoranger with 34 msec maximum change time.

If this isn't enough, a full repertoire of options and compatible systems instruments is available to satisfy your measurement needs.

Price: \$4100

Call your local Hewlett-Packard field engineer or write direct to Dymec Division of Hewlett-Packard, 395 Page Mill Rd., Palo Alto, California 94306, Tel. (415) 326-1755; Europe: 54 Route des Acacias, Geneva.

HEWLETT  PACKARD  
DIGITAL VOLTMETERS

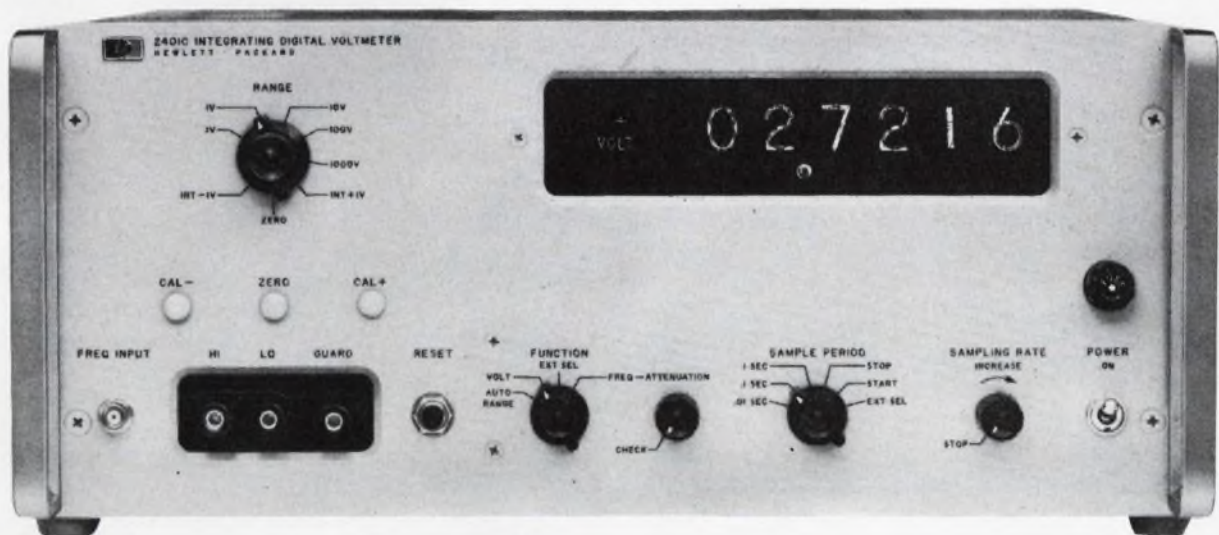

ON READER-SERVICE CARD CIRCLE 39

it is common to both  $C_{1a}$  and  $C_{1b}$ . The current through  $Q5$  is adjusted by  $R_p$ .

Since this is basically a dc adjustment, it can be done remotely, without affecting the characteristics of the square-wave and sawtooth outputs.

The value of  $R_p$  for a desired frequency output ( $F_o$ ) is found by the equation:

$$R_p = (R_f F_{max}/F_o) - R_f,$$

where

$R_f$  = fixed 5 k $\Omega$ .

$F_{max}$  = high end calibrated frequency with  $R_p = 0$ .

$F_o$  = frequency output.

$R_p$  = program resistor.

With  $C_{1a}$  and  $C_{1b}$  values as shown and  $F_{max}$

set for 8 MHz (by means of the high-end calibration adjustment potentiometer), the frequency of the multivibrator can be changed from 8 MHz to 160 KHz by varying  $R_p$  from 0 to 245 K with a linearity of  $\pm 3\%$ .

Figure 1b shows one way of setting up a remote coarse selector, by using miniature relays on the circuit board to switch larger capacitors across  $C_{1a}$  and  $C_{1b}$ . This lowers the range of the multivibrator. The over-all range of the multivibrator is 10 MHz to 1 Hz, with the square-wave output rise and fall times under 20 ns.

*Ralph Aiello, Test Equipment Design Engineer, Communications Systems Div., Radio Corp. of America, Camden, N. J.*

NOTE FOR 111

## Wide-range multivibrator uses IC flip-flop

When testing integrated circuits, a pulse source with compatible outputs is usually required. The circuit (Fig. 1a) uses a TTL J-K flip-flop and a unijunction-transistor relaxation oscillator, to obtain pulses with a duty cycle variable over a wide range. The frequency can also be varied by a simple modification. The outputs are complementary and capable of driving ten TTL circuits each.

Assuming that the flip-flop is in the 1 state,  $Q1$  is on and  $Q2$  is off. The timing capacitor  $C$  begins to charge through  $R2$ ,  $D2$  and  $(1-x)R$ , where  $x$  is the percentage of the resistance of potentiometer  $R$ . When the peak-point voltage is reached, a positive-going pulse is produced across  $L$ . This is amplified and triggers the flip-flop to the 0 state.

Capacitor  $C$  now charges through  $R1$ ,  $D1$  and  $xR$ . Again when the peak voltage is reached, the positive-going pulse across  $L$  is amplified and triggers the flip-flop back to the 1 state. The cycle is then repeated.

When  $R1$  and  $R2$  are large enough ( $> 10$  k $\Omega$ ) for the effects of the isolating diodes to be neglected, the timing intervals are given by:

$$T_1 = C(R1 + xR) \log [1/(1 - \eta)],$$

$$T_2 = C[R2 + (1 - xR)] \log [1/(1 - \eta)],$$

where  $\eta$  is the intrinsic stand-off ratio of the unijunction transistor. The frequency is therefore constant and is given by:

$$F = 1 / (T_1 + T_2) \\ = 1 / [C(R1 + R2 + R) \log 1/(1 - \eta)]$$

If  $R$  is much greater than  $R1$  and  $R2$ , the duty

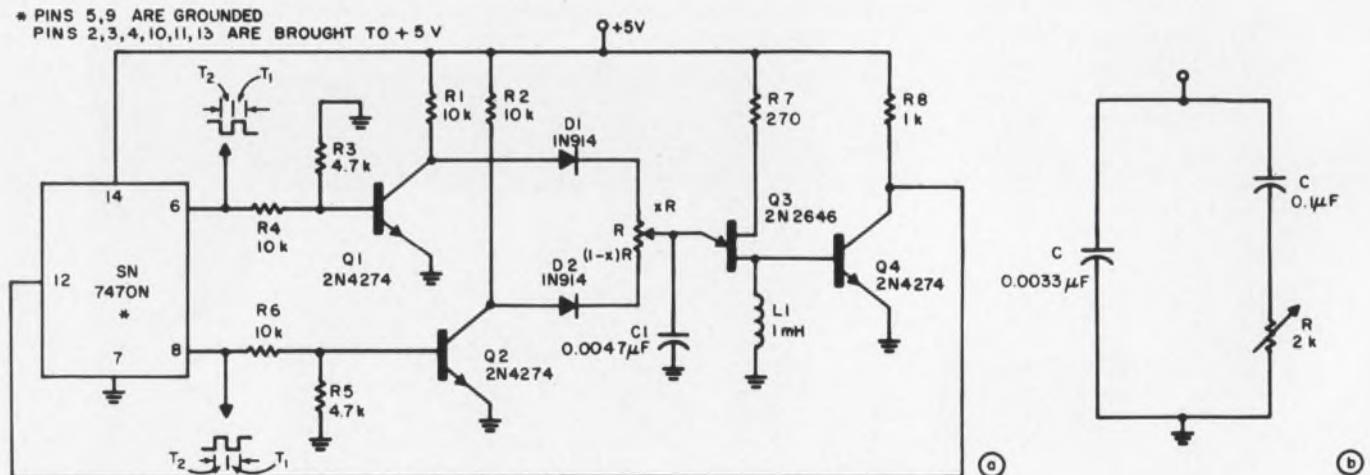

Duty cycle of the output pulses can be varied from 4 to 96 per cent with potentiometer  $R$ . If frequency variation is

desired, capacitor  $C1$  may be varied or network (b) may be used in place of  $C$ .



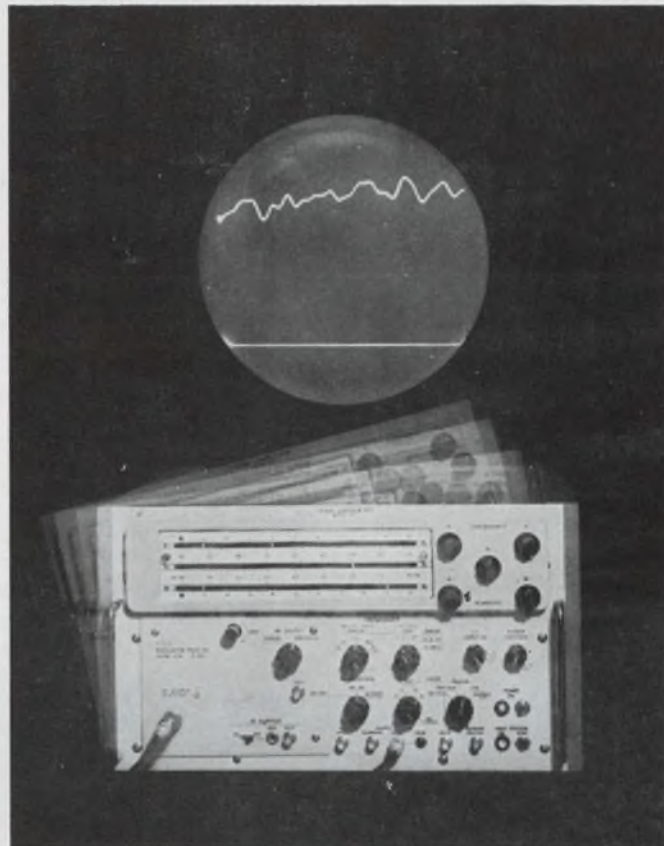
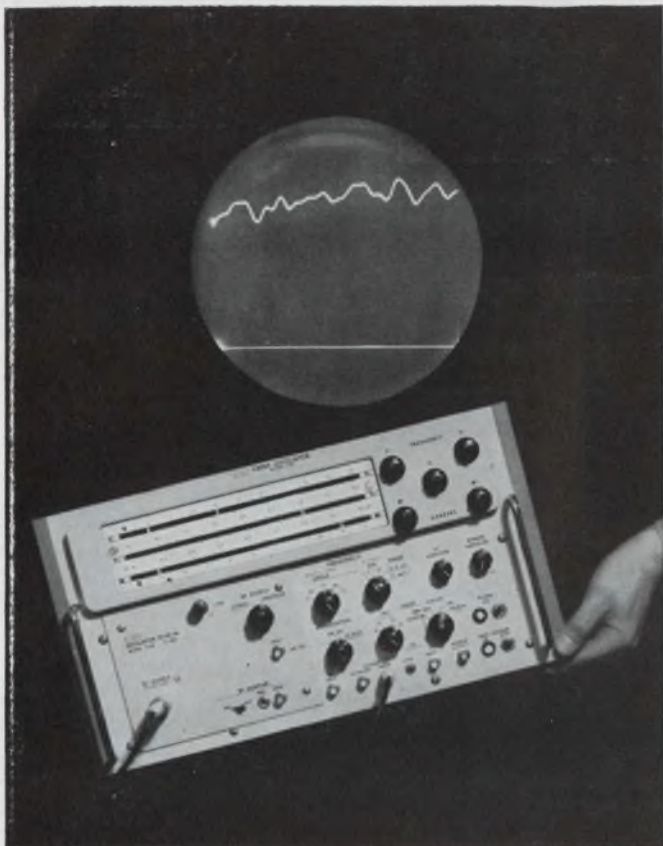

# WILL THE SWEEPER YOU BUY STAND THE 4" DROP TEST?

## The Alfred 650 Will!

These two photos graphically demonstrate the rugged reliability of the Alfred 650 Sweep Oscillator. Notice, there's no jitter on the scope trace even at the moment of impact.

But unequalled sturdiness is only one of the virtues of the Alfred 650. We use the plug-in approach to save you money and at the same time give you top performance specifications. Typically, you can save over \$4,000 in the 1 to 12.4 GHz range over comparable equipment.

For ease of operation, the controls are laid out in a completely non-ambiguous way. Anyone even slightly familiar with sweepers can run an Alfred 650.

The unique ALFRED three-story slide rule dial with five frequency controls provides unmatched flexibility. Two completely independent

sweeps may be pre-set and selected: broadband sweep  $F \rightarrow F_2$  and the symmetrical sweep  $F_0 \pm \Delta F$ . The independent sweeps permit you to evaluate components first during the broadband sweep,  $F_1 \rightarrow F_2$ , over one frequency range, and subsequently, during the symmetrical sweep  $F_0 \pm \Delta F$  over another frequency range. No readjustment of the frequency controls is required to change from one sweep mode to another. Five single frequencies are available:  $F_1$ ,  $F_2$ ,  $F_0$ ,  $M_1$  and  $M_2$ , which may be pre-set and selected with a convenient front panel control. The single frequencies may be pre-set during swept operation and then selected sequentially for five precise single frequency measurements. Three independent frequency markers may be introduced:  $F_0$ ,  $M_1$ , and  $M_2$ . Only ALFRED Sweep Oscillators provide three frequency markers which may be set anywhere in the band and which are independent of the sweep.

Ease of service makes the trouble free Alfred 650 an operator's dream. All components and modules are clearly marked and accessible. Because of low power consumption, (150 watts), there's no need to install a troublesome fan and blow dust all over etched circuits.

The Alfred 650 is available with plug-ins to cover a range of 250 MHz to 40 GHz. PIN diode leveling is offered to 12.4 GHz and grid leveling to 40 GHz. Price of the main frame is \$1,550. Plug-in oscillators start at \$1,550.

For full information, please call your nearest Alfred engineering sales and service center (See EEM or MEH) or address us at 3176 Porter Drive, Palo Alto, California 94304. Phone (415) 326-6496. TWX: (415) 492-9421.

## ALFRED ELECTRONICS

ON READER-SERVICE CARD CIRCLE 40

cycle can be varied over a wide range without affecting the frequency. With the values shown, it can be varied from 4% to 96%.

Transistors *Q1* and *Q2* are necessary to ensure that *C* can be charged to a voltage larger than the peak voltage of the unijunction transistor. The output of the flip-flop alone is not enough to ensure this in all cases. *D1* and *D2* serve to isolate the timing capacitor from the collector of the conducting transistor. *Q4* should be a high-speed transistor, to ensure that the positive-going edge has a rise time of less than 150 ns to trigger the flip-flop.

In some cases the circuit would be more useful

if the frequency were also variable. This can be done by varying *C*. Because large variable capacitors are not readily available, a more convenient method would be to use the network shown in Fig. 1b. With this scheme, however, the duty cycle and frequency adjustments would not be quite independent. The reason is that the impedance of this network has a real part, which affects the equivalent value of *R* in the expressions for *T<sub>1</sub>* and *T<sub>2</sub>*. This only becomes apparent at very high and very low duty cycles.

*John Sobolewski, Assistant Engineer, Washington State University, Pullman, Wash.*

NOTE FOR 112

## Low-cost op-amp integrator has range from dc to over 1 MHz

The problem was to design a wide-band integrator for operation from dc to 1 MHz with less than 0.1 dB change and with low enough source current for up-to-1-megohm integrating resistors to be used. The integrator was to be used in a portable function generator, so the precision timing capacitors had to be kept small and the time dissymmetry had to be less than 1% on any range.

Chopper-stabilized amplifiers were considered but they were too costly and suffer from cycle-to-cycle time jitter, especially around the chopper

frequency. Integrated operational amplifiers were possible, but those with low source current afford only limited bandwidth. Those with characteristics near what was desired were difficult to frequency-compensate for integrator operation beyond 1 MHz because few points are brought out of the case. Potted amplifiers were available but costs were very high.

General Electric 2N3856 epoxy-case transistors have excellent gain-bandwidth characteristics at very low currents, so the circuit shown in the figure was designed. A double Darlington front end was used with the pairs of 2N3856s matched for  $\beta$  and  $V_{BE}$ . They were then epoxied together

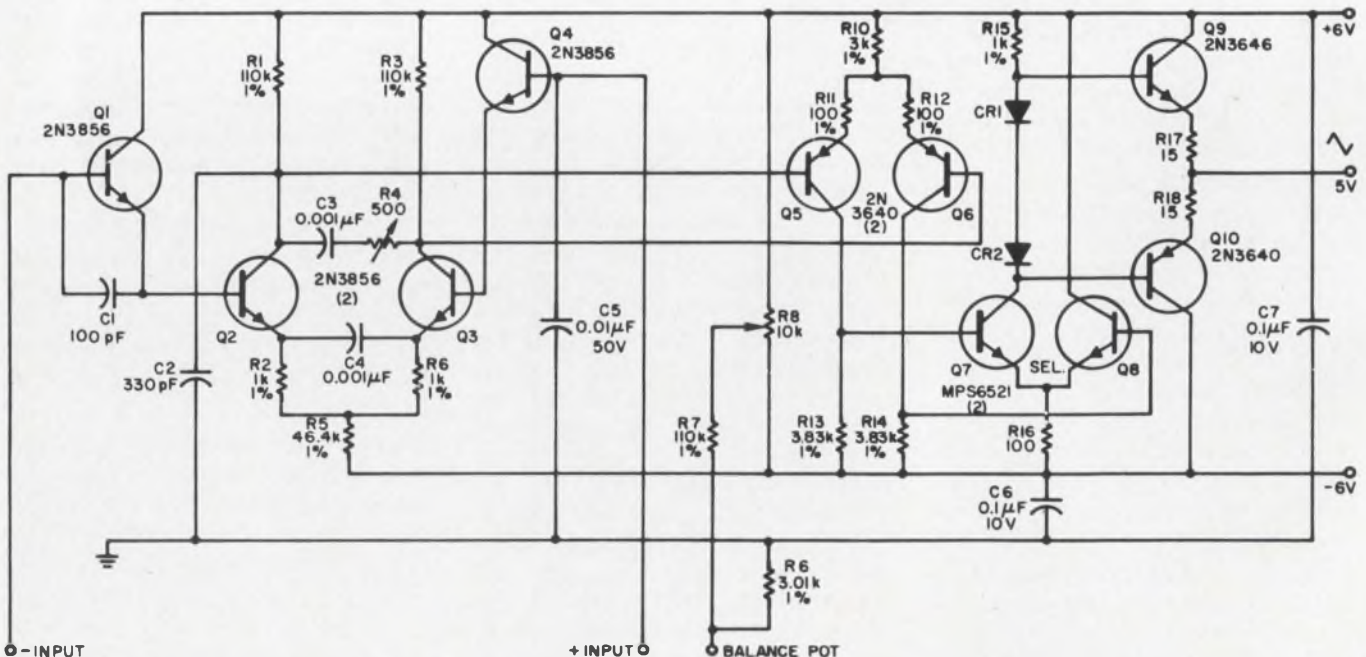

Epoxy transistors (*Q1* through *Q4*) offer excellent gain bandwidth at low currents in a wide-band integrator. The

front end uses a double Darlington circuit with pairs of matched transistors epoxied together.

# TTL Trends

from Texas Instruments

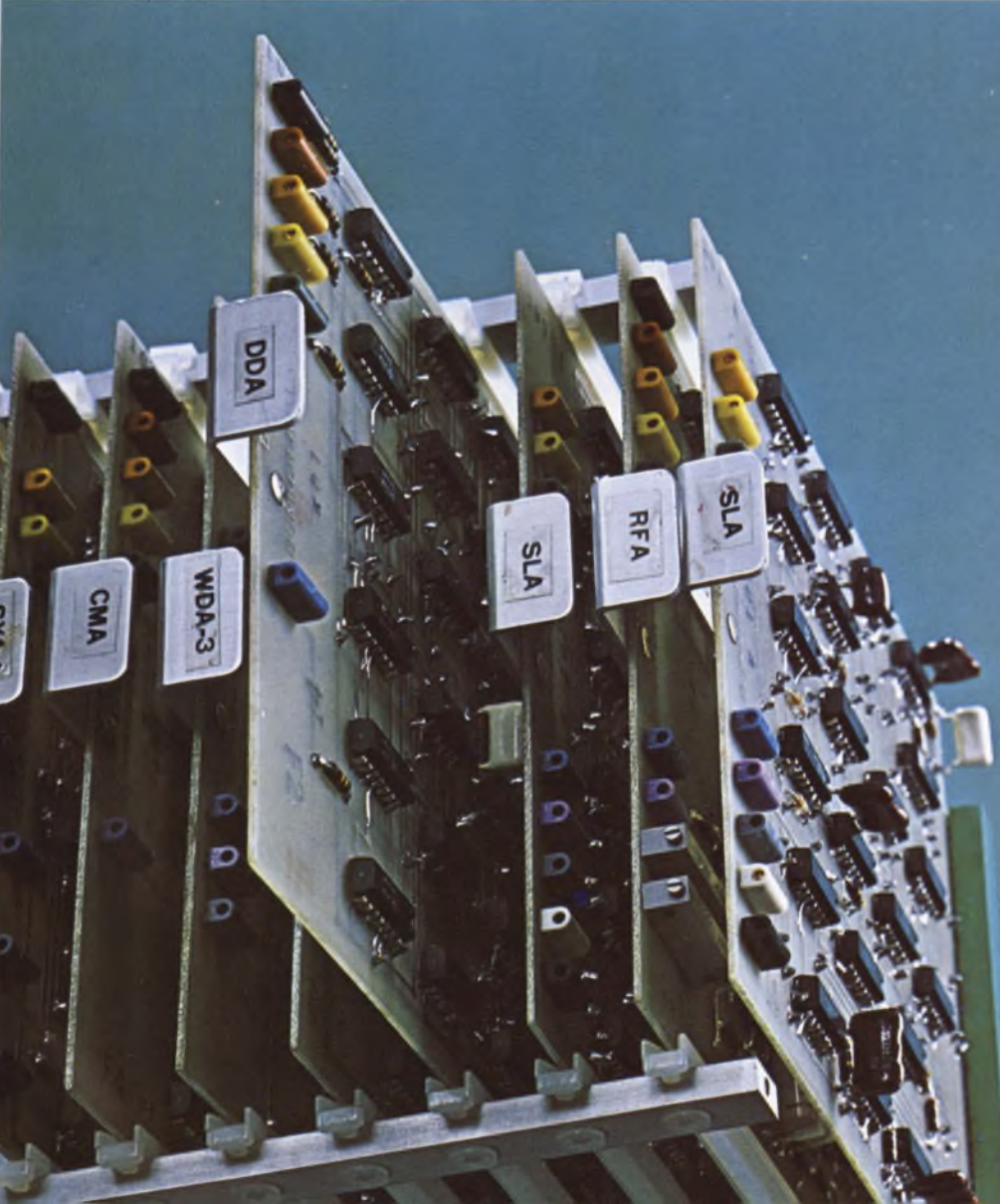

This rack contains electronics for the new Bunker-Ramo 2100 machine tool numerical control system. By using Series 74 TTL complex-function ICs from Texas Instruments, B-R keeps costs far below that of other systems of similar capability. At the same time, the already high reliability is further increased by an order of magnitude, while noise immunity and computing speed capability are also greatly improved (see page B). Many OEMs are building greater business opportunities for tomorrow by going with the complex-function TTL trend in their product designs today.

# Why Bunker-Ramo chose TTL complex functions for new NC systems



These low-cost numerical control systems offer as standard most of the functions normally found in far more expensive equipment. They are the first such systems to employ ICs for all non-power functions. Shown with Dean W. Freed, General

Manager of the NC Division, the Bunker-Ramo 2100 (right) is a two-axis positioning and straight-cut control, while the 2200 (left) is a three-axis positioning and straight-cut control, with optional two-axis incremental slope and arc capability.

Series 74 complex-function TTL integrated circuits from Texas Instruments have enabled Bunker-Ramo to further improve reliability and performance, while reducing size and cost of the numerical control systems shown above.

Series 74 TTL offered many performance as well as cost advantages. These included higher noise immunity and faster speed, plus

the economies made possible by complex-function circuits.

## High noise immunity

Since numerical control systems usually operate in an electrically noisy environment, the high noise tolerance (typically one volt) and the low input impedance (70 to 150 ohms) of Series 74 circuits are big

advantages. Bunker-Ramo engineers found that this reduced shielding and line-filtering requirements, while simplifying many associated design problems.

## High speed

TTL's high speed gives important design advantages, even though today's NC systems often do not

# Do ICs really cut costs?



The answer is an emphatic yes! That's no promise. It's a fact... with proof to back it up.

We've gathered some of the proof in the folder pictured at the left. This 6-page brochure describes how other industrial manufacturers have achieved revolutionary product advances with ICs. Like these OEMs, you too can significantly reduce equipment size and weight . . . make major performance improvements... *dramatically reduce costs!* For your copy, check No. 200 on the TI information service card.

But that's not all! Check number 202 for the 48-page brochure that contains performance, application, and catalog information on all 180 Series 54/74 TTL ICs.

An 84-page report provides results of TI's "Tougher-than-military" testing program. It's yours for the asking. Check number 203.

A new 24-page color brochure that gives information on all plastic-encapsulated semiconductors—including Series 54/74 ICs—is also available. Check No. 204.

## Please send the following:

- |  |  |
|--|--|
| 200 <input type="checkbox"/> 6-page case history brochure          | 203 <input type="checkbox"/> 84-page IC plastic package reliability report |
| 201 <input type="checkbox"/> 48-page complex-function IC data book | 204 <input type="checkbox"/> 24-page plastic S-C brochure                  |
| 202 <input type="checkbox"/> 48-page TTL brochure                  | 205 <input type="checkbox"/> 16-page "Total Reliability at TI"             |

NAME \_\_\_\_\_

TITLE \_\_\_\_\_

COMPANY \_\_\_\_\_

ADDRESS \_\_\_\_\_

CITY \_\_\_\_\_ STATE \_\_\_\_\_ ZIP \_\_\_\_\_

ED



To get the literature you want, check the appropriate numbers, fill out the card, and drop it in the mail. If you prefer, circle the same numbers on the magazine Reader Service card.

E

SN7482 is a two-bit binary adder that has a typical carry time of only 8 nsec per bit. The logic diagram shows the complexity of an SN7482.

SN7483 is a four-bit binary adder that is equivalent to 34 gates in a single package.

**BCD-to-decimal decoder/driver**

Here is a real cost saver! The SN7441 replaces conventional decoding consisting of one dual four-input gate, two triple three-input gates and a dual two-input gate, plus four inverters and ten transistors. Output is sufficient to directly drive gas-filled readout

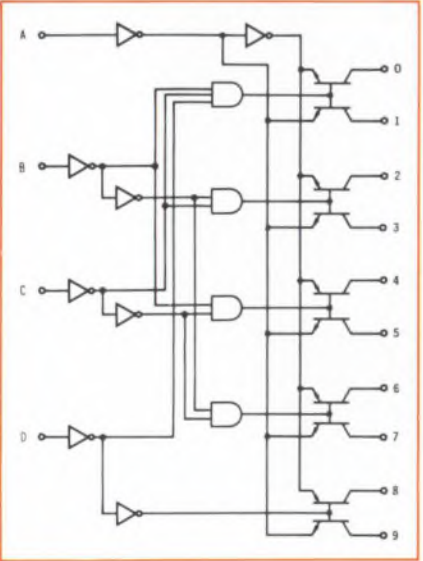

tubes, miniature lamps, and many small relays. The logic diagram (above) shows the complexity of an SN7441.

**Quadruple latch**

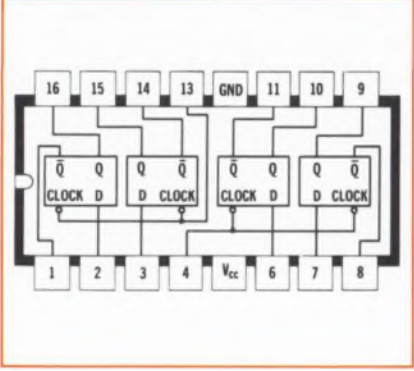

A single SN7475 quadruple latch replaces eight AND-OR-INVERT gates...greatly reducing package count and costs.

This monolithic quadruple bistable latch offers complementary Q and Q-bar outputs. The device is ideally suited for such applications as temporary storage of binary information between processing units and input/output or indicator units.

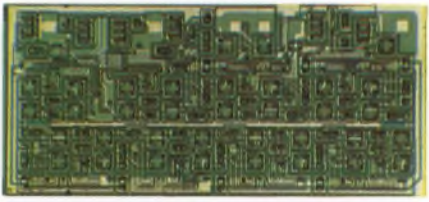

**Shift register**

SN7491A is a monolithic serial-in, serial-out eight-bit shift register that is composed of eight R-S master/slave flip-flops. It includes both input gating and clock driver, and is capable of storing and transferring information at clock rates up to 18 MHz.

Want to know more about how you can upgrade your new designs with Series 54/74 TTL from Texas Instruments? Start by sending for the comprehensive literature offered on the Information Service Card . . . or call your nearest TI sales engineer or authorized TI distributor.

**AIR MAIL**

First Class  
Permit No. 7284  
Dallas, Texas

**BUSINESS REPLY MAIL**

NO POSTAGE STAMP NECESSARY IF MAILED IN THE UNITED STATES

Postage Will Be Paid By

**TEXAS INSTRUMENTS INCORPORATED**

P. O. Box 5474  
Dallas, Texas 75222

Attention: Inquiry Answering  
Mail Station 407

# Quality analysis... TI reliability starts here!



Any really successful reliability program must start with correcting the causes of failure *before they occur in the field*, and TI's Reliability Analysis Laboratory... established in 1962... has been examining the "where, what, when, how and why" aspects of IC failures for more than five years.

This lab has facilities to analyze each individual element within even the most complex integrated circuit and can duplicate failure mechanisms under precisely controlled conditions.

Typical of these quality-analysis studies is the X-ray video monitoring facility shown at the left. This important analytical tool permits full 360° observations in both vertical and horizontal planes. It reveals failure mechanisms that might otherwise escape detection.

Following identification of failures, the analysis is forwarded to a corrective-action group. Here, TI's in-depth technical resources — including physicists, chemists, and metallurgists, as well as research, design, and manufacturing engineers — are focused on the problem. After evaluation of all data and reports, necessary corrective actions are undertaken.

Quality analysis is only one of many steps taken by TI to ensure reliability of integrated circuits. Other important steps are described in a new 16-page brochure in full color... *Total Reliability at TI*. Check number 205 on the TI information service card for your copy.



TEXAS INSTRUMENTS  
INCORPORATED

require all the speed available. While clock rates of 4 MHz are common today, 20 MHz and up are possible with TTL. To the user, this reserve speed gives an extra measure of performance insurance...and longer productivity before obsolescence.

In addition, B-R found that the extra speed of TTL also made possible simpler circuitry. For example, a function that would have had to be performed in parallel fashion with lower speed logic can now be performed in serial fashion with Series 74 TTL. This results in fewer circuits and a simpler, less expensive, more reliable system.

### 20 percent fewer ICs

The complex-function circuits available in the Series 74 line also made possible a 20 percent reduction in package (and circuit board) count. Since the cost of any system is largely proportional to the number of elements used, Bunker-Ramo designers were able to realize important economies.

For example, a decade counter is often made up from four J-K flip flops and a gate...perhaps three packages. Bunker-Ramo used a single SN7490N instead. Since about 40 decade counters are used in a typical NC system, the savings in integrated circuit and circuit board costs are substantial.

### Improved reliability

By using Series 54/74 ICs in the new 2100 and 2200 NC systems, Bunker-Ramo engineers found that they were able to surpass reliability standards established

by existing discrete-component designs, since the number of soldered connections were substantially reduced. Also, B-R engineers could place more functions on each circuit board...reducing the number of circuit boards by about 20 percent and further improving reliability.

### You get a broader choice of complex-function circuits in Series 54/74 from TI

Complex-function circuits to add, count, store, decode, and perform many other jobs are available in TI's Series 54/74 TTL line...industry's most complete logic family. These complex-function ICs can help you achieve the same kinds of performance and economic advantages realized by Bunker-Ramo.

For a comprehensive data book describing all Series 54/74 complex-function ICs, just check 201 on the TI information service card.

### Counters

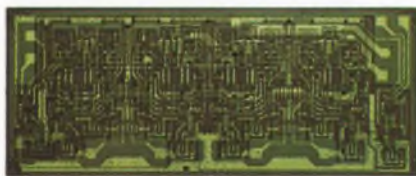

TI offers counters capable of dividing by 2, 3, 4, 5, 6, 8, 10, 12, and 16 at typical rates of 18 MHz. When used singly or in combination, they can perform most division or counting functions that might be required. Furthermore, they afford tremendous reductions in package count, soldered connections, and

costs. In addition to the SN7490Ns used by B-R, SN7492 divide-by-twelve counters and SN7493 four-bit binary counters are available. As may be required by the application, each of these devices offers the flexibility of several alternative interconnection arrangements in the system circuitry.

### Adders

If you need adders, TI offers a broad selection. SN7480 is a high-speed, single-bit binary full adder with complementary inputs, complementary sum outputs, and inverted carry output.

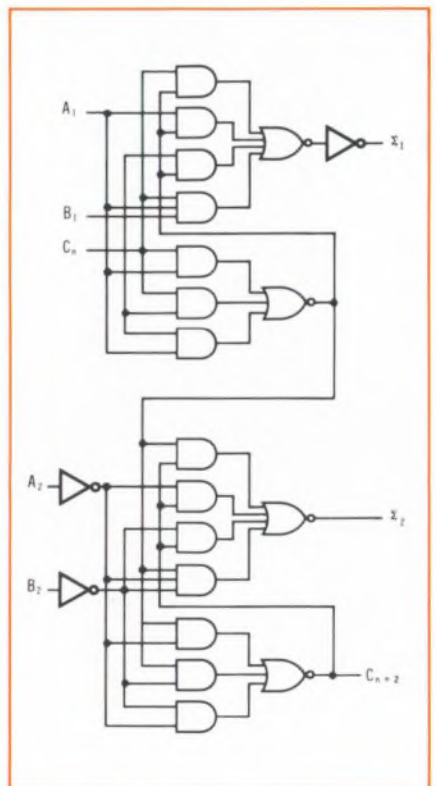



at their flat sides. Two more gain stages were added with a push-pull emitter-follower output. The circuit gives approximately 40 mA of source current. Switching is used to balance the resistances in the plus and minus inputs when large integrating resistors are used, to minimize offset

due to the small source currents. Epoxy transistors used throughout keep costs down.

*Jerry F. Foster, Chief Engineer, WAVETEK, San Diego, Calif.*

VOTE FOR 113

## LF triangular wave generator has just a few components

This simple three-transistor, one-operational-amplifier circuit will generate a low-frequency triangular wave.

Point A (see figure) is at  $-6.2$  volts, the Zener voltage of CR1 when Q3 is on. The base of Q1 is normally biased at  $+5.4$  volts through R2 and R3. The emitter of Q1 is reverse-biased through diodes CR2 and CR3 by  $[5.4 - (3.3 + 0.7)] = 1.4$  volts, turning Q1 off. The  $-6.2$ -volt step input to the integrator produces a positive ramp at point B. When the voltage at point B is  $6.3$  volts, diode CR5

breaks down ( $5.6 + 0.7 = 6.3$ ) and turns Q2 on and Q3 off. The emitter of Q1 is now forward-biased and point A is set for  $+6.2$  volts by adjusting R5. The positive step produces a negative ramp, turning off Q2 at  $-6.3$  volts, which are set by adjusting R12. Q3 is on again and the cycle repeats.

The frequency of the generator is determined by R7, R8 and the two capacitors. With the values shown it can be as low as about 0.05 Hz.

*Nelson M. Nekomoto, Designer, Tasker Instruments, Van Nuys, Calif.*

VOTE FOR 114

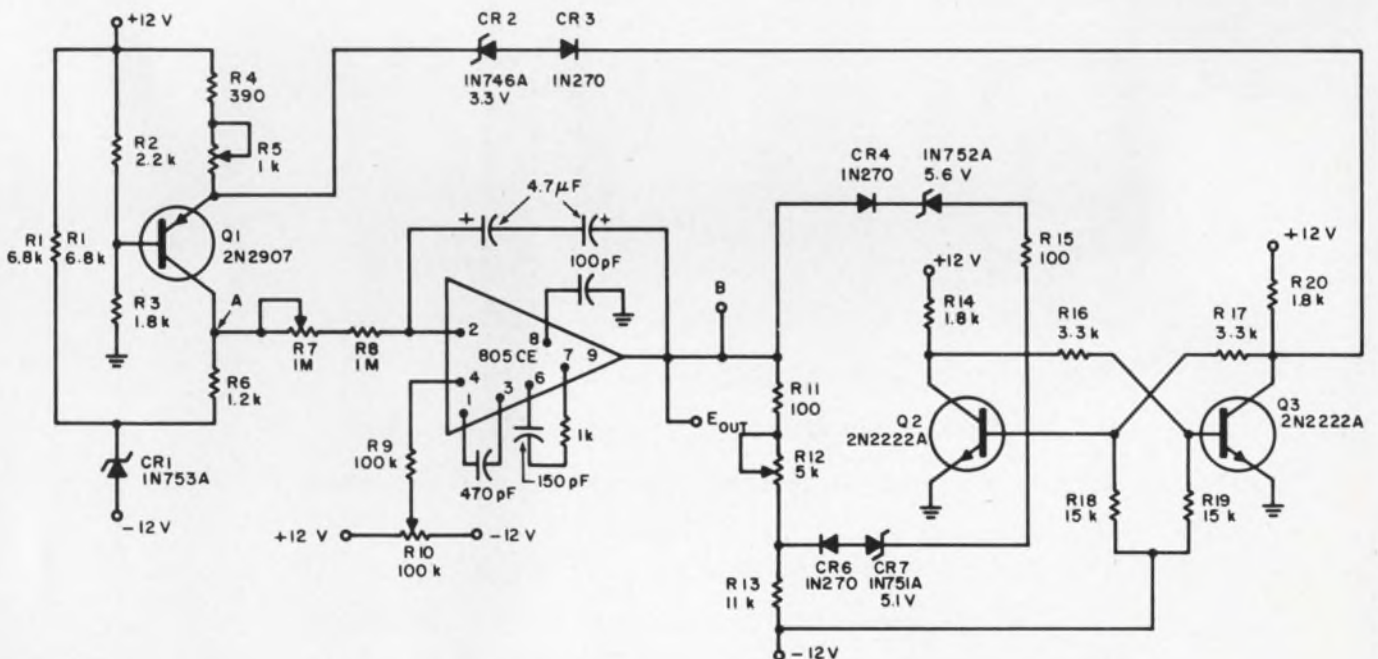

Low-frequency triangular-wave generator produces good

wave shapes. Frequency is adjusted with R7.

### IFD Winner for August 16, 1967

**H. L. Han**, Staff Member Technological University, Delft, Netherlands.

His Idea, "Foolproof dc regulator uses minimum of components," has been voted the \$50 Most Valuable of Issue Award.

**Cast Your Vote for the Best Idea in this Issue.**



**First full-range\***  
**DC Voltage Calibrator**  
**with .01% accuracy for under \$1000—**



**Cohu's new Model 324A!**

\*Output voltage ranges: 10-V Range: 0 to 11.11110 volts (10 $\mu$ V steps)  
 100-V Range: 0 to 111.1110 volts (100 $\mu$ V steps)  
 1000-V Range: 0 to 1111.110 volts (1mV steps)

Output current capability: 0 to 25 milliamperes nominal at any voltage setting.

Accuracy: 0.01% of setting.

Stability: Within 30 PPM for 24 hours, 50 PPM for 30 days.

Visual display: In-line readout, automatic decimal point positioning.

Dimensions: Cabinet: 10 $\frac{1}{2}$ " W x 5 $\frac{1}{4}$ " H x 15 $\frac{1}{2}$ " D.  
 Rackmount: 19" W x 5 $\frac{1}{4}$ " H x 15 $\frac{1}{2}$ " D.

Price: Cabinet (324A): \$995. Rackmount (324AR): \$1050.  
 F.O.B. San Diego. Additional export charge.

Delivery: Immediate, from stock.

For full details, contact your Cohu engineering representative.

For illustrated brochure on how this instrument is applied in the industry, write for bulletin ED5-29

**COHU**  
**ELECTRONICS, INC**  
**SAN DIEGO DIVISION**

Box 623  
 San Diego, California 92112  
 Phone: 714-277-6700

ON READER-SERVICE CARD CIRCLE 41

# Products

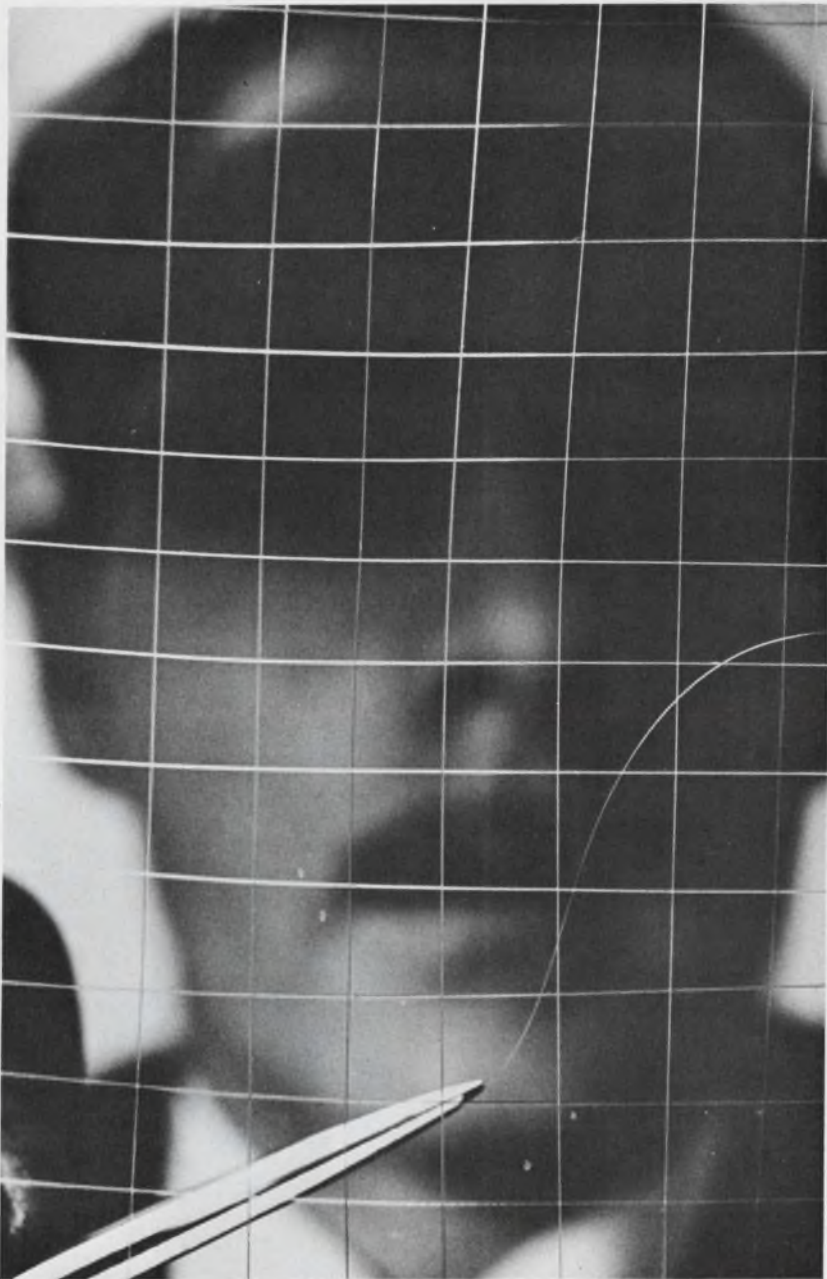

**A single-crystal sapphire** exhibits 70 million lb/in.<sup>2</sup> elasticity while remaining strong at temperatures to 1200° C. Page 108

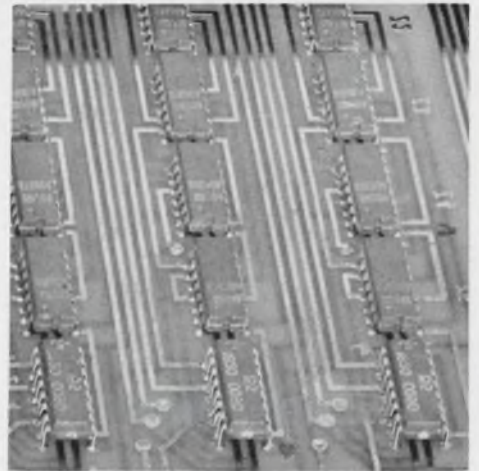

**Hybrid switches** for D-to-A converters have 10- or 14-bit accuracy. Page 119.

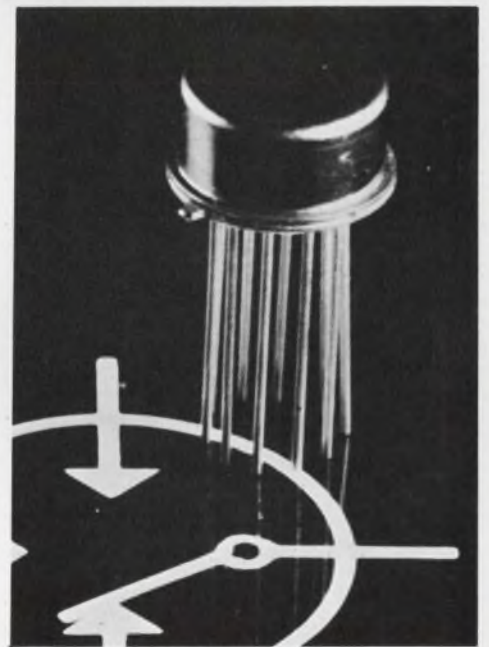

**Digital voltage source** uses plug-in cards for 50- $\mu$ s response. Page 120.

## Also in this section:

**Prevent the adhesion** of urethane, epoxy, vinyl, and polyester resins. Page 109

**Computer-controlled signal source** provides dc for BCD or binary logic. Page 120B

**Design Aids**, Page 124

**Application Notes**, Page 125

**New Literature**, Page 126

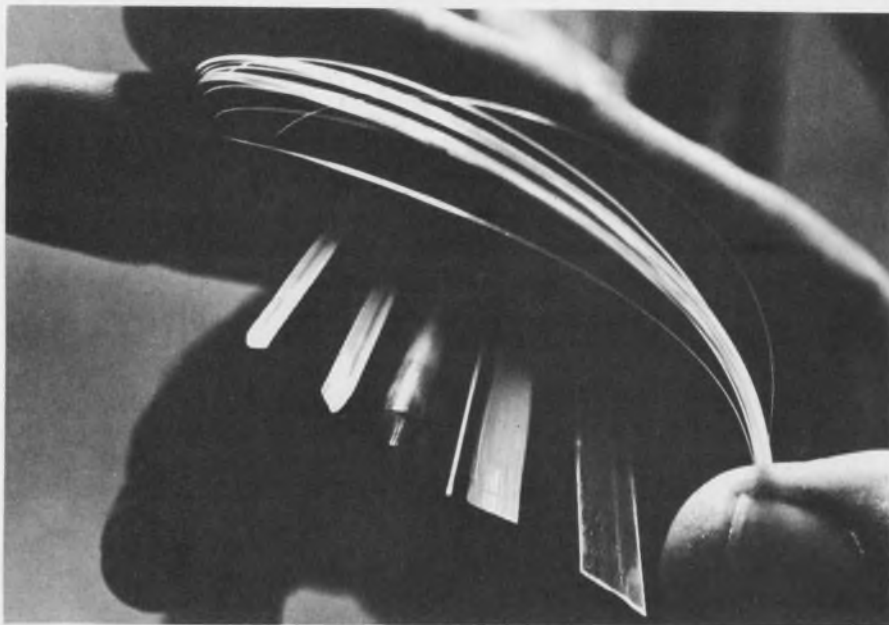

## 70 million lb/in.<sup>2</sup> elasticity in single-crystal sapphire

Tyco Labs., Inc., Waltham, Mass.  
Phone: (617) 899-2400.

The first single-crystal sapphires ever produced in continuous lengths have been developed by Tyco Labs., Inc., of Waltham, Mass., and the U.S. Air Force Materials Lab., Non-Metallic Materials Div., Wright Patterson AFB, Dayton, Ohio. The sapphire filaments, which approximate the thickness of a human hair, have a modulus of elasticity of 70 million lb/in.<sup>2</sup>. The continuous-filament material is single-crystal, high-modulus, high-strength, aluminum oxide (Al<sub>2</sub>O<sub>3</sub>), also known as sapphire.

According to R.T. Schwartz, chief of the Non-Metallic Materials Div., aluminum oxide was selected for the work at Tyco because it is the only high-modulus, high strength dielectric fiber that maintains its strength and compatibility with metals up to high temperatures. Coinventors of the process at Tyco's Laboratory are Harold E. La Belle, staff scientist, and A.I. Mlavsky, Vice President.

An unusual characteristic of the material is that it has the density of boron and is lighter than titanium. It loses its strength at 1200° C and melts at 2000° C. Above all its modulus of elasticity is twice as high as chrome steel.

Research on continuous sapphire filament was spurred by requirements for high-strength, nonmetallic structural materials. Experimental data indicate that the mechanical properties of the new material approach those of boron, which is presently the only filamentary, high modulus reinforcing material available in substantial quantities. Measurements on earlier filaments of sapphire showed average values of tensile strength around 300,000 lb/in.<sup>2</sup> with high values of 500,000 lb/in.<sup>2</sup>. Its modulus of elasticity is around 50 million lb/in.<sup>2</sup>.

"We see good prospects," said Dr. Mlavsky, "that further development of the process will lead to filaments having properties comparable with those of sapphire whiskers—namely, tensile strength in the range of 12 million lb/in.<sup>2</sup> and a modulus of elasticity of about 70 million lb/in.<sup>2</sup>."

The new material is an excellent insulator and so is useful to making such nonmetallic structural units as radomes, which must be transparent to radio frequencies. The only other materials previously suited to this application, were glass or silica fibers, which exhibit a modulus of only about 10 to 12 million lb/in.<sup>2</sup>.

As often is the case with newly developed materials, sapphire fila-

ments have bonus properties that may be useful in applications other than structural. They may, for instance, open up applications in the field of electronics and optics, for not only is it an efficient electrical insulator, but it is also a good conductor of heat. Its crystallography is such that it may be used as a substrate for silicon in the fabrication of an entirely new generation of integrated circuits. Ruby-chromium-doped aluminum oxide—can be produced by the same process used to form the sapphire filament. This may lead to the construction of more efficient lasers. The sapphire filament's transparency over a wide range of wavelengths suits it for use in specialized fiber optic devices, especially those employed in high-temperature applications.

CIRCLE NO. 400



Nonmetallic fiber has a modulus of elasticity of 70 million lb/in.<sup>2</sup>



# COMPONENT CAPSULES

New low-cost triode  
for airborne  
oscillators and amplifiers

We designed it specifically for the 1090 megahertz master-oscillator power amplifier function in the AIMS APX-72 tri-service IFF-ATC transponder. But it's also a natural for new tunable DME designs and/or for broadband amplifiers in the 1025-1150 megahertz range. It easily meets all their size, weight, shock and cost requirements. You can depend on Y-1537's to operate at power levels well above the specified minimum of 500 watts. **Circle Number 90.**



Actual size GE Y-1537 planar ceramic triode

And another  
GE transistor line  
goes epoxy.  
Result: Cost savings  
up to 50%



GE D33 transistor—  
shown actual size

No loss in performance. No change in electrical characteristics. Latest group to make the switch is our GE line designed for high grade and critical, industrial and military applications. Several series choices, too. Among them: the D33A general purpose amplifier; D33B (2N3973-76, 2N4951-54) medium current, general purpose switch/amplifier/driver; D33D high gain driver; D33E (2N3605-07, 05A, 06A) high speed digital switch; D33G (2N5029, 30) low current, high speed digital switch; D33K high current core driver and medium current, high speed switch; and D33L low voltage, very high speed switch. Seen our latest epoxy transistor reliability story? Order a copy now. **Circle Number 91.**

150-grid relays  
now rated 2 amps . . .  
now come in 4 forms

That's right. We've doubled our 150-grid relays' current ratings from 1 amp to 2. And now there are four forms to choose from—the 2 Form C, 4 Form C, 4 Form C AND logic, and the 50 mW 1 Form C (or 1A + 1B). All 150-grid relays are just 0.32" high. Take advantage of the space-saving size and get performance as good or better than much larger mil spec relays. **Circle Number 92.**

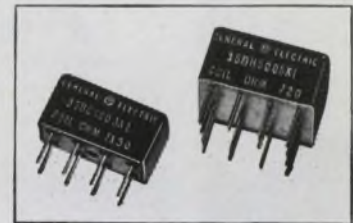

Actual size

Proved:  
In-circuit reliability  
for military uses

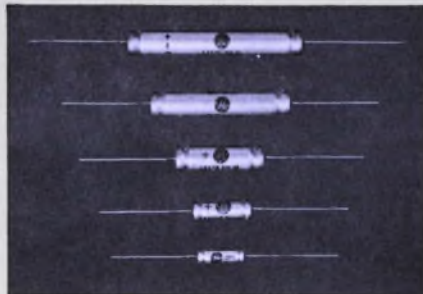

GE tantalum capacitors

More than 20 million GE tantalum foil capacitors have already been applied. They are designed to withstand unsuspected voltage reversals and are self-healing. Low impedance circuits or catastrophic failures are no problem with GE tantalum foils. Ratings are available up to 450VDC, 0.15 to 3500  $\mu$ f —55C to 85C, or 125C with voltage derating. For all the facts on these capacitors, **Circle Number 93.**

**WE MAY NOT OFFER EVERYTHING YOU WANT FROM ONE COMPONENTS SUPPLIER. BUT WE DO COME A LITTLE CLOSER THAN ANYONE ELSE.**

CONTAMINANT-FREE

# THIN FILM COATINGS

AUTOMATICALLY

TEMESCAL CONTINUOUS HIGH-VACUUM SYSTEMS ASSURE:

■ Consistent high-quality coatings ■ Complete freedom from contamination ■ Rate-controlled uniform deposition ■ Programmed automatic control ■ Minimum maintenance ■ Reliable high productivity ■ Evaporation, sputtering and glow-discharge cleaning can now be accomplished automatically in a continuous, contaminant-free, high-vacuum environment. Temescal continuous and fast-cycle thin-film coating systems are designed to maintain coating-chamber pressure as low as  $10^{-7}$  Torr for more than a thousand cycles between each maintenance clean-up. Substrates are simply moved in and out of the coating chamber through vacuum locks. ■ Coatings produced in this type of environment are exceptionally pure because of the continuous vacuum and because the evaporant remains completely outgassed. Uniformity throughout the production run is assured by Temescal's new rate monitor which remains free of coatings during long production runs. ■ Systems range in size from the Model FC-1100 (shown here), to megawatt systems with coating chambers large enough to coat 10-x 12-foot substrates.

Write or call  
for details

## AIRCO Temescal

A DIVISION OF AIR REDUCTION COMPANY, INCORPORATED

2850 Seventh Street  
Berkeley, California 94710  
Telephone 415 841-5720



ON READER-SERVICE CARD CIRCLE 43

## MATERIALS

### Micro-thin nickel foil by electroforming

*Electrofabrication & Engineering Co., Ltd., Gloucester Rd., West Chirton Industrial Estate, North Shields, England. Phone: 71251. Price: \$9.80 per lb.*

Being produced is pure nickel foil by electroforming. Electroformed nickel foil has advantages, such as greater uniformity in thickness, and a crystal structure which makes uniform etching possible. The foil is produced in 14 in. widths on a continuous basis, and various surface finishes are available. In addition, a gold finish suitable for decorative work, or a silver finish suitable for light reflectors can be applied. It is expected that the product will have a wide variety of applications; for example, in the electronic field, where on miniaturized printed circuit boards welding is replacing soldering on account of the strength and reliability of tiny welded joints.

CIRCLE NO. 328

### Osmium tipped pivots exhibit low friction

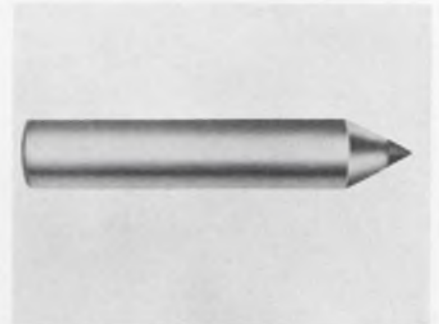

*Welton V. Johnson Engineering Co., Inc., 95 Summit Ave., Summit, N.J.*

Pivots tipped with osmium can be used to support the moving element in electrical indicating instruments. Non-magnetic and corrosion-resistant, they are intended for use in applications where low friction and long life are essential. Consisting of an osmium alloy tip welded to a spring temper K monel shank, the pivot is used with a sapphire bearing.

CIRCLE NO. 278

## Polycarbonate film 0.0008 in. thick

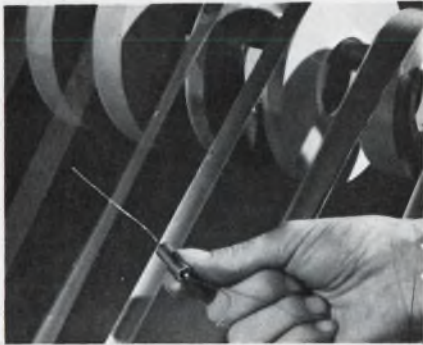

Kimberly Clark Corp., Lee, Mass.  
Phone: (413) 243-1000.

Polycarbonate capacitor film, made in thicknesses as thin as 0.0008 in., is used primarily in precision instrument, computer, military electronics, optical and specialized communications equipment applications. Sales of the product will be sold under the trade name Kimfol. Initially produced will be both plain and metalized Kimfol capacitor film in 0.0008, 0.00014 and 0.00024 in. thicknesses. The 8-gauge film, introduced this year, is the thinnest dielectric available for production of smaller size wound capacitors for use in transistorized circuitry.

CIRCLE NO. 326

## "Nonstickenstoffe" prevents adhesion

Contour Chemical Co., 40 Rugg Rd.,  
Allston, Mass. Phone: (617) 254-3001.

This chemical prevents the adhesion of urethane, epoxy, vinyl and polyester resins. It works at temperatures from 0 to 500°F. and at all pressures it coats and bonds well to molds made of epoxy, polyester or phenolic resins, aluminum and stainless steel. This mold coating is non-transferring and non staining. It does not suppress foam development or interfere with any curing mechanism. It is useful in fabricating solid castings, foams and bag molded or press-cured laminates. All pieces are clean and dry, and may be painted or bonded as they come from the mold. It releases up to 300 pieces per application. It is aerosol applied and the full properties of the film are obtained after 15 min. at 200°F.

CIRCLE NO. 385

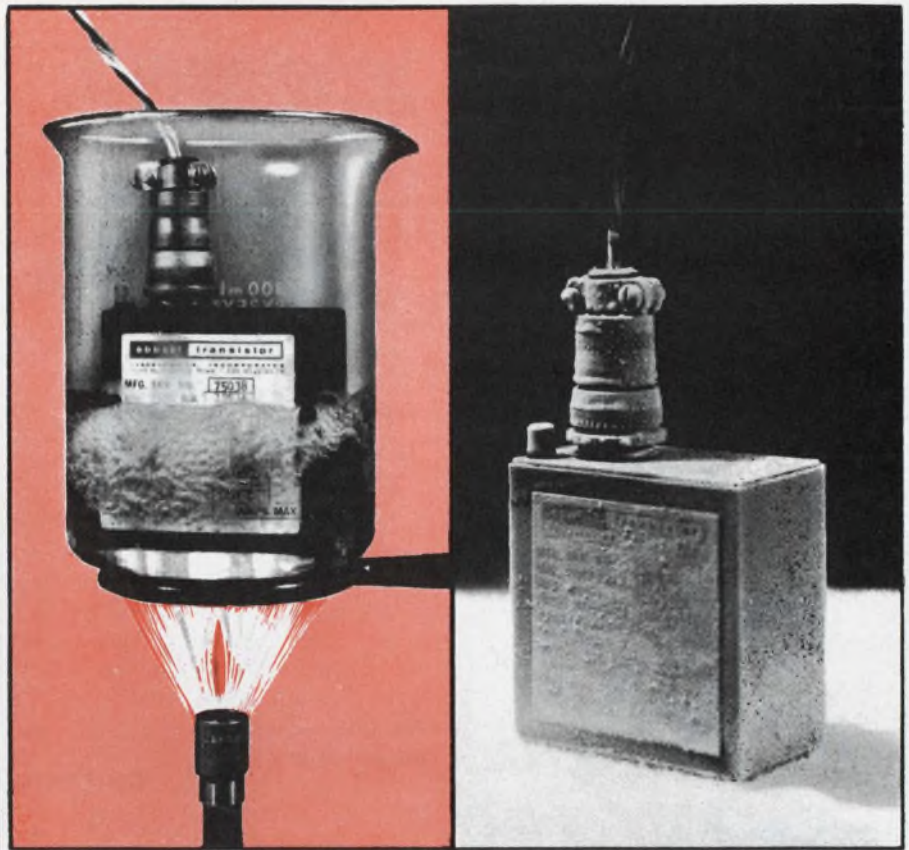

### ENVIRONMENTAL TEST No. 1

Converter runs fine  
at +212°F

### ENVIRONMENTAL TEST No. 2

Converter runs fine  
at -65°F

New Abbott converter (Hi-Temp Model B1A-110A) operates at -65°F to +212°F base temperature. The Model B1A shown above is available with any output voltage you need from 5 volts to 3,500 volts DC with an input of either 28 VDC or 115 VAC.

Using all silicon semi-conductors, this new line of converters is constructed in hermetically sealed, all steel containers to meet Mil-Specs. Advanced circuits yield regulation of 0.2% for input line variations. Highest quality components are used, including all teflon wire, tantalum capacitors, and MIL-T-27A transformers. A complete four-page description of these units is given on Pages 20-25 of the new Abbott catalog.

Abbott manufactures a wide variety of over 2400 different types of power supply modules. These include:

60 $\text{AC}$ to DC, Regulated	28 VDC to 400 $\text{AC}$ , 1 $\phi$ or 3 $\phi$
400 $\text{AC}$ to DC, Regulated	60 $\text{AC}$ to 400 $\text{AC}$ , 1 $\phi$ or 3 $\phi$
28 VDC to DC, Regulated	60 VAC or 400 $\text{AC}$ to DC, Unregulated

The DC output models come with a broad range of voltages and powers — the smallest units are about the size of a pack of cigarettes and weigh less than a pound. The AC output models are available with voltages of 115 volts or 26 volts, 400 cycles, in power levels up to 300 volt-amperes. Unregulated DC output models are low in cost with prices starting at \$64 each.

Some useful data is also included in the new Abbott catalog. It contains a discussion of thermal considerations in using power supply modules, operating hints for power supplies, and a detailed listing of environmental testing parameters with associated costs.

Please send for your FREE copy  
of this new catalog or see EEM  
(1967 ELECTRONIC ENGI-  
NEERS MASTER Directory),  
Pages 1665 to 1678.

**abbott transistor**

LABORATORIES, INCORPORATED  
5200 W. Jefferson Blvd. • Los Angeles 90016  
Area Code 213 • WEbster 6-8185

TO: Abbott Transistor Labs, Inc., Dept. 42  
5200 W. Jefferson Blvd.  
Los Angeles, California 90016

Sir:  
Please send me your latest catalog on power  
supply modules:

NAME \_\_\_\_\_ DEPT. \_\_\_\_\_

COMPANY \_\_\_\_\_

ADDRESS \_\_\_\_\_

CITY & STATE \_\_\_\_\_

ON READER-SERVICE CARD CIRCLE 44

# Design.

## Today's Best Buy ... 84¢ per db

Our rugged SA-50 and SA-70 rocker switch attenuators cover a range of 0 to 102 db in 1 db steps; the SA-58 and SA-78 cover a range of 0 to 82.5 db in 0.5 db steps from DC to 1000 MHz. Typical insertion loss is 1.5 db at 500 MHz, 3.0 at 1000 MHz. The rocker switches enable the user to vary attenuation quickly and accurately with finger tip control. Good attenuators come in small (6½" x 1¾" x 1¾") packages. Connectors are BNC female. Designed for durability and consistency, the price is right—\$85.00. SA-50 and SA-58 are 50 ohm; SA-70 and SA-78 are 75 ohm. Quick delivery from stock.

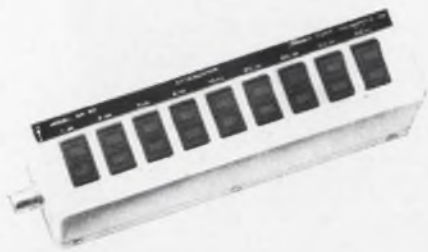

Specialists In Electronic Instrumentation

**Texscan**  
CORPORATION  
*tr*  
51 Koweba Lane  
Indianapolis, Indiana 46207  
Ph. (317) 632-7351  
ON READER-SERVICE CARD CIRCLE 45

## MICROWAVES

### Balanced mixers tune 3 bands



Aertech, 815 Stewart Dr., Sunnyvale, Calif. Phone: (415) 967-9492.

Doubly balanced Schottky diode mixers cover 1 to 8 GHz frequency range in 3 octave bandwidth models. These mixers cover the L, S and C band. Typical specifications for the 1 - 2 GHz model are 20 dB port to port isolation, 8 dB noise figure, 7.5 dB max conversion loss. Input and output VSWR's are 2:1.

CIRCLE NO. 299

### Beam director for laser use

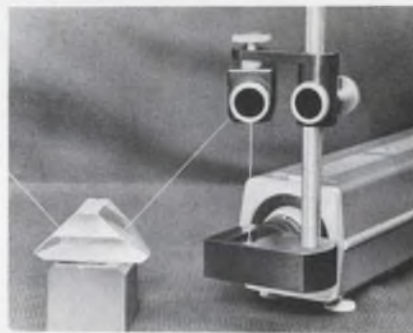

Tropel, Inc., 52 West Ave., Fairport, N.Y. Phone: (716) 377-3200. P&A: \$234; stock.

The tropel model 250 beam director consists of two plane mirrors, one of which is capable of angular adjustment so that the light beam may be directed 270 in two coordinates. Vertical displacement adjustment of one mirror with respect to the other is accomplished by a helical rack and pinion and covers a range of from 1 to 7.5 in. The rectangular mirrors are flat and will accommodate a beam up to 0.5 in. in diameter. Also available are adapters which mount the beam director to any Perkin-Elmer, Quantum Physics or Spectra Physics laser.

CIRCLE NO. 292

### Integrated filter isolator covers 5.25 to 5.95 GHz



Gombos Microwave Inc., Webro Rd., Clifton, N.J. Phone: (201) 773-6633.

The tunable filter provides frequency selection across the band of interest while the isolator assures a good match on the output regardless of the reactance presented to the filter input. By integration, interface reactance and phase problems are eliminated. These integrated packages are available with multiport circulators for use with tunnel diode amplifiers from 750 MHz to 18 GHz.

CIRCLE NO. 318

### Glass diode has 6 dB noise

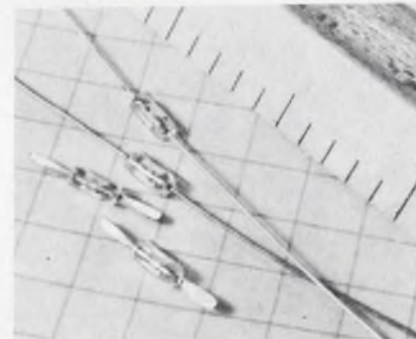

Alpha Industries, Inc., 381 Elliot St., Newton Upper Falls, Mass. Phone: (617) 969-8480.

S-band subminiature glass microwave diode has a 6.0 dB noise figure. The type MO 2301 C is suitable for use in strip transmission line applications, since the hermetically sealed case is furnished with flat ribbon leads. Units are also available with axial wire leads for ease of soldering into appropriate holders. It has a test frequency of 3.06 GHz, a VSWR of 0.6 and an IF impedance of 350 to 450 Ω.

CIRCLE NO. 325



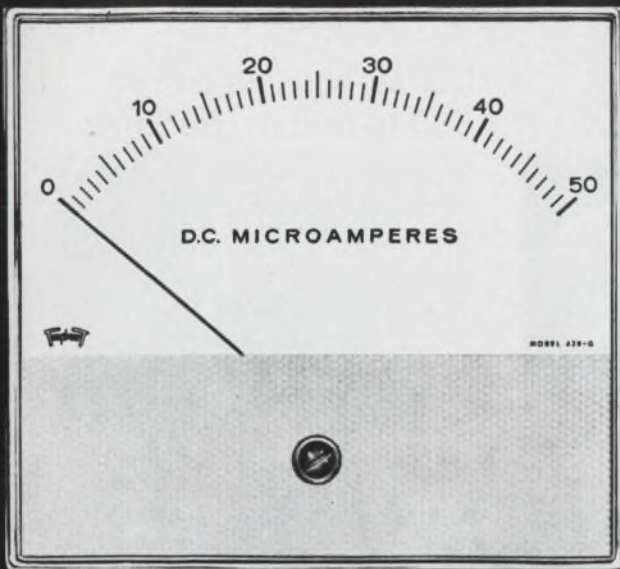

*now you see it*

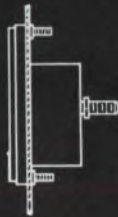

*now you don't*



## THE PANEL INSTRUMENT WITH BUILT-IN FLEXIBILITY

**TWO NEW SIZES!**

**5½" and 1½" (Miniature)**

**TRIPLET**

New Triplet G-Series Panel Instruments offer a modern design that features a greater degree of flexibility and interchangeability.

- 1** Two types of mounting are available—conventional flush type or behind-the-panel with a bezel for modern picture window appearance.
- 2** The insert shield on the front of the meter can be custom painted or printed to meet customer's requirements.
- 3** Triplet's famous self-shielded Bar-Ring magnet, with one-piece die-cast frame, in all DC and DC suspension type instruments.

In five popular sizes: 5½" DC and AC; 4½" DC and AC; 3½" DC and AC; 2½" DC and AC; 1½" (conventional flush mounting only) DC and AC rectifier type.

**NOW IN FIVE POPULAR SIZES:**

1½" (Miniature); 2½"; 3½";  
4½"; & 5½".

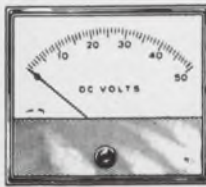

# NOW, ABOUT ELECTROLYTIC CAPACITORS... DID YOU KNOW THAT...

- \* Conventional electrolytic capacitors can act as voltage generators, producing undesirable voltages in the millivolt range!
- \* When an electrolytic capacitor is intended for energy storage applications it must be especially designed for this purpose!
- \* At Industrial Condenser, by special design, leakage currents can be kept to the micro-ampere range, resulting in insulation resistance greater than paper capacitors!
- \* There is only one grade of Royalitic Capacitor made—the best—from the highest purity aluminum foil available!
- \* Royalitic Capacitors can be obtained with a capacitance tolerance as low as  $\pm 10\%$ !

When your circuit calls for an electrolytic capacitor, use the best—

ALWAYS SPECIFY

## Royalitic



—and when you have special requirements in capacitors, send them to the specialists!

Write for Catalog No. 1165B



3243 No. California Ave.  
Chicago, Illinois 60618

ON READER-SERVICE CARD CIRCLE 47

## MICROWAVES

### Optical perfection with sapphire etalon

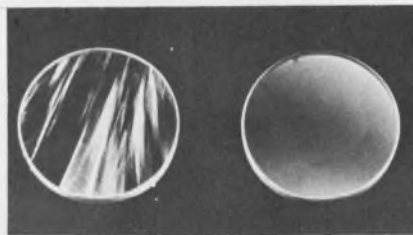

Union Carbide Corp., 4120 Kennedy Ave., East Chicago, Indiana. Phone: (219) 398-9274.

Technological refinement of the Czochralski crystal growth process (similar to that used in the manufacture of the laser ruby) has resulted in large diameter, melt-pulled sapphire material of high purity, virtual absence of strain and lineage, low dislocation count, and improved damage resistance. The material exhibits an absence of scattering sites and crystallographic misorientations of the order of minutes, compared to degrees of misorientation in a conventional Verneuil sapphire. The optical perfection of the Czochralski sapphire etalon, on the right, is evident when compared to a flame-fusion sapphire (crossed polaroids at approximately 1.5 magnification.)

CIRCLE NO. 294

### S band diodes have VSWR of 1.5

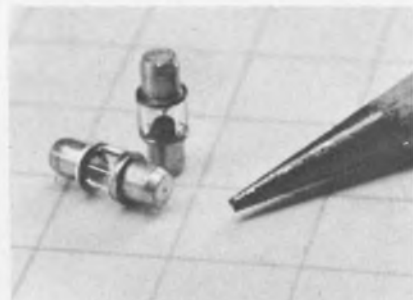

Alpha Industries, Inc., 381 Elliot St., Newton Upper Falls, Mass. Phone: (617) 969-8480.

An SLX silicon point contact mixer diode exhibits a noise figure of 5.5 dB. The type MO 300G provides a replaceable type unit for stripline and coaxial applications. The unit is for plug-in stripline shunt and coax shunt or series designs and its small package size provides good broadband characteristics. Its test frequency is 3.06 GHz with a max. VSWR of 1.5, and an IF impedance of 325-525  $\Omega$ .

CIRCLE NO. 327

### Ultraviolet measured 300 to 500 m/microns



International Light, Inc., 12 Unicorn St., Newburyport, Mass. Phone: (617) 465-5923. P&A: \$199; stock.

The IL411T photoresist photometer is designed for the measurement and control of ultraviolet sources used to expose photoresistive coatings. The SC100A photosensor assembly, supplied with the IL114T, selectively responds to the wavelength region from 300 to 500 m/microns emitted from the ultraviolet source. Use of this instrument can optimize and control intensity level, beam uniformity, alignment, distance and focus in the photoresist processing of semiconductors, microelectronic circuits, printed circuit cards, and milled components.

CIRCLE NO. 355

### Create holograms 3-D in 1 hour



University Labs., Inc., 733 Allston Way, Berkeley, Calif. Phone: (415) 848-0491. Price: \$195.

With the model 210 Holography kit, holograms can be produced under conditions found in ordinary laboratories. The kit includes a complete laboratory manual covering theory and step by step instructions, spectrographic plates, beam splitters, front surface mirrors, lenses, stands and holders, developing and fixing chemicals, trays and tanks, and other necessary items. With this equipment, a three-dimensional hologram can be made in under an hour.

CIRCLE NO. 288

## Frequency mixer accepts 2 to 6 GHz

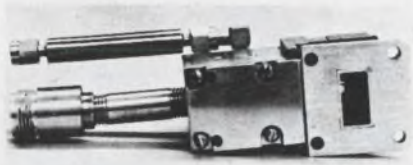

Raven Electronics, 101 W. Alameda Ave., Burbank, Calif. Phone: (213) 476-4781.

A frequency translator accepts input frequencies from 2 to 6 GHz and has output frequencies in the 8 to 12 GHz range. The input-output ratio is 3:1. No tuning is required, either during installation or operation of the translator. The unit also features inherent suppression of the 14 GHz frequency. Conversion loss is 8 dB nominal. Input VSWR is 2.5:1 maximum referenced to 50 Ω. The mixer is designed to MIL-E-5400 requirements. It weighs 5 oz and measures 5 x 1.75 x 1.5 in. with connectors.

CIRCLE NO. 263

## Backward-wave oscillator spans 18 to 26.5 GHz



Watkins Johnson Co., 3333 Hillview Ave., Palo Alto, Calif. Phone: (415) 326-8830.

This backward-wave oscillator covers 18 to 26.5 GHz and has applications as a local oscillator in radar receivers, as a master oscillator in frequency diversity transmitters and in ECM equipment. The SE-218 features permanent magnet focusing, smooth power over the band, low-cathode current (10 mA) and two control electrodes. Power output (20 MW) can be modulated with either the grid or anode, or both. The unit weighs 4 pounds and is 2½ x 2½ x 5 in. in size.

CIRCLE NO. 393

## Breakthrough by Dearborn!

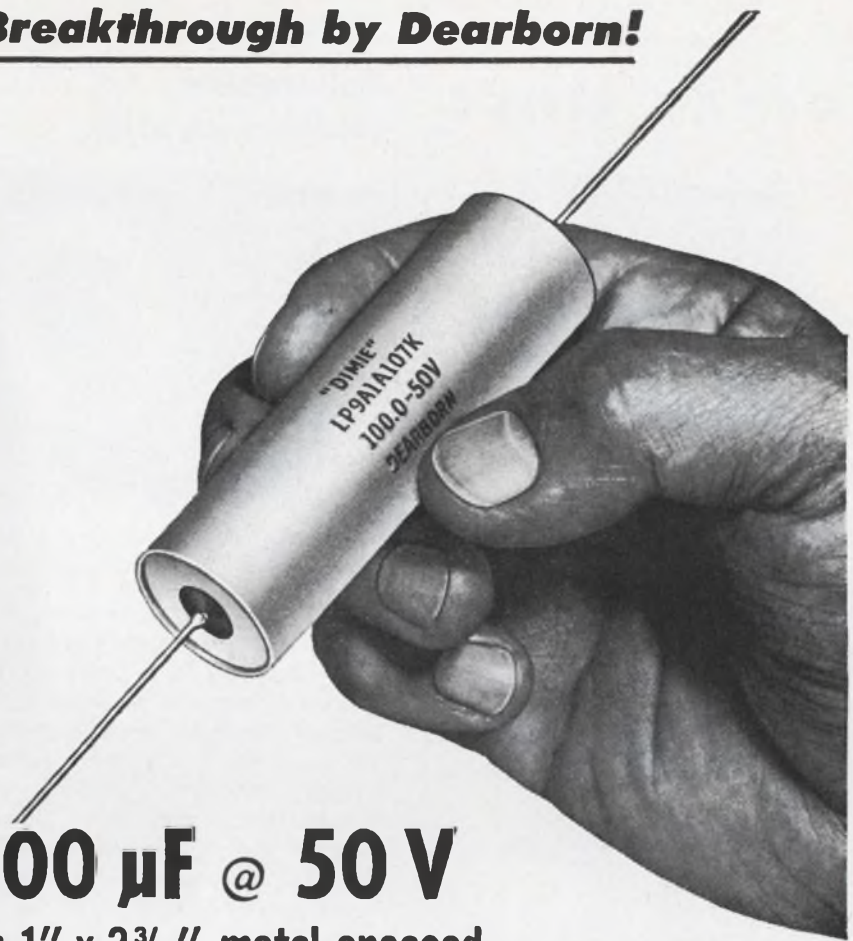

# 100 μF @ 50 V

in 1" x 3¾" metal-encased

## METALLIZED POLYCARBONATE-FILM CAPACITORS

⊕ Capacitance range of Dearborn DIMIE® Series now extended to almost 18 times higher than previously-available values!

⊕ A new order of size and stability in capacitors for critical low-voltage miniaturized circuits.

⊕ Rated for operation at temperatures to +125 C without derating.

⊕ Low loss characteristics, high current-carrying capabilities—ideally suited for specialized a-c and r-f applications.

For complete technical information, write to Dearborn Electronics, Inc., Box 530, Orlando, Fla. 32802.

**Dearborn Electronics, Inc.**  
(a subsidiary of the Sprague Electric Company)  
**FOREMOST IN FILM CAPACITORS**

10-710781

ON READER-SERVICE CARD CIRCLE 48

## DELAY LINES

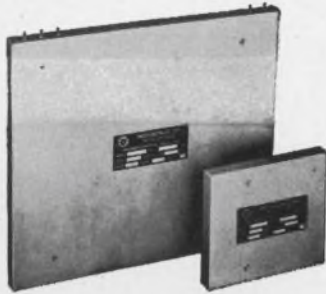

### GENERAL

Delay .4 to 10,000 usec at frequencies from 10 to 400 mc. Wide bandwidth and low spurious response for excellent pulse reproduction and dynamic range.

### COMPUTER STORAGE SYSTEMS

Ultrasonic delay lines using fused quartz or special glasses represent an ideal medium for high-speed Computer Storage, up to 20 mc rates.

Send for Microsonics' Brochure #5350.

### DIGITAL DELAY LINES

Delay lines for storage of high-speed digital pulses with zero temperature coefficient of delay for Computer applications. Design Bulletin available on request.

### MAGNETOSTRICTIVE DELAY LINES

Microsonics, Inc. has a broad delay line and systems experience with capability to deliver both off-the-shelf and custom-designed systems for any specific application.

Systems provide for the delay or storage of both analog and digital signals and are available to handle all modes of modulation (RZ, NRZ and Bipolar). Output signals are available in either clocked or unclocked signal.

Send for Microsonics' Brochure #M735.

### VARIABLE AND TAPPED DELAY LINES

Featuring all usual advantages of superior fixed Delay Lines.

## MICROSONICS INC.

A subsidiary of the  
SANGAMO ELECTRIC CO.

60 Winter Street  
Weymouth, Mass.

Area Code (617) 337-4200



DELAY LINES  
QUARTZ CRYSTAL PRODUCTS

ON READER-SERVICE CARD CIRCLE 49

## COMPONENTS

### Ball tracker replaces joy stick

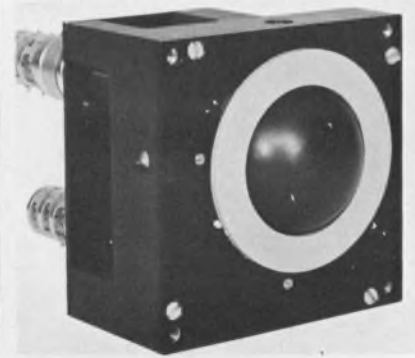

Instrument Corp., 131 Eileen Way,  
Syosset, N.Y. Phone: (516) 921-6310.

On course and cross course, information is fed into the ball by pressure of the operator's palm. Rotation of the ball about any axis which lies in the plane of the control panel is resolved into its X and Y components through infinite resolution couplings and transmitted to the system through digital encoders, synchros, or potentiometers, as required. The tracking force necessary to rotate the ball is approximately 3 oz. One revolution of the ball will rotate the X and Y shafts from 1.35 to 2 revolutions.

CIRCLE NO. 341

### Temperature sensors tell up to 600° C

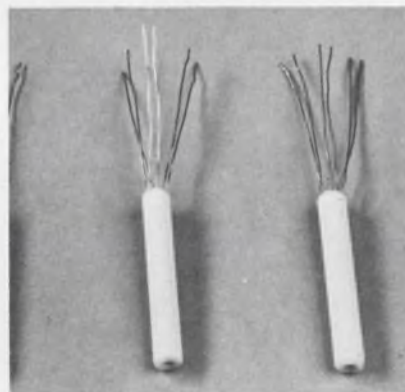

Electric Thermometers, Inc., 10  
Glover Ave., Norwalk, Conn. Phone:  
(203) 847-7265.

Triple wound industrial temperature sensors have 3 independent platinum windings in one body. The 3 windings are each calibrated to a standard value of  $100 \pm 1 \Omega$  at  $0^\circ \text{C}$ . The maximum operating temperature is  $600^\circ \text{C}$ . The overall body size is 1-1/4 in. long x 0.2 in. in dia. with 1-1/4 in. long leads.

CIRCLE NO. 316

### Resonator oscillator withstands 50 g shock

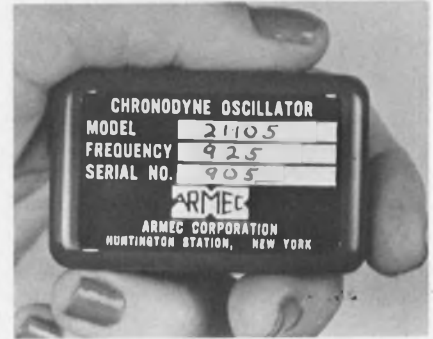

Armec Corp., 195 West Hills Rd.,  
Huntington Sta., L.I., N. Y. Phone:  
(516) 427-7787.

Oscillator model 211 operates in a range of environmental conditions which include 10-g vibration at operating frequency, 50-g shock, 20-g acceleration in any direction and temperature from  $-65^\circ$  to  $+125^\circ \text{C}$ . Frequency accuracy to 0.01% is a function of temperature with 0.025% from  $-40^\circ$  to  $+80^\circ \text{C}$ . A size of (1.65 cu. in.), a flat configuration and hermetic sealing are packaging techniques used in this device.

CIRCLE NO. 334

### Tuning fork weight 1/2 oz.



Barden Co., 675 Valley Dr., Hermosa  
Beach, Calif. Phone: (213) 376-8841.

Micro-miniature tuning forks occupy less than 0.29 in.<sup>3</sup> and weigh under 1/2 oz. Designed to meet MIL-STD 202B, specifications include accuracy to 0.001%; stabilization time approximately 1 s, 0.2  $\mu\text{s}$  or less rise and fall time, an operating temperature from  $-55$  to  $+125^\circ \text{C}$  and a square wave output frequency range from 30 Hz to 25 KHz. Various input voltage and output level models are available including a low power consumption unit designed for space applications.

CIRCLE NO. 315

For SALE

# OXIDE ISOLATION

Step 1.

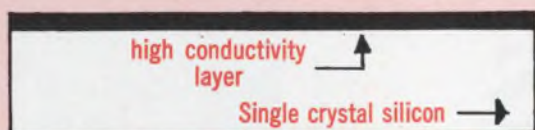

Step 2.

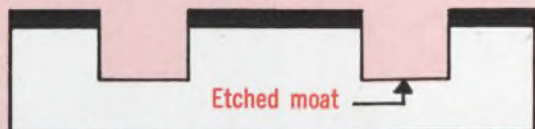

Step 3.

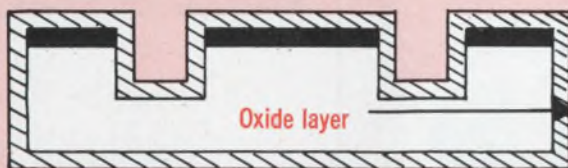

Step 4.

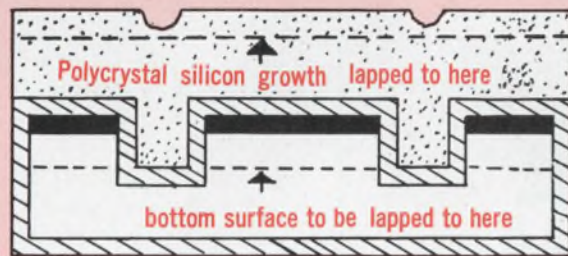

Step 5.

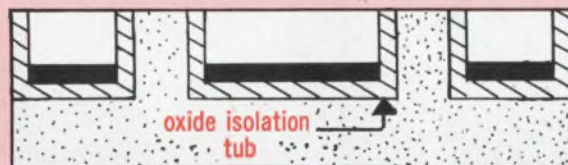

**Final-polished slice ready for standard component diffusions**

## CUSTOM INTEGRATED CIRCUIT PRODUCTS

Because Industro is equipped to produce oxide-isolated silicon slices, it is ideally prepared to service customers who wish to purchase standard or custom-designed slices after further integrated circuit processing as well.

1. Slices can be purchased at the completion of all diffusion and photo-engraving steps required for component fabrication. Some customers will wish to add their own thin-film resistor or interconnection layers themselves. Often a single slice design can be used as a "master-slice" with which only a change of contact and interconnection masks is required to produce many different circuits.
2. Slices can be purchased after all slice work is done, including interconnections, and ready for probing and assembly.
3. Completely assembled and final-tested integrated circuits are also available from  to supply your custom requirements.

## MATERIAL SERVICES

Using your isolation mask, we will supply slices which contain all the oxide-isolation processing and which are ready for your further manufacturing steps.

By using our skills, we can move you out of the tricky, almost endless R & D stage directly into the production of "oxide-isolation" integrated circuits.

### Consider the following advantages:

1. Oxide isolation replaces diffused P-N junction isolation and thus reduces or eliminates parasitic substrate leakage and capacitance.
2. Oxide isolation prevents 4-layer latch-up and greatly enhances radiation resistance.
3. High conductivity buried layers are easily included in the structure, permitting higher voltage transistors to maintain low V (sat).
4. Devices are built in high quality Czochralski-grown silicon, rather than epitaxial layers, thus permitting the widest possible choice of resistivity and type.
5. Oxide isolation permits selective gold doping in neighboring devices.
6. Isolation voltage can exceed 1,000 volts, making possible high voltage circuits.
7. New circuit designs are much less likely to require costly trial-and-error re-designs of masks because of the absence of the major cause of "parasitics"-junction isolation. Designers can eliminate consideration of some of the phantom-parasitics and rely on results and circuit performance associated with discrete components.
8. All materials of construction are completely compatible; Silicon, SiO<sub>2</sub>. No need to fear either contamination problems, melting point problems or thermal expansion match-up problems stemming from foreign materials used in other forms of dielectric isolation structures.

Technical details concerning mask and component design can be discussed with no obligation.

## HYBRID CIRCUIT PRODUCTS

Here, too, oxide isolation adds a new and highly desirable degree of freedom for circuit designers. Products are available in slice form and chip form. For chip-and-wire assemblers, there are many advantages to having the bottom of the transistor, diode, resistor or capacitor chip isolated from the active regions on the top.

1. Possibly eliminate ceramic printed circuitry, making maximum use of thermal properties of standard metal base headers. Increase power ratings of components and circuit.
2. No lead time needed on new circuit designs since they can be produced by simply moving chips around on a standard multi-pin TO-5 base without fear of shorting any of the oxide-isolated chips.
3. Scribbling out of matched pairs and multiple component arrays (diodes, transistors) is now possible, reducing number of separate chips involved and thus making assembly faster, safer. Can even include a multi-component interconnection pattern which then reduces number of wire-bonds needed.
4. Component design can take advantage of maximum range of resistivity and type choices which arise from use of Czochralski-grown silicon instead of epitaxial layers. Further, component design can include optional use of high conductivity buried layers for minimum V (sat).
5. Custom design blocks of resistors and capacitors can be supplied with oxide-isolated bottoms, as well.
6. Standard silicon chip assembly methods will be perfectly applicable.



**INDUSTRO TRANSISTOR CORPORATION**

35-10 36th AVENUE / LONG ISLAND CITY, NEW YORK 11106 (212) EX 2-8000

ON READER-SERVICE CARD CIRCLE 50

# reliable switches

## FOR THE BOEING 727

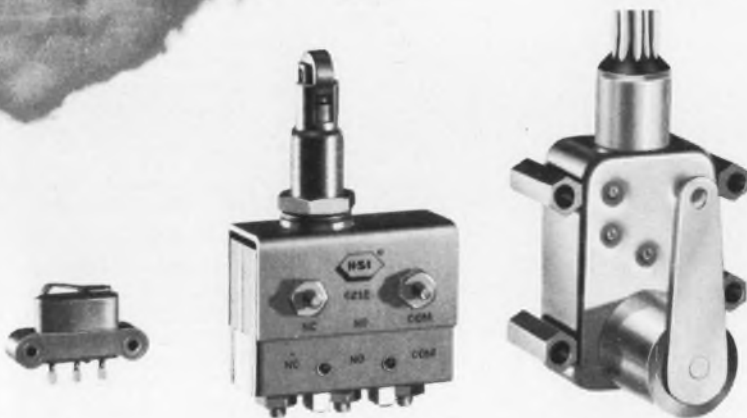

HSI sealed switches have successfully performed critical tasks on the Boeing 727 since the start of the program. That means faithful performance during thousands of flight hours.

The HSI Flap, Leading Edge Slat, and Landing Gear Switches have patented elastomer-bonded rotary seals and heliarc welded stainless steel enclosure. These features provide positive protection against severe environmental conditions of humidity, altitude and temperature.

The HSI hermetically sealed Engine Thrust Reverser Lockout Switches operate in ambient temperatures of  $-65^{\circ}$  to  $+660^{\circ}$ F. This capability comes from years of experience with high temperature applications. Furthermore, the one-piece blade design of these switches provides unusually high contact pressures making the switches insensitive to severe vibration conditions. Call HSI for answers to special switching problems. Send for data sheets.



**HAYDON SWITCH & INSTRUMENT, INC.**

*Where Optimum Performance is Standard*

1500 Meriden Road, Waterbury, Conn. 06720/Area Code (203) 756-7441

ON READER-SERVICE CARD CIRCLE 51

## SEMICONDUCTORS

### Hybrid switches for D to A converters

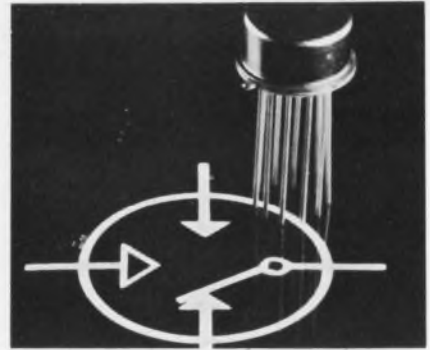

*Crystalonics, Inc., 147 Sherman St., Cambridge, Mass. Phone: (617) 491-1670. Price: \$44 (1-99); stock.*

Available are 3 standard hybrid circuits, designated CDA 1-1, 2 and 3; for negative reference R/2R D to A converters. These packages use all military grade semiconductors, and feature complete switch and interface functions in one package. They are available in several configurations permitting operation directly from low or high level positive or negative logic, including MOS. All types feature a saturation resistance of  $5 \Omega$  and an offset voltage of 1 mV. Having 10-bit accuracy, they are also available in sets for up to 14 bits. High component density achieved by bonding chips directly to the substrate. This technique gives a unique chip-testing capability.

CIRCLE NO. 312

### P-channel MOS FET handles 40 V

*Union Carbide Electronics, 365 Middlefield Rd., Mountain View, Calif. Phone: (415) 961-3300.*

This MOS FET (the UC 1700) needs no precautionary handling, a fact which is indicated by its  $\pm 150 \text{ V } V_{GSS}$  rating. The device is a P channel enhancement mode type. Other features of the unit include a minimum breakdown voltage of 40 V,  $-10^{15} \Omega$  input resistance, and a minimum of 2000  $\mu\text{mho}$ . The package is a TO 72 JEDEC. The UC 1700 can be specified for electrometers, high impedance amplifiers, and multiplex and commutating applications.

CIRCLE NO. 290

**Motorized cutter travels at 4 speeds**

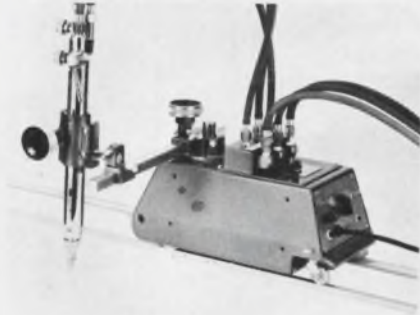

Tescom Corp., 2633 S.E. Fourth St., Minneapolis. Phone: (612) 331-1311.

This portable cutting machine features modular design for quick replacement of several control and drive parts. A plug-in circuit board, consisting of solid-state electrical systems for machine control, can be replaced in a matter of minutes. The units also feature interchangeable motor and gear head assemblies. Four assemblies are available providing four different travel-speed ranges. The standard assembly provides a travel-speed range of 3 to 70 in. per minute; other assemblies provide 1-1/2 to 35, 6 to 140 and 12 to 240 in. per minute ranges.

CIRCLE NO. 293

**Handler tests ferrite cores**



Computer Test Corp., 3 Computer Dr., Cherry Hill, N.J. Phone: (609) 424-2400. P&A: \$3850; 4 wks.

The CH-30 core handler provides the means for physically moving large ferrite cores through a test position and then depositing each tested core into either an accept or reject receptacle, depending upon the decision of associated signal-analysis equipment. Cores 0.08 to 0.5 in. OD can be handled at rates up to 100 cores/min.

CIRCLE NO. 254

# Columbia Components Thick-film hybrids.

**Send us your specs for fast action.**

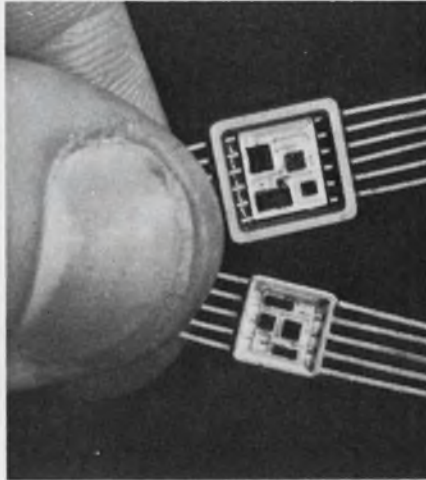

The answers to your micro-packaging problems are as close as this coupon.

The hybrid circuit is a versatile tool in the hands of the design engineer faced with problems in high power ratings, thermal tracking, precision component tolerances, intermixing monolithic IC's and other interfacing circuitry and components. In applications where the design may undergo changes up to the first production article, the hybrid offers the designer freedom to institute necessary changes with minimal cost and time.

Columbia Components Corporation's Thick-Film Hybrid Circuits are capable of reproducing any given circuit without degradation in circuit functions. These hybrids also present the most economical approach to most problems.

Please sketch schematic (or print, if available) and attach.

Application \_\_\_\_\_

Customer Print # \_\_\_\_\_

Rev: \_\_\_\_\_ Lead Forming \_\_\_\_\_

Is qualification acceptance required? \_\_\_\_\_

Is lot acceptance required? \_\_\_\_\_

Package style & size: \_\_\_\_\_

Body Material: \_\_\_\_\_

Lead materials: \_\_\_\_\_

MAXIMUM RATINGS

Storage Temp. Range \_\_\_\_\_ Operating Temp. \_\_\_\_\_

Ambient Temp. \_\_\_\_\_ Power Dissipation of 25°C \_\_\_\_\_

Have your engineer call.

Send descriptive literature.

R	Value	Tol.	T.C.	Wattage	Q	Generic Type	Tol.
R1					Q1		
R2					Q2		
R3					Q3		
R4					Q4		
R5					Q5		
R6					Q6		
R7							
R8							
R9							
R10							

C	Value	Tol.	Rated Voltage	CR	Generic Type	Tol.
C1				CR1		
C2				CR2		
C3				CR3		
C4				CR4		
C5				CR5		
C6				CR6		
C7						
C8						
C9						
C10						

Environmental Specifications \_\_\_\_\_

Military Specs., if any \_\_\_\_\_ Frequency \_\_\_\_\_

Other applicable specs \_\_\_\_\_

Voltages \_\_\_\_\_

Name \_\_\_\_\_ Title \_\_\_\_\_

Company \_\_\_\_\_

Address \_\_\_\_\_ Telephone \_\_\_\_\_

City \_\_\_\_\_ State \_\_\_\_\_ Zip \_\_\_\_\_

**COLUMBIA COMPONENTS CORP.**  
 A Subsidiary of Computer Instruments Corp.,  
 92 Madison Ave., Hempstead, N.Y. 11550. Tel: (516) 483-8200.

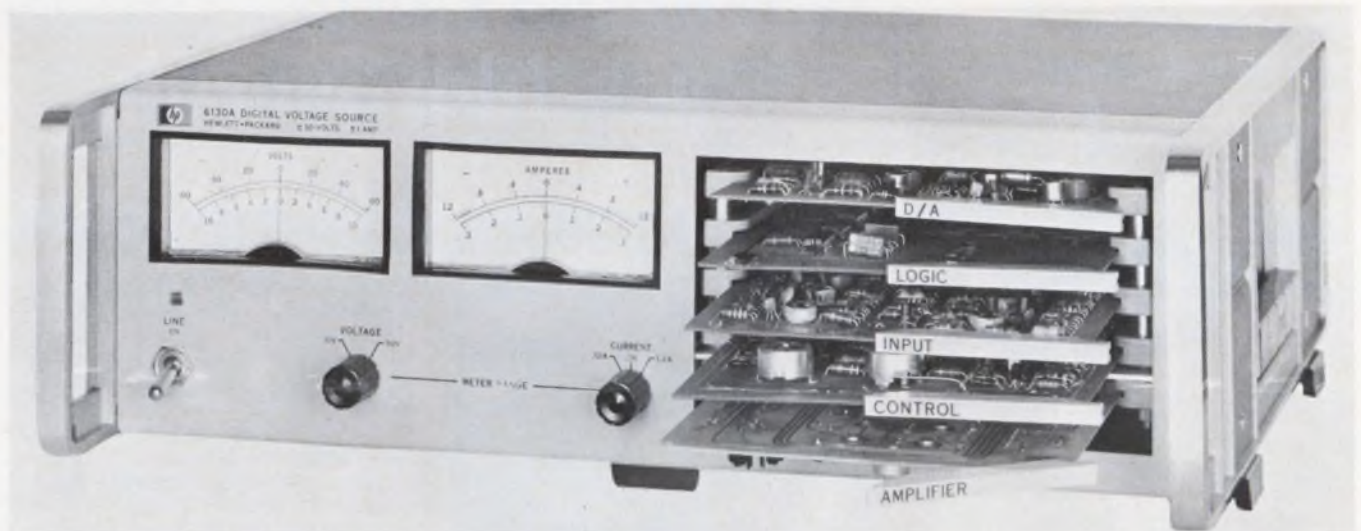

## Digital voltage source delivers 50-W output

*Hewlett Packard, Harrison Div., 100 Locust Ave., Berkeley Heights, N.J. Phone: (201) 464-1234. Price: \$1500.*

In computerized instrumentation systems, speed is of the essence. To accommodate this requirement, the 6130A digital voltage source, a digital-to-analog power converter, has a through-zero response time that is under 100  $\mu$ s. Together with its 50-W output rating and its input capability of 16 bits plus sign, the unit can be a foundation instrument in any digital system.

It can be fed 17 bits of voltage and polarity data in 8-4-2-1 BCD code from a digital programmer, digital voltmeter, computer, or any other digital instrument that puts out parallel data. The data entering the 6130A first pass through isolator circuits, which consist of keyed 10-MHz oscillators followed by isolation transformers and rectifiers. The data bits then pass through an all-solid-state logic circuit, which makes the D-A conversion possible even when going from negative to positive values.

Current limit magnitude and range are provided by the programmer or the current limit switches on the digital voltage source, depending on the state of the auto/manual signal from the programmer, as in the voltage range input. The current limit magnitude input is a two-bit code that selects a current limit of

20, 50, 70 or 100 mA. The current limit range input multiplies the magnitude by 1 or 10. In the  $\times 10$  range, the current limit is programmed to 200, 500, 700 or 1000 mA. These inputs are decoded and compared with a sample of the load current. If the output current exceeds the programmed current limit, the power amplifier output is electronically open-circuited, and the programmer notified of the current overload.

The manual/automatic switch al-

lows the computer to decide which method of control will be used; if a computer or other programmer does not control the manual/automatic switch, the manual-control mode of current limit value and voltage range must be used.

If the 6130A is inadvertently unconnected to the computer, an interlock circuit closes which shorts the output terminals and protects the load from an overvoltage.

CIRCLE NO. 391

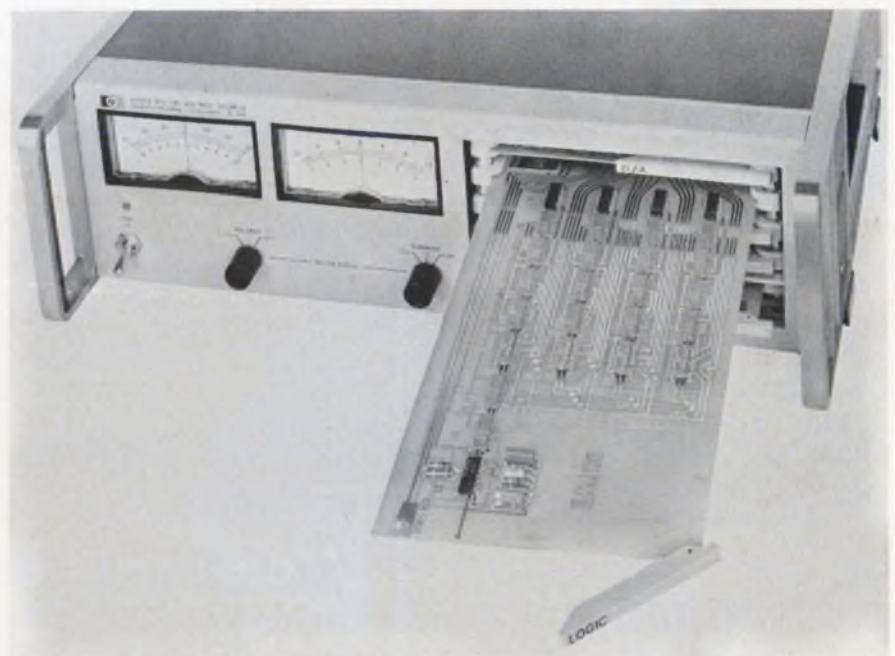

The accessible circuit boards allow 17 bits of data to be fed in.



No need! Nearly twenty years of flight time on aircraft from the B-29 to the C-5A have proven the dependability of wiring insulated with TEFLON fluorocarbon resins. Lab tests are O.K.; we've got hundreds on record, but nothing tops the proof of use . . . and TEFLON has the proof

of millions of flying hours in scores of aircraft.

Ask for our brochure explaining in detail why there are no test flights for TEFLON. It may help you eliminate one unnecessary variable from *your* next test flight. Write Du Pont Company, Room 5617E, Wilmington, Delaware 19898.

\*Reg. U.S. Pat. Off. for Du Pont fluorocarbon resins and films.

**There are no test flights for Teflon\***



Better things for better living  
...through chemistry

TEFLON... the proven performer

# COOL

KLYSTRONS • MAGNETRONS • TRANSFORMERS  
TRAVELING-WAVE TUBES • SWITCH TUBES  
WAVE GUIDES • DUMMY LOADS • LASERS

**with New ELLIS and WATTS  
Liquid-to-Air Heat Exchangers\***

One of the new Ellis and Watts Heat Exchangers may be the answer to a need for tailoring a cooling system to your type of electronic equipment. Minimum space, low noise level and optimum performance have been achieved in each of a wide range of designs which include indoor/outdoor types in ratings from 5 to 300 KW. Proved in military, aerospace and commercial applications, these designs offer flexibility for quick modification to meet any specific cooling requirements.

Why not put the widely recognized Ellis and Watts custom-cooling "know-how" to work for you. Write us at the address below.



\*Liquid-to-Liquid Heat Exchangers also available.



**ELLIS AND WATTS COMPANY**  
Ellis and Watts Company, P.O. Box 36033  
Cincinnati, Ohio 45236

ON READER-SERVICE CARD CIRCLE 98

## SYSTEMS

### ICs help computer to cycle in 1.5 $\mu$ s



*Digital Equipment Corp., 146 Main St., Maynard, Mass. Phone: (617) 897-8821. Price \$12,800.*

The PDP-8/I, a follow-up to the PDP-8, uses ICs, has a 1.5- $\mu$ s cycle time and performs 333,333 additions per second. The basic unit is pre-wired so that the first extra 4096 words of core memory and the most popular peripherals can be plugged in without further interface. Expansion of the PDP-8/I core memory is accomplished by the addition of one to seven memory modules.

A memory parity option provides automatic checking of the transfer of each word between the processor and core memory by generating a thirteenth parity bit for each word written in core memory and then checking parity during memory reading. A program interrupt is initiated when a parity error is detected. The core memory is expandable to 32,768 words. An extended arithmetic option is available which permits multiplication and division in approximately 6 and 6.5  $\mu$ s, respectively. In addition to standard teletype, the PDP-8/I operated on all of Digital's optional devices. These include DEC-Disc, DECtape, IBM magnetic tape, high-speed perforated tape readers and punches, card equipment, a line printer, analog-to-digital and digital-to-analog converters, cathode-ray tube displays, magnetic-drum systems, and communications equipment. The unit is available for mounting in a 19-in. rack. It will also be offered in a pedestal-mounted version and a tabletop model.

CIRCLE NO. 392

### Penciled records enter EDP systems



*Hewlett Packard, 1501 Page Mill Rd., Palo Alto, Calif. Phone: (415) 326-7000. P&A: \$2500; stock.*

The Optical Mark Reader senses pencil marks and punches made on standard tab cards and can enter the data into any system that is compatible with Dataphone. According to Hewlett-Packard, it would work well under the most adverse conditions.

It occupies a space 12-3/4in. wide, 20 in. deep and 7 in. high. Errors in penciled entries can be corrected with a good rubber eraser. Preprinted marking boxes will accept 39 characters of alphanumeric information on each card. The preprinting is clearly visible to the eye, but not to the machine's photosensors, which respond only to the punched or penciled markings. Since the device handles both kinds of entries without discrimination, part of any card may be prepunched for special purposes, to eliminate need for repetitive human entries.

Reading rate and output format of the reader are compatible with standard telephone data sets, and appropriate for simple data communications by teletypewriter, Data Speed, or other tape perforators. The standard rate is 105 characters per second; 10 characters per second is optional. Transmissions match the requirements of any receiving terminal which will receive Bell system 202C (105 rate) or 103A (10 character rate) equipment. The reader is equally compatible with large network systems, where computer polling and multiplexing facilities are available.

It has been designed to operate in such environments as construction sites, machine shops, weather stations, and other locations where vibration, temperature, or humidity may be problems.

CIRCLE NO. 395

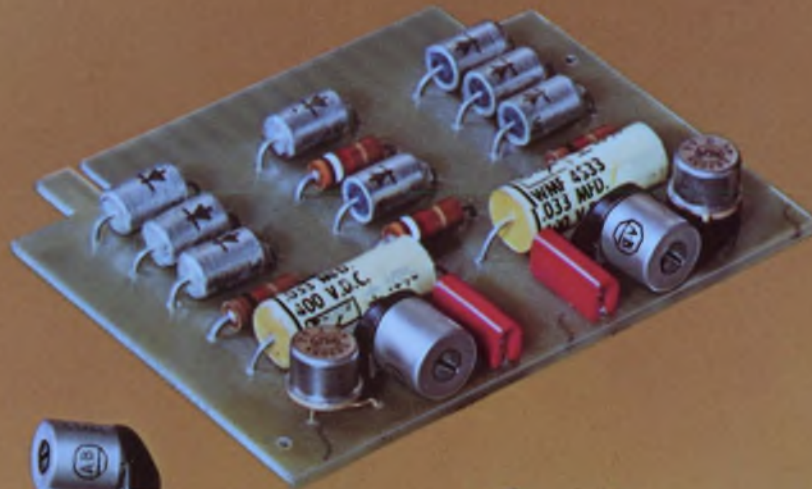

All components  
shown actual size



## Only the new Allen-Bradley Type S cermet trimming resistors have all these features

### Type S

shown twice actual size

for side  
adjustment



for top  
adjustment

The Allen-Bradley Type S is a one turn cermet trimmer in which you will find incorporated a wider range of features than in any other trimmer now on the market. Here are a few of the more important features.

- **COMPACT**—body is  $\frac{3}{8}$ " dia.
- **BUILT FOR EITHER TOP OR SIDE ADJUSTMENT**
- **50 OHMS THRU 1 MEGOHM**
- **THE SEALED UNIT** is immersion-proof
- **TEMPERATURE COEFFICIENT** less than 250 ppm/°C over *all resistance values and complete temperature range*
- **UNIQUE ROTOR DESIGN** provides exceptional stability of setting under shock and vibration
- **SMOOTH CONTROL**, approaches infinite resolution
- **PIN TYPE TERMINALS** for use on printed circuit boards with a  $\frac{1}{10}$ " pattern
- **VIRTUALLY NO BACKLASH**
- **WIDE TEMPERATURE RANGE** from -65°C to +150°C
- **RATED  $\frac{1}{2}$  watt @ 85°C**
- **EXCEPTIONAL STABILITY** under high temperature or high humidity
- **MEETS OR EXCEEDS ALL APPLICABLE MIL SPECS**
- **COMPETITIVELY PRICED!**

You'll find the new Type S trimmer equal to the traditional Allen-Bradley quality. You really ought to know more about the Type S. Won't you write for detailed specifications? Allen-Bradley Co., 222 W. Greenfield Ave., Milwaukee, Wis. 53204. In Canada: Allen-Bradley Canada Limited. Export Office: 630 Third Ave., New York, N. Y., U.S.A. 10017.



**ALLEN-BRADLEY**  
QUALITY ELECTRONIC COMPONENTS

- 7 STANDARD single, dual, and triple units, including units with concentric shaft and vernier operation.

---

- 16 STANDARD resistance values from 50 ohms to 5 meg.

---

- 2 STANDARD tolerances 10% and 20%.

---

- 5 STANDARD resistance tapers.

---

- 18 STANDARD electrical tap options.

---

- 46 STANDARD shaft lengths from 3/8" to 6.0".

---

- 3 STANDARD shaft endings.

---

- 9 STANDARD variations of bushings.

---

- 4 STANDARD locating lug options.

---

- 4 STANDARD switch options with single and double pole.

# Allen-Bradley offers a 1,000,001 standard variations of Type J Potentiometers



Allen-Bradley Type J  
hot molded variable resistors  
rated 2.25 watts @ 70°C

These *standard* variations in the Allen-Bradley Type J hot molded potentiometer line eliminate the need for a "special" control. When you include the numerous special resistance values and tapers in which the Type J can be supplied, the variations become virtually infinite.

Yet, all of these Type J variable resistors have one thing in common—each and every one is made by the same A-B hot molding process—your guarantee of "tops" in quality. The solid hot molded resistance track assures extremely long life—exceeding well beyond 100,000 complete operations on accelerated tests with less than 10% resistance change. Control is always smooth and free from the sudden turn-to-turn resistance changes of wire-

wound units. And being essentially noninductive, Type J controls can be used at the higher frequencies—where wire-wound units are totally impractical.

Let Allen-Bradley Type J variable resistors be the answer to your special requirements—it's almost certain there's a "standard" unit in the Type J line. And you *know* you're obtaining the ultimate in reliability and performance. For more complete information on Allen-Bradley Type J potentiometers, please write for Technical Bulletin 5200: Allen-Bradley Co., 222 W. Greenfield Ave., Milwaukee, Wis. 53204. In Canada: Allen-Bradley Canada Limited. Export Office: 630 Third Ave., New York, N.Y., U.S.A. 10017.



**ALLEN - BRADLEY**  
QUALITY ELECTRONIC COMPONENTS

## D to A converters accept to 14 bits



RC-95, Inc., 9 E. 38th St., N. Y.  
Phone: (212) 689-9775.

The series 210 accepts data input words of any length from 4 to 10 bits and responds at the rate of 4 V/ms. The series 214 accepts input words of 11 to 14 bits and has a conversion time of 2 V/ms. Serial or parallel data is accepted by both series at a bit rate of 3 MHz. Rated stability vs. temperature ranges from 2 ppm/°C for 4 bits, and stability vs time (one year) from 0.005% (14 bits) to +0.1% (4 bits).

CIRCLE NO. 324

## Magnifying comparator has 6 scales



Finescale Co., 3258 W. Sixth St., Los Angeles. Phone: (213) 385-6834. Price: \$24.50.

This magnifying comparator set includes six white scale reticles showing placement of tracks on the tape or in the head stack. For tape inspection, the recorded tape is dipped in one of the available dispersion developers and allowed to dry. The white scales permit magnified inspection of the tape immediately showing any track misalignment. Reticles are provided for all I.R.I.G and IBM track configurations, one scale to a reticle. Two additional reticles, 1 black and 1 white, are provided for general purpose measurements. These scales are 1/2 in. long with 0.005 in. divisions.

CIRCLE NO. 322

## Tape search system spans 5 Hz to 200 kHz

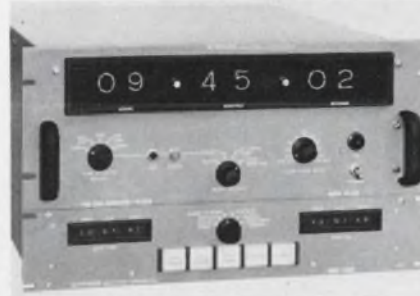

Systrom-Donner Corp., 888 Galindo St., Concord, Calif. Phone: (415) 682-6161. P&A: \$5360; stock.

The model HI-150 time code generator and tape search unit serves dual functions. It generates a precise time reference which can be used for recording time code indices on magnetic tape, oscillographs and camera film during data recording. The time reference can also be used on the magnetic tape during data reduction or playback for translating to visual time-of-day display and/or search for desired blocks of data sequences for transferring time to oscillographs.

CIRCLE NO. 396

## D-to-A converter stores 12 bits



Philco-Ford Corp., 3939 Fabian Way, Palo Alto, Calif. Phone: (415) 326-4350.

The series 500 is an 8-bit straight binary digital-to-analog converter which is expandable to 12 bits with the addition of one storage module. Units consist of an 8-bit data storage register and a 12-bit summing network with associated analog switches and operational analog switches and operational amplifier. Data is stored in clocked flip-flops. Accuracy of the unit is 0.1% full scale, driving a signal of  $\pm 10$  V into a load of 3 k $\Omega$ .

CIRCLE NO. 397

## Outstanding Technical Books

from McGRAW-HILL

### 1 MOSFET IN CIRCUIT DESIGN: Metal-Oxide Semiconductor Field-Effect Transistors for Discrete and Integrated-Circuit Technology.

By ROBERT H. CRAWFORD.

This sixth book in the Texas Instruments Electronics Series gives circuit designers the basic principles necessary in MOSFET device and circuit engineering, and includes a description of an actual MOSFET complex integrated circuit. **144 pp., \$10.00.**

### 2 COMMUNICATION SYSTEM ENGINEERING HANDBOOK.

By DONALD H. HAMSHER.

This practical compendium of basic data and the combined experience of 33 specialists gives you an informed overview of the entire field and shows you how to apply the systems approach to communication engineering. Includes data and material not published elsewhere. **600 pp., \$28.50.**

### 3 ANALYSIS AND DESIGN OF INTEGRATED CIRCUITS.

By The Engineering Staff, Motorola Inc. Semiconductor Products Division.

This book establishes analytical and experimental techniques to bring about the balance between system, circuit, and device research and development required in integrated circuits. **500 pp., \$16.50.**

### 4 DIGITAL LOGIC AND COMPUTER OPERATIONS.

By ROBERT C. BARON and ALBERT T. PICCIRILLI.

For anyone with some basic math training, this book stresses matter applicable to all computers, and shows how to use various methods to solve a given problem. It is the ideal preparation for anyone intending to use a computer for the first time. **352 pp., \$13.50.**

### 5 CHARACTERISTICS AND OPERATION OF MOS FIELD-EFFECT DEVICES.

By PAUL RICHMAN.

Beginning with fundamentals, this book provides a concise, straightforward introduction to the theory, characteristics, and operation of metal-oxide semiconductor field effect transistors (MOSFET) and related devices. **200 pp., \$10.00.**

At your bookstore or send coupon for:

10 DAYS FREE EXAMINATION

McGRAW-HILL BOOK CO., Dept. 23-ED-1122  
330 West 42nd Street, New York, N.Y. 10036

Send me the book(s) circled below for 10 days on approval. In 10 days I will remit for book(s) I keep, plus a few cents delivery costs, and return others postpaid.

1 13475-9    2 25960-6    3 43526-3  
4 03760-6    5 52340-7

Name (print) \_\_\_\_\_

Address \_\_\_\_\_

City \_\_\_\_\_

State \_\_\_\_\_

Zip Code \_\_\_\_\_

For prices and terms outside U.S. write McGraw-Hill Int'l. NYC

23-ED-1122

ON READER-SERVICE CARD CIRCLE 53

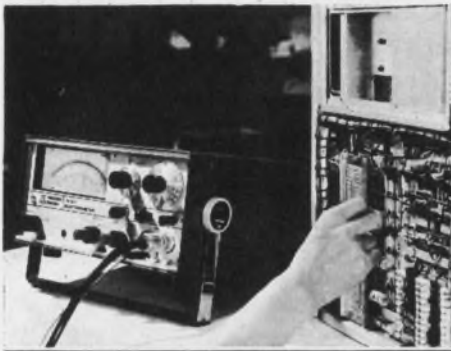

## EXTREMELY HANDY, TAKEDA'S -TR-8651 ELECTROMETER IS BOTH ACCURATE AND ECONOMICAL



### FEATURES:

**-TR-8651 ELECTROMETER** is conveniently used for:  
Measurements of ● Semiconductor resistivity ● Insulation ● Piezo-electric charge ● Photo-electric current

**-TR-8651 ELECTROMETER** measures:

● **Voltage** from 1 mV to 100 V f.s. (11 range) with  $\pm 0.5\%$  accuracy ● **Charge** from  $10^{-12}$  to  $10^{-5}$  coulomb f.s. ● **Current** from  $10^{-14}$  to 0.3 A.f.s. ● **Resistance** from 100 to  $10^{14}$   $\Omega$  f.s.

### SPECIFICATIONS:

#### RANGE:

● **Voltage:** 1, 3, 10, 30 mV, 0.1, 0.3, 1, 3, 10, 30 and 100 V f.s. ● **Charge:**  $10^{-12}$  to  $10^{-5}$  coulomb f.s. (1 $\times$  and 3 $\times$  overlapping ranges) ● **Current:**  $10^{-14}$  to 0.3 A.f.s. (1 $\times$  and 3 $\times$  overlapping ranges) ● **Resistance:**  $10^2$  to  $10^{14}$   $\Omega$  f.s. on linear 1 $\times$  and 3 $\times$  overlapping ranges.

For further details, write to:



**Takeda Riken  
Industry Co., Ltd.**

285, Asahi-cho, Nerima-ku, Tokyo, Japan.  
Cables: TRITRONICS TOKYO Phones: 930-4111

ON READER-SERVICE CARD CIRCLE 54

## SYSTEMS

### 2 function generators on one board

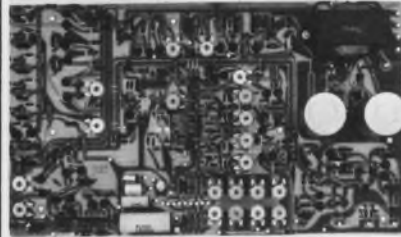

Exact Electronics, Inc., Hillsboro, Ore. Phone: (503) 648-6661. Price: 501 \$350, 502 \$385.

Developed for systems or individual applications, the models 501 and 502 are built on a single printed circuit board. Both models feature independently adjustable dual amplifiers to provide square wave, pulse, ramp, reverse ramp and triangle outputs, at frequencies from 0.001 Hz to 1 MHz. The model 502 also provides a variable frequency sine-wave output in the same frequency range. Pulse and square wave outputs are obtained from amplifier #1, with selections of 15 pk-pk, symmetrical about ground, or zero to 6-V pk signals of positive or negative polarity.

CIRCLE NO. 323

### Test modules for timing and pulse



Honeywell Computer Control Div., Framingham, Mass. Phone: (617) 235-7450.

Honeywell has added difference amplifier, discriminator and calibrator modules to its line of solid state test modules for magnetic and digital applications. Series 2000 modules may be combined to provide a variety of timing and pulse controls. The difference amplifier unit amplifies low level signals with a gain of 10. It provides seven inverted and seven non-inverted outputs. Two amplifiers in series provide a gain of 100 with a bandwidth approaching 50 MHz. Output signal limiting occurs at 1 V.

CIRCLE NO. 390

### Auto gain amplifier spans 1 Hz to 100 kHz

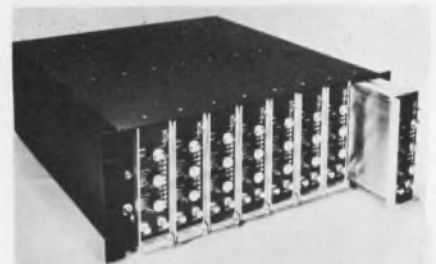

Ithaco Inc., 413 Taughannock Blvd., Ithaca, N.Y. Phone: (607) 272-7640. Price: \$960.

This device changes its gain automatically in order to condition wide dynamic range signals to amplitude levels suitable for recording, processing and display. The model 441 switches gain automatically, in 10 dB steps, in response to average input signal level. A dynamic range of over 120 dB is accommodated. Maximum gain is 80 dB. Broadband noise is 3  $\mu$ V referred to input at maximum gain. Gain accuracy and stability are  $\pm 0.1$  dB long term.

CIRCLE NO. 313

### Binary computer uses 4096 word modules

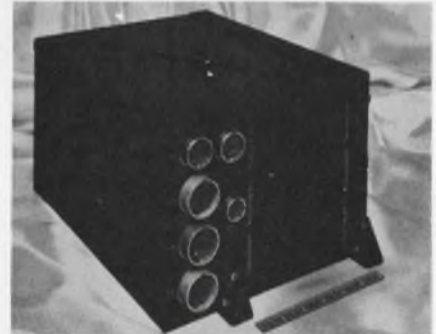

Litton Industries. Guidance and Control Systems Div., 9370 Santa Monica Blvd., Beverly Hills, Calif. Phone: (213) 273-7500.

This general-purpose binary computer is designed for computer-centered avionics and ground mobile tactical systems. Designated the LC-728, the computer weighs 29.7 pounds and occupies 0.55 ft.<sup>3</sup>. Each 4096 word memory module may be used, but only the number required for a particular mission need be installed. Two modules may be plugged into the computer with the balance mounted on the outside.

CIRCLE NO. 258

**Modular Pushbutton Operators with variety of buttons or lighted display screens, mounting hardware, and optional hold-in coils.**

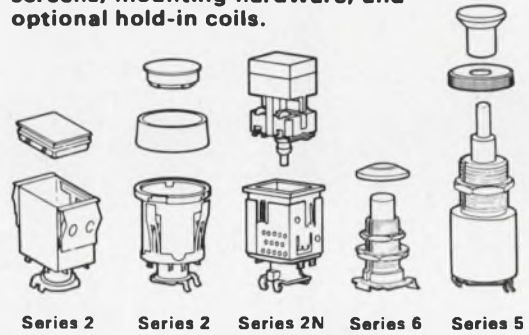

**Each of these typical operator modules...**

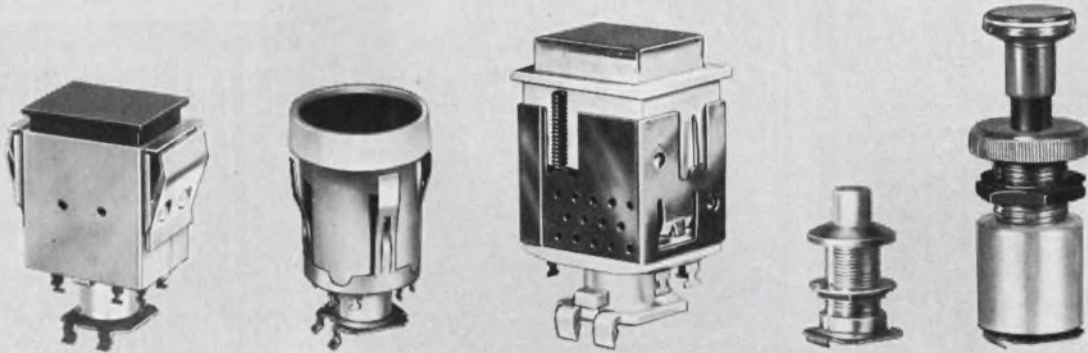

**...snaps on to any of these switch modules**

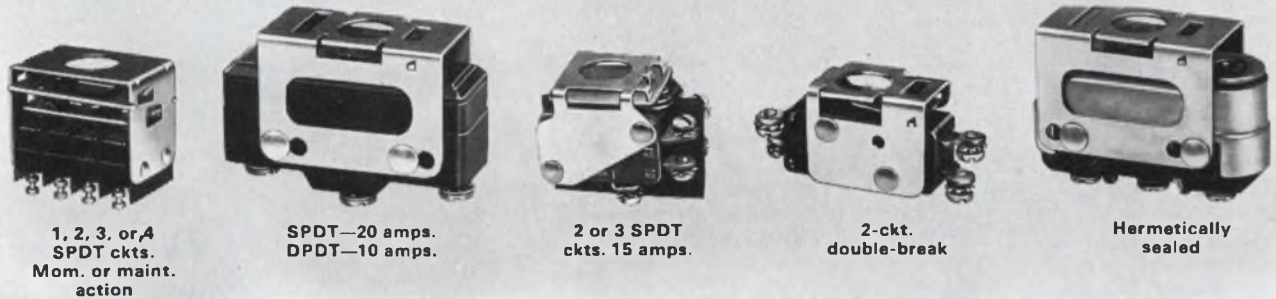

1, 2, 3, or 4 SPDT ckts. Mom. or maint. action

SPDT—20 amps. DPDT—10 amps.

2 or 3 SPDT ckts. 15 amps.

2-ckt. double-break

Hermetically sealed

## **Modular pushbuttons provide custom design freedom**

You can get 25 different pushbutton assemblies using only the few modules shown above. Hundreds of modules are listed in MICRO SWITCH Catalog 51—providing you with a choice of literally thousands of different assemblies. Modularity provides many benefits. You get all the custom-design freedom you can use; specifying is easier; you cut production costs (e.g., wire switch module *before* snapping onto panel-mounted operator module); and you simplify maintenance for the man who buys the equipment you build.

Call a Branch Office or Distributor (Yellow Pages, "Switches, Electric"). Ask about Series 2, Series 5 and Series 6 pushbutton modules. Or, write for Catalog 51.

## **MICRO SWITCH**

FREEPORT, ILLINOIS 61032  
A DIVISION OF HONEYWELL

HONEYWELL INTERNATIONAL — Sales and service offices in all principal cities of the world. Manufacturing in United States, United Kingdom, Canada, Netherlands, Germany, France, Japan.  
ON READER-SERVICE CARD CIRCLE 55

# The naked truth!

Now for the first time ever! The unexpurgated Redcor/Module's complete 10-channel multiplexer facts are laid bare! A lascivious thrill will run down your spine when you learn of its voluptuous 100 kc throughput rate! Its luscious 5  $\mu$ sec settling time! Your blood will thunder through your veins, your mind reel, at the wildly exciting possibility of eliminating multiplexer

modulations and offset! All this and more are yours in a bold new data sheet, "Sex & Specs & our Multiplex", available to all red-blooded engineers at **no cost!** Engineers under 18 must have a note from mommy.

**REDCOR** 7800 DEERING AVENUE  
CANOGA PARK, CALIFORNIA 91304  
(213) 348-5892 • TWX 910-494-1228

ON READER-SERVICE CARD CIRCLE 56

## Design Aids

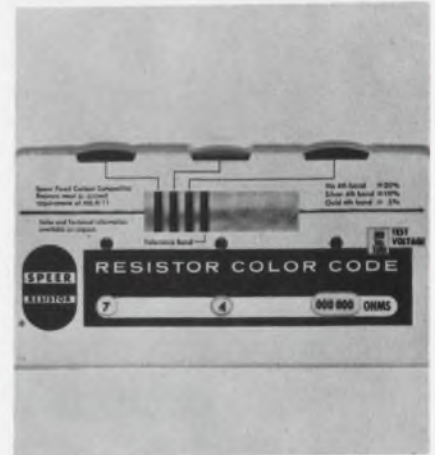

### Resistor inductor coder

There is a way to find resistor or inductor color codes instead of the Bad Boys etc. methods. Turn the wheels until the right color appears and read the resistance values that appears in the window. The reverse side does the same for inductors. Speer Resistor Div., Speer Carbon Co.

CIRCLE NO. 317

# Vector

## Vector systems help you CUT BREADBOARDING TIME

Choose the type that meets your needs

1. Circuit set-up kits and parts with solderless transistor and tube sockets, and new solderless T-32 U-clips.
2. Same as above but with solderable push-in terminals.
3. Handsome new extruded aluminum rails that make into expandable circuit cases or chassis in virtually any size and shape. Hardware for mounting in plug-in racks or chassis.
4. Pre-punched Copper Clad Plugboards for do-it-yourself, etched circuit cards.

May we send you complete information including sample Vectorbord and terminals? There is no obligation.

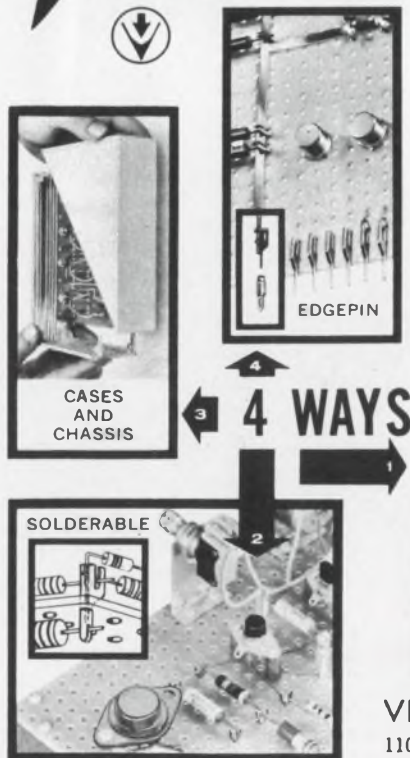

**VECTOR ELECTRONIC CO., INC.**  
1100 Flower Street, Glendale, Calif. 91201 • 245-8971

ON READER-SERVICE CARD CIRCLE 57



### Reliability computer

A reliability computer solves problems of reliability and confidence for continuous operating and one-shot devices. One side calculates the mean time between failure and failure rate for confidence levels of 60%, 80%, 90%, 95%, and 99% and up to 1000 failures. A point estimate scale is also included. The reliability can then easily be solved for any mission time. The other side calculates reliability for up to 1500 tests and 500 failures observed at various confidence levels. An additional scale converts between standard deviations and one-sided and two-sided distributions.

Available for \$6.75 from INFO, Inc., 13 Boyd St., Newton, Mass.



# Application Notes



## Transistor reliability

A Motorola reliability report summarizes results after two years and 10 million device hours of testing in a continuing reliability program investigating operating and storage life, parameter stability, resistance to moisture, and the effects of mechanical and thermal stress. Test methods and techniques used in the analysis, as well as quality control testing information, are included. The test results are presented in the form of graphs and histograms. Motorola Semiconductor Products, Inc.

CIRCLE NO. 335



## Thin-film transducers

To assist the prospective user in his selection of the thin film transducer best suited to his particular needs, Statham has produced a promotion package, "Thin Film Strain Gage Pressure Transducers," which contains a description of each transducer, with respect to individual characteristics, features of particular interest, suggestions for general and special-purpose applications, and detailed specifications. Statham Instruments, Inc.

CIRCLE NO. 261

Hydraulic-magnetic time-delay relays offer certain distinct advantages.

You'd never think that price would be one of them.

The advantages are important ones:

A continuous duty coil that permits the time-delay relay to double as a load relay.

A delay device much less affected by ambient temperature changes than thermal elements.

An optional recycling time only 15% as long as the delay. Regardless of the frequency of repetition.

You naturally would expect to pay more—not less—for this kind of construction.

But the fact is that our Silic-O-Netic® Time-Delay Relay costs considerably less than most other types on the market.

How much less? It depends on the quantity.

Drop us a line. We'll send you Bulletin 5006, so you can decide which of our five models best fits your needs.

Then ask us for a quote. We think you'll be pleasantly surprised.

Heinemann Electric Company, 2800 Brunswick Pike, Trenton, New Jersey 08602



HEINEMANN

3783

ON READER-SERVICE CARD CIRCLE 58

# New Literature



## Precision potentiometers

A 31-page booklet containing standards for wirewound and non-wirewound precision potentiometers includes VRCI-P-100 terms and definitions for wirewound and non-wirewound precision potentiometers and VRCI-P-200 inspection and test procedures. Because of the inherent construction difference between wirewound and non-wirewound resistance elements, specific terms and specific test procedures have been developed separately for wirewound precision potentiometers and for nonwirewound precision potentiometers. Variable Resistive Components Institute.

CIRCLE NO. 398

## Electronic parts

Listed in a 400-page electronics catalog are products of various manufacturers. A handy index enables readers to locate products listed under 17 different categories. The volume features a useful industrial tube cross-reference table and a catalog index arranged by item as well as by manufacturer. The index contains a new products section for those interested in checking the latest in electronic devices. Products ranging from semiconductors and resistors to hi-fi equipment are discussed; however, the emphasis in the brochure is on industrial electronics. Electronic Publishing Co. Inc.

CIRCLE NO. 399

## Three-dimensional planning

The secret to successfully realizing the objectives of a program or plan is described in an 11-page brochure. Its use will enable a planner to communicate with management, and management to communicate the plan and the reasons behind it to those who will carry out the plan. It will aid management in evaluating the completeness and soundness of proposed actions. Equally important, the planning system helps management to make decisions by highlighting time/cost/resources/tradeoffs. Planalog, Inc.

CIRCLE NO. 255



## Planar thyristor guide

Design engineers can obtain information about thyristors in a planar thyristor selection guide. The 8-page bulletin offers descriptions of the manufacturer's thyristor packages, together with a breakdown of characteristics for its silicon controlled rectifiers. Fairchild Semiconductor.

CIRCLE NO. 339

## Epoxy properties

A properties chart on epoxy molding compounds has been issued. The properties of 13 compounds are listed in four categories - electrical encapsulation, general purpose, high heat resistance and impact. One or more compounds in each classification are formulated to meet or exceed proposed military specifications. Allied Chemical Corp.

CIRCLE NO. 257

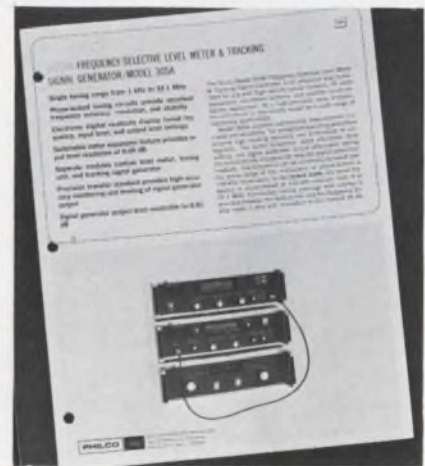

## Meter and signal generator

A frequency selective-level meter and tracking signal generator, model 305A, for use with high-density carrier systems, hf radio equipment, microwave systems and satellite communications equipment is the subject of a brochure recently issued. The catalog describes the three units, the signal generator, frequency selective level meter and the tuning unit, and details the use of the model 360 spectrum display as a companion instrument. Philco-Ford Corp.

CIRCLE NO. 344

## In-line indicators

Edge-lit indicators and details on 26 models from tiny instrument read outs are discussed in a catalog being offered. K.G.M. indicators should be of particular interest to design engineers because of their flexibility which permits custom features to be provided at reasonable cost. Inter-Market, Inc.

CIRCLE NO. 264

## Wattmeter versatility

A 19-page catalog describes the manufacturer's Wattmeter line. It indicates how these electro-dynamometer recorders provide information unobtainable in any other way, and gives details of recording ac Watts, dc and ac-dc Watts and KVA and KVAR. Esterline Angus.

CIRCLE NO. 400

# TAKE ONE

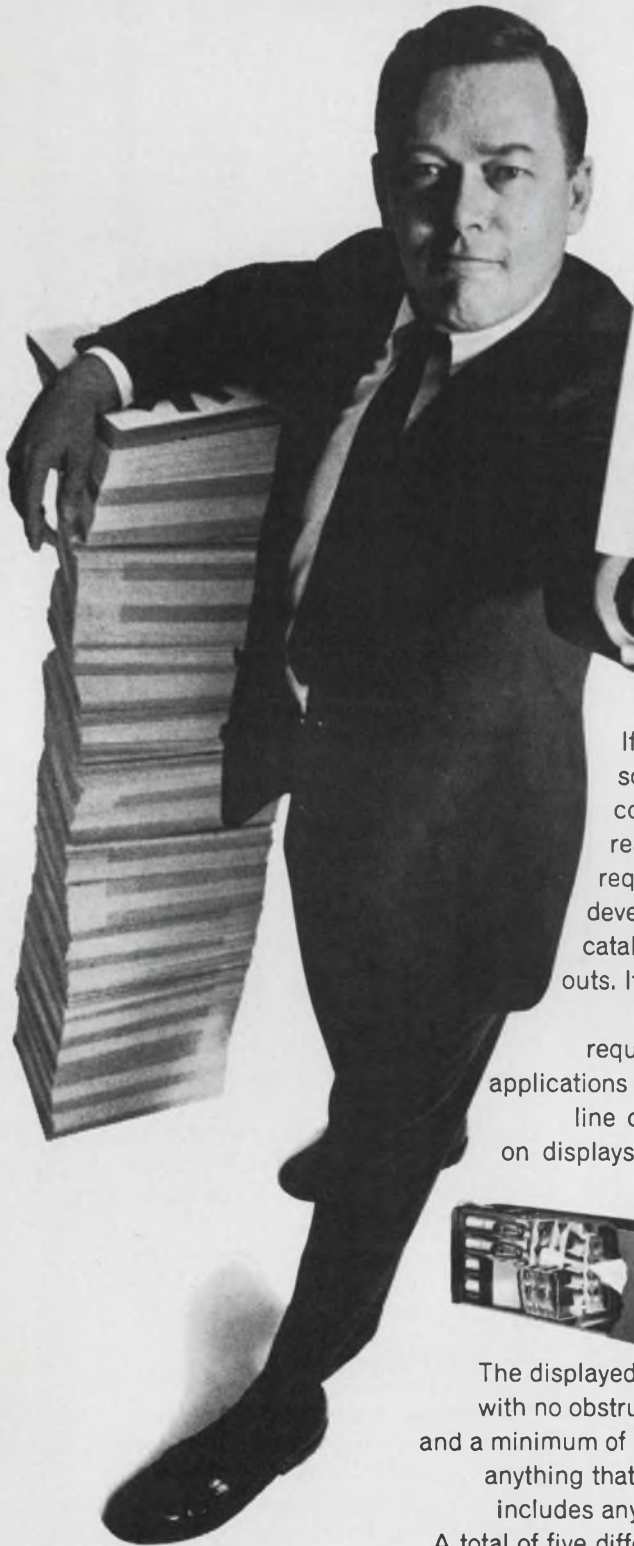

If your work has anything to do with visual readout, there's something in this IEE Catalog for you. It contains the most complete, up-to-date information available on rear projection readouts. If you design, manufacture, market or use products requiring visual display, you should become familiar with current developments in rear projection display. It's in this catalog. The catalog explains the operating principles of rear projection readouts. It also describes the unique results you get with this product.

You will easily see why it is specified for applications requiring readability, appearance and versatility. One of these applications could be yours. In addition to specifications on the complete line of IEE projection readouts, the catalog includes information on displays, assemblies, accessories, lamps and prices. It's complete.

Ask us for a copy now.

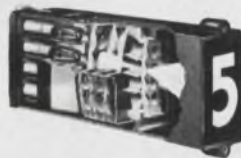

*The Rear Projection Readout:* When one of the 12 lamps at the rear of the readout is lighted, it illuminates one of 12 film messages, focuses it through a lens system, and projects it onto the non-glare viewing screen at the front.

The displayed message is clearly and distinctly projected on a single plane, with no obstruction from unlighted filaments. There is a wide viewing angle and a minimum of interference from ambient light. It is extremely versatile, since anything that can be put on film can be displayed on an IEE readout. That includes any combination of colors, symbols, numbers, letters and words. A total of five different models offering character sizes ranging from  $\frac{1}{8}$ " to  $3\frac{3}{8}$ ".

"I double-E," the world's largest manufacturer of rear projection readouts.  
Industrial Electronic Engineers, Inc., 7720 Lemona Ave., Van Nuys, Calif.



ON READER-SERVICE CARD CIRCLE 59

# RCA SEMINARS IN AUTOMATION AND COMPUTER TECHNOLOGY

A series of complete 5-day programs researched by RCA Institutes, Inc., for engineers and other technical personnel faced with the challenging new areas of expanding technologies and systems refinements.

LOGIC DESIGN	San Francisco	9/11
	Chicago	10/9
	New York	10/16
	Albuquerque	11/6
	Detroit	11/13
	Denver	12/4
DIGITAL SYSTEMS ENGINEERING	Washington, D.C.	12/11
	Atlanta	9/18
	Denver	9/25
	Washington, D.C.	10/16
	Rochester	10/23
DIGITAL ELECTRONICS	Long Island	11/6
	Los Angeles	12/4
	Washington, D.C.	9/11
	Los Angeles	9/18
	Dallas	10/16
	Detroit	10/23
	Atlanta	11/6
	New York	11/13
	Boston	12/4
San Francisco	12/11	
DIGITAL COMMUNICATIONS	Dallas	9/18
	Long Island	9/25
	San Francisco	10/9
	Cherry Hill	10/30
	Chicago	11/13
	New York	12/11
INTEGRATED CIRCUITS	New York	9/18
	Boston	9/25
	Palm Beach	10/9
	Los Angeles	10/16
	Denver	10/30
	Pittsburgh	11/13
	Washington, D.C.	12/4
	Dallas	12/11

Dates shown are seminar starting dates. Schedules are subject to change and additions.

Special in-plant seminars can be arranged. For full information and registration, call Mr. Bradford Daggett, 212, 247-5700 or use coupon below.



**Bradford Daggett, Director**  
Institute for Professional Development  
**RCA Institutes, Inc., Dep't EIDN7**  
132 West 31 Street, New York, N. Y. 10001  
Please send me complete information on RCA's 5-day seminars, and keep me informed on future programs.

Name \_\_\_\_\_ Title \_\_\_\_\_

Company \_\_\_\_\_

Address \_\_\_\_\_

City \_\_\_\_\_ State \_\_\_\_\_ Zip Code \_\_\_\_\_

ON READER-SERVICE CARD CIRCLE 60

## NEW LITERATURE



### IC flat packs

An integrated circuit flat-packs data sheet containing information in English, German and French is available. The presentation includes a standard configurations chart on the manufacturer's standard line of flat packs which utilizes such materials as hard glass, nickel iron cobalt, and alumina glass compositions. Also included is a chart showing flat-pack sealing profiles and a description of the model which is used to seal the standard line of flat packs. GTI Corp.

CIRCLE NO. 283

### Surge suppressor catalog

A 16-page catalog has been released which covers the manufacturer's selenium surge suppressors. The suppressors are designed to suppress high-voltage transients in the protection of silicon rectifier devices, silicon controlled rectifiers and similar electronic components. Information concerning the more popular sizes is tabulated throughout the brochure. Charts are included in the presentation. FMC Corp.

CIRCLE NO. 342

### Wirewound resistors

A 20-page catalog covering precision wirewound resistors will aid you in planning your design projects. A resistor cross-reference chart and engineering illustrations are included in the presentation. Precision Resistor Co., Inc.

CIRCLE NO. 395

**This new memory may not  
do everything better.  
But it does everything.  
And it takes up  
less space doing it.**



All together, the specs on our medium capacity memory systems are unsurpassed. Some systems may have slightly faster cycle times, but they don't offer speeds of 650 nanoseconds in a unit that's so small you'll be surprised to find a power supply and tester also included—just like the I.C. electronics and 2½ D magnetics. All are contained in only 2⅝ cubic feet (7"x19"x21.5").

Capacities range up to 295,000 bits per unit. Multiple module capability is available for larger capacity requirements.

Compact as it is, the design doesn't get in the way of maintenance. The systems are extremely easy to repair. Stacks, electronics and tester are on plug-in modules—all are accessible and slip in and out easily.

Information on both the Nanomemory 2650 (650 nsecs cycle time) and Nanomemory 2900 (900 nsecs) are in our compact (8½x11") brochure. Write for Litpak 200.

**EM** **electronic memories**

12621 Chadron Aveune, Hawthorne, California 90250  
(213) 772-5201

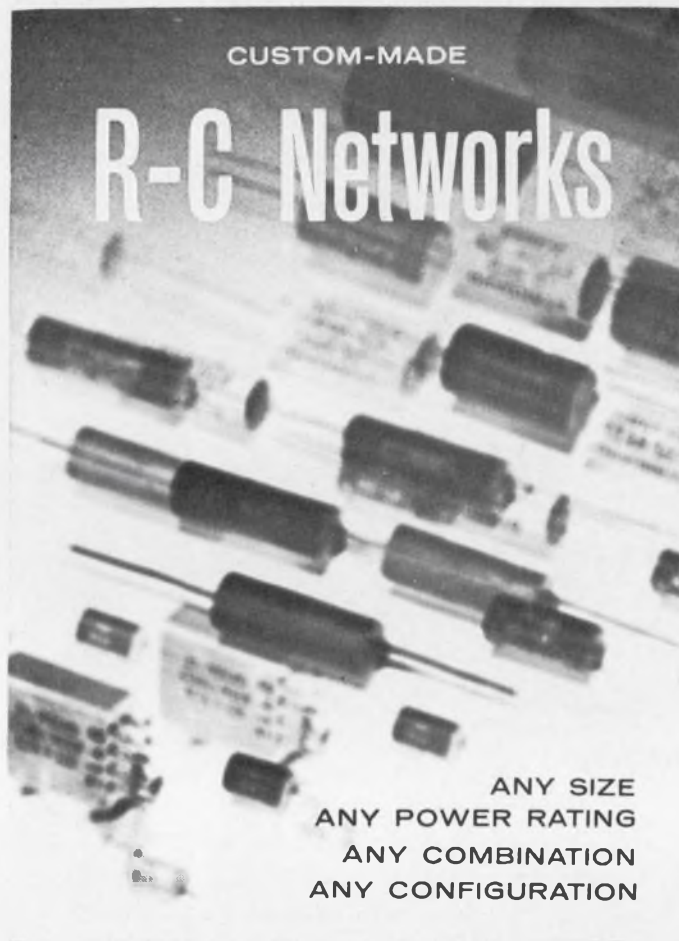

- For • RFI Suppression • Arc Suppression
- Relay Contact Protectors • Noise Filters
- Spark Suppression

R-C Networks available in any combination, for example:

**Capacitor Section can be**... Mylar, Metalized Mylar, Polystyrene, Polycarbonate... any voltage or tolerance.

**Resistor Section can be**... Composition, Wirewound, Metal Film, Deposited Carbon... in any wattage or tolerance.

Total Networks available in tolerances as close as  $\pm 1\%$ .

All Networks are manufactured under rigid Quality Control to meet your specific requirements.

Send us your specifications for quotation. Prototype quantities furnished prior to production.

For Complete details write Dept. ED-II



1065 W. Addison Street, Chicago, Illinois 60613

ON READER-SERVICE CARD CIRCLE 62

NEW LITERATURE

**Thermistor housing manual**

A 28-page catalog deals with thermistor housings and compatible thermistor elements. It lists pressure, shock, vibration and acceleration ratings for each unit. Design of electrical characteristics, matching and calibration, typical application suggestions and dimensional drawings of each housing are included in the presentation.

Available on company letterhead from Fenwal Electronics, Inc., 63 Fountain St., Framingham, Mass.

**Reprints Available**

The following reprints are available free and in limited quantities. To obtain single copies, circle the number of the article you want on the Reader-Service Card.

Ladder Networks are easy to design (No. 386)

Delay distortion can be diminished (No. 387)

Tiny Exploding World of Microcircuits (No. 388)

**Solution to problems on page: 93**

**Problem 1**

	Prod.A budget	Prod.B budget	Total plant budget
Rent	-	-	1000
Elect.	200	200	400
Direct labor	2400	2400	4800
Indirect labor (supv.)	520	520	1040
Material	2000	2400	4400

**Problem 2**

	Prod.A budget	Prod.B budget	Total plant budget
Rent	-	-	1000
Elect.	210	225	435
Direct labor	2580	2850	5430
Indirect labor (supv.)	520	520	1040
Material	2095	2685	4780

# versatile automation tool!

## CLARE-ELECTROSEAL

Solid State  
Stepping Switch Timer

- Provides positive, programmed sequence for full automatic control

The Model TSS1 serves time or switching logic. Use it with rotary selector switch for fixed or adjustable scan rates for telemetry or instrumentation. Add limit switches for go-no-go and alarm circuits. Program stop cycle and repeat cycles for full automatic control of machines and processes. No maintenance required.

For complete information, circle Reader Service Number . . . or ask for Bulletin 1135 . . . Write Group A11

- Serves sequential switches: up to 52 contacts on each level . . . up to 12 levels
- Operates switches from 100-130 vac; 22-29, 42-57, 100-140 vdc



## CLARE-ELECTROSEAL CORP.

Subsidiary of  
C. P. CLARE & CO.

a GENERAL INSTRUMENT company

946 North Ave., Des Plaines, Ill. 60016

ON READER-SERVICE CARD CIRCLE 63

# If You're Still Using A V.T.V.M. It's Time To Change ... Go Solid-State!

A Kit  
IM-16  
\$44.95  
Wired  
IMW-16  
\$64.95



B Kit  
IM-25  
\$80.00  
Wired  
IMW-25  
\$115.00

## These New Heathkit Solid-State Meters Feature State-Of-The-Art Performance At Prices You Can Afford

- Modern, stable, long-life solid-state circuitry
- New low-voltage ranges to accurately analyze modern transistor circuits
- Full capability to go "out on the job" . . . instant selection of internal battery power or 120/240 v. 50-60 Hz AC operation
- Exceptional accuracy . . . 3% on DC volts, plus a large, easy-to-read 6" meter face
- High impedance F.E.T. input for minimum circuit loading

### A New! Deluxe Solid-State Volt-Ohm Meter

Features 8 DC and 8 AC voltage ranges from 0.5 v to 1500 v full scale; 7 ohmmeter ranges (10 ohms center scale) x1, x10, x100, x1k, x10k, x100k, & x1 megohm; 11 megohm input on DC ranges; 1 megohm on AC ranges; internal battery or 120/240 v 50-60 Hz AC power for portable or "in shop" use; large readable-across-the-bench 6" meter; separate switches for individual functions; single test probe for all measurements; modern, stable solid-state circuit-board construction.

Kit IM-16, 10 lbs. . . . . \$44.95; Wired IMW-16, 10 lbs. . . . . \$64.95

### B New! Deluxe Solid-State Volt-Ohm-Milliammeter

All silicon transistors plus FET's. Features 9 AC and 9 DC voltage ranges from 150 mV to 1500 volts full scale; 7 ohmmeter ranges (10 ohms center scale) x1, x10, x100, x1k, x10k, x100k, & x1 megohm; 11 current ranges from 15 uA to 1.5 Amperes full scale; 11 megohm input on DC voltage ranges; 10 megohm input on AC voltage ranges; internal battery power or 120/240 v 50-60 Hz AC power for maximum versatility; easily readable 6" meter face;  $\pm 3\%$  accuracy on DC volts;  $\pm 4\%$  on DC current;  $\pm 5\%$  accuracy on AC voltage and current; separate range switches "human engineered" for efficiency in actual use; modern circuit board construction; all solid-state components; easy to assemble.

Kit IM-25, 10 lbs. . . . . \$80.00  
Wired IMW-25, 10 lbs. . . . . \$115.00

before you buy another trimming potentiometer...



look into **NUTRON**

## NUTRON wirewound trimming potentiometers feature:

- Utmost reliability and stability
- Rugged "inside-out" construction
- Unique manufacturing techniques, sophisticated materials
- Fewer customer rejects than any other trimming pot!
- Improved resolution
- Superior linearity
- Minimal drift, low noise
- Shock- and vibration-proof construction
- Simplified, efficient design
- Top performance at low cost



Send today for  
FREE literature.

"Built on Integrity —  
Growing on service"

**NUTRON**

Div. of Occidental Equipment Rental System

790 Hemmeyer Lane • Mountain View • California 94040 • (415) 961-6070

ON READER-SERVICE CARD CIRCLE 64

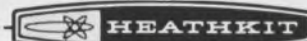

HEATH COMPANY,  
Benton Harbor, Mich. 49022 Dept. 520-26  
In Canada, Daystrom Ltd.

- Please send my FREE 1968 Heathkit Catalog.  
 Enclosed is \$ \_\_\_\_\_, plus postage.  
Please send model(s) \_\_\_\_\_

Name \_\_\_\_\_

Address \_\_\_\_\_

City \_\_\_\_\_ State \_\_\_\_\_ Zip \_\_\_\_\_

Prices & Specifications subject to change without notice. TE-165

ON READER-SERVICE CARD CIRCLE 65



**PARAX**<sup>®</sup>

**A NEW  
CONCEPT IN  
ENERGY  
CONVERSION**

A basic discovery that transfers transient-free energy without the use of mutual inductance.

**WANLASS ELECTRIC CO.** 

A Subsidiary of American Bosch Arma Company  
2175 South Grand Avenue/Santa Ana, California 92705

**ON READER-SERVICE CARD CIRCLE 66**

# Advertisers' Index

Advertiser	Page	Advertiser	Page
AMP, Incorporated	4, 5	International Rectifier	41
Abbott Transistor Laboratories Incorporated	111	JFD Electronics Co./Components Division	85
Airco Temescal, A Division of Air Reduction Company, Incorporated	110	McGraw-Hill Book Co.	121
Alfred Electronics	103	MicroSwitch, A Division of Honeywell	123
Allen-Bradley Co.	120 B-C	Microdot, Inc.	12
Austron, Inc.	38	Microsonics, Inc.	116
Automatic Electric, A Subsidiary of General Telephone & Electronics	48	Monsanto	43
Barnes Development Company	134	Motorola Semiconductor Products, Inc.	7
Bishop Industries	135	National Semiconductor Corporation	34, 35
Bourns, Inc.	37	Nutron, A Division of Occidental Equipment Rental System	131
Breeze Corporations, Inc.	135	Nytronics, Inc.	23
Buckbee Mears Company	96	Phelps Dodge Electronic Products	40
Clare & Co., C.P.	68, 69	Phillips Electronic Measuring Instruments	31
Clare-Electro Seal Corp.	131	RCA Electronic Components and Devices	16, 44, 133, Cover IV
Clary Corporation	134	RCL Electronics, Inc.	6
Cohu Electronics, Inc.	106	RCA Institutes, Inc.	128
Comar Electric Company	80	Redcor Corporation	124
Components, Inc., Maine Division	39	Rowan Controller Co., The	25
Computer Logic Corporation	21	Sigma Instruments, Inc.	99
Dale Electronics, Inc.	Cover III	Sprague Electric Company	10, 33
Dearborn Electronics Laboratories, Inc.	115	Standard Condenser Corporation	130
Delco Radio, Division of General Motors	8, 9	Sylvania Electric Products, Inc. Electronic Tube Division	32A-H
Du Pont Company	120A	Systron-Donner Corporation	2
Eldre Components, Inc.	135	Takeda Ricken Industry Co. Ltd.	118
Electronic Memories, Inc.	129	Tektronix, Inc., Oscilloscopes	46
Ellis and Watts Company	120B	Texas Instruments Incorporated Components Group	104A-F
Fluke Mfg. Co., Inc., John	19	Texscan Corporation	112
General Electric Company, Panel Meters	86, 87	Transistor Devices, Inc.	36
General Electric Company, Tantalum Capacitors	109	Triplet Electrical Instrument Company	113
General Radio Company	1	Union Carbide Corporation	15
Giannini	42	Vector Electronic Co. Inc.	124
Haydon Switch & Instrument Inc.	118	Wanlass Electric Co.	132
Heath Company	131	Waveline, Inc.	32
Heinemann Electric Company	125	<i>Career Advertising</i>	
Hewlett-Packard	Cover II, 27, 101	Boeing Company, The	97
Honeywell, Computer Control Division	28	Lear Siegler, Inc.	96
IRC, Inc.	74	Lockheed Electronics Company	94
ITT Semiconductors, A Division of International Telephone and Telegraph Corporation	136	Tecknit-Eastern Division	94
Industrial Condenser Corporation	114		
Industrial Electronic Engineers, Inc.	127		
Industro Transistor Corporation	117		

# Your Heart Fund Fights

**HEART ATTACK  
STROKE  
HIGH BLOOD PRESSURE  
INBORN HEART DEFECTS**





# Everyone knows that to make a Triac to control 720 watts you have to use an expensive press-fit package

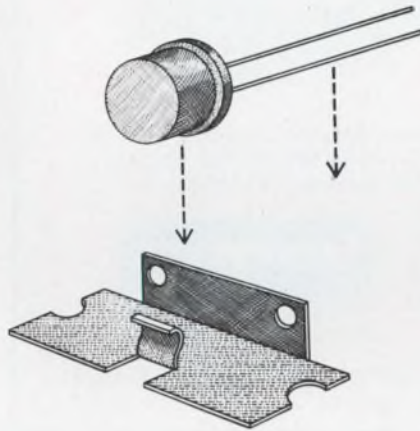

## Well, everyone is wrong!

**RCA designed the low-cost two-lead 40485  
TO-5 package to control 720 watts when used  
with an associated heat spreader!**

The 40485 Triac is designed for 120V line operation for the phase control of ac loads in applications such as light dimming, universal and induction motor control, and heater control. *It sells for only \$1.50\** The 40486 Triac can control 1440 watts, 240V line operation, *and it sells for only \$1.98\**

Both new Triacs are delivered in hermetically sealed, all-welded, tin-plated modified TO-5 packages which offer the advantage of small size where space restrictions are a primary consideration. And because they are tin-plated, they can be soldered directly to a heat spreader as illustrated. This allows the use of mass produced, pre-

punched parts, and batch soldering techniques, and simplifies mechanical mounting and heat sinking. The process is a simple one. RCA salesmen are ready to demonstrate in your own office just how easy it is.

So save the money you'd spend for a comparable press fit unit, and take advantage of the small size and superior performance of RCA 40485 and 40486 Triacs. Your RCA Field Representative can give you all the information, including delivery. For additional technical data, write RCA Commercial Engineering, Section RG11-2 Harrison, N.J. 07029. See your RCA Distributor for his price and delivery. *\*Prices in quantities of 1,000 up*



**RCA Electronic Components and Devices**

**The Most Trusted Name in Electronics**

ON READER-SERVICE CARD CIRCLE 67

# PROBLEM SOLVERS!

## BARNES CARRIERS, CONTACTORS AND SOCKETS FOR DUAL-IN-LINE HANDLING AND TESTING

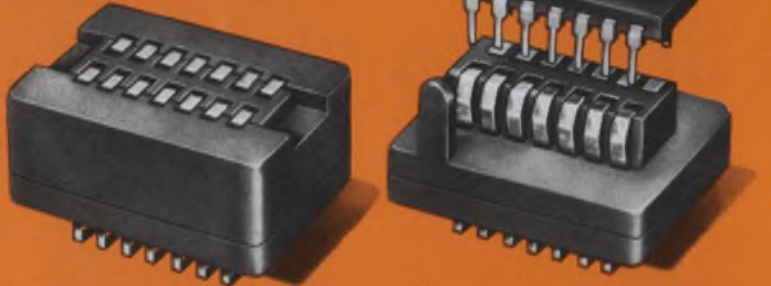

Looking for the right answers to dual-in-line handling and test problems? Now you can guarantee fast, reliable device testing with Barnes new easy-insertion 14 and 16 lead DIP Sockets and Contactors. For high-speed automatic handling . . . device marking, environmental test and automatic production mounting on P.C. boards . . . use Barnes Carriers to speed production and increase yields. Drop us a line for the full story.

**barnes**  
DEVELOPMENT COMPANY

Lansdowne, Pa. 19050 • 215/MA2-1525

**barnes** / THE FIRST WORD IN CARRIERS, CONTACTORS AND SOCKETS FOR I.C.'S  
ON READER-SERVICE CARD CIRCLE 68

## ATTENTION SYSTEMS ENGINEERS

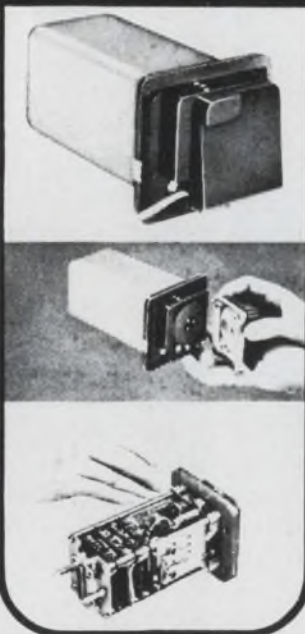

## NOW AVAILABLE! CLARY MODEL AN16

Alpha-Numeric Strip Printer  
for Digital Systems

— with all of these features:

- **COMPACT** only 78 cubic inches
- **SOLID STATE** integrated circuitry
- **HIGH RELIABILITY**
- **ONLY 14 MOVING PARTS**
- **SPEED**, 1500 characters per minute up to 25 characters per second
- **WEIGHT**, less than 4 pounds
- **CHARACTER SELECTION** 64 characters, alpha-numeric
- **PAPER TAPE** 5/16" wide pressure sensitive
- **TAPE CAPACITY** 75 feet
- **INPUT CODE** 6 bit parallel B.C.D.
- **TAPE TAKE-UP**, Spooler available as accessory



**CLARY CORPORATION**  
MILITARY PRODUCTS DIVISION  
320 West Clary Avenue • San Gabriel, California 91776  
Phone (213) 287-6111 • TELEX 674604

ON READER-SERVICE CARD CIRCLE 69

## Electronic Design

ELECTRONIC DESIGN's function is:

- To aid progress in the electronics manufacturing industry by promoting good design.
- To give the electronic design engineer concepts and ideas that make his job easier and more productive.
- To provide a central source of timely electronics information.
- To promote two-way communication between manufacturer and engineer.

**Want a subscription?** ELECTRONIC DESIGN is sent free to qualified engineers and engineering managers doing design work, supervising design or setting standards in the United States and Western Europe. For a free subscription, use the postfree application form inside the back cover. If none is included, write to us direct for an application form.

If you do not qualify, you may take out a paid subscription for \$25 a year in the U.S.A., \$35 a year elsewhere. Single copies are \$1.50 each.

**If you change your address**, send us an old mailing label and your new address; there is generally a prepaid postcard for this inside the back cover. You will have to requalify to continue receiving ELECTRONIC DESIGN free.

The accuracy policy of ELECTRONIC DESIGN is:

- To make reasonable efforts to ensure the accuracy of editorial matter.
- To publish prompt corrections whenever inaccuracies are brought to our attention. Corrections appear at the end of the Letters column.
- To refuse any advertisement deemed to be misleading or fraudulent.

**Microfilm copies are available** of complete issues of ELECTRONIC DESIGN and individual articles, published since the beginning of 1961. Complete issues cost 4¢ a page, articles cost 50¢ a page; shipping and handling charges are extra. The minimum charge is \$3. For further details and to place orders, contact University Microfilms, Inc., 300 N. Zeeb Road, Ann Arbor, Mich. 48106; telephone (313) 761-4700.

**Want to contact us?** If you have any comments or wish to submit a manuscript or article outline, address your correspondence to:

Howard Bierman, Editor,  
ELECTRONIC DESIGN,  
850 Third Avenue,  
New York, N.Y. 10022.

# Designer's Datebook

DECEMBER							JANUARY						
Sun	Mon	Tue	Wed	Thu	Fri	Sat	Sun	Mon	Tue	Wed	Thu	Fri	Sat
3	4	5	6	7	8	9	1	2	3	4	5	6	
10	11	12	13	14	15	16	7	8	9	10	11	12	13
17	18	19	20	21	22	23	14	15	16	17	18	19	20
24	25	26	27	28	29	30	21	22	23	24	25	26	27
31							28	29	30	31			

For further information on meetings, use Reader Service card.

## Dec. 4-6

**Data Communications Seminar (New York City)** Sponsor: Institute for Automation Research, Inc.; IAR, Inc., Tavern Square, 110 North Royal St., Alexandria, Va. 22314.

CIRCLE NO. 380

## Dec. 5-7

**Vehicular Communications Conference (New York City)** Sponsor: IEEE; A. Katz, Amperex Electronics Corp., 230 Duffy Ave., Hicksville, N. Y. 11802.

CIRCLE NO. 381

## Jan. 16-18

**Reliability Symposium (Boston)** Sponsor: IEEE; L. J. Blumenthal, Melpar, Inc., 7700 Arlington Blvd., Falls Church, Va. 22042.

CIRCLE NO. 382

## Jan. 16-19

**Dynamic Measurements in Ocean Sciences (Cocoa Beach, Fla.)** Sponsor: ISA; Ocean Sciences Short Course, ISA Headquarters, 530 William Penn Place, Pittsburgh, Pa. 15219.

CIRCLE NO. 383

## Jan. 22-26

**Marine Sciences Instrumentation Symposium (Cocoa Beach, Fla.)** Sponsor: Instrument Society of America; M. Reed, Meetings Coordinator, Instrument Society of America, 530 William Penn Place, Pittsburgh, Pa. 15219.

CIRCLE NO. 105

## Jan. 27

**Quality Control Conference (Pomona, Calif.)** Sponsor: San Bernardino Section of the American Society for Quality Control; W. J. Willey, 327 Cimmaron Trail, Glendora, Calif. 91740.

CIRCLE NO. 384

# Design Data from Manufacturers

Advertisements of booklets, brochures, catalogs and data sheets. To order use Reader-Service Card.

(Advertisement)

## Free Electronic Circuit Symbol Catalog



Save artwork and drafting time cut costs with thousands of electronic drafting aids and symbols featured in the new 28-page Catalog No. 102 from Bishop. In it are the industry's only selection of predrawn complete circuit component symbols; integrated circuits, logics, semiconductors, flatpacks, transistors, printed circuits, welded modules, etc. Also: tapes, pads, corners, connectors, schematic symbols, reference numbers and more. Included are illustrations, range of sizes and complete price information. Send today for your free copy.

### Bishop Industries Corp.

11728 Vose Street  
North Hollywood, California 91605

# 171

## Laminated and Molded Bus Bars For Power Distribution



A 16 page Technical Bulletin is now available, describing a new concept in power distribution. Basic mechanical and electrical design principles, along with descriptive pictures and diagrams, are included in this bulletin. These compact buses can replace bulky cable harnesses and repetitive wiring for computer or modular application. This method of construction satisfies the demanding requirements of low inductance and resistance of high speed, solid state systems while controlling electrical noises.

### Eldre Components, Inc.

1239 University Avenue  
Rochester, New York 14607

# 172

## Slip Ring and Rotary Switch Catalog



Breeze Catalog SRA 67 covers all basic types of slip ring assemblies, with information on design, methods of production, materials, capabilities, and performance. It describes typical custom assemblies for general purpose power and control, for handling radio and video frequencies, for high voltage, for high speed instrumentation, and for switching. Also drawings and specs for 8 STANDARD SLIP RING ASSEMBLIES that can be made up in many sizes and configurations at minimum expense.

### Breeze Corporations, Inc.

718 Liberty Avenue  
Union, N. J. 07083

# 173

# The Predictables.



**When ITT people  
ship your Series 930 DTL order  
you get on-time delivery.**

More than 97% of your Series 930 DTL orders get delivered on time. How's that for predictability? We offer the same 15 circuit functions in the same packages as those people you've been having delivery problems with. Doesn't that justify a change?

To see how little trouble DTL buying can be, try the ITT "Predictables." Order off the shelf from your distributor or direct from your factory representative. Our shipping people may have to work late, but your receiving people won't.

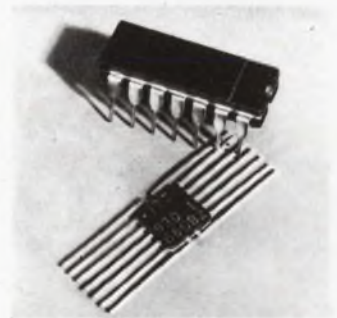

**Integrated circuits** **ITT**

FACTORIES IN WEST PALM BEACH, FLORIDA; PALO ALTO, CALIFORNIA; LAWRENCE, MASSACHUSETTS; HARLOW AND FOOTSCRAY, ENGLAND; FREIBURG AND NURENBERG, GERMANY

ON READER-SERVICE CARD CIRCLE 70

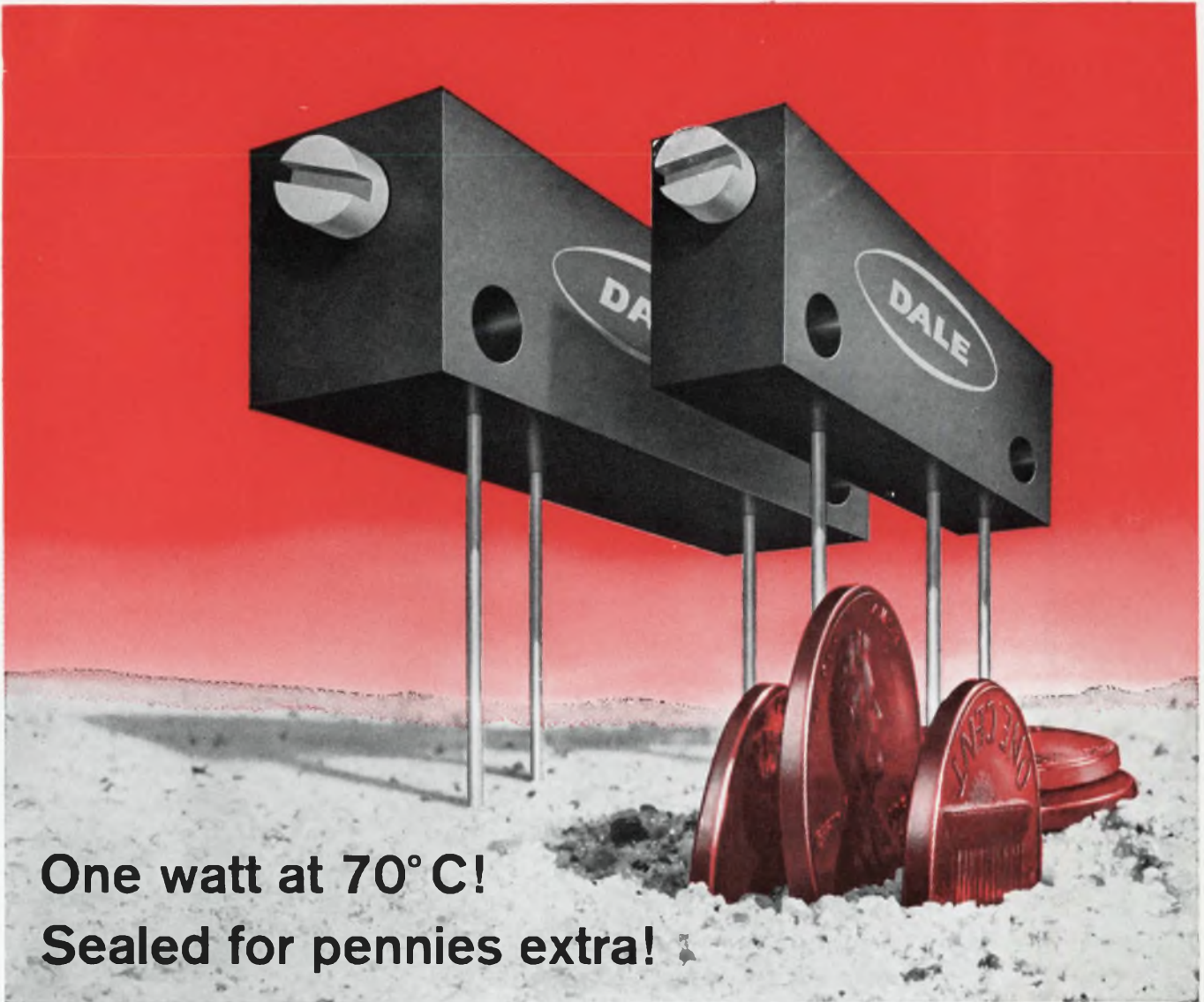

**One watt at 70° C!  
Sealed for pennies extra!**

## 2 very good reasons why Dale sells so many Commercial Wirewound Trimmers

**PERFORMANCE:** Dale's 2100 and 2200 series are the commercial counterparts of RT-11 and RT-10 respectively. They can be sealed for just a few cents per unit, yielding mil-level performance in all areas except temperature.

**PRICE:** Competitive and then some! Check Dale's new lower commercial prices. They were made possible through an extensive value analysis program which actually improved overall unit quality.

**DELIVERY:** New automated production facilities plus a factory stocking program combine to put your order in your plant without delay.

*Simplify trimmer ordering — a call to Dale will do it.  
Phone 564-3131, Area Code 402*

### SPECIFICATIONS

	2100	2200
<b>CASE DIMENSIONS</b>	.28 high x .31 wide x 1.25 long	.18 wide x .32 high x 1.00 long
<b>STANDARD MODELS</b>	2187 — printed circuit pins, 21 AWG gold plated. 2188 — 28 AWG stranded vinyl leads. 2199 — solder lug, gold plated.	2280 — printed circuit pins, 22 AWG gold plated. 2292 — solid wire, 26 AWG gold plated. 2297 — 28 AWG stranded vinyl leads.
<b>POWER RATING</b>	1 watt at 70° C, derating to 0 at 125° C	
<b>OPERATING TEMPERATURE RANGE</b>	-65° C to + 125° C	
<b>ADJUSTMENT TURNS</b>	25 + 2	15 + 2
<b>RESISTANCE RANGE</b>	10 ohms to 100K ohms	10 ohms to 50K ohms
<b>STANDARD TOLERANCE</b>	± 10% standard (lower tolerances available)	

**Write for Catalog B**



**DALE ELECTRONICS, INC.**  
1328 28th Avenue, Columbus, Nebraska  
In Canada: Dale Electronics, Canada, Ltd.



ON READER SERVICE CARD CIRCLE 243

# Take me to RCA... your leader of traveling-wave tubes for advanced ECM systems



RCA Developmental Type A1383

From laboratory to commercial device, RCA has paced the progress of traveling-wave tube development. Since 1956, when the first commercial low-noise tube was announced, RCA TWTs have participated in every major ECM system. Adept in the application of PPM traveling-wave tubes operating in a memory storage loop over a full octave bandwidth, RCA has introduced:

- First practical PPM traveling-wave tubes for airborne applications.
- First ruggedized PPM traveling-wave tube for military airborne systems.
- PPM traveling-wave tubes with temperature compensation.
- First PPM traveling-wave tubes for commercial service.

- First PPM traveling-wave tubes operating in a memory storage loop over a full octave frequency.
- First reliable, long-life PPM traveling-wave tube in an orbiting communications satellite.
- First use of a high-sensitivity photocathode with a Helix structure in a traveling-wave tube.

Consult your RCA Representative for more information or write: Commercial Engineering, Section K18Q-4, RCA Electronic Components and Devices, Harrison, N.J. 07029.



**The Most Trusted Name in Electronics**