

Tumbling prices shift digital chips to what was once strictly analog territory. Averagers, sine-cosine generators and filters—all can be built with digital circuits. But

don't discard the familiar analog design formulas. The z operator helps adapt them to digitalized circuits. For a special report on this new field, turn to page 41.

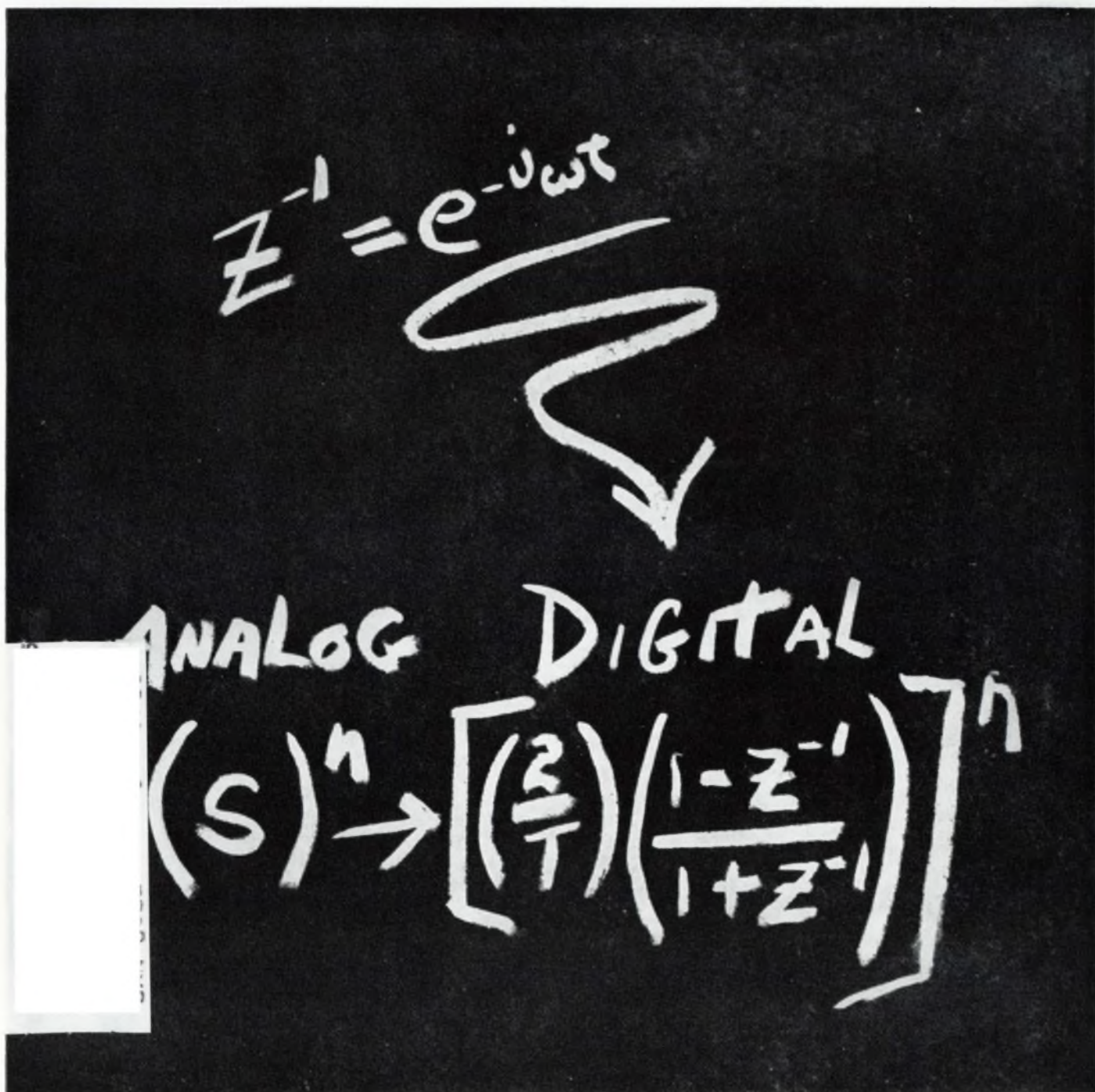



NOW  
SEE  
IT

BIG

## *New 20 MHz X-Y-Z Monitor*

The extraordinarily wide dc to 20 MHz bandwidth on all three axes of the new hp 1300A provides an X-Y-Z capability not found in any other monitor. You get 20 times the bandwidth, twice the brightness found in other monitors—for only \$1900! Use it whenever you need extra large, accurate, easy-to-read displays. The internal graticule, 8 x 10-inch, 20 kV CRT gives you large, bright displays you can see across a big room—with no parallax error.

The 1300A Monitor writes at better than 20 inches/ $\mu$ sec for bright display of signals—even low duty cycle signals. Sensitivity of 100 mV/in provides large displays of low level signals. The compact 12" high rack space package weighs only 47 pounds, including self-contained power supply. All solid-state circuitry requires only 175 watts of power. Control and amplifier options available to increase versatility.

Get full details on the new hp 1300A X-Y Monitor from your hp field engineer. Or, write to Hewlett-Packard, Palo Alto, California 94304. Europe: 54 Route des Acacias, Geneva. Price: hp 1300A X-Y Monitor, \$1900.00.

087/31

HEWLETT  PACKARD

OSCILLOSCOPE SYSTEMS

ON READER-SERVICE CARD CIRCLE 122



## Test electrolytics per MIL and EIA specs

With our 1617 Capacitance Bridge, you can measure capacitors that are as large as 1.1 farad or as small as 1 picofarad. But an exceptionally wide C range is only one feature that makes the 1617 "the bridge" for testing capacitors, particularly aluminum and tantalum types. It is no coincidence that most features of this bridge are those required to test electrolytics per MIL and EIA specifications; the bridge was designed specifically to meet these specs.

This bridge is a "must" for any capacitance-test station because it . . .

- has a C range of  $10^{12}$ , from 1 pF to 1.1 F, with an accuracy of  $\pm 1\%$  to 0.11 F and  $\pm 2\%$  from 0.11 F to 1.1 F;

- has a D range from 0 to 10 with an accuracy of approximately  $\pm 2\% \pm 0.001$ ;

- is completely self-contained; just plug it into a power line and start making measurements. The 120-Hz generator, tuned detector, adjustable dc polarizing voltage and bridge circuits are all contained in a Flip-Tilt cabinet/ carrying case;

- has an internal, metered dc polarizing voltage that is adjustable from 0 to 600 volts;

- provides for 2-, 3-, 4- or 5-terminal connections; effects of residual impedances are practically eliminated;

- measures leakage current down to  $0.5 \mu\text{A}$ ;

- can be used at frequencies up to 1000 Hz with an external generator;

- has panel safety lights to indicate when bias voltage is being applied and when the charge on the unknown capacitor exceeds one volt; has ORTHONULL® balance finder, which eliminates sliding balance when high-D capacitors are measured;

- has a phase-reversible 120-Hz generator to reduce the effects of stray voltage; amplitude is selectable and limited to 0.2 V, 0.5 V, or 2 V; meets or exceeds the requirements of MIL-C-39003 (Solid Tantalum), MIL-C-39018 (Aluminum Oxide), MIL-C-62C (Polarized Aluminum), MIL-C-26655B (Solid Tantalum), MIL-C-3965C (Tantalum Foil and Sintered Slug), (EIA) RS 154B (Dry Aluminum), (EIA) RS 205 (Electrolytic), and (EIA) RE 228 (Tantalum).

The many features of the 1617 also make it an excellent general-purpose 1% bridge to measure *any* type of capacitor as well as the capacitance and loss of cables, transformers, insulating materials, and electric motors.

Call your nearest GR office for a demonstration. For complete information, write General Radio, W. Concord, Massachusetts 01781; telephone (617) 369-4400; TWX (710) 347-1051.

## GENERAL RADIO



Type 1617-A Capacitance Bridge, \$1195 in USA.



# king me!

## Outwit Your Data Simulation Problems

Crown the Datapulse Model 201 16-Bit Data Generator with a pulse generator and solve your data simulation problems economically.

For only \$680.00, the 201 provides these superior features: 16-bit cycle lengths, bit rates to 10 MHz (from an external clock), NRZ outputs to 10V, variable baseline offset to  $\pm 10V$ , and continuous or command recycle.

To king the 201 simply add a Datapulse 101 Pulse Generator — \$395.00 — or any other async-gated pulse generator with the output characteristics you need.\* The result: a system capable of producing variable parameter RZ formats — ideal for a host of simulation tests on components, circuitry, memory elements, or data transmission links — the perfect programmer for developing time related sequential signals to command systems operations.

Interconnect several 201's for longer serial words or additional parallel channels. Then set up programs for core testing, drive any gate array from zero to +10V, produce true complimentary outputs to drive adders, etc.

There's one more thing about the 201. It's small. Two units can be mounted in just 3½ inches of rack panel height.

If the 201 doesn't solve all your data simulation problems, pick up a copy of our catalog! We offer more off-the-shelf digital test instrumentation than any other manufacturer in the world, so if you don't have our catalog, do something about it!

Your move!

\*Datapulse Model 111 for ultra-fast linear rise times; Datapulse Model 108 for 50V outputs; Datapulse Model 110A for fully controllable fast pulses, etc.



## NEWS

- 13 News Scope
  - 17 **Commercial firms jump at navy satellite**  
Three companies ready receiver/computer for air, sea and geodetic use.
  - 21 Split beams deepen holograms to four feet.
  - 22 **The tiny flaws in medical design can kill**  
Errant currents from faulty electronic equipment imperil patients' lives.
  - 29 Washington Report
  - 32 Li-Te cell puts out 500 watts a pound
  - 33 Raw IC chips bought from random samples.
  - 37 **Editorial: Treat obsolescence trauma with a technological retreat.**
- 

## TECHNOLOGY

- 41 **Staff Report: Digital chips shift into analog territory.**
  - 42 **Digital roads to analog functions** are paved with inexpensive ICs. To make the most of them, you should know the whys and hows.
  - 48 **From theories to hardware**—The design of a digital ramp generator and an averager shows the practical considerations.
  - 54 **Build filters with MOS chips:** They can reproduce most analog response shapes and yield accurate and predictable results.
  - 60 **Resolve angles with samples** if your main goal is precision. But if it is speed, the analog approach is still unbeatable.
  - 66 **Design better agc FET amplifiers.** Use simple, experimental techniques and know the pros and cons of reverse and forward agc.
  - 74 **Are you a quiz whiz?** Try this test of your breadth of knowledge of electronic technology from aquadag to YIG. Good luck!
  - 82 Ideas for Design
- 

## PRODUCTS

- |                   |                          |
|-------------------|--------------------------|
| 92 Components     | 102 Production Equipment |
| 98 Test Equipment | 103 Microwaves           |
| 101 Systems       |                          |
- 

## Departments

- |                    |                         |
|--------------------|-------------------------|
| 104 New Literature | 108 Advertisers' Index  |
| 106 Reprints       | 111 Designer's Datebook |
-



...in just 4 nanoseconds!  
 YOU CAN GENERATE ANY OF THESE:  
 $X, Y, Z; \bar{X}, \bar{Y}, \bar{Z}; X + \bar{Y} + Z;$   
 $X + Y + Z; \bar{X}\bar{Y}\bar{Z}; \bar{X}YZ$

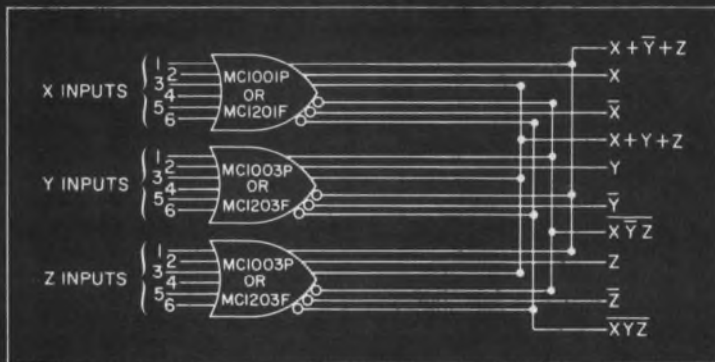

(where X, Y, Z  
 each stands for  
 six variables  
 "ORed" together)

**(MECL II MAKES IT POSSIBLE!)**

Yes, you can do it easily with MECL II, in just 4 ns with 3 gates and a total power dissipation of 250 mW. The unique wired "OR" feature of MECL II allows you to obtain the OR function of two or more gate outputs by tying the outputs together. As a result, you save delay time, power dissipation, extra gates and design headaches. More importantly, the flexibility of this system allows for an almost infinite number of logic design possibilities!

### The Family for Logic Designers

The growing MECL II family of digital integrated circuits already has 24 members and is designed for easy use from audio frequencies to above 100 MHz. The gates shown, MC1001P, 1003P and MC1201F, 1203F are all Six-Input Gates in the new MECL II series. Each provides three simultaneous "OR"/"NOR" or "AND"/"NAND" output functions. By

omitting all or part of pulldown resistors, three emitter follower output options are provided on basic MECL II gates.

These 6-input gates (MC1000 & MC1200 series) feature 4.0 ns propagation delay at a fan-out of 3 and a total fan-out of 25 (min) per output. The limited-temperature-range 1000 series (0° to +75°C) is available in the 14-pin dual in-line plastic package, while the full-temperature-range 1200 series (-55° to +125°C) is in the 14-pin ceramic flat package.

For complete details about the fastest, most flexible logic family available, write for complete data sheets and application notes. Then, see how many high-speed gate functions you can synthesize!



**MOTOROLA**  
**Semiconductors**

*-where the priceless ingredient is care!*



Good things do  
come in small  
packages!

ALL THE FEATURES  
FOUND IN  
LARGER SIZE

SWITCHES...*except the larger size*

# 1/2" ROTARY SWITCHES

INDUSTRY'S MOST COMPLETE SELECTION

Up to 12 positions per deck SHORTING OR NON-SHORTING / Up to 6 poles per deck / Shorting and NON-SHORTING poles can be grouped in any combination on one deck / Individual deck parts self-contained and permanently molded into place / Extremely low and uniform contact resistance (.004  $\Omega$  average) / Life expectancy 200,000 mechanical operations minimum / "Off-The-Shelf" Delivery

## RCL

ELECTRONICS, INC.

General Sales Office

700 So. 21st Street

Irvington, New Jersey 07111

# add sweep and offset

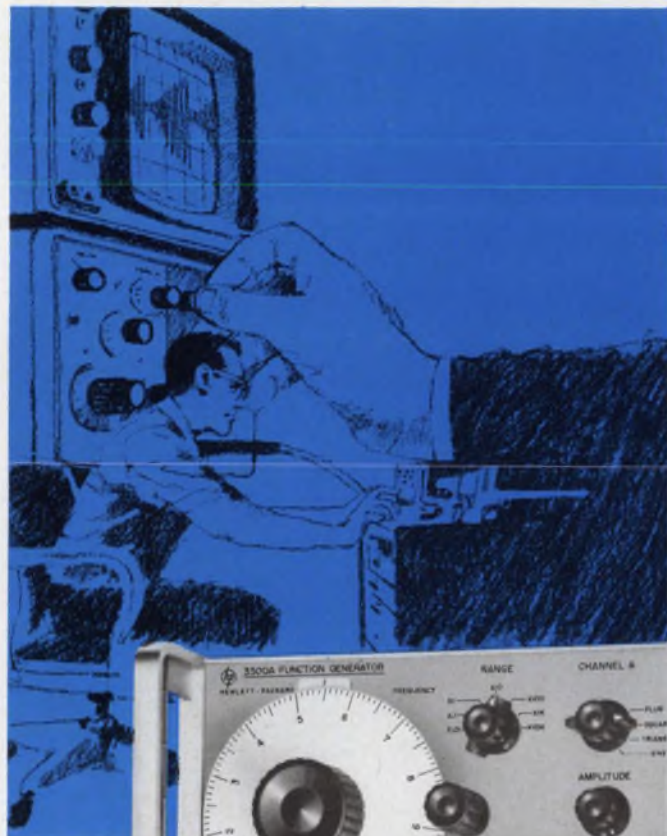

## to Your 3300A Function Generator

### Get One Source for Any Waveform to 100 kHz

Linear sweep in decade steps over a 0.01 Hz to 100 kHz—sine, square and triangular waveforms—variable dc offset for each function including sawtooth—from one source, the hp 3304A Sweep/Offset Plug-in and the 3300A Function Generator.

**Manual Sweep:** start frequency and sweep width are individually adjustable over at least one decade for easy location of sweep range. Swept frequencies and the sawtooth are simultaneously available for display on oscilloscope or recorder.

**Programmable Sweep:** External sweeping or programming over a decade of frequency is possible with 0 to -10 V with the basic function generator.

**DC Offset:** Use the dc offset with any waveform— $\pm 16$  Vdc range with a  $\pm 1$  V vernier control. Makes hard-to-get driving functions readily available.

The 3300A/3304A combines to give swept and CW sine (<1% distortion), square (<250 ns rise time),

triangular (<1% linearity) waveforms, and sawtooth waveforms (with <5% flyback time).

Two fully-floating non-interacting outputs with separate amplitude controls provide up to 35 V p-p.

Price: hp 3300A Function Generator, \$625.00; hp 3304A Sweep/Offset Plug-in, \$250.00. For full specifications, contact your nearest hp field engineer. Or, write to Hewlett-Packard, Palo Alto, California 94304, Tel. (415) 326-7000; Europe: 54 Route des Acacias, Geneva.

097/15

HEWLETT  PACKARD

ON READER-SERVICE CARD CIRCLE 5



# Thank goodness we have competition in miniature power regulation.

## Now we can say we're No. 1

But more important — now you can say it:  
Because we were first to enable you to build a  
precision power supply in minutes — using any  
DC power source.

And because now we've gone ahead and upped  
your capability 104 times.

You can choose from 104 different super/reg<sup>®</sup>  
precision miniature regulators — both shunt and  
series versions. Just connect rough DC from what-  
ever source you have — semi-filtered, half-wave  
rectified transformer output, or even a battery —  
you get instant precision DC power where you need  
it: at the load itself.

Each super/reg power regulator is uniquely de-

signed for maximum heat transfer and power-hand-  
ling ability. Ultra-compact configurations provide  
maximum flexibility over a wide range of voltage  
levels. Point-of-load installation eliminates distri-  
bution-line losses and cross-talk.

Write for complete data sheets and applications  
bulletins.

Make us prove our #1 claim — we'll be happy  
to do it 104 ways.

Trio Laboratories, Inc.,  
Plainview, L.I., N.Y. 11803.  
Tel: (516) 681-0400.



- Type 75TE Shunt Regulator**
- 75 Watt or 3 Amp capability
  - Output voltages from 3.9-56 Volts
  - .01% Regulation — output Z from .002 ohms
  - Hermetically sealed TO-36 case

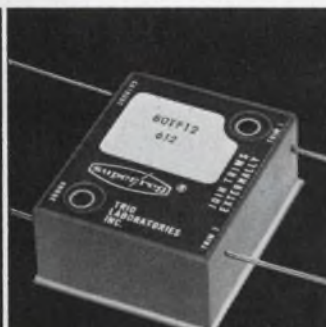

- Type 80TF Shunt Regulator**
- 80 Watt or 3 Amp capability
  - Output voltage from 3.9-56 Volts
  - .01% Regulation — output Z from .002 ohms
  - Encapsulated construction

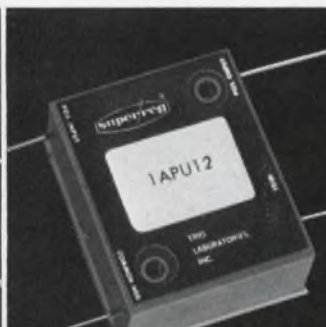

- Type 1AP Series Regulator**
- Economy priced
  - Output voltages from 5-24 Volts
  - 1% Regulation — output Z from .06 ohms
  - Full 1 Amp load capability

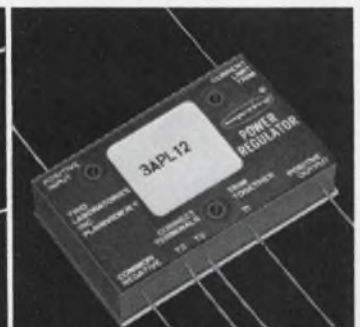

- Type 3AP Series Regulator**
- Full 3 Amp load capability
  - Output voltages from 2.33 Volts
  - .01% Regulation — output Z from .002 ohms
  - Adjustable overload protection

ON READER-SERVICE CARD CIRCLE 7

# Yesterday in op Today, look:

# amps, a nobody.

**1** NS7560A – This and the 7560 are the non-monolithics. Output swing is  $\pm 5V$  with  $100\Omega$  load and  $\pm 12V$  supplies. Operating temperature range  $-55^\circ C$  to  $+125^\circ C$ . Guarantees offset voltage of  $3mV$ , bias current of  $25nA$ , and offset current of  $2nA$ . Gives slew rate of  $10V/\mu s$  with  $15$  MHz bandwidth.

**2** NS7560 – Almost identical to 7560A. Offset voltage is  $10$  mV. Bias current is  $100nA$ . Offset current is  $50nA$ .

**3** LM709 – The old standby. Built on a single silicon chip, it works with supply voltages from  $\pm 9V$  to  $\pm 15V$ . Has class B output with momentary short circuit protection. Operating temperature range is  $-55^\circ C$  to  $+125^\circ C$ . Power consumption is less than  $170mW$  at  $\pm 15V$ . Offset voltage is  $5.0$  mV and offset current is  $200nA$ . Furnishes a  $\pm 10V$  output swing with a  $2K\Omega$  load.

**4** LM 709C – This is the commercial-industrial version of the 709. It's like the 709 except that it is specified for operation in a temperature range of  $0^\circ C$  to  $70^\circ C$ .

**5** LM 101 – The best Op Amp around. Same pin configuration as the 709. Minimum voltage gain of  $50,000$ , compensated for unity gain by only one  $30$  pF capacitor. Class B output with continuous short circuit protection. It provides at least a  $\pm 10V$  output swing with a  $2K\Omega$  load. The  $\pm 30V$  differential input range reduces the chance of burnout from overload. It's specified for operation from  $\pm 5V$  to  $\pm 20V$ , with a power consumption less than  $100$  mW at  $\pm 20V$  supplies.  $5$  mV offset voltage,  $200nA$  offset current and  $\pm 12V$  common mode range.

**6** LM 201 – Our newest Op Amp. Similar to the 101 but a replacement for the 709C. It costs much less than the 101. Operates in a temperature range of  $0^\circ$  to  $70^\circ C$ . The minimum  $15,000$  voltage gain is compensated by only one  $30$  pF capacitor. Offset voltage is  $7.5$  mV, offset current is  $500nA$ , and common mode range is  $\pm 12V$ .

We have a package put together with all the specs for each of them. Write us.

**National Semiconductor Corporation,**  
2950 San Ysidro Way, Santa Clara,  
California 95051 (408) 245-4320.

## (to be continued)

Yesterday



Pierre Lamond, Microcircuit Division Manager

Today



Pierre Lamond, Microcircuit Division Manager

ON READER-SERVICE CARD CIRCLE 8

# Now from Sprague!

QUALITY  
STABILITY  
RELIABILITY  
SMALL SIZE

## All the advantages of tantalum in one **LOW COST** capacitor!

### EPOXY-DIPPED TANTALEX<sup>®</sup> CAPACITORS...

For industrial, commercial, and entertainment electronic applications where tantalum capacitors were previously too expensive!

⊣ Type 196D Solid-electrolyte Tantalum Capacitors have special epoxy-dip coating which keeps costs down without sacrifice in dependability. Positively seals capacitor section while providing excellent electrical insulation. Protects against mechanical damage in handling.

⊣ Radial lead design for plug-in mounting on printed wiring boards. The .250" lead spacing will fit standard .125" grids.

⊣ High stability—very little capacitance change, even at outer limits of operating temperature range.

⊣ Low dissipation factor of these capacitors permits higher ripple currents.

⊣ Meet environmental test conditions of Military Specification MIL-C-26655B.

⊣ Prime capacitance and voltage ratings. Based on rating popularity of other types of solid tantalum capacitors.

⊣ Designed for continuous operation at temperatures from  $-55^{\circ}\text{C}$  to  $+85^{\circ}\text{C}$ .

For complete technical data, write for Engineering Bulletin 3545 to Technical Literature Service, Sprague Electric Company, 347 Marshall Street, North Adams, Massachusetts 01247.

Now available for fast delivery from your Sprague Industrial Distributor

### SPRAGUE COMPONENTS

CAPACITORS  
TRANSISTORS  
RESISTORS  
INTEGRATED CIRCUITS  
THIN-FILM MICROCIRCUITS  
45C-4136R1

PULSE TRANSFORMERS  
INTERFERENCE FILTERS  
PULSE-FORMING NETWORKS  
TOROIDAL INDUCTORS  
ELECTRIC WAVE FILTERS

CERAMIC-BASE PRINTED NETWORKS  
PACKAGED COMPONENT ASSEMBLIES  
BOBBIN and TAPE WOUND MAGNETIC CORES  
SILICON RECTIFIER GATE CONTROLS  
FUNCTIONAL DIGITAL CIRCUITS

**SPRAGUE**<sup>®</sup>  
THE MARK OF RELIABILITY

Sprague and "S" are registered trademarks of the Sprague Electric Co.

ON READER-SERVICE CARD CIRCLE 9

# News



**Lamont oceanographic vessel** is one of the first to use navigation satellites. Page 17



**Tiny defects in the design** of medical equipment jeopardize patients' lives. Page 22



**Portable electronic keyboard** allows computer data to be fed in over telephone lines. Page 34

## Also in this section:

**Split beams increase hologram's depth of field** to four feet. Page 21

**Raw IC chips bought from random samples** end vendor-customer friction. Page 33

**News Scope**, Page 13 . . . **Washington Report**, Page 29 . . . **Editorial**, Page 37

# Union Carbide's New Integrated Circuit Operational Amplifier

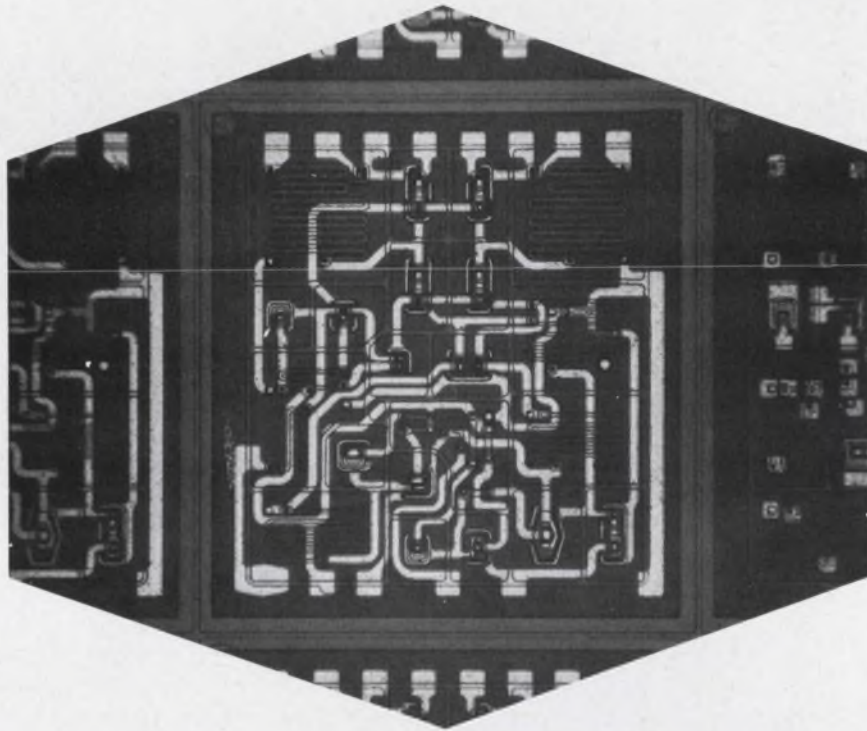

## The 15nA Operational Amplifier UC4000

- 15nA differential input offset current (max)
- 175pA/°C differential input offset current drift (max)
  - 5mV input offset voltage (max)
- 10 $\mu$ V/°C input offset voltage drift (max)
  - 50nA input biasing current (max)
  - $\pm$ 10V common mode voltage (min)
  - $\pm$ 10V output voltage swing (min)
  - 2mA output current drive (min)
  - 20,000 open loop voltage gain (min)
- -55°C to +125°C operating temp. in TO-101
- Offset Voltage adjustable to zero with external potentiometer
  - Off the shelf delivery

*applications:* A to D converter • Bridge amplifier • DC amplifier • Differential amplifier  
Integrator (DC to AC) • Sample and hold amplifier



**ELECTRONICS**

Semiconductor Department / 365 Middlefield Road, Mountain View, California 94040 TWX: 910-379-6942; Telephone (415) 961-3300

ON READER-SERVICE CARD CIRCLE 10

ELECTRONIC DESIGN 18, September 1, 1967

## USPO drives to streamline nation's mailing operations

The U.S. Post Office, after almost 200 years of hibernation, is taking urgent steps with full Congressional backing to modernize the nation's postal operations.

Part of its multifaceted drive has been aimed at arousing the interest of industry in its problems. "We are actively looking for unsolicited proposals," says Dr. Leo S. Packer, head of the Post Office's year-old Bureau of Research and Engineering. "Early in November, 1967, we are going to invite representatives of about 200 companies—electronic, aerospace and others—to give them a feel for the Post Office's problems and how they can participate in their solutions. Undoubtedly, the bureau's staff will do some in-house development, but the bulk of the work will have to be done by private industry."

Just how great is the Post Office's problem and what steps have been taken to deal with it? A few statistics are enough to answer the first question. This year the Post Office will handle 80 billion



Manpower fluctuations will be monitored continuously by the \$33.5 million postal Source Data System.

pieces of mail, a figure that grows by 5 per cent every year. This is the equivalent of nearly 400 pieces of mail for every man, woman and child in the country, and costs nearly \$6 billion to deal with. The Post Office has operated at a deficit every year but three since 1920.

To tackle a problem of such massive proportions requires a vigorous attack from many directions. To this end, the Postal Institute of Technology (PIT), with headquarters in Washington, D. C., and numerous branches elsewhere, is due to open its doors early next year. It will train postal staff in the management and technology needed to operate a modern mail system.

PIT will form part of Dr. Packer's bureau, which aims to expand its staff rapidly from its present 250 members to 965 by 1972. The main purpose of the bureau is to apply a systems approach to postal problems. "We intend to adopt the highly successful DOD methods of system analysis and integration, including the cost-effectiveness concept," explains Dr. Edward M. Reilley, the bureau's new director of R&D.

This system thinking is clearly reflected in several of the 94 R&D contracts that the Post Office has already awarded. Control Data Corp., notably, has a \$33.5 million contract to build a so-called Source Data System. This is already being set up and will compute information gathered from 75 of the nation's largest post offices. Between them they handle 56 per cent of the national total volume of mail and employ half the Post Office's work force. The system will eliminate more than 8 million time cards and 25 million official work forms.

Another example of the systems approach is a contract for Stanford Research Institute to "design, de-

velop and test a conceptual and simulation model of the total mail-handling system."

A mathematical model's need for immediately available, up-to-the-minute information is being met by means of a postal data bank. This will store a variety of functional data on mail flow, to provide an instantaneous picture of postal operations. One of the uses for these data will be to schedule the transportation of mails.

Slightly further into the future, whole systems of mail-handling equipment will be tested under actual operating conditions in a \$16.5 million Engineering Test Center that will start work outside Washington, D. C., in 1972.

Closely related to present efforts is the newly established Research and Engineering Advisory Council. This is made up of 29 representatives of industry, engineering colleges, research laboratories, professional fields and other government agencies. They will aid the Postmaster General in laying down guidelines for Post Office research and development.

A good description of what the Post Office needs can be found in a brochure entitled *The Post Office Challenge to Industry* (POD publication No. 48, May, 1967), available free from Dr. Packer's office.

## LBJ orders full review of U.S. telecommunications

President Johnson has ordered a blue-ribbon committee to be set up to review U.S. telecommunications in detail.

To be chaired by Eugene V. Rostow, Undersecretary of State for Political Affairs, the panel is to:

- Review the nation's foreign and domestic policies on telecommunications.
- Study existing domestic operations and service, including the need for satellite systems.
- Consider the desirability of merging all U.S. international common carriers, including the Communications Satellite Corp.
- Determine requirements for new legislation.

The President's order was contained in a message to Congress. In it he expressed his concern at the effect on the public interest of the

divided ownership of U.S. international communications. He also voiced a plea for world support of the International Communications Satellite Consortium (Intelsat).

The President's directive was not made lightly. Many of his comments to Congress directly reflect the views of the strongest critics of this nation's international common carriers. They also ultimately pit the executive office (and by association, the Democratic Party) against three of the country's industrial giants—ITT, RCA, and Western Union—just before an election year.

Most other countries, the President declared, employ only one central agency for the control of international telecommunications and this is usually government-owned. In the U.S., operations are split among five major organizations—the three already named and the American Telephone Co. and Comsat Corp.

Repeating the traditional arguments of critics, President Johnson pointed out that the normal desire for free enterprise does not necessarily apply, since price competition is restricted by Federal control of rates and practices. Multiplication of facilities induces excessive charges, he suggested, and the nation's international bargaining position is hurt by the divided front.

The President pointed out that disagreements persist between Comsat Corp. and other carriers over the future ownership of ground stations outside the U.S. Finally, he warned that future defense communications may suffer from restrictions or delay imposed by the independent carriers.

In addition to the possibility of merger, the committee will study these other major questions, the President stated:

- "Are we making the best possible use of the electromagnetic frequency spectrum?"

- "How soon will a domestic satellite system become economically feasible?"

- "Should a domestic satellite system be general-purpose or specialized, and should there be more

than one system?"

- "How will these and other developments affect Comsat and the international communications carriers?"

The President repeated his invitation to the Soviet Union and the Eastern European nations to join and support Intelsat, the 58-nation consortium for global satellite communications. He reaffirmed the U.S. commitment to the consortium and urged that separate satellite systems that might weaken or jeopardize it should not be established. He expressed the hope that the Soviet Molniya domestic satellite system might eventually be linked with that of Intelsat.

The President further emphasized that U.S. domestic satellites must be compatible with the global system and operating practices subordinate to Intelsat regulations and specifications.

## Project Profile aims at better space navigation

A rapid, more accurate method for obtaining navigational fixes aboard Earth-orbital or near-Earth spacecraft is being sought by the U.S. Air Force in a new program dubbed Project Profile.

Following a three-year feasibility study by scientists at MIT, the Instrumentation Laboratory there will determine if certain Earth radiations can be employed reliably by manned or unmanned spacecraft to fix their position accurately with respect to a geographical spot on the Earth.

The laboratory was allocated \$1.5 million for the first year to design and develop instrumentation for two satellites to be launched in 1970 and 1971. Although the program was initiated May 1, the first announcement was made only recently.

On-board equipment will consist of a totally integrated experimental package developed and fabricated by the laboratory plus a surplus Apollo-spacecraft inertial guidance platform. (The latter will be provided by NASA following recovery from early unmanned Apollo test flights.) Each MIT system will include two infrared and two ultraviolet scanners, a star tracker, a special-purpose digital data processor, data recorder, and PCM and pulse-

modulated telemetry.

The IR scanner will use the very latest thermistor-bolometer techniques, according to laboratory officials. Both the IR and the UV instrumentation will be developed by MIT, but will ultimately be purchased from industry.

The star tracker will be the Lunar Module Optical Rendezvous Subsystem developed by Hughes Aircraft Co. for NASA. (This subsystem competed with rendezvous radar for use in NASA's Apollo program but lost in final selection.)

The sensor fields of view will be forward and backward along the orbital path and will be centered on the Earth's limb (that is, the atmospheric sheath surrounding the Earth's disk) at about 100,000-ft altitude. Sensors will be referenced to the inertial platform. The latter will be complemented by the star tracker to provide absolute stellar directional data.

To provide a meaningful profile from the radiation measurements, spacecraft orientation with respect to the Earth must be known at all times. The Air Force global tracking net will provide these data.

## Lease-a-laser-laboratory offered by Westinghouse

A complete laser laboratory, with skilled engineers to boot, is being offered on a rental basis by Westinghouse Corp., Pittsburgh.

The "lease a lab" concept is intended to enable prospective users to determine the suitability and potential of lasers as an industrial machine tool.

A user who wants to try out a new technique will not have to buy a laser machine tool and install it on his production line. Instead, he sends materials or devices directly to the company's laser laboratory. There, the material will be cut, drilled, welded or finished to the user's specifications. The laboratory's equipment provides a wide variety of laser energy spot sizes, pulse widths, and laser head configurations.

The user will receive a comprehensive engineering analysis of the results, a suitability study of the process, and an economic comparison with conventional machining.





## Reduce friction and keep cool with Mystik Teflon® Tapes

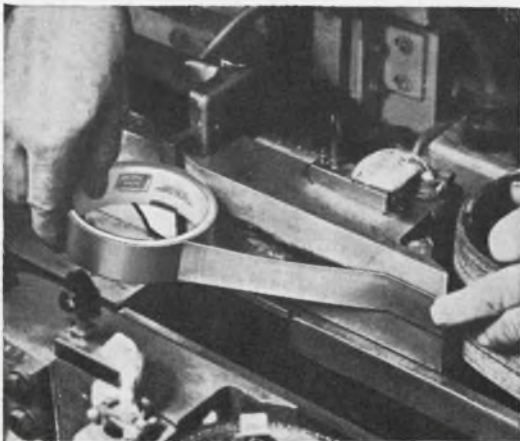

Mystik's Teflon tapes combine the advantages of TFE Teflon film with a silicone pressure-sensitive adhesive. As a result, they offer high dielectric strength, low coefficient of friction, and high performance within a temperature range from  $-100^{\circ}\text{F}$  to  $+450^{\circ}\text{F}$ .

These remarkable tapes are particularly useful in reducing friction on high speed equipment and as insulators of electrical apparatus, but they have many other applications in the electrical and electronic industry.

Of course, Mystik Teflon Tapes represent only a few of the high quality paper, film, and glass cloth tapes available for special applications. For assistance in selecting the best ones for your needs, contact your local Mystik distributor. He's listed in the Yellow Pages under "Tape" or write The Borden Chemical Co., Mystik Tape Div., 1700 Winnetka Avenue, Northfield, Illinois 60093.



**BORDEN  
CHEMICAL**

ON READER-SERVICE CARD CIRCLE 11

# 2,000V

## NPN — PNP QUADS

### BVCEO (SUSTAINING) TYPES

NPN	*BVCEO @IC=25MA Sustained	BVCBO @200 ua VOLTS	BVEBO @100 ua VOLTS	HFE IC=50MA VCE=5V	VCE. SAT. IC=50MA IB=5MA VOLTS	VBE. SAT. IC=50MA IB=5MA VOLTS	ICBO @25°C <ua	VCB VOLTS	GBW IC=50MA VCE=10V @20MC	MAX COB uuf IE=0 VCB=15V f=2 MC
	TRD-300S	300	350	6	30	1.0	1.0	300	5.0	2.5
TRD-400S	400	450	6	30	1.0	1.0	400	5.0	2.5	15
TRD-500S	500	550	6	30	1.0	1.0	500	5.0	2.5	15

PNP	*BVCEO @IC=25MA Sustained	BVCBO @200 ua VOLTS	BVEBO @100 ua VOLTS	HFE IC=25MA VCE=10V	VCE. SAT. IC=25MA IB=2.5MA VOLTS	VBE. SAT. IC=25MA IB=2.5MA VOLTS	ICBO @25°C <ua	VCB VOLTS	GBW IC=10MA VCE=20V @20MC	COB uuf IE=0 VCB=15V f=2 MC
	TRDP-300S	300	300	5	25	3.0	1.0	200	5.0	1.0
TRDP-400S	400	400	5	25	3.0	1.0	300	5.0	1.0	20
TRDP-500S	500	500	5	25	3.0	1.0	400	5.0	1.0	20

\*Pulse Width: 300µsec, Duty Cycle <2%

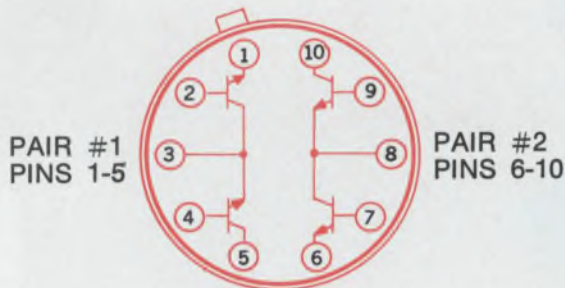

BOTTOM VIEW

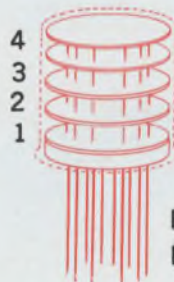

	A	B	C
PAIR #1	2-NPN	2-NPN	2-PNP
PAIR #2	2-NPN	2-PNP	2-PNP

The High Voltage Quad is a standard 10 pin TO-5 package containing 2 pairs of series-connected high voltage silicon transistors. The high component density is achieved by using 4 vertically-stacked ceramic discs, each holding one fully passivated high voltage transistor. By proper internal connections, the first pair is series connected—(collector-to-emitter) and the second pair similarly series-connected. For purposes of more general utility, the 2 pairs are not connected to each other. This is illustrated by the internal wiring diagram displayed in the bottom view of the TO-5 package.

The individual transistors, when series-connected, have a resultant Vceo rating (pins 1 and 5 or pins 6 and 10) which is the sum of their individual ratings. The unique engineering capabilities at  make it possible to offer both high voltage NPN and high voltage PNP transistors as the building blocks for the High Voltage Quad.

Determine first the type (NPN or PNP) for each pair of transistors. Refer next to the table of specifications above which describes the available standard NPN and PNP devices; select the types you wish for each pair.

**Example: Pair #1 NPN—2—TRD—500S**  
**Pair #2 PNP—2—TRDP—500S**

By proper selection (as in the example above), it is possible to have pair #1 NPN with a resultant Vceo (pins 1-5) of 1000V, and pair #2 PNP with a resultant Vceo (pins 6-10) of 1000V. By making both pairs the same type (both NPN or both PNP) and by connecting pins 5 and 6 externally, it is possible to series connect all 4 devices to get a resultant Vceo (pins 1 and 10) of 2000V.



**INDUSTRO TRANSISTOR CORPORATION**

35-10 36th AVENUE / LONG ISLAND CITY, NEW YORK 11106 / (212) EX 2-8000

# Commercial firms jump at navy satellite

## Three companies ready receiver/computers for oceanographic, survey and aircraft use

Charles D. LaFond  
Chief, Washington News Bureau

President Johnson's approval of the release of information on the Navy Navigational Satellite System (NNSS) for commercial exploitation has drawn enthusiastic response from U.S. industry and potential users.

Three manufacturers—The Magnavox Co., ITT Corp., and Honeywell, Inc.—are well ahead with development of practical receivers for ship and aircraft operations. A host of oceanographic organizations, oil-exploration companies, and commercial shipping firms are already in line for early delivery of the navigation sets.

Potential aircraft users are more cautious since, to be practical for their in-flight operation, the NNSS would have to be expanded into a 12-satellite configuration. The system is designed to use four orbital spacecraft spaced 45° apart, but only three are presently deployed.

The recommendation to declassify data on the system was made to the President by the Navy under pressure from the Marine Sciences Council. The President's decision

was first announced by Vice President Humphrey in an address at Bowdoin College, Brunswick, Me., on July 29 (see "News Scope," ED 17, Aug. 16, 1967, p. 14). He stressed, however, that the Navy was not committed to maintain the system indefinitely for nonmilitary use.

To implement commercial use of the system, the U.S. Dept. of Transportation is to prepare a plan to take account of future nonmilitary navigational requirements, Humphrey said. The Navy will supply all the necessary technical and user information to industry through the National Security Industrial Association. NSIA officials have indicated that a meeting to disseminate the data will be held within the next two months.

The Navy achieves a navigational accuracy with the satellite system that is better than 300 ft. Present shipboard receiver sets, using available external computers, cost roughly \$40,000. The equipment is highly sophisticated. For many potential users, such navigational equipment is both too costly and needlessly exact.

Nevertheless, off-shore oil and

mining exploration and the entire field of oceanography would be enhanced by such a system, since the needs for precise position determinations are extreme.

The system's value to the United States' 1200 merchant ships is less easy to assess. Oil tankers appear to have the greatest immediate need, since they inherently have the fastest turn-around time and typically spend 75% of the time at sea.

The U.S. Maritime Administration has made a hypothetical study of cost penalties due to navigator and navigational error, according to Charles G. Kurz of the Office of Research and Development. These were assessed against a typical 18-knot Class-C cargo ship on a transatlantic crossing. They totaled \$8000—navigator, \$2500; fuel, \$1500; all other ship costs, \$3300; and loss of profit, \$700. A general cargo vessel operates 50 to 55 per cent of its time at sea, Kurz said.

With reasonable weather, such ships using celestial navigation are accurate to within 2 miles on dead reckoning and the expected error rate is 1% of the distance traveled. In bad weather, however, the navigational error can be as high as 50 miles. The early merchant marine market, said Kurz, will depend on turn-around time and route length. The containerization of cargo ships will increase sea time and thus the need for improved navigation. But, he stressed, navigational satellite receiver manufacturers must still compete with existing Loran-A and -C, Omega, and Decca navigation systems.

### Magnavox is bullish

Of the three firms now developing or producing navigational satellite receiving and computing equipment, Magnavox appears to be nearest to having hardware ready for commercial use.

The company's Government and Industrial Div., Fort Wayne, Ind., has completed prototype development and testing on its Model 702

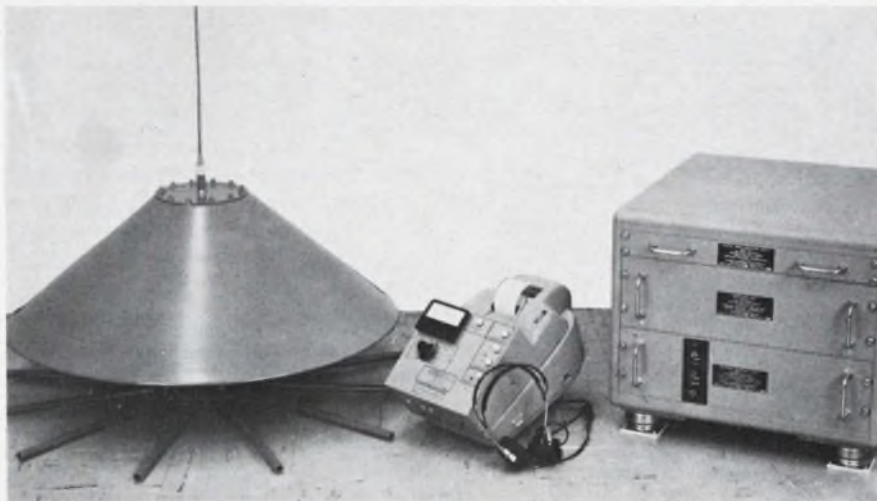

Satellite navigation set, AN/SRN-9, was forerunner of today's smaller commercial designs. Honeywell flight-tested the electronics group in 1965.

(Navy satellite, *continued*)

CA shipboard NNSS receiver under a \$620,000 contract from Scripps Oceanographic Institute, La Jolla, Calif. Separate computer development is under way and a Model 706 CA shipboard NNSS position locator is well into the development phase. The latter is an integral receiver/computer system.

The division is also developing the Model 707 CA geceiver for the Applied Physics Laboratory, Johns Hopkins University, Silver Spring, Md. For use in fixed-station position determination, it is designed to accept data from the Geos and Anna geodetic satellites as well as the

NNSS. It can be operated unattended for long periods to provide topographical data (latitude, longitude, elevation) that are accurate to within 15 ft.

The 702 CA, working with an external computer, and the 706 CA will be capable of determining positions to within 300 ft, and to within 100 ft relative to another satellite receiving station.

Commercial pricing of the 702 CA is expected to be under \$30,000. An associated integral computer could add another \$20,000 for the complete 706 CA system, a Magnavox spokesman said.

Scripps originally ordered 11 receivers but this purchase has now been raised to 30. Other units are on order for the Canadian govern-

ment and for the British National Environmental Research Laboratory, the firm said.

William Chamberlain, the division's market manager for NNSS receiver sales, foresees a potential of 400-500 units within the next two years. However, he warned that any major breakthrough with a lower-cost, simpler system could radically alter present sales forecasts.

**ITT sees varied uses**

A follow-on production contract for 16 SRN-9 receivers was awarded to ITT Aerospace Div. late last year. This was increased this year by 67 more units for delivery by the end of 1968. The receivers are for use in conjunction with existing shipboard computers. Present unit price is believed to be about \$40,000.

The San Fernando, Calif., facility is currently working with several computer manufacturers to interface available equipment with the receiver for commercial sales. One such computer, the \$10,000 desktop, PDP-8S produced by Digital Equipment Corp., Maynard, Mass., is ready now, according to Joseph Chernof, Director of ITT's Space, Navigation and Tracking Laboratory.

ITT will ultimately develop an integral receiver/computer system for commercial use, probably in the \$24-28 thousand price range. Preliminary design work is now in progress, Chernof disclosed.

Three immediate markets have opened up, he asserted, as a result of the President's decision to release the naval satellite system for commercial use:

- Geophysical survey and other oceanographic applications.
- Commercial shipping. Actual distance traveled would be cut from 10 to 15 per cent, saving both time and fuel costs significantly, he pointed out.
- Air traffic control through improved aircraft navigation.

Chernof also foresaw the possibility of land-survey applications. These might include use in target location and fire control for high-caliber artillery. Two sets could be used, he said, with one in a fixed position as a reference to cancel out satellite-induced errors.

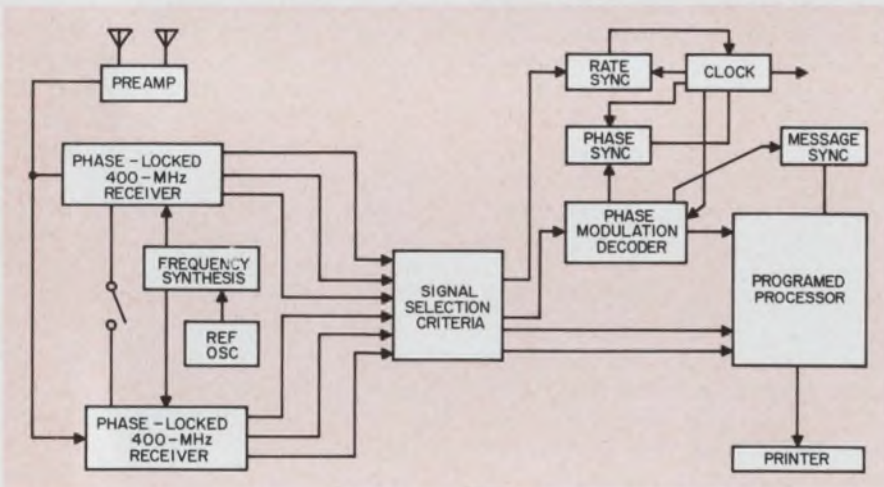

**ITT-Aerospace Seaway commercial navigation system** depends on addition of available subsystems by the user. System is similar to the Navy's new improved AN/SRN-9. Developers are now working on an integral computer.

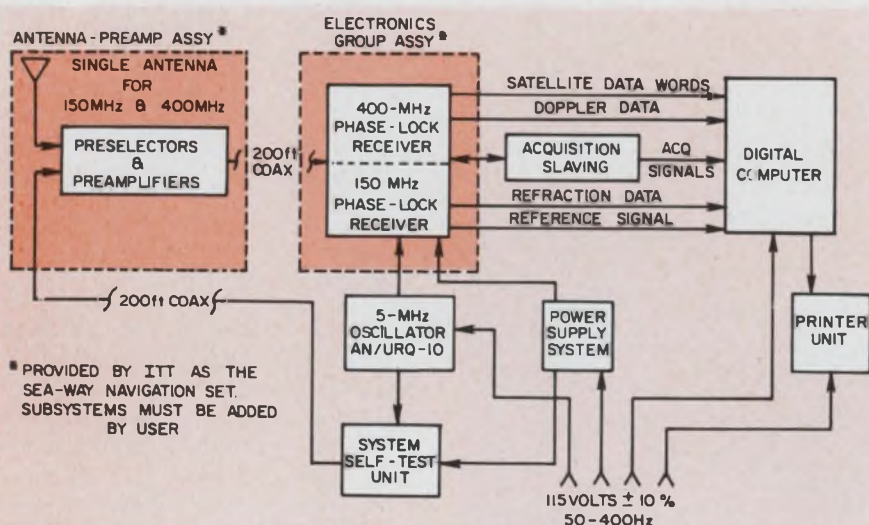

**Magnavox Model 706 CA** will provide an integral receiver/computer system. Now in development, it will weigh under 50 lbs, cost over \$40,000. Receiver sensitivity has a threshold of -145 dBm and dynamic range to -90 dBm.

**Yes. You can get every  
wire and cable you need  
for a computer system in  
one neat package... from  
Brand-Rex**

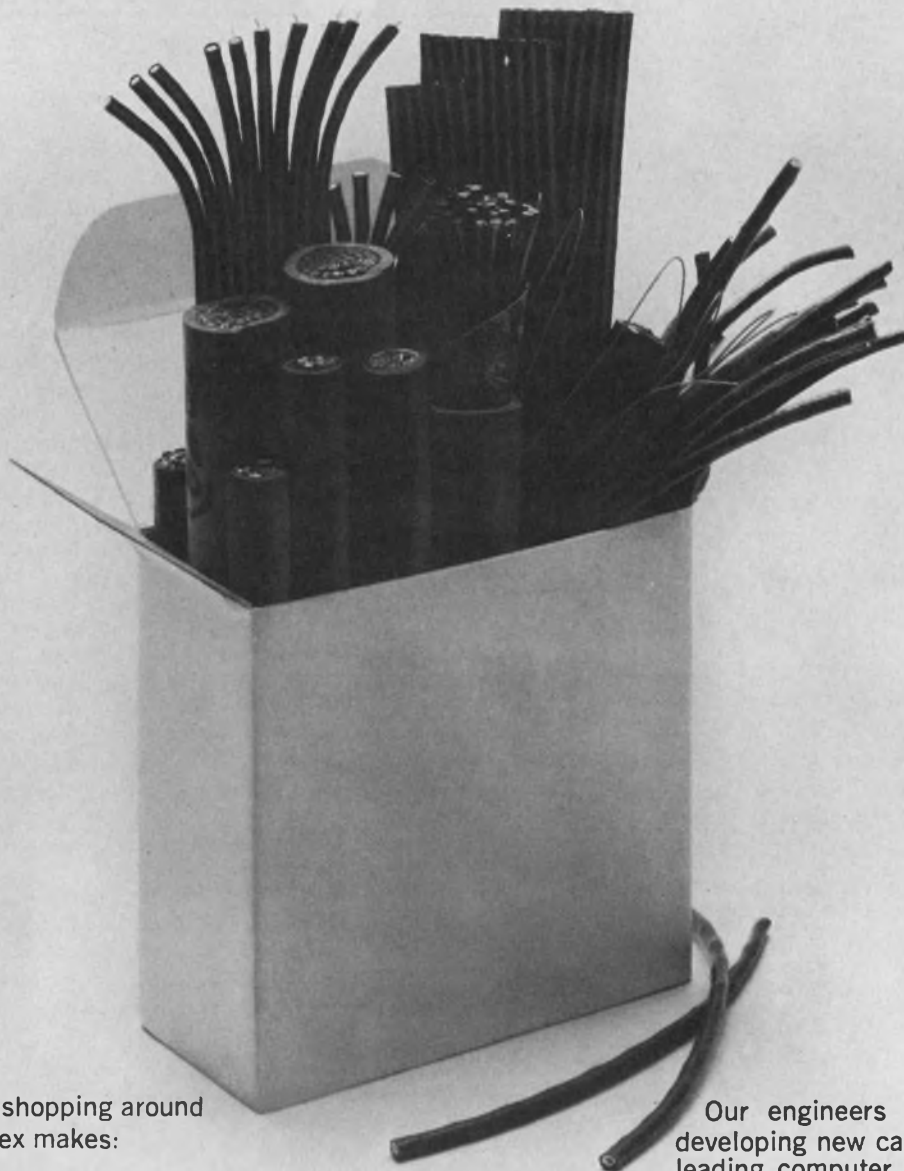

You save a lot of shopping around because Brand-Rex makes:

- **Back-Panel Wires**
- **Hook-Up Wires**
- **Miniature, Air-Spaced Coaxial Cable**
- **Power Supply Wires**
- **Patch Cord Wires**
- **Interconnecting Cables**
- **Communication Cables.**

You can have just about any configuration... single wire, round cable, ribbon cable, custom profiles... and your choice of insulations including Kynar, Polysulfone, Teflon (FEP and TFE), PVC, semi-rigid PVC, PVC/nylon, polyethylene, foamed polyethylene, FEP/nylon, Rulan and Neoprene. Matched colors if you want.

Our engineers are constantly developing new cable designs for leading computer manufacturers. So if existing Brand-Rex products don't meet your needs, we'll come up with new designs that will.

Hooking-up a computer system? Get all the wire and cable from one good source. Ask Brand-Rex.

AMERICAN ENKA CORPORATION

BRAND-REX DIVISION

WILLIMANTIC, CONNECTICUT 06226  
PHONE 203 423-7771



ON READER-SERVICE CARD CIRCLE 13

(Navy satellite, *continued*)

Last March, Honeywell Inc.'s Aerospace Div. at St. Petersburg, Fla., won a contract award from the Applied Physics Laboratory to develop an integral receiver/computer for both aircraft and shipboard use. Prototypes are now in various stages of development and delivery of the first advanced model is scheduled for this October. The equipment will later be test-operated in a Navy P3C patrol aircraft.

Although the fact is not generally known, Honeywell demonstrated the feasibility of aircraft navigation by the satellite system in December, 1965. This was done during 10 test flights and using a Honeywell H-386 inertial platform interfaced with the standard SRN-9 receiver. Accuracies obtained then were up to 0.3 nautical miles (608 yards), according to John Wagner, Honeywell's market manager for navigation products.

#### Low-cost system sought

The new system will consist of a satellite Doppler-signal receiver and a computer subsystem. A complete unit fits a standard rack within an aircraft, occupies 1-1/2 ft<sup>3</sup> and weighs 18 lbs. For flight operation, the computer would be fed velocity data from the receiver or from an inertial navigator. Aircraft altitude data would be provided by the on-board air-data computer. For shipboard operation, velocity and heading would be provided by the ship's log and gyrocompass, Wagner explained.

In either application, the vessel's position will be determined instantaneously and fully automatically, he stated. A design goal is to produce a system of relatively low cost and high accuracy for both tactical

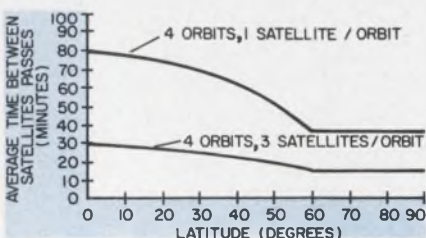

**Satellite availability:** Curves compare satellite pass integral vs latitude of observer using 4 and 12 vehicles.

and strategic aircraft or shipboard use.

Following development and test of this system, Honeywell plans to improve the design further by reducing over-all size and weight from 25 to 50 per cent. At that time the firm will strive for a unit price of under \$25,000, declared Wagner. Such equipment can be made available in 12-18 months, he estimated. Success of the aircraft application, however, is contingent on a 12-sat-

ellite system to reduce the time between measurements, he stressed.

While Magnavox, ITT, and Honeywell have designed similar shipboard navigation sets, their approaches differ largely in the number of functions contained in their respective designs.

ITT's Sea-Way Model 4007 AB provides a minimal receiver system including only an antenna assembly; all other subsystems must be added by the user. ■ ■

### Navy established system in 1964

The present Navy Navigational Satellite System was initiated in 1958 by the Navy and the Applied Physics Laboratory of Johns Hopkins University in Silver Spring, Md. The concept had evolved during the previous year from the work of two APL scientists, Drs. W. H. Guier and G. C. Weiffenbach, who, while monitoring radio signals from the Soviet Union's Sputnik satellite, noted the effects of Doppler shift when the data were plotted. They later found that all orbital parameters of the spacecraft could be determined by one ground station from a single pass of the satellite.

It followed shortly that the inverse also was true—that from a known satellite ephemeris, Doppler shift could be employed by a ground station to determine its own location. The Navy bought the idea readily since it was faced with the problem of ensuring precise navigational data for its new Polaris submarine force then in development.

Under the direction of APL's Dr. R. B. Kershner, now Director of the Laboratory's Space Development Div., the Transit system was produced and became operational in 1964. It later was renamed the Navy Navigational Satellite System and it presently consists of three orbiting vehicles and four ground tracking stations. Two of these are used as injection stations to transmit data to the spacecraft periodically. The satellites are in staggered polar orbits, near-circular at 600-nautical-mile altitudes.

User equipment consists of the AN/SRN-9 receiver and antenna assembly, a digital computer, and a printer for read out of position. In brief, the user picks up transmissions from a satellite as

it comes into radio view. There are two signals at 150 and 400 MHz. During a typical 18-minute satellite pass, nine measurements of Doppler shift are obtained, an amount more than sufficient to determine position within 0.1 nautical mile (200 yards). Coded in the satellite transmission are its identification and orbital position with respect to time. Repeated satellite measurements further refine position to better than 300 ft. Shipboard inputs to the system are heading and relative speed.

Two frequencies are employed as a means to determine ionospheric refraction of the satellite signals at any given orbital location. Through use of dual frequencies, a 200-300 ft improvement in accuracy is obtained over that of a single frequency. Should one channel fail, the remaining signal with repeated measurements will provide accuracies from 0.1 to 0.5 nautical mile.

The greatest system-error source results from the uncertainty of satellite location, due largely to incomplete knowledge of the Earth's shape and surface variations.

APL developed the original SRN-9 navigation set (dual frequency) in 1962 and completed operational testing the following year. The Magnavox Co. was the first principal subsystems contractor, providing over 30 devices now in operational use. Later, ITT-Aerospace Div. won a contract to improve and produce SRN-9's for delivery to the Navy by 1968. The present SRN-9 is all-transistorized and consists essentially of a very stable oscillator, the dual receivers, logic circuitry and a power supply.

## Split beams deepen holograms to 4 feet

A Bell Telephone Laboratories scientist has devised a technique for increasing the depth of field of holograms. For the first time, 4-foot depths have been achieved. Up to now the limit has been 1 foot.

Increased depth is obtained by successively splitting the laser beam so that different sections of the object are illuminated separately. The new method permits objects with dimensions greater than the coherence length to be recorded. In any laser beam, two points are coherent if they oscillate with a phase difference that is constant for the distance between them. If this phase difference is not preserved, then the beam is incoherent for length.

The coherence length sets a limit on the dimensions of the subject that can be recorded holographically, since the light reflected from the subject must interfere coherently with the reference beam. The illuminating and reference beams are adjusted to travel equal paths, so that as many wavelengths as possible are kept in phase.

It is not clear whether the hologram of a single, continuous object would be flawed by the appearance of fringes where the individually illuminated sections join. In the photograph below, the chessmen are discrete objects at the center of 1-foot fields.

The hologram was made by D. O. Melroy at Murray Hill, N. J. ■ ■



Chess pieces spaced 6 inches apart are encompassed in one hologram.



## Stradivarius... and Nytronics make the difference!

A Stradivarius violin and a Nytronics High Q variable shielded inductor have much more in common than meticulous craftsmanship and quality materials. Both also have the special built-in ability to be precisely adjusted. This is a most desirable quality in an inductor, permitting the engineer to tune it accurately for most efficient performance in any given circuit simply by turning the adjusting head

Their range of 0.10uh to 12hy makes them ideal for all uses in any packaging technique. Hermetically sealed, with no physical contact between adjusting screw and the inductor itself, they provide a stepless adjustment of inductance over a minimum of  $\pm 5\%$  range from nominal — and without strain on printed circuit mountings. With an operating temperature of  $-55^{\circ}\text{C}$  to  $+125^{\circ}\text{C}$ , they meet the requirements of MIL-C-10535C, Grade 1, Class B.

Available from stock in the following package sizes:

WEE V-L—0.300" dia. x 0.400" high; range 0.10uh to 100,000uh  
 ATE-11 — 45/64" dia. x 3/4" high; range 0.01hy to 0.18hy  
 ATE-0 — 1 1/16" dia. x 1" high; range 0.22hy to 1.50hy  
 ATE-4 — 1 19/64" dia. x 1 1/4" high; range 1.80hy to 12.0hy

Nytronics off-the-shelf inventory also includes a wide range of capacitors, delay lines, and resistors. Write today for complete engineering data.



# NYTRONICS®

...for Precision Electronic Components

550 Springfield Ave., Berkeley Heights, N.J. 07922 ■ (201) 464-9300 ■ TWX: 710-984-7977

ON READER-SERVICE CARD CIRCLE 14

# The tiny flaws in medical design can kill

## Errant currents from faulty electronic equipment are reported imperiling patients in certain cases

Ronald Gechman  
West Coast Editor

A seemingly harmless current of 20 millivolts can kill a hospital patient under certain conditions. Moreover such a current may be generated by poorly designed electronic equipment.

Add to that the fact that there are today no Federal, state or local standards to regulate the design, construction and electrical safety of equipment used in a hospital room or doctor's office, and the potential for continuing tragedy exists.

This is the picture painted by medical and engineering critics of some of today's electronic equipment. Deaths have, in fact, already resulted, they say. The cause may be attributed on the death certificate to "ventricular fibrillation" or some comparable medical term.

Two major flaws in equipment are turning up, according to the critics, as medical electronics, still in its infancy, reaches out toward growing markets:

- Faulty components in instrumentation and monitoring devices.
- Wiring systems that do not provide maximum protection for a patient.

Efforts to set safety design standards are being pressed by such professional groups as the Safety Committee of the Instrument Society of America, the Corresponding Committee of the IEEE and the Standards Committee of the Association for the Advancement of Medical Instrumentation. However, they report little headway toward achieving their goals. To fill the void, some manufacturers have begun to set their own standards. And in Congress a bill has been introduced in the House of Representatives to create a national commission that would study the quality controls and manufacturing procedures of, among others, companies that make medical instrumentation

equipment.

Basic to the problem, the critics say, is that many hospitals lack adequate grounding systems for their electrical wiring. Except for their use in operating rooms, isolation transformers, designed to protect a patient from grounding accidents, are reported in scarce supply. Some hospitals do not use ground wires but rely on the conduit alone for grounding.

A leading critic, Dr. Paul Stanley, Professor of Aeronautics, Astronautics and Engineering Sciences at Purdue University, Lafayette, Ind., says that doctors are well

aware that small electric currents applied to the body can be fatal, but that they are not fully aware that malfunctioning hospital instruments can produce these voltages. The malfunction may be no more than a leaky capacitor in the instrument's power supply, and it may go unnoticed for some time, Dr. Stanley says.

A number of studies indicate that ventricular fibrillation is responsible for the majority of deaths from electrical shock, he reports. In ventricular fibrillation various groups of the heart muscle fibers stop operating in rhythm; instead they operate independent of one another. The result is weak, sporadic heart action that produces death.

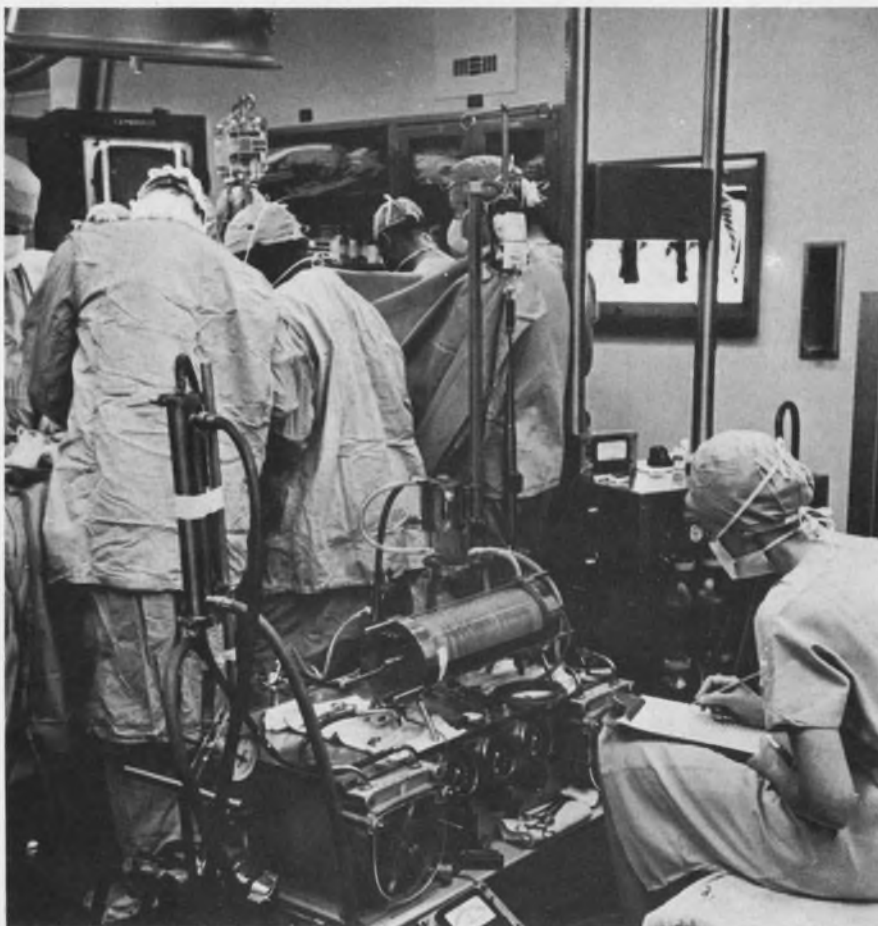

Heart-lung machines and other electrical and electronic equipment used in hospitals may be hazardous to patients because of the danger of electrical shock. Numerous examples of poor design in medical electronic equipment have been uncovered.



Accurate figures on deaths occurring from accidental shocks in hospitals are nearly impossible to obtain, Dr. Stanley concedes. However, instances of death or near-death are reported from time to time.

At one Midwest hospital, according to Dr. Stanley, 40 to 50 patients were shocked over a few months in 1965, owing to a design error in an electromechanical dye injector. He declines to identify the hospital publicly, but he says the machine has since been removed from the market. Parts of it were anodized before assembly, and while this effectively insulated the parts and caused a high resistance path to ground, the patients were grounded through other instruments. Since the patients were a better ground than the dye injector, current from the injector through the patients produced severe shock.

Similar cases were reported that same year by the University of Wisconsin. One patient died and six others were severely shocked by the same dye injector.

In Europe the leading British medical journal, *The Lancet*, reported two instances where patients were severely shocked by broken ground connections. Another case was reported last January in a news story from Yugoslavia telling of a patient's death from electrical shock caused by a defective electrocardiograph.

It is bad enough when a healthy person is subjected to such shocks, Dr. Stanley says, but the problem is drastically compounded when a hospital patient, especially one suffering from a heart problem, receives the shock from an electrical device attached to his body.

In an ordinary, nonmedical situation, the resistance of two electrodes placed on the skin can vary from 500 ohms to 5 k $\Omega$ , depending upon moisture, oils in the skin and the amount of dead skin under the electrodes. But needle electrodes inserted into the body of a patient often reduce the body resistance to zero.

"Under these circumstances, a current as low as 20  $\mu$ A will probably cause fibrillation," according to Dr. Stanley. He adds that a voltage as low as 20 mV can be fatal and that a voltage of even 2 mV can be seriously harmful.

## How To Solve Your Power Supply Problem—



**28 VDC to 400  $\text{A}$  3 $\phi$**   
Model Q10D-115A-400Y  
Size 6" x 6" x 4" — Wt. 8.3 lbs.  
Output 100 volt amps



**400  $\text{A}$  to DC (Reg)**  
Model T3D-48.6A  
Size 2 $\frac{3}{4}$ " x 3" x 3 $\frac{1}{4}$ " — Wt. 2.3 lbs.  
Output 48 VDC at 618 ma



**60  $\text{A}$  to DC (Reg)**  
Model V6D-27.6A  
Size 4 $\frac{1}{2}$ " x 6" x 4" — Wt. 10.3 lbs.  
Output 28 VDC at 2.1 amps



**28 VDC to DC (Reg)**  
Model AK1D-1970A  
Size 1 $\frac{1}{2}$ " x 2 $\frac{3}{4}$ " x 3" — Wt. 1 lb.  
Output 2000 VDC at 5 ma

### NEW! Mil-Spec Quality Power Supply Modules for All Types of Power Conversion

Abbott has a new line of power supply modules. They are built to meet military environment-MIL-E-5272C. All types are available with any output voltage you need from 5 volts to 10,000 volts DC — and DC to 400  $\text{A}$  inverters with either 1 $\phi$  or 3 $\phi$  outputs.

**DC to 400  $\text{A}$ , 3 $\phi$**  — This new inverter changes 28 VDC battery voltage to three phase power with outputs of 33, 66, and 100 volt amps, 400 cycles or 800 cycles, as well as output voltages of 115 VAC or 27 VAC. All three phases are independently regulated at 1%. Also, 1 $\phi$  output units are available with powers of 30, 60, 120 and 180 volt amps, 400 cycles or 800 cycles, at 115 VAC or 27 VAC. All of these solid state inverters are completely described on Pages 12 and 13 of our new catalog.

**60  $\text{A}$  to DC** — These modules are the smallest, lightest weight 60  $\text{A}$  to DC power supplies we have seen. They are well regulated for line and load changes. Hermetically sealed for military environment they will operate to 160°F heat sink temperatures. They are available in any output voltage you need — 5 volts to 10,000 volts.

with power outputs of 5, 10, 20, 30, 60, 120, and 240 watt sizes as standard catalog listings. You will find them completely described with prices on Pages 2, 3, and 4 of our new catalog.

**400  $\text{A}$  to DC (Reg)** — Designed especially for 400  $\text{A}$  input power, this line of converters is available with any output voltage you want — 5 volts to 10,000 volts DC. Power outputs of 5, 10, 20, 30, 60, 120, and 240 watt sizes are standard. Well-regulated and hermetically sealed, these units are described on Pages 5, 6, and 7 of our new catalog.

**DC to DC (Reg)** — Some of these DC to DC converters are as small as a package of cigarettes and weigh less than a pound. Output voltages from 5 volts to 10,000 volts are all listed as standard models in our new catalog. Power outputs come in standard sizes from 5 to 240 watts. These converter modules feature close regulation, short circuit protection and hermetic sealing for rugged applications found in military environment. They are listed in order of increasing output voltage on Pages 8, 9, and 10 of our new catalog.

If you need a power supply module in a hurry please check Pages 1579 to 1592 in your **EEM** (1966 **ELECTRONICS ENGINEERS MASTER Directory**). Most of the above units are listed there. Or, for a complete list of our power supply line please send for your FREE 36-page catalog.

**abbott transistor**

LABORATORIES, INCORPORATED  
5200 W. Jefferson Blvd. • Los Angeles 90016  
Area Code 213 • WEBster 6-8185

TO: Abbott Transistor Labs, Inc., Dept. 41  
5200 W. Jefferson Blvd.  
Los Angeles, California 90016

Sir:  
Please send me your latest catalog on power supply modules:

NAME \_\_\_\_\_ DEPT. \_\_\_\_\_

COMPANY \_\_\_\_\_

ADDRESS \_\_\_\_\_

CITY & STATE \_\_\_\_\_

## (medical design, continued)

Assailing "poorly designed and shoddily built" equipment, Dr. Stanley says: "In some instances, circuits have been lifted directly from published articles on the design of medical instruments, without verifying the circuit's adequacy for the company's particular application."

One example of a design error in a heart-lung machine, he says, was one in which the manufacturer put the fuses for six critical motors inside the machine; it took 15 minutes to remove enough screws to reach the fuse box. The manufacturer subsequently relocated the fuses to a more convenient spot.

Other examples of poor equipment design cited by Dr. Stanley include these:

- Defibrillators that produced excessive shock energies.
- Equipment with chattering relays that produced high-voltage leakage currents.
- Pacemakers that were sensitive to pulses on the power line.

An instance where a cardiogram was being taken illustrates what can happen from faulty wiring, Dr. Stanley says. The technician received a severe shock every time she attempted to attach the leads to the patient. The problem was traced to a bed lamp frame that was shorted to its frayed ac line cord. The lamp was touching the bed frame and so was the patient's arm. Since the cardiogram was grounded through a three-prong plug and the lamp was not, the full ac line voltage, 117 volts, was shooting through both the patient and technician.

**Isolation transformers needed**

To prevent similar situations from arising, Dr. Stanley suggests that all supplies be connected through isolation transformers with a separate ground for each room. The transformer would prevent a shock from accidental grounding.

Dr. Jerome Silver, a former electrical engineer and now a surgeon at the Weiss Memorial Hospital in Chicago, echoes Dr. Stanley's concern over hospital safety. He was instrumental in forming rules for

the hospital that require every electrical item to be equipped with a three-prong plug, and the plug must be installed by the hospital staff.

In addition Dr. Stanley suggests that all hospitals employ an engineer, who will be responsible for all their electrical systems and equipment. The engineer's duties, he says, should include:

- Inspecting all plugs on a periodic basis, to make sure they are in proper working order.
- Replacing tubes in the electronic equipment at recommended intervals, to minimize equipment failure at critical times.
- Checking instruments at recommended intervals, to ensure that they are properly calibrated.

One complaint hospitals have is that some manufacturers are unwilling to supply sufficient information for independent repair of defective instruments, because they

receive extra revenue from the repair of their own equipment. When defective equipment is too large to be sent back to the company for repair, the hospital typically must pay \$150 a day for the company to send out an engineer to repair it.

Dr. Leon Riebman, president of American Electronics Laboratories of Colmar, Pa., notes a problem that manufacturers face in designing medical equipment. "Many doctors and hospitals," he says, "cannot agree among themselves on an acceptable design approach for a new medical instrument. This disagreement has caused so much confusion among the companies trying to develop new instruments that the companies are not apt to spend their funds for new instrument designs which could be used more profitably in other areas."

David Kilpatrick, head of American Electronic's Medical Engi-

**How faulty design can hurt**

Errors in hospital-equipment design may not impair the operation of equipment, but it may cause an electric current that exceeds the maximum safe limits to flow through a patient. The following examples illustrate two possible situations:

Figure 1 shows the circuit connection for a cardiac monitor attached to a patient undergoing a cardiac catheterization (insertion of a catheter into the heart).

If an isolation transformer is not used in the ac supply line and a leak occurs in  $C_1$  of 100 mA, no noticeable impairment in the operation of the equipment will occur. However, the leak will cause current to flow from  $C_1$  to ground through the conduit, often used as the ground system. Such a situation is possible and could cause as much as 65 mV, 30 times the safe value, to be placed across the patient's ventricular wall, which separates the chambers of the heart.

If two failures should occur at the same time, even with the use of an isolated supply line, a dangerous shock hazard will develop. Figure 2 shows two instruments plugged into the same isolated ac line. The patient is connected to both chassis grounds. If a ground should open in one of the cords coupled with a defective

capacitor, such as a leak in  $C_4$ , a current of nearly 20 mA, a possibly fatal amount, would flow through the patient.

Neither the open ground nor the leaky capacitor may be detected in the normal operation of the equipment.

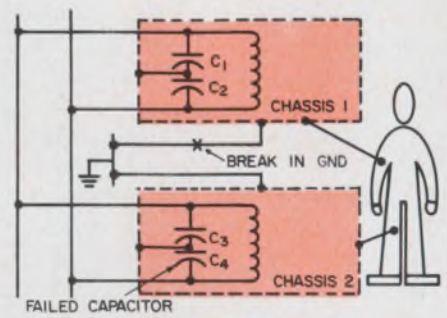
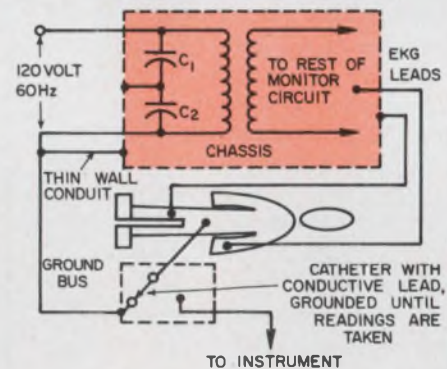

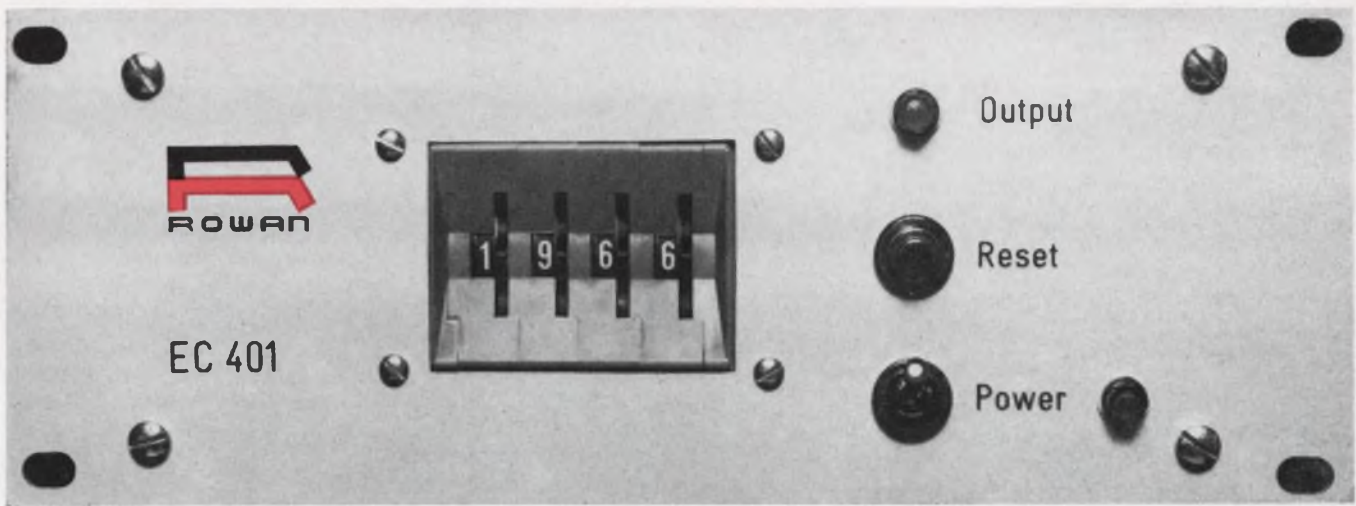

Model EC 401— HALF RACK

ROWAN'S NEW **EC SERIES**  
 ELECTRONIC COUNTER...  
 OFFERED IN 15 MODELS—  
**10 KHz COUNTING SPEED**  
**FULL AND HALF RACK**  
**4,5,6 DIGITS**  
**SOLID STATE/SILICON**  
**HIGH NOISE IMMUNITY**  
**TOTALIZING—SINGLE OR DUAL PRESET**  
**MANUAL, REMOTE OR AUTOMATIC RESET**



*For more information, call or write*

**THE ROWAN CONTROLLER COMPANY**

OCEANPORT, NEW JERSEY 07757

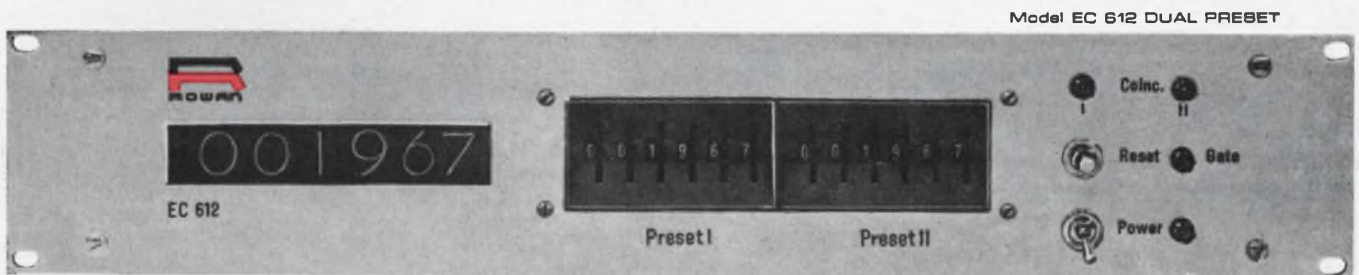

Model EC 612 DUAL PRESET

(medical design, continued)

neering Div., says that because of the lack of general standards, the company has developed its own for medical equipment.

### Alarm checks grounds

Among the company's rules for its designers are these:

- All equipment must have three-wire, color-coded cords and plugs.
- The hot side of the line must be fused no more than 200 per cent of design current.
- Power switches must be installed on the hot side of the line or both sides, but never on the neutral side only.

■ Modular combination of sub-systems on a single patient must be made through a junction box that contains ground current monitoring, alarm and disconnect circuitry.

For wiring in hospital rooms, Dr. Stanley recommends that every electrical outlet have a No. 10 or No. 8 ground wire going to a ground bus. Each bus should handle a group of rooms and have a No. 0 wire going to a separate earth ground, he says. He also recommends that isolation transformers be used throughout the hospital.

Another recommendation of his is the use of a device to detect and sound an alarm automatically if an open ground connection occurs in a piece of operating equipment. The National Electric Code requires that such an alarm be installed in operating rooms, but it is not required elsewhere in the hospital.

Under the bill introduced in the House of Representatives last February by Rep. Ed Reinecke (R-Calif.) a National Devices Standards Commission would be set up. The commission would not only study the instrumentation equipment used in hospitals and doctors' offices, it would also determine what Federal regulation of the equipment was needed to ensure that it meets minimum performance standards. The regulations would come under the jurisdiction of the Food and Drug Administration. Rep. Reinecke's bill, H.R. 6165, is under study.

At present the danger of shock

from electrical equipment attached to a person is not limited to hospitals and doctor's offices. It could extend to test equipment used in schools. One example brought to light recently involved a three-year study completed by the University of North Carolina for the Public Health Service.

The study was designed primarily to obtain information on the calibration and general operating condition of audiometers. It uncovered disturbing information about the safety of the machines. More than 25 per cent of them were found dangerous to operate. Two of the 100 machines tested had a potential of 117 volts on the outside case when plugged into the ac line, and 25 more units tested had enough potential on the case to produce a shock when touched. In addition not a single machine tested met the study's calibration specification.

Dr. Joseph Stewart, audiology consultant for the study, says that an audiometer that is out of calibration can cause serious errors in large-scale screening programs.

"It can, for example, miss the child with a potentially dangerous infection of the middle ear."

The audiometers tested were obtained from health departments, public schools, physicians and hospitals, military and industrial installations, the Veteran's Administration and hearing-aid dealers.

The study traced the inaccuracy of most test instruments to owners or operators who apparently had been unaware of the need for periodic calibration. Nearly half of the instruments had not been calibrated from the day they were purchased.

When technicians removed the back of one audiometer being used by a physician, they found a rat's nest inside, constructed in part from bits of the instrument's wiring and insulation materials.

Most manufacturers, the study found, were not utilizing the latest electronic techniques, such as solid-state construction. Kilpatrick says that some audiometers on the market today are at least 30 years behind modern technology.

One of the audiometers tested was a brand new unit. When it was removed from its packing case, it was found to be so badly out of calibration that it had to be torn apart and completely rebuilt. ■ ■

## ENGINEERING SALES REPRESENTATIVES

ALABAMA, Huntsville  
Orbe, Inc.  
Tel: (205) 881-8230

ARIZONA, Phoenix  
Southwest Engineering Company  
Tel: (602) 944-1521

CALIFORNIA, Costa Mesa  
Duncan Electronics, Inc.  
(Factory Sales Office)  
Tel: (714) 545-8261

CALIFORNIA, San Francisco  
Jack Pyle Company  
Tel: (415) 349-1266

COLORADO, Denver  
Hyde Electronics Co., Inc.  
Tel: (303) 936-3456

CONNECTICUT, New Haven  
Gerber Sales Co., Inc.  
Tel: (203) 777-6279

FLORIDA, Orlando  
Orbe, Inc.  
Tel: (305) 424-0978

FLORIDA, St. Petersburg  
Orbe, Inc.  
Tel: (813) 894-0687

ILLINOIS, Chicago  
Carlson Electronic Sales Co.  
Tel: (312) 774-0277

MARYLAND, Baltimore  
Biechler Associates, Inc.  
Tel: (301) 825-8222

MARYLAND, Rockville  
Biechler Associates, Inc.  
Tel: (301) 762-6210

MASSACHUSETTS, East Longmeadow  
Gerber Sales Co., Inc.  
Tel: (413) LAurel 5-3059

MASSACHUSETTS, Waltham  
Gerber Sales Co., Inc.  
Tel: (617) 891-8040

MICHIGAN, Detroit  
Grant Shaffer Company  
Tel: (313) 273-5390

MINNESOTA, Minneapolis  
Carlson Electronic Sales Co.  
Tel: (612) 788-4111

MISSOURI, Kansas City  
Harris-Hanson Company  
Tel: (816) 444-9494

MISSOURI, St. Louis  
Harris-Hanson Company  
Tel: (314) 647-4350

NEW JERSEY, Harrington Park  
B. B. Taylor Corporation  
Tel: (201) 768-0969

NEW MEXICO, Albuquerque  
Hyde Electronics Co., Inc.  
Tel: (505) 265-8895

NEW YORK, Baldwin, L.I.  
B. B. Taylor Corporation  
Tel: (516) 223-8000

NEW YORK, Rochester  
Reed Electronics, Inc.  
Tel: (716) 473-2767

OHIO, Cleveland  
Rockford Controls Ohio, Inc.  
Tel: (216) 531-4841

OHIO, Dayton  
Rockford Controls Ohio, Inc.  
Tel: (513) 274-1911

PENNSYLVANIA, Millersville  
Biechler Associates, Inc.  
Tel: (717) 872-2793

PENNSYLVANIA, Pittsburgh  
Rockford Controls Ohio, Inc.  
Tel: (412) 731-4600

TEXAS, Dallas  
Robert R. Thomas Company  
Tel: (214) 363-8591

TEXAS, Houston  
Robert R. Thomas Company  
Tel: (713) 644-2369

WASHINGTON, Seattle  
Hamilton-Electro Corporation  
of the Pacific Northwest  
Tel: (206) 624-5930



DUNCAN electronics, inc.



# introducing the "PIXIEPOT"<sup>TM</sup> at an IMPossibly low price!

Duncan Electronics now offers for the first time in the history of the potentiometer industry a PRECISION, TEN-TURN WIREWOUND pot for less than \$6.00. In fact, the new Model 3253 "PIXIEPOT" potentiometer is yours for as low as \$3.97 each in production quantities and only \$5.95 each for 1-24 units.

#### Outstanding "PIXIEPOT" potentiometer features:

- Length: ONLY 3/4"
- Diameter: 7/8"
- Linearity: ±0.25%
- Resistance Range: 100 ohms to 100K ohms
- Power Rating: 2 watts @ 20°C
- Temperature Range: -25°C to +85°C
- Resolution: Better than any precision pot twice its size.

The Model 3253 "PIXIEPOT" potentiometer incorporates all of the fine engineering workmanship you've come to expect from other Duncan products. Only our new, unique production techniques enable us to bring this potentiometer to you at these unheard of prices.

And if you need your "PIXIEPOT" potentiometers in a hurry, we guarantee they'll be on an airplane out of Los Angeles within 24 hours after receipt of your order!

How can a "PIXIEPOT" potentiometer help you?

Call or write your Duncan representative (listed on the facing page). He will personally deliver to you, FREE, a 1K "PIXIEPOT" potentiometer for your evaluation in exchange for the filled out certificate.

#### This certificate redeemable for one 1K "PIXIEPOT"

(TYPE OR PRINT)

MY APPLICATION IS \_\_\_\_\_

NAME \_\_\_\_\_

COMPANY \_\_\_\_\_ TITLE \_\_\_\_\_

ADDRESS \_\_\_\_\_ DIVISION \_\_\_\_\_

CITY \_\_\_\_\_ STATE \_\_\_\_\_ ZIP \_\_\_\_\_

This offer expires December 1, 1967



DUNCAN ELECTRONICS, INC. • 2865 FAIRVIEW ROAD, COSTA MESA, CALIFORNIA 92626

# Shhh!

Bodine has made  
a quiet motor...  
quieter

with noise-damped ball bearings...  
the next best thing to dead silence.

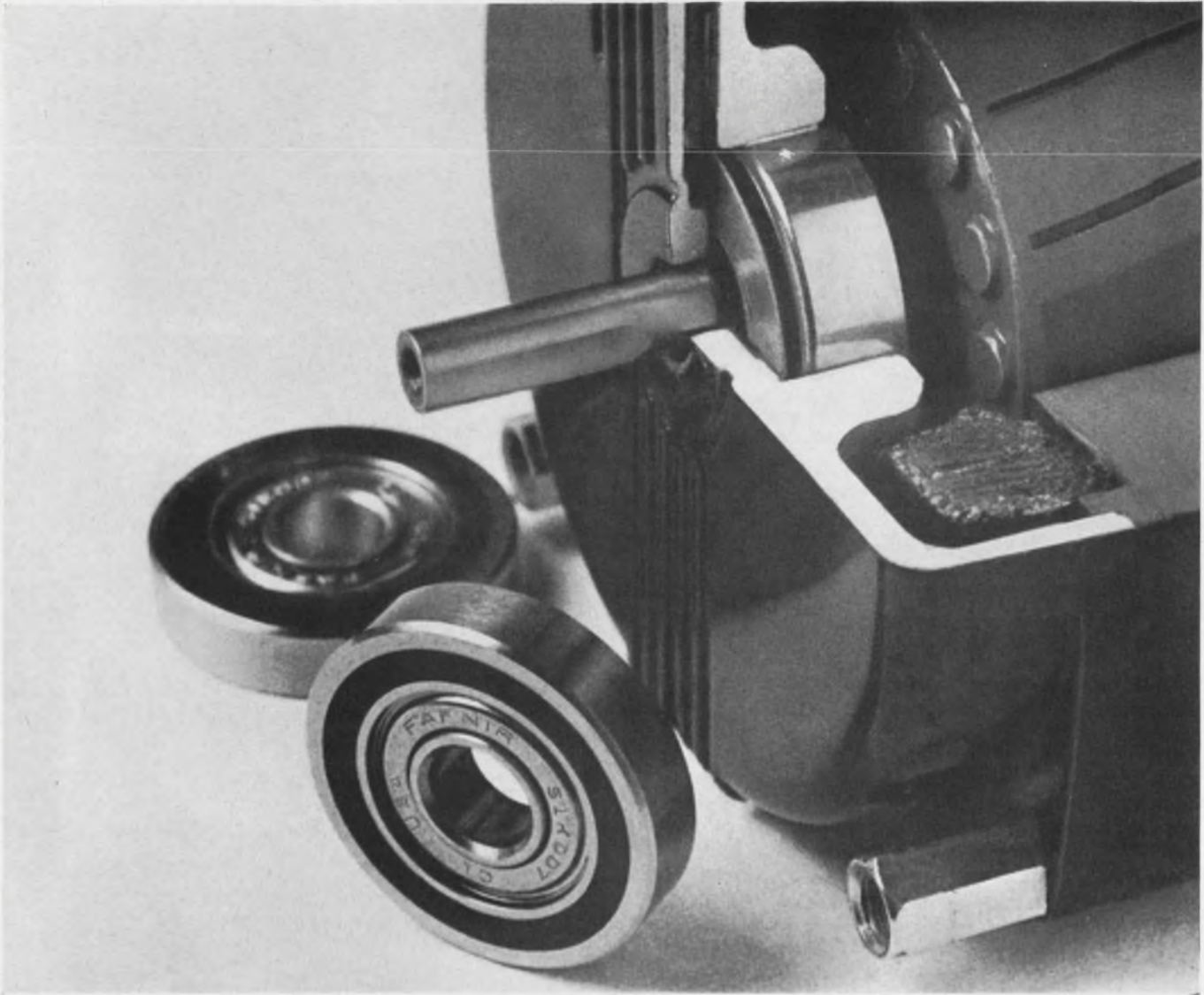

Bodine's K-2 fractional horsepower motor is now available with a special noise-damped ball bearing for equipment where extra-quiet operation is a must... equipment like medical instruments or sound recorders—where sound levels are especially critical.

Super-silent is the word for this new, noise-damped bearing. It's made with a unique combination of rubber and steel rings. A 1/16" thick rubber ring is bonded to the outside of the bearing—then a steel ring is bonded to the outside of the rubber ring. It is lubricated with low-torque-loss grease.

Result: What little sound there is in standard K-2 motors is reduced to a new low level.

Bodine K-2 motors and reducer motors are available from 1/2000 to 1/270 hp, synchronous or non-synchronous—and with spur or helical reduction gearing. Write for data sheet on this modification... and for bulletin S which describes over 275 stock types and sizes of Bodine motors—from 1/2000 to 1/6 hp.

Bodine Electric Company, 2528 West Bradley Place, Chicago, Illinois 60618.



*Bodine motors wear out—  
it just takes longer*

**BODINE**  
fractional/horsepower  
**MOTORS**



*...the power behind the leading products*

ON READER-SERVICE CARD CIRCLE 18

Military R&D funds cut by Viet war



## Military R&D funds continue to dwindle

Big increases in military spending occasioned by the Vietnam war are, predictably enough, channeling more dollars into conventional weapons, ammunition, construction and troop salaries, but not into research and development. The percentage of federal R&D funds going into military projects continues its downtrend of recent years; nonmilitary Federal R&D programs are continuing to grow. This is the gist of the latest annual National Science Foundation exercise in R&D trend-spotting. It is contained in the foundation's study of federal R&D spending for fiscal year 1965, the latest year for which complete figures are available.

Based on its prediction of the trend, the foundation anticipates a 1968 Federal R&D expenditure of \$25 billion, \$4.5 billion more than in 1965. In fiscal 1968, which began July 1, nonmilitary R&D will account for approximately 70 per cent of Federal R&D spending. In this context, military R&D consists of Defense Dept. and selected Atomic Energy Commission weapons and related programs.

## Imports from Japan on increase

The Commerce Dept.'s Business and Defense Services Administration has officially confirmed that Japanese exports of electronic products to the U.S. are on the increase. In 1966, the last year for which figures are available, the total value amounted to \$464 million, an increase of 47 per cent over 1965, according to an official report. The U.S. received more than half of Japan's total electronics exports.

TV receiver exports to the U.S. were up eight per cent over the year to \$67 million. (Color TV exports, reported for the first time, reached \$44 million.) Exports to the U.S. of radios containing three or more transistors increased 29 per cent to \$104 million. Tube-type units declined 40 per cent. Transistor radio-phonographs were up to more than \$10

# Washington Report

S. DAVID PURSGLOVE,  
WASHINGTON EDITOR

million, a \$3 million increase over 1965. The figure for conventional sets was unchanged. The value of TV picture tubes shipped from Japan to the U.S. soared from \$486,000 to \$5.1 million (94 per cent of that figure represents color tubes). Receiving tubes increased 15 per cent to \$13 million.

Other significant increases were made in sound recorders and reproducers, amplifiers, capacitors, resistors, oscilloscopes, and detection and navigation equipment.

## Rail-crossing demonstration ordered

Transportation Secretary Alan S. Boyd has ordered an immediate program to reduce rail-highway grade-crossing accidents. The program will be largely electronics-oriented. Boyd has invoked a little-known clause of the Federal highway aid program law to pay for the some 200 demonstrations in his "immediate action" scheme.

Although special attention is to be given crossings in the Northeast Corridor where high-speed trains will begin to operate between Washington, New York and Boston this fall, the program is likely to involve all 50 states. Boyd has instructed Federal Highway Administrator Lowell Bridwell and Railroad Administrator Scheffer Lang to request each state highway department to pick one grade crossing in every 4,000 miles of Federal-aid highway system for testing "the most suitable known or proposed system of protection." About 200 crossings will be involved in an experiment that Boyd hopes will improve the design and speed the development of protective devices for more general use.

Boyd points out that up to 10 per cent of the funds available to states under the Federal-aid highway program can be used to improve or eliminate grade crossings in the Federal-aid highway system. Other funds available to the states under the 1966 Highway Safety Act for inventorying and appraising crossing problems on highways and streets

# Washington Report

CONTINUED

outside the Federal-aid highway system.

Boyd has also ordered Bridwell and Land to encourage the railroads to begin action on their own, to intensify the Government's investigation of grade-crossing accidents, and to "launch a research and development program for more effective measures and devices to reduce occurrence of grade-crossing accidents."

## Electronic controls speed traffic

Firms that develop or make electronic road traffic controls were complimented in a recent speech by Transportation Secretary Alan Boyd in his home state of Florida.

For several years the Federal government has been promoting a combination of better engineering and better traffic controls as the best immediate solution to highway congestion. Traffic controls are proven safety aids. Transportation Dept. research has now shown that new traffic engineering techniques combined with largely electronic traffic control devices "can double traffic capacity and increase average speeds by 25 per cent," Boyd reported. Traffic departments can realize those gains, Boyd said, by installing control systems for a wide range of purposes. These include making traffic signal operation respond to traffic conditions, diverting traffic away from congested areas, setting up part-time one-way operation, reversing traffic flow on selected lanes, and separating bus lane control. He pointed out that these are the kinds of uses to which cities and states should put the funds made available to them under the Federal Highway Administration's TOPICS (Traffic Operations Program to Increase Capacity and Safety) for cities with populations of 5,000 or more (see "Washington Report," ED 14, July 5, 1967, p. 30).

## U.S. industry profile published

Electronics industry: big but not a giant. This is what the raw figures indicate in a survey of eight years of growth by U.S. industry just released by the Commerce Dept. The survey covers 1958 through 1965, a period of general rapid growth, and treats 409 industries. At the close of the period, nearly 18 million Americans were employed in manufacturing and jointly earned almost \$114 billion a year. Nearly 13 million workers

actually on production lines had average incomes of \$5,478 and an average hourly pay of \$2.69.

In terms of payroll costs, the "radio and television communications equipment" industry was third largest, at \$2,645,205,000. The motor vehicles and parts industry had the largest payroll costs (\$6,297,935,000), the most employees, the greatest value of shipments and the second largest capital expenditure. The blast furnace and steel mill business had the second largest payroll (\$4,436,609,000), second highest number of employees and value of shipments, and the highest capital expenditure.

The value of radio and TV equipment shipped was \$6,864,467,000, trailing autos, iron and steel, petroleum, meat and aircraft, but ahead of organic chemicals.

Radio and TV equipment and computer manufacturing were among the industries showing the largest gains in employment over the eight years. Others included frozen foods, bottled soft drinks, synthetics, games and toys, and publishing.

The report, *Industry Profiles*, is available for \$1.00 from the U.S. Government Printing Office, Washington, D. C. 20402, and from Commerce Dept. field offices.

## NASA launches new incentives program

NASA has initiated a new incentive awards program designed to elicit more new ideas from its own employees and contractor personnel. The space agency wants to encourage not only more patentable inventions, but also more nonpatentable innovations of the sort that appear in its "Tech Briefs." It is smarting under Congressional and industry criticism of its "technology utilization program" (see "Washington Report," ED 16, Aug. 2, 1967, p. 30) and is straining against some of its own rules on patent waivers to contractors imposed by government policy. Following nearly a year's effort largely by NASA industry affairs chief Ernest W. Brackett, the agency has changed its rules and issued a new policy directive and management instructions.

Under old rules, awards were harder to come by, limited in number and were worth at least \$1,000. In the future, almost any proposed idea that meets certain qualifications will bring the originator a \$50 check, even before it goes to a higher evaluation board. Any thought that is published as a Tech Brief, whether or not it later qualifies for an incentive award, will be worth an immediate \$25.



# What has the little red school house got to do with engineering?



In the context of the Little Red School House, our publication serves as a "blackboard" for the communication of knowledge . . . knowledge that is vital to the creative force within the electronics industry, specifically the 155,000 engineering and engineering manager readers of *Electronic Design*. The communicators of this knowledge are our editors. They are engineers who find enjoyment and satisfaction

discovering, analyzing, interpreting, reporting and teaching through the pages of *Electronic Design*.

If you've ever thought about teaching, consider communicating in another dimension as an editor of *Electronic Design*. The rewards can be many. Call or write Howard Bierman, our Editor, or drop by our booth at Wescon.



**Hayden Publications**  
850 Third Avenue  
New York, N.Y. 10022

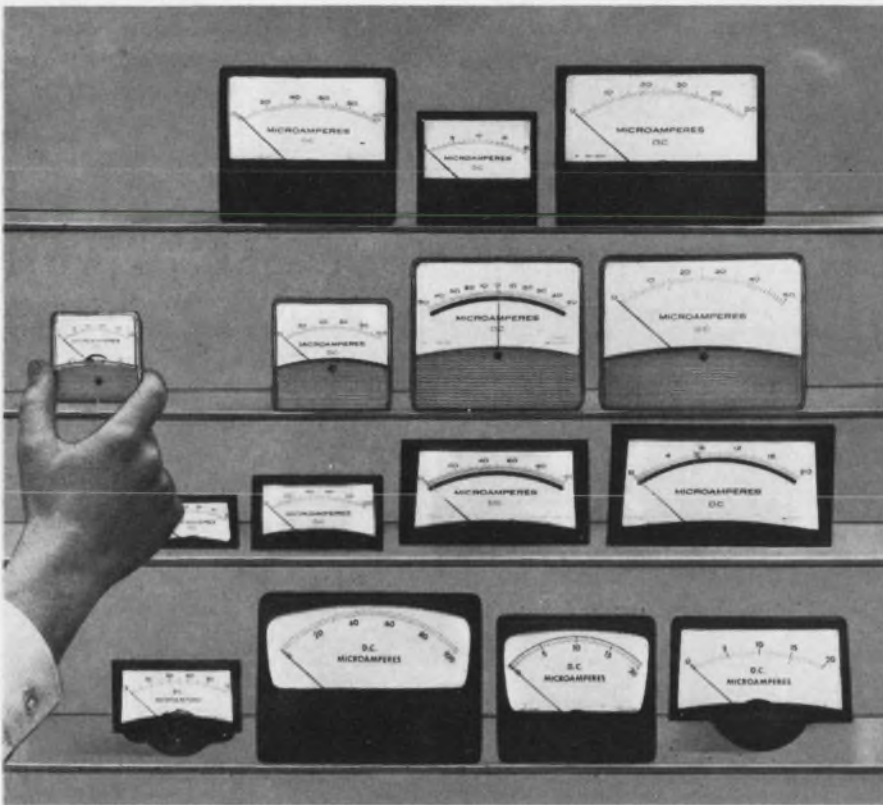

## Li-Te cell puts out 500 watts a pound

A lithium-tellurium storage battery used in conjunction with a fuel cell might be the answer to the problem of insufficient peak power in electrically propelled automobiles, says an Argonne National Laboratory scientist who participated in its development. The device, although still in the experimental stage, has been shown to provide up to 500 watts a pound of weight, an extremely high ratio. Over-all efficiency is said to vary from 70 to 85 per cent, depending on the rapidity of charging and discharging.

Dr. Arthur D. Tevebaugh, section leader in the Chemical Engineering Div., Argonne, Ill., says that a fuel cell, which offers relatively long life but low peak power, could be coupled with the bimetallic storage batteries, to meet peak power demands. He says the combination would not be overly bulky.

Dr. Tevebaugh stresses that the characteristics of this battery have not yet been fully demonstrated. For example, no exact figures are available on lifetime. He did say, however, that it would exceed that of lead storage cells. The device is inherently limited by how long the chemical reaction between the two metals can be maintained. He says that voltage and current do not deteriorate until the anode is almost totally consumed.

The new cells have a 1.75-volt open-circuit potential and produce 80 to 90 watthours per pound of weight. This contrasts with roughly 10 watthours per pound from conventional lead-acid car batteries.

In the cell, lithium is used as the anode, a lithium-tellurium alloy as the cathode, and a mixture of lithium halides (hydrofluoric, hydrochloric and hydrobromic acids are examples) as the electrolyte. The materials are maintained at 880°F in a molten state during operation. This temperature would be contained in normal use through insulation of the cell. ■ ■

## Off-the-Shelf Only from api

- 1% tracking
- taut-band
- no extra charge
- 20 to 100  $\mu$ a

There's extra value, but no extra cost, in API's line of DC panel meters in the 20 to 100 microampere ranges. Tracking of  $\pm 1\%$  is standard. Frictionless taut-band construction produces meters that are the most accurate, sensitive to smaller signals, vibration-proof and durable.

No other manufacturer offers these bonus features at firm catalog prices.

### 15 Models in Stock

You'll get off-the-shelf delivery of the economically priced Panelist, Stylist and black phenolic meters shown above. Choose from these full-scale DC ranges:

**Microamperes:** 0-20, 0-50, 0-100

**Millivolts:** 0-5, 0-10

If ultra-precision tracking is the least you'll settle for, API offers 0.5% tracking at reasonable cost. This "super-calibration" is another API exclusive, again backed by published prices.

**Ask for Bulletin 47.**

*Also stocked nationally by Allied Electronics and Newark Electronics.*

"See these instruments at the ISA Show, Booth 411"

**api INSTRUMENTS CO.**  
CHESTERLAND, OHIO 44026 (CLEVELAND-216) 729-1611 • TWX: 810-427-9230

# IDEAS

from SYLVANIA Electronic Components Group

## DIODES

### Now, planar diode arrays that drive cores faster

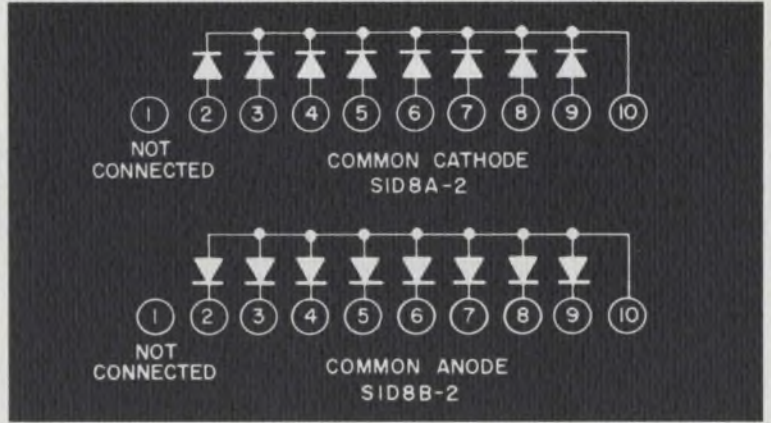
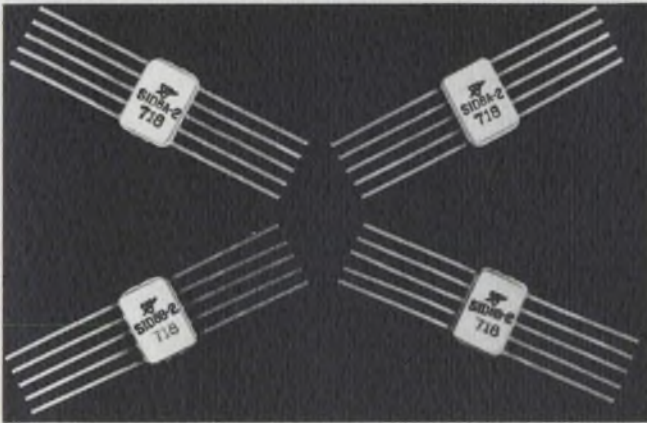

The benefits of packaged diode arrays over a similar number of individual diodes are well known by circuit designers. The user gets reduced costs in the form of lower assembly labor, fewer external wires and less handling of components. There are also the benefits of higher reliability and packaging density which result from the integrated method of manufacture. With Sylvania's new planar core driver arrays you get all these benefits plus ultra-fast switching characteristics in configurations ranging from two to sixteen diodes.

The combination of high forward conductance, fast recovery, low capacitance and tight performance tolerances makes Sylvania's new diode arrays well suited for high speed core driver applications.

Typical of these new units are the

SID8A-2 and SID8B-2, eight diode core drivers with forward current ratings of 300 mA and power ratings of 300 mW per diode. Couple this power drive capability with ultra-fast recovery and designers have diode arrays which meet the demanding requirements for memory drivers in military and aerospace computers as well as commercial computers.

Reverse recovery time of these diodes is a maximum of 60 nsec even at such extreme switching conditions of a forward current of 300 mA and an  $I_R$  of 30 mA. Typical values for the recovery time of  $I_F$  and  $I_R$  switching from 300 mA to 30 mA is 35 nsec.

Sylvania's SID8A-2 and SID8B-2 are monolithic silicon diode arrays assembled in hermetically sealed flat packs (0.250" x 0.175") or dual-in-line plug-in packages. Available in a com-

mon cathode (SID8A-2) or common anode (SID8B-2) configuration, these planar devices feature silicon dioxide passivated construction. They are fabricated on a high resistivity layer which is epitaxially grown on a low resistivity substrate.

The manufacturing process used to produce these arrays results in diodes which have closely matched electrical characteristics over a wide temperature and current range. Passivation insures that performance remains stable over a long operating life. Manufactured to standard MIL quality  
*(continued)*

## This issue in capsule

**Microwave Components**—A diode oscillator that may reduce the cost, size, and complexity of your next X-brand design.

**Integrated Circuits**—How to build an eight-stage fast adder using only twelve IC packages; also, some special IC problems... with SUHL<sup>(TM)</sup> answers.

**Photoconductors**—Sylvania announces a new generation of PCs, all with 15:1 resistance ratio; also, a new device with high sensitivity and diode isolation.

**CRTs**—Upgrading your readouts with a two-color one-gun tube.

#### MAXIMUM RATINGS AT 25°C (each junction):

Reverse Voltage, $V_R$	40 volts
Forward Current, $I_F$	300 mA
Peak Forward Current, $I_{FP}$	1.0 amp (0.1 $\mu$ sec, 25% D.C.)
Average Power Dissipation, $P_{AV}$ (3)	300 mW (500 mW total package)
Junction Temperature, $T_J$	-65°C to +150°C
Storage Temperature, $T_{stg}$	-65°C to +300°C

NOTES:  
1. Pulse test < 300  $\mu$ sec, < 2% duty cycle.  
2. Forward Voltage drop of highest reading diode junction shall be within 200 mV of lowest reading diode.  
3.  $\theta_{JC}$  0.1°C/mw;  $\theta_{CA}$  0.2°C/mw. Linear derating +25°C to +150°C.

#### ELECTRICAL CHARACTERISTICS AT 25°C (each junction):

	Conditions	Min	Max	Unit
Forward Voltage Drop, $V_F$ (Note 1)	$I_F = 300$ ma	—	1.25	V
Forward Voltage Drop, $V_F$ (Note 1)	$I_F = 500$ ma	—	1.40	V
Forward Voltage Drop, $V_F$ (Note 1)	$I_F = 800$ ma	—	2.00	V
Reverse Current, $I_R$	$V_R = 30$ V	—	0.1	$\mu$ A
Peak Inverse Voltage, PIV	$I_R = 10$ $\mu$ A	40	—	V
Capacitance, C	SID8A-2 SID8B-2 0V, 1 MHz	—	3.0 6.0	pf pf
Reverse Recovery, $t_{rr}$	$I_F = 300$ ma $I_R = 30$ ma $I_F = 3$ ma $R_L = 100$ ohm $I_F = 500$ ma	—	50	nsec
Forward Voltage Match, $\Delta V_F$	(Notes 1. and 2.)	—	0.2	V

**DIODES** (continued from page 1)  
assurance requirements, these packaged arrays meet MIL-S-19500.

Other core drive arrays available on request from Sylvania include units with two to sixteen diodes con-

nected common cathode or common anode.

CIRCLE NUMBER 300

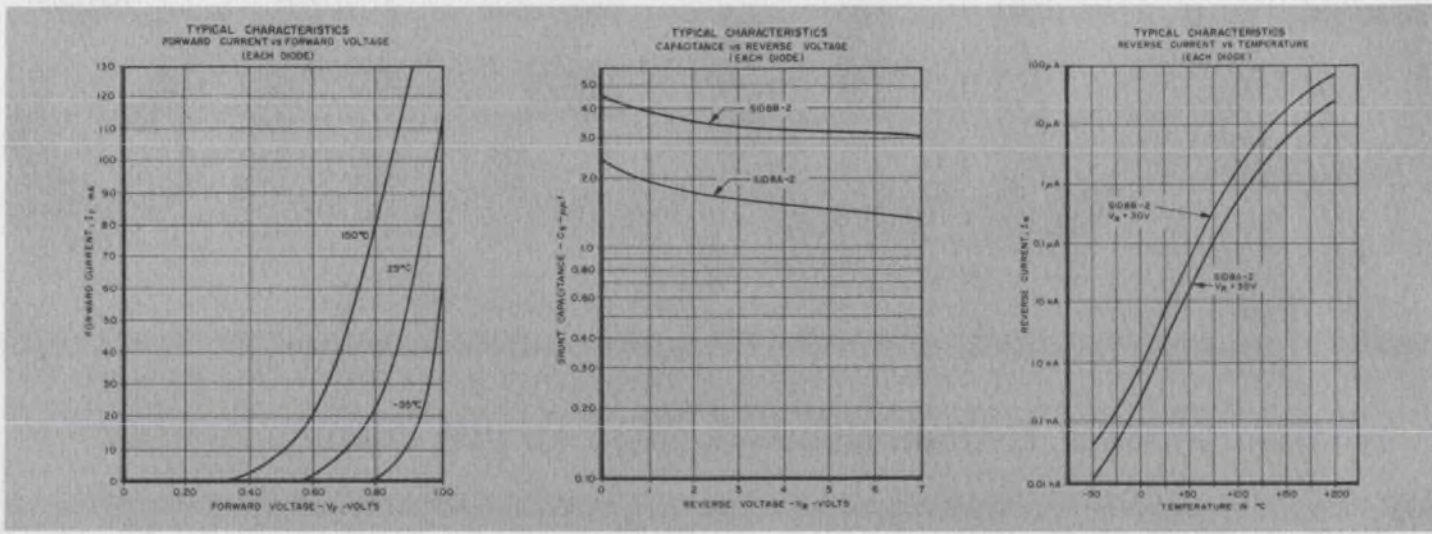

**PHOTOCONDUCTORS**

# Newest PC component gives high sensitivity and diode isolation

If you wonder why we say Sylvania is the logical source for photoconductive devices, just mentally list the different types of devices in Sylvania's PC lines. You'll find power ratings of 50 mW to 500 mW; TO-18, T-2, T-4 and T-33 packages; custom PC matrices; ultraviolet detectors; and photoconductor-lamp (PL) assemblies. Now, with the availability of a TO-18 type Diode Photocell assembly, there's another reason for saying Sylvania has become the logical source for all photoconductive devices.

Any of Sylvania's TO-18 type photocells are now available with a built-in silicon diode. In this integral assembly, a diode chip, mounted on the same rugged ceramic substrate as the photo-sensitive material, is series-connected to the PC. The resulting electrical combination of a diode-PC series circuit is particularly useful in logic circuits where it gives diode iso-

lation without the need for any additional components.

The silicon diodes in these assemblies have peak inverse voltage ratings of up to 50 volts. The PC cells feature very compact construction, improved response time characteristics and 50 mW power dissipation. Resistance values of from 10,000 to 100,000 ohms at 2 footcandles illumination are available. Dark resistance is at least 100 times the 2 FC values.

Improved photosensitive material used in these integral assemblies provides response times approximately twice that of the cadmium sulfide material presently used in T-2 and T-4 types. The fast response time, a dissipation rating of 50 mW, and the diode function are combined in one of the smallest hermetically sealed packages available. Thus, designers gain a product suitable for many circuit uses. They're good for just about

any application where the sensitivity of a photoconductor and the circuit isolation of a diode are required.

With these Diode-PC assemblies, designers gain circuit simplicity, better utilization of space and increased reliability through the use of fewer parts, fewer wires, and fewer soldered junctions and terminals. Typical applications are in card readers, to recognize such functions as configuration and position, and in a host of logic functions.

The reliability and long-life characteristics basic to solid state devices are enhanced in these diode-photocells by the manufacturing process used at Sylvania. The TO-18 devices are manufactured using such proven transistor technology processes as controlled dry box atmosphere, projection welding, and vacuum bake out.

CIRCLE NUMBER 301

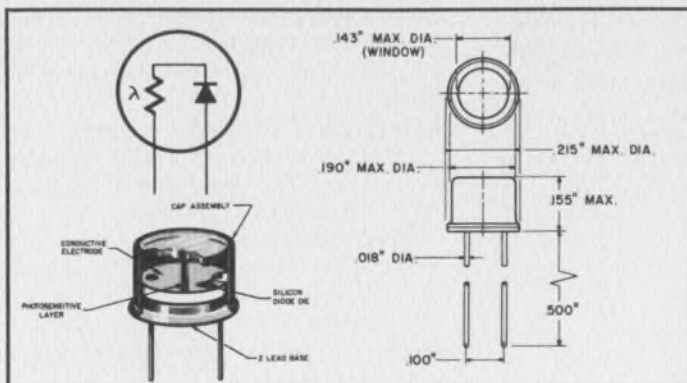

**OPTICAL DATA TO-18 DIODE-PC CHARACTERISTICS & RATINGS**

Wavelength of Maximum Spectral Response .....5300 to 6300 Angstroms  
Various Peaks can be Obtained Within the Above Response Range.

**RATINGS (Absolute Maximum Rating System)**

Breakdown Voltage .....Up to 200 V  
Dissipation  
T-Amb. = 25°C .....50 mW  
T-Amb. = 75°C .....0 mW  
Derate linearly from 25°C to 75°C  
Ambient Temperature Range .....-40 to +75°C  
Peak Inverse Voltage .....Up to 50 mV

**CHARACTERISTICS**

Cell Resistance at 2FC .....Various Values Available From 10K to 100K Ohms  
Dark Resistance .....In Megohm Range  
Ratio (2FC to Dark) .....Minimum Ratio 100: 1  
Average Ratio 1000: 1

# SUHL solutions...to some special IC problems

*In integrated circuits, it's not enough to provide the designer with just basic logic elements. In the Sylvania SUHL™ integrated circuit line, the NAND/NOR gates, the AND-NOR gates, and the flip-flops are supplemented by devices which overcome the interface and other special problems which IC circuits and systems must overcome if they are to be of practical use. Here are just four of these devices and some of their special applications.*

Standard Sylvania IC units can overcome many of the special problems associated with system and subsystem design. When requirements call for wire ORed outputs, the SG-160 series of SUHL devices will solve the problem. The SG-130 series of dual drivers is the answer for high current, high fanout applications. Availability of SUHL AND-OR gates like the SG-280 eases implementation of a host of system functions including up-down counters. Combining a Schmitt trigger and an AND gate into one IC makes Sylvania's SG-80 units useful in many timing circuits. Practical applications of these Sylvania TTL units follow.

The SG-160 series of triple two-input bus drivers can perform logical ORing at its outputs because, in these ICs, the standard SUHL active pull-up output networks are replaced with internal 5K pull-up resistors. These pull-up resistors, which are brought out to separate terminals, can

be externally connected to the collector of the output transistors, allowing the bus driver to function as an integral circuit (Figure 1). Turnoff delay is a function of the RC time constant of the load capacitor and pull-up resistors plus storage time of the device. When a very precise delay time is required, discrete external pull-up resistors can be used to increase or decrease the delay time.

The SG-160 series is ideal for matrices which interface TTL and other logic types including DTL, RTL, CTL, ECL and CML. Key electrical characteristics include: a high logic swing with typical values of 0.26 volts for logic 0 and 5.0 volts for logic 1; a current output of 30 mA minimum for military versions and 15 mA for industrial units; and a high noise immunity rating of 900 mV at 25°C and worst case fanout.

The high fanout dual drivers of the SG-130 series are ideal for applications which require high current drive (Figure 2) to lamps, cables, transformers, relays and similar devices. Capable of a fanout of over 30, these SUHL drivers are designed for 20-MHz systems. They feature a typical propagation delay time of 25 nsec with a 1000 pf load.

Sylvania's SG-280 AND-OR gates and SG-290 input expanders, provide logic designers with an AND-OR system which facilitates system design with other SUHL elements. Each SG-280 package contains two four-

input AND gates with non-inverting amplifiers. Thus, each gate can function as an AND element (in positive logic) or as an OR element (in negative logic). The SG-290 expanders allow single wire feed-in to the SG-280 when performing the wired OR function without degradation of SG-280 fanout, noise immunity or waveform integrity. With the SG-280 and -290, no complex loading rules are needed because input and output are isolated and no buffer or logic level restoration is needed. Figure 3 shows how these units are used with other SUHL devices in an Up-Down counter.

A double Schmitt trigger is the key element in the SG-80 ICs. Combining each Schmitt trigger and its own three-input AND gate with a SUHL output network in one IC makes the SG-80 useful in a host of circuits: one-shot multi-vibrators, wave shapers, threshold detectors, integrators, delay generators, oscillators, pulse generators, pulse restorers, line receivers, and similar subsystem functions. For example, the SG-280 may be easily adapted for a one-shot multi-vibrator capable of producing output pulses of less than 50 nanoseconds to pulses greater than a millisecond. Figure 4 shows a typical logic diagram for this operation.

Another example, the SG-80 may be used as a pulse absence detector, to recognize the absence of a pulse in a train of pulses.

CIRCLE NUMBER 302

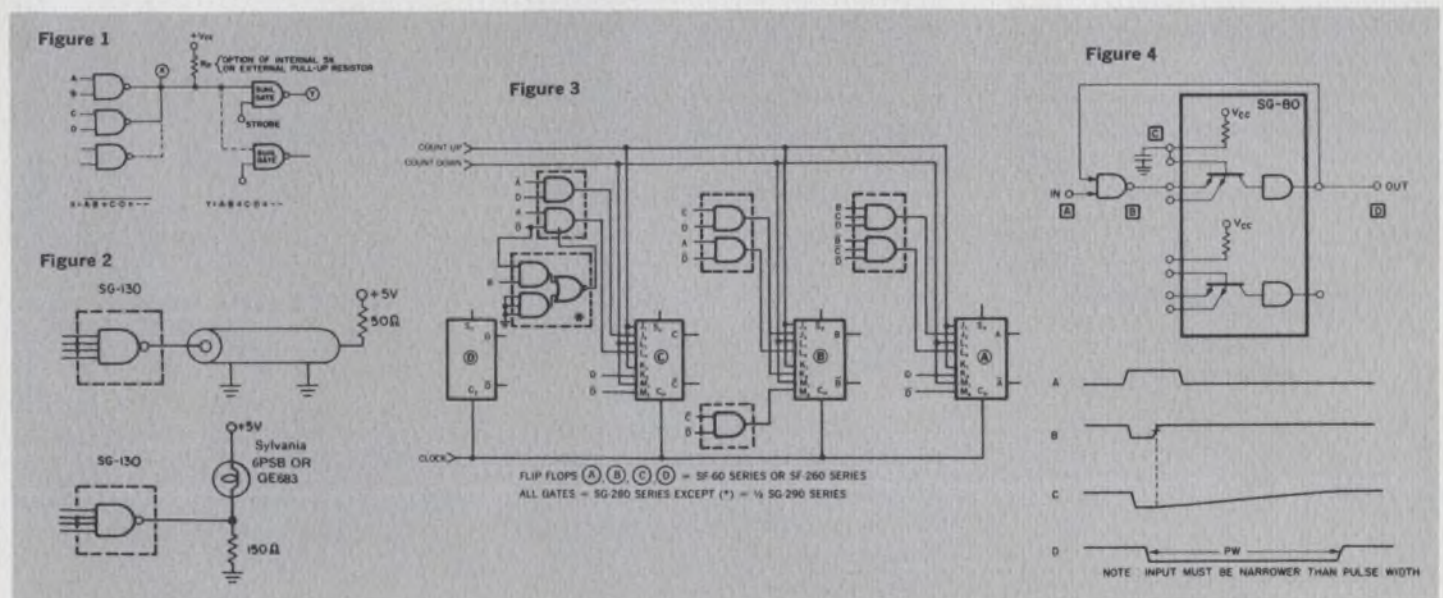

# Diode oscillator reduces cost, size and complexity of X-Band designs

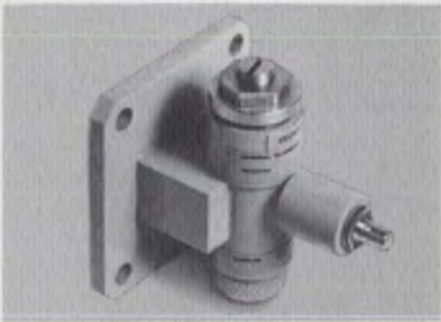

Although introduced only a few months ago, Sylvania's SYA-3200 X-band avalanche diode oscillator is fast becoming a workhorse device adaptable to many circuit functions. Operating at any frequency in X-band (8.2 to 12 GHz), it has use in local oscillators, parametric amplifier pump sources, and also in such equipments as a-m and f-m modulated transmitters and transponders, doppler radar, security systems and PCM microwave relays.

As a parametric amplifier pump source, the avalanche diode oscillator offers significant advantages over the two conventional pump sources, klystrons and varactor multipliers. Klystrons require very large and expensive power supplies, and varactor multipliers usually require many semiconductors and complicated circuitry. The avalanche diode oscillator is much simpler and less expensive than the varactor multiplier. It requires a simple and lightweight power supply and has inherently longer life.

Parametric amplifiers pumped by the SYA-3200 avalanche diode oscillator exhibit performance indistinguishable from that obtained with conventional klystrons. In one application, a parametric amplifier operating in L-band was pumped at 11 GHz by an SYA-3200. The resulting

noise figure of 1.8 db was exactly what was obtained using a klystron. In addition, overall weight and size of the amplifier was reduced by 50 percent and gain, bandwidth and stability were unchanged.

Avalanche diodes can operate as power amplifiers as well as oscillators, and have approximately the same output power in either mode. High level power gain of 10 to 15 db has been obtained at X-band. Figure 1 shows results with a silicon diode amplifier. Here, maximum power

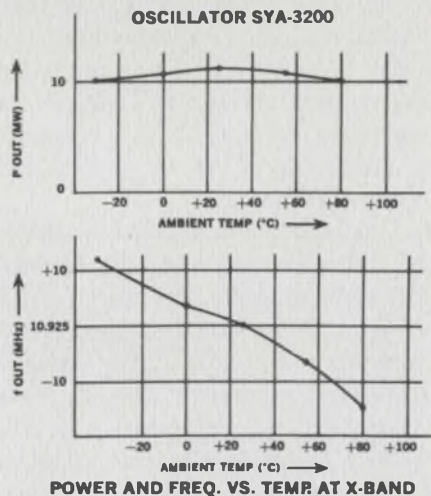

output is 38 mW and instantaneous bandwidth is about 100 MHz with no attempt made to optimize bandwidth. The same diode used as an oscillator at the same frequency and bias level has a 40 mW output.

Short range zero i-f frequency doppler radar systems, including police radar and security surveillance systems, can use the SYA-3200 because avalanche diode oscillators exhibit low noise at frequencies close to the carrier.

Because the avalanche diode oscillator is a current-controlled device whose amplitude of oscillation is nearly a linear function of bias current, it is easily amplitude-modulated by varying bias current. Pulse and video modulation is faithfully reproduced with modulation indices of up to 80 to 90% at modulating rates exceeding 10 MHz. Thus, the oscillator can be used as an amplitude-modulated source for communications or data transmission without adding an

AFC LOOP FOR AVALANCHE OSCILLATOR

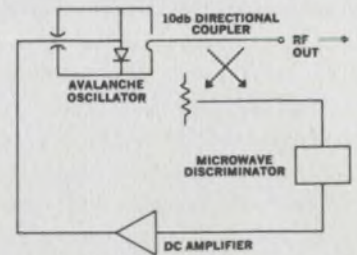

external modulator.

In these applications, there is little variation of performance of the SYA-3200 over wide temperature ranges. Figure 2 gives power output and frequency from  $-30^{\circ}\text{C}$  to  $+85^{\circ}\text{C}$ . Total power change is less than 1 db, and total frequency variation is less than 25 MHz; performance which compares favorably with that of reflex klystrons. Most of the frequency variation in the SYA-3200 is attributable to the thermal coefficients of the metals used in the cavity. The actual diode is extremely stable with temperature. Development of a cavity having metals with lower or better matched coefficients is expected to produce even better frequency stability.

Although the cited figures already show the SYA-3200 to be very stable with temperature, there are ways to provide additional stabilization. Injection and sub-harmonic locking will effectively stabilize the oscillator to the reference source frequency. Tightly coupling an exterior cavity to the oscillator will reflect additional reactance into the oscillator circuit and effectively increase its Q. This reduces frequency fluctuations from variations of diode and external circuit parameters.

Frequency stability of the oscillator can also be increased by an AFC loop which uses a microwave discriminator. The amplified output of the discriminator can be used as a feedback signal to correct the oscillator frequency. A tuning varactor may be used as the control device for this purpose. Electronic tuning of an avalanche oscillator over several hundred MHz has been demonstrated with little change in output power and at very high tuning speeds.

CIRCLE NUMBER 303

PERFORMANCE OF X-BAND AVALANCHE DIODE POWER AMPLIFIER

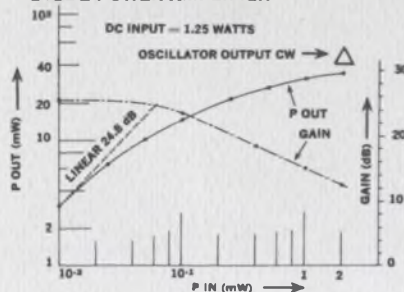

# Upgrade your readouts: add 2 colors with a 1-gun tube

With the introduction of Sylvania's new 2-color one-gun CRTs at the Society for Information Display (SID) show in May, designers in the display and oscillography field gained a valuable design tool. Here's why the tube is causing so much interest among designers. But to really be convinced, plan to see our live demonstration at WESCON or ask your local field office to set up one in your plant.

Sylvania's recently introduced one-gun multicolor industrial cathode ray tube has given equipment designers a new tool to meet increasing demands being put on visual displays. Now, there's a practical two-color tube that simplifies the design of new equipment in which the display must provide quick and positive recognition of information from diverse sources. Display system design has been eased because Sylvania has eliminated the need for multiple guns or dot phosphors to get a two-color capability in one CRT. This, in turn, has led to simplified electronic control circuits to accomplish switching from one color to another.

Multilayer phosphors of red and

green produce the two-color output at the face of the new tube. Selection of a red or green output is accomplished by switching the voltage on one of the tube's anodes.

The extra two guns and three-dot phosphor used in conventional color CRTs aren't needed. This eliminates the precise shadow-mask control and alignment procedures normally used in color CRTs. And because dots of three different phosphors are no longer required for each information point, the new tube has very high resolution. This means more information can be displayed in a given area, increasing display space efficiency.

Since, in the improved tube, the colors are changed by placing discrete voltage variations on one of the tube's anodes, color switching is extremely reliable. Elimination of the three-dot phosphors means there's no chance of misalignment which can cause the wrong phosphor to be activated by the wrong gun.

The new tube uses green and red phosphors to provide high contrast and color separation. The result is displays which are both easy to read

and highly accurate. These displays are ideal for those applications requiring discrete-color information—applications which are limited only by the system designer's imagination.

The basic concepts used in the new tubes can be applied to a wide range of CRTs. Custom sizes which supplement Sylvania's standard units can be developed. In addition, the techniques are applicable to other CRT types, such as two-gun tubes, to meet special custom applications.

A specific example of how this new approach is used in a one-gun device is CRT Type SC-4689. This standard unit, available since May, gives excellent color separation from red to green by switching the voltage on anode No. 3 from 6,000 to 12,000 V. The red phosphor used in the tube is the Sylvania-developed europium-activated phosphor. The SC-4689 offers a 5" diameter screen and a high resolution gun. It has spiral post deflection acceleration which minimizes changes in deflection sensitivity and pattern linearity when anode No. 3 is switched.

CIRCLE NUMBER 304

**SPECTRAL ENERGY DISTRIBUTION (PHOSPHOR TYPE "PSO")**

**MAXIMUM RATINGS (Absolute Maximum Values)**

Anode No. 3 Voltage	13,000 Volts dc
Anode No. 2 Voltage <sup>(1)</sup>	7,000 Volts dc
Anode No. 1 Voltage	1,100 Volts dc
Grid No. 1 Voltage	
Negative Bias Value	220 Volts dc
Positive Bias Value	0 Volts dc
Positive Peak Value	2 Volts
Peak Heater-Cathode Voltage	
Heater Negative	
with respect to Cathode	140 Volts dc
Heater Positive	
with respect to Cathode	140 Volts dc
Peak Voltage Between Anode No. 2 and Any Deflection Plate	550 Volts
Post Deflection Spiral Resistance	100-400 Megohms

**TYPICAL OPERATING CONDITIONS**

	Red Operation	Green Operation
Anode No. 3 Voltage	6,000	12,000 V. dc
Anode No. 2 Voltage	3,000	3,000 V. dc
Anode No. 1 Voltage for Focus	150-400	150-400 V. dc
Gnd No. 1 Voltage Required for Cutoff <sup>(2)</sup>	-30 to -70	-30 to -70 V. dc
Deflection Factor		
Deflecting Plates 1-2 <sup>(3)</sup>	70-90	95-115 V. dc/in.
Deflecting Plates 3-4 <sup>(4)</sup>	65-85	90-110 V. dc/in.
Line Width "A" @ I <sub>3</sub> = 25 μA	.012	.010 In.
Brightness, 2" x 2" raster		
I <sub>3</sub> = 25 μA (approx.)	4	35
Anode No. 3 Current @ E <sub>g1</sub> = cutoff (approx.)	7-30	21-90 μA dc

**SC-4689 CHARACTERISTICS**

Focusing Method	Electrostatic
Deflect on Method	Electrostatic
Heater Voltage	6.3 Volts
Heater Current	0.6 Ampere
Minimum Useful Screen Diameter	4.5 inches
Weight (approx.)	2.5 Pounds
Mounting Position	Any

**CIRCUIT VALUES**

Grid No. 1 Circuit Resistance	1.5 Megohms Max.
Deflection Circuit Resistance <sup>(5)</sup>	5 Megohms Max.

**NOTES:**

- The product of the Anode No. 2 Voltage and the Average Anode No. 2 Current should be limited to 6 Watts.
- Visual extinction of undeflected focused spot.
- Deflecting Plates 1-2 are nearer the screen.
- Deflecting Plates 3-4 are nearer the base.
- It is recommended that the deflecting electrode resistances be approximately equal.

# Announcing a new generation of PCs, all with 15:1 resistance ratio

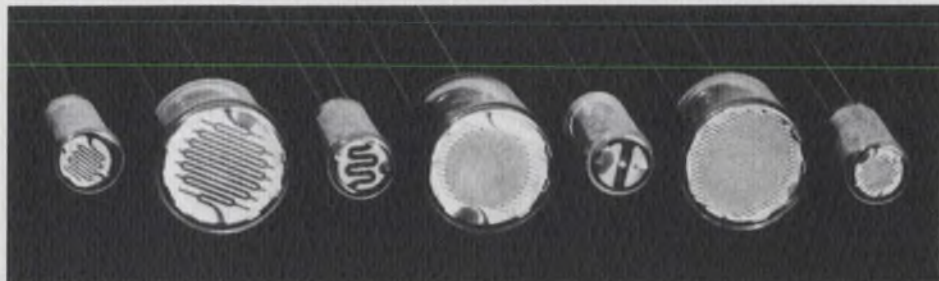

Two months ago we described a new sensitive, low-resistance photoconductor available from Sylvania. We explained that this new device, type 8760, represented the latest advance in cadmium sulfide photoconductors. Now, many of the improvements first used in the 8760 have been incorporated into each unit in Sylvania's broad line of T-2 and T-4 photoconductors. The result is a new generation of extremely sensitive pressed-wafer photocells.

Increased sensitivity of every device in Sylvania's T-2 and T-4 photoconductor line is the result of improvements in materials selection, device design and processing techniques. But increased sensitivity is only one of the superior characteristics of these improved photocells. Sylvania leads the way in other photoconductor advances: increased stability, lower light resistance, higher dark resistance and improved breakdown voltages.

Now circuit designers have a tailored product line which offers a wide cell impedance choice, 75 and 300 milliwatt dissipation ratings, 1/4-inch and 1/2-inch sizes, and socket or solder-in bases. More than ever before, designers can select the cell that is best suited for the particular application.

Increased sensitivity of these improved devices is reflected in the high 15:1 minimum resistance ratio (2 FC to 100 FC) for all units. Typical values range to 30:1. Dark to 2 FC ratio is at least 100:1, with typical values from 500:1 to 1500:1.

Units have light resistance as low as 250 ohms at 2 FC (see table of characteristics and ratings). With these Sylvania units, there's no worry about voltage breakdown. Ratings of 175 to 400 volts comfortably exceed normal application requirements.

Stability of the improved character-

istics has been proven by life tests at above rated dissipation for over 500 hours. Typical units show less than 10 percent resistance change from initial values.

In addition to the controls on materials and manufacturing of the basic cadmium sulfide light-sensitive wafer, physical mounting and sealing also play important roles in the improved electrical and life characteristics.

Each wafer assembly is inserted into a protective glass envelope and the unit back filled with extremely dry gases and then sealed. The all-glass envelopes are strain free and provide a true hermetic seal. To assure hermeticity, each cell incorpo-

rates the famous Sylvania "Blue Dot." This visual indicator changes to pink in as little as 0.02% moisture, warning of impending cell degradation.

A rigid mount structure adds to the cells' ability to take shocks of up to 300 g. An epoxy band between the cadmium sulfide wafer and its metal supporting clip provides solid mounting of the wafer plus a thermal path for better heat dissipation. This means longer life and higher dissipation capability for the cells.

Electrical connections are also epoxied for ruggedness and noise-free operation. Lead wires are welded and brought out of the envelope through a glass-to-metal seal.

The high quality levels of Sylvania's photoconductors are assured by a wide range of acceptance and design tests including accelerated life, voltage breakdown, impact shock, vibration, noise, thermal shock, dark storage, light storage, response time and spectral response.

CIRCLE NUMBER 305

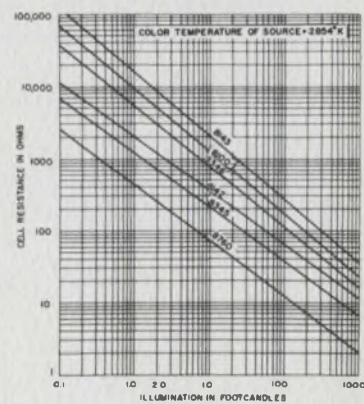
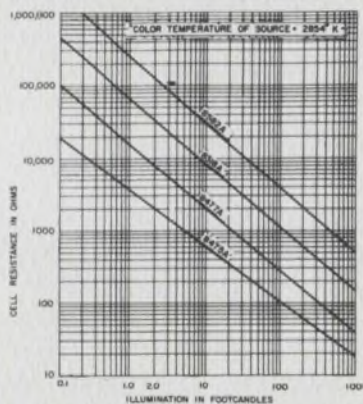

CHARACTERISTICS AND RATINGS								
Sylvania Type Number	Cell Resistance <sup>(1)</sup>			Resistance Ratio <sup>(1)</sup>				Max. Cell Voltage <sup>(4)</sup> (volts)
	At 100 FC <sup>(2)</sup> (ohm)	At 2 FC <sup>(2)</sup> (ohm)	At Dark <sup>(2)</sup> (megohm)	Dark to 2 FC		2 FC to 100 FC		
				(min.)	(typ)	(min.)	(typ)	
<b>T-2—75 Milliwatts<sup>(5)</sup> 1/4 Inch Diameter</b>								
8475A	100	2000	0.2	100:1	500:1	15:1	20:1	200
8477A	300	8000	0.8	100:1	500:1	15:1	25:1	300
8318A	1000	32,000	10.0	100:1	500:1	15:1	30:1	300
8582A	4000	128,000	13.0	100:1	500:1	15:1	30:1	300
<b>T-4—300 Milliwatts<sup>(5)</sup> 1/2 Inch Diameter</b>								
8760	12.5	250	0.1	200:1	500:1	15:1	20:1	175
8345	35	750	0.2	200:1	500:1	15:1	20:1	400
8142	60	1500	0.5	200:1	1500:1	15:1	25:1	400
8346	120	3000	1.0	300:1	1500:1	15:1	30:1	400
8100	165	5000	1.0	200:1	1000:1	15:1	30:1	400
8143	300	9000	1.0	200:1	500:1	15:1	30:1	400

NOTES: 1. Measured after 60 minutes minimum exposure at approximately 50 FC illumination (ambient room light).  
 2. Typical Values.  
 3. Minimum Value. Measured in complete darkness at least 10 seconds after removal of 2 FC illumination.  
 4. Measured in complete darkness at a pulse rate of 120 pps, 50 sec. duration. Voltage in excess of the rated value may damage the cell. Maximum DC voltage is limited by maximum dissipation and minimum dark resistance rating.  
 5. -40 to +40°C. (Above +40°C derate per dissipation curve.)



# How to build an eight-stage fast adder using only 12 IC packages

Sylvania's basic TTL fast adder digital subsystem, part of a family of monolithic digital functional arrays, makes possible a whole new breed of large-scale, high-performance, general-purpose digital computing systems. These systems not only offer significant speed advances over conventional computers; they will be smaller, more reliable and far less costly than equivalent systems built from standard integrated circuits.

Using only 12 of Sylvania's single-stage fast adder circuits, you can build an 8-stage fast adder with anticipated carry having a total add time of only 50 nanoseconds. Only 96 of the new packages are needed to make a fast anticipated carry adder of 64 bits having a 300-nanosecond total add time. An equivalent 64-bit fast adder using conventional integrated circuits would require at least 320 separate packages.

This new transistor-transistor-logic circuit array represents the first time

that highly complex fast adders with anticipated carry have been integrally formed on a single monolithic silicon chip without compromising system performance characteristics. This Sylvania circuit has a noise margin of  $\pm 1.0$  volt, power dissipation of 120 milliwatts, and a fan-out of 6 to 15.

The basic fast adder circuit configuration is interconnected with three standard metalizations to form either a single-stage full adder (SM-10 series), a single-stage dependent carry fast adder (SM-20 series), or a single-stage independent carry fast adder (SM-30 series). To build parallel fast adders larger than 4 bits, the independent and dependent fast adders are used in conjunction with a specifically designed carry decoder package, the SM-40, which extends the anticipated carry operation beyond four stages. Two dependent adders, SM-20 circuits, form the first and last stages of each of eight stages to provide for end-around carry operations.

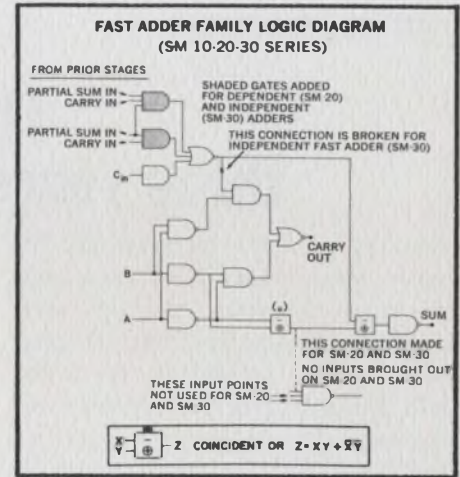

Circuits in the fast adder family are available in Sylvania's standard 14-pin dual-in-line plug-in package as well as in the TO-85 flat pack.

These circuits are completely compatible with all circuits in Sylvania's advanced SUHL™ integrated circuit line. SUHL ICs comprise a total of 120 circuits, by far the biggest TTL line in the industry. In all, these integrated circuits provide superior performance in terms of speed, fan-out, noise immunity, high logic swing, and low power consumption. SUHL circuits offer the fastest saturated logic available for applications down to 5 nanoseconds.

CIRCLE NUMBER 306

8-STAGE ANTICIPATED CARRY FAST ADDER MADE FROM SM-20, SM-30 & SM-40 MONOLITHIC DIGITAL FUNCTIONAL ARRAYS

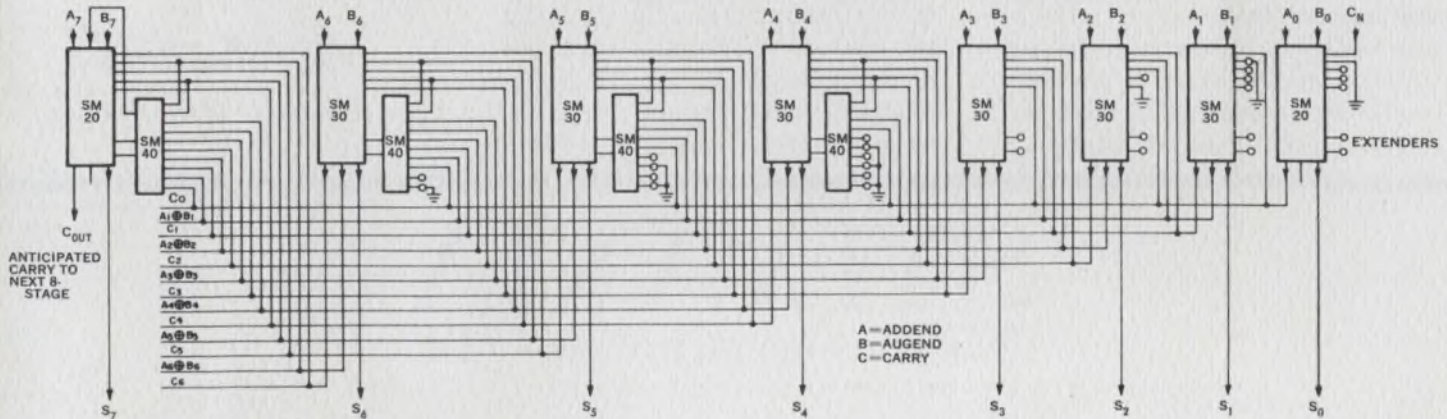

SEE OUR SPECIFICATIONS IN  
**VSMF**  
MICROFILM CATALOG  
FILE

FIRST CLASS  
Permit No. 2833  
Buffalo, N. Y.

**BUSINESS REPLY MAIL**  
No Postage Stamp Necessary if Mailed in the United States

POSTAGE WILL BE PAID BY  
**SYLVANIA ELECTRONIC COMPONENTS GROUP**  
Sylvania Electric Products Inc.  
1100 Main Street  
Buffalo, New York 14209

Dept. B7 7 7

Use Sylvania's "Hot Line" inquiry service, especially if you require full particulars on any item in a hurry. It's easy and it's free. Circle the reader service number(s) you're most interested in; then fill in your name, title, company and address. We'll do the rest and see you get further information almost by return mail.

# The **color bright 85** tube: three years old...and still the one to beat

Virtually all major manufacturers of color picture tubes have completed extensive expansion programs with additional emphasis being directed toward product sophistication. Along with this emphasis, TV receiver manufacturers have recently stepped up their programs for improvement in set performance.

Sylvania foresaw these needs in the early 1960's when we embarked on special color picture tube engineering, production and quality programs. Prime areas considered were uniformity, purity reserve, focus and screen quality. And in June, 1964, the revolutionary new *color bright 85* picture tube was announced, a tube which was some 40% brighter than all previous types.

For ease of setup by both TV receiver manufacturer and servicemen, new beading jigs for gun mounting were designed, built and utilized in production. Sylvania became the first manufacturer to eliminate the color shift between the glass face and aperture mask during tube manufacture.

The glass face panel is pre-stabilized; that is, tempered to pre-determined density. Pre-stabilized glass

means near perfect alignment between phosphor dots and the pin-point holes of the aperture mask. The dimensional stability of each *color bright 85* tube's screen locks screen and mask into tight registry. To put it another way, Sylvania *color bright 85* tube face plates are actually pre-shrunk.

Other improvements were introduced that today are still basic to these tubes. Automatic "Q" spacing machinery is in use at our plants to provide better beam landing and purity reserve. Precise computer measurements taken at five points are then used in a computer to optimize the match of the face panel to mask, assuring tube to tube uniformity in the relationship of the mask to the screen. Also, rigid techniques were established to control phosphor dot size, which also contributes to better quality on purity reserve.

Screen quality is a major factor with color picture tubes. Sylvania's unique dusting process in screening the rare earth europium phosphor eliminates "spokes" and mottling that tend to degrade colors. Inspection criteria of screened panels have been

tightened and improved processing controls have been incorporated into production to provide the best possible color fidelity and brightness.

An engineering analysis program of all brands of tubes is in full swing to make certain that no better tube is available in the industry. Recent engineering evaluation shows that Sylvania's *color bright 85* tube—first with rare earth europium phosphor—is unexcelled by the best competitive product for white brightness and other characteristics. To date, five TV receiver manufacturers have also confirmed this analysis.

No, Virginia, the *color bright 85* tube is not obsolete! With sound, progressive engineering, quality and manufacturing programs in motion, we intend to keep offering the latest improvements under the same, famous *color bright 85* tube name. Believe me, Virginia, you'll never see a finer picture!

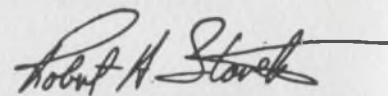

ROBERT A. STAREK  
PRODUCT MANAGER, ENTERTAINMENT CRTs

This information in Sylvania Ideas is furnished without assuming any obligations.

## SYLVANIA

SUBSIDIARY OF  
GENERAL TELEPHONE & ELECTRONICS GTE

NEW CAPABILITIES IN: ELECTRONIC TUBES • SEMICONDUCTORS • MICROWAVE DEVICES • SPECIAL COMPONENTS • DISPLAY DEVICES

NAME \_\_\_\_\_  
 TITLE \_\_\_\_\_  
 COMPANY \_\_\_\_\_  
 ADDRESS \_\_\_\_\_  
 CITY \_\_\_\_\_ STATE \_\_\_\_\_

Circle Numbers Corresponding to Product Item

300      301      302      303      304  
 305      306

Please have a Sales Engineer call



### HOT LINE INQUIRY SERVICE

Need information in a hurry? Clip the card and mail it. Be sure to fill in all information requested. We'll rush you full particulars on any item indicated.

You can also get information using the publication's card elsewhere in this issue. Use of the card shown here will simplify handling and save time.

## Raw IC chips bought from random samples

Engineers at Hughes Aircraft have hit upon a way to purchase un-packaged microcircuit chips from semiconductor manufacturers that is mutually agreeable to both vendor and customer.

In the Hughes scheme, the vendor supplies his customer with two sealed containers of chips—one large package that contains 1000 chips and another smaller package containing 30 chips. The chips in the small package are randomly sampled from the larger lot. All the chips are 100% tested by the vendor for the dc parameters most critical to the customer's application.

When the customer receives the two sealed packages, he breaks open the smaller one, wires its chips into his circuits, and gives them full ac and temperature tests. After evaluating the results of his own tests, the customer may either keep or reject the unopened, large lot of chips. Should he choose to reject it, he pays only for the 30 chips he used. He must, however, send the chips that didn't perform properly back to the vendor. ■ ■

### Testing model system



Model of Boeing Co.'s jet transport, designed to carry Air Force's proposed airborne warning and control system, is tested for quality of antenna reception.

# This is the smallest optical encoder that can resolve 14 bits in one revolution under avionics conditions. It's one example of what Datex offers you in optical encoders. We'll send you others in return for your name and address. Write:

Datex Division / Conrac Corporation  
1911 Walker St., Monrovia, California  
(213) 359-5381

Dallas, Texas (214) EM 3-6417  
Dayton, Ohio (513) 253-1104  
Des Plaines, Illinois (312) 827-8141  
Huntsville, Alabama (205) 539-9396  
New York, New York (212) 661-4070  
Pasadena, California (213) 681-7152  
Washington, D.C. (202) 244-8700



Model 01-809  
Actual Size

# FREE

## NEW 1968 **ALLIED** INDUSTRIAL ELECTRONICS CATALOG

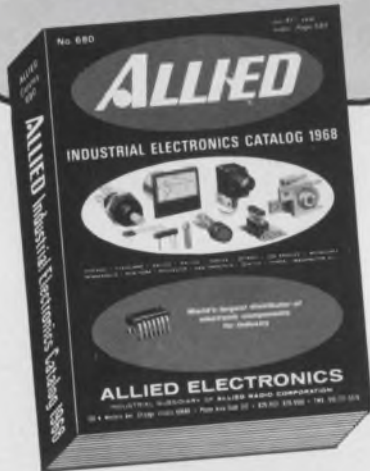

### World's Largest Selection of Electronic Components for Industry

- Scores of new products
- All merchandise stocked in depth
- Same-day shipment
- Factory OEM prices

**600 VALUE-PACKED PAGES**

# P&B

RELAYS

### SEE THE 1968 ALLIED CATALOG

Allied stocks Potter & Brumfield Relays in depth: General purpose, special purpose, power, high performance, mercury wetted contact, telephone types

Write for Your Copy Today to Dept. 76J

## **ALLIED** **ELECTRONICS**

A Subsidiary of Allied Radio Corp.

Our 47th Year

100 N. Western Ave. Chicago, Ill. 60680

## NEWS

### Computer keyboard plugs in telephone

A low-cost computer input-output device that enables a time-sharing computer to be interrogated and to answer by telephone has been developed by Radio Corp. of America.

The user would "hunt and peck" among 128 alphanumeric characters with a selection "pen." This generates coded tone sequences that are transmitted over ordinary telephone lines. Once the computer had solved the problem, it replies in simulated speech.

According to Morton H. Lewin of RCA Laboratories of Princeton, N. J., the inventor, "It is meant to be carried around and plugged into any telephone in a perfectly legal way. It is portable, battery-operated and cheap." He estimated that the production cost would be about \$50. RCA has announced no plans to market the device, which is still in experimental form.

Lewin pointed out that portable teletypewriting instruments with adapters for use with telephone handsets also have acoustic coupling, but they are far more expensive. Existing Touch-Tone telephones, on the other hand, which send coded messages to remote stations and receive vocal replies from computers, have only numeric capability. The new device would extend their capability at low cost.

He said the device would be useful to banks, brokerage houses, schools, department stores and engineering firms. It would simply clamp directly onto the mouthpiece



Computer input-output device can be carried around and plugged into any telephone.

of the handset, a method that is permitted by the utility companies.

Lewin said that he made several assumptions about the use of his invention:

- The query can be either merely acknowledged or answered briefly.
- Since there is no display, long chains of data cannot be accommodated. For example, it would not be feasible to debug a computer program in this fashion.
- The user truly needs both letters and numbers.
- The computer must have a voice output, such as Dataphone.

### Simplicity is the keyword

Operation is simple. The user touches the desired character with the selection pen. This pen contains both a pressure-actuated switch and a conductive path to the input of an analog-to-digital converter.

Once contact is made with a character, a pulser is triggered by the pressure-sensitive switch. The output of the pulser advances a decade counter, which consists of four flip-flops.

The counter feeds a decoder in such a manner that each of the decoder outputs is selected, one at a time, to be high during a particular time slot. The output lines from the decoder to the character areas (four in all) have resistances of different values, so that each path has a different current level. The resistors are connected to the A/D converter by the selection of a character area by the pen. Therefore, the converter transforms one of four analog current levels from the pen into one of four possible logic signals: 11, 10, 01 or 00. The outputs of the converter are gated to a two-frequency, digitally controlled oscillator. The presence of a 1 or a 0 determines whether the oscillator produces a high or a low tone.

The high-frequency tone is called a "mark" and the low tone a "space," corresponding to 1270 Hz and 1070 Hz, respectively.

The combination of logic signals gives an eight-digit output (seven characters plus parity bit), in accordance with ASCII coding. ■ ■

# If your exhibit wasn't on display in the New York Coliseum at the recent Microwave show...

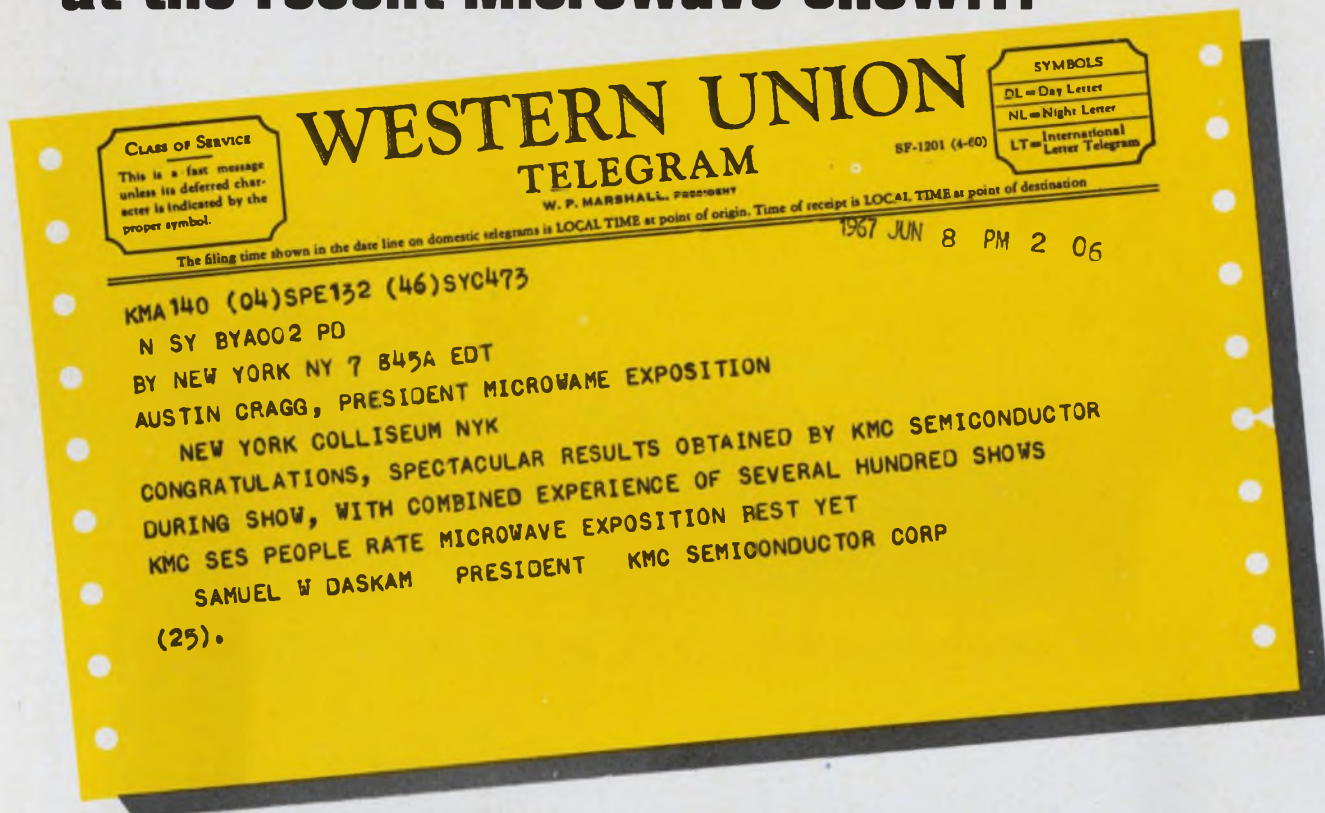

## You missed a great opportunity to increase your share of the market!

*Reserve space today for* MICROWAVE EXPOSITION/68

**PLACE:** San Francisco Hilton

**DATES:** June 4, 5 and 6 (Tuesday, Wednesday and Thursday)

**COST:** \$600 per 10' x 10' space

**CO-SPONSORED BY:** Hayden Publishing Co.

**ANTICIPATED ATTENDANCE:** 4,000 microwave engineers  
who can make on-the-spot decisions!

CALL OR WRITE OR WIRE

**MICROWAVE EXPOSITIONS, INC.**

100 Avenue of the Americas • New York, New York 10013 • 212-925-1200

ON READER-SERVICE CARD CIRCLE 23

## TRW introduces Low Voltage Avalanche!

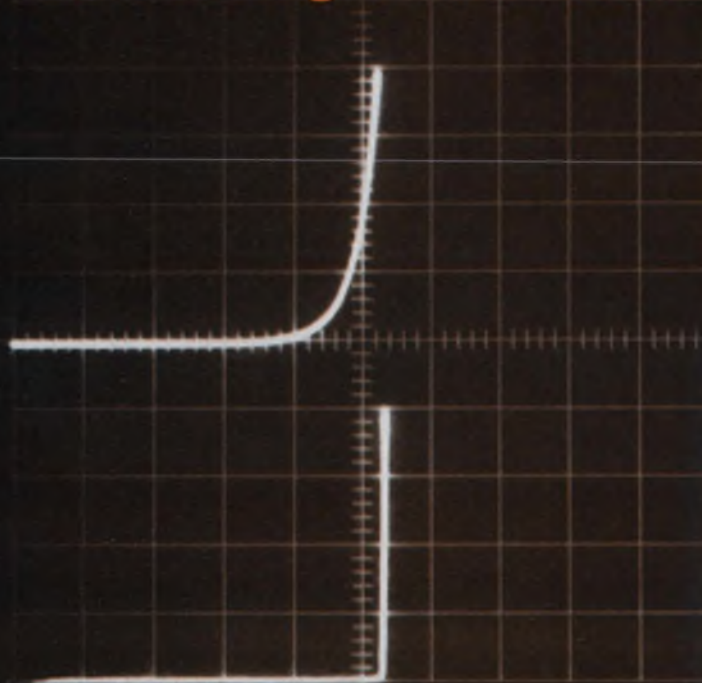

Unretouched scope comparison of 5.6 volt Military zener (upper) and new 5.6 volt LVA. (Tektronix Type 575, 1V/div. horizontal, 1mA/div. vertical.)

### Sharpest Breakdown Below 10 Volts!

The LVA™ is more than just a new diode: it represents a major breakthrough in low voltage regulators (patent pending). Wherever you need a zener below 10 volts, the LVA will significantly improve circuit performance with its avalanche breakdown characteristics.

With the LVA you can design better low current circuits, battery-operated circuits, and operational

amplifier clamping networks. And now for the first time, you can make zero TC reference below 5 volts!

The LVA is available in 10 values from 10 volts down to 4.3 volts. Delivery is off-the-shelf from factory or authorized distributors.

If you'd like to compare, write for test samples and applications data on company letterhead to

ON READER-SERVICE CARD CIRCLE 24

TRW Semiconductors, Ray Koch, 14520 Aviation Boulevard, Lawndale, California 90260. Phone (213) 679-4561. TWX 910-325-6206. *TRW Semiconductors Inc. is a subsidiary of TRW INC.*

# TRW®

**Co-Publishers**

James S. Mulholland, Jr.  
Hugh R. Roome

**Editorial Director**

Edward E. Grazda

**Editor**

Howard Bierman

**Managing Editor**

Robert C. Haavind

**Technical Editors**

Jeffrey N. Bairstow  
Peter N. Budzilovich  
Maria Dekany  
Roger K. Field  
David H. Surgan

**Careers and Management Editor**

Howard S. Ravis

**News Editors**

Ralph Dobriner, Chief  
Richard N. Einhorn

**Washington News Bureau**

Charles D. LaFond, Chief

**East Coast Editor**

Neil Sclater

**West Coast Editor**

Ron Gechman

**Copy Editor**

Peter Beales

**New Products Editor**

Steven B. Futterman

**Directory Editor**

William Alvarez

**Washington Editor**

S. David Pursglove

**Editorial Production**

Dollie S. Viebig  
Marian Arkin

**Art Director**

Clifford M. Gardiner

**Art Assistant**

William Kelly

**Technical Illustrators**

Cheh Nam Low  
Sheila F. Ward  
Richard Hartman

**Production Manager**

Thomas V. Sedita

**Asst. Production Manager**

Helen De Polo

**Production Assistants**

Bernard Wolinsky  
Robert M. Henry  
Murray Friedman

**Circulation Manager**

Nancy L. Merritt

**Reader Service**

Diane Mandell

## EDITORIAL



## Treat obsolescence trauma with a technological retreat

No decent engineer wants to grow obsolete. Especially you. Yet look what happened to Joe D. Ziner.

One morning not too long ago he bolted awake from a lurid nightmare. He'd been swept overboard from a ship, wearing his design outfit—bow tie, yellow suspenders, long socks, his slide rule clutched in his hand. Mightily, he had struggled against the tossing sea as he was washed toward a rocky shore. Finally he was deposited on a slippery boulder by a wave, and on scrambling to higher, drier rocks, he turned toward the ship—just in time to see it sailing off with Andy Shrewdy, the new engineer at the plant, at the helm.

Fortunately he sized up his difficulty quickly. He was suffering from a case of obsolescence trauma. Saving a \$25 psychiatrist's fee, he prescribed his own remedy, or at least he tried to.

He needed a fast job of technological retreading, so that he'd be ready for the coming world of phased arrays, LSI, ditherable magnetrans, and statistical decision theory. It just happened that he'd received the day before a list of "refresher" and "updating" courses from a local university. Choosing an appropriate-sounding one, he approached his chief engineer and got a quick OK, despite the \$200 fee. In fact, the chief engineer decided to go, too.

Both engineers were in for disappointments. The updating course they attended turned out to be extremely theoretical, with little bearing on actual design problems. One professor used the teaching platform to espouse his own recent contribution to technological minutiae. Joe and his boss picked up the text after the first day's lecture and found that a one-week intensive course just didn't leave enough time for reading the book with real comprehension.

There's a lesson to be learned from this by all engineers who happen to be competing with young Andy Shrewdies. Yes, take as many refresher courses as you can. Find out about as many as you can—there are more and more every year around the country. But to get the most from them, analyze each program carefully to see if it really meets your needs; get the text well in advance and read it perceptively; note the background and orientation of the instructors; drop a line to the most appropriate instructor, suggesting that he include in his coverage of the subject some of the problems you're interested in. Then follow up your course by reading more material in the areas you were exposed to. You'll find you can cover territory much more quickly than usual while some of the important concepts are fresh in your memory.

Proper preparation can lead to better dreams in your future.

ROBERT HAAVIND

# 4 ways to view displays with the Tektronix Type 564

## split- screen storage oscilloscope

The Tektronix Type 564 is virtually two instruments in one. It offers all the advantages of a storage oscilloscope plus those of a conventional oscilloscope.

### Split-Screen Displays

An unique split-screen display area enables you to simultaneously use either half of the screen for storage and the other half for conventional displays, or use the entire area for stored or conventional displays.

Independent control of both halves of the screen permits you to take full advantage of the storage facilities. For example, you can use half the screen to store a reference waveform, the other half to display waveforms for comparison. You can erase or retain either half of the display area as you choose.

### Bistable Storage Advantages

With bistable storage oscilloscopes, such as the Type 564 and Type 549, the contrast ratio and brightness of stored displays are constant and independent of the viewing time, writing and sweep speeds, or signal repetition rates. This also simplifies waveform photography. Once initial camera settings are made for photographs of one stored display, no further adjustments are needed for photographs of subsequent stored displays.

Storage time is up to one hour, and erase time is less than 250 milliseconds. An illuminated 8 cm by 10 cm graticule facilitates measurements and aids in taking photographs with well-defined graticule lines. Adding to the operating ease is a trace position locator that indicates, in a nonstore area, the vertical position of the next trace or traces.

Tektronix bistable storage cathode ray tubes are not inherently susceptible to burn-damage and require only the ordinary precautions taken in operating conventional oscilloscopes.

### Plug-In Unit Adaptability

The Type 564 accepts Tektronix 2 and 3-series plug-in units for both vertical and horizontal deflection. Display capabilities of these units include single and multi-trace with normal and delayed sweep; single and multiple X-Y; low-level differential; dual-trace sampling; spectrum analysis, and many other general and special purpose measurements.

Type 564, without plug-in units . . . . . \$ 925

Rack-Mount RM564 . . . . . \$1025  
Similar electrical characteristics to Type 564. 7" high.

Type 3A6 Dual-Trace Amplifier Unit . . . . . \$ 525  
DC to 10 MHz from 10 mV/div to 10 V/div. 5 display modes. Internal signal delay line.

Type 3B4 Time Base Unit . . . . . \$ 425  
Sweep speeds from 0.2  $\mu$ s/div to 5 s/div. Single sweep. Up to X50 direct-reading magnifier extends fastest sweep to 50 ns/div.

U.S. Sales Prices FOB Beaverton, Oregon



Entire screen can be used for a stored display.

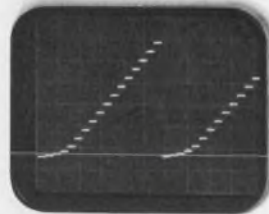

Entire screen can be used for a nonstored display.

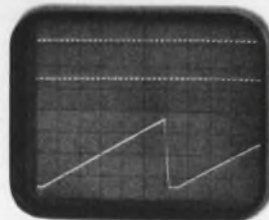

Each half of split-screen can be used independently for stored displays.

Either half of the split-screen can be used for a stored display, the other half for a nonstored display. (Shown below).

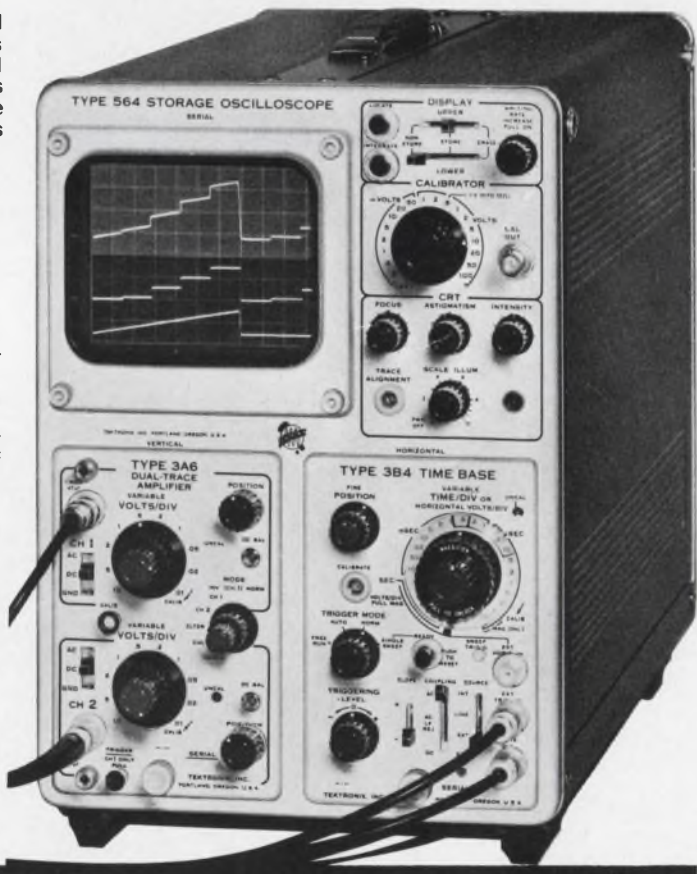

**Tektronix, Inc.**



For a demonstration, contact your nearby Tektronix field engineer or write: Tektronix, Inc., P. O. Box 500, Beaverton, Oregon 97005.



# Technology

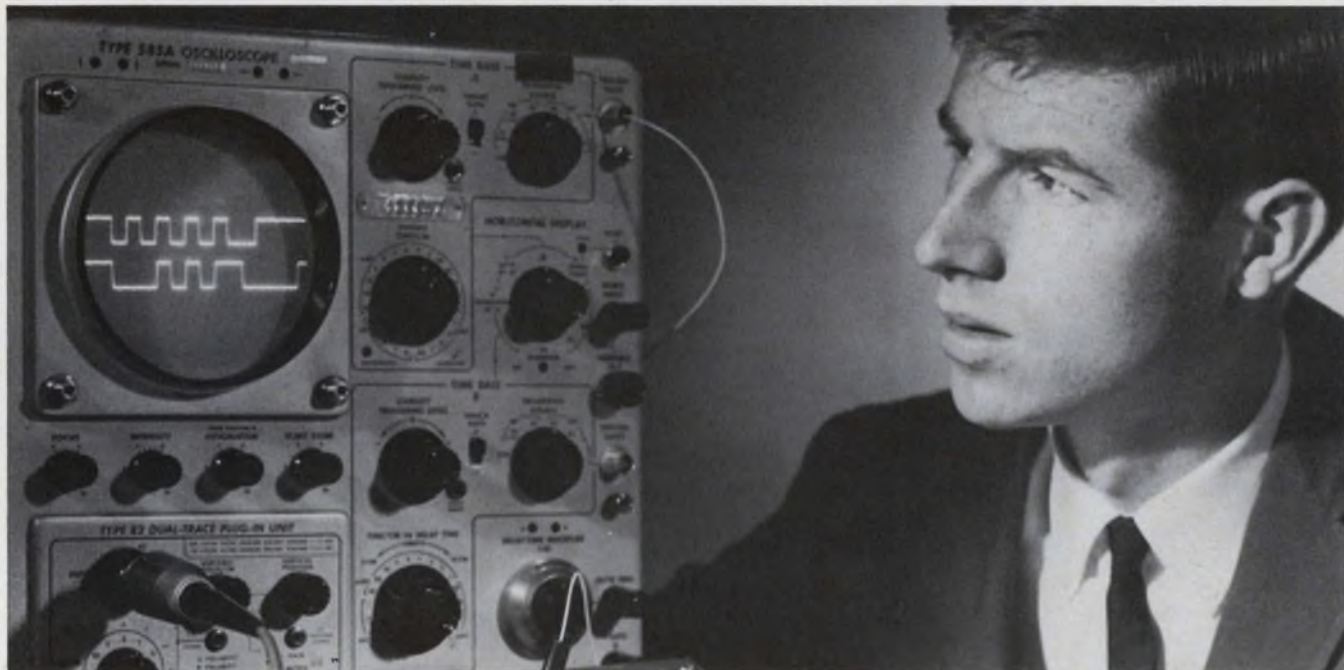

Digital integrated circuits are invading areas that were once the exclusive domains of ana-

log circuits. MOS arrays help keep down the cost and size of this new approach. Page 41

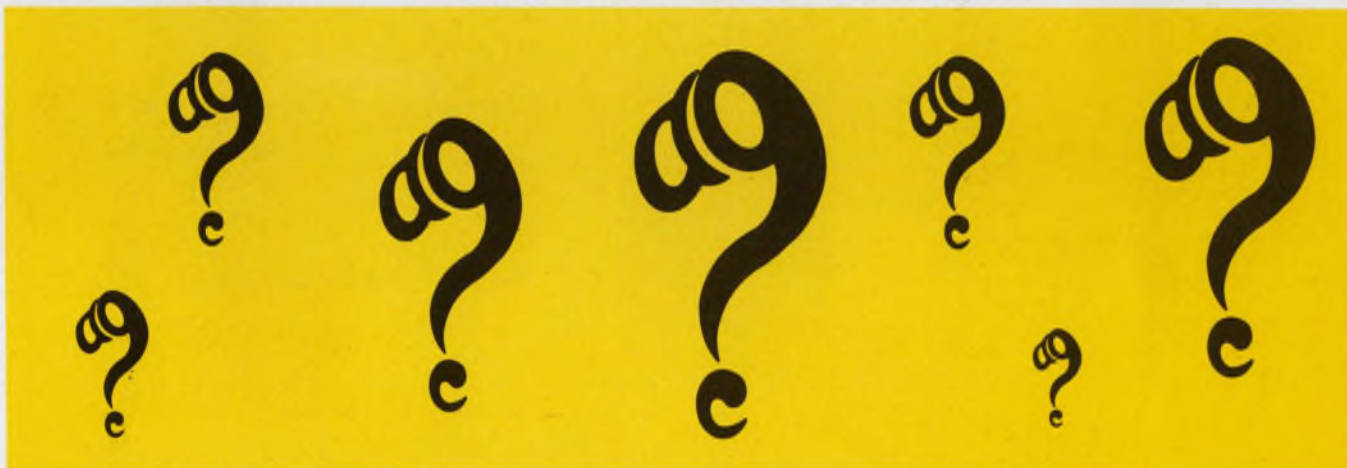

The questions of automatic gain control in FET circuits are whether forward or reverse

agc is preferable and which configuration to adopt. Answers to these appear on page 66.

## Also in this section:

A quiz tests your knowledge of electronic technology. Page 74

Ideas for Design. Pages 82 to 88.

# this is the freshest relay design approach since 1956.

(or was it '37?)

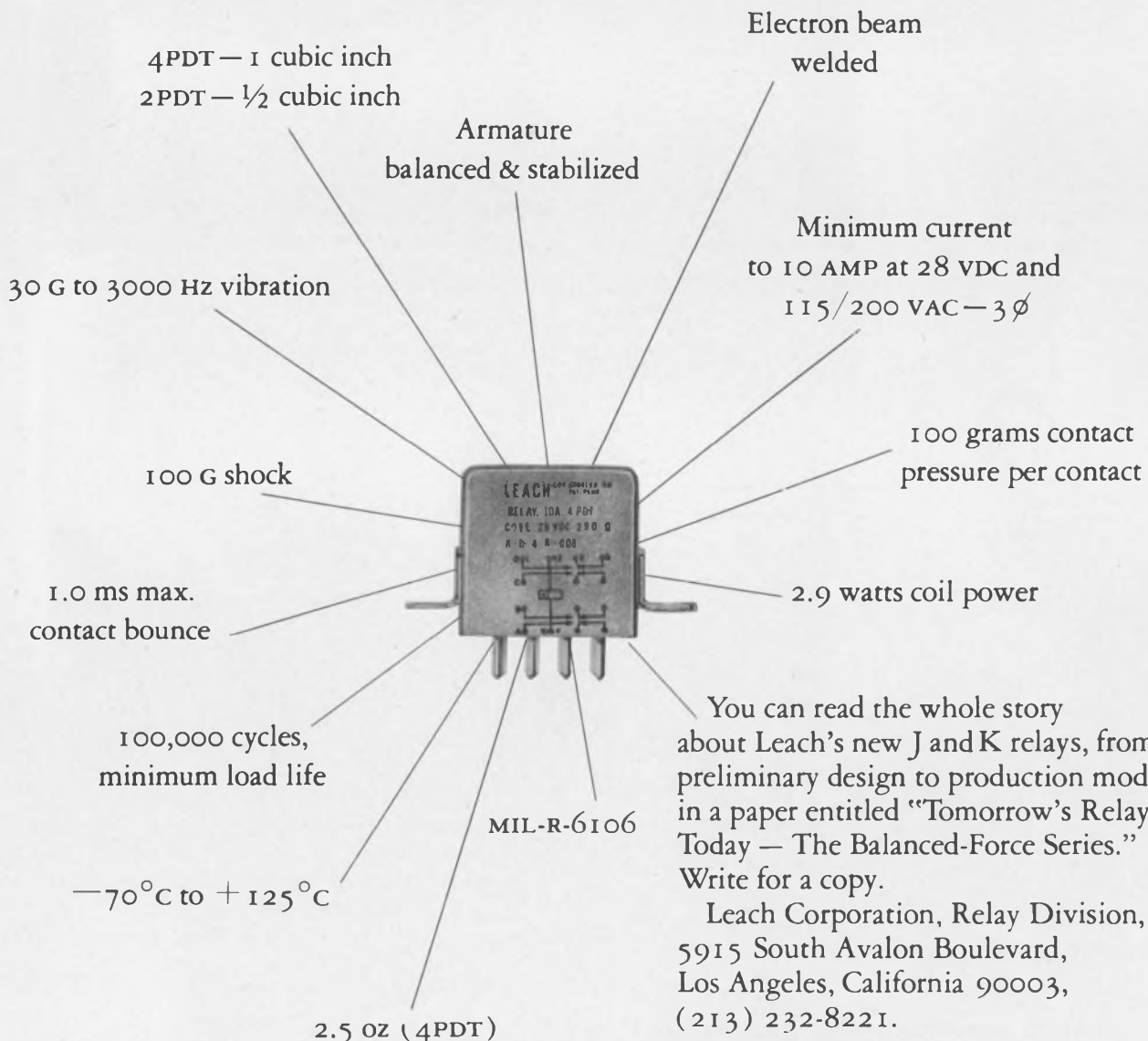

## LEACH

ON READER-SERVICE CARD CIRCLE 26

ELECTRONIC DESIGN 18, September 1, 1967



ELECTRONIC DESIGN SPECIAL REPORT

# Digital chips shift into analog territory

Edited by Maria Dekany, Technical Editor

# Digital roads to analog functions

are paved with inexpensive ICs.  
To make the most of them, you  
should know the whys and hows.

There is a noticeable trend nowadays toward the use of digital hardware to perform many of the circuit functions that were once the exclusive province of the analog component.

The engineer who contemplates a digital approach to perform an analog function must have a good grasp of two basics; *why* the digital approach should be used, and *how* it should be used.

Over the years, design engineers have amassed a considerable body of knowledge about analog techniques which enables them to synthesize a wide variety of circuits, such as integrators, differentiators, and filters, from a few basic analog building blocks, such as resistors, inductors, capacitors, and operational amplifiers. Given a transfer function in  $s$ , the Laplace variable, available synthesis procedures will supply a usable network configuration and formulas for computing the values of the network elements.

Analog theory can equally be used to choose a satisfactory transfer function for a digital system, but new design procedures are needed to realize the transfer function with digital networks and digital building blocks.

## Why use a digital approach?

The typical systems that have been built with digital hardware include integrators, filters, arithmetic signal-processing and precision speed and positioning servomechanisms. They help pinpoint some of the decisive factors. The digital approach

has offered greater accuracy, dynamic range, stability and linearity than the analog. It is free from drift, component-tolerancing problems, component aging, and power-supply variations. The adjustment potentiometer, for example, has been virtually eliminated. These improvements have been accompanied in many instances by reductions of size, weight, power consumption and cost. The system in Fig. 1 is a typical example.

Digitalized systems are easier to build than analog systems. Multiplication and division operations may be more readily performed.\* Digital filters can be designed with a response closer to ideal (uniform pass-band response, infinite attenuation in the stop band) than their analog counterparts.† There are no impedance-matching problems and no insertion losses. The digital approach can be used to build filters with a response that is impossible with analog hardware. A digital system can accept remote control inputs to produce large changes in such circuit parameters as gain or bandwidth. This capability is needed in adaptive systems with time-varying parameters.

Digital systems are readily addressed by automatic equipment. This makes possible the automatic setting and adjusting of scale factors, gains, test limits, time constants, etc. This capability, too, may result in significant cost savings over the operating life of the equipment.

But don't rush to digital methods without a thorough study of all the factors. Continuous component improvements in various areas demand constant reevaluation of alternative design approaches to any problem.

## Mathematical tools relate to frequency domain

After the reasons why, consider a number of mathematical ideas that relate to *how* the digital approach is made.

Design procedures for analog equipment are strongly oriented toward synthesis techniques that implement the basic operators:  $s$  or  $1/s$ .

This present approach to digital implementation will substitute a numerical operator for each power of  $s$  (or  $1/s$ ) into the analog transfer function. Although most signals encountered in

Donald Breslow, Staff Electronic Engineer, Itek Corp., Burlington, Mass.

\*See p. 54 for details.

†See p. 48.

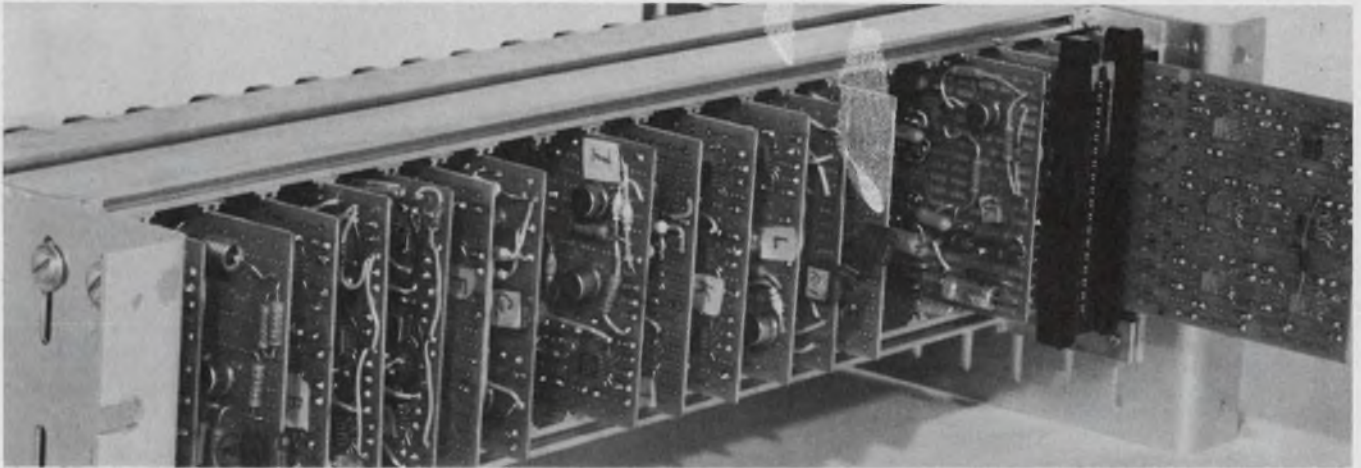

1. **Digital speed-control servomechanism** generates a digital word proportional to the desired shaft speed, measures the actual speed, computes the error, generates

a compensating signal, and supplies an analog output for the servo amplifier. Mounted in a 19-inch-long rack, it is more accurate and stable than the analog version.

engineering practice are complex, it is frequently convenient to decompose a signal into its Fourier components, so that the output of a network at a specific frequency may be assessed. The numerical substitute forms will therefore be analyzed in terms of their behavior with a single sinusoidal input. The results of this analysis will be expressed in terms of  $\exp(j\omega T)$  and the more compact form,  $z^{-1}$ .

Substituting a numerical form in  $z$  into an analog transfer function provides a numerical transfer function, which shows the computations needed to realize the analog response digitally.

In addition to the usual arithmetic operations, four basic operations are needed to perform most processing: sampling, integration, differentiation and data reconstruction. Even though sampling and data reconstruction are outside the basic topic—digital approximation of analog functions—they can contribute significant errors. A brief discussion is therefore appropriate.

Signals to be processed by digital hardware must be entered into the processor in proper format. Conversion from continuous to discrete form is performed by the sampler, or A/D converter.

Consider the analog signal which is impulse-sampled at regular  $T$ -second intervals. (All signals will be sampled at a constant rate). Each im-

pulse of the train is converted into a digital word, the value of which is proportional to the amplitude of the analog signal at the instant of sampling. Sampling is regarded as a form of impulse modulation which creates sidebands. Given an analog signal of frequency  $f_i$  and a sampling rate of  $f_s$ , the spectrum of the sampled signal contains a component at  $f_i$  plus sidebands at  $nf_s$  and  $nf_s \pm f_i$ , where  $n$  ranges from 1 to infinity.

Shannon's sampling theorem<sup>1,2</sup> states that as long as the sampling frequency, in this case  $1/T$ , is at least twice as great as the highest frequency in the original signal, the original signal may be constructed from the samples. To appreciate the need for a minimum sampling rate, consider the sampler input to be a single sine wave at frequency  $f_i$ , contained in a band that is limited to  $f_{max}$ . The spectra of the original signal and the sampled signal are shown in Fig. 2. As long as  $f_s$  is at least twice  $f_{max}$ , the lower sideband ( $f_s - f_i$ ) of the sampled signal is above  $f_{max}$ . Figure 2c shows that when  $f_s$  is less than  $2f_{max}$ , the lower sideband can fall within the band ranging from 0 to  $f_{max}$ . This phenomenon is known as "aliasing" and must be avoided if the input signals within the band from 0 to  $f_{max}$  are to be unambiguously recovered from the sample set.

The use of a sampling rate twice the highest frequency represents the theoretical minimum

requirement. But the selection of a sampling rate is governed by other practical factors.<sup>3</sup>

A low sampling rate, near the theoretical minimum, may be attractive because it may tend to minimize the number of ensuing arithmetic calculations. Such an approach might be used with an open-loop system, which is tolerant of any time delays that might be introduced by the numerical processing procedure. On the other hand, a closed-loop system is often intolerant of such additional time delays. Since these additional delays are often inversely related to sampling frequency, a rate of 5 to 10 times the theoretical minimum is often recommended to ensure stability.

### Integration through summation

The next operation to be considered is integration. The integration process is very important, because it offers a numerical substitute for that corner-stone of analog synthesis,  $1/s$ , the Laplace transform operator for an integration.

Integration may be interpreted as the area under a curve. Using this approach, a number of well-known numerical formulas will be examined to see which best approximates the analog version.

The simplest integration procedure is the rectangular rule, illustrated in Fig. 3. Approximate the area under the curve as:

$$A = f(t_0 - T)T \quad (1)$$

Unless  $f(t)$  changes very slowly or  $T$  is very short, this integration will be imprecise. Assume the input to the integrator is a single complex exponential function of time,  $C_n \exp(j\omega t)$ , where  $C_n$ , the amplitude of the Fourier component at an angular frequency  $\omega$ , may be taken to be unity. The area computed by the rectangular rule is given by:

$$A' = f(t_0 - T)T = \exp[j\omega(t_0 - T)]T. \quad (2)$$

The true area is given by:

$$A_{true} = \int_{t_0 - T}^{t_0} \exp(j\omega t) dt \\ = \frac{\exp(j\omega t_0) - \exp[j\omega(t_0 - T)]}{j\omega T}. \quad (3)$$

The concept of relative transfer function<sup>4</sup> helps check the accuracy of the approximation. It is the ratio of the computed value of the area with numerical integration to that with true integration. This ratio should be equal to unity over all frequencies, indicating that the numerical operator was a perfect replacement for its continuous counterpart. This ideal response can be obtained over a fairly wide frequency range.

For the rectangular rule, divide Eq. 2 by Eq. 3, to find the ratio:

$$R_{rect}(\omega) = \frac{\exp[j\omega(t_0 - t)]T}{\{\exp(j\omega t_0) - \exp[j\omega(t_0 - T)]\}/j\omega}$$

$$= \frac{j\omega T \exp(-j\omega T)}{1 - \exp(-j\omega T)}. \quad (4)$$

Simplify Eq. 4 by multiplying both numerator and denominator by  $\exp(j\omega T/2)$  and expressing the resulting terms as trigonometric functions:

$$R_{rect}(\omega) = \frac{j\omega T \exp(-j\omega T) \exp(j\omega T/2)}{[1 - \exp(-j\omega T)] \exp(j\omega T/2)} \\ = \frac{j\omega T \exp(-j\omega T/2)}{2j \sin(\omega T/2)} \\ = \frac{\omega T}{2} \csc\left(\frac{\omega T}{2}\right) \angle -\frac{\omega T}{2}.$$

The value of the dimensionless parameter  $\omega T$  is inversely related to the number of digital samples per period of input signal,  $t_{signal}$ . The period is given as:

$$t_{signal} = \frac{2\pi}{\omega}.$$

Therefore, the number of samples per period of signal is:

$$\frac{t_{signal}}{T} = \frac{2\pi}{\omega T}. \quad (6)$$

The absolute value of the relative transfer function is plotted in Fig. 4.

At low values of  $\omega T$ , the departure from the ideal integrator,  $1/s$ , (from a unity relative transfer function) is not severe for rectangular approximation.

The trapezoidal rule (Fig. 5) improves the accuracy of integration. The area under the curve is given as:

$$A' = \frac{T[f(t_0) + f(t_0 - T)]}{2}. \quad (7)$$

Again, assume a complex input function of the form  $\exp(j\omega t)$ . Then Eq. 7 becomes:

$$A' = \frac{T}{2} \{\exp(j\omega t_0) + \exp[j\omega(t_0 - T)]\} \quad (8)$$

$$= \frac{T}{2} \exp(j\omega t_0) [1 + \exp(-j\omega T)]$$

The true value of integration is again given by Eq. 3, so that the relative transfer function may be written as:

$$R_{trap}(\omega) = \frac{(T/2) \exp(j\omega t_0) [1 + \exp(-j\omega T)]}{\exp(j\omega t_0) [1 - \exp(-j\omega T)]/j\omega} \\ = \frac{j\omega T [1 + \exp(-j\omega T)]}{2[1 - \exp(-j\omega T)]}. \quad (9)$$

The actual calculation of relative transfer functions can be simplified with the aid of the unit delay function,  $\exp(-j\omega T)$ , or the  $z$  operator. For a more detailed and easy-to-follow explanation of the  $z$  operator, check Reference 1, pp. 198-210. The unit delay operator,  $z^{-1}$ , is defined as

$$z^{-1} = \exp(-j\omega T). \quad (10)$$

A relationship:

$$y(t_0) = \int_0^{t_0} y'(t) dt. \quad (11)$$

has the  $z$  form;

$$\frac{y(z)}{y'(z)} = \left(\frac{T}{2}\right) \left[ \frac{1+z^{-1}}{1-z^{-1}} \right]. \quad (12)$$

The form in Eq. 12 is frequently used in the literature.

Equations 9 and 12 are functionally identical, and may be simplified to read:

$$R_{trap}(\omega) = (\omega T/2) \cot(\omega T/2). \quad (13)$$

### Remember Simpson's rules

A higher-order approximating polynomial with more ordinates may be used to obtain a better fit to a curve and hence improved integration accuracy. Two such formulas<sup>5</sup> are Simpson's 1/3 rule (3 points), given by:

$$A'_{1/3} = (T/3) [f(t_0 - 2T) + 4f(t_0 - T) + f(t_0)], \quad (14)$$

and Simpson's 3/8 rule (4 points), given by:

$$A'_{3/8} = (3T/8) [f(t_0 - 3T) + 3f(t_0 - 2T) + 3f(t_0 - T) + f(t_0)]. \quad (15)$$

The corresponding  $z$  transform operators are as follows. For Simpson's 1/3 rule:

$$A'_{1/3} = \left(\frac{T}{3}\right) \frac{1 + 4z^{-1} + z^{-2}}{1 - z^{-2}}, \quad (16)$$

and for Simpson 3/8 rule:

$$A'_{3/8} = \left(\frac{3T}{8}\right) \frac{1 + 3z^{-1} + 3z^{-2} + z^{-3}}{1 - z^{-3}}. \quad (17)$$

The relative transfer functions for sine-wave inputs are:

$$R_{1/3}(\omega) = \frac{\omega T}{3} \left[ \frac{2 + \cos(\omega T)}{\sin(\omega T)} \right], \quad (18)$$

and:

$$R_{3/8}(\omega) = \frac{3\omega T}{8} \left[ \frac{\cos(3\omega T/2) + 3\cos(\omega T/2)}{\sin(3\omega T/2)} \right]. \quad (19)$$

The trapezoidal and Simpson's rules do not contribute excess phase shift. The rectangular rule does.

All relative transfer functions are periodically related to  $\omega T$  and possess poles (infinite gain) at some function of  $\omega T$ —their denominators go to zero. The behavior of the four relative functions is shown in Fig. 4.

For integration of predictable accuracy, the designer must know the highest frequency signal in the input and the sampling rate to avoid these poles. *The importance of this last statement can not be overemphasized.* In many cases, it will be necessary to band-limit the input signal with an analog filter before sampling and processing.

It has been seen how the continuous integration operator,  $1/s$ , may be replaced by various discrete forms. Operators to approximate higher powers

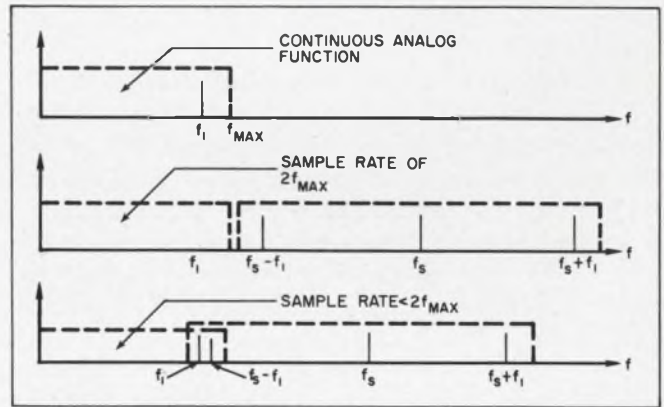

2. Spectra of a sampled signal show that the sampling frequency should be at least twice the highest frequency of the input signal. Otherwise the sidebands will interfere and aliasing occurs.

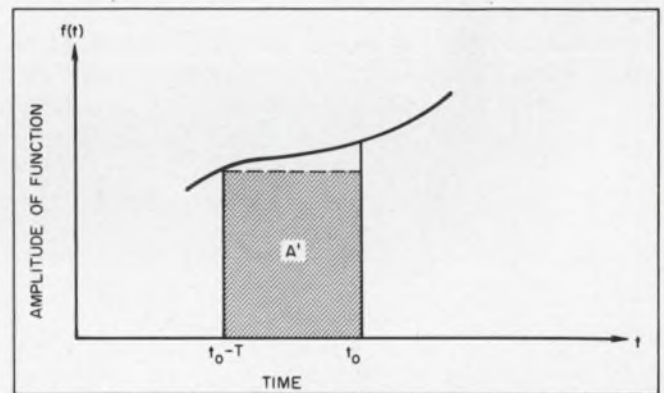

3. Integration with the rectangular rule involves approximation of the area under the curve by the shaded rectangle. This is the simplest numerical integration method.

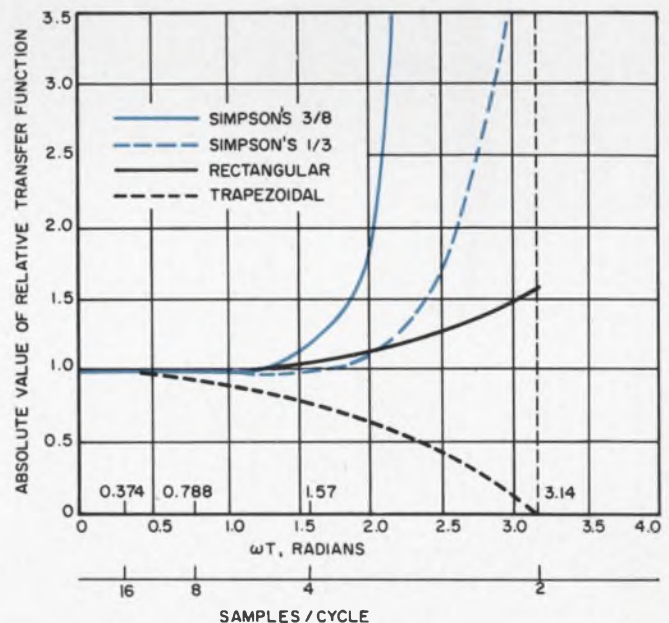

4. Relative transfer functions of various numerical integration methods are plotted against frequency and samples per cycle. These pinpoint the poles of the transfer functions—the gain shoots up to infinity. For example, Simpson's rule of 3/8 blows up at about 3 samples per second, or at 2.2  $\omega T$  radians.

of  $(1/s)^n$ , corresponding to the  $n^{\text{th}}$  integral, are also possible.<sup>6,7,8</sup>

The integration operators approximated  $1/s$  or its powers. The reciprocal of  $(1/s)$  is  $s$ , a differentiator. Accordingly, the reciprocals of the integrating forms will approximate  $s^n$  (i.e., the  $n^{\text{th}}$  derivative) by computing the  $n^{\text{th}}$  difference.

The numerical forms will again contain poles and zeros, indicating that derivatives may be badly overestimated or underestimated at certain frequencies. The relative transfer function of the differentiators will be reciprocal of the integrator relative transfer functions. An operator that underestimates an integral will overestimate a derivative.

The accuracy of the integration process was improved by using a higher-order approximate polynomial. But a similar technique would not improve the accuracy of the differentiation process.<sup>9</sup> In Fig. 6, an oscillating polynomial is fitted through four points; it is obvious from inspection that the local slope of the approximation may bear no resemblance to that of the true function.

Numerical differentiation may also become

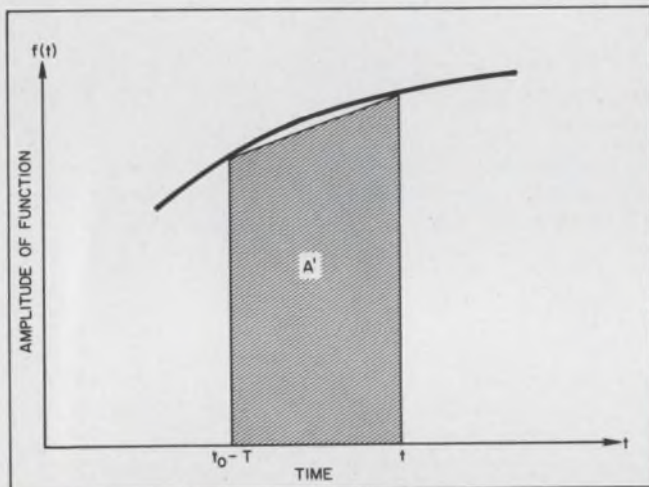

5. Trapezoidal rule of integration offers better accuracy than the rectangular method, since it approximates the actual area more closely.

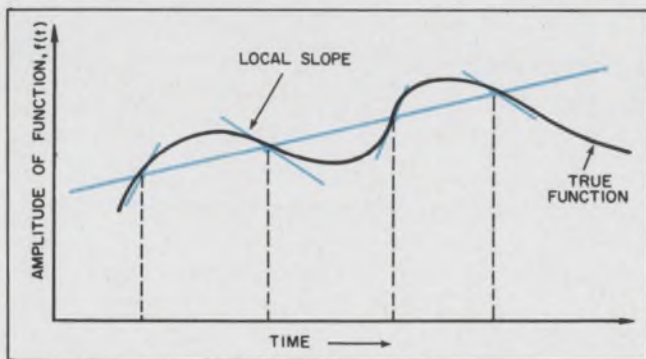

6. Differentiation by numerical approximation is not improved by using a higher-order polynomial, that is, by using more points, since the local slope of approximation may bear no resemblance to that of the original function.

quite noisy due to the quantization process.

Sampling converted a continuous function into a series of discrete samples; the sample string was then used as the input to a digital processor. Data reconstruction (D/A conversion) converts the output back to a continuous signal.

A simple but effective data reconstruction filter is the zero-order hold, on a sample-and-hold network (see Fig. 7). The transfer function of a zero-order hold is given by:<sup>10</sup>

$$G_H(j\omega) = \frac{\sin(\omega T/2)}{\omega T/2} e^{-j\omega T/2}. \quad (20)$$

The holding operation attenuates the higher frequencies and introduces a phase lag.

### Is real-time really on time?

In analyzing numerical integrators, the tacit assumption was made that the computations were done in negligible time. For the cases of real-time, on-line systems, the processing delay can affect the results.

All data and operations have been keyed to a sampling period of  $T$  seconds. We shall assume that the arrival of each new input sample should cause the computer to initiate a new series of calculations. Some time,  $t_1$ , will be required to process the data at each step. To make sure that the computer will be able to keep up with the input data,  $t_1$  must be less than  $T$ , the sampling time.

The total delay may be tolerable in an open-loop application. The excess delay caused by processing and reconstruction may lead to instability in a closed-loop system. The reconstruction delay may be minimized by using a shorter sampling time,  $T$ , but this in turn may impose hardware complications in maintaining  $t_1$  at an acceptable value. A trade-off study considering such factors as sampling rate, numerical operator, allowable time delay, ratio of sampling frequency to controlled bandwidth, and processing hardware is needed. ■ ■

### References:

1. J. Tou, *Digital and Sampled-Data Control Systems* (New York: McGraw-Hill Book Company, Inc., 1959), Chap. 3, pp. 69-76.
2. F. Kuo and J. Kaiser, *System Analysis by Digital Computer* (New York: John Wiley & Sons, 1966), Chap. 7, pp. 222-225.
3. J. Tou, *op. cit.*, pp. 83-92.
4. R. Hamming, *Numerical Methods for Scientists and Engineers* (McGraw-Hill Book Company, Inc., 1962), Chap. 25, pp. 324 ff.
5. R. Boxer, "A Note on Numerical Transform Calculus," *Proc. IRE*, XLV, Oct., 1957, 1401.
6. A. Tustin, "A Method of Analyzing the Behavior of Linear Systems in Terms of Time Series," *IEEE* (London), XCIV, No. 11-A (May 1957), 130.
7. R. Boxer and S. Thaler, "A Simplified Method of Solving Linear and Non-Linear Systems," *Proc. IRE*, XLIV, June, 1956, 89.
8. J. Truxal, "Numerical Analysis for Network Design," *Trans. IRE*, Vol. CT-1, Sept., 1954, 49.
9. R. S. Ledley, *Digital Computer and Control Engineering* (McGraw-Hill Book Company, Inc., 1960) p. 197.
10. J. Tou, *op. cit.*, pp 76 ff.



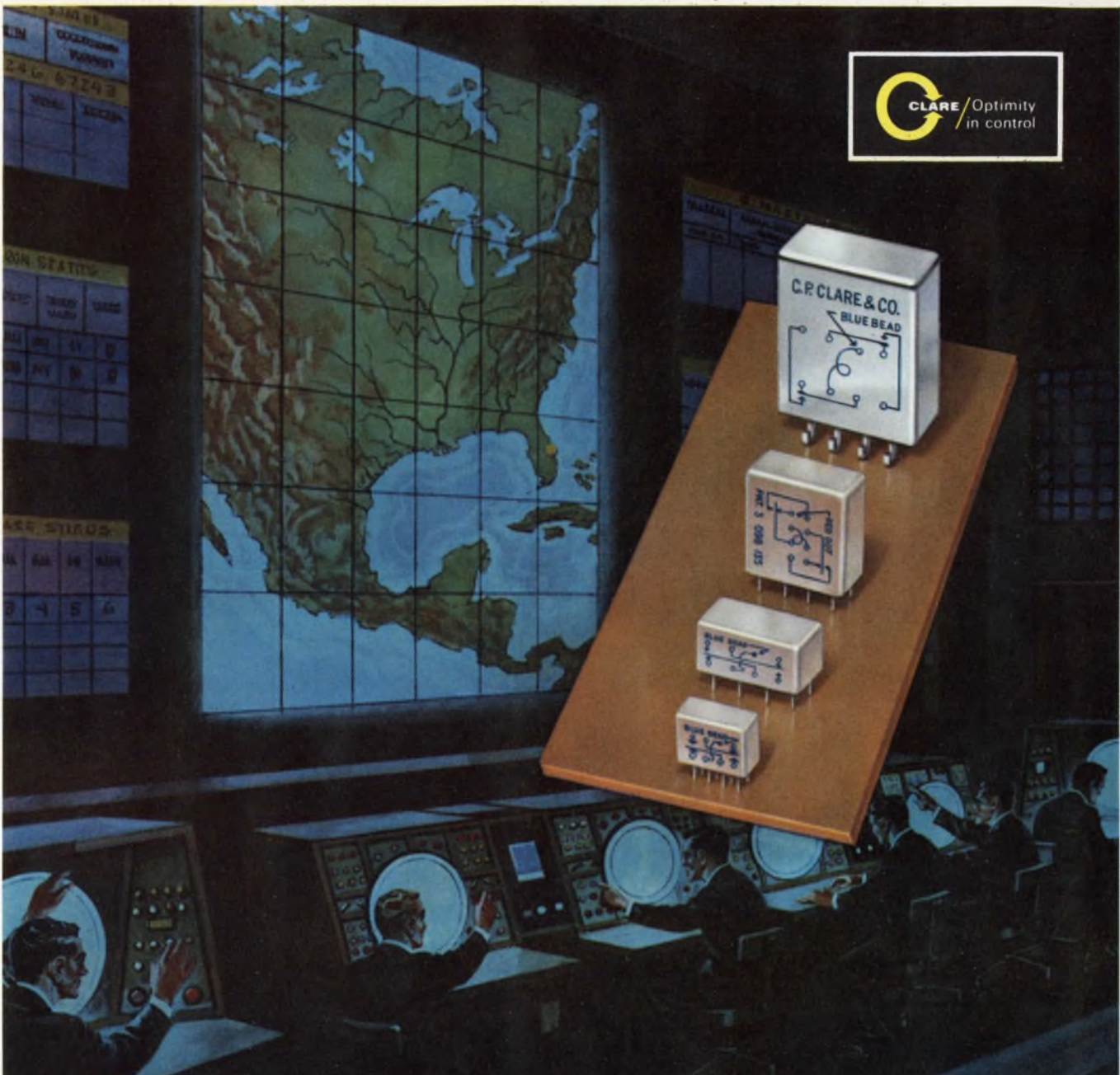

# Problems in aerospace/ground support? Clare puts you in control

Everywhere contact switching is indicated, Clare capability can put you in control. In aerospace and ground support systems, where reliability is the key to success. In cost-conscious industrial process control, or high-speed data processing systems. In demanding communications networks, or instruments of utmost accuracy.

Wherever contact switching can optimize control systems—whenever long life, high reliability, advanced capability, and maximum economy are needed—let Clare put you in control.

C. P. Clare & Co.—worldwide.

Clare contact switching... for optimality in

Industrial Process Control    Electronic Data Processing    Aerospace and Ground Support    Communications    Instrumentation



ON READER-SERVICE CARD CIRCLE 27

# From theories to hardware

The design of a digital ramp generator and an averager shows the practical points.

The digital problems that face a design engineer normally fall into one of two categories. If a general-purpose computer is available, his main concern is with programming techniques. Otherwise, he has to design special-purpose hardware, and in this case his focus is on logic design with functional building blocks for example, the A/D converter in Fig. 1.

If, for instance, the designer has to tackle the generation of a linear ramp waveform with a rate of rise of  $a$  volt/second, he can calculate this with digital hardware by integrating a unit step. The more conventional analog approach would be to do this by charging a capacitor.

If he is working with a general-purpose computer, the ramp can be derived from the FORTRAN-type statement:

$$E_{out}(t+T) = E_{out}(t) + \alpha T, \quad (1)$$

where  $T$  is the sampling period. This is the equivalent of rectangular integration. It is accurate enough for ramp generation because it fulfills the basic requirement of matching its analog counterpart exactly at dc, that is, its relative transfer function is unity at dc. The general-purpose digital hardware has to be able to add and multiply.

When the digital hardware has to be designed, the designer has to find the simplest path to integration. The simplest method would seem to be counting pulses which have a rate scaled to reflect the desired sweep rate. This is the approach used in the circuit of Fig. 2. It requires far less hard-

ware than the straightforward method based on incrementing and adding.\*

This pulse-counting procedure can be illustrated simply by the design of the circuit in Fig. 2 which delivers a long linear sweep of 10 seconds' duration and 10 volts peak amplitude ( $a = 1V/s$ ). The considerations involved in both the analog and digital approaches offer a fair comparison.

A typical requirement for a 10-second ramp is that the slope, or writing-speed, error should not exceed 0.1%.

The analog circuit needs a high-gain amplifier<sup>1</sup> to control a constant-current source, which in turn charges a polystyrene capacitor. The slope error, expressed as voltage  $E_s$ , for a  $T$ -second ramp in the analog circuit is:

$$E_s = T/RC, \quad (2)$$

where  $R$  combines the internal resistance of the charging source and the capacitor's insulation resistance.

A slope error of 0.1% would require an  $RC$  time constant 1000 times greater than the sweep duration; a 10-second sweep would thus require a 10,000-second time constant. The high-gain operational amplifier tends to increase the time constant by  $A$ , the amplifier gain. But practical values of resistances in the 100-k $\Omega$  region still require a high-quality polystyrene capacitor of 1 to 10  $\mu F$ .

## Counted clock pulses yield analog level

With the digital approach, the output ramp is obtained by counting clock pulses  $f_c$ ; the count is converted to an analog level by a D/A ladder converter. The output signal increases in a series of discrete steps of value  $V_{max}/2^N$ , where  $N$  is the number of bits in the counter.

The most important criterion in the digital system is the displacement error, which is the difference between the actual sweep and a straight line between zero and the maximum level. The digital sweep contains a displacement error equal to the step size,  $V_{max}/2^N$ , but making  $N$  large enables this error to be kept quite small. A 12-bit counter will keep this error to less than 1 part in 4000. It is assumed that the apparatus receiving

Donald Breslow, Staff Electronic Engineer, Itek Corp., Lexington, Mass.

\*See p. 54.

the sweep is low-pass in nature and is tolerant of the quantizing steps.

The slope error,  $a$ , in volts per second, and the output voltage,  $E_{out}$ , are given by:

$$\left. \begin{aligned} a &= f_c V_{max}/2^N, \\ E_{out} &= f_c V_{max} t/2^N. \end{aligned} \right\} \quad (3)$$

The stability and the accuracy of the slope rate is governed by  $f_c$ , the clock frequency. Since a compact crystal oscillator may have a stability of one part in  $10^7$ , the errors in the digital approach become an order of magnitude less than in the analog design. An error of one part per thousand is difficult to achieve with analog components, even with a temperature-regulated oven.

In the block diagram of the digital ramp generator (Fig. 2), the counter performs the numerical integration and the D/A ladder reconstructs a staircase output.

Many multiple-count binary frequency dividers are available in a single package. D/A converters are available from several sources, among them Digital Equipment Co. of Maynard, Mass. General Instrument is marketing MTOS arrays which could also be used. The circuit in Fig. 2 could thus be built with a few custom flat packs (less the clock). Gating circuitry, needed to control the clock input and set the dwell time between sweeps, may also be added, along with circuits that change the sweep rate or synchronize the auxiliary equipment.

The main advantages of this digital approach are accuracy, stability, linearity and greatly reduced volume.

The digital approach has other advantages, or more precisely, lacks many of the disadvantages of analog system. For example, it takes time to reset or discharge the sweep capacitor in an analog circuit, and this time may be excessive. Transients have to be coped with. Dielectric saturation has to be considered; the capacitor's dielectric cannot be completely deenergized in a short time. When the reset circuit is removed, a terminal voltage may appear. This is a hysteresis effect that may degrade accuracy. With long, linear sweeps it is difficult to measure sweep linearity and locate errors of the hysteresis type. None of these problems besets a digital system.

The digital sweep can be "frozen" at its last

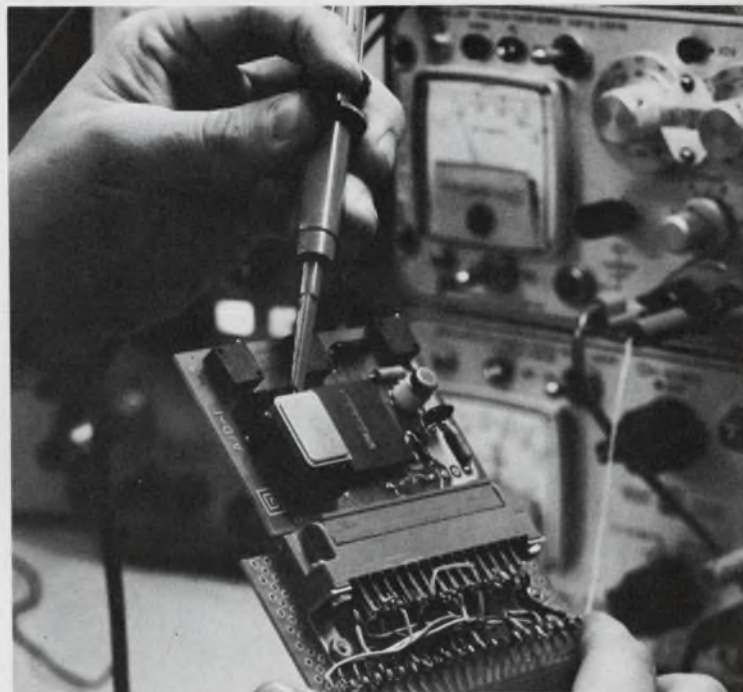

1. At the tip of the probe is the monolithic chip of General Instrument Corp., built into a 10-bit analog-to-digital converter.

value by halting the clock. The output of the D/A ladder may then be evaluated with an accurate dc voltmeter. Most analog-generated sweeps are monitored by Schmitt triggers or other comparators that mark levels for synchronizing allied apparatus. Such circuits are always subject to dc drift; the level of the digital circuit can be decoded by a logical gate quite simply and accurately.

A digital filter is realized by specifying a computational method that defines how an output value of a function is to be found from past and present values of data.<sup>2,3,4,5,6</sup> The filters may or may not use feedback. With a given memory, the ones with feedback—recursive types—provide sharper cutoffs than nonrecursive types at the expense of more complex processing. Speech processing, for example, requires very sharp cutoff, to prevent crosstalk, and amenable to recursive types. Nonrecursive types have linear phase shifts, which are important in preventing signal distortion in radar and sonar ranging.

The design of recursive filters starts with a continuous transfer function in  $s$ . Then  $s$  is replaced by a numerical operator,  $s'$ , which may be expressed in terms of the  $z$  operator:†

$$s' = G(z).$$

A very important reason for using this approach is that it makes full use of well-known analog filter theories. Consider an input band-limited to  $f_{max}$ . If some low-pass filtering has to be performed with cutoff frequency,  $f_c$ , as shown in Fig. 3a, then the problem is to find the replacement numerical operator that will best approximate the continuous filter over the band of interest.

Take for example an all-pole, low-pass filter which has this analog transfer function:

$$H(s) = \omega_c^n / (s^n + C_1 s^{n-1} + \dots + C_n s + \omega_c^n), \quad (4)$$

or in terms of powers of  $s^{-n}$ :

$$H'(s) = (1/s)^n \omega_c^n / [1 + C_1(1/s) + \dots + \omega_c^n (1/s)^n]. \quad (5)$$

The replacement of  $s$  with a numerical operator that has a unity relative transfer function out to  $f_{max}$  would exactly match this analog response. On the assumption that the minimum sampling rate is being used (i.e.,  $2f_{max}$ ), the relative-transfer functions of typical numerical operators are shown in Fig. 3b, on the same scale as  $f_c$  and  $f_{max}$ . The relative transfer function corresponding to the trapezoidal rule is the only operator that shows a monotonic decrease everywhere in the band 0 to  $f_{max}$ . This operator is therefore selected.

If the sampling rate is increased above the minimum, the trapezoidal rule is still the only one that is free from poles in the band from 0 to  $f_{max}$ . Even if a pole is outside the range, it may still have adverse effects, because it reduces attenuation in the cutoff region.

The powers of  $s$  can be represented with the  $z$  operator:‡

$$s^n \rightarrow \left[ \left( \frac{2}{T} \right) \left( \frac{1 - z^{-1}}{1 + z^{-1}} \right) \right]^n. \quad (6)$$

(The  $n^{\text{th}}$  power indicates a repeated use of the trapezoidal rule.) The substitution described by Eq. 6 is also known as the bilinear transformation.

In a discrete form of a Butterworth filter, the magnitude of the analog type's frequency response is given by:

$$\left| \frac{E_{out}}{E_{in}}(\omega) \right| = \frac{1}{[1 + (\omega/\omega_c)^{2n}]^{1/2}}, \quad (7)$$

where  $n$  is the number of sections. The response is 3 dB down (0.707) at the cutoff frequency ( $\omega = \omega_c$ ). To obtain the digital version, the operator  $s$  is replaced by its numerical counterpart,  $s'$ . Setting  $s' = j\omega'$ , it may be shown that:

†See p. 44.

‡See p. 45 for definition.

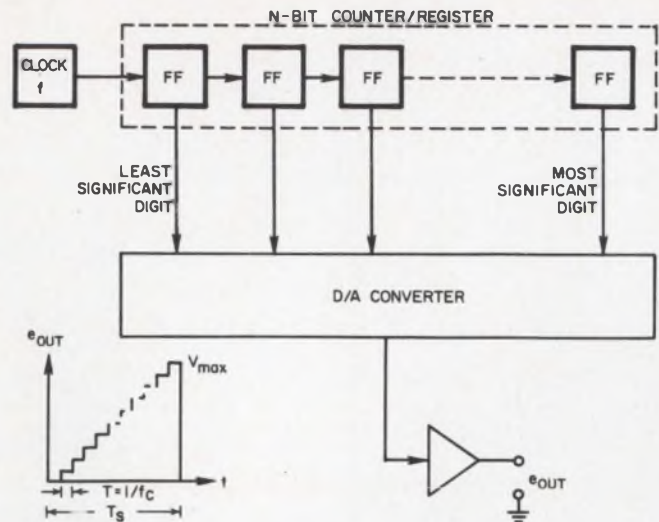

2. Simplest approach to a digital ramp generator involves the counting of pulses. Their rate is scaled for the desired sweep rate. The slope error is  $f_c V_{max}/2^N$ , where  $N$  is the number of steps in the counter and  $f_c$  is the clock frequency.

$$\omega' = \left( \frac{2}{T} \right) \left( \frac{1 - z^{-1}}{1 + z^{-1}} \right) = \frac{2}{T} \tan \frac{\omega T}{2}, \quad (8)$$

since  $z^{-1} = \exp(-j\omega T)$ .

This is called "warping" of the frequency scale, and it is caused by the quantization. Substituting the result of Eq. 8 into Eq. 7 yields:

$$\left| \frac{E_{out}}{E_{in}} \right| = \frac{1}{\left\{ 1 + \left[ \frac{(2/T) \tan(\omega T/2)}{\omega_c} \right]^{2n} \right\}^{1/2}}. \quad (9)$$

Here  $\omega_c$  still represents the cutoff for the analog function. To achieve a 3-dB cutoff at  $\omega_c$ , it also must be adjusted to compensate for the quantization of  $\omega$ . This is accomplished through a "pre-warping" of the cutoff value:†

$$\omega'_c = \frac{2}{T} \tan \left( \frac{\omega_c T}{2} \right) \quad (10)$$

When the value of  $\omega'_c$  of Eq. 10 is substituted into Eq. 9, the response is 3-dB down at  $\omega_c$ . In the case of the trapezoidal rule, the attenuation of the digital filter above  $\omega_c$  becomes higher than it is for its continuous counterpart; the attenuation is infinite at  $f_{max}$ . The extra attenuation after cutoff results from the fact that the replacement numerical operator,  $s'$ , is greater than  $s$ , that is, the relative transfer function,  $(1/s')/(1/s)$ , is less than unity.

### Low-pass filter is easy to design

In the design of a two-section ( $n = 2$ ), 10-radian-per-second, low-pass filter, a sampling time of 0.01 second is chosen on the assumption that the maximum input frequency,  $f_{max}$ , is 50 Hz, or 314 rad/s. The second-order Butterworth polynomial is of the form:

$$B_2(s) = s^2 + (\sqrt{2})s + 1,$$

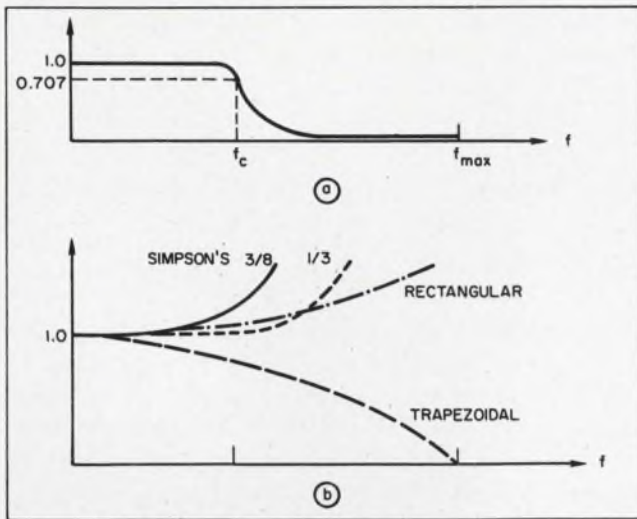

3. Low pass filtering requires the spectrum in (a) with a cutoff frequency  $f_c$  at the 3-dB point. The relative transfer functions of four numerical integrators (b) show that the trapezoidal operator approaches most closely the analog shape.

and its analog response becomes:

$$\frac{E_{out}}{E_{in}} = \frac{1}{s^2 + (\sqrt{2})s + 1} \quad (11)$$

The transformation to  $\omega'_c$  radians per second is made by substituting  $s/\omega'_c$  for  $s$  in Eq. 11:

$$\frac{E_{out}}{E_{in}} = \frac{(\omega'_c)^2}{s^2 + (\sqrt{2})\omega'_c s + (\omega'_c)^2} \quad (12)$$

The prewarped value,  $\omega'_c$ , is given by

$$\begin{aligned} \omega'_c &= \frac{2}{T} \tan\left(\frac{\omega_c T}{2}\right) = \frac{2}{0.01} \tan\frac{(10)(0.01)}{2} \\ &= 10.006 \approx 10. \end{aligned}$$

(A value of 10 will be used to simplify calculations.)

The transformed and prewarped continuous transfer function becomes:

$$\frac{E_{out}}{E_{in}} = \frac{100}{s^2 + 14.14s + 100} \quad (13)$$

Now the bilinear substitution is made in order to obtain the numerical equivalent. This yields:

$$\frac{E_{out}}{E_{in}}(z) = \frac{100}{D}, \quad (14)$$

where:

$$\begin{aligned} D &= \left[ \left( \frac{2}{T} \right) \left( \frac{1 - z^{-1}}{1 + z^{-1}} \right) \right]^2 \\ &+ 14.14 \left( \frac{2}{T} \right) \left( \frac{1 - z^{-1}}{1 + z^{-1}} \right) + 100. \end{aligned}$$

Substitute  $T = 0.01$ , multiply both numerator and denominator by  $(1+z^{-1})^2$ , and collect terms. The result is:

$$\frac{E_{out}(z)}{E_{in}(z)} = \frac{100(1 + 2z^{-1} + z^{-2})}{E}, \quad (15)$$

where  $E = 42,928 - 79,800z^{-1} + 37,272z^{-2}$ . Since

$z^{-1} = \exp(-j\omega T)$ , the final form of the output voltage is:

$$\begin{aligned} E_{out}(t_0) &= \{100[E_{in}(t_0) + 2E_{in}(t_0 - T) \\ &+ E_{in}(t_0 - 2T)] + 79,800E_{out}(t_0 - T) \\ &- 37,272E_{out}(t_0 - 2T)\} / 42,928. \quad (16) \end{aligned}$$

Hardware that can perform the arithmetic specified by Eq. 15 or Eq. 16 will synthesize the desired filter.

#### A quick check of accuracy

One method of checking the result is to rely on the fact that, for low-pass filters, a unit step input results in a steady-state unit amplitude output. The  $z$ -transform final value theorem can be used to verify the accuracy of the transfer function of Eq. 15. This theorem defines the relation between the final, steady-state values in the time domain and in the  $z$  domain of any function:

$$\lim_{t \rightarrow \infty} f(t) = \lim_{z \rightarrow 1} \frac{z-1}{z} F(z).$$

where  $F(z)$  is the  $z$  form of  $f(t)$ . Since the  $z$  transform of a unit step is  $z/(z-1)$ , the test criterion simplifies to:

$$\lim_{t \rightarrow \infty} f(t) = \lim_{z \rightarrow 1} F(z).$$

By this test, Eq. 15 takes on the value 400/400, the desired unity gain.

The design of the 2-pole Butterworth filter by the  $z$  transform (Eq. 15) requires general-purpose hardware with the ability to multiply, add and divide.

An alternative solution is to use digital-differential-analyzer (DDA) techniques. A serial-type DDA module, performing rectangular integration, is available from General Instrument. Although the device can perform serial multiplication on a bit-by-bit basis, by adding and shifting, some approximations will be made to avoid this in the interests of computation speed.

#### Approximation speeds computer

The original transfer function contained terms in 100 and  $10\sqrt{2}$ . These constants may be approximated with the nearest power of 2, namely, 128 and 16. This permits multiplication to be done by shifting the binary point in a single step, rather than on a bit-by-bit shift-and-add basis, thus saving considerable computing time. The analog transfer function becomes:

$$\frac{E_{out}}{E_{in}} \approx \frac{128}{s^2 + 16s + 128} \quad (17)$$

The use of 128 in place of 100 and 16 in place of  $10\sqrt{2}$  preserves the Butterworth response, although some deviation will occur in other cases. The resulting filter (see Fig. 4) cuts off at 11.3 rad/s, about 10% higher than the intended design.

This is no worse than could be expected with analog components with 10% tolerances. If the hardware is to be kept simple, maximum use has to be made of such devices to avoid time-consuming bit-by-bit multiplication with a single register and adder. However, read-only memories are becoming available in LSI form and could be used to store the coefficients, if greater accuracy were needed. The sequential operation requires the following steps:

$$\left. \begin{aligned} E_1 &= E_{in} - E_{out} \\ E_2 &= 8 E_1 \\ E_3 &= E_2 - E_5 \\ E_4 &= 16 E_3 \\ E_5 &= E_5 + E_4 T \end{aligned} \right\} \quad (18)$$

The hardware required to implement Fig. 4 costs much more than the inductor, resistor and capacitor needed for the analog approach. Should the designer need to filter digital data, however, it is cheaper than a D/A or A/D.

Because feedback exists, care must be taken to avoid additional, excessive phase shifts due to discrete operation. The rectangular rule is attractive because of its minimum hardware requirements, but since each integrator contributes an excess phase lag of  $\omega T/2$  radians, a sampling rate 5 to 10 times greater than the theoretical minimum is suggested, to maintain acceptable response.

#### For averaging, use filters without feedback

A nonrecursive filter is one with an output that is solely a function of the inputs, that is, there is no feedback. The output is a convolution product

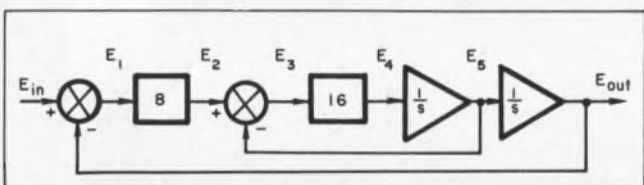

4. Butterworth filter is designed with analog programming techniques and digital devices. The multiplication is performed by shifting the binary point in a single step.

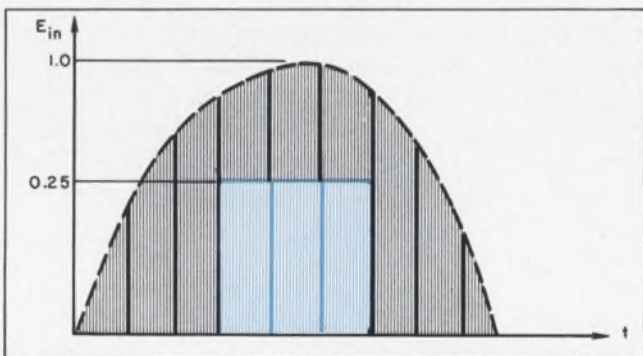

5. A non-recursive filter essentially averages the input. The output is a convolved product of the sampled input and the transfer function of the filter. Such a convolution is shown above, of a sampled sine wave and the filter's aperture that's four samples wide.

of the sampled input and the filter's transfer function. A general quantized form of transfer function of such a filter is given by:

$$E_{out}(z)/E_{in}(z) = A_0 + A_1 z^{-1} + A_2 z^{-2} + \dots + A_n z^{-n} \quad (19)$$

Since  $z^{-1}$  is the unit delay operator of  $T$  seconds, Eq. 19 may also be written:

$$E_{out}(t) = A_0 E_{in}(t) + A_1 E_{in}(t-T) + A_2 E_{in}(t-2T) + \dots + A_n E_{in}(t-nT) \quad (20)$$

The coefficients  $A_k$  are determined by the required time-domain response. These coefficients form a time-base window, or aperture. All  $A_k$ s may be set equal to  $1/k$ , thus making the output the arithmetic average of the last  $k$  input component. In essence, the filter averages the input.

For the sake of discussion, assume a value of 4 for  $k$ , a single-frequency sinusoidal input and a minimum sampling rate. The convolution is illustrated in Fig. 5. The response in the frequency domain is found by summing the output series:

$$E_{out} = \frac{1}{4} [e^{j\omega t} + e^{j\omega(t-T)} + e^{j\omega(t-2T)} + e^{j\omega(t-3T)}] \\ = \frac{1}{4} e^{j\omega t} [1 + e^{-j\omega T} + e^{-j2\omega T} + e^{-j3\omega T}] \quad (21)$$

Since  $E_{in} = e^{j\omega t}$ , then:

$$\frac{E_{out}(\omega)}{E_{in}(\omega)} = \frac{1}{4} [1 + e^{-j\omega T} + e^{-j2\omega T} + e^{-j3\omega T}] \quad (22)$$

After algebraic manipulation, the latter equation may be simplified to:

$$\frac{E_{out}(\omega)}{E_{in}(\omega)} = \frac{\sin(2\omega T)}{\sin\left(\frac{\omega T}{2}\right)} \angle -\frac{3\omega T}{2} \quad (23)$$

The negative side lobe in the response curve in Fig. 6 may be removed by using 4 samples per cycle as the minimum rate. In this case, the transfer function becomes zero at the highest frequency input. The rather slow rate of cutoff is characteristic of nonrecursive filters.

The method of averaging may be readily generalized to include  $m$  consecutive samples. The sampling time  $T$  may be made very short in comparison with the highest frequency in the input; in other words, a great many samples may be taken per cycle. A continuous shortening of  $T$  and increase of  $m$  result ultimately in the continuous or analog aperture.

The impulse response of the continuous aperture is:

$$\frac{1 - e^{-s\tau}}{s} \quad (24)$$

The frequency response of the continuous aperture is:

$$\frac{\sin\left(\frac{\omega\tau}{2}\right)}{\omega\tau/2} \angle -\frac{\omega\tau}{2} \quad (25)$$

This result is identical to that of the sample-and-

hold, or data-reconstruction filter.

A numerical aperture with a small  $T$  has a response almost identical to that of the continuous averaging window. A large number of samples results in a frequency response of:

$$\frac{E_{out}(\omega)}{E_{in}(\omega)} \approx \frac{\sin\left(\frac{\omega\tau}{2}\right)}{\frac{\omega\tau}{2}} \angle -\frac{\omega}{2}, \quad (26)$$

where it has been assumed that:

$$m-1 \approx m$$

$$mT = \tau \approx (m-1)T$$

$$\text{If } \omega T \ll 1 \text{ radian, } \sin(\omega T/2) \approx \omega T/2$$

Equations 25 and 26 are identical, indicating that the numerical approximation can approach very close the ideal analog averaging window. The digital approach in fact more nearly resembles the ideal window with its infinitely steep sides and flat top than do realizable analog designs, which have sloping sides and may sag on the top.

The block diagram of the averaging circuit is in Fig. 7. A register is required to store each input sample. The procedure for updating the average and reading in a new sample comprises four steps:

- The oldest sample is subtracted from the output register.
- The three remaining samples are advanced or shifted forward to the next highest register.
- The newest sample is registered and added to the output; the new output register total is shifted two places to the right to divide by four and obtain the average.
- The procedure is repeated before the arrival of the next sample; after four steps, a sample is discarded.

The technique of averaging can be extended to design other apertures, such as Gaussian and triangular. The frequency responses may be found by summing the output series.

In summary, a continuous transfer function may be approximated in digital form by substituting a numerical form for the continuous operator,  $s$ . Knowledge of the highest frequency component of the input signal is used to select an appropriate sampling time,  $T$ , and the discrete operator. The relative frequency transfer function of the discrete operator may then be used to prewarp the continuous transfer function, so that the numerical transfer function better matches its continuous counterpart. The final step in the synthesis procedure is to substitute the numerical operator into the prewarped continuous form.

Several numerical forms are available and the optimum design involves a trade-off study among hardware complexity, the sampling time  $T$ , and the amount of arithmetic processing.

The successful design of digital devices requires a working knowledge of basic numerical-analysis

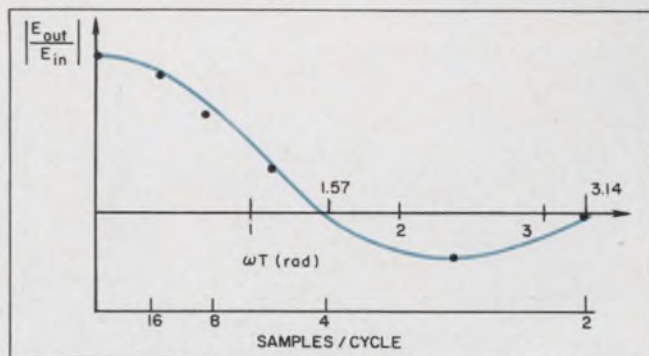

6. Frequency response of averaging filter that takes in four samples has a negative sidelobe. The unwanted sidelobe may be eliminated by selecting a sampling rate of four samples per cycle, which makes the transfer function zero at the highest frequency input.

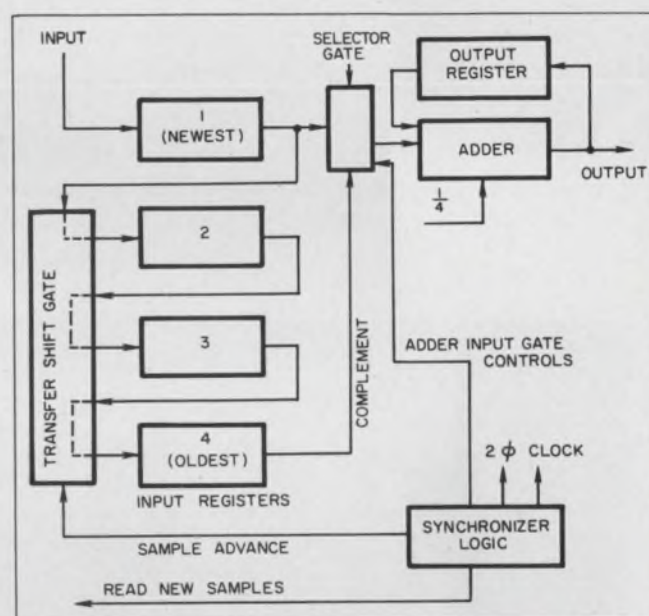

7. Logic diagram of an arithmetic averager uses four samples, updates the average and reads out the result in four steps.

techniques. The design emphasis is on applying functional building blocks rather than individual components, to realize hardware specified by a numerical transfer function. ■ ■

#### References:

1. Donald Breslow, "Infinite  $Z_{out}$  Current Source Generates Long, Linear Sweeps," *ELECTRONIC DESIGN*, XIII, No. 13, (July 19, 1965), 28-31.
2. R. Boxer and S. Thaler, "A Simplified Method of Solving Linear and Nonlinear Systems," *Proc. IRE*, XLIV, June, 1956, 89.
3. R. Boxer, "A Note on Numerical Transform Calculus," *Proc. IRE*, XLV, Oct., 1957, 1401.
4. F. Kuo and J. Kaiser, *System Analysis by Digital Computer*, (New York: John Wiley & Sons, 1966), Chap. 7, pp. 222-225.
5. C. Rader and B. Gold, "Digital Filter Design Techniques," *Proc. IEEE*, LV, No. 2 (Feb., 1967), 149.
6. J. Salzer, "Frequency Analysis of Digital Computers Operating in Real Time," *Proc. IRE*, XLII, Feb., 1954, 457.
7. F. Kuo and J. Kaiser, *op. cit.*

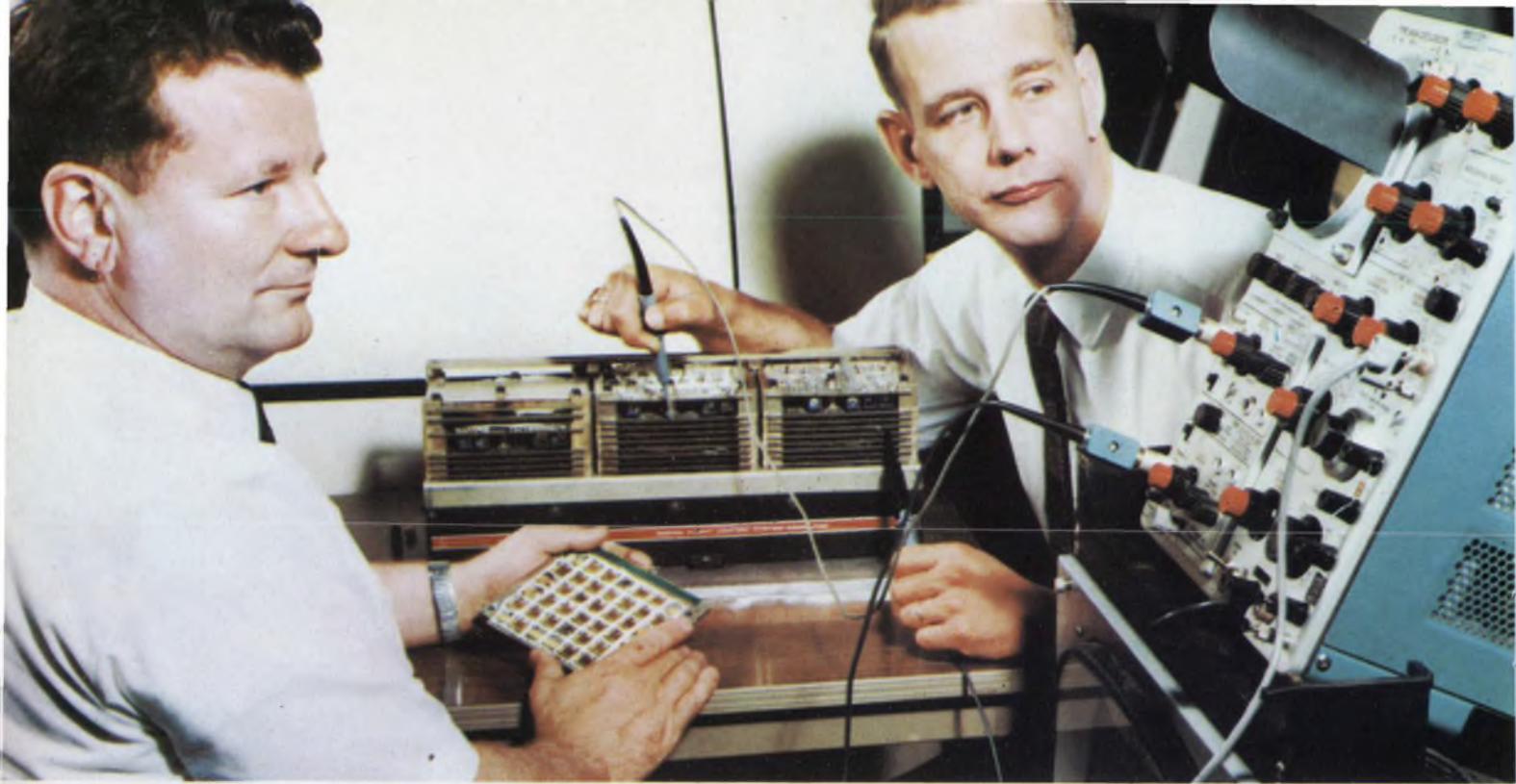

Checking out a digital control system, George Sendzuk eyes the waveforms on the oscilloscope, while John Prince

probes the circuits. About 600 flatpacks are used in the system, mounted on boards, like the one in George's hand.

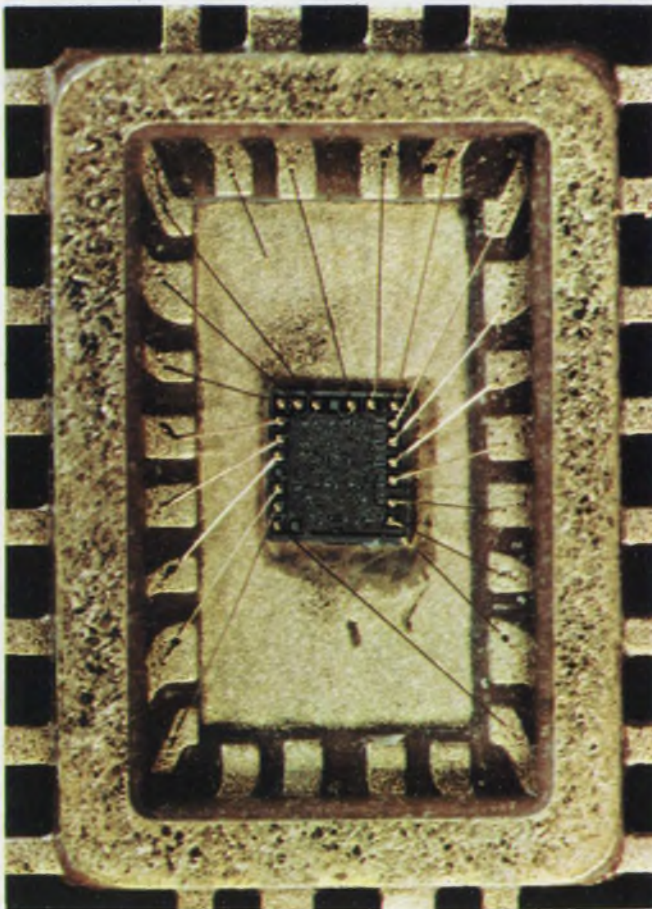

Increment selector has two control inputs, to clear all storage and to hold the operation. The latter allows the operator to check the results.

Salted away in this tiny variable storage array are 296 devices. The array is shown surrounded by table-salt crystals. It is one of the four MOS building blocks.

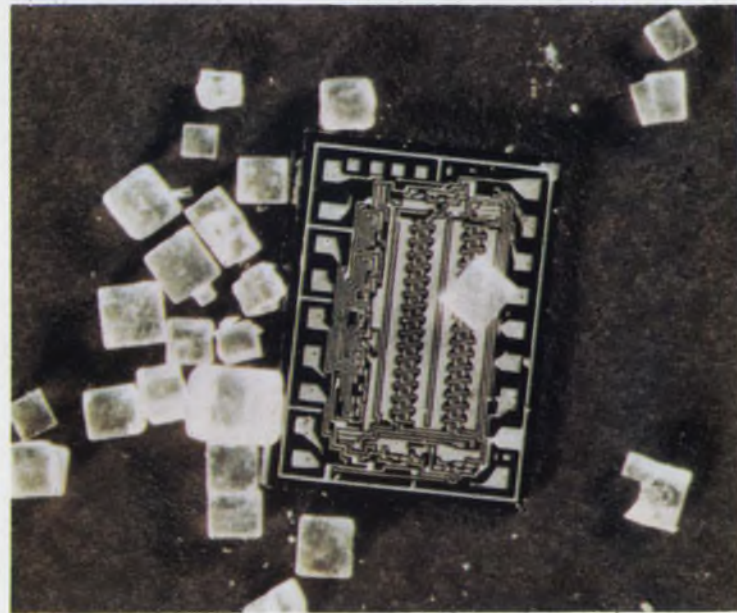



# Build filters with MOS chips:

they can reproduce most analog response shapes and yield accurate and predictable results.

Driftless filters with time constants ranging from a few milliseconds to several days and with exactly zero-dB dc gain are now at the fingertips of knowledgeable designers.

Four digital flat packs of metal-oxide silicon semiconductor arrays make this feat possible. They can be wired together to build high-order filters with complex transfer functions. The designer "programs" for the desired response curve through the wiring.

Besides accurately predictable performance, the digital approach is simple and does not cost much. It pays to use it to solve very basic problems like lead or lag filters, for example, as well as more complicated cases, such as control systems where the input consists of samples of continuous variables. Other possibilities include threshold detection, limiting of variables, threshold logic for control purposes, nonlinear filters with variable time constants, and data-mixing filters with more than one input.

The following discussion of filters takes a time-filtering point of view, but the independent variable does not need to be time. In filtering radar information, for example, the independent variable could just as well be the sequential numbers of the target returns. Such a filter could then be used to average fluctuations that do not depend on time.

The digital approach to filters is based on the solution of their differential equation. The MOS

---

George T. Sendzuk, Manager, and John S. Prince, Special Circuits Engineer, GE Avionic Controls Dept., Johnson City, N. Y.

arrays are wired together to solve this equation in real time by numerical integration. The integration is accomplished through a so-called incremental digital computation. The incremental technique involves calculating only the change in the variable, which occurs between successive solutions. Of course, it would also be possible to add up all the increments, to find the total change.

## The basic tool is incremental computation

The multiplication of two variables illustrates the method of incremental computation. It also provides a background for understanding the function of each of the four types of MOS array. Any mathematical manipulation that can be accomplished with only one increment-selection process is defined as an algorithm. A single level of integration is an algorithm, for example. Double integration requires two algorithms. This concept of algorithm will be handy later, when the number of flat packs has to be determined.

Let the desired product be:

$$Z = UV/S_z, \quad (1)$$

where  $S_z$  is a constant scale factor. In a mathematical sense, this is a perfectly valid expression. In a practical system that operates with a finite number of digits, however, the equality cannot be met at all times. The following numerical example, for instance, results in an infinite binary fraction:

$$Z = (10)(10)/9 = 11.11111\text{+ (decimal)}.$$

Because the output of each calculation is the change in the answer  $\Delta Z$ , any error, no matter how small, will be cumulative over many iterations and will cause the calculation to drift. The above definition is therefore unsatisfactory. The basic, scaled multiplication operation must be redefined, so that the answer is exactly correct with a finite number of digits.

## The trick is a remainder

The introduction of a fractional residue or remainder term solves this accuracy problem. If the computation is taken to involve integers only, with variables scaled up to achieve the desired precision, the scaled product may be defined as:

$$Z + R/S_z = UV/S_z. \quad (2)$$

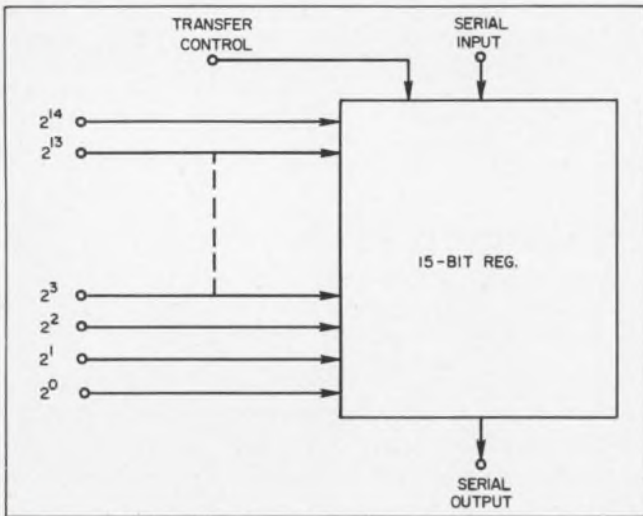

1. **Scale-factor array** generates scaling factor  $S_z$  by transforming a parallel input number into a 15-bit shift register. The chip contains 145 devices in a 0.037-by-0.074-inch area.

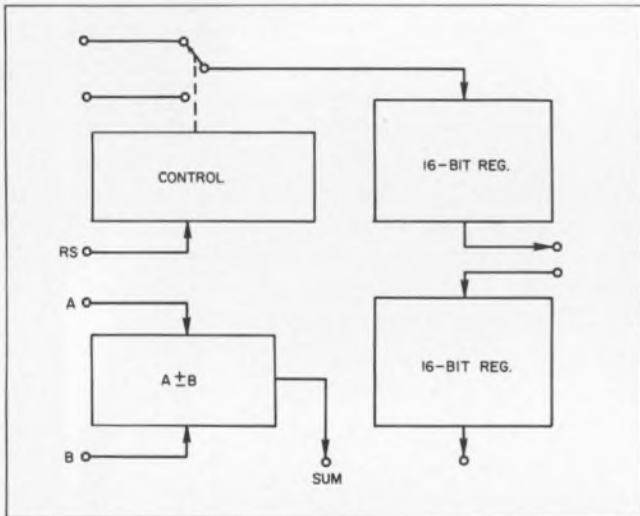

2. **Variable-storage array**, or register chip, has two shift registers and an adder-subtractor (a). It generates and stores the whole-number form of the needed variables, and updates their values. The chip (b) contains 296 devices in a 0.061-by-0.084-inch area.

In this case only integers are involved. The quantity  $R/S_z$  represents any fractional part of the scaled product and Eq. 2 is an exact representation.

Now it is possible to find  $\Delta Z$ , the change in the product between any two successive solutions.

First, eliminate the fractions by multiplying both sides by  $S_z$ , and add subscripts to identify the  $i^{th}$  iteration:

$$S_z Z_i + R_i = U_i V_i. \quad (3)$$

By definition of increments and whole numbers, the following statements are valid:

$$\left. \begin{aligned} U_i &= U_{i-1} + \Delta U_i. \\ V_i &= V_{i-1} + \Delta V_i. \\ Z_i &= Z_{i-1} + \Delta Z_i. \end{aligned} \right\} \quad (4)$$

Equation 3 may therefore be written in terms of the previous iteration, to introduce the parameter of interest,  $\Delta Z$ :

$$S_z Z_{i-1} + S_z \Delta Z_i + R_i = (U_{i-1} + \Delta U_i)(V_{i-1} + \Delta V_i). \quad (5)$$

At the end of the previous iteration, Eq. 3 has the form:

$$S_z Z_{i-1} + R_{i-1} = U_{i-1} V_{i-1}. \quad (6)$$

To find  $\Delta Z_i$ , it is necessary only to subtract Eq. 6 from Eq. 5:

$$S_z \Delta Z_i + R_i = R_{i-1} + U_i \Delta V_i + V_{i-1} \Delta U_i. \quad (7)$$

To simplify the terminology, let Eq. 7 be equal to a quantity  $\rho_i$ :

$$S_z \Delta Z_i + R_i = \rho_i = R_{i-1} + U_i \Delta V_i + V_{i-1} \Delta U_i. \quad (7a)$$

The remainder term,  $R$ , can be eliminated by considering the previous iteration,  $R_{i-1} = \rho_{i-1} - S_z \Delta Z_{i-1}$ . Substitute this expression into Eq. 7a to obtain:

$$\rho_i = \rho_{i-1} - S_z \Delta Z_{i-1} + U_i \Delta V_i + V_{i-1} \Delta U_i. \quad (8)$$

Equation 7a yields the incremental change in the multiplication product:

$$\Delta Z = (\rho_i - R_i) / S_z \approx \rho_i / S_z. \quad (8a)$$

The approximation is valid since the aim is to have the smallest possible remainder,  $R_i$ . The quantity  $R$  is a whole-number residue, which remains after a  $\Delta Z$ , an integer, is selected to represent the change in the scaled product.

To avoid drift, which is the cumulative error over several iterations, the residue must be saved after each iteration and introduced into the succeeding iteration as an input. Because of timing requirements, the quantity  $\rho_i$  is placed in storage in actual operation. But, since it contains the residue information, it also makes possible the continual computation of the double precision product of  $U_i$  and  $V_i$ .

### MOS LSI arrays offer flexibility

Four steps are necessary to solve the typical algorithm just worked out:

- Generate the arbitrary scale factor.
- Find the whole-number form of variables.

Table 1. Examples of typical functions

FUNCTION	NO. OF FLAT PACKS	FUNCTION	NO. OF FLAT PACKS
$Z = X_{\text{INPUT}}$	3	$Z = \sqrt{S_w W \pm XY}$	11
$Z = S \pm X$	1	$Z = \frac{UV \pm XY}{S_z}$	12
$Z = \sqrt{S^2 \pm X^2 \pm Y^2}$	12	$Z = \frac{S_w W + S_x X + S_y Y}{S_z}$	10
$Z = \frac{S_w W \pm XY}{V}$	12	$Z = \frac{S_w W \pm XY}{S_z}$	10

- Multiply the selected whole number by an increment and sum the product with another whole number.

- Provide the ratio of the two whole numbers.

Large-scale integration (LSI) makes it possible to construct only four MOS arrays to perform these operations. Each chip takes care of one of the above steps.

The scale-factor array (Fig. 1) generates the serial scaling constant,  $S_z$  by performing the parallel transfer of an externally wired number into a 15-bit shift register, and then shifting the number into the calculation as required.

The register chip generates the whole-number form of the variable  $U_i$  by summing the  $\Delta U_i$  increments. This MOS array contains two 16-bit shift registers, which are normally cascaded to provide storage for a 32-bit word, and a whole-word adder-subtractor (Fig. 2). By forming a loop of the registers and adder-subtractor, it is possible to add  $\Delta U_i$  to the whole word,  $U_{i-1}$ , which is stored in the register.

The old value of a whole-word variable is available at the register output, and the updated value is available at the adder-subtractor output. This type of circuit is used for the accumulation and storage of the whole numbers  $U_i$ ,  $V_{i-1}$ , and  $\rho_i$ . This chip has the logic equivalent of a single-pole, double-throw switch at its input for the circuit that may feed in the initial whole number.

The increment multiplier chip (Fig. 3) can multiply a whole number by an increment and sum this product with another whole number. It forms the products indicated in Eq. 8 and adds the products formed by other multiplier chips.

The sign of the increment input to an increment multiplication is handled separately. The sign bit goes to a complemter which passes the input number unchanged in case of a positive increment, or takes the two's complement when the sign is negative.

The increment selector circuit (Fig. 4) evaluates Eq. 8a by examining the bits of  $\rho_i$  and  $S_z$  as they enter its logic circuitry. At the time of transfer of the sign bits of these two input numbers, the chip provides their ratio, expressed to the closest power of two or zero. The mechanization in this case is somewhat simplified because the choice is between 0 and  $2^0$ .

As in the increment multiplier, the sign of the increment is handled separately. The signs of bits  $\rho$  and  $S_z$  determine the sign of the increment. Both the magnitude and sign of  $\Delta Z$  are stored in internal flip-flops, to await a control pulse that signifies the beginning of the next solution. At that time both  $+\Delta Z$  and  $-\Delta Z$  are transferred simultaneously to all the places needed in the overall calculations. The data transfer pulse normally occurs coincidentally with the sign bit, so that no

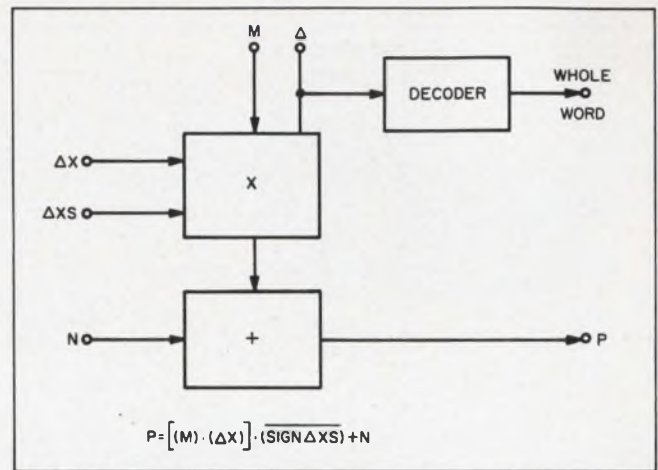

3. Increment multiplier chip multiplies a whole number by an increment and adds the result to another whole number. It forms the products in Eq. 7a. Additional logic is available through  $\Delta XS$ , which is a switching input.

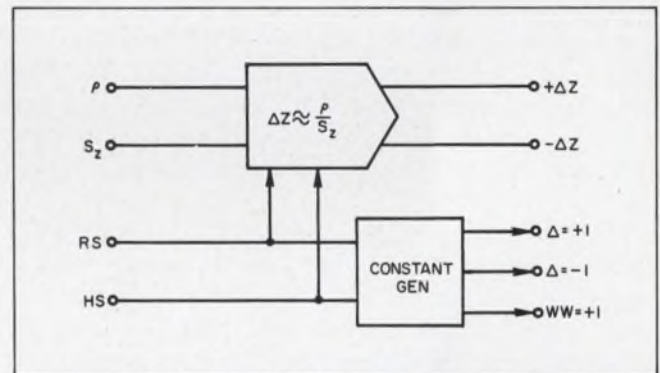

4. Increment selector chip provides the ratio of two whole numbers, expressed to the closest power of two or zero. The two controlling inputs are a reset switch input, RS, that clears the storage for reset, and a hold switch input, HS that stops the transfer of  $\Delta Z$ s and allows the operator to check for correctness.

Table 2. Some first-order filters

TRANSFER FUNCTION	FREQUENCY RESPONSE	NO. OF FLAT PACKS
$\frac{Z}{X} = \frac{1}{T_2 S}$		6
$\frac{Z}{X} = T_1 S$		6
$\frac{Z}{X} = \frac{T_1 S}{T_2 S + 1}$		8
$\frac{Z}{X} = \frac{1}{T_2 S + 1}$		8
$\frac{Z}{X} = \frac{T_1 S + 1}{T_2 S}$		8
$\frac{Z}{X} = T_1 S + 1$		8
$\frac{Z}{X} = \frac{T_1 S + 1}{T_2 S + 1}$		10

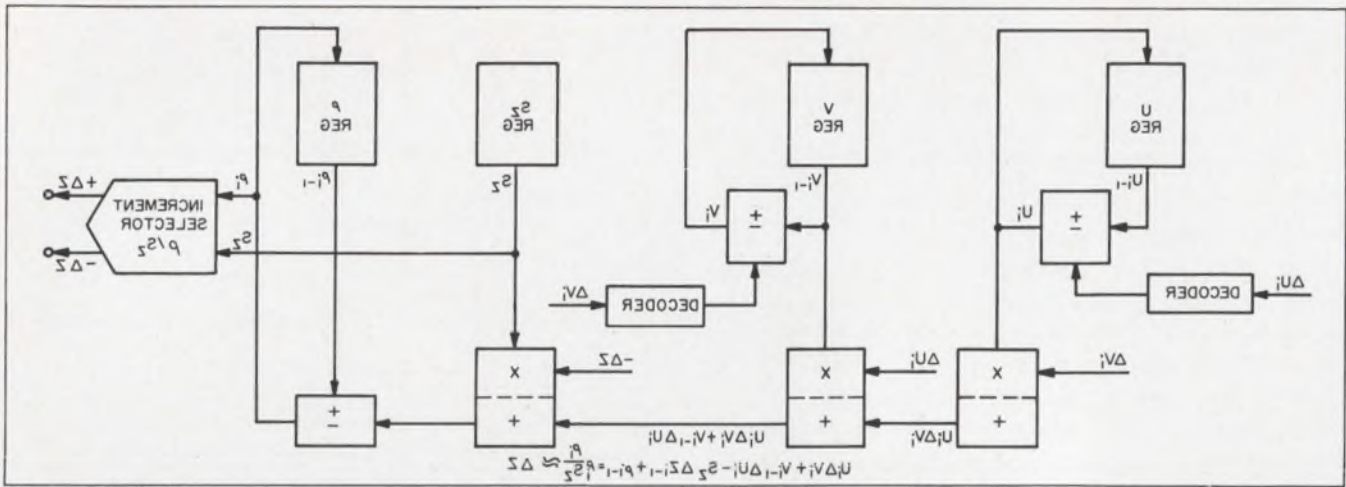

5. Multiplication scheme uses eight flat packs: three registers, one scale-factor array, three multipliers and

one increment selector. The solution rate may be as high as 10,000 bits per second.

time is wasted between successive solutions.

The increment-selector array also includes circuits that generate the constant increments +1 and -1, which represent increments for the integration with respect to time, and can also function as constants in certain other calculations. The number +1 may also be useful as a scale factor.

Two controlling inputs are needed for the increment selector: *RS*, a reset switch input, which clears all storage for computer reset, and *HS*, the hold switch input. When the *HS* terminal is grounded, the algorithm goes into the hold mode of operation: the transfer of its  $\Delta Z$  outputs is inhibited until *HS* is ungrounded. The calculations otherwise proceed normally. This mode is a very useful debugging tool; it permits the unscaled answer for the "holding" computation to accumulate in the  $\rho$  register, where it can easily be examined for correctness.

### Two auxiliary circuits increase versatility

The design of the multiplier chip can be expanded to include some logic and program-branching capability. The  $\Delta XS$  switching input in Fig. 3a is called the *increment input terminal*. If the increment that drives the  $\Delta XS$  input has a negative sign, the product,  $M \cdot \Delta X$ , becomes equal to zero for that iteration, where  $M$  may be the output of the register chip. If the  $\Delta XS$  increment has a positive sign, the product is allowed to pass and is added to the input.

The other auxiliary building block is an *addition increment decoder*. It is built into the increment multiplier array, but used in conjunction with the variable storage-register chip. It comes into play when increments appear in a two-bit code that is incompatible with the whole-word arithmetic. The increment decoder then changes the format of this irregular two-bit number to the

equivalent 32-bit, two's complement number, and feeds the proper value to the whole-number adder-subtractor.

The system that performs the multiplication consists of eight flat packs: three registers, one scale-factor array, three multipliers and one increment selector, connected as shown in Fig. 5.

Many other mathematical functions can be mechanized as a single operation. A partial list of typical functions of up to four variables are compiled in Table 1, along with the number of chips needed to realize them. For each of these operations, the summation of the  $\Delta Z$ s is the whole-number answer. The accuracy is  $\pm 1$  unit of  $Z$ , provided that the true answer does not change at a rate that exceeds one unit per solution of the computer. If the answer does exceed this rate dynamically, the residue will temporarily build up in the  $\rho$  register while the  $\Delta Z$  output proceeds at its maximum rate toward the correct answer. Such a condition, known as rate limiting, occasions only a temporary transient error.

Note that the scale factors can be either positive or negative integers. The computer calculates only the real part of square roots, that is, the square root of a negative number appears as zero.

### First-order filters are built with 10 flat packs

This computing concept has potential for evaluating and building frequency-response compensation filters. By integrating their differential equations in real time, a nearly unlimited variety of responses can be obtained with time constants ranging from a few milliseconds to several days. For present purposes, the filters will be grouped according to the power of  $s$  (or  $j\omega$ ) in the transfer function; first-order means that only  $s^1$  appears, second-order means that  $s^2$  is also involved, and so on.

Seven different forms of first-order filter are

shown in Table 2 with the required number of MOS circuits. Filters with transfer functions of the form  $as + b$  turn out to be noisy and are not normally used. Instead, forms of the type  $as/(bs+1)$  or  $(as+1)/(bs+1)$  are preferred in practical systems, despite their limited high-frequency gain. Their denominators' time constant is made short enough for it to have no adverse effect on system performance, but long enough to limit high-frequency noise.

The block diagram of a typical lead-type filter is shown in Fig. 6. This filter, which has numerator and denominator time constants of 1.0 and 0.1, respectively, can be built from only ten flat packs. Because the time constants are determined by programmed digital numbers, they are not subject to drift. Neither is the dc gain of the filter; it is precisely zero dB and determined by the computational algorithm.

Each of the filters in Table 2 can be cascaded either with circuits that perform arithmetic calculations or with the other filters.

Cascaded simple filters yield second-order filters with complex transfer functions. Table 3 is a partial list of second-order filters with the number of MOS arrays needed to realize them. The numbers beside the response curves indicate the gain-versus-frequency slope in units of 6 dB/octave, or 20 dB/decade. These slopes are useful in estimating the respective phase characteristics, as each form is a minimum-phase filter.

The last three filters in Table 3 are particularly useful for automatic flight control of flexible space vehicles and large supersonic aircraft. A problem of these vehicles is structural vibration modes that are within the frequency spectrum of flight-control system response. If the vibration modes are allowed to excite the control system, aircraft instability may result. A notch filter is therefore needed to eliminate such signals from the control loop.

### More work is needed at high frequencies

The results to date look very encouraging for the application of the LSI MOS incremental calculation to control-system problems. Scaling must be done carefully, however, to take advantage of the computer's high solution rate. This is particularly true in the case of filters with substantial high-frequency gains, because rate limiting will temporarily degrade filter performance near the high-frequency end of the response curve. The predominant effect is excessive phase lag, which increases rapidly with frequency. A lesser effect is a reduction of the filter's high-frequency gain.

The development of MOS circuitry with nearly two orders of magnitude increase in rate-following ability will help solve this problem. ■ ■

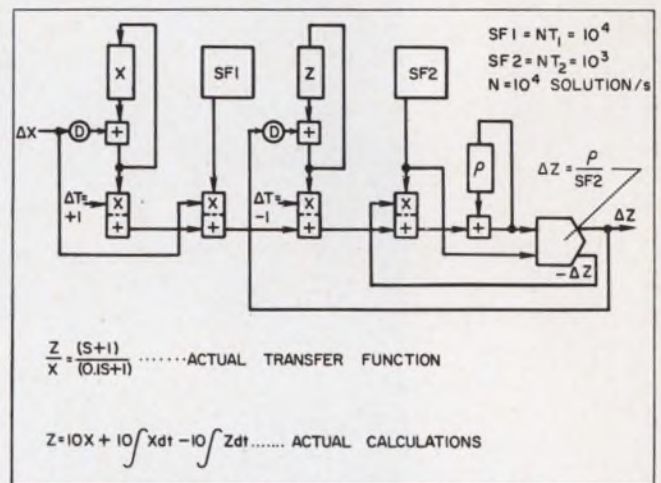

6. Lead filter needs 10 flatpacks to realize the transfer function of  $(s + 1)/(0.1s + 1)$ . This is converted first to its integral equivalent form and then to a form that can be executed with the chips.

Table 3. Some second-order filters

TRANSFER FUNCTION	FREQUENCY RESPONSE	NO. OF FLAT PACKS
$\frac{Z}{X} = \frac{k}{S^2}$		12
$\frac{Z}{X} = \frac{k(T_1 S + 1)}{S^2}$		14
$\frac{Z}{X} = \frac{k(T_1^2 S^2 + 2\zeta_1 T_1 S + 1)}{S^2}$		16
$\frac{Z}{X} = \frac{T_1 S + 1}{T_2^2 S^2 + 2\zeta_2 T_2 S + 1}$		18
$\frac{Z}{X} = \frac{kS(T_1 S + 1)}{T_2^2 S^2 + 2\zeta_2 T_2 S + 1}$		18
$\frac{Z}{X} = \frac{T_1^2 S^2 + 2\zeta_1 T_1 S + 1}{T_2^2 S^2 + 2\zeta_2 T_2 S + 1}$		20

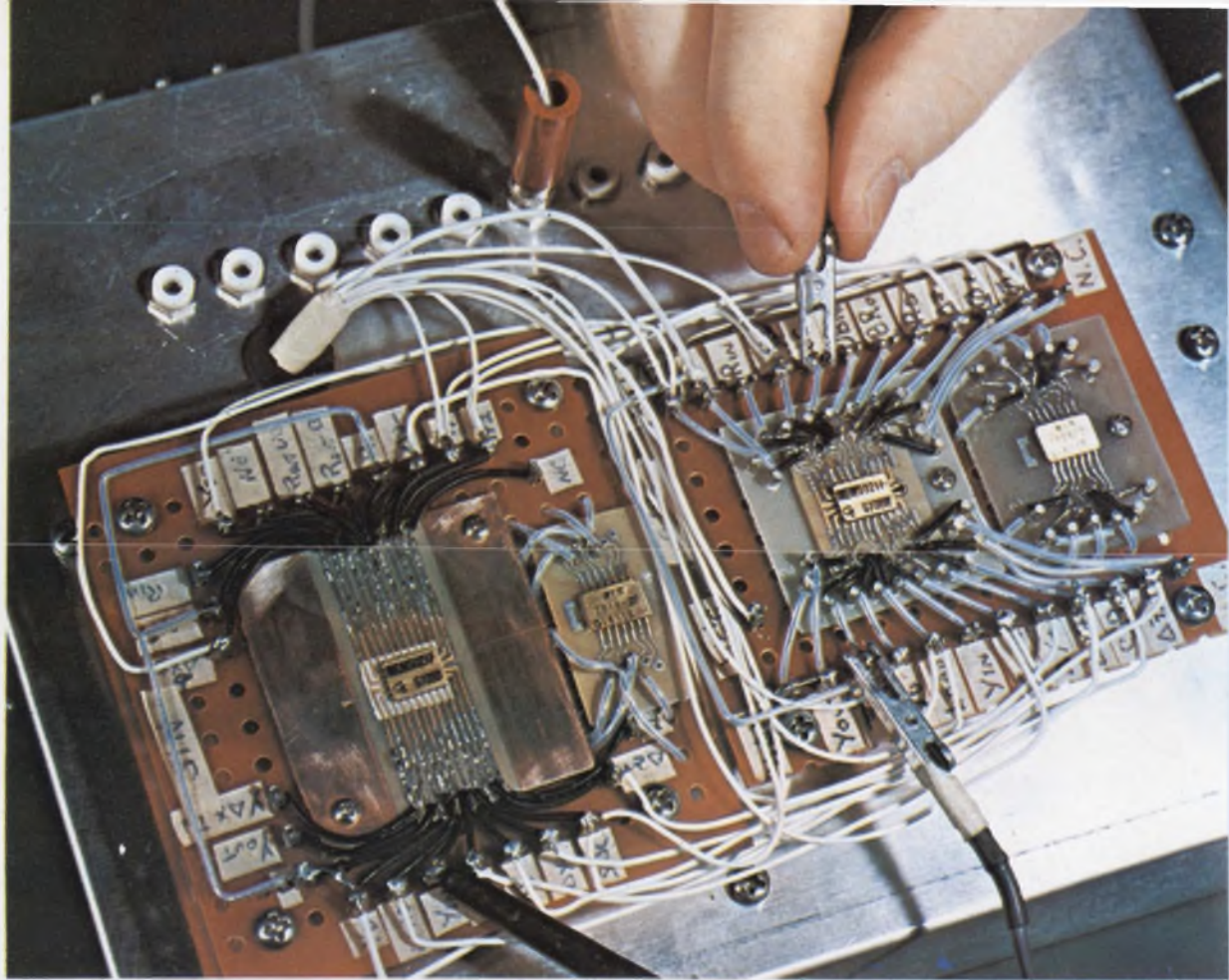

Basic integrator of sine-cosine generator consists of an adder and a shift register. Both are available from several manufacturers.

Testing the digital sine-cosine generator, Jim Garvey inspects the two signals on the 'scope that represent the sine and the cosine functions.



# Resolve angles with samples

if your main goal is precision; but if it is speed, the analog approach is still unbeatable.

Sine and cosine generation is important in many control systems where coordinate transformation is essential. Environment, size and weight consideration usually demand that a system should be small, accurate and reliable.

In the all-electronic category analog resolvers have hitherto been unchallenged. But the development of digital-differential-analyzer (DDA) integrators on two metal-oxide silicon chips has made the cost of a digital approach comparable to that of the analog.

Now the choice has to be made on the basis of performance. Using conventional designs, an analog and a digital version were built and tested. The general conclusions are not novel, but the specific numerical values give insight into future possibilities. Briefly, the over-all conclusion was that even though the digital approach is slower now, it is an acceptable alternative to the analog method, because it offers better accuracy at comparable cost and size. In addition, climbing clock rates are expected to make operating speeds more competitive soon.

The two approaches are evaluated with the following considerations in mind:

- Accuracy.
- Reliability.
- Speed.
- Ease of system implementation.

For the analog approach, these considerations mean examining the operational amplifiers' frequency response, gain, drift and offset, and their effect on system accuracy and speed, as well as component tolerance.

For the digital approach, the pertinent parameters are the speed of the MOS arrays, and round-off and approximation errors.

The basic coordinate transformation problem involves a simple vector rotation, shown in Fig. 1.

A vector  $R$  is rotated through an angle  $\theta$  from its initial position at  $X, Y$  to the new position at  $X', Y'$ . The basic transformation equations are:

$$X' = X \cos \theta - Y \sin \theta. \quad (1)$$

$$Y' = Y \cos \theta + X \sin \theta. \quad (2)$$

The sine and cosine functions, then, are necessary to solve these coordinate rotation equations.

## Analog system built around IC op amp

The analog technique performs the trigonometric computations with integrated-circuit operational amplifiers connected to operate as a harmonic oscillator (Fig. 2).

The oscillator consists of two integrators, each contributing  $90^\circ$  of phase shift, and an inverter, contributing  $180^\circ$  of phase shift in a feedback loop. This configuration oscillates, when the loop is closed through switch  $S1$ . The outputs of the two integrators are the sine and cosine functions, and are described by:

$$V_{x'} = V_{max} \cos(\omega t + \phi) \quad (3)$$

$$V_{y'} = V_{max} \sin(\omega t + \phi) \quad (4)$$

where:

$$V_{max} = (V_x^2 + V_y^2)^{1/2}, \quad (5)$$

the frequency of operation is:

$$\omega = 1/RC, \quad (6)$$

and the phase shift is:

$$\phi = \arctan (V_y/V_x). \quad (7)$$

$V_x$  and  $V_y$  represent the initial conditions and are found by closing switches  $S2$  and  $S3$  before the oscillation is started.

To observe some of the error sources involved in this technique, a circuit was built with RCA's 3008 operational amplifiers. For convenience,  $V_x$  was set to zero and  $V_y$  to  $-V_{max}$ . This corresponds to an initial position of  $\theta = -90^\circ$  at  $t = 0$ .

A master clock (Fig. 3) controls the oscillator through four electronic switches, which are dual-emitter 3N93 devices. The clock sets up the period of oscillation, and the period of setting up initial conditions.

James Garvey, Associate Member, RCA, Burlington, Mass.

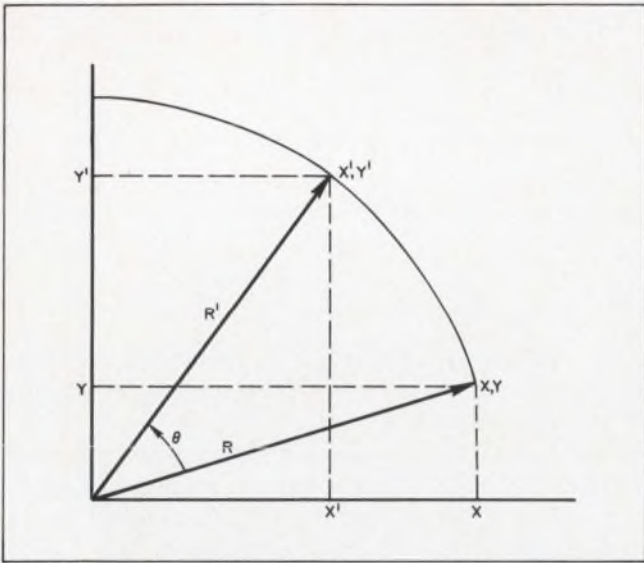

1. **Coordinate transformation**, needed in control systems, is accomplished by the rotation of vector  $R$  from its initial position  $(X, Y)$  to a new position,  $(X', Y')$ . The rotation involves the calculation of  $\sin \theta$  and  $\cos \theta$ , which may be performed either by digital or analog methods.

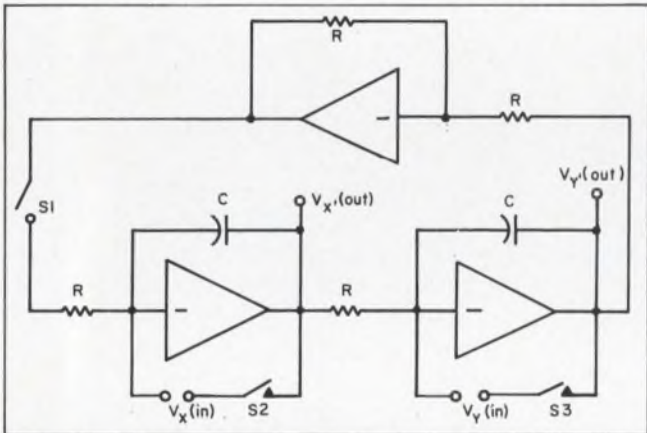

2. **Harmonic oscillator** is the heart of the analog system. It is built with IC op amps—two integrators and an inverter in the feedback loop. The outputs of the two integrators are the sine and cosine functions.

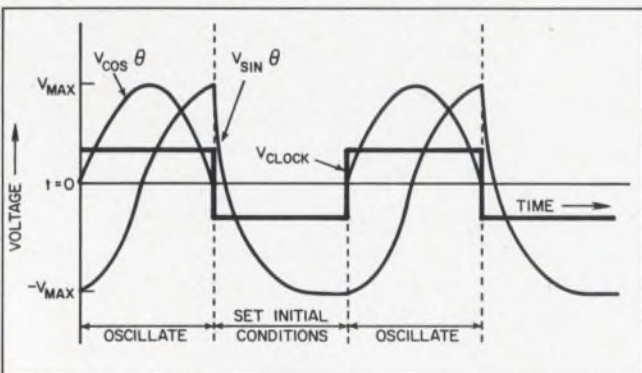

3. **The oscillator is controlled by a master clock** that establishes the two phases of operation: (1) the period of setting up the initial conditions, and (2) the period of oscillation. Each takes one-half of the clock's period.

For one-half period of the clock, the initial conditions are placed on the capacitors. During the other half period, the loop is closed and allowed to oscillate. For convenience, the clock frequency was chosen to be about the same as that generated by the oscillator, so that the oscillator would generate only slightly more than half a cycle before switching over to the initial-conditions mode again.

The oscillation of the clock restricts the input signal,  $\theta$ , to  $\pm 90^\circ$ . The input usually appears in the form of a voltage level which is converted to a time interval with a ramp generator and a comparator.

The ramp is also controlled by the clock. At  $t = 0$ , the ramp voltage starts at  $+V_{max}$ . As the oscillator starts, the ramp decreases linearly with a time constant  $RC$  and reaches  $-V_{max}$  in the time it takes for one half cycle of the oscillator. The ramp output is compared with the input signal (a dc voltage representing  $\theta$ ), and when it becomes equal to  $-V_{\theta in}$ , the comparator output will change state. The time interval between these changes is proportional to  $\theta$  (Fig 4). Again, RCA's CA3008s were used for both the ramp and comparators. At the time the comparator switches, then, the desired outputs exist at the outputs of the two integrators.

In the actual circuitry, the clock and the frequency of oscillation were about 2 kHz, so that the result was obtained within a millisecond of the start-up of the oscillator. With 1% resistors and 10% capacitors, the system generated sinusoidal functions to within 2% of the maximum value of the sinusoid. More precise components and wider dynamic range should improve the accuracy.

### Error sources of the analog system

Component errors are the most obvious error sources, specifically the values of  $R$ s and  $C$ s in the harmonic oscillator loop, in the ramp generator and in the comparator. These errors lead to an error in the timing of the ramp generator with respect to the oscillator's frequency.

The errors of the operational amplifier are well known—finite open-loop gain, drift, and offset. The transfer functions of the operational amplifiers can be approximated as:

$$V_{out}/V_{in} = -A_o(\omega)Z_f/[Z_f + Z_R + A_o(\omega)Z_R], \quad (8)$$

where:

- $A_o(\omega)$  = open-loop amplifier gain,
- $Z_f$  = feedback impedance,
- $Z_R$  = source, or input, impedance.

For an ideal operational amplifier,  $A_o(\omega) \rightarrow \infty$ . Hence:

$$V_{out}/V_{in} = -(Z_f/Z_R), \quad (9)$$



so that:

$$V_{out} = -(1/RC) \int V_{in} dt \quad (10)$$

for the integrators. But the finite gain in real operational amplifiers modifies this value.

Offset errors are due to a mismatching of the operational amplifiers' differential input transistors. Temperature changes will vary the temperature-dependent parameters of the operational amplifier, causing a variation of gain and offset, which in turn results in a drift in the output level.

These are the types of error that the design engineer must cope with if he wants to use the analog approach.

Based on these principles, analog resolvers' have been built with about 17 off-the-shelf integrated circuits for about \$500, which is comparable to the price of a size-11 electromechanical resolver. The solutions are represented by the widths of output pulses generated by a zero-crossing detector technique. The units' accuracy is said to be 0.1% and their 2-in size is compatible with the 1-1/8-in. diameter of the size-11 electromechanical resolver.

#### The DDA integrator offers greater accuracy

The digital approach to the generation of sines and cosines is a direct analogy of the analog method. Two digital-differential-analyzer (DDA) integrators and an inversion set up realize the oscillation. A digital counter provides the number of input pulses needed for a given input signal. A DDA sine/cosine generator is a special application of the digital filter technique, where a low-pass digital filter performs the integration.

The DDA can be thought of as a digital analog computer used instead of analog computers where greater accuracy is required. Recent advances in MOS technology overcame its main hardware problem: size. The entire integrator can now be put on two silicon chips. One chip is the adder element, the other is a dual shift-register of any desired length.

The DDA integrator is an incremental machine, that is, the input and output pulses represent changes in the total input or output signal. Figure 5 is a functional diagram of a DDA integrator.

The basic function of an integrator is the evaluation of the equation:

$$Z(x) = \int_{x^0}^x Y(x) dx, \quad (11)$$

which is numerically approximated by:

$$Z = \sum Y_i \Delta X_i. \quad (12)$$

If all  $\Delta x$ s are equal to one unit, this reduces to:

$$Z = \sum Y_i. \quad (13)$$

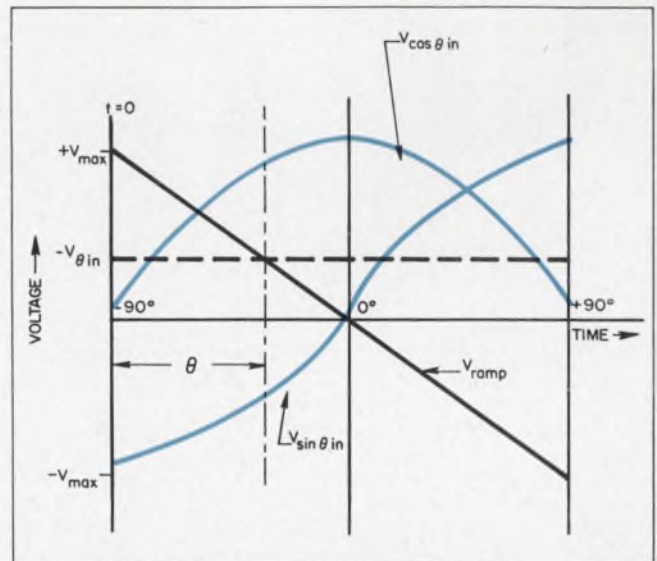

4. Waveforms of the ramp generator, and of the sine and cosine of the input show time sequence. The comparator switches state when the ramp voltage reaches  $V_{\theta in}$ .

The integrand  $Y$  can be varied when an increment  $\Delta x$  occurs, by adding an increment  $\Delta y$  to the previous value of  $Y$ . The occurrence of  $\Delta x$  thus triggers two processes: the integrand  $Y$  is updated by adding a  $\Delta Y$ , and the integral  $Z$  is updated by adding the new values of  $Y$  to  $Z$ .

The two addition/subtraction functions are:

$$Y_{n+1} = Y_n + \Delta Y_{n+1} \quad (14)$$

and:

$$R_{n+1} = R_n + Y_{n+1} \cdot \Delta X_{n+1}. \quad (15)$$

To make the inputs and outputs of a DDA integrator compatible, and to account for the finite size of a shift register, an incremental output representing the  $R$ -register overflow is used. Therefore the measure of the integral  $Z$  is the net number of + and - overflow ( $\Delta Z$ ) pulses that are produced (a negative overflow is called an underflow). These  $\Delta Z$  pulses can be either inputs to a succeeding DDA integrator's  $Y$ -register, or they may be stored in some other shift register. The contents of the  $R$  register are then a remainder left after the  $Z$  overflow, and represents an error. The quantities  $Y$  and  $Z$  are stored in the  $Y$  and  $R$  registers, respectively, when there is no operation.

The initial conditions are loaded directly into the  $Y$  and  $R$  registers through separate inputs. As shown, the initial conditions are for  $\theta$  to start at zero degrees, where the sine is zero and the cosine is maximum. Here it is scaled to equal 1/2.

#### Two DDAs generate sine and cosine

Two DDA integrators are connected to form a sine/cosine generator in Figure 6. The  $\Delta Z$  output pulses of one integrator are the  $\Delta Y$  inputs to the other. To obtain the inversion, or the addi-

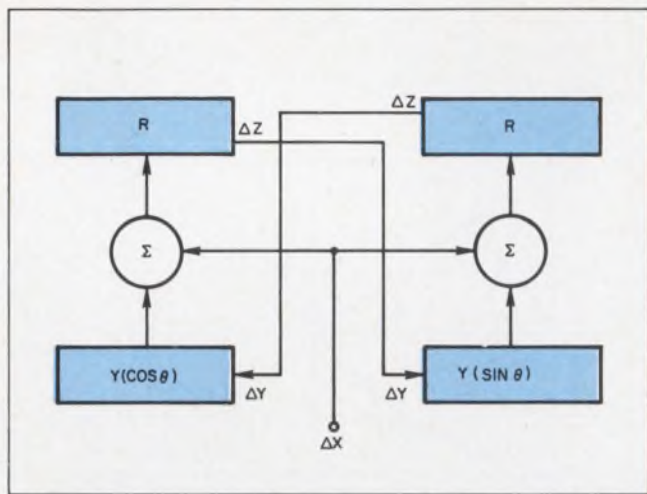

5. Sine and cosine generator uses two DDAs and an inversion scheme to obtain oscillation. The basic idea is an exact counterpart of the analog approach. The timing is controlled by a digital counter.

tional  $180^\circ$  phase shift for an unstable condition, the overflows ( $\Delta Z+$ ) of the sine integrator produce a signal that subtracts a  $\Delta Y$  from  $Y$  of the cosine integrator, and the underflows ( $\Delta Z-$ ) of the sine integrator produce a signal that adds  $\Delta Y$  to the cosine integrator.

The number of  $\Delta X$  input pulses that are required for one complete cycle is  $(2\pi) 2^n$ , where  $n$  is the word length excluding the sign bit. Since the maximum value in this system is  $1/2$  (one initial condition was that  $(\cos \theta)_{max} = 0.5$ ), the number of input pulses required is also modified by  $1/2$ . More than 100,000 pulses are required for a fifteen-bit word ( $n = 15$ ). This underlines the necessity of a very fast clock speed. The speed-versus-accuracy trade-off of the digital system is shown in Fig 6. Speed is inversely proportional to accuracy—each additional accuracy bit doubles the time necessary for the solution. With a clock frequency of 100 kHz, and a 15-bit word plus a sign bit, it is possible to observe the sinusoidal functions on an oscilloscope, for their period is about 65 s. A 15-bit accuracy represents about 0.003% error.

An accuracy of 0.1% requires 10 bits, which means 6,431 input pulses. These can be supplied by a 13-bit binary counter. The clock rate is 6,431 times 11 (one bit for the sign), or 70,741 clock pulses. At the maximum frequency of the clock, specified in data sheets as 1 MHz, it takes about 70 ms to generate one cycle. For an accuracy of 2%, which is comparable to that of the analog version, 6 bits are sufficient, and the computation takes about 3 ms—much slower than the analog technique.

It is clear that clock rates are the limiting factor in digital systems, but they are on the rise. Some shift registers are already operating at 5 MHz. These rates are expected to climb to about

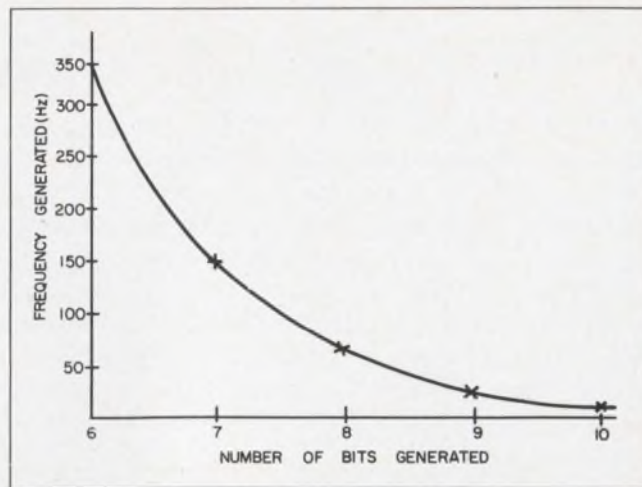

6. Speed versus accuracy of DDA sine/cosine generator shows trade-offs for the first cycle of oscillation. The clock frequency is 1 MHz. With a clock frequency of 15 MHz, a 10-bit solution would be available in 15 ms.

15 MHz in the future, which will permit a 10-bit solution in 15 ms.

Analog systems are less dependent on the speed of operation, so accuracies of 0.1% appear to be feasible in the  $1\text{-}\mu\text{s}$  range.

If the sine/cosine generator described is allowed to continue for many cycles, the magnitude of the sinusoidal outputs will grow as the number of iterations increases. This is due to the nature of the error sources in the digital system. These are round-off and truncation errors. Both are referred to as quantization noise and are the result of the approximation of exact amounts.

Quantization noise is additive, that is, it increases with the number of iterations. In a sine/cosine generator, where the only interest is in the first cycle generated, the quantization error is insignificant. If allowed to continue for many cycles, however, the error increases exponentially, and eventually becomes prohibitive. For a 15-bit word plus one sign bit, there are 5 bits of error after about 50 cycles. This represents about 0.1% error, which still compares favorably with that of the analog approach. ■ ■

#### Bibliography:

- "Application of the RCA CA3008 and 3010 Integrated-Circuit Operational Amplifiers," RCA Application Note (ICAN-5015), Nov., 1965.
- Callan, J. D. "MTOS Integrated Digital Differential Analyzer," General Instrument Corp., Hicksville, N. Y., Application Note, March, 1967.
- Gold, Bernard, and Rader, Charles M. "Effects of Quantization Noise in Digital Filters," 1966 Spring Joint Computer Conference. (AFIPS Conference Proceedings, Vol. XXVIII.) New York, 1966.
- Goldstein, S. "Digital-Differential-Analyzer Integrator Using MOS Arrays," RCA New Semiconductor Devices Course, Nov. 16, 1966. Lecture Note No. 8.
- Kidd, M. C., and Drew L. C. "Extending Integrated Circuit Applications in Aerospace Systems," Systems Support and Aerospace Systems. Camden, N. J.: Radio Corp. of America, Defense Electronic Products, 1966.

Printed circuit board from General Radio Type 1680 Automatic Capacitance Bridge showing use of A-B Type CB ¼ watt fixed resistors and Type F ¼ watt adjustable resistors.

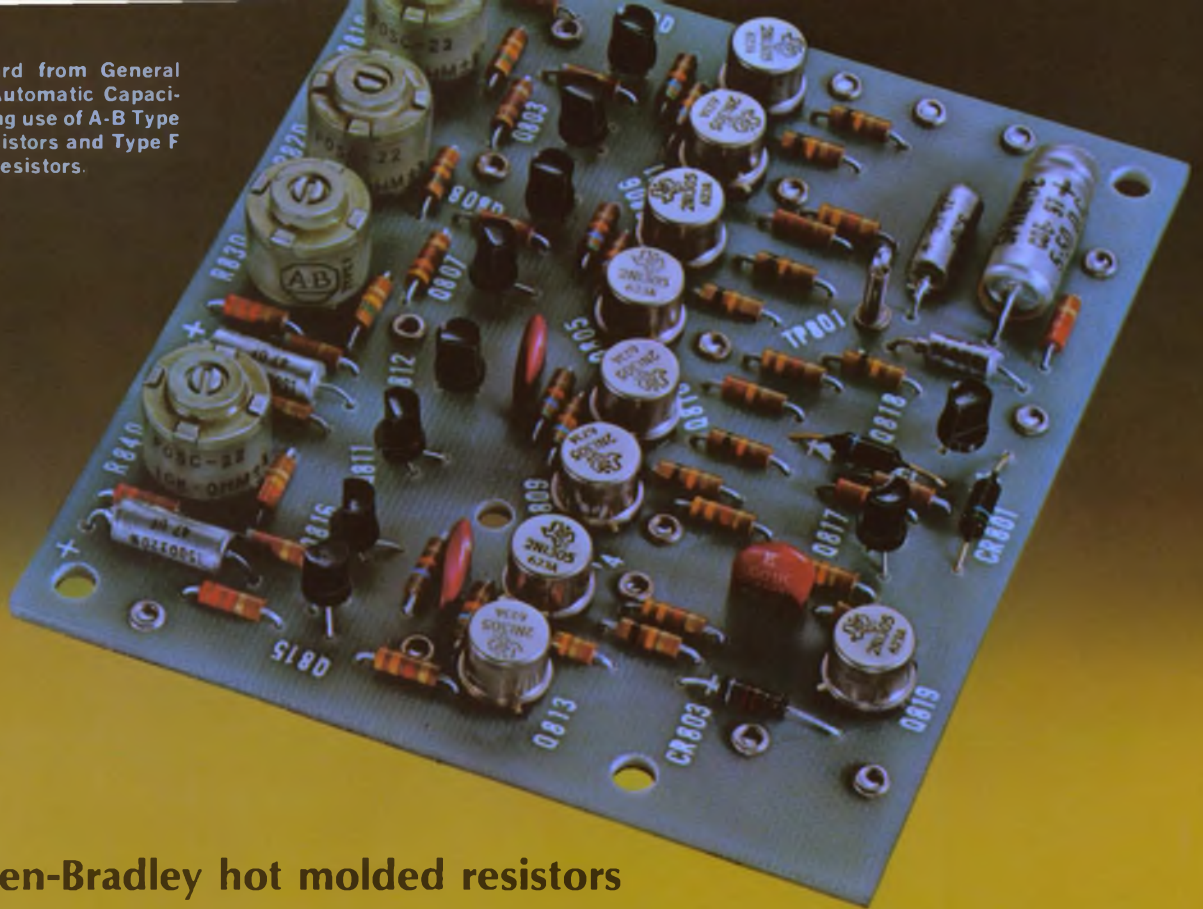

**“we use Allen-Bradley hot molded resistors because their consistent, stable characteristics—month to month and lot to lot—ensure repeatable measurements by our instruments.” GENERAL RADIO CO.**



General Radio Type 1680 Bridge automatically measures capacitance and loss simultaneously, generates coded digital output data, and displays measured values in about one-half second. The basic accuracy is  $\pm 0.1\%$  and the range is from 0.01 pF to 1000  $\mu\text{F}$ .



**Type F variable resistor** with pin type terminals for mounting directly on printed wiring boards. Rated ¼ watt at 70°C. Total resistance values from 100 ohms to 5 megohms. Shown actual size.

**A-B hot molded fixed resistors** are available in all standard resistance values and tolerances, plus values above and below standard limits. Shown actual size.



Just as surely as automatic equipment saves its users' money when it is in operating condition, it is virtually worthless when failure of a component has made the entire device inoperative. To insure the reliable and accurate performance of their new automatic capacitance bridge, General Radio designers selected Allen-Bradley hot molded fixed and variable resistors.

Allen-Bradley resistors are made by a hot molding process using completely automatic machines developed by Allen-Bradley. This results in such precise uniformity from one resistor to the next—year in and year out—that long term resistor performance can be accurately predicted. Furthermore, there is no known instance of catastrophic failure of an Allen-Bradley hot molded resistor.

The same manufacturing technique is used with the Type F variable resistors. Their solid hot molded resistance track assures smooth control from the very beginning and which improves with use—and are completely devoid of the abrupt changes to be expected of wire-wound controls. In addition, A-B variable resistors are essentially noninductive, permitting their use at frequencies far beyond range of wire-wound units.

For more complete information on the full line of Allen-Bradley quality electronic components, please write for Publication 6024: Allen-Bradley Co., 222 W. Greenfield Ave., Milwaukee, Wis. 53204. In Canada: Allen-Bradley Canada Limited. Export Office: 630 Third Ave., New York, N. Y., U.S.A. 10017.



**ALLEN - BRADLEY**  
QUALITY ELECTRONIC COMPONENTS



*explorer I*  
*explorer IV*  
*tiros*  
*telstar*  
*syncom*

*ranger VII*  
*ranger VIII*  
*ranger IX*  
*saturn I*  
*surveyor*



## the most honored resistor in the Space Program

■ Allen-Bradley hot molded resistors were chosen to participate in these many history-making space projects for only one vital reason—a history of proven performance that dates back for more than a quarter of a century! A record more conclusive than any testing program could possibly provide!

The superiority of Allen-Bradley resistors is found in the exclusive hot molding process. Through the use of completely automatic machines—developed and used *only* by Allen-Bradley—there is obtained such uniformity of characteristics from resistor to resistor, year after year, that the resistors' long term performance can be accurately predicted. Furthermore, no Allen-Bradley hot molded resistor has ever been found to have failed catastrophically.

The widespread use of the Allen-Bradley hot molded resistors in these space programs should convince you that to include this plus value in the equipment which you produce gives it the mark of "extra quality." Let us tell

you more about the complete line of Allen-Bradley electronic components. Please write for Publication 6024. Allen-Bradley Co., 222 W. Greenfield Ave., Milwaukee, Wis. 53204. In Canada: Allen-Bradley Canada Limited. Export Office: 630 Third Ave., N. Y., N. Y. U.S.A. 10017.



**HOT MOLDED FIXED RESISTORS** are available in all standard resistance values and tolerances, plus values above and below standard limits. Shown actual size.



TYPE BB 1/8 WATT

TYPE CB 1/4 WATT

TYPE EB 1/2 WATT

TYPE GB 1 WATT

TYPE HB 2 WATTS

# ALLEN - BRADLEY

QUALITY ELECTRONIC COMPONENTS



# SEMICONDUCTOR

Union Carbide Electronics, Mountain View, California has just placed the largest exclusive advertising campaign in magazine publishing history.

Their objective: To become an even greater factor in the fast-paced twenty-one billion dollar electronics industry.

Their campaign: 138 pages over the next 12 months.

Their magazine: **Electronic Design.**

Union Carbide Electronics and their agency, Hal Lawrence, Inc., decided the best return on their advertising investment would be achieved by concentrating in the magazine read by the greatest number of their prime customers and prospects.

They backed up their decision by scheduling multi-page semiconductor advertise-

ments in every bi-weekly issue of **Electronic Design.**

Advertisements that will be selling the men who specify what goes into what the sales department sells, the accounting department accounts, the production department produces.

138 pages over the next 12 months . . . that's **impact.**



## Electronic Design

**MOST READ BY THE MEN WHO SPECIFY**

Winner of Industrial Marketing and Jesse Neal Awards for Editorial Excellence in 1966

**Hayden Publishing Co., Inc.**, 850 Third Avenue, New York 10022

Publishers of **Electronic Design** and **Microwaves** Magazines . . . Hayden, Rider and Ahrens Books

# Design better agc FET amplifiers.

Use simple, experimental techniques and know the pros and cons of reverse and forward agc.

With field-effect transistors as inexpensive as they are today, there is hardly a plausible reason left to exclude them from broadcast and communications equipment. FETs are ideally suited for use in automatic-gain-control circuitry. As part of the rf and mixer stages, they ensure very low distortion and spurious-response characteristics.

Nor are they especially hard to work with. They are simpler than bipolars, largely because of better input-output isolation, and only slightly more complex than vacuum tubes. But the designer who would use FETs in basic agc circuitry should first examine the good and bad sides of reverse and forward agc in common-source and common-gate configurations.

## Choose an agc mode

Gain reduction of FET stages may be achieved in different ways. The voltage across the FET may be held relatively constant and the dc drain current varied, changing the transadmittance ( $y_{21}$ ) of the FET and therefore the gain of the stage. Such operation can be considered "reverse agc," and is quite similar to the method by which vacuum-tube amplifiers are gain-controlled. In fact, present depletion FETs (including all junction FETs and some MOSFETs) have transfer characteristics that closely resemble those of sharp-cutoff pentodes. The transfer characteristic of an n-channel TIS58, shown in Fig. 1, is a typical example. Transadmittance is the slope of this curve and as shown by the dashed line, an almost linear reduction of transadmittance with increasing gate-to-source voltage,  $V_{GS}$  is obtained.

Another method of reducing FET amplifier gain is to adjust the bias circuitry so that increases in drain current reduce the FET impedances in a way that lowers circuit gain. This "forward agc" usually results in larger ranges of gain control than is possible with reverse agc, but selectivity is sacrificed because of the loading effect on the tuned networks.

In addition, spurious-response rejection characteristics may be somewhat degraded. This, however,

may not be a problem if the agc is delayed until fairly strong signals are received. Nevertheless, the designer must keep this in mind.

## Consider other parameters, too

In addition to the range of gain variation, other amplifier characteristics, such as detuning, band-pass-deforming effects and signal-handling ability, are also important, and their dependence on the shifting bias level must be considered.

In any unneutralized rf amplifier design, mismatch loss must be provided by the coupling networks when potentially unstable devices are used. Present high-frequency FETs have sufficient feedback capacitance to be potentially unstable well into the uhf range when operated common-source. Common-gate operation provides greater degrees of stability with some sacrifice in gain. Reverse and

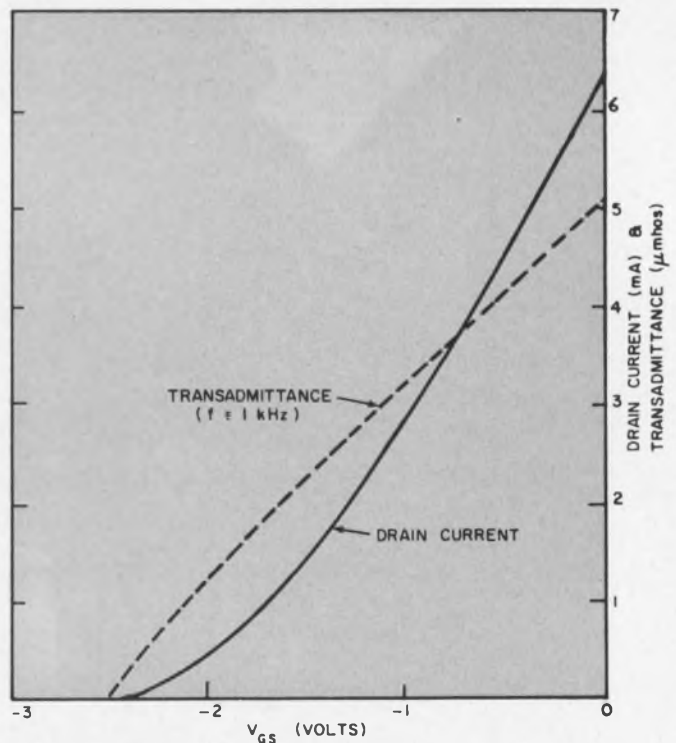

1. Transfer characteristic of an n-channel FET (TIS58) indicates that the transadmittance (dashed curve) is practically a linear function of the gate-to-source voltage,  $V_{GS}$ .

Charles L. Farell, Applications Engineer, Texas Instruments Inc., Dallas, Tex.

forward agc will be considered first for the common-source configuration and then compared with common-gate operation.

Reverse agc with common-source stages is relatively simple. Maximum gain occurs at the bias point, determined by the self-bias source resistor, when  $V_{agc} = 0$ . The transducer gain of an rf amplifier in terms of the active-device  $y$  parameters and terminating admittance is:

$$G_T = \frac{4\text{Re}(Y_S)\text{Re}(Y_L) |y_{21}|^2}{|(y_{11} + Y_S)(y_{22} + Y_L) - y_{12}y_{21}|^2}$$

where:

$y_{11}, y_{12}, y_{21}, y_{22}$  = standard  $y$  parameters,

$$y_{11} = \frac{i_1}{e_1} \quad \text{When } e_2 = 0$$

$$y_{12} = \frac{i_1}{e_2} \quad \text{When } e_1 = 0$$

$$y_{21} = \frac{i_2}{e_1} \quad \text{When } e_2 = 0$$

$$y_{22} = \frac{i_2}{e_2} \quad \text{When } e_1 = 0$$

$Y_S$  = composite transistor source admittance composed of both the input network and its source.

$Y_L$  = composite transistor load admittance composed of both the output network and its load.

This expression for transducer gain includes the effects of the degree of admittance match at the transistor input terminals, but it does not take into account input and output network losses.

The terminating admittances are set to provide an adequate margin of stability at the maximum gain point, since this is the least stable point. For reverse agc, changes in  $y_{11}$  and  $y_{22}$  are minor compared with the variation of  $|y_{21}|$ ; thus the gain variation is caused almost wholly by variation of  $|y_{21}|$ . The variation of  $|y_{21}|$  and  $|y_{12}|$  with  $V_{GS}$  for a typical TIS58 ( $I_{DSS} = 6$  mA) is shown in Fig. 2. These curves show that  $|y_{21}|$  becomes equal to the reverse transadmittance,  $|y_{12}|$ , as  $V_{GS}$  approaches the cut off value  $V_{GS\ off}$ . For  $V_{GS}$  greater than  $V_{GS\ off}$ , the signal drain current that flows is the direct feedthrough current that results from the drain-gate capacitance,  $C_{dg}$ . This feedthrough current limits the amount of gain reduction possible with reverse agc.

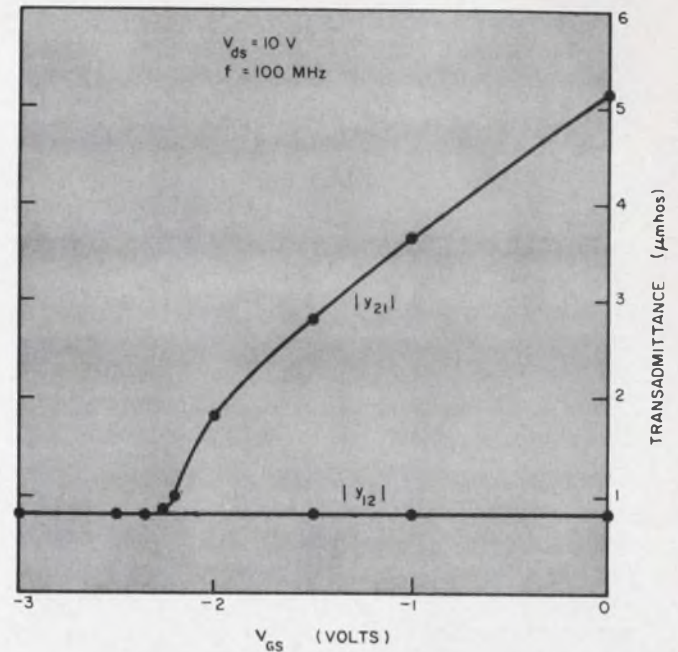

2. Transducer gain of an rf amplifier almost wholly depends on the variations of  $y_{21}$ .

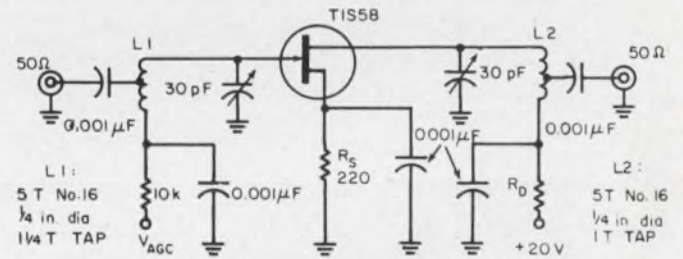

3. Reverse and forward agc characteristics for a common-source configuration were obtained with this circuit. The input and output was tuned to 100 MHz. For the reverse agc test  $R_D$  is shorted out; for the forward agc the source lead is returned to dc ground.

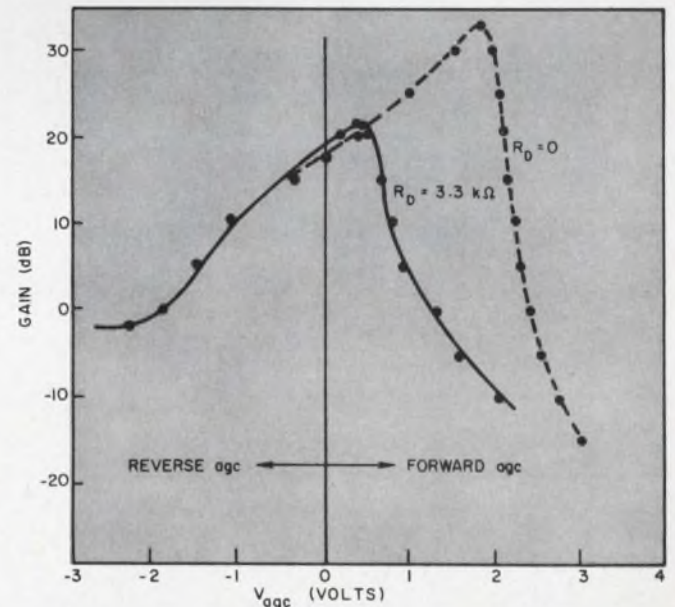

4. Agc characteristics for the circuit of Fig. 3 show relative merits of reverse and forward agc. The undesirable gain peaking with forward agc is reduced by choosing a suitable value of  $R_D$ .

rent limits the amount of gain reduction possible with reverse agc.

### Evaluating reverse agc

The circuit in Fig. 3 was built to evaluate the agc capability of junction FETs in the common-source configuration. The input coil tap was determined by the transformation necessary to step the 50-ohm generator impedance up to the optimum source impedance for best noise performance. For the TIS58, this optimum source is about 1000 ohms at 100 MHz. The output tap was adjusted for an over-all 3-dB bandwidth of 1.0 MHz at the initial bias point established by the source resistor,  $R_s$ . The terminating impedances established by these tap points resulted in margins of stability greater than 20 dB for all devices tested in the TIS58 spread. The input and output circuits were tuned to 100 MHz at the maximum gain point, and negative values of  $V_{agc}$  were then applied to reduce the gain by reverse agc.

The gain reduction with reverse agc is shown in the left-hand half of Fig. 4. With  $V_{agc} = 0$ , the maximum gain was about 18 dB. As negative values of  $V_{agc}$  were applied, the gain fell off, until  $V_{agc}$  reached approximately -2.2 volts. Beyond this value, the FET channel is completely pinched off, and fur-

ther increases in  $V_{agc}$  have no effect on the gain. In this region,  $|y_{21}| = |y_{12}|$ , and the output is caused solely by the  $C_{dg}$  feedthrough current. This limits the minimum gain in this case to -2 dB and restricts the total range of gain variation to about 20 dB. Since  $|y_{12}|$  is essentially a capacitive susceptance, the feedthrough current will vary with frequency of operation.

Another detrimental effect of  $C_{dg}$  is that it creates an additional component of input capacitance because of the Miller effect. This Miller capacitance contributes to the total tuning capacitance of the input circuit and has a value of  $(1-A)C_{dg}$ , where  $A$  is the voltage gain from gate to drain. Then, as the gain changes with agc, the tuning capacitance also changes, causing a shift in the center frequency. The left-hand half of Fig. 5 shows the increase in center frequency, along with a spreading of the upper and lower 3-dB frequencies.

The bandwidth increase with reverse agc is caused by two effects. The first is that the center frequency of the input circuit shifts farther than the center frequency of the output circuit, causing a stagger-tuning effect. The other effect is illustrated in Fig. 6. This is the equivalent circuit of the stage when the FET is pinched off—that is, when the gain is minimum. It is simply a double-tuned filter network with

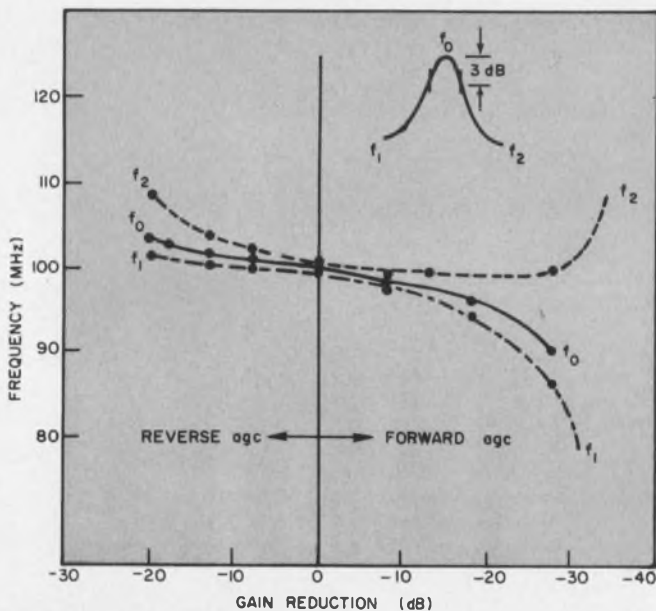

5. Increase in bandwidth occurs for both types of agc because drain-to-gate capacitance,  $C_{dg}$ , is a function of gain.

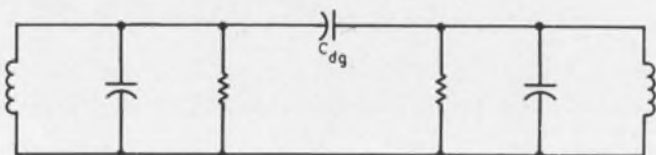

6. Overcoupling occurs when FET is pinched off and the value of  $C_{dg}$  becomes large. In this case the circuit of Fig. 3 reduces to a stagger-double-tuned circuit with the increased bandwidth.

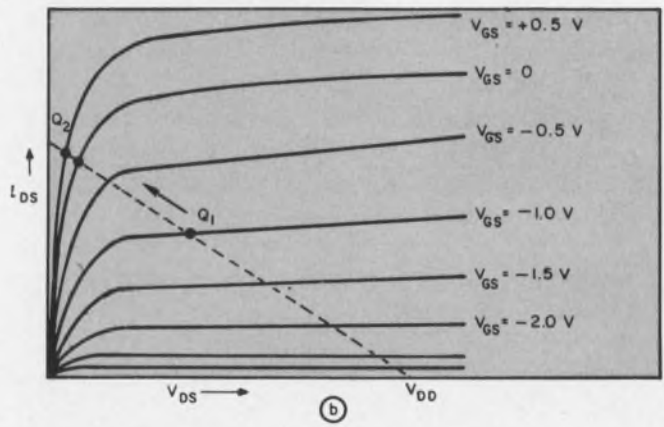
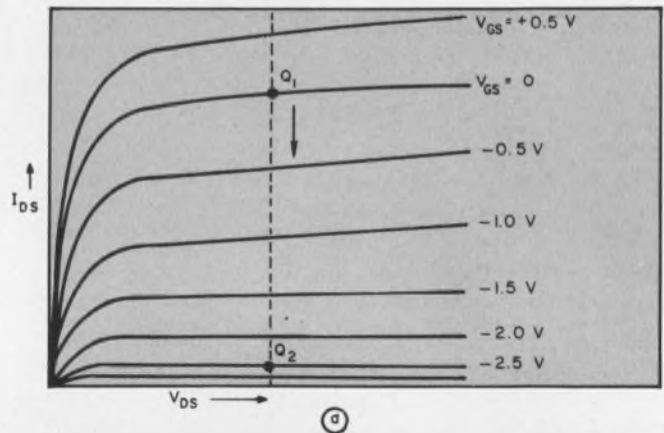

7. Dc load lines for two values of the drain resistor ( $R_D$  in Fig. 3) demonstrate how the gain peaking for forward agc can be minimized by using standard "triode curve" shown in (b).



capacitive coupling, where  $C_{dg}$  may be large enough to cause a critical or even over-coupled bandpass characteristic. Therefore, as minimum gain is approached, the bandwidth increases.

### Forward agc has more range

Greater range of gain variation is possible with forward agc. With forward agc, gain reduction is accomplished by reducing the impedance levels at the terminals of the FET. This introduces added mismatch loss. With the lowered impedance levels, the feedthrough current is not as effective in developing an output. Also, when enough positive agc voltage is applied to forward-bias the gate-source junction, the input impedance is lowered and the signal voltage that appears at the gate is reduced. The smaller signal voltage at the gate results in a smaller feedthrough current.

The application of positive values of  $V_{agc}$  to the circuit of Fig. 3 causes the drain current to increase above the level set by the 220-ohm source resistor. This initial operating point is the maximum gain point for reverse agc, but is not necessarily so for forward agc. As the drain current is increased, the gain can go through a sizable peak before it begins to fall. This is illustrated by the dashed-line curve in the right-hand half of Fig. 4. This curve shows the gain variation with positive values of  $V_{agc}$  when no series drain resistor is used. With no drain resistor, the dc load line is similar to that in Fig. 7a. Because of the low resistance in the drain-source circuit, the operating point can shift from  $Q1$  to  $Q2$  with only a very small change in  $V_{DS}$ .

Since the operating point remains in the flat region of the output characteristics, the impedance level of the output circuit remains essentially unchanged as the drain current varies. Gain reduction, then, occurs only when the gate-source junction becomes forward-biased and lowers the impedance level of the input. Before this occurs, however, the higher transadmittance resulting from the increasing drain current during forward agc causes the gain to increase. The maximum gain occurs when the gate-source voltage reaches about +0.3 volt. Depending on the setting of the initial operating point and the margin of stability at this point, the gain increase may be so large that oscillation occurs before the gain peak is reached. Tests showed that the circuit of Fig. 3 was stable at all points, but the gain increased by 15 dB before it began to fall. Such behavior is obviously not permissible.

The gain peak can be minimized by setting the initial operating point high enough for only small increases in drain current to occur before the gate-source junction becomes forward-biased. This puts the initial drain current near  $I_{DSS}$ , however, and makes the drain current variation from one device to another equal to the full  $I_{DSS}$  spread.

A more satisfactory characteristic is illustrated in

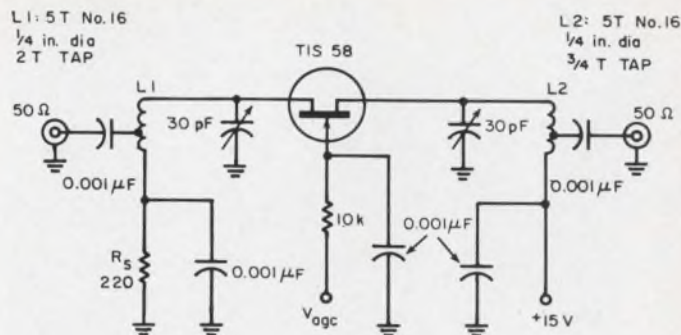

8. Common-gate configuration results in better agc characteristics but the initial gain is lower.

Fig. 7b. The dc load line here is altered by adding the series drain resistor  $R_D$  (see Fig. 3). With this additional resistance, a moderate increase in drain current causes a substantial decrease in  $V_{DS}$ , placing the new operating point in the so-called "triode region" of the output characteristics, where the output impedance is low. The lower impedance and reduced transadmittance in this region tend to compensate for the gain increase.

The value of  $R_D$  that is chosen should be the largest possible that sets the initial operating point in the flat region of the output characteristics. Any increase in current then shifts the operating point into the triode region. For example, the TIS58, which has an  $I_{DSS}$  spread of 4 to 8 mA, will have an average drain current of around 3 mA with a 220-ohm source resistor<sup>1</sup>. A drain-source voltage of 5 volts will place the operating point of the TIS58 just in the flat region at this current level. With a supply voltage of 15 volts, this corresponds to  $R_D = 3.3 \text{ k}\Omega$ . The solid line in the right-hand half of Fig. 4 shows the forward-agc gain variation with a  $3.3 \text{ k}\Omega$  series drain resistor in place. This curve shows a gain increase of only 3 dB before gain reduction starts. Minimum gain with forward agc was -20 dB, so that the total gain variation was 38 dB, considerably more than was possible with reverse agc.

The major disadvantage of forward agc is the virtually complete loss of selectivity under minimum-gain conditions. As forward agc is applied, the input is detuned more than the output circuit. This creates a stagger-tuned response, with two distinct peaks, until the input peak is eliminated by forward gate bias. This stagger tuning results in a sizable increase in bandwidth. Ultimately all selectivity is eliminated because of heavy loading on the tuned circuits. This is shown in the right-hand half of Fig. 5.

### Common-gate operation gives better agc

If lower initial gain is permissible, better agc characteristics can be obtained with the common-gate configuration. Common-gate operation allows greater isolation of the input and output circuits, because the drain-to-source capacitance,  $C_{ds}$ , is usually at least an order of magnitude less than  $C_{dg}$ , the corresponding parameter in common-source

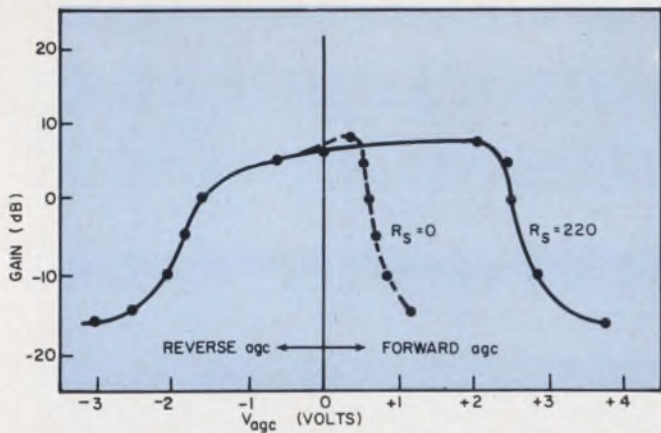

9. Agc characteristic for common-gate circuit of Fig. 8 indicates its superiority over those obtained in the common-source configuration of Fig. 3. Note the effect of the source resistor,  $R_S$ , on the forward agc curve.

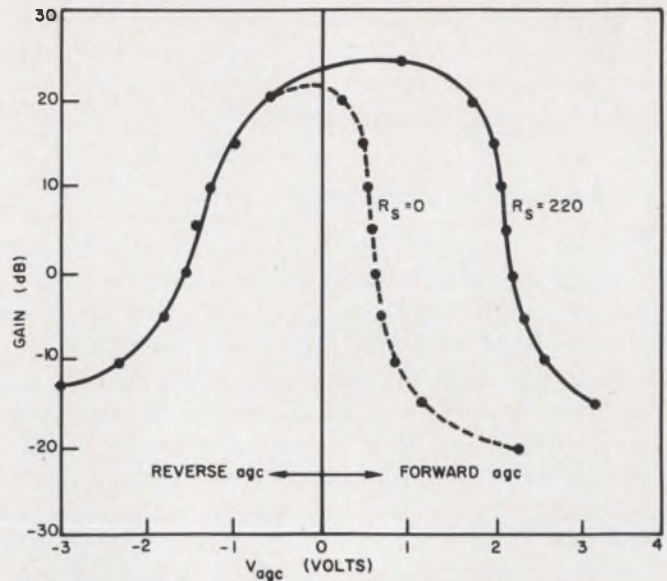

12. Agc characteristics for the cascode circuit of Fig. 11 compare favorably with either the common source (Fig. 3) or common gate (Fig. 8) circuits.

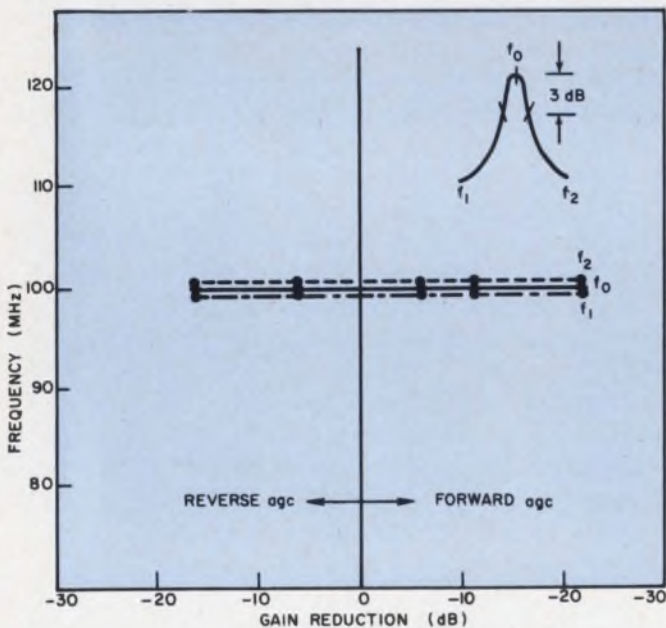

10. Constant-bandwidth-versus-gain changes are obtained with the common-gate circuit of Fig. 8.

stages. This results in lower feedthrough current and allows the gain to be reduced to much smaller values.

For example, the test circuit of Fig. 8 was built and tested with the same FETs that were used in the common-source circuit of Fig. 3. The input and output taps were adjusted for maximum gain, with a bandwidth of about 1 MHz. The left-hand half of Fig. 9 shows a minimum gain of  $-17$  dB for the common-gate circuit with reverse agc. This compares with  $-2$  dB for the common-source circuit. Although the initial gain of the common-gate circuit is lower (6 dB compared with 18 dB), the total gain variation of 23 dB is obtained because of the lower minimum gain. The solid line in the right-hand half of Fig. 9 is the forward agc gain variation of the common-gate circuit. The dashed line demonstrates the effect on the agc characteristic of eliminating the 220-ohm source resistor and connecting the source to dc ground. This shows that the setting of the initial bias point provides a control by which forward agc may be delayed by various amounts.

The Miller capacitance effect, which shifts the tuning of common-source stages, is absent in common-gate stages because of the small coupling from drain to source. Because of this, there is practically no change in center frequency and bandwidth as forward to reverse agc are applied to common-gate stages. This is illustrated in Fig. 10, which is plotted on the same scale as Fig. 5.

In both common-source and common-gate stages, the value of the source resistor is arbitrarily chosen and is a compromise between permissible drain-current variation from device to device and the amount of agc control voltage necessary to vary the operating point. For the TIS58, a source resistance of 200 ohms reduces the drain current variation to approximately 60% of the  $I_{DSS}$  spread. It increases the required agc voltage by about two volts when for-

L1: 5T No. 16  
1/4 T TAP  
1/4 in. dia

L2: 5T No. 16  
3/4 T TAP  
1/4 in. dia

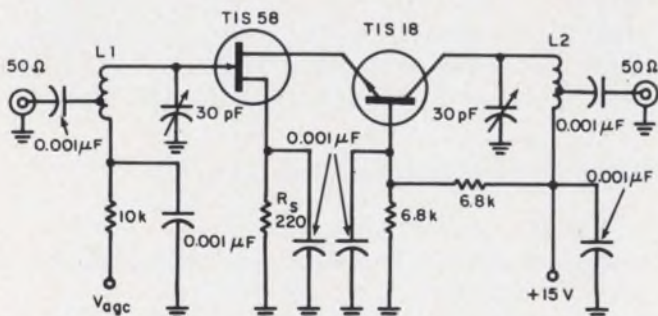

11. A cascode circuit attains high initial gain of a common-source configuration and good agc action (gain reduction) of a common-gate amplifier (the bipolar could be replaced by a common gate FET).

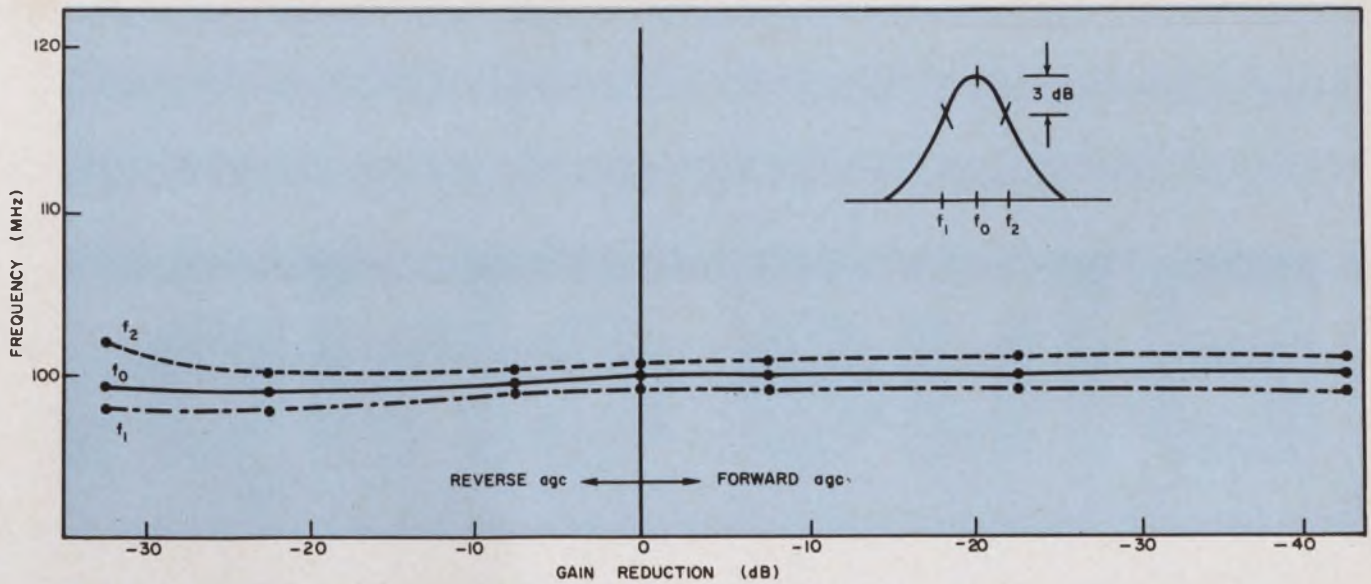

13. Both the bandwidth and the center frequency remain practically constant with gain variations in the cascode circuit of Fig. 11. In addition, as can be seen from Fig. 12,

ward agc is used, but it does not affect the agc voltage appreciably with reverse agc.

### Consider a cascode circuit

The advantage of constant bandwidth and center frequency with common-gate stages can be combined with the higher gain of common-source stages by a cascode circuit similar to that in Fig. 11. Here a TIS18 bipolar transistor is used for the second half of the cascode, but another FET could equally well be used with similar results. The advantage of the circuit is that the feedback capacitance of the composite pair is very small, while the gain of the circuit is essentially determined by the common-source FET portion of the cascode. The feedback capacitance of the circuit is small because the input and output terminals are isolated, being terminals actually of separate devices. The drain-gate capacitance of the common-source FET has negligible effect on the input tuning, because the voltage gain from gate to drain is so small. If the transconductance of the first and second devices in the cascode are defined as  $g_{m1}$  and  $g_{m2}$ , respectively, the voltage gain  $A$  from gate to drain is  $-g_{m1}Z_L$ . The load impedance,  $Z_L$ , presented by the emitter of the common-base transistor is approximately  $1/g_{m2}$ , so that  $A \approx -g_{m1}/g_{m2}$ . The effective Miller capacitance on the input is  $(1-A)C_{dg}$ , or  $(1+g_{m1}/g_{m2})C_{dg}$ . Since  $g_{m1}/g_{m2}$  will always be near unity or less, changes in gain will have negligible effect on the tuning capacitance. When a bipolar transistor is used for the second half, its normally high transconductance causes  $g_{m1}/g_{m2}$  to be small and further minimizes the effect of gain variation on the circuit tuning.

As before, the loading on the circuit of Fig. 11 was adjusted for 1-MHz bandwidth at maximum gain. The reverse and forward agc characteristics are plot-

ted in Fig. 12. The initial gain ( $V_{agc}=0$ ) is 21 dB, higher than for either the common-gate or common-source circuit. The minimum gain with reverse agc is -13 dB, slightly more than the common-gate circuit had but considerably lower than was possible with the common-source circuit. The total range of reverse-agc is 34 dB, greater than either the common-gate or common-source circuits. The range of forward-agc is limited only by the amount of gate current the control circuit can supply, Figure 13 shows that the center frequency and bandwidth remain practically constant with forward and reverse-agc.

Signal-handling ability under minimum gain conditions is an important consideration with gain-controlled stages. Overload is defined here as the maximum input signal level that can be applied without causing any discernible shift in the dc operating point. At minimum gain, the circuits discussed in this article could handle about 40 to 50 millivolts with reverse agc and over 200 millivolts with forward agc.

The extremely high dc impedance of the gate is advantageous because it permits the operating point to be shifted with practically no power from the agc circuit. This allows the use of high resistances for the control circuitry, and minimizes the loading on the rf circuit from which the agc voltage is taken. When reverse agc is applied, gate current does not flow. With forward agc, gate current flows when the gate-source junction becomes forward-biased. However, this gate current does not have to be large for effective gain reduction. The forward-agc gain reductions shown in Figs. 4, 9, and 12 with less than 100  $\mu$ A of gate required current. ■ ■

Reference:

### Reference:

1. David N. Leonard, "Improve fm performance with FETs," *ELECTRONIC DESIGN*, XV, No. 5 (March 1, 1967), 63-67.

# Blue chip.



## COLLEGE IS BUSINESS' BEST FRIEND

Published as a public service in cooperation with The Advertising Council and the Council for Financial Aid to Education.



**SPECIAL TO MANAGEMENT**—A new booklet of particular interest if your company has not yet established an aid-to-education program.

Write for: "THE RATIONALE OF CORPORATE GIVING," Box 36, Times Square Station, New York, N. Y. 10036.



## EMCOR®II— for people with custom ideas

EMCOR II is custom cabinetry at popular prices . . . as close to perfection as electronic enclosures can be. With EMCOR II, you can customize each and every piece with the use of personalized nameplates, hardware, and other components. You make your own designs and give them a personal touch.

The custom look of EMCOR II will compliment the quality of your instrumentation in every way. Fine

*EMCOR/distinguished cabinetry*

materials and exacting craftsmanship are applied to each component, providing tolerances that are precise, not flexible. On the outside—no blisters, paint runs, or rough surfaces. And, the color of your choice is carefully baked on.

When you need a cabinet, or a complete system, call your local EMCOR Sales and Service Engineer. Or write for our new EMCOR II catalog.

Albany: 436-9649; Albuquerque: 265-7766; Alexandria: 836-1800; Atlanta: 939-1674; Baltimore: 727-1999; Binghamton: 723-9661; Bridgeport: 368-4582; Chicago: 676-1100; Cleveland: 442-8080; Dallas: 631-7450; Dayton: 298-7573; Del Mar: 454-2191; Denver: 934-5505; Detroit: 357-3700; Fort Lauderdale: 564-8000; Ft. Lee (No. N.J.): 944-1600; Ft. Walton Beach: 243-6424; Houston: 526-2959; Huntsville: 539-6884; Indianapolis: 356-4249; Kansas City: 444-9494; Los Angeles: 938-2073; Minneapolis: 545-4481; Newport News: 245-8272; N.Y.C. area: 695-0082; Orlando: 425-5505; Palo Alto: 968-8304; Philadelphia: 242-0150; Pittsburgh: 884-5515; Phoenix: 273-1673; Rochester, N. Y.: 473-2115; St. Louis: 647-4350; Seattle (Bellevue): 454-5224; Syracuse: 471-7274; Tulsa: 742-4657; Utica: 732-3775; Valley Forge (So. N. J.): 265-5800; Wilmington, Mass.: 944-3930; Winston-Salem: 725-5384.  
EMCOR Reg. U. S. Pat. Off. . . . .

**Ingersoll Products** 1025 West 120th St., Chicago, Illinois 60643

DIVISION OF BORG-WARNER CORPORATION

**electronic  
equipment**



## Are you a quiz whiz? Try this test of your breadth of knowledge of electronic technology from aquadag to YIG. Good luck!

Here's a quiz designed to test your general knowledge of electronic technology and the industry. It's a simple test; no equations, derivations or calculations are involved. It's based on the test we use on applicants for technical-editor positions on our staff. They are generally design engineers with industry experience and a wide interest in the latest trends and developments in electronics. The test gives us an idea of how extensive their interests have been

prior to applying for an editor's job. Some engineers have become so narrowly specialized, and made so little effort to keep in touch with the rest of the technology, that outside of their own sphere they know little or nothing of what's happening.

How broad is your knowledge of the industry? Take the quiz and then circle Reader Service No. 474 on the card at the back of the magazine. We'll send you the answers.

### Underline the best answer.

1. **An aperture mask is used in-**  
antenna horns   TV color picture tubes   silk screens   dc motors   core memories
2. **Aquadag is used in making-**  
printed circuits   power tubes   CRTs   relays   transistors
3. **Bifilar is most appropriately associated with-**  
composition resistors   capacitors   transformers   tubes   diodes
4. **Baluns are found in-**  
network analysis   impedance matching   current reading   frequency detection  
coding theory
5. **An electron multiplier tube would most likely be found in-**  
digital computers   analog computers   scintillation counters   wattmeters   voltmeters
6. **The material which might experience electrostriction is-**  
alnico   barium titanite   glass   nickel alloy   Mylar
7. **The characteristic of a laser beam that most clearly distinguishes it from a lamp beam-**  
tunability   detectability   power   reflection coefficient   coherence
8. **In filters, one might design a-**  
A-type   comb-type   radiator-type   button-type   gain-type
9. **A filter which prevents feedback along common circuits in a multistage amplifier-**  
band-pass filter   choke-input filter   cutoff filter   decoupling filter   frequency filter
10. **The shorter of the two intervals of time which comprise a sawtooth wave is-**  
snap back   flyback   playback   offtime   shorttime
11. **A circuit that converts a frequency-modulated signal into an amplitude-modulated signal-**  
ratio detector   Hogan circuit   crystal diode   switcher   analog converter
12. **The forward voltage drop across a silicon diode is about-**  
300 mV   2V   100  $\mu$  V   16V   0.7V

13. **A resistor used to provide a discharge path in parallel with the grid coupling capacitor is-**  
breakdown grid bias overload class-C safety valve grid leak
14. **Varactor diodes would most likely be found in-**  
multivibrators power dividers deflection circuits frequency multipliers  
motor controllers
15. **A vacuum-tube oscillator circuit identified by a tuned circuit with a tapped winding connected between the grid and plate of the tube, with the tap going to the cathode-**  
Armstrong Colpitts R-C Hartley Miller
16. **NOR circuits are often used in computer circuitry because of their-**  
logic versatility low power consumption high speed temperature stability  
voltage levels
17. **A steady, unmodulated radio-frequency output is a-**  
modulator speech carrier signal oscillation
18. **The analysis of the frequency components of any signal is called-**  
Dirac autocorrelation Fourier sideband synthetic
19. **A circuit commonly used to compensate for delay distortion in an amplifier is a-**  
signal stretcher all-pass network converter flip-flop speed-up capacitor
20. **The voltage that a capacitor can withstand continuously is its-**  
maximum minimum working output optimum
21. **A unit containing several amplification stages is called-**  
dynamic saturation cascade video tandem
22. **A resistance connected across the voltage and tapped at various points is a-**  
divider bleeder tap multistage-bias ballast
23. **A resonance circuit associated with an oscillator in transmitter amplification is called-**  
parasitic plate crystal tank coupler
24. **A circuit for checking power output and making operating adjustments is called-**  
superheterodyne control-grid dummy-antenna parasitic-oscillation neutralizing
25. **The reason for making half-wave antennas 5 per cent less than half-wave length is-**  
polarization band-spreads end effect leakage frequency variation
26. **A frequency-modulation detector is a-**  
discriminator static limiter amplitude-modulator decoder
27. **The discipline in which the "bathtub" curve is common is-**  
noise analysis multiplexing reliability circuit design physics
28. **A device sometimes used in modulating laser signals is a-**  
thermistor Kerr cell lasistor Q-switch interferometer
29. **The unit that combines the output of a local oscillator with the incoming signal-**  
generator subaudible tuning converter super-regenerator
30. **A circuit most likely to be found in a digital computer's arithmetic unit is a-**  
shift register sense amplifier level shifter operational amplifier multiplier
31. **The term used to mean showing potential difference under mechanical stress is-**  
piezo lever filter potentiometric radiation

## Are these statements true (T) or false (F)?

- |  |   |   |
|--|---|---|
| 1. Wirewound resistors are preferred to carbon composition types in video circuits.  | T | F |
| 2. The power transformer is one of the more expensive components in ac-dc sets.  | T | F |
| 3. A 10-kV CRT power supply may be less dangerous than a 115-V line because the CRT supply is poorly regulated.  | T | F |
| 4. A YIG filter might be found in a microwave system.  | T | F |
| 5. A crystal filter oscillator is noted for its wide frequency range.  | T | F |
| 6. An important difference between an audio amplifier and a servo amplifier is that the former has a wide frequency range and the latter has a narrow frequency range. | T | F |
| 7. A multivibrator is a popular oscillator for generating sinusoidal waveshapes.   | T | F |
| 8. A blocking oscillator is noted for its unusual frequency stability.   | T | F |
| 9. The I-V characteristics of a FET closely resemble those of a pentode.   | T | F |
| 10. A good paper capacitor should have very high leakage resistance.   | T | F |

## What do these abbreviations stand for?

1. a-m.....
2. agc.....
3. B-H curve.....
4. BFO.....
5. cosh.....
6. kVA.....
7.  $BV_{CEO}$ .....
8.  $M\Omega$ .....
9. pnip.....
10. PCM.....
11. spdt.....
12. PRF.....
13. rms.....
14. VSWR.....
15. wvdc.....



16. alnico.....
17. CAD.....
18. PIV.....
19.  $h_{fe}$ .....
20.  $\lambda$ .....
21.  $TE_{01}$ .....
22.  $\beta$ .....
23.  $\bar{A}^*$ .....
24. TTL.....
25. Megger.....
26. Maggie.....
27. Class-B.....
28.  $j$ .....
29.  $r_p$ .....
30. shf.....
31. LSI.....
32. S meter.....
33. T pad.....
34. VFO.....
35. IR.....
36. WWV.....
37. Y cut.....

**Match the names with the most applicable subjects.**

- |              |                        |
|--------------|------------------------|
| (a) Cauer    | (1) Coding             |
| (b) Hamming  | (2) Control theory     |
| (c) Shannon  | (3) Computers          |
| (d) Boole    | (4) Network synthesis  |
| (e) Liapunov | (5) Information theory |

**For the answers, circle Reader Service No. 474.**

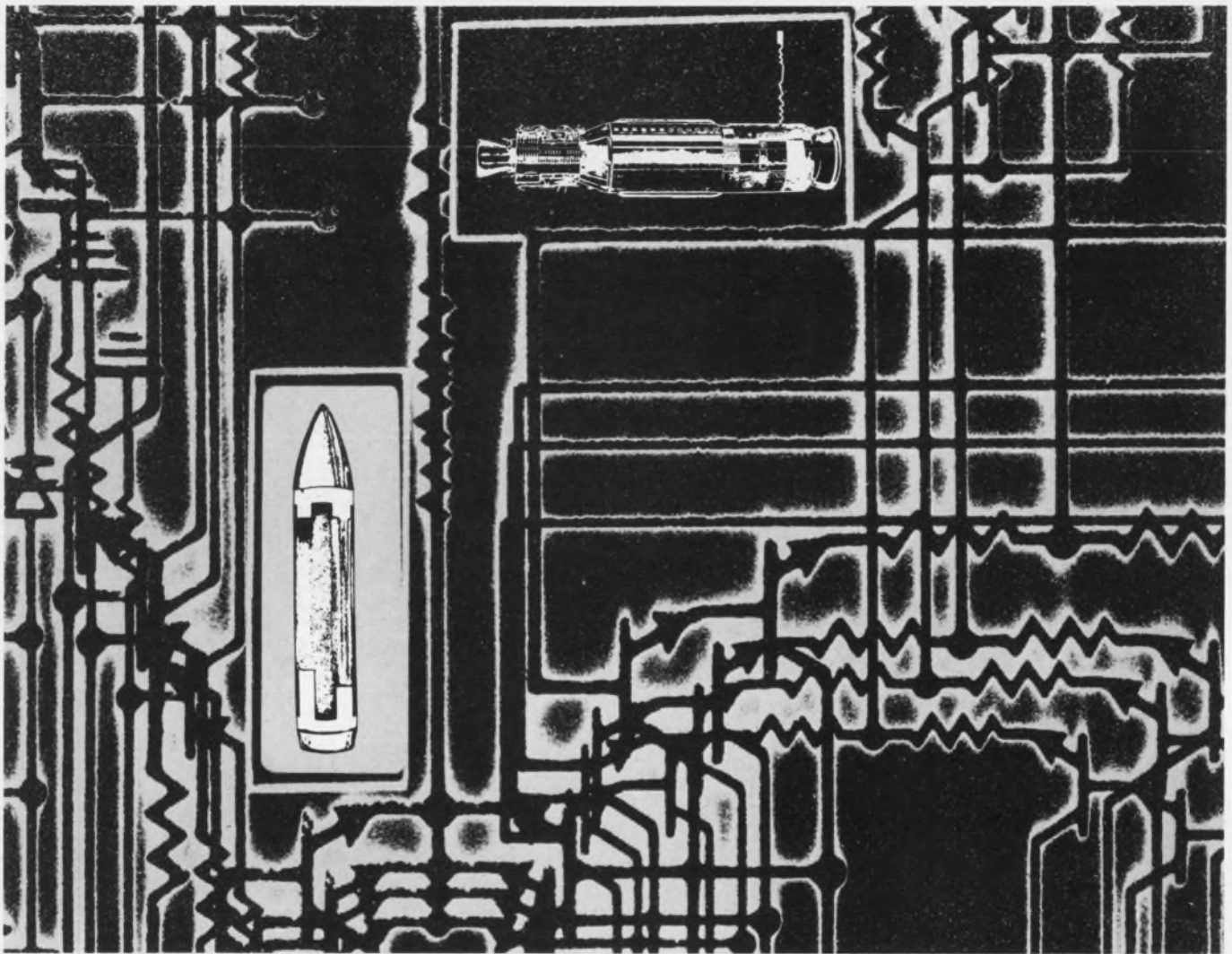

*up.  
down.  
on the ground.  
the place for new electronics advances is Lockheed.*

Whatever environment you now work in—land, sea, or space—you'll find it to your advantage to look into opportunities at Lockheed. Take Agena and Poseidon for example. Major technical expansion is under way on both of these vital programs. And both Agena and Poseidon share the need for new concepts and major technical advances. □ Typical Agena assignments will include: digital communication systems for data transmission and command, digital and analog flight control systems, optical and infrared sensors, solar power panels, and power conditioning. □ Poseidon's general area of requirements ranges from weapon effects on electronics to the design and use of state-of-the-art test check-

out equipment in one of the largest checkout programs ever mounted. □ Undersea, Lockheed is active in the expanding field of deep submersibles and ocean mining. Now under way—the Navy's unique Deep Submergence Rescue Vehicle and Lockheed's Deep Quest research vehicle designed to operate down to 8000 feet. □ On land, Lockheed is engaged in the development of unique land vehicle systems, information systems for states and hospitals, and many other important programs. □ For more complete information, you are invited to write Mr. R. C. Birdsall, Professional Employment Manager, P.O. Box 504, Sunnyvale, California. Lockheed is an equal opportunity employer.

**LOCKHEED**  
MISSILES & SPACE COMPANY  
A GROUP DIVISION OF LOCKHEED AIRCRAFT CORPORATION

ON CAREER INQUIRY FORM CIRCLE 901

# Free Career Inquiry Service

## Absolutely Confidential

Respond to the career opportunities advertised in this issue. Fill out and send us this handy resume. **Electronic Design** will do the rest – neatly typed copies of this form will be mailed to the companies of your choice, indicated by the circled Career Inquiry Numbers at the bottom of this page.

# 18

<b>Name</b>		<b>Home Phone</b>	
<b>Home Address (Street)</b>		<b>City</b>	<b>State</b>
			<b>ZIP Code</b>
<b>Age</b>	<b>U.S. Citizen</b>	<b>Security Clearance</b>	
	<input type="checkbox"/> Yes <input type="checkbox"/> No		

Prime Experience	Secondary Experience

<b>Desired Salary</b>	<b>Avallabilty Date</b>
-----------------------	-------------------------

**Employment History – present and previous employers**

Company	City, State	Dates	Title
		to	
		to	
		to	

**Education – indicate major if degree is not self-explanatory**

Degree	College	City, State	Dates
			to
			to
			to

**Additional Training – non-degree, industry, military, etc.**

---



---



---

**Professional Societies**

---

**Published Articles**

---

**Career Inquiry Numbers:**

- |     |     |     |     |     |     |     |     |     |     |
|-----|-----|-----|-----|-----|-----|-----|-----|-----|-----|
| 900 | 901 | 902 | 903 | 904 | 905 | 906 | 907 | 908 | 909 |
| 910 | 911 | 912 | 913 | 914 | 915 | 916 | 917 | 918 | 919 |

**ELECTRONIC DESIGN**  
 850 Third Avenue  
 New York, New York 10022

THE EXCITING SURGE OF ELECTROSYSTEMS



Dr. E. B. Carne,  
author of "Artificial  
Intelligence  
Techniques";  
Assistant General  
Manager—Systems,  
Greenville Division,  
LTV Electrosystems.

## ARTIFICIAL INTELLIGENCE HE WROTE THE BOOK

Would you like to teach a machine to think?

Dr. Carne and the engineers of LTV Electrosystems are doing just that within one of the most exciting R & D programs in the country.

Greenville Division researchers have successfully programmed contemporary "thinking machines"—digital and analog computers—to take giant steps beyond their present capabilities as memory banks and simple automatic controllers. The electronic brains have been taught to perform certain basic humanistic intellectual functions, such as making plans, setting up hypotheses, recognizing analogies and actually executing decisions based upon logical choices.

Sounds like ivory tower experimentation?

Not at all. Systems engineering means immediate application of the latest technologies at LTV Electrosystems. Artificial intelligence systems serve a real and practical function within the advanced electronics projects under development at Greenville Division, a major producer of sophisticated, multi-sensor surveillance and reconnaissance systems; highly accurate navigation systems (using stellar, doppler, and iner-

tial modes); ground and airborne tracking systems; and ground and airborne command and control systems.

Research and development programs are also adapting artificial intelligence to in-flight monitoring of instrumented aircraft to detect or predict failures of the airframe or the avionics systems.

Consider a career with LTV Electrosystems. The opportunity equals the technology: exciting and unlimited in potential. In addition to analysis and design of advanced electronic systems, selected openings are available in electro-optics, antenna design, stress analysis and other mechanical disciplines, programming . . . much more.

In addition to the Greenville Division, LTV Electrosystems includes the Garland Division and the Continental Electronics subsidiaries, all with opportunities in many disciplines at several locations.

For full information, write or call collect, Mr. Bill Hickey / P. O. Box 6118 / Dallas, Texas 75222 / Telephone (214) 276-7111. (A Subsidiary of Ling-Temco-Vought, Inc.) an equal opportunity employer m/f.

**LTV ELECTROSYSTEMS, INC.**

ON CAREER INQUIRY FORM CIRCLE 902

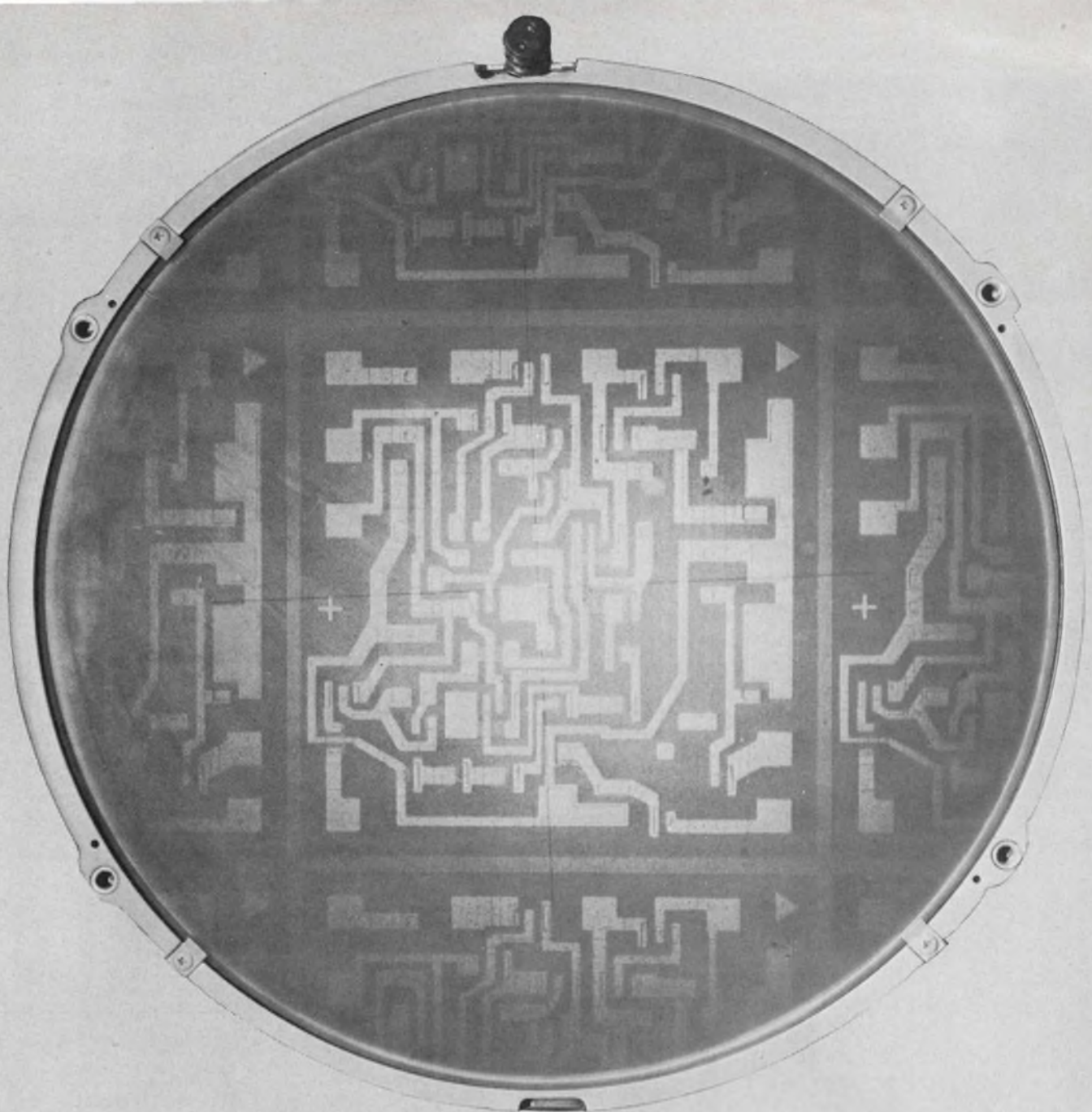

## Challenge In Microelectronics

You'll find it at Delco Radio in a variety of research/development and manufacturing programs. Rapid expansion of microelectronics and silicon device projects has created new career opportunities for the B.S., M.S., Ph.D. in Chemistry, Electrical Engineering, Mechanical Engineering, Metallurgy, Physics, Physical Chemistry, and related fields.

### Research and Development Programs in:

Linear and digital circuitry, embracing monolithic . . . thick film . . . thin film . . . and hybrid microcircuits

Silicon transistors from low power 10 milliampere through 25 ampere; voltages to 1200

High frequency transistors to 1GHz

Thyristors from 50 millampere through 500 ampere, 2000 volts

Silicon rectifiers from milliampere through 250 ampere, 3000 volts

### Process Engineering Positions:

Unlimited opportunities in this area to develop and create new processes for manufacturing germanium and silicon semiconductor devices, integrated circuits, and automobile radios. Includes development of automatic and semiautomatic fabrication equipment, pilot line operation and general cost savings investigations pertinent to semiconductor manufacturing.

**Call us collect** for an interview or more information. Area Code 317/459-2808. Ask for C. D. Longshore. Or send your resume to Mr. Longshore, Supervisor, Salaried Employment, Dept. 103, Delco Radio Division of General Motors, Kokomo, Indiana.

**DELCO RADIO**  
DIVISION OF GENERAL MOTORS • KOKOMO, INDIANA

An equal opportunity employer



# Versatile pulse generator made by combining three ICs

Combining three inexpensive integrated circuits as shown in the accompanying figure yields a versatile pulse generator capable of driving low-impedance, high-capacity loads. The circuit has adjustable pulse widths and variable delay with reference to the externally supplied trigger. Used in conjunction with a time-mark generator, the device can easily substitute for a commercial pulser, and can therefore free expensive equipment for more sophisticated use.

The Amelco IC (011-004) is a monostable multivibrator (MV) with an output pulse width controlled by an external capacitor. The pulse width is related to the capacitor by:

$$\text{pulse width } (\mu\text{s}) \approx \text{capacity (pF)} \times 0.006.$$

The output of *MV1* (which can be triggered by any positive signal) is fed into a Sylvania SUHL SG 130 driver, where it is inverted. It is then differentiated, so that the trailing edge of the pulse generated by *MV1* serves as the trigger for *MV2*. The output of *MV2*, which can be varied in width by *C2*, is then fed to the other driver in the SUHL package.

Output amplitude across a 200-ohm resistive load is -3 volts to ground; rise time is less than 5 ns. Pulse width and delay can be as short as 10 ns

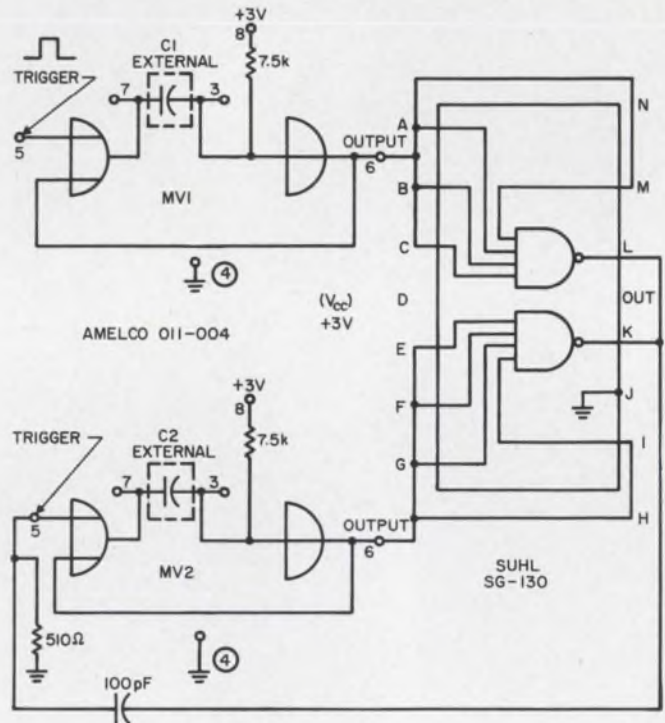

Adjustable pulse width generator uses three ICs and several discrete components.

with selected MV units.

*R. M. Zilberstein, Sr. Project Engineer, Microsonics, Inc., Weymouth, Mass.*

VOTE FOR 110

**VOTE!** Go through all Idea-for-Design entries, select the best, and circle the appropriate number on the Reader-Service-Card.

**SEND US YOUR IDEAS FOR DESIGN.** You may win a grand total of \$1050 (cash)! Here's how. Submit your IFD describing a new or important circuit or design technique, the clever use of a new component or test equipment, packaging tips, cost-saving ideas to our Ideas-for-Design editor. You will receive \$20 for each accepted idea, \$30 more if it is voted best-of-issue by our readers. The best-of-issue winners become eligible for the Idea Of the Year award of \$1000.

## Feedback loop provides high dc stability

Stabilization of the quiescent current in the output transistors of a push-pull amplifier is difficult to achieve, especially if large ambient temperature extremes are encountered, or if the power transistors are operated at high temperatures. This circuit is one approach to high dc stability.

Two feedback resistors, *R5* and *R6*, provide dc feedback for temperature stabilization of all stages in the circuit. These resistors stabilize the voltage division across power output transistors *Q5* and *Q6* and also fix the zero signal current through the



# new disciplines in DC

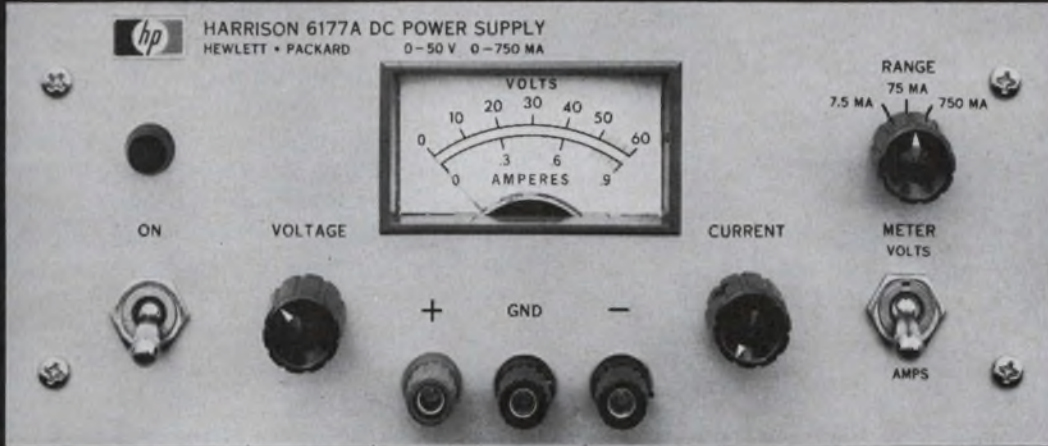

## take the constant current model with < 200 microsecond recovery

### Accurate DC Voltage Monitoring Circuit Eliminates Output Resistance Degradation

A new series of compact, precision regulated, all-silicon DC power supplies features constant current output useful down to the microamp region. Ripple, regulation, and stability are orders of magnitude better than comparably priced constant current supplies, and permit CCB models to be used as general purpose laboratory constant current sources for semiconductor circuit development, and for component evaluation and testing.

A constant current DC power supply must be able to change its output voltage rapidly in order to minimize load current transients. With the CCB Series, less than 200  $\mu$ s is required for transient load recovery to within 0.1%—even for load changes requiring full rated output voltage changes!

Placing a voltmeter across the output terminals of a normal constant current power supply degrades the load regulation and diminishes the load current both by a factor of  $R_L/R_L + R_V$ . ( $R_L$  = load resistance,  $R_V$  = voltmeter resistance.) The CCB Series eliminates this error by using an operational amplifier to feed the front panel voltmeter. This "replica" of the output voltage is also presented on rear terminals for possible connection to a more accurate differential or digital voltmeter, thus increasing the utility of these constant current supplies for component testing and sorting systems.

Three-Position Output and Meter Range Switch, 10-Turn Output Control With Resolution to 0.1  $\mu$ A • Continuously Variable Voltage Limiting • Output Impedance to 20,000 Megohms, Depending on Model Number and Range • High Speed Remote Programming From Resistance or Voltage Input, Can Be Modulated Using External AC Source • No Overshoot on Turn-On, Turn-Off, or Power Removal • Front and Rear Output Terminals • Half Rack Width, Rack Mounting Hardware Available.

CCB SERIES SPECIFICATIONS			
Output Current	0-750 MA	0-300 MA	0-100 MA
Voltage Compliance	0-50 V	0-100V	0-300V
Load Regulation	Less than 10 PPM of output +5 PPM of range setting		
Line Regulation	Less than 10 PPM		
RMS Ripple	Less than 100 PPM of output +10 PPM of range setting		
Size	3½" (89 MM) H x 8½" (216 MM) W x 12¾" (321 MM) D		
Model	6177A	6181A	6186A
Price	\$425.	\$425.	\$425.

Contact your nearest Hewlett-Packard Sales Office for full specifications.



POWER SUPPLIES

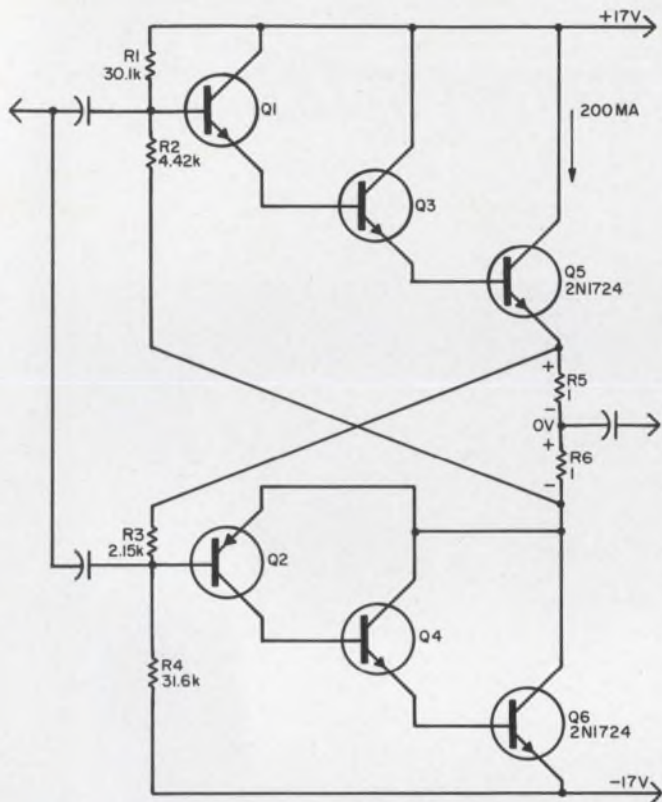

Feedback resistors R5 and R6 stabilize the voltage division across the output power transistors and provide temperature stabilization.

power transistors at a specific value, to minimize crossover distortion. Positive ac feedback provides high input impedance. Dc coupling and an emitter-follower circuit configuration yield excellent frequency response and low distortion.

The amplifier has been designed for a quiescent current of 200 mA. A change in transistor parameters that would tend to cause a larger quiescent current to flow would produce  $IR$  drops in R5 and R6, as indicated in the schematic. This would cause the dc bias of Q1 to become more negative and that of Q2 more positive, tending to restore the circuit to its original condition.

Since there is no phase inversion in the circuit, the feedback loop will feed an in-phase ac signal back to the input, which results in high input impedance.

Bjorn H. Engelhardt, Orlando, Fla.

VOTE FOR 111

## Computer analysis spots twin-T filter troubles

Twin-T networks and operational amplifiers make excellent bandpass filters, but there are some pitfalls to avoid. Several such pitfalls not mentioned in the recent literature were exposed

by a computer analysis of the circuit of Fig. 1a. The computer analysis was necessary to avoid the burdensome theoretical analysis.

The first discrepancy was that the filter center bandpass frequency differed from the twin-T notch frequency, i.e.,  $f_o = 1/2\pi RC =$  twin-T notch frequency,  $f_m \approx 1/2\pi RC + 1/2\pi R_f C$  (frequency at maximum output).

Thus, the filter pass band is always above the twin-T notch. The center-frequency magnitude of this error can become quite serious; for example, when  $R_f = 10 R$ ,  $f_m \approx 1.10 f_o$ .

The second discrepancy arose as a result of the first. The filter gain at maximum would be expected to be the familiar relation,  $A_v = -R_f/R_i$ . Such is not the case, nor is there a simple relationship (See Fig. 1a). Depending on the value of  $b$  and the ratio  $R_f/R$ , the maximum will vary both above and below  $-R_f/R_i$ . This is caused by the resultant current feedback through the notch

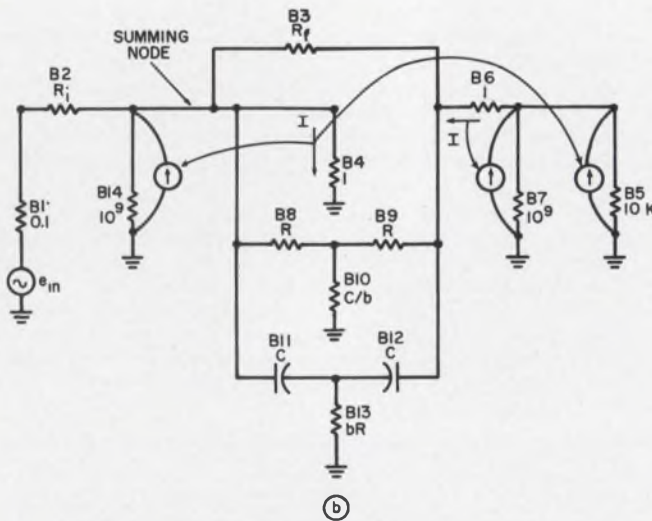
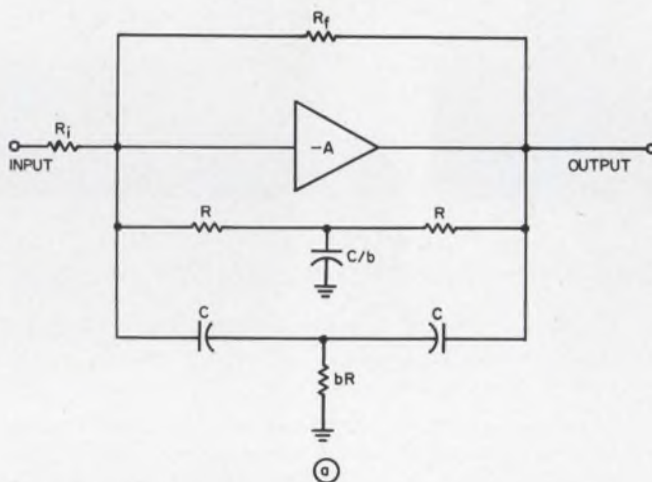

1. Twin-T active-filter (a) performance analysis by a computer reveals that both the bandpass frequency and filter gain deviate from the commonly used expressions. The ECAP computer model of the active filter is shown in (b).



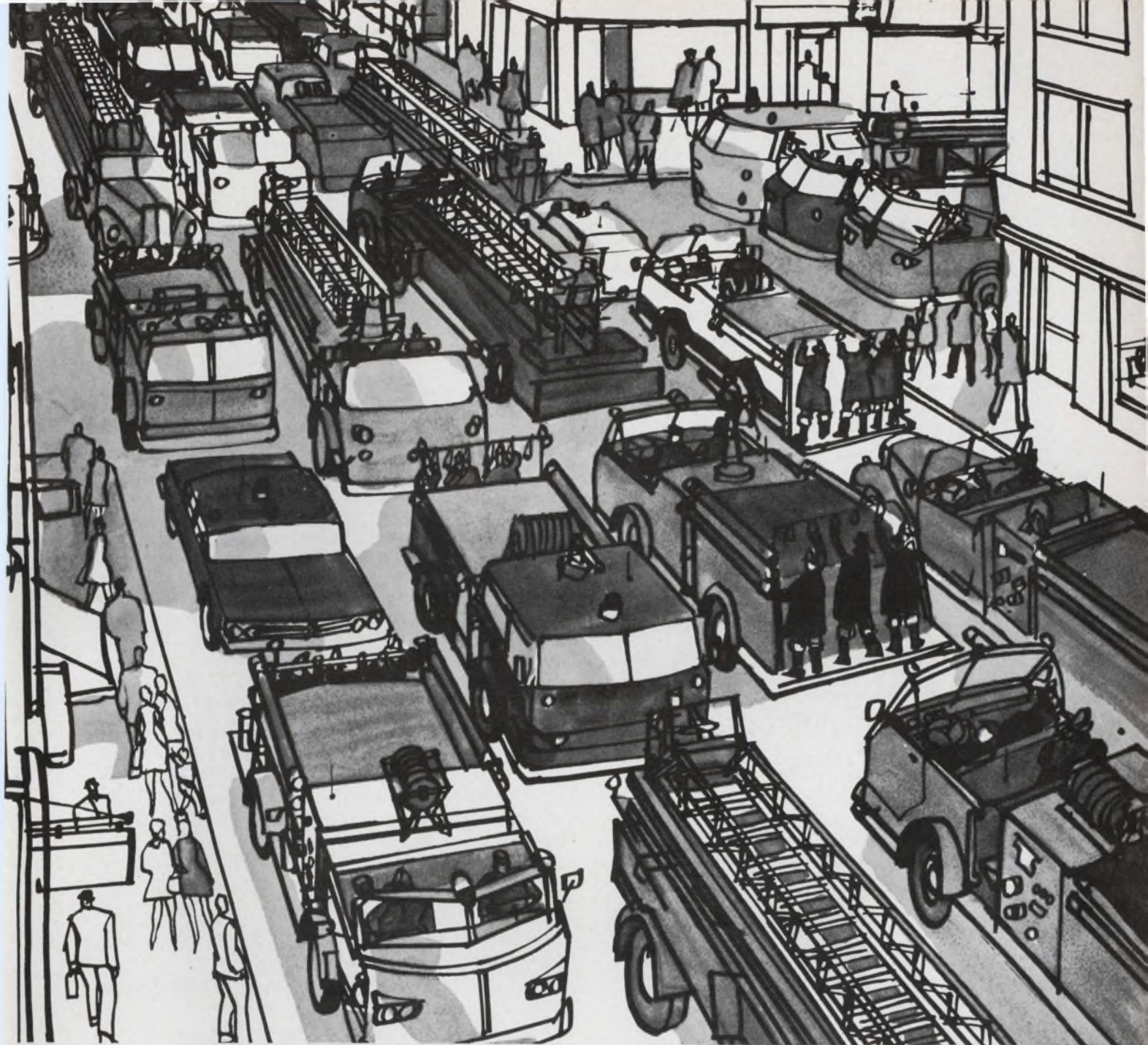

# 11,331 radio-dispatched fire-engines and only one tetrode rated for PTTS\*

The fire fighter is rarely on the air for as long as 60 seconds and he is "otherwise occupied" for at least five minutes between calls. The same goes for most radio-dispatched vehicles.

PTTS\* (Push-To-Talk-Service), with its duty cycle of ONE MINUTE ON and FOUR MINUTES OFF has been shown to be the most realistic, economical and practical rating system for vehicular communications systems.

For this reason, Amperex developed the 8637, the only twin tetrode ever designed and rated for PTTS. Featuring high thermal inertia anodes and

incorporating a wealth of twin-tetrode manufacturing experience, the 8637 offers the designer a new approach in creating a better vehicular radio. Fewer, and less costly components may be used. Some typical operating conditions which bear this out are shown on the chart at right . . . lower plate voltage, lower drive and higher efficiency at the VHF frequencies.

The 8637 is a 'small tube', (only 3 1/8" seated height), perfectly suited for today's low-profile designs. Its cost is lower than ICAS and CCS rated tube types of the same power.

For data, applications reports and engineering assistance, write: Amperex Electronic Corporation, Tube Division, Hicksville, L. I., N. Y. 11802.

ALL THIS—and AMPEREX QUALITY, TOO!			
ONE 8637—PUSH-PULL			
Internally Neutralized Throughout Entire Freq. Range			
50 MHz	PLATE	OUTPUT	DRIVE
CCS	375v.	25w.	0.67w.
ICAS	450v.	34w.	0.82w.
PTTS	600v.	84w.	0.86w.
175 MHz			
CCS	300v.	18w.	1.4w.
ICAS	350v.	26w.	1.6w.
PTTS	560v.	63w.	2.2w.



**Amperex**<sup>®</sup>  
TOMORROW'S THINKING IN TODAY'S PRODUCTS

filter (since  $f_m \neq f_0$ ) canceling or adding to the feedback current through  $R_f$ . For the case when  $R_f = 10 R$  and  $b = 0.525$ ,  $A_{vm} \approx 1.1$  ( $-R_f/R_i$ ), and when  $b = 0.510$ ,  $A_{vm} \approx 1.3$  ( $-R_f/R_i$ )—a serious error in both cases.

The ECAP computer model used to simulate this circuit is shown in Fig. 1b. It affords simulation of a high-gain operational amplifier with dependent current sources. The circuit-model operation is as follows: The current flowing into  $B4$  is put back across  $B5$  (multiplied by a factor  $\beta$ ) to give a voltage gain of  $(10 \text{ k}\Omega \div 1 \Omega) \times \beta$ .

The current flowing through  $B4$  is also put back in across  $B14$  to replace the current drawn from the input node by  $B4$ . The current flowing from the output through  $B6$  is put back in  $B7$  so that the output is independent of the feedback loading.

The result is an ideal model of an operational amplifier with an open-loop gain that can be varied by changing the factor  $\beta$ .

*Thomas H. Lynch, Bunker-Ramo Corp., Canoga Park, Calif.*

VOTE FOR 112

## Motor-speed change time is computed graphically

The time required to reverse the rotation of a servo motor, or to go from any one speed to another, can be found by applying an interesting graphical integration technique to the motor torque-speed curve. If the motor is running initially at a speed  $\omega_1$ , a moment after the voltage is reversed its speed can be considered to be  $-\omega_1$ . Its speed then decreases in magnitude, goes through zero as it reverses, and builds up to  $\omega_1$  in the new direction. These points are shown on a typical two-quadrant servo motor torque-speed diagram (see figure).

To set up the integration, start with the relationship  $T = J\alpha = Jd\omega/dt$ . Going to finite differences,  $T \approx J\Delta\omega/\Delta t$  or, by rearrangement,  $\Delta t/J \approx \Delta\omega/T$ . Now, from the point on the torque-speed curve corresponding to  $-\omega_1, T_1$ , draw a construction line down to  $-\omega_2$  on the speed axis; thus  $\omega_2 - \omega_1$  represents a change in speed of  $\Delta\omega_1$ . The time it takes the motor to accomplish this  $\Delta\omega_1$  change in speed is  $\Delta t = J\Delta\omega_1/T_1$ . (In practice, it is generally more convenient to pick a  $\Delta t$  and calculate a  $\Delta\omega$  to draw the construction line, rather than to pick the  $\Delta\omega$  and calculate the  $\Delta t$ , as above. The two are equivalent, so long as  $\Delta\omega$  is much less than the no-load speed, or  $\Delta t$  is much less than the motor time constant).

Next, from this new value of speed,  $-\omega_2$ , mark the corresponding torque,  $T_2$ , on the torque-speed

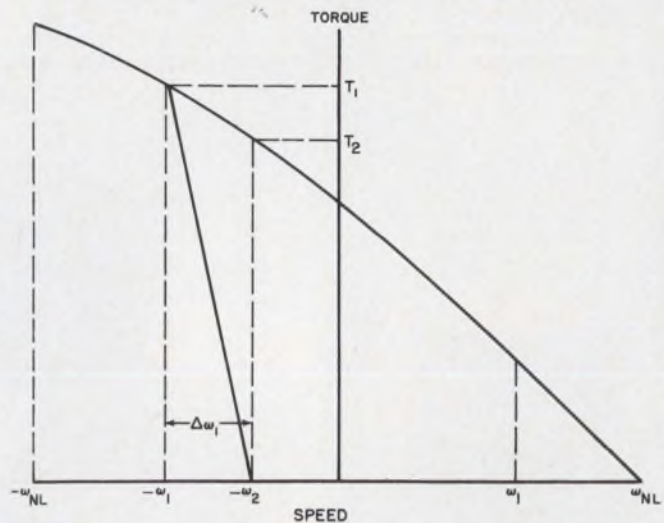

Time required for a motor-speed change can be computed from the two-quadrant servo motor torque-speed plot. A line from the point  $-\omega_2, T_2$  parallel to the line from the point  $-\omega_1, T_1$  to  $-\omega_2$  gives the next increment of speed,  $\Delta\omega_2$ . Multiplying the number of required  $\Delta\omega$ s by  $\Delta t$  gives the total time required to change the speed.

curve. A second construction line, drawn from this point parallel to the first line, gives a  $\Delta\omega_2$  such that  $\Delta\omega_2/T_2 = \Delta\omega_1/T_1$ . Thus, the time increment required to accomplish  $\Delta\omega_2$  is the same  $\Delta t$ . Continue marking the new torque, drawing a new construction line parallel to the others for a new  $\omega$ , until the newest  $\omega$  equals  $\omega_1$ . The total number of repetitions multiplied by the time  $\Delta t$  represented per construction is the total time required for the speed change.

*Jesse Roth, Raff Analytic Study Associates, Inc., Silver Spring, Md.*

VOTE FOR 113

## Constant-current regulator has low dissipation

Figure 1a shows a commonly used constant-current regulator in which transistor  $Q1$  draws a constant current  $I_o$  through load  $R_L$ . If  $V_{be}$  and  $I_b$  are ignored, the value of collector current  $I_c$  ( $= I_o$ ) for a low-leakage, high- $\beta$  transistor is:

$$I_c = I_o = V_1/R_L \quad (1)$$

A limitation of this circuit is that transistor dissipation is directly proportional to collector voltage,  $V_c$ . Maximum dissipation occurs when  $R_L = 0$ , and is:

$$P_{a \text{ max}} = I_o V_{cc} \quad (2)$$

Equation 2 is plotted in Fig. 1c as curve  $a$ . Higher-power circuits may require several transistors in parallel to handle this dissipation.

Figure 1b shows the circuit modified by the

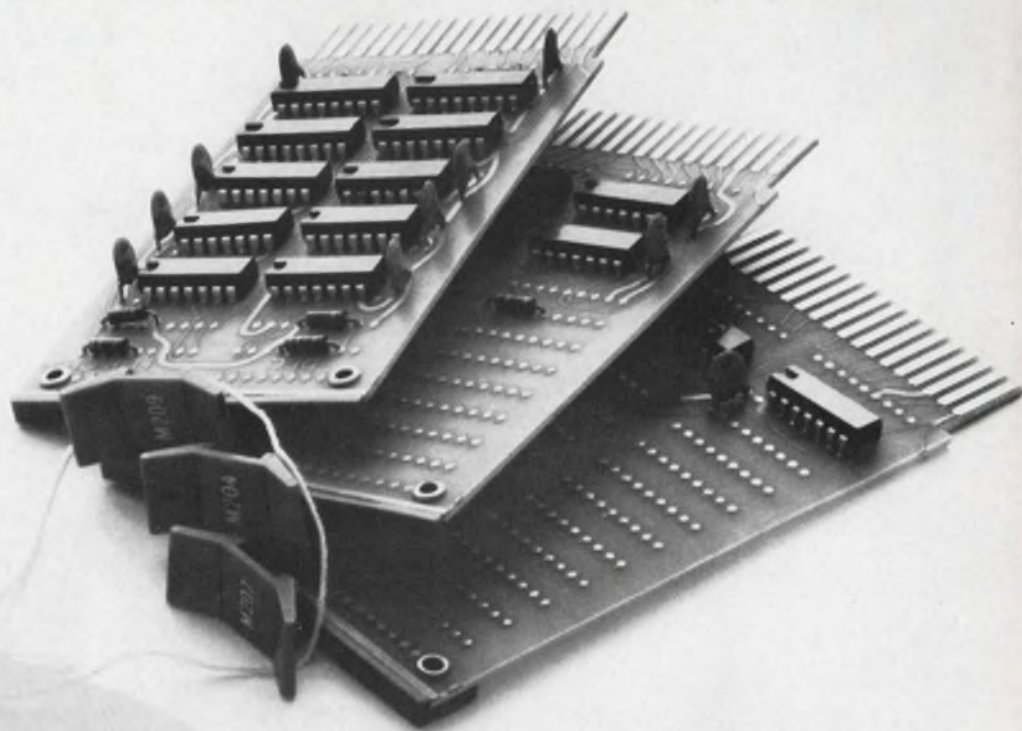

**Digital  
M Series  
I/C Modules  
do more,  
cost less.**

**What more  
can we say?**

Cost vs. performance is what every designer ultimately judges. So judge!

DIGITAL's new M series are high fan out modules, with high capacitance drive, excellent noise margins — and they are fast. DC to 10 MHz fast.

They do more. Dual in-line TTL packages on a 36-pin circuit card permit functional logic arrays never available before. One small module contains 4 JK flip-flops as a general purpose counter. Another contains an 8-bit shift register. Still another holds an 8-bit up or down counter; a BCD to Decimal, or a Binary to Octal, decoder is just one circuit card.

And the prices. Lowest cost per gate in the industry. And we're not afraid to publish them.

#### M Series Price List

Type	Function	Price
M050	12 — Lamp Driver	\$31.00
M113	10 — 2 Input Nand	23.00
M115	8 — 3 Input Nand	24.00
M117	6 — 4 Input Nand	24.00
M121	6 — And/Nor Gates	25.00
M161	BCD to DEC/BIN to Octal Decoder	60.00
M203	8 — R/S Flip Flops	32.00
M204	4 JK Flip Flops, General Purpose Counter	36.00
M206	6 D Type Flip Flops	42.00
M207	6 JK Flip Flops	42.00
M208	8 Bit Shift Register	84.00
M209	8 Bit Up/Down Counter	84.00
M302	Dual Delay Multi	46.00
M401	Variable Clock	55.00
M502	2 — Negative Input Conv.	26.00
M602	2 — Pulse Amplifiers	28.00
M617	6 — 4 Input Power Nand	27.00
M627	6 — High Speed Nand Power Amplifier	32.00
M652	Negative Output Converter	26.00

Effective Aug. 1, 1967 until further notice

Write for further details and free Logic Handbook.

**digital**  
MODULES • COMPUTERS

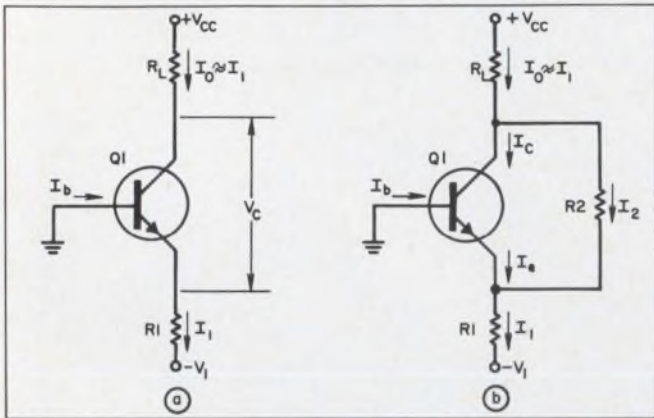

Constant-current regulator can be built to have very low dissipation (b) by adding a bypass resistor R2 to a stand-

ard circuit (a). Q1 dissipation curves (c) show the difference. Another version of the circuit is shown in (d).  
 addition of current bypass resistor R2, connected from collector to emitter. This reduces the maximum transistor dissipation by a factor of four, yet preserves the constant-current nature of the Q1-R2 combination as seen by load RL. This allows one transistor to do the work of four, since the necessary internal circuit loss is dissipated mostly by R2.

The fact that RL sees a constant current independent of R2 can be shown as follows: If V1 is large in comparison with Vbe, the voltage across R1 is constant. Therefore current I1 is constant, as in Fig. 1a. At the junction of R1 and R2, this current divides between Ie and I2, so that:

$$I_e + I_2 = I_1 = \text{constant} \quad (3)$$

For a high-β transistor, Ic equals Ie within a few per cent. Equation 3 now becomes:

$$\begin{aligned} I_c + I_2 &= I_1 = \text{constant}, \\ I_o = I_c + I_2 &= I_1 = \text{constant}. \end{aligned} \quad (4)$$

It may seem startling that a constant-current source can be paralleled with a resistor and remain a constant-current source. The value of current Io is independent of R2 and is:

$$I_o = I_1 = V_1/R1.$$

These results are due to the fact that R2 is

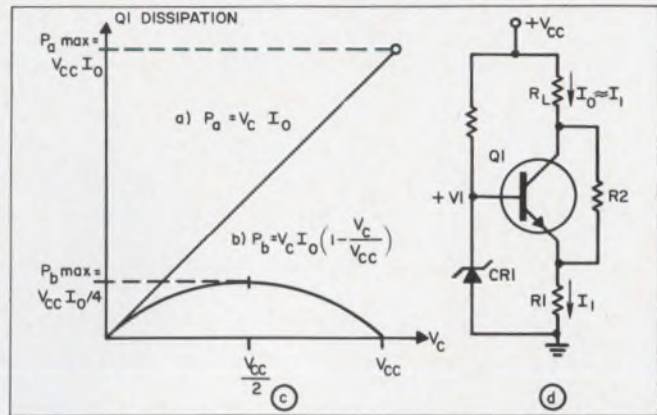

ard circuit (a). Q1 dissipation curves (c) show the difference. Another version of the circuit is shown in (d).

returned to the emitter. If the lower end of R2 were grounded, none of the above would hold. If R2 is set equal to Vcc/Io, transistor dissipation is given by:

$$P_b = V_c I_o (1 - V_c/V_{cc}).$$

This equation is plotted in Fig. 1c as curve b.

Q1 just reaches cutoff when RL = 0. The dissipation curve for Q1 is now an inverted parabola, and peak dissipation occurs at half voltage and half current:

$$P_{b \max} = (V_{cc}/2)(I_o/2) = V_{cc} I_o/4.$$

Thus:

$$P_{b \max} = P_{a \max}/4.$$

Maximum power in R2 occurs when RL = 0:

$$\begin{aligned} P_{R2 \max} &= I_o V_{cc} \\ &= P_{a \max}. \end{aligned}$$

Thus the dissipation requirements have shifted from Q1 to R2; only 25 per cent remains in Q1.

Figure 1d shows the same idea applied to a single-source form of this circuit. If Zener CR1 is replaced with a resistor, Io is proportional to Vcc and independent of both RL and R2.

Allan G. Lloyd, Project Engineer, Avion Electronics, Inc., Paramus, N. J.

VOTE FOR 114

## Rf plate choke uses simple components

A 2-amp, 5000-volt dc rf plate choke of simple and economical design was required. It was put together with DuPont Delrin rod for the form (see figure). Delrin exhibits excellent electrical properties when used as an insulator. A 3/4-by-5-1/4-inch rod was drilled to accept a 3-by-0.33-inch-diameter ferrite rod. A 60-turn coil was then wound over 4 inches of the form. This choke had

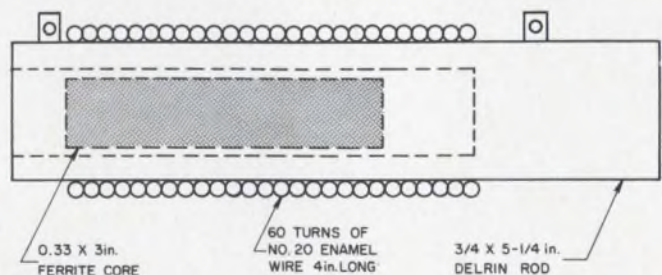

A 2-A, 5000-V dc rf plate choke is built with a Delrin rod, piece of ferrite rod, and a few turns of wire. The choke has inductance of 90 mH and a Q of 225.

an inductance of  $90 \mu\text{H}$  and a  $Q$  of 225. In addition, a troublesome series resonant frequency was moved far above the operating range to 43 MHz.

*William Deane, Design Engineer, Deane Enterprises, San Diego, Calif.*

## UJT and SCR reset self-latching relay

This circuit is useful for applications where an automatic relay reset is required after a short lapse of time (80 seconds maximum in this case). The control contacts of the relay might be used to actuate some mechanism for a definite, short time interval.

The timing cycle is started by depressing a momentary switch,  $S1$ , which energizes the relay (a one-shot multivibrator might be used instead of  $S1$ ). Relay contacts 1 and 2 are wired in parallel with  $S1$  and provide relay holding current after the  $S1$  contacts open. Simultaneously, the opening of contacts 5 and 6 starts the timing cycle which is a function of  $R$  and  $C$  and the unijunction  $Q1$ . Upon firing, the unijunction output pulse at  $B1$  triggers the SCR, which shorts the relay coil and so causes the relay to release. Since this action

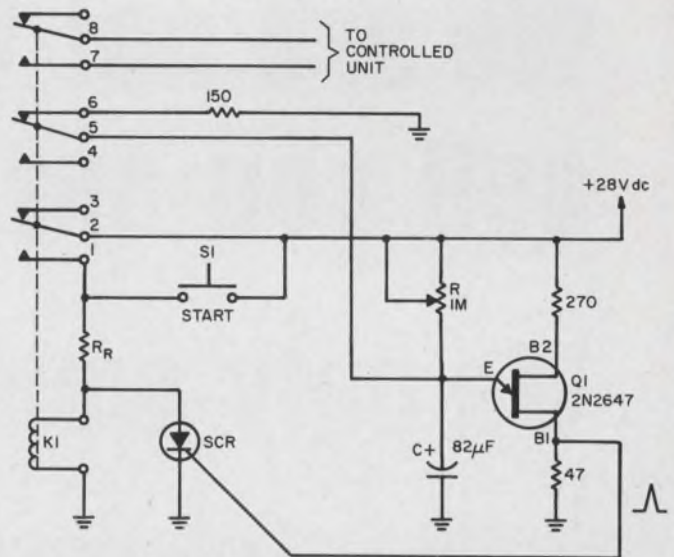

A pair of relay contacts can be closed for any desired time interval by adjusting values of  $R$  and  $C$ . In the circuit shown, the maximum on-time for contacts 7 and 8 is 80 seconds.

removes the anode voltage from the SCR, the SCR also resets. The circuit is now back to its initial state.

*Herbert Elkin, Senior Engineer, Applied Devices Corp., College Point, N. Y.*

VOTE FOR 115

## Ring counter uses optical triggering

This ring counter demonstrates the use of light as a control signal. In a conventional ring counter only one stage is in the high state, and the trigger, which switches each stage to its low state, steps the high state from one stage to the next.

In this circuit (see figure) which uses optically triggered SCRs as the bistable elements, the light pulses delivered simultaneously to all stages from a strobe source switch each stage to its conducting

(low-voltage) state. In the process, the stage which had been high transmits a negative pulse to the following stage, which then switches into its nonconducting (high) state.

In this way, each time a light pulse is applied, the high (nonconducting) stage will shift one place to the right around the loop. This circuit has operated in ambient room illumination at speeds from 0 to 400 Hz, the limit of the General Radio Strobotac used as the light source.

*Robert C. Hoyler, Engineer, Westinghouse Electric Corp., Pittsburgh.*

VOTE FOR 116

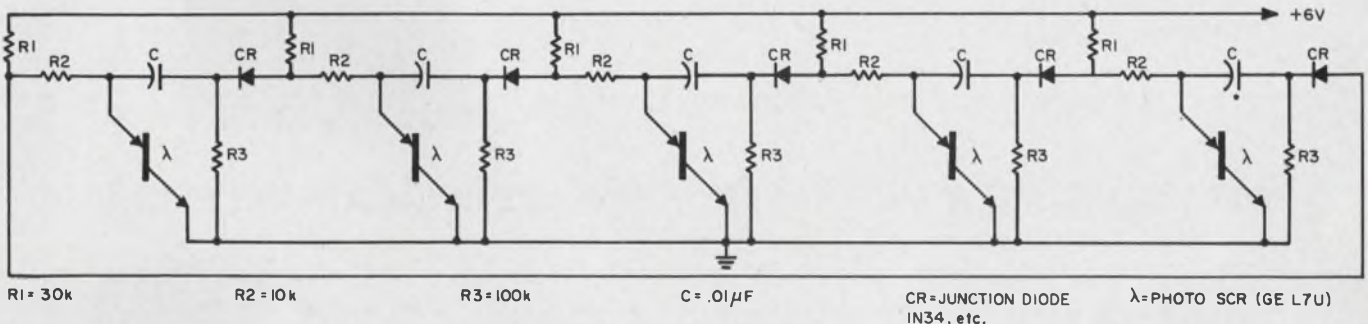

Optical ring counter uses several identical stages to count light pulses at speeds from 0 to 400 Hz. Higher

counting frequency was not investigated. Light-triggered SCRs are used for switching.

# We are not trying to sell you anything...

# We only want to help you

## FOR INSTANCE

**WHEN THE ELECTRONIC INDUSTRY** asked for etched kovar clip leads, BMC made them. We make leads up to .015 thickness for micro-circuit packaging, in any configuration, in sheets up to 12" x 18".

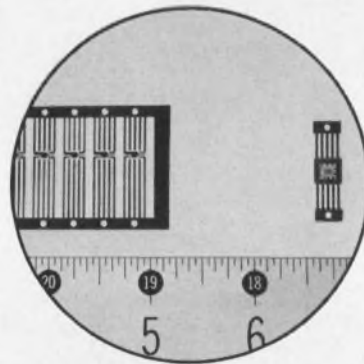

**WHEN THE CHEMICAL INDUSTRY RE-**QUIRED A MORE ACCURATE SIEVE to measure particle sizes, BMC made it. Now makes sieves with openings as small as five microns.



**WHEN THE U.S.A.F. ASKED FOR RE-**SOLVING POWER TEST TARGETS, BMC made them. High and low resolution targets are available on 35 mm film in 20 foot rolls.



**DO YOU HAVE A PROBLEM? PERHAPS WE CAN HELP YOU**

**BUCKBEE MEARS COMPANY**



245 East 6th St. / St. Paul, Minnesota 55101 / Phone 227-6371

ON READER-SERVICE CARD CIRCLE 34

# Products

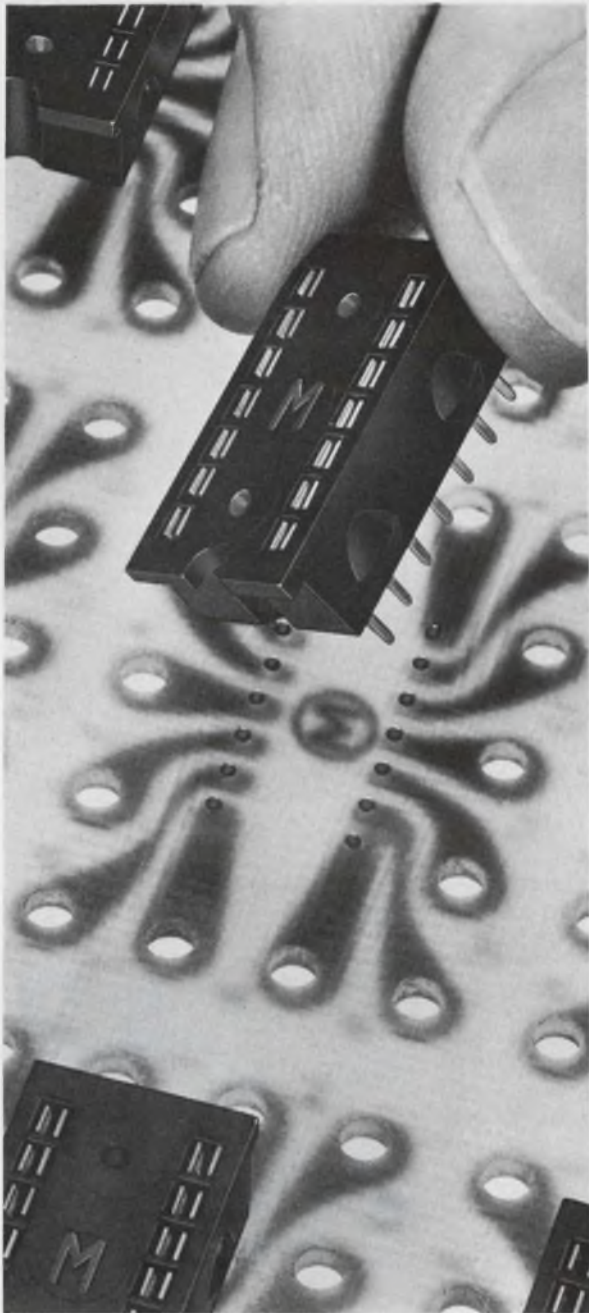

**Dual-in-line IC sockets snap in PC boards of aluminum or epoxy glass. Page 92**



**Desk-top analog computer expandable to full hybrid using an external digital computer. Page 101**

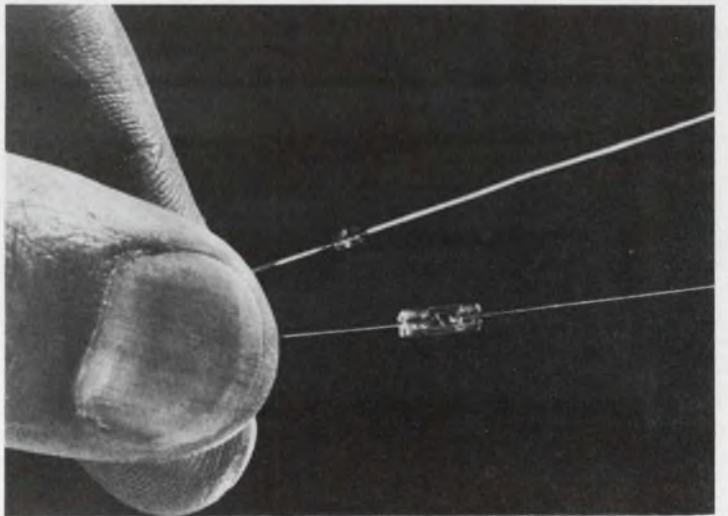

**Whiskerless diodes have logarithmic response and are 90% smaller than a DO-7 package. Page 94**

## Also in this section:

**Bench dc supplies priced under \$100. Page 99**

**Count and display module gives 16 mA BCD out. Page 94**

**Tiny telemetry filters measure 0.07 cubic inch. Page 103**

## Dual-in-line sockets snap in place

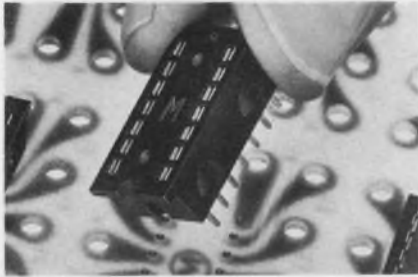

Methode Mfg. Corp., 1700 Hicks Rd., Rolling Meadows, Ill. Phone: (312) 867-9600. P&A: 15¢ up; 4 wks.

Mounting on boards with standard 0.1 x 0.3-inch pin spacing, these sockets have special snap-in features for mounting into punched aluminum or epoxy-glass panels to 1/8-inch thick. They are made for 14 and 16-pin dual-in-line ICs. Three types of terminations are available. They are designed with printed circuit type, 0.025-inch-square wrap post type, and 0.008-inch conventional wiring type terminations.

CIRCLE NO. 251

## Twin reed oscillators are transistorized

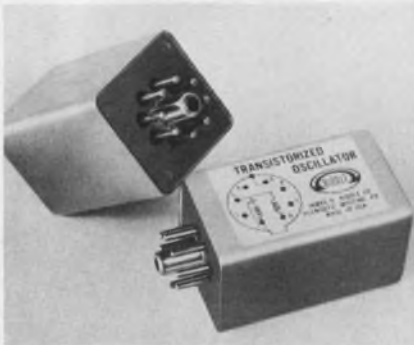

James G. Biddle Co., Township Line and Jolly Roads, Plymouth Meeting, Pa. Phone: (215) 646-5200.

These completely transistorized twin reed oscillators eliminate the need for external amplifiers on the sending end. They are powered by a 9-V battery, and permit operation on a range of frequencies from 67 through 1600 Hz. Frequency tolerance of  $\pm 0.25\%$  is maintained over a temperature range of  $+5^{\circ}\text{C}$  to  $+50^{\circ}\text{C}$ .

CIRCLE NO. 252

## Twenty-turn trimmers have teeth drive

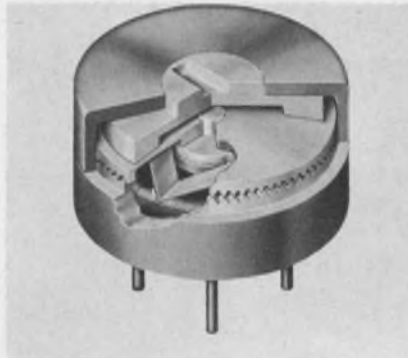

Digilog Electronics Corp., 701 Third Ave. North, Seattle. Phone: (206) 284-6811.

Twenty-turn electrical and mechanical travel, with clutch and stops, is provided in this 0.312-inch diameter 0.18-inch high trimmer. A flush, slotted screw head is integrally molded with a plastic driving disc, the bottom of which has two opposed pads projecting below the surface. These serve to flex a driven disc of slightly larger diameter, so that the teeth engage with teeth molded into the base of the housing at points  $180^{\circ}$  apart. The driven disc is coupled to the rotating wiper by a friction clutch. The wiper travels  $288^{\circ}$  before encountering a stop molded into the housing, resulting in electrical and mechanical travel of 20 turns.

Temperature range is  $-55^{\circ}$  to  $175^{\circ}\text{C}$ . Standard resistance tolerance using wirewound elements is  $\pm 5\%$ ,  $\pm 20\%$  with metal film elements. The models range from 0.5 W to 1 W and 50  $\Omega$  to 25-M $\Omega$ .

CIRCLE NO. 253

## Bias oscillator also erases

Nortronics Co., Inc., Golden Valley, Minn. Phone: (612) 545-0401. Price: \$4.50.

This bias oscillator features plug-in dip-solder terminals and has the same ferrite E-core construction and electrical characteristics as Nortronics' T60-Tz transformer. The unit will furnish up to 110-kHz bias and erase power to full-track heads or to both channels of a stereo recorder.

CIRCLE NO. 254

## Solid-state comparator has 2 mV sensitivity



Zeltex, Inc., 1000 Chalomar Rd., Concord, Calif. Phone: (415) 686-6660. P&A: \$80; 2 wks.

Sensitivity of this model is 2 mV over the entire frequency range from dc to 10 kHz. Two low-impedance outputs have fast response even when driving capacitive loads. Input impedance is 10 k $\Omega$   $\pm 20\%$ , drift vs temperature is 25  $\mu\text{V}/^{\circ}\text{C}$  maximum. Output levels are determined by two supply voltages connected to the output level supply terminals. They may be the same as the analog supply voltages ( $\pm 15\text{ V}$ ) or different as required, allowing the outputs to swing between a large range of externally provided levels.

CIRCLE NO. 255

## Metal film resistors do not vary

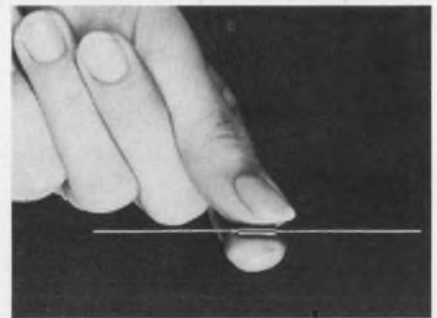

Mallory Distributor Products Co., 101 South Parker Ave., Indianapolis. Phone: (317) 636-5353.

Rated at 1/4 W at  $70^{\circ}\text{C}$  and 1/8 W at  $125^{\circ}\text{C}$ , these metal film resistors exhibit a  $\pm 0.5\%$  change after 1000 hours load life. Standard temperature coefficient is 100 ppm/ $^{\circ}\text{C}$ . Low resistance contact to the end cap and lead assembly is assured by firing gold bands onto each end. An undercoating of silicon and a final coating of molded epoxy provide environmental protection.

CIRCLE NO. 256



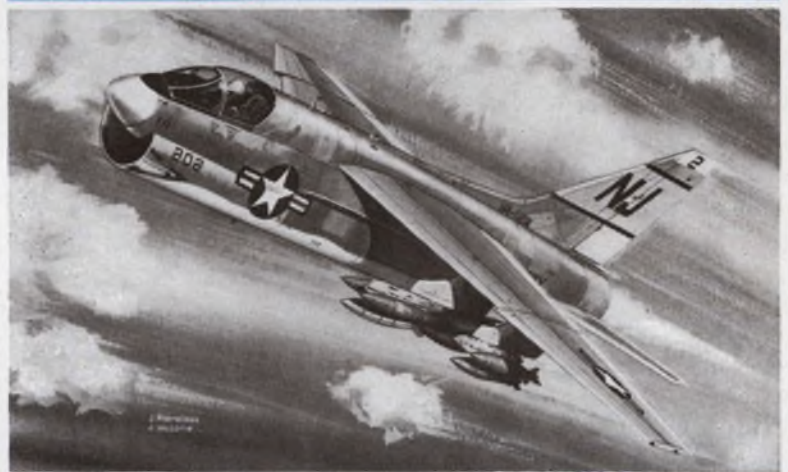

Sperry Rand Corporation has solved a unique oscillator application problem for multi-mode radars on the RF-4C and the A-7A. Texas Instruments Incorporated, prime contractor for both radar systems, needed a dual function tube — one which could serve as local oscillator in the radar, and would also work in the test and check-out circuit.

Sperry suggested the SRU-2161, and tests proved they were right. Today every AN/APQ-99 (for the RF-4C) and AN/APQ-116 (for the A-7A) system carries two of these Sperry reflex klystron oscillators.

The SRU-2161 delivers 50 mW at Ku band, while operating from a 300 V power supply. Since the oscillator has Sperry's unique adjustable reflector voltage, both tubes in the system can be driven from a single power supply. Mode shapes can be controlled to comply with the exacting tolerances of both systems.

If you need unusual performance from klystron oscillators, Sperry is the place to look. Contact your Cain & Co. representative, or write Sperry Electronic Tube Division, Sperry Rand Corporation, Gainesville, Florida 32601.

**SPERRY**  
**MICROWAVE ELECTRONICS AND**  
**ELECTRONIC TUBE DIVISIONS**  
**CLEARWATER AND GAINESVILLE, FLORIDA**



**Why multi-mode radars for RF-4C and A-7A depend on dual-purpose oscillators from Sperry... the first name in microwaves.**

ON READER-SERVICE CARD CIRCLE 35

### Low-leakage capacitors rated to 20 $\mu$ F

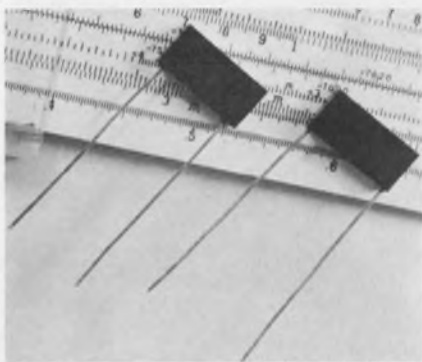

The Potter Co., Chem-Electro Research Div., 11144 Penrose St., Sun Valley, Calif. Phone: (213) 875-1090. P&A: \$2.50 to \$30; 4 to 6 wks.

In a case size of 0.7 x 0.34 x 0.26 inches, these capacitors have a rating of 100 V dc with a BX temperature characteristic. Available as both axial-lead and radial-lead, the components have a dissipation factor of less than 0.025 and a leakage resistance of 1000  $m\Omega/\mu$ F. They are available from 1 to 20  $\mu$ F.

CIRCLE NO. 257

### Lighted pushbuttons mounted easily



Maxson Electronics Corp., Ives Rd., Wallingford, Conn. Phone: (203) 269-8701.

These units consist of four-lamp lighted panel switches designed to meet the requirements of MIL-S-22885. Features include single-screw mounting, two-step relamping and factory-installed internal lamp bussing. Switches are offered with customized messages in a range of display styles and color coding. They are available with two, three or four-pole momentary or alternate action switching.

CIRCLE NO. 258

### Silicon mono diode with mini cloak

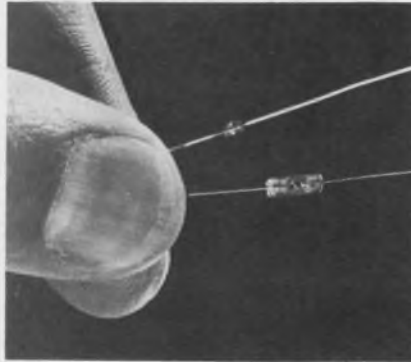

Continental Device Corp., 12515 Chadron Ave., Hawthorne, Calif. Phone: (213) 772-4551.

The 1N5315 and 1N5316 are silicon epitaxial diodes that have logarithmic response to high current levels and ns recovery. Glass gettering and heavy surface glassification insure immunity to reverse parameter degradation. The devices are hermetically sealed, whiskerless glass diodes with symmetrical dumet studs. Total volume of these diodes is less than 1/9th of the standard subminiature DO-7 glass package.

CIRCLE NO. 259

### Ceramic capacitors have $\pm 0.25\%$ accuracy

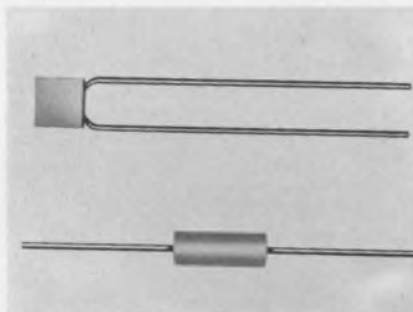

Electro Materials Corp., 11620 Sorrento Valley Road, San Diego, Calif. Phone: (714) 459-4355.

Ceramic capacitors are available in encapsulated radial and axial configurations, having tolerances of  $\pm 0.25\%$ ,  $\pm 0.5\%$  and  $\pm 1$ , and a capacitance range from 1 pF to 200,000 pF. The series features ultra-stable NPO dielectric ( $\pm 30$  ppm/ $^{\circ}$ C) and is unaffected by voltage and temperature variations. Applications are in delay lines, A to D conversion, filtering timing circuits and ratio matching.

CIRCLE NO. 260

### Shielded black boxes come in four types

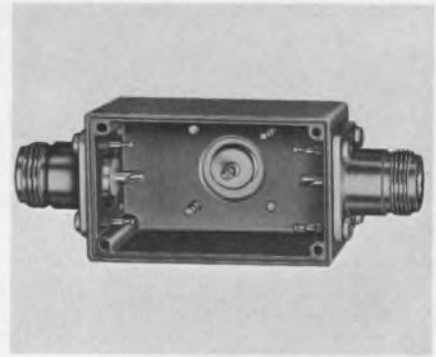

Pomona Electronic Co., Inc., 1500 E. 9th St., Pomona, Calif. Phone: (714) 623-3463.

These units provide shielded packages for custom-designed voltage dividers, passive or active networks, attenuators, isolation networks or other circuitry needed for electronic testing requirements. Each of the items offers a different combination of connectors. Model 2418 offers UHF receptacles in a 3-way T, model 2420, a BNC receptacle to type N plug and model 2421, a type N receptacle to BNC plug. Boxes are die-cast aluminum. Operating range is  $-55^{\circ}$  to  $+150^{\circ}$  C.

CIRCLE NO. 261

### Count/display module gives 16 mA BCD out

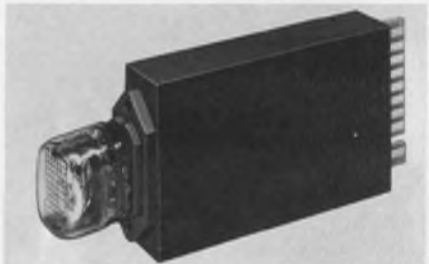

Integrated Circuits Electronics, Inc., P. O. Box 647, Waltham, Mass. Phone: (617) 899-2700. P&A: \$60; 30 days.

This count-display module incorporates reset and carry functions, and affords unidirectional decimal base counting to 15 MHz. The count is displayed directly on a cold-cathode neon tube, and is presented electrically in 8421 BCD code for driving a punch or printer. The unit uses monolithic ICs, printed wiring with edge connection, and an encapsulated package.

CIRCLE NO. 262

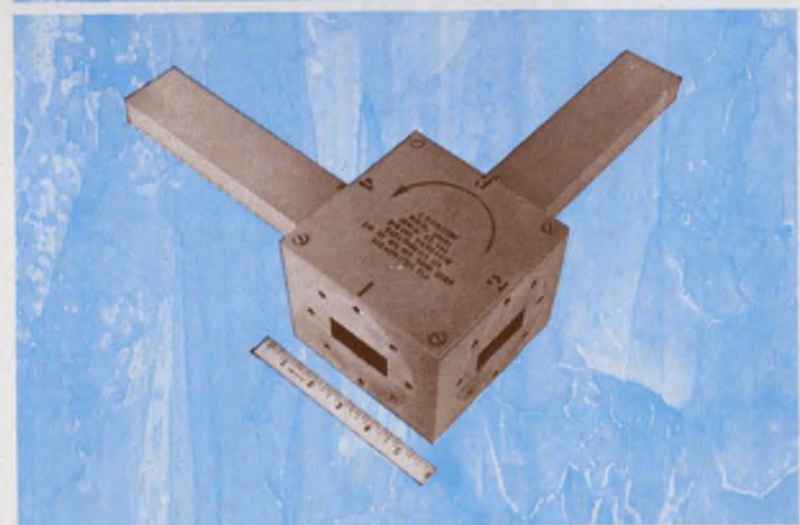
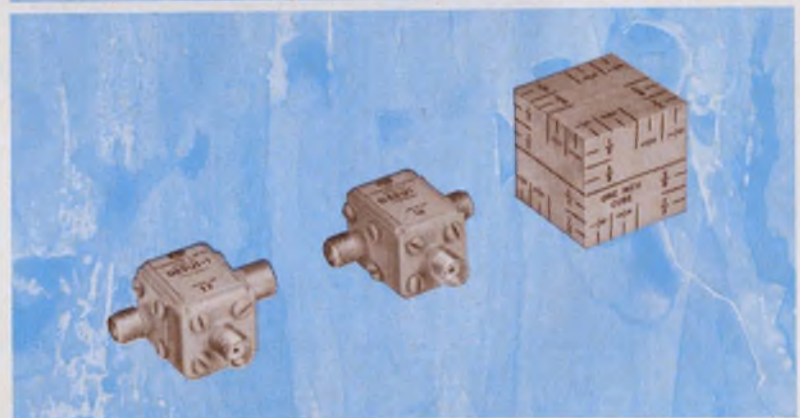
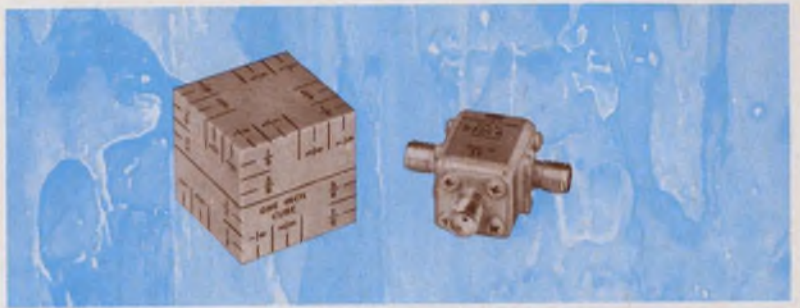

How much isolation does your microwave system need? How low must isolator insertion losses be?

Regardless of your answers, the right isolator or circulator is most likely to come from Sperry, no matter what frequency range you're working in.

After all, the coaxial isolator was invented at Sperry, and Sperry has set the pace in its development. Today the Sperry line is unquestionably the industry's most comprehensive.

You can get 217 models of standard Sperry isolators and circulators. Frequencies range from 0.1 to 40 GHz. Isolation can be as high as 40 db; insertion loss as low as 0.3 db. Remarkable custom development capability is also available.

Write for our new catalog and look over the line. Then, if you don't see exactly what you want, ask for it. Ask your Cain & Co. man or write Sperry Microwave Electronics Division, Sperry Rand Corporation, Box 4648, Clearwater, Florida 33518.

**SPERRY**  
**MICROWAVE ELECTRONICS AND**  
**ELECTRONIC TUBE DIVISIONS**  
**CLEARWATER AND GAINESVILLE, FLORIDA**

**The world's most comprehensive line of microwave isolators/circulators comes from Sperry... the first name in microwaves.**

ON READER-SERVICE CARD CIRCLE 36

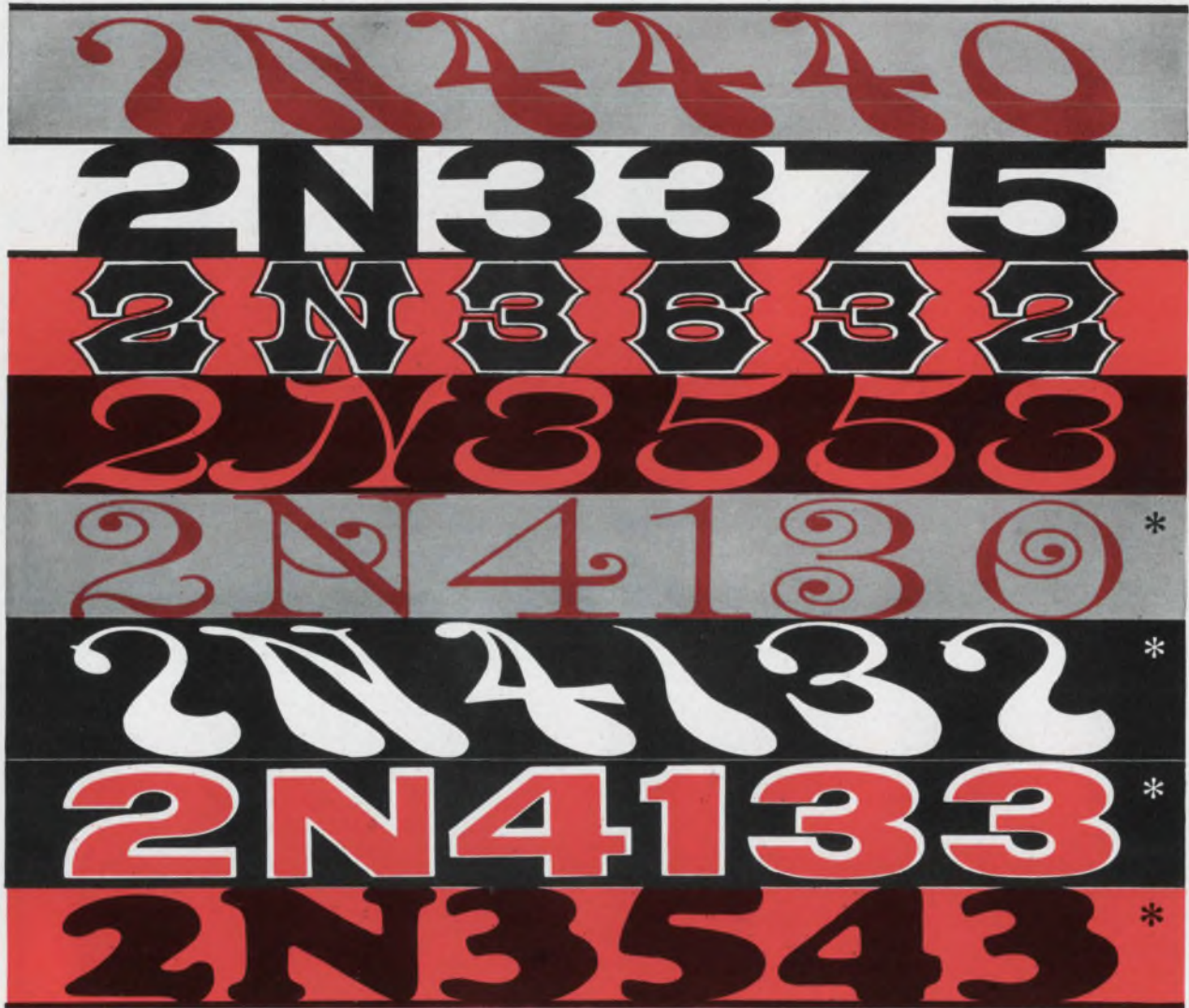

## ITT has eight instant solutions to your VHF/UHF power transistor procurement problems.

Is there something missing from your procurement cycle for RF power transistors? Is it predictable delivery? Better-than-competitive pricing? Superior performance?

Let ITT "crack" your RF power vacuum. The eight popular part numbers listed above are in stock and

ready to go — at the ITT factory and at every one of ITT's distributors. Next time you send out an RFQ, send it to The Predictables, and fill your power vacuum.

ITT Semiconductors is a Division of International Telephone and Telegraph Corporation, 3301 Electronics Way, West Palm Beach, Florida.

\*New state-of-the-art devices, exclusive from ITT, 1 to 50 W, 30 to 70 MHz.

semiconductors **ITT**

FACTORIES IN WEST PALM BEACH, FLORIDA • PALO ALTO, CALIFORNIA • LAWRENCE, MASSACHUSETTS • ENGLAND • GERMANY • PORTUGAL • AUSTRALIA

# ITT Distributors

## ALABAMA

Airwork / Gulf Corp.  
4809 Bradford Blvd  
Huntsville, Ala 35805  
(205) 837-6106

## ARIZONA

Kierulff Electronics, Inc.  
2633 East Buckeye Road  
Phoenix, Ariz 85009  
(602) 273-7331

## CALIFORNIA

Fortune Electronics  
695 Veterans Blvd.  
Redwood City, Calif. 94063  
(415) 365-4000

Santa Monica Bell  
Electronics  
306 E. Alondra Blvd.  
Gardena, Calif. 90247  
(213) 321-5802

Wesco Electronics  
2620 E. Walnut Street  
Pasadena, Calif. 91107  
(213) 795-9161

Wesco Electronics  
3973 E. Bayshore Road  
Palo Alto, Calif. 94303  
(415) 968-3475

Wesco Electronics  
8799 Balboa Avenue  
San Diego, Calif. 92123  
(714) 279-3471

## COLORADO

Kierulff Electronics, Inc.  
1200 Stout Street  
Denver, Col. 80204  
(303) 825-7033

## CONNECTICUT

Cramer Electronics, Inc.  
60 Connolly Parkway  
Hamden, Conn. 06514  
(203) 288-7771

## FLORIDA

Cramer of Florida  
4141 N.E. Sixth Avenue  
Ft. Lauderdale, Fla. 33308  
(305) 566-7511

Airwork / Gulf Corp.  
1740 N.W. 69th Avenue  
Miami, Fla. 33148  
(305) 885-2401

## ILLINOIS

Semiconductor Specialists  
P.O. Box 8725  
O'Hare International Airport  
Chicago, Ill 60666  
(312) 279-1000

## MARYLAND

Pioneer Washington  
Electronics  
1037 Taft Street  
Rockville, Md 20850  
(301) 427-3300

Pytronic Industries, Inc.  
2035 Worcester Street  
Baltimore, Md 21230  
(301) 539-6525

## MASSACHUSETTS

Cramer Electronics, Inc.  
320 Needham Street  
Newton, Mass 02164  
(617) 969-7700

Greene Shaw Company, Inc.  
341-347 Watertown Street  
Newton, Mass. 02159  
(617) 969-8900

## MICHIGAN

Southfield Electronic  
Sales, Inc.  
21250 10 1/2 Mile Road  
Southfield, Mich. 48076  
(313) 357-3700

## MINNESOTA

Semiconductor Specialists,  
Inc.  
7742 Morgan Avenue South  
Minneapolis, Minn. 55423  
(612) 866-3434

## NEW JERSEY

Valley / Hamilton Electro  
1608 Marlton Pike  
Cherry Hill, N.J. 08034  
(609) 662-9337

## NEW MEXICO

Kierulff Electronics, Inc.  
6405 Acoma Road, S.E.  
Albuquerque, N.M. 87108  
(505) 268-3901

## NEW YORK

Arrow Electronics, Inc.  
900 Broad Hollow Road  
Farmingdale,  
L.I., N.Y. 11735  
(516) 694-6800

Cramer / Esco, Inc.  
96 10 23rd Avenue  
Elmhurst, N.Y. 11369  
(212) 478-4000

Milo Electronics Corp.  
530 Canal Street  
New York, N.Y. 10013  
(212) 233-2980

Taylor Electronics Corp.  
2270 Grand Avenue  
Baldwin, N.Y. 11511  
(516) 223-8000

## OHIO

Alpine Industries, Inc.  
2236 Hepburn Avenue  
Dayton, Ohio 45406  
(513) 278-5861

Southfield Electronic  
Sales, Inc.  
5827 Mayfield Road  
Cleveland, Ohio 44124  
(216) 442-8080

## PENNSYLVANIA

Philadelphia Electronics  
1225 Vine Street  
Philadelphia, Pa 19107  
(215) 568-7444

## TENNESSEE

Electra Distributing  
Company  
1914 West End Avenue  
Nashville, Tenn. 37203  
(615) 255-8444

## TEXAS

Arco Electronics, Inc.  
1610 Industrial Court  
Arlington, Tex 76011  
(817) 277-2231

Contact Electronics  
2403 Farrington Street  
Dallas, Tex. 75207  
(214) 631-9530

McNicol, Inc.  
3012 East Yandell  
El Paso, Tex. 79903  
(915) 566-2936

## VIRGINIA

Meridian Electronics  
1001 West Broad Street  
Richmond, Va 23220  
(703) 353-6648

## WASHINGTON

Kierulff Electronics, Inc.  
5940 Sixth Avenue, South  
Seattle, Wash 98108  
(206) 763-1550

## CANADA

Cesco Electronics, Ltd.  
24 Martin Ross Avenue  
Downsview, Toronto, Can.  
(416) 638-5353

Cesco Electronics, Ltd.  
275 Craig Street West  
Montreal, Quebec, Can.  
(514) 861-2411

Cesco Electronics, Ltd.  
1300 Carling Avenue  
Ottawa, Ontario, Can.  
(613) 729-5118

Cesco Electronics, Ltd.  
128 Ouest Rue St. Vallier  
Quebec City, Quebec, Can.  
(418) 524-3518

Preico Electronics, Ltd.  
480 Port Royal Street W.  
Montreal, Quebec, Can.  
(514) 389-8051

## COMPONENTS

### Electrolytic capacitors sheathed in plastic

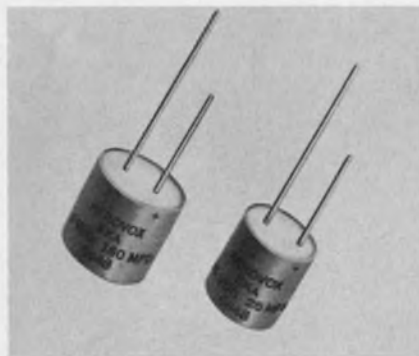

Aerovox Corp., New Bedford, Mass.  
Phone: (617) 922-2604.

A plastic-cased tubular capacitor uses an epoxy end sealing to provide an effective barrier against humidity. The capacitors available in 11 different types with capacitance ranging from 5 to 250  $\mu$ F and in three sizes, the largest of which is 15/32 inches long by 31/64 inches in diameter. Dc voltage ratings available include 3, 6, 10, 15, 25, 35, and 70. Leakage current ratings range from 30 to 120  $\mu$ A and maximum ripple currents from 7.5 to 28  $\mu$ A.

CIRCLE NO. 263

### Battery-operated op amp draws 1 mA quiescent

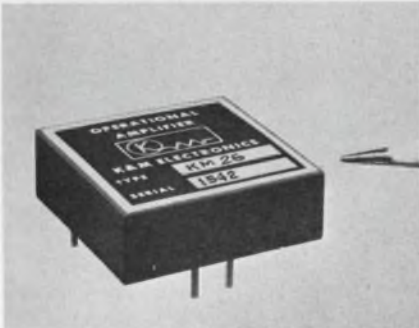

K & M Electronic, Hackensack, N.J. Phone: (201) 343-4518. Price: \$30 to \$45.

This unit draws only 1-mA quiescent current from a 9-V battery. Open-loop gain is 100,000 under the rated load of 5000  $\Omega$ . Warm-up drift is 10  $\mu$ V maximum and wide-band input noise level is 4  $\mu$ V. The typical voltage offset drift vs temperature is 10  $\mu$ V/ $^{\circ}$ C for the model KM-26, and 1  $\mu$ V/ $^{\circ}$ C for the model KM-56. Full-power output is 40 kHz; output is 11 V minimum at an output current of 2.2 mA.

CIRCLE NO. 264

### Fork oscillator weighs 2.5 oz

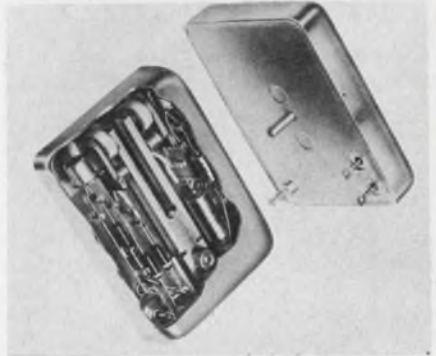

Philamon Laboratories, Inc., 90 Hopper St., Westbury, N.Y. Phone: (516) 333-1700. P&A under \$32 (100 lots); 3 to 4 wks.

Available in discrete frequencies from 400 to 8000 Hz, this oscillator has accuracy of 0.05% at 25 $^{\circ}$ C (0.11% over -55 $^{\circ}$  to +85 $^{\circ}$ C). It measures 1-7/16 x 2 x 3/8 inches and weighs 2.5 ounces. Output voltage at a +12-V dc input is 6 V p-p 50% clipped sine-wave into 6 k $\Omega$  through an external dc blocking capacitor.

CIRCLE NO. 265

### Tiny accelerometer weighs 1 gram

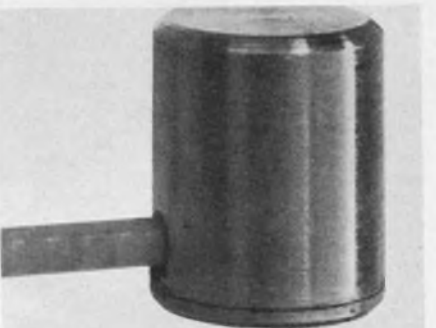

AGAC-Derritron Inc., 600 N. Henry St., Alexandria, Va. Phone: (703) 836-4641. P&A: \$125; 2 wks.

The Model AC-111 accelerometer is designed for use when measurements must be made on light structures since its low weight does not appreciably affect the motion of the structure. It weighs 1 gram and measures from 0.01 to 1000 G with voltage sensitivity of 7 mV/G. A slightly larger version weighs 4 grams and has a 24-mV/G output.

CIRCLE NO. 266

semiconductors **ITT**

**“9 years ago we had a great idea that put us in the high-rel relay business.**



**It's still a great idea, and now we've put it in a one-inch package!”**

Wedge-action\* was the great idea. By combining long precious-metal contact wipe with high contact force, it gives Electro-Tec relays the highest dry-circuit confidence level ever reached. (90%, based on a failure rate of only .001% in 10,000 operations.)



Packing wedge-action into a one-inch envelope wasn't easy. But it was worth it. It gives you maximum reliability in minimum space. And it's available for both 8PDT and 4PDT operations, in relays that exceed all requirements of MIL-R-5757/1 and /7.

The one-inch relay is just one of our family of wedge-action relays, which cover almost every dry-circuit to 2 amp application. When you need a high-rel relay that really works, remember our great idea, and put it to work for you.

\*U. S. Patent No. 2,866,046 and others pending.



**Electro-Tec Corp.**  
SLIP RINGS • RELAYS • SWITCHES • OPTICS

P. O. Box 667 • Ormond Beach, Florida  
(904) 677-1771 • TWX 810-857-0305

Manufacturing Facilities:  
Ormond Beach, Fla. • Blacksburg, Va.

ON READER-SERVICE CARD CIRCLE 38

## TEST EQUIPMENT

### Spectrum analyzer spans 600 kHz to 108 MHz

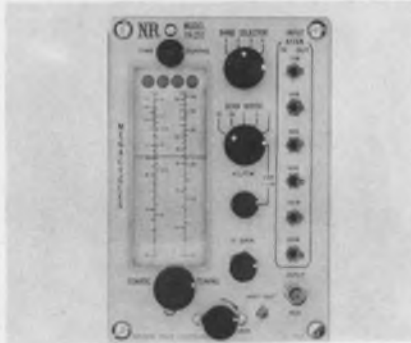

Nelson-Ross Electronics, 5-05 Burns Ave., Hicksville, N. Y. Phone: (516) 433-2730. P&A: \$2060; 30 days.

Consisting of two plug in units, a tuning head and sweep generator, this plug-in is for use with Tektronix 560 series scopes. The spectrum analyzers have a frequency range of 600 kHz to 36 MHz in four bands and up to 108 MHz with harmonics. Tuning is carried out on a slide rule dial, which reads directly in center frequency.

CIRCLE NO. 267

### Regulated power supply for lab use



NJE Corp., 20 Boright Ave., Kenilworth, N. J. Phone: (201) 376-7300. Price: \$525.

At an output of 12 A, this supply is rated for an output of 0 to 36 V and 0 to 15 A. Voltage regulation for load and line changes is 0.05% or 0.5 mV and 0.01% or 1 mV respectively, when operated as a voltage regulated power supply. When used for constant current, the regulation is 1 mA/V change in output and 1 mA on the line. A barrier terminal strip at the rear provides interface connection for input, output, remote sensing, remote programming, dualing and ground.

CIRCLE NO. 268

### Bin and power supply protect nuclear modules

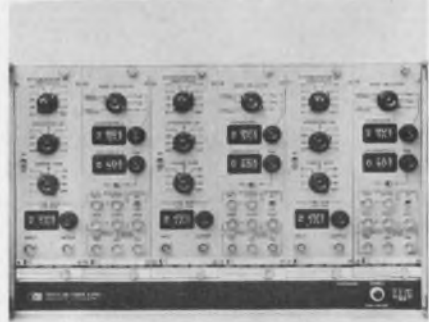

Hewlett-Packard, 1501 Page Mill Rd., Palo Alto, Calif. Phone: (415) 326-7000. P&A: \$775 to \$825; stock.

Thermal and electrical protection for modules that conform to NBS/AEC Nuclear Instrument Module (NIM) specifications is provided by a new power supply and cabinet (bin). The NIM power supply (in two versions) houses combinations of modules and supplies +24 V, -24 V, +12 V and -12 V.

CIRCLE NO. 269

### Plug-in adapters widen scope bandwidth



Tektronix, Inc., P. O. Box 500, Beaverton, Ore. Phone: (503) 644-0161. P&A: \$150; Oct.

This plug-in adapter provides increased measurement capabilities for Tektronix 580-series scopes when used with the 1-series plug-ins. The all-solid-state unit provides the full 50-MHz bandwidth capabilities of the 1A5 differential amplifier plug-in, 1A4 four-channel plug-in and 1A2 and 1A1 dual-channel plug-ins. It also permits the use of sampling plug-ins, spectrum analyzer plug-ins and letter-series plug-ins in all 580-series scopes.

CIRCLE NO. 270

## Bench dc supplies priced under \$100



Hewlett-Packard Harrison Div., 100 Locust Ave., Berkeley Heights, N. J. Phone: (201) 464-1234. P&A: \$90; stock to 4 wks.

Two well-regulated (0.01%) dc power supplies with ratings of 0 to 25 V at 0 to 400 mA (Model 6215A) and 0 to 50 V at 0 to 200 mA (Model 6217A) are priced under \$100. The all-silicon-supply uses an input differential amplifier to compare the output voltage with a reference voltage derived from a temperature-compensated Zener. These input and reference circuits are combined with a high-gain feedback amplifier to achieve low-noise, drift-free performance. Output voltage is fully adjustable down to zero. Overshoot during turn-on or turn-off or when ac power is suddenly removed will not occur.

CIRCLE NO. 271

## Flexible test probes Teflon-lined

Pylon Co., Inc., Attleboro, Mass. Phone: (617) 222-3726.

The Pogo probe consists of a fine gold-plated tungsten wire contact which is spring-loaded and rides in a Teflon-lined flexible metal guide tube. As the guide tubes are of small diameter and easily flexed, the probes can be mounted on extremely close centers. The guide tube diameters are 0.022, 0.013 and 0.01 inches on the standard probe, the mini-probe and the micro-probe respectively. The tungsten wires have diameters of 0.005, 0.003 and 0.003 inches. A sharp point is standard on the probing end. Extension is adjusted by turning the main body in its threaded holder.

CIRCLE NO. 272

## Temperature recorder reads six inputs



Conklin Instrument Corp., Pleasant Valley, N. Y., Phone: (914) 635-2136. P&A: \$4923; 8 weeks.

Each channel of this recorder features individual signal modules, adjustable electrical span ranges from 250  $\mu$ V to 100 V full scale and individual continuously adjustable zero suppression or elevation ranging from 0 to 100 V for each channel. A variable setting voltage supply, accurate to 0.1% and suitable to each channel of the recorder, is utilized for setting electrical values on each channel.

CIRCLE NO. 273

## Synchro display unit knows the angles



Theta Instrument Corp., 22 Spielman Rd., Fairfield, N. J. Phone: (201) 487-3508. P&A: \$990; 4 wks.

This system error bridge continuously measures and displays the angular position of a synchro or resolver system with 7-seconds-of-arc accuracy and 1-second-of-arc resolution. It can be used in the testing of inertial navigation systems, servomechanisms and aircraft instruments. Its range is 0 to 360°, continuous, with a frequency of 400 Hz. Dimensions are 19 x 5-1/4 x 13 inches.

CIRCLE NO. 274

# Got a 30 MHz counter headache?



## Count on Janus for speedy relief!

If your counter instrument or system designs have been a bit sluggish and out of spec, lately, you may have a 30 MHz Counter Headache! Reach for a Janus UC-300 Series 30 MHz BCD Counter-Display, WITH TTL, and get speedy relief! This Series accepts periodic and aperiodic signals to 30 MHz. Important features: BCD outputs, preset to non-zero numbers, external count control and bright in-line display. Input and output levels are compatible with DTL and TTL integrated circuit logic levels. Also available with latch storage for "blur-free" display and BCD data storage. For slower-speed headaches use Janus 5 MHz Counter-Display Modules.

See your local Janus Representative or write for clinical data.



296 Newton St., Waltham, Mass. 02154  
Phone (617) 891-4700

ON READER-SERVICE CARD CIRCLE 40

# ANOTHER FIRST!

MODELS 20 and 21 (Latching)



Logic Relays that operate from .7 to 500V

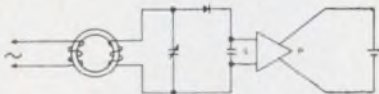

FREQUENCY SELECTIVE RELAY  
FROM Hz to MHz

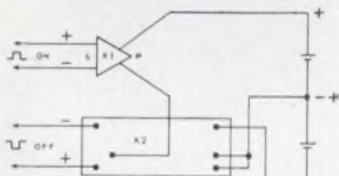

MEMORY RELAY

K1 = #21 RELAY  
K2 = SENSITAK 16B-P or 16C-P

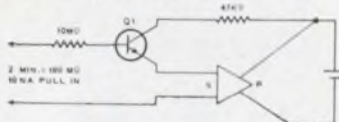

NANOAMPERE SENSING RELAY

Above are three of hundreds of applications possible.

## CONDENSED SPECIFICATIONS

Power Source	10-30V DC
Standby Power	Negligible
Input Impedance	1 megohm
Signal Voltage	
Pull In	+ .7V DC Less than 1 $\mu$ A
Drop Out	-10%
Signal Overvoltage	
Direct	35V
with series resistor of 1 K $\Omega$ /V	500V
Response Time	
Operate	10 milliseconds
Release	7 milliseconds
Output Contacts	DPDT 5 Amp. Res. Load 150V AC — 50V DC
Operating Temp. Environmental	-20°C to 70°C

Only \$7.42 in small production quantities. Complementary NPN and PNP relays available as standard.

Consult us for relay technology to meet individual requirements.

For additional information, contact

**SENSITAK<sup>®</sup>**  
**INSTRUMENT CORP.**  
 531 Front Street  
 Manchester, N. H. 03102  
 Phone (603) 627-1432

ON READER-SERVICE CARD CIRCLE 41

## TEST EQUIPMENT

### Noise generators in many ranges



Elyenco, Inc. 1550 Euclid St., Santa Monica, Calif. Phone: (213) 451-1635. P&A: \$275 to \$570; 30 days.

Series 624A noise generators offer a selection of fixed frequency ranges from 10, 20, 50 and 200 Hz to upper frequencies of 20, 50, 100, 200, 500 and 600 kHz. Output spectrum uniformities are flat within  $\pm 0.5$ ,  $\pm 1$ ,  $\pm 2$ , and  $\pm 3$  dB. Other frequency ranges are available. Each unit supplies a Gaussian noise voltage whose output level is continuously adjustable from 0 to 3 V rms with peak-to-rms capacity of at least 3.5 to 1. Output impedance is 200 $\Omega$ . Maximum resistive loading is 700 $\Omega$ .

CIRCLE NO. 275

### Lock-in amplifier tunes continuously



Emcee Instruments, White Haven, Pa. Phone: (717) 443-9575.

This instrument detects extremely weak signals obscured by background noise. Once the threshold of noise has been approached with standard amplifying and detecting equipment, the solid-state lock-in amplifier takes over. Continuously tunable, it will improve the signal-to-noise ratio by a 40 dB or more. It has a frequency range from 1.5 Hz to 150 kHz in 5 ranges.

CIRCLE NO. 276

### Analyzer studies signal amplitude

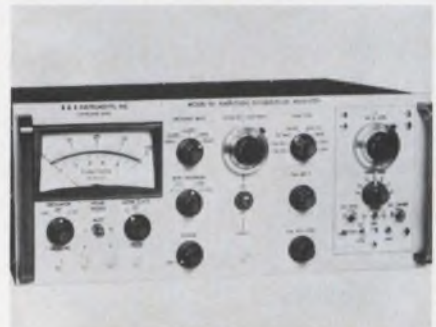

B & K Instruments, Inc., 5111 W. 164th St., Cleveland. Phone: (216) 371-4400.

Amplitude characteristics of random and complex signals can be studied with the Model 161 amplitude distribution analyzer. The 7 x 16-1/2 x 14-inch instrument performs statistical analyses of complex, random, nonperiodic and transient waveforms from dc to 20 kHz, and 20 Hz to 20 kHz (ac). The distribution of stress reversal amplitudes can be displayed in chart form from tape-recorded strain gage data. Outputs are included for counting or measuring level crossing and level crossing rates.

CIRCLE NO. 277

### High-speed meter reads volts, ratios



Lear Siegler, Inc., Cimvion Div. 1152 Morena Blvd., San Diego, Calif. Phone: (714) 276-3200. Price: \$1640.

Reading 1000 samples per second, these IC programable digital volt-ratio meters have accuracy within  $\pm 0.01\%$  of reading maintained for six months. The unit allows direct interface with small computers and fast data logging systems.

CIRCLE NO. 278



## Hybrid computer in desk top unit



*Electronic Associates, Inc., West Long Branch, N. J. Phone: (201) 229-1100. P&A: \$10,000 to \$55,000; October.*

This analog hybrid computing system is a general-purpose, 10-V, 80-amplifier, solid-state system pre-wired for full expansion. It includes up to 70 servo set potentiometers, provisions for an extensive digital logic system and a hybrid control interface in the main console. The EAI 580 offers a completely self-contained, integrated-circuit logic facility within the console. The addition of hybrid control interface equipment in space provided within the basic system provides for integration with external digital computers, making it expandable to a full hybrid system. A full line of readout equipment is also available.

A new electronic keyboard addressing system allows for the automatic setting of up to 70 servo-set potentiometers. They can also be set by a Pot Control Lever which raises or lowers setting values. Settings are displayed instantly on the system's digital voltmeter.

The amplifiers perform at full amplitude over the entire bandwidth with no velocity limiting. A track/store unit provides fast signal tracking (less than 1  $\mu$ s time constant) with a small capacitor, and offers low drift by means of a large capacitor.

The color-coded analog program panel and bottle plugs simplify programming. The programmer needs to learn the basic pattern of only one of eight nearly identical fields on the panel.

The entire computer measures 32 x 51 x 29 inches and weighs less than 600 pounds when expanded.

CIRCLE NO. 279

## PCM signal conditioner computer-controllable



*Electro-Mechanical Research, Inc., Box 3041, Sarasota, Fla. Phone: (813) 955-8153.*

This pulse-code modulation signal conditioner is designed to operate under computer control in digital telemetry systems. It accepts serial PCM at the receiving end of a data transmission system and reconstructs a noise-free bit stream with synchronous bit-rate clock pulses.

Serial PCM input signals received may be any of the eight common digital signals including all forms of NRZ, split-phase, RZ and bipolar. Input levels of 500 mV to 30 V and bit rates ranging from 10 to 10<sup>6</sup> bits per second can be accepted. The unit provides both data and tape-recorder outputs; the serial NRZC data output is accompanied by four bit-rate clock trains. Additional NRZC, NRZM, and split-phase-change outputs are available for tape recording. The unit is constructed with analog and digital IC's.

CIRCLE NO. 280

## Programming system exhibits low capacitance

*Amp, Inc., Eisenhower Blvd., Harrisburg, Pa. Phone: (717) 564-0101.*

Featuring conductor-to-shield capacitance of 0.001 pF, this completely shielded patchcord programming system offers better than 106-dB crosstalk isolation at 100 kHz. At 10-MHz, crosstalk isolation exceeds 74 dB. Back-panel terminations permit plugging boards directly into the rear bay. Other back panel terminations compatible with automatic machine or hand wiring techniques are also available.

CIRCLE NO. 281

# Galvanometer with brains



**ESI has combined the best features of the classic galvanometer and the modern electronic voltmeter in the Model 900 Nanovolt Galvanometer.**

How do you create a galvanometer with true nanovolt sensitivity that is really *practical* to use... an instrument that doesn't require hours of delicate dial twiddling, trapdoor adjustments or experimental hook-ups?

You give it brains. Brains in the form of feedback circuits that automatically control speed of response and damping for each of its 12 calibrated ranges. *Our Model 900 Nanovolt Galvanometer operates from any source resistance without changes in speed of response or damping characteristics.* Noise is less than 2 nanovolts for any source impedance.

The instrument consists of two units—the control unit shown above, which is the brains of the outfit, and a galvanometer unit. The Model 900 is ideal for use with high-accuracy and high-resolution potentiometers and bridges; for the calibration of thermo-couples, strain gauges, thermopiles, standard cells and the like. It also has applications in the measurement of tiny voltages or currents in experimental chemistry, physics, biology or medicine. A fixed input resistance of 1 kilohm allows calibrated ranges for *both* voltages and current.

Through solid state circuitry, we've been able to combine the best of two worlds in the Model 900. It has the high sensitivity and ac rejection of mechanical galvanometers. But it also has the multiple calibrated ranges, meter readout, and operation simplicity of modern electronic voltmeters. It's an honest nanovoltmeter with high sensitivity and complete guarding to simplify measurements in the microvolt area.

You'll have more time to use your own brains if your galvanometer has some of its own.

ESI, 13900 NW Science Park Dr. Portland, Oregon 97229.

Electro Scientific Industries **esi**

ON READER-SERVICE CARD CIRCLE 42



## high quality Electrical Connectors

In the course of manufacturing its primary products, Wiring Assemblies, Jumper Leads and Harnesses, Beman Manufacturing has developed many Electrical Connectors for various applications.

Because of the success of these Connectors, Beman is now offering quality Terminals in strip form, to be applied with semi-automatic machines.

Primarily geared for high-volume production, Beman can offer economical, quality Terminals and aggressive design and production of new Applicators, as you may specify. Beman's machines are designed with simplicity for rugged use.



P. O. Box 370 New Cumberland, Pa., 17070  
Phone: (717) 774-0210

ON READER-SERVICE CARD CIRCLE 34

### PRODUCTION

## Cable harnessing tool handles 10 ties

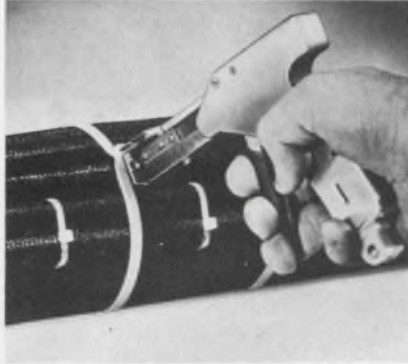

*Panduit Corp., 17301 Ridgeland Ave., Tinley Park, Ill. Phone: (312) 532-1800.*

Handling 10 large cable ties, this tool incorporates a two-position knob which can be adjusted in two seconds. An easy adjustment of the tool sets the tension so every cable tie is tensioned properly. The device handles all of the 10 cable tie sizes from the standard to the extra-long ties. It can be used for identification markers and clamps.

CIRCLE NO. 282

## IC test sets easy to use



*Integrated Systems Corp., Stowe, Vt. Phone: (802) 253-4844. P&A: \$750; 15 days.*

Users and manufacturers of integrated circuits can make performance tests on TO-5, flat pack and dual-in-line integrated circuits with the model 1100 tester. Complex logic functions and amplifier circuits can be created and performance tested. The tester features a 10 x 20 matrix with which the 4 power supplies and taut band meter can be interconnected to any of the three standard IC packages capable of being tested.

CIRCLE NO. 283

## Wavesolder system uses conveyor

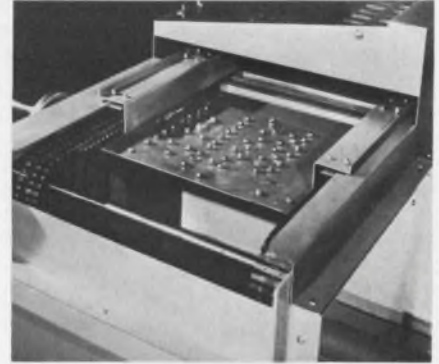

*Electrovert, Inc., 86 Hartford Ave., Mt. Vernon, N. Y. Phone: (914) 664-6090.*

With an adjustable conveyor, this wavesolderer eliminates board-carriers or pallets. The width of the conveyor is adjusted to the PC board and the board is carried directly on the conveyor tracks. Any size board from 2 to 15 inches is slipped into the conveyor and is passed through fluxing, flux-drying, preheating and soldering stations.

CIRCLE NO. 284

## Substrate carrier of Teflon FEP

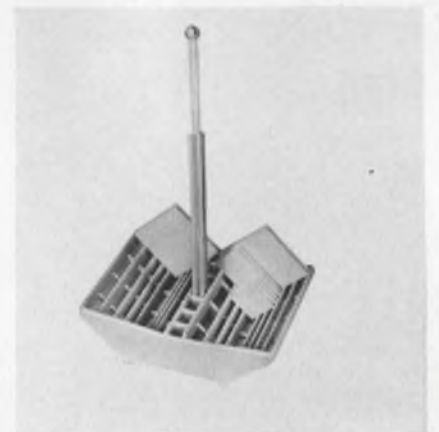

*Fluoroware, Inc., Chaska Industrial Park, Chaska, Minn. Phone: (612) 448-3131. P&A: \$29.50.*

This basket is designed for processing square and rectangular shaped substrates from 3/8 to two inches square. The carrier is made of Du Pont Teflon FEP to resist corrosion from acids and withstand high temperatures. The assembly consists of a 4-1/2-inch by 7/8-inch by 1-7/8-inch basket and a nine-inch handle.

CIRCLE NO. 285

## MICROWAVES

### Klystron oscillators operate 12 to 18 GHz

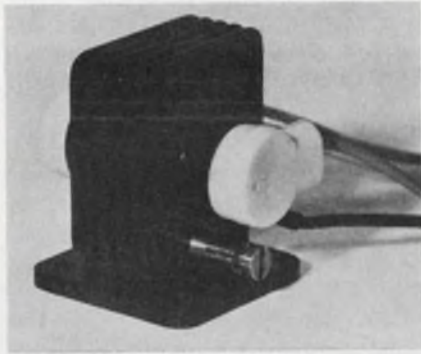

Varian, 611 Hansen Way, Palo Alto, Calif. Phone: (415) 326-4000.

These 5000-hour warranty tubes, operating in the 12-to-18-GHz range, are available in two versions. The first offers an output of 1 W over a 500-MHz tuning range, and the second offers the increased output of 1.5 W over a 100-MHz range. Cooling of this 7-ounce tube is by forced air, and any mounting position may be used. The RF output flange mates with UG-419/U waveguide. Dimensions of the tube are 1.6 x 2.1 x 2 inches.

CIRCLE NO. 286

### Coaxial power heads span 10 MHz to 12.4 GHz



General Microwave Corp., 155 Marine St., Farmingdale, N. Y. Phone: (516) 694-3600. P&A: \$225 to \$250; stock.

These models are designed for use with all cabinet and rack-mount versions of the model 454A thermo-electric power meter, and model 963R junction power box. The power heads are smaller than previous models. A control to compensate for mount inefficiency is in each power head. The heads are available in power ranges of 0.3  $\mu$ W to 10 mW and 0.03  $\mu$ W to 1 mW

CIRCLE NO. 287

### Telemetry filters are 0.07 cubic inch

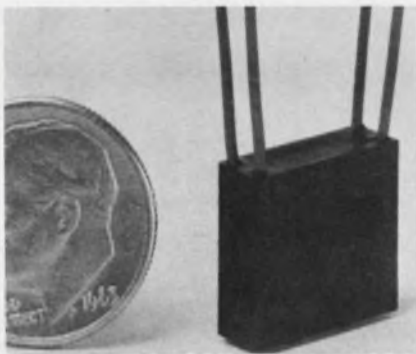

Nelix Research Associates, Inc., 5345 Timken St., La Mesa, Calif. Phone: (714) 465-3557. Price: \$93 (1 to 6).

Miniature telemetry filters are designed for use on IRIG channels 1 through 6, and are available with 10 and 15-k $\Omega$  standard output impedance. They also operate over a 10-to-35-V range with low current requirements, and possess good harmonic distortion characteristics over the -40° to +100°C temperature range.

CIRCLE NO. 288

### Attenuator stand mounts rotaries

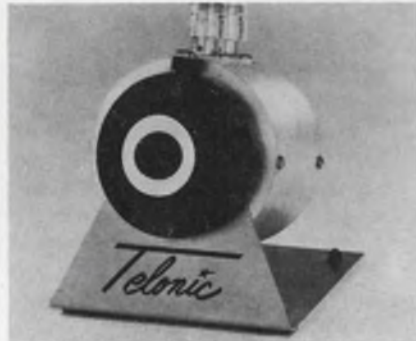

Telonic Instruments, 60 N. 1st Ave., Beech Grove, Ind. Phone: (317) 787-3231. P&A: \$5 (minimum of 5); stock.

A bench-top stand for use with rotary-type attenuators is constructed of steel, has rubber feet, and is designed to attach directly to the body of the attenuator.

The stand is available in two models. The 8012 is for use with Telonic rotary attenuators TA-50, TB-50, TA-75, TC-50, TAB-50, TEB-50 and 8008, and the 8013 stand is used with attenuators TA-109 and TCB-50.

CIRCLE NO. 289

## Elmat Four-Point Resistivity Probe

specifically designed to measure resistivity of slices or ingots of semiconductor materials



### SPECIFICATIONS:

- Manufactured to precision tolerances —  $\pm 1\%$  for point spacing and tip radii.
- Special alloy points are coil-spring mounted to specified gram load displacements (85, 150, or 200) to assure long life and test reproducibility.
- Outstanding ohmic contact characteristics.
- Two and three-point assemblies available; non-standard custom resistivity probes on special order.

### FLAT PACK & CIRCUIT PROBES:

- Flat pack probe assemblies for evaluation of integrated and thin film circuits encapsulated in flat packs available; special probe designs with up to 48 points custom fabricated for flat packs or circuit boards.

### APPLICATION:

May be used in manual or automatic test stations. Manual probe applicator stand available.

For complete descriptive literature and the name of the Elmat representative nearest you, write to:

NAVAN INCORPORATED, Dept. 79  
1320 E. Imperial Highway,  
El Segundo, California 90245

NAME \_\_\_\_\_

TITLE \_\_\_\_\_

FIRM \_\_\_\_\_

ADDRESS \_\_\_\_\_

STATE \_\_\_\_\_ ZIP \_\_\_\_\_

ON READER-SERVICE CARD CIRCLE 44



Quality  
Economy  
Reliability

# NYLATCH®

Step 1: Pressing grommet into removable sheet.



Step 2: Pressing plunger into installed grommet.



Step 3: Installed and ready for insertion into fixed sheet.

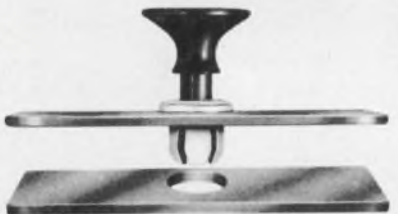

Step 4: Installed Nylatch ready for operation.



Nylatch, the positive interference fastener... is now available molded from a newly developed low viscosity polycarbonate resin. Thoroughly tested for rugged dependable service, Nylatch has been cycled 30,000 times without appreciable loss of holding power.

Available for various sheet thicknesses, Nylatch is being used to replace all manner of latches, captive screws, stud fasteners and spring clips.

High impact strength further extends the hundreds of applications common to the electronic, business machine, lighting, vending machine and neon sign industries.



With only two holes to drill or punch, ten second installation is possible and a simple push-pull operation actuates the latch.



Write today for sample  
and literature:

**The Hartwell Corporation**

9035 VENICE BLVD., LOS ANGELES, CALIFORNIA 90034  
BRANCH OFFICES: CHICAGO • FT. WORTH • HACKENSACK

ON READER-SERVICE CARD CIRCLE 45

## New Literature



### Lafayette's 1968 catalog

Lafayette's 1968 catalog offers a complete selection of stereo, hi-fi, citizen's band 2-way radio, tape recorders, ham gear, test equipment, radios, TVs and accessories, cameras, optics, marine equipment, auto accessories, tools and books. Lafayette Radio Electronics Corp.

CIRCLE NO. 290

### Fluidic amplifiers

A four-page engineering data sheet describes fluidic amplifiers. The brochure opens with a discussion of switching speed. A graph of switching characteristics for a typical Flowtran amplifier is included in the discussion. Also a table of basic fluidic logic is included. The five basic logic functions, AND, OR, NAND, NOR and flip-flop are described complete with definitions, the equivalent electrical circuit, and a schematic of the fluidic circuit. Fluidic Division of Howie Corp.

CIRCLE NO. 291

### Microwave test equipment

This catalog covers miniature thermoelectric power meters for commercial and military systems, portable thermoelectric meters and laboratory thermoelectric power meters. Coaxial and waveguide thermoelectric power heads and bolometers/thermistors/barretters and mounts are shown. Wattmeters, frequency meters, automatic and manual noise figure meters, random noise generators and power supplies with a range of 1 MHz to 140 GHz are also covered. General Microwave Corp.

CIRCLE NO. 292

### Linear circuit performance

Two technical bulletins examine consumer, industrial and military applications for the  $\mu$ A703. One application note (APP-135) describes the performance of this monolithic limiting amplifier in 100 and 200-MHz amplifiers and as a harmonic converter or mixer from 10.7 to 100 MHz. The second paper (APP-145) analyzes the performance of the circuit in two types of color television chroma reference systems. The systems outlined are a voltage-controlled crystal oscillator for AFC systems and an injection-locked crystal oscillator. Fairchild Semiconductor.

CIRCLE NO. 295

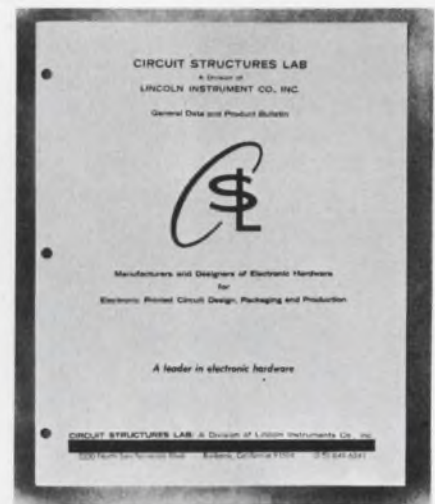

### Circuit design data

An 18-page catalog provides engineering data for printed circuit packaging components. It includes snap-in card guides and frames, transistor insulating pads and a line of printed circuit design aids. Also included are fabricated breadboards. Circuit Structures Lab.

CIRCLE NO. 294

### Hardware catalog

A 24-page brochure provides data on 3000 turret and molded terminals, terminal boards and panel hardware components. Detailed cross-reference tables list NAS, MS and MIL-T-55155 sizes, materials and plating specifications for terminals. D-Cemco, Inc.

CIRCLE NO. 293



### Electronic wire catalog

Belden's 1967 catalog of wire for use in 10 different market areas is available. The 56-page catalog updates their 28-page catalog published two years ago. Over 20 new products have been added—among them heat-shrinkable vinyl tubing for quick insulation of terminal connections or worn cable jackets, heavy-duty portable cords and appliance cords. Belden Co.

CIRCLE NO. 296

### Data on unusual alloys

In the first issue of this periodical the results of a testing program on a corrosion-resistant alloy are discussed in an article entitled, "Winning the War Against Corrosion." Illustrated with photos of actual test specimens, the article describes the corrosion tests conducted in both the laboratory and on a severely corrosive pickling line. Also described is an alloy developed for high-temperature furnace belts. Wilbur B. Driver Co.

CIRCLE NO. 297

### Diode price guide

A 50-page guide lists every type of commercial and military diode from 1N21 to 1N5000 series, and tells who manufactures them and the latest manufacturer's prices. Over 50 manufacturers are represented. Prices are not only for the normal 1 to 99 and 100 to 999 levels but are often indicated up to the 10,000 quantity. The complete service sells for \$59.

The Diode Pricing Service is scheduled to be updated and published four times a year with supplement releases as often as necessary. To introduce the guide, Data-Tek will send free sample pages. Data-Tek.

CIRCLE NO. 298

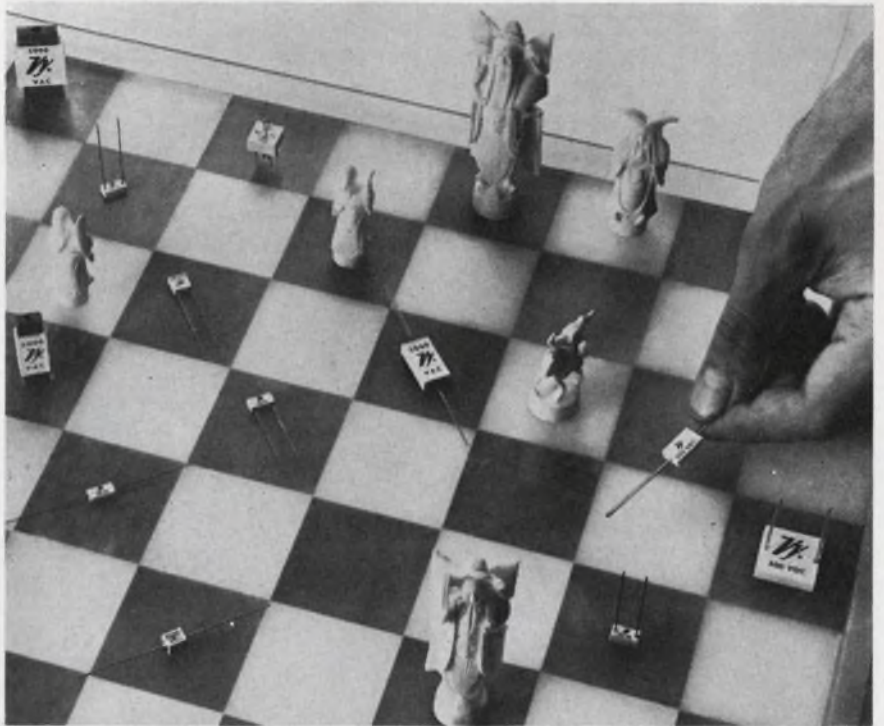

## Make the right move!

### Cover your board with "VY" Porcelain Capacitors

You're making the right move because you can **select** the exact features you need from over 20 styles of porcelain capacitors.

Most important, you obtain the high stability, low-loss characteristics for which the monolithic "VY" Porcelain Capacitor is famous.

In fact, you can **select** capacitors with either a positive, negative or zero temperature coefficient... voltage ratings to 2500 vdc... current ratings to 22 amps RF... capacitance values as low as 0.24 pf, as high as 10,000 pf — all with an extremely long MTBF. You can even obtain space-saving, **thin line** cases.

Want to be sure you're making the right move? Then let us make the first move by handing you our catalog. (It might clear up this complex chess game called 'capacitor selection.')



**Vitramon**

VITRAMON, INCORPORATED  
BOX 544  
BRIDGEPORT, CONN. 06601

In Greater Europe Contact:  
VITRAMON EUROPE  
Wooburn Green, Bucks, England

# Say "Good Bye" to hand loading of charts

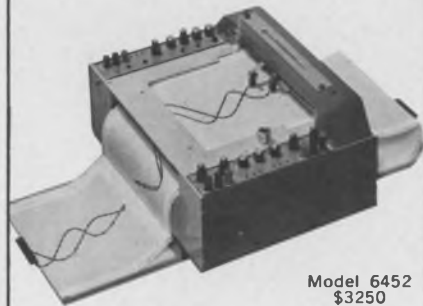

Model 6452  
\$3250

## New Concept in **X-Y-Y'** Recording

- Continuous supply of Z-fold paper charts
- 11" x 17" Recording Surface
- Bi-directional chart control
- Notebook size charts—  
8½" x 11" or 11" x 17"
- Local or remote control of recording mechanism and pen lift
- English/Metric scaling
- 15 in./sec. slewing speed
- 18 calibrated voltage ranges for each axis, continuously variable in between
- ± .2% Accuracy
- ± .1% Repeatability

Ask about our single pen  
versions also

**houison OMNIGRAPHIC corporation**

a subsidiary of houison instrument corporation  
4950 Terminal Ave. / Bellaire, Texas 77401  
(713) 667 7403 / cable HOINCO / TWX (713) 571 2063

ON READER-SERVICE CARD CIRCLE 47

## NEW LITERATURE



### Fluorescent inspection

Describing methods of analysis for PC boards, components, lead wires, welded module assemblies and encapsulating materials, this brochure also has comparative illustrations of analysis by normal light and by black light. The technique is easily performed by nontechnical personnel in the lab or on the production line. Ultra-Violet Products, Inc.

CIRCLE NO. 299

### Micro semiconductor catalog

Listings include logic switch and core driver glass pellet diodes, general-purpose glass pellet rectifiers, Zener glass pellet diodes, stabistors, microminiature high voltage assemblies, micro diode and high voltage modular rectifier assemblies. Also included are industrial avalanche high voltage silicon diodes and rectifiers, silicon pin microdiodes and high voltage npn transistors. Micro-Semiconductor Corp.

CIRCLE NO. 311

### Prepreg specifications

A specification establishes requirements for preimpregnated B-stage epoxy-glass cloth for multi-layer printed circuits. The specification describes type GE (G-10) general-purpose and type GR (FR-4) flame-retardant prepreg material. Included are requirements for thickness, size, applicable industry specifications, mechanical and electrical properties, testing, quality, assurance and acceptance. The Mica Corp.

CIRCLE NO. 312



### PC board manufacture

In eight pages, a capabilities brochure describes services and facilities for production of etched circuits and assemblies, as well as a new prototype service. A step-by-step photographic "flow chart" supplies details of the manufacturing process and equipment used. The brochure also provides a checklist of data required for quotations. Electro-Sonics.

CIRCLE NO. 313

### Magnetic components use

For the circuit designer, who uses magnetic components, this 16-page applications bulletin describes representative circuits covering such areas as computers, blocking oscillators, inverters, SCRs and pulse modulators. The bulletin assists the design engineer by giving representative circuits, from which many variations can be developed. Pulse Engineering, Inc.

CIRCLE NO. 314

### Hybrid circuits

This brochure is a four-color, six-page outline of Sperry's hybrid production capabilities. The contents include sections on types of components, package configurations, test procedures and manufacturing steps. Sperry, Semiconductor Div.

CIRCLE NO. 315

### Free reprint

A copy of the report, "Digital chips shift into analog territory," on pages 41 to 64, will be sent free of charge to readers who circle Reader-Service number 250.

## Advertising Representatives

**New York 10022**  
 Robert W. Gascoigne  
 Thomas P. Barth  
 Samuel M. Deitch  
 Byron Adams  
 850 Third Avenue  
 (212) PLaza 1-5530  
 TWX: 867-7866

**Philadelphia**  
 William C. Repetto  
 P. O. Box 206  
 Merion Station, Pa. 19066  
 (215) MO 4-1073

**Boston**  
 Richard Parker  
 7 Redstone Lane  
 Marblehead, Mass. 01945  
 (617) 742-0252

**Chicago 60611**  
 Thomas P. Kavooras  
 Berry Conner, Jr.  
 720 N. Michigan  
 (312) 337-0588

**Cleveland**  
 (216) 247-7670

**Los Angeles 90303**  
 Stanley I. Ehrenclou  
 Terrence D. Buckley  
 W. James Bischof  
 2930 W. Imperial Highway  
 Inglewood, Calif.  
 (213) 757-0183

**San Francisco**  
 Ashley P. Hartman  
 175 South San Antonio Rd.  
 Ste. 243  
 Los Altos, Calif. 94022  
 (415) 941-3084

**Southwestern 75206**  
 Tommy L. Wilson  
 6200 North Central Express-  
 way  
 Dallas, Tex.  
 (214) EMerson 1-2311

**London W. 1**  
 Brayton C. Nichols  
 44 Conduit Street

**Verviers, Belgium**  
 Andre Jamar  
 1, Rue Mallar, 1  
 (087) 253.35

**Tokyo**  
 Yoshihiro Takemura  
 International Planning  
 Service, Inc.  
 Room 231 Tokyu-Mita Bldg.  
 1, Shiba-Mita Koun-cho  
 Minato-ku, Tokyo



**AMERICAN BUSINESS PRESS, INC.**



## INDUSTRIAL TAGS

Metal or Plastic

### MULTI-PURPOSE & ELECTRICAL

#### INVENTORY TAGS TOOL CHECKS PROPERTY TAGS

Aluminum, Brass, Steel, Colored  
 Aluminum, etc. Consecutively  
 or special sequence numbered.

Write for Free  
 Complete Catalog

#### SLOT & TONGUE

Single or double slot and tongue  
 patterns.  
 Identify groups of wires posi-  
 tively.

#### WRAP AROUND

Perfect for single wire identi-  
 fication.

#### STRAP-ON TAGS

For items of large diameter.

## NATIONAL BAND & TAG CO.

721 York St., Newport, Ky. • Phone 261-2035

ON READER-SERVICE CARD CIRCLE 48

## Elmat Joystick Positioners

needlepoint accuracy with faster  
 adjustments than other positioners

#### SPECIFICATIONS:

- Positive, precise 360-degree hori-  
 zontal positioning
- 25:1 motion reduction for instant  
 positioning
- Setscrew adjustment for variable  
 gram loading
- True vertical probe-needle motion.

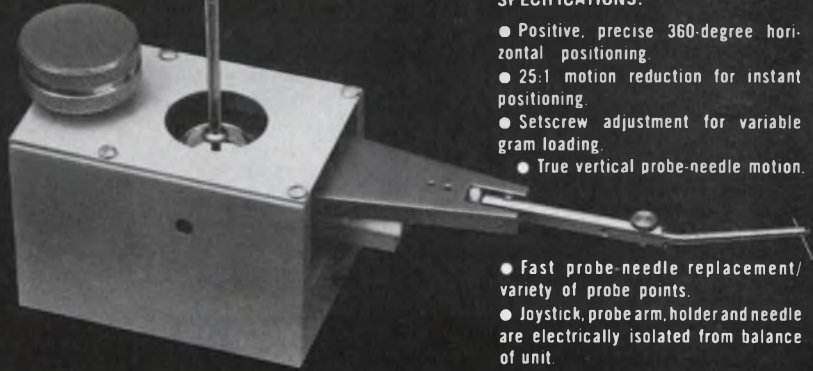

- Fast probe-needle replacement/  
 variety of probe points
- Joystick, probe arm, holder and needle  
 are electrically isolated from balance  
 of unit
- Adaptable to a variety of test/probe  
 station applications
- Available independently or in inte-  
 grated testing stations with up to 40  
 probes

#### APPLICATIONS:

Probe testing of sub-miniature areas; micro-tool applica-  
 tions; micro-biological studies; micro-surgery

For complete descriptive literature and the name of the Elmat represen-  
 tative nearest you, write to:

NAVAN INCORPORATED, Dept. 49,  
 1320 E. Imperial Highway, El Segundo, California 90245

NAME \_\_\_\_\_ TITLE \_\_\_\_\_  
 FIRM \_\_\_\_\_  
 ADDRESS \_\_\_\_\_ STATE \_\_\_\_\_ ZIP \_\_\_\_\_

ON READER-SERVICE CARD CIRCLE 49

# GIANNINI on inter- valometers

"Our programmable intervalometers can handle just about any sequencing operation you can think of, where precise timing is required. They're probably the most versatile gadgets of their type available.



The unit shown above, for example, is programmable in both time and mode. We make others where the sequence, too, can be programmed from the face of the unit. You can select the time interval, with 5% accuracy, from 100 milliseconds to 9.99 seconds, in 0.01 second increments. They are simple to operate, and extremely reliable.

These are the first programmable intervalometers, to be specifically designed for military airborne use. They meet the environmental requirements of MIL-STD-810. All the armature and stepping relays are manufactured by us, and conform to MIL-R-6106.

If you have any kind of sequence switching requirement where precise timing is a factor, let us show you how we can adapt these little devices to your exact needs.

*Gabriel M. Giannini*

**Giannini**  
WHITTIER

12140 E. RIVERA RD., WHITTIER, CALIF. 90606  
PHONE: 213-723-3371, TELETYPE: 213-685-6261

ON READER-SERVICE CARD CIRCLE 50

108

## Advertisers' Index

Advertiser	Page	Advertiser	Page
API Instruments Inc. ....	32	Industro Transistor Corporation .....	16
Abbott Transitor Laboratories Incorporated .....	23	Ingersoll Products, Division of Borg Warner Corporation .....	73
Advertising Council .....	72	Janus Control Corporation .....	99
Allen-Bradley Co. ....	64 A-B	Leach Corporation, Relay Division .....	40
Allied Electronics, a Subsidiary of Allied Radio .....	34	Lundey Associates, Inc. ....	109
Amperex Electronic Corporation .....	85	Beman Mfg. Inc. ....	102
Bishop Industries Corp. ....	111	Bodine Electric Company .....	28
Borden Chemical Co., The Mystic Tape Division .....	15	Brand Rex, Division of American Enka Corporation .....	19
Buckbee Mears Company .....	90	Clare & Co., C. P. ....	47
Clare & Co., C. P. ....	47	Curtis Development & Mfg. Co. ....	111
Curtis Development & Mfg. Co. ....	111	Dale Electronics, Inc. ....	Cover III
Dale Electronics, Inc. ....	Cover III	Datapulse, Incorporated .....	2
Datapulse, Incorporated .....	2	Datex Division/Conrac Corporation .....	33
Datex Division/Conrac Corporation .....	33	Digital Equipment Corporation .....	87
Digital Equipment Corporation .....	87	Duncan Electronics, Inc. ....	26, 27
Duncan Electronics, Inc. ....	26, 27	ESI/Electro Scientific Industries, Inc. ...	101
ESI/Electro Scientific Industries, Inc. ...	101	Edmund Scientific Company .....	109
Edmund Scientific Company .....	109	Eldre Components, Inc. ....	110
Eldre Components, Inc. ....	110	Electro Tec Corp. ....	98
Electro Tec Corp. ....	98	General Radio Company .....	1
General Radio Company .....	1	Giannini Whittier .....	108
Giannini Whittier .....	108	Globe Industries, Division of TRW, Inc. ...	109
Globe Industries, Division of TRW, Inc. ...	109	Hartwell Corporation, The .....	104
Hartwell Corporation, The .....	104	Hayden Publishing Company, Inc. ....	31
Hayden Publishing Company, Inc. ....	31	Hewlett-Packard .....	Cover II, 5, 83
Hewlett-Packard .....	Cover II, 5, 83	Houston Omnigraphic Corporation .....	106
Houston Omnigraphic Corporation .....	106	III Semiconductors, A Division of International Telephone and Telegraph Corporation .....	96, 97, 112
III Semiconductors, A Division of International Telephone and Telegraph Corporation .....	96, 97, 112	Industro Transistor Corporation .....	16
Industro Transistor Corporation .....	16	Ingersoll Products, Division of Borg Warner Corporation .....	73
Ingersoll Products, Division of Borg Warner Corporation .....	73	Janus Control Corporation .....	99
Janus Control Corporation .....	99	Leach Corporation, Relay Division .....	40
Leach Corporation, Relay Division .....	40	Lundey Associates, Inc. ....	109
Lundey Associates, Inc. ....	109	Microwave Expositions, Inc. ....	35
Microwave Expositions, Inc. ....	35	Motorola Semiconductor Products, Inc. ...	4
Motorola Semiconductor Products, Inc. ...	4	National Band and Tag Co. ....	107
National Band and Tag Co. ....	107	National Semiconductor Corporation ....	8, 9
National Semiconductor Corporation ....	8, 9	Navan, a Subsidiary of North American Aviation, Inc. ....	103, 107
Navan, a Subsidiary of North American Aviation, Inc. ....	103, 107	Nytronics, Inc. ....	21
Nytronics, Inc. ....	21	Philips Electronic Measuring Instruments	31
Philips Electronic Measuring Instruments	31	RCA Electronic Components and Devices .....	Cover IV
RCA Electronic Components and Devices .....	Cover IV	RCL Electronics, Inc. ....	6
RCL Electronics, Inc. ....	6	Rowan Controller Co., The .....	25
Rowan Controller Co., The .....	25	Schweber Electronics .....	110
Schweber Electronics .....	110	Sensitak Instrument Corp. ....	100
Sensitak Instrument Corp. ....	100	Sperry Rand Corporation .....	93, 95
Sperry Rand Corporation .....	93, 95	Sprague Electric Company .....	10
Sprague Electric Company .....	10	Sylvania Electric Products, Inc., ....	32 A-H
Sylvania Electric Products, Inc., ....	32 A-H	TRW Semiconductors, Inc. ....	36
TRW Semiconductors, Inc. ....	36	Tektronix, Inc., Oscilloscopes .....	38
Tektronix, Inc., Oscilloscopes .....	38	Trilo Laboratories, Inc. ....	7
Trilo Laboratories, Inc. ....	7	Union Carbide Corporation .....	12
Union Carbide Corporation .....	12	Vitramon, Incorporated .....	105
Vitramon, Incorporated .....	105	Career Advertising	
Career Advertising		Delco Radio Division, General Motors ...	81
Delco Radio Division, General Motors ...	81	LTV Electrosystems, Inc. ....	80
LTV Electrosystems, Inc. ....	80	Lockheed Missiles & Space Company ....	78
Lockheed Missiles & Space Company ....	78		



# NEW and Unique

## The Lundey Clinch-Loc<sup>®</sup> HERMETIC TEFLON<sup>\*</sup> TERMINAL

*the ultimate in simplicity*

**IT'S DUAL-PURPOSE**  
*... and economical*

\* Dupont Trademark

Use it as a moisture-proof terminal or a conventional panel feed-thru and get *low initial cost, fast and economical assembly, ruggedness and mechanical reliability*—plus the excellent thermal and electrical values of Teflon.

U.S. Patent 3,166,634  
Canadian Patent 727,204  
Other Foreign Patents  
Applied For

Designed to meet Mil-T-27B  
requirements



Spring push-nut locks it in position on panel—providing an hermetic seal

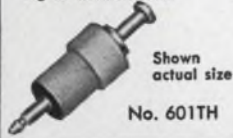

Shown actual size  
No. 601TH

**WRITE NOW FOR SAMPLE KIT**  
includes product samples and literature  
another quality product in THE LUNDEY LINE

**LUNDEY ASSOCIATES, INC.**  
694 Main St. Waltham, Mass. 02154

ON READER-SERVICE CARD CIRCLE 51

GLOBE

**Gearmotors**  
*in tune*  
**with your needs**

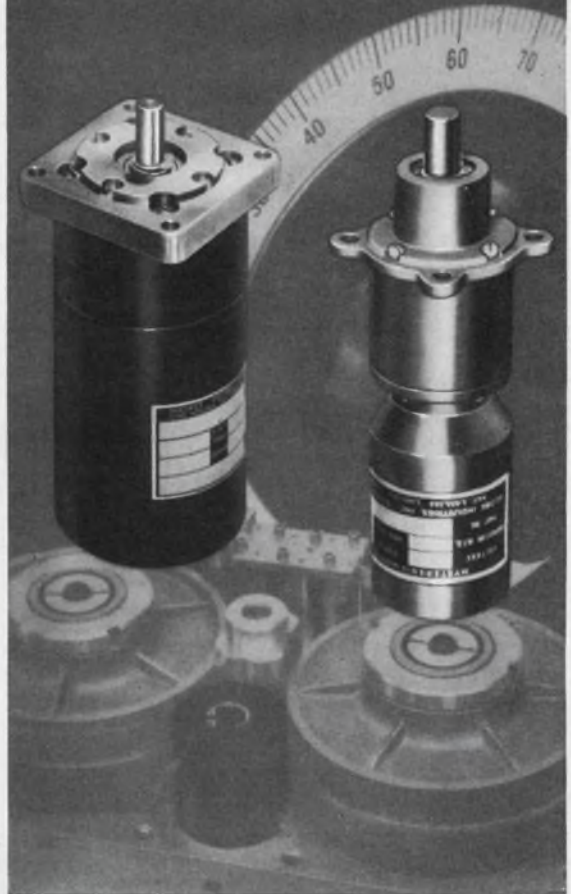

Globe Type FC and MC hysteresis synchronous planetary gearmotors are widely used for automatic tuning of transmitters and receivers. They're in tune with many other applications, too—tape transports and printers, laser shutters, timers, actuators, and fail-safe recorders, for a few examples.

FC planetary gearmotors (1-11/16" dia.) develop torques to 1250 oz. in. continuous. MC gearmotors (1-1/4" dia.) give torques to 1000 oz. in. A wide selection of shaft sizes, flange types, speeds, voltages, and frequencies provide a repertoire of several thousand standard versions.

When you need high torque, light weight, and economy with MIL-spec environmental protection and reliability, try Globe Type FC or MC gearmotors. Available in prototype or production quantities, they'll hum you a profitable tune. Write for Bulletins FC and MC.

**GLOBE INDUSTRIES**  
DIVISION OF TRW INC.

2275 Stanley Ave., Dayton, Ohio 45404, Tel: 513 222-3741

ON READER-SERVICE CARD CIRCLE 53

109

**FREE CATALOG!**  
**NEARLY 4,500 BUYS**  
**FOR INDUSTRY**

**OPTICS! SCIENCE! MATH!**  
**GIANT 148 PAGES**

Many on-the-job Helps . . . Quality Control Aids  
Write for this completely new, 1967 Catalog. New items, new categories, new illustrations. 148 easy-to-read pages packed with hundreds of charts, diagrams, illustrations. A treasure-house of optical and scientific information . . . unusual bargains galore. Optics for industry, research labs, design engineers, experimenters, hobbyists! Instruments for checking, measuring—to speed work, improve quality, cut production costs. We give you facts: what it is—how it works—where it's used.

### Comparators, Magnifiers, Microscopes

Hard-to-get war surplus bargains—ingenious scientific tools—imported—domestic. Thousands of components: lenses, prisms, wedges, mirrors, mounts, accessories of all descriptions. Dozens of instruments: magnifiers, stereo microscopes, telescopes, binoculars, infrared equipment, photo attachments. Shop by mail. No salesman will call. Use the Catalog of America's greatest Optics—Science—Math Mart. Known for reliability. Mail the coupon below for Catalog "DA."

EDMUND SCIENTIFIC CO., BARRINGTON, N. J.

### Mail Coupon for FREE Catalog "DA"

EDMUND SCIENTIFIC CO., Barrington, N. J. 08007

Please send FREE Giant 148-page Catalog "DA"

NAME .....

ADDRESS .....

CITY..... STATE..... ZIP.....



ON READER-SERVICE CARD CIRCLE 52

ELECTRONIC DESIGN 18, September 1, 1967

## Electronic Design

ELECTRONIC DESIGN's function is:

- To aid progress in the electronics manufacturing industry by promoting good design.
- To give the electronic design engineer concepts and ideas that make his job easier and more productive.
- To provide a central source of timely electronics information.
- To promote two-way communication between manufacturer and engineer.

**Want a subscription?** ELECTRONIC DESIGN is sent free to qualified engineers and engineering managers doing design work, supervising design or setting standards in the United States and Western Europe. For a free subscription, use the postfree application form inside the back cover. If none is included, write to us direct for an application form.

If you do not qualify, you may take out a paid subscription for \$25 a year in the U.S.A., \$35 a year elsewhere. Single copies are \$1.50 each.

**If you change your address,** send us an old mailing label and your new address; there is generally a prepaid postcard for this inside the back cover. You will have to requalify to continue receiving ELECTRONIC DESIGN free.

**We strive for accuracy,** but despite our strenuous efforts, an occasional error does slip through. Whenever this occurs and it comes to our attention, we publish a prompt correction. Corrections appear at the end of the Letters column.

**Microfilm copies are available** of complete issues of ELECTRONIC DESIGN and of individual articles published since the beginning of 1961. Complete issues cost 4¢ a page, articles cost 50¢ a page; shipping and handling charges are extra. The minimum charge is \$3. For further details and to place orders, contact University Microfilms, Inc., 300 N. Zeeb Road, Ann Arbor, Mich. 48106; telephone (313) 761-4700.

**Want to contact us?** If you have any comments or wish to submit a manuscript or article outline, address your correspondence to:

Howard Bierman, Editor,  
ELECTRONIC DESIGN,  
850 Third Avenue,  
New York, N.Y. 10022.

## GE Electronic Capacitor Catalog



This 36 page catalog describes GE's popular line of capacitors in all its varied phases. There are six sections and each one is devoted to a different capacitor specialty. These are: Electrolytic, Film, Metallized Film (Mylar and Polycarbonate), SCR Commutation, DC and AC Paper—Oil. Of the twenty distinct capacitor series listed in this catalog, Schweber stocks as many as sixteen on the shelf in all popular capacity—voltage values. Capacitor characteristics, outline drawings, and ratings are clearly listed for easy reference.

### Schweber Electronics

Westbury, New York  
516-334-7474

# 174

## Laminated and Molded Bus Bars For Power Distribution



A 16 page Technical Bulletin is now available, describing a new concept in power distribution. Basic mechanical and electrical design principles, along with descriptive pictures and diagrams, are included in this bulletin. These compact buses can replace bulky cable harnesses and repetitive wiring for computer or modular application. This method of construction satisfies the demanding requirements of low inductance and resistance of high speed, solid state systems while controlling electrical noises.

### Eldre Components, Inc.

1239 University Avenue  
Rochester, New York 14607

# 175

## How To Write Technical Articles



A guide for the engineer-author, "How to Write Articles for Electronic Design" shows how easy it is to write for publication—once the engineer knows what to write and how to write it. The Author's Guide includes a complete run-down of the types of articles published by Electronic Design—plus detailed instructions on how to prepare technical articles and short special features. A MUST for every "would-be-writer" in the electronics industry. Send for your complimentary copy by circling the number to the right.

### Electronic Design

850 Third Avenue  
New York, N.Y. 10022

# 176

# Manufacturers

Advertisements of booklets, brochures, catalogs and data sheets. To order use Reader-Service Card (Advertisement)

# Designer's Datebook

SEPTEMBER						
S	M	T	W	T	F	S
					1	2
3	4	5	6	7	8	9
10	11	12	13	14	15	16
17	18	19	20	21	22	23
24	25	26	27	28	29	30

OCTOBER						
S	M	T	W	T	F	S
1	2	3	4	5	6	7
8	9	10	11	12	13	14
15	16	17	18	19	20	21
22	23	24	25	26	27	28
29	30	31				

For further information on meetings, use Reader Service card.

## Sept. 6-8

**IEEE Computer Conference** (Chicago) Sponsor: IEEE; S. S. Yau, Northwestern University, Dept. of Electrical Engineering, Evanston, Ill. 60201

CIRCLE NO. 446

## Sept. 7

**The Management of New Developments** (Newark, N. J.) Sponsor: IEEE, Newark College of Engineering; J. J. Golembeski, Bell Telephone Laboratories, Room 2D-211, Murray Hill, N. J. 07971.

CIRCLE NO. 451

## Sept. 11-14

**ISA Conference and Exhibit** (Chicago) Sponsor: Instrument Society of America, 53 William Penn Place, Pittsburgh, Pa., 15219

CIRCLE NO. 447

## Sept. 11-16

**International Congress on Magnetism** (Cambridge, Mass.) Sponsor: American Institute of Physics; Dr. J. S. Smart, Secretary, 1967 ICM, IBM Watson Research Center, Yorktown Heights, N. Y. 10598

CIRCLE NO. 448

## Sept. 21-22

**Microelectronics Applications Symposium** (Garden City, N. Y.) Sponsor: IEEE; L. I. Kent, Executive Secretary, c/o Airborne Instruments Laboratory, Commack Road, Deer Park, N. Y. 11729

CIRCLE NO. 449

## Sept. 25-27

**International Electronics Conference and Exposition** (Toronto) Sponsor: IEEE; R. G. deBuda, 1819 Yonge St., Toronto, Ont., Canada.

CIRCLE NO. 452

## Sept. 26-28

**Conference on Magnetic Materials and Their Applications** (London) Sponsor: IEE; R. G. Cox, IEE, 2, Savoy Pl., London, W.C.2, England.

CIRCLE NO. 453

## Terminal Block Selector



A new 24-page, completely illustrated catalog contains photos, descriptions, ratings, engineering drawings, and prices of the complete line of Curtis terminal blocks. Included are printed circuit, insulated feed-thru, quick disconnect, track type, and high current terminal blocks. Handy selection chart quickly locates the perfect block for your particular requirements. Send today for your free copy.

### Curtis Development & Mfg. Co.

3236 North 33rd Street  
Milwaukee, Wisconsin 53216

# 177

## Free Electronic Circuit Symbol Catalog



Save artwork and drafting time cut costs with thousands of electronic drafting aids and symbols featured in the new 28-page Catalog No. 102 from Bishop. In it are the industry's only selection of predrawn complete circuit component symbols; integrated circuits, logics, semiconductors, flatpacks, transistors, printed circuits, welded modules, etc. Also: tapes, pads, corners, connectors, schematic symbols, reference numbers and more. Included are illustrations, range of sizes and complete price information. Send today for your free copy.

### Bishop Industries Corp.

11728 Vose Street  
North Hollywood, California 91605

# 178

## Engineers' Relay Handbook



A definitive work that is fast becoming a standard reference text for the relay user. Prepared and edited by the National Association of Relay Manufacturers, this book is a complete guide to the principles, properties, performance characteristics, application requirements, specifications, and testing of relays. Systems and product engineers will find the Handbook an indispensable help in determining the correct types of relays for their applications. For further information about this unique sourcebook, write Dept. ED.

### Hayden Book Co., Inc.

116 W. 14th Street  
New York, N. Y. 10011

# 179



24 x ACTUAL SIZE

# Order ITT 4-layer diodes— they're big for simplifying oscillator, protective and switching circuits

An ITT 4-layer diode stays "off" until the voltage across it reaches a specified level. Then it switches "on" in nanoseconds and remains so until current through it falls below a specified minimum. Because gating components are eliminated, the device is ideal when circuit simplification is the goal. You can specify it in glass DO-7 or top hat packages, with firing voltages from 20 to 100.

For application notes that will help you simplify your own circuits, as well as specification sheets and prices, use the coupon at right. ITT Semiconductors is a division of International Telephone and Telegraph Corporation, 3301 Electronics Way, West Palm Beach, Florida.

ITT SEMICONDUCTORS 3301 Electronics Way, West Palm Beach, Fla.		
NAME _____		
TITLE _____	COMPANY _____	
ADDRESS _____		
CITY _____	STATE _____	ZIP _____

ON READER-SERVICE CARD CIRCLE 54

FACTORIES IN WEST PALM BEACH, FLORIDA • PALO ALTO, CALIFORNIA • LAWRENCE, MASSACHUSETTS • ENGLAND • GERMANY • PORTUGAL • AUSTRALIA

semiconductors **ITT**

# You've named it!

Here's the winner:  
Dale's new



## "Econo-Trim"

**Our contest proved it...  
you want a better 1" commercial  
trimmer (for less than a buck)\*.**

Our 2300 Series has created so much industry interest that several thousand engineers, procurement specialists and even a few vice presidents suggested names for it. For example:

**J. P. Thompson of Lockheed MSC** wanted to call it the *Sta-Set*; which has merit because the way we install the 2300's lead screw creates excellent setting stability.

**Abe Pearlman of Westinghouse** suggested *Quik-Trim*. Good idea, but maybe a bit too close to competitive models (with which our 2300 Econo-Trim Series is directly interchangeable).

We picked **Econo-Trim** submitted first by **Barry Donohue of Teledyne**. It describes the cost and performance breakthroughs made by Dale in the commercial trimmer field. What's an *Econo-Trim*? It's a lot of mil-style trimmer features for less than a buck.\*

**Call us today for Econo-Trim details – including  
delivery information. Phone 402-564-3131.**

\*In 1,000 quantities



**DALE ELECTRONICS, INC.**

1328 28th Ave., Columbus, Nebraska 68601  
In Canada: Dale Electronics Canada, Ltd.



ON READER-SERVICE CARD CIRCLE 123

#### **SPECIFICATIONS:**

**Standard Resistance Range:** 10 ohms to 50K ohms

**Resistance Tolerance:**  $\pm 10\%$  standard

**Resolution:** .18% to 1.82%

**Power Rating:** 0.5 watt at room temperature to 0 watt at 85° C

**Operating Temperature Range:** -55° C to 85° C

**Mechanical Adjustment:** 15 turns nominal

**Mechanical Stops:** None. Clutch mechanism permits overtravel without damage

**Dimensions:** 1.0" L x .36" H x .28" W

**Terminals:**  
P.C. terminals (Model 2387)  
Hook-type solder lugs (Model 2389)

# Caught with their ceramic-metal down

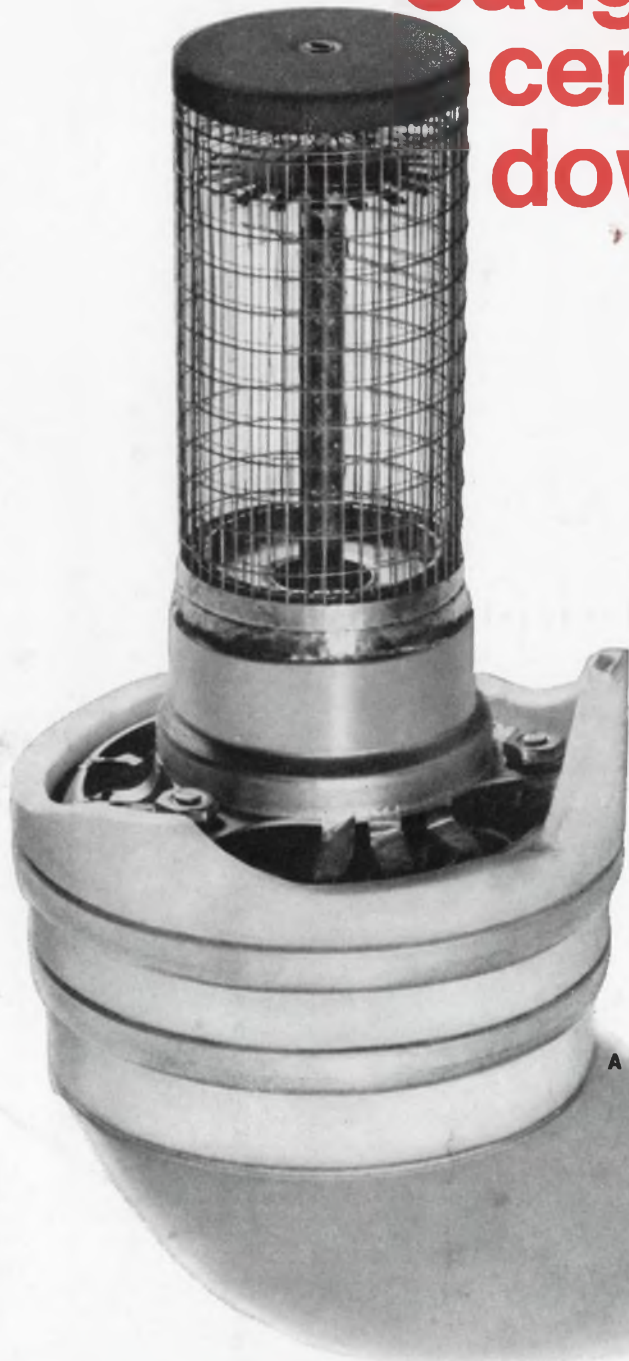

A FRIEND

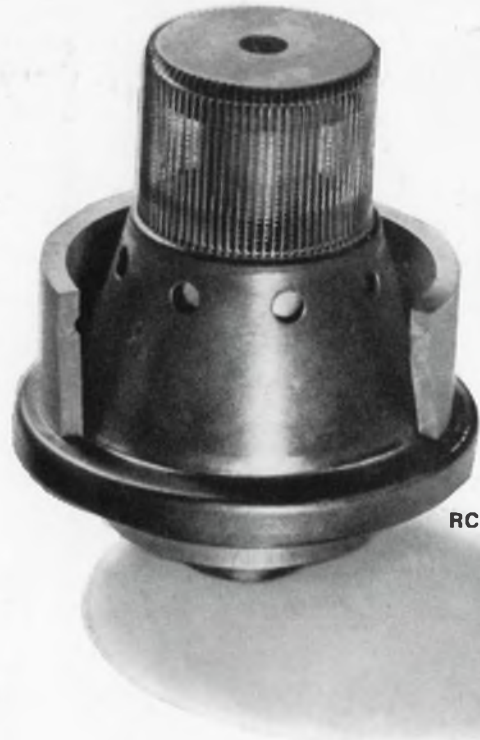

RCA-4628

## all similarly rated tubes are not equal

Construction of the high-gain Cermolox® RCA-4628 is far superior. In SSB Communications and FM Broadcast service, particularly, the RCA-4628 delivers even more outstanding performance as a result of its compact coaxial structure, precision-aligned electronically-machined grids, and ceramic-to-metal seals.

RCA-4628, rated to 400 MHz, provides 10 Kw PEP output in the 2 to 30 MHz range with lower distortion and better gain than its nearest counterpart. In FM Broadcast service, it offers higher gain with non-critical broadband neutralization techniques.

From now on, look "inside" as well as outside when you need tubes. In the RCA-4628, you'll find ruggedness, compactness, and long-life reliability. Mechanically-induced noise is very low and, because of UHF capabilities, you have no need for complex neutralization circuits at HF. The RCA-4628 is your obvious choice.

For more information on this and other RCA Cermolox® tubes, see your RCA Representative. For technical data on specific tube types, write: RCA Commercial Engineering, Section I18-P, Harrison, N.J.

ALSO AVAILABLE FROM YOUR RCA INDUSTRIAL TUBE DISTRIBUTOR



RCA Electronic Components and Devices

THE MOST TRUSTED NAME IN ELECTRONICS