

Electronic Design **EXTRA**

1967 SHOW AND CONVENTION

WESCON

The lowdown on the latest products

Are you ready to step up to manager?

Fluidics: Where opportunity gushes

Staying on top of the weather

The best of technical papers—a preview

Electronics booming in Bay Area

Burroughs eliminates a sizable point

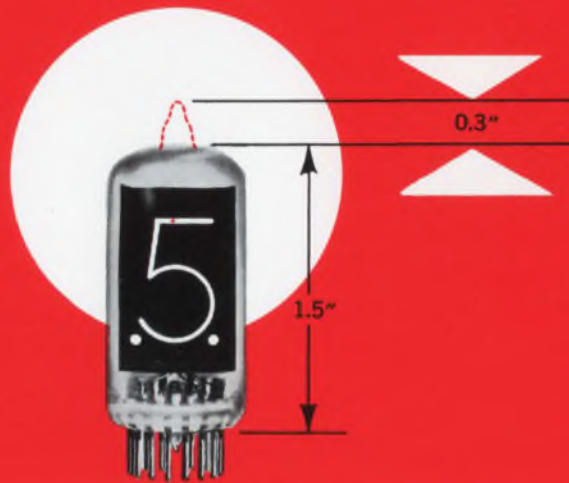

The B5440A series NIXIE® tubes are real space savers.

Now, you can shrink your instruments in both height and cost and assure the highest reliability. Burroughs has improved their side viewing NIXIE tube by rounding off the bulb to save you 16 $\frac{2}{3}$ % panel height and to reduce the possibilities of breakage. Burroughs design with extra stem pins and "hidden" tubulation offer these additional advantages:

- Smallest side-viewing tube in low cost category
- Pins directly solderable to PC boards
- Smallest sockets for every type of mounting

- Ultra long life and high reliability characteristics
- Built-in "keep alive" for rapid ionization - particularly useful in strobe applications (optional)
- Fine mesh wrap-around screen for better readability
- Two decimal points left and right (optional)
- Electrically interchangeable with Burroughs B-5440 series

For further information contact: Burroughs Corporation, Electronic Components Division, P.O. Box 1226, Department N1, Plainfield, N.J. 07061. Tel: (201) 757-5000

"WESCON Booth 2816"

Only Burroughs manufactures NIXIE Tubes



Burroughs Corporation

ON READER-SERVICE CARD CIRCLE 836



Enough to keep you busy for a week

Turnout of 40,000 is expected at Cow Palace for West Coast's biggest electronic spectacle

It's the electronic industry's biggest happening on the West Coast, but it didn't just happen. WESCON, 1967, was planned by nearly 400 volunteer committeemen, some of whom worked on the huge project for nearly a year.

Before the spectacle folds in the Cow Palace on Friday, Aug. 25, more than 40,000 persons—executives, engineers, sales personnel—are expected to troop through the cavernous showplace in search of

prize products and nuggets of technical knowledge. To accommodate them, more than 600 companies are displaying their best output in 1100 booths in the labyrinth of aisles, and 20 technical sessions are being held in the Palace's Convention Hall.

Microelectronics lessons offered

A new feature, and one of importance to "learners," is a two-day

symposium on "Microelectronics Comes of Age." It is being held in the San Francisco Hilton Hotel for a fee of \$30, and the topics to be covered include "The Hybrid Approach," "The Monolithic Approach" and "Reliability and Cost Effectiveness," among others. The symposium start Wednesday, Aug. 23, at 8:30 a.m.

Another two-day symposium at the Hilton is the "Eighth Annual International Electronic Circuit Packaging Symposium," also for a fee of \$30. It begins Monday, Aug. 21.

Prize products? These might be a few:

- A three-channel, dc-to-3kHz, direct-writing strip-chart recorder has no moving parts. It uses no ink, arcing or heat elements in the writing process. An entirely new method of strip-chart recording, it combines electrostatic principles with integrated digital electronics. (Varian Associates, Palo Alto, Calif., Booths 2309-2317).

- A panel meter made up of three PC cards provides a stable, three-digit readout. Using the dual-slope integration method of analog-to-digital conversion, the meter can be adapted to many applications. The PC cards lift out of the 4.5-inch-deep package. The meter is reported to give accuracy of 0.1 per cent, plus or minus a digit, for 10 ranges of voltage and current measurements. (Weston Instruments, Inc.,

Contents

Bay area enjoys electronics boom	E6
Future looks promising for West Coast electronics	E8
Weather satellites aim for better local forecasts	E14
From 'micro' to 'macro' packaging	E16
WESCON dropouts cite high costs	E20
WESCON plans a ladies' happening	E24
Have fun after show hours	E28
Eat smart in San Francisco	E40
WESCON exhibitors and where to find them	E46
Junior scientists display projects	E58
Discount coupons	E77
WESCON USA	U81

Newark, N. J. Booths 2511-2522.)

■ The standard 703 RF-IF amplifier now has a beam-lead version. With air isolation to reduce parasitics, the circuit's unity-gain frequency has been pushed past 1 GHz. (Raytheon Semiconductors, Mountain View, Calif., Booths 4418-4422.)

A varied technical diet

A sampling of the technical program shows sessions on "Data Compression," "FETs in RF Circuits," "Digital Approach to Analog Functions," and "Fluidics Applications."

WESCON is sponsored annually by two groups: the Western Electronic Manufacturers Assoc., with 400 member companies in the western states, and Region 6 of the IEEE, representing 20,000 engineers in the Los Angeles and San Francisco areas. The manufacturers' group and the IEEE have been partners in the growth of WESCON since 1952. The aim has been twofold: a major exposition of progress in the manufacturing arts and an important forum for new theories and applications of electronic technology.

Most of the exhibitors are from the Pacific states of Alaska, Washington, Oregon, California and Hawaii (83.3 per cent in 1966), but other areas of the country are represented. The figures last year follow: Middle Atlantic states, 4.8 per cent; East North Central, 2.9; New England, 2.2; Mountain states, 2.0; South Atlantic, 0.9; West North Central, 0.7; West South Central, 0.6; East South Central, 0.2; Foreign nations, 0.6, and Unclassified, 1.8.

Sidelights at WESCON include the Industrial Design Awards. Six products have been chosen for top honors from a field of 16 finalists. The winners and the finalists are on view on the Cow Palace floor. Nearly 200 products were entered in the competition at the outset.

Marketing tips available

"New Techniques in Electronic Marketing" will be presented at a seminar sponsored by the Hayden Publishing Co. The program starts at 9 a.m. Wednesday, Aug. 23, in the Terrace Room of the Fairmont.



More than 40,000 persons are expected to visit the 1100 booths and 20 technical sessions at the Cow Palace.

Hayden's exhibit at the Palace includes what is described as a "breakthrough" in holography. Stop-action scenes will be shown in cooperation with the Conductron Corp. Heretofore holography could not "stop" moving objects. The new technique is another small step in the use of holography as a photo-

graphic medium. (Booths 3621-3922).

And for the young at heart, there's the Future Engineers Show. Thirty of the outstanding student engineers in the West have brought their experiments and technical manuscripts to WESCON to compete for scholarship awards. ■ ■

WESCON calendar of events

	Tuesday August 22	Wednesday August 23	Thursday August 24	Friday August 25
Exhibit hours	9:30 a.m.-5:30 p.m.	9:30 a.m.-9:30 p.m.	9:30 a.m.-5:30 p.m.	9:30 a.m.-5:30 p.m.
Contributed sessions	10:00 a.m.-12:30 p.m. Sessions 1 thru 3 2:30 p.m.-5:00 p.m. Session 4	10:00 a.m.-12:30 p.m. Sessions 5 thru 8	10:00 a.m.-12:30 p.m. Sessions 9 thru 12	10:00 a.m.-12:30 p.m. Sessions 13 thru 16
Special sessions	2:30 p.m.-5:00 p.m. Electronics and Meteorology	2:30 p.m.-4:30 p.m. LSI of Computer Design	2:00 p.m.-4:30 p.m. The Frequency Spectrum	2:00 p.m.-4:30 p.m. Natural Resources Control
Special events	8:00 a.m. ELECTRONIC DESIGN Writing Seminar 12:00 Noon-WESCON Keynote luncheon 6:00-8:00 p.m.- WESCON Cocktail Party	8:00 a.m. ELECTRONIC DESIGN Writing Seminar 12:00 Noon-WEMA Annual luncheon meeting	8:00 a.m. ELECTRONIC DESIGN Writing Seminar 12:00 Noon-Eta Kappa Nu Awards luncheon 12:00 Noon-Ladies Fashion Show Luncheon and Tour	8:00 a.m. ELECTRONIC DESIGN Writing Seminar

Wescon Extra is published exclusively for those attending the 1967 Western Electronic Show and Convention. It is published by Hayden Publishing Company, Inc., 850 Third Avenue, New York, N. Y. 10022. James S. Mulholland, Jr., President. Printed at Poole Bros., Inc., Chicago, Ill. Copyright© 1967, Hayden Publishing Company, Inc., 15,000 copies this issue.





new disciplines in DC



take the models that MEMORIZE YOUR VOLTAGE SETTING

0.01% resettability featured in 8 precision-regulated all-silicon supplies

Set the five front panel dials to any desired voltage; output will be within 0.1% of setting. Change to another setting. Later, return to the first setting—output voltage will be within 0.01% + 200 μ V of original value, in spite of any changes (within rating) of line voltage and load current, ambient temperature changes up to 3°C, and elapsed time up to 8 hours.

All eight highly-stable STB Series instruments have performance at least an order of magnitude better than well-regulated laboratory supplies. Typical specs include: Regulation, Load or Line, 0.001%; Ripple and Noise 40 μ V RMS; **Controlled Environment Stability, 0.0005% + 10 μ V for eight hours** (constant load, line, and ambient temperature).

Can be used as a precision general purpose bench supply, as a portable DC reference or calibrator with high output current capability, as an adjustable reference or master supply for systems applications. Model 6110A also serves as an exceptionally stable photomultiplier supply.

All models except 6110A have Remote Programming, Remote Sensing, and four-position Multiple Range Meter Switch which sets full scale voltmeter and ammeter values at either 100% or 10% of nominal output rating.

Short-Circuit-Proof • Continuously Variable Current Limit Control
No Overshoot on Turn-On, Turn-Off, or AC Power Removal • Floating Output,
Ground Either Positive or Negative Terminal • Rack Mounting Hardware Available.

Contact your nearest Hewlett-Packard Sales Office for full specifications.

100 Locust Ave., Berkeley Heights, New Jersey 07922
Telephone 201-464-1234 TWX 710-984-7972

5-DIGIT FRONT PANEL DECADE CONTROL 5¼" H, Half Rack Width		
DC OUTPUT	MODEL	PRICE
0 - 10V, 0 - 2A	6113A	\$375.
0 - 20V, 0 - 1A	6111A	375.
0 - 40V, 0 - 500MA	6112A	375.
0 - 100V, 0 - 200MA	6116A	375.
0 - 3000V, 0 - 6MA	6110A	495.

10-TURN FRONT PANEL OUTPUT CONTROL 3½" H, Half Rack Width		
DC OUTPUT	MODEL	PRICE
0 - 20V, 0 - 1A	6101A	\$265.
0 - 40V, 0 - 500MA	6102A	265.
0 - 100V, 0 - 200MA	6106A	265.

HEWLETT  PACKARD
POWER SUPPLIES

Bay area enjoys electronics boom

Stanford University and its industrial park are the nucleus of electronics activities in the bay area

Ron Gechman
West Coast Editor

Gold brought the forty-niners to California by the thousands. Now thousands are making the trip to San Francisco for the gold in the Cow Palace—the technical information and the panorama of products and technology offered by WESCON '67.

Visitors may well wonder why this peninsula jutting into the Pacific should have become the United States' third largest area for electronics research and production. Only the Boston and Los Angeles areas are larger.

One reason may be that the San Francisco Bay area is the birthplace of many electronic developments that have shaped the course of our present electronics industry.

It was here, in 1912, that a vacuum tube first amplified a signal. The oscillations have been heard ever since, heralding, as they did, a U.S. electronics industry with 1967 sales expected to reach \$21.3 billion.

Stanford leads the way

For many years the "guiding light" organization for electronics research and development in the area has been Stanford University, at Palo Alto, about 18 miles south of San Francisco's International Airport.

More recently, two of its most publicized off-campus enterprises, Stanford Industrial Park and Stanford Research Institute, have earned world wide repute for many important applied-research developments.

Actual construction of the Stanford Industrial Park set a trend. Begun in the early Fifties, it is generally regarded as the spark that not only set off the scientific and economic boom in the area, but also launched the entire industrial-park concept. It is one of the most successful of these parks and has served as a model for similar science and research facilities

across the country. Its proximity to the University, its wealth of scientists and reference sources, and the desire of many companies to be near a major institution of higher learning have played a major role in its success.

It will eventually cover 700 acres of Stanford University land; the final 250 acres are now under development. About 60 companies have leased land and over 15,000 people are employed in the park.

Stanford Research Institute, established by the university as a separate nonprofit organization in 1946, performs contract research for industry, government and foundations in the U.S. and abroad. Its fields of interest are the physical and life sciences, economics and management sciences, and engineering (primarily electronics).

It has grown from a staff of three to its present size of about 3000. More than 700 research projects are under way for clients all over the U.S. and in about 30 other countries.

In electronics, the institute has become a world center for work on communications and propagation,

including observations of reentry phenomena. Other research efforts center around meteorology and air navigation, weapons systems, nuclear engineering, computer applications and rocket propulsion, to name but a few.

Many industrial and research companies have established facilities on the peninsula to take advantage of the technical talent fostered at Stanford. The companies have built modern buildings in pleasant, green surroundings designed to promote creativity among their scientists and engineers.

Sales justify growth

For the most part, the companies in this area rely on government programs, which are, of course, liable to sharp cutbacks from time to time. During the last few years, however, many companies have attempted to diversify into commercial production.

Aside from occasional military cutbacks which have temporarily interrupted the area's growth, the economic position of the electronics industry is healthy and on the upsurge.

Electronic sales substantiate this general picture of progress by the



Hewlett-Packard, founded 28 years ago, has grown into a company with 12,000 employees and annual sales of \$200 million.

local industry. Last year, \$1.2 billion in sales were recorded, an increase of \$200,000 over the previous year. Employment has also been rising steadily. The 225 electronic firms in the area now employ 68,000 persons, 10,000 more than a year ago.

According to WEMA (Western Electronic Manufacturers' Association), the 1967 forecast for electronic sales is \$1.45 billion, a 15 per cent gain over 1966. This is over 6 per cent of the total U.S. production.

Dr. Robert Noyce, vice-president and group executive of Fairchild Semiconductor in Mountain View, said his company's long-term growth is projected at 20 per cent a year. "This year, if we don't meet it, we will be very close," he added.

John Beckett, government relations manager for Hewlett-Packard Co. in Palo Alto and 1967 WES-CON Convention Director, said that in 28 years' existence HP has grown into a company with 12,000 employees and annual sales of more than \$200 million. He said that in five years it expected to double in size. What tomorrow will bring to the Bay area's electronics industry is difficult to predict, he added, "but whatever the future, it's bound to eclipse all that has been accomplished to date."

John McCullough, a vice president of Litton Industries and president of WEMA, noted that the optimistic 1967 forecast cannot be realized unless certain depressing factors now affecting the electronics industry

are dispelled.

He cited tight money, delays in government funding of nondefense items, and dwindling customer confidence in the nations' economy as deterrents to continued growth. With the year already past its meridian, these factors seem to have been overcome and the industry appears likely to come up to expectations.

Historical events have helped, too

Statistics of sales and employment figures do not alone tell the success story of electronic development in the West. In less than two decades, the Bay area electronics industry has surged from virtually unknown status to a position of world leadership. But the story goes back much further than that.

Its start might well be put in 1912 in Palo Alto where the first amplifier and oscillator tube were developed. Dr. Lee de Forest and his associates demonstrated the amplification characteristics of the triode by picking up the footsteps of a house fly walking across a sheet of paper and amplifying the sound throughout the room.

Key developments such as cascade amplification and oscillation emerged from western laboratories in the early days of electronics. Regularly scheduled radio broadcasts were being made from San Francisco before World War I, some eight years before the first radio station went on the air in the

East. The Bay area was also the site of some of the first experiments in television in the 1920s.

In the physics department of Stanford University, the velocity-modulated tube was born and christened the klystron, following developmental work by Russell and Sigurd Varian. This single invention made radar possible and, later, began a trend to high-power communications and microwave frequencies. The cyclotron, linear accelerator and X-ray microscope were all products of western research.

Spin-offs not uncommon

A number of students have formed their own companies to put into practical use theories they helped to develop while doing research at Stanford. Two well-known companies founded by ex-Stanford students are Hewlett-Packard and Varian Associates.

William Hewlett, while a graduate student at Stanford, built the first practical resistance-tuned oscillator. In 1938, he and David Packard, also a Stanford graduate, founded the company that bears their names. Today the company is the world's largest producer of electronic instruments and equipment.

Russell Varian was working in the Physics Laboratory of Stanford when he began classifying ideas for the development of a tube to operate at centimeter wavelengths. The invention of the klystron by Russell, his brother Sigurd and Dr. William Hanson led to the formation of Varian Associates.

Another major development in the area is the two-mile-long linear electron accelerator developed by the university. Located on a 400-acre site in the Stanford foothills, the accelerator is buried 35 feet in the ground. The accelerator will be manned by 750 persons. Initially, 240 klystrons will be employed with an ultimate expansion to 960 to provide 20 to 45 giga-electron volts for studying atomic particles.

The University's physicists predict that the accelerator will not only give more exact information about neutrons and protons, but also reveal something of the structure of electrons and mesons. It will produce all presently known particles, including antineutrons and antiprotons, and might even generate particles hitherto unidentified. ■ ■

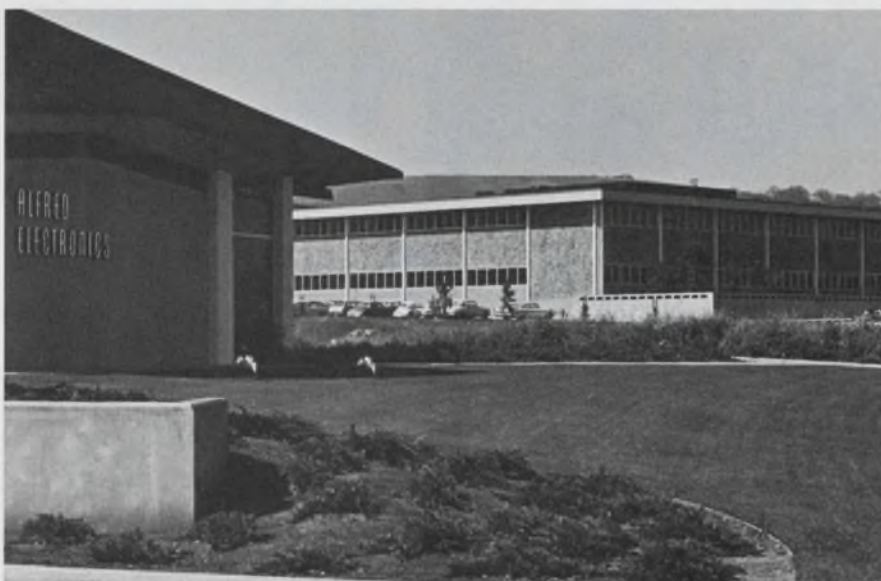

Alfred Electronics is one of 60 companies located in Palo Alto's world-famous 700-acre Stanford Research Industrial Park.

Future looks promising for West Coast electronics

R&D and avionics expected to expand. The U.S. space program is biggest area of uncertainty.

Howard S. Ravis,
Careers & Management Editor

The outlook for the West Coast electronics industry in the next 12 months is rosy.

The industry will continue to grow. Plant expansions will continue. New firms will be born. Employment figures will continue to rise. So the predictions go.

At the same time, however, it will be a year of watching . . . watching the Vietnamese war, watching federal spending on antipoverty and other domestic programs, watching for the future direction of the space program.

Here are some trends to look for in the next 12 months on the West Coast:

- More research and development of new products and concepts than in recent years.
- A reexamination of the entire space program and its objectives.

- Growth of the aircraft electronics (avionics) field.

- Greater use of electronics in industrial controls.

Returning to R&D

"Until a few months ago many of us were devoting our energies to supporting the continuing effort in Southeast Asia," says John S. McCullough, president of the Western Electronic Manufacturers' Association. "This is now tapering off and we are back to a phase of research and development and away from production."

He terms this a good thing for the electronics industry on the West Coast. "It means we are in an improved position. We've always prospered in R&D. We have a reservoir of talent in R&D and can easily attract new talent."

The trend back to R&D developed this spring, says McCullough, who

is vice president, Microwave Div., Components Group, Litton Industries, Inc., San Carlos, Calif. "And it will be more and more the case in the next 12 months."

Last year at this time, notes McCullough, there was much pipeline filling and refurbishing of equipment for Southeast Asia. "Now, it is strictly consumables—no more filling up of logistics pipelines there."

The trend away from production for Southeast Asia is not universal, however. For example, Electro-Optical Systems in Pasadena, Calif., reports it is doing considerable production for the war effort. "I cite just one product to illustrate this," a spokesman says. "Demand for our night-vision viewing devices is continually growing."

This official notes that Electro-Optical started "as a manufacturer of aerospace devices and systems. Now we find that is about 60 per cent of our effort, with the other 40 per cent in military and industrial manufacturing."

A spokesman from another aerospace firm agrees. "Actually, the



Billion-dollar semiconductor industry is expected to continue to increase its output and to lower its product prices in 1967-68. Total industry sales of integrated circuits grew by 66% last year and may increase another 50% this year.

Now from Sprague Electric!

241 LOGIC CIRCUITS IN PLASTIC DIP

Choose from 8 families of DTL and TTL
in low-cost plastic dual in-line packages

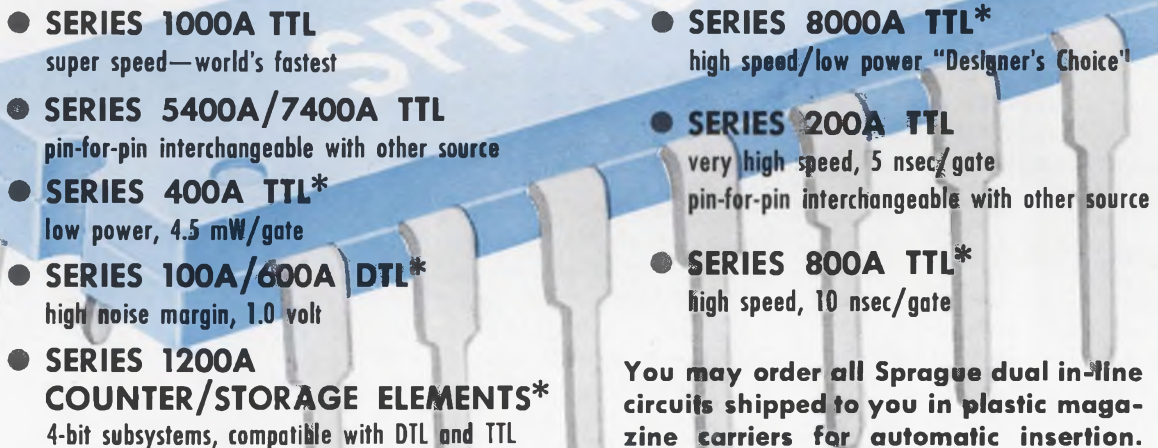
- 
- **SERIES 1000A TTL**
super speed—world's fastest
 - **SERIES 5400A/7400A TTL**
pin-for-pin interchangeable with other source
 - **SERIES 400A TTL***
low power, 4.5 mW/gate
 - **SERIES 100A/600A DTL***
high noise margin, 1.0 volt
 - **SERIES 1200A
COUNTER/STORAGE ELEMENTS***
4-bit subsystems, compatible with DTL and TTL
 - **SERIES 8000A TTL***
high speed/low power "Designer's Choice"
 - **SERIES 200A TTL**
very high speed, 5 nsec/gate
pin-for-pin interchangeable with other source
 - **SERIES 800A TTL***
high speed, 10 nsec/gate
- You may order all Sprague dual in-line circuits shipped to you in plastic magazine carriers for automatic insertion.

*Circuits have pin-for-pin and spec-for-spec dual source availability through the Sprague/Signetics technology interchange.

For complete technical data on the circuits in which you are interested, write to Technical Literature Service, Sprague Electric Company, 347 Marshall Street, North Adams, Mass. 01247

SPRAGUE COMPONENTS

INTEGRATED CIRCUITS
THIN-FILM MICROCIRCUITS
TRANSISTORS
CAPACITORS
RESISTORS

PULSE TRANSFORMERS
INTERFERENCE FILTERS
PULSE-FORMING NETWORKS
TOROIDAL INDUCTORS
ELECTRIC WAVE FILTERS

CERAMIC-BASE PRINTED NETWORKS
PACKAGED COMPONENT ASSEMBLIES
BOBBIN and TAPE WOUND MAGNETIC CORES
SILICON RECTIFIER GATE CONTROLS
FUNCTIONAL DIGITAL CIRCUITS

SPRAGUE®
THE MARK OF RELIABILITY

Sprague® and ® are registered trademarks of the Sprague Electric Co.

term aerospace is misleading. Many of us who still call ourselves aerospace firms are moving into the production of devices for limited, or should I say tactical, wars."

Developing new products

WEMA President McCullough expects a growing number of new products and concepts to evolve in the next 12 months from the increased R&D. "More controls industries will be moving to the use of electronics," he says, "and there will be increased use of electronics where it already exists—in the avionics field, for one."

The outcome of the current House Commerce Committee probe into air safety is likely to have strong implications within the avionics field (see "CAS: Aid to traffic safety in crowded skies," ED 10, May 10, 1967, pp. 17-23). Two recent collisions of commercial airliners with private aircraft have spurred public pressure for improved air safety devices. This in turn has stepped up the Congressional effort in this area. McCullough foresees the House Committee calling for short-term solutions to avert future midair collisions.

Recent studies show that 285 of the 547 U.S. airports served by commercial airlines—more than half do not have control towers. Eighty per cent (434) lack radar which would permit them to keep a safe distance between incoming and outgoing aircraft.

Viewing NASA differently

McCullough expects work on NASA projects to remain unchanged for the immediate future. "Until NASA makes peace with Congress, nothing new will develop in this area," he says. "The Apollo program is awaiting renewed confidence. Still, there is a lot of money being spent by the Government for the space program—nearly \$5 billion a year. In general, however, new development opportunities will be limited for the time being."

Other officials see the Government taking a long, hard look at the future of the space program in the next 12 months.

"President Kennedy gave the space race its impetus," a company official commented. "And he did a



Increased West Coast R&D may yield many new products and concepts during the next year, industry experts predict.

good thing for the industry. It gave the economy a real shot in the arm. But that era is ending.

"Several factors in the past couple of years have greatly changed the attitude towards the space program. The space race in this country certainly has been slowed down by recent setbacks."

Other pressures may also influence the future of the space program. "The Vietnam war certainly has put a financial strain on the nation," says one industry spokesman. "And now, there may be more money going for antipoverity and other domestic programs."

"Will all this mean fewer, the same or more funds for the space program? No one knows, but the next 12 months could be a bellwether for the space industry's future."

Prices continue to drop

The growth of the electronic components field will continue in the coming months, and average prices will continue to drop. Sales totalled \$6.16 billion last year.

Fairchild Semiconductor Div., Mountain View, Calif., the largest producer of semiconductors in the nation, reports that total industry sales of integrated circuits grew by 66 per cent in 1966-67, making semiconductors alone a billion-dollar-a-year industry.

Jerry Sanders, the division's marketing director, says that there probably will be another 50 per cent increase in the current fiscal year. "Actually, the increase in actual numbers will be even greater, but the price per piece will be lower," he says. This is due to increased production, stronger competition and improved production methods. ■ ■

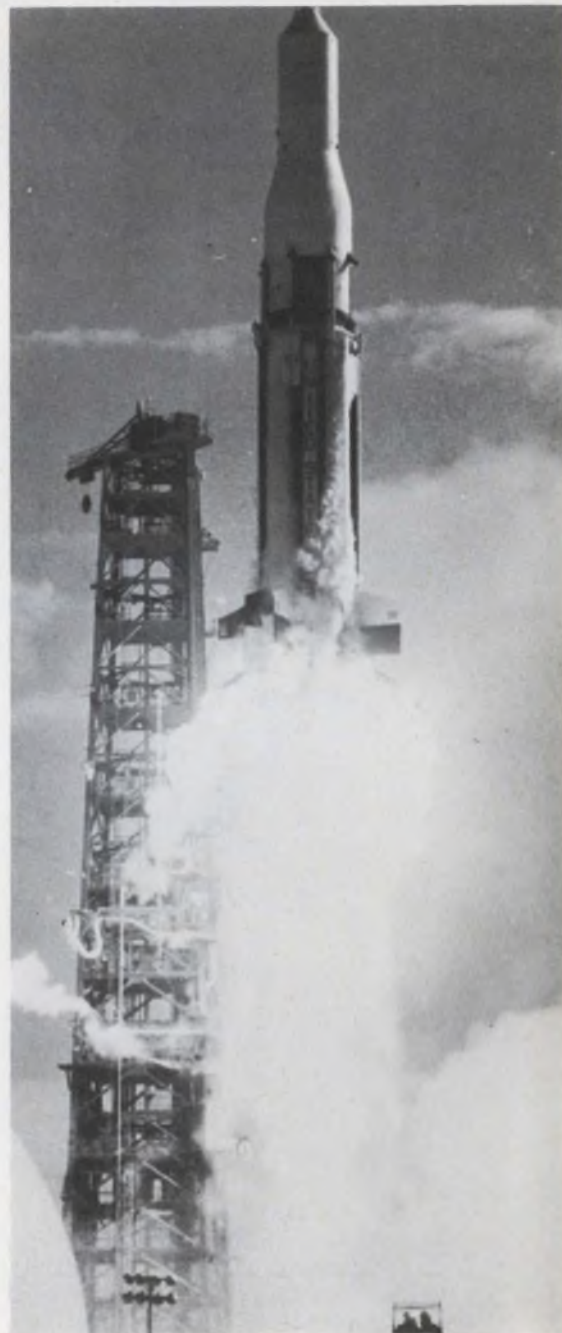

The space program's future may become clear in the coming year. The big question is still: Where do we go after Apollo?

Now from Sprague!

ECONOLINE* SILICON PLANAR PLASTIC TRANSISTORS

can save you **30 to 40%**
over metal-encased types

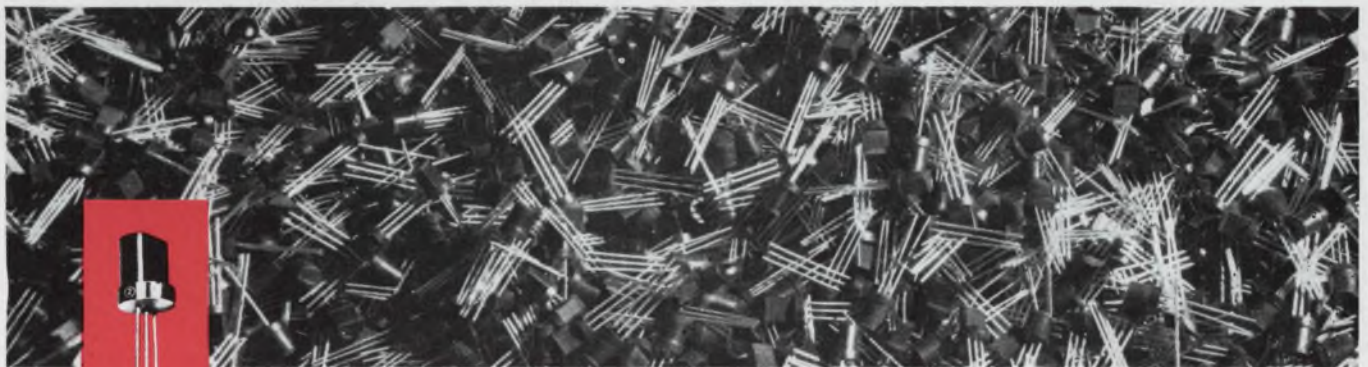

**56 POPULAR N-P-N TYPES IN VOLUME PRODUCTION
FOR OFF-THE-SHELF DELIVERY**

- Small-signal amplifiers
- Medium-speed switches
- Large-signal amplifiers
- High-frequency amplifiers
- Oscillators
- High-voltage indicator drivers

Sprague Econoline transistors . . . quality planar devices in plastic packages. You save the cost of metal cans. And with dual source back-up, too. For further information and prices call your local Sprague office today.



For comprehensive specifications write for catalog CN200 A to:

Technical Literature Service
Sprague Electric Company
347 Marshall Street
North Adams, Mass. 01247

*trademark

SPRAGUE COMPONENTS

TRANSISTORS
INTEGRATED CIRCUITS
THIN-FILM MICROCIRCUITS
CAPACITORS
RESISTORS

PULSE TRANSFORMERS
INTERFERENCE FILTERS
PULSE-FORMING NETWORKS
TOROIDAL INDUCTORS
ELECTRIC WAVE FILTERS

CERAMIC-BASE PRINTED NETWORKS
PACKAGED COMPONENT ASSEMBLIES
BOBBIN and TAPE WOUND MAGNETIC CORES
SILICON RECTIFIER GATE CONTROLS
FUNCTIONAL DIGITAL CIRCUITS

SPRAGUE
THE MARK OF RELIABILITY

'Sprague' and '®' are registered trademarks of the Sprague Electric Co.

455-7104R1

ON READER-SERVICE CARD CIRCLE 839

Marketing made easy at Hayden seminar

The tenth semiannual marketing seminar sponsored by Hayden Publishing Co. will be held on Wednesday, August 23, at 9 a.m. in the Terrace Room of the Fairmont Hotel in San Francisco. Held twice each year, during IEEE and WESCON week, this session's theme is "New Techniques in Electronic Marketing." The seminar is primarily directed to persons engaged in marketing electronic products, but sales-minded engineers are also invited to attend. Check in first at Hayden's exhibit booth, 3621. Topics to be covered during the seminar are:

"Input-Output Theory for the

Electronics Market"—The speaker will be Merrick Stevensor, president of Samson Associates, Inc.

"Project MISER—A Computerized Method of Optimizing Media Selection"—Emmett Brownell, manager of advertising and sales promotion for Varian Associates will be the speaker.

"Challenges Facing Industrial Marketing"—Views on this topic will be given by Robert Cummins, director of advertising and public relations for P. R. Mallory & Company, Inc.

The seminar will conclude with a panel discussion entitled, "Selling and Advertising to the Inte-

grated Circuits Market." The panel speakers will be Richard Hanschen, vice president of semiconductor marketing for Texas Instruments, Inc.; Jerry Sanders, director of marketing for Fairchild Semiconductor; G.A. 'Bud' Hildebrand, marketing manager at Union Carbide Electronics, and Thomas Connors, marketing manager for Motorola Semiconductor Products Div.

Coffee will be served in the morning with cocktails at 12:00 and luncheon at 12:30.

The Fairmont Hotel is located atop San Francisco's Nob Hill on Powell and California Streets. ■ ■

Design literature free to show visitors

Once again, as in previous WESCON shows, exhibitors will be giving away booklets on a diversity of subjects. So come with a large folder or shopping bag when you start making the rounds.

Some of the literature that showgoers can pick up free of charge includes the following:

Theory and Use of Operational Amplifiers—Analog Devices Inc. (5021).

Treatises on perfect layer winding—Coil Winding Equipment Co. (1802).

Proceedings of the Kodak seminar on microminiaturization and proceedings of the second annual Kodak seminar—Eastman Kodak Co. (5224).

Fotofoil Manual—Fotofoil Co. (2324).

The Ferroresonant Transformer—Geo-Space Corp. (4723).

Networks for Computers (how to design and specify resistor networks) and notes on a ratiometric method of measurement—Julie Research Laboratories, Inc. (4607).

Power Supply Handbook—Kepco,

Inc. (2715).

Micronotes—Microwave Associates, Inc. (3723).

The Meaning and Measurement of Spectral Purity and resonant reed application notes—Motorola Communications & Electronics, Inc. (3116).

How to Magnetize, Measure and Stabilize Permanent Magnets and Transistor Home-Study Course—RFL Industries, Inc. (2307).

Analogical testing, programing techniques and defect analyses—Teradyne (3205).

Industrial designs test judges' mettle

It wasn't easy, but . . . Judges of WESCON's Industrial Design Awards get down to shirt-sleeve action as they narrow the hunt for winners. From the left: Harold Zierhut of Zierhut-Vedder-Shimano, Van Nuys, Calif.; Richard Coyne, publisher, CA Magazine, Palo Alto, Calif.; Jack Crist, coordinator of industrial design at San Jose (Calif.) State College; J. Budd Steinhilber of Tepper-Steinhilber Associates, Inc., San Francisco, and Robert Montgomery, manager of engineering design, Varian Aerograph, Walnut Creek, Calif.



New from Sprague!

This Resistor has 5 Times the Resistance of a Conventional Metal-Film Resistor of Equal Size!

This Resistor is 21 Times Smaller than a Conventional Metal-Film Resistor with Equal Resistance Value!

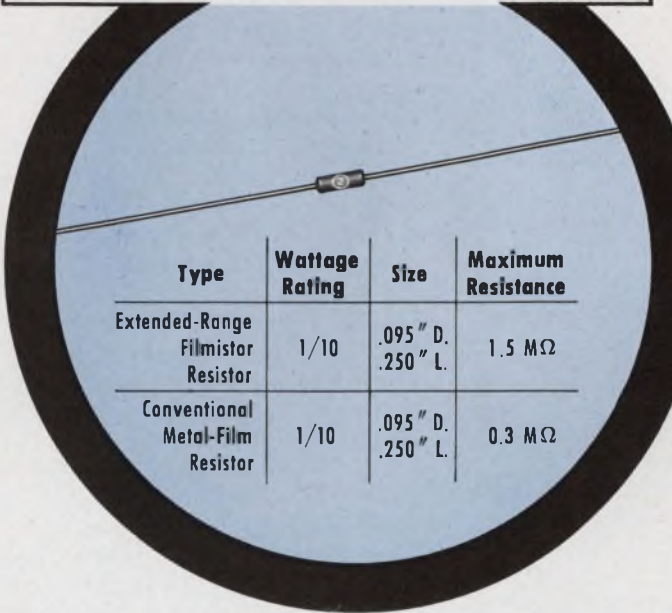

Type	Wattage Rating	Size	Maximum Resistance
Extended-Range Filmistor Resistor	1/10	.095" D. .250" L.	1.5 M Ω
Conventional Metal-Film Resistor	1/10	.095" D. .250" L.	0.3 M Ω

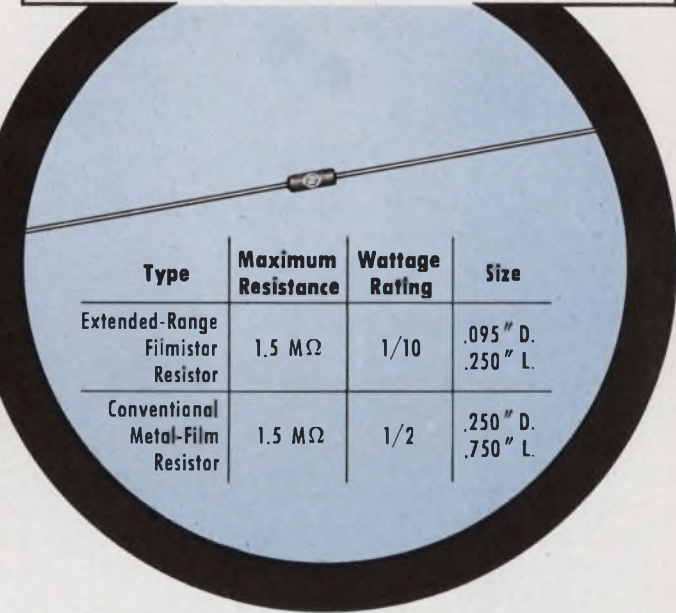

Type	Maximum Resistance	Wattage Rating	Size
Extended-Range Filmistor Resistor	1.5 M Ω	1/10	.095" D. .250" L.
Conventional Metal-Film Resistor	1.5 M Ω	1/2	.250" D. .750" L.

Both Resistors are one and the same...they're Sprague's new **EXTENDED-RANGE FILMISTOR[®] METAL-FILM RESISTORS**

Substantial saving of space in all wattage ratings—1/20, 1/10, 1/8, 1/4, 1/2, and 1 watt—with absolutely NO SACRIFICE IN STABILITY!

New manufacturing techniques at Sprague Electric have made possible a major breakthrough in resistance limits for metal-film resistors. Extended-Range Filmistor Resistors now offer, in addition to accuracy . . . stability . . . reliability . . . extended resistance values in size reductions which were previously unobtainable. Size and weight advantages of Filmistor Resistors now make them the ideal selection for applications in high-impedance circuits, field-effect

transistor circuits, etc., where space is at a premium. Many designs which previously had to settle for the higher temperature coefficients of carbon-film resistors in order to obtain required resistance values can now utilize the low and controlled temperature coefficients of Filmistor Metal-Film Resistors.

Other key features are $\pm 1\%$ standard resistance tolerance, low inherent noise level, negligible voltage coefficient of resistance, and tough molded case for protection against mechanical damage and humidity.

For complete technical data, write for Engineering Bulletin 7025C to Technical Literature Service, Sprague Electric Company, 347 Marshall Street, North Adams, Massachusetts 01248.

SPRAGUE COMPONENTS

RESISTORS	PULSE TRANSFORMERS	CERAMIC-BASE PRINTED NETWORKS
CAPACITORS	INTERFERENCE FILTERS	PACKAGED COMPONENT ASSEMBLIES
TRANSISTORS	PULSE-FORMING NETWORKS	BOBBIN and TAPE WOUND MAGNETIC CORES
THIN-FILM MICROCIRCUITS	TOROIDAL INDUCTORS	SILICON RECTIFIER GATE CONTROLS
INTEGRATED MICROCIRCUITS	ELECTRIC WAVE FILTERS	FUNCTIONAL DIGITAL CIRCUITS

SPRAGUE[®]
THE MARK OF RELIABILITY

'Sprague' and '®' are registered trademarks of the Sprague Electric Co.

ON READER-SERVICE CARD CIRCLE 840

Weather satellites aim for better local forecasts

Spacecraft with new instruments proposed as part of a daily world watch on the atmosphere

Neil Sclater
East Coast Editor

If your last planned picnic was rained out despite a favorable forecast from the weatherman, you may not appreciate the great strides that have in fact been made in the nation's electronic weather-satellite program.

Satellite programs have added to man's knowledge of worldwide weather patterns. But the local weatherman still cannot make precise predictions from a limited number of observations even with the aid of a computer.

Scientists and engineers active in meteorological research programs are aware of the shortcomings of even the most advanced satellites in determining short-duration weather phenomena. Some of the programs proposed to probe the atmosphere for more meaningful weather clues are:

- Launching a meteorological satellite to operate at synchronous altitudes in cooperation with low-altitude satellites now in polar orbit.

- Improving instrumentation in such satellite programs as Nimbus, Tiros and the Applications Technology Satellites (ATS series).

A special technical session at WESCON is examining the electronic instruments for meteorology. The session organizer is Dr. Myron Ligda, manager of the aerophysics laboratory of the Stanford Research Institute, Menlo Park, Calif. Four papers to be delivered cover such topics as laser ranging, television cameras, the progress and future of the Nimbus program, and proposed Apollo weather experiments.

At present, weather information is obtained from satellites in two different orbits—600-to-700-mile polar and 22,300-mile synchronous equatorial. The Environmental Science Services Administration (ESSA) series of Tiros satellites are in polar orbits; the Applications

Technology Satellite, ATS-1, is in a near-synchronous orbit.

The ESSA series are intended for operational use. In similar orbits are the Nimbus satellites, which are research platforms, designed to develop the atmospheric sensors and techniques for polar-orbiting satellites.

The ATSS are test beds for high-altitude satellites. Although there is now no operating synchronous-altitude counterpart of the ESSA satellites, NASA and ESSA would like to loft one.

Nimbus project manager Harry Press says at NASA's Goddard Space Flight Center, Greenbelt, Md., that these programs are complementary and to some extent competitive. Personnel in the different programs review each other's findings and profit from the lessons learned. However, Press adds, the different operating altitudes and missions often dictate different so-

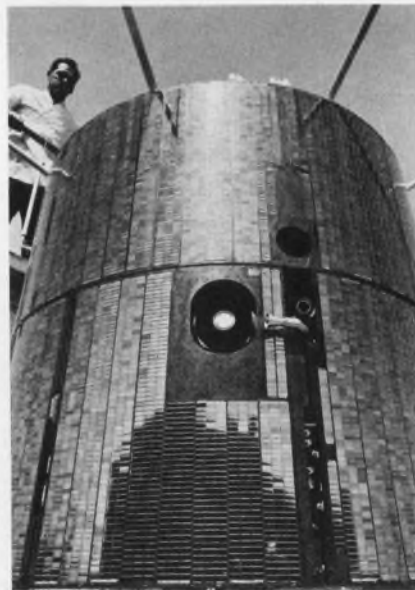

The spin-scan cloud camera, the prime meteorological experiment on the ATS-1 satellite, projects from the center of the spacecraft. It produces global pictures of the earth from its 22,300-mile synchronous orbit. An improved version that takes color pictures will be flown on an ATS satellite this fall.

lutions to instrumentation problems.

Television systems on such polar-orbiting satellites as Tiros and Nimbus see the earth only once each day, but with the addition of infrared viewing sensors, they can double their views. They have already proved the importance of global weather analysis.

Press says that meteorologists are working toward a World Weather Watch, in which stations all over the world would pool their daily observations. Since three-quarters of the world is covered by water and much of the land has inadequate weather-station coverage, the satellite continues to be the best method for acquiring such global data. The goal is two-week forecasts.

NASA and ESSA have proposed placing three satellites in a 22,300-mile-high orbit coincident with the equator. The satellites' orbital period would match the earth's daily rotational period. With the earth stationary with respect to the satellites, the sensors of each could view approximately 40 per cent of the globe. The new pictures would supplement those obtained by the polar orbiting satellites, to provide constant weather-watching.

The ATS program has demonstrated a spin-scan camera capable of providing pictures of approximately a quarter of the earth's surface from a synchronous orbit. A weather-facsimile system has also been developed and demonstrated in this program. It uses the ground system developed for the Nimbus and Tiros programs.

The facsimile system relays analyzed weather data from a central facility to small operational units. The ATS program is also working on advanced sensor systems, color cameras, day-night cameras and an interrogation system.

In the latter system, the satellite would interrogate instrumented platforms within the atmosphere and relay this information together with platform position data to a central facility for processing and analysis.

Over the last six years the Tiros

and Nimbus programs have developed effective data-processing techniques that would be used in the proposed program.

Camera scans the earth

The results of observations of the Earth's cloud cover with the spin-scan camera have been a complete success. Prof. Verne Suomi of the University of Wisconsin discusses the results at the WESCON special session. The camera uses the spin of the ATS-1 satellite for east-west, or horizontal, scan.

An improved version of the spin-scan camera has been developed. It can take high-resolution color photographs to survey the displacement, development, boundaries and altitude of clouds. It will be used on an Applications Technology Satellite in the fall to study tropical weather systems.

The Nimbus satellites are making possible research on new sensors, subsystems and system, designs. Two of the spacecraft are now in near-polar orbits. The only one now operational, Nimbus II, has an instrument payload that includes an advanced vidicon camera system an automatic picture transmission system and radiometers. The radiometers yield nighttime cloud photographs and data on stratospheric temperature, the earth's albedo and water-vapor distribution.

NASA's Harry Press is telling the WESCON session about advanced Nimbus plans. Among the equipment he is discussing are sensors that have been developed to determine vertical temperature, humidity, ozone and wind profiles around the globe.

The Stanford Research Institute has studied the possibility of using lasers in satellites to determine cloud heights and the densities of cirrus clouds. These wispy high-altitude clouds seem to defy reliable observation from the ground and even by satellite television. Meteorologists agree that cirrus clouds are indicators of large-scale circulation features, such as cyclones and jet streams. They are also of interest in connection with infrared studies of the earth.

William E. Evans, a meteorologist for the institute, is discussing at WESCON the feasibility of laser detection and ranging (lidar) in future satellites. ■ ■

AC/DC SIGNAL SOURCE

Ballantine Model 421A Precision Calibrator with Model 2421 Error Computer

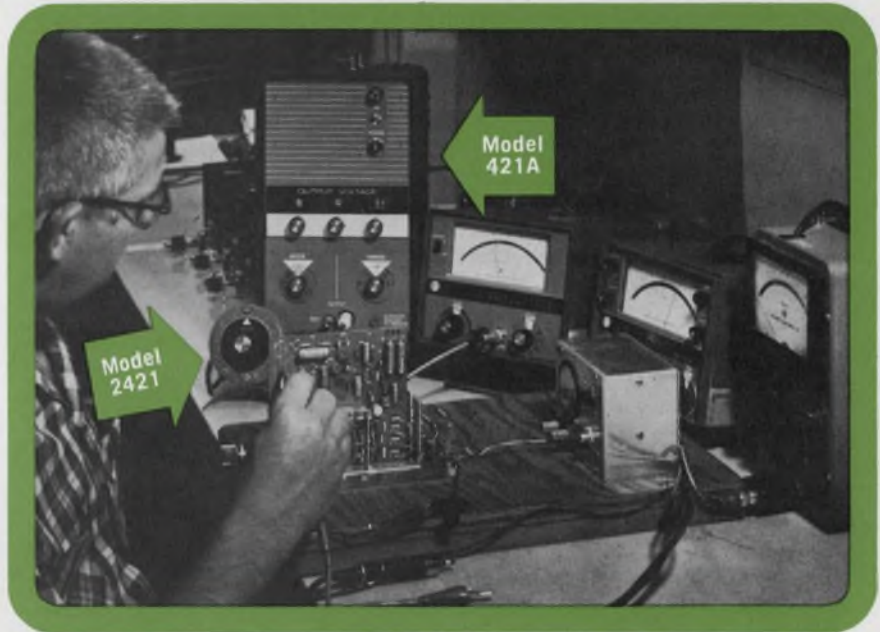

Model 421A provides an accurate, stable source of voltage in a typical production Q.C. set-up. Other instruments measure levels at several points. Model 2421 Error Computer speeds up measurements by changing the 421A output by an accurately indicated percentage.

Generates \pm DC, or AC at 400 or 1000 Hz, RMS or Peak-to-Peak

The Ballantine Model 421A Precision Calibrator provides an accurately known stable source of ac or dc voltage for calibration of voltage sensitive devices, or for measurements of gain or loss, or as a source for bridges or strain gauges. The output may be + or - dc, or it may be ac at 400 or 1000 Hz, rms or peak-to-peak. Accuracy to 111 volts ac or dc is 0.15%, and from 111 to 1110 volts ac is 0.3%. A high order of stability is obtained by monitoring the input to the attenuator with a bridge circuit whose output compensates for effects of changing line voltage, aging tubes and ambient temperature.

Model 2421 Error Computer is an optional accessory which, when connected to Model 421A, provides for a change in its output up to $\pm 5\%$, as read directly on the dial of the 2421. The device under calibration is fed its nominal voltage by setting the voltage knobs on Model 421A. The dial on the 2421 is then adjusted until the device reads its nominal voltage, and the % error of the device is then directly from the scale of the 2421.

Rack versions of Model 421A are available

Write for Brochure giving full Specifications

If you have a production line Q.C. requirement for a known stable source of dc or ac, and a means for measuring % deviation from a nominal value, the 421A Calibrator and 2421 Error Computer may be exactly what you need. Write us for full details today.



BALLANTINE LABORATORIES INC.
Boonton, New Jersey

CHECK WITH BALLANTINE FIRST FOR DC AND AC ELECTRONIC VOLTMETERS/AMMETERS/OHMETERS, REGARDLESS OF YOUR REQUIREMENTS. WE HAVE A LARGE LINE, WITH ADDITIONS EACH YEAR. ALSO AC/DC LINEAR CONVERTERS, AC/DC CALIBRATORS, WIDE BAND AMPLIFIERS, DIRECT-READING CAPACITANCE METERS, AND A LINE OF LABORATORY VOLTAGE STANDARDS FOR 0 TO 1,000 MHZ.

From 'micro' to 'macro' packaging

Face-down chip bonding and 'hybrid' thick-thin film networks among innovations cited at symposium

David H. Sorgan
Technical Editor

Innovations in packaging, aimed at bridging the gap between the circuit designer's requirements and package realities, are being explored at a symposium in the San Francisco Hilton Hotel. WESCON's eighth such gathering, Monday and Tuesday (Aug. 21-22), is planned for a broad spectrum of interests. It began with microcircuits and is ending with macrosystems.

Face-down bonding studied

Face-down bonding for single-chip packaging was explored in Session I in a paper given by W. L. Doelp of Philco-Ford's Microelectronics Div. He covered conventional PC-board wiring and micro-

circuit interconnection schemes produced on silicon substrates. Pointing out that the circuit element, the chip itself, is actually packaged twice before it is finally used, Doelp said:

"Consider the packaging of a device with 14 electrical connections into a flatpack. The chip is first bonded to the flatpack for mechanical and thermal connections. Wires are then bonded sequentially from the chip pads to the flatpack leads—a total of 28 connections. Following sealing, the packaged device is then repackaged by the systems manufacturer, by attaching it to a substrate—another 14 connections.

"Thus, before the microcircuit element—the chip—can perform in the system, it must actually be packaged twice. It is obvious that

any technique which can eliminate this redundancy would offer potential advantages. If the chip could be directly attached to the printed-circuit card by the simultaneous attachment of all 14 terminals—a three-to-one reduction in bonds—the attendant cost of double packaging, handling and testing could be completely eliminated."

Bonding methods vary

Several methods of bonding are currently in use:

- Ultrasonic.
- Thermal compression.
- Diffusion.
- Beam lead.
- Solder.

Philco-Ford chose soldering for an RTL 3-input gate. "The selection of soldering does not indicate a preference over the other four," Doelp said. "The emphasis was on the use of one such method in packaging, not the development of

1. Once optical alignment is completed, Fairchild's DTL microcircuit is thermocompressionally bonded in place into its Fairpak. Face-down bonding can eliminate two-

thirds of the bonds made before a circuit is used. The chip has aluminum bumps on its bonding pads, and the package has a matching gold-plated lead pattern.

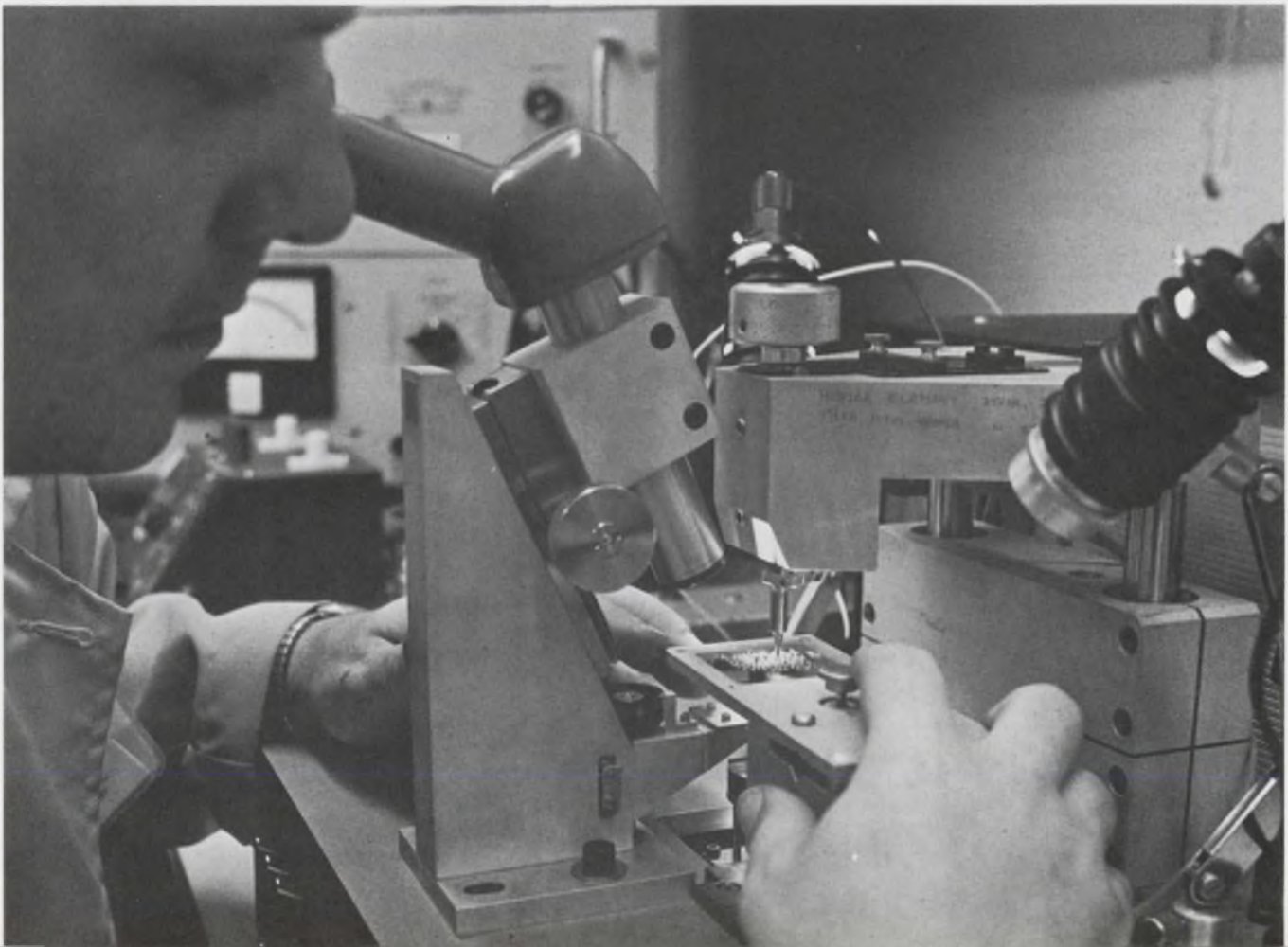

Does Ford Make Automobiles ?



Does IBM
Make Computers ?

Does Boeing Make Airplanes ?



Does CLIFTON Make Servo Packages ?

Sure, it's a Big part of our Business !

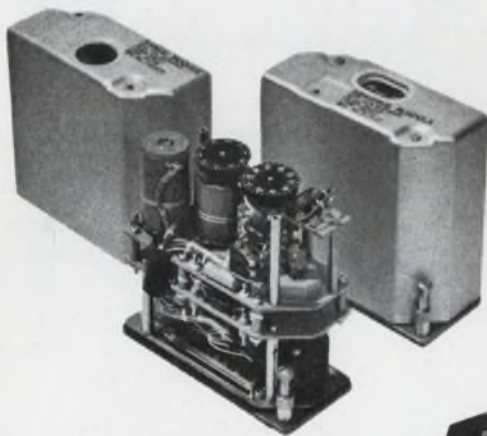

TACAN
RANGE AND
BEARING COUPLERS

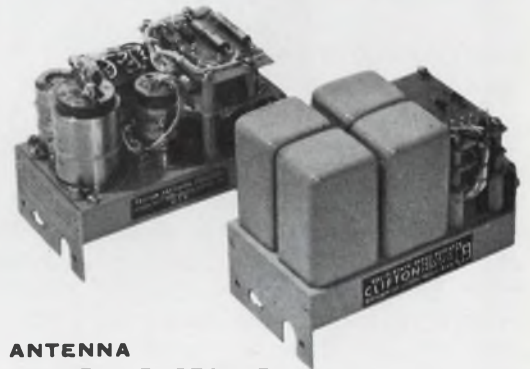

ANTENNA
CONTROL REPEATER
ELECTRO-MECHANICAL OR SOLID STATE

DISCRETE MESSAGE INDICATOR
DATA LINK SYSTEMS



AUTOMATIC
STABILIZATION
ACTUATOR—SEA KNIGHT

Our Special Devices Group for the past 10 years has designed, developed, and manufactured an extremely wide variety of electro-mechanical and electronic packages for aircraft and ground support equipment. We are also well versed in the solid state technology which is replacing electro-mechanics in some instances. We are flying in the F-111, A7A, CH47A, 727 and dozens of our country's most important aircraft.

In your next "make or buy" situation, let Clifton engineering solve your problem—and with CLIFTON QUALITY built in!

For further information call your local Clifton Sales Office or Ed Fisher 215 622-1000; TWX 215 623-1183.

CLIFTON 
DIVISION OF LITTON INDUSTRIES

(packaging, continued)

the best bonding method."

The performance of the mounted chip was reported to parallel TO-5 package performance. So far as reliability is concerned, the failure rate was given as 0.08%/1000 hours, compared with 0.02%/1000 hours for other packages.

Although still developmental at Philco-Ford, face-down bonded single chips are already offered by several manufacturers. Fairchild Semiconductor manufactures a dual-in-line (Fig. 1), and Western Union uses beam-lead attachment to fabricate dual-in-line packages. IBM has taken the idea one step further. Its multichip SLT uses face-down solder bonding.

Films steal the show

Thick- and thin-film technology and an interesting "hybrid" of the two, are covered in Session II.

Thin-film processing uses vacuum-deposition techniques, such as evaporated nichrome or sputtered tantalum, for resistive elements in conjunction with evaporated conductor networks. Thick-film technology employs cermet resistive compositions (Fig. 2) and the more economical processes of screening and firing the conductor patterns.

Both approaches provide devices that are essentially two-dimensional, but a combination of fired conductors and crossovers can add a "third dimension" to the design of thin-film circuits. However, since sputtered-tantalum thin-film devices exhibit superior long-term stability and reliability, advantageous designs can be achieved by combining fired conductor-crossover networks with tantalum passive components. The process, developed by Western Electric, Allentown, Pa., is described by Halle Abrams in his paper. It makes use of a combination of gold and platinum-gold frits and a dielectric glaze fired on in the proper sequence to effect an insulated circuit crossover. The resistance between conductors is characteristically greater than 10^{11} ohms, with crossover capacitance on the order of 0.002 pF/mil², a dissipation factor at 1 kHz of approximately 0.005, and leakage, measured at 40 volts, of less than 0.01

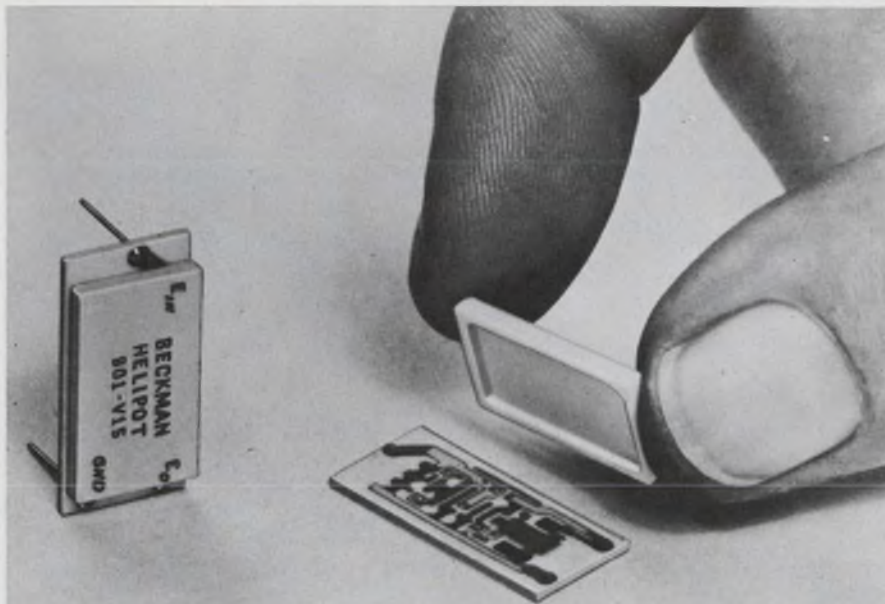

2. Thick-film voltage regulator from Beckman uses cermet passive elements and semiconductor chips bonded to an aluminum substrate. Interconnections are made by thermocompression lead bonding.

nanoamperes. The crossovers can be either conductor-dielectric-conductor or conductor-dielectric-resistor structures.

Abrams cites these advantages for the hybrid process:

- Low production costs.
- High reliability.
- Less capital investment (as compared with evaporation).
- Adaptability to automatic processing.
- High density (circuitry on the substrate back layered designs).
- Bonding flexibility.
- Circuit layout flexibility.

The favorable economics of the crossover thick-film conductor network design, as compared with other thin-film designs, are based on the elimination of back evaporation and feedthroughs or eyelets. Abrams reports that a cost comparison was made of the two processes with two logic gate circuits; yields and outputs were estimated hourly. For both circuits, the crossover design completely eliminated evaporation, and the cost was about 10 per cent lower than that for the thin-film circuit.

Multilayered thick-film circuitry, materials and processes are covered in Session II by W. Giesfeldt of Globe-Union's Centralab Div. Multilayered conductors can cut the complex wiring of industrial circuits and raise conductor and component density.

There are various techniques for

fabricating multilayered circuits. Equipment ranging from complex vacuum and sputtering machines to simple eyeletting and screen-printing machines can be used. The materials can vary from exotic refractory metals and noble metals to the common copper-clad phenolic board. Giesfeldt's process, however, involves only the use of screen printing and high-temperature maturing of noble metals and inorganic insulators on ceramic substrates, to form the circuit layers. Relatively inexpensive equipment and materials are needed along, and there are no unusual processing conditions. All circuit layers and interconnection between layers are formed through screen-printing and firing. Secondary operations, such as laminating, through-hole plating and eyeletting, are not required. Other benefits of inorganic systems are high-temperature stability, moisture resistance, durability, compactness and electrical stability.

Because of the inertness and stability of the ceramic and noble metal materials used, encounters with high temperature, humidity and voltages can be sustained without difficulty. However, there are limitations to be considered, such as the conductivity of the metallizing, dielectric properties of the insulating layers and the size of the circuit that can be economically processed. ■ ■



SCR SERIES POWER SUPPLIES



NEW styling...



SMALLER size...



LESS ripple...



Brand new design and a new concept and production of proprietary electronic filtering, all in the SCR from the oldest sole-manufacturer of power supplies, guarantees quality, highest performance and lowest cost.

Model No.	Voltage Range	Current Range	Voltage Regulation Line or Load
SCR 10-1000	0 to 10	0 to 1000	0.1% or 5MV
SCR 10-500	0 to 10	0 to 500	0.1% or 5MV
SCR 10-250	0 to 10	0 to 250	0.1% or 5MV
SCR 20-500	0 to 20	0 to 500	0.1% or 10MV
SCR 20-250	0 to 20	0 to 250	0.1% or 10MV
SCR 20-125	0 to 20	0 to 125	0.1% or 10MV
SCR 40-250	0 to 40	0 to 250	0.1% or 20MV
SCR 40-125	0 to 40	0 to 125	0.1% or 20MV
SCR 40-60	0 to 40	0 to 60	0.1% or 20MV
SCR 120-80	0 to 120	0 to 80	0.1% or 60MV
SCR 120-40	0 to 120	0 to 40	0.1% or 60MV
SCR 120-20	0 to 120	0 to 20	0.1% or 60MV
SCR 160-60	0 to 160	0 to 60	0.1% or 80MV
SCR 160-30	0 to 160	0 to 30	0.1% or 80MV
SCR 160-15	0 to 160	0 to 15	0.1% or 80MV
SCR 500-20	0 to 500	0 to 20	0.1% or 250MV
SCR 500-10	0 to 500	0 to 10	0.1% or 250MV
SCR 500-5	0 to 500	0 to 5	0.1% or 250MV

RMS Ripple: 10MV Transient Resp: to within 2% in 50 M/S



Write for more information.

THE ROWAN CONTROLLER COMPANY

OCEANPORT, N. J. 07757

ON READER-SERVICE CARD CIRCLE 843

WESCON dropouts cite high costs

Some companies report poor sales, but the show cautions that exhibitors must promote their booths

Ron Gechman
West Coast Editor

Some companies are conspicuous by their absence from WESCON this year. Among the missing are Texas Instruments' Semiconductor-Components Div., Beckman Instruments, Motorola Semiconductor, Philco-Ford Microelectronics and Fairchild Semiconductor.

Why have they dropped out?

A sampling of opinion among them shows that the paramount reason is dollars and cents. Many of the dropouts said that sales resulting from the show did not appear to justify the cost of exhibiting.

Other reasons included these:

- New products originally scheduled for introduction at the show were not ready in time.
- Companies were unhappy with their booth location.
- Few people who actually buy the company's product were attending the show.

WESCON's assistant general manager, Ted Shields, says in rebuttal:

"If exhibitors feel all that is required is to rent space and wait for their customers to come walking by, then it is understandable why their results are disappointing. Exhibi-

tors have an obligation to promote attendance by their potential customers, and we try to help them by preparing many aids which are offered to every exhibitor."

Among the aids offered are computer-prepared complementary tickets and five different pieces of literature that exhibitors can mail to their potential customers; art work for advertising the show, pre-printed mailing stickers and a list of the previous year's registrants. In addition the WESCON staff holds seminars during the year to instruct exhibitors on how to exhibit effectively.

Shields points out that a number of companies drop out of active participation in the show only to come back in through sales representatives, who may represent a number of companies. This has affected the total number of exhibitors renting space at the show but does not reflect the total number of companies represented.

Dropouts report that hidden costs are a major factor in the cost of exhibiting. One company spokesman said that a significant part of its total cost of exhibiting included transportation costs for employees and equipment, employee salaries during the show and labor charges for setting up and removing the booths and equipment. Other cost

factors cited included potential sales that were not made on the road while salesmen were at the show while salesmen were at the show and printing costs for literature handed out at WESCON.

Regis McKenna, marketing services manager for Philco-Ford Microelectronics, said: "We found that trade shows present us with the highest advertising cost per person visiting the booth. It costs us around \$1 to \$5 per person to advertise through direct mail and trade magazines, compared to well over \$30 per person for exhibiting at trade shows."

A spokesman for Beckman Instruments echoed this view: "Of the large attendance at our booth during this year's IEEE show, only a very small number of visitors were considered to be genuine sales prospects. The cost was extremely high—about \$4000 for each prospect to exhibit at the show."

He added that the company was not against trade shows; that it was studying the reasons for its disappointing results at the IEEE show and planned to try exhibiting again in the future.

An official of one former exhibitor said: "We stopped exhibiting because it didn't pay from a publicity, as well as economic, standpoint. It cost us about \$5 for each visitor at our booth, and we would rather channel our efforts toward trade magazine advertising."

Charles Granieri, advertising



Number of WESCON exhibitors has been declining in the last five years, but the square footage rented indicates that fewer exhibitors are now occupying more booth

space. Held alternately in San Francisco and Los Angeles, WESCON has sold a record high in booth space for this year's San Francisco show.



**Remember
The Whisker
Contact?
It Was Before
The S-Bend.**



**Remember
The S-Bend?
It Was Before...**



RamRod

**The First New Zener Diode Construction In 9 Years...
Gives You Safe, Sure, Lead-To-Die Contact!**

A new reliability "plus" has been added to 250 mW and 400 mW zener diodes... called RamRod* zener diodes! Now, with RamRod devices you get:

- straight-through lead alignment that prevents S-bend mismatches, shorts to substrates and parameter shift due to contact resistance and pressure change
- increased power dissipation through direct, more massive lead-to-metal-over-oxide-die soldered contact
- continuous device operation when subjected to shock or vibration

The reasons are state-of-the-art:

RamRod design is simplicity itself which yields increased reliability and non-variability of assembly; thermal expansion coefficients are closely matched and a perfected final seal process achieves, simultaneously, a glass-to-glass hermetic seal and metallic solder bond of the lead to die with less than *half* the compressive load on the die as that required for sealing S-bends.

Reliability and electrical stability of RamRod units are so superior that not one device selected at random from production runs has failed above-and-beyond Mil-S-19500-type tests like 10,000 G step stress shock, 225°C, liquid-environment, thermal shock excursions at 25°C/

sec change and 100 G variable frequency vibration at 100 to 2000 Hz.

Motorola has supplied reliability-proven RamRod types since 1965:

MILITARY TYPES		
1N746 Series	400 mW, 2.4 to 200 V	MIL-S-19500/127
1N962 Series		MIL-S-19500/117
1N4370 Series		MIL-S-19500/127

INDUSTRIAL TYPES		
¼ M2.4AZ Series	250 mW, 2.4 to 200 V	±5% to ±20% Tolerance
1N4099 Series	250 mW, 6.8 to 100 V	±5% Tolerance

Send for a new RamRod reliability report and data sheets today: Box 955, Phoenix, Arizona 85001. Contact your franchised Motorola distributor for evaluation units.

*Trademark of Motorola Inc.

-where the priceless ingredient is care!



MOTOROLA
Semiconductors

ON READER-SERVICE CARD CIRCLE 844

Exhibitors decline, but booth space goes up

YEAR	SHOW LOCATION	Square feet Sold (Net)	Total No. of Exhibitors
1963	Cow Palace, San Francisco, Calif.	109,260	747
1964	Sports Arena and Hollywood Park, Los Angeles, Calif.	108,540	707
1965	Cow Palace, San Francisco, Calif.	91,350	597
1966	Sports Arena and Hollywood Park, Los Angeles, Calif.	113,244	670
1967	Cow Palace, San Francisco, Calif.	110,900	603

manager for Motorola Semiconductor, said that the company usually had a large crowd at its booth but that not enough sales resulted.

"We got our share of people at the booth," he noted, "but our main problem was to show top management measurable results from the show."

WESCON's assistant general manager concedes that the cost of exhibiting at a show is more expensive than advertising, but he says a company cannot compare direct mail or magazine advertising with exhibiting.

"Advertising is not the same as a face-to-face conversation with a potential customer while demonstrating a product," Shields says.

WESCON has been trying to help exhibitors reduce some of their costs. This year the show introduced a "European style" booth, aimed at reducing a company's cost of constructing, shipping and setting up its own booth. The "European" booths are 10 by 20 feet, with

walls on three sides, and an exhibitor can install a conference room, if desired. The rental price includes carpeting and painting, all electrical power and a company sign. All a company has to do, Shields said, is move in its equipment and furniture.

The Beckman spokesman reported that during recent shows the company felt it was not seeing the people it considered influential in buying its products.

"From our experience, the majority of people attending the exhibit is company management, and we feel that the real buying influence is the working design engineer," the Beckman spokesman explained.

Some companies have discouraged working engineers from attending conventions on company time, and this has cut attendance by these potential visitors, according to Beckman.

Shields says that some company's views about attendance are at variance with the show's tabulated statistics.

"WESCON prepares many statistics concerning registration and classification of showgoers, and these figures sometimes contradict the unofficial statistics prepared by individual companies," he said.

He emphasized that WESCON's statistics were audited by the nationally recognized Business Publications Audit of Circulation, Inc.

Noting that many companies tried to key their exhibits to the introduction of a new product, Shields commented.

"Some companies who contract early for space have found that their new product is not ready in time to exhibit at the show and cancel out. This year we had 50 cancellations, but they have all been replaced, and the exhibit area is a complete sellout."

Two notable examples of the larger companies that are exhibiting at WESCON for the first time this year are the Olivetti Underwood Corp. and the Raytheon Co.'s Computer Operation. ■ ■

Briefly stated . . .

■ **Hungry showgoers** will find a new cafeteria in the southwest corner of the East Exhibit Hall, right next to the Science Film Theatre.

■ **Free paper-reproduction services**, another innovation at WESCON '67, are being offered to exhibitors. Two Xerox 2400 copiers have been installed at the two information booths in the exhibit area.

■ **Information booths** are also in operation in the San Francisco Hilton, the Mark Hopkins, Del Webb's Townhouse, the Fairmont, the Jack Tar and Sheraton Palace Hotels, as well as at the airport. All the booths have direct phone lines to the Cow Palace.

■ **Head-hunting is banned again** this year. In a booklet sent to all exhibitors, Phillip Gundy, chairman of the WESCON board of di-

rectors, has asked all exhibitors to join in a "gentlemen's agreement" against the recruitment of engineers during the show.

■ **A change from previous years** will be the new evening show hours. The exhibits will be open on Wednesday from 9:30 a.m. to 9:30 p.m. The exhibit hours this year for all days except Wednesday are 9:30 a.m. to 5:30 p.m.

Some of our FET's are "me too's"

Some of our FET's are "me only's"

(THREE NEW JEDEC TYPES FOR LOW NOISE AT LOW FREQUENCY)

Our "me too's" include the 2N3823 and 2N4416, the industry's very popular, high performance, n-channel junction FETs. They're in everybody's line, including ours.

But our "me only's" are something special; they have lower noise—at low frequency—than any n-channel junction FET in the entire JEDEC list. They are available now—from stock—at volume prices.

If you need a really low noise, high gain FET for low frequency applications, you need our 2N5105. It has an equivalent noise voltage of only $40 \text{ nV}/\sqrt{\text{Hz}}$ at 10 Hz and transconductance of 5,000 to 10,000 μmhos .

It's ideal for small signal circuits from 10Hz to 200MHz:

- Low level operational amplifiers
- High impedance instrument inputs (scope/voltmeter probes, recorder pickups)
- IF and RF linear stages
- Wideband amplifiers

As a group, the 2N5103, 2N5104 and 2N5105 have the highest figure of merit (g_m/I_{DSS}) of all n-channel junction FETs available today, whether high or low frequency. And all three offer low feedback capacity, low input capacity, and small leakage currents.

KEY PARAMETERS: AMPEREX "ME ONLY" N-CHANNEL, JUNCTION FET'S*

CHARACTERISTICS	SYMBOL		2N5103	2N5104	2N5105	UNITS
EQUIVALENT NOISE VOLTAGE	e_n		100 @ 100 Hz	50 @ 10 Hz	40 @ 10 Hz	$\text{nV}/\sqrt{\text{Hz}}$
TRANSCONDUCTANCE AT 1 KHz	$ Y_{fs} $	Min. Max.	2000 5000	3500 7500	5000 10,000	μmhos
DRAIN TO SOURCE CURRENT	I_{DSS}	Min. Max.	0.5 3.0	2.0 6.0	5.0 15.0	mA
INPUT CAPACITY	C_{i11}	Max.	1	1	1	pf
FEEDBACK CAPACITY	C_{r11}	Max.	5	5	5	pf

*In TO-72

For complete data and applications assistance on Amperex n-channel junction FETs, write: Amperex Electronic Corporation, Semiconductor and Receiving Tube Division, Department 371, Slatersville, Rhode Island 02876.

Amperex[®]

Tomorrow's Thinking In Today's Products

ON READER-SERVICE CARD CIRCLE 845

WESCON plans a ladies' 'happening'

Continental breakfasts, a luxury luncheon, an elegant cocktail party and a homes tour are in store.

Diane Vasilkioti, Reporter

San Francisco—Old-fashioned cable cars, sparkling bay, honky-tonk Chinatown, and the Golden Gate welcome you to this fascinating city. Glittering lights and foggy dew, spreading watery expanse and abrupt vertical planes, ultra-modern, swinging and hip, charming and quaint, elegant, capricious, and always exciting, compelling—this is San Francisco.

Come alive! Come to the Big Show! It's WESCON '67 and it's now! New products, new techniques, seminars, conferences and sessions—these are fun, we suppose, for the men, but what's in it for us? Mrs. Philip Rice, chairman, and her Women's Activities Committee have planned a full calendar of events to keep you pleasantly occupied and to make your WESCON trip as memorable for you as it is valuable to the men.

The program includes:

- A hospitality room at the Fairmont Hotel.
- Complimentary continental breakfasts.
- A grand cocktail party.
- A luxury luncheon.
- A tour of elegant homes.

A welcoming coffee kicks off the week on Tuesday morning at 9 a.m. at the Top of the Mark, where the whole of San Francisco is literally at your feet—the full-circle view encompasses the whole city. There may also be diversion in the form of amateur entertainment.

After a continental breakfast on the house, go to the California Room of the Fairmont Hotel. This is the hospitality suite for WESCON ladies, a home base where they may meet, rest, and take refreshment during the convention. Here at 11 a.m., every lady will receive a favor and be given information about the city, including maps. New-found friends then have an opportunity to start exploring San Francisco.

Do take a ride on the antiquated but fiercely loved cable cars and gaze on the beautiful vistas that abound in this town of steep hills plunging into the bay. Tiny alleys, Victorian mansions, a potpourri of foreign quarters, redwood trees, parks, museums, all the diversity that Nature and a turbulent history have bestowed bring serendipity to every traveler to this "Port of Gold."

Do dress warmly, for the city's residents wear winter suits in August, when the daytime temperature is in the 50° to 60° range.

There is a great deal to see and do, but don't exhaust yourself on this first day, for in the evening at 6 p.m. everyone is invited to an all-industry cocktail party at the Grand Ballroom of the Fairmont and you will want to look your stunning best.



Chinatown's pagoda roofs along Grant Avenue look down on ornate lamp posts embossed with dragons and strung with lanterns.



Fisherman's Wharf is the scene of the ladies program luncheon.

There will be free tickets available for the Gypsy Rose Lee television show on Wednesday afternoon; you may inquire about these at the Fairmont hospitality suite.

The main event for WESCON ladies takes place on Thursday: a luxury luncheon on famous Fisherman's Wharf followed by a personal tour of some of San Francisco's most gracious and elegant homes. Buses will leave simultaneously from the Fairmont and the Peninsula (where many of the electronics companies are located) at 11:15 in the morning. If you are staying outside the city, inquire at the hospitality suite about arrangements that have been made for your convenience.

You will be taken to Sabella's Restaurant on Fisherman's Wharf, where the special menu will include Crab Louis salad and San Francisco's renowned hot sourdough rolls. Favors donated by the Joseph Magnin department store will be given to all the ladies at the luncheon.

You may expect a succulent repast, for the Sabella family are seasoned restauranteurs who have two restaurants on the Wharf. Your particular one was originally established for San Francisco's World Fair in 1939, and was destroyed by a spectacular fire in



Telegraph Hill topped by Coit Tower beckons WESCON visitors.

1964. Edward Wong took inspiration from the Mediterranean to design the new building. The other restaurant was opened in 1920 by the proprietor's father, who started out in life selling crabs from a basket on the street.

After lunch, the buses will take you on a tour of five marvelous homes. Hostesses attired by Joseph Magnin in at-home fashions will greet you and describe the many objets d'art and points of interest in each house. Since these homes are located in three different areas, you will be treated to a tour of the city at the same time. Each bus will have a hostess who is knowledgeable in city lore.

This outing will last until 5 p.m., and, incidentally, is the only event for which there is a charge. This is

\$8.50; the portion of the ticket that covers the tour of homes, \$2.50, is tax-deductible, as it is a charitable contribution.

Go out on the town Thursday night and savor the city's cosmopolitan delights, but leave word to be waked in time for a free continental breakfast at the Fountain Room of the Fairmont at 9 a.m., Friday. There Robert Ward of Ultec, chairman of WESCON hospitality committee, will talk to you about WESCON. Afterwards, buses will take you to the Cow Palace where guides will conduct tours of the WESCON show. ■ ■

(see also p. E66)

(Pictures by courtesy of San Francisco Convention and Visitors' Bureau)

Free shuttle buses for WESCON visitors

"Leave the driving to us" service is again available to the Cow Palace from various hotels in San Francisco and from the Peninsula. Free shuttle runs to the exhibit hall and back are operating from these downtown San Francisco points:

- Downtown Airline Bus Terminal (375 O'Farrell St., corner of Taylor, adjacent to the San Francisco Hilton Hotel).

- Fairmont Hotel (Mason Street

side).

- Jack Tar Hotel (Van Ness Street side).

- Townhouse Hotel (8 Street, corner of Market Street).

- San Francisco International Airport (bus zone, lower level, central terminal).

Free bus service is also operating from the Peninsula between Rickey's Hyatt House in Palo Alto and the Cow Palace.

Buses are available every 10 min-

utes both ways between the Downtown Airline Bus Terminal and the Cow Palace. Connecting service is taking visitors to the Bus Terminal from the Fairmont, Jack Tar and Townhouse Hotels.

The bus service is operating daily through Friday, Aug. 25, until a half hour after the closing of exhibits each night. The closing time on Tuesday, Thursday and Friday is 5:30 p.m., and on Wednesday it is 9:30 p.m. ■ ■

Departure point	Starting time		Frequency	Destination
Downtown Airline Bus Terminal	8:00 a.m.		Every 10 min	Cow Palace
Fairmont Hotel	7:45 a.m.		Every 15 min	Airline Bus Term.
Jack Tar Hotel	7:30 a.m.		Every 30 min	Airline Bus Term.
Townhouse Hotel	7:40 a.m.		Every 30 min	Airline Bus Term.
S. F. Int'l. Airport	7:40 a.m.		Every 30 min	Cow Palace
Rickey's Hyatt House, Palo Alto	8:00 a.m.	1:30 p.m.		Cow Palace
	9:15 a.m.	2:30 p.m.		
	10:45 a.m.	6:00 p.m.*		
	11:45 a.m.	7:00 p.m.*		
Cow Palace	9:30 a.m.	5:00 p.m.†		Rickey's Hyatt House
	10:30 a.m.	5:15 p.m.*		
	12:15 p.m.	6:15 p.m.†		
	1:15 p.m.	10:00 p.m.*		
	4:00 p.m.*	11:00 p.m.*		

*Wednesday only

†Tuesday, Thursday and Friday only

Giveaways galore at the booths

From antenna computers to a home-study course, the visitor to this year's WESCON booths can collect complimentary gifts of product samples and clever gimmicks.

Here is a sampling of what the visitor can pick up.

Antenna computer (a transmission line selector slide chart)—Andrew Corp. (2610).

A pocket counter (after you fill out a questionnaire)—Burroughs Corp. (2816).

Sample assignment from the CREI home-study program—The Capitol Radio Engineering Institute (3507).

Wire/cable harnessing and mark-

ing evaluation kit for designers—Electrovert Inc. (1111).

Metal desk nameplates to those bringing a print, sketch or sample of their currently used nameplates, instrument panels, dials, etc.—Fotofoil Co. (2324).

Key chains—Geo-Space Corp. (4723).

Terminated samples of Signalpoint post terminations—Kent Corp. (1106).

Plastic pocket protectors, imprinted with engineering conversion charts—Microtran Co. (4307).

Samples of over 300 different inserts and studs—Newton Insert Co. (1817).

Sealed integrated-circuit packages—Solid State Equipment Corp. (1014).

A pair of plastic magnets—RFL Industries Inc. (2307). ■ ■

How to write for pay

A daily free seminar at the San Francisco Hilton is telling WESCON-goers how to write articles for ELECTRONIC DESIGN magazine and get paid for them. The sessions, which are in North Continental Parlor 7, start with coffee and danish at 8 a.m. and a slide presentation at 8:30. ■ ■

narda SOLVES YOUR **Peak Power** PROBLEMS — With less Equipment, Time and Expense and Improved Accuracy

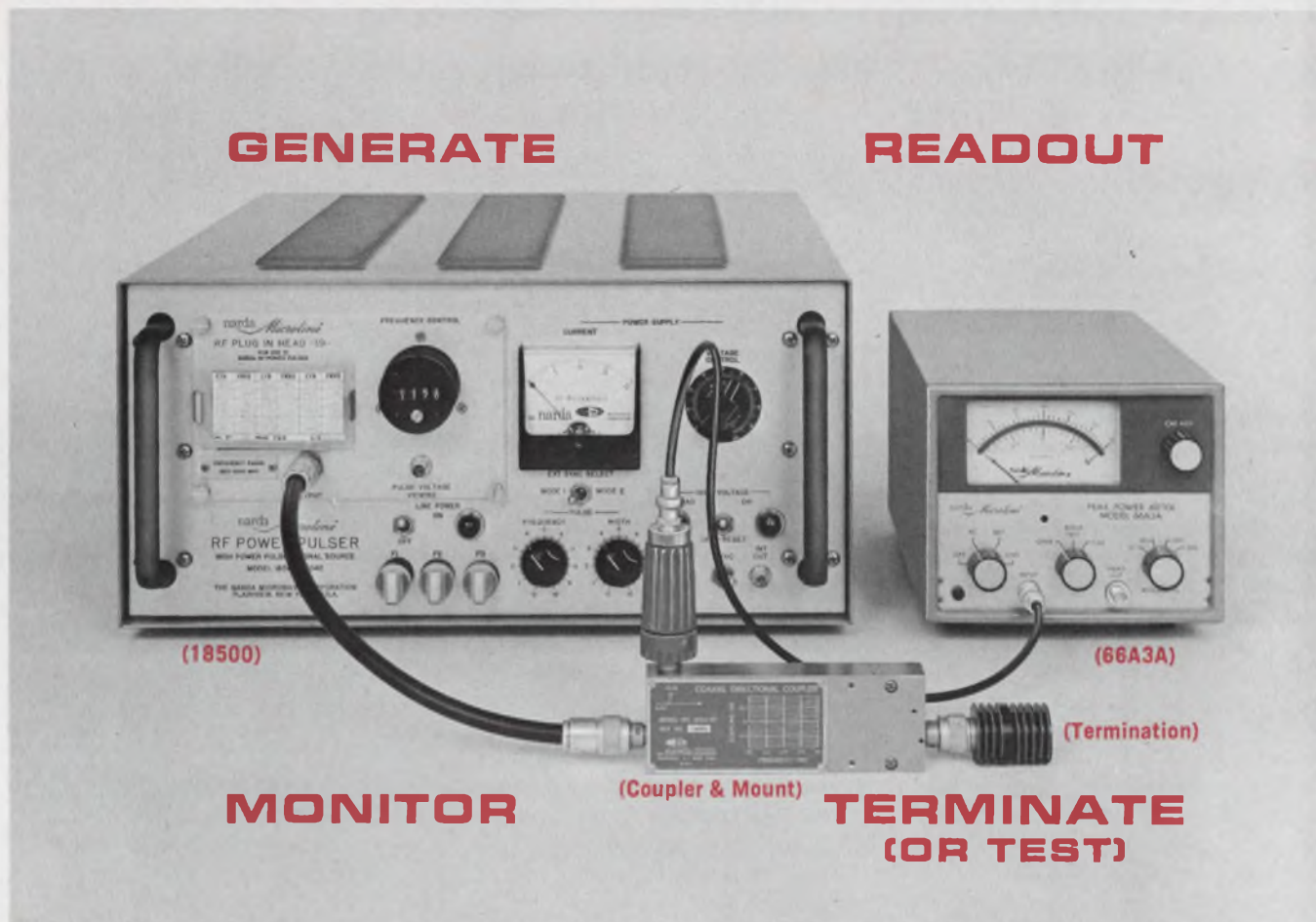

Narda's total capability for power measurements can satisfy any system or component test requirement with catalog test devices. This means convenience and economy to you. Give us your problem and we will help you solve it with a complete measuring set-up. The above peak power measurement set-up shows one of Narda's answers to a measurement problem.

NARDA MICROLINE 18500 RF POWER PULSER

- From 200 to 9500 MHz with 11 plug-in- r-f heads
- Continuously variable peak power to 5 KW depending on r-f heads
- Internal pulse generator
- Variable pulse width from .25 to 6.0, μ sec depending on r-f head
- Continuously variable PRF from 150 to 4000 pps built-in DC to 4000 pps external
- External pulse viewing capability
- Multipulse capability

NEWLY IMPROVED PEAK POWER METER 66A3A — 33B3 BOLOMETER MOUNT

- New shielding effectiveness now permits power meter operation in high Peak Power environments
- Peak power output read directly from 0 to 300 mw. over frequency range of 0.5 to 12.4 GHz with Narda bolometer mounts
- Accuracy of $\pm 5\%$ of full scale
- Transistorized, battery-operated, immediately operative
- Calibration accuracy of Narda bolometer mounts traceable to NBS

MAXIMALLY FLAT COAXIAL COUPLER — 3040 SERIES

- Frequency: from 0.125 to 12.4 GHz
- Flatness: ± 0.2 db over octave ranges
- Directivity: 20 DB
- Coupling: 10, 20, 30 db values (special on request) calibrated and permanently marked at 5 frequencies

MEDIUM POWER COAXIAL TERMINATIONS 370 SERIES

- Cover entire frequency range of DC to 12.4 GHz
- Power levels up to 40 watts average
- Small, lightweight — low cost

Call our factory or local representative for demonstration of this system or its catalog components.

narda *Microline*[®]

THE NARDA MICROWAVE CORPORATION • PLAINVIEW, L.I., NEW YORK 11803

516 - 433 - 9000 • TWX : 510 - 221 - 1867 • CABLE : NARDACORP PLAINVIEW NEWYORK

ON BOARD-SERVICE CASE CIRCUIT 800

Have fun after show hours

San Francisco swings until the wee hours, so leave some energy for the evenings

WESCON closes daily at 5:30 p.m. (except Wednesday, when it shuts at 9), but San Francisco stays open till shortly before dawn.

Take your pick of entertainment: night spots for every mood and pocketbook, big-league baseball, theaters, concerts, museums.

Following is a small sampling of the exotic and sublime in the Golden Gate city.

Cabarets

Sophisticated and elegant, the Venetian Room of the Fairmont Hotel headlines Frank Gorshin. The cover charge is \$3.50 during the week, \$4 on Friday and Saturday night (closed Monday). Dancing starts at 9 p.m.; there are shows nightly at 9:30 and midnight.

Downstairs at the Fairmont, there's dancing at the more casual Tonga Room, which is decorated in South Sea Islands motif and serves Cantonese foods and exotic rum drinks. No cover or minimum.

The hungry i, San Francisco's

famous basement bistro, has reopened at a new site in Ghirardelli Square, 900 North Point, with Glenn Yarbrough. Shows are at 9:30, 11 and 12:30 every night except Sunday. Admission to the show is \$3.50.

The Purple Onion, 140 Columbus, is another dimly-lit cellar that features big names in the folk field. Singers and comics entertain and admission averages \$1.50, with drinks starting at 90¢. There is no food.

The biggest ballyhoo on Broadway since the Barbary Coast days is the topless craze, and you can see the girl who started the commotion at The Condor, 300 Columbus. Comedians and rock 'n' roll are also on the program; there is no cover or minimum, and all drinks are \$1.50. Open every night.

The Red Balloon, 1031 Kearny, is a rather zany cross between a carnival and a nightclub. You can walk sedately down the stairs to the front entrance or sweep in on a

giant slide. A bumper-car ring in the center of the room is surrounded by tables heaped with popcorn. You may throw darts at balloons, shoot rifles in the gallery, have your palm read, pound nails in a log, sketch a model for free or engage in various other activities. Open daily 5 p.m. to 2 a.m. No cover or minimum during the week; 50¢ cover on Friday and Saturday after 9 p.m.

Bimbo's, 1025 Columbus Avenue, boasts "the biggest, boldest and most lavish" nightclub revue in town. Cover charge is \$2 during the week and \$2.50 on Saturday and holidays. There is no minimum, however, and drinks start at 75¢. The first show starts at 7:30 p.m.

The best in modern jazz—experimental and established—is presented at the Jazz Workshop, 473 Broadway. There is no cover, but you will pay a two-drink minimum, and drinks are \$1.35 each. The music is continuous from 9 p.m. to 2 a.m. every night, with matinees on Sundays from 3:30 to 7:30 p.m.

Famous Finocchio's, 506 Broadway, has four shows a night, each complete with chanteuse, comedienne, stripper and production finale—except that all the she's are he's. Finocchio's is the city's only "all-male girlie show." It is open nightly, with shows at 9, 10:20, 11:40 p.m. and 1 a.m. Cover is \$1.50 during the week; \$2 on Friday and Saturday. There is no minimum; drinks start at 75¢.

The in place for local jazz buffs is Both/And, 350 Divisadero, and if you're wondering about the cryptic name, that's "as opposed to Either/Or." Half the fascination here is "watching" the music as it's played: the green, red and blue lights are keyed electronically to the amplifier. The cover charge is \$1, and there is a two-drink minimum. Drinks start at 50¢; the music starts at 9 p.m. The club is closed Monday and opens at 4 p.m. on Sunday for a matinee.

For traditional Dixieland, try Pier 23 Cafe on The Embarcadero, just north of Market. No cover or



San Francisco's Broadway, like New York City's Great White Way, means bright lights, restaurants, theater and night life.

Our I.C. digital modules reject more noise than anybody's.

Integrated flip-flops, inverters and buffer amplifiers in T Series modules are made to our proprietary design and hermetically sealed in TO-5 cans.

Full-width copper ground plane sandwiched between epoxy-glass boards minimizes circuit inductances and discourages noise spikes. Mounting cases also have full-width shield planes to retard noise coupling between logic wiring.

T Series input and load resistors, made to much tighter tolerances than can be attained with integrated components, are mounted outside the integrated circuit containers, eliminating power dissipation problems.

Discrete input diodes enable us to place the switching threshold right in the middle of the logic swing.

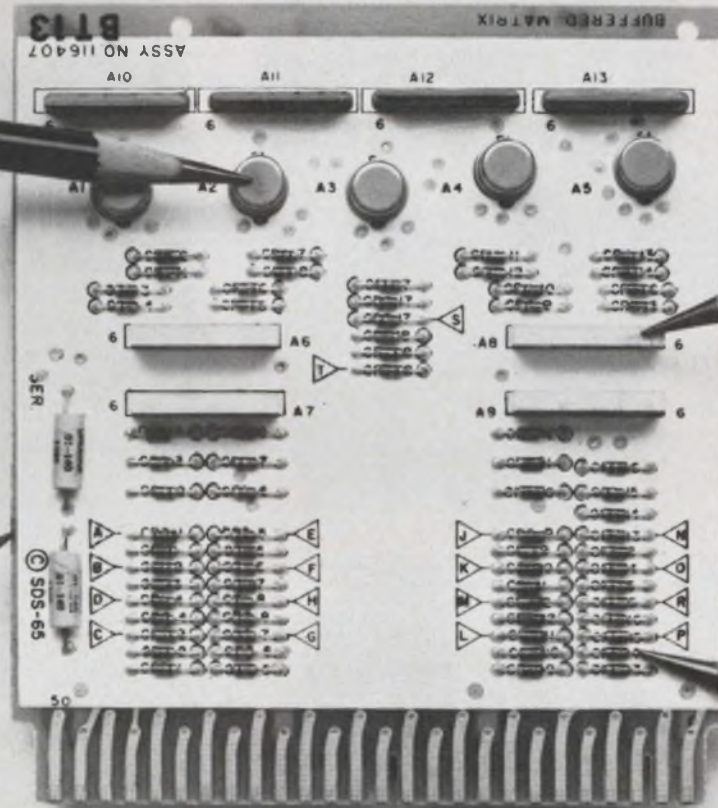

The payoff.

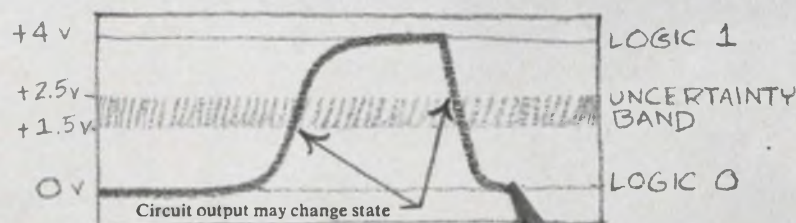

T Series logic levels are 0 and +4 volts, and noise rejection is 1.5 volts minimum, leaving a maximum uncertainty band only one volt wide within which noise can trigger the circuit output. This uncertainty band of 25% is far narrower than those of other I.C. modules on the market.

SDS
Scientific Data Systems,
Santa Monica, California

**A
standard
fastener
from the
WORLD'S
MOST
COMPLETE
LINE
will
save you
TIME
and
MONEY**

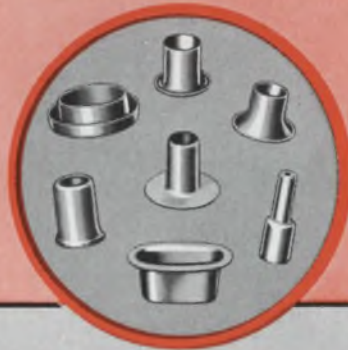

Instead of a special, perhaps one of our standard fasteners can meet your requirements.

We make a tremendous variety of eyelets, grommets, rivets, washers, snap fasteners, ferrules, hole plugs, terminals, and other similar fasteners. Tell us what you need and let us submit a standard fastener.

Send for our general catalog which illustrates over 1000 metal articles.



Stimpson



70 FRANKLIN AVENUE,
BROOKLYN, NEW YORK 11205
ULster 5-3131

1515 S.W. 13th COURT,
POMPANO BEACH, FLA. 33060
WEbster 3-3355

minimum in this friendly old club. Pier Buoy sandwiches, stuffed with three different meats, are the hearty specialty for 70¢. Drinks start at 50¢, and the club is open from noon to 2 a.m. The music starts at 9:15 p.m., except for Monday nights and Wednesday, when there is no music.

Theater

"Man of La Mancha," Broadway hit, stars Richard Kiley, Marion Marlowe and Ray Middleton. It is a Civic Light Opera Production at Curran Theater, 445 Geary St., nightly except Sunday, matinee Wednesday and Saturday.

"The Committee" employs the revue format to satirize current events, topics and issues. The first show, at 9 p.m., is always established material, and the second show, at 11 p.m., is totally improvised. Fridays and Saturdays there are three shows—at 8:30, 10:30 and 12:30—and all are rehearsed material. Tickets on nights during the week are \$2 (includes both shows), and on weekends \$3 for each show. There is no minimum, but a full menu of snacks and dinners is available.

Long-running "America Hurrah" plays nightly except Monday at 8:30 and at 8 and 11 on Friday and Saturday.

"The Fantasticks," a charming musical ideally suited to the intimacy of the small theater, has performances Friday at 8:30 and Saturday at 8 and 10:30 at the Ghirardelli Theatre in the Square, 900 North Point.

"You're a Good Man, Charlie Brown" is at the Little Fox Theater, 533 Pacific Avenue, nightly except Monday.

Weekend performances of "Once Over Nightly" are given in the Ralston Room of the Sheraton-Palace Hotel.

Music

Arthur Fiedler conducts the Pops Concerts in the Civic Auditorium on Aug. 23 and 26.

The Los Caballeros Youth Band from Torrance, Calif., appears at the Fleishhacker Playfield at 2 p.m. on Aug. 27.

Band concerts are given free every Sunday at 2 at the Music Course in Golden Gate Park.

(continued on p. E32)

Uniring grounds a shielded cable in less time than it takes to heat a soldering iron.

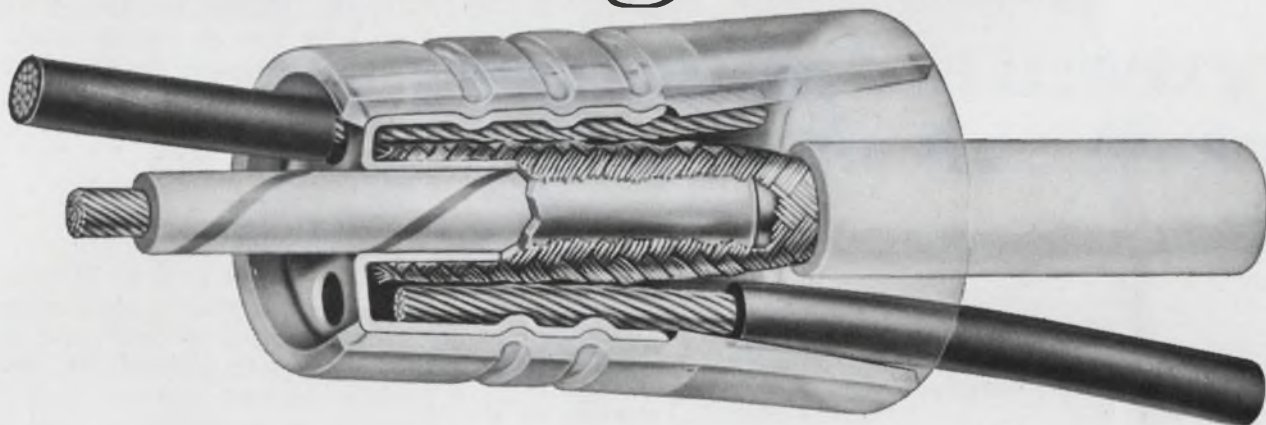

Uniring combines inner and outer ferrules in unitized construction. Simply insert a stripped conductor and tap wire, then crimp. One crimp does it. No heat. No burnt cables. Result: A vibration-resistant, noise-free connection that is mechanically and electrically stable. A uniform connection that takes virtually no time to make.

Uniring terminations are color coded for fool-proof size selection. And the insulated Uniring employs a nylon sleeve that's flared for fast, easy insertion of the shielding braid and tap. (These connectors are also available uninsulated.) No other type of connector is as fast, as reliable, or as low in cost to use. Time and labor savings offered

by the compression method of grounding and terminating shielded cable are recognized by the military and referred to in MIL-E-16400 and MIL-I-983. Burndy Uniring terminations conform in all details to MIL-F-21608 (dated 1/5/59). Send for a copy of our catalog YEC-66-4.



 **BURNDY**
Norwalk, Connecticut

1970

(continued from p. E30)

Art

The M. H. De Young Memorial Museum of Golden Gate Park is exhibiting photographs by Edward Miller, in addition to its permanent collection of pre-1850 world art. The Avery Brundage Collection of Oriental Art is permanently displayed in the new wing. Hours: 10 a.m. to 5 p.m. Admission is free.

At the white marble California Palace of the Legion of Honor in Lincoln Park, a museum featuring European paintings of the 17th and 18th centuries and noted as much for the beauty of its building as for its fine collection, you may view contemporary prints by European Artists until Aug. 27 from 10 a.m. to 5 p.m.

Sports

The S. F. Giants are playing both day baseball games, starting at 1 p.m., and night games, starting at 8 p.m. They meet St. Louis on the 22 (night), 23 and 24. Atlanta will challenge them on Aug. 25 (night), 26 (double header, 1 p.m.) and 27 (double header, 10:30 a.m.). The ticket offices are at Candlestick Park and Roos/Atkins, 798 Market St.

Special events

Ice Follies of 1967, by Shipstads and Johnson, present world champion skaters, comic stars and the Ice Folliettes; performances Wednesday through Saturday at 8:30 and an extra matinee at 2:30 on Wednesday and Saturday and at 1:30 and 4:30 on Sunday. Winterland, Post and Steiner Sts.

Horticulturists will not want to miss the San Francisco County Fair Flower Show, Aug. 25-27. It emphasizes flowers that are best suited to the San Francisco Bay area climate, in particular the begonia, fuchsia, dahlia and rose. Sections are devoted to flower arrangements, bonsai, succulents and African violets. It opens at the Hall of Flowers, Golden Gate Park at 10 a.m. and closes at 10 p.m., except Sunday, when the closing time is 6 p.m.

For a gay time, go to the Fourth Annual Bernal Heights Street Fair. Artists and craftsmen from the Bay area, entertainment and folk dancing fill Prescita Avenue. ■ ■

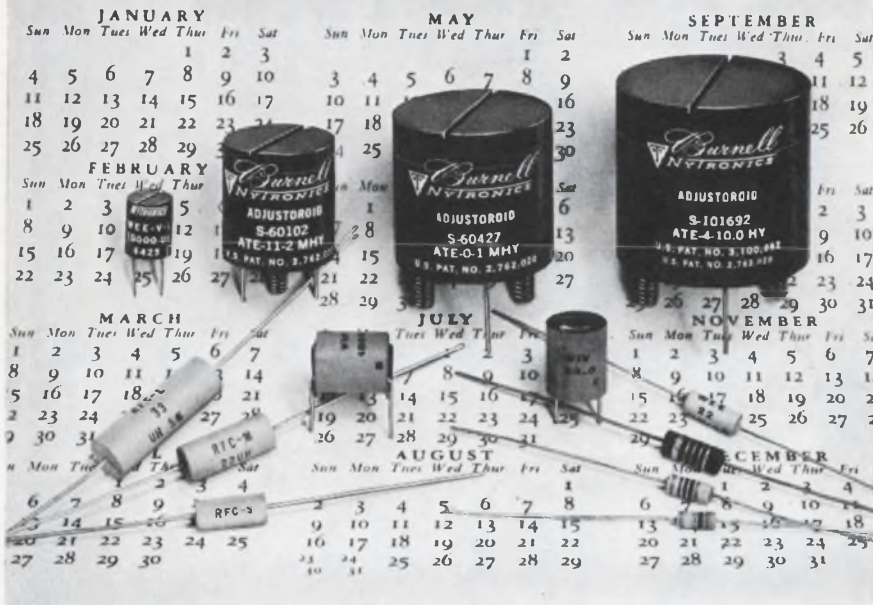

Nytronics Inductors are ahead of their time!

Nytronics continuous research and development have produced standardized quality inductors with the superb precision and stability to meet the demanding requirements of tomorrow's circuitry. Yours *today* — delivered off the shelf from a large inventory. Pioneering is a Nytronics speciality!

WEE-DUCTOR — Magnetically shielded with inductance range 0.1 to 180,000uH, designed to MIL-C-15305, Grade 1, Class B. Encapsulated Envelope: 0.157" diameter x .450" length.

SUPER WEE-DUCTOR/90537 TYPE — Manufactured in accordance with MS90537, Molded Magnetically shielded with inductance range 0.1 to 100,000uH ±10% tolerance. Molded Envelope: 0.163" diameter x 0.410" length.

WEE WEE-DUCTOR — Magnetically shielded with inductance range 0.1 to 10,000uH. Designed to MIL-C-15305. Encapsulated Envelope: 0.125" diameter x 0.335" length.

DECI-DUCTOR — Subminiature with inductance range 0.1 to 1000uH. Designed to MIL-C-15305, Grade 1, Class B. Molded Envelope: 0.100" diameter x 0.250" length.

S-M-L INDUCTORS — Non-shielded with inductance range 0.1 to 10,000uH. Designed to MIL-C-15305, Grade 1, Class B. Molded Envelope: "S" Type — 0.188" diameter x 0.44" length, "M" Type — 0.25" diameter x 0.60" length, "L" Type — 0.31" diameter x 0.90" length.

VARIABLE INDUCTOR — Unshielded with adjustable range 0.1 to 4700uH. Designed to meet MIL-C-15305, Grade 1, Class B. Encapsulated Envelope: 0.400" diameter x 0.500" length. Vertical or Horizontal mounting.

WEE V-L — Magnetically shielded adjustable range 0.1 to 100,000uH. Designed to MIL-C-15305, Grade 1, Class B. Epoxy Molded 0.300" diameter x 0.400" length.

ADJUSTOROID — Adjustable toroid available in nominal values from 0.01Hy to 12Hy. This unit provides stepless adjustment in a completely hermetically sealed package.

Nytronics off-the-shelf inventory also includes a wide range of capacitors, delay lines, and resistors. Write today for complete engineering data.



550 Springfield Ave., Berkeley Heights, N.J. 07922 ■ (201) 464-9300 ■ TWX: 710-984-7977

ON READER-SERVICE CARD CIRCLE 850

ON READER-SERVICE CARD CIRCLE 851 ➤

CATALOG No. 266

High Density Dual-in-line Packaging Panels

DESIGNED FOR AUTOMATIC WIRE-WRAPPING

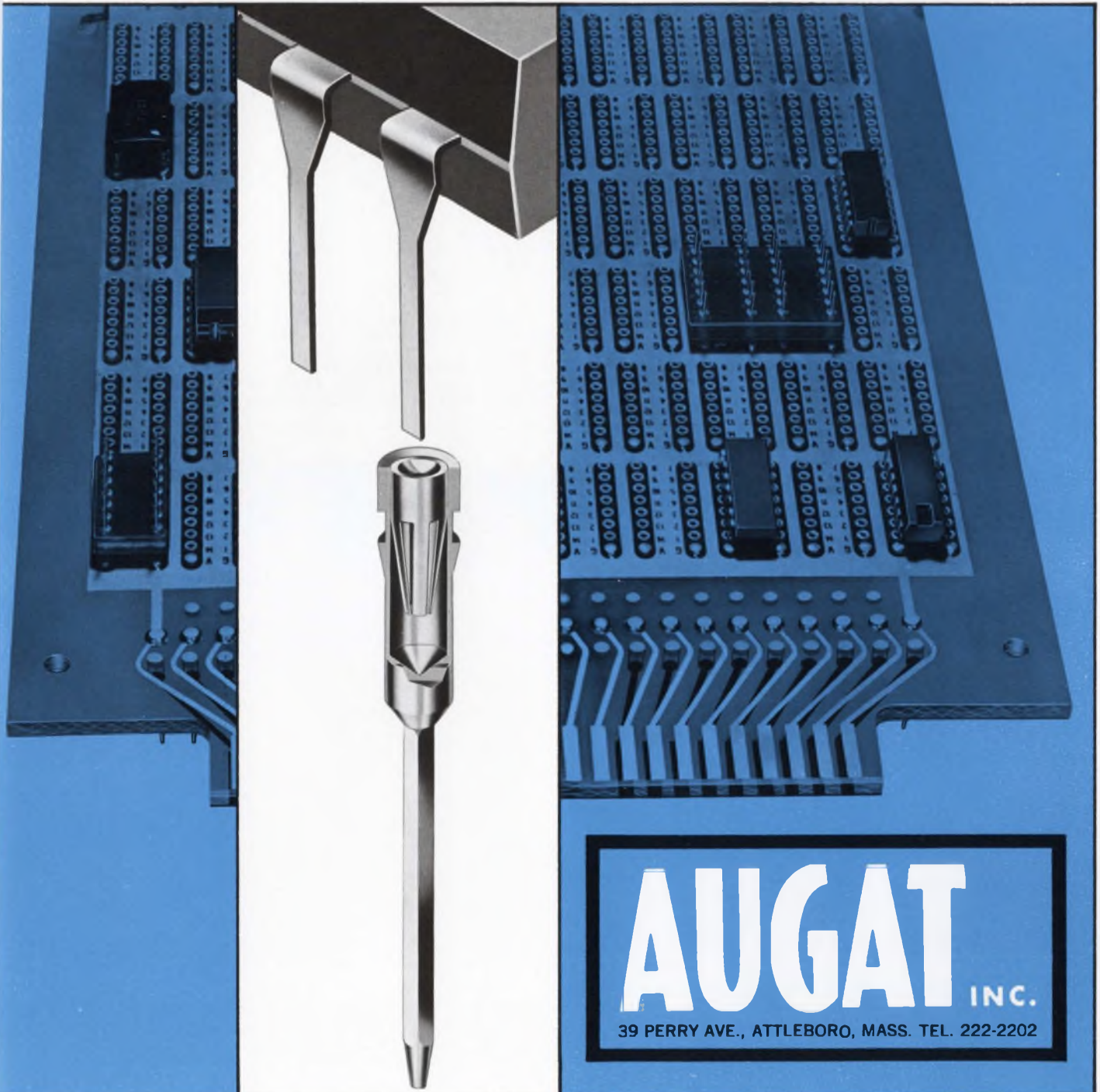

AUGAT INC.

39 PERRY AVE., ATTLEBORO, MASS. TEL. 222-2202

HIGH DENSITY DUAL-IN-LINE PACKAGING PANELS

for 14 and 16 lead plug-in integrated circuits

8136 SERIES

2 rows of interconnecting pins

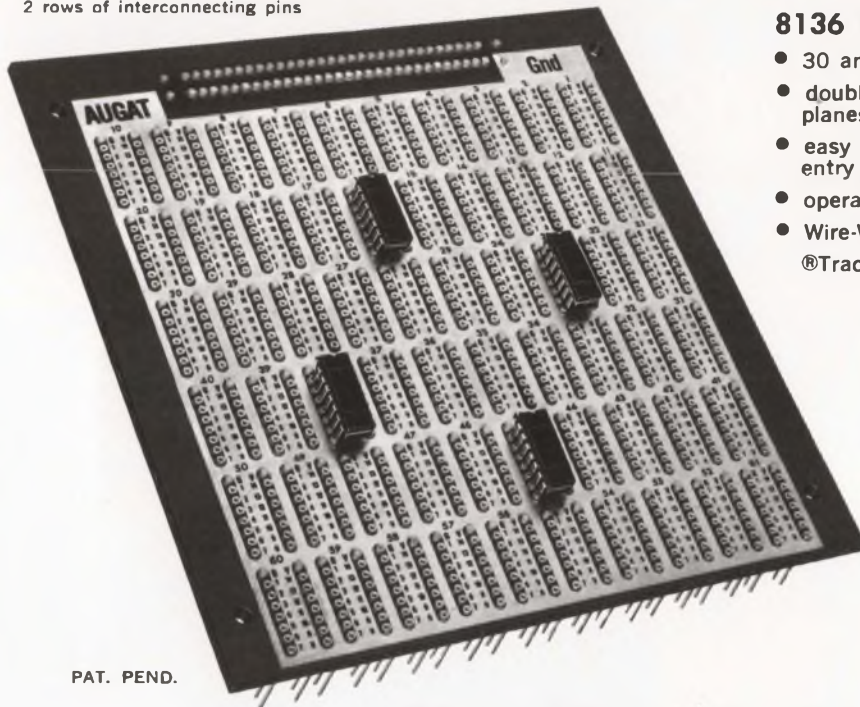

PAT. PEND.

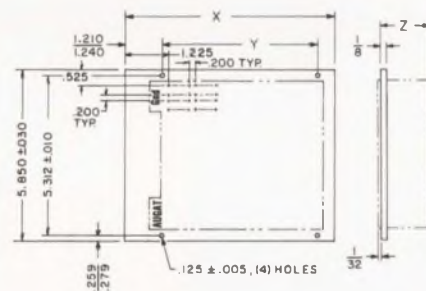

8136 Series

- 30 and 60 patterns standard
 - double-sided board with power and ground planes at each pattern
 - easy IC insertion — large contoured, closed-entry contacts
 - operating temperature range - 65° to 150°C
 - Wire-Wrap® or solder pot terminals
- ®Trade Mark Gardner-Denver Company

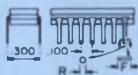

MATERIALS: P/C Board— $\frac{1}{8}$ thick glass epoxy, 2 oz. copper circuitry both sides, tin plated
 Socket/Terminal
 Terminal — Brass, gold over nickel plated
 Female contact — Beryllium copper, gold over nickel plated
 Gold plate .000040 thick per MIL-G-45204, type II

PART NUMBERS

ROUND OR FLAT LEADS 	NO. OF IC LEADS	PART NO.	NO. OF PATTERNS PER BOARD	REFER TO FIG. 1			*SOCKET/TERMINAL		
				$\pm .030$ X	$\pm .010$ Y	$\pm .015$ Z			
									STYLE
F — .015 to .023 R — Up to .019	14	8136-DG1	60	7.000	5.200	.664	WIRE- WRAP	LSG-1FG1-1	
		8136-DG1-30	30	4.300	2.500				
	16	8136-FG1	60	7.600	5.800	.365	SOLDER POT	LSG-1BG2-1	
		8136-FG1-30	30	4.600	2.800				
	F — .024 to .031 R — .020 to .025	14	8136-DG2	60	7.000	5.200	.773	WIRE- WRAP	LSG-2FG1-1
			8136-DG2-30	30	4.300	2.500			
16		8136-FG2	60	7.600	5.800	.474	SOLDER POT	LSG-2BG2-1	
		8136-FG2-30	30	4.600	2.800				
14		8136-DG3	60	7.000	5.200	.773	WIRE- WRAP	LSG-2FG1-1	
		8136-DG3-30	30	4.300	2.500				
16	8136-FG3	60	7.600	5.800	.474	SOLDER POT	LSG-2BG2-1		
	8136-FG3-30	30	4.600	2.800					
14	8136-DG4	60	7.000	5.200	.474	SOLDER POT	LSG-2BG2-1		
	8136-DG4-30	30	4.300	2.500					
16	8136-FG4	60	7.600	5.800	.474	SOLDER POT	LSG-2BG2-1		
	8136-FG4-30	30	4.600	2.800					

*To further extend the scope and flexibility of our standard packaging panels, SOCKET/TERMINALS may be purchased as separate items.

ACCESSORIES

ADAPTOR PLUGS

Used for interposing discrete components and for modular construction with P. C. boards and sub-strates

PART NUMBER	FIG.	NO. OF IC LEADS	A	$\pm .005$ B	$\pm .000$ - .010 C
8136 - 29G1	1	14	$+.000$ - .010 .702	.600	.450
8136 - 30G1	2	14	.750	.600	—
8136 - 30G3	3	14	.750	.600	—
8136 - 29G2	1	16	.850	.700	.450
8136 - 30G2	2	16	.850	.700	—
8136 - 30G4	3	16	.850	.700	—

Unless otherwise specified Decimals $\pm .005$ Fractions $\pm 1/64$

MATERIALS: BASE — Glass Epoxy
PIN — Phosphor Bronze. Gold over nickel plated

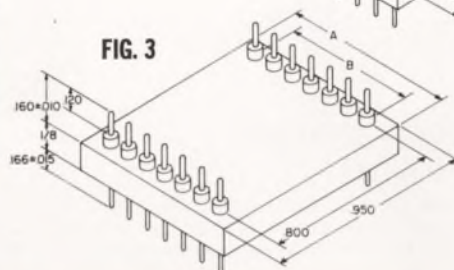
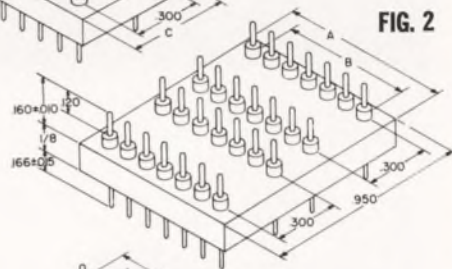
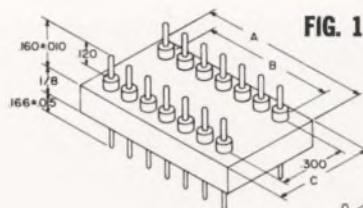

INTER-FACING PLUG

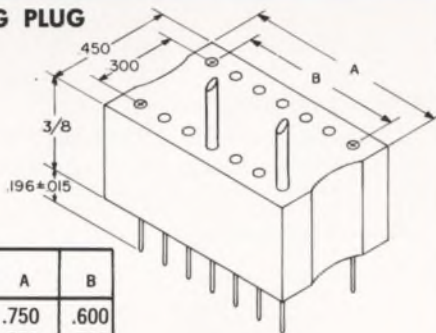

Part No.	No. Pins	A	B
8136-34G1	14	.750	.600
8136-34G2	16	.850	.700

Plugs supplied unassembled. No special assembly tool required. Pins are self locking. Accepts #26 AWG Max wire size.

MATERIALS: INSULATOR — Black Phenolic
PIN — Phosphor Bronze, Gold over Nickel plated.

SOCKET/TERMINAL REPLACEMENT KIT

Part No. 8136-23G1

Contents:
(20 ea.) LSG-1FG2-1
Socket/Terminal
(1 ea.) T8136-1 Removal Tool

To remove damaged Socket/Terminals, tap out from back side with tool.

EXTRACTOR TOOL

Part No. T114-2

A simple tool that assists removal of IC. Accelerates handling and minimizes IC lead damage.

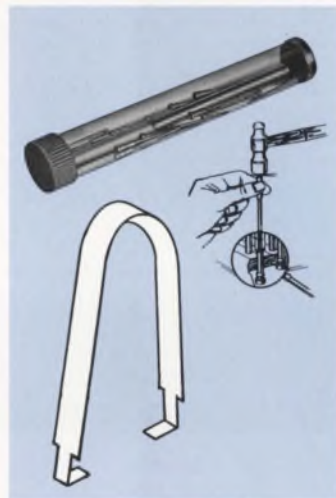

TEST DATA

AUGAT 8136 SERIES HIGH DENSITY PACKAGING PANELS have been subjected to the following laboratory tests without mechanical damage or loss of electrical performance.

TEST	CONDITION	RESULT
VIBRATION	10 to 2000cps @ 20g's per MIL-STD-202, test condition D, method 204A (monitored for one microsecond opening)	No mechanical damage to assembly or loss of continuity
SHOCK	100g's per MIL-STD-202A, method 202B (monitored for one microsecond opening)	No mechanical damage to assembly or loss of continuity
CAPACITANCE	Between opposite terminals @ 1 kc. per MIL-STD-202 method 305	.38pfd max.
	Between adjacent terminals @ 1 kc. per MIL-STD-202 method 305	.86 pfd max.
TERMINAL ANCHORING RETENTION (min.)	Pull against barb locking action	12 lbs.
THERMAL SHOCK	- 65 C to + 150 C per MIL-STD-202, test condition F, method 107	No change in insulation resistance, loss of continuity or mechanical damage to assembly
BOND STRENGTH OF PADS	5 cycles of soldering and unsoldering per MIL-P-55110 paragraph 4.8.7.	Pads withstand a force equivalent to 2000 psi
LIFE vs CONTACT RESISTANCE	1000 cycles insertion/withdrawal of IC 14 lead device	Average before test: 5.3 milliohms Average after test: 6.4 milliohms

CUSTOM DESIGNS

to your specification

Illustrated at right is a typical modification of our standard concept. Special shapes and sizes may be furnished without a premium charge. Flexibility in our design and fabrication permits fast turn-around time for custom designs.

We welcome special requirements that will receive prompt engineering assistance and service.

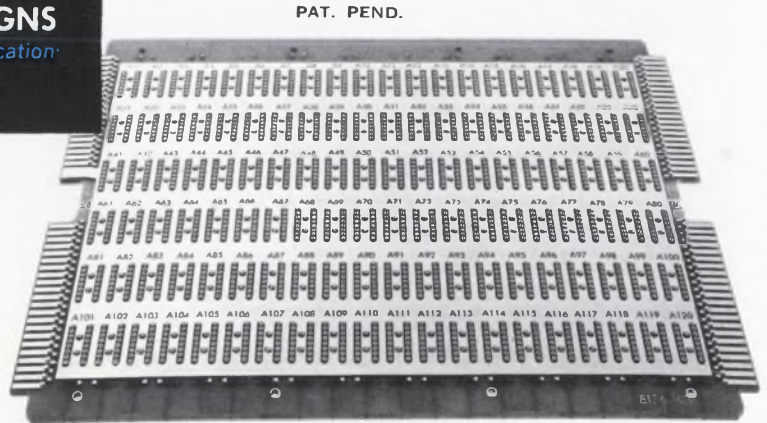

OUTSTANDING FEATURES

DESIGN FLEXIBILITY

The construction of this panel allows complete flexibility of design. Any combination of logic and/or analog micro circuits may be inserted and interconnected to the desired function. Changes in design may be readily made since all micro circuits are inserted into sockets and all interconnections are wired at the pins. This feature saves time and money since changes do not require new board layouts as in present printed circuit board concepts.

INTERFACE LOGISTICS

Micro circuits mounted on printed circuit boards most always result in a problem of interconnecting many leads on a single plane without crossover conflicts. This problem is completely solved since all interfacing between circuits are made at the pins, allowing universal adaptations.

GROUND and POWER PLANES

Reduces electro static coupling between each micro circuit, improves high frequency performance. Standard boards furnished with two additional blank terminals per pattern for appropriate interconnection to power and ground socket/terminals. Custom boards may be furnished with power and ground planes directly tied to power and ground socket/terminals thus eliminating the two additional blank terminals.

COST COMPARISON — PACKAGING, REPAIR, REPLACEMENT

High density inter-connections with wire-wrapping eliminates expensive multi-layer boards. Repair or replacement at the component level instead of at the card or module level is less costly.

SOCKET/TERMINALS

Easy to assemble — pilot SOCKET/TERMINAL in recommended mounting hole and press terminal head until shoulder is seated. "Barb" securely anchors terminal in board.



4 leaf contact

*CONTROLLED WIRE-WRAP LENGTH $.025 \pm .003$ square, with $.003$ maximum radii on corners. (30 ga. wire — up to 3 connections of 8 wraps each. Use Gardner Denvet bit #507063 and sleeve #507100 for wrapping terminals on $.100$ centers.)

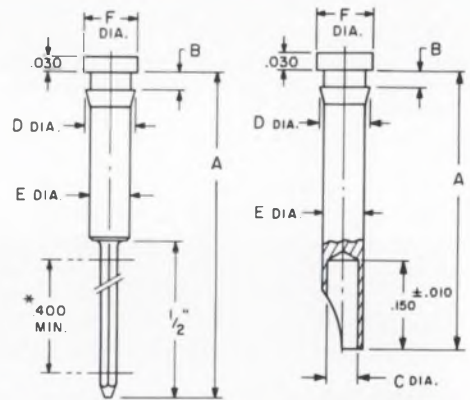

PART NUMBERS

ROUND OR FLAT LEADS	PART NO.	FIG. NO.	$\pm .015$ A	$\pm .003$ B	$\pm .003$ C	$\pm .003$ D	$\pm .003$ E	$\pm .003$ F	RECOMMENDED MOUNTING HOLE
F—.015 to .023 R—Up to .019	LSG-1FG1-1	2	.664	.028	—	.060	.053	.072	#54 Drill (.055 Dia.)
	*LSG-1FG2-1	2	.664	.062	—				
	LSG-1BG2-1	3	.365	.028	.038				
F—.024 to .031 R—.020 to .025	LSG-2FG1-1	2	.773	.028	—	.082	.073	.085	#48 Drill (.076 Dia.)
	†LSG-2FG3-1	2	.773	.062	—				
	LSG-2BG2-1	3	.474	.028	.055				
*LSG-1FG2-1 †LSG-2FG3-1	Replacement SOCKET/TERMINALS (see kit—page 5)								

**HIGH DENSITY DUAL-IN-LINE
PACKAGING PANELS
WITH CONNECTOR TAKE-OFF**
for 14 lead plug-in integrated circuits

8136 K SERIES

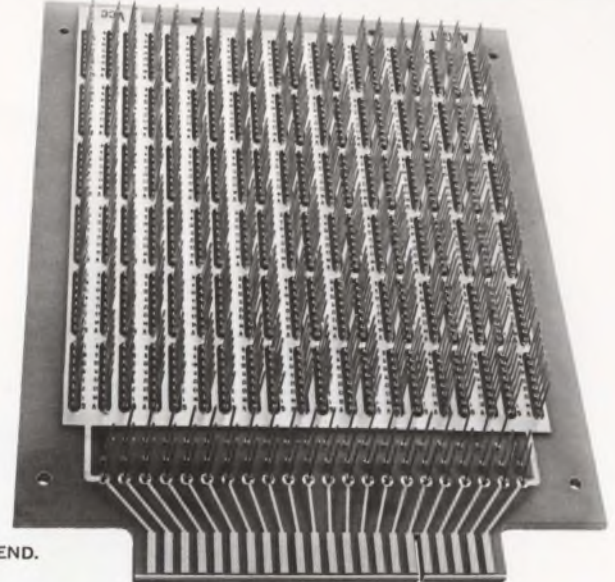
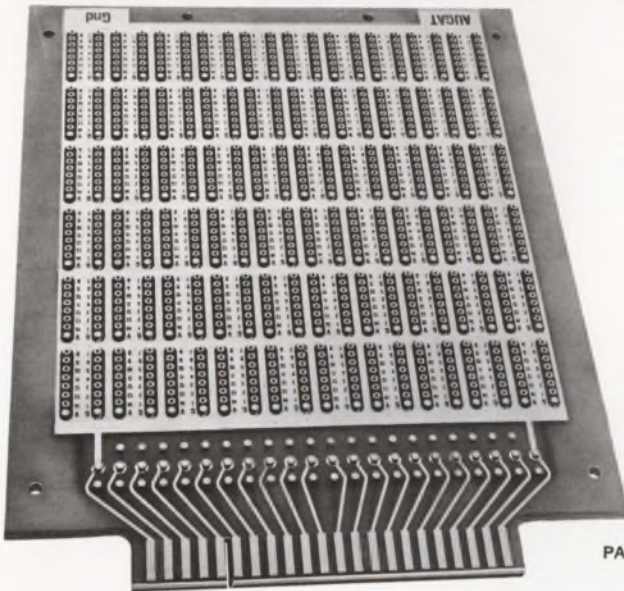

PAT. PEND.

8136K Series

- 30 and 60 patterns standard
- double-sided board with power and ground planes at each pattern
- easy IC insertion — large contoured, closed-entry contacts
- operating temperature range — 65° to 150°C
- Wire-Wrap® or solder pot terminals
- Also available for 16 lead package.

MATERIALS: P/C Board — 1/8 thick glass epoxy, 2 oz. copper circuitry both sides, tin plated. Connector fingers gold plated.

Socket/Terminal

- Terminal — Brass, gold over nickel plated
- Female contact — Beryllium copper, gold over nickel plated
- Gold plate .000040 thick per MIL-G-45204, type II

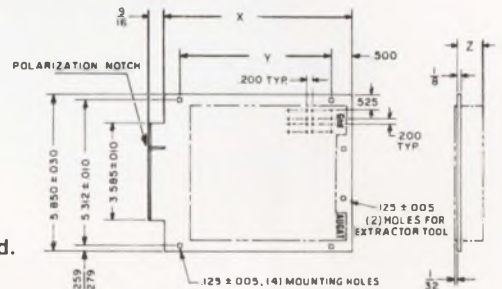

PART NUMBERS

ROUND OR FLAT LEADS 	NO. OF IC LEADS	PART NO.	NO. OF PATTERNS PER BOARD	REFER TO FIG. 1			*SOCKET/TERMINAL	
				± .030	± .010	± .015		
				X	Y	Z		
F—.015 to .023 R—Up to .019	14	8136-KG1	60	6.938	6.000	.664	WIRE-WRAP	LSG-1FG1-1
		8136-KG1-30	30	4.238	3.300			
		8136-KG2	60	6.938	6.000	.365	SOLDER POT	LSG-1BG2-1
		8136-KG2-30	30	4.238	3.300			
F—.024 to .031 R—.020 to .025	14	8136-KG3	60	6.938	6.000	.773	WIRE-WRAP	LSG-2FG1-1
		8136-KG3-30	30	4.238	3.300			
		8136-KG4	60	6.938	6.000	.474	SOLDER POT	LSG-2BG2-1
		8136-KG4-30	30	4.238	3.300			

CONNECTOR SUPPLIED SEPARATELY — PART NO. 8136-19P1 (22 contact, dual leadout, for mating with 8136-K Series Panels). Diallyl Phthalate body, gold plated beryllium copper contacts.

*To further extend the scope and flexibility of our standard packaging panels, SOCKET/TERMINALS may be purchased as separate items.

**OTHER DUAL-IN-LINE
PRODUCTS**

Available for both 14 and 16 Pin packages

8135 SERIES
FOR USE WITH
EDGE CONNECTOR

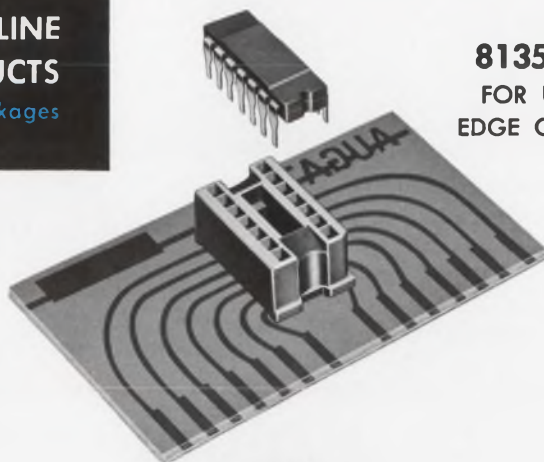

8130 SERIES
FOR TESTING, BREADBOARDING
WITH SOLDERLESS JUMPER
INTER CONNECTIONS

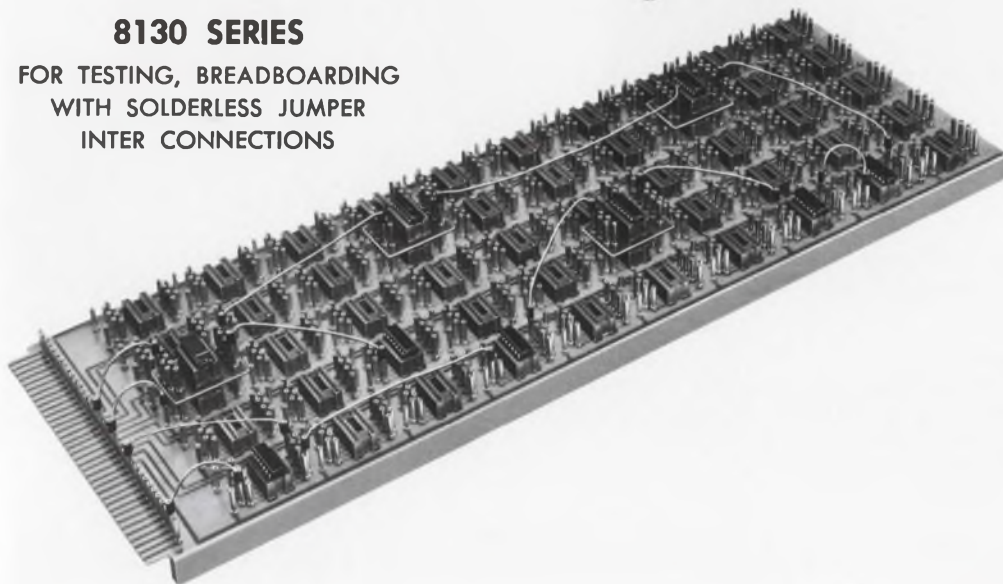

**314 and 316
SERIES**

FOR TESTING;
BREADBOARDING;
PACKAGING

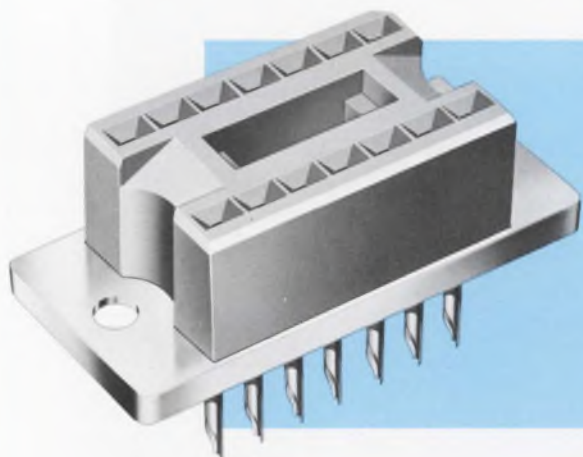

**LOW
PROFILE**

COMPLETE I. C. FOLDER ON REQUEST

SEE YOU AT WESCON
BOOTH # 3905

AUGAT INC.

39 PERRY AVE., ATTLEBORO, MASS. TEL. 222-2202

WESCON attendance

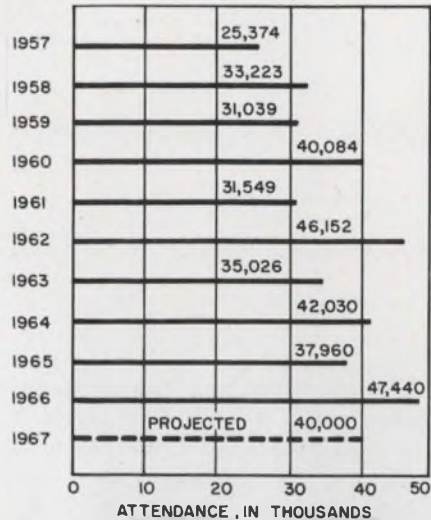

WESCON expects four day attendance of 40,000 visitors, compared with 37,960 in 1965, the last year in which the event was held in San Francisco. During the last ten years, over-all attendance has shown a decided upward trend. Next year the show will again be held in Los Angeles.

Moxon's magic again



A magic show will be given every 45 minutes at Booth 2616. Moxon's Magic Theatre will feature Eddie Tullock, making his fifth WESCON appearance. It's rated as one of the most popular shows around.

No.



You cannot pull the cable out of our Micon Emlock® connectors.

No tricks. Our claim is that it is impossible to pull the cable out of one of our Emlock® compression fit, miniature connectors. Disengagement will be caused only by failure of the braid, not pullout of the compression. We believe this extraordinary capability beats crimped type connectors all hollow. Yes, and competitive compression types, too.

Prove it to yourself. Have one of our Technical Representatives call on you. He'll attach any one of our stock Emlock® connectors to a section of braided cable. Then, as he holds the connector body with a pliers, he'll hand you the chain nose, and you pull! The assembly will break away,

of course. He will then disassemble the connector and show you that there is still enough wire trapped to prove that Emlock® compression held and the braid failed!

Here's your chance to gain a new concept in miniature connector reliability. Remember, only Emlock® connectors offer this basic capability and only we have Emlock®.

Write for the name of our Technical Representative in your territory. He'll phone for an appointment and give you a chance to prove it to yourself. *While you are about it, why don't you ask for Bulletin MMC, Issue 1 describing the complete line of Emlock® connectors?*

Micon is now a part of

PHELPS DODGE ELECTRONIC PRODUCTS
NORTH HAVEN, CONNECTICUT



ON READER-SERVICE CARD CIRCLE 852

Eat smart in San Francisco!

Few cities can offer so wide a choice of food and atmosphere, and the prices have a palatable range, too.

Lynda Rothstein, Reporter

Whether your taste is for Oriental exotica or Grandma's traditional, remember that San Francisco is one of the world's acknowledged gastronomic capitals. Within easy reach you will find a wide variety of cuisines and prices.

Listed below are some highly recommended eating places serving delights to whet every appetite. They range in price from the more expensive to the moderate and are grouped according to regional cooking style. Whatever you do, don't let the fervor of WESCON make you miss out on one of the highlights of the city; join in San Franciscan's favorite indoor sport—Eat Hearty!

American

Alfred's—886 Broadway; phone: SU 1-7058. Open from 4 p.m. to 12:30 a.m. daily, this steak lover's haven is known for its generous

servings. Full dinners range from \$3.95 to \$7.00.

Phil Lehr's Downtown Steakery—232 Eddy (around the corner from the Hilton Hotel); phone: OR 3-6800. Luncheon and dinner are served on weekdays; the restaurant opens for dinner at 4 p.m. on Saturday and Sunday. You cut your own piece of steak, which is then prepared to order. A full dinner beginning with salad and ending with as much coffee as you like runs around \$5.00.

Mexican

Señor Pico—Ghirardelli Square at Larkin and Beach Streets; phone: 776-9660. Open from 11 a.m. to 2 a.m. daily. New, grand décor and an open view of the Golden Gate Bridge make this a popular dinner choice. Reservations are recommended. All dishes are à la carte and prices run from \$2.25 to \$4.00.

Pancho's—Ellis and Leavenworth; phone: GR 4-8303. Open from 4 p.m. to 9:30 p.m.; closed Wednesday. A homey atmosphere enhances substantial servings of enchiladas, tacos and other south-of-the-border specialties. Dinners range from \$1.25 to \$1.60.

French

Fleur de Lys—777 Sutter St.; phone: OR 3-7779. Open from 5:30 p.m. to 2 a.m.; closed Sunday and Monday. Gracious Gallic service and excellent French food earn the Fleur de Lys the description, "restaurant de luxe." Prices before 7:30 p.m. run around \$6.50; after 7:30 p.m., all dishes are à la carte.

La Bourgogne—320 Mason St.; phone: DO 2-7352. Open from 5 p.m. to 12 midnight daily; Sunday, 4:30 p.m. to 11 p.m. Located in the heart of the downtown theater district, this fashionable Parisian restaurant features delicious, craftily spiced food. Prices are all à la carte; entrées range from \$4 to \$8.

Des Alpes—732 Broadway; phone: GA 1-9909. Open every day. A little less fancy and a lot less expensive than some places, this dining spot is enlivened by the robust personalities of its two patrons, Monsieur and Madame Bordalange. Known for generous servings, the restaurant has two table d'hôte choices every evening: one at \$3.25, the other at \$4.

International

Alexis—1001 California St.; phone: TU 5-6400. Open from 5 p.m. to 12 midnight; closed Sunday. Exotically decorated, this classic restaurant atop Nob Hill offers elegant dining in a relaxed atmosphere. Music accompanies dinner; à la



Blue Fox restaurant is famous for its elegant private dining room. Its renowned cellar offers diners 300 varieties of wine.

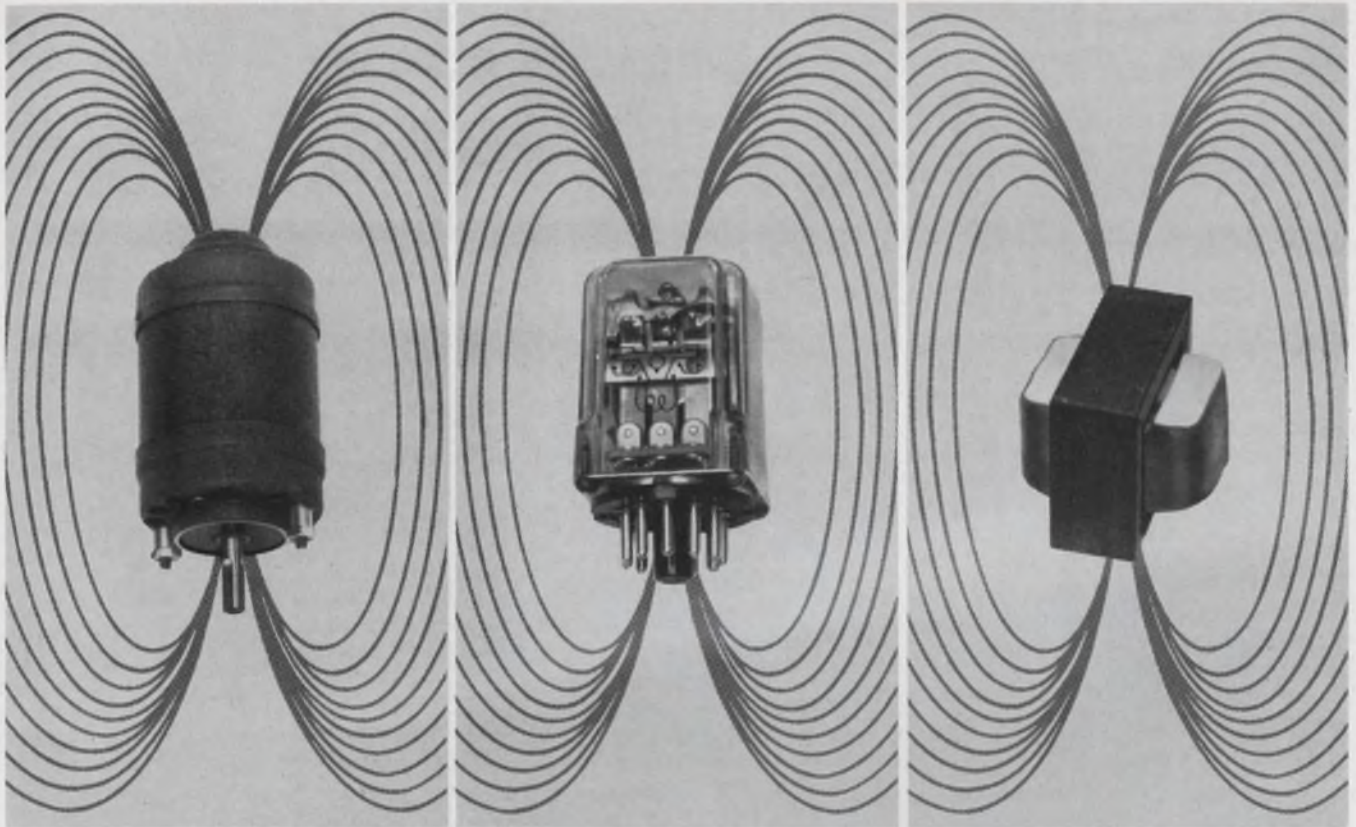

Now, Get 6 Volts Noise Immunity For Your Digital Control System With New MHTL Integrated Circuits!

You'll get the "right" signal every time in your numerical control, supervisory control and computer peripheral equipment with the new Motorola-developed high threshold integrated circuit logic series. Called MHTL, it's the first family of integrated circuits to offer a noise margin of 6 volts (typ) and a 15 volt ($\pm 1V$) operating voltage. And, it's priced, packaged, and specified for application in equipment designed for use in high noise industrial environments.

MHTL combines high noise immunity with a voltage swing of 13 volts, broad operating temperature range, large fan-out and a 35 mW power dissipation rating. In short, it offers you discrete circuit characteristics PLUS the price, size, and reliability advantages of integrated circuitry.

Here are some of the MHTL specifications:

CHARACTERISTICS	MHTL
Operating Voltage	15 \pm 1 Volts
Noise Immunity	6 Volts (typ)
Fan-out (Gate)	10 (min)
Clock Rate (Flip-Flop)	4 MHz (typ)
Operating Temperature Range	-30°C to +75°C

Offered in the 14-pin dual in-line plastic Unibloc* package, the circuit functions and prices for the MHTL family are as follows:

TYPE	DESCRIPTION	PRICE (1,000 UP)
MC660P	Dual 4-Input Gate	\$3.50
MC661P	Dual 4-Input Gate (Passive Pull-Up)	\$3.50
MC663P	Dual J-K Flip-Flop	\$6.10
MC664P	Master Slave R-S Flip-Flop	\$4.05

Other functions planned for the immediate future include a Dual 4-Input Line Driver, Triple Input Interface, Quad Output Interface, Dual Monostable Multivibrator, and Quad 2-Input Gate.

To find out how easily your designs can conquer high-noise-environments with MHTL, write for our data sheets. We'll also send you our latest application note on how MHTL solves your noise problems. For circuits you can try right now — call your nearby franchised Motorola Semiconductor distributor. He has high-noise-immunity MHTL in stock!

*Trademark of Motorola Inc.

- where the priceless ingredient is care!



MOTOROLA Semiconductors

MOTOROLA SEMICONDUCTOR PRODUCTS INC. / P. O. BOX 955 / PHOENIX, ARIZONA 85001 / (602) 273-6900 / TWX 910-931-1334

ON READER-SERVICE CARD CIRCLE 853

ELECTRONIC DESIGN 17, August 16, 1967

E41



Ernie's, one of the city's top restaurants, has a Victorian decor. The photo shows the alcove leading to the upstairs dining room.

carte prices range from \$3.75 to \$7.25.

Jack's—615 Sacramento St.; phone: GA 1-9854. Open from 11:30 a.m. to 9:30 p.m. daily; Sunday from 4 p.m. Unpretentious and dignified, this long-established restaurant is a favorite of businessmen familiar with San Francisco. Prices range from \$1.85 to \$6.50 à la carte; complete dinners, served from 5 p.m. to 9 p.m., are \$6.

Ernie's—847 Montgomery St.; phone: EX 7-5969. Open from 5:30 p.m. to 12 midnight. Excellent service and studied elegance await you here. Dinner before 7:30 p.m. runs about \$7 without wine; after 7:30 p.m., the prices are somewhat higher.

The Blue Fox—659 Merchant St. (can be entered either from Montgomery or Kearny); phone: YU 1-1177. Open from 6 p.m. to 12 midnight; closed Sunday. Fine fare is served in a suite of glittering, spacious dining rooms. Prices range from \$5 to \$10 for à la carte dinner.

Italian

Amelio's—1630 Powell St.; phone: SU 1-9643. Open from 6 p.m. to 11 p.m. Don't lose the address or you may miss out on some fine Italian cookery. Prices range from \$4.25 to \$6 for à la carte dinner.

English

The White Horse Tavern—637 Sutter St.; phone: PR 1-1708. Open from 5 p.m. to 11 p.m.; closed Sunday. Decorated with old English motifs, this restaurant looks like the proper setting for a Tom Jones feast. Dinners range from \$3.25 to \$5.75.

The Coachman—1057 Powell St.; phone: EX 2-9903. Open from 5:30 p.m. to 10:30 p.m. daily. Brass lanterns help to suggest an English pub. Steak-and-kidney pie and steaks are highlights. Dinners run from \$2.95 to \$4.75.

Jewish

David's—Located on Theater Row at 468-474 Geary St.; phone: PR 1-1600. *David's* is a haunt of the casts of visiting shows and San

Francisco's own actors and actresses. Open from 9 a.m. to 3 a.m. daily. You can savor anything from a light snack to a full-course dinner. Prices for the latter range from \$3.95 up.

Middle Eastern

Omar Khayyam's—196 O'Farrell St.; phone: SU 1-1010. Open daily from 4 p.m. to 12 midnight; Sunday from 2 p.m. to 10 p.m. The specialty is kouzou kziertma; savor it amid mural interpretations of *The Rubáiyát*. The proprietor makes a supreme effort to educate his patrons in his native Armenian cuisine; your best bet may be to leave the ordering in his capable hands. Dinners range from \$4 to \$5.50.

Cairo Restaurant—77 Fourth St.; phone: SU 1-6819. Closed Sunday. Authentic Middle Eastern cooking and low prices make this an attractive choice for dinner. It is situated in a less fashionable section, but don't be put off—the food is worth it. Dinner prices start at \$1.90 and up to \$3.00.

Oriental

Kan's—708 Grant Ave.; phone: YU 2-2388. Opened from 12 p.m. to 10:45 p.m.; Saturday and Sunday from 4:30 p.m. This Cantonese restaurant's specialty is "the eight immortal flavors." Prices range from \$2.50 to \$4.50 for family dinners. The more exotic dishes run higher.

The Imperial Palace—919 Grant Ave.; phone: YU 2-4440. Open from 11:30 a.m. to 11 p.m.—till 2 a.m. on Saturday. All the classic dishes of Cantonese cuisine are available in this sumptuous locale. Complete dinners range from \$3.95 to \$5.95.

Yamato—717 California Street; phone: EX 7-3456. Open from 11 a.m. to 2 p.m. for luncheon; from 5 p.m. to 10 p.m. for dinner; closed Monday. This Japanese restaurant is one of the best-known in North America. A Japanese garden framing a facsimile traditional bridge is the focal point of the décor. Dinner can be served to you either Japanese fashion or seated at a regular table. Prices for complete dinners start at \$3.35.



NEW

DO-T200™ SERIES

ULTRAMINIATURE TRANSISTOR TYPE AUDIO TRANSFORMERS

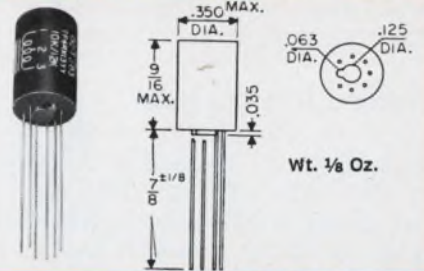

U. S. PAT. NO. 2,949,591; others pending.

This DO-T200 series of transistor transformers and inductors has been newly added to the UTC lines of stock items available for immediate delivery. These transformers provide the unprecedented power handling capabilities and the inherent reliability found only in the basic structural design of the UTC DO-T Family of miniature transformers. This reliability has been dramatically proven in the field.

Leads are 7/8" long, .016 Dumet wire, gold plated, and may be either welded or soldered. They are uninsulated and are spaced on a .1" radius circle, conforming to the termination pattern of the "TO-5" cased semiconductors and micrologic elements.

DO-T200 series of transformers are designed for Class R application. On special order they may be designed to Class S Specifications. No additional life expectancy is gained by using Class S insulation systems at Class R temperatures.

In pulse coupling impedance matching applications, (when measured with a 30 microsecond input pulse voltage wave), typical values for these transformers are: 5% or less droop, zero overshoot, and less than 10% backswing.

Special unit modifications, such as additions and deletions of leads, changed lead lengths, different impedance ratios and incorporation of electrostatic shields, etc., are available in these constructions.

• Manufactured and successfully tested to complete environmental requirements of MIL-T-27B

- Most Ruggedized MIL Structure, Grade 4, Metal Encased
- Hermetically Sealed
- Immediate Delivery From Stock
- Straight Pin Terminals
- Full Conformance to MIL Mounting Requirements
- Excellent Response
- Solderable and Weldable Leads
- High Efficiency
- Low Distortion

Type No.	MIL Type	Pri. Imp.	D. C. ma \ddagger in Pri.	Sec. Imp.	Pri. Res.	Mw Level	Application
DO-T255	TF4RX13YY	1K/1.2K CT	3	50/60	115	100	Output or matching
DO-T275	TF4RX13YY	10K/12K CT	1	1.5K/1.8K CT	780	100	Interstage
DO-T277	TF4RX13YY	10K/12K CT	1	2K/2.4K split	560	100	Interstage
DO-T278	TF4RX13YY	10K/12.5K	1	2K/2.5K CT	780	100	Driver
DO-T283	TF4RX13YY	10K/12K CT	1	10K/12K CT	975	100	Isol. or Interstage or Pulse
DO-T288	TF4RX13YY	20K/30K CT	.5	.8K/1.2K CT	830	50	Interstage
DO-T297	TF4RX16YY	200,000 CT	0	1000 CT	8500	25	Input and Chopper
DO-T200SH	Drawn Hipermalloy shield provides 15 to 20 db shielding through side of case						

\ddagger DCma shown is for single ended usage. For push pull, DCma can be any balanced value taken by .5W transistors. Where windings are listed as split, 3/4 of the listed impedance is available by paralleling the winding.

THE DO-T FAMILY OF COMPONENTS



These items manufactured and successfully tested to complete environmental requirements of MIL-T-27B, Grade 4, Class R, Life X. Except PIP: to MIL-T-21038B, Grade 6, Class R, Life X. Grades 4 and Grades 6 of MIL-T-27B & MIL-T-21038B respectively, are identical.

DO-T Flexible leads. Freq range 300 CPS—10KC & up. Power up to 1/2 W. Size 3/16 dia x 1 1/2" h. Wt approx 1/10 oz.

DI-T Flexible leads. Freq range 400 CPS—10KC & up. Power up to 1/2 W. Size 3/16 dia x 1 1/4" h. Wt approx 1/15 oz.

DO-T200 Series. See above

DI-T200 Series Straight pin gold plated. Dumet leads. Freq range 400 CPS—100KC. Power up to 500 mw. Size 3/16 dia x 3/8" h. Wt approx 1/15 oz.

PIL Inductors range from .025 hy to .8 hy, DC 0 to 10 ma. Transformers from 500 ohms to 10,000 ohms impedance. Freq range 800 cps—250 KC; power up to 100 MW. Size 3/16 dia x 3/16" h. Wt 1/20 oz.

PIP (Pulse) Flexible leads. Wide application pulse transformers, to MIL-T-21038B specifications. Size 3/16 dia x 3/16" h. Wt 1/20 oz.

DO-T400 (Power) Flexible leads, power transformer. Power output 400 mw @ 400 cycles. Size 3/16 dia x 1 1/2" h. Wt 1/10 oz.

AND SPECIAL, CUSTOM BUILT COMPONENTS TO YOUR SPECIFICATIONS

Write for catalog of over 1,300 UTC TOP QUALITY STOCK ITEMS IMMEDIATELY AVAILABLE from your local distributor.



UNITED TRANSFORMER CO.

DIVISION OF TRW INC. • 150 VARICK STREET, NEW YORK, N. Y. 10013

India House—629 Washington St.; phone: EX 2-0744. Luncheon is served from 11 a.m. to 2:30 p.m.; dinner from 6 p.m. to 10:30 p.m.; closed Sunday. Fine curries, pulao and sambals make this an outstanding Indian restaurant. Eastern music accompanies the meal; the waiters are Indian and clad in traditional attire. Prices range from \$2.25 to \$8.50.

Seafood Restaurants

The bay and the excellent fish it yields make San Francisco famous for fine seafood. The center for seafood dining is Fisherman's Wharf, which is readily accessible by the Bay-Taylor cable car from Market and Powell Streets. The various restaurants in the seafood compound are open for both luncheon and dinner daily and are fairly moderately priced. Each has its own slightly different atmosphere and specialties.

Fishermen's Grotto No. 9—phone: OR 3-7025. This well-known seafood house operates its own fishing fleet and offers 150 selections to choose from. It is right on Fisherman's Wharf. Prices range from \$2.50 to \$7.50.

Franciscan Restaurant—Pier 43-1/2; phone: DO 2-7733. An excellent view of the bay, choice seafood selections and a sweeping view over the bay make this a fine choice for dinner. Prices range from \$2.25 to \$5.00.

DiMaggio's—Facing Yacht Harbor; phone: OR 3-2266. A fashionable eating place that also serves some Italian dishes, its specialty is an outstanding seafood platter. Prices range from \$2.00 to \$6.75.

Tarantino's—Directly across from *DiMaggio's*; phone: PR 5-5600. This restaurant is built on pilings over the water. The view is exceptional and the food excellent. Diners run from \$2.95 to \$5.00.

Pompei's Grotto—340 Jefferson St. This is a friendly place with no bay view but it serves some of the best seafood at moderate prices. Dinners run from \$1.40 to \$3.50.

Still Hungry? Here are a few more restaurants for you to sample.

American

Canlis at the Fairmont—Fairmont Hotel, California and Mason Sts.; phone: 392-0113. Open from 5:30 p.m. to 11 p.m. daily. All dishes are à la carte.

Cliff House—1090 Pt. Lobos Ave.; phone: 751-7220. Open from 9 a.m. to 9:30 p.m. Monday through Saturday; 10 a.m. to 8:30 p.m. Sunday. Prices range from \$3.85 to \$5.95.

Grisson's Chicken House—2050 Van Ness Ave.; phone: 885-2050. Open 5 p.m. to 10:45 p.m. Tuesday through Saturday; 2 p.m. to 9:45 p.m. Sunday; closed Monday. Diners run from \$3.75 to \$4.85.

The Hippo—2025 Van Ness Ave.; phone 775-3362. Open 24 hours a day. Prices range from \$1.00 to \$2.50.

Le Boeuf—545 Washington St.; phone: 421-2914. Open Monday through Saturday 5:30 p.m. to 10:30 p.m.; Sunday 5 p.m. to 9:45 p.m.; closed holidays. Steaks only. Prices start at \$4.50.

Chinese

Four Seas—731 Grant Ave.; phone: 397-5577. Open Monday through Friday, noon to midnight; Saturday, Sunday and holidays, 5 p.m. to midnight. Prices range from \$3.75 to \$5.50.

Nam Yuen—740 Washington St.; phone: 781-5636. Open from 11:30 a.m. to 2:45 a.m.; closed Monday. Prices start at \$2.75.

Continental

Coq d'Or—230 Jackson St.; phone: 956-4545. Open from 11:30 a.m. to 11 p.m. Monday through Friday; 5:30 p.m. to 11 p.m. Saturday; closed Sunday and holidays. Prices start at \$4.50.

Julius' Castle—302 Greenwich St.; phone: 362-3042. Open from 12 noon to 2:30 p.m.; 5 to 10:30 p.m.; closed Sunday and holidays. Prices start at \$5.50.

Owl 'n' Turtle—615 Washington St.; phone: 397-0335. Open from 11:30 a.m. to 2:30 p.m. and 6 p.m. to 11 p.m. Monday through Satur-

day; closed Sunday. Prices range from \$3.95 to \$6.95.

Rolf's Since 1960—757 Beach St.; phone: 673-8881. Open Tuesday through Saturday 11:30 a.m. to 12 a.m.; Sunday brunch from 10:30 a.m., dinner to midnight; closed Monday. Prices range from \$4.75 to \$7.25.

French

Chez Marguerite—2330 Taylor St.; phone: 775-9785. Open from 6 p.m. to 10 p.m. Wednesday through Saturday; Sunday 5:30 to 9:30 p.m.; closed Monday and Tuesday. Prices range from \$4.75 to \$7.25.

Le Trianon Restaurant Français—242 O'Farrell St.; phone: 982-9353. Open from 4:30 p.m. to 11:30 p.m.; closed Sunday. Prices start at \$5.25.

L'Orangerie—419 O'Farrell St.; phone: 776-3600. Open from 5:30 p.m. to 10:30 p.m. daily; closed Sunday. All dishes are à la carte.

Place Pigalle—3721 Buchanan St.; phone: 931-5644. Open Tuesday through Saturday, 4:30 p.m. to 11:30 p.m.; Sunday 4:30 p.m. to 10:30 p.m.; closed Monday. Prices run from \$4.50 to \$5.50.

Italian

Fior d'Italia—621 Union St.; phone: 986-1886. Open from 11:30 a.m. to 11 p.m. Monday through Friday; Saturday 5 p.m. to midnight; Sunday 4 to 11 p.m. Prices range from \$3.50 to \$7.50.

Oreste's—118 Jones St.; phone: 474-5811. Open from 11:30 a.m. to 12 a.m. Monday through Friday; 5 p.m. to midnight Saturday and Sunday. Prices range from \$5.75 to \$7.95.

Veneto—389 Bay St.; phone: 986-4553. Open Monday through Friday from 11:30 a.m. to 12 midnight; Saturday 4 p.m. to 12 midnight. Prices range from \$4.10 to \$6.95.

Giovanni's—Ghirardelli Square; phone: 771-2880. Open from 11:30 a.m. to 10:30 p.m. daily; closed Monday. Prices range from \$3.95 to \$4.50. ■ ■

What a line!

The broadest, most complete array of perforated tape readers available.

25 to 1000 char/sec....mechanical and photoelectric.

Model 500 R
1000 char/sec search
500 char/sec synchron.
200 char/sec asynchron.

Model R150
150 char/sec

Model 424
60 char/sec

Model 464
120 char/sec

Model 500 RF/10
Ruggedized
1000 char/sec search
500 char/sec synchron.
150 char/sec asynchron.

Model HR150
High Reliability
150 char/sec

Model R30
30 char/sec

Model 625
25 char/sec

And that's no line!

Not shown, Models 500 RM, 500 RF, and 500 T photoreaders which operate at up to 1000 char/sec in the search mode, 500 char/sec synchronously and 200 char/sec asynchronously. Model 500 RM is a full MIL-SPEC reader. Model 500 T requires external reeling. All photoreaders work without pinch rollers, friction brakes or solenoids. For complete information, call your full-service Tally sales engineer (see EEM) or write Tom Tracy, Tally Corporation, 1310 Mercer Street, Seattle, Washington 98109. In the U.K. and Europe, address Tally Europe, Ltd., Radnor House, 1272 London Road, London, S.W. 16, England.

TALLY

WESCON exhibitors' list

Here are the exhibitors and where to find them

(All booths are at the Cow Palace. Consult adjoining map for exact booth location).

- AAI Corp.
Pacific Div.
4712-4713
- Ace Engineering & Machine Co., Inc.
1423
- ACI
Div. of Kent Corp.
1106-1107
- Adage, Inc.
2111-2112
- Advanced Energy Conversion
4710
- Ad-Yu Electronics, Inc.
3302
- Aerometrics
Div. of Aerojet-General Corp.
3304A-3305A
- Aerovox Corp.
4201-4202
- AGA Corp.
4703
- Agastat Timing Instruments
Div. of Elastic Stop Nut Corp. of America
4511-4512
- Airpax Electronics
2801-2802
- Aladdin Electronics
Div. of Aladdin Industries, Inc.
4524
- Alford Manufacturing Co.
3309-3311
- Alfred Electronics
2606-2607
- Algo
Div. of Hamilton Electronic Corp.
1310
- Almac Cryogenics, Inc.
2120
- Alpha Industries, Inc.
3615
- Alpha Wire
1403
- Ameco, Inc.
4708-4709
- American Chamber of Commerce
D-5
- American Electronic Laboratories, Inc.
5106
- American Optical Co.
Instrument Div.
1518
- American Optical Co.
Space Defense Div.
2014
- Amglo Corp.
5026
- Amperex Electronic Corp.
3912-3914
- Amphenol Corp.
4501-4507
- Anadex Instruments, Inc.
3303
- Analog Devices, Inc.
5021-5922
- Anchor Plating Co., Inc.
1711
- Andrew Corp.
2610-2611
- Angelica Uniform Co.
1119
- API Instruments Co.
2621-2622
- Arco Electronics
Div. of Loral Corp.
4517
- Arra Inc.
3404
- The Arrow-Hart & Hegeman Electric Co.
5025
- Associated American Winding Machinery, Inc.
3217
- Associates Testing Laboratories, Inc.
4812-4812A
- Astrodata, Inc.
2613-2614
- Atec Inc.
2303
- Audio Video Forum
4813
- Augat, Inc.
3905
- Austron, Inc.
5243
- Automated Measurements Corp.
4711
- Automatic Electric Co.
4221-4222
- Automatic Metal Products Corp.
4408
- Axion Corp.
1215
- Baird-Atomic, Inc.
2216A-2217A
- Baldwin Kongsberg Co.
2114-2117
- Barnes Development Co.
4905-4906
- Barry Instrument Corp.
4814
- Bausch & Lomb, Inc.
3306
- Bel Fuse, Inc.
4910
- Belden Manufacturing Co.
1820-1821
- F. W. Bell, Inc.
2517
- The Bendix Corp.
2812-2815
- Bird Electronic Corp.
2601-2602
- The Birtcher Corp.
Industrial Div.
1503
- The Birtcher Corp.
Instrument Div.
2605
- Bliss Eagle Signal
Div. of E. W. Bliss Co.
3401-3402
- Blue M Engineering Co.
1606
- Bonus-Bilt, Inc.
1907
- Boonton Electronics Corp.
2713-2714
- Borg-Warner Corp.
Ingersol Products Div.
3108-3109A
- R. W. Borrowdale Co.
1007-1008
- Bourns, Inc.
4305-4306
- W. H. Brady Co.
1624-1625
- Branson Corp.
4104
- The Bristol Co.
3915-3916
- BTU Engineering Corp.
1206-1209
- Buchanan Electrical Products Corp.
4509-4510
- Buckbee Mears Co.
5308
- The Buckeye Stamping Co.
1117
- The Bunker-Ramo Corp.
5023-5024
- Burgess Battery Co.
3904
- Burndy Corp.
5344-5346
- Burr-Brown Research Corp.
3212-3212A
- Burroughs Corp.
Electronic Components Div.
2816-2817
- Bussmann Mfg.
Div. of McGraw-Edison Co.
3818
- California Electro-Scientific Corp.
2109
- California Instruments Corp.
2710
- Cambridge Thermionic Corp.
4103
- Camloc Fastener Corp.
1504
- Canadian Dept. of Industry
Canadian Government Exhibition Commission
3604
- The Capital Radio Engineering Inst.
3507
- Carpenter Manufacturing Co., Inc.
1506
- Caw Engineering, Inc.
1214
- Celco Pacific
Div. of Constantine Engineering Laboratories
5004
- Centralab Electronics
Div. of Globe-Union, Inc.
5235-5238
- Century Electronics & Instruments*
3104A
- Chassis-Trak, Inc.
1010
- Christie Electric Corp.
2523
- C. P. Clare & Co.
5132-5135
- Clarostat Mfg. Co., Inc.
5129
- Clean Room Products, Inc.
1706
- Coherent Radiation Laboratories
3214
- Sigmund Cohn Corp. of Calif.
1016
- Cohu Electronics, Inc.
3001
- Coil Winding Equipment Co.
1802-1803
- Coleman Engineering Co., Inc.
3012
- Collins Radio Co.
3923-3924
- Components, Inc.
5009-5010
- Computer Design Publishing Corp.
3514
- Computer Test Corp.
4808-4809
- Consolidated Avionics
2217
- Consolidated Electrodynamics Corp.
3113-3115
- Consolidated Graphics, Inc.
3414
- Consolidated Products Corp.
1522
- Consolidated Vacuum Corp.
5228-5230
- Continental Connector Corp.
3805-3806
- Control Data Corp.
4602-4604, 4717, 4720-4721
- Control Equipment Corp.
2110
- Control Logic, Inc.
2005
- Controlled Environment Equipment Corp.
1917
- Cook Electric Co.
5227
- Wm. C. Copp & Associates
D-4
- Cornell-Dubilier Electronics
Div. of Federal Pacific Elec. Co.
5244-5245
- Corning Glass Works
4003-4004, 4119-4120
- Crescent Niagara Corp.
1623
- Curtis Development & Mfg. Co.
1013
- Curtis Instruments, Inc.
4611

Cow Palace: Exhibit Areas

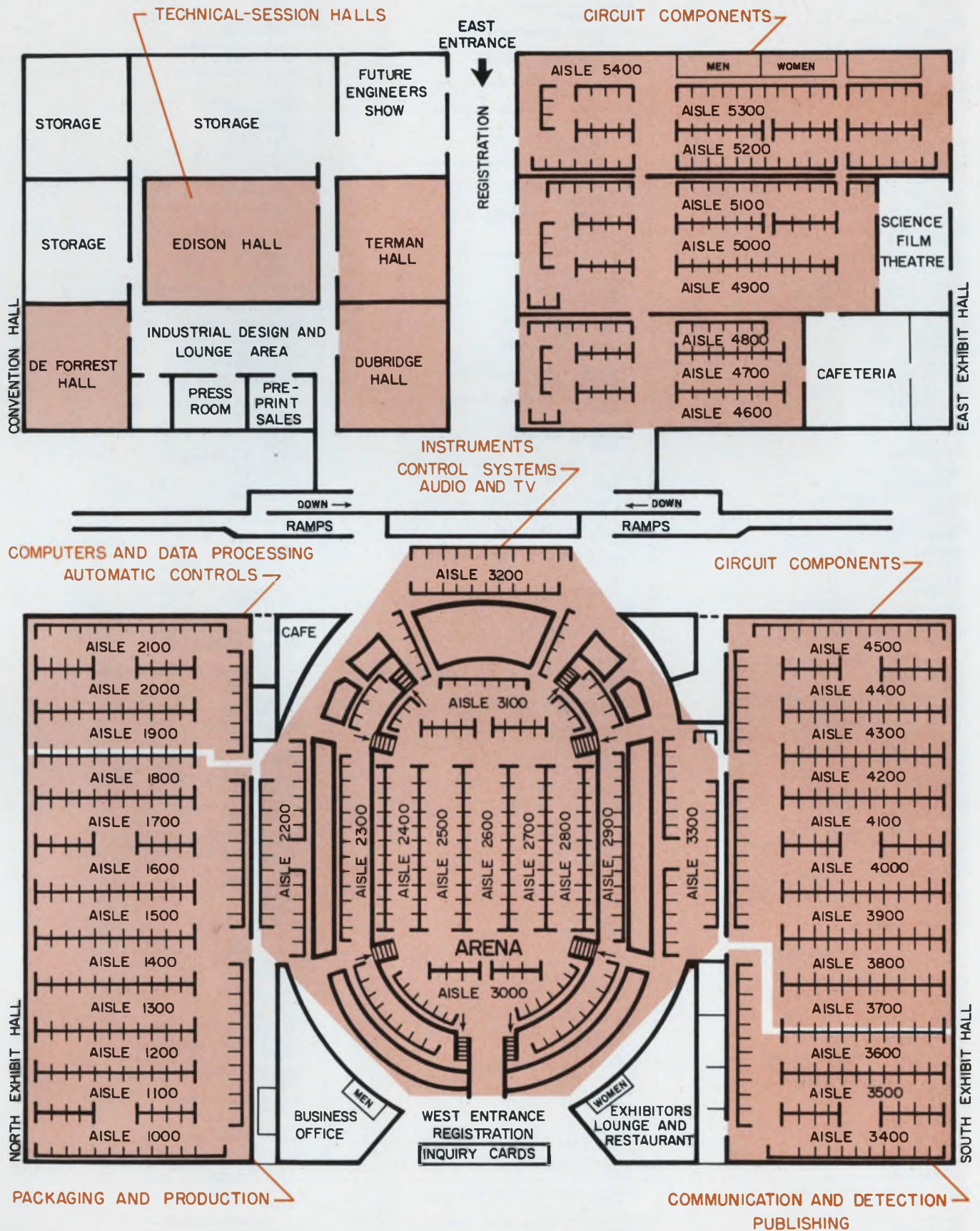

exhibitors' list

- Custom Materials, Inc.
3524
- Cutler Hammer, Inc.
4313-4317
- Cyclo-Tronics, Inc.
1024
- Dana Laboratories, Inc.
2406-2409
- Darcy Industries, Inc.
Behlman-Invar & Transistor Specialties Div.
2211-2214
- Data Technology, Inc.
3103
- The Datak Corp.
1417
- Datapulse Inc.
2719-2721
- Dearborn Electronics, Inc.
5212
- Decontamination, Inc.
1406
- Delco Radio
Div. of General Motors Corp.
5035-5037
- Del Electronics Corp.
5005
- Deltrol Controls Corp.
5317-5318
- Dempa Publications, Inc.
3501
- Dentronics, Inc.
5313
- Diallight Corp.
5239-5240
- Digital Equipment Corp.
2102-2105
- Diotran Pacific
1220
- DoAll Co.
5324-5325
- Dodge Industries
1120-1121
- Dolan-Jenner Industries
5128
- Dormeyer Industries
5100-5101
- Dow-Key Co.
4917
- Drake Mfg. Co.
5030
- Dressen-Barnes Electronics Corp.
4017-4019
- Wilbur B. Driver Co.
3903
- E. I. du Pont de Nemours & Co.
Freon Products
1404-1405
- E. I. du Pont de Nemours & Co.
1304-1306
- Durant Manufacturing Co.
2124-2125
- Dymo Products Co.
1901
- Dynamic Gear Co., Inc.
1805
- Eagle-Picher Industries, Inc.
1218-1219
- Eastern Industries
Div. of Laboratory for Electronics, Inc.
1507-1508
- Eastern Marking Machine Corp.
1301
- Eastman Chemical Products, Inc.
5223
- Eastman Kodak Co.
5224-5226
- Eastman Kodak Stores, Inc.
5406-5408
- The Ednalite Corp.
OCVI Instrument Div.
1810
- EG&G
Products Div.
5241-5242
- E-H Research Laboratories, Inc.
3319-3322
- Eico Electronic Instrument Co., Inc.
3308
- Elco Corp.
4323-4324
- Eldorado Electronics
3123
- Eldre Components, Inc.
1313-1314
- Electralab Electronics Corp.
1407
- The Electro Motive Mfg. Co., Inc.
5002-5003
- Electro Scientific Industries, Inc.
2717-2718
- Electro Switch Corp.
4513
- Electroglas, Inc.
1915-1916
- Electronic Associates, Inc.
2725, 2729, 4908
- Electronic Controls, Inc.
5113-5114
- Electronic Design
3621-3622
- Electronic Enclosures, Inc.
1502
- The Electronic Engineer
3515
- Electronic Engineering Co. of Calif.
4114-4115
- Electronic Industries Association
3122
- Electronic News
3612-3613
- Electronic Representatives Association
3312
- Electronic Specialty Co.
3510-3511
- Electronized Chemicals Corp.
1115-1116
- Electrovert, Inc.
Components Equipment Div.
1111
- Electrovert, Inc.
Electromechanical Div.
1807-1808
- Emerson & Cuming, Inc.
2901-2902
- Engelhard Industries, Inc.
1617-1618
- Engineered Electronics Co.
4112-4113
- Engineered Machine Builders
1006
- Enviroco, Inc.
Subsidiary of Becton, Dickinson & Co.
1311
- Epoxy Dispensing Equipment Mfg.
Div. of Electric Switches, Inc.
1216
- Equipment & Materials Reporter
3508
- The Eraser Co., Inc.
1918
- Esterline Angus Instrument Co., Inc.
4705
- ETC, Inc.
5214-5215
- Ethyl Corp.
Industrial Chemicals Div.
1923-1924
- Exact Electronics, Inc.
3315
- Fairchild Camera & Instrument Corp.
2504-2509, 2524-2529
- Fetty Schoenduve, Inc.
5104-5105
- Field Emission Corp.
4804-4805
- Filmohm Corp.
4411
- Filtors, Inc.
4108-4109
- The Filtron Co., Inc.
3007
- John Fluke Mfg. Co., Inc.
3209-3211
- Fluoroware, Inc.
4916
- Franklin Electronics, Inc.
4609-4610
- Friden Inc.
3422-3423
- Fusite Corp.
1510
- Gardiner Solder Co.
1324-1325
- W. K. Geist Co.
2209-2210
- General Electric Co.
4301, 4322
- General Instrument Corp.
5401-5404
- General Magnetic Corp.
5329-5330
- General Precision, Inc.
GPL Div.
2322-2323
- General Radio Co.
3015-3018
- General Resistance Corp.
2207
- Geoscience Instruments Corp.
1307
- Geo Space Corp.
Industrial Products Div.
4723-4725
- Globe Industries, Inc.
4219-4220
- Gordos Corp.
5102-5103
- W. L. Gore & Associates, Inc.
1822
- Gorman Machine Corp.
1925
- Gould-National Batteries, Inc.
5305-5306
- Granger Associates
2907-2908
- Granville-Phillips Co.
1418
- Graphic Controls Corp.
3203-3204
- Grayhill, Inc.
4110-4111
- Gremar Mfg. Co., Inc.
4016
- Guardian Electric Mfg. Co.
4514-4515
- Gudebrod Bros. Silk Co., Inc.
1622
- Gulton Industries, Inc.
5314-5315
- W & L E. Gurley
2903
- Halliburton Enterprises, Inc.
Mfg. Div.
1523-1524
- Hallmark Standards, Inc.
3110-3111
- The Hartwell Corp.
1513-1514
- Hastings-Raydist, Inc.
2904
- Hathaway Instruments, Inc.
5321-5322
- Hayden Book Co., Inc.
3620
- Hayden Publishing Co.
3621-3622
- Heinemann Electric Co.
3921-3922
- Heller Industries, Inc.
1512
- Hellermann Ltd.
5405
- Hermetic Seal Corp.
4525
- Carl Herrmann Associates
1411-1412
- Hewlett-Packard
2909-2921, 4217-4218
- Hexacon Electric Co.
1904
- The Hickok Electrical Instrument Co.
3002-3003
- Hi-G, Inc.
4009-4011
- Honeywell, Inc.
2701-2703
- Hoyt Electrical Instrument Works, Inc.
4312
- Hudson Tool & Die Co., Inc.
1302-1303
- Huggins Laboratories
4203-4204
- Hughes Aircraft Co.
Vacuum Tube Products Div.
1704-1705, 3004
- Hugle Industries
1919-1920
- Hull Corp.
1813
- Hunter Industries
1809
- Hunter Spring
Div. of Ametek, Inc.
3521
- Hysol of Calif.
1421
- IBM Corp.
5012-5015, 5121-5124
- Icore Electro-Plastics, Inc.
1616
- Ideal Industries, Inc.
1806
- Ideal Precision Meter Co., Inc.
3305
- The IEEE, Inc.
West Registration Area
- The IEEE, Inc.
San Francisco Section
East Registration Area
- Illumination Industries, Inc.
4914
- IMC Magnetics Corp.
2118-2119

160V

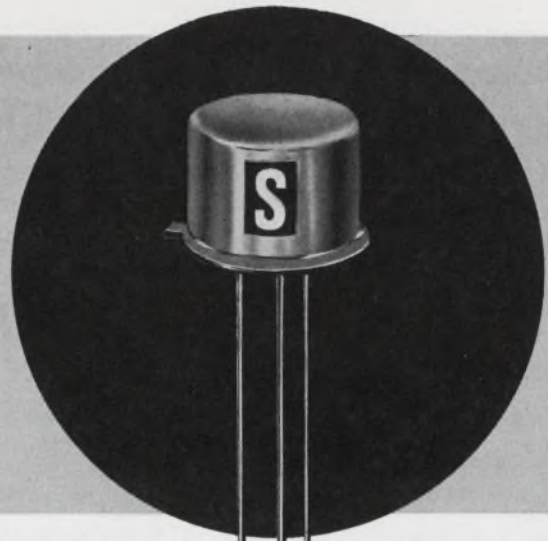

pnp silicon chopper transistors

from

Solitron

Solitron, now in full production of small signal transistors, has a complete line of PNP Silicon Choppers with voltage capabilities up to 160 Volts. Identified as the SSS 1001-4 Series, these devices are available in the TO-5 package. They offer high reliability, low saturation voltages and can be purchased as pairs with offset voltages matched to $100 \mu\text{V}@T_A=25^\circ\text{C}$. A few of their many circuit applications include modulators, servos, telemetry and multiplexing.

Type Number TO-5	Power Dissipation $T_A = 25^\circ\text{C}$ (mW)	Rated Breakdown Voltages			I_{ECX}			I_{p1}		$V_{CE(sat)}$		C_{obo}	
		V_{BECBO} (Volts)	V_{BEC10} (Volts)	V_{BECBO} (Volts)	Max (na)	V_{ec} (Volts)	V_{ec} (Volts)	Max (na)	V_{ec} (Volts)	Max (mV)	I_b (μa)	Max (pf)	V_{ce} (Volts)
2N 1920	250	-40	-18	-40	-2.5	10	-15	-1.5	10	3.0	-500	14	-6
2N 1921	250	-50	-50	-50	-10	10	-30	-2.0	10	4.0	-750	14	-6
2N 3345	250	-50	-50	-50	—	—	—	—	—	3.0	-1000	25	-0
2N 3346	250	-50	-50	-50	—	—	—	—	—	1.5	-1000	25	0
2N 1922	250	-80	-80	-80	-10	10	-50	-2.0	10	4.0	-750	14	-6
SSS 1001	400	-100	-100	-100	-10	10	-60	-3.0	10	2.0	-750	30	-6
SSS 1002	400	-120	-120	-120	-10	10	-70	-3.0	10	2.0	-750	30	-6
SSS 1003	400	-140	-140	-140	-10	10	-80	-3.0	10	2.0	-750	30	-6
SSS 1004	400	-160	-160	-160	-10	10	-90	-3.0	10	2.0	-750	30	-6

*Emitter Offset Current **Emitter Offset Voltage

DIAL 1- 800-327-3243 FOR A NO CHARGE TELEPHONE CALL AND FURTHER INFORMATION

Solitron DEVICES, INC.

1177 BLUE HERON BLVD. / RIVIERA BEACH, FLORIDA / (305) 848-4311 / TWX: (510) 952-6676

Leader in Germanium and Silicon Transistors, Cryogenic Thermometers, High Voltage Rectifiers, Hot Carrier Diodes, Temperature Compensated Zeners, Voltage Variable Capacitors, Random/White Noise Components, Microelectronic Circuits, and Power-Sink Interconnection Systems.

ON READER-SERVICE CARD CIRCLE 856

exhibitors' list

Industrial Electronic Engineers, Inc.
3201-3202
Industrial News
3618
Industrial Test Equipment Co.
2304
Information Control Corp.
2006
Information Handling Services, Inc.
4601-4722
Information Retrieval, Inc.
3907-3908
Insaco, Inc.
1615
Instrulab, Inc.
4816
Intercontinental Instruments, Inc.
3104
International Instruments, Inc.
4605
International Telephone & Telegraph Corp.
3807-3816
Instruments Specialists
3213
Iota-Cam Corp.
4807
I-T-E Circuit Breaker Co.
5119
I-Tel, Inc.
3610-3611
B. Jadow & Sons, Inc.
1103
James Electronic Tool Co.
1221
Jey-El Products, Inc.
5007
J-B-T Instruments, Inc.
4206
Jerrold Electronics Corp.
Subsidiary of the Jerrold Corp.
3118-3120
JFD Electronics Co.
Components Div.
4015

E. F. Johnson Co.
5326
Jonathan Manufacturing Co.
1202
Julie Research Laboratories, Inc.
4607
K.C. Shokai Limited
4714-4715
Kasper Instruments Inc.
1906
Kay Electric Co.
2804-2806
Kedman Co.
1911
Keithley Instruments, Inc.
3008-3009
Kelsey-Hayes Co.
Utica Tool Div.
1905
Kennedy Co.
2416
Kepco, Inc.
2715-2716
Keuffel & Esser Co.
1509
Kester Solder Co.
1601
Kings Electronics Co., Inc.
4915
Kingsley Machine Co.
1420
Mathias Klein & Sons, Inc.
1707
Kole Enterprises, Inc.
1020
Komatsu Electronic Metals Co., Ltd.
5110
Korad Corp.
2708
Krohn-Hite Corp.
3307
Kruse Storke Electronics
4706
K S M Products, Inc.
1011-1012
Kulka Electric Corp.
4025
Kyoto Ceramic Co., Ltd.
5219

Lambda Electronics Corp.
5303-5304
Landis & Gyr, Inc.
5340-5341
Lawrence Laboratory, Inc.
3605
Leach Corp.
3005-3006
Lear Siegler, Inc.
Cimron Div.
2603-2604
Lear Siegler, Inc.
Power Equipment Div.
2013
Ledex, Inc.
5216-5218
Leeds & Northrup Co.
2203-2204
Leesona Corp.
1725
Leesona Moos Laboratories
Div. of Leesona Corp.
4911
E. Leitz, Inc.
4824
LFE Electronics
Div. of Laboratory for Electronics, Inc.
2025
Lindberg Hevi-Duty
Div. of Sola Basic Industries
1712-1714
Licon/Paktron
Div. of Illinois Tool Works, Inc.
4412-4413
Line Electric Co.
5020
Littelfuse, Inc.
4401
Litton Industries
4207-4216
Littrell Western Sales, Inc.
1521
Lockheed Electronics Co.
Avionics & Industrial Products Div.
5220
Lockheed Missiles & Space Co.
3519-3520
The London Co.
2208
L & R Mfg. Co.
1001-1002
Luscombe Engineering Co.
4521-4523
Luxo Lamp Corp.
1410
Lyon Van & Storage Co.
1118
Mactier Publishing Corp.
3408
Magnecraft Electric Co.
4023
Magnetic Shield
Div. of Perfection Mica Co.
1602
Malco Manufacturing Co., Inc.
5311-5312
P. R. Mallory & Co., Inc.
4020-4022
The Maltby Co.
1318-1322
Marconi Instruments
Div. of English Electric Corp.
2619-2620
Markem Machine Co.
1112-1113
Master Specialties Co.
5126-5127
Matrix
Div. of Schafer Electronics
2608
McFadden Electronics Co.
2007
McLean Engineering Laboratories
3107
Measurement Control Devices, Inc.
4707
Measurements
Div. of McGraw-Edison Co.
2803
Mechanical Enterprises, Inc.
3415
Adolf Meller Co.
3619
Melpar, Inc.
4425
Memcor, Inc.
Components Div.
3917-3918
Microdot Instrument Co.
4710-4711
Microlab
Subsidiary of F X R Corp.
3424-3523
Micro Science Associates
1224

The naked truth!

Now for the first time ever! The unexpurgated Redcor/Module's complete 10-channel multiplexer facts are laid bare! A lascivious thrill will run down your spine when you learn of its voluptuous 100 kc throughput rate! Its luscious 5 μ sec settling time! Your blood will thunder through your veins, your mind reel, at the wildly exciting possibility of eliminating multiplexer

modulations and offset! All this and more are yours in a bold new data sheet, "Sex & Specs & our Multiplex", available to all red-blooded engineers at **no cost!** Engineers under 18 must have a note from mommy.

REDCOR 7800 DEERING AVENUE
CANOGA PARK,
CALIFORNIA 91304

(213) 348-5892 • TWX 910-494-1228

ON READER-SERVICE CARD CIRCLE 857

Think
vertically.

Get your
functional
circuit
designs
stacked
in a
MicroCircuit
Pack™...
ready to
mount.

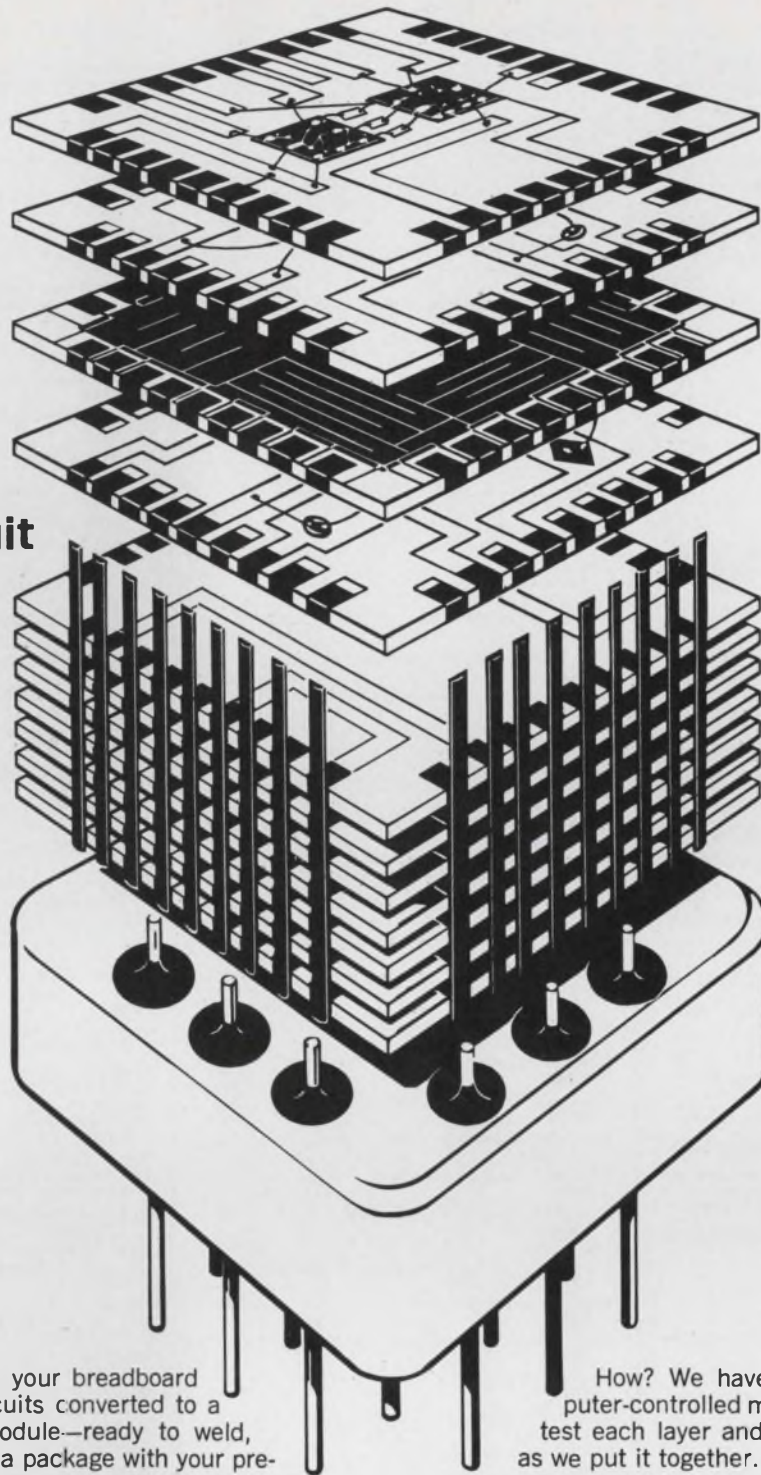

SEE US
AT
WESCON

Wouldn't you like to see your breadboard model of functional circuits converted to a fully microelectronic module—ready to weld, solder, or plug in? Want a package with your preferred mix of semi-conductors, monolithic integrated circuits, thin film and discrete devices ready to perform a number of system functions, either analog or digital—one that combines all the advantages of vertical, multilayer stacking, welded interconnections, hermetically-sealed enclosure, and uniform modular assembly?

That's no pipe dream with Hamilton Standard's MicroCircuit Pack technology. We can deliver a custom-built module of up to 15 ceramic wafers, pretested to meet your design, in either evaluation or production quantities. And it will cost far less than you would think.



Actual size

How? We have developed flexible, computer-controlled methods of manufacture. We test each layer and each module step-by-step as we put it together. And we use electron-beam scribing, welding and sealing under ultraclean vacuum conditions. Results? Your packaged module is strong and reliable, will resist moisture and radiation, and will operate over a wide temperature range.

Whatever your system requirements might be, investigate going to MicroCircuit Packs direct. Consider all the in-between expenses you can save. For more information, price quotations, or assistance in component selection and system layout, contact the Marketing Manager, Electronics Department, Hamilton Standard, Windsor Locks, Conn., 06096. Phone (203) 623-1621, ext. 2012. TWX 710-420-0586.

Hamilton Standard DIVISION OF UNITED AIRCRAFT CORPORATION
WINDSOR LOCKS, CONNECTICUT

U
A

ON READER-SERVICE CARD CIRCLE 858



Actual photograph of a 0.0001" diameter hole drilled through a human hair. This is precision micro-drilling, but it's crude compared to what can be done with NAJET know-how.

DRILL ULTRA-SMALL HOLES

If you have a requirement for small and ultra-small holes in any phase of circuit or component fabrication, take a look at the capabilities National Jet can give you. NAJET is the only firm in the world that supplies both drilling machines and drills for microtechnology, featuring standard catalog equipment that lets you drill virtually any material with holes from 0.0001-inch to 0.125-inch diameter, and with size and location tolerances unmatched by any other method.

MICRODRILLING SERVICE !

If drilling volume is too low to warrant the purchase of micro-tooling equipment, NAJET will drill your products to your own specifications at its factory—another exclusive in the microminiature drilling field.

WORK UP, NOT DOWN.

Consider carefully this basic concept: you can cut design time drastically, reduce rejects to practically zero, and eliminate "trial-and-error" drilling completely by WORKING UP to your size requirements with NAJET equipment, rather than painstakingly working down to your requirements with other equipment.

**write today
for details**



**NATIONAL
JET
COMPANY**

10 CUPLER DRIVE, LAVALE,
CUMBERLAND, MARYLAND 21502

ON READER-SERVICE CARD CIRCLE 859

exhibitors' list

- Micro Switch
Div. of Honeywell
4012-4014
- Microtech Co.
Div. of Ovitron Corp.
4918-4919
- Micro Tech Mfg., Inc.
1222-1223
- Microtran Co., Inc.
4307
- Microwave Associates, Inc.
3723-3724
- Microwave Development Laboratories
3522
- Microwaves
3621-3622
- James Millen Mfg. Co., Inc.
3817
- J. W. Miller Co.
3823
- Miller Dial & Name Plate Co.
2324-2325
- Millivac Instruments, Inc.
2510
- 3M Co.
1613-1614
- 3M Co.
Visual Products Div.
1612
- MM Electronic Enclosures, Inc.
1023
- Mohawk Data Sciences Corp.
2101
- Monitor Products Co., Inc.
4205
- Monitor Systems, Inc.
2008
- Monsanto Co.
4701-4702
- Motorola, Inc.
Precision Instrument Products
3116-3117
- Moxon Electronics Corp.
2616-2617
- Murata Mfg. Co., Ltd.
5006
- Mystik Tape
Div. of the Borden Chemical Co.
1719-1720
- The Narda Microwave Corp.
2704-2705
- National Beryllia Corp.
1724
- National Electronic Distributors
3220
- National Research Corp.
1715-1718
- National Tel-Tronics Corp.
4909
- National Wire & Cable Corp.
1908-1909
- Navan, Inc.
Subsidiary of North American Aviation, Inc.
1701-1703; 1801
- Neff Instrument Corp.
5001
- New Hermes Engraving Machine Corp.
1525
- Newton Insert Co.
1817
- Nexus Research Laboratory, Inc.
2420-2421
- The J. M. Ney Co.
4508
- N J E Corp.
2218
- Non-Linear Systems, Inc.
2807-2811
- North American Aviation, Inc.
5201-5202
- North Atlantic Industries, Inc.
3215-3216
- O'Halloran Associates
2709
- Ohmite Manufacturing Co.
3901-3902
- Omni Spectra, Inc.
3601-3603
- Optimation, Inc.
3208
- Opto-Metric Tools, Inc.
4825
- Pamator, Inc.
1910
- Panduit Corp.
1902-1903
- Parker Seal Co.
1721-1722
- Pek, Inc.
4414
- Perkin-Elmer Corp.
Electronic Products Div.
5307
- Perrygraf Corp.
4822-4823
- Phaestron Instrument & Electronic Co.
2401
- Phelps Dodge Electronic Products Corp.
3502
- Philbrick Researches
A Teledyne Co.
3313-3314
- Philco-Ford Corp.
Western Development Laboratories Div.
2122-2123
- Photocircuits Corp.
4409-4410
- Physical Sciences Corp.
4907
- PIC Design Corp.
4024
- Plastic Capacitors Inc.
4308
- Polarad Electronic Instruments
Div. of Polarad Electronics Corp.
3101-3102
- Politi Associates
5222
- Pomona Electronics Co., Inc.
5203
- Potter & Brumfield
4101-4102
- Power Designs, Inc.
3121
- PRD Electronics, Inc.
3105-3106
- Precision Instrument Co.
2009-2010
- Precision Systems Co., Inc.
1210-1212
- Prentice-Hall, Inc.
3512
- Presin Co., Inc.
2003
- Princeton Applied Research Corp.
2706-2707
- Probe-Rite Co.
1217
- Commonwealth of Puerto Rico (EDA)
4612-4613
- Qualitron Corp.
1914
- Quan-Tech Laboratories, Inc.
2219-2220
- Quik-Set, Inc.
4717-4718
- Radiation Inc.
Microelectronics Div.
5130-5131
- Radio Corp. of America
Electronic Components & Devices
3701-3705, 3718-3722
- Radyne International, Inc.
1308-1309
- Ram Television Products
Div. of Canoga Electronics Corp.
2615
- Rantec
Div. of Emerson Electric Co.
2301-2302
- Raychem Corp.
1609-1610
- Raytheon Co.
4418-4422
- Raytheon Computer
2001-2002
- RCK, Inc.
1114
- Redcor Corp.
2215-2216
- Remex Electronics
2011-2012
- Resilofam, Inc.
Subsidiary of General Plastics Corp.
1003-1005
- R F Communications
2722
- RFL Industries, Inc.
2307-2308
- RHG Electronics Laboratory, Inc.
3607-3608
- Rimbach Publications
Div. of Chilton Co.
3614
- RO Associates, Inc.
3609
- Robison Electronics, Inc.
5231-5232
- Rogan Brothers, Inc.
1312
- Rosan, Inc.
1213

JFD's Capacitor Progress Report '67-'68

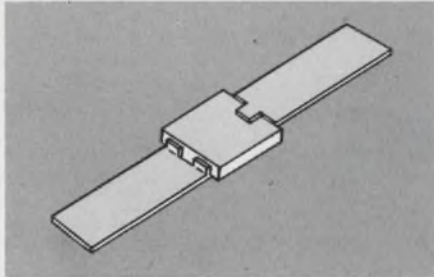

up to 7.5 KV RF, 10 KVDC
up to 12 amps RF, 24 KVAR
Solid Silver terminals

Uniceram
MINIATURE RF POWER CERAMIC CAPACITORS

up to 2500 V peak @ 2 MHz & 200°C
0.5 to 5.0 pf
Q > 2000 @ 1 MHz

**JFD Precision — HIGH VOLTAGE
QUARTZ VARIABLE CAPACITORS**

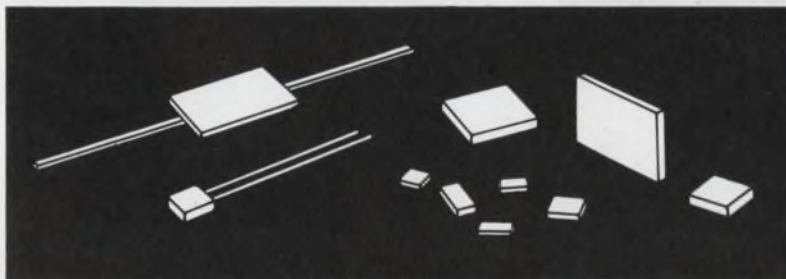
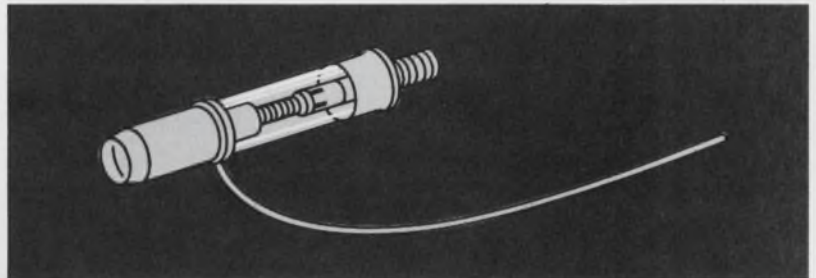

.001 to 1.5 Mfd
25 to 200 WVDC
T.C.: ±15% (—55°C to +125°C)

**Uniceram — HIGH K
CERAMIC CAPACITORS**

0.1 to 50.0 Mfd
Epoxy-dip coat
Quality @ low cost

Stangard
MINIATURE SOLID TANTALUM CAPACITORS

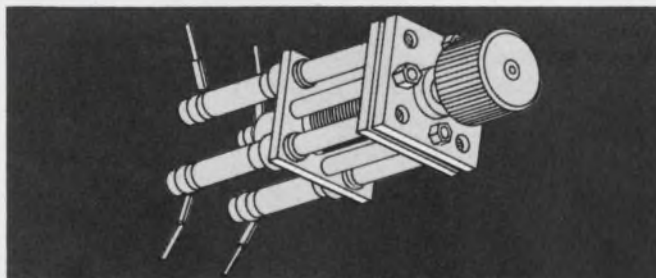
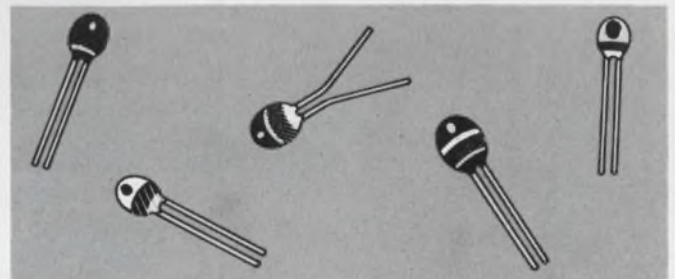

NEW Standardized drive
4 & 8 element models
wide choice of capacitance

JFD Long Life
Modular COMPACTUNERS

VISIT JFD'S WESCON BOOTH 4015

Write for your JFD/CCS. A one stop components reference file!

"TODAY'S COMPONENTS BUILT FOR TOMORROW'S CHALLENGES"

JFD

JFD ELECTRONICS CO. / COMPONENTS DIVISION • 15th Avenue at 62nd Street • Brooklyn, New York 11219 / Phone 212-331-1000
Sales Offices — Arcadia, California / Chicago, Illinois / Baltimore, Maryland / Saxonville, Massachusetts / Brooklyn, New York
New Hartford, New York / Cincinnati, Ohio / Philadelphia, Pennsylvania / Pittsburgh, Pennsylvania / Paris, France / Azor, Israel

ON READER-SERVICE CARD CIRCLE 860

exhibitors' list

Rosemount Engineering Co.
4810-4811

The Milton Ross Co.
1804

Rotron Manufacturing Co., Inc.
4415-4417

The Rowan Controller Co.
5233-5234

Royal Zenith Corp.
1201

Rucker Electronics
4121

Rustrak Instrument Co., Inc.
4817

Les Sachs Associates
1408

Sanders Associates, Inc.
4325, 4423-4424

San Fernando Electric Mfg. Co.
4124-4125, 4223

Sangamo Electric Co.
3010-3011

Schry-Way Cases
1409

Scientific-Atlanta, Inc.
1422, 2305-2306

SCM Corp.
2004

Seaelectro Corp.
4309-4311

Secs, Inc.
5331

Seiscor Mfg. Co.
4801-4802

Semikron International, Inc.
5347

Shibaden Corp. of America
2201-2202

Siemens America, Inc.
4818-4819, 5027-5028

Signetics Corp.
5016-5018, 5120

Silicon Transistor Corp.
5323-5323A

Simonds Machine Co., Inc.
1009

Simpson Electric Co.
2501-2503

The Singer Co.
Metrics Div.
2410-2415

Skydyne, Inc.
1818-1819

Herman H. Smith, Inc.
4123

Solidstate Controls, Inc.
2121

Solid State Equipment Corp.
1014-1015

Solid State Products, Inc.
5115-5116

Sonobond Corp.
1921-1922

Sony Corp. of America
3316-3317

Sorensen Operation
Raytheon Co.
2422-2423

Southco, Inc.
1204-1205

Specific Products
2518

Spectra-Physics, Inc.
2922-2925

Speer Carbon Co.
5327-5328

Sprague Electric Co.
3801-3804, 3819-3822

J. W. Stacey, Inc.
3525

Staco, Inc.
5204

Stanford Applied Engineering, Inc.
5112

Starlite Industries, Inc.
1519-1520

Sterling Instrument
Div. of Designatronics, Inc.
1611

Stevens-Arnold, Inc.
4318

Geo. Stevens Mfg. Co., Inc.
1816

Stewart Stamping Corp.
1225

The Superior Electric Co.
2318-2321

750 MHz Sampling Oscilloscope for \$995



If your present oscilloscope has a minimum band width of 50 KHz, you can convert it into a high speed sampling oscilloscope using the Aerometrics dual channel pulse sampler. The Model SA-300 may also be used with an inexpensive X-Y recorder for permanent recording of fast computer wave forms, radar pulses, semiconductor characteristics, etc. The all solid state Aerometrics sampler offers rise time of typically one nanosecond and sweep speeds from 10 nanoseconds to 5 microseconds per full sweep. Like other Aerometrics instruments, the SA-300 features portability through compactness and light weight.

Multimeters, Pulse Generators & Electronic Counters

A full range of instruments which excel in precision, compactness, ruggedness, portability and flexibility—the most dependable instruments you'll ever use—and all in competitive price ranges. Be sure and check Aerometrics' specifications before investing in test equipment.



See us at WESCON Exhibit Booth Nos. 3304-A & 3305-A
and at ISA Exhibit Booth No. 544

AEROJET
GENERAL TIRE
GENERAL

AEROMETRICS

San Ramon, California 94583 • P.O. Box 216

See us at ISA Exhibit Booth No. 544

ON READER-SERVICE CARD CIRCLE 861

ELECTRONIC DESIGN 17, August 16, 1967

Direct Reading Precision Phase Measurements to 1MHz



The Aerometrics Model PM-720 Phase Meter covers from 0 to 180 degrees in four ranges. For measurements above 180 degrees, the PM-720 utilizes automatic lead-lag indicator lights to give direct reading capability to 360 degrees. The amplitude ratio of the two input signals can be as high as 5000 to 1 with sensitivity of 100 mv (p-p) to 500 v (option available to 1 mv). For direct meter readings the accuracy is $\pm 2\%$ but increase accuracy of $\pm .2\%$ can be obtained by utilizing the DC voltage output which reads directly in degrees on a DVM. The compact, all solid state construction offers true portability (total weight 7 pounds). Aerometrics also offers Model PM-730 which covers 0 to 360 degrees in four ranges. The frequency is extended to 1 MHz. The PM-730 also offers the unique advantage of measuring phase relationship between dissimilar wave forms.

Do you have Phase Measurement Problems to 750 MHz?

The PM-730 can be used with the Aerometrics Model SA-300 pulse sampler to give precision phase measurements to 750 MHz. For further information, write or visit us at the ISA and WESCON Shows.

See us at WESCON Exhibit Booth Nos. 3304-A & 3305-A and at ISA Exhibit Booth No. 544

AEROMETRICS
San Ramon, California 94583 • P.O. Box 216

See us at ISA Exhibit Booth No. 544

ON READER-SERVICE CARD CIRCLE 862

ELECTRONIC DESIGN 17, August 16, 1967

Susumu Industrial Co., Ltd.
4912
Swiss American Precision Imports, Inc.
1517
Switchcraft, Inc.
3906
Sylvania Electric Products, Inc.
3706-3717
Synthane Corp.
1401
Systems Research Corp.
2612
Systron-Donner Corp.
2402-2405
Tally Corp.
2608
The Taylor-Winfield Corp.
1102
Technibilt Corp.
3318
Technical Information Corp.
3616-3617
Technical Measurement Corp.
3606
Technical Products Co.
4815
Technical Wire Products, Inc.
1501-1603
Tektronix, Inc.
2818-2823
Tel-Com Instruments, Inc.
4803
Teletype Corp.
3504-3505
Telonic Engineering Co.
Div. of Telonic Industries, Inc.
3124-3125
Telonic Instruments
3126-3128
Tempil Corp.
1021-1022
Teradyne
3205-3207
Texas Instruments Inc.
4105-4107
Texscan Corp.
4820-4821
Thermco Products Co.
1315-1317
The Thomas & Betts Co.
1104-1105
Thomas & Skinner, Inc.
4008
Tool Components, Inc.
1124
Torr Laboratories, Inc.
2113
Tracor, Inc.
2205-2206
Transformer-Electronics Co.
5109
Transistor Automation Corp.
1912-1913
Transitron Electronic Corp.
3909-3911
Trimm, Inc.
5213
Triplett Electrical Instrument Co.
3013-3014
Tronic Corp.
1814-1815
TRW Electronics
4402-4404
Trygon Electronics Inc.
2618
Trymetrics Corp.
3112
Ungar Electric Tools
Div. of Eldon Industries, Inc.
1604-1605
Unholtz-Dickie Corp.
4806
Uniform Tubes, Inc.
1414
Union Carbide Corp.
3218-3219, 5310
United Aircraft Corp.
5031-5034, 4901-4904
United Air Lines, Inc.
3412
United States Dynamics
1419
United Technical Publication
Subsidiary of Cox Broadcasting Corp.
3625
United Transformer Co.
Div. of TRW Inc.
3925
United Van Lines, Inc.
1511
Unitek Corp.
Weldmatic Div.
1515-1516

exhibitors' list

Unitrode Corp.
5107-5108
Universal Instruments Corp.
1607-1608
Vaco Products Co.
1125
Vacco Electronics
Div. of Vacco Industries
5111
Valor Associates
5117-5118
Valpey Corp.
3416-3417
Varian Associates
2309-2317

Varo, Inc.
5342-5343
Vector Electronic Co., Inc.
4122
Veeco Instruments, Inc.
5301-5302
Velonex
Div. of Pulse Engineering, Inc.
3301
Vero Electronics, Inc.
5008
Victor Comptometer Corp.
2015
Viking Industries, Inc.
4001-4002
Virginia Panel Corp.
5029
Vitramon, Inc.
3919-3920
Waber Electronics, Inc.
4516

Wakefield Engineering, Inc.
5332
Wang Laboratories, Inc.
2016-2017
Warner Electric Brake & Clutch Co.
2022-2024
Watkins-Johnson Co.
Stewart Div.
1323
Watkins-Johnson Co.
3623-3624
Wavetek
2417-2418
Wayne Kerr Corp.
2905-2906
Weckesser Co., Inc.
1413
Weinschel Engineering Co., Inc.
4606
The Welch Scientific Co.
1415-1416
Wells Electronics, Inc.
1122-1123
Welwyn International Inc.
4913
Western Electronic Manufacturers Assoc.
North Concourse
3506
Western Electronic News, Inc.
3506
Western Microwave Laboratories, Inc.
3418
Westinghouse Electric Corp.
5205-5210, 5334-5339
Westline Products
1823
Weston Instruments, Inc.
2511-2514, 2519-2522
S. S. White Co.
Industrial Div.
1811-1812
Whittaker Corp.
Gencom Div.
2723-2724
Wiltron Co.
2711-2712
B. J. Wolfe Enterprises
4704
Xcelite Inc.
1402
X-Ion Corp.
4608
Yellow Springs Instrument Co., Inc.
5309
Zeltex, Inc.
5319-5320
The Zippertubing Co.
1505

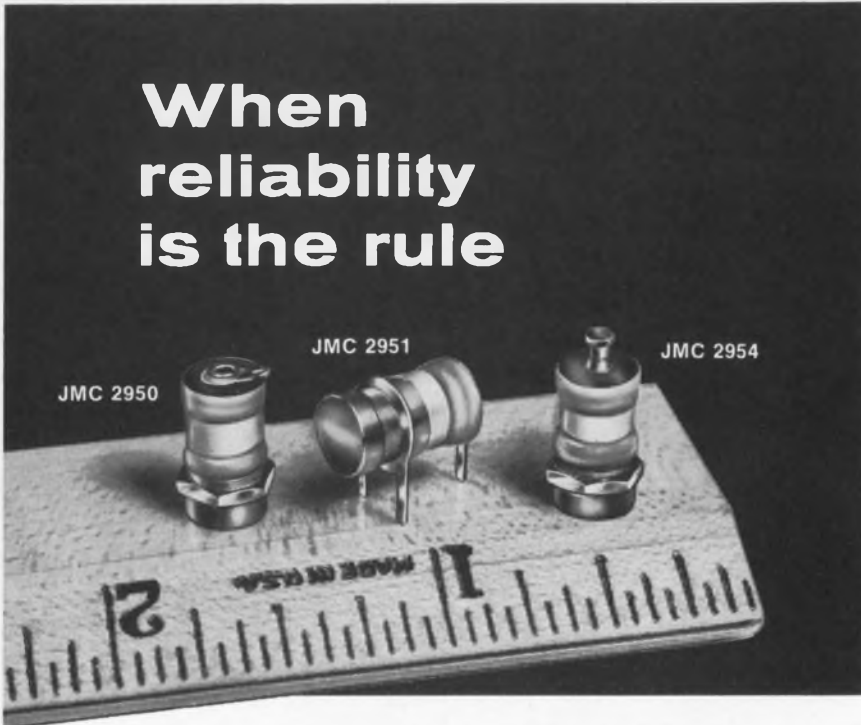

When reliability is the rule

JMC 2950 JMC 2951 JMC 2954

... specify *Johanson*

HIGH Q, HIGH FREQUENCY VARIABLE AIR CAPACITORS

This versatile series provides, in miniature size, exceptionally high Q, superior ruggedness for protection against shock and vibration, -55° to $+125^{\circ}\text{C}$ operating temperature range, protection against fungus, salt spray and humidity... plus all the other construction and performance features that have made Johanson capacitors the industry standard for excellence.

Specifications

Capacitance Range: 0.8 — 10.0 pF
Dielectric Withstanding Voltage:
Rating 250 VDC breakdown >500 VDC
Insulation Resistance: $>10^6$,
megohms @ 500 VDC
Q: >2000 @ 100 mc
Temperature Coefficient: 0 ± 20 ppm/ $^{\circ}\text{C}$
Rotational Life: >800 revolutions

Write Today for Complete Catalog, Prices.

Johanson **MANUFACTURING CORPORATION**
400 Rockaway Valley Rd., Boonton, N.J. 07005, (201) 334-2676

Electronic Accuracy Through Mechanical Precision

ON READER-SERVICE CARD CIRCLE 863

WESCON greeter



Robert Ward, chairman of WESCON's hospitality committee, will discuss highlights of the show with visiting ladies.

ON READER-SERVICE CARD CIRCLE 864 ➤



king me!

Outwit Your Data Simulation Problems

Crown the Datapulse Model 201 16-Bit Data Generator with a pulse generator and solve your data simulation problems economically.

For only \$680.00, the 201 provides these superior features: 16-bit cycle lengths, bit rates to 10 MHz (from an external clock), NRZ outputs to 10V, variable baseline offset to $\pm 10V$, and continuous or command recycle.

To king the 201 simply add a Datapulse 101 Pulse Generator — \$395.00 — or any other async-gated pulse generator with the output characteristics you need.* The result: a system capable of producing variable parameter RZ formats — ideal for a host of simulation tests on components, circuitry, memory elements, or data transmission links — the perfect programmer for developing time related sequential signals to command systems operations.

*Datapulse Model 111 for ultra-fast linear rise times; Datapulse Model 108 for 50V outputs; Datapulse Model 110A for fully controllable fast pulses, etc.

Interconnect several 201's for longer serial words or additional parallel channels. Then set up programs for core testing, drive any gate array from zero to +10V, produce true complimentary outputs to drive adders, etc.

There's one more thing about the 201. It's small. Two units can be mounted in just 3½ inches of rack panel height.

If the 201 doesn't solve all your data simulation problems, pick up a copy of our catalog! We offer more off-the-shelf digital test instrumentation than any other manufacturer in the world, so if you don't have our catalog, do something about it!

Your move!



SEE THEM ALL AT WESCON, BOOTHS 2719-21



Datapulse Incorporated — A Subsidiary of Systron Donner Corporation, 10150 West Jefferson Blvd., Culver City, California 90230. Telephone: (213) 836-6100, 871-0410. TWX: 910-340-6766. CABLE: Datapulse • Microwave Division: DeMornay-Bonardi.

Junior scientists display projects

Here are the winners in WESCON's annual competition for future engineers. Thirty-seven teenagers are showing their experiments.

WESCON is really two shows.

There is WESCON, and there is JUNIOR WESCON, or the Future Engineers Show.

The younger version is being put on by 37 teen-agers from eight western states. They are the winning contestants in WESCON's 11th annual competition for future engineers. Their 35 experimental projects (two are by co-designers) are on display in the Cow Palace.

In addition JUNIOR WESCON is holding its own technical symposium on Aug. 3 (to which grown-up engineers are invited), its own field trips and an awards luncheon.

The winning projects were chosen by professional IEEE committeemen at local science fairs held in the spring. Represented in this year's Future Engineers Show are Alaska, Arizona, California, New Mexico, Oregon, Utah, Washington and Idaho.

The experiments on display bear such impressive titles as "A Quantitative Investigation of the Hydrogenation of Benzene Using an Electrical Corona," "Construction of a He-Ne Gas Laser," and "Development of a Boundary Layer Disturbance Theory for Drag Reduction by Acoustical Interaction with Neutral

Boundary Layer Disturbance Frequencies."

College scholarships totaling \$2800 will be presented at the awards luncheon for the best experiments and symposium papers at JUNIOR WESCON. The top awards at stake are the Lee DeForest exhibit prize of \$1000 and the Frederick Emmons Terman symposium award of \$300.

More than 300 entrants participated in the WESCON competition, which aims to encourage careers in science and engineering. The winners and their school science instructors received round-trip air



Touch-tone signaling is the theme of William Strack Jr.'s science project.



Analog computers are easy to understand, observes Gary Murray of Riverside Calif.



What is Project Artemis? Craig McCluskey will gladly demonstrate and explain.

tickets to WESCON and a subsistence allowance.

Alan Simpkins of the Hewlett-Packard Co. and Fred MacKenzie of the Stanford Research Institute headed the volunteer committee that planned the four-day JUNIOR WESCON.

The future engineers, their schools and their project titles are as follows:

Alaska

Albert Swank, 17, West Anchorage High School, *Plasma Consignment by Means of Cusp Mirror System.*

Arizona

Buddy Gene Clifton, Douglas Sr. High School, *A Working Laser Model.*

Ronald Clot, West High School, Phoenix, *A Quantitative Investigation of Hydrogenation of Benzene Using an Electrical Corona.*

Joe Rosbeck, Catalina High School, Tucson, *Modulation of Visible Light.*

Northern California

Philip W. Lee, Sacramento High School, *Diffusion Cloud Chamber.*

Ronald William Hunt, 17, Clovis High School, *Electronic Binary Computer.*

George Fong, Oakland High School, *The Effects of Radiation on Semiconductors.*

Larry B. Sorensen, 17, Peterson High School, Sunnyvale, *Triboluminescence.*

Burton L. Johnson, Newark High School, Newark, *Construction of a He-Ne Gas Laser.*

Tom Nozaki Jr., Cubberley High School, Palo Alto, *Model Hydroelectric Power Plant.*



"Detecting Elementary Particles with the Spark Chamber" is the title of John Lillig's award-winning project.

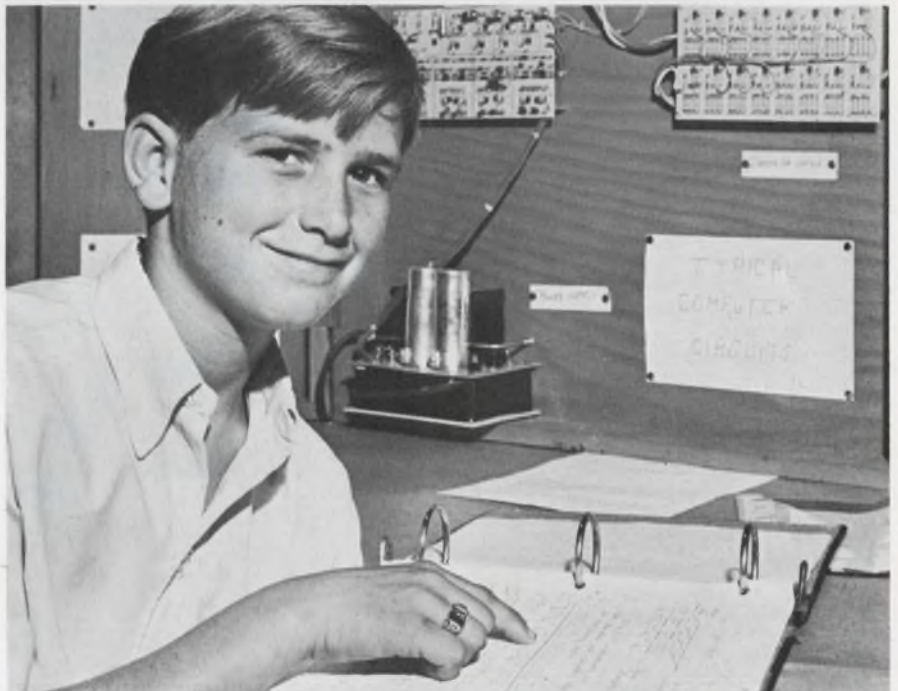

One of the youngest future engineers is 13-year old Ronald Evans. His winning project is called "Typical Computer Circuits."

EXCLUSIVE!

Now Measure Your Controlled Temperatures to 0.01°C



Model 390

EXPANDABLE SCALE THERMOMETER

with Expanded 1°C increment
Scale over 0 to 100° Range.

Solid state and direct-reading, the 390 features two modes, 0 to 100°C, with 1°C increments and 1-0-1°C range with 0.02°C increments — permitting for the first time, monitoring of temperatures directly to within 0.01°C resolution.

In ovens and baths, the 390 permits *direct* temperature measurement of material being treated or tested.

With second probe, temperature gradients or differential temperature measurements are possible in air, gas or fluids.

Large, easy-to-read meter, high stability, tilt-top meter housing, battery operated.

Other ranges available at no extra charge from -100°C to +500°C. In spans of 100°.

Price: \$690.00, less batteries, FOB Boonton (with one probe).



For Technical Data or
Free Evaluation Loan —
Write or Call John Carson

RFL Industries, Inc.

FORMERLY RADIO FREQUENCY LABORATORIES, INC.

Thermocontrol Div. • Boonton, N. J. 07005

Tel: 201-334-3100 / TWX: 710-987-8352 / CABLE RADAIRCO, N. J.

"See us at Booth No. 2307
and 2308 WESCON"

ON READER-SERVICE CARD CIRCLE 865

E60

Rick Mann, Fremont High School, Sunnyvale, *Waves: Electrical, Mechanical, Optical.*

Peter Aronstam, Lowell High School, San Francisco, *Binary-Digital Electro-mechanical Computer.*

Niles Severy, Santa Rosa Sr. High School, *Radioactivity Measurements With Home-Made Scaler.*

Masaaki Yamato, 17, Oakland High School, *Ion-Propelled Aircraft.*

Southern California

Steven Noll, 14, Balboa Jr. High School, Ventura, *Planetary Analysis Module.*

John Stephen Borjon, 17, Wasco Union High School, *Ultrasonic Doppler Motion Indicator.*

William Albert Strack Jr., 17, Santa Ana, Foothill High, Tustin, *Practical Application of Touch Tone (telephone) Signaling to Two-Way Communications.*

Ronald Kenneth Evans, 13, Crest View School, Huntington Beach, *Typical Computer Circuits.*

David King Frey, 17, Agoura High School, Agoura, *Beat Frequency Phenomenon.*

Steven Jeffrey Jacobs, Audubon Jr. High School, Los Angeles, *Format Resonator Analog.*

Richard Morris Katz, 14, John Burroughs Jr. High School, Los Angeles, *Corresponding Audio*



Visual light images, their audio representation and the reversion process is explained to WESCON visitors by Richard Katz.

Representation of Visual Light Images and Reversion Process.

John Edward Lillig, Don Bosco Technical High, South San Gabriel, *Detecting Elementary Particles With the Spark Chamber.*

Craig William McCluskey, 17, Westchester High School, Los Angeles, *Project Artemis: Astronomical and Communicational Uses of Moon Reflection.*

Thomas Allen Moshenrose, Don Bosco Technical High, *Electron Digital Desk Calculator.*

Gary Lee Murray, Chemawa Jr. High School, Riverside, *Analog Computer.*

Eugene W. Warren, 17, Los Angeles High School, *Conic Parabola Equation Point Calculator.*

William Pat Edwards and Jay M. Bernard, Crawford High School, San Diego, *Linear Electron Accelerator.*

Idaho

Gordon Lynn Brown, Madison High School, Rexburg, *Fluctuations of the Zodiacal Cloud Related to Solar Prominence Activity.*

New Mexico

Tyrone Mitchell, Cloudercroft High School, Sunspot, *Some Practical Applications Resulting from Development of AND, OR, NOR Logic Circuitry Interacting with a Universal Comparison Code.*

Scott Alan Jenkins, Alameda, Valley High School, Albuquerque, *Development of a Boundary Layer Disturbance Theory for Drag Reduction by Acoustical Interaction with Neutral Boundary Layer Disturbance Frequencies.*

Oregon

Vance Bodhaine, Wilon High School, Portland, *Digital Computer.*

Utah

Gaylen Atkinson and Dean Malmstrom, Hillcrest High School, Midvale, *A Balloon Telemetry.*

Washington

Steven G. Morton, Inglemoor High School, Bothell, *Project Mcalpha.*

Mark McKay, John R. Rogers High School, Spokane, *The Effects of Unstable Voltage.*

John A. Esteb, Okanogan High School, Okanogan, *Five-Foot Tesla Coil.* ■ ■

Blue chip.



COLLEGE IS BUSINESS' BEST FRIEND



Published as a public service in cooperation with The Advertising Council and the Council for Financial Aid to Education.

SPECIAL TO MANAGEMENT—A new booklet of particular interest if your company has not yet established an aid-to-education program.

Write for: "THE RATIONALE OF CORPORATE GIVING," Box 36, Times Square Station, New York, N. Y. 10036.

The Hughes/NASA Syncom stands still at 6875 mph to talk to a billion people.

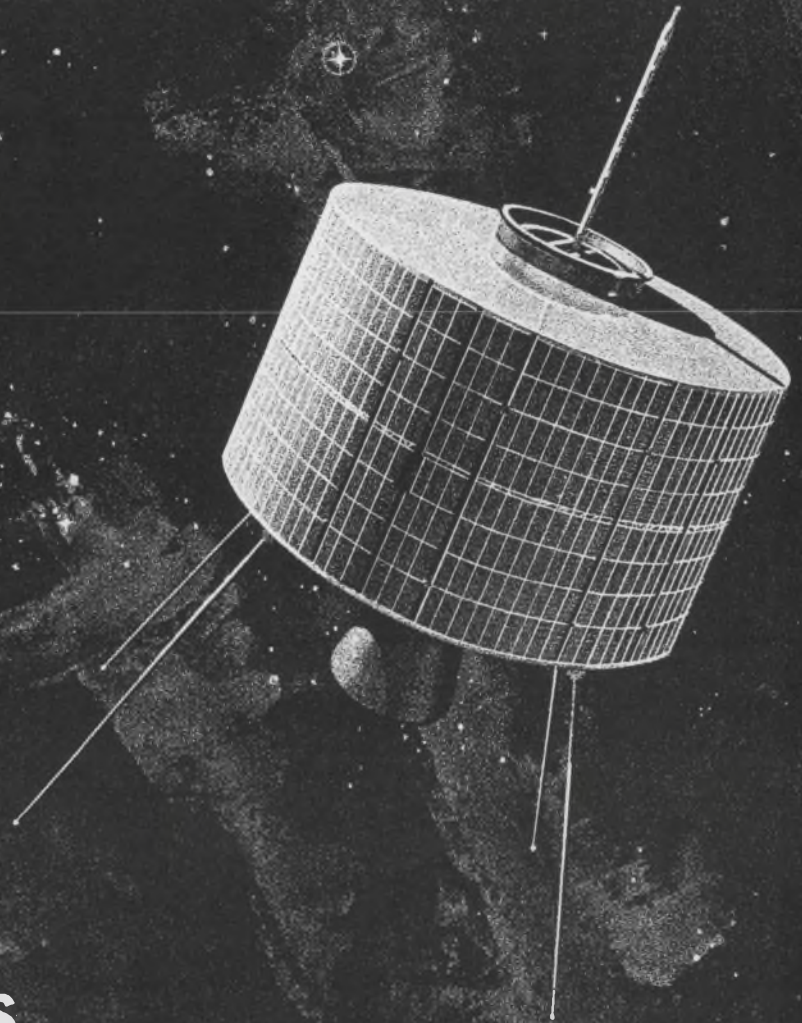
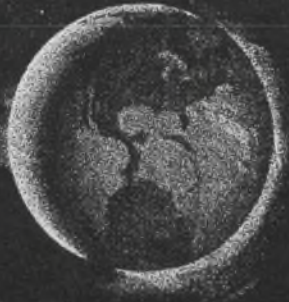

CIRCUIT DESIGNERS... is your appointment in space with Hughes?

Today, Hughes is one of the nation's most active aerospace/electronics firms: Projects include: F-111B PHOENIX Guided Missile System, TOW Anti-Tank Missile System, Communication Satellites, ATS-Advanced Technology Satellites, VATE, Hard Point Defense and others.

This vigor will assist the qualified engineers and scientists towards more and better opportunities for both professional and personal growth.

Many immediate openings exist. The engineers selected for these positions will be assigned to the following design tasks: the development of high power airborne radar

transmitters, the design of which involves use of the most advanced components; the design of low noise radar receivers using parametric amplifiers; solid state masers and other advanced microwave components; radar data processing circuit design, including range and speed trackers, crystal filter circuitry and a variety of display circuits; high efficiency power supplies for airborne and space electronic systems; telemetering and command circuits for space vehicles, timing, control and display circuits for the Hughes COLIDAR (Coherent Light Detection and Ranging).

If you are interested and believe that you can contribute, make your appointment today.

For immediate consideration, please airmail your resume to:

Mr. Robert A. Martin
Head of Employment, Dept. 58
Hughes Aerospace Divisions
11940 W. Jefferson Blvd.
Culver City, California 90230

Creating a new world with electronics

HUGHES

HUGHES AIRCRAFT COMPANY

AEROSPACE DIVISIONS

An equal opportunity employer.

U.S. CITIZENSHIP REQUIRED

Free Career Inquiry Service

Absolutely Confidential

Respond to the career opportunities advertised in this issue. Fill out and send us this handy resume. **Electronic Design** will do the rest – neatly typed copies of this form will be mailed to the companies of your choice, indicated by the circled Career Inquiry Numbers at the bottom of this page.

Extra

Name		Home Phone	
Home Address (Street)		City	State ZIP Code
Age	U.S. Citizen <input type="checkbox"/> Yes <input type="checkbox"/> No	Security Clearance	

Prime Experience	Secondary Experience

Desired Salary	Availability Date
-----------------------	--------------------------

Employment History – present and previous employers

Company	City, State	Dates	Title
		to	
		to	
		to	

Education – indicate major if degree is not self-explanatory

Degree	College	City, State	Dates
			to
			to
			to

Additional Training – non-degree, industry, military, etc.

Professional Societies

Published Articles

- Career Inquiry Numbers:**
- | | | | | | | | | | |
|-----|-----|-----|-----|-----|-----|-----|-----|-----|-----|
| 900 | 901 | 902 | 903 | 904 | 905 | 906 | 907 | 908 | 909 |
| 910 | 911 | 912 | 913 | 914 | 915 | 916 | 917 | 918 | 919 |

ELECTRONIC DESIGN
 850 Third Avenue
 New York, New York 10022



EE'S

with military communications
equipment experience

call us collect

area code 317/459-2808

Rapid expansion of our ground based and airborne military communications capability has created urgent requirements for electrical engineers (B.S. or M.S.) at Delco Radio.

Opportunities at all levels—beginning, through supervisory, with 2-10 years experience—in the following areas:

Digital communications in the HF, VHF, and UHF bands

Single side band design, HF, and VHF

Frequency synthesizer techniques in all frequency ranges

Wide range electronic tuning

Retransmission techniques

Secure communications techniques

Man-portable and vehicular battle area communications equipment

Acoustic transducers, antennas, and micro-electronics applications.

Call us collect for an interview or more information. Area Code 317/459-2808. Ask for C. D. Longshore. Or send your resume to Mr. Longshore, Supervisor, Salaried Employment, Dept. 203, Delco Radio Division of General Motors, Kokomo, Indiana.



DELCO RADIO

DIVISION OF GENERAL MOTORS • KOKOMO, INDIANA

An equal opportunity employer

We're constantly drumming up new business.



Even though we have a staff of nearly 2,000, do business in the tens of millions, and occupy 264,000 gross square feet of floor space for our research, engineering, manufacturing and other activities, we enjoy a reputation for technical excellence and on-time—or ahead of schedule—delivery. Our company pride wouldn't let us have it any other way.

All things considered, that's saying quite a lot when you think that Conduccion pioneers in the design, development and manufacture of special-purpose electromechanical systems, interface equipment and components, including micro-miniaturized circuits. We're a volume hardware producer of avionics and ground support checkout equipment. We're involved in advanced communications and micro-electronic circuitry. And we've just entered the institutional field with PARAMETRON®, the most flexible bio-medical critical monitoring device yet offered to hospitals.

For our customers, who range from companies in the defense and space industries to those in the commercial and institutional markets, Conduccion engineers developed and produced such diverse items as McDonnell Mercury and Gemini simulators for training our astronauts, and the Orbital Timing Device—standard equipment in all Gemini space capsules.

At the present time, Conduccion is producing flight training simulators for the Boeing 747, 737, 727, Douglas DC8, DC9, and Lockheed C5A. Customers include Eastern, United and Piedmont Airlines and Lockheed for the U.S. Air Force. We are also putting our know-how to work for other customers in the areas of data systems, communications and a wide spectrum (140 separate checkout systems) of aerospace ground support equipment. Then, too, we're producing visual and radar landmass training simulators and developing holo-

graphic techniques to produce a three dimensional aspect for pilot training.

We like our work. So do our customers. We think you will too.

Conduccion-Missouri's facilities are located in suburban St. Charles, Mo., just 22 Freeway miles from Downtown St. Louis and close to excellent cultural, educational and recreational facilities.

If you are a graduate engineer with 2 to 5 years' experience, who is interested in an outstanding growth opportunity with a leader in the electronics industry, we have current openings in these categories:

**SYSTEMS, ELECTRONIC or ELECTRICAL ENGINEERING
MATH MODELING • SCIENTIFIC PROGRAMMING
LOGIC DESIGN • MECHANICAL, RELIABILITY or
MAINTAINABILITY ENGINEERING • MANUFACTURING
ENGINEERING • OPTICS • COMMUNICATIONS
ENVIRONMENTAL TESTING • AERODYNAMICS
VALUE ENGINEERING**

Send your résumé in complete confidence to Mr. Thomas Walenga, Professional Employment Office, Dept. _____.



CONDUCCION-MISSOURI

Division of Conduccion Corporation

2600 N. Third Street, Box 426, St. Charles, Missouri 63301

For WESCON Interviews contact Jim Hoose at the Thunderbolt Hotel, 101 Bayshore Freeway, Milbrae, Calif. Telephone: 415-697-7700

We are and always have been an equal opportunity employer.

ON CAREER INQUIRY FORM CIRCLE 916

PROGRAMMING MANAGER

Our Company, pioneer in communication systems and the largest manufacturer of commercial telephones, dial systems and allied equipment for the Independent Telephone Industry has an opening for a Programming Manager.

The candidate we select will direct and coordinate the efforts of a technical programming staff responsible for the development of the application, diagnostic and support programs in a computer centered switching system. Other areas of responsibility include—schedule development, budget awareness and control, technical direction of the project and personnel evaluation.

A Bachelors or Masters degree preferably in a technical discipline plus a minimum of 7 years experience in programming and some experience in supervising a programming staff. The candidate must be knowledgeable in the use of assembly languages in a real-time application and in the techniques of on-line program maintenance.

We offer a professional atmosphere, excellent benefit program and attractive salary. Please send resume detailing education, experience, present and expected salary requirement to:

Mr. W. R. Kaplinski
Professional Employment

Automatic Electric Company

400 North Wolf Road; Northlake, Illinois 60164

an equal opportunity employer,
a Member of the G.T.&E. Family of Companies.

ON CAREER INQUIRY FORM CIRCLE 917

WESCON Ladies' Program

Tuesday: 9:00 Welcoming Coffee, Top of the Mark.

11:00 Hospitality Get-Together, California Room, Fairmont Hotel.

6:00 Cocktail Party, Grand Ballroom, Fairmont Hotel.

Thursday: 11:00 Meet at Fairmont for luncheon at Sabella's Restaurant and tour of homes. Tickets: \$8.50.

Friday: 9:00 Continental Breakfast, Fountain Room, Fairmont Hotel.

10:30 Guided Tour of WESCON, Cow Palace.

ELECTRO-MAG LO-HI FREQUENCY SHIELD

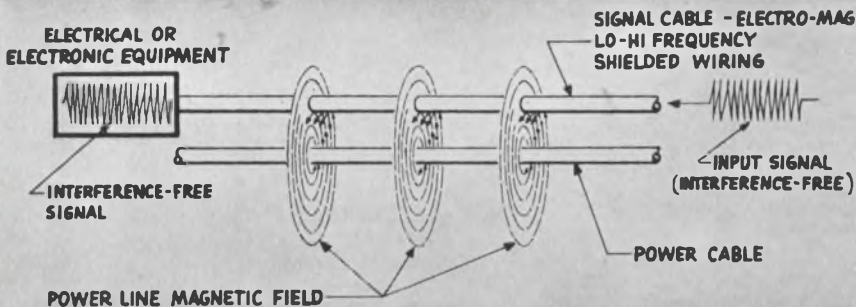

A new method of attenuating electro magnetic interference over an extremely wide frequency range 60 CPS to 10 KMC. Can be applied over power cable and assemblies to reduce noise.

Write for literature and test report.



Manufacturers of Electronic wire, cable, cable assemblies and custom products.

ELECTRONICS CORP.

17360 S. Gramercy Place, Gardena, California

SEE US AT BOOTH 1522

B&B

ON READER-SERVICE CARD CIRCLE 875



The Wescon ladies program will be coordinated by Mrs. Philip Rice (upper), and Mrs. Robert DeLiban.



Unit Citation

We're honored! Not that we've won our crusade yet...just another battle ribbon. A while back we scored a military victory with our Model 880, the *first* solid state Mil Spec counter. This time it's a fully-militarized 5MHz all-silicon solid state universal counter-timer. Call it AN/USM-245, sir.

There's a good reason you should be interested. You see, the military model had its basic reliability well proved by our original commercial version, Model 607A. Now *there's* the one for you! It offers more features and capabilities than even the Admirals asked for. And it's available on-the-double.

Now hear this: Our lowest-bidder-type price is only \$1,575. (Check *that* saving against our competitor!) Then check these features: Model 607A is ideal for wide-range frequency measurements, frequency ratio determination, period and multiple period or time interval measurements, and pulse count totalizing. Time base is a 1 MHz crystal oscillator (for 1 microsec resolution). Display is six decade inline with display storage. BCD output transfers directly to CMC Model 410 tape printer, computer systems, etc. Automatically positioned illuminated decimal. Either ac or dc coupling of input signal. Front and rear A and B channel inputs. Rugged, compact (approx. 3½" high). Available for bench or rack.

THANKS

With all our pride and excitement over our AN/USM-245 award, and other new products, we haven't forgotten our fellow Crusaders who've made this success possible...YOU. A FREE Crusading Engineers medal is our fun-loving way of saying thanks. Get yours by writing for data so you can "Check the Specs" of our 607A. Your "chief" will be so proud of you at mail call!

12973 Bradley / San Fernando, California
Phone (213) 367-2161 / TWX 910-496-1487



Relax and take in a movie

A wide range of films for engineers is being shown in the Cow Palace during WESCON from 10 a.m. to 4 p.m. daily. Most of the movies are brief; so it's possible to take in several while resting weary feet at the show.

The place is the Science Film Theatre in the southwest corner of the East Exhibit Hall. The schedule for the films follows:

A.M.

- 10:00—"A Legacy of Gemini" (NASA).
- 10:28—"Henry Larsen" (National Film Board of Canada).
- 10:44—"Attaching Flat Packs to Printed Circuit Boards" (Weltek).
- 10:56—"Orbital Otolith Experiment T (S) 4" (NASA-AMES).
- 11:27—"Vast" (PRD Electronics).
- 11:43—"Steffanson: The Arctic Prophet" (National Film Board of Canada).
- 11:58—"Window Unto Space: A

Non-Magnetic Satellite for Space Exploration" (TRW).

P.M.

- 12:09—"One-One Zero-Zero" (General Dynamics-Convair).
- 12:36—"Rare Earth Oxides for Laser" (Korad).
- 12:51—"To Catch a Shadow: Electronic's Part in Submarine Detection" (Lockheed).
- 1:20—"Advanced Microelectronic-PCM Telemetry System" (Radiation, Inc.).
- 1:43—"The Story of Navigation" (Litton Industries).
- 1:59—"A Beginning Without End" (University of California Radiation Laboratory).
- 2:29—"Images for the Future" (ITT).
- 2:41—"Solar Eclipse 1966" (University of California Los Alamos Scientific Laboratory).
- 3:13—"To Blaze New Trails" (TRW). ■ ■

Ex-Defense aide giving keynote talk

A former Assistant Secretary of Defense, Dr. Eugene G. Fubini, will deliver the keynote address at WESCON. Five hundred technical and industrial leaders will hear him talk on "Reality vs Requirements" on Aug. 22 at a luncheon in the Cow Palace.

Dr. Fubini, now a vice president and group executive of the International Business Machines Corp., was in the Defense Dept. from 1961 until June, 1965. As an Assistant Secretary from 1963 through 1965, he was deputy director of Defense Research and Engineering.

Educated in Italy, Dr. Fubini came to the United States in 1939. During World War II he was active in R&D—and, later, applications—of electronic reconnaissance and countermeasures. He served as scientific consultant and technical observer to the U.S. Army and Navy from 1943 to 1945.

He is a Fellow of the IEEE, the author of more than 30 technical papers, and holds 11 patents. He has received the Presidential Certificate of Merit and the Defense Medal. ■ ■

Unbelievable! Unavailable! Until now.

Next time someone walks up to you and asks, "Does Redcor/Modules' new 770-440 give you instrumentation amplifier performance at module amplifier prices?" look him right in the eye and say yes. You might also mention that its unique patented dynamic bridge design principle means great closed-loop specs like differential input impedance of 10 megohms; common mode input impedance of 1000 megohms, from dc to 60 cps;

differential gains of 20 to 1000; and a gain accuracy of $\pm 0.02\%$ FSR 20V. Then tell him all this performance costs less than one-fifth a kilobuck per each. There. You did a fine job. Now request complete data so you can really sock it to the next guy that asks.

REDCOR 7800 DEERING AVENUE
CANOGA PARK,
CALIFORNIA 91304
(213) 348-5892 • TWX 910-494-1228

ON READER-SERVICE CARD CIRCLE 867



Dr. Eugene Fubini, Assistant Secretary of Defense, will be the keynote speaker at the Wescon luncheon.

Want to benefit from a Hayden Happening?

Attend the Hayden "Write-In" at Wescon!

It's for engineers who want practical advice on how to write a technical article.

It's for engineers who have written articles and want them evaluated.

It's for engineers who have ideas for technical articles and want to discuss them with editors.

It's for engineers who have ideas (or even a completed manuscript) for a technical book and want a publisher's reaction.

It's for engineers who would like to meet editors over coffee and danish to discuss the benefits of writing for publication.

It's at the North Continental Parlor 7 of San Francisco's Hilton. Please feel free to drop in anytime between 8 A.M. and 10 A.M., Tuesday, Wednesday, Thursday or Friday.



Hayden Publishing Co., Inc.
Publishers of Electronic Design and
MicroWaves magazines...Hayden,
Ahrens and Rider books.

Sample and hold. Sample and hold. Do dah. Do dah.

The closed-loop performance of Redcor/Modules' new Sample-and-Hold will put a smile on your face and a spring in your step. The 770-715 has an accuracy of 0.01%. If that don't get you, try a settling time of 5 microseconds for 20V step input. Or how about an input impedance of 10 megohms at 1 kc? Maybe a frequency response of DC to over 50 kHz? This performance, friends, is yours for a mere \$250 in quantities of 50. Redcor makes equally appealing comparators,

dynamic bridge and buffer amplifiers, 8-channel multiplexers, plus 0.1% Sample-and-Holds. They all have a great new pin layout that for the first time lets you easily interconnect modules with dual in-lines. So quit clapping your hands long enough to request complete data.

REDCOR 7800 DEERING AVENUE
CANOGA PARK,
CALIFORNIA 91304
(213) 348-5892 • TWX 910-494-1228

ON READER-SERVICE CARD CIRCLE 868

SEALED / POWER MODULES

**NUCOR NPS
POWER MODULES** are sealed to provide absolute assurance from dust, humidity, salt spray—uniquely designed, they will operate under the severe military environment of MIL-E-16400, MIL-E-5400, MIL-T-21200, MIL-E-4158.

- **TEMPERATURE TO 100° C**
No Derating
- **MTBF 100,000 HOURS**
Mean Time Between Failure
- **RIPPLE 250 μ v RMS**
Typical
- **REGULATION 4 mv**



NUCOR POWER SUPPLIES ARE
DIRECT RETROFITS IN
YOUR EQUIPMENT.

485 standard models available



Write today to
NUCLEAR CORPORATION OF AMERICA
2 RICHWOOD PLACE, DENVER, NEW JERSEY 07834

ON READER-SERVICE CARD CIRCLE 869

Briefly stated . . .

■ A new Bay Area attendance record is predicted at WESCON this year, with 40,000 registrations expected. This would surpass by over 2000 the number who checked in for 1965 WESCON, which was the last time the Bay Area was host to the convention. During last year's convention, held in Los Angeles, a new high in registrations was recorded: over 47,000.

■ Video taping will be used in an attempt to sharpen technical presentations. Symposium speakers will rehearse their presentations in front of the TV camera, to see and hear themselves as their audiences do.

■ Blue shirts and stage makeup may be part of the uniform of the day for speakers at two of the sessions. Plans are being made to video-tape two of the actual sessions for replay at a later date. The two sessions scheduled for video-taping are Session 7, "Patient Monitoring Systems: Progress, Problems, Prospects," and Special Session B, "Large Scale Integration of Computer System Design."

■ A major innovation at this year's WESCON, according to Emmet Cameron, show director, are solid wall exhibiting stands, comparable to those used by leading European expositions. The new booths are 20 feet wide and 7 feet deep, with side walls, carpeting and identification signs. The advantages to exhibitors, Cameron explains, are greater flexibility, elimination of display construction costs and the option of adding a small conference room to the booth. One such stand is about equal in size to two conventional spaces. Twelve companies are using the new stands this year.

■ For the weary exhibit visitor, eight new lounges have been set up to rest tired feet. Seven lounges are scattered throughout the aisles of the exhibit area, and another is in the convention hall that houses the technical sessions.

There's no faster delivery of Heinemann circuit breakers than across-the-counter...



...and we've got 43 counters:

AUTHORIZED HEINEMANN STOCKING DISTRIBUTORS

Alabama Electro-Tech, Inc. Huntsville (205) 539-1250	Parts Service Corp. Winter Park (305) 647-5343	Maryland Lee Electric Co. Baltimore (301) 752-4080	New York Federal Electronics Inc. Vestal (607) 748-8211	Texas G. E. Jones Electric Co. Amarillo (806) 372-5505
Arizona Kierulff Electronics, Inc. Phoenix (602) 273-7331	Georgia Electro-Tech, Inc. Hapeville (404) 758-7205	Pytronic Industries Inc. Baltimore (301) 727-5100	Schweber Electronics Westbury, Long Island (516) 334-7474	Warren Electric Co. Beaumont (713) 833-9405
California Wesco Electronics Palo Alto (415) 968-3475	Kansas Hall-Mark Electronics Kansas City (913) 236-4343	Massachusetts Apparatus Service Co. Allston (617) 787-1300	North Carolina Electro-Tech, Inc. Charlotte (704) 333-0326	Hall-Mark Electronics Dallas (214) 231-6111
Wesco Electronics Pasadena (213) 795-9161	Kentucky E & H Electric Supply Co. Louisville (502) 587-0991	Electrical Supply Corp. Cambridge (617) 491-3300	Ohio Midwest Equipment Co. Cincinnati (513) 821-1687	Nelson Electric Supply Dallas (214) 741-6341
Colorado Kierulff Electronics, Inc. Denver (303) 825-7033	Marine Electric Co., Inc. Louisville (502) 587-6511	T. F. Cushing, Inc. Springfield (413) 788-7341	Radio & Electronic Parts Cleveland (216) 881-6060	Hall-Mark Electronics Houston (713) 781-0011
Connecticut MarLe Company Stamford (203) 348-2645	Louisiana Poulan's Electrical Co. Monroe (318) 323-7701	Mississippi Ellington Electronic Supply, Inc. Jackson (601) 355-0561	Oklahoma Hall-Mark Electronics Tulsa (918) 835-8458	Warren Electric Co. Houston (713) 225-0971
Florida McDonald Distributors of Florida Inc. Fort Lauderdale (305) 563-1255	Hall-Mark Electronics New Orleans (504) 242-7581	New Jersey Valley Electronics, Inc. Cherry Hill (609) 662-9337	Oregon Platt Electric Supply Portland (503) 222-9633	Messner Electric Supply Longview (214) 753-4484
Industrial Electronics Associates, Inc. West Palm Beach (305) 848-8686	Maine Stanley J. Leen Co., Inc. Portland (207) 774-6266	Federated Purchaser, Inc. Springfield (201) 376-8900	Pennsylvania West Chester Electric Supply Co. West Chester (215) 696-7500	The Perry Shankle Co. San Antonio (512) 223-1801
		New Mexico Kierulff Electronics, Inc. Albuquerque (505) 268-3901	Rhode Island William Dandreta & Co. Providence (401) 861-2CJO	Washington Kierulff Electronics, Inc. Seattle (206) 725-1550

HEINEMANN ELECTRIC COMPANY



Trenton, New Jersey 08602

ON READER-SERVICE CARD CIRCLE 870

Hughes' engineer to be honored

A self-taught engineer, inventor and electronics pioneer, Lawrence A. "Pat" Hyland, vice president and general manager of the Hughes Aircraft Company, will receive the 1967 Western Electronic Medal of Achievement.

Formal presentation of the Western Electronic Manufacturers Association's highest honor will be made Wednesday, Aug. 23, during WEMA's annual luncheon in the Fairmont Hotel in San Francisco.

Hyland will be the ninth recipient of WEMA's medal "for significant contributions to the advancement of electronics in the West."

Horace A. Shepard, president of TRW, Inc., will be the luncheon speaker. A native of Mobile, Ala., he received a B.S. in aeronautical engineering from Auburn University in 1934. He joined the Army Air Corps and rose from flying cadet in 1934 to brigadier general in 1947, serving as chief of the Procurement Div. of the Air Materiel Command at Wright-Patterson Air Force Base in Dayton, Ohio, and later as director of procurement and engineering at Air Force Headquarters in the Pentagon. Shepard joined TRW in 1951 as vice president and assistant to the general manager.

A radar pioneer

In announcing the selection of Hyland for the achievement medal, WEMA's president, John S. McCullough, said:

"We are honoring Pat Hyland for his important scientific achievements, his leadership in Western industry and for his contributions to his country.

"Today we experiment in elaborately equipped research facilities, but in 1932 Pat Hyland operated from an old truck in a Virginia cornfield and trained his radar on the dirigible Los Angeles to demonstrate the reflection of radio

waves from fixed and moving objects.

"Even before this important step in the discovery of radar, his ignition shielding device made possible reliable communication between aircraft and aircraft-to-ground stations.

"Under his 13 years of leadership at Hughes Aircraft, the company has become a major force in Western industry and played a vital role in our nation's space-exploration program."

Hyland was vice president in charge of engineering for the Bendix Aviation Corp. when he left to join Hughes in 1954. At that time Hughes had one product line—aircraft. Since 1954 it has grown to include 80 product lines. Its physical facilities have increased to almost 6,000,000 square feet of plant space at 10 major facilities.

Space work, too

Entering the space field in 1960, a Hughes-financed program led to the first synchronous-orbit communications satellite, Syncom, built for NASA and successfully launched in 1963. The satellite became the forerunner of a worldwide commercial system for the Communications Satellite Corporation, which launched the Hughes Early Bird in 1965.

Today every commercial communications satellite in operation is a Hughes synchronous satellite.

In 1960 Hughes also demonstrated the world's first operating laser at its research laboratories in Malibu, Calif.

Other successes under Hyland's leadership include the Surveyor soft-landing spacecraft for NASA. Surveyor I took more than 11,000 photographs of the lunar surface last year. Seven were ordered by NASA in preparation for the Apollo manned mission to the moon.

The company today has a work

force of more than 30,000 and annual sales exceeding \$500 million.

Began as radioman

Hyland's first exposure to electronics was while serving as chief radioman with the Navy from 1920 to 1926.

For his contributions in radar, Hyland received the Navy's Medal for Distinguished Public Service in 1950. He holds patents for the Doppler radar. He is a member of numerous Federal commissions, professional societies and foundations.

Previous WEMA medals were awarded to Sigurd and Russell H. Varian, founders of Varian Associates; Charles B. Thornton, chairman of the board, Litton Industries, Inc.; Howard Vollum, president, Tektronix Inc.; Dr. Frederick E. Terman, vice president and provost emeritus, Stanford University; Dr. Daniel E. Noble, executive vice president, Motorola Inc.; Dr. Arnold O. Beckman, chairman of the board, Beckman Instruments; David Packard, chairman of the board, Hewlett-Packard Co.; and H. Leslie Hoffman, chairman of the board, Hoffman Electronics Corp. ■ ■

C. F. O'Donnell to speak

Expert speaker at the Eighth International Electronic Circuit Packaging Symposium on Monday, Aug. 21, is Cedric F. O'Donnell, R&D director at Autonetics since 1963. The two-day symposium is being held in the Imperial Ballroom of the San Francisco Hilton as a concurrent activity of WESCON. At the Autonetics Div. of North American Aviation, where he is senior vice president, O'Donnell has served as chief of the Digital Computer Section and of Computers and Data Systems.



Microwave Drive Power

Tung-Sol Electron Multiplier Tubes employ secondary emission multiplication to provide power suitable for driving microwave devices such as traveling wave tubes, lasers and hydrogen thyratrons. Operating from negligible input power, the tubes produce a positive or negative-going peak output pulse of up to 1000 volts at 4 amps. Output rise time is less than 10 nanoseconds. Total delay is under 20 nanoseconds. Write for complete information. Tung-Sol Division, Wagner Electric Corporation, One Summer Avenue, Newark, New Jersey 07104.

TYPICAL OPERATION	5-STAGE TYPES		2-STAGE TYPES
	8455	8428	DT1527A
Peak Pulse Output Voltage	1000v	600v	50v
Peak Pulse Output Current	4A	4A	1A
Peak Pulse Output Power	4.0kw	2.4kw	50w
Average Output Power	40w	24w	

TUNG-SOL®
ELECTRON MULTIPLIER TUBES

® REGISTERED TRADEMARK WAGNER ELECTRIC CORPORATION

ON READER-SERVICE CARD CIRCLE 872

Manufacturers' representatives wanted

A number of manufacturers are interviewing applicants for sales representatives at their show booths. The following manufacturers desire representation.

Company	Product	Area
Christie Electric Corp. (2523)	Dc power supplies and battery-charging equipment.	Minneapolis, North and South Dakota.
Fotofoil Co., Div. of the Miller Dial & Name Plate Co. (2324)	Nameplates, dials, instrument panels and other markings.	Tennessee, Colorado, Alabama, Mississippi, South Carolina, Florida.
Hoyt Electrical Instrument Works (4312)	Panel meters.	Southeastern states, Western Pennsylvania.
Illumination Industries, Inc. (4914)	Short-arc lamps.	Southeastern and New England states.
Information Control Corp. (2006)	Digital modules, core memories, light pens, data collection systems.	Midwest, Maryland, Virginia, Washington, Pacific Northwest, Michigan, W. Pennsylvania.
RFL Industries, Inc. (2307)	Temperature controllers.	West Coast (Only distributors, no representatives).
Technibilt Corp. (3318)	Materials-handling carts.	Midwest and South.
Valor Associates, Inc. (5117)	Telescopes.	Washington, Canada, Texas, Oklahoma.
Valpey Corp. (3416)	Laser rods, laser optics.	Southwestern states.
Watkins-Johnson, Stewart Div. (1323)	Firing furnaces.	Dallas and Houston.

WESCON exhibits: Shades of Dr. Frankenstein

A modern Dr. Frankenstein's laboratory, cartoons by electronics and a magic show are among the diversions for visitors to the WESCON exhibit area.

No classic horror movie was ever complete without a high-voltage Jacob's ladder. A four-foot version of the ladder is the crowd-drawer at Geo-Space Corp.'s colorfully lighted display (Booth 4723). Among other equipment on show are three working seismometers, including one used in nuclear-blast detection; a 5-by-7-foot electroluminescent panel inverter; a ferroresonant constant-voltage transformer contrasted with standard transformer; and

a 200-volt solid-state operational amplifier.

At Booth 2816, the Electric Components Div. of Burroughs Corp. is showing continuous cartoon-drawing, preprogramed by five X and five Y counters, designed to show the versatility of the company's bi-directional counters.

A magic show highlights Moxon's 17-booth area in the main arena. Conjuror Eddie Tullock, performing in Booth 2616 every 45 minutes, is making his fifth WESCON appearance.

For those who miss their tele-viewing while at the convention, Ameco, Inc., has help at Booth 4708.

Its continuous demonstration of cable television reception, using Ameco CATV cable and Pacesetter solid-state amplifiers, picks up programs from San Francisco's ETV station.

Visitors to the Teradyne exhibit (Booth 3205) can test integrated circuits with the company's new Analog testing equipment. Lamps on a display board show the progress of tests.

At Valor Associates (Booth 5117) there's an opportunity to view a 3.5-by-4-inch test pattern some 600 feet away from the booth through a telescope. The pattern, invisible to the naked eye, is on the ceiling of the Cow Palace. ■ ■

Design Data from Manufacturers

Advertisements of booklets, brochures, catalogs and data sheets. To order use Reader-Service Card.

(Advertisement)

Transistor Design "How-To" Tips



Modern Transistor Electronics Analysis and Design, by Fred K. Manasse, Charles R. Gray, & John A. Ekiss, brings you a modern approach with practical "how-to" tips for transistor and integrated circuit design. Contains original material on two-terminal active devices, tunnel diode, p-n avalanching diodes, and Gunn effect diodes. Gives you a detailed examination of linear tuned amplifiers with practical analysis of design approach. Also covers transistor switching circuits, noise in transistors, choppers, and multiplexing. Pub. Sept. 1967, 512 pp., \$12.95. Order your 15 day examination copy by circling the number to the right.

Prentice-Hall, Inc.
Englewood Cliffs, N.J. 07632

171

Engineers' Relay Handbook



A definitive work that is fast becoming a standard reference text for the relay user. Prepared and edited by the National Association of Relay Manufacturers, this book is a complete guide to the principles, properties, performance characteristics, application requirements, specifications, and testing of relays. Systems and product engineers will find the *Handbook* an indispensable help in determining the correct types of relays for their applications. For further information about this unique sourcebook, write Dept. ED.

Hayden Book Co., Inc.
116 W. 14th Street
New York, N. Y. 10011

172

Total System Power Supply Capability



Dynage manufactures three different standard styles of equipment. The voltage references and standards are packaged for circuit board and chassis mounting. The low current power supplies (Dynage "D" series up to 1.0 amperes) are packaged for chassis mounting in Mil-T-27A cans. The highest current power supplies (H series up to 60 amperes) are racked type modules. The advantages to the Dynage approach are repairability, service, cost, delivery, (72 hours on standard D & H series power supplies), flexible packaging, color coordination and an extremely wide selection of voltages and currents.

Dynage, Inc.
1331 Blue Hills Avenue
Bloomfield, Connecticut 06002

173

Co-Publishers
James S. Mulholland, Jr.
Hugh R. Roome

Editorial Director
Edward E. Grazda

Editor
Howard Bierman

Managing Editor
Robert C. Haavind

Technical Editors
Jeffrey N. Birstow
Peter N. Budzilovich
Maria Dekany
Roger K. Field
David H. Surgan

Careers and Management Editor
Howard S. Ravis

News Editors
Ralph Dobriner, Chief
Richard N. Einhorn

East Coast Editor
Neil Sclater

West Coast Editor
Ron Gechman

New Products Editor
Steven B. Futterman

Copy Editor
Peter Beales

Directory Editor
William Alvarez

Washington Editor
S. David Pursglove

Editorial Production
Dollie S. Viebig
Marian Arkin
Anne T. Lombardi

Art Director
Clifford M. Gardiner

Art Assistant
William Kelly

Technical Illustrators
Cheh Nam Low
Sheila F. Ward
Richard Hartman

Production Manager
Thomas V. Sedita

Asst. Production Manager
Helen De Polo

Production Assistants
Bernard Wolinsky
Robert M. Henry
Murray Friedman

Circulation Manager
Nancy L. Merritt

Reader Service
Diane Mandell

NEW! Modular

Integrated Circuit

Digital-Analog Converters

Visit Us — WESCON
Booth Nos. 2209-2210

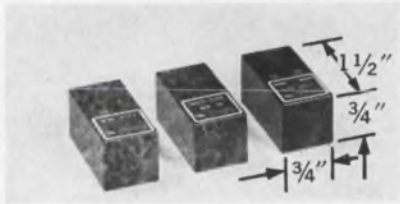

D/A/D Series is a group of compatible integrated circuit modules for Digital-to-Analog and Analog-to-Digital Conversion Systems. MODEL RM—2734 is a Jam Transfer Storage Register for up to 12 bits. On strobe command it will accept and store numbers. MODEL RSN—2698 is a Switching Resistor Network and Reference Source. It can be switched by micrologic input levels and provides output binary weighted currents to a summing point. MODEL AM—2612 is a Combination of Two Operational Amplifiers with Feedback Networks for converting currents from RSN—2698 to output voltages. The use of operational amplifiers provides a variety of output ranges at low impedance.



MODEL DAC-10_{ic} shown above is one of the many configurations in which the D/A/D Series Modules can be combined. It accepts 10 bit strobed parallel binary input in 1 microsecond slew time.

MODEL DAC-12_{ic} accepts 6, 7, 8, 9, 10, 11 or 12 bit strobed parallel binary inputs.

PASTORIZA
ELECTRONICS, INC.

385 Elliot St., Newton Upper Falls, Mass. 02164
(617) 332-2131

ON READER SERVICE CARD CIRCLE 877

Advertisers' Index

Advertiser	Page	Advertiser	Page
Adams & Westlake Company	U161	JFD Electronics Co./Components Division	E53
Ad-Yu Electronics, Inc.	U178	Johanson Manufacturing Corp.	E56, U172
Aerogel General	E54, E55	Johnson Company, E. F.	U182
Airways-Rent-A-Car	U206	Kennedy Co.	U174
Aladdin Electronics	U167	Kester Solder Company	U86, U87
Allen-Bradley Co.	U112A-B	Kidde & Company, Inc., Walter	U165
Amperex Electronic Corporation	E23, U171	Krohn-Hite Corporation	U153
Amersil, Inc.	U191	L & R Manufacturing Company	U198
Anadex Instruments, Inc.	U168	Lear Siegler Inc.	U190, U191
Arnold Engineering Company, The	U175	Line Electric Company	U170
Air Wire and Stamping Co.	U176	Measurements, A McGraw-Edison Division	U188
Augat, Inc.	33-38	Monsanto	U117
Automatic Electric, A Subsidiary of General Telephone & Electronics	U185	Mosaic Fabrications, Inc.	U197
Automatic Metal Products Corporation	U130	Motorola Semiconductor Products, Inc.	E21, E41, U125, U159
B & B Electronics Corp.	E66	NJE Corporation	U183
Ballantine Laboratories, Inc.	E15	Narda Microwave Corporation, The	E27
Bausch & Lomb Electronics Division	U169	National Jet Company	E52
Boonton Electronics Corp.	U134	National Semiconductor Corporation	U110, U111
Branson Corp.	U184	Nexus Research Laboratory, Inc.	U181
Bulova Electronics Division of Bulova Watch Company	U196	Nuclear Corporation of America	E70
Bundy Electronics Corporation	U194	Nytronics, Inc.	E32
Bunker Ramo Corporation, The	U156	Pamotor, Inc.	U200
Burdur Corporation	E31	Pastoriza Electronics, Inc.	E76
Burroughs Corporation	E Cover II	Phelps Dodge Electronic Products	39
Cambridge Thermionic Corporation	U132	Philbrick Researches, Inc.	U195
Centralab, The Electronics Division of Globe-Union, Inc.	U123	Philco-Ford Corporation	U129, U131, U133, U135
Chassis-Trak Inc.	U160	Polarad Electronic Instruments, Polarad Electronics Corporation	U139
Clifton, Division of Litton Industries	E17, U151	Potter & Brumfield Division of American Machine & Foundry Company	U119
Comar Electric Company	U207	Prentice-Hall, Inc.	E75
Computer Measurements Company	E67	RCA Electronic Components and Devices	U141, U142, U143, E Cover IV
Cornell-Dubilier Electronics	U152 A-B	RFL Industries, Inc.	60
Curtis Development & Mfg. Co.	U208	Raytheon Company, Semiconductor Division	U163
Cutler-Hammer	U105	Redcor Corporation	E50, E68, E70, U168, A-B
Datapulse, Incorporated	E57	Reeves Hoffman Division of DCA	U206
Delco Radio, Division of General Motors	U126, U127	Rowan Controller Co., The	E19
Digital Sensors, Inc.	U140	Scanbe Manufacturing Corp.	U202
Dynage, Inc.	E75	Scientific Data Systems, Inc.	E29
ESI/Electro Scientific Industries, Inc.	U193	Siemens America, Incorporated	U158
Eagle Signal, A Division E. W. Bliss Company	U145	Signetics Integrated Circuits, A Subsidiary of Corning Glass Works	U187
Eastman Chemical Products, Inc.	U204	Solitron Devices, Inc.	E49
Ehrenreich Photo Optical Industries, Inc.	U208	Sprague Electric Company	E9, E11, E13
Electronic Controls, Incorporated	U199	Stimpson	E30
Electronic Research Associates, Inc.	U124	Switchcraft, Inc.	U203
Electrovert, Inc.	U186	Tally Corporation	E45
Emporium Specialties, Inc.	U208	Technical Information Corp.	U166
Ericsson Centrum, Inc.	U138	Thomas & Skinner, Inc.	U164
Fluke Mfg. Co., Inc., John	U144	Topaz Transformer Products, Inc.	U186
Gardner-Denver Company	U94, U95	Triplet Electrical Instrument Company	U177
General Instrument Corporation	U106, U107	Tung-Sol Division, Wagner Electric Corporation	E73
General Precision, Kearfott Products Division	U150	Union Carbide Corporation	U137
General Radio Company	U157	United Transformer Corp.	E43
Guardian Electric Manufacturing Company	U179	Victor Comptomer Corporation	U209
Hamilton Standard, Division of United Aircraft Corporation	E51	Zeltex, Inc.	U205
Hayden Publishing Company, Inc.	E61, E69, U201	Career Advertising	
Heinemann Electric Company	E71	Automatic Electric Company	E66
Hewlett-Packard	E5, U149, U155	Conductron-Missouri	E65
Honeywell Test Instrument Division	U146, U147	Delco Radio, Division of General Motors	E64
Hudson Tool & Die Company, Inc.	U173	Hughes Aircraft Company	E62
Hughes Aircraft-Company Electronic Dynamics Division	U154	ITT Cannon Electric, A division of International Telephone and Telegraph Corp.	U162
Industro Transistor Corporation	U189	Industro Transistor Corporation	U189



Save

Worth \$1.99

"Transistor and Diode Network Problems and Solutions," by Harry Stockman sells regularly for \$9.95. It is available for \$7.96 when you present this coupon at Hayden Book Company's booth, 3621.

**Save
\$2.10**

(See other side)

**20%
Reduction**

(See other side)



Save

Worth \$1.60

K. L. Dumas and L. Sand's "Microwave Systems Planning," sells for \$8.00. It can be ordered for \$6.40 when this coupon is presented at Hayden Book Company's booth, 3621.



Save

Worth \$2.39

The widely acclaimed "Engineers' Relay Handbook" by the National Association of Relay Manufacturers costs \$11.95. You can order it for \$9.56 when you present this coupon at Hayden Book Company's booth, 3621.

**Save
\$2.55**

(See other side)



Save

Worth \$2.10

"Planning and Preparing Data-Flow Diagrams" by J. J. DiCerto sells regularly for \$10.50. You can order it for \$8.40 when you present this coupon at Hayden Book Company's booth, 3621.

**20%
Reduction**

(See other side)

**Save
\$1.60**

(See other side)



Save

Worth \$1.59

"Transistors in Audio Frequency" authored by Guy Fontaine, is available for \$6.36 when you present this coupon at Hayden Company's booth, 3621. The book normally sells for \$7.95.



Save

Worth \$2.55

The widely acclaimed "Electronic Design Techniques" edited by Edward Grazda costs \$12.75. You can get it for \$10.20 when you present this coupon at Hayden Company's booth, 3621.

**20%
Reduction**

(See other side)

WESCON USA

Whether you're a showgoer or a 'no show,'
check this compact preview of the highlights



HURRY, HURRY...

It's called "Eight Shows in One." It runs from Aug. 22 through 25, and it features performances by more than 600 companies in 1100 booths.

WESCON, 1967, is open.

The Cow Palace at San Francisco has been transformed into a dazzling electronic spectacle that is expected to draw 40,000 engineers and managers.

Along the colorful aisles, products are grouped in eight broad categories. These are the eight shows of WESCON.



WESCON IS STARTING

And there's more in the wings. Technical sessions are planned on 20 subjects. In addition, the Eighth International Electronic Circuit Packaging Symposium opens Aug. 21 in the San Francisco Hilton. And a major symposium on microelectronic developments, "Microelectronics Comes of Age," starts Aug. 23 in the same hotel.

Join ELECTRONIC DESIGN's guided tour of the significant at this year's WESCON. Begin here:

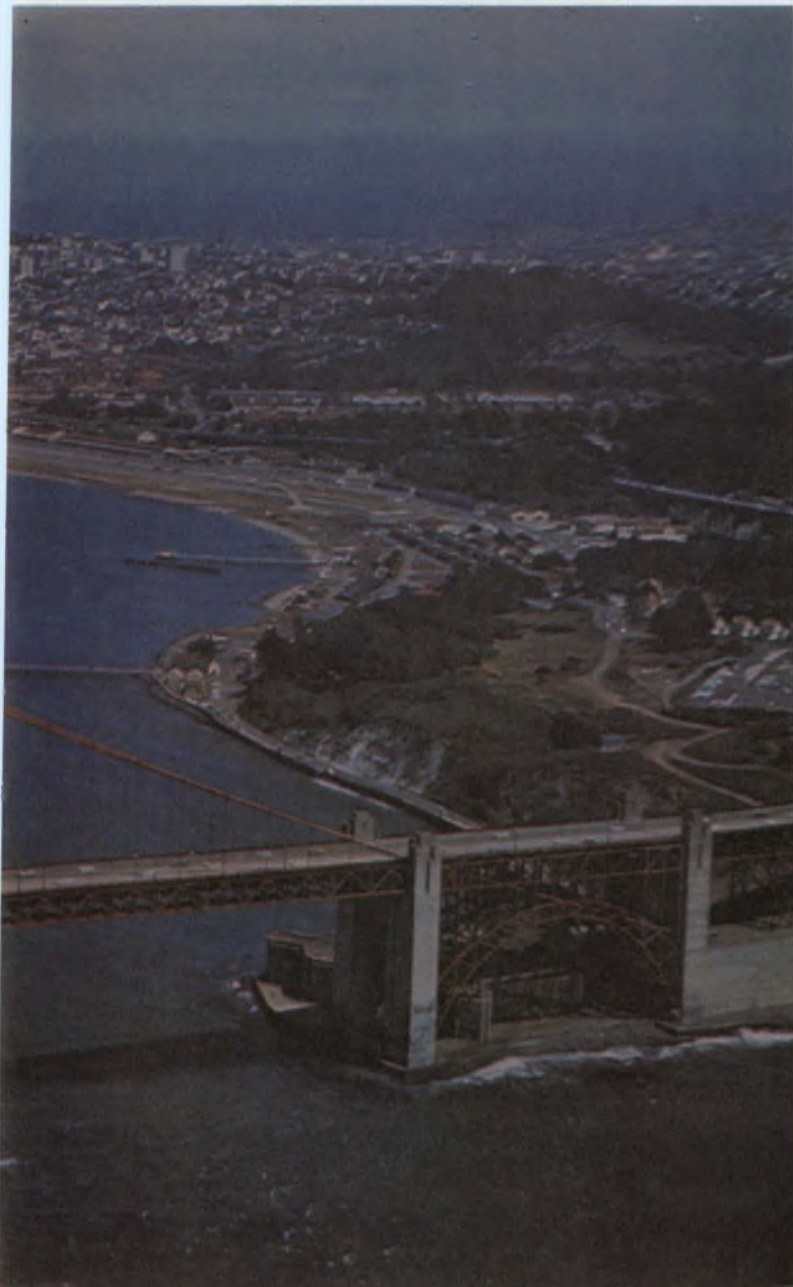

Design trends in the major engineering disciplines, as reflected in new products on display and technical papers

Circuit Designer.....	U 88
Communications Engineer.....	U 90
Computer Engineer.....	U 91
Materials and Packaging Engineer..	U 96
Medical Electronics Engineer.....	U 97
Microcircuit Systems Designer.....	U 99
Microwave Engineer.....	U 102
The engineer manager.....	U 84
When, where and what to hear, listed by engineering specialty.....	U 112
Progress in fluidics.....	U 108
As seen by the camera—	
Touring the exhibit areas.....	U 120
Industrial design awards.....	U 210
Outstanding new products	
Packaging & Production.....	U 122
Computers & Data Processing.....	U 136
Instruments & Control Systems.....	U 148
Communication & Detection.....	U 180
Circuit Components.....	U 192

SUDDENLY, YOU'RE A MANAGER

And for the many engineers who find themselves unprepared, WESCON considers some remedies

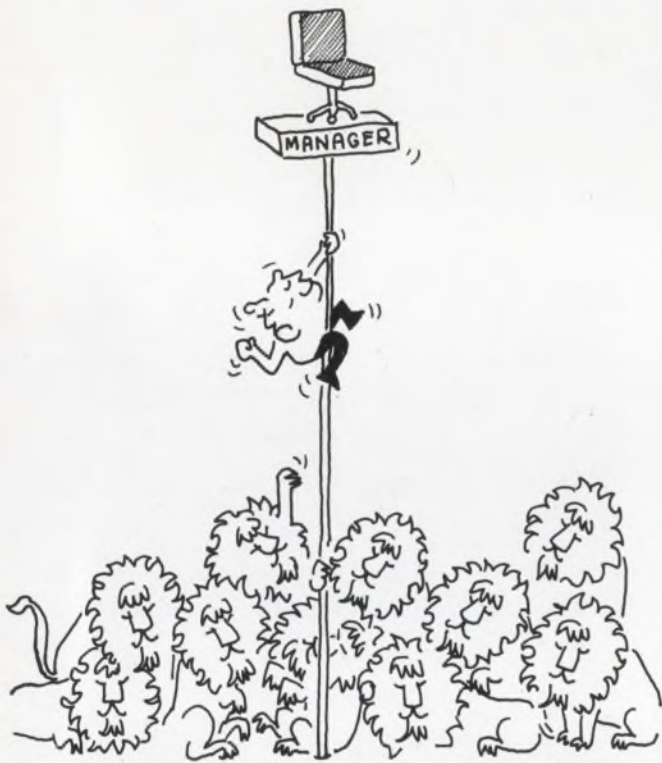

Manage or Perish: Many engineers must make the choice of moving into management or reaching the dead end!



Meet the Financial Department: Many engineers move into management with little or no financial training. Personnel in the two departments should get to know each other.

Howard S. Ravis,
Careers & Management Editor

More and more engineers are moving into management positions, with little or no management training.

"It is a situation the engineering field has known for a long time," notes a WESCON official, "but no one wanted to talk about it. The industry is finally recognizing the fact that the technical man can no longer stay completely technical."

Engineering colleges have been partly to blame: they have trained future engineers to be engineers only. Several years after graduation from such schools, many have found themselves suddenly at a turning point in their careers. Like the professor in college who is commanded to "publish or perish," engineers in many instances face this prospect: "Manage or perish!"

Often with little or no preparation, the engineer must ask himself and must answer quickly: Am I qualified and will I be happy as a manager? Will I find myself spending most, if not all, of my time as an administrator instead of as a creative engineer? What will happen to me if I refuse the management position? Will the company let me go? Will I become professionally stagnant?

Recognizing the need for more engineering management discussion in the industry, WESCON this year is incorporating for the first time a section on the nontechnical side of engineering management. WESCON officials expect the subject to take on increased emphasis in future conventions.

"Business Management: The Engineer Becomes Manager" is the title of this year's session, designed to help both the engineer in management and the one who may make the move.

Managing people

"Once the engineer becomes a manager, he is part of the team which must manage the company resources in a manner that will ensure survival of the business," notes one of the WESCON panel-

ists, James F. Riley, president of Signetics Corp., Sunnyvale, Calif. He lists "technology, capital and people" as the three main company resources.

"There is more than enough emphasis on the technical and capital resources," Riley contends, "but less than adequate emphasis on people resources. More than anything else, the success of a manager depends on the functioning of his people and the direction and retention of them."

Riley is convinced that on-the-job training is best for developing managerial talent. "The home environment is the best training ground," he says. "The company can train the manager in the same environment in which he will manage. Thus top management sees him actually working with the people he also will work with in the future."

If the manager or potential manager attends an outside management session, Riley argues, he is dealing with people he has never seen before and probably will never see again: "Thus, how he works with and supervises these people is of limited value when he returns to his home plant."

Managing money

As the engineer becomes a manager, he becomes more directly involved in capital matters. He now is responsible for a budget; the costs of the project must be watched.

Another panelist, Daniel G. White, president of the Commonwealth National Bank of San Francisco, lists the "pitfalls in money management":

- Ideas alone have little real value. They will assume value only when the idea is translated into a product or service that fulfills a need.

- Avoid overoptimism. Confidence alone does not sell the product. Beware of the unexpected. Expect the worst—it may happen. Plan at the outset for a second line of defense.

- Bankers look at cost projections rather than sales projections. There is often a tendency to let costs get out of hand. Keeping them down will influence the later economic life of the product.

- Engineers must be motivated to the concept of making money. Too often the engineer is aloof to this aspect of the business. Idea must be translated into dollars and cents.

White admits there is no sure-fire way for an engineer to gain this economic education.

"A good way to start, however," he says, "is for closer correlation between the engineering and financial people of a company. Too often they are in different worlds within a firm. They're on different floors and never see each other, except perhaps for a chance meeting at a coffee break. The departments should know each other."

Managing technology

A third panelist, Charles H. Keller, president of

Illumination Industries, Inc., of Sunnyvale, Calif., says that company management must ask itself: "Why does the company exist?"

He continues: "A company cannot have technical superiority as a goal. This sounds very nice, but it is unreal, if not impossible. The electronics field is too vast for one company to achieve complete technical superiority, and the company management must realize this."

The answer, according to Keller, is that the company exists "to satisfy the demands that others make of it." He cites these six groups that make demands on a company: customers, employees, owners, suppliers, the Federal Government and the local community.

"A successful enterprise must utilize its demand-meeting capabilities to meet these demands in the stated order," Keller says. "When the demand-meeting resources are consistently misapplied, the enterprise will either fail or be set back until the proper order is established by pressure from the displaced group or recognition by management of the error of its ways."

Once the company knows the demands, it can manage its technology to meet these demands. "It is equally as dangerous to overestimate as to underestimate these demands," Keller adds.

Managing a turnaround

All three of the company's resources—people, money and technology—are put to the test when a company is forced into a major turnaround.

"The entire technological function of the company needs a change," notes Martin H. Dubilier, executive vice president of Friden, Inc., of San Leandro, Calif., who is also a panelist.

"Perhaps the most important thing a manager can do during this transition," says Dubilier, "is to keep the engineer completely informed when making the change. The management of most companies is reluctant to inform its engineers, fearing it will give away secrets, which the engineers in turn will give away."

"Management cannot afford to be reluctant, however. It is of greater significance to the company that their engineers be made part of the change so that they can conform or adapt to the new process."

Management must expect morale to drop during a changeover, Dubilier concedes. But he adds:

"By keeping your engineers informed, the drop can be lessened. And, finally, and perhaps more importantly, the engineer can be of great help to management—first, in recognizing the need for change and then in helping to achieve this change successfully."

Donald C. Hoefler, columnist for *Electronic News*, is the panel chairman of the WESCON session. ■ ■



The Kind of Knowledge that makes traffic control possible...

Every year more cars join the traffic scramble. As congestion thickens, bottlenecks occur more often. And traffic flow screeches to a halt.

How can we help keep the nation's expressway traffic moving from coast to coast? One way is with remote traffic control systems, like the one pictured above on the Kennedy Expressway in Chicago.

This system reverses lane directions as changes occur in traffic density during morning and evening rush hours. Through a system of gates, signal arrows and directional lights, an express lane can be changed from inbound to outbound—and vice versa. To date, this unique system is doing a great job helping keep Chicago traffic moving.

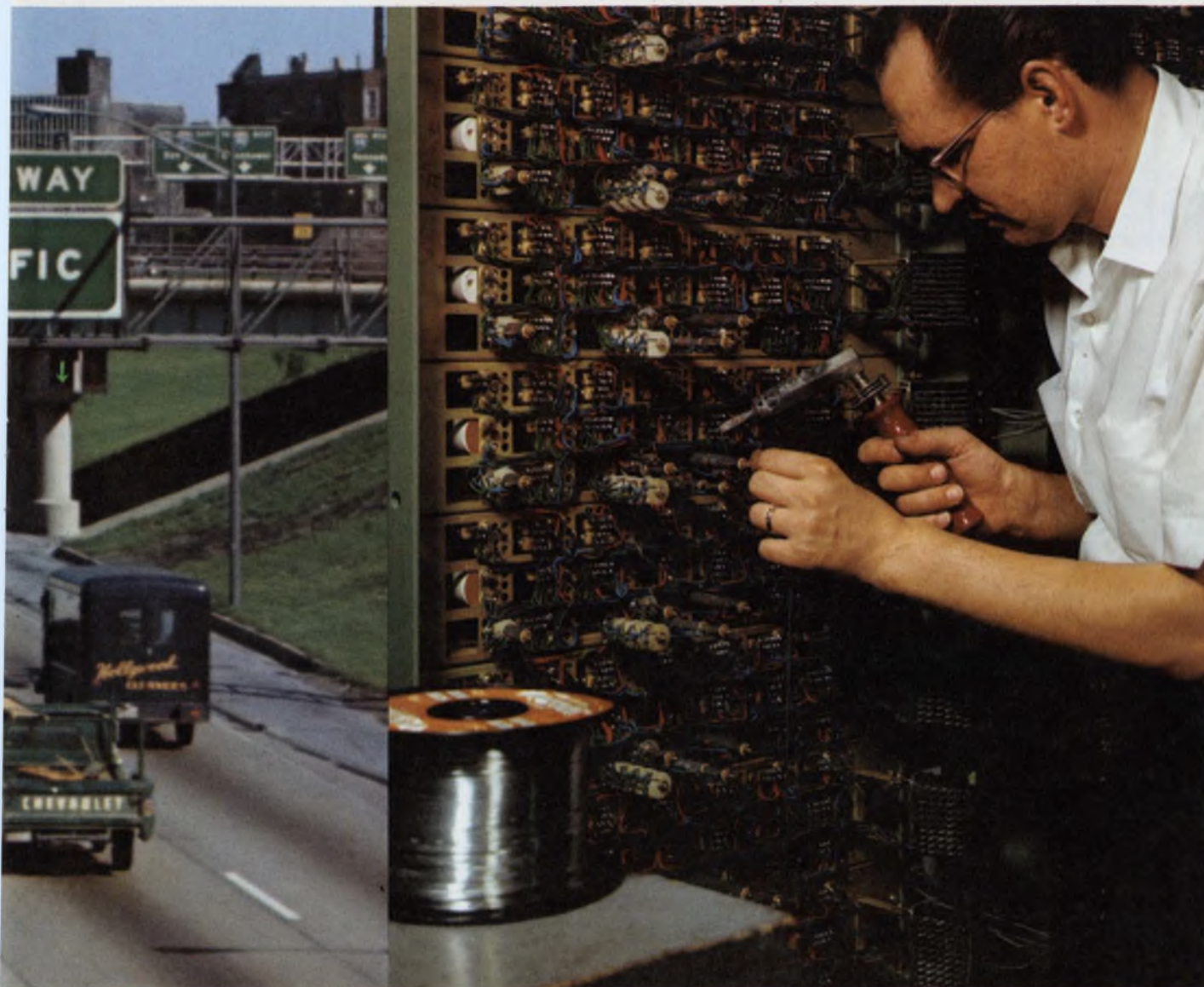

IS THE KIND OF KNOWLEDGE YOU GET FROM KESTER

Regulating such a complex control system takes hundreds of precision electromechanical relays and stepping switches. That means connections must be soldered for maximum reliability.

In assembling this traffic control system the manufacturer used Kester Solder. Both the solder and flux were specially formulated to meet stringent requirements.

The kind of knowledge that goes into traffic control systems is the kind of knowledge you get from Kester Solder. From formulating the finest solder and flux to expert assistance on soldering applications, Kester stands ready to serve you. Write, phone or wire for specific information.



KESTER SOLDER COMPANY 

DIVISION OF LITTON INDUSTRIES

4201 Wrightwood Avenue, Chicago, Illinois 60639 • Newark, New Jersey 07105 • Anaheim, California 92805 • Brantford, Ontario, Canada

1899-1967—68 years devoted to production of products of the highest reliability—solders and fluxes

ON READER-SERVICE CARD CIRCLE 55

ELECTRONIC DESIGN 17, August 16, 1967

U87

THE TECHNICAL SIDE OF WESCON

Here is a summary of the significant papers and trends evident at the show, arranged by engineering specialty

Circuit designer

FETs and plastic devices are finding wide use

Field-effect transistors, still relative newcomers to design, are now more practical than ever. This is evidenced by the fact that a complete session at WESCON (No. 8) is devoted to the design of rf circuits using FETs. Each paper presents practical design procedures and considerations, readily usable by a design engineer.

Of particular importance is the paper entitled "High-Frequency Power FETs," by J. B. Compton of Siliconix, Inc. He shows how the high input impedance and lack of secondary breakdown characteristic in FETs are used in the design of rf power amplifiers to get outputs of 0.5 watt.

A year or so ago one criterion for good circuit design was considered to be the number of active (transistor) devices used—the fewer the better. The major reason for this goal was the high cost of active devices.

This approach now appears to be obsolete. Plastic devices are rapidly coming down in price to the point where some compare favorably with the price of a resistor. Even such "sophisticated" devices as 400-MHz, 10-dB FETs can be bought for 95 cents. A unijunction transistor costs only about 65 cents. Silicon small-signal transistors sell for a dime or less.

Today the circuit designer need not worry about adding a transistor or two. He can achieve better reliability by increasing the number of active devices in the circuit, thereby avoiding the need to work a minimum of transistors at their highest limits. In fact, it is possible today for the designer to keep an assortment of his "pet" transistors in boxes (just as he would his resistors)

above the laboratory bench.

With the prices of plastic devices so low, the obvious question is will they make a reliable package? Two researchers from the Army Electronics Command at Fort Monmouth, N. J.—Edward B. Hakim and Roland Canepa—ask and partly answer this question in their paper, "A Preliminary Investigation of Plastic-Encapsulated Transistors," to be delivered at the Eighth International Electronic-Circuit Packaging Symposium. The paper presents a summary of various tests carried out on seven types of plastic-encapsulated transistors.

Several important conclusions have been reached by the authors as the result of their evaluation project. It was found that plastic devices pass present short-term military tests. The question of long-term effects, however—and whether plastics will introduce increasing failure rates, compared with metal packages—was not explored.

Two tests were found particularly helpful. One was a high-humidity and-temperature test, with an applied electric field across the device. In relatively short periods of time (less than four weeks) significant deterioration was observed in the plastic devices.

Another test, checking ionic contaminants, was the standard inversion layer test used on most pnp metal-encapsulated devices. It included high-temperature storage (150°–200°C) and 50 to 75 per cent of rated BV_{CBO} or BV_{CEO} of the transistor. The parameter measurements were made after the devices had cooled to room temperature and the voltage was removed. Again, deterioration was observed in the plastic devices.

Specifically, the following tests were performed:

- Temperature storage: +200° C.
- Temperature cycling (1/2 h at each temp.): -48°C to +200°C.
- -40°C and power cycle (1.5 min on, 30 min

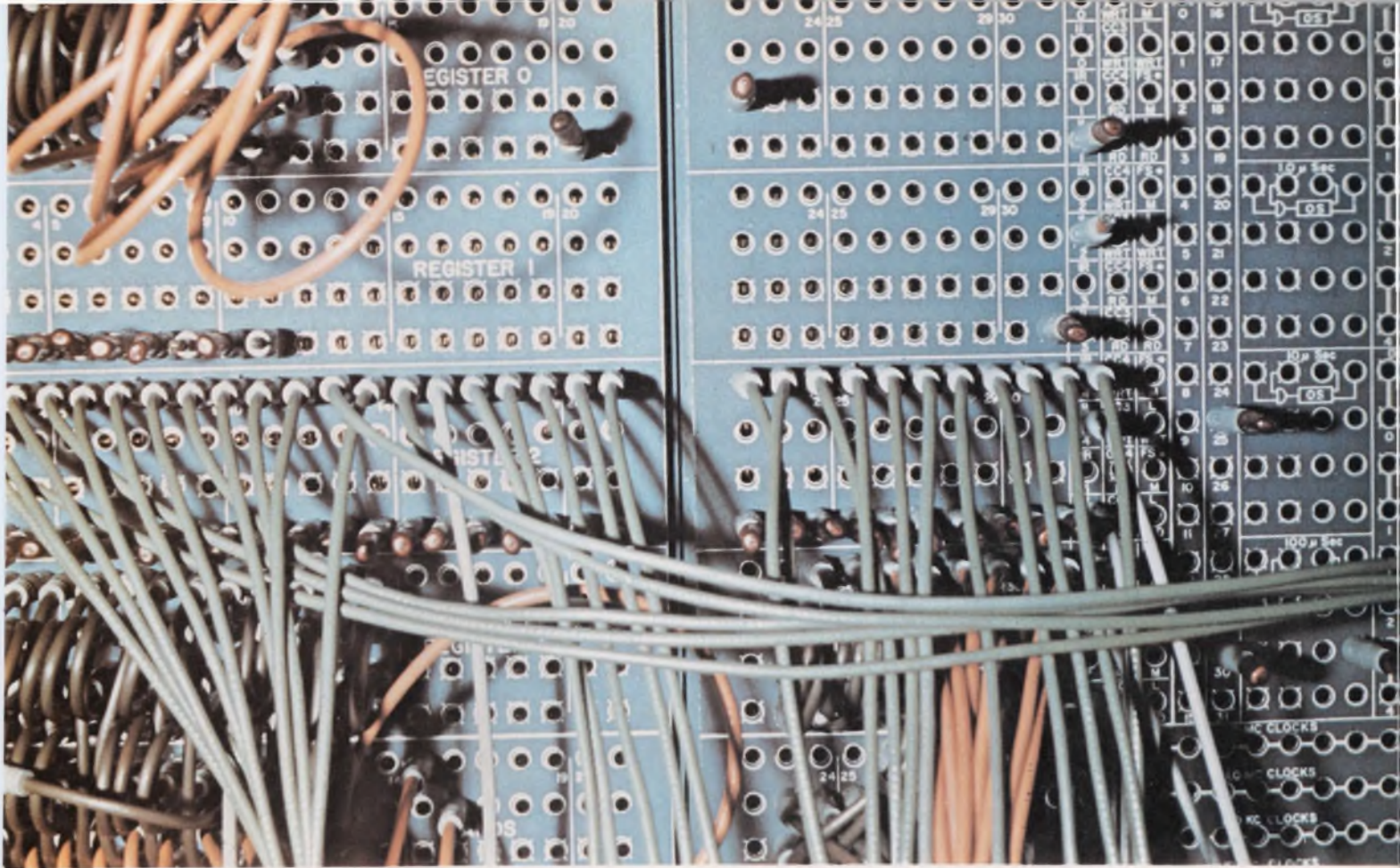

General-purpose interface, looking like a telephone switch-board, enables experimenters at Michigan University to

transfer digital or analog signals to and from a nuclear-physics laboratory and a computer. (Paper 16/2).

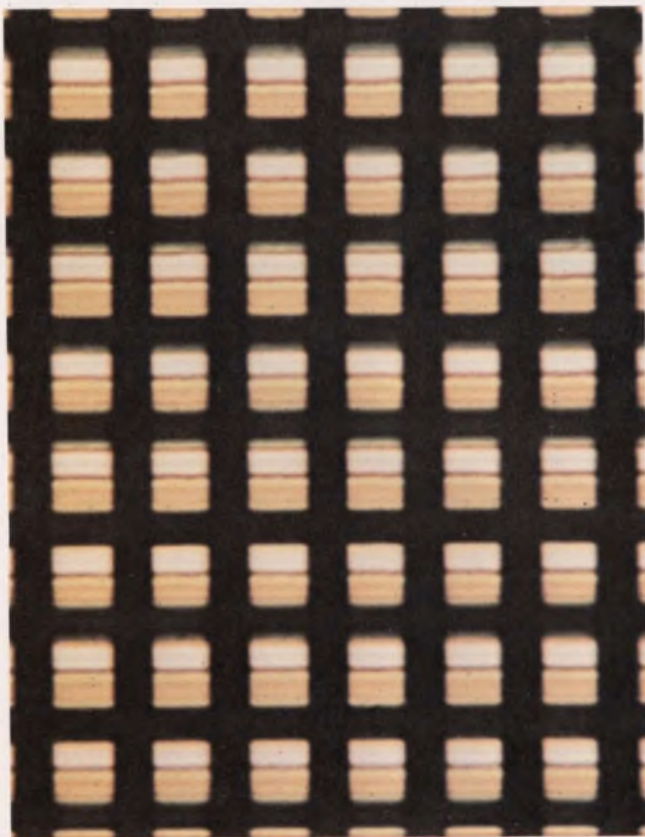

Photoconductor array at left contains 32,400 elements (180 by 180) and is part of a self-scanned image sensor

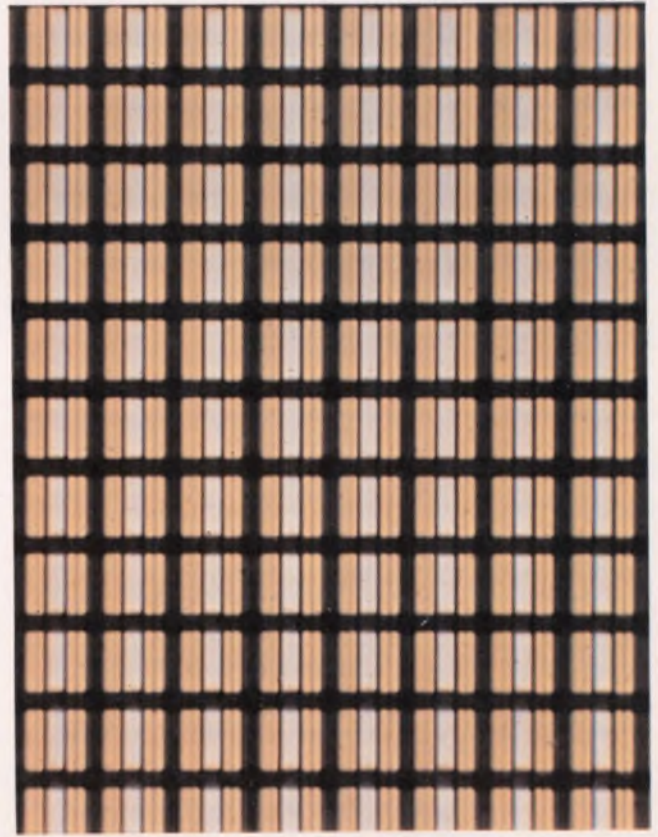

for an experimental, tubeless TV camera. A 360-by-360-element array is shown at the right (Paper 13/3).

off).

- -40°C and voltage cycle (1.5 min on, 30 min off).
- Humidity cycle and power: $+25^{\circ}$ to 65°C ; 80% to 98% relative humidity.

The report points to rapid improvements in plastic materials. Thus the authors state: "The testing of plastic-packaged transistors initially indicated that with plastics available at the start of this program silicone was more desirable than epoxy. However, epoxy devices are now available which appear as good as silicone in both high-temperature and moisture stability."

Communications engineer

Communicate, don't travel, is the goal of designers

A dozen or so years from now, the engineer too busy to travel to electronic shows across the country may pick up his picture phone and scan the exhibits. If a booth looks interesting, he may dial the engineer on duty and talk to him. Such are the possibilities envisioned by communications specialists.

The idea of substituting communication for transportation in many situations of daily life is not fancy, says Dr. Timothy Healy of the University of Santa Clara. It began, he notes, when telephone calls replaced trips across town. The questions now are how far and how fast.

According to Dr. Healy, the opportunities are virtually limitless. For example, attempts are being made today to eliminate the exchange of money through data links between a customer's bank and the places where he buys goods.

Psychological and economic problems

But there are formidable obstacles, Dr. Healy says. As he sees it, the two biggest are economic and psychological.

The most urgent problem is economic: data transmission is expensive. One minute on a video phone costs up to \$200 at present—out of reach of most would-be users. But Dr. Healy believes in the spirit of private enterprise. The cost of phone calls has dropped considerably over the years, he notes; video phones will follow suit.

The psychological problems are mostly long-range, Dr. Healy says. Can we really do without our work environment, for example? Can salesmen sell without face-to-face confrontation? Can housewives shop by television? Can executives give up the battles at round tables? There is no answer yet to these questions, but he will attempt

to shed light on ways to look at these problems in Session 9.

Curiously enough, Dr. Healy does not see any serious technological problems. He realizes that the expected increase in transmitted data will be astronomical, but he observes: "Obviously radio waves are out of question on the long range. Satellites will be a terrific boost for the next 10 to 15 years, but after that we'll have to use cable lines for data transmission. If you want to be really futuristic, then modulated light in cables may be the real answer."

For the next decade, he envisions "belts" of 15 or 20 satellites with highly directive antennas in S band, for instance, to handle data traffic with spatial multiplexing.

Cut cost of data compression

But before these ideas can be realized, designers must find more efficient ways of transmitting data. Already hardware capabilities are being strained. Straightforward approaches to increasing the capability of links run into trouble quickly because of cost, says a group of engineers at the Lockheed Missiles and Space Co., Sunnyvale, Calif. (Session 6).

At the transmitting end of systems, one solution

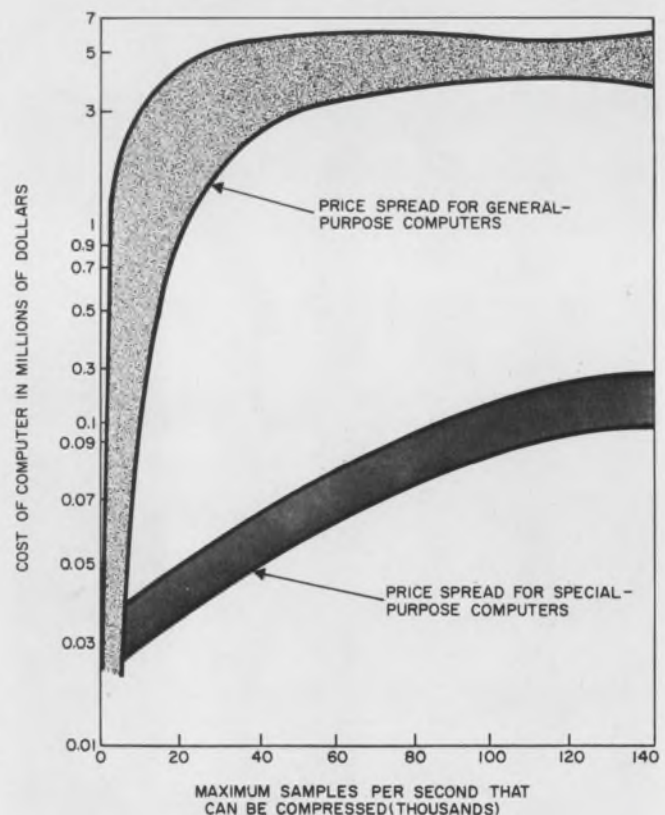

1. **Cost-performance trade-off** of computers for data compression clearly indicates the advantages of special-purpose types. Data-compressing computers are now developed that can handle many input types and allow the selection of processing that offers the best compression ratio.

lies in data compression—in the rejection of redundant data before transmission. The Lockheed group has come up with a hardware approach that can compress a variety of telemetry data, reconstruct the result when needed and display any selected two channels on a strip recorder. According to John J. Dowing, supervisor of the data-compression group, the technique avoids the need to design a special instrument for each application and manages to keep the cost far below that of a general-purpose computer (see Fig. 1 for cost comparison).

The compressor accepts 10-bit parallel digital input words that identify the channel and contain the data. This input may come directly from the telemetry multiplexer or from a decommutation station at a rate of more than 50,000 words a second. The experimental model can accept 1024 data channels, and separate tolerance levels can be established for each channel. To obtain the best compression ratios, each channel can be set for either averaging or exponential digital filtering and for one of several popular compression methods. The output is pulse-code modulated. It may be recorded and fed back to the machine, which then reconstructs the original uncompressed data.

How to predict fading

But even the most efficient data-compressing system will not do much good, if the data get lost in the propagation media. Robert F. Daly, a scientist at the Stanford Research Institute (Session 9), points out that theories abound on channels where the noise is assumed to be Gaussian or nearly Gaussian, but not much is available to help engineers deal with signal fading.

Fading, or signal distortion, becomes significant in high-speed digital data transmission, Daly says, since the loss of even a small data segment can be critical.

The communication problem in the presence of fading differs in several ways from the problem with additive noise only, but one difference is particularly important to system designers, according to Daly. With only additive noise in the channel, any desired small error can be achieved by increasing the transmitting power level, whether optimum or suboptimum receivers are used. This is important, says Daly, because it is easier to increase signal power than to obtain a better receiver.

But fading channels do not go by this rule. Without an optimum receiver, the transmission suffers an irreducible error, due to self-jamming. The channel distorts the signal so that some of the energy interferes with the desired transmission. Higher power levels increase both the signal and the interference, so nothing is gained, points out Daly. For the same reason, more sensitive receivers

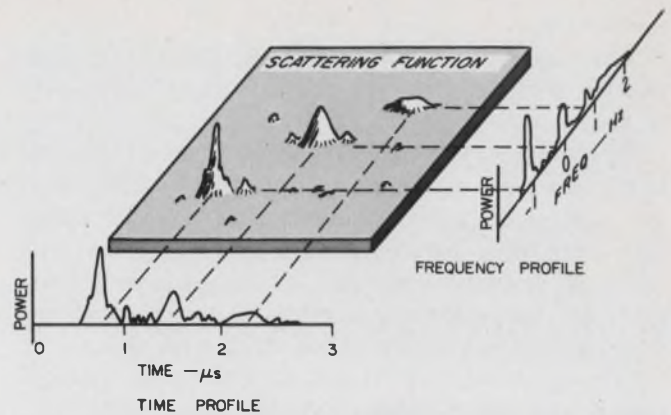

2. Time-frequency plane of scattering function in communication channel for hf signals show nodal nature of the function. It introduces both frequency and time variations in the signal.

do not help either.

Daly sets up a model for the fading channel that allows the accurate prediction of error rates over an hf link.

When setting up the model, he assumes that the signal undergoes both time dispersion and frequency dispersion, because of scattering in the channel.

The received signal is scattered by irregularities in the dielectric constant of the channel (particles, for example, are such irregularities). The energy from these scatterers arrives by a different path, causing a differential time delay, or time dispersion and resulting in frequency-selective fading. But the scatterers are in motion, which results in a Doppler shift. Since the Doppler shift is different for each scatterer, frequency dispersion is also introduced. Thus, both the time and frequency structure of the transmitted signal will become smeared out, and the transfer function of the channel displays both frequency and time dependence. Such a scattering function for an hf link is shown in Fig. 2.

He models this channel as a linear time-variant filter, and introduces some design points for optimum receivers that help reduce fading errors.

Computer engineer

Computers as components or will it be vice versa?

The computer engineer finds himself at a crossroads today: there is a wide road, along which computers are merely components, parts of a larger system; and there is a narrower road, along which components are computers, formed by large-scale integration (LSI). Which way does he

have to go?

Knowledgeable computer engineers are preparing to zigzag between the two paths, by adding to their skills along the way.

System design calls for the ability to integrate hardware and software, to optimize systems that use computers as components and to solve interface problems. Not only man-machine interfaces but also machine-machine interfaces are important, as, for example, in digital control systems. LSI requires an appreciation of the techniques of fabrication and, in particular, of the economics of large- and small-volume production.

Bob L. Ryle of the Planning Research Corp., Los Angeles, presents a strong case for considering software as another engineering discipline for the computer engineer (Session 16). He believes that the idea of software as an "esoteric art form" must be dispelled; it must be treated as a scientific discipline, he says. This will become even more necessary if, as seems likely, the software of operating systems is handled by hardware. An example of this is the use of LSI as a read-only memory storing an executive system.

Optimum design is needed

Maximum effectiveness of third-generation computers is the concern of authors David L. Stein and Joe L. Glaser of Scientific Data Systems, Santa Monica, Calif. They define third-generation computers as variable combinations of control units—memory and input/output units communicating freely with each other through standard interfaces.

Now a system designer can produce a whole range of systems to do a specific problem, according to the authors. The art is to find an optimum design, one that will do the job faster, more accurately or, perhaps more importantly, more cheaply. Although the criteria may be easy to determine, the effect of altering a system design may not. Simulation of proposed systems is likely to be one way out of this particular difficulty. The authors admit they do not have all the answers.

In the same session, Dr. J. V. Kane of Michigan State University shows how, as a nuclear physicist, he has had to solve an interface problem to use a third-generation time-sharing computer as a component of his laboratory. His general-purpose interface enables experiments to control not only a cyclotron but also several independent experiments. Dr. Kane cites the advantages of his system as follows:

- Experiments will be able to record and analyze data whenever they wish.
- The time required to set up and alter experiments will be reduced.
- Experiments may be operated remotely by researchers in distant or small institutions.

Computers help improve patient care

The computer as an element in the medical environment is the concern of Dr. Shannon Brunjes and his colleagues at the Los Angeles County Hospital. In their paper, the authors describe a system of out-patient prescription-information storage that uses remote CRT displays on line to the hospital's IBM 360/30. Envisaged is a larger information system, including in-patient drug orders and clinical information entered directly by the physician. Dr. Shannon notes that the hardware to do this is available now but that the programs are not. Specialized software is a necessary part of system design, he indicates. (If you want to hear more about the use of computers in medicine take a look at Session 7, where Dr. Donald C. Harrison of the Stanford University School of Medicine discusses on-line patient care.)

LSI is nearing reality

The effect of LSI on computer system design will be examined by a panel in Special Session B. Opening the discussion will be Richard Petritz of Texas Instruments, Dallas, who will be covering the state of LSI technology principally in monolithic integrated circuits, hybrid arrays and large arrays with discretionary wiring. Another enthusiastic proponent of LSI is Gordon Moore of Fairchild Semiconductor, Palo Alto, Calif. He predicts that LSI will be a reality by 1970, with costs of 5 cents a gate and memory costs of 2 or 3 cents a bit. He hopes to be able to establish a set of economic ground rules for the computer designer, in terms of quantities for feasible production runs and turn-around times for changes to designs in production. Debating the applications of LSI for large-scale systems will be Gene Amdahl of the International Business Machines Corp., San Jose, Calif., and covering small systems will be L. C. Hobbs of Hobbs Associates, Corona del Mar, Calif.

In the debate that will follow the presentations, some of the questions the computer engineer might like to hear answered could be these:

- When will there be some industry agreement on what constitutes LSI?
- When are the manufacturers of integrated circuits going to produce examples of LSI that are nontrivial and economic for the computer manufacturer?
- When and how is the problem of multilayer interconnection on a chip going to be solved?

Design automation will reduce costs

Both semiconductor and computer manufacturers agree that the problems of the design of LSI arrays will require automated design techniques to allow economic use. Thomas F. Prosser

(continued on page U96)

Engineers can design their own microcircuits by means of Norden's Master Dice Breadboard. The monolithic integrated layout contain 6 transistors, 33 resistors (Booth 5031).

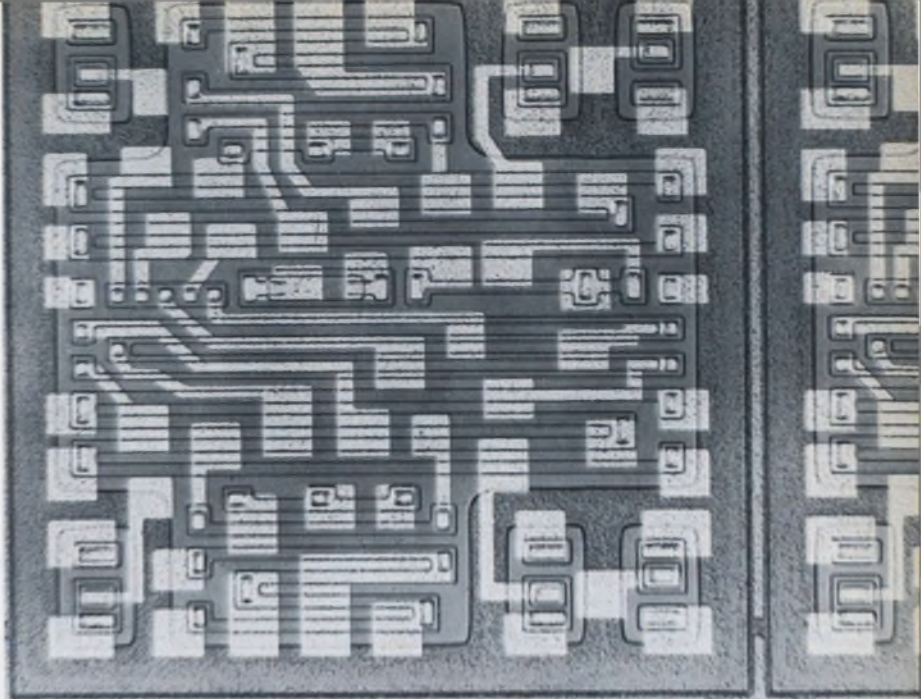

Fluidic control is used in Univac's pneumatically controlled document-handling system. A motion control track is shown (Paper 11/5).

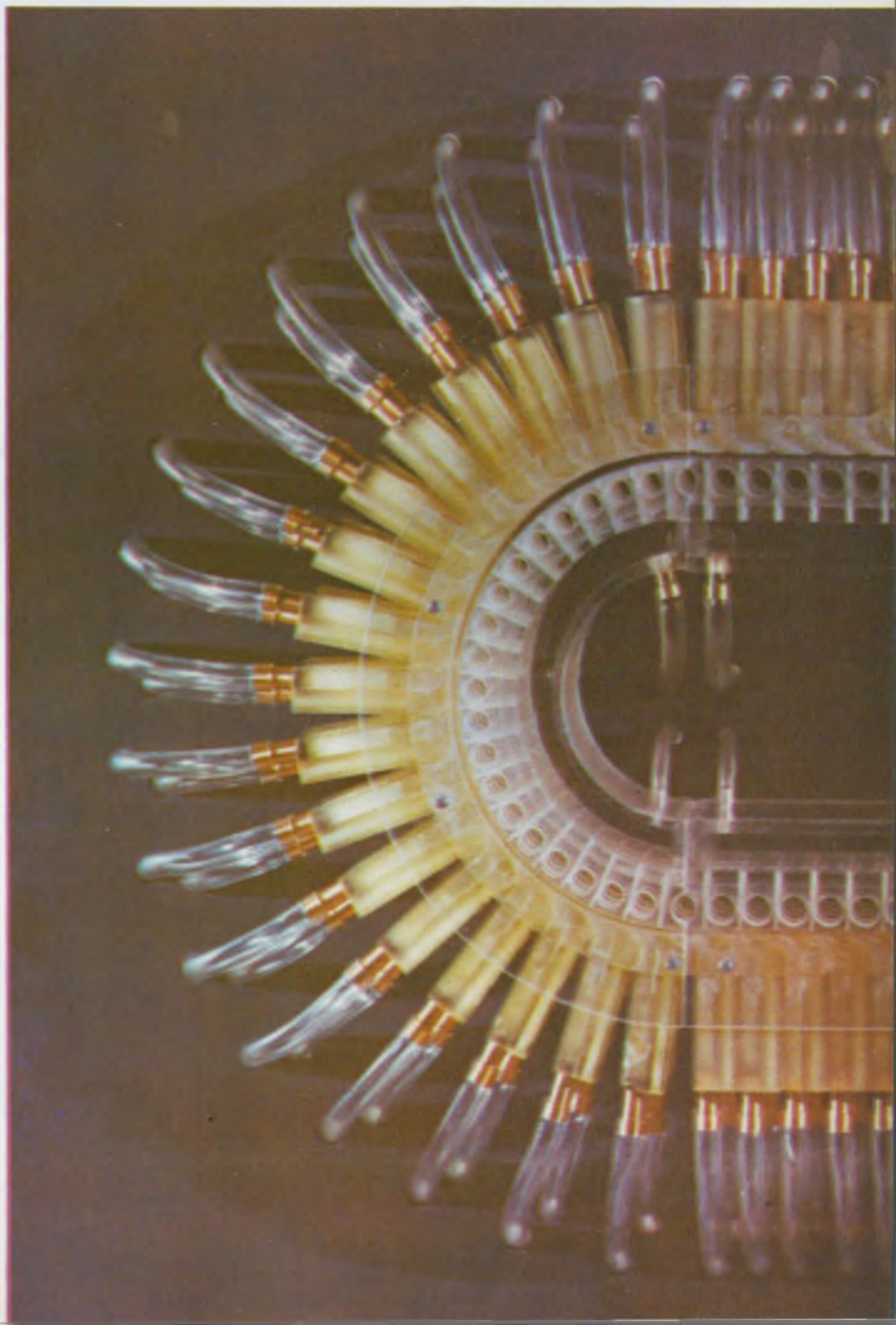



Reliable electrical connections

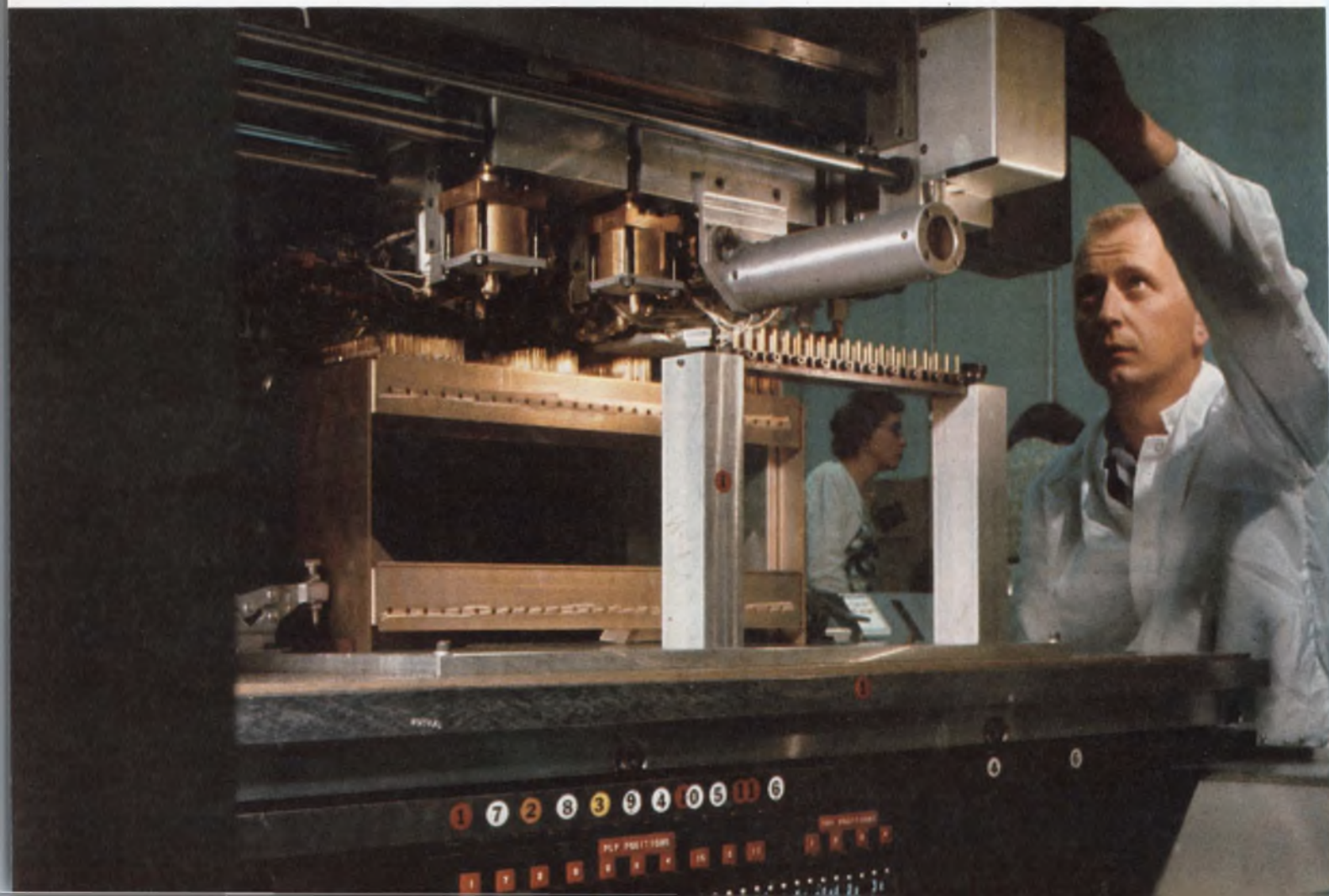

Your choice of power for hand "Wire-Wrap" tools . . . electricity, compressed air, or rechargeable battery. We also make manual tools for field servicing. Bulletins 14-1, 14-3 and 14-7.

Solderless electrical connections are wrapped to stay . . . wrapping time is less than one second each . . . Using Gardner-Denver "Wire-Wrap"® tools. You save hours of handwork. You save inspection and rework time as well, because "Wire-Wrap" tools make reliable connections, even in inexperienced hands. Widely used for wiring television, instruments, communications equipment, computer panels and missile guidance systems.

in less than one second each

Modular panels are quickly and securely wired on Gardner-Denver automatic "Wire-Wrap" machines, which are programmed with punched cards for maximum flexibility. Bulletin 14-121.

Reliable! More than 40 billion solderless wrapped connections have been made with "Wire-Wrap" equipment without a single reported electrical failure.



Film is scraped from wire and terminal at contact points. High pressure metal-to-metal contact invites solid state diffusion, maintaining low connection resistance.



Solderless wrapped connections remain gastight even when exposed to severe changes of temperature and humidity . . . so they're not affected by atmospheric corrosion.



Initial pressure may go as high as 100,000 psi. Pressure drops as wire relaxes, but stabilizes at a value greater than 29,000 psi.

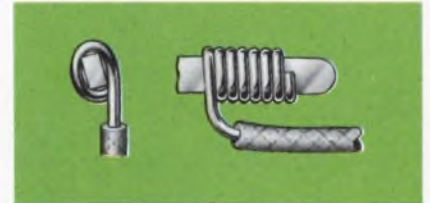

Flexible lead-off absorbs vibration and handling shocks . . . permits wrapped connection to stay tight and mechanically stable.



SEE WHAT AIR IS DOING NOW...SEE

GARDNER - DENVER

Gardner-Denver Company, Quincy, Illinois

ON READER-SERVICE CARD CIRCLE 56

(continued from p. U92)

of the Philco Ford Corp., Santa Clara, Calif., in a paper in Session 4 of the Eighth International Electronic-Circuit Packaging Symposium cites a component cost reduction factor of 10 or more through the use of computer-aided design. Proponents of LSI are painting a rosy future for it, by citing the advantage of tremendous computing power at very low cost. However, opponents are likely to retort that for large systems, the circuitry costs are likely to be only 5 per cent of the total, so that even a 50 per cent reduction in circuit costs will not significantly reduce the total system cost.

High-density recording packs them in

Bulk storage has always been important to computer users and designers. The cheapest bulk storage device is still the magnetic-tape unit (less than 0.001 cents a bit), although it is being hard-pressed by the other electromechanical storage devices, principally the magnetic disk (0.02 cents a bit). As a result there is considerable pressure on tape-unit manufacturers to improve the performance of their products.

Reporting on their work in Session 12 are Donald T. Best of the Ferroxcube Corp., Saugerties, N. Y., with a paper on magnetic head design, and Kermit Norris of the Leach Corp., Azusa, Calif. Norris describes a novel technique that uses a relatively simple one-track system, yet achieves a density of 10,000 bits an inch with an error rate of less than 1 in 10^8 bits. More unusual are the electron-beam and laser recording methods to be reviewed by Charles F. Spitzer of the Ampex Corp., Redwood City, Calif. These methods use modulated electron and laser beams on thermoplastic and silver halide films, which are developed and then coated with a plastic scintillator. When scanned with electron or light beams, the scintillator emits light that is detected with photomultipliers. Much of the work is still in the developmental stage, although a large computer manufacturer hopes to deliver an electron-beam system shortly. The author looks for a factor-of-10 improvement over magnetic tape and cites densities of the order of 10^7 bits a square inch.

Materials engineer

Microelectronic packages: The approaches fan out

The revolution in electronic components in the last decade has been accompanied by an upheaval in packaging and in the methods used to inter-

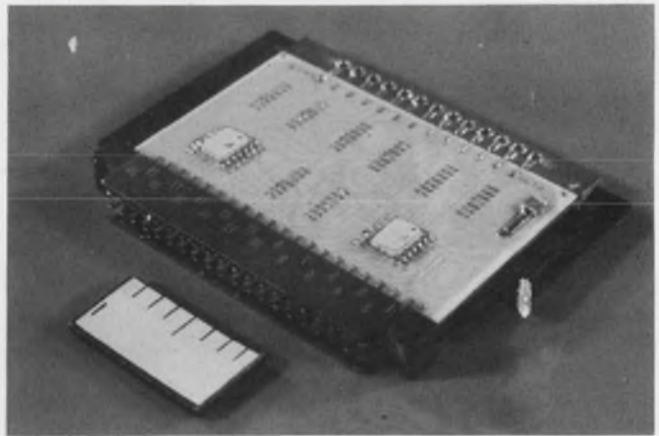

Four-layer digital logic module from Sylvania is formed by firing and screening metal and glass layers alternatively on alumina substrate. Thermal characteristics are reportedly some 50 times better than glass-epoxy.

connect components.

The stamped metal chassis needed to hold tubes, and the wire, installed by women with soldering irons, have been superseded by printed-circuit boards with their plated interconnection patterns. Dip soldering fastens scores of components in place, allowing one worker with a tub of boiling peanut oil to do the work of a dozen girls with soldering irons.

Now, the popularity of integrated circuits makes even greater demands on packaging and interconnection techniques, and designers are meeting this challenge by creating multilayered interconnections in packages that can be batch-processed.

The simplest approach to multilayer interconnections is the double-sided printed-circuit board. Here, plated wires are photoformed on both sides of the printed-circuit board. Where current must flow from one side of the board to the other, eyelets, or plated holes in the board, provide the paths. Components can be mounted on either or both sides of the board.

More complex boards can contain several insulated layers of plated interconnections on one side. The additional interconnection density afforded by multilayered boards costs considerably more than lower-density wiring approaches.

Another approach to the solution of sophisticated wiring problems is the numerically controlled installation of ordinary, flexible wire. Here, a machine working under the direction of a set of programmed instructions automatically interconnects a rack of contact pins.

Designers encounter problems amenable to a similar solution in the pursuit of large-scale integrated arrays: LSI requires the development of a flexible, automatic interconnection method that can operate in a microscopic framework. At present the individual sub-circuits of a wafer are probe-tested and then interconnected by a special metalization pattern that is automatically gener-

ated by a computer. Unfortunately the computer time expended on the generation of a mask for one wafer is not applicable to the interconnection of the next wafer.

These and other aspects of interconnection and packaging technology are reported at WESCON's Technical Session 4.

Medical electronics engineer

Better cardiac monitors sought to cut death rate

The engineer attending the medical electronics session will hear that his efforts are needed to save the lives of 200,000 persons a year—cardiac-care patients who die from heart failure and shock because the doctors' stethoscopes cannot pick up the danger signs in time. Improved electronic monitoring must be developed to cut the toll.

Patient-monitoring systems are proliferating because their value in around-the-clock observation of persons who have been stricken with coronary occlusions—heart attacks—has been dramatically demonstrated. Already more than 300 of the approximately 7000 hospitals in the

United States are reported to be equipped with coronary-care wards—most in the last year or two. As Dr. Curtis E. Miller, head of medical research at Beckman Instruments, Inc., Fullerton, Calif., and chairman of the WESCON session, says: "Many people who have heart attacks are candidates for further trouble within two weeks after their attack."

Before electronic monitoring, about 40 per cent of the coronary patients admitted to hospitals died before medical help could be marshaled. Patient-monitoring systems are said to have cut this mortality in half.

Dr. Eliot Corday, a cardiologist at Cedars-Sinai Hospital in Beverly Hills, Calif., who will deliver the opening paper at the WESCON session, underlines the importance of these systems:

"We know that we are going to save the lives of 100,000 coronary patients a year when we get every patient who has a coronary monitored with electrocardiographic equipment minute by minute, and I read this into the *Congressional Record* in April," he told ELECTRONIC DESIGN.

"We are still losing 200,000 lives due to heart failure and shock, and it's obvious that to save those patients we're going to need other types of monitoring equipment to measure blood pressure, cardiac output and various pressures on the right



Cardiac parameters are displayed on oscilloscope at Columbia Presbyterian Medical Center, New York. Many

lives are saved, but more are lost because the ubiquitous stethoscope cannot reliably predict further trouble.

and left sides of the heart.”

Dr. Corday says that the greatest need right now is for a simple apparatus that can record blood pressure from within an artery from second to second (it would be left inside the patient), and for something that will measure cardiac efficiency externally (an indirect measurement which does not require anything to be implanted).

“This is what we’re shooting for,” Dr. Corday says, “and I hope we can have it in a few years. . . . We’re not recognizing the danger signs of heart failure and shock; we’re not picking them up on our stethoscopes.”

Another WESCON panel member, Dr. Donald Harrison, chief of the cardiology division at the Stanford Medical Center, says:

“It is useful to be able to measure cardiac output. One way of gaining some idea of this output is to measure the oxygen content of the central venous system by means of fiber optics. This gives an insight into how well the heart is functioning. The devices are not now practical for cardiac-care units, but I think they will be. The problem is one of size: it is necessary to get them small enough. I think that within a year or two they will be used widely.

“However, I have given up, after several years of intensive study and discussion with engineers, on getting useful indirect measurements. We’re going to have to live with catheters and tubes and fiber optic bundles. I don’t believe there is much capability in a year or two for indirect measure-

ments. In five years, perhaps.”

Dr. Harrison’s mention of catheters and tubes was a reference to the devices now being developed by such companies as Statham Medical Instruments, of Los Angeles, to measure blood pressure accurately. These involve the insertion of a tube into a blood vessel, so that a transducer can produce a continuous waveform output. In the fall Statham plans to introduce a subminiature blood-pressure transducer—less than 0.060 inch—that can be implanted for at least the duration of the patient’s stay in the cardiac-care ward. Present catheter-transducer devices must be replaced after a few days. However, transducers such as Statham’s are regarded as only an intermediate step.

The more general purpose of the WESCON session is to permit doctors who have had direct experience with patient-monitoring to give a critical review of this healing art: its problems, progress and prospects.

According to Dr. Miller, many hospitals think they need patient-monitoring systems but are uninformed about what they need. At WESCON the speakers will try to provide information both to the medical profession and to the instrument manufacturers.

For example, equipment should be designed with personnel in mind. Will engineers be in attendance in the hospitals? Or will the equipment be operated by nurses? What about maintenance?

There are other types of patient-monitoring



Cardiac pacemaker restores a patient’s heart beat when the monitor detects an irregularity. The unit is used in

the intensive care ward of University Hospital, NYU Medical Center, New York.

systems besides the cardiac units. Beckman Instruments is developing a device to protect premature babies against a common tendency for them to stop breathing. Nowadays a nurse walks around the incubators and checks. With the Beckman device, an alarm goes off when respiration stops.

Intensive care is another form of monitoring for patients who are seriously ill from a variety of causes: shock, traumatic surgery, brain damage, burns. These patients have to be checked extremely closely to detect the onset of difficulties that are secondary to the major illness.

Still other monitoring devices are used mainly in diagnosis. For example, a person may complain that his heart is fluttering or causing him pain. The electrocardiogram taken in the doctor's office may not show anything abnormal. But the physician knows from experience that patients have walked out of his office in similar circumstances, only to succumb to heart failure a day or two later. Now there are on the market portable tape recorders that, attached to a person, permit continuous recording of an electrocardiogram for up to 10 hours. The tape can be played back very rapidly under computer control to reveal pathological symptoms.

The computer itself has not yet begun to reach its full potential in patient-monitoring. In a very few hospitals time-shared computers are used for monitoring arrhythmia—irregular heartbeat—from electrocardiographic inputs. Dr. Harrison is confident that they will come into wider use, particularly when the number of parameters that have to be monitored increases.

"I think the next generation of time-sharing computers will lend themselves to monitoring," he says. "The data could be preprocessed on analog systems before they are run in the digital machines."

Publicity accorded the introduction of computers in the hospitals seems to have been misdirected, in the opinion of some experts. A spokesman for Montefiore Hospital in New York City says that the first things hospitals have done with the machines were the housekeeping chores—payrolls, purchase orders and the like. But many have been at a loss to use the computers in direct medical applications. Programming is said to be a problem. One doctor's description of symptoms might differ from another's.

Some of the computer applications instituted by Montefiore are:

- A daily printout on every floor of laboratory tests run for patients on that floor. Instead of laboriously copying reports by hand, a nurse could post the printout at the foot of the patient's bed.
- Storage of all X-ray records going back four years. Any time an unusual condition occurred,

records of similar conditions could easily be tuned up.

- Analysis of the results when two different radioisotopes are administered to the same patient. To separate the results, it is necessary to solve equations. The computer can accomplish in 2 minutes what it took a mathematician a day and a half to solve.

Microcircuit systems designer

MOS arrays and linears are reaching maturity

There are four important trends in microcircuits today: the proliferation of stable, producible MOS arrays; the explosion of linear microcircuits—monolithic circuits that perform analog functions; the tendency to perform these analog functions with inexpensive digital microcircuits; and the spiraling of microcircuit complexity. The latter trend, semiconductor manufacturers believe, will lead to development of large-scale arrays and will place in the manufacturers' hands responsibility for the design of a substantial portion of future electronic systems.

WESCON does not pretend to be a microelectronics show. Yet, its technical sessions and an accompanying two-day symposium touch on each of these four important areas. Unfortunately, two of the most interesting technical sessions 8B and 10 conflict with the two-day microcircuit symposium. There is, however, a profitable recourse.

The experienced designer can attend Session 1 ("Linear Integrated Circuits"), Session 8B ("Large-Scale Integration of Computer System Design") and Session 10 ("Digital Approach to Analog Functions").

The beginner can attend the two-day symposium, "Microelectronics Comes of Age."

Four of the five papers at Session 1 describe the design and application of a specific microcircuit made by the author's company. Ralph Seymour of Signetics, for example, discusses the application of a Signetics chip containing two transistor triads (driven by a small bias circuit) for i-f or rf amplification. Similarly Motorola's Leo Wisserman and Bill Ehram discuss a dual operational-amplifier microcircuit recently introduced by Motorola. Jerry Gibbs of Amelco Semiconductors, Mountain View, Calif., describes the marketing considerations that inspired Amelco to introduce an inexpensive version of the 709C operational amplifier, which it calls the 809C. He shows those

areas where the 809C performs adequately enough for the designer not to have to resort to the 709C, a chip of greater size and complexity. The 809C costs \$4.50, but Gibbs feels that its small size will allow the company to drop the price into the \$3 range in two to three years and still make a profit. Fairchild's μ A709C is presently selling for \$4.95.

Session 8B presents a panel of experts conversant in LSI (large-scale integration), that popular conversational gambit usually found at the other end of the digital microcircuit rainbow.

The electronics industry is about to witness a boom in linear microcircuits (see "Tiny exploding world of linear microcircuits," ED 15, July 19, pp. 49-72). The linears are, however, lagging several years in development behind their digital counterparts. Session 10 sheds some light on that area of systems design where it may well be easier to use digital microcircuits to perform analog functions, than to design linear microcircuits.

A paper to watch is the second presentation of the session. It is entitled "Four Digital Arrays Do All Algorithms," by George Sendzuk of General Electric, Binghamton, N. Y. He describes how four digital MOS arrays can simulate an analog filter of any frequency response. Hooking together the four arrays in the appropriate manner can save the designer of a digital system the trouble of converting a pulse train to an analog signal,

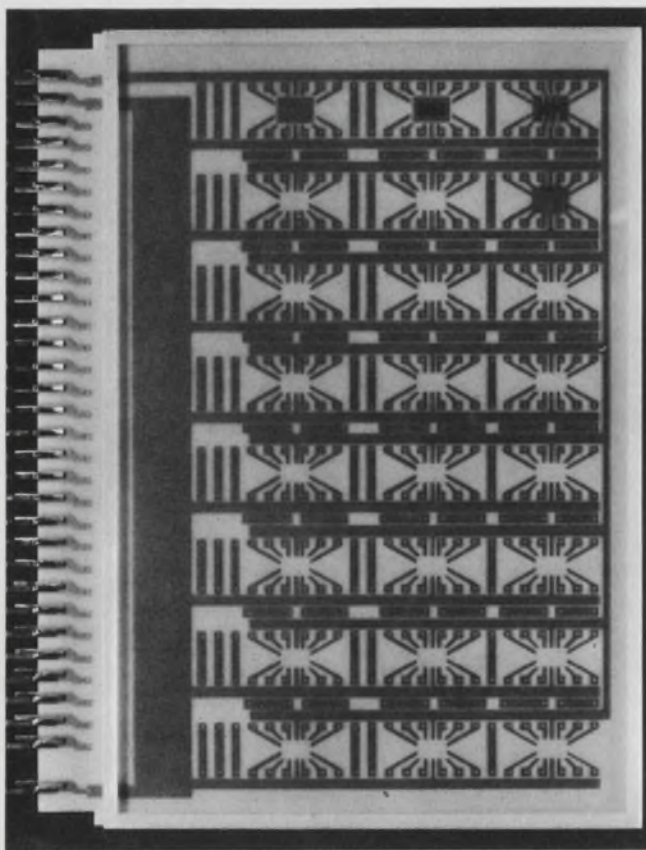

Interim approach to large-scale integration is exemplified by this card-sized ceramic board which is designed to carry 24 uncased circuit chips. Here only two are shown in place—one right side up and one flipped.

filtering it, and converting it back to a pulse train.

The two-day microelectronics symposium offers the designer who lacks experience with micro-miniaturization more than the technical papers offer the designer who has already acquired a good deal of microcircuit savvy. It covers the basics of every area of production, from thin and thick films to monolithic integrated circuits. It describes the basic theory of the devices of microcircuitry, from bipolar to MOS transistors, and from ordinary thick-film resistors to multilayered, thin-film capacitors. It presents basic applications information for both digital and linear integrated circuits. Packaging and wiring techniques as mundane as mechanical wiring are discussed right after those as esoteric as large-scale integration, which at the moment is an interconnection problem requiring computers for its solution.

The first day's symposium papers are divided, as is the field of microelectronics itself, into the hybrid (multichip) approach and the monolithic (single-chip) approach. A particularly interesting account of an automated hybrid production line is given by Mort Penberg of the Aerojet-General Corp., Azusa, Calif. Using an automatic vacuum deposition system developed at Aerojet-General, the automated production line deposits up to 40,000 thin-film circuits onto substrates in one pump-down; attaches transistors to the substrates automatically, with numerical control machines; and then checks each circuit on computer-controlled test equipment. The Aerojet-General system can manufacture and test a wide variety of thin-film circuits. In another paper, Wayne Moyers, head of microelectronics at the Lockheed Electronics Div., Lockheed Aircraft Corp., describes the design and manufacture of a mass-produced thin-film circuit used in touch-tone telephones. The circuit, developed at Bell Telephone Laboratories for the Bell System's manufacturing division, Western Electric, uses a beam-lead microcircuit as an oscillator.

The afternoon session delves into the monolithic approach to integrated circuits. Several papers deal with the basic theory-processing and design of bipolar microcircuits. Other papers explore those three new stars of monolithic integrated circuitry: the MOS array, the linear microcircuit and the microwave microcircuit. These are presented in papers 3/5, 3/6 and 3/7 by M. Sussman of the General Instruments Corp., Newark, N. J.; Jack Gifford of Fairchild Semiconductor, Mountain View, Calif., and V. Gelnovatch of the Army Electronics Command, Fort Monmouth, N. J. MOS arrays have been around for several years, but instability problems that have prevented their widespread use have been solved and sophisticated circuits that use four-phase logic and complementary transistors have been devel-

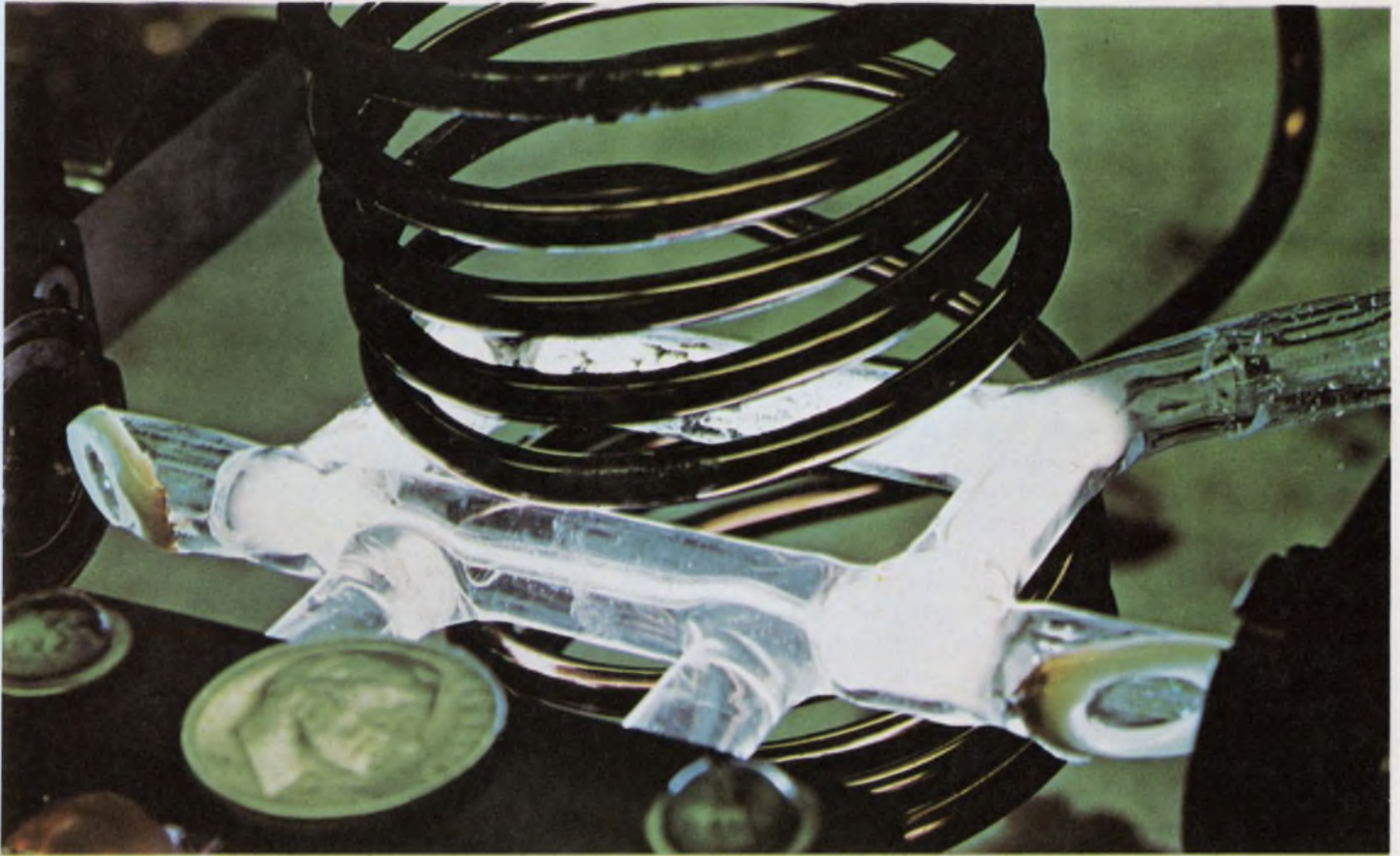

Variations in the output frequency of gas lasers—such as this helium-neon setup—may be caused by shifts in the

pressure of the constituent gases. Possible solutions to the problem are described in Paper 5/2.

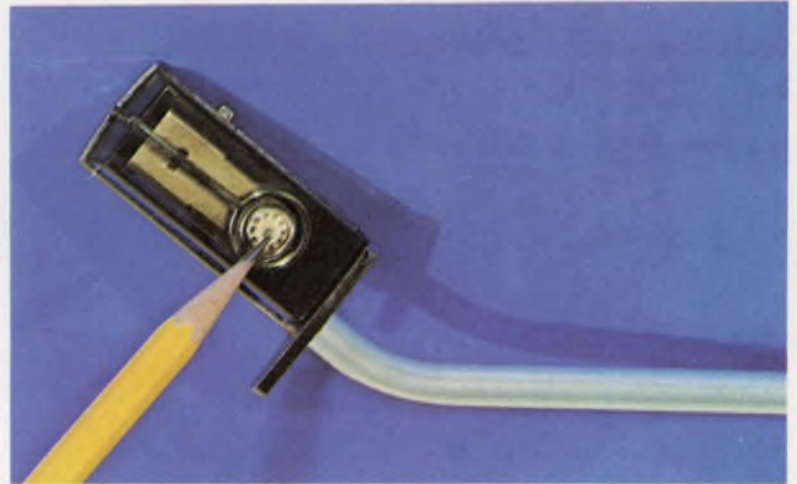

IC preamplifier by RCA replaces magnetic cartridge in phono arm. It's another example of the inroads ICs are making in the consumer products areas (Microelectronics symposium).

Improved communication with reentry space vehicles is the goal of researchers at Kirtland AFB, N. M. The visi-corder output provides transmission data on various spacecraft window materials subjected to high temperatures by a 330-kW arc plasma generator in the background (Paper 5/2).

oped since the last WESCON.

Linear microcircuits, long the orphan of the semiconductor industry, are starting to come into their own. Their obvious home is the consumer market, where high volume helps offset the large development costs associated with linear microcircuits. Scores of linears for home entertainment products, like RCA's dual Darlington amplifier designed for a phonograph cartridge (see photo), are starting to appear on the market.

The use of high frequencies can exploit the limited size of capacitors that can be fabricated on a chip. Stripline techniques can even be used to make distributed inductors, which have usable values at microwave frequencies.

The key to microwave microcircuits is the development of good, high-frequency transistors, and that, in turn, requires extremely narrow emitter widths and shallow diffusions. One experimental approach to the fabrication of such fine geometries is Westinghouse's electron-beam etching machine. It operates on the principle that glass tends to etch faster when it is bombarded with electrons. Hence it uses the glass itself as a photoresist in the microcircuit production process.

Production techniques have progressed considerably faster than the education of the design community, says Glen Madland, president of the Integrated Circuit Engineering Corp., Phoenix, Ariz. Madland peers into his crystal ball at the symposium to spot trends in the integrated-circuit field.

The two-day symposium will not make an expert of an integrated-circuit novice, but for \$30 it offers working knowledge of the techniques and is a good place to start.

Microwave engineer

Phased-array makers consider mass output

The hottest topic in the microwave industry is phased arrays. If they make it, they can provide a much-needed new market for the microwave industry. The question is, will they? To hear the opinions of experts, drop in on Session 14 ("The Future of Solid-State Phased Arrays").

The problem is not R&D; it is the cost of production, according to at least one member of the session's panel, Malcom Vosberg of the Institute for Defense Analysis.

"We cannot afford the arrays we are building now; we've got to get the cost down," he says, "and mass production is the only way to do it."

Phased arrays are just about the only microwave system where mass-production techniques

are applicable, because they have many identical elements. (An element contains the steering circuit, or phase shifter; the drive circuit for the shifter; the transmitter; the duplexer and a low-noise receiver-preamplifier.)

A controversy arises at this point. How many elements should be used in phased arrays? One school of thought in industry leans toward arrays with 10,000 to 100,000 elements; the other favors the use of as few as possible—on the order of hundreds. Both sides will be represented on the panel.

The trade-off revolves around the power-aperture product of the antenna. "With many apertures, we can stop pushing for high powers in each element," says Vosberg, "but this means that their cost must come down to about \$100 to \$200 per element." If there are 100,000 elements, it does not matter much if 10 or 100 of them stop working; tolerances and reliability requirements can be relaxed. This reduces the cost.

With a few apertures, the power requirements go up, along with reliability and tolerances, thereby increasing the cost. One example of this approach is the radar designed by Bell Telephone Laboratories of Murray Hill, N. J., for the Nike X.

The lack of efficient assembly-line production techniques made the second approach the accepted solution, says Vosberg.

Where are the markets?

To find the market, the panel will examine the advantages and limitations of phased arrays, as well as three major applications areas that appear to be promising at this time.

The first area is, of course, where the electronically controlled scanning of phased arrays tops other antenna types in providing fast coverage. In ballistic missile radars, phased arrays are already replacing parabolic types.

The second area of promise for phased arrays is when the antenna becomes too large to be moved mechanically—for example, in space tracking. Phased arrays are installed permanently; hence their size is not limited. "You can make them the size of the Empire State Building," says Vosberg.

The third applications area may become the most significant in the long run. The idea is to put the array on the outer surfaces of aircraft and space vehicles. This design allows communication in all direction without swinging dishes around on gimbles, which comes in handy in satellite communications. The concept is aptly called conformal phased arrays.

Some members of the WESCON panel feel that these possibilities will hardly be sufficient to start a mad scramble among manufacturers. They estimate that only a few companies will end up in

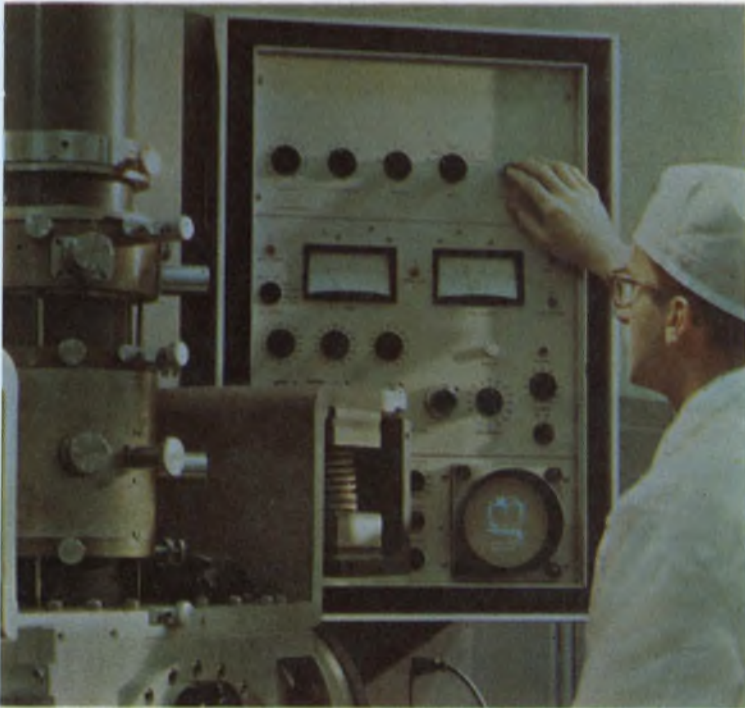

Electron-gun etching machine developed by Westinghouse can be used to etch glass coatings on microcircuits with no photoresist (Microelectronics Symposium Paper 3/1).



Noise figure measurements on an rf FET mixer are made by Siang Pink Kwok of Motorola Semiconductor, Inc. (Paper 8/1).

Arrays of silicon photo-transistors, operating in a photon flux integration mode, are reported to make it possible to obtain full frame storage at even commercial television rates. The linear array (above), developed by Fairchild Semiconductor, contains 200 phototransistors, although only 50 are hooked up (Paper 13/2).

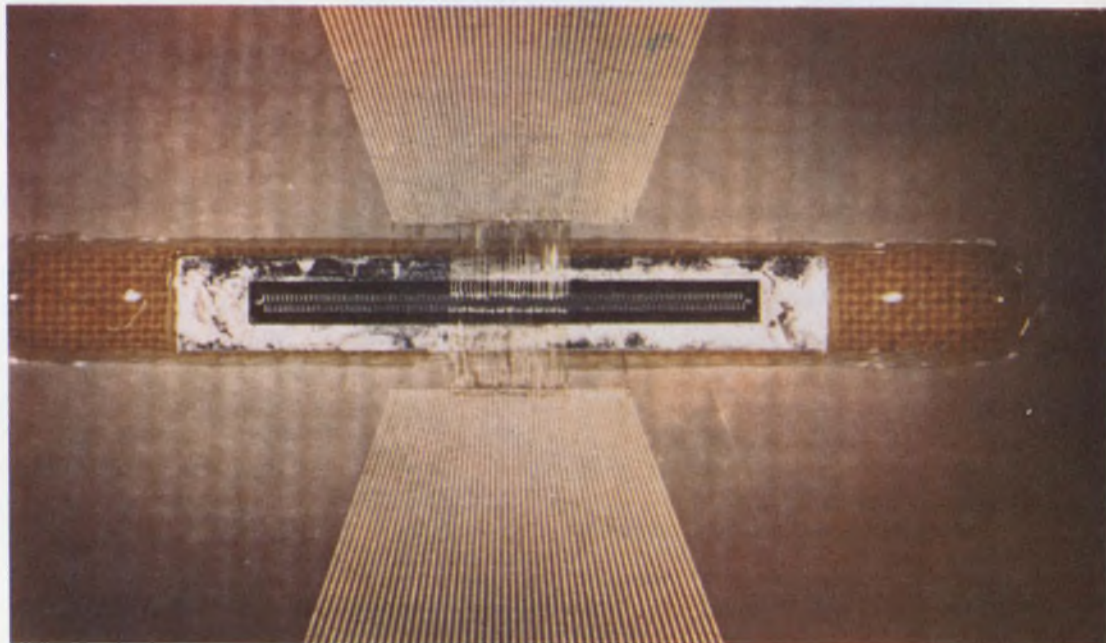

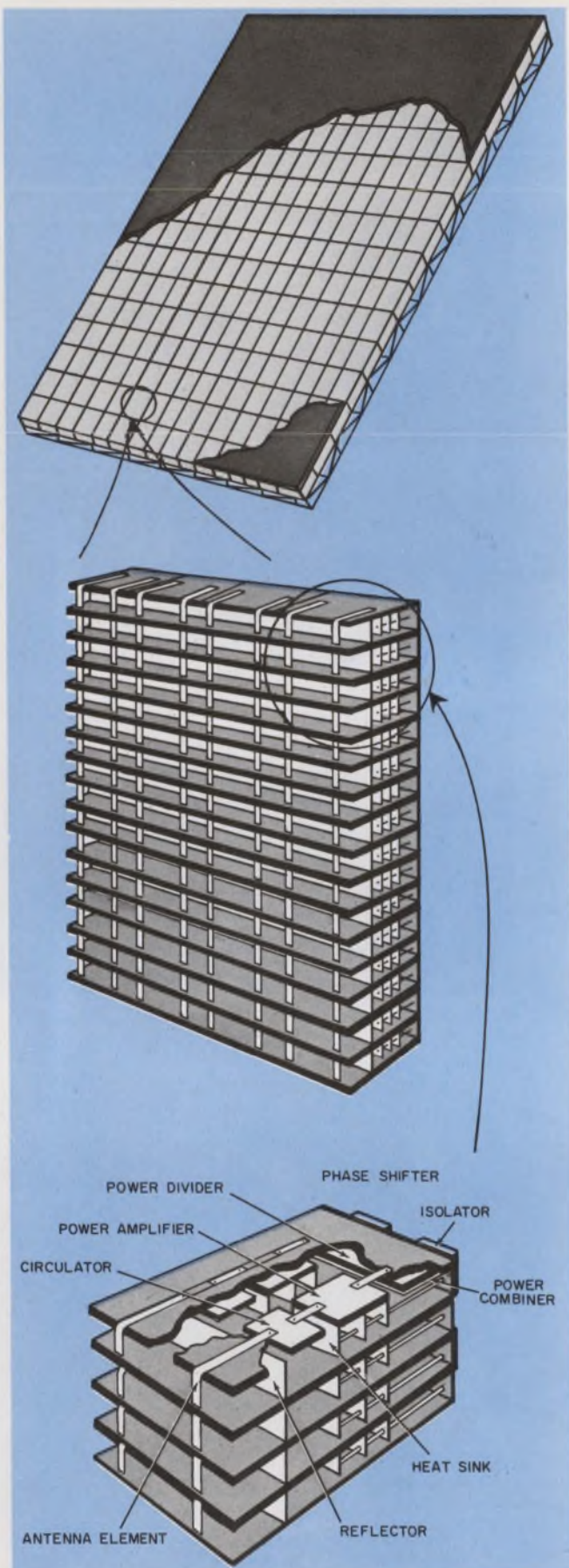

1. Design concept of solid-state phased arrays is based on a modular approach. The array face (top) has plug-in modules that provide 128 solid-state elements (center). Each plug-in unit (bottom) has eight amplifiers, radiating elements and transmitting and receiving circuitry.

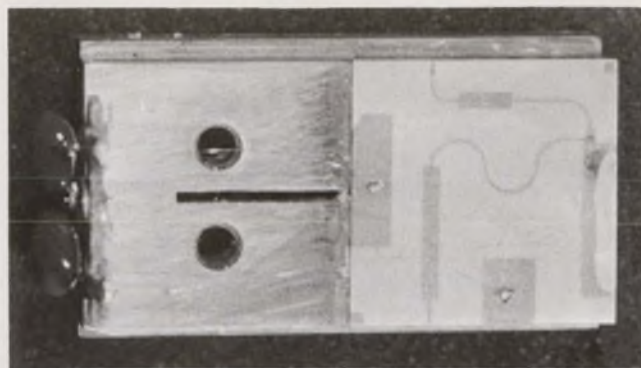

2. Integrated microwave receiver contains a miniature X-band ferrite circulator that leads to a tunnel-diode rf amplifier (not shown), a mixer, a wide-band i-f amplifier and circuits that generate an X-band local-oscillator signal. A four-times multiplier provides the X-band signal from an S-band input in this RCA unit.

this field. This centralization will change the component supply somewhat, experts say. At the moment, talents are scattered; the designer may want to go to Texas Instruments for a receiver transistor, to RCA for a power transistor and to Microwave Associates for a switching diode. But those who will get into the business of mass production will have to try to combine all these talents under one roof, to make their operation as efficient as possible.

Getting down to the finer points of engineering, the panel will try to establish guidelines for specific system parameters. Frequency and power levels for both solid-state and tube systems appear high on the agenda.

Solid state and the increased use of microwave integrated circuits are of interest, not only from purely engineering considerations but also because they help to reduce cost and facilitate mass production.

Most panel members agree that monolithic fabrication is just not suitable for microwave circuits at present. The transmission lines that constitute the inactive parts can be built only in a hybrid fashion. Microwave integrated circuits mean flat chips on a substrate, which may be ferrite for frequencies where ferrite devices are needed—mostly above S band. Below S band, semiconductor devices seem to take over all switching and beam-steering functions.

At least one panel member says that he would rather hold off the solid-state approach till transistors with 15 to 20 watts' output become available. "It does not make much sense to push development above L band, since we are just beginning to get transistors with a few watts of output in these frequencies and noise figures around 4 dB," says Vosberg, "and I'd like to see 10 or 20 watts before I can get serious about solid-state transmitters."

But it's an even bet that others on the panel will challenge him on this.

...and switch to the highest quality switches ever made: Shallcross!

These are the switches designed for function and performance, not to low price. Yet they're priced competitively!

They give you a quality "feel." A solid feel. The kind you don't get in cheaper switches.

Not surprising. Because we use only the best materials and conservative design standards in creating Shallcross rotaries. For both commercial ratings and switches designed to MIL-S-3786.

All this pays-off for you. With Shall-

cross switches, you get lower initial contact resistance. So you can use them on more exacting applications.

You get better contact-resistance stability, so your equipment holds calibration better.

And you get better voltage and current ratings for a given size. More switch per volume.

You get versatility, too. Select from 1" wafer, 1 3/4" deck, and 2 1/2" deck configurations, plus round and oval ceramics —for every rotary application.

Join our rotary club. Switch to the Number One rotary switch: Shallcross. See your local Cutler-Hammer Sales Office or Shallcross Stocking Distributor. Or write for catalog LA-163-0217.



Cutler-Hammer offers a complete selection of other quality switches. Commercial forms are covered in catalog LL-290, Military ratings in Catalog LL-291.



CUTLER-HAMMER
Milwaukee, Wisconsin 53201

Join our rotary club



Switch to No. 1

More than just switches:
prompt availability,
field help, innovation,
quality assurance too.

ONE COMPANY

has demonstrated the capability to design, produce and deliver the only broad line of complex **MTOS** arrays (LSI) available today...

MTOS MICROCIRCUIT ARRAYS ($T_A = -55^\circ\text{C}$ to $+85^\circ\text{C}$)

SHIFT REGISTERS		STATIC	DYNAMIC	FREQUENCY	NUMBER OF BITS	INPUT		OUTPUT		NUMBER OF CLOCKS	SUPPLY VOLTAGE (VOLTS)
TYPE	FUNCTION					PARALLEL	SERIES	PARALLEL	SERIES		
MEM 3005PP	5-BIT PARALLEL IN/ PARALLEL OUT	X		dc to 1.0 MHz	5	X	X	X		2	-27V \pm 1V
MEM 3005SP	5 BIT SERIAL IN/ PARALLEL OUT	X		dc to 1.0 MHz	5		X	X		2	-13V \pm 1V -27V \pm 1V
MEM 3008PS	8-BIT 2 ϕ PARALLEL IN/SERIAL OUT	X		dc to 1.0 MHz	8	X	X		X	2	-13V \pm 1V -27V \pm 1V
MEM 3012SP	12-BIT SERIAL IN/ PARALLEL OUT	X		dc to 1.0 MHz	12		X	X		1	-27V \pm 1V
MEM 3016-2	DUAL 16-BIT	X		dc to 1.0 MHz	32(16,16)		X		X	2	-13V \pm 1V -27V \pm 1V
MEM 3016-2D	DUAL 16-BIT		X	10 kHz to 1.0 MHz	32(16,16)		X		X	2	-13V \pm 1V -27V \pm 1V
MEM 3020	20-BIT	X		dc to 1.0 MHz	20		X		X	2	-13V \pm 1V -27V \pm 1V
MEM 3021	21-BIT	X		dc to 500 kHz	21(1,4,16)		X		X	1	-27V \pm 1V
MEM 3021B	21-BIT	X		dc to 250 kHz	21(1,4,16)		X		X	1	-27V \pm 1V
MEM 3032	6-1 ϕ BINARY WEIGHTED	X		dc to 1.0 MHz	32(1,1,2,4,8,16)		X		X	1	-13V \pm 1V -27V \pm 1V
MEM 3050	DUAL 25-BIT		X	10 kHz to 500 kHz	50(25,25)		X		X	2	-27V \pm 1V
MEM 3064	64-BIT SERIAL ACCUMULATOR	X		10 kHz to 5.0 MHz	64		X		X	4	NONE

plus these other exclusive MTOS devices...

MTOS SILICON P-CHANNEL ENHANCEMENT MODE FIELD EFFECT TRANSISTORS ($T_A = 25^\circ\text{C}$, BODY GROUND)										
TYPE	V_{GS1} (VOLTS TYP)	I_D (ON) (mA TYP)	I_{DSS} (mA TYP)	I_{GSS} (nA TYP)	BV_{DSS} (VOLTS)	BV_{GSS} (VOLTS)	Y_{fs} ($\mu\text{mho TYP}$)	C_{gd} (pF TYP)	$r_{DS(ON)}$ (Ω TYP)	
MEM 511	-4.0	-6	-0.5	-0.1	-30	-30	2500	2.0	150	
MEM 517	-3.5	-60	-0.8	-0.1	-30	-25	12,000	10	30	
MEM 517A	-3.5	-60	-0.8	-0.1	-30	-25	12,000	10	30	
MEM 517B	-3.5	-60	-0.8	-0.1	-30	-25	12,000	10	30	
MEM 520	-4.0	-6	-0.5	-0.03	-30	NA	2500	2.0	150	
MEM 550	-4.0	-5	-0.1	-0.1	-30	-25	1400	1.1	250	
MEM 551	-4.0	-5	-0.5	-0.03	-30	NA	1400	1.1	250	
2N4353	-4.0	-6	-0.5	-0.1	-30	-30	2500	2.0	150	

LOGIC CIRCUITS ($T_A = -55^\circ\text{C}$ to $+85^\circ\text{C}$)		POWER CONSUMPTION (mW)	SUPPLY VOLTAGE (VOLTS)	PROPAGATION DELAY (ns)	CAPACITANCE (pF) (TYP)	FREQUENCY (kHz)
TYPE	FUNCTION					
MEM 1000	DUAL FULL ADDER	< 70 TOTAL	-13V \pm 1V -27V \pm 1V	350 (TYP)	3.0	—
MEM 1002	DUAL 3-INPUT NOR GATE	< 40 (MAX)	-27V \pm 1V	200 (TYP)	3.0	—
MEM 1005	R-S-T FLIP-FLOP	< 80	-27V \pm 1V	950 (MAX)	3.0	dc to 500 kHz
MEM 1008	DUAL EXCLUSIVE OR/NOT GATE	50 (TYP)	-27V \pm 1V	500 (TYP)	3.0	—
MEM 1013	QUAD 2 INPUT NOR GATE	9 mW/circuit	-13V \pm 1V -27V \pm 1V	300 (TYP)	3.0	—
MEM 1014	QUAD 2 INPUT AND GATE	14 [Circ. (1,2,3)] 42 [Circuits 4,5]*	-13V \pm 1V -27V \pm 1V	300 (TYP)	3.0	—
MEM 1015	DUAL J K FLIP-FLOP	60	-13V \pm 1V -27V \pm 1V	—	3.0	dc to 1 MHz
MEM 1022	9-BIT PARALLEL PARITY DETECTOR	50	-27V \pm 1V	500 (TYP)	3.0	dc to 500
MEM 1050	4 STAGE BINARY UP-DOWN COUNTER	300	-27V \pm 1V	—	2.0	—
MEM 1051	BUFFERED D/A CONVERTER	25	-13V \pm 1.5V -25V \pm 3V	—	3.0	dc to 500 kHz

*The MEM 1014 provides Four 2-Input and Gates (Circuits 1, 2, 3, 4) plus One 2-Input N and Gate (Circuit 5)



WESCON BOOTHS 5401-5404

**at prices that reflect the
highest yields in the industry...**

LARGE DIGITAL SUBSYSTEMS		POWER CONSUMPTION	SUPPLY VOLTAGE (VOLTS)	CLOCK RATE	DESCRIPTION
TYPE	FUNCTION				
MEM 5014	A/D-D/A CONVERTER ELEMENT	135 mW	-27V ± 2V	dc to 200 kHz	Complete logic and analog switching for 10-bit successive approximation A/D converter.
MEM 5015	16 CHANNEL RANDOM ACCESS MULTIPLEXER	70 mW	-27V ± 1V	100 kHz	Sixteen Channel Multiplexer with address storage and decoding.
MEM 5021	DDA ELEMENT	100 mW	-13V ± 1V -27V ± 1V	500 kHz	Ternary type DDA performing rectangular integration.
MEM 5031	SERVO ADDER	25 mW	-13V ± 1V -27V ± 1V	dc to 1.0 MHz	Shift Register content decision unit
MEM 5035	SIGMA DELTA "Y" SUMMER	25 mW	-13V ± 1V	10 kHz to 1 MHz	2 Input Delta "Y" Summer used in conjunction with the MEM 5021
S-C-100	MINIATURE A/D CONVERTER SYSTEM	300 mW	-27V ± 2V -15V ± 2V +15V ± 2V REF. VOLT	100 kHz	Complete 10-BIT A/D Converter System

MULTIPLEXER CIRCUITS (T _a = -55°C to +85°C)		OFF RESISTANCE (Ω TYP)	ON RESISTANCE (Ω TYP)	CAPACITANCE (pF) C _{gd}	BV ₀₁₅ (VOLTS)	BV ₀₁₅ (VOLTS)
TYPE	FUNCTION					
MEM 2002	5 CHANNELS (4 Channels —Common Drain)	10 ¹⁰	200	1.1	-30	-30
MEM 2003	4 CHANNELS (Protective Diodes)	10 ¹⁰	200	1.1	-30	-30
MEM 2004	4 CHANNELS (No Diodes)	10 ¹⁰	200	1.1	-30	±60
MEM 2005	4 CHANNELS (Dual 2 Channel)	10 ¹⁰	200	1.1	-30	-30
MEM 2006	3 CHANNELS (2 Channels —Common Drain)	10 ¹⁰	200	1.1	-30	-30
MEM 2009	6 CHANNELS (Protective Diodes)	10 ¹⁰	150	1.9	-30	-30

SERIES SHUNT CHOPPER		OFFSET VOLTAGE	CLOCK φ	FREQUENCY (kHz)	ON RESISTANCE PER UNIT (SERIES OR SHUNT) (Ω TYP)	OFF RESISTANCE PER UNIT (SERIES OR SHUNT) (Ω TYP)	SIGNAL VOLTAGE HANDLING RANGE (TYP)
TYPE	FUNCTION						
MEM 2008	INTEGRATED SERIES SHUNT CHOP. CIRCUIT	0	1	100	6K	10 ¹²	1μV-10V

Contact your authorized General Instrument Distributor for off-the-shelf delivery. In Europe, contact General Instrument Europe, Via Turati 28, Milano, Italy. Write for complete data.

FLUIDIC LOGIC TAKES TO THE AIR

Control elements that use gases can guide missiles and stabilize helicopters

Roger Kenneth Field
Technical Editor

Despite the great flood of publicity about fluidics, designers find the new technology obscured by the shadow of electronics. Yet fluidic logic and control elements can reliably perform many intricate tasks, particularly where the equipment is expected to work in the face of temperature extremes, stifling humidity, chronic vibrations or violent shock.

Fluidics refers to a technology invented in 1958 in which streams of fluids—liquids or gases—are controlled by other streams of fluids. These fluids travel in channels and passageways that are gouged, etched, molded or milled in many materials, such as clays, glass, plastics, and ceramics as well as metal alloys like beryllium copper and tungsten steel. The reliability of fluidic systems hinges on the stability of the materials that comprise them, and the relatively simple fabrication requirements of fluidic elements allows the use of extremely tough materials.

The military needs a flip flop

Fluidics, like many other technologies, was spun off military research. The basic fluidic logic element, the flip-flop, was developed at what was then the Harry Diamond Ordnance Laboratory. For the Department of Defense in 1958, fluidics represented a rocket control system that was immune to radio-frequency jamming; it now represents a missile control system that is unaffected by ionizing X-ray radiation propagated in space by an enemy's anti-missile.

There are two pure fluid systems for the control of rocket engine exhaust. One is an analog system, which uses four proportional vortex amplifiers operating in a push-pull mode at the rocket's exhaust to control the push direction of the tail. The other is a digital system which expels a portion of the exhaust through a giant fluidic flip-flop built into the tail. A fluidic guidance system in this missile determines the relative switching time for

each of the flip-flop outputs that keeps the missile on course.

The basic theory and design of the proportional system is revealed in a paper presented at the WESCON fluidics session (Session 11). Using a warm gas (2000°F) for the control of the engine's hot exhaust, four vortex amplifiers steer the missile. The injected stream pumped by an amplifier into the tail of the missile creates a shock wave that disturbs the laminar flow of the rocket's exhaust. This induces the cross section of the exhaust to be asymmetrical and the resulting force moves the tail of the missile in the direction of the vortex amplifier creating the shock. Jerome Rivard, head of propulsion controls, Bendix Research Laboratories, Southfield, Mich., describes the performance of this analog control system.

The digital missile control was developed by the Honeywell Aerospace and Defense Group, at Minneapolis. This fluidic control system controls the missile's spin by venting a portion of the exhaust through a giant flip-flop, to one side of the missile or the other. The Aerospace and Defense

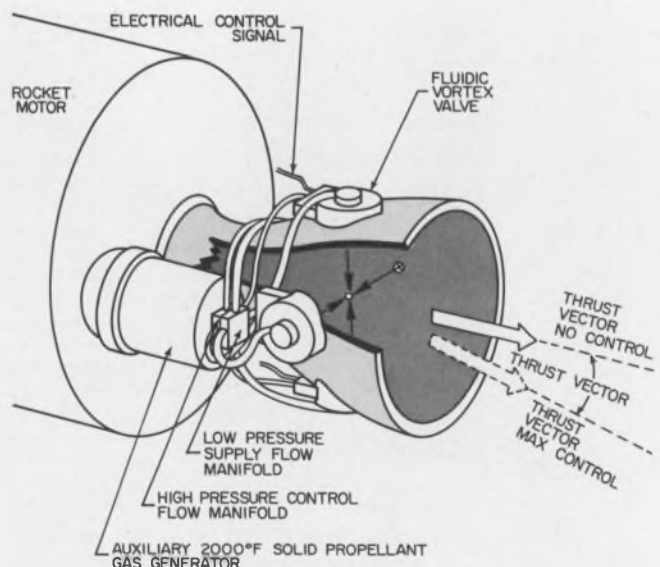

The Bendix analog rocket control uses four fluidic vortex valves to direct the tail.

Group is now developing an all fluidic control system to stabilize a helicopter. The firm hopes to test the system aboard a Navy CH-46A tandem-rotor helicopter at the Patuxent River Naval Air Station, Md., this fall. The system will sense the helicopter's attitude with three vortex rate sensors, amplify and process the information with fluid amplifiers, and adjust the helicopter's attitude by actuating conventional hydraulic control servos with fluidic-to-hydraulic transducers. Honeywell believes that this fluidic stabilizing system will be able to withstand the vibrations of the helicopter's jet engines far better than electronic controls, yet it will be able to respond to sudden instabilities more quickly and reliably than pneumatic and hydraulic control systems, which rely on moving mechanical parts.

Industrial uses for fluidics are hard on the heels of these military applications. The Sperry Utah Div. of Sperry Rand, Salt Lake City, Utah, has developed a fluidic proportional control system to regulate an important step in the extraction of gold. In another paper at WESCON's session 11, Sperry's Robert Blosser describes the operation and design of a system that his company put into service at the Carlin Gold Mine. He encountered two interesting problems: the response of the fluidic controls was so fast that the system oscillated about the ideal operating point and the valve that controlled the flow of gold slurry tended to cycle open and closed; and the slurry kept clogging a probe in the system.

The first problem was solved simply by the addition of sufficient damping to the feedback network. To solve the clogging problem, Sperry had to develop special probes that would sense the slurry level without clogging. One of the problems with fluidics at this early point in its development

is the fact that relatively few sensing devices have been designed, and, although there is a more than ample supply of logic elements for the design of many systems, most special sensing requirements almost inevitably demand the design of new transducers.

Though the designer of fluidic systems must contend with the dearth of sensors, transducers and interface equipment that accompanies the introduction of any logic technology, there is readily available a number of convenient systems for forming compact fluidic logic circuitry. The goal of these systems is to make it easy for the logic designer to string together the elements required by his design, and to be able to do so confident that it will work.

The latest approach is a system that will soon be announced by Corning Glass, Corning, N. Y. With it, each logic element is connected into the system by screwing it into a common manifold. Thus, rather intricate logic schemes can be implemented with preformed, standard logic elements such as gates, flip-flops and inverters. The final assembly is more than adequately compact for most industrial control applications, and it doesn't look like a prototype, which inevitably sports a maze of plastic tubes running in every conceivable direction.

With fluidics, as with microelectronics, the intraconnection of complex systems is a formidable problem. Already, fluidic manufacturers have developed various methods for integrating logic elements. Corning, for example, stacks glass slides into which fluidic channels have been etched and then fires the slides to fuse them into a solid ceramic-glass circuit.

Martin-Orlando does the same sort of stacking with etched, thin sheets of beryllium copper.

Fluidics' airy humor

For the electronic logic designer, fluidics offers a certain comic relief. After one grows accustomed to nanosecond delays, discussion of the millisecond response time of fluidic elements is often tinged with amusement. Fluidic designers discuss their systems in electrical terms, and it seems almost facetious to speak of the inductance of a long, fine air-tube or the capacitance of a bell jar. Yet just such analogies make it extremely easy for an electronic designer to feel at home in the airy field of fluidics. Sophisticated systems are being built. Fluidics now offers manufacturers of industrial controls a very quick alternative to pneumatics and hydraulics, the two technologies with which they have become thoroughly familiar. WESCON's session 11 sheds some light on to what is to many electronic designers the murky world of fluidics. ■ ■

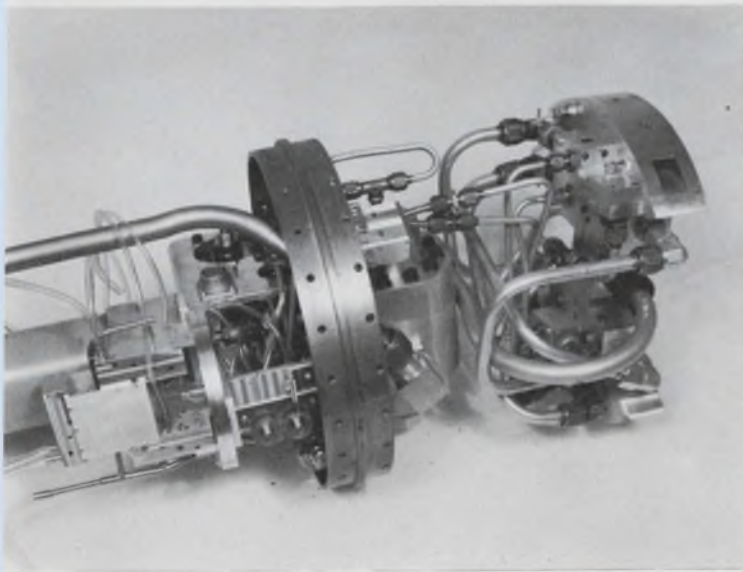

Honeywell's giant flip flop at the extreme left keeps a small test missile from spinning.

Look who's now

big in MOS.

Prodded by Dan Izumi, we now make the fastest, lowest-powered two phase shift register in the whole wide world.

We call it the MM400. He calls it the Izumi 400. Call it what you like, it's still the world's best dual 25 bit dynamic register. Primarily because it uses only -10 volt VDD and -16 volt clock voltage. That's at least a good 11 volts under any other. And guaranteed operation is at 1MHz over a temperature range that goes up to 125° centigrade.

There's also very little power dissipation — typically 40mw at 1 MHz operation — making it just perfect for ground systems,



instrumentation, airborne computers and a variety of other applications. Price is an inscrutable \$40 in 100 lots. Send for details or get them off the shelves of our distributors. Ask for the Izumi 400. See if they know what you mean.

National Semiconductor Corporation, 2950 San Ysidro Way, Santa Clara, California 95051, (408) 245-4320.

National Semiconductor

ON READER-SERVICE CARD CIRCLE 59

Wescon Technical Program

WHEN, WHERE AND WHAT TO HEAR

Here's the complete technical program at the show, by session, including times and places for each paper.

1

Linear Integrated Circuits

(Tues./a.m./D)

Chairman: Jerry Eimbinder, *EEE Magazine*.

1/1 Applications for rf/i-f Integrated Circuit Amplifiers—*Ralph Seymour, Signetics Corp.*

1/2 Dual Integrated-Circuit Operational Amplifiers—*Leo L. Wisseman and Bill Ehram, Motorola Semiconductor Products.*

1/3 The Trade-Off Between Cost and Performance in Operational-Amplifier Integrated Circuits:

Part 1—Designing for Industrial/Consumer Applications—*Jerry W. Gibbs, Amelco Semiconductor.*

Part 2—The Performance/Economics/Marketplace Interrelationships—*Jack Gifford, Fairchild Semiconductor.*

2

Business Management: The Engineer Becomes Manager

(Tues./a.m./T)

Chairman: Don C. Hoefler, *Electronic News*.

2/1 Management Is the Direction of People—*James F. Riley, Signetics Corp.*

2/2 Pitfalls in Money Management—*Daniel G. White, Commonwealth National Bank of San Francisco.*

2/3 A Model for Management Action—*Charles H. Keller, Illumination Industries.*

2/4 Managing a Major Turnaround—*Martin H. Dubilier, Friden, Inc.*

3

Radar Performance on Hypersonic Reentry Vehicles

(Tues./a.m./De)

Chairman: Lloyd M. Melick, *Sandia Corp.*

3/1 Microwave Transmission Studies through a Hypersonic Air Plasma—*D. W. Boyer, Cornell Aeronautical Lab.*

3/2 Effect of Reentry Vehicle Environment on Electromagnetic Transmission—*J. B. Chown, Stanford Research Institute.*

3/3 An Experimental Evaluation Technique for Reentry Vehicle Antenna Windows—*Lt. Bruce J. Benedict, Kirtland AFB.*

3/4 A Technique for Analyzing Antenna Pattern and Radar Return Effects on Spinning Vehicles—*James A. Cooper and C. D. Oувerson, Sandia Corp.*

4

Varactor Tuning of Receivers

(Tues./p.m./D)

Chairman: Johnnie Cochran, *Motorola Semiconductor.*

4/1 Designing around the Tuning Diode Inductance—*G. Schaffner, Motorola Semiconductor.*

4/2 Application of Electronic Tuning to Tactical Communications Equipments—*E. A. Janning, Avco Electronics.*

4/3 Voltage-Variable-Capacitor Tuning of Radio-Frequency Amplifiers—*Jorge E. Roza, General Dynamics Electronics Div.*

4/4 Varactor Tuning Applied to Radio Receivers—*Rinaldo DeCola, Warwick Electronics.*

4/5 Hyperabrupt Tuning Diode The-

ory and Application to a-m Radio—*Peter M. Norris, Motorola Semiconductors.*

A Special Session

Electronics and Meteorology

(Tues./p.m./De)

Chairmen: Bruce B. Lusignan, *Stanford University*, and Allen M. Peterson, *Stanford Research Institute.*

A/1 Feasibility and Utility of Satellite Lidar—*William E. Evans, Stanford Research Institute.*

A/2 Observations of Earth's Cloud Cover from Synchronous Satellite—*Dr. Verne Suomi, University of Wisconsin.*

A/3 Weather Experiments for Apollo Applications—*Dallas Evans, NASA.*

A/4 Meteorological Satellite Elec-

Code to abbreviations

The abbreviations used within this index are as follows:

a.m. — Morning sessions (10 a.m. to 12:30 p.m.)

p.m. — Afternoon sessions (2 p.m. to 4:30 p.m.)

All sessions will be held in the Cow Palace Convention Hall as follows:

D—DuBridge Hall

T—Terman Hall

De—Deforest Hall

E—Edison Hall

Numerals refer to sessions and to papers within a session — for example, 4/1 is paper 1 in session 4.



All components
shown actual size



Only the new Allen-Bradley Type S cermet trimming resistors have all these features

Type S
shown twice actual size

for side
adjustment



for top
adjustment

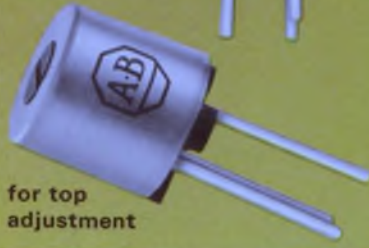

The Allen-Bradley Type S is a one turn cermet trimmer in which you will find incorporated a wider range of features than in any other trimmer now on the market. Here are a few of the more important features.

- **COMPACT**—body is $\frac{3}{8}$ " dia.
- **BUILT FOR EITHER TOP OR SIDE ADJUSTMENT**
- **50 OHMS THRU 1 MEGOHM**
- **THE SEALED UNIT** is immersion-proof
- **TEMPERATURE COEFFICIENT** less than 250 ppm/°C over *all resistance values and complete temperature range*
- **UNIQUE ROTOR DESIGN** provides exceptional stability of setting under shock and vibration
- **SMOOTH CONTROL**, approaches infinite resolution
- **PIN TYPE TERMINALS** for use on printed circuit boards with a 1/10" pattern

- **VIRTUALLY NO BACKLASH**
- **WIDE TEMPERATURE RANGE** from -65°C to +150°C
- **RATED $\frac{1}{2}$ watt @ 85°C**
- **EXCEPTIONAL STABILITY** under high temperature or high humidity
- **MEETS OR EXCEEDS ALL APPLICABLE MIL SPECS**
- **COMPETITIVELY PRICED!**

You'll find the new Type S trimmer equal to the traditional Allen-Bradley quality. You really ought to know more about the Type S. Won't you write for detailed specifications? Allen-Bradley Co., 222 W. Greenfield Ave., Milwaukee, Wis. 53204. In Canada: Allen-Bradley Canada Limited. Export Office: 630 Third Ave., New York, N. Y., U.S.A. 10017.



ALLEN-BRADLEY
QUALITY ELECTRONIC COMPONENTS

CERAMIC MAGNETS

Remington takes advantage of the high energy of Allen-Bradley ceramic permanent magnets to achieve the small size required for the ideal performance of their 500 *Selektronic* shaver

This custom designed ceramic magnet is the result of cooperative efforts by Remington and Allen-Bradley engineers. Despite the complex geometry of the magnets, Allen-Bradley was able to achieve high volume production at reasonable cost.

Allen-Bradley MO5-C ceramic permanent magnets are radially oriented and can be furnished in segments for d.c. motors measuring no more than $\frac{3}{4}$ " diameter up to a maximum rating of 10 hp. Coordinated and adequate manufacturing facilities at Allen-Bradley and tight quality control assure delivery in quantity —on time!

Allen-Bradley application engineers will be pleased to cooperate in the design of your motor magnets to obtain optimum performance. Allen-Bradley Company, 222 W. Greenfield Ave., Milwaukee, Wis. 53204. In Canada: Allen-Bradley Canada Limited. Export Office: 630 Third Ave., New York, N. Y., U.S.A. 10017.



A-B ceramic magnets
used in the 500 *Selektronic* shaver
shown actual size.

TYPE MO5-C CERAMIC PERMANENT MAGNETS Typical Characteristics—stated values have been determined at 25° C.

Property	Unit	Nominal Value
Residual Induction (B_r)	Gauss	3300
Coercive Force (H_c)	Oersteds	2300
Intrinsic Coercive Force (H_{ci})	Oersteds	2400
Peak Energy Product ($B_d H_d$ max)	Gauss-Oersteds	2.6×10^6
Reversible Permeability	—	1.09
Curie Temperature	+°C	450
Temperature Coefficient of Flux Density at B_r	%/°C	-0.20
Specific Gravity	—	4.85
Weight per Cu. In.	Lb.	0.175



The 500 *Selektronic* shaver features a unique dial which adjusts the shaving heads to four shaving positions for any combination of skin and beard, plus TRIM position for sideburn trimming and CLEAN position for instant cleaning. The shaver operates on its rechargeable energy cells or from an electric cord.



ALLEN-BRADLEY
QUALITY MOTOR CONTROL
QUALITY ELECTRONIC COMPONENTS

tronics Requirements of the Future—
Dr. Harry Press, NASA.

5

Gas Laser Stabilization

(Wed./a.m./E)

Chairman: D. E. Caddes, Sylvania Electronic Systems.

5/1 The Spectrum of a Laser Oscillator—A. E. Siegman, Stanford University.

5/2 Pressure Shifts and Related Effects in the He-Ne Laser—Arnold L. Bloom, Spectra-Physics, Inc.

5/3 Frequency Stabilization of Gaseous Zeeman Lasers—W. Culshaw, J. Kannelaud, and D. G. Peterson, Lockheed Missiles and Space Co.

5/4 A Frequency Stabilized fm Laser—Russell Targ and L. M. Osterink, Sylvania Electronic Systems.

6

Data Compression

(Wed./a.m./D)

Chairman: C. M. Kortman, Lockheed Missiles & Space Co.

6/1 Mechanization of a Digital Compressor for Biomedical Data—G. M. Loh, Lockheed Missiles & Space.

6/2 The Effect of Channel Errors on Data Compression—L. D. Davisson, Princeton University.

6/3 Adaptive Buffer Design for Data Compression Systems—G. R. Schwarz, IBM Federal Systems Div.

6/4 General-Purpose vs Special-Purpose Computers for Data Compression—D. Hochman, Adcom, Inc.

6/5 General-Purpose Telemetry Data Compression—J. J. Downing, W. E. Smith and J. E. Stubbles, Lockheed Missiles & Space Co.

7

Patient Monitoring Systems: Progress, Problems, Prospects

(Wed./a.m./T)

Chairman: Dr. Curtis E. Miller, Beckman



Instruments.

7/1 Dr. Eliot Corday, Cedars-Sinai Hospital, Los Angeles.

7/2 Dr. C. William Hall, Baylor University College of Medicine.

7/3 Dr. Donald C. Harrison, Stanford University School of Medicine.

7/4 John Mannes, Methodist Hospital, Houston,
(Paper titles to be announced)

8

Designing Radio-Frequency Circuits Using FETs

(Wed./a.m./De)

Chairman: Robert Dale, Motorola Semiconductor.

8/1 Field-Effect-Transistor rf Mixer Design Techniques—Siang Ping Kwok, Motorola Semiconductor.

8/2 Field-Effect-Transistor rf Power Design Techniques—J. B. Compton, Siliconix.

8/3 Field-Effect-Transistor rf Amplifier Design Techniques—Roy Hejhall, Motorola Semiconductor.

8/4 Field-Effect-Transistor Design Techniques at Broadcast Frequencies—Donald L. Wollesen, Philco Microelectronics Div.

8/5 Using Insulated-Gate Field-Effect Transistors as Versatile Oscillator Elements—George D. Hanchett, RCA.

B Special Session

LSI in Computer System Design

(Wed./p.m./E)

Chairman: W. H. Davidow, Hewlett-Packard.

B/1 The State of LSI Technology—Richard Petritz, Texas Instruments.

B/2 Present and Future Cost Factors in LSI—Gordon Moore, Fairchild.

B/3 Use of LSI in Future Large Computer Systems—Gene M. Amdahl, IBM Corp.

B/4 LSI in Small Systems: Practicality and Economic Considerations.—L. C. Hobbs, Hobbs Associates.

9

Recent Developments in Communications Systems

(Thurs./a.m./E)

Chairman: John V. N. Granger, Granger Associates.

9/1 Trends in Communications Systems Development—W. R. Vincent, Stanford Research Institute.

9/2 Limitations of Radio Propagation Media—Thomas Kailath and Paul Shaft, Stanford Research Institute.

9/3 Progress in Modulation and Demodulation Techniques—W. L. Hatton, Defense Telecommunications Establishment, Ottawa.

9/4 Transportation or Communications—Some Broad Considerations—Timothy Healy, University of Santa Clara.

10

Digital Approach to Analog Functions

(Thurs./a.m./D)

Chairman: James F. Kaiser, Bell Telephone Laboratories.

10/1 Why Use Digital ICs for Analog Functions?—Donald Breslow, Itek Corp.

10/2 Four Digital Arrays Do All Algorithms—George T. Sendzuk, General Electric Co.

10/3 A Comparison of Analog and Digital Integrated-Circuit Techniques for Sine and Cosine Generation—James R. Garvey, RCA Aerospace Systems Div. A brief summary by Dr. Kaiser will be followed by a panel discussion with audience participation.

11

Progress in Fluidics Applications

(Thurs./a.m./T)

Chairman: D. F. Folland, Sperry Utah Co.

11/1 Secondary-Injection Thrust Vector Control Using Fluidic Vortex Valves—Jerome G. Rivard, Bendix Research Laboratories.

11/2 Fluidic Time Optimal Adaptive Control System—Robert F. Turek, Bowles Engineering Corp.

11/3 Fluidic Device Testing—Harold L. Fox, Fluidonics Research Labs. Div. of Imperial Eastman Corp.

11/4 Proportional Control Systems in Industry—Robert L. Blosser, Sperry Utah Co.

11/5 A Pneumatically Controlled Document-Handling System—R. R. Coleman, Jr., and Richard S. Gluskin, Univac Div. of Sperry Rand Corp.

12

High-Density Recording Techniques

(Thurs./a.m./De)

Chairman: Roy D. Sturkie, Leach Corp. Controls Div.

12/1 High-Density Electron and Lightbeam Recording—Charles F. Spitzer, Ampex Corp.

12/2 Magnetic Heads for High-Density Digital Recording—Donald T. Best, Ferroxcube Corp.

12/3 A Technique for High-Density Digital Recording—Kermit Norris, Leach Corp. Controls Div.

12/4 Ultra-High Data-Packing-Density Recording Related to Manned Spacecraft—Donald Ray Smith, NASA.

C

Special Session

The Frequency Spectrum—An International Resource

(Thurs./p.m./E)

Chairman: James D. O'Connell, Executive Office of the President.

A panel of experts led by James D. O'Connell, Director, Telecommunication Management, Office of the President, will discuss various aspects of frequency spectrum management.

13

Solid-State Imaging—An Evolving Technology

(Fri./a.m./E)

Chairman: Carl Huggins, Marshall Space Flight Center.

13/1 100 x 128 Element Solid-State Imaging System—D. E. Callahan, R. A. Anders, W. F. List, M. E. Wing, and D. H. McCann, Westinghouse Electric Corp.

13/2 A Report on the Development at Fairchild Semiconductor of Integrated Arrays of Silicon Photodetectors of Image Sensing—G. P. Weckler and R. H. Dyck, Fairchild Semiconductor Research and Development Laboratory.

13/3 A Self-Scanned Solid-State Image Sensor—P. K. Weimer, G. Sadasiv, J. E. Meyer, L. Meray-Horvath and W. S. Pike, RCA Laboratories.

13/4 Solid-State Image Intensifier—R. D. Stewart, General Electric.

15/3 Application & Design Aspects of a 2.5-kVA Solid-State Frequency Converter for An Airborne Installation—S. G. Campbell and T. H. Ussher, The de Havilland Aircraft Co. of Canada, Ltd.

15/4 Static Stand-by Power Systems—Chris F. Seyer, Fansteel Metallurgical Corp.

15/5 Redundancy and Switching in Stand-by Systems—Stuart P. Jackson and Dennis M. Swing, Solid-State Controls, Inc.

16 The Computer as a System Component

(Fri./a.m./De)

Chairman: Pete England, Scientific Data Systems.

16/1 The Impact of Third-Generation Computers on System Design—David L. Stein and Joe Glasier, Scientific Data Systems.

16/2 A Third-Generation Computer in a Nuclear Physics Laboratory—Richard F. Au, John V. Kane, and William E. Merritt, Michigan State University.

16/3 Software as a Component in Computerized Systems—Bob L. Ryle, Planning Research Corp.

16/4 On-Line Computers and Patient Care—Shannon Brunjes and Robert F. Maronde, University of Southern California; Stanley Seibert, Los Angeles County Hospital; John C. Soutter, IBM.

D Special Session

Systems Approach to Natural Resources Control

(Fri./p.m./E)

Chairman: R. J. Pafford, Jr., Bureau of Reclamation, Sacramento, Calif.

D/1 Integrating Hydro and Thermal Generation—E. F. Kaprielian, Pacific Gas and Electric Co.

D/2 Systems Analysis Applications for the Future—John Eichelman, Stanford Research Institute.

D/3 Missouri Basin Flood Control and Water Conservation—Tim Waara, Missouri River Div., U.S. Corps of Engineers.

D/4 Bonneville Power Administration System Control—Marvin Harris, Bonneville Power Administration.

14 Panel Session The Future of Solid-State Phased Arrays

(Fri./a.m./D)

Chairman: Arthur S. Robinson, RCA Missile & Surface Radar Div.

Panelists:

R. D. Alberts, Air Force Avionics Lab., Wright-Patterson AFB;

Carl Blake, Lincoln Laboratories;

Douglas Mather, Rome Air Development Center, Griffis AFB;

Thomas Hyllin, Texas Instruments;

Frank A. Brand, Electronic Components Laboratory, Fort Monmouth;

Thomas Madigan, Bell Telephone Laboratories;

Malcom Vosburg, Institute of Defense Analysis;

Arthur S. Robinson, RCA Missile & Surface Radar Div.

15 Static Power Systems: Controls, Inverters, Rectifiers, Power Systems

(Fri./a.m./T)

Chairman: David W. Borst, International Rectifier Co.

15/1 Problems in Designing a dc Power Transmission System—Stuart P. Jackson, Solid-State Controls, Inc.

15/2 Current Regulators for Electrochemical Rectifier Systems—R. P. DePuy and J. W. Luoma, General Electric Co.

Exclusive Technical Session Order Form

Please send me the following WESCON technical session preprints at \$2.00 per session (average: four papers per session), plus \$1 mailing charge per complete order. I understand this order will be mailed to my address within two weeks after receipt. Offer good until November 1, 1967.

(Note: Papers bound by sessions; no individual papers available).

Session No.	Quantity
1	
2	
3	
4	
6	
8	
9	
10	
11	
12	
13	
15	
16	

Total Sessions x \$2.00 = \$ _____

Plus \$1.00 Mailing Charge = \$ 1.00 _____

Total Cost = \$ _____

Make check payable to WESCON and mail with this form to:

WESCON
3600 Wilshire Blvd.
Los Angeles, Calif. 90005

DATE _____

NAME _____

FIRM _____

STREET ADDRESS _____

CITY, STATE, ZIP CODE _____

THE PACKAGING SYMPOSIUM

Here's a guide to the Electronic Packaging Symposium to be held Aug. 21 and 22 at the San Francisco Hilton.

1 Considerations for Joining Techniques

(Mon./a.m.)

Moderators: D. A. Beck, Bendix Research Labs., and E. C. Neidel, Sandia Corp.

1/1 Influence of Surface Structure on the Quality of Gold Electrodeposits—*J. B. P. Williamson and Morton Antier, Burndy Corp.*

1/2 Ultrasonic Soldering and Bonding Techniques—*Paul J. Bud, Electrovert, Inc.*

1/3 Nondestructive In-Process Weld Evaluation—*Forest C. Deal, Martin-Marietta Corp.*

1/4 Electromechanical Design of a Matched Impedance Connector—*H. H. Blonder and R. T. Evans, IBM.*

1/5 System Packaging At The Chip Level—*W. L. Doelp, Jr., Philco-Ford Corp.*

2 Advances in Packaging Techniques

(Mon./p.m.)

Moderators: H. J. Scagnelli, Bell Telephone Labs., and T. A. Telfer, General Electric Co.

2/1 A Preliminary Investigation of Plastic Encapsulated Transistors—*Edward B. Hakim and R. Canepa, U. S. Army Electronics Command.*

2/2 Development of Thin-Film Circuits with Thick-Film Conductor Networks and Crossovers—*Halle Abrams, Western Electric.*

2/3 Thick-Film Techniques and Design Criteria for Space-Vehicle Application—*A. Ottaviano and J. Thomas, General Electric.*

2/4 The Application of Thick-Film

Technology in Multilayered Circuitry—*W. O. Giesfeldt, Centralab.*

3 Linking the Electronics

(Mon./p.m.)

Moderators: W. J. Prise, Lockheed Missiles & Space Co., and G. E. Gless, University of Colorado.

3/1 Fabricating Reliable Multilayer Boards—*D. H. Rossi, Conductron-Missouri.*

3/2 A Flat-Pack Module Intrac connected by Molded Printed Circuits—*L. Eugene Jayden and Cornelius D. Flynn, Westinghouse Electric Corp.*

3/3 Equipment Design for Integrated-Circuit Packaging—*J. P. Focarlie and C. D. Irish, Bell Telephone Labs.*

3/4 Flexible Circuit Connections—*F. R. Sullivan, Lockheed Missiles & Space Co.*

4 The Computer and Electronic Packaging

(Tues./a.m.)

Moderators: E. J. Lorenz, IBM Corp., and T. G. Boe, *EDN Magazine.*

4/1 Packaging Aspects of Computer-Designed Multilayer-Interconnection Printed-Wiring—*Gerald L. Ginsberg, Philco-Ford.*

4/2 Large-Scale Integration—Computer Aids and Systems Aspects—*Thomas F. Prosser, Philco-Ford Corp., Microelectronics Div.*

4/3 Computer-Automated Design and Thermal Analysis of Printed Circuits—*B. Hyman and M. J. Merges, Bell Telephone Labs.*

4/4 Packaging Flat-Pack Integrated Circuits for Earth Satellites—*Robert C. Moore, Johns Hopkins University.*

5 Some Aspects of Thermal Design

(Tues./a.m.)

Moderators: R. C. Mayne, JPL, and J. R. Goodykoontz, TRW.

5/1 Thermal Design Considerations of a Very High-Speed Computer—*Kenji Taniguchi and Yuichiro Oya, Central Research Laboratory.*

5/2 Thermal Design for IBM System/360 Model 91—*V. W. Antonetti, R. C. Chu and J. H. Seely, IBM.*

5/3 Thermal Problems Encountered in the Design of the Electronics Packages of the LMS-Band Steerable Antenna and the Apollo High-Gain Antenna—*Allen L. Schmidt, Dalmo Victor.*

5/4 Temperature Predictions Within an Electronics Section of an Externally Mounted Aircraft Missile During Mach-4.0 Carry Flight—*S. A. Casazza, Raytheon Co.*

5/5 Simplified Transmitter Cooling System—*L. R. Paradis, Raytheon Co.*

6 Meeting the Challenge in Electronic Packaging

(Tues./p.m.)

Moderators: J. C. Rubin, Eastman Kodak Co., and S. Shuey, Sprague Electric.

6/1 Packaging Design of a Solenoid Array Correlator—*John G. Simon, Sylvania Electronic Systems.*

6/2 The Integration of Microelectronics and the Product—*J. F. Hinchey, Friden, Inc.*

6/3 Packaging Design of the Apollo-Lunar-Module Abort Computer—*Thomas B. Hibler, TRW, Inc.*

6/4 Packaging a Capacitor Read-Only Memory—*C. P. del Cano and H. E. Mayles, IBM.*

Latest in the line of Monsanto IC counter/timers.

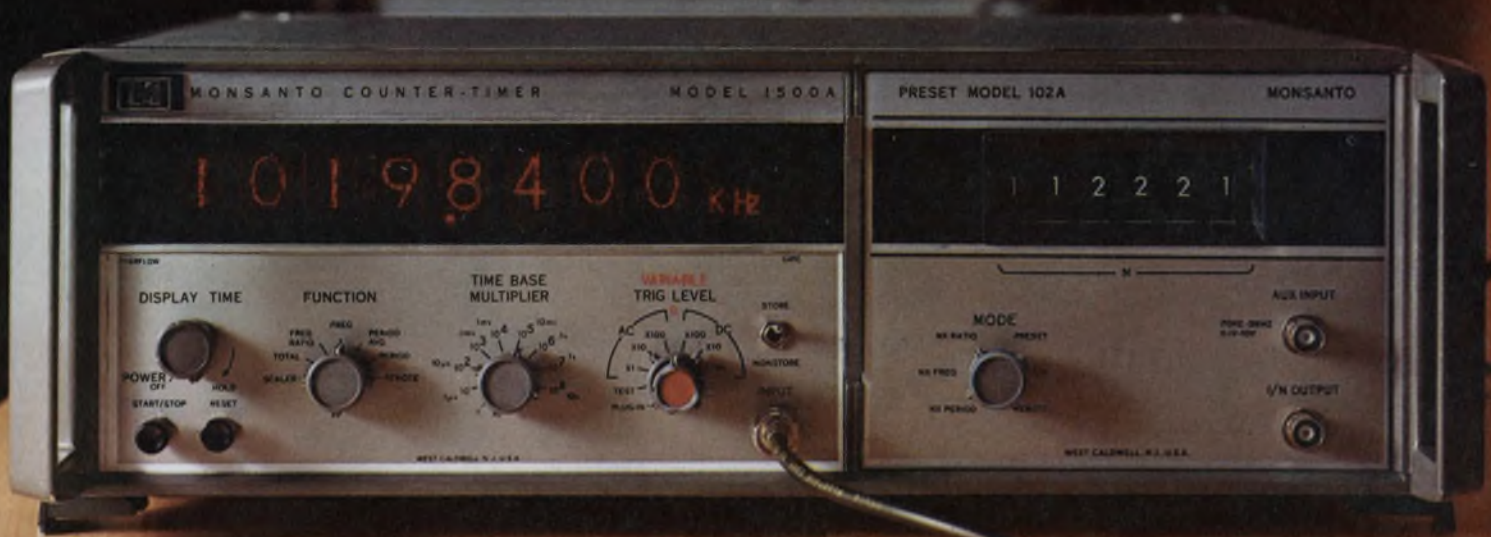

AVAILABLE PLUG-INS: TWO FREQUENCY CONVERTERS (50 MHz TO 500 MHz; 100 MHz TO 3 GHz); PRESCALER (dc TO 1 GHz); PRESET UNIT (20 Hz TO BEYOND 10 MHz); VIDEO AMPLIFIER (1 mV SENSITIVITY, 10 Hz TO 200 MHz); TIME INTERVAL UNIT (100 ns RESOLUTION); NON-COMMITTED PLUG-IN.

With 90% integrated circuit construction this new "4th generation" instrument is the most advanced plug-in counter/timer yet.

Our new model 1500A takes full advantage of IC capabilities to bring you: main-frame counting range from dc to over 125 MHz; to 3 GHz with a single plug-in. Remote programability by either contact closure or voltage level. Provision for external time base up to 10 MHz. And

naturally, the inherent stability and reliability of integrated circuit construction, as indicated by our two-year warranty. All this for only \$2,850 (U.S. dollars, FOB West Caldwell, N.J. exclusive of plug-ins). Circle the inquiry number for full technical details, or contact us directly at: Monsanto Electronics Technical Center, 620 Passaic Avenue, West Caldwell, N.J. 07006. Phone: (201) 228-3800; TWX 710-734-4334.



ELECTRONICS

Technical Program

"MICROELECTRONICS COMES OF AGE"

Here's a guide to a special technical symposium to be held Aug. 23 and 24 at the San Francisco Hilton.

1

An Introduction to Microelectronics

(Wed./a.m.)

Keynote Address: Microelectronics in Perspective—E. Keonjian, Grumman Aircraft Engineering Corp.

1/1 Terminology and Classifications—S. M. Stuhlberg, Raytheon.

2

The Hybrid Approach

(Wed./a.m.)

Session Organizer: Wayne Martin—RCA.

2/1 Thin-Film Networks—M. Penberg, Aerojet General Corp.

2/2 Thick-Film Networks—R. C. Early, General Electric Co.

2/3 Microcomponent Parts and Assembly—M. Ohanian, Raytheon Co.

2/4 Microbonding—R. Eggleston, Kullicke & Soffa, Inc.

2/5 Microassembly Production Techniques Using Thin Films—W. D. Moyers, Lockheed Electronics.

2/6 Microassembly Production Techniques Using Multichips—J. Welty, Amelco Co.

2/7 Microassembly Production Techniques Using Thick Films—R. Lia, IBM.

3

The Monolithic Approach

(Wed./p.m.)

Session Organizer: Carl H. Worebrand, Adage, Inc.

3/1 Basic Theory—H. C. Lin, Westinghouse Molecular Electronics.

3/2 Processing—C. Awad, Raytheon

Semiconductor Operation.

3/3 Design Parameters—R. E. Bohn, Sylvania Semiconductor.

3/4 Bipolar Digital Circuit Applications—W. R. Rhoades, Hughes Aircraft Co.

3/5 MOSFET Circuit Applications—M. Sussman, General Instruments Corp.

3/6 Linear Circuit Applications—J. Gifford, Fairchild Semiconductor.

3/7 Microwave Circuit Applications—V. Gelnovatch, U. S. Army Electronics Command.

4

Interconnection and Packaging Technology

(Thurs./a.m.)

Session Organizer: Donald Sherman—Raytheon Co.

4/1 Current and Future Packaging Methods—J. J. Staller, Sylvania Electric Co.

4/2 Large-Scale Integration—J. Lathrop, Texas Instruments.

4/3 Mechanical Wiring Technology—L. Katzin, Jet Propulsion Laboratory.

4/4 Multilayer Wiring Technology—A. Levy, RCA.

4/5 Thermal Management—J. R. Baum, Motorola Inc., Government Products Div.

4/6 Future Manufacturing Methods—Maurice Nelles, University of Virginia.

5

Reliability and Cost Effectiveness

(Thurs./p.m.)

Session Organizer: Jules A. Rothman—Ikor Inc.

5/1 Microelectronics Reliability—Eldon Hall, MIT Instrumentation Labora-

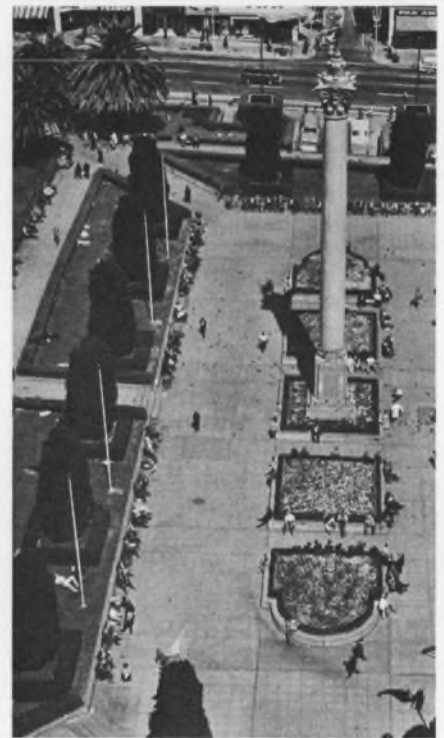

Union Square, near the Hilton, is the hub of San Francisco's shopping area.

tories.

5/2 Reliability Characteristics of Integrated Circuits—D. I. Troxel, RCA.

5/3 Cost Effectiveness—H. Gunther Rudenberg, A. D. Little, Inc.

5/4 The DOD View—Ernest C. Wood, Department of Defense.

6



A Look into The Future

(Thurs./p.m.)

Session Organizer: Jules A. Rothman—Ikor Inc.

6/1 Systems of the Future—W. W. Gaertner, Gaertner Research, Inc.

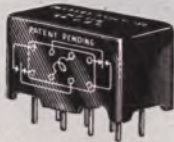
6/2 The Future of Integrated Circuits—Glen R. Madland, Integrated Circuit Engineering Corp.

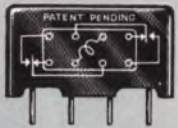
NEW! A commercial relay this  small with 2-ampere dpdt contacts. Printed circuit or socket terminals.  Has Lexan dust cover. This design bonus from our aero/space program is ideal for tape recorders, desk-top computers,  copying machines, television cameras, alarm systems, etc., etc., etc., etc., etc., etc., etc.

High density relay packaging becomes a reality with the low profile HP Series. Only one-fifth of a cubic inch is required for each relay. Seated height in socket or printed circuit board is 0.49". Mechanical life is placed at 10 million operations.

The DPDT contacts are rated from low level to 2 amperes at 30V DC resistive or 0.5 ampere maximum at 120V AC. Coil voltages range from 6V to 48V DC . . . with 12- and 24-volt models available from authorized electronic parts distributors.

These microminiature relays are direct descendants of our military, aero/space designs and have been engineered to perform with singular reliability in modern commercial equipment.

HP SPECIFICATIONS

GENERAL:

Temperature Range: -45°C to +70°C.

Dimensions: 0.49" x 0.88" x 0.48" max.

CONTACTS:

Arrangement: DPDT, 2 Form C.

Rating: Low level to 2 amps @ 30V DC, resistive;
0.5 amps max. @120V AC.

Contact Resistance: 50 milliohms before life
measured at maximum rated load.

COILS:

Power: Approximately .662 watts nominal @ 25°C.
1.0 watts max. @ 25°C.

Duty: Continuous.

Pick-up: 75% of nominal @ 25°C.

Operate Time: 5 milliseconds max. at nominal coil
voltage and 25°C.

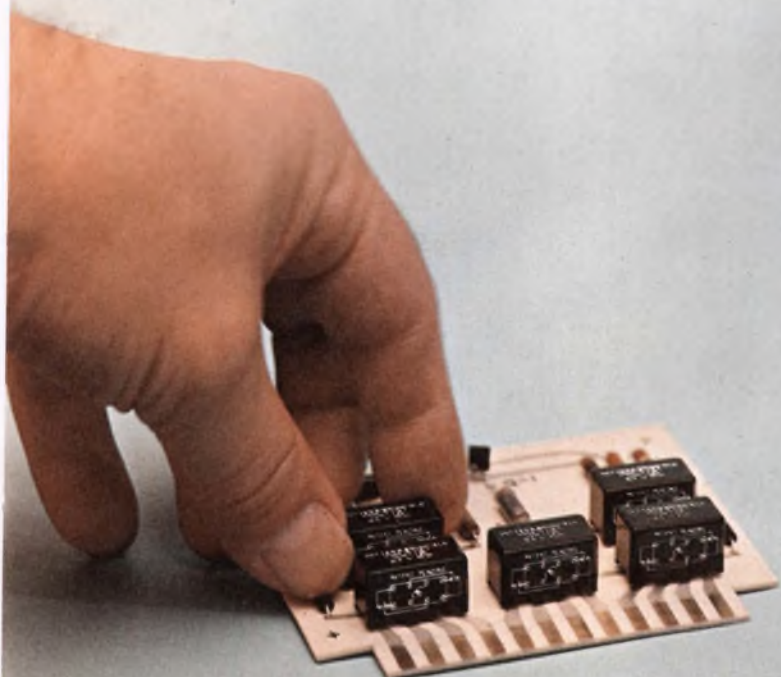

Call your electronic parts distributor



POTTER & BRUMFIELD

Division of American Machine & Foundry Co., Princeton, Ind. 47570
Export: AMF International, 261 Madison Ave., New York, N.Y. 10016

TOURING THE EXHIBIT AREAS

What's new? An electrostatic strip chart recorder, a microwave hybrid and the wares of some 600 exhibitors. Tour the aisles and then "shop the show" using the Reader Service card.

Packaging & Production..... U122
Computers & Data Processing... U136
Instruments & Control Systems... U148
Communication & Detection..... U180
Circuit Components..... U192

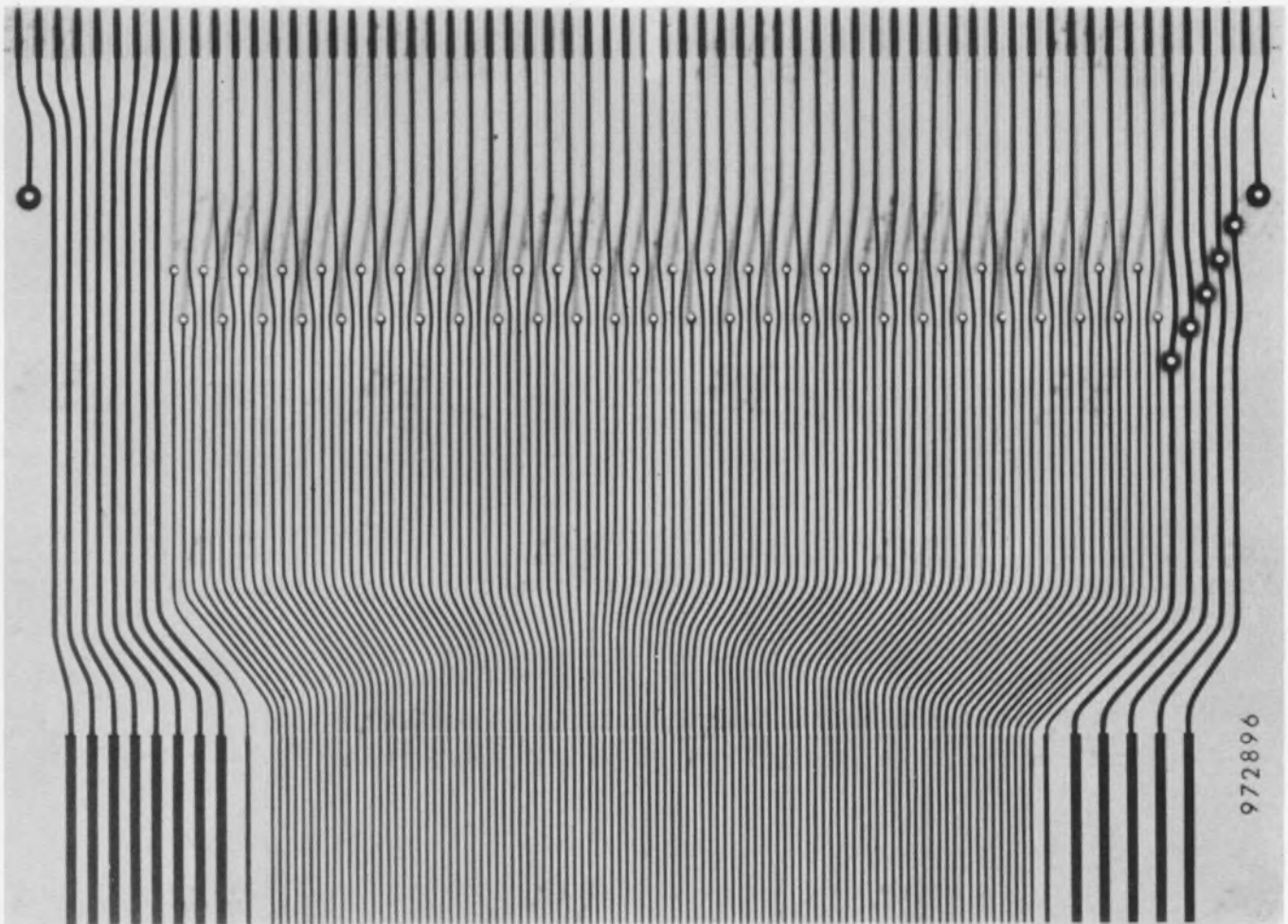

The electrostatic recorder writes as only the paper moves on. Event (left) and time-interval (right) styli flank the 100 fixed data styli in the recording head of Varian's electrostatic strip-chart recorders. With no moving parts

other than the transport, the units record dc-to-3-kHz data with a writing speed of better than 20,000 inches per second. Showgoers can see it at Booth 2309, stay-at-homes on p. U148.

Triple-barreled current probe makes dc, pulse and high-frequency measurements. Use it from dc to 50 MHz to evaluate a wide range of parameters in your semiconductor or SCR circuits. See it at Booth 2818 and on p. U152.

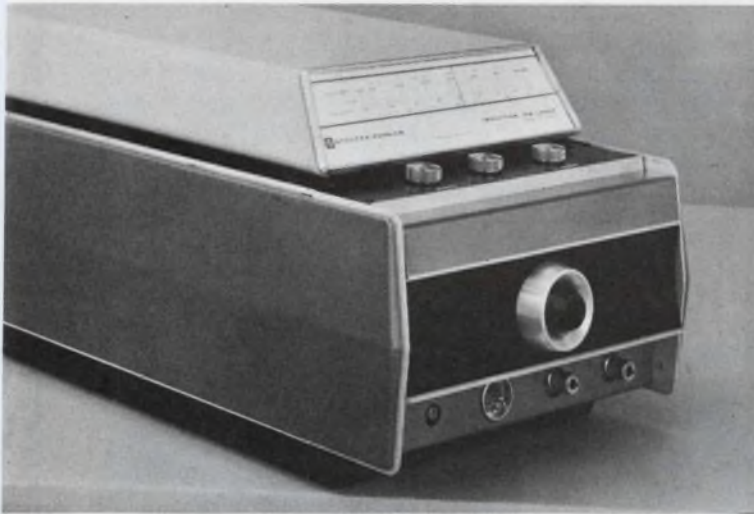
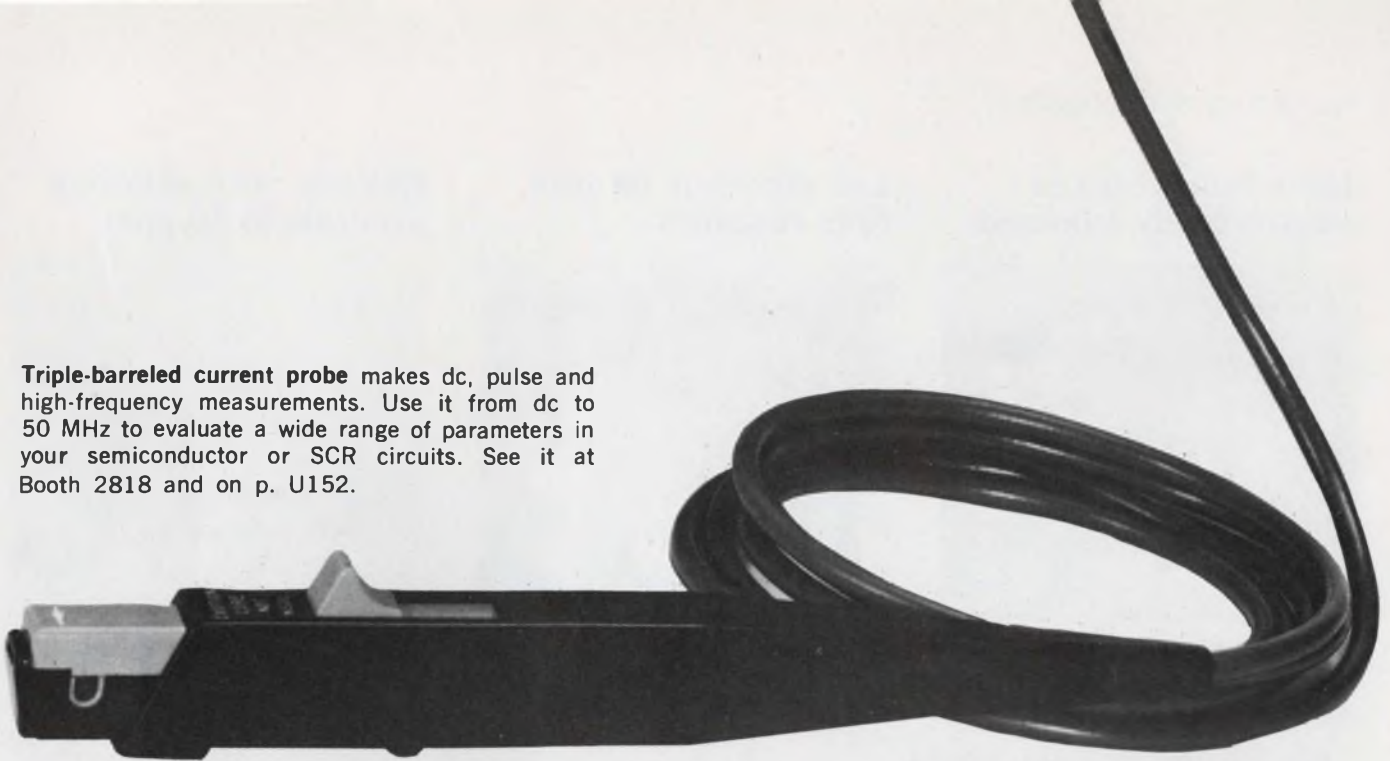

Long-lived ion laser is based on ring-discharge plasma excitation. Its high-power can be used in large-format information displays or to shorten exposure time in holography. At WESCON, it's at Booth 2922; or you can see it on p. U180.

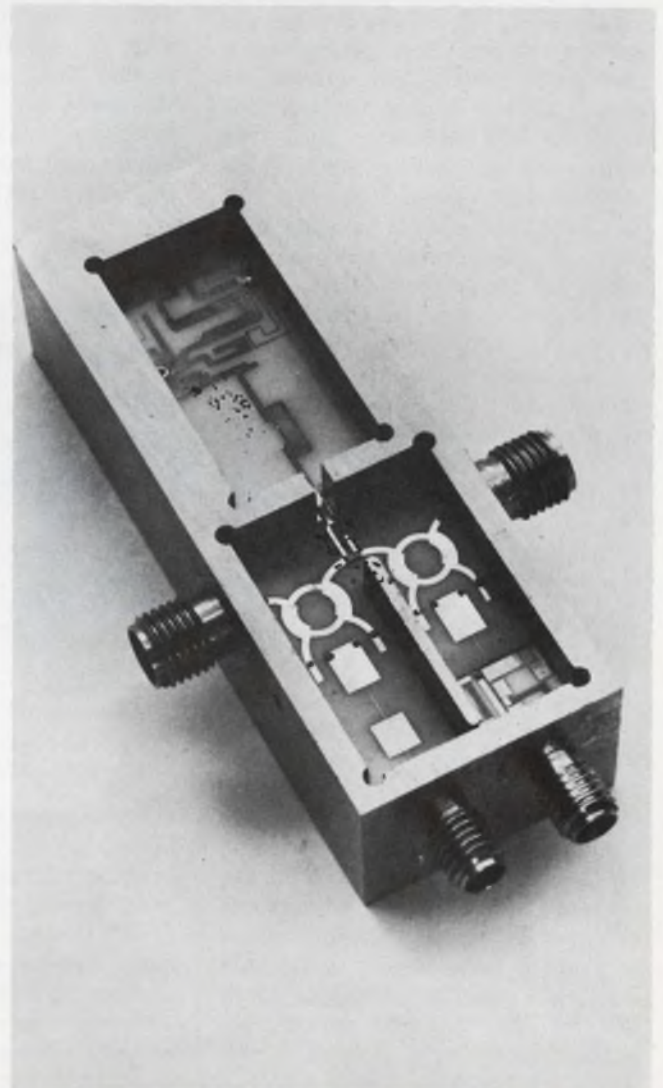

Hybrid integrated mixer and local oscillator assembly performs as well as waveguide and stripline units. Put its size and reliability to work in manpack or airborne pulsed and fm radar receivers. Microwave Associates can tell you about it at Booth 3723, or you can read about it on p. U194.

Thick-film resistors electronically trimmed



Precision Systems Co., Inc., U.S. Highway 22, P. O. Box 148, Somerville, N. J.

For adjusting thick-film resistors, this equipment uses a high-frequency field operating at high voltage and low current. The complete system consists of a generator and a monitor. The generator, using single or multiple-fixed probes, energizes the fired resistor causing a change in value. The process is clean, rapid, nondestructive, controllable and accurate. Once the unit is set up to adjust a run of resistors, time for each resistor adjustment can be set from a few milliseconds to several seconds. Because of the repeatability of the equipment, it is suited to automatic production applications.

The monitor is an electronic, chopper-stabilized bridge-amplifier circuit. The target resistance is preset into the monitor with two 10-turn pots. Tolerances from a fraction of a per cent to over 5% and target resistances from 1 Ω to 5 M Ω can be selected. The potentiometers may be calibrated externally with any accurate bridge or DVM plugged into calibrating jacks on the monitor panel.

Accessories available include a three-numeral digital ohmmeter to provide resistance readout. A simple, manually switched system is also available using a null-point bridge. This system depends on the operator to shut off the adjustment process. To adjust multiple resistors on the same substrate, the unit may be sequenced or two or more systems can be used, working simultaneously.

Booth No. 1210 Circle No. 341

Lab conveyor furnace fires resistors



Watkins Johnson Co., Stewart Div., Bean Creek Rd., Santa Cruz, Calif. Phone: (408) 438-2100. P&A: \$3975; 6 to 8 wks.

Designed specifically for thick-film firing of resistors, capacitors, and conductors, this lab conveyor furnace has four independently controlled temperature zones available with analog or digital set points and a straight-through quartz muffle. The controlled positive atmosphere flow assures uniform atmosphere quality and gives good binder and solvent removal.

Booth No. 1323 Circle No. 340

Floating insert prevents misalignment



Newton Insert Company, 6500 Avalon Blvd., Los Angeles. Phone: (213) 753-4271.

These inserts simplify the assembly of curved surfaces and permit broader tolerances when using flat head screws. Incorporating "waveform" threads, the units roll their own threads in soft metals and plastics without creating chips. They compensate for misalignments up to 0.04 inches in mating parts.

Booth No. 1817 Circle No. 339

Resistor sorting bridge accurate to 50 ppm



Electro Scientific Industries, Inc., 13900 N.W. Science Park Dr., Portland, Ore. Phone: (503) 646-4141. P&A: \$2595; stock to 30 days.

Designed for sorting or measuring resistors at production speeds, this guarded four-terminal Kelvin bridge design permits measurements from well under 1 Ω to more than 100 M Ω in six ranges. The front panel meter allows direct readout of percent deviation on any of the seven calibrated ranges from $\pm 0.01\%$ to $\pm 10\%$ end scale. Panel lights indicate go-no-go sorting.

Booth No. 2717 Circle No. 281

Low-noise blower delivers 150 cfm



McLean Engineering Laboratories, Princeton Junction, N. J. Phone: (609) 799-0100.

This unit fits into a 3-1/2 inch slot in the front panel of an enclosure and forces a slot of air 12-1/2 inches wide to cool the equipment. Air is delivered in one long continuous discharge. The velocity and pressure ensure cooling of densely packed electronics. Each blower is equipped with an aluminum dust filter. The motor is a two-pole operating on 115-volt, 50/60-Hz single-phase power.

Booth No. 3107 Circle No. 316

For a clear picture of Centralab...

...keep an eye on our ripples

In our years of manufacturing miniature and subminiature components, we've made many ripples, and a few splashes, in the electronics industry:

Centralab designed and produced the world's first carbon composition potentiometer and for more than 40 years has been an industry leader. In 1936 we introduced the first temperature-compensating ceramic capacitor in America. We were first to offer dual controls and to add integral line switches to variable resistors. Our exclusive <PEC> integrated circuits have been key elements in the miniaturization of electronic equipment. During World War II days Centralab developed the ceramic disc capacitor design for military requirements. And our Ultra-Kap[®] ceramic disc capacitor has replaced millions of larger, more costly devices.

Centralab sales have increased substantially every year and our services have grown proportionately. Our products are sold, by separate sales groups and from separate warehouses, to original equipment and distributor markets.

Centralab's tested and proven products include capacitors, packaged circuits, rotary switches, potentiometers and technical ceramics. In October, 1966, we erected a push button switch manufacturing plant and in May, 1967, we acquired solar devices and semiconductor facilities.

Innovation, growth and stirring the waters are nothing new at Centralab; and we don't intend to stop. As technology advances and components become smaller, more complex and more sophisticated, we'll keep our feet wet.

To help keep abreast of Centralab developments, we'll be happy to send you our periodical "This Is Centralab." Write for future issues.



CENTRALAB

Electronics Division
GLOBE-UNION, INC.
5757 NORTH GREEN BAY AVENUE
MILWAUKEE WISCONSIN 53201



ON READER-SERVICE CARD CIRCLE 68

Connect This New Over-Voltage Protector Wherever it's needed...

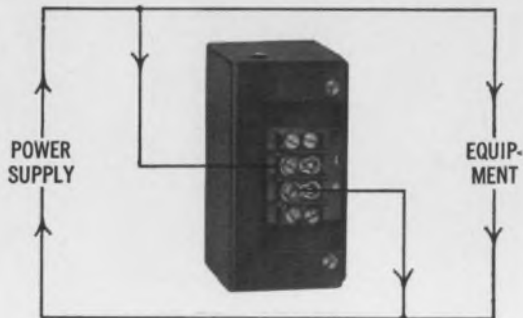

and get Maximum Protection

3 Big Advantages over "Built-In" Over-Voltage Protection

1. Connects at any location along DC supply bus. Provides full protection where needed such as directly at equipment terminals.
2. Completely independent of connected supply or source. Applicable to all types of power supplies and unaffected by the type of power supply failure.
3. Protects against all types of over-voltage conditions. Provides protection against inductive line spikes, switching transients, as well as power supply failure.

ERA Transpac "OV" over-voltage protectors are designed to protect electronic equipment against all types of over-voltage conditions. These units may be connected anywhere along the DC feed line, and offer complete protection, within microseconds, independent of the type of supply or source of transient over-voltage.

These new ERA units are two-terminal designs which may be connected at any location with no external power source connection. Since the units monitor only the voltage impressed across the two-terminal input, any type of power supply may be utilized including unregulated supplies, multiple supplies, or equipment with switching arrangements.

SPECIFICATIONS:

Trip Voltage Range: 4.5 to 40 VDC.
Trip Point Setting: Within 500 millivolts or 5% above output whichever is greater.
Shunt Impedance, Tripped: Less than 10 milliohms.
Response: Within 10 microseconds after exceeding trip voltage.
Maximum Allowable Shunt Current (Peak): 200 amperes for 16 microseconds.

Maximum Shunt Current (Continuous): 10 amperes.
Resolution: Within 100 millivolts of trip point setting.
Operating Temperature Range: -40°C to +71°C
Type: Two-terminal.
Standby Current: 30 milliamperes max.
Temperature Coefficient: 5 millivolts/°C or 0.05%/°C, whichever is greater.

STANDARD MODELS

CURRENT	VOLTAGE	WEIGHT	SIZE (IN.)	MODEL	COST
0-8 amps	4.5-40 VDC	10 oz.	1½ x 3½ x 1¼	OV448	\$59.00
0-8 amps	4.5-40 VDC	10 oz.	1½ x 3½ x 1¼	OV448M*	\$95.00

* Military Component Type. Incorporates MIL Specification Parts Where Applicable.

Write for Catalog #152



ELECTRONIC RESEARCH ASSOCIATES, INC.

67 Sand Park Road, Cedar Grove, N.J. 07009 (201) Center 9-3000
 Subsidiaries: ERA Electric Co. • ERA Acoustics Co. • ERA Dynamics Corp. • ERA Pacific, Inc.

ON READER-SERVICE CARD CIRCLE 65

PACKAGING & PRODUCTION

Coil winding unit has many applications

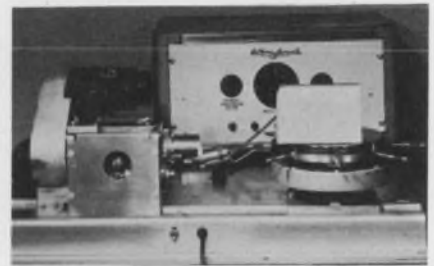

Coil Winding Equipment Co., Railroad Plaza, Oyster Bay, N. Y.
 Phone: (516) 922-5660

Lattice-wound, pi-wound and progressive universal windings are produced by this equipment. In addition, patterns that cannot be wound on conventional machines are possible. The wire is rapidly distributed across the face of the coil without the use of cams and reciprocating parts. The high winding speeds and free flow of the wire through the winding head is mated with a transfer mechanism so that both winding and transfer time are held down.

Booth No. 1802 Circle No. 344

Arc illuminator puts out 6500 W



Christie Electric Corp., Box 43187, 3410 W. 67th St., Los Angeles.
 Phone: (213) 750-1151.

High-intensity xenon arc illuminators have applications in photochemistry, semiconductor photorealist processes, high-speed photography and general research. The system includes the lamp, power supply, and lamp housing with optics and igniter. Systems are available in lamp ratings from 200 to 6500 watts with various types of optics and three performance classes of power supplies.

Booth No. 2523 Circle No. 321

**"New I/C Dual Op Amp (Op Amp²)
Provides 36-Million
Voltage Gain!"**

Naturally, you would have no need to use that much gain (right now) . . . yet, the fact remains that with a typical open-loop voltage gain of 6,000 in *each* of the two amplifier sections of the MC1535 (Op Amp²) – the total theoretical voltage gain of the pair in cascade is 36,000,000! Now, for a really large number from the industry's first I/C dual op amp, consider the power gain – where you square the above number . . .

Even more importantly, you can use whatever gain you need in practical applications without having to cascade. Since two operational amplifiers are constructed on a single

monolithic chip and contained within the same package – you can save on component costs – and, on assembly time, too! In addition, you save even more on the low initial cost of the MC1535 Op Amp² – priced at only \$8.50 (100-up) in the TO-100 package.

In addition to excellent gain characteristics, the MC1535 Op Amp² also offers excellent stability, with a minimum of external components; so, it functions well in summing amplifiers, integrators or other amplifiers where operating characteristics are a function of feedback. Some of the specifications that help to make possible the versatile and unusual

performance of the MC1535 Op Amp² are:

CHARACTERISTIC	SYMBOL	TYPICAL RATING	UNIT
Temperature Drift	$T_{c\ v_{io}}$	10.0	$\mu V/^{\circ}C$
Output Voltage Swing	V_{out}	± 3.6	V
Input Offset Voltage	V_{io}	1.0	mV
Output Impedance	Z_{out}	1.7	k Ω
Input Impedance	Z_{in}	45.0	k Ω
Input Offset Current	I_{io}	0.05	μA
DC Power Dissipation	P_D	100.00	mW

The MC1535 Op Amp² is currently available, from stock, in both the 10-pin metal can and 14-pin ceramic flat pack. For complete details about this exciting, new integrated circuit, write for our data sheet.

where the priceless ingredient is care!



MOTOROLA Semiconductors

MOTOROLA SEMICONDUCTOR PRODUCTS INC. / P.O. BOX 955 / PHOENIX, ARIZONA 85001 / (602) 273-6900 / TWX 910-951-1334
ON READER-SERVICE CARD CIRCLE 63

**To get
high energy
circuitry
at the
lowest cost:
start here.**

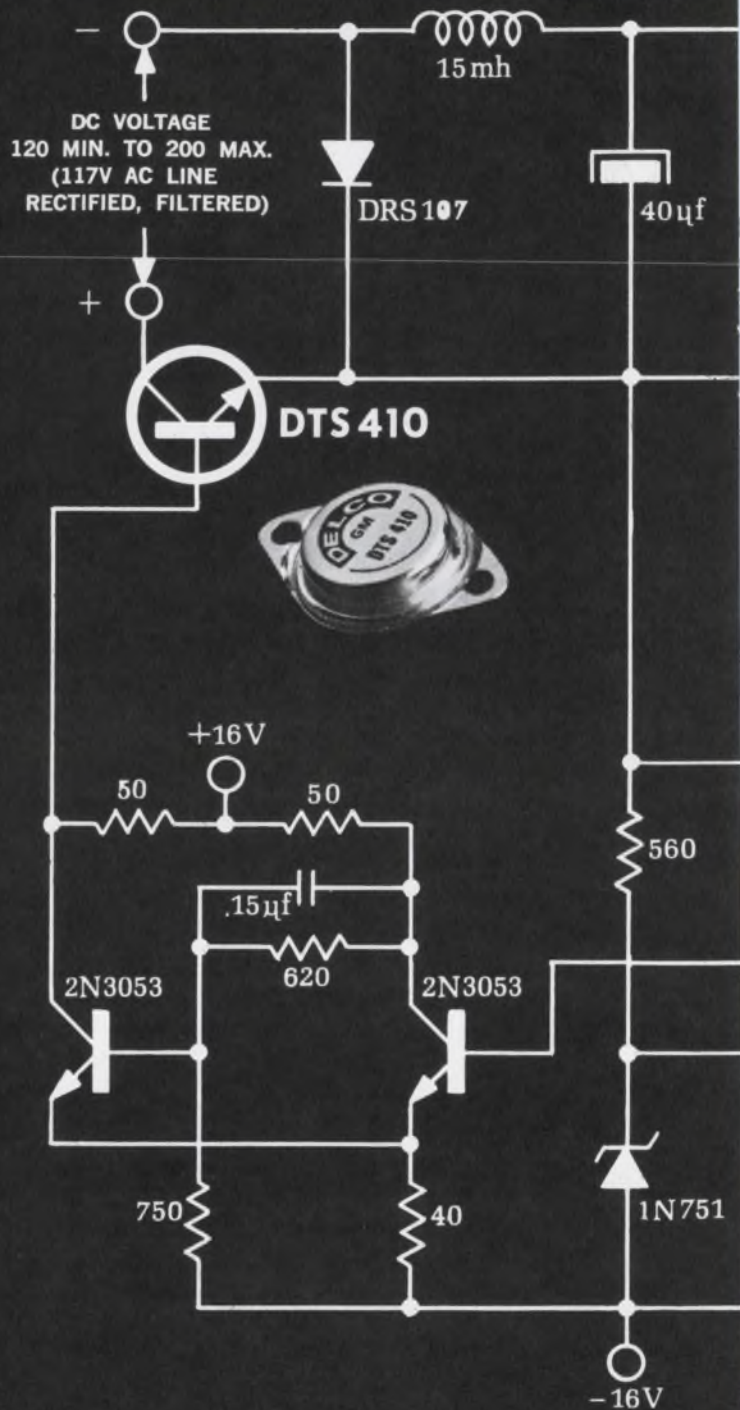

Application of Delco high voltage silicon power transistors:

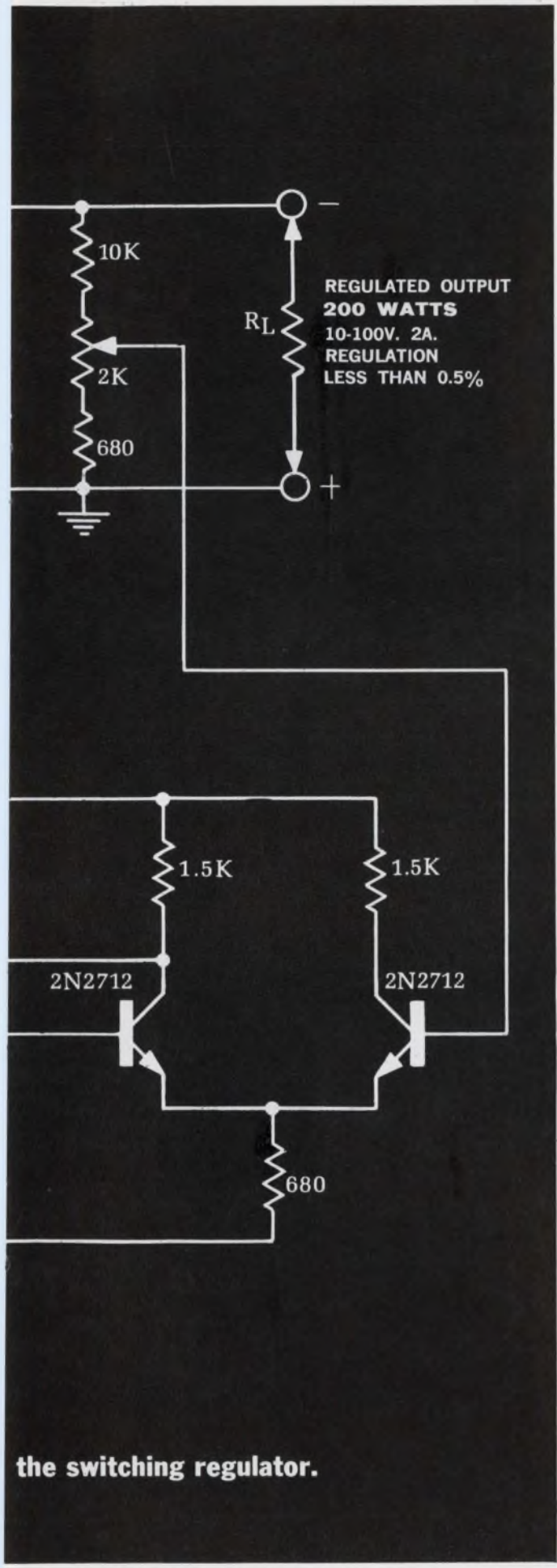

the switching regulator.

Start with circuit designs using Delco high voltage silicon power.

The simple switching regulator in the diagram at left turns out 200 watts (2 amps) output at efficiencies exceeding 85%. And it does it with just one series element working directly from rectified line voltage: the new Delco DTS-410 transistor at just \$1.95 each*.

Or if you need regulation of 250 volts DC and 400 watts output, the DTS-411 may be your answer. Cost? Just \$3.15 each*. And for extra-high voltage applications, there's the DTS-423, now priced at \$4.95 each*.

Now combine our new low prices with these other cost-cutting advantages of Delco high voltage silicon power transistors: you can reduce the number and complexity of input, output and filtering components. This means more compact circuitry, greater reliability and lower assembly costs.

These NPN silicon transistors are packaged in a rugged TO-3 case for low thermal resistance. Inside, they are mounted to withstand mechanical and thermal shock because of special bonding of the emitter to base contacts.

There's no need to be concerned about delivery. They are available right now in production quantities. Call us. Or order samples from your Delco distributor.

For details on the switching regulator circuit ask for application note number 39.

*Prices shown are for quantities of 1,000 or more.

TYPE	V _{CEO}	V _{CEO} (sus)	I _C Max	h _{FE} Min @ I _C V _{CE} = 5V	Power Diss Max
DTS-410	200V	200V (min)	3.5A	10 @ 2.5A	80W
DTS-411	300V	300V (min)	3.5A	10 @ 2.5A	100W
DTS-423	400V	325V (min)	3.5A	10 @ 2.5A	100W

FIELD SALES OFFICES
 UNION, NEW JERSEY** Box 1018 Chestnut Station (201) 687-3770
 DETROIT, MICHIGAN 57 Harper Avenue (313) 873-6560
 SYRACUSE, NEW YORK 1054 James Street (315) 472-2668
 CHICAGO, ILLINOIS** 5151 N. Harlem Avenue (312) 775-5411
 SANTA MONICA, CALIFORNIA** 726 Santa Monica Blvd. (213) 393-1465
 General Sales Office: 700 E. Firmin, Kokomo, Ind. (317) 459-2175

**Office includes field lab and resident engineer for applications assistance.

DELCO RADIO
 Division of General Motors, Kokomo, Indiana



Portable tape preservers available in 2 sizes



Magnetic Shield Division, Perfection Mica Co., 1322 N. Elston Ave., Chicago. Phone: (312) 384-2122. P&A: \$50 to \$80, 2 to 4 wks.

Portable magnetic tape preservers measure 7-3/4 x 12 x 12 inches and hold 5 magnetic tapes 1 inch wide and 11-1/2 inches in diameter. The Model holds 3 similar magnetic tapes. The unit can be equipped with locks for additional security. Booth No. 1602 Circle No. 372

Acid-gold solutions plate pure



Engelhard Industries, Inc., Chemical Div, 113 Astor St., Newark, N. J. Phone: (201) 242-2700.

Engelhard is offering a pair of new gold-plating solutions. Acid-gold electroplating process E 71 produces high-purity, relatively low-stressed, bright gold deposits of 140 to 200 Knoop hardness. Abrasion and wear resistance meets MIL-G-4520A, type II. Solution E-56 gives an ultra-pure deposit (99.99%) and meets all requirements of MIL-G-45204A, type I, and shows good resistance to heat and discoloration at high temperatures.

Booth No. 1617 Circle No. 343

Desolder components with hand-held tool

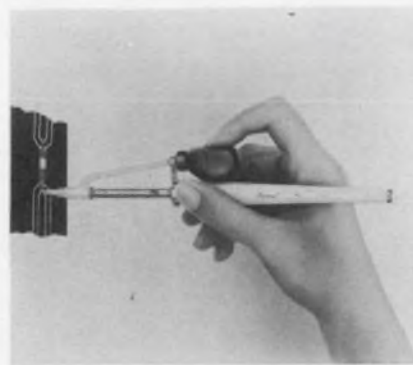

Ungar Electric Tools, 2701 El Segundo Blvd., Hawthorne, Calif. Phone: (213) 757-2151.

Nonclogging and nonsticking features are incorporated in this desoldering tool. Held in one hand, the operator has the other hand free for removal of IC chips and discrete devices during rework and repair. Clogging in the tip is eliminated by the stainless steel lining. The replaceable tip has an 0.033-inch aperture.

Booth No. 1604 Circle No. 361

Wire laying machine uses 2-axis control

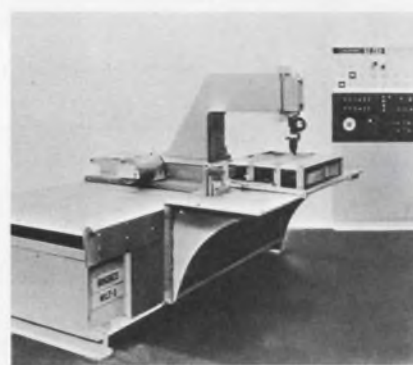

Hughes Aircraft Co., 5261 W. Imperial Hwy., Los Angeles. Phone: (213) 391-1711. P&A: \$45,000; 4 to 5 mos.

For jumper-wire connections, single-terminal connection and wire harness laying, this 2-axis machine uses solid-state logic. The table operates at a traverse speed of 400 inches per minute, with a resolution of 0.001 inches. Positioning accuracy per axis is ± 0.003 inches. The photoelectric tape reader reads 60 lines per second.

Booth No. 1704 Circle No. 381

Diffusion furnace for wafer makers



Electroglas, Inc., 150 Constitution Drive, Menlo Park, Calif. Phone: (415) 325-1536.

An all-solid-state controller, matched to the equipment, gives this furnace fast response and stability. The controller's high-gain amplifiers provide for narrow operating proportional bandwidths; as low as 1.5°C. All amplifier stages and thermocouple cold junctions are temperature-controlled within the controller to 65°C. Neither electrical nor mechanical choppers are required.

Booth No. 1915 Circle No. 338

1000-W power meter monitors cw lasers

Coherent Radiation Laboratories, 932 E. Meadow Dr., Palo Alto, Calif. Phone: (415) 328-1840.

This meter is capable of measurement and direct indication of intense cw laser radiation at the 10.6-micron wavelength. Model 203 consists of a direct-absorption water-cooled head with adjustable table-top stand and a control and indicator unit. The head is capable of dissipating up to 1.5 kilowatts on a continuous basis. The rear of the assembly is in intimate thermal contact with the water-cooled heat sink and the resultant longitudinal heat flow is sensed by an intermeshed system of thermocouples. The voltage thus generated by the thermopile is amplified in the control unit and indicated on the calibrated meter.

Booth No. 3214 Circle No. 313

The Innovator: Philco-Ford.

The Product: A 5-way better digital IC family. 1. Only our 9930 Series DTL is available in these three packages: E-line epoxy dual inline, ceramic flat packs, and ceramic dual inline packages. 2. For absolute minimum power dissipation, we've developed a unique MEL (Micro Energy Logic) family of medium-speed TTL integrated circuits (gate, buffer, and register flip flop elements). These circuits have a typical power dissipation of 440 μ W per gate function — lowest in the industry. 3. Super RTL is also available: high speed, medium power NAND/NOR log (8ns with 5.3 mW per function). 4. To date, our digital IC's have logged over 65 million device-hours; reliability data available on request. 5. Immediate delivery. Philco-Ford Corporation, Microelectronics Division, Santa Clara, California 95051.

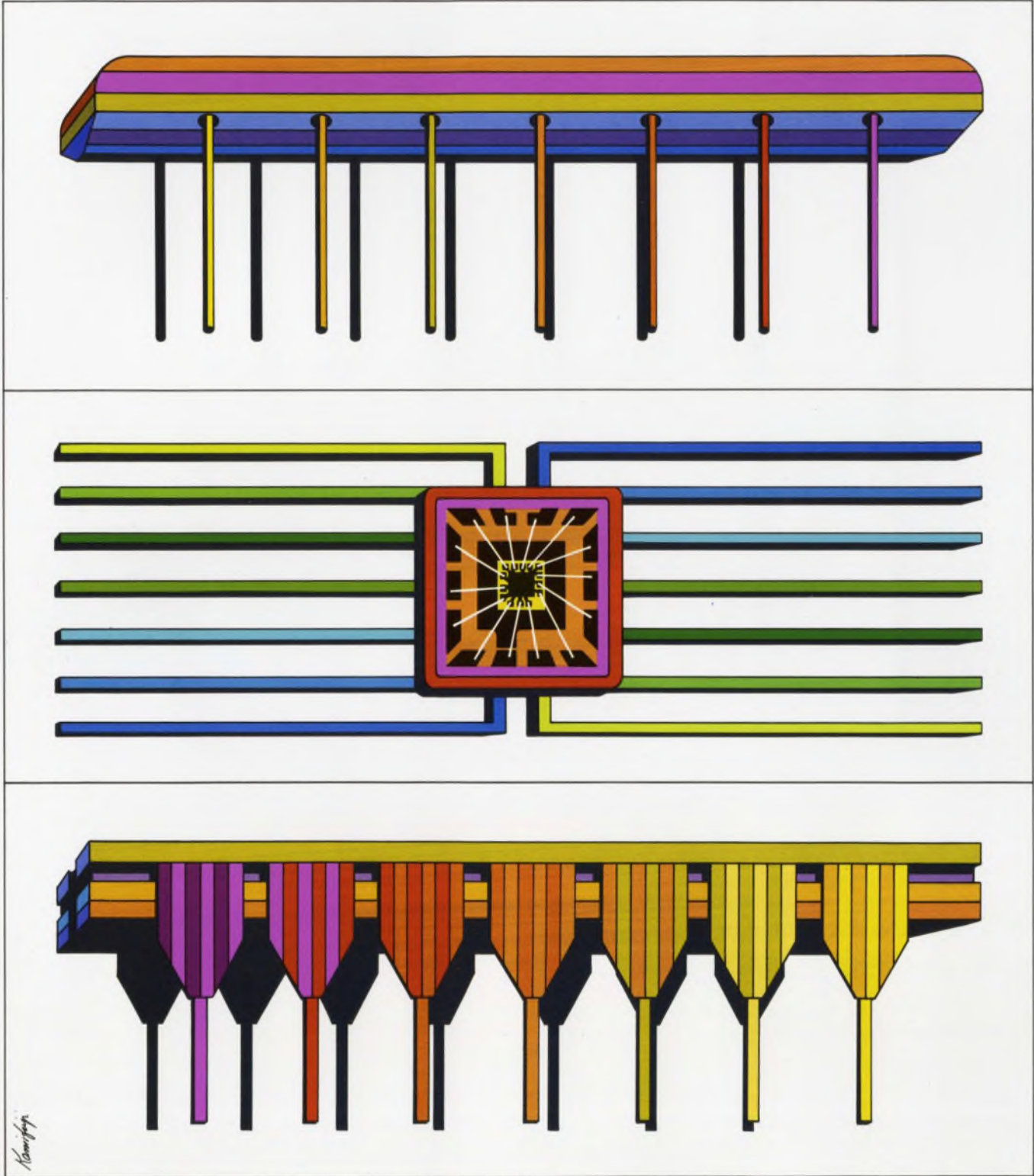

MILC-22557

series tmm
(threaded coupling)



series mmp
(snap-on coupling)



series mms
(slide-on coupling)



Series
tmm, mmp
and mms
are compatible
with ConheX™
connectors

A complete line of MICRO and SUB MIN COAXIAL CONNECTORS

for semi-rigid and flexible cables, in both 50 and 75 ohm versions, offering a very wide selection of cable clamping and crimping techniques

Highly reliable and rugged, with excellent electrical characteristics, these versatile connectors offer complete design flexibility for today's critical miniaturization requirements.

Complete catalogs are available.
Write or phone today.

ConheX, Reg. TM Sealectro Corp.

automatic

METAL PRODUCTS CORPORATION
323 Berry St., B'klyn, N.Y. 11211 • Tel: (212) EV 8-6057

EXCLUSIVE CALIFORNIA DISTRIBUTOR
BELL ELECTRONICS
Northern California: Phone (415) 323-9431
Southern California: Phone (213) 321-5802

SEE US AT WESCON — BOOTH 4408

ON READER-SERVICE CARD CIRCLE 66
U130

PACKAGING & PRODUCTION

Marker plates for wire harnesses



Panduit Corp., 17301 Ridgeland Ave., Tinley Park, Ill. Phone: (312) 532-1800.

For identifying bundles up to 4-inch diameter, these markers are 3/4-inch wide and available in lengths of 1-1/2, 1-3/4, 2, 2-1/2 and 3-1/2 inches. They are nylon and can be hot-stamped or marked with a pen. All five sizes are easily secured to bundles using standard harness ties. The plates are available in packages of 100, bulk packages of 1000 and continuous rolls of 1000. Booth No. 1902 Circle No. 347

Low-noise ion generator neutralizes charges

Controlled Environment Equipment Corp., 344 South Ave., Whitman, Mass. Phone: (617) 447-4436.

Laminar flow equipment is available with an air-ionizing unit to eliminate all electrostatic charges from the work area. Since statics are random, it is important to generate both positive and negative ions directly in the air stream. Thus, static charges of either polarity are neutralized. The ion generating unit does not generate ozone, nor is there radiation or shock hazard.

Booth No. 1917 Circle No. 355

For a complete listing of the technical papers at the show, see page U 112. For reprints of most of the papers, fill out the order form on page U 115.

Teflon cable covering zips closed



Zippertubing Co., 13000 S. Broadway, Los Angeles. Phone: (213) 321-3901.

Zippertubing, using Teflon fluorocarbon material, withstands environmental extremes of temperature and abrasion. Operable at temperatures to +500° and -425°F, the product comes with the zip-on, zip-off closure which permits easy jacketing application. The material is chemically inert, resistant to outdoor exposure, and has moisture absorption of less than 0.01%.

Booth No. 1505 Circle No. 353

Gas sputtering system modularly constructed



Consolidated Vacuum Corporation, 1775 Mt. Read Blvd., Rochester, N. Y. Phone: (716) 458-2550.

Each chamber of this system is a bolt-on module which can be fastened end-to-end to other chambers. Or, they can be joined to another chamber by means of a transport valve so that the two chambers can be operated at different pressures for multiple sequential processing of the same substrate. All materials now being sputtered in microelectronic circuit fabrication can be deposited in this system.

Booth No. 5228 Circle No. 354

ON READER-SERVICE CARD CIRCLE 222 ▶

The Innovator: Philco-Ford.

The Product: A 9-way better epoxy transistor. 1. PET TO-18's ambient power dissipation is typically greater than 400 mW (chip dependent). Θ_{JC} is typically 105°C/W. 2. PET TO-5's ambient power dissipation is typically greater than 450 mW. Θ_{JC} is typically 100°C/W. 3. PET packages have reliability factors equal to or exceeding that of metal cans. 4. PET's are immediately available in large volume production quantities. 5. PET's have a special deep-well interlock construction that insures hermeticity and reliability. 6. PET packages are permanently and legibly marked—lettered black on white. 7. PET's are packaged in our low-cost Taiwan production facility—to keep your cost low. 8. PET amplifiers operate on currents ranging from 10 μ A to 1 A; PET switches to speeds 8 ns turn on and 11 ns turn off. 9. PET's cover frequencies from 40 MHz to 1400 MHz. Philco-Ford Corporation, Microelectronics Division, Santa Clara, California 95051.



Solid-state programmer recovers in 1 ms

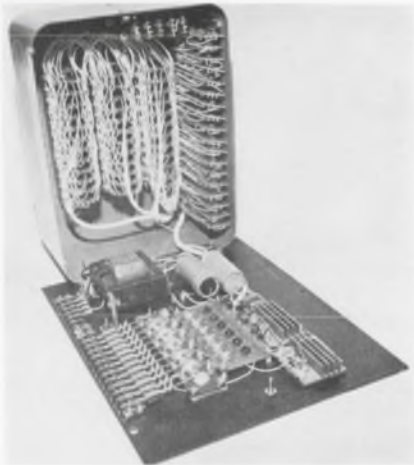

Leach Corp., Relay Div., 5915 Avalon Blvd., Los Angeles. Phone: (213) 232-8221.

This programmer uses ICs to perform logic and counting functions to control, in a selectable time sequence, the operation of semiautomatic machines, process control equipment, recording and tracking systems. The programmer initiates and terminates timing cycles, with durations as low as hundredths of a second and up to 29.9 seconds. The input power required is 1 A at 115 V ac, 60 Hz. The unit operates over a temperature range of 15° to 55°C.
Booth No. 3005 Circle No. 322

PC connector has wire-wrap terminals

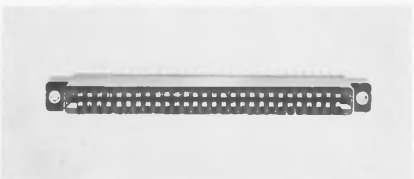

Continental Connector Corp., 34-63 56th St., Woodside, N. Y. Phone: (212) 899-4422.

Printed circuit card-edge connectors feature terminations designed for wire-wrapping. They are available with 28 dual contacts providing 56 wiring terminals on 0.125-inch center-to-center spacing. Contact terminals are 0.025-inch square to permit wire-wrapping for up to three #26 AWG wires on each. Body material is glass-reinforced diallyl phthalate and contacts are gold-plated phosphor bronze.

Booth No. 3805 Circle No. 254

Circular connector mates simply



Viking Industries, Inc., 21001 Nordhoff St., Chatsworth, Calif. Phone: (213) 341-4330.

Miniature circular connectors for nonmilitary applications have crimp, removable high-density contacts. The entire plug/receptacle housing and insulators are molded in one unit eliminating costly separate metal housings and coupling devices. To mate, the user inserts the plug until it snaps to a locked position. By squeezing the finger grips on the plug housing, the plug releases and can be removed from the receptacle by pulling the plug.
Booth No. 4001 Circle No. 251

Heat transfer devices cool off TO-92s

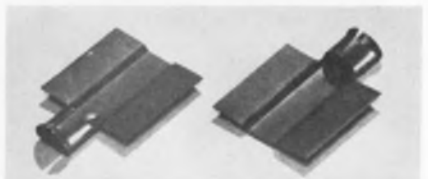

Wakefield Engineering, Inc., Wakefield, Mass. Phone: (617) 245-5900.

Two cooling devices are designed for TO-92 packages. The heat sink accommodates one TO-92 plastic transistor. It is made of aluminum with black immersion or irridite finish. For power dissipation of 0.2 watts, collector lead temperature rise above ambient is 18°C with black immersion or 20°C with irridite finish. The temperature equalizer for dual TO-92 units has three sizes to accept all different case size TO-92s. Material is aluminum or beryllium copper.

Booth No. 5332 Circle No. 264

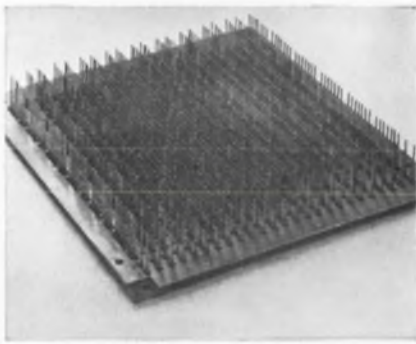

You're more productive with back-plane wiring

These new panels let you get the most out of wire-wrapping techniques. By combining specially drawn Wire-Wrap* terminals (for machine or hand-gun interconnection) with CAMBION®'s exclusive cage jack (for IC pluggability) you can have both packaging density and high production.



The concept of these panels allows you to order a size to meet your space or function requirements whether you're mounting 50 or 500 dual in-line IC's. If you are redesigning with integrated circuits, let CAMBION help you make the most of your design effort. For complete specifications on this reliable interconnection technique, contact: Cambridge Thermionic Corporation, Digital Products Division 433 Concord Avenue, Cambridge, Massachusetts 02138. Phone: (617) 491-5400.

®REG. U.S. PAT. OFF.
*T. M. Gardner-Denver

CAMBRIDGE THERMIONIC CORPORATION
CAMBION®

Standardize on CAMBION . . .
21,541 guaranteed electronic components

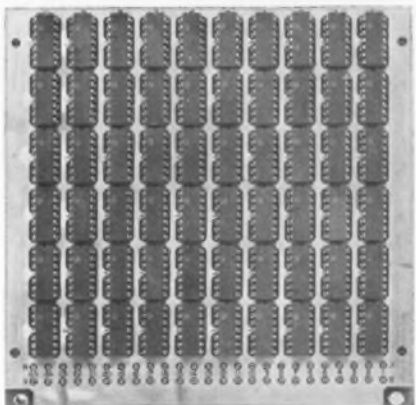

The Innovator: Philco-Ford.

The Product: A 5-way better linear IC line. 1. Only linear line that covers the entire frequency spectrum from DC through VHF. 2. Our PA 7600 RF/IF video amplifier offers the highest gain bandwidth available in the industry (passband to 9000 MHz). 3. PA 7601 RF/IF bandpass amplifier offers extreme linearity with AGC. 4. PA 7713 RF/IF video amplifier: a special linear circuit featuring high gain bandwidth at low power (500 MHz at 18 mW). 5. Immediate delivery. Philco-Ford Corporation, Microelectronics Division, Santa Clara, California 95051.

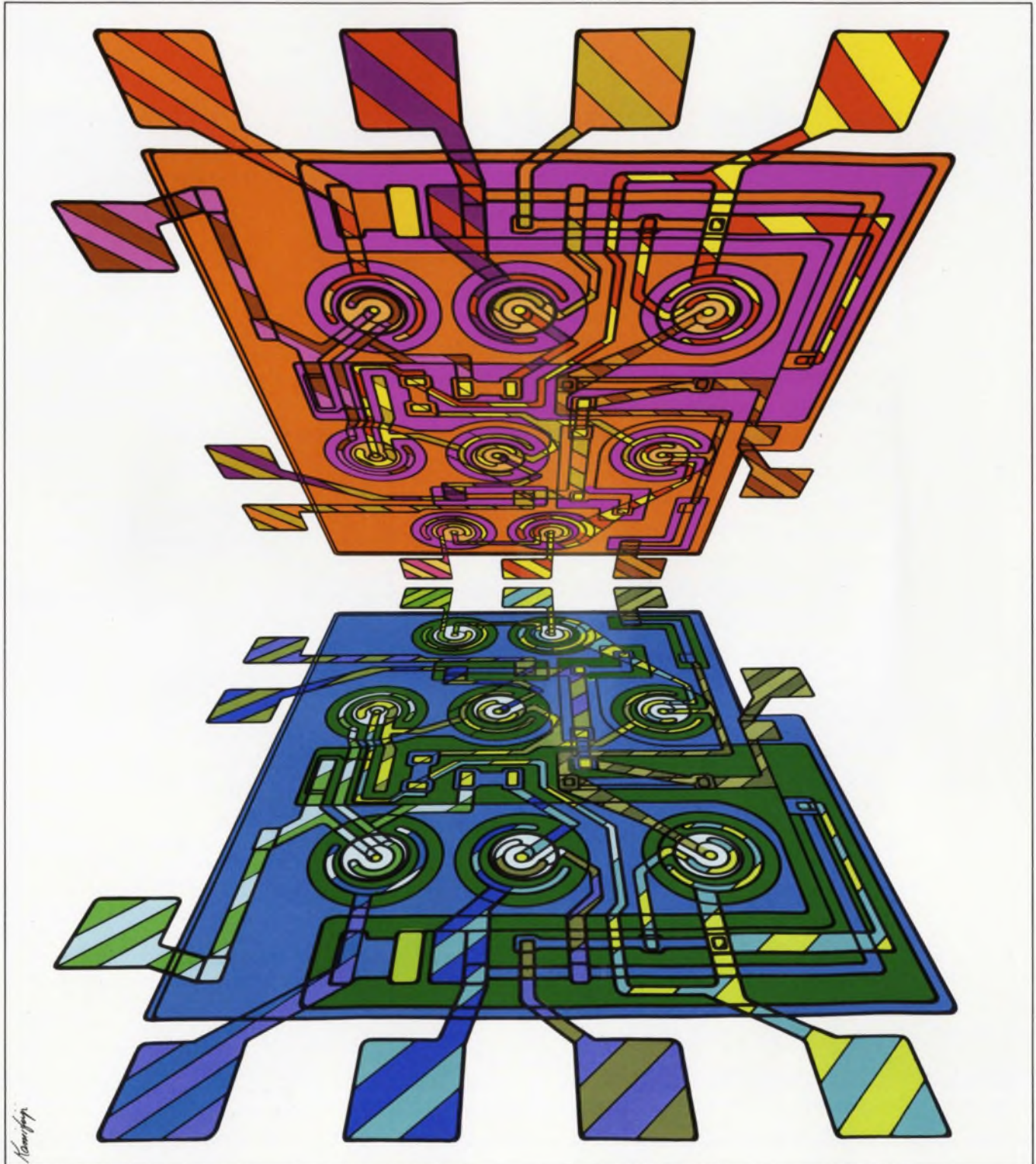

Kleinberg

We are No. 1 in RF Voltmeters

and you better believe it!

We have sold more sensitive RF Voltmeters than anyone else because we have been doing a lot of things right. We have given you 2% accuracy. We have given you the highest input impedance to make that accuracy meaningful. We have given you the highest AC and DC overload protection (probe diodes last longer that way). We have given you the fast response you need for peaking and nulling (sluggish sampling voltmeters can't make the grade). We have given you a well-mannered probe which works without any "backtalk" pulses pumped into your circuit (again, sampling voltmeters flunk out)! We have given you a clean, trouble-free design with a choice of features in three models ranging from \$495 to \$650. Check on the specs (we'll send them) that have made us No. 1.

**BOONTON
ELECTRONICS**
CORPORATION

ROUTE 287
PARSIPPANY, N. J. 07054
Telephone: 201-887-5110
TWX: 710-986-8241

PACKAGING & PRODUCTION

IC sealing system seams cold

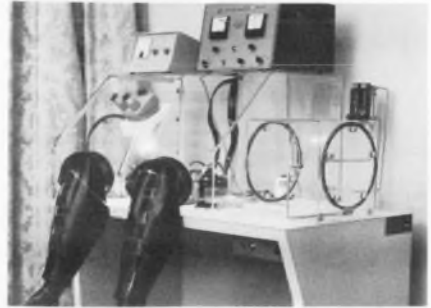

*Solid State Equipment Corp., 4343
E. River Dr., Philadelphia. Phone:
(215) 844-3501. Price: \$8250.*

Designed to seal all types of hybrid and monolithic integrated circuits, from 1/8 to 3 inches, this system will accomplish sealing either by welding or reflow brazing. Only a small temperature rise occurs within packages being sealed, minimizing resistance shifts of thin- or thick-film resistors during sealing. Sealing may be accomplished in a wide variety of inert atmospheres such as nitrogen, helium or argon.
Booth No. 1014 Circle No. 337

Kynar sleeving cut to your spec

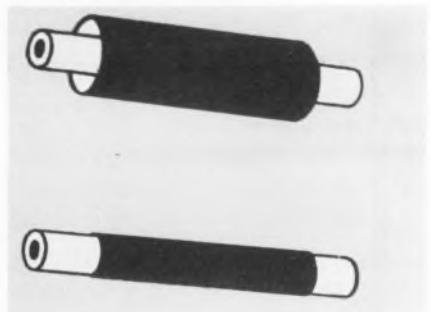

*Westline Products, 220 S. Rose St.,
P. O. Box 2980 Terminal Annex,
Los Angeles. Phone: (213) 627-
2641.*

Permanently printed tubular markers in heat-shrinkable Kynar can be used for identification of wires, cables, terminals, leads, connectors and component parts. Kynar is a clear, tough polyvinylidene fluoride which shrinks to 50% of its supplied diameter. Kynar will not cold-flow, does not burn, never melts and will not split over sharp or irregular surfaces. It has a continuous operating temperature from -55° to $+175^{\circ}\text{C}$.

Booth No. 1823 Circle No. 345

ON READER-SERVICE CARD CIRCLE 69

ON READER-SERVICE CARD CIRCLE 224 ➤

The Innovator: Philco-Ford.

The Product: MOS. 1. The first major manufacturer to take MOS from the theoretical to the practical. 2. Finest MOS manufacturing technique in the industry. 3. Most experienced MOS team in the industry: R&D, engineering, and systems know-how people. 4. Proven systems capability in MOS and large scale integration (LSI). 5. One of our Philco-Ford MOS circuit types has logged over 2.5 million device-hours; reliability data on MOS circuits available on request. Philco-Ford Corporation, Microelectronics Division, Santa Clara, California 95051.

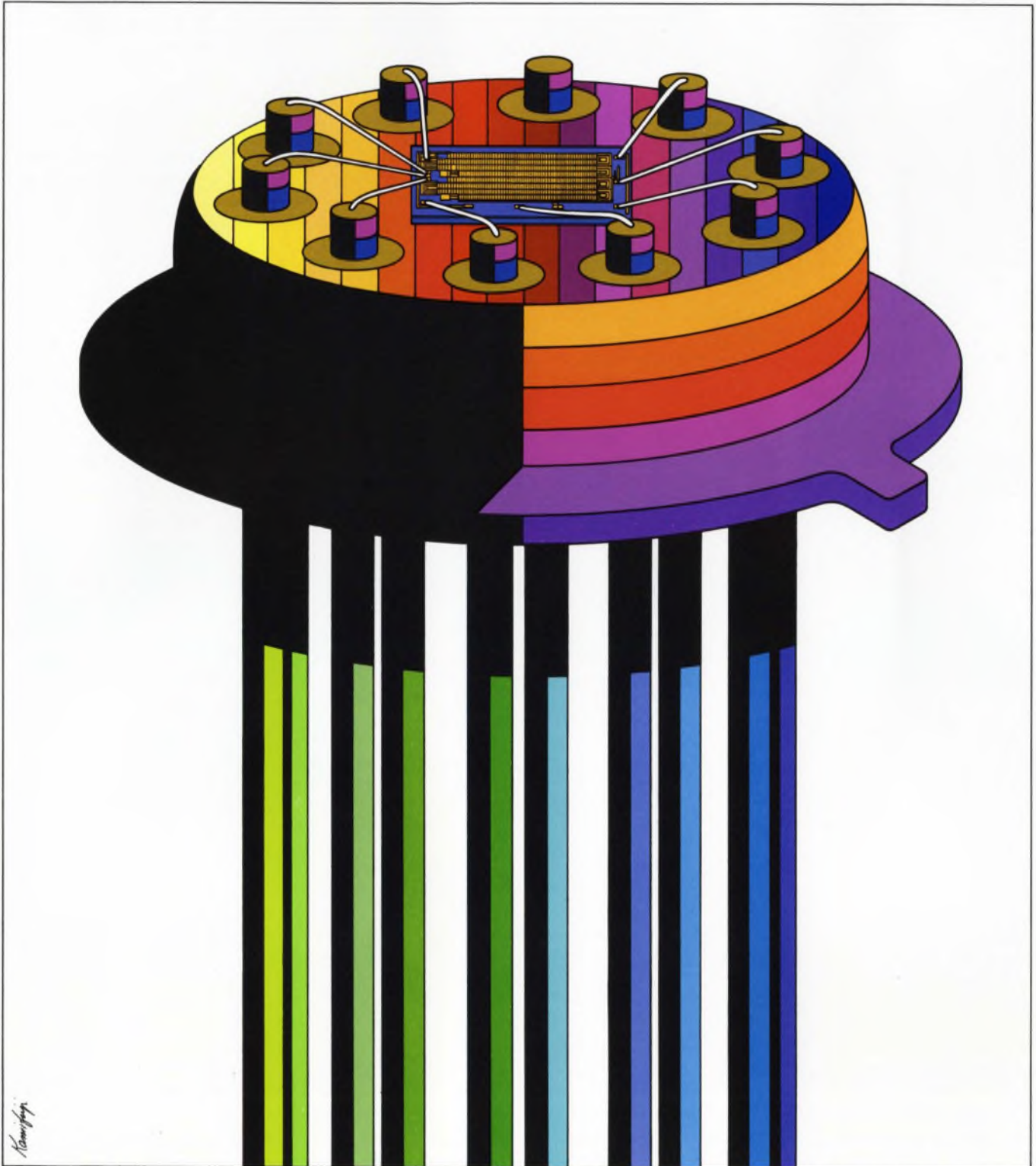

Tape spooler feeds 1000 characters/second

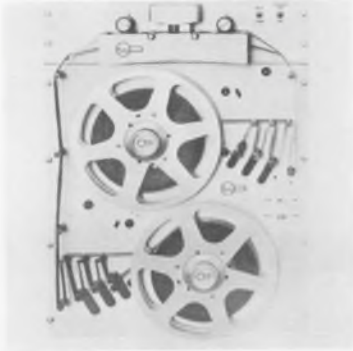

Remex Electronics, 5250 W. El Segundo Blvd., Hawthorne, Calif. Phone: (213) 772-5321. Price: \$2195.

This all-solid-state spooling machine's speed is 1000 characters per second with a full 2000 feet of tape on 10-1/2-inch reels. Rewind speed is 2000 characters per second in either direction. Any input line frequency from 50 to 400 Hz at 115 volts can power the unit with 230-volt optionally available.

Booth No. 2011 Circle No. 336

Micrologic cards accept dc-to-10-MHz input

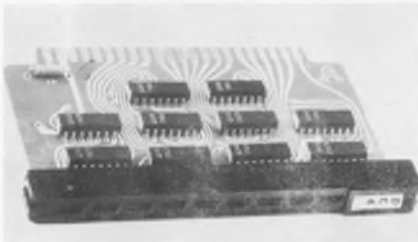

Control Logic, Inc., 3 Strathmore Rd., Natick, Mass. Phone: (617) 655-1170. Price: \$150 (4-stage card).

Four to 8 decade dividers connected in groups of 2 dividers each are provided on this card. The CDC-114 base card features two groups of 2 dividers, each providing two independent stages, or one 4-digit divider. Additional dividers, up to a maximum of eight, may be added to order. Each divider group has a separate count input. Each divider employs ripple carry with gated transfer and operates with dc-to-10-MHz inputs with less than 100-ns over-all delay.

Booth No. 2005 Circle No. 334

Stepped-up torque from small motor

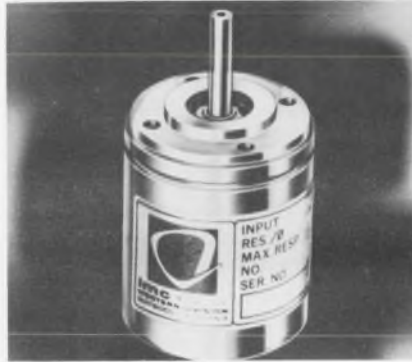

IMC Magnetics Corp., 570 Main St., Westbury, N. Y. Phone: (516) 334-7195. Price: \$50 (over 500).

A 1.095-inch long, 50-gram permanent magnet step-servo motor, offers bidirectional operation with power consumption of 1.74 watts. Responding at rates of up to \$10 pps in 90° steps, the unit meets a variety of X-Y plotter, switch positioning, computer, remote control actuator and digital integrating requirements.

Booth No. 2118 Circle No. 342

High-speed reader operates bidirectionally

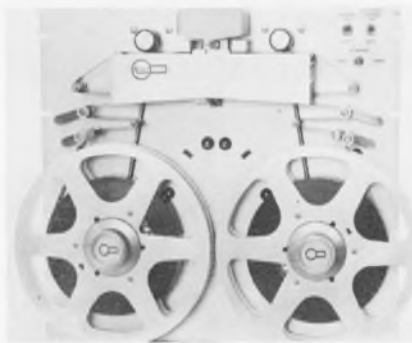

Remex Electronics, 5250 W. El Segundo Blvd., Hawthorne, Calif. Phone: (213) 772-5321. Price: \$3580.

This photocell punched-tape reader and spooler offers a 500-characters-per-second reader and a 50-inch-per-second spooler equipped with 10-1/2-inch diameter reels. Total height is 21 inches. It is all-solid-state with a choice of output signals. The spooler portion includes an independent high-speed, bidirectional rewind and soft take-up feature that precludes the possibility of breaking tapes.

Booth No. 2011 Circle No. 324

Digital calendar/clock advances automatically



Durant Manufacturing Co., Milwaukee. Phone: (414) 271-9300.

Continuous visual readout and remote electrical readout on command are provided by this clock for date/time information in six-figure form. It is designed for use in data reduction systems, to control batching, to aid in computing piece rates in all production processes, and in all types of data or material handling where a date/time base is required. Manual set-up switches on the front panel are provided to establish initial date and time.

Booth No. 2124 Circle No. 335

Digital printer totals 10 columns



Victor Comptometer Corp., 3900 N. Rockwell St., Chicago. Phone: (312) 539-8210.

Standard features of this device include 0 to 10 digits and print command, a choice of 24 V dc at 0.98 A or 48 V dc at 0.63-A solenoid voltage and choice of punctuation. Also on accumulators is a print command total and minus, all with signal-sector symbol printing. Nonadd and subtotal solenoid operation is optional.

Booth No. 2015 Circle No. 333

Replace 80% of all FET types with one!

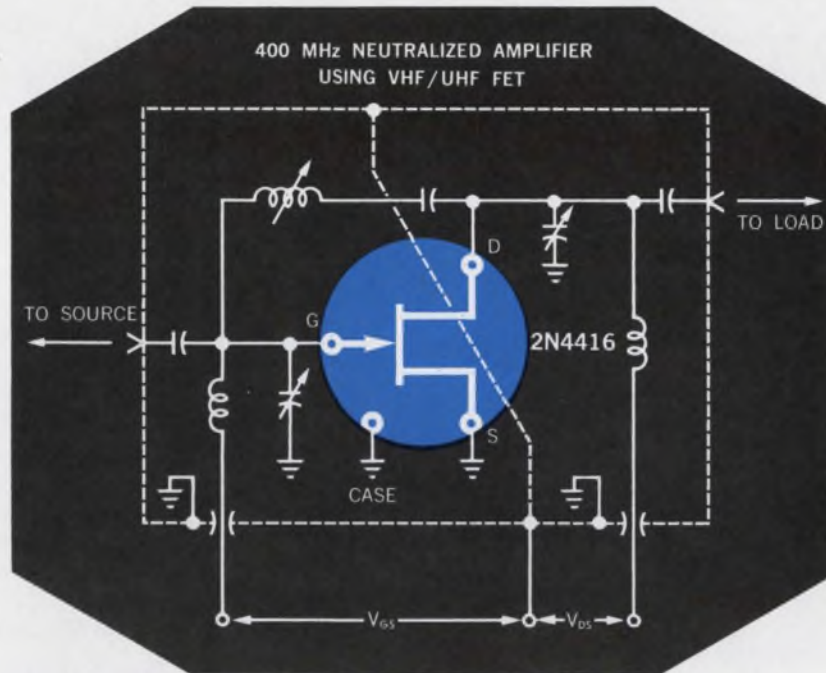

Here's how: Buy the Union Carbide 2N4416 universal FET in quantity, and you can select transistors over the entire frequency range covered by 80% of all field effect types. The 2N4416 is specified below as a VHF/UHF amplifier. However, from any class lot of this device you can select (1) general purpose, low noise, high gain amplifiers from D.C. to 900 MHz, or (2) ultra low noise devices for low frequency applications. This device is also available in a ribbon lead ceramic package (.138" dia.) as the low capacitance 2N4417. Use for TV tuners, FM sets, IF strips, mixers, oscillators, or even switches. Write for complete specifications.

CHARACTERISTICS Small Signal, Common Source @ 25°C	2N4416 T0-72	Frequency
Forward Transconductance RE (Y_{re}) (min.)	4000 μ mhos	400 MHz
Input Capacitance, C_{in} (max.)	4.0 pf	1.0 MHz
Output Capacitance, C_{out} (max.)	2.0 pf	1.0 MHz
Reverse Transfer Capacitance, C_{rs} (max.)	0.8 pf	1.0 MHz
Spot Noise Figure (Neutralized), NF (max.)	4.0 dB	400 MHz
Spot Noise Figure, NF (max.) (Neutralized)	2.0 dB	100 MHz
Power Gain, G_{ps} (min.) (Neutralized)	10.0 dB	400 MHz

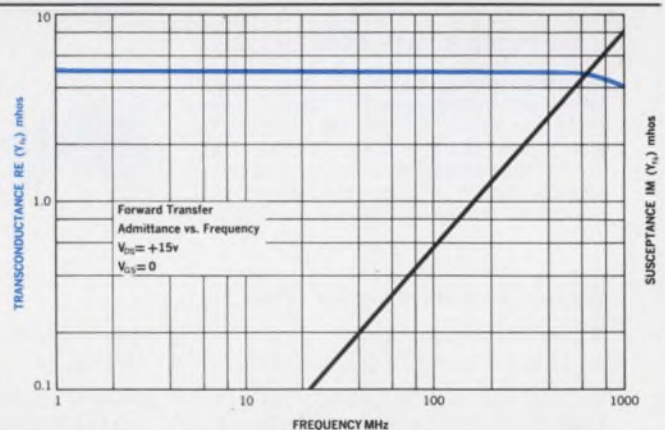

ELECTRONICS

Semiconductor Department / 365 Middlefield Road, Mountain View, California 94040 / Telephone: (415) 961-3300 / TWX: 910-379-6942

ON READER-SERVICE CARD CIRCLE 70

MAKING THE RIGHT CONTACTS...

for sequencing, data processing, programming, control and other industrial switching?

Ericsson offers an across-the-board selection of reliable, long-life and economical switching components for a broad spectrum of applications:

100-POINT PROGRAM BOARD

Multiple selection programmer for rapid circuit selection. 100 crosspoints in a 10 by 10 configuration, 2 1/4" square, 1-1/16" deep. Contact springs beryllium — copper bronze, gold-plated. Shorting pins color-coded in five colors. Solder-type terminals at bottom of board. Boards can be multiplied either horizontally or vertically.

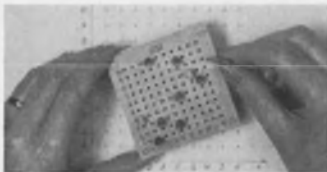

120-POINT SINGLE "CROSSBAR VERTICAL" MULTI-CONTACT RELAY

Replaces ten ordinary relays. Saves space, multiple wiring and complex wiring diagrams and circuitry. Silver alloy or gold bifurcated contacts. 8, 10 or 12 fixed contact strips, common to all ten (or split five and five) sub-relays and associated contact springs. 24 or 48 VDC coils. Special coils available. Life: 200 million operations.

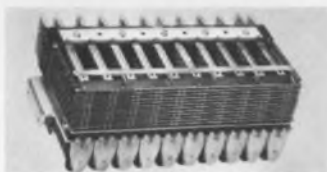

500 & 600-POINT CROSSBAR SWITCHES

Extremely high switching capacity, speed and reliability in an economical package. No rotary or sliding parts — minimum maintenance. Multipath selection by means of horizontal select bars and associated vertical contact strips. Silver alloy or gold contact strips and springs. 24 or 48 VDC coils. Special coils available.



1,000 & 1,200-POINT CROSSBAR SWITCHES

Same superior features as small size switches, with up to 1,200-point switching capacity. Mechanical life of all switches 25 million operations per vertical, 60 million per horizontal select bar, without maintenance or adjustment. 70 million operations per contact. Operate times from select to hold 35 to 75 milliseconds.

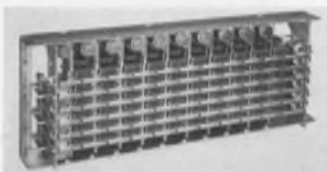

2,040-POINT BINARY CODE SWITCH

Compact switching matrix with wide range of input/output arrangements. Positive locked contacts — no sustaining power needed. Program will not change if power fails. New V-type positive-wipe copper/silver or silver/palladium contacts standard. Custom, built-in intermodular contact multiplying. Quick-connect plug-in wiring.



Ericsson also offers similar values in:

- Telephone-Type Relays
- Rotary Switches
- Lighted Push-button Switches
- Test Cords

You can rely upon the proven experience and continuing advanced capabilities of Ericsson — a leader in worldwide communications and switching technology for more than 81 years.

SEE US IN BOOTH 3503 AT WESCON



ERICSSON CENTRUM, INC.
Component Products

16 E. 40th St., New York, N.Y. 10016



AVAILABLE IN CANADA — L. M. Ericsson Ltd., 2300 Laurentian Blvd., Montreal

ON READER-SERVICE CARD CIRCLE 74

COMPUTERS & DATA PROCESSING

Impulse counters stack up small



Landis & Gyr, Inc., 45 W. 45th St., N. Y. Phone: (212) 586-4644.

A compact, low-wattage impulse counter is suited for multiple-counter installations where panel space is at a premium. Plug-in design provides for both surface and flush panel mounting. The counters are available with manual or electric reset or with no reset. Available counting speeds are 10, 25 or 60 Hz. Dimensions are 1.89 by 0.94 by 2.83 inches.

Booth No. 5340 Circle No. 258

Digital display easy to read



Litton Industries, Aero Service Div., 4219 Van Kirk St., Philadelphia. Phone: (215) 533-3900.

Consisting of two optical shaft transducers (one for X axis, one for Y axis), a power supply and a remote dual-axis, bidirectional display, this unit gives a 5-digit read-out with polarity sign to the nearest 0.001 inch. On-off switch and reset controls are mounted on the coordinate graph together with all cabling. The system eliminates the necessity of scale dials and tapes by permitting the operator to view the coordinate data directly on the remote display. It is available in three working area sizes and eight individual configurations.

Booth No. 4207 Circle No. 376

ON READER-SERVICE CARD CIRCLE 75 ➤

Polarad modular microwave signal instruments offer you new flexibility. Build the system you need now, rearrange or add new modules later.

Choose from 12 modules. Signal generators and sources cover a 0.95 to 11 GHz range. Doublers obtain frequencies to 21 GHz. Frequency stabilizers and a common modulator are available too. Rack, stack, or interchange in minutes.

Performance? Closely regulated power supplies, $\pm 0.5\%$ digital frequency readout accuracy, bimetallic cavity stabilization and other features assure lowest drift and incidental AM and FM, greatest freedom from spurious signals.

Polarad Signal Modules include:

Signal Generators	Frequency—GHz
1105	0.95 to 2.4
1106	2.0 to 4.6
1107	3.8 to 8.2
1108	6.95 to 11.0
Signal Sources	
1205	0.95 to 2.4
1206	1.95 to 4.2
1207	3.8 to 8.2
1208	6.95 to 11.0
Frequency Doublers	
1509	10.0 to 15.5
1510	15.0 to 21.0

Other Instruments

1001	Modulator
3815	Frequency Stabilizer

Let your Polarad field engineer demonstrate the flexibility and performance of these modular microwave instruments, and prove their economy too. Call him directly or contact Polarad Electronic Instruments, 34-02 Queens Boulevard, Long Island City, N. Y. 11101. Telephone: (212) 392-4500.



"Visit our booths 3101 and 3102 at Wescon"

**use these Polarad instruments
as an extended range
pulse modulated signal generator today...
give them separate assignments tomorrow**

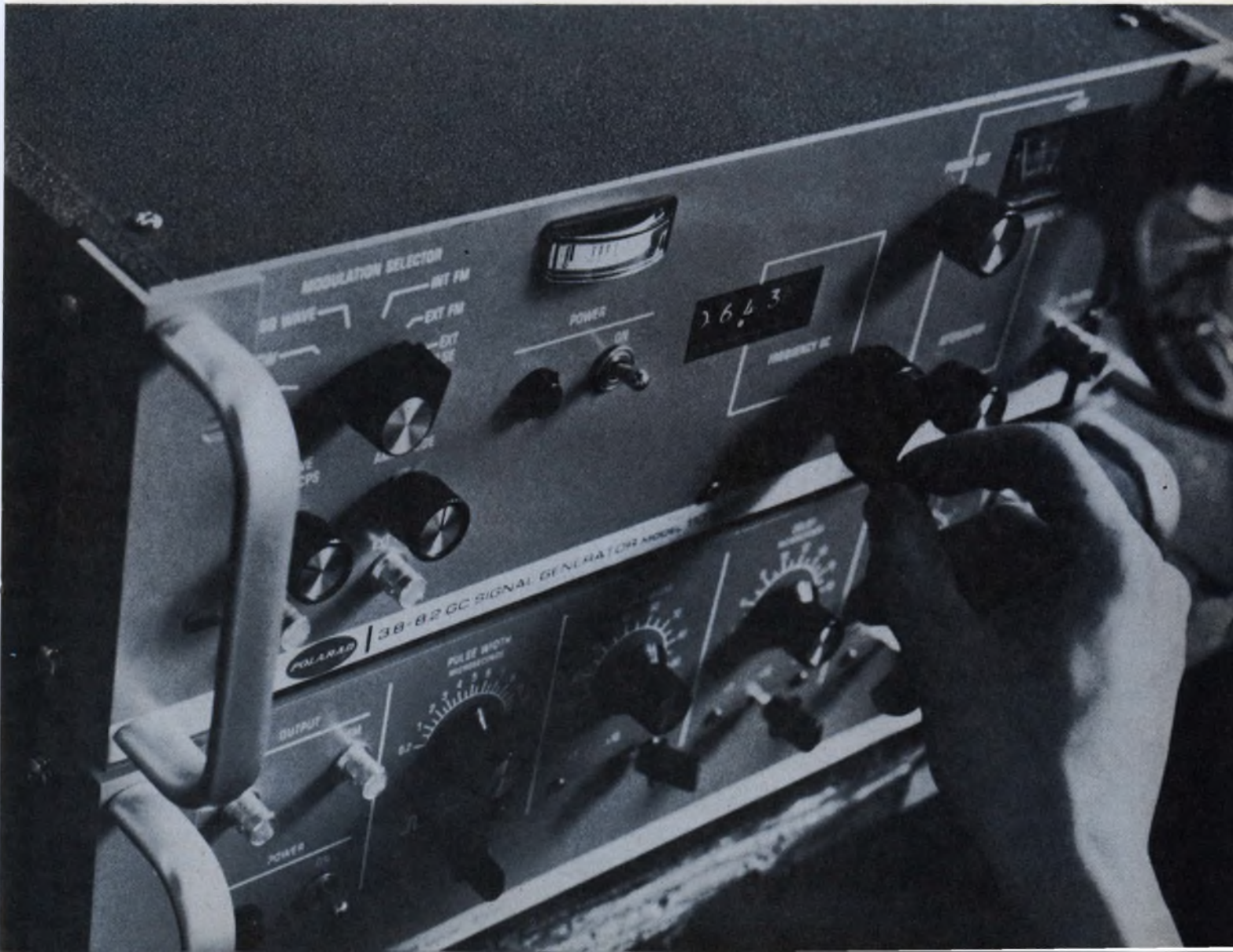

FLAT DRAWER CABLE

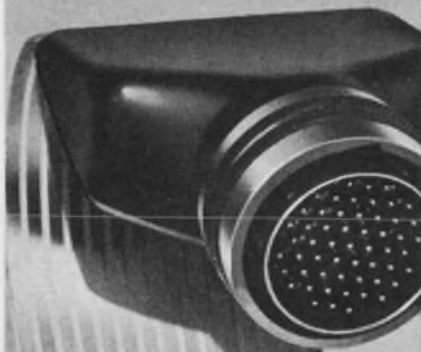

- Will flex or roll in thin spaces
- Any type of connectors
- Longer flex life
- Shielding available
- Eliminates cable retracting devices
- Sizes: miniature to mammoth
- Military or commercial
- Fits existing spaces without system modification.

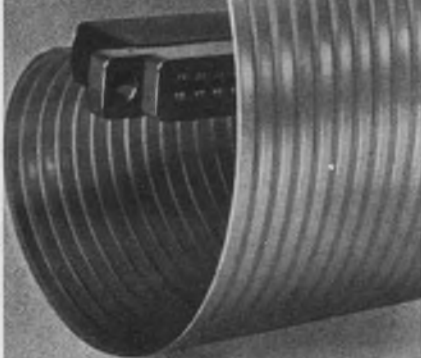

 **FLEX-WELD**

DIGITAL SENSORS INC.
4127 N. Figueroa Street
Los Angeles, California 90065
(213) 223-2333 • TWX 213-226-1230

COMPUTERS & DATA PROCESSING

Analog data processor plugs in functions

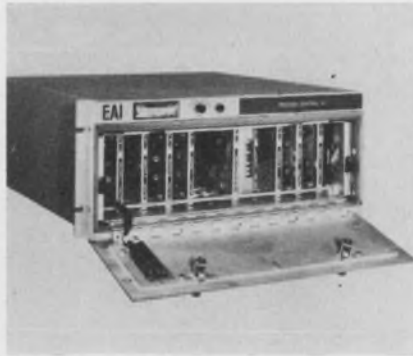

Electronic Associates, Inc., West Long Branch, N. J. Phone: (201) 229-1100. P&A: \$3000 to \$5000; 3 months.

A selection of plug-in components provides this analog data processor with a high degree of function flexibility. Depending on modular configuration, it can be used for operator guides, closed-loop control, signal conditioning and instrumentation. Modules now available include eight which have dual-function capability and one which can perform four functions. Each slot in the unit may be modified to dual function to provide up to 20 circuits per processor.

The module selection consists of three dual voltage-to-current and three dual current-to-voltage converters, a low-level wide-bandwidth diff amp, a dual amplifier resistor network which requires either one or two plug-in amplifiers and is the universal amplifier module, a time division multiplier, a variable diode function generator, a relay comparator, a dual integrator network which requires one or two FET high-input-impedance amplifiers and a quad coefficient network.

Power circuitry is built into each module. Test points and trimming potentiometers can be reached without removing the module from the housing. Modules may be cut out of the circuit for trimming purposes by turning a switch on the amplifier card.

Booth No. 2727 Circle No. 378

For a complete listing of the technical papers at the show, see page U 112. For reprints of most of the papers, fill out the order form on page U 115.

Satellite recorder operates unattended

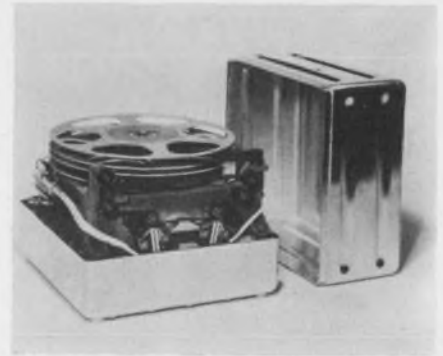

Leach Corp., 717 N. Coney Ave., Azusa, Calif. Phone: (213) 682-3506.

Capable of recording analog data over 1 kHz to 1 MHz, this unit is capable of providing a minimum of 1000 hours unattended operation in orbit. Measuring 7.1 x 8.1 x 5.25 inches, the recorder accommodates 280 feet of 1/2-mil tape using a packing density of 10 kHz per inch. Data can be recorded at 25, 50 or 100 inches per second.

Booth No. 3005 Circle No. 382

Ten-channel recorder changes paper simply

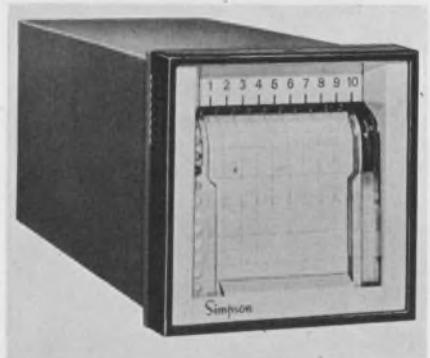

Simpson Electric Co., 5200 W. Kinzie St., Chicago. Phone: (312) 279-1121. Price: \$175.

The chart paper of this 10-channel event recorder can be quickly changed just by removing the front cover. If rack-mounted, this means that it is not necessary to remove the unit or go behind the panel. The unit is supplied with two chart speeds (20 or 120 mm per hour), which are switch-selected. Recording is on pressure-sensitive paper.

Booth No. 2501 Circle No. 363

No trace of overload problems

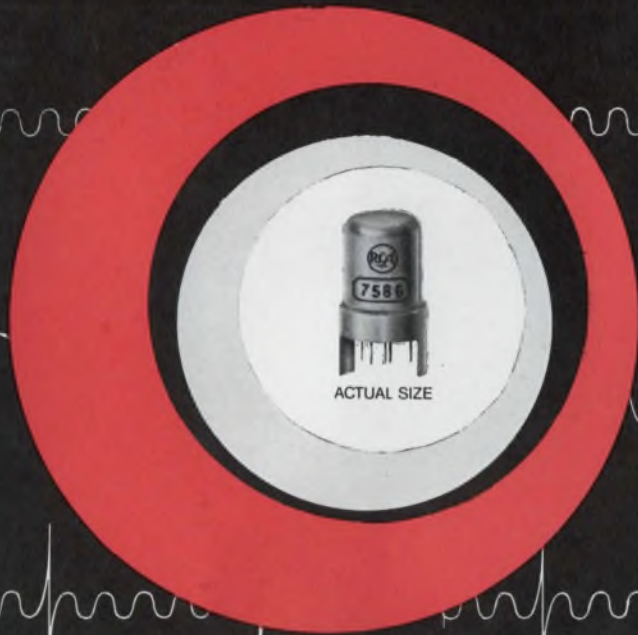

withstand -100 V to +4 V signal surges

withstand 2:1 power supply surges

withstand -100 V to +100 V momentary signal transients

When you use RCA nuvistors

If you find it necessary to include overload protection in your solid-state circuit designs, look to RCA nuvistors. Nuvistors can withstand severe signal and power surges without catastrophic failure.

Nuvistors eliminate many other problems, too, through the benefits of their unique construction: demonstrated reliability of 99.901% per 1,000 hours out to 30,000 hours of operation; temperature stability, $\Delta gm \cong 4 \mu\text{mho}$ per degree C over the range -55°C to $+250^\circ\text{C}$; dependable performance in the presence of both pulse and steady state nuclear radiation; low RF and sub-audio noise; 1,000 g shock rating, and exceptional uniformity of electrical characteristics from tube to tube and throughout life.

For complete data on the entire RCA line of nuvistors for industrial and military applications, call your nearest RCA District Office or write RCA Commercial Engineering, Section H-18-DE, Harrison, N.J. 07029.

On Reader Service Card Circle 109

RCA DISTRICT OFFICES—OEM SALES: EAST: 2075 Millburn Ave., Maplewood, N.J. 07040, (201) 485-3900 • MID-ATLANTIC: 605 Marlton Pike, Haddonfield, N.J. 08034, (609) 428-4802 • MID-CENTRAL: 1600 Keith Bldg., 1621 Euclid Ave., Cleveland, Ohio 44115, (216) 241-3450; 2511 East 46th St., Bldg. Q2, Atkinson Sq., Indianapolis, Ind. 46205, (317) 546-4001 • CENTRAL: 446 East Howard Ave., Des Plaines, Illinois 60018, (312) 827-0033 • WEST: 6363 Sunset Blvd., Hollywood, Cal. 90028, (213) 461-9171 • INTERNATIONAL OPERATIONS, RCA International Division: Central and Terminal Aves., Clark, N.J. 07066, (201) 485-3900 • 118 Rue du Rhone, Geneva, Switzerland, 35 75 00

RCA Electronic Components and Devices, Harrison, N.J. 07029



The Most Trusted Name in Electronics

See RCA Nuvistors in Booths 3701/3705

These 14 New Devices Make RCA

the Triac Leader of the Industry

Now, RCA offers you the industry's broadest line of Triacs, with an unmatched choice of ratings and triggering characteristics in space-saving packages ... all at truly economical prices! Triacs are today's most modern, effective component for ac phase-control and load switching. Because they can perform the functions of two SCR's, Triacs make possible new economies in full-wave power circuit design and cost for industrial and commercial applications.

So for efficient, inexpensive solid-state control of motors, lighting, and heating, look to RCA, the Triac Leader. Your RCA Sales Representative will be happy to give you more details, including price and delivery. Also, ask him about RCA's complete line of SCR's. For additional technical data, write RCA Commercial Engineering, Section RC8-2, Harrison, N.J. 07029. See your RCA Distributor for his price and delivery.

*Priced in quantities of 1,000 and up.

On Reader Service Card Circle 107

Current Rating $I_T(\text{rms})$	Low Voltage (100V)	120V Line (200V)	240V Line (400V)	Package
2.5A ($I_{GT} = 3 \text{ mA max}$)	40525	40526	40527	modified 3-lead TO-5
2.5A ($I_{GT} = 10 \text{ mA max}$)	40528	40529	40530	modified 3-lead TO-5
6A		40429	40430	TO-66
6A		40485	40486	modified 2-lead TO-5
6A		40431 (with integral trigger)	40432	modified 2-lead TO-5
15A		TA2834	TA2835	TO-66

RCA Electronic Components and Devices



The Most Trusted Name in Electronics

See us at WESCON, Booths 3701-05, 3718-22

Sensitive-Gate Triacs under \$1.00*

Extremely high gate sensitivity...rms (on-state) current = 2.5A...and a price level that makes possible a new generation of controls for small appliances, induction motors, and sensing circuits. Maximum gate sensitivities of 3 mA or 10 mA are actually many times greater than that of conventional Triacs! This means simplified triggering circuits and reduced component costs. The 100V versions (40525 and 40528) sell for \$.95*; the 200V types (40526 and 40529) are priced at \$.98*; and the 400V units (40527 and 40530) are available at \$1.40*!

6A Triacs in 2-lead TO-5 to Control up to 1440 Watts

With the new 40485 and 40486 6A Triacs, RCA doesn't have to use an expensive press-fit package to control a lot of power. Both types employ the low-cost TO-5 case which can be easily mounted on heat spreaders using mass produced pre-punched parts and batch soldering techniques for improved heat-sinking ability. The 40485 sells for only \$1.50* and controls 720 watts. The 40486 can control 1440 watts and sells for \$1.98*. And reliability is assured with surge current protection up to 100A!

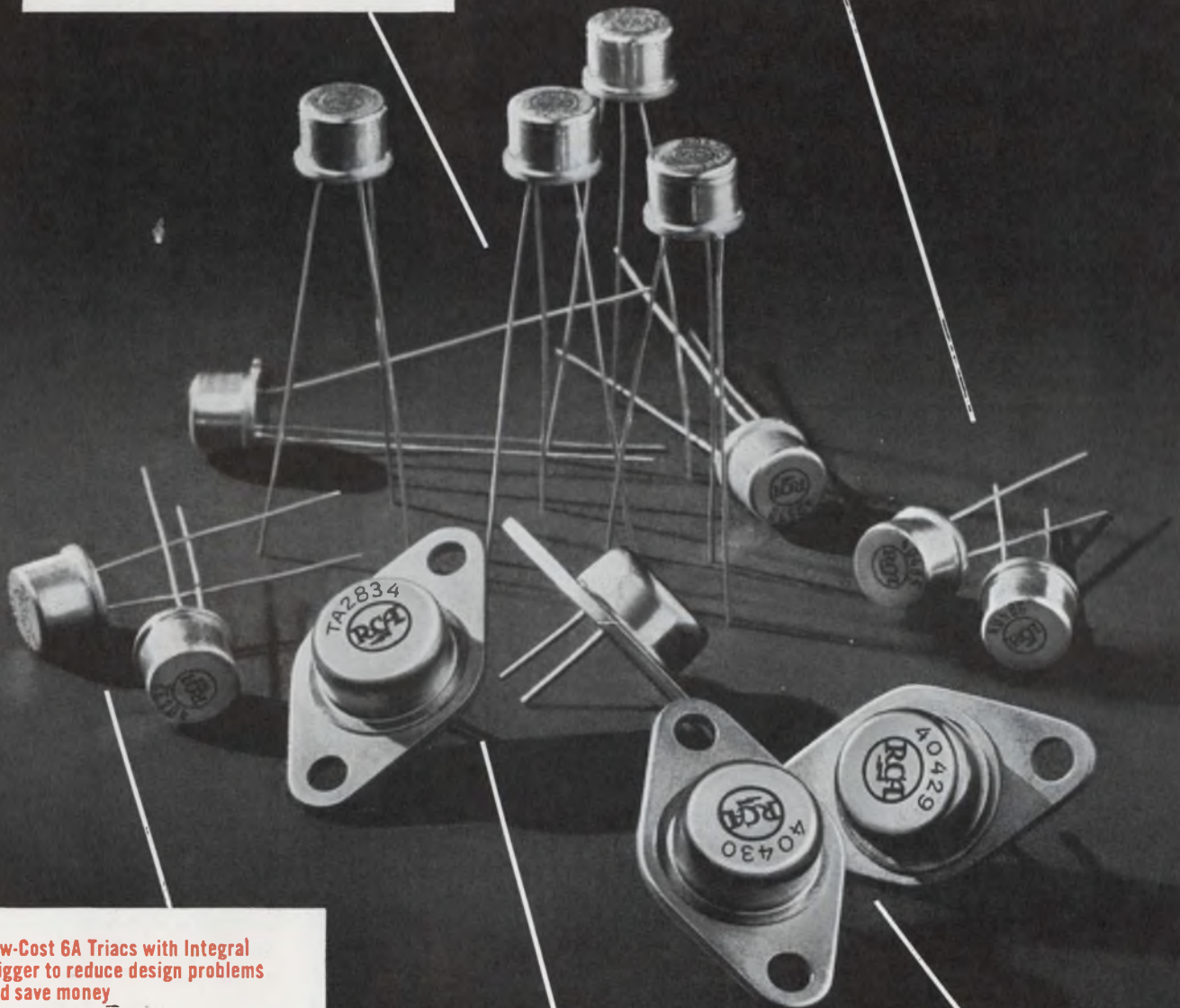

Low-Cost 6A Triacs with Integral Trigger to reduce design problems and save money

Because the triggering device and the firing characteristics of the 40431 and 40432 Triacs are coordinated inside a compact TO-5 case, you don't have to worry about designing in additional triggering components. You benefit further from reduced circuit and assembly costs, plus improved packaging densities! So if your ac-load control circuits require a trigger, why not have it built-in for you? The 40431 controls 720 watts at 120V and costs \$1.80*; the 40432 controls 1440 watts at 240V and costs only \$2.48*.

15A Triacs for Load Control up to 3600W

RCA developmental types TA2834 and TA2835 Triacs extend solid-state control way up into the kilowatt range. These powerful TO-66 units have surge current protection up to 100A, plus all of the other design benefits of RCA's lower current Triacs. Possible applications include power supplies, heating controls, motor drivers, and many other industrial and commercial usages.

6A Triacs in Popular TO-66 Package

Need full-wave control of up to 1440 watts in a TO-66 package? RCA 40429 and 40430 Triacs are your answer... they feature high gate sensitivity, symmetrical triggering characteristics ($I_{GT} = 25 \text{ mA max}$), and surge current protection up to 80A. The 200V 40429 costs \$1.50*, the 400V 40430 only \$1.98*.



NEW DIFFERENTIAL MULTIMETER.

Model 853A uses differential techniques to measure voltage, resistance and current to high accuracies. Range is 0 to 1100 volts AC/DC, 0 to 10 amps AC/DC, and 0 to 100 megohms. Price is a low, low \$445.

NEW RMS DIGITAL VOLTMETER.

Model 9500A offers true RMS response with fully automatic operation. Measures from 0-1100 volts RMS within $\pm(0.05\% + 0.015\%$ of range) digit and has options for remote control, printer output, and low capacity probe input. Price \$2,395.



NEW DC DIFFERENTIAL VOLTMETER.

Model 891A features infinite input resistance at null over entire 1100 volt range. Accuracy is $\pm 0.02\%$ Light weight and small, the new unit is priced at \$595. Battery option \$100.



NEW POWER SUPPLY.

Model 415A precision high voltage power supply offers up to 3 kv and 20 mills output in a 3 1/2" panel. Price is modest \$495.



NEW DC CALIBRATOR.

Model 335A combines a DC voltage standard with a high impedance voltmeter/null detector for ultimate versatility. The instrument performs as a 0-1100 volt $\pm 0.003\%$ voltage calibrator or infinite input resistance differential voltmeter; a 10 microvolt to 1100 volt voltmeter/null detector with 10 megohm and 100 megohm input resistance, or as a precision 50 ma source to drive a calibration system while separately detecting nulls. Price \$2,485.



NEW COMPARATOR. Fluke/Monotronics Model 103A performs short term stability measurements with no peripheral equipment. Priced at a low \$1,995. The Model 103A costs 40% less than competitive equipment.



NEW METER CALIBRATOR.

Model 760A does the work of five separate instruments for about half the cost and much more conveniently too. Use it to calibrate AC and DC voltmeters, ammeters and ohmmeters. Accuracy ranges from 0.1% to 0.25%. Price is \$2,485.

FOR WESCON '67, FLUKE EXPRESSES SEVEN GREAT IDEAS ABOUT MEASUREMENT IN SEVEN NEW PIECES OF HARDWARE.



See them all at the Fluke show, Wescon '67, Booths 3209, 3210, and 3211. Perchance you're one of the nine out of ten not going to the show, don't get shook! We'll be happy to send you full data and, if you like, arrange a visit from your full service Fluke sales engineer. Simply write or call us.

Fluke, Box 7428, Seattle, Washington 98133. Phone (206) 774-2211, TWX: (910) 449-2850. In Europe, address Fluke International Corporation, P.O. Box 5053, Ledeborstraat 27, Tilburg Holland. Telex: 844-50237.



COMPUTERS & DATA
PROCESSING

IC logic modules
quiet to 10 MHz

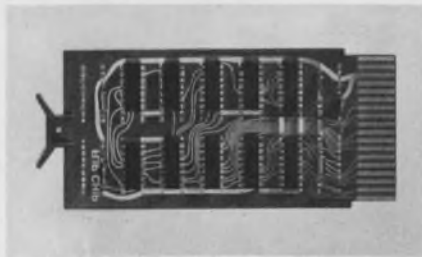

Digital Equipment Corp., 146 Main St., Maynard, Mass. Phone: (617) 897-8821.

High-speed, high-power TTL logic models are offered on 36-pin cards. In the logic 0 state (0 to 0.4 V), the driver sinks a maximum 1.6 mA from the driven load. In the logic 1 state (2.4 to 3.6 V), only the leakage current of the driven load must be supplied. Dc noise is 1 volt at either the logic 1 or logic 0 level. Absolute worst-case noise margin is 400 mV at either level.

Booth No. 2102 Circle No. 364

Core memory system
cycles in microseconds

Information Control Corp., 1320 E. Franklin Ave., El Segundo, Calif. Phone: (213) 322-6930.

For small data processing and data collection systems, these memory systems are available in two models. The ComRac 100 exhibits a cycle time of 1 μ s, an access time of 0.45 μ s, and is available in capacities up to 4096 words by 24 bits. The 150 exhibits a cycle time of 1.5 μ s, an access time of 0.7 μ s and is available in capacities up to 8192 words by 24 bits.

Both are organized as four-wire current systems and employ 20-mil lithium ferrite cores. They can be operated in standard modes of read/restore, clear/write, buffer read and buffer write. The entire memory, including power supply, is packaged in a 5-1/4-inch rack-mounted chassis.

Booth No. 2006 Circle No. 362

For a complete listing of the technical papers at the show, see page U 112. For reprints of most of the papers, fill out the order form on page U 115.



In
"THE GREAT
RELAY RACE"



A FREE RELAY IS YOURS . . . to run your own relay race (evaluation test) in your own plant . . . under your own conditions.

YOU BE THE OFFICIAL JUDGE! You'll find out what we already know (see our race results below). Eagle Relays run longer . . . and better. There's no premium in cost . . . and they're readily available.

YOU'LL BE A WINNER EVERYTIME! Send for your Official Judge's Entry Blank now by contacting: R. W. Emelander, Eagle Signal Division, E. W. Bliss Company, 736 Federal Street, Davenport, Iowa, 52808 or circle reader service number below.

CONTACTS	COMPETITIVE BRANDS						EAGLE RELAYS
	"A"	"B"	"C"	"D"	"E"	"F"	
Arrangement	3 PDT	3 PDT	3 PDT	3 PDT	3 PDT	3 PDT	3 PDT
Rating	5 Amp.	5 Amp.	5 Amp.	5 Amp.	5 Amp.	5 Amp.	5 Amp.
LIFE							
Mechanical	15,061,261 Operations	14,077,866 Operations	28,808,000 Operations	21,625,333 Operations	16,923,133 Operations	29,433,600 Operations	34,492,950 Operations
ELECTRICAL							
5 Amp. Resistive	295,466 Operations	490,433 Operations	129,600 Operations	235,700 Operations	778,200 Operations	921,400 Operations	948,675 Operations
1.6 Amp Inductive	488,666 Operations	1,071,666 Operations	496,000 Operations	284,333 Operations	3,529,466 Operations	1,842,000 Operations	3,102,200 Operations

FOR A FAST START in Eagle's "Great Relay Race" see us at the Wescon Show, San Francisco Cow Palace, Aug. 22-25. Booth No. 3401.



A DIVISION OF THE E. W. BLISS COMPANY

At Wescon, stop at Eagle's booth No. 3401 for the latest "race results"

ON READER-SERVICE CARD CIRCLE 80

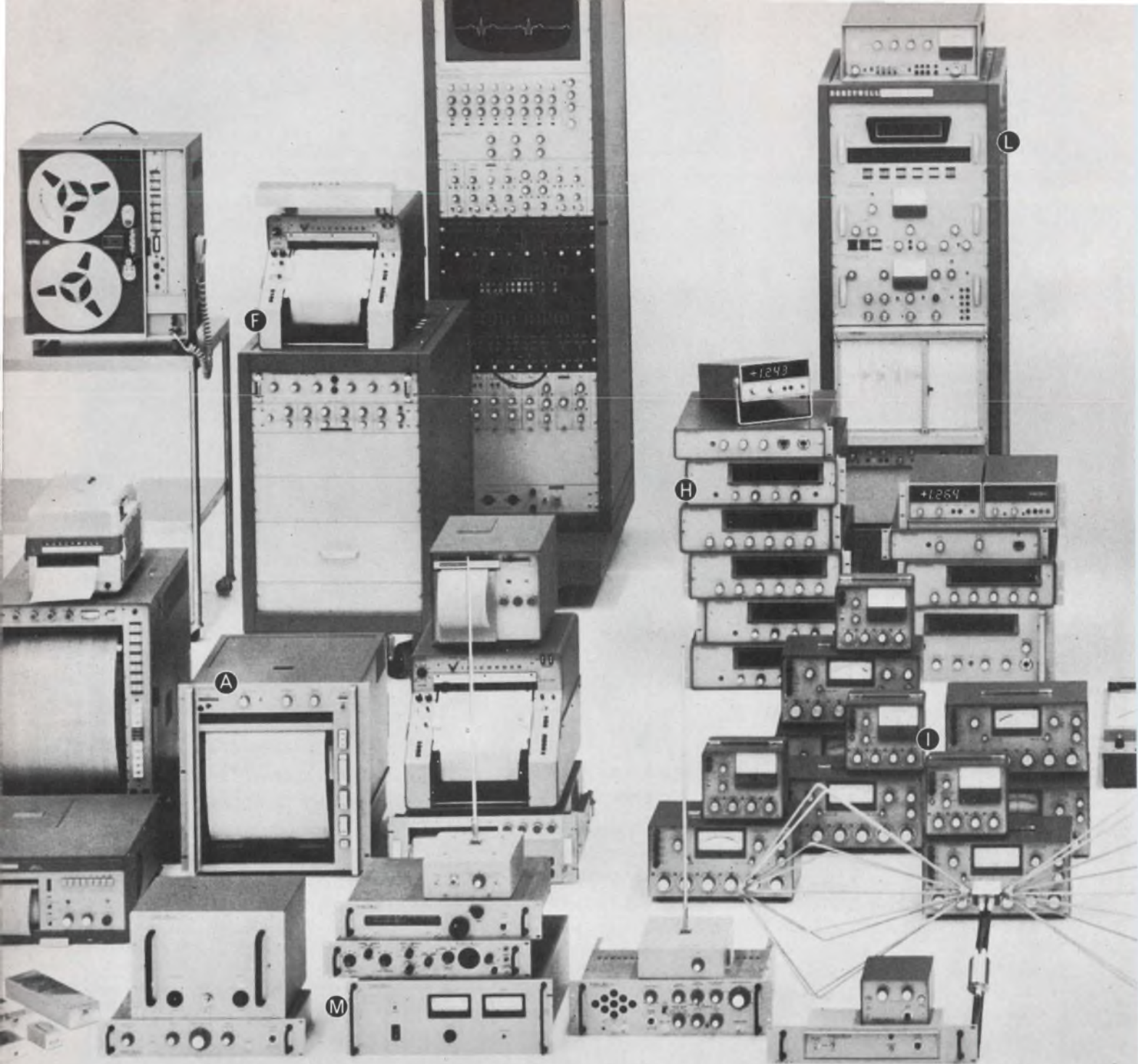

Here's just part of the full Honeywell line, which includes: **A** 117 Visicorder direct-recording oscillographs in 6", 8", and 12" models; **B** 2 Model 1806 fiber-optics CRT Visicorder oscillographs; **C** 26 magnetic tape systems, including the 7600 Series in 10½" and 15" reel versions; **D** 84 amplifiers and other signal-condi-

We build **847**
instruments to be sure we
have the exact **1** you need.

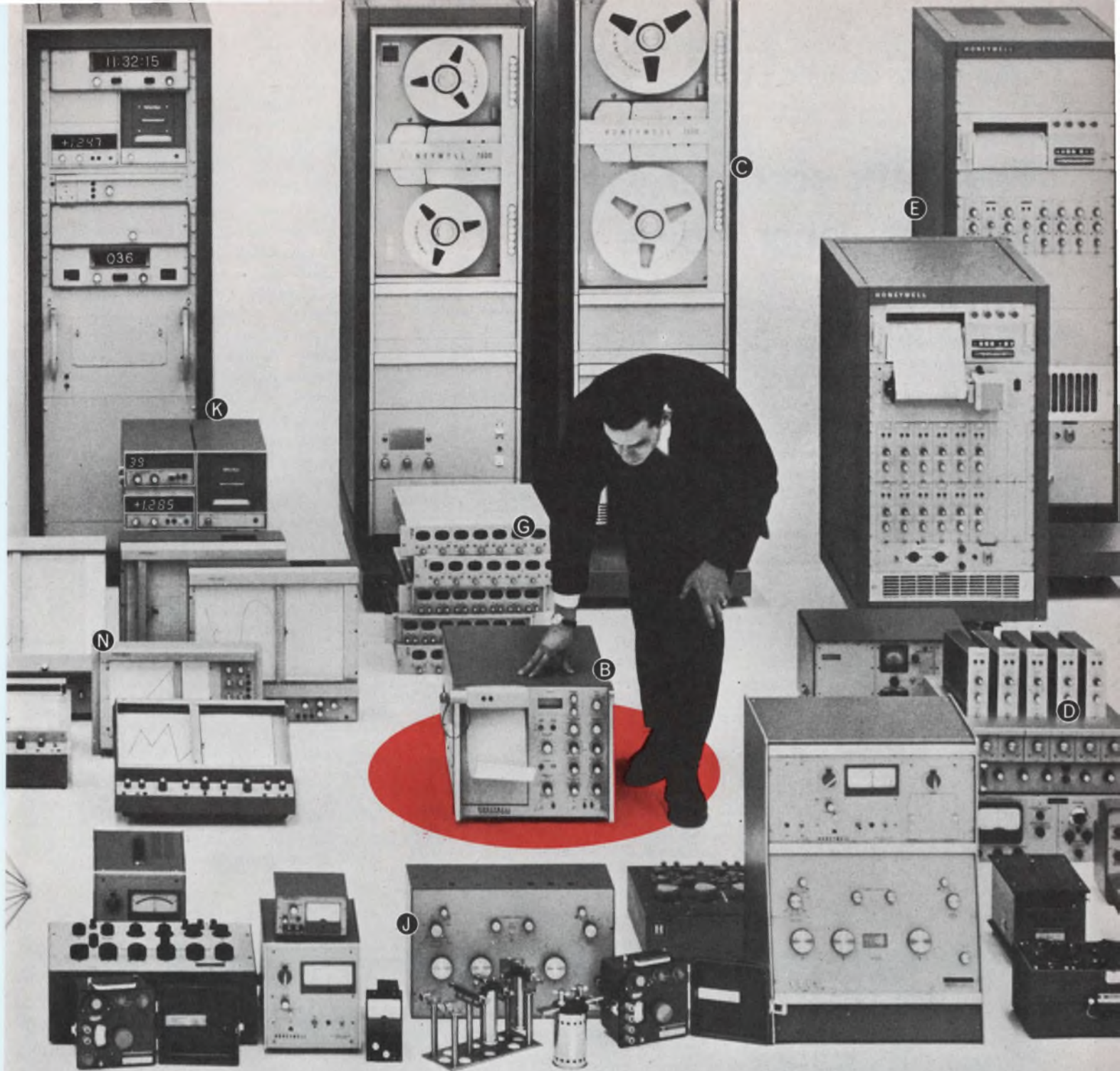

tioning units; E 78 analog recording systems; F 46 electronic medical systems; G 14 oscilloscopes; H 37 digital multimeters; I 29 differential voltmeters; J 179 precision laboratory standards and test instruments; K 128 data loggers; L 9 analysis systems; M 61 EMI products; N 37 X-Y graphic recorders.

Your Honeywell sales engineer can zero in on the *precise* solution to your instrumentation problems. Quickly and efficiently. You won't have to settle for "almost" what you need because the Honeywell sales engineer isn't handicapped by a limited line. He can choose from 847 basic instruments whose combinations and permutations approach the infinite.

The solution might be a Visicorder recording oscillograph. Or one of our modular magnetic tape systems. Or an X-Y recorder, a digital multimeter, or a portable potentiometer. But whether it's a single instrument or a complete data system, you can be sure the solution will be the right one, carefully thought out with your future requirements considered as well as your current needs.

Local service and nationwide metrology facilities back up your Honeywell instrument or system. And, we can even provide factory training courses for *your* operating personnel. For the full story on how Honeywell can help you, call your local sales engineer or write: Honeywell, Test Instruments Division, Denver, Colorado 80217.

Honeywell

Honeywell engineers
sell solutions

The static recorder writes, only the paper moves on

Varian Associates, 611 Hansen Way, Palo Alto, Calif. Phone: (415) 326-4000. P&A: \$7100, late fall (Statos I); \$4700, early 1968 (Statos II).

An entirely new method of strip-chart recording combines electrostatic recording with integrated digital electronics. The result?

- A three-channel dc-to-3-kHz direct-writing strip-chart recorder with no moving parts, ink, arcing or heat elements in the writing.

- A writing speed of 20,000 in./s with less than 1% overshoot.

- Direct interface for computer readout or computer processing.

- Integral grid-chart imprinting with interchangeable grid patterns.

- Continuously variable chart speeds with correlated time-base logging.

Called the Statos I (high-frequency data recorder) and Statos II (50-channel event recorder), respectively, both units make analog records with digital accuracy.

Statos I has a fixed recording-head assembly which will simulta-

neously record two analog signals and one digital signal across 100 millimeters full-scale. With no moving pens, galvanometers, mirrors or other mechanical writing components, Statos I records three simultaneous signals, at either dc to 1.5 kHz (full-scale, 100-mm resolution) with 1% accuracy, or dc to 3 kHz (50-mm resolution) with 2% accuracy. The recorder also has 8 event-marker channels.

On/off, go/no-go or other binary events may be recorded by external contact closures or a 5-V dc change. Another function of the recorder head assembly is to imprint timing lines across the full width of the chart paper in exact relationship with the data signals. Five time-line intervals from 0.1 second to 10 minutes can be selected.

The chart grid-lines themselves are electrostatically printed on the paper. The Statos I system is supplied with two different chart grids selected by a switch. Any desired grid patterns can be supplied. The paper transport system has a 6000-to-1 speed range with 14 calibrated

chart speeds from 0.2 cm/min to 20 cm/s electronically selectable and continuously variable.

Basically, the technique involves using a fixed recording head to place electrostatic charges on dielectrically coated paper. The paper then passes through a toner and a permanent black image is formed immediately.

The 250-foot paper rolls are inexpensive (up to 50% less than light-sensitive or direct-write papers), insensitive to light and have excellent archival qualities. Continuous monitoring of any one of three data signals is provided by digital read-out tubes, which indicate signal amplitude as a percentage of full scale.

Statos I has two plug-in differential analog preamplifiers with a sensitivity of 100 μ V and 13 ranges, from 1 mV/cm to 10 V/cm. In addition to the two analog input signals, a third signal in BCD format may be simultaneously recorded.

The companion product, Statos II, records up to 50 channels of two-level events by the same fixed-recording-head, electrostatic recording technique. The chart paper channels are preprinted in 250-foot-long rolls 7 inches wide. Events with a duration of 2 μ s or longer can be recorded. The time relationship between events can be resolved to 1-ms accuracy at a chart speed of 20 cm/s using the full-scale timing lines.

Booth No. 2903

Circle No. 318

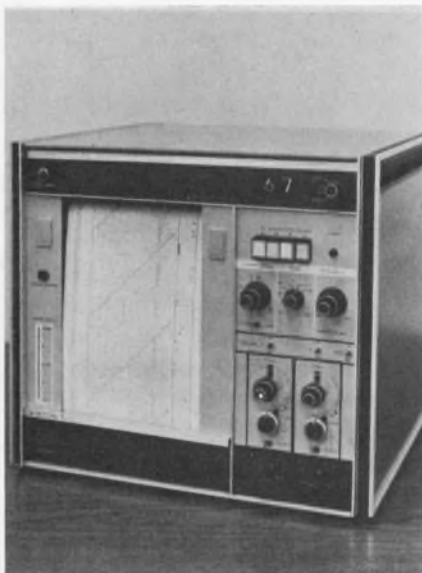

One hundred times faster than direct-writing processes, the electrostatic recorder writes at 20,000 inches per second, prints dc to 3 kHz data.

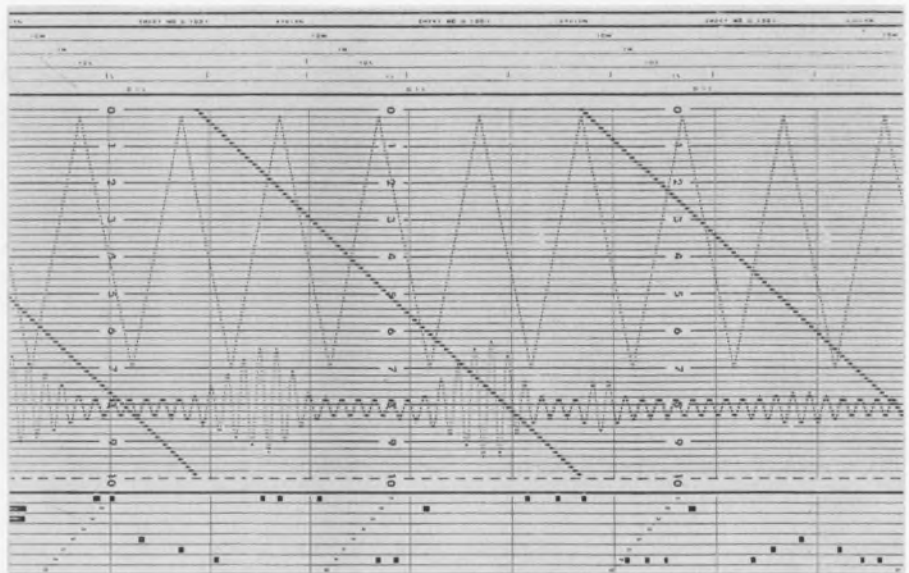

An analog presentation with digital accuracy, this 3-channel recording shows good clarity and resolution of both the grid pattern and the printed data. Note full-width time lines with time code at the top and event marks at the bottom of the 7-inch-wide paper.

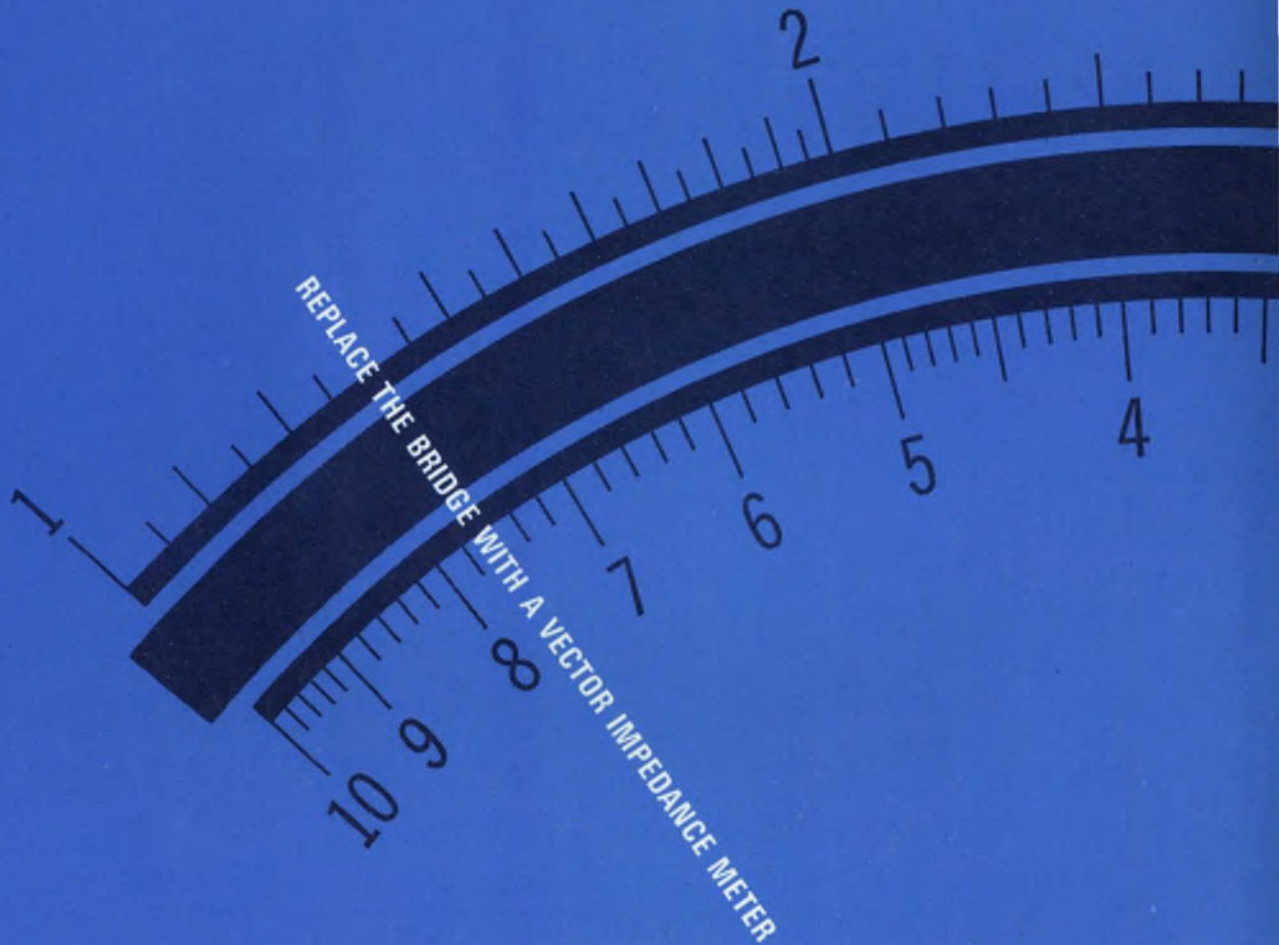

Vector Impedance Meter makes measurements in seconds



MODEL 4815A OFFERS DIRECT READOUT OF HIGH FREQUENCIES IN OPERATING CIRCUITS
 The 4815A offers direct readout of impedance and phase angle measurements from 500 kHz to 108 MHz with continuous tuning. Probe on five-foot cable simplifies in-circuit measurements. Price: \$2,650.00. Complete specifications are yours on request.

Now there's no excuse for not making all the impedance measurements that previously have been too bothersome to make. The Hewlett-Packard 4800A Impedance Meter eliminates bridge balancing and nulling. It does for AC measurement what the ohmmeter does for DC testing. Just plug it in and read it. The 4800A may be mechanically swept to produce measurements over its full frequency range. You get direct readings of impedance and phase angle from 5 Hz to 500 kHz. Analog outputs of frequency, impedance and phase are available for X-Y recording.

The 4800A is an all solid-state integrated vector impedance *system* that reads out directly in Z and θ . Low-level signal strength prevents overloading of the test component. Price: \$1,650.00. For complete specifications, contact your local Hewlett-Packard field engineer or write: Hewlett-Packard, Green Pond Road, Rockaway, N.J. 07866.

HEWLETT  PACKARD

IMPEDANCE INSTRUMENTS

1071B

SERVO PACKAGE PROBLEMS?

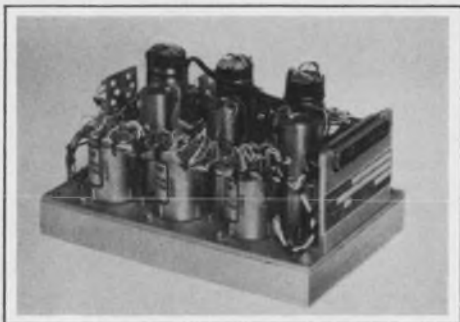

Three-Axis Coordinate Transformation Servo for airborne instrument landing system. Electrical inputs to CT's represent position in roll, pitch and yaw. Electrical outputs are a coordinate transformation of the aircraft's coordinates with respect to ILS coordinates.

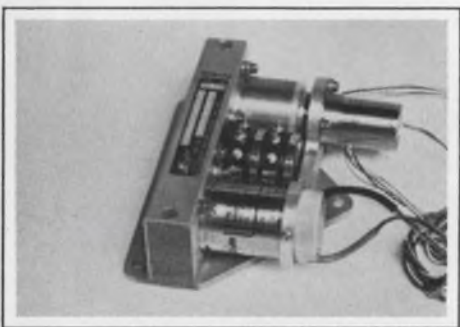

Inertial Navigation System Coupler for side-looking radar used in RF4B and RA4C aircraft. Vibration snubbers overcome 500 cps, 30 g vibration.

When it comes to servo packages, we've got the technical considerations licked. That goes for both components and packaging design.

We can give you the "tightest" job at the lowest price and meet your delivery requirements, too.

We have literally thousands of different servo components. Motors: stepper, synchronous, braked, viscous-damped and inertial-damped. Motor generators: rate, damping, integrating and high-signal-to-noise. Synchros and resolvers of all descriptions. Clutches, brakes and gearheads.

We design and build all the associated electronics: servo and buffer amplifiers, stepper-motor logic packages, phase-shifting capacitors, quadrature rejection circuits, electronic choppers and summing, isolation and switching networks.

Shown here are servo assemblies we've designed and produced to customer requirements using not-so-standard Kearfott elements and experience.

All you have to do to solve similar problems is call one single source—Kearfott. Write for our new brochure "Kearfott Servos." Address: Kearfott Products Division, General Precision, Inc., Aerospace Group, Dept. 1450, 1150 McBride Ave., Little Falls, N.J. 07424.

KEARFOTT PRODUCTS DIVISION

**GP GENERAL
PRECISION INC.**

AEROSPACE GROUP

Little Falls, New Jersey 07424.

General Precision, Inc. is a subsidiary of General Precision Equipment Corporation.

ANSWER: KEARFOTT'S "ALL-UNDER- ONE-ROOF" SERVICES.

ON READER-SERVICE CARD CIRCLE 83

THE NEW GENERATION



SILVERLINE^{T.M.*}

a new, superior line of Clifton Synchros

- Higher Accuracy. 5' standard
- Outstanding Repeatability of Calibration Pattern
- Stability of Calibration over Temp.
- 150°C Standard Operating Temp.

Keeping pace with the developing aerospace field, Clifton announces SILVERLINE, a new, superior line of standard synchros. □ These units, a natural evolution from our present line of quality synchros, embody certain new manufacturing techniques and space age materials. The result is a standard synchro which outperforms pres-

ent synchros in four distinct ways shown above. □ SILVERLINE synchros are in the field now. Call your local Clifton Sales Office for price, delivery and further information.

cppe CLIFTON □
DIVISION OF LITTON INDUSTRIES

Triple-barrelled probe spans dc to 50 MHz



Tektronix, Inc., P. O. Box 500, Beaverton, Ore. Phone: (503) 644-0161. Price: \$600.

This probe is useful for evaluating the performance of semiconductor and SCR circuits where a wide range of parameters exist. Fast switching transients, low-frequency response, and dc current level will be displayed simultaneously. Type P6042 has dc, pulse and high-frequency capability. Calibrated deflection factor ranges from 1 mA/div to 1 A/div in a 1-2-5 sequence (oscilloscope set at 50 mV/div). It has a bandwidth of dc-to-50 MHz and risetime of 7 ns. The output impedance is 50 Ω and is terminated into 50 Ω at the input of conventional oscilloscopes. When the probe is clipped around two wires carrying current in the same direction, the sum is displayed; when one of the wires is reversed, their difference is displayed. For increased sensitivity, several loops of one wire may be placed through the probe, increasing the sensitivity by the number of the loops.

Booth No. 2818 Circle No. 317

Get nanovolt sensitivity in dc testing



Keithley Instruments, Inc., 28775 Aurora Rd., Cleveland. Phone: (216) 248-0400. Price: \$1795.

A sensitive nanovolt amplifier extends the range of accurate dc voltage measuring systems. It can be used to obtain nanovolt sensitivity

with digital voltmeters, differential voltmeters, A-to-D converters and any digital data handling systems. Model 140 has selectable gains from 10^2 to 10^5 , allowing a choice of sensitivity. Its maximum output of 10 volts is more than sufficient to be accurately measured with a DVM. Since only two instruments are used, interface and connection problems within the system are minimized. Accuracy is between $\pm 0.005\%$ and 0.01% depending upon measurement conditions. A choice of three rise times is available: 5 seconds for low-noise measurements, and 0.5 or 0.05 seconds for fast measurements with little additional noise. To minimize circuit loading errors in the recording instrument, output resistance is less than 0.2 Ω . Battery operation permits maximum isolation from power lines and ground. The battery will be charged automatically when the model 140 is connected to the line, whether it is turned on or off. When battery operated, the line is internally disconnected.

Booth No. 3008 Circle No. 325

Amplifier finds signals 51 dB below noise



Princeton Applied Research Corp., P.O. Box 565, Princeton, N. J. Phone: (609) 924-6835 P&A: \$765; 60 days.

The lock-in amplifier operates as an amplifier, detector and filter combination with an equivalent noise bandwidth of less than 0.0083 Hz. The operating frequency is locked to the input signal, eliminating drift problems encountered when narrow-banding to eliminate noise. With a signal channel input impedance of 10 M Ω shunted by 30 pF and a noise figure of less than 3 dB at 1 kHz, the amplifier has minimum full-scale sensitivity of 100 μ V for low level signal detection.

Booth No. 2706 Circle No. 299

Integrating DVM holds its calibration



Cohu Electronics, Inc., Box 623, San Diego, Calif. Phone: (714) 277-6700. P&A: \$1495 to \$2750; 28 days.

This integrating digital voltmeter has an accuracy of 0.01% of reading ± 1 digit in four ranges from 1.5 to 1000 volts dc. Features include five-digit readout with over-ranging digit, polarity and decimal, manual and automatic range selection and constant 10-M Ω input impedance. No zero adjustment is required between six month calibration periods.

Booth No. 3001 Circle No. 287

Integrating DVM takes 40 readings per second

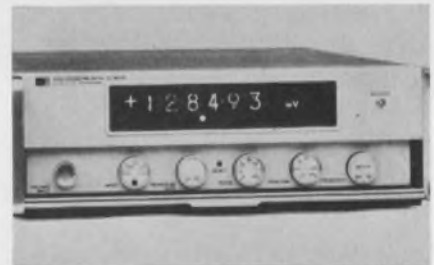

Hewlett Packard, 1501 Page Mill Rd., Palo Alto, Calif. Phone: (415) 326-7000. P&A: \$4800; 2 months.

Five measurement ranges, from ± 0.1 V to ± 1000 V full scale are featured in this voltmeter. Resolution on the 0.1-V range is 1 μ V, enabling the voltmeter to measure millivolt signals accurately without a preamp. The measurement linearity is 0.003%. Accuracy is $\pm 0.01\%$ of reading $\pm 0.005\%$ of full scale. The instrument automatically opens the input circuit when overloaded, and resets itself at the start of the next measurement cycle. Input resistance is 10 M Ω shunted by 200 pF on all ranges.

Booth No. 2909 Circle No. 297



The wrapped tubular explosion!

When you think of wrapped mylar capacitors, you naturally think of Cornell-Dubilier. Over the years, our type WMF has become an industry standard.

But our wrapped mylars are just a small part of the biggest selection of wrapped tubular capacitors made. The CDE line also includes type MFP pressed mylars, military grade type CTM mylars, type MMW metal-

ized mylars and two brand new types. WCR polycarbonates and MCR metallized polycarbonates.

All are SPRINT stock standards. All are available through CDE's Authorized Industrial Distributors.

CDE **CORNELL-DUBILIER**

— STOCK STANDARDS — WRAPPED TUBULAR CAPACITORS —

WMF — GENERAL PURPOSE MINIATURE

STANDARD STOCK RATINGS

‡ Tolerance ±20% or ±10%

Cap. Mfd.	100V DCW			200V DCW			400V DCW			600V DCW			Cap. Mfd.	100V DCW			200V DCW			400V DCW			600V DCW		
	†Type WMF—	Size D x L (In.)	Lead Size	†Type WMF—	Size D x L (In.)	Lead Size	†Type WMF—	Size D x L (In.)	Lead Size	†Type WMF—	Size D x L (In.)	Lead Size		†Type WMF—	Size D x L (In.)	Lead Size	†Type WMF—	Size D x L (In.)	Lead Size	†Type WMF—	Size D x L (In.)	Lead Size	†Type WMF—	Size D x L (In.)	Lead Size
.001	1D1	.156 x 1/2	—	2D1	.156 x 1/2	—	4D1	.156 x 3/8	—	6D1	.170 x 3/8	—	.056	1S56	.265 x 3/8	—	—	—	—	—	—	—	—	—	
.0012	1D12	.156 x 1/2	—	—	—	—	—	—	—	—	—	—	.068	1S68	.280 x 3/8	—	2S68	.350 x 3/8	4S68	.390 x 1	6S68	.500 x 1	—	—	
.0015	1D15	.156 x 1/2	—	2D15	.156 x 1/2	—	4D15	.156 x 3/8	—	6D15	.170 x 3/8	—	.082	1S82	.270 x 3/8	—	—	—	—	—	—	—	—	—	
.0018	1D18	.156 x 1/2	—	—	—	—	—	—	—	—	—	—	.1	1P1	.290 x 7/8	—	2P1	.410 x 7/8	4P1	.465 x 1	6P1	.520 x 1 1/8	—	—	
.0022	1D22	.156 x 1/2	—	2D22	.156 x 1/2	—	4D22	.156 x 3/8	—	6D22	.187 x 3/8	—	.12	1P12	.315 x 7/8	—	—	—	—	—	—	—	—	—	—
.0027	1D27	.156 x 1/2	—	—	—	—	—	—	—	—	—	—	.15	1P15	.335 x 7/8	—	2P15	.500 x 7/8	4P15	.515 x 1 1/4	6P15	.625 x 1 1/2	—	—	
.0033	1D33	.156 x 1/2	—	2D33	.160 x 1/2	—	4D33	.190 x 3/8	—	6D33	.203 x 3/8	—	.18	1P18	.350 x 1	—	—	—	—	—	—	—	—	—	—
.0039	1D39	.156 x 1/2	—	—	—	—	—	—	—	—	—	—	.22	1P22	.385 x 1	—	2P22	.500 x 1 1/8	4P22	.565 x 1 1/8	6P22	.660 x 1 1/2	—	—	
.0047	1D47	.156 x 1/2	—	2D47	.170 x 1/2	—	4D47	.200 x 3/8	—	6D47	.234 x 3/8	—	.27	1P27	.380 x 1 1/8	—	—	—	—	—	—	—	—	—	—
.0050	1D5	.156 x 1/2	—	—	—	—	—	—	—	—	—	—	.33	1P33	.415 x 1 1/8	—	2P33	.550 x 1 1/8	4P33	.600 x 1 1/8	6P33	.687 x 2	—	—	
.0056	1D56	.156 x 1/2	—	—	—	—	—	—	—	—	—	—	.39	1P39	.460 x 1 1/8	—	—	—	—	—	—	—	—	—	
.0068	1D68	.175 x 1/2	—	2D68	.200 x 1/2	—	4D68	.250 x 3/8	—	6D68	.265 x 3/8	—	.47	1P47	.475 x 1 1/4	—	2P47	.600 x 1 1/4	4P47	.700 x 1 1/8	6P47	.855 x 2	—	—	
.0082	1D82	.175 x 1/2	—	—	—	—	—	—	—	—	—	.50	1P5	.500 x 1 1/4	—	—	—	—	—	—	—	—	—	—	
.01	1S1	.200 x 1/2	—	2S1	.230 x 1/2	—	4S1	.300 x 3/8	—	6S1	.290 x 3/8	—	.56	1P56	.525 x 1 1/4	—	—	—	—	—	—	—	—	—	—
.012	1S12	.215 x 1/2	—	—	—	—	—	—	—	—	—	.68	1P68	.570 x 1 1/4	—	2P68	.650 x 1 1/8	4P68	.790 x 1 1/4	6P68	.970 x 2	—	—	—	
.015	1S15	.235 x 1/2	—	2S15	.290 x 1/2	—	4S15	.360 x 3/8	—	6S15	.312 x 7/8	—	.82	1P82	.585 x 1 3/8	—	—	—	—	—	—	—	—	—	—
.018	1S18	.255 x 1/2	—	—	—	—	—	—	—	—	—	1.0	1W1	.625 x 1 1/2	—	2W1	.750 x 1 3/4	4W1	.875 x 2	6W1	1.165 x 2 1/2	—	—		
.022	1S22	.275 x 3/8	—	2S22	.260 x 3/8	—	4S22	.320 x 3/4	—	6S22	.335 x 7/8	—	1.25	1W1P25	.690 x 1 1/2	—	2W1P25	.825 x 1 3/4	4W1P25	.950 x 2	6W1P25	1.340 x 2 1/2	—	—	
.027	1S27	.300 x 3/8	—	—	—	—	—	—	—	—	—	1.5	1W1P5	.770 x 1 3/4	—	2W1P5	.900 x 1 3/4	4W1P5	.975 x 2 1/4	6W1P5	1.275 x 3	—	—		
.033	1S33	.300 x 3/8	—	2S33	.270 x 3/8	—	4S33	.350 x 7/8	—	6S33	.350 x 1	—	2.0	1W2	.955 x 1 3/4	—	2W2	.980 x 1 7/8	4W2	1.250 x 2 1/4	6W2	1.460 x 3	—	—	
.039	1S39	.245 x 3/4	—	—	—	—	—	—	—	—	—	3.0	1W3	1.100 x 2 1/2	—	—	—	—	—	—	—	—	—	—	
.047	1S47	.265 x 3/4	—	2S47	.320 x 3/4	—	4S47	.400 x 7/8	—	6S47	.415 x 1	—	4.0	1W4	1.250 x 2.500	—	—	—	—	—	—	—	—	—	—
.050	1S5	.265 x 3/4	—	—	—	—	—	—	—	—	—	—	—	—	—	—	—	—	—	—	—	—	—	—	

† Order by complete type no.; e.g., WMF1D68 Type numbers listed are ±10%; Available to 1.0 mfd in ±20% tolerance. To specify ±20% add -20

MFP — FLAT MYLAR™ WRAP

STANDARD STOCK RATINGS

‡ Tolerance ±20% or ±10%

Cap. Mfd.	100V DCW			200V DCW			400V DCW			600V DCW		
	†Type MFP—	L x W x T (Inches)	Lead Size	†Type MFP—	L x W x T (Inches)	Lead Size	†Type MFP—	L x W x T (Inches)	Lead Size	†Type MFP—	L x W x T (Inches)	Lead Size
.01	★	—	—	2S1	.500 x .312 x .187	—	4S1	.625 x .437 x .312	—	6S1	.750 x .343 x .218	—
.015	★	—	—	2S22	.625 x .343 x .218	—	4S22	.750 x .375 x .250	—	6S22	.875 x .343 x .218	—
.022	1S22	.625 x .343 x .218	—	2S33	.750 x .343 x .218	—	4S33	.875 x .406 x .281	—	6S33	1.000 x .406 x .281	—
.033	1S33	.625 x .312 x .187	—	2S47	.750 x .375 x .250	—	4S47	.875 x .500 x .312	—	6S47	1.000 x .468 x .343	—
.047	1S47	.750 x .312 x .187	—	2S68	.750 x .437 x .250	—	4S68	1.000 x .531 x .312	—	6S68	1.000 x .562 x .500	—
.068	1S68	.750 x .343 x .218	—	2P1	.875 x .500 x .312	—	4P1	1.000 x .531 x .312	—	6P1	1.375 x .593 x .406	—
.1	1P1	.875 x .343 x .218	—	2P15	.875 x .562 x .375	—	4P15	1.250 x .625 x .500	—	6P15	1.375 x .687 x .500	—
.15	1P15	.875 x .406 x .250	—	2P22	1.125 x .562 x .406	—	4P22	1.375 x .625 x .500	—	6P22	1.625 x .750 x .531	—
.22	1P22	1.000 x .468 x .281	—	2P33	1.125 x .625 x .500	—	4P33	1.625 x .656 x .500	—	6P33	2.000 x .781 x .562	—
.33	1P33	1.125 x .500 x .312	—	2P47	1.250 x .656 x .500	—	4P47	1.625 x .781 x .593	—	6P47	2.000 x .937 x .718	—
.47	1P47	1.250 x .531 x .375	—	2P68	1.625 x .718 x .531	—	4P68	1.750 x .875 x .687	—	6P68	2.000 x 1.062 x .843	—
.68	1P68	1.250 x .687 x .468	—	2W1	1.750 x .812 x .625	—	4W1	2.000 x .937 x .750	—	6W1	2.500 x 1.250 x 1.062	—
1.0	1W1	1.500 x .718 x .500	—	2W1P25	1.750 x .960 x .687	—	4W1P25	2.000 x 1.062 x .843	—	6W1P25	2.500 x 1.437 x 1.218	—
1.25	1W1P25	1.500 x .718 x .562	—	2W1P5	1.750 x 1.000 x .781	—	4W1P5	2.250 x 1.062 x .843	—	6W1P5	3.000 x 1.406 x 1.093	—
1.50	1W1P5	1.750 x .843 x .656	—	2W2	1.875 x 1.062 x .843	—	4W2	2.250 x 1.312 x 1.125	—	6W2	3.000 x 1.593 x 1.281	—
2.0	1W2	1.750 x 1.062 x .843	—	—	—	—	—	—	—	—	—	

★ Covered by Parent Case size. Use next higher voltage for same case size. † Order by complete type no.; e.g., MFP1S22. ‡ Type numbers listed are ±20%; to specify ±10% add -10 to type no.

MMW — MINIATURE MYLAR WRAP — METALLIZED

STANDARD STOCK RATINGS

Tolerance ±20%

Cap. Mfd.	200V DCW			400V DCW			600V DCW			Cap. Mfd.	200V DCW			400V DCW			600V DCW		
	†Type MMW—	D x L (Inches)	Lead Size	†Type MMW—	D x L (Inches)	Lead Size	†Type MMW—	D x L (Inches)	Lead Size		†Type MMW—	D x L (Inches)	Lead Size	†Type MMW—	D x L (Inches)	Lead Size	†Type MMW—	D x L (Inches)	Lead Size
.01	★	—	—	4S1	.180 x 3/16	—	6S1	.200 x 3/8	—	.22	2P22	.340 x 1 1/16	—	4P22	.400 x 1 1/4	—	6P22	.575 x 1 1/4	—
.015	★	—	—	4S15	.180 x 1/16	—	6S15	.250 x 3/4	—	.33	2P33	.390 x 1 1/16	—	4P33	.450 x 1 1/2	—	6P33	.560 x 1 3/8	—
.022	★	—	—	4S22	.210 x 1/16	—	6S22	.300 x 3/4	—	.47	2P47	.370 x 1	—	4P47	.520 x 1 1/2	—	6P47	.675 x 1 3/4	—
.033	2S33	.180 x 3/16	—	4S33	.250 x 1/16	—	6S33	.370 x 3/4	—	.68	2P68	.420 x 1	—	4P68	.625 x 1 1/2	—	6P68	.800 x 1 3/4	—
.047	2S47	.200 x 3/16	—	4S47	.300 x 1/16	—	6S47	.325 x 1 1/16	—	1.0	2W1	.500 x 1	—	4W1	.675 x 1 3/4	—	6W1	.950 x 1 3/4	—
.068	2S68	.200 x 1/16	—	4S68	.350 x 1/16	—	6S68	.400 x 1/16	—	1.5	2W1P5	.540 x 1 1/4	—	4W1P5	.825 x 1 3/4	—	6W1P5	950 x 1 3/4	—
.1	2P1	.240 x 1/16	—	4P1	.325 x 1	—	6P1	.450 x 1 1/16	—	2.0	2W2	.620 x 1 1/4	—	4W2	.950 x 1 3/4	—	—	—	—
.15	2P15	.280 x 1/16	—	4P15	.375 x 1	—	6P15	.475 x 1 1/4	—	—	—	—	—	—	—	—	—	—	—

★ Use next higher voltage rating. † Order by complete type number; e.g., MMW2S33.

MCR — FILM WRAP METALLIZED POLYCARBONATE

STANDARD STOCK RATINGS

Tolerance ±20%

Cap. Mfd.	200V DCW			Lead Size	400V DCW			Lead Size	600V DCW			Lead Size	Cap. Mfd.	200V DCW			Lead Size	400V DCW			Lead Size	600V DCW			Lead Size
	†Type MCR—	Size D x L (In.)	Lead Size		†Type MCR—	Size D x L (In.)	Lead Size		†Type MCR—	Size D x L (In.)	Lead Size			†Type MCR—	Size D x L (In.)	Lead Size		†Type MCR—	Size D x L (In.)	Lead Size		†Type MCR—	Size D x L (In.)	Lead Size	
.01	2S1	.150 x 3/16	24	4S1	.200 x 3/16	24	6S1	.245 x 3/4	24	.47	2P47	.370 x 1	22	4P47	.550 x 1 1/2	20	6P47	.775 x 1 3/4	18	—	—	—	—		
.012	2S12	.175 x 3/16	24</																						

**S-band klystrons
give 500 kW cw**

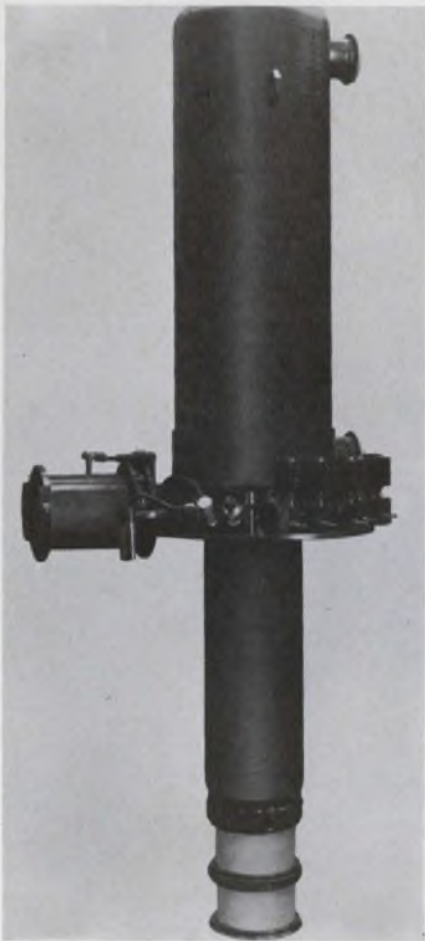

EIMAC Division of Varian, 301 Industrial Way, San Carlos, Calif. Phone: (415) 592-1221.

Producing over 500-kW continuous wave power at S-band, this tube is reportedly the highest power klystron yet delivered. The five-cavity klystron features 56% efficiency and 56-dB gain, and has an instantaneous bandwidth of 20 MHz. The tube may be operated in any attitude, including antenna mounting. The collector is rated at a megawatt, allowing amplitude modulation of the drive level or full removal of drive without overheating. Digital counters are provided to facilitate tuning.

Beam voltage may be varied from 45 kV (130-kW output) to 63 kV (500-kW output) without retuning. The output window is a single beryllium oxide structure in a half-wave circular configuration. The magnet requires only a single power supply at a fixed current for all operating conditions and powers.
Booth No. 2309 Circle No. 285

... IT's the MOST ...
EXCEPT FOR PRICE

NEW **KH** ALL-SILICON

R-C OSCILLATOR
holds PERFORMANCE but
LOWERS PRICE

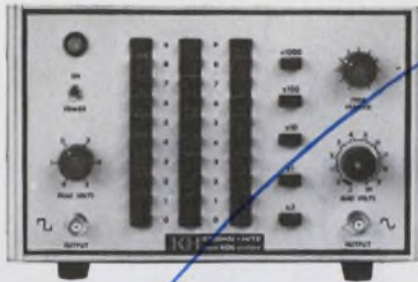

MODEL 4100, brand new R-C Oscillator with push-button frequency control. Sine- and Square-Wave simultaneously from 0.01 Hz to 1 MHz. Price \$550. Provides performance of higher priced units. 5 1/4" H x 8 3/4" W x 14 1/2" D.

Using advanced circuit techniques, Krohn-Hite has produced a new R-C Oscillator, at a medium price, with traditional K-H Quality.

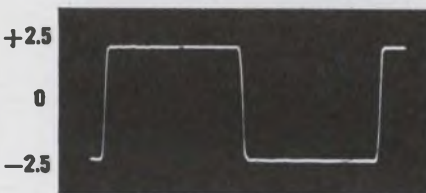
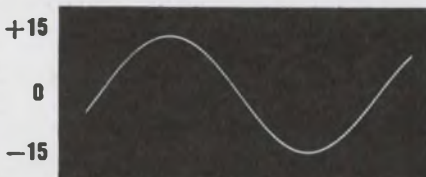

SIMULTANEOUS SINE AND SQUARE-WAVE outputs pack real power (up to 1/2 watt into 50 ohms). Photos show open circuit output voltages at 1 MHz.

These outputs typify the performance of the Model 4100. Add to this half-watt output, 0.5% frequency accuracy, 0.03% distortion, 0.02% hum and noise, 0.02 db frequency response and 0.02%/hr. amplitude stability and you get a clearer picture of what we're talking about.

There's much more in KH Data Sheet 4100

Write for a copy

KH KROHN-HITE
CORPORATION
580 Massachusetts Avenue, Cambridge, Mass. 02139
Telephone: 617/491-3211

that's what they all say!

But K-H really means it!

Puts out Both Sine and Square Waves?

Sure... and with power

That's a great 1 MHz Square Wave

As they said... it's the Most

Except for Price

*Where's the Bingo Card?
Go SEE it at
WESCON booth 3307*

Only \$5,000

**for the most powerful,
longest-lasting pulsed argon-ion
laser on the market**

Compare our new Model 3041H with any other pulsed argon-ion laser that's available.

Compare it for performance. The 3041H has a peak power output (multimode) of 20 watts minimum . . . produces 4½ million single pulses in six or more wavelengths simultaneously in the blue-green "easy vision" portion of the spectrum. Its unique

mirror-prism unit lets you select the one you want to use.

Then compare it for price. You'll soon discover that units with considerably lower power, less versatility, and much shorter lives have price tags 40% to 75% higher than the 3041H's modest \$5,000. (And a smaller, lower peak power

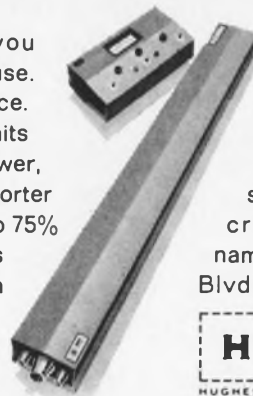

Model 3040H is available for even less.)

Does this grab you? Then write for our spec sheet. Special questions about your setup? Fire away! Hughes Aircraft Company, Electron Dynamics Division, 3100 W. Lomita Blvd., Torrance, California 90509.



Transistor Parameter Measurements

with the hp 8405A Vector Voltmeter

Measurement of transistor h, y or z parameters becomes increasingly difficult above 100 MHz through an inability to obtain consistently good open- and short-circuits. Tedious adjustment of tuning stubs is usually required for each measurement frequency, and unwanted circuit oscillations often occur.

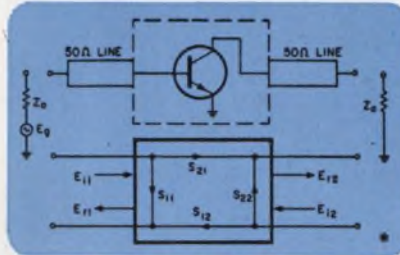

With the 8405A Vector Voltmeter, however, it is easy to measure a slightly different set of parameters—the "s" or scattering parameters. Measurement is simple over a wide frequency range and since the parameters are measured with a Z_0 load, there is little chance for oscillation. The measured s parameters can be plotted directly on a Smith Chart and easily manipulated to establish optimum gain with matching networks. Or the s parameters can be translated into h, y, or z parameters if desired.

Free Application Data

Hewlett-Packard has prepared an application note on s parameter measurements. Write today for your copy of Application Note #77-1, "Transistor Parameter Measurement", to Hewlett-Packard, Palo Alto, California 94304. Europe: 54 Route des Acacias, Geneva.

The hp 8405A Vector Voltmeter is a new, wideband, 2-channel RF millivoltmeter-phasemeter. With the 8405A, measurements that were formerly difficult or impossible can now be made quickly, easily and accurately.

Major Specifications, HP 8405A Vector Voltmeter

Frequency Range is 1 to 1000 MHz in 21 overlapping octave bands; automatic tuning within each band.

Voltage Range for Channel A (synchronizing channel), 300 μ v to 1 v rms (10-500 MHz), 500 μ v to 1 v rms (500-1000 MHz), 1.5 mv to 1 v rms (1-10 MHz).

Voltage Range for Channel B (input to Channel A required), 100 μ v to 1 v rms, full scale. Full-scale meter ranges from 100 μ v to 1 v in 10 db steps. Both channels can be extended to 10 v rms with 11576A 10:1 Divider.

Phase Range of 360° indicated on zero-center meter with end-scale ranges of $\pm 180^\circ$, $\pm 60^\circ$, $\pm 18^\circ$, $\pm 6^\circ$. Phase meter OFFSET of $\pm 180^\circ$ in 10° steps permits use of $\pm 6^\circ$ range for 0.1° phase resolution at any phase angle.

Price: \$2750.

•NPN Transistor in common emitter configuration and its equivalent 2 port scattering diagram.

A NEW TIME-SAVING TECHNIQUE

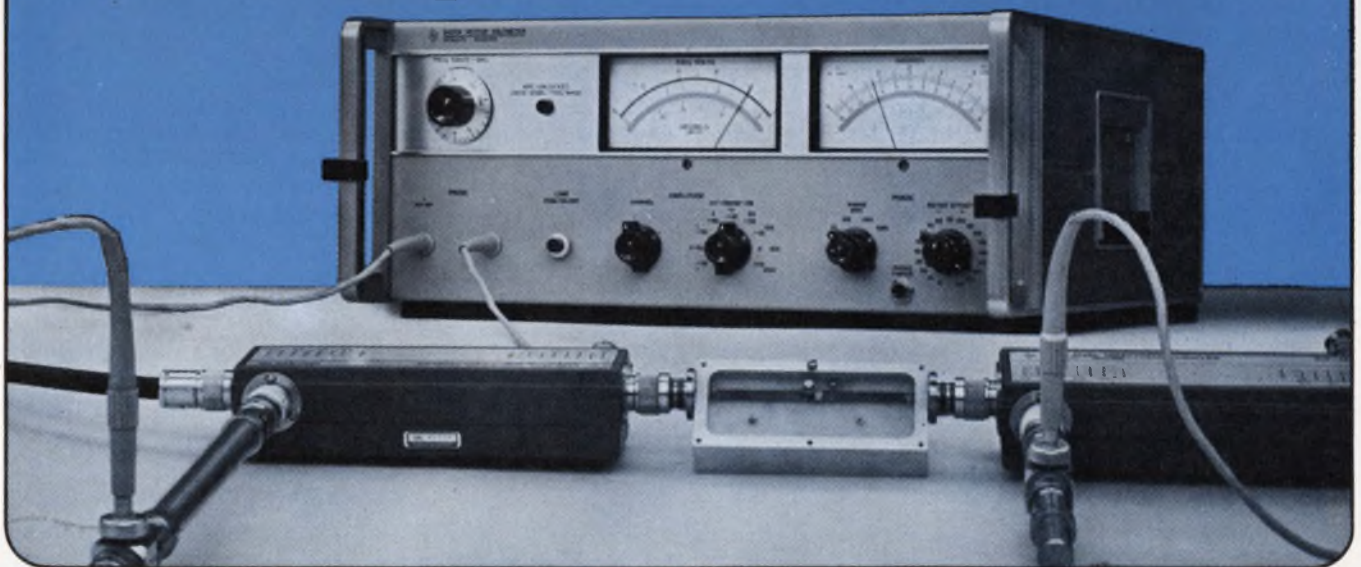

HEWLETT **hp** PACKARD

1697R

ON READER-SERVICE CARD CIRCLE 88

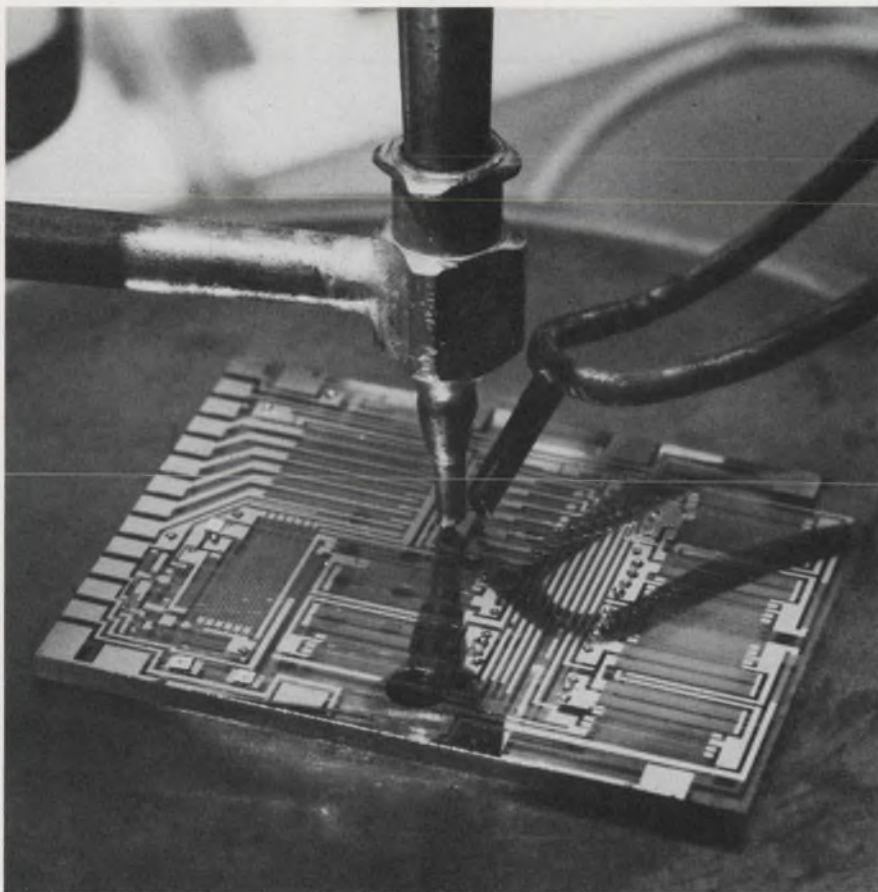

UNUSUAL REQUIREMENTS CALL FOR UNUSUAL TALENTS

In the seven years we've been in business we've concentrated on providing the best technical performance in certain specialized areas.

For instance, using a proprietary process we trim resistors to .01%. We specialize in meeting unique function and packaging requirements by combining chips, LIDS, and flip-chips on thin-film substrates with a variety of discrete components. And we adjust and match the temperature coefficient of resistance to track to within $\pm 5\text{ppm}/\text{C}^\circ$. Complete environmental facilities allow us to test your finished circuit under almost any required environmental conditions.

Naturally we have the latest equipment, but so does everybody else who is really serious about being in the hybrid microcircuit business. What we're offering you is the unique technical know-how that allows you to get exactly the precision you want in the package that meets your needs. And that means we don't cut corners on costs at the expense of performance. Why not give us a call. We'll be glad to tell you more about our approach to hybrid microcircuit technology.

Contact Joe Crist, Sales Manager, Microelectronics Operation, (213) 346-6000, Extension 546, or write to:



THE BUNKER-RAMO CORPORATION
DEFENSE SYSTEMS DIVISION
8433 FALLBROOK AVENUE • CANOGA PARK, CALIFORNIA 91304
ON READER-SERVICE CARD CIRCLE 89

INSTRUMENTS & CONTROL

Precision phase standard accurate to 0.015°



Ad-Yu Electronics Inc., 249 Terhune St., Passaic, N. J. Phone: (201) 472-5622. Price: \$4365.

This device features self-calibration and self-checking by means of fundamental bridge balancing, without the use of an external standard. Its phase shift can be set from 0° to 360° with 7-digit resolution. The instrument accepts a stable sine wave and produces two output signals. Type 209 can be used over the range of 50 Hz to 10 kHz. It does not require interpretation of patterns on a scope, or electrical sampling of many cycles.

Booth No. 3302 Circle No. 294

Frequency synthesizer spans dc to 100 kHz



Measurements, McGraw Edison Div., Boonton, N. J. Phone: (201) 334-2131. Price: \$2850.

This instrument spans dc to 100 kHz with digital selection of 0.01 cycle. A variable oscillator provides continuous frequency selection over the range of any digit except the 10 kHz. The unit operates on the direct synthesis principle, avoiding the problems common to phase-locked oscillators. Frequency generation is under control of a 1-MHz quartz oscillator with short-term stability of one part in 10^8 . Digital assemblies may be omitted with a price reduction of \$170 per digit.

Booth No. 2803 Circle No. 283



We've Pushed Signal-Generator Performance to the Limits

An innovation in signal-generators brings about 10-to-1 better frequency stability and improved accuracy and resolution, without sacrificing other performance features. The key to this performance is the frequency-generating system — a single-range, optimally designed oscillator followed by frequency dividers to provide the successively lower ranges. Thus, the stability of one range is the stability of all, and range switching is accomplished without transient instability. After warmup, drift is typically less than 1 ppm per ten minutes, at least 10 times better than that of any other generator. Because of all-solid-state circuitry, total warmup drift is less than 150 ppm in three hours. Frequency changes caused by band switching or variations in line voltage, load, or level are virtually nonexistent.

The 1003 covers a 67-kHz-to-80 MHz frequency range, and tuning this instrument is as much fun as it is convenient and fast. You can coarse-tune by motor over the main slide-rule dial to within 0.25% at a rate of about 7% per second, and fine-tune manually with a large control whose dial divisions correspond to 0.01% of the main scale. For greater resolution, a "ΔF" control provides electronic, backlash-free settability to 2 ppm. The motor-driven frequency control is fully utilized in the model containing the auto-control unit, which lets you preset frequencies. The preselected frequencies are useful either as limits for automatic sweeping or for programmed frequency selection (repeatable to 0.1%).

Frequency, incremental frequency, and automatic sweeping can all be pro-

grammed, as can output level and modulation-percentage. A crystal calibrator with 1-MHz, 200-kHz, and 50-kHz outputs is also supplied with the model containing the auto-control unit. This calibrator allows you to calibrate to within 0.002 percent.

The 1003 requires only 20 watts and delivers 180 milliwatts of leveled CW power into a 50-ohm load (6 volts behind 50 ohms). Envelope distortion is less than 2% at 70% a-m, with the modulating signal of 400 Hz or 1 kHz provided. Incidental phase modulation is less than 0.1 radian with 30% a-m. The highly accurate, 10-dB-per-step attenuator and a continuously adjustable carrier-level control give an over-all 155-dB dynamic range.

This instrument must be seen to be appreciated. A demonstration will show that very-narrow-bandwidth measurements can be made in 10 seconds with a 1003 signal generator and an oscilloscope. Try that with any other signal generator.

Price of the 1003 is \$2995 (\$2795 without the auto-control unit and crystal calibrator). For complete information, write General Radio Company, 22 Baker Avenue, W. Concord, Massachusetts 01781; telephone (617) 369-4400; TWX (710) 347-1051.

GENERAL RADIO

See the Type 1003 Standard-Signal Generator at WESCON, Booths No. 3015-3018.

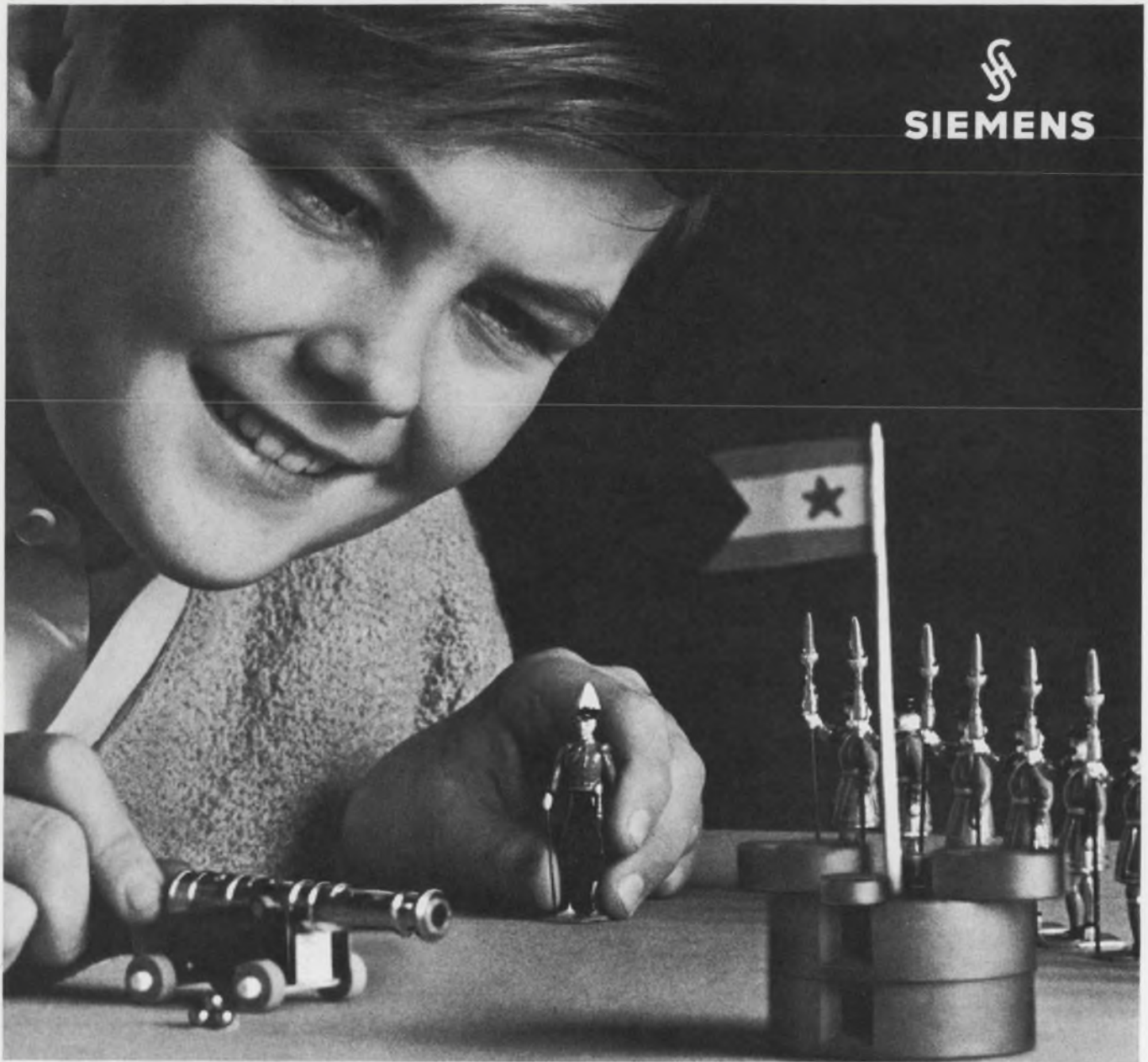

uniformity

Month after month, the electrical characteristics of Siemens pot cores are consistent. Precision engineered for adjustable high stability, high-Q coils, they meet the most critical requirements for filters used in multiplex and other carrier-frequency applications. Low distortion and self-shielding are two important plus features. Available out of stock, too. Let a Siemens engineer show you how Siemens pot cores fit into your application. It's child's play.

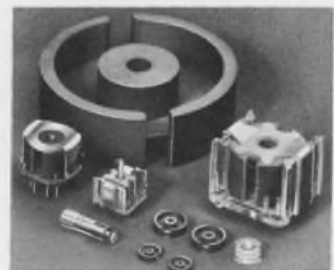

SIEMENS FERRITE POT CORES

8 different materials, 18 different sizes (.22 to 2.75 inches diameter) and more than 250 standard types afford optimum properties for all filter, oscillator and transformer applications. High Q value with high stability is typical: a 26 x 16 core of N22 or N28 material AL 315 at 100 kc/s shows a Q value of approx. 950. Siemens components include ferrite materials, metallized polyester and polystyrene capacitors, all electronic and microwave tubes, rectifiers and a complete line of semi-conductors.

SIEMENS AMERICA INCORPORATED

VISIT BOOTH 5027/28 WESCON SHOW

Components Division • 230 Ferris Avenue, White Plains, N.Y. 10603

U158

ON READER-SERVICE CARD CIRCLE 121

ELECTRONIC DESIGN 17, August 16, 1967

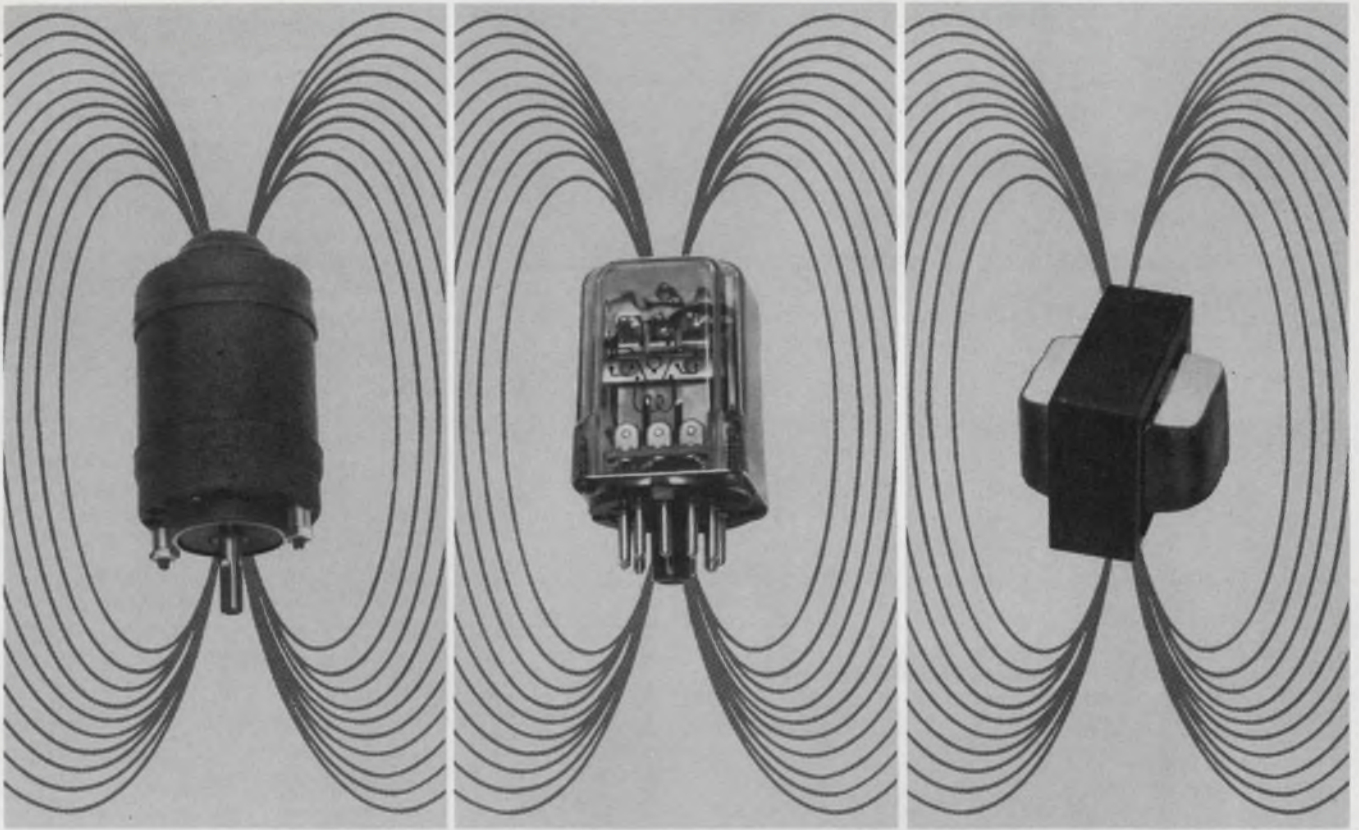

Now, Get 6 Volts Noise Immunity For Your Digital Control System With New MHTL Integrated Circuits !

You'll get the "right" signal every time in your numerical control, supervisory control and computer peripheral equipment with the new Motorola-developed high threshold integrated circuit logic series. Called MHTL, it's the first family of integrated circuits to offer a noise margin of 6 volts (typ) and a 15 volt ($\pm 1V$) operating voltage. And, it's priced, packaged, and specified for application in equipment designed for use in high noise industrial environments.

MHTL combines high noise immunity with a voltage swing of 13 volts, broad operating temperature range, large fan-out and a 35 mW power dissipation rating. In short, it offers you discrete circuit characteristics PLUS the price, size, and reliability advantages of integrated circuitry.

Here are some of the MHTL specifications:

CHARACTERISTICS	MHTL
Operating Voltage	15 \pm 1 Volts
Noise Immunity	6 Volts (typ)
Fan-out (Gate)	10 (min)
Clock Rate (Flip-Flop)	4 MHz (typ)
Operating Temperature Range	-30°C to +75°C

Offered in the 14-pin dual in-line plastic Unibloc* package, the circuit functions and prices for the MHTL family are as follows:

TYPE	DESCRIPTION	PRICE (1,000 UP)
MC660P	Dual 4-Input Gate	\$3.50
MC661P	Dual 4-Input Gate (Passive Pull-Up)	\$3.50
MC663P	Dual J-K Flip-Flop	\$6.10
MC664P	Master Slave R-S Flip-Flop	\$4.05

Other functions planned for the immediate future include a Dual 4-Input Line Driver, Triple Input Interface, Quad Output Interface, Dual Monostable Multivibrator, and Quad 2-Input Gate.

To find out how easily your designs can conquer high-noise-environments with MHTL, write for our data sheets. We'll also send you our latest application note on how MHTL solves your noise problems. For circuits you can try right now — call your nearby franchised Motorola Semiconductor distributor. He has high-noise-immunity MHTL in stock!

*Trademark of Motorola Inc.

- where the priceless ingredient is care!



MOTOROLA Semiconductors

MOTOROLA SEMICONDUCTOR PRODUCTS INC. / P. O. BOX 955 / PHOENIX, ARIZONA 85001 / (602) 273-6900 / TWX 910-931-1334

ON READER-SERVICE CARD CIRCLE 122

ELECTRONIC DESIGN 17, August 16, 1967

U159

**Get a complete
Electronic Package
from Chassis-Trak
of Indianapolis**

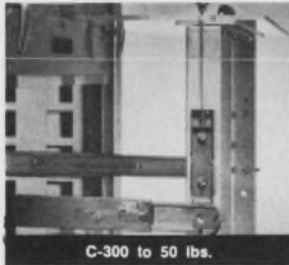

C-300 to 50 lbs.

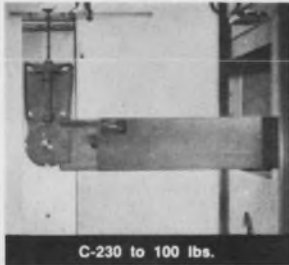

C-230 to 100 lbs.



CTB to 175 lbs.



CB to 1000 lbs.



3000 Series

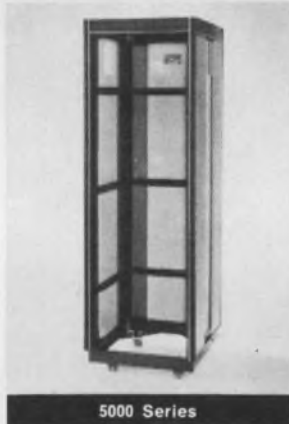

5000 Series

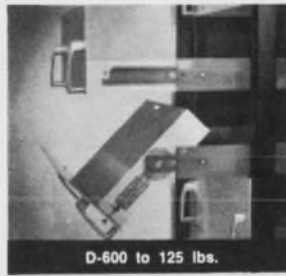

D-600 to 125 lbs.



VENT-RAK Modular Chassis



1000 Series



5050 Series

See you at
WESCON



Whatever your electronic packaging needs, military or commercial, light-weight or heavy-duty, Chassis-Trak offers a complete line of slides in capacities from 50 lbs. to 1,000 lbs., hardware, and cabinets in a wide range of styles, sizes and materials. The *Chassis-Trak* of Indianapolis name on your electronic package is your assurance of quality and economical *versatility*.

To learn more about *total electronic packaging* write Chassis-Trak, Inc.

525 South Webster Avenue, Indianapolis, Indiana 46219

ON READER-SERVICE CARD CIRCLE 123

INSTRUMENTS & CONTROL

**Thin-line counter
spans 0.3 to 12.4 GHz**



Systron-Donner Corp., 888 Galindo St., Concord, Calif. Phone: (415) 682-6161. Price: \$4650.

A new integrated circuit counter has been added to Systron-Donner's "Thin-line" (ED 5, Mar. 1, 1967, p. 114). Featuring automatic measurements from 300 MHz to 12.4 GHz and a direct 100-MHz counting range, the unit combines a built-in Acto (automatic computing transfer oscillator) with a 100-MHz frequency counter for the wide range and automatic operation.

The Acto technique performs phase lock and selection of the proper harmonic automatically. Readout of measurements in the 0.3-to-12.4 GHz range appear instantaneously in 8 digits (9 digits optional) and with a "lok" annunciator that appears only when the Acto has achieved a phase lock with the unknown input. Designed principally of ICs, the unit offers such features as a 1-3/4-inch panel height, slide switches, an optional high-stability oscillator (5 parts in 10¹⁰ per 24 hrs) and 9-digit readout.

Booth No. 2402 Circle No. 288

**Audio phase meter
ranges 10 Hz to 2 MHz**



Wiltron Co., 930 E. Meadow Dr., Palo Alto, Calif. Phone: (415) 321-7428. P&A: \$995; 10 wks.

Covering 10 Hz to 2 MHz, this audio phase meter has a dynamic range of 60 dB and a swept frequency capability. A 1-millivolt sensitivity in both channels eliminates the need for external or plug-in preamplifiers which may introduce phase error of their own.

Booth No. 2711 Circle No. 293

Adlake Mercury Wetted Relay — Application Data

Measurement of "Dynamic Contact Noise" for Low Level Signal Applications



**Adlake AWCS
26000 Series Relay —
2 Switch Form C**

In small signal applications, such as computers, telemetric systems, strain gauges, etc. generated emf. within the system's relays must be taken into account.

Dynamic Contact Noise is a "coined" phrase used to indicate an undesired generated emf. upon contact closure. It is the result of mechanical oscillation of the armature—caused by the impact of the armature on the stationary contacts — sweeping the coil flux.

Typical illustrations of this noise are shown in the oscillograms, with the relay being driven at nominal voltage in the test circuit shown below. The frequency and amplitude are integral functions of system bandwidth and coil drive conditions.

The slight ripple seen at the end of each trace is not noise, but due to resolution of test equipment and test circuit.*

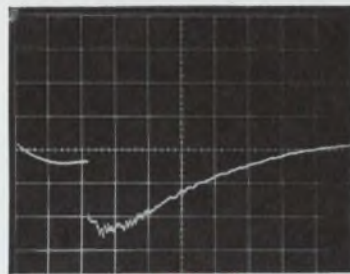

FIGURE 1

Horizontal Deflection 1.0 ms/cm
Vertical Deflection 20 μ V/cm
Systems Bandwidth .06–60 Hz.

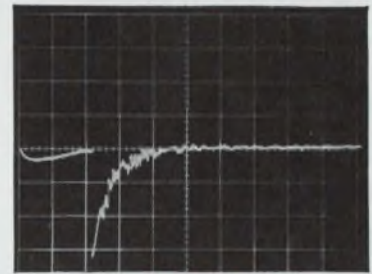

FIGURE 2

Horizontal Deflection 1.0 ms/cm
Vertical Deflection 100 μ V/cm
Systems Bandwidth .06–600 Hz.

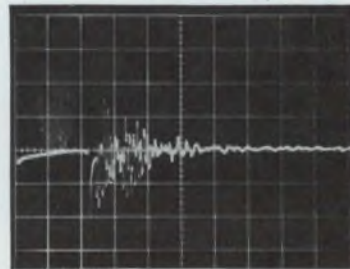

FIGURE 3

Horizontal Deflection 1.0 ms/cm
Vertical Deflection 200 μ V/cm
Systems Bandwidth .06–6K Hz.

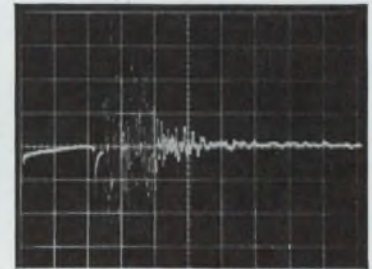

FIGURE 4

Horizontal Deflection 1.0 ms/cm
Vertical Deflection 200 μ V/cm
Systems Bandwidth .06–60K Hz.

TEST CIRCUIT

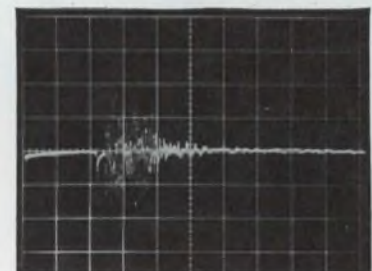
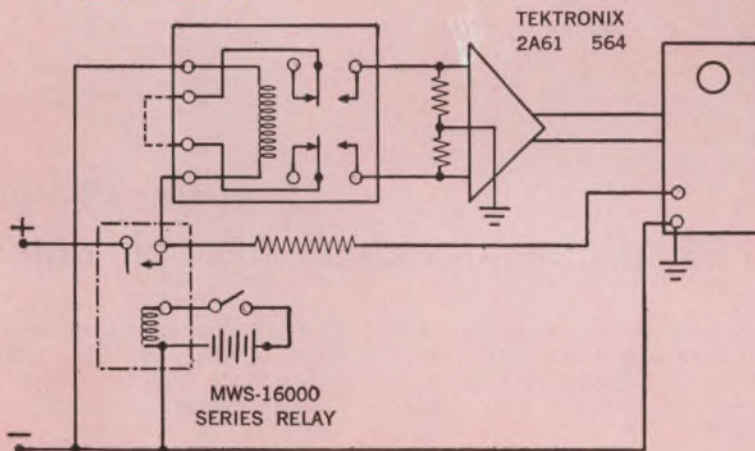

FIGURE 5

Horizontal Deflection 1.0 ms/cm
Vertical Deflection 500 μ V/cm
Systems Bandwidth .06–100K Hz.

* If you have a problem regarding relay applications to a particular system our engineering staff is ready to help you. Contact Mr. Le Roy Carlson, Chief Project Engineer.

Backed by sound research and disciplined engineering, Adlake applies the industry's broadest line of mercury displacement and mercury wetted relays to the creative solution of design circuit problems. However unique or special your application, Adlake can assist you in

developing it. For prompt, personal and knowledgeable attention to your relay needs, contact the one source that is the complete source in the mercury relay field. Contact Adlake today for catalog and further information.



THE ADAMS & WESTLAKE COMPANY

A SUBSIDIARY OF ALLIED PRODUCTS CORPORATION

ELKHART, INDIANA 46514 • AC 219 • 264-1141

Dept. 1087

TRANSPORTATION EQUIPMENT • ARCHITECTURAL PRODUCTS • MERCURY RELAYS • DOORS AND ENTRANCES • CONTRACT MANUFACTURING



Meet the eliminator. Make a clean sweep of RFI problems with our filter pin contacts.

When RFI started giving trouble, we did something about it. ITT Cannon developed filter pin contacts to achieve optimum RFI rejection in the connector assembly. And because our filters are an integral part of the connector — and terminated like standard contacts — they also eliminate filter boards and all the attendant expenses of engineering, assembly, wiring, inspection and testing of separate filter units.

Even crowded corners are no longer an obstacle to RFI filtering. CANNON®

Plugs with filter pin contacts are up to 75% *smaller* and 62% *lighter* than connectors with separate clusters of filters — and up to 500 times more effective.

This better idea in RFI-resistant connectors is available in many shapes and



sizes: miniature circular connectors designed to MIL-C-26482 and NAS1599 specifications, miniature and sub-miniature rectangular rack and panel, and RF coaxial connectors.

For further information and literature, write to ITT Cannon Electric, 3208 Humboldt Street, Los Angeles, California 90031.

A division of International Telephone and Telegraph Corporation.



CANNON ITT

HLT²L RAYTHEON HLT²L RAYTHEON HLT²L RAYTHEON HLT²L RAYTHEON
 RAYTHEON HLT²L RAYTHEON HLT²L RAYTHEON HLT²L RAYTHEON HLT²L
 HLT²L RAYTHEON HLT²L RAYTHEON HLT²L RAYTHEON HLT²L RAYTHEON
 RAYTHEON HLT²L RAYTHEON HLT²L RAYTHEON HLT²L RAYTHEON HLT²L
 HLT²L RAYTHEON HLT²L RAYTHEON HLT²L RAYTHEON HLT²L RAYTHEON
 RAYTHEON HLT²L RAYTHEON **50 MHz DUAL J-K FLIP-FLOP**

Now – Raytheon completes the line!

Raytheon's 50MHz Dual J-K Flip-Flops (RF120 Separate Clock and RF130 Common Clock) are available for delivery now.

As with all Raytheon MIL Spec IC's, our HLT²L line features —55°C to 125°C temperature range, true hermetic seals guaranteed to 5x10⁻⁸ cc/sec Helium, and a complete battery of electrical and physical quality assurance tests and inspections.

Raytheon HLT²L evaluation samples and data sheets are ready for immediate delivery. Raytheon Company, Semiconductor Operation, 350 Ellis Street, Mountain View, California 94040.

See us at Wescon. Booth # 4421





NEWS

from Mr. MAGNETICIAN™



SPECIALISTS IN MAGNETIC MATERIALS



PERMANENT MAGNETS

Custom-engineered to size, shape and specific magnetic properties for sophisticated applications from a complete range of permanent magnet alloys. Production availability of new high energy product Columax 9 and ultra-high coercive force Alnico 8-C.

Write for Bulletin M-304-C.



LAMINATIONS

Punchings of various shaped Silicon Iron laminations for use as stacked magnetic cores for electro-magnetic devices such as transformers, solenoids, rectifiers, chokes, etc. Most shapes and sizes available from stock.

Write for Catalog L-523.



MAGNETIC INSTRUMENTATION

Precise measuring and testing equipment for laboratory and production operation. Includes Magnetchargers, Demagnetizers, Magnetic Stabilizer, Permanent Magnet Charger, Magnetic Pole Indicator, and Balanced Magnetic Bridge Recording Permeameter.

Write for Bulletin A-930.



TAPE WOUND CORES

Orthosil® "C", "E", "Y" and Toroidal transformer cores using thin gauge (1 through 4 mil) oriented silicon iron for single phase and three phase applications.

® Orthosil is a registered trademark of Thomas & Skinner, Inc.

Write for Catalog W-102-C.

NEW PRODUCTS ON DISPLAY AT WESCON 67

Be sure to visit Mr. Magnetician at Booth 4008, South Exhibit Hall, Cow Palace, San Francisco during Wescon 67.



Thomas & Skinner, Inc.

Box 102, 1120 East 23rd Street, Indianapolis, Indiana 46205
Phone 317-923-2501

ON READER-SERVICE CARD CIRCLE 127

INSTRUMENTS & CONTROL

Impedance plots made with pulsed rf



Wiltron Co., 930 E. Meadow Dr., Palo Alto, Calif. Phone: (415) 321-7428. P&A: \$3900; 6 wks.

A pulse adapter extends the capabilities of Wiltron's circuit analyzer so it can operate on pulsed signals from 2 MHz to 4 GHz. It is possible to make impedance plots with very short pulses. This is essential in checking mixers whose characteristics change with input level and duty cycle. An important application for this pulse capability is in the testing of the phase shift through microwave tubes where testing can be done with pulses as short as 0.2 μ s and phase resolution of better than 1° over the whole range. A dynamic range of 20 dB is automatically handled and can be extended by choice of signal levels.

Booth No. 2711 Circle No. 320

C-band amplifier hits 1 MW peak

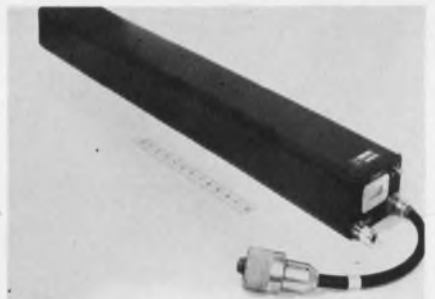

Litton Industries, Electron Tube Div., 960 Industrial Rd., San Carlos, Calif. Phone: (415) 591-8411.

With excellent phase and gain characteristics as well as high power outputs over wide bandwidths, this cold-cathode device requires only a dc power supply for operation. At the end of the rf input pulse it automatically ceases operation within a few nanoseconds. Between pulses, there is no current drawn from the supply. No complicated pulse circuitry is required to amplify pulse trains with varying pulse widths and repetition rates.

Booth No. 4207 Circle No. 279

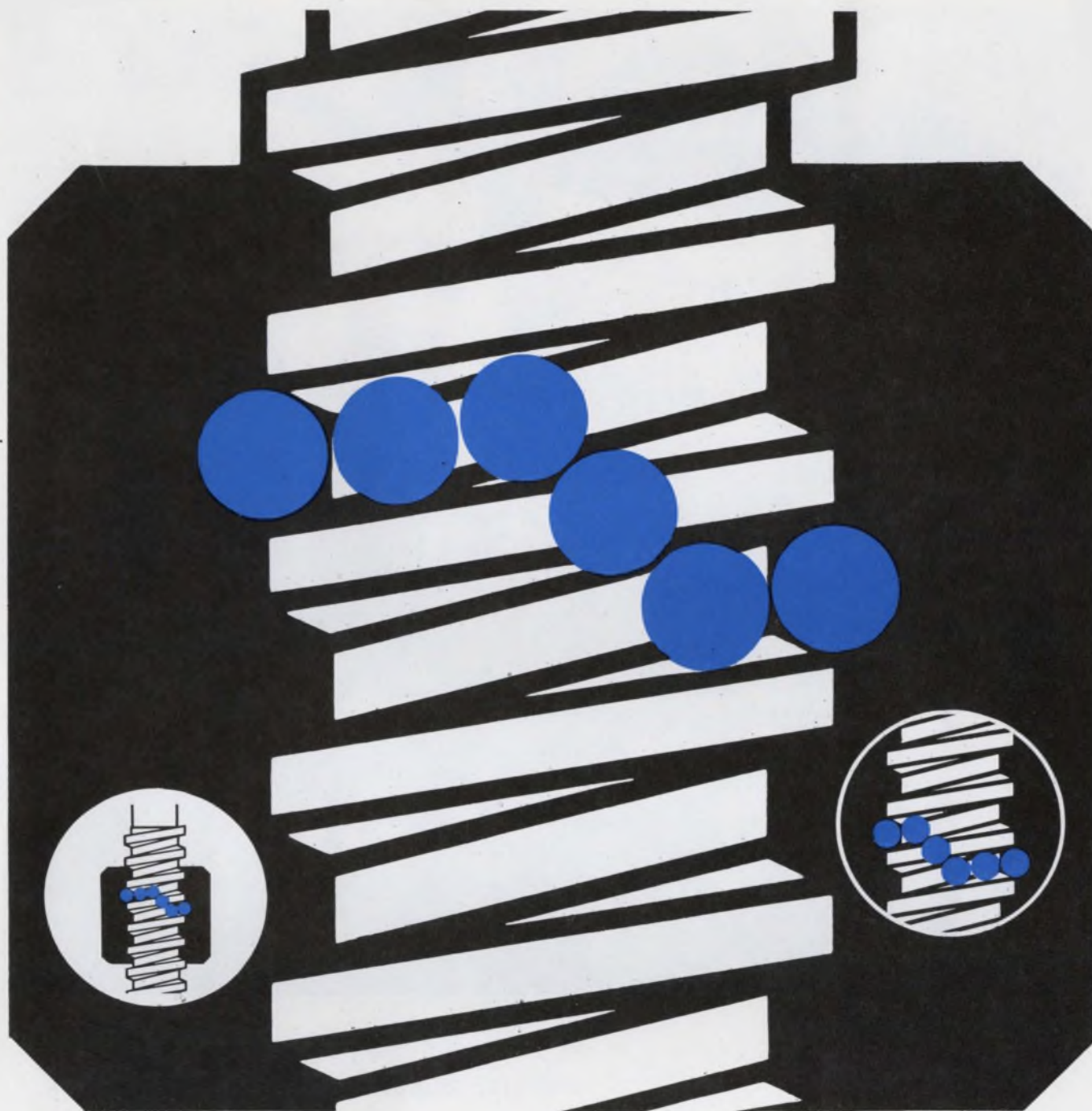

Kidde Ballscrews

SIZE AND WEIGHT PROBLEM SOLVERS

Kidde Ballscrews do more than solve friction problems of prime movers and drives. They can solve size and weight problems, too—and meet the demands for high efficiency transfer of motion and power. Here's why:

Their compact design results in smaller envelope dimensions. Weight is reduced because external tubes and fittings are eliminated. Kidde designs allow optimum usable power, due to extremely high efficiencies.

To solve these major problems, Kidde has designed a

wide range of Ballscrew sizes—from units less than 1" long to 32 foot custom assemblies. From 6" diameters down to 1/8"; sizes 3/16" to 1-1/2" (with various lead) are stocked.

Learn how Kidde Ballscrews can become your problem solver. Write for your free copy of "Standard and Precision Ballscrews." Walter Kidde & Company Inc., 675 Main Street, Belleville, New Jersey 07109.



ON READER-SERVICE CARD CIRCLE 128

ELECTRONIC DESIGN 17, August 16, 1967

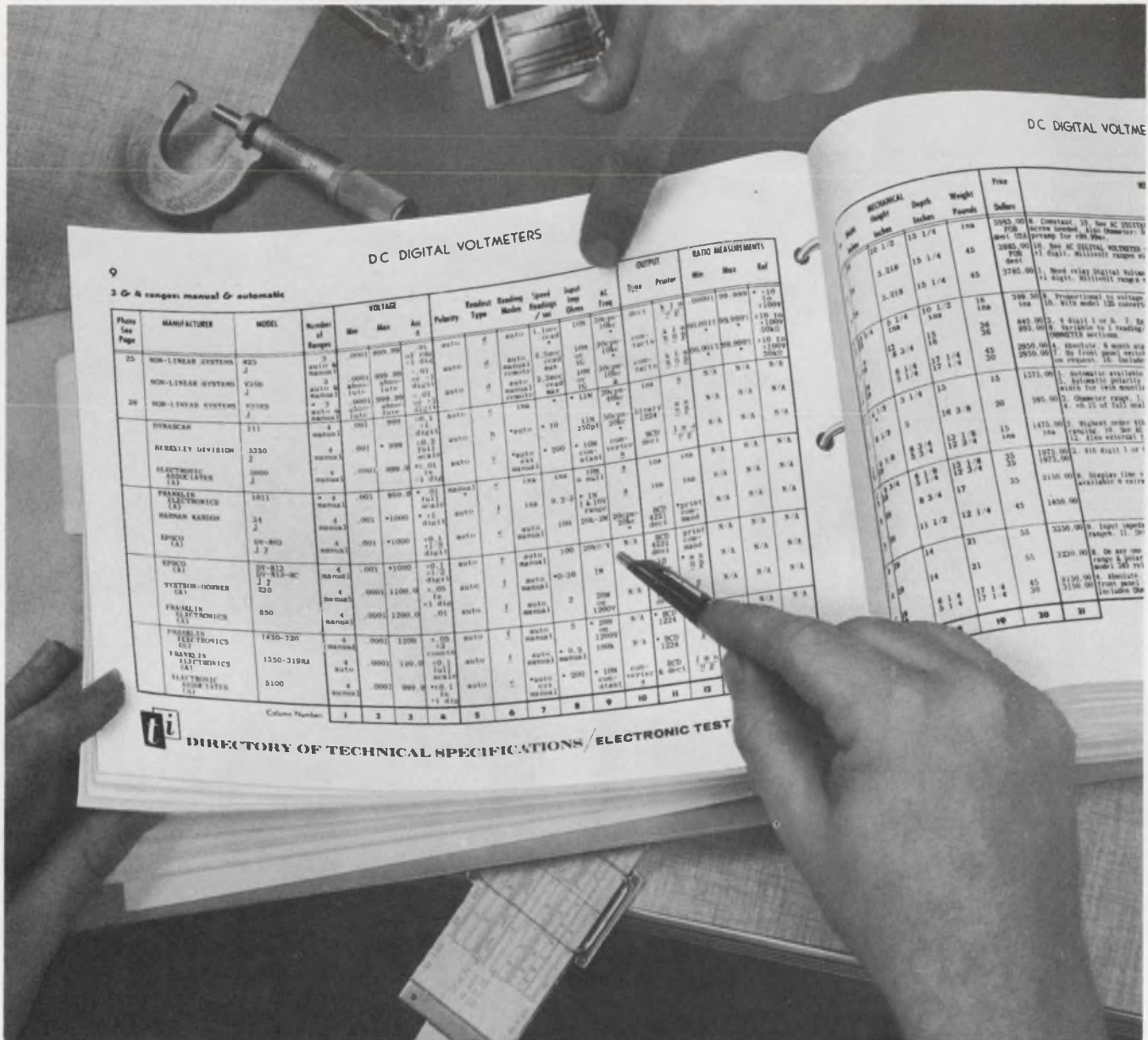

DC DIGITAL VOLTMETERS

3 & 4 ranges manual & automatic

Photo See Page	MANUFACTURER	MODEL	Number of Ranges	VOLTAGE			Polarity	Resolution Type	Reading Method	Speed Readings / sec	Input Impedance	AC Freq	Type	Protector	RATIO MEASUREMENTS		
				Min	Max	Acc %									Min	Max	Ref
25	NON-LINEAR SYSTEMS	#25	4	0.001	999.999	+0.1	auto	5	auto	1.0 sec	100	20-200	100	100	100	100	100
	NON-LINEAR SYSTEMS	V350	3	0.001	999.999	+0.1	auto	5	auto	1.0 sec	100	20-200	100	100	100	100	100
28	NON-LINEAR SYSTEMS	V700	3	0.001	999.999	+0.1	auto	5	auto	1.0 sec	100	20-200	100	100	100	100	100
	HYDRACOR	311	4	0.001	999.999	+0.1	auto	5	auto	1.0 sec	100	20-200	100	100	100	100	100
	REBELLY DIVISION	5350	4	0.001	999.999	+0.1	auto	5	auto	1.0 sec	100	20-200	100	100	100	100	100
	ELECTRONIC ASSOCIATES (E)	2800	4	0.001	999.999	+0.1	auto	5	auto	1.0 sec	100	20-200	100	100	100	100	100
	FRANKLIN ELECTRONICS (E)	1811	4	0.001	999.999	+0.1	auto	5	auto	1.0 sec	100	20-200	100	100	100	100	100
	HARMAN HARDON	34	4	0.001	999.999	+0.1	auto	5	auto	1.0 sec	100	20-200	100	100	100	100	100
	EPICO (E)	24-802	4	0.001	999.999	+0.1	auto	5	auto	1.0 sec	100	20-200	100	100	100	100	100
	EPICO (E)	24-802	4	0.001	999.999	+0.1	auto	5	auto	1.0 sec	100	20-200	100	100	100	100	100
	SYSTEM-HOBBS (E)	09-813	4	0.001	999.999	+0.1	auto	5	auto	1.0 sec	100	20-200	100	100	100	100	100
	SYSTEM-HOBBS (E)	09-813-BC	4	0.001	999.999	+0.1	auto	5	auto	1.0 sec	100	20-200	100	100	100	100	100
	SYSTEM-HOBBS (E)	220	4	0.001	999.999	+0.1	auto	5	auto	1.0 sec	100	20-200	100	100	100	100	100
	FRANKLIN ELECTRONICS (E)	850	4	0.001	999.999	+0.1	auto	5	auto	1.0 sec	100	20-200	100	100	100	100	100
	FRANKLIN ELECTRONICS (E)	1430-320	4	0.001	999.999	+0.1	auto	5	auto	1.0 sec	100	20-200	100	100	100	100	100
	FRANKLIN ELECTRONICS (E)	1250-319A	4	0.001	999.999	+0.1	auto	5	auto	1.0 sec	100	20-200	100	100	100	100	100
	ELECTRONIC ASSOCIATES (E)	5100	4	0.001	999.999	+0.1	auto	5	auto	1.0 sec	100	20-200	100	100	100	100	100

Columns Number: 1 2 3 4 5 6 7 8 9 10 11 12

ti DIRECTORY OF TECHNICAL SPECIFICATIONS / ELECTRONIC TEST

If you are buying or selling **Digital Voltmeters, Signal Generators, Receivers, Microwave Equipment or Oscilloscopes**, a Directory of Technical Specifications will allow you comparative and current analysis of manufacturer's pertinent specifications... *at your fingertips.*

A one year subscription for \$300 contains 47 categories bound in 47 separate sections (includes six storage binders).

TECHNICAL INFORMATION CORP.

P.O. BOX 514 SMITHTOWN, N.Y. 11787 (516) 234-0100
 SEE US AT WESCON BOOTHS 3616 AND 3617



ON READER-SERVICE CARD CIRCLE 129

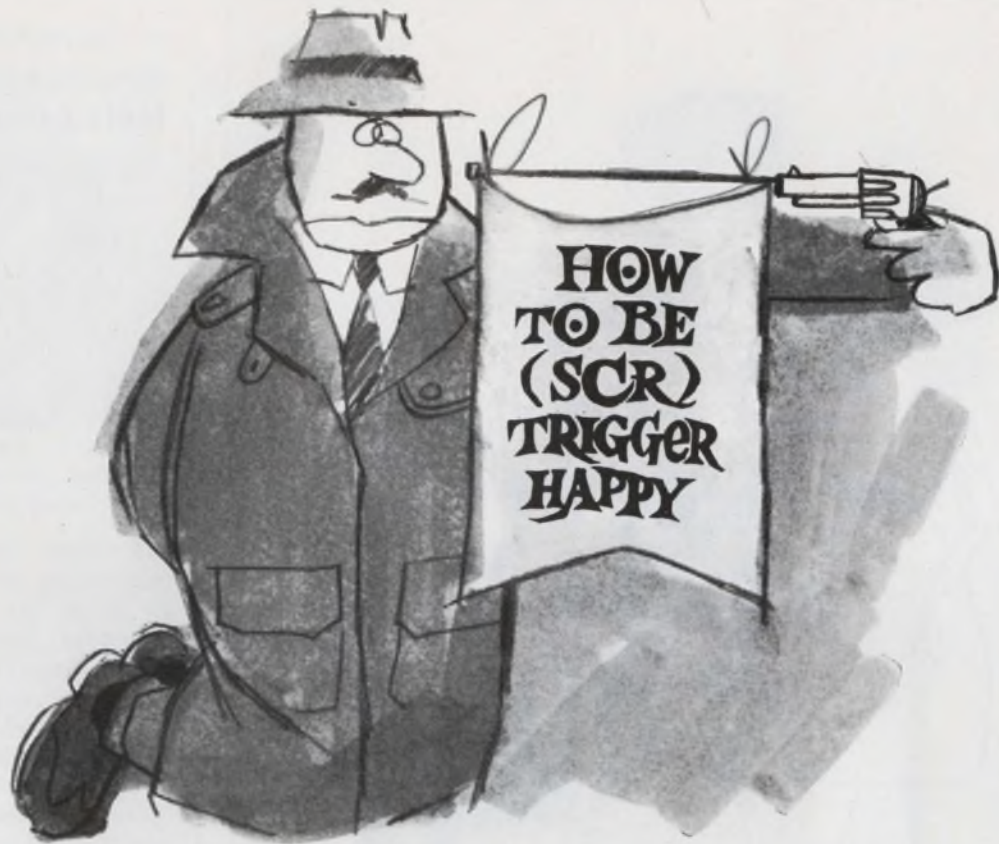

fire them this flexible, economical, precise, fail-safe way

... with Aladdin pulse transformers ... allows triggering from a high impedance control circuit ... provides isolation from the trigger source; permits triggering through the use of fewer components (reducing overall circuit cost). Applicable to both closed and open loop systems; gate isolation permits use of both AC and DC circuits. Precise firing depends on characteristics of the pulse transformer and semi conductor elements—the extensive Aladdin transformer line affords maximum “trading” of characteristics for optimum results. Readily available—the chart lists some of the most common ratios of 1:1 and 1:1.1.

For other applications, consult our applications engineers. Meanwhile send for bulletin 195 listing other standard SCR transformers and additional performance data.

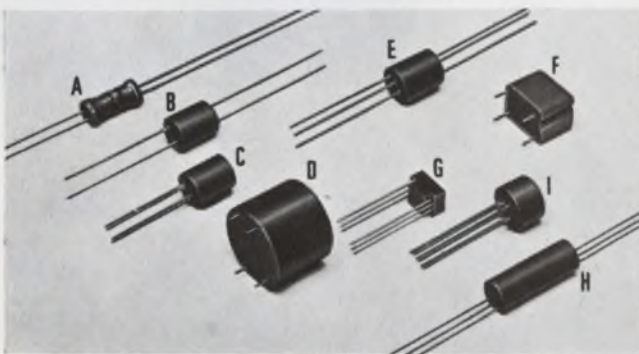

Part Number	Package Style	OCL (mh)	Turns Ratio (± 10%)	High Potential Test Voltage
307-102	A	.2 min.	1:1	1600
90-2569	B	1.3 min.	1:1	550
306-136	C	1.3 min.	1:1	550
314-162	D	3.5 min.	1:1	550
90-2510	B	5.0 min.	1:1	550
72-2040	F	5.0 ± 20%	1:1	1750
314-141	D	6.6 ± 20%	1:1	1000
02-1864	E	6.0 ± 20%	1:1	700
90-1055	B	6.0 ± 20%	1:1	700
90-2364	B	8.5 ± 20%	1:1	700
90-2555	B	24.0 ± 20%	1:1	700
314-142	D	41.0 ± 20%	1:1	1000
314-143	D	162 ± 20%	1:1	1000
307-101	H	.045 ± 10%	1:1.1	700
78-2028	G	.7 min.	1:1.1	1000
90-2397	B	1.3 min.	1:1.1	550
312-114	I	1.3 min.	1:1.1	550
90-2398	B*	5.0 min.	1:1.1	550
90-2362	E*	6.0 ± 20%	1:1.1	700
02-2062	E*	6.0 ± 20%	1:1.1	1250
314-144	D*	6.6 ± 20%	1:1.1	1000
02-2066	E*	14.0 min.	1:1.1	1000
02-1861	E*	15.0 ± 20%	1:1.1	700
314-139	D*	21.0 ± 20%	1:1.1	700
314-170	D*	28.0 ± 20%	1:1.1	1000
314-145	D*	41.0 ± 20%	1:1.1	1000

Aladdin Electronics can custom design to individual needs for higher interwinding voltage strengths.
*Package configuration are same as shown except for the additional leads required for 1:1.1 transformers.

where the magic of magnetics is a science...

Aladdin[®]
electronics

Nashville 10, Tennessee

ON READER-SERVICE CARD CIRCLE 130



Meet The Anadex Freq Family

Pictured above is a portrait of the Anadex family of high-performance, low-cost frequency instruments for **measuring, generating, converting, and manipulating frequencies** in the 0-200 KC range. There is a member of the Anadex "Freq" Family especially designed for each of these functions and many more:

- $V_o = KF$, Frequency-To-DC Conversion
- $F_o = KV$, DC-To-Frequency Conversion
- $F_o = KF$, Frequency-To-Frequency Conversion
- $V_i = KF$, Frequency Limit Detection
- $\theta_m = KF$, Frequency Meter Indication
- plus F_1 / F_2 , $F_1 \times F_2$, $F^{1/2}$, and Frequency Generators

Complete literature on the "Anadex Freq Family" containing detailed specifications is available. Send for it today.



... THE NAME YOU CAN COUNT ON

7833 HASKELL AVENUE, VAN NUYS, CALIFORNIA 91406
PHONE 213-873-6620 • TWX 213-781-6811

Visit our Booth 3303 at WESCON August 22-25

ON READER-SERVICE CARD CIRCLE 131

INSTRUMENTS & CONTROL

Picosecond pulser tests sampling scopes



Tektronix, Inc., P. O. Box 500, Beaverton, Ore. Phone: (503) 644-0161. Price: \$525.

Available outputs of this pulser include all the signals required to check the risetime, vertical deflection factors and horizontal sweep rates of sampling systems. The repetition rate of the pulse generator is 50 kHz with a pulse duration of 1 μ s and a flatness of $\pm 3\%$ or better. A pre-trigger is available that occurs either 5 ns or 50 ns before the pulse output. Rise time is 50 ps. Squarewave outputs with a period of 10 μ s, 1 μ s or 100 ns and amplitudes of 1 V, 100 mV or 10 mV into 50 Ω may be selected. Sinewave outputs of 10 ns or 1 ns period are available for checking fast sweep rates.

Booth No. 2818 Circle No. 315

Directional rf wattmeter accurate to 100 W



Bird Electronic Corp., 30303 Aurora Rd., Cleveland. Phone: (216) 248-1200. Price: \$895.

With all components assembled in an 11 x 9-1/2 x 6-3/8-inch case, this rf wattmeter remains accurate to 100 watts. A section of machined 50- Ω reference line for insertion into the users coax system is connected to a 5-1/2-inch taut-band meter, which permits readings without residual jewel friction. Five 100-watt plug-in elements cover a continuous frequency range from 2 to 1000 MHz.

Booth No. 2601 Circle No. 329

ON READER-SERVICE CARD CIRCLE 91,92

It tests all digital integrated circuits & costs only \$60,000

per dozen.

1. REDCOR's new IC tester does everything 150,000 testers do. Except cost \$50,000. True, it's somewhat slower than expensive units, but as it costs only one-tenth as much, perhaps you could manage with less than overwhelming speed.

2. The 990 IC tester has to be the perfect tester for small run production, incoming inspection, and laboratory analysis. It performs both pulse and dc parameter tests as well as functional tests without external equipment. Measurement accuracy is 1%. (For an extra thousand bucks we build in a digital readout that gives an accuracy of 0.1% on all ranges.)

3. The 990 is easy to operate. You can train a bright girl to be a proficient operator in half a day. Test programming is accomplished with thumbwheels and requires less than 60 seconds for most IC's.



4. Power supply accuracy is 0.1% ± 1 mv. All supplies have adjustable current or voltage limiting and will both source and sink. Kelvin connections are provided to the device under test.

5. For more information on the 990, flip the page.

An outlined guide to testing IC's

cheap

start here

8

7

BRILLIANT PERFORMANCE

The 990 stimulates and measures all dc parameters without additional equipment. In combination with an oscilloscope it measures ac parameters.

6

FETCHING MODULARITY

The standard complement of modules is three voltage supplies, one current supply, one swept voltage supply, one dual loads module, and one dual output pulse generator. All modules are individually powered from ac line and are floating. Current and voltage are continuously variable with indication when limits are reached.

STUNNING ACCURACY

The 990's metering capability is comparable to that of testers ten times its cost. With the optional DRO, accuracy is $0.1\% \pm 1$ mv. Kelvin referencing means that the actual voltage or current at the lead is just what it should be. (Greater accuracy in low-level current measurements.)

RATHER SWIFT PROGRAMMING

Test programming for any available device can be set up in less than sixty seconds. Thumbwheel/pushbutton programming gives instantaneous verification of testing conditions. A complete line of device adaptors is available.

CRASHINGLY SIMPLE OPERATION

From the programming to the actual testing, the model 990 can be operated by nearly anyone (even salesmen). Why don't you call one of ours and see.

9

2

DELIVERY
Immediate.

4
12

³ FURTHER INFORMATION

Call collect to Dick Barr, our sales manager for this product.

11

10.

Ka-band oscillators pump paramps

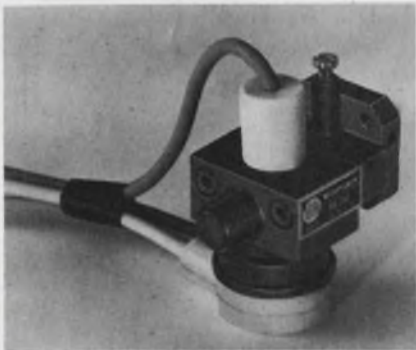

Varian Associates, 611 Hansen Way, Palo Alto, Calif. Phone: (415) 326-4000.

Reflex klystron oscillators covering the frequency range between 26.5 and 35 GHz are designed for use as pump tubes in parametric amplifiers. Tuning over a 1-GHz range, the tube delivers 150 mW at a beam voltage of 550 V. Mechanical tuning range is 700 MHz and the tube delivers 500 mW at 26 GHz and 250 mW at 35 GHz.

Booth No. 2309 Circle No. 286

Frequency program unit presents slim profile

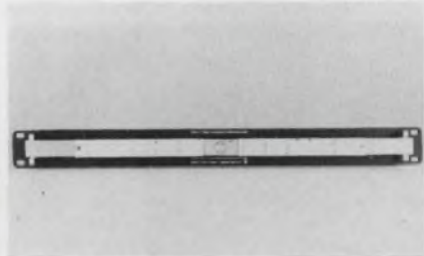

General Radio Co., West Concord, Mass. Phone: (617) 369-4400.

Designed for use with GR frequency synthesizers with remote digit programming, this frequency program unit can be preset to select up to 40 seven-digit frequencies. A single contact closure is required for complete selection of each frequency. The digit-programming switches are contained in plug-in trays which can be changed quickly if more than one program of 40 frequencies is needed. Manual control of any or all digits of the synthesizer overrides the preset program.

Booth No. 3015 Circle No. 292

ON READER-SERVICE CARD CIRCLE 132 >

ON READER-SERVICE CARD CIRCLE 91, 92

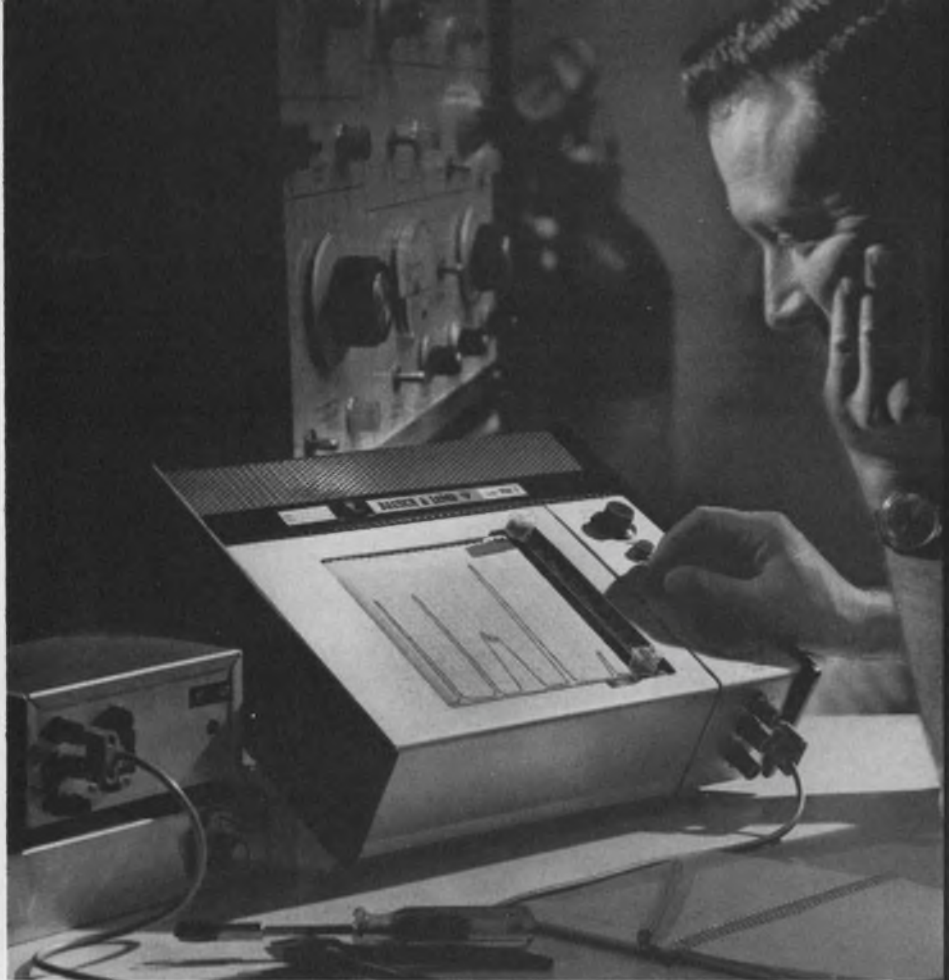

SO MUCH FOR SO LITTLE...

Can the price be right?

There's no mistake.

At Bausch & Lomb we know electronics. We've come up with a remarkable line of recorders . . . the V.O.M. They have more of the features you want, *built-in*, than units costing up to twice as much. They're uniquely able to directly measure and record D.C. volts, ohms and milliamps. They are extremely accurate and sensitive, have high off-balance impedance.

At no extra charge there's an event marker. There are five chart speeds—the same instrument can be used for short term, intermediate or long term recordings. Nothing has been spared to assure top performance. We use a zener diode reference supply, a photoelectric modulator and a durable, smooth-writing sapphire-tipped pen.

Choose the model having the sensitivity you need. Get the right recorder without paying a premium price or buying expensive options.

And for any special applications . . . we can modify to suit your needs. Send for our Catalogs 37-2174 and 37-2194. Write Bausch & Lomb, Electronics Division, 91544 Bausch Street, Rochester, New York 14602.

	V.O.M.-5	V.O.M.-6	V.O.M.-7	V.O.M.-8
Voltage range:	10 mv-500v D.C.	2.5 mv-125v D.C.	0.5 mv-10v D.C.	Absorbance/ Transmittance Measurement (voltage, current, resistance ranges same as V.O.M.-5)
Current range:	10 ma-100 ma	2.5 ma-25 ma	1 μ a-10 ma	
Resistance range:	1 ohm-100 K ohms	0.25 ohms-25 K ohms	1 ohm-100 K ohms	
Weight:	18 lbs.	18 lbs.	20 lbs.	16 lbs.
Prices: (suggested list)	\$675 COMPLETE	\$745 COMPLETE	\$910 COMPLETE	\$995 COMPLETE

BAUSCH & LOMB 
ELECTRONICS DIVISION

In Canada, Bausch & Lomb Optical Co., Ltd., 16 Grosvenor St., Toronto.

See them at the Wescon Show, Booth No. 3306

You'll find two types of relay manufacturers around today.

**Group A: those who care.
Group B: those who don't.**



Group A consists of that very select, very rare bunch who make you feel like *you're* the customer. Group B contains the losers. You know them. You come across them 95% of the time you want something done that requires a little effort.

Line Electric belongs to group A.

We manufacture the best relays in the business. Every unit is put through nine performance tests before you get it. Our sales force is courteous and qualified. Our prices are the best in the industry. And we guarantee delivery in six weeks, not eight like other companies.

To service you properly, we have a sales office in every state and one in Milano, Italy; we have stocking distributors in 68 cities in 28 states, with one in Ottawa, Canada.

Proof of performance? Oh, yes. Our sales have increased by over 400% in the past six years and this year shipments are 80% ahead of last year. And that doesn't happen if your in group B.



But you'll have to try us to believe us. Talking about it won't prove a thing.



The Line Electric Company. Manufacturers of Relays and the best service in the business. Subsidiary of General Precision Equipment Corporation. Send for 64 page catalog:

305 U.S. Highway 287, Parsippany, N.J. 07054
"See us at WESCON, Booth 5020"

ON READER-SERVICE CARD CIRCLE 133

Inductor analyzer spans micro to kilohenries

Marconi Instruments, 111 Cedar Lane, Englewood, N. J. Phone: (201) 567-0607. P&A: \$1485; stock.

Twenty-seven controls and a CRT provide ease of balance on this inductance bridge. With a range from 0.3 μ H to 21,000 H, this true inductor analyzer incorporates a low and medium-current bridge and the nucleus of a complete high-power inductor test assembly. It can be used from 20 Hz to 20 kHz and has internal frequencies of 10 kHz, 1 kHz and 60 Hz line. The display gives a positive indication of direction of inductor balance and tells if the inductor is capacitive at the test frequency.

Booth No. 2619 Circle No. 291

Random data generator weighs 25 pounds



Datapulse, Inc., 10150 W. Jefferson Blvd., Culver City, Calif. Phone: (213) 836-6100.

This 10-stage shift register operates in a closed loop with feedback into the first stage selectable from any two of the stages in the register. It provides a pattern up to 1023 bits long, two units provide over a million bits, three over a billion bits. On pseudo-random operation, the unit may generate the pseudo-random sequence under internal control or synchronize the sequence to a selected sync pattern in external data. Or, it uses the content of preceding bits in external data to generate the proper next bit in the sequence.

Booth No. 2719 Circle No. 282

Amperex

FETS, Zeners & Dual Isolated Diodes, RF & IF Amplifiers and Switches

Now Available in



VERY HIGH FREQUENCY RF AMPLIFIER (NPN)

LDA 407
functionally replaces types:
2N2857, 2N5053/4

HIGH GAIN, LOW CAPACITY IF AMPLIFIER (NPN)

LDA 410
functionally replaces type A473

VERY HIGH SPEED SWITCH (NPN)

LDS 205
functionally replaces type 2N709

LOW "ON" RESISTANCE D/A SWITCHES (NPN)

LDS 206
LDS 208

LOW NOISE FETs (N-CHANNEL JUNCTION)

LDF 603/604/605
functionally replace types:
2N5103/4/5

PLANAR ZENER DIODES (4 to 10 Volts, 5%)

LDZ 70 SERIES

HIGH SPEED LOGIC/SWITCHING DIODES

SINGLE TYPE LDD5
DUAL ISOLATED TYPE LDD15
functionally replaces type 1N914

Other types

HIGH SPEED SWITCHES (NPN)

LDS 200/201
functionally replace types:
2N706, 2N708, 2N743/4,
2N834/5, 2N914, 2N2368/9

GENERAL PURPOSE AMPLIFIERS (NPN)

LDA 402/403
functionally replace
general-purpose amplifiers
operating from
1 to 100 ma, such as:
2N696/7, 2N1613, 2N2218/9,
2N3390/1

MEDIUM CURRENT AMPLIFIER AND SWITCH (NPN)

LDA 404/405
(Complement to LDA 452 and
LDA 453)
functionally replaces types:
2N2217/8/9, 2N2220/1/2, 2N1613,
2N1711, 2N718A, 2N871

HIGH FREQUENCY RF AMPLIFIER (NPN)

LDA 406
functionally replaces type 2N918

GENERAL PURPOSE AMPLIFIER AND SWITCH (PNP)

LDA 450/451
functionally replaces types:
2N2604/5

HIGH GAIN, LOW LEVEL AMPLIFIERS (NPN)

LDA 400/401
functionally replace types:
2N929/30, 2N2483/4

MEDIUM CURRENT AMPLIFIER AND SWITCH (PNP)

LDA 452/453
(Complement to LDA 404 and
LDA 405)
functionally replaces types:
2N2904/5/6/7

DUAL, GENERAL PURPOSE AND HIGH SPEED SWITCHING DIODES

COMMON CATHODE TYPE LDD10
COMMON ANODE TYPE LDD50

To meet any hybrid I.C. application

Amperex's expanded line of LID semiconductors now can satisfy all your design requirements for hybrid IC's. First introduced by Amperex early in '66, the LID, an all-ceramic microelectronic package for semiconductors, has proven to be the answer for high yield, low cost production of hybrid integrated circuits.

Evaluation level quantities of LIDS are available now from your local franchised Amperex distributor. Mechanized production techniques now in full swing have resulted in price reductions across the board. For data, write: Amperex Electronic Corp., Semiconductor & Receiving Tube Div., Dept. 371, Slatersville, R. I. 02876.

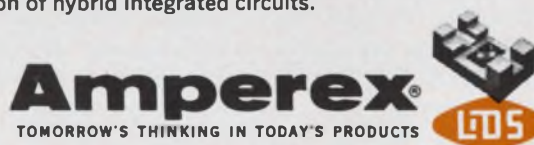

ON READER-SERVICE CARD CIRCLE 134



Sub-Miniature Low-Inductance Capacitor

High Q >1500 @ 500 mc

10:1 capacitance ratio in micro miniature size — extra fine tuning <.35 pF per turn. High Q, (greater than 1500 at 500 mc).

Specifications

Size: 1/8" diameter, 1/2" length
Capacitance Range: 0.35 pF to 3.5 pF
Working Voltage: 250 VDC
 (test voltage, 500 VDC)
Q @ 100 mc: >5000; @ 250 mc, >2000
Insulation Resistance: >10⁴ Megohms
Temperature Range: —55°C to 125°C
Temperature Coefficient: 50
 ± 50 ppm/°C

Features 570° Solder. Prevents distortion. Not affected by conventional soldering temperatures.

Call or write for complete information.

Johanson

**MANUFACTURING
CORPORATION**

400 Rockaway Valley Road
 Boonton, N.J. 07005 • (201) 334-2676
 Electronic Accuracy Through Mechanical Precision

ON READER-SERVICE CARD CIRCLE 135

U172

INSTRUMENTS & CONTROL SYSTEMS

Digital measuring system fully modular



Hickok Electrical Instrument Co.,
 Cleveland. Phone: (216) 541-8060.
 Price: \$320 (main frame), \$175 to
 \$240 (plug-ins).

The main frame of this all-solid-state system (with digital readout) accepts any of five plug-ins. It measures dc voltage, frequency or period, resistance, capacitance, or performs event counting. The flexible system features wide measurement ranges for each plug-in.

Booth No. 3002 Circle No. 328

Portable VTVM uses no filters



Industrial Test Equipment Co., 20
 Beechwood Ave., Pt. Washington,
 N. Y. Phone: (516) 767-9190.

The unit measures in-phase voltage, quadrature voltage, true rms voltage and phase angle. It operates over a 50-Hz-to-10-kHz frequency range and rejects noise and harmonics (40-dB down) without the use of filters. For field use where suitable power sources may not be available, D cells may be used.

Booth No. 2304 Circle No. 314

Stock panel meters customized to suit

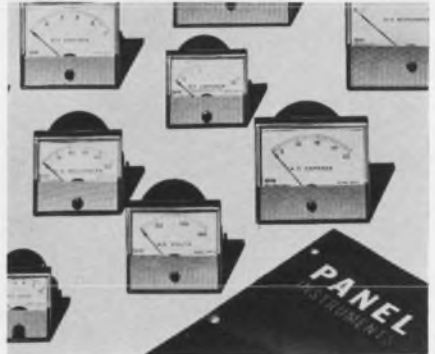

Triplett Electrical Instrument Co.,
 Bluffton, Ohio. Phone: (419) 351-
 4912.

These panel meters give the user a dial design that provides an area for multiple scales and other special applications. The instruments are available in five sizes from the four ounce 1-1/2-inch to the 2-1/2, 3-1/2, 4-1/2 and 5-1/2 inch units. Accuracy is 2% for all types, 3% for the ac rectifier type.

Booth No. 3013 Circle No. 330

Economy DVM accurate to 0.01%

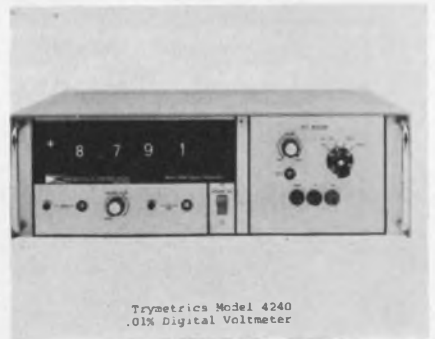

Trymetrics Corp., 204 Babylon
 Turnpike, Roosevelt, N. Y. Phone:
 (516) 378-5020. Price: \$595.

Capable of 10 samples per second with a readout accuracy of 0.01% over three dc voltage ranges, this 4-digit DVM operates without display blinking or running numbers. IC counter circuits and a temperature-stabilized pulsed oscillator voltage-to-time conversion system maintain the accuracy and display stability. The unit has ranges of 0.999, 9.999, 99.99 and 999.9 volts full scale.

Booth No. 3112 Circle No. 311

ON READER-SERVICE CARD CIRCLE 136 ➤



TAKE A
CLOSE
LOOK AT
**HUDSON'S
ELECTRI-CITY**

- OF
- ENCLOSURES
 - STAMPINGS
 - ASSEMBLIES

**WESCON SHOW
BOOTHS 1302-1303**

Our particular specialty is Deep Drawn Electronic Enclosures. We've solved the nation's housing problems for more than twenty-seven years . . . with over 5,000 varied shape units in a variety of materials.

Looking at our Electri-City, you can see that we stress individuality. So, if you can't find the exact accommodations for your housing problems, we'll alter the skyline . . . just for you!

**HUDSON
TOOL & DIE
COMPANY, INC.**

*Enclosures, Stampings
and Assemblies*

NEWARK, N.J. 07105 U.S.A.



**What do Hewlett-Packard •
Kimball Systems • Auto-Trol •
Systron-Donner • Berkeley
Scientific Laboratories • Vidar •
Calma • Victoreen Instrument •
Bisset-Berman • Baird-Atomic •
and Raytheon Computer have
in common?**



US

The outstanding firms listed above, and many others, include Kennedy incremental magnetic recorders in their data gathering systems because of the simplicity, reliability, and easy handling designed into every Kennedy recorder.

See them at WESCON 67—San Francisco at Booth 2416.

We may have a lot in common with you.

THINK
INCREMENTAL **Kennedy Co.**

Altadena, California 91001 • (213) 681-9314 • TWX 910-582-3203
ON READER-SERVICE CARD CIRCLE 137

INSTRUMENTS & CONTROL

**Time interval counter
features dc gating**

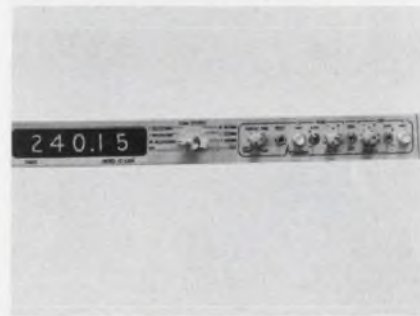

*Anadex Instruments, Inc., 7833
Haskell Ave., Van Nuys, Calif.
Phone: (213) 782-9527.*

Interval measurements such as pulse length, pulse spacing and time between electrical events are provided by this counter. It has start/stop dc levels which are adjustable from +30 to -30 V with slope control. A switch is provided for single line or two line gate inputs. Measurements from 10 μ s to 100,000 seconds are possible. Digital readout may be displayed for an adjustable interval or the display may be held indefinitely until reset.

Booth No. 3303 Circle No. 331

**Nanovolt galvo accepts
any source impedance**



*Electro Scientific Industries, Inc.,
13900 N.W. Science Park Dr., Port-
land, Ore. Phone: (503) 646-4141.
P&A: \$2595; stock to 30 days.*

This galvanometer-type null detector operates from any source impedance without changes in response or damping characteristics. The unit has infinite common-mode rejection and multiple calibrated ranges. It measures voltage or current from 10 nV (10 pA) to 3 mV (3 μ A). Noise is less than 2 nV or 2 pA p-p.

Booth No. 2717 Circle No. 280

CHEMICALLY MILLED MAGNETIC LAMINATIONS & SMALL METAL PARTS

Chemical milling permits faster delivery of prototypes and far lower re-designing costs. The process produces flat, thin, burr-free, close tolerance parts which are too thin to produce by normal stamping methods.

Typical precision metal parts in gages from 0.0002" to 0.020" include miniature transformer and recording head laminations, mechanical and semiconductor strain gages, micromodules with integrated circuitry used in the new flat packs, metal and glass masks used for semiconductor product manufacturing, electrical motor laminates and electrical contacts. Other precision devices made by this process are tube grids and CRT screens, alpha-numeric symbols and letters for electronic display tubes and devices, light attenuation masks (optical filters) and photographic shutters. The process also lends itself to fabrication of small metal parts using non-magnetic materials such as Beryllium Copper, Tungsten, Kovar and Alloy 52.



THE ARNOLD ENGINEERING COMPANY, Main Office MARENGO, ILL.
BRANCH OFFICES and REPRESENTATIVES in PRINCIPAL CITIES

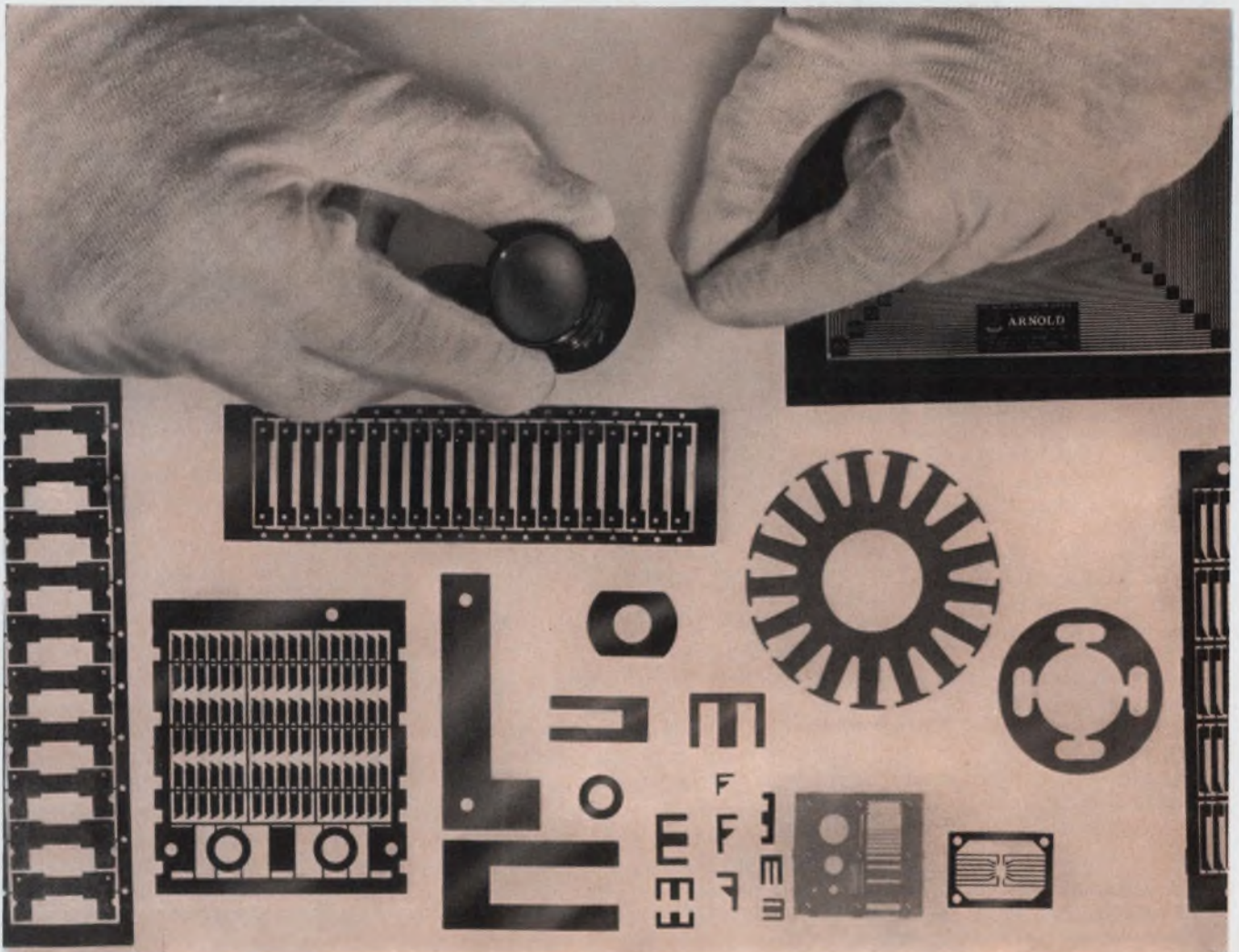

ON READER-SERVICE CARD CIRCLE 138

**What stays
anchored
better than a
headed lead?**

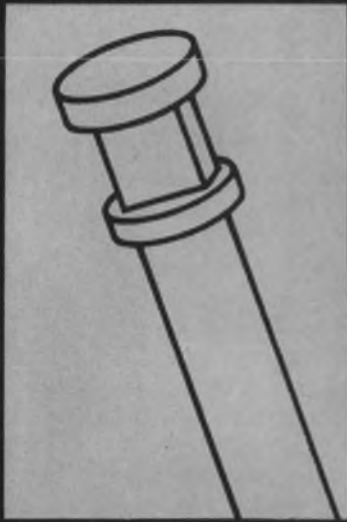

**... a double
upset lead
with
Torque-Lock flat!**

If you can't meet mechanical strength specs with your present epoxy or glass sealed headed leads, get in touch with Art Wire. We have developed high speed automatic machines that can produce double upsets as close as .030" apart, with a flat between, on .015" to .090" diameter wire. The flat eliminates twisting. The second upset at the seal surface improves mechanical bonding and eliminates flashing.

Cost is surprisingly low, not much more than single headed leads. Find out. Send a part or a drawing and we'll quote on it.

Write for catalog.

ART WIRE & STAMPING COMPANY
14 Boyden Place, Newark, N. J. 07102

ON READER-SERVICE CARD CIRCLE 139

U176

INSTRUMENTS & CONTROL SYSTEMS

**Dc-to-freq converter
linear to 0.01%**

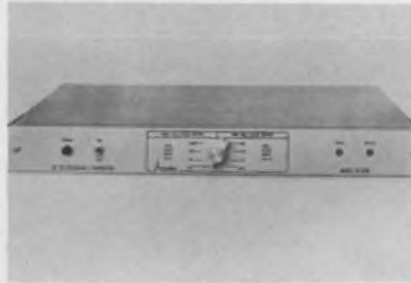

Analex Instruments, Inc., 7833 Haskell Ave., Van Nuys, Calif. Phone: (213) 782-9527. P&A: \$450; 1 month.

An output frequency directly proportional to the input voltage is provided by this converter. By means of a range switch, the user may select any of four input voltage ranges from 10 mV to 10 V full scale with a 10-kHz output, or four input voltage ranges from 100 mV to 100 V with a 100-kHz output. Front-panel controls provides a 0-to-50-kHz output frequency for zero input on any range. The output changes less than $\pm 0.01\%$ for any $\pm 10\%$ change of line voltage.

Booth No. 3303 Circle No. 332

**Turret attenuators
operable to 12.4 GHz**



Narda Microwave Corp., Plainview, N. Y. Phone: (516) 433-9000.

Model 710 turret attenuator provides a 0-to-60-dB attenuation range in 10-dB steps, model 711 ranges 0 to 10 dB in 1-dB steps and model 712 is a dual-turret device combining both attenuation ranges. Turrets are mounted in a cast-aluminum housing, and all units are equipped with type N female connectors. Positive attenuator rf mating is ensured by spring-loaded inner and outer conductors.

Booth No. 2704 Circle No. 319

**Solid-state monitor
displays X-Y-Z**



Hewlett Packard, 1501 Page Mill Rd., Palo Alto, Calif. Phone: (415) 326-7000. P&A: \$1900; September.

A CRT monitor with an 8 x 10-inch display area has 20-MHz response on all 3 axes. The CRT writing rate is faster than 20 inches/ μ s. The power consumption is 175 W (the unit has a self-contained power supply). Input sensitivity of the X and Y amplifiers is 0.1 V/inch and a 2.5:1 vernier amplitude control is included on each axis.

Booth No. 2909 Circle No. 312

**Frequency distribution
unit accepts 8 plug-ins**

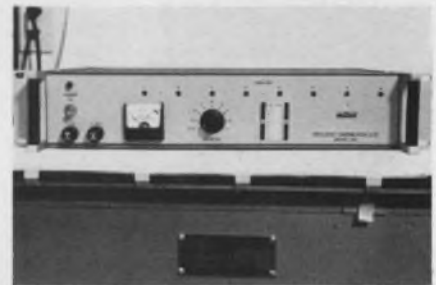

Tracor, Inc., 6500 Tracor Lane, Austin, Tex. Phone: (512) 926-2800.

This unit features modular construction, adjustable gain, low distortion, output level monitoring, short-circuit protection and instantaneous switchover to an external dc standby supply should ac power fail. The modules, which plug in from the rear of the unit, are available in frequencies of 5 MHz, 1 MHz and 100 kHz. There are two outputs available from each module, with either output capable of delivering a minimum of one volt rms to a 50- Ω load at the end of a 300-foot length of RG 58/U cable.

Booth No. 2205 Circle No. 296

**WORLD'S LARGEST SELLING
AND WORLD'S NEWEST**

Hand Size v·o·m's

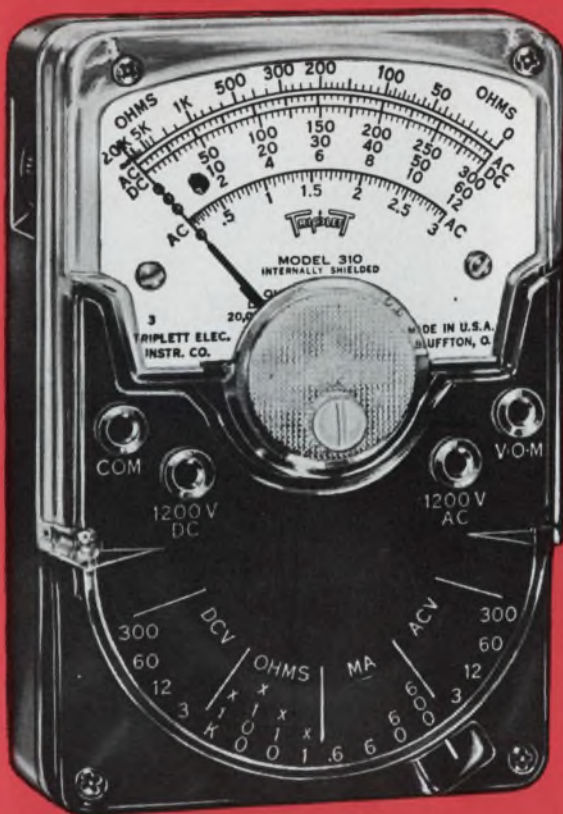

MODEL 310
World's Largest Selling
Volt-Ohm-Milliammeter

MODEL 310-C
World's Newest
Volt-Ohm-Milliammeter



**BOTH TESTERS
SHOWN
ACTUAL SIZE**

- 1** **HAND SIZE AND LIGHTWEIGHT**, but with the features of full-size V-O-M's.
- 2** **20,000 OHMS PER VOLT DC; 5,000 AC (310)—15,000 AC (310-C).**
- 3** **EXCLUSIVE SINGLE SELECTOR SWITCH** speeds circuit and range settings. The first miniature V-O-M's with this exclusive feature for quick, fool-proof selection of all ranges.

SELF-SHIELDED Bar-Ring instrument; permits checking in strong magnetic fields. FITTING INTERCHANGEABLE test prod tip into top of tester makes it the common probe, thereby freeing one hand. UNBREAKABLE plastic meter window. BANANA-TYPE JACKS—positive connection and long life.

Model 310—\$42.00 Model 310-C—\$53.00 Model 369 Leather Case—\$4.00

ALL PRICES ARE SUGGESTED U.S.A. USER NET, SUBJECT TO CHANGE

THE TRIPLETT ELECTRICAL INSTRUMENT COMPANY, BLUFFTON, OHIO

310-C PLUS FEATURES

1. Fully enclosed lever range switch
2. 15,000 Ohms per volt AC (20,000 O/V DC same as 310)
3. Reversing switch for DC measurements

MODELS 100 AND 100-C

Comprehensive test sets. Model 100 includes: Model 310 V-O-M, Model 10 Clamp-on Ammeter Adapter; Model 101 Line Separator; Model 379 Leather Case; Model 311 leads. (\$78.00 Value Separate Unit Purchase Price.)

MODEL 100—U.S.A. User Net...\$74.00
MODEL 100 - C — Same as above, but with Model 310-C, Net.....\$84.00



USES UNLIMITED: FIELD ENGINEERS • ELECTRICAL, RADIO, TV, AND APPLIANCE SERVICEMEN • ELECTRICAL CONTRACTORS • FACTORY MAINTENANCE MEN • ELECTRONIC TECHNICIANS • HOME OWNERS, HOBBYISTS
THE WORLD'S MOST COMPLETE LINE OF V·O·M's • AVAILABLE FROM YOUR TRIPLETT DISTRIBUTOR'S STOCK

THE MOST ACCURATE and SIMPLEST WAY:

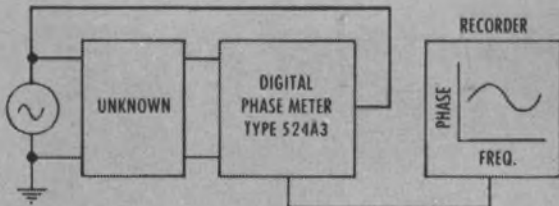

Read phase angle in 4-digits and automatically plot phase curve vs. frequency from 10 Hz to 500 KHz.

DIGITAL PHASE METER Type 524A3

Phase angle in degrees directly represented in four digits. No amplitude adjustment. No frequency adjustment. Analog output available for external recorder or programmable systems. Accuracy $\pm 0.03^\circ$. Phase response from 5 Hz to 500 KHz.

Write for free technical bulletin—
"DIGITAL PHASE MEASUREMENT"



WORLD FAMOUS IN PHASE-TIME MEASUREMENT

ADYU ELECTRONICS, INC.
249 TERHUNE AVE., PASSAIC, N. J.
PHONE: (201) 472-5622
CABLE: ADYU PASSAIC

"See our Booth No. 3302 at the Wescon Show"
ON READER-SERVICE CARD CIRCLE 141

Narrow marker plug-in triples in brass



Kay Electric Co., Maple Ave., Pine Brook, N. J. Phone: (201) 227-2000.

Essentially a fancy marker plug-in unit using ICs, this device is a complex frequency marking system consisting of:

- a direct reading variable pulse marker a few Hz wide and accurate to $\pm 0.05\%$.
- a slave pulse marker that can be accurately and simultaneously set a few Hz away.
- a mixer-amplifier providing all marker coupling and 30-dB preamplifier gain.

Designed to operate in Kay's sweep generator, the plug-in covers a frequency range from 100 kHz to 70 MHz, providing pulse markers whose width is approximately 0.5% of total sweep display over a wide range of sweep widths and sweep rates. It is narrow enough to mark filters a few Hz wide. A three-digit, ten-turn dial provides readability of an Hz from 100 kHz to 1 MHz, of 10 Hz from 1 to 10 MHz and of 100 Hz from 10 to 70 MHz. Accuracy increases linearly on each of these ranges from the $\pm 0.05\%$ spec to $\pm 0.005\%$ at the high frequency end.

Incremental dial accuracy (and the accuracy of the spacing between markers) is better than 2%. The 30-dB gain mixer-amplifier provides input impedance of 100 M Ω , variable gain and an output of 4 volts peak to peak into a 500- Ω load.

Booth No. 2804 Circle No. 284

why should you buy a relay that promises less ?

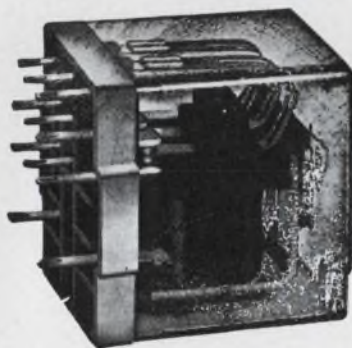

Because this one—the Guardian 1220—promises less of the things you *don't* want. Like wasted space, breakdowns, and high cost. The

1220 is an extremely compact relay. It has a new "Uni-Guard" one-piece switch that eliminates many internal solder connections.

The terminal panel is used as the male plug, dispensing with radio-type plug, extra wiring, and sub-assembly. This advanced design boosts dependability, because with fewer parts, there are fewer reasons for breakdown. The U.L. recognized, 10 amp. DPDT or 3PDT 1220 is tightly enclosed (so, no problems from dust or moisture), and it's available from stock. Price? Only \$1.85 in quantities. Write today for our free Bulletin B4—it includes full technical specs, dimensions, mounting variations.

GUARDIAN  **ELECTRIC**

1550 West Carroll Avenue, Chicago, Illinois 60607

ON READER-SERVICE CARD CIRCLE 142

Argon ion laser based on rf induction



Spectra-Physics, 1255 Terra Bella Ave., Mountain View, Calif. Phone: (415) 961-2550.

This unit is based on Spectra-Physics' method of rf induction excitation of ion-laser discharges. In this method, a radio frequency H field is air-coupled to a closed-circuit laser tube so that the plasma forms the equivalent of a one-turn secondary winding of an rf transformer. This ensures a long life time of the plasma tube, far in excess of the dc cathode type of plasma excitation.

Booth No. 2922 Circle No. 295

Transmit-receive pair for fm relay links

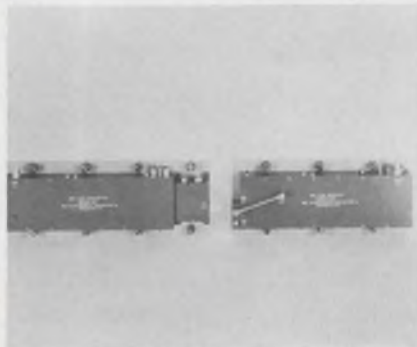

RHG Electronics Laboratory, Inc., 94 Milbar Blvd., Farmingdale, N. Y. Phone: (516) 694-3100. P&A: \$5900; 8 wks.

Fm transmitter and receiver combinations are intended to be used as basic modules in relay links. They provide a microwave relay capability in a volume of 75 cubic inches each. Standard units are available from 1.4 to 2.3 GHz and offer baseband response to 4.5 MHz. System performance is compatible with EIA and CCIR standards for monochrome TV.

Booth No. 3607 Circle No. 277

Vhf-uhf varactors break down at 120 V



Alpha Industries, Inc., 381 Elliot St., Newton Upper Fall, Mass. Phone: (617) 969-8480.

A high power varactor suitable for vhf and uhf multipliers has high input and output power levels. The type 1210 of the 1200 series exhibits the following specifications: minimum and maximum junction capacitance of 5 to 10 pF, maximum series resistance of 3.5 Ω, maximum thermal resistance of 15°C/W and breakdown voltage of 120 V minimum.

Booth No. 3615 Circle No. 274

Pre-TR/TR tube protects TWTs

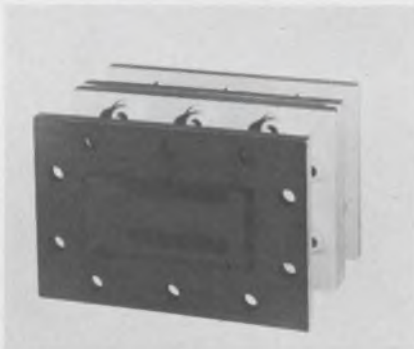

Microwave Associates, Burlington, Mass. Phone: (617) 272-3000.

A dual pre-TR/TR tube provides positive receiver protection for traveling wave tubes. The S-band tube covers a frequency range of 3.35 to 3.65 GHz and operates at a maximum peak power of 750 kW with a maximum recovery time of 30 μs. The compact package provides for an insertion loss of 0.5 dB. It is designed for use in air search radar systems.

Booth No. 3723 Circle No. 269

Solid-state oscillators for fm relay links

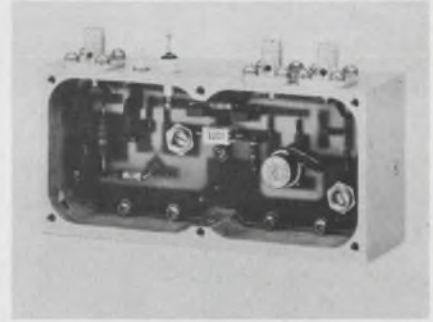

RHG Electronics Laboratory, Inc., 94 Milbar Blvd., Farmingdale, N. Y. Phone: (516) 694-3100. P&A: \$995; 30 days.

Capable of being frequency modulated at baseband rates to 12 MHz, this oscillator is used as the basic exciter unit in wideband microwave relay systems. Oscillators are available from 250 to 380 MHz, and can be deviated over 9 MHz with linearity of 2%.

Booth No. 3607 Circle No. 271

Voice, data recorder weighs five pounds



Leach Corp., 717 N. Coney Ave., Azusa, Calif. Phone: (213) 334-8211.

A cartridge-loaded voice and data recorder/reproducer measures only 7 x 4.5 x 4.5 inches and weighs five pounds. The 4-channel cartridge-load unit eliminates complicated tape threading and assures simple tape changes. Each cartridge holds 260 feet of 1/4-inch magnetic tape. The unit will record and reproduce at speeds up to 30 ips.

Booth No. 3005 Circle No. 270

Nexus devises
6 new operational
amplifiers...each
of which may bring
a little happiness
into the life of a
hard-pressed
engineer



3 low-cost, high-performance OP AMPS

These three nifty little modules give better temperature characteristics and lower input bias currents than you would believe possible for the price. Just try to find anything else in the ballpark that comes close to these typical specifications:

TYPICAL PERFORMANCE @ 25°C

	Q-101	Q-102	Q-103
Output	$\pm 11V/\pm 5.5mA$	$\pm 11V/\pm 5.5mA$	$\pm 11V/\pm 2.5mA$
Input \bar{z} Diff.	1 Megohm	1 Megohm	5 Megohms
Input Bias Current	$\pm 3nA$	$\pm 3nA$	$\pm .5nA$
Bias Current Drift	$\pm 0.4nA/^{\circ}C$	$\pm 0.4nA/^{\circ}C$	$\pm .05nA/^{\circ}C$
Initial Offset Voltage (Ext Trim)	$\pm 0.2mV$	$\pm 0.2mV$	(Ext Trim)
Max. Drift vs Temp.	$15\mu V/^{\circ}C$	$15\mu V/^{\circ}C$	$15\mu V/^{\circ}C$
-A Version	$5\mu V/^{\circ}C$	$5\mu V/^{\circ}C$	$5\mu V/^{\circ}C$
List Price	\$22	\$25	\$22
-A Version	\$25	\$28	\$25

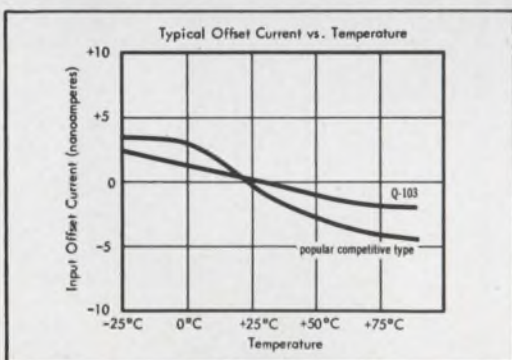

1 lowest-cost FET OP AMP

FET prices have gone ffft with the new Nexus QFT-5 which sells for \$22 in moderate quantities.

TYPICAL PERFORMANCE @ 25°C

Output	$\pm 11V/\pm 5.5mA$
Input impedance	10^{10} ohms
Gain	100,000
Drift	$50\mu V/^{\circ}C$
Gain-bandwidth	2MHz
Slewing rate (full output)	$5.0V/\mu s$

SEE ALL THESE GREAT NEW
OP AMPS AT WESCON BOOTH 2420

Prices F. O. B. Canton, Mass, U. S. A.

2 ultra-fast differential OP AMPS

Both these new units, the FSL-4 and FSL-5 can handle inverting, non-inverting or differential functions with full output at frequencies up to 1 MHz.

- Smooth Loop Dynamics: 6dB/Octave Roll-off
- $60V/\mu s$ Slewing, Either Inverting Or Non-Inverting
- 4 μs Settling Time To 0.1% With 20 Volt P-P Square Wave Output
- $\pm 0.2nA/^{\circ}C$ Maximum Input Bias Current Drift (FSL-5)
- $\pm 10\mu V/^{\circ}C$ Maximum Offset Voltage Drift (FSL-5)
- ± 10 Volt @ $\pm 20mA$ Output

The following test photos compare FSL-4 performance with a typical competitive (Brand X) unit.

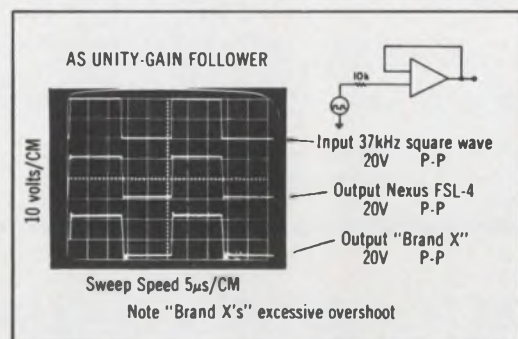
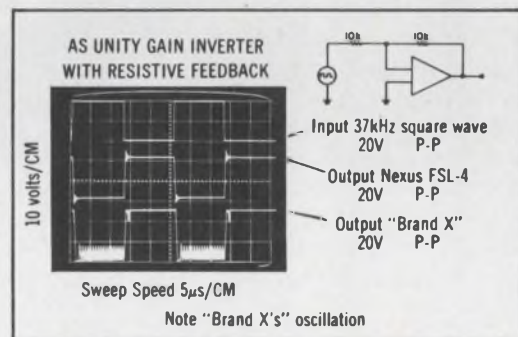

 **NEXUS**
A TELEDYNE COMPANY

480 Neponset St., Canton, Mass. 02021, Tel: (617) 828-9000 TWX (710) 348-1323

Johnson Introduces Two NEW Components to save space, cut costs!

1. Save space with new, horizontal-mounting, printed circuit, type "U", machined-plate capacitors. Available in various sizes, with capacity values ranging from 1.2 pf to 24.5 pf, these tiny trimmers provide tuning accessibility from edge of board. Printed circuit boards can be close-spaced, resulting in compact equipment designs. TC—plus 45 ± 15 PPM/ $^{\circ}$ C. "Q"—greater than 1500 at 1 MHz. All metal parts silver plated. Famous Johnson quality throughout.

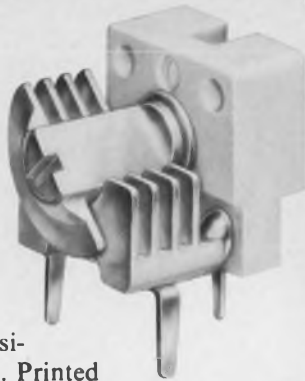

2. Cut costs with new, Johnson RIB-LOC™ Tip Jacks that save production line time with *press-in* design. No mounting hardware to assemble or handle. Simple insertion tool presses Tip Jack into pre-drilled chassis hole for a secure mount that resists loosening and turning. Jack accepts 0.080" tip plug in a recessed, closed-entry type contact. Insulating body is molded of low-loss polyamide. Brass solder terminal is silver-plated and Iridited. Low cost.



**SEE 'EM AT WESCON
BOOTH 5326 AT THE COW PALACE**

*Stop in for details and specifications
on all Johnson Components*



E. F. JOHNSON COMPANY
3346 Tenth Ave. S.W., Waseca, Minnesota 56093

ON READER-SERVICE CARD CIRCLE 145

COMMUNICATION & DETECTION

Beacon magnetron compact, powerful

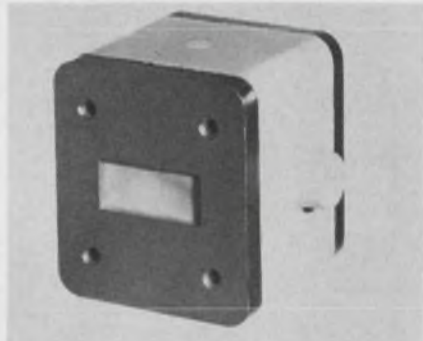

*Microwave Associates, Burlington,
Mass. Phone: (617) 272-3000.*

A compact 7-kW fixed-frequency X-band beacon magnetron weighs 21 ounces. It is designed to operate at a fixed frequency in the 8.5-to-9.6-GHz range with a 0.5 μ s pulse width and an 0.005 duty ratio. Input connections are made through flexible leads or solder lugs and the output connector mates with a UG-3/9U cover flange. This unit is designed for beacon and navigation systems, radar detection applications, missile ground support equipment, transponders and airborne radar applications.

Booth No. 3723 Circle No. 268

Glass tuning varactors have Q to 1000



*American Electronic Laboratories,
Inc., Colmar, Pa. Phone: (215) 822-
2929.*

DO-7 glass tuning varactors are designed for electronic tuning applications in equipment operating at frequencies up to 3 GHz. The units display a Q of 1000. They are suited for hand-solder or stripline insertion. The capacitance ratios, up to 5.2:1, make it possible to design resonant circuits which are tunable over octave bands. The varactors are available in a capacity range from 4 to 27 pF.

Booth No. 5106 Circle No. 276

POWER SUPPLIES UNLIMITED

at WESCON Booth 2218.



See 15 NJE power supplies.
Get the lowdown on 216 more.

There's no guessing when you select a power supply from NJE's huge line. No "goofs"! The NJE line covers any conceivable power requirement you may have, so you don't have to underbuy or overbuy. What's more, NJE's slotted supplies narrow the ranges, so you don't have to pay extra for power you can't use. To see just how easy power supply selecting can be, visit us at WESCON Booth 2218.

IMMEDIATE DELIVERY

NJE CORPORATION
Electronic Development & Manufacturing

Kenilworth, New Jersey 07033 / (201) 272-6000
Telefax: FFP • TWX: (201) 276-7630

A SUBSIDIARY OF

CONDEC

CORPORATION

See these NJE power supplies at WESCON Booth 2218.

SVC line NJE all-silicon power supplies provide voltage and/or current regulation for lab or system use. Available in Lab-Rak laboratory bench units, rack adaptable, or full rack construction. 0-40 VDC/0-5 Amps/.01% Reg./1 mv RMS Ripple.



Model SVC 40-5-M

NJE's custom capabilities include design and manufacture of multiple output power supplies for use in systems requiring more than one voltage simultaneously. SIX 20 VDC/0-1.5 Amps/.01% Reg./1 mv RMS Ripple.



Model C6S-20SR1.5

SY "system" NJE power supplies provide the regulation and ripple usually only found in high-cost lab equipment. Unique design provides the maximum power at the lowest dollar-per-watt ratio, but still incorporating "wide slot" adjustment range. 10-36 VDC/0-30 Amps/.01% Reg./1 mv RMS Ripple.



Model SY 36-30-M

312

ON READER-SERVICE CARD CIRCLE 146

THE FIRST



FLAT PACK RELAY

NEW from BRANSON -

TO-87 RELAY

This TO-87 size relay creates new design flexibility and capability in low profile applications including circuit boards, packaging with semiconductors, part of integrated circuits and hybrid devices, etc. The TO-87 DPDT relay, rated at ¼ amp. at 28 volts, measures 3/8" x 1/4" x 1/10" and weighs 1 gram. It is hermetically sealed and exceeds all applicable MIL specifications.

Send For Complete Detailed Specifications

OTHER BRANSON PRODUCTS . . .



SOLID STATE TIME DELAY RELAY



4 POLE 1/6 SIZE RELAY



6 POLE DT CRYSTAL CAN RELAY



1/2 CRYSTAL CAN 4 PDT RELAY

*Relays...
Our Only Business*

BRANSON CORP.

VANDERHOOF AVENUE
DENVER, NEW JERSEY
(201) 625-0600

SEE US AT WESCON—BOOTH 4104
ON READER-SERVICE CARD CIRCLE 147

COMMUNICATION & DETECTION

Multiplier varactors cover vhf to Ku band



Microwave Associates, Burlington, Mass. Phone: (617) 272-3000.

High-efficiency multiplier varactors cover vhf to Ku-band. The all-silicon epitaxial diffused junction devices have a multiple junction feature, obtained by the series connection of two diodes. Each diode junction is mounted in its own ceramic package and then welded into a single assembly. A typical unit is useable over 5 to 8 GHz with typical output power of 3.5 W.

Booth No. 3723 Circle No. 266

Vacuum coax relay accepts 12 inputs

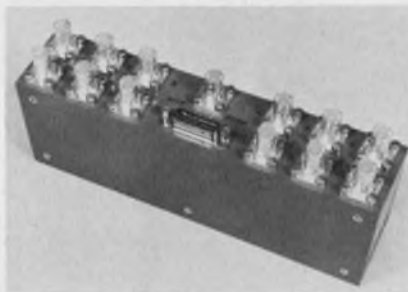

ITT Jennings, P. O. Box 1278, San Jose, Calif. Phone: (408) 292-4025.

A 12-input, common-output vacuum coax relay uses vacuum relays as the interrupting elements. The maximum power switching is limited directly by the BNC type rf connectors. The vacuum construction keeps insertion losses and contact resistance low and isolation of input to input and output to any input high. VSWR at 30 MHz is less than 1.2. In a typical application, a telemetry receiver receives information from 12 separate antennas in any order. Switching speed is 10 ms.

Booth No. 5807 Circle No. 257

Recorder features 8-speed transport

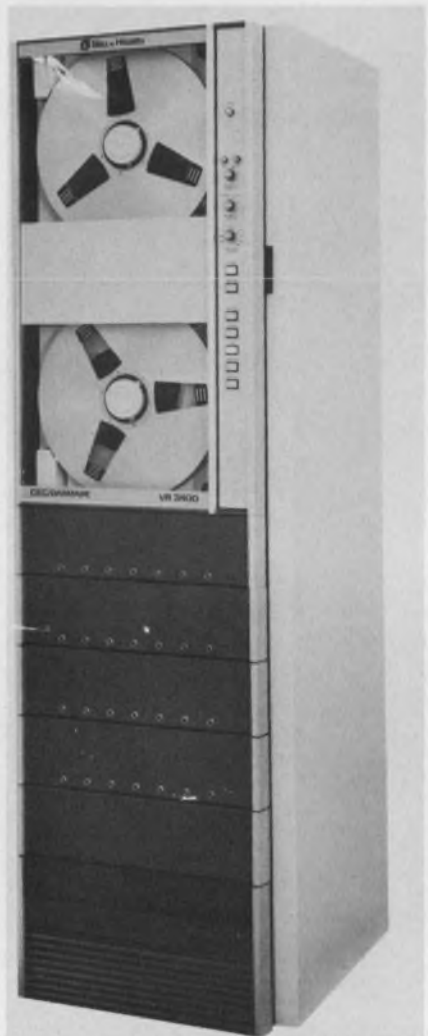

Consolidated Electrodynamics Corp., 1500 Shamrock, Monrovia, Calif. Phone: (213) 796-9381.

A 15-inch reel capacity and recording rates convertible from 100 kHz to 1.5 MHz give this recorder large capacity. All eight bi-directional speeds are automatically selected by one rotary switch, and no adjustments are required throughout the speed range. The electronic capstan control features automatic fail safe operation, assuring continuous recording even in the event of signal loss or minor component failure. The VR-3400 offers direct response to 600 kHz at 120 ips and a low end response of 50 Hz at 1-7/8 ips. Fm electronics permit operation with standard fm (20 kHz at 60 ips) or wideband fm (80 kHz at 120 ips) interchangeably.

Booth No. 3113 Circle No. 323

Now AE gives you complete PC Correed logic modules



The Automatic Electric PC Correed (dry reed switch) is now available as an integral part of a complete printed circuit board assembly. It's made up of type G10 epoxy-glass laminate, 1/16 inch thick, with the necessary PC Correeds and associated components mounted and soldered. The assembly is a complete circuit package—ready for direct insertion into an edge-type connector.

The high-reliability epoxy-glass cards feature copper-nickel-gold circuit paths and standard 0.800 inch card spacing. They're rigidly inspected and tested before shipment.

You give us your circuit—and we'll take it from there! We do the entire packaging to your specifications—including circuitry and artwork.

You get a completely wired circuit module, which eliminates the need to design, assemble and

wire discrete components.

AE's type PC logic modules give the system designer flexibility, reliability and economy. They provide isolation between input and output, and high immunity to electrical noise. Packaged logic circuits are particularly suited for supervisory and telemetering equipment, process controls, check-out and ground support equipment, test equipment and engineering models.

There's a lot of helpful, detailed information in our new 8-page brochure. To get your copy, just write for Circular 1113 to the Director, Electronic Control Equipment Sales, Automatic Electric, Northlake, Illinois 60164.



AUTOMATIC ELECTRIC
SUBSIDIARY OF
GENERAL TELEPHONE & ELECTRONICS **GTE**

ON READER-SERVICE CARD CIRCLE 148

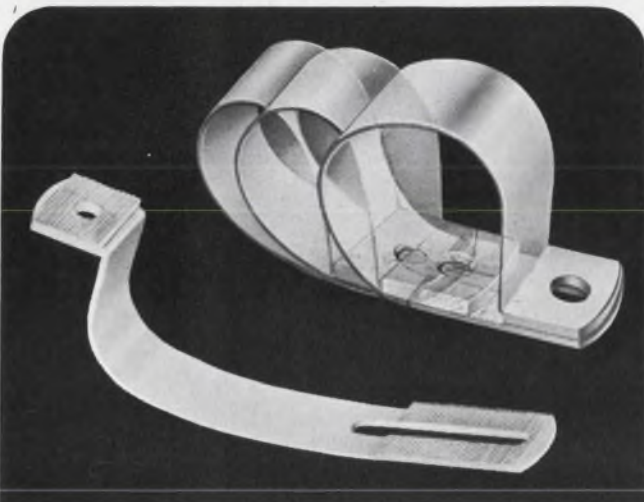

ADJUSTABLE P-CLIPS

Only nine sizes provide controlled tension for all bundle and cable diameters from 1/8" thru 2". Add or remove wires and the same clip can be adjusted to the new bundle diameter. Molded nylon ratchet teeth provide positive locking action — no slip, no slide — even under vibration or shock. Adjustable P-Clips simplify work, ordering, and inventories.

Send for Free Samples

ELECTROVERT INC.

Components Division
86 Hartford Ave., Mt. Vernon, N. Y. 10553
Milwaukee, Wis. • Burbank, Calif.



SOLD COAST-TO-COAST THROUGH AUTHORIZED DISTRIBUTORS

See us at Booth 1111
ON READER-SERVICE CARD CIRCLE 149

REGULATED POWER

FOR SENSITIVE EQUIPMENT



INVERTERS
DC to Quality AC

FREQUENCY CHANGERS
Inferior AC to Quality AC

For mobile and emergency operation of electronic instruments, video tape recorders or other sensitive equipment. Field-proven and available from stock.

- Output: 115 V \pm 5%; 60 \pm .03 sine wave, maximum 6% harmonic distortion
- Input: Inverters—11-15 or 22-30 VDC
Changers—95-125 VAC, 50-500 cps
- 1000, 500, 250 and 125 VA models
- All-transistorized for high reliability, low acoustic noise and instant turn-on
- Used by Industry and Military

SEND FOR
COMPLETE CATALOG



TOPAZ, INCORPORATED
3800 HOUSTON STREET
SAN DIEGO, CALIF. 92110

ON READER-SERVICE CARD CIRCLE 150

C-band magnetron yields 0.5 to 3 MW

Raytheon Co., Waltham, Mass.,
Phone: (617) 862-6600.

Model QKS1343 is an integral magnet tube with waveguide input and output. It covers 5.4 to 5.9 GHz without electrical or mechanical adjustment when used with a modulator having proper load-line characteristics. In typical operation, peak power is 0.5 MW with 15-kW average power output. At 0.03 duty, pulse duration is 200 μ s.

Booth No. 4418 Circle No. 385

Line terminations withstand 10 kW cw

Bird Electronics Corporation, 30303
Aurora Rd., Cleveland. Phone: (216)
248-1200.

Line terminations weighing 6.5 lbs can be bolted to the end of a line in any position. Model 8736 with a 1.625-inch flange and model 8732 with a 3.125-inch flange have cw power ratings of 10 kW with 4 gal/min water cooling. Fifty- Ω units have 1.1 VSWR to 1 GHz and 1.14 VSWR to 1.4 GHz.

Booth No. 2601 Circle No. 386

Circulator tunes 400 MHz to 1.2 GHz

Scientific-Atlanta, P. O. Box 13654,
Atlanta. Phone: (404) 938-2930.
P&A: \$1000; 1 month.

Electrically tunable from 400 MHz to 1.2 GHz, this circulator has an instantaneous bandwidth of greater than 30 MHz. VSWR is below 1.35. The circulator is furnished with a variable-voltage dc power supply and tuning control with linear, direct readout of frequency from 500 MHz to 1 GHz. Tuning from 400 to 500 MHz and 1 to 1.2 GHz is by calibration chart. An external voltage source permits the circulator to be tuned or swept at rates to 60 Hz.

Booth No. 2305 Circle No. 387

DCL*

DESIGNER'S CHOICE LOGIC

Signetics puts IC systems design decisions back in the hands of the systems designer.

Some IC families put severe limits on the decisions the systems designer can make. He's often held back by the speed, power, and noise immunity trade-offs built into the family by the IC manufacturer. Now Signetics Designer's Choice Logic changes all that. Signetics DCL* Series 8000 includes high speed TTL circuits, slower low power TTL circuits that offer high AC noise immunity, and low power DTL circuits that provide high DC noise margins. The series also includes large functional arrays for counting and storage applications. All elements in the 8000-Series are specified compatibly. And we've got a 46-page data

handbook — the most complete one of its kind ever offered — to guide you in using these flexible circuits. In designing with DCL* you can optimize your system performance without drawn-out calculations, expensive and time-consuming ground-plane designs, or extensive use of outboard discrete components. The handbook provides special sections directed to systems, evaluation and design engineers. Find out fast what can be done with our DCL* series, and how to loosen constraints on your designs. Write Signetics for your DCL* handbook: 811 East Arques, Sunnyvale, California 94086.

*SIGNETICS TRADEMARK

**SIGNETICS
INTEGRATED
CIRCUITS**



A SUBSIDIARY OF CORNING GLASS WORKS

SIGNETICS SALES OFFICES: Metropolitan New York (201) 992-3980; Upper New York State (315) 469-1072; Southwestern (214) 231-6344; Western Regional (213) 272-9421; Eastern Regional (617) 245-8200; Mid Atlantic (609) 858-2864; Southeastern (813) 726-3734; Midwestern Regional (312) 259-8300; Northwestern (408) 738-2710.

DISTRIBUTORS: Compar at all locations listed below. Semiconductor Specialists, Inc. (312) 279-1000; Terminal Hudson Electronics (212) 243-5200; Wesco Electronics (213) 684-0880; Wesco Electronics (405) 968-3475; Hammond Electronics (305) 241-6601; Avnet Electronics Corp. of Massachusetts (617) 272-3060.

DOMESTIC REPRESENTATIVES: Jack Pyle Company (415) 349-1266. Compar Corporation at the following locations: Alabama (205) 539-8476; Arizona (602) 947-4336; California (203) 245-1172; California (415) 697-6244; Colorado (303) 781-0912; Connecticut (203) 288-9276; Florida (305) 855-3964; Illinois (312) 775-5300; Maryland (301) 484-5400; Massachusetts (617) 969-7140; Michigan (313) 476-5758; Minnesota (612) 922-7011; Missouri (314) 428-5313; New Jersey (609) 429-1526; New Mexico (505) 265-1020; New York (518) 436-8536; New York (607) 723-8743; New York (716) 684-5731; New York (201) 471-6090; North Carolina (919) 724-0750; Ohio (216) 333-4120; Ohio (513) 878-2631; Texas (214) EM 3-1526; Texas (713) 649-5756; Washington (206) 725-7800.

INTERNATIONAL SALES: France, Germany, Italy, Belgium, Holland, Luxemburg, Spain — Sovcor Electronique, 11, Chemin de Ronde, Le Vesinet, (S.-&O.) France. United Kingdom, Ireland, Sweden, Denmark, Norway, Switzerland, Austria, Portugal — Electrosil Ltd., Lakeside Estate, Coinbrook-By-Pass Slough, Buckinghamshire, Great Britain. Australia — Corning, 1202 Plaza Building, Australia Square, Sydney, N.S.W. 27-4318. Canada — Corning Glass Works of Canada, Ltd., Leaside Plant, Ontario, Canada (416) 421-150. Israel — Optronix, P.O. Box 195, Ramat Gan, Israel 724-437. Japan — ASAHII Glass Co., Ltd., Corning Products Sales Dept. No. 2, 3-Chome Marunouchi, Chiyoda-ku, Tokyo, Japan.

ON READER-SERVICE CARD CIRCLE 151



MEASUREMENTS



MODEL 500A STANDARD FREQUENCY SYNTHESIZER

- 0 to 100 Kcs
- Smallest digital step .01 cps
- Stability 1 part in 10^6
- Output 0 to 2 volts
- Harmonics below 40 db
- Spurious outputs below 60 db
- Vernier oscillator for continuous frequency sweep
- Provision for remote control
- Modular construction
- All solid-state design

PRICE: \$2850.00 f.o.b. Boonton, N. J.

Laboratory Standards

MEASUREMENTS

A McGraw-Edison Division

P.O. Box 180, Boonton, N. J. 07005

Phone: 201-334-2131

ON READER-SERVICE CARD CIRCLE 152
U188

COMMUNICATION & DETECTION

Four-arm connectors combine rf signals

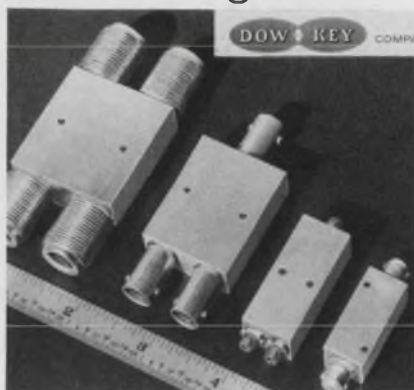

Dow Key Co., 2260 Industrial Lane, Broomfield, Colo. Phone: (303)466-7303.

Matched or standard connectors are used to connect 3 or 4 coax transmission lines. They are commonly used to divide or combine rf signals with any connector used as input or output. They are offered in two basic types: parallel wired similar to standard tee adapters, and resistive match power dividers, where each arm is matched when the other arms are terminated. They are useful up to 1 GHz with VSWR at 1.1 up to 500 MHz and 1.2 to 1 GHz. Power rating is 0.5 W cw, 5 kW peak.

Booth No. 4917 Circle No. 272

Tapped delay line has 5-ns rise time

Bel Fuse, Inc., 198 Van Vorst St., Jersey City, N. J. Phone: (201) 432-0463.

This unit has a total delay of 15 ns with taps every nanosecond and a rise time of less than 5 ns. Designed for printed circuit mounting, the line is available in impedance values of 93, 200 and 500 Ω . The delay line is suitable for many computer applications.

Booth No. 4910 Circle No. 273

For a complete listing of the technical papers at the show, see page U 112. For reprints of most of the papers, fill out the order form on page U 115.

Compact unit converts digital to synchro



AstroSystems, Inc., 6 Nevada Dr., New Hyde Park, N. Y. Phone: (516) 328-1600. P&A: \$1000 to \$2500; 6 to 8 wks.

This unit accepts a parallel 10-bit binary angle and provides a synchro output equivalent to the digital input. Inputs are compatible with microelectronic logic levels at updating speeds to 10,000 words per second. The conversion technique uses toroidal transformers and solid state ac switches to drive a load without the use of amplifiers. The unit provides a standard 3-wire synchro output signal of 11.8 volts at 400 Hz completely isolated from ground and input. Serial and parallel interfaces can be accommodated. Accuracy from no load to full load is 0.5° . The unit mounts in a RETMA rack.

Booth No. 4522 Circle No. 275

Switching modules drop into coax line

Hewlett-Packard, 1501 Page Mill Rd., Palo Alto, Calif. Phone: (415) 326-7000. P&A: \$100 to \$175; stock.

Hermetically sealed switching modules in HP's 3600 series are packaged as coax sections that can be inserted as part of a coax line. The units have a dc-to-18-GHz bandwidth, 0.5-to-2.2-dB loss and 1.5-to-2.3 VSWR. They can be brazed, clamped or pressed into place and match semirigid lines with 0.141- and 0.188-inch ODs. They can be adapted to 0.276-inch OD lines. Switching speed runs 10 to 50 ns.

Booth No. 2909 Circle No. 384

NEW

NPN / PNP HI-QUALITY! HI-VOLTAGE! SILICON TRANSISTORS

...Attention Designers! Satisfy Your Most Demanding High Voltage Requirements with the Following Premium Devices From...



NPN

TO-5 OUTLINE	V_{CER} V_{CBO}	V_{CEO}	I_{CBO}	$V_{CE(SAT)}$
2N5092	400V	350V	500NA	0.5V
2N5095 2N5101*	500V	400V	500NA	0.5V
2N5097	600V	450V	500NA	0.5V
2N5098	700V	500V	500NA	0.5V
2N5099	800V	550V	500NA	0.5V

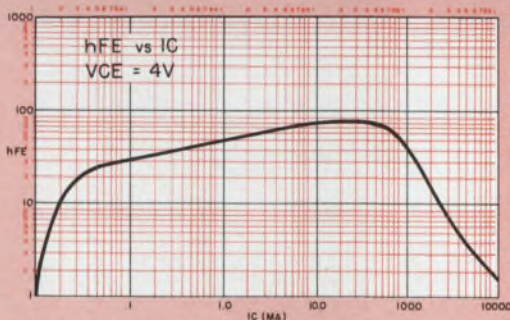

$h_{FE} > 25$ from $I_C = 1.0$ MA to I_C 100 MA

*MD-14 OUTLINE

PNP

TO-5 OUTLINE	V_{CER} V_{CBO}	V_{CEO}	I_{CBO}	$V_{CE(SAT)}$
2N5091	350V	300V	500NA	3.0V
2N5093	400V	350V	500NA	3.0V
2N5094 2N1510*	450V	400V	500NA	3.0V
2N5096	500V	450V	500NA	3.0V

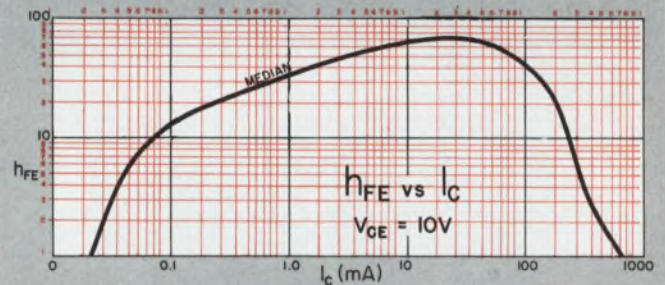

$h_{FE} > 20$ from $I_C = 1.0$ MA to I_C 100 MA

*MD-14 OUTLINE



INDUSTRO TRANSISTOR CORP.

35-10 36th Avenue • LONG ISLAND CITY, NEW YORK 11106
TELEPHONE (212) 392-8000

ON READER-SERVICE CARD CIRCLE 153



This is the fastest clutch or brake in the world!

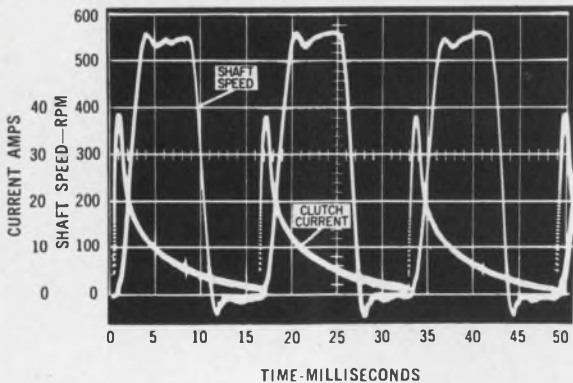
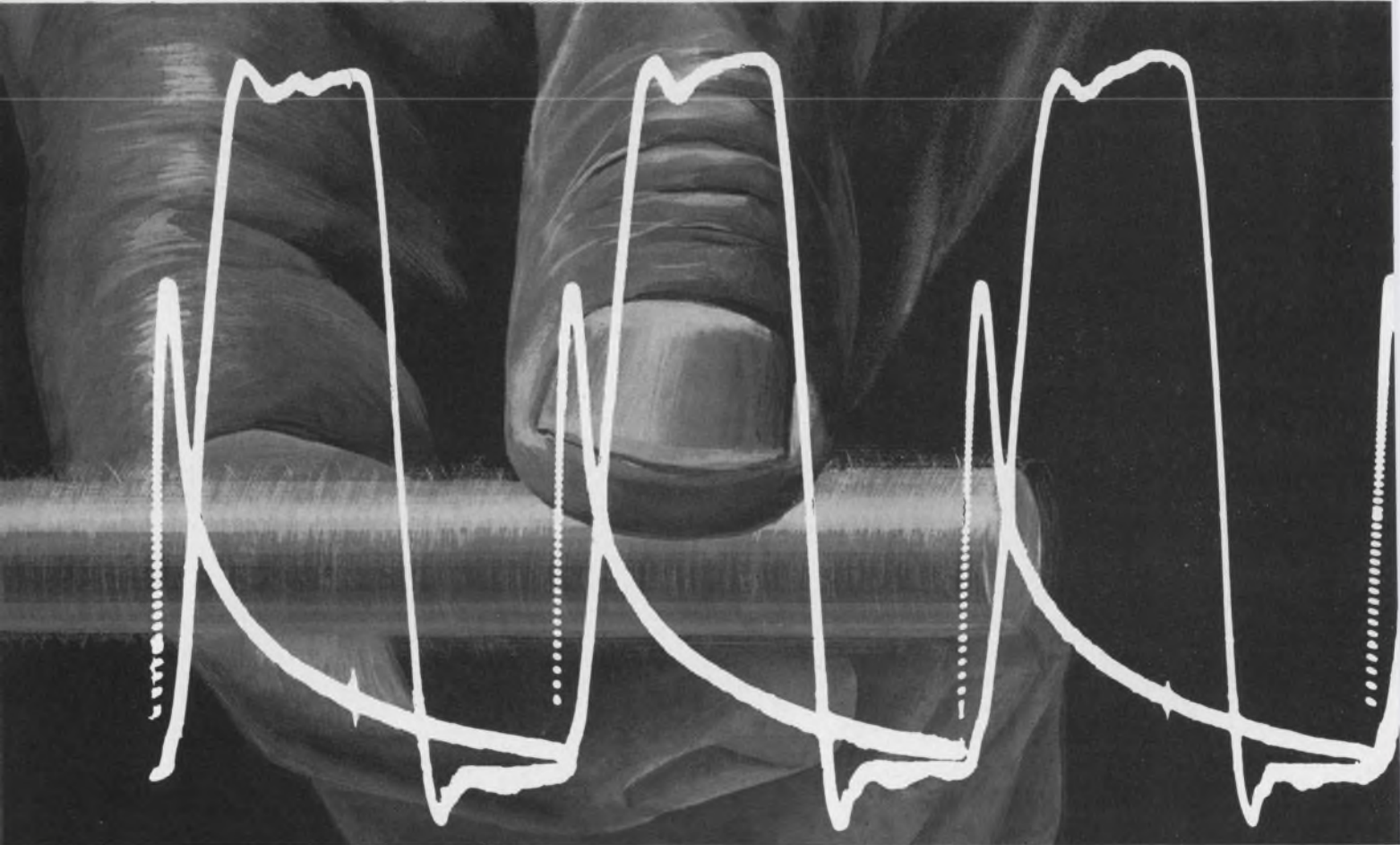

The **FASTEP** offers the fastest response on the market today. This scope picture illustrates the capability of a **FASTEP** clutch and brake to perform a high speed indexing function. The rate is 60 steps per second and the external inertial load is 100×10^{-5} lb. in. sec.². When the slope of the shaft velocity trace becomes a straight line, full torque has been achieved. In this case, it is less than $1\frac{1}{2}$ milliseconds from signal for constant acceleration, or full torque.

**RESPONSE SO FAST YOU CAN HARDLY FEEL IT . . .
PROVE IT ON YOUR OWN SCOPE!**

LSI's **fastep** clutch represents a new state-of-the-art in Magnetic Particle units. Used as either a clutch or a brake, it attains fast response yet it doesn't sacrifice the inherent advantages of soft starts and stops. Its capabilities include long life and repeatability. In fact, customer tests have substantiated life expectancy of over 500 million cycles. LSI magnetic particle clutches and brakes are used in a variety of applications including tape drives, numerical control, printers, remote actuation, tensioning devices and business machines.

LEAR SIEGLER, INC.



POWER EQUIPMENT DIVISION
P.O. BOX 6719 • CLEVELAND, OHIO 44101
Phone 216-662-1000

**You've
got to
see it
to believe it!**

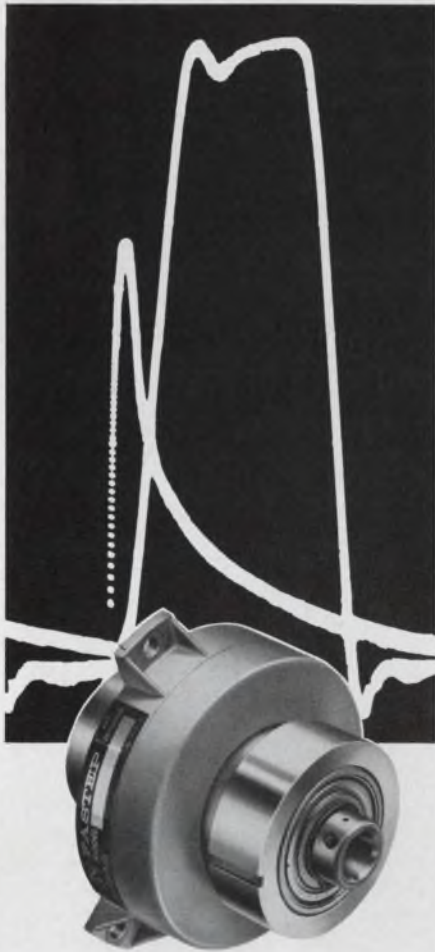

You can, because we'll have our *fasted* Magnetic Particle units in operation at our booth during the WESCON Show. So come in and see for yourself this amazing performance.

WESCON SHOW
AUGUST 22-25
SAN FRANCISCO
BOOTH 2013



ON READER-SERVICE CARD CIRCLE 154
ELECTRONIC DESIGN 17, August 16, 1967

COMMUNICATION & DETECTION

**Latching switches
carry 500 V rms**



Microwave Associates, Burlington, Mass. Phone: (617) 272-3000.

Specs of this 500-V latching switch include 60-dB interposition isolation from dc to 12.4 GHz, VSWR of 1.5 and insertion loss of 0.5 dB. Units can be stacked side-by-side for multichannel double-throw and other multiple switching uses. Latching is advantageous in applications in which switching power drain must be limited.

Booth No. 3723 Circle No. 374

**X-band multipliers
for fm transmitters**

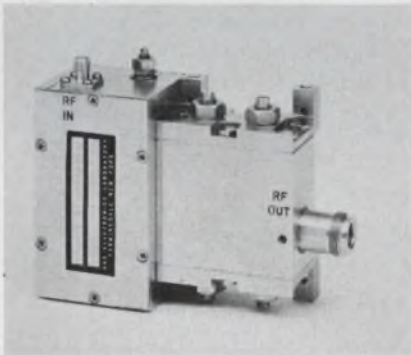

RHG Electronics Laboratory, Inc., 94 Milbar Blvd., Farmingdale, N.Y. Phone: (516) 694-3100. P&A: \$1495; 6 to 8 wks.

These units provide output powers to 2 watts in S band, 1 watt in C band, and 1/2 watt in X band. The use of step-recovery varactor multiplier diodes, coupled with an integral cavity filler assembly, provides efficiency with low spurious content.

Booth No. 3607 Circle No. 377

**Amersil
Fused Quartz
Tubing
Quality
Ensures
Dependability**

Use Amersil fused quartz for furnace muffles in temperatures up to 1400°C for

**DIFFUSION
CALCINING
SINTERING
DEPOSITION**

Economical operation is possible because of low inclusion content, high purity, and resistance to devitrification.

Sizes

Transparent
.040" to 9" dia.

Opaque
.125" to 25" dia.



685 RAMSEY AVENUE
HILLSIDE, NEW JERSEY 07205

ON READER-SERVICE CARD CIRCLE 155

U191

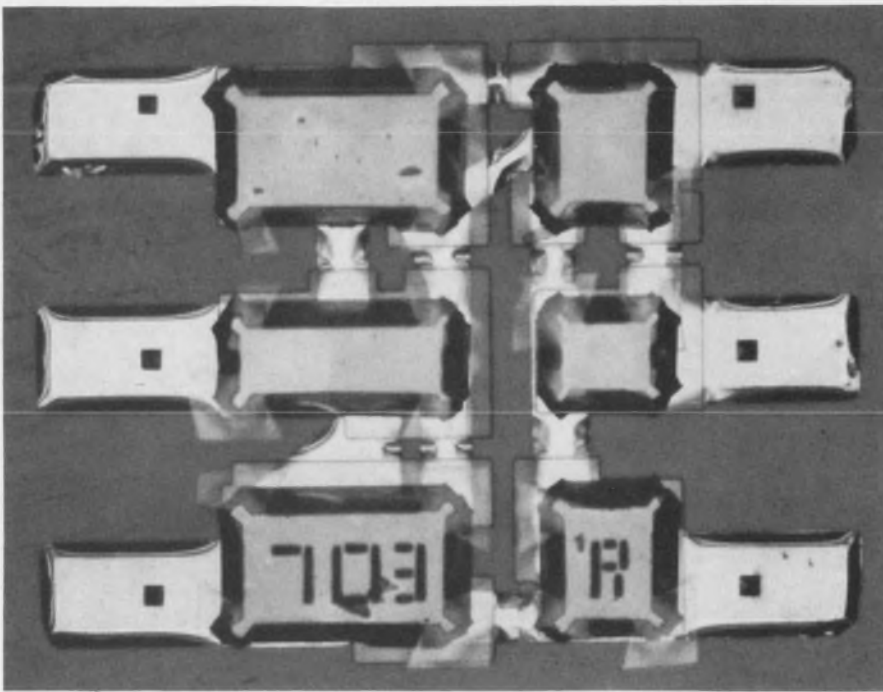

Beam leads, air isolation push 703 past 1 GHz for unity gain

Raytheon Semiconductors, 350 Ellis St., Mountain View, Calif. Phone: (415) 968-9211. P&A: about \$5 for military market; 8 wks (sample quantities).

A beam-lead version of the standard 703 rf-i-f amplifier has been developed by Raytheon Semiconductors. Using air-isolation to reduce parasitics, the circuit's unity-gain

frequency is pushed past 1 GHz.

The microcircuit's four resistors and two transistors are isolated from each other by air. Each component occupies its own little island of silicon, and the silicon islands are held together by thick gold leads, which also form the contacts.

The isolation of its components allows the rf amplifier a substantially higher frequency response

than its p-isolated counterpart. The latter's gain, for example, falls off to unity at about 100 MHz; the beam-lead version reaches 1 GHz.

Though the gold leads themselves are electroformed in the same way as the Bell Labs' beam leads (ED 4, Feb. 15, 1967, p. 17) the metallurgy that bonds the leads to the chip and makes good ohmic contact with the silicon is somewhat different. Where the Bell Labs method uses layers of platinum, titanium, and platinum between the gold lead and the glass, the Raytheon method uses a single layer of chromium. Where the Bell Labs method forms platinum silicide in the contact hole to insure low resistance between the silicon and the gold lead, Raytheon substitutes a different metal, which they choose not to reveal.

The advantage of the Raytheon system is that it does not require the use of sputtering or back-sputtering in the production of the chip. Instead, metal can be vapor deposited just as in the production of an ordinary circuit. Raytheon feels that the simplified production requirements of its metallurgy make it a natural for the development of high-volume, high-performance microcircuits.

The primary market for the new devices is expected to be in the area of military or satellite communications equipment. Since the air-isolation eliminates the substrate leakage currents, the beam-lead devices are much more resistant to high-radiation environments than are standard units.

Booth No. 4418

Circle No. 461

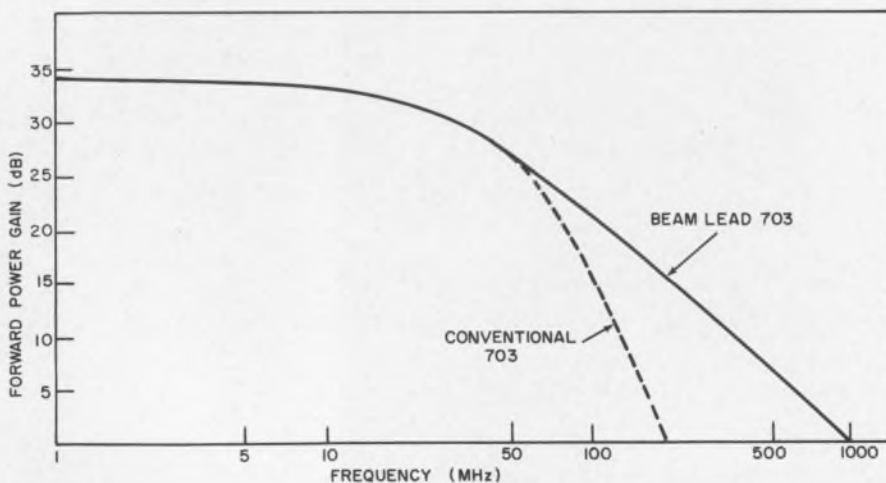

Reduced parasitics associated with air isolation improve roll-off of the 703. The 0-dB gain frequency moves from less than 200 MHz to past 1 GHz with 6-dB/octave roll-off. Component geometry itself is unchanged from the standard 703 layout.

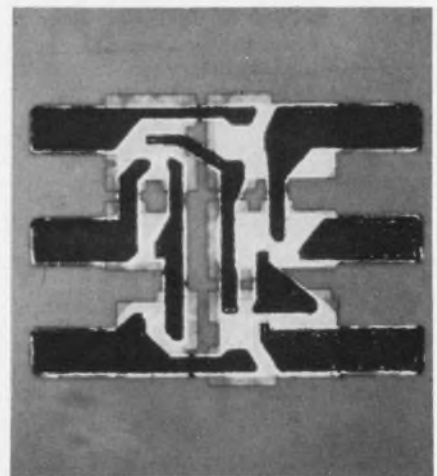

'Bottom' view of the 703 shows thick gold leads (dark areas). Corresponding light areas on chip photo above are chromium.

Support your local Resistance.



	Multi-purpose instruments			Resistance Bridges			Ratio/Deviation Bridges		
Model	250 DE	292	300	231	232	242	122	500	261
Range	.1Ω-12MΩ	.1Ω-1.2MΩ	.01Ω-500MΩ	.01Ω-12GΩ	.1Ω-500MΩ	.001Ω-120MΩ	.001Ω-100MΩ	.1Ω-111MΩ	10Ω-2MΩ
Accuracy	.1%	.05%	.02%	.01%	.01%	50ppm	0.2ppm	.01%	.1%
Price	\$475	1380	875	2050	1075	3500	4000	2595	Appr. 350
Comments	R, C and L	R, C, L and G	R, E, I and Ratio			Ratio and deviation ranges	1:1, 10:1 ratios	Deviation ranges ±10% to ±.01%	1:1 ratio ±1%, 5%, 20% ranges

Resistance measurement is very much a local matter, requiring resistance measuring instruments designed to match your local needs. Whether the job is production testing, on-line inspection, or laboratory calibration and certification—you want an instrument specifically tailored to the task.

The chart illustrates the wide range of approaches ESI can offer to meet your resistance measuring needs. Among them, you're sure to find the ranges, accuracies and special features that suit your particular application. In many cases, you may be able to answer a number of different electronic measurement requirements in a single multi-purpose instrument.

It's not by chance that every major manufacturer of precision resistors uses an ESI measuring instrument. You'll find, as they have, that ESI instruments are fast and easy to use. And they give you the greatest reliability and accuracy for your dollar. That's a good local cause to be supporting, ESI, 13900 NW Science Park Drive, Portland, Oregon 97229.

Electro Scientific Industries Inc. **esi**[®]
WESCON Booths 2717-18

ON READER-SERVICE CARD CIRCLE 156

NOW! Narrowband active filters with 20 and 24 Hz spacing from 350 to 3500 Hz.



Bundy's active filters makes available more frequencies for more channels.

Active bandpass filters in channel spacings of 20 Hz from 385 to 3495 Hz and 24 Hz from 353 to 3503 Hz. The 20 Hz active filter has a bandwidth of 5 Hz and a crossover attenuation of 12 db. The 24 Hz active filter has a 10 Hz bandwidth and 18 db crossover attenuation. That's a lot of performance in a package just 2" x 1 1/2" x 3/4".

Write for technical bulletin No. B-101.

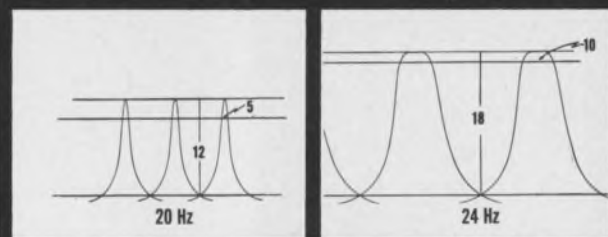

Fadem Road • Springfield, N. J. 07081
Telephone: (201) 376-8150

CIRCUIT COMPONENTS

Hybrid mixer/LOs shrink receiver size

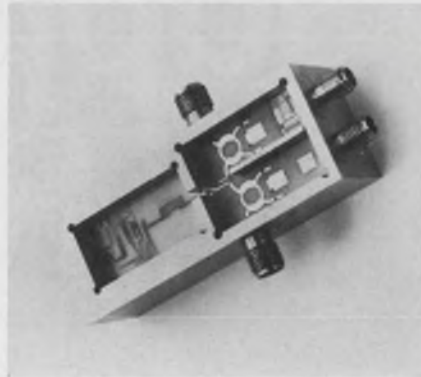

Microwave Associates, Burlington, Mass. Phone: (617) 272-3000.

A solid-state hybrid integrated mixer and local oscillator assembly using microstrip circuitry weighs 2 ounces with dimensions of 1 x 2.3 x 0.75 inches. Incorporated in the device are two Schottky-barrier diode balanced mixers and a transistor preamp in addition to an integrated microstrip local oscillator. This portion of the microwave receiver front end performs all of the mixing functions for the signal and afc channels, signal channel i-f preamplification and local oscillator generation. The two balanced mixers utilize two-element branch line couplers for the 3-dB power dividers and passivated silicon Schottky diode chips are mounted as the semiconductor device element. The balanced mixers have a 9-dB noise figure with an rf-to-i-f gain of 20 dB. The i-f frequency is 150 MHz with a 50-MHz bandpass. The LO module consists of an L-band transistor oscillator that has an output power of 200 mW. The oscillator feeds a X6 varactor multiplier and subsequently a bandpass filter for spurious rejection. The oscillator module has an output of approximately 10 mW at X-band with all spurious signals 30-dB down. An electronic tuning range of over 100 MHz is possible for electronic frequency control in an afc circuit.

The circuits use alumina substrates with the center conductors fired onto the alumina. The conductor is composed of silver, copper and gold. The coupling from substrate to substrate is made by a ribbon jumper soldered between the 50-Ω center conductors.

Booth No. 3723 Circle No. 259

Buy this ten dollar Philbrick Operational Amplifier

...and let everyone think
you paid twenty.
They'll believe it,
when they see
its performance.

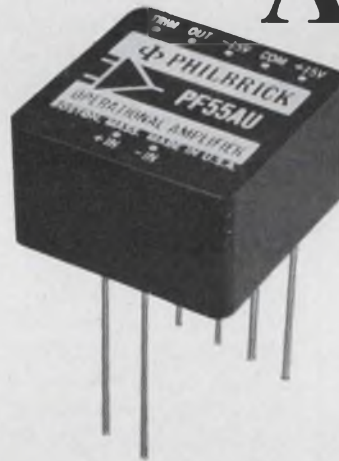

Plain language—our low prices come from volume-production savings and new packaging efficiencies. Others achieve them by cutting corners—thereby making your design job more expensive, more difficult, and more restricted.

Here's what we mean—Economy-Grade Philbricks give you *design resilience* the others don't have. Things like:

Safe, conservative operation at any supply voltage between ± 7.5 V and ± 22 V; a full ± 11 V output swing with a ± 15 V supply (even more at higher supply levels); gain to spare—enough to let you take full advantage of their low offset drifts; remarkably low quiescent power; exceptionally wide stability margins.

We know—that nine times out of ten, you would save money if you paid *twenty* dollars for a resilient Philbrick—but we don't ask you to; just pay what you would for a narrow-margin stiff one. Call us—we've

got what you want, at low prices you'll be surprised to find.

EXAMPLE: This new PF55AU preformed-case epoxy encapsulated miniature has open-loop gain of 40,000 driving $10k\Omega$, 1.5 MHz bandwidth, CMR of at least 1000:1, will slew at 1.5 V/ μ sec, 20 μ V/ $^{\circ}$ C offset limit, and all the resilience described above. It outperforms the cut-spec cheapies, yet it's a genuine Philbrick, through and through. PF55AU price: In lots of 1,000 . . . \$10.00 (even less in larger quantities.)

Send for new Operational Amplifiers price list and 12 page brochure: Bulletin 6111. Philbrick Researches, Inc., 46-G Allied Drive at Rte. 128, Dedham, Mass. 02026.

Phone: (617) 329-1600 TWX: (617) 326-5754.



GOING THE MICROCIRCUIT ROUTE? There's a resilient easy-to-stabilize Philbrick in a modified TO-5 package, too—at only \$6.95 (less in 100-lot quantities or more).

ELECTRONIC ANALOG COMPUTING EQUIPMENT for MODELLING, MEASURING, MANIPULATING and MUCH ELSE

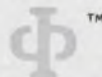

PHILBRICK
A TELEDYNE COMPANY
ON READER-SERVICE CARD CIRCLE 158

The more you need from crystal filters, the more you need Bulova!

Today's sophisticated systems call for filters with "difficult" characteristics. Difficult, that is, for everyone but Bulova! Bulova has had so much experience with crystal filters, there's hardly anything we don't know about them.

Take single side-band filters, for example: Attenuation figures alone are not enough to adequately describe today's military communication filters. More and more filters require limitations on envelope time delay, while others must follow a precise time-delay envelope curve.

Bulova has been testing for these parameters — providing measurements both in terms of phase linearity and, in many cases, directly in envelope time-delay readings. As a result,

Bulova can engineer and produce to the exact measurements you specify. And at a realistic price!

Proof: Here are the actual curves and specs for just one Bulova filter, Model 562.

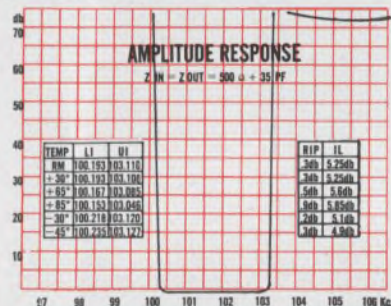
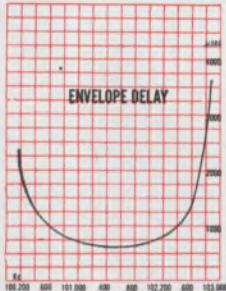

- Bandwidth (1db) 100.255 to 103.035 Kc
- Bandwidth (60 db) 99.990 to 103.260 Kc
- Carrier frequency — is 100 Kc
- Loss at carrier — 55 db min.
- Ultimate attenuation — 70 db
- Max. insertion loss — 6 db
- Max. ripple — 1 db max.
- Operating temperature— -40° to +65°C
- Impedance — 500Ω (in and out)
- Differential envelope time delay — 500 μsec max. over 80% of pass band

With specs like these you can see why we say — the more you need from a filter, the more you need Bulova! Call or write Dept. ED-21.

Try Bulova first!

FREQUENCY CONTROL PRODUCTS

ELECTRONICS DIVISION
OF BULOVA WATCH COMPANY, INC.

61-20 WOODSIDE AVENUE
WOODSIDE, N.Y. 11377, (212) DE 5-6000

ON READER-SERVICE CARD CIRCLE 159
U196

CIRCUIT COMPONENTS

Silicon transistor amplifies to 4 GHz

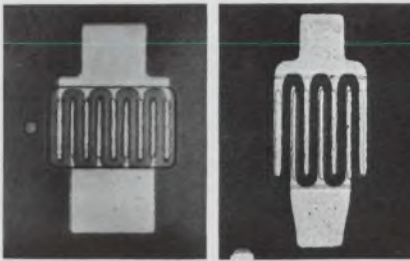

Texas Instruments, Inc., 13500
North Central Expressway, Dallas.
Phone: (214) 238-3741.

A pair of microwave silicon transistors are designed for practical oscillator applications above 4 GHz with a third device useful as an amplifier to 4 GHz, with guaranteed noise and gain performance at 2 GHz. The L-187 and 187A are fundamental oscillators with typical power output (at 4 GHz) of 40 and 75 mW. Both can be tuned over octave ranges, attaining maximum frequency of oscillation of approximately 6 GHz.

The amplifier, L-186, features a typical noise figure of 5 dB at 2 GHz. Common-emitter unneutralized gain under the same operating conditions is 8 dB. Higher gain with a slight increase in noise figure can be obtained by operating the device at 8 V and 5 mA. The 187 and 187A oscillators are also useful as amplifiers, delivering a somewhat higher saturated output than the 186. Gain is similar but noise figure is higher because of the higher operating current.

All three devices are npn double-diffused, epitaxial planar transistors, and all are available in a pill-type package for use in stripline circuitry. The package has common-lead inductance of 0.16 nH, and feedback capacitance of 0.02 pF. The oscillators are connected in a common-base configuration, and the amplifier common-emitter.

Booth No. 4105 Circle No. 357

For a complete listing of the technical papers at the show, see page U 112. For reprints of most of the papers, fill out the order form on page U 115.

Recirculating memory compatible with DTL

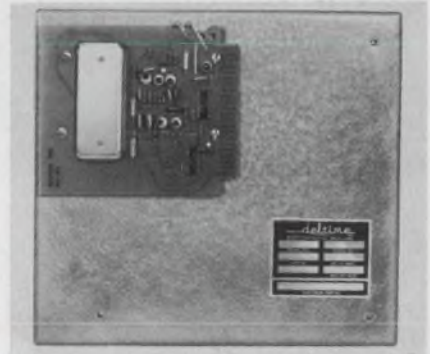

Seaelectro Corp., Mamaroneck, N. Y.
Phone: (914) 698-5600.

Fully compatible with ICs, (DTL 930), this recirculating delay line memory module accepts a variety of delay lines to provide storage capabilities between 20 and 10,000 bits and delays between 20 and 15,000 μs. Applications include sequential information storage for CRT displays, buffer memories for teletype information and programing for numerically controlled machines. The module operates on -10 V dc at 20 mA, +10 V dc at 21 to 56 mA, +5 V dc at 35 mA, and includes trigger, inhibit and clock inputs.

Booth No. 4309 Circle No. 256

Rf power transistors designed 'fail-safe'

Amperex Electronic Corp., Slatersville, R. I. Phone: (401) 762-9000.

Silicon npn rf power transistors feature high power output and high power gain with excellent fail-safe characteristics. The low-voltage devices are intended for use in 12-V battery-operated 175-MHz mobile communication systems. The units are designed to withstand higher current surges without going into secondary breakdown. This minimizes the effects of short or open-circuit antenna or load mismatch.

Using the A200 as a low-power stage driver, the transistors produce 36 watts from a 0.12-W input source with a 3-device series-parallel arrangement.

All are single-chip devices, with the A200 packaged in a TO-39 case and the A201 and A202 enclosed in a TO-60 stud package.

Booth No. 3912 Circle No. 356

WHO'LL make the next breakthrough in EDP design?

Could be YOU: with Mosaic's Fiber Optics!

EDP systems design engineers are only beginning to tap the potential of fiber optics. Yet, after a brief acquaintance with this broad, new technology, they have made breakthroughs already . . . obsolescing "standard" EDP design solutions. Advances like greater speeds. Design freedom. New capabilities. Reliability and lower costs.

Did you hear about the oscillograph equipped with a fiber optic cathode ray tube? The CRT tube's electron beam is the writing device. Printout is nearly 100 times faster (1 million inches per sec.) than any direct-writing system in existence!

Do you know the story on Mosaic's Fiber Optic systems? In new EDP readers, printers, punched tape and card verifiers . . . in keypunch and teletype equipment, they're more dependable, less complicated, less costly and over 4 times faster than heat, wear and friction-prone mechanical systems!

Mosaic's fiber optics can help you make breakthroughs to advance the EDP state-of-the-art, too. Give those specific design problems of yours a hard look now. Then get going with the solution. Start by contacting Mosaic Fabrications, the people who know fiber optics inside-out . . . the largest single source of fiber optics technology, capability and productivity on earth!

Mosaic will work with you to solve your EDP design problems now . . . will help you design and develop,



from prototype to production, the specific EDP fiber optic hardware to put you way ahead!

Call or write Mosaic Fabrications, Inc.,
Galileo Park, Sturbridge, Mass. 01518,
(617) 347-9191 for descriptive literature today!

Bendix **Electronics**

ON READER-SERVICE CARD CIRCLE 160

WANTED

YOUR CLEANING PROBLEMS

FREE LABORATORY
"CLEAN-TEST"*

Right now stubborn contaminants and faulty cleaning procedures are causing rejects, downtime and labor waste in your plant. Unnecessarily. There is an optimum way to remove every known contaminant . . . and L & R's laboratory will find it for you. Hardened greases, oils, fluxes, impacted waxes, finishing compounds, dust specks — anything — can resist ordinary cleaning techniques and adversely affect product performance.

*To have your components "clean-tested", simply send them to L & R just as they would come off the production line. After testing we will recommend the correct cleaning equipment, specific cleaning solutions and ideal cleaning procedures in detail. There is absolutely no cost or obligation for this service. Isn't it just plain good sense to use our experience in this vital aspect of your production? When sending samples for cleaning, please include brief description of present cleaning methods and production requirements.

L & R
Ultrasonic
Cleaning
Unit,
Model 430 . . .

just one of many L & R Industrial
Cleaning Systems available from
1 pint to 5 gallon capacity.



L & R[®] Manufacturing Company

577 Elm Street • Kearny, New Jersey 07032
(201) WY 1-5330

55 E. Washington St., Chicago 60602
215 W. 5th St., Los Angeles 90013
L & R Ultrasonics, Ltd., 20 Northburgh St.
London, E. C. 1, England

952 A

"See us at Booths 1001 & 1002, WESCON Show"

CIRCUIT COMPONENTS

Monolithic regulators give 2-A output

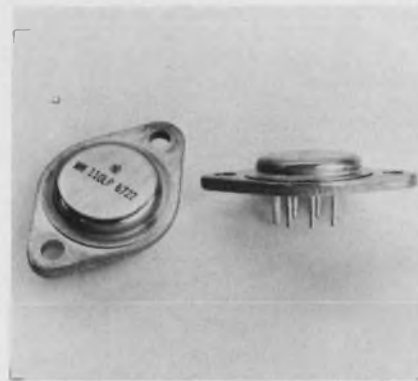

Westinghouse, Molecular Electronics
Div., Elkridge, Md. Phone: (301)
796-3666. P&A: \$25 (over 50);
stock.

The 2-A output of this unit is sufficient to drive 10-to-50-A power transistors to outputs from 5 to 25 A. For additional power-handling, a discrete power transistor can be added. The additional transistor will make the output stage a triple Darlington. The power transistor's heat sink must be isolated from the monolithic circuit's heat sink, and the power limitations of the IC must be observed. As a power supply regulator, it can produce 0 to 2 A from 8 to 48 V. An additional lead is provided so that external Zener references may be used. This permits the unit to be used for outputs less than 8 V. The case is at ground potential and it is possible in some systems to bolt the package to chassis or structural members for heat sinking without resorting to mica washers or other substances that impair the heat removal path. With a 5-mA constant current source, the WM 330 will deliver regulation of 0.1 to 0.2% for input variations of 20% and load variations of 0 to 1 A.

Short circuit protection is available by using a small series resistor at pin 2. This resistor connected to a transistor could cut the bias of the monolithic's Darlington and shut it down. The units can be used in systems as local regulators for noise isolation rather than one central power supply. The circuits can be inconspicuously spotted right onto the PC boards and mother boards for which they supplied the regulated power.

Booth No. 5205

Circle No. 383

ON READER-SERVICE CARD CIRCLE 161

INTRODUCING!



tiny-T-flatpack relay

- **TINY-T[®] is the first relay of its kind**
- **.340" off-the-board height**
- **1000V. Interrupt**
- **10 Milliohms or less contact resistance**
- **Switches 150W. per contact**
- **100-Million operating cycles**
- **Inexpensive cost and operation**

OPERATIONAL SAMPLES AVAILABLE!

At last . . . here's the four-pole flatpack relay that everyone has asked for! Offering the ideal dimension off-the-board (.340"), the Tiny-T[®] features a standard .100 x .100 grid terminal layout, making it ideal for printed circuit board applications. ■ We'll gladly send you a sample at a special \$4.00 introductory price so you can put Tiny-T[®] to the test. Our representatives are ready for your orders in all quantities. So are we! ■



electronic controls, inc.

T-Bar Switch/Relay Div. • Danbury Road, Wilton, Conn.
phone (203) 762/8351

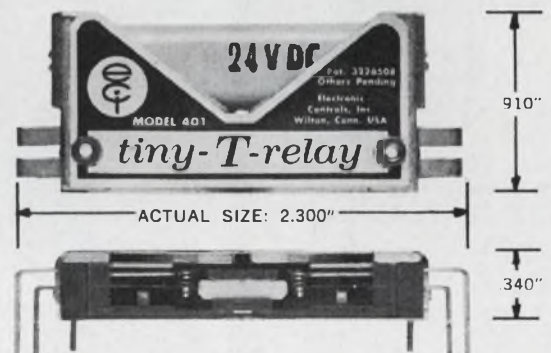

Electronic Controls, Inc.
Switch, Relay Division
Danbury Road
Wilton, Connecticut 06897

- Enclosed is our Purchase Order for \$4; please rush a Tiny-T Relay Sample.
- Have a representative call with more details.
- Send Bulletin #TB401 on the Tiny-T.

I anticipate using the Tiny-T Relay for _____

NAME _____ TITLE _____
DIVISION _____
FIRM _____
STREET _____
CITY _____ STATE _____ ZIP _____

. . . See us at BOOTHS 5113-5114—WESCON '67 . . .

ON READER-SERVICE CARD CIRCLE 162

Compare the
All-New PAMOTOR
Model 4500 with
the miniature
axial fan
you're now using!



COMPACT SIZE

Only 4 1/16" x
4 1/16" x 1 1/2".
Weighs just 1 1/4
lbs. Inter-
changeable with
similar, less reli-
able 4 1/16" fans.

POWERFUL MOTOR
Dependable shaded-
pole motor
operates with low
internal heat rise.
Efficient inside-
out design.

ALL-METAL CONSTRUCTION

Precision die cast housing, hub, impellers.
Corrosion resistant. Natural heat sink.
Warp-free, unlike conventional plastic fans.

**115 CFM WITH LESS
THAN 37.5 dB SIL***

*Speech Interference Level

- Lubrication-free life in excess of 20,000 operational hours, continuous duty at 55° C.
- Delivers more air at a lower noise level, yet priced under similar conventional plastic fans.
- Model 4500 designed for 117V/50-60 Hz operation. Model 4550 operates at 230V/50-60 Hz.
- Now available for immediate delivery through leading electronic distributors or directly from factory stock.
- Has Underwriters' Laboratories Inc. Yellow Card Component Recognition Number E41168.

Write to
PAMOTOR, INC., 312 Seventh St.
San Francisco, California 94103.

PAMOTOR, INC.

ON READER-SERVICE CARD CIRCLE 163

U200

CIRCUIT COMPONENTS

Pulse transformers trigger xenon lamps

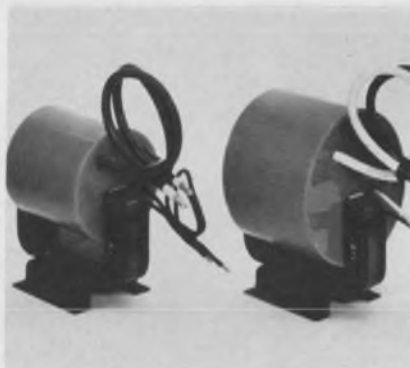

Pek, Inc., 825 E. Evelyn Ave., Sun-
nyvale, Calif. Phone: (408) 245-
4111. P&A: \$125, \$175, \$250; stock.

Designed for series-triggering
xenon flash lamps, these trigger
pulse transformers have special ap-
plications in flash photolysis and
high-performance pulsed laser oper-
ation. The three models feature long
term secondary rms current ratings
of 20, 30 and 40 A with peak sec-
ondary current ratings of 10, 14
and 12 kA. Saturated secondary in-
ductance is 16 μ H and secondary re-
sistance is 2.5 M Ω .

Booth No. 4414 Circle No. 261

Economy hybrid isolator has infinite Z_{in}

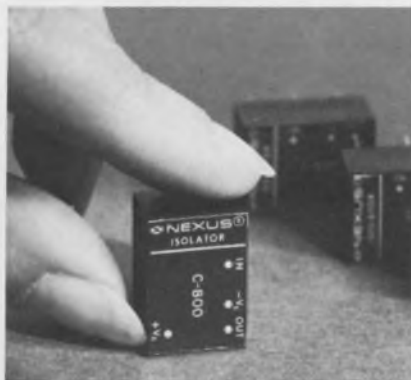

Nexus Research Laboratory, Inc.,
480 Neponset St., Canton, Mass.
Phone: (617) 828-9000. P&A: \$24
(1 to 9); stock.

This unity-gain noninverting iso-
lation amplifier features very high
input impedance and wide band-
width. The amplifier has unity gain
to an accuracy of typically 0.02%.
Its impedance at dc is 10¹² M Ω .
Output voltage range is \pm 10 V into
a 5-k Ω load.

Booth No. 2420 Circle No. 327

Silicon power transistor sustains 80 volts

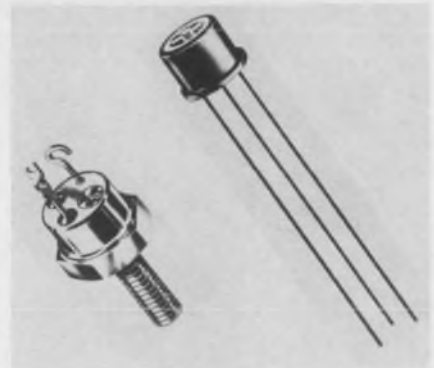

Silicon Transistor Corp., East Gate
Blvd., Garden City, N. Y. Phone:
(516) 742-4100. P&A: \$8 to \$16
(100 lots).

A line of pnp silicon single-
diffused power transistors offers
sustaining voltages of 40 volts for
the 2N5110 and 80 volts for the
5111. Both are offered in the TO-5
package. The equivalent 2N5112
and 5113 are packaged TO-59. All
are designed with a 1-A collector
current and dissipate 5 W at 25° C
in the TO-5 package, 34 watts in the
TO-59 package.

Booth No. 5323 Circle No. 349

Dc regulators give 1-A outputs



Bendix Corp., Semiconductor Div.,
Holmdel, N. J. Phone: (201) 747-
5400. Price: \$4 (1000 up).

Low cost 1-A dc voltage regulator
modules are contained in a JEDEC
TO-3 package and fit all standard
heat sinks. They are available in
units rated at 5, 6, 12, 18 or 25
volts, \pm 10% setting tolerance.
Load regulation is \pm 2% from min-
imum to maximum load. Tempera-
ture coefficient is 0.1%.

Booth No. 2812 Circle No. 260

What has the little red school house got to do with engineering?



In the context of the Little Red School House, our publication serves as a "blackboard" for the communication of knowledge . . . knowledge that is vital to the creative force within the electronics industry, specifically the 155,000 engineering and engineering manager readers of *Electronic Design*. The communicators of this knowledge are our editors. They are engineers who find enjoyment and satisfaction

discovering, analyzing, interpreting, reporting and teaching through the pages of *Electronic Design*.

If you've ever thought about teaching, consider communicating in another dimension as an editor of *Electronic Design*. The rewards can be many. Call or write Howard Bierman, our Editor, or drop by our booth at Wescon.



Hayden Publications
850 Third Avenue
New York, N.Y. 10022

Who makes specialized card packaging hardware? Scanbe does!

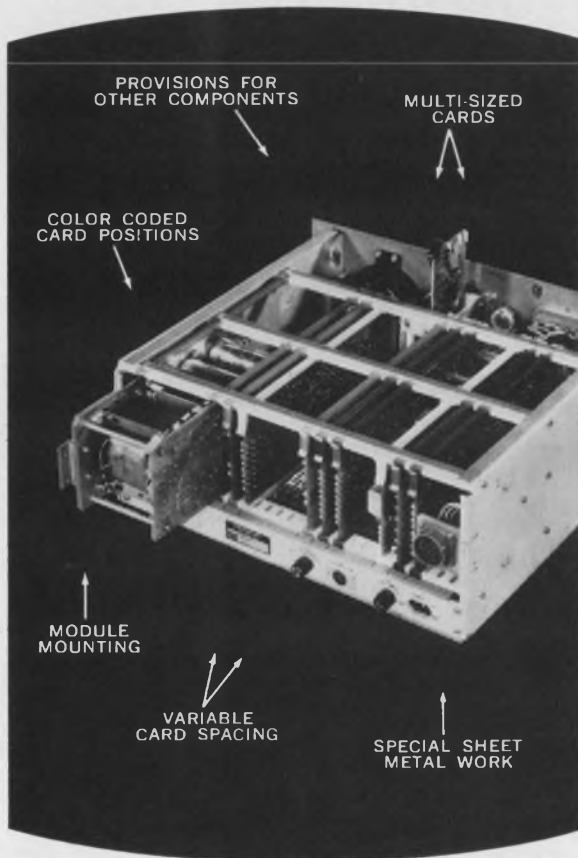

The design and manufacture of special card packaging configurations to your specifications is our business.

- **Specialized design and engineering** capability ready to assist you.
- **Specialized Factory facilities** equipped to handle high volume production as well as prototypes and small runs.
- **Specialized components** for high density, unusual shapes, and environmental applications.

Look to one source for all your card packaging requirements. Contact Scanbe, the specialist for electronic packaging hardware.



SCANBE MANUFACTURING CORP.

1161 MONTEREY PASS RD., MONTEREY PARK, CALIF. 91754

TELEPHONE (213) 264-2300

TWX 910-321-4336

Distributor Inquiries Invited

CIRCUIT COMPONENTS

Economy op amp has FET input

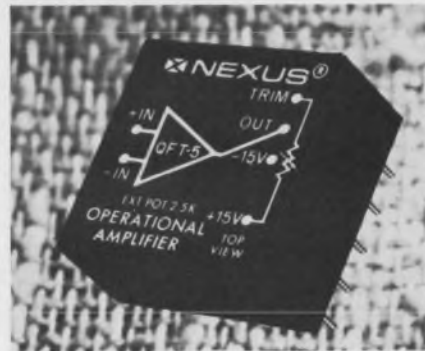

Nexus Research Laboratory, Inc.,
480 Neponset St., Canton, Mass.
Phone: (617) 828-9000. P&A: \$29;
stock.

The QFT-5 provides $10^{10} \Omega$ differential and common-mode impedances, less than 1-nA of input offset current, and high tolerance to capacitive loads. Its output voltage range is ± 11 V at ± 5.5 mA. The supply voltage is ± 15 V. The unit rolls off at 6 dB/octave.

Booth No. 2420 Circle No. 326

Molded MIL chokes μ H available to 1000 μ H

Cambridge Thermionic Corp., 445
Concord Ave., Cambridge, Mass.
Phone: (617) 491-5400. P&A: 22¢
to 33¢ (100 to 249); stock.

Molded chokes in 3 series conform to MS 75052, 75053 and 75054 respectively. The first covers inductance values from 47 to 150 μ H in a 0.25-inch diameter by 0.56-inch long package. Q ranges from 18 to 75. The second covers 180 to 390 μ H in a configuration of 0.31-inch diameter by 0.56-inch long. Q values span 80 to 75. Another series spans 470 to 1000 μ H and measures 0.375-inch diameter by 0.625-inch long. Q values are 80 through 70. All chokes are hot molded using epoxy and are color-banded.

Booth No. 4103 Circle No. 265

For a complete listing of the technical papers at the show, see page U 112. For reprints of most of the papers, fill out the order form on page U 115.

An engineering forum is supposed to be a discussion. Somehow I get the feeling that Switchcraft is going to be doing all the talking.

We sincerely hope not. We want the Forum to be truly an interchange of ideas on the technical aspects of the products we make, let the chips fall where they may. A "switch craft" forum as well as a "Switchcraft Forum."

We hope that, with a lively response from design engineers in the field, we can develop enough questions and ideas so that a future Forum might examine, for example, all sides of a single aspect of a single type of switch, whether you agree with our viewpoint or not.

(Obviously, as we are paying for the space, we will make a solid attempt to convert you to our viewpoint.)

For this, our first edition, we will have to start the ball rolling, which means we will be doing most of the talking.

We thought a good place to start would be a discussion of stack switches and, naturally, why our stack switches are best.

Naturally. But why lead off with stack switches? Why not one of the newer, more exotic circuit controls?

SWITCH CRAFT

Versatility can be pretty exotic. And that's what stack switches are. You have a wide selection of contact materials, insulation, mounting and actuation methods. Versatility is an integral part of stack switches and a quality line such as ours should be a basic component in every engineer's design arsenal. **Impressive. But how about some specifics?**

Quality is very specific. It is definitely related to materials and manufacturing techniques. Switchcraft quality is easy to explain.

For instance, all of our stack switches use a special nickel silver alloy for the contact and actuator springs. This material is fabricated to our specifications on hardness to assure proper characteristics for long switch life. We gain a 10% improvement in tensile strength over switches made with other spring materials.

Let's talk about contact assemblies. For typical medium level stack switch applications, we offer

large silver contacts solidly staked to the spring. This forms a pointed contact which mates with a flat contact. The result is higher unit pressure and lower contact resistance. (See figure).

For dry circuit or low level applications, palladium, silver or gold contacts are welded, rather than riveted, to the spring for low contact resistance and bond strength uniformity.

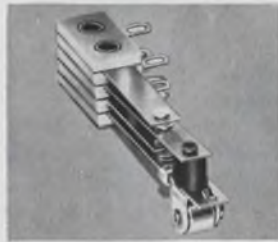

Typical stack switch assembly

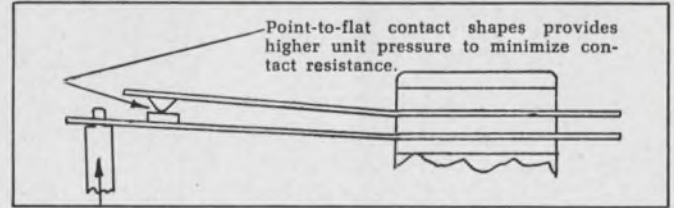

Sounds good so far, but what other engineering factors are involved?

And you were worried that we would be doing all the talking. We don't have space here to even get into all the engineering parameters involved.

But we do have a comprehensive engineering article and a catalog we would be happy to send you. (Check the Reader Service Number below).



Just briefly, we could cover one more point. Insulation. XP and XXP Phenolic fibre insulators have about the same breakdown voltage.

XXXP has better insulation resistance, less leakage current. We use nothing but the XXXP.

In a nutshell, Switchcraft offers a well-designed, quality-constructed stack switch for just about every application an engineer would ever have for a stack switch. And Switchcraft prices are competitive, right down the line.

FORUM

I'm beginning to think your Forum idea will work. But how are you going to get more engineers to join in? Ask the right questions? Come up with ideas?

That's what we're doing right here. If you have anything to ask, or say, about any type of switch we make, or for that matter any type of product we make, send us your questions or comments. If your questions are loaded, or controversial, so much the better. This is where product development comes from.

We're waiting to hear from you.

SWITCHCRAFT

5529 N. Elston Ave.
Chicago, Ill. 60630

Time-delay relays fixed or adjustable



Potter & Brumfield, Princeton, Ind. Phone: (812) 385-5251. Price: \$12.50.

Low-cost time-delay relays are designed for delay on operate applications in machine tool controls, coin-operated machines or process controls. Two versions, fixed time delay on operate and resistor adjustable, are offered in ac and dc models. Timing ranges of 1, 5, 10, 30, 60 and 120 seconds are available. Timing tolerance is $\pm 5\%$, reset time is 100 ms. Relay contacts are rated at 10 A at 28 V dc or 120 V ac.

Booth No. 4101 Circle No. 255

Tubular feedthrough accepts 2 leads

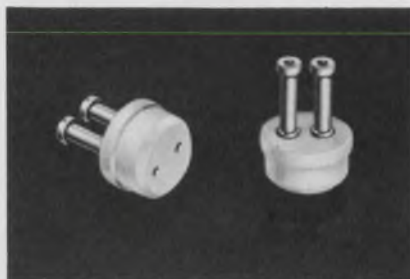

Sealectro Corp., 225 Hoyt, Mamaroneck, N. Y. Phone: (914) 698-5600.

With dual tubular lugs mounted in a single Teflon bushing, this two-pin feedthrough terminal is designed for multiconnection applications. Component leads come up from beneath the chassis, through holes in the lugs and are then soldered in place. Circuit wiring can then be attached to the outer lugs, completing the package. The unit is made of Teflon and has gold flash over silver-plated brass lugs measuring 0.207 inch and lugs with solder areas 0.045 inch in diameter.

Booth No. 4309 Circle No. 263

Time delay relays withstand line changes



Heinemann Electric Co., Magnetic Dr., Trenton, N. J. Phone: (609) 882-4800. Price: \$20 and \$26.

Using a solid-state timing circuit, this relay's delay time, within the total range, is adjusted by a self-contained pot and is not subject to extreme time variations caused by changes in line voltage. A time interval repeatability of $\pm 2\%$ at 70° F and 115 V ac is not affected by line variations from 100 to 135 V ac. The unit is available in two models: delay-on-make and delay-on-break. Corresponding ranges are 1 to 60 and 1 to 30 seconds.

Booth No. 3921 Circle No. 262

EASTMAN 910® Adhesive offers... reduced bonding costs in precision gaging instruments.

EASTMAN 910 Adhesive reduces the component assembly costs of the Sheffield Electrojet® precision gaging transducer. Manufactured by Bendix Corporation's Automation and Measurement Division, this transducer, a mechanical contact type size sensing unit is widely used in the automo-



tive and machine tool industry.

Applied to junctions where pressure bonding is impractical, EASTMAN 910 Adhesive is used to bond acrylic to acrylic, to steel and to brass. Long lasting bonds are made in seconds, at room temperature with only contact pressure. With use of this adhesive, manpower and material costs have been reduced. Not one bond failure has been reported during five years of use.

EASTMAN 910 Adhesive will form bonds with almost any kind of material without heat, solvent evaporation, catalysts, or more than contact pressure. Try it on your toughest bonding jobs.

For technical data and information, write to Chemicals Division, EASTMAN CHEMICAL PRODUCTS, INC., subsidiary of Eastman Kodak Company, Kingsport, Tenn. EASTMAN 910 Adhesive is distributed by Armstrong Cork Company, Industry Products Division, Lancaster, Pa.

Here are some of the bonds that can be made with EASTMAN 910 Adhesive

Among the stronger: steel, aluminum, brass, copper, vinyls, phenolics, cellulose, polyesters, polyurethanes, nylon; butyl, nitrile, SBR, natural rubber, most types of neoprene; most woods. Among the weaker: polystyrene, polyethylene (shear strengths up to 150 lb./sq. in.).

There is no adhesive like EASTMAN 910® Adhesive

- SETS FAST**—Makes firm bonds in seconds to minutes.
 - VERSATILE**—Joins virtually any combination of materials.
 - HIGH STRENGTH**—Up to 5000 lb./in.² depending on the materials being bonded.
 - READY TO USE**—No catalyst or mixing necessary.
 - CURES AT ROOM TEMPERATURE**—No heat required to initiate or accelerate setting.
 - CONTACT PRESSURE SUFFICIENT.**
 - LOW SHRINKAGE**—Virtually no shrinkage on setting as neither solvent nor heat is used.
 - GOES FAR**—One-pound package contains about 30,000 one-drop applications. (Or in more specific terms, approximately 20 fast setting one-drop applications for a nickel.)
- The use of EASTMAN 910 Adhesive is not suggested at temperatures continuously above 175°F., or in the presence of extreme moisture for prolonged periods.

See Sweet's 1967 Product Design File 6a/Ea.

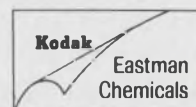

Take a close look at the total area your present Monolithic Integrated Circuit Differential Amplifiers are using, and compare with the new ZELTEX 161/162 Hybrid Circuit family. These high-reliability devices are truly universal. They flush mount in less space than splayed-lead TO cans and require no external components to insure stability in all modes of operation. ■ Performance? Model 162, for example, is the only FET IC Diff Amp on the market and, like the rest of the family, it's burnout-proof! ■ So, take a close look at ZELTEX integrated Circuit Amplifiers now. The price is as small as the size — totally!



Key Specifications — Model 162

- Input Impedance 10^{11} ohms
- DC Gain 200,000
- Input Current 25pa
- Fully Stabilized (-6db/octave)
- Output $\pm 10v$ @ 4ma
- Drift $10\mu v/^{\circ}C$
- Common Mode Voltage 10v
- Short Circuit Proof

Zeltex Inc., 1000 Chalomar Road, Concord, California 94520, Phone (415) 686-6660

*total
size
is what
makes an
IC amplifier
universal*

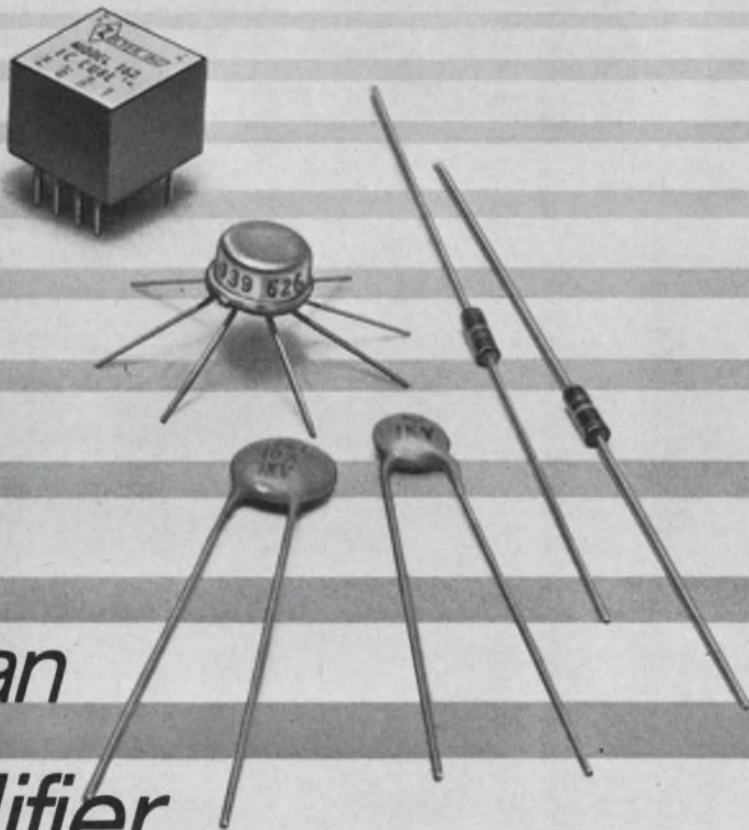

it costs you nothing to call on experience:

Reeves-Hoffman design and manufacture
is 100% custom . . .
let us quote your needs!

★ quartz crystals

★ crystal filters

★ oscillators

★ discriminators

★ standards

★ ovens



400 WEST NORTH STREET, CARLISLE, PENNSYLVANIA 17013
Telephone 717-243-5929

Md., Del., D.C., Va., W.Va., N.C.
Valley Electronics, Inc.
Baltimore, Maryland
(301)668-4900; (202)659-1760

New England
Howard Jappe Company
Wakefield, Mass.
(617)245-9359

Pa. (except Pittsburgh), So.N.J.
Eastern Components, Inc.
Philadelphia, Pa.
(215)927-6262

New York (except N.Y.C.)
Midstate Research Sales Co.
Syracuse, New York
(315)478-8314; (315)478-0715

New York City, No.N.J.
G M Moch Company
Ridgefield, New Jersey
(201)945-0080; (212)279-6758

So. California
Ash M. Wood Company
Arcadia, California
(213)283-1201; (213)287-0449

No. California
L & M Engineering
Santa Clara, Cal.
(408)243-6661

Ill., Ind., Wis., Minn.
PGM Sales, Inc.
Chicago, Illinois
(312)622-8183

Ohio, W.Pa., Mich., Ky.
Tri-State Marketing, Inc.
Cincinnati, Ohio
(513)631-5060

Texas, Okla., Ark.
Carter Associates, Inc.
Garland, Texas
(214)276-7151

Ariz., N.M., Las Vegas
Carter Associates, Inc.
Scottsdale, Arizona
(602)947-4355

ON READER-SERVICE CARD CIRCLE 182

CIRCUIT COMPONENTS

Rotary switch ends knob twirling

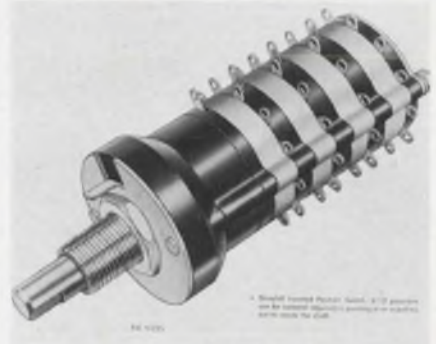

Grayhill Inc., P. O. Box 373, La-
grange, Ill. Phone: (312) 354-1040.

An isolated-position rotary switch prevents knob twisters from turning on or turning off one or more circuits. Any combination of switch positions can be isolated by requiring either a push or pull of the rotary switch shaft by the operator before the isolated position can be reached. Typical applications include equipment that requires an off or calibrate position and/or a stand-by position. Externally, the isolating mechanism appears as an additional switch deck without terminals located immediately behind the detent system. This feature is available with up to 4 decks with 30° angle of throw.

Booth No. 4111 Circle No. 252

Vacuum fixed caps rated at 12 kV



ITT Jennings, P. O. Box 1278, San
Jose, Calif. Phone: (408) 292-4025.

With capacities ranging 1 through 5 pF, these fixed capacitors combine a high-strength ceramic housing and low-loss copper plates with vacuum dielectric. The capacitors are 0.77 inch in diameter and 3.25 inches in length. Peak voltage is 30 kV at 60 Hz. Current ratings are as high as 12 A rms at 20 MHz. Operating temperatures are up to 125°C.

Booth No. 3807 Circle No. 267



"I DON'T MIND PAYING A LITTLE LESS"

With An Airways Businessman's Credit Card He'll Save Even More Money

Being a practical man and a business traveler, this man knows he qualifies for a special Rent-A-Car discount by presenting his AIRWAYS BUSINESSMAN'S CREDIT CARD at any of over 200 AIRWAYS offices. He knows AIRWAYS regular rates are lower than other rent-a-car companies including their 20% corporate discounts. With an AIRWAYS BUSINESSMAN'S CREDIT CARD he knows he'll enjoy even greater savings. He knows AIRWAYS provides 1967 Chevrolets, Buicks, Pontiacs—even Cadillacs. He also knows he'll save time because he simply calls when he arrives at the airport and AIRWAYS will probably arrive before his luggage. We have downtown offices, too. He knows it — AIRWAYS knows it — now YOU know it.

Send for your free AIRWAYS BUSINESSMAN'S
CREDIT CARD now. Write to: Dept. 6ED

AIRWAYS RENT-A-CAR

8405 Pershing Drive

Plaza Del Rey, California 90291



Pontiac Le Mans



ON READER-SERVICE CARD CIRCLE 183

Comar doesn't shy away from the tough one's



Anyone can handle the easy relay applications, but it takes a company with engineering knowhow, manufacturing superiority and just plain "guts" to take on the tough one's.

The engineers at Comar have an enviable record of rolling up their sleeves and burning the midnight oil to meet stringent relay specifications . . . shock, vibration, miss testing, humidity, special operating characteristics.

The next time someone tells you "it can't be done," call Comar. No miracles, just technical experience and the finest relay test laboratory in the world!



Comar electric company

3349 Addison Street
Chicago, Illinois 60618

TELEPHONE TYPE RELAYS • SUBMINIATURE RELAYS •
RELAY ASSEMBLIES • SOLENOIDS • SOLENOID ASSEMBLIES

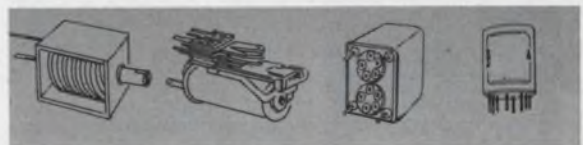

ON READER-SERVICE CARD CIRCLE 184



MEET THE HEAD

that solved the problem
for \$41.75

Double, multi-diameter heads with nib for precision positioning040", 18 gauge copper wire . . . nominal tolerances: $\pm .0003$ " wire diameter . . . $\pm .002$ head concentricity . . . $\pm .001$ distance between heads . . . $\pm .001$ nib length . . . 8 times actual size.

What's your problem . . . design . . . material . . . plating . . . production . . . For precision formed wire heads that withstand . . . pulling . . . bending . . . twisting, contact . . .

EMPORIUM SPECIALTIES INC.
Wire Forms Division

Plant and Engineering: Austin, Pennsylvania
General Sales Office: 2800 East 116th Street
Cleveland, Ohio 44120
Telephone: (216) 795-1640

ON READER-SERVICE CARD CIRCLE 185

TERMINAL BLOCKS

CURTIS

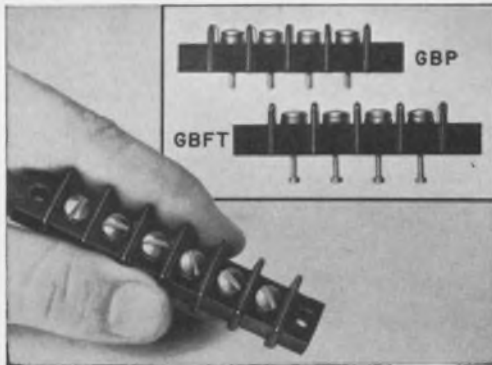

FEED-THRU GB-SERIES

Versatile flat base feed-thru terminal blocks with choice of interior turret-type solder terminals or .062 dia. printed circuit pins. Inserts are bright tin plated for excellent solderability, conductivity, and long shelf life.
Rated — 20 amps, 300 volts.
Available — 1 to 18 terminals, $\frac{3}{16}$ " center-to-center terminal spacing.
#6-32 screw connections.
accept up to #12 AWG wire.

FREE! Full details, descriptions and prices in new Curtis 24-page illustrated catalog.



CURTIS DEVELOPMENT & MFG. CO.
3236 N. 33rd St. • Milwaukee, Wis. 53216



SEE US AT WESCON, BOOTH 1013
ON READER-SERVICE CARD CIRCLE 186

CIRCUIT COMPONENTS

One-piece carrier for 1/4-inch flat packs

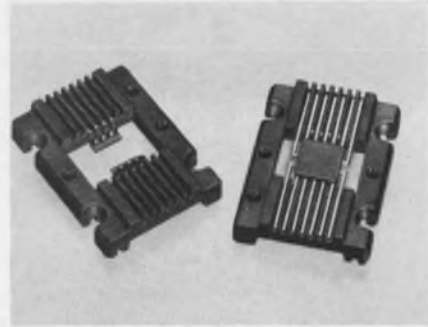

Barnes Development Co., 213 West Baltimore, Lansdowne, Pa. Phone: (215) 622-1525. P&A: 1¢ to 10¢; stock to 10 days.

For 1/4 x 1/4 inch flat packs, this carrier uses an integrally molded device retention feature that protects the IC. The carriers are molded of polysulfone for continuous operation from -65°C to 150°C . They are designed for automated and semiautomated testing and handling, including handling in both magazines and bowl feeders.

Booth No. 4905 Circle No. 358

Turbine-impeller blower outdoes squirrel-cage



Rotron Manufacturing Co., Inc., Woodstock, N. Y. Phone: (914) 679-2401.

This turbine-impeller blower delivers more air with greater efficiency than conventional squirrel-cage units. The unit delivers up to 250 cfm at free delivery from a substantially smaller, maintenance-free package. No centrifugal starting switches or relays are used, eliminating the cause of most single-phase motor failures. The blower is designed for electronic cabinets requiring large volumes of cooling to be delivered against high static pressures.

Booth No. 4415 Circle No. 253

The Victor Digital Printer, just \$335. \$335?

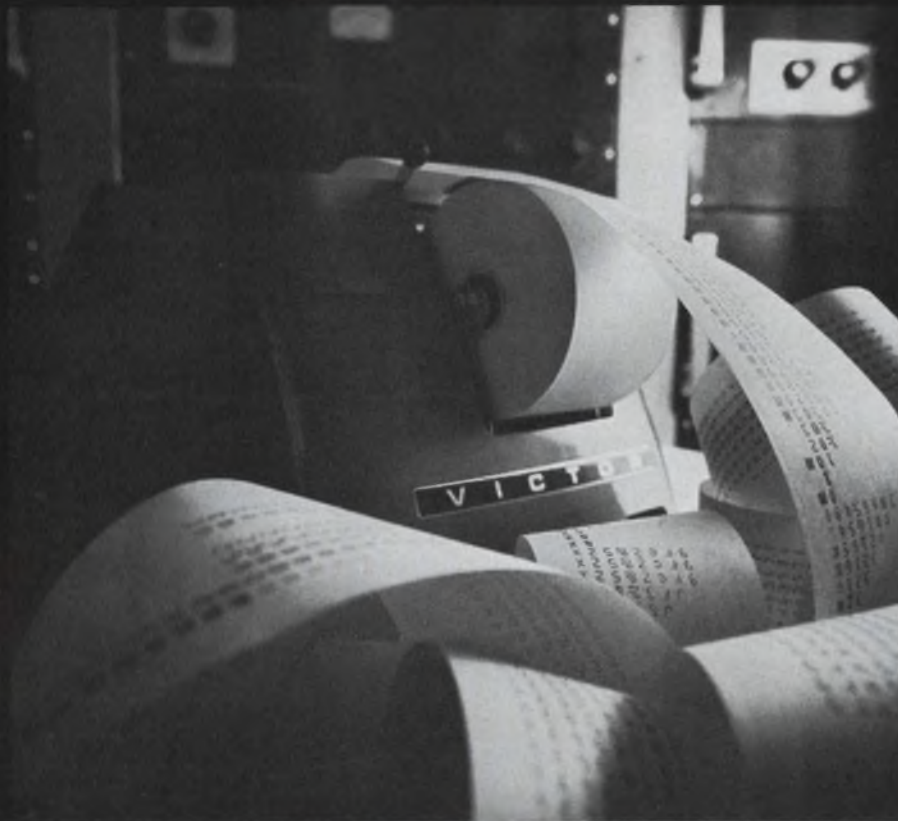

That's right; the Victor Digit-Matic does what any high quality serial entry printer does. And for less money. The Digit-Matic lists 8-column figures from remote sources, on either 24 or 48 volt solenoids. Printing press action reduces wear, eliminates parts, and assures clear, uniform print-out under all conditions.

For just \$50 more, the Digit-Matic will also add and subtract. Ten-column capacity, just \$20 more!

Factory-trained service representatives located across the country. OEM and quantity discounts available.

Wherever clear print-out is required, call for a Victor Digit-Matic specialist. Write: Victor Comptometer Corporation, Business Machines Group, 3900 N. Rockwell St., Chicago, Ill. 60618.

**Call on Victor
and you're in business.**



VICTOR CALCULATORS • ADDING MACHINES • CASH REGISTERS • TEMPORARY HELP • ELECTROWRITER COMMUNICATIONS

ON READER-SERVICE CARD CIRCLE 187

THE BEST IN PRODUCT DESIGN

Here are the six winners of WESCON's 1967 industrial-design awards of excellence and the 10 other finalists that competed against them. All these products will be on display at the show.

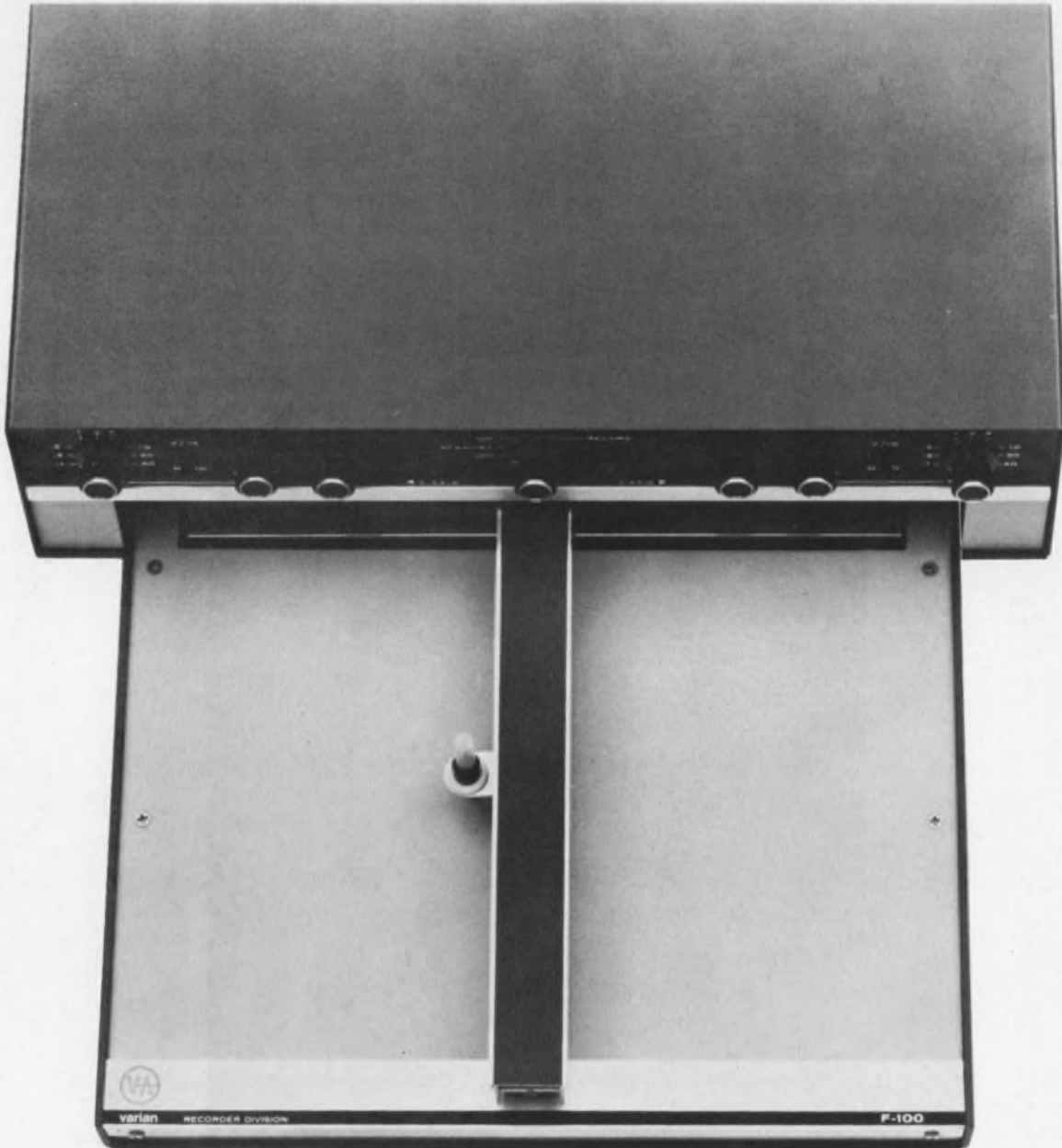

X-Y graphic recorder contains no moving parts; the reverse side of the chart paper is coated with a passive iron ink that holds the paper down on the platen, which acts as a large magnet. Nonmagnetized paper can be held down simply by throwing a paper clip on top.

Company: Varian Associates
Designer: Anthony P. H. Chan

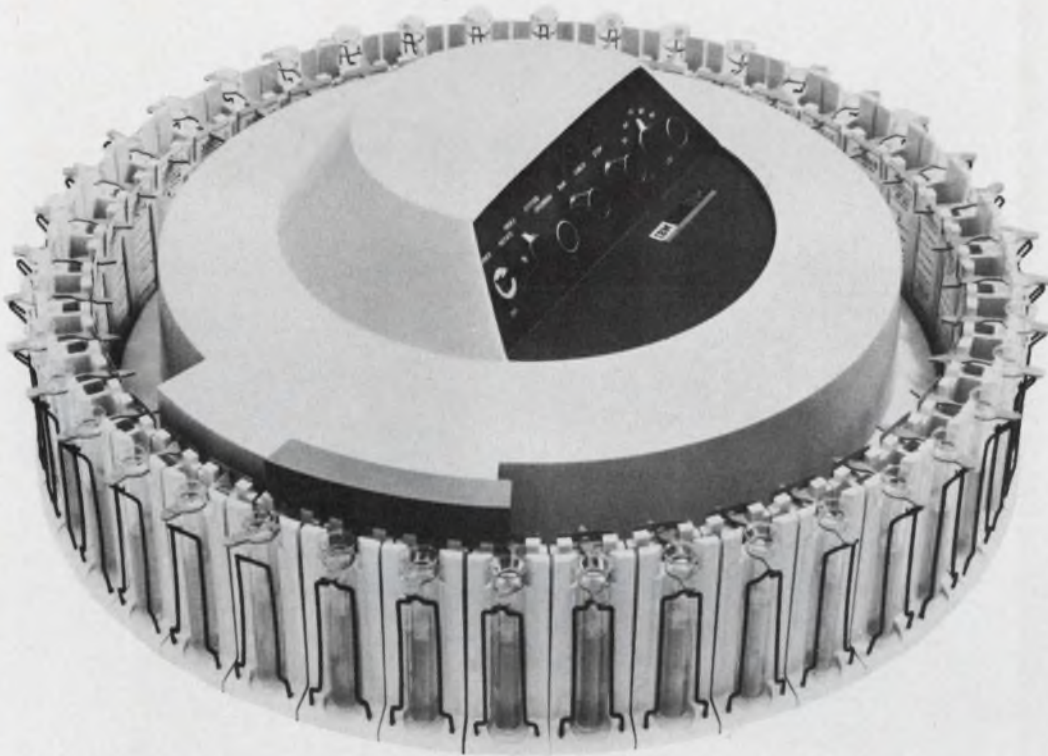

Award-winning sampler reader automatically analyzes and records medical specimens, such as blood or urine. The sophisticated self-cleaning package is used in conjunction with the IBM 1080 data acquisition system and Technicon analytical equipment.

Company: IBM/Systems Development Div.
 Designers: Donald H. Wood, Donald A. Moore
 Consultant: Eliot Noyes

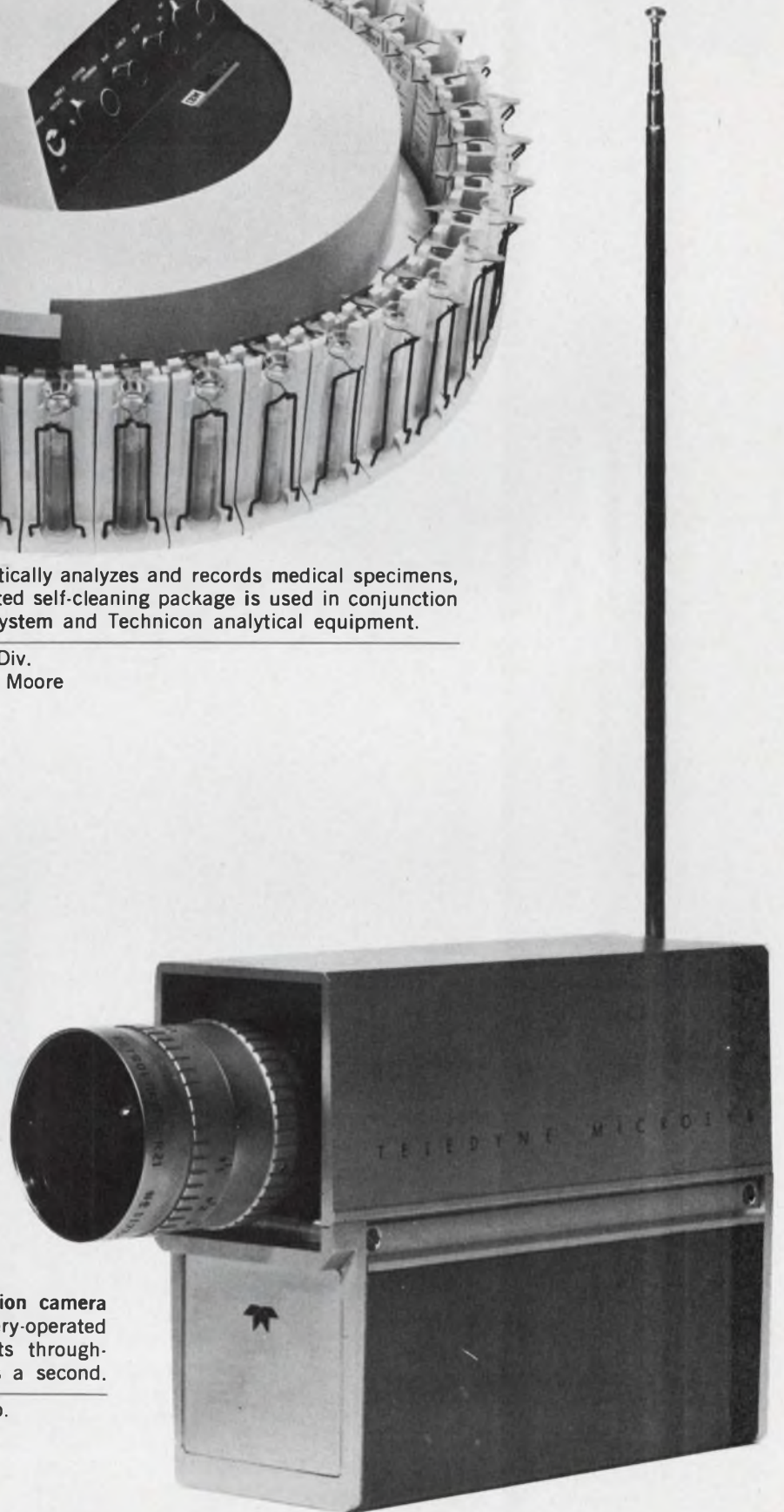

Award-winning microeye television camera weighs just 4 pounds. It is battery-operated and contains integrated circuits throughout. Its scan rate is 525 lines a second.

Company: Teledyne Systems Co.
 Designer: H. E. Shanks



Portable video camera is part of a battery-powered video-tape-recorder-and-camera combination. It weighs less than 50 pounds and is designed primarily for remote high-speed taping of news events by a single operator.

Company: Ampex Corp.

Designer: Gene Bozarth, F. T. Walsh

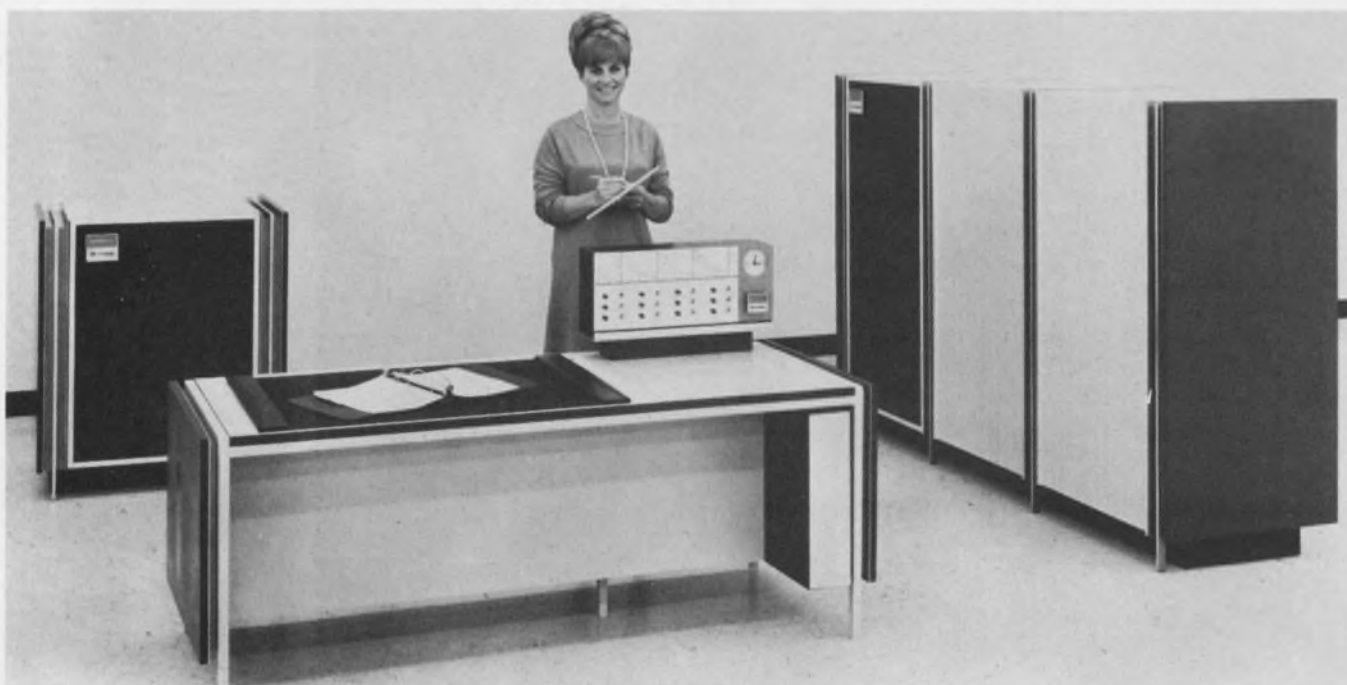

Data communications system is designed to handle complete communications problems, including message protection and error control. The general-purpose system can handle inputs up to 400 characters per second and interfaces with a variety of terminal devices.

Company: Marshall Communications, Inc.

Designers: Clarence Zierhut, Moro Shimano, Robert Noyer

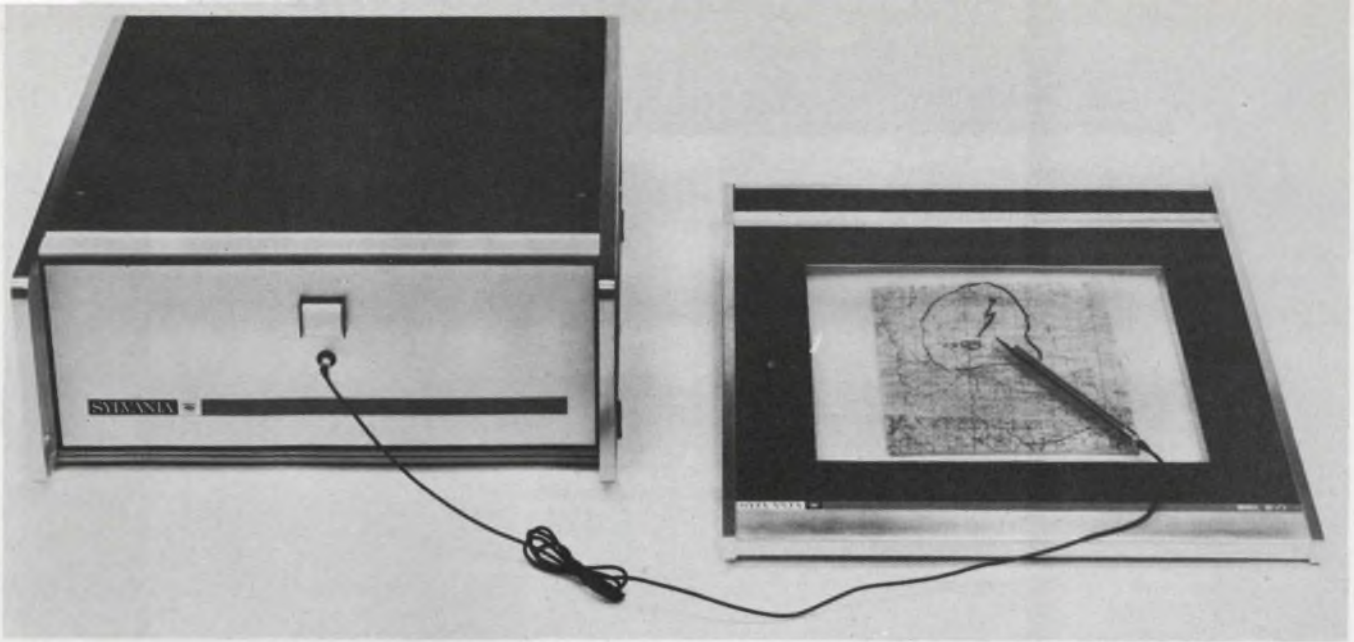

Computer graphical input system comprises an electronic pen and transparent conductive data tablet. Handwritten information is sampled and converted for computer storage and processing. Both analog and digital outputs are available.

Company: Sylvania Electronic Systems
 Designer: Oskar Heining

Multiple-beam interferometer used in surface microtopology (measurement of surface irregularities) can measure the thickness of film depositions down to 20,000 Å or 0.00008 inch.

Company: Varian Associates, Vacuum Products Div.
 Designer: Anthony P. H. Chan

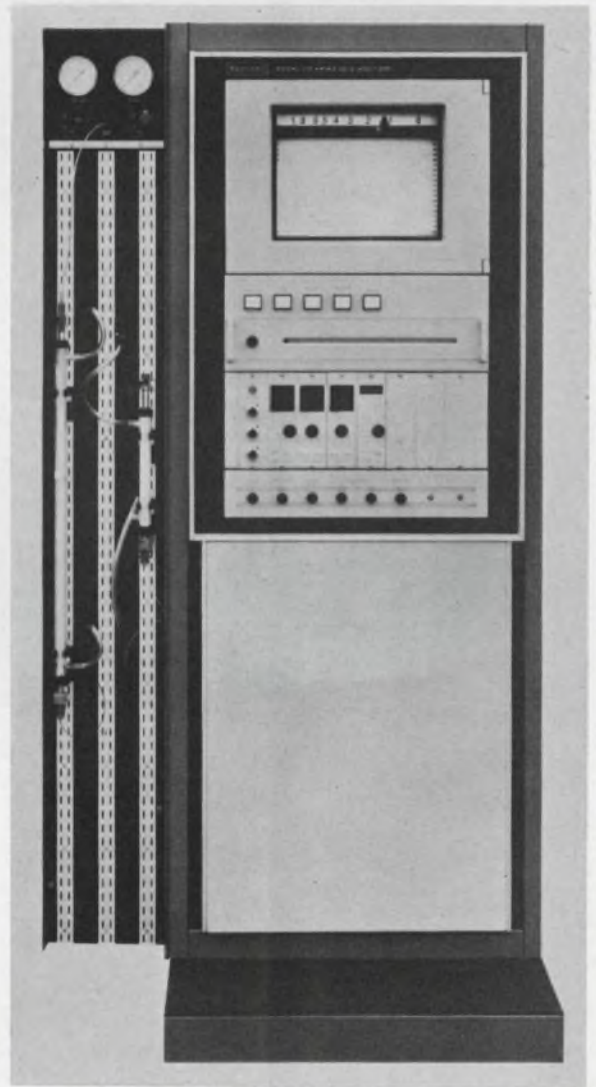
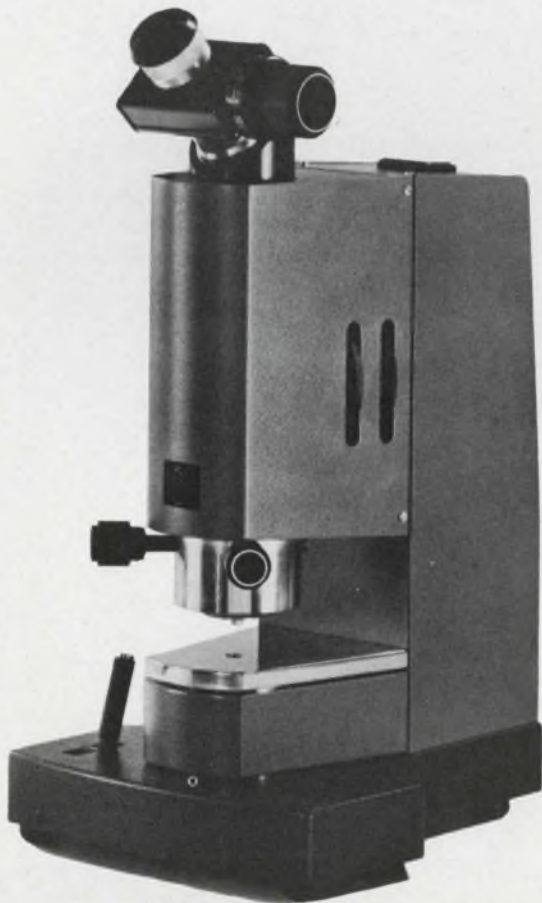

Amino acid analyzer identifies and analyzes amino acids and peptides for medical and pharmaceutical research by means of ion exchange chromatography. It is completely automated, so that the chemist needs only to start it.

Company: Beckman Instruments, Inc., Spinco Div.
 Designer: Charles W. Dodge

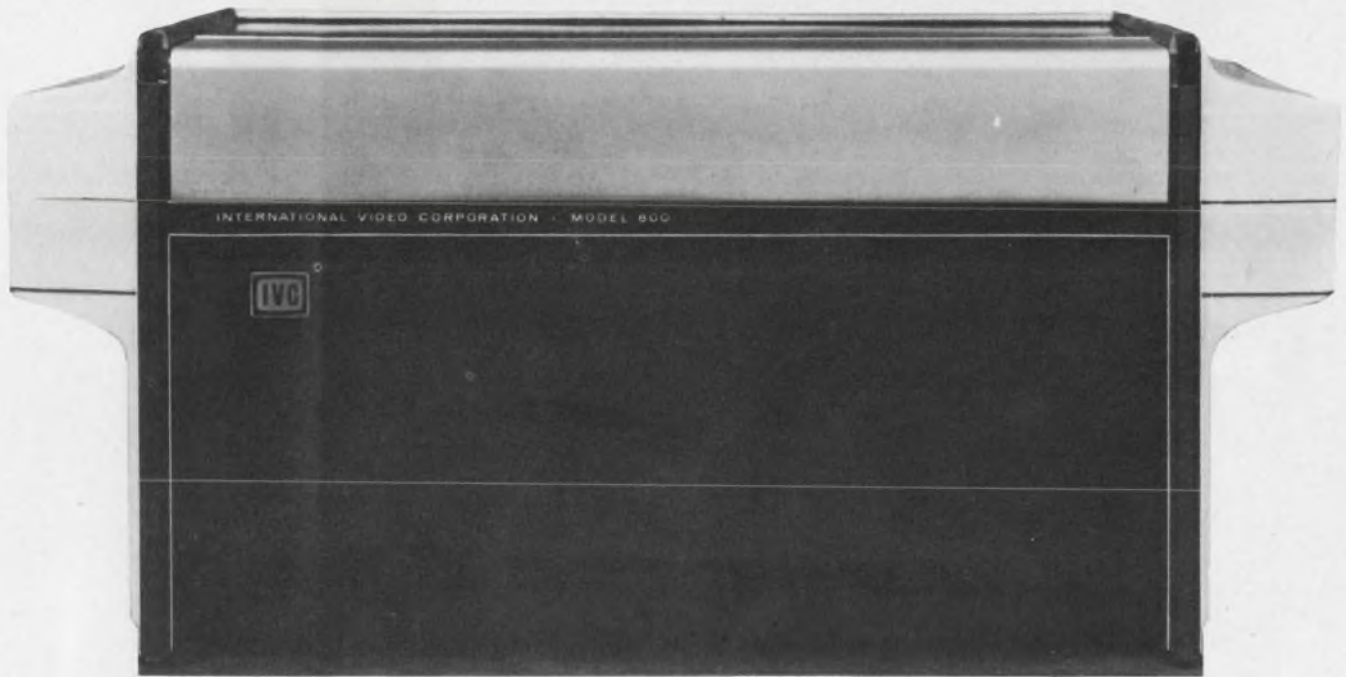

Award-winning video tape recorder for closed-circuit color television can record with any standard camera and play back with any standard monitor or television receiver. It has a 5-MHz bandwidth and operates at 6.9 in./s to save tape.

Company: International Video Corp.
Design consultant: Gruye-Vogt-Opperman, Inc.



Award-winning infrared thermometer, carried in a holster, can measure temperatures of objects without physical contact. It comes in seven models with a total range of 60°F to 3000°F. One model, the Circuit Ryder, is specifically designed to measure the temperature of PC-board components.

Company: Raytek, Inc.
Designer: J. Budd Steinhilber (Tepper/Steinhilber Associates)



Remote control unit and timer is part of an instant-replay color-TV recording system. It can play TV action back almost immediately at normal, fast and slow speeds and is capable of frame-by-frame stop action.

Company: Ampex Corp.
Designers: R. W. Bornschlegel, F. T. Walsh

Studio camera is a highly flexible, low-cost unit capable of easy modification to suit customers' needs. It accommodates four lenses of any type, with front or rear zooms, and vidicon or plumbicon tubes. The modular circuitry is readily accessible through side housings locked in place by simple thumb screws.

Company: Ampex Corp.
Designers: Donald E. Leman, Stanley E. Lenhart, Mervin LaRue, Arden Farey, Rein Narma

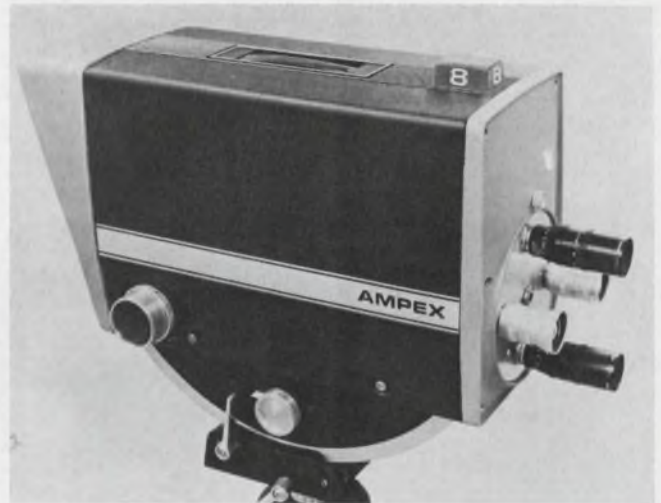

Microspec infrared spectrophotometer uses simplified monochromator optics to print out precise graphs of chemical compounds' absorbance or reflectance of IR wavelengths. Characteristic signatures of compounds are identified for clinical and industrial research.

Company: Beckman Instruments, Inc.
Designers: Robert L. Greene, Hugh O. Brown

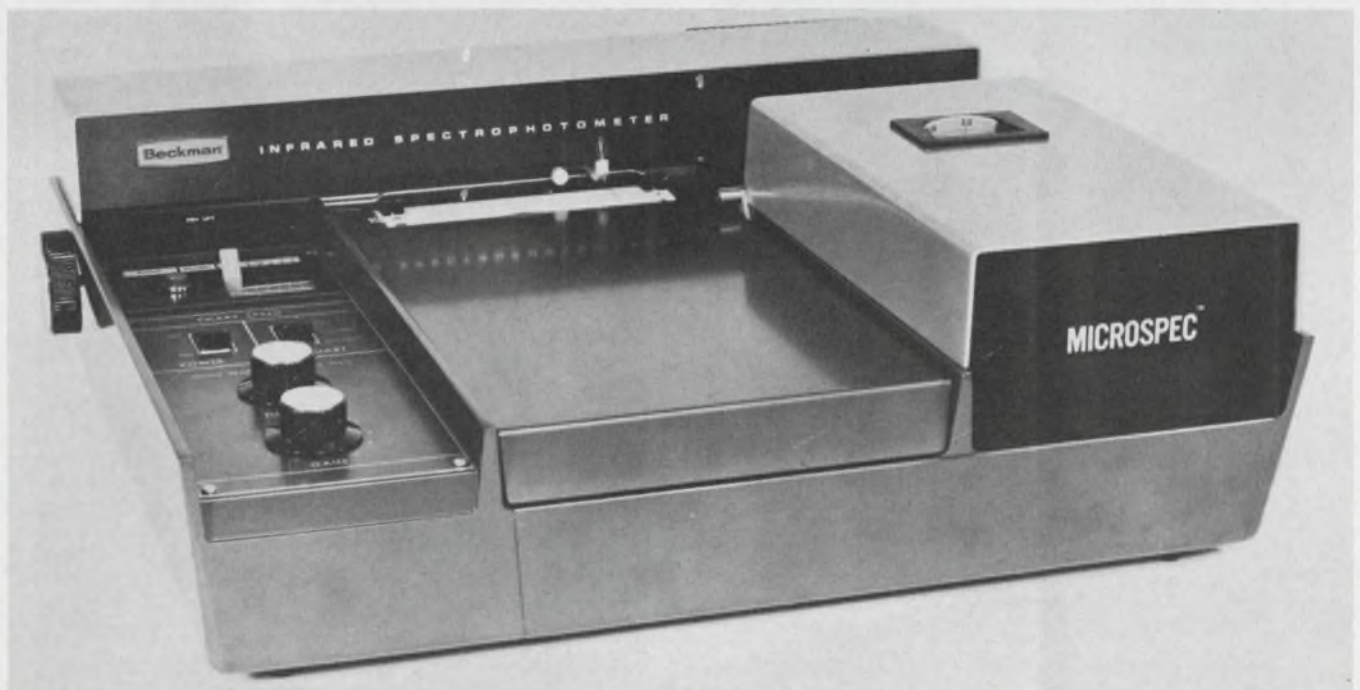

Award-winning CO₂ gas laser system is specifically designed as a self-contained unit for industrial applications. It emits approximately 100 watts of continuous power at a wavelength of 10.6 microns, and is capable of some 200 hours of continuous operation on a single bottle of CO₂.

Company: Coherent Radiation Laboratories
Designers: W. Mefford, R. Rorden, S. Jarrett, C. Nunes
Consultants: Gruye-Vogt-Opberman, Inc.

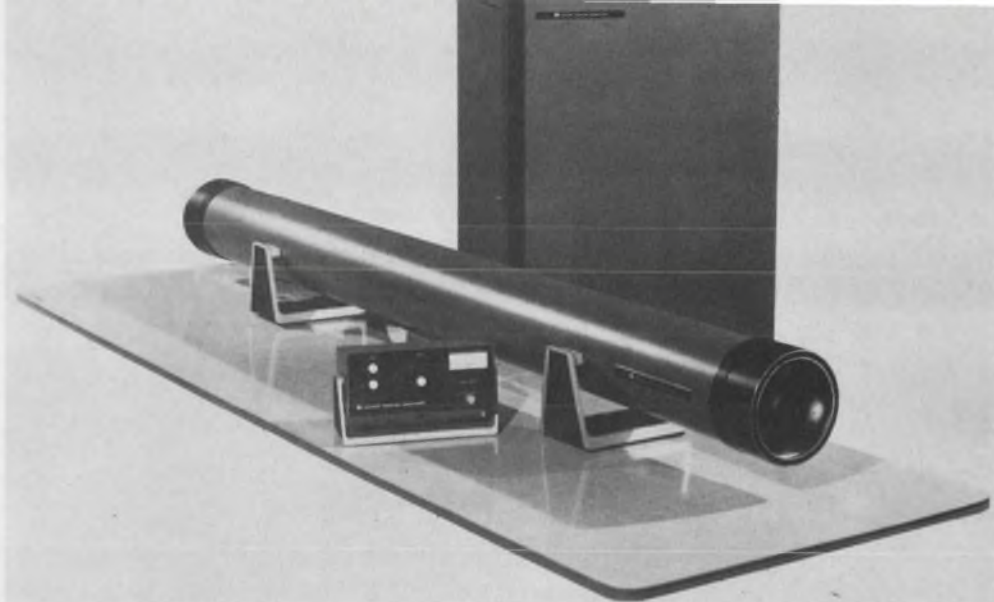

Award-winning ultracentrifuge for biochemical research is capable of 65,000 r/min, generating up to 420,000 g. Indicator lights on the well-grouped display panel pinpoint the location of any malfunction. Rotor temperatures can be precisely controlled from 5° below ambient to 0°C. The whole unit is enclosed in a vacuum chamber.

Company: Beckman Instruments, Inc., Spinco Div.
Designer: Charles W. Dodge

Induction ion laser provides 2-W cw output in the yellow-green-to-blue-violet spectrum. The closed glass ring containing argon or krypton serves as the secondary of an rf transformer. Excitation is applied through a coil.

Company: Spectra-Physics
Designer: Carl J. Clement

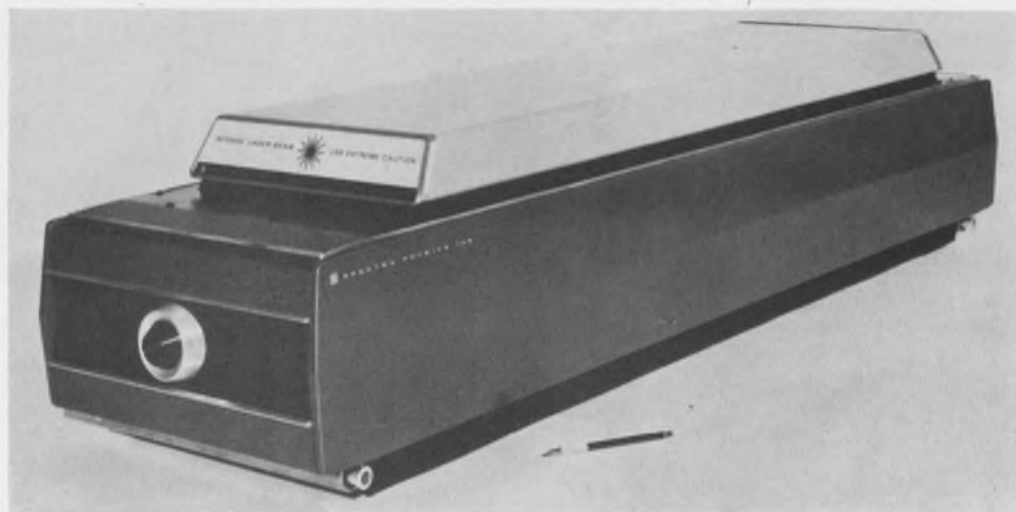

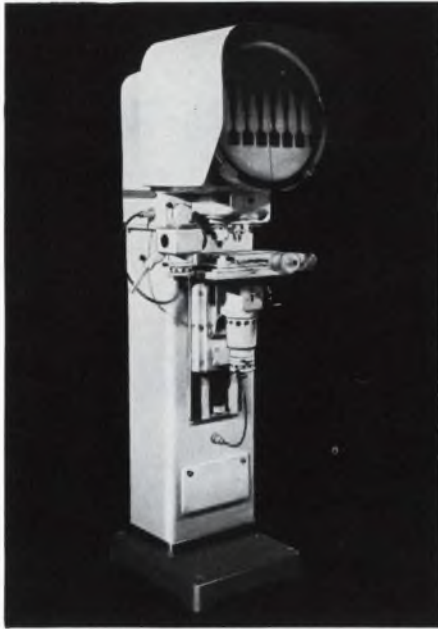

Profile Projector 3C 14" screen

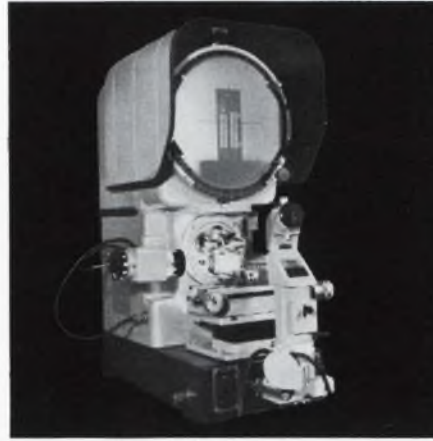

Profile Projector H-14 14" screen

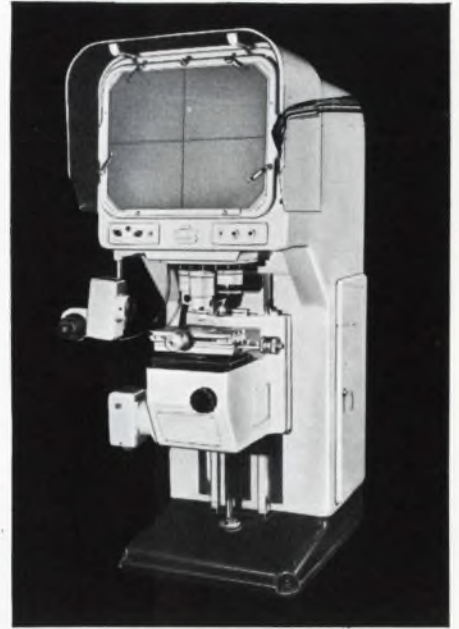

Profile Projector 5A 18x22" screen



Profile Projector 6 12" screen

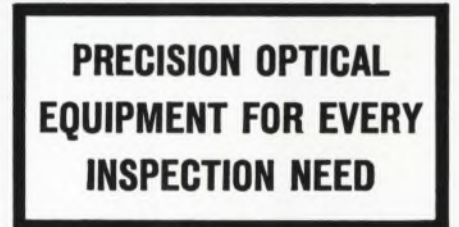

Stereo Zoom Microscope SMZ 4X to 120X

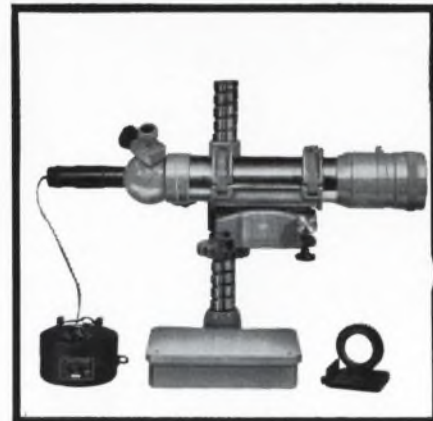

Auto Collimator 6 reads to 0.5 sec. of arc



Measurescope Toolmakers Microscope

Nikon Profile Projectors, microscopes and auto-collimators are essentially inspection tools — practical, reliable tools that more than earn their keep in time-cost savings. They have proved themselves many times over in product design, production, component screening, quality evaluation, quality control, and in numerous other applications requiring fast, accurate inspection, or precise dimensional measurements. The list of users of Nikon optical inspection equipment reads like a 'who's who' of American technology. For complete details, write to

NIKON INCORPORATED • INSTRUMENT DIVISION • 623 STEWART AVE., GARDEN CITY, N.Y. 11533

Subsidiary of EHRENREICH PHOTO-OPTICAL INDUSTRIES, INC.
Visit our booths 56 and 57, at the pathology meeting at the Palmer House
ON READER-SERVICE CARD CIRCLE 873

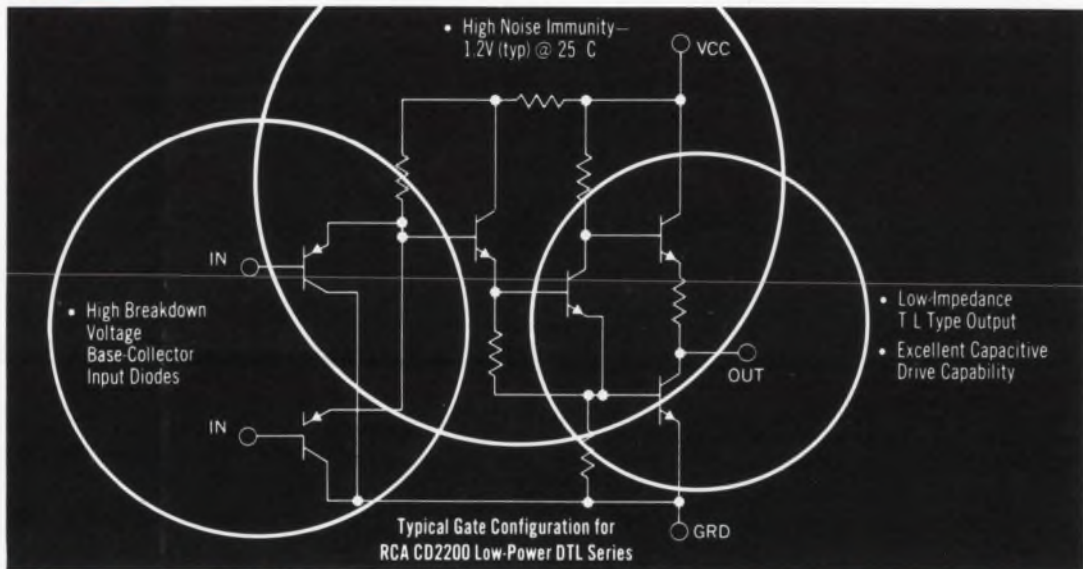

2.3 mW DTL

- Immediate Availability
- -55° to $+125^{\circ}\text{C}$ Operation
- New Buffer Gate (F-0 of 25)
- New AND/OR/NOT Gate
- Improved Characteristics



Now RCA offers an expanded line of Low Power Digital Integrated Circuits—at economy prices. Six versatile logic functions are available—operating at power supply voltages from 3.8V to 6.3V, with a fan-out of 6 over the full voltage and temperature range. New data sheets and an extensive application note are now available on these types. For details, check your RCA Representative or your RCA Distributor.

Family features RCA's unique ultra-reliable hermetic ceramic-to-metal 14-lead flat package

Write for Technical Data on the CD2200 Low Power DTL series to RCA Commercial Engineering, Section ICG-8, Harrison, N.J. 07029



TYPE	DESCRIPTION	PRICE (1000+)	TYPE	DESCRIPTION	PRICE (1000+)
CD2200	dual 4-input gate with expander node	\$3.75	CD2203	J-K Flip-Flop dual DC set and DC reset inputs dual J and K clock steering inputs split clock input	\$5.00
CD2201	quadruple 2-input gate	\$3.95	NEW! CD2204	dual 4-input gate expander	\$2.95
NEW! CD2202	dual 4-input buffer gate with expander node	\$3.95	NEW! CD2205	dual 3-input AND/OR/NOT gate ("phantom OR" capability)	\$3.75

RCA DTL TYPES ARE NOW AVAILABLE FROM STOCK-CHECK YOUR RCA DISTRIBUTOR FOR HIS PRICE AND DELIVERY

RCA Electronic Components and Devices



The Most Trusted Name in Electronics

ON READER-SERVICE CARD CIRCLE 874