

Electronic Design 10

VOL. 15 NO.

THE MAGAZINE OF ESSENTIAL NEWS, PRODUCTS AND TECHNOLOGY

MAY 10, 1967

Midair collisions will continue, declares the FAA. No foolproof scheme is in sight, but systems under study will warn pilots and inform them how to take evasive

action even at supersonic speed. The objective of designers is to develop an avoidance system for all aircraft. For an inside look at the major approaches, see p. 17.



New hp 141A: Variable Persistence & Storage Make It...

THE SCOPE WITH AN ADJUSTABLE MEMORY

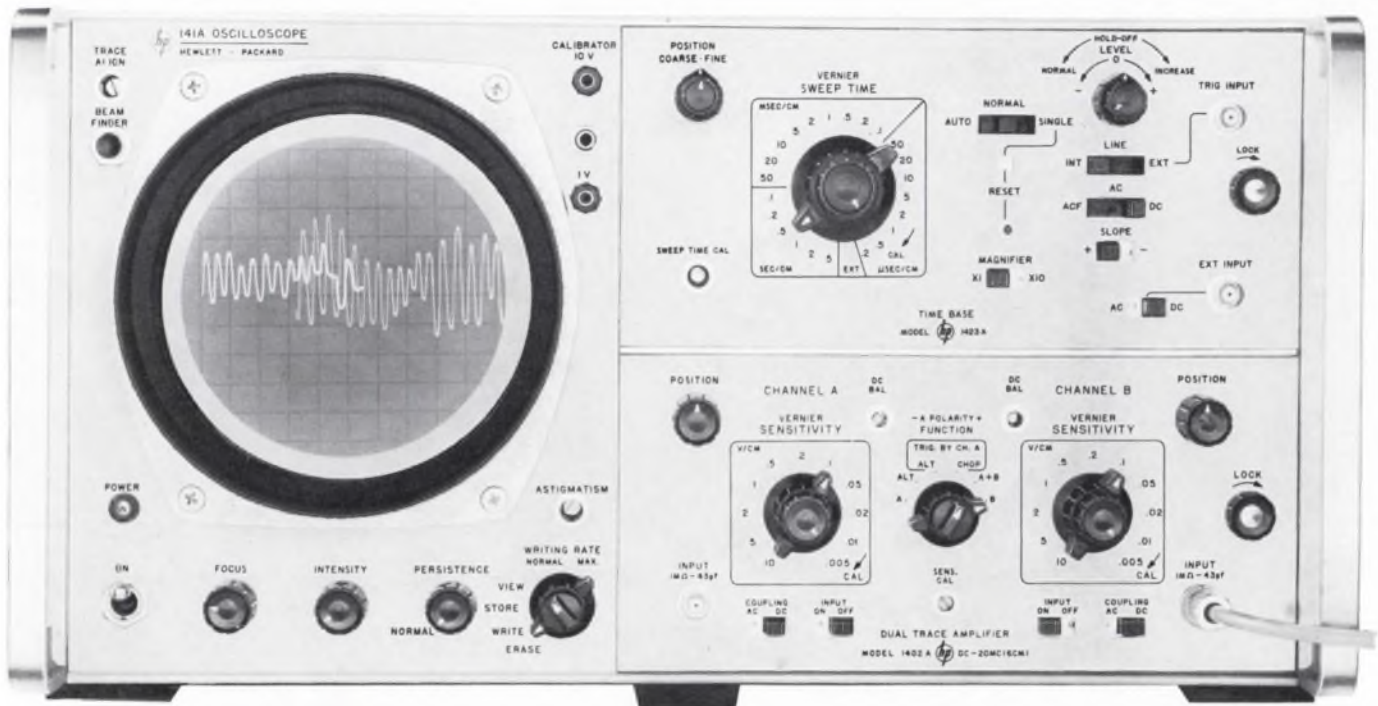

New hp 141A also gives you a choice of 17 high-performance plug-ins for clearly superior results in: 20 MHz Wideband • High-Sensitivity with no dc drift • 150 ps TDR • 12.4 GHz Sampling with delayed sweep —all with variable persistence and storage

- Match the persistence of your screen to any signal for steady traces without annoying flicker
- Store waveforms for side-by-side comparison
- Cover the entire measurement spectrum to 12.4 GHz with 17 high-performance hp plug-ins

At the twist of a knob, you can adjust the 141A's memory span (trace persistence) from 0.2 sec to more than a minute. This adjustment is "variable persistence". It enables you to: (1) Get bright displays of fast, low rep rate pulses because each trace reinforces the previous one, (2) see signal trends while making circuit adjustments by simply making persistence long enough so that several traces appear on the screen simultaneously, (3) see slow signals such as EKG, transducer and sampling waveforms by adjusting persistence so that the old trace fades as the new one is being written, and, (4) get maximum resolution on swept frequency measurements by sweeping slowly and increasing persistence.

In addition to exclusive variable persistence, the 141A gives you storage for side-by-side comparison of waveforms. In this mode, traces can be held intact for more than an hour (overnight, in fact, with the scope turned off). Fast 1 cm/ μ sec storage writing rate enables you to capture single-shot transients.

The 141A also gives you conventional CRT persistence. So, the 141A gives you three scopes in one: variable persistence, conventional persistence, and storage. Further, you can choose from 17 high-performance hp plug-ins to make virtually any oscilloscope measurement. Price, 141A mainframe: \$1395.

Get the complete picture from your hp Field Engineer, or write for Data Sheet 140A and see for yourself how much more you can do with this radically advanced hp scope. Hewlett-Packard, Palo Alto, California, 94304. Tel. 415 326-7000. In Europe: 54 Route des Acacias, Geneva.

087/16 e

HEWLETT  **PACKARD**
An extra measure of performance



Fourier Components
bandwidth: 3 Hz
recording range: 80 dB

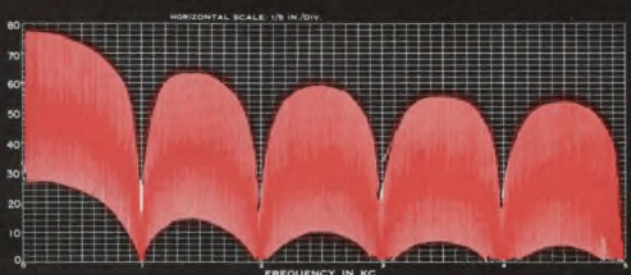

Periodic Wave
bandwidth: 50 Hz
recording range: 40 dB

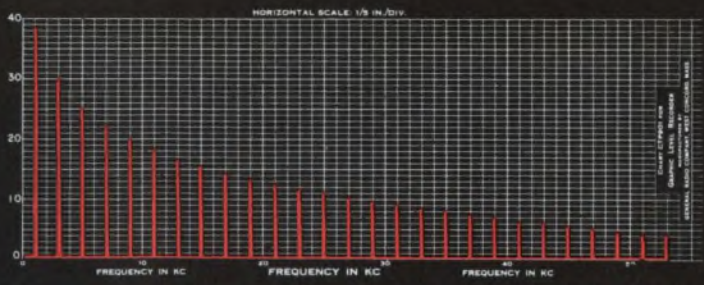

Modulation Noise
bandwidth: 10 Hz
recording range: 80 dB

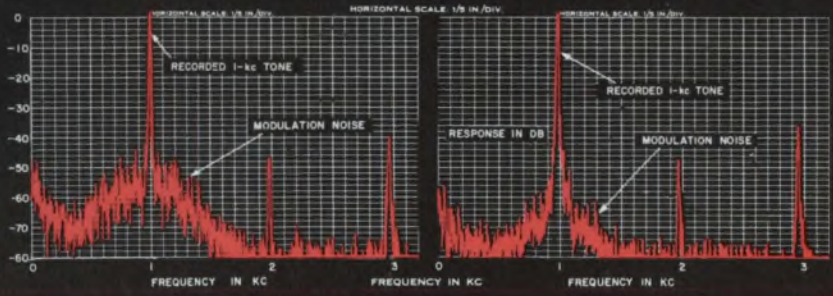

Spectrum Uniformity
bandwidth: 50 Hz
recording range: 20 dB

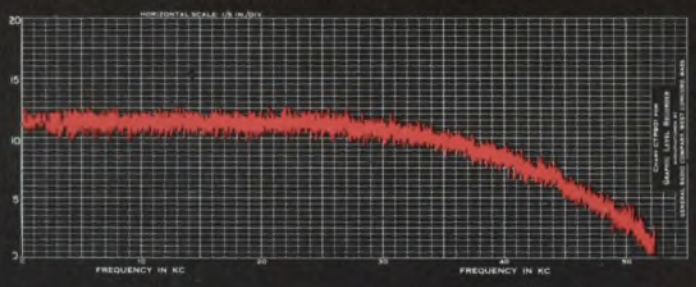

Choose from one different model

The GR Type 1910-A Recording Wave Analyzer does the work of several less-versatile instruments. With it you can select the bandwidth, recording range, averaging properties and chart resolution to match scores of different analyzing needs.

The 1910-A is a combination of a wave analyzer (Type 1900-A) and a graphic level recorder (Type 1521-B). It automatically sweeps and records input levels of $2 \mu\text{V}$ to 300 V over a range of 20 to 54,000 Hz with 80-dB dynamic range (when set to read 100 mV, or more, full scale). Included are 3-, 10-, and 50-Hz bandwidths, 40- and 80-dB full-scale recording ranges, and several sweep and writing speeds. Optional accessories (at extra cost) extend the sensitivity to submicrovolt levels,

add a 20-dB full-scale recording range and provide still more sweep speeds.

For a complete listing of the many operating modes of the 1910-A, write General Radio Company, 22 Baker Avenue, W. Concord, Massachusetts 01781; telephone (617) 369-4400; TWX 710 347-1051.



Type 1910-A Recording Wave Analyzer . . . \$3955 in U.S.A.

GENERAL RADIO
ON READER-SERVICE CARD CIRCLE 2

You'll flip too! A 16-bit data generator for only **\$680.00.**

The new Datapulse 201 offers

bit rates to 10MHz,

NRZ outputs to 10V,

variable baseline offset to $\pm 10V$, and

continuous or command

recycle. Multiple units

can be sequenced for

extended program

lengths or

paralleled for

additional

channels.

SHOWN FULL SIZE — two units require only 3½ inches of rack panel height.

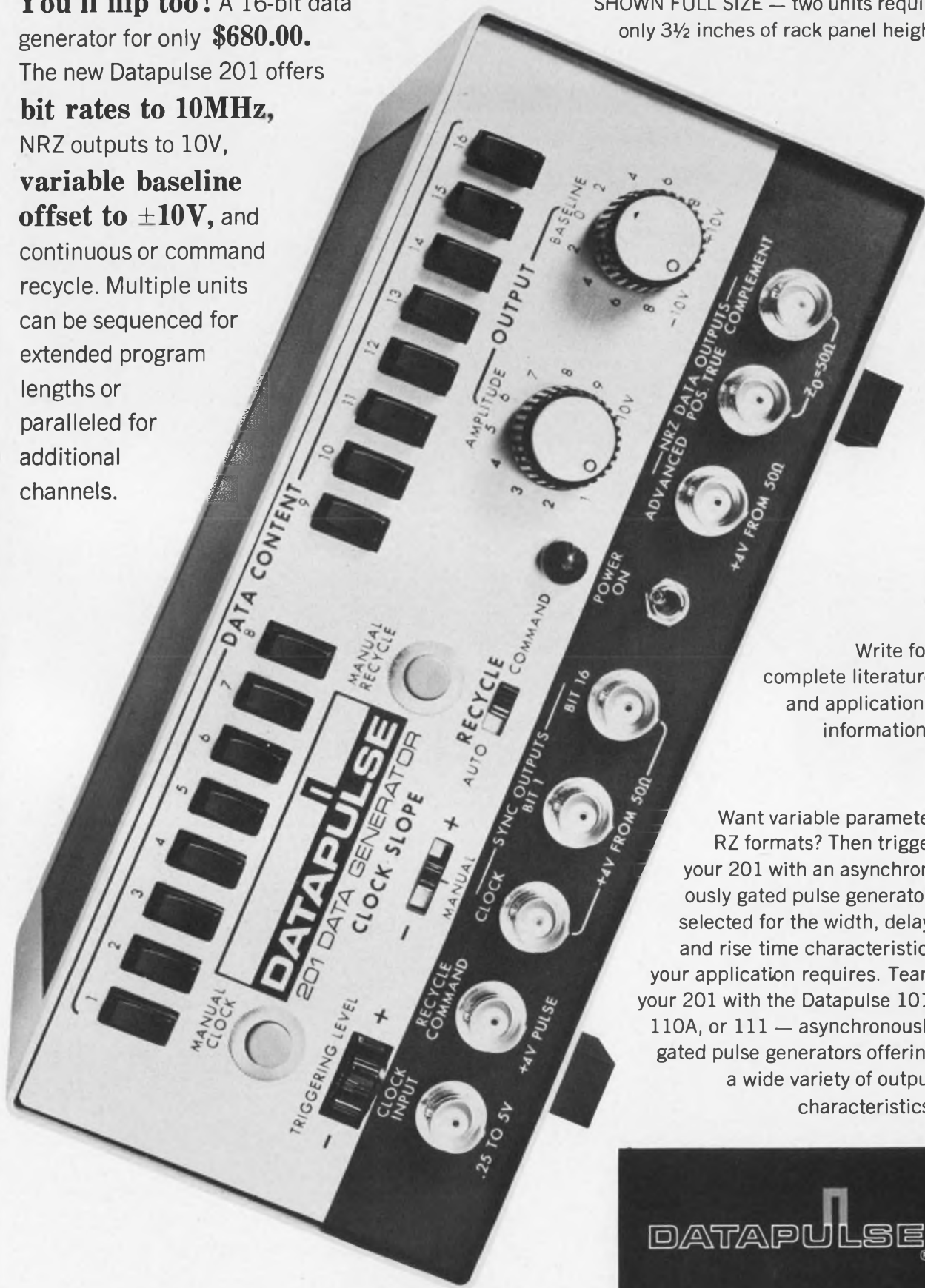

Write for complete literature and applications information.

Want variable parameter RZ formats? Then trigger your 201 with an asynchronously gated pulse generator, selected for the width, delay, and rise time characteristics your application requires. Team your 201 with the Datapulse 101, 110A, or 111 — asynchronously gated pulse generators offering a wide variety of output characteristics.

DATAPULSE/Division of Datapulse Inc./10150 Jefferson Blvd., Culver City, Calif. 90230/(213) 671-4334, 678-4275/TWX: 910-328-6109/Cable DATAPULSE
DATAPULSE • NESCO INSTRUMENTS • DE MORNAY-BONARDI • KRS INSTRUMENTS

ON READER-SERVICE CARD CIRCLE 3

ELECTRONIC DESIGN 10, May 10, 1967

Electronic Design 10

VOL. 15 NO.

THE MAGAZINE OF ESSENTIAL NEWS, PRODUCTS AND TECHNOLOGY

MAY 10, 1967

NEWS

- 10 News Scope
- 17 **CAS: Aid to traffic safety in crowded skies**
Airlines and electronics firms strive for a new collision-alarm system by July.
- 24 **The logic element of 'tomorrow': cheap wire**
Traveling magnetic domains do the work of conventional computer devices.
- 29 Washington Report
- 33 Short-backfire antenna may soon be uhf boon.
- 38 **Expo 67 to provide fun and culture**
Electronics will play a large role throughout the fairgoer's visit.
- 42 Letters
- 53 **Editorial: Look ahead, before you freeze the design.**

TECHNOLOGY

- 56 **Make a filter out of an oscillator** to get better stability than that of passive LC filters. The design is easy with IC amplifiers.
- 60 **Design a dc level-shifting amplifier** using a complementary current division technique. Complete analysis supplies design values.
- 64 **Stabilize power tubes at uhf and vhf** in a few simple steps. Beware of the distributed impedances inside the tube envelope, and you'll have no problems.
- 70 **Go/no-go technique tests amplifiers** rapidly and precisely. A simple setup enables a variety of measurements to be read out visually.
- 78 **Simplify magnetic-core coil design** with this direct and practical approach. Over 100 pilot designs and a core-selection chart form the basis.
- 86 **Maintainability specs bothering you?** If so, clear away the haze. Here's what they mean and how you should respond to them.
- 90 Ideas for Design
- 102 NASA Tech Briefs

PRODUCTS

- 108 **Components:** RF amplifier module can be cascaded for gains up to 70 dB.
- 144 **Test Equipment:** Accessory adapts oscillograph for simultaneous microfilming.
- | | |
|----------------------|--------------------------|
| 159 Materials | 173 Microwaves |
| 166 Microelectronics | 176 Systems |
| 170 Semiconductors | 178 Production Equipment |

Departments

- | | |
|--------------------|-------------------------|
| 104 Book Reviews | 186 Advertisers' Index |
| 180 Design Aids | 189 About the magazine |
| 182 New Literature | 190 Designer's Datebook |

ELECTRONIC DESIGN is published biweekly by Hayden Publishing Company, Inc., 850 Third Avenue, New York, N. Y. 10022. James S. Mulholland, Jr., President. Printed at Poole Bros., Inc., Chicago, Ill. Controlled-circulation postage paid at Chicago, Ill. and New York, N. Y. Application to mail at controlled postage rates pending in St. Louis, Mo. Copyright © 1967, Hayden Publishing Company, Inc. 62,409 copies this issue.

**"You can use
these 4 new
linear integrated circuits
at least 27 different ways!"
(How Many More Can You Think Of?)**

"Here's a monolithic 1-watt power amplifier that features 3 gain options, low distortion and a fantastic 0.2 ohms output impedance"

The MC1554G is more than adequate for driving speakers to normal room listening levels, thereby eliminating the need for an output transformer since the load can be connected directly to the output terminal. In addition, the low distortion output (0.4%) of this new monolithic circuit enables it to function extremely well in low-power servo systems. In the 10-pin metal "can," the MC1554G is priced at just \$15.00 (100-up).

Use the MC1554G in these applications:

- Wide-range, low-distortion audio amplifier
- Single-power-supply amplifier
- DC amplifier for servo systems
- AM modulator
- Servo systems driver
- Power oscillator
- Restricted-frequency-range communications amplifier

MC 1554G — TYPICAL PERFORMANCE

		@ Av Options
Output Power (P _{out})	1.0 W (min)	—
Output Gain (A _v)	10 V/V	10
	20 V/V	20
	40 V/V	40
Input Impedance (Z _{in})	10 k Ω	—
Output Impedance (Z _{out})	0.2 k Ω	—
Power Bandwidth (e _{out} = <5% THD)	270 kHz	10
	250 kHz	20
	210 kHz	40
Total Harmonic Distortion (P _{out} = 1.0 Watt)	0.4%	10
	0.53%	10
Total Harmonic Distortion (P _{out} = 0.1 Watt)	0.4%	10
	0.53%	10

"Two monolithic video amplifiers offer high stable gains, wide bandwidth and moderate prices"

The MC1552-53 integrated circuit video amplifiers offer the user a wide choice of gain and bandwidth, as indicated by the specifications below. And, each gain option provides a different gain-bandwidth product — as high as 7 GHz. The basic circuit that provides this outstanding performance level is a three-stage direct-coupled common emitter cascade, incorporating feedback from the third stage emitter back to the first stage emitter. An emitter-follower is used at the output. Both circuits are priced at just \$8.00 (100-up), and are packaged in the low profile 10-pin metal can.

Use the MC1552-53 in these applications:

- Wideband linear amplifier
- Fast-rise pulse amplifier
- Differential input Schmitt trigger
- Tuned amplifier
- Envelope detector
- Mixer, modulator & product detector
- RF communications output
- Radar system pulse amplifier
- Output stages — AM & FM radio

MC1552-53 — TYPICAL PERFORMANCE

		@ Av Options
Voltage Gain (V _{out} /V _{in})	MC1552	34 dB ± 1 dB
		50 100
	MC1553	52 dB ± 1 dB
		200 400
Bandwidth	MC1552	40 MHz
		35 MHz
	MC1553	35 MHz
		15 MHz
Voltage Gain Variation (-55°C to +125°C)		± 0.2 dB @ 200 kHz
		All
Noise Figure	5 dB @ 30 MHz	—
Temperature Drift	+0.002 dB/°C	—

"This versatile new monolithic I/C differential comparator is interchangeable with μA710"

The wide range of applications indicated below stems largely from the differential input characteristics of the MC1710 (G & F), as shown in the chart. In addition, this new integrated comparator is mechanically and electrically interchangeable with type μA710. Yet, it's priced substantially lower . . . only \$28.00 (100-up) in the 8-pin TO-99 package and \$36.00 (100-up) in the ceramic flat package.

Use the MC1710 in these applications:

- Voltage comparator
- Variable threshold Schmitt trigger
- Pulse-height discriminator
- Memory sense amplifier
- High-noise-immunity line receiver
- Analog to digital converter
- Digital line receiver
- Free-running multivibrator
- Hysteresis comparator
- Monostable vibrator
- Switching regulator

MC1710 — TYPICAL PERFORMANCE

Input Offset Voltage (V _{io}) V _{out} = 1.4 V; T _A = 25°C	2.0 mVdc
Temperature Coefficient (TC _{V_{io}})	5.0 mV/°C
Output Resistance (R _{out})	200 Ω
Differential Voltage Range: Positive Output Voltage (V _{OH}) Negative Output Voltage (V _{OL})	3.2 Vdc -0.5 Vdc
Response Time (t _a)	40 ns

For complete details about any or all of these state-of-the-art linear integrated circuits, write for our data sheets. We'll also send you our latest application notes on their uses. For circuits you can try right now, contact your nearby franchised Motorola Semiconductor distributor or district sales office.

where the priceless ingredient is care!



MOTOROLA Semiconductors

MOTOROLA SEMICONDUCTOR PRODUCTS INC./P. O. BOX 955/PHOENIX, ARIZONA 85001/(602) 273-6900/TWX 910-951-1334

ON READER-SERVICE CARD CIRCLE 4



We produce the world's
broadest line of tubes
for electronic countermeasures.

They include CW magnetrons, TWT's, M-type BWO's, crossed-field amplifiers and BARRATRON® transmitting tubes. We make tubes for both active and passive applications — with versatility to match any system requirement. Come to Litton for your ECM tubes — you'll find we've got plenty to crow about. Electron Tube Division, 960 Industrial Road, San Carlos, California.



LITTON INDUSTRIES
ELECTRON TUBE DIVISION

ON READER-SERVICE CARD CIRCLE 5

Do you think a bright young engineer should spend his most imaginative years on the same assignment?

Neither do we.

That's why many of our areas are organized by function—rather than by project.

At Hughes, you might work on spacecraft this year, communications satellites next year, tactical missiles the next year.

All you need is an EE, ME or Physics degree, 2-8 years experience, and talent. If you qualify, we'll arrange for you to work on several different assignments . . . and *you* can help pick them.



You may select specialized jobs, or broad systems-type jobs. Or you can choose *not* to change assignments if

you'd rather develop in-depth skills in one area.

Either way, we think you'll like the Hughes approach—the chance to be assigned by function, if desired. It means you'll become more versatile in a shorter time. (And your salary will show it.)

Then too it's nice to know that when a project is finished, you're not.



Some of the current openings at Hughes.

Electro-Optical Engineers
Microcircuit Engineers
Space Systems Engineers
Missile Systems Engineers
Guidance & Controls Engineers
Spacecraft Design Engineers
Weapon Systems Engineers
Components & Materials Engineers
Circuit Design, Development &
Product Engineers

Send resume to:
Mr. Robert A. Martin
Head of Employment, Dept. 31
Hughes Aerospace Divisions
11940 W. Jefferson Blvd.
Culver City, California 90230

U.S. Citizenship required
An equal opportunity employer



ONE POUND NET

TRANSISTORS EN 2369A

FAIRCHILD
SEMICONDUCTOR

Get them by the pound.

There are 712 epoxy TO-5's to a pound; 1,516 epoxy TO-18's. Armed with this basic knowledge you are now ready to assimilate a few more facts about Fairchild epoxy devices.

Full line: We have epoxy PNP's, epoxy NPN's, epoxy FET's, epoxy anythings.

Metal-can performance: Our new EN epoxy transistors are equivalents of their metal-can counterparts, up to 70°C. (For example, an epoxy EN 2369A is the equivalent of a metal-can 2N 2369A.)

Fast delivery: We make more silicon epoxy devices than all the rest of the industry put together. (We can ship 2 to 3 tons per week — 5,000,000 devices to be exact.)

Low Prices: Our low epoxy prices are even lower now, while our special one pound discounts are in effect.

Call a Fairchild Distributor: Ask him to deliver a pound of your favorite transistors. And don't forget to redeem your coupon.

25¢

This coupon is good
for 25¢ at your neighborhood
Fairchild Distributor on purchase
of one pound of Fairchild
epoxy transistors.

25¢



25¢

FAIRCHILD
SEMICONDUCTOR

A Division of Fairchild Camera and
Instrument Corporation ■ 313 Fairchild Drive,
Mountain View, California 94040.
(415) 962-5011 ■ TWX: 910-379-6435

25¢

ON READER-SERVICE CARD CIRCLE 6

STOP using so many ICs

All Sprague low-power Series 400 TTL circuits are dual or quad functions. Cut your can count and minimize equipment size. And the Series 400 has dual-source availability through the Sprague/Signetics full technology interchange.

Circuit Function	TO-88 Hermetic Flatpack		Plastic DIP Package		
	-55 to +125 C	0 to +70 C	0 to +70 C		-15 to +55 C Commercial
			Military GSE	Industrial	
DUAL 4-input NAND gate	SE416J	NE416J	NE416A	ST416A	SP416A
DUAL 3-input NAND gate	SE417J	NE417J	NE417A	ST417A	SP417A
DUAL A-C binary	SE424J	NE424J	NE424A	ST424A	SP424A
DUAL 4-input Exclusive OR gate	SE440J	NE440J	NE440A	ST440A	SP440A
DUAL 4-input buffer/driver	SE455J	NE455J	NE455A	ST455A	SP455A
QUAD 2-input NAND gate	SE480J	NE480J	NE480A	ST480A	SP480A



For complete technical data on Series 400 integrated circuits, write to Technical Literature Service, Sprague Electric Company, 347 Marshall Street, North Adams, Mass. 01247

SPRAGUE COMPONENTS

INTEGRATED CIRCUITS
THIN-FILM MICROCIRCUITS
TRANSISTORS
CAPACITORS
RESISTORS

PULSE TRANSFORMERS
INTERFERENCE FILTERS
PULSE-FORMING NETWORKS
TOROIDAL INDUCTORS
ELECTRIC WAVE FILTERS

CERAMIC-BASE PRINTED NETWORKS
PACKAGED COMPONENT ASSEMBLIES
BOBBIN and TAPE WOUND MAGNETIC CORES
SILICON RECTIFIER GATE CONTROLS
FUNCTIONAL DIGITAL CIRCUITS



Sprague and the logo are registered trademarks of the Sprague Electric Co.

ON READER-SERVICE CARD CIRCLE 7

News



A universal collision-avoidance system is the key to safety in the skies. Airlines and indus-

try aim to complete specifications for one that will meet FAA standards before July. Page 17



Electronics pervade Expo 67 in Montreal, where this cone of Douglas fir timber marks the fair-theme pavilion. Page 38

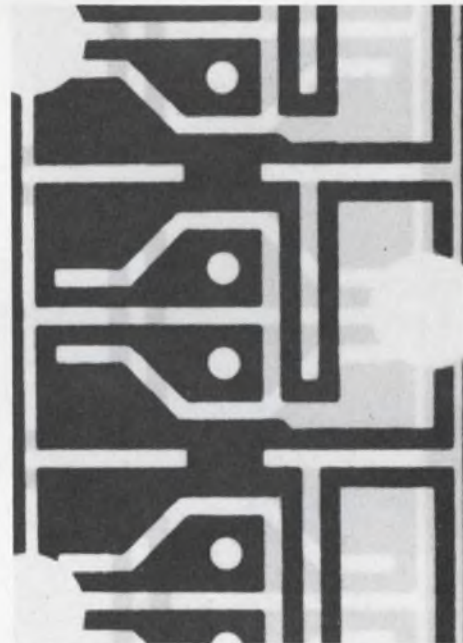

New logic elements make use of traveling domain wall. Page 24

Also in this section:

Materials research criticized as too device-oriented. Page 32

Short-backfire antenna should improve satellite-tracking and uhf applications. Page 33

News Scope, Page 13 . . . **Washington Report**, Page 29 . . . **Editorial**, Page 53

CEA

This new IRC metal film resistor handles **4 power ratings**



Think of the convenience and savings

Now, an all-purpose precision metal film resistor that offers design flexibility and opportunities for substantial cost savings. Type CEA can be used at four different ratings with ΔR 's that are all well within MIL limits.

$\frac{1}{2}W @ 70^{\circ}C$ $1\% \Delta R$ $\frac{1}{4}W @ 70^{\circ}C$ $.5\% \Delta R$
 $\frac{1}{4}W @ 125^{\circ}C$ $1\% \Delta R$ $\frac{1}{8}W @ 125^{\circ}C$ $.5\% \Delta R$

Flexibility is built-in. Even up to 300% overload, the CEA can be specified where low ΔR 's are required, or for a variety of ambient temperatures. Economy is built-in, too. You can combine your metal film needs to save money and simplify stocking.

All-purpose CEA resistors also have a moisture-resistant coating and a rugged cap and lead assembly. Write for data, samples and prices. IRC, Inc., 401 N. Broad Street, Philadelphia, Pa. 19108.

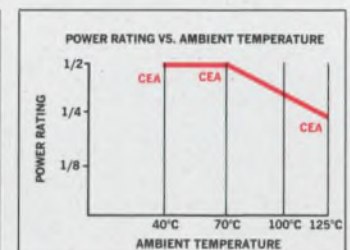
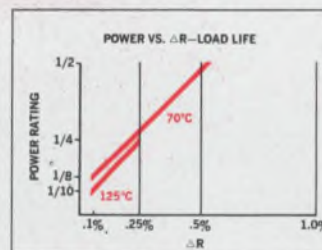

CAPSULE SPECIFICATIONS

MIL-R-10509 Meets or exceeds all performance requirements
Resistance 10Ω to 1.5 meg.
Tolerance $\pm 1\%$
Temp. Coef. $\pm 100 \text{ppm}/^{\circ}C$



ON READER-SERVICE CARD CIRCLE 8

The large-computer debate: 3 paths, but which is best?

Will the next generation of large computers simply be large single central processing units or will they be arrays of 250 or more central processing units? Or a combination of both?

These questions were raised in a lively panel discussion on "The Best Approach to Large Computing Capability" at the Spring Joint Computer Conference in Atlantic City, N. J. The consensus of the views was that:

- The single processor will be able to handle an increasing variety of programs but not all efficiently.

- Large parallel processors should prove to be most efficient for matrix and similar problems—for example, global weather forecasts.

- Multiprocessors will probably be successful in general-purpose applications, but they must be closely analyzed for cost effectiveness.

Conference chairman Gerhard L. Hollander of Hollander Associates, Fullerton, Calif., listed four possibilities in the development of large-scale computing systems:

- Multiple central processing units with separate computer-controlled input-output.

- Associative parallel processing that would allow the execution of

arithmetic in memory.

- Array computers using hundreds of central processors as elements of the array. Such systems could give parallel execution in each processor.

- Larger and faster single processors of the type presently in use.

But the real controversy, Hollander contended, will more and more "revolve around the relative advantages of each [system] architecture for different applications."

Introducing the multiprocessor approach, George P. West of the System Development Corp., Santa Monica, Calif., gave several criteria for a suitable system:

- The processors should be word-oriented with capability for shared memory.

- It should have a small character-oriented (byte) computer for input and output.

- Peripherals should have simple and reliable electromechanical design, with a minimum of control logic.

- A high-speed communications network should be used between processors and memory modules.

Such a system, West said, would reduce overhead time, since the executive program would be handled by the input-output computer; lower-cost peripherals would result because some logic functions would be taken over by the input-output machine.

Richard H. Fuller of General Precision, Inc., Glendale, Calif., introduced the associative parallel processor, a proposed system the memory of which would consist of logic units so arranged that arithmetic operations could take place in a parallel pattern in hundreds or thousands of memory locations.

Fuller listed these advantages for the associative parallel processor:

- Versatile performance characteristics as a result of simple word

and bit logic operations.

- Ability to modify the functional structure, without physical alteration, by weighting memory contents.

- Gain in speed, due to parallel processing.

Prof. David L. Slotnick of the Department of Computer Science, University of Illinois, put forward the case for the array computer. He cited the \$14 million ILLIAC IV project currently under consideration at the University of Illinois (see "ILLIAC IV development goes to Burroughs and Illinois U., E.D. 5, March 1, 1967, pp. 21-22). The ILLIAC IV will consist of 256 central processing units, arranged in four subarrays with individual control units.

Professor Slotnick gave these reasons for his choice:

- Technology has now so advanced that computers will be able to keep pace with the needs of scientific and military research.

- The parallel system will make maximum use of available storage devices.

- Some degree of design mechanization—that is, computer-aided computer design—can be used to build the system.

A supporter of the single-processor approach, Dr. Gene M. Amdahl of the International Business Machines Corp., Sunnyvale, Calif., disputed the savings claimed for parallel operating systems.

He said that 40% of most problems appeared to be concerned with data management, which is largely sequential in nature. Thus improvement in problem efficiency will depend on the degree of parallelism exhibited.

Dr. Amdahl noted another drawback: systems of partial differential equations may have irregular boundaries when dealing with physical problems, producing severe complications in the regular geometrical-array type of computer.

Airborne radar may penetrate jungle canopy

Research is under way at the Air Force Cambridge Research Laboratories, Mass., to perfect an airborne radar that will detect trucks, tanks, artillery and metal targets hidden in thick jungle growth.

Such military metal hardware



What's in store for the future?

scatters electromagnetic radiation strongly when the radar wavelength is about equal to the dimensions of the object on the ground. Radars designed to detect this scattered radiation from objects of a given dimension are known as resonant-region radars.

Project Shedlight aims to apply the technique, using frequencies lower than are normally used for airborne radar reconnaissance, to Southeast Asia. The lower frequencies penetrate jungle vegetation and also exploit the resonance effects which produce a strong radar echo relative to background clutter.

The scientists' main problem is that of target location, because the relatively broad antenna pattern inherent in low-frequency operation precludes usual scanning and beam-pointing methods. To overcome this, the laboratories are investigating the effectiveness of phase-comparison techniques.

A low-frequency multielement antenna has been built at Ipswich, Mass., and is being tested on metal objects against both land and sea background reflections. If the tests are successful, the laboratories will undertake design of an operational airborne system.

Beam-aiming device sharpens laser scalpel

Bell Telephone Laboratories, Inc., Murray Hill, N. J., has perfected a device that facilitates the surgical use of a laser beam for cutting tissue. It enables a surgeon to control the direction of the beam with ease and exactitude.

The beam is aimed through a series of hollow, aluminum tubes, which are mounted at right angles to each other. The angles contain ball bearings, which enable each tube to be rotated about its longitudinal axis while it retains its perpendicular relationship to the tubes to which it is connected. This arrangement gives complete freedom of movement to a hand-held probe at the end of the tubes. The probe

contains a lens which focuses the beam at a point a few inches beyond the tip of the probe.

Any type of laser may be used with the laser scalpel, because the optics inside the series of tubes consist of prisms that reflect the beam at right angles corresponding to the angles between the tubes.

Use of the laser scalpel avoids the ripping of tissue that is caused by the mechanical stresses induced by a surgical knife. The beam vaporizes tissue at its focus and its heat cauterizes the wound as the incision is made, reducing loss of blood and the chances of infection. The manipulability and precision of the instrument enable the surgeon to trace a sharp, fine line.

The laser scalpel is presently being tested at the Manhattan Ear, Nose and Throat Hospital and the Columbia Presbyterian Medical Center, both in New York.

Multicolor CRT will have single phosphor coating

A single-phosphor cathode ray tube for multicolor displays will be developed by a division of the International Telephone and Telegraph Corp. under a contract awarded by NASA Electronics Research Center, Cambridge, Mass.

Dr. Robert T. Watson, president of ITT Industrial Laboratories Div., Fort Wayne, Ind., said that such multicolor display tubes will be useful in aircraft cockpit displays, radar displays, air-traffic-control displays and monitors for alphanumeric data.

"It is very often desirable," he said, "to use color variation to emphasize critical portions of numerical or alphabetical displays. For many displays it is not necessary to provide the complete color spectrum, which requires costly, weighty and complex multiple-gun color tubes. Therefore, development of a multicolor phosphor permitting a simple single-gun cathode-ray tube will offer great advantages."

Electron depositions can now be measured

A technique that permits measurement of the deposition of electrons in a material is reported at

GE's Re-entry Systems Div. Electron impacts on one side of the material result in changes in the resistance of a manganin wire gauge fastened to the other side.

Weather satellites may aid friend and foe

Weather pictures from ESSA and NIMBUS satellites are alerting U.S. pilots to favorable meteorological conditions over North Vietnam, but they may be tipping off North Vietnamese air defenses, too.

Video images from the orbiting TV camera platforms are received and processed by U.S. Air Force weather stations in South Vietnam and Thailand. Still-wet prints of pictures that may have been taken just minutes previously are sped to headquarters in Saigon. There the United States Air Commander in Vietnam, Lt. Gen. William M. Momyer, diverts aircraft to targets that are clear of cloud cover. This aid is particularly valuable when the weather is bad.

Since the United States weather program is unclassified and part of an international program, equipment that can receive the satellite transmissions is available to many countries, including the Soviet Union. With equipment of this sort, stations in Hanoi could also be spotting breaks in the cloud cover and preparing for air raids.

U.S. computer programs are offered to industry

NASA computer programs that can be adapted for industrial use are being distributed by a new center at the University of Georgia. Called Cosmic (Computer Software Management and Information Center), the service is offering computer programs on tape or in punched-card form.

Requests are being filled for \$20 a program. If more than one program is ordered, however, and all can be copied onto one tape, the charge for additional programs is \$10 apiece. A listing of what is available can be obtained free.

For information, write Cosmic, Computer Center, University of Georgia, Athens, Ga. 30601, or call (404) 542-3265.

Air variables from JFD solve your high Q high frequency problems

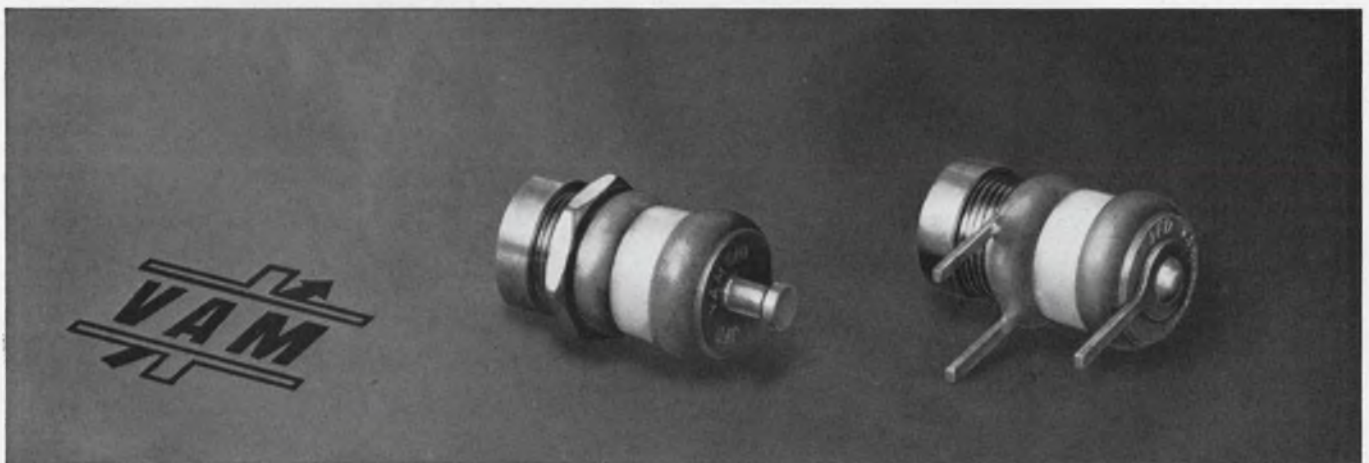

Capacitors shown enlarged 120%

The JFD air variable miniature capacitor series—VAM—is specifically designed for high frequency applications that demand extreme stability, small size and high Q (greater than 2,000 measured at 10 pf and 100 MHz) VAM's have rugged construction, measure approx. ½" in length and are completely interchangeable with competitive devices.

ELECTRICAL DATA — ALL VAM MODELS

Cap. Range at 1 MHz ... 0.8 to 10.0 pf

Q at 10 pf & 100 MHz ... >2,000

Insulation Res. at 25°C ... 10⁴ megs.
at 100 VDC

Temp. Coeff. of Cap. (-55°C to
+125°C) ... 0 ±20 PPM/°C

WVDC ... 250 VDC

Test Voltage ... 500 VDC

ACTUAL SIZES

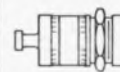

VAM 010*
Panel Mount w/Turret Terminal



VAM 010M
Panel Mount w/Lug Terminal

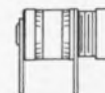

VAM 010W
Printed Circuit

*VAM 010 also available as VAM 010H with 4-40 threaded stud replacing turret terminal.

Write for catalog VAM-66-A

"TODAY'S COMPONENTS BUILT FOR TOMORROW'S CHALLENGES"

JFD

JFD ELECTRONICS CO. / COMPONENTS DIVISION • 15th Avenue at 62nd Street • Brooklyn, New York 11219 / Phone 212-331-1000
Sales Offices — Arcadia, California / Chicago, Illinois / Baltimore, Maryland / Saxonville, Massachusetts / Brooklyn, New York
New Hartford, New York / Cincinnati, Ohio / Philadelphia, Pennsylvania / Pittsburgh, Pennsylvania / Paris, France / Azor, Israel

ON READER-SERVICE CARD CIRCLE 9

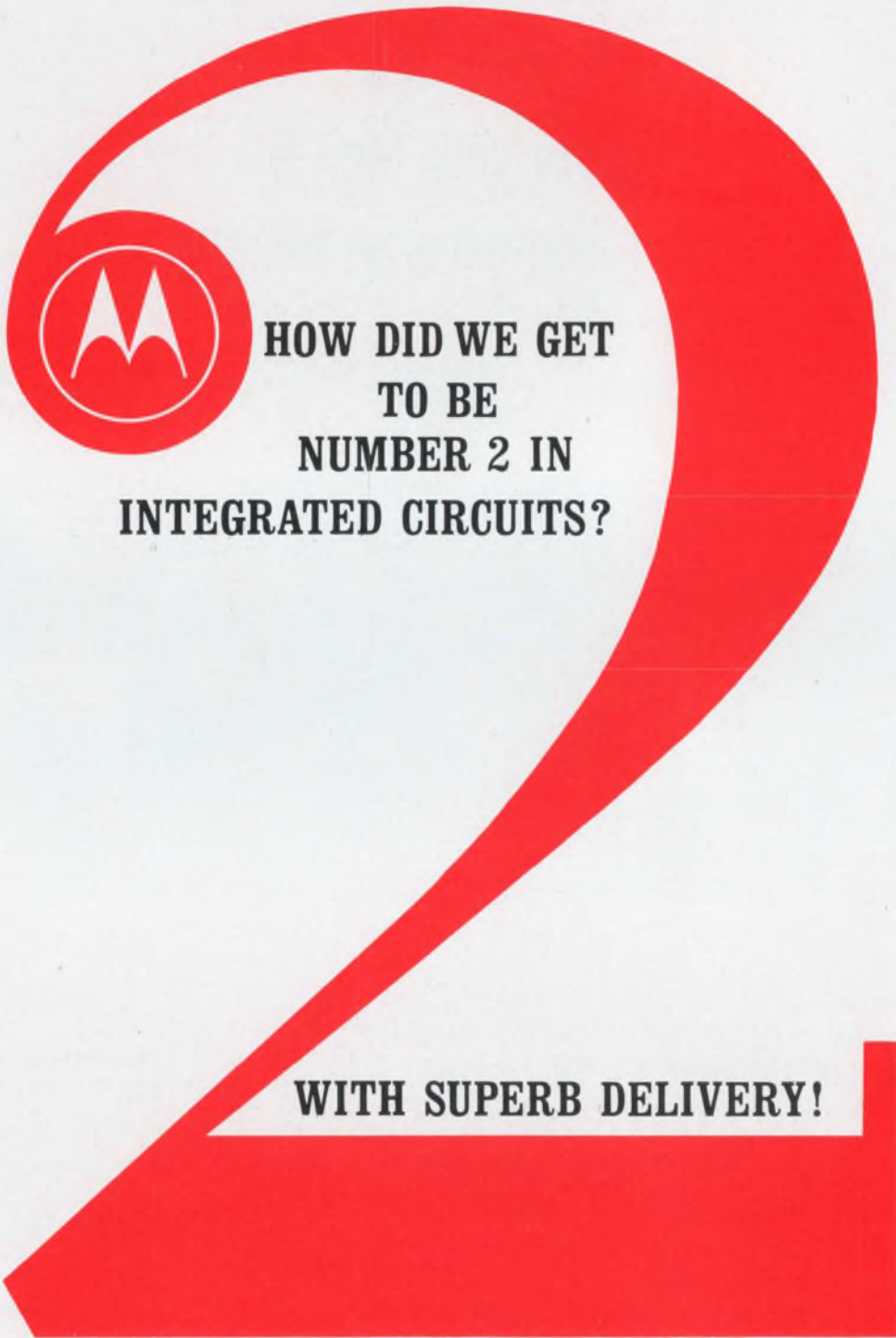

**HOW DID WE GET
TO BE
NUMBER 2 IN
INTEGRATED CIRCUITS?**

WITH SUPERB DELIVERY!



MOTOROLA Semiconductor Products Inc.

ON READER-SERVICE CARD CIRCLE 10

CAS: Aid to traffic safety in crowded skies

FAA, airlines and industry delegates strive for collision-avoidance-system accord by July

Neil Sclater
East Coast Editor

Hardly a week goes by without several near collisions between two flying aircraft in the United States. For modern jets, potential disaster has a closing rate that exceeds the velocity of a bullet. When supersonic transports take to the air, they will approach one another at four times the speed of sound.

The prospects worry the nation's airlines and safety officials in the Federal Aviation Administration. To counteract the hazard, they are calling on the electronics industry to develop a universal anticollision system. The airlines are willing to accept a solution that is less than perfect and are not even placing any limits on cost.

One such system has already been devised and is now in operation: the EROS I, built by the McDonnell Co. But it is being used only aboard McDonnell combat planes when they are flight-tested near the com-

pany's assembly plant at St. Louis. EROS I is not designed to accommodate the large numbers of civil aircraft in the nation's airways. Nor is it tied in with the FAA's traffic-control system; it depends on ground stations that are not now acceptable to all possible users.

McDonnell has designed a new version of its system. Called EROS II, it is the company's candidate for a universal air-collision-avoidance system.

Spearheading the drive to develop a reliable universal system—one that could be used by the airlines, private planes and the military—is the Air Transport Association of America. The association has sponsored meetings in Washington in the last year at which representatives of the airlines, the FAA and the electronics industry have discussed possible approaches. Their immediate goal: specifications by June 30 for a collision-avoidance system that will meet FAA standards.

The companies participating in

the discussions are McDonnell; the Collins Radio Corp., Cedar Rapids, Iowa; the TRG Div. of the Control Data Corp., Melville, N. Y., the Bendix Radio Div., Baltimore; the National Co., Melrose, Mass., and the Sierra Research Corp., of Buffalo.

What they anticipate is a collision-avoidance system—or a CAS, as the specialists refer to it—that will use radio pulses as a kind of "one-way radar" to alert any aircraft to the presence of others. Impending collisions will be determined by a knowledge of separation distance and closing rate. These data will be obtained by timing the transit of the radio pulses to determine separation distance or range and then using the frequency shift of the pulses to determine the relative speed of any two converging planes. But a major problem is this: The accuracy of the system depends on both planes keeping the same time to a high degree of accuracy.

The transmitting frequency of each plane in the system will be derived from an on-board master clock, and the propagation time of received signals will be measured

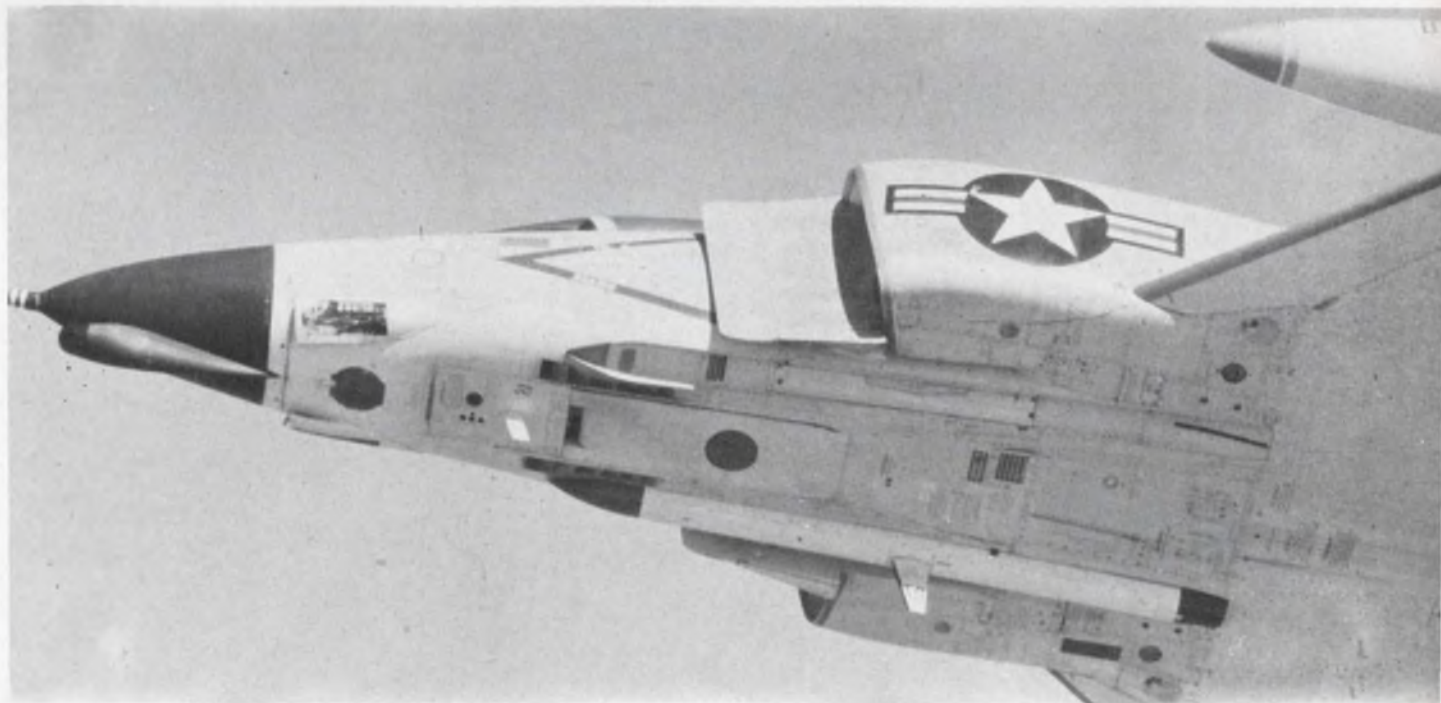

Collision-avoidance circuitry is packaged in a slender Sparrow missile pod and slung under the fuselage on this

McDonnell F-4 Phantom. The small fin on the pod is an antenna. Another antenna is on top of the fuselage.

(anticollision, continued)

by using the clock as a reference. A major engineering decision to be reached is the choice of the best airborne clock and the best means of synchronizing it to all others so all are within a microsecond of the same time. One approach calls for master ground stations, another for air-to-air synchronization.

Airlines in this country have been seeking a practical collision-avoidance system for more than 12 years. But there was little interest on the part of manufacturers until two airliners collided over the Grand Canyon in June, 1956, killing 128 persons. Then manufacturers began to submit proposals. None was developed as successful hardware until the McDonnell Co. demonstrated EROS I in the fall of 1965. (The acronym stands for "Eliminate Range 'O' System.") The company acted after a midair collision between two of its planes in the summer of 1960.

Today McDonnell makes routine use of its CAS system to protect its F-4 Phantom fighters while they are undergoing tests in limited air space near the company's plant. The McDonnell system forms the basis for most engineering discussions about a universal CAS.

The McDonnell EROS I system is known as a "cooperative" type—that is, all planes must be equipped

with comparable equipment. It gives the pilot of an equipped aircraft a warning of 60 seconds if it is in danger of colliding with another equipped aircraft. An aural warning is accompanied by simple visual collision-avoidance directions on a panel instrument: "fly up," "fly down" or "fly level." The system works, McDonnell says, at closure rates four times the speed of sound, whether the planes are turning, climbing, descending or flying level. At slowest closing rates, the system reacts when the planes are at least one and a half miles apart.

System is portable

The EROS I system contains most of the desired features in a universal collision-avoidance system. It is not part of the permanently installed equipment in the F-4 Phantoms; it is removed before the planes are delivered to the military. Because no space for the installation is available within the F-4, the system is packaged in a Sparrow missile pod that is suspended in a rack under the fuselage.

Each aircraft equipped with EROS is assigned a precise time slot during which it transmits range and altitude information for all other EROS aircraft to receive. The system is arranged so that no two aircraft transmit at the same time. Transmission of data occurs during only a fraction of the assigned slot time, and there are 1000

available slots. Each aircraft can be identified by its assigned time slot.

Each plane has a time clock from which all range and range-rate data are derived. Signals from a ground station reset these clocks every two seconds.

For McDonnell's test-flight purposes, the number of time slots available is adequate. With a maximum of 37 planes using the system at any one time, 1000 slots are ample. However, permanent assignment of only 1000 slots would severely hobble a universal civil system. This has led to a number of suggestions by McDonnell and other companies on better methods of assigning slots for the thousands of aircraft likely to be in operation. One scheme would assign slots on the basis of a different transmission frequency in discrete altitude bands.

The airlines and the Air Transport Association are optimistic about developing a workable universal system. Frank White, manager of communications and data processing for the association, says:

"There is no longer any doubt that a practical CAS can be built; there is no longer any question about the technique to use. What remains to be settled now are the trade-offs—the weighing of different design details against their corresponding operational benefits or drawbacks."

Ideally a collision-avoidance system should be noncooperative—

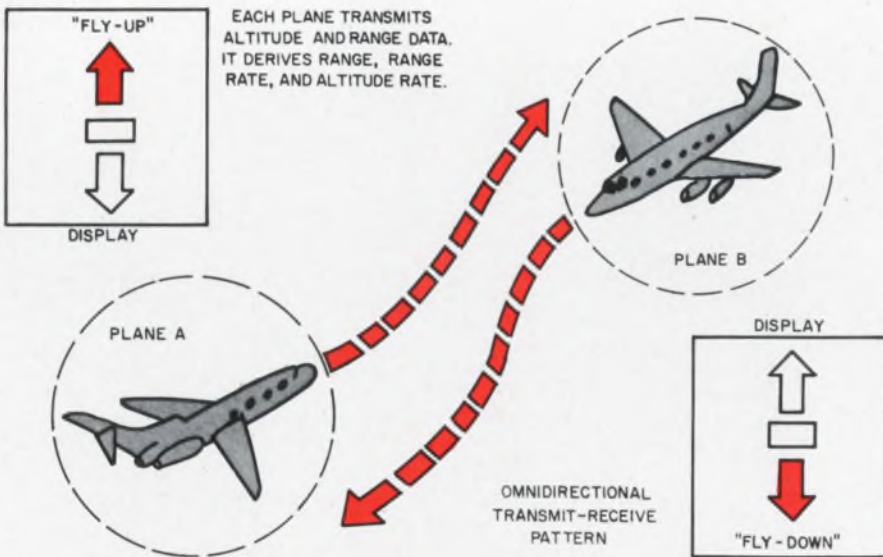

Basically "one-way radars," collision-avoidance systems back up ground air-traffic control. They detect and evaluate hazards and direct the pilots to take evasive action. In this situation, plane A is directed to "fly down" and plane B to "fly up." Indicators are on the instrument panels of the planes.

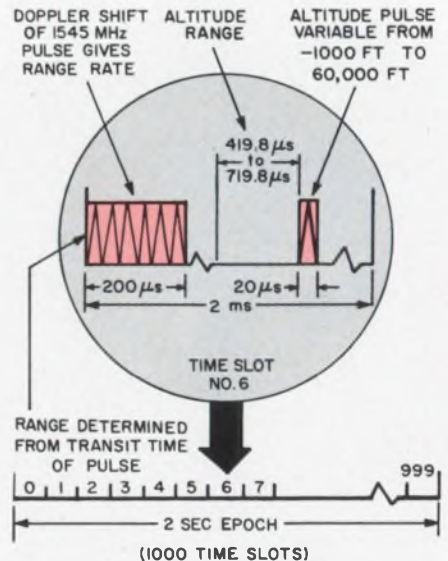

Data format of McDonnell's operational EROS I illustrates how range and altitude are encoded for use in the system.

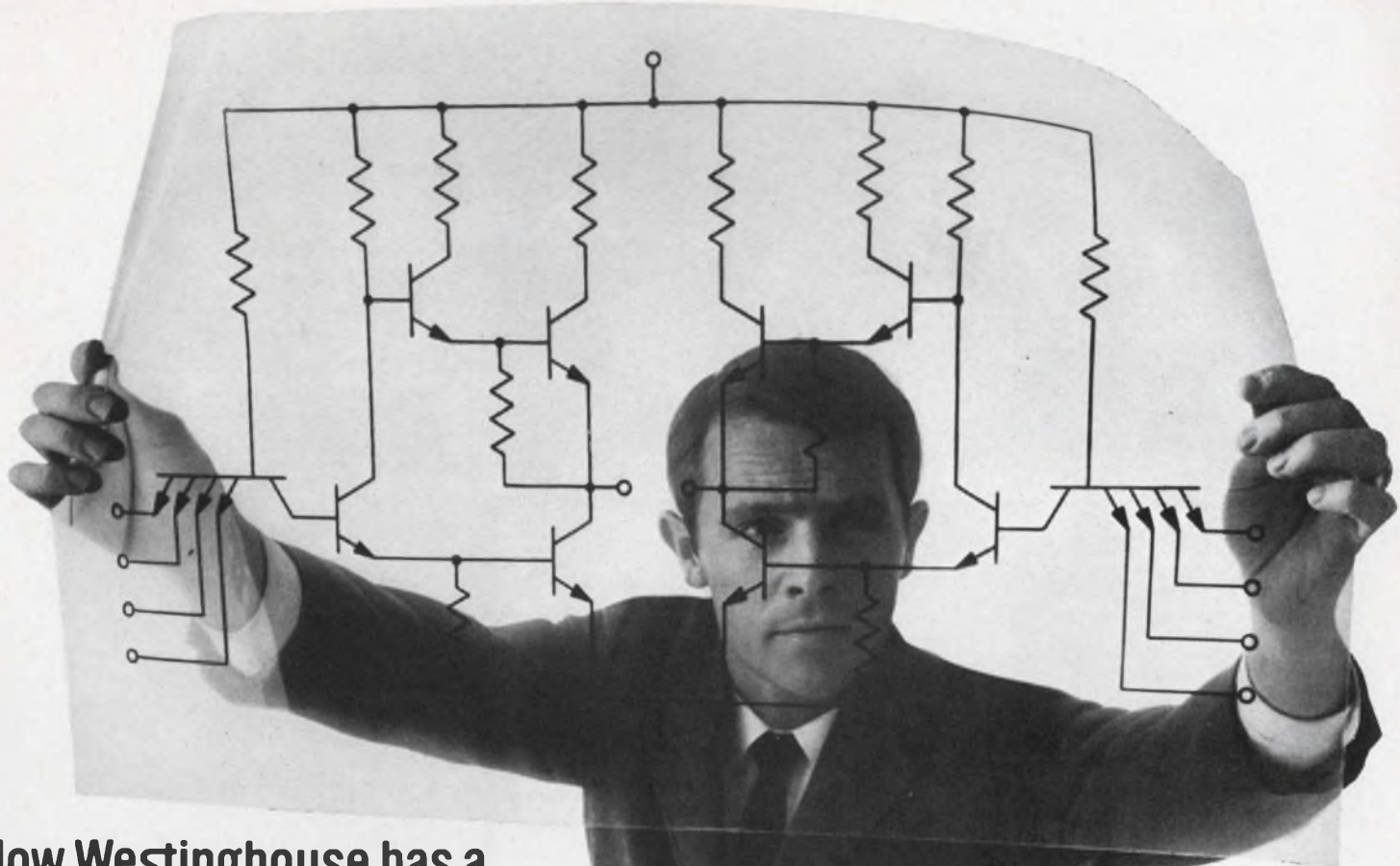

**Now Westinghouse has a
pin-for-pin replacement for
the industry-accepted TTL.**

**But don't think of us only
as a second source.**

There's a very good reason why you should make Westinghouse TTL your *first* source.

Because this is the TTL line that is available now.

It's a direct mechanical and electrical replacement for the industry-accepted SUHL II. And all circuits are available in industry-standard dual-in-line and flat packages.

They include: 6G260 Single 8-input NAND/NOR Gate, 6G241 Dual 4-input NAND/NOR Gate, 6G221 Quadruple 2-input NAND/NOR Gate, 6G210 Dual Expandable OR/NAND Gate, 6G250 Quadruple Expandable OR/NAND Gate, 6G130 Dual 4-input Driver, 6G270 Dual OR Expander, 6F251 AND input JK Flip-Flop, 6F261 OR input JK Flip-Flop.

In fact, it makes good sense to make Westinghouse first choice for all your IC's. Because our goal is to help keep your products competitive now and into the 1970's.

For evaluation quantities, contact your Westinghouse Electronic salesman. Or phone Westinghouse at (301) 796-3666. Or write Westinghouse Molecular Electronics Division, Box 7377, Elkridge, Maryland 21227.

You can be sure if it's Westinghouse

J-09142



Did You Know Sprague Makes 32 Types of Foil Tantalum Capacitors?

125 C TUBULAR TANTALEX® CAPACITORS



Type 120D polarized plain-foil
Type 121D non-polarized plain-foil
Type 122D polarized etched-foil
Type 123D non-polarized etched-foil

ASK FOR BULLETIN 3602C

ON READER-SERVICE CIRCLE 821

85 C TUBULAR TANTALEX® CAPACITORS



Type 110D polarized plain-foil
Type 111D non-polarized plain-foil
Type 112D polarized etched-foil
Type 113D non-polarized etched-foil

ASK FOR BULLETIN 3601C

ON READER-SERVICE CIRCLE 822

RECTANGULAR TANTALEX® CAPACITORS



Type 300D polarized plain-foil
Type 301D non-polarized plain-foil
Type 302D polarized etched-foil
Type 303D non-polarized etched-foil

ASK FOR BULLETIN 3650

ON READER-SERVICE CIRCLE 823

TUBULAR TANTALUM CAPACITORS TO MIL-C-3965C



CL20, CL21 125 C polarized etched-foil
CL22, CL23 125 C non-polarized etched-foil
CL24, CL25 85 C polarized etched-foil
CL26, CL27 85 C non-polarized etched-foil
CL30, CL31 125 C polarized plain-foil
CL32, CL33 125 C non-polarized plain-foil
CL34, CL35 85 C polarized plain-foil
CL36, CL37 85 C non-polarized plain-foil

ON READER-SERVICE CIRCLE 824

RECTANGULAR TANTALUM CAPACITORS TO MIL-C-3965C



CL51 polarized plain-foil
CL52 non-polarized plain-foil
CL53 polarized etched-foil
CL54 non-polarized etched-foil

ON READER-SERVICE CIRCLE 825

For comprehensive engineering bulletins on the capacitor types in which you are interested, write to:

Technical Literature Service
Sprague Electric Company
347 Marshall Street
North Adams, Mass. 01247

SPRAGUE®
THE MARK OF RELIABILITY

® Sprague and ® are registered trademarks of the Sprague Electric Co.

NEWS

(anticollision, continued)

that is, it should not require matching equipment in all aircraft. However, all leading technical authorities agree that this is unfeasible in the present state of electronics technology.

According to the FAA, a collision-avoidance system must be able to do the following to meet its standards:

- Evaluate the hazards and determine the precise maneuver needed to avoid a collision.

- Indicate when the maneuver should be started to guarantee safe clearance.

- Work uniformly well in light, slow planes as well heavy, supersonic craft.

- Be compatible with the existing and future FAA air-traffic-control systems.

- Accommodate large numbers of aircraft within radio communication range.

All participants in the Air Transport Association conference have accepted these objectives.

FAA officials say that theoretically the perfect CAS would reduce the probability of a collision to zero. But technical considerations, they concede, make this impractical. The aim is to make collisions highly improbable.

'Tau Criterion' used

All systems make use of the "Tau Criterion" as the basis for design. Tau is a critical time value obtained when range, or separation distance, is divided by closing speed, or range rate. A value of Tau from about 40 to 60 seconds is determined as the time in which aircraft should begin reasonable collision-avoidance maneuvers. All systems obtain Tau from the transmissions of all other aircraft within radio range. An alarm is sounded when the value of Tau equals or falls below the critical collision-avoidance time.

Most experts agree that time-frequency techniques should be used to derive Tau. This means that all time values and transmission frequencies must be derived from the same precise time source. The clocks on all aircraft must agree within a microsecond. With precise, synchronized, common time, the range of an approaching aircraft

The ABC of CAS circuitry

A basic collision-avoidance system (CAS) for aircraft is the McDonnell Co.'s EROS. In the block diagram below, the basic system is in black outline. The functions outlined in color are in dispute by designers in industry. The solid-color blocks are proposed additions to the logic.

A clock (1), controlled by a frequency standard (perhaps 5 MHz), generates the timing and also synchronizes the frequencies for the transmitter and receiver. The clock triggers the slot generator (2), which generates cycle spacings as well as the pulse spacings for the time slots. The frequencies, assumed to be around 1600 MHz, are generated by the coherent RF multiplier (9) for the transmitter carrier (6) and for the receiver local oscillator (11).

Time-slot selection logic (3) gates on the transmitter modulator (5) whenever the time slot occurs for an aircraft with CAS aboard. A signal is derived from the altimeter by means of the altitude transducer (8), and this is time-delayed by the data encoder (7) to form altitude position pulses. Command messages that are generated by the transmit command circuit (18) from the alarm logic

(19) are superimposed in the transmitter by the modulator. A receiver (11) converts the incoming transmissions from other aircraft to IF.

Video detection of these received signals gives range information in the range circuit (12) and permits decoding the altitude in the altitude circuit (14) and any command messages in the command receive circuit (17). The local altitude information is compared with the decoded altitude information (14) in the alarm logic. The frequency discriminator (10) delivers a signal that is directly proportional to the Doppler shift impressed on the received signal by the relative motion of the two aircraft. The Tau logic (15) takes and stores the information and activates the alarm logic if either the range or the Tau criterion is reached. Altitude filters can be employed to restrict the alarm conditions to an altitude band.

The alarm logic (which may be a computer) computes and evaluates the collision threat. A display tells the pilot of the protected aircraft the evasive action to take. The maneuver that the other aircraft is performing is also displayed for the pilot.

The time clock synchroniz-

er (13) compares and corrects errors between the slot generator and selector circuits and is used in resynchronization. In the case of resynchronization from the ground or air while the aircraft is airborne, the transmitter-receiver components can be employed to obtain round-trip range measurements. These, along with transmissions of timing signals, can be used to establish resynchronization.

Both multiplier (9) and discriminator (10) are optional. Range rate can be derived by taking the difference between successive range measurements and dividing by the time lapse. Block 16 shows range rate \dot{R} derived without the aid of the discriminator.

The altitude of an oncoming plane is derived from a pulse-position modulated signal. The time difference is noted between the start of range and altitude pulses. Collins Radio proposes that altitude rate be determined from successive measurements. TRG proposes to transmit altitude by slot selection (shown by colored lines leading from 11 and 8 to 3).

True air speed and heading are other proposed additions to the logic.

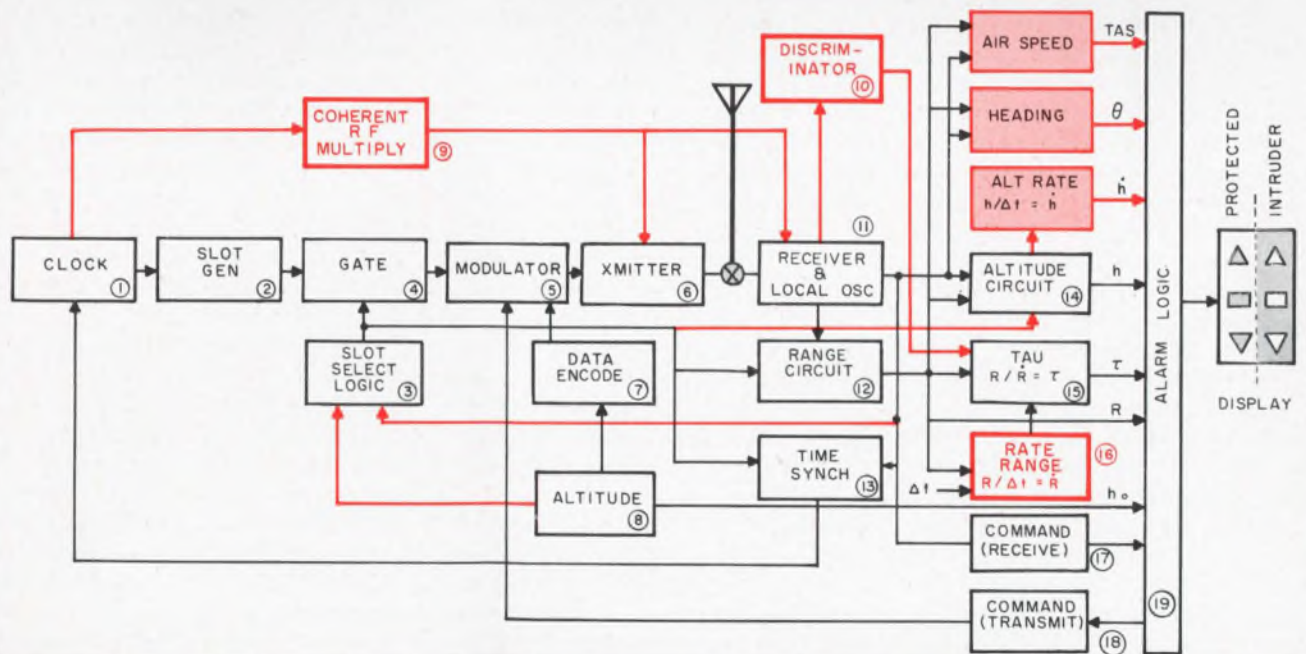

(anticollision, *continued*)

can be accurately determined from the one-way radio-frequency transit time. In addition range rate can be derived from the Doppler shift of an RF pulse at a standard coherent frequency.

Other points that have generally been agreed upon are these:

- Altitude values are necessary to determine the probability of collision. They should be determined from each plane's barometric altimeter and should be transmitted to all other aircraft.

- Transmissions should be between 1540 and 1660 MHz.

According to Air Transport Association conference records, the principal engineering questions to be resolved once and for all include:

- What is the best method to synchronize the airborne clocks?

- What is the best way to obtain altitude rate? Should it be transmitted or obtained from successive measurements?

- What frequency should be used for transmissions?

- What is the optimum data-transmission format?

McDonnell believes its proposed EROS II will fill the bill. Basically the same as EROS I, it would offer improvements in the data format, the transmission power and the time-slot selection method. EROS I transmits a peak power of 300 watts, whereas EROS II would transmit a peak of about 1000 watts.

Collins Radio, on the other hand, is working on a concept that will include the transmission of altitude rate. It is committed to ground stations, but they would use more precise clocks and fewer synchronization stations than the McDonnell system. The FAA is financing a Collins study and simulation program.

TRG favors a system using "floating time." All planes within collision range would send time signals to one another and synchronize their clocks at an average time. This, says TRG, would simplify the resynchronization problem and eliminate the need for ground stations.

McDonnell has done considerable spadework with its basic design of EROS I. That system uses a 200- μ s pulse at 1545 MHz to transmit the

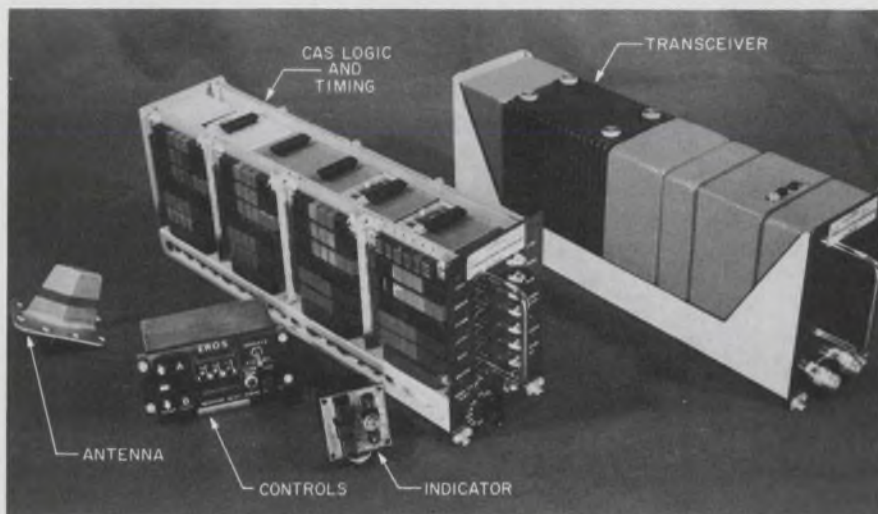

Mock-up of McDonnell's proposed CAS for civil use. Expected to weigh about 30 pounds, it would be lighter than the company's present pod-mounted unit.

range data. The range, or separation difference between any two aircraft, is determined in the receiving plane from one-way RF propagation time, based on the assumed knowledge of the start of transmission from the transmitting plane. Range data are determined from the Doppler shift of the precise frequency detected by the receiving plane. The altitude of the transmitting plane can be determined from the position of a 20- μ s, 1545-MHz altitude pulse. For example, a pulse delayed 419.8 μ s after the start of the range pulse would represent an altitude of -1000 feet, and a pulse delayed 719.8 μ s an altitude of 60,000 feet. Intermediate times of arrival would be proportional to altitudes between these limits.

The cockpit indicator in the McDonnell system has arrows pointing up ("fly up") and down ("fly down") and a horizontal bar ("fly level"). When a collision is imminent, the CAS logic flashes the appropriate directions on the panel.

The ground station resynchronizes a precision crystal oscillator, used for airborne time-keeping. Two-way transmission of signals from the station keep all aircraft using the system on fixed time. The station also has a plan-position scope, to permit a ground controller to observe the position of each plane.

The crystal 5-MHz oscillator clock used in each airborne CAS has a stability of better than one part in 10^8 . A frequency multiplier uses this time base to produce the 1545-

MHz transmission frequency. Unless the clock is resynchronized frequently, drift will introduce errors in timing and in determining the separation distance and closing rate. The ground station performs this function by sending synchronizing signals.

A cesium or rubidium primary standard clock would minimize these errors, but they are considered too heavy and costly for airborne use at present. They would have a stability of at least one part in 10^{10} . McDonnell's solution in the proposed EROS II is a network of ground stations using standards of at least this quality for transmission of synchronizing signals.

This approach is disputed by some experts. The cost of installing and operating such a network would be too high, they fear. The possibility of "blank areas" in the system is also of concern: Would the network, for example, cover low-flying planes in areas remote from the established airways? And what if it were desired to extend the system to international travel? Ships or patrolling aircraft would have to be used as "stations" over the ocean.

McDonnell replies that ground stations are justified because they would permit the installation of less costly and less precise clocks in each aircraft, thereby encouraging the installation of equipment in all planes, even the small private ones.

As a clincher, McDonnell offers this potential: Its collision-avoidance ground stations, with modifications, could replace present

navigational aids, such as Distance Measuring Equipment (DME). Robert Perkinson, chief engineer of EROS, put it this way in a recent speech in Dayton, Ohio, to a national meeting on the subject of collision avoidance:

"When the full impact of this capability sinks in, it becomes obvious that we have a tiger by the tail, since a time-synchronized system such as we have been discussing is quite capable of taking over all of the functions which are now being carried out with separate interrogate-respond systems spread over the air-traffic-control, navigation and communication complexes."

The National Co. advocates the use of atomic clocks in aircraft. It is building under FAA contract a prototype position-holding system for planes flying the Atlantic. The system makes use of an atomic clock to help maintain separation between planes. National would like to adapt its design to CAS.

Bendix has suggested a scheme for increasing the capacity of a common CAS with a frequency and time multiplexing scheme.

Sierra Research Corp. recommends more study of the pulse-coding schemes, time slots and frequency allocation.

Not all industry observers are convinced that the solution to the collision-avoidance problem is as straightforward as McDonnell would have them believe. They say that not enough attention is being given to limiting the reception of CAS, so it will not pick up signals from planes that may be hundreds of miles beyond collision range.

Building pilot trust is another objective that worries the observers. They say that slight errors, possible from a number of sources, could negate the value of the system. On the other hand, they fear that if the system is made too sensitive, it might give false alarms, which could destroy confidence in CAS.

The FAA has shown a willingness to finance some studies, but it has not offered to underwrite a full development program. Moreover the Air Transport Association does not believe that this is necessary. It believes there are enough companies that can see a future market in CAS to undertake development on their own. ■ ■



Cure for circuitry headaches

Solve your critical circuitry problems with two extraordinary new miniaturized ceramic capacitors — the product of Nytronics research and development in the continuing pursuit of excellence.

New NYT-CHIP, an ultra-stable chip capacitor, has such advantages as superior packaging flexibility and mounting versatility, particularly for outboard mounting on integrated, thick and thin film circuitry. Dimensions, with tinned terminals, 0.170" x 0.065" x 0.070", with capacitance range of 4.7 pf through 82 pf, and 0.280" x 0.195" x 0.070" for 100 pf to 4700 pf.

NYT-CAP, an ultra high stability ceramic capacitor series is packaged in a miniature molded epoxy tubular package 0.1" diameter by 0.250" in length, with capacitance range of 4.7 pf to 82 pf. The remainder of series in miniature, molded epoxy case 0.350" long by 0.250" wide by 0.1", with a range of 100 pf to 4700 pf.

Both NYT-CHIP and NYT-CAP have a temperature coefficient that does not exceed ± 40 ppm/ $^{\circ}$ C over temperature range of -55° C to $+125^{\circ}$ C, and working voltages of 200 D.C.

As a pioneer in the concept of standardization, Nytronics maintains large volume inventories of these two products, as well as of many other standardized high quality components: inductors, delay lines, and resistors. Write for complete engineering data.

 **NYTRONICS**[®]
...for Precision Electronic Components

550 Springfield Ave., Berkeley Heights, N.J. 07922 ■ (201) 464-9300 ■ TWX: 710-984-7977

ON READER-SERVICE CARD CIRCLE 13

The logic element of 'tomorrow': cheap wire

Traveling magnetic domains in Bell Labs setup do the work of conventional computer devices

Maria Dekany
Technical Editor

A permalloy wire setup that costs next to nothing may soon eliminate magnetic cores and other cumbersome devices in computers.

Coils wound around the wire create small traveling magnetic domains that are used to perform all basic logic functions. The phenomenon is called domain wall motion, and it opens up "intriguing possibilities," according to its developers at Bell Telephone Laboratories, Murray Hill, N. J.

Prototypes of the new logic elements have been built and could go into mass production "tomorrow," Bell scientists report. With proper refinement, they assert, the concept could evolve into a full-fledged computer.

"Even though the concept of computers with distributed magnetic logic and memory is not yet fully developed," says Dr. Reg A. Kaenel, supervisor at Bell, "I see no fundamental difficulties in realizing it through the phenomenon of traveling domain."

At present, Dr. Kaenel reports, the wire structures can provide all Boolean functions. "When we learn how to interconnect the wire segments efficiently," he adds, "any arbitrary logic array structure may be built."

The advantages of the new technique are impressive:

- It retains the intrinsic advantages of magnetics—namely, operation without standby power and ease of recording or changing the

information with currents.

- It needs only low drive currents—of the order of several milliamperes, which are compatible with IC capabilities.

- The fabrication is simple, resulting in low cost.

"The cost of raw materials is practically nil," Dr. Kaenel observes. "In addition there is no need for multimillion-dollar investment in production equipment, as there is in the semiconductor industry."

Using the new method, Bell has built logic packages that are widely used in digital systems, including parallel-to-series converters and character detectors (Fig. 1). These prototypes are competitive with their semiconductor counterparts, Kaenel says, and can be produced commercially.

3 steps to traveling domains

The domain wall motion in the wire involves the following steps: The wire is first magnetized in one direction. Then, along the length of the wire, islands of magnetic areas are created in the opposite direction. Buffer areas—domains with the original magnetization—isolate these reverse-magnetized domains.

The islands can be made to move against the uniform magnetization, very much like rowing a boat upstream. Carrying the analogy further, one can expand or shrink the domains like a collapsible boat. The controlled lengths of the domains are used to indicate the presence or absence of data. The length of a bit, including the buffer area, is about

400 mils.

The domains are manipulated through external magnetic fields, supplied by solenoids around the permalloy wire. The two critical values of the external fields are the nucleation threshold field, H_N , and the propagation threshold field, H_W (see Fig. 2). H_W remains pretty much constant at about 1 oersted over the length of the wire, but H_N usually varies between 7 and 10 oersteds.

The creation of a domain requires a magnetic field that is larger than the nucleation threshold field. Its direction opposes that of the wire magnetization (Fig. 3a).

The dimensions of an existing domain are controlled by a field that must be larger than H_W , says Kaenel. If this field is applied along the magnetization of the domain, the domain will expand over the length of the wire. If its direction coincides with the original wire magnetization, the domain will collapse (as shown in Figs. 3b and c). Reverse-magnetized domains may be considered as ones and collapsed do-

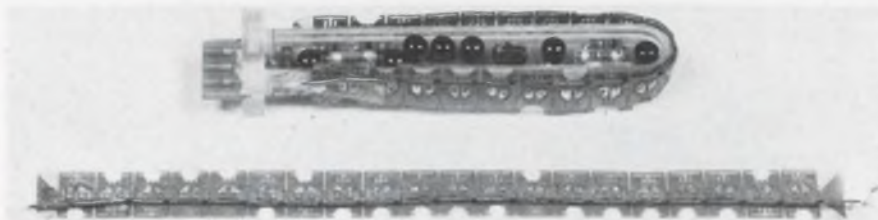

1. A 20-bit character recognizer operates from a 2-V battery. The magnetic structure (bottom) is wrapped around the drive circuits (top).

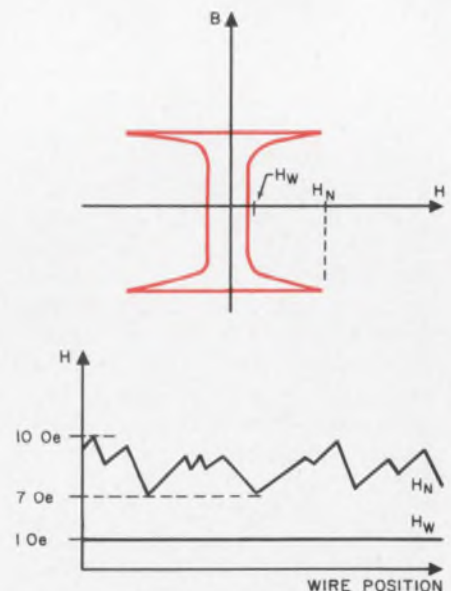

2. Typical magnetization characteristic of permalloy wire (a) shows the two critical parameters: H_N is the nucleation threshold field, and H_W is the propagation threshold field. The measured values of the two fields along the wire (b) indicate that H_N fluctuates between 7 and 10 oersteds.

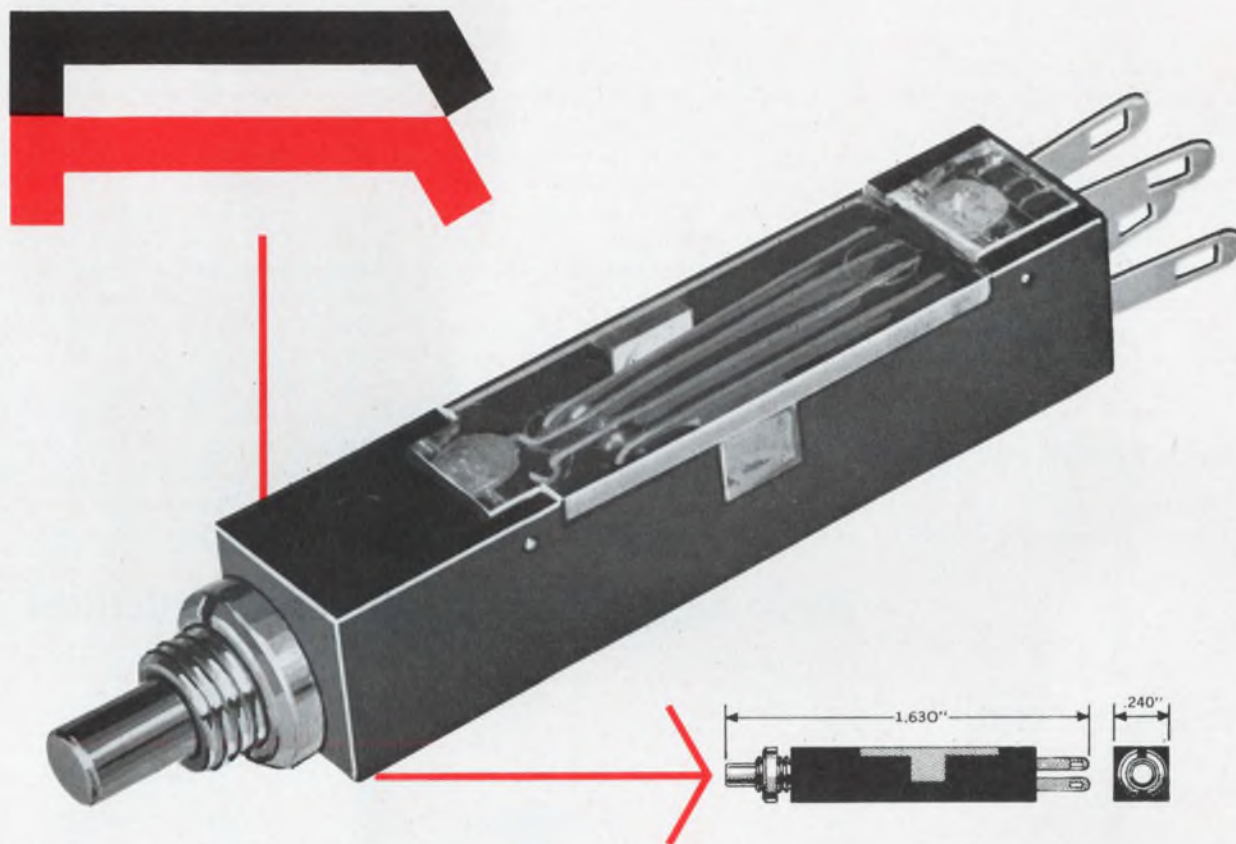

ROWAN'S NEW PS SWITCH ...

is a momentary action, two-circuit switch with a maximum contact rating of 500 milliamps, 50 volts AC or DC, and featuring:

1. Sub-miniature size measuring 1.63" x 0.24".
2. High density, modular pack of four switches (8 circuits) per $\frac{1}{2}$ square inch.
3. Very long life, repeatedly tested in excess of 5,000,000 electrical operations.
4. Very low resistance—very low voltage drop.
5. Extremely low bounce.

The PS Switch is standard with either two N/O, two N/C, or one N/O and one N/C contacts. Weighing 2.2 grams, it is mounted in a 0.166" panel hole by means of either circular, hex or knurled nut. Square or round buttons are offered in any of five colors.



For more information, call or write

THE ROWAN CONTROLLER COMPANY

OCEANPORT, NEW JERSEY 07757

ON READER-SERVICE CARD CIRCLE 14

(wire logic, continued)

mains as zeros (see Fig. 3d). The velocity of the domain expansion or collapse is proportional to the difference between the applied field and H_N , and it may be as high as 2×10^5 cm/s.

A commutator coil, wrapped around the wire, creates the magnetic field that moves the logic pattern down the wire. The detection of the pattern is simple: Changes in the magnetization of the domain walls induce electrical pulses that are picked up by a sensing coil.

How to spot proper data pattern

The sequential nature of the propagation of domain walls along

the wire suggests their use in character recognition and generation, says James Smith, another member of Kaenel's group.

Using the domain-wall motion for character recognition is a simple matter, according to Smith. He has installed test regions along the wire that can detect the presence of either a one or a zero. Each of these regions is defined by a coil that is energized by a one or a zero, but not by both. When the detection of a bit is completed, the domain pattern on the wire advances one code position.

The test regions are coded, and when all bits of the pattern match the coded coil sequence, the wire is returned to its original magnetic state.

The advantages of this system, according to Smith, are low standby power, small size, large allowable

power-supply variations and large allowable temperature variations.

A parallel-to-serial converter has been built by Robert F. Fischer, Dr. Kaenel and J. Giacchi. It accepts 64 bits of parallel data in $10 \mu\text{s}$ and delivers it sequentially upon command at a rate of up to 50 kbits/s. The device can sense the ON state down to 10 mA.

The magnetic structure of the converter consists of an 0.8-mil diameter annealed permalloy wire, encapsulated in a 10-mil diameter polycarbonate tube. Three sets of solenoids are wrapped around it to perform the logic functions. One pair of windings creates the reverse magnetized domains according to the input data, the second moves the domain pattern along the wire to the detection point, and the third detects the reverse-magnetized domains as they pass by. ■ ■

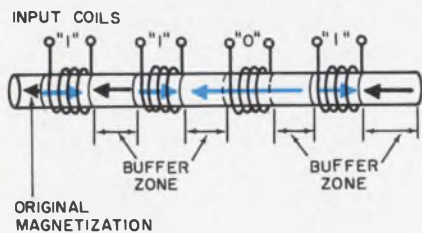
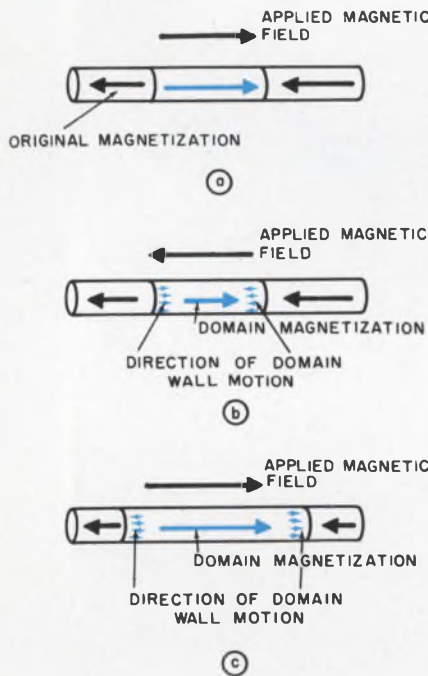

3. A domain is created by a magnetic field that is larger than H_N and opposes the direction of the original magnetization (a). The domains may be shrunk (b) or expanded (c) by a field. The pattern of 1101 is shown in (c).

Basic logic functions with wire structures

CONFIGURATION / LOGIC FUNCTION	INPUTS BY COILS, OUTPUT ALONG WIRES	ONE INPUT ALONG WIRE, OTHER INPUTS BY COILS, OUTPUT ALONG WIRES
AND		
OR		
INHIBIT		
INVERSION		
EXCLUSIVE OR		
SWITCH		

Helipot's new Model 77 trimmer comes clean without fail.

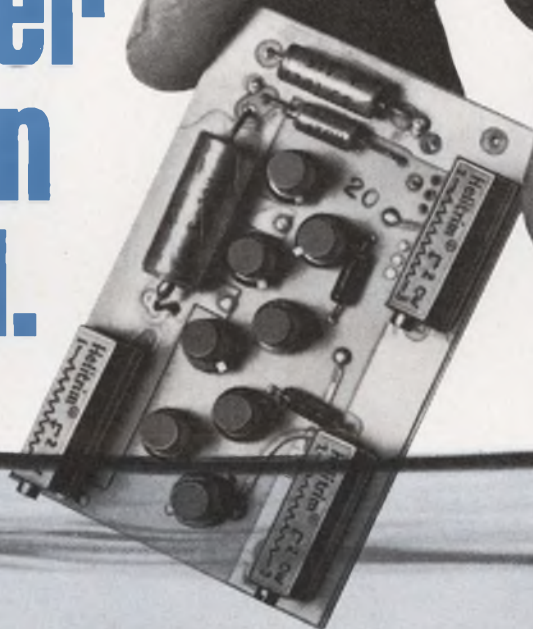



First \$1.10 cermet trimmer that's sealed for board washing!

The new Model 77 is an inexpensive wash-and-wear trimmer that's sealed for solvent washing on the board without failure. The cermet element gives wider performance parameters than any other adjustment potentiometer now on the market. Its pin spacing also makes it directly interchangeable with competitive models 3067 and 3068.

In the low price field, only Model 77 offers essentially infinite resolution, wide resistance range (10 ohm to 2 megohm), and other spec advantages shown at right. Quantity prices are as low as \$1.10.

Call your Helipot rep now for a free evaluation sample. Compare Model 77 with unsealed trimmers . . . you'll see there's really no comparison.

	 Helitrim Model 77	 Competitive Model 3067 Wirewound	 Competitive Model 3068 Carbon
Resistance Range, ohms	10-2 meg	50-20 K	20 K-1 meg
Resistance Tolerance	10%	10%	20%
Resolution	Essentially infinite	1.7 (100 Ω) to 0.3 (20 K)	Essentially infinite
Sealing	Yes	No	No
Power Rating, watts	0.75	0.5	0.2
Maximum Operating Temp. °C	105	85	85

Beckman

INSTRUMENTS, INC.

HELIPOT DIVISION

FULLERTON, CALIFORNIA • 92634



In-depth documentation...

**... speeds you from sketch
to I/C μ -PAC system
installation without
costly re-design**

You get documentation that means a lot more than just a spec sheet when you design with I/C μ -PAC digital logic modules. It means design aids, detailed instruction manuals, reliability facts, wiring & assembly notes, application notes. It means the best design support you can get — support based on nearly 14 years of module experience.

Whether you face design of a one-shot black box, or an entire product line, why not rely on μ -PACS. You'll never have to read between the lines to figure out what to do with them. It's spelled out in page after page of documented facts. Write for details. Honeywell, Computer Control Division, Old Connecticut Path, Framingham, Massachusetts 01701.

Honeywell

 **COMPUTER CONTROL**
DIVISION

Global net to cost \$1 billion.



Washington Report

S. DAVID PURSGLOVE,
WASHINGTON EDITOR

Pentagon speeds Project Mallard

The Defense Dept. has stepped up its program to develop a totally new system of battlefield communications for use by the U.S. and its allies. Until press leaks compelled the Pentagon to disclose details of Project Mallard (see Washington Report, ED 9, April 26, 1967, p. 29), it was understood that senior U.S., Canadian and Australian staffs had expected planning to be performed in-house. Now, however, the Defense Dept. is prepared to commit \$100 million at once to industry for project definition and preliminary research. The ultimate cost of the system, which may employ communications satellites, is expected to be over \$525 million, and to top one billion dollars once the mostly brand-new hardware has gone into production.

If the U.K., which has withdrawn from the project for financial reasons, can be brought back in, R&D outlays could exceed \$550 million by 1975-77. The U.K. took part in the early planning phases. Its decision to back out is believed to have stemmed from as high up as Prime Minister Harold Wilson's office, where it is said that another Skybolt missile fiasco was feared. U.S. officials still hope they can persuade Britain to change its mind, perhaps to take a "participating observer's" role that would allow the U.K. to spend as little as Australia and Canada (about \$40 million each) and postpone any major procurement commitment until the latest possible moment.

In revealing the details, the Pentagon said Project Mallard "will employ all modes of message and data transmission, ranging from simple written messages and voice-radio links to automatically switched, digital systems and possibly communications satellites." The primary operating element, known as the International Joint Engineering Agency, will, like the U.S. program manager's office, be located at Fort Monmouth, N. J. Defense Secretary Robert S. McNamara said that the schedule calls for a five-to-seven-year R&D program followed by a production program. He

made a point that "participation by industry of all three countries will be encouraged in the conduct of certain supporting technique efforts."

Project Mallard will make use of modular equipment construction, to ensure flexible interoperation between the field armies of the three nations presently involved. With the proper subsystems, the Pentagon states, intercommunications will range from frontline combat units through major echelons to tie-ins with worldwide systems. It is hoped that it will eventually become as easy for an Australian infantry patrol leader, say, to call in U.S. fighter-bomber support as for the Pentagon to confer with the National Defense Ministry in Ottawa.

Industry's initial role in Project Mallard was originally expected to be help with the refinement of the general concept of multinational communications systems and execution of project definition of long-range hardware needs. Official indications are now that industry will be asked to have a crack at some more specific programs. Digital switching systems and secure battlefield communications satellites are two areas mentioned, but highest on the priority list is said to be development of extremely high-speed field switchboards.

Contractors sought for EROS program

The U.S. Geological Survey has begun to compile a list of bidders and contractors for the EROS (Earth Resources Observation Satellites) program. The agency has asked interested firms with extensive experience in the satellite and spacecraft fields, particularly in the electronics of them, to submit capability statements. It is looking for competence in design and evaluation of spacecraft sensors and communications.

The Interior Dept., of which the Geological Survey forms a part, hopes to launch the first of a series of EROS satellites in 1969. Their purpose is to spot potential areas for

Washington Report

CONTINUED

agricultural development, to map vegetation and to detect the first signs of crop diseases before they have time to spread. Dr. William T. Pecora, survey director and head of the EROS program, has stated that he is satisfied that the basic concept of the program has been already proved out by sensors carried in high-flying aircraft.

Company statements of capability should be sent to the Procurement Office, Room 5201, U.S. Geological Survey, 18 and F Streets, N. W., Washington, D. C. 20242. The agency has set an unlikely precedent by stating that interested firms' communications "need be submitted in only one copy."

Single packaging concept not feasible

The Pentagon and NASA have been disappointed by expert findings in a survey of the packaging of electronic components. Both agencies were perturbed at the number of electronics malfunctions that were traced to shipping damage due to faulty packaging and set up committees to seek universal standards for components packaging. Their objective was to come up with a small number of package configurations that could be made mandatory for most electronics.

A study performed for the Redstone Arsenal, Huntsville, Ala., by the Battelle Memorial Institute showed that packaging varied both according to the requirements of the equipment to be shipped and the facilities of the contractor. After reviewing 17 manufacturers, the Battelle team reported that the wide variety of components and facilities made a single standard approach to packaging impossible.

Handbook on programing offered by USAF

Computer programing costs can be estimated easily with the aid of a new handbook prepared by System Development Corp. for the U.S. Air Force. The principal author, E. A. Nelson of System Development Corp., says that the book is based on experience and rules of thumb. Its aim is to provide the manager of computer programing projects with the methods and data that will enable him to forecast the resources required and to incorporate these estimates into cost evaluation studies, project plans and cost control systems.

The handbook gives guidelines for the estimation of such resources as man-months, computer hours and months elapsed—the data needed to carry out the six activities of program development. These activities are tagged as preliminary planning and cost evaluation; information system integration test; information system analysis and design; computer program design, code and test; information system installation and turnover; and computer maintenance.

The handbook is available to anyone from the Commerce Dept.'s Clearinghouse, Springfield, Va. 22151, order number AD-648-750. Called *Management Handbook for the Estimation of Computer Programming Costs*, it costs \$3.00, or 65¢ in microfiche.

NASA news index available

The National Aeronautics and Space Administration has issued a 751-page index of most of the news releases and speeches it released during 1963-66. The comprehensively cross-indexed volume includes many items of interest to electronic designers and others in the electronics industry on such topics as RL-10 engine development, Gemini guidance and control, Gemini experiments, and NASA contract management. *Index to NASA News Releases and Speeches* is available from Scientific and Technical Information Division, Code USS-A, NASA Headquarters, Washington, D. C. 20546.

Space treaty won't stop 'spy in sky'

The treaty establishing general principles for the peaceful exploration and use of outer space, recently approved by the U.S. Senate, is not expected to stop U.S. and Soviet launching of reconnaissance "spy" satellites or the use of communications and weather satellites for military purposes.

Nor will the treaty stop the launching of a manned orbiting laboratory to determine man's military usefulness in space.

Testifying before the Senate in favor of the treaty, General Earle Wheeler, Chairman of the Joint Chiefs of Staff, predicted that the treaty is expected to have the ironic effect of leading to increased military efforts in space so that the U.S. may determine whether the Soviet Union was abiding by the treaty's prohibition on the orbiting of nuclear weapons.

From RCA Versatility plus Economy...

FROM DC

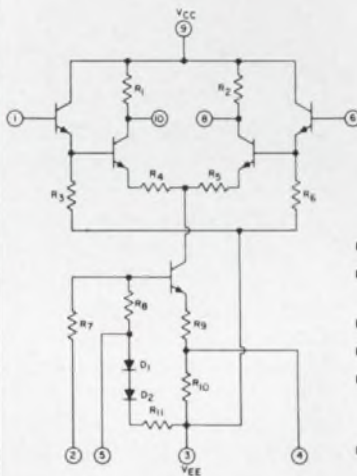

CA3000

- 37 dB Voltage gain (typ)
- 98 dB Common-mode rejection ratio (typ)
- 90 dB AGC range (typ)
- Push-pull input and output
- Temperature range stable operation from -55° to $+125^{\circ}\text{C}$
- 10-lead TO-5 package

TO RF

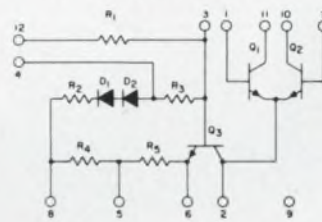

CA3005

- 0-100 MHz operation
- 20 dB (typ) Cascode power gain @ 100 MHz
- 16 dB (typ) Differential power gain at 100 MHz
- 101 dB (typ) Common-mode rejection ratio @ 1 KHz
- -60 dB (min) AGC Range @ 1.75 MHz
- 12-lead TO-5 package

ECONOMY \$2.95 (1,000+)

VERSATILITY

- Schmitt Trigger
- RC-coupled Feedback Ampl
- Mixer
- Comparator
- Modulator
- Xtal Osc
- Sense Amplifier

AVAILABILITY

FROM STOCK

ECONOMY \$1.75 (1,000+)

VERSATILITY

- | | |
|-----------------|------------------------|
| Wideband Ampl | Mixer |
| Narrowband Ampl | Limiter |
| AGC | Modulator |
| Detector | Cascode Ampl |
| RF Ampl | and |
| IF Ampl | Uncommitted collectors |
| Video Ampl | for broad |
| | design flexibility |

AVAILABILITY

FROM STOCK

Ask your RCA Representative about CA3000 and CA3005. Or check your RCA Distributor for his price and delivery schedules. For technical literature, write RCA Commercial Engineering, Section (CF5-1), RCA Electronic Components and Devices, Harrison, N.J. 07029.

SEE YOUR RCA DISTRIBUTOR FOR HIS PRICE AND DELIVERY



RCA ELECTRONIC COMPONENTS AND DEVICES

The Most Trusted Name in Electronics

ON READER-SERVICE CARD CIRCLE 17

Materials research too device-oriented

Materials research, once too independent of device research, is now becoming enslaved to it, according to an Air Force scientist.

Speaking before a recent meeting of a NASA Research Advisory Committee on Materials, Charles Ryan of Air Force Cambridge Research Laboratories, Hanscom Field, Mass., observed: "Although we are presently witnessing an increasing stream of new ideas, materials, techniques and applications, we can discern a point on the horizon where the pace may slow down."

Ryan believes that so many researchers are so busily engaged in narrow and isolated aspects of semiconductor R&D that a broader perspective of the field of semiconductor materials is becoming lost.

A disproportionate amount of semiconductor materials research is too closely associated with specific, existing devices, he said. "Not enough emphasis is given to a range of problems common to many classes of devices and to phenomena which would lead to the understanding necessary to predict and invent basically new types."

Ryan reviewed a number of approaches that he feels might serve to redress the balance, and areas that need substantially increased support. He suggested that researchers should:

- Investigate correlations among chemical-bond phenomena at one deeper level of comprehension.
- Support basic theoretical efforts such as band theory.
- In III-V compounds, emphasize wider-gap materials, particularly gallium and aluminum phosphides.
- In group IV, emphasize β silicon carbide.
- Determine the conditions needed for epitaxy and heterotaxy of compound semiconductors.
- Extend the capacity to grow quality semiconducting and insulating crystals from 1500° to 2500°C.
- Investigate new methods of more rapidly, accurately and economically evaluating the chemical and structural quality of semiconducting crystals, particularly wide-band-gap materials. ■ ■

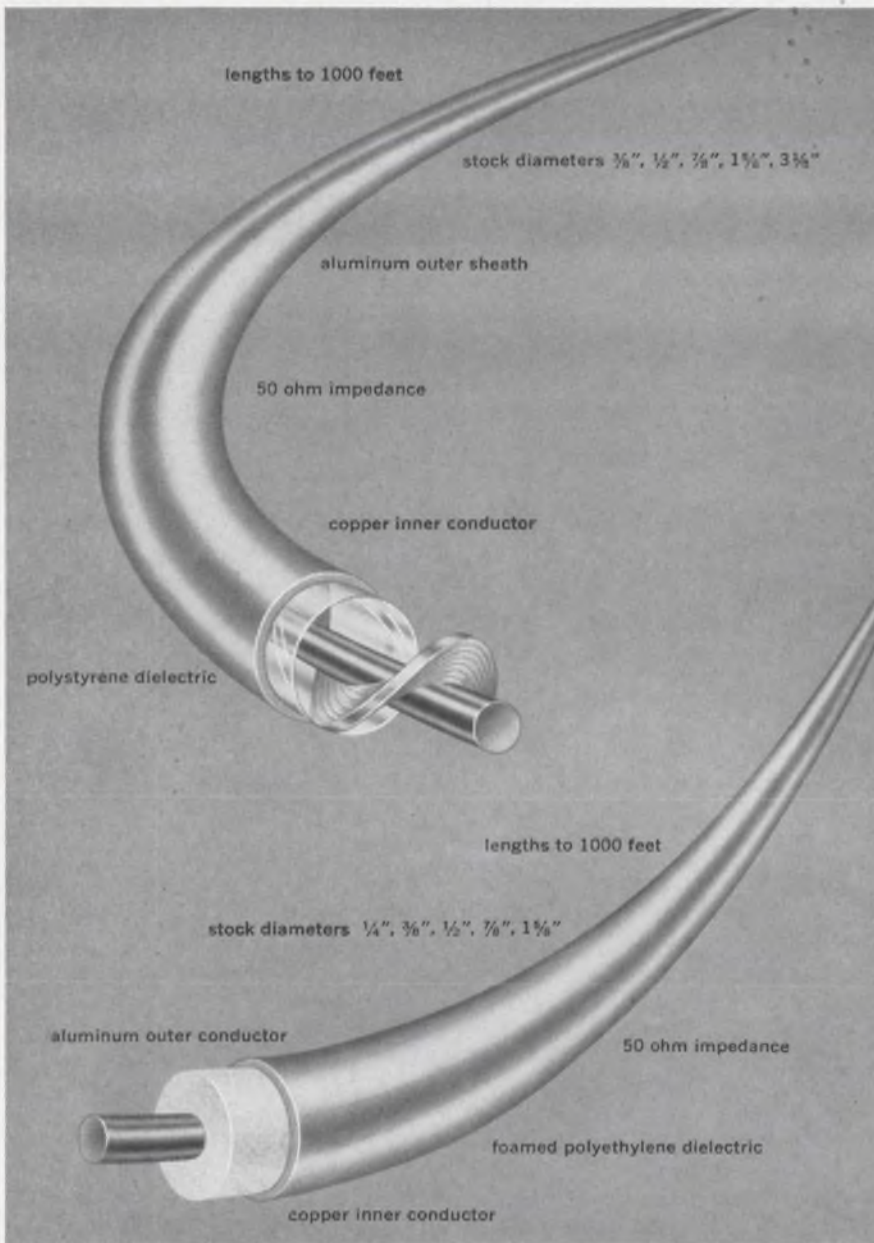

Coaxial cable to meet every need.

STYROFLEX® Here's a coaxial cable with an extraordinarily high degree of physical stability. Essentially an air dielectric cable, Styroflex inherently exhibits lower attenuation and higher velocity of propagation than solid dielectric types. Temperature cycling affects attenuation by less than 1% per 5°C of change. Continuous support assures perfect centering of the conductor during the load cycling.

If you're concerned with systems design in AM, FM, VHF and UHF transmission, microwave communications, radar, forward scatter systems and telemetering, multichannel long line telephone networks or general pulse work, we urge you to look into Styroflex coaxial cable.

A good start? Write for *Bulletin PS, Issue 5.*

FOAMFLEX If you're a pinch-penny when it comes to paying for coaxial cable, you'll go for Foamflex. Introduced back in 1955 as the first foam dielectric cable, Foamflex has been high on the list of cable bargain hunters ever since.

Foamflex is a semiflexible cable construction and a black pigmented polyethylene jacket can be supplied for added protection. Foamflex is the ideal low cost answer in extremely demanding applications in telemetry, missile guidance, microwave, delay lines and other airborne and GSE installations where high performance, light weight and absolute reliability are required.

May we tell you more about Foamflex? Write for *Bulletin FF, Issue 4.*

PHELPS DODGE ELECTRONIC PRODUCTS
NORTH HAVEN, CONNECTICUT



ON READER-SERVICE CARD CIRCLE 18

Short-backfire antenna may be uhf boon

A physicist at Air Force Cambridge Research Laboratories, Bedford, Mass., says that his recently developed "short-backfire" antenna could be a boon to home uhf television viewers as well as NASA satellite tracking stations.

It is based on Hermann W. Ehrenspeck's own "backfire" antenna—a relatively little-known approach to antenna design. According to its inventor, the backfire antenna operates on a combination of surface-wave and open-cavity principles and introduces gains of from 15 to 30 dB. Moreover, sidelobes are said to be reduced to below 20 dB, backlobes below 30 dB. One backfire antenna is claimed to have a gain of 23.5 dB above isotropic—higher than the gain of a commercial 16-element Yagi array or a 36-element cavity-backed slot array—typical tracking and telemetry antennas.

The name derives from the use of a large plane reflector opposite the feed of an endfire antenna like the Yagi. The signal is propagated along an array of dipoles, reflected from a flat plate and redirected across the dipole array. Thus, the main beam fires backwards and the dipoles serve double duty.

The double-reflector configuration is analogous to that of a laser cavity, which employs two end mirrors to build up the energy level.

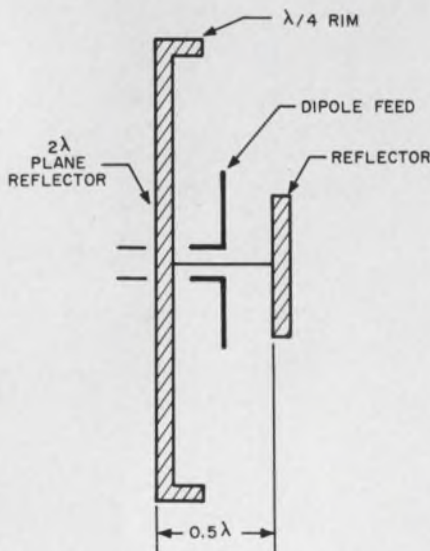

1. Short-backfire antenna uses two reflectors to build up energy level

As shown in the figures, the short-backfire antenna is the most abbreviated type conceivable—approximately one-half wavelength long—and consists of a 2λ -diameter flat plate with a circular quarter-wave rim, a dipole feed spaced a quarter-wave in front of this reflector, and a smaller disk spaced a quarter-wave in front of the dipole.

An array of short-backfire antennas uses far fewer elements to produce the same gain as other types with the same total aperture area. Thus, a short-backfire antenna $\lambda/2$ long can replace a 5.5λ , 27-element Yagi; an array of 8 short-backfire antennas (or 4 backfire antennas) can replace a monopulse array of 36 slot elements or 48 dipoles. Weight savings permit the use of a smaller, less expensive mount.

The element feeds can be cross or circularly polarized, and the short-backfire antenna is adaptable to monopulse arrays as well as pencil-beam operation. It is also said to perform excellently in feeding paraboloidal antennas.

Representatives of NASA's Goddard Space Flight Center, Greenbelt, Md., are reported to be interested in a network of telemetry stations using this antenna.

Ehrenspeck said uhf set owners could use "chicken-wire" short-backfire antennas for good reception. ■ ■

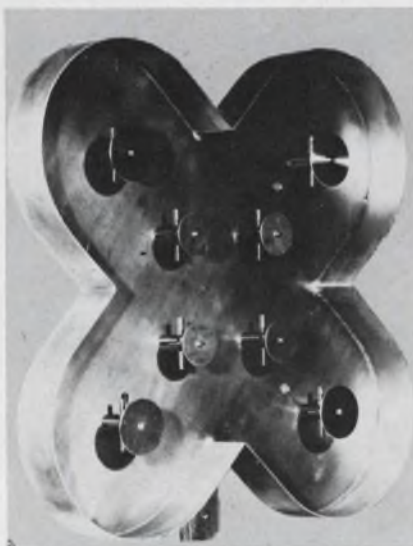

2. Cloverleaf of short-backfire antennas form monopulse array

the only
all-metal fan
that gives you
reliable operation
in a compact
3 1/2"
package!



PAMOTOR Model 3000 Miniature Axial Fans

- Over 20,000 operational hours at 45°C
- Extremely low-noise level
- Delivers 65 cfm
- Efficient inside-out induction type motor
- Low-cost design
- 50-60 Hz operation at 117 or 230 vac

IMMEDIATE DELIVERY THROUGH
LEADING ELECTRONIC DISTRIBUTORS
OR DIRECTLY FROM FACTORY STOCK

Write for technical data to:
PAMOTOR, INC., 312 Seventh Street
San Francisco, California 94103

PAMOTOR, INC.

ON READER-SERVICE CARD CIRCLE 19

Now there's a "4th generation"



M HENRARDI COUNTER-TIMER MODEL 1500A
139.00572 MHz

HENRARDI MODEL 1502A
800003

of plug-in digital counters



The use of IC's in a prize-winning package design gives you more of what you want in a counter, from DC to microwave.



THE 125 MHz MAIN-FRAME ACCEPTS ANY OF THESE PLUG-INS: Model 1104A 0.3-3 GHz Converter; Model 1102A Six-digit Preset; Model 1101A 1GHz Prescaler; or the Model 1103A 50-500 MHz Converter. Available soon: compatible video preamplifier, DVM plug-in and microwave frequency converters.

Look what you get in Monsanto's new Model 1500A plug-in digital counter-timer: Cool, solid reliability of its IC circuits; 125 MHz main-frame range; built-in remote programmability compatible with either passive contact closures or active circuits; increased flexibility, by trigger level control, by overflow and gate indicators, by the ability to accept *any* external time base up through 10 MHz; new package detail which includes a unique lever latch that frees a plug-in with the flip of a finger. With the Model 1500A you get a lot of counter for just \$2,850! (U.S.A. dollars, f.o.b. New Jersey; plug-ins extra)

Monsanto Electronics Technical Center,
620 Passaic Avenue, West Caldwell, N. J.
07006. Phone: (201) 228-3800.

Monsanto
ELECTRONIC
INSTRUMENTS

Now that you're going to buy
an ac voltmeter,
get hp's
extra measure of

Performance

Sonar, acoustics, audio response, servo, communications measurements – or ac to dc conversion and amplification – these and many more are yours with a Hewlett-Packard 400-Series AC Voltmeter!

The 400-Series Voltmeters are wide bandwidth, average-responding, rms calibrated instruments. They are solid state, externally battery operable, equipped with the exclusive hp taut-band meter.

Each of the instruments in the 400-Series is outstanding in frequency, or sensitivity or dB range. The 400E/EL voltmeters, for example, have a broad frequency range of 10 Hz to 10 MHz. The 400F/FL meters have 100 μ V full-scale sensitivity. They also have a low-pass filter to take out unwanted high frequencies for low-level audio measurements. The 400GL measures –100 to +60 dB for the greatest range available in a voltmeter.

How to choose the right ac voltmeter that exactly matches your requirements? Call your hp field engineer, he can show you the widest range of these instruments now available. Get that hp extra measure of performance in your ac voltage measurements!

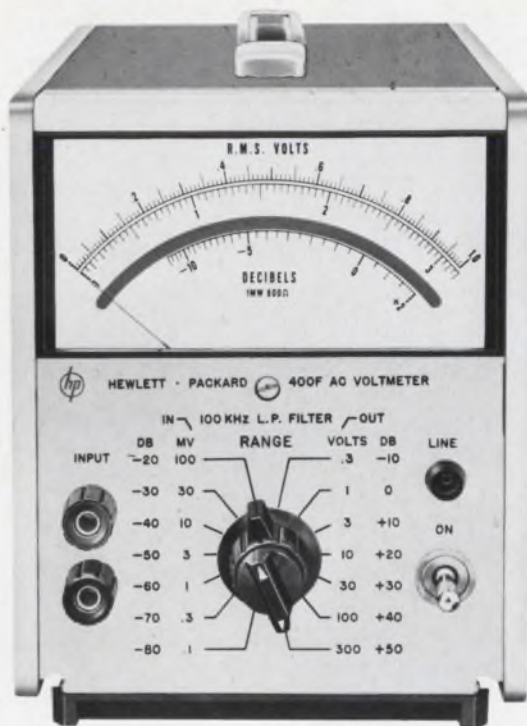

hp Model 400E/EL
for Broad-Frequency

Performance

The hp 400E/EL solid-state simple-to-operate ac voltmeters give a wider

frequency coverage than any other comparable instrument! They cover a frequency range from 10 Hz to 10 MHz and have a constant 10 M Ω input impedance on all ranges.

These voltmeters give exceptionally long-term stability. Calibration is not dependent on components subject to aging.

Either Model 400E or 400EL can be used as a wide-band ac voltmeter, high-gain ac amplifier or as an ac to dc converter.

The 400E has full scale accuracy of 1% on the linear voltage (upper) scale. Lower scale is log dB. The 400EL has 1% full scale accuracy on the linear dB (upper) scale. Lower scale is log volts.

Option 02, available on both 400E and 400EL, provides a front panel relative control for a variable 3 dB change in sensitivity on each calibrated range. This gives a convenient level, such as 0 dB, for relative voltage measurements. The control has a detented position to insure calibration accuracy.

AC-DC Converter:—The 400E/EL Voltmeters provide a linear dc output (1 Vdc for full scale meter deflection) proportional to meter deflection which can be used as a 10 Hz to 10 MHz ac to dc converter, with an accuracy of $\pm 0.5\%$.

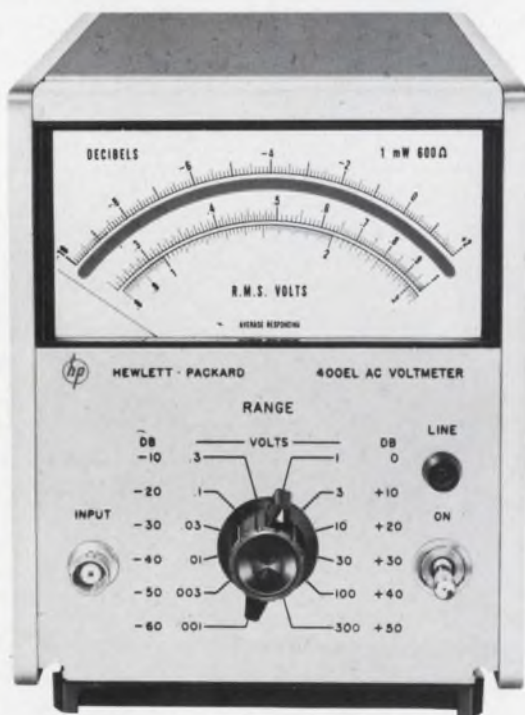

PREPAR

Pick the 400E or 400EL when you need broad frequency range performance. See table for comparative specifications.

*hp Model 400F/FL
for High Sensitivity*

Performance

In addition to the 100 μ V full-scale sensitivity, the 400F/FL AC Voltmeters contain a low-pass 100 kHz filter for controlling the bandwidth of noise—reduces the effects of unwanted high frequencies to give you more accurate low-level audio measurements.

You get fast response with these instruments—a reading in less than two seconds after turn-on—and <2 seconds overload recovery, too!

The 400F has 0.5% full scale accuracy on the linear voltage (upper) scale. Lower scale is log dB. The 400FL has 1% accuracy full scale on the linear 12 dB (upper) scale. Lower scale is log volts.

Amplifier:—Models 400F/FL are stable, low distortion, wideband ac amplifiers, with a maximum open circuit gain of 80 dB. AC output is 1V rms (full scale) open circuit, or 0.5 V rms into 600 Ω and is proportional to meter indication on voltage scale. Frequency response: 20 Hz to 4 MHz. Noise level <5 μ V referred to input.

For general purpose low level audio, servo, communications or sonar measurements with low noise, choose the hp Model 400F or 400FL AC Voltmeter. Check the comparative specifications in the table.

*hp Model 400GL
for Broad dB Range*

Performance

With the -100 to +60 dB measurements range (100 μ V to 1000 V full scale), the hp Model 400GL AC Voltmeter is the instrument with the greatest dB range—20 dB linear log scale!



This voltmeter was especially designed to increase efficiency and speed of acoustic and sonar measurements. It can be used in calibration laboratories because of its speed of response, accuracy, high sensitivity and low noise.

The 400GL also can be used as a high-gain ac amplifier with 80 dB amplification.

When you need a ruggedly-built ± 0.2 dB accurate voltmeter for broad-range dB measurements, hp Model 400GL is your best choice! See table for more specifications.

hp Model 11074A Probe

The hp Model 11074A Voltage Divider Probe (10:1 division ratio) provides constant 10 pF with 10 M Ω input impedance at the point of measurement. Probe and suitable adapter are usable with all the 400-Series AC Meters. Price: hp Model 11074A Probe, \$45.00, plus adapter.

Pick Your

Performance

	400E/EL	400F/FL	400GL
Frequency Range	10 Hz to 10 MHz	20 Hz to 4 MHz	20 Hz to 4 MHz
Sensitivity	1 mV-300 V	100 μ V-300 V	100 μ V-1000 V
dB Range	-72 to +52	-92 to +52	-100 to +60
Low Pass Filter	No	100 kHz	100 kHz
AC-DC Converter	1 V at 1 mA	No	No
AC Amplifier	150 mV/50 Ω	1 V/600 Ω	1 V/600 Ω
Price	400E: \$310.00 400EL: \$320.00	400F: \$300.00 400FL: \$310.00	400GL: \$290.00

Option 01: Available on 400E and 400F, puts log scale uppermost for greater resolution in dB measurements. Other scale options available on request.



For assistance in selecting the ac voltmeter that best fills your needs, contact your nearest hp field engineer—he has full specifications. Or, write to Hewlett-Packard, Palo Alto, California 94304, Tel. (415) 326-7000; Europe: 54 Route des Acacias, Geneva.



ON READER-SERVICE CARD CIRCLE 21

007/78

MANAGE

EXPO 67 to provide fun and culture

Electronics will play a large role from the time a visitor arrives until he leaves.

From late last month, Montreal has become a major center of attraction of the western hemisphere. The reason—EXPO 67.

Before it closes, on October 27, millions of visitors to the Universal and International Exhibition, which is what EXPO is officially called, will see first hand the traditions, cultures and industrial developments of more than 70 nations. And from the time they get within hailing distance of Montreal to the time they wearily leave the exhibition grounds, the visitors will be guided, informed, assisted and controlled by an array of electronic systems.

Actually, electronics will play a role for some visitors months before they even set out for Canada. Such will be the case if they book their lodgings through Logexpo, a separate corporation that handles accommodations in the Montreal

area. A computer system will allow Logexpo to maintain up-to-the-minute records on the availability of more than 150,000 lodging facilities daily.

As visitors approach Montreal, they will enter a vast traffic control system specifically set up for EXPO 67 and relying heavily on radio and data-processing equipment. Electronics will again take over when, after arriving at their lodgings and taking a quick shower, the fairgoers board the automated Expo-Express for the trip to the exposition site. Once they are aboard, the operator pushes a start button and automatic control takes over—accelerating the train to speed, slowing it for curves, and stopping it at the stations.

At the entrances to the site, visitors will be greeted by double-sided electronic billboards, 40 feet high and 30 feet wide. These display lat-

est information on waiting times at pavilions, availability of tickets for free shows, etc.

At the entrances, visitors can also rent Teleguide units for \$1. These earpiece-equipped receiving units allow the wearer to receive taped messages giving details of each pavilion he passes. There are more than 200 of these individual receiving areas throughout the site—including one that produces an ugly shriek in the Teleguide should someone put it in his pocket and forget to return it as he leaves.

These are only some of the roles electronics is playing at EXPO 67. There are many others, such as closed-circuit TV systems for returning lost children and apprehending pickpockets, and computerized statistics-taking, the results of which are used in the day-to-day operation of every facet of EXPO 67.

With the underlying role of electronics in mind, take a quick look at the EXPO 67 grounds on p. 40:



St. Lawrence River serves as site of EXPO 67. Much of the land for the site was artificially created in the river itself. More than 25 million tons of landfill was used to extend an

existing island, Sainte Helene, construct a new island, and to extend and build up a breakwater providing cover for the Port of Montreal.

8,960 ways to whip up your sales!

Our "Designer Line" switches *alone* won't make a success out of your appliances (or business machines or machine tools or whatever you make).

But they'll help!

That's because Cutler-Hammer gives you more design freedom and styling flexibility to begin with than you've ever enjoyed before.

Like 8,960 variations of switches. Resulting from eight high-style levers. Seven brilliant colors. Three different ampere ratings. Five circuit arrangements. Three terminal configurations.

And if we still don't have the switch that turns you on, we'll build the special that will!

Our switches won't come back to haunt you either—they're AC/DC quick-make/quick-break, and double insulated.

Now, mix with fast service and complete application help from the local sales office near you—and you can see why more people buy Cutler-Hammer switches than any other! Call our local sales office; we'll switch you over to our side.



Looking for just the right switch? We'll "create" it for you—out of the variety of levers, colors, terminations and bases above! Nobody else offers you so many switch combinations!



Switch
to No. 1

More than just switches:
prompt availability,
field help, innovation,
quality assurance too.



CUTLER-HAMMER

Milwaukee, Wisconsin 53201

(EXPO 67, *continued*)

Bubble-shaped pavilion of the United States (left) and USSR pavilion (right) will be joined by a bridge, called Cosmos Walk in honor of the space pioneering of the two nations.

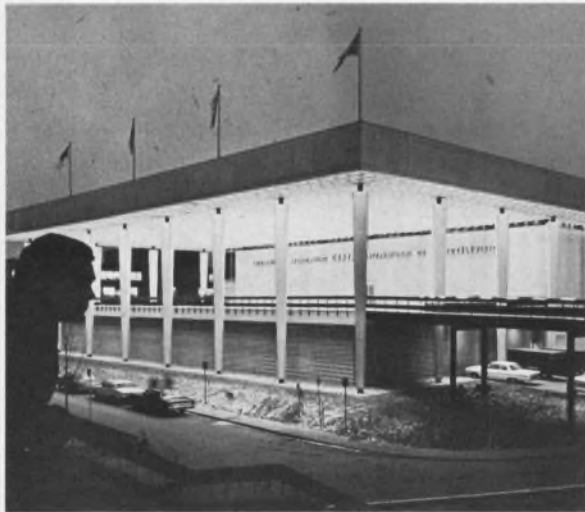

World Broadcasting Center will provide modern radio and television facilities for all the broadcasting media of the world covering EXPO 67. The center will double as an exhibit, giving the visitor an intimate view of radio and TV production.

Habitat 67 will undoubtedly be one of the most talked about exhibits at EXPO 67. Containing 158 dwelling units, each individually fabricated of reinforced concrete, Habitat attempts to solve some of the problems of today's urban development.



Expo Express is controlled by electronic signals transmitted through the rails and picked up by car-carried receiving and processing equipment. Operating commands are presented by different audio signal frequencies.

END/FIN



14,187 radio-dispatched tow-cars and only one tetrode rated for PTTs*

The tow-car driver is rarely on the air with his dispatcher for as long as 60 seconds and he drives at least 5 minutes between calls. The same goes for most radio-dispatched vehicles.

PTTS* (Push-To-Talk-Service), with its duty cycle of ONE MINUTE ON and FOUR MINUTES OFF has been shown to be the most realistic, economical and practical rating system for vehicular communications systems.

For this reason, Amperex developed the 8637, the only twin tetrode ever designed and rated for PTTs. Featuring high thermal inertia anodes and

incorporating a wealth of twin-tetrode manufacturing experience, the 8637 offers the designer a new approach in creating a better vehicular radio. Fewer, and less costly components may be used. Some typical operating conditions which bear this out are shown on the chart at right . . . lower plate voltage, lower drive and higher efficiency at the VHF frequencies.

The 8637 is a 'small tube', (only 3 1/2" seated height), perfectly suited for today's low-profile designs. Its cost is lower than ICAS and CCS rated tube types of the same power.

For data, applications reports and engineering assistance, write: Amperex Electronic Corporation, Tube Division, Hicksville, L. I., N. Y. 11802.

ALL THIS—and AMPEREX QUALITY, TOO!

ONE 8637—PUSH-PULL

Internally Neutralized Throughout Entire Freq. Range

50 MHz	PLATE	OUTPUT	DRIVE
CCS	375v.	25w.	0.67w.
ICAS	450v.	34w.	0.82w.
PTTS	600v.	84w.	0.86w.

175 MHz

CCS	300v.	18w.	1.4w.
ICAS	350v.	26w.	1.6w.
PTTS	560v.	63w.	2.2w.



Amperex

TOMORROW'S THINKING IN TODAY'S PRODUCTS

Letters

Editorgrams keep us on the beam

The steady flow of Editorgrams sent in by our readers are an invaluable help to ELECTRONIC DESIGN's editors. Short enough to be scanned through rapidly but long enough to convey a message, they are carefully read by the whole editorial staff. They enable us to know what interests you, what bugs you, and what we should do to keep the magazine at the top of your priority reading list. Don't slack off; keep the Editorgrams coming so that we may serve you better. Use the one inside the back cover of this issue; it will cost you only a couple of minutes of your time, nothing more.

We've already acted on these

Here is a selection of your comments. These first ones have already spurred editorial action.

"When citing reports available from the Clearinghouse, U.S. Dept. of Commerce, please give the number of the report and its title in addition to the price." (From Fort Belvoir, Va.)

(Note: Vital reference numbers are now included, wherever they are applicable and available.)

* * *

"The articles would be more useful to me if they could be easily removed for inclusion in a notebook, as I cannot possibly store all of these books." (From Baltimore)

(Note: Technical articles are printed on consecutive pages. Two different topics do not, as far as possible, appear on the two sides of a single page. In this manner we try to ensure that everything in the Technology Section can be clipped easily for filing.)

* * *

"Use solder dots on all schematics to indicate a connection." (From Menlo Park, Calif.)

(Note: All circuit connections are now shown with solder dots.)

* * *

"Can you group the new products

into functional categories?" (From Philadelphia)

(Note: The Products Section is divided into nine categories—Components, Materials, Microelectronics, Microwaves, Power Equipment, Production Equipment, Semiconductors, Systems, Test Equipment—so that new products are grouped according to function.)

* * *

"I'd like to see more NASA Tech Briefs." (From Ann Arbor, Mich.)

(Note: These are already appearing more frequently.)

* * *

"I still use your 1965 Semiconductor Directory. How about another one?" (From Nutley, N. J.)

(Note: The last issue, ED 9, which appeared on April 26, contained the latest edition of the Semiconductor directory.)

* * *

"I'd like to see instrument surveys published in ELECTRONIC DESIGN." (From Irvington, N. Y.)

(Note: The Test Instrument Reference Issue, ED 20 to be published on Sept. 27, will cover exactly this.)

Article suggestions are welcome

Many readers suggest article subjects that they would like to see dealt with in the magazine. Many of these are already in the editorial process and will be appearing in the months ahead. Others we are still looking for.

A selection of these suggestions is printed below. If you feel competent to write on these topics, or on any others with broad appeal to electronic designers, why not get in touch with us? If you send us an outline of your article idea, one of our specialist technical editors will gladly review it promptly. And of course, every published article is paid for.

Here are some recent suggestions for future articles:

"I'd like to see an article on the

intrinsic safety of electronic devices and components, including the criteria for their attributes, safety analysis methods and safety validation methods." (From Brigham City, Utah)

* * *

"... very high-speed digital circuit design, including transmission media." (From Phoenix, Ariz.)

* * *

"... more on tunnel diode applications and IC circuits to replace them." (From New York)

* * *

"... how to measure open-loop characteristics and how to determine a compensation network for stable feedback conditions." (From Brussels, Belgium)

* * *

"... application of statistical techniques to electronic design." (From West Lafayette, Ind.)

* * *

"... more theoretical articles that have practical applications." (From Warsaw, Poland.)

* * *

"... biasing and bootstrapping of transistor devices." (From Ashburnham, Mass.)

* * *

"... the key points of packaging principles and their application." (From Orlando, Fla.)

* * *

"... methods of testing electronic components, including actual data or examples of the practical use of the theoretical concept." (From Los Angeles.)

* * *

"... power supply designs and switching regulators." (From Cedar Rapids, Iowa)

* * *

Well now, what do you think of ELECTRONIC DESIGN? What suggestions do you have?

(LETTERS con't on p. 46)

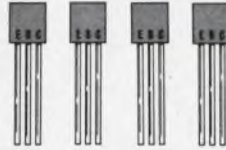

What's Here Besides The World's Four Best-Performing Low-Level Complementary Silicon Plastic Transistors?

Economy, that's what!

TRY THEM. See if you don't blaze new design paths within a wide range of tough circuit applications . . . and, simultaneously, lick "tight budget" problems with Motorola's significant, state-of-the-art achievement — the NPN/PNP 2N3903-06 silicon annular* transistor series. The data here signifies a new era in plastic capability for fully-specified 100 μ A to 100 mA performance of the high-level! Check the chart — see what we mean.

. . . And Check these Budget-Minded Prices!

NPN	PNP	1000-Up Quantities
2N3903	2N3905	\$.37
2N3904	2N3906	.41

We're stocked and ready with "production-run" quantities. So, whatever your need — demonstration samples or quick delivery on a large quantity order, contact your Motorola sales representative or nearest authorized distributor. For more technical information, write Motorola Semiconductor Products Inc., Dept. TIC, Phoenix, Arizona 85001.

*Annular semiconductors patented by Motorola Inc.

EVALUATE AND COMPARE THESE COMPLEMENTARY SPECIFICATIONS:

	NPN — 2N3903/4			PNP — 2N3905/6		
	Type	Min	Max	Type	Min	Max
BV_{CE0} ($I_C = 1$ mA dc)		40 Vdc			40 Vdc	
h_{FE} ($I_C = 0.1$ mA dc, $V_{CE} = 1$ V dc)	2N3903	20	—	2N3905	30	—
	2N3904	40	—	2N3906	60	—
($I_C = 1.0$ mA dc, $V_{CE} = 1$ V dc)	2N3903	35	—	2N3905	40	—
	2N3904	70	—	2N3906	80	—
($I_C = 10$ mA dc, $V_{CE} = 1$ V dc)	2N3903	50	150	2N3905	50	150
	2N3904	100	300	2N3906	100	300
($I_C = 50$ mA dc, $V_{CE} = 1$ V dc)	2N3903	30	—	2N3905	30	—
	2N3904	60	—	2N3906	60	—
($I_C = 100$ mA dc, $V_{CE} = 1$ V dc)	2N3903	15	—	2N3905	15	—
	2N3904	30	—	2N3906	30	—
f_T ($I_C = 10$ mA)	2N3903	250 MHz		2N3905	200 MHz	
	2N3904	300 MHz		2N3906	250 MHz	
C_{ob} ($V_{CE} = 5$ V dc, $I_E = 0$, $f = 100$ kHz)			4.0 pF			4.5 pF

— where the priceless ingredient is care!



MOTOROLA
Semiconductors

100-bit MOS

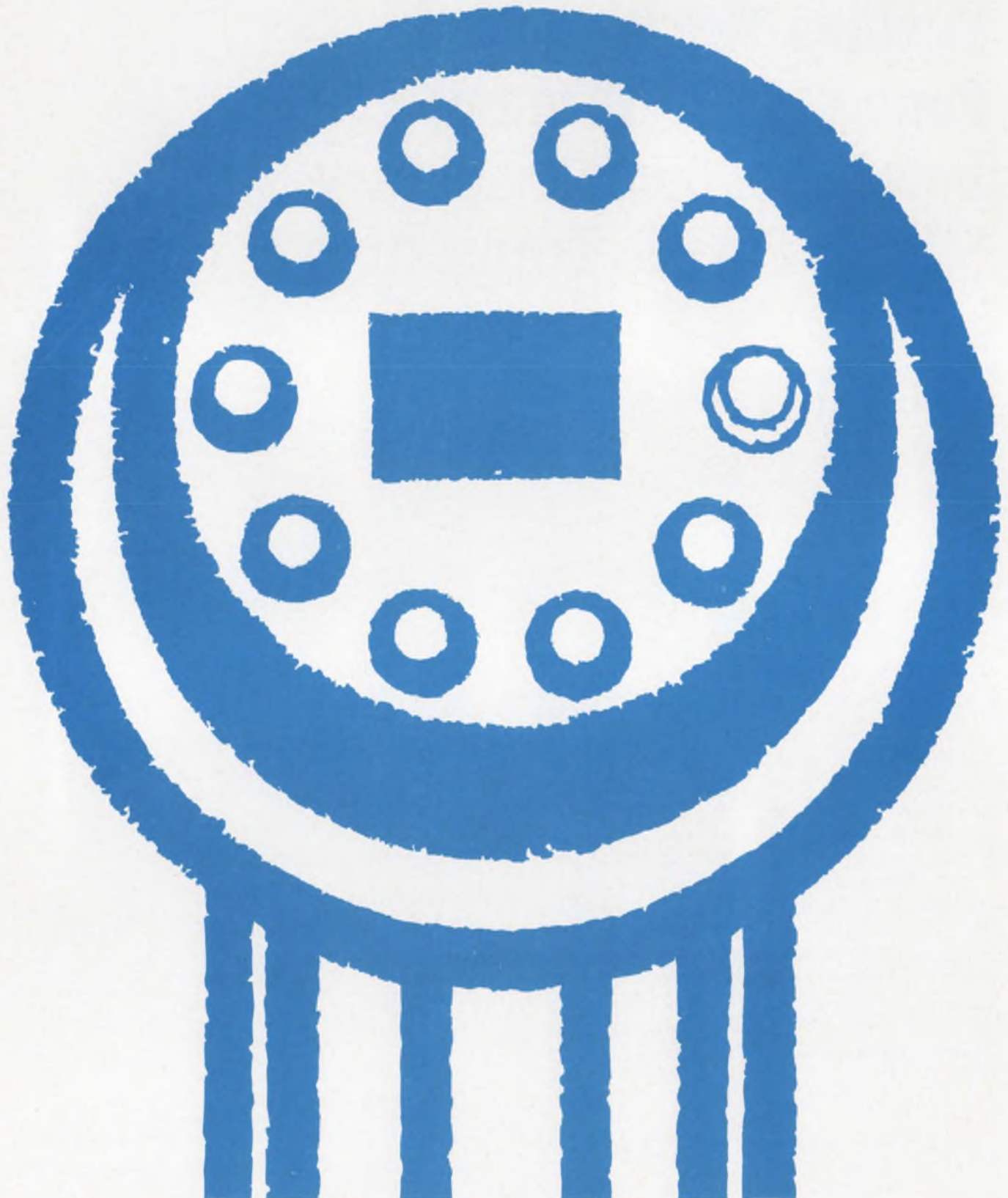

The most significant standard product advance in large scale integration: Philco's pL5R100 dual 50-bit MOS shift register.

Available now at a price of 61¢ per bit in quantities of 100.

Full MIL or limited temperature ranges.

For delivery information, call the following Division Sales Offices or sales representatives.

CALIFORNIA

Philco-Ford Sales Office
2920 San Ysidro Way
Santa Clara, California
Phone: (408) 245-2966

Philco-Ford Sales Office
999 North Sepulveda
Suite 414
El Segundo, California
Phone: (213) 772-6226

COLORADO

Straube Associates
P. O. Box 1649
Boulder, Colorado 80301
Phone: (303) 443-8600
TWX: 910-940-3244

CONNECTICUT

J & J Associates
953 Dixwell Avenue
Hamden, Connecticut 06514
Phone: (203) 624-7800

FLORIDA

Philco-Ford Sales Office
1215 Drew Street
Clearwater, Florida
Phone: (813) 446-0124

ILLINOIS

The John G. Twist Company
5222 West Diversey Avenue
Chicago, Illinois 60639
Phone: (312) 777-2250
TWX: 312-265-1165

INDIANA

R. O. Whitesell & Associates
6620 East Washington Street
Indianapolis, Indiana 46219
Phone: (317) 359-5374
TWX: 810-341-3320

Central Building, Room 272
Fort Wayne, Indiana 46802
Phone: (219) 743-4411
TWX: 219-241-0894

IOWA

Technical Marketing Associates
850 Lindale Drive
Marion, Iowa 52302
Phone: (319) 377-4555

KENTUCKY

R. O. Whitesell & Associates
3620 Lexington Road
Lex-Manor Building, Room 223
Louisville, Kentucky 40207
Phone: (502) 893-7303

MASSACHUSETTS

Philco-Ford Sales Office
Northwest Industrial Park
Second Avenue
Burlington, Massachusetts 01803
Phone: (617) 272-1600

MICHIGAN

R. O. Whitesell & Associates
16801 Wyoming, Room 109
Detroit, Michigan 48221
Phone: (313) 862-2225
TWX: 313-342-0648
303 Fidelity Building
Benton Harbor, Michigan 49022
Phone: (616) 927-2041
TWX: Detroit Office

MINNESOTA

Technical Associates, Inc.
6121 Excelsior Boulevard
Minneapolis, Minnesota 55416
Phone: (612) 929-6115
TWX: 910-576-3400

MISSOURI

Technical Marketing Associates
2050 Woodson Road
Suite 210
St. Louis, Missouri 63114
Phone: (314) 427-3600
TWX: 314-426-3149

7546 Troost

Kansas City, Missouri 64131
Phone: (816) JA 3-7865

NEW YORK

Philco-Ford Sales Office
New York, New York
Phone: (212) 244-1373

Graydon-Sherman Inc.
Davis Building
Fayetteville, New York 13066
Phone: (315) 637-9611
TWX: 710-541-0241

OHIO

R. O. Whitesell & Associates
Magek Building
21139 Lorain Avenue
Cleveland, Ohio 44126
Phone: (216) 333-2585
TWX: 810-421-8521

4133 South Dixie Avenue
Dayton, Ohio 45439
Phone: (513) 298-9546
TWX: 810-459-1827

1172 West Galbraith
Cincinnati, Ohio 45231
Phone: (513) 521-2290
TWX: Dayton Office

1350 West Fifth Avenue
Columbus, Ohio 43212
Phone: (614) 488-9731
TWX: Dayton Office

PENNSYLVANIA

Philco-Ford Sales Office
Benson Manor, Suite 114B
Washington Lane
Jenkintown, Pennsylvania
Phone: (215) 885-0430

R. O. Whitesell & Associates
Penn Center Building
201 Penn Center Boulevard
Pittsburgh, Pennsylvania 15206
Phone: (412) 242-0100
TWX: Cleveland Office

TEXAS

Dunbar Associates
417 Meadows Building
Dallas, Texas 75206
Phone: (214) 363-2536
TWX: 910-861-4368

WASHINGTON

Philco-Ford Sales Office
Suite 208
700-108th Street, N.E.
Bellevue, Washington
Phone: (206) 454-5061

WASHINGTON, D.C.

Philco-Ford Sales Office
815 Connecticut Avenue, N.W.
Washington, D.C. 20006
Phone: (202) 298-7810

SPECIAL OFFER

For your *free* MOS book,
write to 2920 San Ysidro Way
Santa Clara, California 95051.



PHILCO-FORD CORPORATION
Microelectronics Division
Santa Clara, California • 95051

ON READER-SERVICE CARD CIRCLE 25

Bidirectional counter said to have serious drawback

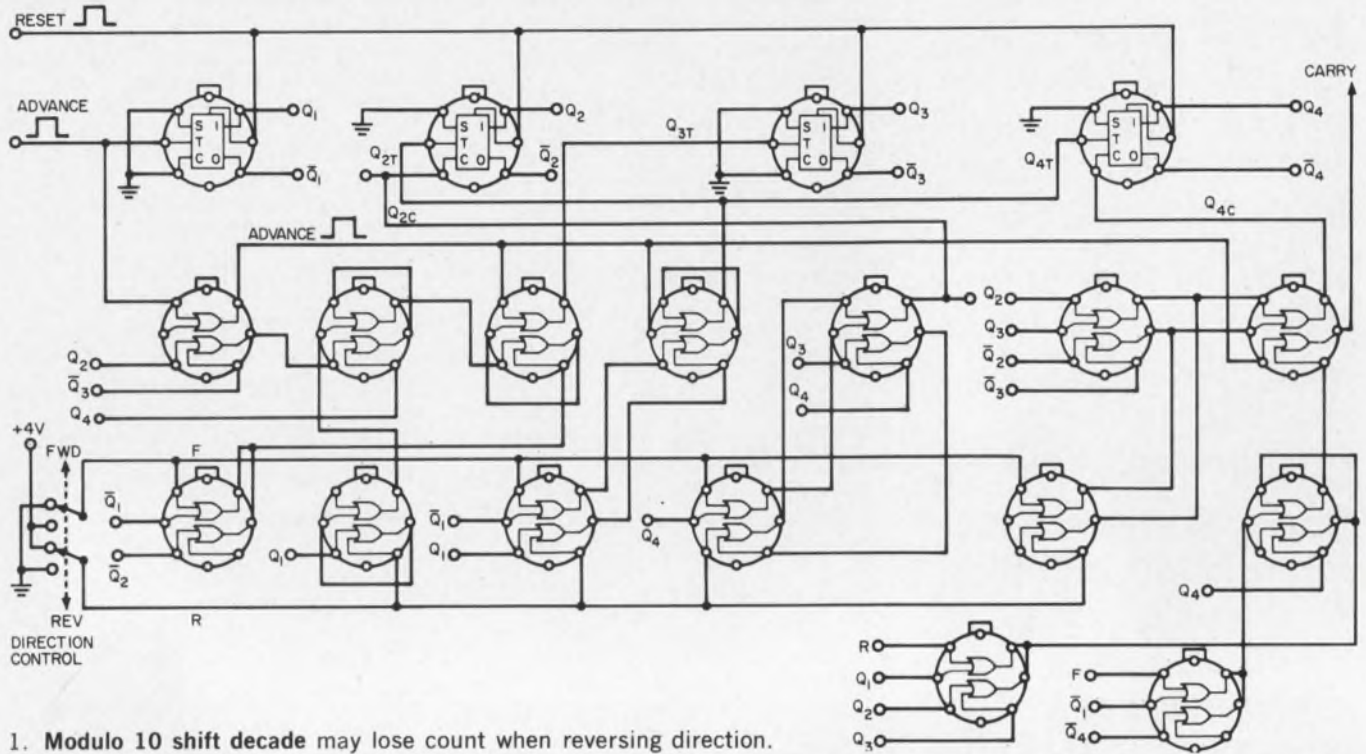

1. Modulo 10 shift decade may lose count when reversing direction.

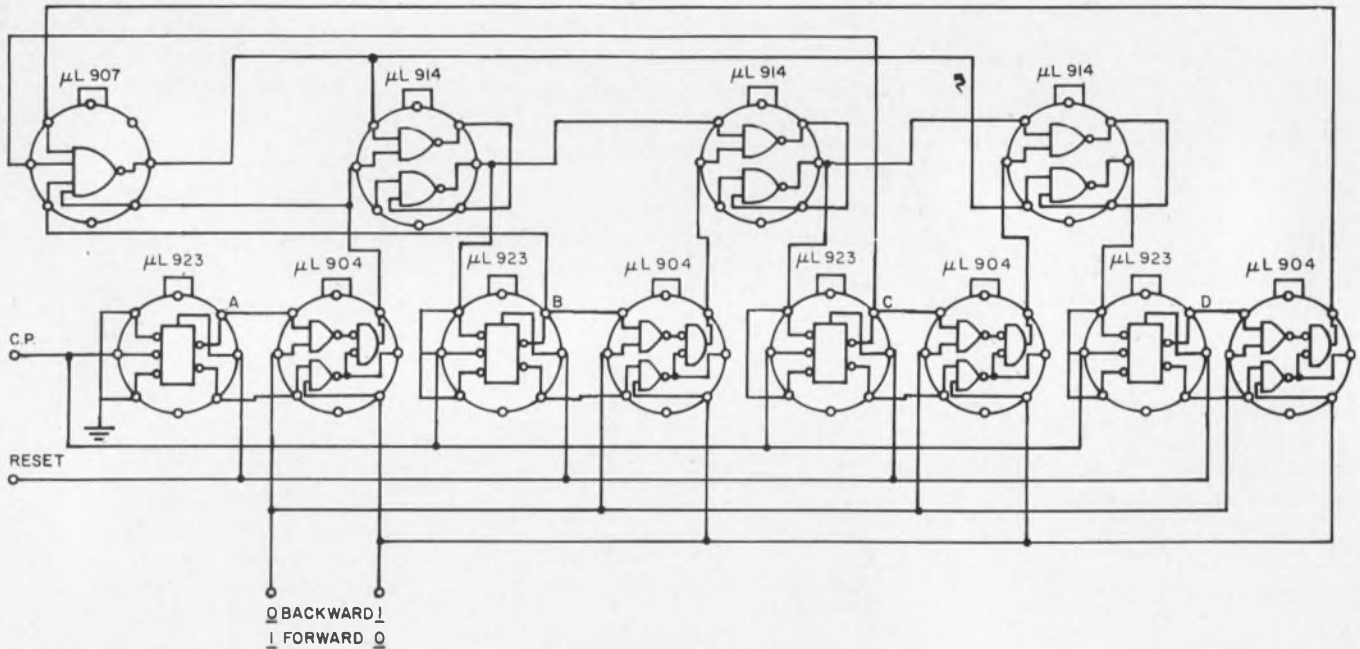

2. 1-2-4-8 decimal counter does not change state when direction is reversed.

Sir:

After reading the article "IC bi-directional counters cost less" by Kay D. Smith (ED 2, Jan. 18, 1967, pp. 58-63), I would like to call attention to a drawback of the circuit in Fig. 4, p. 61 (reproduced as Fig. 1 above), which may seriously limit the usefulness of this counting scheme.

An obvious requirement for a reversible counter is that its content must not be altered by a simple in-

version of the counting direction. This requirement is not satisfied by the circuit in question.

To prove the point, consider, for example, the transition from forward to reverse counting while the counter is at count 3 of the sequence (i.e., with Q_1 and Q_2 high, and Q_3 and Q_4 low) and the Advance input is high. It can be seen that the input, Q_{3T} , of flip-flop 3 undergoes a transition from high to low when the counting direction is

changed from forward to reverse. Since flip-flop 3 has both J and K inputs grounded, it will change its state to Q_3 high, thus altering the content of the counter. This drawback can be avoided if the counting direction is changed only while the Advance input is low. This, however, is a very serious limitation in most applications for a reversible counter.

The drawback can be eliminated

(continued on p. 50)

GOOD THINGS COME IN SMALL PACKAGES

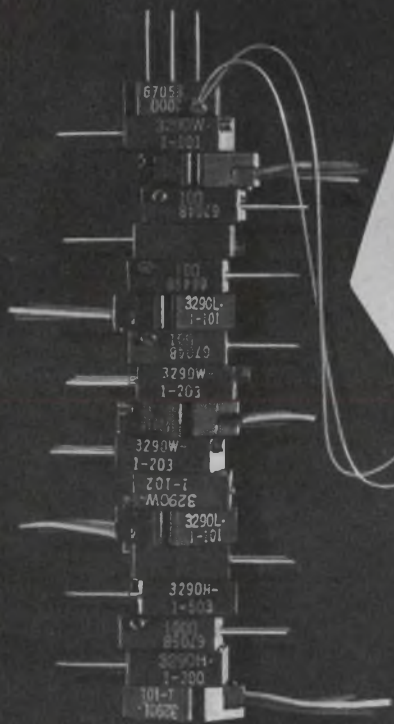

**THINNER
3/8" SQUARE
POTENTIOMETER
NOW AVAILABLE**

the Model 3290 TRIMPOT® Potentiometer. This outstanding high-quality unit measures only $\frac{3}{8}$ " x $\frac{3}{8}$ " x less than $\frac{1}{32}$ " thick, yet offers specifications available in larger units—all at the competitive price of \$5.48*.

Available with leads and three printed circuit-pin mounting styles, the Model 3290 meets or exceeds requirements of MIL-R-27208... is rated at 1 watt at 70°C, and has a temperature range of -65°C to +175°C. The all-plastic case is sealed against liquids and potting compounds and a resistance range of 10Ω to 50K gives you plenty of selection for your projects.

When your designs and programs call for the very best in potentiometer quality and small size, at competitive prices... test and then specify the Model 3290! Write today for complete technical data or contact your nearest Bourns office or representative.

*100-piece price



SPECIFICATIONS

Size	$\frac{3}{8}$ " x $\frac{3}{8}$ " x .150"
Standard Resistance Range	10Ω to 50KΩ
Resistance Tolerance	±5% Standard
Resolution	1.01% to 0.10%
Power Rating	1 watt at 70°C
Operating Temperature Range	-65°C to +175°C
Temperature Coefficient	50 PPM/°C max.
Moisture Resistance (MIL-R-27208)	100 megohms min. insulation resistance
Mechanical Adjustment	25 turns



BOURNS, INC., TRIMPOT DIVISION • 1200 COLUMBIA AVE., RIVERSIDE, CALIF.
TELEPHONE (714) 684-1700 • TWX: 910 332-1252 • CABLE: BOURNSINC.

Look what you can get OFF-THE-SHELF from your Union Carbide Distributor THE FIRST LOW COST FET TYPE OP AMPS

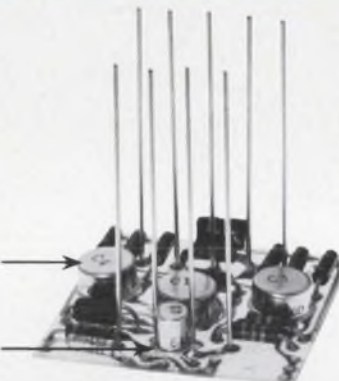

No Plastic — All Metal and Hermetically Sealed Mil Grade Components Throughout

FET Transistor in Front End For Low Input Current & High Impedance

Low-Profile Package: 0.4 inches for P.C. Board Mounting*



H7010A OPERATIONAL AMPLIFIER: \$42

- Very Low Input Current (40 pA typ.) Avoids Drift Problems
- Front-end with FET devices provides Input Impedance of $10^{11} \Omega$
- Immediately Available Off-the-Shelf from Union Carbide Electronics Distributors

APPLICATIONS

Infrared Sensors • pH Sensors • Piezo-Electric Transducers • Ionization Gauges • EEG and EKG Pre-Amplifiers • Analog Integrators • Electrometric Type Voltage Followers • Sample and Hold (e.g. charge amplifier)

DATA SHEETS

For a complete set of data sheets on all Op Amps listed, use reorder service card or contact your distributor.

EIGHT FET TYPES AVAILABLE

Op Amp Type	Temp Range °C	Open Loop Gain dB	Band Width MHz	Z_{IN} M Ω	Max Voltage Drift μ V/°C	Input Current pA	Rated Output V/mA	Price (1-4)
H7010A H7010B	-25 to 85	95	3.0	10^5	± 50	40	$\pm 10/\pm 2$	\$42.00 45.00
H7020A H7020B	-40 to 100	95	3.0	10^6	± 25	40	$\pm 10/\pm 2$	60.00 65.00
H7030A H7030B	-40 to 100	97	3.0	10^6	± 25	40	$\pm 20/\pm 6$	77.50 82.50
H7000 H7000A	-55 to 125	90	2.5	10^6	± 25	40	$\pm 10/\pm 2$	82.00 75.00

"A" Pkg. — 1.5 x 1.5 x 0.4 inches, "B" Pkg. — 1.8 x 1.2 x 0.6 inches, No Letter Suffix — $1\frac{1}{8}$ x $1\frac{1}{8}$ x $\frac{3}{8}$ inches. For complete specifications write for catalog listing the entire line of operation amplifiers available from UCE.

* $\frac{1}{4}$ " Pins available upon request.



ELECTRONICS

Your engineering data sheet
Pull out and keep



Semiconductor Department / 365 Middlefield Road / Mountain View, California 94040 / (415) 961-3300

ON READER-SERVICE CARD CIRCLE 27



ELECTRONICS

OPERATIONAL AMPLIFIER SILICON MODULAR H7000/H7000A

Differential Input • Extremely High Input Impedance • Extremely Low
Input Currents • Wide Bandwidth • Wide Temperature Range • Phase
Compensated for Closed Loop Stability • Hermetically Sealed Transistor Construction

MAXIMUM RATINGS

@ 25°C (UNLESS OTHERWISE NOTED)

	H7000/H7000A
Positive Supply Voltage	+20 Volts
Negative Supply Voltage	-20 Volts
Storage Temperature	-65 to +125°C
Operating Temperature	-55 to +125°C
Input Voltage (Differential)	± Supply Voltage
Input Voltage (Common Mode)	± Supply Voltage
Output Load (Continuous)	Zero Ohms

ELECTRICAL CHARACTERISTICS

@25°C and Supply Voltage ±15.0 Volts (UNLESS OTHERWISE NOTED)

SPECIFICATION	SYM.	H7000/H7000A			Units	TEST CONDITIONS	
		Min.	Typ.	Max.			
Open Loop DC Voltage Gain;	A_v	86	92	—	dB	$R_L = 10\text{ K}\Omega$, $R_i = 0$, $R_f = \infty$	
Equiv. Diff. Input Impedance	R_{in}	10^5	10^6	—	M Ω	$-10\text{ V} < V_{out} < +10\text{ V}$ $f = 1\text{ KHz}$	
	C_{in}	—	5.0	—	pf		
DC Output Resistance	R_{out}	—	85	200	ohms	$R_i = 1.0\text{ K}\Omega$ $R_f = 100\text{ K}\Omega$ $A_v = 100$, $e_{out} < 1\text{ V p-p}$	
Output Voltage	V_{out}	±10	±12	—	Volts	$R_L \geq 5\text{ K}\Omega$	
Short Circuit Output Current	I_{out}	—	±3.3	±4.0	mA	$R_L = 0\Omega$	
Equivalent Input Offset Voltage	V_{os}	Adjustable to Zero ⁽¹⁾			mV	Initial	
		—	±1.5	±2.5			$V_{os} = 0\text{ V @ } 25^\circ\text{C}$, $T_A = +125^\circ\text{C}$
		—	±1.2	±2.0			$V_{os} = 0\text{ V @ } 25^\circ\text{C}$, $T_A = -55^\circ\text{C}$
		—	±5	±25			$V_{os} = 0\text{ V @ start}$, $T = 24\text{ hrs.}$
		—	100	500			ΔV^* (or ΔV^-) = $1\text{ V} \cdot \left(\frac{V_{os}}{\Delta\text{Supply V}} \right)$
Equivalent Input Offset Current	I_{os}	—	±10	±50	pA	Initial ($V_{out} = 0\text{ V}$, $T_A = +25^\circ\text{C}$) $V_{out} = 0\text{ V}$, $T_A = +125^\circ\text{C}$ $V_{out} = 0\text{ V}$, $T_A = +85^\circ\text{C}$ $V_{out} = 0\text{ V}$, $T_A = -55^\circ\text{C}$ $V_{out} = 0\text{ V}$, @ start, $T = 24\text{ hrs.}$	
		—	±5	±25	nA		
		—	±0.2	±2.5	nA		
		—	±2	±50	pA		
		—	±3.0	±10	pA/24 hrs.		
		—	±1.0	±10	pA/volt		ΔV^* (or ΔV^-) = $1\text{ V} \cdot \left(\frac{I_{os}}{\Delta\text{Supply V}} \right)$
Common Mode Rejection	CMR	65	86	—	dB	$V_{out} = 0\text{ V}$, $V_{cm} = \pm 1\text{ V}$	
Common Mode Voltage Range	V_{cm}	±10	±11	—	Volts	CMR > 50 db	
Input Bias Current	I_{bias}	—	-15	-100	pA	$V_{out} = 0\text{ V}$, $T_A = +25^\circ\text{C}$	
		—	-0.75	-5.0	nA	$V_{out} = 0\text{ V}$, $T_A = +85^\circ\text{C}$	
		—	—	-50	nA	$V_{out} = 0\text{ V}$, $T_A = +125^\circ\text{C}$	
		—	—	—	nA	$-10\text{ V} < V_{out} < +10\text{ V}$ $-10\text{ V} < V_{cm} < +10\text{ V}$	
Common Mode Input Resistance	R_{cm}	10^5	10^6	—	M Ω		
Equiv. Input Wideband Noise Voltage	e_n	—	0.5	2.0	$\mu\text{V RMS}$	$R_i = 0$, $R_f = \infty$, $R_L = \infty$	
Small Signal Bandwidth (-3 dB)	BW	2.0	2.5	—	MHz	$R_i = \infty$, $R_f = 0$ $A_v = 1.0$, $R_L = 10\text{ K}\Omega$	

⁽¹⁾ External 200 Ω Potentiometer

ELECTRICAL CHARACTERISTICS

@25°C and Supply Voltage ±15.0 Volts (UNLESS OTHERWISE NOTED)

SPECIFICATION	SYM.	H7000/H7000A			Units	TEST CONDITIONS
		Min.	Typ.	Max.		
Phase Margin	ϕ	30	50	—	Degrees	$R_i = 0, R_f = \infty$ $A_v = 1.0, R_L = 10 \text{ K}\Omega$
Slewing Rate	$\Delta V/\Delta t$	—	1.3	—	V/ μ sec.	$R_i = \infty, R_f = 0$ $A_v = 1.0, R_L = 10 \text{ K}\Omega$ $-10 \text{ V} < V_{out} < +10 \text{ V}$ $t_r = 10 \text{ nsec}, \text{PRR} \approx 1 \text{ KHz}$
Full Power Frequency	f_{mp}	—	20	—	KHz	$R_i = 1 \text{ M}\Omega, R_f = 1 \text{ M}\Omega$ $A_v = 1.0, R_L = 10 \text{ K}\Omega$ $V_{out} = 20 \text{ V p-p}, \text{THD} \leq 5\%$
Quiescent Power Supply Current	I_q	—	4.2	5	mA	$V_{out} = 0, R_L = \infty$
Full Load Power Supply Current	$I_{ps} (+15\text{V})$	—	6.5	8.0	mA	$V_{out} = \pm 10 \text{ V}, R_L = 5.0 \text{ K}\Omega$
	$I_{ps} (-15\text{V})$	—	3.9	5.0	mA	$V_{out} = \pm 10 \text{ V}, R_L = 5.0 \text{ K}\Omega$

TYPICAL PERFORMANCE CURVES

INPUT CHARACTERISTIC

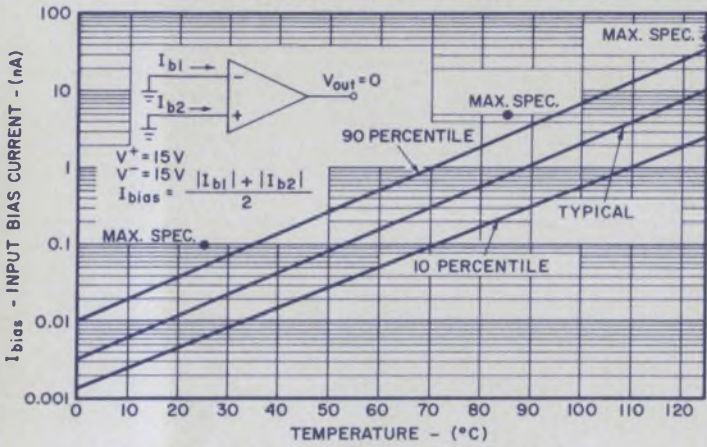

INPUT BIAS CURRENT VS. TEMPERATURE

FIGURE 1

INPUT CHARACTERISTIC

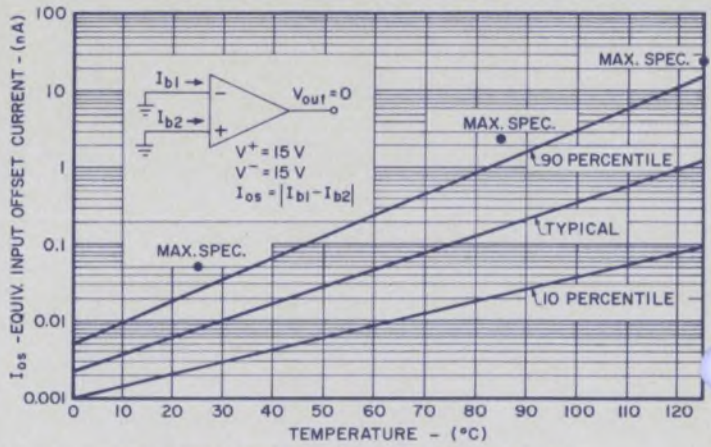

INPUT OFFSET CURRENT VS. TEMPERATURE

FIGURE 2

INPUT CHARACTERISTIC

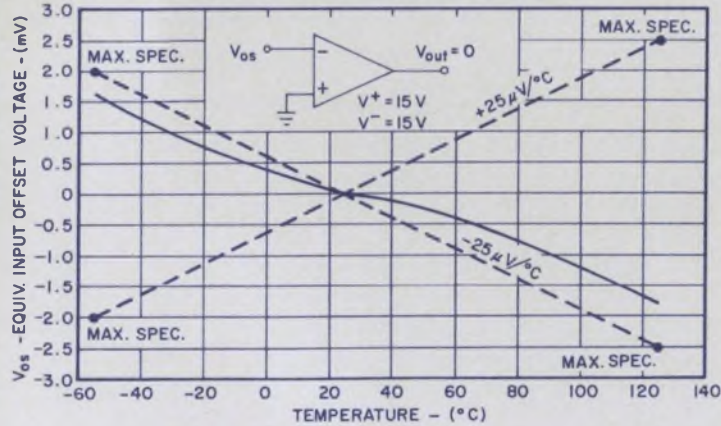

INPUT OFFSET VOLTAGE VS. TEMPERATURE

FIGURE 3

OUTPUT CHARACTERISTIC

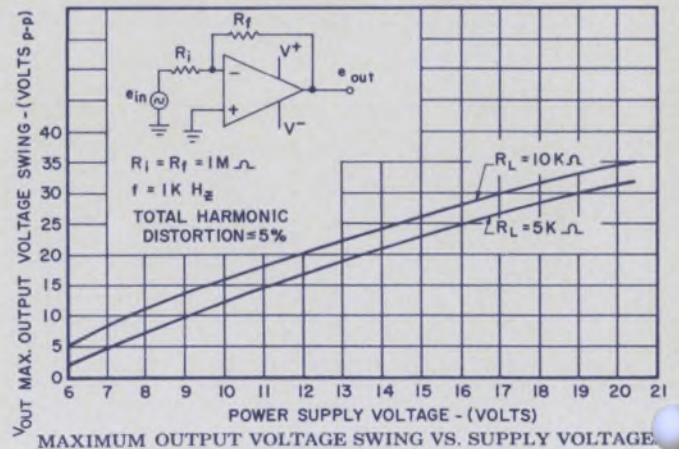

MAXIMUM OUTPUT VOLTAGE SWING VS. SUPPLY VOLTAGE

FIGURE 4

TRANSFER CHARACTERISTIC

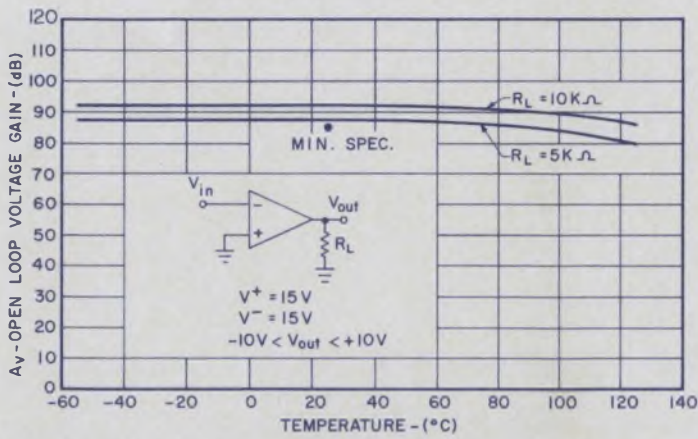

OPEN LOOP VOLTAGE GAIN VS. TEMPERATURE

FIGURE 5

TRANSFER CHARACTERISTIC

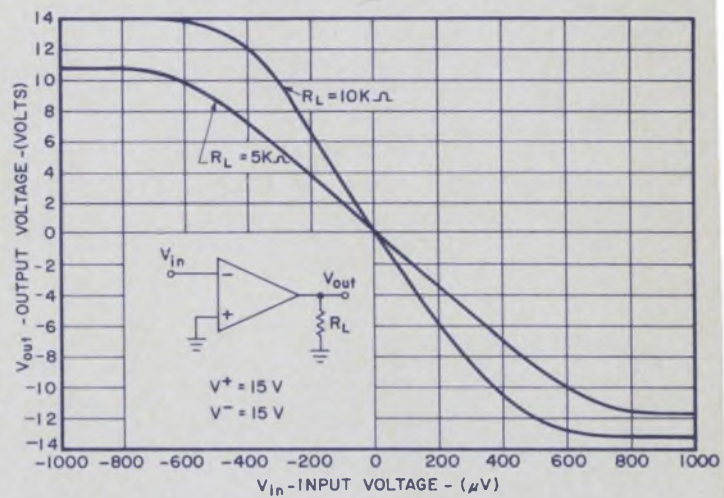

INPUT VOLTAGE VS. OUTPUT VOLTAGE

FIGURE 6

TRANSFER CHARACTERISTIC

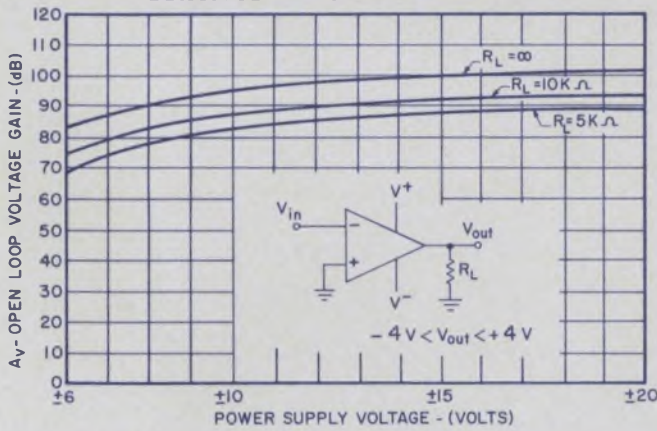

OPEN LOOP VOLTAGE GAIN VS. POWER SUPPLY VOLTAGE

FIGURE 7

SMALL SIGNAL CHARACTERISTIC

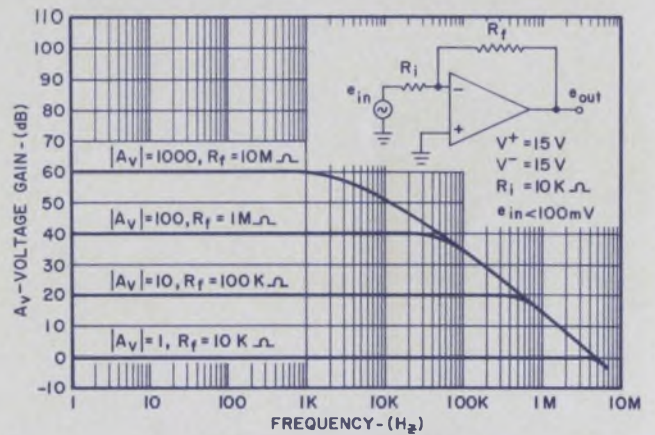

CLOSED LOOP GAIN VS. FREQUENCY

FIGURE 8

SMALL SIGNAL CHARACTERISTIC

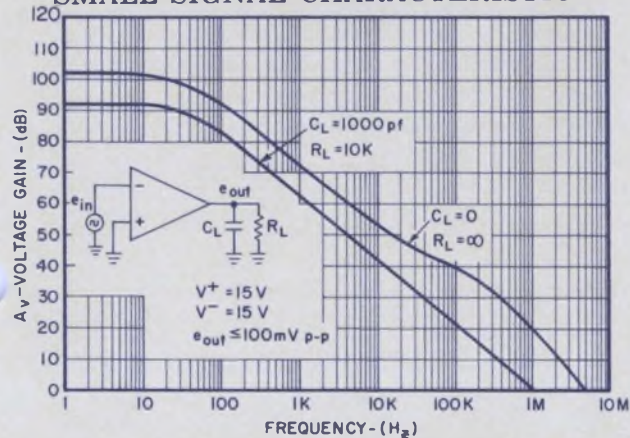

OPEN LOOP GAIN VS. FREQUENCY

FIGURE 9

SMALL SIGNAL CHARACTERISTIC

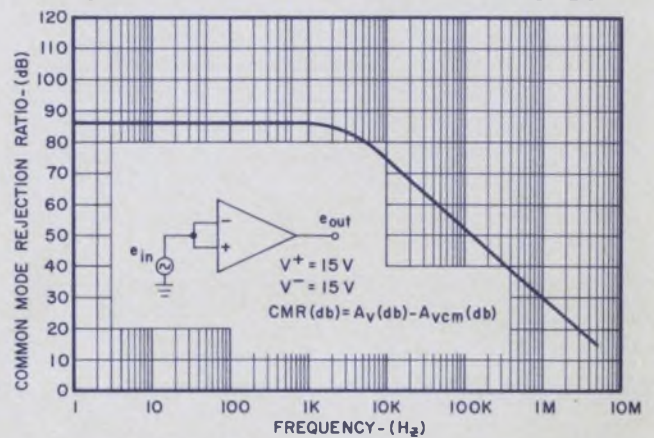

COMMON MODE REJECTION RATIO VS. FREQUENCY

FIGURE 10

POWER SUPPLY INPUT CHARACTERISTIC

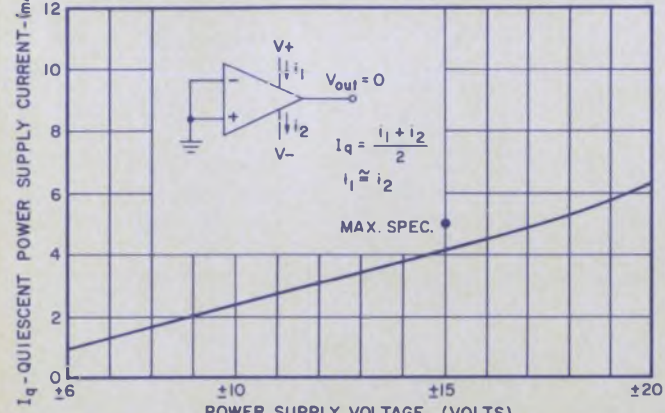

QUIESCENT POWER SUPPLY CURRENT VS. POWER SUPPLY VOLTAGE

FIGURE 11

POWER SUPPLY INPUT CHARACTERISTIC

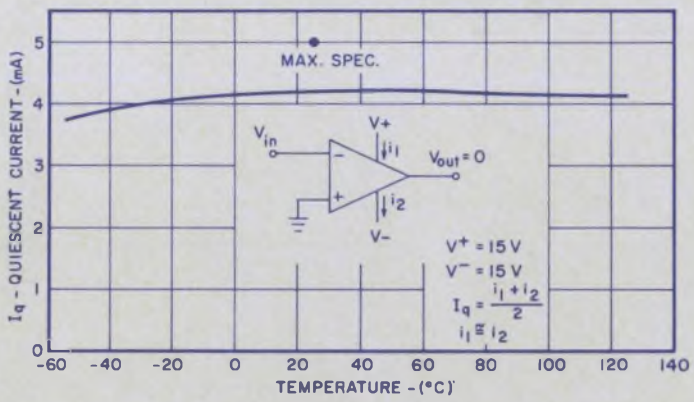

QUIESCENT CURRENT VS. TEMPERATURE

FIGURE 12

LARGE SIGNAL CHARACTERISTIC

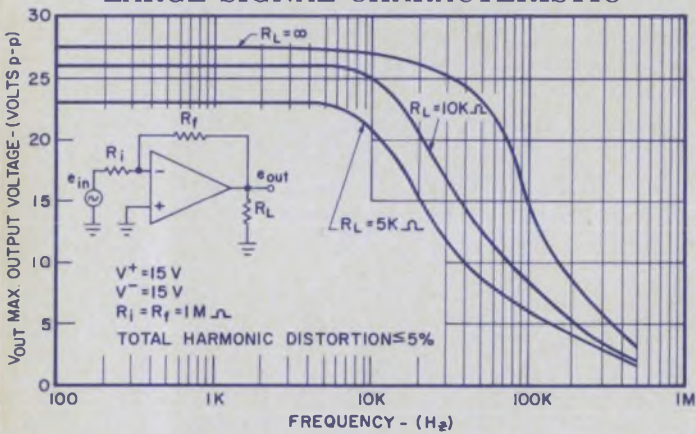

MAXIMUM OUTPUT VOLTAGE SWING VS. FREQUENCY

FIGURE 13

NOISE CHARACTERISTIC

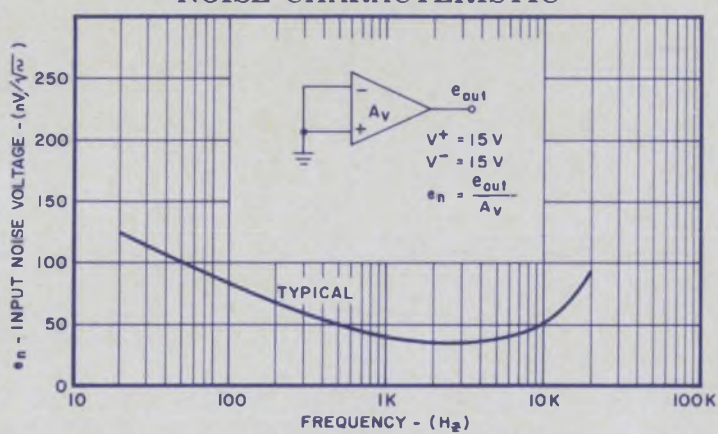

EQUIVALENT INPUT NOISE VS. FREQUENCY

FIGURE 14

MECHANICAL DATA

Case: Material . . . Epoxy
(All dimensions nominal in inches, unless otherwise noted)

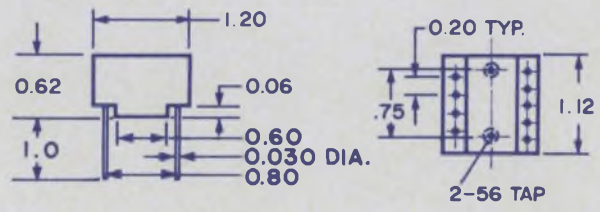

H7000

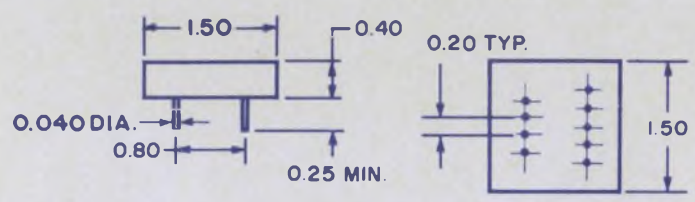
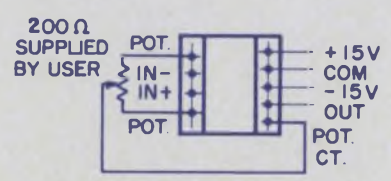

H7000A

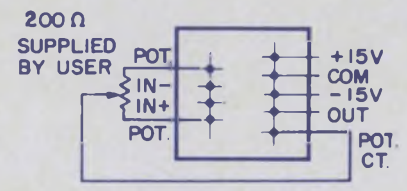

ELECTRONICS

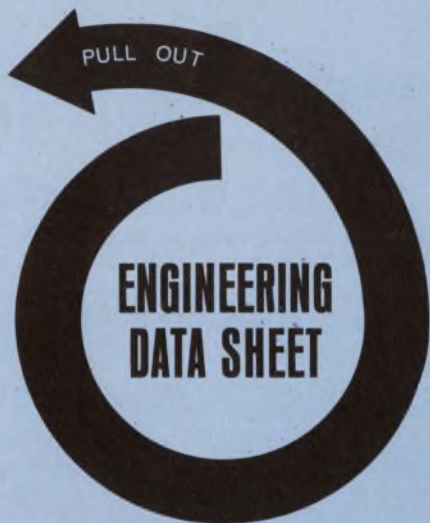

If somebody beat
you to it, write to:
Union Carbide
Electronics
or call your UCE
distributor
IN THE WEST

ARIZONA, Phoenix

Avnet Electronics • (602) 272-6821

CALIFORNIA,

Culver City

Avnet Electronics • (213) 870-6141

Los Angeles

K-Tronics • (213) 685-5888

Mountain View

Avnet Electronics • (415) 961-7700

Newport Beach

Western Electronic Components •

(714) 540-1322 (213) 631-6119

Palo Alto

Kierulff Electronics, Inc. • (415) 968-6292

San Diego

Avnet Electronics • (714) 279-1550

San Diego

Kierulff Electronics • (714) 278-2112

COLORADO, Denver

Newark-Denver Electronics •

(303) 757-3351

WASHINGTON, Seattle

Washington Electronics • (206) 682-8981

Factory Sales Offices

CALIFORNIA

Mountain View

(415) 969-9390

Fullerton

(213) 691-0958



ELECTRONICS

ON READER-SERVICE CARD CIRCLE 27
ELECTRONIC DESIGN 10, May 10, 1967



FROM STOCK

COMPLETE LINE OF

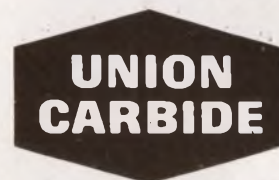

SEMICONDUCTORS

CALL YOUR KEY
UCE DISTRIBUTOR
IN THE EAST:

**EASTERN
RADIO CORP.**
N.J. 201-471-6600
N.Y. 212-244-8930
(DIRECT N.Y. LINE)
TWX 710-989-7052

CALLEASTERNFIRST

Winner of
Outstanding Sales Achievement
AWARD

As Union Carbide Distributor of the year
1966

ON READER-SERVICE CARD CIRCLE 28

(continued from p. 56)

altogether if a synchronous scheme is used for the counter. In this case, in fact, changing the counting direction will affect only the *J* and *K* inputs of the flip-flops, and this will not affect the contents of the flip-flops, whichever the state of the clock input.

Counters in Figs. 2 and 3 of Smith's article, because they use a synchronous scheme, do not suffer from the aforementioned drawback.

Finally I submit for your attention the enclosed scheme in Fig. 2 for a reversible counter, which is particularly simple and efficient. It counts in 1-2-4-8 code; its outputs are coherent, and do not change when count direction is reversed.

S. Iannazzo

Digital Group
Application Laboratory
SGS Fairchild
Milan, Italy

The author replies

Sir:

Mr. Iannazzo is correct in stating that the content of the reversible counter of Fig. 4 in my article will be altered by a simple inversion of the counting direction, *provided* that the *Advance* input is high. Neither this counter nor the counters of Figs. 2 and 3 were designed to change direction during the count, i.e., when the *Advance* input is high. They were designed to change directions between counts, when the *Advance* input is low. Since the *Advance* input need be high only for 250 ns, ample time is available between pulses for direction changing. For low-frequency square-wave counting, where a direction change may occur while the *Advance* input is high, all that is needed is for a 250-ns single-shot multivibrator to be put on the front end of the first stage of the counter. Since the carry, *C*, from each counter is a function of the *Advance* pulse, subsequent counter stages need not be preceded by a one-shot.

Iannazzo states that the drawback can be eliminated by use of a synchronous design similar to Figs. 2 and 3. This is not true unless some change is made in the carry output. Consider, for example, the carry output of Fig. 4 where *C* equals:

$$F \cdot \overline{Q_1} \cdot \overline{Q_4} + (Q_1 \cdot Q_2 \cdot Q_3 \cdot Q_4) \text{ Advance}$$

It would be a simple matter to redesign the counter so that Q_{2T} , Q_{3T} and Q_{4T} were not a function of the *Advance* input; then a direction change with the *Advance* input high would not alter the contents of the counter. Such a design would produce a carry pulse, however, thus altering the content of the next stage of the counter. To prove this, consider, for example, the transition from forward to reverse counting while the *Advance* is high and the counter is at count 9 of the sequence. For this state of events, the carry output reduces to

$$C = \overline{(F \cdot \overline{Q_1} \cdot \overline{Q_4}) \text{ Advance}} \\ = F \cdot \text{Advance}$$

Now, if the *Advance* input is high, then *Advance* is low, or logical 1, and $C = \overline{F}$. Thus any direction change would generate an erroneous carry output. It is clear that a synchronous design would not solve the problem, and the only solution is to change directions while the *Advance* input is low. From the information he gives, it would seem that Mr. Iannazzo has neglected the carry output.

Kay D. Smith

Senior Design Engineer
General Instrument Corp.
Advance Electronic R&D Center
Salt Lake City, Utah.

Government also wants to make 'best buys'

Sir:

Your editorial in the April 1, 1967, issue of ED ["It's time the U.S. encouraged industry to sound off," p. 59] raises questions on which I wish to comment. By any standard, government procurement is large and at times complicated. It would pay anyone interested in doing business with the government to study a copy of the Armed Services Procurement Regulations (ASPR) and learn the procedures under which procurement is made.

Government scientists and procurement personnel did not write the laws with which these regulations must comply. Congress wrote the laws which call for the labor surplus set-aside, the small-business fair-share program, and all the other exceptions and special provisions

NEW! DIGITAL PANEL METERS 0.1% ACCURACY



DIGIMETER MODEL DM-25 \$260
OEM discounts available

For every application where a conventional panel meter is inadequate

- AC or DC measurements
- Single or multiple ranges
- 1 μ A to 1,000 A. full scale
- 10 mV to 10,000 V. full scale
- Other functions & ranges to order

Send for detailed literature



2 Sixth St., New Hyde Park, L. I., N. Y. 11044
516 CH 8-8060

UNIVERSAL CALIBRATOR Model MC-10



Fast, accurate calibration of panel meters, multimeters, oscilloscopes, vtvm's, other measuring instruments. Full accuracy without correction curves. Meter indicates directly the % Error in device under test. All solid-state. Meets MIL specs for temperature, humidity, vibration, shock, RFI.

AC & DC VOLTAGE: $\pm 0.2\%$, 0-1000 volts in 1 millivolt steps, 0-20 mA load
AC & DC CURRENT: $\pm 0.2\%$, 0-1 ampere in 1 microamp steps, 0-1 volt burden
RESISTANCE: $\pm 0.1\%$, 0-1,000,000 ohms in 1 ohm steps

Send for detailed literature



2 Sixth St., New Hyde Park, L. I., N. Y. 11044
516 CH 8-8060

that are required. It is true these factors do influence the awards in a small percentage of contracts.

In most government procurements and especially those involving large dollar values, many hours of review and discussion go into the selection of the contractor before the award is made. Government personnel are just as interested in obtaining a good product at a fair and reasonable price as any other taxpayer. In most cases, the government scientist is more interested because his reputation is at stake when the contract involves his brainchild which he is turning over to industry to produce. Anything that can be done to encourage a "best buy" decision rather than a "safe buy" would be appreciated.

Ivor D. Groves

Physicist
Government Laboratory
Orlando, Fla.

Guts are best answer to personality tests

Sir:

How the devil can you include an article about cheating on personality tests ["Cheat on personality tests," ED 5, March 1, 1967, pp. 92-96] with a ridiculous editorial about Charles Steinmetz ["And where are the Steinmetzes of today?" p. 53]?

Do you really expect to develop bold, independent Steinmetzes by teaching us how to become adept at deception and falsehood?

You should rather be teaching us how to have the guts to tell that "nervous little man" what he can do with his test.

Walter W. Zandi
Sanders Associates, Inc.
Nashua, N. H.

Accuracy is our policy

In "IC bidirectional counters cost less," ED 2, Jan. 18, 1967, pp. 58-63, an error appears in Fig. 1, p. 59. The NOR gates' outputs should be $A \cdot B$ and $C \cdot D$; because of bad printing definition, however, these outputs appear in some copies as $A B$ and $C D$.

ELECTRONIC DESIGN 10, May 10, 1967

SOLVE YOUR VOLTAGE OR CURRENT SENSING PROBLEMS

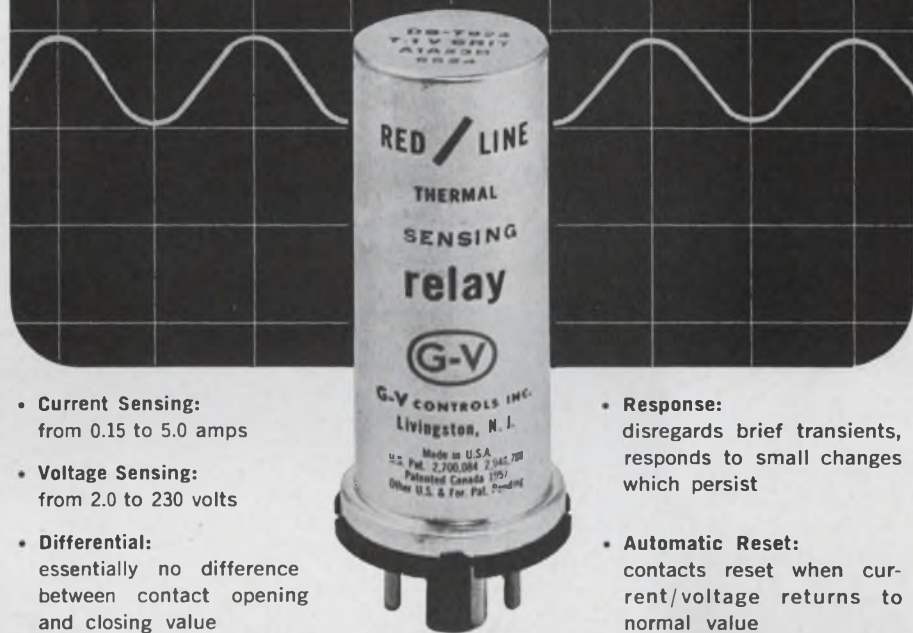

- **Current Sensing:**
from 0.15 to 5.0 amps
- **Voltage Sensing:**
from 2.0 to 230 volts
- **Differential:**
essentially no difference between contact opening and closing value
- **Response:**
disregards brief transients, responds to small changes which persist
- **Automatic Reset:**
contacts reset when current/voltage returns to normal value

With the widest selection of thermally actuated voltage/current sensing devices

...from G-V

If your component or equipment can be damaged by extended exposure to over voltage or overload . . . a G-V thermally actuated current or voltage sensing device will provide positive protection. These unique devices offer precise cut-off levels, choice of selective response times, automatic reset, and are ambient temperature compensated. Operation is independent of the frequency of the applied voltage, **AC or DC**, in any position. Available in both military and industrial versions. Typical applications include: overload protection, voltage regulation, over-voltage cut-off, under-voltage alarm, low frequency cut-off, battery charge control, and other current or voltage sensing functions.



...Bulletin #70-5 includes: applications, functions, response time selection chart, types and mounting forms available, electrical, mechanical and environment specifications.



G-V CONTROLS INC.
LIVINGSTON, NEW JERSEY 07039
(201) 992-6200

ON READER-SERVICE CARD CIRCLE 30





When Reliability is the Rule...Specify

Johanson

A Complete Line of HIGH Q VARIABLE CAPACITORS AIR • GLASS • QUARTZ

IMPORTANT

All models feature 570° F Solder. Prevents distortion. Not affected by conventional soldering temperature.

SERIES	FEATURES	SPECIFICATIONS
 <p>5200</p>	<p>Improved one piece rotor construction with built-in torque for longer and more reliable adjustment life. Reliability tested and certified by independent laboratory. (results available on request)</p>	<p>CAPACITANCE RANGE: 0.8 to 10.0 pF. BREAKDOWN: > 500 VDC INSULATION RESISTANCE: > 1,000,000 Megohms @ 500 VDC Q @ 100 MC: > 3000 TEMPERATURE COEFFICIENT: 0 ± 20 ppm/°C TORQUE: .5 — 5 in. oz. SHOCK: > 275 g (6.0 millise.) ROTATIONAL LIFE: > 1000 Revolutions rotor screw</p>
 <p>4700 4701 4702</p>	<p>10:1 capacitance ratio in micro miniature size — extra fine tuning < .35 pF per turn. High Q, (greater than 1500 at 500 mc)</p>	<p>CAPACITANCE RANGE: 0.35 pF to 3.5 pF WORKING VOLTAGE: 250 VDC (test voltage, 500 VDC) Q @ 100 MC, > 5000; @ 250 MC, > 2000 INSULATION RESISTANCE: > 10⁶ Megohms TEMPERATURE RANGE: —55°C to 125°C TEMPERATURE COEFFICIENT: 50 ± 50 ppm/°C</p>
 <p>GQ 1115</p>	<p>Solid metal electrode bands. Meets or exceeds applicable requirements of MIL-C 14409/B. Low minimum capacitance (.5 pF). High current (up to 2 amps).</p>	<p>CAPACITANCE RANGE: 0.5 pF to 5.0 pF WORKING VOLTAGE: 2500 VDC & 2500 v peak RF @ 30 MC applied simultaneously Q @ 1 MC: 2000 minimum INSULATION RESISTANCE: 10⁶ Megohms TEMPERATURE COEFFICIENT: 0 ± 100 ppm/°C OPERATING TEMPERATURE: —40 to +200°C</p>
 <p>4642 4640</p>	<p>High capacity in a small package — exclusive round nut permits installation in tight places or miniaturized packaging. Ultra-rugged construction.</p>	<p>CAPACITANCE RANGE: .4 pF to 6 pF (> 8 Turns) WORKING VOLTAGE: 250 VDC (Test Voltage 500 VDC) Q @ 100 MC: > 5000 INSULATION RESISTANCE: > 10⁶ Megohms TEMPERATURE COEFFICIENT: 50 ± 50 ppm/°C TEMPERATURE RANGE: —65°C to +125°C</p>
 <p>6100</p>	<p>Modular design. Available in one to five section modules in a wide variety of capacitance range and plate configurations.</p>	<p>CAPACITANCE RANGE: Max. 145 pF, Min. 9.5 pF per section (180° Rotation) CAPACITY VARIATION: Straight Line Capacity TEMPERATURE RANGE: —55°C to +125°C BREAKDOWN: 1000 VDC LOW TORQUE: 3-5 oz. in.</p>

OTHER LINES

2950 SERIES: CAP: 0.8 — 10 pF • 250 VDC • Q > 2000 @ 100 MC • TC: 0 ± 20 ppm/°C
 3901 SERIES: CAP: 1.0 — 14 pF • 250 VDC • Q RANGE > 1500 to > 3000 max. to min. C @ 100 MC • TC: 0 ± 50 ppm/°C
 3906 SERIES: CAP: 1.0 — 20 pF • 250 VDC • Q RANGE > 1200 to > 3000 max. to min. C @ 100 MC • TC: 0 ± 50 ppm/°C
 3908 SERIES: CAP: 1.0 — 30 pF • 250 VDC • Q RANGE > 750 to > 3000 max. to min. C @ 100 MC • TC: 0 ± 50 ppm/°C
 2902 SERIES: CAP: 1.0 — 10 pF • 400 VDC • Q > 2000 @ 100 MC • TC: 0 ± 20 ppm/°C
 MH — 112 SERIES: .1 — 1 pF • 250 VDC • .075 dia.

All lines available with special high reliability processing. Includes 100% burn-in and screening and historical test data.



MANUFACTURING CORPORATION

400 Rockaway Valley Road, Boonton, N. J. • Phone (201) 334-2676

ON READER-SERVICE CARD CIRCLE 31

Co-Publishers

James S. Mulholland, Jr.
Robert E. Ahrensford

Editorial Director

Edward E. Grazda

Editor

Howard Bierman

Managing Editor

Robert C. Haavind

Technical Editors

Jeffrey N. Bairstow
Peter N. Budzilovich
Maria Dekany
Frank Egan
Roger K. Field

Careers & Management Editor

Archimedes Doria

News Editors

Ralph Dobriner, Chief
Richard N. Einhorn

East Coast Editor

Neil Sclater

West Coast Editor

Ron Gechman

Copy Editor

Peter Beales

New Products Editors

David H. Sorgan
Daniel R. Butterly

Washington Editor

S. David Pursglove

Editorial Production

Dollie S. Viebig
Karen L. Sherman

Art Director

Clifford M. Gardiner

Art Assistant

William Kelly

Technical Illustrators

Cheh Nam Low
William Alvarez
Sheila F. Ward

Production Manager

Thomas V. Sedita

Asst. Production Manager

Helen De Polo

Production Assistants

Bernard Wolinsky
Robert B. Lichtig

Circulation Manager

Nancy L. Merritt

Reader Service

Diane Mandell

EDITORIAL



Look ahead, before you freeze the design

Jan. 27, 1967: An Apollo space vehicle is undergoing routine tests at Cape Kennedy. One day it will carry three promising astronauts on the first U.S. flight to the Moon. The craft is a marvel of engineering resourcefulness—until there is the sudden cry of "Fire!" In less than a minute all three astronauts are dead.

March 9, 1967: A DC-9 jetliner over Ohio is preparing for a routine landing with 25 aboard, while, a few miles away, a light executive plane cruises smoothly toward a second airport, still some distance away. Both planes are well designed; their engines function perfectly, their airframes are sturdy. There is only basic flaw as they collide near Urbana: neither plane has a built-in collision-avoidance system. Twenty-six persons die as a result.

Both tragedies have been caused by the same engineering defect: failure to build foresight into the design.

Most people would agree that hindsight is better than foresight. It's certainly a surer bet. But in today's revolutionary world senior electronic engineers cannot wait for hindsight. In aerospace research or oceanography, in the consumer-goods market or in the workaday realm of semiconductors and ICs—no matter where they work, the best engineers anticipate events. With their design talents, they not only help expand man's knowledge, not only create new and better solutions for old problems—they also halt disaster before it has a chance to occur.

And it's not enough to practice foresight in just one direction. The future lies not only straight ahead; it frequently winds to either side.

Investigation of the Apollo fire has disclosed so far that the designers of the capsule built plausible oxygen-supply and escape systems—but strictly for operation in space; they neglected to consider fully that the same systems would have to undergo long tests on the ground. What was a reasonably safe design for the airless environment above the earth became a death trap in the atmosphere on the ground.

As for mid-air collisions, they have become accepted as an inevitable danger that will increase until the electronic industry (with the belated benefit of hindsight) comes up with a universal collision-avoidance system. For a look at how designers are wrestling with the problem, see page 17.

But the question remains: Why does it always seem to take a disaster to stimulate action?

And how much foresight are you building into your design?

HOWARD BIERMAN

Tektronix Type 453 oscilloscope has

- 50 MHz Performance
- Dual Trace ● Delayed Sweep
- Easy-to-Use Triggering



and-----it's designed to be carried!

Pick it up and be convinced. The Type 453 weighs 28½ pounds and is built to go when and where you go.

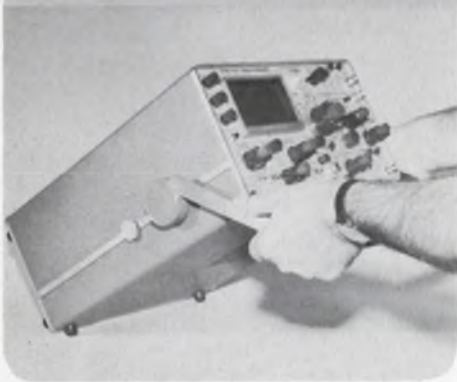

Don't worry about damaging the front panel and knobs—they're protected by a cover that also carries the accessories.



Take the Type 453 through tight places easily . . . the vertical carrying position increases portability.



Take it anywhere. The rain/dust cover is a standard accessory and carries the complete manual and optional viewing hood.



The Type 453 is a portable instrument with rugged environmental capabilities plus the built-in high performance normally found only in multiple plug-in instruments.

The vertical amplifier provides dual trace, DC to 50 MHz bandwidth with 7 ns risetime from 20 mV/div to 10 V/div. (DC to 40 MHz, 8.75 ns T_r at 5 mV/div.) The two included Type P6010 miniature 10X probes maintain system bandwidth and risetime performance at the probe tip—DC-50 MHz, 7 ns—with an increase in deflection factors of 10X. You can also make 5 mV/div X-Y and 1 mV/div single trace measurements.

The Type 453 trigger system takes the guesswork out of triggering. Pushing all the lever switches up provides a sweep and the most often used trigger logic. The sweep triggered light gives the operator a positive indication of a triggered sweep and the automatic triggering provides greater usability.

You can operate the delayed sweep with ease. Lever con-

trol to the right and HORIZ DISPLAY switch to A INTEN DURING B gives delayed sweep operation. Setting the B TIME/DIV and the DELAY-TIME MULTIPLIER to meet your requirements and switching to DELAYED SWEEP allows $\pm 1.5\%$ delay measurements to be made.

The Type 453 is a continuation of the Tektronix commitment to quality workmanship. Its design and layout make it easy to maintain and calibrate. Transistors plug in and are easily removed for out-of-circuit testing. An accurate time ($\pm 0.5\%$) and amplitude ($\pm 1\%$) calibrator permits quick field calibration.

The front panel protection cover carries all the accessories with the complete manual carried in the rain and dust cover. The Type C-30 Camera and a viewing hood that fits in the rain cover also are available.

Type 453 (complete with probes and accessories) . . .	\$1950.00
Type C-30 Camera	\$ 390.00
Collapsible Viewing Hood	\$ 7.50

U.S. Sales Prices, FOB Beaverton, Oregon

Tektronix, Inc.



For complete information, contact your nearby Tektronix field engineer or write:
Tektronix, Inc., P.O. Box 500, Beaverton, Oregon 97005

ON READER-SERVICE CARD CIRCLE 32

Technology



Go/no-go technique uses one display to check successive amplifier parameters. Page 70

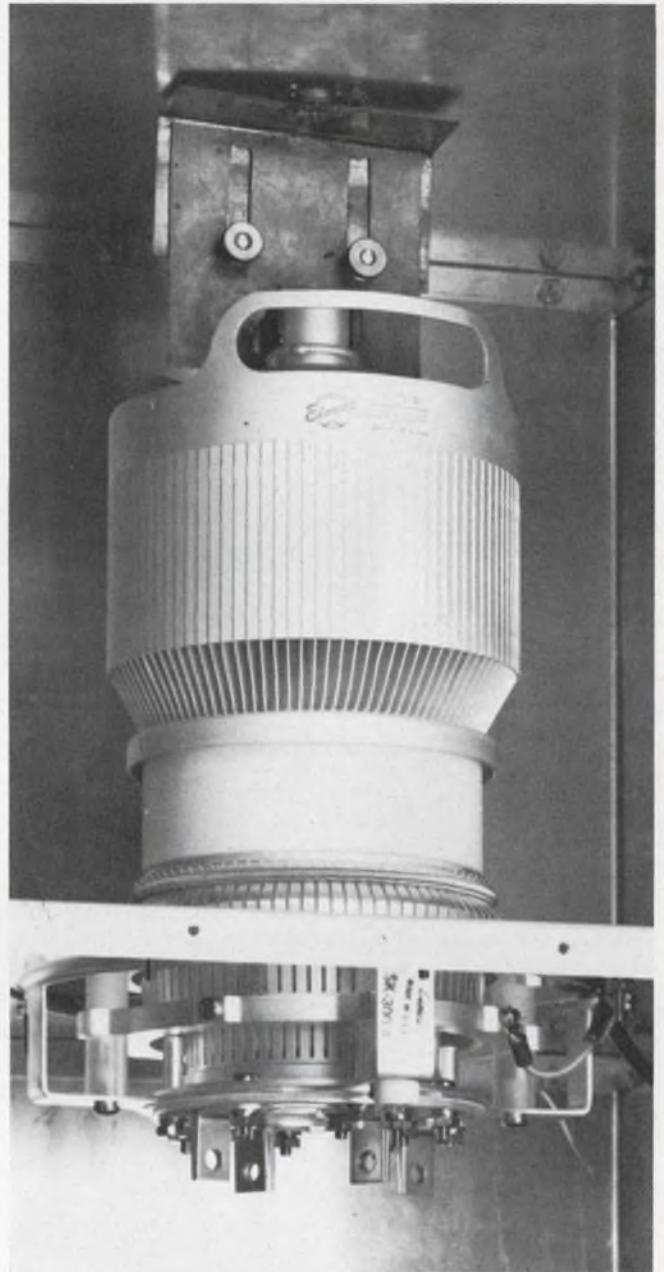

Power tubes operate stably at uhf and vhf when neutralized in these bands. Page 64

Also in this section:

Filter made out of an oscillator has better stability than passive LC filters. Page 56

Dc level-shifting amplifier designed by complementary current division technique. Page 60

Magnetic-core coil design is simplified by use of three charts. Page 78

Make a filter out of an oscillator

for better stability than that of passive LC filters.

The design is easy with IC amplifiers.

Very stable active RC filters with high Q s are not a matter of witchcraft. The trick is to reduce the Q sensitivity to variations in the gain and in component values. Here is a design approach that shows how to do it—and do it simply. The resultant circuit can be built with ICs—another advantage of the method.

Conventional RC filters have a well-deserved reputation for instability. This is due to the fact that their center frequencies and Q s are highly sensitive to drift in both passive and active elements.

The technique introduced here—and adapted from analog-computer circuitry—makes RC active filters more stable than passive LC filters. This feat is accomplished by a reduction of the Q sensitivity by about two orders of magnitude. Using commercially available RC components, the method yields circuits with thermal coefficients of 0 ± 20 ppm/°C. Furthermore, the resonators maintain this stability over the full military-specified temperature range. These filters may be built with IC operational amplifiers.

The causes of instability

Both passive and active RC filters are usually analyzed in terms of the complex frequency variable, $s = \sigma \pm j\omega$. The transfer functions must have poles only on the negative real axis of the s plane. The transfer function is defined conventionally as the ratio of output current (or voltage) to input current (or voltage).

Passive networks, with poles on the negative real axis, can give selective filters.¹ But the large number of elements makes this approach impractical.² However, if we insert an amplifier into the network, then economical high- Q resonators are immediately obtained in a considerable variety of ways. A typical case is the method³ that uses the configuration of Fig. 1. Here the transfer impedance is:

$$Z_{12}(s) = E_2/I_1 = A/[y_2(s) - (A-1)y_1(s)]. \quad (1)$$

Philip R. Geffe, Fellow Engineer, Westinghouse Electric Co., Baltimore, Md.

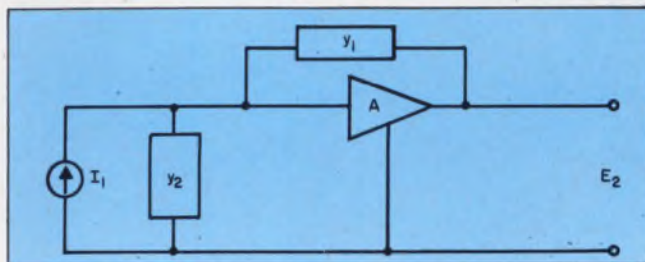

1. Conventional RC filter has an active element (amplifier A). A very small change in the nearly equal passive admittances or in the gain will cause large changes in its bandwidth.

Thus when $A = 2$, the denominator is simply the difference between the two admittances. Since the admittances can be made as nearly equal as desired, so, too, can the voltage magnification be as high as desired—and this is a definition of high Q (with poles out in the complex plane).

The very method by which high Q is obtained is also inherently and irremediably a cause of instability. A minute change in the nearly equal passive admittances or a tiny change in gain will cause a relatively large change in bandwidth.

As a yardstick for measurement, two quantities may be defined: gain sensitivity and passive-element sensitivity.

The gain sensitivity of Q is the ratio of the fractional change in Q to the fractional change in gain:

$$S_A^Q = \frac{\partial Q/Q}{\partial A/A}. \quad (2)$$

In the circuit of Fig. 1 this number is about $4Q$.

The passive-element sensitivity of Q is the ratio of a fractional change in Q to the fractional change in element value:

$$S_B^Q = \frac{\partial Q/Q}{\partial \beta/\beta}, \quad (3)$$

where β is a measure of passive-element magnitudes usually taken as a ratio of passive-element products. In Fig. 1 this quantity is about $2Q$.

Perhaps the best⁴ of the popular RC-active methods is shown in Fig. 2. Here the transfer

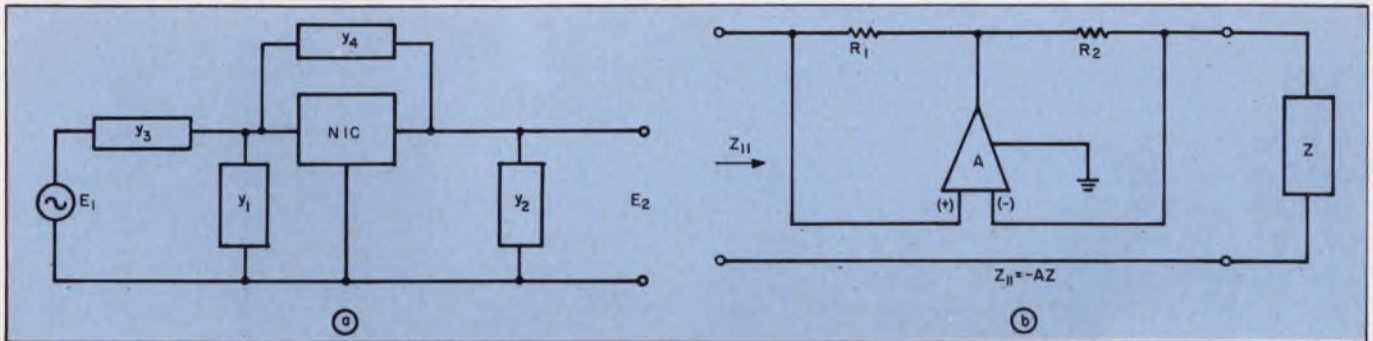

2. Active high-Q RC filter uses a negative impedance converter (NIC) (a). A high-gain differential amplifier is the

usual way to realize the NIC (b). In the latter, A represents the conversion factor.

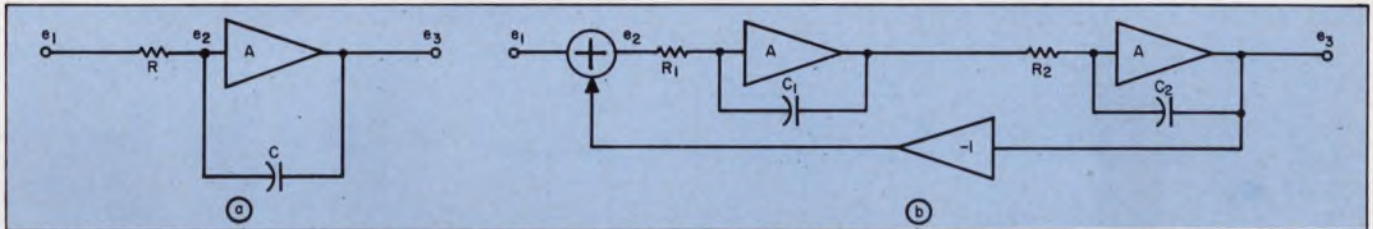

3. An active integrator (a) is the basic building block for RC filters. Its input admittance and output impedance are

zero. Two such integrators and the feedback loop form the oscillator in (b).

function is:

$$E_2/E_1 = [y_4 - y_3] / [(y_4 - y_3) + (y_2 - y_1)], \quad (4)$$

and the negative impedance converter (of the current-inversion type) can be realized with a high-gain differential amplifier,⁵ as in Fig. 2b. In this figure, A is the conversion factor and the sensitivity of Q to A is about 2Q.

Start with an oscillator

It is possible to make both passive and active sensitivities independent of Q, and to keep these values small.⁶

Consider the circuit of Fig. 3a. The voltage gain of the amplifier is very high and its input admittance and output impedance are zero. Then the nodal equations are:

$$e_2 = e_1 \left[\frac{1/Cs}{R + (1/Cs)} \right] + e_3 \left[\frac{R}{R + (1/Cs)} \right]; \quad (5)$$

$$e_2 = e_3/A. \quad (6)$$

Solving these yields:

$$\frac{e_3}{e_1} = \frac{-1}{\left(\frac{RCs + 1}{-A} \right) + RCs}, \quad (7)$$

and

$$\lim_{A \rightarrow \infty} (e_3/e_1) = -(1RCs). \quad (8)$$

The circuit in Fig. 3a is the basic building block for RC filters. The addition of an extra stage and a feedback loop results in the oscillator of Fig. 3b. The analysis remains simple. If infinite gain is assumed and Eq. 8 applied, the nodal equations become:

$$e_2 = e_1 - e_3, \quad (9)$$

$$e_2 = e_3(R_1 R_2 C_1 C_2) s^2; \quad (10)$$

which yield:

$$G(s) = e_3/e_1 = 1 / [(R_1 R_2 C_1 C_2) s^2 + 1]. \quad (11)$$

The network has a pole on the $j\omega$ -axis, hence it oscillates at:

$$\omega_0 = 1/(R_1 R_2 C_1 C_2)^{1/2}. \quad (12)$$

The sensitivity for a small change in a single element is the same as it would be for a single-tuned LC circuit, where $\omega_0 = 1/(LC)^{1/2}$.

Drift has no effect

In practice both the capacitors and the resistors would be expected to drift. If uniform drift for like devices is assumed, and $R_1 = R_2 = R$ and $C_1 = C_2 = C$, then:

$$\omega_0 = 1/RC, \quad (13)$$

so that the sensitivity of the center frequency to the passive-element drift is twice that of an LC circuit.

It is now possible to transform the oscillator of Fig. 3b into a high- Q resonator, as shown in Fig. 4a. Here the nodal equations are the same as Eqs. 5 and 6 except that Z , the parallel combination of G and C , is written in place of $1/Cs$:

$$Z = 1/(Cs + G) = 1/C(s + d) = 1/Cp, \quad (14)$$

where $p = s + d$, and $d = G/C$. Accordingly, the analysis of the complete resonator in Fig. 4b gives the same result as that of Fig. 3, except that p is written instead of s :

$$\begin{aligned} G(s) &= e_3/e_1 = 1(\tau^2 p^2 + 1) \\ &= 1/[\tau^2(s + d)^2 + 1] \\ &= \tau^{-2}/[s^2 + 2ds + d^2 + 1/\tau^2], \end{aligned} \quad (15)$$

where $\tau = RC$ and $d = 1/rC$.

The gain pole has now been shifted from the $j\omega$ -axis into the left half plane by a distance d . If d is not negligible, then the frequency of peak response becomes:

$$\omega_0 = (d^2 + 1/\tau^2)^{1/2}, \quad (16)$$

and the design formula is:

$$RC = 1/(\omega_0^2 - d^2)^{1/2}. \quad (17)$$

The Q of the circuit is the ratio of center frequency to half-power bandwidth:

$$Q = \frac{[1 + (r^2/R^2)]^{1/2}}{2}. \quad (18)$$

Only two assumptions were made in the analysis: infinite amplifier gain and uniform drift in like components. The latter assumption is perfectly acceptable in practical circuits. It makes Q independent of drift in the element values, according to Eq. 18.

The effects of finite amplifier gain are not difficult to evaluate. First apply Eq. 7 instead of Eq. 8 to the circuit of Fig. 3b to obtain:

$$G(s) = \frac{1}{\tau s + \left(\frac{\tau s + 1}{-A}\right)^2 + 1}. \quad (19)$$

The denominator of Eq. 19 vanishes when:

$$\tau^2(A - 1)^2 s^2 - 2\tau(A - 1)s + (A^2 + 1) = 0, \quad (20)$$

which gives the real and imaginary parts of the transfer function:

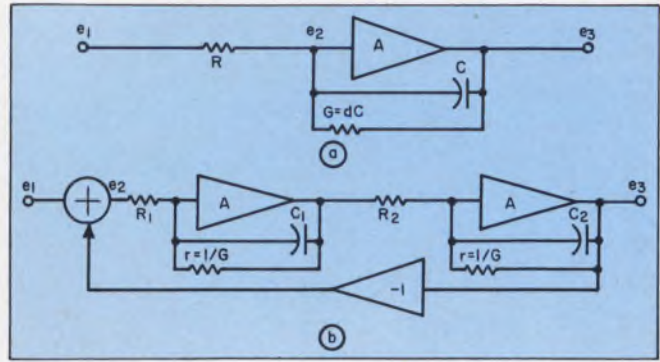

4. Damped form of the integrator (a) is needed for active resonators, such as the ultrastable high- Q type in (b). When cascaded, the resonators form bandpass filters.

(Real part)

$$\sigma_0 = \frac{-1}{\tau(A - 1)}; \quad (21)$$

(Imaginary part)

$$\omega_0 = \frac{1}{\tau(1 - 1/A)}. \quad (22)$$

Here σ_0 must be interpreted as an error in d . In other words, finite gain damps the oscillator exactly the same way as resistance would. If the gain is stable, then σ_0 can be exactly compensated for. With IC amplifiers in mind, it may be assumed that gain drifts are $\pm 1/3$. Hence the irreducible error in d would be:

$$\Delta d = 3/\tau(A - 3), \quad (23)$$

and

$$\Delta Q \approx 3/A. \quad (24)$$

Thus an amplifier gain of 1000 ± 333 gives a bandwidth drift of $\pm 0.3\%$. This amount, tolerable in most applications, can be reduced by use of higher gain.

Composite bandpass filters may be designed by cascading the self-isolated resonators, exactly as in the design of stagger-tuned IF amplifiers. ■ ■

Acknowledgment:

The author is indebted to Dr. D. A. Calahan, of the University of Michigan, and to M. J. Gay, R. C. Foss, and B. J. Green, of The Plessey Co., Ltd., Towcester, England, for much information on the circuit and its history.

References:

1. E. A. Guillemin, *Synthesis of Passive Networks* (New York: John Wiley & Sons, Inc., 1957), p. 553.
2. W. N. Tuttle, "Applied Circuit Theory," *IRE Trans. on Circuit Theory*, June, 1957, pp. 29-32.
3. S. S. Hakim, "RC-Active Filters Using an Amplifier as the Active Element," *Proc. IEE*, May, 1965, pp. 901-912.
4. T. Yanagisawa, "RC-Active Networks using INIC," *IRE Trans. on Circuit Theory*, Sept., 1957, pp. 140-144.
5. A. S. Morse, "Use of Operational Amplifiers in Active Network Theory," *Proc. Nat'l. El. Conf.*, 1964, pp. 748-752.
6. E. F. Good, "A Two-Phase Low-Frequency Oscillator," *Electronic Engineering*, April 1957, pp. 164-169.

HYBRIDIZATION . . . the fine art of converting your discrete component circuit to a microcircuit.

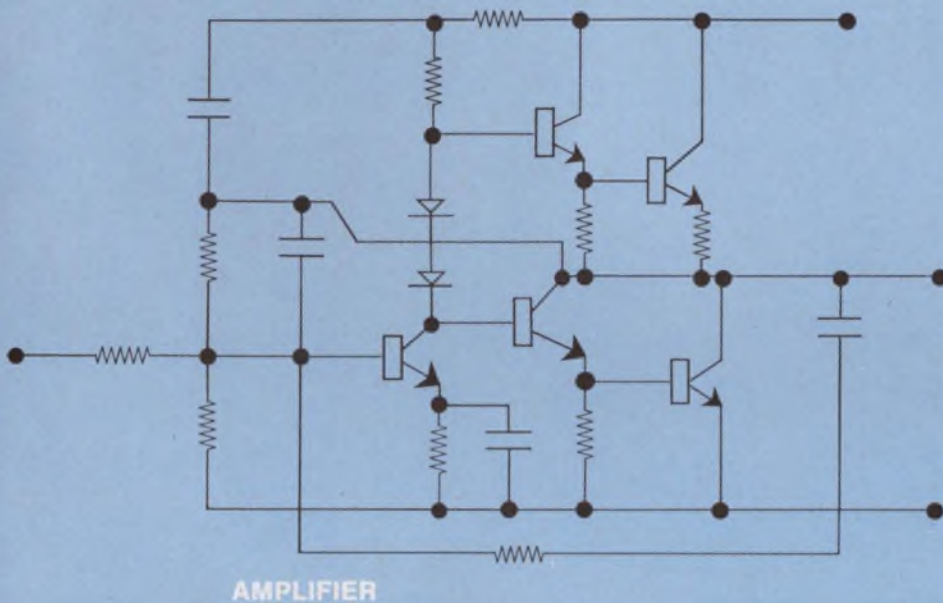

Volume microcircuit production of your analog or digital circuit is accomplished at Mepco by HYBRIDIZATION. The ability to manufacture precision passive film components is complemented by a wide variety of semiconductor attachment techniques. These capabilities provide the required flexibility to microminaturize your circuit at the lowest possible cost. Consider these exceptional performance characteristics.

- Matched semiconductor parameters
- Ratio match of resistance values to .1%
- Power dissipation — 10 watts per sq. inch
- Temperature coefficient tracking of ± 20 ppm maximum

Write or call today for complete details.
 Mepco, Inc., Columbia Road, Morristown, N.J. 07960
 (201) 539-2000 TWX: 710-986-7437
 O.E.M. Sales Offices from Coast to Coast



A Heritage of Reliability

Resistors . . . Potentiometers . . . Microcircuits . . . Capacitors

Design a dc level-shifting amplifier

using a complementary current division technique.

Complete analysis supplies design values.

Complementary current division can be used in many applications where good linearity and temperature stability are required.

To demonstrate the versatility of this circuit technique, two examples are presented here: a dc level-shifting amplifier and a video pulse-summing amplifier.

To extend the usefulness of these examples, a complete analysis of a basic, complementary current division amplifier precedes them.

Analyze the circuit

The complementary current division amplifier is shown in Fig. 1.¹ Its output voltage can be found as a function of the input as follows:

$$i_r = (V_{cc} - V_{e2})/R_{c1}, \quad (1)$$

$$i_{e1} = (e_{in} - V_{BE1})/R_{e1}, \quad (2)$$

$$i_{c1} = \alpha_1 i_{e1}, \quad (3)$$

$$i_{c2} = \alpha_2 i_{e2}, \quad (4)$$

$$i_{e2} = i_r - i_{c1}. \quad (5)$$

Combining Eqs. 1 to 3 and 5 gives:

$$i_{e2} = [(V_{cc} - V_{e2})/R_{c1}] - \alpha_1 [(e_{in} - V_{BE1})/R_{e1}], \quad (6)$$

$$e_{out} = \alpha_2 R_{c2} i_{e2}. \quad (7)$$

Combining Eqs. 6 and 7 gives:

$$e_{out} = \alpha_2 R_{c2} \{ [(V_{cc} - V_{e2})/R_{c1}] - \alpha_1 [(e_{in} - V_{BE1})/R_{e1}] \}, \quad (8)$$

or

$$e_{out} = \alpha_2 (R_{c2}/R_{c1}) (V_{cc} - V_{e2}) - \alpha_1 \alpha_2 (R_{c2}/R_{e1}) e_{in} + \alpha_1 \alpha_2 (R_{c2}/R_{e1}) V_{BE1}. \quad (9)$$

$$V_{e2} = V_{b2} + V_{BE2}. \quad (10)$$

Equation 9 now becomes:

$$e_{out} = \alpha_2 (R_{c2}/R_{c1}) (V_{cc} - V_{b2}) - \alpha_2 (R_{c2}/R_{c1}) V_{BE2} - \alpha_1 \alpha_2 (R_{c2}/R_{e1}) e_{in}$$

$$+ \alpha_1 \alpha_2 (R_{c2}/R_{e1}) V_{BE1}. \quad (11)$$

Let:

$$\alpha_2 (R_{c2}/R_{c1}) = K_1, \quad (12)$$

$$\alpha_1 \alpha_2 (R_{c2}/R_{e1}) = K_2; \quad (13)$$

now Eq. 11 becomes:

$$e_{out} = K_1 (V_{cc} - V_{b2}) + (K_2 V_{BE1} - K_1 V_{BE2}) - K_2 e_{in}. \quad (14)$$

Equation 14 is that of a dc level-shifting amplifier, where:

$$K_1 (V_{cc} - V_{b2}) + (K_2 V_{BE1} - K_1 V_{BE2}) = \text{level shift}, \\ - K_2 = \text{gain}.$$

Rewriting Eq. 14 gives:

$$e_{out} + K_2 e_{in} = K_1 (V_{cc} - V_{b2}) + (K_2 V_{BE1} - K_1 V_{BE2}). \quad (15)$$

Thus, for a given V_{cc} , K_1 , K_2 , and V_{b2} :

$$e_{out} + K_2 e_{in} = \text{constant } (C). \quad (16)$$

Figure 2 shows Eq. 16 for several values of K_2 and C .

The only temperature-dependent terms in Eq. 14 are V_{BE1} and V_{BE2} , assuming that α_1 and α_2 are constant. Thus, if $K_1 = K_2$ and $V_{BE1} = V_{BE2}$, Eq. 14 becomes:

$$e_{out} = K_1 (V_{cc} - V_{b2}) - K_2 e_{in}, \quad (17)$$

and from Eq. 16:

$$K_1 (V_{cc} - V_{b2}) = C. \quad (18)$$

The amount of level shift may be changed by varying V_{b2} in Eq. 17. The input and output impedance for the amplifier may be given as:

$$Z_{in} \cong \beta_1 R_{e1}, \quad (19)$$

$$Z_{out} \cong R_{c2}. \quad (20)$$

Applying the theory

As an example of this technique, consider the following example::

$$C = 12, \quad V_{cc} = 24,$$

$$K_2 = 1, \quad V_{BE1} = V_{BE2} = 0.6 \text{ volt.}$$

Let $R_{c2} = 2.4 \text{ k}\Omega$. From Eqs. 11 and 13:

$$\text{Gain} = \alpha_1 \alpha_2 (R_{c2}/R_{e1}) = 1, \quad (21)$$

$$R_{e1} = \alpha_1 \alpha_2 (R_{c2}/\text{gain}), \quad (22)$$

Richard S. Hughes, Senior Electronic Engineer, U.S. Naval Ordnance Test Station, China Lake, Calif.

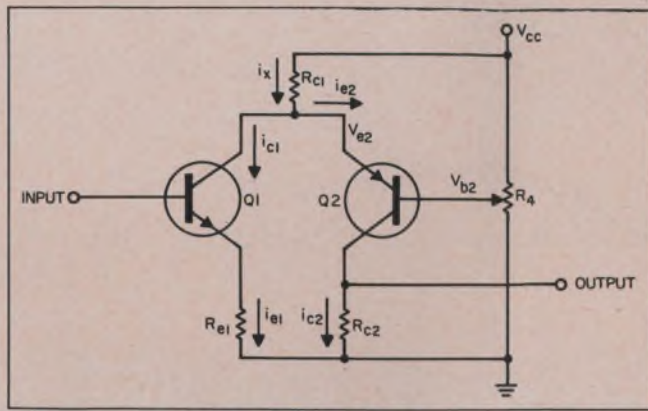

1. Complementary current division amplifier employs two transistors—one pnp and one npn. See text for complete analysis.

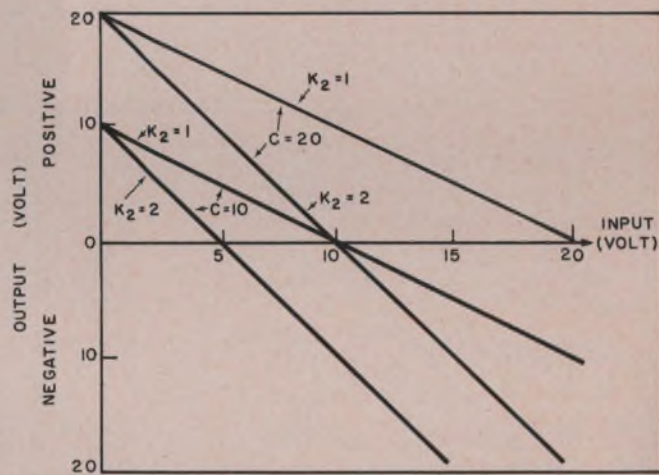

2. Perfect linearity of output vs input is demonstrated when final equation for the amplifier output is plotted for several values of K_2 .

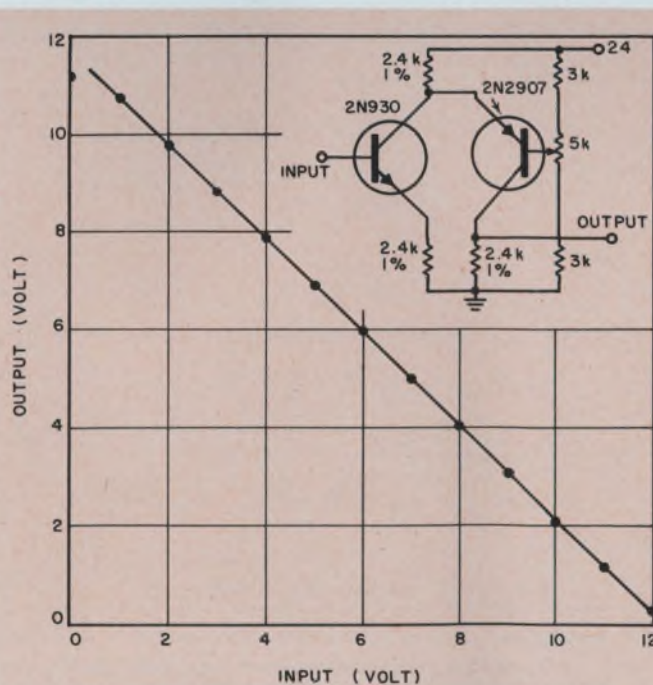

3. Output linearity and temperature stability of a circuit designed on the basis of the developed equations are demonstrated above. No changes in the output occurred when temperature varied from -50°C to $+100^{\circ}\text{C}$.

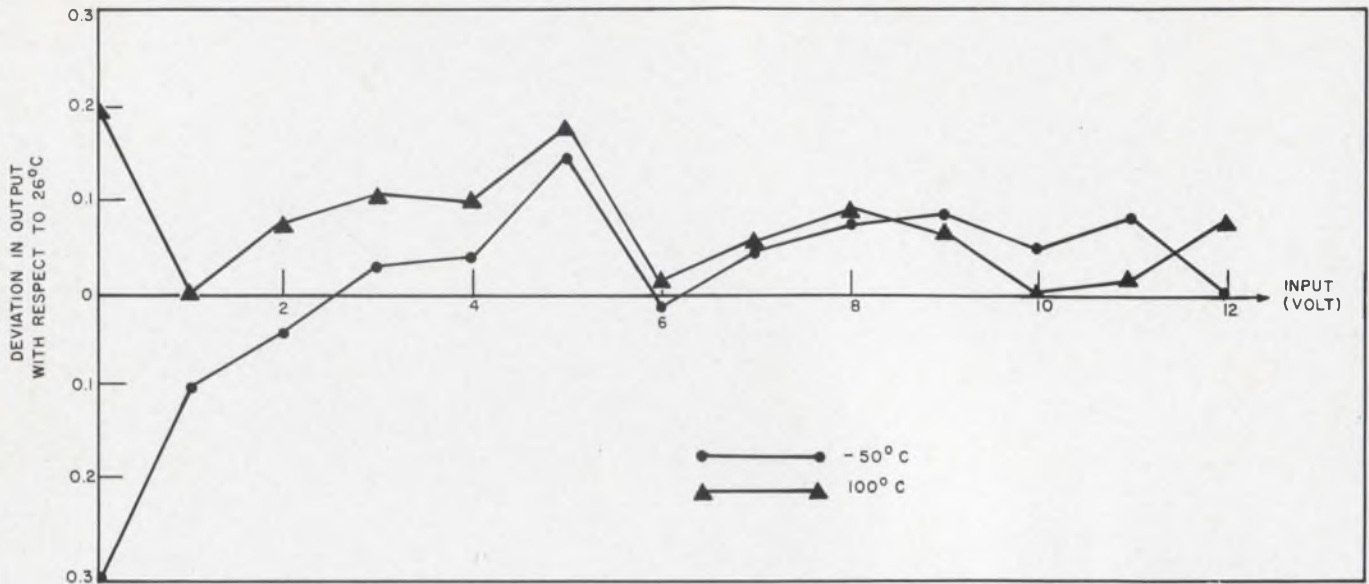

4. Temperature stability for the dc level-shifting inverting amplifier of Fig. 3 can be appreciated from this plot.

$$\alpha_1 \cong \alpha_2 = 0.99.$$

Thus, from Eq. 22:

$$R_{e1} = 2.35 \text{ k}\Omega. \quad (23)$$

2.35 k Ω is not a standard value, so let:

$$R_{e1} = 2.4 \text{ k}\Omega.$$

For temperature stability:

$$\alpha_2 (R_{c2}/R_{c1}) = \alpha_1 \alpha_2 (R_{c2}/R_{e1}), \quad (24)$$

or:

$$R_{c1} = R_{e1}/\alpha_1. \quad (25)$$

For this example:

$$R_{c1} \cong 2.4 \text{ k}\Omega. \quad (26)$$

Solving Eq. 14 for V_{b2} , one obtains:

$$V_{b2} = V_{cc} - V_{BE2} - (\alpha_1 R_{c2}/R_{c1})(e_{in} - V_{BE1}) - (R_{c1}/\alpha_2 R_{c2})e_{out}. \quad (27)$$

Solving Eq. 27 for the given conditions:

$$V_{b2} = 12 \text{ volts}. \quad (28)$$

Figure 3 shows the output-input relationship for the example given. The measured gain for this circuit is -0.96 , which compares favorably with the calculated gain of:

$$\text{Gain} = \alpha_1 \alpha_2 (R_{c2}/R_{e1}) = -0.98. \quad (29)$$

Figure 4 illustrates the temperature stability of the circuit referenced to 26°C .

The complementary current division amplifier may also be used as a video pulse-summing amplifier. Figure 5 shows the basic pulse-summing circuit.

Deriving Eq. 11 in terms of V_{B1} and V_{B2} :

$$e_{out} = (\alpha_2 R_{c2} V_{cc}/R_{c1}) - (\alpha_2 R_{c2} V_{BE2}/R_{c1}) + (\alpha_1 \alpha_2 R_{c2} V_{BE1}/R_{e1}) - (\alpha_2 R_{c2} V_{B2}/R_{c1}) - (\alpha_1 \alpha_2 R_{c2} V_{B1}/R_{e1}). \quad (30)$$

The output from A is:

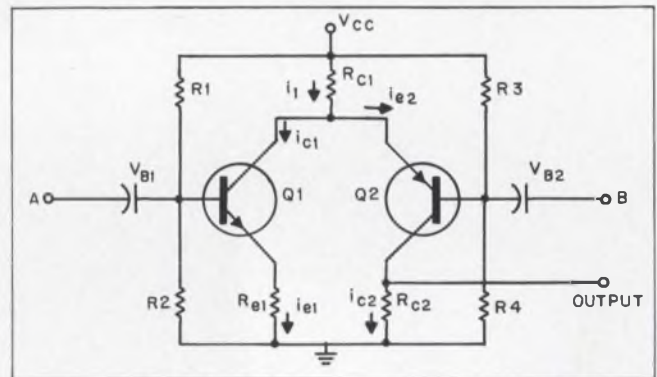

5. Video pulse-summing amplifier can be built from the complementary current division amplifier analyzed previously.

$$d e_{out}/d V_{B1} = -\alpha_1 \alpha_2 R_{c2}/R_{e1}, \quad (31)$$

and the output from B is:

$$d e_{out}/d V_{B2} = -\alpha_2 R_{c2}/R_{c1}; \quad (32)$$

or:

$$e_{out}|_A = -\alpha_1 \alpha_2 R_{c2} A/R_{e1}, \quad (33)$$

and:

$$e_{out}|_B = -\alpha_2 R_{c2} B/R_{c1}. \quad (34)$$

Thus, the total output becomes:

$$e_{out}|_{total} = -\alpha_2 R_{c2} (\alpha_1 A/R_{e1} + B/R_{c1}). \quad (35)$$

The output is an inverted sum of the two inputs, where:

$$\text{Gain}|_A = -\alpha_1 \alpha_2 R_{c2}/R_{e1}, \quad (36)$$

and

$$\text{Gain}|_B = -\alpha_2 R_{c2}/R_{c1}. \quad (37)$$

Reference:

1. Richard S. Hughes, *Selected Semiconductor Circuits* (China Lake, Calif.: U.S. Naval Ordnance Test Station, July, 1966), NAVWEPS Report 9039, NOTS TP 4038.

**Proven in 3rd generation computers —
 CTS Series 770 HIGH-POWER PRECISION
 CERMET RESISTOR MODULES
 can open new design
 concepts for you!**

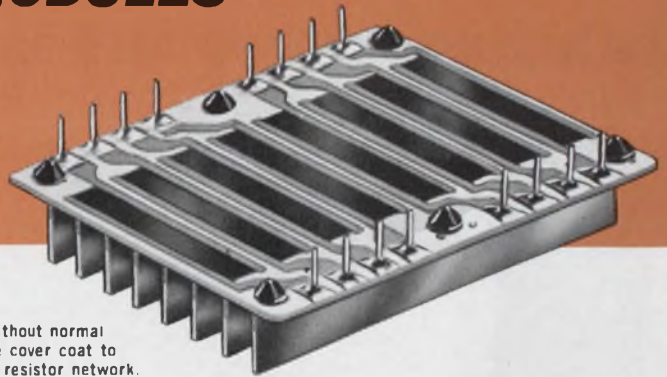

Shown without normal insulative cover coat to illustrate resistor network.

Consider these characteristics

- Cermet reliability now available for power applications.
- Compact modular packaging—overall dimensions are only 1.500" by 1.225" by 0.370" with heat sink.
- High power—8 to 20 watts per module depending upon allowable operating temperature, air flow, duty cycle and number of pins used.
- Low inductance—less than 10 nanohenries up to 200 megacycles.
- Layout flexibility—up to 24 external pins on .125" centers can accommodate a dozen or more cermet resistors.
- $\pm 1\%$ standard tolerance from 20 ohms to 1 megohm.
- Special low resistance values available down to 10 ohms.
- Available in quantity NOW—over 250,000 already produced.
- Available with copper heat sink bonded to alumina substrate.
- Dual-in-line staked pins for rapid insertion—can withstand 7.5 lbs. tensile or compressive force.

**770 Series Environmental
 Specifications**

Load Life: 9 watts for 1,000 hours at 55°C ambient in 300 fpm air flow	0.4% ΔR max. 0.1% ΔR av.
Moisture Resistance: 95% R.H. at 70°C, 10 days load, 10 days no load	0.2% ΔR max. 0.05% ΔR av.
Standard temperature coefficient of resistance	-50 to +350 ppm/°C
Thermal Cycling: 5 cycles, -60°C to +125°C no load	0.10% ΔR max. 0.03% ΔR av.

**Samples are available off the shelf.
 Kit of three modules for \$13.00.**

order yours today!

Think about it!



Founded 1896

CTS RESEARCH, INC./LAFAYETTE, INDIANA

Subsidiary of CTS Corporation, Elkhart, Indiana

Stabilize power tubes at uhf and vhf

in a few simple steps. Beware of the distributed impedances inside the tube envelope, and you'll have no problems.

Power tetrodes and other vacuum tubes can operate stably and reliably at uhf and vhf. Their stabilization through neutralization in these bands requires measuring their self-neutralization frequency and shifting it to the band of interest. To accomplish this, the engineer should be thoroughly familiar with the distributed nature of the components inside the tube envelope.

At frequencies below uhf and vhf, the internal impedances appear lumped and neutralization can be achieved with a variety of circuits that damp the feedback voltage from the output to the input port. This voltage can have a most harmful effect on the amplifier's performance, for its magnitude, phase and rate of change with frequency and loading determine the dynamic stability of the amplifier tube.

One such damping circuit for a cross-coupled push-pull configuration is shown in Fig. 1. The classic analysis of the feedback circuit involves the feedback capacitance and the input circuit. These two form a voltage divider, as shown in Fig. 2. If their impedances are of the same order of magnitude, a large portion of the RF plate voltage appears between the control grid and the cathode. This incomplete theoretical approach has caused many engineers to draw incorrect conclusions about the stability of tetrode amplifiers and pentode amplifiers.

An analysis which takes into account the distributed constants inherent in the construction of a tetrode or pentode, however, presents a different picture. The more complete feedback circuit must include not only the grid-to-plate capacitance, C_{g1p} , but the plate-to-screen capacitance, C_{g2p} , the grid-to-screen capacitance, C_{g1g2} , and the screen-grid lead inductance, L (see Fig. 3).

The plate voltage e_b causes a current i to flow through C_{g2p} and L . If the reactance of L is less than the reactance of C_{g2p} , this current will lead

plate voltage e_b by 90° . This current flowing through L will develop a voltage, e_L , which is 180° out of phase with e_b , and the voltage e_{fb} is then fed back to the grid through C_{g1p} . This process is illustrated with vectors in Fig. 4. The total voltage of $e_b + e_L$ is applied across a capacitive voltage divider, consisting of the grid-to-plate capacitance, C_{g1p} , and the grid-to-screen capacitance, C_{g1g2} .

At some frequency the voltage developed across L , e_L , will just equal e_{fb} , the feedback through C_{g1p} :

$$(1/\omega C_{g1g2}) / (1/\omega C_{g1p}) = e_L / e_{fb}$$

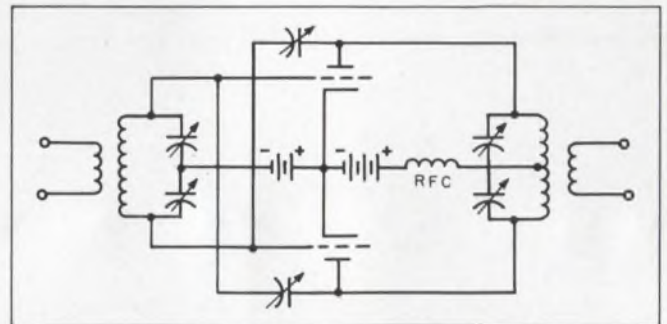

1. Typical neutralizing circuit for low frequencies, where all components may be considered lumped, or small, compared with the wavelength of operation, is a version of a capacitance bridge. It is a push-pull configuration.



Inserting a power triode into its test fixture, authors Sutherland (right) and Barkley set out to measure the self-neutralizing frequency.

Robert Sutherland, Supervisor, and William Barkley, Development Engineer, EIMAC, Div. of Varian Associates, San Carlos, Calif.

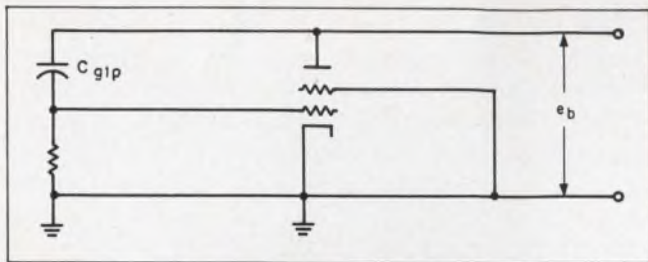

2. Classical representation of feedback circuit uses a simple voltage divider. If the impedances of the input circuit and the feedback capacitance are about equal, then a large portion of RF plate voltage appears between the control grid and cathode, and this in turn gives rise to instability in the amplifier.

The frequency at which e_{fb} is canceled is the self-neutralizing frequency. This usually occurs in the vhf portion of the spectrum.

All elements comprising the neutralizing circuit are within the tube; the connection of the tube into the circuit, either by wire or socket, will alter the self-neutralizing frequency. Therefore when measurements are made, the actual socket or a facsimile must be used with the tube.

From the preceding equation it is clear that no inductances in the grid or plate enter into the cancellation of the feedback voltage.

The screen inductance is the only variable in the

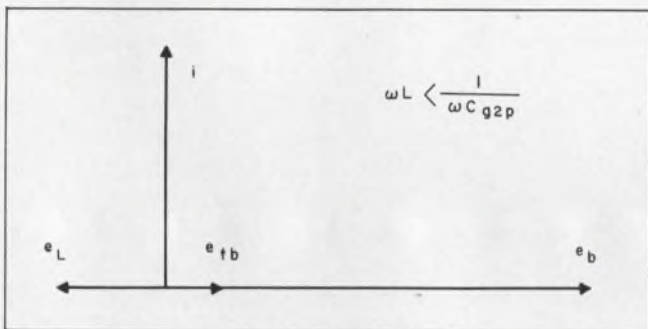

4. Vectorial presentation of the voltages that determine the self-neutralizing frequency. At this frequency, the voltage across the screen-grid lead inductance, e_L , becomes equal to e_{fb} , the feedback voltage across C_{g1p} .

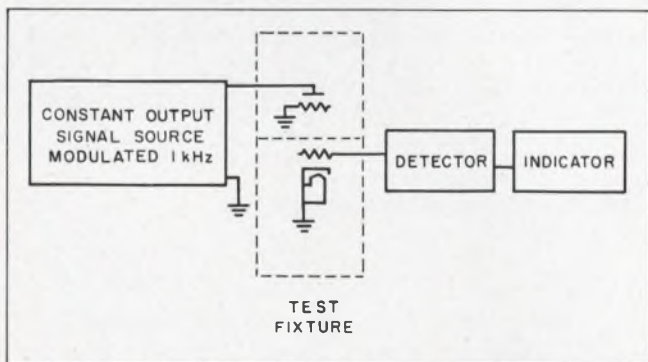

5. Test setup measures transmission vs frequency in the tube and socket. The signal source must maintain a constant output.

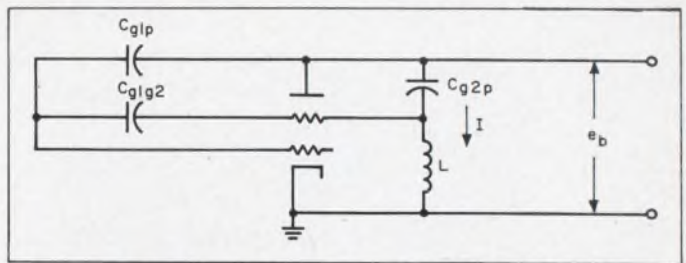

3. Distributed constants are included in this feedback circuit for a more complete analysis. The factors are the grid-to-plate capacitance, C_{g1p} , the plate-to-screen capacitance, C_{g2p} , the grid-to-screen capacitance, C_{g1g2} and the screen-grid lead inductance, L . By considering these factors, the engineer can secure stable operation.

equation; it furnishes the out-of-phase voltage. Shifting the self-neutralizing frequency must therefore be accomplished through changes in the screen inductance.

Once the mechanism of self-neutralization is understood, the engineer may then seek to modify the band of frequencies where neutralization occurs by changing the external circuitry.

If the frequency of interest is above the self-neutralizing frequency, then the voltage developed across the screen inductance will be greater than the voltage fed back through the grid-to-plate capacitance. The solution is either to reduce the effective screen inductance or increase the feedback capacitance.

If the frequency of interest lies below the self-neutralizing frequency, the voltage developed across L is insufficient to cancel the feedback voltage. The remedy is to increase the effective screen inductance, or supplement the internal neutralizing voltage with conventional cross-neutralization.

Measure the self-neutralizing frequency

One effective test method is to treat the tube as a passive three-terminal network and measure transmission vs frequency (Fig. 5). The tube is inserted into a test fixture that has the recommended socket and provides good isolation between input and output. These fixtures take the form of rectangular or cylindrical shield cans, which enclose the tube to be investigated. A solid partition with the socket divides the enclosure into two isolated compartments, the input and output terminals, as shown in Fig. 6. The dimensions of the enclosure are chosen to minimize volume and appreciable shunt capacitance. The purpose of this criterion of minimum volume is to reduce the possibility of fixture resonance occurring in the vicinity of the expected self-neutralizing frequency.

Evaluation is done with no dc power supplied to the tube. Elements, normally at RF ground in a circuit, are physically strapped to ground with the

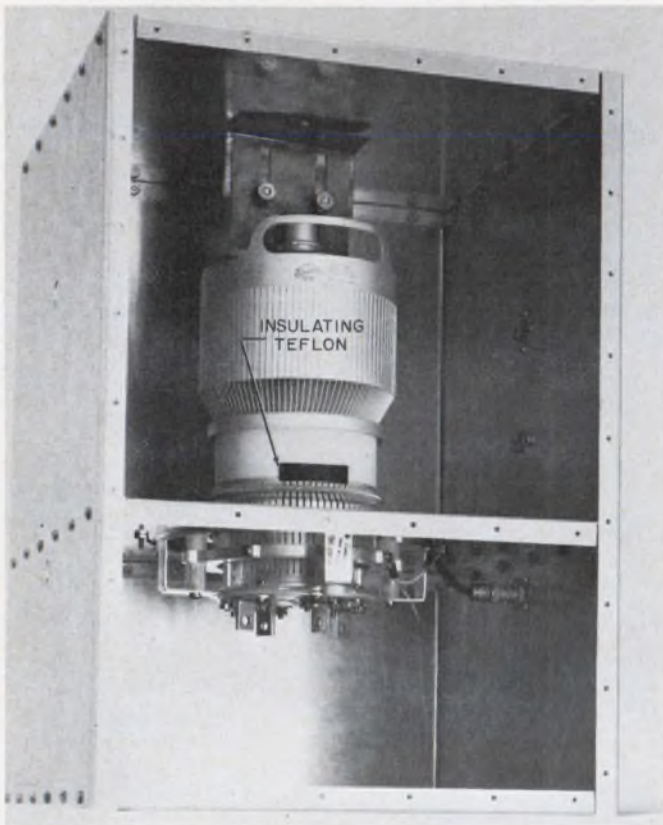

6. Typical test fixture is divided into two isolated compartments, the input and output terminals. The terminals are coaxial fittings and connected to the anode and grid by low-inductance straps. The dimensions of the enclosure are chosen to avoid its resonance near the self-neutralizing frequency and to reduce shunt capacitances.

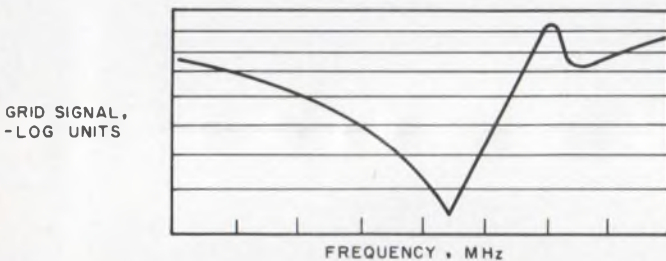

7. Typical plot of relative transmission of the tube and its socket with respect to frequency. The point of minimum transmission is the self-neutralizing frequency. This point may be moved on the frequency scale by certain external adjustments.

shortest possible connections. These precautions ensure that the measured frequency depends only on the tube and socket. The input and output terminals of the network are coaxial fittings, connected to the anode and grid, respectively, by low inductance straps (see Fig. 6).

The constant-output signal source in Fig. 5 is a signal generator. If the generator's output changes with frequency, a slotted line should be inserted between the signal generator and the test fixture, and its output should be regulated by attenuators to give a constant maximum reading from the slotted line probe at a maximum voltage.

Since the measurement to be made is one of transmission with respect to frequency, the input must be kept constant. With a constant input to the test fixture, the energy fed through the tube is detected and indicated. The sensitivity range of the indicator is adjusted to some reference level at the low end of the band of interest and is kept constant throughout the test.

The frequency is then gradually increased, and the indicator reading is recorded for each increment. When the entire band of interest has been covered, the results may be plotted on a graph. A typical example of the transmission of the network as a function of frequency appears in Fig. 7. The point of minimum transmission is the self-neutralizing frequency. Instead of plotting, the engineer may use a sweep generator for a quick spot check of nulls and peaks in the band. Here the frequency of nulls and peaks must be recorded.

The vertical axis of the graph in Fig. 7 is labeled "grid signal, - log units." This terminology is used because nothing is known about the impedance of the input or output. It would be improper to indicate that this was the isolation through the tube in decibels.

The graph illustrates an ideal case, where only one minimum appears in the output. Occasionally, the graph may have several minima, but only one of these is the self-neutralizing frequency. The proper frequency is immediately identifiable from knowledge of the properties of the neutralizing circuit. An increase in the screen lead inductance will make the self-neutralizing frequency move lower in frequency. A peak, or maximum transmission, that usually occurs immediately above the frequency of the self-neutralizing frequency, is the series resonance of plate-to-screen capacitance, C_{gp} , and the screen lead inductance, L . This, too, should move lower in frequency with an increase in lead inductance.

Once the proper self-neutralizing frequency has been identified, other deviations from a smooth curve should be investigated to determine their causes. Most deviations (peaks and nulls) can be traced to a resonance in the test fixture. Their identification involves painstaking tests like observing the effects of slight changes in the test socket or in the width of the straps. For example, the removal of one strap from a 4CX5000R tube lowers the frequency, as shown in Fig. 8.

How to change screen inductance

The neutralization band is usually about 10 to 15 MHz wide in the uhf and vhf regions. Therefore aging and other long-range changes in the tube's characteristics will not require continuous shifting of the self-neutralizing frequency. The adjustment is usually a one-shot operation that will last the life of the tube or transmitter.

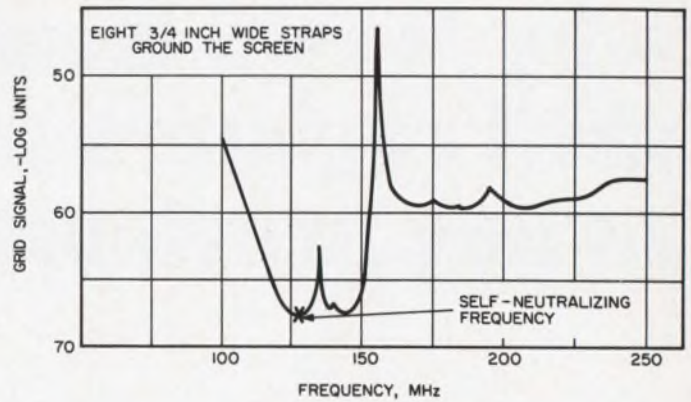
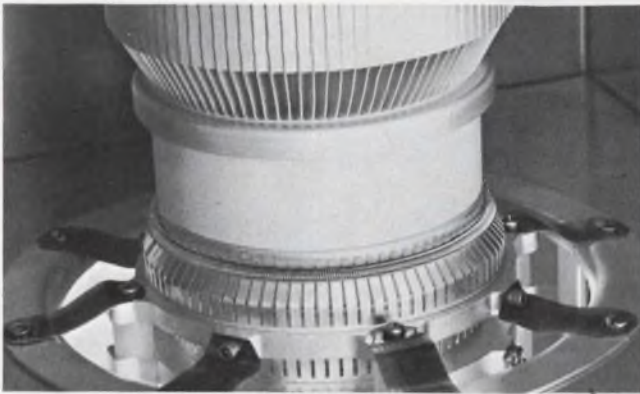

(a)

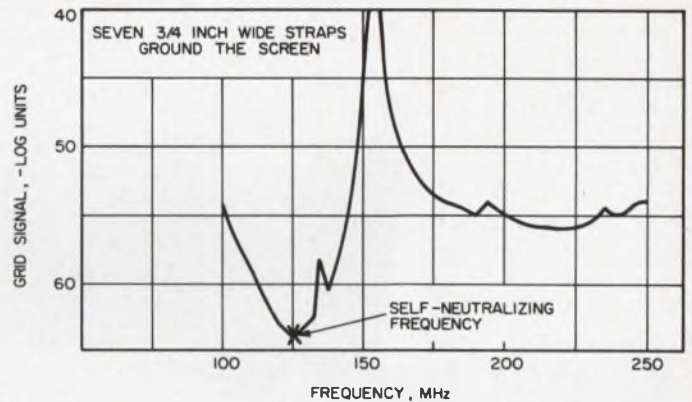
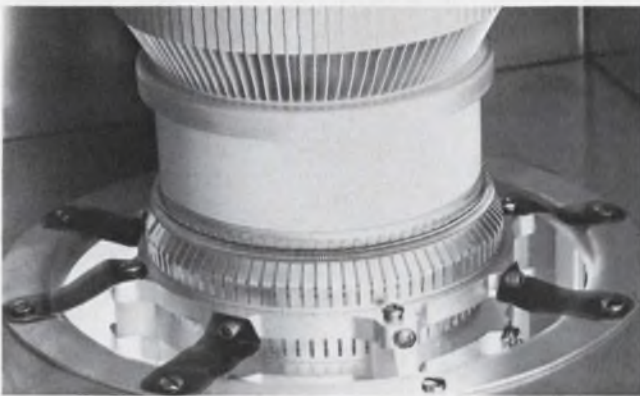

(b)

8. The removal of a strap lowers the self-neutralizing frequency by several megahertz, and reshapes the transfer curve. When the tube is tested with eight straps (a), the

transfer curve has two minima near each other. The removal of one strap (b) eliminates one null and the self-neutralizing frequency can be clearly identified.

To lower the self-neutralizing frequency, the screen lead inductance has to be increased. There are several ways to accomplish this:

- Increase the path length from the screen to ground by adding a length of wire between the screen contacts and the bypass capacitor. The length of the wire depends on the stray impedances, type of socket, tube, frequency and the amount of shift needed.

- Decrease the number of screen contact fingers on coaxial tubes. This usually involves either isolation of the contact fingers or their physical removal. Isolation is possible with a piece of Teflon inserted between the screen and the contact, as shown in Fig. 6. Here a 1-inch-square piece is used to increase the inductance by about 1 to 2 nH. The tube is a type 4CX5000R, operating at 125 MHz. Removal of the fingers is not recommended, because the process cannot be undone, heat transfer from the screen is reduced and the localized current flow may cause heating.

To raise the self-neutralizing frequency, it is necessary to decrease the screen inductance, or increase the plate-to-grid capacitance, C_{gp} .

The screen inductance may be reduced by canceling some of it with series capacitance. A varia-

ble capacitor of 15 to 20 pF is sufficient to do this in most cases.

The grid-to-plate capacitance can be increased by a wire connected to the grid terminal and extending through the chassis up to, but not connected to, the plate.

If an amplifier is to operate over a narrow band that includes the self-neutralizing frequency, it is preferable to vary the screen lead inductance by partial cancellation with series capacitance. The inductance from the capacitor leads can lower the self-neutralizing frequency to the low-frequency end of the band, but the variable capacitor permits it to be shifted to the high-frequency end. This control enables the operator to optimize amplifier stability at any frequency in the band.

Another application of self-neutralizing frequency is to eliminate a vhf parasitic in a hf transmitter. If the self-neutralizing frequency and the parasitic frequency are made to coincide, the parasitic frequency will vanish. The later addition of cross-neutralization for the fundamental frequency will not disturb this vhf neutralization, so long as the fundamental neutralizing circuit involves only voltages of the fundamental frequency. ■ ■

why MTOS monolithic shift registers are superior to any previously available...

MEM #	STATIC	DYNAMIC	FREQUENCY		NUMBER OF BITS	INPUT		OUTPUT		NUMBER OF CLOCKS	NUMBER OF POWER SUPPLIES
			LOW	HIGH		PARALLEL	SERIAL	PARALLEL	SERIAL		
			3005 SP	X			DC	1.0MHz	5		
3005 PP	X		DC	1.0MHz	5	X		X		2	2
3008 PS	X		DC	1.0MHz	8	X			X	2	2
3012 SP	X		DC	100kHz	12		X	X		1	1
3016-2	X		DC	1.0MHz	32 (16, 16)		X		X	2	2
3016-2D		X	10kHz	3.0MHz	32 (16, 16)		X		X	2	1 ^o
3020	X		DC	1.0MHz	20		X		X	2	2
3021	X		DC	500kHz	21 (1, 4, 16)		X		X	1	1
3021 B	X		DC	250kHz	21 (1, 4, 16)		X		X	1	1
3050		X	10kHz	500kHz	50 (25, 25)		X		X	2	1 ^o
3064		X	10kHz	5.0MHz	64		X		X	4	NONE

^orequired for output circuit only

they're LSI

And only General Instrument devices incorporate the exclusive MTOS[†] process which provides Large Scale Integration (without the need for high-cost discretionary wiring) in the only broad line of shift registers available anywhere.

[†]Metal-Thick-Oxide-Silicon

and LSI means...

lower cost: Low initial device cost plus elimination of most printed circuit boards, assembly labor and external wiring.

higher reliability: External connections are minimized, eliminating a major failure mechanism in electronic systems.

highest packaging density ever.

No matter what your design requirements, chances are you'll find the shift register you need in General Instrument's broad line, at authorized GI distributors now. If you don't, contact us. Our line is being broadened regularly.

Write for complete data and Application Notes, "MTOS Shift Registers."

GENERAL INSTRUMENT CORPORATION
600 WEST JOHN STREET, HICKSVILLE, L. I., NEW YORK

ON READER-SERVICE CARD CIRCLE 35





PIN diode leveling plus oscillator plug-in plus 250 Mc to 40 Gc range equals the sweeper value choice

No other sweeper on the market today combines all the fine features of the new Alfred 650 Sweep Oscillator Series to give you more Gc's per dollar, user convenience, and technical performance.

Here are just a few of the more important features and performance characteristics...PIN diode leveling to 12.4 Gc and grid leveling to 40 Gc...nine oscillator plug-ins to cover the range of 250 Mc to 40 Gc...power variation leveled as low as ± 0.3 db with minimal residual FM...5 stable single frequency settings...3 rf or video markers...50/400 cps, 115/230 volt operation...broadband and symmetrical sweep...two manual sweeps...unique F_0 control.

Price of the basic Model 650 is \$1600. Plug-in oscillators start at \$1550. For example, S and C band oscillator plug-ins are priced at \$1600 and \$1550 respectively.

Series 650 Sweepers are the latest step in Alfred's continuing evolution of quality plug-in sweeping oscillators. Alfred introduced the first plug-in sweeper in 1957.

For more information and an immediate demonstration call your nearest Alfred engineering sales and service center (listed in EEM and MEH). Or you may write us at 3176 Porter Drive, Palo Alto, California 94304. Phone: (415) 326-6496. TWX: (415) 492-9421.

ALFRED ELECTRONICS

ON READER-SERVICE CARD CIRCLE 36

Go/no-go technique tests amplifiers

rapidly and precisely. A simple setup enables a variety of measurements to be read out visually.

Manufacturers and large-scale users of differential, operational and general-purpose linear amplifiers face a common problem: many parameters must be guaranteed for the devices to function in a system; yet these parameters are not suited to rapid final-test or incoming-inspection measurements. Conventional test techniques take excessive time (10 to 15 minutes a unit) and may involve sophisticated equipment operated by skilled personnel.

A rapid go/no-go test setup using one visual display to check all parameters has been designed. It enables a relatively unskilled operator to carry out up to 15 tests in as little as 20 seconds.

It is no longer necessary to take individual measurements with different equipment to check each parameter—such as input-output impedance, gain, common-mode rejection ratio, etc. The visual method uses a test box, made up of a few resistors, capacitors and choppers, and an oscilloscope display. The same equipment is equally able to check differential, operational and general-purpose linear amplifiers.

With conventional test techniques, measurement accuracy often depends on signal-generator output levels, or oscilloscope or ac-voltmeter calibration. These factors, often ignored, require constant attention and recalibration when a large number of amplifiers are tested.

The visual comparison method offers these advantages:

- Calibration of the oscilloscope is not critical, because the measurements are not absolute but relative. The display gives go/no-go answers with an accuracy determined by fixed, precision resistor ratios, independent of input signal level, amplifier gain or oscilloscope calibration.

- Potential operator error in reading the comparative display is minimal; relatively unskilled personnel can perform the measurements. Conventional techniques require a higher degree of technical competence.

- Measurements can be presented in rapid succession on the display, and they look the same for each test.

- The technique can be adapted to automatic and semiautomatic circuit testers, and can also yield precise parameter values instead of go/no-go limits, although such measurements take more time.

Two waveforms compared

For the sake of uniformity, the test sweep is set up so that the reference waveform appears at the left of the oscilloscope and the measurement waveform at the right. This is done by keeping the chopper frequency considerably lower than the oscillator test frequency, and sweeping the oscilloscope so that one complete cycle of the chopper frequency occupies the full trace width.

Suppose that gain is to be measured. The horizontal axis is swept in synchronization with the chopper switching frequency. A display similar to that in Fig. 1 will appear. If the measurement waveform is as big as, or bigger than, the reference waveform (Fig. 1a), the unit passes the test. If it is smaller (Fig. 1b), it fails. The technique is the same no matter what parameter is measured.

The following procedure is followed for measuring any parameter:

- The equation that defines the parameter to be measured is written down. In most cases it contains terms proportional to gain, input and output voltages or currents, and possibly scale factors.

- The equation is manipulated so that the output voltage (or current) appears on the left-hand side, equal to the product of input voltage (or current) and a factor containing all other terms.

- The value of the parameter being measured at the go/no-go point is substituted into the equation.

- Inspection of the right-hand side of the equation reveals that a voltage of equal value may be derived by performing the indicated algebraic functions electrically.

- A factor equal to gain is obtained by ampli-

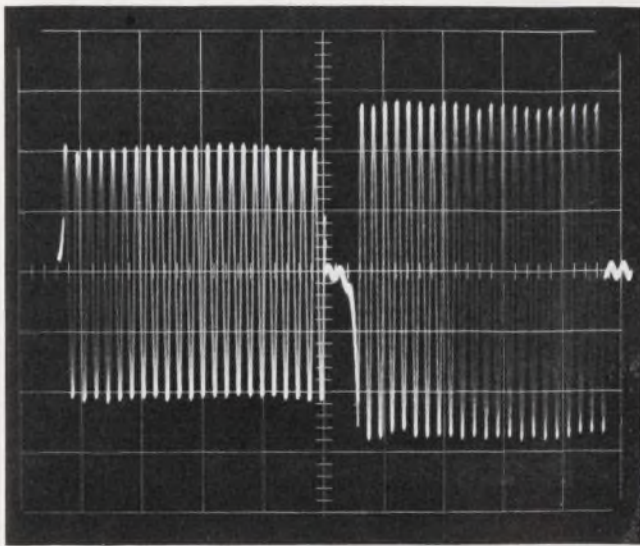

(a)

1. Passing (a) or failing (b) the amplifier test is determined by comparing the measurement trace (on the right)

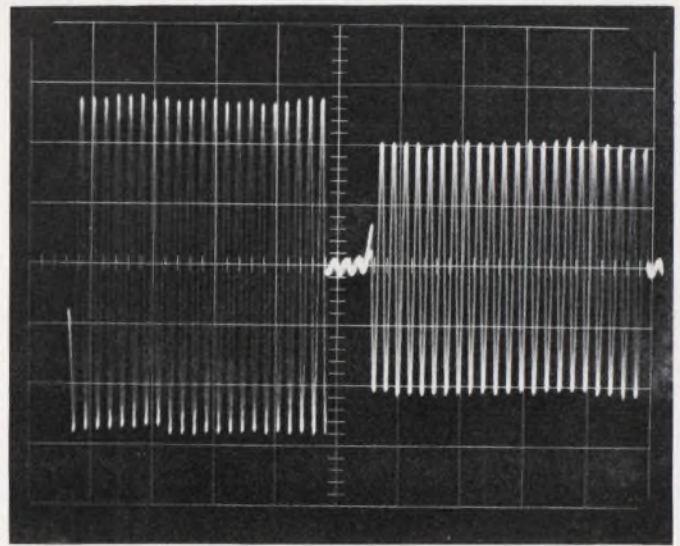

(b)

with the reference (on the left). The measurement trace must be as big as or bigger than the reference.

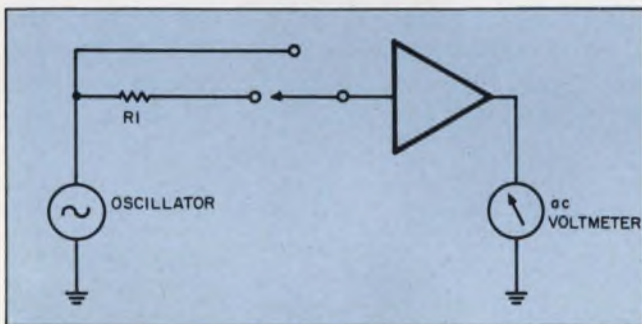

2. Conventional input impedance measuring necessitates taking several readings and several calculations. This can result in errors and is time-consuming.

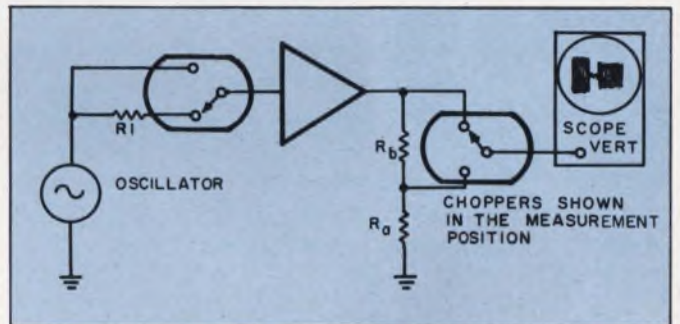

3. Visual-comparison input impedance measuring requires only one operation—a look at an oscilloscope (see Fig. 1 for actual traces).

fyng the input signal with the device under test.

- A constant factor less than unity is obtained by attenuating with a resistive divider during the reference half of the display.

- A constant factor greater than unity is inserted as a resistive divider during the measurement half of the display.

Using the method

Figure 2 shows the method commonly used to measure input impedance. For simplicity, a single-input, single-output amplifier is shown, and it is assumed that dc levels are unaffected by changes in series input resistance.

With conventional methods, the input is first driven from a low-impedance voltage source (oscillator), and the output measured (V_{o1}). Then $R1$ is inserted in series with the input, and the output is measured again (V_{o2}). Then:

$$Z_{in} = R1 V_{o2} / (V_{o1} - V_{o2}). \quad (1)$$

To avoid the need for calculation every time such a conventional measurement is made, $R1$ is

often made equal to the minimum allowable value of Z_{in} ; the device under test passes if $V_{o2} \geq V_{o1}/2$. Even with this simplification, the test operator must either mentally calculate $V_{o1}/2$ for each unit as V_{o1} varies with gain, or adjust the input level for some standard output V_{o1} for each unit. This gives him a convenient reference for deciding whether the unit has a passing or a failing V_{o2} . But both alternatives are time-consuming and prone to operator error.

Applying the procedure for visual comparison to Eq. 1, the terms are regrouped so that:

$$V_{o2} = V_{o1} Z_{in} / (Z_{in} + R1) \quad (2)$$

$$= V_{osc} A_v Z_{in} / (Z_{in} + R1). \quad (3)$$

Then the pass-fail value, $Z_{in(lim)}$ is substituted for Z_{in} and a convenient value of $R1$ selected. $R1$ does not necessarily have to equal $Z_{in(lim)}$ for this test. Examination of Eq. 3 term by term shows that the input voltage is V_{osc} . This is amplified by the voltage gain, A_v . $A_v V_{osc}$ is then multiplied by the ratio $Z_{in(lim)} / (Z_{in(lim)} + R1)$. From Fig. 3 it can be seen that this ratio is simulated by re-

sistors R_a and R_b , where:

$$R_a / (R_a + R_b) = Z_{in(lim)} / (Z_{in(lim)} + R1). \quad (4)$$

With the chopper contacts in the measuring position, $R1$ is inserted in series with the input, and the actual value of V_{o2} is measured. If $Z_{in(actual)}$ equals $Z_{in(lim)}$, both halves of the scope trace are equal, and the unit passes the test. If Z_{in} is greater than $Z_{in(lim)}$, the unit again passes; the trace appears as in Fig. 1a. If the converse is true, the trace appears as in Fig. 1b; the unit fails.

An increase in oscillator level, voltage gain or oscilloscopic sensitivity would cause the entire waveform to expand vertically but would not affect the validity of the measurement. Accuracy is determined solely by $R1$ and the ratio of R_a to R_b , and these may be set precisely as desired when the test fixture is built.

Common sense helps

In this input impedance example as in all others, departures from nonideal amplifier characteristics can disturb the comparative measurements or render them unreadable, unless a bit of common sense is used in the test circuit design. For example, in the case of a direct-coupled transistor-input amplifier, insertion of $R1$ in series with the input will allow the inevitable base current to superimpose an effective dc input on the original level. This would result in a vertical shift of the right-hand half of the comparison trace, proportional to voltage gain and input bias current. As well-known optical-illusion demonstrations prove, such displacement makes accurate comparison nearly impossible.

A solution that uses capacitors to test a differential input amplifier appears in Fig. 4. Since this is a differential input impedance test, $R1$ is split into two resistors to prevent a low common-mode input impedance from disturbing

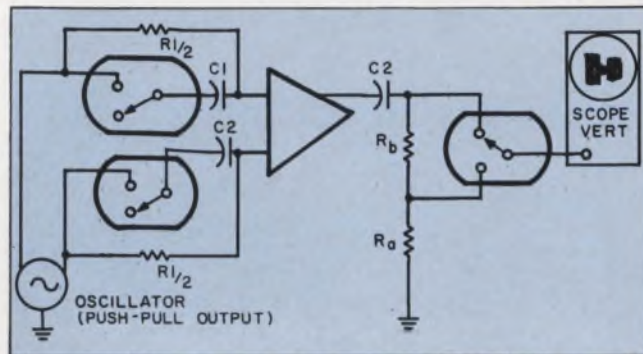

4. Input impedance of a differential amplifier can be measured by using this setup. Capacitors prevent dc level shifts between the reference and measurement halves of the display.

the measurement. The reactances of the coupling capacitors, $C1$ and $C2$, should, of course, be much lower than $R1/2$ at the test frequency.

The traces of Figs. 1a and 1b were obtained with a chopper rate of 60 Hz and an oscillator frequency of 3 kHz. The choice of oscillator frequency is often dictated by existing specifications for the device under test; practical tests indicate that a ratio of oscillator-to-chopper frequency of at least 10:1 is desirable, to avoid operator eye fatigue. Power-line operation of mechanical choppers is also convenient, because it allows the oscilloscope's horizontal sweep to be triggered in the "line" mode, which is available on most oscilloscopes. Phase relationship (in phase or 180° out) between choppers and the oscilloscope is important, since a reversal would cause an inversion of the pass-fail criteria.

Resistors loading various points of the amplifier under test should have values that do not disturb the measured parameter, or at least that contribute equal disturbances under both reference and measurement conditions. The coupling capaci-

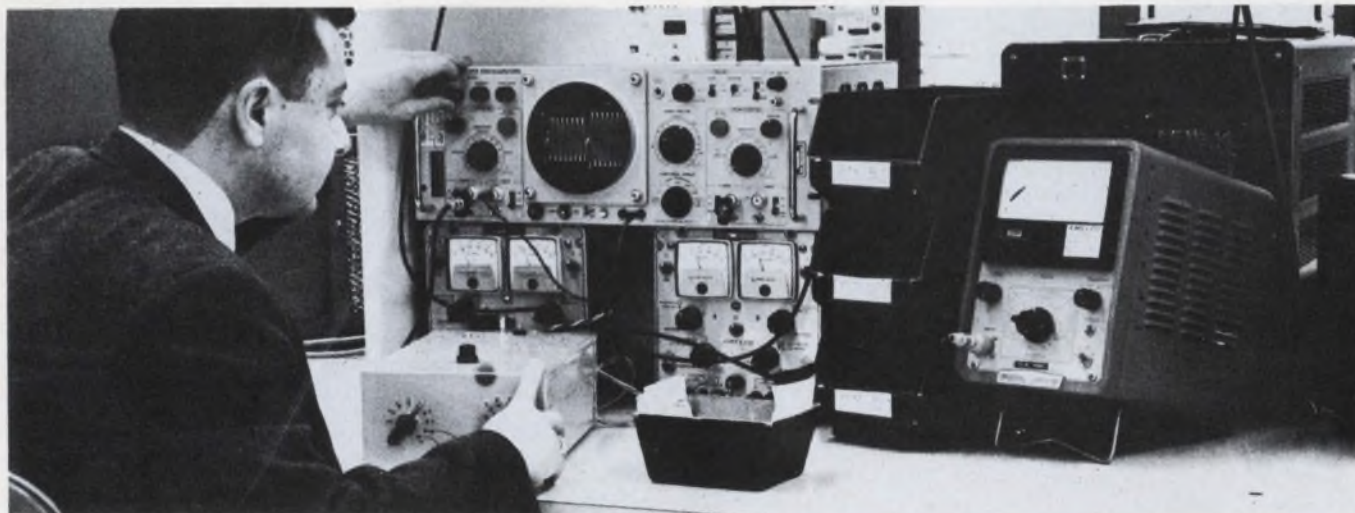

"A variety of amplifier parameters can be checked quickly using a simple test set, an oscillator and an oscilloscope,"

says the author, Bob Hirschfeld, shown observing a passing pattern on the scope.

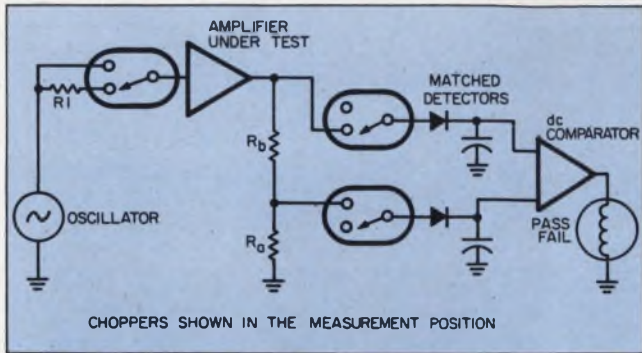

5. Automatic testing of input impedance can be achieved through synchronous detection of the comparative waveforms. The output of the dc comparator can be used to energize a relay.

tors must have reactances far below the associated circuit impedances at the test frequency. In the case of a high-frequency test, such as for bandwidth, good RF construction practice, including low-capacitance choppers, should be used.

Absolute measurements possible

While the visual-comparison method was originally developed to produce fast go/no-go production tests, it is also useful when rapid data-taking is desired. All pass-fail points depend either on an absolute resistor value or on a precise resistor ratio within the test circuit. If, for example, a precision potentiometer, such as a 10-turn helical, is substituted for the input resistor R_1 in Fig. 3, it can be adjusted by the operator until the two halves of the comparison waveform are equal in height; then the resistance is read from a turn-counter dial, and it is proportional to the actual input impedance, related by Eq. 4. If $R_a = R_b$ in Eq. 4, the potentiometer resistance equals Z_{in} .

A similar procedure is used when the pass-fail limit is determined by a resistor ratio; in this case, the potentiometer is substituted for the fixed resistors, and the turns-counter dial gives the ratio directly. The use of a potentiometer slows testing, of course, but it provides actual readings, if needed.

Testing automatically

The comparative method can be refined further to provide automatic detection of the pass-fail criterion, as in Fig. 5. An added chopper is driven synchronously with the reference-measurement choppers. During the reference half of the cycle, one detector is used; during the measurement half, the other detector receives the circuit output. A dc comparator can then be used to compare the resultant voltages, giving either a "pass" or a "fail" digital output.

An extension of the synchronous detector

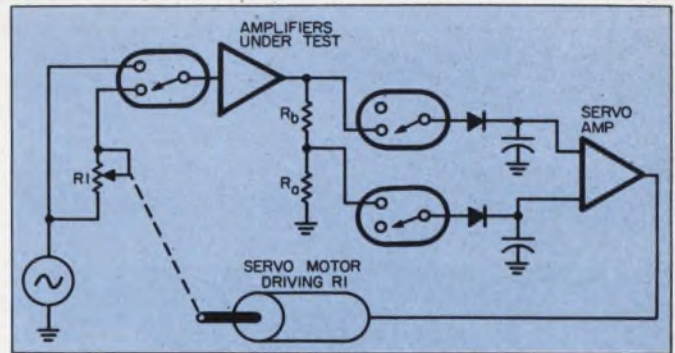

6. For data logging or analysis, a servo feedback system and synchronous detection can be used to obtain readings proportional to the parameter values. Here the output of the dc comparator drives a potentiometer.

method would be to close the loop around the circuit under test, as in Fig. 6. The dc comparator would drive a servomotor, which would adjust a potentiometer in the circuit, just as was done manually for actual value measurement. This feedback would cause the potentiometer to assume a setting that would give equal reference and measurement outputs. In this case, the setting of the potentiometer might be converted to an output suitable for automatic print-out or tape, which could be used for subsequent data processing—for example, statistical production-run analysis.

An alternative to the mechanical servodrive system would be an all-digital system, in which the feedback loop would switch higher or lower fixed resistors into the test circuit, until the minimum difference between reference and measurement waveforms was obtained.

Building the test set

As can be seen from the diverse applications of the visual-comparison technique shown in Fig. 7, many or all of these tests can be combined in a single test box. Switching from one test configuration to another can be done with a multiple-pole rotary switch, mounted close to the test socket, or possibly with fast reed relays, controlled either by a manual rotary test switch or by an automatic sequencer.

Since all tests have been reduced to a common display, resistor values can be scaled, so that approximately the same comparison waveform appears for each test. The phase relationship between choppers and oscilloscope sweep can be set by additional switch contacts. These would connect the chopper coil drive, so that the test criterion—that the right-hand waveform must be as large as, or larger than, the left-hand side—is true for both maximum and minimum limit tests.

Thus an unskilled operator can perform the test sequence without knowing the significance of each test. ■ ■

(measuring techniques are summarized on next page.)

Parameter	Equations	Pass IF	Single Ended Input and Output
Voltage Gain (A_v)	$V_{ref} = V_{osc}$ $V_{meas} = \frac{R_a}{R_b + R_a} A_v V_{ref}$ Limit Point: $\frac{R_a}{R_b + R_a} = 1$ $\frac{R_a}{R_b + R_a} = A_v \text{ (lim)}$	Min: $V_M \geq V_R$ Max: $V_M \leq V_R$	
Input Impedance (Z_{in})	$V_{ref} = A_v V_{osc} \frac{R_a}{R_a + R_b}$ $V_{meas} = A_v V_{osc} \frac{Z_{in}}{R_1 + Z_{in}}$ Limit Point: $\frac{Z_{in} \text{ (lim)}}{R_1 + Z_{in} \text{ (lim)}} = \frac{R_a}{R_a + R_b}$	Min: $V_M \geq V_R$ Max: $V_M \leq V_R$	
Output Impedance (Z_{out})	$V_{ref} = A_v V_{osc} \frac{R_a}{R_a + R_b}$ $V_{meas} = A_v V_{osc} \frac{R_L}{R_L + Z_{out}}$ Limit Point: $\frac{R_L}{R_L + Z_{out} \text{ (lim)}} = \frac{R_a}{R_a + R_b}$	Min: $V_M \leq V_R$ Max: $V_M \geq V_R$	
Common Mode Rejection Ratio (CMRR) (Measured over max CM range)	$V_{ref} = A_{dd} V_{osc} \frac{R_a}{R_a + R_b}$ $V_{meas} = A_{cd} V_{osc}$ Limit Point: $\frac{A_{dd}}{A_{cd}} = CMRR = \frac{R_a + R_b}{R_a}$	Min: $V_M \leq V_R$	APPLICABLE ONLY TO AMPLIFIERS HAVING DIFFERENTIAL INPUTS.
Power Supply Rejection Ratio (PSRR) (Measured over max PS range)	$V_{ref} = A_v V_{osc} \frac{R_a}{R_a + R_b}$ $V_{meas} = V_{om} \text{ (} V_{osc} \text{ applied to P.S. lead)}$ Limit Point: $\frac{V_{om}}{A_v (V_{osc})} = PSRR = \frac{R_a}{R_a + R_b}$	Max: $V_M \leq V_R$	
Bandwidth (BW)	$V_{ref} = A_v (f_{ref}) V_{osc} (ref) \frac{R_a}{R_a + R_b}$ $V_{meas} = A_v (f_{BW}) V_{osc} (BW)$ Limit Point: let: $\frac{R_a}{R_a + R_b} = .707 = \frac{A_v (f_{BW})}{A_v (f_{osc})}$ set: $V_{osc} (BW) = V_{osc} (ref)$ $f_{BW} = \text{min. 3db bandwidth; } f_{ref} \ll f_{BW}$	Min: $V_M \geq V_R$	

7. Six commonly specified amplifier parameters can be measured with the visual-comparison technique. All chopper

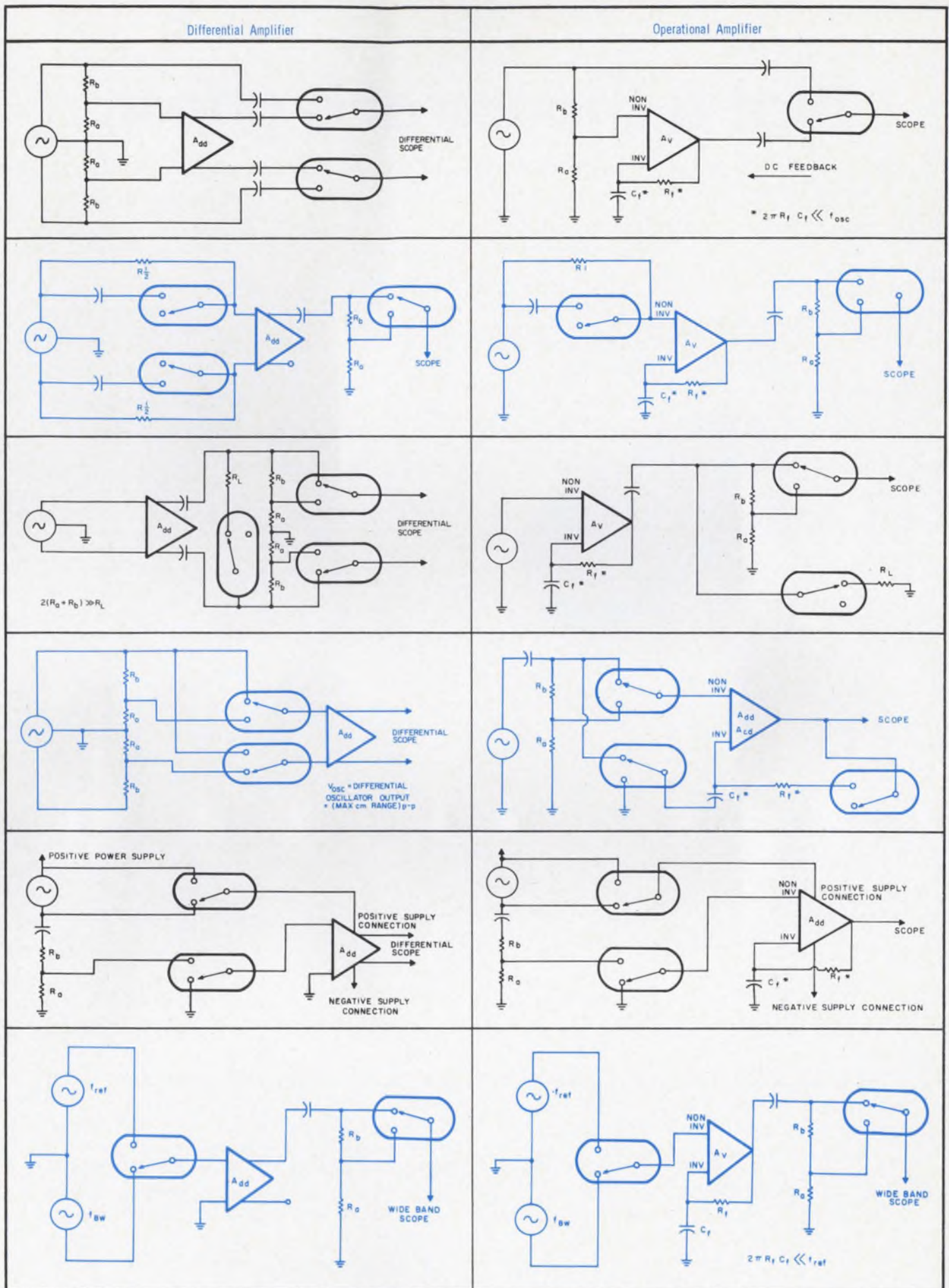

contacts are shown in the measurement position. Low-capacitance choppers are used to measure the bandwidth.

Not a chance of a ghost.



Not with Bruning 21 drafting vellum. We call it the ghost chaser. Lets you forget all about ghost lines, smearing or smudging. Takes pen or pencil.

21 also has a fast reprint speed that saves you time and money at your reproduction center. Its locked-in transparentizing agents are there to stay.

In all modesty, we feel it's the best drafting vellum

you can buy. And it stays that way sheet after sheet, run after run, year after year.

Is your drafting room haunted by ghosts? Get rid of them for good . . . with the ghost chaser. Call your Bruning man. He's listed under Bruning or Addressograph Multigraph in the telephone directories of most major cities. Or write Dept. G, Mt. Prospect, Illinois.

BRUNING division  CORPORATION
...helping people communicate

Adlake Mercury Wetted Relay — Application Data

Measurement of "Dynamic Contact Noise" for Low Level Signal Applications



**Adlake AWCS
26000 Series Relay —
2 Switch Form C**

In small signal applications, such as computers, telemetric systems, strain gauges, etc. generated emf. within the system's relays must be taken into account.

Dynamic Contact Noise is a "coined" phrase used to indicate an undesired generated emf. upon contact closure. It is the result of mechanical oscillation of the armature—caused by the impact of the armature on the stationary contacts — sweeping the coil flux.

Typical illustrations of this noise are shown in the oscillograms, with the relay being driven at nominal voltage in the test circuit shown below. The frequency and amplitude are integral functions of system bandwidth and coil drive conditions.

The slight ripple seen at the end of each trace is not noise, but due to resolution of test equipment and test circuit.

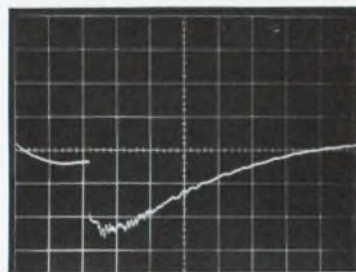

FIGURE 1

Horizontal Deflection 1.0 ms/cm
Vertical Deflection 20 μ V/cm
Systems Bandwidth .06–60 Hz.

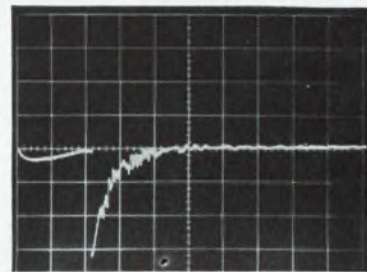

FIGURE 2

Horizontal Deflection 1.0 ms/cm
Vertical Deflection 100 μ V/cm
Systems Bandwidth .06–600 Hz.

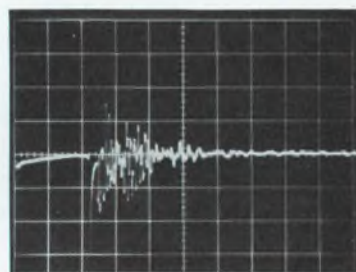

FIGURE 3

Horizontal Deflection 1.0 ms/cm
Vertical Deflection 200 μ V/cm
Systems Bandwidth .06–6K Hz.

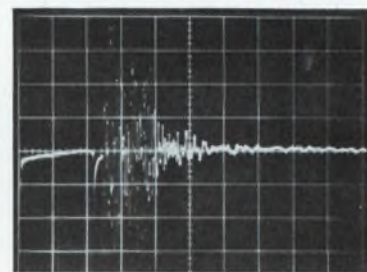

FIGURE 4

Horizontal Deflection 1.0 ms/cm
Vertical Deflection 200 μ V/cm
Systems Bandwidth .06–60K Hz.

TEST CIRCUIT

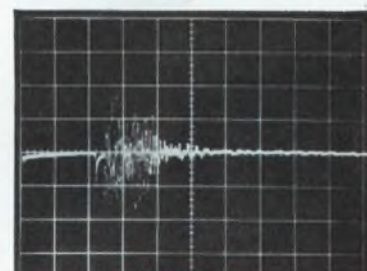
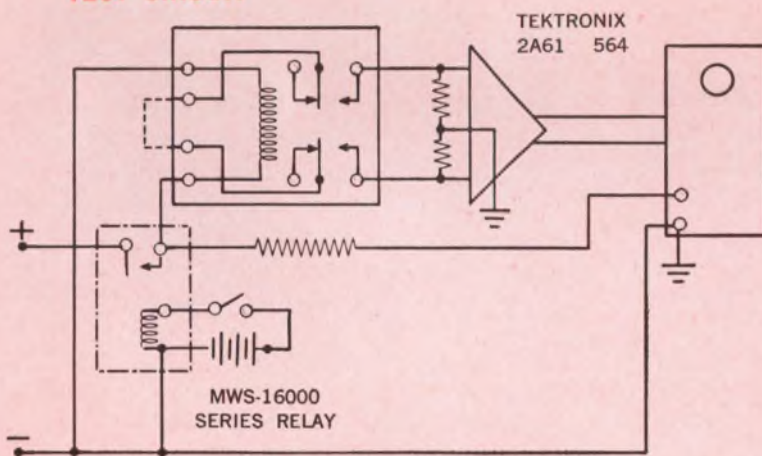

FIGURE 5

Horizontal Deflection 1.0 ms/cm
Vertical Deflection 500 μ V/cm
Systems Bandwidth .06–100K Hz.

***** If you have a problem regarding relay applications to a particular system our engineering staff is ready to help you. Contact Mr. Le Roy Carlson, Chief Project Engineer.

Backed by sound research and disciplined engineering, Adlake applies the industry's broadest line of mercury displacement and mercury wetted relays to the creative solution of design circuit problems. However unique or special your application, Adlake can assist you in

developing it. For prompt, personal and knowledgeable attention to your relay needs, contact the one source that is the complete source in the mercury relay field. Contact Adlake today for catalog and further information.



THE ADAMS & WESTLAKE COMPANY

Dept. 1057 Elkhart, Indiana, U.S.A. 46514 • (AC 219) 264-1141

TRANSPORTATION EQUIPMENT • ARCHITECTURAL PRODUCTS • MERCURY RELAYS • DOORS AND ENTRANCES • CONTRACT MANUFACTURING

ON READER-SERVICE CARD CIRCLE 38

Simplify magnetic-core coil design

with this direct and practical approach. Over 100 pilot designs and a core-selection chart form the basis.

Choosing the proper proportions for a magnetic core's air gap and metallic path length is a common problem in the design of magnetic-core coils and transformers that must carry both direct current and the desired alternating current. The customary approach is to follow guidelines established by Hanna¹ (see Box).

A more direct approach to optimum core dimensions, however, will quickly indicate the suitability of a given core material for a specific inductance, coil resistance and dc current. This approach employs a core selection chart and tabulations of more than 100 designs for a highly grain-oriented, cold-rolled, silicon-iron alloy core material. From these listings, core dimensions and other design data can be readily obtained. Where specific requirements do not match any of the tabulated designs, the core selection chart serves as the basis for a suitable design.

Tabulations based on pilot designs

In a magnetic-core transformer or coil design, the inductance, maximum coil resistance, maximum dc current, ac voltage and operating frequency are all usually specified. The problem is then to size the requisite core correctly, to select the core material, to calculate the necessary turns, wire size and air-gap spacing, and to determine the total flux level. The figures in Tables 1 and 2 relate these factors and were compiled by carrying out a series of pilot designs. An understanding of the basis on which these pilot designs were executed is important if full benefit is to be derived from the tabulations.

The inductance of an iron-core coil is inversely proportional to the effective length of the magnetic path. The value of incremental permeability depends on the values of ac flux density (B_{ac}) and dc flux density (B_{dc}) in the core. The sum of these densities should not exceed the saturation value of the core material used. A combination of core

area, air-gap length and number of coil turns that will yield the proper inductance must therefore be selected. In other words, B_{ac} and B_{dc} must be of such a value that at maximum dc current they will provide the highest inductance for a given "optimum volume" of core material without producing magnetic saturation. The term optimum volume is used in reference to minimum core size and weight.

The size of the opening in a selected core depends on the number of turns of wire, wire size and insulation requirements. For magnetic material in the form of cut-C cores, the relationship of the geometry of one core is not necessarily proportional to that of another, because there are several possible core-opening sizes for a given core cross-sectional area. Considering the product of these two variables alone does not suffice as a means for tabulating various designs.

A relationship between the parameters of a dc-carrying inductor and the size or weight of the inductor exists. Once a core has been selected and an arbitrary set of specifications established from which a pilot design can be made, this core can be classified in terms of energy content.

In essence a pilot design is evolved by arbitrarily selecting a core and winding it to full capacity. The necessary air-gap spacers are inserted on the basis of an arbitrary level of dc operating flux and

Conventional approach

Conventional design of magnetic-core inductors involves calculations that are based on known characteristics of the magnetic materials being used and on the effects of air gaps of various lengths inserted in the magnetic circuit.

With an estimated correct core volume, the optimum value of applied field is computed, and from this value the number of turns in the coil is obtained. The resulting coil resistance is then calculated to determine if it is satisfactory for the application. If not, a new core volume is assumed and the calculations are repeated until the desired winding resistance is attained.

Robert A. Booth, Electronic Research Engineer, Jet Propulsion Laboratory, Pasadena, Calif.

Table 1. Design tabulations

L (H)	I _{dc} (mA)	R _{coil} (Ω)	Core (no.)	Wire AWG (no.)	Turns (no.)	l _g (mils)	Copper weight (lbs)	Core weight (lbs)	B _{dc} (kG)
0.002	4,400	0.1	3	15	93	22.6	0.303	0.2	10.5
0.0037	12,500	0.11	35	11	156	107.0	2.31	1.19	10.9
0.0042	22,500	0.054	155	7	121	150.0	6.71	4.05	10.7
0.005	22,500	0.059	155	7	131	150.0	6.71	4.05	11.6
0.0072	12,500	0.48	35	14	304	208.0	2.31	1.19	10.9
0.01	8,000	0.14	29	11	164	77.5	2.8	2.21	10.3
0.01	12,500	0.11	35	16	454	331.0	2.31	1.19	10.3
0.012	8,000	0.15	29	11	176	77.5	2.8	2.21	11.0
0.012	12,500	1.2	35	16	484	331.0	2.31	1.19	10.9
0.025	4,000	0.49	26	14	324	75.3	2.51	1.31	10.3
0.028	4,000	0.51	26	14	342	75.3	2.51	1.31	10.9
0.035	2,000	0.91	54	17	386	46.0	1.24	0.599	10.1
0.041	2,000	0.99	54	17	418	46.0	1.24	0.599	10.9
0.32	600	9.7	6	24	1005	34.5	0.523	0.55	10.5
0.34	600	10.0	6	24	1045	34.5	0.523	0.55	10.9
0.70	290	33.8	138	28	1585	25.8	0.302	0.293	10.7
0.73	290	34.5	138	28	1620	25.8	0.302	0.293	10.9
0.80	375	24.0	6	26	1580	33.6	0.523	0.55	10.6
0.85	375	24.9	6	26	1630	33.6	0.523	0.55	10.9
0.98	150	51.8	2	29	2010	16.6	0.292	0.14	10.9
1.0	300	25.6	7	26	1590	27.0	0.555	0.511	10.6
1.1	300	26.4	7	26	1630	27.0	0.555	0.511	10.9
1.3	200	54.0	138	29	2010	22.1	0.302	0.293	10.9
1.3	300	40.3	7	27	2000	33.0	0.555	0.511	10.9
1.5	200	57.5	138	29	2140	22.1	0.302	0.293	11.6
1.54	150	131.0	2	31	3140	25.9	0.292	0.14	10.5
2.0	200	57.4	7	28	2230	27.0	0.555	0.511	9.8
2.1	400	44.4	35	24	2800	61.6	2.31	1.19	10.9
2.3	150	309.0	2	33	4710	39.0	0.292	0.14	10.9
2.4	130	106.0	9	29	3800	27.2	0.594	0.21	10.9
2.4	200	63.0	7	28	2450	27.0	0.555	0.511	10.8
2.5	130	108.0	9	29	3880	27.2	0.594	0.21	11.2
2.8	300	50.0	15	26	2550	42.1	1.06	1.12	10.9
3.0	150	83.0	11	28	3060	25.3	0.725	0.39	10.9
3.5	50	145.0	126	33	2980	8.5	0.142	0.106	10.5
3.8	50	150.0	126	33	3080	8.5	0.142	0.106	10.9
3.9	400	168.0	35	27	5330	118.0	2.31	1.19	10.9
4.0	65	256.0	250	34	4000	14.3	0.1595	0.106	10.9
4.0	175	98.0	8	29	2860	29.4	0.588	0.75	10.2
4.0	250	61.0	64	25	3220	44.8	2.075	1.085	10.8
4.4	200	90.5	10	28	3060	33.6	0.798	0.88	10.9
4.5	50	226.0	126	34	3715	10.3	0.142	0.106	10.8
4.5	200	91.3	10	28	3090	33.6	0.798	0.88	11.0
4.6	50	228.0	126	34	3750	10.3	0.142	0.106	10.9
4.6	100	320.0	3	33	4700	25.9	0.303	0.2	10.9
4.6	175	105.0	8	29	3050	29.4	0.588	0.75	10.9
4.8	50	281.0	235	34	4850	13.4	0.174	0.096	10.9
5.0	65	415.0	250	35	5150	19.0	0.1595	0.106	10.6
5.0	100	333.0	3	33	4880	25.9	0.303	0.2	11.3
5.0	200	75.3	15	27	3100	34.5	1.06	1.12	10.8

Table 1 (continued)

L (H)	I _{dc} (mA)	R _{coil} (Ω)	Core (no.)	Wire AWG (no.)	Turns (no.)	l _g (mils)	Copper weight (lbs)	Core weight (lbs)	B _{dc} (kG)
5.2	200	76.3	15	27	3140	34.5	1.06	1.12	10.9
5.2	250	98.3	64	26	4120	56.8	2.075	1.085	10.9
5.3	65	427.0	250	35	5300	19.0	0.1595	0.106	10.9
5.4	65	309.0	2	33	4710	16.9	0.292	0.14	10.9
5.5	50	437.0	235	35	5980	17.6	0.174	0.096	10.2
5.5	200	142.0	10	29	3810	42.0	0.798	0.88	10.9
6.0	200	149.0	10	29	4000	42.0	0.798	0.88	11.4
6.3	50	470.0	235	35	6400	17.6	0.174	0.096	10.9
6.6	85	785.0	2	35	7560	35.4	0.292	0.14	11.0
7.0	50	491.0	235	35	6720	17.6	0.174	0.096	11.5
7.0	150	154.0	8	30	3550	25.8	0.588	0.75	12.4
7.2	15	65.0	115	31	2200	1.82	0.144	0.08	10.9
7.3	200	124.0	27	26	4920	54.0	2.61	1.13	10.9
7.5	50	418.0	1	34	5720	15.8	0.26	0.13	10.9
7.5	400	52.0	34	23	3060	72.1	4.55	5.72	10.1
7.9	125	163.0	8	30	3760	25.8	0.588	0.75	11.0
7.9	150	163.0	8	30	3760	25.8	0.588	0.75	13.1
7.9	200	132.0	18	28	3850	42.4	1.155	1.35	10.9
8.0	85	1050.0	2	36	8000	32.6	0.292	0.14	12.6
8.0	300	68.0	31	24	3530	66.8	4.05	4.23	9.55
8.5	50	650.0	1	35	7020	20.8	0.26	0.13	10.1
8.5	200	137.0	18	28	4000	42.4	1.155	1.35	11.3
8.6	400	55.9	34	23	3280	72.1	4.55	5.72	10.8
8.9	200	188.0	27	27	6050	66.7	2.61	1.13	10.9
9.0	125	250.0	8	31	4520	32.8	0.588	0.75	10.4
9.2	50	404.0	251	34	5650	15.6	0.251	0.16	10.9
9.9	50	700.0	1	35	7580	20.8	0.26	0.13	10.9
10.0	90	317.0	48	31	5720	29.5	0.736	0.406	10.5
10.0	125	263.0	8	31	4760	32.8	0.588	0.75	10.9
10.0	200	198.0	27	27	6400	66.7	2.61	1.13	11.6
10.3	65	1200.0	2	36	9100	32.6	0.292	0.14	10.9
10.3	85	1200.0	2	36	9100	32.6	0.292	0.14	14.3
10.4	90	317.0	48	31	5720	28.4	0.736	0.406	10.9
10.5	110	253.0	8	31	4560	28.8	0.588	0.75	10.5
10.6	300	77.5	31	24	4040	66.8	4.05	4.23	10.9
10.8	90	330.0	48	31	5950	29.5	0.736	0.406	10.9
10.9	100	142.0	10	29	3810	21.0	0.798	0.88	10.9
11.0	200	298.0	27	28	7450	82.0	2.81	1.13	10.9
11.4	110	263.0	8	31	4760	28.8	0.588	0.75	10.9
11.6	30	427.0	250	35	5300	8.77	0.1595	0.106	10.9
12.0	30	435.0	250	35	5400	8.77	0.1595	0.106	11.1
12.0	100	149.0	10	29	4000	21.0	0.798	0.88	11.4
13.0	10	97.0	115	32	2640	1.45	0.144	0.08	10.9
13.0	75	330.0	48	31	5950	24.6	0.736	0.406	10.9
14.7	50	935.0	251	36	9000	24.8	0.251	0.16	10.9
14.9	80	377.0	14	31	6450	28.4	0.84	0.42	10.9
15.0	75	480.0	48	32	7000	29.4	0.736	0.406	10.7
15.6	75	490.0	48	32	7120	29.4	0.736	0.406	10.9
16.0	80	532.0	14	32	7320	34.0	0.84	0.42	10.3
17.8	80	561.0	14	32	7720	34.0	0.84	0.42	10.9
20.0	15	580.0	115	36	6300	5.3	0.144	0.08	10.7
20.9	15	591.0	115	36	6400	5.3	0.144	0.08	10.9
35.0	15	1360.0	126	38	8720	7.3	0.142	0.106	10.7
36.3	15	1380.0	126	38	8880	7.3	0.142	0.106	11.0

Table 2. Core selection chart

Core no.	Core energy content	Strip width (in.)	Build up (in.)	Window width (in.)	Window length (in.)	Bobbin width (in.)	Effective core-cross-section-area (in ²)
	(E.C.)	(D)	(E)	(F)	(G)	(B)	(A _c)
115	10.0	0.375	0.25	0.375	1.0	0.905	0.0846
126	13.2	0.375	0.3125	0.375	1.0	0.905	0.1053
235	15.2	0.375	0.25	0.375	1.1875	1.093	0.0846
250	18.0	0.5	0.25	0.375	1.0	0.905	0.1125
1	21.25	0.5	0.25	0.5	1.125	0.9687	0.1125
3	28.9	0.75	0.25	0.5	1.125	0.9687	0.1692
9	32.5	0.625	0.25	0.625	1.5625	1.468	0.1404
251	34.0	0.5	0.3125	0.4375	1.1875	1.093	0.1404
138	38.8	0.5	0.5	0.5	1.125	1.843	0.225
2	44.6	0.75	0.1875	0.5	1.125	0.9687	0.1269
11	45.7	1.0	0.2812	0.625	1.5625	1.468	0.2529
7	49.6	1.0	0.375	0.5	1.5625	1.468	0.3375
48	56.2	1.0	0.3125	0.625	1.5625	1.468	0.2817
6	61.0	0.75	0.5	0.5	1.5625	1.468	0.3375
14	67.0	1.125	0.3125	0.625	1.6875	1.593	0.3168
8	78.0	1.0	0.5	0.5	1.5625	1.468	0.45
54	81.0	1.0	0.375	0.75	1.9375	1.843	0.3375
10	101.0	0.875	0.625	0.625	1.5625	1.468	0.4923
15	109.0	1.0	0.625	0.625	1.9375	1.843	0.5625
64	129.5	1.375	0.4375	0.875	2.25	2.124	0.5418
18	144.0	1.25	0.625	0.625	1.9375	1.843	0.7029
26	154.0	1.25	0.5	0.9375	2.5	2.374	0.5625
27	164.0	1.5	0.375	0.9375	2.5	2.374	0.5058
31	270.0	1.5	1.0	1.0	3.0	2.844	1.35
35	377.0	0.75	0.75	1.1875	1.75	1.655	0.5058
34	388.0	2.0	1.0	1.0	3.0	2.844	1.8
155	650.0	2.0	0.75	1.375	3.0	2.844	1.35

allowable dc current. The coil inductance and resistance can then be determined. From this pilot design the energy content of the core can be calculated from:

$$EC = LI_{dc}/R^{1/2}, \quad (1)$$

where

- EC = core energy content,
- L = inductance,
- I_{dc} = dc current,
- R = coil resistance.

The core is now classified in terms of its energy content. Similar pilot designs are then carried out for other cores until sufficient data are obtained to compile the core selection chart (Table 2). In this process, the parameters initially specified for each pilot design do not include a value of inductance, since this is a derived quantity. Once the core is tabulated, however, the design process is reversed—the inductance is specified and the air-gap spacing and turns are calculated. In this manner Table 1 is compiled.

In the actual work of compiling Tables 1 and 2,

the pilot designs were initially calculated. However, empirical data were also obtained and served to verify the design results.

The highly grain-oriented, cold-rolled, silicon-iron alloy core material used for the pilot designs has exceptionally low iron losses, high saturation flux densities of about 20,000 gauss, high permeability at both high and low flux densities, and high incremental permeability. The material is available under the trade names M6X, Hipersil, Supersil, Silectron, Trancor 3X and Corosil. Its composition is 97 per cent iron and 3 per cent silicon, grain-oriented, with an actual saturation flux density of about 19,700 gauss.

The design calculations assumed for convenience a 4-mil tape thickness, an iron-stacking factor of 0.9, and a copper resistance factor of 1.1 for a coil temperature rise of 50°C.

How to use the tabulations

A total of 104 pilot designs are tabulated in Table 1 in order of increasing inductance. To use

the data for a specific design application, locate the tabulation that matches the parameters of the coil being designed; for a typical design, this will include the inductance, the dc current and the coil resistance. From this information the tabulation supplies the core number to be used (from Table 2), the AWG wire size (heavy Formvar is assumed), the number of turns, the total air-gap spacing, the total copper weight, the total core weight, and the level of dc magnetization that will result.

For a design that does not satisfactorily fit into any specific tabulation, one or more of the following adjustments can be made:

- Calculate the core energy content of the particular design. Then select the corresponding core from Table 2 and compare this with the

tabulation in Table 1 that most nearly fits the design inductance, to see if the values match satisfactorily.

- Adjust the total number of turns for the required design inductance. (Note that the pilot designs assume a stacking factor of 70 per cent.) Care must be exercised when doing this, since, if the total turns are reduced below the values given in Table 1, core saturation may result with large values of ac voltage. This is because changing the total number of turns not only changes the value of inductance (as the square of the turns), but also the dc and ac flux levels.

- Change the wire size slightly to satisfy more nearly the coil resistance.

- If the dc current of the actual design is greater than the dc current given in the tabulation, calculate the dc magnetization level, B_{dc} , from the equation $B_{dc} = 0.55 NI_{dc}/l_g$, where N = number of turns and l_g = air-gap length. The value should be less than 20,000 gauss to prevent saturation and resultant loss of inductance. This is because, when the air gap remains fixed, the inductance will decrease gradually while the dc current increases until near saturation occurs. Then at this point a sudden drop in inductance takes place, indicating saturation.

- If a swinging choke is desired, the actual design is determined by the mean inductance at the maximum dc current. The resultant choke size is then compared with the closest available tabulation.

Table 3. Wire table

AWG	Turns/in ²	Ω/in. (20°C)	Ω/lb (Type hf)
8	57	0.0000532	0.01246
9	72	0.0000671	0.01983
10	90	0.0000845	0.03148
11	113	0.000105	0.05004
12	141	0.000132	0.07950
13	176	0.000167	0.126
14	220	0.000211	0.209
15	273	0.000266	0.318
16	350	0.000334	0.510
17	432	0.000422	0.798
18	540	0.000532	1.27
19	668	0.000671	2.02
20	850	0.000845	3.19
21	1045	0.001065	5.08
22	1300	0.001345	8.10
23	1650	0.00169	12.7
24	2030	0.00214	20.4
25	2500	0.00270	32.4
26	3160	0.00341	51.6
27	3880	0.00424	81.1
28	4770	0.00541	130
29	5920	0.00682	201
30	7300	0.00863	328
31	9260	0.0110	520
32	11100	0.0137	794
33	13900	0.0173	1280
34	16900	0.0216	2050
35	22300	0.0274	3280
36	26900	0.0346	5160
37	33100	0.0436	7830
38	40000	0.0550	12600
39	51800	0.0692	21300
40	66200	0.0875	34700
41	90000	0.1102	52000
42	110000	0.1382	81800

Any design possible with core selection chart

When design requirements still cannot be met satisfactorily by any of the 104 designs listed in Table 1, the desired coil can still easily be designed by using Tables 2 and 3 and by carrying out the following procedure.

1. Note the specific design requirements:

L (in H),
 R_{coil} (in Ω max),
 I_{dc} (in mA dc),
 E_{ac} (in V rms),
 f (in Hz).

2. Calculate the core energy content, EC :

$$EC = LI_{dc}/R_{coil}^{1/2}.$$

3. Select the core from Table 2.

4. Record all data from Table 2.

5. Calculate the mean length of each turn of wire, MT :

$$MT = 2(D + E) + \pi F,$$

where D , E and F are taken from Table 2.

6. Calculate the weight of copper wire:

$$Wt_{(lb)} = (0.25)(B)(F)(MT)(space\ factor),$$

where $space\ factor = 0.5-0.7$.

7. Calculate the wire ohms per pound:

$$\Omega/lb = R_{coil} / (Wt_{(lb)} \cdot CRF),$$

where $CRF =$ copper resistance factor
 $= 1.1$ for a rise of $50^{\circ}C$ in the coil.

8. Resolve the value of wire ohms per pound, calculated in Step 7, into AWG wire size by use of Table 3.

9. Record the turns per square inch, based on the selected wire size, by means of Table 3.

10. Calculate the required number of turns, N :

$$N = (\text{turns}/in^2)(B)(F)(space\ factor),$$

where B and F are taken from Table 2.

11. Calculate the actual coil resistance and compare it with the original design requirements:

$$R_{coil(\Omega)} = (MT)(N)(\Omega/in.)(CRF),$$

where:

$MT =$ value from Step 5,

$N =$ value from Step 10,

$\Omega/in. =$ value from Table 2,

$CRF =$ value from Step 7.

12. Calculate the required gap length, l_g :

$$l_{g(in.)} = 0.55 N I_{dc} / B_{dc},$$

where:

$I_{dc} =$ design value (in A),

$B_{dc} = 10$ kilogauss.

13. Calculate the actual inductance:

$$L_{(H)} = 3.2 N^2 A_{c(in^2)} 10^{-8} / l_{g(in.)},$$

where $A_c =$ effective core cross-sectional area, taken from Table 2.

14. Calculate the actual dc flux level, B_{dc} :

$$B_{dc} = 0.6 N I_{dc} / l_{g(in.)}.$$

15. Calculate the ac flux level, B_{ac} :

$$B_{ac} = 3.49 E_{ac(rms)} 10^6 / f A_{c(in^2)} N,$$

where $f =$ frequency in Hz.

16. Check the total flux density level to see if it is below saturation:

$$B_{total} = B_{ac} + B_{dc}. \quad \blacksquare \quad \blacksquare$$

Reference:

1. C. R. Hanna, "Design of Reactances and Transformers Which Carry Direct Current," *AIEE Journal*, XLVI, Feb. 1927, 128-131.



**IF THIS
MINIATURE METAL
FILM RESISTOR
DOESN'T CHANGE YOUR
design ideas**

...try one of these



Part No.	Power	Ohms	Tol.	Temp. Coef.
PME 50	1/20 W	10Ω to 1M	±1% to .1%	T-0, T-2, T-9
PME 55	1/10 W	10Ω to 3M	±1% to .1%	T-0, T-2, T-9
PME 60	1/8 W	49Ω to 7.5M	±1% to .1%	T-0, T-2, T-9
PME 65	1/4 W	49Ω to 20M	±1% to .1%	T-0, T-2, T-9
PME 70	1/2 W	24Ω to 30M	±1% to .1%	T-0, T-2, T-9
PME 75	1 W	49Ω to 50M	±1% to .1%	T-0, T-2, T-9

The stability and accuracy of Pyrofilm's PME metal film resistors makes their use ideal in applications where before only wire wound resistors could be used. These resistors are virtually unaffected by environmental conditions and withstand constant exposure to high moisture conditions without change in specifications. PME resistors meet or surpass all requirements of MIL-R-10509F.

Send for fact-filled literature sheet!

PYROFILM RESISTOR COMPANY, INC.

3 SADDLE ROAD • CEDAR KNOLLS, NEW JERSEY • 201-539-7110

IC counters

Step into the future with the Thin Line—the sleek, ultra-reliable counters Systron-Donner now builds with integrated circuits.



Look, no knobs! Sliding switches are easier to set, easier to read. Prevent errors in control settings. The modern touch on the outside that reflects the advanced design inside.

9 digits for top resolution. Thin Line counters give you readings with a resolution of 1 part in a billion.

1. Microwave counter. Reads frequency directly in gigacycles from 0.3 to 12.4 GHz. Displays final answer instantly and automatically by means of built-in automatic computing transfer oscillator. No tuning. No calculations. Phase lock for counter accuracy.

2. 100 MHz Universal Counter-timer. This Thin Line packs more utility in a smaller cabinet than any other instrument you've seen. Measures frequency, time interval, period, and frequency ratio — or just counts cycles under local or remote control.

3. 100 MHz Frequency Counter. A best buy for people who want to measure frequency and period only. Provides the wide range from dc to above 100 MHz.

4. Counter-DVM. A 5 MHz counter and an integrating DVM in one compact cabinet. DVM is referenced to an internal temperature-compensated Zener diode. It provides four ranges (1, 10, 100, & 1000v), 1 μ v resolution, automatic polarity indication, floating inputs, and selectable filters.

5. 10 MHz Universal Counter-timer. All the functions of the 100 MHz counter-timer at frequencies to 10 MHz and above.

6. 5 MHz or 10 MHz Frequency Counter. Frequency and period measurements only: dc to 5 MHz, or dc to above 10 MHz.



are here!

They pack an unprecedented frequency range (to 12 GHz) or six different functions into 1³/₄ inches of rack space.

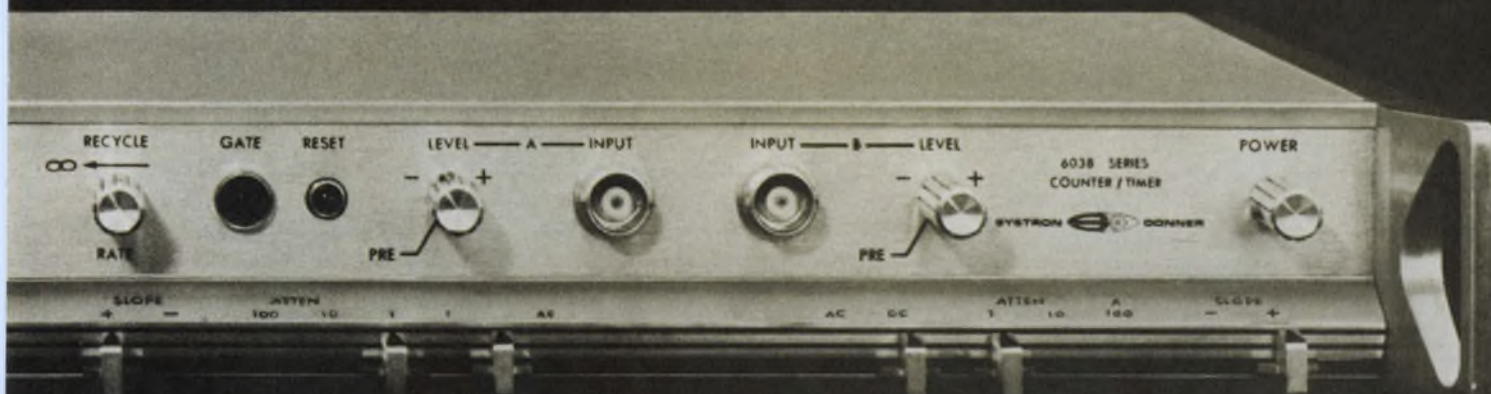

Champion space saver.

Nothing could be less demanding of rack space – only 1³/₄ inches required. When there is "no room left," a Thin Line counter may save the day.

Breakthrough in accuracy.

A new high-stability oscillator with an aging rate of 5 parts in 10¹⁰ per day – unmatched by any other counter manufacturer.

Remote control. Lets you plug Thin Line counters into a larger system and control all operations with electrical signals.

1.

6.

4.

5.

Send for
free
brochure

The Thin Line



Step into the future
with IC counters
from Systron-Donner

SYSTRON  DONNER

Maintainability specs bothering you?

If so, clear away the haze. Here's what they mean and how you should respond to them.

Many requests for proposals from government and other prime contractors now include maintainability requirements. Some elements of this relatively new discipline are vague or even unknown to many designers, with the result that they sometimes bid themselves out of competition by responding to needless maintainability requirements. The best way to avoid this situation is to understand the customer's reasons for requesting specific maintainability requirements and what he has a right to expect for his money.

If what is being bid for is a new development or the hardware involved is complex, the buyer may require a maintainability program to be an integral part of the effort. If he wishes to be in the running, the seller must know the important elements of a maintainability program and the significance of quantitative and qualitative maintainability requirements.

What are quantitative requirements?

Quantitative maintainability requirements are usually specified as the time needed to perform specific maintenance tasks. The commonly used terms are mean time to repair (MTTR), maximum time to repair (Mmax), and maintenance man-hours per operating hours (MMH/OH). Sometimes a finer gradation of time is specified by the inclusion of requirements for preventive, or scheduled, maintenance time and for access and removal time.

When none of these quantitative maintainability requirements is specified, the seller's response to them should be minimal. If such requirements are specified, but the quality assurance section of the specification does not demand that they be demonstrated and there is a reasonable assurance that the equipment can meet them, the requirements have minor significance. The buyer in this event would have difficulty establishing whether or not the requirements were fulfilled. The buyer may nonetheless choose to run his own evaluation of the delivered hardware.

Jerry M. Okamura, Engineer, ITT Gilfillan, Inc., Los Angeles.

In the event that a demonstration of maintainability is required to verify the specified quantitative requirements, the seller must determine whether or not he can meet the requirements. This leads to four possible situations:

- The requirements can be achieved easily.
- The requirements can be achieved.
- The requirements cannot be achieved by anyone.
- The seller cannot meet the requirements but his competition can.

If the seller feels that the requirements can be met easily, he should recommend the buyer to waive the demonstration requirements with documented proof that the maintenance tasks can easily be performed in the specified time. If the risks in fulfilling the requirements are reasonable, a maintainability program should be set up before the actual demonstration to assure both parties that the requirements can be met with a high degree of confidence. If the requirements are felt to be unreasonable and cannot be met by the seller or his competition, documented evidence of this fact should be offered with a recommended solution. The fourth possibility needs no explanation.

What are qualitative requirements?

Qualitative maintainability requirements usually demand that a specific maintenance feature or capability be incorporated into the product. The primary purpose of such requirements is to minimize the costs and complexity of maintenance. The most effective way to do this is to minimize the number of maintenance personnel needed and maintenance error. These requirements, when in conflict with the product, should be evaluated and alternative methods for fulfilling them recommended to the buyer. Most buyers are interested in obtaining the best equipment at least cost. Remember that the buyer is not as familiar with the seller's products as the seller.

When preparing to respond to maintainability requirements, the first step is to establish exactly the maintenance capability of the equipment to be offered. How great a task this is depends on the complexity and type of equipment, and on the

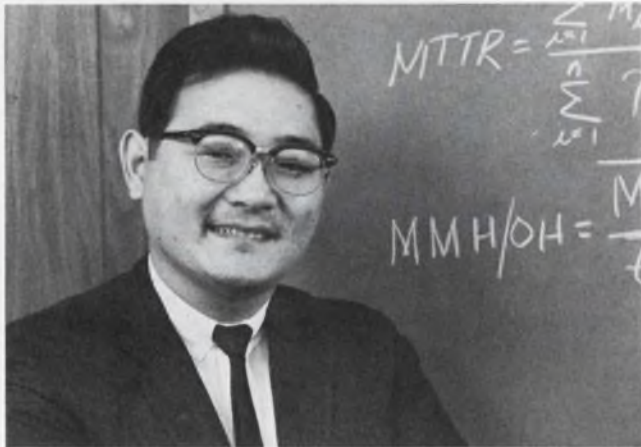

Two terms frequently used to specify quantitative maintainability requirements, says author Okamura, are mean time to repair (MTTR) and maintenance man-hours per operating hours (MMH/OH).

environment in which it will most likely operate. The following areas should be considered in determining maintenance capability:

Maintenance environment—The anticipated environment in which the equipment will operate and its probable failure modes are important elements. These, in turn, require a knowledge of all levels of maintenance, the activity and responsibility of each level, the caliber of personnel who will perform the maintenance work, the anticipated support equipment that will be available, and the environment in which the maintenance work will be carried out.

Maintenance time requirements—Maintenance time requirements are very important for a complex device or a repairable product. The normal methods of specifying maintenance time are mean time to repair (MTTR), mean active corrective maintenance time (\overline{M}_{ct}), mean active preventive maintenance time (\overline{M}_{pt}), maintenance man-hours per operating or flight hour (MMH/OH or MMH/FH), and maximum repair time (Mmax) to some probability level. The equations for deriving MTTR and MMH/OH are:

$$MTTR = \sum_{i=1}^n M_i \lambda_i P_i / \sum_{i=1}^n \lambda_i P_i,$$

where the terms are defined as:

- M_i = active repair time per maintenance task,
- λ_i = failure rate per maintenance task,
- P_i = population of maintenance item under consideration;

and:

$$MMH/OH = \overline{M}_{ct} \overline{P}_c / \overline{t}_c + \overline{M}_{pt} \overline{P}_p / \overline{t}_p,$$

where:

- \overline{M}_{ct} = mean active corrective maintenance time,
- \overline{M}_{pt} = mean active preventive maintenance time,
- \overline{t}_c = mean time between active corrective maintenance tasks,
- \overline{t}_p = mean time between preventive maintenance tasks,
- \overline{P}_c = average number of personnel required to perform each corrective maintenance task,
- \overline{P}_p = average number of personnel required to perform each preventive maintenance task.

Both \overline{M}_{ct} and \overline{M}_{pt} can be calculated by means of the MTTR equation.

Other maintenance time requirements that may be specified are access time, removal/replace time, and active test time. These are normally applicable only when the equipment is in its actual operating environment.

When calculating maintenance time requirements, it is important to realize that certain variables are outside the seller's control and should not be taken into consideration. These include supply downtime and administrative time. Supply downtime is the time during which necessary maintenance is delayed solely because a needed item is not immediately available. Administrative time is that portion of nonactive maintenance time that is not included in supply downtime. As independent variables, these maintenance times are not predictable. So for his protection the seller should take exception to them whenever they are not clearly eliminated from the specified maintenance time requirements.

Inherent maintenance capability—The inherent maintenance capability of a product should be

very carefully evaluated, because this could be the deciding factor between competitors when maintainability and maintenance requirements are all being met and costs are the same. In this case, the buyer's decision would favor the seller who has the best inherent maintenance capability. Common factors that enhance this capability are standardization of parts and interchangeability, of modules. Other desirable maintenance features are:

- Ease with which a fault can be identified to a replaceable module or part.
- Minimal amount of support equipment.
- Ease of repair, to the part level.
- Minimal adjustments and alignments.
- Fail-safe features to reduce the consequences of failure.
- Audible or visible warnings to indicate malfunctions.
- Minimal requirements for depot or factory maintenance.
- Ease of handling, transportability, and storability.
- Simple and standard maintenance procedures.
- Minimal possibility of undetected failure.

What is a maintainability program?

If quantitative requirements and a demonstration to prove their fulfillment are specified, it is certain that a maintainability program will also be required. Such a program can be divided into three major categories: quantitative/qualitative analysis, design assurance, and test and demonstration.

The quantitative/qualitative analysis is straightforward, if an in-house effort to prepare for maintainability has already been put into effect in the manner described. The analysis involves apportionment of the specified maintenance time requirements to a subsystem level, prediction of the maintenance time required for the system, optimization of maintenance tasks by designing for easy maintenance, and the analysis of failure reports. In predicting maintenance time, it is advisable to prepare a troubleshooting diagram or chart, as this will be useful in the design assurance effort and in the test and demonstration phase.

The design assurance effort assures both seller and buyer that maintainability will be an integral and monitored part of the design. Typical elements of a design assurance effort are the indoctrination of engineering personnel in the principles of maintainability, the establishment of design guidelines for maintainability, design reviews, vendor control, drawing control, trade-off studies, and program reporting, scheduling, and budgeting.

Maintainability definitions (MIL-STD-778)

Active maintenance time—The time during which preventive and corrective maintenance work is actually being done.

Active repair time—The time during which one or more technicians are working to effect a repair.

Corrective maintenance time—The time from the first observation of a malfunction to when the item is restored to satisfactory operation. It may be subdivided into active maintenance time and nonactive maintenance time, and does not necessarily contribute to equipment or system downtime in cases of alternate modes of operation or redundancy.

Mean time to repair (MTTR)—The statistical mean of the distribution of times to repair. It is the sum of active repair times during a given period divided by the total number of malfunctions during that period.

Preventive maintenance time—The portion of calendar time devoted to preventive maintenance. It comprises time spent in performance measurement; care of mechanical wear; front-panel adjustments, calibration and alignment; cleaning and so forth.

Repair—The process of returning an item to a specified condition. It includes preparation, fault location, spare procurement, fault correction, adjustment and calibration, and final test.

The test and demonstration is the most important part of a maintainability program. It is the phase when proof is given that the quantitative/qualitative requirements have been fulfilled. Maintenance time requirements are usually shown to have been met by inserting a malfunction into the item to be demonstrated. The malfunction is taken from a statistical sample, which is selected by a random technique such as the Monte Carlo method. The personnel who will repair the malfunction must meet the qualifications of the buyer, and will normally require buyer approval.

The data-taking team must take no active part in the fault-insertion process or in obtaining spares or test equipment, and must not communicate with the repair personnel. This will avoid disagreement over the validity of their data. The seller should at all times reserve the right to eliminate any selected tests that would not be in his best interest. It must be borne in mind, however, that the reasons for eliminating any test in the sample must be valid.

Adequate time should be allowed prior to the demonstration to ensure that all coordination for the test is complete before it begins. This includes obtaining spares, test equipment, data-taking equipment, and troubleshooting instructions, if required. ■ ■

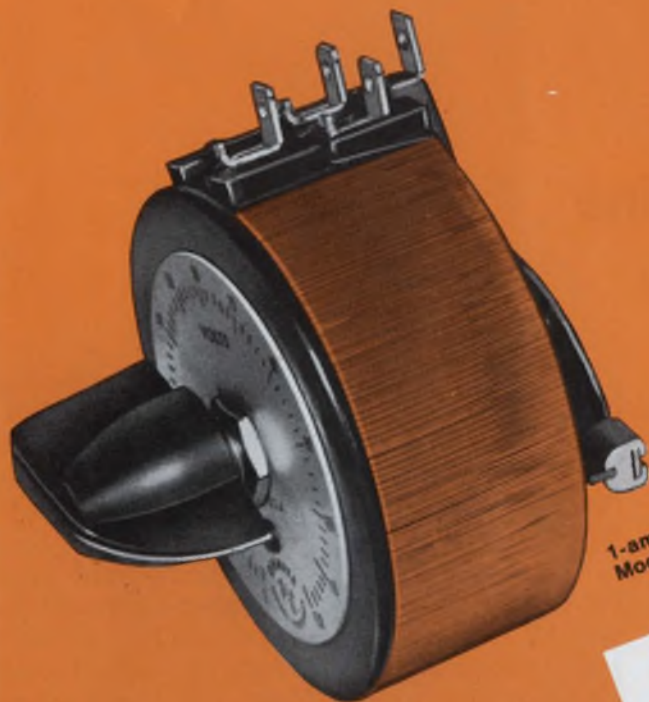

1-amp Ohmitran[®] variable transformer
Model VT1 (actual size)

Smallest for power line frequencies



It's in the
Ohmite
"Answer Book"

Why pay for power you don't need? Or waste valuable space? The VT1 is part of Ohmite's "Low-Power" series that gives you a choice of 6 ratings from 1 to 3 amps! They're a natural where space is tight and cost is important. The "Low-Power" series is another indication of Ohmite's progressive engineering which anticipates and paces industry's requirements. Together with other Ohmite variable transformers ranging to 25 amperes, the "Low-Power" series forms a complete line to satisfy almost any industrial need. Numerous options include

fixed and portable enclosures, ganged assemblies, metered models, and motor driven assemblies. It's all in the Ohmite "Answer Book," Catalog 500. Write Ohmite Manufacturing Company, 3643 Howard St., Skokie, Illinois 60076. Phone: (312) ORchard 5-2600.

 **OHMITE**
MANUFACTURING COMPANY

RHEOSTATS ■ POWER RESISTORS ■ PRECISION RESISTORS ■ VARIABLE TRANSFORMERS ■ RELAYS
TAP SWITCHES ■ TANTALUM CAPACITORS ■ SOLID STATE CONTROLS ■ R. F. CHOKES

ON READER-SERVICE CARD CIRCLE 40

Coupling posts in comb-line filters boost performance

Strategically-placed coupling posts between the resonators of microwave comb-line filters can double the bandwidth, improve the unloaded Q and reduce losses in the pass band.

Conventional comb-line filters consist of resonators that are shorter than $\lambda/4$, which is the length required for resonance. Capacitances at the open ends are used to achieve resonance. This physically compact structure degrades the Q and increases losses. Quarter-wavelength-long resonators are not used because they become uncoupled, owing to the cancellation of equal electric and magnetic fields with opposite phases. As the resonators are shortened (usually to 45° electrical length), the electric and magnetic couplings are no longer equal and a net coupling results.

The idea of unequal coupling can be realized with quarter-wave resonators if a coupling post is placed in the region of strong electric fields between adjacent resonators (see figure).

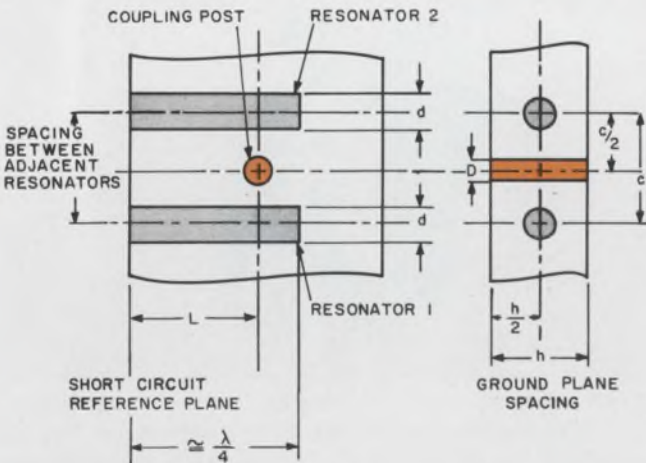

Post-coupled comb-line filter uses quarter-wave resonators for wide bandwidths and low losses in the band pass. The coupling posts reduce the electric coupling and permit a large magnetic coupling.

VOTE! Circle the Reader-Service-Card number corresponding to what you think is the best Idea-for-Design in this issue.

SEND US YOUR IDEAS FOR DESIGN. Submit your IFD describing a new or important circuit or design technique, the clever use of a new component, or a cost-saving design tip to our Ideas-for-Design editor. If your idea is published, you will receive \$20 and become eligible for an additional \$30 (awarded for the best-of-issue Idea) and the grand prize of \$1000 for the Idea of the Year.

This post effectively reduces the electric coupling between adjacent resonators and permits a substantial net magnetic coupling. This coupling technique has been used to achieve adjacent resonator coupling bandwidths in excess of 10% of the filter's center frequency.

The coupling post's diameter, D , should be between 15% and 20% of the filter's ground-plane spacing, h . Post locations, L , should be between 60 and 70 electrical degrees from the filter's short-circuit reference plane. Final post diameters and locations will require empirical determination.

With design procedures for interdigital band-pass filter structures, coupling bandwidths are possible that are slightly greater than twice the coupling bandwidth of a comb-line structure of identical resonator cross section and identical spacing, c , between adjacent resonators.

Multiresonator band-pass filters can be fabricated quite economically with round-rod resonators parallel to the broad walls of nonpropagating rectangular waveguide tubing. The coupling post technique can also be applied to comb-line band-pass filters through use of dielectric-filled strip-transmission-line resonators with either single or double ground planes.

R. M. Kurzrok, Consulting Engineer, New York. (Work performed while the author was employed at the Advanced Communications Laboratory, Radio Corp. of America, New York.)

VOTE FOR 110

Voltage-sensing circuit is temperature-compensated

A simple and accurate voltage-sensing circuit shown on p. 91, which operates a latching relay when the input exceeds a preselected threshold voltage, uses transistors for temperature compensation. The threshold voltage is primarily determined by the Zener voltage of $CR1$ and the potentiometer setting of R_{pot} , and is expressed by:

$$E_{threshold} \approx V_Z R_{pot} / R1.$$

Threshold voltage can easily be selected by adjustment of the potentiometer.

The voltage at the base of $Q1$ is very nearly that

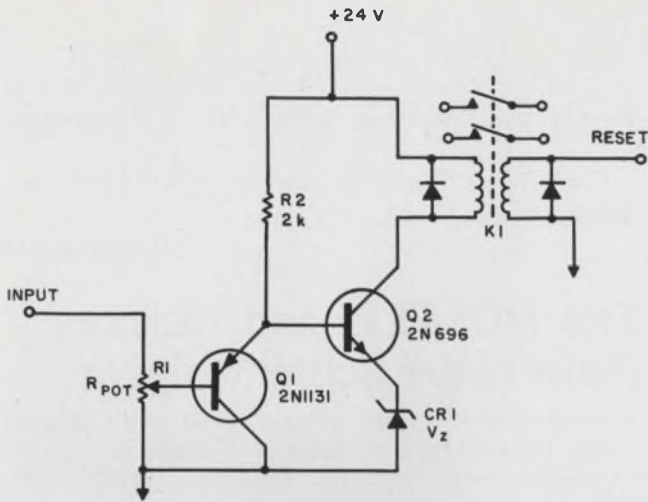

Temperature compensation in the voltage sensing circuit is achieved through use of complementary transistors.

at CR1, until threshold voltage is reached, because of the V_{BE} cancellation of complementary transistors Q1 and Q2. Furthermore, the fact that Q1 and Q2 are complementary compensates for the temperature variation of their V_{BE} .

The emitter-follower input stage provides a high input impedance to prevent loading of the monitor circuit. Normal supply voltage variation has no effect on the circuit.

Adjustment of R_{pot} is required to select the threshold voltage, because of the limited amount of different-voltage Zener diodes, the voltage tolerance of Zener diodes, and the imperfect V_{BE} cancellation of Q1 and Q2.

One application of this circuit is as a fail-safe device, which uses the relay contacts to remove power from a system or to perform another function when a critical voltage monitor exceeds the threshold voltage.

M. Furukawa, Lockheed Missiles and Space Co., Sunnyvale, Calif.

VOTE FOR 111

Inexpensive NOR gate makes shift-register stage

A single shift-register stage is normally made with one J-K flip-flop, but it can also be put together with four 2-input NOR gates, as shown in the figure. (Positive logic is assumed, that is, a high voltage is a logical 1 and a low voltage is a logical 0.)

One pair of gates is connected as an R-S flip-flop and the other pair is connected as a pulse gate to transfer the signal from one flip-flop to the next on command of the shift pulses. For proper shifting, the width, t_{ic} , of the shift pulse S must be chosen so that $t_p < t_{ic} < 2t_p$, where t_p is the propagation delay of a single gate.

What makes this circuit interesting is that in

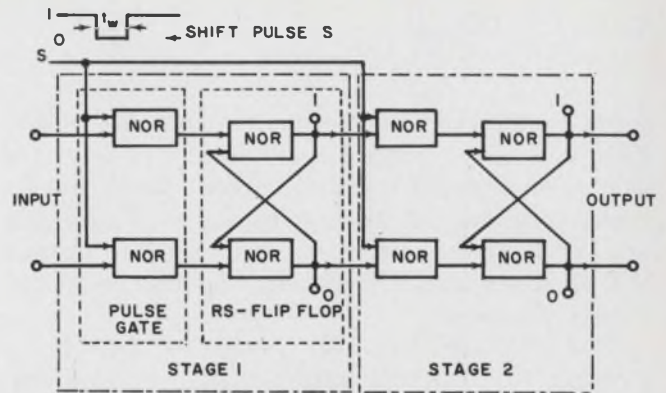

Two-stage shift register uses only NOR gates instead of the usual J-K flip-flops.

several commercial lines of flat-pack integrated circuits a quad 2-input NOR gate costs about 20 per cent less than a comparable J-K flip-flop. In practical applications the following points should, however, be borne in mind:

- Shift pulse S makes the properties of the illustrated circuit more critical than a J-K flip-flop.

- The J-K flip-flop may prove less expensive where the cost of wiring is significant, because the J-K flip-flop requires only about half the number of connections to the device as the quad gate.

- The J-K flip-flop package has a special preset terminal. Although a shift register using the NOR stages can easily be set to all 1s or all 0s by application of the proper input level and a sufficiently long shift pulse, other states may require considerably more logic.

Donald R. Haring, Research Engineer, Concord, Mass.

VOTE FOR 112

Simple tester checks FET V_p and g_m

In circuit development work, a quick tester for FETs is often useful. The circuit shown in the figure measures the FET pinchoff voltage, V_p , at a current set by the potentiometer.

The current flowing through the FET will be

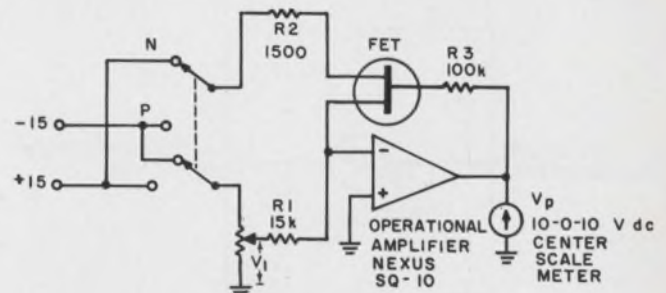

Pinchoff voltage of a FET can be measured quickly with this simple circuit. Varying I_{DS} with the potentiometer also enables g_m to be checked.

equal to the current flowing through $R1$, if the FET is working, since the amplifier will drive the gate toward cutoff until no current flows into its input terminal. At that point $I_{DS} = V_1/R1$. $R2$ and $R3$ limit the current to low values to protect the device, should the polarity switch be in the wrong position.

The FET's g_m can also be checked quickly by varying I_{DS} with the potentiometer and observing the change in V_p .

John C. Alderman, Jr., Accelerator Dept., Brookhaven National Laboratory, Associated Universities, Inc., Upton, L. I., N. Y.

VOTE FOR 113

Simple bridge circuit checks resistance element linearity

Electromechanical systems employing potentiometers are frequently sensitive to nonlinearities of the resistive elements making up the potentiometers. Firms which manufacture such systems are often faced with the problem of checking their linearity.

Fully automatic resistance-element checking equipment is expensive and difficult to maintain. The linearity checker shown provides a quick and simple means of checking resistance elements.

This checker is basically a ratiometer with a mechanical link between the wiper of a linear, precision, multiturn potentiometer and the element under test. The bridge circuit formed by the two potentiometers is excited by a 12-V dc source. The wiper may be positioned on the test element to give an initial null ratio indication. If the test element is linear, the null will be maintained as the wipers traverse the resistance elements. If the test element is nonlinear, a voltage difference will be indicated on the meter. The allowable error band can be indicated directly on the face of the meter to simplify operation. Different lengths of resistance elements may be accommodated by

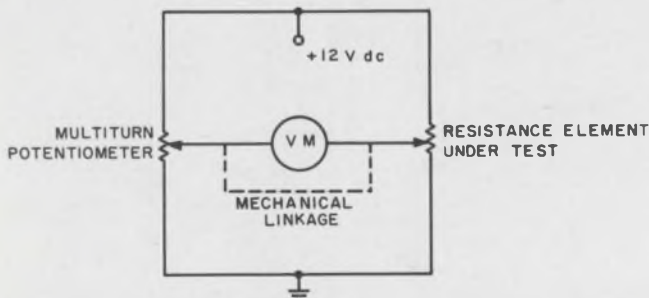

Linearity of a resistance element can be checked quickly with a simple bridge circuit.

moving the mounting block with a micrometer head.

Fred Kear, Engineer, Sparton Southwest, Inc., Albuquerque, N. M.

VOTE FOR 114

Two MOS-FETs and resistors make better Schmitt trigger

A considerable improvement in Schmitt trigger speed, temperature stability and input impedance is possible with a design that uses MOS-FETs. Since the only active elements are MOS devices, the circuit may be miniaturized by monolithic microcircuit techniques.

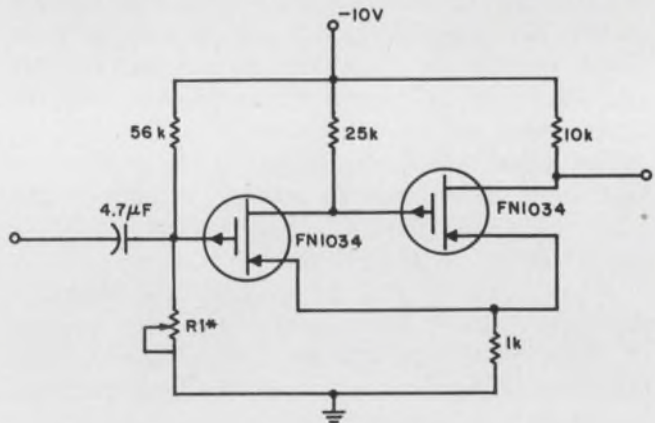

* $R1 = 18k$ FOR $V_{TRIGGER} = -1V$

Stable Schmitt trigger uses only two MOS-FETs and a few resistors.

The illustration shows a variable-trigger-level Schmitt trigger using two Raytheon FN 1034 MOS-FETs. The trigger level may be set from -2 volts to $+2$ volts by the appropriate selection of $R1$.

The circuit shown yields the following results:

- Trigger voltage stability = ± 0.05 volt from -55° to $+125^\circ C$.
- Input impedance = $10 k\Omega$, according to $R1$.
- Hysteresis = 0.5 volt at room temperature.
- Switching times = $0.5 \mu s$ to $1.0 \mu s$ (and $E_{in} = 400\text{-Hz}$ sine wave).

Steven Biren, Sperry Gyroscope Co., Inc., Great Neck, L. I., N. Y.

VOTE FOR 115

Four-layer diode clock has relay closure output

A simple clock can be built from a series RC circuit where a four-layer diode serves as the timing control. Designed for simplicity, this

POWER SUPPLIES FOR LOGIC CARD SYSTEMS.

Now available in any current to 40 amps.

Current (amps)	Voltage (volts)	Model	Price
0.5	12	HT12-0.5A	\$75
1.5	12	HT12-1.5A	\$99
4.0	12	HT12-4.0A	\$138
8.0	12	HT12-8.0A	\$198
14.0	12	HS12-14.0	\$268
20.5	12	HS12-20.5	\$340
40.0	12	FS12-40.0	\$515

CONSOLIDATED AVIONICS



800 Shames Drive, Westbury, L.I., New York, (516) ED 4-8400

TWX: 510-222-6151

The modules shown on this page, designed specifically for logic card systems, are just part of Con Avionics' line of power supplies. Those shown all operate at 12 volts. (We make just as many at 3, 6, 18 or any other logic card voltage.) The modules have a combined line and load regulation of $\pm 0.05\%$.

Like all Con Avionics power supplies, these are unconditionally guaranteed for five years. Models with a current rating below 10 amps have a typical M.T.B.F. of 100,000 hours. Others have an M.T.B.F. of 35,000 hours.

You'll find Con Avionics supplies for relay applications, IC systems, or any systems requirement, all listed and priced in our Catalog 66A. For your copy, circle card, or write, call or TWX Mr. Gerry Albers.

ON READER-SERVICE CARD CIRCLE 41

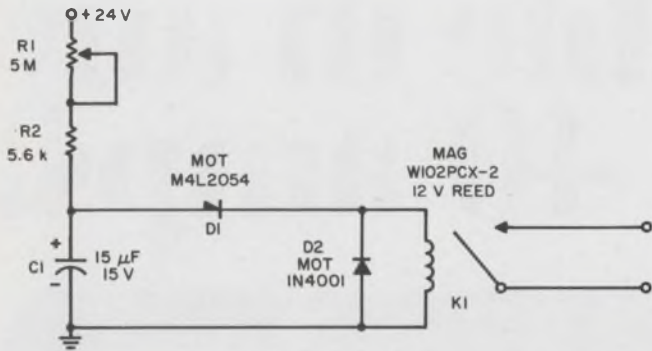

Four-layer diode oscillator drives reed relay directly, eliminating the need for a transistor driver stage.

circuit will provide repetitive closures at rates from 1 pulse/minute to 10 pulses/second.

In this circuit (see schematic) capacitor *C1* charges through *R1* and *R2* at a rate determined by the setting of the variable resistor, *R1*. When

C1 reaches 12 volts, four-layer diode *D1* turns on and discharges *C1* through reed relay *K1*, which it energizes. The relay remains energized until the discharge current drops below approximately 5 mA. At this point the four-layer diode switches off. Capacitor *C1* now begins a new charging cycle and the process is repeated.

The closure time of the relay is approximately 10 ms for all repetition rates. This time may be stretched by increasing the value of *C1*. Repetition rates lower than 1 pulse/minute may be achieved but the leakage of *C1* will determine the lowest frequency attainable. Care should be exercised not to exceed the relay's 12-VA contact rating.

David T. Krausman, Electronics Engineer, Pavlovian Laboratory, Johns Hopkins University, Baltimore.

VOTE FOR 116

Pulse generator uses IC logic

A low-level pulse generator with a variable period (600 ns - 6 µs) and a variable pulse width (20 ns - 120 ns) can be built with five CTµL packages for twenty-five dollars or less. This inex-

pensive circuit can eliminate the need for a piece of equipment that may cost a thousand dollars.

The circuit has the advantage of being directly applicable to CTµL integrated circuits, and is therefore extremely useful for breadboarding purposes.

The RC network of *R1* and *C1* furnishes the

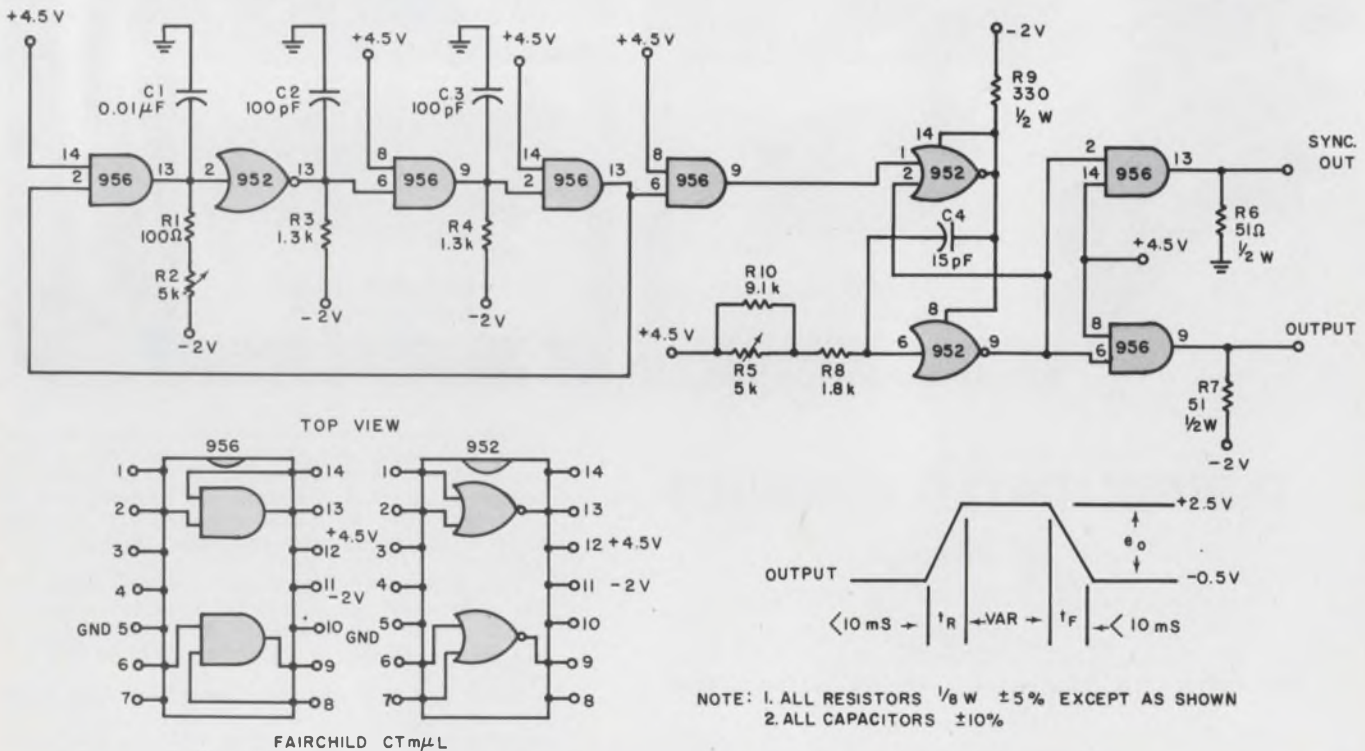

Low-level pulse generator uses a few ICs and discrete components. Pulse width is variable.

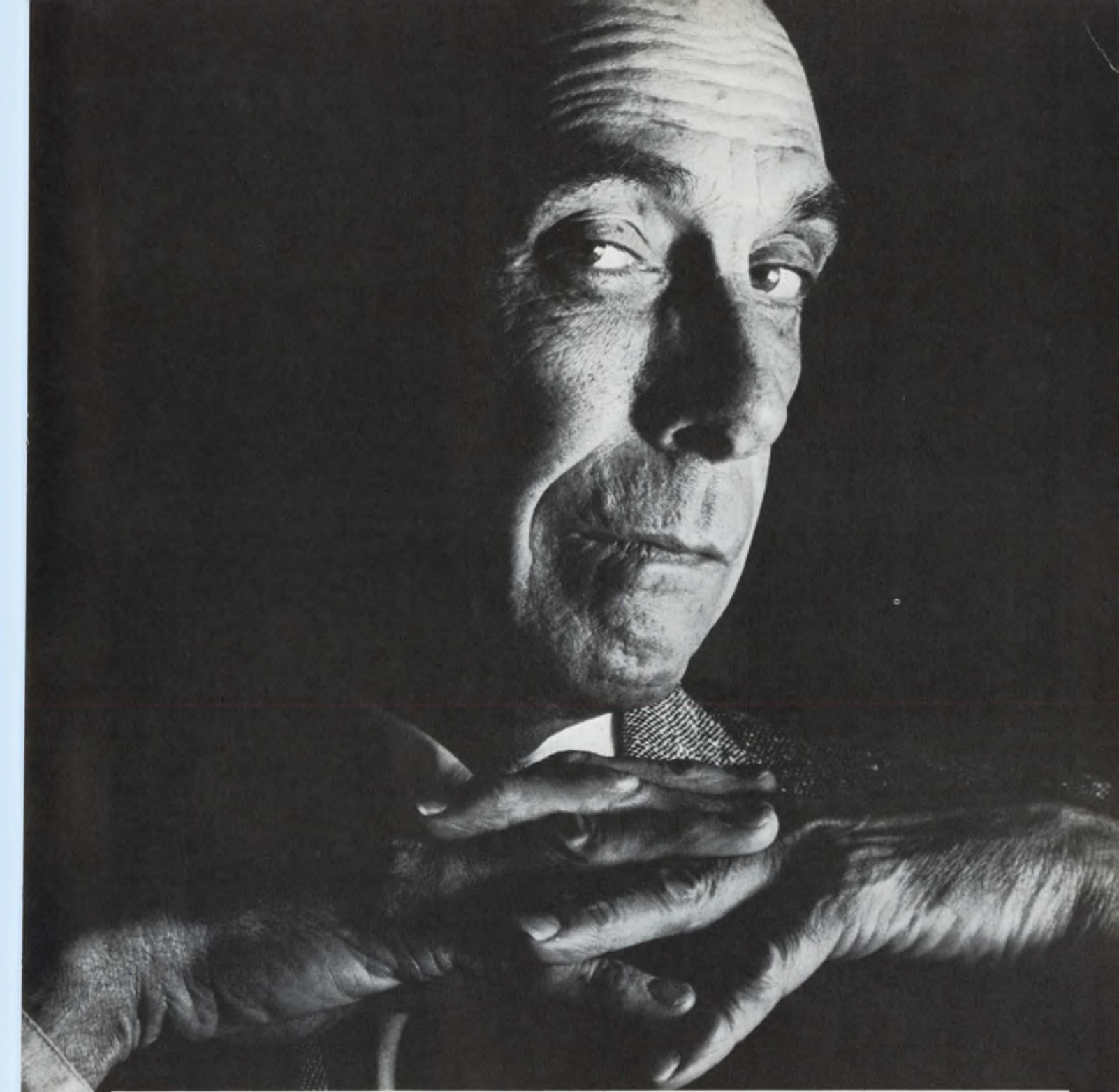

**Would you give
gallium arsenide
to your wife?**

Only if you were married to an optical encoder. Then she'd light right up. You see, gallium arsenide is the light source for the most desirable encoder you can acquire. Virtually unshockable. With dependability you can count on. Comes in sizes to your liking. Will do anything you ask. Add to this a long, carefree life and you begin to see how attractive the low ultimate cost of ownership will be. Come to Litton Encoder Division. Let us put you and gallium arsenide together for life. Encoder Division, 20745 Nordhoff St., Chatsworth, California.

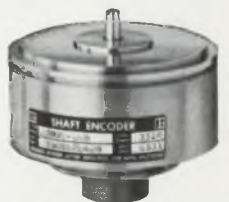

 **LITTON INDUSTRIES
ENCODER DIVISION**

frequency control. The RC networks of $R3C2$ and $R4C3$ provide the feedback loop with the extra delay needed for a wide frequency range. Use of a one-shot makes pulse shaping possible and yields frequency stability. It is the RC network of $R5C4$ in the one-shot that provides the variable pulse width. The last stage is used for the circuit drive and scope synchronization.

Richard Belanger, Fairchild Memory Products, Mountain View, Calif.

VOTE FOR 117.

Coupling circuit has dc dead zone

Pulses below a certain level or parts of a dc signal are often undesirable in an output signal. The undesirable information may be ignored in the following manner: A transistor is biased by $R1$ (see Fig. 1a) to some particular characteristic curve (Fig. 1b). Load resistor $R2$ is then chosen. As the input voltage increases, the output voltage remains negligible (point B in Fig. 1b) until the knee of the characteristic is reached. As the input is increased further, the output follows (point C in Fig. 1c). In this manner the initial part of the

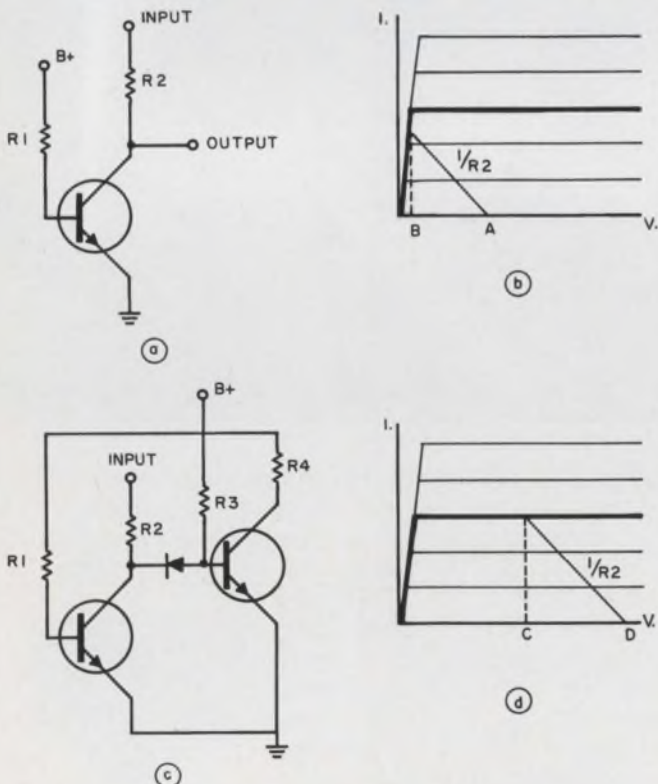

Coupling circuit with a dead zone used as a switch (d) relies on biasing determined by $R1$ and/or $R2$ (a) in accordance with the curves (b). (c).

dc signal is not recognized. The choice of $R1$ and $R2$ provides control over the portion of the dc signal not desired in the output. The advantage of this method is that the dead zone may be readily adjusted by varying $R1$ and/or $R2$.

If the coupling circuit is used as a switch, a simple method of coupling is shown in Fig. 1d, where the initial portion of the dc switching signal is ignored.

Ben A. Tripp, Test Set Engineer, Northern Electric Co. Ltd., London, Ont., Canada.

VOTE FOR 118

IC and four resistors compose inexpensive voltage regulator

A simple voltage regulator can be constructed by the addition of four resistors to an inexpensive RCA integrated circuit. A unique feature of the circuit is the use of one of the transistors as the voltage reference element.

It is not widely known that the reverse base-to-emitter breakdown characteristics of many types of transistor are similar to those of a Zener diode. A stable reference element can be obtained by taking advantage of the negative temperature coefficient of the collector-to-emitter junction in series with the reverse-biased base-to-emitter junction, which has a positive temperature coefficient.

The circuit with the values shown will provide a 9-volt dc output at currents up to 50 mA with an input of 12 to 20 volts dc. Under high-input-voltage conditions, the output current should be kept

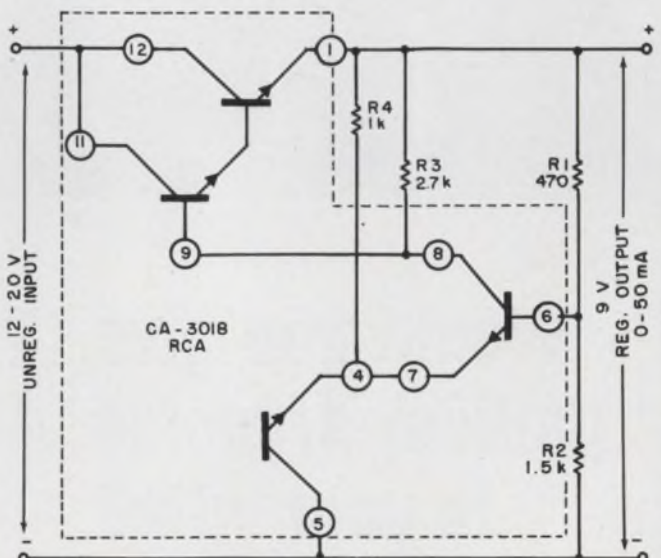

One IC and four resistors are all that is required to build a voltage regulator. Current output can be increased by addition of a pass transistor.



gets high!

the Highest-Rating Rectifier in the Industry!

**HIGH IN VOLTAGE!
HIGH IN TEMPERATURE!
HIGH IN DENSITY!**

Uni-Sel

**The Newest of Syntron's Fine
Selenium Rectifiers**

High Voltage! High Temperature! High Density! The Rectifier That Obsoletes All Other Selenium Rectifiers! Reduced Cell Sizes! Lower Unit Cost! Better Quality!

Available in all cell sizes with voltage ratings as high as 45 volts.

Write For Literature



SYNTRON COMPANY

283 LEXINGTON AVENUE • HOMER CITY, PA. 15748

TELEPHONE 412-479-8011

Sales Representatives Coast-to-Coast

67R4

low enough for the power dissipated in the IC not to exceed 300 mW, the maximum specified by the manufacturer.

Output current capability can be increased to 1 A by the addition of a pass transistor. The output voltage can be made variable by varying the ratio of $R1$ and $R2$. It should be pointed out that the reverse breakdown voltage varies from unit to unit, therefore the exact values of $R1$ and $R2$ must be determined for each individual IC.

Les Toth, Project Engineer, Diamond Electronics, Lancaster, Ohio.

VOTE FOR 119

Hybrid technique applied to a binary full adder

The application of hybrid circuits to the design of a binary full adder saves transistor count and minimizes delay. Such an adder has been designed with three Schmitt triggers¹ as shown. Arranging the triggers in parallel gives only one level of delay between the three inputs and the two outputs for the sum and carry. The high sensitivity of these triggers permits the designer to achieve identical input and output levels. Furthermore, the use of differential pairs rather than single transistors² makes the circuit inherently less temperature-sensitive.

All three input currents are tied to one common resistor. These currents, summed at a common input node, yield three discrete input voltage levels, and each trigger is set to fire at one of these levels. From the truth table it is known that the sum output must change state with each additional input. Each trigger has one output current that is in phase, and one that is out of phase, with the input. Therefore, the in-phase output of triggers 1 and 3 and the out-of-phase output of trigger 2 can be tied across a common resistor to add or subtract alternately an I_1 to produce the desired sum.

The carry output is simple to obtain since it follows the majority-logic rule. Two or more inputs yield a carry. Trigger 2, which switches with two input currents and does not change state after a third input appears, gives the desired carry.

Binary full adders, using AND/OR logic, typically require several stages of delay and more than six transistors. In the illustrated parallel arrangement either the in-phase or the inverted output of any current switch represents one stage of delay from the input. Consequently, both the sum and the carry have identical delays of only one stage. The direct feedback connections within

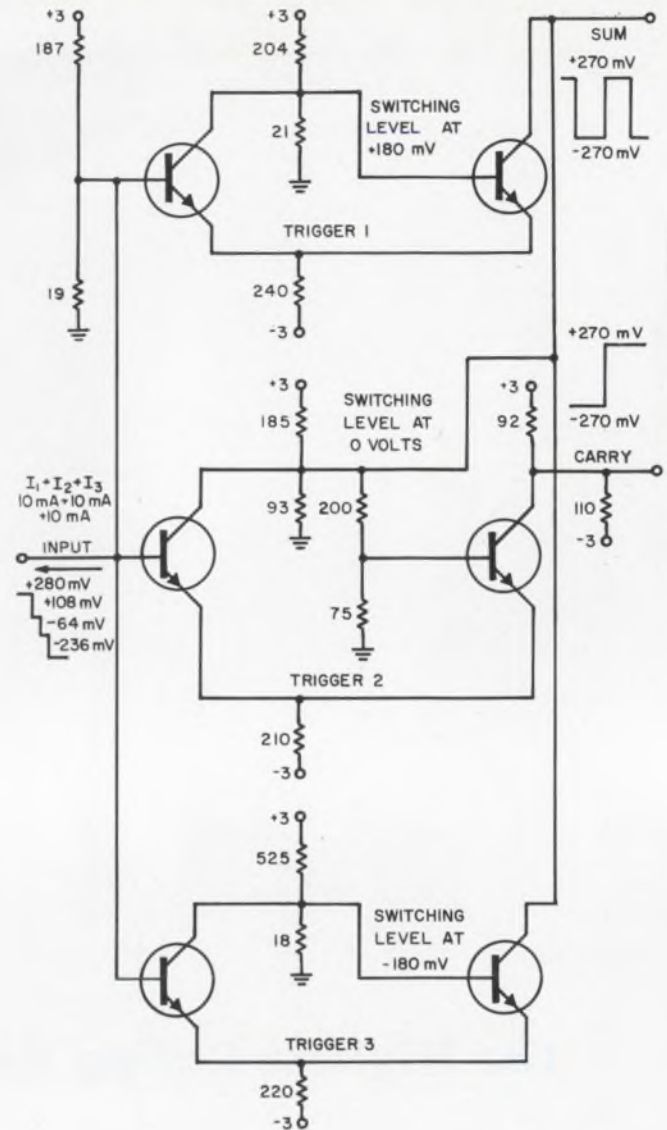

Identical delays of only one stage for both the sum and carry are possible with this circuit.

each level-sensitive switch limit the output amplitude to no more than the permissible forward bias from base to collector. Translating networks in the feedback loop would permit larger voltage swings.

References:

1. U.S. Patent No. 3,248,529.
2. S. C. Chao, "A Generalized Resistor-Transistor Logic Circuit and Some Applications," *IRE Trans. on Electronic Computers*, Vol. EC-8, No. 9, pp. 8-12.

Fred Hilsenrath, Systems Development Div., International Business Machines Corp., San Jose, Calif.

VOTE FOR 120

IFD Winner for Feb. 1, 1967

Jean F. Delpech, Institut d'Electronique, Orsay, France.

His Idea, "Simple thermometer converts temperature into voltage," has been voted the \$50 Most Valuable of Issue Award.

Cast Your Vote for the Best Idea in this Issue.

MAGNETIC INTERFERENCE STOPPED PERMANENTLY

by Netic Co-Netic Shields designed and fabricated by Magnetic Shielding Specialists

New shield designs meet the new shielding specifications... from a few gammas to several thousand gauss. Over 80% of all magnetic shield designs currently used were engineered and designed here. This design experience is at your service.

Sheet Stock also available.

Applications

Military Command & Control Systems • Strategic Systems • Tactical Systems • Computer Display Systems

Unique Features of Netic Co-Netic Shields

Provide permanently effective shielding • Insensitive to ordinary shock • Minimally retentive • Provide up to 80 db attenuation.

DELIVERY 3-4 WEEKS IN MOST INSTANCES

Request Short Form Catalog No. 67



Photomultiplier & CRT Shields

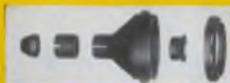

CRT Sectionalized Shields

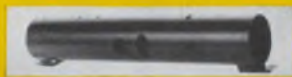

Scan Converter Tube Shields



MAGNETIC SHIELD DIVISION

Perfection Mica Company

1322 N. ELSTON AVENUE, CHICAGO, ILLINOIS 60622

ORIGINATORS OF PERMANENTLY EFFECTIVE NETIC CO-NETIC MAGNETIC SHIELDING

ON READER-SERVICE CARD CIRCLE 44

FREE TECHNICAL MICA MANUAL K-6

gives electrical and physical data on all types of mica

No tooling cost on numerous fabricated parts of natural and built-up mica.

Pre-punched insulating wafers to electrically isolate transistors, diodes, etc. from heat sinks.

Corrugated mica to reduce handling and fabrication costs for thermal elements.

All grades of mica offered.

Immediate delivery from stock on many items.

PERFECTION MICA CO.

1322 No. Elston Ave.

Chicago, Illinois 60622

Phone: 312, EV 4-2122

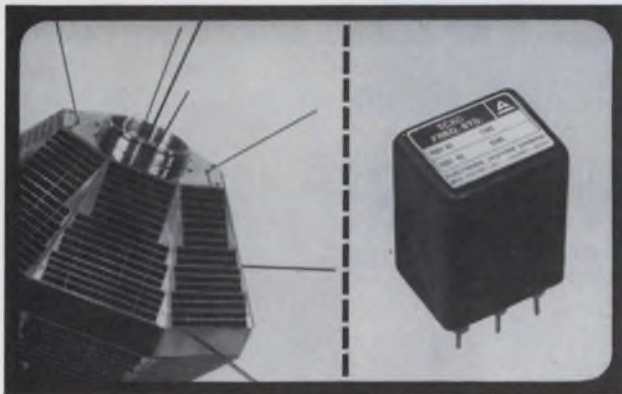

TEMPERATURE COMPENSATED CRYSTAL OSCILLATORS

New Arvin TCXOs solve frequency management problems with oven-like accuracy in miniaturized communications and aerospace equipment.

- Volume, to one cubic inch
- No oven required
- 1 Hz to 200 MHz frequency
- Low power drain
- To ± 5 PP 10^8 stability
- Instant warm-up

All circuit values are computer optimized to provide precise, stable frequency standards. Units may be specified to conform to commercial, MIL, or NASA specifications. Write for Bulletin TCXO 101.

ARVIN FREQUENCY DEVICES



2505 North Salisbury Street, West Lafayette, Indiana 47906

ON READER-SERVICE CARD CIRCLE 45

ELECTRONIC DESIGN 10, May 10, 1967

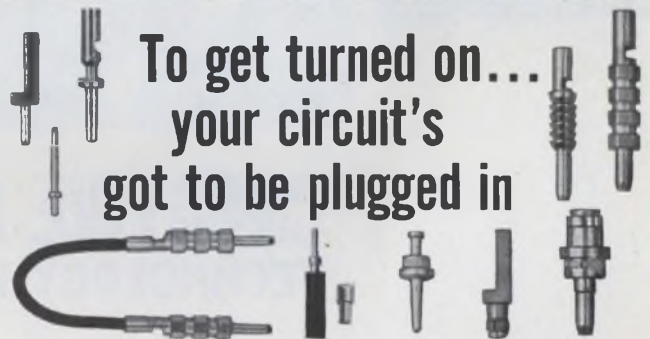

To get turned on... your circuit's got to be plugged in

And CAMBION®'s got all the plugs, jacks, patchcords, patch panels, patch strip assemblies and piggy-back set ups from .025" to .080" sizes (including 35 miniature types) — you need to make quick, tight, space-saving interconnections in both printed and conventional circuit designs.

What makes CAMBION connectors so special? CAMBION's unique 3 point contact cage jack design which combines low contact resistance with extremely high reliability. Full pressure contact is made with up to 60% of plug circumference compared with 5-10% in ordinary connectors. Proved in over 30,000 insertion/extraction cycles.

All CAMBION components meet or exceed the accepted military standards.

For complete details on all CAMBION connectors, call or write Cambridge Thermionic Corporation, 410 Concord Ave., Cambridge, Massachusetts 02138. Phone: (617) 491-5400. In Los Angeles, at 8703 La Tijera Boulevard 90045. Phone: (213) 776-0472.



Standardize on CAMBION . . . 21,541 guaranteed electronic components

ON READER-SERVICE CARD CIRCLE 46



Dr. Harold Goldberg.
Vice President and
Director, LTV Electro-
systems; General
Manager, Garland
Division; co-author of
"Principles of Guided
Missile Design."

THE EXCITING SURGE OF ELECTROSYSTEMS

CREATIVE SYNTHESIS: TECHNOLOGY IN MANAGEMENT

It's nice to have the boss speak your language.

Dr. Harold Goldberg, IEEE Fellow, weapons systems specialist, scientist and manager, typifies the technically oriented management at LTV ElectroSystems.

The Garland Division is drawing upon its experience in electronics and mechanics to penetrate new markets for its guidance systems, RF and specialized antennas, digital communications, electronic warfare systems, space systems, automatic controls, large-scale parabolic antennas and other advanced systems.

Never has the career opportunity been greater than it is right now at LTV ElectroSystems' Garland Division and throughout the entire company, where a whole new generation of electronic systems for military and civilian application is being developed.

LTV ElectroSystems has grown — in only nine years — from annual sales of \$12.7 million, less than 1,200 employees and one facility to last year's record sales of \$123 million, more

than 8,500 employees (over 2,300 of whom are scientists, engineers and technicians) and a complex of 12 major facilities in five states.

For scientists and engineers who prefer to work at the most advanced level of electronics technology, our Garland and Greenville divisions and the Continental Electronics subsidiaries offer diverse opportunities in an exciting and productive environment.

Specialists in the following (and related) disciplines are invited to examine the advantages of a career with LTV ElectroSystems: Analysis and design (RF and digital systems and circuits); electro-optics; transmitter design; airframe design; weights and stress analysis; electro-mechanical engineering; information theory; physics and scientific programming.

Write or call: Mr. Bill Hickey / Supervisor of Professional Placement / LTV ElectroSystems, Inc. / P. O. Box 6118 / Dallas, Texas 74222 / Telephone (214) 276-7111. An equal opportunity employer — m/f.

LTV ELECTROSYSTEMS, INC.
A SUBSIDIARY OF LING-TEMCO-VOUGHT, INC.

ON CAREER INQUIRY FORM CIRCLE 901

Free Career Inquiry Service

Absolutely Confidential

Respond to the career opportunities advertised in this issue. Fill out and send us this handy resume. **Electronic Design** will do the rest – neatly typed copies of this form will be mailed to the companies of your choice, indicated by the circled Career Inquiry Numbers at the bottom of this page.

10

Name				Home Phone	
Home Address (Street)			City	State	ZIP Code
Age	U.S. Citizen <input type="checkbox"/> Yes <input type="checkbox"/> No		Security Clearance		
Prime Experience			Secondary Experience		
Desired Salary			Availability Date		
Employment History – present and previous employers					
Company					
City, State					
Dates	to		to		to
Title					
Specialty					
Education – indicate major if degree is not self-explanatory					
Degree					
College					
City, State					
Dates	to		to		to
Additional Training – non-degree, industry, military, etc.					
Professional Societies					
Published Articles					

Career Inquiry Numbers:

- | | | | | | | | | | |
|-----|-----|-----|-----|-----|-----|-----|-----|-----|-----|
| 900 | 901 | 902 | 903 | 904 | 905 | 906 | 907 | 908 | 909 |
| 910 | 911 | 912 | 913 | 914 | 915 | 916 | 917 | 918 | 919 |

ELECTRONIC DESIGN

850 Third Avenue
New York, New York 10022

Oscilloscope tests semicons in circuit

Problem: Devise a method of testing semiconductors without removing them from the circuitry. Earlier techniques required semiconductors to be unsoldered from the circuit for checkout.

Solution: An oscilloscope, with specially developed test circuitry, checks the major parameters of transistors and diodes. With transistors, the approximate gain and linearity can be determined and pnp or npn types can be identified. With diodes, open or short circuits, and reverse polarity show up plainly. The condition and the estimated breakdown voltage may be obtained on low-voltage Zener diodes.

When a pnp transistor is under test, the emitter has a positive voltage applied through $R1$ and the collector is at a negative potential. Unless there is current flow in the base-emitter circuit, only a very small leakage current flows in the collector-emitter circuit.

Whenever the alternate half cycle makes the emitter positive, emitter-base current flows through $R3$ and $R4$ ($R3$ is used for current-limiting when $R4$ is at zero). The current flow is measured as a voltage across $R3$

and $R4$ at the horizontal terminals of the oscilloscope, and is a measure of the transistor's input current.

Since the collector-emitter circuit is forward-biased by $B1$, it follows that when base current flows, collector current flows through $R1$. This is the output current, which is read as a voltage at the vertical terminals of the oscilloscope. When the slope is 45° , it means that the input voltages are equal. The voltages depend on the current flow through resistors $R1$, $R3$ and $R4$. If $R4$ is set at zero to get a 45° slope, then there is 10 times the current flowing through output resistor $R1$ than through input resistor $R3$, to make their voltage drops equal. The output current is 10 times the input current, so the transistor has a current gain, β , of 10. As the value of $R4$ is increased to set the scope trace at 45° , the ratio of the output current to input current goes up. With a numbered dial plate under knob $R4$, the approximate gain can be read.

During calibration, when switch S is closed, equal voltage appears across $R1$ and $R2$, resulting in equal deflection voltages across the scope's horizontal and vertical inputs. (The scope sweep-selector must be set

to horizontal input or external sweep.) Through adjustment of the scope vertical and horizontal gain controls, a sloping 45° line can be obtained on the screen. This sets the scope controls for equal gain on the vertical and horizontal channels.

When testing a low-voltage Zener diode, the horizontal leg will break down at some distance from the junction if the Zener is rated at less than 10 volts. Higher back resistance shows up on the trace as a downward slant of the horizontal leg. With poor forward resistance, the vertical leg slants to the right.

In-circuit testing will reveal these traces if the circuit resistance is more than the component under test; if not, the trace will vary by the degree of external circuit properties. When the printed-circuit board has more than one identical circuit, it is a simple matter to compare these, to find a bad component.

When testing a diode, apply 6.3 Vac to the diode. The positive half cycle forward-biases the diode and the negative half cycle reverse-biases it. When the diode is conducting, it is the same as short-circuiting the scope's horizontal terminal to ground, and the full voltage will appear across $R1$. The scope shows only a vertical line under these conditions. However, when the diode is not conducting, there is no current flowing through $R1$ and therefore there is no vertical deflection, but full horizontal deflection. When the recurrent half cycles are combined in the scope trace, the pattern is half vertical and half horizontal for a perfect diode. The poorer the diode, the less perfect is the pattern.

Inquiries concerning this invention may be directed to: Technology Utilization Officer, Marshall Space Flight Center, Huntsville, Ala. 35812 (B66-10447).

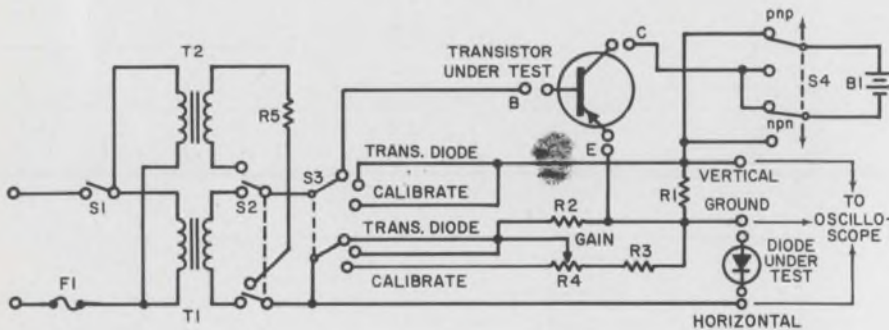

AT 45° BETA IS 10 IF $R4$ IS AT 0



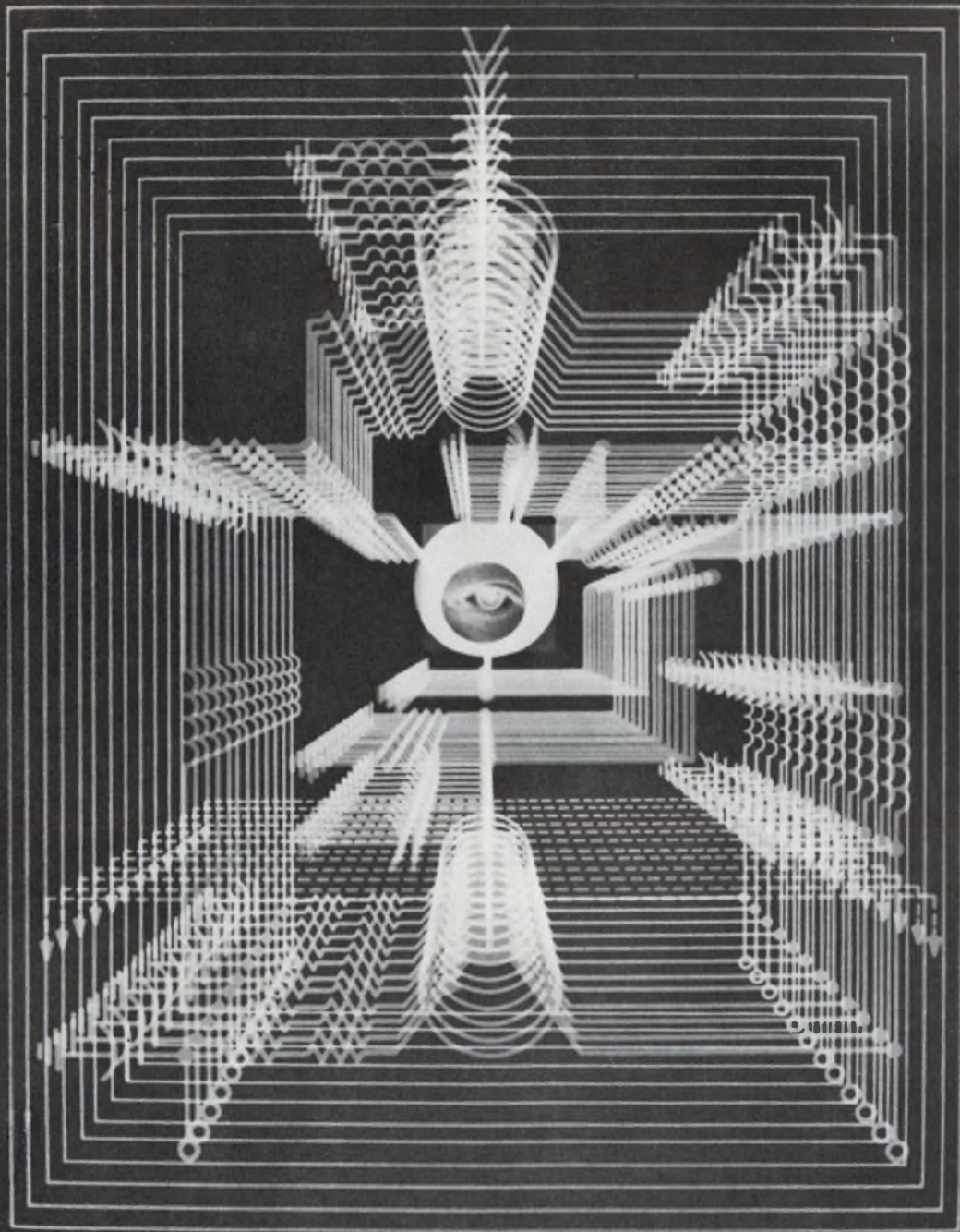

Look into the vehicles of opportunity at Lockheed...for circuit designers.

Opportunity broad enough to interest every circuit designer, that's the sweep of electronics assignments at Lockheed. Big, wide-ranging programs that extend from deep sea to deep space. And with ever-growing commitments comes an increasing need for new concepts and major technical advances in flight controls, communications, antennas and state-of-the-art electronics checkout equipment in both spacecraft and fleet ballistic missiles. In addition to its major vehicle programs... Agena, Poseidon, and Polaris, Lockheed is involved in deep submersibles; unique advanced land vehicles; information systems for states and hospitals; and many other technically alluring programs. For complete information, write Mr. R. C. Birdsall, Professional Placement Manager, P.O. Box 504, Sunnyvale, California. Lockheed is an equal opportunity employer.

LOCKHEED

MISSILES & SPACE COMPANY

A LOCKHEED COMPANY OF LOCKHEED AIRCRAFT CORPORATION

ON CAREER INQUIRY FORM CIRCLE 902



CIRCUIT DESIGN

The strictly realistic art of circuit design relates directly to our projects in inertial guidance and digital computer systems. If you have fine-line experience in the design and development of micro-electronic circuits for servo, analog and digital applications, write Mr. Frank R. McCarter.

— An equal opportunity employer M/F —



LITTON INDUSTRIES, Guidance & Control Systems Division
5500 Canoga Avenue, Woodland Hills, California

ON CAREER INQUIRY FORM CIRCLE 903

Book Reviews

Audio-frequency applications

Transistors for Audiofrequency: Audiofrequency Amplification, G. Fontaine (Hayden Book Co., New York), 384 pp. \$7.95.

This is a very detailed study of the principles of audio-frequency applications of the transistor. A thorough explanation is given of the significance of the various parameters and characteristics specified by the manufacturer, and the various ways in which these can be used in the design of an audio-frequency stage. Despite the nicety of many of the arguments, the calculations are kept simple enough for the reader to follow, while all phenomena of particular interest are explained with the aid of physical models. The first chapter stresses the importance of concentration curves, a relatively new means of explaining both static and dynamic effects, which can also serve for a qualitative explanation of the capacitive effects encountered in semiconductors.

Systems theory

Networks and Systems, Peter H. O'N. Roe (Addison-Wesley, Reading, Mass.), 336 pp. \$12.50.

The primary purpose of this text is to give insight into a unified discipline of physical systems theory, without resorting to the traditional methods that depend on converting one kind of system into another by means of analogies. Writing with an operational point of view, which utilizes only measurable variables, the author leads to a concise, precise method that encompasses RCLM network theory (including transistors, etc.) and is easily extended to deal with other kinds of systems. The most efficient methods for network and systems analysis and precise criteria for their use are given. A special feature of the book is the inclusion of state equations.

Requirement: Maximize radiation coverage and at the same time minimize aerodynamic problems in missile telemetry and command oper- ational tests.

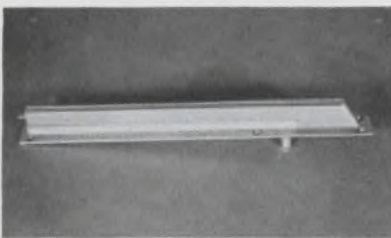

Solution: Amecom's Blade Antennas that provide horizontal and vertical polarization; 2% bandwidths tunable over a 15% band, with less than 2.0:1 VSWR.

Units are currently available for 250, 400 and 1000 megacycle operation.

The simple construction of these antennas gives them excellent reliability in missile environments with no change in VSWR or bandwidth.

Their low silhouette configuration minimizes drag and instability effects on a missile.

Present units have operated during missile reentry conditions, and designs that use Amecom's spacecraft reentry antenna construction techniques are available for even higher temperatures.

The Problem Solvers of Amecom's Antenna Systems Department will be pleased to review the hard-to-meet antenna requirements in your missile, rocket or space program.

Call or write: Amecom Division, 1140 East-West Highway, Silver Spring, Md. 20910, Tel: (301) 588-7273.

AMECOM 
DIVISION OF LITTON INDUSTRIES

ON READER-SERVICE CARD CIRCLE 156

When you're as busy as we are, it's hard to toot your own horn.

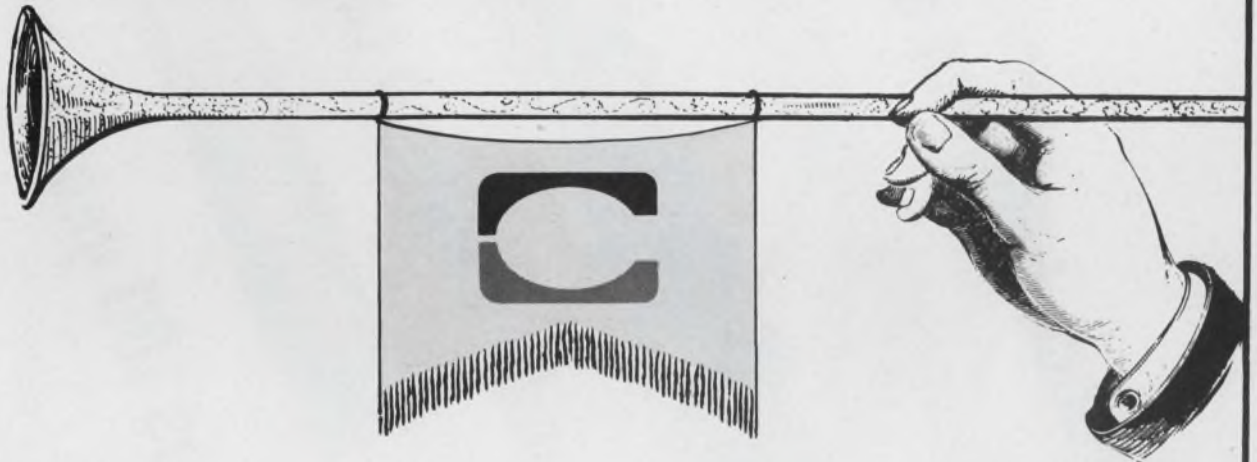

It's not as though we couldn't. We have plenty to be proud of.

It wasn't long ago that the astronauts trained in Mercury and Gemini Simulators that were developed and produced by Conductron engineers, for McDonnell. Aboard the Gemini flights, they used our Orbital Timing Device. Very soon, commercial and Air Force pilots will be training in Boeing 727, 737; Douglas DC8, DC9; and Lockheed C5A Simulators produced by the St. Louis-based Conductron-Missouri.

But this is just one aspect of our electronic capabilities. Conductron pioneers in the design, development and manufacture of a wide range of special-purpose electromechanical systems; interface equipment; and components, including microminiaturized circuits.

To provide our ever growing list of customers with electronic products for defense, space, commercial and institutional markets, Conductron is expanding its horizons. Right now, we are active in communications, data systems, microelectronics, avionics and aerospace ground support systems. Conductron is also producing landmass and radar operator training simulators.

We have nearly \$2 million invested in the most modern test equipment for the use of our engineers. With 383 engineers and scientists and the need to double this professional force in just three years, you can foresee the opportunity we offer for promotion.

Located in suburban St. Charles, just 22 freeway miles from downtown St. Louis, Conductron-Missouri is just minutes from the outstanding cultural, educational, and recreational activities of the Gateway City.

If you are a graduate engineer with 2 to 5 years experience, who is interested in an outstanding growth opportunity with a leader in the electronics industry, we have current openings in these categories:

**SYSTEMS, ELECTRONIC or ELECTRICAL
ENGINEERING • MATH MODELING • SCIENTIFIC
PROGRAMMING • LOGIC DESIGN • MECHANICAL,
RELIABILITY or MAINTAINABILITY ENGINEERING
MANUFACTURING ENGINEERING • OPTICS
COMMUNICATIONS • ENVIRONMENTAL TESTING**

Send your résumé in complete confidence to Mr. Thomas Walenga, Professional Employment Office, Dept. _____.



CONDUCTRON-MISSOURI

Division of Conductron Corporation

2600 N. Third Street • Box 426 • St. Charles, Missouri 63301

We are and always have been an equal opportunity employer

The difference between a terminal strip

and a Deutsch terminal junction

is 100 years



Terminal strips haven't changed much since Faraday (1791-1867). The wires need soldering, wrapping or splicing and lugging. The strip needs potting or shielding when there's no air for insulation. The result is prone to trouble.

Difficult to maintain and inspect. And it all takes more tools, more time, and more money than you need spend.

Today Deutsch makes Terminal Junctions which end all that.

The wires are prepared with one standard crimping tool. Deutsch Terminal Junctions meet most Mil Spec connector environmental and electrical performance specifications.

The result is trouble-free. Easy to maintain. Easy to inspect.

And connections and disconnections are made with one cheap expendable tool.

Deutsch Terminal Junctions come in modules holding up to 8 wires each. You can fit 64 wires in the space a terminal strip would take for 28. And Deutsch T. J.'s gang in multi-module strips to let you interconnect and terminate as many wires as needed. Deutsch Terminal Junctions are the cleanest, fastest, most reliable way to make terminations.

They take one quarter the time, one quarter the space and are one fifth the weight.

There is also a complete line of Deutsch Rear Release products including feed-throughs, Jiffy Junctions[®] adaptor junctions, step-downs, grounding junctions, and component terminations.

Write Deutsch, Electronic Components Division, Municipal Airport, Banning, California for more information on them all.

Do it now—before you specify another terminal strip.



DEUTSCH

Electronic Components Division, Municipal Airport, Banning, California

ON READER-SERVICE CARD CIRCLE 47

Products



Sharply etched IC lead frames obtained with Fe-Ni-Co glass-metal sealing alloy. Page 163

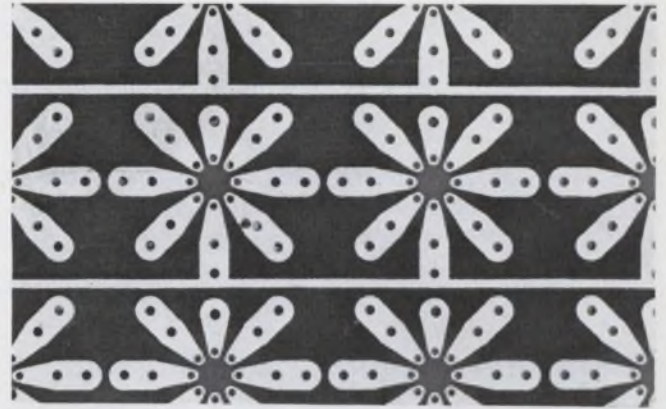

Breadboard integrated circuit prototypes with glass-epoxy module cards. Page 162

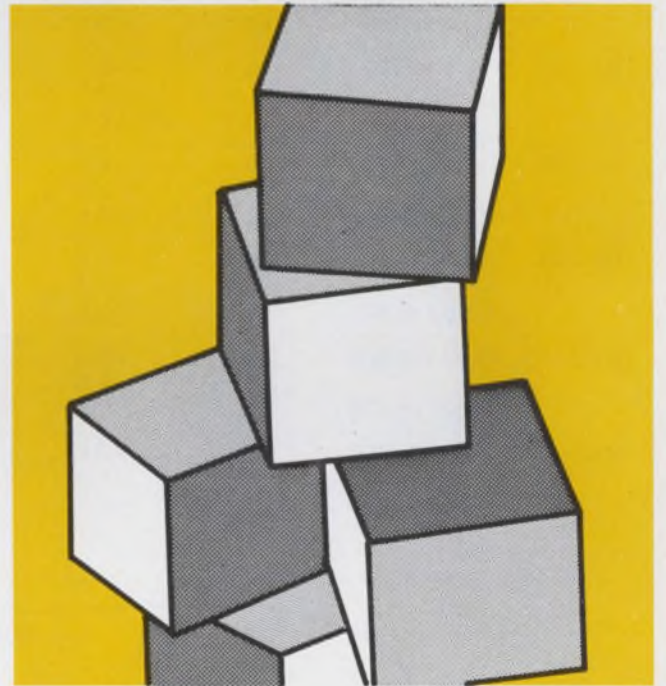

RF amplifier building blocks are cascaded to get gains ranging to 60 or 70 dB. Page 108

Also in this section:

Accessory adapts oscillograph for simultaneous microfilming. Page 144

Water-cooled SCRs are rated at 630 amps. Page 172

Design Aids, Page 180 . . . New Literature, Page 182

Cascaded RF amplifier modules yield gain to 70 dB

Avantek, Inc., 2981 Copper Rd., Santa Clara, Calif. Phone: (408) 739-6170. P&A: \$125 to \$140; stock to 30 days.

A series of RF amplifier modules each provide 10-dB gain, flat within 1 dB over a multi-octave range. In addition, the modules may be cascaded, without impedance-matching

problems, to achieve any amount of gain from 10 to 60 or 70 dB. Dubbed "Unit Amplifiers" (a "unit" of gain being 10 dB), the wideband building blocks range from 1 kHz to 500 MHz. Full specs are given in the Table.

Gain cascading has been easily achieved in dc, video or operational amplifiers. However, over such a

wide RF spectrum, difficulties of interstage impedance-matching have made cascading to get gain as high as 70 dB impractical. The manufacturer, Avantek, Inc., uses unique feedback and input-output matching networks (patents pending) and stripline circuitry to achieve the excellent impedance-matching. Input and output impedance levels are 50 Ω for all modules.

Conventional RF amplifiers generally cover an octave or less, provide 20 to 30 dB gain, exhibit high vswr and show passband flatness of 2 to 4 dB. Cascading those units causes considerable degradation of these parameters. On the other hand, the Unit Amplifier may be cascaded and still maintain the exceptional gain flatness (Fig. 1).

Six module types (UA101 through 106) are now available. An AGC module, with the same good flatness over a 10-to-500-MHz range, and a 1-to-1000-MHz module are in the offing. Avantek is also working on a module capable of delivering 20-dBm output at the 1-dB compression point over 10 kHz to 400 MHz.

In practice, the user would generally cascade units of increasing output power levels, +5 dBm being the highest power module at this time. The units can be used as an integral part of the user's electro-mechanical layout or housed in available cases; or, filters, attenuators, mixers and detectors may be integrated with the modules.

Input power requirement is +12 Vdc at 10 mA. Stripline solder tabs on each module are supplied for RF connections.

CIRCLE NO. 250

Table. Unit amplifier specifications

Model	Frequency (MHz)	Gain (dB)	Flatness (dB)	NF (dB)	P_{out} for 1 dB gain comp. (dBm)
UA-101	5 to 500	10.5	+0.5 -1.0	5.5	-14
	10 to 400	10.5	± 0.5	4.5	-14
UA-102	5 to 500	10	+0.5 -1.0	6.5	-4
	10 to 400	10	± 0.5	5.5	-4
UA-103	10 to 500	10	+0.5 -1.0	8.5	+5
	20 to 400	10	± 0.5	7.5	+5
UA-104	0.001 to 500	10.5	+0.5 -1.0	5.5	-14
	0.002 to 400	10.5	± 0.5	4.5	-14
UA-105	0.001 to 500	10	+0.5 -1.0	6.5	-4
	0.002 to 400	10	± 0.5	5.5	-4
UA-106	0.002 to 500	10	+0.5 -1.0	8.5	+5
	0.005 to 400	10	± 0.5	7.5	+5

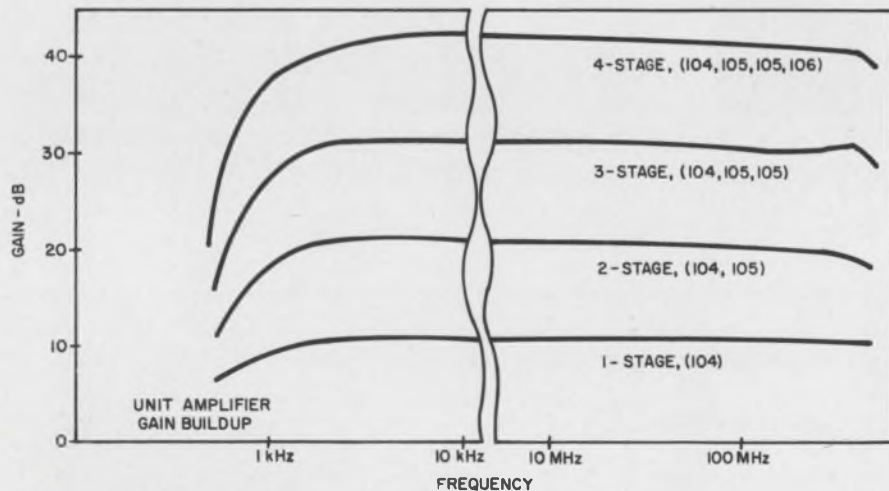

1. Each additional amplifier module cascaded adds 10 dB of gain. Response is flat from a few kHz to beyond 100 MHz.

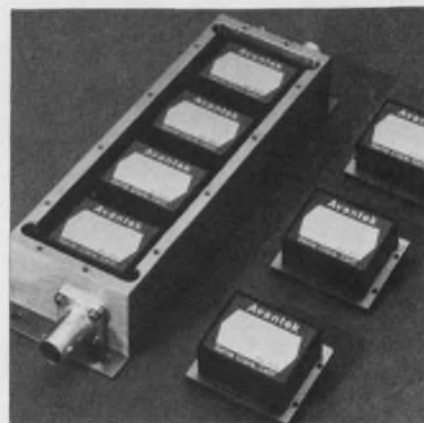

2. Four-module stage amplifier provides 40 dB from 1 kHz to 500 MHz. RF input connector is BNC but other options are available.

Second
Editions



A free post-graduate course in money-making

Some people think of Digital Equipment as a manufacturer of digital computers and modules for the university and scientific community exclusively. They're wrong.

Since the PDP-8/S was introduced in August of 1966, more than 300 such machines have been sold to be part of other people's money-making devices — blood analyzers, X-ray diffractometers, spectrum analyzers, batch controllers for cookie baking. One pipeline manufacturer ordered 25 PDP-8/S computers just to log data. (PDP-8/S is the world's first under-\$10,000 computer.)

For bigger, faster problems, the bigger, faster PDP-8

has been incorporated into money-making automatic transistor check out equipment, petroleum controllers, thickness testers for rolled steel. (PDP-8 costs \$18,000.) PDP-9 is bigger yet.

And modules. We sell more digital logic circuit modules to manufacturers who resell them as part of their instruments and systems than to all our university customers combined.

So we're very big in the universities. True.

But if you make instruments or systems (and particularly if you sell these instruments to the scientific disciplines) maybe you should discover us. Before we get too well known.

digital
MODULES • COMPUTERS

DIGITAL EQUIPMENT CORPORATION, Maynard, Massachusetts 01754. Telephone: (617) 897-8821 • Cambridge, Mass. • New Haven • Washington, D.C. • Parsippany, N.J. • Rochester, N.Y. • Philadelphia • Huntsville • Pittsburgh • Chicago • Denver • Ann Arbor • Houston • Los Angeles • Palo Alto • Seattle • Carleton Place and Toronto, Ont. • Reading, England • Paris, France • Munich and Cologne, Germany • Sydney and West Perth, Australia • Modules distributed also through Allied Radio

GLASS ENCLOSED Thermostatic DELAY RELAYS



by
AMPERITE



Offer true
hermetic
sealing —
— assure
maximum
stability
and life!

Delays: 2 to 180 seconds

Actuated by a heater, they operate on A.C., D.C., or Pulsating Current... Being hermetically sealed, they are not affected by altitude, moisture, or climate changes... SPST only — normally open or normally closed... Compensated for ambient temperature changes from -55° to $+80^{\circ}$ C... Heaters consume approximately 2 W. and may be operated continuously. The units are rugged, explosion-proof, long-lived, and inexpensive!
TYPES: Standard Radio Octal and 9-Pin Miniature... List Price, \$4.00
PROBLEM? Send for Bulletin No. TR-81.

AMPERITE

BALLAST REGULATORS

Hermetically sealed, they are not affected by changes in altitude, ambient temperature (-50° to $+70^{\circ}$ C.), or humidity... Rugged, light, compact, most inexpensive.

List Price, \$3.00

Write for
4-page
Technical
Bulletin
No. AB-51

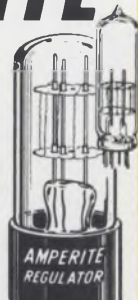
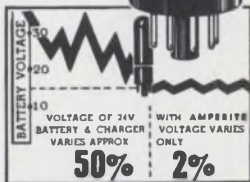

AMPERITE

600 PALISADE AVE., UNION CITY, N.J. 07087

Telephone: 201 UNION 4-9503

In Canada: Atlas Radio Corp., Ltd.,
50 Wingold Ave., Toronto 10

ON READER-SERVICE CARD CIRCLE 49

COMPONENTS

Transient-free switch closes on null voltage



Genistron Div., Genisco Technology Corp., 18435 Susana Rd., Compton, Calif. Phone: (213) 774-1850.

Suitable for operation with currents from 0.1 to 50 A, this transient-free switch eliminates high-frequency contact bounce, preventing spike deterioration and increasing the reliability of any component with which it is used. Because no mechanical contacts in any form are utilized, the switch also completely eliminates arcing normally encountered in electrical circuits. Sensing the point at which the line voltage goes to zero, the switch allows current flow only after the null voltage is reached.

CIRCLE NO. 251

Submin edgewise meter sensitive to 400 μ A

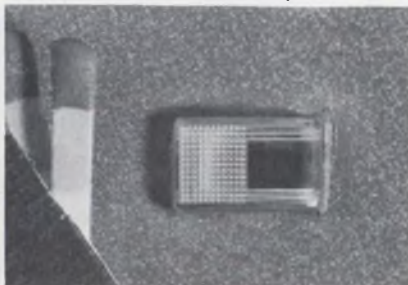

International Electronics Corp., 316 S. Service Rd., Huntington Station, Melville, N. Y. Phone: (516) 694-7700. P&A: \$1 to \$3; 60 to 90 days.

Subminiature edgewise indicating meters have a sensitivity of 400 μ A and an insulation resistance of $650 \Omega \pm 20\%$ at 20° C. Physically, the back-of-panel meter measures 0.67 x 0.669 inches with a 0.69-inch depth. The 0.09-inch diameter mounting holes are on a 0.945-inch center.

CIRCLE NO. 252

TO-5 can houses tiny crystal oscillator



Marconi Co., Ltd., Chelmsford, Essex, England.

Completely sealed inside a tiny TO-5 can, this "micro-oscillator" consists of an IC feedback amplifier with a crystal mounted above it. The microcircuits are attached to the TO-5 header in the normal position, while the crystal is supported on its two connections to this circuit. A fifth overtone, AT-cut crystal is used to give an oscillator frequency of 100 MHz, and an external inductor and trimming capacitor are necessary. Frequency range is 60 to 140 MHz and power consumption is 40 mW.

CIRCLE NO. 253

Thermal time-delay for electrical systems



Sylvania Electric Products, Inc., Lighting Products Div., Danvers, Mass. Phone: (617) 774-6000.

A thermal time-delay relay for on-off control of electrical systems is offered. It is a compact bimetal unit that inhibits current flow from three to 30 seconds when used in applicable electrical systems. It operates on 6- to 18-Vdc power sources.

CIRCLE NO. 254

Let Honeywell extend your EMI measuring capabilities with these off-the-shelf products.

RG-3 INTERFERENCE RASTER GENERATOR – For determining sources of interference signals from computers, voice and digital communications, and telemetry.



\$1365

4856 WIDEBAND RASTER GENERATOR – Designed for the same applications as the RG-3, but with wideband (25MHz) capability, solid-state electronics, and 50 ohm input.



\$1645

AW-204 TRANSISTORIZED WIDEBAND AMPLIFIER – Used as a preamplifier with standard EMI meters and calibrated signal sources to provide rapid, remote measurement of extremely low level electric field signals in the 14kHz – 30MHz frequency range.



\$880

2854 WIDEBAND AMPLIFIER – A high gain, low noise, video amplifier used to detect low level wideband signals. Solid-state electronics; 1kHz – 10MHz frequency range.



\$1070

2855 ASSOCIATED PREAMPLIFIER – For matching rod antenna impedance to 50 ohm input of receivers or amplifiers (typically Honeywell 2854). Low noise solid-state electronics with self-contained battery; 300Hz – 10MHz frequency range.

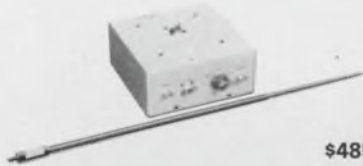

\$485

4857 LOW FREQUENCY IMPULSE GENERATOR – Provides flat spectrum of calibrated amplitude signals in 120Hz – 250kHz range for signal substitution or calibration of receivers and field intensity meters. Solid-state electronics.



\$550

PLT-1/PP REGULATED AC POWER SUPPLY – A solid-state, 60Hz, 115v rms supply for use in any application requiring extreme amplitude and phase stability. Low distortion; 1 KVA.



\$2450

3858 – 3861 LOW FREQUENCY POWER LINE IMPEDANCE STABILIZATION NETWORKS – Used for conducted interference testing of equipment requiring high level input power line current. Frequency range: 14kHz-5MHz; 50ohm line impedance.



\$230 – \$290

3862 HIGH FREQUENCY POWER LINE IMPEDANCE STABILIZATION NETWORK – Same as 3858 – 3861 networks, but for 4MHz – 1GHz frequency range; 80 amp capability.



\$220

Honeywell engineers sell solutions

The instruments shown here are more examples of how Honeywell's broad line, backed by local sales and service, can provide the *precise* solution to your instrumentation problems. For full details on any or all of these fine products, call your local Honeywell Representative, or write: Honeywell, Test Instruments Division, Annapolis Operation, Box 391, Annapolis, Md. 21404.

Honeywell

ON READER-SERVICE CARD CIRCLE 50

Looking for a fast & precise way to...

- test crystal devices?**
- identify frequency?**
- determine signal purity?**
- check dynamic impedance?**
- find band-pass filter response?**
- equalize transmission lines?**
- align a color TV tuner?**

Those assignments, plus a few thousand others, are routine for a Telonic Sweep Generator. You'll find the above applications and many more described in detail in Catalog 70. Also included are specifications for all Telonic Sweep Generators and Accessories, data on sweep generator operation, and frequency marking techniques. Send for a copy.

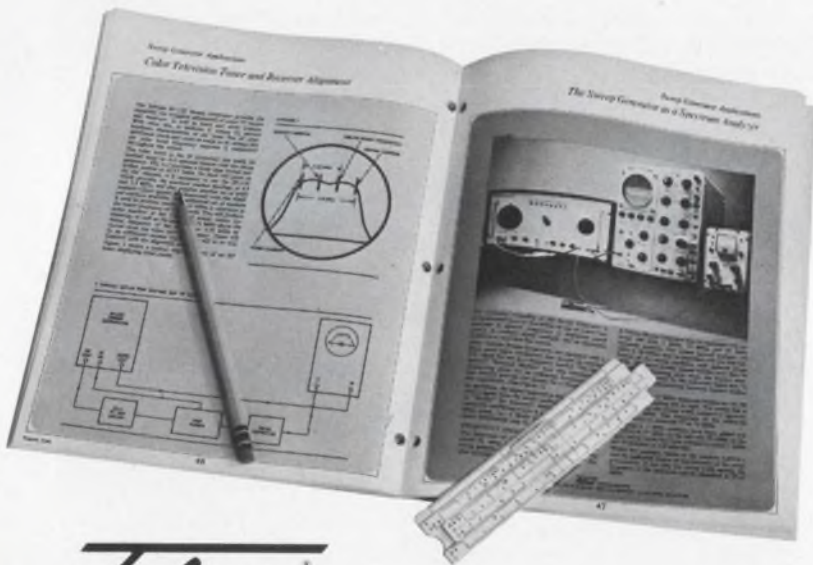

Telonic INSTRUMENTS

A DIVISION OF TELONIC INDUSTRIES, INC.
60 No. First Ave., Beech Grove, Indiana 46107. TEL: (317) 787-3231 TWX - 810 - 341-3202



Telonic INSTRUMENTS

60 No. First Ave., Beech Grove, Indiana 46107
TEL: (317) 787-3231 TWX - 810 - 341-3202

Yes, send a copy of Catalog 70, Sweep Generators and their Application, to

Name _____
Firm _____
Address _____
City _____ State _____ Zip _____

ON READER-SERVICE CARD CIRCLE 51

COMPONENTS

Industrial op-amp priced at \$8

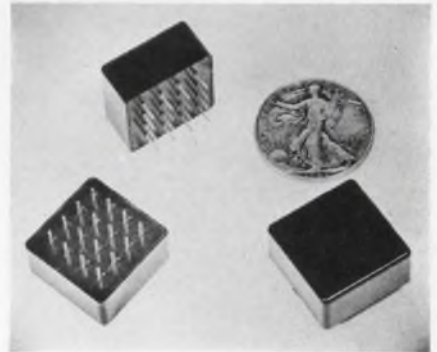

Optical Electronics, Inc. P. O. Box 11140, Tucson. Phone: (602) 624-3605. P&A: \$8 (10 lots); stock.

A low-cost single-ended input and output op-amp is designed for inverting applications where the closed loop gain is not higher than 5. Applications include a dc-to-1-MHz, 60-dB logarithmic amplifier, fast integrator, differentiator, summing amplifier, voltmeter or sine wave oscillator. Input impedance is 30 k Ω , output impedance is 100 Ω , unity gain frequency is 10 MHz, slewing rate is 30 V/ μ s and output swing is ± 5 V.

CIRCLE NO. 255

Heat dissipators are liquid-cooled

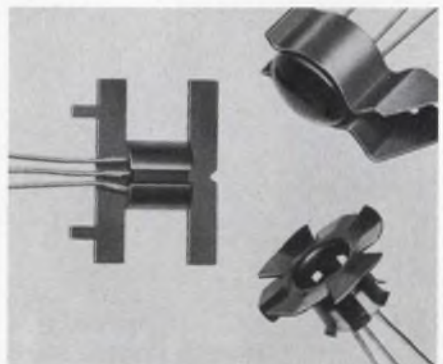

International Electronics Research Corp., Division of Dynamics Corp. of America, 135 W. Magnolia Blvd., Burbank, Calif. Phone: (213) 849-2481.

Utilizing any normal coolant, these heat dissipators require only 42 to 45 in³ for dissipation of 1000 W. Applications include use as dissipators for high power, high duty cycle power systems and in laboratories as water-cooled, constant-temperature heat sinks.

CIRCLE NO. 256

An open metal carrying case is shown from a high-angle perspective. Inside the case, several memory modules are stacked in a tray. The modules are densely packed with electronic components. The case has a handle on the right side and a latch mechanism. The background is a plain, light-colored surface.

**if you're ready to buy
the smallest, fastest
military memory available,
put on the coffee and call us.
we'll be right over.**

Our SEMS 5 weighs less than 7 pounds, operates on 60 watts maximum at a data transfer rate of 16,000,000 bits per second. It has a 2 μ sec cycle time and stores 4096 words of 32 bits. Capable of taking a bruising 30g's vibration, it meets all applicable portions of MIL-E-5400, MIL-E-4158 and MIL-E-16,400.

Our number: (213) 772-5201. That's black, one sugar.

EM electronic memories

12621 Chadron Avenue, Dept. 3E,
Hawthorne, California 90250

ON READER-SERVICE CARD CIRCLE 52

**for fast
delivery of
cables up to
2" in diameter
with virtually
any number
and any type
of conductors**

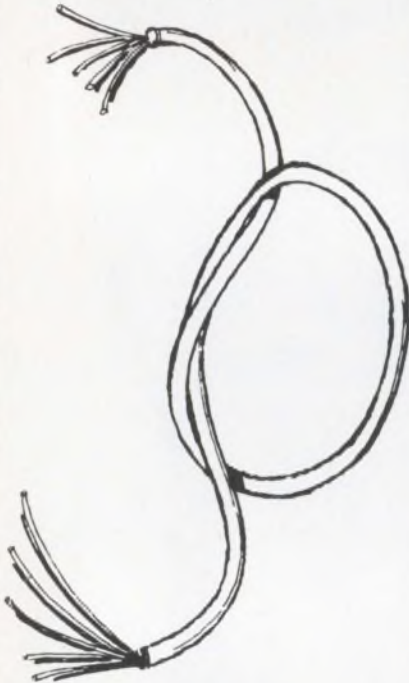

**tie-in with
Columbia Wire,
they deliver
what you need.**

write for our fully-illustrated catalog



Columbia
WIRE PRODUCTS COMPANY
2850 Irving Park Rd. • Chicago, Ill. 60618

ON READER-SERVICE CARD CIRCLE 53

COMPONENTS

**Crystal oscillator
for 4-to-50-MHz range**



Accutronics, Inc., 12 South Island Ave., Batavia, Ill. Phone: (312) 879-1000.

A low-profile crystal oscillator features frequency tolerances of $\pm 0.005\%$ from -20° to 60°C in the frequency range of 4 to 50 MHz. The series is applicable to PC boards and is for driving RTL, DTL and T²L logic. Typical output voltage is 3 to 6 V peak, depending on the logic used. The dimensions are 1-1/2 x 1-1/2 x 1/2 in., depending on frequency and whether flange or stud mounting is used.

CIRCLE NO. 257

**Photodetector mounts
in TO-5 can**

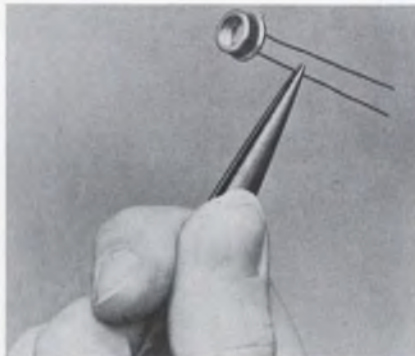

United Detector Technology, P.O. Box 2251, Santa Monica, Calif. Phone: (213) 457-2314.

The PIN-5 photodetector features standard transistor mounting in a low profile TO-5 can. Response of the PIN-5 is from the ultraviolet to the near infrared range; detectivity is as large as that of PbS. The dark current is less than $0.5 \mu\text{A}$ and the light current from a few foot-candles illumination is greater than $10 \mu\text{A}$.

CIRCLE NO. 258

**Cabled connectors
meet MIL specs**

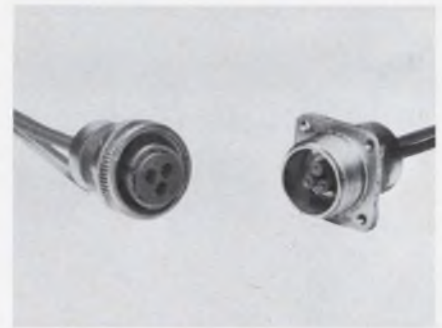

Viking Industries, Inc., 21001 Nordhoff St., Chatsworth, Calif. Phone: (213) 341-4330.

Environmental high-voltage cabled connectors are designed to meet the environmental requirements of MIL-C-26482 class P. The assemblies will operate at 2kV rms, 60 Hz at sea level; and 10 kV rms, 60 Hz at 100,000 feet altitude. Contact current rating is 7.5 A. Contact configurations are 1, 2 and 3 #20 AWG and may be bussed internally or shielded, using high-voltage wire. Insulators are silicone rubber per MIL-R-5847.

CIRCLE NO. 259

**Quartz trimmer cap
has high RF voltage**

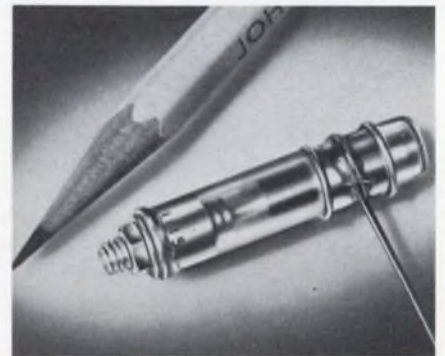

Johanson Manufacturing Corp., Boonton, N. J. Phone: (201) 334-2676.

A quartz trimmer capacitor is designed to bridge the application gap between the low power handling capabilities of piston trimmer capacitors and the high power handling capabilities of vacuum capacitors. Model GQ11115 permits a working voltage of 2500 Vdc and 2500 V peak RF at 30 MHz with a dielectric strength of 7000 Vdc.

CIRCLE NO. 260

In Making Masks for
Electronic Components . . .
. . . there's no
Margin for Error!



With sharp blade, outline the areas to be masked. Do not cut through the backing sheet. The Ulano Swivel Knife does the job quickly, easily.



Now carefully peel off the film as outlined leaving a completed photo mask, positive or negative, that corresponds exactly to the desired pattern.

**THAT'S WHY EXPERIENCED DESIGNERS
AND ENGINEERS ALWAYS INSIST ON...**



RUBYLITH™

HAND-CUT MASKING FILM FOR THE GRAPHIC ARTS

**THE KNIFE-CUT, LIGHT-SAFE MASKING FILM
LAMINATED TO A STABLE POLYESTER BASE**

The most versatile line of hand-cut masking films, including

**.0075—RUBYLITH 75 DR* .005 RUBYLITH 5 DR
.005 AMBERLITH 5 DA**

These new, thick Ulano films provide the positive answers where exact register assumes a critical importance.

** Available in sheets only, cut to your specifications.*

by

Ulano™

ulano™

610 DEAN STREET, BROOKLYN, N. Y. 11238

NEW YORK • CALIFORNIA • CHICAGO • ZURICH

In Europe: ULANO A. G., Untere Heslibachstrasse 22, Kusnacht 8700, Switzerland

Write on your letterhead for special electronic test kit (no charge) No. 4127

ON READER-SERVICE CARD CIRCLE 54

BERLOX®

means...
BERYLLIUM
OXIDE
CERAMICS

Capabilities: Unmatched high temperature ceramic fabrication and ceramic-to-metal seal experience plus complete facilities provide components to your exacting electrical and dimensional requirements.



- From 1 to 1,000,000 or more pieces
- In extremely simple or complex shapes
- In either prototype or mass production

BERLOX ADVANTAGES . . . excellent thermal conductivity (comparable to aluminum metals) . . . superior electrical and thermal shock resistance at elevated temperatures. **Write for complete facilities brochure.**

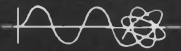

NATIONAL BERYLLIA CORPORATION

Haskell, New Jersey 07420

ON READER-SERVICE CARD CIRCLE 55

Ever need plug-in power supplies in a hurry?

Send for our 1967 catalog.

It lists 62,000 different types.

The one you need will be shipped in 3 days.

(We've never failed to make good on this promise)

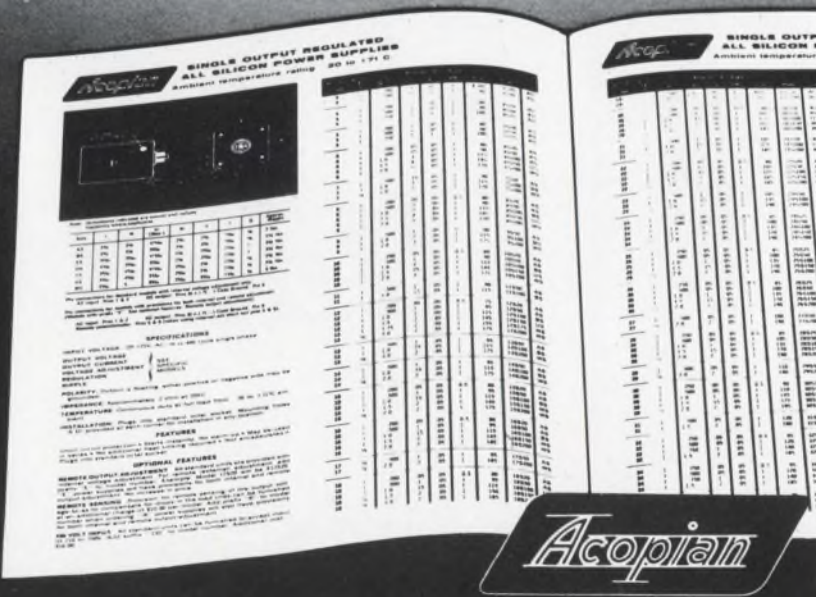

Acopian Corporation, Easton, Pennsylvania, (215) 258-5441

ON READER-SERVICE CARD CIRCLE 56

COMPONENTS

Square 3/8-in. trimmer resists heat, humidity



Amphenol Controls, 120 S. Main St., Janesville, Wis. Phone: (608) 754-2211.

A humidity-proof 3/8-inch square trimmer uses a silicon O-ring seal to shut out dust and humidity. The lid and case are permanently welded. Resistance values are available from 100 Ω to 20 k Ω . Power rating is 0.5 watt at 40°C. The trimmer has silver-brazed terminations, gold-plated terminals and damage-proof clutch.

CIRCLE NO. 261

Pulse low-pass filters have low overshoot

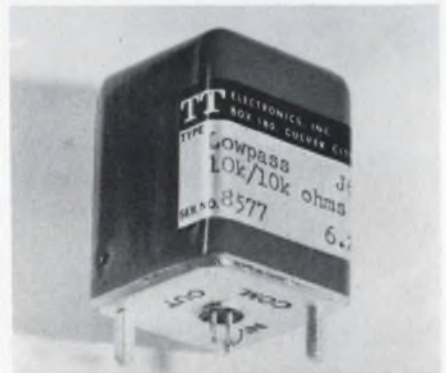

TT Electronics, Inc., P. O. Box 180, Culver City, Calif. Phone: (213) 870-6001. P&A: \$50; 2 wks.

Low pass filters for the transmission of pulses have maximum overshoot of $\pm 2.5, 5$ or 10% of the pulse height. They can be specified with respective cutoff ratios of 3, 2.5 or 2 to 1 (octave slope). The stop bands are 40 dB down or 100 times below the pass band level. The filters are available for any cutoff frequency from 1 kHz to 100 kHz as standard filters. Insertion loss is less than 0.5 dB.

CIRCLE NO. 262

Rotary stepping switch mounts PC boards

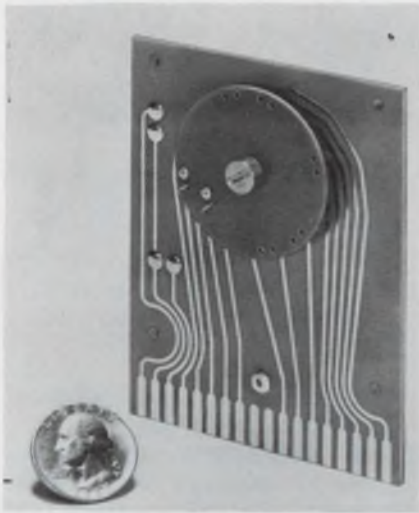

A. W. Haydon Co., 232 N. Elm St.,
Waterbury, Conn. Phone: (203)
756-4481.

Printed-circuit rotary stepping switches for sequential circuit switching, pulse counting, and programing operate on 12 or 28 Vdc, or rectified 115 V, 60 Hz. Power requirement of 5 watts may be applied continuously without damage. Step rate is up to 15 steps per second, and 3, 4, 5, 6, 10 and 12-position switches are available. Rated life is over 6,000,000 steps at 5 to 250 mA resistive, or 5 to 50 mA inductive, 28 Vdc.

CIRCLE NO. 263

Broadband RF balun accepts 6-kW input

Montedoro Corp., 2740 Orcutt Ave.,
P.O. Box 1401, San Luis Obispo,
Calif. P&A: \$125; 2 to 3 wks.

This RF balun operates over the 2-to-30-MHz range with an input power of 1500 watts average, 6000 watts peak. Having a dual impedance output, it permits coupling a 50- Ω unbalanced input to either a 300 or 600- Ω balanced load with an insertion loss of less than 0.15 dB. The transformer has an input vswr less than 1.25 when coupled into a matched load. It performs at full power with continuous operation even when coupled into a 2.5 to 1 mismatch. Balance of the output terminals to ground is within 5% at any frequency.

CIRCLE NO. 264

Varian high power microwave filters

Over 10 years of experience building microwave filters for tactical and fixed high power microwave systems.

Varian has several lines of system-proven, high-power filters featuring low VSWR and low insertion loss. Both absorptive and reflective filters, incorporating harmonic, spurious-rejection or bandpass attenuation, are available. They will remove most of the out-of-band spurious and harmonic signals your system generates. We also develop filters to meet unique design requirements.

For more information on Varian high power filters, write:
Varian, Palo Alto Tube Division, 611 Hansen Way,
Palo Alto, California 94304.

In Europe: Varian A.G., Zug, Switzerland. In Canada:
Varian Associates of Canada, Ltd., Georgetown, Ontario.



ON READER-SERVICE CARD CIRCLE 57

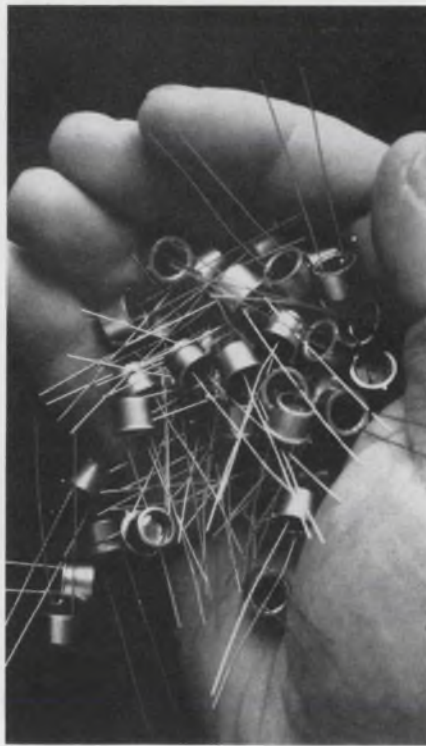
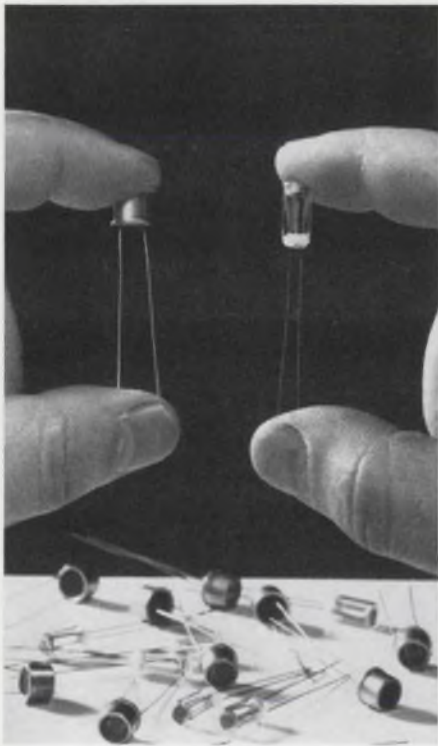

Need thirty different photocells? Or thousands exactly alike?

In either case, specify "Raytheon." Raytheon now offers standard and special types with cadmium sulfide or selenide sensors, TO-5 case or glass vial packaging, and a wide range of operating characteristics. These photocells are interchangeable with competitive types, available to MIL specifications, priced from 90¢ to \$1.60 in production quantities.

All Raytheon photocells feature: rugged mechanical construction, small size, light weight. Low noise, completely ohmic light-dependent vari-

able resistors, their characteristics and high voltage capabilities ensure fast switching, temperature stability and linear response to illumination.

Wide range of characteristics. Our CK1201, for example, features 150 ohms resistance at 100 ft. candles, rise-fall time of 3 and 60 ms, 75 mw power dissipation (maximum). And our CK1266 features 2500 ohms resistance at 100 ft. candles, rise-fall time of 1.5 and .6 seconds, and power dissipation of 100 mw maximum.

Send reader service card for data on the complete line of standard Raytheon photocells. Or tell us about your special requirements.
Raytheon Company, Components Division, Quincy, Mass. 02169.



Industrial Components Operation — A single source for Circuit Modules/Control Knobs/Display Devices/Filters/Hybrid Thick-Film Circuits/Industrial Tubes/Optoelectronic Devices/Panel Hardware

ON READER-SERVICE CARD CIRCLE 58

COMPONENTS

IC test sockets accept dual-in-lines

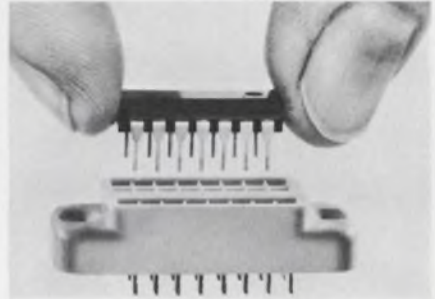

Textool Products, Inc., 1410 Pioneer Drive, Irving, Tex. Phone: (214) 631-5585.

Dual-in-line IC test sockets accept packages with up to 24 wire, flat or rolled leads interchangeably. The series offers a choice of four standard entry patterns for 0.2- or 0.3-inch centers or a single unit combination of the two. Socket body material is polysulfone and contact material is tempered beryllium copper, gold-plated. Minimum lead length accepted is 0.1 inch and standard terminations may be dipped or hand soldered. The socket may be either riveted or screw-mounted to a PC board.

CIRCLE NO. 265

Submin pushbutton handles 100 mA

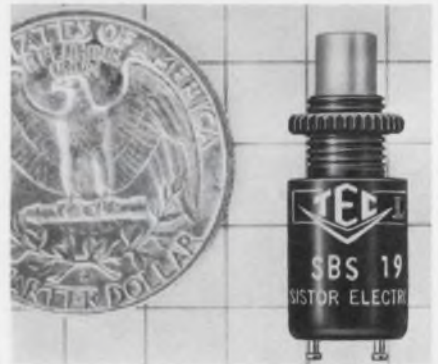

Transistor Electronics Corp., Box 6191, Minneapolis. Phone: (612) 941-1100.

Measuring only 0.36 inches in diameter by 0.468 inch long, this tiny switch mounts from the rear on mounting centers as close as 3/8 inch. The switch is rated for one million cycles of operation while carrying a 100-mA, 115-Vac, noninductive load. The gold-finished brass turret terminals are electrically isolated from the switch body.

CIRCLE NO. 266

Junction compensator mounts PC boards



*Consolidated Ohmic Devices, Inc.,
115 Old Country Rd., Carle Place,
N. Y. Phone: (516) 488-1606.*

A thermocouple cold junction compensator mounts on printed-circuit boards. Essentially, the module is one-half of a Wheatstone bridge. When matched with the other part of the bridge in an instrument circuit, it compensates voltage to provide a measurement reference at the cold junctions of the thermocouple. The device consumes 50 μ W when made for chromel-alumel thermocouple wire. It warms up instantly and provides a nominal output reference of 11 mV.

CIRCLE NO. 267

High range resistors use metal glaze

*EMC Technology Inc., 1133 Arch
St., Philadelphia. Phone: (215)
563-1340. P&A: \$1 to \$10; stock to
6 wks.*

A line of stable high range resistors features voltage and temperature coefficients less than one-fourth those of corresponding carbon film types. Developed primarily for use as bleeders, grid leaks, or in voltage dividers and high resistance standards, the resistors use a proprietary metal glaze which assures that performance changes will not exceed 1%/1000 hours, even under full loading. The resistors derate to 175°C, are corona resistant and able to tolerate high surge voltages. Seven standard sizes are available, ranging from 1-1/16-inch long rated at 2 watts, to 10-1/2-inches long rated at 115 watts maximum power. Top resistance range of the line is 4800 M Ω .

CIRCLE NO. 268

Varian high power microwave water loads

Over 15 years of experience building high power water loads for the microwave industry.

Varian offers an extensive line of high power, low-VSWR water loads for a wide variety of system applications. This line of high-performance units includes: compact "mina-mega" loads for ultra-high power (500 kW CW) dissipation; Teflon-wedge types for broadband applications; and glass tube models for very-broadband (50 to 75%) applications. We can readily modify standard units, or design and fabricate new loads to meet unique requirements.

For more information on Varian high power water loads, write: Varian, Palo Alto Tube Division, 611 Hansen Way, Palo Alto, California 94304.

In Europe: Varian A.G., Zug, Switzerland. In Canada: Varian Associates of Canada, Ltd., Georgetown, Ontario.



ON READER-SERVICE CARD CIRCLE 59

Miniature Indicator and Panel Lamps

For better, more readable light

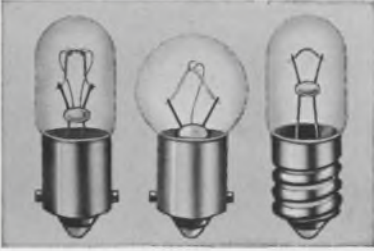

Superior bulbs for aircraft, automotive and other instrumentation, as well as commercial radio and television applications. Design volts from 2.0 to 28.0. Candlepower to 6.0.

For complete information, write: Hudson Lamp Company
518 Elm St., Kearny, N. J. 07032

On Reader Service Card Circle 167

Sub-Miniature Lamps

Space-savers for aircraft and indicator applications.



Sophisticated bulbs available in a wide range of base styles including the well-known "Tu-Pin" (originated by Hudson) for transistor and soldered connection sockets and fast plug-in on printed circuit boards.

For complete information, write: Hudson Lamp Company
518 Elm St., Kearny, N. J. 07032

On Reader Service Card Circle 168

Micro Miniature Lamps

Lives from 25,000 to in excess of 100,000 hours

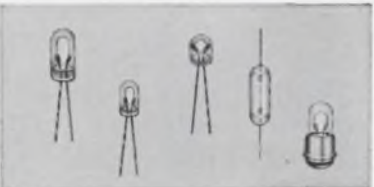

The ultimate in miniaturization in lamps for electronic applications, including transistorized circuitry, punch-card readers, computer tape readouts and photoelectric logic systems. Wire terminal or sub-midget flanged bases. Sizes from .093 dia., as short as .0145 in.

For complete information, write: Hudson Lamp Company
518 Elm St., Kearny, N. J. 07032

On Reader Service Card Circle 169

COMPONENTS

Tiny module performs analog division

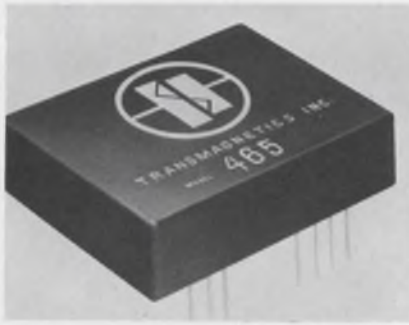

Transmagnetics, Inc., 134-25 Northern Blvd., Flushing, N. Y. Phone: (212) 539-2750. P&A: \$120 (100 lots); 2 to 6 wks.

Dividing a wideband ac voltage by a dc voltage can be accomplished in a 1/2-in³ package arranged for PC board mounting. This nonmagnetic module has no hysteresis and less than 0.5° phase shift when numerator frequency is varied between 380 and 420 Hz. Specifications include 0 to 1 V rms input to the numerator at 200 to 30,000 Hz and 0.1 to 1 Vdc positive input to the denominator. Output is 0 to 2 V rms, 100-Ω impedance.

CIRCLE NO. 269

Crystal oscillator stable to 0.0001%



Varo, Electrokinetics Div., 402 E. Gutierrez St., Santa Barbara, Calif. Phone: (805) 963-2055.

Model 6202 crystal oscillator can be supplied temperature-compensated or uncompensated in the same package. The unit uses integrated circuitry for frequency translation and provides both output and physical characteristics compatible with IC systems. Frequency range is 10 kHz to 10 MHz with stability of ±0.02% to ±0.0001% from -55° to +105°C.

CIRCLE NO. 270

CdS photocells rated at 2000 V



National Semiconductors Ltd., 2150 Ward St., Montreal 9, Canada. Phone: (514) 744-5507.

Cadmium sulphide photoconductive cells are rated at 2000 volts. They have a resistance of 10 kΩ ±40% at 35 footcandles, dark resistance of 100 MΩ, maximum dissipation of 1 watt, dark capacitance of 5 pF and spectral response similar to the human eye. Main applications include illumination controls operating at 220 or 550 Vac. The low capacitance and high voltage suggest applications in high-voltage power supplies and video attenuators.

CIRCLE NO. 271

Bussing strip connects without tools



B. W. Olson & Co., 3261 N. Harbor Blvd., Fullerton, Calif. Phone: (714) 879-1141.

For power or ground bussing, terminated wires may be connected and disconnected to this buss strip without tools. Standard male contacts may be crimped or soldered to wires from size AWG 16 to 24. Connection to the strip is made by pushing the contact into place. Any connection may be released, without disturbing the others, with any small diameter probe; a pencil point is a good example. The strips are available in any length to connect 5 or more wires.

CIRCLE NO. 272

ON READER-SERVICE CARD CIRCLE 61 ➤



*"the rumor was true, Boris...
Guardian has added **QUICK-CONNECT**
terminals to their 98¢ relay"*

If Boris could have waited we would have given him all the details! Engineers have been asking for a 3/16" quick-connect version of the famous Guardian 98¢ Relay for some time now. It's here at last. The ideal unit for any applications where maintenance and down-time are critical. This relay snaps

in place quickly, ends costly soldering and maintenance expense. A quality unit, made in the U.S.A., it outperforms relays costing far more. Simplified design enables 8 parts to do the work of 22! One-piece field and core. New capsulated coil with cover. Contacts: DPDT with rating of 10 amps at

110VAC resistive load. Coil: Voltages 24, 115, 230VAC or 6, 12, 24VDC. This new 910 "quick connect" Series Relay is available right now from stock—minimum order, 200 pieces. (Or, it is available from your Guardian authorized Distributor in quantities up to 199 units.) Write for further information.

GUARDIAN  ELECTRIC

Guardian® Electric Manufacturing Co. • Dept. ED 567 1550 West Carroll Avenue • Chicago, Illinois 60607



Juke Box

THERMISTORS



Astronaut Power Pack

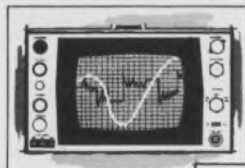

Computer

Micro-wave Instrumentation

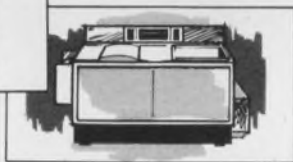

Xerox 2400 Copier/Duplicator

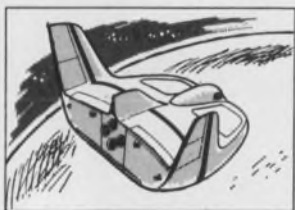

Martin Soft Landing Re-entry Vehicle



Digital Voltmeter

for every application

- BEADS • BULBS
- DISKS • WASHERS
- GLASS PROBES • RODS
- CRYOGENIC THERMISTORS
- SENSOR ASSEMBLIES
- THERMISTOR CATHETERS
- MILITARY GRADE
- THINISTORS®
- Thin film thermistors

From office business machines and juke boxes to computers and CATV distribution systems, engineers and designers have discovered that VECO thermistors can do the job better, with greater reliability and often at lower cost than conventional devices.

If your products require PRECISE temperature measurement, control or compensation with FAST RESPONSE it will pay for you to investigate VECO thermistors. VECO supplies a wide range of standard thermistors in various sizes, shapes, temperature coefficients and resistance values.

VECO's engineering staff is available to assist you in product application and circuit design. Write for Catalog MPG 681

VECO First in Progress • First in Service

J-7739



VICTORY ENGINEERING CORP.

136 Springfield Ave., Springfield, N. J. 07801
Tel: 201-379-5900 TWX 710-983-440

COMPONENTS

Coax terminal block has nine 75-Ω jacks

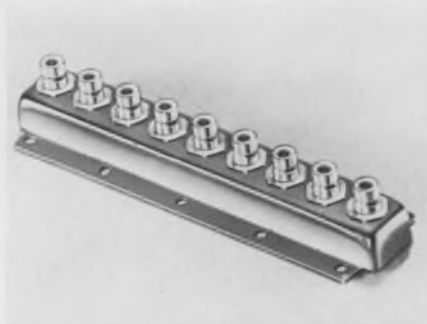

Sealectro Corp., 225 Hoyt St., Mamaroneck, N. Y. Phone: (914) 698-5600.

A nine-unit coaxial terminal block includes nine 75-ohm snap-on jacks that have been bussed together. The terminal block permits the use of shielded coax connectors in bussing applications. The individual units are bussed with AWG #22 solid copper wire. They are available in 3, 5, 7 and 9-unit one-piece blocks. They are also available with screw-on, snap-on or slide-on connectors in 50 or 75-Ω impedances.

CIRCLE NO. 273

Solid-state relays switch at 1 ms

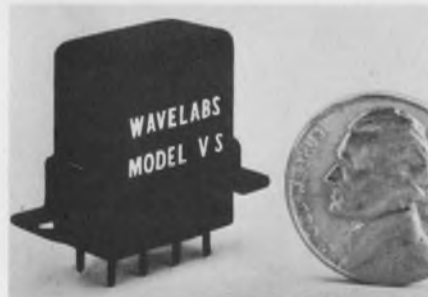

Wavelabs, Inc., 1925 Euclid Ave., San Diego, Calif. Phone: (714) 288-2171. P&A: \$25 (voltage-sensitive), \$50 (current-sensitive); 30 to 45 days.

Solid-state relays are available in both current-sensitive and voltage-sensitive switch type. The relays will withstand vibration of 20 G to 30 kHz and shock to 30 G. Output options include Form A, Form B, Form C and various combinations of each. The points at which the relay actuates and deactuates may be controlled either by factory setting or by adjustable pots.

CIRCLE NO. 274

the
con
nector
THING



MICRODOT

TAKES YOU TO THE MOVIES

*a periodical periodical,
designed admittedly to boom
the sales of Microdot Inc.
connectors and cable. Published
wholly in the interest of profit.*

Once in a lifetime, a motion picture comes along with a scope broader than "Gone With The Wind," a message even more searching than "Mary Poppins." Such a colossal epic is Microdot's new film on the MARC 53 multi-pin connector—the adults-only story of a man and his connector against a world of reliability problems.

FILMED IN GLORIOUS MICROCOLOR AND MICROVISION

And starring the world's smallest and most flexible microminiature high density cylindrical multi-pin connector: MARC 53. Straight from sterling performances in many of the nation's leading aerospace productions! MARC 53 combines the world's best interfacial seal—our exclusive POSISEAL—with the safest finger-tip push-pulling coupling—POSILOCK. There's no mismatching even in "blind" conditions, and the contacts are completely scuff-proof.

A NEW STAR IS BORN

Now, the rear-insertable MARC 53 RMD also gives you a genuinely field-serviceable version that takes mass-produced pre-crimped wires and requires neither insertion nor extraction tools for assembly. When you see our film you'll thrill at the blurring speed and effortless ease with which both versions of MARC 53 are assembled. But to further pique your curiosity for this 10-minute extravaganza, Microdot is offering tremendous, gigantic prizes:



WIN A COMPLETE MOVIE OUTFIT!

Magnificent first prize is an 11-piece movie outfit, from electric eye f1.8 Argus camera to projector, screen, and movie light. Second great prize is a long, long red carpet, suitable for welcoming royal guests to your own movie premiere at home. Third prizes—six of them—are high-class imitation Oscars. Each Oscar will have the winner's name inscribed on it, together with some very complimentary, Hollywood-type superlatives.

HOW TO SEE MOVIE AND WIN PRIZES

First, collect an audience. Any group concerned with connector specifying will do. Send the coupon below to Microdot. We'll have your local representative call you for an appointment to show the MARC 53 film at your office. That's fine about the movie, but how about the prizes?

GIVE MARC 53 A HOLLYWOOD MONICKER!

Let's face it, MARC 53 is a lousy name for a film star. What we need is something like Rip Torn or Stark Naked, but suitable for a fast, small, dynamic connector. You make one up. After the movie, we'll give each viewer an entry form for suggested names for the MARC 53. A panel of aging animal stars will select the best names.

CONTEST IS UTTERLY VOID!

...where unpleasant restrictions, taxes or bans exist. Everything's over midnight of July 31, 1967.

WINNERS EVERY MONTH!

For those of you who have become regular devotees of the "Connector Thing" contest, here's a list of winners of our famous TWIST/CONCEPT CONTEST held earlier in the year. Each of these men received twelve Capitol record albums of his choice. Winners were Richard Trummer, G. V. Fay, Dale T. Wingo, Claron W. Swonger, Simon T. Wrynn and Don Huelsman. Congratulations, gentlemen.

**MICRODOT
INC.**



Microdot Inc.
220 Pasadena Avenue, South Pasadena, Calif. 91030

Dear C. B. de Microdot:

- I have a few guys who'd like to see that stirring epic of yours. Me, too. Have your Rep call me.
- Send me some technical memorabilia on this MARC 53 and on coax connectors.
- Unable to see movie now, but I'm entering contest anyway. My Hollywood name for MARC 53 RMD is _____.
- I am female, 23, a blonde, cute, and would like to meet your producer and/or director.

Name _____
Title _____
Company _____
Street _____
City _____
State _____ Zip _____
Telephone _____

Note: MARC 53, MARC 43, Posilock and Posiseal are registered trademarks of Microdot Inc. Stark Naked isn't.

ON READER-SERVICE CARD CIRCLE 63

The Big One



Is New Again and Bigger

New Gases / New Equipment
New 12 Page Mixture Section
Write for your copy today

MATHESON

P. O. Box 85, East Rutherford, N. J. 07073

ON READER-SERVICE CARD CIRCLE 185

Telrex

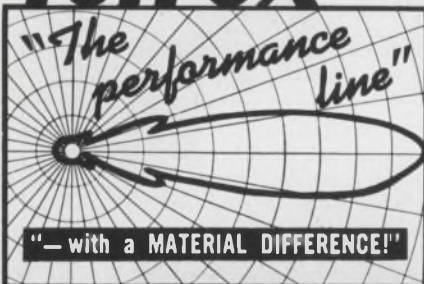

Telrex Communication Engineering Laboratories provides the Most Technically-Perfected, Finest Communication Arrays — Precision Engineered, Manufactured, Tuned, Matched, Calibrated and "Balun" Fed for "Balanced-Pattern" and Maximum S/N Ratio.

**Telrex "Beamed-Power"
"Balanced-Pattern"**

**ANTENNAS AND
ANTENNA SYSTEMS**

The Standard of Comparison, and the Choice of the Discriminating, Successful, Communication Engineer.

Telrex Antennas and Antenna Systems provide Optimum Performance and Reliability per element, per dollar, from 500 Kc to 1500 Mc.

Send for free Military, Commercial Tech Catalog CMS67, illustrating Antennas and Systems, Rotator-Selector-Indicator Systems, "Baluns," Towers, Masts and Accessories.

COMMUNICATION
Engineering
SINCE 1921 **telrex** Laboratories
ASBURY PARK, N. J. 07712, U. S. A.

ON READER-SERVICE CARD CIRCLE 64

COMPONENTS

Vacuum variable cap claims highest power

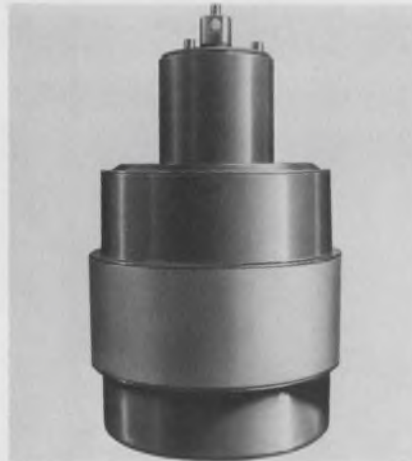

ITT Jennings Div., P. O. Box 1278, San Jose, Calif. Phone: (408) 292-4025.

Claiming to be the largest and highest power vacuum variable capacitor, this unit carries 800 A rms at 16 MHz. The working voltage at this frequency is 48 kV, and the peak test voltage is 70 kV. The unit has a capacity range of 100 to 1600 pF. It is constructed of ceramic interior insulation and heavy copper plates.

CIRCLE NO. 275

Dc diff-amp packs 40-watt punch



Analog Devices, 221 Fifth St., Cambridge, Mass. Phone: (617) 491-1650. P&A: \$275; stock.

This dc differential power amplifier develops a 40-V, 2-A output swing (± 20 volts, 2 A) from a single 28-Vdc supply. By operating from one regulated supply rather than the usual pair of series-connected plus-and-minus supplies, model 401 can halve the initial power supply outlay. The amplifier

achieves its push-pull 40-V output swing by using a dc bridge configuration in the output stage. Although one side of the power supply remains grounded, output voltage swings up to 20 V in both polarities. Specifications include 5-kHz full power response, 60- μ A input bias current, 250- μ V/ $^{\circ}$ C voltage drift, 25-k Ω input impedance and 1% linearity. Closed-loop gain is 20 \pm 5%. The amplifier is short-proof and operates over -40° to 70 $^{\circ}$ C. Applications include torque motors, servo valves, acoustic and magnetostrictive transducers, CRT deflection coils, magnet windings, generator field windings, dc solenoids, position and velocity servos and other high-power applications.

CIRCLE NO. 276

Transistor chopper has high signal isolation

Airpax Electronics, Inc., Cambridge Div., Cambridge, Md. Phone: (301) 228-4600.

Low voltage offset and low dynamic "on" resistance are achieved in these choppers with bipolar silicon transistor switches in a back-to-back inverted arrangement. The solid-state modulation-demodulation choppers are equivalent to spdt switches. High isolation between drive and signal is obtained by use of a small toroidal transformer. Frequency range is dc to 5 kHz.

CIRCLE NO. 277

RFI filters available single or three-phase

Elpac, Inc., 3760 Campus Dr., Newport Beach, Calif. Phone: (714) 546-8640.

RFI filters are available for single and three-phase power systems in a choice of voltage, current and insertion loss values. Standard voltage values include 28 and 100 Vdc, as well as 400 Vdc/125 Vac and 600 Vdc/250 Vac, both in 0 to 60 Hz or 0 to 400 Hz frequency ranges. Standard current ratings range from 1 through 10 A in terminal-lug style. Insertion loss values may range from 100 kHz to 20 MHz.

CIRCLE NO. 278

circuit problems?

Signalite Glow Lamps have solved problems in these areas:

- Voltage Regulation & References • Photo-Cell Drivers • SCR Triggering
- Timing • Photo Choppers • Oscillators • Indicator Lights • Counters
- Voltage Dividers • Surge Protectors • Logic Circuits • Flip-Flops
- Memory • Switching • Digital Readouts

Signalite glow lamps combine long life, close tolerance and economy, and are manufactured with a broad range of characteristics to meet individual application requirements. For a creative approach to your design problem . . . contact Signalite's Application Engineering Department.



VOLTAGE REGULATORS BETTER THAN 1% ACCURACY These subminiature voltage regulators are used in regulated power supplies, as reference sources, photomultiplier regulators, oscilloscope calibrators, etc. They are available in voltages from 82 to 143 V. They are used in multiples as regulators in KV ranges.

SEE Signalite Application News Vol. 3 No. 2 for TYPICAL APPLICATIONS.

Reader Service No. 161



NEON LAMPS WITH TRANSISTORS The A079 is recommended as an indicator light for transistor circuits, transistorized flip-flops, and other general low voltage operations. The advantages result from the low current and low voltage requirements, the absence of heat generated and extremely long life.

SEE Signalite Application News Vol. 2 No. 5 for TYPICAL APPLICATIONS.

Reader Service No. 162

SIGNALITE APPLICATION NEWS



is used to communicate new and proven techniques and applications of Signalite's neon lamps and gas discharge tubes. Signalite Application News provides a forum for an exchange of ideas to keep the design engineer aware of the versatility of neon lamps and their many applications. Copies are available from your Signalite representative or by contacting Signalite.

Reader Service No. 163



TRIGGER LAMPS FOR OPERATION OF SCR'S AND TRIACS The A057B lamp is recommended for use as a triggering device for both SCR'S and TRIACS in motor speed controls and light dimmer circuits. Its properties of stable operation and high current capabilities qualify it for this application.

See Signalite Application News Vol. 2 No. 4 for TYPICAL APPLICATIONS.

Reader Service No. 164

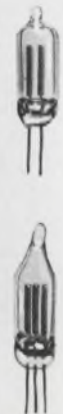

MEMORY SWITCHES Neon lamps have proven to be an excellent memory switch since they store information and provide visual indication. The properties of neon lamps provide a large differential between breakdown and maintaining voltages, stable electrical characteristics and high "off" resistance (20,000 meg ohms). Other applications include switching, information storage, timing circuitry, etc.

SEE Signalite Application News Vol. 4 No. 3 for TYPICAL APPLICATIONS.

Reader Service No. 165

Signalite

INCORPORATED

NEPTUNE, NEW JERSEY 07753

(201) 775-2490



SUBSIDIARY OF GENERAL INSTRUMENT

NEW SOLID STATE CYCL-FLEX® TIMER



CE300

YOUR BROADEST SCOPE

RENOWNED ELECTROMECHANICAL CYCL-FLEX TIMER



HP5

The Man from E.A.G.L.E.* offers you a range of accurately controlled Cycl-Flex time delays that run all the way from 1/20 second to 60 hours. These timers, housed in their now famous plug-in cases, may in fact be interchanged. The HP5 Cycl-Flex is a synchronous, motor driven, precision instrument providing accurate delay between control-circuit actuation in the operation of load circuits. Maximum settings range from 5 seconds to 60 hours with minimum settings from 1/6 second to 2 hours. The CE300 Cycl-Flex is a solid state timer that overlaps the HP5 in the lower time ranges. The 300 series offers dial ranges of 10 seconds and shorter, with minimum settings from 1/20 second to 1/2 second. Depending on contact load, average mechanical life is more than 10,000,000 operations.

Whether you need short time cycles at a fast repetitive rate, or longer but still precisely-controlled delays, the Cycl-Flex Series will give you exactly the right answer... for specifications, get our HP5 Series Bulletin 125 and our CE300 Series Bulletin 155. Write Eagle Signal Division, E. W. Bliss Company, 736 Federal Street, Davenport, Iowa 52808; or call (319) 324-1361.

BLISS  **EAGLE SIGNAL**

A DIVISION OF THE E. W. BLISS COMPANY

*E.A.G.L.E.—Engineering Assistance Given Locally—Effectively.

For Information on CE300 Timer Circle Reader Service Card Number 106



INSTANT EAGLE RELAYS

Test Them Immediately...Get Production Quantities in Two Weeks!

That's right . . . Eagle challenges you to compare them with any relay on the market. NOW you can get immediate delivery on these general-purpose or medium-power relays. Test results prove they're the finest of their kind in the world. Eliminate your relay delivery problems. Call your "Man from E.A.G.L.E." . . . listed below. You'll find he has full details and specifications on Eagle relays.

YOUR "MAN FROM E.A.G.L.E."

Distributors

Burlingame, California
415-697-6244
Glendale, California
213-245-1172
Englewood, Colorado
303-781-0912
Hamden, Connecticut
203-288-9276
Orlando, Florida
305-855-3964
Baltimore, Maryland
301-484-5400
Newton Highlands, Mass.
617-969-7140
Minneapolis, Minnesota
612-922-7011
Clifton, New Jersey
201-471-6090
Haddonfield, New Jersey
609-429-1526

Albuquerque, New Mexico
505-265-1020
Albany, New York
518-436-8536
Depew, New York
716-684-5731
Endwell, New York
607-723-8743
Fairborn, Ohio
513-878-2631
Fairview Park, Ohio
216-333-4120
Dallas, Texas
214-363-1526
Houston, Texas
713-649-5756
Seattle, Washington
206-725-7800

Representatives

Scottsdale, Arizona
602-947-4336
Pasadena, California
213-681-4421
Jacksonville, Florida
305-388-7656
Orlando, Florida
305-422-4295
Roswell, Georgia
404-993-6498
Chicago, Illinois
312-775-5300
Chicago, Illinois
312-784-7314
Baltimore, Maryland
301-276-1505
Norwood, Massachusetts
617-769-3600
Minneapolis, Minnesota
612-922-0243
St. Louis, Missouri
314-428-5313
Hackensack, New Jersey
201-342-2602
Latham, New York
518-785-5032
Rochester, New York
716-436-4410
Skaneateles, New York
315-685-6172
Fairfield, Ohio
216-333-4120
Havertown, Pennsylvania
215-528-6640
Dallas, Texas
214-748-7788
Houston, Texas
713-224-9715
Bellevue, Washington
206-454-5200
Charleston, West Virginia
304-342-2211



A DIVISION OF THE E. W. BLISS COMPANY
736 Federal Street, Davenport, Iowa

For information on HP5 Timer Circle Reader Service Card Number 107

COMPONENTS

Resistive bridge is 4-way, 4-wire

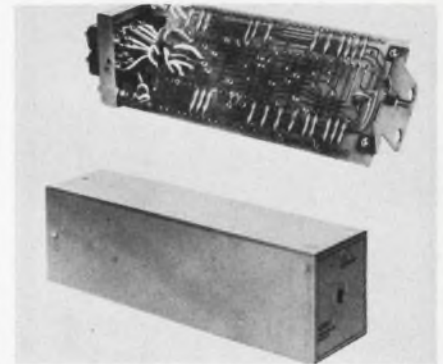

Quindar Electronics, Inc., 60 Fadem Rd., Springfield, N. J. Phone: (201) 379-7400.

This 4-way, 4-wire bridge, a resistive network composed of 24 identical resistors, is designed to enable four 4-wire circuits to be combined to establish a 4-way conference bridge. The unit is a plug-in resistive hybrid network. Insertion loss is 15 dB nominal (one input to three outputs). There is no transmission between each input and its own output (loss is 60 dB or greater). Impedance is 600 Ω , input and output balanced for all four channels.

CIRCLE NO. 279

Crystal filters centered at 21 MHz



Microsonics, Inc., 60 Winter St., Weymouth, Mass. Phone: (617) 337-4200.

A 21.4-MHz crystal filter features good selectivity and spurious rejection. The center frequency is 21.4 MHz \pm 1 kHz with a 1-dB and 3-dB bandwidth of 70 and 75 kHz respectively. The 60-dB-to-3-dB bandwidth ratio is 1.35:1 max with a spurious rejection of 70 dB minimum.

CIRCLE NO. 280

**220,000 pF
BREAKTHROUGH**

**higher capacitance
smaller size
no compromise**

Another first from USCC. New Ceramolithic® construction offers you higher capacitances and smaller sizes than previously available.

USCC's fabulous new C20 Series gives you greatly reduced cordwood sizes in all values from 10 pF to 220,000 pF.

(220,000 pF = .250" x .140" dia)

Equally important. No sacrifices in electrical characteristics.

You get 5 times as much stable capacitance—size for size—than ever before.

For complete technical information on the new C20 Series, contact:

USCC

U. S. CAPACITOR CORPORATION
2151 NO. LINCOLN STREET • BURBANK, CALIFORNIA 91504
(213) 843-4222 • TWX: 910-498-2222

ON READER-SERVICE CARD CIRCLE 68

COMPONENTS

Right-angle adapter handles high voltage



Phelps Dodge Electronic Products Corp., 60 Dodge Ave., North Haven, Conn. Phone: (203) 239-3311.

A new right-angle adapter has been added to the manufacturer's coaxial connector line. The connector incorporates a high-voltage type SC connector and a right-angle adapter to a modified EIA flange. The connector is treated with a dull chrome finish for high temperature resistance. The unit is available in a variety of sizes.

CIRCLE NO. 281

Magnetic reed keyboard lives to be 10 million



Marco-Oak Div. of Oak Electro/Netics Corp., 207 S. Helena, Anaheim, Calif. Phone: (815) 459-5000.

A magnetic-reed, illuminated push-button keyboard switch has a life expectancy of 10 million operations at full load. The switch is rated at 10 W with a maximum working voltage of 200 Vdc. Maximum current is 0.5 A and breakdown voltage is 400 Vdc. Both square and round buttons are offered, each in 0.5, 0.625 and 0.75-inch sizes. The units are spst-NO with an independent lamp circuit.

CIRCLE NO. 282

Phase sequence detector takes delta or Y input



Betamite Electronic Devices, 6321 W. Slauson Ave., Culver City, Calif. Phone: (213) 877-7726.

This phase sequence detector monitors phase sequence from a 3-wire input, either delta or Y, pulling in when the source is in-phase and dropping out during out-of-phase conditions. Units are available in 2-pole and 4-pole contact types rated for 2 and 10 A resistive, and a solid-state single-pole switch rated for 150 mA. The unit is suited for subsystem application where frequent removals and reinstallations in larger systems occur.

CIRCLE NO. 283

ICs protected from 3-to-8-V overvoltage



RO Associates, Inc., 917 Terminal Way, San Carlos, Calif. Phone: (415) 591-9443. P&A: \$39.50; stock to 3 wks.

Completely self contained, this crowbar SCR circuit is designed for overvoltage protection of ICs. Model OV100 has an adjustable trip point of 3 to 8 volts, a response time of 10 μs, and it acts as its own heat sink. The fuse is matched to the SCR surge rating. The all-silicon device is rated at 10 A and can be used with all types of supplies.

CIRCLE NO. 284

Even though Fluke differential voltmeters feature dc accuracies high as 0.0025%, ac accuracies of 0.05%, and 100 microvolts full scale sensitivity, they are so well designed that use is both simple and easy. Solid state bench top models are adaptable for half- or full-rack mounting... Many are offered in both line and rechargeable battery operated versions. Vacuum-tube models are available in cabinet or full-rack configurations. There are many accessories, too. All the fine features of Fluke differential voltmeters should surprise no one familiar with the Fluke line. For uncommon standards laboratory performance in portable instrumentation has always been and continues to be *standard*.

For particulars, write Fluke, Box 7248, Seattle, Washington 91833. Phone: (206) 774-2211. TWX: (910) 449-2850. In Europe address Fluke International Corporation, Sophialaan 2, The Hague, The Netherlands.

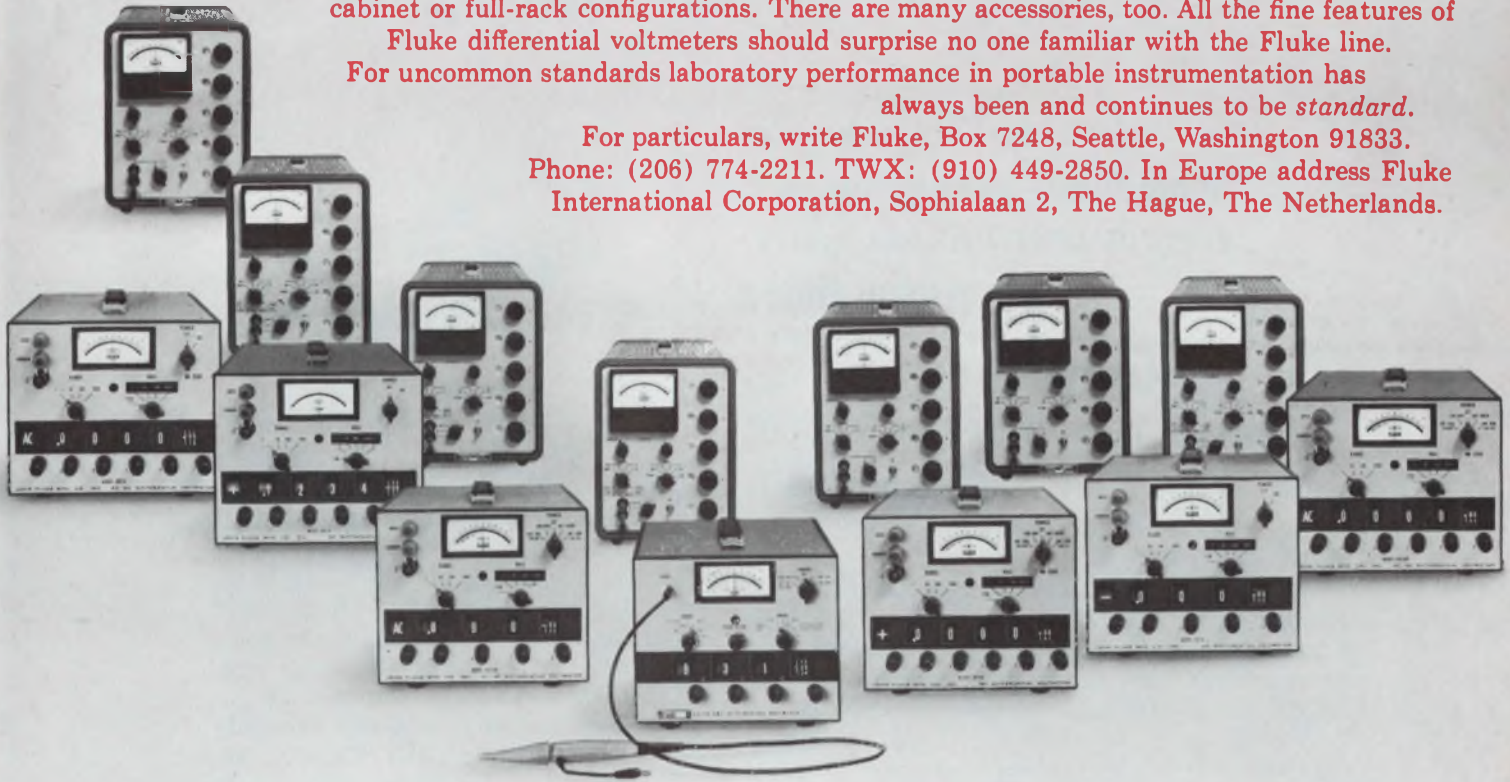

Count 'em. It's the world's largest, most sophisticated line of differential voltmeters. And what a line! You can buy a solid state dc, ac/dc, or true rms voltmeter. Or our vacuum tube version. You'd think Fluke invented the differential voltmeter. (Well, we did.)

DC DIFFERENTIAL VOLTMETERS								
MODEL	INPUT VOLTAGE	ACCURACY % OF INPUT	INPUT IMPEDANCE	MAX. METER RESOLUTION	PRICE	NOTES		
801B	0-500 VDC	±0.05%	Infinite at null	50 µV	\$ 485.00	+\$20 for rack models		
825A	0-500 VDC	±0.02%		5 µV	\$ 590.00			
821A	0-500 VDC	±0.01%		5 µV	\$ 795.00			
871A*	0-1100 VDC	±0.02%		Infinite at null	10 µV		\$ 565.00	+\$130.00 for rechargeable battery pack
881A*	0-1100 VDC	±0.005%		to ±11V 10 Meg	1 µV		\$ 825.00	
885A*	0-1100 VDC	±0.0025%	above ± 14V	1 µV	\$ 965.00			
895A*	0-1100 VDC	±0.0025%	Infinite at null to ±1100V	1 µV	\$1,195.00			
AC/DC DIFFERENTIAL VOLTMETERS								
803B	0-500V AC or DC	±0.05% DC, ±0.2% AC	Infinite at null DC	50 µV	\$ 875.00	+\$20 for rack models		
803D	0-500V AC or DC	±0.02% DC, ±0.1% AC		5 µV	\$1,055.00			
823A	0-500V AC or DC	±0.01% DC, ±0.1% AC	1 Meg, 35-50 pf AC	5 µV	\$1,215.00	+\$160.00 for rechargeable battery pack		
873A*	0-1100V AC or DC	±0.02% DC, ±0.2% AC		Infinite at null to 10	10 µV		\$ 875.00	
883A*	0-1100V AC or DC	±0.005% DC, ±0.1% AC	1 Meg above 11 VDC	1 µV	\$1,215.00	+\$100.00 for rechargeable battery pack		
887A*	0-1100V AC or DC	±0.0025% DC, ±0.05% AC		1 Meg, 40 pf AC	1 µV		\$1,375.00	
TRUE RMS DIFFERENTIAL VOLTMETER								
931A*	0-1100V AC	±0.05% AC	1 Meg, 8 pf with BNC Input	20 ppm of dial setting	\$ 895.00	+\$ 50.00 for permanent probe		
			1 Meg, 5 pf with probe			+\$100.00 for rechargeable battery pack		



*Solid State

**General Technology's
Rubidium "atomic clock"
records over million hours
operational time.**

**Reliability now proven;
MTBF established at 23,000
hours per unit.**

Records kept since 1961 on every Rubidium Frequency Standard made by GTC show the average time between random component failures to be 87,000 hours — almost 10 years!



The Model 304-B shown here is but one in a complete family of all solid-state atomic frequency standards made by GTC for use in field and laboratory. Short term stability: 1 part per 10^{11} (Standard Deviation) for one second averaging time. Long term stability: 5 parts per 10^{11} for one year. Special versions meet environmental and other requirements for tactical and missile/aircraft use.

For solutions to your stable-oscillator problems, write General Technology Corporation, subsidiary of TRACOR, Inc., 6500 Tracor Lane, Austin, Texas 78721. Phone 512-926-2800.

**Time & Frequency
Instruments by** 

TFA - 1367 R

ON READER-SERVICE CARD CIRCLE 70

COMPONENTS

Rectangular trimmers bushing-mounted



IRC, Inc., 401 N. Broad St., Philadelphia. Phone: (215) 922-8900. P&A: \$4.01 (500 lots); 30 days.

Panel mounting capabilities have been added to IRC's RT-11 flexible lead types. The 1/4-inch-long bushing on the adjustment screw end of the trimmer is secured to the panel with a 12-28 hex nut. Type 600-OOM is rated at 3/4 watt at 85° C. It is housed in a diallyl phthalate case and meets MIL-R-27208. Resistance values offered are 10 Ω to 50 k Ω , $\pm 5\%$ tolerance.

CIRCLE NO. 285

Crystal can relay magnetically latched

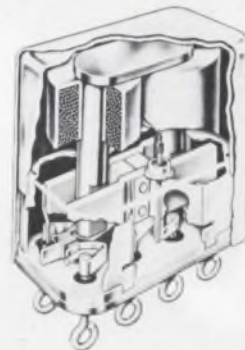

Hart Manufacturing Co., 110 Bartholomew Ave., Hartford, Conn. Phone: (203) 525-3491.

Magnetically latched crystal can relays feature bifurcated contacts, welded construction, hermetically sealed coil chamber and hinged armature suspension. The TL versions are bistable and polarity sensitive and can be furnished with two types of coil configuration. Type 1 is a continuous coil with a sensitivity of 12.5 mW at pull-in and maximum dissipation of 0.5 W.

CIRCLE NO. 286

THIS LITTLE THREAD HELPS OUR AIR-SPACED COAX DO BIG THINGS FOR IBM

Our coax can do the same for you! A spiral of flame-retardant polyethylene thread air-spaces the center conductor of Brand-Rex Turbo® 209A Coaxial Cable. The result: a tough, miniature coax, with excellent electricals for high-speed transmission, at moderate cost. □ We first developed the Turbo 209A for use in the IBM Computer /360, but you may find this space-saving performer

useful in a variety of data processing and communications applications. □ It is available as single cable, cemented ribbon cable (illustrated), or conventional round multiconductor cable. □ Substantially lower in price than standard 95 ohm High Temperature types, it also offers lower attenuation; higher velocity of propagation. A spiral drain wire under the shield simplifies termination.

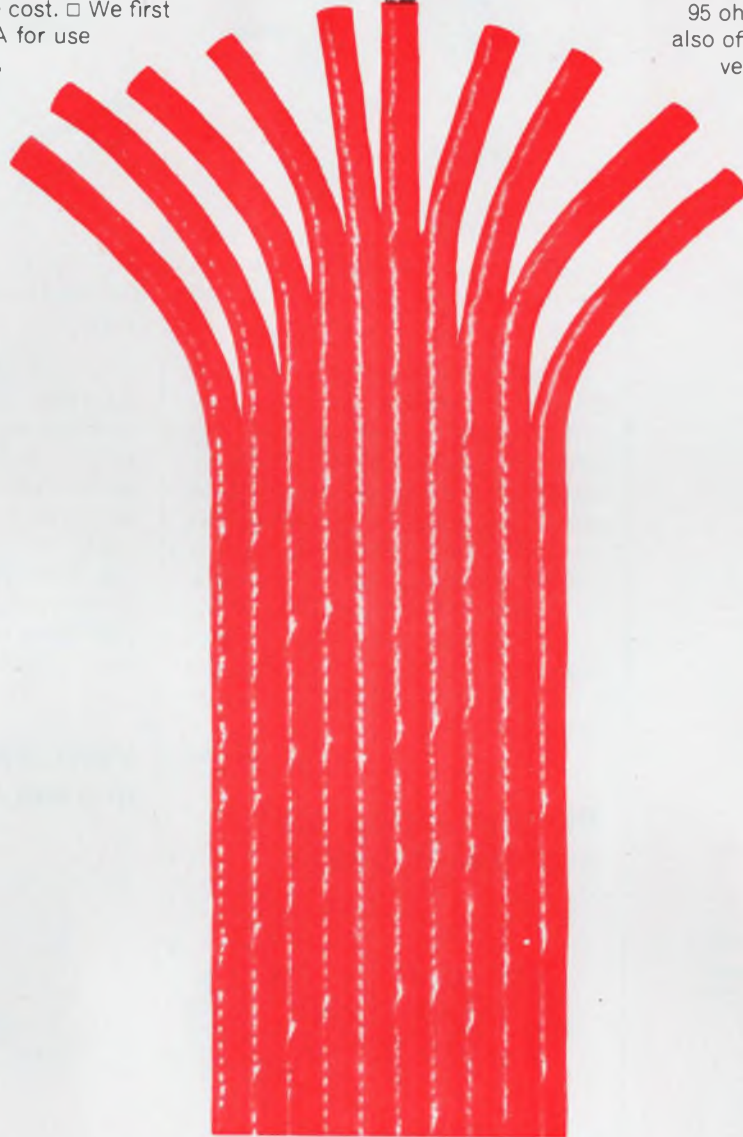

Check the specs. Sound good? Write for full information.

Brand-Rex Turbo 209A Coax U.L. Approvals. Style 1354 (single), Styles 2384, 2385, 2386, 2387, 2388 (cable).

Nominal voltage: 600 volts rms.

Nominal impedance: 95 ohms, +6 -4.

Nominal capacitance: 13.5 pf/ft.

Max. attenuation: 14 db/100 ft at 400 Mc.

Velocity of propagation: 80%.

Inner conductor: #29 AWG silver-coated Turballoy C.

Cable core: Air-spaced, flame-retardant polyethylene. 0.072-0.078" O.D.

Drain wire: #29 AWG silver-coated Turballoy C spirally applied for flexibility and fatigue resistance.

Shield: #38 AWG tinned copper braid, providing 90% min coverage.

Jacket: High-density vinyl, 0.112" nom. O.D.; 0.122" max O.D. at drain wire points.

AMERICAN ENKA CORPORATION

BRAND-REX DIVISION

Willimantic, Connecticut 06226

Phone: (203) 423-7771



5 AMP SWITCHING!



■ The TE 11S rhodium plated reed switch is capable of switching 5 amps at 50 VA for over 1 million operations and switches in any lower current area with considerably more than 1×10^6 reliable operations. The switch is available in a standard glass envelope 2.5" long. Other specifications include operating time of less than 1.0 ms (including bounce), power rating of 50 VA, and an initial contact resistance value of less than 25 milliohms.

ADC

ADC PRODUCTS

A DIVISION OF MAGNETIC CONTROLS CO.
6405 CAMBRIDGE STREET • MINNEAPOLIS, MINN. 55426

COMPONENTS

NASA connectors hermetically sealed



Gulton Industries, Inc., 1644 Whittier Ave., Costa Mesa, Calif. Phone: (714) 642-0163.

Available in shell sizes from 8 to 22, these hermetic connectors are NASA-modified versions of the standard MIL-C-26500. Metal-to-metal mating surfaces provide good shock and vibration characteristics for critical applications such as explosive actuators and detonators, and airborne instrumentation systems. Specifications include a leak rate of 1.2×10^{-10} cc helium/s and insulation resistance of $10^{12} \Omega$ at 300° F.

CIRCLE NO. 287

Photomultiplier tube available flat-form



Amperex Electronic Corp., Hicksville, N. Y. Phone: (516) 931-6200.

With a unique configuration and design, this photomultiplier features a rectangular cross-section, through-the-wall-dynode connections, a ladder of overlapping hemispherical dynodes on rigid ceramic supports and 3/4-inch end-on cathode. The dynode connections are instrument-type screw terminals that feed directly through the tube walls. This reduces leakage currents, even at overvoltages, and produces freedom from inductive pickup.

CIRCLE NO. 288

Humidity-proof trimmer panel-mounted

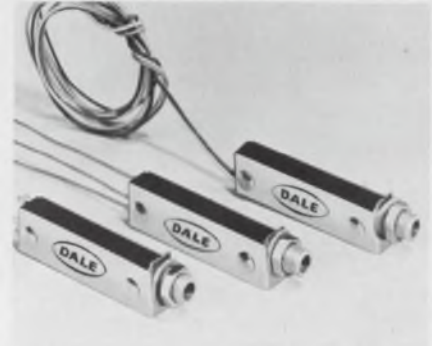

Dale Electronics, Inc., P. O. Box 488, Columbus, Neb. Phone: (402) 564-3131.

A panel-mount configuration is featured by this humidity-proof trimmer pot. To accommodate a variety of panel or open-access installations, the lead screw shaft is extended 1/4 inch, threaded, and fitted with a lock washer and hex plain nut. The 1600 series models have power ratings of 1 W at 70°C and a resistance range of 10 Ω to 100 k Ω with a standard tolerance of $\pm 5\%$.

CIRCLE NO. 289

Polycarbonate caps in axial or radial lead

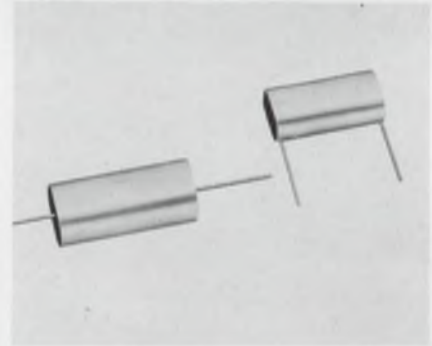

SEI Manufacturing, 18800 Parthenia St., Northridge, Calif. Phone: (213) 349-4111.

Rectangular metallized polycarbonate capacitors with wrap-and-fill construction are available in axial and radial-lead versions. Series 22W (axial) and 22U (radial) capacitors are available in 200 and 400-V sizes in capacitance ratings from 0.001 to 10 mF with 20% to 1% tolerances. Specifications include a $\pm 1.5\%$ capacitance change over the full temperature range and a 0.3% dissipation factor.

CIRCLE NO. 290



SEMICONDUCTORS

NEW IDEAS IN APPLICATION AND DESIGN

■ ACCURACY UP, RFI DOWN WITH GE'S NEW LOW-COST A-C POWER CONTROL MODULE

"Zero-voltage switching" is the key. GE's new S200 synchronous switch power control provides much lower RFI levels than are possible with electromechanical thermostats or phase-controlled semiconductors. And it has high accuracy with control point repeatability better than $\pm 0.5\%$ of sensor resistance. Keys to this high performance are a monolithic integrated firing circuit and a Triac power control device. Its user need only provide power, a resistive load (such as a resistance heater), a variable resistance sensor and a reference control resistor.

Potential uses include any resistive load application where a-c power control is needed. S200 power control modules are available in ratings of 10 and 15 amps RMS, at 120, 240 and 227 volts RMS, 50 to 60 Hz, for controlling resistive loads up to 4150 W. Use with General Electric's new Man-Made[®] diamond thermistor permits sensing and control of temperatures to 450 C. Housing dimensions of the S200 power control module are roughly $1\frac{1}{8}$ by $2\frac{1}{4}$ by $3\frac{1}{4}$ inches.

Circle Number 811 for full details on these new GE power control modules.

■ NEW ECONOMY POWER TRANSISTOR

Thermal dissipation.....1.2W (free air)
Beta holdup.....to 500 mA

It's GE's D28A.

- P_T1.2 W at 25 C (ambient)
- h_{FE} 75-225 and
180-540 at 2 mA, 4.5 V
20 min. at 400 mA, 1 V
- BV_{CEO}25 and 50 V
- $V_{CE(SAT)}$...0.05 typical
0.3 V (max.) at $I_C/I_B =$
50 mA/3 mA

Other characteristics closely match those of the 2N3414-17.

All of this comes in a low-cost plastic package with three in-line leads that can easily be formed to a TO-5 pin circle. Price: less than 30¢ in volume.

Try D28A medium power silicon transistors for output stages in stereos and other phonographs, TV's, radios and other kinds of audio equipment. Or for oscillators, amplifiers, buffers and as drivers for very high power amplifiers. Circle Number 812 on the magazine inquiry card.

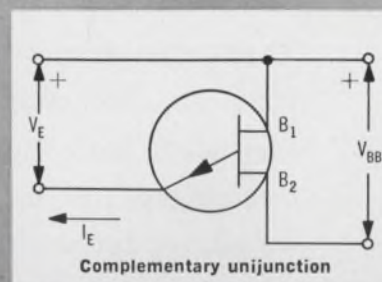
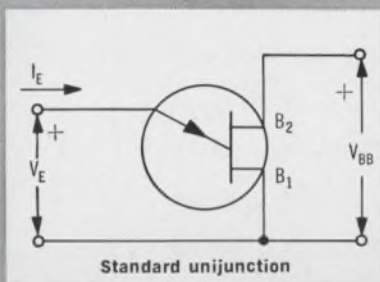

Introducing the Complementary UJT for Improved Stability and Accuracy in Oscillator and Timer Circuits

It's an entirely new kind of unijunction called the D5K. General Electric's D5K has superior temperature stability and product uniformity through utilization of planar processing techniques. Its characteristics are like those of a standard unijunction transistor except that the currents and voltages applied to it are of opposite polarity.

With GE's D5K you can build oscillator and timer circuits with better than 0.5% accuracy from -40 to $+120$ C. Its intrinsic stand-off ratio (η) is just 0.58-0.62 or $\pm 3\%$. You save

test costs by determining your best compensating resistor for temperature stability at room temperature. And the D5K gives you a low base 1 to emitter voltage drop at high current... permits generation of high output pulses with low base-to-base voltages.

GE D5K's are priced at \$4.64 in 100-lot quantities. Take advantage of GE's continuing UJT leadership and superior application help. D5K's are available for both military and industrial uses. Circle Number 813 for more information.

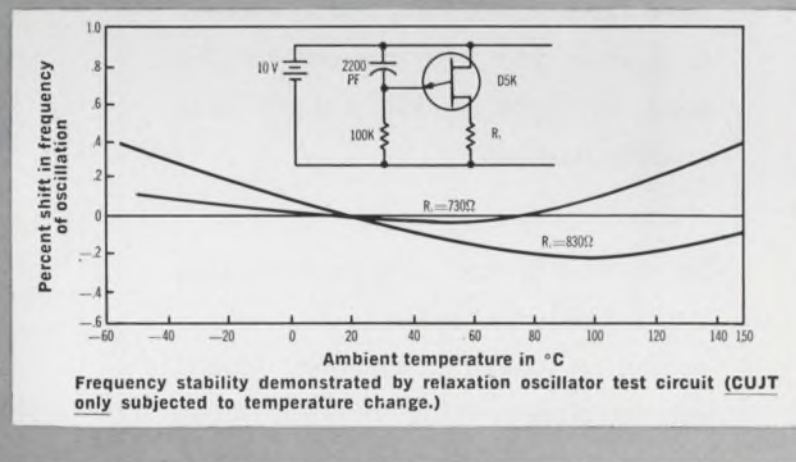

These are just three more examples of GE's total electronic capability. For more information call your GE engineer/salesman or distributor. Or write to Section 220-55, General Electric Company, Schenectady, New York. In Cana-

da: Canadian General Electric, 189 Dufferin St., Toronto, Ont. Export: Electronic Components Sales, IGE Export Division, 159 Madison Ave., New York, N.Y., U.S.A.

GENERAL  ELECTRIC

MANY OF OUR CONTACTS ARE CONTACT PEOPLE

That's the strange thing about our business. We often don't know just who needs help with contacts. Our own people find many of the people we serve, but the rest of our leads come from customers themselves.

That's why we urge you to let us know when contact problems beset you. Or, as we say, "contact us, so that we can contact you." Once you indicate your particular need, we put skilled, experienced contact specialists to work on a solution. They work with the most modern facilities and technology to provide you with the contact you need, when you need it, and at a reasonable cost too.

So, do us a favor . . . do yourself one, too. When the subject of contacts comes up, contact Deringer. You'll get the closest thing to tailor-made contact service you'll find anywhere.



1250 Town Line Road - Mundelein, Illinois 60060
ON READER-SERVICE CARD CIRCLE 76

COMPONENTS

Be-Cu terminals mate round or square

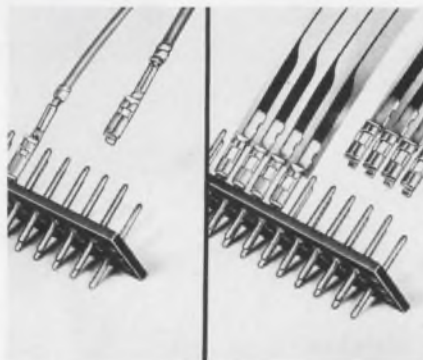

Berg Electronics, Inc., New Cumberland, Pa. Phone: (717) 938-6711.

A beryllium-copper terminal is a female disconnect that mates with an 0.025-inch square or 0.028-inch round male pin. The design permits spacing on as close as 0.125-inch centers. The terminal is available for crimp application to AWG #18 to #32 wire or, on the flexible circuit version, two staking lugs insert through prepunched holes in the flexible tape and mechanically clinch to the circuitry. Soldering completes the electrical connection. The two-piece design incorporates a beryllium-copper, heat-treated spring within a brass terminal body. The spring allows continual cycling on a male pin with negligible reduction in contact pressure and retention force. Contact resistance is less than 5 m Ω and the terminals are rated for continuous operation within a temperature range of 1.6° to 65°C.

CIRCLE NO. 291

Parylene film caps available with 0 TC

Union Carbide Corp., Components Dept., P. O. Box 5928, Greenville, S. C. Phone: (803) 963-7421.

For precision component matching in electronic circuitry in which capacitance stability is essential, these capacitors are available in three different temperature coefficient characteristics, including zero. Capacitance values can range from 1000 to 100,000 pF. In addition to characteristic A, nominally -200 ppm/°C, the Flat-Kap capacitors are available with characteristics B and C, which are both rated at zero plus-or-minus 100 or 50 ppm/°C.

CIRCLE NO. 292

Adage makes the fastest A-to-D converter on the market

8 bits at 1 Mc, 1 μ s conversion time (Model VT7-AB)
14 bits at 200 Kc, 4 μ s conversion time (Model VT13-AB)

Adage has been making solid-state analog-to-digital converters, and compatible sample-and-hold amplifiers, multiplexers, and D-to-A converters, since 1957 — longer than anyone else. We like to think our record of performance is also unmatched.

May we send you literature describing our products — or an applications engineer to help you with your problem? Write Leon Dall, Product Manager, Adage, Inc., 1079 Commonwealth Ave., Boston, Mass. 02215, (617) 783-1100.



Adage
INC

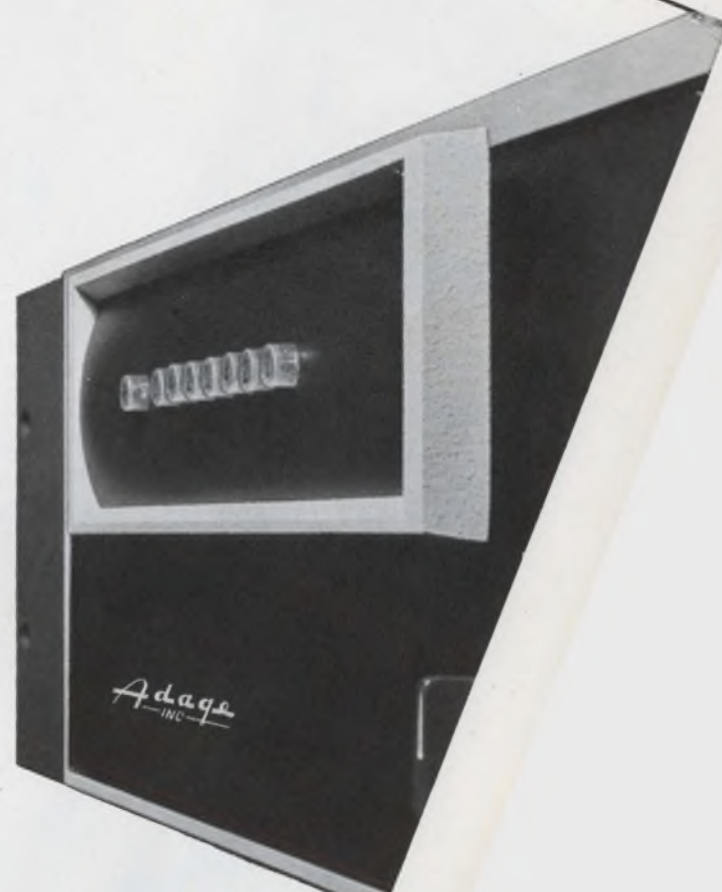

ELECTRONIC DESIGN 10, May 10, 1967

ON READER-SERVICE CARD CIRCLE 77



**this
DIMCO
snapslide
fastener...**

**holds assemblies
securely...**



**instantly
engages/releases...**



**write for
new
handbook**

Dimco-Gray Snapslide Fasteners hold assemblies firmly despite shock or vibration... never need adjustment, even with repeated use. Instant snap action engages or releases fastener... no tools required. Approved under Military Standards. Handbook illustrates typical applications, stimulates design ideas, describes attachment methods. Write for free copy today.

DIMCO-GRAY CO., 219 E. SIXTH ST., DAYTON, OHIO 45402

ON READER-SERVICE CARD CIRCLE 78

COMPONENTS

Miniature uhf circulator ranges 450 to 900 MHz



Huggins Laboratories, Inc., 999 East Arques, Sunnyvale, Calif. Phone: (408) 736-9330.

Miniaturized uhf magnetically shielded three-port coaxial circulators operate over a frequency range of 450 to 900 MHz with typical bandwidths of 4% to 5%. They feature 18-dB minimum isolation, 1-dB maximum insertion loss and 1.35 maximum vswr. Operable over a temperature range of -20° to $+55^{\circ}\text{C}$, the units are capable of handling up to 10 watts of cw input power.

CIRCLE NO. 293

Variable delay trimmer mounts PC board



Computer Devices Corp., 63 Austin Blvd., Commack, N. Y. Phone: (516) 543-4220. P&A: \$32 (1 to 9); 2 to 3 wks.

Miniature variable delay lines are designed for use in circuits requiring precision delay adjustment. The series is designed for PC card mounting and offers a profile 0.31 inches high by 0.62 inches wide. A choice of two delay-to-rise time ratios is offered. A 3:1 delay-to-rise time ratio is available in units with a case length of 1.75 inches and a 6:1 ratio in a case length of 3.5 inches. The series provides a choice of delay ranges from 0 to 10 ns to 0 to 500 ns, and impedance ranges from 100 to 1000 Ω .

CIRCLE NO. 294

Rotary switch assembly is quiet at 300 rpm



J. M. Ney Co., Maplewood Ave., Bloomfield, Conn. Phone: (203) 242-2281.

A rotary switch assembly claims a lifetime of 10 million revolutions with a noise level of 1 mV. Rotating at 300 rpm, the assembly is capable of switching 0.5 A at 30 Vdc non-inductive. The commutator in the standard model affords a standard two-pole, 36-position pattern but other patterns can be designed. The use of a solid-controlled precious metal alloy is said to avoid such common plating defects as porosity, flaking, peeling, pits and inclusions.

CIRCLE NO. 295

Crystal oscillators range to 100 MHz



McCoy Electronics Co., Mt. Holly Springs, Pa. Phone: (717) 486-3411.

A series of miniature crystal oscillators housed in an HC-6 U crystal can have a sine wave output from 5 to 100 MHz. Measuring 0.775 by 0.725 by 0.352 inch, the units are useful in applications where miniaturization is a factor. The oscillators are available in a range of input voltages from 5 to 30 Vdc.

CIRCLE NO. 296

Here's a sample of the values you'll find in BURR-BROWN'S 1967 Operational Amplifier line

SPECIFICATIONS

MODEL NO.	KEY SPECIFICATIONS	PRICE
3009/15	General Purpose — $\pm 10V$, 5mA; $\pm 20\mu V/^{\circ}C$ maximum, $-25^{\circ}C$ to $+85^{\circ}C$; 10KHz full power bandwidth: 5mA maximum quiescent drain.	\$ 25.00
3015/15	General Purpose — Smallest $\pm 10V$, 50mA unit on market. 1.2" x 1.8" X 0.6"	\$ 65.00
3003/15	General Purpose — $\pm 10V$, 20mA. Input drift: $1\mu V/^{\circ}C$ (typ), $3\mu V/^{\circ}C$ (max.); differential input — non chopper; $3\mu V$ rms input noise.	\$ 95.00
1556/15	FET Input — low drift, $5\mu V/^{\circ}C$ (max). 10V, 20mA. 100KHz full power bandwidth. 50pA bias current.	\$125.00
3010/25	Chopper Stabilized — 1 MHz full power. Ultra low drift: $0.5\mu V/^{\circ}C$ (max.). No external drive required. Bias current drift: $.5pA/^{\circ}C$ (typ). 10mA quiescent drain.	\$175.00
3013/15	Wideband — Fast — fast settling time: $< 1.5\mu sec$. 10 MHz bandwidth. 8mA quiescent drain (max.). Differential input impedance: 10^4 Ohms.	\$ 95.00
1901/19	Military Type — encapsulated amplifier. Meets MIL-STD-202C and MIL-STD-810. 10V, 20mA. 5mA quiescent drain.	\$ 95.00

Demonstrator units are available on all of these models. Contact your Burr-Brown Representative. Most of these units are in Burr-Brown Jet-Stock for immediate shipment from your local representative's office.

Get the complete story in our 16-page short-form catalog... it contains information on Burr-Brown operational amplifiers, instrumentation amplifiers, function modules, active filters, power supplies and complete accessories. It's available, now, from your Burr-Brown Representative... or, use this publication's reader service card.

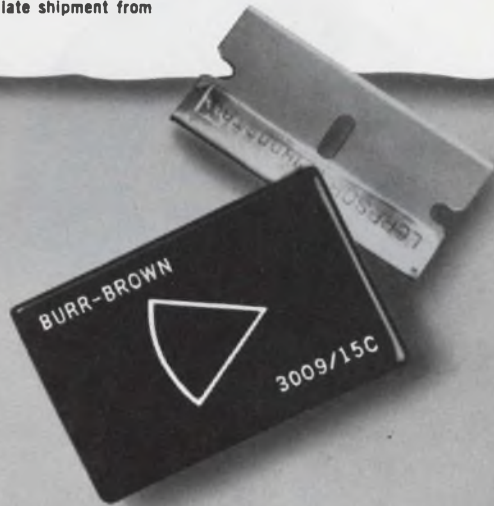

BURR-BROWN

RESEARCH CORPORATION

International! Airport Industrial Park • Tucson, Arizona 85706
TELEPHONE: 602-294-1431 • TWX: 910-952-1111 • CABLE: BBRCORP



Operational Amplifiers
Instrumentation Amplifiers
Function Modules
Analog Simulators
Geophysical Instruments

ENGINEERING REPRESENTATIVES: ALABAMA, HUNTSVILLE (205) 534-1648 / ALASKA, ANCHORAGE (907) 272-5231 / ARIZONA, PHOENIX (602) 254-6085 / CALIF., LOS ANGELES (213) 665-5181, SAN FRANCISCO (408) 245-3321 / COLO., DENVER (303) 388-4391 / CONN., MILFORD (203) 874-9222 / FLORIDA, ORLANDO (305) 425-2784 / ILLINOIS, CHICAGO (312) 286-6824 / LA., NEW ORLEANS (504) 834-6598 / MD., SILVER SPRING (301) 588-8134 / MASS., BOSTON (617) 245-4870 / MICH., DETROIT (313) 353-3822 / MINN., MINNEAPOLIS (612) 781-1611 / MO., ST. LOUIS (314) 524-4800 / N.C., GREENSBORO (919) 273-1918 / N.J., CAMDEN (609)

365-2450 / N.M., ALBUQUERQUE (505) 255-1638 / N.Y., ALBANY (518) 436-9649, BINGHAMTON (607) 723-9661, BUFFALO (716) 632-2727, MT. VERNON (914) 968-2200, NEW HARTFORD (315) 732-3775 / OHIO, CINCINNATI (513) 761-5432, CLEVELAND (216) 884-2001, DAYTON (513) 277-8911 / OKLA., TULSA (918) 835-2481 / OREGON, PORTLAND (503) 292-8762 / PENN., PITTSBURGH (412) 243-6655 / TEXAS, DALLAS (214) 363-1671, HOUSTON (713) 928-3251, UTAH, SALT LAKE CITY (801) 468-8709 / WASH., SEATTLE (206) 622-0177 / CANADA, TORONTO (416) 293-7011, VANCOUVER (604) 736-6377

If you're not happy with your present delivery of special motors...



Call this number collect.



And if this gives you the idea that we may be among the last of the Big Spenders, good! We think we've earned the reputation when it comes to special motors. We've just spent 1.5 million dollars on new facilities to speed up the production and delivery of instrument servo motors, special induction, D-C, and hysteresis synchronous motors. We've gambled that these facilities will produce more of these motors, faster, than any of our competition . . . and *deliver* them faster too. Here's one example of how fast it is now: our delivery of instrument servo motors is eight weeks from receipt of order!

You know our reputation for product quality and company stability. On top of that now, put fast delivery of production quantities. To find out how fast, just call John Kachmar or Jim Ryan, Customer Service Department, THE SINGER COMPANY, Diehl Division (201) 725-2200.

SINGER

INDUSTRIAL CONTROLS

D-121

ON READER-SERVICE CARD CIRCLE 80

COMPONENTS

**Volt-sensitive driver
has 0.01% hysteresis**

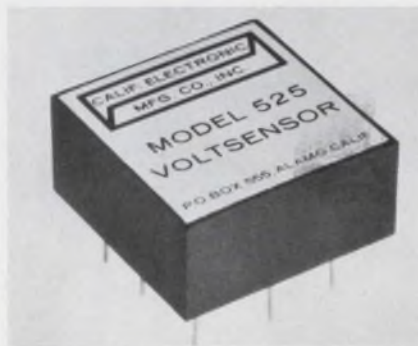

California Electronic Manufacturing Co., Inc., P. O. Box 555, Alamo, Calif. Phone: (415) 932-3911. P&A: \$48 (1 to 9); stock.

A voltage-sensitive relay driver has 0.002%/°C trip point stability and less than 0.01% hysteresis. Model 525 Voltsensor has an adjustable trip point variable continuously through zero with no discontinuity. Features include a trip point range of ± 20 V, infinite resolution, hysteresis less than 4 mV, ± 100 -V input overvoltage protection and repeatability better than 1 mV.

CIRCLE NO. 297

**Cermet variable resistor
rotates 100,000 cycles**

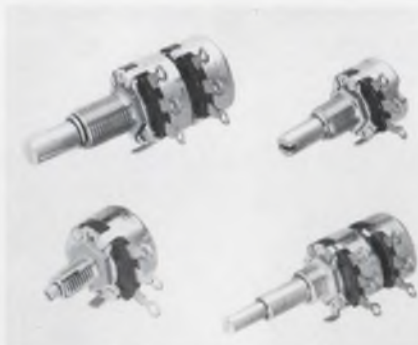

CTS of Berne, 406 Parr, Berne, Ind. Phone: (219) 232-2106.

Series 550 2-watt 3/4-inch diameter cermet variable resistor combines the characteristics of carbon and wirewound controls. Equivalent noise resistance is $\pm 2\%$ ($\pm 1\%$ available at extra cost), rotational life is 50,000 cycles (100,000 cycles available) and temperature coefficient can be held to ± 100 ppm/°C. Resistance range is 50 Ω to 5 M Ω .

CIRCLE NO. 298

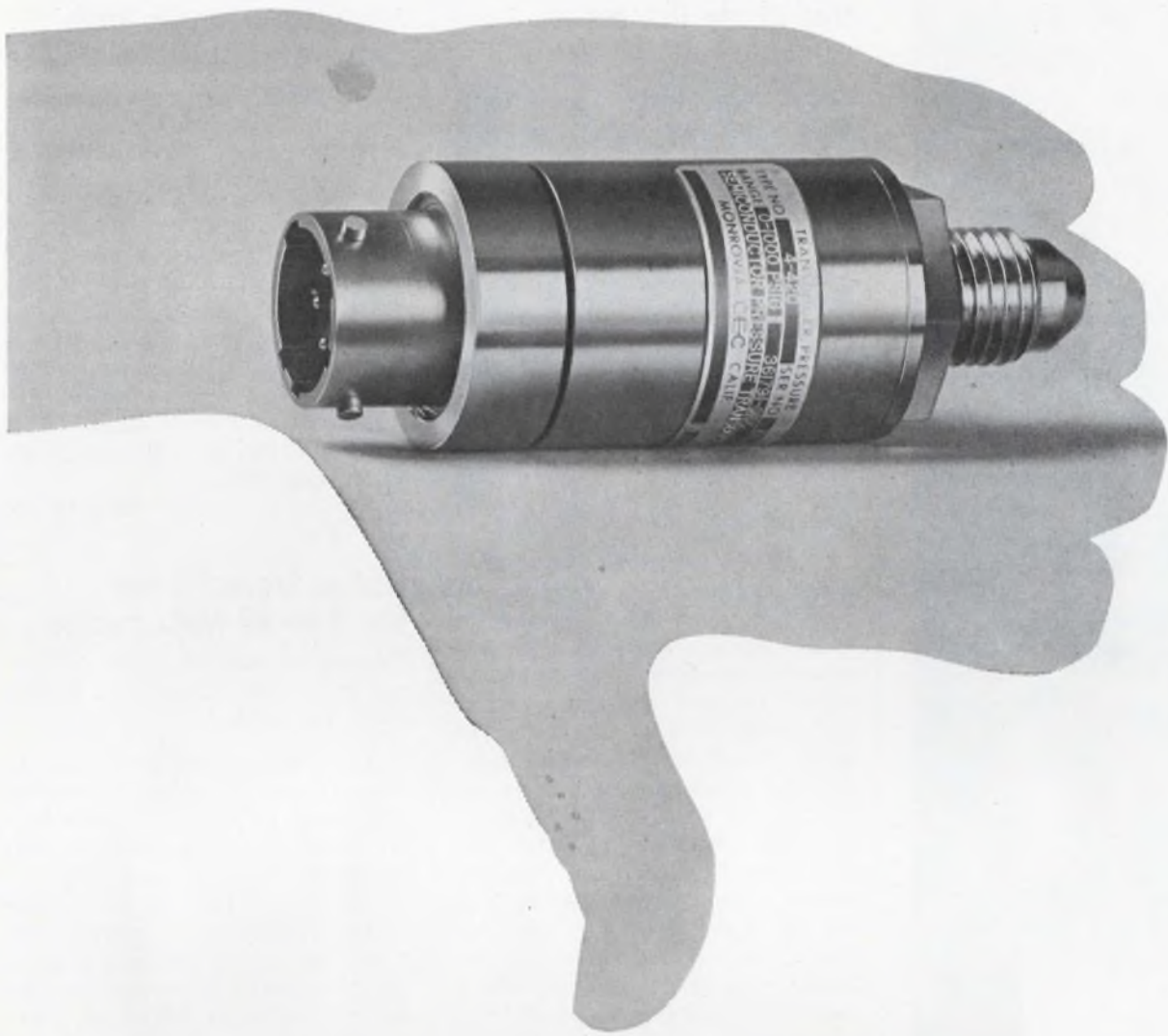

This one said no to the status quo

CEC's new 4-420 Semiconductor Pressure Transducer may look familiar. But when it goes into action, it behaves in a most unconventional way.

For the 4-420 is the *first and only* unit available with both high accuracy and a high unamplified output. And—it has higher accuracy for a broader operating temperature range.

Combined linearity and hysteresis is accurate within 0.15%. Temperature is compensated from 0 - 200°F, with a thermal sensitivity shift of less than 0.010% per degree F. over the compensated range.

Furthermore, the solid-state 4-420 has a full range output of 250 mv dc for an excitation voltage of 10 v dc or ac rms. And other units are available with integral electronics for an output of 0—5 v dc and isolated input of 28 v dc.

Weight? Less than 3.0 oz.

Obviously, the 4-420 is the logical choice for aerospace, aircraft and missile applications. Or wherever a semiconductor pressure transducer with superior performance and minimum weight is required.

For all the facts, call your nearest CEC Field Office. Or write Consolidated ElectroDynamics, Pasadena, California 91109. A subsidiary of Bell & Howell. Bulletin 4420-X 8.

CEC
TRANSDUCER PRODUCTS

 **BELL & HOWELL**

ON READER-SERVICE CARD CIRCLE 81

Free Samples



T1



T1-1/4



T1-3/4

Miniature Lamps

Our miniature lamp prices are so low—about one-half the cost of competitive lamps—people sometimes wonder about their performance. So we're giving away samples to prove they are top quality, in spite of the low cost. In fact, most of our aged and selected lamps are priced lower than competitive lamps that are not aged and selected.

Simply drop us a line on your company letterhead, describing your application, and we'll send you a sample box of 10 IEE lamps. You select the lamp numbers. We'll do the rest.

We have a wide selection available in stock right now. So drop us a line and we'll send you some. Free.

IEE INDUSTRIAL ELECTRONIC ENGINEERS, INC.

Dept. ED, 7720 Lemona, Van Nuys, Calif.
ON READER-SERVICE CARD CIRCLE 82

COMPONENTS

Vhf diode limiter operates at 1 MW

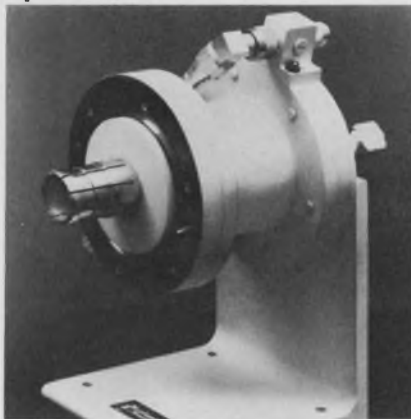

Microwave Associates, Burlington, Mass. Phone: (617) 272-3000.

A passive semiconductor limiter which operates in the 50-to-65 MHz frequency range allows passage of microwave energy below a certain power threshold to a subsequent receiver, limiting the energy above this threshold to a safe level. The device consists of two diode stages: the first composed of a large number of pin diodes which radially shunt the coaxial transmission line. The second stage uses varactor diodes to reduce the leakage from the pin diode section to a low level. The limiter provides complete receiver protection over any 20% bandwidth and can be operated at power levels up to one megawatt.

CIRCLE NO. 311

No armature bounce in 10-A relay



Babcock Electronics, 3501 Harbor Blvd., Costa Mesa, Calif. Phone: (714) 540-1234.

Elimination of armature bounce is claimed for an anti-bounce bracket incorporated in the BR7 10-A crystal can relay. It will switch dry circuit to 10 A and withstand shock to 100 G (11 ms) and vibration to 30 G. Units are offered for both ac and dc operation.

CIRCLE NO. 312

Miniature log IF amp can be gain-matched

Varian LEL Division, 75 Akron St., Copiague, N. Y. Phone: (516) 264-2200. P&A: \$975; stock to 30 days.

A miniature, wide-dynamic-range logarithmic amplifier for use in microwave receivers provides a logarithmic video output with an 80-dB input dynamic range. Video output is proportional (± 1 dB) to the logarithm of the input over an input range of -80 to 0 dBm. The standard model is available at 30, 60 or 70-MHz center frequency, 10-MHz bandwidth.

CIRCLE NO. 313

Balun transformer for 2-to-32-MHz range

Granger Associates, 1601 California Ave., Palo Alto, Calif. Phone: (415) 321-4175.

A 25-kW (100 kW peak envelope power) balun transformer matches 50- Ω coax to 600- Ω balanced lines transforming the unbalanced coax transmission mode into the balanced open-wire mode. Power transfer efficiency is greater than 97% over the range from 2 to 32 MHz. The vswr is below 1.2 and the balun operates at full rated power into a load vswr as high as 2.5.

CIRCLE NO. 314

Mounting pads vanish after soldering

Sawyer Associates Inc., 3 Alpha Dr., Chelmsford, Mass. Phone: (617) 256-6583.

Designed to eliminate two major problems in flow-soldering, Van-o-pads vanish when dissolved in water or solvent after the solder connection has been made. They act as solid component anti-wetting supports during the flow-solder operation. The pads facilitate conformal coating by eliminating oil-filled capillaries which cause blow holes, pin holes and voids. Used under components in high density printed circuit boards, they eliminate open-circuit breakdowns due to lead separations resulting from a thermal cycle.

CIRCLE NO. 315

RCL OFFERS "OFF-THE-SHELF" SHIPMENTS! 1/2" ROTARY SWITCHES

INDUSTRY'S BEST DELIVERY

Up to 12 positions per deck . . . up to 6 poles per deck . . . shorting and non-shorting poles can be grouped in any combination on one deck . . . individual deck parts self-contained and permanently molded into place. Extremely low and uniform contact resistance: $.0025\Omega$ average. Life expectancy: 200,000 mechanical operations.

RCL

Write for complete engineering information

ELECTRONICS, INC.

General Sales Office: 700 So. 21st St., Irvington, New Jersey 07111

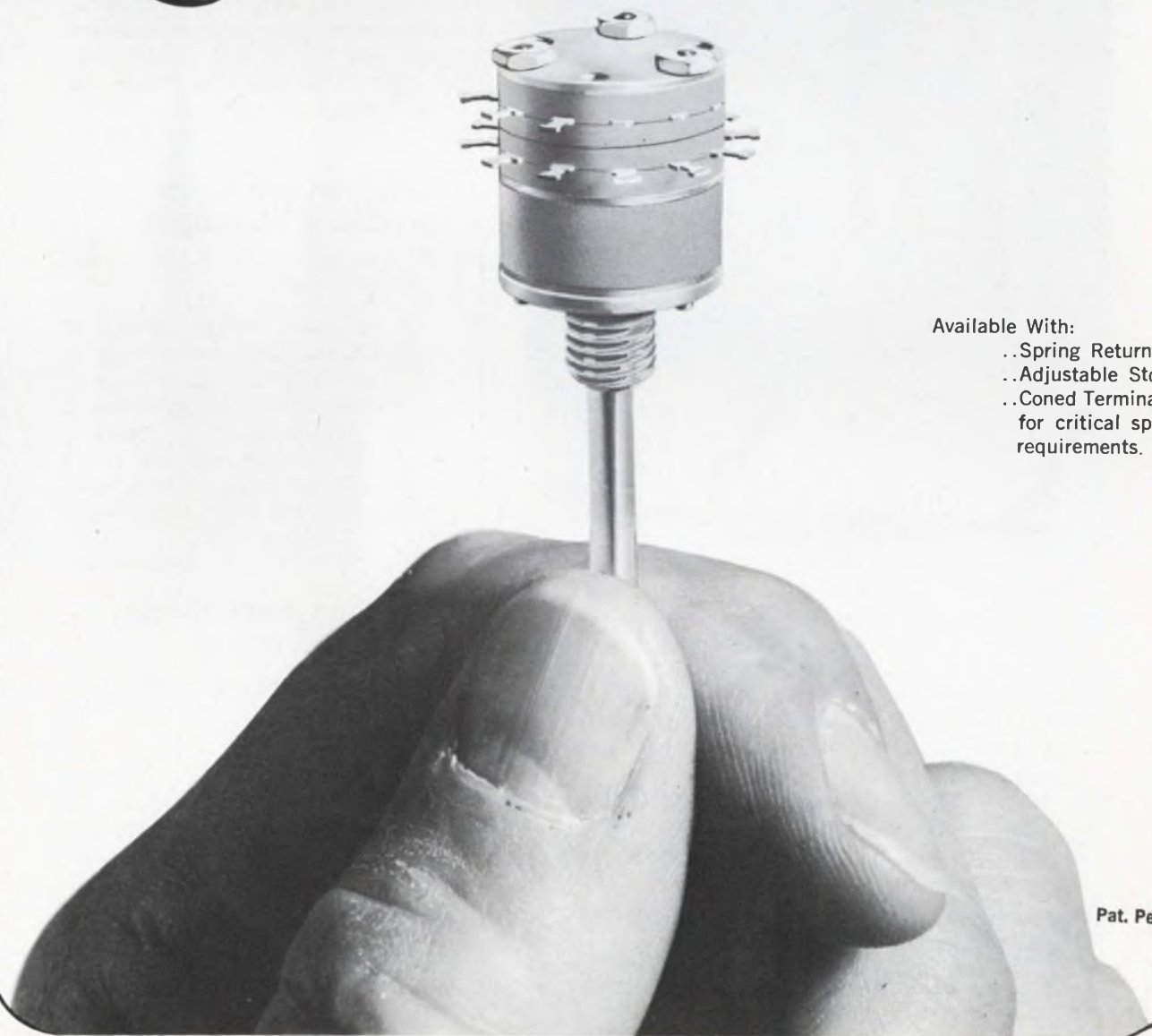

Available With:

- ..Spring Return
- ..Adjustable Stops
- ..Coned Terminals
for critical space
requirements.

Pat. Pend.

ON READER-SERVICE CARD CIRCLE 83

**These two
heat-shrinkables
are hungry for
tough mil-spec
insulation problems.**

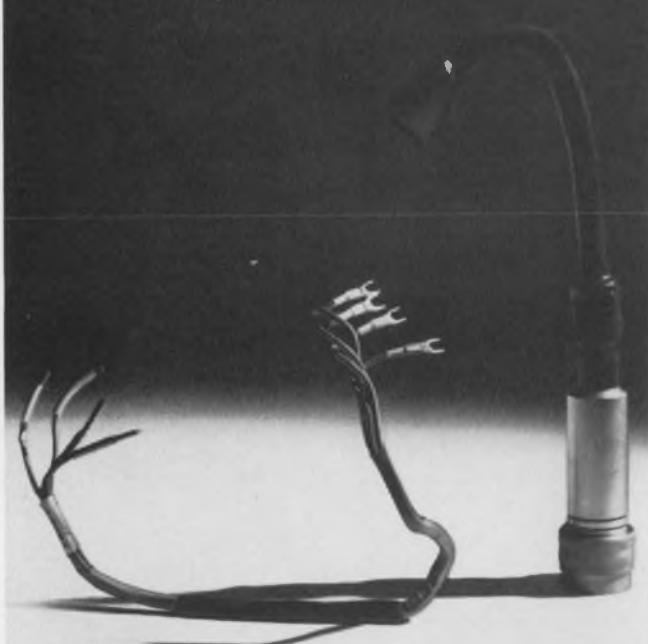

Feed them.

New Insultite® SR-350 eats up shock, strain and vibration like only a semi-rigid, irradiated polyolefin can. It combines superior dielectric characteristics with high structural strength. From 3/64" to 1" I.D.

Insultite FP-301, on the other hand, has a flexible polyolefin appetite that devours mil-spec applications. Quickly. Totally. From 3/64" to 4" I.D.

SR-350 meets classes 3 and 4 of MIL-I-23053A and NASA 276A. FP-301 meets classes 1 and 2.

Both are available in ten standard colors. Write today for free samples. (Specify diameters, please.)



**ELECTRONIZED CHEMICALS
CORPORATION**

A subsidiary of High Voltage Engineering Corporation
Burlington, Mass. 01803, Area Code 617-272-2850

E. C. C. heat shrinkables are recognized under UL component file E39100.

ON READER-SERVICE CARD CIRCLE 84

COMPONENTS

Molded plastic seals high-voltage connectors

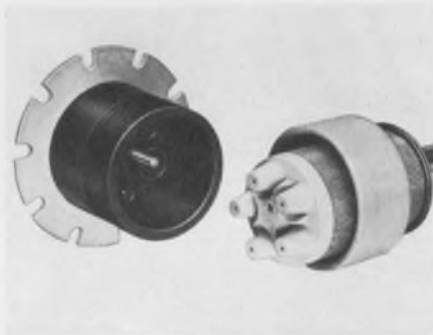

AMP, Capatron Div., Elizabethtown,
Pa. Phone: (717) 363-1105.

The WJH connector line uses a high-temperature plastic dielectric to achieve a hermetic seal. The process of bonding the special plastic to metal permits use of high-conductivity copper alloy contacts. Connectors maintain a hermetic seal even when cycled from -55 to $+125^{\circ}\text{C}$. Ratings extend into the kV range.

CIRCLE NO. 316

Compact multiplier produces X6 output

Micromega, Venice, Calif. Phone:
(213) 391-7137.

A solid-state multiplier yields at least 2 W at 3 GHz from an input of 12 W at 500 MHz. Because frequency multiplication is achieved with a single high-power step recovery diode, the unit is only 3.5 x 3 x 0.625 inch and weighs 8 oz without connector. Operating temperature range is -30 to $+60^{\circ}\text{C}$.

CIRCLE NO. 317

Isolation remote relay handles 5 amps

Alco Electronic Products, Inc.,
Lawrence, Mass. Phone: (617) 686-
3888.

This relay combines an isolated step down transformer and a sensitive low-voltage relay in a single laminated-core construction. Although a 110-Vac source is required, the relay portion is activated simply by shorting the isolated low-voltage circuit which can be run through ordinary circuit wiring.

CIRCLE NO. 318

10 amp subminiature relays at less than a buck an amp

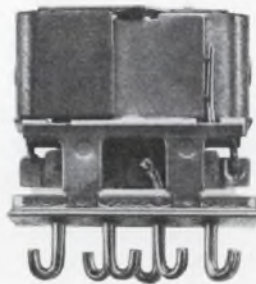

It's a new design. Not a short cut, but an instrumentation quality device that is built to MIL-R-5757.

(Seems we've built them so good, so long, we can't do it any other way, at any price.)

These 10 amp 2PDT relays come up to the 50 G shock and 15 G vibration specs and pass the 100K life cycling test.

They just aren't built to go through all those extreme space environ-

ments, so why pay the missile price?

You get them by ordering our Series D. In several mounting and terminal configurations. And, of course, the under-a-buck-an-amp part does mean in quantity.

Get all the details by phoning us at Leach Corporation, Relay Division (213) 323-8221.

Or write: 5915 South Avalon Boulevard, Los Angeles 90003. Export is Leach International S.A.

LEACH

GREAT NEW WAY TO BUY DC POWER



ERA's Wide-Range, Variable, All-Silicon DC Power Modules at Low, Low Prices

ERA's new Value-Engineered DC Transpac® power modules provide all-silicon, DC power in a wide-range, variable, low cost module.

Stocking problems are reduced to a minimum and power module obsolescence is practically eliminated. Design changes are easily accommodated since all units can be set to desired voltages by a simple external tap change.

Output Voltage (DC)	Current (71°C)	Model	Price
4-32	0-750 ma	LC32P7	\$ 89.00
4-32	0-2 amps	LC322	\$115.00
4-32	0-5 amps	LC325	\$179.00
4-32	0-10 amps	LC3210	\$215.00
30-60	0-1 amp	LC601	\$145.00

Over-Voltage Protector Option: Add \$25.00 to above prices and Suffix V to Model No. (i.e. LC325V, etc.).

SPECIFICATIONS

Input: 105-125 VAC, 50-400 cps
Ripple: Less than 800 microvolts RMS or .005%, whichever is greater
Line Regulation: Better than $\pm 0.01\%$ or 5 mv for full input change
Load Regulation: Better than 0.05% or 8 mv for 0-100% load change
Voltage Adjustment: Taps and screwdriver adjustment
Short Circuit Protected: Automatic recovery
Vernier Voltage: External provision
Transient Response: Less than 50 microseconds
Operating Temperature: -20°C to + 71°C free air, full ratings
Maximum Case Temperature: 130°C
Temperature Coefficient: Less than 0.01% per degrees C or 3 millivolts
Long-Term Stability: Within 8 millivolts (8 hours reference)

Write Today for Catalog #147



ELECTRONIC RESEARCH ASSOCIATES, INC.

Dept. EDN-4 67 Sand Park Road
 Cedar Grove, N. J. 07009 • (201) 239-3000
 Subsidiaries: ERA Electric Co. • ERA Acoustics Corp.
 ERA Dynamics Corp. • ERA Pacific, Inc.

ON READER-SERVICE CARD CIRCLE 86

Accessory adapts oscillograph for simultaneous microfilming

Honeywell, Test Instruments Div., 4800 E. Dry Creek Rd., Denver. Phone: (303) 771-4700. P&A: from \$3500; 60 to 90 days.

An accessory recorder prints oscillographic data on 35-mm microfilm at the same time the information is being displayed on the direct-writing recorder. Writing speed on the microfilm exceeds 70,000 ips; the recorder maintains its speed at 40,000 ips with the accessory in place. If desired, either the recorder or the microfilmer can operate independently. The accessory operates with Honeywell's direct-writing Visicorder models 1508, 1612 and 1912 (see ED 29, Dec. 20, 1966, p. 112).

Key to the operation of the unit is an optical "beam-splitting" arrangement. It is used to reflect visi-

ble light from the oscillograph's galvanometers up through a slotted opening in its cover to the microfilm unit. A series of folding mirrors and a final lens direct the light to the microfilm magazine. At the same time, ultraviolet portions of the galvanometer's light pass through the "beam-splitter" via the Visicorder's optical system for recording identical data on the oscillograph's direct-print paper. In effect, this arrangement gives the user two separate, high-speed analog recording instruments. Systems are incorporated into the microfilm unit for generating grid lines and record numbers. A separate time line system, synchronized to operate with the identical oscillograph function, is also built into the microfilm unit.

When both instruments are re-

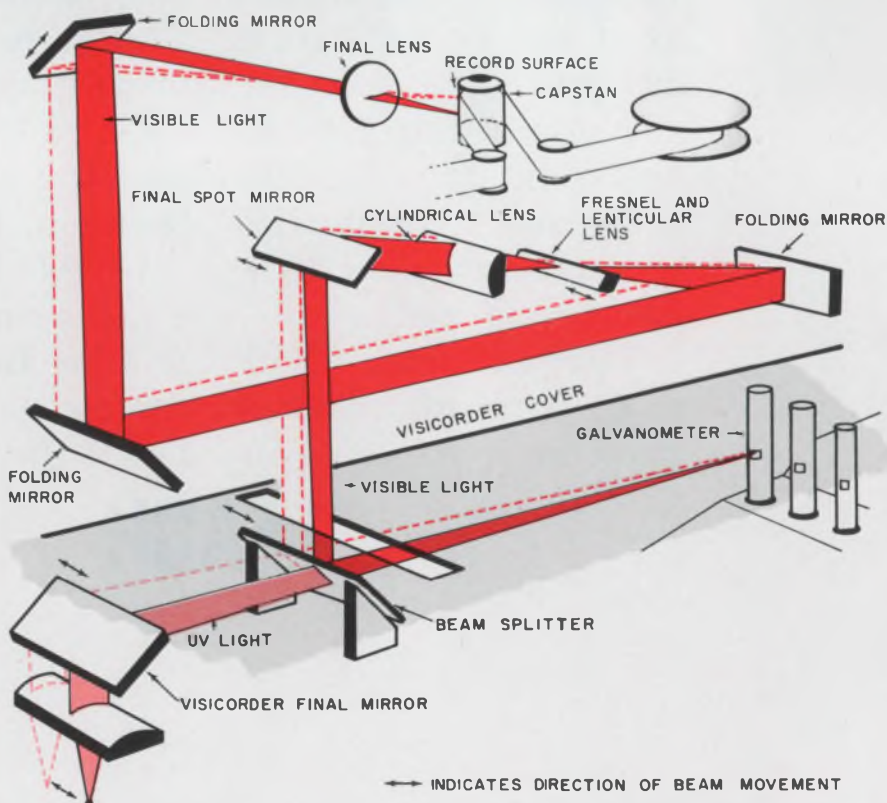

1. Optical beam splitter is key to the microfilm recorder's operation. It takes visible light from the oscillograph galvos, through a series of mirrors, to the magazine. Ultraviolet portions of the light do the oscillograph recording.

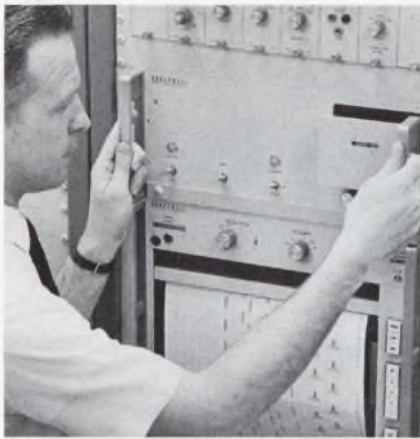

2. Microfilm accessory mounts directly above its companion oscillograph in 22-in.-deep rack.

cording simultaneously, the microfilm unit can record data at the same speed as the oscillograph, or at a higher or lower speed. For example, using the microfilm unit with a model 1508 Visicorder, the Visicorder could be recording data on direct-print paper at its fastest paper speed of 80 ips, while the microfilm unit would be recording the same data at equivalent paper drive speeds up to 320 ips.

Honeywell forecasts major savings in data recording. For example, one 100-foot roll of microfilm-recorded data would be equal to 1000 feet of 12-inch-wide, direct-print paper containing the same data. Comparing current costs of the two types of recording media shows Plus X Pan, 35-mm film, priced at about 1/20 of the cost of the standard 12-inch, direct-writing paper. Microfilm records can be reproduced full size in a Xerox "copyflow" processor which has been reversed or adapted to handle negative records. Cost of full size records are then approximately 1/2 cent per square foot.

Minor modifications can be made to existing Visicorder units at the factory or in the field. The microfilm recorder unit is rack-mounted directly above its companion oscillograph. A plug-in magazine, containing supply and take-up spools and a drive capstan, is provided with each recorder. An additional magazine, available as an option, permits changeover in less than 10 seconds. Recording medium can be any 35-mm unperforated film, Plus X or equal, in 100-foot rolls.

CIRCLE NO. 319

Ballantine High Voltage AC/DC Calibrator

Model 421A

Price: \$650

Portable

0-111 V dc

0-1110 V ac

400 or 1000 Hz,
RMS or Peak-to-Peak

May be used with
Optional Error
Computer



NEW!

Accurately Calibrates to 0.15% Vm's, 'Scopes, Recorders...

Ballantine's new Model 421A is an accurate source of dc or ac voltage that can be set precisely to any value desired up to 111 volts on dc or up to 1110 volts on ac. It's small, rugged, portable . . . enabling you to check with ease a wide range of instruments without loss of down time. You'll find it useful, too, as an accurate, stable source for measurements of gain or loss, and as a stable source for bridges or strain gauges.

The selected voltage is indicated digitally to four significant figures on each of six decade ranges. The voltage indicated may be dc, or it may be ac at 400 Hz or 1000 Hz, RMS or Peak-to-Peak.

Note, for example, the settings in the photo — 42.35 volts RMS at 1000 Hz output. And with an accuracy that you can be sure is better than 0.15%. The receptacle on the lower right of the instrument is for high voltage outputs from 100 volts to 1110 volts at 400 Hz, RMS or Peak-to-Peak.

The new instrument also features a connection for an optional Model 2421 Error Computer that enables you to read calibration errors directly in percentages, speeding up your calibrations considerably.

In addition to its greater voltage range on ac, the Model 421A has a lower source impedance on ac than the Model 421 it replaces. Line voltage effects on the instrument are negligible. A $\pm 10\%$ line voltage change, for instance, causes less than a 0.05% change in output voltage.

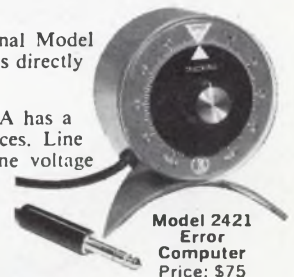

Model 2421
Error
Computer
Price: \$75

Write for brochure giving many more details



BALLANTINE LABORATORIES INC.

Boonton, New Jersey

CHECK WITH BALLANTINE FIRST FOR DC AND AC ELECTRONIC VOLTMETERS/AMMETERS/OHM METERS, REGARDLESS OF YOUR REQUIREMENTS. WE HAVE A LARGE LINE, WITH ADDITIONS EACH YEAR. ALSO AC/DC LINEAR CONVERTERS, AC/DC CALIBRATORS, WIDE BAND AMPLIFIERS, DIRECT-READING CAPACITANCE METERS, AND A LINE OF LABORATORY VOLTAGE STANDARDS FOR 0 TO 1,000 MHz.

ON READER-SERVICE CARD CIRCLE 87

**THIS IS A
CHOPPER.**



**THIS IS A
LIGHT
CHOPPER
BY MELPAR.**

Both are designed for specific jobs.

RELIABLE — DEPENDABLE — SHARP

When the need arises for LIGHT BEAM Modulation, Pulsing, Scanning, Sweeping and Control, consider the exclusive features and unlimited applications of . . .

***MELPAR LIGHT CHOPPERS**

EXCLUSIVE FEATURES:

1. SIZE
2. JEWELLED BEARINGS
3. LOWER POWER INPUT
4. WIDER ANGLE OF EXCURSION
5. OPTICAL QUALITY
6. HIGH REFLECTIVITY

SPECIFICATIONS:

MIRROR EXCURSION: UP TO 20°
 MIRROR FINISH: OPTICAL ALUMIZED FRONT SURFACE MIRROR.
 MIRROR SIZE: APPROX. 1 Cm²
 FREQUENCY: TO 500HZ (Standard)
 INPUT POWER: SINE WAVE. 1 1/2 VOLTS (typical)
 POWER CONSUMPTION: 25 MILLIWATTS (typical)
 SIZE: 1 29/32 X 1 15/32 X 0.8"

For a solution to your particular requirements—get the full story from your Melpar representative, call or write,

Attention: Product Marketing Department

**WABCO
MELPAR INC**

A Subsidiary of Westinghouse Air Brake Company
 7753 ARLINGTON BLVD. • FALLS CHURCH, VA. • (703) 534-6000

ON READER-SERVICE CARD CIRCLE 88

TEST EQUIPMENT

**Digital meter
is three-in-one**



Technology, Inc., 7400 Colonel Glenn Hwy., Dayton, Ohio. Phone: (513) 426-2405.

A general-purpose digital meter combines the features of three commonly used laboratory instruments. It is a 100- μ V resolution dc digital voltmeter, a 1-MHz multifunction counter and an integrator. It features extensive use of ICs and plug-in modules along with circuit sharing. No external plug-ins or adapters are required. As a DVM, this instrument offers automatic polarity, five dc voltage ranges from ± 100 mV to ± 1000 V, calibrated overranging to 40%, an accuracy of $\pm 0.1\%$, 100- μ V resolution and an input impedance greater than 10 M Ω . As an integrator, it displays the digital value of the time integral of the analog input signal. Inhibit and reset functions are controlled by either front-panel switches or remotely by external voltage inputs. Three counter modes are offered: rate, period and count. Sensitivity, level and coupling features are provided to enable operation with a variety of input waveforms.

CIRCLE NO. 320

**Power supplies in
silicon card modules**

Deltron, Inc., Wissahickon Ave., North Wales, Pa. Phone: (215) 699-9261.

A series of silicon card module precision power supplies feature the manufacturer's twin amplifier, controlling voltage or current with automatic crossover to either mode. Any number of the units may be connected in series or parallel without need of special terminals or complicated connections, monitored by one master control. The units are convection-cooled.

CIRCLE NO. 321

This AE Type 44 Rotary Stepping Switch Thrives on Solitude.



So do all the rest of our hermetically sealed stepping switches. That's because we build switches so they can't bind, never overthrow.

Most of the secret's in our stepping-mechanism. We don't use a pawl stop block. Instead, we use a unique "free-floating" pawl—with a set of stopping teeth on the end of the armature.

This way, the armature not only steps the wiper or cam assembly to the next position—it

also *locks* the rotor in the correct position. Overthrow is impossible. So is pawl wear and bind against a pawl stop block—even at low temperatures.

Where can you use these sealed switches? Almost anywhere. Some people take them out in the desert or down to the bottom of the ocean. Others fly them above 40,000 feet, where the mean temperature is -55 degrees Centigrade. You might want them for a particularly dusty location in your shop.

How can you use reliable, versatile rotary stepping switches? There's a lot of helpful design information in our Circular #1698. It's yours for the asking. Just write the Director, Relay Control Equipment Sales, Automatic Electric Company, Northlake, Illinois 60164.

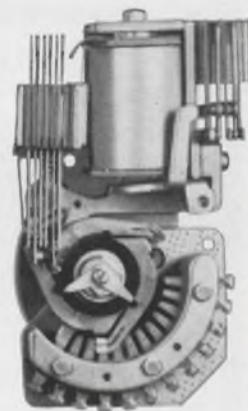

AUTOMATIC ELECTRIC
SUBSIDIARY OF
GENERAL TELEPHONE & ELECTRONICS GTE

ON READER-SERVICE CARD CIRCLE 89

OVER 200 BASIC JACKS

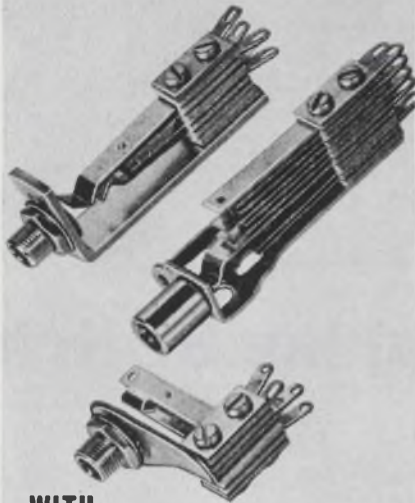

WITH
ONE BASIC QUALITY

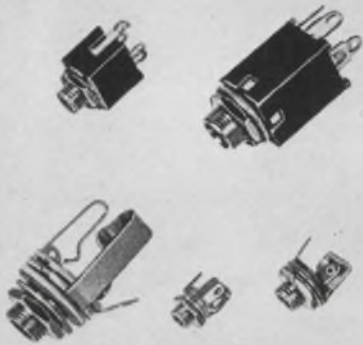

EXCELLENCE

SWITCHCRAFT PHONE "JAX"

Keep this one time-saving fact in mind: SWITCHCRAFT MAKES OVER 200 DIFFERENT PHONE JACKS, ALL OF INCOMPARABLY UNIFORM AND HIGH QUALITY, AT NO HIGHER COST THAN THE SECOND BEST JACKS. Period! New enclosed molded jacks . . . Tini-D and Hi-D Jax . . . phone jacks, Tini-Jax, Micro-Jax, Littel-Jax, Twin-Jax, Extension Jax, short and long frame Telephone-type Jax, Shielded Jax, Mil-types, 2-conductor or 3-conductor, stereo, bushing, P.C. board, rivet or jack panel mounting, thick panel jacks 1/4" or 3/8" bushing lengths, .2085", .250 or .210" bushing diameters, insulated or non-insulated jack sleeves . . . and more switching circuits available than any other commercial jacks on the market! Each is 100% quality inspected and hand adjusted prior to shipment. You name it—chances are it's "from stock," and listed in the incomparable line of Switchcraft Jacks.

SEND FOR CATALOGS J-101 and J-103 or see your Switchcraft Authorized Industrial Distributor for immediate delivery at factory prices.

SWITCHCRAFT®

5529 North Elston Avenue
Chicago, Illinois 60630

TEST EQUIPMENT

PCM simulator has 3 word types



Datapulse Inc., 10150 Jefferson Blvd., Culver City, Calif. Phone: (213) 671-4334. P&A: \$4750; 10 wks.

Programable and perturbable serial digital data in up to 512 word frames is available from model 215C PCM simulator. Three independent word types, RZ or NRZ formats, clock rates to 1 MHz and provision for blanking and bit jitter are featured. Frame program is controlled by binary toggle switches, selectable from 1 to 512 words. Word types include sync word, fixed as word 1, special word, available as any word in frame except first, and common words for any position except those used for sync or special words. Word lengths are selectable from 1 to 32 bits. Word content is defined by toggle switch positions for each bit.

CIRCLE NO. 322

Six-decade box is conductance standard



Beckman Instruments, Inc., 2500 Harbor Blvd., Fullerton, Calif. Phone: (714) 871-4848. Price: \$175.

A direct-reading instrument for checking and calibrating conductivity equipment has six decade dials to cover 1 μ mho to 1,111,110 μ mho. In addition, the instrument may be used as a conductance standard in bridge measurements. All calibrating resistors are wirewound on mica cards with a temperature coefficient of 5 ppm/°C. Accuracy is $\pm 0.25\%$ on the 100 k Ω decade, $\pm 0.1\%$ on the 10-k Ω decade, and $\pm 0.05\%$ on the 1000, 100, 10 and 1.

CIRCLE NO. 323

Ac power recorder handles 600 V, 150 A



Rustrak Instrument Co., Inc., Municipal Airport, Manchester, N. H. Phone: (603) 623-3596. Price: \$205.

A portable power tester and recorder handles voltage, current or both. It features a time-sharing system which permits the stylus to record independent traces for both voltage and current. The system provides full-chart-width resolution with voltage plotted as a continuous trace and current as an interrupted trace. A dual concentric switch selects ac voltage ranges of 0 to 150, 0 to 300 or 0 to 600 volts and ac current ranges of 0 to 15, 0 to 30, 0 to 60 or 0 to 150 amperes. It can be calibrated for any frequency from 50 to 400 Hz. Accuracy is 3% of full scale.

CIRCLE NO. 324

Ac line monitors range 85 to 270 V



United Systems Corp., 918 Woodley Rd., Dayton, Ohio. Phone: (513) 254-3567. Price: \$195.

Digital line voltage monitors are available in two models. The 351 will monitor voltages within the range of 85 to 135 V and the model 352 covers the range of 170 to 270 V. The instruments are accurate with a $\pm 0.1\%$ of midscale reading maintained over a wide range of operating temperatures. The units can be modified to accept a 1000- Ω retransmitting pot for analog output recording of monitored data.

CIRCLE NO. 325

ON READER-SERVICE CARD CIRCLE 90

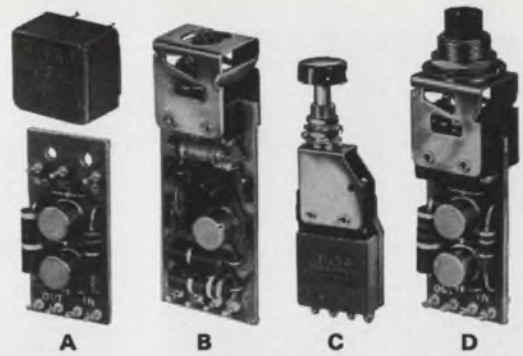

A: Circuit packages for printed circuit or conventional mounting. **B, C and D:** typical switch-circuit assemblies for panel mounting.

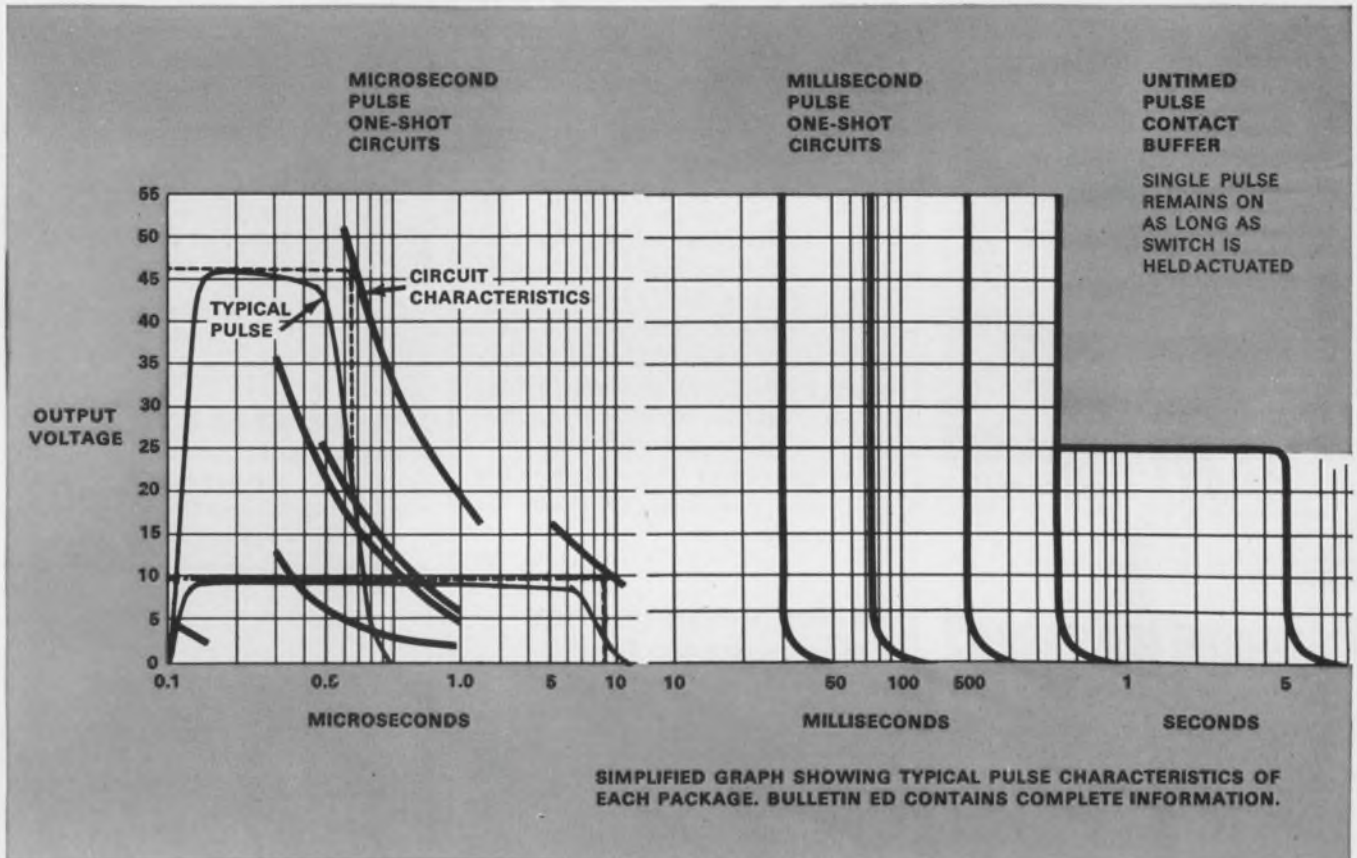

**Need a pulse input,
but don't have the
engineering time?**

A full line of electronic pulse circuit packages is now available from MICRO SWITCH.

These compact packages provide a single output pulse for each actuation of the controlling switch. They provide versatility in packaging and mounting—save engineering time, assembly costs and space.

Microsecond, millisecond and untimed pulse circuits are available pre-assembled to a variety of push-button switches, or as separate packages.

Send for this new design guide and application manual. Keep it handy for quick reference. Save time and money the next time you need an electronic pulse circuit.

Or call a Branch Office or Authorized Distributor (Yellow Pages, "Switches, Electric")



BULLETIN ED

MICRO SWITCH

FREEPORT, ILLINOIS 61032

A DIVISION OF HONEYWELL

HONEYWELL INTERNATIONAL—Sales and service offices in all principal cities of the world. Manufacturing in United States, United Kingdom, Canada, Netherlands, Germany, France, Japan

ON READER-SERVICE CARD CIRCLE 91



Cramped for space?

Use Couch 1/7-size Relays

Space/weight problem? The new Couch 2X 1/7-size crystal can relay gives you tremendous savings in space and weight. 0.1" grid — plus many outstanding specs — *all in micro-miniature*. Thoroughly field-proven in electronics and space applications.



ACTUAL SIZE

	2X (DPDT)	1X (SPDT)
Size	0.2" x 0.4" x 0.5"	same
Contacts	0.5 amp @ 30 VDC	same
Coil Operating Power	100 mw 150 mw	70 mw 100 mw
Coil Resistance	60 to 4000 ohms	125 to 4000 ohms
Temperature	-65°C to 125°C	same
Vibration	20 G	same
Shock	75 G	same

Broad choice of terminals, coil resistances, mounting styles. Write for detailed data sheets.

RUGGED ROTARY RELAYS  Dynamically and Statically Balanced

COUCH ORDNANCE INC.

3 Arlington St., North Quincy, Mass. 02171, Area Code 617.
 CYpress 8-4147 • A subsidiary of S. H. COUCH COMPANY, INC.

ON READER-SERVICE CARD CIRCLE 92

TEST EQUIPMENT

10-MHz counter housed in small package



Elron Electronic Industries, Ltd.,
 Box 5390, Haifa, Israel. Phone:
 64613.

A 10-MHz Minicounter measures 7-1/2 x 4-1/4 x 9 inches and weighs just over 5 pounds. The counter features the use of integrated circuits, high input sensitivity and impedance, 1-MHz crystal clock, 5-digit in-line readout, over-range indication and gating and clock time units from 1 μ s to 10 s. It can be used for frequency, counting, period and ratio measurement.

CIRCLE NO. 326

Analog memory drum delays signals to 2 s



Electron Ohio, Inc., 1278 West 9th St., Cleveland. Phone: (216) 621-5196.

An analog delay memory drum delays and stores analog signals for durations from 1 ms to 2 seconds. It contains from 1 to 10 channels and has a frequency range from dc to 1 kHz. The drum rotates at speeds concurrent with desired delay time. The signal is impressed, reproduced or erased by heads that do not touch the drum surface. The surface is oxide-coated, plated or fitted with a magnetic rubber sleeve.

CIRCLE NO. 327

10-20% LOWER COST... COMPARE TRESKO LVDT QUALITY

Parameter	TRESKO Series 65 (Standard Line)	Brand X
Sensitivity (mV/.001"/Vin) @ 60~		
a \pm 0.05" travel	1.50 mV	.73 mV
b \pm 0.50" travel	1.00 mV	.26 mV
c \pm 2.00" travel	0.60 mV	.05 mV
Resolution	infinite	infinite
Linearity	0.5%	0.5%
Temperature Range	-65°F to 300°F	-65°F to 300°F
Null	0.5% of full scale	0.5% of full scale

Comparison based on published specifications, of the best known competitive standard line of Linear Variable Differential Transformers. Test points are characteristic of values over the complete operating ranges.

Get more transducer for your money:

Write for Bulletin No. 108DT

TRESKO, INC.
 3824 TERRACE ST., PHILADELPHIA, PA. 19128
 (215) IV 3-1383

ON READER-SERVICE CARD CIRCLE 93

We look forward

to seeing you at

MICROWAVES

EXPO 67,

New York Coliseum

June 6, 7, 8.

The Editors of
Electronic Design

Low-cost counter system meets industrial needs



Eldorado Electronics, Inc., 601 Chalomar Rd., Concord, Calif. Phone: (415) 686-4200. P&A: \$600 to \$1500; stock.

A low-cost system of counting and measurement instruments provides functions ranging from simple totalizing to the operations of a fully reversible counter and timer. Basic units of the nine-instrument system are the 10-MHz model 1000 totalizer and the model 1100 reversing totalizer, each of which can be equipped with either a 60-Hz or 100-kHz clock to form a frequency counter. Both models include an automatic trigger system which accepts signals over a range of 250 mV to 100 V with automatic noise rejection.

Other instruments in the system include model 10 universal counter and model 11 preset universal counter, both with high-stability 1-MHz clocks, to equip the basic units for time interval measurements and more flexible timing and multiple resolutions. Model 12 preset offset, model 13 single preset controller (1 MHz), model 14 dual preset controller (1 MHz) and models 15 and 16 single and dual preset controllers (10 MHz) are available.

The entire system permits any instrument to operate singly with either model 1000 or 1100, or in combination with any other instrument in the system. Each instrument is housed in a 3-1/2-inch half-rack chassis and contains its own power supply. The system is remotely programable and remotely operable. Any two instruments can be located as much as 100 feet apart. Options include a selection of format for a variety of digital printers and a battery pack for field operation.

CIRCLE NO. 328

another  solution

TEFLON* SPACER/BUSHINGS FOR MOUNTING P.C. BOARDS TO METAL PANELS OR CHASSIS

Completely eliminate nuts, bolts, lockwashers, insulators, metal stand-offs and spacers, with Sealectro's new and unique Press-Fit® Teflon Spacer/Bushings. Simply drill or punch a hole in a chassis, panel, or other mounting area . . . pop in a spacer bushing . . . drill or punch a mating hole in the P.C. board . . . snap them together . . . that's all there is to it. They can't be shaken apart but can be unsnapped at will for service, test or modification

Press-Fit Spacer/Bushings are precision machined from pure Teflon. Stand-off heights from .125" to .750" with a standard diameter of 3/16" are included in the complete line.

If you need a fast, reliable and inexpensive means to mount P.C. boards, consider Sealectro's new Spacer/Bushings. Sealectro is your No. 1 source for all types of electronic hardware. Complete information and drawings are yours for the asking.

*Registered Trademark E. I. DuPont De Nemours & Co.

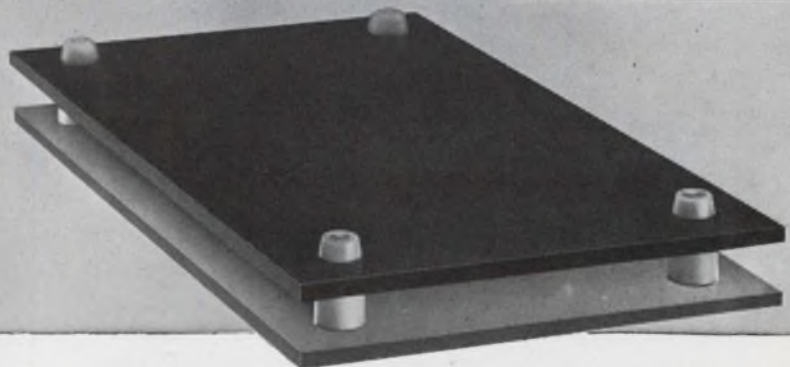
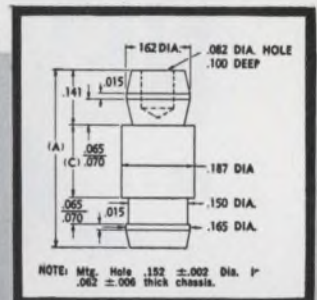

CIRCUIT HARDWARE DIVISION

SEAELECTRO

CORPORATION

MAMARONECK • NEW YORK

PHONE: 914 698 - 5600

TWX: 710-566-1110

Sealectro Ltd., Portsmouth, Hants, England



Packs a wide frequency range in small space

The Hewlett-Packard 3200B VHF Oscillator offers continuous coverage of frequencies from 10 to 500 MHz, yet takes up little space on the bench or in the rack. The 3200B provides $\pm 0.002\%$ frequency stability over a 5-minute period, a high RF output level, and an output attenuator. It is ideal as a general purpose source of CW signals and will also accept external pulse or amplitude modulation. The 3200B may be used with an accessory doubler probe to extend the frequency coverage to 1000 MHz. Size: 7 $\frac{1}{8}$ " wide, 6 $\frac{1}{2}$ " high and 13 $\frac{1}{8}$ " deep. Price \$525. For more complete information, contact your local Hewlett-Packard field engineer or write: Hewlett-Packard, Green Pond Road, Rockaway, New Jersey 07866.

HEWLETT  PACKARD

1074

ON READER-SERVICE CARD CIRCLE 96



NEW MINIATURE NYLON CONNECTORS

Up to 15 circuit capacity with these low-cost, miniature nylon connectors! Contacts automatically crimped to leads, then securely snap-lock into the housings. Positive polarity prevents misconnections and integral mounting ears provide easy panel installation.

Write for complete specifications and samples on any of these connectors.

MOLEX® PRODUCTS COMPANY
5224 Katrine Avenue
Downers Grove, Illinois 60515
(312) 969-4550 TWX 910-695-3533



ON READER-SERVICE CARD CIRCLE 97

TEST EQUIPMENT

Video sweeper ranges to 25 MHz



Telonic Instruments, 50 N. First Ave., Beech Grove, Ind. Phone: (317) 787-3231.

Covering video frequencies from 20 kHz to 25 MHz, this sweep oscillator is designed as a plug-in unit for Telonic's SM-2000 sweep generator chassis. The oscillator has a dual-range sweep width for test procedures requiring very narrow or very broad coverage. On a narrow-band setting, the unit sweeps a frequency width adjustable from 2 kHz wide to 1 MHz wide. On wide band, the sweep width may be set from 20 kHz up to 25 MHz.

CIRCLE NO. 329

Card sensor reads up to 80 IBM columns

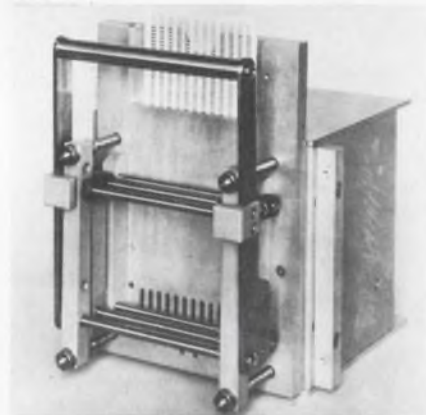

Taurus Corp., Academy Hill, Lambertville, N. J. Phone: (609) 397-2390.

Read from 1 to 40 columns of an IBM card with this card reader. After the card is inserted and the handle closed, a punched hole has a closed switch and a no-hole an open switch. Applications include automated industrial functions, batching operations, component testing, programing and sampling.

CIRCLE NO. 330

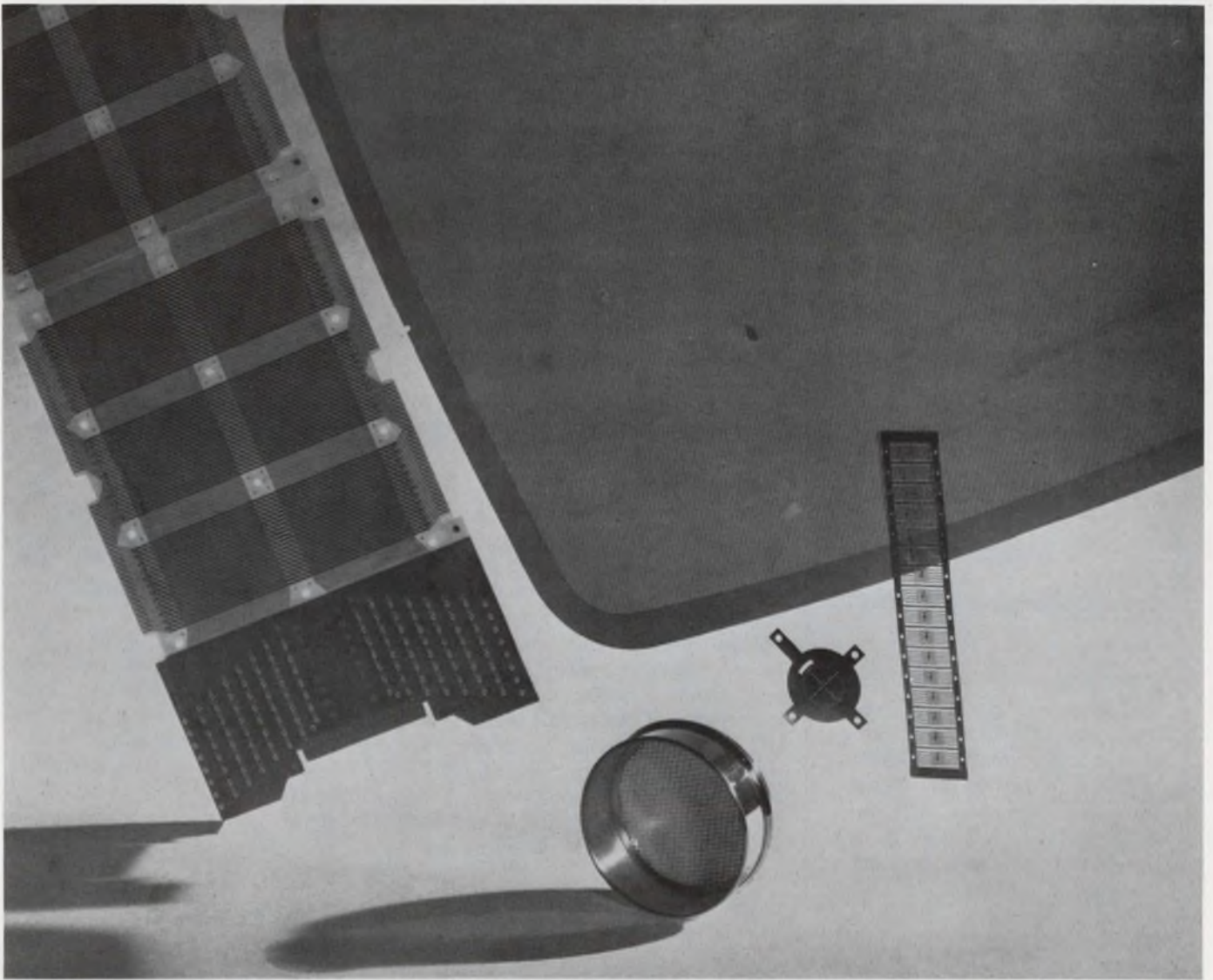

IF

It hasn't been made before,
If it is sub-miniature,
If it requires tolerances to $\pm .000039$,
If you require 2,000 lines per inch,

YOU ARE LOOKING FOR OUR KNOW-HOW

Anything that can be drawn in line can be reproduced by our photomechanical processes—in glass, metal, or plastic—flat, curved, or hemispheric.

For Instance — in the photograph is an assortment of items from our current production. Can you identify — an aperture mask for color television, a micro-mesh sieve, a calibrated dial, an etched kovar clip, a multi-layer circuit.

Do these suggest a sub-miniature item requiring close tolerances that we might help you develop — just call us —

BUCKBEE MEARS COMPANY

245 East 6th St., St. Paul, Minnesota 55101



ON READER-SERVICE CARD CIRCLE 98

**We're
Excited...**



**about
the
Smallest
Things!**

Mixer-preamplifiers, for example. You'll get excited, too, with the performance you get from these tiny, thin-film-integrated-circuit mixer-preamps. Newest addition to our proven line of thin film, microwave components, LEL-LINE TF, they weigh less than an ounce and measure a mere 1½" x 1½" x 17/32".

Specifications

- RF frequencies 1250 — 5900 MHz
- IF frequencies 30, 60 or 70 MHz
- Noise figures from 7.5 dB
- IF bandwidth 20 MHz
- RF to IF gain 20 dB
- LO input power (Typical) 2 mW
- Max. mixer input signal -24 dBm

Send now for full information on these and such other LEL-LINE TF components as

- mixers
- hybrids
- power dividers & couplers.



ON READER-SERVICE CARD CIRCLE 99

TEST EQUIPMENT

Up to 480 circuits automatically analyzed



Sigma Engineering, Inc., 95 Bridge St., Lowell, Mass. Phone: (617) 453-3091. P&A: \$1711 to \$5860; 30 to 90 days.

Parameters of up to 480 circuits can be either automatically or manually tested with this unit. It consists of an automatic switching section which operates at externally adjustable rates from five circuits per second to one every 3 minutes, and a control section that indicates the number of the circuit under test and the test function, and decides whether to accept or reject the circuit. The latter is accomplished by a comparison of test results with pre-set limits. Provisions are made for homing, recycling or bypassing of a fault circuit, visual display or accept or reject status, and for the connection of an optional data printer. The unit contains its own power supplies for the switching, indicator and control sections. The maximum input impedance of the switching section is 0.048 Ω.

CIRCLE NO. 331

Evaluate components high-go-low



Hewlett-Packard, 1501 Page Mill Rd., Palo Alto, Calif. Phone: (415) 326-7000. P&A: \$1575, \$40 up (plug-ins); July.

Fast high-go-low measurements for component evaluation, sorting or matching are made with this comparator. It is useful for making circuit adjustments, testing ICs, sub-module checkout or complete

system checkout. The input to the model 3434A can be a dc voltage, an ac voltage, a direct current, or a resistance. The instrument compares the input to a pre-selected pair of limits and shows by illuminated indicators whether the input lies between the selected limits (GO), or is greater than the upper limit (HIGH), or less than the lower limit (LOW). The instrument also provides relay closures, according to the results of the measurement, which may be used to operate external equipment such as sorting machinery or a printer. Limits, with 3-digit resolution and with either polarity, may be selected manually or they may be programed. The range of limit comparisons is from 100 mVdc to 1000 Vdc, 10 Vac to 1000 Vac, 100 A to 1 A, and 1000 Ω to 10 MΩ (ranges are determined by the plug-in signal conditioners). The accuracy of dc voltage comparisons is typically better than ±0.05% of reading at full scale; ac is better than ±0.12%. Resistance comparison accuracy is ±0.25% up to 1 MΩ, 1% above.

CIRCLE NO. 332

Low-cost sweeper tests TV tuners



Telonic Instruments, 60 N. First Ave., Beech Grove, Ind. Phone: (317) 787-3231. P&A: under \$350; stock.

For production-line testing of uhf-TV tuners, model 1005 sweep generator features continuously variable tuning from 450 to 910 MHz. Output level is 0.5 V rms and sweep width may be varied from 5 to 50 MHz. Options include a selection of attenuators, 10-dB and 3-dB steps, or 50-dB continuously variable at 50 and 75-Ω impedances, remote control of sweep width and/or attenuation and either birdy or pulse marker systems.

CIRCLE NO. 333

**DVM calibration
guaranteed 1 year**

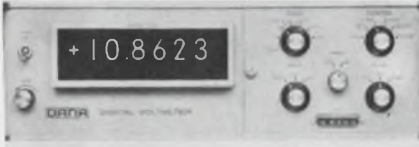

Dana Labs, Inc., 2401 Campus Dr.,
Irvine, Calif. Phone: (714) 833-
1234.

Carrying a one-year calibration guarantee, a test circuit is included in this DVM to check the stability from one calibration to the next. Model 5700 is a five-digit (with sixth-digit overrange) instrument that autoranges from $\pm 10 \mu\text{V}$ to $\pm 100 \text{ V}$ and has a dc accuracy across this span of $\pm 0.004\%$ reading $\pm 0.0009\%$ of full scale. The reference is guaranteed to remain within 100 ppm for one year without recalibration. It measures dc voltages on four ranges: ± 1.1 , ± 11 , ± 110 and ± 1110 volts. It has a built-in dc filter that offers the user a choice of 0, 37 or 80-dB superimposed-noise rejection.

CIRCLE NO. 403

**Freq-to-freq converter
accurate to 0.05%**

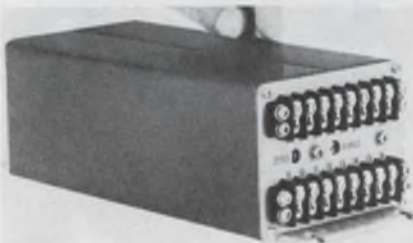

Anadex Instruments, Inc., 7833
Haskell Ave., Van Nuys, Calif.
Phone: (213) 782-9527. P&A:
\$650; 4 wks.

Output frequency of this converter is proportional to input frequency with an accuracy of better than 0.05%. Model FF-100 is useful in applications requiring frequency normalizing or for frequency multiplication to permit short sampling time and higher resolution. Full scale input frequencies lie between 250 Hz and 10 kHz with the adjustable full scale output frequency between 250 Hz and 100 kHz.

CIRCLE NO. 404

Low Cost 4 DIGIT

400 SERIES INTEGRATING DC DIGITAL VOLTMETER



Extended Range Measurements: Fifth digit over-range.

Precise Measurements: With accuracies to 0.05%.

Input Flexibility: Four voltage ranges and a micro-current input for measuring in "Engineering Units" (psi, degrees, etc.)

System Compatibility: BCD Outputs and Remote Programming.

High Noise Rejection: Differential input and integration techniques provide common mode rejection greater than 120 db at 60 Hz.

Economical: 3 and 4 digit models range from \$349.50 to \$495.50.

These DVM's are not only **NEW**, they're **AVAILABLE** from Janus representatives from coast to coast!

CALL OR WRITE FOR A DEMONSTRATION.



296 NEWTON STREET • WALTHAM • MASSACHUSETTS 02154 • TEL: (617) 891-4700
ON READER-SERVICE CARD CIRCLE 100

Finally...

a
reasonably
priced

Taut- Band* METER



... that meets
your performance
requirements.

- * Will handle meters as large as 7"
- * Excellent balance
- * Good Damping and response
- * No drift
- * Tracking $\pm 1\%$ or $\pm 2\%$

Send for Data today

BEEDE

ELECTRICAL INSTRUMENT CO., INC.
PENACOOK, NEW HAMPSHIRE 03303
Area Code: 603-753-6362

ON READER-SERVICE CARD CIRCLE 101

TEST EQUIPMENT

Low-cost unit probes wafers, dice



Siliconix, Inc., 1140 W. Evelyn Ave., Sunnyvale, Calif. Phone: (408) 245-1000. P&A: \$495; stock.

A manual 4-point probe for wafers, dice and mounted devices is useful during the diffusion process for probing selected portions of ICs such as individual diodes, transistors and resistors. The micrometer-controlled Z-axis and fingertip adjustments of each probe-point assembly assure accurate point-pad contact. Probe points are adjustable to any device pattern on wafers up to two inches in diameter. Each probe point covers an area 0.125 inch square. With special fine points, bonding pads as small as 0.5 mil can be probed. A Delrin chuck is available for holding TO-18, TO-5 and TO-84 mounted devices.

CIRCLE NO. 334

Generator supplies 100-bit words at 10 MHz



Texas Instruments, Inc., 3609 Buffalo Speedway, Houston. Phone: (713) 526-1411. P&A: \$3000; 30 to 45 days.

Complete digital words composed of a combination of pulses up to 100 bits long are supplied by this word generator. By operating switches

on the front panel of the unit, the content of the word is completely controlled. Series 6300 word generators feature 100-bit capability in single or multiple channels. Bit repetition rate is variable to 10 MHz, with word lengths available as the product of any two integers from 1 to 10. Multiple channels with independent controls are available within the 100-bit limit, and programs can be set up with front panel switches. The series has the capability of bit programming direct from a computer. Models available include single-bit, single-word and gated outputs.

Output amplitude is variable to 5 volts, positive or negative, with rise and fall times less than 6 ns. Both RZ and NRZ outputs are available, and delay between RZ and NRZ channels can be supplied from 20 ns to 80% of bit width. Bit width for RZ is variable from a 20-ns minimum. Selectable bit sync output allows synchronization of a scope at any desired point in a full 10-bit word.

CIRCLE NO. 335

Table-top recorder holds paper magnetically



Varian, 611 Hansen Way, Palo Alto, Calif. Phone: (415) 326-4000. P&A: \$1395; 90 days.

X-Y recorders hold 8-1/2 x 11-inch chart paper in place by permanent magnetism. The recorders are accurate to 0.25% of full scale and have range sensitivity of 100 $\mu\text{V}/\text{inch}$. Slewing speed (60 Hz) is 15 ips and repeatability is 0.2% of full scale. The platen is a magnet-impregnated hard rubber pad, and the paper is printed on one side with a magnetic ink pattern. Attraction between the two firmly maintains paper alignment and eliminates the need for electrostatic or vacuum hold-down devices commonly used on X-Y recorders. The paper position on the platen can be easily adjusted. No electronics are used for paper hold-down.

CIRCLE NO. 336

SILVERLINE

the New Generation of CLIFTON Synchros

Keeping pace with the developing aerospace field, Clifton announces SILVERLINE, a new, superior line of standard synchros.

These units, a natural evolution from our present line of quality synchros, embody certain new manufacturing techniques and space age materials. The result is a standard synchro which outperforms present synchros in the following five distinct ways.

Higher Accuracy • 5' Standard

SILVERLINE is a complete line of five-minute units—synchros and resolvers—with three-minute units obtainable through design and not on a "pick-and-choose" or yield basis. These accuracies are possible because of mechanical improvements and electrical design changes which minimize basic causes of synchro error.

The normal polar calibration pattern generated by former units will generally contain a high second-harmonic error as evidenced by an elliptical plot. The cause of this second harmonic is generally due to out-of-roundness of the air gap or eccentricities in the mechanical fits. SILVERLINE eliminates these mechanical problems to such a degree that the calibration pattern is nearly circular.

Outstanding Repeatability

SILVERLINE's second salient feature is repeatability of calibration. Once the error curve has been obtained for any unit, it holds to that original pattern—even after environmental testing.

Temperature Stability

SILVERLINE units repeat their room-temperature calibration within very narrow limits even at the extreme temperatures given in today's specifications. Zero shifts are limited to plus or minus three arc minutes over the operating temperature range, and the majority of units will be run well below that.

Extended Temperature Range

Due in part to a gradual upgrading of materials and in part to inherently better thermal stability, we can now extend top operating temperature range for SILVERLINE from the present standard of



125°C up to 150°C (302°F). SILVERLINE can also be adapted into our ultra-high temperature series for ambients up to 232°C.

Lower Null Voltages

Maximum total null voltages have been reduced to 20mv on 26v CX's, CT's, and CD's. Lower total null voltage means fewer saturation problems with high gain control amplifiers and therefore better servo response.

SILVERLINE synchros are in the field NOW. Call your Clifton Sales Office for price, delivery and further information.

ELECTRICAL CHARACTERISTICS SIZE 8 SILVERLINE

SYNCHRO FUNCTION	CPC TYPE	ROTOR AS PRIMARY					STATOR AS PRIMARY					D.C. RESISTANCE		IMPEDANCE			Max Null Voltage Total (mv)	Max Null Voltage Fund (mv)	NOTES
		Input Voltage (400-)	Input Current (Amps)	Input Power (Watts)	Output Voltage (Volts)	Phase Shift (deg/lead)	Input Voltage (400-)	Input Current (Amps)	Input Power (Watts)	Output Voltage (Volts)	Phase Shift (deg/lead)	Rotor (Ohms)	Stator (Ohms)	Zro (Ohms)	Zsc (Ohms)	Zrss (Ohms)			
Torque Transmitter	G08-A-1	26	.170	.93	11.8	9.5	—	—	—	—	—	24	7.5	32+j150	7.3+j26.2	55+j15	20	1.5	15
Torque Transmitter	G08-A-7	26	.100	.54	11.8	8.5	—	—	—	—	37	12	54+j260	12+j45	88+j22	20	1.3	15	
Torque Transmitter	G08-A-9	115	.029	.80	11.8	11	—	—	—	—	700	10.4	950+j3850	10+j36	1550+j420	80	1.4	60	
Control Transformer	T08-A-1	—	—	—	—	—	11.8	.087	.21	23.5	9	143	24	210+j690	28+j114	250+j73	20	2	15
Control Transformer	T08-A-4	—	—	—	—	—	11.8	.030	.073	22.5	8.5	365	64	470+j1770	81+j330	590+j190	20	2	15
Control Transformer	T08-A-6	—	—	—	—	—	11.8	.022	.058	22.5	9.2	550	100	800+j2500	120+j450	940+j280	20	2	15
Electrical Resolver	S08-A-1	26	.038	.39	10.8	20	11.8	.080	.25	23.5	11	230	27	270+j630	39+j142	340+j67	30	2	22
Electrical Resolver	S08-A-4	26	.038	.39	26	20	26	.030	.23	21.5	12	230	170	270+j630	250+j830	340+j67	30	2	22
Torque Differential	D08-A-1	—	—	—	—	—	11.8	.087	.21	11.5	9	36	24	38+j122	28+j114	47+j13	20	2	15
Differential Resolver	DS08-A-2	11.8	.027	.080	22.5	11.5	26	.013	.095	11.8	10.3	98	377	109+j362	560+j1900	134+j34.5	30	2	22

Electrical characteristics are specified as nominal values at 25°C. Synchro testing is performed in accordance with SAE Aeronautical Recommended Practice 461 B.

NOTES:

1. Rotor moment of inertia = 0.81 gm-cm²
2. Rotor moment of inertia = 0.82 gm-cm²
3. Unit torque gradient = 2200 mg-mm/deg
4. Unit torque gradient = 2400 mg-mm/deg
5. Unit torque gradient = 2800 mg-mm/deg

MECHANICAL CHARACTERISTICS

Temp Range	-55°C. to +150°C.	Shaft Runout	0008 max.
Shaft End Play, 8 oz. ld.	.0008 max.	Friction max. @ 25°C.	4 gm.-cm.
Shaft Radial Play, 4 oz. ld.	.0005 max.	max @ -55°C.	16 gm.-cm.

**ACCURACY: 5' STANDARD
3' ON SPECIAL ORDER.**

CLIFTON 
DIVISION OF LITTON INDUSTRIES

DUAL-IN-LINE SOCKETS

for testing and packaging plug-in IC's

LOW COST • HIGH PERFORMANCE • WIDE APPLICATION

- Sockets for 14 and 16 lead packages having flat or round leads
- Large contoured entry holes for easy IC insertion
- Gentle wiping leaf contacts provide high reliability
- Available with or without mounting saddle for panel mount or printed circuit applications
- Molded diallyl phthalate body; beryllium copper, gold-plated contacts

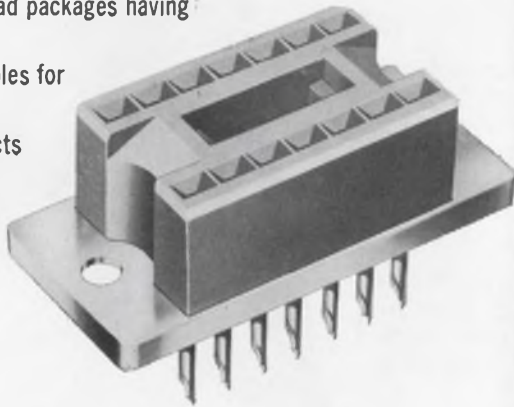

Request Catalog 364 describing our complete line of integrated circuit products for Testing, Breadboarding, and Packaging.

AUGAT

INC. 31 PERRY AVE., ATTLEBORO, MASS. 02703

ON READER-SERVICE CARD CIRCLE 103

TEST EQUIPMENT

Three-pen instrument is trend recorder

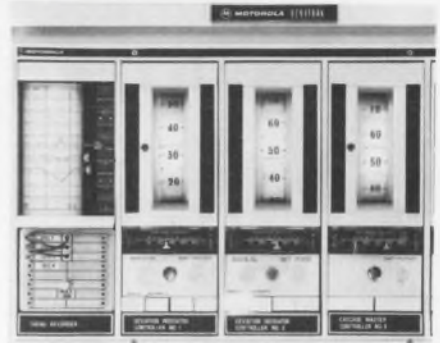

Motorola Instrumentation and Control, Inc., P. O. Box 5409, Phoenix. Phone: (602) 959-1000.

Used primarily with deviation indicating controllers which have no recording facility, this trend recorder may be used to record up to three variables simultaneously. The recorder chassis is wired to accept one, two, or three standard pen-drive modules, which can be added or removed as desired. There is no need for additional amplifiers. Inputs from up to 16 controllers can be handled by a front-panel patch-board. This permits plug-in connection of any desired input in a few seconds. This 16-input capacity is advantageous in high panel-density installations.

High-torque, servo-positioned pens record on the 4-inch horizontal chart. The pen drive system is actuated by a variable inductance feedback loop; there are no slide-wires or pulleys. Each servo-drive pen module has provision for switch selection of either fast or slow frequency response (0.5 Hz and 0.07 Hz, respectively, at 3-dB points).

CIRCLE NO. 402

Environmental chamber tests semiconductors

Standard Cabinet Co., Inc., Totowa, N. J. Phone: (201) 256-2200.

The semiconductor environmental test system can subject large quantities of small electronic devices to controlled low and high temperature conditions while simultaneously providing access for the application of electrical loads and the acquisition of pertinent test data. The units feature removable interchangeable component carrier trays.

CIRCLE NO. 337

YOKE SPECIFYING PROBLEM?

ASK AN EXPERT...

A SYNTRONIC DEFLECTION YOKE SPECIALIST



Since we make more types of yokes than anyone else, it's natural enough for our team of experts to know more about yoke design, application engineering, and quality control.

Specifying can be a challenging problem, and with this in mind, we put our experience at your disposal. Don't hesitate to call or write us when you're puzzled as to the right deflection yoke for your display.

syntronic

INSTRUMENTS, INC.
100 Industrial Road, Addison, Illinois
Phone: Area 312, 543-6444

ON READER-SERVICE CARD CIRCLE 104

MATERIALS

Molded insulation for crimp terminations

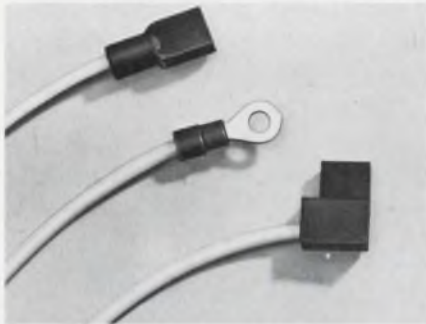

Beman Manufacturing, Inc., P. O. Box 370, New Cumberland, Pa. Phone: (717) 774-0210.

A technique for molding insulation on crimped wire terminals consists of crimping standard open barrel terminals onto wire leads, and then encapsulating any desired portion of the terminal with molded plastic. The plastic used is normally polyvinylchloride but other thermoplastic materials can be furnished. This technique can be used in place of preinsulated terminals or post-insulation methods such as clamp-on nylon covers for push-on type receptacles. The Mold-A-Terms can be applied singly or in multiples as required.

CIRCLE NO. 338

Transistor pads are Mylar-backed

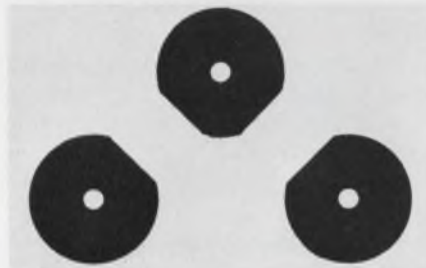

By-Buk Co., 4326 W. Pico Blvd., Los Angeles. Phone: Price: from \$4.

Precision die-cut transistor pads are in group position on transparent Mylar pressure-sensitive carrier film for stability. They are pre-cut so each set of three can be applied as a group unit. The pads are available from 0.1-inch outside diameter to 0.3-inch outside diameter, and 0.015-inch inside diameter to 0.08-inch inside diameter. They are packaged in quantities of 250 or 1000.

CIRCLE NO. 339

NEW!

**DRIVE
THESE
ULTRA
SENSITIVE
REED
RELAYS ...**

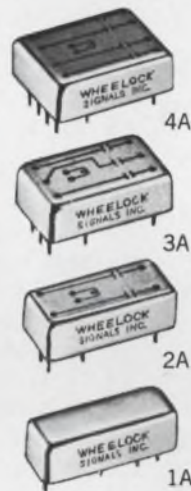

ACTUAL SIZE

**Directly
from
YOUR I.C.'s**

Wheelock announces a new generation of reed relays with the 442S Series. They are sensitive enough to be activated with I.C.'s, eliminating expensive driver stages . . . small enough to allow 40 2-pole relays to be mounted on a 4½" x 5½" pcb.

- Operates on 60 milliwatts power
- Contacts Rated at 7 watts
- Occupies 0.05 cubic inches per pole PC board mount

BY *Wheelock* OF COURSE

Contact Wheelock first for any of your relay design problems.

WHEELOCK SIGNALS, INC.
273 Branchport Avenue
Long Branch, New Jersey 07740
(201) 222-6880

Write for detailed literature on the new 442S Series



at 500 watts
or 30KW...

PEK

means reliability in high pressure Xenon Arc Lamps

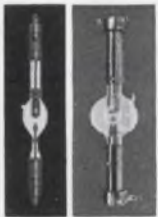

PEK high wattage xenon arc lamps are manufactured with just one criterion in mind—

reliable performance. And, when we say performance we mean performance up to and beyond today's exacting requirements in solar simulation, color projection, instrumentation, or wherever high order radiant energy sources are employed. □ Whether your need is 500 watts or as high as 30KW, you can count on dependable glass-to-metal seals, maximum arc stability and long life when you specify PEK. □ Send for our new Product Reference Guide or tell us what your special need is. There's a PEK lamp to fit your application.

PEK

PEK / 825 E. Evelyn Avenue
Sunnyvale, California
(408) 245-4111 / TWX 737-9973

ON READER-SERVICE CARD CIRCLE 121

MATERIALS

Urethane elastomer has low toxicity



H. V. Hardman Co., Inc., 600 Cortlandt St., Belleville, N. J. P&A: 85¢ to \$1.65/gallon; stock.

A low-stress, low-exotherm, two-part urethane elastomer cures at room temperature to a tough, resilient material. Dielectric strength is 550 V/mil, dielectric constant is 3.12 and dissipation factor is 0.06, both at 1 kHz. Thermal conductivity is 3.3×10^{-4} cal/cm/cm²/s/°C. In addition, Kalex 70 exhibits desirable low moisture vapor transmission and water absorption properties. Under test, original volume resistivity of 10^{15} dropped to 10^{12} after 24 hours immersion in superheated water (230 F). It is used in a 1:1 volume ratio and is compatible with materials commonly found in electrical/electronic apparatus.

CIRCLE NO. 340

Rigid-material is high-temp dielectric



Hi-Temp Products Co., 13855 Silver Spring Dr., Menomonee Falls, Wis.

A new material in rigid form has high temperature resistance (1800°F), excellent dielectric strength, freedom from thermal shocks and little or no thermal expansion. It acts as an excellent thermal and electrical insulator and can be cut or molded into various shapes. Called K-1 Board, the product claims exceptional dimensional stability.

CIRCLE NO. 341

Gold solution plates 99.99% pure

Transene Co., Inc., Route 1, Rowley, Mass. Phone: (617) 948-2501. P&A: \$20 (pint), \$30 (quart), \$80 (gallon); stock.

Pure gold SG-10 is processed from hyper pure gold compounds and is well buffered. The solution deposits pure gold (99.99%) with a center cubic structure and Rockwell hardness of 24. The optical properties of SG-10 afford high reflectivity, greater than 90%, in the infrared region. The solution is used for electrical contacts and terminals, electronic tube base pins, switches, printed circuits and waveguides.

CIRCLE NO. 342

Casting system for high temperature

Hysol Corp., 1100 Seneca Ave., Olean, N. Y. Phone: (716) 372-6300.

A casting and impregnating system for operating temperatures to 155°C is intended for transformers and coils meeting MIL T27B requirements for Class V operation. The encapsulant system is chemically the same as the impregnant, with fillers added to increase viscosity and produce a low shrinkage, thermal-shock-resistant casting. Dielectric strength of both systems is 375 V/mil. Volume resistivity is $7 \times 10^{13} \Omega$ at 30°C and exotherm during cure is negligible. The impregnant and encapsulant are both two-component systems.

CIRCLE NO. 343

Diode package uses copper-clad flange

Ceramics International Corp., 36 Siding Pl., Mahwah, N. J.

A line of varactor and diode package designs are available in various flanges and pedestals, in standard ceramic sizes from 0.08 inch OD. A super-strength copper-clad flange employs two metals; Kovar for rigidity and copper for low yield point. The copper, brazed adjacent to the ceramic component, yields and absorbs the stress due to difference in thermal expansion between the ceramic and the Kovar.

CIRCLE NO. 344

another Aerovox B-R-E-A-K-T-H-R-O-U-G-H in the state-of-the-art

1.0 MFD. 25 VDC molded case Ceralam in CK06 style

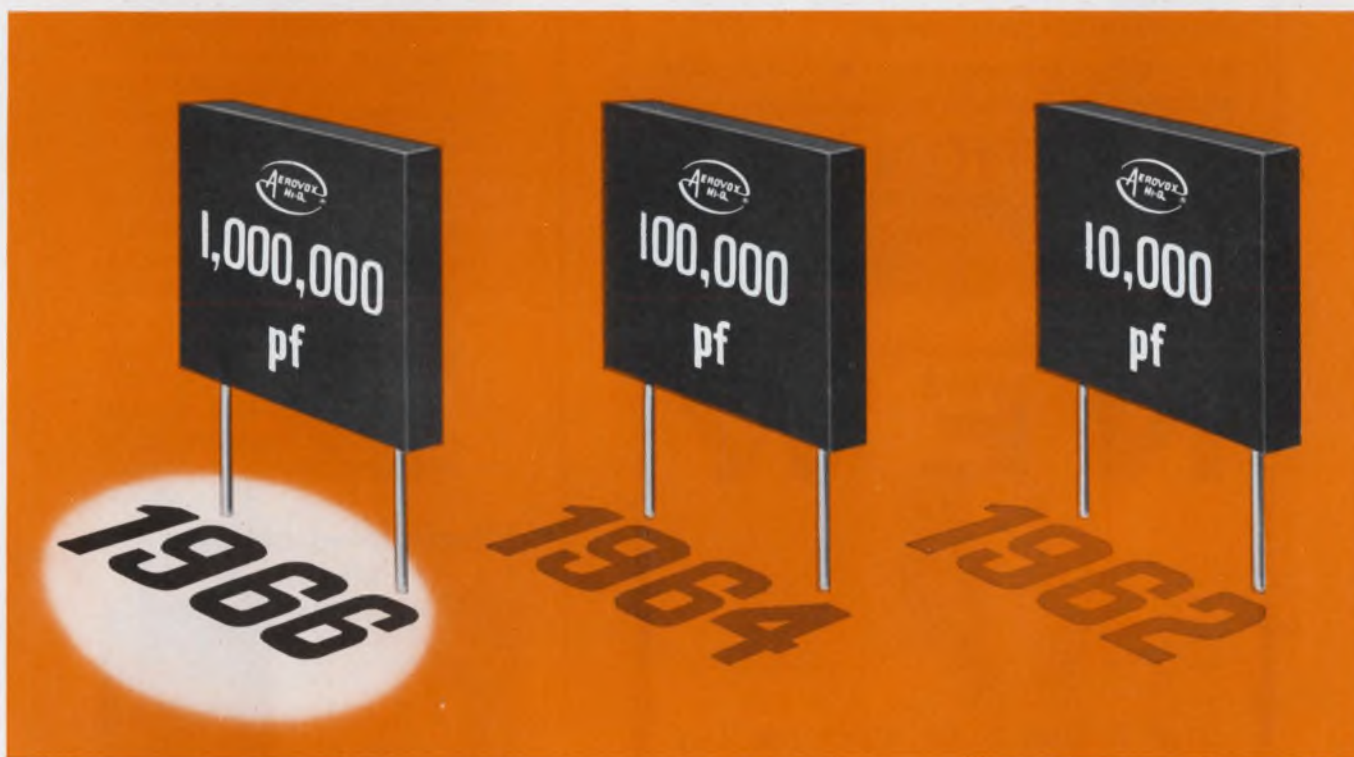

Just the ticket for those solid-state applications ... greatly increased capacitance ranges at a reduced voltage. This Aerovox breakthrough features a 1.0 mfd, CK06 made with Ceralam established reliability, semi-stable Characteristic "C" material ($\pm 15\%$ temperature coefficient).

In addition to the CK06, greater capacitance is made available in all Aerovox configurations and standard ceramic compositions. These include a 0.1 mfd CKR12, a 0.33 mfd CK05, and values up to 7.5 mfd in the Aerovox MC89 tubular series.

Aerovox's well established reliability has been a prime consideration in the development of these new units and careful adherence to conservative voltage stress limits has been maintained. Although rated at 25 volts, units are life

tested at twice rated voltage. Capacitors of similar low voltage rating such as electrolytics are tested only at rated voltage. Units may also be screened by "burning-in" at twice rated voltage for periods up to 250 hours without shortening the life of the capacitor and thereby bringing quality to the levels specified in MIL-C-39014.

For complete details contact your local Aerovox sales representative or write ...



AEROVOX
CORPORATION
OLEAN, N. Y.

Selected commercial and military products are available off-the-shelf from Authorized Aerovox Distributors
ON READER-SERVICE CARD CIRCLE 125



National NL-BEZ-84 Bezel Assembly

TTL IC Drivers for NATIONAL[®] Readout Tubes

From stock: Decoder/Driver, Decimal Counter/Driver and Decimal Counter/Driver with Latching Memory.

- 15 MHz Counting Rate
- For all side and end view National readout tubes.

NATIONAL REQUEST BULLETIN

ELECTRONICS, INC.
a varian subsidiary

PHONE: (312) 232-4300 • GENEVA, ILLINOIS, 60134

ON READER-SERVICE CARD CIRCLE 122

NEW



Model 8095
Howard
Cyclohm Fan

Mounts on 2.81"
Centers. Free
air delivery, 22 CFM

Latest Addition to the *Cyclohm* Line of Fans and Blowers with Air to Spare

Face mounting matches industry standards. Rear mounting is a plus feature. Indestructible Nylon blades. All metal construction (no cracking, warping or distortion). Whisper-quiet operation. Guaranteed for 5 years to require no maintenance or re-lubrication.



For immediate delivery, contact Standard Motor Products Sales, 23 Broadway, Des Plaines, Ill. 60016. Telephone 312-827-7743. TWX 910-233-1658. For Cyclohm Fan and Blower Bulletins, address



HOWARD INDUSTRIES
MSL INDUSTRIES, INC./MOTOR GROUP
1760 STATE STREET
RACINE, WIS, 53404

ON READER-SERVICE CARD CIRCLE 123

MATERIALS

Glass-epoxy boards breadboard ICs

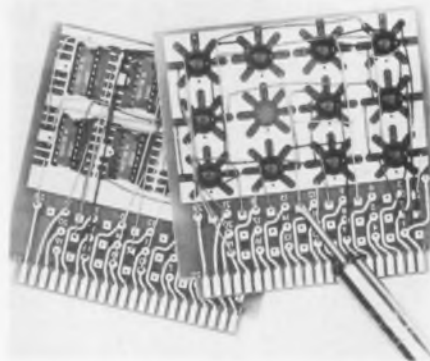

Elgin Electronics, Inc., Walnut St., Waterford, Pa. Phone: (814) 794-5501.

Glass-epoxy module cards for IC prototypes are available in dual-in-line, 8-pin TO-5, 10-pin TO-5 and flatpack circuit patterns. The same models with power connections in place are optionally available. In use, the ICs are soldered to the board and interconnecting leads soldered in holes provided. Terminators (44 total) are standard 22-position double readout edge tabs to accept standard receptacles and connectors. Contacts are gold-plated with standard 0.156-inch spacing. There is a copper ground plane on the component side.

CIRCLE NO. 405

Silver-plated bellows for RFI shielding

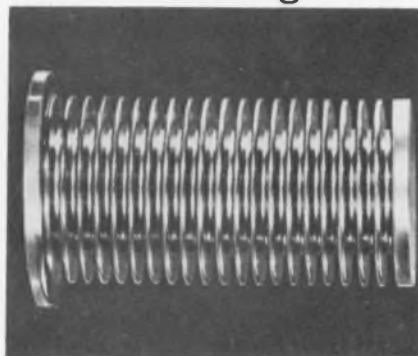

Servometer Corp., 82 Industrial East, Clifton, N. J. Phone: (201) 773-0474.

A silver-plated bellows is designed for RFI shielding applications in microwave systems. The thin-walled resilient nickel bellows are plated with pure silver to provide required resistance to heat and high sensitivity.

CIRCLE NO. 406

Etching-grade alloy for IC lead frames

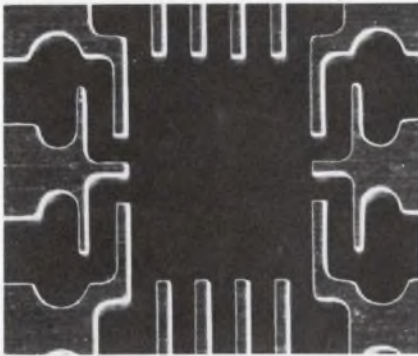

Wilbur B. Driver Co., 1875 McCarter Highway, Newark, N. J. Phone: (201) 482-5550.

Etching grade Rodar is a glass-to-metal sealing alloy for the etching of IC lead frames. The alloy can be etched sharply and matches the expansion characteristics of glass so that it can be hermetically sealed in glass. It consists of 53% iron, 29% nickel, 17% cobalt and trace elements. It is available in thicknesses of 0.01 to 0.0005 inches and can be produced thinner if required. Maximum width is now 8 inches, but 12-inch strip will be available.

CIRCLE NO. 407

Semi-flexible epoxy for sensitive components



3M Company, 2501 Hudson Rd., St. Paul, Minn. Phone: (612) 733-4033.

A medium thixotropy, black-pigmented, semi-flexible epoxy resin is designed for use with strain-sensitive components. Resin XR5140 has a low temperature curing cycle. Curing starts at 65° C and may range as high as 120° C. Gel time is 23 minutes at 121° C. Dielectric constant at 100 Hz and 23° C is 3.56 and dissipation factor is 0.054. Volume resistivity exceeds 10¹⁵ Ω/cm.

CIRCLE NO. 408

188 ~~113~~ STANDARD MODELS...

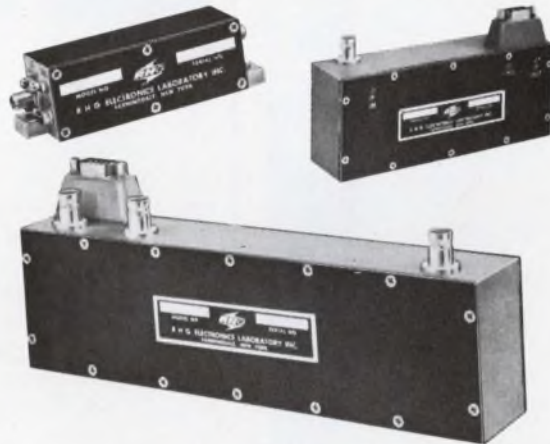

RHG IF AMPLIFIERS

- Linear or Log response
- Solid State, Tube, and Ultra-miniature
- RFI Protected
- IF and Video Outputs
- MIL Grade
- Matched Units
- IC MODELS AVAILABLE

RANGE OF SPECIFICATIONS

Center Frequency:	5 to 160 MHz
Bandwidth:	.25 to 100 MHz
Gain:	to 100 db
Noise Figure:	to 1.4 db
Price:	From \$185

In addition to offering the widest line of off-the-shelf units in the industry, an additional 268 CUSTOM DESIGNS have been produced. The solution to your problem may be on file in our library now.

For specials, test our ONE-DAY-QUOTE Service. For standards, see complete listing in EEM Section 3400.

RHG

RHG ELECTRONICS LABORATORY, INC.

94 Milbar Blvd., Farmingdale, L.I., N.Y. 11735 • (516) 694-3100

MICROWAVE FM and AM RECEIVERS • MICROWAVE MIXER PREAMPS
LINEAR and LOG IF AMPLIFIERS • RF and OCTAVE AMPLIFIERS

ON READER-SERVICE CARD CIRCLE 124

BIG NEW

narda *Microline* CATALOG

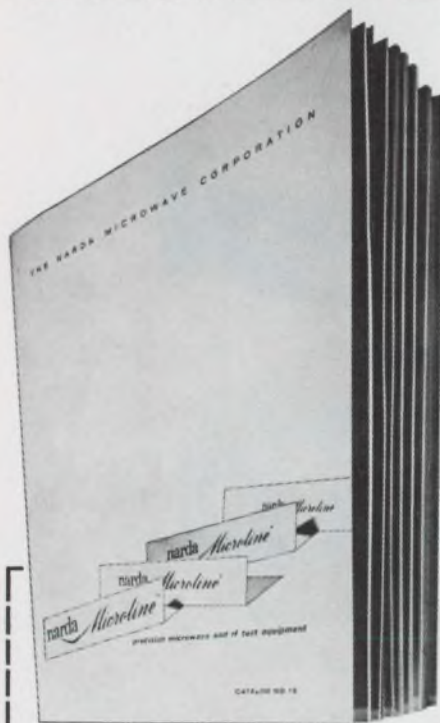

RESERVE YOUR COPY NOW BY WRITTEN REQUEST.

Jammed packed with useful information, tables and product specifications, this easy-to-use catalog will never find its way to the file shelf—keep on your desk as a ready, reliable source for precision microwave and rf test equipment and devices.

Please send me new Narda Microline catalog.

NAME
TITLE
COMPANY
ADDRESS
CITY STATE
ZIP PHONE

I am particularly interested in (application)

My frequency is

- I do not have your previous catalog.
 I do have your previous catalog.

**The Narda Microwave Corporation
Plainview, L. I., New York 11803**

MATERIALS

PC board material makes drilling easy



Westinghouse Electric Corp., Insulating Materials Div., Trafford, Pa. Phone: (412) 256-7000

A drill-back material of resin-paper composition reduces the burr-out of copper-clad circuits experienced with rigid laminates, plexiglass or other materials. The drill-back is a protective backing for both the printed circuit and drill bits during drilling operations. In automatic, high-speed drilling, where blocks of 10 to 20 holes are "gang-drilled" at one time, the drill-back is usually taped to the copper-clad side of the circuit. When two or more circuits are drilled at one time, the drill-back is attached only to the bottom circuit. Thickness ranges from 18 to 25 mils according to needs. The material has a hard surface, with less resin toward the center. The hard surface gives it strength and the soft interior gives a cushioning effect.

CIRCLE NO. 409

Thin-film resistor for mechanical trimming

Riedon Avionics, Inc., 7932 Haskell Ave., Van Nuys, Calif. Phone: (213) 873-3464. P&A: \$1.05 (500 lots) to \$2.25, 97¢ for 1 k Ω , stock.

A thin-film trimmable metal resistor substrate is deposited on a ceramic substrate and supplied for mechanical trimming resistor values and tolerance within 0.5%. To trim, a scribing technique is used; removing a film area and increasing resistance to the needed values. Leads can be soldered or welded to the gold pads. After trimming, a protective coat of epoxy is used. Standard ranges are from 225 Ω in graduated increments to 100 k Ω .

CIRCLE NO. 410

Full-spectrum shielding from 1 Hz to 10 GHz

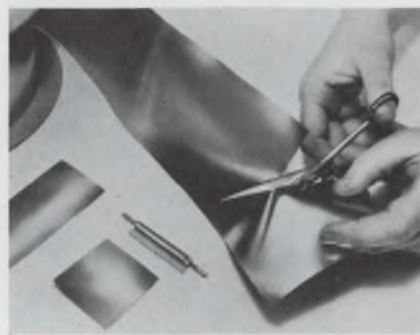

Magnetic Metals Co., 2100 Hayes Ave., Camden, N. J. Phone: (609) 964-7842.

A combination high-permeability, high-conductivity electromagnetic shielding provides full-spectrum shielding from 1 Hz to 10 GHz. Shieldmu 30 CU consists of a 0.0014-inch layer of high-frequency shielding cemented to a 0.004-inch layer of low-frequency shielding. The low-frequency layer is fully annealed to assure permeability as high as 150,000. Magnetic shielding can be formed in place simply by placing a piece of the material over the component and pressing it in place. Standard tape widths include 1, 2, 4 and 12 inch. Over-all thickness is approximately 0.0074 inch including the interlayer adhesive (0.002 inch).

CIRCLE NO. 411

Flexible urethane film protects transformers

CRC Chemicals, Dresher, Pa. Phone: (215) 646-3800.

A permanent, flexible hard urethane insulating film protects electrical and electronic parts and equipment. Available in aerosol spray cans or in bulk, it is a one-component unit with no catalyst necessary for activation. It can be air or heat-cured. The film is resistant to acids, oils, alkali salts and chemicals. It can be used on printed circuits, transformer connectors and other equipment to provide protection from condensation and corrosive atmospheres. It also acts as an insulation varnish for motor component encapsulation and transformers. It is compatible with transformer oil. Temperature range is from -90° to +300°F.

CIRCLE NO. 412

High-permeability cores for pulse transformers

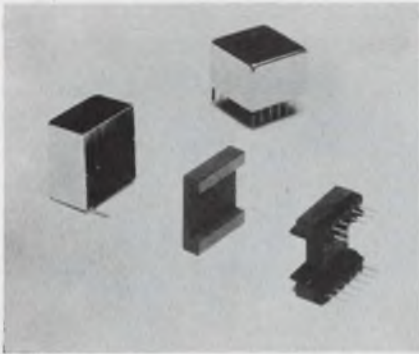

*Ferroxcube Corp., Saugerties, N. Y.
Phone: (914) 246-2811. P&A: \$1.35
(large quantities); stock.*

Ferrite H-cores for broadband transformers have a permeability of 5000; said to be the highest commercially available. Inductance per 1000 turns is 4500 mH. These characteristics are well suited to broadband transformers in the range of 10 Hz to 100 MHz and to pulse transformers for PCM applications with pulse widths from 0.1 μ s. Tuned transformers from 10 Hz to 10 MHz are another application area.

CIRCLE NO. 413

Copper-clad laminates simplify PC production

NVF Co., Maryland Ave. & Beech St., Wilmington, Del. Phone: (302) 655-6371.

Catabond laminate is intended for the production of double-sided or multilayer PC boards which utilize plated through-holes. With a Catabond laminate, copper can be reduced directly on the substrate hole surface. This completely eliminates the need for catalytic seeding and subsequent sanding. Further production economies are made possible by the fact that hole drilling can often be replaced by punching. Consisting of two sides of copper foil bonded to an insulating substrate, Catabond laminates have a catalyst dispersed throughout the substrate. They are offered in cured sheets up to 48 x 39-in. dimensions. Overall thicknesses range from 0.31 to 0.25 in. Copper foil is available on both sides in 1 or 2-oz thicknesses.

CIRCLE NO. 414

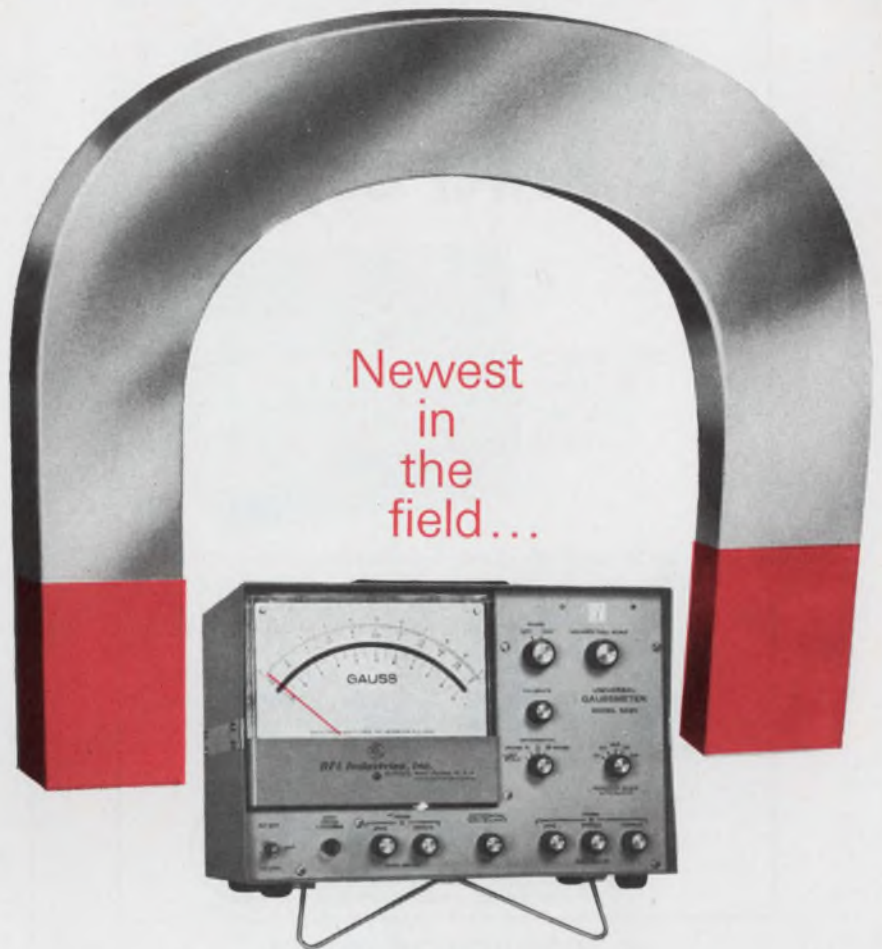

RFL Model 3265 Gaussmeter

3 Modes of Magnetic Measurement:
Absolute, Differential, Incremental

The Model 3265 is a precision Hall-effect gaussmeter capable of three distinct modes of operation: measurement of absolute flux densities from .02 gauss to 50 kilogauss (DC and AC to 400 Hz). Incremental determination of field variations to a resolution of 1 ppm as an expanded scale gaussmeter and a differential mode enabling simultaneous measurement of two separate fields or single field gradients.

All solid-state design provides highly stable operation for laboratory, production line or portable field use. The large seven-inch taut-band meter allows precision measurements with ease of readability.

An accessory DVM may be used for true Digital gaussmeter operation.

Phone Herb Brumbach (201) 334-3100 for engineering evaluation loan or demonstration without obligation — or write for detailed specifications.



Complete range of Hall-effect probes for transverse, axial and tangential fields.



RFL Industries, Inc.

FORMERLY RADIO FREQUENCY LABORATORIES, INC.

Instrumentation Division • Boonton, New Jersey 07005

Tel: 201-334-3100/TWX: 710-987-8352/CABLE: RADAIRCO, N.J.

Audio Amplifier? AC Power Supply?

the Compact
NA Series
gives you
both!



The NA Series of AC Power Supplies are exceptionally flexible sources of audio power. Each power supply consists of a Regulated Audio Power Amplifier with interchangeable fixed or variable Plug-In Oscillators for a wide range of precision AC power

applications. The Amplifier has a full power range of 45-6,000 cycles. With the incorporation of a CML Plug-In Oscillator precise fixed or adjustable output frequencies are available anywhere within this range. For complete information, write today.

CML, Inc. 

A subsidiary of Tenney Engineering, Inc.
350 Leland Avenue · Plainfield, New Jersey
(201) 754-5502 · TWX: 201-756-2064

ON READER-SERVICE CARD CIRCLE 128

MICROELECTRONICS

Custom hybrids, made to your specs

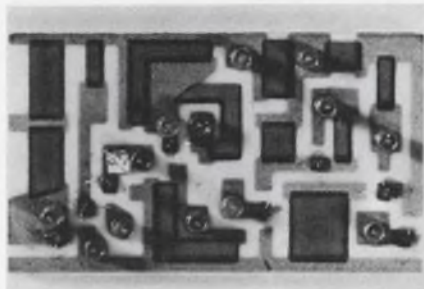

Dictograph Products, Inc., Danbury, Conn. Phone: (203) 744-1900.
P&A: from \$1; 3 to 8 wks.

Custom hybrid integrated circuits in any combination of conductors, resistors, transistor die attachments and encapsulant are offered. The 96% alumina substrates are screen-printed with noble metals and fired at up to 1000°C to form conductors and resistors. Semiconductors and capacitors are then attached to form a circuit, either encapsulated in plastic or TO-5 cans and flatpacks. Resistors ranging from 10 Ω to 10 MΩ, capacitors to 68 mF and wattages range to 20 W/in² with external heat sink.

CIRCLE NO. 415

Solderless test kit breadboards ICs

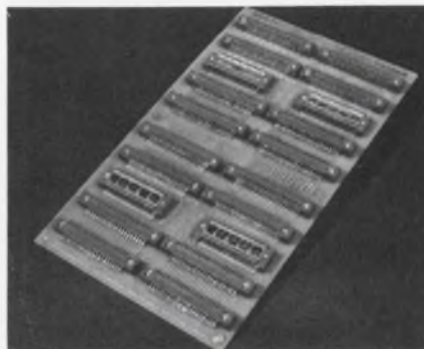

Brown Engineering Co., Inc., Research Park, Huntsville, Ala. Phone: (205) 536-4455. Price: \$35.

A flatpack breadboard kit consists of a 6-1/4-by-10-3/4-inch glass laminate gold-plated PC board, an IC flatpack carrier/connector and 4 board-to-wire connectors. Two screws are needed to attach the connectors to a board. IC flatpacks or chips are held to the carrier-connectors by gold-plated contacts instead of solder.

CIRCLE NO. 416



FREE CATALOG!
NEARLY 4,500 BUYS
FOR INDUSTRY

OPTICS! SCIENCE! MATH!
GIANT 148 PAGES

Many on-the-job Helps . . . Quality Control Aids! Write for this completely new, 1967 Catalog. New items, new categories, new illustrations. 148 easy-to-read pages packed with hundreds of charts, diagrams, illustrations. A treasure-house of optical and scientific information . . . unusual bargains galore. Optics for industry, research labs, design engineers, experimenters, hobbyists! Instruments for checking, measuring—to speed work, improve quality, cut production costs. We give you facts: what it is—how it works—where it's used.

Comparators, Magnifiers, Microscopes

Hard-to-get war surplus bargains—ingenious scientific tools—imported—domestic. Thousands of components: lenses, prisms, wedges, mirrors, mounts, accessories of all descriptions. Dozens of instruments: magnifiers, stereo microscopes, telescopes, binoculars, infrared equipment, photo attachments. Shop by mail. No salesman will call. Use the Catalog of America's greatest Optics—Science—Math Mart. Known for reliability. Mail the coupon below for Catalog "DA."

EDMUND SCIENTIFIC CO., BARRINGTON, N. J.

Mail Coupon for FREE Catalog "DA"
EDMUND SCIENTIFIC CO., Barrington, N. J. 08007

Please send FREE Giant 148-page Catalog "DA"

NAME _____

ADDRESS _____

CITY _____ STATE _____ ZIP _____

ON READER-SERVICE CARD CIRCLE 129

Integrated transfer gate for AND/OR gating

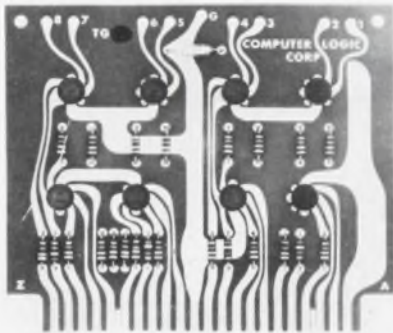

Computer Logic Corp., 1528 20th St., Santa Monica, Calif. Phone: (213) 451-9754.

TG-32 logic cards contain 4 independent structures for AND/OR gating. Each structure has four 2-input NAND/NOR gates followed by inverters. The output of the 4 inverters is common at one pin, and a separate load is provided. Each 2-input gate operates as a low-true NAND, and the output OR result is also low. As many as 40 or 50 2-input NAND gates can OR at one load resistor.

CIRCLE NO. 417

Monolithic chip caps use high-K dielectric



Scionics Corp., 8900 Winnetka Ave., Northridge, Calif. Phone: (213) 341-5500.

Monolithic chip ceramic capacitors offer optional dielectrics (high-K NPO bodies) in five basic configurations. Capacity ranges from 10 pF through 0.1 mF, dissipation factor is 0.1% through 2.5%, depending on dielectric. Voltage rating is 50 wVdc and insulation resistance exceeds 50,000 M Ω . Available tolerances are ± 10 , ± 20 % and guaranteed minimum value.

CIRCLE NO. 418

SPIN YOUR DISHES WITH MECATORN[®]

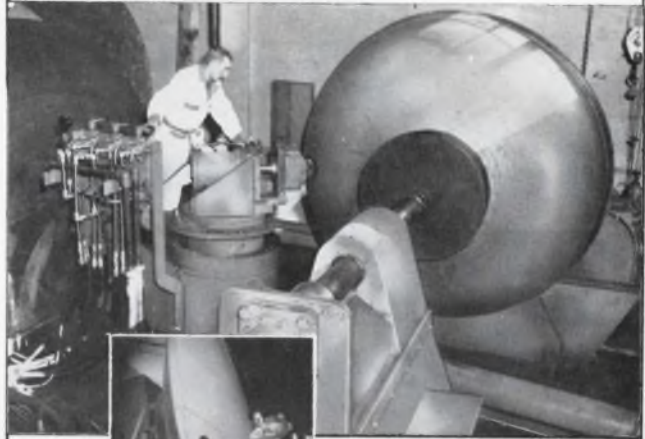

Torngren "dishes"
span the nation,

contributing to the efficient operation of many communication networks both military and commercial.

Our Mecatorm process can mean substantial savings in your program cost while actually increasing the overall efficiency of your system. Reflectors can be Mecatorm spun from 4" to 16 feet diameter.

Metallurgical advantages such as refined grain structure with flow line pattern matched to part configuration, elimination of porosity and occlusions in the metal, automatic self-inspection of work in progress, are all primary benefits attained through the Mecatorm spinning process.

Before you spec, check with Torngren — for parabolic reflectors of superior quality at considerable dollar savings.

Send for a free copy
of our new capabilities
brochure and current
price list #466.



C.W.

TORNGREN

COMPANY, INC.

236 PEARL STREET

SOMERVILLE, MASSACHUSETTS

AREA 617/ MO 6-3250

ON READER-SERVICE CARD CIRCLE 130

Off-the-Shelf Only from api

- 1% tracking
- taut-band
- no extra charge
- 20 to 100 μ a

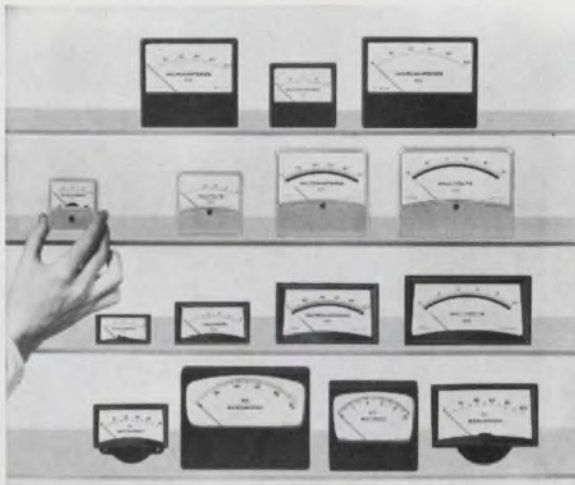

There's extra value, but no extra cost, in API's line of DC panel meters in the 20 to 100 microampere ranges. Tracking of $\pm 1\%$ is standard. Frictionless taut-band construction produces meters that are the most accurate, sensitive to smaller signals, vibration-proof and durable.

No other manufacturer offers these bonus features at firm catalog prices.

15 Models in Stock

You'll get off-the-shelf delivery of the economically priced Panelist, Stylist and

black phenolic meters shown above. Choose from these full-scale DC ranges:

Microamperes: 0-20, 0-50, 0-100

Millivolts: 0-5, 0-10

If ultra-precision tracking is the least you'll settle for, API offers 0.5% tracking at reasonable cost. This "super-calibration" is another API exclusive, again backed by published prices.

Ask for Bulletin 47.

Also stocked nationally by Allied Electronics and Newark Electronics.

api INSTRUMENTS CO.

CHESTERLAND, OHIO 44026 (CLEVELAND-216) 729-1611 • TWX: 810-427-9230

ON READER-SERVICE CARD CIRCLE 131

Ceramic Capacitors

MOLDED CERAMIC TUBULARS

for computer applications. The ultimate in reliability (failure rate 0.001%/1000 hours at 85° C and twice rated voltage.)



DISC CERAMICS

for all commercial and military applications. New production techniques give Skottie a big edge in price, quality and delivery. Ask for a quote and find out if it's not so.



Do you have a problem in ceramic capacitors with special designs, quality, reliability, guaranteed delivery or price? If you do, it might pay you to look into Skottie Electronics. We specialize exclusively in the design and manufacture of ceramic dielectric capacitors. Skottie is a major supplier of ceramic capacitors to the largest computer and radio/TV manufacturers in the world.

Sure we do the military and commercial standards. But in ceramics, when you have special needs (particularly design or delivery) we think you'll find Skottie Electronics your best supplier. Representatives in major cities throughout the United States.

SKOTTIE ELECTRONICS, INC. / Archbald, Pennsylvania 18403
Phone 717-876-1686 TWX-510-656-2979

ON READER-SERVICE CARD CIRCLE 132

MICROELECTRONICS

Counter/storage registers cover MIL range

Signetics Corp., 811 E. Arques Ave., Sunnyvale, Calif. Phone: (408) 739-7700. P&A: \$32.70 (100 lots); stock.

Decade and binary counter/storage registers operate over the full MIL temperature range (-55° to $+125^{\circ}$ C). The 4-bit decade counter/storage register (S8280J) and the 4-bit binary counter/storage register (S8281J) are available in hermetically sealed glass-Kovar flatpacks. The monolithic silicon devices include four J-K flip-flops and 13 gates for a total of 30 equivalent gate functions or 160 discrete components. The decade counter may be used in the BCD (8-4-2-1) mode, or in the biquinary mode to provide the square wave output required for frequency synthesis and similar applications. Mode of operation is determined by the user depending upon how the functions are connected externally.

Both circuits provide counting rates up to 25 MHz and have a power consumption of 100 mW. The binary counter contains separate one-stage and three-stage binary counters which may be cascaded by external connections to obtain a four-stage binary counter. Both of the ICs feature strobed single-ended parallel entry capability and a separate CLEAR line common to all four bits.

CIRCLE NO. 419

IC modules feature high speed and fanout

Digital Equipment Corp., Maynard, Mass. Phone: (617) 897-8222.

These TTL integrated circuits feature high speed, high fanout, capacitance drive capability and good noise margins. The large capacitance drive capability results from the low output impedance of the TTL gates. Modules are provided which perform the functions of shifting, counting, storage, binary-to-octal conversion and gating. All ICs are in 14-lead dual-in-line packages which allow them to be treated in the same manner as discrete components.

CIRCLE NO. 420

Audio power amplifier is multifunction

RCA, *Electronic Components and Devices*, 415 S. Fifth, Harrison, N. J. Phone: (201) 485-3900. P&A: \$2.80 (evaluation quantities); stock.

For use in portable or fixed audio communications systems, a multi-purpose AF power amplifier combines the functions of preamplifier, phase inverter, driver and power output on a single monolithic silicon chip. The RCA CA3020 AF power amplifier finds application in military, industrial and commercial equipment that requires an AF amplifier, servo amplifier, vidicon deflection driver or relay driver.

The circuit is a stabilized direct-coupled amplifier, and performs preamp, phase-inverter, driver and power-output functions without transformers. It is designed to operate from a single power supply between +3 and +9 volts, power output capability being a direct function of the supply voltage used. At a supply voltage of +9 volts, the CA3020 delivers a typical power output of 550 mW with an idling current of 22 mA. At +3 volts, it delivers 65 mW with an idling current of 7 mA. A temperature-tracking voltage regulator in the circuit permits stable operation from -55 to +125°C. Other features include easy application of squelch, low-distortion operation, an optical buffer stage for increased input impedance, high power gain to permit coupling to most detectors without additional amplification, and operation from 10 Hz to 6 MHz.

CIRCLE NO. 421

Logic cards perform many functions

Cambridge Thermionic Corp., 445 Concord Ave., Cambridge, Mass. Phone: (617) 876-2800. P&A: \$36.50 (10 to 49); stock.

Multiply, divide, add, subtract, exclusive OR, exclusive NOR, OR, NOR, AND, NAND, invert, are functions of these 1-bit arithmetic logic IC assemblies. Operation in either serial or parallel mode is optional. In addition, the assemblies may have as many as three input registers, and one for internal storage.

CIRCLE NO. 422

KORAD LASERS when BRIGHTNESS is important

The Korad Model K-1500 oscillator-amplifier laser provides gigawatt giant pulses with brightness 2.5×10^{14} watts/cm²/steradian. Pulse energies exceed ten joules. Other Korad lasers deliver 250 watts cw at 10.6 microns; 150 joules of radiation at 6943Å; 500 megawatts of Q-switched power; 100 Nd pulses per second; 100 watts cw at 1.06 microns. Other lasers available.

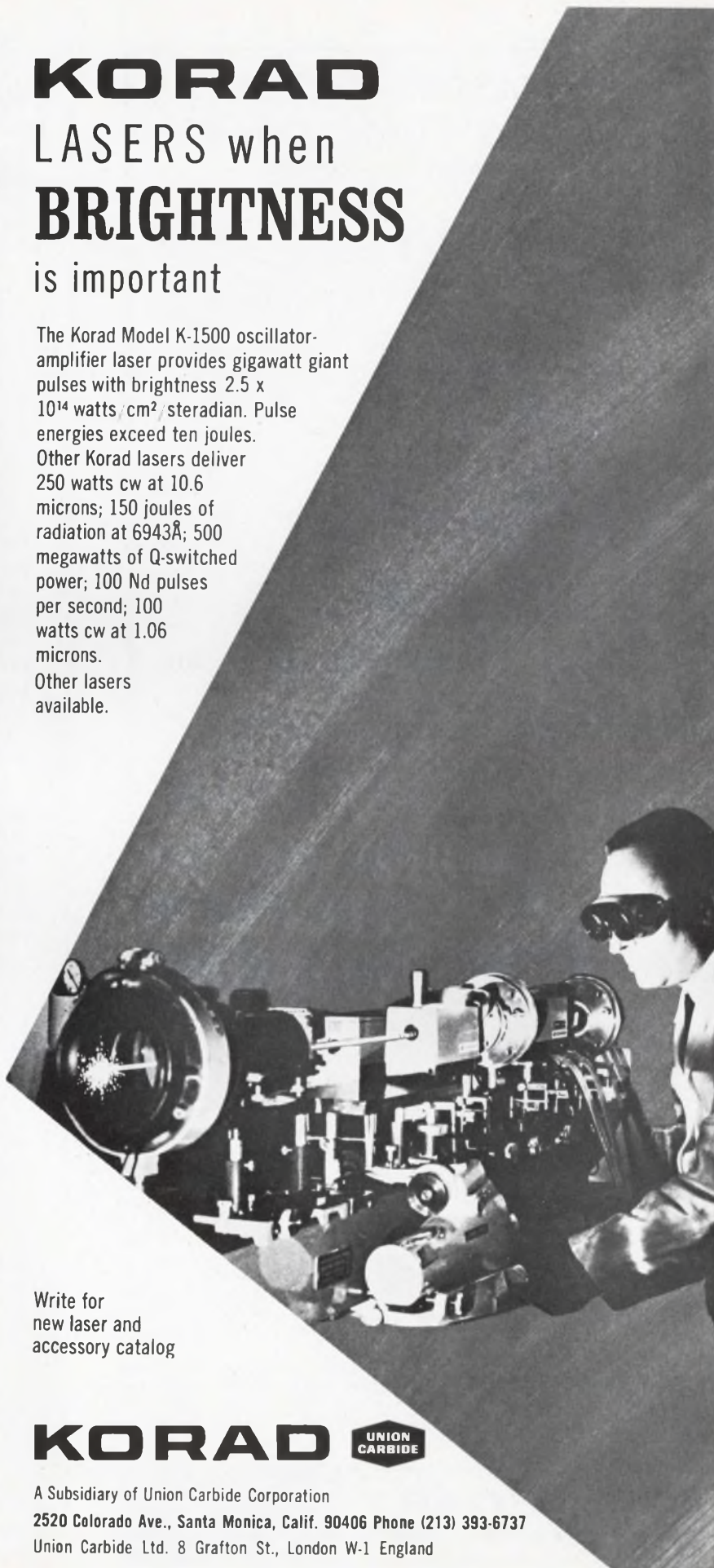

Write for
new laser and
accessory catalog

KORAD 

A Subsidiary of Union Carbide Corporation
2520 Colorado Ave., Santa Monica, Calif. 90406 Phone (213) 393-6737
Union Carbide Ltd. 8 Grafton St., London W-1 England

ON READER-SERVICE CARD CIRCLE 133

CASTING RESINS FREE STYCAST® CHART COMPLETELY REVISED



This chart for notebook or wall mounting has just been brought up to date. It contains comparative property data on over 20 Stycast epoxies and urethanes.

*This Valuable Folder Is Yours.
Write or Use Reader Service Card.*



Emerson & Cuming, Inc.

CANTON, MASS.

GARDENA, CALIF. • NORTHBROOK, ILL.

Sales Offices in Principal Cities

EMERSON & CUMING EUROPE N.V., Oevel, Belgium

ON READER-SERVICE CARD CIRCLE 134

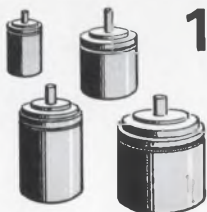

1001 uses for STEPPER MOTORS

Because their output is in discrete increments, Cedar stepper motors have many advantages over conventional motors for precise positioning applications. They are bi-directional and have high torque output. They can be run at high stepping rates or as slow as you wish. Because shaft rotation is incremental, damping is not required. **Some of the applications** for which stepper motors have been used are: replace motor-tachometers in servo systems, control missile ailerons, shutter control on high-speed cameras, open loop positioner in checkout systems, high-speed counter in such applications as rapid firing weapons, replace ultra low-speed dc motors, incremental tape handlers, and digital-to-analog and analog-to-digital conversion equipment.

The uses for stepper motors are as unlimited as your imagination. New applications are constantly being discovered. What new use will you next make of stepper motors? Let us know about your ideas; we'll be happy to work with you.

Cedar Stepper Motors are available in sizes 5, 8, 11 and 15 in both permanent magnet and variable reluctance types, and with a wide variety of stepping angles. All meet the full requirements of MIL-E-5272. For free booklets on stepper motor application ideas, write or call:



5806 West 36th Street, Minneapolis 16, Minnesota. Phone 929-1681

ON READER-SERVICE CARD CIRCLE 135

SEMICONDUCTORS

600-volt rectifier needs no heat sink

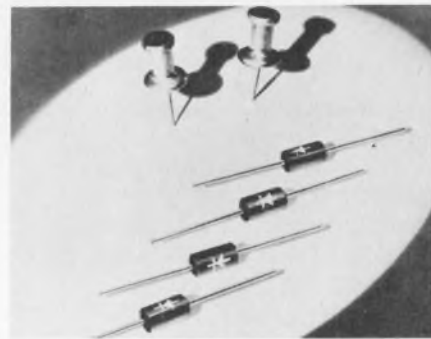

Semtech Corp., Newbury Park, Calif. Phone: (805) 498-2111.

A high-current, axial-lead silicon rectifier is constructed with "tungstaloïd" pins, metallurgically bonded above 900° C to solid silver leads (0.04-inch) at the silicon junctions. The pins match the thermal expansion characteristics of the silicon junction and eliminate the need for heat sinks. PIV rating ranges from 50 to 600 volts, average rectified current is 3 A at 55° C and static reverse current is 10 μ A at 25° C.

CIRCLE NO. 423

Silicon pnp transistor handles 30 amps

Motorola Semiconductor Products, Inc., P. O. Box 955, Phoenix. Phone: (602) 273-6900. Price: \$7.50; \$9.05 (100-up).

Pnp silicon power transistor replacements for germanium devices have current-handling capability up to 30 amperes. Performance for the 2N4398-9 reportedly matches the germanium advantages of low saturation voltages and good current handling. The units are applicable to motor control circuitry, for inverters, switching regulators, series pass regulators, shunt regulators, hammer or relay drivers, as well as high-power audio or servo amplifiers where current demand is high.

At 10 amperes I_c and 30 volts V_{cc} , delay and rise time is 400 ns. The devices permit a swing-down in voltage without loss of current gain to 1 volt at 10 amperes. Collector-to-emitter saturation voltage is 0.75 volt maximum at 10 amperes. Packaged in a copper-base TO-3, the devices have thermal resistance of 0.875°C/W.

CIRCLE NO. 424

Plastic power transistors put out 83 watts

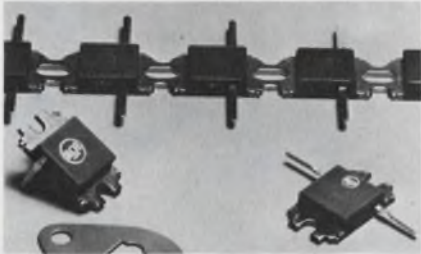

RCA, *Electronic Components and Devices, Harrison, N. J.* Phone: (201) 485-3900.

Six new plastic packaged silicon power transistors with power outputs of 83 watts also offer a choice of package designs. The packages include a straight-lead design for PC board mounting and a bent-lead version compatible with standard TO-3 or TO-66 mounting techniques. The silicon chip is mounted directly onto a solid copper base to provide excellent thermal capability. The devices are the 2N5034, 2N5036, 2N5037, 40513 and 40514. The 2N5034, 2N5036, and 40514 are available in the bent-lead design for use in TO-3 sockets; a special mounting over-clamp can be provided to adapt the units for chassis mounting. The 2N5035, 2N5037 and 40513 are designed for printed-circuit board mounting. All use a homotaxial-base design for protection against second breakdown.

CIRCLE NO. 425

Schottky varactors have ultra-high Q

Solitron Devices, 256 Oak Tree Rd., Tappan, N. Y. Phone: (914) 359-5050.

Ultra-high Q (greater than 1000) large-area Schottky barrier junctions result in a new line of square-law voltage variable capacitors. Because the devices exhibit almost true log slopes, circuit designers can expect highly accurate tuning ranges with a minimum of required voltage swing. All varactors show resistive cutoff frequencies in excess of 250 GHz. Zero voltage capacitance values can be from 1 to 500 pF, breakdown voltage is up to 20 V and Q ranges from 500 to 2000.

CIRCLE NO. 426

TEMESCAL high vacuum VALVES

- Valve sizes from 1/2" to 60" — and larger on special order
- Angle or gate valves capable of being mounted in any position
- Forged brass, cast aluminum, fabricated steel

"The World's Largest Manufacturer of High Vacuum Valves"

Call or write for catalog.



TEMESCAL
METALLURGICAL CORPORATION

2850 Seventh Street
Berkeley, California 94710
Telephone (415) 841-5720

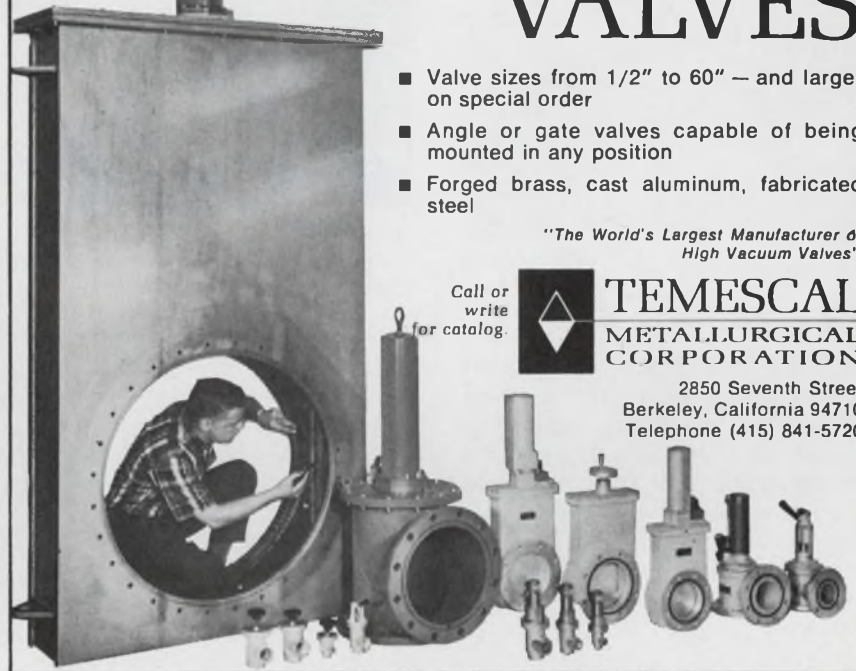

ON READER-SERVICE CARD CIRCLE 109

TOTALLY ENCLOSED ROTARY SWITCHES. TEMPERATURE TO 125 C. MULTI-POLE. 30°, 36°, 45°, 60°, and 90° ANGLE of THROW. 100,000 OPERATIONS.

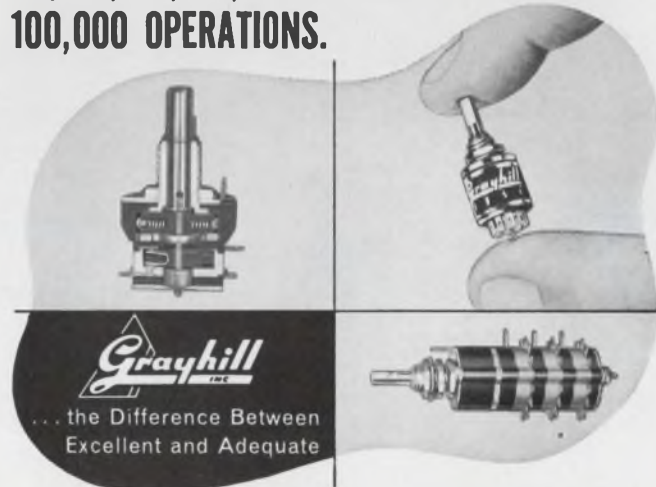

Typical Specifications:

- Explosion Proof
- Contact Resistance 10 Milliohms
- Make or Break 1/4 Amp. to 15 Amps., 115 VAC Resistive
- 1 to 6 Poles per Deck
- 1 to 12 Decks
- 2 to 12 Positions per Pole

Send for Engineering Catalog G304



565 Hillgrove Avenue
LaGrange, Illinois 60525
Area Code 312, Phone 354-1040

"PIONEERS IN MINIATURIZATION"

ON READER-SERVICE CARD CIRCLE 136

Ge power transistor rated at 7 A

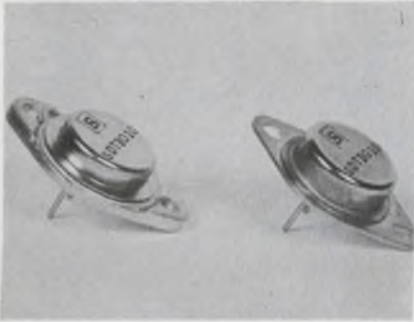

Solitron Devices, Inc., 1177 Blue Heron Blvd., Riviera Beach, Fla. Phone: (305) 848-4311.

A 7-A germanium power transistor is available in a TO-3 package with a steel or copper base. The copper-base unit has a thermal resistance of $0.8^{\circ}\text{C}/\text{W}$; the steel base device provides a thermal resistance of $1.5^{\circ}\text{C}/\text{W}$; other electrical characteristics are identical. Typical characteristics are V_{CER} of 50 V, V_{CBO} of 50 V, V_{EBO} of 20 V and rated I_{C} of 7 A. The 1-A gain is 74 to 250.

CIRCLE NO. 427

Water-cooled SCR rated at 630 A rms

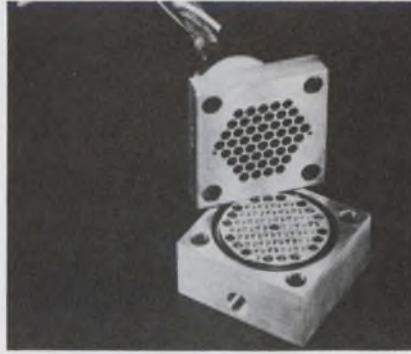

Westinghouse Semiconductor Div., Youngwood, Pa. Phone: (412) 925-7272.

A high-power SCR rated at 630 A rms has a water-cooled heat sink. The heat sink creates low-velocity eddy currents for optimum transfer of heat away from the device. This permits the high current capability in the small 3-in.² by 6-inch package. The SCR is rated at 400 A half-wave average, 630 A rms through 1200 volts. The liquid-cooled heat sink requires a water flow of 1-1/2 gallons per minute.

CIRCLE NO. 428

Selenium rectifier smaller than silicons

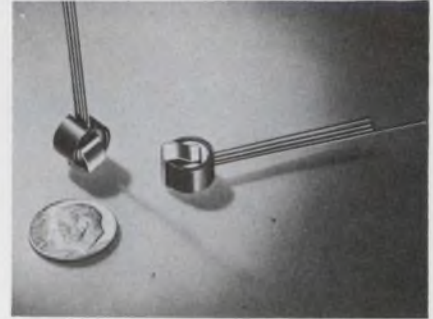

Sarkes Tarzian, Inc., Semiconductor Div., 415 N. College Ave., Bloomington, Ind. Phone: (812) 332-1435. Price: 23¢ to 39¢.

This bridge rectifier offers selenium's inherent protection from high-voltage transients and momentary current overloads, yet measures only 0.4 inches in diameter and 0.35 inches thick. Model XP-29 is rated at 33 V rms maximum input, 300 mA dc maximum output and operates with convection cooling at ambient temperatures up to 40°C . The output is approximately 26 Vdc with a resistive-inductive load.

CIRCLE NO. 429



Looking for a more challenging opportunity? Join Sonotone's fast-growing engineering team in the sky-rocketing field of nickel-cadmium battery design and development. An equal opportunity employer.

Directional coupler has secondary incident probe



Dielectric Products Engineering Co., Inc., New Town Rd., Littleton, Mass. Phone: (617) 486-3575.

A 1.7-to-2.4-GHz directional coupler with a secondary incident probe handles up to 12 kW of continuous power. The coupler provides a maximum main line vswr of 1.05 and a maximum probe vswr of 1.2. Maximum insertion loss is 0.05 dB and coupling is 65 dB for the incident probe, 53 dB for the secondary incident probe, and 55 dB for the reflected probe. Directivity is greater than 25 dB over the band.

CIRCLE NO. 430

Mixer-preamps have low NF to 4000 MHz

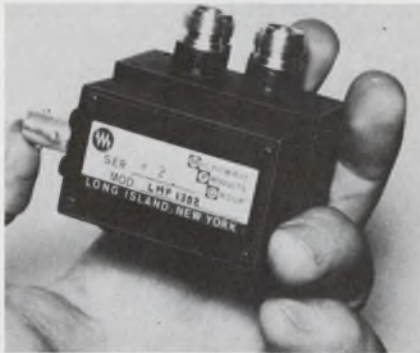

Microwave Products Group, 115 Old Country Rd., Carle Pl., N. Y. Phone: (516) 741-1500.

A line of mixer-preamps offering an extremely low noise figure has been introduced. Maximum noise figures of these mixer-preamps is 6.5 dB in octave band units from 500 to 4000 MHz, 7 dB from 4000 to 10,000 MHz, 7.5 dB from 10 to 12 GHz and 8 dB for a broadband 8-to-12-GHz unit. Gain is more than 25 dB, RF to IF. IF output is 30 or 60 MHz, 10 or 20 MHz bandwidth.

CIRCLE NO. 431

Splitter/adder maintains 50 Ω per port



Bishop Instrument, 440 Forest Ave., Portland, Me. Phone: (207) 774-8311.

Any four 50-Ω sources and loads may be connected with this splitter/adder while maintaining 50 Ω at all ports. A signal can be split between three paths, or three signals can be combined into one path. In the time domain, pulse reflections in a 140-ps system are only 6% with transmitted pulse risetime of 100 ps. Equivalent frequency range is dc to over 2 GHz. Power rating is 1.5 W, 500 V peak. BNC connectors are standard.

CIRCLE NO. 432



**Now...
what'll we
do for an
encore?**

Probably extend the industry's broadest line of nickel-cadmium sealed cells even more!

New product designs continually require new sizes and capacities in rechargeable sealed cells. So we'll keep on doing what comes naturally. Like expanding our line to keep well ahead of an increasing demand. And that adds up to big savings for you. You don't have to wait for someone to tool up for the cells you need. Because we've done it. And can supply your

needs at the drop of an order. If we don't have the cell you need, relax. It's just the excuse we need to broaden the industry's broadest line still further.

Sonotone Batteries 

portable power—from Titan to toothbrush
SONOTONE CORPORATION, BATTERY DIV., ELMSFORD N. Y. 10523

Aircraft, Missile and Satellite Batteries • Power Supplies • Battery Charger/Analyzer
ON READER-SERVICE CARD CIRCLE 137

combination

(low-price switch/circuit breaker)



Here is a low-price circuit breaker that reduces assembly cost and adds sales value to your product by combining two components into a single unit. The Model 112 is available in 5 through 50 amp. ratings, is trip free, and is approximately 1½" x ¾" x 2". Write for Thermal and Magnetic Circuit Breaker Catalog.



**WOOD ELECTRIC
CORPORATION**

244 Broad St., Lynn, Mass. (617) LY 8-5313
ON READER-SERVICE CARD CIRCLE 138

**NEW 1967
catalog**

1967

MINIATURIZED
TRANSFORMERS
MIL-T-27B and INDUSTRIAL
LAMINATED and TOROIDIAL
FROM STOCK

**YOURS FOR
THE ASKING**

MICROTRAN
145 E. Mineola Ave., Valley Stream, N. Y. 11582

ON READER-SERVICE CARD CIRCLE 139

MICROWAVES

Q-switched YAG laser pulses 5000 per second



Raytheon Co., Laser Advanced Development Center, 130 Second Ave., Waltham, Mass. Phone: (617) 688-7148.

A Q-switched, neodymium-doped, yttrium aluminum garnet laser system is capable of up to 5000 pulses per second. It utilizes a double elliptical cavity with two 1000-watt tungsten lamps. Peak output power ranges from 0.75 to 1 kW in pulse widths of 150 to 200 ns. Rep rate of the laser is 1000 to 5000 pulses per second and beam divergence is 5 milliradians. The LCW3-QS is water-cooled and is capable of cw operation with a 1.5-watt output. Output is at 1.06 microns.

CIRCLE NO. 433

Solid-state attenuator is fast-switching

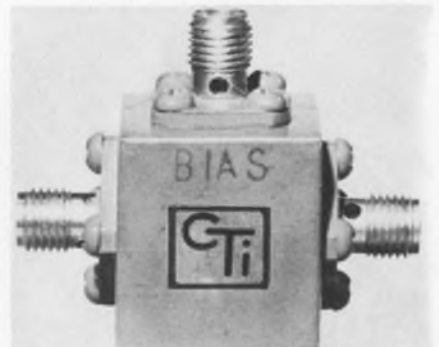

Comtronix, Inc., Box 69, Alpha Rd., Chelmsford, Mass. Phone: (617) 256-9951. P&A: \$295; 2 wks.

A solid-state voltage variable switch attenuator operates in a frequency range of 8 to 12 GHz or at less than 20-ns switching speed. Typical vswr is 1.5, insertion loss is 0.5 dB and control requirement to swing 0.5 to 30 dB is 0.5 mA. It is available with coaxial or stripline connections.

CIRCLE NO. 434

GaAs Gunn oscillator uses 2 to 20 Vdc



Nippon Electric Co., 200 Park Ave., New York. Phone: (212) 661-3420.

GaAs epitaxial Gunn-effect diode oscillators need an applied dc voltage of 2 to 20 volts to generate microwaves and millimeter waves of 4 to 50 GHz. The output power obtained in cw operation is 340 mW at 8 GHz, 150 mW at 10 GHz and 7 mW at 50 GHz. The efficiency is 0.5 to 5.5% and the observed FM noise is reportedly as low as that of a klystron. Nippon Electric, a Japanese-based manufacturer, has life-tested the diodes for 4000 hours and reports no deterioration.

CIRCLE NO. 435

Variable delay line with 2-octave bandwidth

Microwave Associates, Burlington, Mass. Phone: (617) 272-3000.

An electron beam variable delay line features a dynamic bandwidth of approximately 2 octaves, making possible extremely low pulse distortion unattainable with other RF delay devices. Its design allows rapid variation of delay, handling of multiple signals without cross modulation and moderate insertion loss. It is designed for applications including target simulation in radar testing and phased arrays.

CIRCLE NO. 436

Post amplifier puts out 1.5 W at 30 MHz

Varian, LEL Div., Akron St., Copiague, N. Y. Phone: (516) 264-2200. P&A: \$450; stock to 30 days.

Incorporating high-frequency, high-power transistors that have recently been made available, a solid-state post amplifier offers a 1.5-W output at 1-dB compression with a center frequency of 30 MHz and a bandwidth at the 1-dB points of 40 MHz. A second output, at a lower level, is provided for test purposes.

CIRCLE NO. 437

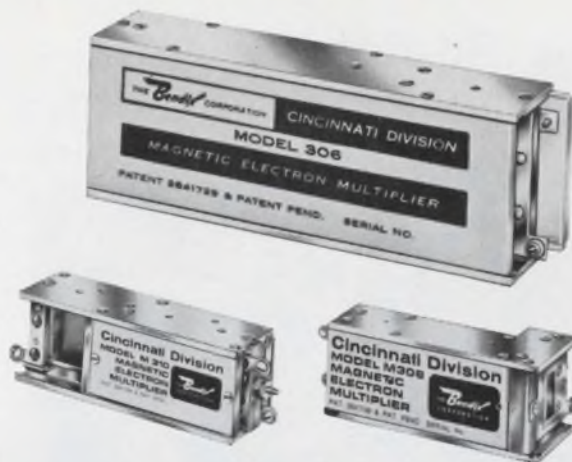

Our electron multipliers are sensitive to just about everything but ambient atmosphere and 350°C.

That's right, there's absolutely *no* deterioration of performance from ambient atmospheric exposure with Bendix® magnetic electron multipliers. Their remarkable sensitivity covers the most extreme ends of the electromagnetism spectrum: for photon and particle counting, far ultraviolet and soft x-ray detection, high-altitude solar radiation, nuclear radiation and ion detection, and even the hard ultraviolet range—something unattainable in other types of detectors.

What's more, the Model 310B is bakeable to 350°C. And there are several other models to choose from—each with the most compact, rugged, lightweight multiplier of its kind. *All with current gains of 10⁸.*

And to power them, our compact Model 1122 power supply was made to order. Its dependable solid state operation assures constant voltage differentials through extreme level variations. And minimum maintenance as well.

Bendix scientific instruments—including mass spectrometers, atomic absorption and flame spectrophotometers, polarimeters, polarographic systems and electron multipliers—are used in over 100 areas of research and analysis. For more information, write: **The Bendix Corporation, Scientific Instruments Division, 3625 Hauck Road, Cincinnati, Ohio 45241. Or phone (513) 772-1600.**

Specifications	Model M 306	Model M 308	Model M 310/310B
Direction of view	side	end	side
Aperture (in mm)	18.3 x 15.5	10.4 x 5.3	12.5 x 12.5
Spectral response	10 ⁸	10 ⁸	10 ⁸
Operating press. max. torr	5 x 10 ⁻⁴	1 x 10 ⁻⁴	1 x 10 ⁻⁴
Length, max. inches	4	2½	2½
Height, max. inches	.81	.93	.80
Width, max. inches	1.32	1.29	.69
Weight, nom. oz.	4½	2	2½

Bendix

ON READER-SERVICE CARD CIRCLE 140



Bodine N-1RD gearmotor: balanced design for long life

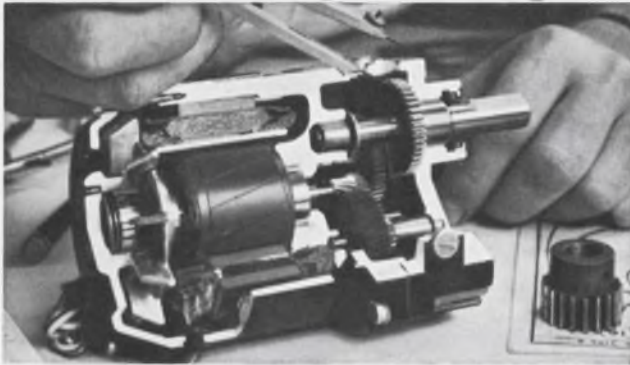

Every part used in the N-1RD gearmotor has been designed and tested to assure approximately the same long life. Result: lasting, rugged operation...consistent, reliable power.

Great overhung load capacity (needle bearings on output shaft) and high torque for its small size. Modifications easily made at minimum extra cost. You also receive such After Delivery Economies (ADE) as minimum rejects, service-free operation, consistent performance.

Only 5" long, 3 $\frac{3}{8}$ " square. Thirteen speeds: 300 to 2 rpm. Output torque ratings: 1.5 to 25 in. lbs. Ask for Bulletin 1025. Bodine Electric Company, 2528 W. Bradley Place, Chicago, Illinois 60618.



ON READER-SERVICE CARD CIRCLE 141



Low cost, benchtop humidity test chamber 24" W x 26" D

Tenney Humidity Jr. is a compact, self-contained, full range benchtop chamber for low-cost humidity simulation. Plug into 115 V outlet for lab work, product development, Mil-spec testing, quality control testing, incubation, etc.—*maintenance-free.*

Humidity Range: 20-95%
Humidity Tolerance: $\pm 1\%$
Temperature Range: $+20^\circ$ F to $+200^\circ$ F
Control Tolerance: $\pm 1/2^\circ$ F
Interior Dimensions: 20" W x 12" D x 15" H (2 cu. ft.)
Off the shelf delivery.

Write or call today for complete details.



1090 Springfield Rd., Union, N.J. 07083 • (201) 686-7870
Western Division: 15700 S. Garfield Ave., Paramount, Calif. 90723 446

ON READER-SERVICE CARD CIRCLE 142

SYSTEMS

Graphic recorder records X-Y-Z

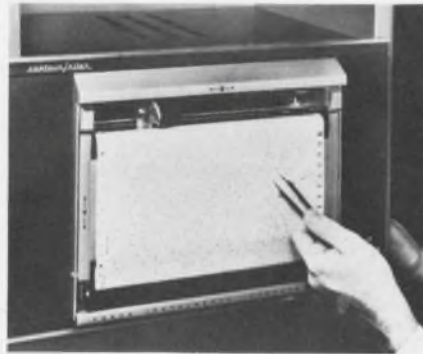

Texas Instruments, Inc., 3609 Buffalo Speedway, Houston. Phone: (713) 526-1411. P&A: about \$3000; 90 days.

The Contour/riter recorder combines the functions of X-Y and multipoint recorders into a single unit. This permits three-input X-Y-Z recording on a single chart. The unit uses null-balancing potentiometric drives for the X and Y axes and a 24-position multipoint head for recording the Z-axis inputs.

Span step response time of the X and Y axes is 5, 10 and 24 seconds standard, with accuracy of $\pm 0.5\%$ full scale, and linearity of $\pm 0.25\%$ of full scale, maximum. Chart frame size is nominally 9.75 by 9.75 inches with other sizes optional. Print rate of the Z axis is once per second, with digit change rate of one per second. Printing mode can be numbers only, color-coded points with numbers, or points only.

CIRCLE NO. 438

Portable tape recorder handles 14 channels

Systems Div., Genisco Technology Corp., 18435 Susana Rd., Compton, Calif. Phone: (213) 774-1850.

A portable magnetic tape recorder-reproducer is capable of handling up to 14 channels of record-reproduce or up to 31 tracks for PCM recording, with intermediate bandwidth capabilities of IRIG document 106-66. Versatile record-reproduce performance of the unit includes FM, direct digital write-read, and PDM, with completely modular, solid-state, plug-in electronics providing interchangeability of all operating modes.

CIRCLE NO. 439

Low-cost core memory stores 1024 words

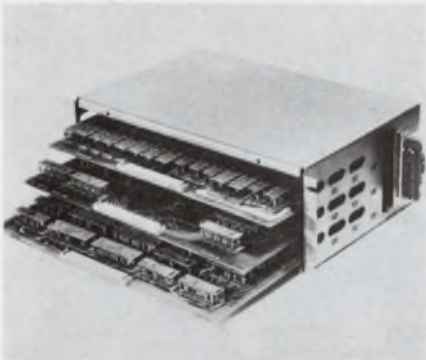

Ferroxcube Corp., Saugerties, N. Y. Phone: (914) 246-2811. P&A: \$1990; 30 days.

The FX-12/E is a 10- μ s, 1024-word by 8-bit memory designed for code or format conversions and speed buffering. By "folding" the stack, the 1024-word memory fits in the compact 15 x 5 x 9-inch package. Other features include all-silicon, cordwood, motherboard construction and low temperature coefficient cores.

CIRCLE NO. 440

Analog computer for educational use

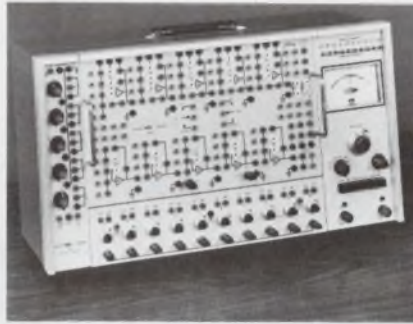

Systron-Donner Corp., 888 Galindo St., Concord, Calif. Phone: (415) 682-6161. Price: \$2250.

Designed primarily for educational use, this portable, desk-top computer has an all-solid-state ± 100 -V design. A removable problem board, a null reference system, visual computer circuits and a variety of plug-in computing accessories are featured. Maximum expansion is 10 amplifiers and 15 coefficient potentiometers (6 and 5 are included).

CIRCLE NO. 441

Rotary servo recorder integrates to 0.1%

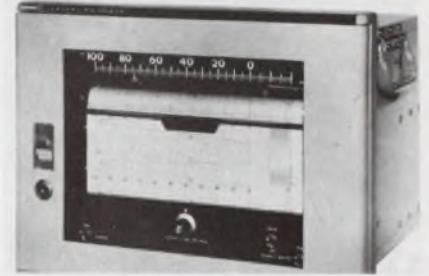

Esterline Angus Instrument Co., Inc., P. O. Box 24000, Indianapolis. Phone: (317) 632-6501.

A single-channel rotary servo recorder can be equipped with either of two types of integrators. One is a ball and disc integrator which automatically determines the area under a recorded curve. The value of this area is written on the recorder's chart. The other provides an electrical output signal suitable for readout of the analog record by digital counters and printers. Accuracy of the integrators is $\pm 0.1\%$ or ± 1 count, whichever is greater.

CIRCLE NO. 442

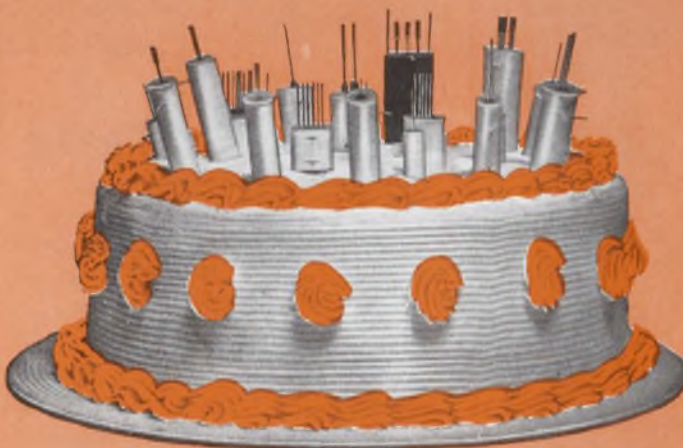

The First 50 Years

We complete our first half century of service to the electrical and electronic industries justly proud of a job well done. Starting with an assist to our Navy in World War I, we have played a major role in supplying these industries, from the gas light era to the space age. We look forward to the challenge of the next 50 years, and to your continued confidence in our ability to serve you.

Coto-Coil Company, Inc. 65 Pavilion Avenue
Providence, R. I. 02905
ELECTRICAL COIL WINDINGS • REED RELAYS AND COILS



ON READER-SERVICE CARD CIRCLE 143

MOTORS, MOTOR SPEED
 Bodine fractional horsepower motors, many full horsepower
CONTROLS, GEARMOTORS,
 motors, Superior Electric Co., Inc. Slo-Syn Motors, B & B
VARIABLE SPEED DRIVES,
 Synchronous Motors, General Electric Motors, Geartronics
STEPPING MOTORS
 Apcor Multi-Speed Gearmotors and Reducers, Zero Max Variable
TIMERS, CHRONOMETERS,
 Speed Drives, Helland Mechanical Overload Couplings, Miller
SPEED INDICATING
 Rectifiers and Transformers, A.T.C. Timers and Counters,
SYSTEMS • ONE SOURCE
 Chronometric Speed Counters, Vis-count Tachometer Speed
IMMEDIATE DELIVERY
 Indicating Systems, Heller Speed Controls. All in our new
FACTORY LOW PRICES
 64 page catalog No. 14-67. Write for your copy.
TECHNICAL ASSISTANCE



B & B MOTOR AND CONTROL CORP.
 96 SPRING STREET
 NEW YORK, N.Y. 10012 (212) 966-5777
 ON READER-SERVICE CARD CIRCLE 144



PRODUCTION EQUIPMENT

**Fracture wafers
 with yields to 100%**



*Mechanization Associates, 2622
 Frontage Rd., Mountain View,
 Calif. Phone: (415) 967-4262.
 Price: \$325.*

A semiconductor wafer fracturer offers fracturing yields approaching 100%. In operation, a wafer is first spray-coated on the reverse side with an air-drying emulsion or waxed to a thin carrier sheet to hold it together after fracture. It is then inserted between a soft rubber endless belt on its upper (scribed) side and a flexible Teflon-coated piece of clock spring steel on its bottom. The wafer travels along and follows closely the presettable curvature of the flexible steel and fractures as it passes over the preset bend radius. It emerges within three seconds all fractured in one direction, is rotated 90 degrees and repeated. Capacity is 300 to 500 wafers per hour.

CIRCLE NO. 443

**Place, solder flat packs
 10 per minute**

*Development Associates Controls,
 725 Reddick Ave., Santa Barbara,
 Calif. Phone: (805) 963-3708.*

Place and solder up to 10 flat packs per minute with this machine. Versions are available to handle boards up to 10 and 15 inches. The operator places the flat pack in a "verifying cavity" to determine that its mechanical configuration is satisfactory. The machine then automatically picks up the flat pack, while simultaneously dispensing an adhesive on the circuit board. The flat pack is transferred to the circuit board, put in position and all 14 leads soldered simultaneously.

CIRCLE NO. 444

Bend component leads 600 per hour by hand

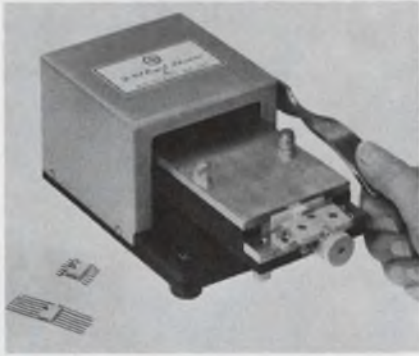

D-Vel Research Labs., Inc., 555 Bedford Rd., Bedford Hills, N. Y. Phone: (914) 666-3455. Price: \$99.95 (basic); \$25 and \$35 (extra dies for other bends).

A hand lead bender bridges the gap between the needle-nose plier method and expensive automatic machines. Four hole center distances are standard: 0.5, 0.6, 0.7 and 0.8 inches. Four bend configurations are standard. Other center distances and bend configurations can be supplied. The unit is completely portable and will not injure components as it handles only the leads. It can process up to 600 pieces/hour. A companion machine for multilead components is available.

CIRCLE NO. 445

PC boards tested two sides at once

McKee Automation Corp., 7315 Greenbush Ave., North Hollywood, Calif. Phone: (213) 983-1193. Price: \$5000.

Quick, low-resistance connections to internal test points on printed circuit and multilayer IC boards are provided by this test adapter in order to check for continuity and insulation resistance. The unit connects to both sides of a 4-layer IC board, checking the two sides simultaneously by means of some 700 plated-through holes on 0.1-inch centers. The board under test is positioned in a sliding holder. A battery of pneumatically operated test probes make contact with the network of test points. Probe contact is maintained as long as test continues. Nominal contact resistance is 50 m Ω .

CIRCLE NO. 446

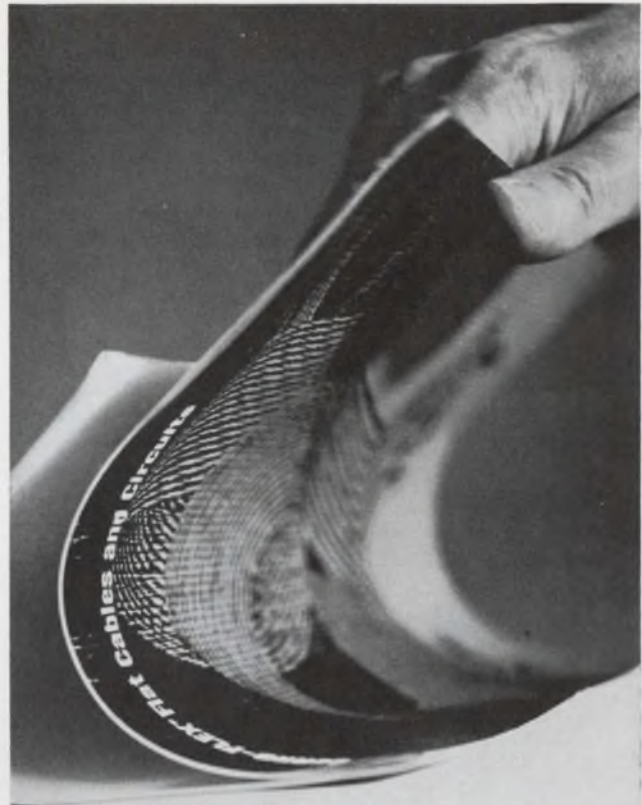

You've heard a lot of talk about flexible cables.

Read these facts.

This new, authoritative, 12-page design guide will help you: 1) decide when and where to use flexible cables and printed wiring; 2) exploit their specific advantages; 3) design the proper form for your application; and 4) choose the right insulation and conductor size.

The booklet is free. Write today. It'll show you how to reduce weight, save space, simplify assembly, increase reliability and uniformity and...cut costs.

Please send me "CERRO-FLEX[®]
Flat Flexible Cables"

NAME _____

TITLE _____

COMPANY _____

ADDRESS _____

[®]Trademark

CERRO WIRE & CABLE CO.

DIVISION OF CERRO CORPORATION
NEW HAVEN, CONNECTICUT 06504

Design Aids

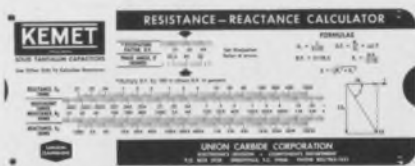

Reactance calculator

Simplify everyday reactance calculations with this handy slide rule. The front side relates reactance, equivalent series resistance, dissipation factor and phase angle. The reverse side determines capacitive reactance for frequencies to 10 kHz and capacitances to 1000 μF . Union Carbide, Electronics Div., Components Dept.

CIRCLE NO. 447

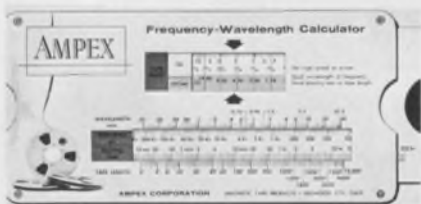

Frequency-wavelength rule

Relate magnetic tape operating parameters with a handy pocket-sized slide rule. By setting the tape speed in one window, the wavelength in mils is read opposite the frequency and the playing time is read opposite the tape length. Ampex Corp., Magnetic Tape Products.

CIRCLE NO. 448

High-temperature metals

In a convenient pocket fold-out chart, high-temperature and refractory metals properties are tabulated. Grade names, AISI numbers and typical analyses of 104 alloys are contained on the chart. Base metals are iron, nickel, cobalt, molybdenum, tungsten, tantalum and columbium. Universal-Cyclops Specialty Steel Div.

CIRCLE NO. 449

Telephone cable table

A table of telephone cable put-ups and weights is offered. Charted for easy identification are aerial, figure 8 and direct burial cable, and figure 8 rural distribution wire in various sizes. Brand-Rex Div. of American Enka Corp.

CIRCLE NO. 450



Plastics comparison chart

Know the salient properties of the major engineering thermoplastics at a glance. This 8-1/2-by-11-inch wall or notebook chart lists chemical, thermal, mechanical and electrical characteristics of 8 major plastics. In addition, the chart tabulates known solvents for each. Gries Reproducer Corp.

CIRCLE NO. 451



Transformer response rule

Typical problems encountered in the use of wideband transformers are solved with this slide rule. The rule covers the 20-Hz-to-10-MHz range. For example, given load or source impedance, the rule calculates the inductance needed in the transformer winding for a given frequency response. Or, given either the source impedance and primary inductance, or the load impedance and secondary, the rule determines that frequency at which the response will be down by a given number of dB. Marks are at -0.1 , -0.25 , -1 dB, etc.

Available for \$1 from Aladdin Electronics, 703 Murfreesboro Road, Nashville, Tenn.

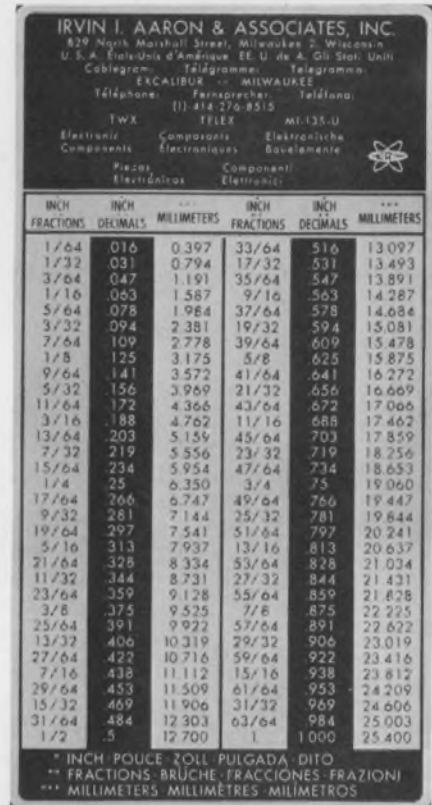

Conversion plate

A heavy gauge metal plate eases the task of converting from the metric to the "American" system of measurement. Europeans should find the plate especially useful in avoiding the use of reference books.

Available for \$1 from Irwin I. Aaron & Assoc., 829 N. Marshall St., Milwaukee.

Wire and cable selector

An 11-by-16-inch wall chart condenses necessary data for the proper selection of interconnecting wire and cable used in process instrumentation. One table classifies signal wire by application according to type of electrical signal, sensor, electrical noise and receiving element. The other table specifies the proper instrument wire for economically delivering a clean signal in each application. Types of noise: static, magnetic, common-mode and crosstalk, are defined, and examples of relative noise levels in various environments are presented. Samuel Moore & Co.

CIRCLE NO. 452

A LOW-COST 1 AMP SPDT RELAY MIGHT DO THE JOB BETTER THAN AN EXPENSIVE ONE.

If it's the new 75-cent
Sigma Series 65.



New Sigma Series 65 miniature relays are specifically designed for low-level DC switching applications where economy is of major importance. Available in quantity for 75 cents, these general purpose relays include extra design benefits:

Superior Switching Performance: The precision knife-edge hinge design of the armature provides better magnetic coupling for full utilization of coil power. This results in heavier contact forces, lower contact resistance and better electrical stability.

Greater Mechanical Strength: Glass-filled nylon, not ordinary phenolic, is used to support contact members assuring long-term mechanical life and stability.

Better Thermal Stability: Use of high-grade, low-

temperature-coefficient materials assures excellent thermal stability over a wide temperature range up to 70°C.

We'd like to give you a new Sigma Series 65— or any of our other standard relays. Test and compare it against the brand you may now be using. It's the best way we know to prove what we say about Sigma relay performance. Just circle our reader service number on the reader service card. We'll send you the new Sigma relay catalog and a "free relay" request form. Return the form to us and your Sigma representative will see that you get the relay you need.

Need fast delivery? The Series 65 is available off-the-shelf from your Sigma distributor.

SIGMA DIVISION  SIGMA INSTRUMENTS INC
Assured Reliability With Advanced Design / Braintree, Mass. 02185
Sigma Instruments (Canada) Ltd., P.O. Box 43, Toronto 18

ON READER-SERVICE CARD CIRCLE 147

New Literature

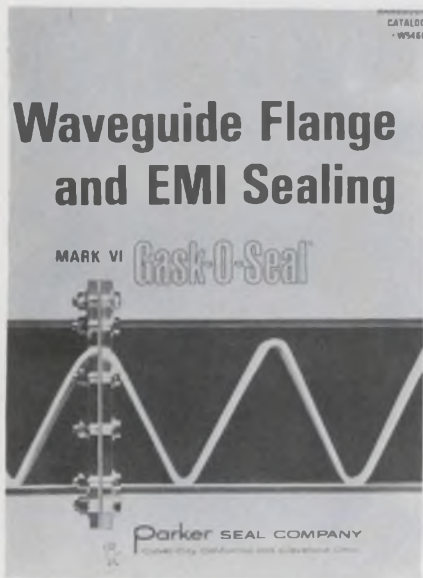

EMI seal design

A 70-page handbook catalog details the technology and devices used to seal waveguide flanges and electronic enclosures against both EMI and fluid leakage. The handbook contains information needed to help minimize loss or contamination of dielectric gases and preserve system performance against power losses and flange heating. It contains fifteen tables of engineering data plus twenty-four technical illustrations covering every aspect of seal design or selection. There are sections dealing with effects of dielectric selection, torque requirements for flange bolts, materials compatibility, flange resistances, effects of frequency and time-temperature parameters of elastomers used in sealing dielectric fluids. Parker Seal Co.

CIRCLE NO. 453

Soldering and welding guide

A nineteen-page guide to techniques for flame welding, soldering and brazing miniature parts is available. The guide centers around eleven applications areas, and is accompanied by an illustrated listing of 50 field applications. Uses include joining wire to wire, joining wire to sheet and flame-stripping insulated wire. A specific application cross-reference guide is included. Henes Manufacturing Co.

CIRCLE NO. 454

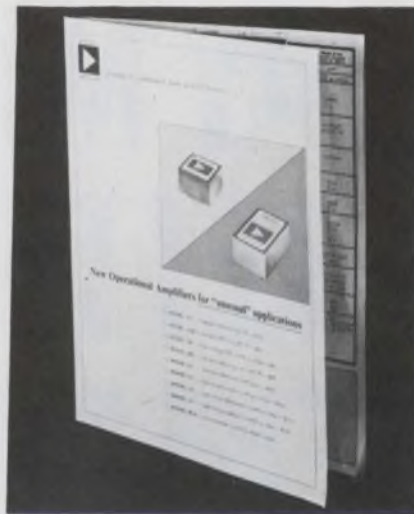

Unusual op-amp uses

This catalog lists full specifications for nine op-amps designed for "unusual" uses. Described are a low-cost chopper stabilized amplifier, a differential amplifier with 250-V/ μ s slewing rate and 5-MHz full power response, a differential unit with 250-mA output at ± 11 volts, a FET amplifier, a chopper-stabilized amplifier, with ± 100 -V output and a differential amplifier with 0.75 μ V/ $^{\circ}$ C drift. Analog Devices.

CIRCLE NO. 455

CRT guide

A 12-page guide lists a line of military and industrial cathode ray tubes for radar display, computer readout and oscilloscope applications. The reference guide gives physical and electrical characteristics, including dimensions, typical operating conditions and resolution capabilities. Included are typical pin connection diagrams which are illustrated for 24 different basic electron gun types. Westinghouse Electronic Tube Div.

CIRCLE NO. 456

62,000 power plug-ins

More than 62,000 different plug-in power supplies are listed in a 14-page catalog. Both single and dual plug-in power supplies are listed, with nominal output voltages from 1 to 900 V and output currents to 3 A. Acopian Corp.

CIRCLE NO. 457

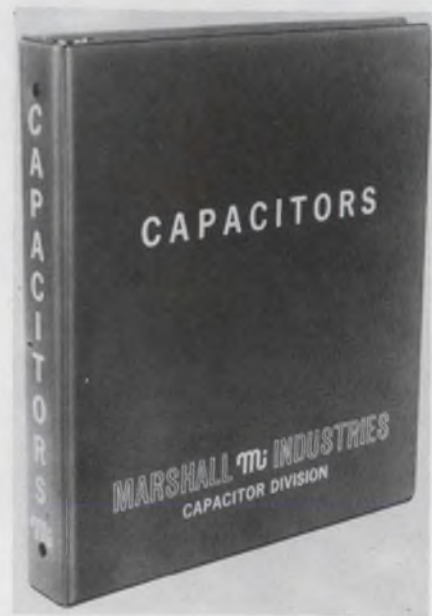

180 pages of capacitors

The complete line of Marshall capacitors is detailed in this 180-page volume. Along with component data, the manual contains a section on the application and selection of capacitors and a discussion of the history, construction and application of ceramic capacitors. Types of capacitors covered in the manual include ceramic dielectric designs, metallized dielectric (polycarbonate, Mylar, paper-epoxy and paper-wax impregnated), and non-metallized dielectric (Mylar and foil, polystyrene and foil, plastic film and foil, and paper/Mylar and foil). Sections on accessories and special types of capacitors are included. Marshall Industries.

CIRCLE NO. 458

Photoconductive modulators

The application of photoconductive cells in low-level signal modulation is discussed in Vol. 2, No. 2 of the Photocell Forum. The eight-page issue of the brochure discusses the application of photoconductive modulators and gives reader suggestions for photoconductive cell use in an industrial engine trouble warning system, a replacement for ganged potentiometers in Wein bridge oscillators, and an automatic locator for an auto in a parking lot. Clairex Electronics, Inc.

CIRCLE NO. 459

TRIPLET

EXTRA QUALITY IS HIDDEN*

MODEL 630 V-O-M PRICE † \$5800

Standard Of The Industry

USES UNLIMITED:

- Field Engineers
- Application Engineers
- Electrical, Radio, TV, and Appliance Servicemen
- Electrical Contractors
- Factory Maintenance Men
- Industrial Electronic Maintenance Technicians
- Home Owners, Hobbyists

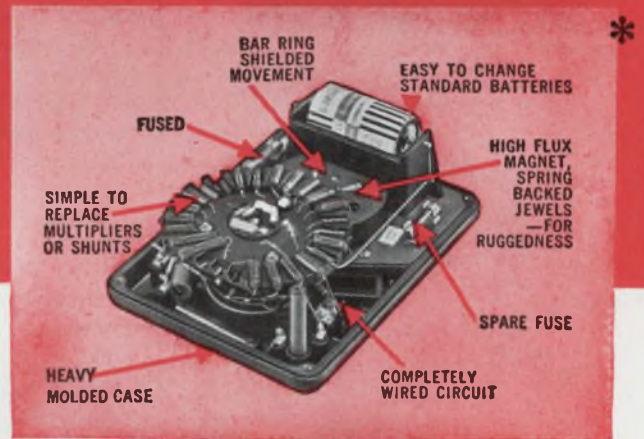

FACTS MAKE FEATURES:

- 1** Popular streamlined tester with long meter scales arranged for easy reading. Fuse protected.
- 2** Single control knob selects any of 32 ranges—less chance of incorrect settings and burnouts.
- 3** Four resistance ranges—from .1 ohm reads direct; 4½ ohm center scale; high 100 megohms.

Attention to detail makes the Triplet Model 630 V-O-M a lifetime investment. It has an outstanding ohm scale; four ranges—low readings .1 ohm, high 100 megs. Fuse affords extra protection to the resistors in the ohmmeter circuit, especially the XI setting, should too high a voltage be applied. Accuracy 2% DC to 1200V. Heavy molded case.

†630A same as 630 plus 1½% accuracy and mirror scale only \$6800
TRIPLET ELECTRICAL INSTRUMENT COMPANY, BLUFFTON, OHIO

RANGES

DC VOLTS	0-3-12-60-300-1,200-6,000 at 20,000 ohms per volt.
AC VOLTS	0-3-12-60-300-1,200-6000 at 5,000 ohms per volt.
OHMS	0-1,000-10,000.
MEG OHMS	0-1-100.
DC MICRO-AMPERES	0-60 at 250 millivolts.
DC MILLI-AMPERES	0-1-2-12-120 at 250 millivolts.
DC AMPERES	0-12.

DB: -20 to +77 (600 ohm line at 1 MW).

OUTPUT VOLTS: 0-3-12-60-300-1,200; jack with condenser in series with AC ranges.



THE WORLD'S MOST COMPLETE LINE OF V-O-M'S. AVAILABLE FROM YOUR TRIPLET DISTRIBUTOR'S STOCK.

REED RELAYS

ENGINEERED FOR TROUBLE FREE, LONG LIFE

COMPETITIVELY PRICED

Computer Components manufactures from standard size thru micro-miniature size for every exacting application. Critical standards are maintained and complete testing procedures are utilized to insure a quality product. All standard relays can be supplied at an accelerated delivery schedule and if required, will meet all applicable portions of MIL-R-5757D.



PC SERIES — STANDARD

Available up to 6 pole normally open and 6 pole double throw.



MPC SERIES — MINIATURE

Available up to 4 pole normally open and double pole double throw.

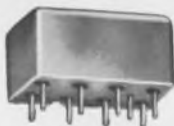

MG SERIES — MICRO MINIATURE

(1/2 size crystal can relay)
Available up to 2 pole normally open and double pole double throw.

All relays are supplied magnetically shielded and epoxy filled. Optional features are as follows:

- Magnetic and Electromagnetic latching
- Bifilar Windings
- Electrostatic shielding
- Pin locations to match existing printed wiring boards

For additional information write for our detailed catalog or contact our Sales Engineering Representative in your area.



COMPUTER COMPONENTS
INCORPORATED

88-06 Van Wyck Expressway
Jamaica, New York
212-AX 1-3500

ON READER-SERVICE CARD CIRCLE 150

NEW LITERATURE



Dc power supplies

Complete details on circuit principles, operating features, performance measurements, and special applications of regulated dc power supplies are contained in this handbook. Four pages of definitions are also included in the 48-page illustrated manual. Hewlett-Packard/Harrison Div.

CIRCLE NO. 460

Multiple-transistor selection

A comprehensive selection guide compares characteristics of 132 different types of Motorola silicon annular multiple-device transistors, arranged in four groups. Complementary pairs, dual transistors, differential amplifiers and Darlington amplifiers are charted. Applications are also shown, ranging from low-noise amplifiers to high-frequency switches. In addition, characteristic curves are provided for all transistors. Dimensions as well as pin locations of six package designs including the flatpack are illustrated. Motorola Semiconductor Products, Inc.

CIRCLE NO. 461

Servo control catalog

A 32-page catalog covers Jordan's product line and basic electric servo control theory. The illustrated volume gives component specifications, ratings, dimensions, selection guides, compatibility curves and wiring diagrams for command input devices, amps, actuators (operators) and systems. Jordan Controls, Inc.

CIRCLE NO. 462



Splicing and terminating kits

Detailed in this 24-page brochure are cable splicing and terminating kits for various shielded and unshielded installations. Illustrations, materials lists, cross-section drawing and chart information for AWG/MCM cable sizes through 15 kV ungrounded are covered. Crescon Accessories Div.

CIRCLE NO. 463



52-page components catalog

Fourteen hundred precision electronic components, available from Mallory distributors in the U.S., Canada and Puerto Rico, are described in this brochure. Included are sections on batteries and flashlights, capacitors, controls, jacks and plugs, semiconductors, switches and circuit breakers, timers and vibrators. Performance charts and product diagrams complete the discussion. Mallory Distributor Products Co.

CIRCLE NO. 464



Fork contacts

Radiused-surface fork contacts are described in a new catalog. Photographs, schematic drawings, and data charts give pertinent information needed to specify and order contacts to meet specific requirements. Methode Electronics, Inc.

CIRCLE NO. 465

Switching tachs

A 10-page technical manual describes solid-state electronic switching tachometers. The literature discusses the theory of operation and details electrical, mechanical and environmental specs. Complete schematics, outline drawings and parts list are provided. Applications include sequential switching, rpm measurement, over-speed alarm and control and frequency sensitive switching. Airpax Electronics, Inc.

CIRCLE NO. 466

Military wire catalog

This brochure includes technical data on both military electronic wire and popular commercial types of wire and cable. It contains 44 pages of "easy reading" tables of wire characteristics and a military specification index. Standard Wire and Cable Co.

CIRCLE NO. 467

Resin selection chart

A selection chart for epoxy and other resins is available. This guide helps to simplify resin selection by supplying key cross-reference data on application methods, resin descriptions, resin type and technical classifications. John C. Dolph Co.

CIRCLE NO. 468

MATCH THIS PERFORMANCE

IN A THREE CHANNEL X-BAND STABLE SOURCE

IF YOU CAN!

(IF YOU CAN'T, COME TO US)

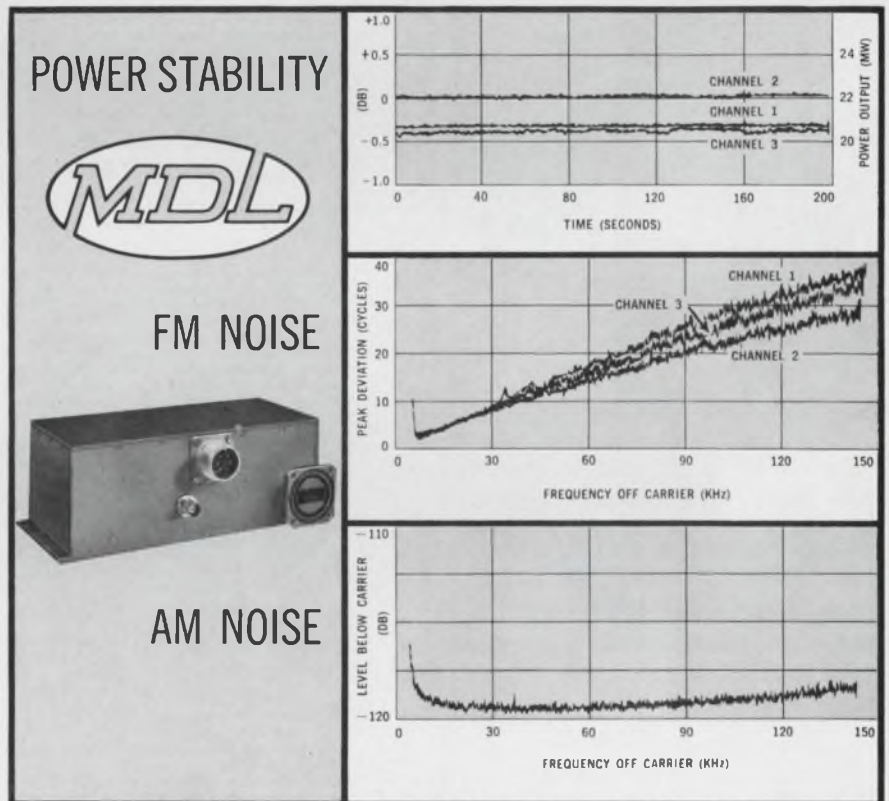

OUTPUT POWER: 20 MW ± 0.5 db at any of three discrete frequencies in a 150 MC bandwidth factory adjustable 8-12GC.

STABLE FREQUENCY: One part per 10^8 per second, one part per 10^6 long term.

LOW AM NOISE: ~ 120 db below output carrier level.

LOW FM NOISE: Less than 50 cycles peak within 100 KC of carrier.

To receive our data sheet No. S0-101, for information on bandwidth, power trade offs etc., contact Mr. Joseph Brumbelow, Director of Our Solid State Department at the address below:

WRITE FOR OUR FREE CATALOG ON SOLID STATE CIRCUITS

MICROWAVE DEVELOPMENT LABORATORIES • INC.
 87 Crescent Road • Needham Heights • Massachusetts 02194
 Telephone: 617-449-0700 • TWX 617-444-2695

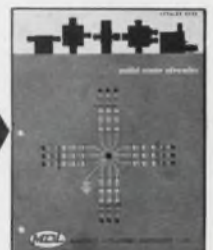

ON READER-SERVICE CARD CIRCLE 151

Astrosystems Inc.

Advanced Instrumentation

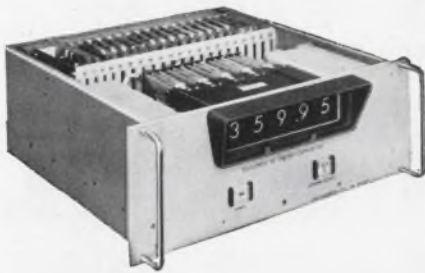

Synchro-to-Digital Converters

A simple, reliable, accurate method of high resolution conversion with resolution and accuracy to 18 bits. Available with straight binary code or BCD code outputs. Ideally suited for use as an interface between analog pickoffs and digital computers or off-line equipment.



Digital-to-Synchro Converters Digital-to-AC Analog Converters

ASI Converters accept and register digital angles in binary or BCD code and convert these inputs to the equivalent synchro or resolver voltages. Digital-to-Analog AC models convert digital input information to linear AC output signals.

Single-speed resolution and accuracies are available up to 18 bits.

Miniature Solid-State Airborne Units



All solid-state converters featuring high density packaging and ultra-reliability. Available as:

Digital-to-Synchro Converters; Synchro-to-Digital Converters; Digital-to-AC Analog Converters; AC Analog-to-Digital Converters.

Astrosystems Inc.

Advanced Instrumentation

6 Nevada Drive, New Hyde Park,
New York 11040 • (516) 328-1600

ON READER-SERVICE CARD CIRCLE 152

Advertisers' Index

Advertiser	Page	Advertiser	Page
ADC Products, A Division of Magnetic Control Co.	132	Kistler Instrument Corporation	188
API Instruments Co.	168	Korad, A Subsidiary of Union Carbide Corporation	169
Abbey Electronics Corporation	50	L E L Division, Varian Associates	154
Acopian Corporation	116	Leach Corporation	143
Adage, Inc.	135	Litton Industries, Electron Tube Division	6
Adams & Westlake Company	77	Litton Industries, Encoder Division	95
Aerovox Corporation	161	Matheson Company, Inc.	124
Alfred Electronics	69	Melpar, Inc.	146
Allen-Bradley Co.	32 A-B	Mepco, Inc.	59
Amperex Electronic Corporation	41	MicroSwitch, A Division of Honeywell	149
Amperite	110	Microdot, Inc.	123
Arvin Frequency Devices	99	Microtran Company, Inc.	174
Astrosystems Inc.	186	Microwave Development Laboratories, Inc.	185
Augat, Inc.	158	Molex Products Co.	152
Automatic Electric, A Subsidiary of General Telephone & Electronics	147	Monsanto Company	34, 35
B & B Motor & Control Corp.	178	Motorola Semiconductor Products, Inc.	4, 5, 16, 43
Ballantine Laboratories, Inc.	145	Narda Microwave Corporation, The	164
Beckman Instruments, Inc., Helipot Division	27	National Beryllia Corporation	116
Beede Electrical Instrument Co., Inc.	156	National Electronics, Inc.	162
Bendix Corporation, The	175	Nylomatic	189
Bishop Industries Corp.	188	Nytronics, Inc.	23
Bodine Electric Company	176	Ohmite Manufacturing Company	89
Bourns, Inc.	47	PEK Labs, Inc.	160
Brand Rex, Division of American Enka Corporation	131	Pamotor, Inc.	33
Bruning Division, AM Corporation	76	Perfection Mica Company	99
Buckbee Mears Co.	153	Phelps Dodge Electronic Products	32
Burr-Brown Research Corporation	137, 187	Philco-Ford Corporation	44, 45
CML, Inc.	166	Philips Electronic Measuring Instruments	31
CTS Research, Inc.	63	Pyronilm Resistor Co., Inc.	83
Cambridge Thermionic Corporation	99	RCA Electronic Components and Devices	31, Cover IV
Cedar Engineering Division, Data Control Corporation	170	RCL Electronics, Inc.	141, 189
Cerro Wire & Cable Co.	179	RFL Industries, Inc.	165
Clifton, Division of Litton Industries	157	RLC Electronics Laboratory, Inc.	163
Columbia Wire Products Company	114	Raytheon Company	118
Computer Components, Inc.	184	Rowan Controller Co., The	25
Consolidated Avionics, A Division of Condec Corporation	93	Sealectro Corporation	151
Consolidated Electrodynamics, A Subsidiary of Bell & Howell	139	Sigma Instruments, Inc.	181
Coto Coil Company, Inc.	177	Signalite, Incorporated	125
Couch Ordnance, Inc.	150	Singer Company, The	138
Curtis Development & Mfg. Co.	190	Skottie Electronics, Inc.	168
Cutler-Hammer	39	Sonotone Corporation	172, 173
Dale Electronics, Inc.	Cover III	Sprague Electric Company	10, 20
Datapulse Instruments Division, Datapulse, Incorporated	2	Switchcraft, Inc.	148
Deringer Metallurgical Corp.	134	Syntron Company	97
Deutsch Electronic Components Division	106	Systronic Instruments, Inc.	158
Digital Equipment Corporation	109	Systron-Donner Corporation	84, 85
Dimco Gray Co.	136	Tektronix, Inc., Oscilloscopes	54
Dzus Fastener Co., Inc.	190	Telonic Instruments, A Division of Telonic Industries, Inc.	112
Eagle Signal, A Division E. W. Bliss Company	126, 127	Telrex Laboratories	124
Eastern Radio	49	Temescal Metallurgical Corp.	171
Edmund Scientific Company	166	Tenney Engineering, Inc.	176
Eldre Components Inc.	188	Torngren Co., Inc., C. W.	167
Electronic Memories, Inc.	113	Tracor, Inc.	130
Electronic Research Associates, Inc.	144	Trisco Inc.	150
Electronized Chemicals Corporation	142	Triplett Electrical Instrument Company	183
Emerson & Cuming, Inc.	170	Ulano	115
Fairchild Semiconductor, A Division Fairchild Camera and Instrument Corporation	8, 9	U. S. Capacitor Corporation	128
Fluke Mfg. Co., Inc., John	129	Union Carbide Corporation	48, 48A-F, 49
G-V Controls, Inc.	51	Varian, Palo Alto Tube Division	117, 119
General Electric Company	133	Victory Engineering Corporation	122
General Instrument Corporation	68	Weckesser Company, Inc.	189
General Radio	1	Westinghouse Molecular Electronics Division	19
Grayhill, Inc.	171	Wheelock Signals, Inc.	159
Guardian Electric Manufacturing Company	121	Wood Electric Corporation	174
Hayden Book Company Inc.	190	Career Advertising:	
Hewlett-Packard	Cover II, 36, 37, 152	Conductron-Missouri	105
Honeywell, Computer Control Division	28	Hughes Aircraft Company, Aerospace Divisions	7
Honeywell Test Instrument Division	111	LTV ElectroSystems, Inc.	100
Howard Industries, Inc.	162	Litton Industries, Guidance & Control Systems	104
Hudson Lamp Company	120	Lockheed Missiles & Space Company	103
IRC, Inc.	12	Conductron-Missouri	105
ITT Semiconductors	192	Hughes Aircraft Company, Aerospace Divisions	7
Industrial Electronic Engineers, Inc.	140	LTV ElectroSystems, Inc.	100
JFD Electronics Co./Components Division	15	Litton Industries, Guidance & Control Systems	104
Janus Control Corporation	155	Lockheed Missiles & Space Company	103
Johanson Manufacturing Corporation	52		

When you measure operational amplifier value



use the whole ruler!



The Right Amplifier — You get the amplifier that's just right for your application from Burr-Brown's broad line. General purpose, FET, chopper stabilized, high voltage, low voltage, military, miniature and custom units are available in a wide range of configurations.

The Right Circuit — Burr-Brown wrote the book on operational amplifier applications. In addition to two popular handbooks, a large Applications Engineering staff is always at your service.

The Right Accessories — Burr-Brown has a complete line of support accessories including: power supplies, connectors, circuit simulators, adapters, and regulators.

Immediate Delivery — After all, "Dash" is our middle name. Exclusive Jet-Stock service puts most units in your hands within 24-hours. We have even designed, built and shipped custom demonstrator units in less than one day.

Guaranteed Performance — Every Burr-Brown unit is tested under a Quality Assurance program designed to meet the requirements of MIL-Q-9858A, MIL-I-45208A, MIL-C-45662A, and NASA NPC-200-3.

Reliability — Conservative component stress design, conservative ratings, and stringent process control procedures result in predicted MTTF ratings in excess of 700,000 hours for most units.

Satisfaction — In ten years, we've built a reputation for customer satisfaction we don't intend to jeopardize.

Guaranteed Source — Burr-Brown is still supplying units introduced in 1956 despite averaging 200 new models a year.

No-Cost Evaluation — We currently have over 1,600 demonstrator units available at Field Offices. Which one would you like to evaluate?

Local Service — Over 80 domestic Burr-Brown Engineering Representatives are ready, willing and able to assist you.

FOR CURRENT CATALOG

on Burr-Brown "maximum value" Operational Amplifiers and Accessories, contact your nearest Engineering Representative, write Burr-Brown, or use this publication's reader-service card.

BURR-BROWN

RESEARCH CORPORATION

International Airport Industrial Park • Tucson, Arizona 85706
TELEPHONE: 602-294-1431 • TWX: 910-952-1111 • CABLE: BBRCORP



*Operational Amplifiers
Instrumentation Amplifiers
Function Modules
Analog Simulators
Geophysical Instruments*

ENGINEERING REPRESENTATIVES: ALABAMA, HUNTSVILLE (205) 534-1648 / ALASKA, ANCHORAGE (907) 272-5231 / ARIZONA, PHOENIX (602) 254-6085 / CALIF., LOS ANGELES (213) 665-5181, SAN FRANCISCO (408) 245-3321 / COLO., DENVER (303) 388-4391 / CONN., MILFORD (203) 874-9222 / FLORIDA, ORLANDO (305) 425-2764 / ILLINOIS, CHICAGO (312) 286-6824 MD., SILVER SPRING (301) 588-8134 / MASS., BOSTON (617) 245-4870 / MICH., DETROIT (313) 353-3822 / MINN., MINNEAPOLIS (612) 781-1611 / MO., ST. LOUIS (314) 524-4800 / N.C., GREENSBORO (919) 273-1918 / N.J., CAMDEN (609) 365-2450 / N.M., ALBUQUERQUE (505)

255-1638 / N.Y., ALBANY (518) 436-9649, BINGHAMTON (607) 723-9661, BUFFALO (716) 632-2727, MT. VERNON (914) 968-2200, NEW HARTFORD (315) 732-3775 / OHIO, CINCINNATI (513) 761-5432, CLEVELAND (216) 884-2001, DAYTON (513) 277-8911 / OKLA., TULSA (918) 835-2481 / OREGON, PORTLAND (503) 292-8762 / PENN., PITTSBURGH (412) 243-6655 / TEXAS, DALLAS (214) 363-1671, HOUSTON (713) 928-5251 / UTAH, SALT LAKE CITY (801) 466-8709 WASH., SEATTLE (206) 622-0177 / CANADA, TORONTO (416) 293-7011, VANCOUVER (604) 736-6377

ON READER-SERVICE CARD CIRCLE 153

Design Data from

Advertising Representatives

New York 10022

Robert W. Gascoigne
Thomas P. Barth
Samuel M. Deitch
850 Third Avenue
(212) PLaza 1-5530
TWX: 867-7866

Philadelphia

Fred L. Mowlds, Jr.
P. O. Box 206
Merion Station, Pa. 19066
(215) MO 4-1073

Boston

Richard Parker
7 Redstone Lane
Marblehead, Mass. 01945
(617) 742-0252

Chicago 60611

Thomas P. Kavooras
Berry Conner, Jr.
720 N. Michigan
(312) 337-0588

Cleveland

Robert W. Patrick
8410 Treetower Drive
Chagrin Falls, Ohio 44107
(216) 247-7670

Los Angeles 90303

Stanley I. Ehrenclou
Terrence D. Buckley
W. James Bischof
2930 W. Imperial Highway
Inglewood, Calif.
(213) 757-0183

San Francisco

Ashley P. Hartman
175 South San Antonio Rd.
Ste. 243
Los Altos, Calif. 94022
(415) 941-3084

Southwestern 75206

Tommy L. Wilson
6200 North Central Express-
way
Dallas, Tex.
(214) EMerson 1-2311

London W. 1

Brayton C. Nichols
44 Conduit Street

Verviers, Belgium

Andre Jamar
1, Rue Mallar, 1
(087) 253.85

Tokyo

Yoshihiro Takemura
International Planning
Service, Inc.
Room 231 Tokyu-Mita Bldg.
1, Shiba-Mita Koun-cho
Minato-ku, Tokyo



Free Electronic Circuit Symbol Catalog



Save artwork and drafting time cut costs with thousands of electronic drafting aids and symbols featured in the new 28-page Catalog No. 102 from Bishop. In it are the industry's only selection of predawn complete circuit component symbols; integrated circuits, logics, semiconductors, flatpacks, transistors, printed circuits, welded modules, etc. Also: tapes, pads, corners, connectors, schematic symbols, reference numbers and more. Included are illustrations, range of sizes and complete price information. Send today for your free copy.

Bishop Industries Corp.

11728 Vose Street
North Hollywood, California 91605

171

Laminated and Molded Bus Bars For Power Distribution



A 16 page Technical Bulletin is now available, describing a new concept in power distribution. Basic mechanical and electrical design principles, along with descriptive pictures and diagrams, are included in this bulletin. These compact buses can replace bulky cable harnesses and repetitive wiring for computer or modular application. This method of construction satisfies the demanding requirements of low inductance and resistance of high speed, solid state systems, while controlling electrical noises.

Eldre Components, Inc.

1239 University Avenue
Rochester, New York 14607

173

Miniature 1/2" Rotary Switches



The industry's most complete selection of 1/2" Rotary Switches is contained in this new RCL catalog. Included is a description of the unique RCL "Spider," which eliminates unnecessary external terminals and unnecessary external wiring. These switches feature life of 200,000 operations (minimum). SHORTING AND NONSHORTING POLES MAY BE GROUPED ON ONE DECK IN ANY COMBINATION. Also featured are "molded-in" terminals, low contact resistance plus up to six poles per deck. Send for free copy.

RCL Electronics, Inc.

700 South 21st Street, Irvington, N. J. 07111
(201) 374-3311

175

Manufacturers

Advertisements of booklets, brochures, catalogs and data sheets. To order use Reader-ServiceCard.

Electronic Design

ELECTRONIC DESIGN's aim is fourfold. It aids progress in the electronics manufacturing industry by promoting good design. It gives the electronic design engineer concepts and ideas that will make his job easier and more productive. The magazine serves as a central source of timely, up-to-the-minute electronics information. And finally it seeks to encourage two-way communication between manufacturer and engineer.

Want a subscription? ELECTRONIC DESIGN is circulated free of charge to qualified engineers and engineering management doing design work, supervising design or establishing standards in the United States, Western Europe and the United Kingdom. If you think that you are entitled to a free subscription, use the postfree application form that you will generally find inside the back cover. When it is not included, write to us direct for an application form.

If you are not qualified, you may take out a paid subscription at the following rates: \$25 a year if you live in the U.S.A. or \$35 a year if you live elsewhere. Single copies may be purchased for \$1.50 each.

If you change your address, send us an old mailing label and your new address; there is generally a prepaid postcard for this inside the back cover. If you have been receiving ELECTRONIC DESIGN free of charge, you will have to requalify to continue doing so.

We strive for accuracy. We take the utmost pains to ensure the highest standard of accuracy throughout the magazine. A single mistake in practical design information can have serious consequences. But to err is human, and for all the care we take, an occasional error slips through. Whenever this occurs, we publish a correction at the earliest opportunity. You will find these corrections printed at the end of the Letters column. If you should spot an error, be sure to let us know. You may save your colleagues heartaches.

Microfilm copies are available of complete issues of ELECTRONIC DESIGN that have been published since the beginning of 1961, and of single articles. Complete issues cost 4¢ a page, individual pages cost 50¢ each; shipping and handling charges are extra. The minimum charge is \$3; delivery time runs from 10 days for single pages to five weeks for complete issues. For further details and to place orders, get in touch directly with University Microfilms, Inc., 300 N. Zeeb Road, Ann Arbor, Mich. 48106; telephone (313) 761-4700.

Want to contact us? If you have any inquiries about these or other matters, or if you have a manuscript outline or article idea, address your correspondence to:

Howard Bierman, Editor,
ELECTRONIC DESIGN,
850 Third Avenue,
New York, N.Y. 10022.

Self-Aligning Molded Nylon Clamps



These new cable clamps have self-aligning molded-in ribs that prevent slipping during installation. They hold their circular shape superbly, and cost considerably less than conventional clamps of the same size. New bulletin gives full details.

Weckesser Company, Inc.

4444 West Irving Park Road
Chicago, Illinois 60641

172

Free: 2,500 Plastic Parts Catalog



New from Nylomatic, molders and fabricators of mechanical plastic components, a highly informative 48-page catalog of more than 2,500 standard parts. It can help you save time and money in design, test and production. Advantages of Nylomatic standard parts: no tooling charges, low unit costs, quick delivery, complete range of sizes. Nylomatic standard parts are made of Nylon, Delrin® and other thermoplastic materials. You'll find our new free catalog a real problem solver for designers, send for it today.

Nylomatic Corporation

Dept. P
Nolan Ave., Morrisville, Pa. 19067

174

Non-Pendulous Servo Accelerometer



Four-page, illustrated Bulletin 315467 explains through description and drawings the design and basic operation of the only non-pendulous, linear, "force balance," servo accelerometer available today. Key features of the Model 305A, such as unique flexure suspension, true-translational motion of the seismic element, closed-loop operation, and simple installation, are fully covered. Specifications are given for both voltage mode and current mode operation. Graphs supply additional performance data.

Kistler Instrument Corporation

8969 Sheridan Drive
Clarence, N. Y. 14031

176

Design Data from Manufacturers

Advertisements of booklets, brochures, catalogs and data sheets. To order use Reader-Service Card.

(Advertisement)

Terminal Block Selector



A new 24-page, completely illustrated catalog contains photos, descriptions, ratings, engineering drawings, and prices of the complete line of Curtis terminal blocks. Included are printed circuit, insulated feed-thru, quick disconnect, track type, and high current terminal blocks. Handy selection chart quickly locates the perfect block for your particular requirements. Send today for your free copy.

See us at Booth 3743, Design Engineering Show, New York City

Curtis Development & Mfg. Co.

3236 North 33rd Street
Milwaukee, Wisconsin 53216

177

Quality Fasteners For All Design Applications



This 8-page catalog provides design data on the complete group of DZUS 1/4-turn self-locking fasteners for standard, high speed and panel applications, as well as universal high strength multiple thread fasteners for high tensile and shear stresses. Dzus stud assemblies, wire forms and receptacles offer an exceptional, wide variety of combinations from stock to fit specific fastening requirements. Diagrams and tables give full details for rapid, unlimited design selection. Condensed Catalog No. S-2 or comprehensive Catalog No. D-3 are available on request.

Dzus Fastener Co., Inc.

Division 32
425 Union Boulevard
West Islip, L. I., N. Y. 11795

178

Engineers' Relay Handbook



A definitive work that is fast becoming a standard reference text for the relay user. Prepared and edited by the National Association of Relay Manufacturers, this book is a complete guide to the principles, properties, performance characteristics, application requirements, specifications, and testing of relays. Systems and product engineers will find the Handbook an indispensable help in determining the correct types of relays for their applications. For further information about this unique sourcebook, write Dept. ED.

Hayden Book Co., Inc.

116 W. 14th Street
New York, N. Y. 10011

179

Designer's Datebook

MAY						
S	M	T	W	T	F	S
1	2	3	4	5	6	
7	8	9	10	11	12	13
14	15	16	17	18	19	20
21	22	23	24	25	26	27
28	29	30	31			

JUNE						
S	M	T	W	T	F	S
4	5	6	7	8	9	10
11	12	13	14	15	16	17
18	19	20	21	22	23	24
25	26	27	28	29	30	

For further information on meetings, use Reader Service card.

May 15-17

Biomedical Sciences Instrumentation Symposium (Pittsburgh)
Sponsor: Instrument Society of America; ISA, 530 William Penn Place, Pittsburgh, Pa. 15219.

CIRCLE NO. 469

May 15-17

Aerospace Electronics Conference (Dayton, Ohio) Sponsor: IEEE; IEEE Dayton Office, 124 E Monument Ave., Dayton, Ohio 45402.

CIRCLE NO. 470

May 16-18

National Telemetry Conference (San Francisco) Sponsors: IEEE, AIAA, ISA; Lewis Winner, 152 W. 42 St., New York, N. Y. 10036.

CIRCLE NO. 471

May 18-19

Midwest Symposium on Circuit Theory (Lafayette, Ind.) Sponsors: IEEE, Purdue University; G. F. Lee, Purdue University, Lafayette, Ind. 47907.

CIRCLE NO. 472

May 22-25

Industrial and Technical Power Systems Conference (Cleveland) Sponsor: IEEE; G. W. Groscup, Cleveland Electrical Illuminating Co., 55 Public Sq., Cleveland, Ohio 44113.

CIRCLE NO. 473

May 24-26

Information Display Symposium and Exhibit (San Francisco) Sponsor: Society for Information Display; R. A. Seitle, 35 Skywood Way, Woodside, Calif. 94062.

CIRCLE NO. 474

Planning to increase your Microwave sales?

You should be! Microwave sales in the Eastern area of the United States exceed \$800 million. From Washington to Boston and from Long Island to Baltimore, the Microwave Industry is booming. Total dollar sales along the Eastern Seaboard are expected to reach \$1.4 billion by 1969. *Right now* is the time for you to talk to the INFLUENTIAL BUYERS who will be deciding whether it is to be your product or your competitor's.

New York Coliseum – June 6, 7 and 8, 1967

Application-oriented seminars plus hundreds of products on display!

Join the group! Call 212 - 925-1200 for a Choice Booth! Cosponsored by the Hayden Publishing Company and its two publications—MICROWAVES AND ELECTRONIC DESIGN.

100 Avenue of the Americas, New York, New York 10013

**CONVINCE THEM OF YOUR CAPABILITY
EXHIBIT AT MICROWAVE EXPOSITION/67**

MICROWAVE EXPOSITIONS, INC.

The Predictables.

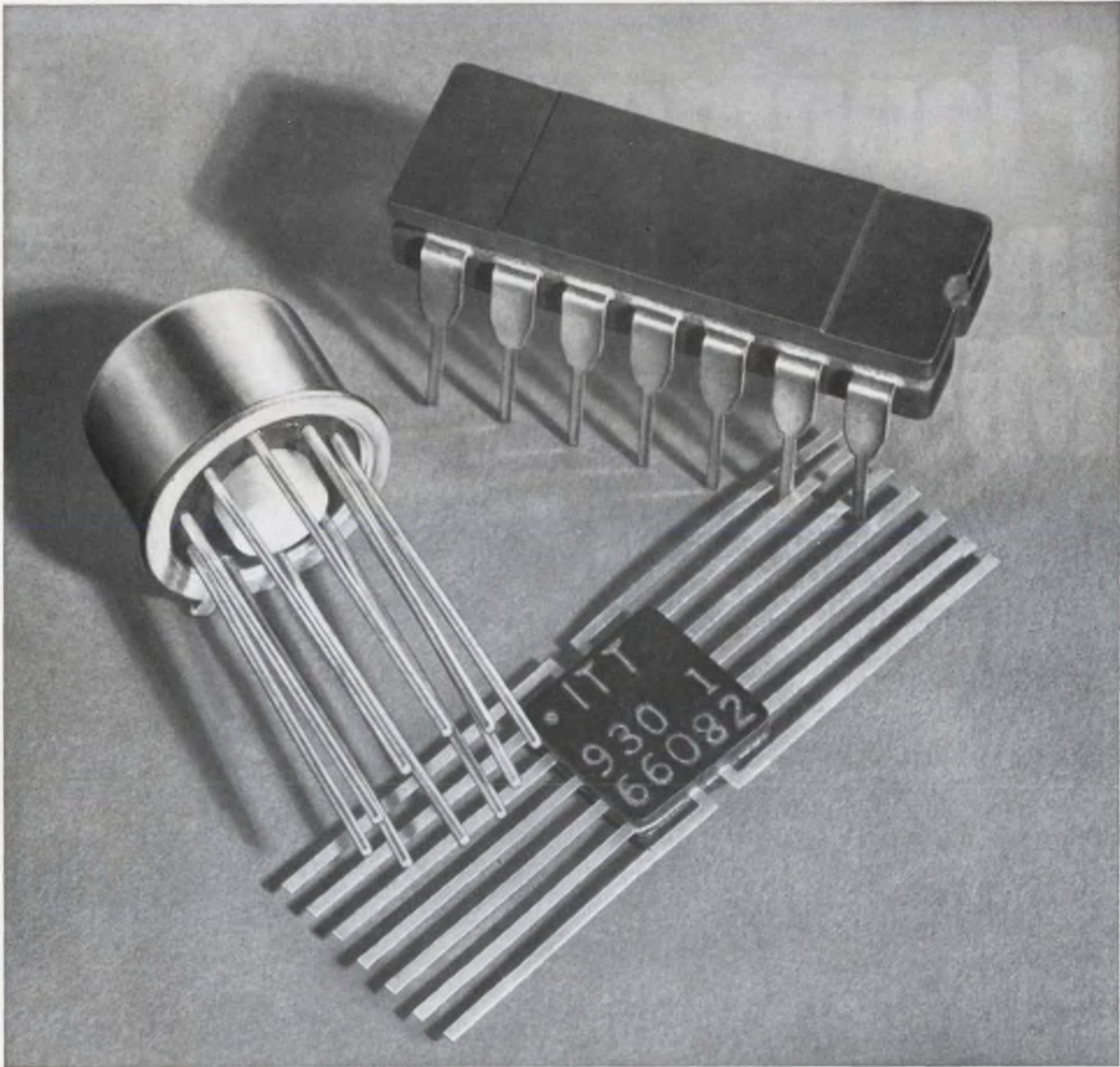

100% DC and dynamic testing verifies the performance of every circuit in ITT's full line of Series 930 DTL

When your order of ITT Series 930 DTL arrives, you can have absolute confidence in its performance. First of all, every circuit gets full DC and dynamic testing at 25°C, plus temperature cycling, centrifuge, and fine leak tests. Then there's 1% AQL testing at -55°C, +25°C and +125°C for 15 DC parameters and at +25°C for 2 dynamic parameters. If circuits flunk, we just don't ship them.

ITT's Series 930 "predictables" come in 15 circuit functions and three package styles. If you're tired of rejecting and returning DTL, try ordering it from ITT. It's available off-the-shelf from your distributor or direct from the factory through your ITT representative. ITT Semiconductors is a Division of International Telephone & Telegraph Corporation.

integrated circuits **ITT**

FACTORIES IN WEST PALM BEACH, FLORIDA; PALO ALTO, CALIFORNIA; LAWRENCE, MASSACHUSETTS; HARLOW AND FOOTSCRAY, ENGLAND; FREIBURG AND NURENBERG, GERMANY

ON READER-SERVICE CARD CIRCLE 157



**3-in-1 T-pot design
gives you more
for your money!**







**One simple, rugged design adds reliability
to all three rectilinear Mil wirewound styles**

RT-10, RT-11, RT-12 – Dale meets all three with a single design. You benefit from this simplification through increased reliability, faster delivery, better price. Call us today!

- ① **ALL-MOLDED HOUSING** design eliminates seal problems. Meets MIL-STD-202 and MIL-R-27208A.
- ② **RUGGED COLLECTOR SYSTEM** assures you of noise levels well below mil requirements.
- ③ **FULL LENGTH WINDING** allows increased power handling capability. Permits use of large diameter thermoconductive mandrel which eliminates "hot spots" by acting as high mass heat sink.
- ④ **1-PIECE WIPER ASSEMBLY** of precious metal insures setting stability under all environmental conditions.
- ⑤ **STAINLESS STEEL ADJUSTMENT SCREW** is electrically isolated by insulated head. Metal-to-metal clutching prevents over-travel damage.
- ⑥ **CONSTANT LEAD SCREW SEAL** is assured by shaft-retaining spring which maintains unvarying pressure against high temperature silicone rubber "O" ring.

DALE MIL-R-27208A MODELS

RT-10		Model 691 P.C. Pin Model 697 Flex. Leads
RT-11		Model 1287 P.C. Pin Model 1288 Flex. Leads
RT-12		Model 1680 P.C. Pin Model 1697 Flex. Leads
RT-22		5000 Series – 1/2" square-trim models meet RT-22, made with same basic design considerations shown here.

WRITE FOR CATALOG B – containing specifications on 57 Dale T-Pots including many special models.



DALE ELECTRONICS, INC.
1328 28th Avenue, Columbus, Nebraska



Elementary!
For solid-state
power sources
from L to X band...
RCA



Looking for microwave power? Try RCA solid-state power devices which provide a wide range of power outputs—from 750 mW at 1225 MHz to 100 mW at 9.9 GHz.

More specifically, these RCA units are frequency-multiplier-oscillator power sources. Available now, they can solve your design problems in those areas of communications requiring a dc input and RF power output—with the added plus of low cost!

You can choose from a line of RCA Solid-State Microwave Packaged Devices. Their technological advances can make your present systems obsolete. Check these examples:

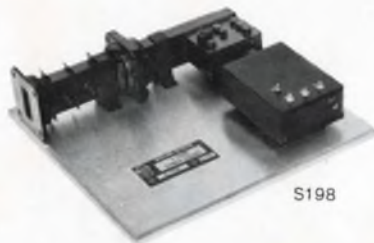

RCA TYPE	S195	S198	S199	S200
Power Output	10-40 mW	100 mW	750 mW	200 mW
Frequency	4.2-5.2 GHz	9.2-9.9 GHz	1225 MHz	1680 MHz

Compact and rugged, these RCA solid-state power sources meet the requirements of equipment designers for low-power radar transmitters, pumps for parametric amplifiers, solid-state "klystrons," low-power relay transmitters,

local oscillators, and FM signal and laboratory applications.

Whatever your requirements, investigate these solid-state devices from RCA—whose design and production resources are unmatched in the industry; whose L-, S-, C-, and X-Band microwave capabilities can thereby help improve your systems designs. For technical data, write: RCA Commercial Engineering, Section E18Q, Harrison, N.J. 07029.

RCA Electronic Components and Devices



The Most Trusted Name
in Electronics