

Electronic Design

THE MAGAZINE OF ESSENTIAL NEWS, PRODUCTS AND TECHNOLOGY

VOL. 15 NO.

8

APRIL 12, 1967

Semiconductor devices spark new concepts in heating and air-conditioning. Pilotless ignition, like that below, and extremely accurate temperature control are already

solid-state realities. And other applications in the billion-dollar climate-control industry are on their way in. For a report on this newly evolving field, see page 17.

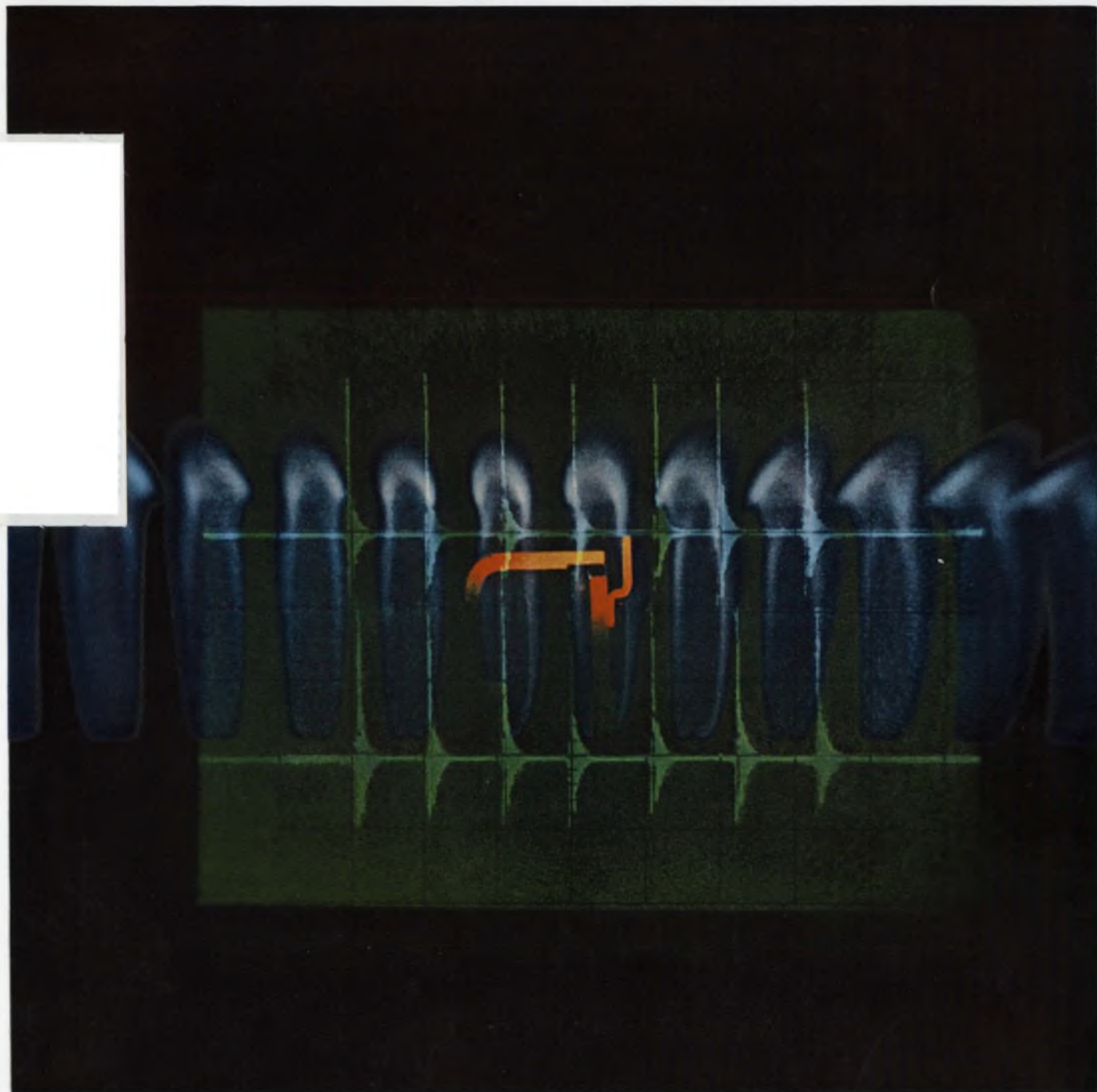

GET PULSES YOU CAN COUNT ON

Select any of these reliable hp pulsers and get accurate, easily interpreted measurements. Each has a *completely* specified waveform so that you can make measurements with confidence. Each has a true 50-ohm source impedance that absorbs error-producing reflections when working into mismatched loads. These hp features assure you clean pulses . . . and test results you can count on! See your hp Sales Engineer, or write to Hewlett-Packard, Palo Alto, California, 94304. Tel. 415 326-7000. In Europe: 54 Route des Acacias, Geneva.

Low-Cost 10 MHz Pulses

This general-purpose hp 222A Pulser gives you an extra measure of performance in every major category: fast 4 ns rise time, continuously variable amplitudes to ≈ 10 V, clean pulse shape, true 50-ohm source impedance, and continuously variable width, delay, rep rate and pulse amplitude—all at a low \$690.

Use it to test switching circuits, measure the pulse response of amplifiers and linear networks . . . modulate signal generators . . . measure time constants . . . generate harmonics, and test semiconductor switching times.

Continuous adjustment is provided for internal rep rates from 10 Hz to 10 MHz . . . pulse widths from 30 ns to 5 ms . . . and amplitude from 0.05 V to 10 V. The 222A also provides square waves from 100 Hz to 10 MHz.

The pulse output can be delayed as desired with respect to the trigger output so that auxiliary equipment can be triggered up to 5 ms in advance of the output pulse. The 222A may also be triggered externally for rep rates of 0 to 10 MHz, and single pulses may be produced with a front panel pushbutton.

hp Model 222A Pulse Generator,

\$690

Clean 5 ns Rise Time Square Waves, 1 Hz to 10 MHz

This wide-purpose solid-state hp 211B Square Wave Generator is continuously adjustable from 1 Hz to 10 MHz. The wave shape is specified in every detail for precise, economical testing of linear or switching circuits—both solid-state and tube circuits as well. It provides both 50-ohm 5 ns rise time, and 600-ohm 70 ns rise time outputs simultaneously. Amplitude for both the 50-ohm 5 V, and 600-ohm 30 V outputs is separately controlled.

Multi-purpose flexibility is provided by a trigger output jack and a sync input jack which allows you to sync other equipment—or use other equipment to sync the 211B.

New hp 211B Square Wave Generator,

\$375



200 Watt, 100 V Pulses

You get 200 watts of pulse power into 50 ohms with hp's 214A Pulse Generator. Two-amp pulses, combined with a fast rise time of 15 ns make this pulser ideal for driving loads requiring high power with clean, accurate pulses. High pulse power plus triggering flexibility make the 214A one of the most versatile pulsers available. Use it for checking high-power semi-conductors, logic circuits, linear circuits and core memories.

Specified pulse shape and true 50-ohm source impedance make it easier for you to evaluate the performance of the circuit under test. Pulse amplitude is continuously adjustable from 80 mV to 100 V into 50 ohms. Width is variable from 50 ns to 10 ms. True 50-ohm source impedance (up to 50 V output) absorbs reflections caused by mismatched loads.

Oscilloscope-type trigger level and slope controls facilitate triggering from external signals, 0 to 1 MHz—internal triggering 10 Hz to 1 MHz. To sync other instruments to the 214A, a trigger out is provided that can be either advanced or delayed with respect to the output pulse.

087/1A

hp Model 214A Pulse Generator,

\$875



HEWLETT **hp** PACKARD
An extra measure of performance

ON READER-SERVICE CARD CIRCLE 2

OSCILLATOR
10 Hz-50 kHz

E 1313-A

SERIAL 125

L RADIO
MASS USA

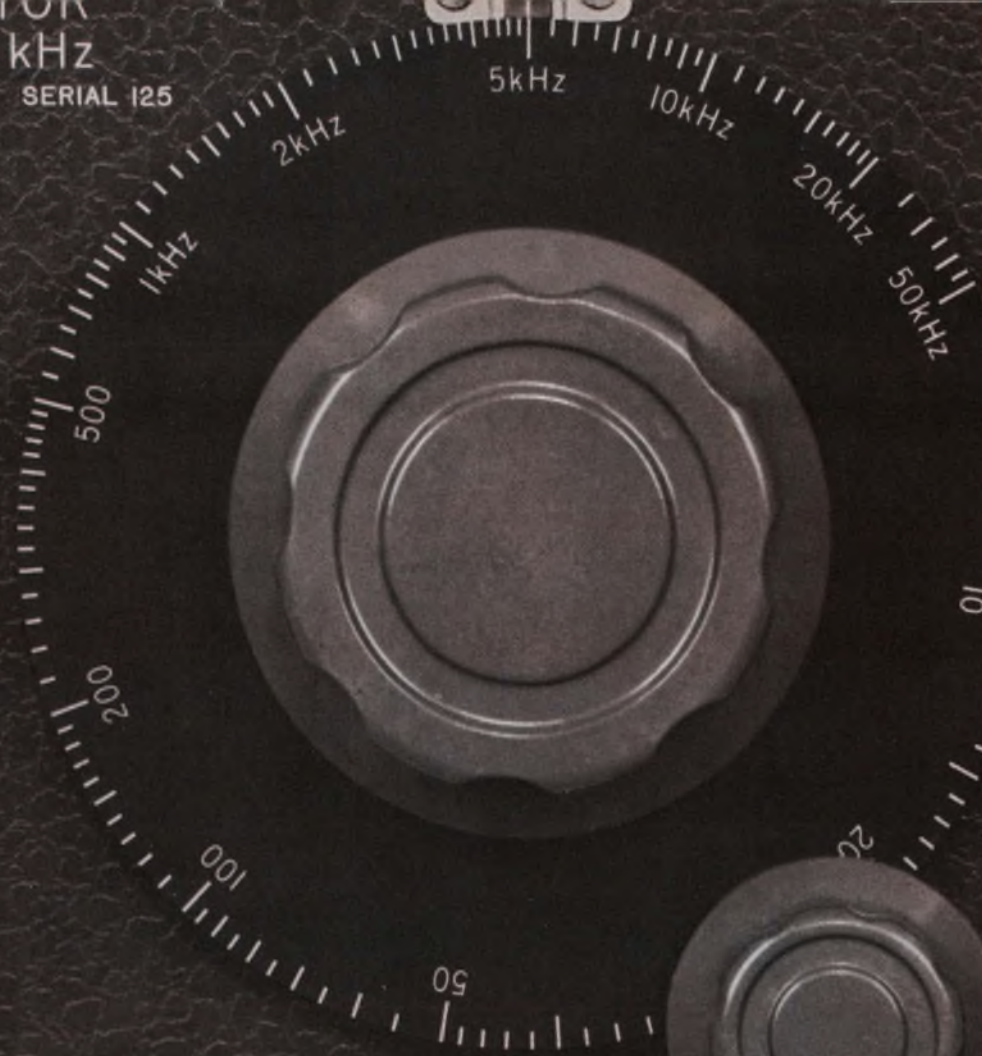

500 MV
50 MV
5 MV
0 V

POWER



OFF

OUTP
600

10 Hz to 50 kHz with one dial turn

With our new Type 1313-A Oscillator, you can manually sweep through its entire frequency range with one turn of the main dial. There are no range-switching transients or ambiguous dial multipliers to contend with; frequency changes can be made quickly and conveniently. The all-solid-state 1313-A provides both sine- and square-wave outputs, has a calibrated 60-dB step attenuator with a zero-volts-behind-600 Ω output position, and a 20-dB continuously adjustable attenuator. Distortion is only 0.5% from 100 Hz to 10 kHz. The 1313-A is the fourth in our new line of "sync-able" oscillators. Like

the others, the 1313-A has a SYNC jack for external synchronization, is completely self-contained, and is small and lightweight (8 by 6 by 8 in., 7 lb). Even the price is a feature — it's only \$325*! For complete information, write General Radio Company, W. Concord, Massachusetts 01781; telephone (617) 369-4400; TWX 710 347-1051.

*Price applies in USA only.



GENERAL RADIO

Variable Rise Time from 4.0ns.

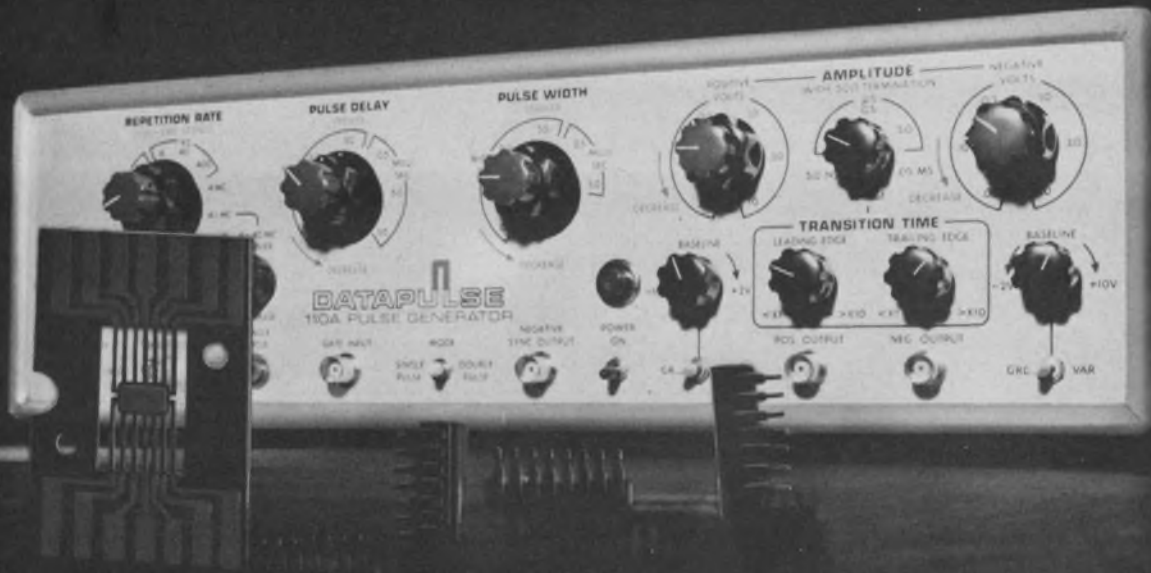

Fully Controllable FAST Pulses

Testing integrated circuits is a made-to-order chore for the 110A Pulse Generator. No matter what stage your circuit's in — from breadboard to end product — the 110A's fully controllable FAST pulses can help you achieve accurate and reliable test results.

In addition to variable rise time from 4.0 ns, the 110A offers repetition rates to 40 MHz, $\pm 10V$ simultaneous outputs, $\pm 10V$ regulated baseline offset, linear and variable rise and fall, single or double pulses, 10 ns to 5 ms pulse widths, and 10 ns advance to 50 ms delay.

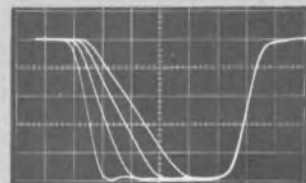

Sampling Oscilloscope
Neg. Pulse 2v, 5ns / cm

Yet, the 110A is not a specialist. Its wide range capabilities can be applied to almost all types of pulse and transient phenomena testing. Fully programmable versions for high speed production testing are also available. For complete details, write for Technical Bulletin 110A. Price: \$1,250.00

The leading producer of solid state pulse instrumentation.

48 Technical Sales Offices & 7 Field Service Centers
in 20 countries.

Datapulse welcomes technical employment inquiries.

DATAPULSE[®]

DATAPULSE/Division of Datapulse Inc./10150 Jefferson Blvd., Culver City, Calif. 90230/(213) 671-4334, 678-4275/TWX: 910-328-6109/Cable DATAPULSE
DATAPULSE • NESCO INSTRUMENTS • DE MORNAY-BONARDI • KRS INSTRUMENTS

Electronic Design

THE MAGAZINE OF ESSENTIAL NEWS, PRODUCTS AND TECHNOLOGY

VOL. 15 NO.

8

APRIL 12, 1967

NEWS

- 13 News Scope
- 17 **Whether it's cold or whether it's hot . . .**
Indoor temperatures are comfortable, thanks to solid-state controls.
- 31 Washington Report
- 36 **Electron tunneling speeds logic switching**
IBM device, operating at better than 800 ps, may lead to cryogenic computers.
- 42 Ka-band radar, designed for atomic studies, is listed as a weather aid for SSTs.
- 46 Letters
- 51 **Editorial: Life begins at 40. . . . Will it for you?**

TECHNOLOGY

- 54 **You don't have to be a programmer** to use a time-shared computer to solve design problems. Here's an example of how you can put this technique to work.
- 64 **UJTs and magnetic cores combine** to generate a wide range of variable duty-cycle and repetition-rate pulses.
- 72 **Inertial damping lends itself well** to high-velocity servosystems. The performance is good and the cost moderate.
- 78 **If you need active filters** with flat amplitude and time delay responses, discard the classical approach. A simple method yields the correct circuit quickly.
- 86 **Find the pattern of offbeat antennas** without long and tedious tests. A "shape-substitution" method yields the far-field voltage with a few equations.
- 95 **Choose the right power connectors** for military and commercial equipment. A chart of military specifications doubles as a handy selection guide.
- 100 Ideas for Design
- 110 NASA Tech Briefs

PRODUCTS

- 118 **Semiconductors:** Plastic MOS-FETs, 300-volt FETs featured in new FET families.
- 120 Beam-lead microwave Schottky diodes are batch-processed.
- 132 **Microelectronics:** 'Complementary' unijunction gives stabler oscillator design.
- 137 **Components:** Single-plane digital readouts shine from a vacuum tube.
- 146 Test Equipment
- 154 Systems
- 158 Production Equipment
- 161 Microwaves

Departments

- 162 Design Aids
- 164 Application Notes
- 166 New Literature
- 172 Advertisers' Index
- 175 Designer's Datebook

Reader Service card inside back cover

ELECTRONIC DESIGN is published biweekly by Hayden Publishing Company, Inc., 850 Third Avenue, New York, N. Y. 10022. James S. Mulholland, Jr., President. Printed at Poole Bros. Inc., Chicago, Ill. Controlled-circulation postage paid at Chicago, Ill., Cleveland, Ohio, and New York, N. Y. Application to mail at controlled postage rates pending at St. Louis, Mo. Copyright © 1967, Hayden Publishing Company, Inc. 61,945 copies this issue.

Control Power And Costs With New Plastic 8-Ampere Thyristors.

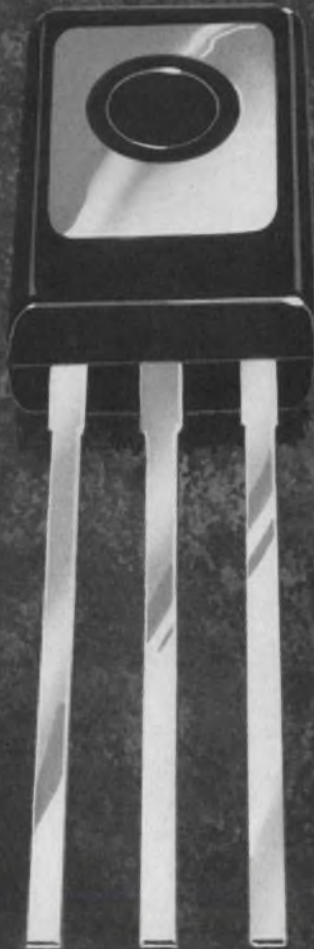

You can win the "power vs price" struggle in home appliances and tools, light dimmers, automotive applications, heat and cooling systems, vending and sewing machines and numerous other consumer/light industrial applications with Motorola's new 2N4441 SCR series.

Volume-priced at only 50¢ for a 200-volt unit, (comparable with other plastic thyristors rated at only a fraction of its current capability) this is the *first* high-energy plastic thyristor to provide:

- up to 2660 watts (240 V, full wave) power-handling capability through 8-ampere, 50 to 600-volt ratings
- low thermal resistance and minimum derating — exclusive Thermopad* heat sink construction provides ultra-short (less than 0.030") chip-to-heat sink thermal path
- easy, simple mounting — single-screw, low-silhouette, keyhole mounting and "finger-bendable" leads give you quick, secure CB or chassis mounting convenience.
- maximum fault protection — 80-ampere surge protection ability is an order of magnitude greater than steady-state rating

New Notes for New Devices . . .

Two new thyristor Application Notes: "RFI Suppression in SCR Circuits," and "SCR Pulse Triggering" — covering important basic thyristor/unijunction circuit design considerations — are available now by writing Box 955, Phoenix, Arizona 85001. Send for them today. Scan these specs . . .

Type	TR		I _{FM(surge)} Amps	V _F [†] Volts	I _{GT} [†] mA	I _{HO} [†] mA
	I _r Amps	V _{ROM} Volts				
2N4441	8	50	80	1.0	10	10
2N4442		200				
2N4443		400				
2N4444		600				

[†]typ. @ 25°C

. . . then contact your franchised Motorola distributor for complete data sheets and evaluation units or your Motorola salesman for production quantities. They are all available right now!

*Trademark of Motorola Inc.

...ON THE MOVE
IN SOLID-STATE
POWER!

- where the priceless ingredient is care!



How To Convert High-Frequency Power To DC in 100 Low-Cost nsec.

In no time at all you can accelerate the performance and efficiency of your high and low speed dc inverter, chopper, free wheeling and charging diode, sonar supply and ultrasonic system circuit components to outstanding levels. It takes just 100 ns for Motorola's new, 1N3879, -3889, -3899, -3909 and -4993, $\frac{3}{4}$ to 30-ampere, fast recovery rectifiers to switch from a forward conducting to reverse blocking mode in all these applications.

This nimble new device line — now broadest in the industry — offers unequalled 50 to 600-volt V_{RM} capability and two speed ranges for maximum cost/performance flexibility: 200 ns max (100 ns typ) and 1 μ s max (0.5 μ s typ) recovery times for 250 to 500 kHz and 50 to 100 kHz applications, respectively. Besides agile switching and less power dissipated in the reverse mode, these diodes hold RFI and transient voltage generation to a minimum, reduce the size, cost and weight of power conversion and filter components in the output circuit and slim down the required input power source, since voltage drops are lower in the output circuitry.

Time-proven, reliable packaging is included: all 3 to 30-ampere fast recovery devices utilize the unique "basic cell" fabrication technique and $\frac{3}{4}$ and 1-ampere units are cased in silicone-polymer Surmetic* packages — long-noted for high-temperature, high-humidity case integrity.

A quick point about price. You can design in Motorola fast recovery rectifiers for as little as \$.45 each (100-up) . . . little more than the moderate cost for similar, standard speed Motorola rectifiers.

Now's the time to see your franchised Motorola distributor about them.

Frequency Requirement	V_{RM}	I_o	T_{rr} (typ)	Motorola Preferred Rectifier Line
250 to 500 kHz	50 to 600 volts	$\frac{3}{4}$ to 30 amps	100 ns	58 High-Speed Units
50 to 100 kHz	50 to 600 volts	$\frac{3}{4}$ to 30 amps	0.5 μ s	30 Medium-Speed Units
10 to 15 kHz	50 to 1,000 volts	1 to 1,000 amps	5 μ s	284 Standard-Speed Units

MOTOROLA Semiconductors

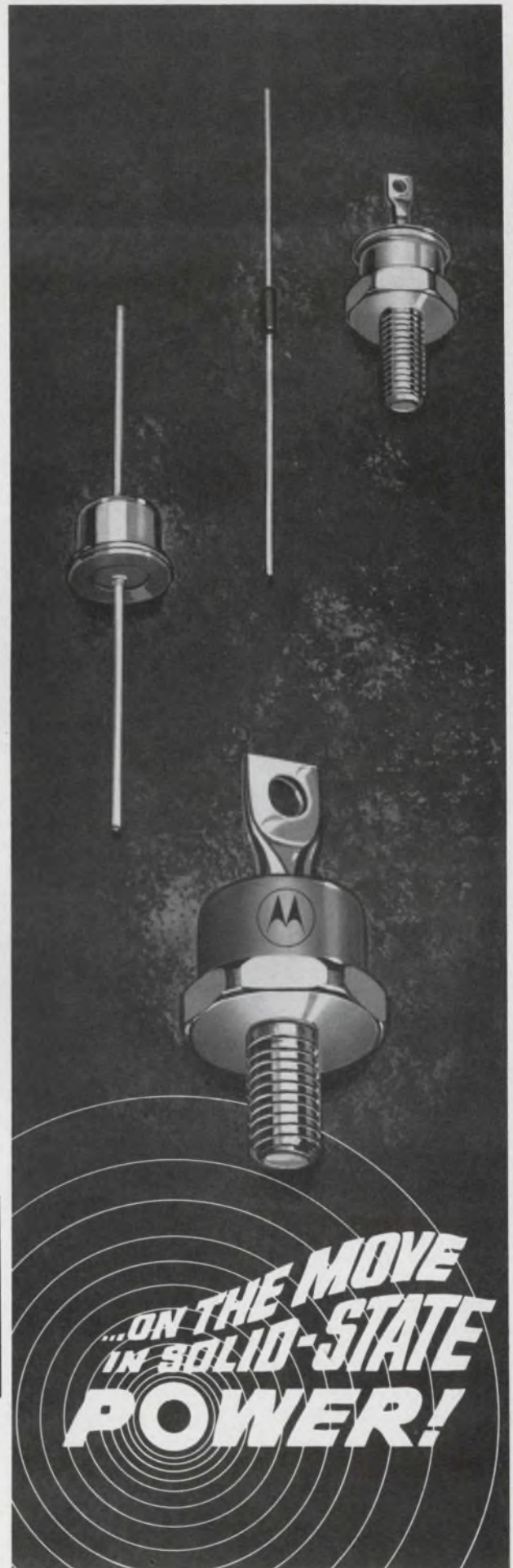

ON READER-SERVICE CARD CIRCLE 136

The simpler the better.

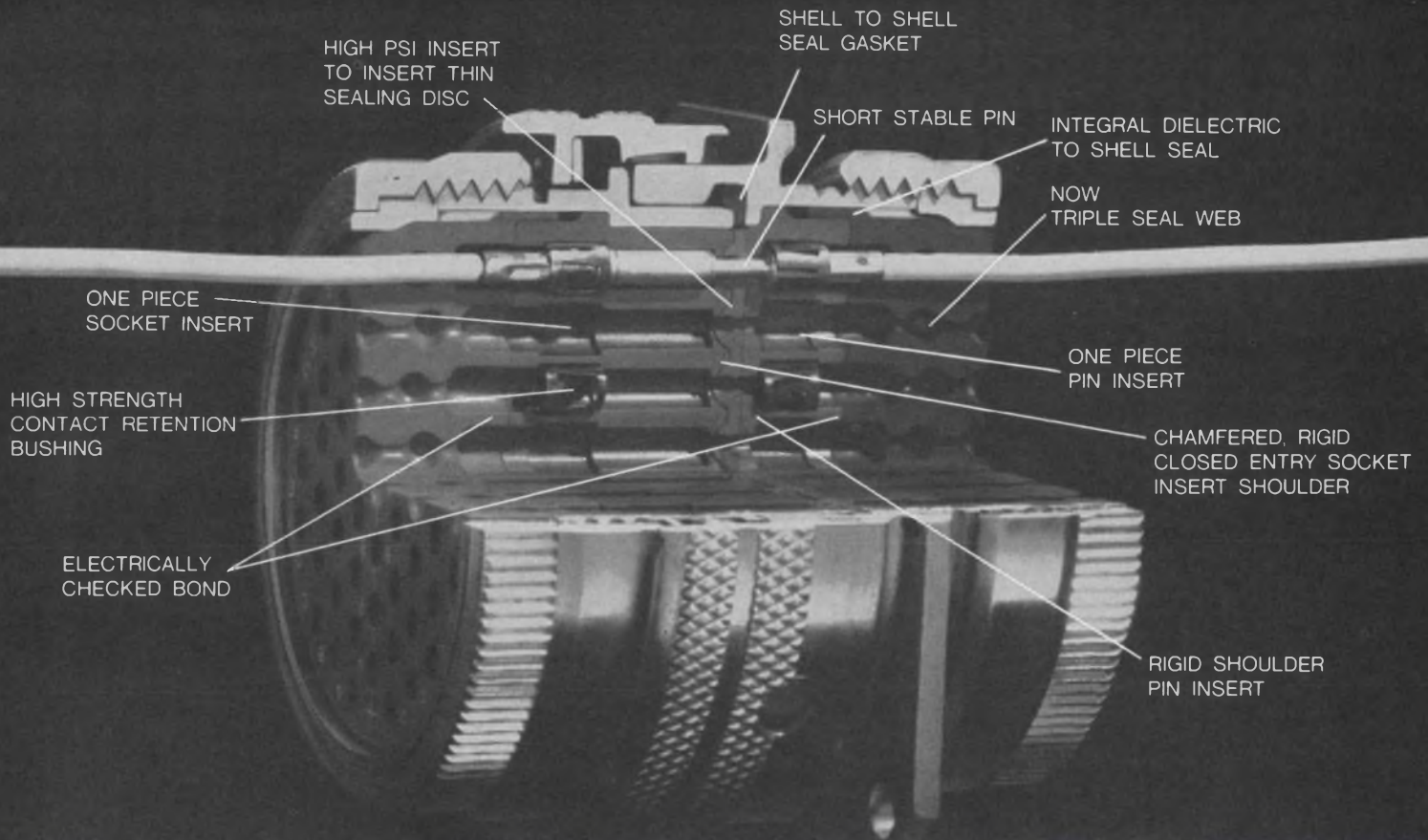

Design simplicity. That's what makes Bendix® JT Pancake™ connectors so reliable. As you can see, Bendix JT connectors have plenty to show: One-piece socket inserts. One-piece pin inserts. Single-piece interfaces. Shell-to-shell sealing with-

out extra components. Plus other features, shown above, that speak for themselves, purely and simply.

What about versatility? Choose from a host of options. Crimp, solder, standard temperatures, high temperatures, grommetted and potted

versions. Hermetic seals in 8 shell types, 9 shell sizes. Choose, too, from 35 insert patterns, 16-, 20-, 22- and 22M-contact sizes that will accept a wire range of 16 through 28 gage. Contact Electrical Components Division in Sidney, New York.

Bendix **Electronics**

ON READER-SERVICE CARD CIRCLE 6



EMCOR®II— for people with custom ideas

EMCOR II is custom cabinetry at popular prices . . . as close to perfection as electronic enclosures can be. With EMCOR II, you can customize each and every piece with the use of personalized nameplates, hardware, and other components. You make your own designs and give them a personal touch.

The custom look of EMCOR II will compliment the quality of your instrumentation in every way. Fine

EMCOR/distinguished cabinetry

materials and exacting craftsmanship are applied to each component, providing tolerances that are precise, not flexible. On the outside—no blisters, paint runs, or rough surfaces. And, the color of your choice is carefully baked on.

When you need a cabinet, or a complete system, call your local EMCOR Sales and Service Engineer. Or write for our new EMCOR II catalog.

Albany: 436-9649; Albuquerque: 265-7766; Alexandria: 836-1800; Atlanta: 939-1674; Baltimore: 727-1999; Binghamton: 723-9661; Bridgeport: 368-4582; Buffalo: 632-2727; Chicago: 676-1100; Cleveland: 442-8080; Dallas: 631-7450; Dayton: 298-7573; Del Mar: 454-2191; Denver: 934-5505; Detroit: 357-3700; Fort Lauderdale: 564-8000; Ft. Lee (No. N. J.): 944-1600; Ft. Walton Beach: 243-6424; Houston: 526-2959; Huntsville: 539-6884; Indianapolis: 356-4249; Kansas City: 444-9494; Los Angeles: 938-2073; Minneapolis: 545-4481; Newport News: 245-8272; N.Y.C. area: 695-0082; Orlando: 425-5505; Palo Alto: 968-8304; Philadelphia: 242-0150; Pittsburgh: 884-5515; Phoenix: 273-1673; St. Louis: 647-4350; Seattle: 722-7800; Syracuse: 471-7274; Tulsa: 742-4657; Utica: 732-3775; Valley Forge (So. N. J.): 265-5800; Wilmington, Mass.: 944-3930; Winston-Salem: 725-5384. EMCOR Reg. U. S. Pat. Off. . . .

Ingersoll Products 1025 West 120th St., Chicago, Illinois 60643

DIVISION OF BORG-WARNER CORPORATION

**electronic
equipment**



ON READER-SERVICE CARD CIRCLE 7

Do you have a "special" photocell problem?

Clairex probably has a "standard" answer with the industry's widest line.

If not, we can design a photoconductive cell to meet your needs.

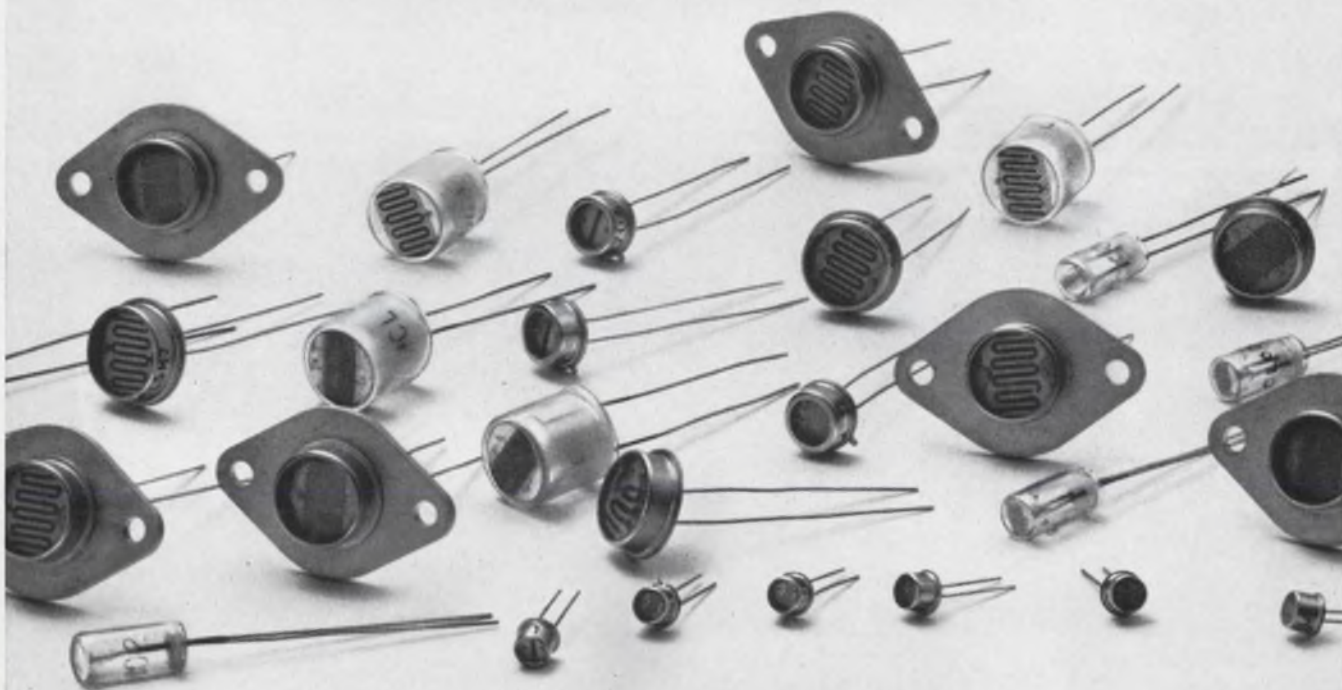

Helping industry solve problems involving light control has been Clairex's only business since 1953. To provide creative engineering to the country's leading companies, we have developed the industry's widest line of photoconductive cells . . . over 80 standard types of CdS and CdSe units.

Standard Clairex cells provide combinations of features that you need to meet most needs . . . high speed, low temperature coefficients, low memory, high linearity, uniform color temperature response, small size, high stability. They come in 6 hermetically sealed packages from TO-18 to TO-3.

If a special photocell is required, Clairex can

design one to meet your requirements. And don't hesitate to call on us for help in setting up your specifications. We are frequently able to save time and money for customers who consult us before establishing detailed cell designs.

If you'd like more information, remember, we wrote the book. Send for your copy of the Clairex Photoconductive Cell Design Manual.



INC. ■ 1239 BROADWAY, NEW YORK, N.Y. 10001

RCA supersedes the 2N681-690 SCR family with better performing devices at "mind-changing" prices!

			
2N690 2N689	2N3899 \$6.50	2N3873 \$6.35	Voltage
2N688 2N687 2N686	2N3898 \$4.50	2N3872 \$4.35	600 V
2N685 2N684	2N3897 \$3.25	2N3871 \$3.10	400 V
2N683 2N682 2N681	2N3896 \$3.00	2N3870 \$2.85	200 V
25 A	35 A	35 A	100 V
			RMS current

Prices in quantities of 1,000 and up

If you're using conventional SCR's in the mid-current range...RCA's 35-amp types offer greater protection from voltage transients, better performance...and just check the prices!

RCA's 2N3870-2N3873, 2N3896-2N3899 35-amp power-rated SCR's offer you a choice of press-fit or stud-mounted packages...and your circuits will not only be more reliable, they'll be a good deal less expensive! Just check the performance advantages of RCA's "mind-changing" SCR's over those of the 2N681-690 family:

	<u>2N681-690</u>	<u>RCA</u> <u>2N3870-2N3873</u> <u>2N3896-2N3899</u>
Forward Current	25 A	35 A
Peak Surge Current	150 A	350 A
Gate Power	5 W	40 W (for 10- μ s duration)
Gate Current	2 A	Any value giving maximum gate power is permissible.
Gate Voltage	10 V	
Thermal Resistance	0.9°C/W	2°C/W

Of course, if your design requirements call for the famous 2N690 family, RCA can still deliver more performance for less cost. Your RCA Field Representative can give you complete details. For additional technical data, write RCA Commercial Engineering, Section RG4-1, Harrison, N.J. 07029. See your RCA Distributor for his price and delivery.

RCA ELECTRONIC COMPONENTS AND DEVICES



The Most Trusted Name in Electronics

ON READER-SERVICE CARD CIRCLE 9

You Can Get All These Microcircuits from Sprague Electric:

SERIES SU300, LU300 UTILOGIC



K Package

For use in commercial, industrial, ground support applications. Available in two operating temperature ranges, -20 C to +85 C, and +10 C to +55 C. Propagation delay of 15 to 40 nanoseconds.

*Trademark of Signetics Corp.

On Reader Service Card Circle 142

*SERIES SE400, NE400 LOW POWER LOGIC



J Package

Operating temperature ranges: -55 C to +125 C, and 0 C to +70 C. For use in Aerospace and other applications where low power drain is required. Optimized speed, noise margin.

On Reader Service Card Circle 143

*SERIES SE100, NE100, US700 DTL LOGIC

(Signetics CS700)



J Package

Eighteen functions in two operating temperature ranges: -55 C to +125 C and 0 C to +70 C. Circuits include NAND/NOR gates, clock and line drivers, gate expanders, RST and JK binary elements, one-shot multivibrator.

On Reader Service Card Circle 141

*SERIES SE500 LINEAR AMPLIFIERS



K Package

Operating temperature range: -55 C to +125 C. Two linear circuits available in 10-lead low silhouette TO-5 case. SE501K is a video amplifier, SE505K is a general purpose differential amplifier.

On Reader Service Card Circle 144

*SERIES SE800, NE800 TTL LOGIC

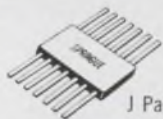

J Package

Designed for high-speed avionics systems. Eight high level circuits including four NAND Gates, Power Gate, Exclusive-OR Gate Input Expander, J-K Flip-Flop.

On Reader Service Card Circle 145

UNICIRCUIT® mW RTL LOGIC



TO-5 Case

Types US-0908 through US-0921 . . . Fully interchangeable mW digital building blocks featuring power consumption of 2 mW/ncde and propagation delay of 40 nsec.

On Reader Service Card Circle 146

UNICIRCUIT® CUSTOM HYBRID CIRCUITS

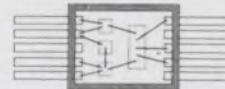

Combine monolithic silicon circuits with tantalum or Ni-Cr alloy resistors. Close resistance tolerances, low temperature coefficient. Resistor matching, $\pm 1/2\%$.

On Reader Service Card Circle 147

DIGITAL-TO-ANALOG CONVERSION CIRCUITS



	4-BIT SERIES	5-BIT SERIES
Ladder Network	UT-1000	UT-1001
Ladder Switch	UD-4001	UD-4036
Buffer Amplifier	UD-4024	UD-4037

On Reader Service Card Circle 148

*Series SE100, NE100,
CS700, SU300, LU300,
SE400, NE400, SE500,
SE800, and NE800
are all available
from Sprague Electric
under technology interchange
with Signetics Corp.

On Reader Service Card Circle 149

For data sheets on the microcircuits in which you are interested, write to:

Technical Literature Service
Sprague Electric Company
347 Marshall Street
North Adams, Mass., 01247

On Reader Service Card Circle 150

SPRAGUE COMPONENTS

INTEGRATED CIRCUITS
THIN-FILM MICROCIRCUITS
TRANSISTORS
CAPACITORS
RESISTORS

PULSE TRANSFORMERS
INTERFERENCE FILTERS
PULSE-FORMING NETWORKS
TOROIDAL INDUCTORS
ELECTRIC WAVE FILTERS

CERAMIC-BASE PRINTED NETWORKS
PACKAGED COMPONENT ASSEMBLIES
BOBBIN and TAPE WOUND MAGNETIC CORES
SILICON RECTIFIER GATE CONTROLS
FUNCTIONAL DIGITAL CIRCUITS

SPRAGUE®
THE MARK OF RELIABILITY

Sprague® and ® are registered trademarks of the Sprague Electric Co

News



Solid state affords precise environmental control throughout large complexes like Los Angeles' Water and Power Building. Page 17



Public computer utilities on the horizon. Page 24



Airborne Ka-band radar, originally designed to check atomic mushroom clouds, is tested

as a prototype weather radar to be used on board the SSTs of the future. Page 42

Also in this section:

Electron tunneling gives superconducting logic device 800-ps switching speed. Page 36

Solar wind to be measured by device that astronauts will set up on the Moon. Page 40

News Scope, Page 13 . . . **Washington Report**, Page 31 . . . **Editorial**, page 51

Helipot's new Model 77 trimmer comes clean without fail.

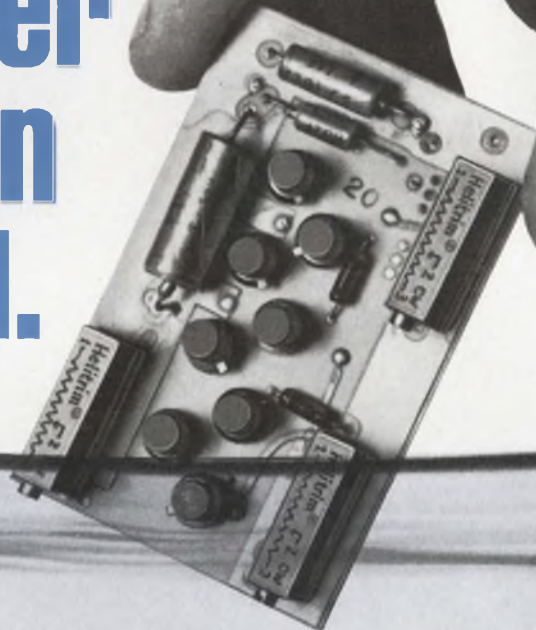

First \$1.10 cermet trimmer that's sealed for board washing!

The new Model 77 is an inexpensive wash-and-wear trimmer that's sealed for solvent washing on the board without failure. The cermet element gives wider performance parameters than any other adjustment potentiometer now on the market. Its pin spacing also makes it directly interchangeable with competitive models 3067 and 3068.

In the low price field, only Model 77 offers essentially infinite resolution, wide resistance range (10 ohm to 2 megohm), and other spec advantages shown at right. Quantity prices are as low as \$1.10.

Call your Helipot rep now for a free evaluation sample. Compare Model 77 with unsealed trimmers . . . you'll see there's really no comparison.

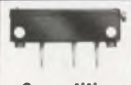
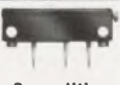
	 Helitrim Model 77	 Competitive Model 3067 Wirewound	 Competitive Model 3068 Carbon
Resistance Range, ohms	10-2 meg	50-20 K	20 K-1 meg
Resistance Tolerance	10%	10%	20%
Resolution	Essentially infinite	1.7 (100 Ω) to 0.3 (20 K)	Essentially infinite
Sealing	Yes	No	No
Power Rating, watts	0.75	0.5	0.2
Maximum Operating Temp. °C	105	85	85

Beckman

INSTRUMENTS, INC.

HELIPOT DIVISION

FULLERTON, CALIFORNIA • 92634

Cryogenics promises a billion-bit memory

The path to a fast, billion-bit memory may well be flooded with liquid helium. RCA Laboratories has disclosed that it is well on the way to developing a billion-bit cryogenic memory.

The memory stores information in the form of little loops of current that circulate in tiny rings of superconducting tin. The rings are photoformed on a glass plate.

"The presence of a circulating current can be detected by piercing a small section of the loop with a magnetic field," says Robert Gange, leader of RCA's project. "The section goes resistive, quenching the current, but as the current expires, a small voltage darts across the leads that access the loop. This voltage indicates the presence of a current in that loop. Sets of thin lead wires carry the currents—which produce the localized magnetic fields that cause the spots of resistivity—to the memory loops."

The team headed by Gange has succeeded in making and operating a 14,120-bit cryogenic memory. It consists of four 1-inch-square arrays. The scientists have already produced sheets that measure 4.5



RCA's R. Gange eyes 250,000 bits.

by 5.4 inches and contain 250,000 bits. It is these large arrays that will be eventually assembled into a billion-bit memory.

The new memory promises to offer computer designers several notable advantages:

- Unlike bipolar integrated memories, it consumes no power while standing idle.

- It is fast. The cycle time is on the order of one microsecond. Each memory loop has practically no associated inductance or hysteresis to slow it.

- It can be addressed by conventional microcircuitry. Operating with extremely low currents and voltages, the driving and sensing circuits can be compact, micropower integrated circuits.

- The external circuitry can "write in" on the back of the same pulse on which it "reads out." This further enhances its speed.

Although research on cryogenic computers was popular in the late fifties, the basic switch, the cryotron, could not compete in speed with fast bipolar and tunnel-diode switching. There also seemed to be no workable scheme for a fast, dense cryogenic memory that would justify the special refrigeration needed to maintain the low temperatures that induce superconductivity in metals of otherwise ordinary resistivity. The cost of such refrigeration has fallen sharply, however, and will continue to fall.

"The price of refrigeration is now about a tenth of a cent per bit with a ten million-bit cryogenic memory," says John Carrona, head of the Cryoelectric Devices Laboratory at RCA's Sarnoff Research Center, Princeton, N. J. "And as you approach the billion-bit mark, it should fall to a few hundredths of a cent per bit."

The International Business Machine Corp. announces that it, too,

has sustained its interest in cryogenic computers. The company reports the development of a subnanosecond cryogenic switch that uses the Josephson Effect (see page 36).

The development of high-capacity, high-speed memories could have an important effect on the development of high, time-sharing computers. Present limits on memory capacity and speed tend to complicate the time-sharing software—the portion of the program that allocates the use of the computer's logic and memory to its many users. A high-speed, "bottomless" memory could reduce the complexity of the allocation decisions such as accessible food surpluses reduce the need for rationing.

Sperry traffic system encounters roadblock

Criticized sharply by New York City's Traffic Commissioner for failure to deliver electromechanical traffic-control units that worked, the Sperry Gyroscope Co. has moved to repair both the units and the damage to its corporate ego.

Traffic Commissioner Henry Barnes assailed the company in a press statement late last month after 55 traffic controllers in a proposed \$5.4 million electronic system had failed to pass acceptance tests. Barnes charged that Sperry, the prime contractor, was causing setbacks that might delay electronic traffic control in New York City for two years.

At Sperry's headquarters in Great Neck, N. Y., a public relations spokesman conceded that the company was encountering "bugs" in its equipment. But he insisted that the basic design was sound; the trouble, he said, lay in the need for adjustments to the equipment in the field. Sperry representatives are engaged in such a "debugging" operation, he said.

The traffic controllers at issue contain logic and electronics that translate traffic data from detectors, sensors and a central computer into commands to traffic lights.

Barnes asserted that in addition to malfunctioning units, Sperry had failed to meet contract delivery dates for all components of the system. He said withdrawal of the contract might be necessary, unless the

company could guarantee future deliveries.

Sperry's spokesman countered that the Commissioner had not taken into account the complexity of the system and the "unexpected" problems that arose.

The system, according to Sperry, will use many pole-mounted microwave sensors to obtain information on traffic density and vehicular speed on main streets. This information will be relayed to a Univac computer, installed at the city's traffic-control center, and also to the electromechanical controllers, mounted at intersections.

Numerous pole-mounted ultrasonic detectors will monitor traffic on intersecting streets and also supply traffic-flow information to the controllers.

Sperry says it will announce a revised delivery schedule for the project by May 15. Problems that developed in the ultrasonic detectors during factory tests have been solved, according to the company spokesman.

250,000 new jobs seen under SST program

The U.S. supersonic transport program will add \$20 billion to \$50 billion to the nation's economic growth and will create 250,000 new jobs—the equivalent of all the jobs in the airline industry today—according to Stuart Tipton, president of the Air Transport Association.

Depending on the number of SSTs built, Tipton predicts that 150,000 new jobs will be created in plants of prime and secondary contractors, and 100,000 in such fields as retail and wholesale trade, finance, the professions and public utilities.

In an address before the Aero Club of Washington, the airline executive noted that "even a 500-aircraft market estimate is a very conservative one." Assuming minimal traffic growth of 8.6 per cent a year and assuming that sonic-boom problems are largely resolved, per-

haps as many as 120 SSTs will be built by 1990, Tipton said.

U.S. Navy is retiring 2 missile 'old timers'

The Navy has ordered a new missile to replace the Tartar and Terrier, which have been mainstays of the fleet since the mid-Fifties.

Improved, multipurpose Standard missiles will be produced by the Pomona, Calif., division of General Dynamics. A \$120 million contract, awarded by the Naval Ordnance Systems Command, covers the production of guidance, control and airframes for the missiles over a six year period.

In addition to protecting ships from aerial attack, the Standard will be capable of destroying surface targets.

An extended-range version of the Standard will replace the Terrier, a two-stage missile, and an intermediate-range model will replace the single-stage Tartar.

The more powerful Standard is reported to have a range of 15 to 35 miles, attainable only with the latest Terriers.

The Standards will be handled and launched with equipment now on the 50 destroyers and escort vessels that will stock the missiles.

General Dynamics plans to extend the Standard concept to air-to-ground weapons for the U.S. Air Force. According to a spokesman, the company is developing an anti-radiation missile, to be used against anti-aircraft missile sites (see "New antiradar missile speeded for Vietnam," ED 29, Dec. 20, 1966, p. 13). The weapon would use the airframe and some guidance and control components of the shipboard version. Fitted with an improved

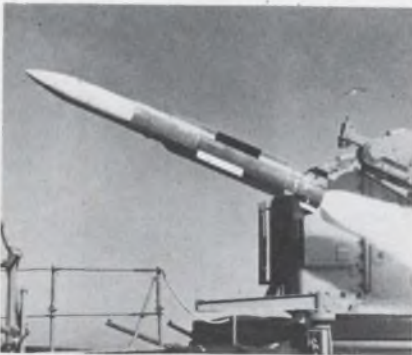

A prototype Standard blasts off

Shrike guidance system, it would home on the radiation emitted by the anti-aircraft radar.

NASA describes its holographic research

A former manager at the National Aeronautics and Space Administration's Electronics Research Center, Cambridge, Mass., predicts a growing role for NASA in holographic research and applications.

Dr. Robert Langford, formerly an assistant director for systems, guidance and control with NASA and now with General Precision, Inc., says that NASA is interested in the following holographic applications:

- Simplification of the simulators for training pilots and astronauts, and the advantage of three-dimensional representation in such training. In general, simulators are large and cumbersome and require such equipment as models of the Moon or terrain, TV cameras on rails, large computers (see p. 22), and a display cockpit. With computer-controlled holographic processes, using small models, much of this equipment could be eliminated.

- Displays for aircraft landings that would enable the pilot to substitute for the readings of a dozen instruments a visual representation of what he would actually see on a clear day.

- Real-time holography in which an image would be read out and a new one put in virtually at the same time.

- A technique of differential holography for observing the vibrations of a system under test.

- Improved microscopy with infinite depth of focus, to give a three-dimensional view of an entire object rather than of merely one layer at a time.

- Word-by-word translation from one language to another by means of holographic filters that substitute a literal equivalent.

At the same time, NASA scientists are striving to improve the basic techniques of holography. Some of the goals are holograms that could be formed and viewed without the need for coherent light from a laser, faster processing of holograms (which require about 20 minutes), and an eventual breakthrough to real-time holography.

The Connector Thing

A periodical periodical designed, quite frankly, to further the sales of Microdot Inc. connectors and cables. Published entirely in the interest of profit.

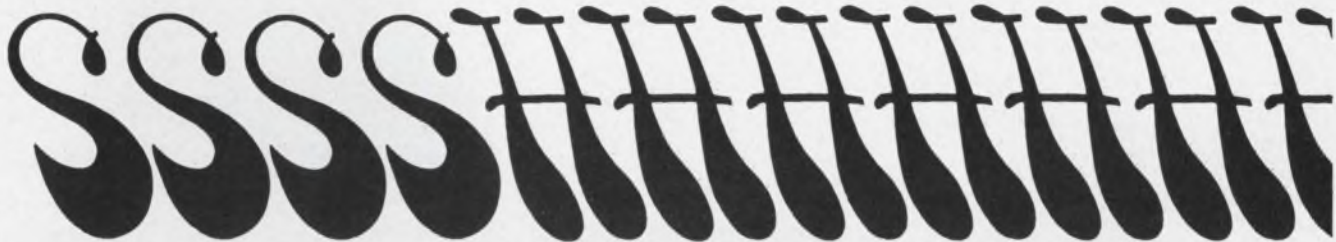

In order to inform you about (very quietly, please) our Mini-Noise coaxial cable, Microdot Inc. is extending a bribe to catch your interest. We are offering as a beautiful prize in this contest a little teeny weeny Sony television set so that you can watch Peyton Place in the office. We are doing this, quite frankly, to impress you with the fact that Microdot Inc. makes the best coaxial cable in the whole wide world. And you won't really know that for sure until you ask, will you? You see how evil we are.



This is the Sony TV you will win

Entering this contest is terribly simple. See this illustration? Many of you are probably too young to remember it, but this fine broth of a man used to decorate the cover of almost every telephone book in the country. As the symbol of Electricity, he also perches atop the American Telephone and Telegraph Building in New York City. All you have to do is hold back tears of memory while you write your own original caption for this illustration. Then send it to Microdot Inc., Great American Cable Contest, 220 Pasadena Avenue, South Pasadena, Calif. 91030. The best caption (judged by a panel of men over forty) will receive the television set. Everybody entering will receive (a) an 11 x 14 repro-



This is the illustration you have to write the caption for

duction of the gentleman surrounded by his miles and miles of cable (b) a free 16-page, two-color catalog of Microdot Inc. miniature coaxial cable and cable assemblies, and (c) a lot of laughs.

To enter this contest, you should have a smattering of knowledge about Microdot Inc.'s Mini-Noise cable. As a design engineer, you are probably often faced with the problem of performance degradation under increasingly severe environmental conditions. Also, you've probably found that the transmission of extremely small signals through coaxial cable is often made unintelligible by audio frequency noise generated in the cable through shock and vibration. No longer. Through a unique proprietary treatment, the noise voltage magnitude in Mini-Noise cable has been reduced by a factor of more than 100 to 1 in comparison to untreated cable.

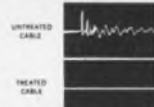

Comparison of untreated cable and treated Mini-Noise cable

Some quick facts about two other Microdot Inc. cable products:

Miniaturized instrumentation means miniature coax cable (in most instances). By using a fine silver-plated copper covered steel wire, Microdot Inc. has been able to manufacture a miniature coax cable with an impedance of 50 ohms that—even with the addition of dielectric, outer shield and protective jacket—does not exceed nominal OD of .080".

Compare, please.

When you find it necessary to send two signals from a single source which must both terminate at a central point, use Microdot Inc. Twinaxial. No need to use two coax cables; therefore, greater flexibility at reduced cost.

One more point about Microdot Inc. cable products: if you've ordered them in the past, it will help you to know that we can now make more of them and make them faster. The reason is our recently completed new facility for cable products, which includes new braiders, new extruders—in short, new equipment and increased capacity for even faster deliveries.

There you have it. Be certain to enter the contest today (April 30, 1967 is your last day). Remember, just caption the illustration and send it to Microdot Inc., 220 Pasadena Avenue, South Pasadena, California 91030. We would hate for you to have to miss even one segment of Peyton Place.



Just because



MICRODOT INC. *Mini-Noise is a registered trademark of Microdot Inc.*

ON READER-SERVICE CARD CIRCLE 11



Model QRE 7.5-10

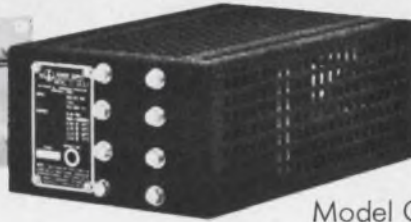
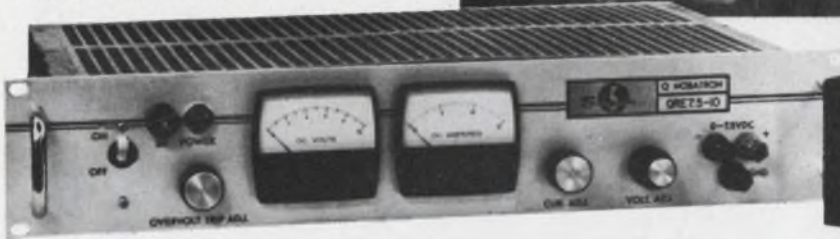

Model QRE 10-3.7

Sorensen Off-the-Shelf Power Supplies Designed for Integrated Circuits:

Sorensen has provided stock availability of the new QRE Series. This series was designed specifically for use with integrated circuits, micro miniature chips, and digital logic circuitry. QRE provides overvoltage protection within 10 microseconds, voltage regulation, line and load combined, is $\pm 0.005\%$ or $\pm 0.01\%$.

All QRE units include these Sorensen features, series/parallel operation, remote sensing, remote programming and high stability. Designed as a space saving system the QRE Series may be selected from either modular or 3 1/2" high rack units.

MODEL	V/A RANGES	PRICES
QRE 10-2.2	0-10V, 0-2.2A	\$135
QRE 10-3.7	0-10V, 0-3.7A	155
QRE 7.5-10	0-7.5V, 0-10A	295
QRE 7.5-20	0-7.5V, 0-20A	465
QRE 7.5-50	0-7.5V, 0-50A	595

For QRE details, or for information on other stock or custom DC power supplies, AC line regulators, frequency changers, or for our free catalog #662A, contact your Sorensen rep., or Raytheon Company, Sorensen Operation, Richards Ave., Norwalk, Conn. 06856. Tel: 203-838-6571.



ON READER-SERVICE CARD CIRCLE 12

Whether it's cold or whether it's hot . . .

Indoor temperatures are comfortable, thanks to solid-state heating and air-conditioning controls.

Frank Egan
Technical Editor

Heating and air conditioning in the United States is a going business, as evidenced by the over four million air-conditioning units and two million heating units shipped by manufacturers during 1966. And the electronics industry, always on the lookout for expansion, is beginning to view this field of environmental comfort as a potentially very lucrative one.

Solid-state electronics is beginning to turn up increasingly in heating and air-conditioning equipment in the form of control devices. A variety of such devices has already been introduced, usually on top-of-the-line equipment, and many more are under development. Manufacturers expect that the somewhat higher cost of these units will be more than offset by their improved performance and reliability.

New applications for semiconductor control circuitry include:

- Gas-ignition systems that replace the pilot flame in furnaces.
- Sensors that detect the presence or absence of burner ignition in furnaces and boilers.
- Automatic speed-control cir-

cuits for warm-air system blowers and cool-air compressors.

- Transducers for converting temperature and humidity into electrical signals, as well as for providing electronic control of pneumatically actuated systems.

- Electric heater zero-point-switching controls that permit proportional control without generating radio frequency interference.

Pilot flames abolished

The pilot flame has long been the weak link in gas heating systems. In early furnaces, with the pilot unmonitored, gas would flow freely if the pilot light went out—often with disastrous results. Even on today's furnaces—in which the pilot flame is monitored by a thermocouple or expansion type of switch—dust and dirt frequently clog the burner, causing ignition problems. The American Gas Association has reported that considerably more than half of its service calls for appliances with pilot lights are caused by the pilots.

It is no wonder that numerous manufacturers are switching to automatic solid-state ignition systems

that abolish the troublesome pilot. Most of these systems use some type of controlled capacitor-discharge circuit to create a flame-igniting spark across two electrodes. They also include control circuitry, to check that ignition has occurred and to shut down the system in the event of electrical or gas-supply failure.

Most automatic ignition systems use separate elements for ignition and flame-sensing. The ignition circuits produce the spark across the electrodes, and another device—such as a warp switch or light or heat sensor—senses the flame when ignition occurs. A new unit, developed by the Controls Corp. of America, now combines both ignition and flame-sensing in the same circuitry.

The new unit (Fig. 1), called Ion-ition, has all its components except the electrodes packaged in a compact, epoxy-encapsulated mounting on the furnace gas valve. When the system is energized by the thermostat, a Zener-controlled capacitor-discharge breaks down the air gap across the ignitor electrodes, causing a continuous spark. Once the spark is established, the electrically operated main gas valve is opened and the incoming gas is ignited at the main burner.

The presence of flame is then

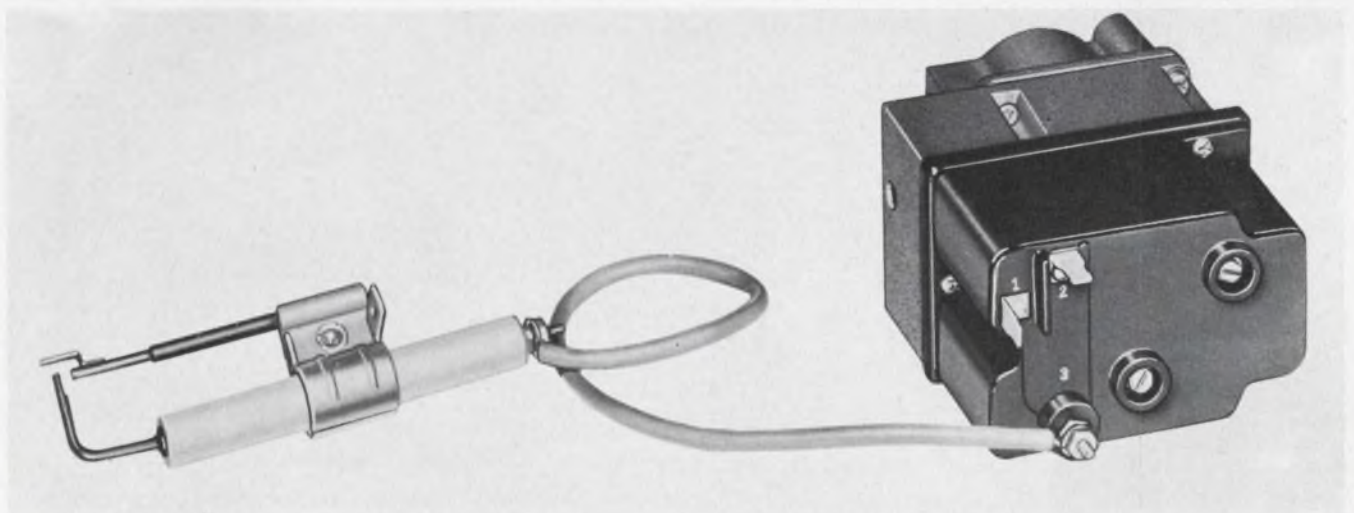

1. Both ignition and flame sensing are done by the two components of the Ion-ition system. Total power require-

ments for the Controls Corp. of America completely solid-state system are 350 mA at 24 V.

(controls, continued)

sensed right at the electrodes, and if ignition has occurred, the safety circuits are switched to a standby condition. Detection is based on the fact that in the presence of flame the resistance across the electrodes decreases because of the ionization of the air. The resulting increase in current flow indicates to the control circuitry that the flame has been established. The circuit that controls the gas valve is a network of SCRs and zener diodes.

The trend toward solid-state replacement of the gas pilot was started a few years ago in a unit called the Electronic Match, developed by the Wilcolator Co. of Elizabeth, N. J. Originally the unit was developed to eliminate pilot flame-outs on gas appliances, but it soon proved its value as a replacement for the pilot altogether.

One form of the Electronic Match circuit is shown in Fig. 2. It consists of a timing circuit, a switching circuit and a high-voltage output transformer. When the circuit is energized, capacitor $C2$ charges to the rectified line voltage, and $C1$ charges through resistor $R1$.

When the voltage across $C1$ reaches the breakdown value of the neon lamp, which occurs about once a second, the lamp is energized, and $C1$ applies a pulse to the gate of the SCR. Capacitor $C2$ then discharges through the primary of the output transformer, which delivers an output of about 18,000 volts across its secondary. This output voltage then generates the gas-igniting spark

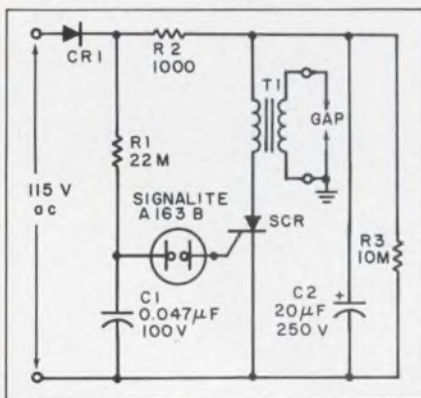

2. High-voltage sparks for gas ignition are produced across the electrodes at the rate of about one a second by the Electronic Match.

across the electrodes.

In gas-fired warm-air systems, solid-state controls can be used to perform other functions in addition to flame ignition and sensing. One of these is to control the speed of the blower motor. Such control can be either manual, as with a hand-adjusted potentiometer, or automatic, in accordance with the temperature changes in the area being heated.

Phase-angle control is used

One form of half-wave speed control¹ that is widely used on universal motors is shown in Fig. 3. This basic circuit can take many forms, depending on the performance and control range required. In operation, the circuit establishes a triggering level for the SCR, which, together with the motor counter emf, controls the phase angle at which the SCR fires. Should the motor tend to change speed, its counter emf changes, and so also does the SCR triggering level. As a result, the phase angle at which the SCR fires changes to maintain a constant motor speed.

A full-wave speed control circuit developed by the Metals and Controls Div. of Texas Instruments is shown in Fig. 4. When the relay or switch is in position A, motor speed is a function of the thermistor temperature and the resistance of the potentiometer. With the relay in position B, the motor speed is constant and depends on the value of resistor $R1$.

In large industrial heating systems thermistors are coming into widespread use in a variety of temperature-sensing and controlling ap-

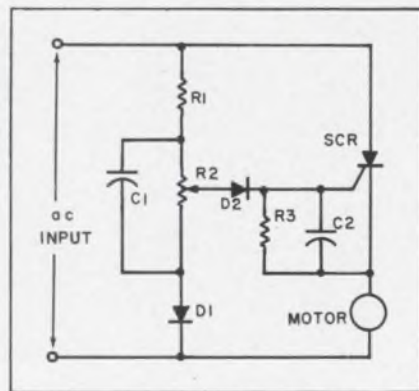

3. Phase control of the applied voltage is used by this SCR control circuit to regulate the speed of a universal motor.

plications. Their large temperature coefficient—as high as 30 ohms per degree F—makes the resistance of even long leadwires negligible. This minimizes calibration requirements and can greatly simplify installation and adjustment.

Most thermistor control units are in the form of some sort of bridge, with the thermistor in one leg and fixed resistors in the other three. Both ac and dc bridges are in widespread use. Ac types have the advantage of lower cost, but often they require the use of shielded cable when long leadwires are required to connect to external sensors and actuators.

The amplifiers used to boost the output of these bridges are usually conventional circuits, consisting of two or more transistor stages. In most cases the amplifier output energizes one or more relays, which correct the temperature by providing the power for repositioning an electrically operated damper or valve motor.

Electric heating controls, too

Electric heating systems represent another area where solid-state controls can perform a variety of functions. Resistance elements are used in baseboard units, fan-coil units or supply air ducts. Controlling these elements, however, represents a problem when on-off thermostats are used. In effect, the elements either produce full heat output or no output, with resultant wide temperature swings in the heated area. This type of performance, says S. J. Nelson, vice president and general manager of Honeywell's Commercial Div., "offsets

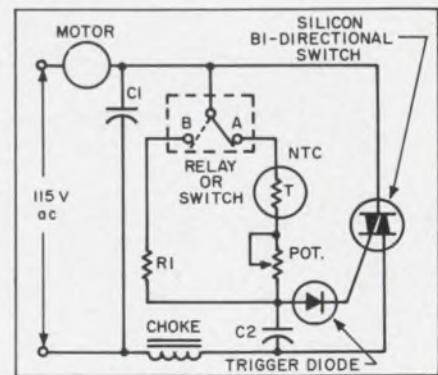

4. Full-wave phase control of a blower motor is provided by this Texas Instruments, Metals and Controls Div. circuit.

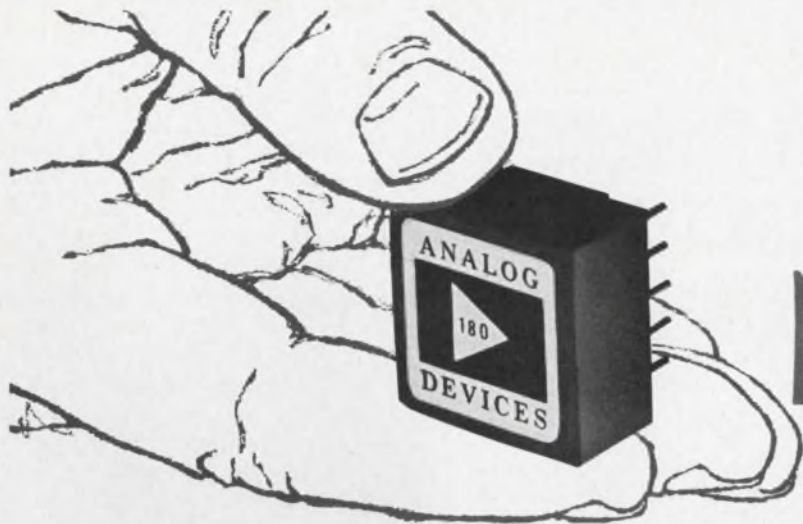

New

Chopperless Operational Amplifiers

1.5 μ V/ $^{\circ}$ C max. drift — \$80. 0.75 μ V/ $^{\circ}$ C max. drift — \$110.

Now you can get chopper stabilized performance in a fraction of the size and at one half the cost. The new Model 180 also offers the versatility of differential inputs to build high impedance (1000 Megohms) voltage followers and high common mode rejection differential amplifiers. Voltage noise is less than chopper amplifier too — only 1 μ V peak to peak.

Low Sensitivity to Thermal Gradients

Unlike most differential amplifiers, the Model 180 is practically immune to offsets due to thermal gradients. Graph below shows transient offset voltage following a 40 $^{\circ}$ C thermal shock from 25 to 65 $^{\circ}$ C — an order of magnitude improvement over conventional op amps. Warm up drift is almost undetectable — typically less than 5 μ V.

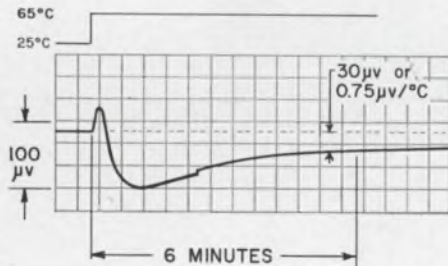

Input Noise

Voltage noise, dc to 10Hz, is typically 1 μ V peak to peak as shown in the graph. Also current noise of only 5pa peak to peak is exceptionally low for a transistor amplifier.

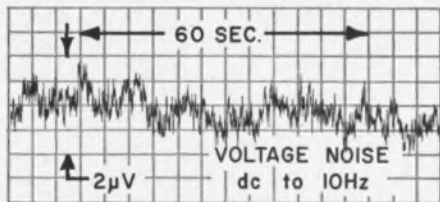

Current Drift

Bias current drift of 0.1na/ $^{\circ}$ C matches the excellent voltage drift of the Model 180. Even more remarkable, current drift at each input tracks to within \pm 0.5na over the temperature range from 10 to 60 $^{\circ}$ C. Model 180 is ideal for mil spec operation over the range from -55 to +85 $^{\circ}$ C.

SPECIFICATIONS

Open Loop Gain	300,000 min.
Rated Output	\pm 10V @ 2.5ma
Voltage Drift, Model A	1.5 μ V/ $^{\circ}$ C, max.
Model B	0.75 μ V/ $^{\circ}$ C, max.
Bias Current Drift	0.1na/ $^{\circ}$ C, max.
Offset Current Drift	0.01na/ $^{\circ}$ C
Voltage Noise	1 μ V (.01-1Hz, p-p)
Current Noise	5pa (.01-1Hz, p-p)
Common Mode Impedance	1000 Megohms
Common Mode Rejection	100,000
Price (1-9)	<u>180A</u> <u>180B</u>
	\$80. \$110.

Sample — Call or write Bill Miller, Application Engineer, for a unit to try in your circuit.

ANALOG



DEVICES

221 FIFTH STREET













CAMBRIDGE, MASSACHUSETTS

617-492-6000

ON READER-SERVICE CARD CIRCLE 13

All from Sprague!

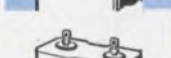
TWELVE OF OUR MOST POPULAR METALLIZED CAPACITOR TYPES

SPRAGUE TYPE	Case And Configuration	Dielectric	Temperature Range	Military Equivalent	Eng. Bulletin
 680P	hermetically-sealed metal-clad tubular	metallized Metfilm* 'A'	-55 C, +85 C	no specification	2650
 431P	film-wrapped axial-lead tubular	metallized Metfilm* 'E' (polyester film)	-55 C, +85 C	no specification	2445
 155P, 156P	molded phenolic axial-lead tubular	metallized paper	-40 C, +85 C	no specification	2030
 218P	hermetically-sealed metal-clad tubular	metallized Metfilm* 'E' (polyester film)	-55 C, +105 C	CH08, CH09 Characteristic R	2450A
 260P	hermetically-sealed metal-clad tubular	metallized Metfilm* 'K' (polycarbonate film)	-55 C, +105 C	no specification	2705
 121P	hermetically-sealed metal-clad tubular	metallized paper	-55 C, +125 C	no specification	2210C
 118P	hermetically-sealed metal-clad tubular	metallized Difilm® (polyester film and paper)	-55 C, +125 C	CH08, CH09 Characteristic N	2211D
 143P	hermetically-sealed metal-clad "bathtub" case	metallized paper	-55 C, +125 C	no specification	2220A
 144P	hermetically-sealed metal-clad "bathtub" case	metallized Difilm® (polyester film and paper)	-55 C, +125 C	CH53, CH54, CH55 Characteristic N	2221A
 284P	hermetically-sealed metal-clad rectangular case	metallized paper	-55 C, +105 C	no specification	2222
 283P	hermetically-sealed metal-clad rectangular case	metallized Difilm® (polyester film and paper)	-55 C, +125 C	CH72 Characteristic N	2223
 282P (energy storage)	drawn metal case, ceramic pillar terminals	metallized paper	0 C, +40 C	no specification	2148A

*Trademark

For additional information, write Technical Literature Service, Sprague Electric Company, 347 Marshall St., North Adams, Mass. 01247, indicating the engineering bulletins in which you are interested.

SPRAGUE COMPONENTS

CAPACITORS
TRANSISTORS
RESISTORS
THIN-FILM MICROCIRCUITS
INTEGRATED CIRCUITS
INTERFERENCE FILTERS
480-6138

PACKAGED COMPONENT ASSEMBLIES
FUNCTIONAL DIGITAL CIRCUITS
MAGNETIC COMPONENTS
PULSE TRANSFORMERS
CERAMIC-BASE PRINTED NETWORKS
PULSE-FORMING NETWORKS



*Sprague and ® are registered trademarks of the Sprague Electric Co.

ON READER-SERVICE CARD CIRCLE 14

NEWS

(controls, continued)

many of the advantages of electricity as a fuel, in the eyes of engineers, architects, contractors and clients."

To overcome this drawback, various control circuits can be used to cycle the heating elements on and off very rapidly. The duration of the on time is determined by the temperature requirements of the space being heated; but the total on-off time always remains the same. The object is to cycle the heat source fast enough for it not to heat up or cool down excessively.

Solid-state control circuits are ideally suited for this rapid switching, and various types can be used. One employs phase control of the applied ac power; the phase angle at which a pair of SCRs or a Triac fires is controlled by the temperature requirements. This technique has the disadvantage of producing electrical interference as a result of the chopping action. Such interference can frequently be highly objectionable, because of its effect on other electronic equipment in the vicinity. Consequently filters are normally included in phase-angle control circuits.

To eliminate the troublesome interference, manufacturers like Honeywell, General Electric and Sprague Electric are turning to zero-voltage switching schemes. In these circuits the input ac power is switched on and off at or near the zero-level crossing of the sine wave. The block diagram of a Honeywell controller of this type is shown in Fig. 5. The average output power delivered to the load is directly proportional to the input signal, which is generated

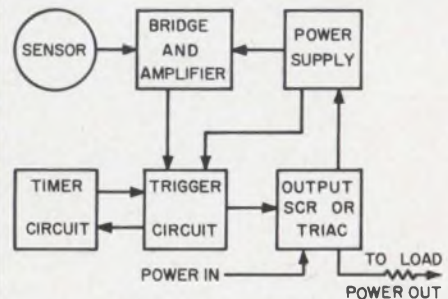

5. Zero-voltage switching is used in this Honeywell solid-state controller for electric heating systems. This technique eliminates the electrical interference inherent in phase-control switching.

by a thermistor sensor.

Another zero-switching scheme² is incorporated in the Motorola Semiconductor Products circuit shown in Fig. 6. ON switching of the SCRs in this circuit takes place when the input voltage waveform crosses zero; off switching occurs when the SCR current falls to zero. The on switching is provided by the phase-advance portion of the circuit, which provides a triggering signal to the gate of SCR 1. The signal peaks at the input-voltage zero crossing.

Transistor Q1 serves as a shunt switch that removes or applies the gate signal, as desired. A signal in phase with the ac input is applied to the base of Q1 by resistor R3 to drive Q1 into saturation a few degrees after the start of each input positive half cycle. Whether or not Q1 turns on each half cycle is determined by the voltage developed across the temperature sensor. If this voltage is higher than the constant reference voltage, Q1 turns on and inhibits the firing of SCR 1.

The zero-point slaving portion of the circuit triggers SCR 2 at the beginning of each negative half cycle following conduction of SCR 1.

Cooling improvements developed

In air conditioning, solid-state controls are making an important contribution as automatic speed-regulating units for air-cooled condenser fans. Their usefulness arises from the fact that it is becoming

increasingly common for many air-conditioning systems to run all-year-round—even when outside temperatures are as low as 0°F.

Systems that use air-cooled condensers are subject to various problems when the outdoor temperature drops below about 50°F. At these temperatures pressure in the condenser is not sufficient to pass enough refrigerant to the evaporator coil, which is indoors. As a result, poor cooling performance results. Semiconductor control circuits remedy this problem by varying the speed of the condenser fan in accordance with the outdoor air temperature. The quantity of air flowing over the condenser coil is thus controlled, making it possible to maintain the condensing temperature at an optimum level.

One circuit³ for accomplishing this is shown in Fig. 7. A thermistor is used as the temperature-sensing element, and it and the unijunction transistor control the firing of the SCR, which provides input power to the condenser motor.

A condenser-fan control developed by the Carrier Air Conditioning Co. is shown in Fig. 8. It is designed for efficient air-conditioner operation over an outdoor temperature range of -20° to +115°F.

Large systems use electronics

Electronics has been used in centralized heating and air-conditioning systems for a number of years.

These centralized systems are generally installed in large buildings, and they provide both control and monitoring of the entire system from a central point. Many such systems are hybrid, incorporating the best features of both all-electronic and all-pneumatic systems.

Nevertheless there are sometimes overriding considerations that dictate the use of either a completely electronic or completely pneumatic system for a specific installation. For example, in an explosive atmosphere—such as in a refinery or a hospital operating room—all-pneumatic control is preferred because it is completely safe. On the other hand, where accuracy is of prime importance—as in a research laboratory or “clean room”—all-electronic control is preferable.

The heart of large centralized systems is normally some sort of electronic master control console. A highly sophisticated example of such a unit is that used with Honeywell's System 30 (Fig. 9).

System 30 consists of three subsystems: a high-speed data-acquisition system, a digital process computer and an on-line control system. The data-acquisition system is connected by cable to up to 250 individual remote heating and cooling systems. Multiplexing decoders periodically connect temperature, flow, pressure, humidity, kilowatt-hour, and alarm sensors located in each of the remote systems to the digital computer.

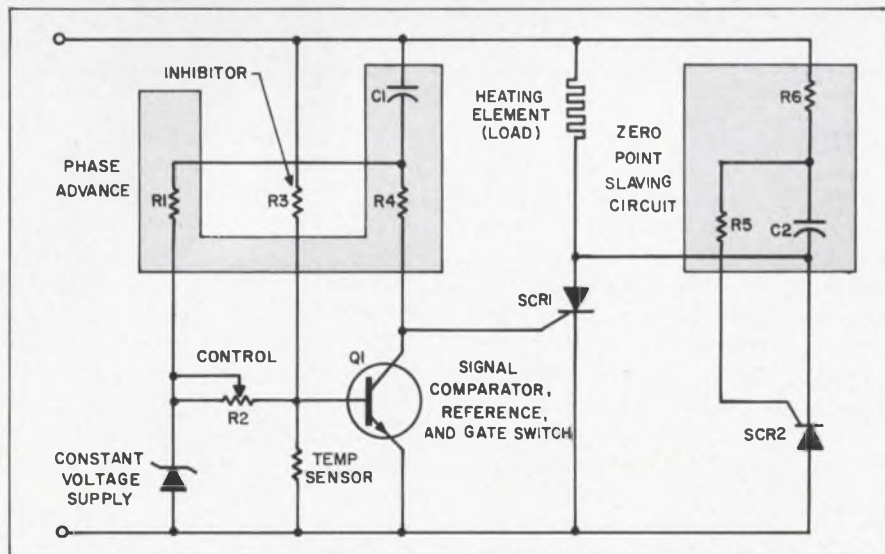

6. Full-wave zero-level switching of power to a heating element is accomplished by this circuit. The circuit can operate half-wave by eliminating SCR-2 and the zero-point-slaving feature.

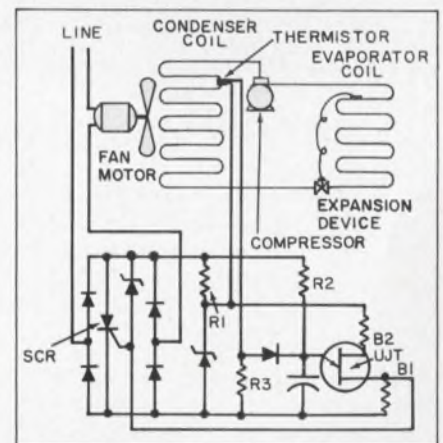

7. All-weather operation of air-conditioning units is made possible with this compressor fan speed-control circuit. A thermistor is used to sense the temperature at the compressor, and the fan speed is then automatically adjusted accordingly.

(controls, continued)

The computer analyzes the system data and sends out various control commands every five minutes to the remote systems, via the on-line control facilities. At the monitoring console, a touch-dial selection system permits the operator to pick out a slide containing the schematic of a particular point in the over-all system. The slide is then projected onto a screen in front of the operator for detailed analysis.

Manual commands can be executed at the console, should it be necessary to override the computer commands. In addition complete recording and alarm-logging facilities are provided. ■ ■

References:

1. Reuben Wechsler, "Improved Solid-State Appliance Controls," Proc. 17th Annual IEEE Appliance Technical Conference, May 17-19, 1966, Paper DAC 66-2.

2. *Ibid.*

3. Russell E. Wood and David B. Dibble, "Solid-State Controller for Air-Cooled Air-Conditioning Units," *IEEE Trans. on Industry and General Applications*, Volume IGA-2, No. 6 Nov./Dec., 1966).

Bibliography:

Hey, John C. "Device Hunting for Motor Speed Control," *ELECTRONIC DESIGN*, XIV, No. 11 (May 10, 1966), 38-41.

Howell, E. K. "Infinite Heat Control Uses Triac and Contacts," *ELECTRONIC DESIGN*, XIV, No. 17 (July 19, 1966), 88-89.

—"Switch From Hot to Cool," *ELECTRONIC DESIGN*, XIV, No. 4 (Feb. 15, 1967), 98-101.

—"Marry Relays and Semiconductors," *ELECTRONIC DESIGN*, XV, No. 5 (March 1, 1967), 84-85.



8. Compact control unit regulates the speed of air-cooled condenser fans in accordance with outdoor temperatures. The unit makes possible air-conditioner operation over an outdoor temperature range of -20° to $+115^{\circ}$ F.

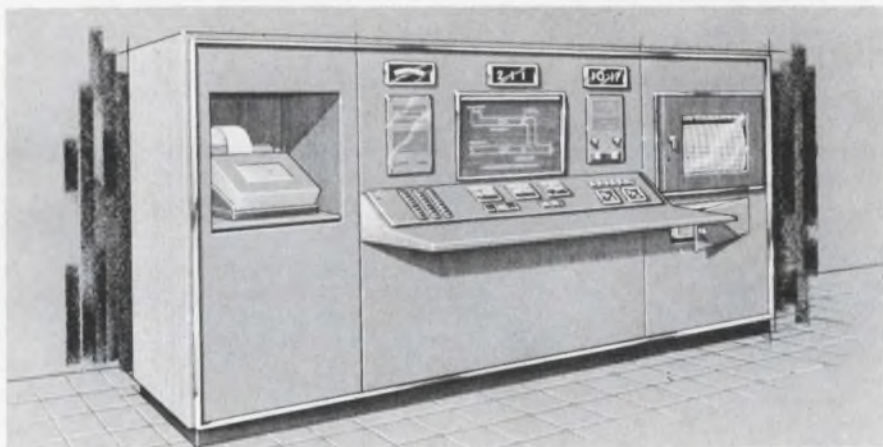

9. Master control console permits monitoring and controlling of large air-conditioning and heating systems. Up to 250 heating and cooling subsystems can be controlled from this Honeywell unit.

Computer creates holograms digitally

A technique that may enable computers to create holograms from nonoptical sources was reported by scientists of the International Business Machines Corp. at the recent International Symposium on Modern Optics. Inputs to the computer may consist of radio, radar, or acoustical waves. The computer is indifferent to just where the waves lie within the spectrum, so long as they are coherent and their reflection pattern can be translated into machine language.

With this technique, astronomers might be able to "illuminate" the

moon with radar pulses. The reflected interference patterns would be digitized and fed to the computer, which would produce a digital version of a hologram. Shifting this radar picture to the optical region would yield a three-dimensional photograph of the moon.

Conventional holograms are formed by exposing the object to a laser beam and recording the resulting interference patterns on emulsions. When the developed film is viewed under the coherent light of a laser, the image is reconstituted in such a manner that the observer

can gain a new perspective simply by shifting his position or that of the hologram. (See "Major advance in wafer-making forecast," ED 15, June 21, 1966, pp. 17-19).

The researchers who developed digital holography are Louis B. Lesem and Peter Hirsch of the IBM Scientific Center, Houston, and James A. Jordan, Jr., of Rice University, Houston.

The three men pointed out that, since the recorded interference patterns are digitized before being fed to the computer, it should be possible to create a hologram from the

mathematical model of an object that does not exist.

In this fashion an architect could see his building three-dimensionally in the drawing-board stage. Similarly, an engineer could refine the thermal design of inertial assemblies without resort to mockups.

From the mathematical model the computer would calculate the pattern that would be recorded if light waves actually were scattered from the "object" and allowed to interfere with waves emanating from a reference beam.

While initial experiments were confined to two dimensions for simplicity, the IBM scientists expect a high degree of success in developing three-dimensional holograms. A spokesman for IBM said that only additional programming for calculating the interference patterns is necessary.

To illustrate their technique, Jordan, Hirsch and Lesem represented the Greek letter lambda (λ) by numbers representing the intensity of points on the symbol. They fed their mathematical model into a computer, which calculated the interference patterns. The digital representation was plotted on a sheet of translucent material by a graphic plotter similar to those used in tracing weather maps. This plotter records data in as many as 32 shades of gray under computer control. The lambda plot was photographed with an ordinary camera using conventional film in a typically illuminated room.

When the resulting transparency was viewed under ordinary light, all that could be seen were patterns like the spectral lines from a diffraction grating. But when coherent light from a laser was directed at the transparency, the lambda was clearly reconstructed.

This is in effect two-dimensional holography of a two-dimensional object. Similar results were predicted for the three-dimensional pictures.

It has been speculated that the IBM digital technique might be able to improve the quality of conventional holograms. A hologram would be photoscanned and the resulting image digitized and fed into the computer. The computer would filter distortions and thereby provide an improved optical hologram. ■ ■



No small print

The Nytronics name on the package is all the insurance you need, to know your sub-miniaturized ceramic capacitors represent the highest standards of quality, stability, and capacitance-to-size-ratio. Available in four complete lines:

NYT-CHIP — An ultra-stable chip capacitor with tinned terminals, 0.170" x 0.065" x 0.070", with capacitance range of 4.7 pf through 82 pf, and 0.280" x 0.195" x 0.070" for 100 pf to 4700 pf. Temperature coefficient does not exceed ± 40 ppm/ $^{\circ}$ C over a temperature range of -55° C to $+125^{\circ}$ C. Working voltage 200 volts D.C.

NYT-CAP — An ultra high stability ceramic capacitor series packaged in a miniature molded epoxy tubular package 0.1" diameter by 0.250" in length, with capacitance range of 4.7 pf to 82 pf. The remainder of series in miniature, molded epoxy case 0.350" long by 0.250" wide by 0.1", with a range of 100 pf to 4700 pf. Temperature coefficient does not exceed ± 40 ppm/ $^{\circ}$ C over a temperature range of -55° C to $+125^{\circ}$ C. Working voltages 200 D.C.

DECI-CAP — A subminiature ceramic capacitor with an epoxy molded envelope 0.100" diameter by 0.250" long, axial leads, with capacitance range 4.7 pf to 27,000 pf, tolerance $\pm 10\%$. Unit designed to meet MIL-C-11015.

HY-CAP — Offers extremely high capacitance range .01 mfd. to 2.5 mfd. in $\pm 20\%$ tolerance. Voltage 100 WVDC, no derating to 125° C. Designed to meet MIL-C-11015.

Write or call for more information. In addition to ceramic capacitors, our inventory of other standardized high quality components includes inductors, delay lines, and resistors.



NYTRONICS®

...for Precision Electronic Components

550 Springfield Ave., Berkeley Heights, N.J. 07922 ■ (201) 464-9300 ■ TWX: 710-984-7977

ON READER-SERVICE CARD CIRCLE 15

Computer 'utilities' move toward reality

Time-sharing networks that would serve even housewives are envisioned in the next decade

Ron Gechman
West Coast Editor

Computer "utility" systems with many remote terminals, capable of solving problems for engineers, scientists, businessmen, students or even housewives, are reported approaching the day of widespread use.

Rooted in time-shared computer centers that are already in operation and in others that are scheduled to be built, such systems will be simplified to the point where customers will converse with computers in everyday language, the experts say. This is already being done experimentally.

Soon the University of Wisconsin will install the largest time-sharing system thus far announced. When completed, over 700 terminal units at campuses throughout the state will be linked to a Burroughs B8500 computer at the campus in Madison, Wis.

This development comes after five years of experimentation with a comparable, though smaller, time-

sharing system at the Massachusetts Institute of Technology. Project MAC, as MIT calls its system, was the first of its kind developed in this country. It is linked to 160 typewriter input stations around the university's Cambridge campus, in a hospital and in the homes of some of the faculty research staff. Through the use of Western Union and Bell Systems line circuits, access to the computer is possible from anywhere in the world.

Other time-shared computer centers are in operation commercially around the country on a limited basis. International Business Machines, General Electric, Keydata, Allen-Babcock, and Tymshare—to name just a few companies—are now selling their computer services to aerospace corporations, banks, colleges, oil companies, accounting firms and consultants in many fields. Computer company officials believe that there are virtually no fields of business, large or small, that could not use this service.

But the specialists also agree

that the concept of the time-shared computer utility is opening up a Pandora's box of social, political, legal and psychological problems that must be resolved before widespread acceptance of such a utility becomes a reality. Major problems revolve around the issue of privacy in time-sharing systems and the protection of data from theft and vandalism.

Government control feared

Even the loosely used term "computer utility" has stirred concern. Dr. Montgomery Phister, vice president of Scientific Data Systems in Santa Monica, Calif., says that it is not a utility but a service; that the word "utility" implies government control and regulation. The companies presently providing computer time-sharing services fear that government control would restrain their opportunities for expansion, profit and possibly some of the services they could offer.

Since all present systems employ telephone circuits, the Federal Communications Commission is reported ready to investigate the transmission of such data over common-carrier lines, to see if it comes under any of the commission's present regulations.

Last month the specialists in the fledgling industry gathered on the campus of the University of California at Los Angeles to discuss mutual problems and progress for three days. The symposium, sponsored jointly by the UCLA College of Engineering, and Informatics, Inc., of Sherman Oaks, Calif., had as its theme: "Computers and Communications Toward a Computer Utility."

Concept called feasible

Prof. Robert Fano, director of MIT's Project MAC, told the conference that computer utilities were entirely feasible and could be widely operative within 10 years. However, more pessimistic experts were inclined to feel that the social and



A man-computer conversation is under way at this Project MAC terminal. Earl Van Horne (seated), an MIT graduate student, is doing the talking, while (left to right) Asst. Prof. Jerome Saltzer, Prof. Robert Fano and Daniel Wilder, a graduate student, watch.



SCR SERIES POWER SUPPLIES



NEW styling...



SMALLER size...



LESS ripple...



Brand new design and a new concept and production of proprietary electronic filtering, all in the SCR from the oldest sole-manufacturer of power supplies, guarantees quality, highest performance and lowest cost.

Model No.	Voltage Range	Current Range	Voltage Regulation Line or Load
SCR 10-1000	0 to 10	0 to 1000	0.1% or 5MV
SCR 10-500	0 to 10	0 to 500	0.1% or 5MV
SCR 10-250	0 to 10	0 to 250	0.1% or 5MV
SCR 20-500	0 to 20	0 to 500	0.1% or 10MV
SCR 20-250	0 to 20	0 to 250	0.1% or 10MV
SCR 20-125	0 to 20	0 to 125	0.1% or 10MV
SCR 40-250	0 to 40	0 to 250	0.1% or 20MV
SCR 40-125	0 to 40	0 to 125	0.1% or 20MV
SCR 40-60	0 to 40	0 to 60	0.1% or 20MV
SCR 120-80	0 to 120	0 to 80	0.1% or 60MV
SCR 120-40	0 to 120	0 to 40	0.1% or 60MV
SCR 120-20	0 to 120	0 to 20	0.1% or 60MV
SCR 160-60	0 to 160	0 to 60	0.1% or 80MV
SCR 160-30	0 to 160	0 to 30	0.1% or 80MV
SCR 160-15	0 to 160	0 to 15	0.1% or 80MV
SCR 500-20	0 to 500	0 to 20	0.1% or 250MV
SCR 500-10	0 to 500	0 to 10	0.1% or 250MV
SCR 500-5	0 to 500	0 to 5	0.1% or 250MV

RMS Ripple: 10MV Transient Resp: to within 2% in 50 M/S



Write for more information.

THE ROWAN CONTROLLER COMPANY

OCEANPORT, N. J. 07757

(time-sharing, continued)

legal problems might cause delays for as long as 10 additional years.

Project MAC began its demonstrations in late 1961 with an IBM 709 computer. Since then the program has been upgraded with the installation of two IBM 7094 computers. The system can handle requests for information from 30 simultaneous users.

The University of Wisconsin system will utilize teletype and CRT display consoles at its more than 700 terminals to communicate with the Burroughs B8500 central computer. Like Project MAC, some of its terminals will also be connected to separate, smaller computer systems that will preprocess the information before it is transmitted to the central computer.

The system will handle dialogue requests from remote users while simultaneously performing batch-type scientific and business data processing. It will also provide real-time monitoring and control of scientific experiments in physics, space and astronomy, psychology, medicine and other research fields.

Ultimately the giant system will contain 16 memory units for holding 262,144 words of main storage. The cycle time will be 0.5 μ s and the access time 30 ms on the average. The software will include programs

using COBOL, ALGOL, FORTRAN IV, INTERP (an arithmetic conversational language) and TEXT EDITOR (a conversational file-maintenance language).

Time-sharing systems for special applications are also being developed, the conference was told. At UCLA a group is developing a system for collecting, recording, analyzing and transmitting medical and hospital records. Dr. Baldwin Lamson, director of hospitals and clinics at UCLA, said the university was developing a totally integrated system to satisfy all the communication needs of a hospital.

Another hospital computer system, developed by the Hospital Systems Group of the Lockheed Missiles and Space Co. in Sunnyvale, Calif., is now undergoing tests at the Mayo Clinic in Rochester, Minn. (see ED 3, Feb. 1, 1967, p. 24). This system is designed to speed communication between doctors, nurses, the hospital pharmacy and laboratories; it has no problem-solving capabilities.

In the typical time-shared computer system used for business applications, each customer has his own program to perform the specific computations he requires. A typical program would select the information file it needs from the computer memory, process the file with updated material, return the file to the computer memory, record

a journal entry of the transaction and determine what information should be printed out on the customer's terminal station.

Tymshare, Inc., of Los Altos, Calif., an early entry in providing time-sharing computer services with an SDS-940 computer, described its operations at the conference. Tymshare's system provides near-instantaneous response—2 to 4 seconds under worst-case conditions—to 60 simultaneous users.

The system can operate in five computer languages: FORTRAN II and IV; BASIC (a simple algebraic compiler that resembles FORTRAN); QED (for editing and storing printed material) and CAL (a conversational algebraic language suited for most numeric problems not requiring much computation and for some kinds of nonnumeric processing). The company expects to make ALGOL available soon to its users.

Users dial the computer

From a teletype set used as a terminal, an operator can dial the Tymshare computer and type in his problems. Programs for solving problems can be put into the computer memory for future use. A user's data in the memory are protected from unauthorized use; each user gets a code or a password.

Raymond Wakeman, vice president of Tymshare, said that an extensive conversational interface had been developed to increase efficiency. Persons completely unfamiliar with programming can learn to converse with the computer in a day or less, he reported. The company has two computer centers—one in Palo Alto and the other in Inglewood, Calif.—and it plans to open more in the future.

The Keydata Corp. of Cambridge, Mass., recently upgraded its time-sharing with the installation of a Univac 494 computer. Formerly it used a Univac 491.

Allen-Babcock Computing, Inc., which began operations last August in Palo Alto, now has a Los Angeles data center tied into its computer in northern California, the conference heard. The system uses an IBM 360, Model 50, that was modified to accept a second "read only" memory that contains 16 additional operation codes for time-sharing. The ad-



Project MAC's time-sharing capabilities are demonstrated by Asst. Director Richard G. Mills (seated at a terminal) with the aid of closed-circuit TV.

The general purpose Fluke Model 845A Null Detector/ Microvoltmeter offers 100 and 10 megohm input resistances, 1 microvolt to 1000 vdc ranges with $\pm 2\%$ accuracy. Input isolation is 10^{12} ohms. The unit will take up to 1200 vdc on any range. Grounded recorder output is isolated from the input. Common mode rejection is 160 db. Price is \$350, or \$395 with rechargeable batteries. Models 841 A & B are designed for laboratory use. For OEM applications we offer Models 840 A & B. "A" models have

a power sensitivity of 8×10^{-16} watt per division. Input resistance is 180 ohms on three ranges of ± 30 na, ± 300 na, and $\pm 3 \mu\text{a}$. "B" models differ in these respects: sensitivity, 5×10^{-9} amp/scale div.; power sensitivity, 4.5×10^{-16} watt/scale div.; input resistance 18 ohms; current ranges, ± 100 na, $\pm 1 \mu\text{a}$, and $\pm 10 \mu\text{a}$. The 841 A or B is priced at \$230 including case and batteries. The 840 A or B costs \$175 plus \$20 for the case and \$5 for the batteries. A rechargeable battery pack and AC line pack are available.



Model 840 A

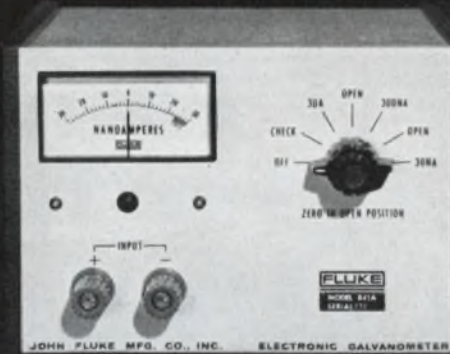

Model 841 A

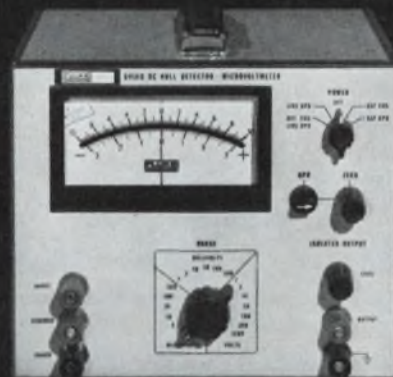

Model 845 AB

Fluke's the place to order null detectors. That's where you get voltage sensitivities as high as 1 microvolt, input resistances as low as 18 ohms or as high as 100 megohms and current sensitivities as great as 30 nanoamperes full scale. All six models are virtually burnout proof. Cases are always at ground so you never need to float the recorder. Fluke Null Detectors meet Mil-Spec shock, vibration, and environmental requirements. Available in plug-in or cabinet models with your choice of rechargeable batteries and/or AC line power. Write us or call your Fluke engineering sales representative for even more information.

Fluke · Box 7428, Seattle, Washington 98133 · Phone: (206) 774-2211 · TWX: (910) 449-2850

In Europe, address Fluke International Corporation
Sophialaan 2, The Hague, The Netherlands · Telex: 844 - 31469

ON READER-SERVICE CARD CIRCLE 17



(time-sharing, continued)

ditional codes perform such tasks as list searching, evaluation of new computer languages and floating decimal arithmetic.

Paul des Jardin, director of programming and systems development for Allen-Babcock, said the company's augmented computer had a 1- μ s access time and 2- μ s cycle time plus 500 K bytes of 3- μ s access time and an 8- μ s cycle time for the background user.

For the conversational user, the maximum response time of the Allen-Babcock system is 3 seconds. For batch processing, the turn-around time—that is, the lag before the computer responds to a question—is a function of the priority setting. The normal setting allows a half hour turn-around for a 3-minute job, and a higher priority setting could complete batch processing in 5 to 10 minutes.

The system can accept 60 simultaneous users, but des Jardin said that performance figures indicated that an increase to 90 simultaneous users might be possible.

In April the company plans to install a second IBM 360/50 in Los Angeles. In the Houston area, it has a remote multiplexer that can drive 10 to 14 simultaneous terminals over a single, voice-grade telephone circuit to the computer in Palo Alto. When the Los Angeles facility becomes operational, the company plans to tie the Houston facility into the Los Angeles complex.

IBM's Quicktran system uses a FORTRAN IV program on an IBM 7094 computer to provide mathematical computation time-sharing services for engineering and business applications, the company reported to the conference. IBM recently announced a Quicktran 2 system that it said was 10 times faster than the earlier system. Quicktran 2 will increase the number of simultaneous users from the 50 possible with the older system to 175. The company began testing the system last March in New York, and it hopes to have it operational later this year. The number of user stations will increase from 5 to 10.

Two keyboards are offered with the system: the Model 1050, used with the older Quicktran, or the Model 2741, which looks like IBM's Selectric typewriter.

The company's Datatext time-sharing system uses an IBM 1460 computer for preparing, revising and recording all types of written information. With a typewriter input (model 2741 typewriter), a secretary can edit text, rearrange sentences and paragraphs and produce a final copy in any page format. The system can also be used for storing records and a wide variety of documents. Datatext provides service to 40 simultaneous users.

Centers are now in operation in San Francisco, Los Angeles, Chicago, Cleveland, New York and Philadelphia. Additional centers are being planned.

On the touchy issue of privacy

(see ED 7, April 1, 1967, p. 13), some specialists feel that it is largely a problem in systems design. But Paul Armer, associate head of the Computer Sciences Dept. at the Rand Corp., Santa Monica, Calif., is pessimistic about absolute guarantees. He told the conference that a determined penetrator could crack any data safeguards if he had the proper resources. The solution, he said, is to make these resources very expensive to employ. He added that the system programmer held one of the most sensitive positions from the standpoint of security, because he would know the mechanics of any safeguards incorporated into a system and would thus know how to go about circumventing them.

Another important problem, it was noted, is reliability in a general computer utility. One speaker at the UCLA symposium asked whether reliability should be assured by the use of redundant circuits or whether integrated circuits were sufficiently reliable so a businessman could rely on them to record and compute millions of dollars worth of business with no hard copy backup. Businessmen will want proof that the computers are reliable, he noted.

Accuracy is not believed to be an important problem. Mistakes are often traced to errors in the original computer program and not to the computer itself. Computer errors are usually not small, Professor Fano observed; they tend to occur on a grand scale and are thus easily spotted. ■ ■

Winners of 1967 'Top Ten' contest named

ELECTRONIC DESIGN's 1967 "Top Ten" contest attracted more than 4000 individual readers' entries. These readers attempted to match their ratings of the 10 most memorable advertisements in the first issue of this year with the "recall-seen" scores from ELECTRONIC DESIGN's regular Reader-Recall survey.

The 10 winning advertisements were reprinted in the last issue of the magazine.

First prize went to Robert Mergliano, a systems engineer at Vitro Laboratories, Silver Spring, Md. He correctly named nine of the 10 winning ads and receives two Air France round-trip tickets between

New York and Paris.

Second prize a Hoffman color television set, went to R. E. Brouillard of Seattle, Wash., who selected eight out of ten correctly.

Bulova Accutron watches went to the following readers who also correctly named eight out of the 10 winning advertisements. Their two wrong selections, however, rated lower "recall-seen" scores than Mr. Brouillard's, and this was the criterion used to place winners who would otherwise have had the same score. These third-prize winners were: B. Spaisman of Silver Spring, Md.; N. D. Clifton of Edwards Air Force Base, Calif.; A. V. Painter

of Anaheim, Calif.; W. W. Steger of Los Alamos, N. M.; S. Gargano of Rome, N. Y.; and A. Cokus of Syracuse, N. Y.

One hundred copies of *Microelectronic Design* were also awarded.

In the special section for employees of manufacturing companies and advertising agencies, the first-prize air tickets were won by Harold S. Pike, Jr., of Nytronics, Inc., Berkeley Heights, N. J. A second-prize color TV set went to J. J. Slawney of Prentice-Hall, Inc., Englewood Cliffs, N. J. A third-prize electronic timepiece was awarded to Myron C. Pogue of the Monsanto Co., West Caldwell, N. J. ■ ■

Rugged, Reliable and Versatile!

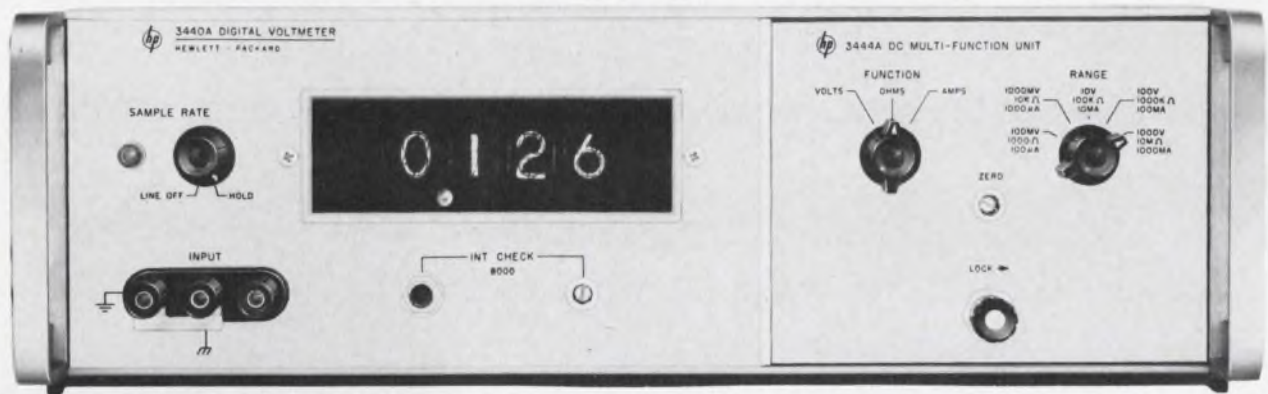

USE THIS hp DVM ANYWHERE!



LABORATORY



PRODUCTION



SYSTEMS

The hp Models 3439A and 3440A Digital Voltmeters are compact, accurate, rapid, multiple function instruments—built rugged, reliable and versatile! With the appropriate plug-in, you get automatic ranging, remote or manual operation with an accuracy of 0.05% of reading on a four-digit readout; 50 Hz to 50 kHz bandwidth with 10 μ V; 10 nA sensitivity!

Rugged!—Models 3439A and 3440A are built with solid-state circuitry and reed relays to provide a rugged instrument. Use of solid-state components also gives a lighter weight for easy portability. These units are test operated at temperatures from 0°C to 50°C with relative humidities of 0 to 95%, vibration tested at 10 to 55 Hz at 0.010" peak-to-peak excursion, and drop-tested four times from four inches. Construction and testing assure you of a rugged instrument—ideal for bench or systems applications.

Reliable!—With either the 3439A or 3440A, you get an internal calibration source with a TC better than 0.002%/°C and a stability typically better than $\pm 0.005\%$ over a three month period. You can verify accuracy of these models simply by pressing a front panel button. You get digital readout on large rectangular display tubes which hold the previous reading until the input voltage is changed. Long-term reliability is assured with solid state components—but, if something should happen, the easy-to-service plug-in circuit cards mounted in the modular enclosure can be quickly replaced to minimize down-time.

Versatile!—You get a dc accuracy of better than $\pm 0.05\%$ of reading ± 1 digit. Specified accuracy is retained to 5% beyond full scale. The ac filter has a rejection of 30 dB at 60 Hz. Response time to a step change is 450 msec to read 99.95% of final value. The 10 M Ω impedance presents a constant load on all voltage ranges.

Add the capability of six plug-ins to these features and you have a truly versatile instrument! *But—that's not all!* You can make true RMS measurements using the dc output of the hp Model 3400A RMS Voltmeter and either the 3439A or 3440A. The 3440A has a BCD recorder output to operate with the hp

Model 562A Digital Recorder to produce a printed, six-column readout.

Plug-in*	3441A	3442A	3443A	3444A	3445A	3446A
AC volts 10V to 1000V	**	**	**	**	X	X
DC volts 10V to 1000V	X	X	X	X	X	X
DC volts 100mV to 1000V			X	X		
DC amps				X		
Ohms				X		
Manual ranging	X	X	X	X	X	X
Auto-ranging		X	X		X	
Remote ranging		X	X		X	X
Remote function						X
Floating input	X	X	X	X	X	X

*3439A and 3440A require a plug-in to operate

**Average response measurements: 100 μ V to 300 volts 50 Hz to 500 kHz—hp-457A or 1 mV to 300 volts 10 kHz to 10 MHz with -hp-400E/EL. True RMS measurements: 1 mV to 300 volts, 10 Hz to 10 MHz use -hp-3400A.

Get the full story on the rugged, reliable, versatile hp Model 3439A or 3440A Digital Voltmeter from your nearest hp field engineer. Or, write to Hewlett-Packard, Palo Alto, California, 94304, Tel. (415) 326-7000; Europe: 54 Route des Acacias, Geneva. Price: hp Model 3439A, \$950.00; hp Model 3440A, \$1160.00, plus plug-ins (\$40.00 to \$575.00).

097/9

HEWLETT  **PACKARD**
An extra measure of quality

ON READER-SERVICE CARD CIRCLE 18



In-depth documentation...

**... speeds you from sketch
to I/C μ -PAC system
installation without
costly re-design**

You get documentation that means a lot more than just a spec sheet when you design with I/C μ -PAC digital logic modules. It means design aids, detailed instruction manuals, reliability facts, wiring & assembly notes, application notes. It means the best design support you can get — support based on nearly 14 years of module experience.

Whether you face design of a one-shot black box, or an entire product line, why not rely on μ -PACS. You'll never have to read between the lines to figure out what to do with them. It's spelled out in page after page of documented facts. Write for details. Honeywell, Computer Control Division, Old Connecticut Path, Framingham, Massachusetts 01701.

Honeywell

 **COMPUTER CONTROL**
DIVISION



Electronics tapped for educational role

The U.S. Office of Education wants the electronics industry to play an increasing part in education, notwithstanding the apparent lack of enthusiasm by Education Commissioner Harold Howe II. His assistant responsible for liaison with private industry has words of encouragement for electronics firms and computer software manufacturers who want to join the growing "education technology industry."

Former television executive Louis Hausman points out that the U.S. budget for education is second only to the military one and that education is the nation's number one growth industry. So, he says, industry's move into such an attractive market is only "natural and healthy." He describes recent mergers between publishers and electronics-oriented firms and the growing amount of education hardware and software as "mutually stimulating" to both industry and government.

Despite Howe's apparent unenthusiasm, he, too, explains that he wants industry to be involved and has pushed hard to swing some of his office's funds away from university research into private industrial laboratories. His concern, however, is that less scrupulous companies may try to make a quick profit by exploiting shoddy, unnecessary hardware and ill-conceived programs—a fear also expressed by more responsible electronics manufacturers.

Howe has already managed to channel some money into industrial contracts, and Hausman says that there will be much more to come. Hausman points out, however, that federal funds are only a small part of available monies, and has some suggestions for firms with a serious interest in the market.

Hausman stresses that the federal role is only to aid local school districts, not to control them. The real market, he says, is at the state and local level. The local systems must approve the use of schools for testing new products and techniques, and decide what, if anything, they will buy.

Washington Report

S. DAVID PURSGLOVE,
WASHINGTON EDITOR

He urges interested firms to familiarize themselves in depth with the problems of a particular school district, and then offer a solution to a specific problem. He warns against peddling panaceas.

Hausman predicts that classroom films and well-designed lecture aids will become a pressing need. He is convinced that these will be brought to students through the medium of closed-circuit television. Above all, he believes that the present caliber of film and television programming for educational purposes is inadequate. "Much of it is bad. Instead of having a teacher boring a classroom full of students, if we're not careful, we may make it possible for him to bore hundreds of classes," he grouses.

Sleeper disturbs anti-bugging bill

When the Judiciary Subcommittee on Administrative Practice headed by Sen. Edward V. Long (D-Mo.) began hearings on the bill to outlaw electronic eavesdropping, most observers foresaw clear sailing for the bill. Most witnesses from the Attorney General down favored a general ban on most forms of wiretapping and other bugging methods. Now an unanticipated snag may spark floor debate and even lobbying against some of the bill.

Most attention has been focused so far on the bill's restrictions on unauthorized snooping. Now electronics manufacturers and some publicists have noticed that the bill, in addition to banning all eavesdropping except in cases of national security, would, in Sen. Long's words, "outlaw the manufacture, shipment and advertisement of wiretapping and eavesdropping devices in interstate commerce."

The subcommittee staff say that they have already received a number of anxious inquiries from component makers and publishers. The gist of these queries has been how will components offered for legitimate use be distinguished from those intended for illicit use. The subcommittee has been hard put to it to come up with any satisfactory answer, for a

Washington Report

CONTINUED

multitude of small components lend themselves to countless applications, including eavesdropping. One solution would be for the legislation to spell out components obviously intended for nefarious use and advertising with a patent appeal to clandestine users. A staff member points out, though, that components for bugging can always be packaged as if for ham operators, and that cheap publications give ample evidence that advertising that says one thing can easily convey a totally different meaning to a selected readership. Referring to the bill, he commented: "Before it's through, the whole thing may turn out to be a bit stickier than we had expected."

NASA's electronics budgeting clarified

The National Aeronautics and Space Administration's Fiscal 1968 budget (see Washington Report, ED 4, Feb. 15, 1967, pp. 29-30) did little to excite electronics contractors. On the whole, where money was to be spent was not spelled out. Now this has been made clearer in an address to Congress by NASA's director of Electronics and Control, Francis J. Sullivan.

One of the most important areas for spending, Sullivan said, will be the improvement of existing electronic devices, including development of better guidelines and practices to use devices more effectively. A major effort would be directed toward integrated circuits. Sullivan predicted that within five years up to 90% of NASA's circuitry would be integrated. Most of the work in this direction would be under the direction of the Electronics Research Center at Cambridge, Mass., but not necessarily in the center's laboratories. Industry, too, would play a significant role.

Sullivan indicated that in the realm of hardware and systems development emphasis would be on guidance systems and their components. He continues to see the electrostatic or electrically suspended gyro as the ideal sensor for very advanced, strapped-down inertial systems. A lot of preliminary work has already been performed, and devices will undergo extensive laboratory and environmental testing imminently. Next year, Sullivan said, the Jet Propulsion Laboratory and the Air Force Avionics Laboratory will

jointly demonstrate the feasibility of such a gyro in aircraft flight tests.

NASA will also make a major effort in one area of instrumentation as part of the development of the gyro. Sullivan noted that "it has become evident that the instruments [gyros] being evaluated have exceeded the capabilities of the test equipment available. NASA is working on this in conjunction with the Massachusetts Institute of Technology."

The main activity in communications, tracking and data acquisition will be to seek "a better understanding of propagation characteristics and the development of technology required for a broad program in optics and microwaves responsive to future NASA needs," Sullivan declared. He said that these needs related to satellites for natural-resources surveys, navigation and even traffic control, for communications and for space astronomy—a list that caught the congressmen's attention. Such applications require "high-powered and efficient space-qualified lasers, microwave transmitters, and large spacecraft antennas, optics and high-data-rate communications systems," Sullivan told them.

In data acquisition and handling, the aim will be to continue to reduce size and weight, to achieve ultimately a family of on-board data-storage systems.

One new activity in the electronics research program at the Cambridge laboratories was discussed with the House Subcommittee on Advanced Research and Technology. This is development of integrated avionics systems for advanced high-speed commercial aircraft. A planning study to pinpoint critical areas for research is almost complete. Attention will zero in during the coming year on analytical studies of those avionic system characteristics that that planning study has tagged as critical to the development of future systems.

NASA seeking holographic aid

Plagued by a spate of component and system failures and consequent adverse publicity, the National Aeronautics and Space Administration has turned to holograms as a possible source of assistance. The Electronics Research Center at Cambridge, Mass., is seeking potential contractors to work on the possible applications of holographic microscopy to the study of the mechanisms of failure in monolithic circuits. Whoever wins the contract will have to lay out a research and development program for the necessary techniques and equipment.

“ We have learned through bitter experience that **Allen-Bradley resistors are unmatched for reliability** ”

Philbrick Researches



Typical Philbrick solid state operational amplifiers. The Model P65A differential operational amplifier with cover removed shows the use of Allen-Bradley hot molded fixed resistors and an Allen-Bradley Type N adjustable fixed resistor for zero balance adjustment.

TYPE BB 1/8 WATT		MIL TYPE RC 05
TYPE CB 1/4 WATT		MIL TYPE RC 07
TYPE EB 1/2 WATT		MIL TYPE RC 20
TYPE GB 1 WATT		MIL TYPE RC 32
TYPE HB 2 WATTS		MIL TYPE RC 42

HOT MOLDED FIXED RESISTORS are available in all standard EIA and MIL-R-11 resistance values and tolerances, plus values above and below standard limits. Shown actual size.

The need for a yearly production capacity of well over a billion units is a testimonial to the uniformity and reliability of all Allen-Bradley hot molded resistors.

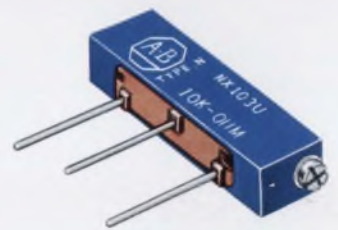

Type N hot molded adjustable fixed resistor rated 1/8 watt at 50°C ambient. Available with nominal resistance values from 100 ohms to 2.5 megohms with tolerances of ±10% and ±20%.

■ “Why have Allen-Bradley hot molded resistors been our first choice since the late 1940’s? In a word: Reliability!” states Philbrick—the leading manufacturer of operational amplifiers. There’s nothing accidental about this superiority of A-B resistors. A unique hot molding process using completely automatic machines, eliminates the “human element” and produces such uniformity from one resistor to the next—year in and year out—that long resistor performance can be accurately predicted. No instance of “catastrophic failures” has ever come to our attention.

Allen-Bradley Type N adjustable fixed resistors likewise use a solid hot molded resistance track. Adjustment is so smooth, it approaches infinite resolution—and settings remain fixed. Being noninductive, Type N controls can be used at high frequency, where wire-wound units would be completely unsatisfactory.

For more details on the full line of Allen-Bradley quality electronic components, please write for Publication 6024: Allen-Bradley Co., 222 W. Greenfield Ave., Milwaukee, Wis. 53204. Export Office: 630 Third Ave., New York, N.Y., U.S.A. 10017.



ALLEN-BRADLEY
QUALITY ELECTRONIC COMPONENTS



Here's your answer to shock and vibration problems

■ Allen-Bradley Type R adjustable fixed resistors are unexcelled for holding precise settings through extreme conditions of shock and vibration. This unusual ruggedness is the result of a manufacturing process—perfected and used only by Allen-Bradley—which hot molds the resistance and collector elements, terminals, and insulating material into an almost indestructible component. Thus, the controls can be mounted by their own rugged terminals *without* additional support.

The solid resistance track assures such smooth control that it approaches infinite resolution. Its smoothness cannot be compared with the abrupt wire-wound turn-to-turn resistance changes which may cause circuit transients. Since Type R controls are essentially non-inductive and have low distributed capacity, they can

be applied in high frequency circuits where wire-wound controls are impractical. The Type R molded enclosures are both dustproof and watertight, permitting encapsulation after adjustment.

Allen-Bradley Type R controls are suitable for use from -55°C to $+125^{\circ}\text{C}$ and are rated $\frac{1}{4}$ watt at 70°C , 300 volts max. RMS. Available as standard in total resistance values from 100 ohms to 2.5 megohms with tolerances of $\pm 10\%$ or $\pm 20\%$. As special, can be furnished down to 50 ohms. Technical Bulletin B5205 contains complete specifications. Please send for your copy today: Allen-Bradley Co., 222 W. Greenfield Ave., Milwaukee, Wisconsin 53204. In Canada: Allen-Bradley Canada Limited. Export Office: 630 Third Ave., New York, New York, U.S.A. 10017.

Allen-Bradley Type R Adjustable Fixed Resistors—Shown actual size

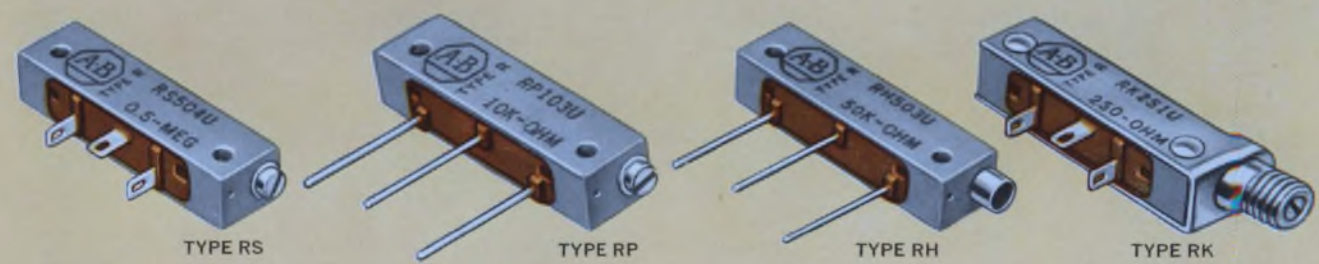

ALLEN-BRADLEY
QUALITY ELECTRONIC COMPONENTS

Car thieves foiled by digital ignition

Just because you remove the ignition key from your car doesn't mean thieves won't steal it. Federal Bureau of Investigation records show that the ignition is locked in at least 20 per cent of the cars stolen in the U.S. every year. Thieves simply short the ignition with jumper wires or aluminum foil.

The Emerson Electric Co. of St. Louis has developed an ignition system that uses digital logic in a coded distributor and in a perforated key. Inserted into the lock system, the key has a unique pattern that must be passed by an IR sensor before it will unlock the car's ignition. In the distributor, as coded disks rotate, light falls on photodiodes in the ignition timing sequence. The photodiodes switch voltage to the spark plugs. No conventional coil is used.

A thief would have difficulty decoding the timing sequence without instruments and could not use a jumper to bypass the lock. ■ ■

On the firing line



Guns roll off the production line—electron guns for color TV tubes, that is—at RCA de Puerto Rico's new plant. In this production step, operators load beading mandrels onto a special oval conveyer. This facility, 30 miles from San Juan, is RCA's latest effort to strengthen its worldwide activities.

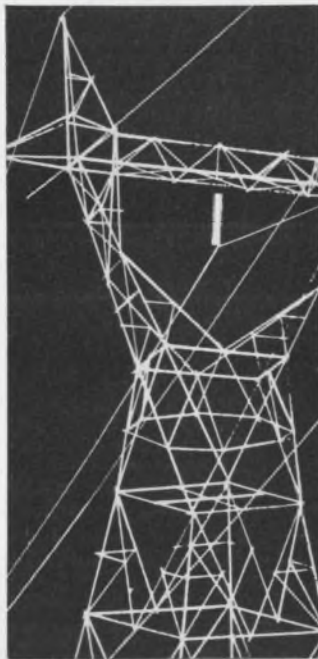

BUGGED BY DIRTY POWER-LINE NOISES?



Keep power clean with Hopkins filters!

Hopkins filters clean dirty lines—remove radiated and conducted interference from your power circuits. Meeting MIL-STD-220A, Hopkins Series 1960 power-line filters suppress interference more than 100 db in frequencies from 14 kc to 10 kmc.

As a pioneer in power-line filtration Hopkins has designed and built more than 2,000 different types of filters. Used in thousands of varied applications under all operating conditions in ground installations, in secure rooms, aircraft, on board ships, HOPKINS POWER-LINE FILTERS HAVE PROVED UNSURPASSED.

Designed for easy economical space-saving installation, Hopkins power-line filters are available individually or in groups (preassembled in cabinets) for multiple-circuit applications. They are available in a choice of three basic series—each with top performance—in the frequency range needed for your circuit.

Send for complete information on Hopkins power-line filters



HOPKINS
Engineering Company

12900 Foothill Blvd., P. O. Box 191, San Fernando, Calif. 91341
Telephone: (213) 361-8691 • TWX 213-764-5998 • Cable: HOP

A Subsidiary of Maxson Electronics Corporation

ON READER-SERVICE CARD CIRCLE 20



**The Series 5000
tests integrated
circuits. It
remembers 900 tests
(or more), performs
them in any order,
makes 100 parameter
checks per second,
and gives you
answers in any
medium or format.
Check on it.**

FAIRCHILD
INSTRUMENTATION

Electron tunneling speeds logic switching

IBM device, operating at better than 800 ps, may lead to competitive cryogenic computers

Richard N. Einhorn
News Editor

A superconducting logic element with switching speeds up to 100 times faster than the cryotron renews hope for cryogenic computers.

The new device, reported by Juri Matisoo of IBM's Research Div., Yorktown Heights, N. Y., switches to either of its bistable states in less than 800 ps. Once switched, it transfers current to a parallel device in 80 to 200 ps. Since it is superconductive at all times, it avoids the gain-bandwidth problems of the ordinary cryotron, which must be driven into and out of superconduction.

Matisoo's superconducting element may be an order-of-magnitude faster than reported. Improved laboratory apparatus should yield finer resolution of measurements at cryogenic temperatures.

The IBM logic device consists of a gate and a control element positioned above it. An insulated ground plane confines the magnetic field and thereby lowers inductance.

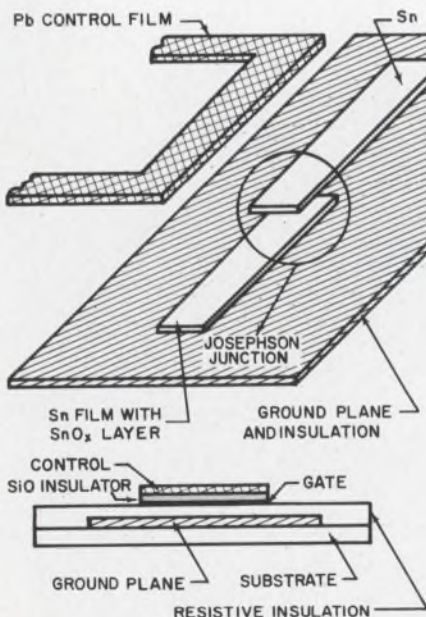

1. Tunneling cryotron switches currents at speeds rivaling room-temperature devices.

Almost any superconductor can be used as the control element, because the control always remains superconducting.

The gate consists of two strips of slightly overlapping superconductors, separated in the region of overlap by an oxide barrier that is permitted to form on the underlying strip. The gate in Fig. 1 consists of Sn-SnO-Sn.

Operation of the gate is based on magnetic switching between two different tunneling mechanisms. In one, predicted theoretically by B. D. Josephson of Cambridge University in 1962, the correlated, or "bound," electron pairs characteristic of superconductors flow through the barrier region without experiencing a voltage drop. Thus the barrier itself behaves like a superconductor, provided that the gap is sufficiently narrow.

In the other type of tunneling, single electrons are broken loose from the pairs and forced across the junction with a voltage corresponding to the energy gap of the superconductor (for tin, approximately 1 mV at 1.7°K).

Transition to the single-electron tunneling state is achieved by applying control and gate pulses

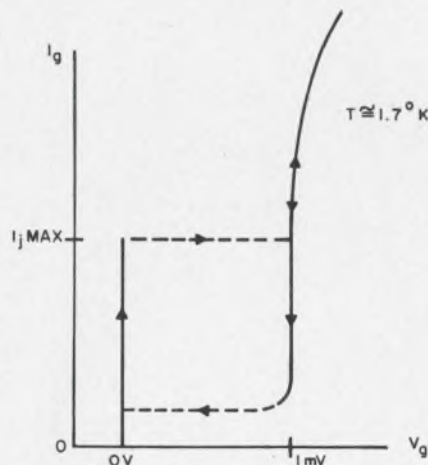

2. Subnanosecond transition to full voltage occurs at critical Josephson junction current, $I_{j \max}$.

simultaneously. The control pulse effectively lowers the critical Josephson junction current, so that the gate pulse exceeds the threshold—typical ANDing.

Now the device switches abruptly to the tunneling mechanism involving a voltage drop (in Fig. 2, about 1 mV). As the current level increases, flow takes place along the 1-mV curve. But when the current recedes past the critical Josephson level, zero-voltage tunneling is not restored until a current level about one-quarter the Josephson threshold is reached. Thus the switching curve resembles a hysteresis loop.

Minijunctions work fast

The voltage developed in the transition tends to drive the current into alternative paths—into other devices in parallel with the first, for example. The voltage is so nearly constant that it is as though a low-impedance battery had been inserted in place of the first device. Current transfer is accomplished in 200 ps for Sn-Sn junctions, 80 ps for Pb-Pb.

It is obviously desirable to make the output voltage as large as possible for computer applications. The energy gap, and therefore the output voltage, is a property of the superconductive material: approximately 1 mV for Sn-Sn junctions, 2 mV for Sn-Pb and 2.5 mV for Pb-Pb. It is independent of gate current and junction geometry. This is fortunate for the designer, since very small sizes are attainable. With the small size comes faster circuit operation.

Matisoo tried a flip-flop comprising two tunneling cryotrons in parallel. As in ordinary cryotrons, current flow in one branch or the other produces the 0 and 1 states. The current is steered back and forth by the application of a control pulse. The gain of the device is defined as the ratio of gate current steered to control current required for transition to the single-electron tunneling state. Matisoo achieved a gain of 4. ■ ■



The Series 5000 tests integrated circuits. It remembers 900 tests (or more), performs them in any order, makes 100 parameter checks per second, and gives you answers in any medium or format. Check on it.

FAIRCHILD
INSTRUMENTATION

The System:

The Fairchild Series 5000 is an automatic test system for integrated circuits. It performs DC and dynamic tests using the new DTVM (Digital Time Voltage Measurement) technique, and makes up to 100 parameter measurements per second in a single socket. All you do is insert the device, manually or automatically. The 5000 stores 45 test sequences of 20 tests each on a magnetic disc, and performs them in any order you choose. It even performs subroutines on the basis of previous test results. You can change tests on the disc, or change discs, in minutes. And you can choose from a complete range of capabilities and configurations.

The Options:

You can get an extra disc for the 5000 to increase its test capacity from 900 to 1800 tests. Or you can get it with a computer tie-in, in which case its test capacity would be limited only by the size of the computer's memory. You can get the 5000 with a variety of automatic handling equipment, and with special facilities for testing performance in extreme environments. The basic system gives you GO/NO GO indications and digital readout, but you can add units to record the tests and their results on cards, punched tape, magnetic tape, or typewriter. You can get equipment to automatically sort the devices on the basis of test results. And our new packaging technique makes all these options fully compatible with the basic system.

Contact us for further information. We'll fit one to your needs.

Fairchild Instrumentation Field Sales Offices

U. S. A.

4546 El Camino Real
Los Altos, California 94022
(415) 941-3111

5410 West Imperial Boulevard
Los Angeles, California 90045
(213) 678-3166
TWX: 910-328-6177

50 Jericho Turnpike
Jericho, L. I., New York 11753
(516) 333-9311

TWX: 510-222-4479
2105 Gulf-To-Bay Boulevard
Suite #4
Clearwater, Florida
(813) 446-4619
TWX: 810-866-0436

8517 39th Avenue, North
New Hope, Minnesota
(612) 544-5220

113 Gentry Road
Hoffman Estates
Roselle, Illinois 60172
(312) 894-2060

EUROPE

FAIRCHILD INSTRUMENTATION LTD.
Grove House, 551 London Road
Isleworth, Middlesex, England
Tel: 560-0838
TELEX: 24693

Grunwalderstrasse 99
Munich 90, West Germany
Tel: 49 18 47
Cable: FAIRINTA MUNICH

FAIRCHILD
INSTRUMENTATION

FAIRCHILD INSTRUMENTATION / A Division of Fairchild Camera and Instrument Corporation ■ 475 Ellis, Mountain View, California 94040, (415) 962-2011 ■ TWX: 910-379-6944

ON READER-SERVICE CARD CIRCLE 21

AE stocks over 200 types of relays and switches

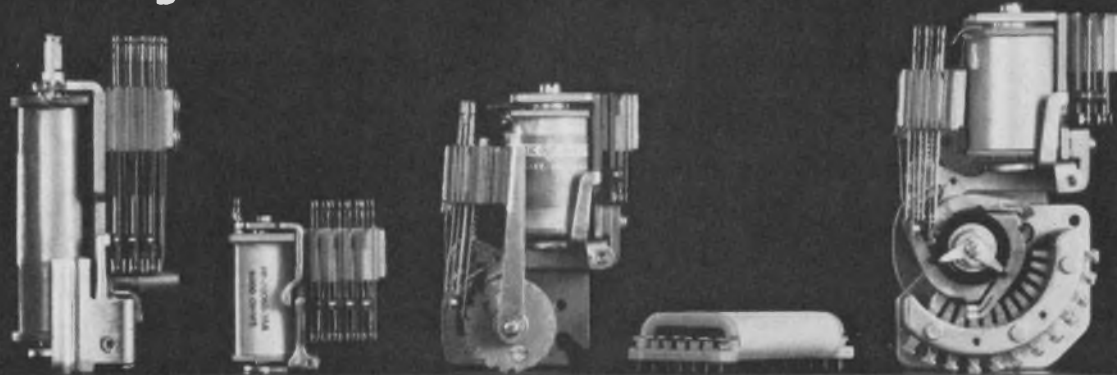

for off-the-shelf delivery within one week!



Get fast, direct delivery—at no extra charge. Thanks to the Automatic Electric Stock Program.

This program keeps growing. Now, we stock over 200 kinds of relays, switches, and accessories. In large enough quantities to fill your normal prototype requirements within 7 days.

That means fast delivery on many of the most popular types from AE's broad line. EIN (integral socket) relays with power contacts; mercury-wetted-contact relays; PC Correeds; rotary step-

ping switches with gold levels for dry- and low-level circuits; ERM (magnetic latching) relays; Class E relays with four different wire termination methods; and many more.

Send for a free copy of Circular 1053, our newest "Stock Letter." It's the latest listing of items you can get quickly. Just write to the Director, Relay Control Equipment Sales, Automatic Electric, Northlake, Illinois 60164.

AUTOMATIC ELECTRIC

SUBSIDIARY OF
GENERAL TELEPHONE & ELECTRONICS GTE

ON READER-SERVICE CARD CIRCLE 22

ON READER-SERVICE CARD CIRCLE 23 >

First come first served.

You can have all the SDS T Series integrated circuit modules you want now. We're in full production.

All T Series active elements are integrated circuits and guarantee reliable operation at clock rates to 10 mc. Each circuit output drives 14 unit loads, even after generous allowances for wiring capacitance.

Outputs switch 60 ma (4 times more than standard IC's). Noise rejection is at least 1.5 volts at the 0 and 4-volt logic levels.

SDS Natural Logic gives you AND and OR as well as NAND and NOR —

Each card uniquely keyed for proper installation.

Test points.

Ground plane laminated through middle of entire glass-epoxy board.

Load resistors separate from IC's for heat isolation.

Discrete diode-resistor inputs for gating flexibility, high noise rejection.

Four pins reserved for ground lines.

Four integrated-circuit buffer amplifiers in each hermetically sealed TO-5 can.

52 ribbon connectors (26 each side) for easy access to all circuits.

All components clearly identified.

Individual power line filters.

Actual size 4¼ x 4¾.

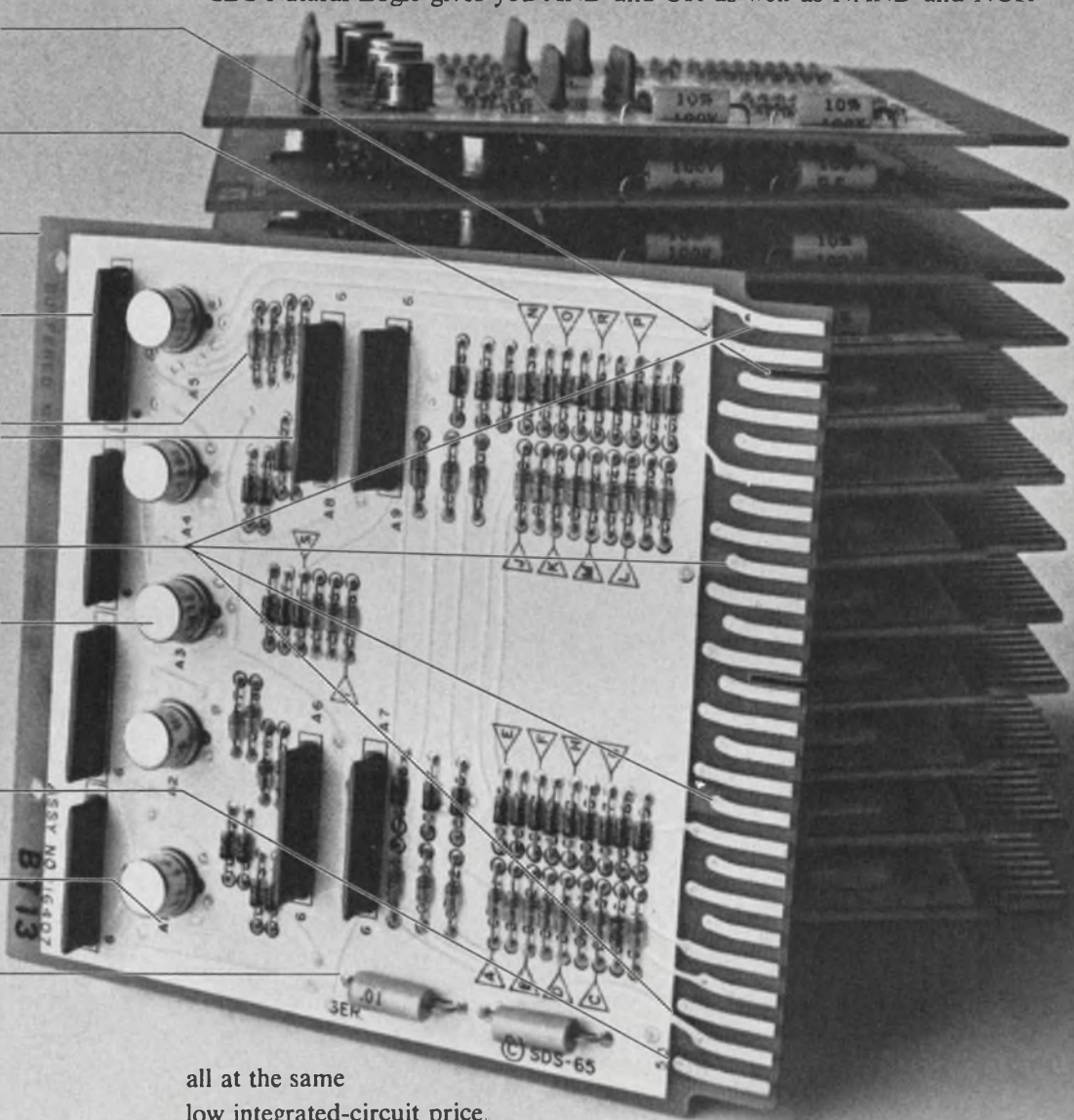

all at the same low integrated-circuit price.

We designed these modules for our new Sigma computers, but we also intend to become the largest manufacturer of logic modules for system designers.

We don't want to give away any of our Sigma secrets. But we'll sell them pretty cheap.

SDS
Scientific Data Systems,
Santa Monica, California

Lunar package to measure solar wind

When the first U.S. astronauts land on the Moon, they will set up a compact, three-legged box with a hexagonal dome. The package is a plasma spectrometer that will measure the so-called solar wind—the low-energy charged particles that stream outward from the sun.

The device is being developed for the National Aeronautics and Space Administration by Electro-Optical Systems, Inc., Pasadena, Calif. It is scheduled to be a prime experiment aboard the Apollo Lunar Surface Experiments Package (ALSEP), scheduled to be placed on the Moon by the Apollo astronauts.

Information from the solar-wind spectrometer is expected to provide data on the Moon's electrical conductivity, its atmosphere and the possible effect of solar corpuscular radiation on its surface. Despite the extreme temperature variations on the lunar surface, electronic components in the cubic-foot-sized, 10-to-15-lb device will be kept to within 25°C, according to G. Baker, manager of the company's Scientific Instrumentation Dept. This will be done by means of thermal control elements, he said, which consist of a

system of louvers made of bimetallic elements that control heat radiation from inside of the instruments.

In operation, the unit will measure the angular distribution, time variations and fundamental properties of the solar wind, including plasma content, particle densities and bulk velocity.

These measurements will be obtained in the following way:

- **Velocity**—By measuring the time intervals of sudden changes in plasma properties at the Moon and at Earth both with the spectrometer and with equipment on earth.

- **Angular distribution**—By computing variations in plasma flux from each of seven detectors in the sensor array.

- **Fundamental properties**—By applying a square-wave ac retarding potential to a grid within each detector. This will modulate the flow of charged particles within a specific measurable energy range.

The instrument, as shown in the photo, consists of a sensor array of seven detectors oriented in a hexagonal pattern which enables the spectrometer to intercept plasma flux over the 28-day lunar cycle.

Each detector is a Faraday cup (an electrostatic filter that ordinarily measures surface potential) with five concentric grids and a collector plate. Three of the grids are at ground potential and serve to shield the collector from the modulating voltage. The retarding voltage placed on the modulating grid determines the plasma energy band that can enter the sensor. The other active grid suppresses secondary emission from the collector plate, ensuring that photoelectrons and electrons do not escape the collector and give false readings.

Each of the seven collector plates produces modulated signals of an amplitude proportional to the plasma flux entering that cup. These signals are then amplified, commutated, demodulated and converted to a pulse-width-modulated signal. An on-board programmer then converts all measured data to digital form and the information is telemetered back to NASA earth stations by the ALSEP subsystem. ■ ■

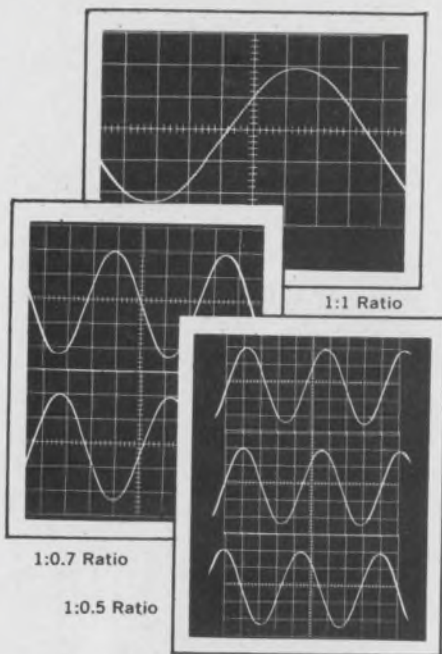

CHANGE YOUR RECORDING RATIO QUICKLY / EASILY

Record at any object-to-image ratio from 1:1 to 1:0.5 without extra lenses with the Beattie-Coleman MIIA Oscillotron. This highly versatile camera also offers these plus features:

- Rugged construction for field test instrumentation.
- Fully enclosed electric shutter actuator and lens.
- Records ultra-high speed traces.
- Synchronous electric shutter.
- Polaroid and 4 x 5 backs.
- Hinged at CRT to swing away for unobstructed viewing when not recording.
- Data recording optional.
- Shutter-open indicator light.

43 different models. Send for catalog. Coleman Engineering Co. Inc. Box 1974, Santa Ana, Calif. 92702

BEATTIE-COLEMAN OSCILLOTRON® OSCILLOSCOPE CAMERAS

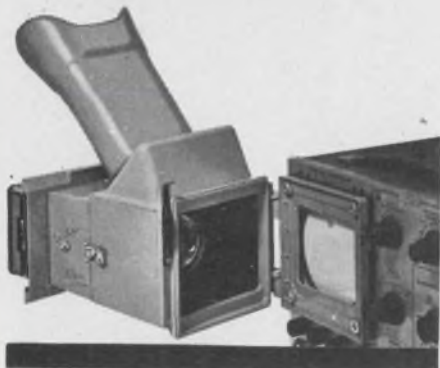

ON READER-SERVICE CARD CIRCLE 24

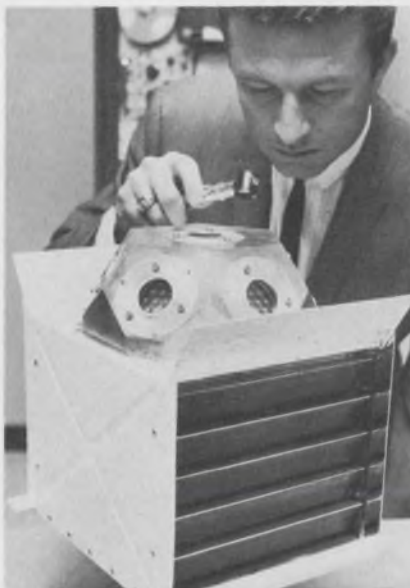

Plasma spectrometer being developed by Electro-Optical Systems will be left on the Moon by Apollo astronauts. It will provide data on the "solar wind"—low-energy charged particles that stream outward from the sun.



Our military switches are sweeping the country!

Quick now, what's the first thing you think of when you think of Cutler-Hammer military switches?

We thought so: airborne equipment.

Not surprising. We created the first line of switches for airborne use back in the roaring 20's. Today, nearly everything that flies—from helicopters to space vehicles—uses Cutler-Hammer switches.

So what's new? Just that designers are discovering that these same switches work as well in ground support equipment, ship-board electronics, and ordnance as they do in the air.

That's because of the painstaking care we take in design and manufacture. The exhaustive in-process inspection. And our rigorous final testing.

The result? Unquestionable reliability, performance, and long life—under extreme environmental conditions.

On your next project—ground, marine, or airborne—specify Cutler-Hammer military switches. Call your local stocking distributor, or write for new catalog LL-291-G217.

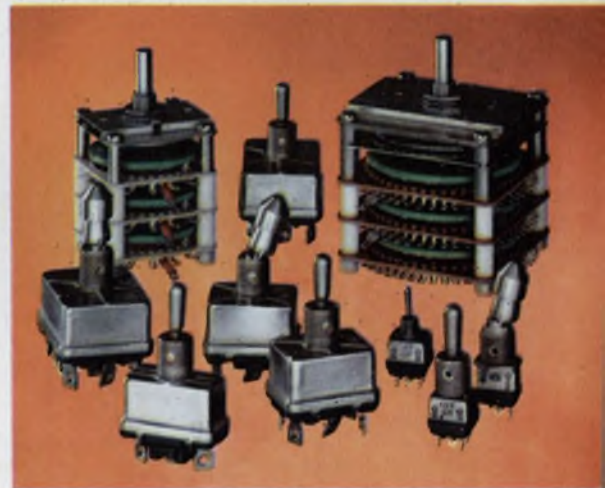

A few of the thousands of military switches available from Cutler-Hammer: miniature, and standard-size positive-action toggle switches (MIL-S-8834), Shallcross rotary switches (MIL-S-3786).

Switch
to No. 1

More than just switches:
prompt availability,
field help, innovation,
quality assurance too.



CUTLER-HAMMER

Milwaukee, Wisconsin 53201

SOME GEARHEAD

SERVO MOTORS

GET HOT

UNDER THE COLLAR

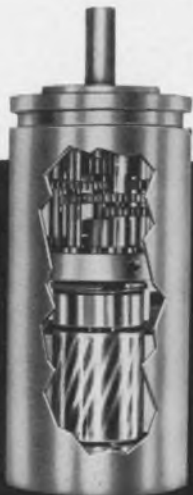

**THIS ONE
PLAYS IT COOL**

One continuous stainless steel case houses both motor and gearhead in Harowe integral-g geared servo motors. There are no joints to block heat flow; no dissimilar metals to expand unevenly. Result is cooler motor operation and excellent thermal stability.

Harowe builds motors and gearheads together to work together . . . and to give you one-source responsibility and industry's fastest deliveries.

New catalog lists 61 standard ratios for sizes 8, 10, 11, 15, and 18 motors and motor-generators. (Special ratios readily available.) Request your copy from—



Servo, Stepper &
Synchronous Motors
Motor Generators • Synchros
Resolvers • Pancakes • Gearheads

HAROWE SERVO CONTROLS, INC.

26 Westtown Road
West Chester, Pa. 19380
(215) 692-2700

ON READER-SERVICE CARD CIRCLE 26

Ka-band radar, designed for atomic studies, is tested as a weather aid for SSTs

An airborne Ka-band radar, originally designed to help analyze the radiation in atomic mushroom clouds, is being tested by the U.S. Air Force as a prototype for weather radars in supersonic transports.

The radar, designated LAPQ-1 by the Bendix Radio Div., of Baltimore, has a peak power of greater than 100 kW, a system noise figure of less than 12 dB and an antenna gain of more than 47 dB.

"The LAPQ-1 equipment is the highest-performance airborne Ka-band radar known to have been developed for weather observation," says George M. Walter, head of Bendix's radar R&D department. He reports that there is industry interest in testing at these frequencies (26.5 to 40 GHz) because of possible application in the next generation of weather radars for the SST program.

Walter adds that industry avionics engineers have suggested the possibility of using radar at two frequencies in the transport aircraft: X and Ka bands. They expect to take advantage of Ka band at high altitudes, where atmospheric attenuation is small. The radars might be used to avoid clear-air turbulence, for example. The lower frequency would be primarily for use at lesser altitudes because it can penetrate precipitation.

The Bendix set, Walter says, was originally designed for the Lawrence Radiation Laboratory of the University of California as part of a "readiness" program, in the event

atmospheric nuclear-bomb testing is resumed.

The weather radar can operate in two modes: plan-position-indicator and range-height-indicator. This gives the airman three-dimensional information at the flick of a knob.

The antenna can scan horizontally over a 90-degree sector, adjustable within a 180-degree range forward of the aircraft. The elevation angle is adjustable from -90 degrees to +90 degrees. When used to determine heights, the antenna can scan either 45-degree or 60-degree sectors.

Four basic units make up the system: antenna receiver-transmitter; indicator and control; power supply-servo assembly, and camera.

The transmitter and receiver are housed behind the antenna reflector to minimize waveguide losses and avoid rotary joints. The transmitter power tube is a magnetron that produces a 1- μ s pulse at a 400-Hz rate. A conventional line modulator controls a thyratron switch tube. The waveguide is pressurized with sulfur hexafluoride by an automatic gas supply system, and air is used to pressurize the receiver-transmitter assembly.

A ferrite differential phase-shift circulator isolates transmitter and antenna and transmitter and receiver to permit the use of a low-power TR tube. Radar signals are detected in a balanced crystal mixer. A reflex klystron local oscillator supplies power to the signal mixer and the afc mixer crystal. ■ ■



Antenna transceiver for a Bendix Ka-band radar has a Cassegrain feed to minimize RF losses. Gain is over 47 dB, and beam width is about 0.75°.

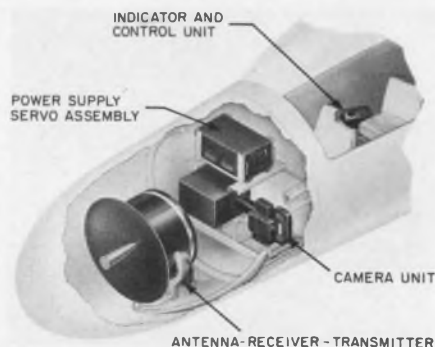

Basic units of the radar as they appear mounted in the nose of an Air Force B-57C. The system is used to analyze nuclear clouds.

ON READER-SERVICE CARD CIRCLE 27 >

The Tantalum Rock

KEMET C-Series Solid Tantalum Capacitors. Tailored for today's go-go electronics.

The KEMET C-Series lets you design tantalum reliability into the whole field of consumer products: radios and TV... CB sets... electronic organs and other instruments... audio equipment... appliances. The reason is simple: we've priced the C-Series in line with conventional aluminum electrolytics.

Abbreviated specs: 0.1 to 220 microfarads. 6 to 50 vdc. -55° to $+85^{\circ}$ C without derating. And remember the unique Union Carbide delivery plan: ultra-fast or staged deliveries of any quantities from thousands to millions — assured.

Now, can you think of any good reason not to use tantalum? See our representative, or mail the coupon.

Clip, fill in name and title, attach to letterhead.

Union Carbide Corporation
Components Department
Dept. ED-42
270 Park Avenue
New York, N. Y. 10017



Please send details on C-Series
KEMET Solid Tantalum Capacitors

Name _____

Title _____

KEMET is a registered trade mark of Union Carbide Corporation.



REGIONAL SALES OFFICES. **New England:** T. J. Roper, 300 First Ave., Needham Heights, Mass. Phone: 617-444-5400. **Mid-Atlantic:** R. H. Robeck, 1341 Hamburg Turnpike, Wayne, New Jersey 07472. Phone: 201-696-2710. **Mid-West and South:** K. S. Collart, P. O. Box 6087, Cleveland, Ohio 44101. Phone: 216-221-0600. **C. F. Fields,** 2 Talcott Road, Park Ridge, Ill. 60068. Phone: 312-825-8189. **West Coast:** D. Purcell, 701 East Whittier Boulevard, Whittier, California 90605. Phone: 213-698-8077. **C. E. Volpe,** 2680 Bay Shore Frontage Road, Mountain View, California 94041. Phone: 415-969-9390. **For Overseas Inquiries contact:** J. G. Egan, 1341 Hamburg Turnpike, Wayne, New Jersey 07472. Phone: 201-696-2710.

NOW 2 REED RELAY SERIES

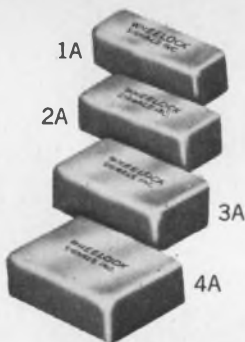

ACTUAL SIZE

ULTRA MINIATURE REED RELAYS SERIES 442

- Smallest multi-pole relays in industry (1-4 poles Form A)
- P.C. Board Mount
- Contacts rated at a full 4 watts
- Occupies 0.055 cu. in. per pole

**SMALL
ENOUGH
TO
CHANGE
YOUR
DESIGN
IDEAS!**



ACTUAL SIZE

ULTRA MINIATURE NEEDLE REED RELAYS SERIES 379

- Occupies only 0.02 cu. in.
- Operates on only 50 mw of power
- Operate time 190 microseconds (typical)
- Insulation resistance as high as 1×10^{14}
- Contacts rated at a full 4 watts

BY *Wheelock* OF COURSE

Contact Wheelock first for any of your relay design problems.

Write for new literature on Wheelock's big family of small relays!

WHELOCK SIGNALS, INC.
273 Branchport Avenue • Long Branch, N. J.
(201) 222-6880



Tuning fork locks motors in step

A humming tuning fork now regulates the speed of many motors used to drive continuous-process fabric-stretching machinery.

Precise speed regulation of textile-stretching machinery has appreciably reduced cloth spoilage, according to Cutler-Hammer, Inc., Milwaukee, manufacturer of the new frequency control system. The company says that it is now possible to achieve a speed accuracy of 0.1 per cent of set speed for synchronous operation of dc motors for periods longer than an hour.

Proportional analog speed regulators based on commercial 60-Hz frequency, which are normally used for precise motor speed regulation, are unable to do this, the firm adds. It reports that high precision in motor speeds is necessary to obtain uniform tension in material being processed.

A signal from a 3.5-kHz tuning fork forms pulses that are compared with other pulses obtained from optoelectric encoders attached to the shafts of the drive motors of continuous-process machinery.

Discrepancies between the two pulse trains are determined and a feedback loop regulates motor speed accordingly. In this manner the pulses obtained from the motors are matched, or slaved, to the master frequency of the tuning fork.

Signals from the motors are generated by rotating disks in the optoelectric encoders. Each disk has equally spaced slits that chop a light beam directed through the encoder. The pulses obtained from this photoelectric conversion are proportional to the motor speed.

The electronic controller circuitry that compares the two pulse trains decreases or increases the voltage on each motor, slowing it down or speeding it up to maintain the desired frequency-lock condition. In another scheme the tuning fork oscillator directly controls only one of the motors. The others in a series are referenced to the tachometer of the lead motor by successive feedback loops. ■ ■



Time's up:
Honeywell now has a taut-band meter that actually goes for even less than a pivot-and-jewel meter.

(About 10% less, on the average.)

What kind of a taut-band meter could we possibly sell at those prices?

An ingeniously simple one.



We designed every single unnecessary part right out of it. (Fewer parts: fewer things to go wrong.)

And we make this meter by machine. (This not only gives us a very good cost advantage. It also gives you a more reliable meter.)

It'll last practically forever because there's no friction in the moving parts. It'll mount anywhere with-



out special calibrating because it's self-shielded.

And you can get one of these low-cost taut-band meters in just about any style you like.

But don't make up your mind yet. Take a look at our catalog first. Write Honeywell Precision Meter Division in Manchester, N.H. 03105.

Honeywell

How long have you waited for a low-cost taut-band meter?



Letters

NEW! DIGITAL PANEL METERS
0.1% ACCURACY



Shown 3/5 actual size

DIGIMETER \$260
MODEL DM-25 OEM discounts available

For every application where a conventional panel meter is inadequate

- AC or DC measurements
- Single or multiple ranges
- 1 μ A to 1,000 A, full scale
- 10 mV to 10,000 V, full scale
- Other functions & ranges to order

Send for detailed literature



2 Sixth St., New Hyde Park, L. I., N. Y. 11044
516 CH 8-8060

UNIVERSAL CALIBRATOR
Model MC-10



Fast, accurate calibration of panel meters, multimeters, oscilloscopes, vtm's, other measuring instruments. Full accuracy without correction curves. Meter indicates directly the % Error in device under test. All solid-state. Meets MIL specs for temperature, humidity, vibration, shock, RFI.

AC & DC VOLTAGE: $\pm 0.2\%$, 0-1000 volts in 1 millivolt steps, 0-20 mA load
AC & DC CURRENT: $\pm 0.2\%$, 0-1 ampere in 1 microamp steps, 0-1 volt burden
RESISTANCE: $\pm 0.1\%$, 0-1,000,000 ohms in 1 ohm steps

Send for detailed literature



2 Sixth St., New Hyde Park, L. I., N. Y. 11044
516 CH 8-8060

Engineers back plea for better conditions

Sir:

You are the second magazine in about a year to come out editorially for an industry-wide engineering pension plan ["Needed: A way to tame the gypsy in us," ED 4, Feb. 15, 1967, p. 75].

I approached the group insurance administrator of the IEEE on this subject some years ago and received some discouraging, if not totally negative, answers.

We all agree that such a plan would benefit everyone, except perhaps some unscrupulous companies that entice engineers to join them with promises of their private pension plans and then cause them to forfeit their pension rights when the mass engineering layoffs occur.

When a company is willing to support a pension plan, it should be one that the engineer can depend on, not one that evaporates when the company decides to lay him off. I hope that, with the backing of your magazine, some progress can be made to that end.

Hans H. Nord

Little Falls, N. J.

Sir:

We need more gypsies! [We need] more engineers who will vote with their feet against the non-professional status they are allotted by many employers. The electronics engineer is shrewd in technical matters, but is a lamb in the business jungle. He plays a vital role in designing products, writing proposals and getting the hardware "out the door." He should command an equitable share both in status and salary. Instead he finds himself in a misrepresented job, reporting to a political savant whose only claim to fame is a good understanding of a magazine article on PERT. The only security in this world is the degree of technical competence that one achieves. The end result of

prostituting oneself for a tenuous promise of security is, in fact, to realize no security at all. The only two questions that an electronics engineer should ask are: "What exactly do you want me to do?" and "How much do you pay?" When he finds that his job has been misrepresented, he should make it known to upper management and be prepared to cast his ballot.

ELECTRONIC DESIGN is needed to publicize the hire/fire cycles, the job misrepresentations, and the often poor working conditions. Why not take a poll? Ask about job content, working conditions, salary, promotions, technical competency of managers, security, misrepresentation in hiring, and why engineers stay on if they are presently dissatisfied.

To the managers who decry incompetent engineers whom they must "carry," I reply that they are not incompetent. They are misdirected by the misassigned.

Marvin Shapiro

Manager

Digital Telemetry Group
Microcom Corp.
Horsham, Pa.

Sir:

Your editorial of February 15, 1967, struck a resonant note in me. The idea of an industry-wide retirement plan is something which I have advocated for years. The question is, who is going to start it? The engineering societies could make a real contribution in this area but they seem to prefer making a nuisance of themselves peddling insurance. Perhaps some smart politician will see a chance to make a name for himself by maneuvering Congress into making it a part of the social legislation so popular these days. Still another good bet would be for some professional engineers' union to make such a retirement program one of the basic appeals in launching a vigorous recruiting campaign.

Let's back off and take a broader look at the unstable employment situation you describe. It is about time that engineers realized that they are expendable and that a little, high-class, professional unionizing might help to stabilize their employment. It is certain that the engineering societies aren't going to

(continued on p. 49)

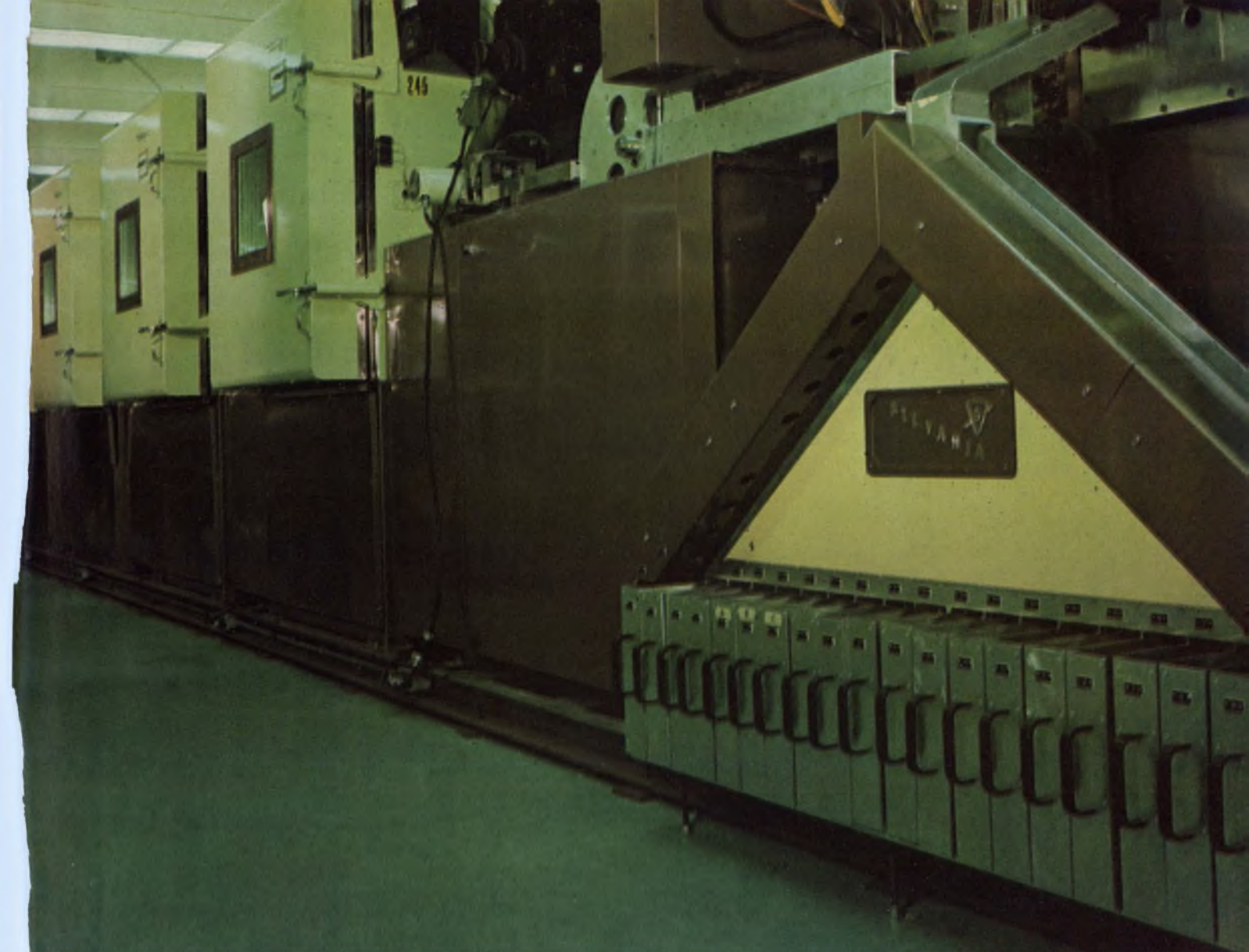

Every military IC must operate at temperatures from -55°C to 125°C in our test chambers.

In order to pass its final test, each Sylvania IC must operate in four consecutive temperature-controlled chambers while a computer records the parameters of each circuit. We call this ultimate testing equipment "Mr. Atomic"—a system with a capacity of about a quarter-million ICs a week.

In each "torture chamber," the ICs are automatically inserted in a wheel that rotates them to the testing point while they're stabilized at test temperature.

The temperature of the first chamber is 75°C . The second is 0°C . The next is 125°C . Then, -55°C . In these four chambers, up to 100 D.C. tests are automatically performed. A fifth testing station, maintained at 25°C , tests up to 30 switching parameters

accurately down to a few nanoseconds. (See inset). Each input is individually tested.

Then Mr. Atomic (for Multiple Rapid Automatic Test of Monolithic Integrated Circuits) directs the circuits to any of 20 bins, according to the computer's priority programs. You get only circuits that are fully guaranteed at temperature extremes—not at just room temperature only.

Sylvania Semiconductor Division, Electronic Components Group, Woburn, Massachusetts 01801.



SYLVANIA
SUBSIDIARY OF
GENERAL TELEPHONE & ELECTRONICS **GTE**

Here's your engineering data sheet-



tear out and keep

THE FIRST LOW COST FET TYPE OP AMPS

No Plastic — All Metal and Hermetically Sealed Mil Grade Components Throughout

FET Transistor in Front End for Low Input Current and High Impedance

Low-Profile Package: 0.4 inches for P.C. Board Mounting

H7010A OPERATIONAL AMPLIFIER: \$45

- Very Low Input Current (40 pA typ.) Avoids Drift Problems
- Front-end with FET devices provides Input Impedance of $10^{11} \Omega$
- Immediately Available Off-the-Shelf from Union Carbide Electronics Distributors

APPLICATIONS

- Infrared Sensors
- PH Sensors
- Piezo-Electric Transducers
- Ionization Gauges
- EEG and EKG Pre-Amplifiers
- Analog Integrators
- Electrometric Type Voltage Followers
- Sample and Hold (e.g. charge amplifier)

Op Amp Type	Temp Range °C	Open Loop Gain dB	Band Width MHz	Z_{IN} M Ω	Max Voltage Drift μ V/°C	Input Current pA	Rated Output V/mA	Price (1-4)
H7010A H7010B	-25 to 85	95	3.0	10^5	± 50	40	$\pm 10/\pm 2$	\$45. 50.
H7020A H7020B	-40 to 100	95	3.0	10^6	± 25	40	$\pm 10/\pm 2$	60. 65.

OTHER TYPES

H7030A H7030B	-40 to 100	97	3.0	10^6	± 25	40	$\pm 20/\pm 6$	77.50 82.50
H7000 H7000A	-55 to 125	90	2.5	10^6	± 25	40	$\pm 10/\pm 2$	110. 95.



ELECTRONICS

Semiconductor Department / 365 Middlefield Road / Mountain View, California 94040 / (415) 961-3300

ON READER-SERVICE CARD CIRCLE 32



ELECTRONICS

OPERATIONAL AMPLIFIER SILICON MODULAR H7010A/H7010B • H7020A/H7020B

Differential Input • Extremely High Input Impedance • Extremely Low Input Currents • High Slewing Rate
Short Circuit Proof for "Continuous" Shorts • Phase Compensated for Close Loop Stability
Hermetically Sealed Silicon Transistor Construction

MAXIMUM RATINGS

@ 25°C (UNLESS OTHERWISE NOTED)

	H7010A/H7010B	H7020A/H7020B	UNITS
Positive Supply Voltage	+20	+20	Volts
Negative Supply Voltage	-20	-20	Volts
Storage Temperature	-65 to +125	-65 to +125	°C
Operating Temperature	-25 to +85	-40 to +100	°C
Input Voltage (Differential)	±Supply Voltage	±Supply Voltage	Volts
Input Voltage (Common Mode)	±Supply Voltage	±Supply Voltage	Volts
Output Load (Continuous)	Zero	Zero	ohms

ELECTRICAL CHARACTERISTICS

@ 25°C and Supply Voltage ±28.0 Volts (UNLESS OTHERWISE NOTED)

SPECIFICATION	SYM.	H7010A/H7010B			H7020A/H7020B			Units	TEST CONDITIONS		
		Min.	Typ.	Max.	Min.	Typ.	Max.				
Open Loop DC Voltage Gain	A_v	86	92	—	86	92	—	dB	$R_L = 10 \text{ K}\Omega, R_i = 0, R_f = \infty$		
Equiv. Diff. Input Impedance	R_{in}	10^4	10^5	—	10^5	10^6	—	M Ω	$-10 \text{ V} < V_{out} < +10 \text{ V},$ $f = 1 \text{ KHz}$		
	C_{in}	—	5.0	—	—	5.0	—	pF			
DC Output Resistance	R_{oc1}	—	38	100	—	38	100	Ω	$R_i = 1.0 \text{ K}\Omega, R_f = 100 \text{ K}\Omega$ $ A_{cl} = 100, e_{out} < 1 \text{ V p-p}$ $R_i = 0, R_f = \infty, e_{out} < 1 \text{ V p-p}$		
	R_{out}	—	15	20	—	15	20	K Ω			
Output Voltage	V_{out}	±10	±11	—	±10	±11	—	V	$R_L \geq 5 \text{ K}\Omega$		
Short Circuit Output Current	I_{out}	±4	±6	±8	±4	±6	±8	mA	$R_L = 0\Omega$		
Equiv. Input Offset Voltage	V_{os}	Adjustable to Zero ^{(1) (2)}			Adjustable to Zero ^{(1) (2)}			mV	Initial	$V_{os} = 0 \text{ V @ } 25^\circ\text{C}, T_A = 85^\circ\text{C}$ $V_{os} = 0 \text{ V @ } 25^\circ\text{C}, T_A = -25^\circ\text{C}$ $V_{os} = 0 \text{ V @ } 25^\circ\text{C}, T_A = +100^\circ\text{C}$ $V_{os} = 0 \text{ V @ } 25^\circ\text{C}, T_A = -40^\circ\text{C}$ $V_{os} = 0 \text{ V @ start, time} = 24 \text{ hrs.}$	
		—	±2.0	±3.0	—	±0.75	±1.5				
		—	±1.5	±2.5	—	±0.5	±1.25				
		—	—	—	—	±1.0	±1.85				
		—	—	—	—	±0.75	±1.65				
		—	±10	±30	—	±10	±25				$\mu\text{V}/24 \text{ hrs.}$
		—	±100	±500	—	±50	±500				$\mu\text{V}/\text{V}$
Equiv. Input Offset Current	I_{os}	—	±30	±100	—	±15	±50	pA	Initial ($V_{out} = 0$) $V_{out} = 0 \text{ V}, T_A = +85^\circ\text{C}$ $V_{out} = 0 \text{ V}, T_A = -25^\circ\text{C}$ $V_{out} = 0 \text{ V}, T_A = +100^\circ\text{C}$ $V_{out} = 0 \text{ V}, T_A = -40^\circ\text{C}$ $V_{out} = 0 \text{ V @ start, time} = 24 \text{ hrs.}$		
		—	±6	±50	—	±3	±20				
		—	±4	±20	—	±3	±10				
		—	—	—	—	±15	±50				
		—	—	—	—	±2	±20				
		—	±3	±15	—	±3	±10	pA/24 hrs.			
		—	±2	±15	—	±1	±10	pA/V		$\Delta V^+ \text{ (or } \Delta V^-) = 1 \text{ V, } \left(\frac{I_{os}}{\Delta \text{Supply V}} \right)$	
Common Mode Rejection Ratio	CMR	55	80	—	65	85	—	dB	$V_{out} = 0 \text{ V}, V_{cm} = \pm 1 \text{ V}$		
Common Mode Voltage Range	V_{cm}	±5	±7	—	±5	±7	—	V	CM Input, $R_f = \infty, f = 1 \text{ KHz}$ THD ≤ 1%		
Input Bias Current	I_{bias}	—	-40	-200	—	-40	-100	pA	$V_{out} = 0 \text{ V}, T_A = +25^\circ\text{C}$ $V_{out} = 0 \text{ V}, T_A = +85^\circ\text{C}$ $V_{out} = 0 \text{ V}, T_A = -25^\circ\text{C}$ $V_{out} = 0 \text{ V}, T_A = +100^\circ\text{C}$ $V_{out} = 0 \text{ V}, T_A = -40^\circ\text{C}$		
		—	-10	-100	—	-10	-50				
		—	-10	-50	—	-10	-30				
		—	—	—	—	-50	-100				
		—	—	—	—	-7	-50				
Common Mode Input Resistance	R_{cm}	10^4	10^5	—	10^5	10^6	—	M Ω	$-10 \text{ V} < V_{out} < +10 \text{ V}$ $-5 \text{ V} < V_{cm} < +5 \text{ V}$		

⁽¹⁾ By Ext. 500 Ω Pot. for H7010A/H7020A, 2 K Ω Pot. for H7010B/H7020B
⁽²⁾ Max. ±1.0 mV for H7010B/H7020B without Ext. Pot.

ELECTRICAL CHARACTERISTICS

@ 25°C and Supply Voltage ±15.0 Volts (UNLESS OTHERWISE NOTED)

SPECIFICATION	SYM.	H7010A/H7010B			H7020A/H7020B			Units	TEST CONDITIONS
		Min.	Typ.	Max.	Min.	Typ.	Max.		
Equiv. Input Wideband Noise Voltage	e_n	—	0.5	5.0	—	0.5	2.0	$\mu\text{V RMS}$	$R_i = 0, R_f = \infty, R_L = \infty$
Small Signal Bandwidth (-3 dB)	BW	2.0	3.0	—	2.0	3.0	—	MHz	$R_i = \infty, R_f = 0$ $A_v = 1.0, R_L = \infty$
Phase Margin	ϕ	30	50	—	30	50	—	Degrees	$R_i = 0, R_f = \infty$ $A_v = 1.0, R_L = 10\text{ K}\Omega$
Slewing Rate	$\Delta V/\Delta t$	—	6.5	—	—	6.5	—	V/ μsec	$R_i = \infty, R_f = 0$ $A_v = 1.0, R_L = 10\text{ K}\Omega$ $-10\text{ V} < V_{out} < +10\text{ V}$, $t_r = 10\text{ nsec}, \text{PRR} \approx 1\text{ KHz}$
Full Power Frequency	$f_{n,p}$	—	100	—	—	100	—	KHz	$R_i = 100\text{ K}\Omega, R_f = 100\text{ K}\Omega$ $A_v = 1.0, R_L = 10\text{ K}\Omega$ $V_{out} = 20\text{ V p-p}, \text{THD} \leq 5\%$
Quiescent Power Supply Current	I_q	—	4.5	5.5	—	4.5	5.5	mA	$V_{out} = 0, R_L = \infty$
Full Load Power Supply Current	$I_{p,s} (+15\text{ V})$	—	5.5	7.0	—	5.5	7.0	mA	$V_{out} = \pm 10\text{ V}, R_L = 5\text{ K}\Omega$
	$I_{p,s} (-15\text{ V})$	—	5.5	7.0	—	5.5	7.0	mA	$V_{out} = \pm 10\text{ V}, R_L = 5\text{ K}\Omega$

TYPICAL PERFORMANCE CURVES

INPUT CHARACTERISTIC

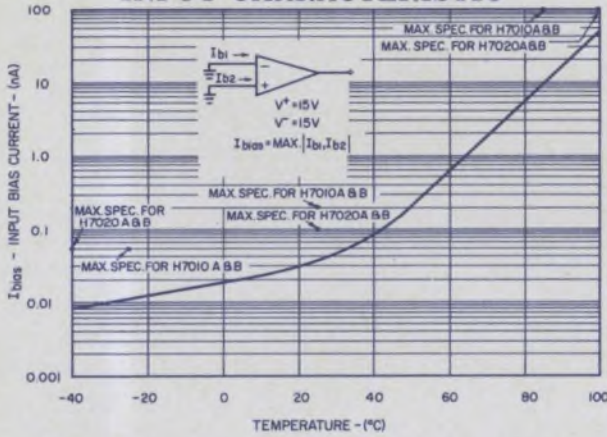

INPUT BIAS CURRENT VS. TEMPERATURE
FIGURE 1

INPUT CHARACTERISTIC

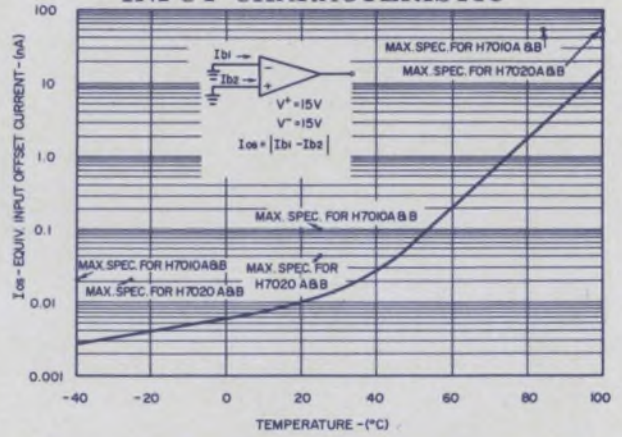

EQUIV. INPUT OFFSET CURRENT VS. TEMPERATURE
FIGURE 2

INPUT CHARACTERISTIC

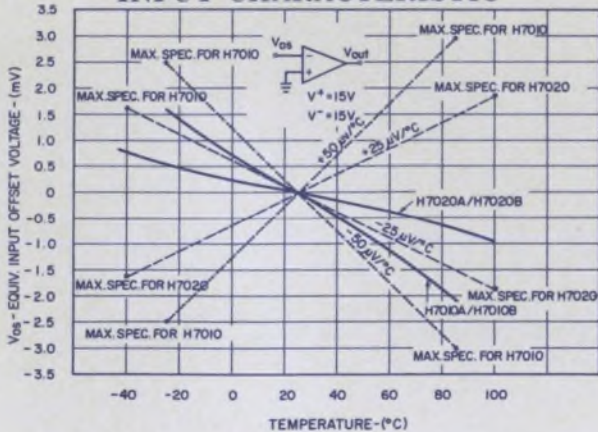

EQUIV. INPUT OFFSET VOLTAGE VS. TEMPERATURE
FIGURE 3

OUTPUT CHARACTERISTIC

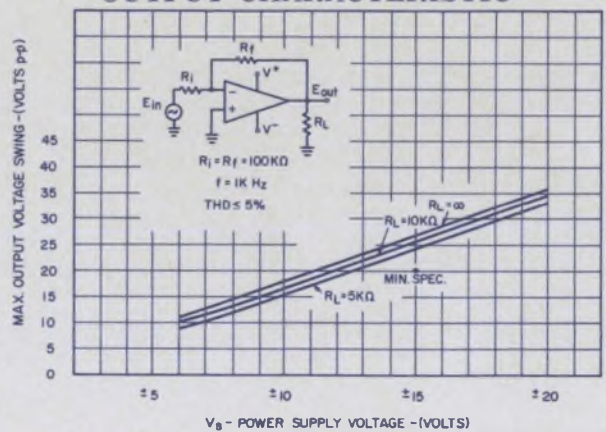

MAX. OUTPUT VOLTAGE SWING VS. POWER SUPPLY VOLTAGE
FIGURE 4

TRANSFER CHARACTERISTIC

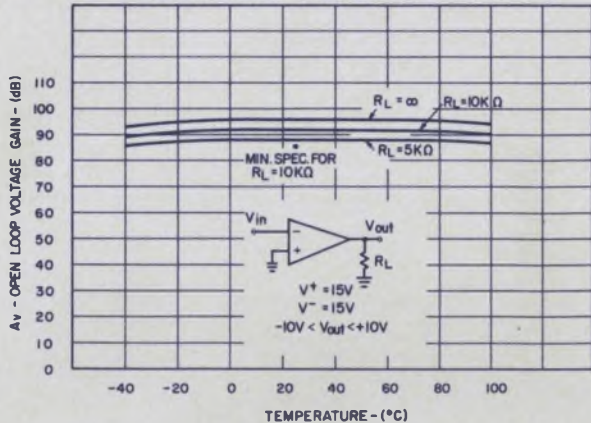

OPEN LOOP VOLTAGE GAIN VS. TEMPERATURE
FIGURE 5

TRANSFER CHARACTERISTIC

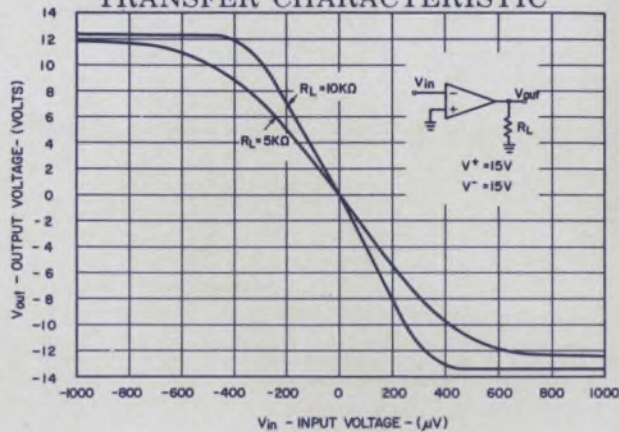

INPUT VOLTAGE VS. OUTPUT VOLTAGE
FIGURE 6

TRANSFER CHARACTERISTIC

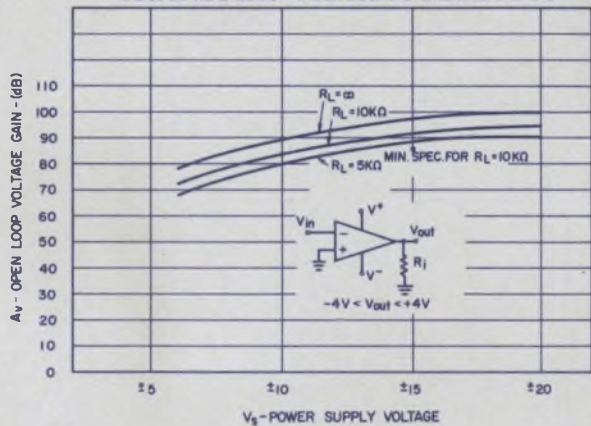

OPEN LOOP VOLTAGE GAIN VS. POWER SUPPLY VOLTAGE
FIGURE 7

SMALL SIGNAL CHARACTERISTIC

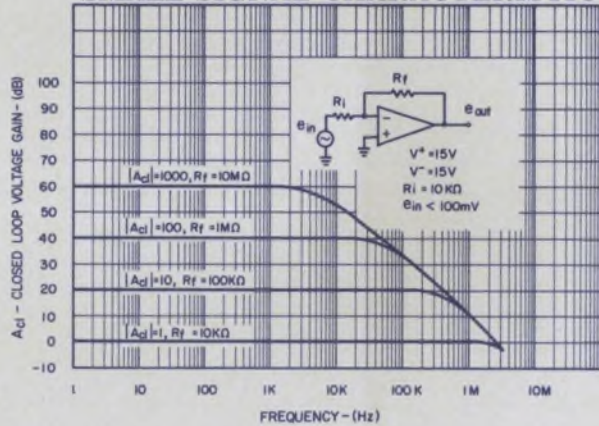

CLOSED LOOP VOLTAGE GAIN VS. FREQUENCY
FIGURE 8

SMALL SIGNAL CHARACTERISTIC

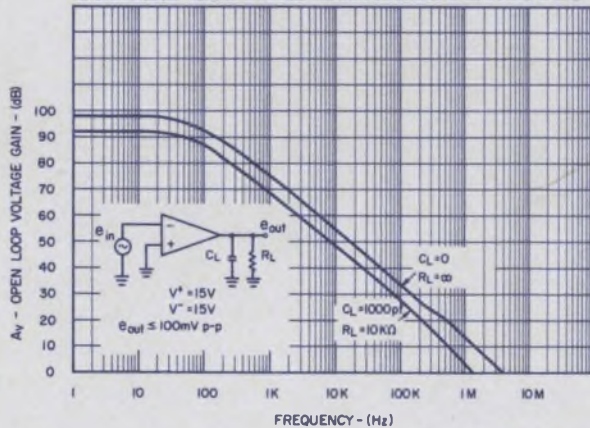

OPEN LOOP VOLTAGE GAIN VS. FREQUENCY
FIGURE 9

SMALL SIGNAL CHARACTERISTIC

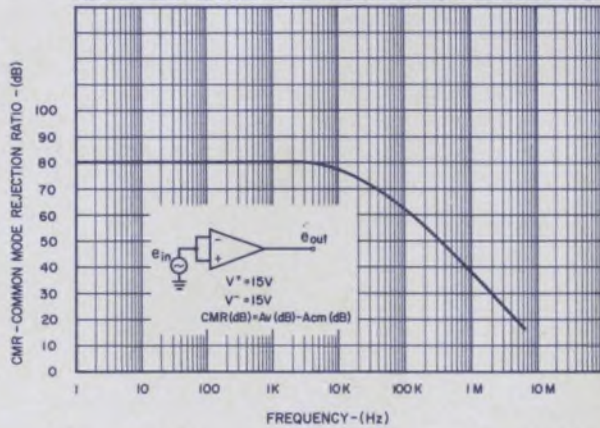

COMMON MODE REJECTION RATIO VS. FREQUENCY
FIGURE 10

POWER SUPPLY INPUT CHARACTERISTIC

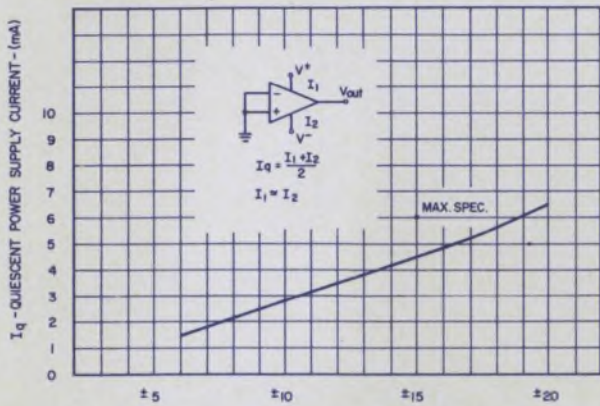

QUIESCENT CURRENT VS. POWER SUPPLY VOLTAGE

FIGURE 11

POWER SUPPLY INPUT CHARACTERISTIC

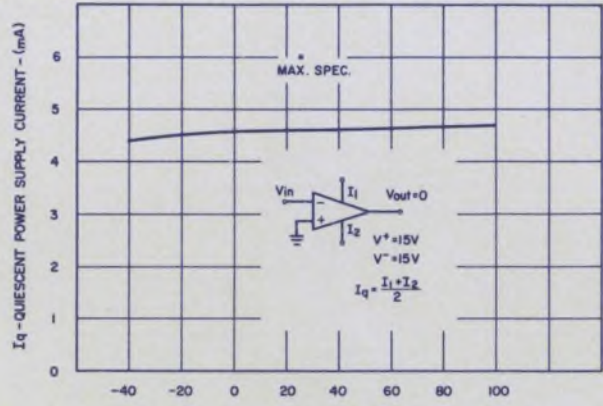

QUIESCENT CURRENT VS. TEMPERATURE

FIGURE 12

LARGE SIGNAL CHARACTERISTIC

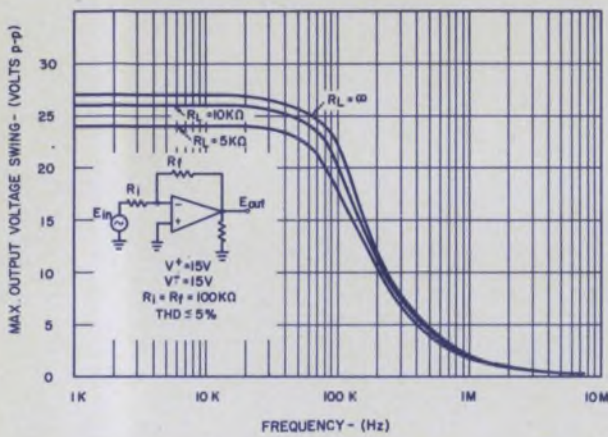

MAXIMUM OUTPUT VOLTAGE SWING VS. FREQUENCY

FIGURE 13

NOISE CHARACTERISTIC

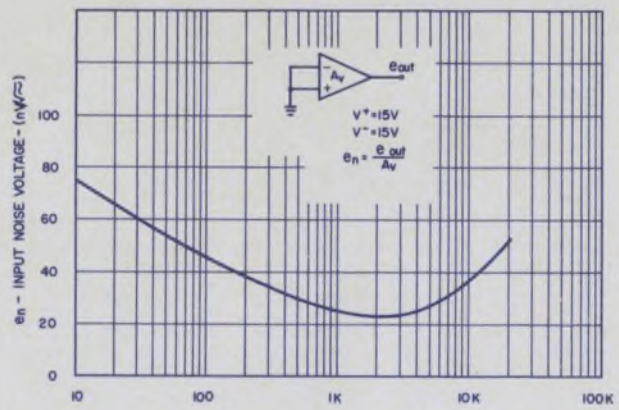

EQUIVALENT INPUT NOISE VS. FREQUENCY

FIGURE 14

MECHANICAL DATA

Case: Material . . . Epoxy
(All dimensions in inches)

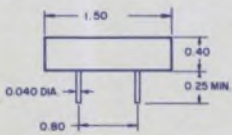

H7010A / H7020A

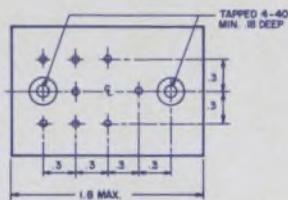
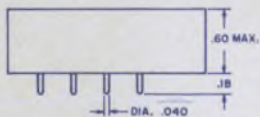
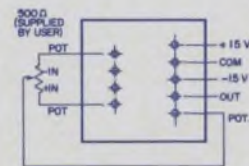

H7010B / H7020B

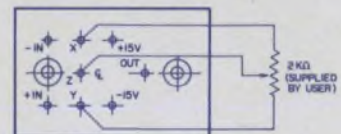

PRINTED IN U.S.A.



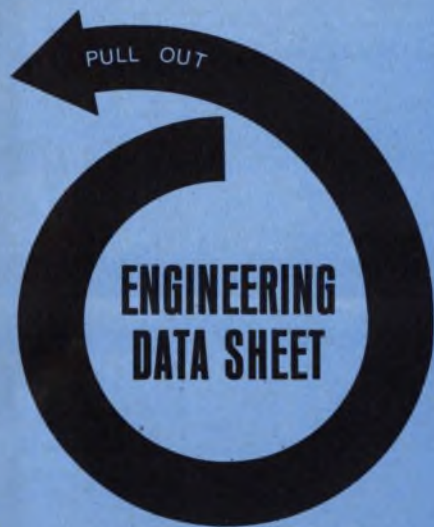

If somebody beat you to it, write to:
Union Carbide Electronics
 or call your UCE distributor
IN THE WEST

ARIZONA, Phoenix
 Avnet Electronics • (602) 272-6821

CALIFORNIA, Culver City
 Avnet Electronics • (213) 870-6141

Los Angeles
 K-Tronics • (213) 685-5888

Mountain View
 Avnet Electronics • (415) 961-7700

Newport Beach
 Western Electronic Components •
 (714) 540-1322 (213) 631-6119

Palo Alto
 Kierulff Electronics, Inc. • (415) 968-6292

San Diego
 Avnet Electronics • (714) 279-1550

San Diego
 Kierulff Electronics • (714) 278-2112

COLORADO, Denver
 Newark-Denver Electronics •
 (303) 757-3351

WASHINGTON, Seattle
 Washington Electronics • (206) 682-8981

Factory Sales Offices

CALIFORNIA
Mountain View
 (415) 969-9390
Fullerton
 (213) 691-0958



ELECTRONICS

LETTERS

(continued from p. 46)

attempt it. They can't! Most of the engineering society potentates are also members of higher management and their first loyalty is to their respective companies. Several years ago, one of my colleagues in one of the major aerospace companies stated that he had implicit faith in the beneficence of "enlightened" management. How naïve can you get? Yet that seems to be the attitude of a lot of engineers. A number of other things besides retirement need attention if the unstable employment situation is to be ameliorated. However, a good retirement program would be a fine initial step.

I hope your editorial gets some action.

Maurice V. Gowdey
 Sunnyvale, Calif.

Sir:

The editorial in the 15 February, 1967, issue of *ELECTRONIC DESIGN*, XV, No. 2 [in "IC bidirectional counters cost less," caption under Fig. 2], Kay D. Smith states that the modulo 10 shift decade counter is the easiest to design, but is hard to interface with accessories. The only reason for such a statement is that probably the accessories are not designed to be code-compatible with the Modulo 10 counter. Actually, it turns out that a decoder to go from Modulo 10 to "one hot" decimal is cheaper to build than a BCD-to-"one hot" decoder:

It might also be worth pointing out at this time, in reply to the many comments about professional status for engineers in the electronic field, that professionalism is like the right-of-way on the highway—you cannot take it, you can only yield it. One can neither claim nor buy professional stature. One must achieve it through professional activity and behavior which connotes the professional approach. I believe that a careful reading of the article by Sheppard would be a good start toward professionalism for any of your readers. It could also provide an impetus toward revising company attitudes about postgraduate, in-company educational programs and goals.

Lewis S. Goodfriend
 Professional Engineer
 Goodfriend-Ostergaard Associates
 Cedar Knolls, N. J.

Editor's reply

The purpose of the editorial was to focus attention on mobility in en-

gineering employment, not on the engineers professional status.

The article in *IEEE Spectrum* cited by Mr. Goodfriend well supports the point made in the editorial that the existing societies have ignored both the career development and the financial well-being of their members.

Peter N. Budzilovich

Modulo 10 decoder poses no problems

Sir:

On page 59 of *ELECTRONIC DESIGN*, XV, No. 2 [in "IC bidirectional counters cost less," caption under Fig. 2], Kay D. Smith states that the modulo 10 shift decade counter is the easiest to design, but is hard to interface with accessories. The only reason for such a statement is that probably the accessories are not designed to be code-compatible with the Modulo 10 counter. Actually, it turns out that a decoder to go from Modulo 10 to "one hot" decimal is cheaper to build than a BCD-to-"one hot" decoder:

Decimal	J-K				Unique output
	1	2	4	8 16	
0	1	1	1	1	1.16
1	0	1	1	1	1.2
2	0	0	1	1	2.4
3	0	0	0	1	4.8
4	0	0	0	0	8.16
5	0	0	0	0	1.16
6	1	0	0	0	1.2
7	1	1	0	0	2.4
8	1	1	1	0	4.8
9	1	1	1	0	8.16

This requires a total of 20 diodes, which is significantly fewer than any other decoding scheme, including binary-coded decimal.

Joseph A. Howells
 Principal Systems Engineer
 Science Accessories Corp.
 Southport, Conn.

Accuracy is our policy

In "Power supply adjusts . . .," in the components listing of the Products section of *ED* 5, Mar. 1, 1967, p. 137, Power/Mate Corp. points out that its Uni 88 supply adjusts from 0 to 34 volts, not 0 to 3/4 volt as printed.

TRW Metallized Capacitors



... stand tall

Type X601PE Metallized Mylars typify TRW's stature in advanced metallized dielectrics.

They're smaller and lighter... *metallized!* Tough and rugged...

epoxy sealed! Ideal for printed circuits...*save space!*

TRW offers many additional styles and dielectrics for demanding Military and Industrial needs.

Product information is available from TRW Capacitor Division, TRW INC., Box 1000, Ogallala, Nebraska. Phone (308) 284-3611. TWX: 910-620-0321.

TRW

Co-Publishers

James S. Mulholland, Jr.
Robert E. Ahrens Dorf

Editorial Director

Edward E. Grazda

Editor

Howard Bierman

Managing Editor

Robert C. Haavind

Technical Editors

Peter N. Budzilovich
Maria Dekany
Frank Egan
Roger K. Field

News Editors

Ralph Dobriner, Chief
Richard N. Einhorn

East Coast Editor

Neil Sclater

West Coast Editor

Ron Gechman

Copy Editor

Peter Beales

New Products Editors

David H. Surgan
Daniel R. Butterly

Washington Editor

S. David Pursglove

Editorial Production

Dollie S. Viebig
Karen L. Sherman

Art Director

Clifford M. Gardiner

Art Assistant

William Kelly

Technical Illustrators

Cheh Nam Low
William Alvarez
Sheila F. Ward

Production Manager

Thomas V. Sedita

Asst. Production Manager

Helen De Polo

Production Assistants

Bernard Wolinsky
Robert B. Lichtig

Circulation Manager

Nancy L. Merritt

Reader Service

Diane Mandell

EDITORIAL

Life begins at 40 Will it for you?

Countless words have been written and spoken about whether engineers should be considered professionals alongside physicians, lawyers and the like. Every kind of parallel has been drawn; the dissimilarities have been pointed up. One factor merits particular attention, yet is too often shunned in discussion—the age obsolescence of engineers.

Where doctors and lawyers are concerned, for instance, a man only gains in value as he accumulates experience, and this increases only with age. In fact, a 45-year-old doctor is deemed a relatively young man.

What about engineers? A recently published report* is packed with data supporting the view that an engineer 45 years of age or older faces a grim future in terms of his possibilities of employment. It indicates, moreover, that no amount of professional training can change this. Thus (and we quote): "Irrespective of their [engineers'] educational background, pre-layoff salary, technical publications, patents, readership in technical magazines, and membership in professional societies, older engineers and scientists remained unemployed for much longer periods of time" [than younger men].

This, coupled with the fact that the huge postwar generation of engineers is rapidly approaching its forties, is frightening.

What is the solution? Obviously the first step is to look into the causes of the situation. What is behind it? Is it the high pay? Or is it the influence of life and medical insurance companies? Whatever it is, the time to find out all about it and take steps toward a satisfactory solution is running out.

Furthermore, in view of the fact that the existing engineering societies do not seem to be concerned with the welfare of their members, concrete steps toward creation of a new organization to study and remedy the problem seem in order.

So next time you talk about professional status, bear in mind the simple truth that you may well be forced into retirement at about 45, unless you migrate into the ranks of management and, as usually is the case, desert the profession per se.

PETER N. BUDZILOVICH

*R. P. Loomba, *A Study of the Re-employment and Unemployment Experiences of Scientists and Engineers Laid Off from 62 Aerospace and Electronics Firms in the San Francisco Bay Area during 1963-65* (San Jose, Calif.: Manpower Research Group, Center for Interdisciplinary Studies, San Jose State College, 1967).



This is no line. This is a choice.

The way new uses for printed circuits are being found, it stands to reason that there should be enough different PC connectors available to insure that your application requirements are met squarely.

Burndy gives you that choice.

In fact, we have more than 200 different PC connectors to choose from. And it's likely you'll find a connector that will meet the requirements of several projects. Individually, and as a group, the application potential is enormous. Call it choice . . . call it versatility. You're right on both counts.

This is part of what you have to choose from:

Card Receptacles

- Crimp removable contacts per MIL-C-

21097/B .156" spacing. Non-spec types for .078" .100" and .156" spacing. (The flexibility and convenience of crimp removable contacts often indicates new applications.)

- Solder or weld termination in spacings down to .050".
- Solderless wrap termination on .150" and .200" spacing.

Two-Piece Connectors

Crimp removable contacts on .100" and .150" centers meet the requirements of the most rugged environments. Round socket contacts support wires against severe vibration and shock.

- Solder dip types on .100" and .150" spacing. 11 sizes from 13 to 92 contacts conform to several NASA drawings and

Signal Corps specifications
SCL6250B
(MIL-C-55302).

Are they reliable?

Today, Burndy PC connectors are being used in everything from business machines and

computers to telemetry systems. They wouldn't be if they weren't exactly that . . . reliable.

If you're involved with printed circuitry you'll want a copy of our PC connector catalog. Write now for catalog PC.

 **BURNDY**
Norwalk, Connecticut

Technology

FREQUENCY
HERTZ

PHASE
DEGREES

GAIN
DECIBELS

129

37.8821

58.3917

167

26.8687

59.5302

215

15.0423

60.2641

278

2.39274

60.5867

359

-10.341

60.4684

464

-22.7883

59.9145

Computer time-sharing offers designers both rapid access to the computer and simplicity

of program language. It lends itself to high-accuracy, repetitive calculations. Page 54

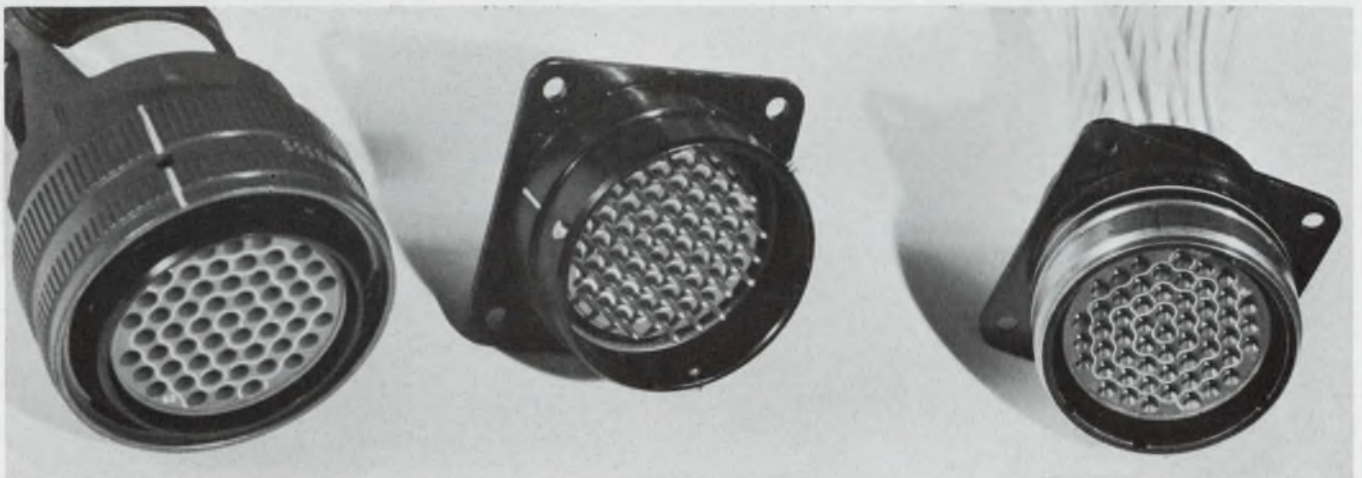

The abundance of connectors may bewilder the designer. Military specifications not only

set standards but are also a useful guide through the maze of devices. Page 95

Also in this section:

UJT's and magnetic cores combined generate a wide range of variable pulses. Page 64

Inertial damping is specially well suited to high-velocity servo systems. Page 72

Irregular antenna patterns are easy to plot by shape substitution. Page 86

You don't have to be a programmer to use a time-shared computer to solve design problems. Here's an example of how you can put this powerful technique to work.

The two main advantages of computer time-sharing with teletype input are rapid access to the computer and simplicity of program language.

With time-sharing a new program can be tested, corrected and retested in a matter of minutes rather than hours or days. Thus a computer is made more efficient for one-of-a-kind engineering problems. The increased efficiency is due to the facts that program 'debugging' time is minimized, that no single user is allowed to monopolize the computer's time, and that the normal middlemen (the programmer and the machine operator) between the engineer and the computer are eliminated.

For the design engineer to make maximum use of computer solutions, he must be able to understand and modify programs. Since most engineers are unfamiliar with the complexities of computer operation, it is important that the program language be as natural (human-oriented) and fool-proof as possible. Several languages that have been developed for computer time-sharing (such as BASIC and CAL) are easy for the beginner to learn and use successfully.

Teletype time-sharing, for all its advantages, does also have two major limitations—the maximum program size and the mode of printout.

The program size is more restricted for time-sharing than for normal computer operation, because the computer's memory must be divided among several users. In a typical time-sharing system, the program length is limited to approximately 6400 binary-coded decimal (BCD) characters. Because the length of the program is limited, the complexity of the problem that can be solved is correspondingly limited.*

The mode of printout effectively limits the amount of data that can be printed out. The teletype machine prints 10 characters/second (in-

*The design engineer who wishes to solve more complex problems should investigate the many generalized programs available. See "Check design program availability," ED 23, Oct. 11, 1966, pp. 76-80, for a description of some of these programs.

Frederick R. Shirley, Senior Engineer, Electronic Design Dept., Sanders Associates, Inc., Nashua, N. H.

cluding blanks) across a 72-column page. At this rate it takes approximately five minutes to generate an 8-1/2-by-11-inch sheet of printout. For a problem occupying 120 pages of printout, it would take the teletype machine about 10 hours to print the solution!

The mode of printout likewise limits the flexibility of the printout format. Graphs, pictures, and printing are confined to a matrix of digitized locations 66 lines long by 72 columns wide for each 8-1/2-by-11-inch sheet. With some time-sharing systems it is possible to get around this limitation by taking advantage of off-line input/output devices at the computation center. These devices (high-speed printers, x-y plotters, card punches, etc.) are operated for the time-sharing user at a nominal fee, and the results are mailed to him.

Typical circuit problem illustrates time-sharing

Time-sharing is especially well suited to engineering problems where solutions require one or more of the following:

- Differential or high-accuracy calculations.
- Difficult test equipment implementation.
- Repeated solutions for several values of an independent variable (temperature, frequency, supply voltage, etc.).

The preamplifier circuit shown in Fig. 1 is typical of the sort of circuit problem that lends itself to computer solution. To complete the engineering analysis, the frequency response (both gain and phase) have to be determined, and the

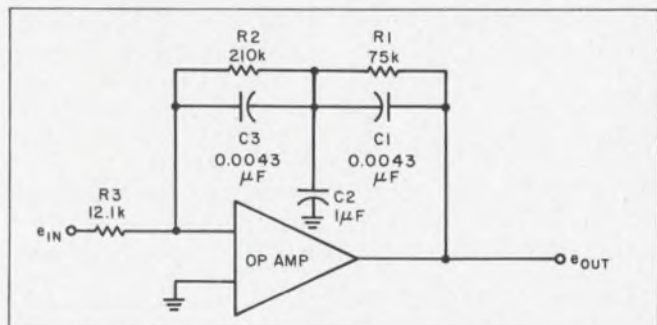

1. Computer analysis of this preamplifier is used to demonstrate the use of time-sharing to solve design problems.

NETWORK ANALYSIS (P 1 OF 3):

THE COMPONENT VALUES ARE:

	1	2	3
R(KOHM):	75	218	12.1
C(UF):	.8843	1	.8843

THE GAIN AND PHASE RESPONSES ARE:

FREQUENCY HERTZ	PHASE DEGREES	GAIN DECIBELS	FREQUENCY HERTZ	PHASE DEGREES	GAIN DECIBELS
1.	18.8598	27.9435	129	37.8821	58.3917
1.29	23.7433	28.2476	167	26.8687	59.5382
1.67	29.5849	28.7185	215	15.8423	68.2641
2.15	36.8299	29.391	278	2.39274	68.5867
2.78	43.8871	38.3356	359	-18.341	68.4684
3.59	49.9185	31.5566	464	-22.7883	59.9145
4.64	56.3457	33.8495	599	-34.3926	58.9574
5.99	61.8713	34.76	774	-44.8614	57.6485
7.74	66.3373	36.6474	1088	-53.9813	56.8369
10	69.6557	38.6525	1298	-61.4118	54.2311
12.9	71.8355	48.7212	1678	-67.6183	52.2583
16.7	72.9465	42.8636	2158	-72.4621	58.2155
21.5	72.9654	44.9882	2788	-76.3649	48.8833
27.8	71.9481	47.1339	3598	-79.4877	45.9227
35.9	69.7789	49.2577	4648	-81.7888	43.7389
46.4	66.3582	51.3454	5998	-83.6321	41.5347
59.9	61.5797	53.3481	7748	-85.8684	39.3216
77.4	55.2652	55.2372	10888	-86.1813	37.1844
108	47.3482	56.9446			

(a)

NETWORK ANALYSIS (P 2 OF 3):

THE COMPONENT VALUES ARE:

	1	2	3
R(KOHM):	75	218	12.1
C(UF):	.8843	1	.8843

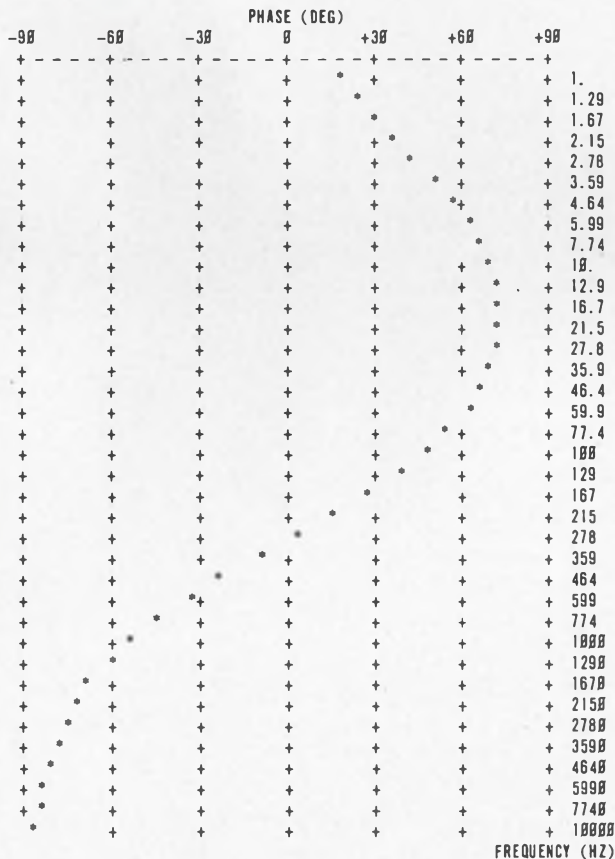

(b)

NETWORK ANALYSIS (P 3 OF 3):

THE COMPONENT VALUES ARE:

	1	2	3
R(KOHM):	75	218	12.1
C(UF):	.8843	1	.8843

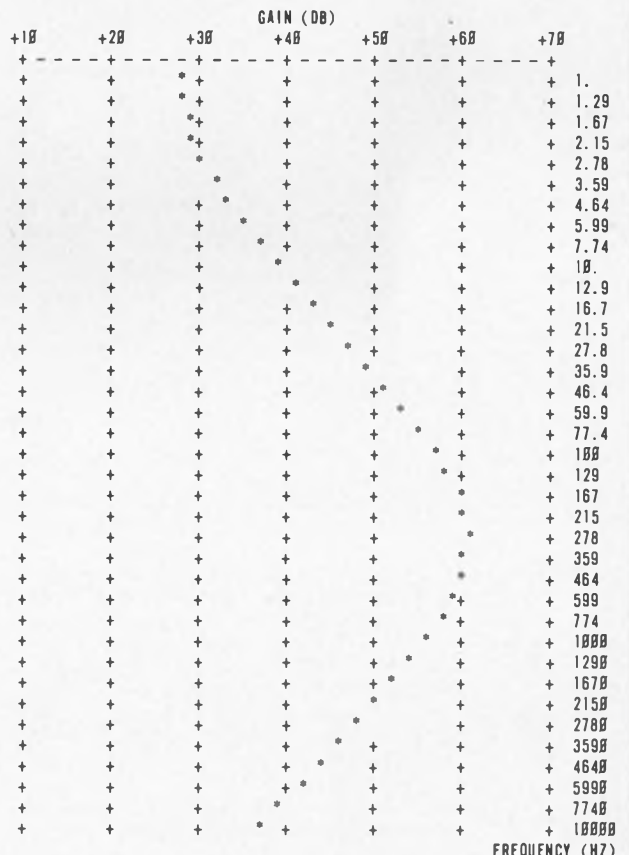

(c)

2. Three-page teletype printout shows results of computer analysis of the circuit in Fig. 1. The first page (a) gives

a table of gain and phase responses. Plots of the same data are shown on the second (a) and third (b) pages.

Table 1. BASIC commands

Type	Word	Function
Nonexecutable	REM	Allows the insertion of remarks in the program listing
	DIM	Reserves extra memory room for large variable arrays
	DATA	Stores numerical data to be used in the problem solution
Input/Output	READ	Obtains numerical data from DATA statements
	PRINT	Types output statements and numerical answers
Computational	LET	Computes variable values according to algebraic formulas
Sequencing	GO TO	Alters the normal order of computation
	IF . . . THEN	Conditionally alters the order of computation
	FOR . . . TO NEXT	Causes the intervening commands to be repeated several times
	GO SUB RETURN	Routes computation to and from a subroutine (subsection) of the program
Termination	STOP	Stops computation (at any point in the program)
	END	Stops computation (this must be the last sequential command in a program)

Table 2. Program block outline

Starting line number	What is accomplished
100	Data input and instructions to user
300	Constants definition and computation of log frequency points (independent variable)
500	Reorganization of input data into a more convenient form
700	Calculation of gain and phase values (dependent variables) at each frequency point
1000	Printout of problem solution
2000	Print subroutine for page headings
3000	Print subroutine for graphs

effects of component value variations found. Here the differential phase measurements make laboratory methods difficult to implement, and the independent variables (frequency and component value changes) make hand calculations tedious.

In order to program the computer to solve the preamplifier problem, the general mathematical solution must first be derived. Assuming that the operational amplifier is ideal, the preamplifier transfer characteristic is the ratio of the feedback and input impedances shown in Fig. 1. With the input impedance equal to $R3$ and the feedback impedance defined as the voltage into the $R1-C1$ side of the network divided by the current out of the $R2-C3$ side, it can be shown that the preamplifier characteristic is:

$$\frac{e_{out}}{e_{in}}(s) = T_4 \left\{ \frac{1 + (s)(T_2)}{[1 + (s)(T_1)][1 + (s)(T_3)]} \right\}, \quad (1)$$

where $s = \sigma + j\omega$, and T_1, T_2, T_3 and T_4 are defined as follows:

$$\begin{aligned} T_1 &= (R_1)(C_1), \\ T_2 &= [(R_1)(R_2)/(R_1 + R_2)](C_1 + C_2 + C_3), \\ T_3 &= (R_2)(C_3), \\ T_4 &= (R_1 + R_2)/R_3. \end{aligned} \quad (2)$$

From basic s -plane theory it is known that the magnitude of the transfer characteristic is the product of the magnitudes of the numerator terms divided by the magnitude of the denominator terms. Likewise, the phase of the transfer characteristic is the sum of the phases of the numerator terms minus the phases of the denominator terms. Therefore, the over-all transfer characteristic in Eq. 1 can be built up from a series of simpler subfunctions. The gain and phase expressions for a typical transfer subfunction (the numerator term $1 + sT_2$) are given in Eqs. 3 and 4. For the steady-state condition, the decibel gain of this term is:

$$\begin{aligned} |1 + j\omega T_2|_{dB} &= 20 \log_{10} [1 + (\omega T_2)^2]^{1/2} \\ &= 10 \log_{10} [1 + (\omega T_2)^2], \end{aligned} \quad (3)$$

and the phase in degrees is:

$$\angle(1 + j\omega T_2) = \tan^{-1}(\omega T_2). \quad (4)$$

The computer solution for the gain and phase responses of the preamplifier problem of Fig. 1 is shown in the three-page printout of Fig. 2. Each page begins with a table of the component values in order to prevent confusion should the problem be rerun at a later date with different component values. The first page (Fig. 2a) gives a table of the gain and phase responses at 37 logarithmically spaced frequency points over a frequency range from 1 Hz to 10 kHz. The second and third pages (Figs. 2b and 2c) are the same data presented in graphical form. The graphical presentations are easier to interpret but are not so accurate (only ± 1.5 and ± 0.5 dB) as the tabular data.

NETWORK ANALYSIS (P 1 OF 2):

THE NOMINAL COMPONENT VALUES ARE:

R(KOHM):	1	2	3
C(UF):	75	210	12.1
	.0043	1	.0043
VARIATION:	C(1)	10.	PERCENT. (= .00473 UF)

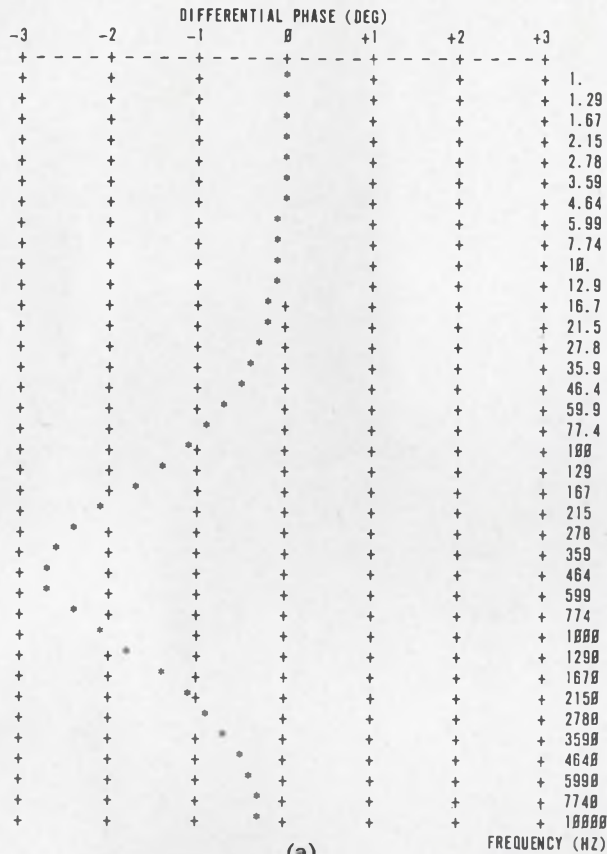

NETWORK ANALYSIS (P 2 OF 2):

THE NOMINAL COMPONENT VALUES ARE:

R(KOHM):	1	2	3
C(UF):	75	210	12.1
	.0043	1	.0043
VARIATION:	C(1)	10.	PERCENT. (= .00473 UF)

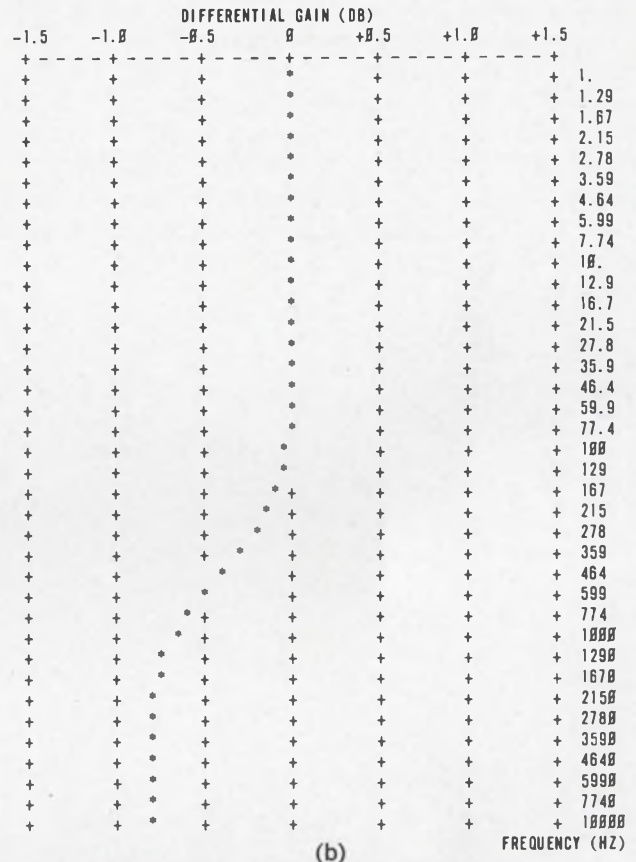

3. A 10% increase in C1 yields the plots of the differential phase (a) and the differential gain (b).

The computer solution for the gain and phase variations from nominal is shown in the two-page printout of Fig. 3. Again each page begins with a table of the nominal component values (and also the variations) to define the input parameters for the printout. The phase variation from nominal is graphed to $\pm 0.05^\circ$ accuracy and the gain variation to ± 0.025 dB at the same frequency points used in Fig. 2. No tabular printout is required here since the resolutions of the differential graphs are sufficiently fine.

BASIC program solves the problem

The computer programs used to generate the printouts of Figs. 2 and 3 are written in "BASIC," a language used with the Dartmouth time-sharing system.[†] A BASIC program consists of a series of typed lines, each beginning with a line number

followed by a command word. Unless told otherwise, the computer performs the commands of the program one line at a time in order of increasing line number (not in the order of typing). To understand a BASIC program, a user must first learn the command words that make up the language vocabulary. Some of these command words together with their meanings are listed in Table 1.

The specific BASIC programs for the solution of the preamplifier problem are PLOT 1 and PLOT 2 shown in Figs. 4 and 5, respectively. Both those programs follow the general outline given in Table 2. The central portions of these programs are the calculation of the gain and phase values at each frequency point (starting at line 700), and the printout of those values (starting at line 1000). The preceding lines of the program are preliminary steps to facilitate the computation; and the succeeding lines are two subroutines used to order the printout.

[†]See "Simplify feedback system design," ED 23, Oct. 11, 1966, pp. 62-67.

(continued on p. 58)

same configuration as that shown in Fig. 1 but different component values, only lines 100 and 110 would need to be changed.

Section 300: In lines 350-390 the values of the independent variable (frequency) are chosen. Here the frequency range from 1 Hz to 10,000 Hz is covered by 37 logarithmically spaced points (rounded to 3 digits for convenience). Line 350 determines the number of frequency points by prescribing the number of times a value of F is calculated. Line 360 calculates the significant figures for each point, and the distance between points. Lines 370-380 determine the number of significant digits to which each point is rounded off, and the decade in which the first point is located.

As an example of the over-all function of these lines, consider the case for $J=12$. In line 360 the computer sets $J1$ equal to $11/9$. In line 370, $J2$ is set equal to the largest integer in J minus 2 (that is, $J2=-1$). Ten raised to the $J1-J2$ power is 166.81, and the largest integer, $166.81+0.5$ (that is, the nearest integer to 166.81), is 167. Therefore, in line 380, $F(12)$ is set equal to $167 \times 10^{-1} = 16.7$.

Section 700: In lines 720 and 730-740 the phase and gain values at the 37 frequency points are calculated. $P(12)$ and $G(12)$, for instance, are the values of the phase and gain at 16.7 Hz. Q , defined in line 710, is simply the frequency multiplied by 2π (in order to convert Hz into rad/s).

In lines 750-760 digitized values of the 37 phase and gain values are calculated for the graphical printout. In line 750, the factor $1/3$, by which $P(J)$ is multiplied, is the scale factor (3 degrees per increment in the graphical printout of Fig. 2b). The addition of 0.5 within the INT parentheses is to provide a round-off function on $P(J)$ rather than a truncation. And the addition of 31 determines the axis location (31 increments above the low end of the graph).

Section 1000: In line 1090 the values of phase and gain at each frequency point are printed. This generates the 37-line table of Fig. 2a.

In lines 1110-1180 the graph of Fig. 2b is printed. Lines 1110-1130 space the printout 11 lines to the top of the next page. Line 150 causes the page heading (page 2 because $K=2$) and component value table to be printed. Lines 1160-1170 print the graph axis label and scale. And line 1180 causes the digitized phase values to be graphed.

Section 3000: The operation of the graph subroutine beginning at line 3000 is less obvious than that of other portions of the program. However, the programming difficulties encountered here are more than compensated for by the fact that, once developed, such a subroutine can be used almost unchanged in many new programs. In lines 3010-3050, either the phase or gain value is chosen for plotting (phase if $K=2$ and gain if $K=3$),

Table 3. Variables used in programs

Name	Definition
E1	$\pi/180$ (phase conversion constant)
E2	(Log. 10/10 (gain conversion constant))
F (37)	Frequency points (Hz)
G (74)	Gain values (dB)
P (74)	Phase values (degrees)
J	Loop (iteration) variable
J1, J2, J3	Dummy variables used in computation of frequency points and in graph printout
K	Index variable
Q	Dummy frequency variable (radians)
T1, T2, T3, T4	Constants related to input data
V (6)	Component value variation factors
X (6)	Component values [$X(1) \cdot X(3)$ are R in $k\Omega$, $X(4) \cdot X(6)$ are C in μF]

depending on the page that is being printed. Then, in the $J1$ loop from 3060 to 3280, each line (63 increments) of the graph is printed in 21 three-increment sections. In line 3070 the dummy variable $J2$ is defined so that if the graph point falls in the first, second or third increments of that section, $J2$ will have the value 0, 1 or 2, respectively. If $J2=2$, line 3110 prints a graph point (asterisk) in the third increment; if $J2=1$, line 3140 prints a graph point in the second increment; and if $J2=0$, line 3160 prints a point in the first increment. If $J2$ is greater than 2 or less than 0, then a graph grid point (plus sign) or nothing at all is printed in that three-increment section according to lines 3180-3270. The semicolon following each print command (lines 3110, 3140, etc.) instructs the computer to continue printing on the same line rather than beginning a new line for each three-increment section. The last print command (line 3290) for each graph line is the frequency value, which is not followed by a semicolon.

The decision where to print the graph grid points (plus signs) is made in lines 3180-3200. Counting graph increments in Fig. 2b shows that graph points occur in the first, fourth, eighth, eleventh, eighteenth and twenty-first three-increment sections. Also, these points occur in the first increment of the eighth and eighteenth sections, the second increment in the first, eleventh and twenty-first sections, and the third in the fourth and fourteenth sections. In line 3180, $(J1+7)/10$ is an integer when $J1=3$ or 13 (that is, in the fourth and fourteenth sections). Therefore, line 3180 and the two following lines contain sufficient information to select the graph point locations.

(continued on p. 60)

now



All welded construction

Inherent wirewound stability

Precision tolerances as close as $\pm 0.05\%$

Low temperature coefficient, $\pm 10 \text{ ppm}/^\circ\text{C}$

Exclusive thermacoat silicone coating

TC Assured to $\pm 10 \text{ ppm}$

IRC Type AS Resistors Save Space and Money, Too

These precision power resistors are now available with an *assured* maximum hot side temperature coefficient of $\pm 10 \text{ ppm}/^\circ\text{C}$ in standard ranges above 50 ohms. This offers greater design stability with the added benefits of miniaturization and economy.

Type AS resistors provide the stability, close tolerances and superior performance of premium metal films costing 20% to 45% more. And at comparable prices you can replace axial lead vitreous enamel types with space and performance advantages.

Special AS resistors can be used as squib fuses. Inductive designs are also available for fixed rise time applications. Send resistance, wattage, frequency and rise time requirements for evaluation samples.

Write for literature and prices to: IRC, Inc., 401 North Broad Street, Philadelphia, Pennsylvania 19108.

CAPSULE SPECIFICATIONS

POWER:	1, 2, 3, 5, 7, 9, 14 watts @25°C $\frac{1}{2}$, 1, 2, 3, 5, 7, 10 watts @125°C
TOLERANCES:	$\pm 0.05\%$, 0.1%, 0.25%, 0.5%, 1%, 3%, 5%
TEMPERATURE COEFFICIENT:	$\pm 10 \text{ ppm}/^\circ\text{C}$ above 50 ohms $\pm 20 \text{ ppm}/^\circ\text{C}$ below 50 ohms
RESISTANCE:	0.1 ohm to 175K ohms
MIL-R-26:	Characteristics G and V. Withstands 350°C hot spot.
MIL-R-23379:	RWP18, 20, 21
LEADS:	60-40 alloy-plated copperweld. Special types available.



ON READER-SERVICE CARD CIRCLE 35

ORDINARY 5 AND 10 AMP RELAYS MIGHT PERFORM LIKE THE NEW SIGMA SERIES 50.

If they had these features.

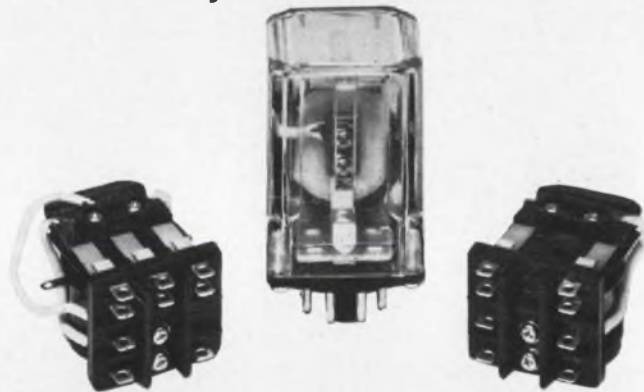

New 1, 2 and 3 pole Sigma Series 50 relays have four advantages over ordinary relays of this type.

Longer Contact Life: Slots in contact base between fixed contacts eliminate build-up of vaporized contact material and leakage paths. This prevents premature failure and is particularly effective at higher loads.

Coil Lead Breakage Eliminated: Molded phenolic bobbin assures positive mechanical interlock with frame preventing coil rotation and lead breakage.

Greater Motor Efficiency: Adjustable armature hinge permits optimum seating of armature on pole face. Assures precise contact alignment as well as maximum use of drive circuit power.

Better Adjustment Stability: Contact base and

armature support made of diallyl phthalate. This material does not deform under mechanical and thermal stresses.

We'd like to give you a new Sigma Series 50— or any of our other standard relays. Test and compare it against the brand you may now be using. It's the best way we know to prove what we say about Sigma relay performance. Just circle our reader service number on the reader service card. We'll send you the new Sigma relay catalog and a "free relay" request form. Return the form to us and your Sigma representative will see that you get the relay you need.

Need fast delivery? The UL listed Series 50 is available off-the-shelf from your Sigma distributor.

SIGMA DIVISION  SIGMA INSTRUMENTS INC
Assured Reliability With Advanced Design / Braintree, Mass. 02185

ON READER-SERVICE CARD CIRCLE 36

**But—
does
Telonic
make
MINIATURE
Filters?**



**Sure—
from
50 MHz
to
12 GHz!**

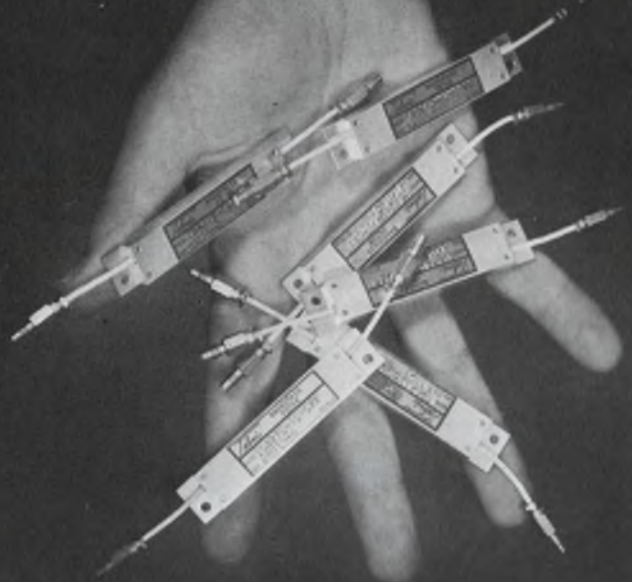

In fact, Telonic has made miniature filters longer than anyone in the business—miniature bandpass and lowpass in tubular, cavity, and interdigital types, with frequency coverage to 12 GHz.

The tabulation below indicates the extensive selection available to the design engineer. All series may be specified with OSM, BRM, Sealectro, or Micon connectors or cables and terminals.

Series	Configuration	Type	Frequency Range (Cut-off or Passband)
TLP	Tubular	Lowpass	100 MHz - 2750 MHz
TLR	Tubular	Lowpass	1000 MHz - 2750 MHz
TBP	Tubular	Bandpass	100 MHz - 2400 MHz
TCA	Cavity	Bandpass	1000 MHz - 3000 MHz
TCG	Cavity	Bandpass	2000 MHz - 6000 MHz
TCB	Cavity	Bandpass	1000 MHz - 2400 MHz
TCH	Cavity	Bandpass	6000 MHz - 12000 MHz
TIF	Interdigital	Bandpass	1000 MHz - 6000 MHz
TTA	Tunable Cavity	Bandpass	48 MHz - 4000 MHz
TSA	(Subminiature)	Bandpass	100 MHz - 1000 MHz

If size is critical in your requirements, you won't have any trouble finding the filter to fit from Telonic's new catalog, C-101. It covers 20 basic series, shows insertion loss, attenuation, length, and connector types for an infinite number of filter variations.

But, if size isn't critical, then just consider Telonic filters for their performance—that's where they're very, very big. Now you hardly need a second source.

Telonic ENGINEERING CO.
Division of Telonic Industries Inc.

P.O. BOX 277, LAGUNA BEACH, CALIF. 92652

REPRESENTATIVES THROUGHOUT THE U.S., CANADA AND OVERSEAS. BRANCH OFFICES
IN MAIDENHEAD, ENGLAND, FRANKFURT, GERMANY, AND MILAN, ITALY.

ON READER-SERVICE CARD CIRCLE 37

UJTs and magnetic cores combine

to generate a wide range of variable duty-cycle and repetition-rate pulses.

The generation of low duty-cycle pulses at extremely slow repetition rates is normally quite difficult. Combining a unijunction transistor relaxation oscillator and a miniature magnetic switching core, however, yields exceptionally good results. The advantages of this approach are:

- Simplicity and versatility.
- Wide range of repetition rates and pulse widths.
- Duty cycle independent of repetition rates.
- High peak power per pulse.
- Astable or monostable operation.
- Simple synchronization and triggering.
- Coincident negative and positive pulses of identical width and independent amplitude.
- Good temperature stability.

In addition, the unijunction/magnetic-core combination can be used as a very simple, cascable, pulse-counting circuit.

Single UJT is sufficient

The basic circuit is shown in Fig. 1a. It consists of a unijunction transistor relaxation oscillator with the primary winding of a transformer in series with the emitter of the transistor. The BH loop of the transformer core is shown in Fig. 1b. The core is biased to saturation by a current drawn through the interbase resistance of the unijunction. When the unijunction goes into conduction, the core is driven from the steady-state operating point at B_0 to $+B_m$. While the core is switching between these end points, the transformer supports the voltage across it. Hence, an output pulse is generated which is sustained until the core saturates (the flux density reaches $+B_m$). Then it falls to zero regardless of whether the capacitor is fully discharged or not. The width of the output pulse is thus independent of the

recovery time of a standard unijunction relaxation oscillator.

The unijunction transistor is a negative-resistance device. Therefore, astable, monostable or bistable operation is theoretically possible. For this application, however, bistable operation will not be considered.

Figure 2 shows the static emitter characteristic of a unijunction transistor. The points of interest are labeled.

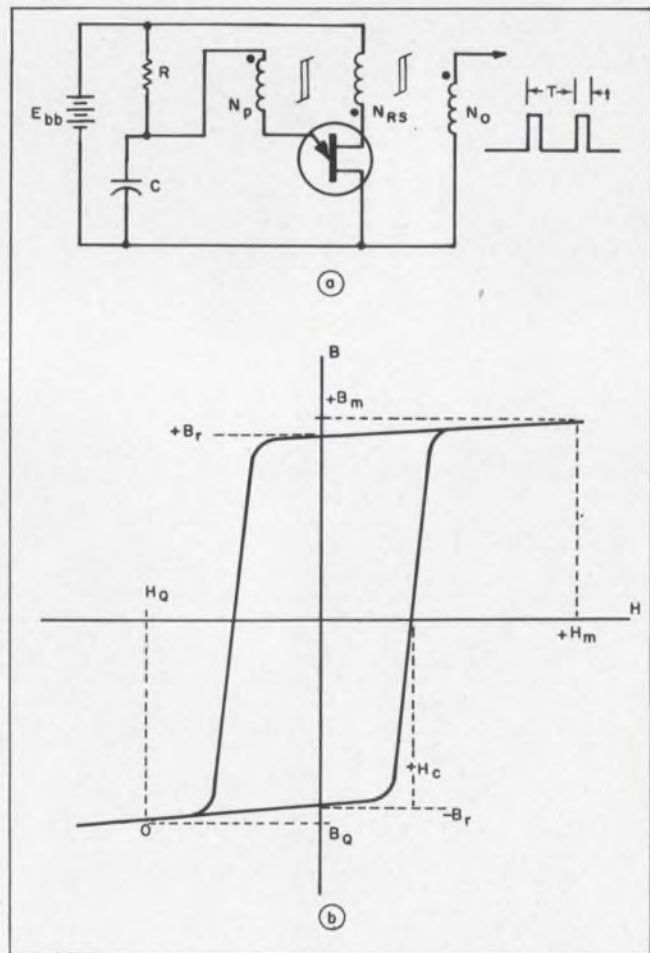

1. Single UJT combined with a transformer (a) wound on a core having square hysteresis loop (b) results in an astable or monostable pulse generator.

Russell W. Walton, Electronic Engineer, Fairchild Instrumentation, Mountain View, Calif.

Repetition rate is determined by UJT's period

The repetition rate of the output pulses is determined by the normal period of the unijunction transistor relaxation oscillator. Referring to Fig. 1, we have:

$$T = RC \ln [1/(1 - \eta)], \quad (1)$$

where:

$$V_v/I_v < R < \eta E_{bb}/I_p,$$

and

- T = repetition period,
- E_{bb} = supply voltage,
- η = intrinsic stand-off ratio,
- V_v = valley voltage,
- I_v = valley current,
- I_p = peak-point emitter current,
- RC = time constant of emitter circuit

Practical limits for R are between 200 ohms and 2.5 M Ω , depending on the characteristics of the unijunction device selected.

To secure proper switching of the magnetic core when the unijunction goes into conduction, the following inequality must be satisfied:

$$C \geq 10 \Phi H_c L / (\eta E_{bb})^2, \quad (2)$$

where:

- L = mean length of magnetic path,
- Φ = flux,
- H_c = coercive force.

With presently available tape-wound bobbin cores and unijunction transistors, Eq. 2 gives a practical lower limit for C of approximately 0.05 μ F.

The maximum value of C depends on the leakage current of the capacitor. Capacitors with sufficiently low leakage with respect to the peak-point emitter current of the unijunction transistor are available with capacitances in excess of 100 μ F. Under these limiting conditions, repetition rates of less than 0.005 Hz to more than 100 kHz are possible.

Pulse width and amplitude defined

The magnetic core that is used has a square

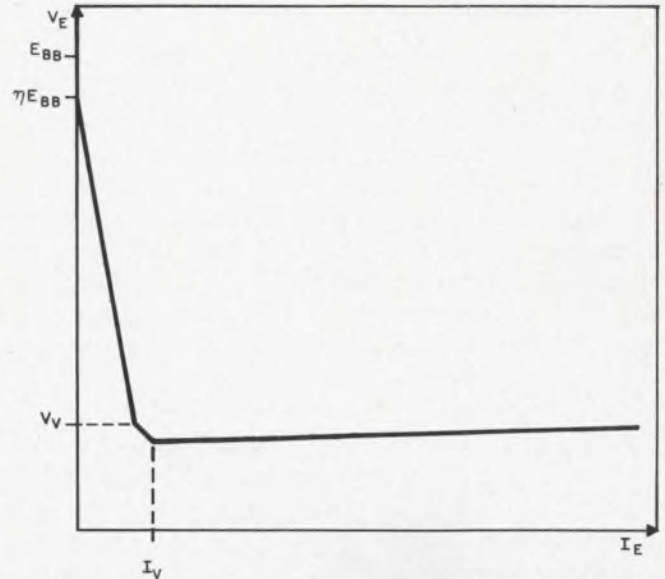

2. Static emitter characteristic of a typical unijunction transistor illustrates the operation of various circuits.

hysteresis loop as shown in Fig. 1b. Such cores have a constant volt-second capacity. The voltage across any winding on a transformer is given by:

$$e = N(d\Phi/dt),$$

where N = number of turns.

Integrating and rearranging give:

$$t = N\Phi/e.$$

When the unijunction goes into conduction (see Fig. 2), the voltage across N_p (primary winding) is:

$$E_{N_p} = \eta E_{bb} - V_v.$$

Therefore, the width of the output pulse, t , is

$$t = N_p \Phi / (\eta E_{bb} - V_v), \quad (3)$$

where:

$$\Phi \approx 2B_r A_c,$$

B_r = residual induction,

A_c = effective cross-sectional area of core;

and the amplitude of the output pulse, e_o , is:

$$e_o = (N_o/N_p)(E_{bb} - V_v). \quad (4)$$

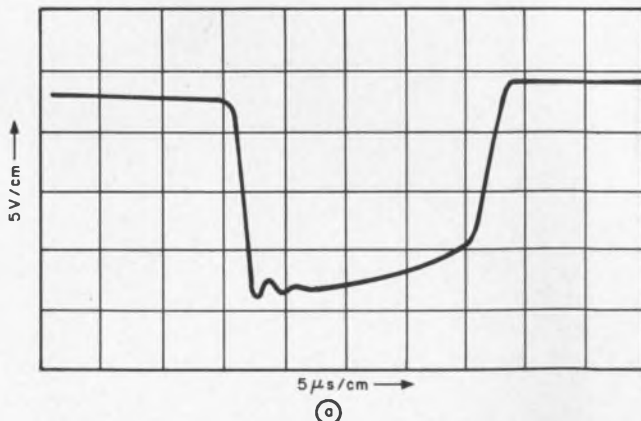

3. Rise and fall times of the output pulses heavily depend on the UJT type. Sharper pulses are possible with 2N2647

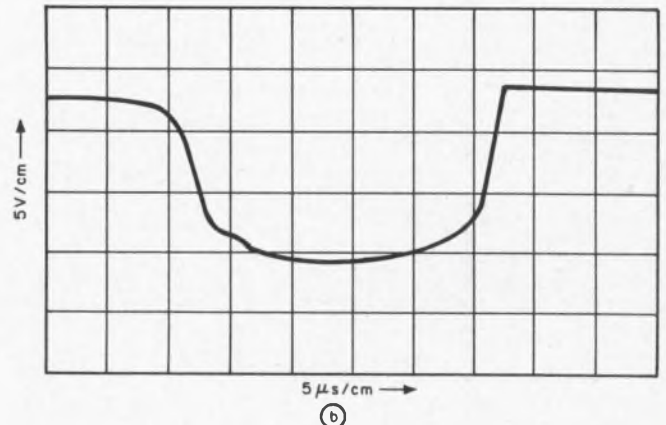

(a) than with the 2N489 (b) when used in the circuit of Fig. 4.

The pulses are sharp

The capacitance of a properly wound bobbin-core transformer and associated circuitry is quite small, and the impedance of the driving circuitry is relatively low at the instant the unijunction turns on. Therefore, the rise time of the pulse largely depends on the turn-on time of the transistor. The turn-on times of unijunctions, however, are not specified by manufacturers. Figure 3 illustrates the difference in pulse rise time of the circuit in Fig. 4 with different devices. Experience has shown these results to be consistent. That is, the newer types of unijunctions are faster.

The fall time of the output pulse is determined by how fast the core flux collapses after its level reaches B_r (see Fig. 1b). That is, the fall time depends on the rate of change of flux density with respect to time between the end points B_r and B_m . Therefore:

$$t_f = \frac{A_c N}{e} \int_{+B_r}^{+B_m} dB = \frac{A_c N}{e} (B_m - B_r),$$

where t_f = fall time.

Prior to saturation, the core supports the voltage across it for time T , given by:

$$T = \frac{A_c N}{e} \int_{-B_r}^{+B_r} dB = \frac{A_c N}{e} (2B_r),$$

Thus there is the useful approximation:

$$t_f/T \approx (B_m - B_r)/2B_r = (1/2)[(1/S) - 1], \quad (5)$$

where $S = B_r/B_m$ = squareness ratio of the core.

The importance of the squareness ratio is evident from Eq. 5. For Orthonal, which has a very high squareness ratio, the fall time can be less than 1% of the width of the output pulse.

Calculating the pulse power

When the unijunction transistor goes into conduction, the capacitor is discharged through the primary of the transformer and the emitter of the device. The energy stored in a capacitor is:

$$W = CV^2/2,$$

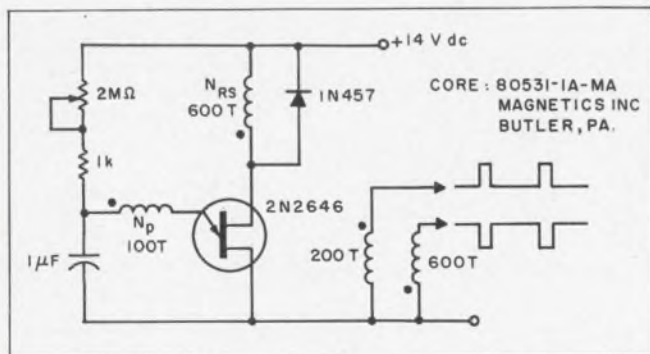

4. Using two secondaries results in output of opposite polarity. The diode across the reset winding, N_{RS} , clamps the small positive pulse occurring during the reset.

where:

W = energy

C = capacitance in farads

V = voltage across capacitor.

In order not to distort the output pulse shape, the energy delivered to the load must be much less than that stored in the capacitor:

$$P_{load} \ll [C(\eta E_{bb})^2]/2t, \quad (6)$$

where:

P_{load} = power delivered to load,

t = width of pulse.

Assuming C is large enough to satisfy the inequality of Eq. 6, the peak power that can be delivered, without regard to transformer losses, is:

$$P_{peak} = (E_{bb_{max}} - V_v) I_{E_{max}}$$

For most unijunctions:

$E_{bb_{max}} = 35$ volts,

$I_{E_{max}} = 2$ amps,

$V_v \approx 1.5$ volts.

These values allow a theoretical maximum power per pulse of approximately 50 watts. In practice, owing principally to capacitor characteristics, maximum attainable power is about 5 watts.

Core is reset with small bias current

Once the core has been switched, it must be reset. This is most easily accomplished with a small steady-state bias current. Such a current must be sufficient to produce a field in the core corresponding to H_q (see Fig. 1b) to ensure complete resetting. The reset field must oppose the switching field set up when the unijunction goes into conduction. Therefore, the polarity of the primary and reset windings must be opposite.

The reset current for the core is drawn through the interbase resistance of the unijunction. The required reset current is:

$$i_{RS} = H_q L/N = E_{bb}/R_{bb}, \quad (7)$$

where R_{bb} = interbase resistance of unijunction. Therefore, the number of turns on the reset wind-

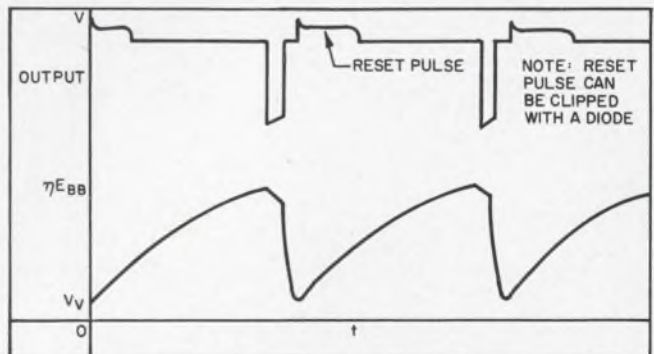

5. Switching action and output waveforms help to understand operation of the circuit of Fig. 4. Actual wave-shapes are depicted in Fig. 3.

ing is:

$$N_{RS} = H_q L R_{bb} / E_{bb} \quad (8)$$

If it is desired to reset the core by some other means, the applicable voltage and resistance can be substituted in Eq. 7.

A finite time is required to reset the core. To ensure proper resetting between successive pulses, the following inequality must be satisfied:

$$D < N_p / 2N_{RS} \times 100\%$$

where D = duty cycle.

The capacitor is charged at a rate that depends on the setting of the 2-M Ω potentiometer (Fig. 4). When the voltage across the capacitor reaches the peak-point emitter voltage (ηE_{bb}) of the unijunction, the device goes into conduction. The repetition rate, output pulse width and output amplitude are given by Eqs. 1, 3 and 4, respectively.

Operating an astable oscillator

A practical free-running circuit is shown in Fig. 4. The diode across the reset winding clamps the small positive pulse which occurs while the core is resetting. Figure 5 illustrates waveforms in the circuit. Photographs of the actual output pulses with two different unijunction transistors are shown in Fig. 3.

The circuit can be synchronized in the same manner as the usual unijunction relaxation oscillator. This is done by either raising the emitter voltage above the peak-point voltage or dropping the interbase voltage to a value such that $V_c > \eta E_{bb}$, where V_c is the voltage across the capacitor.

The frequency stability of a free-running oscillator is generally temperature-dependent. In extreme cases it may even require a temperature-controlled environment or temperature compensation.

With the latest available unijunctions, such as one recently announced by GE, however, many requirements can be met without such precautions;

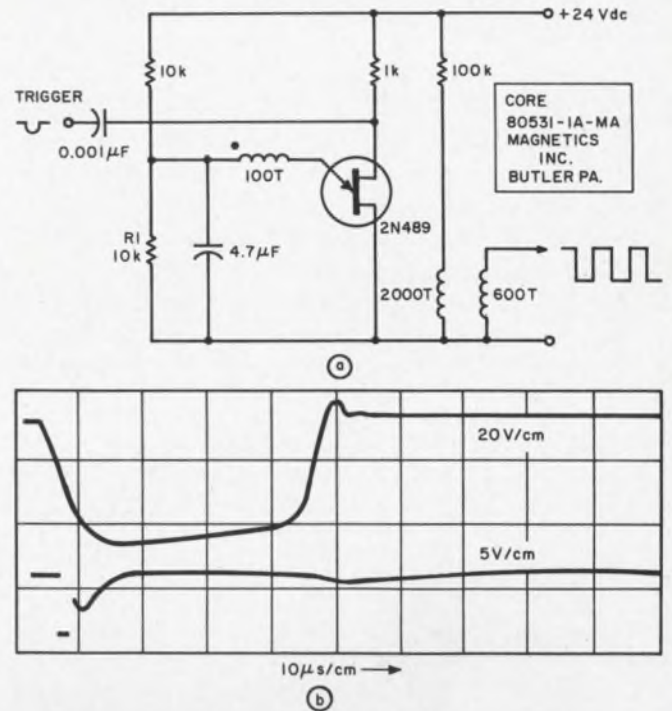

6. Monostable operation is possible by limiting the UJT's firing voltage by the addition of $R1$ (a). Trigger and output waveforms are shown (b).

that is, a single unijunction relaxation oscillator can be built to fulfill most frequency specifications. Where better stability is desired, the addition of a thermistor may be the answer.

Converting to monostable operation

Addition of $R1$ makes the circuit monostable, as shown in Fig. 6a, provided that:

$$V_v < [R1 / (R1 + R)] E_{bb} < \eta E_{bb}$$

Under this condition, an output pulse will be produced when the unijunction goes into conduction. The core will be properly reset by the bias current and the capacitor will charge up to the level set by the resistive divider. The circuit must then be triggered into conduction before the next output pulse appears. Figure 6b is a drawing of

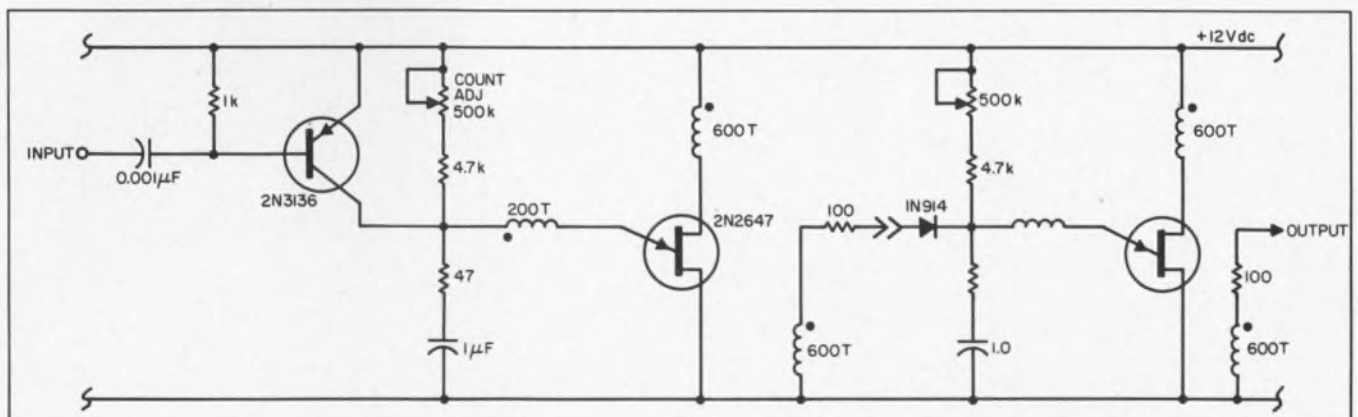

7. Pulse-counting is achieved by cascading basic UJT/core circuits. With sufficient number of turns on each

output winding, no interstage amplification is required. Stable supply voltage aids the performance.

the triggering and output pulses of the monostable circuit of Fig. 6a.

Pulse counting is possible

Two unijunction magnetic-core counter circuits are shown in cascade in Fig. 7. Each stage can divide by an integer from 1 to more than 50, depending on the stability of the supply voltage and environmental conditions.

The pnp transistor furnishes emitter triggering to the first stage. There are sufficient turns on each output winding to drive the next counter

directly without further amplification or isolation. Any number of counter stages may thus be cascaded directly. The only limitation is the maximum RC time constant possible for the unijunction emitter circuit. The 500-k Ω potentiometers in each section vary the natural period of the stage and thereby the count. The 47-ohm resistor in series with the timing capacitor increases the input impedance without degrading performance.

MKS system used for calculation

All calculations should be made by the mks system. Table I gives useful conversion factors. Table II lists some useful Orthonal core parameters. ■ ■

Table 1. Conversion factors

Quantity	Symbol	Emu system	Mks system
Magnetic field intensity	H	oersteds $\times 10^3/4\pi$ (Oe)	ampere-turns/ meter (AT/m)
Flux	Φ	maxwells $\times 10^{-8}$ (Mx)	webers (Wb)
Flux density	B	gauss $\times 10^{-4}$ (G)	webers/square meters (Wb/m ²)

Bibliography:

- Cleary, J. F. (ed.). *Transistor Manual* (6th ed.). Syracuse, N. Y.: General Electric Co., 1962. Pp. 191-195.
- Design Manual Featuring Tape-Wound Cores*. Glendale, Calif.: Magnetics, Inc., 1962. Pp. 33-60.
- Meyerhof, Albert J. *Digital Applications of Magnetic Devices*. New York: John Wiley & Sons, 1960. Chaps. 4 and 5.
- Strauss, Leonard. *Wave Generation and Shaping*. New York: McGraw-Hill Book Co., 1960. Chaps. 11 and 13.

Table 2. Bobbin core parameters

Case dimensions			Mean length (cm)	Window area (cm $\times 10^6$)	Permalloy 80 flux capacity (Maxwells)				Orthonal flux capacity (Maxwells)			
I.D.	O.D.	Ht.			1/8	1/4	1/2	1 mil	1/8	1/4	1/2	1 mil
.100	.220	.100	1.20	.0100	30	50	80	100	60	100	160	200
.130	.250	.100	1.45	.0170								
.165	.285	.100	1.70	.0270								
.225	.345	.100	2.20	.0505								
.100	.200	.170	1.20	.0100	60	100	160	200	120	200	320	400
.130	.250	.170	1.45	.0170								
.165	.285	.170	1.70	.0270								
.225	.345	.170	2.20	.0505								
.290	.410	.170	2.70	.0840								
.350	.475	.170	3.20	.1225								
.410	.535	.170	3.70	.1680								
.475	.600	.170	4.20	.2260								
.225	.380	.170	2.30	.0505	90	150	240	300	180	300	480	600
.290	.440	.170	2.80	.0840								
.350	.500	.170	3.30	.1225								
.225	.410	.170	2.40	.0505	120	200	320	400	240	400	640	800
.290	.475	.170	2.90	.0840								
.350	.535	.170	3.40	.1225								
.410	.600	.170	3.90	.1680								
.475	.660	.170	4.40	.2260								
.290	.600	.170	3.00	.0840	150	250	400	500	300	500	800	1000
.350	.565	.170	3.50	.1225								
.410	.625	.170	4.00	.1680								
.475	.690	.170	4.50	.2260								
.220	.380	.305	2.30	.0485	180	300	480	600	360	600	960	1200
.285	.440	.305	2.80	.0810								
.345	.505	.305	3.30	.1190								
.405	.565	.305	3.80	.1640								
.470	.625	.305	4.30	.2210								
.285	.475	.305	2.90	.0810	240	400	640	800	480	800	1280	1600
.345	.535	.305	3.40	.1190								
.405	.600	.305	3.90	.1640								
.470	.660	.305	4.40	.2210								

*Will
the new
Alfred
6400 Series
Sweeper
make all
other
single-band
sweepers
obsolete?*

*(You be
the
judge)*

We've taken all the advanced features of the best selling Alfred 650 Series with plug-in oscillator heads and packaged them in a single-band sweeper, and users tell us the Series 650 is the most important breakthrough in sweeper technology yet.

Alfred 6400 Series Sweepers cover the frequency range of 1 to 40 GHz. Select from a full line of grid and PIN diode leveled units with internal and external sampling.

Only Alfred offers all these features in a Single-Band Sweeper. Fifty db power control range, leveled or unleveled ☹ Three independently controlled rf markers for broadband sweep, two for narrow band ☹ Low power consumption, no blower needed, 50/400 Hz operation for airborne or remote applications ☹ RF output frequency and marker accuracy better than 1% ☹ Frequency stability better than 0.01% ☹ Residual FM ranges from 0.001% to 0.003% ☹ Low prices start at \$2850.



Your full service Alfred Sales Engineer has the rest of the story. Call him today to arrange a demonstration or get a complete technical description (see EEM or MEH for his phone). Or you may write Alfred Electronics, 3176 Porter Drive, Palo Alto, California.

ALFRED ELECTRONICS

Project responsibility opportunities exist for qualified engineers on our technical staff. An equal opportunity employer.

COMPUTER

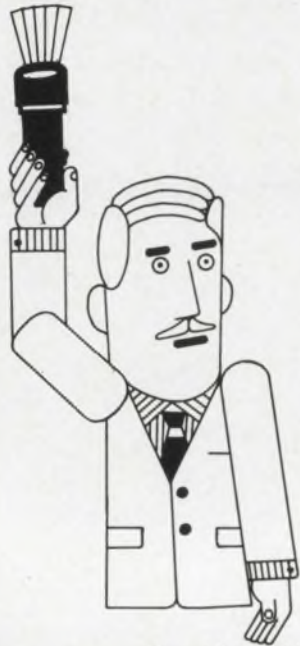

Signal Fairchild
for small signal devices
PRODUCT SELECTOR

MILITARY



Signal Fairchild
for small signal devices
PRODUCT SELECTOR

INDUSTRIAL



Signal Fairchild
for small signal devices
PRODUCT SELECTOR

CONSUMER



Signal Fairchild
for small signal devices
PRODUCT SELECTOR

FAIRCHILD
SEMICONDUCTOR

Please send me

- Military small-signal device selection guide
(Military computers, radar, etc.)
- Industrial small-signal device selection guide
(Instruments, test equipment, etc.)
- Consumer small-signal device selection guide
(AM, FM, TV, etc.)
- Commercial computer small-signal device selection guide
(Core drivers, logic switches, lamp drivers, etc.)

Name _____

Company _____

Title _____

Address _____

City _____ State _____ Zip _____

Four new, Fairchild selection guides for small-signal transistors and diodes. The easiest way to choose the optimum device for your new design.

Free.

Fairchild Semiconductor ■ A Division of Fairchild Camera and Instrument Corporation ■ 313 Fairchild Drive, Mountain View, California 94040 (415) 962-5011 ■ TWX: 910-379-6435

ON READER-SERVICE CARD CIRCLE 39

Inertial damping lends itself well

to high-velocity servosystems. The performance is good and the cost moderate.

High-velocity servomechanisms are finding increasing application in instrument, control and data-processing systems. These systems must have high tracking rates coupled with high accuracies, and therefore require servos with exceptionally high velocity constants (see Box). This requirement for high velocity constants, K_v , in turn means that particular attention must be paid to stabilization. Of the damping methods suitable for stabilization, inertial damping has certain definite advantages. For purposes of comparison, alternative damping techniques and their system configurations are shown in Fig. 1.

Inertial damping has inherent advantages

Servomechanism design involves trade-offs among speed, accuracy, and stability. High K_v designs emphasize high speed and high accuracy at the expense of stability. The key to such design, therefore, is to choose a damping method that provides adequate stability, yet is consistent with the high-speed and high-accuracy parameters. The inertially damped servo system has inherent characteristics that enable it to meet these criteria.

The inertially damped servomotor (Fig. 2) has a high-inertia, permanent-magnet flywheel freely rotatable on its own bearings about an extension of the servo motor's gear shaft. A low-inertia conducting cup made of aluminum is fixed to the shaft and rotates in the field of the permanent magnet flywheel. A drag torque on the motor shaft is thus generated, which is proportional to the difference in rates between the motor shaft (conducting cup) and the flywheel. This type of damping is smooth when the servomechanism is changing rates and vanishes at constant rates, thus allowing high resolution of servo error. The technique yields K_v 's that have approached infinity in practical production packages.

In contrast with some other damping methods, inertial damping is not introduced as an electrical

signal fed through the servo-amplifier, and is thus unaffected by amplifier characteristics. It occurs directly as a drag on the motor shaft during periods of acceleration. It continues to be effective in the presence of noise, large saturation transients and other nonlinearities of instrument servomechanisms. Inertially damped servos operate well under conditions where backlash would otherwise lead to unacceptable oscillations. Furthermore, an inertially damped servomechanism can track smoothly at slow speeds, thereby nullify-

The velocity constant K_v .

The velocity constant of a Type-1 servomechanism is defined as:

$$K_v \left(\frac{\text{length}}{\text{seconds}} \right) = \frac{\text{servo tracking rate (deg/s)}}{\text{servo lag error (deg)}};$$

similarly:

$$\text{Lag error (deg)} = \frac{\text{servo rate (deg/s)}}{K_v \text{ (1/s)}}$$

The lag error, as defined by K_v , is a key accuracy parameter in high-speed servo applications. Consider, for example, a tracking station with a program tracking antenna slaved through an instrument (repeater) servo. The antenna has a 0.5° high-gain pattern and is following the ascent of a missile. Clearly, high-resolution data are desired at the critical point of first-stage separation. Assuming the antenna has a tracking rate of $40^\circ/\text{s}$ and the servo has a K_v of 100—a value found in ordinary servo systems—at the instant of first-stage separation:

$$\begin{aligned} \text{Lag error} &= \frac{40^\circ/\text{s}}{100 \text{ 1/s}} \\ &= 0.40^\circ. \end{aligned}$$

A 0.40° lag error results in reduced antenna gain; hence, received signal power is lost and data are degraded. The accuracy of tracking rate is not in question, but rather the consistent lag introduced at the slaved antenna.

Various manufacturers make inertially damped servo systems for high-speed applications with K_v 's of 2000 to 5000. Lag error in these units is correspondingly reduced to 0.02° to 0.008° . These systems also have the advantages of reduced size and high reliability.

Ralph Bursley, Chief Engineer, Superior Manufacturing and Instrument Corp., Long Island City, N. Y.

Figure 1. Other damping methods

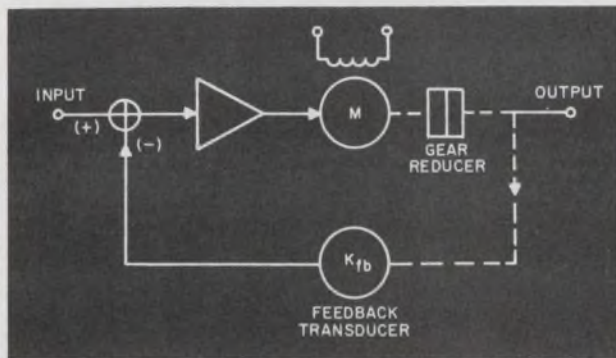

a. **Servomotor internal damping**—Where overshoot is not critical and a bandwidth of 50 rad/s or less is required, internal damping of the servomotor may be sufficient. Generally this technique is only applicable in cases where velocity constants and load friction are moderate.

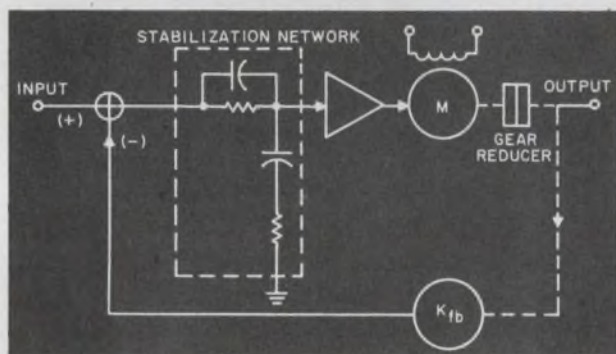

c. **Electrical network damping**—This performs well at high K_v s of 2000 and above. It is a flexible approach, adjustable for various desired dynamic properties. The design is inherently complicated and expensive, however, in ac servomechanisms. Most electrical components are subject to the usual reliability limitations. In addition, some forms of electrical network damping have the added disadvantage of accentuating systems noise.

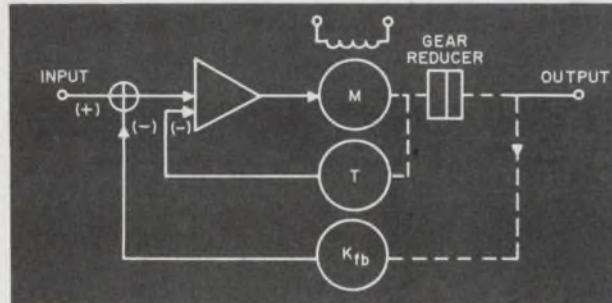

b. **Tachometer damping**—The most popular method of damping, it is easy both to use and to adjust. For high-speed servo applications, however, tachometer damping often becomes ineffective if the K_v is greater than 400 to 500. The input amplifier tends to saturate under high-gain conditions from noise and other transients, as well as from tachometer quadrature (parasitic, out-of-phase feedback) voltage. However, a tachometer-damped servo is useful where very high accelerations are imposed, or where high output shaft stiffness is required.

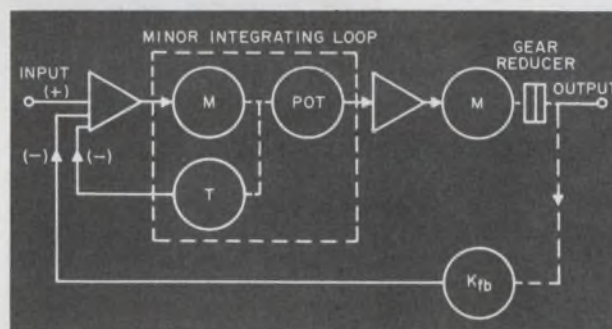

d. **Electromechanical damping**—With a minor integrating loop, this can provide an almost infinite K_v . It has high performance characteristics and flexibility to suit a variety of applications. But it requires an extra servomotor, which involves added expense and could be a source of trouble.

ing irregularities introduced by friction and cogging.

Unlike tachometer-damped servos and many network-damped servos, the loop gain of an inertially damped servomechanism is not reduced by the damping method. Inertially damped servos operate at lower amplifier gains and therefore reduce the effect of noise and other unwanted pick-up that would saturate or adversely affect the dynamic properties of a high-gain loop.

Limited bandwidth serves purpose

At first glance, it might seem that inertial damping tends to resist fast changes in velocity and thus has limited application to systems involv-

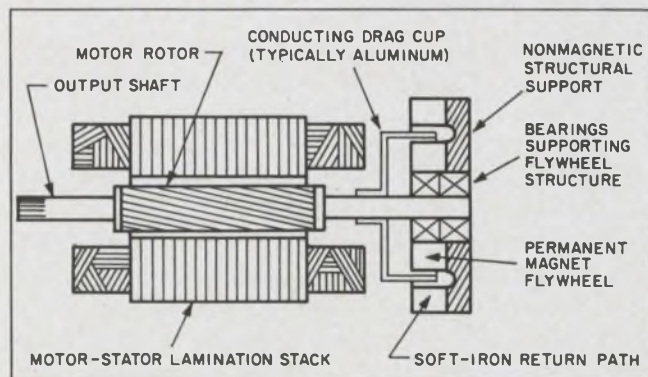

2. Drag torque is generated on the motor shaft of an inertially damped servomotor by the interaction of the magnetic field of the flywheel and the conducting drag cup. Damping is smooth when the servomotor operates at changing rates and drops to zero at constant rates.

Table. Comparison of damping method characteristics

	Undamped servomechanism	Tachometer	Electrical	Electromechanical	Inertial
High K_v	No	Moderate	Yes	Yes	Yes
High K_a (acceleration constant)	No	Yes	Yes	Moderate	Moderate
Ease of application	Yes	Yes	Moderate	Moderate	Yes
Low-gain operation (input amp)	Yes	No	No	Yes	Yes
Simplified design	Yes	Yes	No	No	Yes
Low cost	Yes	Moderate	No	No	Moderate
Temperature stability	Yes	Yes	Moderate	Moderate	Yes
Small package	Yes	Moderate	—	No	Moderate

ing rapid acceleration and deceleration. But as a matter of fact, the limited bandwidth of an inertially damped loop is an advantage.

High K_v loops often tend to have unreasonably wide bandwidths. But with the inertially damped system, the cutoff above a certain input frequency has the positive advantage of eliminating the effect of noise and spurious transients. Moreover, the inertially damped servomechanism's lower cutoff point cuts out frequencies associated with time lags due to resiliencies, secondary time constants and similar time lags, which, although usually ignored, can create problems.

Normally, single-phasing, or the tendency of a servomotor to run with zero control voltage, is considered a defect. This is because single-phasing accentuates the loop stabilization problem (damping is usually dependent upon an error voltage). But since inertial damping provides the necessary stabilization as a direct mechanical torque applied to the motor shaft, an inertially damped servo motor can be designed single-phased to track at any required speed within its range with virtually zero velocity lag.

Selection is important

Probably the principal deterrent to more widespread use of inertially damped servos is their more complex open-loop Bode plots (Fig. 3) and the difficulty of adjusting breadboard parameters. However, the range of available inertially damped motors usually outweighs this difficulty. With a correctly chosen standard motor, the setting of the servo-amplifier gain simultaneously brings about both the performance characteristics and the stability desired. A further increase in gain leads to the usual trade-off between K_v and stability margin.

For example (Fig. 3), ω_1 , ω_2 , ω_3 are the corner frequencies of a servo as specified by the manufacturer, and ω_c is the 0-dB crossover frequency. K_v

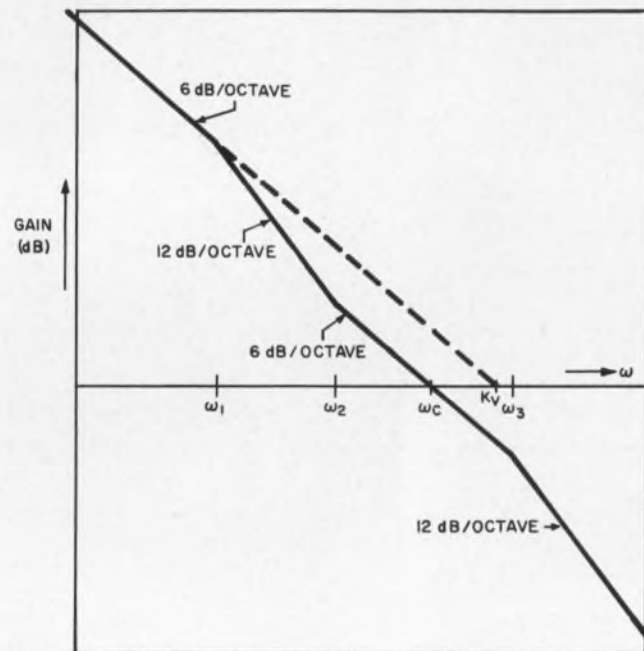

3. Velocity constant (K_v) can be calculated from the Bode plot of an inertially damped servomotor with corner frequencies of ω_1 and ω_2 , and 0-dB crossover frequency of ω_c .

can be calculated from the Bode plot by means of the equation:

$$K_v = \omega_c (\omega_2/\omega_1).$$

Gain can then be increased until $\omega_c = \omega_3$ while still maintaining a good stability margin (45°). Basically, therefore, the example shows that this correctly selected inertially damped servo requires only one adjustment for best performance of all requirements.

A quick comparison of inertial damping with other commonly used damping techniques is given in the Table. The information given has been generalized because of the fact that actual characteristics vary widely. ■ ■

What kind of a Linear Monolithic IC do you get when you put a Bipolar and a MOS/FET on a single chip ?

A BiFET, naturally.



The BiFET's unusual coupling of bipolar and MOS/FET performance on a single chip gives you the unique combination of high input resistance, high transconductance and low noise with high voltage capability.

That's not all. The Amperex BiFET, type TAA320, unlike conventional MOS/FETS can take input transients of 100 volts; it is immune to burnout from static charge and requires no special handling.

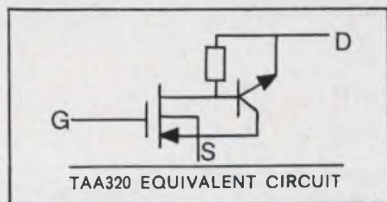

As we see it, the TAA320 is, without qualification, the optimum audio frequency semiconductor device; it's a linear, monolithic IC in a TO-18 with:

- g_m of 50,000 μmhos
- R_{GS} of 10,000 megohms
- V_{GS} of 100 V.

It's available, now, off-the-shelf, in production quantities for under \$1.00. Its low price and its unusual range of applications makes the TAA320 BiFET ideal for large volume production in consumer, professional and industrial applications. It is not only a most universal device, it simplifies circuitry, eliminates discrete components, is extremely simple to work with.

Although it is optimum for audio functions, its importance for professional and industrial applications cannot be overlooked. One TAA320 is a complete preamp and driver for a tape recorder or a high quality phonograph; it's a low-cost IC for timing circuits; an impedance converter; the perfect IC for active filters; it's a high impedance IC for sensing probes that withstand 100 volt transients; it's... it's actually a new, simple, basic building block for electronic circuit designers!

For data and detailed applications information on the TAA320 BiFET and other, new, volume-priced, linear monolithic IC's write: Amperex Electronic Corporation, Microelectronics Division, Dept. 371, Slatersville, Rhode Island, 02876.

Amperex®

TOMORROW'S THINKING IN TODAY'S PRODUCTS

On your mark...get set...draw!

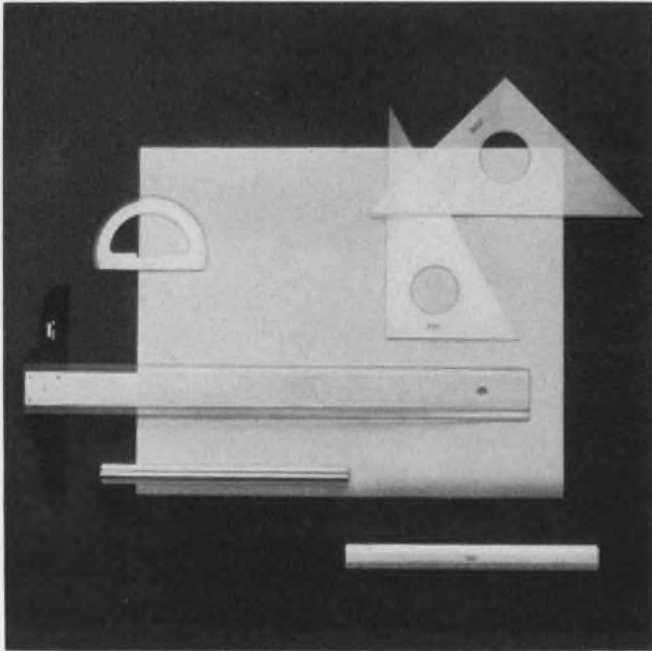

Tools: T square, straightedge, triangle, protractor, scale.

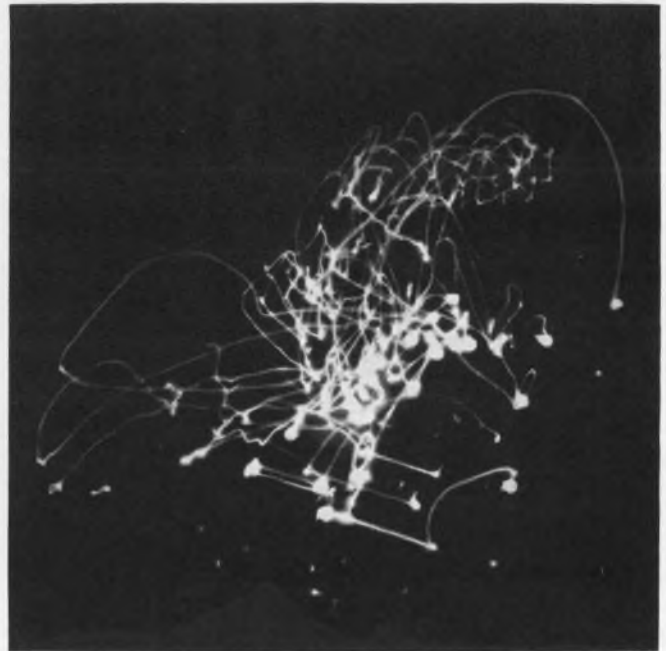

Here are the movements required to make a simple drawing with the "old, accepted" instruments. Photo was made by taping a light to a draftsman's wrist. Time: 2 hours, 11 minutes.

On your mark...get set...draw!

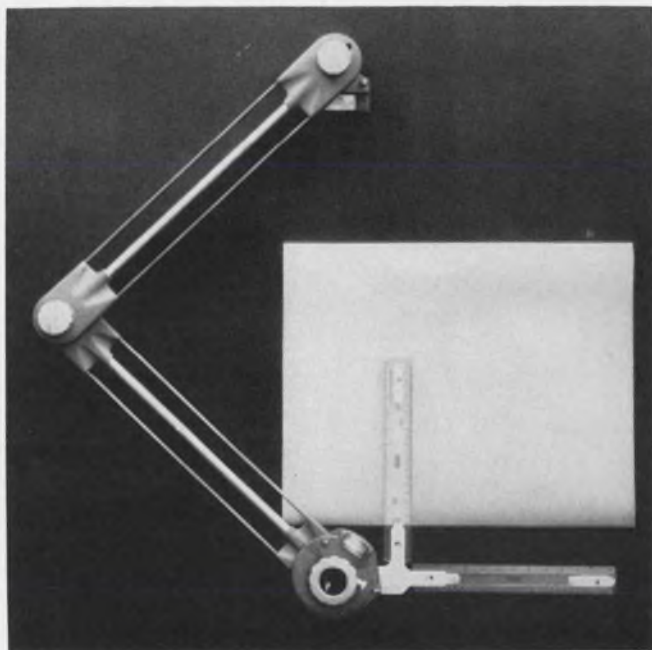

Tool: Bruning Equipoise drafting machine.



Here are the considerably fewer movements required with the Bruning Equipoise. Time: 1 hour, 31 minutes.

The winner: Bruning Equipoise. Your Bruning man can tell you all about the Equipoise (and other Bruning drafting machines). Give him a call. He's listed under Bruning or Addressograph Multigraph in the telephone directories of 155 major cities. Or write Dept. D, Mt. Prospect, Illinois.

Bruning is a U.S. Reg. Trademark of A. M. Corp.

 **Bruning**
Division of Addressograph Multigraph Corp.

ON READER-SERVICE CARD CIRCLE 41

ON READER-SERVICE CARD CIRCLE 42 ➤

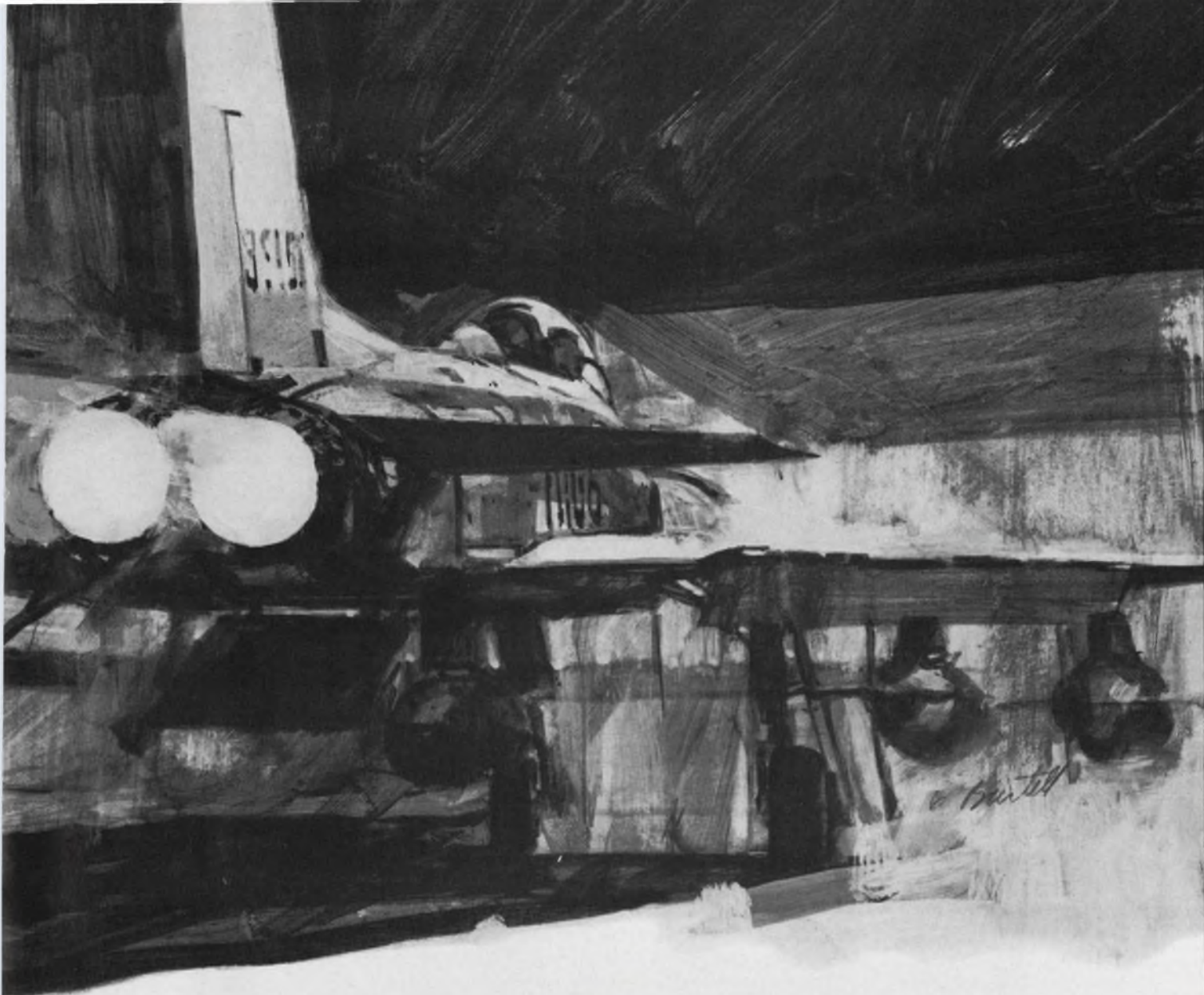

When the heat's on... take the pressure off with Cannon® firewall plugs

Designed to increase maintainability and dispatch-reliability, ITT Cannon's new high performance FRF - firewall - connectors meet tomorrow's high temperature and fluid resistance requirements... in jet aircraft, missiles, and propeller aircraft.

These lightweight connectors exceed the requirements of MIL-C-5015, Class K, and feature front release, rear insertion, crimp snap-in MIL-C-39029 type contacts. They also operate

continuously in temperatures from -55°F to $+400^{\circ}\text{F}$



and up to 2000°F for short term. Besides saving weight by 25%, and assembly and servicing time by 200%, ITT Cannon's FRF plugs offer superior environmental sealing and feature high temperature elastomers which are compatible with aircraft fluids. Other features? One-piece steel shell and barrel hardware... optional self-locking coupling nut... rugged metal clip retention

system... intermateability with MIL-C-5015 connectors.

When the heat's on (for any connector application) let ITT Cannon take the pressure off. For our FRF catalog, write ITT Cannon Electric, 3208 Humboldt Street, Los Angeles, California 90031.

A division of International Telephone and Telegraph Corporation.



CANNON ITT

If you need active filters with flat amplitude and time delay responses, discard the classical approach. A simple method yields the correct circuit quickly.

Most filter designers take either the time-domain or the frequency-domain approach. The choice depends on the relative importance of these two components of the signal. In the vast majority of signals, however, both time- and frequency-domain components have to be taken into consideration. In fact, the design of filters that combine flat amplitude response with flat time delay has not received its share of attention, mostly because of the unwieldy nature of the classical approach.

A new concept for the design of these filters yields relatively simple equations for the amplitude response and component values. It is based on achieving a smooth transition from a flat-amplitude (Butterworth) filter to a flat-time-delay (linear-phase) filter, and then selecting an intermediate response, and is chiefly applicable to two-pole filters.

To appreciate the advantages of the compromise filters, the characteristics of the Butterworth and linear-phase types should be briefly examined.

Why is a compromise needed?

The Butterworth filters, sometimes called maximally flat-amplitude filters, have an amplitude response curve that has minimum attenuation throughout the largest percentage of the frequency band from dc to the cutoff frequency of the filter.

Because its attenuation is ideally flat over a nonzero band of frequencies, it cannot provide a phase shift that increases linearly as the input frequency is increased. When a step function is applied to the input, the nonlinear phase-shift characteristic causes the output to overshoot substantially and to swing above and below the

final value in a damped oscillation, finally settling at the steady-state output value.

The linear-phase filter is characterized by a phase shift that increases almost linearly as the input frequency is increased from dc to the cutoff frequency. Since the phase-shift curve is ideally linear, the slope of the phase-shift curve (or rate of change of phase versus frequency) is constant, yielding an ideally flat envelope delay curve. This means that all frequencies below the cutoff frequency will be delayed equally as they pass through the filter. Because the envelope delay is constant over a nonzero band of frequencies, this filter cannot provide an amplitude response curve that is flat as the input frequency is increased.

In summary, the Butterworth has the flatter amplitude response, the greater percentage of overshoot and the longer settling time to a given accuracy. The linear-phase has the poorer amplitude response, relatively little overshoot and the shorter settling time.

The Butterworth filter is better suited to filter noise and harmonics from signals that are predominantly in the frequency domain, such as a continuous sine wave. The linear-phase filter is better suited to filter noise from signals that are predominantly in the time domain, such as vibration signals.

Whenever both components have to be taken into account, the Butterworth filter's overshoot characteristic will result in poor performance for the time-domain signals, and a true linear-phase filter will lead to attenuation of some of the important frequency-domain signals. It is clear that a filter with less overshoot than the Butterworth and flatter amplitude response than the linear-phase would give optimum over-all system performance.

Transition between extremes is easy

It is possible to adjust filter characteristics in a smooth, continuous fashion from those of the Butterworth to those of the linear-phase. These

Robert S. Melsheimer, Product Manager, Astrodata, Inc., Anaheim, Calif.

"in between" filters with compromise characteristics are named transitional Butterworth-Thompson (TBT) filters.

For the transition between the two extreme characteristics, the design equations of both types are needed. The two basic types of two-pole active filter are shown in Fig. 1. The potentiometric type is simpler, so it will serve as a model for both analyses. The transfer function may be derived and the amplitude and phase responses found by solving the two nodal equations:

$$[(e_1 - e_i)/R_1] + [(e_1 - e_o)/R_2] + (e_1 - e_o)C_1 p = 0, \quad (1)$$

$$[(e_o - e_1)/R_2] + e_o C_2 p = 0. \quad (2)$$

The transfer function is:

$$\begin{aligned} e_o/e_i &= 1/[1 + (R_1 C_2 + R_2 C_2)p + R_1 R_2 C_1 C_2 p^2] \\ &= 1/(1 + a_1 p + a_2 p^2), \end{aligned} \quad (3)$$

where:

$$a_1 = R_1 C_2 + R_2 C_2, \text{ and} \quad (4)$$

$$a_2 = R_1 R_2 C_1 C_2. \quad (5)$$

Substitute $p = j\omega$ into Eq. 3:

$$\begin{aligned} f(j\omega) &= 1/(1 + ja_1\omega - a_2\omega^2) \\ &= 1/[(1 - a_2\omega^2) + ja_1\omega]. \end{aligned} \quad (6)$$

The amplitude response is the absolute value of Eq. 6:

$$\begin{aligned} A &= |f(j\omega)| \\ &= 1/[(1 - a_2\omega^2)^2 + a_1^2\omega^2]^{1/2} \\ &= 1/[1 + (a_1^2 - 2a_2)\omega^2 + a_2^2\omega^4]^{1/2}. \end{aligned} \quad (7)$$

The amplitude response of a two-pole Butterworth filter is:

$$A_B = 1/[1 + (\omega/\omega_c)^4]^{1/2}; \quad (8)$$

hence $a_2 = 1/\omega_c^2$, $a_1^2 - 2a_2 = 0/\omega_c^2$ and $a_1 = 2^{1/2}/\omega_c$ where $\omega_c = 2\pi f_c$ is defined as the cutoff frequency. Once a_1 and a_2 are known, the values of C_1 and C_2 may be found in terms of R_1 , R_2 and ω_c with the aid of Eqs. 4 and 5.

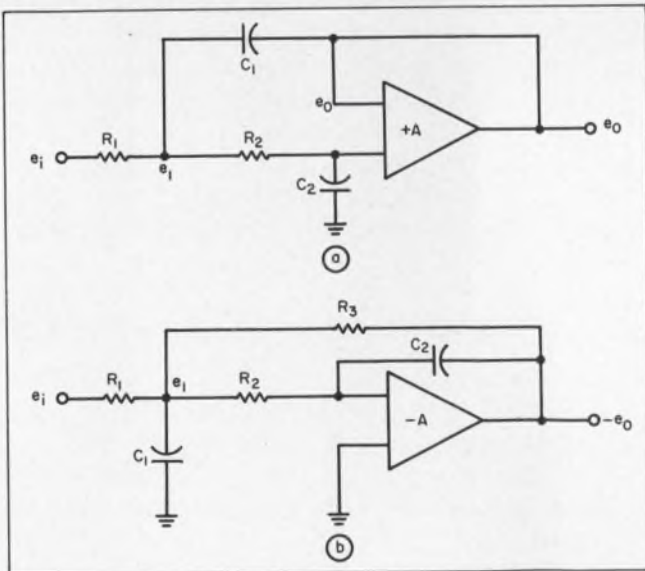

1. The two basic active filters are the potentiometric type (a), with a dc gain of unity, and the operational type (b), with a dc gain of $-R_3/R_1$. The potentiometric one is used for the analyses in the text.

The amplitude response of the two-pole linear-phase filter is:

$$A_{LP} = 1/[1 + (\omega/\omega_c)^2 + (\omega/\omega_c)^4]^{1/2}; \quad (9)$$

hence $a_2 = 1/\omega_c^2$, and $a_1^2 - 2a_2 = 1/\omega_c^2$. Therefore $a_1 = 3^{1/2}/\omega_c$, and again the values of C_1 and C_2 are found in terms of R_1 , R_2 and ω_c from Eqs. 4 and 5.

Parameter of transition is introduced

As the filter characteristic is changed from Butterworth to linear-phase, the factor $a_2\omega_c^2$ remains constant at 1, while the factor $(a_1^2 - 2a_2)\omega_c^2$ changes from 0 to 1.

If the parameter μ is introduced so that:

$$(a_1^2 - 2a_2) = \mu/\omega_c^2 = 2[\sin(m\pi/6)]/\omega_c^2, \quad (10)$$

μ will vary from 0 to 1 as the term m varies linearly from 0 to 1. The term m is the commonly used dimensionless factor that determines the precise characteristic of a TBT filter in terms of its pole locations. As expected, both μ and m are zero for the Butterworth filter and unity for the linear-phase filter.

The amplitude response of a TBT filter may be found from Eqs. 10 and 7, where:

$$a_1^2 - 2a_2 = \mu/\omega_c^2 \text{ and } a_2 = 1/\omega_c^2;$$

so:

$$a_1 = (2 + \mu)^{1/2}/\omega_c. \quad (11)$$

By substitution into Eq. 7, the amplitude response is found to be:

$$A_{TBT} = 1/[1 + \mu(\omega/\omega_c)^2 + (\omega/\omega_c)^4]^{1/2}. \quad (12)$$

The variation of the response with m is shown in Fig. 2.

The phase shift is defined by the phase angle of $f(j\omega)$ and is given by:

$$\begin{aligned} \phi_{TBT} &= \tan^{-1}[-a_1\omega/(1 - a_2\omega^2)] \\ &= \tan^{-1}\{[-(2 + \mu)^{1/2}(\omega/\omega_c)]/[1 - (\omega/\omega_c)^2]\}. \end{aligned} \quad (13)$$

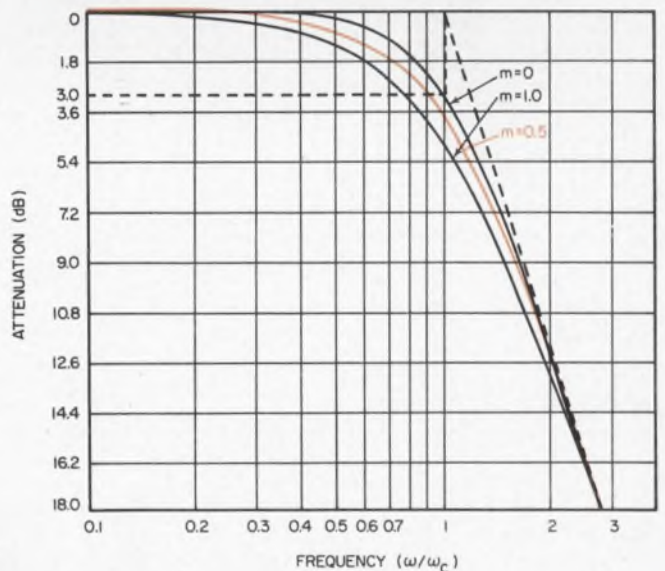

2. Amplitude responses of two-pole Butterworth ($m = 0$), linear-phase ($m = 1$) and transitional filters ($m = 0.5$) show that only the Butterworth type has cutoff and 3-dB attenuation at the same frequency (dashed line).

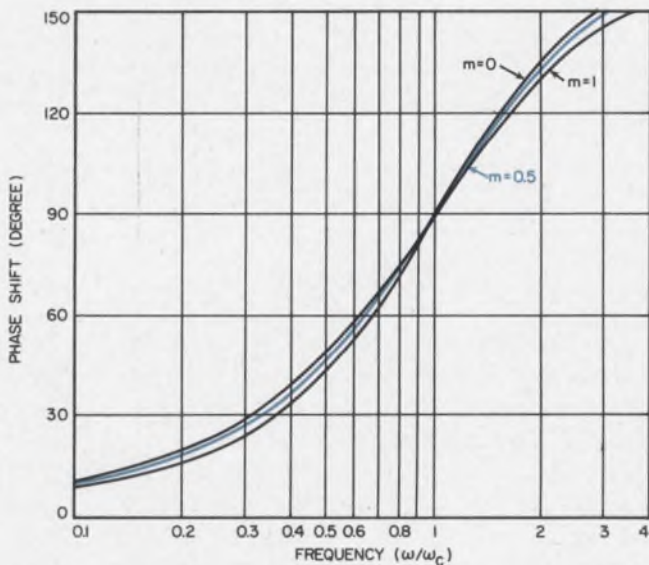

3. Phase shifts of the three filter types show intermediate characteristic of a TBT filter ($m = 0.5$).

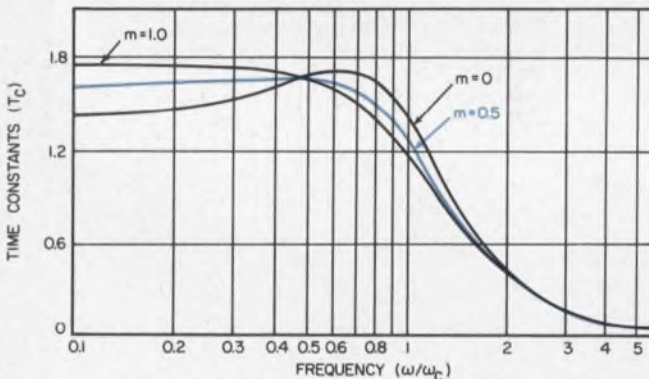

4. Plots of envelope delays emphasize the nonlinear characteristic of the Butterworth type ($m = 0$), that leads to large overshoot when the input is a step function. The TBT filter's response is shown in color.

The phase shifts for $m = 0, 0.5$ and 1 are plotted in Fig. 3.

The envelope delay is given by the derivative of the phase shift with respect to ω :

$$T_{eTBT} = \frac{d\phi_{TBT}}{d\omega} = \frac{[a_1(1+a_2\omega^2)]/[1+(a_1^2-2a_2)\omega^2+a_2^2\omega^4]}{[(2+\mu)^{1/2}/\omega_c][1+(\omega/\omega_c)^2]} = \frac{1+\mu(\omega/\omega_c)^2+(\omega/\omega_c)^4}{1+\mu(\omega/\omega_c)^2+(\omega/\omega_c)^4} \quad (14)$$

Figure 4 shows that the TBT filter's ($m = 0.5$) envelope delay falls between the two extremes, as expected.

Note that the "zero frequency" time delay, where $\omega = 0$, is:

$$T_{0TBT} = \frac{(2+\mu)^{1/2}}{\omega_c} = T_c(2+\mu)^{1/2},$$

or $(2+\mu)^{1/2}$ time constants, where one time constant, T_c , is defined as:

$$T_c = 1/\omega_c = 1/2\pi f_c.$$

Note, too, that $\mu = m$ only when $m = 0$ and $m = 1$. Between these two values of m , μ differs from m by a small amount, reaching a maximum

difference of about 0.018 when $m = 0.565$. The use of m for μ in the equation defining the performance of TBT filters results in errors that are small enough to be neglected in most practical applications.

The equations for the amplitude response, phase shift and envelope delay of the TBT filters may also be applied to two-pole Gaussian and overdamped filters by letting $\mu = 2$ for Gaussian filters and $\mu = 3$ for overdamped filters. For the sake of convenience, the major equations for the Butterworth, linear-phase and TBT filters are tabulated in Table 1.

Table 2 lists the amplitude response of low-pass TBT filters and the frequencies (expressed as a fraction of the cutoff frequency) at which the attenuation is 1%, 10%, 3 dB, 6 dB and 20 dB. As the filter characteristic is varied from Butterworth to linear-phase, the frequency at which the attenuation is 1% changes by a factor of more than 2.6:1, while the frequency at which the attenuation is 20 dB remains nearly constant, changing by a factor of less than 1.03:1. The latter is predictable, since the asymptotes of the normalized frequency response curves of all two-pole filters are coincident.

If the asymptote is extended back toward zero frequency in a straight line, it will intersect the axis denoting 0-dB loss at the cutoff frequency. For this reason that point is often called the "corner frequency." Figure 2 shows that the cutoff frequency and the frequency at which the attenuation is 3 dB are the same only for the Butterworth filter.

The response of low-pass TBT filters to a step function appears in Table 3. This lists the initial overshoot as a percentage of final value, and the time (in time constants) at which the peak occurs. It also lists the number of time constants required for the output to settle to within $\pm 1\%$, $\pm 0.1\%$ and $\pm 0.01\%$ of the final value. A dramatic reduction in the magnitude of the initial overshoot is observed as the filter characteristic is varied from Butterworth to linear-phase; however, the time required for the output to settle to within a given accuracy remains relatively constant for all values of m .

Example demonstrates design method

The design procedure for TBT filters can be illustrated with a typical example. It is assumed that the requirement is for a simple, low-pass, active filter that will overshoot less than 3% of final value in response to a step input, and that will have less than 1% attenuation at 250 Hz and at least 20-dB attenuation at 4 kHz.

A sequence of eight steps leads to the solution:

1. From the data in Table 3 find m . It is clear that all two-pole TBT filters with m equal to or

Table 1. Major design equations for two-pole TBT filters

Parameter	Butterworth (m = 0)	Transitional Butterworth-Thompson $\mu = 2 \sin \frac{m\pi}{6}, 0 \leq m \leq 1$	Linear phase (m = 1)
Amplitude response	$\frac{1}{\sqrt{1 + \left(\frac{\omega}{\omega_c}\right)^2}}$	$\frac{1}{\sqrt{1 + \mu \left(\frac{\omega}{\omega_c}\right)^2 + \left(\frac{\omega}{\omega_c}\right)^4}}$	$\frac{1}{\sqrt{1 + \left(\frac{\omega}{\omega_c}\right)^2 + \left(\frac{\omega}{\omega_c}\right)^4}}$
Phase shift	$\tan^{-1} \frac{-\sqrt{2} \left(\frac{\omega}{\omega_c}\right)}{1 - \left(\frac{\omega}{\omega_c}\right)^2}$	$\tan^{-1} \frac{-\sqrt{2 + \mu} \left(\frac{\omega}{\omega_c}\right)}{1 - \left(\frac{\omega}{\omega_c}\right)^2}$	$\tan^{-1} \frac{-\sqrt{3} \left(\frac{\omega}{\omega_c}\right)}{1 - \left(\frac{\omega}{\omega_c}\right)^2}$
Envelope delay	$\frac{\frac{\sqrt{2}}{\omega_c} \left[1 + \left(\frac{\omega}{\omega_c}\right)^2\right]}{1 + \left(\frac{\omega}{\omega_c}\right)^4}$	$\frac{\frac{\sqrt{2 + \mu}}{\omega_c} \left[1 + \left(\frac{\omega}{\omega_c}\right)^2\right]}{1 + \mu \left(\frac{\omega}{\omega_c}\right)^2 + \left(\frac{\omega}{\omega_c}\right)^4}$	$\frac{\frac{\sqrt{3}}{\omega_c} \left[1 + \left(\frac{\omega}{\omega_c}\right)^2\right]}{1 + \left(\frac{\omega}{\omega_c}\right)^2 + \left(\frac{\omega}{\omega_c}\right)^4}$
Step function response $T_c = \frac{1}{\omega_c}$	$1 + \frac{2}{\sqrt{2}} e^{-\frac{\sqrt{2}}{2} \frac{t}{T_c}} \sin\left(\frac{\sqrt{2}}{2} \frac{t}{T_c} - 135^\circ\right)$	$1 + \frac{2}{\sqrt{2 - \mu}} e^{-\frac{\sqrt{2 + \mu}}{2} \frac{t}{T_c}} \sin\left(\frac{\sqrt{2 - \mu}}{2} \frac{t}{T_c} + \tan^{-1} \frac{\sqrt{2 - \mu}}{-\sqrt{2 + \mu}}\right)$	$1 + 2 e^{-\frac{\sqrt{3}}{2} \frac{t}{T_c}} \sin\left(\frac{1}{2} \frac{t}{T_c} - 150^\circ\right)$
Potentiometric circuit (Fig. 1) C_1	$\frac{R_1 + R_2}{\sqrt{2} R_1 R_2 \omega_c}$	$\frac{R_1 + R_2}{\sqrt{2 + \mu} R_1 R_2 \omega_c}$	$\frac{R_1 + R_2}{\sqrt{3} R_1 R_2 \omega_c}$
C_2	$\frac{\sqrt{2}}{(R_1 + R_2) \omega_c}$	$\frac{\sqrt{2 + \mu}}{(R_1 + R_2) \omega_c}$	$\frac{\sqrt{3}}{(R_1 + R_2) \omega_c}$
Operational circuit (Fig. 2) C_1	$\frac{\frac{R_2 R_3}{R_1} + R_2 + R_3}{\sqrt{2} R_2 R_3 \omega_c}$	$\frac{\frac{R_2 R_3}{R_1} + R_2 + R_3}{\sqrt{2 + \mu} R_2 R_3 \omega_c}$	$\frac{\frac{R_2 R_3}{R_1} + R_2 + R_3}{\sqrt{3} R_2 R_3 \omega_c}$
C_2	$\frac{\sqrt{2}}{\left(\frac{R_2 R_3}{R_1} + R_2 + R_3\right) \omega_c}$	$\frac{\sqrt{2 + \mu}}{\left(\frac{R_2 R_3}{R_1} + R_2 + R_3\right) \omega_c}$	$\frac{\sqrt{3}}{\left(\frac{R_2 R_3}{R_1} + R_2 + R_3\right) \omega_c}$

Table 2. Attenuation vs m

m	1%	10%	3 dB	6 dB	20 dB
0.0	0.37	0.69	1.0	1.32	3.16
0.1	0.31	0.66	0.97	1.30	3.15
0.2	0.27	0.63	0.95	1.28	3.14
0.3	0.24	0.60	0.93	1.26	3.14
0.4	0.21	0.57	0.90	1.24	3.13
0.5	0.19	0.54	0.88	1.22	3.12
0.6	0.18	0.52	0.86	1.21	3.11
0.7	0.17	0.50	0.84	1.19	3.10
0.8	0.16	0.48	0.82	1.18	3.10
0.9	0.15	0.46	0.81	1.16	3.09
1.0	0.14	0.44	0.79	1.14	3.08

Table 3. Overshoot and settling time of two-pole low-pass TBT filters

m	Initial overshoot (per cent)	Number of time constants	Number of time constants to settle to:		
			± 1%	± 0.1%	± 0.01%
0.0	4.32	4.4	6.6	10.2	11.8
0.1	3.65	4.6	6.6	10.0	12.0
0.2	3.05	4.7	6.6	8.0	12.2
0.3	2.52	4.8	6.6	8.2	12.2
0.4	2.07	5.0	6.6	8.3	12.3
0.5	1.67	5.2	6.5	8.4	12.2
0.6	1.32	5.3	6.3	8.6	12.1
0.7	1.03	5.5	5.9	8.7	11.5
0.8	0.79	5.8	—	8.8	10.1
0.9	0.59	6.0	—	8.8	10.3
1.0	0.43	7.3	—	8.8	10.6

**And now
from Varian—
a 40-44 GHz,
1 Watt
pump tube
specifically
designed for
airborne
applications.**



VA-535: minimum power output of 1 Watt over the 40-44 GHz range.

The VA-535 is a two-cavity, fixed-frequency klystron oscillator especially developed to withstand the severe shock and vibration encountered in airborne applications. It can be used in high-altitude operations without pressurization.

This pump tube delivers an output of at least 1 W at any specified frequency between 40 and 44 GHz. The VA-535 provides excellent frequency and power stability, as well as a low-temperature coefficient. It has also proven itself capable of exceptionally dependable, long-life operation.

For specifications on the VA-535, write: Varian, 611 Hansen Way, Palo Alto, California 94304. In Canada: Varian Associates, Ltd., Georgetown, Ontario. In Europe: Varian A.G., Zug, Switzerland.





Since 1 in 10 Integrated circuits in use are our own UTILOGIC units, we thought the line deserved its own handbook. It's yours. Free.

It's the first applications handbook of its kind. Make it your very own. It will give you 32 pages of everything you need to know about using UTILOGIC. Signetics introduced UTILOGIC in 1964; it was the first line designed specifically for the commercial and industrial market. Customers bought them by the millions. No wonder. The UTILOGIC series offers 800 mv minimum noise margins, fan-outs of up to 17 from Gates and J-K Binary and high capacitive drive capability. SU-element operation is guaranteed from -20° to $+85^{\circ}$ C, and LU-elements from $+10^{\circ}$ to $+55^{\circ}$ C. Send for your own UTILOGIC Handbook. Write: Signetics, 811 E. Arques Avenue, Sunnyvale, California 94086.

**SIGNETICS
INTEGRATED
CIRCUITS**



A SUBSIDIARY OF CORNING GLASS WORKS

SIGNETICS SALES OFFICES: Metropolitan New York (201) 992-3980; Upper New York State (315) 469-1072; Southwestern (214) 231-6344; Western Regional (213) 272-9421; Eastern Regional (617) 245-8200; Mid-Atlantic (609) 858-2864; Southeastern (813) 726-3734; Midwestern Regional (312) 259-8300; Northwestern (408) 738-2710.

DISTRIBUTORS: Compar at all locations listed below Semiconductor Specialists, Inc. (312) 622-8860; Terminal Hudson Electronics (212) 243-5200; Wesco Electronics (213) 684-0880, Wesco Electronics (405) 968-3475
DOMESTIC REPRESENTATIVES: Jack Pyle Company (415) 349-1266. Compar Corporation at the following locations: Alabama (205) 539-8476; Arizona (602) 947-4336; California (203) 245-1172; California (415) 697-6244; Colorado (303) 781-0912; Connecticut (203) 288-9276; Florida (305) 855-3964; Illinois (312) 775-5300; Maryland (301) 484-5400; Massachusetts (617) 969-7140; Michigan (313) 476-5758; Minnesota (612) 922-7011; Missouri (314) 428-5313; New Jersey (609) 429-1526; New Mexico (505) 265-1020; New York (518) 436-8536; New York (607) 723-8743; New York (716) 684-5731; New York (201) 471-6090; North Carolina (919) 724-0750; Ohio (216) 333-4120; Ohio (513) 878-2631; Texas (214) EM 3-1526; Texas (713) 649-5756; Washington (206) 725-7800.

INTERNATIONAL SALES: France, Germany, Italy, Belgium, Holland, Luxemburg, Spain—Sovcon Electronique, 11, Chemin de Ronde, Le Vesinet, (S. & D.) France. United Kingdom, Ireland, Sweden, Denmark, Norway, Switzerland, Austria, Portugal—Electrosil Ltd., Lakeside Estate, Colnbrook By Pass Slough, Buckinghamshire, Great Britain. Australia—Corning, 1202 Plaza Building, Australia Square, Sydney, N.S.W. 27-4318. Canada—Corning Glass Works of Canada, Ltd., Leaside Plant, Ontario, Canada (416) 421-150. Israel—Optronix, P.O. Box 195, Ramat Gan, Israel 724-437. Japan—ASAHI Glass Co., Ltd. (IWAKI), Corning Products Sales Dept. No. 2, 3-Chome Marunouchi, Chiyoda-ku, Tokyo, Japan.

ON READER-SERVICE CARD CIRCLE 44

ON READER-SERVICE CARD CIRCLE 45 ➤



**These two
heat shrinkables
are hungry for
tough mil-spec
insulation
problems.**

INSULTITE FROM E.C.C.

E. C. C. heat shrinkables are recognized under UL component file E39100.

Feed them:

New Insultite SR-350 eats up shock, strain, and vibration like only a semi-rigid, irradiated polyolefin can. It combines superior dielectric characteristics with high structural strength.

Insultite FP-301, on the other hand, has a flexible polyolefin appetite that devours mil-spec applications. Quickly. Totally.

SR-350 meets classes 3 and 4 of MIL-I-23053A and NASA MSFC 276A. FP-301 meets classes 1 and 2.

Both feature high abrasion resistance, superior voltage stand-off and excellent dielectric characteristics.

Both SR-350 and FP-301 shrink at a better than 2 to 1 shrink ratio when heat is applied.

Insultite SR-350 and FP-301 come in a variety of sizes and

colors. White, black, red, blue, and yellow, all easily printed for identification purposes, and clear where visual inspection is important. New SR-350 is available from $\frac{3}{64}$ " to 1" ID. FP-301 comes in sizes from $\frac{3}{64}$ " to 4" ID.

Whatever your insulation problem, think shrink with the Insultites. We offer commercial, military grade, flexible and semi-rigid tubing, heat-shrinkable end caps, and exclusive meltable inner-wall tape. Write today for free samples. (Specify diameters, please.)



ELECTRONIZED CHEMICALS CORPORATION

A subsidiary of High Voltage Engineering Corporation

Box 57, Burlington, Massachusetts, Area Code 617-272-2850

Find the pattern of off-beat antennas

without long and tedious tests. A "shape-substitution" method yields the far-field voltage with a few equations.

Simple graphic shapes, like rectangles and triangles, can be used to find the radiation pattern of unusual or irregular antennas. The engineer has to know only the amplitude and phase distribution of the field across the radiating area. The simple technique involves little mathematics.

Once the illumination is known, the aperture distribution is plotted, approximated by straight lines and replaced by rectangular and triangular shapes. The radiation patterns of these component shapes can be found easily. The composite pattern, which is the radiation pattern of the antenna, is obtained by superimposing component patterns.

This shape-substitution method may be applied in cases of asymmetrical variations of amplitude or phase, or both, across the aperture, or to symmetrical aperture illuminations. The technique lends itself to evaluation by digital computers, since only a limited number of equations is necessary to describe the radiation from any irregularly shaped aperture distribution.

The conventional Fourier transform method of obtaining the far-field radiation pattern for a given aperture distribution involves the equation:¹

$$E(u) = (l/2) \int_{-1}^1 f(x) e^{jux} dx, \quad (1)$$

where

- $E(u)$ = far-field voltage pattern,
- l = total aperture length,
- $f(x) = g(x) \exp jh(x)$,
- $g(x)$ = amplitude of relative field intensity over aperture, as a function of x ,
- $h(x)$ = phase of relative field intensity over aperture, as a function of x ,
- x = normalized aperture coordinate ($-1 \leq x \leq 1$),
- $u = (\pi l/\lambda) \sin \phi$,
- λ = wavelength,
- ϕ = angle from plane normal to line source.

This equation can be evaluated by expressing

the irregularly shaped, complex aperture distribution, $g(x) \exp jh(x)$, as a Fourier series. Numerous terms, however, are required for approximation of the actual distribution. In general, actual determination of the Fourier series coefficients, comparison of Fourier series components with the actual aperture distribution, and evaluation of the Fourier integrals for a large number of terms constitute a lengthy, quite tedious process.

In the shape-substitution method, the fluctuating amplitude distribution is simulated by the addition and subtraction of a series of rectangular and triangular shapes. The far-field pattern is then evaluated for these simple shapes. Their combination gives the total far-field pattern, whether the aperture distribution is symmetrical or not.

The procedure is essentially a modification of the standard method used to determine the effects of aperture blocking. There the radiation pattern is first obtained for the total aperture without blocking. Then, to determine the effects of blocking, the radiation pattern of an aperture, representing the blocked version, is subtracted from the unblocked pattern.

For the application of the shape-substitution method, any arbitrary radiation is considered to belong to one of the following groups. These groups are established according to amplitude and phase distributions:

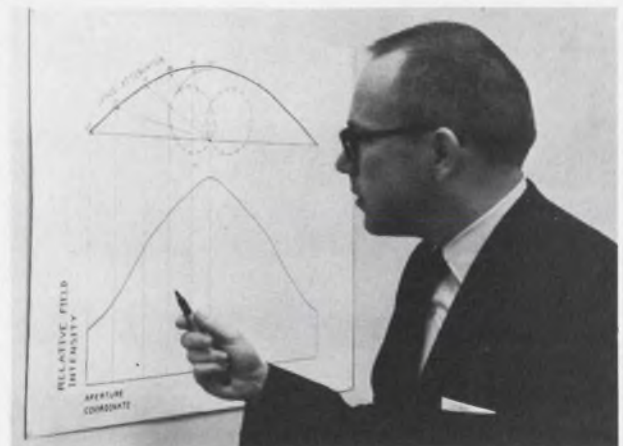

The far-field voltage of antennas is easily found by the shape-substitution method, says author Fischer.

Frederick E. Fischer, Engineering Specialist, Goodyear Aerospace Corp., Akron, Ohio. (Now with Radiation Service Co., Melbourne, Fla.)

- Symmetrical amplitude distribution without phase error.
- Asymmetrical amplitude distribution without phase error.
- Symmetrical amplitude distributions after compensating for the phase error.
- Asymmetrical amplitude distributions after compensating for the phase error.

The mathematical tools for the technique consist of equations that relate the far-field voltage to assumed symmetrical amplitude and phase distributions as measured at the aperture. In addition, equations must be developed to represent the contributions of rectangular and triangular distributions over a section of the radiating area.

These equations will be developed as each of the four cases is discussed. Then a specific example will show how the equations are applied.

Two equations describe far field

The equations needed to describe far-field conditions for all four situations are called sum and difference pattern equations.

The sum pattern equation is simply an integral of the assumed symmetrical amplitude distribution across the aperture:

$$S(u) = l \int_{-k}^k g(x) \cos ux \, dx \quad (2)$$

$$= (l/2) \left[\int_0^k g(x) e^{jux} \, dx + \int_{-k}^0 g(-x) e^{jux} \, dx \right],$$

where $g(x)$ is the symmetrical component of the amplitude distribution across the aperture, from $-k$ to $+k$.

The difference pattern is also defined by an integral:

$$jD(u) = l \int_{-k}^k g(x) \sin ux \, dx \quad (3)$$

$$= (l/2) \left[\int_0^k g(x) e^{jux} \, dx - \int_{-k}^0 g(-x) e^{jux} \, dx \right],$$

where $g(x)$ is again the assumed symmetrical amplitude distribution across the aperture, and the left half of the distribution is 180° out of phase with the right half. In Eq. 2 both halves are in phase.

To arrive at the radiation pattern, the specific cases will be discussed.

The symmetrical amplitude distribution without phase error is the simplest of the four groups mentioned previously, so it will be examined first.

The simulation of the actual distribution starts with the assumption of a uniform distribution. Then symmetrical triangular and rectangular distributions are subtracted or added until the true

situation is best approached.

The radiation pattern is, therefore, a combination of the constant-illumination pattern and the patterns resulting from the triangular and rectangular distributions. The far-field voltage is:

$$E(u) = \sum S_i(u), \quad (4)$$

where $S_i(u)$ is the i^{th} component sum pattern, expressed by Eq. 2.

Mirror image needed for asymmetrical pattern

An asymmetrical distribution can be analyzed easily if symmetry is somehow established. One way of doing it is to assume that there is a mirror image of the asymmetrical distribution, adjacent to, and to the left of the actual aperture. The resultant symmetrical distribution is again easily simulated by the triangular and rectangular shapes.

Both sum and difference patterns have to be found for the component shapes. As indicated by Eqs. 2 and 3, the sum pattern is obtained when both halves are in phase and the difference pattern results when there is a 180° phase difference between the halves. By adding the sum and difference patterns, we cancel the effect of the left half of the distribution. Therefore, the radiation pattern for asymmetrical amplitude distribution is half the vector sum of the two patterns. Hence, the far-field voltage is then:

$$|E(u)| = |(1/2) \sum S_i(u) + j(1/2) \sum D_i(u)|$$

$$= (1/2) \{ [\sum S_i(u)]^2 + [\sum D_i(u)]^2 \}^{1/2}, \quad (5)$$

where $S_i(u)$ and $D_i(u)$ are the sum and difference patterns, respectively, of the same i^{th} component distribution.

The third and fourth cases demonstrate the handling of phase errors.

The effects of phase errors can be determined by calculation of the corresponding in-phase and quadrature distributions. These are obtained by a multiplication of the original distribution with the cosine and the sine of the given phase variation, respectively. This is analogous to writing the term $g(x) \exp jh(x)$ in terms of its real and imaginary parts.

For symmetrical in-phase and quadrature distributions, the simple approximation with triangles and rectangles is again applicable. The far-field voltage then becomes:

$$|E(u)| = |E_I(u) + jE_Q(u)|$$

$$= |\sum S_{Ii}(u) + j \sum S_{Qi}(u)| \quad (6)$$

$$= \{ [\sum S_{Ii}(u)]^2 + [\sum S_{Qi}(u)]^2 \}^{1/2},$$

where the subscripts I and Q refer to the in-phase and quadrature distribution across the aperture.

The final case to be considered is that of asymmetrical distributions with phase variations.

(continued on p. 88)

If the in-phase and quadrature illuminations are not symmetrical, mirror images can again be used. The mirror images are assumed to exist to the left of the actual aperture. The difference patterns can again eliminate their effect from the final radiation pattern. The far-field voltage equation has then this form:

$$\begin{aligned}
 |E(u)| &= |E_i(u) + jE_q(u)| \\
 &= (1/2) |\sum S_{ii}(u) + j \sum D_{ii}(u) \\
 &\quad + j [\sum S_{qi}(u) + j \sum D_{qi}(u)]| \quad (7) \\
 &= (1/2) \{ [\sum S_{ii}(u) - \sum D_{qi}(u)]^2 \\
 &\quad + [\sum D_{ii}(u) + \sum S_{qi}(u)]^2 \}^{1/2}
 \end{aligned}$$

Fourier transform yields component patterns

Equations 4, 5, 6 and 7 are sufficient to describe the radiation pattern of any antenna. The last step in the analysis is to apply the sum and difference distributions, given in Eqs. 2 and 3, over a fraction of the radiating aperture.

In general, the radiation patterns are obtained from the Fourier transform of the amplitude distribution over a finite interval, $-k \leq x \leq +k$.

The usual expression for the far-field pattern of a line source is:

$$E(u) = (l/2) \int_{-1}^1 g(x) e^{jux} dx, \quad (8)$$

where $g(x)$ is the field intensity at the aperture over the interval $-1 \leq x \leq +1$. The corresponding equation for a fraction of the interval, $-k \leq x \leq +k$, is:

$$E_k(u) = (l/2) \int_{-k}^k g(x) e^{jux} dx. \quad (9)$$

A transformation, $y = x/k$, where $-1 \leq y \leq +1$ and $v = ku$, establishes a relation between Eqs. 8 and 9, since:

$$\begin{aligned}
 E_k(u) &= (kl/2) \int_{-1}^1 g(ky) e^{jvy} dy \\
 &= kE(v). \quad (10)
 \end{aligned}$$

The sum and difference patterns are found by establishing the functions that describe the rectangular and triangular distributions and integrating these over the proper intervals.

A rectangular aperture illumination is described by the function $g(x) = C$ over the interval $-k \leq x \leq +k$. The transformed distribution over the interval $-1 \leq y \leq 1$ is:

$$g(ky) = C.$$

The sum pattern found with Eq. 2 is:

$$S(v) = (l/2) \int_{-1}^1 C e^{jvy} dy = lC(\sin v)/v. \quad (11)$$

The corresponding value of $S(u)$ over a fraction,

$\pm k$, of the aperture is obtained from Eq. 10:

$$S(u) = lCk(\sin ku)/ku. \quad (12)$$

The difference pattern is found in a similar manner, except that now Eq. 3 is used:

$$D(v) = [lC(v/2)] [(\sin v/2)/(v/2)]^2. \quad (13)$$

The corresponding value of $D(u)$ for a rectangular distribution over the interval $\pm k$ is:

$$D(u) = (lCk^2u/2) [(\sin ku/2)/(ku/2)]^2. \quad (14)$$

A triangular aperture illumination is described by the function:

$$g(x) = (C/k)(k - |x|)$$

over the interval $-k \leq x \leq +k$. It has the transformed aperture distribution:

$$g(ky) = C(1 - |y|),$$

where $-1 \leq y \leq 1$.

The sum pattern for the transformed triangular distribution² is:

$$S(v) = (lC/2) [(2/v) \sin v/2]^2. \quad (15)$$

The sum pattern for the triangular distribution over the interval $-k \leq x \leq +k$ is given by:

$$S(u) = (lCk/2) [(2/ku) \sin (ku/2)]^2 \quad (16)$$

The difference pattern of the transformed illumination is:

$$D(v) = (lC/\pi) [1 - (\sin v)/v]. \quad (17)$$

The corresponding difference pattern for the actual illumination over the interval $-k \leq x \leq +k$ is:

$$D(u) = (lCk/\pi) [1 - (\sin ku)/ku]. \quad (18)$$

To illustrate the shape substitution, consider an example, where a large phase error exists across the radiating source, which is illuminated in a symmetrical but irregular fashion. The amplitude distribution is shown in black and the assumed phase error in color in Fig. 1.

How to plot the component shapes

To evaluate the effects of the phase error, the in-phase and quadrature distributions must be found. As mentioned previously, these are obtained by multiplying the original distribution by the cosine and sine of the phase error, respectively. The plots of the in-phase and quadrature distributions for this problem are shown in Fig. 2, along with their straight-line-segment approximations.

The straight-line segments are plotted on graph paper and used to determine the component rectangular and triangular shapes, as shown in Fig. 3. The estimation of the component shapes must start from the outside edges and progress toward the center. Therefore the first component for the in-phase distribution is a rectangle, with a height of $-C_1$, since the original distribution has a value offset from zero at the edge. The value of C_1 , (0.24) is read off from the graph paper and it is con-

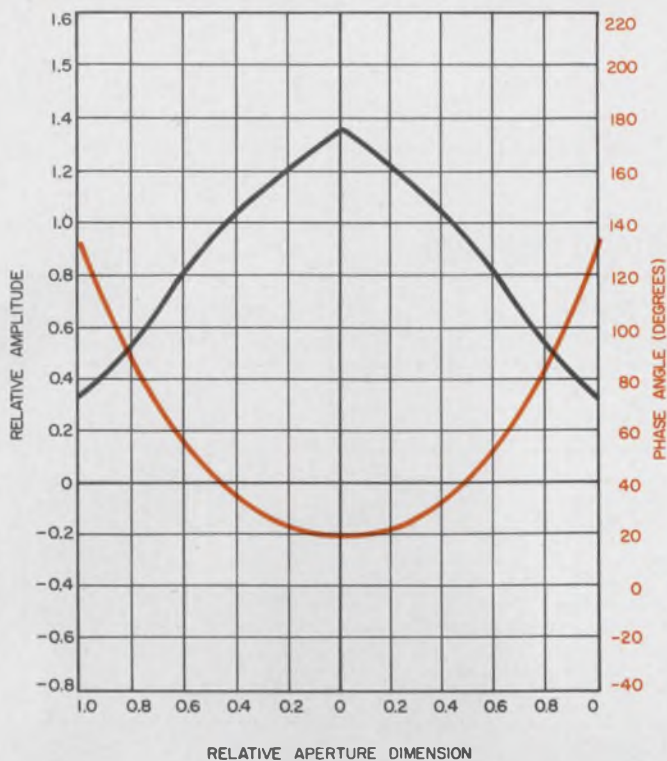

1. Shape substitution will be used to determine the effects of a large phase error (in color) on the radiation pattern. The amplitude distribution (in black) is symmetrical but irregular.

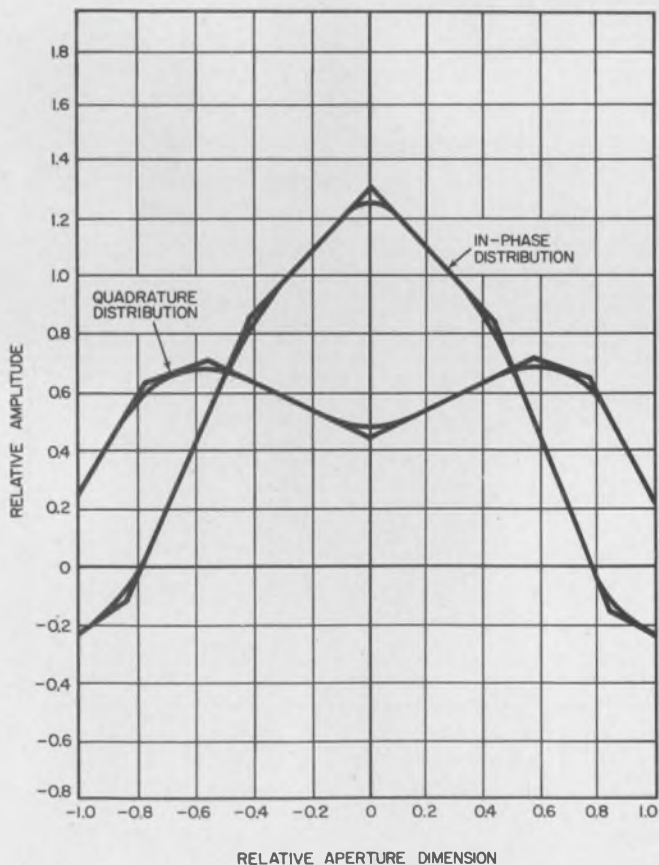

2. To evaluate the effects of the phase error, the in-phase and quadrature distributions must be found. They are obtained by multiplying the original distribution with the cosine and the sine of the phase error, respectively. The curves are then approximated with straight lines.

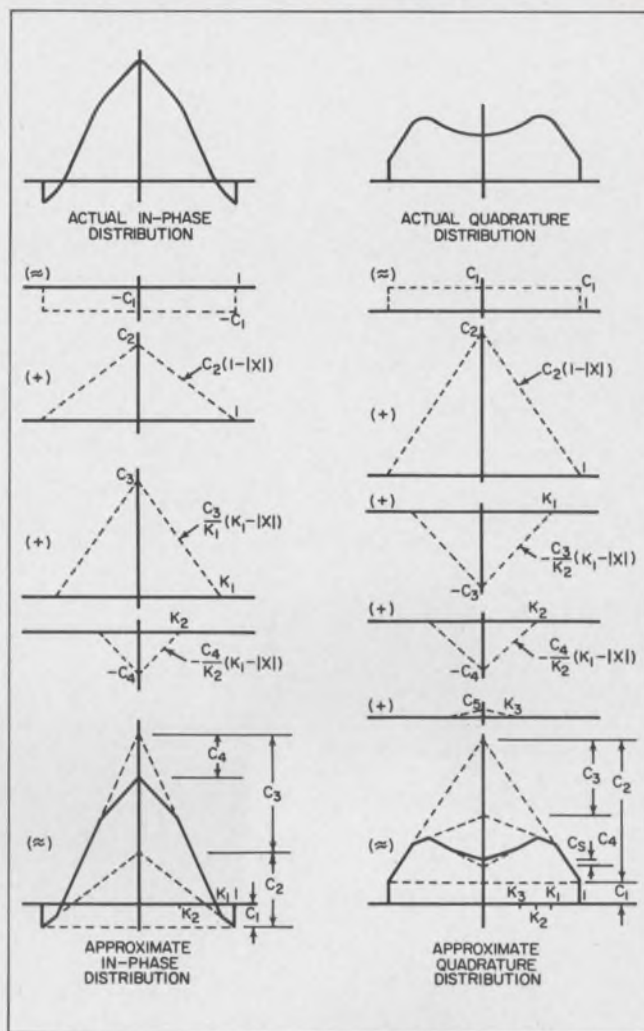

3. Rectangular and triangular shapes form the in-phase and quadrature distributions, shown in Fig. 2. The heights and widths of the shapes depend on the points at which the aperture distribution changes slope. Note that the component shapes are drawn at first in an absolute fashion. The final shape, however, is put together in a sequence, as shown in the sketches in the last row. For easier graphical construction, it is advisable to use standard graph paper when working out an actual project.

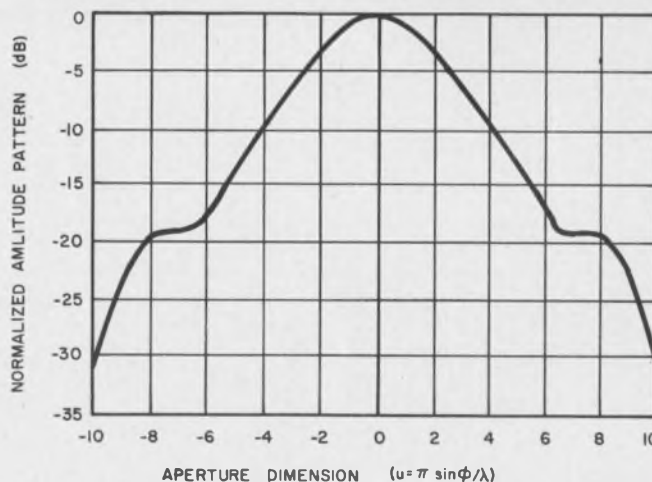

4. Composite radiation pattern shows significant effects of large phase error. The curve was plotted with the aid of Eq. 20 and Tables 1 and 2.

Table 1. Radiation pattern for in-phase aperture distribution

Shape approximation	Aperture range	Aperture distribution, g(x)	$S_{ii}(u)$, radiation pattern, where $u = (\pi l/\lambda) \sin \phi$
- Rectangle	$-1 \leq x \leq 1$	$-C_1$	$-C_1 \left(\frac{\sin u}{u} \right)$
+ Triangle	$-1 \leq x \leq 1$	$+C_2(1 - x)$	$+\frac{C_2}{2} \left(\frac{\sin u/2}{u/2} \right)^2$
+ Triangle	$-k_1 \leq x \leq k_1$	$+\frac{C_3}{k_1}(k_1 - x)$	$+\frac{C_3 k_1}{2} \left(\frac{\sin k_1 u/2}{k_1 u/2} \right)^2$
- Triangle	$-k_2 \leq x \leq k_2$	$-\frac{C_4}{k_2}(k_2 - x)$	$-\frac{C_4 k_2}{2} \left(\frac{\sin k_2 u/2}{k_2 u/2} \right)^2$

Shape, peak amplitude	Fraction of aperture	Coefficient values
$C_1 = 0.24$	$k_1 = 0.85$	$-C_1 = -0.24$
$C_2 = 0.80$	$k_2 = 0.42$	$+C_2/2 = 0.40$
$C_3 = 1.22$		$+C_3 k_1/2 = 0.52$
$C_4 = 0.45$		$-C_4 k_2/2 = -0.094$

Table 2. Radiation pattern for quadrature aperture distribution

Shape approximation	Aperture range	Aperture distribution, g(x)	$S_{oi}(u)$, radiation pattern, where $u = (\pi l/\lambda) \sin \phi$
+ Rectangle	$-1 \leq x \leq 1$	$+C_1$	$+C_1 \left(\frac{\sin u}{u} \right)$
+ Triangle	$-1 \leq x \leq 1$	$+C_2(1 - x)$	$+\frac{C_2}{2} \left(\frac{\sin u/2}{u/2} \right)^2$
- Triangle	$-k_1 \leq x \leq k_1$	$-\frac{C_3}{k_1}(k_1 - x)$	$-\frac{C_3 k_1}{2} \left(\frac{\sin k_1 u/2}{k_1 u/2} \right)^2$
- Triangle	$-k_2 \leq x \leq k_2$	$-\frac{C_4}{k_2}(k_2 - x)$	$-\frac{C_4 k_2}{2} \left(\frac{\sin k_2 u/2}{k_2 u/2} \right)^2$
+ Triangle	$-k_3 \leq x \leq k_3$	$+\frac{C_5}{k_3}(k_3 - x)$	$+\frac{C_5 k_3}{2} \left(\frac{\sin k_3 u/2}{k_3 u/2} \right)^2$

Shape, peak amplitude	Fraction of aperture	Coefficient values
$C_1 = 0.24$	$k_1 = 0.73$	$+C_1 = 0.24$
$C_2 = 1.48$	$k_2 = 0.57$	$+C_2/2 = 0.74$
$C_3 = 0.79$	$k_3 = 0.35$	$-C_3 k_1/2 = -0.29$
$C_4 = 0.53$		$-C_4 k_2/2 = -0.15$
$C_5 = 0.07$		$+C_5 k_3/2 = 0.012$

stant from -1 to $+1$, over the whole aperture. In similar fashion, a series of approximations are made as the peak values, aperture ranges, distributions and contributions of the component shapes to the final radiation pattern are tabulated in Table 1 for the in-phase case, and in Table 2 for the quadrature case.

The triangular shapes are obtained by an extension of the slopes of the straight-line segments until they intersect the axis of symmetry. This axis is the perpendicular bisector of the radiating aperture. The height of the first triangle, C_2 , in Fig. 3a, is the difference between the ordinate values at which the slope intersects the axis and at which the aperture distribution changes slope. The heights of succeeding triangles in the composite figure are the differences between the points of intersection of their lines with the axis of symmetry and the peak ordinate value of the previous triangle, as illustrated by C_3 and C_4 , for example. The width of the triangles is determined by the abscissa values at which the approximate aperture distribution changes slope.

The far-field voltage for the composite radiation pattern is given by Eq. 6:

$$|E(u)| = \{ [\sum S_{li}(u)]^2 + [\sum S_{qi}(u)]^2 \}^{1/2}.$$

It may be normalized by dividing through with the coefficients of the S s:

$$|E(u)|_n = \frac{|E(u)|}{\{ [\sum \text{coeff. of } S_{li}(u)]^2 + [\sum \text{coeff. of } S_{qi}(u)]^2 \}^{1/2}} \quad (19)$$

The numerical values are tabulated in Tables 1 and 2. Substitution of the proper values leads to the following equation which describes the far-field voltage for the composite radiation pattern:

$$|E(u)|_n = \frac{1}{0.805047} \left\{ \left[-0.24 \frac{\sin u}{u} + 0.40 \left(\frac{\sin 0.5u}{0.5u} \right)^2 + 0.52 \left(\frac{\sin 0.425u}{0.425u} \right)^2 - 0.094 \left(\frac{\sin 0.21u}{0.21u} \right)^2 \right]^2 + \left[0.24 \frac{\sin u}{u} + 0.74 \left(\frac{\sin 0.5u}{0.5u} \right)^2 - 0.29 \left(\frac{\sin 0.365u}{0.365u} \right)^2 - 0.15 \left(\frac{\sin 0.285u}{0.285u} \right)^2 + 0.012 \left(\frac{\sin 0.175u}{0.175u} \right)^2 \right]^2 \right\}^{1/2} \quad (20)$$

The resultant field pattern is shown in Fig. 4. ■ ■

References:

1. H. Jasik, *Antenna Engineering Handbook* (New York: McGraw-Hill Book Co., Inc., 1961), pp. 2-25.
2. K. G. Schroeder, "Beam Patterns for Monopulse Arrays," *Microwaves*, II, No. 3 (March, 1963), 20.

JFD Modutrim microminiature Ceramic Variable Capacitors...

Widest ΔC s, highest stability and smallest size

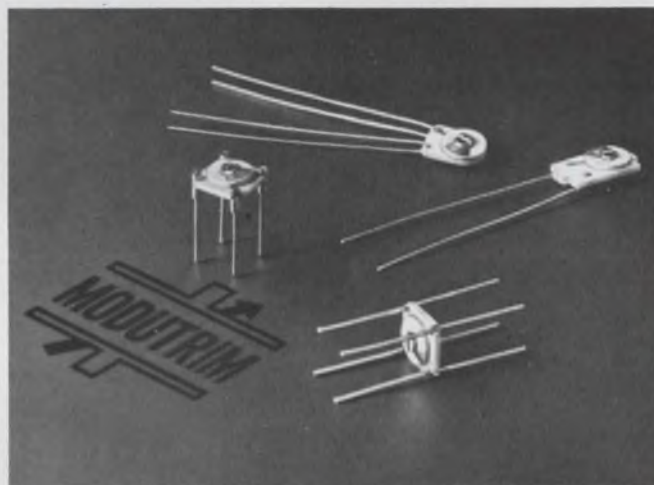

Capacitors shown enlarged 25%

Modutrim microminiature ceramic variable capacitors offer micromodule and hybrid circuit designers a choice of wide ΔC s in extremely small and stable units.

A unique rotor design utilizing a special proprietary ceramic material in a monolithic structure gives excellent stability. Q is in excess of 500 measured at 1 MC for those values under 50.0 pf.

MT 100 Series' design is specifically for channel-mount and cordwood applications, as well as many other micro-module packages.

MT 200 Series offers still further miniaturization, as an ideal answer to high component density problems and various LC networks packaged in TO-5 cans.

MT 300 Series' 4 terminal lead configuration provides optimum mechanical support and is specifically designed for printed, microminiature and module circuits.

MT 400 Series is designed for cordwood and module applications. This configuration has 8 terminations for easy connection above and below the capacitor substrate.

Write for Bulletin MT-65-2.

JFD

TODAY'S COMPONENTS BUILT FOR TOMORROW'S CHALLENGES*

JFD ELECTRONICS CO. / COMPONENTS DIVISION 15th Avenue at 62nd Street Brooklyn, N. Y. 11219 / Phone 212-331-1000 • Sales Offices—Arcadia, Calif. Chi., Ill. / Balt., Md. / Saxonville, Mass. / Bklyn., N. Y. / New Hartford, N. Y. Cinn., Ohio / Phila., Pa. / Pitts., Pa. / Paris, France / Azor, Israel

ON READER-SERVICE CARD CIRCLE 46

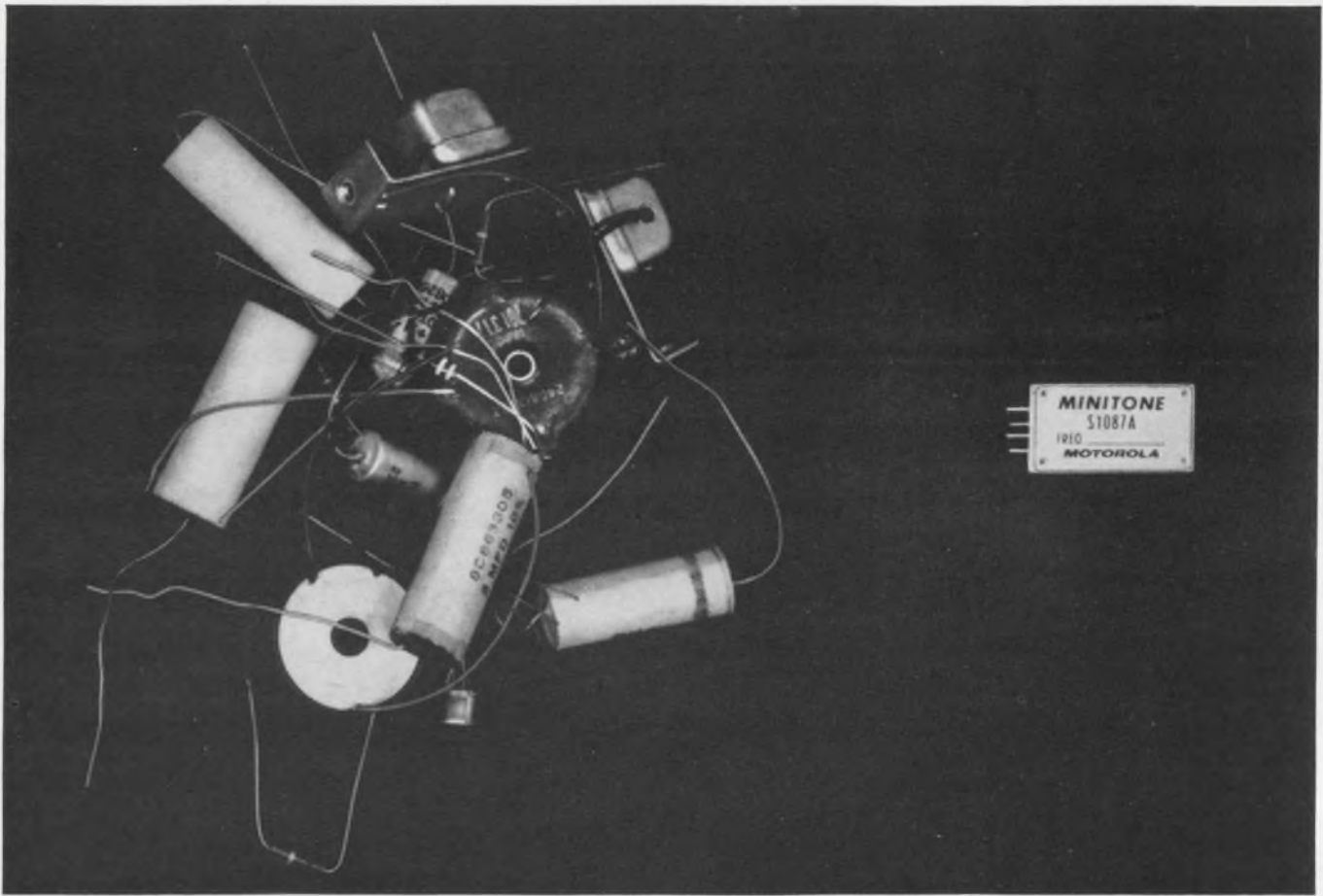

Two ways to achieve selective signaling

The MINITONE reed on the right does it better

Motorola's new miniaturized resonant reed either generates a highly stable audio tone, or provides very selective decoding. It does the job better because it's small, has excellent stability, and contains no contacts to wear out. And the MINITONE resonant reed is more economical; it eliminates the expense of extra components and design time needed to build highly selective tone oscillators and associated compensating circuits. Take a look at these facts:

SMALL SIZE: About $\frac{1}{4}$ of a cubic inch in volume. Measures only 1.11" x 0.619" x 0.393".

LONG LIFE: No contacts to wear out or cause malfunctions; life comparable to solid-state devices. Plus 3-year warranty.

HIGH STABILITY: Frequency tolerance $\pm 0.1\%$. Temperature stability better than $\pm 0.001\%$ per $^{\circ}\text{C}$ between -30°C and $+100^{\circ}\text{C}$ (25°C reference).

WIDE FREQUENCY RANGE: From 67 Hz up to 3150 Hz.

QUICK DELIVERY: Over 200 standard frequencies available from stock.

RUGGED CONSTRUCTION: Exceeds E.I.A. standards for shock and vibration.

PROVEN PERFORMANCE: Reeds have been proven in thousands of demanding situations, such as in aviation, control systems and radio communications applications.

FOR MORE INFORMATION contact your Motorola representative. Or write for bulletin TIC-3213.

MOTOROLA COMMUNICATIONS AND ELECTRONICS INC.
4900 West Flournoy Street
Chicago, Illinois 60644. A subsidiary of Motorola Inc.



ON READER-SERVICE CARD CIRCLE 47

ELECTRONIC DESIGN 8, April 12, 1967

**Yes. You can get every
wire and cable you need
for a computer system in
one neat package...from
Brand-Rex**

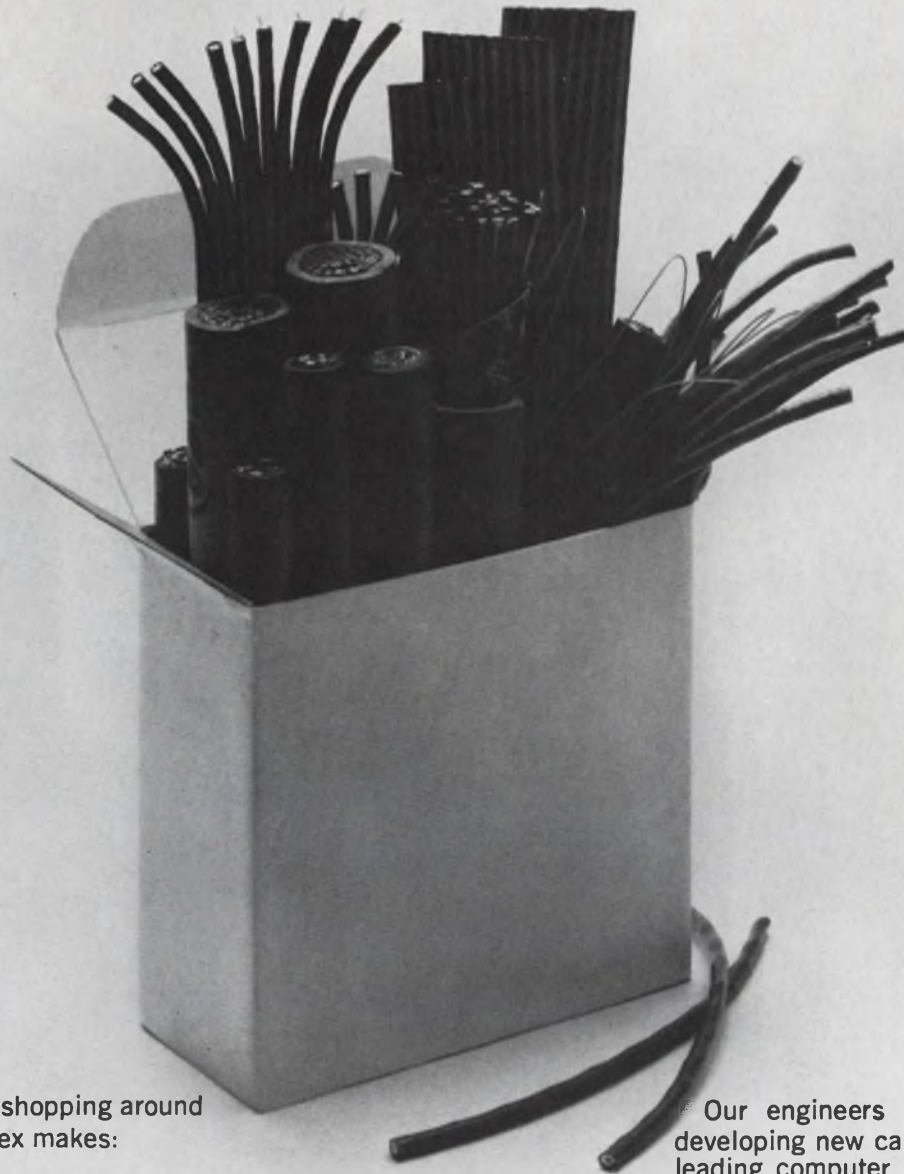

You save a lot of shopping around because Brand-Rex makes:

- *Back-Panel Wires*
- *Hook-Up Wires*
- *Miniature, Air-Spaced Coaxial Cable*
- *Power Supply Wires*
- *Patch Cord Wires*
- *Interconnecting Cables*
- *Communication Cables.*

You can have just about any configuration... single wire, round cable, ribbon cable, custom profiles... and your choice of insulations including Kynar, Polysulfone, Teflon (FEP and TFE), PVC, semi-rigid PVC, PVC/nylon, polyethylene, foamed polyethylene, FEP/nylon, Rulan and Neoprene. Matched colors if you want.

Our engineers are constantly developing new cable designs for leading computer manufacturers. So if existing Brand-Rex products don't meet your needs, we'll come up with new designs that will.

Hooking-up a computer system? Get all the wire and cable from one good source. Ask Brand-Rex.

AMERICAN **ENXA** CORPORATION

BRAND-REX DIVISION

WILLIMANTIC, CONNECTICUT 06226
PHONE 203 423-3771



ON READER-SERVICE CARD CIRCLE 48

if your military stack doesn't have this trademark, it's a modified commercial design

And you're taking an unnecessary chance if you use it in a severe environment. Our exclusive design, the SEMSTAK™ militarized stack, is the only one on the market specifically designed for military environments. A proprietary contact design eliminates riser wires between planes and cuts solder terminations by half. The stack is metal, providing excellent heat dissipation and a nominal thermal gradient of only 2°C. No plastic or printed circuit cards are used within the stack.

And we successfully tested it at 30g's vibration at 2000 cycles per second. This is three times more than the requirements of MIL-T-5422E, the current test specification for airborne electronic equipment.

We just printed a handsome new brochure on this compact design. Write or call us and we'll be happy to send you one. Ask for Litpak 4E.

electronic memories

12621 Chadron Avenue, Hawthorne, California
Telephone (213) 772-5201



Choose the right power connector

for military or commercial equipment. A chart of military specifications doubles as a handy selection guide.

The designer today faces a bewildering array of power connectors to choose from. More than 100 manufacturers offer a multitude of designs, most of which meet one or more of many military specifications. These specifications not only set military standards but also provide an excellent guide to the selection of connectors, whether for military or commercial equipment. The most frequently cited specifications are summarized in the accompanying table.

The first step in selecting the proper connector is to determine the category required; for example, rack and panel, printed-circuit, or multipin circular. Then, decide the exact requirements for the particular application.

Use MIL-spec connectors for commercial equipment

Once both these conditions have been settled, they can be compared with the standards outlined in the military specifications. Often a connector that meets a MIL spec will also satisfy the designer's need, even though his requirements are not exactly the same as the specification. This is because all military specifications set only minimum acceptable performance levels. A manufacturer does not just get by on the minimum standard; more often than not he designs a safety margin into his connector. As a result, careful inquiry and evaluation may lead the designer to choose a standard military connector that will satisfy all the requirements of a particular application and at the same time save him the time and money involved in special tooling.

Using connectors that comply with military specifications in a commercial program offers two advantages. The device will be:

- A standard connector readily available from multiple sources at competitive prices.
- A connector that has already proven its performance capabilities.

Military specifications are based on solid engineering theory and practice. They represent good

design and performance characteristics of production connectors that are as acceptable to the military as to manufacturers.

(continued on p. 96)

A new spec is born

At the time that this issue goes to press, the Navy is releasing MIL-C-81511 as an interim document. This specification will serve as a temporary yardstick until a tri-service specification is approved. MIL-C-81511 sets standards for high-density, environment-resistant, quick-disconnect connectors.



Circular connectors, rack and panel and printed circuit connectors—hundreds are available. The table of MIL-specs can guide your selection.

Richard J. Kaszuba, Engineering Manager, Connector Development, Amphenol Connector Div., Chicago.

Table. Military specifications for power connectors

	CIRCULAR CONNECTORS		
	MIL-C-5015D	MIL-C-26482D	MIL-C-26500B
Coupling force	None	44 in.-lb (max).	38 in. - lb (max) Types T & B 37 in. - lb (max) Type Q
Maintenance aging	None	10 cycles. Size 16 & 20 contacts' insertion force 20 in.-lb (max).	10 cycles of coupling and 10 cycles of contact insertion and withdrawal. Insertion force of last 10% of contacts installed to be 15 lb (max).
Contact insertion force	None	20 lbs max for size 20 and 16 contact. 30 lbs max for size 12 contact.	8 lbs (max) for individual, 15 lbs (max) for last 10% installed.
Thermal shock	5 cycles per MIL-STD-202, method 107, condition B (+128° to -55°C).	+257° to -67°F, 5 cycles (unmated, no dielectric stresses).	+263° to -58°C, 5 cycles (unmated).
Hi-Pot (unmated at sea level)	Per MIL-STD-202, method 301. 7000 Vac for service rating C.	1500 Vac.	1500 Vac rms.
Fluid immersion	20 hours each: MIL-H-5606 & MIL-L-7808.	20 hours each: MIL-H-5606 & MIL-L-7808.	20 hours each: MIL-H-5606 & MIL-L-9236.
Vibration (mated)	Per MIL-E-5272, procedure 1, at room temperature and 100 mA. Interruption to 10 μs (max).	Per MIL-STD-202, method 204, condition B, at room temperature and 100 mA. Interruption to 10 μs (max).	Per MIL-STD-202, method 204, condition D. -55°C, room temperature, +200°C, 100 mA. No interruption permitted.
Physical shock	50 G, JAN-S-44 test apparatus.	50 G.	50 G, JAN-S-44 test apparatus.
Durability	500 cycles (less coupling ring, next subjected to corrosion test).	500 cycles (bayonet coupling).	200 cycles (Type T) (thread coupling), 500 cycles (Type B) (bayonet coupling).
Moisture resistance	Classes E & R: Insulation resistance to be 100 MΩ (min), 20 days, 500 Vac.	Per MIL-STD-202, method 106. Insulation resistance to be 100 MΩ (min).	Per MIL-STD-202, method 106 (except no vibration). Insulation resistance (while in high humidity) to be 1000 MΩ (min).
Corrosion	Per MIL-STD-202, method 101, condition B.	Per MIL-STD-202, method 101, condition B.	Per MIL-STD-202, method 101, condition B.
Air leakage	Classes E and R: 1 in. ³ /hr of air (max) after thermal shock at 30 psi and -55°C.	Classes T, E, F, J and P: after 1 cycle thermal shock 1 in. ³ /hr (max) at 30 psi and low temperature extreme. Class H: 10-8 ft ³ /hr at 15 psi per MIL-STD-202, method 12.	Classes R and G: 1 in. ³ /hr (max) after 30 minutes at low temperature extreme, at 30 psi. Class H: 0.01 micron of Hg per ft ³ /hr (max) at 15 psi containing 10% He (min) by volume.
Contact resistance (Millivolt drop)	21 mV (max) across mated connectors, 35 mV (max) after corrosion test.	Classes E, F, J and P: 50 mV (max) across mated connectors, 60 mV (max) after corrosion test. Class H: 75 mV (max) across mated connectors, 95 mV (max) after corrosion test.	Voltage drop across mated connectors, size 20 contacts with #20 AWG wire at 7.5 A. Class R and G: 15 mV (max) at 25°C and 23 mV (max) after corrosion. Class H: 165 mV (max) at 25°C and 253 mV after corrosion.
Insulation resistance	5000 MΩ (min) per MIL-STD-202, method 302, condition B (except at 25°C).	5000 MΩ (min) at 25° C per MIL-STD-202, method 302, condition B. Not more than 6 pairs of adjacent contacts.	5000 MΩ (min) per MIL-STD-202, method 302, condition B (except to be after 10 cycles of maintenance aging).
Ozone exposure	No requirement	No requirement	2 hrs (min) at room temperature and 0.010 to 0.015% by volume concentration.
Insert retention	150 psi for 5 s (min). Class R or F, size 8 to 12 shell.	75 psi for 5 s (min) (except class H).	75 psi for 5 s (min) (classes G and R only).
Contact retention	10 lb (min) force applied from front or rear for size 16 contact.	15 lb (min) axial displacement of contact 0.12 (max) for size 20 contact.	20 lb (min) for size 20 contact, axial displacement of contact 0.012 (max).
Altitude immersion	No requirement	No requirement	5000 MΩ (min) and 1500 Vac after 3 cycles in 20°C salt water at 1 in. Hg pressure.
Hi-Pot altitude (mated)	No requirement	No breakdown at 70,000 ft (mated), with grommet or potted: 1000 Vac. Per MIL-STD-202, method 105, condition C.	No breakdown at 110,000 ft, 1000 Vac per MIL-STD-202, method 301.

	RACK & PANEL CONNECTORS	PRINTED CIRCUIT CONNECTORS
MIL-C-38300	MIL-C-26518B	MIL-C-21097B
38 in.-lb (max).	60 lb (max) axial force for shell size A at room temperature and 128°C.	Maximum board insertion force: Type A, AD, C, 16 oz/contact, Type D size 15; 16 lb, size 22; 22 lb, size 30; 30 lb, size 42; 40 lb.
10 cycles of coupling and 10 cycles of contact insertion and removal. Insertion force of last 10% of contacts installed to be 15 lb (max).	10 cycles of coupling and 10 cycles of contact insertion and removal. Insertion force of last 10% contacts installed to be 15 in.-lb (max).	None
15 lbs (max) for last 10% installed, 8 lbs (max) for individual.	15 lbs (max) for last 10% installed; 8 lbs (max) for individual.	None
+260° to -65°C, 5 cycles (mated).	+263° to -58°C, 5 cycles (mated).	5 cycles per MIL-STD-202, method 107, condition B (mated).
2100 Vac peak or dc.	1500 Vac rms.	1800 Vac rms for 200 and 156 spacings per MIL-STD-202, method 303. 65 Vac rms for 100 spacing.
20 hours each: MIL-H-5606 & MIL-L-9236.	20 hours each: MIL-H-5606 & MIL-L-9236.	None
Per MIL-STD-202, method 204, condition D, -65°C, room temperature, +200°C, 100 mA. Interruption to 1 μs (max).	Per MIL-STD-202, method 204, condition B, -55°C, room temperature, +200°C, 100 mA. Interruption to 10 μs (max).	Per MIL-STD-202, method 204, condition B. 0.1 A, no interruption permitted after test connector meets engaging requirements.
50 G, per MIL-STD-202, method 202.	50 G, JAN-S-44 test apparatus.	50 G, per MIL-STD-202, method 202.
500 cycles (bayonet coupling). 500 cycles (thread coupling).	500 cycles.	500 cycles.
Per MIL-STD-202, method 106 (except no vibration). Insulation resistance (while in high humidity) to be 1000 MΩ (min).	Per MIL-STD-202, method 106 (except no vibration). Insulation resistance (while in high humidity) to be 1000 MΩ (min).	MIL-STD-202, method 103, condition B after insulation resistance test, 1000 MΩ (min).
Per MIL-STD-202, method 101, condition B.	Per MIL-STD-202, method 101, condition B.	Per MIL-STD-202, method 101, condition B.
1 in. ³ /hr (max) at 30 psi (after 30 minutes at low temperature extreme). Hemetic: 0.01 micron of Hg per ft ³ /hr (max) at 15 psi containing 10% He (min) by volume.	Class R: 1 in. ³ /hr (max) at 30 psi (after 30 minutes at low temperature extreme). Class H: 0.2 micron of Hg per ft ³ /hr (max) at 30 psi and 10% He (min).	No requirement
25 mV (max) across mated connectors, at any required current.	Class R: 12 mV (max) across mated connectors, 23 mV (max) after corrosion test. Class H: 132 mV (max) across mated connector at 25°C, 253 mV (max) after corrosion test.	Types A, AD and C: 0.03 (max) across mated connectors. Type D: 0.03 V (max) across mated connectors, test current 5 A. Per MIL-STD-202, method 307.
5000 MΩ (min) at normal conditions and 1000 MΩ (min) at service conditions per MIL-STD-202, method 302, condition B.	5000 MΩ (min) per MIL-STD-202, method 302, condition B (except after maintenance aging).	5000 MΩ (min) per MIL-STD-202, method 302, condition B (except at 500 Vdc) for unmounted; 500 MΩ for mounted.
2 hrs (min) at room temperature and 0.010 to 0.015% by volume concentration.	2 hrs (min) at room temperature and 0.010 to 0.015% concentration.	No requirement
75 psi for 5 s (min).	45 psi for 5 s (min).	No requirement
20 lb (min) axial displacement of contact 0.012 (max).	15 lb (min) axial displacement of contact 0.12 (max).	None
5000 MΩ (min) and 2100 Vac peak or dc after 3 cycles in 20°C salt water at 1 in. Hg pressure.	5000 MΩ (min) and 1500 Vac after 3 cycles in 20°C salt water at 1 in. Hg pressure.	No requirement
No breakdown at 110,000 ft, 2100 Vac peak or dc (min) per MIL-STD-202, method 301.	No breakdown at 110,000 ft, 1000 Vac per MIL-STD-202, method 301.	No breakdown at 70,000 ft, 450 Vac rms per MIL-STD-202, method 301.

150 MHz, 2.4 ns

NOW! at the probe tip

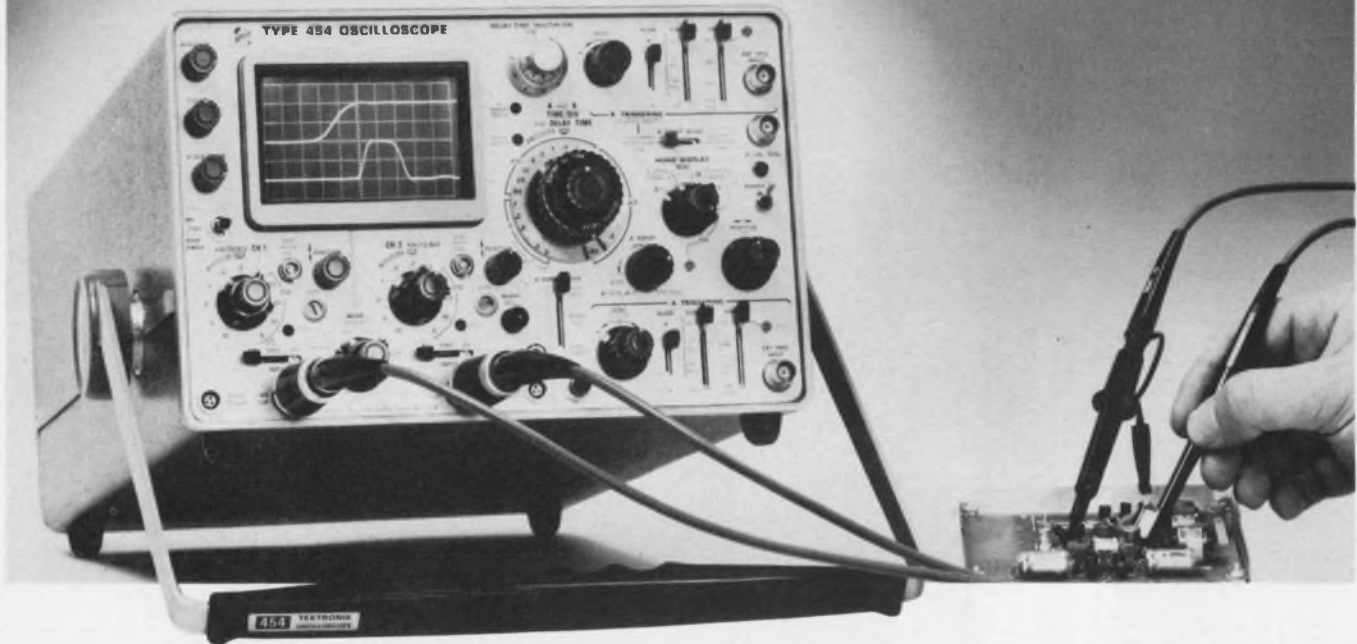

The Tektronix Type 454 is an advanced new portable oscilloscope with DC-to-150 MHz bandwidth and 2.4-ns risetime performance where you use it—at the probe tip. It is designed to let you make convenient measurements of fast-rise pulses and high-frequency signals previously outside the range of conventional oscilloscopes.

The Type 454 is a complete instrument package with dual-trace vertical, high-performance triggering, 5-ns/div delayed sweep and solid-state design, all in a rugged 31-lb. instrument. You also can make 1 mV/div single-trace measurements and 5 mV/div X-Y measurements with the Type 454.

The 2.4-ns risetime and DC-to-150 MHz bandwidth are specified at the tip of the new miniature P6047 10X Attenuator Probe. The dual-trace amplifiers provide the following capabilities with or without probes:

Deflection Factor*	Risetime	Bandwidth
20 mV to 10 V/div	2.4 ns	DC to 150 MHz
10 mV/div	3.5 ns	DC to 100 MHz
5 mV/div	5.9 ns	DC to 60 MHz

*Front panel reading. Deflection factor with P6047 is 10X panel reading.

The Type 454 features a new CRT with distributed vertical deflection plates and a 14-kV accelerating potential. It has

a 6 by 10 div (0.8 cm/div) viewing area, a bright P-31 phosphor and an illuminated, no-parallax, internal graticule. The Type C-30 and the New Type C-40 (high writing speed) cameras mount directly on the oscilloscope.

The instrument can trigger to above 150 MHz internally, and provides 5-ns/div sweep speeds in either normal or delayed sweep operation. The calibrated sweep range is from 50 ns/div to 5 s/div, extending to 5 ns/div with the X10 magnifier. Calibrated delay range is from 1 μ s to 50 seconds.

The Type 454 is designed to be carried and has the rugged environmental characteristics required of a portable instrument. A rackmount, the 7-inch-high Type R454 oscilloscope, is available with the same high performance features. Also available is the new Type 200-1 Scope-Mobile® Cart.

For further information about the Type 454, or about the new Tektronix DC-to-100 MHz *plug-in* oscilloscope, the Type 647A, contact your nearby Tektronix field engineer, or write: Tektronix, Inc., P. O. Box 500, Beaverton, Oregon 97005.

Type 454 (complete with 2 P6047 Probes and accessories)	\$2550
Type R454 (complete with 2 P6047 Probes and accessories)	\$2635
C-30 Camera	\$ 390
C-40 Camera	\$ 540
Type 200-1 Scope-Mobile® Cart	\$ 60

U.S. Sales Prices FOB Beaverton, Oregon



A new Technical Center:



*230,000 square feet devoted to R&D
... part of the Tektronix commitment
to progress in the measurement sciences*

ON READER-SERVICE CARD CIRCLE 50

Reader's Choice

IEE bright, legible, wide-angle readouts:

Any characters desired
Any colors or combinations
Any input, BCD or decimal
Any input signal level
Any mounting, vertical or horizontal

Many sizes
Many configurations
Many lamp lives (to 100,000 hours)
Many brightness choices
Many options and accessories



Standard Readouts: Rear projection principle, like all IEE readouts. A lamp in the rear of the unit illuminates one of the 12 film messages, and projects it to the front viewing screen. Unbeatable readability and versatility.

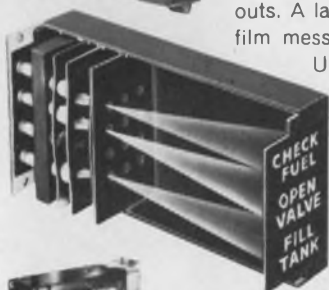

Large Screen Readouts: For reading distances up to 100 feet. Maximum character size $3\frac{3}{8}$ ".



Miniature Readouts: Only 1" wide x $1\frac{5}{16}$ " high, yet can be read at 30 feet because of clarity of one-plane projection. Character size: $\frac{5}{8}$ ".



Micro-Miniature Readouts: Only $\frac{1}{2}$ " wide x $\frac{3}{4}$ " high, but 20 foot viewing distance and maximum 175° viewing angle because of front-plane display. Character size: $\frac{3}{8}$ ".



Hi-Brite Readouts: Special lens system increases character brightness 50%. Particularly good when high ambient light conditions exist.



Cue-Switch Readouts: Rear projection readout with push-button viewing screen. Combination switch and display device.



Bina-View Readout: Accepts binary or teletype code, decodes, and displays the proper character.



Status Indicator Readout: Displays up to 12 different messages, individually or in combination. Viewing screen only 3 sq. in.



Indicator Assemblies: Available with up to 11 rear projection readouts, for indicating seconds, minutes, hours, days, etc.



Driver/Decoder Module: Designed to work with IEE Readouts. Accepts a variety of binary codes for decimal conversion.

The new IEE Display Devices catalog gives complete information and specifications on these products, and their accessories. Ask for it.



"I-double-E", the world's largest manufacturer of rear projection readouts.
Industrial Electronic Engineers, Inc. 7720 Leona Avenue, Van Nuys, California

ON READER-SERVICE CARD CIRCLE 51

Power supply protected by simple circuits

Power supplies frequently have to be protected against three types of fault:

- Overvoltage.
- Undervoltage.
- Overcurrent.

The circuit in the accompanying diagram disconnects the power supply from its load whenever the input voltage is more than 30 V dc or less than 18 V dc, or if the current exceeds 35 A. In each case this is accomplished by opening circuit breaker *SW1*, which is energized by the SCR. The breaker, being of the latching type, also disconnects the control circuit.

Circuit operation for each case is as follows:

Overvoltage condition

Q1 is normally saturated. *R1* and *R2* are chosen so that the intrinsic stand-off ratio of unijunction transistor *Q2* is not exceeded; *Q2* will thus not fire. The voltage at *B2* is clamped at nominal voltage by the sum of Zener voltages V_{Z1} and V_{Z2} . As supply voltage increases, the emitter voltage will go up until the voltage at *E* reaches the intrinsic

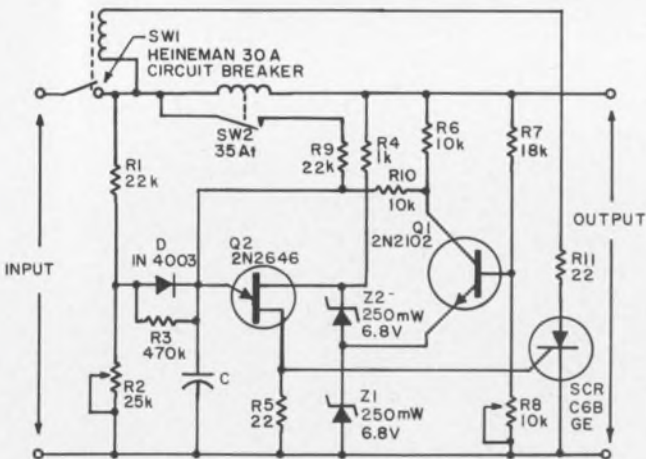

Power supply is disconnected automatically whenever the input voltage is over 30 V dc or under 18 V dc, or the current is over 35 A.

VOTE! Circle the Reader-Service-Card number corresponding to what you think is the best Idea-for-Design in this issue.

SEND US YOUR IDEAS FOR DESIGN. Submit your IFD describing a new or important circuit or design technique, the clever use of a new component, or a cost-saving design tip to our Ideas-for-Design editor. If your idea is published, you will receive \$20 and become eligible for an additional \$30 (awarded for the best-of-issue Idea) and the grand prize of \$1000 for the Idea of the Year.

stand-off voltage ($V_{Z1} + V_{Z2}$) and fires *Q2*, which in turn fires the SCR energizing the coil of *SW1*. The current through the coil should be several times larger than the trip current so that fast speed can be achieved.

Undervoltage condition

Voltage divider *R7* and *R8* is such that the voltage at the base of *Q1* tends to be more than V_{Z1} or V_{BEQ1} . *R6* is then roughly at emitter potential, that is, *Q1* is saturated. When the voltage drops below threshold voltage, *Q1* cuts off and *C* will charge through *R10* and *R6* until *Q2* fires, causing the SCR to fire and operate *SW1*.

Overcurrent condition

A coil is wound round reed switch *SW2*. Miniature reed switches that take about 35 At to pull in are available. When an overcurrent occurs, *SW2* closes, *C* charges through *R9*, and *Q2* fires after interval *R9C*, causing the SCR to fire and open *SW1*.

H. B. Farenbach, President, Etca Co. (Electro and Transformer Consultant Association), New York.

VOTE FOR 110

Microcircuit gate-extender makes fan-in reducer

The problem of driving five or six loads from an integrated microcircuit element with a rated four fanout is commonplace. Ordinarily, the solution is to interpose a buffer or driver, or to revise the circuit to redistribute loading. But sometimes there may be complications: the additional load may be external to an existing printed circuit; in multiple circuits the added buffer or rearranged circuit may make a formidable increase in microcircuit count; added inversions or propagation delays in all signal paths may be undesirable. In these cases, an integrated microcircuit "gate extender" and a few discrete resistors may offer a much simpler over-all solution.

A typical RTL gate element is shown in Fig. 1a; a corresponding gate extender is shown within the outline in Fig. 1b. In normal use the gate extender

In less time than it takes to read this page, you could learn to use this new Universal Impedance Bridge.

Ready? One, two, three, go.

2. Adjust the range switch for an on-scale reading.



3. Obtain a null with the CRL dial. Now, read your measurement.

1. Select the function you want.

Nothing to it. No interacting controls to adjust and readjust. No multipliers. No non-linear dials. AUTO-BALANCE eliminates all that.

This new Hewlett-Packard Bridge is the first one that takes human beings into account as well as impedance. It's made for engineers who don't have time for a half-hour refresher course every time they want to use it.

You get direct digital readout of all C, R, and L values. Indicator lights show up-scale or down-scale unbalance. Decimal point and an equivalent circuit are automatically indicated. No problem with false or sliding nulls either: unique electronic AUTO-BALANCE takes care of that.

For a D or Q measurement, just switch from AUTO to low or high D or Q and turn the DQ control until you obtain another null. Simple. Particularly for low Q and high D cases.

So if you're the kind of engineer who's tired of complicated impedance bridges, Hewlett-Packard has your number: Model 4260A, \$550.

Ask your Hewlett-Packard field engineer for a demonstration. Or write us for complete specs: Palo Alto, California 94304. Tel. (415) 326-7000. Europe: 54 Route des Acacias, Geneva.

HEWLETT  **PACKARD**
An extra measure of quality.

1B44

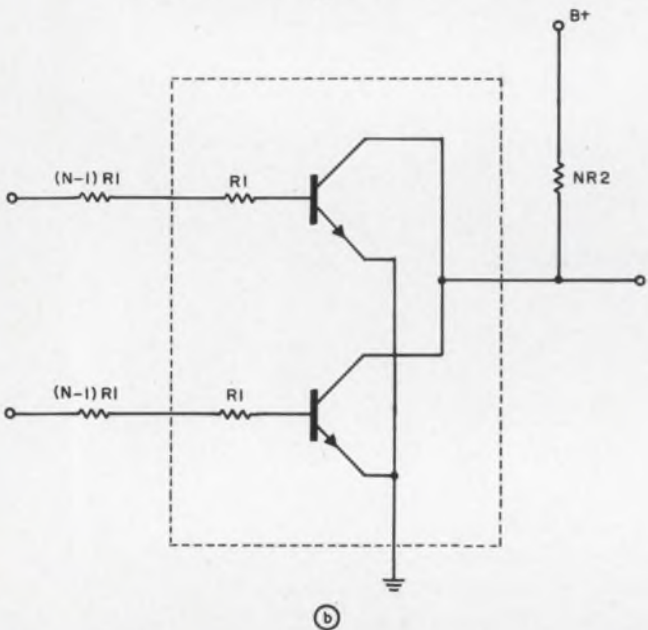
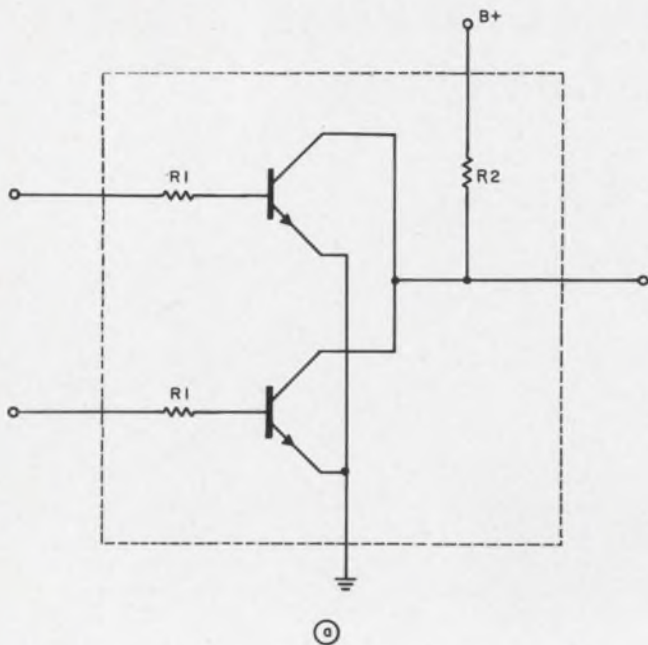

Gate extender plus a few resistors (b) forms a gate with lower fan-in than a standard gate (a).

output is tied to the standard gate output—a two-input gate is converted into a four-input gate. However, the addition of external resistors, as in Fig. 1b, enables a gate extender to be used as a separate gate with reduced loading on its signal sources. If the added input resistors are $N - 1$ times the internal input resistor $R1$, the loading or fan-in is reduced by a factor of N . The normal output swing is maintained with an output resistor that is N times the internal load resistor $R2$ of a normal gate. As a consequence, of course, the drive capability is only $1/N$ th that of a normal gate, but this is often sufficient.

If the microcircuit package contains only a

single gate, that gate may be made into a reduced fan-in gate by the addition of a resistor of $(N - 1)R2$ in series with the internal $R2$. But if multiple gates with common $B+$ terminal are contained within one package, the gate extender must be used.

Some small increase in propagation delays is caused by this circuit.

Robert L. Frank, Senior Research Section Head, Sperry Gyroscope Co., Great Neck, N. Y.

VOTE FOR 111

Monitor phase lead or lag automatically with IC logic

Often it is desirable to monitor automatically the direction of motion of a physical body. Such a body could be anything from a control rod of a nuclear reactor to the carriage of an interferometer.

The monitoring can be accomplished automatically by use of the integrated-circuit (IC) logic shown in Fig. 1. Two analog signals (A and B) are required as inputs to the circuit. The analog signals must be out of phase by greater than 180° , as illustrated in the timing diagrams, Figs. 2 and 3. Each analog signal drives an IC differential comparator ($\mu A710$) used as a Schmitt trigger. A common reference voltage (V_{ref}) is used for both Schmitt trigger circuits. When the input signal exceeds the reference signal, the output switches produce digital outputs A' and B' (see Fig. 2).

The Schmitt trigger circuit has hysteresis in the transfer characteristic. This hysteresis is desirable when large amounts of noise ride on the input signal. The amount of hysteresis (V_H) is determined by resistors $R2$ and $R3$:

$$V_H = R_2(\bar{e}_o - \underline{e}_o) / (R_2 + R_3),$$

where \bar{e}_o = maximum output of the $\mu A710$ and \underline{e}_o = its minimum output. For the $\mu A710$ element used, $\bar{e}_o = +2.0$ V and $\underline{e}_o = -0.4$ V. This produces a hysteresis voltage of 810 mV for the chosen values of $R2$ and $R3$.

Digital output A' is now summed with the derivative of B' and vice versa. This is accomplished by use of IC wide-band dc amplifiers ($\mu A702$). This produces the signals $-(K_1 B' + K_2 dA'/dt)$ and $-(K_1 A' + K_2 dB'/dt)$, where $K_1 = R8/R5$ and $K_2 = R8/R4$.

Selecting appropriate values of K_1 and K_2 enables the magnitude of the derivative which rides on top of the A' or B' signal to be made much larger than the derivative which rides on the bottom of the A' or B' signal.



Proved:
In-circuit reliability
for military uses

More than 20 million GE tantalum foil capacitors have already been applied. They are designed to withstand unsuspected voltage reversals and are self-healing. Low impedance circuits or catastrophic failures are no problem with GE tantalum foils. Ratings are available up to 450VDC, 0.15 to 3500 μ f, -55C to 85C, or 125C with voltage derating. Circle **Number 90** for all the facts on these capacitors.

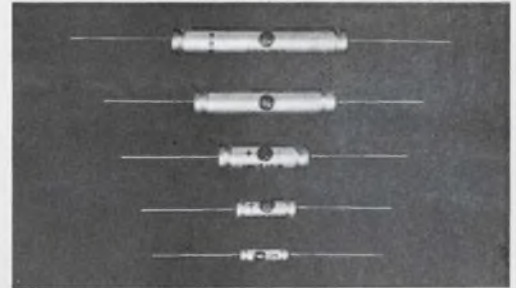

GE tantalum capacitors

Unique:
2-input, 4-output
AND circuit
in a single relay

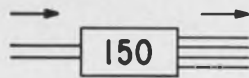

No other components are needed. Just a GE 150 4-pole Grid-space relay thanks to its unique magnetic circuit. The four outputs are switched simultaneously, yet completely independent from each other. And all input and output signals are electrically isolated. Save space. The relay measures just 0.320 by 0.610 by 0.610 inch. Save cost. All GE relay advantages—high power switching, high environmental capability, and GE's unique 150 design—are designed in especially for high performance, military type applications. Circle **Number 91**.

Your choice:
high-speed or
high-voltage
switching
in this compact
SCR

Take your pick.

GE C141 high speed SCR's (2N3654-8) are characterized for applications up to 25 kHz and feature a maximum turn-off time of 10 μ sec. They're ideal for converters and other high speed applications such as triggering a GE H1D1 laser diode.

GE C137 high voltage SCR's are rated up to 1200 volts repetitive peak with both high di/dt and high dv/dt capability . . . excellent for power switching from high voltage sources. Circle **Number 92** for more details on all SCR's available in this compact package from your GE salesman or distributor.



Actual size C141/C137 package

Coming your way . . .
GE's microwave
van



Be sure it visits your plant

See eight interesting displays on new ideas in microwave active components . . . and see them right at your plant. "Live" or operating displays include: distance measuring equipment (DME), radar altimeter, spectrum analyzer, unit oscillator, and some very recent VTM developments.

Ask the questions you want answered about GE klystrons, ceramic gridded tubes, voltage tunable magnetrons, tunnel diodes, and other microwave devices you may use.

Circle **Number 93** for more information.

WE MAY NOT OFFER EVERYTHING YOU WANT FROM ONE COMPONENTS SUPPLIER. BUT WE DO COME A LITTLE CLOSER THAN ANYONE ELSE.

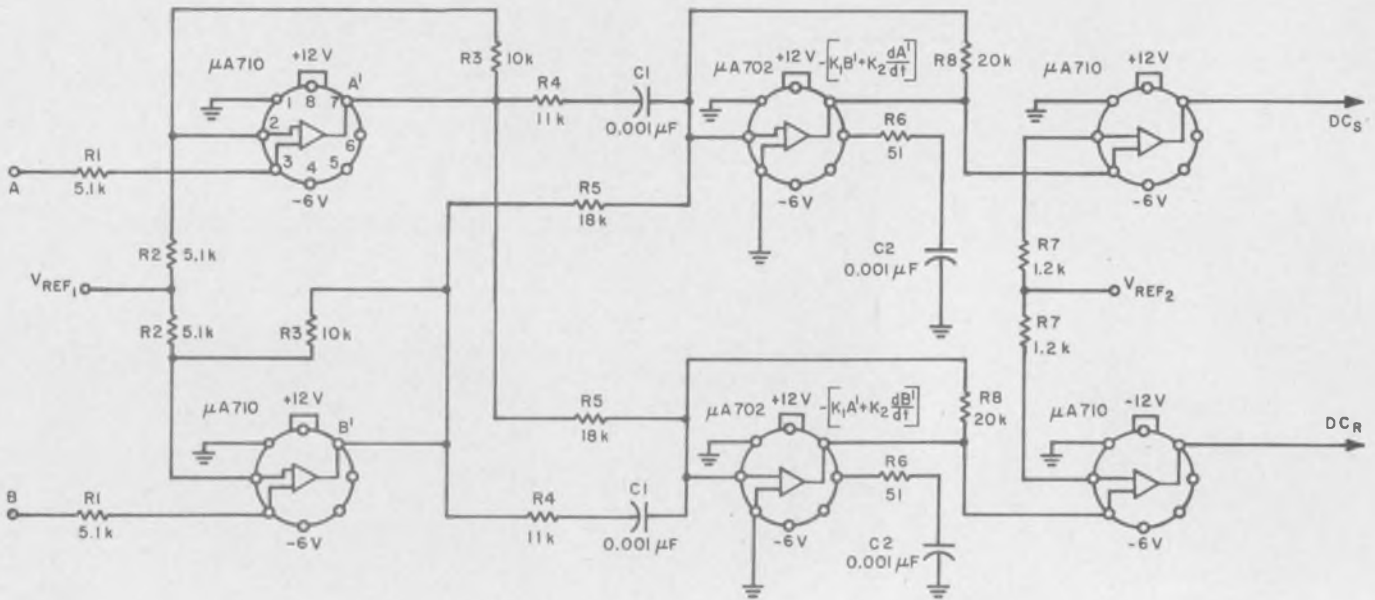

1. Six ICs and few external components can be used to sense direction of motion of a physical body.

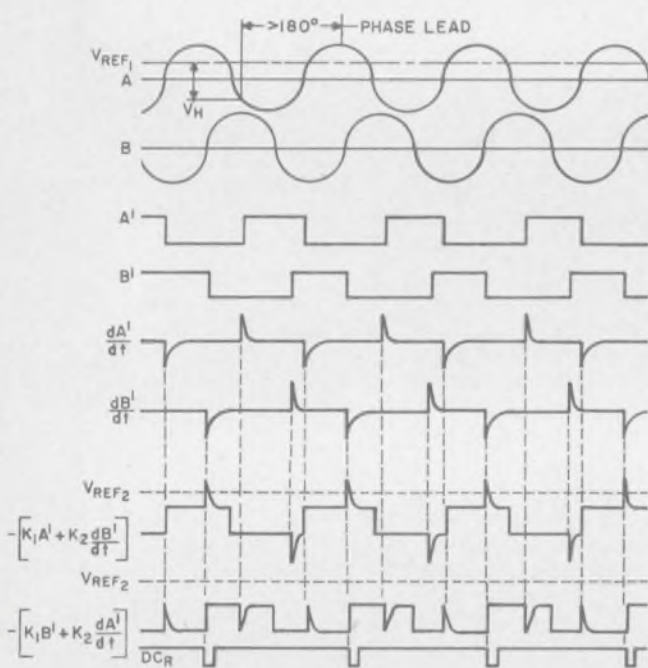

2. Reverse motion direction signals appear like this. Note the timing among various pulses.

Direction monitoring can now be accomplished by use of a pair of IC differential comparators ($\mu A710$) and a second reference source V_{REF2} . Each pedestal derivative ($K_1B' + K_2\frac{dA'}{dt}$) and ($K_1A' + K_2\frac{dB'}{dt}$) is fed to a $\mu A710$ element with a common reference, V_{REF2} . In the forward direction of motion, the pedestal derivative, $K_1B' + K_2\frac{dA'}{dt}$, exceeds V_{REF2} and produces the direction control signal DC_S . The other pedestal does not exceed the reference potential and no output is produced on the DC_R signal. Alterna-

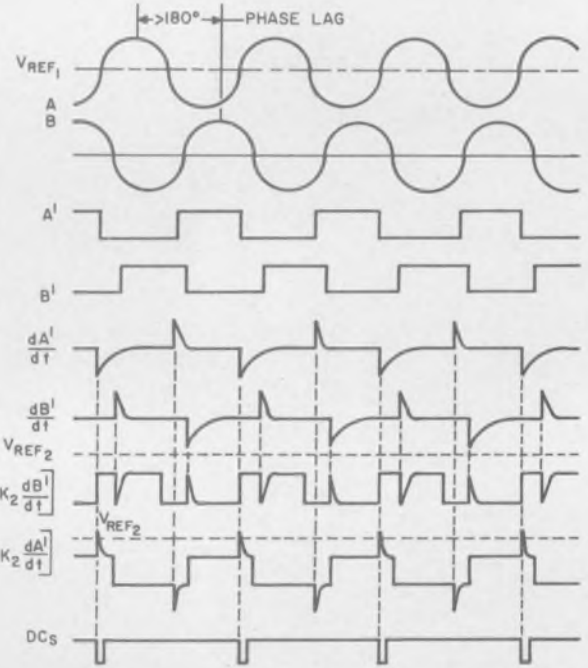

3. Forward motion direction results in the signals shown above. Refer to Fig. 1 for points where they occur.

tively, in the reverse direction of motion, the pedestal derivative, $K_1A' + K_2\frac{dB'}{dt}$, exceeds V_{REF2} and produces the direction control signal DC_R . The opposite pedestal does not exceed the reference potential and no output is produced on the DC_S signal.

Direction monitoring can be completed by feeding the DC_S signal to the set side of a control flip-flop and DC_R to the reset side. This flip-flop then monitors the direction of the device under consideration. The state of the flip-flop can now be



**This Babcock
10 amp. relay
also
switches
dry circuit
with the
same contact set**

Now, your Babcock 10 amp. full size crystal can relay will also switch dry circuit with the same set of contacts. These exclusive universal contacts have greatly simplified your relay stocking requirements. You can order one model to meet a given set of performance parameters without concern for load requirement — *at no cost premium*. Get complete information about this versatile relay, and the entire Babcock line, all with universal contacts.

Write Babcock Relays, Division of Babcock Electronics Corporation, 3501 Harbor Boulevard, Costa Mesa, California 92626; or telephone (714) 540-1234.



The Babcock Model BR7 relay will perform from dry circuit to 10 amps., with universal contacts, and is designed to meet critical aerospace applications.

SPECIFICATIONS

SIZES
1.300" h. x 1.075" l. x .515" w
WEIGHT:
Approx. 1.0 oz.
CONTACT ARRANGEMENTS:
SPDT and DPDT

PULL-IN POWER:
Low as 80 mw.
LIFE:
100,000 operations, min.
TEMP. RANGE:
-65°C to +125°C

FROM THE BABCOCK FAMILY OF CRYSTAL CAN RELAYS



used to control the input to the device electronics. For example, in the case of an interferometer, the "fringe" pulses would feed an up-down counter the direction of which would be controlled by the control flip-flop.

K. D. Smith, Senior Design Engineer, General Instrument Corp., Microelectronics Div., Hicksville, L. I., N. Y.

VOTE FOR 112

Generation of 3-phase square waves simplified

The generation of three square-wave signals, phased 120° apart, is commonly accomplished with a three-bit mobius shift counter. The more economical method illustrated here requires only three DT μ L 946 packages. The figure also shows the resulting wave forms. Notice that the input wave form must be square.

John L. Nichols, Senior System Engineer, Fairchild Semiconductor, Mountain View, Calif.

VOTE FOR 113

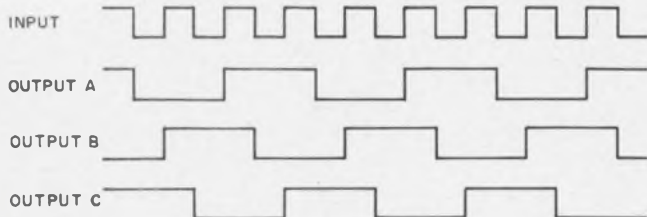
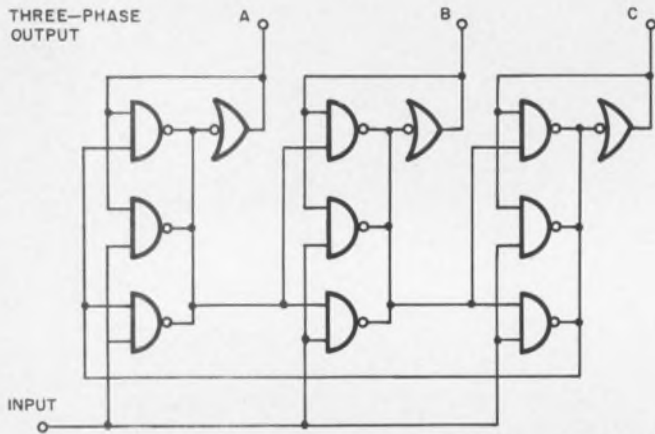

Three-phase square-wave generator can be built with only three DT μ L 946 packages.

Single transistor makes class-A oscillator

This one-transistor oscillator uses a pilot lamp as an age element that keeps the transistor in Class-A mode. The bulb is heated by the RF

coming from the emitter.

If the RF level starts to increase, the bulb will get hotter and the gain of the transistor will drop, keeping the loop gain at one. The output is a very clean 1-MHz sine wave.

Rudy Stefenel, Design Engineer, Microwave Laboratory, Hewlett-Packard, Palo Alto, Calif.

VOTE FOR 114

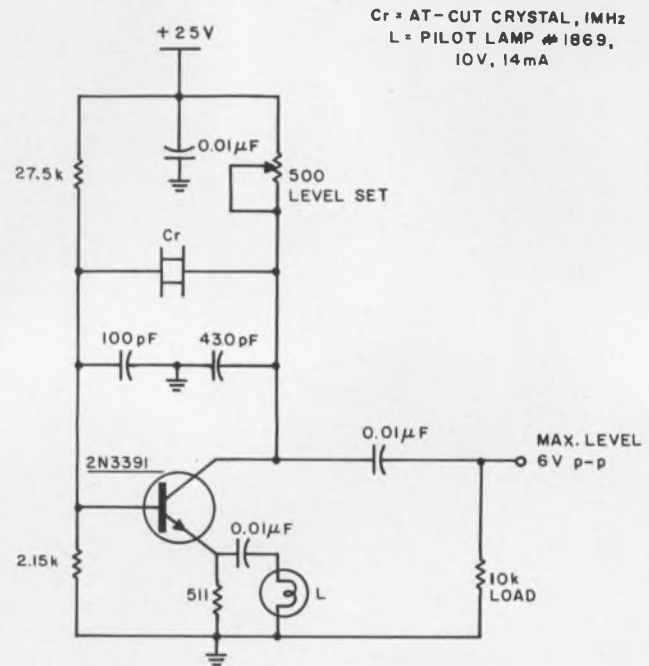

Pilot lamp filament keeps the transistor in Class-A mode by varying its resistance with RF level changes.

Sine- to square-wave converter is self-powered

This circuit is designed to work from a 600-ohm source such as an audio oscillator and may be used in lieu of a standard square-wave generator.

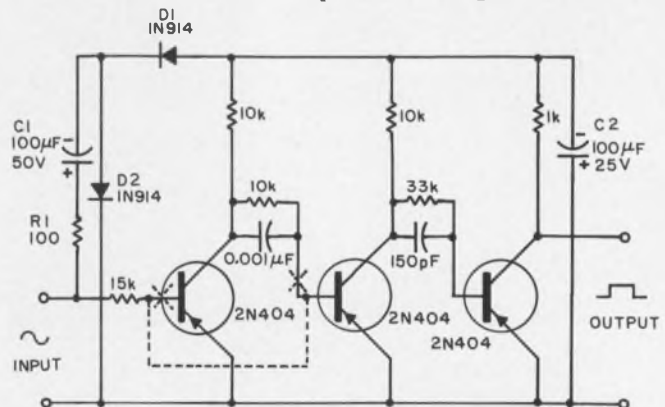

Square-wave generator can be built simply by connecting the above circuit to a 600- Ω audio source. No power supply is required.

**Now available in
16 different configurations
– all with 0.01% accuracy –**

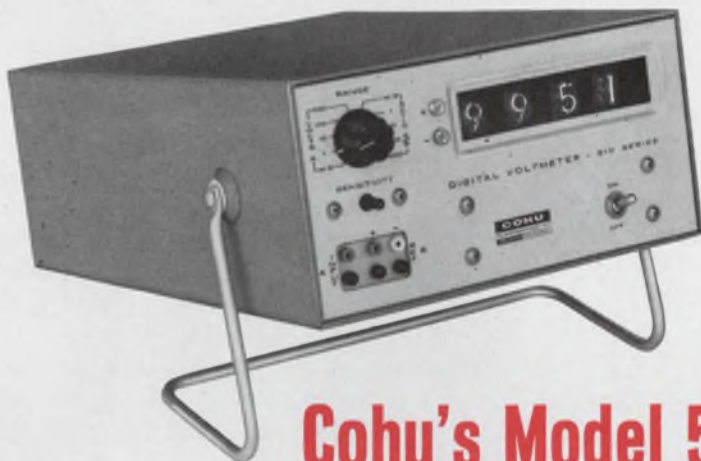

Cohu's Model 510 Series Digital Voltmeter-Ratiometer!

This highly reliable and stable instrument is now being delivered in models to meet virtually every application – laboratory, bench and assembly line. The basic cabinet or rackmount models sell for \$795, FOB San Diego. Additional export charge.

The 510 series is available either with manual ranging only or optionally with both manual and automatic ranging of the four voltage ranges. Electrical output options are biquinary, 1248 BCD, or 1224 logic level outputs, enabling this DVM to drive most types of digital recording devices. An optional accessory probe is also available.



These features are common to all models in the 510 Series:

- 0.01% \pm 1 digit accuracy
- automatic polarity indication
- 4-place reading on all ranges
- 4 manual ranges, 2 functions
(1V to 1000V, 1:1 to 1000:1 ratios)
- single control, range and function
- front panel sensitivity control
- high input resistance
- solid-state reference and circuitry
- bidirectional tracking logic

For full details, contact Cohu engineering representatives in major cities throughout the world.



Box 623
San Diego, California 92112
Phone 714-277-6700

ON READER-SERVICE CARD CIRCLE 55

It is basically a two-stage, overdriven amplifier with initial clipping produced by the action of $C1$, $R1$, $D1$ and $D2$. The combination of these same components forms a half-wave voltage-doubler circuit to furnish the collector supply voltage.

The output is a near perfect square wave the symmetry of which is affected very little, if any, by variations in input amplitude. Output level may thus be controlled by setting the input level as desired.

The circuit will produce square waves from 5 Hz to more than 500 kHz, although rise and fall

times increase as frequency is raised.

The circuit may also be used as shown in the dotted configuration with some loss in top and bottom flatness and further sacrifice of rise and fall times.

Flat square waves may be satisfactorily obtained from 10-V p-p to approximately 50-V p-p input with no change in symmetry.

L. E. Grothe, Senior Electronics Engineer, Babcock Electronics Corporation, Costa Mesa, Calif.

VOTE FOR 115

Simple circuit stretches pulses

A simple circuit (see Fig. 1) can stretch a 60-nanosecond pulse to several microseconds and preserve the input amplitude. By the following method, pulse stretchers of several milliseconds can be set up.

The input pulse charges capacitor $C1$ (see schematic) through the low impedance presented by $Q1$ and $D1$. When the input is removed, $D1$ becomes back-biased, provided that the input

amplitude is greater than the dc voltage across diode $D1$. Capacitor $C1$ is now free to discharge through the large impedance of $Q2$ and $Q3$.

The input also triggers the one-shot, $Q4$ and $Q5$. Once the one-shot is triggered, the collector of $Q5$ goes positive, back-biasing $D4$. With $D4$ back-biased, the output is free to pass through $D3$. After the time constant of the one-shot ($0.69 R1C2$), the collector of $Q4$ becomes almost ground and back-biases $D3$. For long pulse widths, $Q2$ should be a FET source-follower.

Richard S. Hughes, Senior Electronic Engineer, U. S. Naval Ordnance Test Station, China Lake, Calif.

VOTE FOR 116

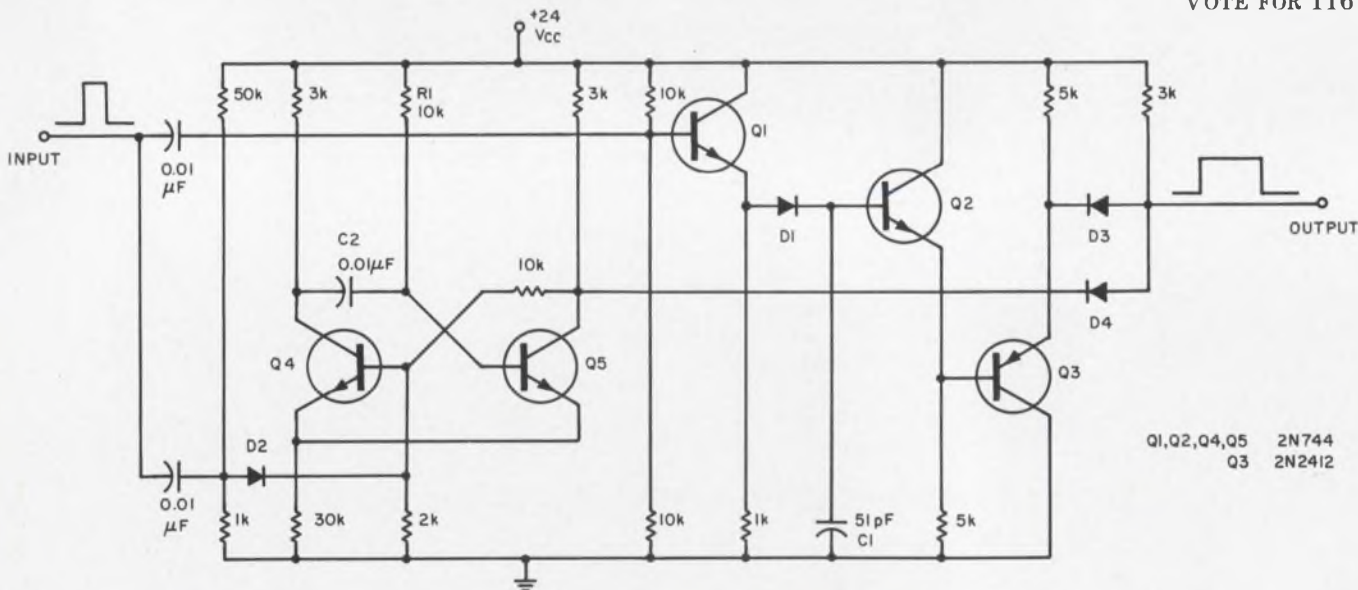

Input pulse can be stretched without altering its amplitude with this simple circuit.

IFD Winner for Dec. 20, 1966

John D. Griffith, M.D., Assistant Professor, Vanderbilt University, School of Medicine, Department of Psychiatry, Nashville, Tenn.

His Idea, "Hearing aid electronics cured by an M.D.," has been voted the \$50 Most Valuable of Issue Award.

Cast Your Vote for the Best Idea in This Issue.

IFD Winner for Jan. 4, 1967

A. G. Engelter, Solid State Electronics Div., National Research Institute for Mathematical Sciences, Pretoria, Republic of South Africa.

His Idea, "An electronic pad transmits handwritten messages," has been voted the \$50 Most Valuable of Issue Award.

Cast Your Vote for the Best Idea in this Issue.

Constant current biasing with field-effect current-limiter diodes.

...for bipolar or FET circuits, these diodes are to current
what Zener diodes are to voltage!

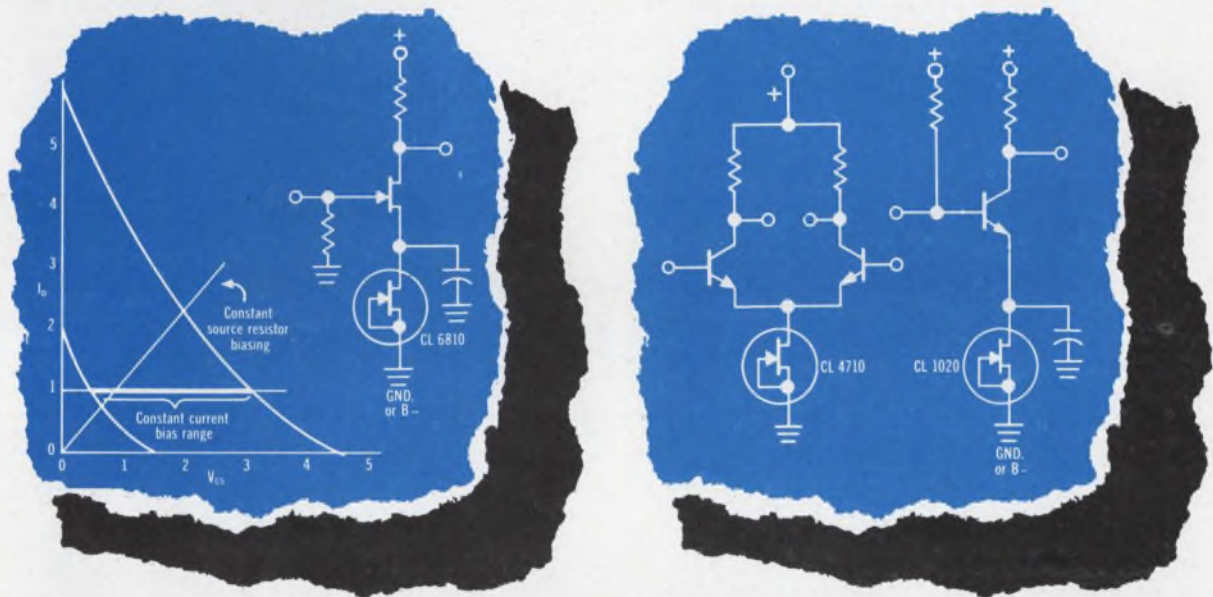

Siliconix assumes no responsibility for circuits shown, nor does it represent or warrant that they do not infringe any patents.

Are you plagued with poor circuit performance because standard FETs have broad I_{DSS} limits? With CL diodes you can fix your operating currents to select values from 0.22 to 4.7 mA.

Designing with bipolars? Forget voltage-divider base biasing, stability calculations and thermal runaway. Bias at constant current with a CL diode. You can direct couple from the previous stage or maintain the base a couple of volts above ground without a negative supply.

Other applications: Constant current charging of timing circuits, constant current d-c supplies, logic circuit pull-up current sources, emitter follower loads, current limiting elements, and on and on. **Ranges and tolerances:** The CL 2210 Series is available in nine RETMA standard values from 0.22 to 4.7 mA. Nominal tolerance—20%. Other currents, tighter tolerances, zero TC available on special order. Solid epoxy case. **Circle the number on the card; we'll send you a data sheet.**

 **Siliconix incorporated**
1140 W. Evelyn Avenue • Sunnyvale, California 94086
Phone 245-1000 • Area Code 408 • TWX 408-737-9948

Distributors: ALA., HUNTSVILLE, Cramer Electronics, Inc., 536-4493 • ARIZ., PHOENIX, Barnhill Associates, 959-2115 • Sterling Electronics, Inc., 258-4531 • CALIF., HOLLYWOOD, Hollywood Radio & Electronics, 466-3181 • LOS ANGELES, Kierulff Electronics, Inc., 685-5511 • MENLO PARK, Hollywood Radio & Electronics, 322-3431 • MOUNTAIN VIEW, Elmar Electronics, Inc., 961-3611 • OAKLAND, Elmar Electronics, Inc., 834-3311 • RIVERSIDE, Electronic Supply, Inc., 683-8110 • SAN DIEGO, Kierulff Electronics, Inc., 278-2112 • COLO., DENVER, Barnhill Associates, 934-5505 • CONN., HAMDEN, Cramer Electronics, Inc., 288-7771 • FLA., CLEARWATER, Perrott Associates, Inc., 446-2535 • ORLANDO, Perrott Associates, Inc., 275-1132 • WEST PALM BEACH, Perrott Associates, Inc., 585-7761 • ILL., CHICAGO, Semiconductor Specialists, Inc., 279-1000 • LA., BATON ROUGE, Sterling Electronics, Inc. • LAFAYETTE, Sterling Electronics, Inc., 234-6331 • NEW ORLEANS, Sterling Electronics, Inc., 522-8726 • MD., HYATTSVILLE, Milgray Electronics, Inc., 864-6330 • MASS., NEWTON, Cramer Electronics, Inc., 969-7700 • MINN., MINNEAPOLIS, Semiconductor Specialists, Inc., 866-3435 • MISS., GULFPORT, Sterling Electronics, Inc., 863-4051 • MO., ST. LOUIS, Semiconductor Specialists, Inc., 521-8866 • N. J., BERGENFIELD, Technical Electronic Distr., Inc., 384-3643 • N. M., ALBUQUERQUE, Barnhill Associates, 265-7766 • Sterling Electronics, Inc., 247-2486 • N. Y., BUFFALO, Summit Distributors, Inc., 884-3450 • NEW YORK CITY, Milgray Electronics, Inc., 989-1600 • SYRACUSE, Eastern Semiconductor Sales, Inc., 455-6641 • OHIO, DAYTON, Alpine Industries, Inc., 278-5861 • OKLA., TULSA, Oil Capital Electronics Corp., 836-2541 • PA., PHILADELPHIA, Simco Electronics, Inc., 229-1880 • TEX., AUSTIN, Sterling Electronics, Inc., 452-0271 • BEAUMONT, Sterling Electronics, Inc., 838-5255 • BRYAN, Sterling Electronics, Inc., 822-1589 • DALLAS, Sterling Electronics, Inc., 357-9131 • LUFKIN, Sterling Electronics, Inc., 634-4222 • HOUSTON, Lenert Company, 225-1465 • Sterling Electronics, Inc., 225-1321 • SAN ANTONIO, Sterling Electronics, Inc., 735-9173 • WASH., SEATTLE, Washington Electronics, Inc., 682-8981 • CANADA: MONTREAL, Prelo Electronics, Ltd., 389-8051 • OTTAWA, Wackid Radio, Ltd., 232-3563 • TORONTO, Electro Sonic Supply Company, Ltd., 924-9251

ON READER-SERVICE CARD CIRCLE 56

design engineers

NAVAL ARCHITECT • MARINE • MECHANICAL
STRUCTURAL • ELECTRICAL • ELECTRONICS
ARCHITECTURAL • CIVIL

Investigate your opportunities in the world's largest ship- building complex



The San Francisco Bay Naval Shipyard provides service to surface and underwater ships and deep submersibles. Assignments include new construction of Polaris nuclear submarines and guided missile frigates; and the repair, overhaul and conversion of all classes of ships. Other projects include research on noise reduction, ASW, replenishment-at-sea, Trieste II and Sea Lab II and III.

Openings exist at all levels in these program areas:

Ship Structure Development

Ship Weight Control

Structural Mechanics

**Nuclear and Conventional
Propulsion Systems**

**Navigation and Communication
Systems**

Sound and Vibration Control

**Cargo Replenishment-at-Sea
Development**

**Shipboard Mechanization
Plant Facilities**

**Ordnance, Guided Missile, Fleet
Ballistic Missile and
Electronic Systems**

**Shipboard Aeronautical Material
and Equipment**

**Shipboard Electrical and Power
Systems**

Naval Tactical Data Systems

Job Locations: San Francisco Bay Naval Shipyard has two work sites located 40 miles apart: San Francisco and Vallejo, California. Each location has ready access to the full cultural advantages of San Francisco and the mild year-round climate of the "Bay Area." All types of recreation from ocean surfing to skiing on the slopes of the Sierras are within easy driving distance.

Send resume or Standard Form 57, Application for Federal Employment, to:
**Coordinator, Professional and Technical Recruitment (Code 174A4)
Employment Division
San Francisco Bay Naval Shipyard
Vallejo, California 94592**

AN EQUAL OPPORTUNITY EMPLOYER

MUST BE A U.S. CITIZEN

ON CAREER INQUIRY FORM CIRCLE 901

Solid-state circuit switches ac load

Problem: Design a solid-state circuit that will switch ac signals with peak amplitudes greater than 5 volts. Conventional circuits have been able to control dc voltages only.

Solution: A differential amplifier circuit biases a switching transistor on and off by a 0.1-to-5.0-volt dc control voltage.

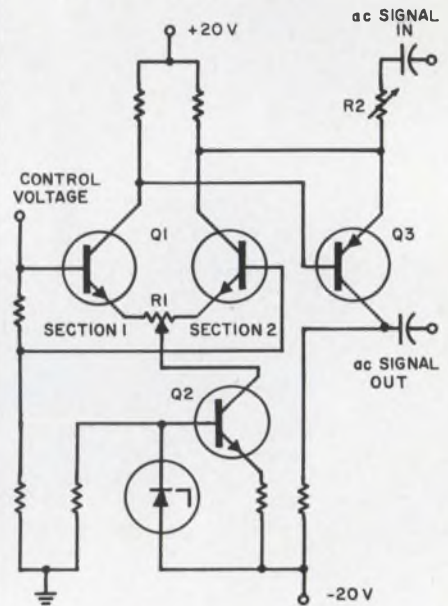

The circuit consists of a dual npn transistor, Q_1 , a current source, Q_2 , and an ac switch. Resistors R_1 and R_2 are initially adjusted to obtain proper switching action and to control the ac gain of the switch.

With no dc control voltage applied, the collectors of Q_1 will essentially be at the supply potential of 20 Vdc, causing the base and emitter of switch Q_3 to be at this same potential. In this condition, Q_3 will not conduct and there will be no ac signal out.

As a dc control voltage of 0.1 to 5.0 volts is applied to the base of section 1 of Q_1 , it causes that section to conduct more heavily than section 2. Thus, the collector of section 1 will be at a lower

(continued on p. 112)

Free Career Inquiry Service

Absolutely Confidential

Respond to the career opportunities advertised in this issue. Fill out and send us this handy resume. **Electronic Design** will do the rest – neatly typed copies of this form will be mailed to the companies of your choice, indicated by the circled Career Inquiry Numbers at the bottom of this page.

8

Name				Home Phone	
Home Address (Street)			City	State	ZIP Code
Age	U.S. Citizen <input type="checkbox"/> Yes <input type="checkbox"/> No		Security Clearance		
Prime Experience			Secondary Experience		
Desired Salary			Availability Date		
Employment History – present and previous employers					
Company					
City, State					
Dates	to		to		to
Title					
Specialty					
Education – indicate major if degree is not self-explanatory					
Degree					
College					
City, State					
Dates	to		to		to
Additional Training – non-degree, industry, military, etc.					
Professional Societies					
Published Articles					

Career Inquiry Numbers:

900 901 902 903 904 905 906 907 908 909
 910 911 912 913 914 915 916 917 918 919

ELECTRONIC DESIGN
 850 Third Avenue
 New York, New York 10022

It took Hughes
engineers 3½ years to
create the
SYNCOM
story.

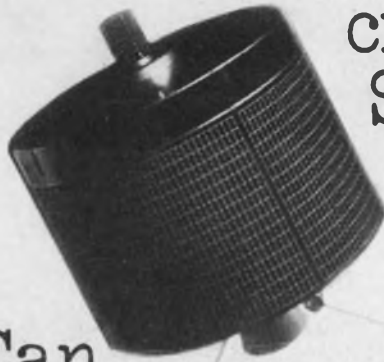

Can
you write it?

Hughes Field Service and Support is urgently seeking qualified E.E.'s for a dual challenge—to your engineering know-how and to your writing ability. You will be closely associated with the latest and most advanced aerospace projects. As a Systems Writing Engineer, your assignment will be to **communicate** your knowledge of these projects.

The Syncom series is just one example of the magnitude and significance of the projects involved. Other subjects include space vehicles, weapons systems, electronic computers, guided missiles, radar and communications, programmed instructional devices, and systems trainers.

You will research drawings, specifications, and reports; you will interview project engineers and make first-hand examinations and inspections. Then you'll interpret and analyze this data and write engineering publications for use by other engineers on allied projects.

This is a demanding position and an important one. If you wish to rapidly broaden your engineering knowledge and gain systems-oriented technical experience, if you have a B.S.E.E. or a B.S. in Physics—and if you can write—please send your resume at once to: Mr. B. P. Ramstack, Hughes Aircraft Company, P.O. Box 90515, Los Angeles, California 90009. U.S. citizenship required.

HUGHES

HUGHES AIRCRAFT COMPANY
FIELD SERVICE & SUPPORT DIV.

An equal opportunity employer

voltage than the collector of section 2, causing $Q3$ to be forward-biased to conduct and pass the ac signal.

Transistor $Q3$ provides a constant-current source for $Q1$ for more stable operation. Resistor $R1$ determines the on/off sensitivity of $Q3$ by unbalancing $Q1$. Resistor $R2$ is the signal gain potentiometer and is adjusted for unity gain so that a 1-volt input signal produces a 1-volt output signal.

Output of this switch is flat within 3 dB from 6 Hz to 21.5 kHz with 1-mF coupling capacitors.

For further information, contact: Technology Utilization Officer, Jet Propulsion Laboratory, 4800 Oak Grove Drive, Pasadena, Calif. 91103 (B66-10465).

Bridge calibrates high-voltage divider

Problem: Obtain fast, accurate, in-circuit calibration of a high-voltage divider while it is operated under normal current and voltage conditions. Since the divider resistance varies with the applied voltage at potentials over 1000 volts, high-potential dividers must be calibrated at their operating voltage for accurate results. Standard low-voltage laboratory calibration equipment is unsuitable for this application.

Solution: A resistance-bridge device, incorporating potentiometer, switches and null detector, calibrates high-potential dividers under high-voltage operation conditions.

Resistors $R1$, $R2$ and $R3$ make up the voltage divider to be calibrated. The calibration device is made up of resistor $R4$, which can be a low-precision resistor capable of supporting the

(continued on p. 114)

THE EXCITING SURGE OF ELECTROSYSTEMS



Dr. E. B. Carne,
author of "Artificial
Intelligence
Techniques";
Assistant General
Manager—Systems,
Greenville Division,
LTV Electrosystems.

ARTIFICIAL INTELLIGENCE HE WROTE THE BOOK

Would you like to teach a machine to think?

Dr. Carne and the engineers of LTV Electrosystems are doing just that within one of the most exciting R & D programs in the country.

Greenville Division researchers have successfully programmed contemporary "thinking machines"—digital and analog computers — to take giant steps beyond their present capabilities as memory banks and simple automatic controllers. The electronic brains have been taught to perform certain basic humanistic intellectual functions, such as making plans, setting up hypotheses, recognizing analogies and actually executing decisions based upon logical choices.

Sounds like ivory tower experimentation?

Not at all. Systems engineering means immediate application of the latest technologies at LTV Electrosystems. Artificial intelligence systems serve a real and practical function within the advanced electronics projects under development at Greenville Division, a major producer of sophisticated, multi-sensor surveillance and reconnaissance systems; highly accurate navigation systems (using stellar, doppler, and iner-

tial modes); ground and airborne tracking systems; and ground and airborne command and control systems.

Research and development programs are also adapting artificial intelligence to in-flight monitoring of instrumented aircraft to detect or predict failures of the airframe or the avionics systems.

Consider a career with LTV Electrosystems. The opportunity equals the technology: exciting and unlimited in potential. In addition to analysis and design of advanced electronic systems, selected openings are available in electro-optics, antenna design, stress analysis and other mechanical disciplines, programming . . . much more.

In addition to the Greenville Division, LTV Electrosystems includes the Garland Division and the Continental Electronics subsidiaries, all with opportunities in many disciplines at several locations.

For full information, write or call collect, Mr. Bill Hickey / P. O. Box 6118 / Dallas, Texas 75222 / Telephone (214) 276-7111. (A Subsidiary of Ling-Temco-Vought, Inc.) an equal opportunity employer m/f.

LTV ELECTROSYSTEMS, INC.

ON CAREER INQUIRY FORM CIRCLE 903

RELIABILITY ENGINEERS

BSEE or BSME-Reliability design review:

Experienced with small electrical components and semiconductors. Prepare procurement, test and design specifications.

BSEE-Reliability analysis:

Experienced in circuit design and analysis. Perform detailed reliability analyses of complex electronic parts and circuits and recommend improvements in design reliability.

BSEE-Reliability test engineering:

Prepare test procedures for electrical and electronic packages and coordinate procedures with test laboratories, conduct proofing of test procedures and test equipment.

BSME-Reliability and inspection:

Perform mechanical and structural reliability analyses. Provide for inspection planning and review prints to determine inspection attributes. Experience in metallurgy and NDT helpful.

Non-destructive testing:

Background in electronics and applied physics plus knowledge of instrumentation related to the use of X-rays, sound waves, electrical fields and optics.

Write Mr. R. C. Birdsall, Professional Placement Manager, Lockheed Missiles & Space Company, P.O. Box 504, Sunnyvale, California. An equal opportunity employer.

LOCKHEED
MISSILES & SPACE COMPANY
A GROUP DIVISION OF LOCKHEED AIRCRAFT CORPORATION

ON CAREER-INQUIRY FORM CIRCLE 904

This coupon could
 help you
 breathe easier.

A CHRISTMAS SEAL SERVICE

NTA
 GPO, Box 2400
 New York, N. Y. 10001

Send me the free booklet, "Your Breathing Troubles: Understand Them, Face Them, Treat Them"

Name _____

Address _____

City _____ State _____ Zip Code _____

Free booklet published by Emphysema-Bronchitis,
 National Tuberculosis Association



applied operating voltage, resistor R_5 , a high-precision potentiometer, switches S_1 and S_2 , and a null detector.

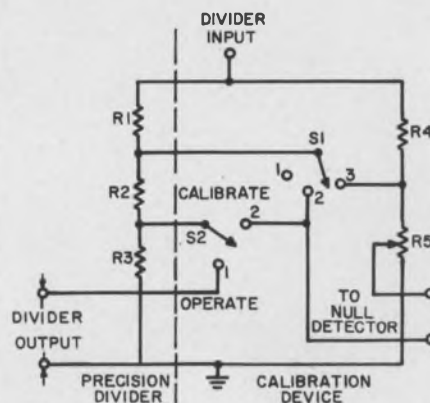

To calibrate a high-voltage divider, the divider input is applied to the input terminals of the calibration circuit, switch S_2 is moved to the "calibrate" position, switch S_1 is moved to position 1, and potentiometer R_5 is adjusted until a null is obtained on the null detector. The same procedure is followed for positions 2 and 3 of switch S_1 . The three resulting R_5 potentiometer readings (P_1 , P_2 , P_3) at the nulls are recorded. These three values are then used in the equation: $E_{out}/E_{in} = R_3/(R_1 + R_2 + R_3) = (P_2 - P_1) P_3/P_3 (1 - P_3)$, to specify completely the resistance ratio of the high-voltage divider.

Calibration can be performed with this device in less than 1 minute at an accuracy of 0.001 per cent.

Additional information is contained in *Rev. Sci. Instr.*, XXXVI, No. 4 (April, 1965), 532-537.

For further information, contact: Office of Industrial Cooperation, Argonne National Laboratory, 9700 S. Cass Avenue, Argonne, Ill. 60439 (B66-10497).

Remember to return your **ELECTRONIC DESIGN** renewal card. Don't miss any issues in '67.

MICROCIRCUIT CHIPS

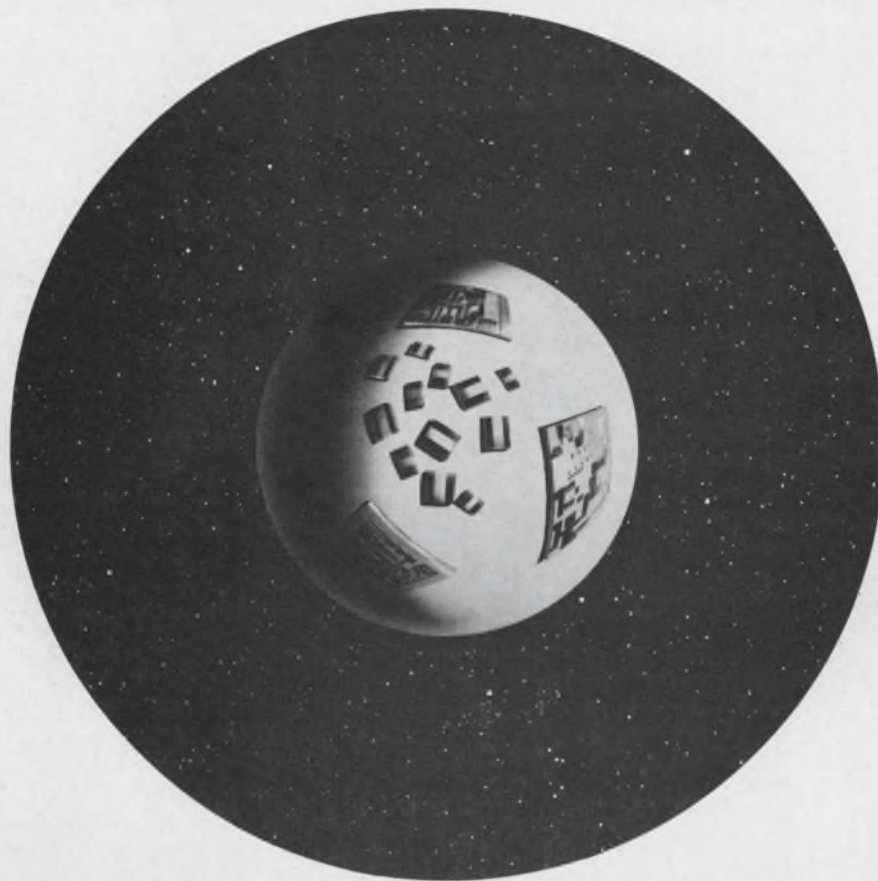

SPACE AGE CAPACITORS

S-CAP 100 A NEW CERAMIC CHIP CAPACITOR DESIGNED FOR THE NEW WORLD OF MICROCIRCUITS. Offering capacitance values ranging from 10 Pf through 0.22 Mf in five optional case sizes (beginning with a chip  .080 X .050 X .050) and four optional dielectrics, all utilizing proprietary method of monolithic construction, the S-Cap 100 Series gives the designer the ultimate in quality — reliability — and flexibility.

With years of experience in manufacturing ceramic capacitors and basic ceramic ware, Scionics is proud to offer S-Cap 100, the finest monolithic ceramic chip capacitor available.

Write today for the S-Cap 100 Technical Literature. For information pertaining to other Scionics products, ask for our General Catalog.

THE SCIONICS CORPORATION — 8900 Winnetka Avenue, Northridge, California/213-341-5500/TWX 213-341-7559

SCIONICS[®]

SCIONICS — SCIENCE AND ELECTRONICS FOR INDUSTRY AND DEFENSE
CAPACITOR DIVISION • INSTRUMENT DIVISION • INFORMATION SYSTEMS DIVISION

ON READER-SERVICE CARD CIRCLE 57

Three Ways To Phase Out Potentiometer / Dial Problems

1 MODEL 3600 KNOBPOT® PRECISION POTENTIOMETER

2 MODEL 3640 KNOBPOT® SENIOR PRECISION POTENTIOMETER

3 MODEL 3650 DIGITAL KNOBPOT® PRECISION POTENTIOMETER

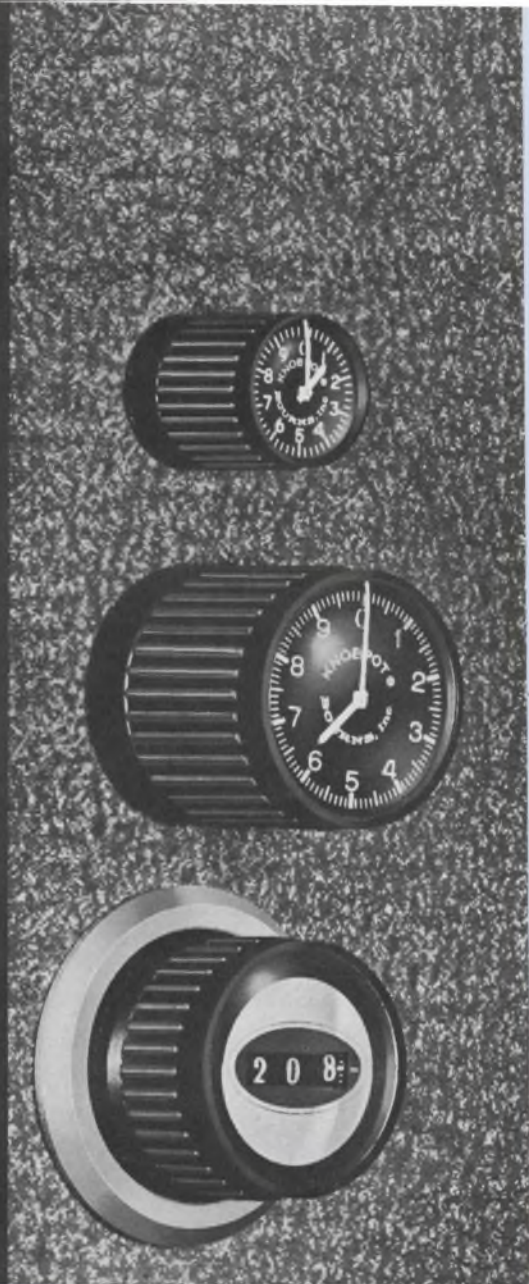

FACTORY PHASED • GUARANTEED ACCURACY • NO AMBIGUITY

Here is how you can eliminate the time and expense of assembling conventional potentiometer/dial combinations. The Bourns KNOBPOT® potentiometers give you everything you need in a self-contained unit. Installation is easy with no separate dial to attach, no complicated mounting procedure and no phasing. Just drill two holes, put the unit on the panel, and tighten the nut.

These units are more accurate than the best potentiometer/dial combination, yet cost no more! Many configurations cost less than \$20.00 each in low production quantities. Select the unit which fits your design requirements... the Model 3600 or 3640 KNOBPOT® potentiometer, or the new digital readout Model 3650.

All units are available in quantity with a complete line of accessories: color snap rings, colored MIL-SPEC knobs, locking brakes and recessed mounting brackets.

For further information on the Bourns KNOBPOT® Potentiometers and their accessories, contact your nearest Bourns representative or the factory direct. These products stocked in depth at your local Bourns authorized distributor.

SPECIFICATIONS	Model 3600	Model 3640	Model 3650
Standard Resistances	100Ω to 250KΩ	100Ω to 500KΩ	100Ω to 500KΩ
Dial Accuracy*	±0.50% All resistances	100-200Ω ±0.20% 500-5K ±0.15% 10K-20K ±0.12% 50K-500K ±0.10%	100-200Ω ±0.20% 500-5K ±0.15% 10K-20K ±0.12% 50K-500K ±0.10%
Repeatability	±0.10%	±0.05%	±0.05%
Power Rating	1.5W at 25°C	2.5W at 25°C	2.5W at 25°C
Max. Operating Temperature	-65°C to +85°C	-65°C to +85°C	-25°C to +85°C
Dimensions (in front of panel)	1" long ¾" dia.	1½" long 1¼" dia.	1¾" long 1¼" dia.

*Includes the Linearity of the Potentiometers



BOURNS, INC., TRIMPOT DIVISION • 1200 COLUMBIA AVE., RIVERSIDE, CALIF.
TELEPHONE (714) 684-1700 • TWX: 910 332-1252 • CABLE: BOURNSINC.

TRIMPOT® and Precision Potentiometers • Miniature Relays • Electronic Modules • Microcomponents.

Products

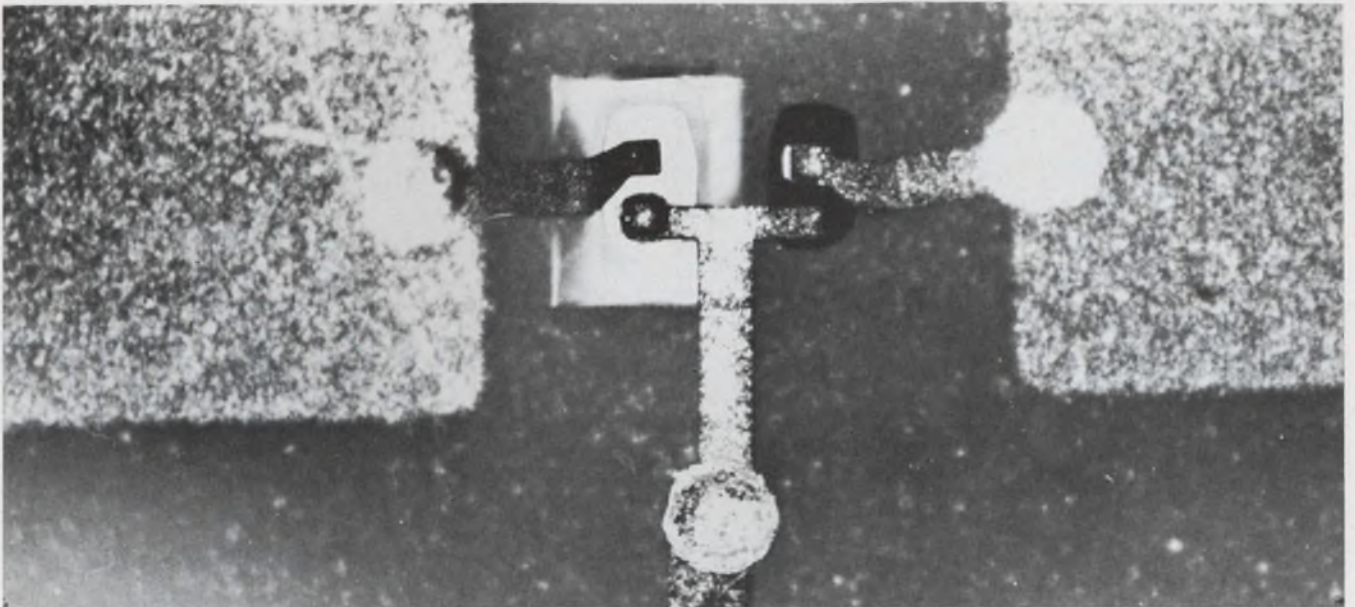

Beam-lead Schottky barrier diodes are one-tenth the size of standard microwave diodes.

Together with the leads, 1000 of these duals are produced on a single wafer. Page 120



Single-plane digital readouts shine from tiny ten-gun cathode ray tubes. Page 137



"Complementary" UJT synthesized by an IC. Stabler oscillator designs seen. Page 132

Also in this section:

Plastic MOS-FETs, 300-volt FETs featured in 6 new FET families. Page 118

Three-and-a-half digit multimeter at one-half the price. Page 147

Power spectral density plots produced in a matter of seconds. Page 154

Design Aids, Page 162 . . . **Application Notes**, Page 164 . . . **New Literature**, Page 166

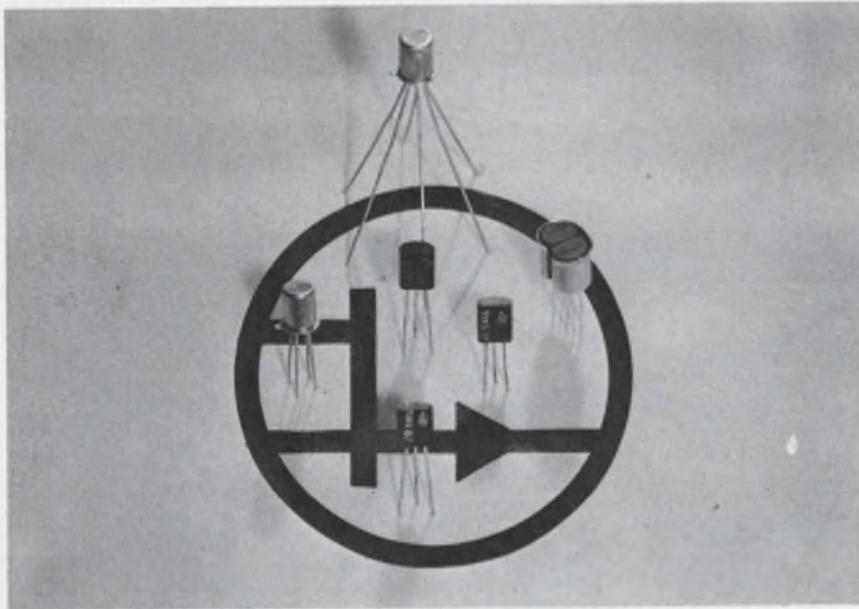

Six new FET families cut cost, push performance

Texas Instruments, Inc., 13500 N. Central Expwy., Dallas. Phone: (214) 235-3111. P&A: \$2.60 (plastic MOS-FET), \$5.25 and \$4.80 (300-V FETs), \$14.95 and \$11.95 (tetrode FETs), \$5.50, \$4.80 and \$4 (matched FET pairs), \$11.25, \$9.80 and \$8.95 (dual FETs), \$4.90 to \$5.95 (metal can switches), \$3.25 to \$3.65 (plastic switches); stock.

Six FET families, containing 20 devices in all, feature reduced cost, improved performance or both. The families are:

- Plastic-encapsulated MOS-FETs.
- 300-volt plastic FETs.
- Tetrode FETs with low reverse capacitance.
- Matched FET pairs in plastic.
- Dual FETs with matched output admittance.
- FET switches with 25- Ω on-resistance.

The plastic-encapsulated MOS-FET, TIXS67, is a p-channel silicon enhancement-mode device. It is designed for switching and high-input-impedance amplifier applications from dc through medium frequencies. The TIXS67 features high transconductance (3500 to 6500 μ mhos), low feedback capacitance (4 pF) and low leakage (50 pA). Breakdown voltage exceeds 25

volts. The device is available in a molded TO-18 pin-circle package.

The two high-voltage FETs, TIXS78 and 79, are n-channel silicon planar units. Drain-to-gate reverse breakdown voltage is 300 volts for the TIXS78, and 200 volts for the TIXS79. Maximum on-resistance is 1.5 k Ω , minimum transconductance is 0.75 mmhos, maximum input capacitance is 15 pF and maximum reverse-transfer capacitance is 3 pF. Applications are found in high-voltage switching and large-signal amplification.

Reverse transfer capacitance of 0.8 pF is offered by the TIXS80 and TIXS81 tetrode FETs. The n-channel silicon planar epitaxial FETs provide tetrode characteristics through electrical separation of the front and back gates of triode devices. Biasing only the back gate with dc voltage significantly reduces capacitance of the gate. Reverse transfer capacitance (C_{RSS}) is thus reduced, making possible a large ratio of forward transfer admittance (Y_{fs}) to C_{RSS} , which, in turn, provides increased amplifier gain at higher frequencies. The devices are usable up to 300 MHz. Gate-to-source cutoff voltage is -1 to -5 V for the TIXS80 and -3 to

-10 V for TIXS81. I_{DSS} is 5 to 20 mA and 15 to 75 mA. Other electrical characteristics are identical for the pair. They are designed for mixer and automatic gain-control applications and can be used in RF amplifiers, eliminating the need for neutralizing circuitry.

Three plastic-encapsulated FETs offered as matched pairs are designated TIS68, 69 and 70. The n-channel silicon epitaxial planar devices are electrically matched and then banded together with a metal clip. Each individual FET features 1-mmho transconductance, 8-pF input capacitance and 4-pF reverse-transfer capacitance. Each FET pair is matched for gate leakage current, gate-to-source voltage, I_{DSS} and transconductance. For example, the TIS68 has a gate-to-source-voltage match of 5 mV at a drain current of 500 μ A, an I_{DSS} match of 5% and a transconductance match of 5%.

Matched output admittance for improved common-mode rejection is offered by three new dual FETs. Packaging of the transistor chips together in a single TO-71 metal package simplifies amplifier design by providing close tracking of device characteristics over a wide temperature range.

The three dual devices are designated 2N5045, 5046 and 5047. Major characteristics of each individual transistor chip include transconductance of 1500 μ mhos, output admittance of 25 μ mhos, input capacitance of 4 pF and noise figure of 5 dB maximum at 10 Hz. The 2N5045 dual FET is matched for an output admittance differential of 1 μ mho, a gate-to-source voltage differential of 5 mV at 50 and 200 μ A, an I_{DSS} match of 5% and a transconductance match of 5%.

A family of six metal-case and three plastic-encapsulated silicon FETs have on-resistance of 25 Ω . The planar epitaxial n-channel FETs are designated 2N4856 through 2N4861 in TO-18 cans and TIS73 through TIS75 in the molded TO-18 pin-circle package. The 25-to-60- Ω on-resistance, combined with drain-to-gate leakages of 0.25 to 1 nA, makes the devices suited for analog switching (series-type) and chopper (shunt-type) circuits.

CIRCLE NO. 392

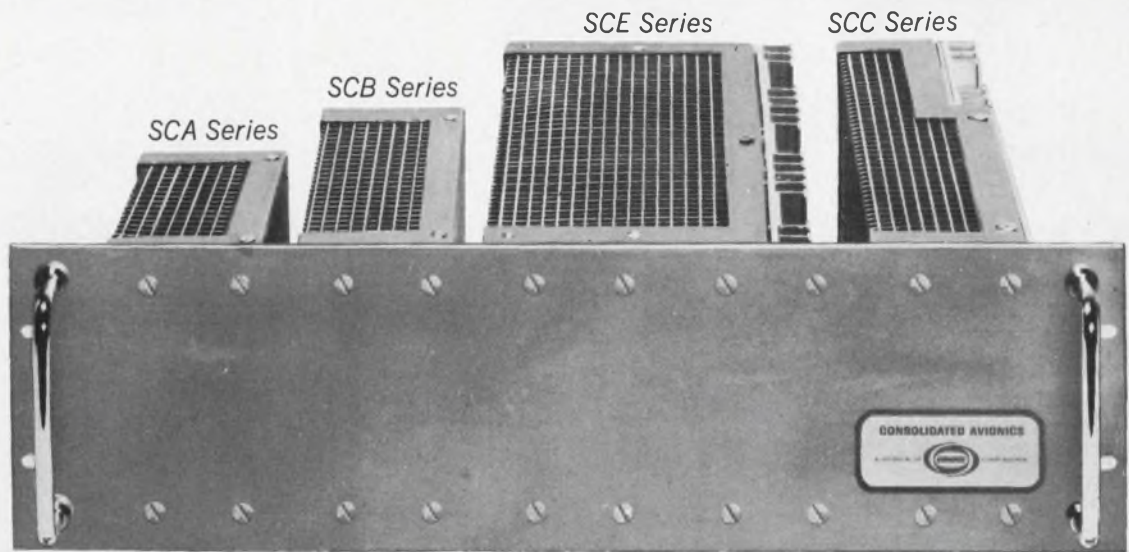

New Packaging Idea in Systems Power Supplies

*Three Mounting Planes
And Slim Package Design
Help You Pack More Power
In A 19" Rack*

SPECIFICATIONS

Input: 105-125V AC, 47-440 cps

Regulation (line and load combined):
±0.05% or 2 mv, whichever is greater.

Ripple: 1mv rms.

Response Time: 20 μsecs.

Temperature Coefficient: 0.015%/°C or
1.8mv/°C, whichever is greater.

Temperature: 75°C max.

Remote voltage adjustment and remote sensing are standard. Overvoltage protection and metered panels available as options.

You can pack as much as 485 watts into a standard systems rack when you use Con Avionics new SC series of power supplies.

There are 88 modules, in four package sizes, to choose from. You can mount any of the modules on any of three surfaces, including a 3½" panel. A wide variety of rack adapters lets you pick a power supply rack to fit your exact requirements.

The units are self-cooled, saving you precious inches you used to need for heat sinking. They are unconditionally guaranteed for five years. Because they were designed under Worst Case Analysis, they will meet their specifications even under the worst possible combinations of operating conditions.

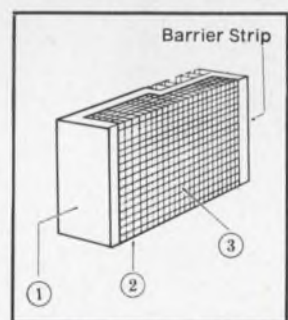

3 Ways To Mount

CONSOLIDATED AVIONICS

A DIVISION OF  CORPORATION

800 Shames Drive, Westbury, L.I., New York
(516) ED 4-8400 TWX: 510-222-6151

REGULATED POWER

FOR SENSITIVE EQUIPMENT



INVERTERS

DC to Quality AC



FREQUENCY CHANGERS

Inferior AC to Quality AC

For mobile and emergency operation of electronic instruments, video tape recorders or other sensitive equipment. Field-proven and available from stock.

- Output: 115 V \pm 5%; 60 \pm .03 cps sine wave, maximum 6% harmonic distortion
- Input: Inverters—11-15 or 22-30 VDC
Changers—95-125 VAC, 50-500 cps
- 1000, 500, 250 and 125 VA models
- All-transistorized for high reliability, low acoustic noise and instant turn-on
- Used by Industry and Military

SEND FOR COMPLETE CATALOG

TOPAZ, INCORPORATED
3800 HOUSTON STREET
SAN DIEGO, CALIF. 92110

ON READER-SERVICE CARD CIRCLE 60

Beam-lead Schottky diodes produced 1000 on a wafer

Sylvania Electric Products, Semiconductor Div., 100 Sylvan, Woburn, Mass. Phone: (617) 933-3500. P&A: \$25 to \$50; 4 to 6 wks.

A series of beam-lead microwave Schottky barrier diodes have been developed by Sylvania. The new diodes, 1/10 the size of normal microwave Schottkys, are the first commercially available devices of this kind, according to Sylvania. The units are mass produced as opposed to virtual individual production formerly required.

Nearly 1000 diodes, including their individual connecting leads, are fabricated simultaneously on a wafer about the size of a quarter and the thickness of a human hair. The beam-lead chip is about 3 by 7 by 1-1/2 mils thick and the distance between beam contacts is 20 mils. By including the attachment of the base and junction lead in the initial manufacturing step, the diodes do not require additional handling operations. They can be incorporated directly into a circuit, eliminating the need for conventional packaging.

One group of the devices is designed for operation in the 10-to-750-MHz range and a second is for application in the 1-to-10-GHz range. Preliminary tests have shown a noise figure of 7 dB at X band. In application, these devices can be used in high-speed switching

and diode arrays.

Matched multiple junctions are fabricated simultaneously in the new diodes. This is the result of the close proximity from junction to junction on the epitaxial substrate. Construction is similar to conventional Schottky diodes. It consists of an epitaxial silicon substrate utilizing a barrier metal junction. However, in the beam lead diode, a thin gold lead is fabricated to the contact areas. The base contact is brought out to the top side of the chip, which allows the devices to be mounted directly between two center conductors of stripline circuitry.

The diodes are available in single or matched pairs, supplied mounted on a ceramic substrate 25 mils thick. Forward current (I_f) is 50 mA at 1 Vdc, total capacitance is 0.5 pF and breakdown voltage (V_B) is 10 V at 6 mA. Matching specifications include a 2-mA I_f spread and a 20-mV V_f spread (junction to junction). These characteristics are typical for the X-band diode.

Although the microwave Schottky barrier diode has been in existence for several years, its application has been limited to systems employing discrete package designs. The rugged beam-lead construction and the ability to produce matched multiple devices should widen the area of application, according to Sylvania spokesmen.

CIRCLE NO. 391

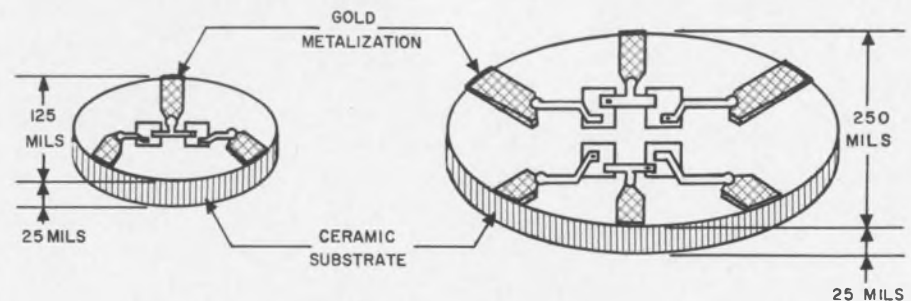

Beam-lead Schottky barrier diodes are available dual (left) or quad (right). Construction is similar to conventional Schottkys except for the thin gold lead fabricated to the contact areas.

ON READER-SERVICE CARD CIRCLE 61 ➤

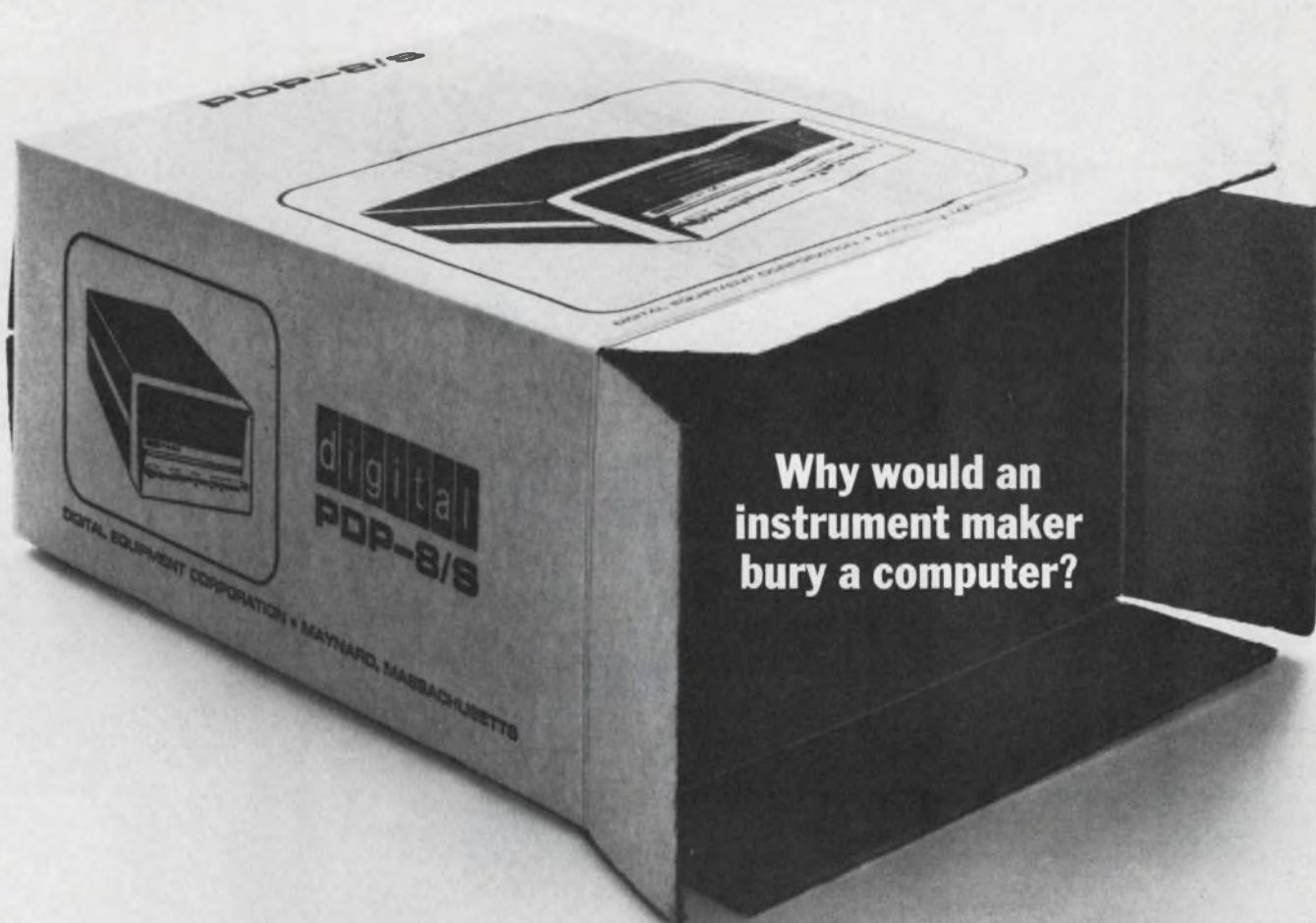

Why would an instrument maker bury a computer?

More than 400 PDP-8/S and PDP-8 general purpose computers have been purchased in the past nine months for burial — inside instruments and process control systems. Blood analyzers. X-ray diffractometers. Spectrum analyzers. Automatic check-out equipment. Why?

Profit.

You can now buy a PDP-8/S general purpose computer for \$10,000 (much less in quantity). The faster PDP-8 sells for \$18,000 (before discounting for quantity). At those prices, here is how your profits mount:

The profit may come because more powerful instruments sell better. And a computer gives power — for analyses, for computerized data collection, for computerized control.

The profit may come because it is easier to sell a more flexible computerized instrument. Your customer can modify

your instrument for his exact needs by writing a computer program (or borrowing somebody else's). Or make the instrument bigger and more versatile by plugging in standard computer options later on. Among scientists, DIGITAL is well established as the leading manufacturer of computers for on-line, real-time, in-laboratory investigations.

If you make more than one instrument, or custom variations of one instrument, you still may require just one design — the difference between instruments just being the different computer programs.

DIGITAL has bigger, faster computers that also might be buried — and complete series of logic modules for interfacing and building. Write to us for our "Small Computer Handbook" and "Logic Handbook". Burying the computer may mean your competitor's funeral.

digital
COMPUTERS • MODULES

DIGITAL EQUIPMENT CORPORATION, Maynard, Massachusetts 01754. Telephone: (617) 897-8821 • Cambridge, Mass. • New Haven • Washington, D.C. • Parsippany, N.J. • Rochester, N.Y. • Philadelphia • Huntsville • Pittsburgh • Chicago • Denver • Ann Arbor • Houston • Los Angeles • Palo Alto • Seattle • Carleton Place and Toronto, Ont. • Reading, England • Paris, France • Munich and Cologne, Germany • Sydney and West Perth, Australia • Modules distributed also through Allied Radio

Silicone-case rectifier saves space

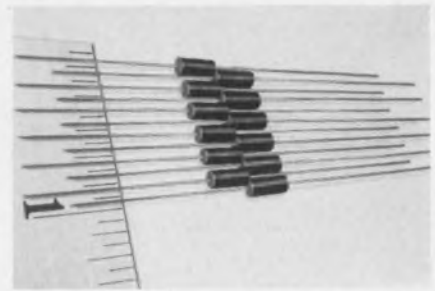

Sarkes Tarzian Inc., Semiconductor Div., 415 N. College Ave., Bloomington, Ind. Phone: (812) 332-1435. Price: 16¢ to 42¢.

Miniature silicon rectifiers measure 1/4 inch long by 1/8 inch in diameter. The series has avalanche characteristics for applications where reverse transient voltage surges are a problem and space is at a premium. Six standard ratings range from 100 to 1000 PIV. Current rating is 1 A with a peak 1-cycle surge current of 70 A. The rectifiers are transfer molded into one-piece silicone plastic cases with 1-1/2-inch gold-plated copper leads.

CIRCLE NO. 361

Dc voltage regulators in TO-3 packages



Bendix Semiconductor Div., The Bendix Corp., Holmdel, N. J. Phone: (201) 747-5400. P&A: \$10.75 to \$12.75 (1000); stock.

Dc voltage regulator modules that replace card and hand-wired plug-in units come in a variety of voltages and weigh approximately 1.2 oz. They are contained in a high-dome TO-3 package that fits all standard heat sinks and mounting hardware. The modules come in both series and shunt varieties, and have a current capability of 1 A.

CIRCLE NO. 362



SRC Model 3569 — Isolated Power Supply
(Shown 2/3 Actual Size)

Where in the World Can You Buy (or Try) a Real Swinging Little Power Supply that has Complete Isolation, 0.02% Regulation, Low, Low Ripple, Puts Out 0 to 30 Volts at a Husky Half an Amp, Weighs Less Than 4 Pounds, Has a Six Foot Line Cord, Yet Costs You Only

\$129⁰⁰

..... from your local S.R.C. representative, that's where and his many fine services are as near as your telephone.

REGION	REP. FIRM	TELEPHONE
Alabama (Huntsville)	Medco	(205) 881-3721
Arizona (Phoenix)	Moxon	(602) 273-7363
California (L.A.)	Moxon	(213) 272-9311
California (San Diego)	Moxon	(714) 274-6525
California (San Mateo)	Moxon	(415) 345-7961
Colorado (Denver)	Brooks-Feeger	(303) 744-3307
Florida (Indianapolis)	Medco	(305) 723-6924
Florida (Orlando)	Medco	(305) 841-2215
Georgia (Atlantic)	Medco	(404) 261-5459
Illinois (Chicago)	Cozzens and Cudahy	(312) 825-1144
Indiana (Indianapolis)	Cozzens and Cudahy	(317) 244-2456
Massachusetts (Boston)	Vector	(617) 489-1400
Missouri (St. Louis)	Cozzens and Cudahy	(314) 831-0010
Minnesota (Minneapolis)	Cozzens and Cudahy	(612) 920-1022
New Jersey (Midland Park)	Moxon	(201) 652-6750
New Jersey (Cherry Hill)	Moxon	(609) 428-7174
New Mexico (Albuquerque)	Brooks-Feeger	(505) 268-4387
Oklahoma (Tulsa)	Brooks-Feeger-Puckett	(918) 835-7942
Texas (Dallas)	Brooks-Feeger-Puckett	(214) 264-3363
Texas (Houston)	Brooks-Feeger-Puckett	(713) 482-7563
Washington D.C.	Ron Davies	(301) 652-6330
Wisconsin (Milwaukee)	Cozzens and Cudahy	(414) 352-3640

Supermite is just one member of the famous line of "Mighty Mite" power supplies manufactured by:

SYSTEMS RESEARCH CORPORATION

2309 Pontius Avenue • Los Angeles, California 90064 • Phone (213) 477-4573

ON READER-SERVICE CARD CIRCLE 62

ARNOLD IS

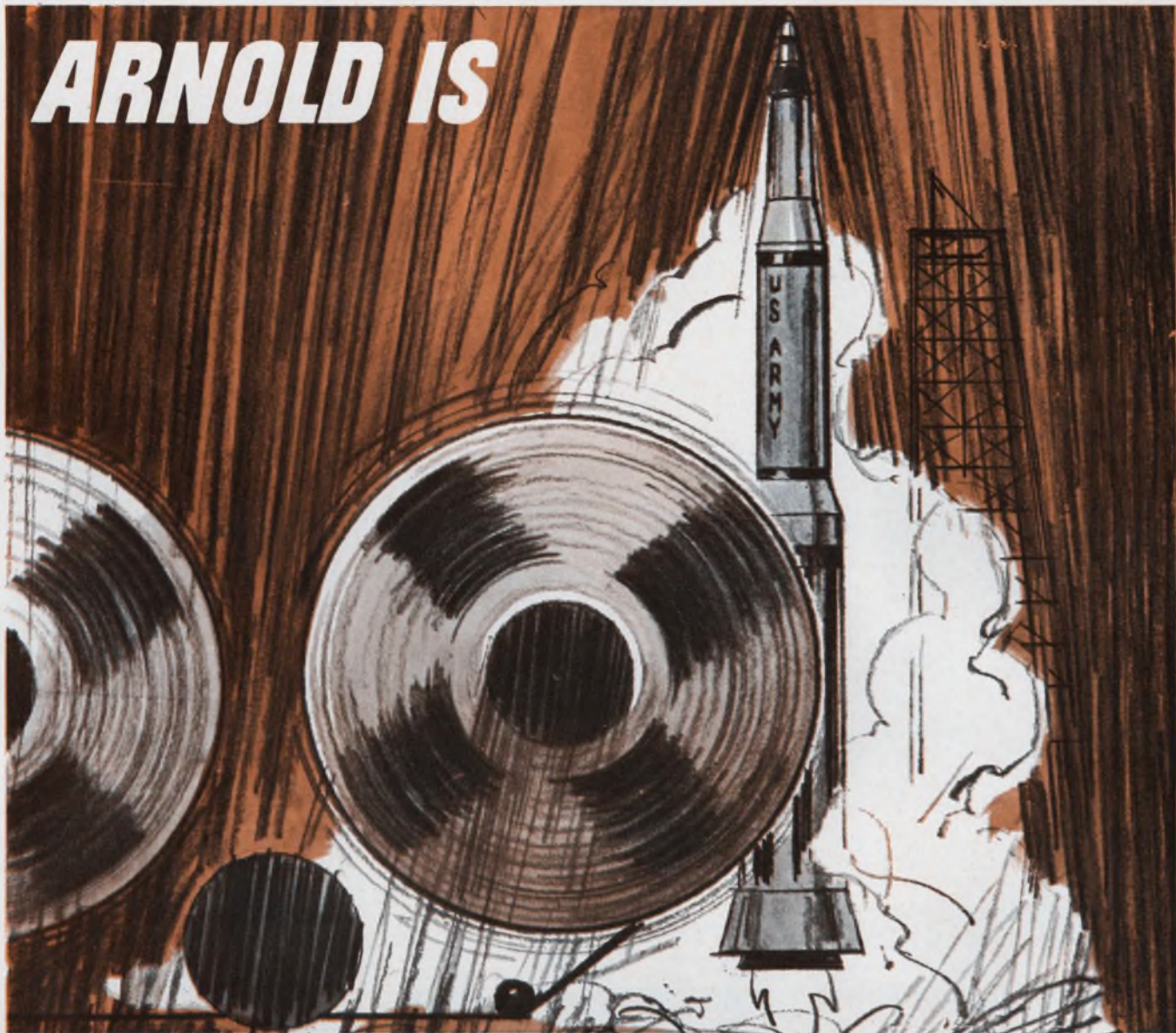

TAPE WOUND BOBBIN CORES

**Standard Cores of 4-79 Mo-Permalloy and Deltamax
on Ceramic or Stainless Steel Bobbins . . .**

engineered for use in sophisticated data processing systems, high frequency magnetic amplifiers, static inverters, timing circuits, shift registers, ring counters, pulse transformers and as static magnetic memory elements. All tapes are rolled on a beta-ray controlled Sendzimir mill in standard gages of 1, $\frac{1}{2}$, $\frac{1}{4}$ and $\frac{1}{8}$ mil and slit to standard widths of 0.031, 0.0625, 0.125 and 0.250. Cores are wound on semi-automatic machines, then annealed at extremely high temperatures in specially designed dry hydrogen atmosphere furnaces to obtain the final magnetic properties. Arnold maintains complete control over all phases of fabrication. Melting, processing, rolling and slitting of raw materials (nickel iron) to winding annealing and final test are all "in-plant" functions.

Write for Catalog TC-108B.



ARNOLD
SPECIALISTS in MAGNETIC MATERIALS

THE ARNOLD ENGINEERING COMPANY, Main Office: MARENGO, ILL.
BRANCH OFFICES and REPRESENTATIVES in PRINCIPAL CITIES



Cramped for space?

Use Couch 1/7-size Relays

Space/weight problem? The new Couch 2X 1/7-size crystal can relay gives you tremendous savings in space and weight. 0.1" grid — plus many outstanding specs — all in micro-miniature. Thoroughly field-proven in electronics and space applications.

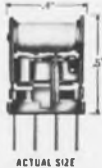

	2X (DPDT)	1X (SPDT)
Size	0.2" x 0.4" x 0.5"	same
Contacts	0.5 amp @ 30 VDC	same
Coil Operating Power	100 mw 150 mw	70 mw 100 mw
Coil Resistance	60 to 4000 ohms	125 to 4000 ohms
Temperature	-65°C to 125°C	same
Vibration	20 G	same
Shock	75 G	same

Broad choice of terminals, coil resistances, mounting styles. Write for detailed data sheets.

RUGGED ROTARY RELAYS  Dynamically and Statically Balanced

COUCH ORDNANCE INC.

3 Arlington St., North Quincy, Mass. 02171, Area Code 617, CYPress 8-4147 • A subsidiary of S. H. COUCH COMPANY, INC.

ON READER-SERVICE CARD CIRCLE 64

SEMICONDUCTORS

Silicon rectifier has speedy recovery



Electronic Devices, Inc., 21 Gray Oaks Ave., Yonkers, N. Y. Phone: (914) 965-4400. P&A: \$3.35 (100); stock.

A pair of 12-A and 6-A silicon rectifiers in a glass-to-metal sealed DO-4 package offer a 300-ns recovery time from 1-A forward current to 30-V blocking. This series is available from 50 to 1000 PIV. It is part of a program of fast recovery power rectifiers up to 240 A and up to 100,000 PIV, making size and weight reduction of power sources possible through use of higher frequencies.

CIRCLE NO. 363

Varactor diodes rated to 200 Vdc



Crystalonics, Div. of Teledyne, 147 Sherman St., Cambridge, Mass. Phone: (617) 491-1670. P&A: \$18 (1 to 99); stock.

Fourteen Varactron voltage-variable capacitance diodes (VA300 through VA313) feature a maximum working voltage rating of 200 Vdc. Qs range up to 100, capacitances from 6.5 to 68 pF and tuning ratios up to 6.8. The package is a standard DO-14. Matched pairs can be supplied.

CIRCLE NO. 364

Flatpack thyristors pass up to 230 A

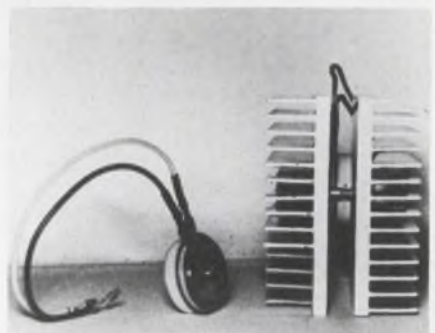

Westinghouse Electric, Semiconductor Div., Youngwood, Pa. Phone: (412) 925-7272.

Two new flatpack high-power thyristors pass up to 50% more current per junction compared to stud-mounted devices. The thyristors are designed for use in motor controllers, power supplies, plating supplies and welding applications. Type 228 is rated at 110 A half-wave average, and type 229 at 230 A half-wave average. Both types use the same kind of cylindrical package, approximately 1/2 inch thick and 1-1/2 inches in diameter. Compression bonded encapsulation results in the devices being free from thermal fatigue. The silicon wafer is cooled from both sides with an equal thermal impedance from the junction to either face of the heat sink. This results in a forward or reverse-polarity mounting capability as opposed to the limited, unidirectional mounting offered by stud devices.

CIRCLE NO. 365

General purpose FET has wide application

Union Carbide Electronics, 365 Middlefield Rd., Mountain View, Calif. Phone: (415) 961-3300.

Over 80% of all field effect transistors are claimed to be replaceable by a new universal FET, the 2N4416. A class lot of these devices provides a choice of low-noise, high-gain amplifiers from dc to 900 MHz, or ultra-low noise devices for low-frequency uses. Applications for the 2N4416 include TV tuners, FM sets, IF strips, mixers, oscillators and switches.

CIRCLE NO. 366

PROGRESS REPORT

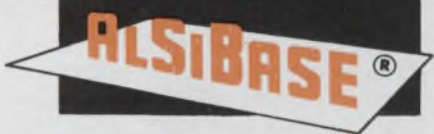

AlSiBase Substrates

AlSiBase Snap-Strates

Thin Flat Ceramic SUBSTRATES with As-Fired Surface for THICK FILM or THIN FILM

Since the early 1950's American Lava technical people have worked closely with customers in developing thin flat ceramic substrates to meet their design requirements. Special requirements are engineered regularly.

Over a period of years, practical solutions to a variety of substrate problems have emerged. Some AlSiMag ceramic compositions and designs are so widely used that they are now carried in stock for prompt shipment. Other designs are classed as "Preferred Style", involve no tooling cost and are promptly available.

Three AlSiMag ceramic materials have emerged as most satisfactory for substrate applications. AlSiMag 614 alumina with an as-fired surface in the range of 25 microinches CLA has been firmly established for thick film uses.

The great need for a smooth as-fired ceramic for thin film work has been met with AlSiMag 772 alumina with an as-fired working surface of 8 microinches or better. This material was especially formulated for this use and has gained followers to such an extent that it seems destined to be the dominant substrate material for thin film.

Where outstanding thermal conductivity is important, AlSiMag 754 beryllia sub-

strates conduct heat like aluminum and have most of the desirable electrical characteristics of the alumina ceramics. AlSiMag beryllia substrates can be pro-

cessed to give you an as-fired working surface on the order of 25 microinches CLA for thick film or as smooth as 8 microinches or better for thin film.

ALSIBASE SUBSTRATES—STOCK ITEMS

ALUMINA	ALUMINA	BERYLLIA
AlSiMag 614. As-fired working surface in range of 25 microinches CLA. Thickness of .025". 1/2" x 3/4" 1" x 1" 1" x 2" 2" x 2"	AlSiMag 772. As-fired working surface of 8 microinches or better. Thickness of .025". 1/2" x 3/4" 1" x 1" 1" x 2" 2" x 2"	AlSiMag 754*. As-fired working surface of 8 microinches or better. Thickness of .025". 1/2" x 3/4" 1" x 1" 1" x 2" 2" x 2"

* Can be supplied with as-fired working surface on the order of 25 microinches CLA about four weeks after receipt of order. Beryllia substrates are stocked only in prototype quantities. Allow normal production time for volume orders.

IN ADDITION TO THESE STOCK ITEMS there are a large number of Preferred Styles where open tooling is available. Give us the approximate size of your interest and your operating conditions and let us see how closely we can approach your needs with Preferred Styles which would mean a substantial saving in time and tooling cost.

SNAP-STRATES have given good results and substantial savings in the finished component in some designs. The basic idea is to complete all film and circuit work on a sizeable ceramic substrate and then divide it into smaller controlled

individual sizes. These ceramics, modified to separate accurately along clean straight lines, were originated by American Lava Corporation and are called **SNAP-STRATES**.

DELIVERIES: During 1966 our substrate facilities were again approximately doubled including specialized production kilns. A basic part of our expansion was the development of trained personnel. This has been successful, and we are handling new volume in agreed production time. We will be glad to discuss your requirements to develop mutually satisfactory delivery schedules.

CODE IDENT. NO. 70371

American Lava Corporation **3M**
A SUBSIDIARY OF COMPANY

PHONE 615 265-3411, CHATTANOOGA, TENN. 37405

For service, contact American Lava representatives in Offices of Minnesota Mining and Manufacturing Company in these cities (see your local telephone directory): Atlanta, Ga. • Boston: Needham Heights, Mass. • Chicago: Glen Ellyn, Ill. • Cleveland, Ohio
Dallas, Texas • Laurens, S. C. • Los Angeles, Calif. • Metropolitan New York: Ridgfield, N. J. • Up-State New York and
Canada: Baldwinsville, N. Y. • Orange, Conn. • Philadelphia, Penna. • Roanoke, Virginia • St. Louis: Lee's Summit, Missouri
So. San Francisco, Cal. • Troy, Mich. • 3M International: c/o American Lava Corp., Chattanooga, Tenn. 37405, U.S.A., 615/265-3411

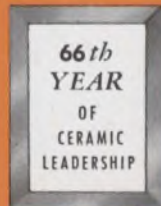

(use time delay relays?)
CHECK AEMCO PRICES!



NEW!
 electronic reliability
\$17.50

(1-24 quantity)

ELECTRONIC RELIABILITY

±5% REPEAT ACCURACY

1-100 SECOND ADJUSTABLE DELAY

PLUG-IN CONVENIENCE

DPDT OUTPUT RATED 10 A.

LOW PRICE! QUANTITY DISCOUNTS!

Budget priced with plug-in convenience where critical timing parameters are not required. Delay adjusted by convenient single knob. Remote adjustment by use of external potentiometer (special order). 117 VAC input. DPDT output rated 10 A. AEMCO type EC.



REPLACES MOTOR TYPES

\$15.50

(1-24 quantity)

ELECTRONIC RELIABILITY

REPLACES POPULAR MOTOR TYPES

±5% REPEAT ACCURACY

1-90 SECOND ADJUSTABLE DELAY

DPDT OUTPUT RATED 10 A.

LOW PRICE! QUANTITY DISCOUNTS!

Packaged to directly replace all popular motor type time delay relays... far more reliable than motor types. Budget priced—real savings when critical timing parameters are not required. 117 VAC input. DPDT rated 10 A. AEMCO type LC.

NEED SPECIALS? Other packaging? Longer timing ranges? Other voltages? DC? Remote adjustment? Write or call outlining your needs. We're eager to serve you, too!

AEMCO DIVISION

MANKATO, MINNESOTA 56001

formerly TELEX/AEMCO

PHONE A/C 507-388-6286



ON READER-SERVICE CARD CIRCLE 66

SEMICONDUCTORS

Pnp transistors in epoxy packages



Fairchild Semiconductor Div. of Fairchild Camera and Instrument Corp., 313 Fairchild Dr., Mountain View, Calif. Phone: (415) 962-2530. P&A: \$1.20 and \$1.80, 48¢ and 72¢ (10,000); stock.

Designed for high-voltage switching applications, two pnp transistors are useful in audio, video, IF, RF and linear amplifier uses in consumer and commercial computer equipment. The LC_{CEO} is 150 V min for both units. They claim a low noise figure over a wide range of impedances, and high beta linearity over a wide current range. Min beta values are 30 and 70.

CIRCLE NO. 367









20-watt overlay for medium frequency

RCA, Electronic Components & Devices, 415 S. Fifth, Harrison, N. J. Phone: (201) 485-3900.

A high-power RF amplifier for use in marine communications equipment operates in the 2-to-3-MHz band. The 20-W overlay transistor operates from a 13-V power supply. It is primarily intended for marine communications equipment as a class B and C RF amplifier for use in medium frequency service with amplitude modulation. The RCA 40444 exhibits a typical gain-bandwidth product of 100 MHz at 3 A and produces an output of 20 W minimum with a 1-W RF power input at 2.5 MHz. It is an epitaxial silicon npn transistor of the overlay emitter electrode construction and is packaged in a JEDEC TO-3 case.

CIRCLE NO. 368

9 good reasons why Philco Epoxy Transistors (PET) are your best buy.

 <p>1. PET TO-18 is rated from 360 to 675 mW at 25°C (chip dependent).</p>	 <p>2. PET TO-5 is rated from 550 mW to 1.2 W at 25°C (chip dependent).</p>	 <p>3. PET packages have reliability factors equal to or exceeding that of metal cans.</p>
 <p>4. PET's are immediately available in large volume production quantities.</p>	 <p>5. PET's have a special deep-well interlock construction that insures hermeticity and reliability.</p>	 <p>6. PET packages are permanently and legibly marked—lettered black on white.</p>
 <p>7. PET's are packaged in our low-cost Taiwan production facility—to keep your cost low.</p>	 <p>8. PET amplifiers operate on currents ranging from 10 μA to 1 A; PET switches to speeds 8 ns turn on and 11 ns turn off.</p>	 <p>9. PET's cover frequencies from 40 MHz to 1400 MHz.</p>

Call or write: **Philco-Ford Corporation Microelectronics Division Sales Offices:** 2920 San Ysidro Way, Santa Clara, California (408-245-2966) / 999 North Sepulveda, El Segundo, California (213-772-6226) / Northwest Industrial Park, Second Avenue, Burlington, Mass. (617-272-1600) / Benson Manor, Suite 114B, Washington Lane, Jenkintown, Pa. (215-885-0430) / 1215 Drew St., Clearwater, Florida (813-446-0124) / 815 Connecticut Avenue, N.W., Washington, D.C. (202-298-7810) / Suite 208, 700-108th St., N.E., Bellevue, Washington (206-454-5061) / New York, N.Y. (212-244-1373).



PHILCO-FORD CORPORATION
Microelectronics Division
Santa Clara, California • 95051

ON READER-SERVICE CARD CIRCLE 67

Modular Analog-Digital Digital-Analog Converters

A-to-D Converters

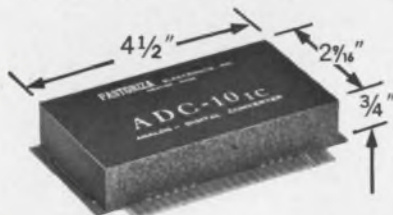

MODEL ADC-10_c provides 10 bit binary parallel output in 10 micro-second conversion time . . . accepts a ten volt input range . . . contains a Clock, Reference Supply, Resistor Network and Comparison Amplifier . . . triggered by an external command signal and provides a "Status" output level to indicate completion of the conversion.

D-to-A Converters

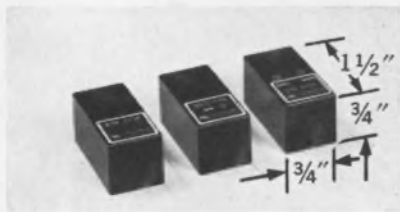

D/A/D Series is a group of compatible integrated circuit modules for Digital-to-Analog and Analog-to-Digital Conversion Systems. MODEL RM—2734 is a Jam Transfer Storage Register for up to 12 bits. On strobe command it will accept and store numbers. MODEL RSN—2698 is a Switching Resistor Network and Reference Source. It can be switched by micrologic input levels and provides output binary weighted currents to a summing point. MODEL AM—2612 is a Combination of Two Operational Amplifiers with Feedback Networks for converting currents from RSN—2698 to output voltages. The use of operational amplifiers provides a variety of output ranges at low impedance.

PASTORIZA
ELECTRONICS, INC.

385 Elliot St., Newton Upper Falls, Mass. 02164
(617) 332-2131

ON READER-SERVICE CARD CIRCLE 68

SEMICONDUCTORS

Pnp power transistors available TO-5 or hex



Crystalonics, Div. of Teledyne, Inc., 147 Sherman St., Cambridge, Mass. Phone: (617) 491-1670. P&A: \$20 (1 to 99); stock.

The 2N3200 series of silicon epitaxial pnp power transistors feature max V_{SAT} of 0.3 V at 1 A. Maximum I_{CEX} is 0.1 μ A up to 100 V and typical h_{FE} is 45 at 1 A. The devices are available in a 40-W 7/16-inch hex-nut package or an 8.75-W TO-5 package.

CIRCLE NO. 369

Overlay transistors provide 20 watts

RCA, Electronic Components and Devices, 415 S. Fifth, Harrison, N. J. Phone: (201) 485-8900.

Silicon npn "overlay" transistors are designed to give high power as class C RF amplifiers for international vhf mobile and portable communications service. The two epitaxial silicon transistors are reportedly the first transistors especially designed for use in the international communications market. Both devices, the RCA 2N4932 and 2N4933, feature protection against load mismatch—a desirable feature for any mobile or portable communications equipment where the possibility of antenna grounding exists. The 2N4932 operates from a power supply of 13.5 V and provides a minimum power output at 88 MHz of 12 W, and the 2N4933 from a 24-V supply with a minimum power output at 88 MHz of 20 W. Both are packaged in a JEDEC TO-60 case.

CIRCLE NO. 370

Silicon power transistors range to 150 volts

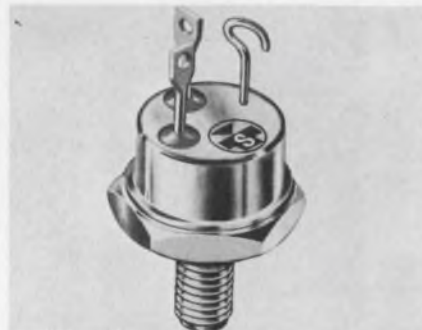

Silicon Transistor Corp., E. Gate Blvd., Garden City, N. Y. Phone: (516) 712-4100. P&A: \$12 to \$36 (over 100); stock.

A line of planar triple diffused npn silicon power transistors are designated series STT2650 through STT2656. The devices range from 30 to 150 volts with a typical frequency of 25 MHz. They have a 75-watt power dissipation.

CIRCLE NO. 371

Silicon rectifiers have PIV of 100 to 1600

International Rectifier, 233 Kansas St., El Segundo, Calif. Phone: (213) 678-6281. Price: \$13.50 to \$91.50 (1 to 99).

A series of silicon rectifiers, rated at 300 A, with a max non-repetitive PIV of 100 to 1600 comes in a DO-9 package. The series is available with standard polarity (cathode to stud) or reverse polarity (anode to stud).

CIRCLE NO. 372

Metal-oxide FET has high-impedance gate

Hughes Semiconductor Devices, 500 Superior Ave., Newport Beach, Calif. Phone: (714) 548-0671. Price: \$17.05.

This metal-oxide, enhancement-mode FET is an insulated gate, P-channel device in a TO-72 package. It is designed for high-impedance applications such as electrometers and VTVM input stages. It has a gate input resistance on the order of 10^{15} with a breakdown rating of ± 80 V, thus eliminating the need to protect the gate with an additional diode.

CIRCLE NO. 373

plugboards that have to withstand severe shock and vibration? MAC ships off-the-shelf.

When the environment will be nasty, you set tight specifications for components and equipment that must operate despite the nastiness. We're not trying to outguess you, but for some kinds of nastiness, the new MAC Series 140 plugboards, receivers and plugwires will meet or exceed your requirements. And we'll ship 'em off-the-shelf, if they're what you want. Here's what they'll do. Each system can withstand up to 50 G's without self-generated contact noise; life tests to 10,000 cycles have shown only random variations in contact voltage drop. 240 to 5,120 positions. Receivers engineered for easy, secure rack mounting. Receiver contacts accept standard MAC taper pins, or can be ordered for Wire-Wrap. Series 140 plugwires are interchangeable with most existing systems; Ball-D-Tent design prevents accidental dislodging, won't mar insert surface, yet provides closely controlled extraction forces; wires available with gold or nickel plating, in color-coded lengths from 5" to 35". Did we outguess you? If not, we'll design—and deliver—what you need. Remember, to think pleasant thoughts about nastiness, think of MAC Series 140 . . . they're mostly nasty-proof.



MAC

O.E.M. DIVISION

MAC Panel Co., Box 5027, High Point, N.C. 27261

ON READER-SERVICE CARD CIRCLE 69

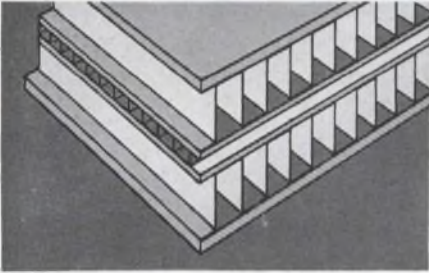

Westinghouse cools hot electronics in Janitrol cold box



Westinghouse Aerospace Div. designed advanced electronic gear into small space for the AWG-10 missile control system on the F-4J. To solve the heat problem, they called on Janitrol's new structural heat exchanger.

The walls of the sealed housing provide mounting and heat exchange surfaces. Walls are only $\frac{5}{8}$ " thick and contain two air circuits straddling a sealed oil cooling circuit.

Janitrol designs and fabricates special structural heat exchanger shapes for your specific heat dissipation requirements. In general, these will handle 10 watts per cubic inch, although higher capacities are possible. For more information write: Janitrol Aero, 4200 Surface Road, Columbus, Ohio 43228.



JANITROL AERO DIVISION
Midland-Ross Corporation

ON READER-SERVICE CARD CIRCLE 72

SEMICONDUCTORS

Avalanche rectifiers deliver up to 2 kW

Sarkes Tarzian, Inc., Semiconductor Div., 415 N. College Ave., Bloomington, Ind. Phone: (812) 332-1435. P&A: 73¢ (F-20); stock.

Four of these 0.07-in.³ rectifiers in a single-phase bridge will deliver as much as 2 kW at 50°C ambient. Rectifier types F-15, F-20 and F-25 have maximum recurrent PIV ratings of 1500, 2000 and 2500 volts. At 25°C, types F-15 and F-20 are rated at 1 A dc and 30 A surge. Type F-25 is rated at 500 mA dc and 20 A surge.

CIRCLE NO. 374

Light-emitting diodes for film recording

Ferranti, Ltd., Electronic Display Dept., Gem Mill, Oldham, Lancashire, England. Phone: Main 6661.

Gallium phosphide (GaP) and gallium arsenide (GaAs) light-emitting semiconductor devices are available. The basic GaP lamp is a plastic-encapsulated device only 0.05 in. long by 0.03 in. in diameter, with two 0.005-in. diameter lead wires extending from the body. The most important application of these lamps is in the recording of high-density information on film with particular reference to aerial reconnaissance photography.

CIRCLE NO. 375

Plastic SCRs control power at 2600 W

Motorola Semiconductor Products, Inc., P. O. Box 955, Phoenix. Phone: (602) 273-6900. P&A: 80¢ to \$3; stock.

Low-cost, plastic-encapsulated silicon controlled rectifiers can control high electric power, such as 2600 watts, 240 volts, full-wave. Typically, 10-mA dc gate current is required to cause switching from the "off" state to the "on" state. The units have a rated blocking voltage range from 50 V to 600 V and are designed for consumer products.

CIRCLE NO. 376

Coors Strate-Breaks™

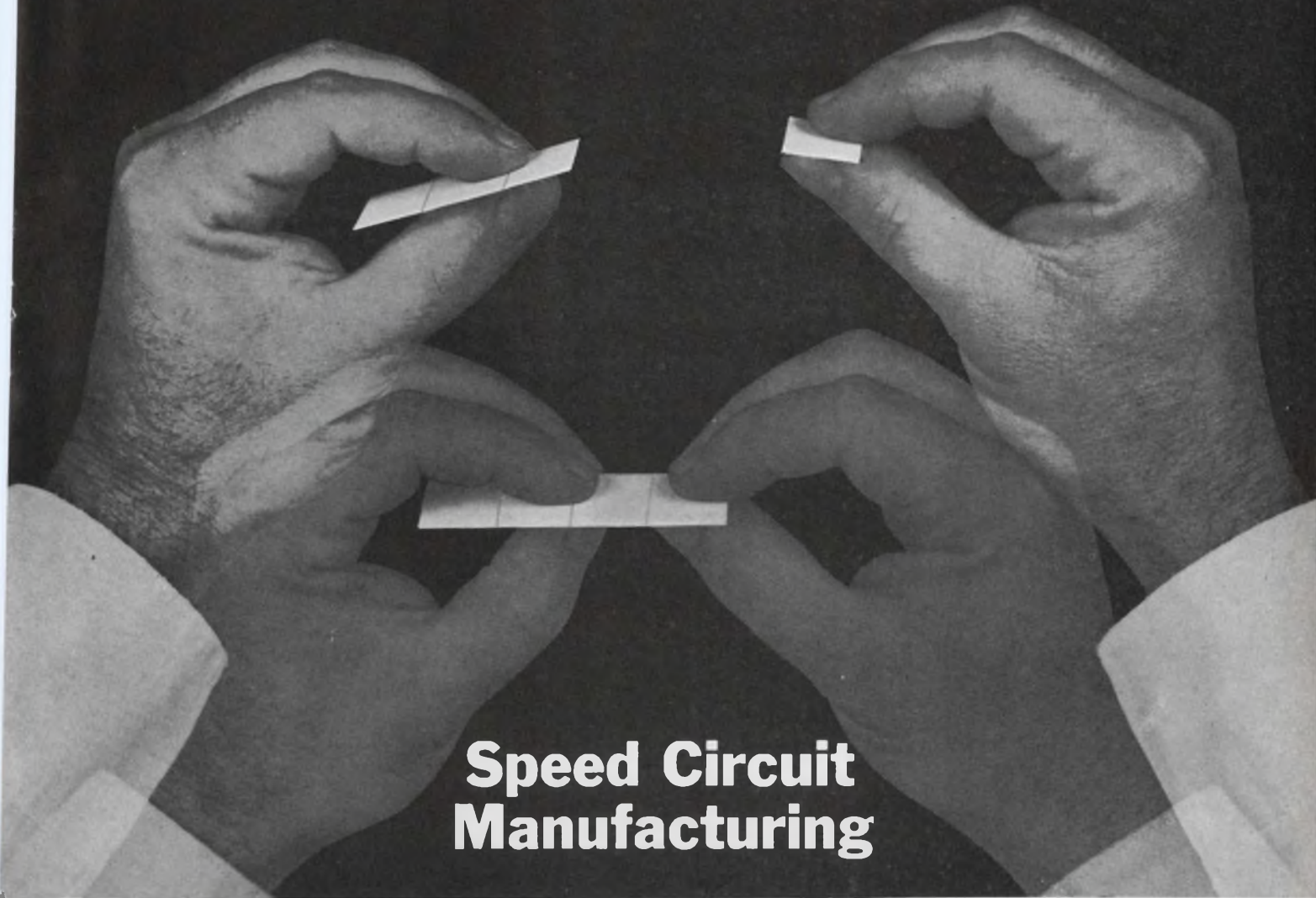

Speed Circuit Manufacturing

High quantity production of integrated circuits with uniform quality, increased precision tolerances, greater economy in the production of micro-ceramic components—all these are yours by gang printing your circuits on Coors *Strate-Breaks*. No cutting apart, no multiple handling before assembly. Just SNAP! . . . and there are your individual components with a straight, smooth, precision edge.

Coors *Strate-Breaks* are made to your specifications in sizes from 1/2" x 1/2" to 4" x 4". They are available unglazed for thick-film circuits, and glazed or unglazed for thin-film circuits. For on-the-spot answers to your questions, dial the Coors "hot line"—303/279-4533, Ext. 351. For full details on Coors *Strate-Breaks*, write for Coors *Strate-Break* Data Sheet 7011.

Patent
Pending

*consider
Coors
ceramics*

Coors

CERAMICS

ALUMINAS • BERYLLIAS • MAGNESIAS • SPECIAL OXIDES
Coors Porcelain Co., Golden, Colo.

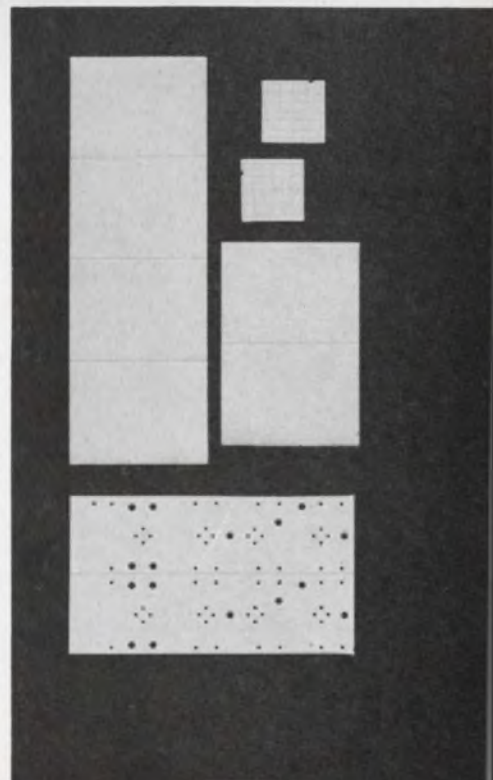

STANDARD FREQUENCY RECEIVERS

FREQUENCY STANDARDIZATION TO THE
NATIONAL BUREAU OF STANDARDS



Model T-60 60 KHZ Time Code Receiver
Round The Clock WWVB 60 KHZ Binary Time Code Broadcasts - Most Accurate Time Signal Available - Can Be Recorded Continuously
Radio Station WWVB is broadcasting complete time information using a level shift carrier time code (10 db level changes). This code, which is binary coded decimal (BCD) is broadcast continuously and is synchronized with the 60 khz carrier signal. \$480.00

Model T-60A Rack Model (3 1/2" H x 19" W x 5" D)



Model SR-60 Price: \$850.00
Model SR-60. WWVB-60 khz. Will calibrate any local standard up to $5 \cdot 10^{10}$ within a short period. Can be easily operated by any technician and performs in any part of the Continental United States.



Model SFD-6R Modular Construction:
A complete system for distribution of standard frequency throughout a plant. All solid State—fail safe—reasonably priced. Price depends upon Modules selected (\$90.00 each). Several Modules available.



Model WVTR Mark II All Silicon Transistor
Five different models of Receivers for WWV and WWVH are available. They receive all frequencies transmitted by WWV and are all crystal controlled double conversion superheterodynes. \$590.00

Special Antenna Assemblies for both VLF and HF are in stock.

Model WWVT \$590.00
Mark II All Silicon Transistor Over All Size 7 1/4" x 9 1/2" x 5" Approx. Weight 7 lbs.



Model 45 \$98.50
A pocket size battery powered Time Base Calibrator, complete with internal battery.

Send for complete specifications. Prices and specifications subject to change without notice. F.O.B. Woodland Hills, Calif.

SPECIFIC PRODUCTS

P.O. Box 425 / 21051 Costanzo Street
Woodland Hills, California
Area Code: 213 340-3131

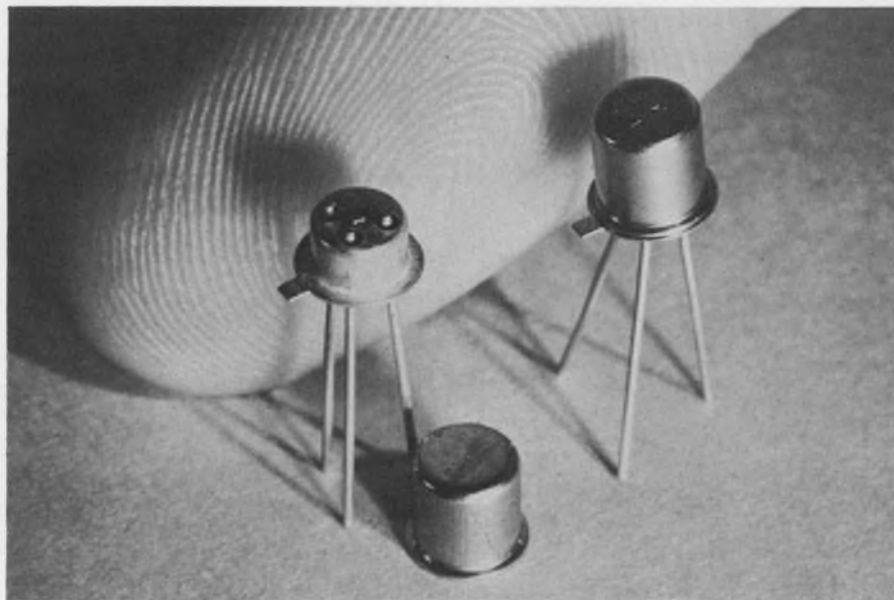

IC synthesizes 'complementary' UJT, stability rivals crystals

General Electric Co., 1 River Rd., Schenectady, N. Y. Phone: (518) 374-2211. Price: \$4.64 (100 to 999).

A new integrated circuit synthesizes the characteristics of a highly stable unijunction transistor operating at the opposite polarity to standard UJTs. This silicon planar passivated device, designated the D5K1 complementary unijunction, offers a set of electrically uniform characteristics of greater stability compared to conventional unijunctions, according to General Electric, the manufacturer. Oscillators built with these devices have shown stability rivaling crystals.

This unit, designed as a low-frequency trigger device, is called a complementary unijunction because it operates in the opposite polarity mode. It can produce both positive and negative trigger pulses.

It can produce both positive and negative trigger pulses.

Circuit designers can apply the D5K1 in standard unijunction circuits with a minimum of circuit adjustment. A complete oscillator can be built using a D5K1 which is stable to 5 ppm/°C when cycled from 25° to 85°C. Low-frequency oscillators which will offer better than 0.5% accuracy from -55° to +150°C can also be built. Oscillators and timers can be simultaneously temperature-compensated and calibrated in one step at room temperature.

The range of applications for unijunctions has been broadened by the complementary unijunction, according to GE. The D5K1 can perform all standard unijunction functions with an order of magnitude increase in stability. In addition, stable oscillators can be built with frequencies up to 100 kHz (an order of magnitude extension of frequency operation). Ultrastable long time interval analog timers may also be realized.

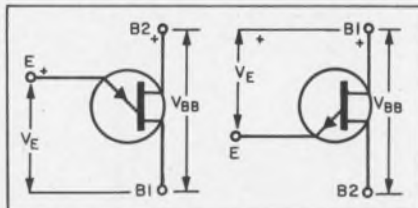

Complementary unijunction transistor (right) is a silicon planar passivated device with characteristics like a standard UJT (left) except that currents and voltages are of opposite polarity.

CIRCLE NO. 390

ON READER-SERVICE CARD CIRCLE 74



Uni-sel for the "IN" Crowd

SYNTRON'S UNI-SEL SELENIUM RECTIFIER
VIRTUOSO PAR EXCELLENCE!

In the crowded electronics industry, Uni-Sel Selenium Rectifiers solo with current ratings up to four times those of other 45-volt cells, double those of 33-volt high density cells. Operate at higher current density with smaller physical size.

Send catalog data about
Syntron Uni-Sel Rectifiers

283

Name/Title _____

Company _____

Street _____

City, State _____ Zip _____



Just out!
New catalog with full
information on Silicon
Diodes and Assemblies.



SYNTRON COMPANY

283 LEXINGTON AVE. • HOMER CITY, PA. 15748

TELEPHONE 412-479-8011

Sales Representatives Coast-to-Coast

67R6

NEW



UNIVERSAL DIRECT-DRIVE REEL TORQUER

One motor covers standard range of all Reel Drive requirements.

FEATURING

- Direct-drive . . . no gears no backlash
- Fast response . . . high speed and efficiency
- New development provides extremely low ripple torque
- New brush design for long, maintenance free performance
- Plus — All previous features incorporated in Inland's original "Pancake" construction. The ONLY DC "Pancake" Direct-Drive Torquer designed exclusively for reel drive application.

APPLICATIONS

- Magnetic tape drives
- Spooling mechanisms and winders
- Magnetic wire take up

An engineering breakthrough in design and manufacturing that gives one DC direct-drive torque motor the capability of handling the drive requirements of all standard reel sizes, tape tensions and tape speeds.

The permanent magnet dc NT-2922A torquer is ideally suited for all magnetic tape drives, spooling mechanisms and winders, and magnetic wire take up applications where the reel drive must be capable of being controlled over a wide range of speeds and torques providing immediate response for either tension or rate reliability.

If you would like complete data on this new NT-2922A torquer, just drop us a line. Inland Motor engineers will be glad to help you solve any of your DC direct-drive problems.



INLAND MOTOR
CORPORATION
OF VIRGINIA
RADFORD, VIRGINIA
703-839-2973

SUBSIDIARY OF **KOLLMORGEN**

ON READER-SERVICE CARD CIRCLE 76

MICROELECTRONICS

Darlington amplifier priced at 35¢

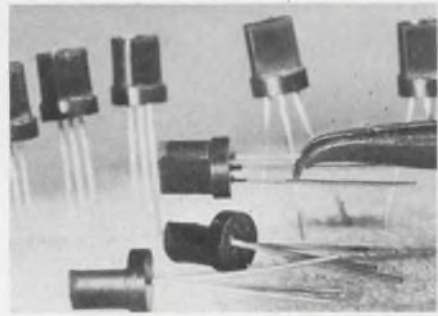

General Electric, Semiconductor Products Dept., Syracuse, N. Y. Phone: (518) 374-2211. P&A: 35¢ (1000 lots); stock.

A low-cost silicon monolithic Darlington amplifier is priced at 35¢ in 1000 lot quantities. The D16-P1-D16P4 series are suited for use in preamplifier input stages, where input impedances of several megohms are required. Input impedance at an input frequency of 1 kHz will be as high as 650 k Ω . The npn monolithic amplifiers have extremely high beta figures. The forward current transfer ratio (H_{FE}) is typically 50,000. Power dissipation in the entire series is 320 mW at 25°C free-air. A GE cast epoxy compound used to form the TO-98 package withstands temperatures approaching 200°C. Maximum collector-to-base operating voltage for the units is 40 V; the steady-state collector current is 200 mA.

CIRCLE NO. 377

Monolithic op-amp packaged in plastic

RCA, Electronic Components and Devices, 415 S. Fifth, Harrison, N. J. Phone: (201) 485-3900. P&A: \$5 and \$5.75 (1000 up); stock.









Two monolithic silicon operational amplifiers are offered in 14-lead dual-in-line plastic packages. Both devices, the RCA CA3029 and CA3030, are designed for use in telemetry, data-processing, instrumentation and communication equipment. The two op-amps offer open-loop voltage gains of 60 and 70 dB, common-mode rejection ratios of 94 and 103 dB and have max output voltage swings of 6.75 and 14 V p-p.

CIRCLE NO. 378

**SELECTION is
only ONE reason
it pays to specify**

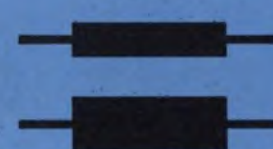

AEROVOX PRECISION RESISTORS WIRE-WOUND / METAL-FILM / CARBON-DEPOSITED

<p style="text-align: center; font-weight: bold;">WIRE-WOUND</p>  <p style="text-align: center;">Established Reliability Series ER 300 and 600</p> <p>Molded high reliability units in all axial and radial lead styles.</p>	<p style="text-align: center; font-weight: bold;">WIRE-WOUND</p>  <p style="text-align: center;">Epoxy cast Series CE 200 Molded Series CE 300 & 600</p> <p>Units to MIL-R-93C. Choice of wire leads or lug terminals in radial and axial styles.</p>	<p style="text-align: center; font-weight: bold;">WIRE-WOUND</p>  <p style="text-align: center;">Printed wiring Series CE 400 Ceramic Series CE 500</p> <p>Units for pc boards and for commercial computer and other industrial requirements.</p>	<p style="text-align: center; font-weight: bold;">WIRE-WOUND</p>  <p style="text-align: center;">Industri-Line Series CE 700 Molded</p> <p>High quality units for commercial and industrial applications.</p>
<p style="text-align: center; font-weight: bold;">METAL-FILM</p>  <p style="text-align: center;">Molded CPFM Series</p> <p>RN55, 60, 65, 70 & 75 to MIL-R-10509F.</p>	<p style="text-align: center; font-weight: bold;">METAL-FILM</p>  <p style="text-align: center;">Conformal coated Series CPFX</p> <p>RN50, 55, 60, 65, 70 & 75 sizes to MIL-R-10509F.</p>	<p style="text-align: center; font-weight: bold;">CARBO-FILM</p>  <p style="text-align: center;">Molded Series CPM Ceramic Series CPC</p> <p>RN55, 60, 65, 70, 75 & 80 case sizes.</p>	<p style="text-align: center; font-weight: bold;">CARBO-FILM</p>  <p style="text-align: center;">Conformal coated Series CPX Special coating Series CP-W65</p> <p>Epoxy coated and painted units in rating from 1/10 to 2 watts.</p>

Aerovox offers you the widest selection of precision resistors in wire-wound, metal-film and carbon-deposited constructions. They meet applicable military specifications and come in a full range of sizes, values, and case styles. You can now *select* the unit that best fits your *need* . . . the established reliability type, the mil approved unit, or the economy priced commercial version for that less critical application.

Along with this wide selection of types and sizes, Aerovox has maintained an enviable reputation for more than two decades for quality precision resistors providing superior performance and incorporating all the latest advances in the state-of-the art; Metal-

Film and Carbo-Film types are available from stocking Aerovox Distributors throughout the country in MIL-BELL and commercial stock values. Send today for your free copy of our new PRECISION RESISTOR CATALOG.



**AEROVOX
CORPORATION**
OLEAN, NEW YORK
BURBANK, CALIFORNIA

ON READER-SERVICE CARD CIRCLE 77

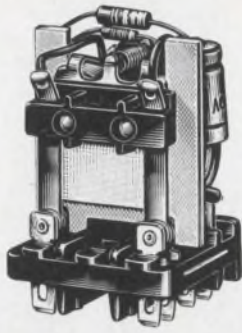

This new solid state time delay relay could be the biggest \$12.50 relay value you've ever seen. Timing tolerance is $\pm 5\%$. Internal dpdt relay is rated at 10 amperes. Fixed timing ranges: 1, 5, 10, 30, 60 and 120 seconds. Quick-connect/solder terminals. Remember...only \$12.50!

This new solid state time delay relay (CU Series) is an outstanding value. It is designed for delay on operate applications in machine tool controls, copiers, office equipment, coin-operated machines, process controls and a host of others. Both AC and DC models are available.

Mounting versatility is a feature of the CU Series. Standard .187" quick-connect terminals are pierced for solder connections. Or, using the special socket, you can enjoy plug-in convenience.

Resistor-Adjustable Models Available

Any timing period up to 120 seconds may be obtained with the use of a resistor applied to two terminals provided on these models. These are available at a slightly higher price. The same wide range of mounting choices is available.

CU SERIES SPECIFICATIONS

Types Available: Fixed time delay on operate and resistor adjustable.
Voltages: AC: 24 and 120.
 DC: 24.

Temperature Range: Recommended for normal indoor use.

Fixed Timing Tol.: $\pm 5\%$ at 25°C.
Transient Protection: Yes.
Reset Time: 100 milliseconds.
Repeatability: $\pm 3\%$.
Internal Relay: DPDT, 10 ampere @ 28V DC or 120V AC resistive. KU Series.



NYLON SOCKET

Special nylon socket is rated at 10 amperes. Choice of solder or printed circuit terminals. Sold separately.

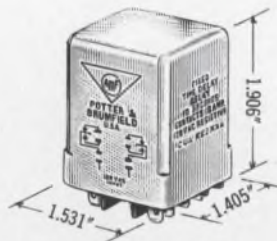

LEXAN CASE

CU Series time delay relays are housed in heat-resistant high-impact Lexan cases. Push-to-test button for manual circuit checking may be specified.

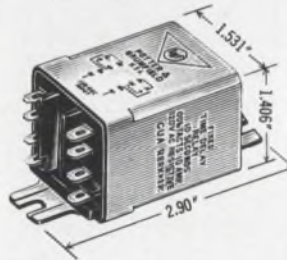

FLANGED CASE

A special flanged case is available for mounting time delay relays directly to chassis. Mounting is on 2.50" centers. Socket cannot be used with this case.

P&B solid state time delay relays are stocked by leading electronic parts distributors.



POTTER & BRUMFIELD

Division of American Machine & Foundry Company, Princeton, Ind. 47570
 Export: AMF International, 261 Madison Avenue, New York, N.Y. 10016

ON READER-SERVICE CARD CIRCLE 78

Do-it-yourself X-RAYS



X-ray inspection where and when you want it with office machine simplicity . . . \$1970!

Until the Faxitron 804, the broad use of X-rays in design and engineering has been limited by the practical considerations of cost, space and personnel.

The Faxitron 804 now makes available a compact, low cost system that brings advanced X-ray capability directly to the workbench, lab or production area. Completely self-contained, it requires no special X-ray room, no highly trained X-ray technician. There are only two controls to set. Operation is as routinely safe and simple as a blueprint machine.

Now you can take your own X-rays—locate hidden problems in potted components, within metal enclosures, deep in solids—define, modify, find solutions, speed development of your project with quick inside looks step by step or any time you need one. Using quick-processing Polaroid® Land film, you can take the radiograph—then view the finished print in 10 to 15 seconds without a dark room. Or you can use standard wet films or cassettes for conventional darkroom processing up to 14" x 17" in size. At the standard 25.5" FTSD, the X-ray beam covers a circle 15" in diameter. With accessory extension collar, this can be

extended to cover the entire 14" x 17" area. A FTSD of 48" to meet MIL specifications can be provided.

Adjustable voltage from 10 to 110 kVP provides excellent contrast over a wide range of object thicknesses and densities. Thickness changes of 1 or 2% can often be observed. Penetration capabilities extend to ¼" of steel, approximately 3" of aluminum, approximately 6" of most plastics.

A new 16-page Application Guide gives detailed description, shows examples of radiographic capability and illustrates some typical uses. Send for your copy. For immediate information or to make arrangements for a free radiographic sample of a product or object of your choosing, call us collect Area Code 503 472-5101. Ask for Dick Siegel or Joe Fowler.

Send for 16-page Application Guide



® Polaroid® by Polaroid Corp.



Field Emission Corporation

McMINNVILLE, OREGON 97128 • AREA CODE 503, 472-5101

ON READER-SERVICE CARD CIRCLE 80

COMPONENTS

Sealed cermet trimmer popularly priced



Helipot Div. of Beckman Instruments, Inc., 2500 Harbor Blvd., Fullerton, Calif. Phone: (714) 871-4848. P&A: \$1.10 (in quantity), \$1.95 (single unit); stock.

A 3/4-in.-long rectangular multi-turn trimming potentiometer is completely sealed against leakage and contamination from PC board soldering and solvent cleaning. It also offers essentially infinite resolution, an 0.75-W power rating, and standard resistances from 10 Ω to 2 MΩ. Production quantity prices run as low as \$1.10.

The 15-turn adjustment trimmer, model 77, measures 0.75 x 0.28 x 0.36 in. The unit is directly interchangeable with widely used industrial wirewound and carbon adjustment potentiometers. The wide range of resistance values should ease design and stocking problems in low-cost commercial and industrial PC board applications.

The cermet resistance element may be set to within ±0.05% (some four times better than wirewounds). The element also eliminates the possibility of catastrophic failure (it will withstand power surges five times its power rating). Standard resistance tolerance is ±10%, and maximum end resistance is 2 Ω. Rotational life of the unit is rated at 200 cycles. Operating temperature range is -55 to +105°C.

Model 77 sealed trimmers have clutch action at both ends to prevent accidental damage during adjustment. Other construction features include glass-filled nylon housing and gold-plated terminal pins.

CIRCLE NO. 379

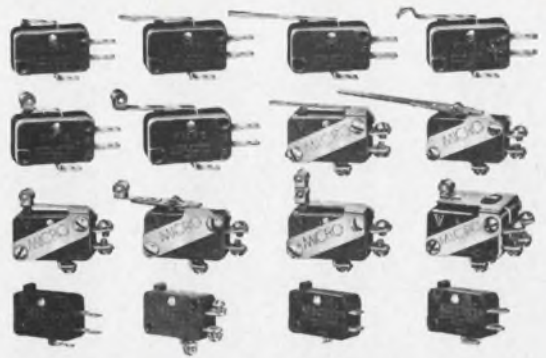

Wide selection of actuators—
both integral and auxiliary types—and terminals.

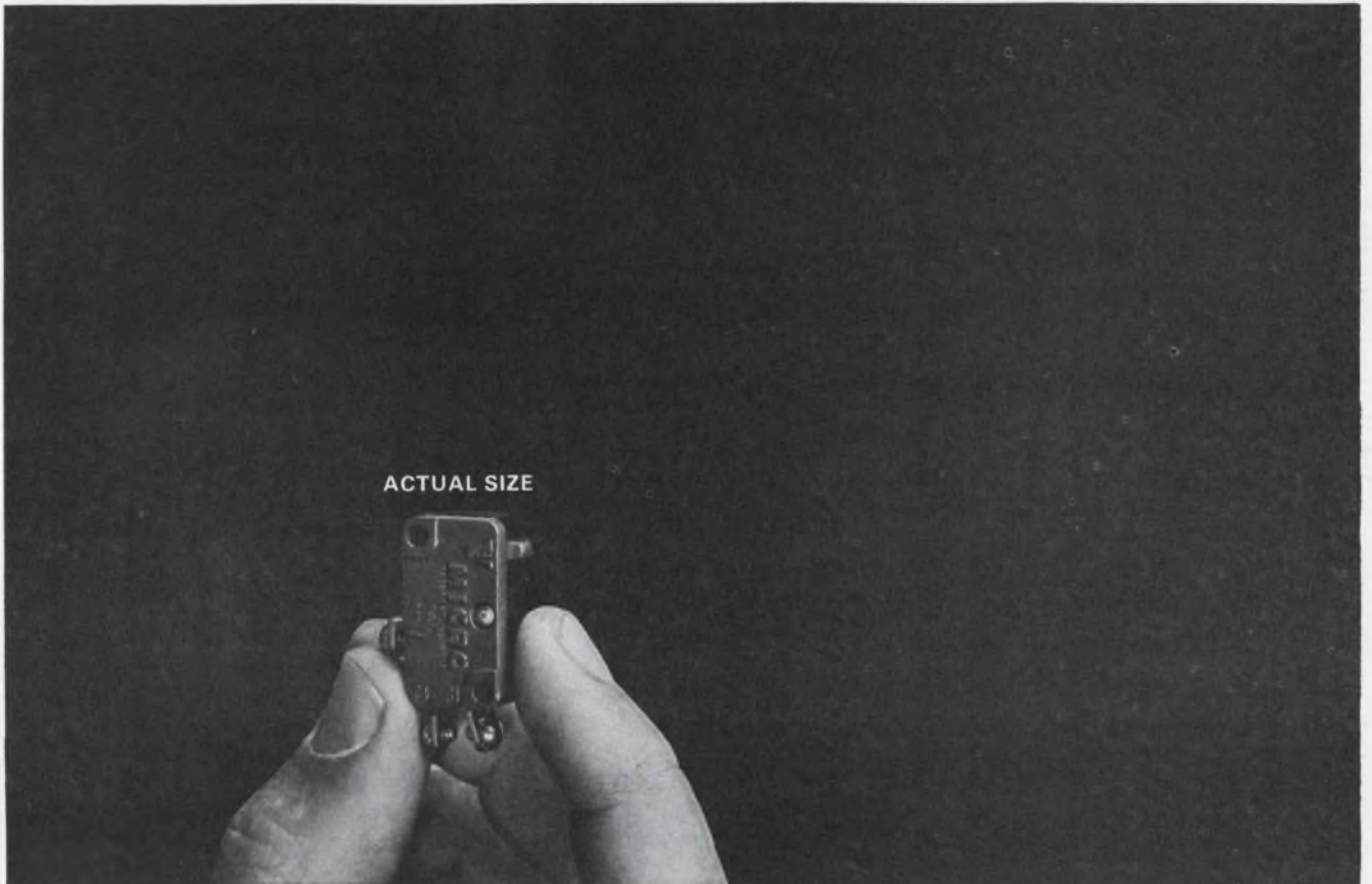

Big-time operator

The MICRO SWITCH V3 is a big-time operator in every sense of the word. It has contributed to the reliability of nearly every important name in the electrical/electronics industry.

If you haven't yet, put it to the test. Or we'll supply you with test data compiled in our Test Lab—the industry's largest and best equipped.

And, the V3 gives you complete freedom of design: over 500 different design combinations including variations in circuitry, electrical capacity, actuators, terminals and resistance to various environments.

Call a Branch Office or Distributor (Yellow Pages, "Switches, Electric"). Or write for Catalog 50.

MICRO SWITCH

FREEPORT, ILLINOIS 61032

A DIVISION OF HONEYWELL

HONEYWELL INTERNATIONAL—Sales and service offices in all principal cities of the world. Manufacturing in United States, United Kingdom, Canada, Netherlands, Germany, France, Japan.

ON READER-SERVICE CARD CIRCLE 81

NEW! VACTEC Photocell-Lamp Control Module

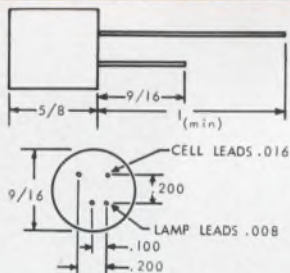

The first of a complete line designed for improved, noiseless volume and tone controls in transistorized amplifiers. Perfect for guitars, organs, musical instruments, radio, TV and the like.

Combines a proven dependable Vactec photocell with an extremely long-life incandescent lamp. Complete low-cost module in a unique epoxy sealed metal enclosure. Leads are spaced on standard .100" centers to simplify circuit board mounting.

Six and 10-volt units now available. Special characteristic designs on request.

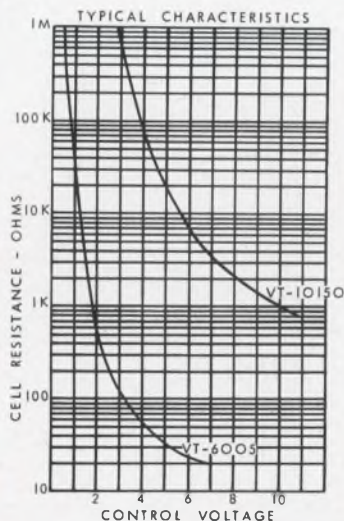

For details, write requesting Bulletin OC-1.



VACTEC, INC.

2423 Northline Ind. Blvd.
Maryland Hts., Mo. 63042 AC 314, 432-4200

See Vactec's listing in EBG under "Semiconductors," and in EEM, Sec. 3700.

ON READER-SERVICE CARD CIRCLE 82

COMPONENTS

Hermetic 2pdt relay cuts coil contamination

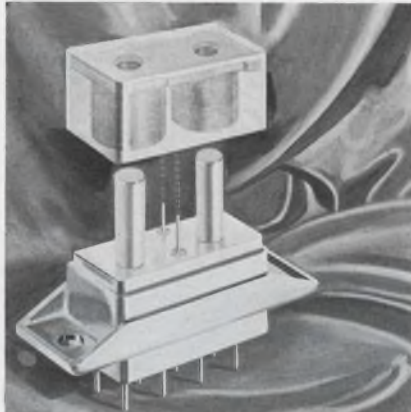

Filtors, Inc., 65 Daly Rd., East Northport, N. Y. Phone: (516) 266-1600.

A unique concept in relay design eliminates the problem of inconsistent contact operation due to contact contamination. The Super-J relay has a hermetically sealed organic-free switching module with its actuating coil assembly mounted outside the relay. Organic contamination is thus dissipated into the atmosphere. Contacts are rated 2 A resistive and switching time is 5 ms at nominal coil voltage and 25°C. Size is standard crystal case.

CIRCLE NO. 380

Button contact worth its weight in gold

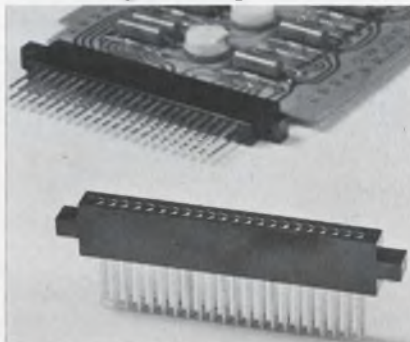

Amphenol Connector Div., Amphenol Corp., 1830 S. 54th Ave., Chicago. Phone: (312) 242-1000.

A new series of connectors uses a solid, precious metal button, 0.007 to 0.01 in. thick, welded to the contact member at the point of electrical contact with the PC board. This eliminates plating the complete contact, including non-functional areas, with precious metal, thereby reducing connector cost.

CIRCLE NO. 381

Thick-film resistors rated to 40 kV

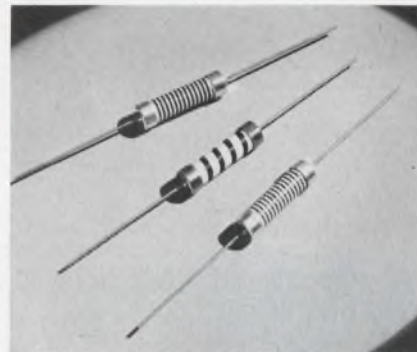

Pyrofilm Resistor Co., Inc., 3 Saddle Rd., Cedar Knolls, N. J. Phone: (201) 539-7110. P&A: 90¢ to \$3; 90 days.

High-voltage resistors utilizing a thick-film technique withstand load surges and have high temperature capacity. PHV series resistors have a temperature coefficient of -500 ppm/°C. Voltage ratings are 3500 to 40,000 V, wattage is 1 to 10 W and resistance range is 10 kΩ to 25,000 MΩ. Units are available in axial leads or radial solder leads. Applications include voltage dividers, power supplies, voltage multipliers, grid leaks, TV high-voltage circuits, CRT circuits, bleeders and photoelectric applications.

CIRCLE NO. 382

Counter line grows to modular status

Veeder-Root, Hartford, Conn. Phone: (203) 527-7201.

Veeder-Root's electrical counter is now expanded into a family of versatile single-wheel counter modules, all featuring electric reset, readout and transfer. The new models in this series consist of a BCD counter and a unit equipped with an "acknowledgment" switching function. The "acknowledgment" decade in the series utilizes a switching function to verify the count registration at a remote location. This model is also available as a subtractive version.

CIRCLE NO. 383

Don't risk missing any issues of **ELECTRONIC DESIGN**. Send in your renewal card today.

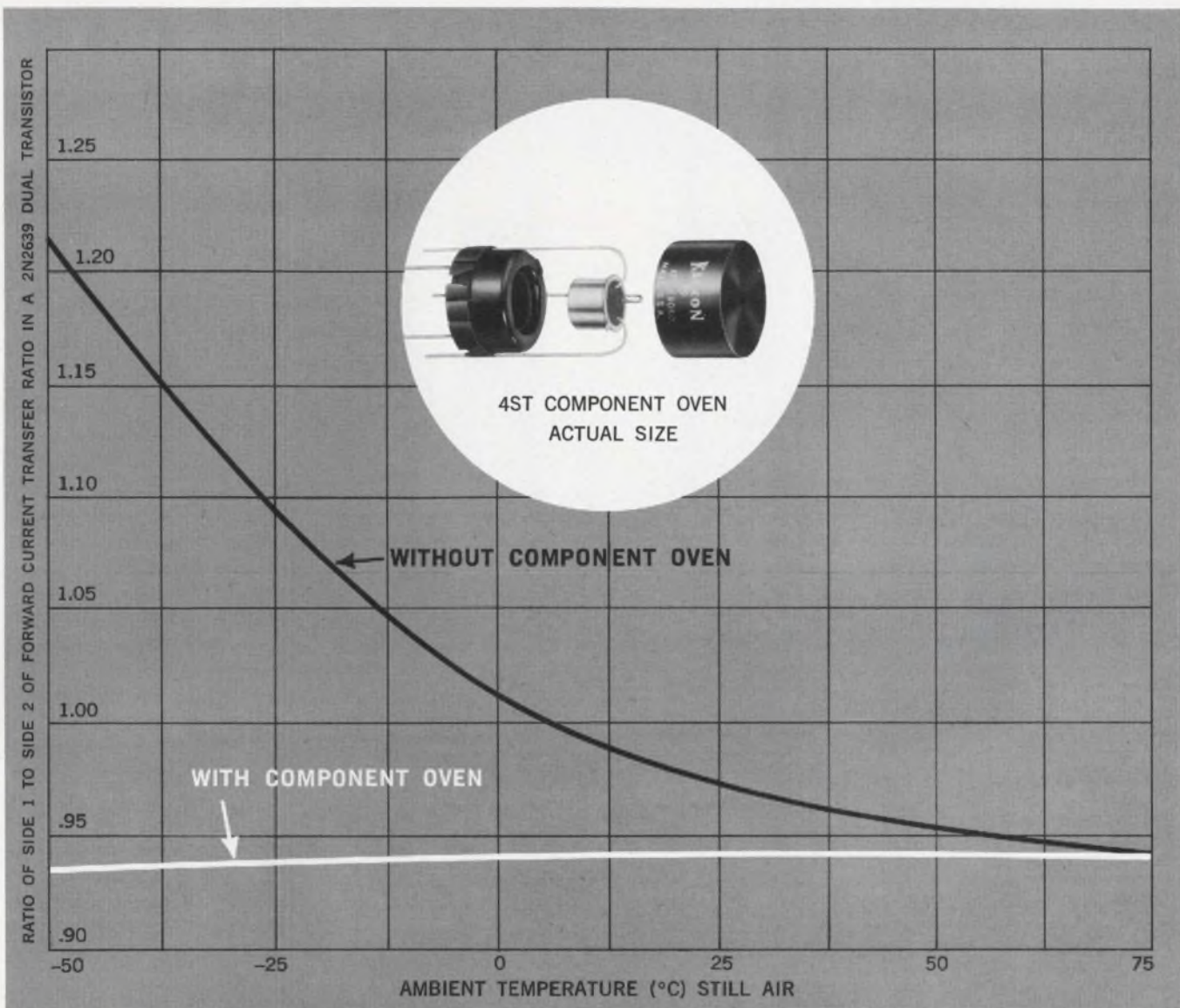

TI offers temperature stabilization for components at half the cost!

TI component ovens use the self-regulating characteristics of a polycrystalline material to provide a stable thermal environment for semiconductor components. This precise control, for example, can increase the performance of lower priced components so significantly they can be used to replace components costing five to thirty times as much . . . Even with the component oven cost, there's a savings of at least 50% . . . and this in the smallest ovens available on the market today.

TI ovens are available in two options: one with a control temperature of 80°C, the other with a control temperature of 115°C. Power requirement at room

temperature is about one watt. Warm up time from -55°C at an air velocity of 100 ft./min. is two minutes, maximum. Control temperature shift with voltage variation from nominal is 0.4°C to 0.6°C per volt.

We offer a complete line of component ovens, precision thermostats, other electromechanical switches, solid state switches, thermal and magnetic circuit breakers, cooling effect detectors, proportional temperature controllers and power storage systems.

For complete information on a product in any of these lines, write to TI Control Products Group, Attleboro, Mass. 02703.



TEXAS INSTRUMENTS
INCORPORATED



Join the Vent-Rak Revolution with this frame!

If you're shooting for rugged strength and ultimate versatility in electronic packaging, Vent-Rak has just what you're looking for!

Unbelievably strong, this frame is the basis for Vent-Rak's 5000 Series Electronic Cabinets, offering component interchangeability, quick accessibility, and easy assembly. Separate frames may be joined together to form bays, meeting practically any commercial electronic packaging requirement. And, a complete range of accessories and options will round out your package.

Find out about the newest, most economical cabinet available that takes shape around this revolutionary frame. Available through industrial distributors, or write:

VENT-RAK, INC.
525 South Webster Avenue
Indianapolis, Indiana 46219



ON READER-SERVICE CARD CIRCLE 83

COMPONENTS

Fiber-optic CRT has 3 x 5-inch face plate



*Sylvania Electric Products, Inc.,
Seneca Falls, N. Y. Phone: (315)
568-5881.*

The largest commercially available fiber-optic CRT, built for high-speed, high-resolution photographic recording of transient displays, uses a 3 x 5-inch fiber-optic face plate. The half-inch-thick face plate is composed of approximately two million glass fibers per square inch, compressed into a solid flat plate. The fibers are clad to prevent light from escaping through their sides. This cladding eliminates diffusion, enabling the plate to transmit light directly from one surface to the other with maximum intensity and resolution.

CIRCLE NO. 384

Plastic photochopper is fast-switching

*Fairchild Instrumentation, 475 El-
lis St., Mountain View, Calif.
Phone: (415) 962-2076. P&A: \$2.50
(1 to 9); stock.*

Fast-turnoff, low-thermal-offset photoconductors are suited for use in chopper applications. Turn-off time of the FPS-300 photoconductor for a resistance increase of 100 is 2 ms. Turn-on time is 0.3 ms. The photoconductor also features excellent long term stability and 10,000-M Ω dark resistance. It can be used in chopper applications to 400 MHz eliminating 1/f noise in the carrier amplifier. The FPS 300 is a light-dependent resistor in a low-profile, plastic-encapsulated package. Active material is cadmium-selenide which is deposited on a ceramic wafer. The device features tin-plated copper leads and has an offset of less than 1 μ V.

CIRCLE NO. 385

ON READER-SERVICE CARD CIRCLE 84 ➤

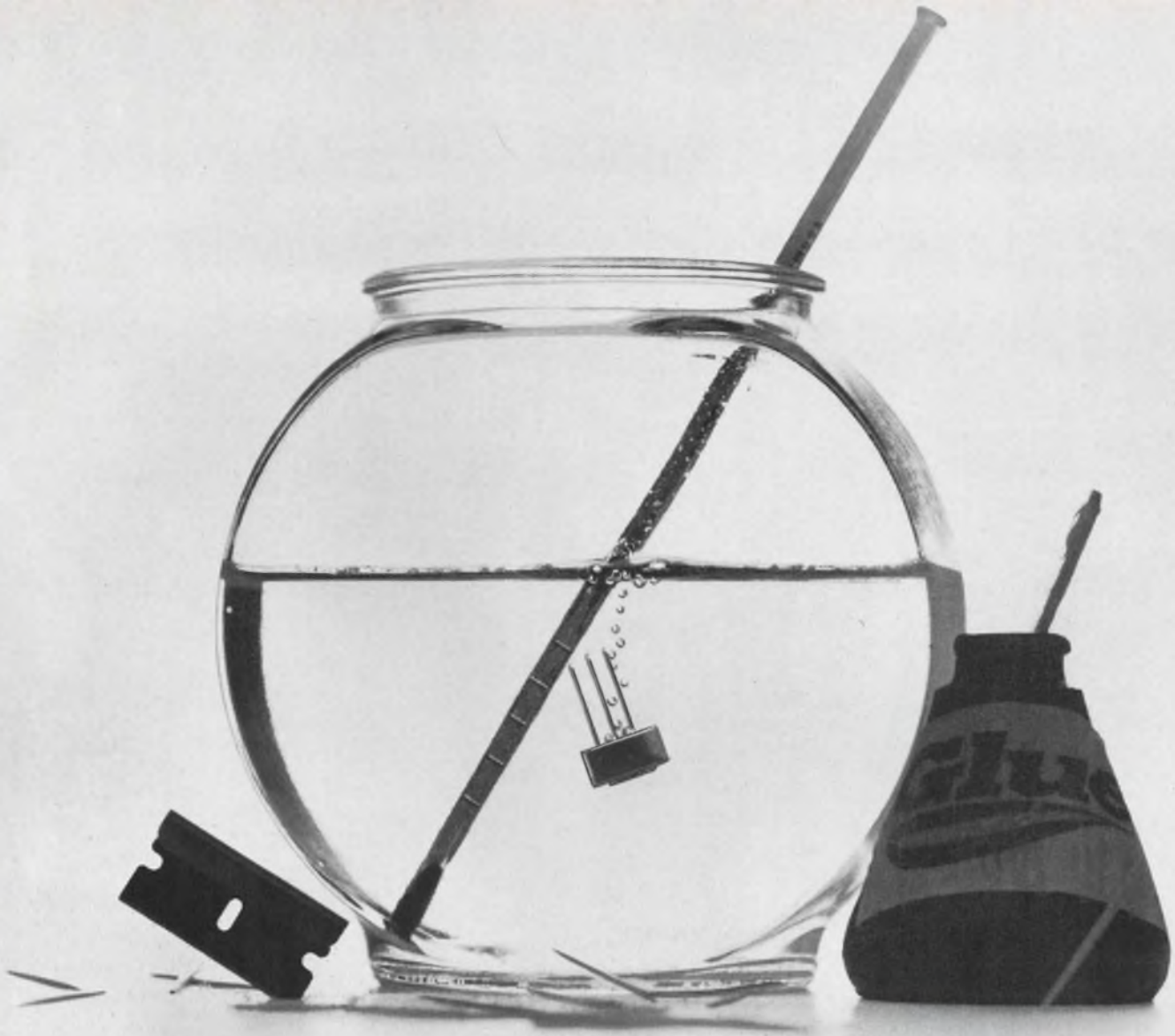

Having trimmer leakage problems?



Not with the Spectrol Model 53!

Here's the end of "toothpick-and-glue" trimmer designs. At last, here's a trimmer with an exclusive seamless construction that virtually eliminates leakage problems through a molding process that provides integral bonding without the use of adhesives or potting. Want to know how we do it? Don't ask. Does Macy's tell Gimbel's? But for technical specs, circle the reader service card.

Spectrol Electronics Corporation
17070 E. Gale Ave. / City of Industry, Calif. 91745



Better Components for Better Systems

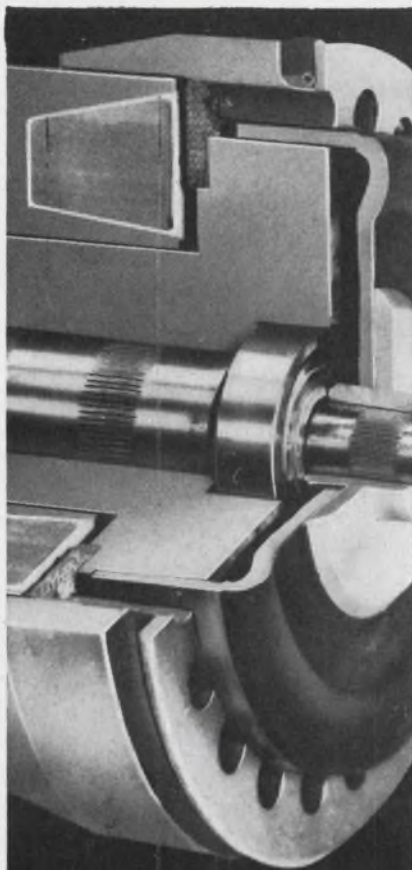

HYSTERESIS BRAKES & CLUTCHES BY MAGTROL

for precise control of

**SPEED
TENSIONING
LOAD SIMULATION
ANTI-BACKLASH**

- absolute precision
- infinite variability, infinite repeatability
- longest life
- from 2 oz. inches to 100 inch lbs.

Write or phone for new 20-page reference booklet containing hysteresis principles and applications, unit specifications and performance charts. Ask for booklet HCB.

MAGTROL INC.
240 SENECA ST. • BUFFALO, N. Y. 14204
716 — 856-7451

HYSTERESIS PIONEERS

ON READER-SERVICE CARD CIRCLE 85

COMPONENTS

RF connectors allow rapid crimping

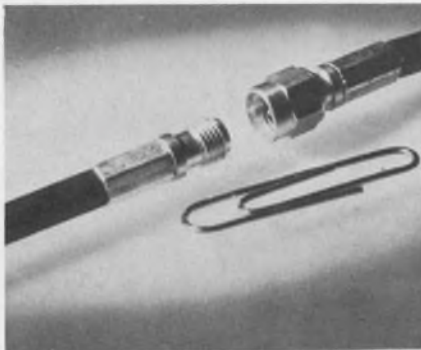

Star-tronics, Georgetown, Mass.
Phone: (617) 352-2741.

Using a simplified assembly procedure with fewer parts and standard crimping tools, these miniature RF connectors may be assembled in a fraction of the time required by normal clamping assemblies. Automatic control of the crimp force is provided by the tool. Braid combing, trimming and forming operations are eliminated and only the center conductor requires soldering.

CIRCLE NO. 386

Events counter resets by pushbutton



A. W. Haydon Co., 232 N. Elm St.,
Waterbury, Conn. Phone: (203)
756-4481.

Instantaneous zero reset by means of a face-mounted pushbutton is featured in this microminiature events counter. The units offer a 3-digit display and register successive events to 999. A solenoid-actuated counter advances one unit each time a pulse is applied to the coil, but voltage can be left applied continuously without damage. Models are 28 Vdc or 115 V, 400 Hz.

CIRCLE NO. 387

Square wave converter has 85-ns rise time

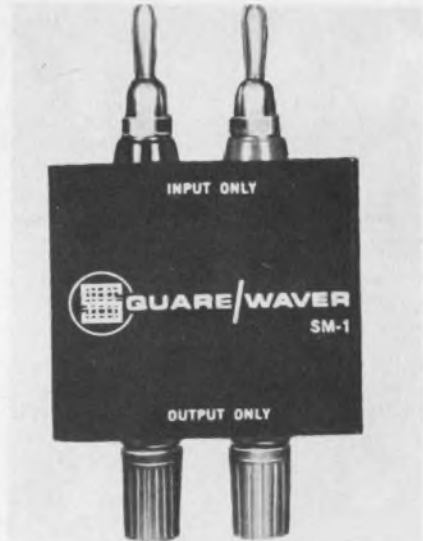

Accutronics, Inc., 12 S. Island, Batavia, Ill. Phone: (312) 879-1000.
P&A: \$35; stock.

A device is offered that converts any signal generator, sine, ramp or saw tooth, to a square wave generator. Simply plug the square waver into the output of any sine wave generator and it becomes a square wave generator with a rise and fall time of less than 85 ns. The unit will accept any signal from 1 Hz to 600 kHz. It requires no batteries or external power.

CIRCLE NO. 388

Laser modulator has low piezoelectric effect

Beckman & Whitley, Inc., 441 Whisman Rd., Mountain View, Calif. Phone: (415) 968-6220.
Price: \$3350.

A laboratory laser light modulator has an operating bandwidth of 1 to 100 MHz. It is a multiple-crystal device operating at low modulation voltages and is designed to compensate for normal changes in ambient temperature. The piezoelectric effect, inherent in electro-optic crystals, has been reduced to a negligible amount; frequency response is nominally flat across the entire operating bandwidth.

CIRCLE NO. 389

It's time to renew your subscription to **ELECTRONIC DESIGN**. Return your renewal card today.

Report from

**BELL
LABORATORIES**

ELECTRONIC GRAPHICS BY COMPUTER

Computer information is most useful when it is displayed in an easily usable form. For this reason, much effort is currently being directed toward finding better visual outputs from computers — graphs and “pictures” instead of numbers. And an important aspect of this problem is improving the graphic quality of the images.

At Bell Telephone Laboratories, researchers M. V. Mathews and H. S. McDonald have devised an efficient and versatile method of “drawing” any conceivable shape or graphical design on the screen of a cathode-ray tube. For example, entire pages of text matter can be drawn on the screen in any desired type font, and then photographed. As a demonstration, the above headline, these words, and the sample mathematics and music below were produced by this experimental method.

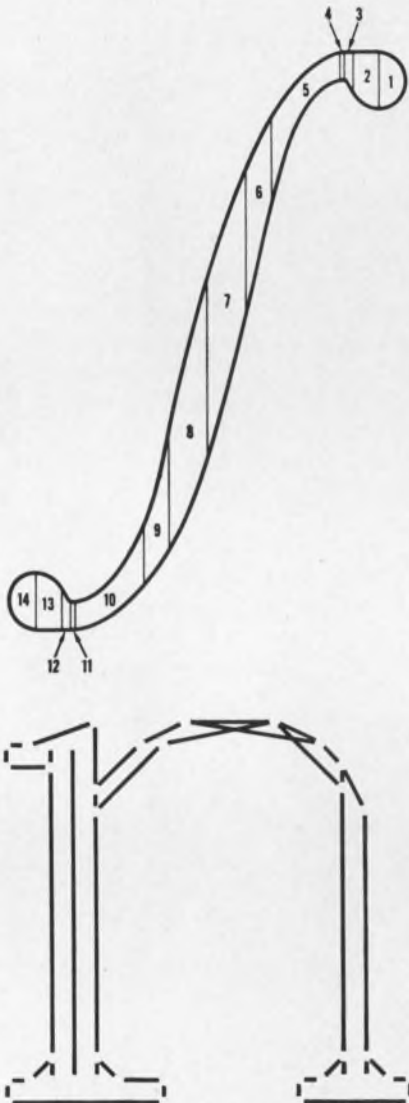

Two programming methods used to generate graphical material: An integral sign (top) is formed by the “patch” method, whereby the image is divided into a number of constituent areas or patches (fourteen patches in this case). After the areas are specified, the electron beam fills each one in. In another method, used here to form the letter “n”, the electron beam follows the paths of the vector lines shown. Beam is wide enough to fill in areas between vectors.

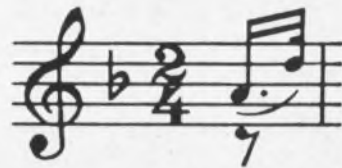

$$\int_0^{\infty} \sqrt{x} e^{-ax} dx$$

At present, information describing the shapes of each of about 450 letters and symbols is stored numerically in a computer. No masks, negatives or other physical forms of the graphics are used. An operator tells the computer what text and/or other matter is to be produced. The computer calls upon its memory and directs the motions of the electron beam in the cathode-ray tube needed to trace out the images.

Preparing material with this technique offers the advantages of current mechanical methods plus the opportunity to correct while writing, change letter style and symbol forms, arrange lines with an even right-hand margin (justification), and vary type size — all with a heretofore unattainable ease and speed.



Bell Telephone Laboratories

Research and Development Unit of the Bell System

"Just building a lipstick size relay that worked would have been easy."



Building one around our great high-rel idea was another story."

Wedge-action*, our great high-rel idea, is 9 years old. Our 2PDT lipstick-case size relay has been around for less than 2 years. But it's already a standard replacement for the competition in lots of MIL-R-5757/8 applications.



Why? Because it outperforms every spec requirement for both high and low-level loads. Like all our wedge-action relays, it combines long contact wipe with high contact force to give you continually clean precious-metal mating surfaces throughout life. Competitively priced with fast delivery.

The lipstick is just one of our family of wedge-action relays, which cover almost every dry-circuit to 2 amp application. When you need a high-rel relay that really works, test one of ours and try your darndest to prove we're wrong. You won't be able to.

*U.S. Patent No. 2,866,046 and others pending.



Electro-Tec Corp.

SLIP RINGS • RELAYS • SWITCHES • OPTICS

P.O. Box 007 • Ormond Beach, Florida
(904) 677-1771 • TWX 810-857-0305

Manufacturing Facilities:
Ormond Beach, Fla. • Blacksburg, Va.

ON READER-SERVICE CARD CIRCLE 87

TEST EQUIPMENT

Three-and-a-half-digits at one-half the price



Fairchild Instrumentation, Fairchild Dr., Mountain View, Calif. Phone: (415) 962-2076. P&A: \$299 (1 to 4), \$249 (25 or more); stock.

A "three and one half" digit integrating digital multimeter is priced at \$249 in quantities of 25 or more. The cost and space advantages are gained by the use of integrated circuits. The low-cost, accurate instrument is suited for production, general test, servicing and education applications. Reading volts and ohms, the instrument provides both dc voltage and resistance capability.

With an accuracy of 0.1% of reading, Model 7050 can replace analog-type meters and panel indicators as well as more expensive digital voltmeters. Using the dual slope technique, it combines the noise rejection capabilities of integration with the accuracy and stability of automatic comparison to an internal standard. Speed is six measurement samples per second.

Three full readout decades plus a fourth digit give full scale readout of 1500. This is equivalent to 50 per cent overranging with no degradation of accuracy. Other standard features are an input impedance of greater than 1000 M Ω , floating input which may be operated 500 volts above ground and readout storage (non-blinking display).

CIRCLE NO. 395

Precision power supplies with in-line readouts

Deltron, Inc., Wissahickon Ave., N. Wales, Pa. Phone: (215) 699-9261.

Two precision power supplies featuring five-decade, digital, in-line readout are useful as reference sources for instrument calibration and potentiometric measurements. Calibration accuracy is 0.05% and line and load regulation is 0.001%.

CIRCLE NO. 396

Pulse generator is programmable

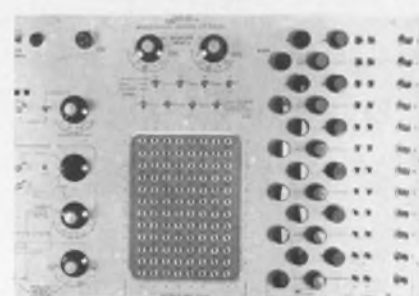

Adar Associates, Inc., 73 Union Square, Somerville, Mass. Phone: (617) 623-3131.

A programmable pulse generator features twelve parallel output channels and operates at stepping rates from 10 MHz to 1 kHz. It is programmed by inserting diode pins into an 8 by 12 program matrix board. A single program pass is constituted by eight time steps and may be repeated a specified number of times under a variable control delay prior to reinitiation.

CIRCLE NO. 397

Power supplies put out 300 watts



Trygon Electronics, Inc., 111 Pleasant Ave., Roosevelt, N. Y. Phone: (516) 378-2800. P&A: \$320 to \$495; stock.

All-silicon lab or bench power supplies feature constant voltage and constant current operation with outputs to 300 W. Eight models are available with voltages from 0 to 20 Vdc at 10 A to 0 to 160 Vdc at 2 A, with 0.01% regulation and 0.5-mV ripple. Other major features include remote voltage programming and sensing, and automatic current-limiting short circuit protection.

CIRCLE NO. 398

Logic power supply heat sinks itself

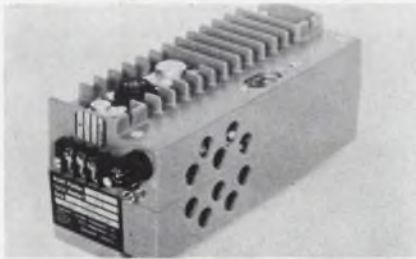

California Systems Components, Inc., 9176 Independence Ave., Chatsworth, Calif. Phone: (213) 341-1050. P&A: \$265; stock.

A new logic power supply features short-circuit protection, over-voltage protection, under-voltage protection and transient suppression. The supply utilizes its casting as an integral package and heat sink. A 5-A version occupies 100 cubic inches and weighs less than 5 pounds. The power supply package is designed to be mounted within a card cage occupying 23 positions.

CIRCLE NO. 393

Curve tracer system has digital readout



Fairchild Instrumentation, 313 Fairchild Dr., Mountain View, Calif. Phone: (415) 962-2076. P&A: \$5000; stock to 60 days.

A digital readout curve tracer system is composed of Fairchild's 6200 BD curve tracer and 7100A-S42 digital voltmeter. Both instruments can be used independently as well as in conjunction with each other. Combined, they provide digital readout of curve tracer tests and optional data logging. The system will digitally read out V_{CE} , I_C , V_{BE} , I_B as well as the ratio of any two parameters including H_{FE} . System accuracy exceeds 2%.

CIRCLE NO. 394

ELECTRONIC DESIGN 8, April 12, 1967

Ballantine Announces a New Solid State DC Digital Voltmeter



Model 353

Gives you fast, accurate readings to 0.02% ± 0.01% f.s. and at a low cost of just \$490

Ballantine's new Model 353 enables you to speed up dc measurements materially over those made on multi-knob differential voltmeters. And with laboratory accuracy from 0 to 1000 volts dc.

It requires just two steps: (1) Set knob to NORMAL mode and read voltage; (2) dial in the first digit in EXPAND mode and read voltage to four places with overrange to five; and, in addition, interpolate to another digit.

The NORMAL mode error becomes submerged by more than ten to one, and the operation is fast and accurate to 0.02% of reading $\pm 0.01\%$ f.s. If the input signal is varying, the last digit may be followed visually, thus providing the advantage of analog display.

Note these other interesting features of the new 353: a left-to-right digital readout; an automatic display of "mV" or "V"; proper placement of the decimal point; 10 megohms input resistance; an automatic disabling of the motor during the "expand" dialing; a red light to indicate overrange or wrong polarity; and provision for a foot-operated switch for a "read" or "hold" function.

Write for brochure giving many more details



— Since 1932 —

BALLANTINE LABORATORIES INC.
Boonton, New Jersey

CHECK WITH BALLANTINE FIRST FOR DC AND AC ELECTRONIC VOLTMETERS/AMMETERS/OHM METERS, REGARDLESS OF YOUR REQUIREMENTS. WE HAVE A LARGE LINE, WITH ADDITIONS EACH YEAR. ALSO AC/DC LINEAR CONVERTERS, AC/DC CALIBRATORS, WIDE BAND AMPLIFIERS, DIRECT-READING CAPACITANCE METERS, AND A LINE OF LABORATORY VOLTAGE STANDARDS FOR 0 TO 1,000 MHZ.

ON READER-SERVICE CARD CIRCLE 88

got a crazy curve?

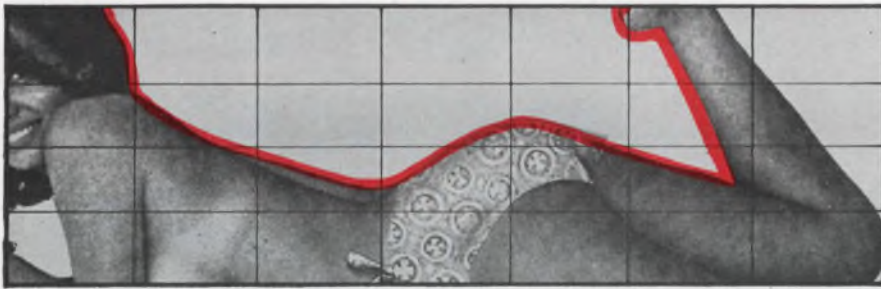

A DUNCAN NON-LINEAR POT CAN MATCH IT!

Even if your non-linear function looks like the Playmate of the Month in profile, Duncan can build a pot to match it. All you have to do is use the new "DUNCAN DO-IT-YOURSELF NON-LINEAR FUNCTION KIT," which we'll send you without obligation if you'll fill out and mail the coupon below. The kit includes a fabulous French curve* plus all other necessary ingredients and instructions. You supply us with the non-linear trace of your function and other supporting data. We'll feed it to our high-speed computer and analyze the data defining the pot's desired function. Then we'll enter the output tape into our servo-controlled machines to produce the variable-pitch winding to meet your function.

To be sure the output of the pot conforms to the specified tolerances, we'll compare it with the theoretical function on our unique conformity tester.

The result? A precision, accurate pot exactly to your specifications.

Our applications engineers can help solve your problems quickly and economically. In many cases they'll be able to match your function using pre-calculated data from our extensive tape library.

So forget about cams, differentials, and non-linear gears. For the direct approach to a complicated non-linear potentiometer problem — for airborne data computation or matching thermocouple curves — depend upon Duncan. You'll have more time to check out other interesting curves!

Send for your free Duncan "do-it-yourself" kit today. For literature only, circle the appropriate number and mail the inquiry card enclosed in this magazine.

DUNCAN ELECTRONICS INC.

Please send me my free "DUNCAN DO-IT-YOURSELF NON-LINEAR FUNCTION KIT" and complete technical literature on Duncan's family of non-linear potentiometers.

I understand that there is no obligation on my part.

Name _____ Title _____

Company _____

Address _____

City _____ State _____ zip _____

*French curve ruler by Birule Co.



DUNCAN electronics, inc.

2865 Fairview Rd., Costa Mesa, California 92626 Tel.: (714) 545-8261 TWX: 910-595-1128

ON READER-SERVICE CARD CIRCLE 89

TEST EQUIPMENT

Testing system for logic circuits



Industrial Inventions, Inc., Monmouth Junction, N. J. Phone: (201) 329-6000. P&A: \$59.50; stock.

System and circuit testing is accomplished with this digital monitor by providing a simultaneous visual indication of the logic states of up to 18 digital or binary circuits. The engineer can thus obtain a total insight into the operation of any discrete or integrated system. The unit will not affect the circuit under test and can be used with any common logic voltage system.

CIRCLE NO. 399

Digital to synchro with IC logic



Northridge Engineering Co., 18758-3 Bryant St., Northridge, Calif. Phone: (213) 349-4732.

Useful for driving ground-based radars, telemetry antennas, launchers, optical trackers and indicators, this digital-to-synchro converter performs trigonometric and analog conversion in a single step, without sequential logic. There are no motors, gears, encoders or adjustments. Monolithic IC logic permits packaging in a 3-1/2-in. package.

CIRCLE NO. 400

Small power supplies have high output range

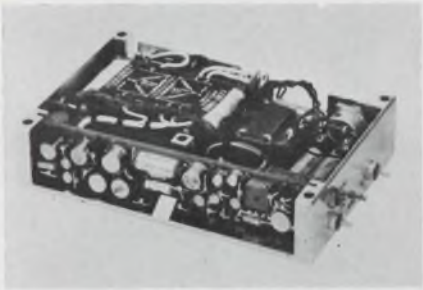

Litton Industries, 9370 Santa Monica Blvd., Beverly Hills, Calif. Phone: (213) 273-7500.

Four switching-regulator power supply models operate from 3 to 30 Vdc at power output ratings up to 120 W. Output voltages range from 3 to 40 Vdc at a max of 2 A per output with total output ratings of 35, 70 and 100 W, and from 3 to 30 Vdc at 24 W for a lighter-weight model.

CIRCLE NO. 401

Op-amp power supplies have 0.25% regulation



Fairchild Instrumentation, 475 Ellis St., Mountain View, Calif. Phone: (415) 962-2076. Price: \$295.

Two isolated power supplies designed for use with op-amps are offered. They feature dual output with low-noise and fast-response characteristics. The high output currents make it possible to operate several amplifiers from the same supply. The new supplies have double shielding with the primary and secondary shields electrically isolated from the case and circuitry. Both supplies have $\pm 0.25\%$ load regulation voltage when changing from no load to full load.

CIRCLE NO. 402

not so unusual...

No, it's not unusual to see thin, flat, flexible aci Signaflo systems in computers, business machines, communication equipment and control systems! Not so long ago packaging engineers discovered that problems lead to solutions at aci. Conventional bulky cabling is being replaced. And, in every case there are good reasons why . . . increased performance levels, lower costs or both. No wonder aci Signaflo wiring systems are not so unusual.



Point to point wiring is a thing of the past! aci "Spread-Pitch" Signaflo wiring system matches hardware dimensions for p.c. board computer interconnection circuitry.

aci
SIGNAFLO
WIRING
SYSTEMS

very unusual...

aci has shown a capacity to respond with practical solutions. This, plus a constant search for advanced wiring techniques has led to some very unusual developments at aci.

- a. Unparalleled uniformity is obtained for Signaflo transmission line systems with controlled characteristics such as impedance, cross-talk, propagation velocity and capacitance.
- b. "Micro-Pitch" Signaflo wiring systems are uniquely presenting imaginative and creative solutions to memory plane and integrated circuit interconnection.

"Acknowledged leader in flat cable systems."



aci DIVISION OF KENT CORPORATION
206 Industrial Center, Princeton, N. J. 08540
Telephone 609-924-3800 TWX. 609-921-2077

254 conductors

Micro-module high density wiring with aci "Micro-Pitch" Signaflo wiring system with conductors on .015" centers and a cumulative error within .002"!



100 ohm with 2 grounds

55 ohm

106 ohm

aci Signaflo systems for signal transmission line wiring, shielded or unshielded, are replacing coax and twisted pairs.

ON READER-SERVICE CARD CIRCLE 94



FOR COMPLETE
DESIGN FREEDOM IN CONTROL PANELS
SPECIFY

SWITCHCRAFT SWITCHES

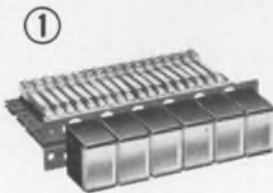

PUSHBUTTON ACTION
ILLUMINATED LITTEL "MULTI-SWITCH." Virtually unlimited lighting effects and switching functions in one ultra-compact unit . . . enables you to design a cybernetically correct, error-reducing panel for your special applications. Single color or split-face lighting. Up to 6PDT in only .6 sq. in. panel space! 1 to 18 stations per row . . . can be ganged and coupled.

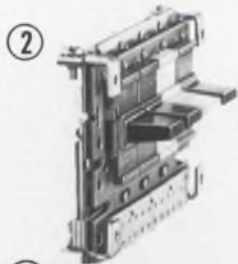

SLIDE ACTION
"MULTI-SLIDE" SWITCHES. New! A slide switch offering all 3 types of actuation: interlock, all-lock, non-lock. Speeds operator reaction while minimizing errors through slide-switch variety and visibility! 1 to 18 stations.

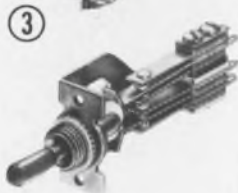

LEVER ACTION
Switchcraft offers the largest selection of illuminated and non-illuminated lever-type switches in the industry. Wide variety of sizes from miniaturized "Feather Lever" (featuring changeable push-on color knobs) to the industry standard "Telever" telephone-type switches with field changeable functions. Specialized types to solve such problems as capacitance build up, need for switches with 1/2 lock and 1/2 non-lock functions, extra length bushings, etc.

WRITE FOR COMPLETE LEVER, SLIDE AND PUSHBUTTON SWITCH CATALOGS or see your Switchcraft Authorized Industrial Distributor for immediate delivery at factory prices.

SWITCHCRAFT®

5529 North Elston Avenue
Chicago, Illinois 60630

ON READER-SERVICE CARD CIRCLE 95

TEST EQUIPMENT

Sensitive galvanometer claims infinite cmr



*Electro Scientific Industries, Inc.,
13900 N. W. Science Park Dr.,
Portland, Ore. Phone: (503) 646-
4141. P&A: \$1975; stock to 60
days.*

Infinite common-mode rejection is claimed for this galvanometer null detector. A special feedback control is said to enable the device to operate from any source resistance without changes in response or damping characteristics. 120-dB ac rejection is claimed. It is applicable to resistance measuring systems, direct reading ratio sets, universal ratio sets and potentiometers.

CIRCLE NO. 403

Strip chart recorders single- and dual-channel

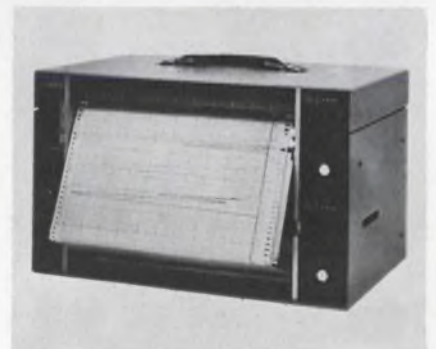

*Varian Associates, Recorder Div.,
611 Hansen Way, Palo Alto, Calif.
Phone: (415) 326-4000. P&A:
about \$1000; 30 to 45 days.*

Both single- and dual-channel instruments with interchangeable input modules are available in a line of 10-in. strip chart recorders. The units are useful with laboratory instrumentation as well as in OEM and systems applications. The recorders are available in either portable or rack-mount cases.

CIRCLE NO. 404

A New Waterproof Series

MINIATURE

TOGGLE SWITCHES

New case design with double high voltage barriers, and low-loss, high impact, high temperature materials. Wide silver contacts. Waterproof 'O' rings and sealed terminals. Available in One, Two, Three and Four Pole configurations all in compact unitized bodies. 6 Amps @ 125 VAC.

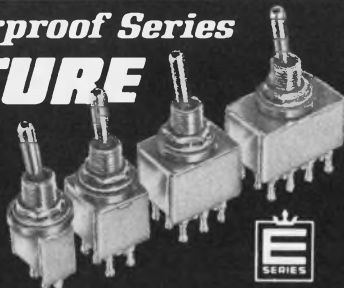

FREE
PRODUCT
PLANNING
CATALOG

SPECIFY THE NEW "E" SERIES BY

ALCOSWITCH

DIV. OF ALCO ELECTRONIC PRODUCTS INC., LAWRENCE, MASS.

On Reader Service Card Circle 70

A New Waterproof Series

MINIATURE $\frac{1}{2}$ " DIA.

Rotary Switches



'O' ring on shaft and bushing. Terminal portion sealed with superior adhesive bonding cement. Withstands water submersion test 9.8 ft. Non-shorting, 36" spacing, $\frac{1}{8}$ " dia. shaft. Available in One, Two, Three and Four Pole configurations. $\frac{1}{2}$ " dia. body. Non-adjustable. 500 ma @ 125 VAC.



FREE
PRODUCT
PLANNING
CATALOG

SPECIFY THE NEW "E" SERIES BY

ALCOSWITCH

DIV. OF ALCO ELECTRONIC PRODUCTS INC., LAWRENCE, MASS.

On Reader Service Card Circle 71

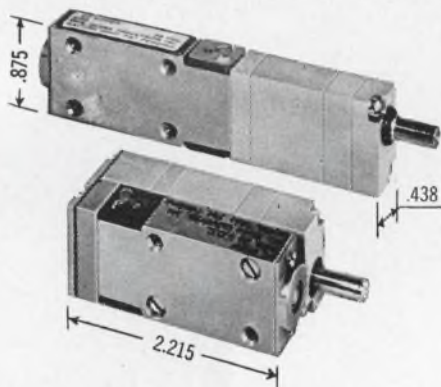

NEW FLAT GEARMOTORS

most compact / most torque

Globe Type VS d.c. gearmotors give up to 70 oz. in. torque (35 oz. in. continuous duty) in two packages, one with a frontal area as small as 0.4 sq. in.! Motor develops .0025 hp in the 8,000 to 17,000 rpm range; many standard armatures, 3 to 50 v.d.c. End mounted gearbox: 62 standard ratios from 7.88:1 to 25,573.65:1. Side mounted gearbox: 27 standard ratios. Case hardened gears. Units designed to meet MIL specs. Bulletin VSG.

GLOBE

Globe Industries, Inc., 2275 Stanley Avenue
Dayton, Ohio 45404, U.S.A., Tel.: 513 222-3741

ON READER-SERVICE CARD CIRCLE 96

ELECTRONIC DESIGN 8, April 12, 1967



Charge Amplifier TRIPLETS!

HIGH PERFORMANCE . . .

DCS Model GCA-1 Charge Amplifier with VCO and Galvo outputs . . . Built-in calibration.



WITH EXTRA FUNCTIONS . . .

DCS Model GCA-2 Charge Amplifier with servo control output and front panel meter.



FOR MULTI-FUNCTION
PIEZOELECTRIC
TRANSDUCER SIGNAL
CONDITIONING . . .

DCS Model GOC-5 Charge Amplifier/VCO combination. Compact for portable and field use.



AND . . . They're omniplugable



with DCS VCO's, Millivolt Oscillators, Low Level Amplifiers, Line Amplifiers, Discriminators, Crystal Oscillators, Translators, signal conditioning, calibrators, and magnetic tape recording equipment.

INTERESTED? Call our office nearest you for information and data bulletins on DCS Charge Amplifiers.

Or write directly to:

Department ED 4-7, Data-Control Systems, Inc.
East Liberty Street, Danbury, Connecticut 06813

Telephone: 203-743-9241 TWX 744-1999



DATA-CONTROL SYSTEMS INC.

Instrumentation for Research

Sales Offices
Silver Spring, Md., Huntsville, Winter Park, Long Beach, Santa Clara,
Albuquerque

Copenhagen London Rome Paris Munich Amsterdam

ON READER-SERVICE CARD CIRCLE 97



NOW! An off-the-shelf systems amplifier with out-of-this-world performance.

Only the new standard Model C44A Amplexer Amplifier — for use in multi-amplifier systems — gives you **all** of these advantages:

- Three simultaneous outputs — filtered and commutated; filtered; wideband (55KHz).
- Six filter bandwidths — 5, 10, 100, 1K, 10K, 20KHz.
- Seven gains—1, 3, 10, 30, 100, 300, 1000.
- Gain accuracy — $\pm 0.01\%$.
- Gain stability and linearity — $\pm 0.005\%$.
- Output — 5 or 10v, 10 or 100ma.

The cost for this outstanding performance? A down-to-earth price of only \$590 per unit—with quantity discounts available.

For details contact:

Beckman®

INSTRUMENTS, INC.
ELECTRONIC INSTRUMENTS DIVISION
FULLERTON, CALIFORNIA • 92634

INTERNATIONAL SUBSIDIARIES: GENEVA; MUNICH; GLENROTHES, SCOTLAND;
TOKYO; PARIS; CAPE TOWN; LONDON; MEXICO CITY

ON READER-SERVICE CARD CIRCLE 98

TEST EQUIPMENT

Measure RF attenuation of 100 dB in one step

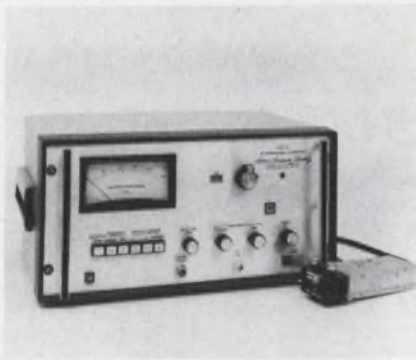

Airborne Instruments Lab., Comac Rd., Deer Park, N. Y. Phone: (516) 595-5823. P&A: \$3500; 60 days.

An RF attenuation calibrator achieves measurement ranges greater than 100 dB of RF attenuation in a single step with less than 0.4-dB error. Measurement is made by the basic IF series substitution method. The attenuator used for comparison is a waveguide below-cut-off type having an attenuation range of 100 dB above its minimum insertion loss. It has an accuracy of ± 0.05 dB per 10-dB increment with a maximum error of ± 0.3 dB. Resolution is 0.05 dB per division full scale and 0.01 dB per division expanded scale. AFC reduces the effect of frequency drift of the external RF generators by a factor of 500 (10-MHz shift at RF would be reduced to a 20-kHz shift at IF).

CIRCLE NO. 405

Tester for aircraft accessory actuators

Magtrol, Inc., 240 Seneca St., Buffalo, New York. Phone: (716) 856-7451.

An electromechanical performance evaluator has been developed for testing aircraft accessory actuators such as trim tab and stick feel. It applies aiding or opposing linear force from 0 to 1000 lbs, in two directions, with rate of travel from 0.005 to 1.0 ips. Force is measured by a strain-gauge arm and servoed to maintain preset value to compensate for the slowly changing load.

CIRCLE NO. 406

It's time to renew your subscription to **ELECTRONIC DESIGN**. Return your renewal card today.

Microsonics

State of the Art Design in Filters Oscillators and Delay Lines



Continuously
Variable Delay
Systems

Bulletins 4301 and 4302



Broad Bandwidth
Highly Selective
Crystal Filters
Bulletin 6350

Comb. Filter Sets
Bulletin 6350



Broad Bandwidth
Delay Lines
Bulletin 4300



Highly Stable
Oscillators — Bulletin 6350



Voltage Controlled
Crystal Oscillators
Bulletin 6350

High Density
Digital Storage
Systems

Bulletin
5350



Send for literature.



MICROSONICS, INC.
60 Winter Street
Weymouth, Mass. 02188
Tel: 617 337-4200

A subsidiary of the Sangamo Electric Company

ON READER-SERVICE CARD CIRCLE 99
ELECTRONIC DESIGN 8, April 12, 1967

A-to-D converters claim higher speed



Computer Labs., Div. of Strandberg Engineering Labs., Inc., 1001 S. Elm St., Greensboro, N. C. Phone: (919) 274-4557.

With only ± 0.75 -ns aperture time, a line of A-to-D converters offers continuous as well as external command, encoding at any random or periodic rate up to the maximum word rate. Both gray and binary outputs are provided. One model produces a 7-bit word rate at 10 MHz, and is capable of encoding an analog bandwidth of 5 MHz, such as high-quality video information.

CIRCLE NO. 407

Quick-writing camera for portable scopes



Tektronix, Inc., P. O. Box 500, Beaverton, Ore. Phone: (503) 644-0161. P&A: \$540; May.

A high writing speed camera is designed for Tektronix type 422, 453 or 454 portable scopes. It has an 80-mm, $f/1.3$, 1:05 lens and uses a Polaroid roll film back that accepts 10,000 speed film. Up to three 6-by-10-division graticules can be recorded on one print by using multiple exposures and the sliding film back. Adapters enable the type C-40 to be used with most Tektronix scopes.

CIRCLE NO. 408

PEAK PULSE - DVM



MODEL 5202

... dc to 50 nanosecond response with memory for single events!

The Micro Instrument Model 5202 is a dc to 20 MHz broad band DVM that never forgets — and won't let you forget! Actually, it's three instruments in one: a single or repetitive pulse peak-reading DVM; a sample-and-hold DVM; and a dc DVM.

The Model 5202 reads the maximum applied voltage of any 50 nanosecond or longer waveform, holds it indefinitely, and digitizes it for read-out on its 3-digit Nixie[®] tube display. And it makes no difference whether the signal is single or repetitive, ac, dc, or rf!

Check the following features. You'll see why the all solid-state Model 5202 is your best buy when it comes to monitoring single events or other voltages.

- 1% accuracy — wide dynamic range
- Sample-and-hold gate operation
- Voltage range to 30 KV with probes
- High input impedance — to 10 megohms
- Analog recorder and printer outputs

All of the Micro Instrument Model 5202's exceptional features are fully described in our technical literature. Send today for your copy of our 4-page brochure covering the theory of operation and specifications of our complete line of pulse measuring instruments. No obligation, of course.

The Model 5202 is priced at \$1495.00 for 5¼" rack mounting chassis.



12901 CRENSHAW BLVD., HAWTHORNE, CALIFORNIA 90250
TELEPHONES: (213) 679-8237 & 772-1275

ON READER-SERVICE CARD CIRCLE 100

Bulova forks solve low frequency problems

Let the experience behind 300,000 forks per year help you!



American Time Products forks are now available up to 25 kc, thanks to years of experience plus new design techniques developed by Bulova. (Including the tiny forks for Accutron® electronic timepieces, Bulova made 300,000 last year alone!)

Result: ATP units provide lower cost, smaller size, lighter weight and greater long term stability in such applications as Computers, Navigation Systems, Doppler Radar, Motor Drives, Encoders and Timers. Accuracies of up to 0.001% are available.

Bulova fork oscillators offer the added advantage of simplicity of design and circuitry. Fewer components mean greater reliability. Finally, Bulova fork products are uniquely capable of withstanding severe shock and vibration environments. No wonder Bulova sold 300,000 last year!

FS-11 FORK FREQUENCY STANDARD

Standard Frequencies: Up to 10,000 cps
Accuracy: Up to $\pm 0.001\%$
Input: 28V DC (others on request)



Output: 5 volts p-to-p min. into 10K ohms
Temperature Range: As low as -55°C to as high as $+85^{\circ}\text{C}$
Size: $1\frac{1}{2}$ in. sq. x $\frac{3}{8}$ "



SUB-MINIATURE TF-500 TUNING FORK

Standard Frequencies: Up to 2400 cps
Accuracy: Up to $\pm 0.001\%$ at 25°C
Input: 28V DC (others on request)
Output: Up to 5V rms into 20K ohms
Temperature Range: As low as -55°C to as high as $+85^{\circ}\text{C}$
Size: $\frac{3}{8}$ " x $\frac{3}{4}$ " x $1\frac{1}{2}$ " max.

Write or call for specifications on Bulova's complete line of tuning fork products. Address: Dept. ED-16

BULOVA

AMERICAN TIME PRODUCTS

ELECTRONICS DIVISION OF BULOVA WATCH COMPANY, INC.

61-20 WOODSIDE AVENUE WOODSIDE, N.Y. 11377, (212) DE 5-6000

ON READER-SERVICE CARD CIRCLE 102

SYSTEMS

Spectral density plots produced in seconds

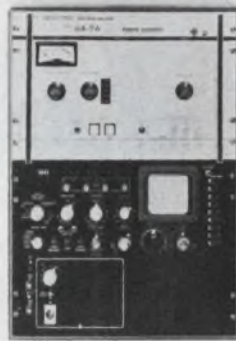

Federal Scientific Corp., 615 W. 131 St., N. Y. Phone: (212) 286-4400. P&A: \$39,000; 90 days

High-resolution power spectral density plots can be recorded immediately without the use of tape loops. Built around the manufacturer's ubiquitous spectrum analyzer, a new unit is designated model PSD-7. Real-time frequency spectra covering ranges up to 10 kHz with 500-element resolutions are successively integrated by the system for recording on a conventional X-Y plotter or other pen or tape recorders. The unit is designed for on-line monitoring or processing of large amounts of data. Since the unit operates 500 times faster than an equivalent swept-frequency unit, data processing which usually required two years can be accomplished in one day. A 500-point digital integrator in the PSD-7 sums as many as 1024 successive spectra point by point as they are produced in real time.

CIRCLE NO. 409

Recorder interface for 400 characters/sec

Digi-Data Corp., 4315 Baltimore Ave., Bladensburg, Md. Phone: (301) 277-9378. Price: \$2650.

Selection of word length up to 8 digits, of record length up to 4095 words and variable recording rate up to 400 characters per second are features of this incremental recorder interface. It offers internal or external sync and choice of binary or BCD mode. The unit permits the coupling of a variety of digital source devices into an incremental recorder.

CIRCLE NO. 410

Memory system stores half a million bits

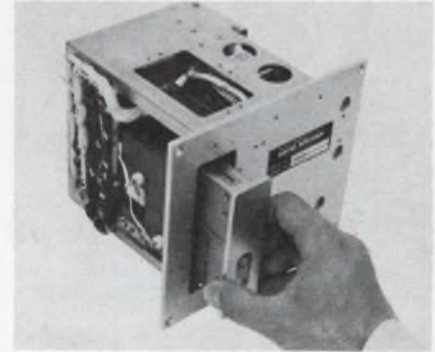

Dacol Div., Hersey-Sparling Meter Co., 210 W. 131st St., Los Angeles. Phone: (213) 321-6283. P&A: \$3000; 30 days.

Over 500,000 bits of data per cartridge can be stored by these magnetic memory tape systems. The reusable cartridges are loaded with 1/4-in., 7-track magnetic tape. Memory tapes can be generated from virtually any computer having a magnetic tape capability. Data transfer or reading rate is 7200 bits per second.

CIRCLE NO. 411

Core memory systems for aerospace computers

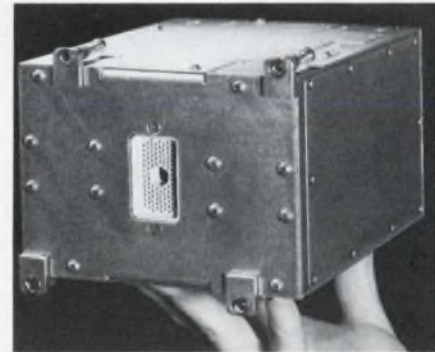

Litton Industries, 1875 Connecticut Ave., Washington, D. C. Phone: (202) 462-8833.

Four core memory systems, designed for the requirements of military and aerospace computers, range from random access, DRO, to serial access, DRO, and random access, NDRO configurations. All four types are of compact, light-weight and low-power designs; the use of switch core selection techniques eliminates a number of semiconductor components.

CIRCLE NO. 412



National NL-BEZ-84 Bezel Assembly

TTL IC Drivers for NATIONAL[®] Readout Tubes

From stock: Decoder / Driver, Decimal Counter / Driver and Decimal Counter / Driver with Latching Memory.

- 15 MHz Counting Rate
- For all side and end view National readout tubes.

NATIONAL REQUEST BULLETIN

ELECTRONICS, INC.
a varian subsidiary

PHONE: (312) 232-4300 • GENEVA, ILLINOIS, 60134

ON READER-SERVICE CARD CIRCLE 103

**TOTALLY ENCLOSED ROTARY SWITCHES.
TEMPERATURE TO 125 C. MULTI-POLE.
30°, 36°, 45°, 60°, and 90° ANGLE of THROW.
100,000 OPERATIONS.**

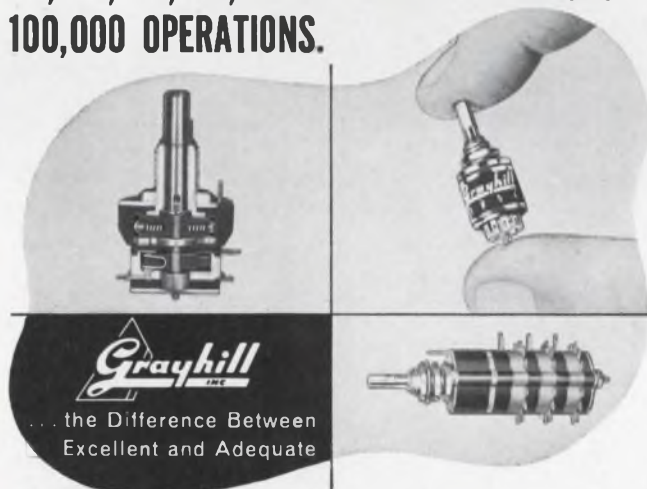

Grayhill
INC.

... the Difference Between
Excellent and Adequate

Typical Specifications:

- Explosion Proof
- Contact Resistance 10 Milliohms
- Make or Break 1/4 Amp. to 15 Amps., 115 VAC Resistive
- 1 to 6 Poles per Deck
- 1 to 12 Decks
- 2 to 12 Positions per Pole

Send for Engineering Catalog G304



565 Hillgrove Avenue
LaGrange, Illinois 60525
Area Code 312, Phone 354-1040
Pioneers In Miniaturization



ON READER-SERVICE CARD CIRCLE 104

ELECTRONIC DESIGN 8, April 12, 1967

*Why is this MKTR
Miniature O.E.M. Relay
so remarkable?*

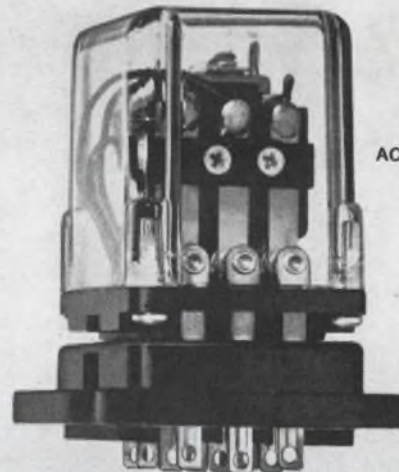

ACTUAL SIZE

*Because it has thirty quality
features for only \$2.05**

Size Low profile. 1-3/16 x 1-3/8 x 1-3/8
A real space saver.

Sensitivity Down to 60 milliwatts per pole D.C.
Ideal for plate circuits.

Contact Ratings 5 amperes and 10 amperes
(AC & DC).

Contact Selections Fine silver (gold flashed) Silver
Cadmium Oxide (gold flashed) Gold
diffused (for low level switching).

Pole Configurations Available in 1, 2 and 3 pole double
throw combinations.

Covers Plastic dust covers made of Styrene,
Butyrate or Polycarbonate. Clear,
Translucent and Opaque in a variety
of colors (no extra charge).
Hermetically sealed.

Indicator Spotlights available to indicate coil
normally open or normally closed.

Terminals Solder lug, Plug-in, Printed Circuit
and .110 Snap-on.

Sockets True 10 amp construction socket. Can
be used in printed circuit boards.
Solder terminals which accept .110
Snap-on terminals standard.

Mountings Available with side or base studs for
chassis mounting.

Applications General purpose. Medium power.
Practically unlimited.



U. L. File No. E36213

For a prototype (specify coil and
contact requirements) and for more
information ask for our Bulletin No. 16.

LINE ELECTRIC COMPANY
Division of Industrial Timer Corporation
205 River Street, Orange, New Jersey
In Canada: Sperry Gyroscope Ottawa Ltd. Ont.



ON READER-SERVICE CARD CIRCLE 105



An encapsulated delay line, used between 8 and 12 Gc, exhibits 100 ns of delay. The overall unit weighs less than 8 pounds and the cable is 70 feet long. The cable is .270" diameter, 50 ohm impedance, with an irradiated polyethylene core. Output connectors are TNC Males.

To achieve 122 nanoseconds of delay and fit tight confines, a pancake configuration measuring 11" x 7" x 3/8" containing 45 feet of .141", Phelps Dodge Electronics 50 ohm miniature semi-rigid coax was potted for use with an airborne radio altimeter.



High density delay line is approximately 5" tall. Approximately 13 feet of cable exhibit 20 nanoseconds delay. The cable is a .270" diameter with an polyethylene dielectric and 50 ohm impedance. Connectors are TNC Male.

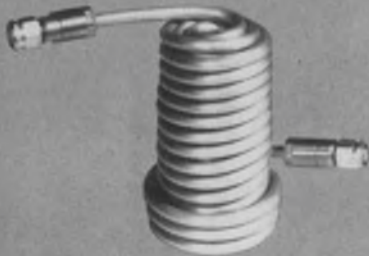

Dual section potted delay line is used for radar calibrating at an operating frequency of 1600 megacycles. The outer race accounts for 980 ns; an inner nest exhibits 61.1 nanoseconds of delay. Aluminum jacketed 50 ohm coaxial cable is .215" diameter with an irradiated polyethylene core. Weight is 25 pounds for the 16" diameter, 3" high package.

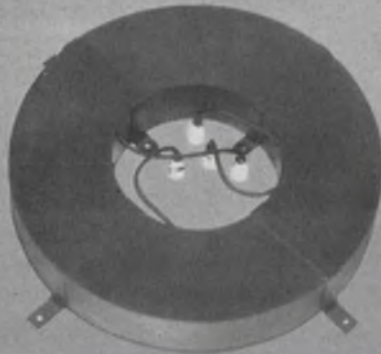

Standard delay line available off-the-shelf for calibration of oscilloscopes, altimeters, radar systems and similar applications. The Foamflex cable unit measures 8 1/2" x 21" x 19" and offers a standard delay of 500 ns, calibrated to ± 0.25 ns.

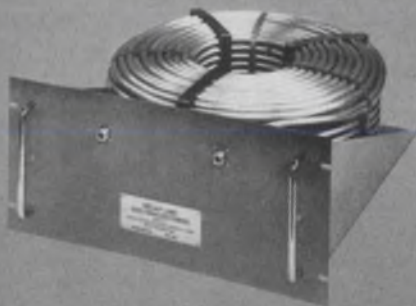

Suddenly signal delay problems are simple

The capability of Phelps Dodge Electronics coaxial cable delay lines to consistently and uniformly meet $\pm .02$ nanosecond delay tolerances in an endless variety of configurations can help solve complex black box problems.

But, that's not all. Here is broader band operation, lower attenuation per nanosecond of delay, greater stability at microwave frequencies. All conventional packaging techniques are available: containers, shock mounting, standard rack-panel

mounting, strapping, potted or encapsulated coils, with mounting brackets and connectors. Delay lines can also be chemically-treated, painted, or enclosed in standard or customized racks or carrying cases. Design parameters: frequencies from 60 CPS to 12 Gc, power from milliwatts to kilowatts, impedances from 50 to 125 ohms, delays from .020 to 1.0 microseconds.

Want more detail? Write for Bulletin DL, Issue 2.

PHELPS DODGE ELECTRONIC PRODUCTS
NORTH HAVEN, CONNECTICUT



ON READER-SERVICE CARD CIRCLE 106

Infrared scanning system has 15,000 elements



Sierra Electronic Div., Philco-Ford Corp., 3885 Bohannon, Menlo Park, Calif. Phone: (415) 322-7222.

An infrared scanning system is offered for detection and display of infrared energy. It presents finely resolved thermal data in raster display similar to a television image, or in single-trace display as in oscilloscope presentation. The system is capable of resolving 0.5°C at 30°C and has a spatial resolution of 0.029 inch. The radiation pattern from a scanned object appears as an image containing 15,000 picture elements with new raster appearing every five seconds.

CIRCLE NO. 413

A-to-D interface compatible with UNIVAC

Datametrics Corp., 8217 Lanker-shim Blvd., N. Hollywood, Calif. Phone: (213) 767-9811.

Model 1108 is a high-speed analog-to-digital interface system compatible with the UNIVAC 1108 computer. The system consists of control logic, interface electronics and two 32-channel, 50 kHz A-to-D multiplexers and converters. It receives instructions from the computer specifying when to convert, on which channel to convert and how many conversions are to be made.

CIRCLE NO. 414

Don't risk missing any issues of **ELECTRONIC DESIGN**. Send in your renewal card today.

IRIG FM discriminator for telemetry playback



Genisco Technology Corp., Systems Div., 18435 Susana Rd., Compton, Calif. Phone: (213) 774-1850.

Designed for playback in FM-FM telemetry applications, this FM discriminator operates on all IRIG channels, 1 to 21 and A through H, with an input sensitivity of 20 mV. The unit will operate on any center frequency from 300 Hz to 300 kHz. Channel selection is accomplished by a plug-in module containing the appropriate bandpass filter and frequency determining networks.

CIRCLE NO. 415

Dynamic device tests made 100 per second

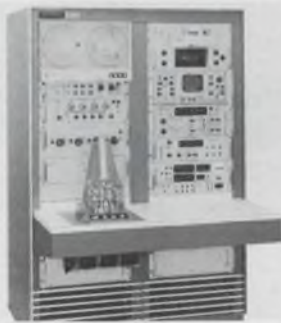

Tektronix, Inc., P. O. Box 500, Beaverton, Ore. Phone: (503) 644-0161.

An automated digital measurement system is capable of more than 100 dynamic tests per second. The system is composed of Tektronix R568 analog display unit, R230 digital measuring unit, and special versions of 3S3 and 3T4 sampling units. System measuring instruments and peripheral equipment are digitally programmed utilizing a rotating-disk memory, programming control circuitry and serial to parallel registers.

CIRCLE NO. 416

ELECTRONIC DESIGN 8, April 12, 1967

Low Cost 4 DIGIT

400 SERIES INTEGRATING DC DIGITAL VOLTMETER



Extended Range Measurements: Fifth digit over-range.

Precise Measurements: With accuracies to 0.05%.

Input Flexibility: Four voltage ranges and a micro-current input for measuring in "Engineering Units" (psi, degrees, etc.)

System Compatibility: BCD Outputs and Remote Programming.

High Noise Rejection: Differential input and integration techniques provide common mode rejection greater than 120 db at 60 Hz.

Economical: 3 and 4 digit models range from \$349.50 to \$495.50.

These DVM's are not only **NEW**, they're **AVAILABLE** from Janus representatives from coast to coast!

CALL OR WRITE FOR A DEMONSTRATION.



296 NEWTON STREET • WALTHAM • MASSACHUSETTS 02154 • TEL: (617) 891-4700
ON READER-SERVICE CARD CIRCLE 107

Matheson Gases for Electronics

Matheson offers the fastest service and accurate mixing on a complete line of gases and gas handling equipment for use in electronics research and production.

Silane & Germane

Available as pure gases or mixtures for epitaxial crystal growth. Create thinner, more efficient layers; provide purer deposits, greater resistivity.

Ozone in Cylinders

Exclusive Matheson process provides OZONE/"FREON"® mixture in stainless steel cylinders. Recovery of up to 15% mol ozone. For use as a strong sterilizing and water purifying agent; extremely energetic oxidant; an active etchant; as a cleansing agent for delicate components, etc.

("Freon-13" is a trademark of E. I. DuPont de Nemours & Co.)

Doping Gas Mixtures

- 5 p.p.m. — 1% Phosphine In Hydrogen, Argon, Nitrogen or Helium.
- 5 p.p.m. — 1% Arsine in Hydrogen, Argon, Nitrogen or Helium.
- 5 p.p.m. — 1% Diborane in Hydrogen, Argon, Nitrogen or Helium.
- 5 p.p.m. — 1% Hydrogen Selenide in Hydrogen, Argon, Nitrogen or Helium.

Data Sheets available on all of the above gases which are used as dopants. Write for Catalog listing over 100 gases and gas handling equipment.

MATHESON

P.O. Box 85 East Rutherford, N. J.
Plants in: E. Rutherford, N. J.,
Cucamonga, Calif., Joliet, Ill.,
La Porte, Texas, Morrow, Ga., Newark,
Calif., Matheson of Canada, Whitby, Ont.

PRODUCTION EQUIPMENT

IC analyzer semi-automatic



Computer Test Corp., 3 Computer Dr., Cherry Hill, N. J. Phone: (609) 424-2400.

A benchtop tester is offered for dc analysis of a wide variety of ICs having a maximum of 40 pin connections. The analyzer has crossbar switch programming, push-button test sequencing, built-in digital readout and an accuracy of 0.1%. Universal test adapters, device protection, variable test time and modular construction are also featured. All standard IC packages can be tested, including TO-5, flatpack, dual-in-line and diode and transistor configurations.

CIRCLE NO. 417

Tool analyzer extends cutting tool life



Stocker & Yale, Inc., Marblehead, Mass. Phone: (617) 631-0038. Price: \$3875.

Extended life for cutting tools, less material spoilage through inspection of incoming tools, and precise readings of all tool geometry for permanent history and repeatability is obtained with this concentricity chuck and tool analyzer. Minute PC drills may be viewed at all precise settings through the complete 360° axial rotation as well as a 180° arc in a horizontal plane at x40 magnification accurate to .0001 in.

CIRCLE NO. 418

Component transport for axial or radial lead

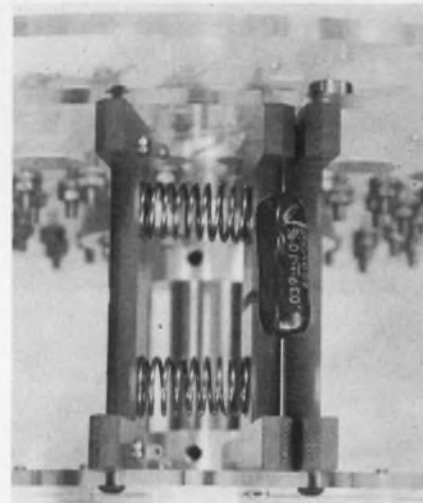

Optimized Devices, Inc., Pleasantville, N. Y. Phone: (914) 769-6100 P&A: about \$2500; 90 days.

This component transport will deliver components to up to ten different test stations each having a four-terminal (Kelvin) measurement contact and then to a series of up to seven ejection stations for sorting. It consists of 24 spring-loaded jaws for holding the components mounted around the periphery of a 12-inch diameter wheel. The index time for the wheel is 0.125 second.

CIRCLE NO. 419

Frequency distribution in rack or bench mount

Specific Products, 21051 Contanso St., P. O. Box 425, Woodland Hills, Calif. Phone: (213) 340-3131.

A solid-state standard frequency distribution system capable of delivering plant frequency standard outputs to calibration benches, production lines and engineering laboratories has been redesigned to permit its use as either bench model or rack mount. The new unit provides complete station isolation. The input is 100 kHz and 18 Vdc; the outputs are 100, 10 and 1 kHz sine and square waves all available simultaneously.

CIRCLE NO. 420

Don't forget to return your **ELECTRONIC DESIGN** renewal card.

NEW HEATHKIT®

Solid-State High Impedance V-O-M

Kit \$80 Wired \$115

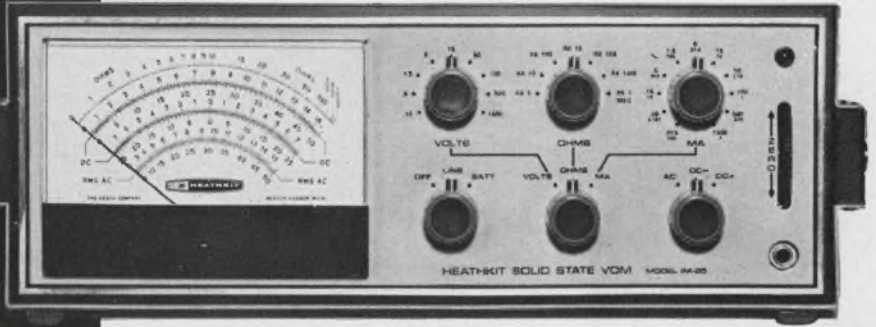

Never Before Has An Instrument With These Features and Performance Been Available At Less Than \$200

- 13 Silicon Transistors Plus 2 Field Effect Transistors
- 11 Megohm Input Impedance on DC
- 10 Megohm Input Impedance on AC
- 9 DC Voltage Ranges From 150 Millivolts Full Scale to 1500 Volts Full Scale . . . Accuracy $\pm 3\%$ Full Scale
- 9 AC Voltage Ranges From 150 Millivolts Full Scale to 1500 Volts Full Scale . . . Accuracy $\pm 5\%$ Full Scale
- 7 Resistance Ranges, 10 Ohms Center Scale $\times 1$, $\times 10$, $\times 100$, $\times 1k$, $\times 10k$, $\times 100k$, $\times 1$ meg . . . Measures From One Ohm to 1000 Megohms
- 11 Current Ranges From 15 Microamps Full Scale to 1.5 Amps Full Scale . . . Accuracy $\pm 4\%$ DC, $\pm 5\%$ AC
- AC Response to 100 kHz
- 6", 200 μ a Meter With Zero Center Scales For Positive and Negative Voltage Measurements Without Switching
- 1% Precision Resistors
- Separate Switch For Each Function Eliminates Constant Changing
- Ten-Turn Thumbwheel Zero Adjustment For Precision Settings
- Built-In 120/240 VAC, 50-60 Hz Power Supply Plus In-Cabinet Holders For Battery Supply During Portable Operation
- Easy Circuit Board Assembly
- New Heath Instrument Styling With "Unitized" Construction and Low Profile Appearance; Color Styled in Handsome Beige and Black

The first of an exciting new line of Heathkit test instruments, the IM-25 Solid-State V-O-M does all the measurement jobs normally required in tube or transistor circuits with the no-loading high impedance of a VTVM, the convenience and versatility of a VOM, and the accuracy and sensitivity of separate lab instruments. Whether you choose the factory assembled model or the new, easier-than-ever kit version, we believe you will find the IM-25 a significant step forward in design and value.

Kit IM-25, 10 lbs. (Available May) \$80.00
Assembled IMW-25, 10 lbs. (Available June) \$115.00

HEATH COMPANY, Dept. 520-26
Benton Harbor, Michigan 49022

Enclosed is \$ _____, plus shipping.

Please send model (s) _____

Please send FREE Heathkit Catalog.

Name _____
(Please Print)

Address _____

City _____ State _____ Zip _____

Prices & specifications subject to change without notice. TE-159

ON READER-SERVICE CARD CIRCLE 109

Need a BAR?

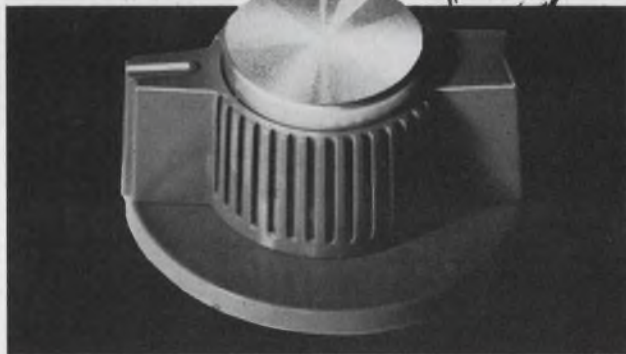

If not, we can fill your needs with other **BUCKEYE Matching Instrument Knobs**

- Complete stock maintained to provide samples and prompt delivery.
 - Available in three stock series in choice of designs and types.
 - Molded of high-impact styrene — with aluminum bushing and two set screws.
 - Wide range of specials and modifications.
 - Six basic sizes in four stock colors.
- Write for catalog and prices*



the **BUCKEYE** stamping co.
555 MARION RD., COLUMBUS, O. 43207
"QUALITY PRODUCTS SINCE 1902"

ON READER-SERVICE CARD CIRCLE 151

HIGH ACCURACY ROTARY COMMUTATING SWITCHES and A.D. CONVERTERS



FREE CATALOG A-65

- Fully illustrated
- Schematic drawings
- Technical data and information
- Product application
- Product descriptions
- Specifications

FREE DESIGN SERVICE . . .

Call Airflyte in the initial stages of design. Our design engineering service offers skilled experts with years of theoretical and practical experience. Call on them now . . . prevent serious, costly problems later.



WRITE on your company letterhead

ELECTRONICS CO.

BOX 207 • BAYONNE, N. J. 07002

PHONE (201) 436-2230 • TWX-710-729-4489



Mite-size miniature 7/16" indicator

These tiny indicators are compact, rugged, versatile and easy to read. They feature a microminiature moving coil core magnet mechanism. A1-21 Indicators operate in -55°C to $+85^{\circ}\text{C}$ environments and are sealed against dirt and dust. Choice of pointer or flag display in a wide variety of electrical sensitivities and functions. Size: 7/16" in diameter, 31/32" in length. Weight: 11.5 grams. Write today for complete information.

AMMON

AMMON INSTRUMENTS, INC.
345 Kelley Street, Manchester, N.H. 03105
ON READER-SERVICE CARD CIRCLE 152

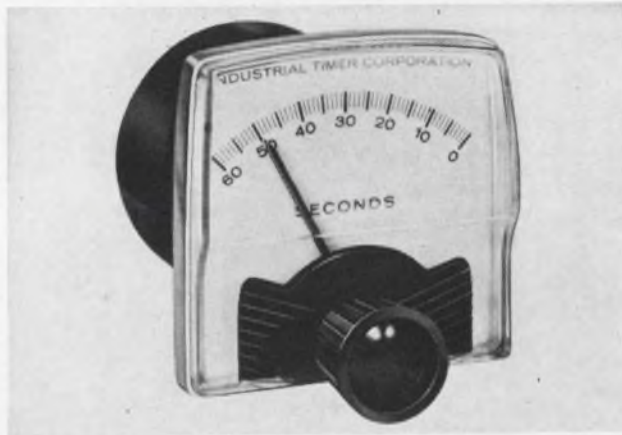

MTD

Bold new look in delay timers

Looks aren't everything—but the new MTD is a glamorous bit of time packaging. This is an automatic reset delay timer available in ten models cycling from 6 seconds to 3 hours. Harmonizes with all modern panel instruments. Write for Bulletin #304.



INDUSTRIAL TIMER CORPORATION

65 U. S. HIGHWAY 287, PARSIPPANY, NEW JERSEY

ON READER-SERVICE CARD CIRCLE 153

PRODUCTION EQUIPMENT

Programmer inspects printed circuit boards

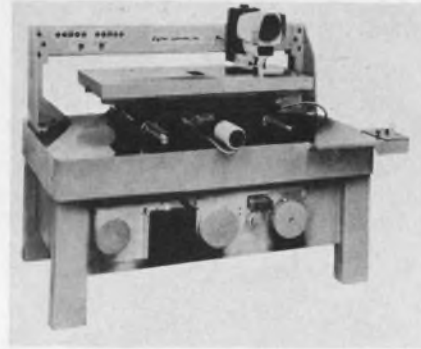

Digital Systems, Inc., 1078 E. Edna Pl., Covina, Calif. Phone: (213) 331-0749.

A tape programmer and inspection system is available for PC manufacturing operations. It can be used to prepare EIA and NAS numerical control tape directly from original artwork or negatives, inspect drilled boards and artwork during any phase of the manufacturing process, edit N/C tape, reproduce N/C and convert N/C tape format. The 20-by-40-in. XY table is positioned under the optical projector with ± 0.0003 -in. accuracy and ± 0.0001 -in. repeatability by joystick controlled stepping motors.

CIRCLE NO. 421

Alloy molds for instant potting

Cerro Corp., 300 Park Ave., N. Y. Phone: (212) 688-8822. P&A: \$4.05 per lb (100-499); stock.

The use of conventional permanent molds for epoxy encapsulation is both time-consuming and costly. Slush-casting with a low-melting point bismuth alloy as the mold material necessitates only one positive master pattern. Only a few minutes are required to slush-cast 100 or more molds—the operator simply dips the master in the bismuth alloy, removes the alloy mold which forms around the master pattern, and dips again for the next mold. All parts can then be encapsulated in one setup.

CIRCLE NO. 422

Remember to return your **ELECTRONIC DESIGN** renewal card. Don't miss any issues in '67.

What company do you call for new ideas in analog comparators?

PPC-1 and PPC-2 ultra-sensitive relay and fast comparators.

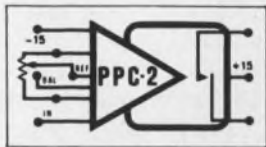

Sensitivity: 200 μ V
 Repeatability: 50 μ V
 Response Time: < 1 ms
 Contacts: 1A, 2A, 1C
 Cost: In moderate quantities:
 PPC-1 < \$30; PPC-2 < \$75



PPC-1 (for P.C. mounting)

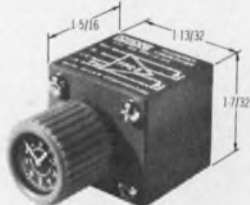

PPC-2 (panel mounting) with ten-turn trip level adjustment

All specs typical @ 25°C.

Write, call, TWX or circle the card.
 We'll send detailed data or evaluation samples.

DDC
 DATA DEVICE CORPORATION

Right!

Data Device Corporation
 Dept. 15
 240 Old Country Road
 Hicksville, L. I., N. Y. 11801
 Phone: 516-433-5330
 TWX: 510-221-1874

MICROWAVES

Two-stage YIG filter for Ku-band tuning



Watkins-Johnson Co., 3333 Hillview Ave., Palo Alto, Calif. Phone: (415) 326-8830.

An electronically-tuned two-stage YIG filter for the Ku-band (12.4 to 18 GHz) features self-shielding magnetic circuitry and claims high reliability and low tuning power requirements. The specified 3-dB bandwidth is optional between 15 and 200 MHz. An 18-MHz/mA or a 9-MHz/mA tuning sensitivity is available without increasing the 6-W tuning power requirement.

CIRCLE NO. 423

Solid-state multiplier gives 2 W at 3000 MHz

Micromega, Div. of Amphenol Corp., 4134 Del Rey Ave., Venice, Calif. Phone: (213) 391-7137.

A compact solid-state multiplier produces a minimum of 2 W at 3000 MHz from an input of 12 W at 500 MHz, over a temperature range of -30° to 60°C. Because frequency multiplication is achieved with a single high-power step-recovery diode, the unit measures only 3-1/2 x 3 x 5/8 in. and weighs only 8 oz, excluding the connector.

CIRCLE NO. 424

Reflex klystrons are Ku-band oscillators

Varian, 611 Hansen Way, Palo Alto, Calif. Phone: (415) 326-4000.

For use as a local oscillator or low-power source, each reflex klystron oscillator in this series delivers 20 mW into a matched load over its 750-MHz mechanical tuning range. Models are available for any specified frequency between 15 and 22 GHz. The 3.5-ounce reflex klystrons are suited to airborne and similar applications without pressurization.

CIRCLE NO. 425

What company do you call for low cost, high input impedance amplifiers?

These low cost DDC operational amplifiers make high stability integrator circuits easy.

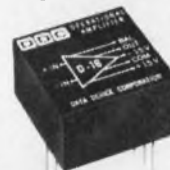

MODEL D-16
 Z_{in} Common Mode: $1.6 \times 10^9 \Omega$
 Z_{in} Differential: $0.7 \times 10^8 \Omega$
 I_{OS} Either Input: 1 nA
 Stability $I_{\Delta t}$: 0.1 nA/°C
 Stability $V_{\Delta t}$: 10 μ V/°C
 Output 11 V @ 2.2 mA
 Price: (1-9): \$38.



MODEL D-15 (FET)
 Input Impedance: 10^{11} ohms
 Initial I_{OS} : 10 pA
 FFO: 35 KHz, either input
 Stability: 10 pA/°C
 Price: D-15, 15 μ V/°C—\$75 (1-9)
 DK-15, 35 μ V/°C—\$45 (1-9)

All specs typical @ 25°C.

Write, call, TWX or circle the card.
 We'll send detailed data or evaluation samples.

DDC
 DATA DEVICE CORPORATION

Right!

Data Device Corporation
 Dept. 16
 240 Old Country Road
 Hicksville, L. I., New York 11801
 Phone: 516-433-5330
 TWX: 510-221-1874

IN TWO CONVENIENT SIZES

Small...

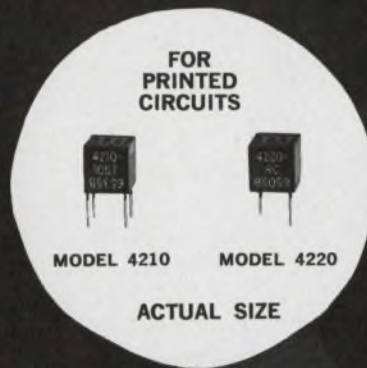

& Now

*Smaller
Than
Small...*

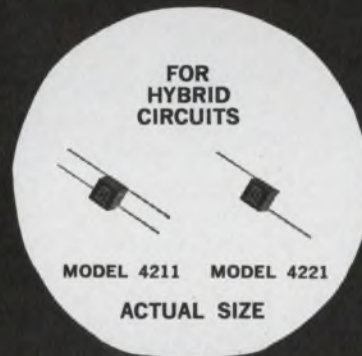

MICROTRANSFORMERS AND MICROINDUCTORS

from Bourns

Introducing the new smaller than small models 4211 microtransformer and the 4221 microinductor. The units are packaged in a $\frac{1}{8}$ " cube, sealed against cyclic humidity per MIL-STD-202B and designed specifically for use in hybrid circuits.

This ultimate performance to size ratio in microtransformers and microinductors is now available from Bourns in addition to the proven small $\frac{1}{4}$ " cube models 4210 microtransformer and 4220 microinductor.

Both sizes exceed the environmental requirements of MIL-T-27B, Grade 5.

For those applications beyond the scope of the standard unit, design flexibility permits taps, wide turns ratio range, various core materials, split coils, and bifilar windings. Application engineering service is available for quick response on such special prototype units.

For additional information and detailed specifications on Bourns microtransformers and microinductors, contact your nearest Bourns sales office or representative, or write the factory direct.

SPECIFICATIONS

Size
Maximum operating temperature
Frequency response
Maximum distortion
Power rating
Insertion loss
Primary impedance range
Secondary impedance range
Turns ratios

MODEL 4210 MICROTRANSFORMER

$\frac{1}{4} \times \frac{1}{4} \times \frac{1}{4}$
130°C
±2 db, 400 to 250kHz
±5% at rated power
50MW at 1 kHz
±3 db max.
100Ω to 100KΩ
3.20 to 10KΩ
to 15:1

MODEL 4220 MICROINDUCTOR

$\frac{1}{8} \times \frac{1}{8} \times \frac{1}{8}$
105°C
±2 db, 2K to 500kHz
±5% at rated power
25MW at 10kHz
±3 db max.
10Ω to 10KΩ
to 10:1

SPECIFICATIONS

Size
Maximum operating temperature
Inductive range

MODEL 4211 TRANSFORMER

$\frac{1}{4} \times \frac{1}{4} \times \frac{1}{4}$
130°C
.08 to 66 hy

MODEL 4221 MICROINDUCTOR

$\frac{1}{8} \times \frac{1}{8} \times \frac{1}{8}$
105°C
0.1 to 3.5 hy



BOURNS, INC., TRIMPOT DIVISION • 1200 COLUMBIA AVE., RIVERSIDE, CALIF.
TELEPHONE 714 684-1700 • TWX: 910 332-1252 • CABLE: BOURNSINC.

Have ALL-MIL 'scopes



will modify
**To A/N system
requirements**

for:

- Mechanical Interface
- Electrical Interface
- Human Factors
- Form Factors
- Exterior Finish

Why compromise your All-MIL A/N system by using a commercial 'scope?

All-MIL (to MIL-E-16400), fully transistorized ETC 'scopes are now available in standard rack and portable (18 lbs.) bench models—in 6 to 10 MHz bandwidth—complete with accessories and plug-ins for non-obsolescence.

Wider bandwidths and unusual form factors and performance characteristics are available on a customized basis.

In Preplanning Your Next System Design, Why Not—Leave the Display Work to Us?

Call or write for free consultation on YOUR 'scope problem.



**GENERAL
ATRONICS**
ELECTRONIC INSTRUMENT DIVISION
PHILADELPHIA • PENNSYLVANIA 19118

ON READER-SERVICE CARD CIRCLE 157

Application Notes

DTL applications manual

Covering 200 of the manufacturer's DTL modules, a 150-page manual gives applications and reliability data. The manual, in a 3-ring binder, is of particular interest to systems designers. California Systems Components, Inc.

CIRCLE NO. 434

Laser absorptimeter

Two data sheets provide a study model of a non-dispersive optical absorptimeter using a gallium arsenide phosphide red laser as the light source. A price list for the series is also available. Monsanto Co.

CIRCLE NO. 435

Design tool

CIRC is an engineering tool designed for use with the SDS 900 series computers. It can analyze complex circuits containing both active and passive elements. Its applications are described in 5 pages of text with tables. Scientific Data Systems.

CIRCLE NO. 436

Optical devices

Logarithmic pulse and photodiode amplifiers, and a unit producing scenographic (perspective) data for scope display, are discussed in five data sheets. Optical Electronics.

CIRCLE NO. 437

Sensitive relays

Three loose-leaf sheets describe applications of the manufacturer's Micropositioner, an ultra-sensitive polarized dc control relay. Schematics and explanatory text are included. Barber-Colman Co.

CIRCLE NO. 438

Optical coupling

The use of optoelectronic coupling for coding, multiplexing and channel switching is discussed in a 2-page data sheet, with charts and schematics. Hewlett-Packard.

CIRCLE NO. 439

Coil winding

Thirty-one pages of solid text devoted to clarification of the problems of precision coil winding on cores having tapered or curved profiles are available, with drawings. Coil Winding Equipment Co.

CIRCLE NO. 440

Variable scale rule

A variable scale rule that performs computations directly on graphs, curves and recordings is the subject of a 39-page handbook of uses and applications. Gerber Scientific Instrument Co.

CIRCLE NO. 441

Sweep measurements

Two pages of text and formulas, with photo and schematic, deal with sweep measurement, reflection and attenuation in coaxial systems. Coaxial component and reflectometer coupler testing is discussed. Narda Microwave Corp.

CIRCLE NO. 442

Diff-amp circuits

Specs and 42 schematics in two loose-leaf sheets explain applications of a differential dc operational amplifier. The external circuitry is specified, with component values, for use of the amplifier in a number of oscillator, modulator, filter, regulator and other applications. Op-Amp Labs.

CIRCLE NO. 443

Lasers aid production

Production applications of laser systems, such as welding, cutting and evaporation of metals, micro perforating, metal removing, micro welding and others are discussed in a 16-page illustrated brochure. Maser Optics, Inc.

CIRCLE NO. 444

It's time to renew your subscription to **ELECTRONIC DESIGN**. Return your renewal card today.



**No
Bounce.**

GORDOS
CORPORATION

250 Glenwood Ave., Bloomfield, N.J. 07003 (201) 743-6800

ON READER-SERVICE CARD CIRCLE 158

New 20 pg. Catalog makes it
Easy to Select

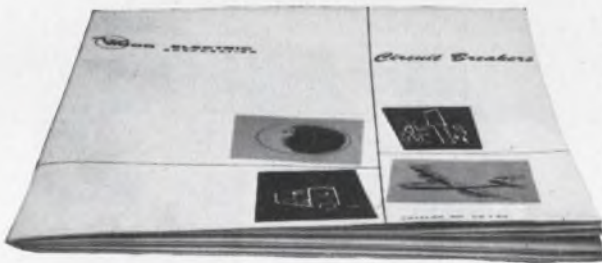

the right Thermal or Magnetic
Circuit Breakers

Write for your
FREE COPY



**WOOD ELECTRIC
CORPORATION**

244 Broad Street, Lynn, Mass. (617) LY8-5313

ON READER-SERVICE CARD CIRCLE 117

ELECTRONIC DESIGN 8, April 12, 1967

The idea here is economy in Instrumentation Lighting

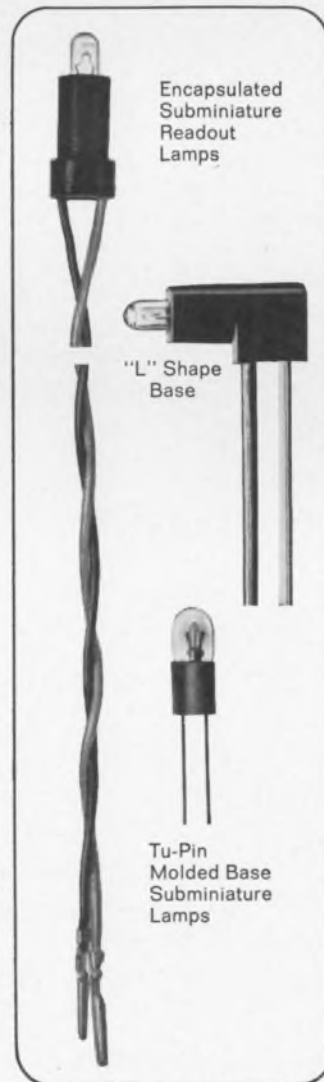
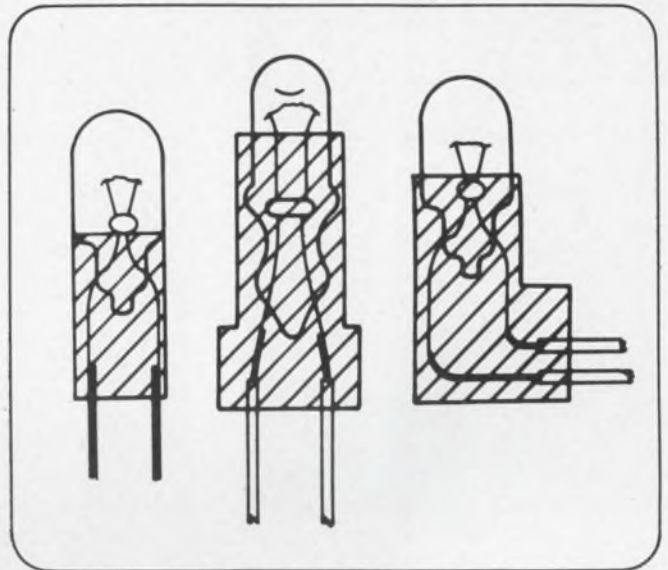

Encapsulated
Subminiature
Readout
Lamps

"L" Shape
Base

Tu-Pin
Molded Base
Subminiature
Lamps

Wherever small bulbs are used for instrument illumination or computer applications, equipment manufacturers will find economy in the Tung-Sol concept. If circuit board type of mounting is practicable, Tung-Sol molded base lamps can provide high reliability with real manufacturing economy. No mounting receptacle is required so you don't have that cost. In addition, the Tung-Sol molded base lamp is more reliable because it completely eliminates the usual cemented-on metal, or plastic base. Installation is as simple as soldering in a semiconductor. In fact, the Tung-Sol Tu-Pin lamp can be applied by automated equipment. Tung-Sol can also mold bases to special configurations and can harness to your specifications. Let's discuss your application in the design stage. Chances are we can save you even more on your assembly costs. Try us. Tung-Sol Division, Wagner Electric Corporation, One Summer Ave., Newark, N.J. 07104.

TUNG-SOL®
**MOLDED BASE
SUBMINIATURE LAMPS**

ON READER-SERVICE CARD CIRCLE 118

New Literature

Precision Clocks, Timers, & Switches



BULOVA TIMER LABORATORY (212) DE 54000
Systems and Instruments Division, Bulova Watch Co., Inc., Bulova Park, Flushing, N. Y. 11370

Clocks and timers

A folder with 28 pages of data relating to timekeeping instruments is available. Clocks, timers and switches are covered by text, photos and tables. Prices and ordering information are included. Bulova Timer Laboratory.

CIRCLE NO. 445

Microminiature connectors

A 20-page publication combines all existing catalog information on the manufacturer's microminiature connectors into one convenient source. Test information, product descriptions and specifications are included. ITT Cannon Electric.

CIRCLE NO. 446

Transistor guide

The characteristics of 132 transistors are tabulated in four groups: complementary pairs, dual transistors, differential amplifiers and Darlington amplifiers. Characteristic curves are included, as well as pin locations of six packages. Motorola Semiconductor Products.

CIRCLE NO. 447

Precious metals

A technical bulletin on high-purity precious metals and alloys lists all the purities available in gold and gold alloys, silver and silver alloys and platinum. Semi-Alloys, Inc.

CIRCLE NO. 448

Coax cable

A 12-page Technical Bulletin describes semiflexible, aluminum-sheathed, air dielectric coaxial cable. The bulletin offers complete electrical, physical and mechanical characteristics on the cable, with curves and tables. Also included is complete data on connectors for the cable with packing and shipping information. Phelps Dodge Electronics.

CIRCLE NO. 449

Logic card brochure

In four pages, information on sixty different logic cards is supplied. In addition, power supplies, card files, card drawers, accessory parts, an automatic module tester and an "experimenter" for breadboarding up to 10 cards are described. Wyle Labs.

CIRCLE NO. 450

Packaging polymers

The use of polymers and similar substances in electronic packaging can meet unusual physical and environmental requirements. They are discussed in 12 pages of descriptive matter and tables. Thiokol Chemical Corp.

CIRCLE NO. 451

Capacitor brochure

Computer-grade electrolytic capacitors are described in a 2-color, 8-page brochure with charts and formulas. Impedance, dissipation factor, leakage current, ripple current and temperature effects are included. The capacitors have values to 200,000 μ F. STM Corp.

CIRCLE NO. 452

Freezing points

Metal freezing point temperature standards are treated in an 8-page illustrated catalog. The manufacturer's instrument is described, with its calibration and operating procedures. Szarko Organization.

CIRCLE NO. 453

Wrought nickel-silvers

The engineering properties of wrought nickel-silvers are treated in a 16-page brochure. Prepared for designers and engineers, it contains data on the composition and physical and mechanical properties of wrought nickel-silver alloys. Corrosion characteristics and joining and fabricating properties are also included. International Nickel Co., Inc.

CIRCLE NO. 454

Coax components

Descriptions, specifications, photographs and prices of the company's line of waveguide and coaxial components and electronic test equipment are detailed in a short catalog. Applications and features are described and a list of both domestic and foreign sales offices are included. PRD Electronics, Inc.

CIRCLE NO. 455

Product catalog aids

Planning on putting out a catalog of your products? Here are some tips. This 4-page folder, called Catalog News, is devoted to the increase of sales through better catalogs. Chelsea Advertising, Inc.

CIRCLE NO. 456

Electronic tube guide

The Westinghouse Electronic Tube Guide, a complete, convenient source of essential data on all receiving and TV picture tubes involved in communications and industrial applications, is available. The comprehensive interchangeability lists are especially useful because they are based on operational rather than static tube characteristics.

Available for \$1.25 from Westinghouse Electric Corp., Electronic Tube Div., Elmira, N. Y.

Don't risk missing any issues of **ELECTRONIC DESIGN**. Send in your renewal card today.

**WE STOPPED
AT NOTHING
TO BRING YOU
THE WORLD'S
MOST VERSATILE RELAY**



SHOWN ACTUAL SIZE

Ounce for ounce, our new vacuum relay controls more power for more applications than any other relay in the world.

We're talking about the wholly new ITT Jennings RFI relay, the relay that gives you a low cost, high quality solution to almost any relay application!

Now, for the first time, the advantages and reliability of vacuum relays are available for an almost unlimited number of switching applications in a package that occupies less than $\frac{1}{3}$ cubic inch . . . weighs less than $\frac{3}{4}$ of an ounce. Yet they cost no more than other relays of their power level.

No other relay comes close to providing all these advantages for so many fields:

COMMUNICATIONS—Switching Radar Transducers, Antenna Switching, RF Coil Tapping, Switching in RF Circuits.

- 2 kv peak operate voltage at 16 mc
- Carries 4 amps rms at 16 mc • 020 ohms maximum contact resistance at 32 mc remains permanently low.

AIRCRAFT/MISSILES/SATELLITES — Switching Grid and Plate Circuits, Switching Ground Control Equipment.

- Resists 10 g to 2000 cps vibration
- Impervious to environmental conditions

INDUSTRIAL CONTROLS—Motor Controls, Railway Signal Controls, Machine Tools, Lighting Controls. • In-

terrupts 1 kw dc power • Interrupts inductive loads • Rapid operation (10 ms maximum)

PROCESS INDUSTRY — Computer/Control Panel Interface. • Long life. 2,000,000 mechanical operations • No contact maintenance • High reliability

Let ITT Jennings introduce you to the reliable world of vacuum relays; there's no one more experienced or more qualified. For complete information on the RFI, and our new relay catalog, write to ITT Jennings, a division of International Telephone and Telegraph Corporation, 970 McLaughlin Avenue, San Jose, Calif. 95108.

JENNINGS ITT

ON READER-SERVICE CARD CIRCLE 119

New! RF Shielded New! Front-Mounting



Eldema's C-Lite Cartridge and D-Holder combination provides both incandescent or neon panel lites. Now D-Holders with the added reliability of RF shielding and the added flexibility of front-mounting. Eldema plug-in cartridge lites are inherently reliable, simple to in-

stall, and easy to replace. Available in a large range of lens shapes, styles, and colors. Matching push switches utilizing C-Lites are also available. Eldema cartridge lites and holders conform to MIL-L-3661. Write for complete brochure and free samples, or use reader service card.

ELDEMA

A Division of Genisco Technology Corporation
18435 Susana Road / Compton, California / (213) 774-1850

ON READER-SERVICE CARD CIRCLE 120

ANOTHER WORLD'S SMALLEST Soshin's Dipped Mica Capacitors/DM05

Developed by SOSHIN ELECTRIC, the only mica capacitor maker in Japan with MIL-C-5C qualifications. This newest and its bigger brothers will meet all your requirements. Volume orders accepted.

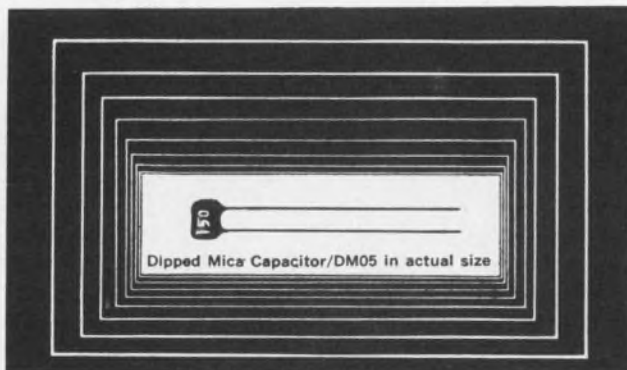

Types	Max Allowable Capacitance (pf)			Dimension (mm)								
	100 WV	300 WV	500 WV	100 WV			300 WV			500 WV		
Standard				L Max	W Max	T Max	L Max	W Max	T Max	L Max	W Max	T Max
DM05	200	130	—	7.0	5.0	3.5	7.0	5.0	3.5	—	—	—
DM10	440	190	330	8.5	5.5	3.5	8.5	5.5	3.5	8.5	5.5	3.5
DM15 (C-MOS)	2000	1200	510	13.0	11.0	6.5	12.5	10.5	6.0	12.0	10.0	5.5
DM19 (7-MOS)	10000	6800	5100	18.0	15.0	8.5	18.0	15.0	8.0	17.5	15.0	7.5

For further information, write to

SOSHIN SOSHINELECTRIC CO., LTD.
18-18, Nakamagome 1-chome, Ohta-ku, Tokyo, Japan
Cables: SOSHINCAPACITOR TOKYO

ON READER-SERVICE CARD CIRCLE 161

NEW LITERATURE

Electronic hardware

A new 36-page catalog of electronic hardware covers electronic terminals single, double and triple turret, tubular, split and milled, prototype boards, pin, threaded and PC categories. It also includes standard and miniature terminal boards, handles, panel and chassis hardware. Concord Electronics Corp.

CIRCLE NO. 457

Switches and relays

The switches described in this 4-page, 2-color brochure feature both square and round button varieties, either illuminated or non-illuminated. Schematic drawings of multiple switches are included in the new brochure, as are socket diagrams, suggested panel layouts and a table of switch characteristics. American Zettler, Inc.

CIRCLE NO. 458

Precision connectors

A 4-page catalog covering a line of Swiss-made, precision-machined connectors covers eight standard sizes from 1/4 inch to 1-5/8 inches in diameter. It deals with single-contact connectors, both coaxial and power; multicontact, up to 104 pins; multicoaxial contact and multicoaxial and power pin combinations. Frazar & Hansen Ltd.

CIRCLE NO. 459

IC accessories

An integrated circuit accessories catalog lists a variety of digital components including a selection of permanent, semi-permanent or temporary mounting provisions for in-line and flatpack circuits. Cambridge Thermionic Corp.

CIRCLE NO. 460

Circuit protectors

Single- and multiple-pole circuit protectors are treated with photos, charts and schematics in a 6-page brochure. Ordering information is included. The units range in current rating from 50 mA to 50 A. Airpax Electronics.

CIRCLE NO. 461

Design Data from Manufacturers

Advertisements of booklets, brochures, catalogs and data sheets. To order use Reader-Service Card.

(Advertisement)

Microswitch catalog

A 44-page publication contains complete ordering information on modular and integral pushbutton switches, with or without lighted display color, and toggle switches. Detailed specifications, mounting instructions and applications are covered, and complete circuitry information is given for each product. Micro Switch, Div. of Honeywell.

CIRCLE NO. 462

Synchronous motors

A 21-page brochure contains design data on hysteresis synchronous motors. The brochure depicts product standards on size 8 through size 23 units and contains complete electrical and mechanical parameters. Formulas for system design and servomechanism conversion factors are also included. McMaster Products Corp.

CIRCLE NO. 463

Thermistor characteristics

Performance characteristics of thermally sensitive resistors are treated in a 4-page loose-leaf data sheet. Graphs and schematics explain zero-power resistance-temperature, static volt-ampere and current-time characteristics of thermistors. G. E. Magnetic Materials Section.

CIRCLE NO. 464

Field-strength meter

The National Bureau of Standards has developed prototype instrumentation for measuring electric-field components of complex, high-level, near-zone electromagnetic fields from transmitters that can cause premature detonation of missile or rocket weapons. The instruments are based on a new form of telemetry in which field information is transmitted from a measuring antenna to a remote readout unit.

Available for 35¢ (Technical Note 345) from Clearinghouse, NBS, U.S. Dept. of Commerce, Springfield, Va.

Don't forget to return your **ELECTRONIC DESIGN** renewal card.

Field Effect Transistors



A quartet of application notes by Motorola engineers that will put you wise to Field Effect Transistors (FET's). "FET's in Theory & Practice" will acquaint you with the latest operational theory. "The FET in Digital Applications" is an up-to-date discussion of switching characteristics. "The FET in Chopper & Analog Switching Circuits" carries the discussion into conquered ground, but "The FET Differential Amplifier" invades a strong bipolar field for the first time. The complete quartet is yours when you circle this one number.

Schweber Electronics

Westbury, New York 11591
516-334-7474

171

Laminated and Molded Bus Bars For Power Distribution

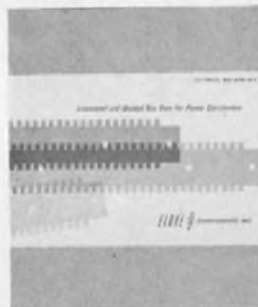

A 16 page Technical Bulletin is now available, describing a new concept in power distribution. Basic mechanical and electrical design principles, along with descriptive pictures and diagrams, are included in this bulletin. These compact buses can replace bulky cable harnesses and repetitive wiring for computer or modular application. This method of construction satisfies the demanding requirements of low inductance and resistance of high speed, solid state systems, while controlling electrical noises.

Eldre Components, Inc.

1239 University Avenue
Rochester, New York 14607

172

Terminal Block Selector



A new 24-page, completely illustrated catalog contains photos, descriptions, ratings, engineering drawings, and prices of the complete line of Curtis terminal blocks. Included are printed circuit, insulated feed-thru, quick disconnect, track type, and high current terminal blocks. Handy selection chart quickly locates the perfect block for your particular requirements. Send today for your free copy. See us at Booth 3K15, IEEE Exhibition, New York City

Curtis Development & Mfg. Co.

3236 North 33rd Street
Milwaukee, Wisconsin 53216

173

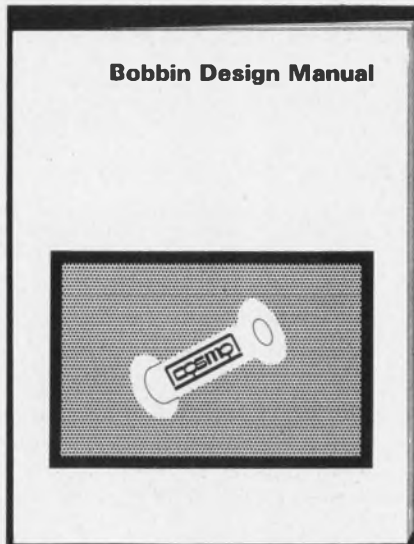

Bobbin design manual

Bobbin design and manufacturing standards relative to high-volume, low-cost, quality bobbin production are set forth in this book. Common bobbin defects, their causes and effects on the part itself and how to avoid and measure them are explained and illustrated. The manual contains an entire section on bobbin design supported with a design engineer's suggestions and a dozen illustrations. Specifications of thermoplastic materials and a table of bobbin tolerances are included. Cosmo Plastics Co.

CIRCLE NO. 465

Epoxy resin systems

Bulletin No. 27 provides the specifications required for determining the best combination of epoxy and hardener for two new lines of epoxies. Included in the brochure are applications requiring thermal and dielectric qualities indicating uses of the adhesive epoxy and the potting resin. Wakefield Engineering, Inc.

CIRCLE NO. 466

Semiconductor catalog

Containing basic specifications and related material on the full Amperex line, this 38-page catalog serves as a quick reference guide. Included in the catalog are spec listings and application references on transistors, diodes, audio amplifier assemblies, integrated circuits, heat sinks and audio kits. Amperex Electronics Corp.

CIRCLE NO. 467

Design Data from

Synopsis Gov't. Wire & Cable Specs



This new brochure presents an easy-to-read synopsis of current government cable specifications and government wire specifications. Contains up-to-date listings on: Hook-up Wire, Multi-conductor Cable, Coaxial Cable, Tubing, Heat Shrinkable Tubing. Send today for your free copy.

Electronic Wholesalers, Inc.

2310 Bob Wallace Avenue, S.W.
Huntsville, Alabama

174

Selection Guide for Tubular Parts



A new Selection Guide for thin metal tubing and tubular parts covers 62 alloys regularly drawn and fabricated including glass-to-metal sealing alloys. To facilitate mating with other parts during assembly, electronic parts are offered with ID-radiused ends. The same machinery that does the cutting and ID-radiusing also forms flares, flanges, bulges and constrictions at the same time thereby minimizing costs. Automated ID-radiusing is limited to O.D.'s of 0.040" to 0.187", walls of 0.003" to 0.025" and lengths of 1/8" to 5/8". Standard forming techniques extend these sizes to 0.625" max. O.D., 0.003" min. O.D., walls as thin as 0.0005" and unlimited lengths.

Uniform Tubes, Inc.

Collegeville, Pa. 19426

175

160 Page Power Supply Handbook



The Kepco Power Supply Handbook covers the subject of regulated DC Power Supplies in detail. Particular emphasis is placed on the programming concept and its myriad applications to complex systems control problems. A comprehensive chapter on Power Supply testing will be of value to the test engineer.

Profusely illustrated with innumerable circuit diagrams, block diagrams and photographs, the Kepco Power Supply Handbook is a valuable addition to any engineering library.

Kepeco, Inc.

131-38 Sanford Avenue
Flushing, N. Y. 11352

176

Manufacturers

Advertisements of booklets, brochures, catalogs and data sheets. To order use Reader-ServiceCard.

Self-Aligning Molded Nylon Clamps



These new cable clamps have self-aligning molded-in ribs that prevent slipping during installation. They hold their circular shape superbly, and cost considerably less than conventional clamps of the same size. New bulletin gives full details.

Weckesser Company, Inc.

4444 West Irving Park Road
Chicago, Illinois 60641

177

Free: 2,500 Plastic Parts Catalog



New from Nylomatic, molders and fabricators of mechanical plastic components, a highly informative 48-page catalog of more than 2,500 standard parts. It can help you save time and money in design, test and production. Advantages of Nylomatic standard parts: no tooling charges, low unit costs, quick delivery, complete range of sizes. Nylomatic standard parts are made of Nylon, Delrin® and other thermoplastic materials. You'll find our new free catalog a real problem solver for designers, send for it today.

Nylomatic Corporation

Dept. P
Nolan Ave., Morrisville, Pa. 19067

178

High-Voltage Test Equipment



Comprehensive 8-page catalog gives detailed specifications and prices (reduced to 40%) on full line of Peschel High-Voltage Test Equipment: AC and DC Hipot Dielectric Test Sets; Corona Test Equipment; Continuity and Dielectric Test Sets; Portable Kilovoltmeters; Power Supplies and Power Packs; and Customized Units built to specification — with improved ripple or regulation, motorized output control, automated test cycle, special metering and packaging, etc. Reliable low-cost instruments are widely used in all high-voltage laboratory or production testing and research applications.

Peschel Instruments, Inc.

P. O. Box 47A, New Route 55
West Pawling, New York 12564

179

Transistor price guide

A quarterly price guide to all transistors, SCRs and integrated circuits lists current price information on 1-99 and 100-999 quantities on all devices. It provides name, location and telephone number of franchised distributors, factory representatives, domestic and international sales offices. In addition to providing data on semiconductors manufactured by over forty firms, it also contains MIL parts, MIL-S-19500 numbers, TX(TFX) types, as well as standard 2N JEDEC numbers. Data-Tek.

CIRCLE NO. 468

Accuracy Policy

It is the policy of ELECTRONIC DESIGN:

To make reasonable efforts to insure accuracy of editorial matter.

To publish promptly corrections brought to our attention.

To reserve the right to refuse any advertisement deemed misleading or fraudulent.

All editorial correspondence should be sent to:

Howard Bierman, Editor
ELECTRONIC DESIGN
850 Third Avenue
New York, N. Y. 10022

Subscription Policy

ELECTRONIC DESIGN is circulated free of charge to qualified design engineers in the U.S., Western European Continent and Britain. To establish your qualifications, send ELECTRONIC DESIGN the following information on your company's letterhead: Your name, engineering title, description of your design duties and a list of your company's major products. The letter must be signed by you personally.

Subscription rates for nonqualified subscribers—\$25 a year in the U.S., \$35 in all other countries. Single copy, \$1.50.

Change of Address

A subscriber's change of address requires a restatement of his qualifications. To expedite the change, and to avoid missing any issues, send along a label from a back copy.

Microfilm Copies

Microfilm copies of all 1961, 1962, 1963, 1964, 1965 and 1966 issues of ELECTRONIC DESIGN are available through University Microfilms, Inc., 300 N. Zeeb Road, Ann Arbor, Mich. 48106

STOP EMI / RFI LEAKS IN CABLE



TO

CONNECTOR TERMINATIONS

HERE'S
HOW!



CONTACT GLENAIR! Glenair offers the most complete line of EMI / RFI shield termination adapter systems available anywhere . . . and leads the field in offering a complete design service on electrical interconnect systems. Glenair understands connectors, cables and the problems that can result in bringing them together . . . regardless of the size, shape or application, Glenair can provide the right EMI / RFI accessory for complete electromagnetic compatibility and cable-to-connector integrity. Should your requirements go beyond the capability of present parts, Glenair will design and fabricate accessories to solve your particular problem. Call, wire or write for more information.



GLENAIR, INC. / 1211 AIR WAY
GLENDALE, CALIFORNIA 91201

Phone: (213) 245-8587 • TWX: 910-497-2066

ON READER-SERVICE CARD CIRCLE 121

Advertisers' Index

Advertiser	Page	Advertiser	Page
ACI Division, Kent Corporation	149	Industrial Electronic Engineers, Inc.	99
Abbey Electronics Corp.	46	Industrial Timer Corporation	160
Aemco Division, Midtek Corporation	126	Ingersoll Products, Division of Borg Warner Corporation	7
Aerovox Corporation	135	Inland Motor Corporation	134
Airflyte Electronics Co.	159	JFD Electronics Co./Components Division	91
Alco Electronic Products, Inc.	151	Janitrol Aero Division, Midland Ross Corporation	130
Alfred Electronics	69	Janus Control Corporation	157
Allen-Bradley Co.	32A-B	Kepeco, Inc.	170
American Lava Corporation	125	Line Electric Company	155
Ammon Instruments, Inc.	160	Littlefuse	174
Amperex Electronic Corporation, Microelectronics Division	75	McGraw-Hill Publishing Co.	175
Analog Devices, Inc.	19	Mac Panel Co., O. E. M. Division	129
Arnold Engineering Company, The	123	Magtrol, Inc.	144
Automatic Electric, A Subsidiary of General Telephone & Electronics	38	Matheson Company, Inc.	158
Babcock Relays, A Division of Babcock Electronics Corporation	105	Micro Instrument Company	153
Ballantine Laboratories, Inc.	147	MicroSwitch, A Division of Honeywell	139
Beckman Instruments, Inc.	152	Microdot, Inc.	15
Beckman Instruments, Inc., Helipot Division	12	Microsonics, Inc.	152
Bell Telephone Laboratories	145	Motorola Communications & Electronics, Inc.	92
Bendix Corporation, Electrical Components Division	6	Motorola Semiconductor Products, Inc.	4, 5
Bourns, Inc.	116, 163	National Electronics, Inc.	155
Brand Rex, Division of American Enka Corporation	93	Nylomatic Corporation	171
Bruning, Division of Addressograph & Multigraph Corp.	76	Nytronics, Inc.	23
Buckeye Stamping Co., The	159	Pastoriza Electronics, Inc.	128
Bulova Electronics Division of Bulova Watch Company	154	Peschel Instruments, Inc.	171
Burndy Corporation	52	Phelps Dodge Electronic Products	156
Clairex Electronics, Inc.	8	Philco-Ford Corporation	127
Cohu Electronics, Inc.	107	Philips Electronic Measuring Instruments	9
Coleman Engineering Co., Inc.	40	Potter & Brumfield Division of American Machine & Foundry Company	136, 137
Consolidated Avionics, A Division of Condec Corporation	119	RCA Electronic Components and Devices	9, Cover IV
Coors Porcelain Company	131	Raytheon Company, Sorensen Operation	16
Couch Ordnance, Inc.	124	Rowan Controller Co., The	25
Coto-Coil Company, Inc.	174	Schweber Electronics	169
Curtis Development & Mfg. Co.	169	Scientific Data Systems, Inc.	39
Cutler-Hammer	41	Scionics Corporation, The	115
Data Control Systems, Inc.	151	Sigma Instruments, Inc.	62
Data Device Corporation	161	Sigmatronics Integrated Circuits, A Sub- sidiary of Corning Glass Works	84
Datapulse Instruments Division, Datapulse, Incorporated	2	Siliconix Incorporated	109
Digital Equipment Corporation	121	Soshin Electric Co., Ltd.	168
Duncan Electronics, Inc.	148	Specific Products	132
Eldre Components, Inc.	169	Spectrol Electronics Corporation	143
Eldema A Division of Genisco Technology Corporation	168	Sprague Electric Company	10, 20
Electro Tec Corp.	136	Switchcraft, Inc.	150
Electronic Design	173	Sylvania Electric Products, Inc., Semiconductor Division	47
Electronic Memories, Inc.	94	Syntron Company	133
Electronic Wholesalers, Inc.	170	Systems Research Corporation	122
Electronized Chemicals Corporation	85	TRW Capacitors	50
Fairchild Instrumentation, A Division of Fairchild Camera and Instrument Corporation	34, 35, 37	Tektronix, Inc., Oscilloscopes	98
Fairchild Semiconductor, A Division Fairchild Camera and Instrument Corporation	70, 71	Telonic Engineering Co.	63
Field Emission Corporation	138	Texas Instruments Incorporated	141
Fluke Mfg. Co., Inc., John	27	Topaz, Inc.	120
General Atronics	164	Tung-Sol Division, Wagner Electric Corporation	165
General Electric Company	103	Uniform Tubes, Inc.	170
General Radio	1	Union Carbide Corporation	43, 48, 48A-B-C-D, 49
Glenair, Inc.	172	Vactec Inc.	140
Globe Industries, Inc.	151	Varian Associates	83
Gordos Corporation	165	Vent Rak, Inc.	142
Grayhill, Inc.	155	Weckesser Company, Inc.	171
Harowe Servo Controls, Inc.	42	Wheelock Signals, Inc.	44
Heath Company	159	Wood Electric Corporation	165
Hewlett-Packard	Cover II, 29, 101, Cover III	Career Advertising:	
Honeywell, Computer Control Division	30	Hughes Aircraft Company	112
Honeywell, Precision Meter Division	45	LTV ElectroSystems, Inc.	113
Hopkins Engineering Company	33	Lockheed Missiles & Space Company	114
IRC, Inc.	61	U.S. Navy, San Francisco Bay Naval Shipyard	110
ITT Cannon Electric	77		
ITT Jennings	167		
ITT Semiconductors	176		

IMPACT

Union Carbide Electronics, Mountain View, California has just placed the largest exclusive advertising campaign in magazine publishing history.

Their objective: To become an even greater factor in the fast-paced twenty-one billion dollar electronics industry.

Their campaign: 138 pages over the next 12 months.

Their magazine: **Electronic Design.**

Union Carbide Electronics and their agency, Hal Lawrence, Inc., decided the best return on their advertising investment would be achieved by concentrating in the magazine read by the greatest number of their prime customers and prospects.

They backed up their decision by scheduling multi-page semiconductor advertise-

ments in every bi-weekly issue of *Electronic Design*.

Advertisements that will be selling the men who specify what goes into what the sales department sells, the accounting department accounts, the production department produces.

138 pages over the next 12 months . . . that's **impact**.



Electronic Design

MOST READ BY THE MEN WHO SPECIFY

Winner of Industrial Marketing and Jesse Neal Awards for Editorial Excellence in 1966

Hayden Publishing Co., Inc., 850 Third Avenue, New York 10022

Publishers of *Electronic Design* and *Microwaves* Magazines . . . Hayden, Rider and Ahrens Books

Reed Relay Problems?

A special hi-reliability relay for the Hawk Missile.

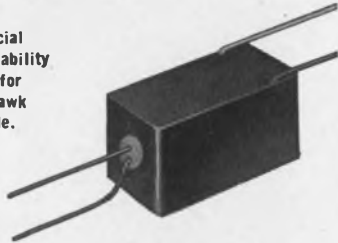

Can We Solve Your Problem?

Operating Inputs: low as 1mA. and 15mW.
 Standard Coil Voltages: 6, 12, 24, 32, 48V in stock for immediate delivery.
 Special Voltage or Resistance, multiple windings for flip flop, memory and crosspoint selection applications — to customer specifications.

Relay Contacts in Form A, B, C and latching. Also high vacuum type 5000V Form A.

Write for catalog and prices of our standard line of magnetic reed relays. For special requirements, give complete details for quotation.

Coto-Coil COMPANY INC.
 59 Pavilion Ave.
 Providence, R. I. 02905
 Phone: (401) 941-3355

ON READER-SERVICE CARD CIRCLE 126



Littelfuse Indicating Microfuse Holders for military and commercial applications. Ranges 2-1/2 to 130 Volts. Also available with RFI shielding.



LITTELFUSE

DES PLAINES, ILLINOIS

ON READER-SERVICE CARD CIRCLE 127

Electronic Design

Advertising Representatives

New York 10022

Robert W. Gascoigne
 Thomas P. Barth
 Samuel M. Deitch
 Richard W. Nielson
 850 Third Avenue
 (212) PLaza 1-5530
 TWX: 867-7866

Philadelphia

Fred L. Mowlds, Jr.
 P. O. Box 206
 Merion Station, Pa. 19066
 (215) MO 4-1073

Boston

Richard Parker
 7 Redstone Lane
 Marblehead, Mass. 01945
 (617) 742-0252

Chicago 60611

Thomas P. Kavooras
 Berry Conner, Jr.
 720 N. Michigan
 (312) 337-0588

Cleveland

Robert W. Patrick
 8410 Treetower Drive
 Chagrin Falls, Ohio 44107
 (216) 247-7670

Los Angeles 90303

Stanley I. Ehrenclou
 Terrence D. Buckley
 W. James Bischof
 2930 W. Imperial Highway
 Inglewood, Calif.
 (213) 757-0183

San Francisco

Ashley P. Hartman
 175 South San Antonio Rd.
 Ste. 243
 Los Altos, Calif. 94022
 (415) 941-3084

Southwestern 75206

Tommy L. Wilson
 6200 North Central Expressway
 Dallas, Tex.
 (214) EMerson 1-2311

London W. 1

Brayton C. Nichols
 44 Conduit Street

Verviers, Belgium

Andre Jamar
 1, Rue Mallar, 1
 (087) 253.85

Tokyo

Yoshihiro Takemura
 International Planning
 Service, Inc.
 Room 231 Tokyo-Mita Bldg.
 1, Shiba-Mita Koun-cho
 Minato-ku, Tokyo



Designer's Datebook

APRIL						
S	M	T	W	T	F	S
2	3	4	5	6	7	8
9	10	11	12	13	14	15
16	17	18	19	20	21	22
23	24	25	26	27	28	29

MAY						
S	M	T	W	T	F	S
1	2	3	4	5	6	7
8	9	10	11	12	13	14
15	16	17	18	19	20	21
22	23	24	25	26	27	28
29	30	31				

For further information on meetings, use Reader Service card.

Apr. 12-14

Conference on Electronic Information Handling (Pittsburgh) Sponsors: Office of Naval Research, Univ. of Pittsburgh, W. Michigan Univ., Goodyear Aerospace Corp.; Allen Kent or Orrin E. Taulbee, University of Pittsburgh, Pa. 15213

CIRCLE NO. 469

Apr. 17-19

International Conference on Urban Transportation (Pittsburgh) Sponsor: Pittsburgh Council for Urban Transportation; W. H. Shepard, Mgr. Public Relations, Aluminum Co. of America, Pittsburgh, Pa. 15219.

CIRCLE NO. 471

Apr. 18-20

Spring Joint Computer Conference (Atlantic City, N. J.) Sponsor: American Federation of Information Processing Societies; Fred Hoar, Radio Corp. of America, 30 Rockefeller Center, New York, N. Y. 10020

CIRCLE NO. 472

Apr. 24-25

National Relay Conference (Stillwater, Okla.) Sponsors: National Association of Relay Manufacturers, Oklahoma State Univ.; Dr. D. D. Lingelbach, School of Electrical Engineering, Oklahoma State University, Stillwater, Okla. 74074.

CIRCLE NO. 473

Apr. 24-28

Integrated Circuit Finance, Management and Technology Seminar (New York City) Sponsor: Integrated Circuit Engineering Corp.; Seminar Registrar, Eastern Area Office, Integrated Circuit Engineering Corp., 4333 East River Drive, Philadelphia, Pa. 19129.

CIRCLE NO. 474

Up-to-date electronics from McGraw-Hill



- TRANSFORMERS FOR ELECTRONIC CIRCUITS.** By NATHAN R. GROSSNER. New. This comprehensive guide explains in simple, logical style, how to apply the basic principles and fundamental relationships of transformer design and selection. It avoids complicated equations and masses of design data and stresses overall comprehension and understanding. The use of charts and tables, and better specifications-writing, are fully covered. **321 pp., \$14.00.**
- NOISE AND ITS EFFECT ON COMMUNICATION.** By NELSON M. BLACHMAN. New. This book unifies the useful information on random processes and their spectra, the effect of nonlinear transformation upon signal and noise, the statistical theory of detection, and information theory, much of it not found in other books. Complicated notation and math are avoided. **224 pp., \$13.50.**
- PRINTED CIRCUITS HANDBOOK.** By CLYDE F. COOMBS, Jr. New. Here is your complete how-to-do-it guide to printed circuits: design, fabrication, assembly and testing. You'll find process details and technical information not available elsewhere, and a wealth of practical detail that enables anyone in the field to establish production facilities and control processes. **544 pp., \$15.00.**
- INTEGRATED CIRCUIT TECHNOLOGY: Instrumentation and Techniques for Measurement, Process, and Failure Analysis.** By SEYMOUR SCHWARTZ. New. Contributors from Westinghouse, Philco, Motorola, General Electric, RCA, North American Aviation/Autonetics, IBM, and NASA have written chapters for this book, covering a wide range of important current topics in measurement, process, and failure analysis of integrated circuits. **325 pp., \$15.00.**

- CIRCUIT DESIGN FOR AUDIO, AM/FM, AND TV.** BY THE ENGINEERING STAFF OF TEXAS INSTRUMENTS INCORPORATED, Dallas, Texas. New. This fifth book in the Texas Instruments Electronics Series covers output and driver design and input design; amplifiers, tuners, and applications; VHF, tuners, video IF amplifiers, automatic gain control, audio amplifier system, sync separators, and oscillators — both vertical and horizontal. **366 pp., \$14.50.**
- SOLID-STATE COMMUNICATIONS.** BY THE ENGINEERING STAFF OF TEXAS INSTRUMENTS INC. From RF to VHF, this book brings you an up-to-the-minute examination of a wide range of the most significant new communications components now applicable in industry, the military and consumer products. **365 pp., \$12.50.**

At Your Bookstore or Direct from Publisher for

-10 DAYS FREE EXAMINATION-

McGRAW-HILL BOOK CO., Dept. 23-ED-412
330 West 42nd Street, New York, N. Y. 10036

Send me the book(s) circled below for 10 days on approval. In 10 days I will remit for book(s) I keep, plus a few cents for delivery costs, and return other book(s) postpaid.

1 2 3 4 5 6

Name (print) _____

Address _____

City _____

State _____

Zip Code _____

For prices and terms outside U.S. write McGraw-Hill Int'l. N.Y.C. 23-ED-412

The Predictables.

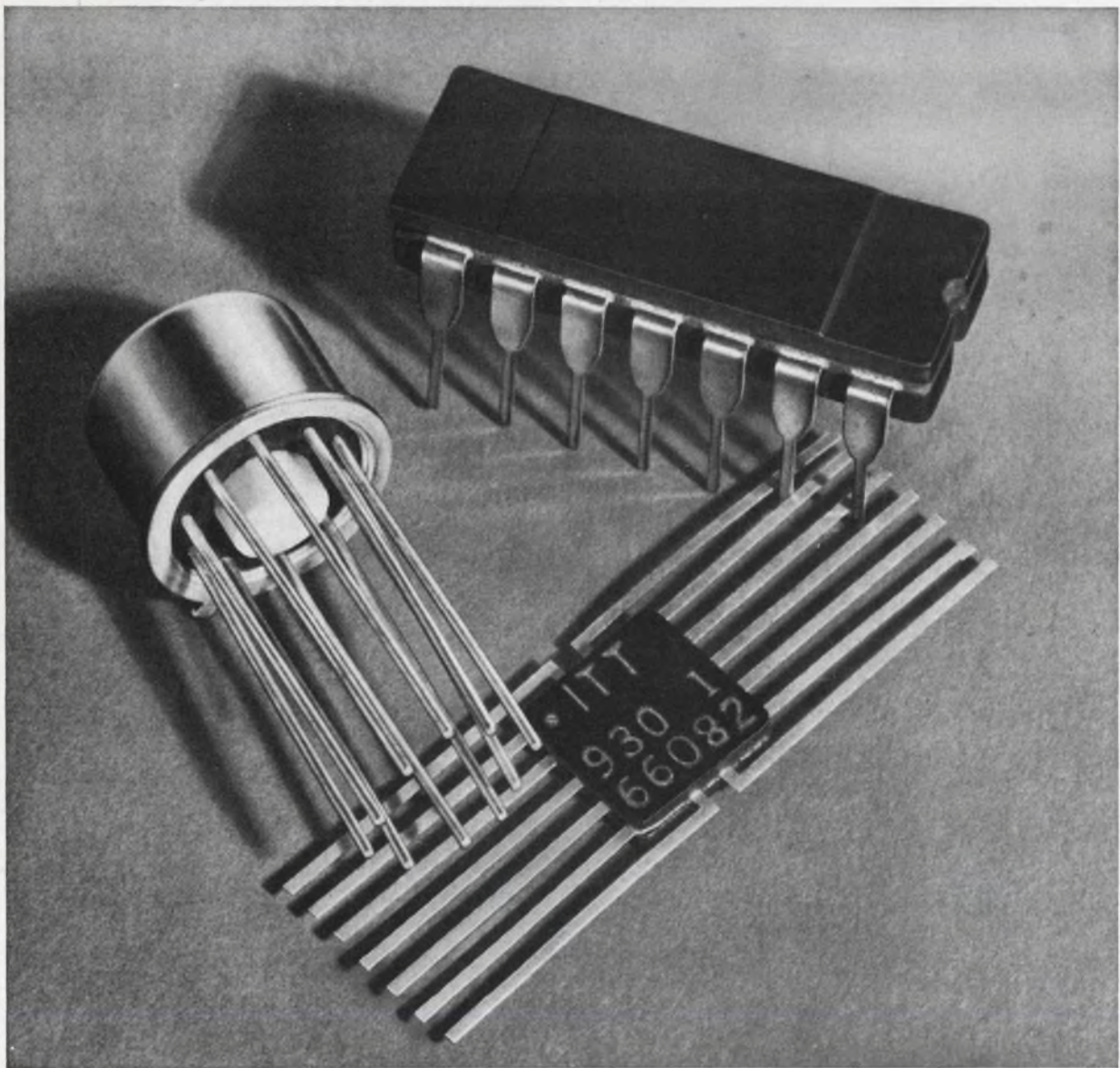

100% DC and dynamic testing verifies the performance of every circuit in ITT's full line of Series 930 DTL

When your order of ITT Series 930 DTL arrives, you can have absolute confidence in its performance. First of all, every circuit gets full DC and dynamic testing at 25°C, plus temperature cycling, centrifuge, and fine leak tests. Then there's 1% AQL testing at -55°C, +25°C and +125°C for 15 DC parameters and at +25°C for 2 dynamic parameters. If circuits flunk, we just don't ship them.

ITT's Series 930 "predictables" come in 15 circuit functions and three package styles. If you're tired of rejecting and returning DTL, try ordering it from ITT. It's available off-the-shelf from your distributor or direct from the factory through your ITT representative. ITT Semiconductors is a Division of International Telephone & Telegraph Corporation.

integrated circuits **ITT**

FACTORIES IN WEST PALM BEACH, FLORIDA; PALO ALTO, CALIFORNIA; LAWRENCE, MASSACHUSETTS; HARLOW AND FOOTSCRAY, ENGLAND; FREIBURG AND NURENBERG, GERMANY

ON READER-SERVICE CARD CIRCLE 129



Handle more heat with smaller resistors

Photo shows comparison of effective heat dissipation area of conventional 10 watt wirewound (top) with that of 10 watt Series G wirewound with beryllium oxide core.



G SERIES ...more design freedom from an unmatched power-size ratio

Beryllium oxide cores in Dale's G Series wirewounds put almost the entire resistance element to work at maximum temperature — not just a tiny area. This creates a design bonus that includes: A power-size ratio 40% to 150% greater than conventional silicone-coated resistors and exceptional stability when derated to MIL-R-26D, MIL-R-26C or MIL-R-23379 levels.

G Series power-stability advantages are available in axial and radial lead styles and with non-inductive winding. For established reliability, check the AGS Series — proven failure rate .000125% per 1000 hours (50% power, 25°C). G Series advantages are easily adapted to your special requirements. For complete information call us now at 402-564-3131.

CORE CONDUCTIVITY AT 275°C

BTU-ft
F²-Hr-F

BERYLLIUM OXIDE (BeO) - 64
STEEL - 33
ALUMINUM OXIDE - 8
STEATITE - 1.5

SPECIFICATIONS

- **Ten sizes:** 1 through 15 watts
- **Meet requirements** of MIL-R-26D, MIL-R-26C and MIL-R-23379
- **Resistance Range:** .1 to 273K ohms, depending on tolerance and size
- **Tolerances:** .05%, .1%, .25%, .5%, 1%, 3%
- **Typical size:** G-1 (1 watt), .250" L. x .078" D.; G-15 (15 watts), 1.781" L. x .375" D.
- **Stability:** When G resistors are operated at the same ratings as conventional MIL-R-26D resistors of equivalent size, the G resistance shift will be 50% or less than that of the conventional resistor.

WRITE FOR CATALOG A



DALE ELECTRONICS, INC.

1328 28th Avenue, Columbus, Nebraska
In Canada: Dale Electronics Canada, Ltd.



Here is power coverage for modern HF, VHF, and UHF communications. Look at the range covered by RCA Cermolox® and ceramic Beam Power Tubes. They're powerful, yet compact. Typical types outlined in the chart are just a few of the more than 25 tubes comprising a field-tested line that is immediately available—and priced to give your circuit extra value. Custom requirements can be filled on request. For applications assistance, contact your RCA EC&D Representative. For technical data on specific types, write: Commercial Engineering, RCA Electronic Components and Devices, Sect. D 18P-2, Harrison, N.J.

ALSO AVAILABLE FROM YOUR RCA INDUSTRIAL TUBE DISTRIBUTOR

RCA POWER TUBES FOR HF, VHF, UHF

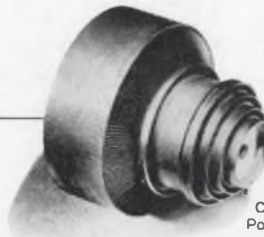

RCA-8501, a typical RCA Cermolox Beam Power Tube

RCA Type	Description	Cooling	Filament (F) or Heater Voltage	Max. DC Plate Ratings (Volts)	Frequency (MHz)	Typical CW Power Output (Watts)
7213	Cermolox	Forced Air	5.5	3000	600	1350
7650	Ruggedized Cermolox	Forced Air	6.3	2500	400	800
8072	Beam Power	Conduction	12-15	2200	50 470	110 85
8122	Beam Power	Forced Air	13.5	2200	50 470	375 300
8226	Cermolox	Forced Air	6.3	2500	1215 400	105 340
8501	Cermolox	Forced Air	8.5 (F)	7000	400	10000



The Most Trusted Name in Electronics

COMMUNICATION POWER

