

Electronic Design 19

VOL. 14, NO.

THE MAGAZINE OF ESSENTIAL NEWS, PRODUCTS AND TECHNOLOGY

AUGUST 16, 1966

Are you WESCON-bound... or are you desk-bound? Either way, this year's show has a lot to offer you. Maybe you need a low-cost plastic transistor or a hot new

laser...or perhaps you would like to catch up on LSI, MOSFETs, LISA and BARTD. For a rundown on these and other show highlights, see WESCON USA (p. U65).





"SPECIAL" CUSTOM BUILT FILTERS

TO YOUR SPECIFICATIONS

ILLUSTRATED ARE TYPICAL SPECIAL FILTERS

RANGE OF FREQUENCIES ON SPECIAL UNITS
IS FROM 0.1 CYCLE TO 400 MC.

Over thirty years of experience in the design and production of special filters have resulted in UTC being a first source for difficult units. Present designs both military and commercial incorporate a wide variety of core structures, winding methods, and capacitors to provide maximum performance, stability, and reliability. Fully experienced, top engineering talent backed by complete environmental testing and life testing facilities assure the highest standard in the industry. Full analysis and evaluation of materials are conducted in UTC's Material and Chemical Laboratories. Rigid quality control measures coordinated with exhaustive statistical findings and latest production procedures results in the industry's highest degree of reliability.

MILITARY AND COMMERCIAL TYPES FOR EVERY PHASE OF THE ELECTRONICS ART

POWER TRANSFORMERS • AUDIO TRANSFORMERS • INDUCTORS • PULSE TRANSFORMERS • ELECTRIC WAVE FILTERS • LUMPED CONSTANT DELAY LINES • HIGH Q COILS • MAGNETIC AMPLIFIERS • SATURABLE REACTORS • REFERENCE UNITS

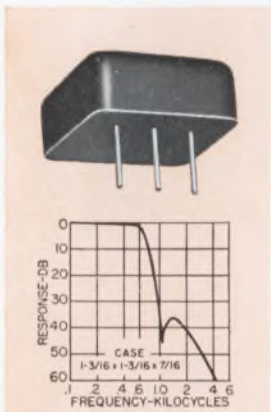

560 — Telemetering low pass filter. Available from 400 — to 70 KC. \pm 7.5% bandwidth flat to 1 db. Attenuation greater than 35 db beyond the 2nd harmonic of — 7.5% frequency. Impedance 47K ohms. MIL-F-18327B. Wt. 0.8 oz.

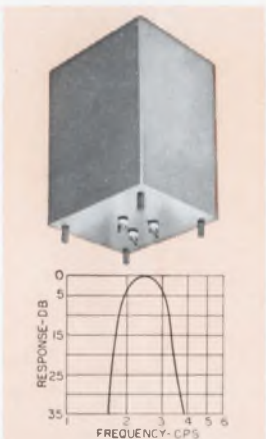

Low frequency band pass filter. Designed for 2.5 cps center frequency. At 2 to 3 cps within 3 db. At 1.5 cps and lower, and 4 cps and higher, greater than 30 db. Source and Load 10K ohms. Size: 4 x 4-11/16 x 6". MA MIL case, MIL-F-18327B.

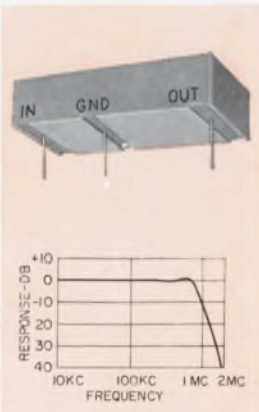

High frequency low pass filter. Zero to 700 KC within 1 db. 1.95 mc to 10 mc 40 db minimum. Source and Load 1000 ohms. Molded flat construction for printed circuit applications. Size: 1 x 2 x 1/2"; Wt: 1 oz. MIL-F-18327B.

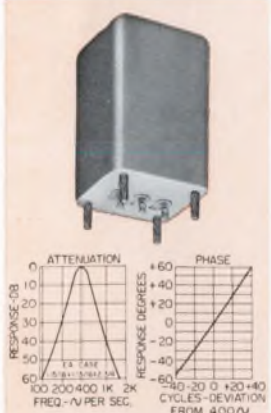

Band pass 400 cycle Gaussian filter. Linear phase response in pass band. Attenuation 380 cps to 420 cps within 0.5 db. 2nd harmonic down 25 db, 3rd harmonic down 45 db. Source and load 5K ohms. MIL-F-18327B Wt., 0.9 lbs.

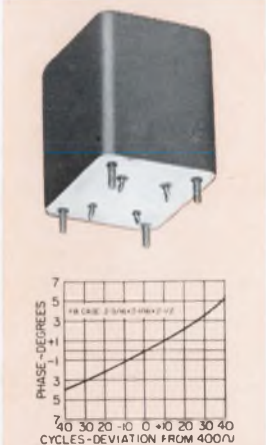

Minimum phase shift 400 cycle band pass filter. Within \pm 1.5 db 370 to 430 cycles, greater than 45 db beyond 1100 cycles. 1K ohms to 100K ohms. MIL-F-18327B; 1 lb.

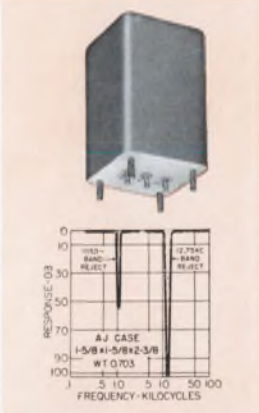

Band reject filters (two shown). The 1050 — filter has 50 db attenuation and is only 3 db at 950 and 1150 cycles. The 12.75 KC filter has more than 100 db attenuation and is only 3 db at 10.8 and 15 KC. Source and load 600 ohms, both are MIL-F-18327B.

Write for catalog of over
1,300 UTC TOP QUALITY
STOCK ITEMS
IMMEDIATELY AVAILABLE
from your local distributor.



UNITED TRANSFORMER CO.
DIVISION OF TRW INC. • 150 VARICK STREET, NEW YORK, N. Y. 10013

RECORD

See New hp Instruments
Attends Measurement Seminars
WESCON—Hollywood Park

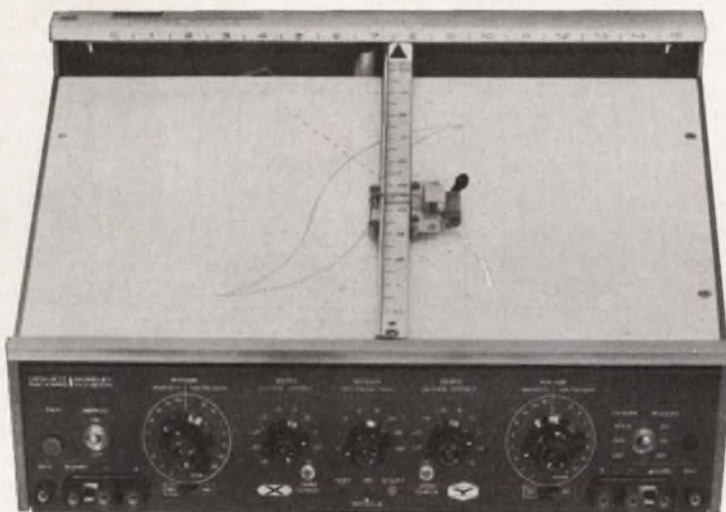

low-level ac

low-level dc

ON THIS SOLID-STATE 11" x 17" X-Y RECORDER

100 μ v/inch dc sensitivity
5 mv/inch ac sensitivity
1-megohm input resistance
high common mode rejection

The Moseley Division 7000A Recorder accepts dc or ac signals on either or both axes, offers dc cmr of 140 db, ac cmr of 120 db. Potentiometric input available on six most sensitive ranges; accepts roll chart and other accessories for maximum versatility. Internal time base switchable to either axis, featuring automatic reset, adjustable sweep length, automatic recycling.

Other features of the 7000A include extended zero offset with calibrated steps,

maintenance-free AUTOGRIP* electric paper holddown, sturdy, compact construction.*Also available from current production is the Model 7001A, identical to the 7000A except for the omission of ac input ranges. Metric and rack mount models available, as well. Price, 7000A, \$2495; 7001A, \$2175.

*Trade Mark Pat. pend.

Data subject to change without notice.
Prices f.o.b. factory.

848

**HEWLETT
PACKARD**  **MOSELEY
DIVISION**



Some things are better flat.

Like flat cable assemblies
from ITT Cannon
(They're going places!)

Today's requirements for high-density, highly sophisticated electronic circuitry create a big, pressing need for reliability and the many other advantages of



flat cable. One case in point: missile systems, guidance computers.

Flat cable is strong. Tough. Thin. Dissipates heat quickly. Fits into corners, turns sharp angles, reaches into small, irregular or very thin spaces . . . places where wire bundles can't go.

Now, thanks to FLEX-WELD® flat cable assembly and the engineering and manufacturing capabilities of ITT Cannon :

- You can order flat cable assemblies, reliably terminated to flat, circular or D Connectors of any size or type. Terminations are welded through the insulation, without stripping, to form a bond strong as the cable material itself.
- You can order flat cable assemblies in whatever quantity, size or shape you need them. Centers to .050". Every assembly is fully tested for reliable performance.

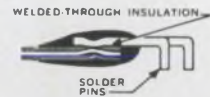

Turn your complex interconnecting problems over to ITT Cannon's staff of flat cable specialists.

Send details of your application or write for literature. ITT Cannon Electric, 3208 Humboldt Street, Los Angeles, Calif. 90031.

A Division of
International
Telephone and
Telegraph Corp.

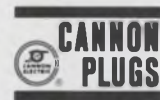

CANNON ITT

FLEX-WELD IS A REGISTERED TRADEMARK OF DIGITAL SENSORS, INC.

NEWS

- 13 News Scope
- 17 **Challenge to transistors in logic circuitry**
Magnetic thin-film devices can give higher density with a reduction in power and manufacturing costs.
- 21 **IC activities filling gap between IF and microwaves**
Inductive transistor and silicon-on-sapphire circuits spur speculation about high-frequency IC applications.
- 24 **Reliability integrates with design**
Drive intensified to prepare engineers to design with an eye on reliability.
- 31 Washington Report
- 34 New theme—music on a cathode-ray tube
- 44 Fog! Diode laser signals warning.
- 54 Letters
- 63 **Editorial:** The UFO puzzle: time for a technical evaluation
-

WESCON USA—A special Section

Pages U65 to U176

TECHNOLOGY

- 180 **Stabilize gain in dc amplifier** by making it depend solely on supply voltage and temperature. Low input current and high collector resistance are needed.
- 186 **Cure switching system noise** problems with this straightforward procedure for isolating switching circuits from power line noise.
- 192 **Cut transistor replacement costs** due to device failure. Use safe-operating-area principles to design power-transistor switching circuits.
- 200 **Check the parameters of pads** graphically with a set of charts that show the errors in terms of percentage errors of the pad resistors.
- 206 **Measure thermal resistances** to find the maximum power that your integrated circuit or discrete transistor can handle.
- 210 **Rid mixers of spurious signals** with the aid of cross-product traces that reveal the position and significance of all signals within the band.
- 218 **Check off the human factors design** of your electronic system—big or small—by using this conveniently classified compilation.
- 232 Ideas for Design
-

PRODUCTS

- | | |
|--------------------------|----------------------|
| 244 Components | 267 Materials |
| 250 Test Equipment | 270 Microwaves |
| 259 Production Equipment | 275 Microelectronics |
| 262 Systems | 277 Semiconductors |
| 266 Power Equipment | |
-

Departments

- | | |
|--------------------|-------------------------|
| 222 Book Reviews | 286 Advertisers' Index |
| 280 New Literature | 288 Designer's Datebook |
-

**CASE FOR
THE MAN
FROM
E.A.G.L.E.**

**NEW TWISTER...
ACCURATE TIME/COUNT CONTROL**

New and consistently better! At the left is the new face of our famous Microflex® reset timers and counters. High-visibility, direct reading dials enable you to make highly accurate settings, easier! The larger, 20-turn scale, for example, may be in minute divisions with the inner in seconds. Settings as short as $\frac{3}{80}$ th of a second with $\pm \frac{1}{60}$ th second accuracy are readily obtained. Other dial selections to 120 hours are available. After the desired pre-set time period, a variety of 15 amp. contacts can be opened or closed to control motors, solenoids, valves, etc. Uniform new lettering and attractive neutral grey color make units compatible with all other Eagle Signal types and with your most advanced machine designs. For full details about these new timers and counters, use Reader Service Card, circle number 50.

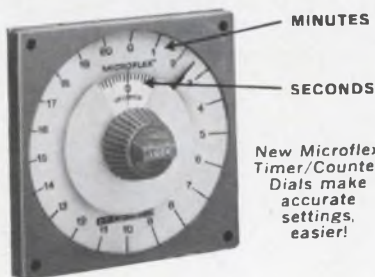

TURN...TURN...TURN...

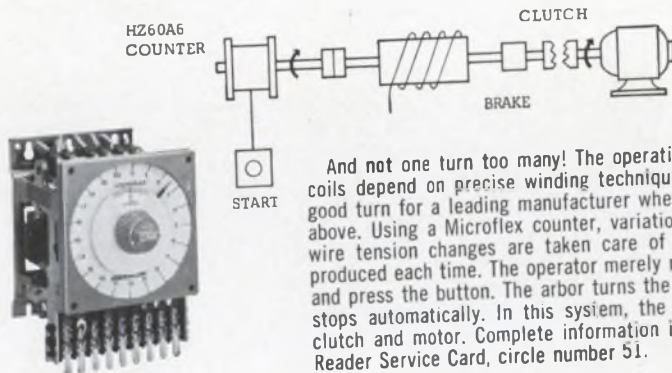

And not one turn too many! The operating characteristics of radio tuning coils depend on precise winding techniques. The Man from E.A.G.L.E. did a good turn for a leading manufacturer when he suggested the system shown above. Using a Microflex counter, variations in motor speed resulting from wire tension changes are taken care of . . . and an accurate product is produced each time. The operator merely needs to set the high-visibility dial and press the button. The arbor turns the pre-set number of revolutions and stops automatically. In this system, the Microflex counter controls brake, clutch and motor. Complete information is in Bulletin 730. For a copy, use Reader Service Card, circle number 51.

DOUBLE IT? NO! CUBIT ...

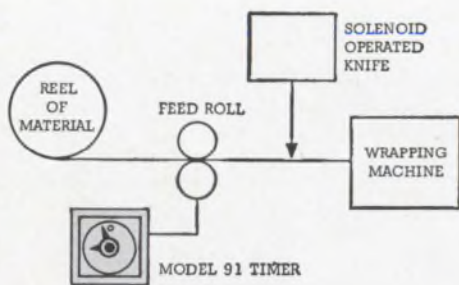

Years ago, a cubit was the distance from a man's elbow to the end of his middle finger. Even then, it might have taken two midgets' cubits to make one basketball player's cubit. But now a cubit is a standard 18 inches. That's why the Man from E.A.G.L.E. didn't have any trouble when a manufacturer of packaging materials asked him to control the length of strapping being fed to a wrapping machine. The operator merely sets a Model 91 timer for duration of time that will give him the number of feet desired and presses button. When the prescribed length is reached, the timer stops the strapping and controls a flying knife, which precisely cuts the strip. Model 91 offers time ranges from 5 seconds to 60 hours. Complete information is in Bulletin 1614. For a copy, circle Reader Service Card Number 52.



BLISS  **EAGLE SIGNAL**

A DIVISION OF THE E. W. BLISS COMPANY

See the Man From E. A. G. L. E. at Booth 1019 (Sports Arena) WESCON SHOW

CASE FOR THE MAN FROM E.A.G.L.E.

UNDERCOVER OPERATOR

22AP Plug-in General Purpose Relay

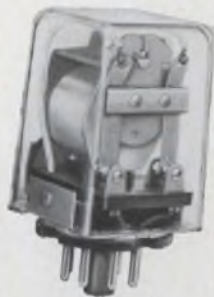

... the epitome of relay craftsmanship and design. Versatile to the Nth degree on loads to 10 amps. Available in 8- and 11-pin styles for AC, DC and plate circuit requirements. Features include: forms to 3PDT plus specials on request; standard units have gold-plated contacts for longer shelf life; lower pull-in voltages (DC: 70% of nominal, AC: 75% of nominal); AC operating voltages 0.5 to 250, DC 0.2 to 130 in current ranges from .005 to 10 amp. Complete information is in our new relay bulletin. For your copy, use Reader Service Card, circle number 54.

SPECIFICATIONS

- Contacts: SPDT, DPDT, 3PDT
- Contact Rating: 5 and 10 amps.
- Pull-in: 22 milliseconds average
- Drop-out Speed: 12 milliseconds average
- Size: $1\frac{3}{8}'' \times 2\frac{1}{8}'' \times 1\frac{3}{8}''$
- Weight: 3 ounces

POWERFUL PARTNER

25PS Medium Power Relay



... toss your toughest medium-power-handling assignments to this workhorse. 25PS types carry loads to 20 amps. on a fast duty cycle in a breeze. UL listed. Features include: rugged $\frac{3}{8}''$ diameter silver cadmium oxide alloy contact; lower pull-in voltages (DC: 75% of nominal, AC: 76% of nominal); AC operating voltages 4 to 250, DC 1 to 130 in current ranges from .02 to 10 amp. For full technical information on this and other Eagle Signal general purpose and medium power relays, use the Reader Service Card, and circle number 55.

SPECIFICATIONS

- Contacts: SPDT
- Contact Rating: 20 amps. 115/230 VAC 60 cycle resistive • 1 HP @ 115/230 VAC motor-inductive
- Pull-in: 50 milliseconds max.
- Drop-out Speed: 30 milliseconds max.
- Size: $2\frac{1}{4}'' \times 1\frac{1}{32}'' \times 1\frac{1}{16}''$
- Weight: 3 ounces

RELAY DESIGNERS' RELAY

25AA Open Frame General Purpose Relay



... and boy what a relay it is! Versatile, dependable, economical. You'll find hundreds of uses for these 5 or 10 amps., UL listed high-reliability types. Standard units have gold-plated contacts which permit longer shelf life. Other significant features include: lower pull-in voltages (DC: 70% of nominal, AC: 75% of nominal). AC operating voltages 0.5 to 250, DC 0.2 to 130 in current ranges from .005 to 10 amp. Detailed specifications on these and other Eagle Signal general purpose relays are given in a new technical bulletin. For your copy, use Reader Service Card, circle number 56.

SPECIFICATIONS

- Contacts: SPDT, DPDT, 3PDT
- Contact Rating: 5A and 10A @ 115 VAC • 5A-1/10 HP @ 115 VAC, 1/6 HP @ 230 VAC • 10A-1/6 HP @ 115 VAC, 1/3 HP @ 230 VAC
- Pull-in: 22 milliseconds average
- Drop-out Speed: 12 milliseconds average
- Size: $1\frac{7}{8}'' \times 1\frac{1}{32}'' \times 1\frac{1}{2}''$
- Weight: 2 ounces

Ask the man from E.A.G.L.E. to open his "showcase" of ideas for you. Many can help solve your process control problems. Want our complete catalog? Use the handy Reader Service Card, circle number 57 or write: Eagle Signal Division, E. W. Bliss Company, Federal Street, Davenport, Iowa 52803.

BLISS



EAGLE SIGNAL

A DIVISION OF THE E. W. BLISS COMPANY

See the Man From E. A. G. L. E. at Booth 1019 (Sports Arena) WESCON SHOW

What do you want from a new operational amplifier?

More gain?



Say 1,000,000 (120 db)?

Lower long-term drift?



Like less than 100 μ V/60 days?

Predictable performance at extreme temperatures?



How about specs that apply from -55°C to $+125^{\circ}\text{C}$?

Tight little package?



Would you believe 3.5 grams in 2cc?

Reliability?



Like you can get from solid state silicon design in an all-welded MicroCircuit Pack™?

Added dividends?



For example, ± 10 volts output at 5mA; short circuit protection?

If that's what you want, you need Hamilton Standard's A-505 operational amplifier. It meets all these expectations and more. We'll send you a data sheet free. And a sample unit for \$95.

For technical data, price and delivery, write to Marketing Manager, Electronics Department, Hamilton Standard, Broad Brook, Connecticut 06016; or call direct: (203) 623-1621, Ext. 6106. TWX: 203-623-0879.

Hamilton Standard
BROAD BROOK, CONNECTICUT

DIVISION OF UNITED AIRCRAFT CORPORATION

U
A

Examine the A-505 on display at WESCON, Los Angeles Sports Arena, August 23-26.

ON READER-SERVICE CARD CIRCLE 3

A BILLION STANDARD POTS AND TRIMMERS? (well, would you believe 211,209,077?)

Of course a number like two hundred million needs explaining. But if you study the Spectrol Catalog and count up such options as mountings, gangable combinations, resistance values, terminal variations, and other available features, you will find that Spectrol offers you 211,209,077 standard potentiometers and trimmers to choose from. But even as one of the industry's leading sources for "standards,"

Spectrol still maintains technical leadership in the design and production of "specials." And, the Spectrol double-edged capability doesn't stop there. For no one else can offer you a broader series of miniature rotary selector switches designed for direct printed-circuit-board application, or more accurate, more readable turns-counting dials.

Still don't believe? Sorry about that. But make your own count. Write for a Spectrol Catalog... or pick one up at our Wescon Booth 1201-1202.

Spectrol Electronics Corporation
17070 East Gale Avenue
City of Industry, Calif. 91745

spectrol

ON READER-SERVICE CARD CIRCLE 4



NAND logic is old hat.

We've invented SDS Natural Logic for our T Series integrated-circuit modules. It's a comprehensive set of gating structures that permit the terms of any Boolean logic equation to be converted directly into hardware.

Now you won't have to manipulate equations to make them fit the restrictions of NAND or NOR gates. With Natural Logic the hardware fits the equations without unnecessary inversions.

So you won't need nearly as many circuits to build your logic system. Your system will cost you a lot less. It will be faster and more reliable. It will be easier to mechanize. And it will take up less room.

Naturally.

Scientific Data Systems

1649 Seventeenth Street, Santa Monica, California
 Offices in principal cities throughout the world



With NAND logic you are stuck with only this, no matter what the equations call for.

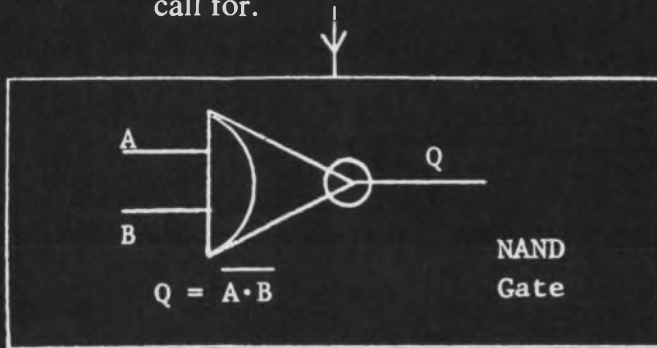

With T-Series NATURAL logic you have all these to choose from at a lower price per circuit.

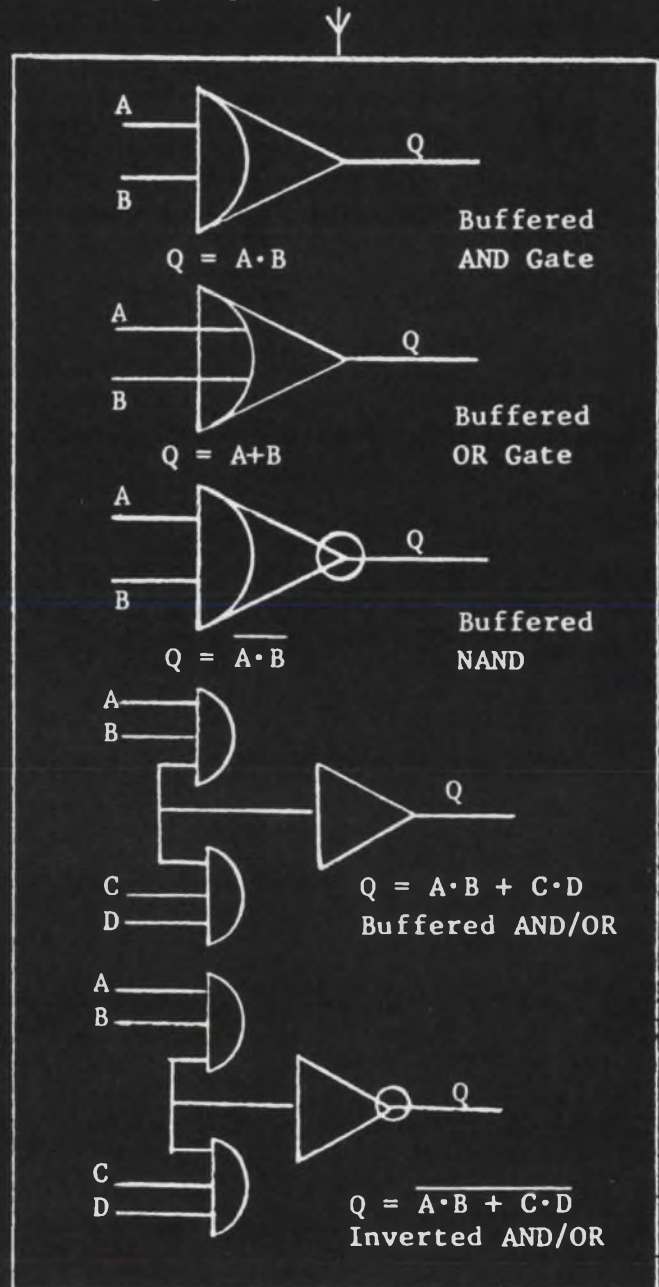



The World's Most Complete Line of...

PRECISION TRIMMER CAPACITORS

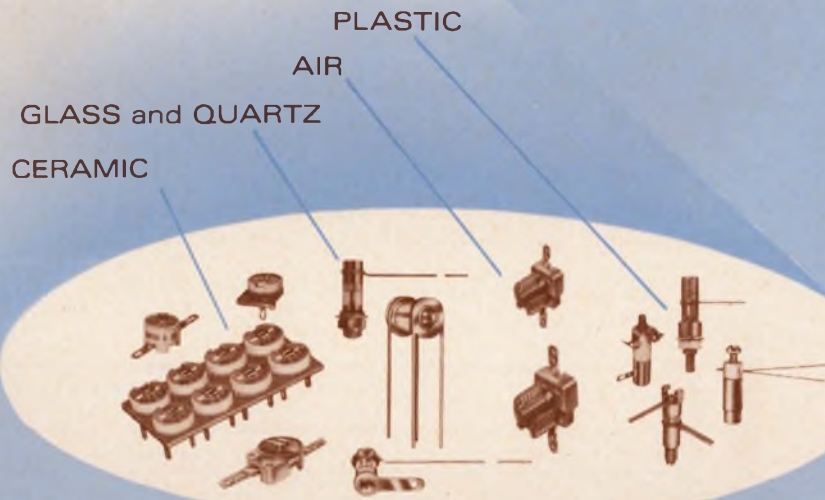

MINIATURIZED ERIE TRIMMER CAPACITORS FOR PRINTED CIRCUIT BOARD... OR PANEL MOUNT APPLICATIONS—MILITARY OR COMMERCIAL TYPES

When knowledgeable engineers discuss quality Precision Trimmer Capacitors... ERIE is the name most often mentioned as the best single-source in the industry.

Today, miniaturized ERIE Trimmer Capacitors are available in a wide selection of dielectrics for virtually any circuit application... Ceramic, Glass, Quartz, Air and Plastic.

For more than 20 years ERIE has earned an enviable reputation for quality components. Quality, however, is a by-product of experience and advanced engineering capability. At ERIE, Precision Trimmer Capacitors are smaller than ever with better than ever quality.

If you have a specific Trimmer Capacitor problem... we suggest ERIE as your one-stop source. One of our standard units will probably fulfill your requirements. If not, our Trimmer Engineering Department will welcome the opportunity to discuss your circuit needs.

Write TODAY for new Precision Trimmer Capacitor catalog.

Another Series of Components in Erie's Project "ACTIVE"
Advanced Components Through Increased Volumetric Efficiency

ERIE

TECHNOLOGICAL

PRODUCTS, INC.



Formerly
Erie Resistor
Corporation

Erie, Pennsylvania



0.5 db

This is the typical wideband noise figure of Sprague Types 2N4383 and 2N4384 high-gain, low-level NPN silicon epitaxial planar transistors. Maximum NF is 2.0 db, one db lower than the type that has been the industry's most popular high-gain, low-level transistor.

Sprague Electric also offers Types 2N4385 and 2N4386, with noise figures of 1.0 db typ., 3.0 db max.

Characteristic	Conditions	2N4383 (TO-5 Case)	2N4384 (TO-18 Case)	2N4385 (TO-5 Case)	2N4386 (TO-18 Case)
BV _{CB0}	I _C = 10 μA	40V min.	40V min.	40V min.	40V min.
BV _{CEO}	I _C = 10mA	30V min.	30V min.	30V min.	30V min.
I _{CB0}	V _{CB} = 30V	10nA max.	10nA max.	10nA max.	10nA max.
I _{EBO}	V _{EB} = 5V	10nA max.	10nA max.	—	—
h _{FE}	V _{CE} = 5V, I _C = 1 μA	60 min.	60 min.	—	—
h _{FE}	V _{CE} = 5V, I _C = 10 μA	100 min.	100 min.	40 min.	40 min.
h _{FE}	V _{CE} = 5V, I _C = 1mA	120 min.	120 min.	100 min.	100 min.
NF	V _{CE} = 5V, I _C = 10 μA, r _g = 10KΩ, Bandwidth = 10 Hz to 15.7 kHz	2db max.	2db max.	3db max.	3db max.

Evaluate these devices without delay. They're available now in production quantities. Call your nearest Sprague Electric district office or sales representative for prices and delivery. Or, write Marketing Dept., Semiconductor Division, Sprague Electric Company, Concord, N.H. 03302.

SPRAGUE COMPONENTS

TRANSISTORS
CAPACITORS
RESISTORS
INTEGRATED CIRCUITS
THIN-FILM MICROCIRCUITS

455-6144

PULSE TRANSFORMERS
INTERFERENCE FILTERS
PULSE-FORMING NETWORKS
TOROIDAL INDUCTORS
ELECTRIC WAVE FILTERS

CERAMIC-BASE PRINTED NETWORKS
PACKAGED COMPONENT ASSEMBLIES
BOBBIN and TAPE WOUND MAGNETIC CORES
SILICON RECTIFIER GATE CONTROLS
FUNCTIONAL DIGITAL CIRCUITS



Sprague and "S" are registered trademarks of the Sprague Electric Co.

News



Electronic music can now be composed on a CRT and played on a computer. Page 34.

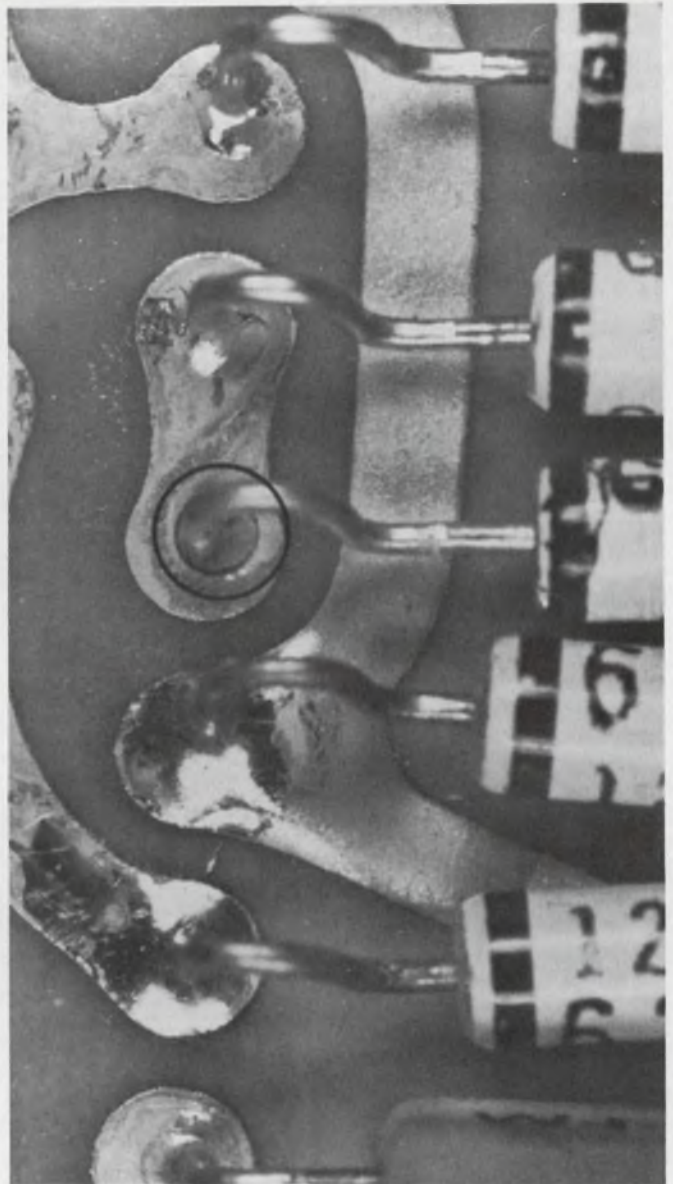

Engineers urged to become reliability men as well as designers. Page 24.

Also in this section:

Magnetic thin-film logic devices challenge transistors . . . Page 17.

ICs looking to break the frequency barrier . . . Page 21.

Diode laser warns of fog . . . Page 44.

News Scope, Page 13 . . . **Washington Report**, Page 31 . . . **Editorial**, Page 63.

New from Sprague!

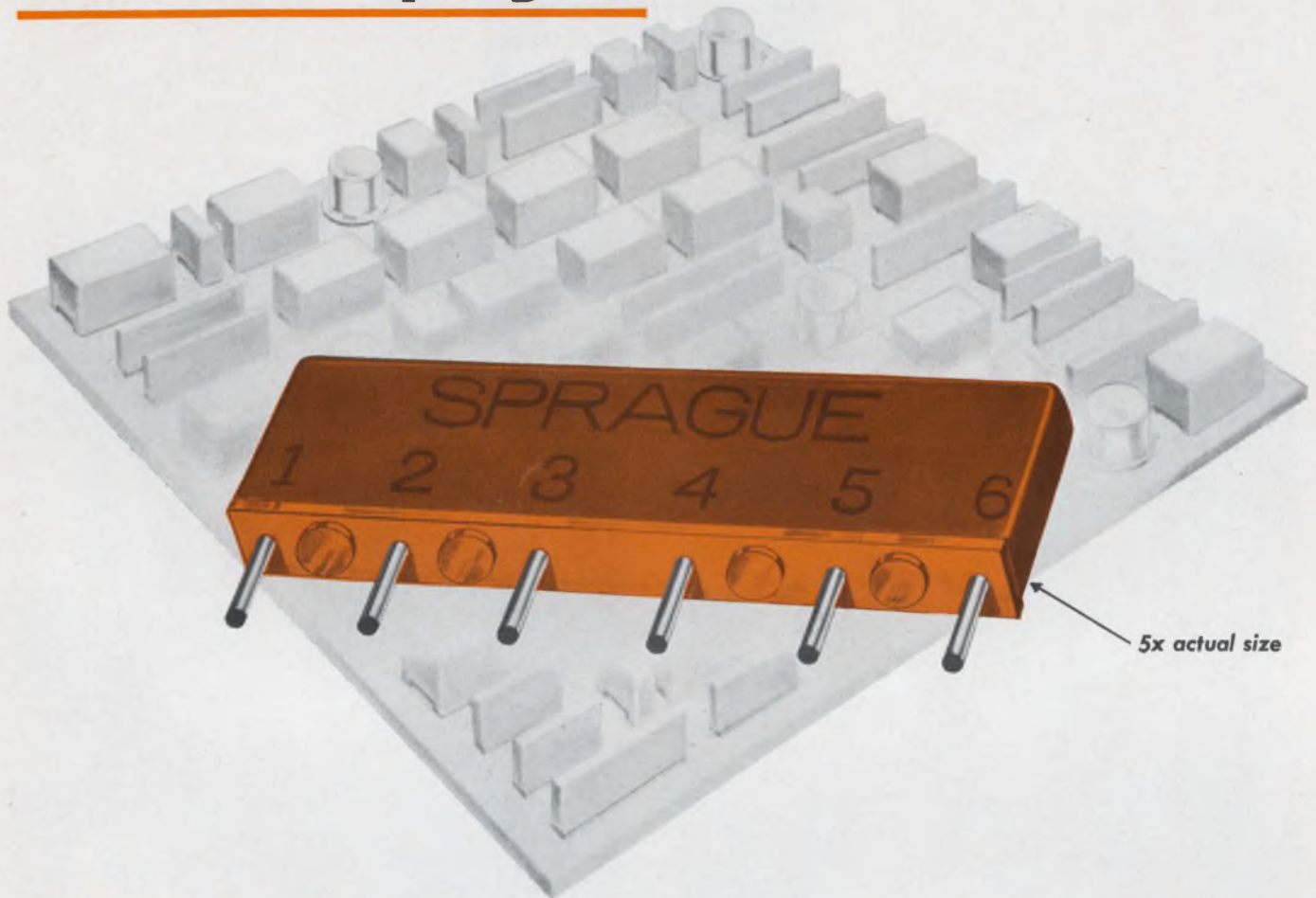

METANET[®] TRUE METAL-FILM NETWORKS **PRECISION RESISTOR**

Save Space, Time, and Money

- High packaging density—4 to 8 times that of individual components.
- Fewer components to stock, handle, inspect, install. Entire module can be hand-inserted faster than one axial-lead component.
- Permit substantial savings over equipment assembled with individual components.
- Epoxy terminal board keeps pin terminals free of resin coating, unlike conventional dipped components, and provides uniform lead spacing.
- Stand-off bosses permit efficient flux removal after soldering. Also prevent dirt and moisture traps around leads.
- Extremely stable and reliable. Meet performance requirements of MIL-R-10509E. Resistance tolerances to $\pm 1\%$.
- Ceramic capacitors can be incorporated for further savings and size advantages over individual components



*For complete information write to
Integrated Circuit Application Engineering Dept.,
Sprague Electric Company, 347 Marshall St.,
North Adams, Massachusetts 01248*

SPRAGUE COMPONENTS

RESISTORS
CAPACITORS
TRANSISTORS
INTEGRATED CIRCUITS
THIN-FILM MICROCIRCUITS

PULSE TRANSFORMERS
INTERFERENCE FILTERS
PULSE-FORMING NETWORKS
TOROIDAL INDUCTORS
ELECTRIC WAVE FILTERS

CERAMIC-BASE PRINTED NETWORKS
PACKAGED COMPONENT ASSEMBLIES
BOBBIN and TAPE WOUND MAGNETIC CORES
SILICON RECTIFIER GATE CONTROLS
FUNCTIONAL DIGITAL CIRCUITS

ON READER-SERVICE CARD CIRCLE 7



'Sprague' and '®' are registered trademarks of the Sprague Electric Co.

News Scope

F-111 delights Air Force; Navy calls it overweight

What's good for the Air Force may not be good for the Navy. Particularly if it happens to be the F-111B. But the fourth version of the F-111B aircraft, recently flown for the first time, is lighter than its developmental predecessors and has been redesigned for high lift.

The F-111 is the outcome of Secretary Robert McNamara's plan to save \$1.5 billion in development costs by designing one aircraft for both the Air Force and the Navy.

The Air Force is delighted with its new plane, the F-111A, but Navy officials have been grumbling for months that their F-111B is a number of tons too heavy for landing on aircraft carriers. Reports place its overweight at from three to seven tons above the prescribed optimum for a landing deck.

Grumman Aircraft, builder of the F-111B under a contract from General Dynamics, states that the F-111B number 4 is lighter than earlier development models. A spokesman for General Dynamics places the weight reduction at "several thousand pounds."

Even Congress has found time to ponder the weighty problem of the F-111B. Representative Robert Sikes (D-Fla.) told the House recently: "At this stage the F-111B is a lemon and the Navy knows it. The Navy is stuck with its version of the TFX. This aircraft is costing a great deal more than was antici-

pated. It is far behind schedule. It is too heavy to use on carriers, and the things that will be sacrificed to make it work will probably result in a second-rate aircraft."

Rep. George Mahon (D-Tex.) termed the consolidated approach "a very noble idea." "But," he added, "it may be like many other ventures in defense: it may turn out to be a failure."

The Secretary of the Navy, Paul Nitze, when asked for his comments on the F-111B, said: "We must make it work."

NASA should state post-Apollo aims

The National Aeronautics and Space Administration's silence about what follows Apollo is unsettling the whole U.S. aerospace industry. It should tell Congress by Dec. 1 just what the next step in space will be after a manned landing on the moon has been achieved.

This is the gist of a report shortly to be released by the House Manned Space Flight Subcommittee. Chairman Olin E. Teague (D-Tex.) claims that the nation's present space manpower force of 400,000 will dwindle to 200,000 by next year and 100,000 by 1968 if NASA sets no new goal.

Ford and Comsat vie for space

The Ford Foundation has come forward with an ambitious plan to tie profitable TV and radio broadcasting to an educational TV network.

The proposal was presented to the Federal Communications Commission by foundation president McGeorge Bundy. It would plow the profits from an \$80 million domestic

satellite system distributing radio and TV shows into paying the costs of the educational network. It is likely to have strong appeal both to the general public and to educators.

But it has also brought the foundation face to face with the Communications Satellite Corp., which contends that Congress intended it alone to supply satellite service.

Ford's proposal was made in response to an invitation issued by the FCC some months ago, after the American Broadcasting Co. had asked to be allowed to launch its own satellite. The scope of Ford's plan, however, completely overshadows others made since the FCC asked for further proposals.

The FCC has given until Oct. 1 to receive comments on all the plans that have been put forward. It will then, presumably, either rule on Comsat's claim to have monopoly rights or pass the issue back to Congress.

Comsat and NASA sign satellite launch accord

NASA will launch two commercial communications satellites for the Communications Satellite Corp. this fall.

The two satellites, each 2-1/2 times more powerful than Early Bird, will be put into synchronous orbit, one over the Pacific Ocean, one over the Atlantic. Early Bird, launched over the Atlantic in April, 1965, is providing the first commercial satellite communications between the U.S. and Europe.

Under an agreement signed by NASA and Comsat, NASA will supply launching and all associated services for the new satellites on a reimbursable basis. Cost per launch is estimated at \$3.57 million. Like Early Bird, the two new satellites will be owned by the International Telecommunications Satellite Consortium, of which Comsat is the U.S. partner.

New solar cells heal themselves

A solution to the problem of making solid-state electronic components radiation-resistant appears to be at hand. A new development uses lithium atoms to plug gaps shot in semi-



Some say, "Too heavy to fly . . ."

conductors by high-speed radiation.

A "self-healing" solar cell, said to be 50 times more resistant to nuclear radiation damage than conventional cells, is the first practical device based on this significant materials discovery. The principle promises reduction or even elimination of the threat of radiation damage to electronic components in spacecraft caused by their passage through the Van Allen radiation belt.

The new solar cell was developed at RCA's David Sarnoff Research Center, Princeton, N.J. under contract to NASA's Goddard Space Flight Center, Greenbelt, Md.

The self-healing property is derived from the presence of minute quantities of lithium diffused throughout the cell structure. The lithium atoms, smaller than silicon atoms, do not enter into a chemical bond with the silicon in the solar cells. Instead they roam freely

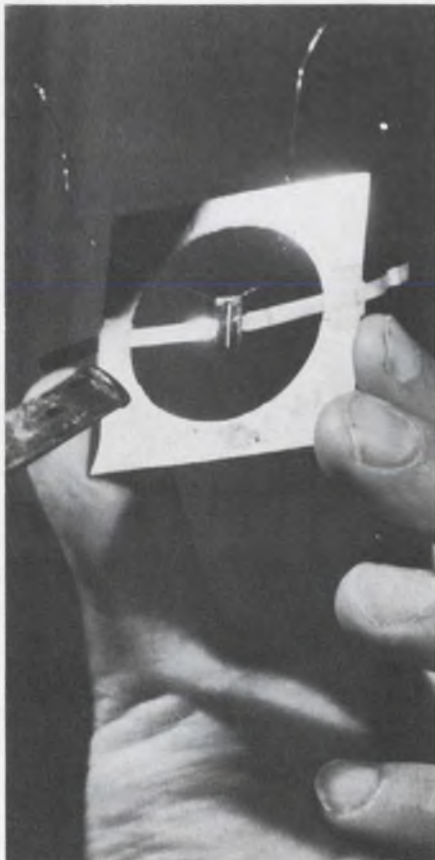

"Self-sealing" solar cell uses lithium atoms to plug radiation damage.

throughout the crystal structure within the cell and are available to "patch" damage done by radiation.

Radiation damage occurs when high-speed electrons, protons or gamma rays burst into the orderly rows of silicon atoms and knock them out of position, thus rendering the device useless.

According to Joseph Wysocki of the RCA Laboratories, the lithium present in the new cells moves in to fill the gaps created by the radiation.

This action prevents electron "traps" which reduce the flow of current in conventional solar cells. At the present time transparent shields made of quartz or sapphire are used to shield conventional solar cells. Wysocki said that the weight of this shielding can be reduced by as much as 90 per cent if the new cells are used.

RCA scientists report that the technique used to make the new solar cells may serve to achieve similar radiation resistance in other silicon components such as transistors, diodes, and ICs.

Surveyor prepares for posthumous portrait

One of Surveyor I's last acts was to prepare to have its picture taken. In response to commands radioed from Earth, it summoned its ebbing strength to position its solar array and high-gain antenna so that they cast as large a shadow as possible when Lunar Orbiter passes overhead.

NASA has changed Lunar Orbiter's flight plan so that it may take high-resolution photographs of Surveyor on two consecutive orbits. These will yield stereographic pictures of the late, great Surveyor with a resolution down to three feet. The "launch window" for Lunar Orbiter is Aug. 9 through 13.

Surveyor, which landed June 2 in the Moon's Ocean of Storms, exceeded all expectations by sending back many thousands of pictures of the Moon's surface before it finally succumbed to the rigors of the lunar climate.

RCA gets big voice in New York transit

New York City Transit Authority has awarded RCA a \$4.2 million contract for the world's largest pub-

lic transportation two-way mobile radio system.

RCA will supply 4,734 radio units over the next 18 months to be installed in buses and other vehicles, and 21 base stations.

A master control station will be set up in East New York, and other, completely transistorized stations will be located at garages throughout the city. The solid-state, Super-Fleetfone-type mobile radios will enable bus drivers to communicate instantly with garage dispatchers or curbside traffic controllers carrying portable two-way units.

The system will be used to gauge the flow of buses to passenger needs and to reroute buses around obstructions. Loudspeakers on the buses will enable the drivers to keep passengers informed of what is happening. The system will also be useful in crime deterrence and control.

Washington eyes scientific policy

The major policies, plans, goals and programs in science and technology of both government and non-government agencies may in the future come under annual Congressional scrutiny.

Sen. Gordon Allott (R-Colo.) has introduced a bill to set up a Joint Congressional Committee on Science and Technology. If adopted, the President would have to submit a report each year to the committee. The proposed committee would function on the lines of the Joint Economic Committee that reviews the President's annual Economic Report.

Night-light satellite to be investigated

The Westinghouse Defense and Space Center is to make a 90-day feasibility study of the possibility of developing an earth-orbiting, light reflection system for night military operations.

N.V. Petrou, general manager of the Center's Aerospace Division, said: "The study may pave the way for an eventual design of an orbiting satellite with a reflective, mirrorlike surface to provide a light source over land masses at night."

The study will be carried out under a \$125,000 contract for the Defense Department and NASA.

Bring on your complex, small, noisy, difficult signals.

We'll give you traces that show them for what they really are.

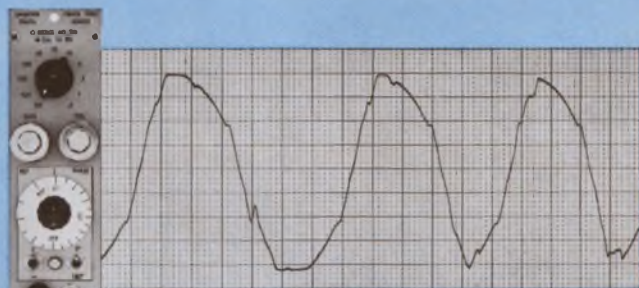

Determine exact phase of servo error with respect to reference signal of 60 Hz to 5 kHz while maximizing rejection of quadrature component.

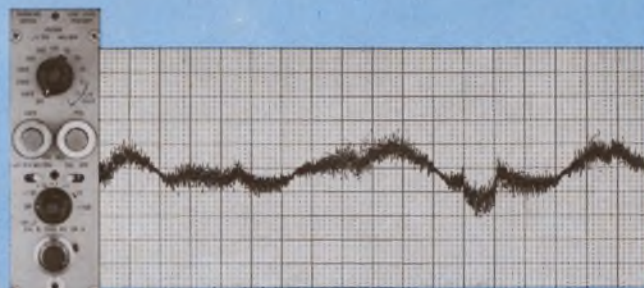

Precisely record changes as small as .001% in DC-100 Hz signals by using calibrated zero suppression.

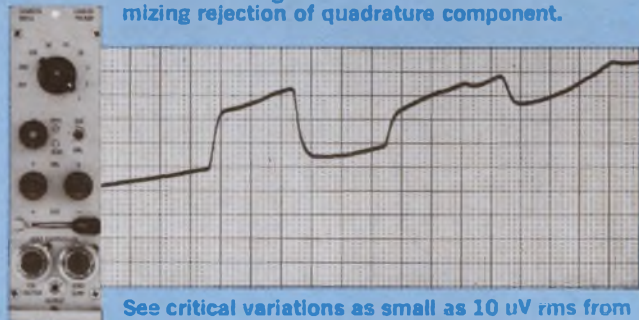

See critical variations as small as 10 μ V rms from strain gages, other AC-excited transducers.

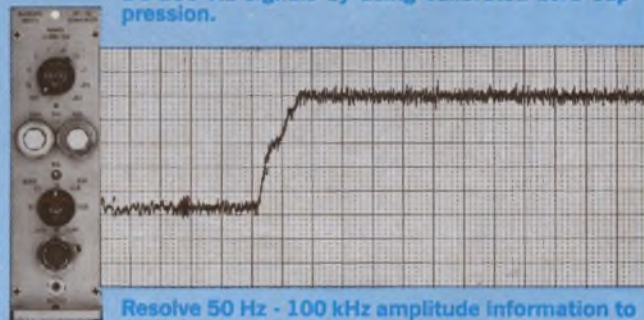

Resolve 50 Hz - 100 kHz amplitude information to 0.02% of full scale signals from 1 volt to 500 volts.

When you need the greatest possible degree of signal-conditioning precision and operational control, Sanborn 7700 Series oscillographs with solid-state "8800" plug-ins will give you chart recordings of maximum resolution and intelligibility.

Seven highly versatile signal conditioners offer unique performance capabilities: three DC types with a 1 μ V - 250 V dynamic range, floating differential input and calibrated zero suppression . . . an AC-DC Converter with calibrated zero suppression and scale expansion permitting resolution better than 0.1%, 10 ms response and isolated, 1 meg. input . . . a phase-sensitive demodulator with calibrated reference phase shift, 90° calibrated dial with four quadrant selections, and a frequency range of 60 Hz to 5 kHz . . . a carrier preamp with 2400 Hz internal transducer excitation supply, calibrated zero suppression, cal. factor control and conversion gain of 10,000 . . . and a general-purpose DC preamp particularly useful for 100 mm wide chart recording.

Use any of these "8800" plug-ins in the 7700 thermal writing oscillograph matched to your packaging and channel requirements — 4-, 6- and 8-channel 7704A, 7706A and 7708A console types . . . 2-channel 7702A system in rack-mount or mobile cart versions . . . single-channel 7701A wide chart (100 mm) portable system. Every one of these thermal writers will give you permanent, rectangular-coordinate recordings whose resolution and accuracy make all your measurements more useful.



For a new brochure describing the advantages and wide choice of Sanborn thermal writing oscillographs, write Hewlett-Packard Company, Sanborn Division, 175 Wyman Street, Waltham, Mass. 02154.

See HP New Instruments and Measurement Seminars at WESCON — Hollywood Park
ON READER-SERVICE CARD CIRCLE 8



HEWLETT
PACKARD  SANBORN
DIVISION

Now: A Fast Signal Averager

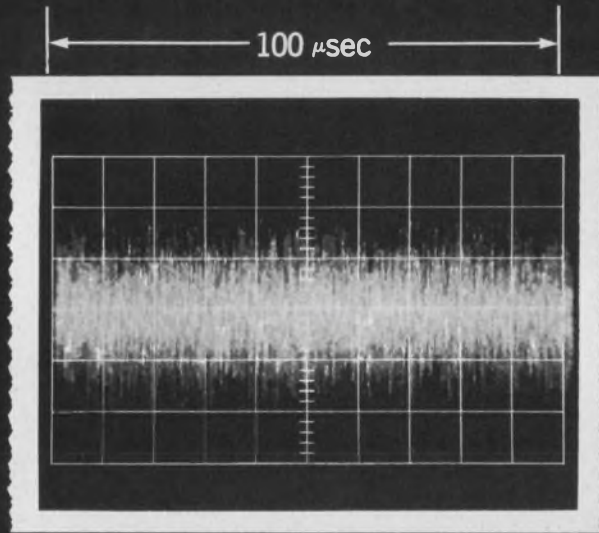

Photo #1—Input to Model TDH-9
SENSITIVITY: 5 V/cm
TIME: 10 μ sec/cm
NOISE-TO-SIGNAL RATIO: 10:1

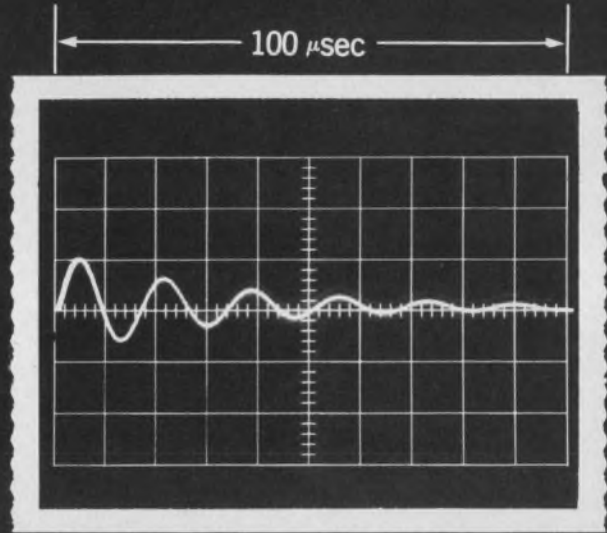

Photo #2—Output of Model TDH-9
SENSITIVITY: 5 V/cm
TIME: 10 μ sec/cm
TDH-9 VOLTAGE GAIN: 10



PAR Model TDH-9 Waveform Educator

Photo #1 is an actual oscillogram of a signal obscured by noise — a situation unfortunately prevalent in many research areas such as studies of biomedical evoked potentials, seismology, spectroscopy, fluorescent lifetime studies, and vibration analysis. Photo #2 shows the dramatic improvement in signal-to-noise ratio when the noisy signal was processed

by the PAR Model TDH-9 Waveform Educator.

This new instrument employs a highly efficient waveform-averaging technique, and at the same time offers the fastest sweep rates obtainable in signal processing equipment of the signal-averaging type. Sweep durations as short as 100 microseconds, with dwell times per channel of 1 microsecond, are obtainable. The high resolution capability of the Model TDH-9 allows observation of waveforms or transients which have heretofore been unresolvable by averaging instruments employing a greater number of channels.

Although the Model TDH-9 Waveform Educator sells for only \$4,200,

See us at WESCON—Booths 253 & 254

we invite functional comparison with the higher-priced digital averagers. We believe you will be pleasantly surprised. For more information about the PAR Model TDH-9, ask for Bulletin No. T-126.

Have a noise problem?

PAR's technical staff, unusually knowledgeable in signal processing problems and techniques as a result of its experience in the development and application of Lock-In Amplifiers, welcomes your specific inquiries. Please call or write.



Challenge to transistors in logic circuitry

Magnetic thin-film devices can give higher density with a reduction in power and manufacturing costs.

Neil Sclater
East Coast Editor

At first glance they look like doodles on the back of a postage stamp. A new series of magnetic, thin-film logic devices, using phenomena known as domain-tip propagation logic (DTPL), are challenging the eminence of transistors in digital circuitry.

Minute regions in a magnetized metallic film can be reversed in polarity and forced to migrate in specific directions in response to externally applied fields. By control of the direction of these "domain tips" and their mutual interaction, all of the usual logic elements may be produced.

The concept was discovered by scientists at the Laboratory for Electronics, Boston, under contract from the Air Force Cambridge Research Labs., Bedford, Mass.

The logic elements fabricated by thin-film deposition require lower power than their transistor counterparts, and they can be manufactured at lower cost. They also have non-volatile memories. In some configurations, the logic elements can be packaged at far higher densities than possible with transistors.

Domain-tip propagation occurs in thin films (approximately 0.1 micron) of permalloy. Initially the nickel-iron-cobalt alloy film is magnetized in one direction, like an ordinary bar magnet. Selective magnetic fields applied in the opposite direction cause regions of the film to reverse their directions of magnetization. These regions of reversed magnetization can be steered across the permalloy layer in long thin spikes or tips at speeds on the order of 10^5 cm/s.

Experimental work has shown that deposition of aluminum on the glass substrate, prior to the deposition of the permalloy layer, inhibited the change in direction of magnetization by increasing its coercive force. It has been found that channels cut or etched through the aluminum result in low coercive force paths, which permit easy passage and control of the domain tips under the influence of the applied magnetic field.

The direction of domain-tip movement depends upon the magnitude and direction of the applied field and the interactions between neighboring tips. The propagation can be directed to one side or the other of

the so-called easy axis depending on the direction of the drive field. The easy axis coincides with the direction of initial magnetic saturation of the permalloy film.

Domain tips which grow in the same easy-axis direction have a net charge of the same sign, while the charge of tips growing in directions opposite to the easy axis are of opposite sign. Domain tips propagated in the same direction were found to repel each other and those propagated in an opposite direction were found to attract each other.

These properties are used, in designing the channel geometry, to form shift registers and the usual logic elements, including AND, OR, NAND and EXCLUSIVE OR.

Information can be transferred without loss in a virtually unlimited number of converging channels. As a result, the power requirements are low ($10\text{-}20 \mu\text{W}/\text{element}$).

High density of the memory and logic elements is made possible by the fineness of the channels.

Shift register first devised

The first successful DTPL configuration was the shift register. This device used in computers stores information in the form of bits and, under the influence of an external signal, shifts them serially. (The shift register in Fig. 1 ap-

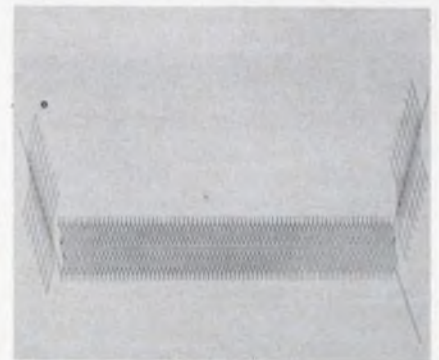
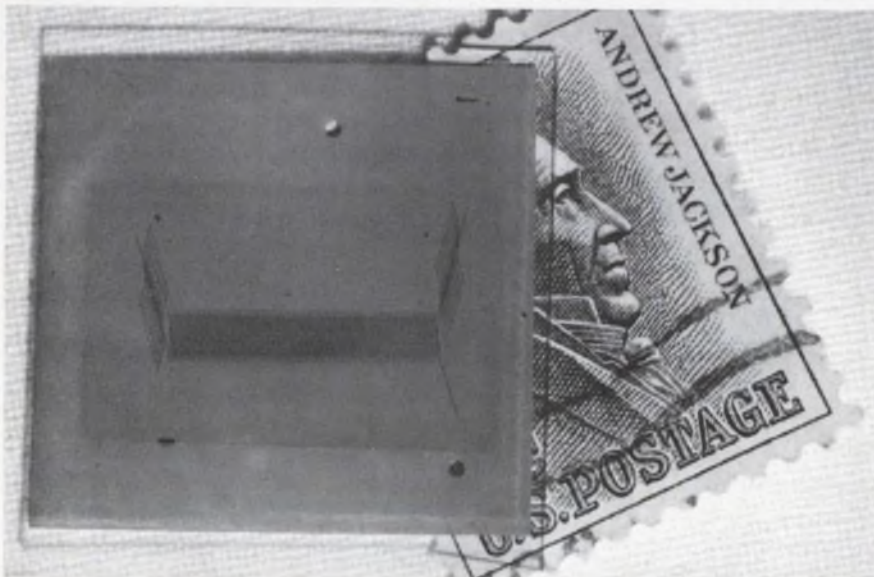

1. Thin-film magnetic shift register operates by domain-tip propagation logic, DTPL. Bit densities are 100 per inch, making 10^5 bits/in² feasible. Zigzag channels are etched on aluminumized substrates prior to permalloy deposition. Inset above is enlarged view of connected parallel series of channels.

(DTPL continued)

pears as a zigzag pattern.)

The transfer of an information bit already stored in the register is accomplished in four steps (Fig. 2):

1. Application of a uniform field to cause growth of the reversed domain from the existing domain tip (black oval) along the channel segment. The direction is determined by the direction of the applied field. (Domain-tip propagation would have been to the left if the field direction had been opposite.)

2. Restoration of the unswitched state of magnetization in the upper portion of the channel by application of a field whose strength decreases toward the lower portion of the zigzag channels. This leaves the small contracted version of the reversed domain at the lower intersection.

3. Application of a second switching field similar to that of Step 1 but with the field applied to favor propagation to the upper right. This causes the tip to propagate toward the upper boundary with a shift to the right.

4. Application of a field to contract the domain back around its upper junction location, to complete the shift.

Information once shifted along the entire length of the zigzag channels can be returned along adjacent, parallel channels. The information-bearing domain, on reaching the end of a zigzag path, can be shunted along a channel segment and thus begin returning the stored information back to the origin along many parallel folded channels.

DTPL shift registers with linear bit densities of 100 bits per inch have already been built, according to Robert J. Spain, project manager of the Laboratory for Electronics. These have been operated with 300-ns clock pulses, he said. With the use of these elements densities of 10^5 bits per cubic inch are feasible.

Thin films used as logic elements

Experimental work has shown that the forces of attraction and repulsion can be used to perform DTPL logic. Films have been provided with channels appropriate to the logic functions desired.

The simplest practical logic cir-

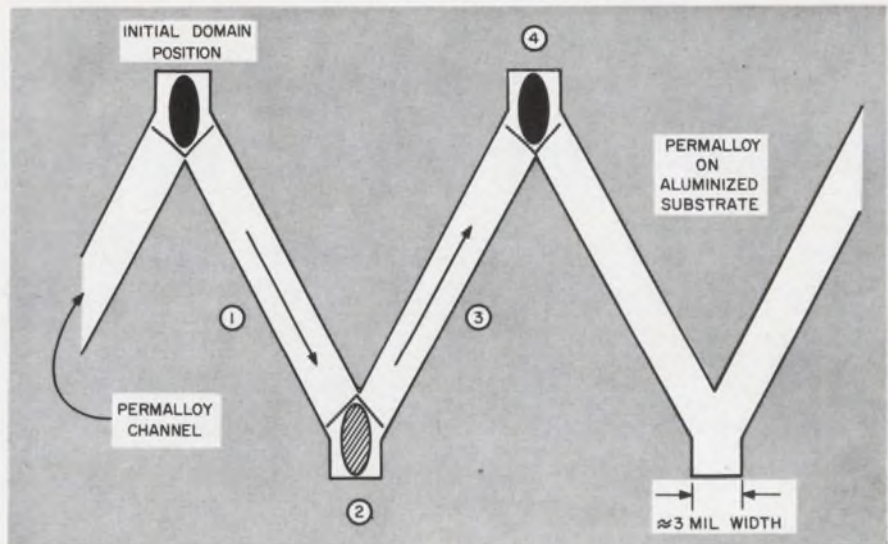

2. Section of zigzag DTPL shift register. Applied magnetic field causes domain tip to travel to right (1). Domain is contracted at lower junction (2). Another field restores domain to upper junction (3), where it is again contracted (4).

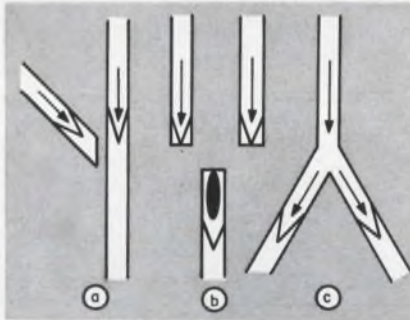

3. Schematics of three versions of DTPL. (a) A simple switch. (b) An AND gate, showing new domain creation as a result of the presence of two tips. (c) A fan-out element which can be used as an OR gate.

cuit is the switch. It uses the forces of attraction and repulsion to perform the logic operation. Channels are formed in the film in close proximity to one another, as shown in Fig. 3a. If a tip is in the left-hand channel, no tip may pass by in the right-hand channel. Thus control over the passage of information-bearing domains is achieved.

Another elementary but useful logic circuit is an AND gate formed when two input channels are placed close to a third channel. This circuit is illustrated in Fig. 3b.

The fields from the channeled domain tips, in combination with driving fields, create a new domain in the third adjacent channel. The presence of only one or none of the two input tips is insufficient to create a new domain in the third channel. Each tip is considered to represent a bit of stored information (1) and the absence of a tip is

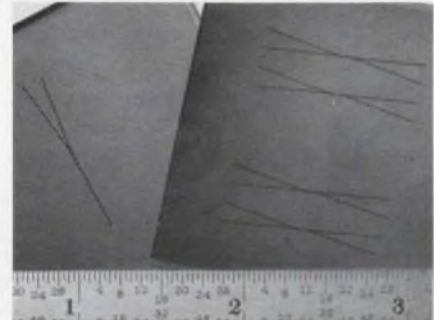

4. DTPL NOR and AND gates on approximately 2- by 2-in. glass substrates. Many other logic modules are possible by application of DTPL phenomena and selection of logic conventions.

considered to be 0. With the presence of two tips, A and B, a new domain C is created. Thus the circuit performs the logic $C = A \cdot B$.

The channel configuration shown in Fig. 3c is a fan-out element. The junction provides fan-out—the ability of the domain to segment into more than one connected channel. It can be used to perform OR logic.

By the use of junction channels, adjacent channels and combinations of the two, a wide range of circuits can be formed. Examples of DTPL logic gates are shown in Fig. 4.

The assignment of prearranged values and the introduction of domains into the circuitry prior to the start of logical operations permit the performance of inverted logic.

In reviewing practical prospects for the devices, Spain said: "Their most immediate applications appear to lie in the field of list memories, buffers, scalars and counters." ■ ■

Why specify Mallory wet slug tantalum capacitors?

One reason: higher precision in timing circuits

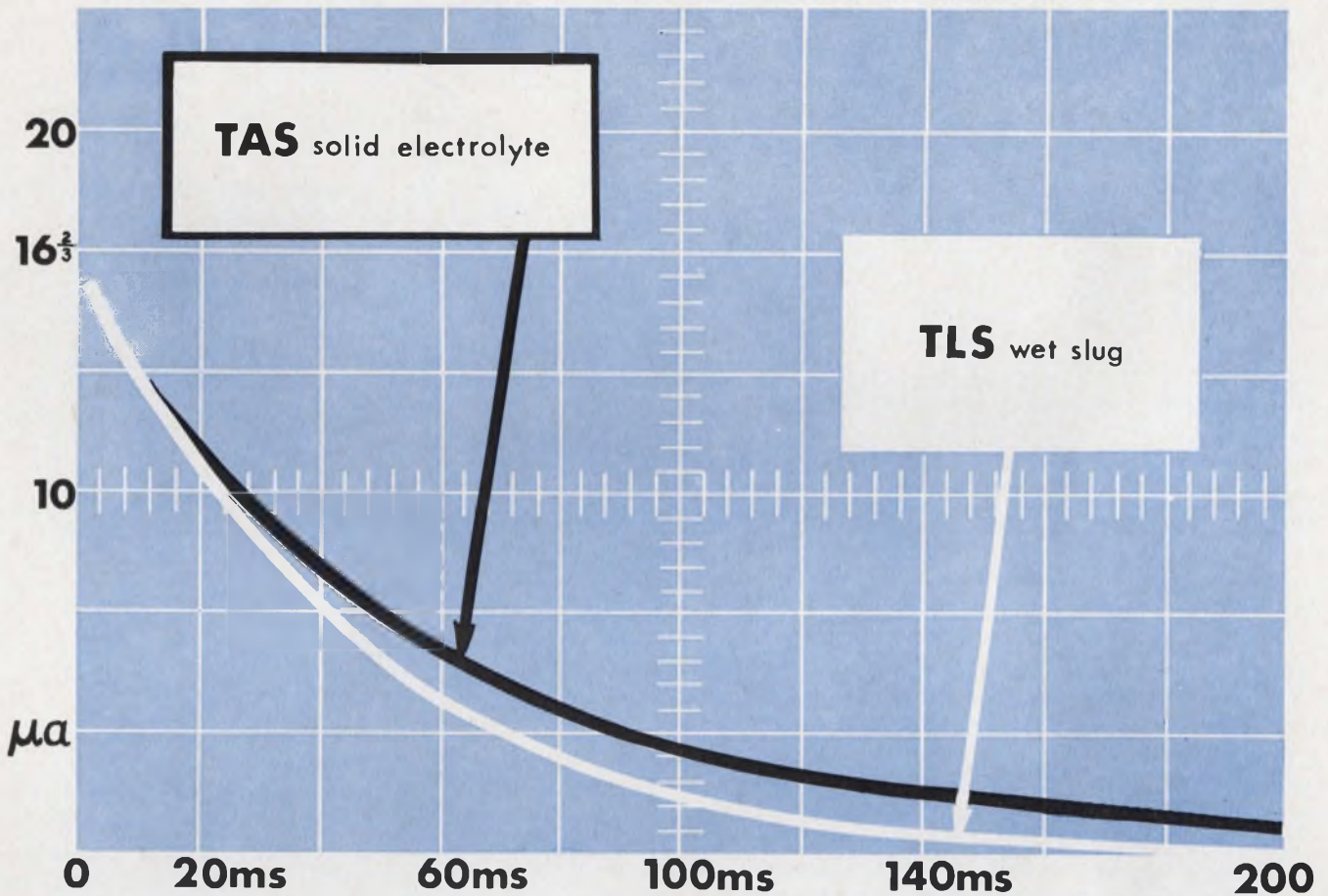

Compare Charging Current-Time Traces reproduced from scope photographs.

Sweep speed: 20 millisecc/div Vertical sensitivity: $3\frac{2}{3}$ μ a/div

DC leakage of a capacitor acts as a parallel resistor. In an RC timing circuit, Mallory wet slug tantalum capacitors produce less time error than solid electrolyte types, because they have only about 10% as much DC leakage.

Want more reasons? Greater freedom from catastrophic failure—documented by millions of unit

test hours. Up to 5 times more rating per unit volume—as much as 172,000 mfd-volts per cubic inch. Highest voltage and temperature ratings. We make all types . . . wet-slug, solid and foil. Ask us for recommendations. Mallory Capacitor Company, a division of P. R. Mallory & Co. Inc., Indianapolis, Indiana 46206.

50th
ANNIVERSARY

MALLORY

Speed Inquiry to Advertiser via Collect Night Letter
ON READER-SERVICE CARD CIRCLE 10

New from Sprague!

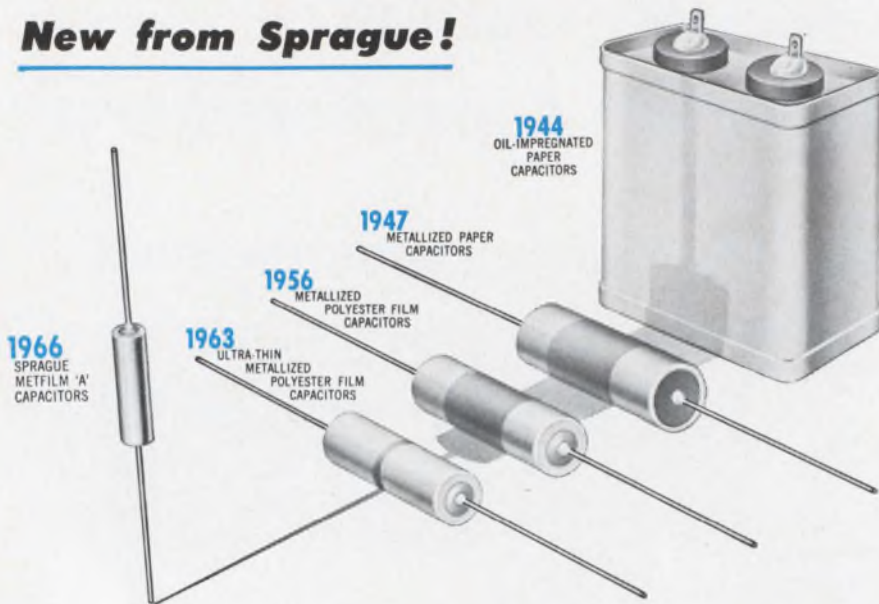

METFILM* 'A' CAPACITORS... dramatically smaller in size, yet more reliable than military-grade capacitors of the past!

Just a few years ago, the only 10 μ F capacitor considered dependable enough for military applications was Type CP70 (to JAN-C-25), and was a block-busting 3 $\frac{3}{4}$ " wide x 1 $\frac{3}{4}$ " thick x 4" high. Today, you can get a military-quality 10 μ F tubular capacitor measuring only $\frac{1}{2}$ " in diameter x 2 $\frac{1}{4}$ " long. And it's more reliable than any capacitor of the past!

Sprague Type 680P Metfilm 'A' Metallized Capacitors meet all environmental requirements of MIL-C-18312, yet they occupy only one third the volume of conventional metallized film capacitors of equivalent capacitance and voltage rating. Employing a new thin organic film dielectric system, Type 680P capacitors use a dual film totalling only 0.00008" thick, as compared to conventional polyester-film capacitors with a single film measuring 0.00015".

Another distinct advantage of the Metfilm 'A' dielectric system is minimum degradation of electrical properties during life.

Hermetically sealed in corrosion-resistant metal cases, capacitor sections are effectively of non-inductive construction, resulting in capacitors with performance characteristics superior to those of comparably-sized capacitors.

Type 680P Metfilm 'A' Capacitors are available with capacitance values to 10 μ F in both 50 and 100 volt ratings.

For complete technical data, write for Engineering Bulletin 2650 to Technical Literature Service, Sprague Electric Company, 347 Marshall Street, North Adams, Massachusetts 01247.

*Trademark

SPRAGUE COMPONENTS

CAPACITORS
TRANSISTORS
RESISTORS
THIN-FILM MICROCIRCUITS
INTEGRATED CIRCUITS
INTERFERENCE FILTERS

PACKAGED COMPONENT ASSEMBLIES
FUNCTIONAL DIGITAL CIRCUITS
MAGNETIC COMPONENTS
PULSE TRANSFORMERS
CERAMIC-BASE PRINTED NETWORKS
PULSE-FORMING NETWORKS



*Sprague' and ® are registered trademarks of the Sprague Electric Co.

ON READER-SERVICE CARD CIRCLE 11

Smuggled recordings fetch up to \$75

Not every concertgoer takes along a battery-powered tape recorder, but those who do can occasionally charge \$75 for a copy of the evening's ambient sounds.

This is the going blackmarket price for an under-the-orchestra-seat recording of the last performance in the Metropolitan Opera House, New York, on April 15, 1966.

The curtain went up at 8:30 p.m. and was not finally rung down until two in the morning. The gala event featured both current Metropolitan stars and famous soloists of the past. In fact, there were so many recording companies whose contracted singers were taking part that it was an impossible task to record the concert formally. Tickets for orchestra seats, such as the one from which the concert was taped, were sold officially for \$200.

The tapes were recorded on Uher 4000-L Report recorder with a lapel microphone. The Audio Times reports the tapes of "reasonably high quality" even though they were recorded at a transport speed of only 3-3/4 ips.

In Lincoln Center's Philharmonic Hall, New York, concert listeners have made tapes in two interesting ways. One member of the audience brought in a Panasonic stereo recorder and taped the concert with a single stereo microphone. And another ingenious method of heightening the stereo effect involved three persons. Two bought seats on opposite sides of the hall. Each carried a wireless FM microphone that broadcast its signal to a third person stationed outside the hall with two FM receivers and Roberts stereo recorder. ■ ■

Watch for "Design Directions"

This regular new feature starts in ED 20, August 30. Design topics of broad significance will be covered in depth by ED's engineers and editors.

IC activities filling gap between IF and microwave

Inductive transistor and silicon-on-sapphire circuits spur speculation about higher-frequency ICs.

Mark B. Leeds
Technical Editor

Significant strides toward using IC components at or near microwave frequencies were made public at the recent St. Louis Microelectronics Symposium. Notable among these reports were one on an "inductive transistor" and one on batch-fabricated, silicon-on-sapphire devices.

This "simulated" inductance, generated by a microcircuit-compatible transistor, produces Q s of 36 at 2 MHz. Among the silicon-on-sapphire (SOS) units were diode structures for microwave harmonic generators and a vertical-junction transistor capable of operating near X-band (5.2 GHz) frequencies.

Composite unit irons-out L needs

As reported by Gopi R. Jindal, research engineer at Sprague Electric's North Adams, Mass., facilities, "all transistors show something of an inductive effect, but composite designs must be turned to if working Q values are to be realized." In a paper co-authored by

Sprague associate Walter Fischer, Jindal described a unit, transistor type 3N90, which features 15 μ H of inductance at 2 MHz. This device, the focus of their investigation of single and cascaded inductive transistors without carrier multiplication, had these characteristics:

- A current transfer ratio very near unity.
- A large ratio of forward-to-reverse transfer admittances.
- A retarding drift field in the base.
- A minimum capacitance at both the emitter and collector junctions due to small geometries and wide-depletion layers at both junctions.
- A matching of the base transit time to the frequency of operation, such that the collector current lags the emitter current.

Jindal anticipated that "off-the-shelf integrated circuits with simulated inductances will be made available within a year." He added: "This approach to obtaining microcircuit Q s is cheaper and less space-consuming than the present tech-

nique—multistage RC phase-shift networks and amplification."

"Inductance values approaching 100 μ H may be realized in 1-1/2 years with composite designs utilizing homogeneous-base devices like the 3N90," he predicted. When used to replace coils in IC-hybrid, tuned-IF circuits, tuning is achieved by varying the IC supply voltage. Typifying these applications was a selective amplifier (see photo) developed by Jindal and Fischer. One drawback of the inductive transistor is its rather high, positive-temperature coefficient, which must be compensated for by external circuitry in some applications.

SOS helps lower IC capacitances

Junction capacitances of less than 0.005pF and storage times of less than 1.0 ns were characteristic of the thin-film structures batch-fabricated by the SOS technique (see figure). Individual step-recovery type diodes and diode matrices (arrays) were constructed.

As reported by Robert Downing, research engineer at the Autonetics Div. of North American Aviation,



Transistors exhibiting a strong inductance property may solve the need for tuned elements in integrated circuits. Co-authors Gopi Jindal (left) and Walter Fischer show the use of 3N90s used as inductors in a selective amplifier.

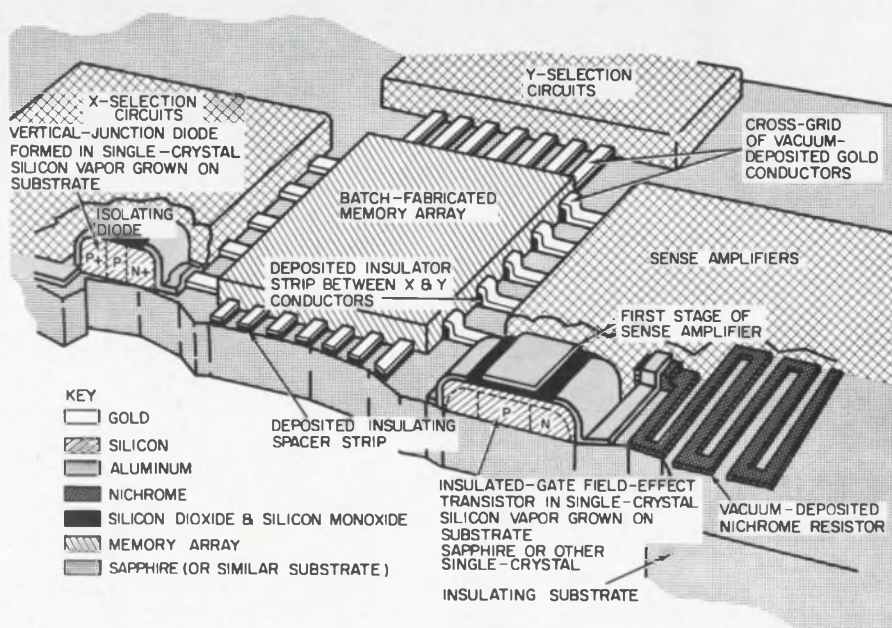

Silicon-on-sapphire integrated electronics concept features 10^{11} ohm-cm isolation between individual thin-film elements. Single crystal device-quality silicon sheets are deposited on sapphire insulating substrate.

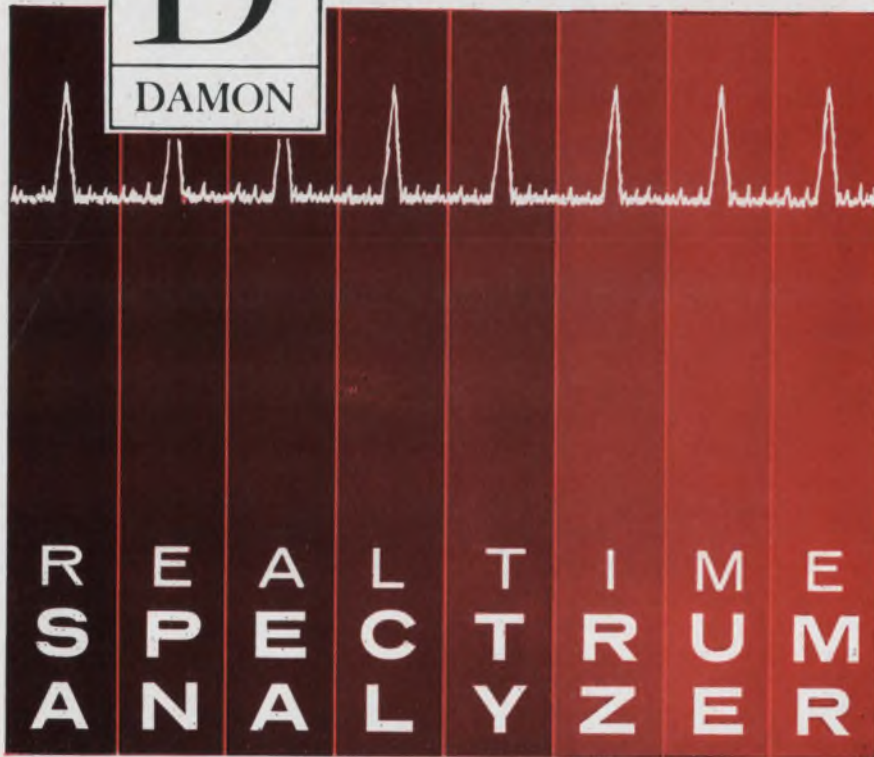

Gaussian or Chebyshev Crystal Filters Solid State Electronic Commutation Uniform Frequency Response

Damon's Multifilter Spectrum Analyzers are adaptive to signal rate, filter time constant or display response. A unique frequency-sharing principle permits optimum utilization of filters for maximum economy. In analysis bands from 100 cps to 10 Mc, multipole crystal filters with bandwidths from 5 cycles to 100 Kc resolve closely spaced signals having large amplitude ratios.

These state-of-the-art Analyzers are illustrative of Damon's capabilities in frequency information retrieval and analysis. Other significant examples include the Telstar Comb Filter and the SPASUR Detection Preselector.

Write for Real Time Multiple Filter
Spectrum Analyzer Brochure.



Spectrum Analyzer
Model 5187A

DAMON ENGINEERING, INC.

240 HIGHLAND AVENUE
NEEDHAM HEIGHTS, MASS. 02194 (617) 449-0800
Speed Inquiry to Advertiser via Collect Night Letter
ON READER-SERVICE CARD CIRCLE 12

NEWS

(IC activities, continued)

Anaheim, Calif., these diodes have:

- Leakage currents < 100 nA.
- Voltage breakdowns > 15 V.
- Forward currents of 0.1-0.5 mA.

Downing, pinch-hitting for Autonetics associate Arnold Miller (the author of the paper), reported: "Silicon-on-sapphire techniques yield circuit functions not now obtainable with conventional microelectronic technologies." He added: "Isolation, limited only by the substrate's conductivity, is superior because sapphire is the best currently available heteroepitaxial substrate for silicon.

"Isolations of 10^{11} ohm/cm between individual thin-film elements is achieved, and this substrate also has excellent thermal properties, thereby allowing for higher power operation than monolithic ICs."

The low capacitance of vertical-junction transistors, typically 0.001 pF, and the relative ease with which these structures can be integrated into microstrip or stripline circuits point the way to SOS microwave ICs. Here the sapphire is used as the dielectric material, with a ground plane on the back side. Unfortunately, low current gain is a problem with these devices: until it is overcome, off-the-shelf low-power, sub-nanosecond, digital ICs will remain just out of reach. But this potential is "more than strong, because of the advantages of batch fabrication* and the SOS concept," Downing suggested. He also explored stable MOS units and complex arrays built with the SOS approach to ICs, and featuring isolations heretofore found exclusively in discrete component design.

Master Dice roll up IC benefits

Further advances in the "Master Dice" (MD) area were reported by two Autonetics project leaders, J. W. (Whit) Slemmons and C. Donald Slaughter. Their development, used for the breadboarding of both analog and digital ICs, was highlighted by low cost, system versatility, minimum implementation time and complex functioning.†

As described by Slemmons, the

*For details on batch fabrication, see ED 1, Jan. 4, 1966, p. 88.

†See ED 14, June 7, 1966, p. 66 for a discussion of a technology advance akin to the Master Dice concept.



Systems application of Master Dice concept is this miniature accelerometer displayed by co-authors Slaught (left) and Slemmons. Autonetics Engineers used the Dice to design the 4-stage differential amplifier and dual trigger in the instrument's electronics.

MD had six npn transistors, 100 k Ω of resistance (available in discrete quantities) and was used with off-the-shelf ICs and a simple thermo-compression bonding machine to build a number of sub-systems.

Representative of the advantages of the MD was a four-stage differential amplifier built in less than half an hour for under \$100. This circuit replaced a transformer and extra gain amplifiers in an accelerometer system (see photo).

Slemmons also showed how the MD could be used to make complementary stages and add precision resistors to ICs. Slaught added: "The cost per circuit drops to \$12 in quantities of 50 or more with the Master Dice approach."

More computers, biophysics soon

The theme of the conference, held July 18-20, was "Microelectronics in Transition." C. Lester Hogan, vice-president and general manager of Motorola Semiconductor Products, Phoenix, Ariz., delivered the keynote address.

Dr. Hogan made a five-year projection for the IC discipline and submitted that "the areas of biochemistry and biophysics and the increased application of computer control and processing to our way of life will occupy the major portion of the electronic spotlight in the next few years." He maintained that "integrated circuits are the keys to these endeavors" and advised engineers to "look forward to an emerging consumer market for ICs and further advances in large-scale-integration activity."

Copies of the proceedings at \$10 each may be secured by purchase orders directed to: 1966 Microelectronics Symposium, Attention Proceedings Sales, P. O. Box 4104, St. Louis, Mo. 63136. ■ ■



basic measuring tools from

**HEWLETT
PACKARD**

hp 203A

Variable-Phase Function Generator

provides reference and variable-phase sine, square waves
range 0.00005 Hz to 60 kHz
distortion less than 0.06%
continuously variable phase shift 0-360°
four simultaneous adjustable outputs 0-30 v peak-to-peak

Use it for:

phase shift measurements
low-distortion signal generation
vibration studies
frequency response measurements
servo applications
medical research
geophysical problems
subsonic, audio testing

Here is a solid-state function generator offering simultaneous sine and square-wave signals 0.005 Hz to 60 kHz in 7 overlapping bands (two optional bands available, down to 0.00005 Hz). Total harmonic distortion hum and noise (0.06%) is less than 64 db below fundamental.

Accurate 1% frequency dial calibration with 180 dial division, vernier drive for precise adjustment. All four floating output circuits have individual 40 db continuously adjustable attenuators. One each of the sine and square-wave outputs

contain the 0-360° phase shifter. A front-panel calibration provision permits easy line-frequency calibration of the oscillator to the environment in which it's being used. Price, \$1200.

For a demonstration of the unique 203A call your Hewlett-Packard field engineer. Or write for complete specifications to Hewlett-Packard, Palo Alto, California 94304, Tel. (415) 326-7000; Europe: 54 Route des Acacias, Geneva.

*Data subject to change without notice.
 Price f.o.b. factory.*

HEWLETT  **PACKARD**
An extra measure of quality

1186



ON READER-SERVICE CARD CIRCLE 13

Reliability integrates with design

Educators and industry join forces to prepare engineers to design with an eye on reliability.

Maria Dekany
Technical Editor

The days of the special reliability engineer are numbered, says R. A. Brenan, of the Hughes Aircraft Co., Microwave Tube Div., Los Angeles.

His place is likely to be taken by design engineers who are also experts in reliability, he says. They will blend design and reliability without leaning on others for guidance. The reliability specialist, according to Brenan, will end up in the ranks of management, where he will check to see that the designer has done a good, complete job.

Brenan, now head of a group of reliability engineers at Hughes, is not alone in his thinking. Educators in engineering schools are calling for a broadening of the curricula to teach all prospective engineers the basic concepts of reliability.

The present role of the reliability engineer, Brenan notes, is that of a consultant to the designer. The designer performs the reliability analysis with the aid of the reliability engineer as the design progresses from the idea stage to the manufacturing.

"Fundamental to any reliability program," he says, "is the thorough knowledge of all possible failure modes during the initial design. The ultimate reliability of the system is usually determined by decisions made at the initial design phase. Changes in the later stages of the development program cost

money and time and result in a patch-up job."

Teach reliability to engineers

Many educators are appalled by engineers' general lack of knowledge and appreciation of reliability.

"There is not enough reliability in engineering education," says Cdr. Donald M. Layton, Assistant Professor of Aeronautics, U.S. Naval Postgraduate School, Monterey, Calif. He recommends that all engineering schools should offer reliability training. Not only would this relieve the reliability engineer from the time-consuming task of explaining the ways and hows to the designer, says Layton, but the knowledge of the principles of reliability is as important to product success as Ohm's Law or beam theory.

To achieve the desired knowledge, it is necessary to teach not only the underlying principles but also the ultimate purpose of reliability, adds Layton.

Others share Layton's opinions. Dr. Paul H. Zorgen, of Vitro Laboratories and American University, Washington, D. C., sums up the challenges and objectives that must be met to satisfy the demands for reliability as follows:

- Qualifying standards must be set up for reliability personnel.
- Educational opportunities must be created for qualified personnel.
- The colleges must integrate reliability and maintainability into

the curricula.

Dr. Zorgen's recommendations are supported by Dr. Dimitri Kececioglu, Professor of Aerospace and Mechanical Engineering, University of Arizona, Tucson: "From an estimate of the present need for upwards of 5000 qualified reliability engineers, efforts in the educating and training field should certainly be substantially boosted." Professional societies, he adds, should increase the number of tutorial sessions at reliability conferences. He criticizes the lack of centralization and co-ordination of information on reliability engineering and recommends establishment of a separate society for this end.

Other recommendations, aimed to help reliability studies, include the setting up of a computerized information center on qualified parts. However, the general feeling among engineers is that companies would be reluctant to give information on their parts, qualified in-house, either to avoid unfavorable comparison or to protect proprietary data.

Most educators agree that reliability engineering should be an integral part of the basic undergraduate training of all design engineers. However, there are some dissenting voices. Dr. Kececioglu feels that, in view of the depth and breadth of the courses a qualified reliability engineer must have, a separate curriculum and degree may be justified. Also, he says that the present trends toward specialization and

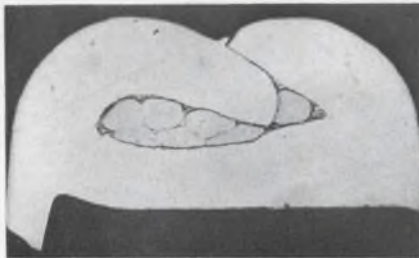

(a)



(b)

1. The degree of crimp of taper pins must be closely controlled to provide reliable wire-to-taper pin connection. Overcrimping (a) deforms the strands; undercrimping (b) allows the movement of the wire relative to the taper pin.

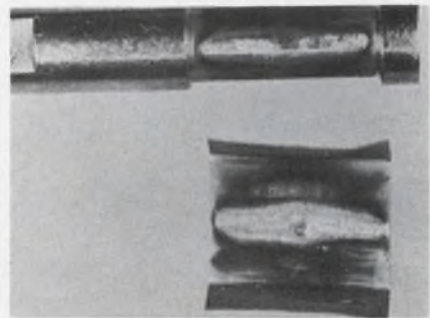

2. Salts from the plating solutions are trapped in the contact area, causing increased contact resistance that attenuates the current pulses and so introduces data errors.

Revolution in Resolution: 0.032% in a TRIMPOT® Potentiometer Package!

Seven inches of wirewound resistance element in a package just 5/16" square and one inch long—that's our new Model 3070! With resolution seven to ten times better than you normally get from wirewound units this small, Model 3070 TRIMPOT potentiometer gives you premium adjustability at no premium in space, weight, or temperature coefficient. Settings you make with this unit stay set, too; the exclusive rotor/wiper design, based on that of our precision potentiometers, is outstandingly stable under shock and vibration.

Model 3070 also offers slip-clutch action, the indestructible SILVERWELD® termination, and resistance wire with twice the normal cross-section area. Units are available immediately in a broad choice of terminal types and mounting styles, including two panel-mount versions.

Write today for free technical data.

Resolution: 0.032% to 0.15%
 Standard resistances: 75 Ω to 50K
 Power rating at 70°C: 1.5W
 Max. operating temp.: 175°C
 Temp. Coeff. (entire unit): 70ppm/°C
 Humidity: Meets MIL-STD-202B, Method 106 (Cycling)
 Size: 5/16" x 3/16" x 1 1/16"

If it's TRIMPOT®, It's BOURNS

TRIMPOT is a registered trademark of Bourns, Inc.

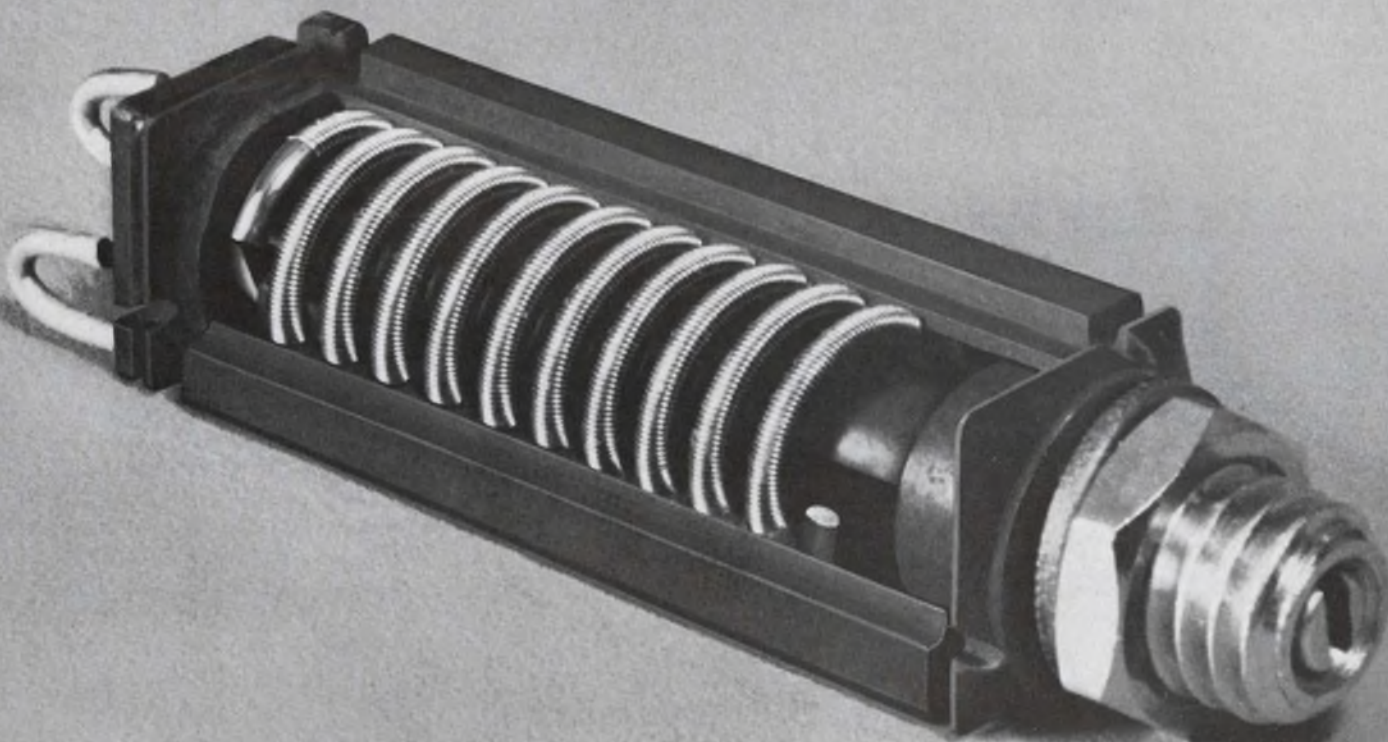
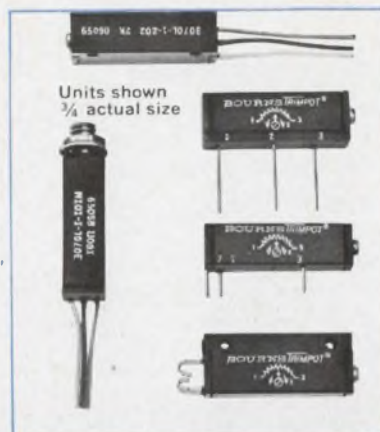

(Reliability, continued)

specialized degrees lend further support to his recommendation.

Industry takes the lead

These comments from educators indicate that there will be a change in the future in the education of engineering students. The fruits of such a change, however, may not be available for several years. Till then, industry has to make shift with the reliability problem and the lack of qualified reliability engineers.

There is plenty of evidence that industry is well aware of the need for a systematic approach to reliability at all stages of the design.

The first instance in which a full-scale reliability program was applied to an aircraft, for example, was in the design of the XB-70 developed by North American Aviation, Inc.

According to William H. Hatton, Principal Scientist, during the conceptual design stages, alternative system concepts were analyzed from the reliability standpoint to



3. Fractured pin of a male connector on a modular printed circuit assembly may result from excess stress during the forming operation.



4. Insufficient "wicking" of the solder from the bottom to the top of the wiring board or fracture of the joint due to movement of the lead before solidification are perpetual sources of intermittency.

provide design trade-offs. During the manufacturing and testing phases, success and failure data were used to monitor the demonstrated reliability. The procedure for conducting a quantitative reliability analysis, says Hatton, involved four steps:

- Defining success and failure for the system.
- Defining the failure modes of the system.
- Determining the failure rates for the components and equipment.
- Deriving and solving the mathematical reliability model.

More reliable components

The great improvement in the reliability of traveling-wave amplifiers, making possible their use in space communication equipment, is the result of close cooperation between designers and reliability specialists at Hughes Microwave Tube Div., according to Brenan. Reliability is designed into the TWT through failure-mode analysis of all parts. A failure-mode chart has been drawn up that helps pinpoint areas where system requirements demand components to operate near their maximum, and redundancy may be needed. The program resulted in TWTs that combine ruggedness, minimum weight and cost with a failure-free life of more than 800,000 hours, says Brenan.

Computers are a great help in the analysis of components. At Bell Helicopter Co., Fort Worth, Tex., reliability data on the Model UH-1D helicopter were fed into a computer. The reliability analysis program uses a storage tape that keeps tab on the number of times that

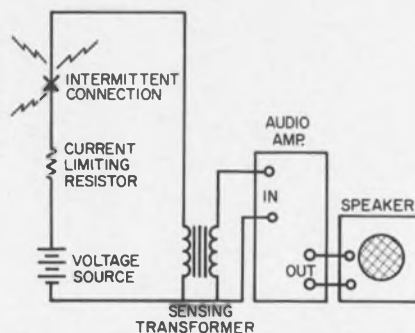

5. Elementary circuit detects intermittent connections. An insulated rod is used to tap the connection. The resultant stress on the intermittent part modulates the loop current through changes in the resistance. The current variation is transferred to the amplifier and appears as an audio signal.

each component is used and the number of times each fails, explains George E. Knudsen, Supervisor, Reliability Data Group. The program then computes the failure rate, the mean time between failures and the reliability values. Provisions in the program and the data files, points out Knudsen, permit the analysis of primary failures, selected time intervals and other limitations. The analyses identify the components that have a record of frequent failure and the data listings present the failure mode of these components, he says.

Better testing methods

New testing techniques for reliability are emerging as a result of designers' increased awareness of reliability.

The detection and location of intermittent electrical connectors in digital monolithic circuits is one area where rapid progress is being made, according to Paul H. Welshinger, Manager, Test and Evaluation Dept., UNIVAC, St. Paul, Minn. His department devised test setups for digital logic modules and for logic modules using monolithic circuits. The most frequent sources of intermittent connections are loosened welded contacts on stitch boards; over- or undercrimped taper pins (Fig. 1); trapping of salts from the plating solution between the male and female pin-type connectors causing the contact resistance to increase beyond the accepted limits (Fig. 2); fractured connector pins (Fig. 3); and marginal solder joints that cause neither a short nor an open circuit but attenuate the pulse current (Fig. 4).

Resistance changes due to these intermittent conditions, Welshinger points out, can easily be observed with the elementary circuit of Fig. 5. As a stress is applied to the intermittent connection, the loop bias current will be modulated by the change in resistance. The technique has only two restrictions: (1) the dc bias current must flow through the internal loops, and (2) the amplifying system must have sufficient gain to allow detection of current variations. Background noise limits the sensitivity of the system, he warns, and shielding of the transformer and wiring to the amplifier is necessary. ■ ■

IF YOU CAN'T AFFORD TO DESIGN WITH FAIRCHILD DT μ L, YOU CAN'T AFFORD TO DESIGN.

Industrial IC's at about \$1.00 per Function: Fairchild Diode-Transistor Micrologic[®] Integrated Circuits are now available at prices you can afford. Take your pick of dual in-line packaging for production line use (at about \$1.00 per function at distributor quantities) or Mil spec rated 1/4" x 1/4" Cerpaks. Either way you get high performance monolithic logic elements for a wide variety of applications.

Complete, versatile line: Fairchild DT μ L circuits offer unique design features: A complete line which includes both binary and gate elements, completely compatible with one another. /

Gates may be wire OR'ed at the output. / Expander inputs can be used with 930, 932, and 944 elements. / Low input current leakage. / High noise immunity.

We can deliver: Fairchild DT μ L circuits are available now, in production quantities, on distributors' shelves. You can get immediate delivery on virtually any number. Don't take our word for it. Call any Fairchild Distributor, now. Or, ask for our complete data sheets.

MICROLOGIC: A FAIRCHILD TRADEMARK

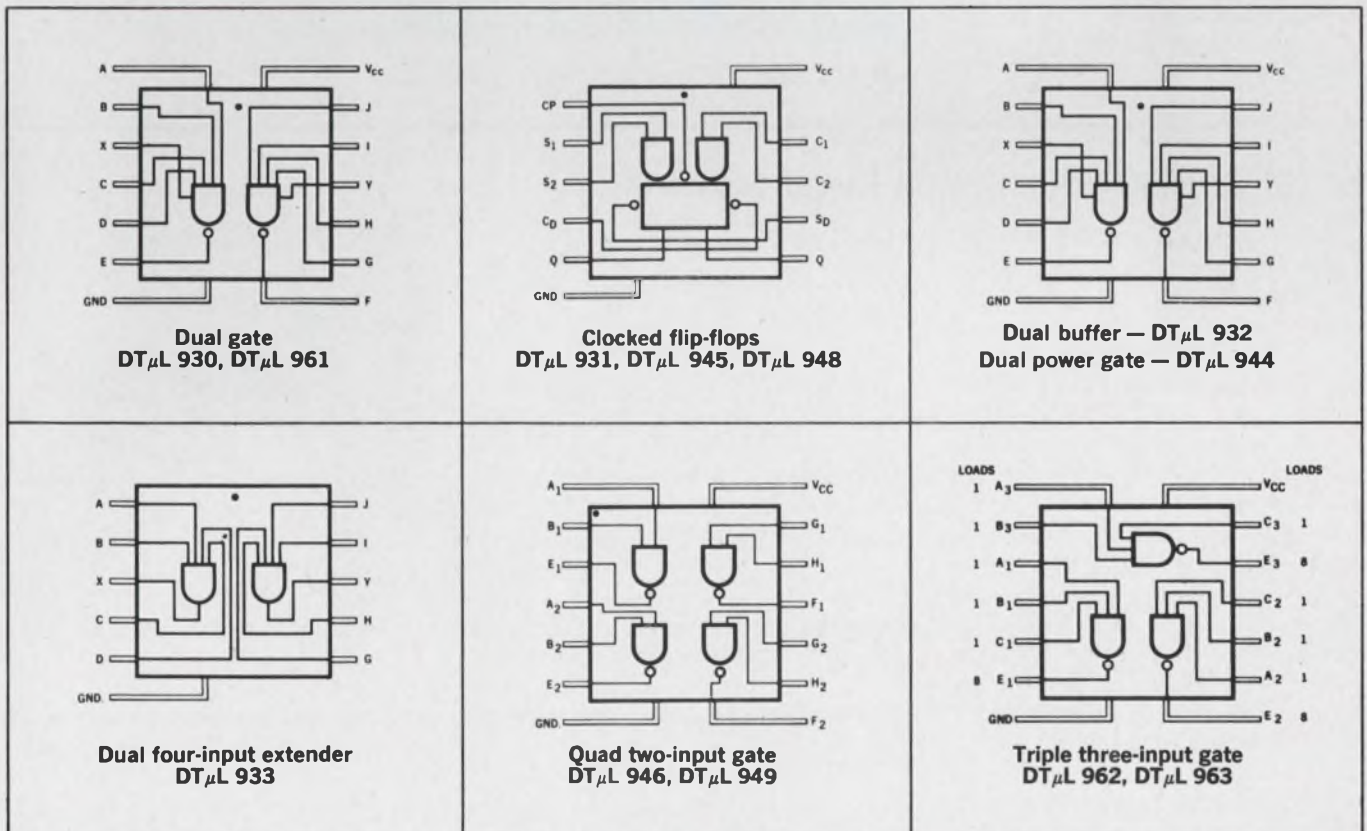

Computer consoles roll into office

When a scientist at Rand headquarters needs to use a computer, he can quickly roll a console into his office and plug it into a central computer.

Two hundred offices at the corporation's headquarters in Santa Monica, Calif., are equipped with special plugs (see photo) that carry ten conductors to the central computer. A time-sharing system allows up to 30 scientists to use the computer at once; yet the chores are executed with such dispatch that each user enjoys apparently unencumbered use of the service.

The scientist communicates with the computer by using a special language, called JOSS, which he can learn in less than an hour. JOSS stands for Johnniac Open Shop System.

The computer holds operating programs and data in its memory; these are not lost even if the console is unplugged. To retrieve this information, the scientist need only plug a console into any JOSS outlet and ask for it. The console is merely a slightly modified electric typewriter. At no time are the services of a trained computer programmer needed. ■ ■

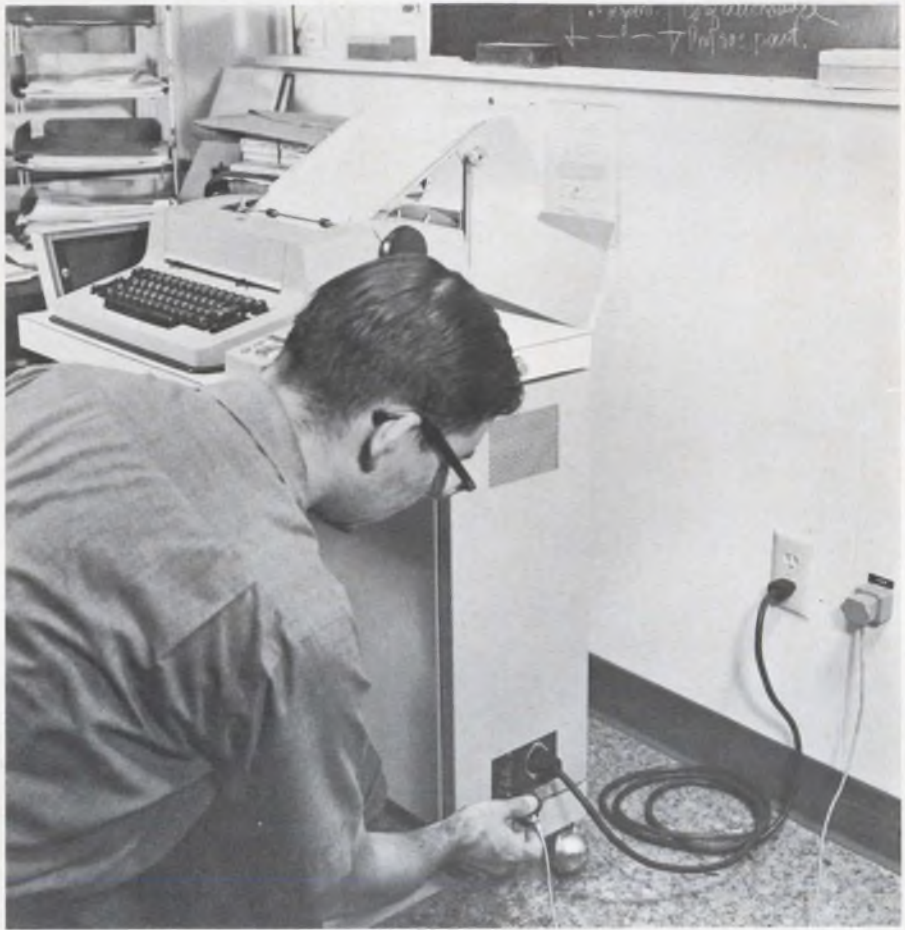

Rolling console plugs into computer jack.

Small transmitter sends lunar pictures

When a project Apollo astronaut leaves the Lunar Excursion Module and roams across the moon's surface, he will transmit pictures with his hand-held TV camera back to the LEM without the use of an umbilical hook-up. This transmission will be accomplished with a subminiature transmitter designed for use with the TV camera.

Built by the Microwave Division of Sanders Associates, the transmitter weighs only 3 ounces and delivers an output of 1/4 watt. It operates at a frequency of 279 MHz.

Power for both the transmitter and the TV camera is supplied by a dry-charge battery pack, which has an output of 18 volts at 330 ma, and a rated life of six hours. The transmitter is a four-stage unit, consisting of a crystal-controlled oscillator,

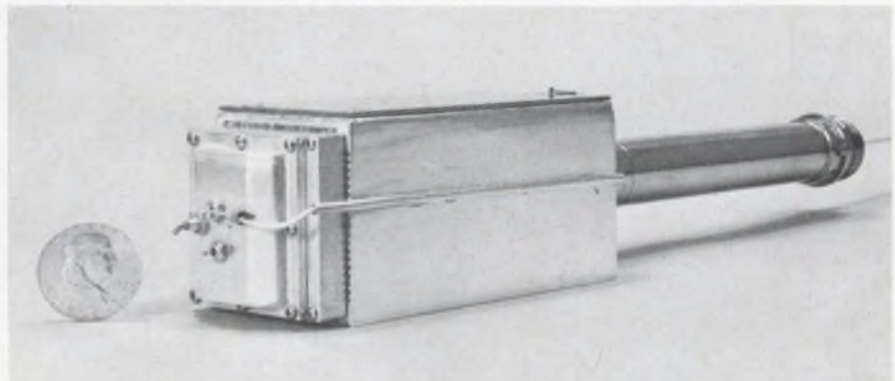

Subminiature transmitter for hand-held TV camera measures 2-1/8 by 2-1/4 by 3/4 inches, and weighs 3 ounces.

two multiplier stages and a final power amplifier.

Although the basic unit was designed for cw operation it can easily be supplied with a built-in amplitude modulator capable of 90 per

cent modulation, linear within 2 per cent from 0 to 500 kHz. A modulation input of 0.4 volt, peak-to-peak, is then required for full modulation with a peak output power of 70 milliwatts. ■ ■

New Philbrick Battery - Powered Instrument - Grade Operational Amplifiers

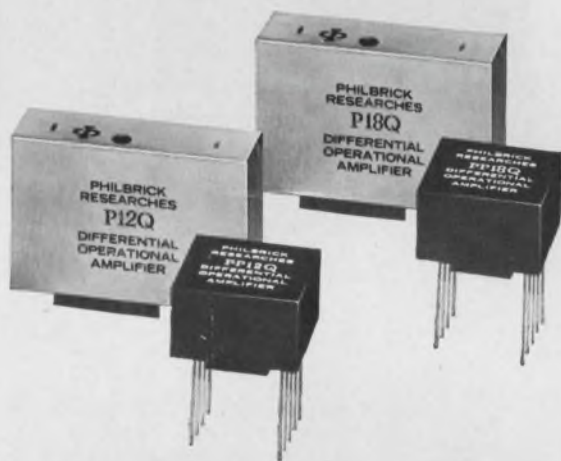

... 2000-5000 hours on two 1.35 V mercury cells

Here are two high-performance amplifier families specifically designed for battery-powered, portable (or non-portable) instrumentation. They operate from a pair of cells: mercury (1.35 V); carbon-zinc penlight (1.5 V); or silver zinc rechargeable (1.5 V). Despite their low voltage and current requirements (2-5 mw quiescent), both designs are rated at a maximum output voltage of ± 1.0 V with a 500Ω load (± 2 mA). Operating life on a pair of standard #502 mercury cells is 2,000-5,000 hours depending on the application. Both amplifiers are available in either a $2\frac{1}{4}'' \times 1\frac{1}{2}'' \times \frac{3}{4}''$ plug-in "P" case or epoxy-molded "PP" modules, $1\frac{1}{8}'' \times 1\frac{1}{8}'' \times \frac{5}{8}''$. The P12Q and PP12Q units, which have FET's in the input circuit, are ideal for high impedance applications requiring very low current offset (I_o about 100 pA), and the P18Q and PP18Q for applications in which common-mode error is significant, and voltage offset must be minimized. For more information, call your nearest Philbrick engineering representative or Philbrick Researches, Inc., 46G Allied Drive, Route 128, Dedham, Massachusetts 02026.

ENGINEERING REPRESENTATIVES — Ala.: Huntsville (205) 536-8393, Mobile (205) 954-9298; Ariz.: Phoenix (602) 265-3629; Cal.: Mountain View (415) 969-9770, Van Nuys (213) 782-1532; Colo.: Denver (303) 733-3701; Conn.: West Hartford (203) 233-5503, Greenwich (203) 661-5140; Fla.: Ft. Lauderdale (305) 564-8000, Orlando (305) 425-5505; Ill.: Chicago (312) 676-1100, (312) 676-1101; Ind.: Indianapolis (317) 356-4249; La.: New Orleans (504) 242-5575; Md.: Baltimore (301) 727-1999; Mass.: Wakefield (617) 245-5100; Mich.: Detroit (313) 838-7324; Minn.: Minneapolis (612) 545-4481; Mo.: St. Louis (314) 741-3779; N.M.: Albuquerque (505) 268-3941; N.Y.: Buffalo (716) 835-6186, DeWitt (315) 446-0220, Valley Stream (516) 561-7791; N.C.: Winston-Salem (919) 725-5384, (919) 725-5385; Ohio: Dayton (513) 298-9964, Westlake (216) 871-8000; Okla.: Tulsa (918) 627-6199; Pa.: Philadelphia (215) 277-0559, Pittsburgh (412) 371-1231; Tex.: Dallas (214) 526-8316, Houston (713) 781-1441; Utah: Salt Lake City (801) 466-4924; Va.: Alexandria (703) 836-1800; Wash.: Seattle (206) 723-3320.

EXPORT: N. Y.: New York (212) 246-2133.

CANADA: Quebec: Montreal (514) 482-9750, Ontario: Toronto (416) 789-4325.

ELECTRONIC ANALOG COMPUTING EQUIPMENT for MODELLING, MEASURING, MANIPULATING and MUCH ELSE



PHILBRICK

ON READER-SERVICE CARD CIRCLE 15



SWITCH TO THE SWITCH WITH THE MOST STABLE TRIGGERING VOLTAGE

Try a new G-E Silicon Unilateral or Silicon Bilateral Switch. SUS's and SBS's are kind of like 4-layer diodes except that they are actually planar integrated circuits rather than "stacked" structure devices.

How do they differ? The SUS switches on in only one direction whereas the SBS—actually two SUS's integrated on the same pellet—switches in either polarity . . . and with exceptionally good symmetry. Both feature triggering voltages in the 6- to 10-volt range that are virtually unaffected by temperature changes.

SUS's and SBS's are excellent devices for triggering SCR's and bidirectional thyristors (Triac's). Light dimmer and speed control circuits are naturals for them, as are simple ring counters that can be designed to count up to 50 kHz. **Circle Number 811** on the Reader's Service Card if you'd like more product and application facts.

WHAT'S THIS? A 40¢ 1 POWER TRANSISTOR?



Actual size G-E D27 device

That's just what you get when you specify new G-E 2N4054 through 2N4057 devices . . . from 150 to 300 volts in G.E.'s newest compact, silicon economy package for prices as low as 40 to 59¢ (in lots of 100,000 or more).

Looking for industrial uses? Try these new NPN transistors as high-voltage differential and operational amplifiers . . . or as Nixie† Tube drivers . . . or as high-voltage power supplies. Operating temperature ranges from -55 to +150 C. Beta is between 30 and 90 at 50 milliamperes, 10 volts. And the new transistors can amplify up to 25 Megahertz.

What about commercial applica-

† Trademark of Burroughs Corporation.

Over 400 pages on the industry's broadest SCR line

Everyone needs a standard reference manual. And this is the one when you're looking for facts about Silicon Controlled Rectifiers. Already G.E.'s well-known SCR Manual is in its Third Edition, and over half its content is previously unpublished application information.

Use the G-E SCR Manual to look up useful circuit and application information. Special related devices are covered in detail, too . . . devices such as G.E.'s light-activated SCR. And there's a special chapter on the reliability aspects of SCR's.

If you haven't already gotten one for yourself, order your copy now. The price is just \$2.00. **Circle Number 813** on the Reader's Service Card.

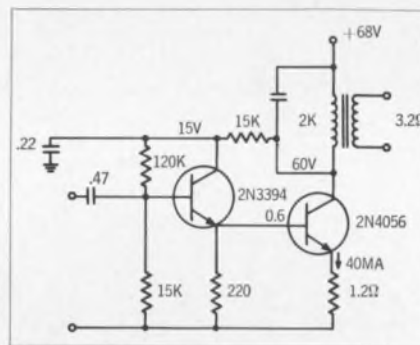

3/4 watt output (100 mv input) TV audio circuit using new 2N4056 transistor

tions? Look how easy it would be to mount this package in a printed circuit board! No extra hand-soldered leads to waste assembly time. You can use them to deliver 1 watt to the loudspeaker of TV receiver Class A audio output stages, phonographs, tape recorders, intercoms or radios. **Circle Number 812.**

G-E 2N4054 Series Minimum Electrical Ratings

	2N-4054	2N-4055	2N-4056	2N-4057
V _{CE} (I _C = 10ma) volts	300	300	240	180
V _{CE0} (I _C = 1.0ma) volts	300	250	200	150
V _{BE0} (I _E = 100µa) volts	7	7	7	7
I _C ma	100	100	100	200
P _T (70 C case temperature) watts*	4	4	4	4
h _{FE} (I _C = 50ma, V _{CE} = 10v)†	30	30	30	30
V _{CE(SAT)} (I _E = 2.5ma) volts	2.5	2.5	2.5	2.5

* Derate 50 mw/°C increase in case temperature above 70 C.
† Pulsed conditions at 2% duty cycle 300 µsec pulse width.

More information on all G-E semiconductor products—one more example of General Electric's total electronic capability—can be obtained by calling your G-E engineer/salesman or distributor. Or write to Section 220-41, General Electric Company, Schenectady, N. Y. In Canada: Canadian General Electric, 189 Dufferin St., Toronto, Ont. Export: Electronic Component Sales, IGE Export Division, 159 Madison Ave., New York, New York.



Washington Report

S. DAVID PURSGLOVE,
WASHINGTON EDITOR

U.S. and industry join hands on auto safety

The automobile will continue to hold Washington's attention long after the new safety-devices law has gone into effect and the traffic safety R&D program has settled down to routine. At least two agencies—the Federal Communications Commission and the Bureau of Public Roads—anticipate roles in General Motors' electronic safety aids development project. And agencies and committees ranging from the Commerce Department and National Science Foundation to the House Committee on Science and Astronautics and the Senate Public Works Committee are already laying the groundwork for an expected federally sponsored effort to revive the electric automobile as an air-pollution abatement measure.

General Motors' project—Driver Aid, Information and Routing System (DAIR)—will soon be tested on Detroit's John C. Lodge Freeway. Testing the system, which resembles the Ford-Philco roadside warning system in purpose but not in operation, will require 100 cars equipped with Citizens' Band transceivers.

The GM Research Laboratories at the company's Warren, Mich., Technical Center have developed DAIR over the past nine years (see ED 18, Aug. 2, p. 26). It has five main parts, each independent of the other, which may be added one at a time to help spread the motorist's costs. The first test will involve erection of highway aid and information centers to radio advice to stranded drivers and about accidents. The centers will also give route information as it is requested over the standard mobile transceivers. This part of the DAIR system would be the first to be adopted by any state highway commission and used by the regular driver.

The other parts of the system are more sophisticated and involve roadside tape recorders and buried magnets. In the event of an accident obstructing an expressway, for example, "traffic central" would activate roadside tapes well ahead of the site of the accident. The car's receiver would be activated

by roadside magnets and pick up the taped warning of an accident ahead. The Ford-Philco system (see ELECTRONIC DESIGN, Aug. 30, 1965, p. 6 ff.) would do the same thing but the tape, prerecorded with dozens of messages, would be carried in the car's trunk and set off by a coded signal to play the proper message through the car radio.

GM plans to petition the FCC to set aside a large portion of the Citizens' Band for DAIR use. The package has been demonstrated at the GM proving ground. Now Commerce Department Bureau of Public Road officials are anxious to watch the first phase tested on the Lodge Freeway. They expect to be inundated by state authorities' requests for evaluation. They also expect the states and Congress to call on them for a comparison of the GM system vs the Ford system. Observers believe that Congress will soon require the Secretary of Commerce or Secretary of Transportation to select one or other system as an official U.S. standard. A Maryland highway official summed up most authorities' thinking when he said that standards would have to be set soon to prevent highway communications and electronic safety methods from becoming a hodgepodge. There is concern lest private communications firms or each state set up separate systems that would be incompatible with each other.

The electric car resurges

The rebirth of interest in electric-powered automobiles (see ED 13, May 24, 1966, p. 17 ff.) is more than just industry chatter. The House Science and Astronautics committee and a retiring Federal Power Commissioner have both recommended that electric cars be developed as a partial answer to the air pollution problem. Now the Senate Public Works Committee has made a strong plea for electric cars and electrified mass transportation. The Committee, in a report on amendments to the Clean Air Act, pointed to the

interrelationship between urban planning and air pollution caused by internal combustion engines. It called on the Administration to form an interdepartmental task force "to investigate means of reducing air pollution by use of new methods of transportation not involving the internal combustion engine."

The Committee declared: "A variety of projects deserve more detailed scrutiny and study. Electrification of mass transit, use of battery-operated delivery vehicles and autos, and prospects for fuel cells to run individual passenger cars—all suggest new research possibilities. The Federal government should ensure that research, development and demonstration work in this area is carried on at maximum levels consistent with orderly progress."

It recorded that 15 Federal agencies were now financing no less than 86 projects in battery research. It also noted that the Electricity Council of Great Britain predicts that within 10 years one million battery-driven cars will be on the U.K.'s roads.

Accident sensing system made public

The government has described the accident sensing and surveillance system developed for the Bureau of Public Roads at Cornell Aeronautical Laboratory. It can record on video tape the events leading up to and occurring in an automobile collision at a city intersection. It consists of two almost independent subsystems. One is a detection-discrimination system, which identifies sounds associated with car crashes while disregarding other sounds common to city streets. The other is a surveillance-storage system, consisting of a pair of continuously operating, narrow-bandwidth television systems and two magnetic tape units. The video signals are continuously recorded on one tape loop. When a "detect" signal is received from the detection-discrimination system, the information is read from the tape loop and re-recorded on a permanent storage tape for later analysis. The report

is available from the Commerce Department's Clearinghouse, Springfield, Va. 22151, at \$3.00, or 75¢ on microfiche. It is No. PB-170 602, "Accident Sensing and Surveillance System."

Another Clearinghouse report dealing with the broadening role of electronics in auto safety is "Surveillance of Accident Locations by Electronic Data Processing Methods" (PB-169 821/SZZ). The 68-page report, priced at \$3.00 (75¢ in microfiche), describes the California Highway Division's use of EDP to identify, rate and analyze problem locations.

One of the most widely awaited reports, and one that will likely settle many arguments over whether modern technology can help to speed emergency aid to an accident scene faster than patrols and telephoned reports from motorists, is PB-169 858/RZZ, "Effect of Television Surveillance on Police Response Time to an Urban Freeway Incident" (\$2.00, 50¢ in microfiche). In a nutshell, the answer is "yes."

The test was made by the National Proving Ground for Freeway Surveillance Control and Electronic Traffic Aids and was supported by 12 states, the city of Detroit and Wayne County, Mich. Surveillance by 14 TV cameras covered 96 per cent of a three-mile section of the Lodge Freeway and resulted in an average saving of 2-1/2 minutes in the police or wrecker's response time to an accident.

Satellites for auto safety?

Official comment by the Commerce Department NASA and Comsat on a recent statement by Henry Ford, 2nd boils down to: "We don't know what he is talking about, but whatever it is, it may not be a bad idea." "It" was the Ford Motor Company board chairman's statement that he would soon present to the government a scheme for a nationwide traffic control system using satellite reconnaissance. Ford, in a New Orleans speech, admitted that it may seem "fantastic" but added that "we believe such a system will be technically feasible and economically sound" (see ED 18, Aug. 2, 1966, p. 13).

The only demurrer came from a Commerce Department spokesman who said: "I think GM's scheme to take attention away from the auto safety bill—their radio gimmicks—makes more public relations sense than Mr. Ford's satellite; those car makers have been trying to figure out how to use satellites for advertising since 1958."

"When we use A-B hot molded resistors instead of some other make, it's one less component we have to worry about"

Digital Equipment Corporation



FLIP CHIP T.M. Modules—The Digital Equipment Corporation trademark for a new kind of digital system module uses Allen-Bradley hot molded resistors exclusively.



Digital Equipment Corporation's PDP-8 programmed data processor, in which these modules are used, is a compact general purpose digital computer with a high speed, random-access, magnetic-core memory for engineering, scientific, and educational applications.

■ Allen-Bradley hot molded resistors have established such a consistently superior performance record over the years that Digital Equipment Corporation uses them exclusively in their computers—with no substitutes permitted under any circumstances!

While Allen-Bradley quality is the number one reason for this standardization, Digital reports that *excellent service* from Allen-Bradley is an advantage of vital importance to them, too. For example: "Recent expansion of FLIP CHIP production to meet the demand for PDP-7 and PDP-8 computers quadrupled our component needs. With Allen-Bradley's help there wasn't a single hitch in the production speedup."

The unvarying quality of Allen-Bradley resistors—million after million, year in and year out—results from an *exclusive* hot molding process. The precision automatic



HOT MOLDED FIXED RESISTORS are available in all standard EIA and MIL-R-11 resistance values and tolerances, and can usually also be furnished in values above and below standard limits. Shown actual size.

equipment developed and used only by Allen-Bradley produces such uniform properties that long term resistor performance can be accurately predicted. Please note, Allen-Bradley hot molded resistors have never been known to fail catastrophically in service.

For complete specifications on Allen-Bradley hot molded fixed and variable resistors, please write for Technical Bulletin 5050: Allen-Bradley Co., 222 W. Greenfield Ave., Milwaukee, Wis. 53204. In Canada: Allen-Bradley Canada Limited. Export Office: 630 Third Ave., New York, N.Y., U.S.A. 10017.

65-08-6E



ALLEN-BRADLEY
QUALITY ELECTRONIC COMPONENTS

An Allen-Bradley announcement of importance to motor designers

The new MO6-C ferrite magnet having 30% higher intrinsic coercive force

■ The new Allen-Bradley MO6-C ceramic permanent magnets provide at least 30% increase in the highest previously available intrinsic coercive force—obtainable with A-B's MO5-C material. This advance is achieved with the same high residual flux density.

Designers of permanent magnet motors have a choice of these advantages—30% higher resistance to demagnetization, or 30% increase in motor output, or 30% increase in cold temperature protection. In fact, where the higher coercive force is not required, the designer can give himself a 30% reduction in magnet size.

This new Allen-Bradley MO6-C material opens the door to such motor designs where permanent magnets heretofore were not practical, namely for motors used in many portable tools and appliances. Like with the MO5-C material, these new MO6-C magnets are radially oriented, and are available in virtually all sizes and shapes currently being produced in segments for motors from 3/4" diameter to 10 hp. While MO5-C magnets will continue to satisfy most needs, MO6-C enables designers to satisfy more exacting motor design requirements because of its unusually high intrinsic coercive force.

Allen-Bradley application engineers will be pleased to help you obtain maximum economy in your motor design through optimizing magnet performance. Please let us hear from you. Allen-Bradley Co., 222 West Greenfield Avenue, Milwaukee, Wisconsin 53204. In Canada: Allen-Bradley Canada Limited. Export Office: 630 Third Ave., New York, N.Y., U.S.A. 10017.

TYPE MO6-C CERAMIC PERMANENT MAGNETS

Typical Characteristics

—stated values have been determined at 25°C.

Property	Unit	Nominal Value
Residual Induction (B_r)	Gauss	3300
Coercive Force (H_c)	Oersteds	2800
Intrinsic Coercive Force (H_{ci})	Oersteds	3100
Peak Energy Product ($B_d H_d$ max)	Gauss-Oersteds	2.5×10^6
Reversible Permeability	—	1.09
Curie Temperature	+°C	450
Temperature Coefficient of Flux Density at B_r	%/°C	-0.20
Specific Gravity	—	4.9
Weight per Cu. In.	Lbs.	0.177

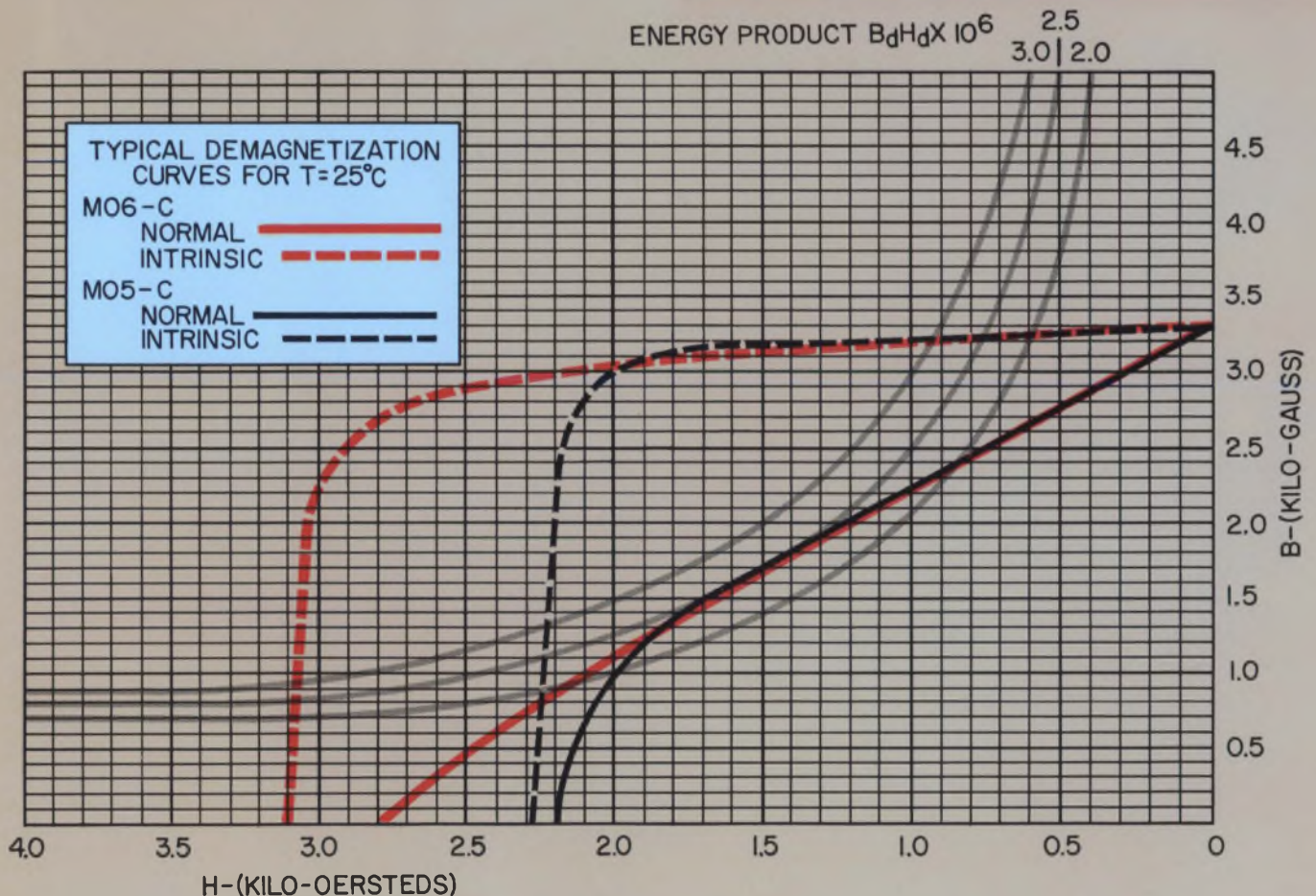

ALLEN-BRADLEY

QUALITY MOTOR CONTROL

QUALITY ELECTRONIC COMPONENTS

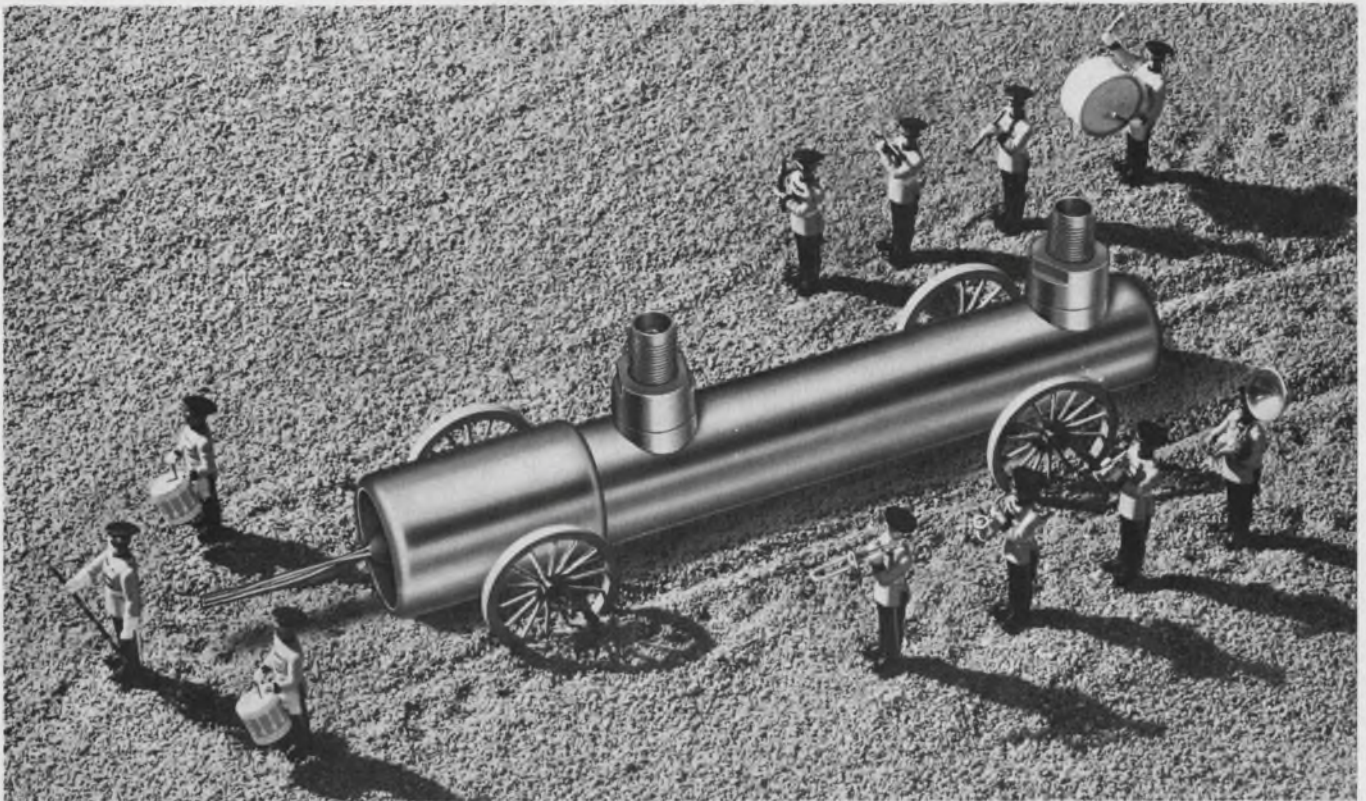

Jump on the broad-band wagon

with the new **ES** traveling-wave tube.

With the introduction of their new, T30AID ultra-broad-band traveling-wave amplifier, Electronic Specialty Co. now covers the microwave spectrum from S to X Band with one TWT. Developed by the Tucor Section of Electronic Specialty's Connecticut Division, the new tube can be used in place of three separate tubes and is designed for high performance airborne or surface systems.

Important specifications for the T30AID include a frequency range

from 2.5 to 11.0 GHz; minimum gain of 10.0 db. with a gain spread of less than 8 db.; and a maximum length of 7 inches by 1 $\frac{3}{8}$ inches in diameter and a weight of 14 ounces. ES traveling-wave amplifiers are rugged, metal-ceramic constructed and fulfill the requirements of MIL-E-5400, MIL-T-5422, and MIL-E-16400. If you're interested in the whole story, and it's an impressive one, jump on the broad-band wagon and write for complete details and the T30AID technical bulletin.

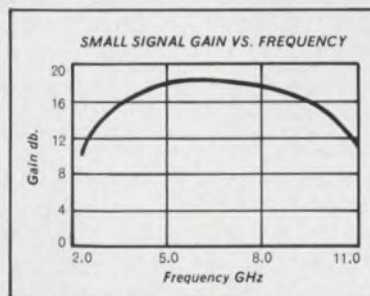

ELECTRONIC SPECIALTY CO. 4561 Colorado Blvd., Los Angeles, California

*Los Angeles, Calif. / Anniston, Ala. / Ft. Madison, Ia. / Harrisonburg, Va. / Hurst, Tex. / Pomona, Calif. / Portland, Ore. / Thomaston, Conn. / Toronto, Ont.
In Europe contact Elektro-Metall, Dusseldorf, Germany.*

Speed Inquiry to Advertiser via Collect Night Letter
ON READER-SERVICE CARD CIRCLE 16

New theme: music on a cathode-ray tube

Graphic console and light-pen give computer composer a new form of score pad and pencil.

Roger Kenneth Field
News Editor

There may come a time when a small boy will pick up his baseball glove and bat and go home to practice music on his computer.

At least so says Dr. Max Mathews, director of behavioral research at Bell Laboratories, Murray Hill, N.J. He has developed an easy system for composing and playing music electronically.

For a number of years engineers

have been able to summon music from the cores of a computer. But they had to use an enormous number of punched cards to do it, and it helped if the composer was also a programmer.

Now a composer can make a few strokes across the face of a cathode-ray tube with a light-pen and type a few simple directions on a keyboard. After a brief computation, the computer plays his new composition. The strokes of the light-pen describe the amplitude, frequency

and duration of each note (see illustrations on this page).

Dr. Mathews' notation system gives the composer enormous flexibility. With great effort he could, of course, translate well-known pieces for string ensemble (or even the entire orchestra) into this notation for the computer. But the real strength of electronic music lies in its ability to fabricate completely new sounds—sounds that couldn't possibly be produced on any mechanical musical instrument. Here the composer isn't limited by the agility of the performer, by the tone color of available instruments or traditional meters and rhythms.

(continued on p. 36)

It takes a light touch to be a 20th-century Beethoven

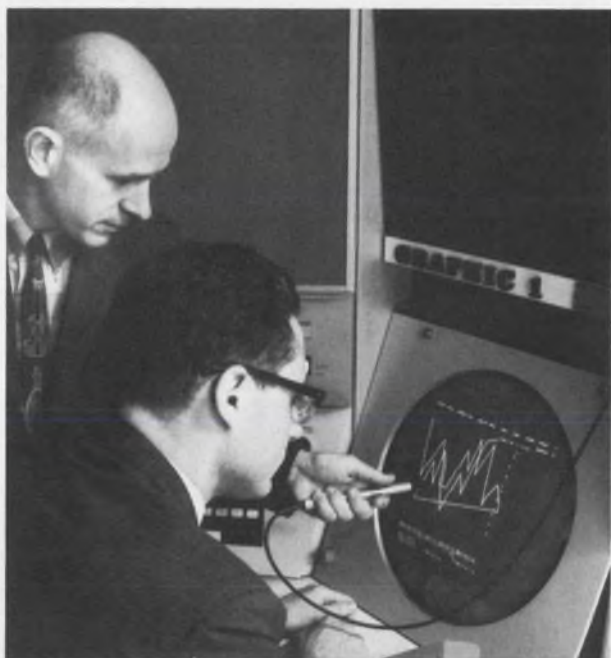

At left: Dr. Max Mathews of Bell Laboratories and a programmer, Lawrence Rosler, compose music the new computer way. Instructions are written as a series of "frames" with a light-pen on a cathode-ray tube. Right: An actual music pattern, or frame, as seen on the tube face. The markings on the right vertical scale refer to the musical terms pianissimo (PP), or very soft; mezzoforte (MF), or medium loud, and fortissimo (FF), or very loud. These markings are used in conjunction with the amplitude curve (AMP 1 20, in which "1" tells the computer that one instruction number—namely "20"—follows, and the "20" tells it that this amplitude pattern covers 20 beats). Similarly FRE stands for frequency, or pitch

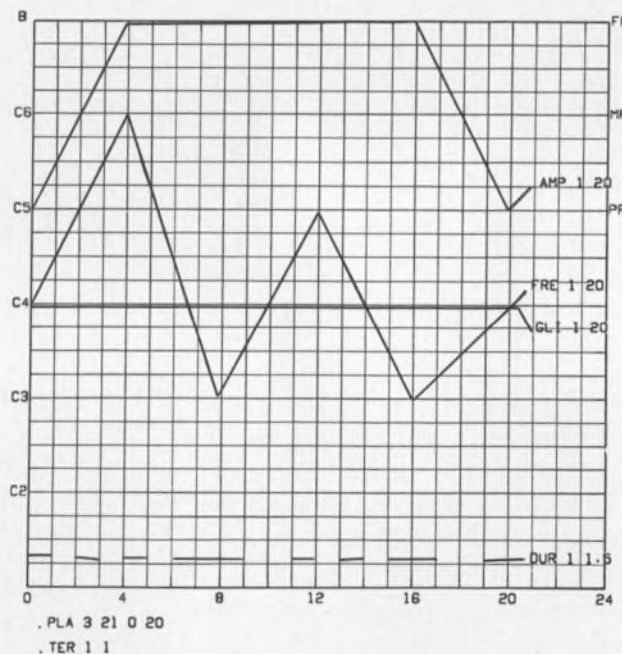

in music; DUR for duration of each note, and GLI for glissando, a term that indicates a slide up to a note. The markings along the left vertical scale represent the frequencies of notes—in this case, the note C. The B in the upper lefthand corner is a letter used to identify this particular frame. Instructions to the computer in the lower lefthand corner mean: PLA (play) 3 (three numbers to follow) 21 (waveform number 21) 0 (starting at beat 0) 20 (ending on the 20th beat). TER 1 1 simply tells the computer to stop when it has finished. Two or more frames like this can be played simultaneously. This frame required about two minutes of time on an IBM 7090.

GOOF- PROOF

VOM



Here's the most foolproof volt-ohm-milliammeter ever made. Protection approaches 100%. It's the VOM you will want to have on hand where inexperienced people are running tests . . . or will reach for yourself on those days when you're all thumbs. The 260-5P will save you all kinds of headaches from burned out meters and resistors, bent pointers, and inaccuracies caused by overheating.

Combined Protection You Won't Find In Any Other VOM

1. Reset button pops out to indicate overload.
2. You cannot reset circuits while overload is present.
3. Protective circuit does *not* require massive overloads which can cause hidden damage to the instrument.
4. All ranges are protected except those not feasible in a portable instrument—1000 and 5000 volts DC and AC; 10 amp DC.

SIMPSON 260-5P

ONLY \$85.00

Write for Bulletin 2072

Ranges—The 260-5P has the same ranges and takes the same accessories as Simpson's famous 260-5 volt-ohm-milliammeter.

Simpson

INSTRUMENTS THAT STAY ACCURATE

Representatives in Principal Cities
...See Telephone Yellow Pages



SIMPSON ELECTRIC COMPANY

5202 W. Kinzie Street, Chicago, Ill. 60644 • Phone: (312) ESTebrook 9-1121
Export Dept.: 400 W. Madison Street, Chicago, Ill. 60606 Cable, Amergaco
In Canada: Bach-Simpson Ltd., London, Ontario
In India: Ruttonsha-Simpson Private Ltd., International House,
Bombay-Agra Road, Vikhroli, Bombay

WORLD'S LARGEST MANUFACTURER OF ELECTRONIC TEST EQUIPMENT

ON READER-SERVICE CARD CIRCLE 17

Why is this \$5 NIXIE[®] tube better than anyone else's readout?

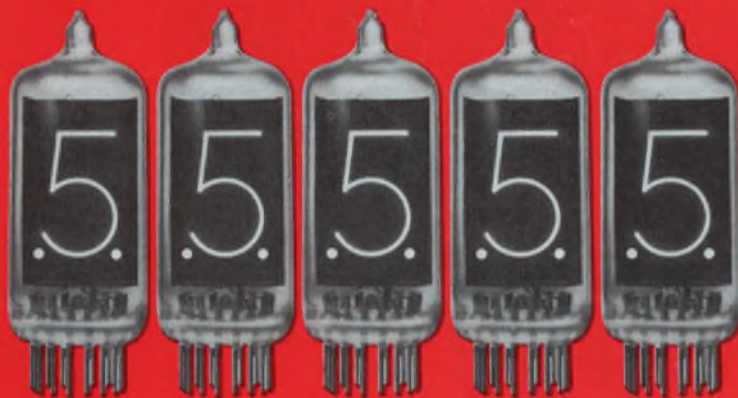

it packages better!

Lowest cost of any electronic readout is only *part* of the story of our Type B-5440 NIXIE tubes.

Another part of the story is how well they package.

Like their size. Overall tube width is 0.75" maximum. You can line them up with less than 0.80" center-to-center spacing. This means you can get 10 digits in a panel 8 inches wide.

The seated height of the B-5440 is a mere 1.8" maximum. Yet, you get a full-size 0.6" character readable at 30 feet.

The tube stem has been especially designed to permit the use of printed-circuit boards with maximum line width

and spacing. This reduces pc-board costs.

And finally there's a socket assembly we've designed that not only allows flush-mounting with the front of the instrument panel, but also is compatible with the latest printed-circuit board techniques. Result: up-front viewing, reduced assembly cost, best packaging density.

For a slight additional cost, you can have independently operable decimal points positioned left and right, as shown above (Type B-5441).

Price of the B-5440? Oh, yes. *Under \$5 in 1000 quantities.* Compact price for a compact package.

Use the reply card, or call us for full information.

Only Burroughs manufactures NIXIE Tubes



Burroughs Corporation

ELECTRONIC COMPONENTS DIVISION
PLAINFIELD, NEW JERSEY 07061

**NEW
FROM
KNIGHTS**

FREQUENCY STANDARD

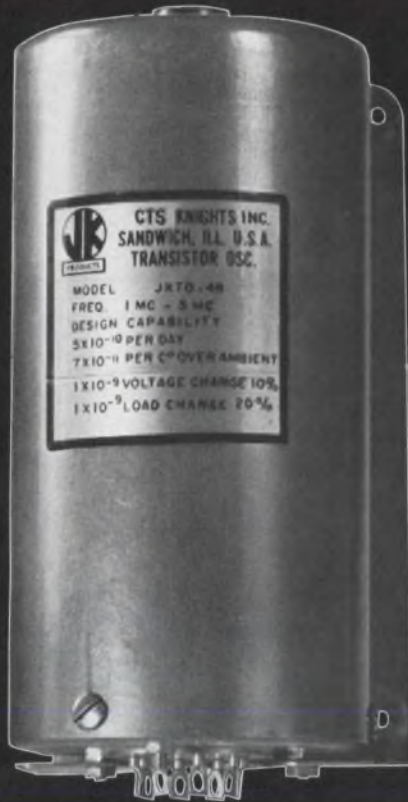

RUGGED COMPACT

Provides Frequency Stability as high as 5×10^{-10} per day as $\pm 7 \times 10^{-11}$ per degree C change in ambient temperature . . . 1mc to 5mc range.

Maximum total input power is $1\frac{1}{2}$ watts.

Available in three model variations offering optional degrees of performance. Panel or chassis mounting; external Varicap control for frequency adjustment on panel mounting models. The JKTO-48 Series provides an economical solution over a wide range of frequency management requirements.

Write for Data Sheet JKTO-48 for complete specifications.



CTS Knights, Inc.

of Sandwich, Illinois
(formerly The James Knights Co.)
a subsidiary of CTS Corporation, Elkhart, Indiana

ON READER-SERVICE CARD CIRCLE 68

PRODUCTION & PACKAGING

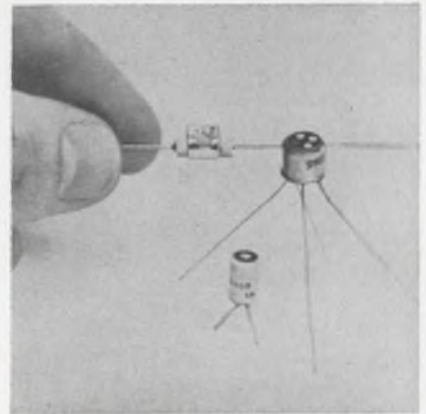

Decal detects heat

Easy-to-use decals are accurate temperature indicators for systems checks. "Temp-Plate" indicates temperature by an irreversible change from pastel to black, serving as a positive record of exposure. Accuracy is $\pm 1\%$. The decals are unaffected by vacuum, can be immersed in hot liquids and are easily removed. They are available in temperature ranges from 100 through 1100°F in sizes from $3/16$ in. diameter to 3×5 in.

William Wahl Corp., 1001 Colorado Ave., Santa Monica, Calif. Phone: (213) 451-9711.

Booth 157 (HP) Circle No. 373

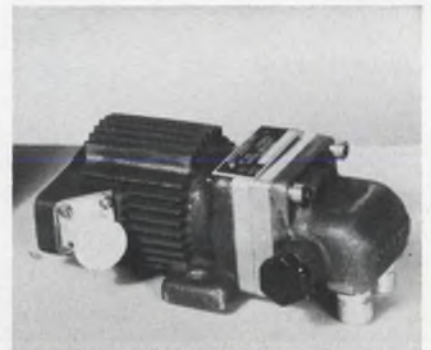

Dry gas pump

Handling small amounts of dry air and other inert gasses, this pump will deliver up to $5 \text{ ft}^3/\text{hr}$ against an external pressure drop of 1 psi. An integral needle valve is included for flow adjustment over a wide range. Suited for circulating gases in sampling loops, this pump meets MIL specs.

Laboratory for Electronics, Inc., Eastern Industries Div., 100 Skiff St., Hamden, Conn. Phone: (203) 248-3841.

Booth 539 (HP) Circle No. 384

Two new high power silicon transistors: 200V & 300V, 3.5A, low cost



These new Delco NPN transistors are designed to do a better job in your medium-high voltage inverters, converters, regulators and switching circuits.

Low saturation resistance (typically 0.3 ohm) and built-in protection against high-voltage transients make these two new devices ideal for rugged switching applications.

High punch-through voltage, high frequency response, and low saturation resistance are provided by the silicon element itself, which is fabricated by our unique triple sequential diffusion process. Exceptional resistance to thermal and mechanical shock are a result of ultrasonic bonding of aluminum to aluminum

base and emitter contacts.

Both devices are packaged in solid copper Delco TO-3 packages which give them ruggedness and low thermal resistance (typically 0.75° c/w).

Contact your nearest Delco sales office or distributor for complete data, the low prices and off-the-shelf delivery.

TYPE	V _{CEO}	V _{CBO}	V _{CEO} (sus)	I _C	I _B	h _{FE} V _{CE} = 5V@I _C	R(sat) typ @ I _C
DTS 410	200V	200V	200V min	3.5A	2.0A	10 @ 2.5A	0.3 ohm @ 1.0A
DTS 411	300V	300V	300V min	3.5A	2.0A	10 @ 2.5A	0.3 ohm @ 1.0A

SEE YOU AT WESCON, BOOTHS 1503-4, SPORTS ARENA

**FIELD
SALES
OFFICES**

UNION, NEW JERSEY*
Box 1018 Chestnut Station
(201) 687-3770
SYRACUSE, NEW YORK
1054 James Street
(315) 472-2668

DETROIT, MICHIGAN
57 Harper Avenue
(313) 873-6560
CHICAGO, ILLINOIS*
5151 N. Harlem Avenue
(312) 775-5411

SANTA MONICA, CALIFORNIA*
726 Santa Monica Blvd.
(213) 870-8807
General Sales Office:
700 E. Firmin, Kokomo, Ind.
(317) 459-2175

*Office includes field lab and resident engineer for applications assistance.

DELCO RADIO 

Division of General Motors
Kokomo, Indiana

ON READER-SERVICE CARD CIRCLE 20

Look what COHU brings you in a DC voltage standard for just \$1600!

outside view:

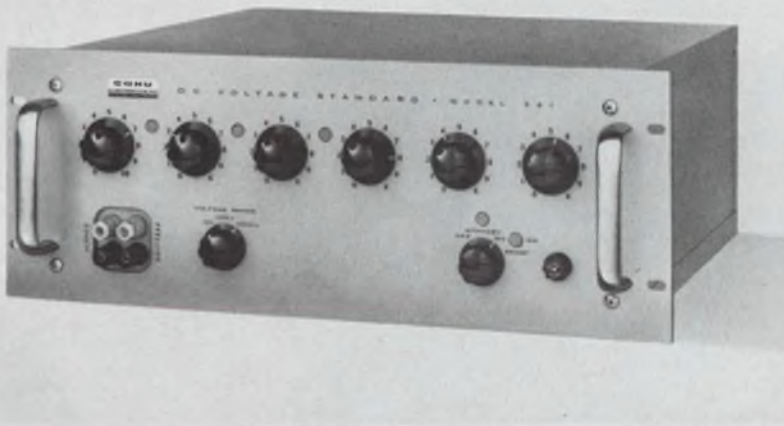

diagrammatic view:

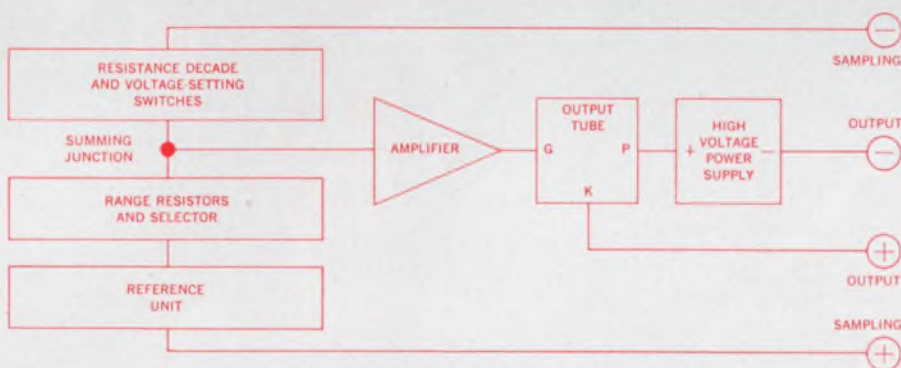

engineer's view:

MODEL 321/323 series
DC VOLTAGE STANDARDS

0 to ± 1111.110 volts

10 volt, 100 volt, 1000 volt ranges

10- μ v, 100- μ v, 1-mv steps

current up to 25 ma

0.01% accuracy

0.0025% voltage output
stability/8 hours

0.005% voltage output
stability/30 days

0.001 ohm source impedance

floating output

overcurrent protection

with nullmeter: \$1700

cabinet: \$1800

cabinet/nullmeter: \$1900

Write today for detailed information or a demonstration of this latest voltage standard in the COHU line. Representatives in all major cities. All prices F.O.B., San Diego, California. (Additional export charge.) See us at WESCON, Hollywood Park, Booth 111

Box 623
San Diego, California 92112
Phone: 714-277-6700

COHU
ELECTRONICS, INC
SAN DIEGO CALIFORNIA

ON READER-SERVICE CARD CIRCLE 21

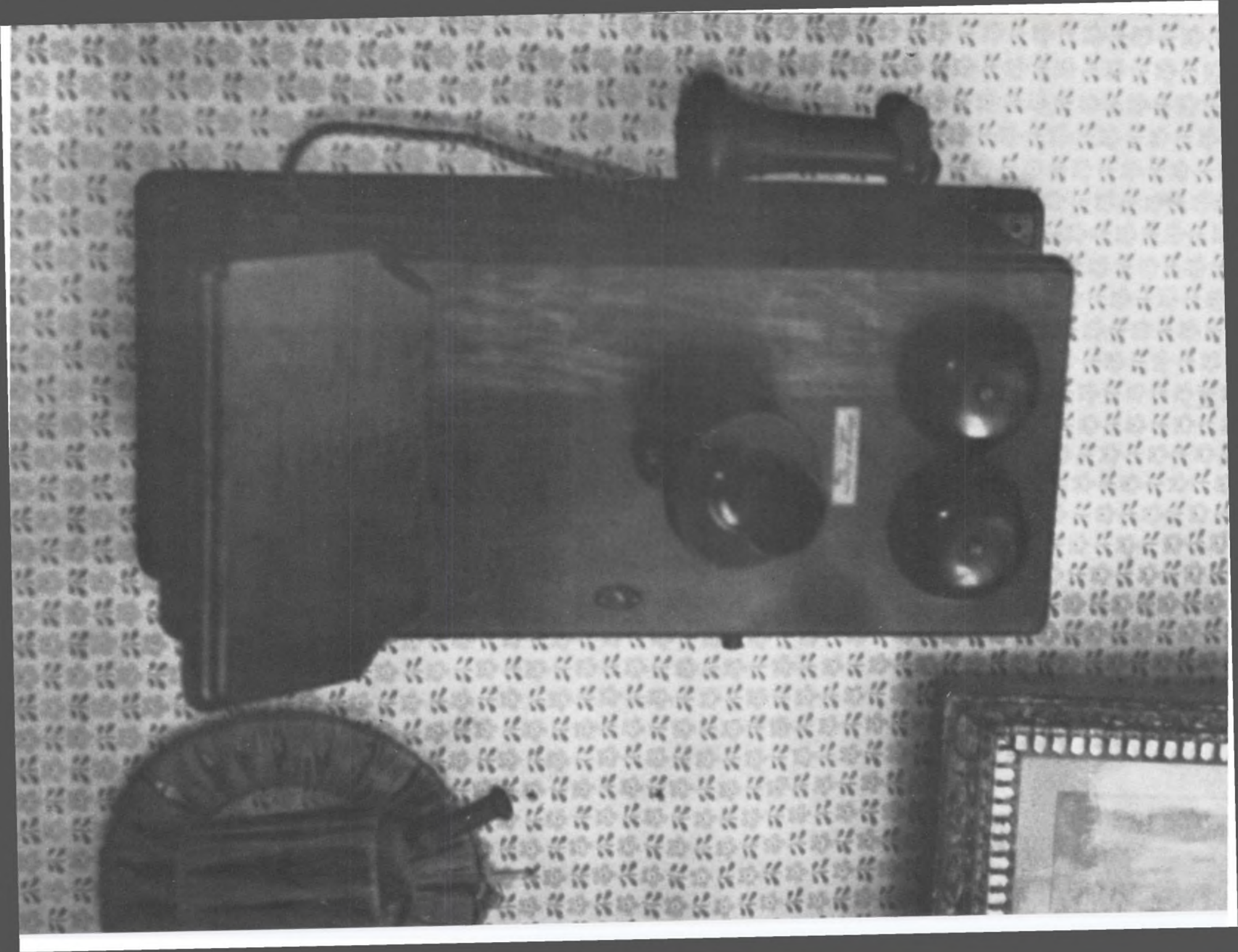

DOW CORNING

Before you abandon that new design . . .

check with us

In 1903 this battery operated telephone was an *innovation* . . . a turn of the crank and you could call one of the few subscribers in the area.

Suppose those who designed this unit had access to *today's* technical skills. Would it have looked like this?

Hardly!

Suppose *tomorrow's* electronic materials know-how were available to *you* right now. Would it affect your next product design? Fact is, a lot of it *is* available now . . . at Dow Corning.

Dow Corning, the acknowledged leader in silicone research and development for over twenty years, has a history of producing materials to meet unheard of performance requirements . . . and materials is our *only* business.

Our Electronic Products Laboratory offers prompt technical assistance in solving your specific problem. Write Dept. 3508, Electronic Materials Department, Dow Corning Corporation, Midland, Michigan 48640. Or phone (517) 636-8940 for more information and the name of the Dow Corning representative in your area.



For transparent encapsulation

of electronic components and systems, specify Sylgard® 182 resin, usable from -65 to 200 C. Designed for potting, embedding, encapsulating, this solventless silicone is applied as a low viscosity fluid . . . cures to a flexible, resilient embedment that permits visual inspection. Cut away for repairs—replace with new resin. Also—Sylgard® 183 resin, *opaque* for security purposes. *Circle No. 851*

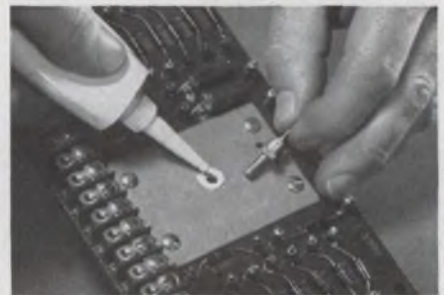

Uprate device power capacity

by specifying Dow Corning® 340 silicone heat sink compound to dissipate heat fast. Does not dry out, harden, gum or melt, even after long exposure to temperatures up to 200 C. This grease-like material fills tiny air spaces, maintains total contact between components and heat sink or chassis . . . assures *faster*, uniform heat transfer. *Circle No. 852*

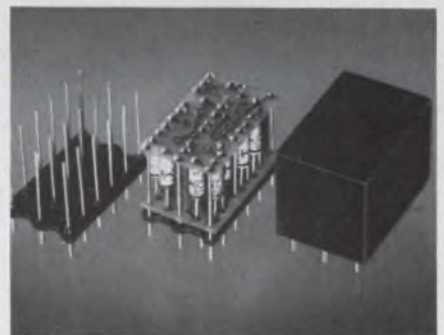

For "zero defect" device packages,

Dow Corning® brand silicone molding compounds are chemically inert . . . do not affect device performance. Designed for transfer molding, compounds produce void-free, dimensionally-stable, self-extinguishing, moisture resistant packages . . . assure reliability from -65 to 250 C . . . low dielectric losses at high frequencies and temperatures. *Circle No. 853*

We're a materials producer exclusively. Let us tailor a material to your need.

Speed Inquiry to Advertiser via Collect Night Letter

Only Norden delivers monolithic integrated circuit chips with dielectric isolation of active elements on a routine production basis.

Norden's *Glastrate* isolation process shields each active element on a monolithic chip from other elements of the circuit. The *Glastrate* layer gives radiation hardening, improved performance and higher reliability by inhibiting parasitic electrical currents.

Through successive oxidation, etching, reoxidation, epitaxial growth and removal of excess silicon, Norden isolates each active area on a silicon wafer within its own *Glastrate* cocoon. Then NPN, PNP or field effect transistors are developed in the isolated regions by the usual diffusion processes.

If you need integrated circuits with improved radiation hardening, higher electrical performance and greater reliability, write Dept. E, Norden Division, United Aircraft Corp., Norwalk, Conn. 06856, or call (203) 838-4471.

Because of its growing role in the microcircuitry field, Norden has many openings for qualified solid state engineers and technicians. Send your resume to Personnel Department, Norden, an equal opportunity employer, M&F.

Norden DIVISION OF UNITED AIRCRAFT CORPORATION
NORWALK, CONNECTICUT



See us at Booths 1130-1132, Sports Arena, WESCON
August 23-26.

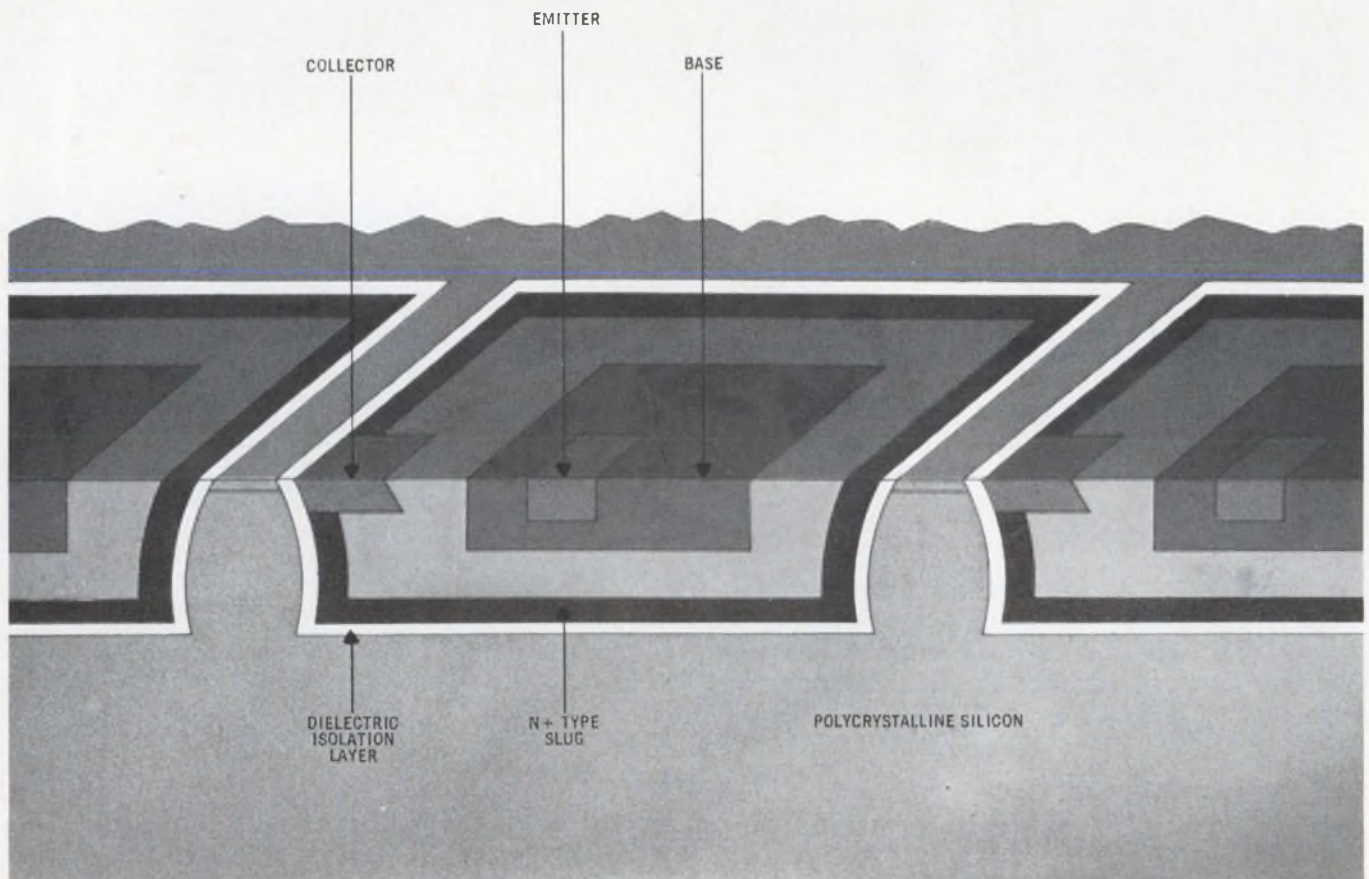

Norden — supplier to the Minuteman • Polaris • Apollo • Saturn • LEM • F-111 • C-5A • IHAS • B-5B.

ON READER-SERVICE CARD CIRCLE 23



no sleight-of-hand here!
you leave nothing to chance with Uni-Sel

Unisel—the newest development in selenium rectifiers—a high density selenium cell, superior to all other types—is found where manufacturers are troubled with high temperature, high voltage conditions. Nothing is left to chance! The product of an extensive research and development program coupled with the industry's most complete selenium facility—this entirely new type of selenium cell has current carrying capability that makes possible reduction in cell size never before achieved.

Available in all cell sizes with voltage ratings as high as 45 volts.



SYNTRON

SYNTRON COMPANY
283 LEXINGTON AVENUE • HOMER CITY, PA.

66R19

ON READER-SERVICE CARD CIRCLE 24

Fog! Diode laser signals warning

A new detector that warns of the presence of fog is based on diode-laser action. It can be used to protect offshore oil rigs, warn highway traffic and supplement existing airport control systems.

The new detector determines fog density, and thus visibility, by measuring the backscatter from its projected beam of near-infrared light. The emission is enhanced against background illumination by modulation of the transmitter light source and by the use of coherent detection in the receiver.

The detector, developed by Hoffman Electronics Corp., Santa Barbara, Calif., uses a gallium arsenide diode-laser transmitter light source. Radiation from the diode is directed into a spherical mirror that converts it into a collimated light beam. The beam, aimed into the atmosphere, is reflected by any fog particles present.

Reflections are measured by a silicon photovoltaic solar cell in the receiver, mounted adjacent to the transmitter. When the reflection intensity reaches a predetermined danger level, a warning is automatically sounded.

Hoffman engineers assert that the detectors would reduce manpower and other costs at manned foghorn stations, eliminate the need for continuous operation of unmanned stations and accurately measure visibility. The engineers also say that groups of detectors

If you don't think
it's possible to fit a
pneumatic timer
into this space...

try an
AGASTAT[®]
time / delay / relay



The miniature AGASTAT pneumatic time/delay/relay packs plenty of performance into spaces like the one above.

It measures only 1½ x 1½ x 5, is as accurate as any large t/d/r, and more reliable than most. Neither voltage changes, temperature changes nor transients will affect its timing cycle. That's because AGASTAT timers have an exclusive pneumatic timing head that recirculates gas through an adjustable orifice to regulate timing.

This pneumatic action also means you get instant recycling, with full timing periods regardless of how often the cycle is interrupted before relay "times out." And be-

cause timing is pneumatic, it can even time without electric power!

These AGASTAT models also have an exclusive dial head that lets you make simple, but accurate, linear adjustments over the full timing range of each unit with just a single revolution of the adjustment screw. (Nine timing ranges cover a total span from 0.03 second to 3 minutes.)

They're available with delay on pull-in or drop-out or both in one unit. You can also choose from a wide selection of mounting and terminal styles. All popular ac or dc operating voltages.

Send for our catalog.

M7

AGASTAT TIMING INSTRUMENTS
ELASTIC STOP NUT CORPORATION OF AMERICA

AGASTAT DIVISION • ELIZABETH, NEW JERSEY
IN CANADA: ESNA LIMITED, 271 PROGRESS AVENUE, SCARBOROUGH, ONTARIO
Speed Inquiry to Advertiser via Collect Night Letter

ON READER-SERVICE CARD CIRCLE 27

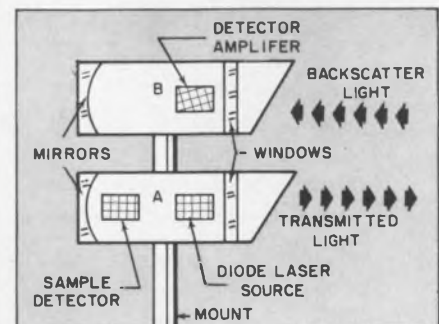

Near-infrared diode laser in transmitter (A) is used to determine fog density and visual range by measuring light scattered back to receiver (B). System is used for navigation warning and traffic control.

Fast, convenient direct reading measurements of impedance and phase angle 500 kHz to 108 MHz...



See New HP Instruments and
Measurement Seminars at
WESCON—Hollywood Park

THE 4815A RF VECTOR IMPEDANCE METER

This new Vector Impedance Meter is a versatile instrument that provides fast, direct reading measurements of impedance and phase angle over the frequency range from 500 kHz to 108 MHz. It is continuous tuning over this frequency range, and does not require balancing or data interpretation. Thus, it is an extremely useful tool for the evaluation of the complex impedance of both active circuits and components. The convenience of probe measurement, ease of operation, and direct reading features make the instrument equally useful for laboratory, receiving inspection or production line measurements.

The 4815A is a convenient and powerful measuring tool for any application involving measurements over a band of frequencies or in-circuit measurements. It may be used to determine the self-resonance point of capacitors, the series and parallel resonance points of crystals, or the characteristics of high frequency transformers and transducers. Price: \$2650 f.o.b. factory. For complete specifications, contact your local Hewlett-Packard field engineer or write Hewlett-Packard, Rockaway Division, Green Pond Road, Rockaway, N. J. 07866; Europe: 54 Route des Acacias, Geneva.

Advantages:

- Fast, continuous tuning from
500 kHz to 108 MHz
- Provides data directly in impedance
and phase angle, 1 ohm to 100K ohms
0 to 360°
- Convenient probe for in-circuit measurements
- Analog outputs permit permanent
data recording
- Self calibration check provides
measurement confidence
- Low-level test signal minimizes
circuit disturbance

HEWLETT  PACKARD
An extra measure of quality

ON READER-SERVICE CARD CIRCLE 28

21

MATTER-OF-FACT REASONS WHY...



BAUSCH & LOMB V.O.M. RECORDERS ASSURE YOU OUTSTANDING PERFORMANCE

- | | |
|--|--|
| <ul style="list-style-type: none"> 1. Directly measure and record d-c voltage, current and resistance 2. Five built-in variable chart speeds 3. Built-in event marker 4. 17 different input ranges 5. Zener diode reference supply 6. High off-balance input impedance 7. Can be used in three positions—flat on bench, at a 30° tilt or wall mounted 8. Photoelectric modulator 9. Full scale zero set—anywhere on chart span 10. Floating input with separate chassis ground 11. Built-in 100' take-up reel 12. Modular assembly and plug-in | <ul style="list-style-type: none"> connections for rapid access service and maintenance 13. Serve as accurate vacuum tube voltmeters in measure position 14. Lightweight and portable 15. All calibration adjustments made without disassembling units 16. Zener diode d-c supply for ohms scale 17. Adjustable damping 18. Efficient pen design 19. Low cost, high quality chart paper 20. Backed by years of experience in engineering sophisticated electronic circuitry 21. An entire division is devoted exclusively to the development and production of electronic products |
|--|--|

Bausch & Lomb V.O.M. Recorders are available in a variety of models with different full scale sensitivity. We have a wide range of accessories that make our recorders equal to just about any task required. For your special needs, we have the capability of designing customized recorders... modified to handle whatever applications you have in mind. Let us hear about your recorder requirements. Write for Catalog 37-2068. Better yet, ask for a personal demonstration. Bausch & Lomb, 91532 Bausch Street, Rochester, New York 14602.

BAUSCH & LOMB 
ELECTRONICS DIVISION

Visit our Booth #112 at the Wescon Show, Los Angeles, Aug. 23-26.

ON READER-SERVICE CARD CIRCLE 29

NEWS

(fog continued)

along low-visibility stretches of highway would permit the necessary precautions to be taken to avoid automobile "pile-up" accidents. Scientific applications include the use of the detectors for various atmospheric-attenuation studies.

Light emanates from the transmitter in an approximately 1-degree beam. The optical axis of the receiver is set to intersect the optical axis of the transmitter at about 10 meters. The receiver focuses light reflected from the fog into a detector. Light scattered from the fog is measured as a dc output voltage proportional to fog density.

Internal comparator and timing circuits permit the system to evaluate changing fog conditions and to reject transient fog or vapor clouds.

The gallium arsenide diode within the system emits 9100-angstrom (near-infrared) light with a spectral distribution of less than 500 Å. It is modulated at 8 kHz.

The silicon solar cell in the detector was selected for peak photon-gathering efficiency in the 9000-Å region.

A battery source of 16 to 11 V provides the required 10 V to operate the unit. Less than 5 W are consumed. ■ ■

Device directs laser beams

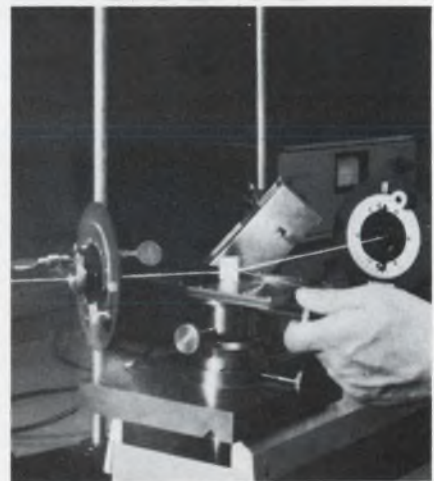

Electronic device, developed by Sylvania Electric Products, Inc., controls incoming and outgoing laser beams in an optical communication system without diminishing their power. Called an optical beam-direction control, the unit directs transmitted beams straight ahead but bends incoming beams to prevent their entering the transmitter.

At last, a line of dual diff-amp transistors with specified differential base current drift

Differential base current drift is a single parameter that lumps the temperature-dependent effects of forward gain and leakage current.

Gain is dependent on temperature . . . and even with perfect V_{BE} matching between transistors . . . and with negligible I_{CBO} , the variation of h_{FE} with ambient temperature will limit the sensitivity and linearity of your differential amplifier design.

Simplified differential amplifier design and accurate prediction of circuit performance are the direct advantages of specifying differential base current drift in addition to the tracking parameters.

Until now it has been customary to ignore both gain and leakage-current tracking and to specify only V_{BE} matching. But now Amperex' advanced matching techniques and more sophisticated test facilities and procedures can produce, measure and guarantee the best gain/leakage tracking available today and V_{BE} matching second to none.

This close tracking of both V_{BE} and I_B is specified over a temperature range of -55°C to $+125^{\circ}\text{C}$, the entire range of useful performance of the transistors and circuit components themselves.

If you specify or design differential amplifiers, the Amperex A600 Series dual diff-amp transistors in 6-lead TO-5 cases offer you the best all around performance you can get as well as the most significant, *designer-oriented* specifications available today.

TYPE NUMBER	 $\frac{\Delta I_{B1} - I_{B2} }{\Delta T}$	$\frac{\Delta V_{BE1} - V_{BE2} }{\Delta T}$	h_{FE} $I_C = 100 \mu\text{A}$	h_{FE} $I_C = 10 \mu\text{A}$
	A607	1.5 nA/ $^{\circ}\text{C}$	5 $\mu\text{V}/^{\circ}\text{C}$	100
A608	1.5 nA/ $^{\circ}\text{C}$	10 $\mu\text{V}/^{\circ}\text{C}$	100	50

$$* \Delta I_B \text{ (differential base current drift)} = \frac{\Delta |I_{B1} - I_{B2}|}{\Delta T_A}$$

$$\Delta V_{BE} \text{ (differential voltage drift)} = \frac{\Delta |V_{BE1} - V_{BE2}|}{\Delta T_A}$$

Detailed specifications on the transistors listed above, applications data and a special engineering report on the significance of I_B tracking are available now. Write: Amperex Electronic Corporation, Semiconductor and Receiving Tube Division, Dept. 371, Slatersville, Rhode Island 02876.

Amperex®

ON READER-SERVICE CARD CIRCLE 30

MICRO-MINIATURE CONNECTORS WITH CRIMP REMOVABLE CONTACTS AND CENTER SCREWLOCK

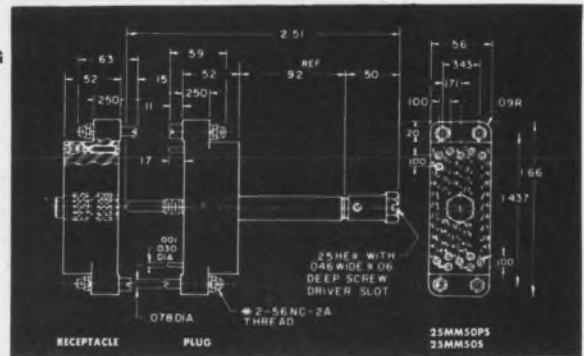
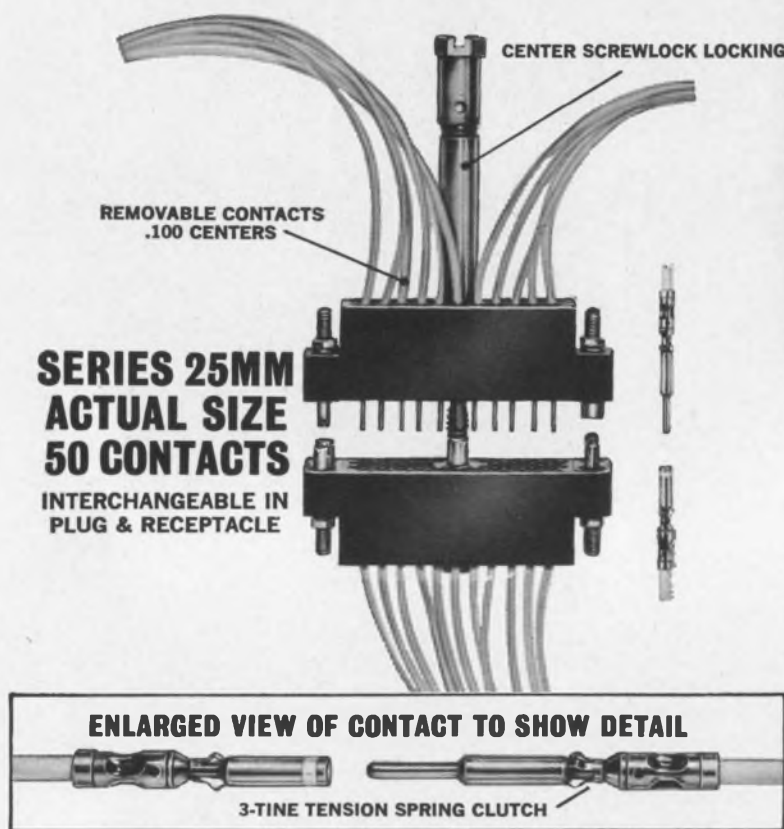

STANDARD TYPE TOOLS FOR REMOVABLE CONTACTS



Now, crimp termination, removable contact connectors are available in microminiature size with the added feature of a center screwlock locking device for plug and socket. Rectangular configuration supplied with 50, 100 or 200 contact sizes. Three-tine tension spring clutch on pin and socket contacts provides maximum holding area between contact and molded block. All sharp-edged "molded-in" metal inserts have been eliminated with this clutch-type construction.

Contacts are supplied separately and wired independently of the connector body. This permits mounting of the plug and

socket units at any convenient time without waiting for completion of the wiring operation.

Write or phone for complete technical information on Series 25MM and Series 25 Removable Contact Connectors. Free 16-page catalog includes outline drawings, specifications and ordering information. Phone (212) TW 9-4422 or write Continental Connector Corporation, 34-63 56th Street, Woodside, N. Y. 11377.



MICRO-MINIATURE • MINIATURE • PRINTED CIRCUIT • RIGHT ANGLE PIN & SOCKET • CENTER SCREWLOCK • SPECIAL DESIGNS

CONTINENTAL CONNECTORS

CONTINENTAL CONNECTOR CORPORATION • WOODSIDE, NEW YORK 11377 • TELEPHONE: (212) 899-4422
SEE US AT WESCON BOOTHS 1248-1249

ON READER-SERVICE CARD CIRCLE 31

NEED A SUPPLIER WHO MAKES RELIABLE REED SWITCHES AND RELAYS?

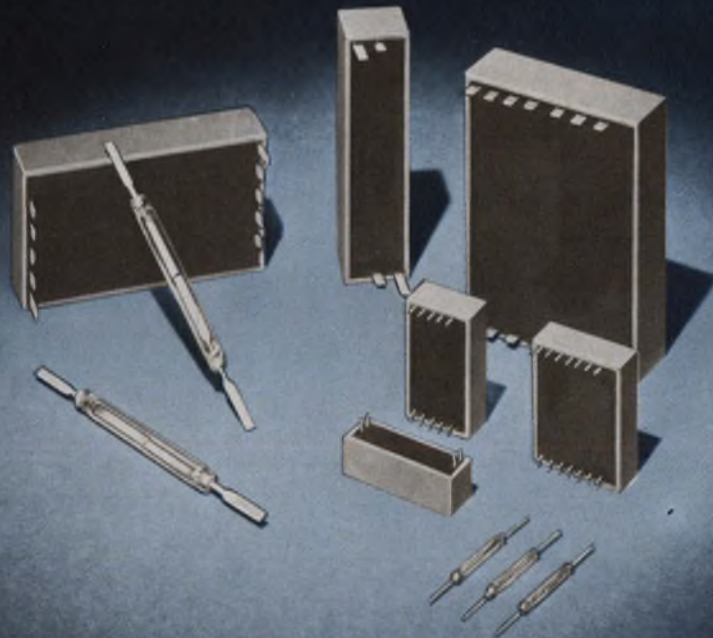

RBM CONTROLS IS DOING IT NOW!

(we call them Bi-Reeds)[®]

We make the complete switch—with automatic equipment in white room facilities for consistent characteristics and reliability. We assemble these unexcelled switches into relay packages. This single source responsibility means total reliability for you. Numerous pole forms are available—miniature or standard switches or relays.

*Ask Your Local RBM CONTROLS Sales Engineer for Special Reports
Relative to Your Application.*



Serving Major Markets Since 1921

RBM CONTROLS

Division Essex Wire Corporation
Logansport, Indiana

RBM
STANDARD CONTROLS
ARE AVAILABLE FROM YOUR
ELECTRONIC PARTS DISTRIBUTORS

SEE US AT THE IEEE SHOW BOOTH 2H35
Speed Inquiry to Advertiser via Collect Night Letter
ON READER-SERVICE CARD CIRCLE 32

WIRE HARNESS LACING, like most manual jobs—costs money!

- Saving by using low cost lacing material seems good economy...

- ...until production lags and rejects pile up!

- For real economy you need the uniformity, the high quality of GUDEBROD LACING TAPE.

- That's why this guarantee can help you cut costs in cable harnessing!



You owe it to your zero defects program to investigate Gudebrod lacing tape. Its guaranteed quality and its constant uniformity are important to you—and to your harnessing operation. Why? Because Gudebrod smooths and speeds the hand operation of lacing and knot tying. There's no need for readjusting or retying. Rejects are minimal. The result? You save time—and that saves money and hastens delivery. Gudebrod sets its manufacturing standards high and adheres to them. When you use Gudebrod tapes you can set production goals and achieve them. This is the combination that saves you money in your harness department. Ask for the Gudebrod Product Data Book.

GUDEBROD CABLE-LACER

The first hand tool engineered for wire harnessing. Handle holds bobbins, feeds tape as needed, grips tape for knotting. Speeds, eases harnessing. Pays for itself in time saving.



Area Code 215, WA 2-1122



GUDEBROD BROS. SILK CO., INC.

FOUNDED IN 1870

Electronics Division

12 SOUTH 12th STREET, PHILADELPHIA, PENNSYLVANIA 19107

ON READER-SERVICE CARD CIRCLE 33

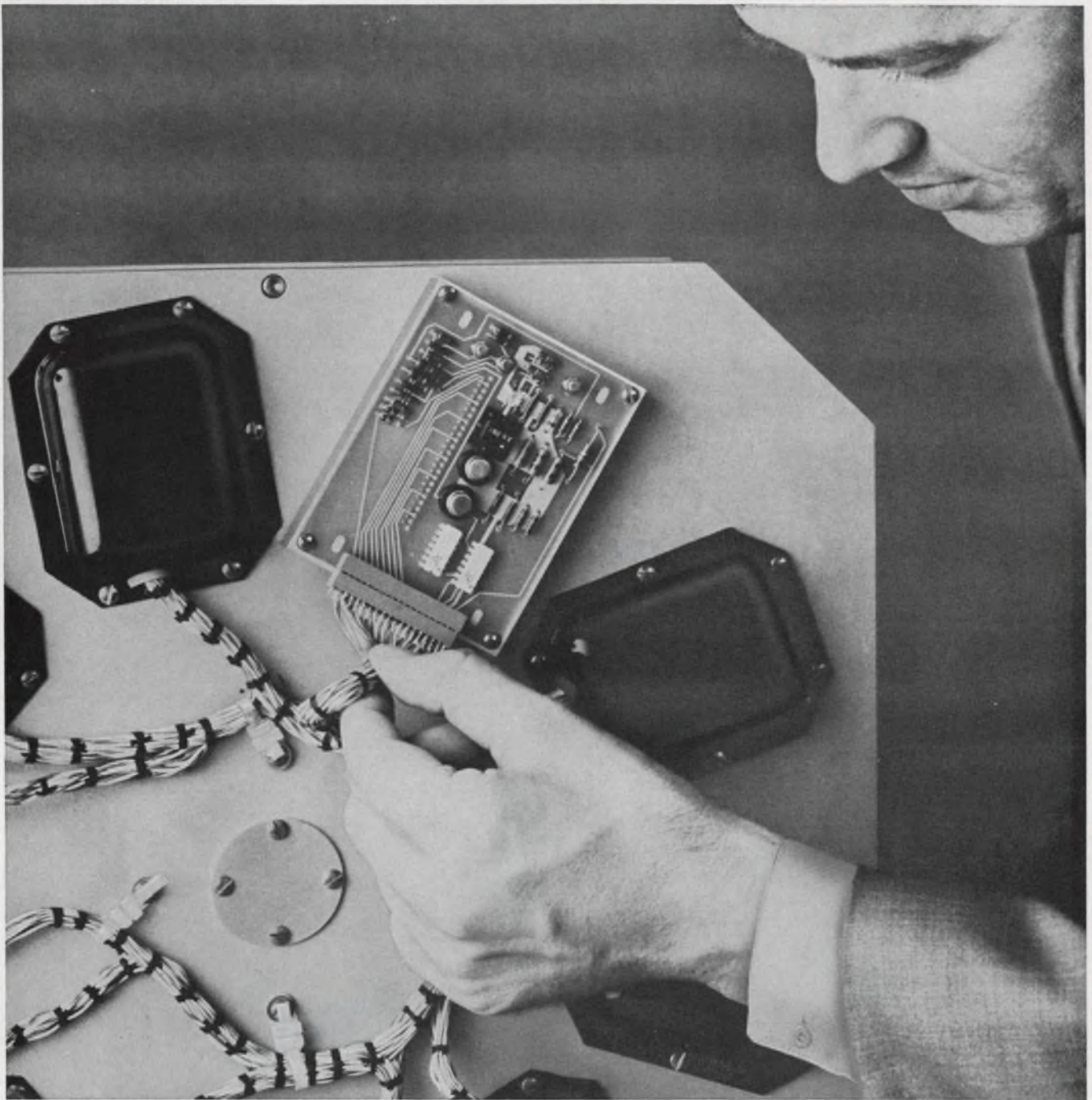

Now Large Memory | at a new | low cost | per bit |

Now, Librascope's new L416 Integrated-Circuit Disc Memory, specifically designed as a high-capacity, fast-access, low-cost disc file for use with low-cost digital computers in commercial applications.

- 6- and 12-million-bit capacity (expandable to 18 or 24), with cost per bit materially reduced by high packing density.
- fast access, averaging 8 milliseconds.
- outstanding magnetic performance, assured by hard-cobalt disc coating and

an automatic-retracting mechanism that prevents flying heads from touching discs even during starting and stopping.

- fully integrated circuitry mounted directly on the head-mounting plates to conserve space, increase operating reliability.
- lightweight: less than 100 pounds for a 12-million-bit memory.
- consider the L416, newest member of the computer industry's most complete line of disc memories.
- for complete details, write for our technical bulletin.

COMPONENTS DIVISION

**GP GENERAL
PRECISION INC.**

LIBRASCOPE GROUP

□ □ □ □ 808 Western Avenue □ □ □ □
□ □ □ Glendale, California 91201 □ □ □ □

CN READER-SERVICE CARD CIRCLE 34

This is a rather unusual frequency converter.

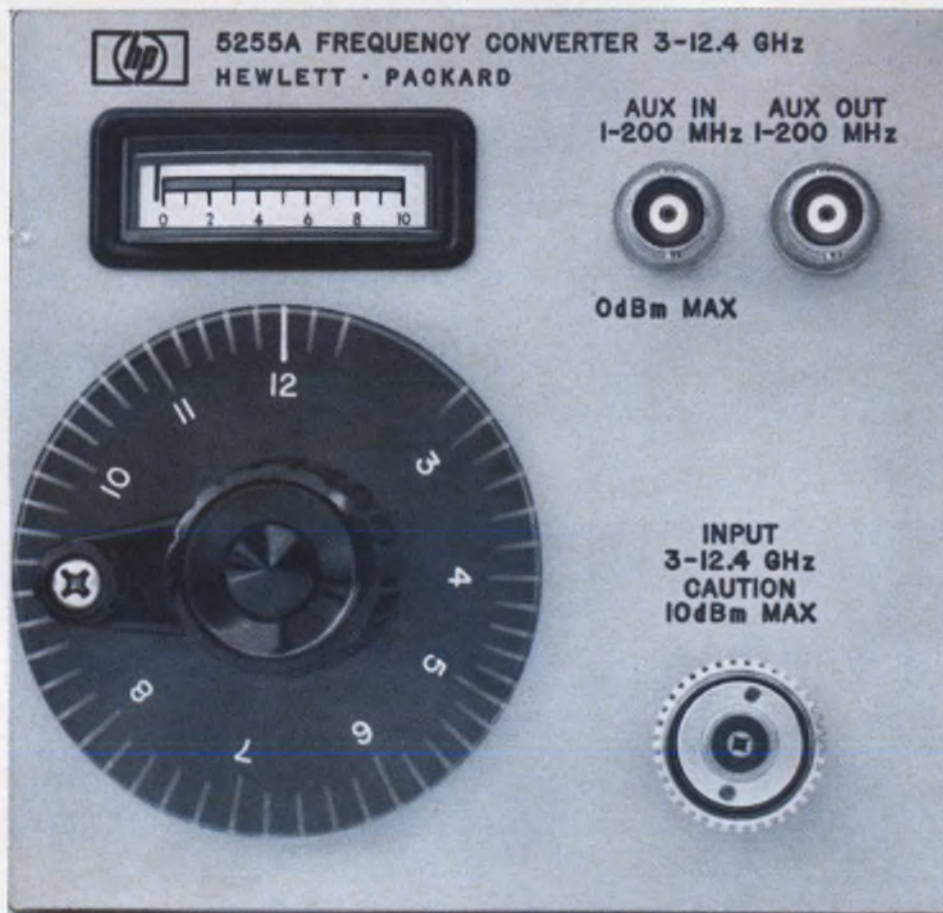

Can you see why?

For one thing, the frequency range is 3 to 12.4 GHz! □ For the first time you can measure through X-band with a heterodyne plug-in converter and electronic counter. □ You get up to 1 Hz resolution with unprecedented speed and simplicity. □ You retain the accuracy and every measurement capability of the 5245L Counter. □ Read about this important development in microwave measurement.

Plug the hp 5255A into your hp 5245L Counter, and you can now measure frequencies from 3 to 12.4 GHz. The high frequency and wide range make the 5255A unique. (By comparison, no other heterodyne converter lets you measure beyond 3 GHz!) And it's so simple, even non-technical operators make fast, accurate measurements.

Readout to 1 Hz in 4 seconds Or 10 Hz in 0.4 seconds, etc.

Heterodyne converter accuracy and simplicity There are no complicated computations. Look at the front panel and you can see how easy it is to make measurements.

Start from the bottom (2.8 GHz) and tune the dial until the level indicator moves into the green. Stop and read the dial. (The marks light up to be sure you read the right one. Each one represents a 0.2 GHz increment from 3 to 12.4 on an almost linear scale.) Then, just add the counter reading to the converter dial reading, and you have your measurement.

Measures frequency modulated signals The 5255A will tolerate many MHz of fm and still accurately measure the average value of input frequency.

No spurious responses No need to waste time trying to figure out which of

several indications is true. (Another safety feature: if an input signal drop-out occurs during measurement, the converter automatically inhibits the counter from making any reading.)

High sensitivity 100 mv rms (−7 dbm), or better over the entire range. Low VSWR input.

Use it as a prescaler or down-converter, too You can use the 5255A as a prescaler to extend the direct readout range of the 5245L to 200 MHz. Inputs from 1 to 200 GHz, at the AUX IN connector, are divided by 4 and displayed directly on the 5245L Counter. No calculations needed. Sensitivity: 5 mv rms.

As a down-converter, it beats inputs from 3 to 12.4 GHz down to 200 MHz, maximum, for scope observation, etc.

Or you can use it as a receiver by adding a detector to the AUX OUT connector.

It's the 9th plug-in for Hewlett-Packard's 5245L Counter, making it by far the most versatile counter you can buy. For a basic investment of \$2950, you can get an easy-to-use counter for measuring frequency, period, multiple period average, ratio and multiples of ratio, and with electrical outputs for recording. Plug-ins for measurements from dc to X-band, for 1 mv sensitivity, time interval measurement, normalizing and preset counting,

and digital dc voltage measurement make it even more useful.

Call your Hewlett-Packard field engineer for complete specs or write Hewlett-Packard, Palo Alto, California 94304, Tel. (415) 326-7000; Europe: 54 Route des Acacias, Geneva.

SPECIFICATIONS

Range:	As a converter for hp Model 5245L Counter, 3 to 12.4 GHz using mixing frequencies of 2.8 to 12.4 GHz in 200 MHz steps. As a prescaler, 1 MHz to 200 MHz.
Input sensitivity:	100 mv rms (−7 dbm) as a converter; 5 mv rms as a prescaler.
Input impedance:	50 ohms nominal.
Input connector:	Precision type N (GPC-7 optional).
Auxiliary output:	1 MHz to 200 MHz difference signal from video amplifier.
Price:	\$1650.

*Data subject to change without notice.
Prices f.o.b. factory.*



HP Model 5245L Electronic Counter and the 3 to 12.4 GHz Plug-in Frequency Converter

See New hp Instruments
Attend Measurement Seminars
WESCON—Hollywood Park

HEWLETT  **PACKARD**
An extra measure of quality

ON READER-SERVICE CARD CIRCLE 35

LETTERS

Nuvistors in preamps are popular idea

Sir:

I read G. C. Kuipers' design idea ["Nuvistor and bipolars form low-noise preamplifier," ED 15, June 21, 1966, pp. 108 & 110] with considerable interest. The application of a nuvistor input in a hybrid preamplifier for low noise and high input impedance is, indeed, a popular idea; in fact, our company has been using it for years.

The diagram (see below) shows the preamplifier of our infrared spectro-photometer. It is a typical circuit, used with slight modifications in a number of our products. The circuit diagram speaks for itself; gain and stability are somewhat better than Kuipers' figures, due to a higher feedback factor in the transistor section. The 13CW4 nuvistor was found superior to other types in all respects at low frequency (10 Hz), and the feedback loop around the input stage ensures much higher input imped-

ance and gain stability.

A. D. Boronkay
Senior Electronics Engineer
Scientific Instruments Division
Beckman Instruments, Inc.
Fullerton, Calif.

Author's reply:

A. D. Boronkay's remarks and interest are greatly appreciated. My amplifier design was intended and used in a power-limited, extremely lightweight optoelectronic device in which the entire correlation-receiver-type signal process, including read-out display, consumed less than 900 milliwatts. As mentioned in the second paragraph of the article, "in power-limited" applications, half-power, half-size Nuvistors, such as the A15274B with rated filament power of 400 milliwatts (the 13CW4 is rated at 810 mW), enable use of a Nuvistor first stage at least to be

considered as a trade-off for noise figure when compared with mono- or bipolar solid-state devices.

Attractive compromises which evidently possess inferior noise characteristics but which have been used by others are the low-noise audio types A15466 and A15460 which consume 630 milliwatts of filament power.

The preamp employing two Nuvistors, four transistors, and dual feedback loops presented by Boronkay as typical in several of his firm's instruments is, as he points out, obviously superior with respect to stability and input impedance at the expense of additional power. The output is not buffered, which evidently was not required for his application.

George C. Kuipers
Associate Sr. Research Engineer
G.M. Defense Research Labs.
General Motors Corp.
Santa Barbara, Calif.

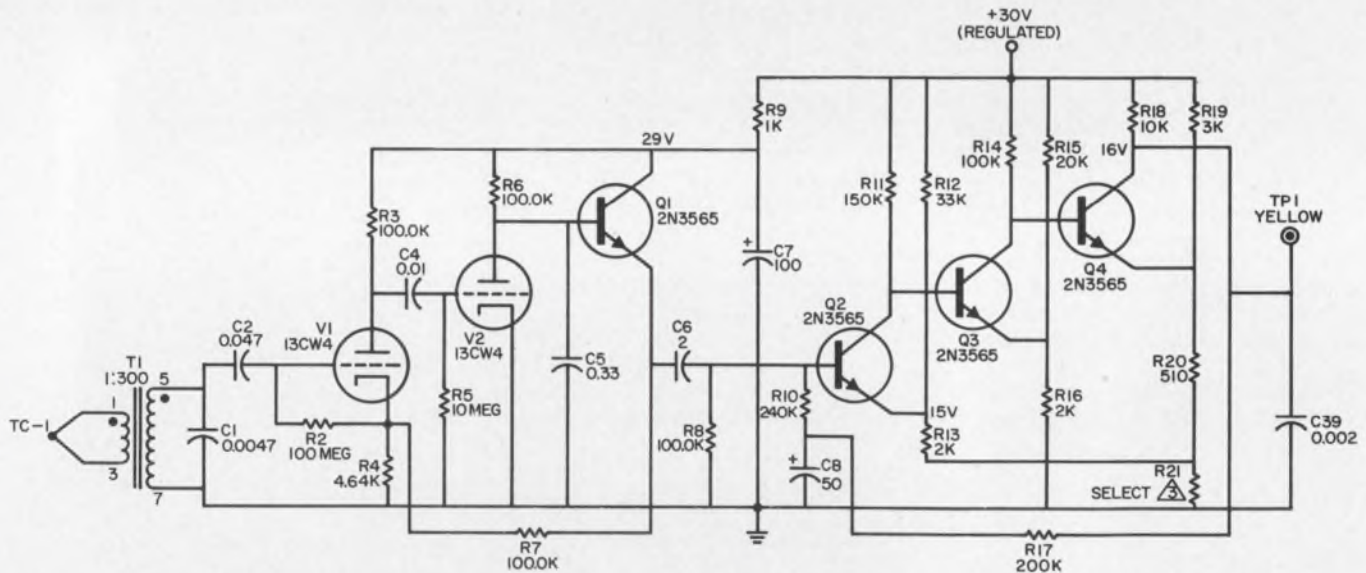

Siemens and hertz: pro and con

Sir:

I was astonished to read an attack by Thomas W. Parsons [ED 10, Apr. 26, 1966, pp. 35 & 38] on the siemens and hertz, especially as he commits the common technician's error of neglecting to consult the history of technology before writing: "Who was Siemens, any-

way; what did he do?" Objectivity and concern for facts are not evident in his continuation: "I have not yet found anyone who knows." This is all the more regrettable since U.S. universities have courses in the history of technology that are the envy of the present writer, since there are no similar courses in

Denmark.

A European is also surprised to read that "Siemens does not belong in the company of Faraday, Henry and Ohm." Research in Denmark and other European countries reveals that there is precisely one book about Henry and the British

(continued on p. 56)

Now Commercial High Speed TTL I/C's in dual in-line packages 10 ns gates 82¢ per gate function.

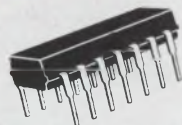

Signetics very high speed TTL integrated circuits are now available for as little as 82¢ per gate function in distributor quantity. 10 ns gate delays and 35 MHz flip-flops make SP800 series especially suitable for high speed computers and very high speed counters. Molded dual in-line packages offer lower cost, high performance and easy handling.

SP 800A (+15°C +55°C) Series available from distributor stock
ST 800A (0°C to 70°C) available on factory order only

SIGNETICS INTEGRATED CIRCUITS



A subsidiary of Corning Glass Works
811 East Arques Avenue, Sunnyvale, California
Tel.: (408) 739-7700 TWX: (910) 339-9220

		1000-2499	1 Type 100-999	Mixed 100-999	25-99	1-24
SP806A	Dual 4-Input Gate Expander	2.95	3.10	3.25	3.70	4.65
SP808A	Single 8-Input NAND Gate	2.95	3.10	3.25	3.70	4.65
SP816A	Dual 4-Input NAND Gate	2.95	3.10	3.25	3.70	4.65
SP825A	J-K Binary Element	4.55	4.80	5.05	5.75	7.20
SP826A*	Dual AC Binary Element	8.00	8.40	8.80	10.10	12.60
SP840A	Dual Exclusive-OR Gate	3.30	3.50	3.70	4.20	5.25
SP855A	Dual 4-Input Power Gate	3.30	3.50	3.70	4.20	5.25
SP870A	Triple 3-Input NAND Gate	3.30	3.50	3.70	4.20	5.25
SP880A	Quadruple 2-Input NAND Gate	3.30	3.50	3.70	4.20	5.25

*Available after July 15

Nine compatible elements

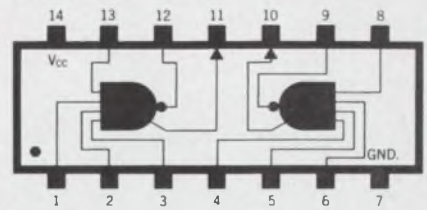

SP806A Dual 4-Input Gate Expander

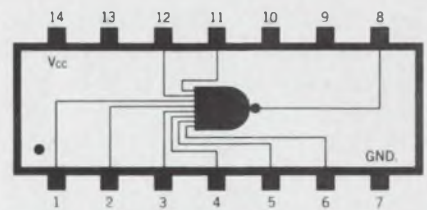

SP808A Single 8-Input NAND Gate

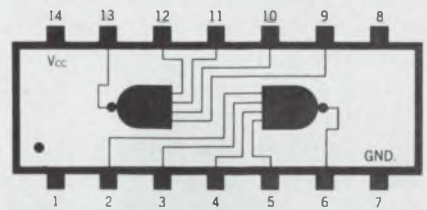

SP816A Dual 4-Input NAND Gate
SP855A Dual 4-Input Power Gate

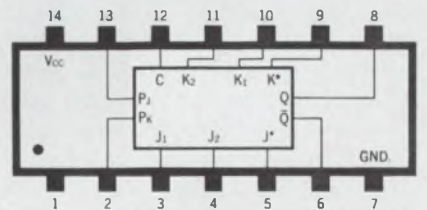

SP825A J-K Binary Element

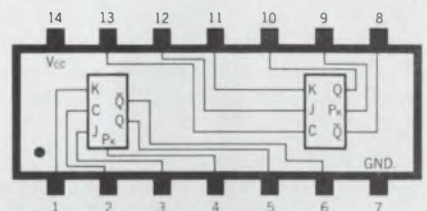

SP826A* Dual AC Binary Element

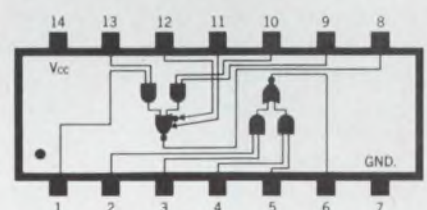

SP840A Dual Exclusive-OR Gate

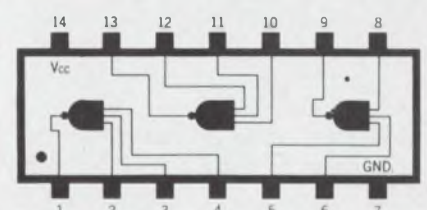

SP870A Triple 3-Input NAND Gate

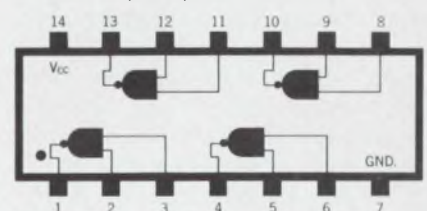

SP880A Quad 2-Input NAND Gate

See us at WESCON—Booths 1526-1528—Sports Arena
ON READER-SERVICE CARD CIRCLE 36

LETTERS

(continued from p. 54)

Museum Library possesses the only copy, as far as I know. The U.S. Embassy in Copenhagen was unable to procure a single book about this man, although they had copious literature about other American research workers in electronics. It is therefore not unreasonable to ask: "Henry? Who was he?" If Parsons could give me the necessary literary references, I should be delighted to spread knowledge of this man, who is known to us only as a footnote to accounts of Morse and Vail!

As for siemens vs ohm, the latter designation is exclusive to the U.S., for siemens is used throughout Europe. One siemens was defined as the conductivity of a column of mercury 1 mm² in cross section and one meter long at a temperature of 0°C. This unit was established in 1860, provisionally accepted by the Paris Electrical Congress of 1881 and (please note, Mr. Parsons) approved in principle by the Chicago Congress of 1893, whose only modification was in the method of measuring to be employed.

Let me sketch in the career of Werner von Siemens in order to show why we feel there is reason to honor him:

Werner von Siemens (1816-1892) invented in 1845 the electromagnetic pointer-telegraph with automatic switching (later used by the railroads) and the rubber-coated underground cable. In 1847 he was asked to install the first underground cable from Berlin to Grossbeeren. He used gutta-percha as the insulating medium; this was used later for the first submarine cable. The same year he made the first commercial electromagnetic telegraph using a new type of cable and thus laying the foundation of a later, great cable industry. In May that year he patented a typewriter to be used in connection with his telegraph. In 1848 he put together the first telegraph relay, which became one of the features of the underground line he laid from Berlin via Halle, Erfurt and Kassel to Frankfurt am Main. He invented a fire-alarm system, which, by the way, also came into use in the U.S. In 1854 he discovered how to make telephone calls by the so-called

differential method. He wrote an article on the capillary galvanometer for resistance measurements in 1874, and the next year he built one of the first selenium cells. He made very important improvements in the Bell system, and in 1878 discovered the principle of the electrodynamic telephone, on which modern loudspeakers are still based. In other technical fields Siemens' name is connected with naval mines, cable machines, ozone valves, electric railways and so on.

Finally, a word or two about Heinrich Hertz, since Parsons cannot understand why we commemorate him by using his name for a unit of frequency.

Heinrich Hertz (1857-1894) was the first to investigate the physical basis of Maxwell's mathematical discoveries. This made possible the generation of electromagnetic vibrations and consequently the whole of wireless telegraphy. He built a transmitter and a receiver and devised the tuning principle for transmitting maximum power. Hertz was, in fact, the first to carry out radio transmission, and it was on the basis of his work that Marconi became world-famous. Hertz was the physicist, Marconi the technician and businessman.

Europeans consider Siemens and Hertz to be great men in the history of electronics and with the siemens (S) and hertz (Hz) we honor their work as we do that of Ohm, Ampère and Volta, and indeed—Henry.

Mogens Boman

Lecturer
Academy of Engineering
Copenhagen, Denmark

Sir:

We Americans change the names of things at times, too. We have been known to change the name of a dam, an airport, a cape, etc. to Kennedy. Herren Lickfeld, Olf, Neumann and Niemyer [ED 15, June 21, 1966, pp. 50 & 54] and Muschler [ED 16, July 5, 1966, p. 33] all argue eloquently for us to change the name of the mho to siemens. Perhaps, using the same logic, they could accept changing the name of West Berlin to Rooseveltstadt in honor of that grand old gentleman who did so much to make it what it is.

In the U.S., scientists, engineers and optometrists have been using

the metric system for decades. Since the English word for cycle is almost the same as both the German and French counterparts, the recent change of name for frequency still "hertz." But now that Europe has had its way, perhaps in recompense they could accept a new international monetary unit—the dollar.

R. Cameron Barritt
Avionic Devices
Washington, D. C.

Social progress needs economy, efficiency

Sir:

Vladimir Kenn made a statement in the June 21, 1966, issue of Electronic Design [ED 5, p. 65], that engineers "would make social and political 'progress' in a negative direction" if they as a group became active. He concludes that this is so because engineers have been trained to be conservative, economical and efficient.

Obviously, he believes that the opposite is required—that the answer for social problems is to be liberal, uneconomical and inefficient. That is the unfortunate story of the "Great Society."

John W. Jensen
Research Engineer
Litton Industries
San Carlos, Calif.

Accuracy is our policy

In "3-stage pulse limiter has short recovery time," ED 13, May 24, 1966, pp. 86 and 88, errors were made in the schematic. The +3-V supply was shown tied to ground; it should have gone to the common collectors of Q2 and Q3. R1 and R2 were shown as potentiometers; they are in fact fixed resistors. A corrected diagram is shown below:

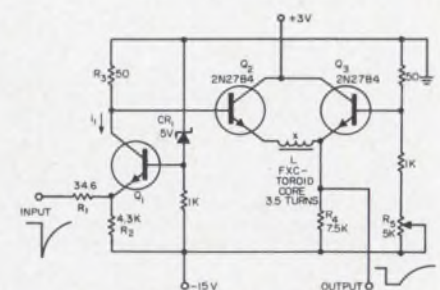

100 μ v resolution auto polarity-display storage overrange digit



[\$595]

See New hp Instruments
Attend Measurement Seminars
WESCON—Hollywood Park

The new Hewlett-Packard 3430A Digital Voltmeter is a high-performance utility instrument ideal for production line work, repair or inspection stations, in the lab or for quality control. It offers the highest value available today in terms of price and performance.

- 100 μ v sensitivity for low-level measurements
- Auto polarity
- Non-blinking display, ideal for faster, easier, less vulnerable measurements
- 60% overrange with an extra digit
- Floating measurement with 10 Meg input impedance
- Fast (half second) response
- Analog dc output from amplifier, useful as a 100:1 voltage amplifier
- RATIO measurement option

Nowhere else can you get these extra "luxury" features at such a low cost. High-speed measurement, 100 mv-1000 v, accuracy 0.1% of full scale ± 1 digit, plus the 4th digit for over-ranging. Measure to ± 500 v dc with respect to ground. No worry about circuit loading with the high input impedance. High stability with the voltage accuracy guaranteed to 3 months, one-year warranty on the instrument. The only DVM of its type available with ratio measurement capability, at an accuracy of $\pm 0.15\% \pm 1$ digit. With the ratio option 01 (\$80), you can normalize transducer dc outputs without taking time for recalculation. It offers all polarity combinations. The bonus amplifier output, $\pm 0.1\%$ accuracy, increases testing flexibility.

Call your Hewlett-Packard field engineer for a demonstration or write for complete specifications: Hewlett-Packard, Palo Alto, California 94304, Tel. (415) 326-7000; Europe: 54 Route des Acacias, Geneva.

Data subject to change without notice. Price f.o.b. factory.

HEWLETT  PACKARD
An extra measure of quality

ON READER-SERVICE CARD CIRCLE 37

WE JUST DROPPED OUR RTL EPOXY

PRICES.

RTL epoxy TO-5 prices now as low as 18¢ per
2-Input Gate function: 67¢ per JK Flip-Flop function.

+15°C to +55°C

DEVICE	PART NO.	PACKAGE	1-99	100-999	1,000
Buffer	U8A990028X	Epoxy TO-5	\$.80	\$.54	\$.36
Dual 2-Input Gate	U8A991428X	Epoxy TO-5	.80	.54	.36
JK Flip-Flop	U8A992328X	Epoxy TO-5	1.50	1.00	.67

FAIRCHILD
SEMICONDUCTOR



The Absolute Ohm

How a classic ESI system can bring you closer to the absolute in resistance measurement, and why it can be of more than academic interest in many electronic labs and plants.

The Absolute Ohm is a theoretical ideal, which can be ever more closely approached, but never attained.

Its legal value is the resistance standard maintained by The National Bureau of Standards. The accuracy of your resistance measurement depends on the degree of "direct traceability" to this NBS standard.

The ESI 242 Resistance Measuring System permits a chain of measurements to any resistance level from a single, directly traceable reference standard—with comparison accuracies of 1 ppm. Measurements can be

made swiftly and simply; results are read directly, without calculation.

Even when you are not looking for greater accuracy in your resistance measurement and calibration, you may have good reason to consider our 242. It could help you speed up the pace of lab or quality control operations. Or in-

crease reliability. Or get better results from less experienced people on your production line.

The 242 includes Ratio Bridge, Decade Standard, Generator-Detector and 4-Terminal accessories.

We can't promise The Absolute Ohm in resistance measurements. But with the 242, we do offer The Definitive System. ESI, 13900 NW Science Park Drive, Portland, Oregon (97229).

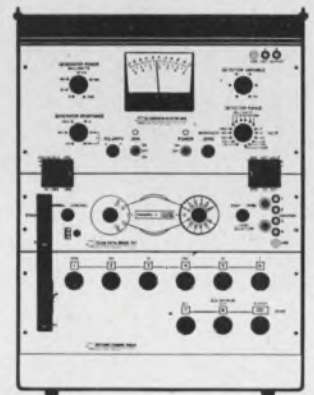

The Absolute Ohm's home away from home — our 242 Resistance Measuring System. Price: \$3400.



The legal residence of The Absolute Ohm is Washington, D.C.—at the National Bureau of Standards.

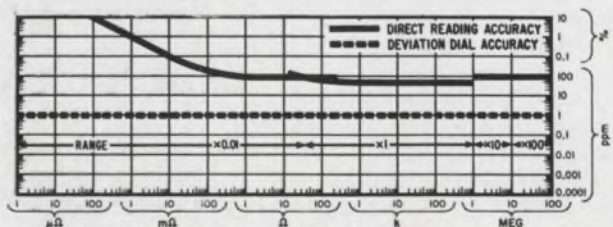

Accuracy of 242 System over specified ranges.

Electro Scientific Industries **esi**

See ESI at WESCON—Hollywood Park—Booth numbers 401-402-403- and 404

ON READER-SERVICE CARD CIRCLE 39

Hoffman micro-glass zener regulators are the most reliable ever made



and that's a claim you
can see through

Unretouched photograph of unpainted Hoffman Micro-Glass Zener Regulator.

The reasons are hermetically sealed in glass. That's our exclusive way of keeping contaminants out and preventing any fusion of the metal-glass interface. The passivated silicon wafer looks like it's floating in the sleeve — the glass doesn't touch the junction anywhere.

Take a look at the slugs; you'll see they butt right up against the wafer. No intermediate contacts. And the leads are brazed not

welded or soldered to the slugs. They conduct better that way, and are about 12 times stronger than if we'd welded or soldered them.

One thing you can't see is the coefficient of expansion of the glass, slugs and wafer. They're a matched seal. That, you can test, if you must.

Thirty-seven of our 1.5 watt regulators, IN4460 through IN4496 replace 749 Jedec types. They're designed for micro-

circuitry, small space limitations and excess power requirements. Every one *guarantees* maximum limits on low level impedance, reverse leakage current and zener voltage regulation.

If you need regulator reliability, there's only one place you can get it — painted and marked to your specifications. Phone (213) 686-0123, or write: Hoffman/Semiconductor, Hoffman Electronic Park, El Monte, California 91734

Hoffman | SEMICONDUCTOR
A Division of Hoffman Electronics Corporation

ON READER-SERVICE CARD CIRCLE 40

Why does Bodine die cast its own rotors?



—to assure highly uniform operation of Bodine motors



Rotors are so important to fractional horsepower motor running characteristics that we die cast our own. This is an example of how we maintain precise controls on the quality of our parts...to be sure of consistent and dependable operation of Bodine motors.

Raw materials are purchased from strict engineering specifications. Mechanical tolerances are very close. Latest die casting methods give us excellent control of quality. In fact, we control every stage of rotor manufacture to be sure of an even air gap for quiet, dependable operation and long motor life.

Doesn't your product deserve a high quality motor? A Bodine motor. Bulletin S describes over 275 stock types and sizes from 1/2000 to 1/6 hp. Write Bodine Electric Company, 2528 West Bradley Place, Chicago, Illinois 60618.

Speed Inquiry to Advertiser via Collect Night Letter
ON READER-SERVICE CARD CIRCLE 41

*Bodine motors wear out—
it just takes longer*

BODINE
fractional/horsepower
MOTORS



... the power behind the leading products

TRW
Varicap
**DIODES
STRETCH
YOUR
TUNING
RANGE**



...up to 20% greater Δc !

You have a lot of things working for you when you design your tuning system around TRW Varicap diodes. First of all, your circuit will provide controlled tuning range to spare—in many cases you can eliminate additional band switching.

Circuitry is simplified and fewer components are required. Varicap-controlled tuning systems assure the performance characteristics required in the most sensitive communications and monitoring networks.

TRW Varicap diodes are true abrupt junction devices, pro-

duced by proprietary processes. This construction gives the designer maximum capacitance change with voltage; optimum uniformity and tracking and superior performance under all operating conditions.

Varicap Bulletin No. 101 discusses wide-range theory in detail. Get a copy from your authorized distributor or write TRW Semiconductors Inc., 14520 Aviation Boulevard, Lawndale, California (213) 679-4561.

Varicap is the trademark of silicon voltage-variable capacitors manufactured by TRW Semiconductors Inc.

TRW SEMICONDUCTORS

ON READER-SERVICE CARD CIRCLE 42

Co-PublishersJames S. Mulholland, Jr.
Robert E. Ahrens Dorf**Editorial Director**

Edward E. Grazda

Editor

Howard Bierman

Managing Editor

Robert C. Haavind

Technical EditorsJoseph J. Casazza
Rene Colen
Maria Dekany
Mark B. Leeds**News Editors**Frank Egan
Roger K. Field**East Coast Editor**

Neil Sclater

West Coast EditorsRalph Dobriner
Peer Fossen**Copy Editor**

Peter Beales

New Products EditorsDavid Sorgan
Genevieve Adee**Washington Editor**

S. David Pursglove

Editorial ProductionDollie S. Viebig
Anne T. Lombardi**Art Director**

Clifford M. Gardiner

Art Assistant

William Kelly

Technical IllustratorsLewis D. Hill
Cheh Nam Low
Douglas Luna
Robert Ranta**Production Manager**

Thomas V. Sedita

Asst. Production Manager

Helen De Polo

Production AssistantsCarl Merkin
Bernard Wolinsky**Circulation Manager**

Nancy L. Merritt

Reader Service

Diane Pellechi

EDITORIAL



The UFO puzzle: time for a technical evaluation

In recent years there have been puzzling, persistent reports in this country and elsewhere of unidentified flying objects (UFOs). People who have told of sighting them are agreed on some common characteristics: the objects are shaped like saucers or cigars and frequently have lights that change color.

Most people haven't seen UFOs; so most people have been inclined to scoff at the reports. But the matter is not lightly dismissed. For one thing, the reports are fairly widespread. For another, responsible people have told of seeing UFOs—policemen, pilots, astronomers, even some engineers.

One original skeptic, John Fuller, a columnist for the *Saturday Review*, decided to check a UFO report to its source. He thought it might make an interesting column for the magazine. He ended up writing a book (*Incident at Exeter* [New York: G. P. Putnam's Sons, 1966]). Fuller visited Exeter, N. H., where two policemen—one a former flier—had seen a lighted, metallic "saucer" hover over a field. Before he was finished, he had tape-recorded more than 60 interviews with reputable citizens, all of whom had seen UFOs in the area.

Fuller raises some interesting questions in his book.

Are UFOs a mass hoax, perpetrated on the public by practical jokers? The Government evidently doesn't think so. The Air Force has been looking into and analyzing UFO reports for years (at the Foreign Technology Div., Air Force Systems Command, Wright-Patterson AFB). But, according to Fuller, the Air Force has offered no meaningful explanation for many of the sightings by trustworthy observers, despite extensive efforts to have such information released.

Is there some relationship between the electromagnetic field around power lines and the presence of UFOs? Many UFOs have been reported in the vicinity of power lines. Power failures and electrical disturbances are sometimes preceded by UFO reports in the area. Minutes before the great Northeast Blackout last fall, UFO reports were received from upstate New York, Rhode Island, Massachusetts and New Jersey.

One thing is certain: somebody is seeing something. And the Government has yet to issue a full technical report on its investigations.

We believe that the public has a right to be informed of whatever data have been gleaned so far. Then, a careful study program, using electronic instrumentation, might be in order. Much could be learned, or disproved, by a detailed study of the electromagnetic characteristics of these objects.

But first, let's have a full and frank report from the Air Force.

HOWARD BIERMAN

(PS—We'd be interested to hear from any engineers who may personally have observed such phenomena. Names will be kept in confidence.)

Push
Null
Read

Accuracy: 0.002% of reading + 0.0002% of range
 Highest resolution (0.2 ppm of range) -1, 10, 100, 1000 v ranges
 Stability: 1 ppm/hour, 5 ppm/day, 30-day calibration cycle
 RATIO measurements: four ranges with 6-digit resolution
 True isolation, battery operation

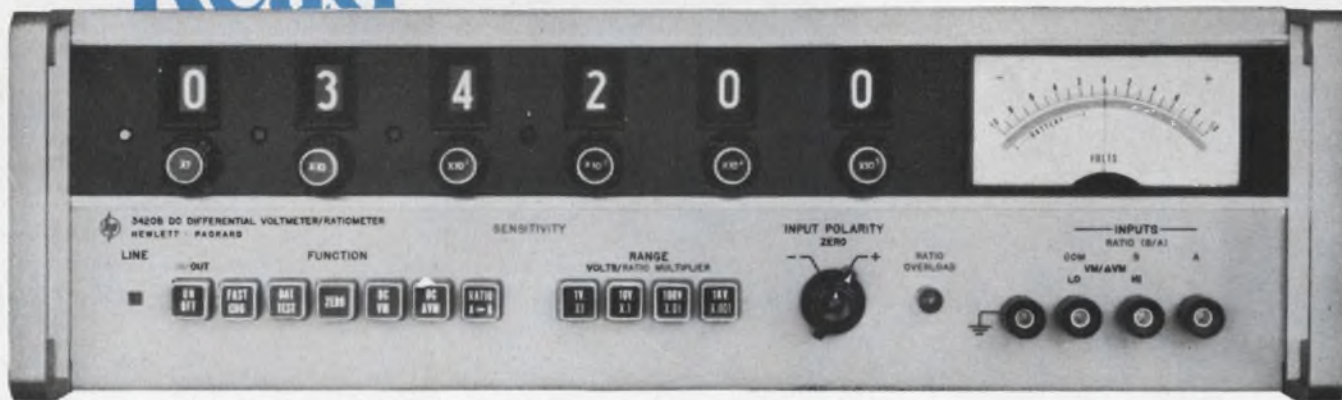

hp 3420A/B

for today's most accurate dc differential volt/ratio meter measurements!

accuracy Here's the most accurate dc voltmeter available today, backed by a minimum 30-day calibration cycle and temperature coefficient of 4 ppm/°C. With a sensitivity of $\pm 10 \mu\text{V}$ full scale, six-digit resolution is meaningful for measurements in standards and calibration labs, design labs . . . and all areas (physics, biomedical, electro-chemical, university, processes, control) where high precision and stability are essential.

ratio Then add *four ranges* of ratio capability with 0.002% accuracy and make both resistance and voltage ratio measurements. The customary precision voltage source required for resistance ratio is no longer necessary.

isolation A line/battery operated model permits true "floating" measurements and provides portability not available at this accuracy level before.

There is 10% overranging on all voltmeter functions, with overload recovery of less than three seconds, and immunity

to damage by overload. The recorder output at ± 1 volt and 1 milliamp will drive any recorder.

ease of operation Pushbutton function and range selection, plus a full in-line six-digit readout, permits convenient and time-saving measurements. Six discrete decade dividers with concentric null sensitivity pushbuttons now make nulling very simple. The zero pushbutton disconnects the input source and decades, and internally shorts input terminals . . . no need to return decades to zero.

All silicon solid-state, with plug-in circuit board design for easier maintenance in both the 3420A (line operated) at \$1175, and the 3420B (line/battery operated) at \$1300.

Ask for a demonstration by calling your Hewlett-Packard field engineer. Or get complete specifications with the same call or by writing Hewlett-Packard, Palo Alto, Calif. 94304, Tel. (415) 326-7000; Europe: 54 Route des Acacias, Geneva.

Data subject to change without notice. Prices f.o.b. factory.

See New hp Instruments
Attend Measurement Seminars
WESCON—Hollywood Park

HEWLETT  PACKARD
An extra measure of quality

ON READER-SERVICE CARD CIRCLE 43

1649



WESCON USA

What is WESCON USA	U67
Probing the technical sessions	U68
Index of technical papers	U86
Microelectronics at Wescon	U96
Touring the exhibit areas	U102
Measurements and instruments	U104
Production and packaging	U116
Circuit components	U124
Audio, TV and automatic control	U156
Air and space control systems	U158
Data processing	U160
Communication and detection	U166
Industrial design awards	U170



3 times out of 4
our distributor has your
switch order in the bag.

The bag
we call
Uni-Pak.

Your Cutler-Hammer Distributor sells more than 10,000 different commercial switches and military switches. One of these will do your job, or we're ready to design the special that will.

More often than not, he can fill your switch order from right off his shelf. Because of Uni-Pak.

What's Uni-Pak all about?

First, Uni-Pak covers the 350 basic commercial and military switch models that account for 75% of our Distributors' orders. Next, Uni-Pak is convenient packaging: one switch with mounting hardware per sealed plastic bag; 25 bags per carton.

Most important, Uni-Pak provides immediate local availability of all these popular, conveniently packaged switches. Your Distributor's stocks are substantial. Our factory back-up stocks truly enormous.

Now you have immediate switch selection without tying up dollars in inventory. For prototype production. To cover unexpected rush orders. The switches you need today, you order today. Or yesterday at the earliest.

Chances are excellent that our Uni-Pak switch program can pay-off in better service for you. Plan to discuss it soon with your nearby Cutler-Hammer Distributor.

CUTLER-HAMMER

Milwaukee, Wisconsin 53201





What is WESCON USA?

This special section brings the 1966 Western Electronic Show and Convention to design engineers all over the United States. If you are not attending in person, tour the show through these pages. If you will be on hand in Los Angeles, August 23-26, you will find this section an invaluable aid in planning your activities in advance.

For those who can't attend

If you are not planning on attending Wescon, the following sections of WESCON USA will bring Wescon to you:

- **Touring the exhibits.** New products to be shown are arranged by show area (Measurements and Instruments, page U104; Production and Packaging, page U116; Circuit Components, page U124; Audio, TV and Automatic Control, page U156; Air and Space Control Systems, page U158; Data Processing, page U160; Communication and Detection, page U166).
- **Probing the technical sessions.** Informative summaries of some of the technical sessions start on page U68.
- **Microelectronics at Wescon.** A wrap-up for all those interested in microelectronics begins on page U96.
- **Technical paper order form.** Order the proceedings for the Wescon technical sessions using the convenient order form on page U89. A list of the papers, by session, starts on page U86.
- **Industrial design awards.** Eighteen finalists in the Wescon Industrial Design Contest are displayed, beginning on page U170.

For those who will attend

If you are going to Wescon, the following sections of WESCON USA will help you make plans in advance so that your time at the show can be spent most efficiently:

- **Technical paper index.** A complete list of the technical papers, by session, starts on page U86. Summaries of some of the papers are given beginning on page U68.
- **Technical paper order form.** Save yourself the trouble of carrying the technical session proceedings back from the show. Order the ones you want by using the form included on page U89.
- **Touring the exhibits.** New products to be shown are arranged by show area (Measurements and Instruments, page U104; Production and Packaging, page U116; Circuit Components, page U124; Audio, TV and Automatic Control, page U156; Air and Space Control Systems, page U158; Data Processing, page U160; Communication and Detection, page U166).
- **Other features.** Preview microelectronics at Wescon, starting on page U96, and the finalists in the Industrial Design Contest, starting on page U170.

Technical session summaries

Listen to what the speakers will say

With 23 contributed sessions, special invited sessions and an extra "last minute dividend" session on Surveyor 1, the Wescon technical program this year covers a diversity of topics of interest to the design engineer. Electronic Design's editors have taken a representative sample of the technical sessions and have summarized the major points of interest to the designer.

Up-to-date high-frequency amplifier design discussed

High-frequency amplifier design raises several basic questions: Where and when is it best to apply each of the major semiconductor types? What's the best approach to design? What trade-offs should be made to yield over-all optimum circuit performance?

The answers are covered in Session 22, a symposium on semiconductor devices as applied to amplifiers operating at 0.5 MHz to 5.0 GHz. A panel of six specialists focuses on bipolar transistors, junction FETs, MOSFETs and varactors.

The frequency interval 0.5 to 1.0 GHz is analyzed by Richard Q. Lane of Fairchild Semiconductor Research and Development Laboratory, Mountain View, Calif. He judges the design and relative performance of bipolar, junction-FET and MOS small-signal amplifiers according to the following criteria:

- Maximum stable gain and stability factor, k (reciprocal of Linvill's critical factor, c).
- Noise figure.
- Ease of gain control.
- Overload distortion.

Lane concludes that when the first three criteria dominate, the bipolar transistor is superior to other small-signal devices. But if overload distortion in the form of cross-modulation is an overriding consideration, FETs or MOSs are best.

Large-signal circuits considered

Broad advice on handling solid-state power in large-signal circuits is given by Roy C. Hejhall, of Motorola Semiconductor Products, Phoenix, Ariz. With stress on varactors and silicon bipolar transistors, he considers device capabilities and circuit design at power levels above 1 W. Among

the points he covers:

- Transistor performance from the standpoint of efficiency and linearity.
- The step-recovery type of varactor, which yields the highest power outputs in multiplier circuits.
- The large-signal impedance method of amplifier design.

Hejhall says that at the higher frequencies varactors out-power other semiconductors.

A broad look at the FETs

FETs—both junction and MOS—are explored in separate papers by J. B. Compton, of Siliconix, Inc., Sunnyvale, Calif., and Paul E. Kolk, of KMC Semiconductor Corp., Long Valley, N. J.

Compton shows that the desirable high-frequency and vhf performance characteristics of vacuum tubes—such as low cross-modulation, reverse age and low noise figure—are available in FETs. Based on a wide range of FET applications in vhf circuitry, he says, a triode vacuum tube can be replaced by a FET in many RF applications, with changes in supply voltage and some retuning.

According to Kolk, the MOSFET is advancing rapidly toward microwave performance. The high-frequency performance of MOSs, he says, is predictable from the geometry and the transconductance characteristics and is a function of gate voltage. The latter, he notes, dictates the performance of the device for improved intermodulation, cross-modulation and spurious response effects.

The MOSFET, Kolk adds, has a large dynamic range and operates over an extremely broad temperature range. It is essentially insensitive to bias voltage and current variations. In designing a circuit with MOSs, Kolk says, the engineer can use the high-frequency techniques applicable to existing bipolar transistors. He can even, he suggests, use techniques applicable to vacuum-tube circuit

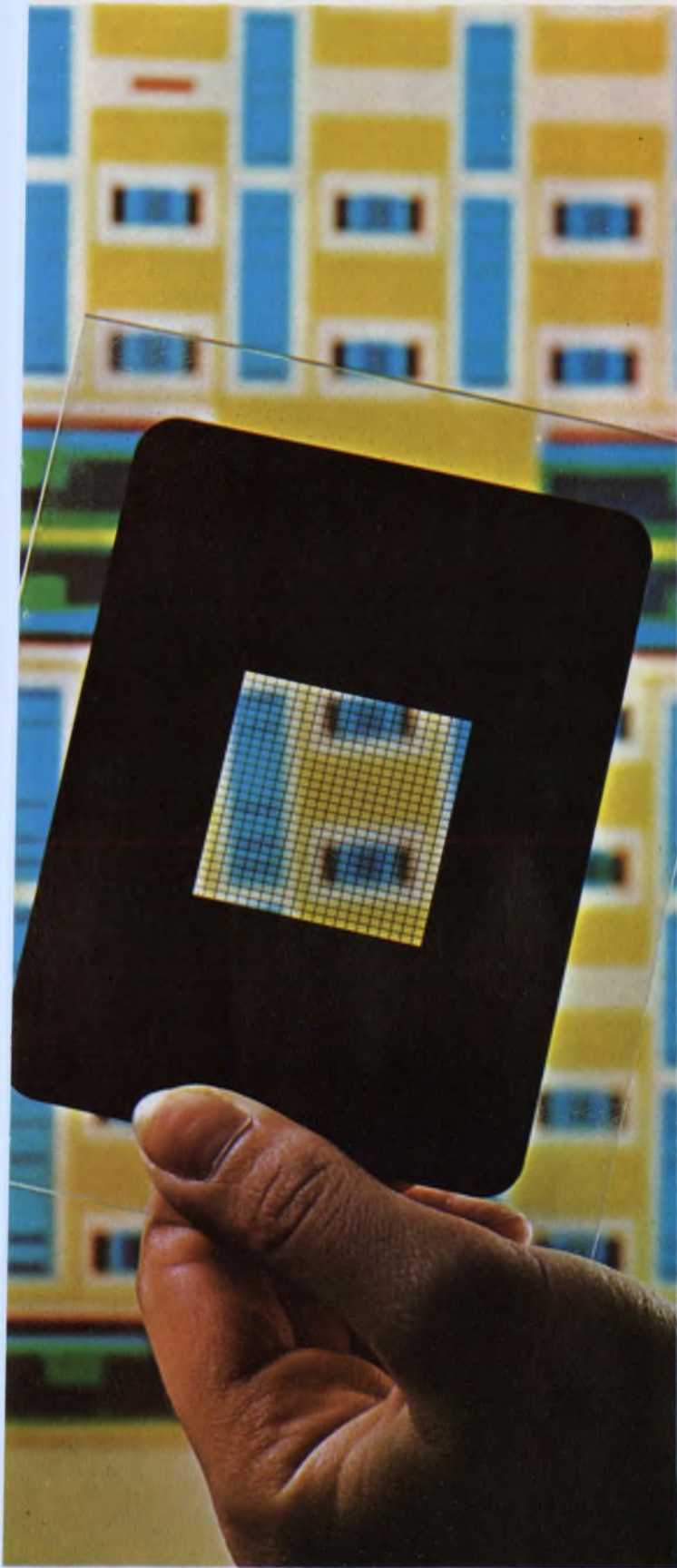

Photomask, used by IBM in the development of monolithic integrated circuits, was designed with the help of a computer. In the background are the color layouts for the different masks for a single, complete monolithic chip (paper 1/4).

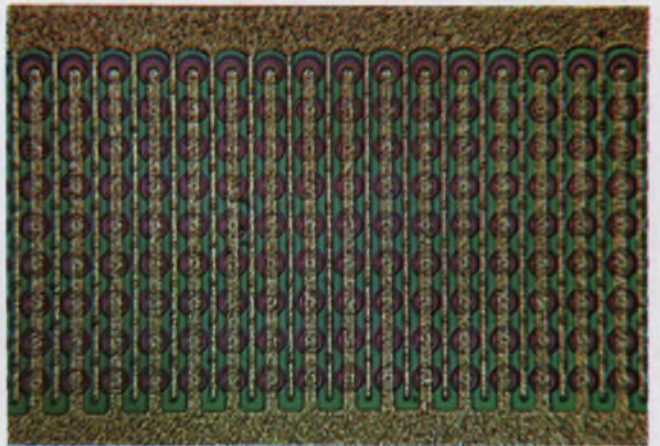

Availability of high-power and high-frequency overlay transistors is giving impetus to the development of all-solid-state mobile communication equipment, according to RCA engineers (paper 8/1).

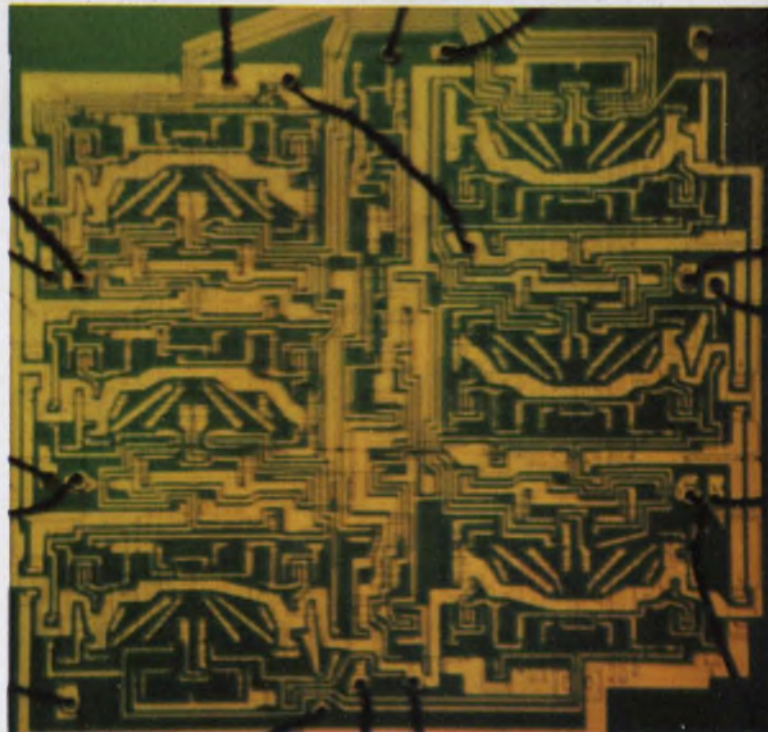

Array of seven flip-flops, manufactured by Texas Instruments, Inc., forms Johnson Counter on a 135- by 135-mil chip (paper 20/6).

designs at high frequencies.

Advice on noise and trade-offs

The matter of noise in microwave amplifiers is dealt with by George D. Johnson of Texas Instruments, Inc., Dallas. Germanium microwave transistors have been developed that have useful power gain to 4 GHz, he reports, and noise figures of 4.5 dB have been measured at 3 GHz.

Hints on design trade-offs are offered by R.

Minton of RCA Electronic Components and Devices, Somerville, N. J. Both circuitry and device-parameter trade-offs are considered in his paper, with focus on the overlay transistor as a representative bipolar for high-frequency amplifiers.

Session 22 has been organized by ELECTRONIC DESIGN. It will be held in the Biltmore Music Room on Friday, Aug. 26, from 9:30 a.m. to noon. The chairman is Dr. John Moll of the Electrical Engineering Department of Stanford University, and the audience is invited to participate in a "test your design knowledge" quiz before, during and after the session. ■ ■

Spectacular growth foreseen for plastic semiconductors

"Since their acceptance a little over three years ago, plastic semiconductors have experienced a growth rate unrivaled by any other product innovation in the already fast-growing semiconductor industry." The words are those of George Berryman, Semiconductor Components Div., Texas Instruments, in one of the Session 18 papers. This basic theme and the reasons behind it are covered in detail in the four papers that make up Session 18, "Plastic Transistors—Their Impact on the Industry."

Rosy future predicted

Both the existing and the new markets that are opening for low-cost plastic semiconductors are explored by James H. Bockhaus of General Electric in paper 18/1, "Economy Semiconductors—Their Future." According to Bockhaus, both the economy and performance capabilities of plastic devices are convincing responsible design engineers of their value in consumer, military and industrial applications. And as the market expands, the large variety of plastic semiconductors it engenders will give ample opportunity to the designer to optimize his equipment designs for the particular market served.

The cost savings of the new devices, says Bock-

haus, can be tremendous. Most of the plastic-encapsulated transistors sell for at least 10¢ less than their hermetically sealed counterparts, and on many the savings are as much as 30 to 40¢ per unit. At this rate a yearly usage of 3,000,000 units would produce a savings of at least \$300,000. Asks Bockhaus: "If your competitor is using plastic encapsulated semiconductors, can you really afford not to use them?"

The author estimates that the switch to transistorization in the full spectrum of consumer electronics will create a potential demand approaching 600,000,000 plastic units. This consumer volume coupled with increased use of plastic semiconductors in industrial and military markets is the driving force that is leading several semiconductor manufacturers to set up large-volume production capacity. Typical of the companies already in the market are Bendix, Continental Devices, Fairchild, General Electric, Motorola, Signetics, Sprague Electric and Texas Instruments.

How reliable are plastic semiconductors?

"A great deal of skepticism regarding reliability was to be found when plastic encapsulation was in its early stages, some of it justifiable. Even

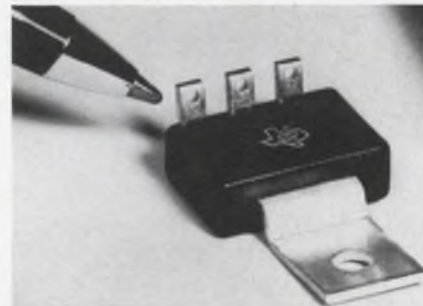
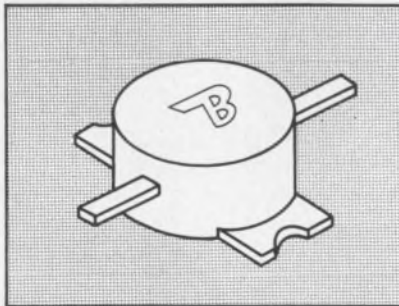
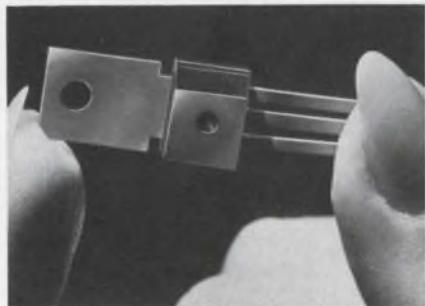

A variety of plastic transistors are now on the market. Representative of these are the devices made by General Electric (left), Bendix Semiconductor (center) and Texas Instruments (right).

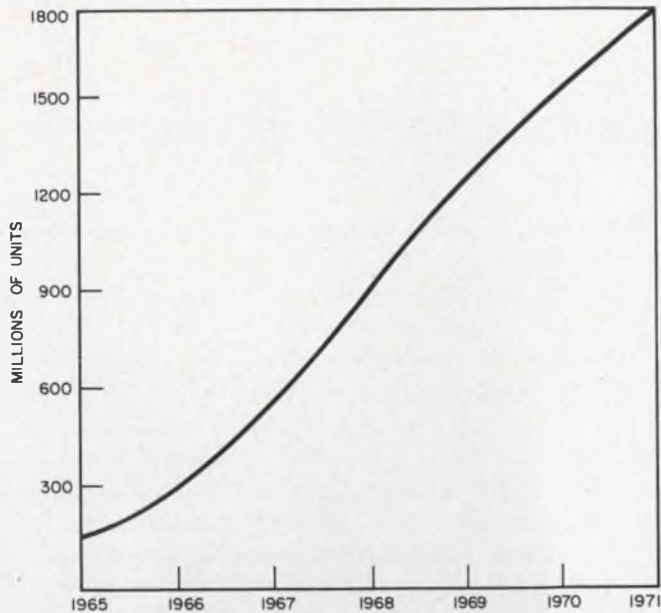

Estimated world-wide use of plastic semiconductors shows sharp increase over the next five years.

today doubt exists in the minds of many and the question is often asked of plastics, 'How reliable are they?' While a great deal of data is yet to be isolated on hermetic-seal types, current data generated at Texas Instruments indicate that plastic devices are capable of meeting military specifications and are as reliable as their counterparts in metal cans tested under the same conditions." So says Berryman in paper 18/2, "The Reliability Impact of Plastic Encapsulated Semiconductors."

In describing the results of reliability testing conducted by Texas Instruments, Berryman points out that for plastic semiconductors the areas of reliability most frequently queried are:

- Moisture and humidity resistance.
- Package stability (effect of plastic on wafer).
- Effects of thermal shock.
- Effects of physical shock.

In all these areas the plastic devices have recorded acceptable results. But despite the extensive data already compiled, much more are needed to predict accurately their failure rate over long periods of time—five years or more. And to do this, acceleration factors must be developed that can be used with confidence. One example of the work being done in this area, according to Berryman, is Texas Instruments SILECT Reliability Program, which when completed will have accumulated more than 50 million transistor hours.

Consumer industry leads the way

The impact of plastic semiconductors on the consumer industry is explored in paper 18/3 by John S. MacDougall, of Fairchild Semiconductor.

According to the author, Fairchild, in 1962, made the decision to enter the consumer elec-

tronics field with low-cost "fallout" silicon transistors. Now, only four years later, the company makes and sells several million plastic-encased silicon transistors per month at an average selling price of under 30¢. This huge increase in the consumer area may be credited mainly to the recent acceptance and use of transistors in television, radio and audio applications. Other consumer market areas, such as appliances and automobiles, have yet barely started to use solid-state devices. But it is expected that as a result of the advantages they afford, a similar and perhaps greater impact will eventually be felt on the automotive and appliance industries.

One significant reason for the consumer industry's acceptance of plastic semiconductors, says MacDougall, is that they are developed for a specific application and intended to be sold only for that application. As the author puts it: "A particular device is intended for a specific socket in the FM receiver market. Although this requires a considerable amount of circuit applications work on the part of the manufacturer, the resulting customer acceptance of the devices fully justifies it."

Power units becoming available

"Plastic encapsulated power semiconductors will open new potential markets to the electronic industry," according to Hy Newman, of Bendix Semiconductor Division, in paper 18/4, "Silicon Power Plastic Transistor."

After describing the fabrication and testing techniques presently used for the Bendix B5000 power transistor, which is encapsulated in a silicon molding compound, the author asserts that the future of the plastic power transistor is tremendous. They make possible, he says, higher-voltage and higher-current devices to form building blocks for power-switching modules. In addition, high-voltage devices for TV and automobile applications, which are basically switching devices, can now be fabricated and manufactured at realistic price levels.

The plastic power transistor is also discussed in paper 18/1. In it James Bockhaus says: "The market for a low-cost silicon power transistor is waiting anxiously to be served and many manufacturers are rushing to fill the vacuum. Power ranges from about 4 to 25 watts are now available, and within the next 24 months the circuit designer can expect a range of plastic silicon power transistors ranging from 100 mA to 3 or 4 A and a voltage selection ranging from 50 to about 400 V. Designers can expect the plastic transistors to sell in the 35¢ and \$1.50 price range, with current-handling capability playing a large role in price determination." ■ ■

(continued on p. U72)

Semiconductor devices: trends and accomplishments discussed

Solid-state devices and integrated circuits are the subject of Session 2—a tutorial meeting organized by the IEEE Group on Electron Devices. Metal semiconductor Schottky-barrier diodes, unpackaged devices, trends in advanced integrated electronics technology and ultra-low-power microwave linear circuits are discussed.

Bright future for Schottky barriers

Many new devices based on the Schottky-barrier concept are now in various stages of laboratory development and will soon become available. Among these are current limiters, high-voltage high-frequency rectifiers, low-voltage high-speed switching elements, 10-20 GHz photodiode detectors and photomultipliers.

In one paper, M. M. Atalla, H. P. Associates, Palo Alto, Calif., reviews the current state of the art in the field and assesses the future of Schottky-barriers and their applications as discrete devices and in integrated circuits.

Considerable progress has been made during the past five years in the technology and engineering of metal semiconductor Schottky barriers and devices. Because the devices are substantially free of minority-carrier injection and related storage effects, they are already in use in many high-frequency applications such as microwave sampling, mixing and detecting.

Atalla predicts that, in addition to their use as discrete circuit elements, Schottky-barrier devices will soon be incorporated in many integrated circuits for various applications. Among these are high-speed diode and transistor logic circuits, diode arrays for high-speed memory, and photo diode arrays for imaging.

Ever more complex arrays

Major trends in advanced integrated electronics technology are:

- The broadening of the integrated-circuit concept to a large class of circuit functions.
- The processing of more complex circuits within relatively small chips of silicon.
- The processing of very large electronic functions on complete slices of silicon.

The latter trend, array technology, is developed in some detail in a paper by R. L. Petritz, Texas Instruments, Dallas. He also briefly compares the processes by which circuits are fabricated by means of discrete devices with those used for integrated circuits, and discusses the key prob-

lems which must be solved in order to develop an array technology.

The author identifies three avenues of direction for today's dominant trends.

The first is the application of the integrated-circuit concept to a much wider variety of functions, and the application of these functions to all electronic markets. While the primary impact of the first-phase integrated-circuit technology was to logic circuits in the military markets, today's developments are affecting linear, microwave, infrared, and power integrated circuits, penetrating the industrial and consumer market as well as the military market. In addition to silicon, compound semiconductors and other materials will be important in expanding the scope of integrated circuits. Advanced devices such as those based on the Gunn effect will enlarge the technical base. Molecular concepts, such as the use of optoelectronic phenomena for coupling, will play an important role.

A second trend is the processing of more complex circuitry within relatively small chips (e.g., 50 x 50 mils) that are then scribed out of the slice of silicon.

More complex circuits are being processed without increasing the size of the basic chip because smaller devices are being used. The improvement in photolithographic techniques is a major contribution to this advancement. But at the same time, in some cases the basic chips are becoming somewhat larger. Fundamental optical problems are encountered in attempting to achieve very small geometries over a single large area. Step-and-repeat techniques are used to achieve simultaneously high resolution over relatively small regions (e.g., 50 x 50 mils) and at the same time utilize effectively a large slice area (one to two in. in diameter).

The third, and in many aspects the most dramatic, trend of integrated electronics technology is toward fabricating very large electronic functions on complete slices of silicon. This technology has been given several names: computer on a slice, large-scale integration, or array technology. A basic tenet of array technology is the interconnection of an array of unit cells into a logically powerful electronic function. The unit cell may be a simple NAND-NOR gate, occupying, for example, an area 10 x 10 mils on the slice, or a rather complex circuit function consisting of 20 to 40 gates occupying 100 x 100 mils. Determination of the unit cell size depends on a number of consid-

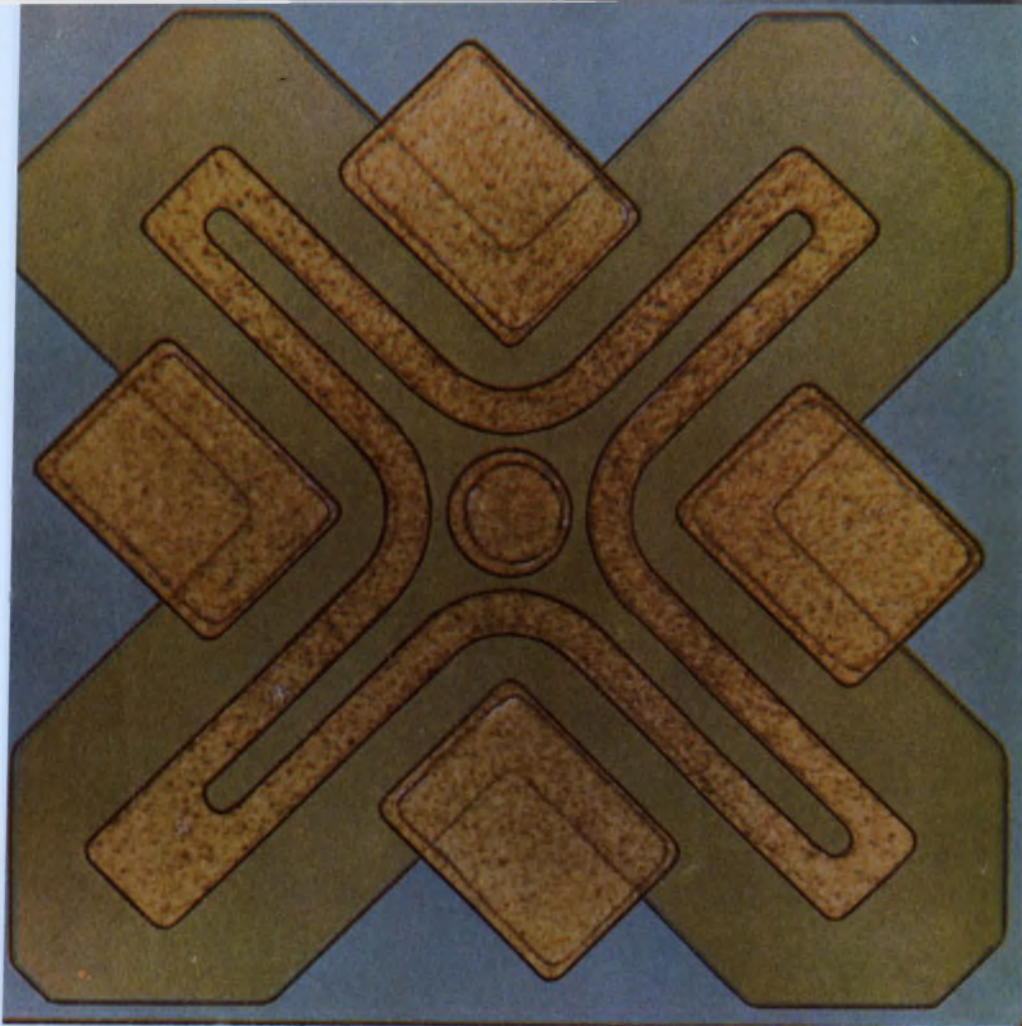

Spotting the best device to use for semiconductor high-frequency amplifiers will be an easier task for attendees of Wescon Session 22. Bipolars, junction-FETs, MOS-FETs (like this geometry) and varactors will be considered. The topic is high-frequency amplifier design—which devices should be used, why and how they are to be used, and which circuits they are best suited for.

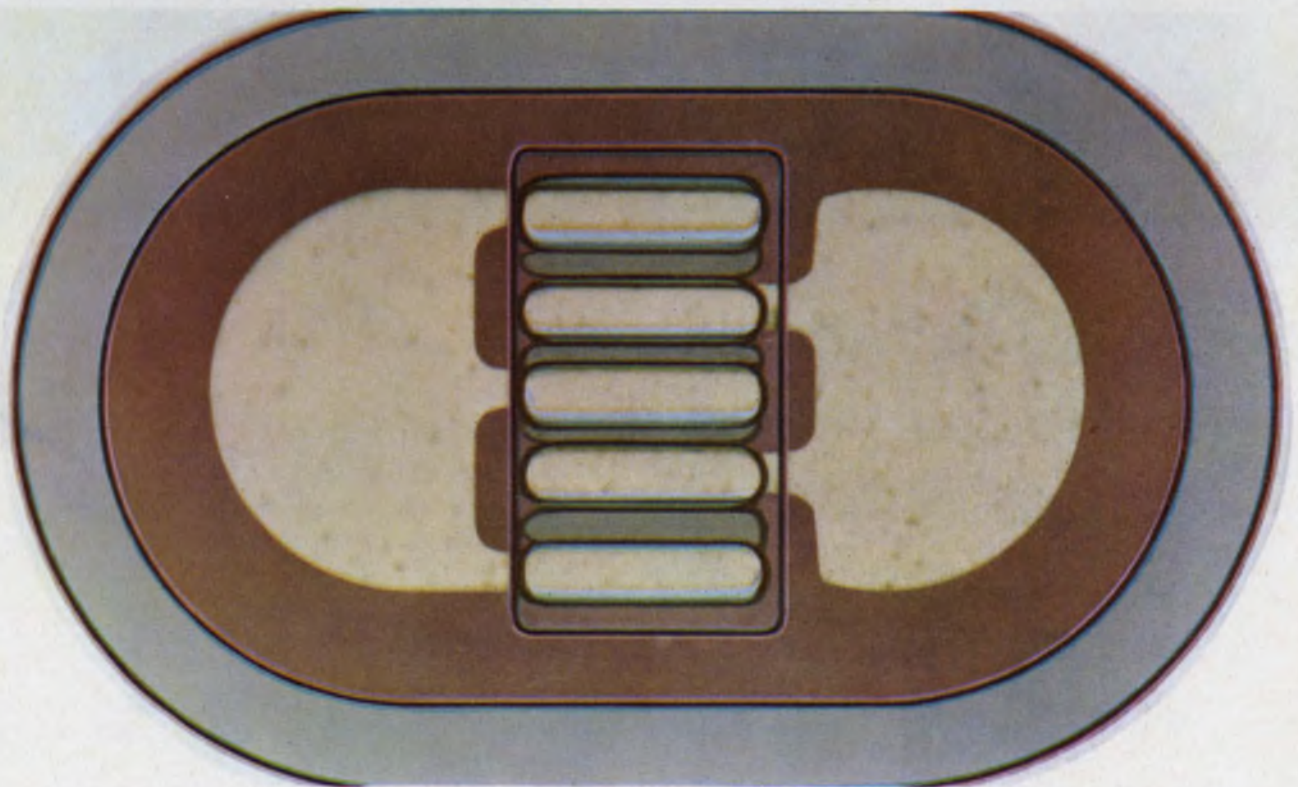

Multiple-emitter bipolar transistors (like this one) as well as various other semiconductors, all as applied to the

design of high-frequency amplifiers, are covered in depth in Session 22.

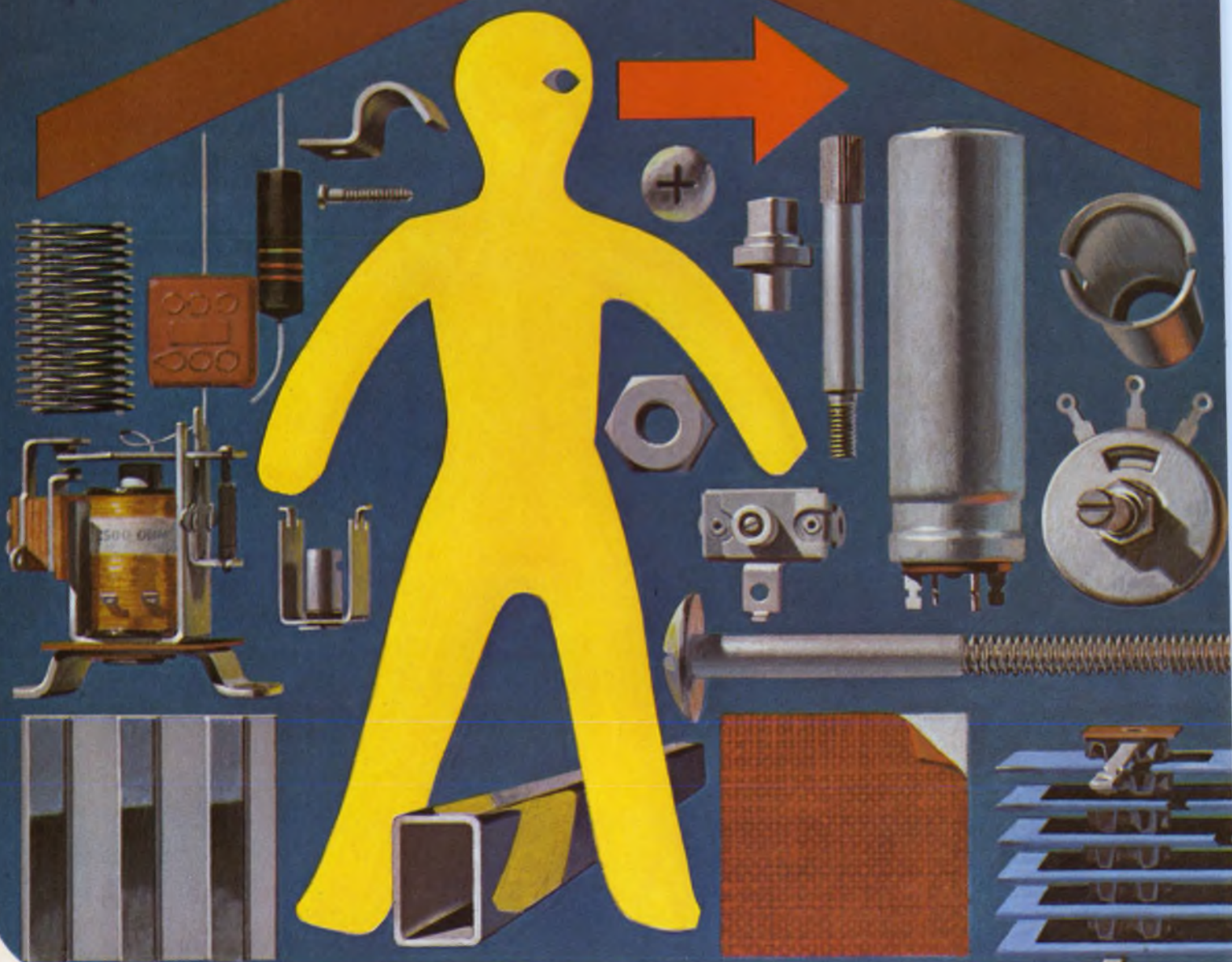

**Alcoa Aluminum
makes your choice
easier when you
must meet all
5 product-
personality
requirements.**

ON READER-SERVICE CARD CIRCLE 217



Environment

Alcoa® Aluminum is durable. In the lab or in the field, lightweight, corrosion-resistant Alcoa Aluminum will stand up against everyday wear and tear. Pound for pound, it's stronger than steel. And Alcoa has the alloys that can meet your most exacting requirements.



Application

Alcoa Aluminum is versatile. It's nonmagnetic, nonsparking, dampens vibration and, since it is an excellent conductor of both heat and electricity, it's suitable for a wide variety of enclosed applications.

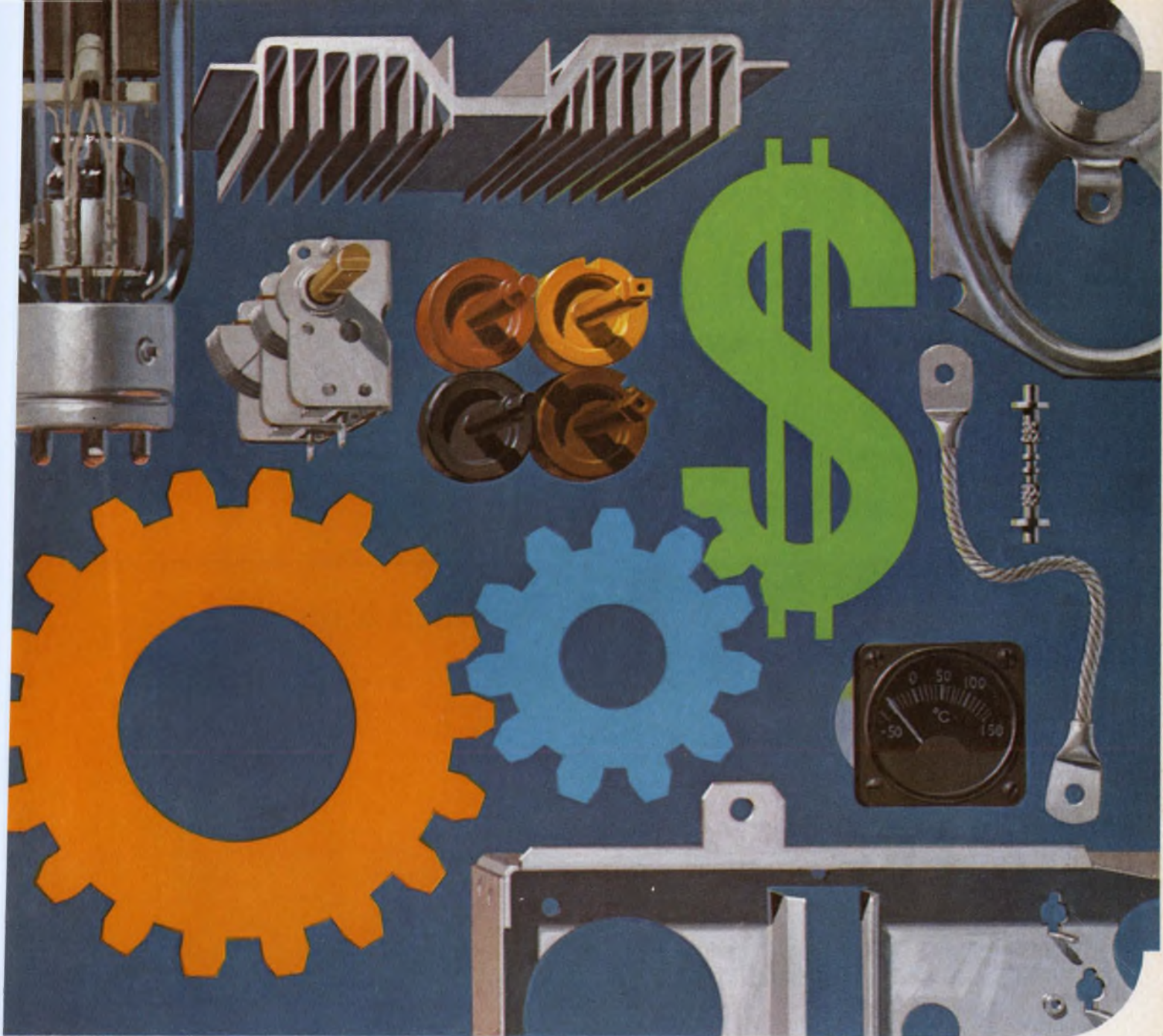

Aesthetics

Alcoa Aluminum is easy to finish. Either alone or in combination with many other materials, natural aluminum has a pleasing appearance that can be enriched by embossing the surface or by the addition of color—in a broad spectrum.

Production

Alcoa Aluminum is easy to fabricate. It can be cast, forged, extruded, machined or drawn . . . formed or fastened by practically any method, often at cost savings.

Customer Satisfaction

Alcoa Aluminum is oriented to your customer's needs. A wide variety of shapes and sizes, alloys and finishes, properly applied, assure the best performance of your product.

For complete information on how to put aluminum's five-point

personality into your product, contact your nearest Alcoa sales office. Or write: Aluminum Company of America, 1780-H Alcoa Building, Pittsburgh, Pa. 15219.



ALCOA

Change for the better with Alcoa Aluminum

erations including the optical restrictions mentioned earlier. The step-and-repeat process allows for repetition of the basic unit cell over the entire slice of silicon.

Submicropower circuits on the way?

The need for ultra-low-power or micropower circuits in portable military communications and surveillance equipments has taken on increasing importance in recent years.

According to J. D. Meindl and P. H. Hudson, U.S. Army Electronics Command, Ft. Monmouth, N. J.: "The quiescent power requirements of today's low-frequency, wideband, tuned, and low-noise amplifiers as well as oscillators, mixers and

detectors often can be lowered by more than an order of magnitude."

In their paper, the authors discuss optimum design techniques with which the power consumption of linear and quasi-linear circuits can be lowered. This, they say, can be accomplished by:

- Using transistors having the largest maximum gain-bandwidth product. Frequently, a large power saving can be achieved by using an extremely small geometry microwave transistor at a frequency well below its maximum capability.

- Selecting circuit configurations which demonstrate superior low-power performance. A "circuit-oriented power saving" in excess of 10 times may often be achieved in low-power linear circuits.

- By describing the quiescent power requirements of each circuit in terms of its primary small-signal design constraints. ■ ■

Rapid transit rides into Wescon with computers blazing

As automobile traffic in the metropolises of America grinds almost to a halt, city planners around the country have begun to realize that the ubiquitous and seemingly omniscient computer can be of great assistance. Already it is at work in Syracuse, N. Y., and Tampa, Fla., giving orders to signal lights that control automobile traffic. And starting in the autumn, section after section of New York City's traffic signals will consult sectional computers before they blink at pedestrians and motorists. Wasted time costs money, and city fathers realize that they must provide modern equipment to speed constituents to their destinations.

A number of leaders in the electronic industry recognize the potential for growth into the automotive field. Electric power is clean, cheap and quiet, and electronic controls are, by their nature, best suited to regulate this power.

At Session 16, two papers describe the rapid transit innovations in the San Francisco Bay area. One paper gives a broad view of the problem of transporting people about a city.

Take an automatic train to your electric car

John Beckett, government relations manager, Hewlett-Packard Company, takes a long-range look at the role of electronics in urban transportation during the coming decades.

Plans for the development of future transportation systems should not offer the traveler merely a choice of private auto or mass rapid transit. Rather, the commuter should be able to select his mode of travel from a number of alternatives.

These could include a variety of rented vehicles, such as electric taxis, rented electric cars, rapid transit vehicles operating on exclusive rights of way with electronic controls. The public's choice could then be made with regard to convenience, comfort, speed and cost.

Beckett suggests that a single charge card could apply to many or all of these services. Each person could be billed at the end of the month. In fact, urban transportation could be treated much like a utility.

The two essential ingredients for fast, dependable, clean and silent transportation about our big cities, says Beckett, are the computer and the electric car. Automatic billing, two-way communications, electronic safety devices and automatic control systems would accompany these two developments.

BART experiments on a large scale

Deane Aboudara, San Francisco Bay Area Rapid Transit District, describes the alternatives, problems, decisions and goals of the largest experimental program in modern rapid transit in the United States.

Aboudara gives an account of the power distribution system of BART* (Bay Area Rapid Transit), its propulsion system, its automatic control system, the evaluation of possible fare collection methods, and some design considerations that are peculiar to rapid transit, such as headway, braking to a station and wheel-wear compensation.



One man can dispatch all the trains at the new BART transit system for the San Francisco Bay Area. Computers

At this time, BART is experimenting with dc motors that use SCRs to control the flow of ac current as well as frequency-controlled ac motors powered with dc. Similarly, computers aboard the moving cars are being compared with computers located at wayside sites. And fare tickets with imbedded ferrite slugs are being judged against tickets with iron oxide coatings.

Some trains have brains

C. William Woods reports on the contribution of Westinghouse Air Brake Company (WABCO) to the BART experiment. WABCO's automatic control system places a good deal of the control equipment aboard each vehicle. This enables the vehicles on the track to continue to operate even

are located aboard the trains and at the wayside. This experiment evaluates four systems.

if some of the central equipment malfunctions. Woods stresses that there is a big difference between moving people and moving materials, trains or equipment: Goods and unladen trains can stand idle indefinitely, whereas people have limited patience.

The movement of people must take place on schedule in utter safety, and Woods feels that this can best be accomplished with control and safety equipment located on each vehicle. Woods' paper discusses a method by which a wire-carried signal can alert a motorman to dangers up the track and even control the spacing and speed of the vehicles along the track. Its analog signals are continuously evaluated by a central DDP-24 digital computer made by Computer Control Company. ■ ■

Mobile radios turn to overlay transistors

Within five years, all mobile communications equipment will be solid-state and the most favored device for the job is the overlay transistor. So say RCA engineers in five papers due for delivery in Session 8. And the reason that they give is that the overlay transistor has high current gains at high radio frequencies, and high power dissipation and current-handling ability.

They also discuss the extended frequency and

power ranges of the overlay transistor. These create special design problems in such basic building blocks as straight-through amplifiers, oscillators, amplifier-multipliers and oscillator-multipliers.

The transistors must be designed, or selected, to satisfy the very special properties of mobile transmitters. These include the operating voltage that may be 24 to 28 or 12 volts, breakdowns that may

occur during tune-up or sudden changes in the load, and the need for adequate cooling.

The design of transistor power circuits operating at microwave frequencies involves two steps: (1) the determination of the load and the input impedances under dynamic operating conditions and (2) the design of filtering and matching circuits for optimum performance, according to Hon C. Lee, of RCA Somerville Division. He points out that the lack of large-signal representation of microwave transistors prevents an analytical design approach to power circuits. The dynamic input and load impedances are difficult to calculate, since the transistor's parameters under large-signal operation differ considerably from small-signal values. The power levels, too, affect the parameters. Therefore the designer is better off using experiments to find out the dynamic impedances, says Lee. He recommends the slotted-line measuring technique since the test setup can also be used to evaluate the transistor's power output, power gain and efficiency.

The choice of common-emitter or common-base configuration is the next decision the designer has to face, continues Lee. The decision must be based on the dual consideration of performance and stability. With regard to performance, common-base amplifiers provide higher gains and common-emitter circuits yield higher output powers while the bandwidth and collector efficiencies are about comparable.

From the stability point of view, Lee contends that the widespread assumption that common-emitter circuits are more stable is not quite valid for microwave and uhf operations. The reason for this assumption stems from linear analysis of transistors without taking into account parasitic elements. For high-power operation at uhf and microwave frequencies, the parasitics must be treated together with the intrinsic transistor, he explains. Moreover, RF transistors must be con-

sidered nonlinear devices rather than four-terminal linear devices.

Mobile transmitters complicate design

When these high-power, high-frequency amplifiers are designed for mobile transmitters, other problems rear their heads. The low-voltage supplies (either 24 to 28 or 12 volts) and the required high-power levels result in small impedances and hence large RF circulating currents, according to Stanley Matyckas, also from RCA, Somerville, N. J. The peak current may be as high as 20 A for a supply voltage of 12 V and an output RF power of 60 W, since the collector load impedance must be about 1 ohm. "In view of these factors," he says, "the well-proven vacuum-tube techniques become practically useless." Because the collector-to-base capacitance of the overlay transistor depends on the voltage, the neutralization of large-signal amplifiers is impractical, Matyckas asserts.

To improve the performance of large-signal transistor amplifiers in mobile transmitters, Matyckas recommends output-matching circuits that present a high impedance to the harmonic currents generated at the collector. The more widely used circuits are shown in Fig. 1.

Impedance problems become more apparent when several transistors must be paralleled to increase the available output power. Matyckas points out that with transistors the bases cannot be tied together directly as with vacuum tubes. Each transistor should have a base input coil that permits the adjustment of the drive levels, and the connection should be made through these base coils. The collectors may be tied together except when the supply voltage is 12 V. In that case, he recommends that the connection should be made through individual collector coils for higher impedance levels.

How to suppress instabilities

Instabilities in transistorized vhf amplifiers can take several forms. Commonly these occur at frequencies far below the operating frequency,

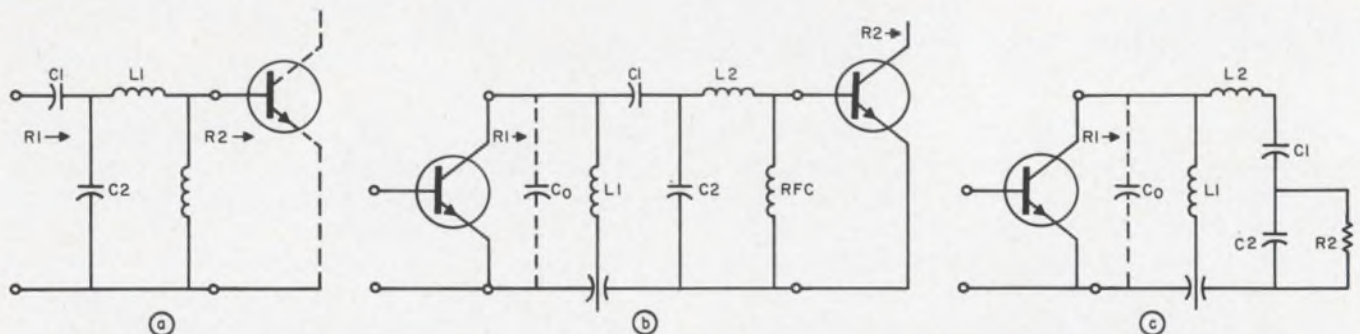

1. Typical matching networks for transistor power amplifiers for the input (a), interstage (b) and output (c) sec-

tions. The output matching circuit should present a high impedance to the harmonics generated at the collector.

where the gain increases rapidly, according to Matyckas. He points out several remedies as shown in Fig. 2:

- Because the base-emitter junction is highly capacitive, at low frequencies a resonant circuit can be formed with the addition of a choke (*RFC*). The formation of this resonant circuit can be avoided with a low-*Q* ferrite-type choke or a wire-wound resistor in place of *RFC*.
- The emitter bypassing should be done with two capacitors to cover the low frequencies.
- The dc power wiring should have adequate bypassing at both the operating and the low frequencies to shunt out stray inductances.
- The output matching circuits should use a coil. Its inductance is usually lower than that of self-resonant RF chokes, resulting in lower reactances at lower frequencies.

How to use instabilities

Oscillations occurring at or near the operating frequencies when the input power is removed are usually caused by the parasitic elements of the package, says Lee. A useful harnessing of such oscillation is possible with circuits like the one in Fig. 3. It is a fundamental-frequency oscillator using an RCA overlay transistor which is still in the development stage. The circuit operates from 1.5 to 2.2 GHz and can deliver 150 mW at the upper frequency limit.

Mobile radio applications place severe requirements on the transistors. The two major considerations are the so-called second breakdown and the need for adequate cooling, according to Nicholas G. Richards *et al.*, RCA, Meadow Lands, Pa. Second breakdown results in a collector-to-emitter short circuit and is caused by sudden changes in the load or by improper tuning. Richards points out that the transistor must handle not only increased dissipation but also sudden energy surges that can

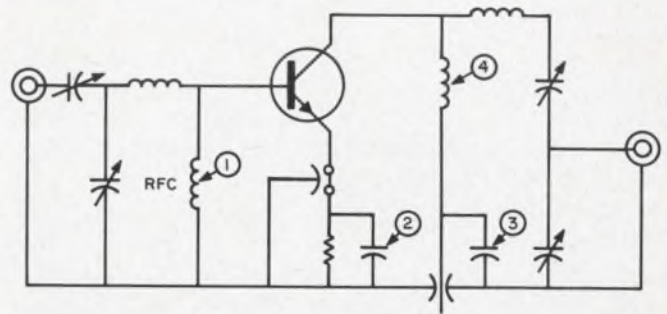

2. Simple precautions with the components indicated with the circled numbers can prevent oscillations at low frequencies.

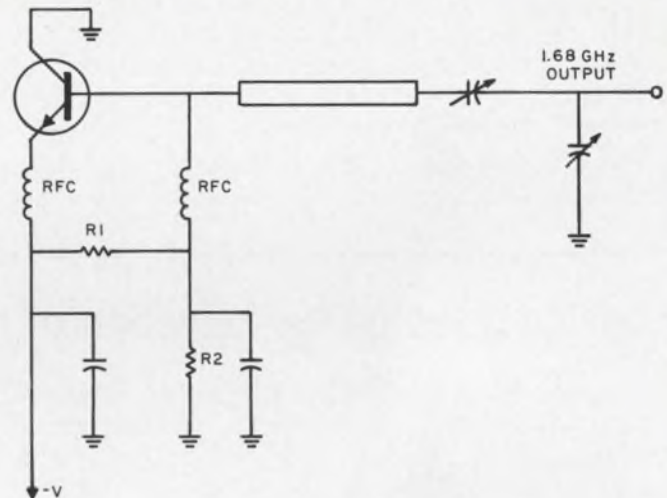

3. Fundamental-frequency oscillator operates from 1.5 to 2.2 GHz and puts out 150 mW at 2.2 GHz with a developmental RCA overlay transistor. The efficiency is 20% at a collector supply voltage of 25 V.

destroy it in a matter of microseconds. The heat conduction problem may be solved with an aluminum die-cast chassis that has a large radiating surface area, he explains. Matyckas adds that as an extra precaution, a thermostat can be mounted on the heat sink to reduce the transmitting power if the temperature becomes excessive. ■ ■

FET popularity continues to grow

To judge by the attention given to FETs at the show, FET manufacturers can look forward to a continuing healthy market.

An exhaustive and informative examination of the devices, their importance and applications is offered at Session 11, "Field-Effect Transistors." The program is well worth while to all interested in a refresher course on FET basics or in acquiring an initial exposure to these tube-like semiconductors.

A general perspective of the whole area is given by Donald L. Wollesen, Motorola Semiconductor Products Inc., Phoenix, Ariz. Wollesen's paper,

"FET vs Bipolar Transistor Characteristics," uses audio amplifying applications as a basis for comparison. He attempts to show where the FET is preferable to the bipolar, and vice versa, and how to recognize their respective advantages.

James S. Sherwin then takes over on the use of the FET in amplifiers. He shows why to use the devices, where to apply them, and how to go about designing FET amplifiers.

Shewing, Manager of FET applications at Siliconix Inc., Sunnyvale, Calif., concentrates on those areas where FETs outperform bipolar transistors. In particular, he touches on high-frequen-

cy circuits, including a 200-MHz amplifier and a 45-MHz RF cascode arrangement.

The third paper studies fundamentals in "The FET as a Switch." Presented by Carroll Perkins, application engineer for Raytheon Semiconductor's Mountain View, Calif., facility, his dissertation focuses on the IGFET type of field-effect devices. Perkins discusses both analog and digital switching applications.

A comprehensive review of such high-frequency FET applications as RF and IF amplifiers, mixers, oscillators and discriminators is contained in the next paper, "Circuit Simplification with MOS-FETs." Delivered by George C. Luettgenau, Research Manager, TRW Semiconductor, Lawndale, Calif., it goes into the theoretical reasoning

and advantages in using "versatile" FETs in these circuits.

Luettgenau also treats the basic physical and electrical properties of MOSFETs. Luettgenau maintains that "we will soon have MOS devices which are duals of the traditional multifunction vacuum tubes," and that this will lead to complete system building blocks fabricated entirely with MOS techniques."

Michael Dix, Application Engineer at Philco's Microelectronic Div., Santa Clara, Calif., gives the last paper. He deals with the basic considerations involved in designing with MOS-arrays. This newer generation of field-effect units is becoming increasingly popular and is competing well with conventional digital integrated circuits in complex switching applications.

The session itself is the second organized by EEE magazine, of New York, and will be chaired by its editor-in-chief, George Rostky. ■ ■

Advice given on the selection of microwave receiver devices

Session 19 is devoted to reporting the state of the art in practical, commercially available, microwave-frequency devices. Because of continuous improvements, low-noise, traveling-wave amplifiers (LNTWAs) and backward-wave oscillators (BWOs) are retaining their share of systems assignments, despite serious inroads by their solid-state equivalents. A report is given on the improvements in quality and size reduction in YIG devices, and application advice is given to systems engineers on ferrite devices.

Low-noise TWTs improving

The LNTWA is still unsurpassed for low-noise

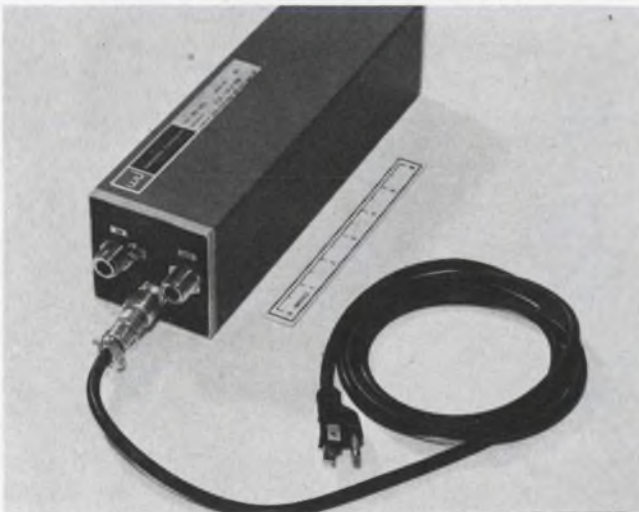

Low-noise, traveling-wave-tube amplifier with integral power supply operates across the 8 to 12 GHz band. Improvements in packaging and decreases in noise figure with retention of high gain and output power are recent development trends.

microwave preamplification. According to Drs. B. P. Israelsen, K. B. Niclas and Mr. C. C. Billat, of Watkins-Johnson Co., Palo Alto, Calif., the LNTWA offers the best combination of properties for low-noise microwave amplification compared with tunnel diodes, transistors and parametric amplifiers.

Among the other advantages cited for LNTWAs by the authors are instantaneous frequency coverage, high saturated power output, wide dynamic range, gain compactness, reliability, simplicity of operation, and low cost per operating hour.

The Palo Alto engineers say that recent developments in specialized amplifiers, including matched channel combinations, multiple-octave amplifiers and more efficient units will mean a wider choice and improved special characteristics for the prospective user.

BWOs still strong

The backward-wave oscillator, BWO, long an important electronically tuned microwave oscillator, is holding its own against formidable competition from other devices.

It is still the best tunable source for frequencies above 4 GHz, according to A. T. Isaacs and B. Kaiser of Watkins-Johnson Co., Palo Alto, Calif. In their joint paper they also say that even below 4 GHz the BWO is, in most respects, the favored choice. This has been the result of concerted R&D efforts to increase bandwidth while retaining low tuning voltages and improving packaging. ■ ■

**This is a
direct display
of a
microwave frequency.**



**It was obtained
with all the ease
and accuracy
of simple
frequency counting.**

**let
Systron-Donner
show you how...**

Systron-Donner takes all the fuss out

with plug-ins from this comprehensive counter system



Solid-state counter takes all plug-ins at right. Choice of counter-timer, 50 MHz, \$2450 (100 MHz, \$2950) or simple frequency counter, 50 MHz, \$1925 (100 MHz, \$2525)



ACTO, 0.3 to 3 GHz, \$975

ACTO, 3 to 8 GHz, \$1,950

ACTO, 8 to 12.4 GHz, \$1,975

Instant readings to 12.4 GHz with ACTO® plug-ins

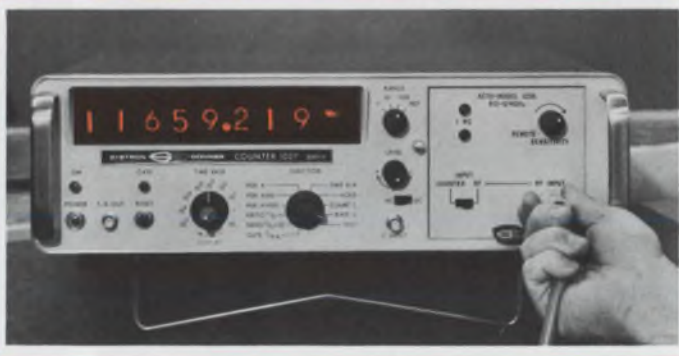

Quick as you couple the signal, a microwave reading appears. Notice the reading is "11,659.219 Mc," an actual microwave frequency—presented with counter accuracy because the input is phase locked. No calculations. No risk of human error. You simply plug in the ACTO for the range you're working in, then use the instrument just as though it were a simple frequency counter.



ACTO's for HP counters?

People keep asking us if ACTO's will work with Hewlett-Packard Model 5245L frequency counters. The answer is **yes**. We didn't build our ACTO for HP counters, but it turns out that a slightly modified ACTO (our Option W) will slip into the HP plug-in cavity and perform beautifully. So if you already have an HP 5245L, we won't insist that you buy another counter to get ACTO performance. You can have ACTO's for your HP counter to cover the full 0.3 to 12.4 GHz range.

When you change the input frequency, the reading changes right along with it. All automatically. No operating adjustments whatever. That's why we call our plug-in "ACTO" for "Automatic Computing Transfer Oscillator." It enables people with very little technical skill to make precise measurements rapidly and without mistakes.

**See them
in action
at WESCON.**

Hollywood Park
Booths 147 to 149

of microwave frequency measurement



50 MHz to 15 GHz transfer oscillator, \$1,500



Transfer oscillator, 50 MHz to 26 GHz with external mixers, \$1,550



50 to 500 MHz het frequency extender, \$550



Input video amplifier, \$350



Integrating DVM, \$575

Simple 2-step readings to 15 GHz with one plug-in



1. Tune transfer oscillator until a zero beat—any zero beat—appears on the built-in scope. The transfer oscillator is now phase-locked to the input.



2. Adjust harmonic preset until the reading appears. Notice the counter reads "10,803.722 Mc," an actual microwave frequency presented with counter accuracy.

Transfer oscillator plug-in gives you the enormous range from dc to 15 GHz in a single cabinet plus the ability to measure pulsed rf, FM center frequency and FM deviation.

The harmonic preset on the Systron-Donner transfer oscillator eliminates all need to calculate the harmonic number if you have even a rough idea of the frequency of the signal—as is nearly always the case. In the example above the frequency was known to be about 10.8 GHz. The following readings appeared as the harmonic preset was increased:

Harmonic preset number	Reading
84	10,676.634 Mc (Far too low)
85	10,803.722 Mc (Obviously correct)
86	10,928.860 Mc (Far too high)

The center reading was obviously the correct indication—located quickly, unambiguously and without calculation.

Send this card now for complete data

- Please have a sales representative contact me
- Send catalog with complete data on your frequency measuring equipment
- Send data on ACTO's for HP counters

Please print:

Name _____

Title _____ Phone _____ Ext. _____

Organization _____

Address _____

Why Systron-Donner counters measure with unmatched accuracy

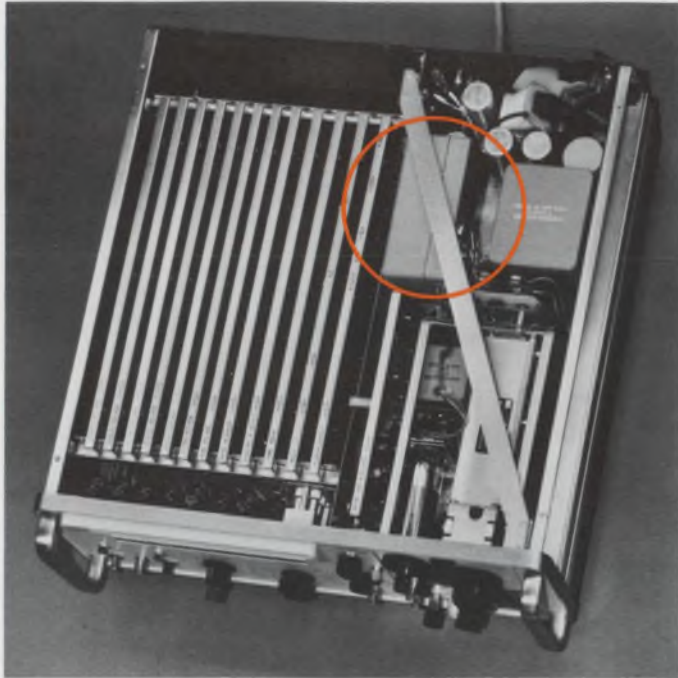

The answer is the oscillator.

Systron-Donner counters with Option B give you accuracy based on an oscillator with an aging rate of only 1 part in 10^9 per 24 hours. That's three times the stability you can find in any other frequency counters. It means more accurate frequency readings right up to 15 GHz—and less need for periodic calibration.

What's more, you can turn off a Systron-Donner counter with assurance that it will still be accurate next time you turn it on. (That assurance is hard to come by because most counter manufacturers don't specify the effect of a shutdown on accuracy.) Systron-Donner Option B oscillators are specified to return to within 5 parts in 10^9 of the turn-off frequency *one hour* after turned on. This means you can move Systron-Donner counters around the lab freely and still make measurements of the highest accuracy. It also means that you

can get a counter from the calibration lab to the bench with assurance that you have not lost the benefit of calibration in the process. And the fast one-hour warm-up means no waiting.

Check and you'll see that no other frequency counters can match these extraordinary oscillator specs:

Aging rate after 30 hours use: 1 part in 10^9 per 24 hours

Aging rate after 1400 hours use: 2 parts in 10^{10} per 24 hours

Turn-off/turn-on accuracy: Returns to within 5 parts in 10^9 of turn-off frequency within 1 hour after turn-on

Stability averaged over 1-second counting period: 1 part in 10^{10} rms

Price: \$400 (Standard Option B)

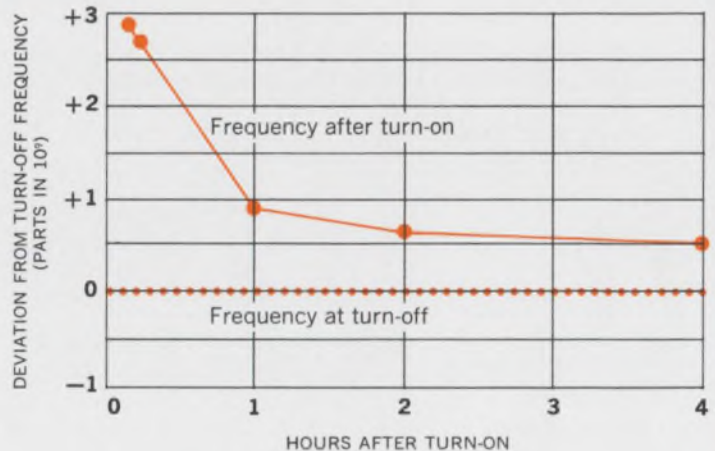

Recovery of an Option B oscillator after being turned off one week. This oscillator returned to within 1 part in 10^9 of turn-off frequency within an hour. Recovery is conservatively specified to be 5 parts in 10^9 .

SYSTRON  **DONNER**

SYSTRON-DONNER CORPORATION
888 GALINDO STREET CONCORD, CALIFORNIA 94520
PHONE: (415) 682-6161 TWX: 415-687-3200
CABLE: SYSTRONDONNER

FIRST CLASS
PERMIT NO. 57
CONCORD
CALIFORNIA

BUSINESS REPLY MAIL

No postage required if
mailed in the United States

POSTAGE WILL BE PAID BY

Systron-Donner Corporation
Electronic Instruments Division
888 Galindo Street
Concord, California 94520



Computers aid electronic circuit design and analysis

Computer-aided electronic design is no longer a pipe dream. It's here to stay. Any doubt about this is erased by the papers that make up Session 1, "Circuit Engineering by Digital Computation."

The amount and diversity of information presented at Wescon this year gives a good indication of just where design-by-computer is headed. Ranging from network analysis to control system simulation and synthesis—heretofore a specialty of the analog computer—the design tasks that have been successfully performed by the digital computer point to a bright and expanding future for this still very young design tool.

The Wescon papers, four in all, deal with IC mask design, linear system analysis, servosystem design, and RLC network analysis—all computer-aided.

LISA offers simpler language

In the paper entitled "LISA—a program for Linear Systems Analysis," K. L. Deckert and E. T. Johnson of IBM's Systems Development Division, San Jose, Calif., describe LISA, an experimental program designed for circuit analysis. LISA is an integrated package of 7090/94 FORTRAN IV programs that is capable of analyzing linear systems using La Place transform techniques. Networks, two block control systems, or a system of linear equations having polynomial elements in its coefficient matrix can be analyzed.

The user can describe his problem to the machine by using any one of several approaches: topological circuit description, transfer function, matrix equation or block diagram. Outputs, in either listing or graphic-plot form, can be either root locus, sensitivity, poles and zeros, or frequency and transient response.

Perhaps the most outstanding feature of LISA is its ability to accept data in free format form. This means that the user can place input words and data anywhere on a card separated by commas.

Computer used for RLCT analysis

Transient and complex frequency analysis by computer is also treated in a paper delivered by K. Lock, also of IBM's Systems Development Division. Rather than describing a program, however, Lock presents a mathematical method for use in describing RLCT (i.e., RLC plus ideal transformer) networks.

Lock's method involves network description completely in node-pair voltages, which allows

transformer constraints to be handled in a manner similar to Kirchoff's voltage equations. Analysis can be performed either by considering the network as a whole or by partitioning it into a number of subnetworks which are then sequentially analyzed.

Computer analyzes, simulates servosystem

Starting with a method of analyzing a servosystem's linearity, D. B. Gaisch, of the same IBM division, proceeds to a complex statistical analysis and simulation of the system.

A portion of Gaisch's paper is devoted to problems related to the computer simulation and analysis of a dynamic system. Describing the method as applied to two different dynamic systems, the author tells how: (a) each system was mathematically described before actual construction; and (b) how the mathematical description was used as basis for digital computer simulation of both systems. Using the print-out and graphic output data resulting from the computer's analysis, the author was able to synthesize both systems.

Computer designs IC masks

Integrated circuit mask design by digital computer is well represented at Wescon. A method for checking and making monolithic integrated circuit masks is described in a paper by D. M. Sheppard, W. T. James, M. E. Harris and A. M. Barone of IBM's Component Div. in Hopewell Junction, N. Y.

The authors describe the techniques they developed to aid the chip designer in developing an efficient layout procedure, checking the logic against the layout and converting the layout diagram into master artwork for etching or screening. The "master slice" concept was used as the basis for the computer program. With this approach, a fixed set of circuit elements is arranged on the wafer and then the desired circuits are determined by the interconnection pattern. This approach offers the advantage of having a single set of diffusion masks serve a number of different functional chips.

Wire-routing information can be fed to the computer by a mechanical X-Y digitizer or by drawing the wiring diagram on the console of a visual display unit and storing it in memory. The authors believe that the visual display method offers greater potential accuracy and when time shared, will offer cost advantages over the mechanical digitizer. ■ ■



COUNTERS

CRUSADING ENGINEERS: WRITE FOR LITERATURE AND "CHECK THE SPECS."

ALL SILICON SOLID-STATE 2.5, 5, & 225 MC

CMC's 600 series counters use all silicon semiconductors for higher reliability, superior temperature stability. Simplified design and advanced "Mother Board" circuitry reduce components. Temperature operation -20 to +65°C standard. -30 to +75°C available. All silicon memory (display storage), a standard feature, is not subject to slow response and upper temperature limitations of photoconductor memory circuits. Automatic decimal point. 0.1 volt rms sensitivity.



5 MC UNIVERSAL COUNTER-TIMER

Measures frequency, period, multiple period average, frequency ratio, time interval, and totalizes. Frequency measurement range: 0 to 5 mc. Period: 0 to 1 mc. Multiple period average measurement to 10⁷ from 0 to 2.5 mc. 1 mc crystal time base: stability ±2 parts in 10⁷ per month. Six decade inline biquinary display. Model 607A.



2 CPS TO 2.5 MC FREQUENCY COUNTERS

Six models. Measure frequency, period, time interval with internal or external clock, frequency ratio, and totalize. Four to six decades with double-column neon lamps or inline long-life biquinary display. All silicon solid-state. Models 600A, 601A, 602A, 603A, 604A, 605A.



NEW 2.5 MC ALL SILICON PRESET COUNTER

Model 614A Preset Multi-function Counter, extends applications to normalizing and multiplication by any preselected constant. Gate time presets to any interval from 10 μsec to 100 seconds. Gate time presets by remote selection. Direct display as mph, rpm, ms per N periods, etc. 614A also measures frequency and period and totalizes. Frequency range 2 cps to 2.5 mc. Period and frequency ratio ranges: 2 cps to 500 kc. Preset count circuitry operates dependably at frequencies through 300 kc — up to three times as fast as other variable gate time counters. 100 kc crystal time base: stability ±2 parts in 10⁸ per week. Standard five decade inline biquinary display (sixth optional), with automatic decimal point and memory.



NEW 225 MC FREQUENCY METER

Model 616A provides low cost direct frequency measurement from 10 cps to 225 mc by use of a built-in prescaler. Plug-ins extend frequency to 1000 mc, 3000 mc or 12 gc. 1 mc crystal time base: stability ±2 parts in 10⁷ per month. Front panel switch permits selection of (1) direct frequency measurement, 10 cps to 10 mc, (2) preselected frequency measurement, 500 kc to 225 mc, or (3) extended frequency measurement with plug-in frequency converter. Automatic decimal and memory are standard. Model 633A Time Interval Meter plug-in for Model 616A has range of 1 μsec to 10 sec with resolution of 1 μsec (.1 μsec optional). Model 634D Frequency Converter plug-in for Model 616A provides additional measurement capability up to 3000 mc.

SOLID-STATE DUAL PLUG-IN

25 MC, 50 MC, 110 MC

CMC's Digi-Twin* is the most versatile solid-state counter available. Frequency to 110 mc direct counting. Time measurements to 10 nanosecond resolution. Select frequency range and function plug-ins as your needs change. Buy plug-ins, not new instruments. Printer output. Automatic decimal. Power supply in basic chassis. NIXIE* readout, 1 mc crystal oscillator with decade countdown time base and related circuitry.



The Model 800 has 8 decade readout, memory standard. Gate times: 1 μsec to 100 sec in decades. Oscillator stability: ±3 parts in 10⁸ per day.

THREE FREQUENCY RANGE MODULES

Maximum frequency ranges for plug-ins: Model 801A is 25 mc. Model 802A is 50 mc. Model 803A is 110 mc. Same accuracy as basic counter.

FUNCTIONAL PLUG-IN VERSATILITY

Three basic function modules available, two frequency period and one counter-timer. Period measurement: 831A and B 0.5% accuracy; 832 and 833A and B 0.3% accuracy. Time interval measurement range: 0.1 μsec to 10⁸ sec with 801A and 802A; 0.3 μsec to 10⁸ sec with 803A. "B" Models are remotely programmable. Five special purpose modules are currently available: Model 834B, 600 mc heterodyne converter offers range measurement from 50 mc to 600 mc in 10 mc steps. Model 834D, heterodyne converter with frequency range from 100 mc to 3200 mc. Model 835A, Integrating Digital Voltmeter with measurement ranges of 0.1v, 1.0v, 10.0v, 100v, and 1000v full scale. Model 838A, digital phase meter with range from 10 cps to 100 kc, and accuracy of 0.5. Model 846A, is a 0.1 gc to 12 gc transfer oscillator with self-test.

NEW 10-Line/Sec. DIGITAL PRINTER



HIGH-SPEED, NEW LARGE DIGITS, SOLID-STATE DRIVE AND LOGIC

Fastest, easiest to read, not a modified adding machine or calculator. 35 millisecond data acquisition. Prints 12 columns at 10 lines per second. Electrically positioned decimal without loss of digit. Left zero elimination. New simple electromagnetic design eliminates commutators and moving contacts. Column suppression on command. Half rack size. Up-front pushbutton controls. Eight columns standard, others optional. Model 410A.

MILITARIZED SOLID-STATE



FULLY MILITARIZED 100 MC COUNTER

Model 880A is the first and only solid-state counter fully militarized to meet Mil Specs. It measures frequency, period, multiple period average, frequency ratio, frequency ratio average, time interval with internal and external clock, and totalizes; scales input frequency in decade steps; provides standard frequency outputs. Price close to commercial counters. Check these specs: 0 to 100 mc frequency range; oscillator stability of 1 part in 10⁸; meets or exceeds MIL-E-16400, including appropriate temperature, humidity, vibration, shock, and RFI Specs. Built-in time interval measurement. Eight decade inline display.

PLUG-INS FOR MILITARIZED 880A

Model 884A, Frequency Converter plug-in extends Model 880A range to 500 mc. Solid-state circuitry. Acceptance-tested to MIL-E-16400, MIL-S-901, and MIL-I-16910. Step selector switch. Model 885A, Heterodyne Frequency Converter with range from 100 mc to 3200 mc. Model 886A, Transfer Oscillator plug-in with frequency range from 0.1 gc to 1.0 gc (on band 1) and 1.0 gc to 12 gc (on band 2).



ORDER YOURS

Mail this coupon for complete technical data, and earn your free Crusading Engineers Medal.

Mail to: CMC, 12973 Bradley Ave. San Fernando, California, U.S.A.

Send data on models _____
 Send Crusading Engineers medal.

NAME _____
COMPANY _____
ADDRESS _____
CITY _____ STATE _____

WRITE CMC · SAN FERNANDO, CALIFORNIA · PHONE (213) 367-2161 · TWX 213-764-5993 · OR SEE LOCAL REPRESENTATIVE FOR MORE INFORMATION

Speed Inquiry to Advertiser via Collect Night Letter
ON READER-SERVICE CARD CIRCLE 44



PULSE & TIME DELAY GENERATORS

RUTHERFORD HIGH VOLTAGE PULSE GENERATORS ARE THE STANDARD OF THE INDUSTRY

The B-7 series of vacuum tube pulse generators have earned a reputation for high performance, precision and reliability. They have the accuracy and versatility to meet today's rigid standards of testing, research and development. They have proven their capabilities as systems components as well as in field operation.



Model B-7B features rep rates to 2 MHz and outputs of 50 volts into 50 ohms. Printed circuit boards. Variable rise time control. Trouble-free single unit construction. Overload protection. Stabilized noise-free repetition rate schedule. Rack mountable.



Model B-7D incorporates all of the time-proven specifications of the popular Model B-7B with several extra features. Simultaneous positive and negative output pulses are available at front panel connectors. The rise and fall time of each pulse is separate and independent, and may be degraded with out affecting the other. The DC level of each output may be set to zero by front panel control, or may be offset.



Model B-7F adds the following features to the basic specs of Model B-7B: (1) repetition rate is continuously variable from 2 Hz to 2 MHz; (2) output pulse rise or fall time may be independently degraded to approx. 1 μ sec; (3) either single or double pulse output available by front panel control.

NEW—REMOTELY PROGRAMMABLE PULSE GENERATOR

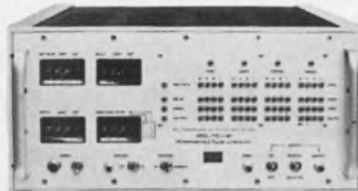

Model PPG3 is the only solid state, digitally controlled programmable pulse generator of its type. No other automatic pulse generator offers the degree of accuracy, stability, reliability, or range of easy operation. It exceeds requirements of today's most sophisticated automatic checkout systems. All major parameters may be programmed, sequentially or in parallel, with digital information from tape or card readers. Remotely programs to control six to eight information bits. Internal rep rate is 2 μ sec — 999 sec in 8 ranges. Pulse delay of 0 to 999 sec. Pulse width at 50% amplitude points is 0.1 μ sec — 999 sec. Pulse amplitude is 0.25 volt. Rise and fall time \leq 20 nsec.

SOLID-STATE PULSE GENERATORS



Model B-14 is a low cost, highly versatile, compact and portable general purpose pulse generator. It features repetition rate of 20 Hz to 2 MHz. Delay is 0 to 10,000 μ sec. Amplitude is 15v into 1,000 ohms, 8v into 50 ohms. Pulse width of .06 to 10,000 μ sec. Rise and fall time is less than 10 nanosec. fixed. Rechargeable battery pack available for completely portable operation.

Model B-15 has the same fast rise and fall time, delay and pulse width as Model B-14. In addition, B-15 offers a repetition rate of 5 Hz to 5 MHz. Also, its amplitude is 10v into 50 ohms. Both units are only 12" wide x 5" high x 11 1/2" deep. Rechargeable battery pack available.



Model B-16 all transistorized pulse generator offers a rep rate of 20 Hz - 20 MHz. Variable rise and fall times of less than 5 nsec to greater than 200 nsec. Pulse width is 0.015 - 10,000 μ sec. Amplitude is 0 to 10 volts, peak. Single or pulse pair operation. Rack mount available.

SOLID STATE DIGITAL TIME DELAY GENERATORS

These three time delay generators are designed with solid state circuitry for reliability and maintenance free performance. Their high accuracy with very low delay jitter lets you calibrate synchroscope sweeps, produce accurately spaced pulses for biological investigations, measure waveform timing, measure pulse width, use with pulse generator for more accurate delay, etc.

All three models below have these specifications: Delay range of 0.0 to 999,999.9 μ sec in increments of 100 nsec. Delay accuracy of \pm (0.001% of set delay + 2 nsec.) Delay jitter less than 1 nsec.



Model A10 provides 3 delayed pulses. Also offers amplitude of 10 volts, peak, min., into \geq 50 ohms. Approx. 15 nanosec rise time. Approx. 50 nsec width. Instrument is 8 3/4" high x 19" wide x 12" deep.



Model A11 offers single delayed pulse with same basic delayed pulse specs as A10 except amplitude is 6 volts, peak, min., into \geq 50 ohms. And rise time is approx. 10 nsec. Unit is half rack size (5 1/4" high x 9 1/2" wide x 14 1/2" deep). Rack mounting unit is available.



Model A12 produces three delayed pulses, and has same basic delayed pulse specs as A10 except amplitude is 70 volts, peak, min., into \geq 50 ohms. Width is 3 μ sec min. Rise time is approx. 0.1 μ sec. Repetitive and manual reset operation. Manual offers fail safe triggering to protect against loss of information.



FREE

Mail this coupon for complete technical information, and earn your free Crusading Engineers Medal with Rutherford service bar. Mail to CMC/Rutherford, 12973 Bradley Avenue, San Fernando, California, U.S.A.

Send data on models _____
 Send Crusading Engineers medal _____
 Name _____
 Company _____
 Address _____
 City _____ State _____ Zip _____

WRITE CMC/RUTHERFORD · SAN FERNANDO, CALIFORNIA · PHONE (213) 367-2161 · TWX 213-764-5993 · OR SEE LOCAL REPRESENTATIVE FOR MORE INFORMATION

Speed Inquiry to Advertiser via Collect Night Letter
 ON READER-SERVICE CARD CIRCLE 45

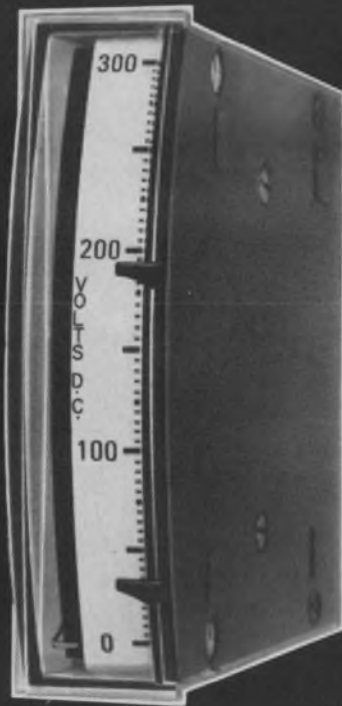

**THIS IS A COMPLETE
CONTROL METER
(ACTUAL SIZE)**

PARKER MINITROL

Not only the most compact, but also the simplest, fastest-acting, most rugged and dependable yet to reach the market.

Minitrol ER35 (above), with $3\frac{1}{8}$ " scale, is $\frac{7}{16}$ " thin and $4\frac{1}{2}$ " deep, handles up to 300 MA at 100 V internally — thanks to the unique PARKER etched-coil movement and the new contactless, mirrorless, prismless all-solid-state photo switching. Modules for high-density monitor/control applications assemble 22 abreast in a 19" rack.

Surface-mounting models (right) have the same self-contained switching and brilliant performance in cases also $\frac{7}{16}$ " thin.

Ask for Bulletin M-5.



SR35/3½" SURFACE-MOUNTING



SBR35 & 45/3½" & 4½" SURFACE-MOUNTING



PARKER INSTRUMENT CORP. 200 HARVARD AVE / STAMFORD, CONN 06904 / (203) 325-4361 / TWX 710-474-3390

ON READER-SERVICE CARD CIRCLE 46

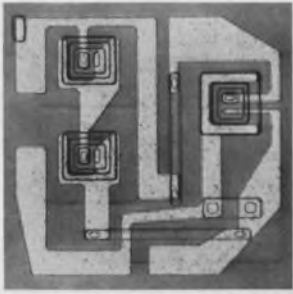

Most designers use MECLTM circuits just because they're the fastest available...

(they may be overlooking a good bet!)

Sure, speed is important. And, when you need speed, you should use fast (6 nsec propagation delay) Motorola MECL integrated circuits.

But, we think the designer may be missing a lot if he doesn't take advantage of the simultaneous complementary logic function you get with MECL circuits. What better way can you eliminate those extra inverter circuits *and* minimize can count. (Not to mention the money you save.)

And, the designer *should* take advantage of wide range of circuit types available with MECL — all the way from the ultra-fast J-K Flip-Flops to a whole series of multi-input gate circuits . . . including some 17 specific circuits. Then, too, you can get all circuits in both the MC300 Series for

military designs (-55°C to $+125^{\circ}\text{C}$ range) and the industrial MC350 Series (0 to $+75^{\circ}\text{C}$ range) for commercial equipment designs. Circuit prices start as low as \$1.95 in 100 quantities.

One other point. They're available *now* for immediate production application in your newest designs.

So don't use MECL circuits "just because they're fast". Take advantage of all the extra design benefits you get. If you'd like more information about how Motorola MECL integrated circuits fit your newest designs, see your local Motorola representative or write: Technical Information Center, Motorola Semiconductor Products Inc., Box 955, Phoenix, Arizona 85001.

SEE HIGHLIGHTS OF **WESCON** AT BOOTH 1301-1304



MOTOROLA Semiconductors

- where the priceless ingredient is care!

Speed Inquiry to Advertiser via Collect Night Letter
ON READER-SERVICE CARD CIRCLE 47

Technical program

When, where and what to hear at Wescon

Here is the complete Wescon technical program, by session, including times and places for each paper. A form for ordering paper reprints is also included.

1 Circuit Engineering by Digital Computation

(Tues./a.m./B)

Chairman: D. W. Cooper, IBM Systems Development Div.

- 1/1 A Computer-Oriented Method for Analyzing Networks with RLC Elements and Ideal Transformers—*K. Lock, IBM Systems Development Div.*
- 1/2 LISA—A Program for Linear Systems Analysis—*K. L. Deckert and E. T. Johnson, IBM Systems Development Div.*
- 1/3 Computer-Aided Design of Two Servosystems—*D. B. Gasich and R. H. Friesen, IBM Systems Development Div.*
- 1/4 A Computer-Aided Method for Checking and Making Monolithic Integrated Circuit Masks—*D. M. Sheppard, et al, IBM Components Div.*

Code to abbreviations

The abbreviations used within this index are as follows:

a.m.—Morning sessions

p.m.—Afternoon sessions

All sessions will be held in the Biltmore, as follows:

B—Biltmore Bowl

Ba—Biltmore Ballroom

G—Biltmore Galeria Room

M—Biltmore Music Room

R—Biltmore Renaissance Room

Numerals refer to sessions and to papers within a session—for example, 4/1 is paper 1 in session 4.

2 Solid-State Devices and Integrated Circuits

(Tues./a.m./Ba)

Chairman: P. Myers, Bunker-Ramo Corp.

- 2/1 Metal Semiconductor Shottky Barriers and Devices—*M. M. Atalla, Hewlett-Packard*
- 2/2 Unpackaged Devices—*J. M. Goldey and J. M. Early, Bell Telephone Lab.*
- 2/4 Micropower Linear Circuits—*J. D. Meindel and P. H. Hudson, U.S. Army Electronics Command*
- 2/4 Micropower Linear Circuits—*J. D. Meindel and P. H. Hudson, U. S. Army Electronics Command*

3 Piezoelectric Ceramic Devices and Applications

(Tues./a.m./M)

Chairman: O. M. Steutzer, Sandia Lab.

- 3/1 Improved Ceramics for Piezoelectric Devices—*G. H. Haertling, Sandia Lab.*
- 3/2 Switching Properties of Polycrystalline Ferroelectrics—*R. H. Plumlee, Sandia Lab.*
- 3/3 The Theory of Linear Multi-electroded Piezoelectric Plates—*R. W. Holland, Sandia Lab.*
- 3/4 Ferroelectric Ceramic Logic and NDRO Memory Devices—*D. G. Schueler, Sandia Lab.*
- 3/5 Small-Signal Applications of Monolithic Multiport Piezoelectric Devices—*C. E. Land, Sandia Lab.*

4 Satellite Communications

(Tues./a.m./R)

Chairman: F. Druding, Litton Mellonics, Systems Development Div.

- 4/1 Communications Satellite System Operations—*G. D. Dill, Communications Satellite Corp.*

4/2 Multiple Access—A Survey of the State-of-the-Art—*R. R. Cagnon, TRW Systems*

4/3 Evaluation of Techniques for Scheduling Satellite Communications Systems—*M. D. Lenske, Litton Mellonics, Systems Development Div.*

4/4 "Mascot," A Military Air Transportable Satellite Communications Terminal for Crises Management—*J. M. Rosenberg, et al., Philco Western Developments Labs.*

4/5 Satellite for TV Distributions—*P. S. Visher, Hughes Aircraft*

5 Recent Advances in Non-Digital Applications and Interconnection Aspects of Integrated Electronics

(Tues./a.m./G)

Chairman: A. J. Khambata, Univac

- 5/1 Laser-Induced Resistivity Changes in Film Resistors—*S. J. Lins and R. D. Morrison, Univac*
- 5/2 Thin-Film Memory Sense Amplifier Using Linear Integrated Circuits—*J. W. Staubus, Univac*
- 5/3 Laminate Printed Circuit Interconnection of Integrated Circuits—*J. A. Kimlinger, Univac*
- 5/4 Packaging Monolithic Integrated Circuits in the Univac 1824 Aerospace Computer Central Processor—*R. A. Beck and E. I. Moore, Univac*
- 5/5 Some Future Aspects of Microelectronics—*V. Uzunoglu, Arinc Research Corp.*

6 Electron Devices

(Tues./p.m./Ba)

Chairman: W. R. Luebke, Eimac Div., Varian Associates

- 6/1 High Power Linear Beam Tubes—*T. Moreno, Varian Associates*
- 6/2 Recent Advances In Beam-Plasma Amplifiers—*P. Chorney, Microwave Associates*

6/3 Television Cathode-Ray Display Tubes—*F. Townsend, Westinghouse Electric*

6/4 Solid-State Switching Devices—*V. Sundra, Transitron Electronics*

7 The Application of State-Variable Techniques in Communication and Radar

(Tues./p.m./M)

Chairman: H. L. Van Trees, Department of Electrical Engineering and Research Lab. of Electronics, M.I.T.

7/1 Detection and Continuous Estimation Theory—*H. L. Van Trees, M.I.T.*

7/2 The Use of State-Variables and Markov Processes to Problems of Analog Communication—*D. Snyder, M.I.T.*

7/3 Maximum *a Posteriori* Interval Estimation—*A. Baggeroer, M.I.T.*

7/4 Signal Optimization for Additive Noise Channels with Feedback—*J. K. Omura, Stanford Univ.*

7/5 A Modern Approach to Signal Design—*F. Schweppe, Michael Athans, M.I.T.*

8 Recent Advances in High Frequency Solid-State Transmitter Systems

(Tues./p.m./R)

Chairman: E. E. Spitzer, RCA

8/1 R/F Transistor Considerations—*S. Matyckas, RCA*

8/2 Application of Overlay Transistors to Solid-State Mobile Equipment—*N. Richards, RCA Broadcast Communications Div.*

8/3 Microwave Transistors—*H. C. Lee, RCA Industrial Semiconductor Operation Dept.*

8/4 High Power Microwave Varactors and Varactor Multipliers—*J. Collard, RCA*

8/5 Microwave Solid-State Multipliers for Space Systems—*W. Dodds, RCA Microwave & Power Tube Operations*

9 Advanced Spaceborne Computer Concepts

(Tues./p.m./G)

Chairman: W. Semon, Burroughs Corp.

9/1 Spaceborne Multiprocessing Organizations—*T. E. Burke, NASA Electronics Research Center*

9/2 Associative Memories for Space Applications—*D. Gunderson, Honeywell Systems and Research Div.*

9/3 Logic Design Techniques for Er-

ror Control—*J. Goldberg, Stanford Research Institute*

9/4 A Systems Approach to the Voice Insertion of Data—*W. Brodey, NASA Electronics Research Center*

10 Large Scale Integration

(Wed./a.m./B)

Chairman: D. E. Rosenheim, T. J. Watson Research Center

10/1 Systems Consideration for L.S.I.—*M. G. Smith, T. J. Watson Research Center*

10/2 Design Automation for L.S.I.—*H. Freitag, T. J. Watson Research Center*

10/3 Discretionary Wiring Approach to Large-Scale Integration—*J. Kilby and J. Lathrop, Texas Instruments Inc.*

10/4 A New Dimension in Microelectronic Systems—*A. C. Lowell and T. Mitsutomi, Autonetics*

10/5 Micromatrix Approach to MOS Complex Arrays—*L. Vadasz, Fairchild Semiconductor*

11 Field Effect Transistors

(Wed./a.m./Ba)

Chairman: G. Rostky, EEE—The Magazine of Circuit Design Engineering

11/1 FET vs Bipolar Transistor Characteristics—*D. L. Wollesen, Motorola Semiconductor Products*

11/2 The FET as an Amplifier—*J. Sherwin, Siliconix*

11/3 The FET as a Switch—*C. Perkins, Raytheon Semiconductor*

11/4 Circuit Simplifications with FETs—*G. Luetgenau, TRW Semiconductor*

11/5 Considerations of the FET in Complex Arrays—*M. Dix, General Microelectronics*

12 Millimeter Wave Techniques and Applications

(Wed./a.m./M)

Chairman: D. D. King, Aerospace Corp.

12/1 Solid-State Millimeter Wave Power Generation and Amplifications—*R. Rafuse and D. Steinbrecher, Research Lab. for Electronics, M.I.T.*

12/2 Some Applications of Millimeter Waves in Atmospheric Research—*R. L. Mitchell, Aerospace Corp.*

12/3 Millimeter Wave Radio Astronomy—*D. Thornton, Space Science Lab., Univ. of California*

12/4 Millimeter Spectroscopy and Applications to High Temperature and Unstable Molecules—*J. J. Gallagher, Martin-Marietta*

12/5 Solid-State Millimeter Wave Receivers—*J. Kirwan and C. Abronson, Space-General Corp.*

13 Theory, Design, and Testing of Error-Correcting Devices

(Wed./a.m./R)

Chairman: A. E. Fein, Westinghouse Defense and Space Center

13/1 Forced Erasure Decoding—*R. M. Heller and R. G. Marquart, Westinghouse Electric Corp.*

13/2 Design and Test of a Simple Error-Correcting Coding System—*J. M. Van Horn, Codex Corp.*

13/3 Design and Performance of a Time Spread Coder—*L. E. Hayden and A. E. Fein, Westinghouse Electric Corp.*

13/4 Evaluation of Error Correction Block Encoding for High-Speed Data—*L. Brayer and O. Cardinale, The Mitre Corp.*

14 Effective Utilization of Grid-Based Interconnection Systems

(Wed./a.m./G)

Chairman: S. V. Worth, Elco Corp.

14/1 Effective Utilization of Grid-Based Interconnecting System—*S. M. Paulson, Interstate Electronics Corp.*



Technician examines enlarged computer-produced interconnection pattern for an array of circuits. The actual array is shown in the foreground (paper 10/2).

WESCON USA

14/2 Design Parameters for Programmed Machine Wiring—*D. P. Brouwer, Gardner-Denver*

14/3 Design Criteria for Metal-Plate Connectors—*B. Sheingold, Elco Corp.*

14/4 Tolerance Specification by Multiple Alignment Statistics—*L. Nannis, Institute of Direct Energy Conversion, Univ. of Pa.*

15 Engineering Education for Student and Professional (Panel)

(Thurs./p.m./B)

Chairman: *D. J. M. Pettit, Stanford Univ.*

Panel members: *Dr. F. E. Terman, Foundation for Science and Engineering, Southern Methodist Univ.*

Dr. T. F. Jones, Jr., President, Univ. of South Carolina

Dr. R. E. Samuelson, Motorola, Inc. Military Electronics Div./Western Center

Dr. R. W. Kulterman, IBM Corp.

Dr. F. K. Willenbrock, Associate Dean of Engineering, Harvard Univ.

16 Electronic Systems for Urban Rapid Transportation

(Thurs./a.m./Ba)

Chairman: *R. C. Wigger, Advance Data Systems Div., Litton Industries*

16/1 Engineering Tomorrow's Transit Today for BARTD—*D. N. Aboudara, San Francisco Bay Area Rapid Transit District*

16/2 Computer Control of Transit Cars—*C. W. Woods, Westinghouse Air Brake Co.*

16/3 Urban Rapid Transportation and Automatic Revenue Control—*R. Silver, Litton Advance Data Systems*

16/4 Application of Electronics in Urban Public Transportation Systems—*J. C. Beckett, Hewlett-Packard Co.*

17 Design and Performance Capabilities of Solid-State High-Frequency Linear Amplifiers

(Thurs./a.m./M)

Chairman: *R. S. Engelbrecht, Bell Telephone Labs.*

17/1 Comparative Appraisal of High-Frequency Solid-State Linear Amplifiers—*R. S. Engelbrecht, Bell Telephone Labs.*

17/2 Analytical and Experimental Design Procedure for Microwave Tunnel-Diode Amplifiers—*C. S. Kim, General Electric Co.*

17/3 Field Effect Transistor Amplifiers—*P. D. Stark, Bell Telephone*

17/4 Microwave Transistor Amplifiers—*P. D. Stark, Bell Telephone Labs.*

18 Plastic Transistors—Their Impact on the Industry

(Thurs./a.m./R)

Chairman: *J. E. Harrison, Bendix Semiconductor Div.*

18/1 Economy Line Semiconductors—Their Future—*J. Bockhaus, General Electric Co.*

18/2 Market Impact of Plastic Semiconductors—*G. Berryman, Texas Instruments*

18/3 The Technical Aspects of Production—*J. McDougall, Fairchild Semiconductor*

18/4 Silicon Plastic Power Transistor—Its Introduction to the Market—*H. Newman, Semiconductor Div., Bendix*

19 Parameters to be Considered in Choosing Sophisticated Microwave Devices in the Design of New Microwave Receiver Systems

(Thurs./a.m./G)

Chairman: *B. Kaiser, Watkins-Johnson Co.*

19/1 State-of-the-Art Advances in Ultra-Low-Noise TWT's and Their Applications—*B. P. Israelsen and C. C. Billat, Watkins-Johnson Co.*

19/2 New Advances in the Design of BWOs: Their Applications and Relative Merits—*B. Kaiser and A. T. Isaacs, Watkins-Johnson Co.*

19/3 YIG Devices: Their Technology, Application, Advantages and Disadvantages in the Design of Sophisticated Microwave Receiver Systems—*L. B. Fletcher and R. W. Peter, Watkins-Johnson Co.*

19/4 Application of Ultra-Miniature Ferrite Devices for Advanced Receiver Systems—*V. E. Dunn, et al, Watkins-Johnson Co.*

20 Power and Control Integrated Circuits

(Fri./a.m./B)

Chairman: *M. J. Hellstrom, Westinghouse Electric Corp.*

20/1 A Monolithic Voltage Regulator—*J. Jennings, N. Oppenheimer, Westinghouse Molecular Electronics*

Div., and E. A. Karcher, ITT Semiconductors

20/2 A Logic-SCR Driver Integrated Circuit—*M. Oppenheimer, Westinghouse Molecular Electronics Div.*

20/3 An Integrated Amplifier-Firing Circuit—*M. Hellstrom and C. Laughinghouse, Westinghouse Molecular Electronics Div.*

20/4 Low Power Solid-State Inverters for Space Applications—*P. Vergez, V. Glover, Texas Instruments, and B. Willis, NASA Astrionics Lab.*

20/5 Power Devices for a Solid-State Inverter—*D. Manus, et al, Texas Instruments*

20/6 Monolithic Integrated Circuit Arrays for a Solid-State Inverter—*P. S. Newcomb, Texas Instruments*

21 High Availability Computer Systems

(Fri./a.m./Ba)

Chairman: *W. C. Carter, IBM Corp.*

21/1 Criterion for Assessing the Reliability of Total Computer Systems—*W. E. Marshall, Control Data Corp.*

21/2 System Effectiveness as a Generalization of System Availability—*S. W. Leibholz, Auerbach Corp.*

21/3 Monitoring Reliability Requirements by Total System Specification

Surveyor 1

An extra session, designated Session X and devoted to Surveyor 1, was added to the technical program in light of the widespread interest in the successful Surveyor mission.

X Surveyor 1

(Thurs./p.m./B)

Chairman: *S. C. Shallon, Hughes Aircraft Co.*

X/1 Surveyor 1 Telecommunication and Command Subsystems—*R. J. Rechter and F. K. Rickman, Hughes Aircraft Co.*

X/2 Tracking and Data Acquisition System for Surveyor 1—*Dr. N. A. Renzetti, Jet Propulsion Lab.*

X/3 Surveyor 1 Terminal Descent System—*Dr. H. D. Marbach, Hughes Aircraft Co.*

X/4 Surveyor 1 Lunar Survey Television—*T. B. Horne and F. J. Wolf, Hughes Aircraft Co.*

X/5 Scientific Information Obtained from Surveyor—*T. H. Bird, Jet Propulsion Lab.*

and Design—*R. Thomas, Jr., Defense Communications Agency*

21/4 Design and Use of a Fault Simulator for Saturn Computer Design—*F. J. Hardie and R. J. Suhocki, IBM, Federal Systems Div.*

21/5 System Design for High Availability—*C. M. Davis, IBM Systems Development*

21/6 Modular System Approach to High Availability—*T. S. Stafford, IBM Systems Development*

22 High-Frequency Amplifier Design

(Fri./a.m./M)

Chairman: *J. Moll, Department of Electrical Engineering, Stanford Univ.*

22/1 Small-Signal Design (Systems Handling Less Than 1 Watt)—*Speaker to be announced from Fairchild Semiconductor*

22/2 Large-Signal Design (Systems Handling More Than 1 Watt)—*R. Hejhall, Motorola Semiconductor Products*

22/3 Junction-FET High-Frequency Amplifiers—*J. B. Compton, Siliconix*

22/4 MOS-FET High-Frequency Amplifiers—*P. E. Kolk, KMC Semiconductor*

22/5 Designing for Low-Noise—*G. Johnson, Texas Instruments Semiconductor Components Div.*

22/6 Design Trade-Offs—*R. Minton, RCA Electronics Components and Devices*

23 The Impact of Ultra-Wideband Sampling and Associated Developments on Electronic Instrumentation

(Fri./a.m./R)

Chairman: *B. M. Oliver, Hewlett-Packard*

23/1 The Ultra-Wideband Sampling Gate—An Analysis, Characterization and Application Discussion—*D. Howard, Hewlett-Packard*

23/2 Sampling Based Phase-Locked Loops—*G. Alonzo, Hewlett-Packard*

23/3 Sampler-Based Instruments for Complex Signal and Network Analysis—*R. W. Anderson, Hewlett-Packard*

23/4 Random Sampling—A Statistical Measurement Approach—*J. Boatwright, Hewlett-Packard*

24 Array Antennas for Space Applications

(Fri./a.m./G)

Chairman: *L. C. Van Atta, NASA/Electronics Research Center*

24/1 Antenna Requirements for Interplanetary Communications—*R. D. Kodis, NASA/ERC*

24/2 Recent Advances in the Theory and Practice of Array Antennas—*B. L. Diamond, MIT, Lincoln Labs.*

Exclusive WESCON Technical Session Order Form

Please send me the following WESCON technical session preprints at \$2.00 per session (average: four papers per session), plus \$1 mailing charge per complete order. I understand this order will be mailed to my address within two weeks after receipt. Offer good until November 1, 1966.

(Note: Papers bound by sessions; no individual papers available).

Session No.	Quantity	Session No.	Quantity
1		12	
2		13	
3		14	
4		16	
5		18	
6		19	
7		20	
8		21	
9		22	
10		23	
11		24	

Total Sessions x \$2.00 = \$ _____

Plus \$1.00 Mailing Charge = \$ 1.00 _____

Total Cost = \$ _____

Make check payable to WESCON and mail with this form to:

WESCON
3600 Wilshire Blvd.
Los Angeles, Calif. 90005

Date _____

Name _____

Firm _____

Street Address _____

City, State, Zip Code _____

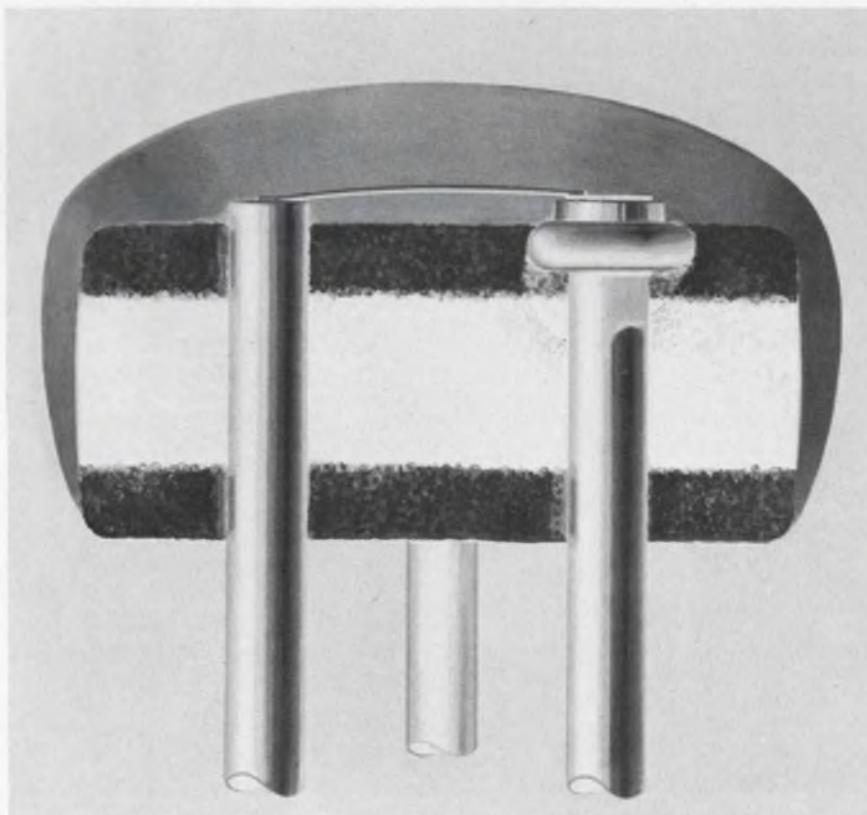

Plastic semiconductors, such as this germanium FET of Texas Instruments, are having a jolting effect on the electronics industry (Session 18).

24/3 An Adaptive Antenna System for Maximizing Signal-to-Noise—*R. T. Adams, Communications Systems Inc.*

24/4 A Novel Spacecraft Antenna Array—*W. T. Patton, RCA*

24/5 An Electronically Scanned K-Band Phased Array for a Spaceborne Radiometer—*M. E. Louapre, Space-General Corp.*

Special invited sessions

A Information Management: A Technology Amplifier

(Wed./p.m./Ba)

Chairman: R. M. Hayes, Univ. of California

A/1 An Overview of the Information Retrieval Field—*R. M. Hayes, Institute of Library Research, UCLA*

A/2 Available Hardware for Information Storage and Retrieval—*J. C. R. Licklider, T. J. Watson Research Lab., IBM*

A/3 The Chemists' Approach to the Information Problem—*H. R. Koller, Research and Development, U. S. Patent Office*

A/4 Developments in the Improvement of Scientific and Technical Information Exchange—*M. Day, Scientific and Technical Information Div., NASA*

A/5 A Plan for Technical Society Information Retrieval and Exchange—*M. Rubinoff, Univ. of Pa.*

B On-Line Computing—Capabilities, Constraints, and Challenges

(Thurs./p.m./Ba)

Chairman: R. H. Wilcox, Office of Naval Research, Department of the Navy

B/1 On-Line Educational Techniques—*D. Bitzer, Univ. of Illinois Coordinated Science Lab.*

B/2 Uncommon applications—*L. C. Clapp, Computer Research Corp.*

B/3 Command and Control Applications—*W. D. Wilkinson, Bunker-Ramo Corp.*

B/4 An Electrical Engineering Application—*Speaker to be announced from Project MAC*

C The Characteristics of Electricity Supplied from Electrical Power Systems

(Fri./p.m./Ba)

Chairman: To be announced



Seismic survey crew from Litton Industries' Western Geophysical Division is shown setting off a marine seismic blast (Science Film Theater)

Science film theater

Again this year the Wescon Science Film Theater will present timely science and engineering motion pictures each day of the show. The theater is located at Hollywood Park and is free to all show-goers. The following are the films that will be presented:

I General

1. **Ideas Sylvania**, Sylvania Electric Products.
2. **Footprints in the Sea**, U.S. Naval Ordnance Test Station
3. **Dept. of Defense Documentation Center**, DOD
4. **Facts of Life Cycle Cost**, Martin Co.
5. **Eclipse '65**, Douglas Aircraft
6. **Treasures of Earth**, Litton Industries
7. **Shape of Aerospace Marketing**, Aviation Week
8. **Road to 4 Corners**, Martin Co.

II Electronics

1. **Accelerometer Calibration for Flight and Laboratory**, Endevco Corp.
2. **Microelectronics, Key to Tomorrow**, Boeing Co.
3. **Laser Research at NEL**, Naval Electronics Lab.

III Electron Applications and Manufacturing

1. **Auto Production of Vacuum Deposit Thin-Films**, Sloan Insti-

tute

2. **New Era in Cooking, Microwave Cooking Food**, Litton Industries
3. **Rush Hours, Space Age**, Litton Industries
4. **Overlay Transistor**, RCA

IV Nuclear Energy

1. **Snap 10A, First Nuclear Reactor in Space**, Atomics Int'l., Div., North American Aviation
2. **Plowshare**, AEC & Lawrence Radiation Lab.
3. **Reaching for the Stars**, General Dynamics

V Space Exploration

1. **Log of Mariner 4**, J. P. L.
2. **Build Me a Mountain**, TRW Systems
3. **Aerospace Biotechnology**, Douglas Aircraft
4. **Ranger 9 Photos of Moon**

VI Satellites for communication and Nuclear detection

1. **Yardstick for New Age**, Cubic Corp.
2. **Sons of Zeus**, TRW Systems
3. **Live via Early Bird**, Douglas Aircraft

VII Computers and data management

1. **Control Data at CERN**
2. **Mark of Man**
3. **Case of the Little Green Wire**, Data Management System

CTC

CONTROLLED TEMPERATURE CHARACTERISTIC

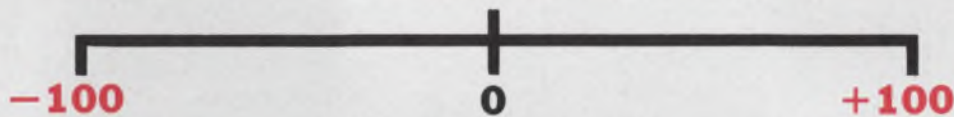

IRC metal film resistors with any specified TC between -100 and +100ppm

Now, IRC announces Controlled Temperature Characteristic—a new line of precision metal film resistors available with any specified TC between -100 and +100ppm, ± 5 ppm.





New CTC resistors offer fast rise times, negligible inductance and capacitance, and superior reliability . . . especially at higher resistance values. They replace wirewound resistors with significant space and cost savings.

Previously available only as a costly "lab" item or "special," IRC offers delivery at a price that makes them practical for temperature compensating in analog computers and delicate sensing instruments. Write for data and prices. IRC, Inc., 401 N. Broad St., Philadelphia, Pa. 19108.

CAPSULE SPECIFICATIONS

	
SIZE	RN65
TC	Any TC between -100 and +100ppm, ± 5 ppm
TEMP. SPAN	Any 50°C increment between -55°C and 165°C
POWER	$\frac{1}{4}$ -W@125°C, $\frac{1}{2}$ -W@70°C
RESISTANCE	50 Ω to 1 meg Ω
STD. TOLERANCES	0.1, 0.06, 0.025%

INDUSTRY'S LARGEST SELECTION OF METAL FILM RESISTORS

 <p>ASSURED RELIABILITY METAL FILM</p> <p>An industry first. 0.1, 0.01 or 0.001% levels. 1/20 to 2 watts. 20 ohms to 1 meg. $\pm 25, 50$ and 100ppm. 0.25, 0.5 and 1% tolerances.</p>	 <p>HIGH STABILITY METAL FILM</p> <p>Molded and coated types, including microminiature, 1/10 to 2 watts. 30 ohms to 10 meg. 8 TC's from ± 25ppm. Tolerances from 0.05%.</p>	 <p>ECONOMICAL METAL FILM</p> <p>Molded and coated types for MIL-R-10509. TC guaranteed to within 100ppm. 1/10 to 2 watts, 10 ohms to 10 meg. 0.5 and 1% tolerances.</p>	 <p>DEPOSITED CARBON FILM</p> <p>Molded types from $\frac{1}{8}$ to 2 watts, coated types from $\frac{1}{2}$ to 2 watts. 10 ohms to 1 meg. 0.5, 1 and 2% tolerances. MIL-R-10509.</p>
--	--	--	---



Speed Inquiry to Advertiser via Collect Night Letter
ON READER-SERVICE CARD CIRCLE 48

5 new EMI/RFI Shielded Cabinet Components

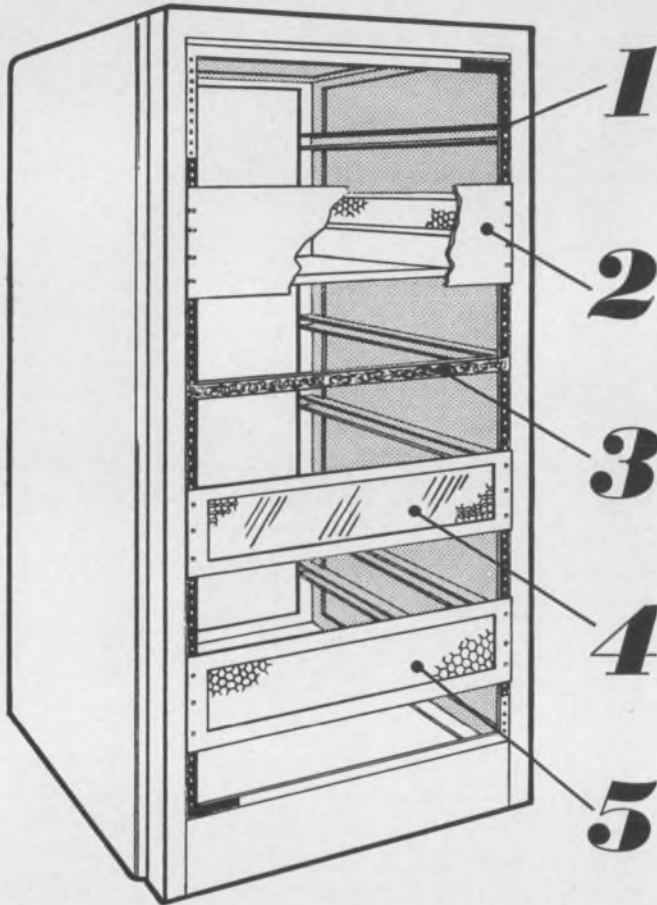

TECKMAG GASKET/STRIP

EIA Rack Mounted

- attaches magnetically • eliminates fasteners and adhesives.
 - drastically reduces installation costs.
- Data Sheet #EMC-064

TECKNIT SHIELDED ENCLOSURES

EIA Rack Mounted

- Ready-to-install standard sizes
 - Honeycomb vented • EMI/RFI Gasketed • removable front, rear, top and bottom panels.
- Data Sheet #EMC-065

TECKNIT INTERMEDIATE BAR

EIA Rack Mounted

- for EMI/RFI Shielding between Panels.
- Data Sheet #EMC-062

TECKNIT EMC GLAS

EIA Rack Mounted

- EMI/RFI Shielded viewing windows available in clear, red, amber, green, circular polarized plexiglass and plate glass.
- Data Sheet #EMC-063

TECKCELL PANELS

EIA Rack Mounted

- Honeycomb vent panels
- Data Sheet #EMC-061

Write or call today for complete technical details about these new EMI/RFI components. Find out how they can fit into your production plans.



TECHNICAL WIRE PRODUCTS, INC.

129 Dermody Street, Cranford, N. J. 07016
(201) 272-5500 — TWX (710) 740-7891

See us at Booths 547 and 548 at WESCON, Hollywood Park

ON READER-SERVICE CARD CIRCLE 49

IRG

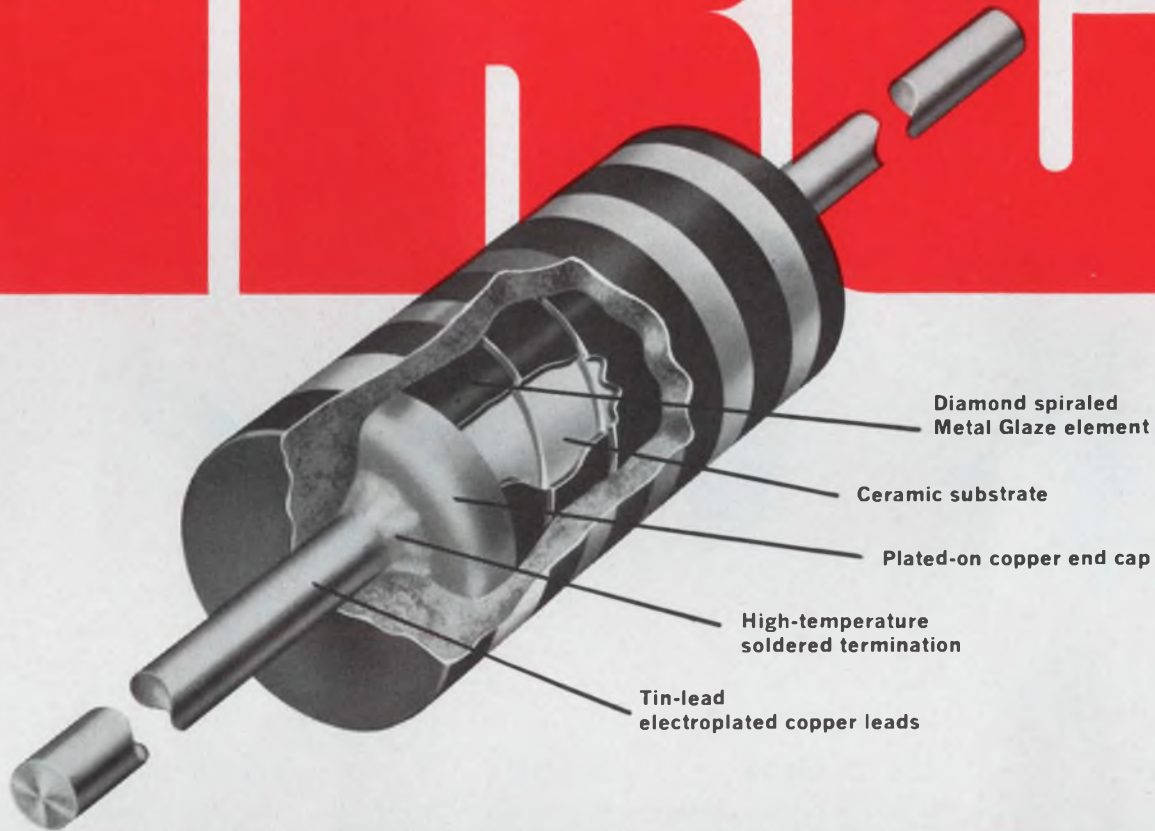

New low-cost Metal Glaze[®] resistors for MIL-R-22684

4 times better load-life stability

IRC's new molded Metal Glaze resistors provide stability, reliability and precision unmatched anywhere for the price.

Tested for over 15 million unit hours, they meet or exceed all MIL-R-22684 requirements. Load life stability, for instance, is four times better than MIL allowance. Typical ΔR is 0.5% after 1000 hours, full load at 70°C. Even at higher temperatures, ΔR is still typically under MIL limits.

The Metal Glaze resistance element is extremely rugged. It is 100 times thicker than conventional films and is impervious to environmental extremes. The tough, uniform molded body resists solvents and the mechanical abuse of automatic machines.

New IRC molded Metal Glaze resistors are immediately available in four forms of packaging to cut your production costs. For complete data, prices and samples, write to: IRC, Inc., 401 N. Broad St., Philadelphia, Pa. 19108.

CAPSULE SPECIFICATIONS

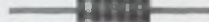
		
MIL-R-22684B:	RL07	RL20
WATTAGE:	¼ W @ 70°C	½ W @ 70°C
RESISTANCE:	51 Ω thru 150K Ω	10 Ω to 470K Ω
TOLERANCES:	± 2%, ± 5%	± 2%, ± 5%
TEMPERATURE COEFFICIENT:	± 200ppm/°C max.	± 200ppm/°C max.
VOLTAGE:	250V max.	350V max.
SIZE:	.250" x .090" dia.	.375" x .138" dia.
IRC TYPE:	RG07	RG20



Speed Inquiry to Advertiser via Collect Night Letter
ON READER-SERVICE CARD CIRCLE 58

COMAR GOES FARTHER...

LATEST RELAY TECHNOLOGY

FROM COMAR

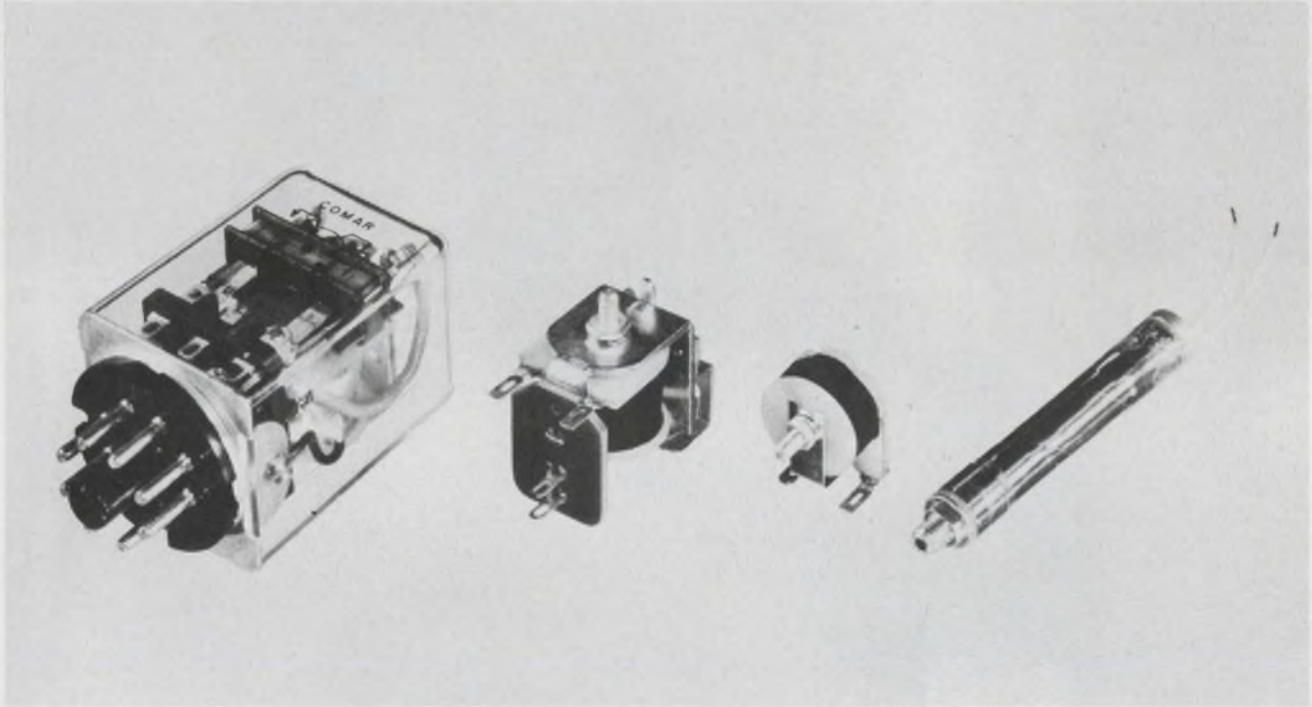

YUL RELAY

YUL Relay terminal lugs are permanently bonded in the Diall molded terminal board to insure dependable operation in stress conditions. The YUL Relay goes further to meet all of your light duty, general purpose applications.

Switch combination. AC or DC operation. Open, or enclosed in clear Lexan case.

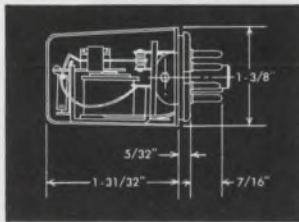

TYPE C RELAY

Comar goes further to design a relay for applications where sensitivity, small space, simplified mounting and economy is essential.

SPDT coil power 3.4 V amperes. Coil voltage to 220 V AC. Maximum contact rating of 3 amp at 115 V AC resistive.

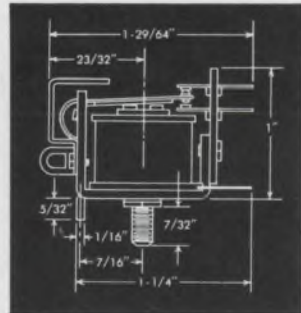

BUZZER

This high quality, smooth acting buzzer economically meets office equipment and other applications requiring audio recognition. Furnished for AC application only. Maximum coil 115 V AC.

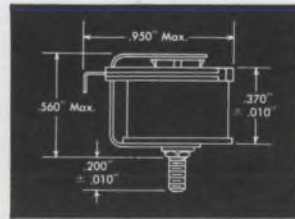

PENCIL SOLENOID

The Pencil Solenoid is a unique electro-mechanical device for utilization in office machines, computers, and photographic equipment. Designed for push or pull operation in limited space applications.

2 1/4" long x 3/8" O.D. Intermittent or continuous duty operation. Continuous duty operation will move 120 grams at 1/16", 50 grams at 1/8", and 18 grams at 1/4". Curves on request.

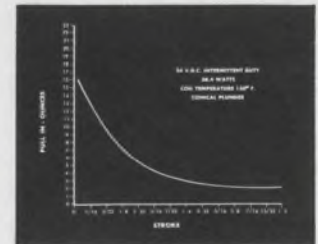

COMAR ELECTRIC COMPANY

3349 Addison Street, Chicago, Illinois 60618

RELAYS • SOLENOIDS • COILS • SWITCHES • HERMETIC SEALING

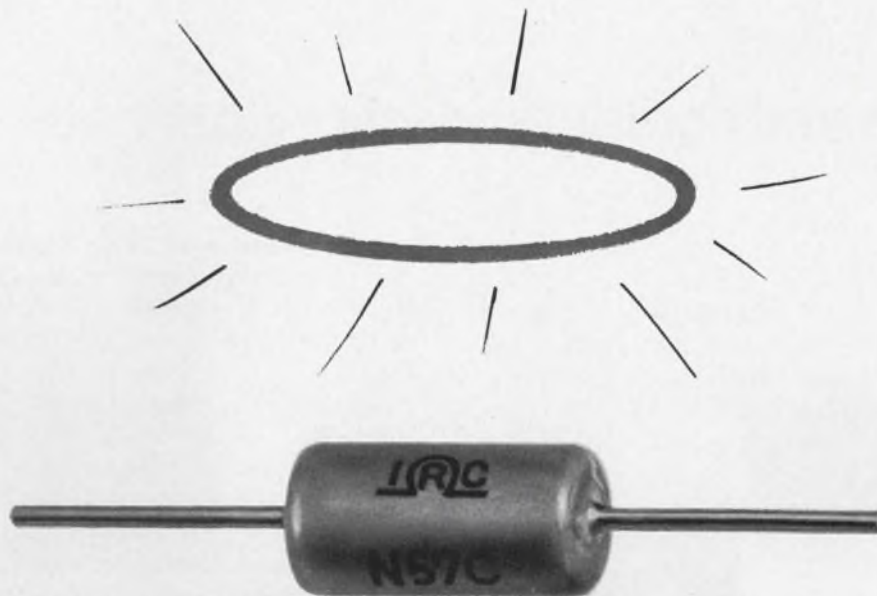

Reliability is a halo some companies wear better than others

IRC type XLT resistors have undergone over a 1/2-billion unit hours of testing to various stress levels without a single failure. Documented failure rate is less than 0.0003%/1000 hours, full load at 125°C. This far exceeds the toughest MIL-R-55182 requirements.

Since 1959, IRC has supplied over 2 million XLT resistors for critical circuit use in Minuteman, Saturn, Surveyor, Agena, Apollo, LEM, Mariner and many others. Not a single failure.

We have earned our halo. For no one can match IRC's record of reliability—or its experience in achieving it.

Most XLT resistance values are available

from stock. And, production lead time is fully geared to your needs. Write for data and prices. IRC, Inc., 401 N. Broad Street, Philadelphia, Pa. 19108.

CAPSULE SPECIFICATIONS



STYLE	RNR57C, E, G
ESTABLISHED F.R.	<0.0003%/1000 hrs. @ 60% conf.
WATTAGE	1/8 W @ 125°C
TOLERANCES	±0.5% and ±1.0%
RESISTANCE	10 Ω to 200K
TEMPERATURE COEFFICIENT	±25, 50 and 100ppm/°C
CONSTRUCTION	evaporated metal film, hermetically sealed



Speed Inquiry to Advertiser via Collect Night Letter
ON READER-SERVICE CARD CIRCLE 60

Microelectronics at Wescon

Power ICs and computer design dominate sessions

Rene' Colen
Microelectronics Editor

If the Wescon program is an indication, it won't be long before integrated circuits infiltrate the hallowed ranks of discrete-component power systems. The belief that monolithic integrated circuits are limited to only low-power applications will soon be revised. Focus at the microelectronics sessions will be on two series of papers. One describes a number of integrated power devices; the other covers a power inverter system that uses integrated circuits to accomplish drastic reductions in size and weight.

Circuit designers, with an eye on the practical, and perhaps immediate, will find the series of papers on Power and Control Integrated Circuits (Session 20) quite interesting. System designers, and those with an eye toward the future, will want to attend the session on Large-scale Integration (Session 10). Session 5, Interconnection Aspects of Microcircuits, emphasizes the continued growth of computer and automation techniques for micro-electronic circuit design and manufacture.

Power ICs appear feasible

The encroachment of IC devices on power applications is described in three papers presented by staff members from the Westinghouse Molecular Electronics Division. The monolithic voltage regulator (paper 20/1) is built on a silicon block that is 140 by 120 mils (a rather large size) and contains three transistors, a reference diode, and one resistor. Two of the transistors, connected in a Darlington configuration, serve as the series control element; the other transistor, with the reference diode in the emitter line and the resistor in the collector line, acts as the feedback amplifier.

When it operates at a nominal input voltage of 18 V and an output voltage of 11.9 V, regulation was found to be better than 0.2% for a $\pm 20\%$ input voltage variation and over a 0.5- to 2.5-ampere load current range. To achieve this performance, however, the amplifier's collector resistor has to be returned to a constant current source, rather than to just the unregulated input voltage. Only two discrete components are required to complete the circuit: a variable resistor

to pick off and adjust the feedback voltage, and a capacitor, at the output of the feedback amplifier (a terminal is available), to suppress any internal oscillations due to the high gain in the feedback loop.

A linear SCR trigger circuit is described by Mel Hellstrom (paper 20/3). The circuit, shown in Fig. 1, is quite complex and includes a gain stage, a Darlington-connected differential amplifier, a temperature-compensated constant-current source, a complementary-transistor pulse detector, an internal power supply regulator, and the SCR itself. The SCR characteristics are, in part, a 0.5 to 0.7 amperes steady-state current capability, a breakdown voltage of more than 50 volts, a holding current of 1 to 2 milliamps, and a current-pulse capability as high as 5 amp. The 50-by-60-mil chip is shown in Fig. 2.

The third Westinghouse paper (paper 20/2) describes a logic-SCR driver circuit. A three input AND gate has its output connected to an SCR. The circuit was developed to act as an interface between standard logic circuits and power output functions. The circuit operates at 3 volts, with the SCR handling one ampere. The three transistors, two npns and one pnp, are in a differential ampli-

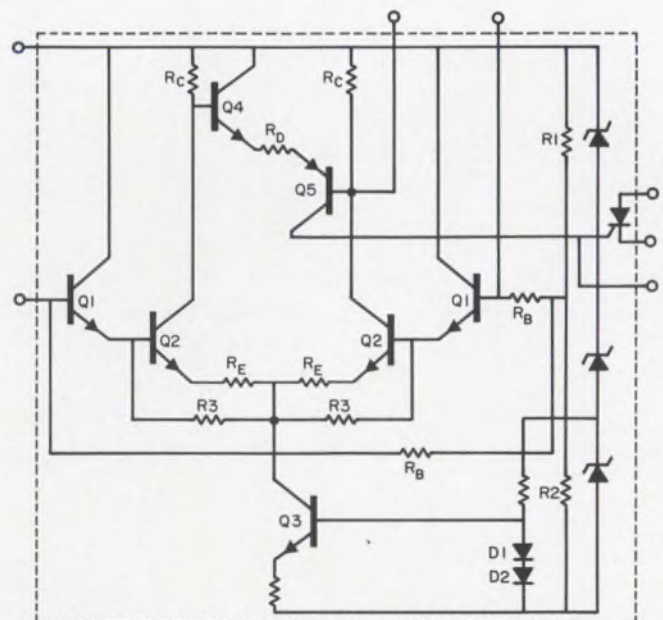

1. Monolithic, linear, SCR trigger circuit has good temperature stability and high sensitivity, all in small size.

fier arrangement, with the complementary pair feeding the SCR gate.

Digital IC arrays used in power inverters

In a series of three papers, all in Session 20, staff members from Texas Instruments Inc. and NASA-Huntsville describe the development of static power inverters using integrated circuitry. The system (paper 20/4) uses various complex array counters to generate a series of properly phased pulse signals. These signals feed the power amplifiers that switch currents in the primaries of the three-phase output transformer. The output signal consists of a summation of the square-wave voltages, and appears as a sine wave made up of small, discrete voltage steps. A 75 VA unit, now in development, provides a 400-Hz, 3- ϕ , sine-wave signal with an efficiency of 60%, and less than 5% distortion. Final weight of the complete package will be under 16 lbs.

Naturally, all of the digital circuitry is integrated (paper 20/6) and appears as four separate packages. Each package contains a single silicon chip. Three of the packages, $\div 256$, $\div 12$, and $\div 10$ counters, use the same manufacturing masks, except for the final, metal interconnection mask. The fourth package, a 12-bit Johnson counter, uses a much more complex circuit as the basic design unit and thus a different set of masks. Each of the counters is packaged in a modified version of TI's Industrial Series 16-pin package. The Johnson counter, for example, is approximately 300 times smaller than an interchangeable discrete-component counter also built by TI.

But integration of this inverter system did not stop with the low-power digital circuits. The power amplifiers—there are six of them in the system—are also integrated. Paper 20/5 describes the circuit, its characteristics, and a major consideration that had to be evaluated: second-breakdown effects. The amplifier unit consists of two Darling-ton-connected stages with a single diode across the emitter-collector of the output units. It is not, however, a monolithic circuit; placed in a special stud package, the power amplifier is actually made up of two discrete chips, each having two transistors and a diode diffused on to it.

LSI still with us, only more so

Large-scale integration remains high on the interest list with an entire session devoted to this topic. The first paper (10/1), presented by Merlin Smith of the IBM Watson Research Center, provides an over-all view of present and future problems in this still-new field. Starting out with the definition of large-scale as meaning more than 50 circuits per chip, he delves into the many advantages and disadvantages of LSI.

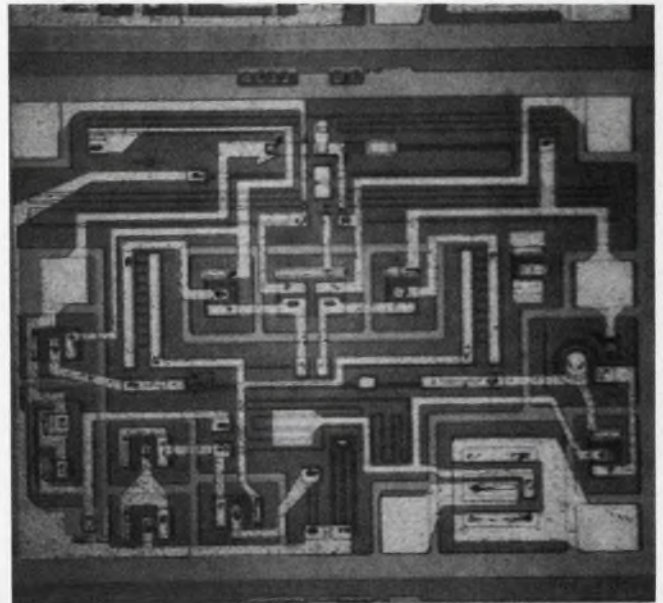

2. Monolithic chip is only 50- by 60-mils, and contains all the circuitry shown in Fig. 1 to form SCR trigger circuit.

One of the biggest problems is that of the "impact of change," which should be reduced in order to reduce cost. Essentially, this means providing an extremely fast turn-around time. To this end, IBM has been working on design automation techniques which are described in paper 10/2. Called the Programmed Interconnect Process, it is essentially a discretionary wiring procedure. A processed wafer, holding an array of some basic logic element and possessing no interconnections between elements, is electrically tested. The results are stored in a computer and a computer routine then designs an interconnection pattern that uses only the good circuits. The output of the computer, the interconnection pattern, is then fed to an automatic exposure apparatus which produces the desired pattern directly on the wafer.

On a research basis, arrays with as many as 80 circuits have been made. The array described in this paper has 4-input NOR gates as the basic logic block, with field-effect transistors as the basic circuit element. The channel spaces that separate each logic block are used for the interconnecting runs. Where cross-overs occur, previously diffused-in connecting lines, located at each channel junction and also between circuits, are used.

The automatic exposure apparatus consists of a fixed, intense light source that focuses a 2-mil light spot on the wafer. The wafer is then digitally stepped in the x and y directions according to the computer's instructions and forms the interconnect pattern on the wafer's sensitized surface.

This system is slightly different from the one described by Lathrop of Texas Instruments Inc. in paper 10/3. TI's Multilevel Interconnect Generator (MIG), uses a high-resolution cathode-ray tube with a fiber-optic face-plate and contact-prints the interconnect directly on the wafer. ■ ■

Corning quietly announces

CORNING
EP-1
1100



the FP Resistor: new, blue, and flameproof!

Low-power resistors that won't burn under extreme overloads will soon be available in 2, 3, 4, 5, 7 and 10 watt ratings. The same sizes and stability as in the famous CORNING® LPI Resistors. Available only from

CORNING
ELECTRONICS

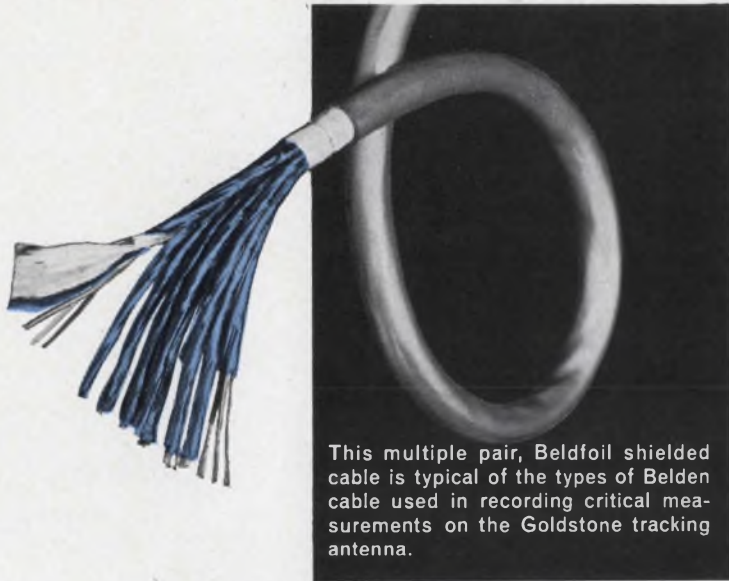

This multiple pair, Beldfoil shielded cable is typical of the types of Belden cable used in recording critical measurements on the Goldstone tracking antenna.

BELDFOIL* SHIELDED CABLE

SOLVED

CRITICAL NASA INSTRUMENTATION PROBLEM!

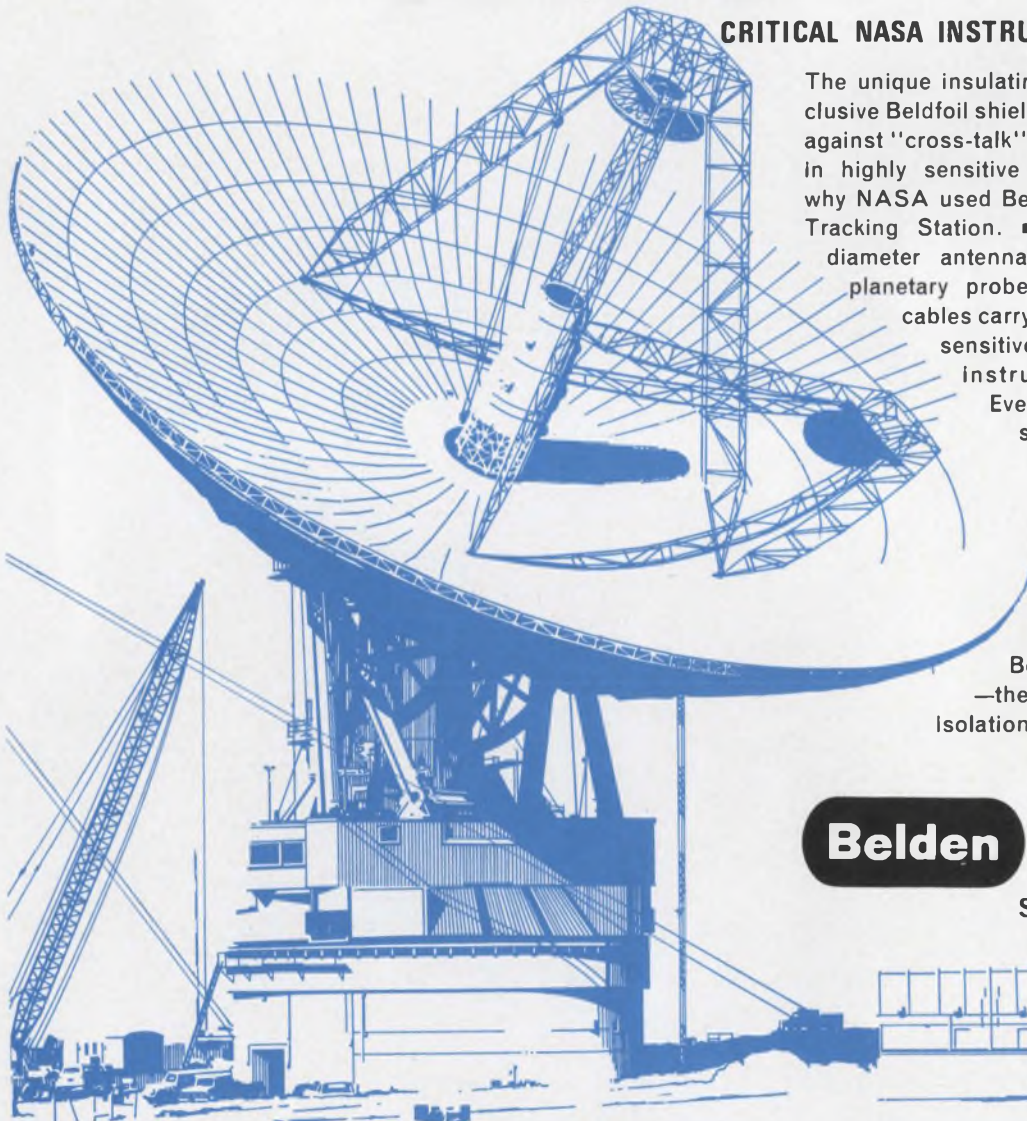

The unique insulating properties of Belden's exclusive Beldfoil shielding provides 100% protection against "cross-talk" and spurious signal impulses in highly sensitive circuit applications. That's why NASA used Beldfoil cable for its Goldstone Tracking Station. ■ In this massive 210 foot diameter antenna, built to track lunar and planetary probes, Belden Beldfoil shielded cables carry instrumentation signals from sensitive structural detectors to an instrumentation facility nearby. Every measurement of critical structure deflection, angular position, structure temperatures, and bearing pressures are recorded and analyzed prior to tracking operations. ■ Get the same precision analyzation in your critical Instrumentation. Specify Belden Beldfoil shielded cable —the only cable providing 100% Isolation.

*Belden Trademark Reg. U.S. Pat. Off.



FOR COMPLETE INFORMATION
CONTACT YOUR BELDEN
DISTRIBUTOR.

See Us In Booths 509-510

BELDEN MANUFACTURING COMPANY • P.O. Box 5070A • Chicago, Illinois 60680

ON READER-SERVICE CARD CIRCLE 61

Heat Dissipation Bonus of Beryllia Worth An Extra Two Cents?



Coors Beryllium Oxide Ceramic offers you the bonus of 10 times the thermal conductivity of aluminum oxide ceramic—approximately the heat transfer qualities of aluminum metal. Ordinarily, beryllia is thought to be too expensive, except for designs where maximum heat dissipation is an essential. However, we find the additional cost of using beryllia in small metallized assemblies adds only a few cents to the total cost of the completed part. For an “extra two-cents worth” Coors offers a beryllia-to-metal assembly that allows you to use more power . . . or allows you even further miniaturization than with alumina . . . or gives you longer component life—or a combination of all three. When you design micro-substrate assemblies—Consider Coors Metallized Ceramics—and get the bonus of beryllia’s thermal conductivity. Write for Coors Metallizing Data Sheet 9502, or call the Coors “hot line”—303/279-4533, Ext. 351.

*consider
Coors metallized
ceramics*

Coors

CERAMICS

ALUMINAS • BERYLLIAS • MAGNESIAS • SPECIAL OXIDES
Coors Porcelain Co., Golden, Colo.



THIS COORS
METALLIZED BERYLLIA
MICRO-COMPONENT
DISSIPATES THE SAME
QUANTITIES OF HEAT

AS THIS COORS
METALLIZED ALUMINA
MICRO-COMPONENT



Touring the exhibit areas

New products at this year's show are conveniently arranged into exhibition categories. Products within each area are pinpointed by booth number. Desk-bound or Wescon-bound, you can browse at the booths quickly. Shuttle service between Hollywood Park (HP) and the Sports Arena (SA) is right at your fingertips.

Measurement & instruments	P U104
Production & packaging	P U116
Circuit components	P U124
Audio, TV & automatic control	P U156
Air & space control systems	P U158
Data processing	P U160
Communication & detection	P U166



FET scope probe measures response of high-frequency (30 MHz) amplifiers with no loss of circuit's gain.

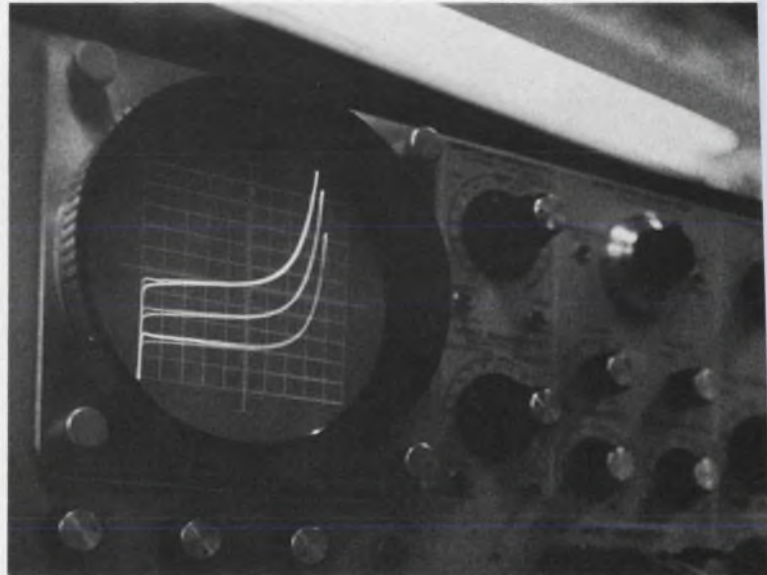

Programmable curve tracer operates in pulse mode.

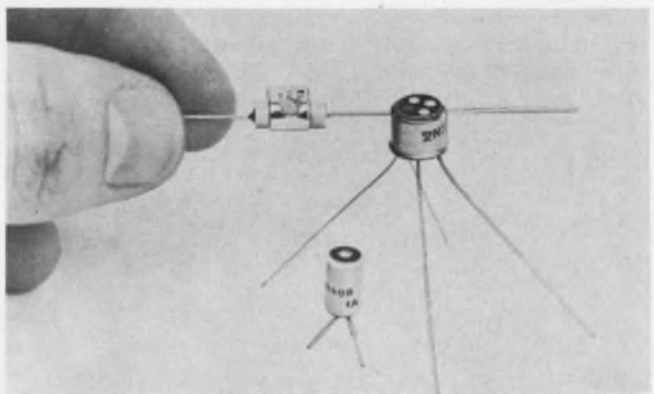

Find burn-outs or hot-spots of up to 100°F. Easy-to-use decals are accurate ($\pm 1\%$) temperature indicators.

Self-erecting antennas pop-up from coils to heights of up to 100 feet. The rigid tubes exhibit good gain characteristics, and, in some cases, outdo monopole units of equivalent height. Since remote length control is easily accomplished, the tubes can quickly be tuned to specific frequencies.

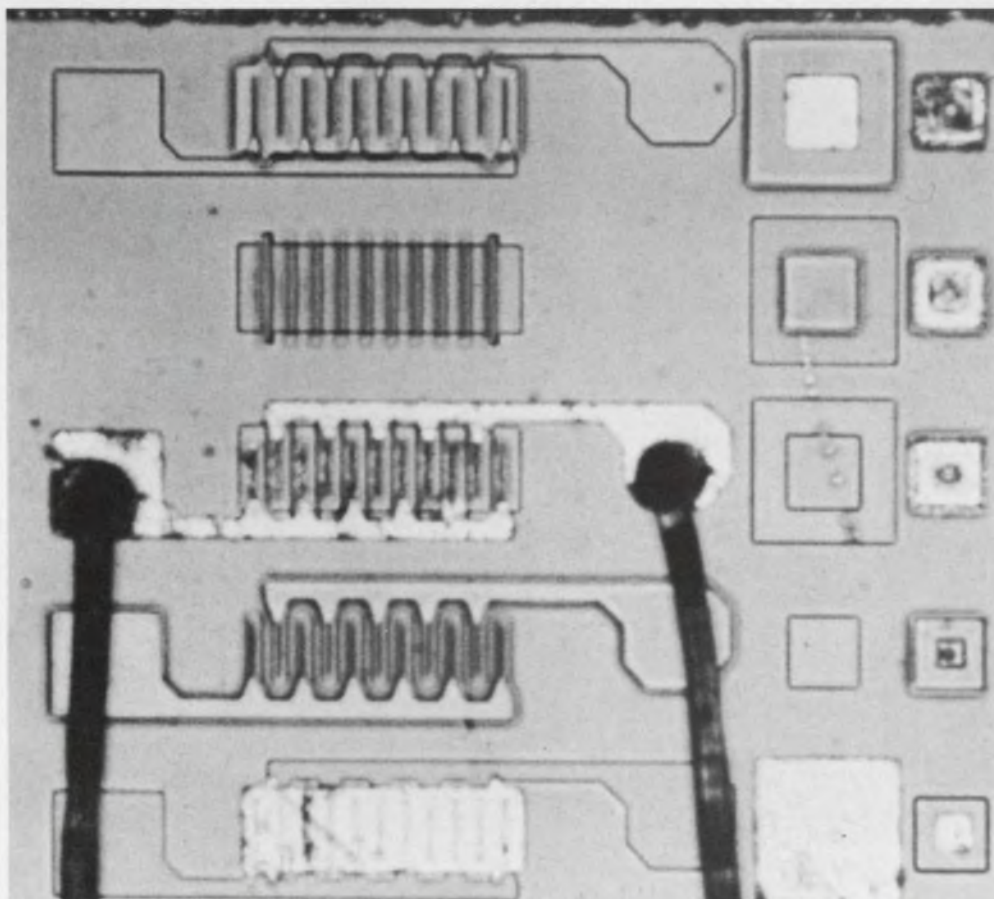
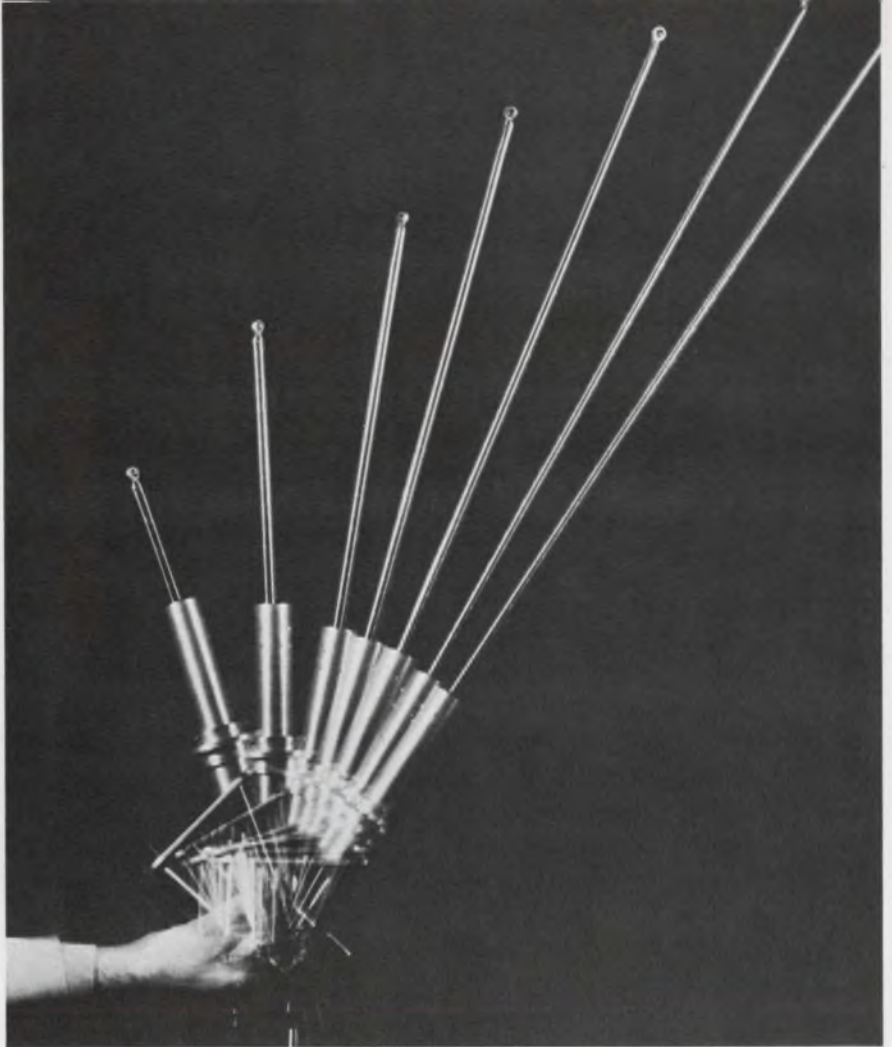

A FET operating at uhf? For mixers and amplifiers, this silicon planar field-effect is reportedly operable up to 800 MHz.

Sampling plug-ins add real-time features, thrust scopes into X-band and beyond

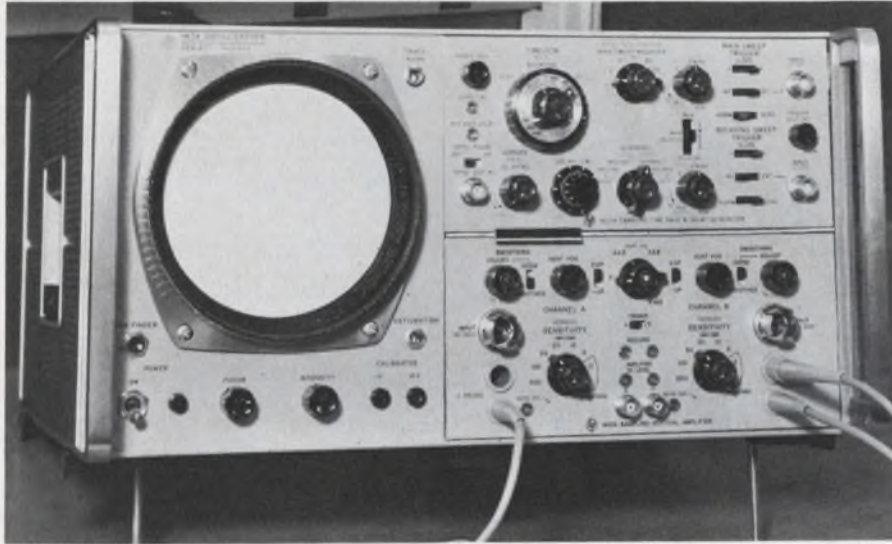

Sampling scope sports delayed sweep, automatic trigger

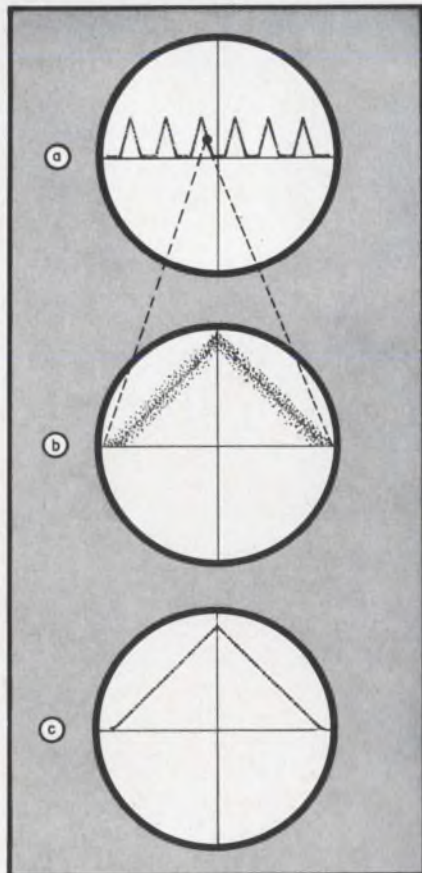

1. Scope sweep is triggered on single pulse (a) for jitter-free display (c). Choosing faster sweep allows display of actual jitter (b).

With operation and performance nearly parallel to that of real-time scopes, this 1-GHz sampling system boasts delayed sweep and automatic triggering capabilities previously unknown to sampling scopes. Totally compatible with Hewlett-Packard's 140A and 141A (variable persistence/storage) scope main frames, the samplers should prove ideal for fast waveform studies.

Delayed sweep capabilities are of greatest value in pulse train studies (see Fig. 1). The observer moves a bright dot along a pulse train, and the touch of a switch expands the pulse selected. The scope sweep can be triggered on the chosen single pulse after the delay period for a display free of input rate jitter (1c). Or, the faster sweep may be chosen immediately at the end of the delay interval to actually show the extent of the jitter present (1b).

The vertical amplifiers have built-in delay lines to initiate automatic triggering on a variety of signals to 1 GHz from either of the two inputs. Thus, the leading edge of any waveform is completely displayed. A small portion of the input is fed to the horizontal plug-in (sweep generator) to start the sweep. The major portion of the sig-

nal passes through the delay line to the sampler and is displayed. Thus, the input signal serves not only to drive the sampler, but the trigger pick-off circuit as well. Sensitivity at 1 GHz is 1 mV/cm.

High-Z probes containing the samplers take scope measurements directly to the circuit of interest. 50- Ω terminated operation results by plugging either probe (or both) back into the amplifier's chassis.

Plug-ins have been designated model 1410A (vertical amplifier) and 1425A (delayed sweep generator). Automatic triggering in the delayed sweep generator provides a base line in the absence of signal and locks in at the signal's start for quick trace set-up. For high time-resolution, calibrated sweeps to 10 ps/cm may be selected. A front panel pushbutton returns the sweep to X1 magnification for a "quick look" at the source and identity of the expanded trace. Single scans are possible if storage of drifting, changing or multiple traces are desired.

P&A: \$1600; 8 to 12 wks. (1410A and 1425A).

..... to X-band and beyond

An external sampler chassis, a two-channel vertical amplifier plug-in and the sweep time-base just described take the same main frames up to X-band for direct cw observation. Sampling heads are attached to the amplifier with an umbilical cord to permit measurements to be made at the signal source. Pulse carriers can be viewed directly without waveshape degradation (crystal detectors are eliminated). Time domain reflectometry is extended: The manufacturer's 20-ps rise time pulse generator and the 28-ps scope response time gives a combined TDR system rise time of less than 40-ps. Discontinuities spaced millimeters apart can be resolved.

Basic sampler design is shown in Fig. 2. The trigger from the horizontal sweep generator causes the sampling pulse generator to turn



Who says 1-amp epoxy rectifiers can't stand humidity?

Write for free water-soaked samples from ITT:

Choose the PRV rating that fits your application best and write for samples. We'll ship them immersed. You'll find that ITT epoxy rectifiers exceed the humidity requirements of MIL-STD-750. While you're at it, check for cool operation, low thermal impedance and extreme stability. All are made possible by ITT's patented* "double nail-head" design. Send for your free bottle of ITT rectifiers today! *Patent No. 3081374

ITT SEMICONDUCTORS
3301 Electronics Way
West Palm Beach, Florida



Please send me a pair of water-soaked 1-amp silicon epoxy rectifiers with the PRV rating I have indicated.

- 100 V 200 V 300 V 400 V
 500 V 600 V 800 V 1000 V

NAME TITLE

COMPANY

ADDRESS

CITY STATE ZIP

ITT

SEMICONDUCTORS

ITT SEMICONDUCTORS IS A DIVISION OF INTERNATIONAL TELEPHONE AND TELEGRAPH CORPORATION, 3301 ELECTRONICS WAY, WEST PALM BEACH, FLORIDA. FACTORIES IN WEST PALM BEACH FLORIDA, PALO ALTO CALIFORNIA, LAWRENCE MASSACHUSETTS, HARLOW AND FOOTSCRAY ENGLAND, FREIBURG AND NURENBERG GERMANY

ON READER-SERVICE CARD CIRCLE 63

continued

the sampling gate on and opens the stretcher gate. Voltage on the sampling capacitor is then amplified and stored in the stretcher for display. Stretcher output is fed to the capacitor via the feedback attenuator so that the voltage across the capacitor equals the input voltage at the time of the last sample. Thus, only input voltage differences are sampled and the gain of the vertical amplifiers is a function of the feedback attenuator, not the forward gain.

Sampler design is aimed at making optimal use of the high-speed switching diodes. The two-diode feedthrough sampler has no internal termination. Input and output are 7-mm airlines. The input line passes through a modified 50-ps biconical cavity. Impedance of the dielectric filled cavity is maintained at 50 Ω . Within the cavity, a fast rise pulse from a step-recovery diode turns the sampler on. This switch-on arises from a controlled reflection of the switch-off pulse against the short-circuited end of the cavity. The reflected wave, in cancelling the forward wave, determines the length of time that the sampling diodes are conducting. Diode capacity remaining, which has not been masked out by the dielectric, is utilized in a low-vswr filter section.

There are three samplers. Model 1430A is optimized for flat pulse response with 28-ps risetime. Model 1431A, optimized for flat frequency response from dc to 12.4 GHz and low vswr. Model 1432A is a 4-GHz, 90-ps risetime unit. The 1425A time base has been described previously. A less costly unit without a delay generator (model 1424A) triggers beyond 5 GHz.

A single vertical amplifier, model 1411A, functions with any of the samplers. The 2-channel amplifier has recorder outputs and an A vs B

Programable oscillator

Designed for automatic frequency selection and optional automatic amplitude selection, this programable signal standard covers 0.1 Hz to 99.99 kHz. Required programming time is 5 ms min. Harmonic distortion is 0.01%, frequency response is ± 0.01 dB, amplitude calibration is $\pm 0.25\%$ and amplitude stability is

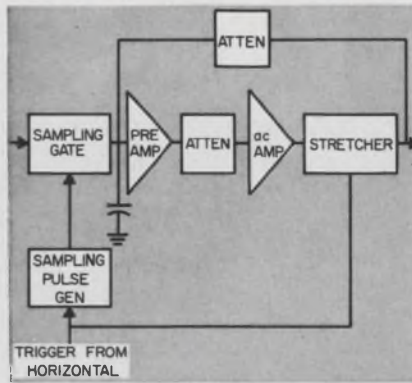

2. Time constant of the sampling gate conductance, source impedance and sampling conductance exceeds sampling time. Thus, voltage across the capacitor after the sample is taken is a fraction of the input voltage. Attenuator maintains sampling efficiency as sensitivity is changed.

mode for X-Y scope presentations. A rise time control allows for optimal overshoot, noise and rise time trade-offs.

For TDR applications, the 1105A 20-ps pulse generator has a flat pulse output. Accessories include the 1106A tunnel diode mount which may be triggered to produce a 20-ps pulse. The 1105A triggers the mount through a length of coax to generate the pulse as near to the circuit as desired.

An 18-GHz countdown supply (1104A) functions with the mount to produce a 100-mV, 100-MHz counted down signal for synchronized triggering of the sampling base from 1 to 18 GHz.

Amphenol GPC-7 connectors, specified to 18 GHz, are used throughout.

P&A: \$3000 (1430A and 1431A), \$1000 (1432A); 8 to 12 wks., \$700 (1411A); 8 to 12 wks., \$1200 (1424A); 5 to 6 months, \$200 (1104A); 12 to 14 wks., \$200 (1105A); 2 to 4 wks., \$550 (1106A); 2 to 4 wks. Hewlett-Packard, 1501 Page Mill Rd., Palo Alto, Calif. Phone: (415) 326-7000. Booth 305 (HP) Circle No. 260

$\pm 0.01\%$ /hr. The relay-operated oscillator meets signal standard requirements in terms of frequency response, sine wave purity and stability of a calibrated output amplitude.

P&A: \$1335 to \$2325; October. Krohn-Hite Corp., 580 Massachusetts Ave., Cambridge, Mass. Phone: (617) 491-3211. Booth 151 (HP) Circle No. 511



Deviation thermometer

This direct reading thermometer measures deviation from fixed temperatures in crystal holders to a resolution of 0.01°C. It has two ranges: a 100°C band selected from a span of -100°C to 500°C, and an expanded scale range of 1-0-1°C. The 100°C scale $\pm 0.5^\circ\text{C}$ accuracy and the 1-0-1°C scale has $\pm 0.1^\circ\text{C}$ accuracy. The unit also has a 0 to 43-W recorder output. The probe contains a miniature platinum resistance element.

P&A: \$600; December. Radio Frequency Labs., Boonton, N. J. Phone: (201) 334-3100. Booth 255 (HP) Circle No. 308

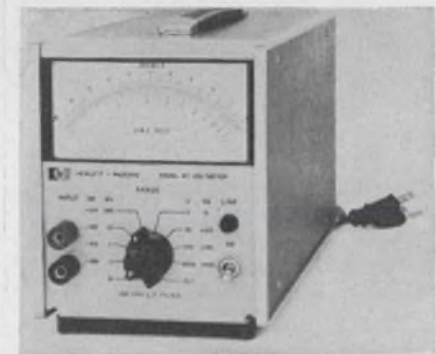

Ac voltmeter

With a linear dB scale on each range, this ac voltmeter has a 100- μV full-scale range, and 10-M Ω input impedance. Full-scale range is 1000 V max. A built-in amplifier produces 1 V rms ac for full-scale deflection. On the 100- μV range, the amplifier has 80-dB gain with 5- μV max noise. Frequency range is 20 Hz to 4 MHz. Accuracy in 100-Hz to 1-MHz range is 0.2 dB.

P&A: \$290; 4 to 6 wks. Hewlett Packard, 1501 Page Mill Rd., Palo Alto, Calif. Phone: (415) 326-7000. Booth 305 (HP) Circle No. 313

Our DTL offers one feature we didn't license

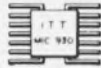

on-time delivery

ITT is licensed to build all DTL integrated circuits from the 930 series. Quantity production is a reality in ITT Semiconductors' facility in West Palm Beach, Florida.

Doubtful? Ask your ITT Semiconductor distributor, who has plenty of DTL circuits in stock. Ask your ITT Semiconductor factory salesman, who can arrange two-week ARO shipment of your quantity orders.

It's easy to recognize the DTL circuits that come from ITT in West Palm Beach. They're the ones you don't have to wait for.

ITT Semiconductors is a division of International Telephone and Telegraph Corporation, 3301 Electronics Way, West Palm Beach, Florida.

Type Number	Circuit Function
MIC930	Dual 4-input Gate with Expander
MIC932	Dual 4-input Buffer
MIC933	Dual 4-input Expander
MIC944	Dual 4-input Power Gate
MIC945	R-S or J-K Flip-Flop
MIC946	Quad 2-input Gate
MIC948	R-S or J-K Flip-Flop
MIC949	Fast Quad 2-input Gate
MIC950	Pulse-triggered Binary

ITT
SEMICONDUCTORS

FACTORIES IN WEST PALM BEACH, FLORIDA; PALO ALTO, CALIFORNIA; LAWRENCE, MASSACHUSETTS; HARLOW AND FOOTSCRAY, ENGLAND; FREIBURG AND NURENBERG, GERMANY

ON READER-SERVICE CARD CIRCLE 64

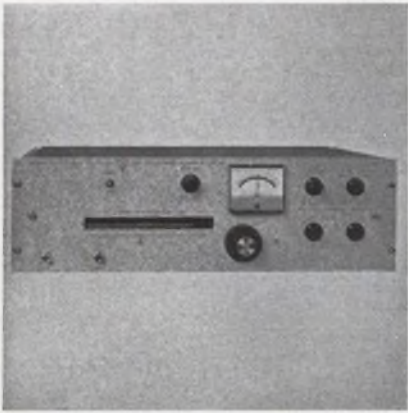

Phase and time detector

Measuring phase angle and time delay from 1 to 8.2 GHz, this detector has accuracy better than 0.1° or 1% over the 0 to 360° range. Readability is better than 0.05 ps and resolution is infinite. As a null indicator, minimum input signal requirement is 0.1 V rms. The ratio of the two input signals can be varied from 1:1 to 10:1. Error due to harmonics and noise is zero for even harmonics and inversely proportional to the order of odd harmonics.

P&A: \$2386; stock. Ad-Yu Electronics Inc., Passaic, N. J. Phone: (201) 472-5622.
Booth 219 (HP) Circle No. 309



Thermopile detectors

Wirewound thermopile detectors have a signal speed ranging from 0.05 to 0.8 s. Sensitivity is typically 0.1 mV/mW and impedance is typically 200 Ω . The thermopile is linear up to intensities of 300 mW/cm².

Eppley Laboratory Inc., 12 Sheffield, Newport R. I. Phone: (401) 847-1020.
Booth 424 (HP) Circle No. 305

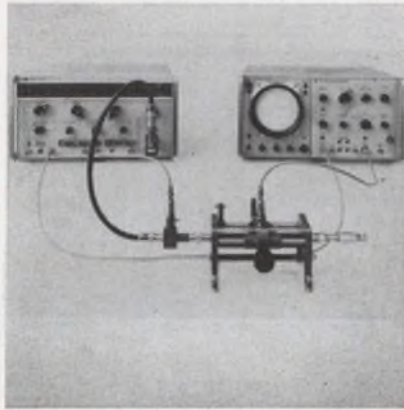

Slotted-line system

Slotted-line vswr measurements from 2 to 18 GHz are implemented with this swept slotted-line system. It consists of a slotted line and a swept slotted-line adapter with two matched, untuned detectors and a simulated section of slotted line. One sampling detector levels the associated microwave sweep oscillator and the other is used on the slotted-line carriage for readout.

Hewlett Packard, 1501 Page Mill Rd., Palo Alto, Calif. Phone: (415) 326-7000.
Booth 305 (HP) Circle No. 352



FM signal generator

Covering the FM band from 86 to 108 MHz, this generator has frequency deviation response within 1 dB from dc to 75 kHz and less than 3 dB down at 200 kHz. The output system is a mutual inductance attenuator with 50- Ω source impedance providing low vswr. Output voltage is metered and continuously variable from 0.1 to 100,000 μ V ($-128, -8$ dBm) across 50 Ω .

Price: \$585. McGraw-Edison, Measurements Div., Boonton, N. J. Phone: (201) 334-2131.
Booth 322 (HP) Circle No. 292



Standards calibrator

Type 9000 is a self-contained system of measuring and calibrating standards. A 2- or 4-terminal resistance measuring system is incorporated with a range of 1.1 M Ω max and resolution of 1 $\mu\Omega$ max. Temperature measurements have an accuracy and resolution of $\pm 0.001^\circ$ C. A 111-V direct-reading dc pot provides additional ranges of 11, 1, 0.1 and 0.0 V at ± 5 ppm accuracy. A 10-decade 4-terminal variable resistor is temperature/controlled to $\pm 0.1^\circ$ C.

P&A: \$9700; 6 to 8 wks. Hallmark Standards Inc., 145 Library Lane, Mamaroneck, N. Y. Phone: (914) 698-8460.
Booth 446 (HP) Circle No. 386



Spectrum display

In conjunction with a frequency-selective voltmeter this unit displays signals in a selected frequency band on a CRT. Frequency accuracy is ± 1 kHz for 120-kHz sweep width. Frequency coverage and total dynamic range equal that of the voltmeter. Sweep width is 120 or 12 kHz. Stability for 120-kHz sweep width is ± 2500 Hz. Flatness and level stability at 0 dB are ± 0.5 dB.

Philco Corp., Sierra Electronic Div., 3885 Bohannon, Menlo Park, Calif. Phone: (415) 322-3885.
Booth 453 (HP) Circle No. 535

Learn why

Please send me a FREE copy of "VHF/UHF Power Transistor Amplifier Design" along with complete specifications for ITT's 2N3375.

Name Title

Company

Address

City State Zip

every ITT 2N3375 gives you 66% more P_{OE} than EIA specs demand

28V CLASS B POWER OUTPUT VS FREQUENCY

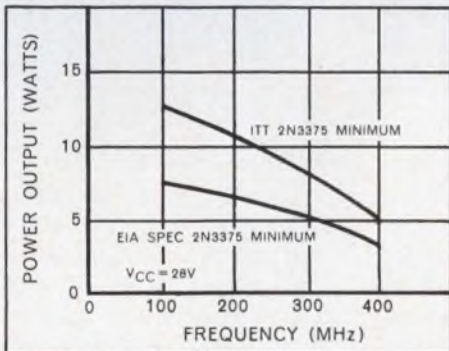

When you apply ITT 2N3375s, you get 5 watts minimum saturated power output at 400 MHz and $V_{CC}=28$ V, tested 100%.

The secret lies in ITT's unusually close control of resistivity, combined with interdigitated construction.

To find out more about the superior performance of the ITT 2N3375, write today for your free copy of "VHF/UHF Power Transistor Amplifier Design" and complete 2N3375 specs. Or see for yourself — order sample quantities off-the-shelf from your ITT distributor or factory representative. ITT Semiconductors is a division of International Telephone and Telegraph Corporation, 3301 Electronics Way, West Palm Beach, Florida.

ITT

SEMICONDUCTORS

Factories in West Palm Beach, Florida; Palo Alto, California; Lawrence, Massachusetts; Harlow and Footscray, England; Freiburg and Nuremberg, Germany.

ON READER-SERVICE CARD CIRCLE 65

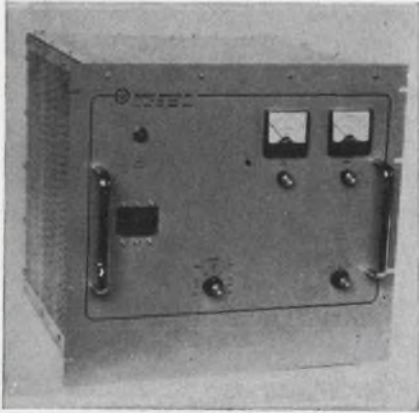

3-GHz signal generator

Coverage of telemetry and communication bands from 1 to 3000 MHz is achieved by this AM-FM-pm signal generator. Model 440 uses a crystal-controlled time base generator and has an accuracy to $\pm 0.0003\%$ and stability of $\pm 0.0006\%/hr.$ RF output is $0.1 \mu V$ to 1.0 V. Accuracy is ± 1 dB and modulation distortion is 2% max. Peak deviation is constant for a 0.8- to 6-V input.

P&A: \$12,000; 90 days. Microdot Inc., 220 Pasadena Ave., South Pasadena, Calif. Phone: (213) 799-9171.

Booth 213 (HP) Circle No. 264

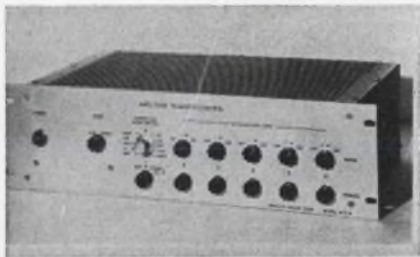

Vibration monitor

Control of sinusoidal vibration tests from up to six acceleration inputs or from the phase-insensitive average of input magnitudes is provided by this unit. Control in transfer mode maintains acceleration at each input at a preset 0.1 to 100 G. Average mode operation provides control from the weighted average of input magnitudes. An optional arrangement allows each channel to operate in either mode.

Unholtz-Dickie Corp., 2994 Whitney Ave., Hamden, Conn. Phone: (203) 288-3358.

Booth 190 (HP) Circle No. 382



18-GHz sweep analyzer

Swept frequency over the 20-MHz to 18-GHz range is provided by this phase, amplitude and impedance analyzer. A test signal varying in power over a 60-dB range can be measured. The unit can be used on both cw and pulsed signals. For impedance plotting, the resolution is 1% allowing a 1.02-vswr measurement or a 40-dB return loss. For measurement of insertion loss, accuracy is 0.5 ± 0.1 dB for each 10 dB up to 50 dB.

P&A: \$4200 (analyzer), \$3750 to \$8900 (resolver); 8 wks. Wiltron Co., 930 East Meadow Dr., Palo Alto, Calif. Phone: (415) 321-7428. Booth 241 (HP) Circle No. 504



Selective voltmeter

Signals from 10 kHz to 32.1 MHz are measured by this frequency-selective voltmeter. Signal components of $1 \mu V$ min in bandwidths of 250 or 3100 Hz can be measured. The main tuning dial is phase-locked in 100-kHz steps or continuously tuned from 0 to 32.1 MHz. The incremental dial covers -10 to 100 kHz with scale markers every 500 Hz. Measurement accuracy is ± 0.2 dB at 1 MHz.

Philco, Sierra Electronic Div., 3885 Bohannon, Menlo Park, Calif. Phone: (415) 322-7222.

Booth 453 (HP) Circle No. 505



Temperature controllers

A line of digital set point temperature controllers, including time proportioning and SCR proportioning models, is offered. Temperature is set with a knob which drives a 3-digit indicator. Temperature is maintained automatically, with any momentary deviation indicated by a null meter. The controller reacts to $1\text{-}\mu V$ signal changes. Deviations are shown in $^{\circ}F$, $^{\circ}C$ or μV . Full-scale standard temperature ranges are 500, 1000 and $2000^{\circ}F$, and 500 and $1000^{\circ}C$. Full-scale millivolt ranges are 10, 20, 30, 40 and 50 mV. SCR models include integral power packages with capacities to 9.2 kW.

P&A: from \$200; 6 to 8 wks. API Instruments Co., Chesterland, Ohio. Phone: (216) 423-3131.

Booth 337 (HP) Circle No. 520



Vector voltmeter

For in-phase, quadrature and true rms voltage measurements, this vector voltmeter's noise and harmonic rejection are 40 dB down. The circuitry permits operation from 15 Hz to 30 kHz without filters. Voltage accuracy is $\pm 2\%$ from 1 mV to 300 V with phase angle accuracy of ± 1 . Input impedance is $10 M\Omega$ shunted by $25 \mu F$.

Price: \$1100. Luscombe Engineering Co., 610 S. Arroyo Pkwy., Pasadena, Calif. Phone: (213) 684-2000.

Booth 436 (HP) Circle No. 523

off-the-shelf-delivery!

GENERAL INSTRUMENT'S

MEM 3050 MOS MONOLITHIC

DYNAMIC DUAL 25-BIT

SHIFT REGISTER

featuring:

- LOW POWER DISSIPATION - TYPICALLY 10 TO 20 mW TOTAL
- OPERATING FREQUENCY - 10 kHz TO 500 kHz
- HIGH NOISE IMMUNITY - TYPICALLY 3V
- OPERATING TEMPERATURE - 55° C to +85° C
- AVAILABLE IN LOW PROFILE 10 LEAD TO-74 OR 14 LEAD FLATPAK.
- \$55.80 EACH IN QUANTITIES OF 100 UP
- NOW AVAILABLE FROM YOUR AUTHORIZED GENERAL INSTRUMENT DISTRIBUTOR



FOREMOST
in SEMICONDUCTORS

Write for free Data-Pak on the MEM 3050 and the complete line of GENERAL INSTRUMENT Monolithic MOS devices.

GENERAL INSTRUMENT CORPORATION 600 West John Street, Hicksville, N. Y.

ON READER-SERVICE CARD CIRCLE 66



Impedance bridge

Measurements of C, R, L, D (dissipation factor of capacitors) and Q may be made by this impedance bridge. C, R and L readout is digital and units of measurement are automatically shown. Model 4260A is balanced with a voltage-tuned resistor by phase-controlling the balance leg so it is null. The resistor is controlled by a phase detector.

P&A: \$550; stock. Hewlett Packard, 1501 Page Mill Rd., Palo Alto, Calif. Phone: (415) 326-7000.

Booth 305 (HP) Circle No. 530

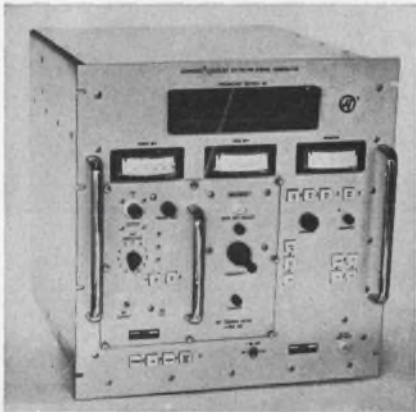

Frequency changer

Sixty-Hz three-phase power is converted to 400-Hz by this frequency changer. The solid-state unit utilizes a vector sum approach in the inverter design. Output is 5 kVA, 120/208 V with frequency stability to 0.001% over a range of 0 to 45°C. This unit measures 17-1/2 x 19 x 17 in.

Microdot Magnetics Inc., 5960 Bowcroft St., Los Angeles. Phone: (213) 870-7491.

Booth 213 (HP) Circle No. 536



Ac-to-dc converter

Featuring 0 to 5 Vdc floating output with $\pm 0.025\%$ terminal linearity, this frequency-to-dc converter provides meter indication of input frequency and a pulse output. The converter has a low impedance dc output with 20-mA max loading, proportional to the frequency or pulse rate of the input. Input frequency range of 5 to 51,200 Hz is provided by 10-position range selector switch and over-lapping adjustment pot.

P&A: \$395; 4 wks. Anadex Instruments Inc., 7833 Haskell Ave., Van Nuys, Calif. Phone: (213) 782-9527.

Booth 208 (HP) Circle No. 314

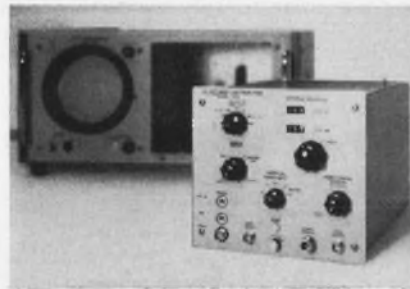

Sweep log analyzer

A sweep log analyzer system is designed for insertion gain or loss, return loss (vswr) or gain, absolute power or reflection coefficient measurements. The 60-dB dynamic range allows using internal analog electronics to compensate for crystal performance above the square-law region. A built-in RF signal generator provides calibration for power level measurements to an accuracy of ± 0.3 dB at +20 dBm and ± 0.6 dB at -40 dBm.

Price: \$1250. Alfred Electronics, 3176 Porter Dr., Palo Alto, Calif. Phone: (415) 326-6496.

Booth 352 (HP) Circle No. 273



Differential null detector

An ac, line-operated isolated null detector provides 20-nV measurement sensitivity. Said to have true differential input, model 3990 null detector performs over 7 ranges from ± 0.1 V to 100 mV. The symmetrical input feature offers the signal reversal (bipolar) capability of a conventional galvanometer. The high Z_{iN} gives the unit capability to operate with resistance sources to 6 k Ω .

Honeywell Inc., Test Instruments Div., 4800 E. Dry Creek Rd., Denver, Colo. Phone: (303) 771-4700.

Booth 1229 (SA) Circle No. 540



Vswr/attenuation meter

Vswr and attenuation are measured by this solid-state direct reading amplifier. The high-gain unit incorporates a power supply with an indicator calibrated for signal inputs from crystal or bolometer square-wave detectors. Input of the crystal is 100 and 500 Ω unbiased, 1 V into 1 k Ω biased. Input of the bolometer is 200 Ω . Noise level is 7.5 dB below full scale. Attenuation range is 70 dB in 10-dB and 2-dB steps. Accuracy is 0.05 dB max cumulative error between 2-dB steps.

PRD Electronics, Inc., 1200 Prospect Ave., Westbury, N. Y. Phone: (516) 334-7810.

Booth 459 (HP) Circle No. 510

Lambda adds new WIDE VOLTAGE RANGE PROGRAMABLE power supplies to all-silicon LM series

Up to 60 volts.
Up to 35 amps.
7 power packages.
Prices starting
at \$69.00.

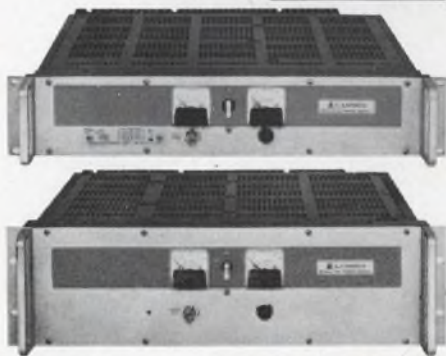

Package A 3 1/16" x 3 1/4" x 6 1/2"

Accessory Metered Panels: \$40.00

Model	ADJ. VOLT. RANGE VDC	I MAX. AMPS ¹				Price
		40 C	50 C	60 C	71 C	
LM 251	0-7	0.15	0.31	0.29	0.27	\$ 69
LM 201	0-7	0.85	0.75	0.70	0.55	79
LM 202	0-7	1.7	1.5	1.4	1.1	89
LM 252	0-7	2.0	1.8	1.4	1.1	99
LM 257	0.14	0.27	0.24	0.23	0.22	69
LM 203	0-14	0.45	0.40	0.38	0.28	79
LM 204	0-14	0.90	0.80	0.75	0.55	89
LM 258	0-14	1.2	1.1	1.0	0.80	99
LM 259	0.24	0.18	0.16	0.15	0.14	69
LM 260	0-24	0.35	0.30	0.25	0.20	79
LM 261	0-24	0.70	0.65	0.60	0.45	89
LM 262	0-24	0.80	0.75	0.70	0.60	99
LM 263	0.32	0.14	0.12	0.11	0.10	69
LM 205	0-32	0.25	0.23	0.20	0.15	79
LM 206	0-32	0.50	0.45	0.40	0.30	89
LM 264	0-32	0.66	0.60	0.50	0.32	99
LM 265	0.60	0.08	0.07	0.07	0.06	79
LM 207	0-60	0.13	0.12	0.11	0.08	89
LM 208	0-60	0.25	0.23	0.21	0.16	99
LM 266	0-60	0.35	0.31	0.28	0.25	109

Package B 3 1/16" x 4 1/16" x 6 1/2"

Accessory Metered Panels: \$40.00

Model	ADJ. VOLT. RANGE VDC	I MAX. AMPS ¹				Price
		40 C	50 C	60 C	71 C	
LMB-0-7	0-7	2.8	2.6	2.3	1.5	\$109
LMB-0-14	0-14	1.6	1.5	1.3	1.2	109
LMB-0-32	0-32	0.80	0.70	0.60	0.5	109
LMB-0-60	0-60	0.45	0.40	0.35	0.3	109
LM 217	8.5-14	2.1	1.9	1.7	1.3	119
LM 218	13-23	1.5	1.3	1.2	1.0	119
LM 219	22-32	1.2	1.1	1.0	0.80	119
LM 220	30-60	0.70	0.65	0.60	0.45	129

Package C 3 1/16" x 4 1/16" x 9 1/4"

Accessory Metered Panels: \$40.00

Model	ADJ. VOLT. RANGE VDC	I MAX. AMPS ¹				Price
		40 C	50 C	60 C	71 C	
LM-225	0-7	4.0	3.6	3.0	2.4	\$139
LMC-0-14	0-14	2.2	2.0	1.8	1.5	139
LMC-0-32	0-32	1.1	1.0	0.90	0.80	139
LMC-0-60	0-60	0.60	0.55	0.50	0.45	139
LM-226	8.5-14	3.3	3.0	2.5	2.0	139
LM-227	13-23	2.3	2.1	1.7	1.4	139
LM-228	22-32	2.0	1.8	1.5	1.2	139
LM-229	30-60	1.1	1.0	0.80	0.60	149

Package D 4 1/16" x 7 1/2" x 9 3/4"

Accessory Metered Panels: \$40.00

Model	ADJ. VOLT. RANGE VDC	I MAX. AMPS ¹				Price
		40 C	50 C	60 C	71 C	
LM-234	0-7	8.3	7.3	6.5	5.5	\$199
LMD-0-14	0-14	4.9	4.2	3.4	2.7	199
LMD-0-32	0-32	2.5	2.1	1.7	1.3	180
LMD-0-60	0-60	1.3	1.1	0.95	0.75	239
LM-235	8.5-14	7.7	6.8	6.0	4.8	199
LM-236	13-23	5.8	5.1	4.5	3.6	209
LM-237	22-32	5.0	4.4	3.9	3.1	219
LM-238	30-60	2.6	2.3	2.0	1.6	239

Package E 4 1/16" x 7 1/2" x 11 1/4"

Accessory Metered Panels: \$40.00

Model	ADJ. VOLT. RANGE VDC	I MAX. AMPS ¹				Price
		40 C	50 C	60 C	71 C	
LME-0-7	0-7	12.0	10.5	8.5	6.8	\$249
LME-0-14	0-14	7.4	6.4	5.2	4.1	249
LME-0-32	0-32	3.7	3.2	2.6	2.1	249
LME-0-60	0-60	2.1	1.7	1.4	1.1	249

Package F 3 1/2" x 19" x 16 1/2"

For metered models, add suffix (M) to model number and \$30.00 to the price below.

Model	ADJ. VOLT. RANGE VDC	I MAX. AMPS ¹				Price
		40 C	50 C	60 C	71 C	
LMF-0-7	0-7	25.0	21.0	17.0	14.0	\$425

Package G 5 1/4" x 19" x 16 1/2"

For metered models, add suffix (M) to model number and \$30.00 to the price below.

Model	ADJ. VOLT. RANGE VDC	I MAX. AMPS ¹				Price
		40 C	50 C	60 C	71 C	
LMG-0-7	0-7	35.0	29.0	24.0	20.0	\$575

¹ Current rating is from zero to I max. Current rating applies over entire output voltage range. Current rating applies for input voltage 105-132 VAC 55-65 cps. • For operation at 45-55 cps derate current rating 10%. • For operation at 360-440 cps consult factory for ratings and specifications. • ² Prices F.O.B. Factory, Melville, N. Y. All specifications and prices subject to change without notice.

Features and Data Meet Mil. Environment Specs. RFI—MIL-I-16910: Vibration: MIL-T-4807A: Shock: MIL-E-4970A • Proc. 1 & 2: Humidity: MIL-STD-810 • Meth. 507: / Temp. Shock: MIL-E-5272C • (ASG) Proc. 1: Altitude: MIL-E-4970A • (ASG) Proc. 1: Marking: MIL-STD-130: Quality: MIL-Q-9858.

Convection cooled—no heat sinking or forced air required

Wide input voltage and frequency range—105-132 VAC, (200-250 VAC, optional at no extra charge) 45-440 cps

Regulation (line) 0.05% plus 4MV (load) 0.03% plus 3MV; Ripple and Noise—1 MV rms, 3MV p to p

Temp. Coef.—0.03%/°C

RACK ADAPTERS

LRA-3—5 1/4" height by 2 7/16" depth. Price \$35.00

LRA-4—3 1/2" height by 14" depth. (For use with chassis slides) Price \$55.00

LRA-6—5 1/4" height by 14" depth. (For use with chassis slides) Price \$60.00

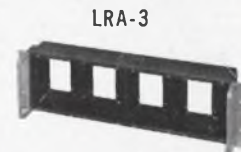

LRA-5—3 1/2" height by 2 7/16" depth. Price \$35.00

SEND FOR NEW CATALOG ON FIXED VOLTAGE AND WIDE RANGE MODULAR POWER SUPPLIES



LAMBDA ELECTRONICS CORP. A **Veeco** SUBSIDIARY
515 BROAD HOLLOW ROAD • MELVILLE, L. I., NEW YORK • 516 MYRTLE 4-4200

SEE US AT WESCON, BOOTHS 1634-1635

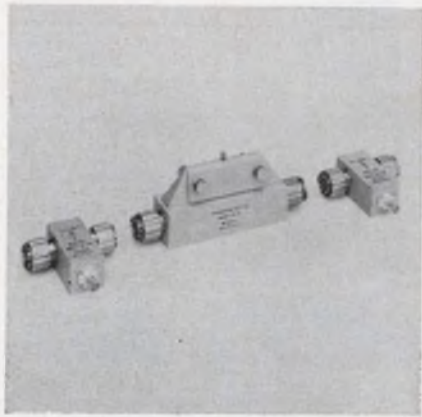

Microwave transistor characteristic plotter

Providing a plot of four S parameters vs frequency, this analyzer consists of a series of resolvers, each covering an octave, a transistor holder, two bias tees and an electronics processing unit. The bias tees and the transistor test jig are rated up to 4 GHz. Connectors maintain a low vswr path to the semiconductor junction. The processing unit provides a Smith chart readout for impedance, a polar plot for transfer function and meter readout for the phase and amplitude components of the reflected and the transmitted signal.

P&A: \$575 (transistor test jig), \$295 (bias tee), \$5300 (resolver), \$4200 (electronics unit); 10 wks. Wiltron Co., 930 E. Meadow Drive, Palo Alto, Calif. Phone: (415) 321-7428.

Booth 241 (HP) Circle No. 385

Lab test console

This standards laboratory console contains four matching units: A precision pot for voltage measurements from 0 to 2222 V, a high-resolution null detector with 20-nV sensitivity, interchangeable volt boxes and a constant current power supply. The potentiometer has 20 ppm calibrated accuracy, four ranges from 0 to 11.11 V and thermal emf or less than 0.1 μ V. The null detector has guarded differential input for bipolar operation and high Z_{IN} .

Honeywell Inc., Test Instruments Div., 4800 E. Dry Creek Rd., Denver, Colo. Phone: (303) 771-4700.

Booth 1229 (SA) Circle No. 547



Bridge indicator

Strain levels of 1/4-, 1/2- and full-bridge transducers are indicated as a per cent of load range or per cent of full scale capacity of transducers by this bridge indicator. Direct linear readout in pounds or per cent of full load is provided. Input power is 115 Vac, 60 Hz, linearity is 0.5% of full scale and accuracy is 0.5% of full scale. The balance control is adjusted for zero. The 10-lb unit measures 12 x 0.5 x 9.5 in.

Lockheed Electronics Co., 6201 E. Randolph St., Los Angeles. Phone: (213) 722-6810.

Booth 1822 (SA) Circle No. 514



True rms voltmeter

A true rms voltmeter operates from a rechargeable battery or a 115/230-V, 50- to 400-MHz source. Voltage range is 300 μ V to 330 V, with null indicator range of 100 to 300 μ V. Frequency band is 10 Hz to 20 MHz and accuracy is 2% of reading from 50 Hz to 10 MHz. The 5-in. voltage scales are logarithmic. Model 323 is useful in measurements of sine waves, distorted sine waves, random noise, square waves or 0.1- μ s pulses having a duty cycle as low as 0.04.

P&A: \$485 (line), \$520 (battery); stock. Ballantine Labs. Inc., P. O. Box 97, Boonton, N. J. Phone: (201) 334-1432.

Booth 413 (HP) Circle No. 282



Impedance/phase meter

Over a 500-kHz to 108-MHz range, this RF vector impedance meter gives impedances from 10 to 100,000 Ω and phase angles from 0 to 360° simultaneously. A sampling agc loop maintains the current constant at 4 μ A. Voltage response is detected and read out in impedance. Resolution is better than 2°. Model 4815A may be swept by an external sweep oscillator up to 1 MHz. The front-panel monitor delivers 150 mV min into 50 Ω . The instrument measures capacitances up to 0.1 μ F and inductances up to 10 mH.

P&A: \$2650; 30 to 60 days. Hewlett Packard, 1501 Page Mill Rd., Palo Alto, Calif. Phone: (415) 326-7000.

Booth 305 (HP) Circle No. 394

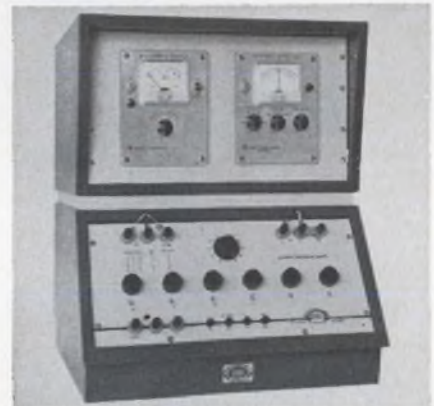

Wheatstone bridge

An 11-position switch dial covering a multiplier range of 10⁻⁵ to 10⁵ is employed by this Wheatstone bridge console. The switch contacts appear in the detector branch and in series with either a 10- or 100-k Ω resistor. With a contact resistance of 0.001 Ω , the maximum ratio error introduced by contact resistance is 0.1 ppm. Accuracy is 0.01%. The unit has a range of 0.1 Ω to 11,111 M Ω .

P&A: \$2800; 8 wks. James G. Biddle Co., Plymouth Meeting, Pa. Phone: (215) 646-9200.

Booth 140 (HP) Circle No. 289

new from RADIATION: IC Operational amplifiers

...eliminate stabilizing networks

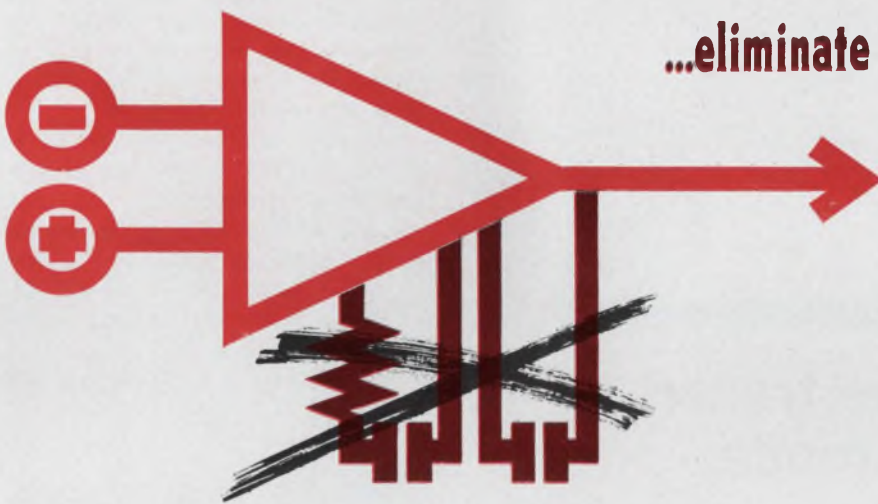

Radiation announces a new line of universal building blocks for integrated analog circuitry. Three different types of operational amplifiers are available to serve your individual needs: general-purpose, broadband, and high-gain circuits.

These highly-stable wide band amplifiers operate at unity gain *without* external stabilization. Thus, design cost and packaging space are reduced.

Further, superior design provides outstanding performance: Parasitics are eliminated, thanks to Radiation's unique dielectric isolation technique. Tighter tolerances and improved temperature coefficients are achieved through use of thin film resistors over the oxide.

Radiation operational amplifiers are ready for *immediate* shipment. Write or phone for data sheets which include worst-case limits, and contain all information required by design engineers. Radiation Incorporated, Physical Electronics, Department ED-08, Melbourne, Florida 32901, Phone: (305) 723-1511, extension 554.

See us at WESCON — Booth 1737-8

Typical electrical characteristics

PARAMETER	UNIT	General Purpose	Broad Band	High Gain
		RA-238	RA-239	RA-240
Phase margin		60°	45°	60°
Bandwidth (unity gain)	MHz	7	15	6
Voltage gain		2,700	2,700	50,000
Offset voltage	mV	2.0	2.0	2.0
Offset current	nA	80	400	80
Thermal drift	$\mu\text{V}/^\circ\text{C}$	5	5	5
Output swing	V_{P-P}	21	21	9
Power consumption	mW	90	160	90
Common mode rejection	db	100	100	100
Power supply rejection	db	80	80	80
Input bias current	μA	0.4	1.2	0.4

Standard temperature range: -55°C to $+125^\circ\text{C}$

All Radiation integrated circuits are dielectrically isolated.



RADIATION
INCORPORATED

Sales offices: Suite 622, 650 North Sepulveda Blvd., El Segundo, Calif. (213) 772-6371 ■ Suite 232, 600 Old Country Road, Garden City, N. Y. (516) 747-3730 ■ P.O. Box 37, Melbourne, Florida (305) 723-1511, extension 554.

Speed Inquiry to Advertiser via Collect Night Letter
ON READER-SERVICE CARD CIRCLE 67

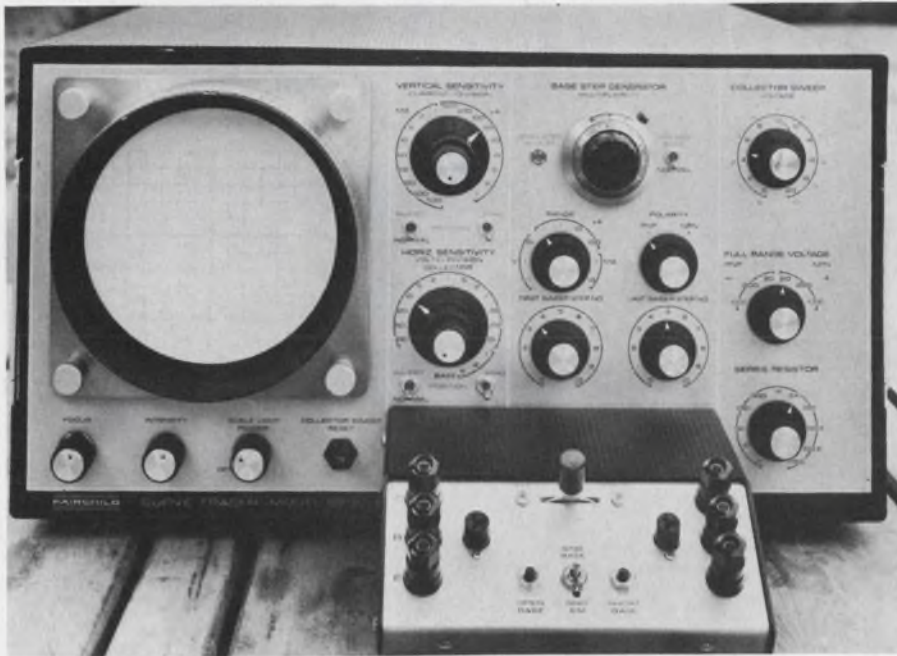

Programable curve tracer operates in pulse mode

Nondestructive testing of small-signal devices at high currents is possible under pulse mode operation of the 6200B transistor curve tracer. Programming capabilities bring the unit into the quality-control laboratory or on to the production line. The versatility of this unit derives essentially from its 100-nA to 500-mA base step generator.

Instead of producing a minimum of four base steps and using a potentiometer for increments, the base drive allows selection of the first and last steps in order to display only specific curves of interest. Single steps alone may also be displayed. By use of the combination of selectable base steps and continuously variable increments, the parameter h_{FE} may be measured at exact collector current and voltage. I_{GF} (gate firing current) and V_{GF} (gate firing voltage) of SCRs can also be determined. If a single step for display is selected and its amplitude varied, the pinch-off voltage of a junction FET or the gate threshold voltage of a MOSFET may be evaluated.

The generator supplies from 10 to 35 V directly in 10 steps (1 to 11 multiplier range). Current steps are as low as 100 nA. Thus, a complete family of MOSFET or UJT

curves may be displayed. Continuous sweep duty cycle is 100%.

In the pulse mode, the base generator's drive is applied for 800 μ s at the peak of each sweep from the collector generator. This results in a 10% duty cycle in the test device for nondestructive small-signal work.

The collector sweep generator has sweep ranges of 0 to 1000 V at 100 mA, 0 to 200 V at 500 mA and 0 to 20 V at 5 A. All ranges are at twice the power line frequency. Collector series resistance is selectable in 11 steps from 3 Ω to 1 M Ω .

The characteristics of 1000-V devices may be displayed, and gain and saturation measurements made with continuous or pulse operation.

To make the unit programable, 30-Vdc reed relays are added. The modified unit (6200B/P) programs five functions:

- Vertical and horizontal display sensitivity.
- Collector dissipation resistance.
- Collector sweep generator range.
- Collector sweep generator polarity.
- External base input.

In order to activate any of these functions, 30-Vdc must be supplied to the correct pin at the rear panel. A programmer (3509B) is available

containing a 30-Vdc supply, a six-stage ring counter, a nine-reed relay matrix and a diode voltage distribution matrix on a PC card. The 3509B can be automatically or manually sequenced from test to test.

Vertical display sensitivity extends from 1 μ A/division to 500 mA/division directly while the horizontal display goes directly to 100 V/division. Two inverting switches orient the display into any quadrant of the CRT. Thus, pnp and p-channel FET curves may be viewed from the lower left corner in a left-to-right direction.

Circuitry of the curve tracer is all plug-in PC board with all-silicon, planar transistors.

P&A: \$1495, \$1995 (programable unit), \$995 (programer); stock. Fairchild Instrumentation, 475 Ellis St., Mountain View, Calif. Phone: (415) 962-2011.

Booth 359 (HP) Circle No. 566



Ultrasonic epoxy bonder

This bonder features operator control for pilot line production and automatic ultrasonic epoxy transistor assembly. A 6-in. stamped or chemically etched strip with several transistors is fed through the die and wire bonds in a magazine strip carrier. Magazines average 1000 to 1500 units. After the operator aligns the wires to the target area on the die, the machine moves each tool to the corresponding post section of the strip, ultrasonically bonds the wire to the post and severs the wire.

Kulicke and Soffa Industries, Inc., 135 Commerce Dr., Fort Washington, Pa. Phone: (215) 646-5800.

Booth 762 (HP) Circle No. 538



Coordinate measuring machine for small parts

Designed for inspecting small parts, PC boards and art. pin connectors and similar components, this 3-axis machine measures the dimension of a part, hole or surface location with an optical electronic sensing stylus. Digital readout or tape or typewriter printout are offered. Measuring range is 16 x 12 x 10-in. under the Y-axis carriage and readout is to 0.0001-in. Readout is positive with automatic \pm quadrant indication from floating 0.

Sheffield Corp., P. O. Box 893, Dayton, Ohio. Phone: (513) 254-5377.

Booth 5377 (SA) Circle No. 304

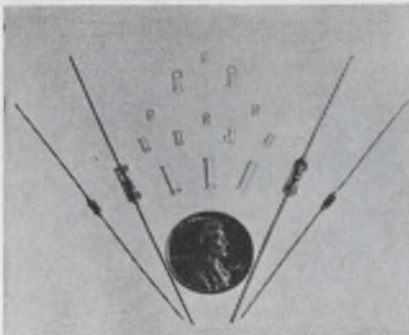

Low-alkali sealing glass

This sealing glass minimizes or eliminates electrical degradation of enclosed semiconductor devices due to alkali poisoning. The extremely low alkali content (0.11%) of the glass is of particular benefit when it comes into contact with the device. One use is in the encapsulation of miniature, slug or stud type diodes. The glass is available as cut tubing. Dielectric constant at 20°C and 1 MHz is 6.02 and loss factor is 0.42%.

Corning Glass Works, Corning, N. Y. Phone: (607) 962-5011.

Booth 1562 (SA) Circle No. 556



new!

swift, precise circuit board drilling machine: Gardner-Denver GRID DRILL*

The Gardner-Denver Grid Drill: by far the fastest, most precise unit of its kind available. Spindles operate at 50,000 rpm . . . infinitely variable from 10,000 to 50,000 rpm! *Accuracy?* Maximum spindle runout at a distance of 1" from the collet is .0005" T.I.R.! Table positioning accuracy of $\pm .0006$ " maximum, repeatability of $\pm .0003$ " maximum. *And so flexible*—both in spindle number and spacing! Each spindle package contains its own power unit, allowing for different rpms for each package. Produces up to 120 holes per minute per spindle. There's lots more information you should have. Write Gardner-Denver now. Ask for Bulletin 15-1.

*Trade Mark Gardner-Denver Co.



SEE WHAT AIR IS DOING NOW...SEE

GARDNER - DENVER

Gardner-Denver Company, Quincy, Illinois

ON READER-SERVICE CARD CIRCLE 69

Feasibility Studies

Filters

A series of papers on methodology for filter feasibility studies. Includes a monograph detailing procedures for obtaining performance spec analysis and computer-selected special filters from basic in-stock components; 8-page engineering bulletin No. 140 designating characteristics of commonly used filters, profusely illustrated with graphs, schematics; a filter specification form with a universal curve that can be related to the characteristics of any filter. Aladdin Electronics.

Circle No. 191



Aladdin can deliver special filter samples quickly, because an organized plan goes into action as soon as we have your specifications.

First, the feasibility study. A free service. It amounts to a computerized analysis that tells whether one of Aladdin's "standard" types will meet your specs, using stock components.

Second, if the feasibility study is affirmative, a quotation on a sample lot of Aladdin filters to your specs.

Third—along with this quote and before we even make the samples—a quote on production quantities just like the samples.

Fourth—if you order the sample lot—quick service . . . because we combine stock components and hardware with Aladdin-tailored inductance values.

Aladdin Electronics at Nashville, Tennessee. Aladdin Electronics/Skyborne at Santa Fe Springs, California. For bulletin circle the number below on the card in the back of this publication.

Circle No. 192

PRODUCTION & PACKAGING



Thermoplastic cases

Thirty new equipment cases are molded of high-strength thermoplastic. The cases range in size from approximately 8- x 6- x 6-in. to 47- x 14- x 18.5-in. The thermoplastic used is acrylonitrile-butadiene-styrene.

Skydyne Inc., River Rd., Port Jervis, N. Y. Phone: (914) 856-5241.

Booth 668 (HP) Circle No. 297

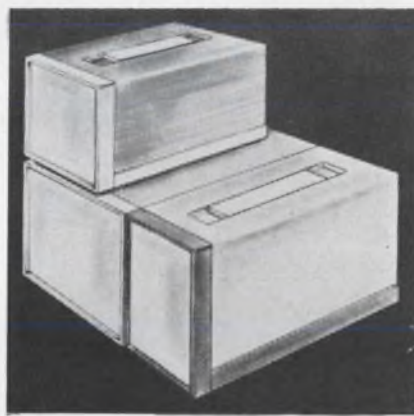

Instrument cases

Aluminum instrument cases in heights from 6-1/2- to 10-in. are offered in half-rack, third-rack, and two-thirds-rack widths. Removal of two screws in the rear panel allows the top-side-and-rear section of the cabinet to be lifted from the front bezel and bottom pan. A slot is provided in the rear panel for cable exit. The front panel and chassis are held in place by two screws in the rear leaving the area available for equipment.

Scientific-Atlanta Inc., P. O. Box 13654, Atlanta. Phone: (404) 938-2930.

Booth 530 (HP) Circle No. 372

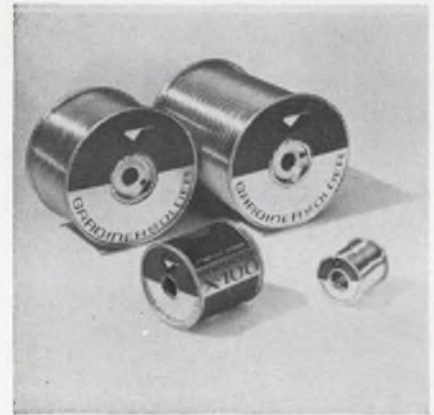

Flux-cored solder

After-soldering resin residue of X-100 flux-cored solders is non-conductive, non-corrosive, non-hygroscopic and resistant to oxidation and decomposition. Lead, tin, silver, bismuth and antimonial alloys to customer specification are available in wire sizes from 0.01 to 0.3125-in. with flux cores ranging from 0.5% to 4.5% in 0.5% increments.

Gardiner Metal Co., 4820 S. Campbell Ave., Chicago. Phone: (312) 847-0100.

Booth 756 (HP) Circle No. 501



Wire-wrapping system

Spiral type wrapping for flexible electric harnesses and cables offers strength and simple application. It forms a single cable from a bundle of wires and bends easily to follow the path of the wires. "Spiroband" retains its elasticity and shape and will unwrap easily. It permits individual lead-offs or additions at any point. Each size (1/8, 1/4 and 1/2-in.) is available in natural, ultraviolet resistant and fire-retardant polyethylene.

Electrovert Inc., 86 Hartford Ave., Mt. Vernon, N. Y. Phone: (914) 664-6090.

Booth 623 (HP) Circle No. 310

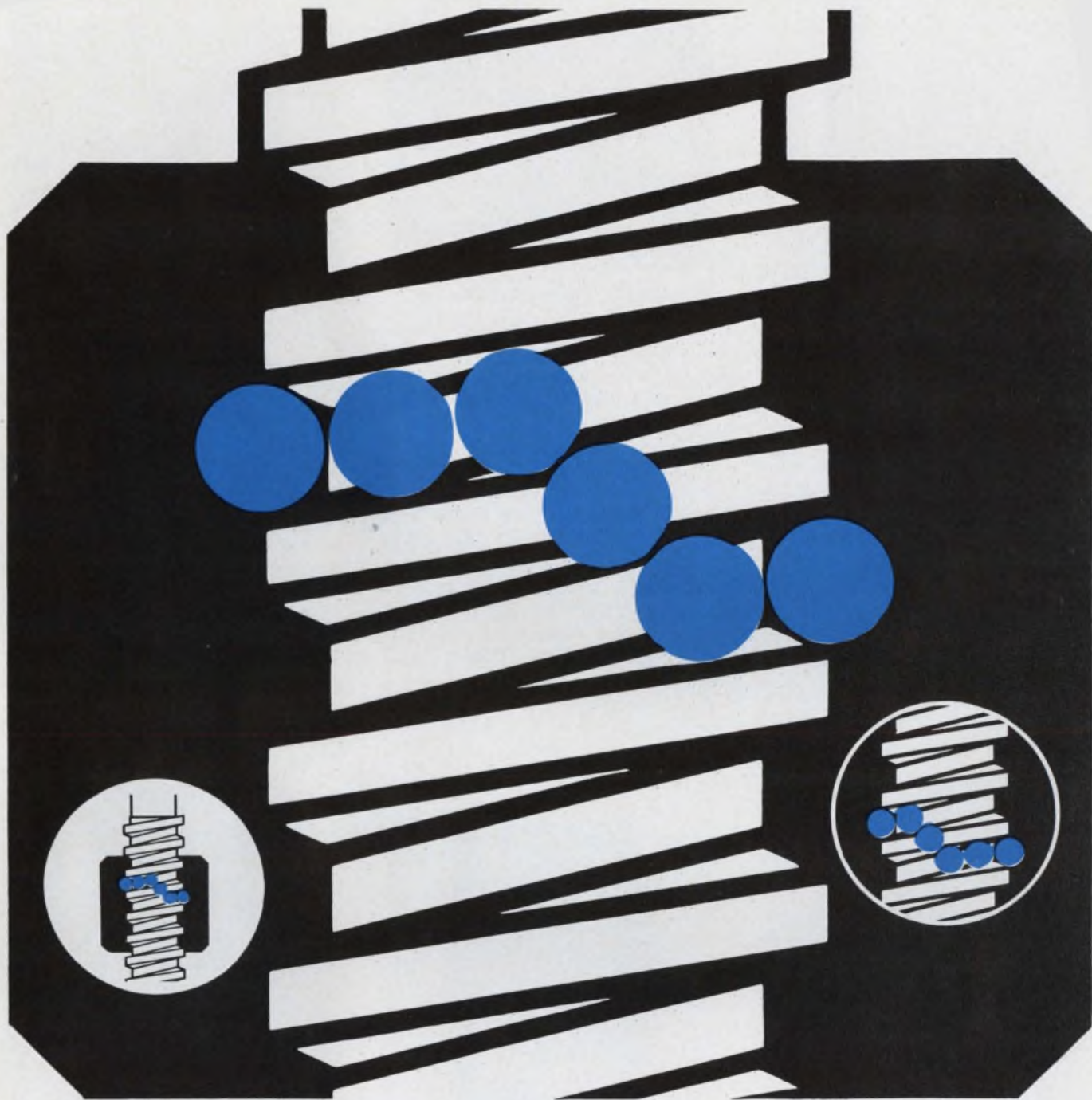

Kidde Ballscrews

SIZE AND WEIGHT PROBLEM SOLVERS

Kidde Ballscrews do more than solve friction problems of prime movers and drives. They can solve size and weight problems, too—and meet the demands for high efficiency transfer of motion and power. Here's why:

Their compact design results in smaller envelope dimensions. Weight is reduced because external tubes and fittings are eliminated. Kidde designs allow optimum usable power, due to extremely high efficiencies.

To solve these major problems, Kidde has designed a

wide range of Ballscrew sizes—from units less than 1" long to 32 foot custom assemblies. From 6" diameters down to 1/8"; sizes 3/16" to 1-1/2" (with various lead) are stocked.

Learn how Kidde Ballscrews can become your problem solver. Write for your free copy of "Standard and Precision Ballscrews." Walter Kidde & Company Inc., 675 Main Street, Belleville, New Jersey 07109.



ON READER-SERVICE CARD CIRCLE 821

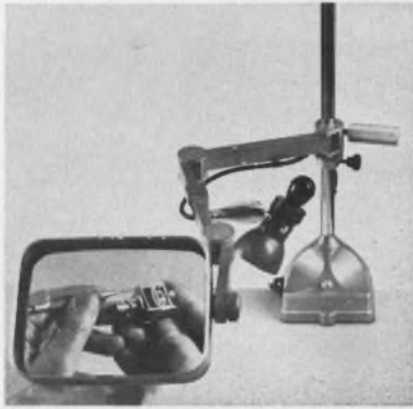

Work/inspect station

This system consists of a work inspection station with a magnification tool and floodlight. The instrument provides a work area of over 40 in.². The lens is mounted on a 3-joint arm which may be extended 19 in. from its main pivot. The high-intensity air-cooled floodlight is made for gravity attachment to any part of the arm. It supplies 100 ft-candles at 12 in.

P&A: \$179; stock. Ednalite Research Corp., 210 N. Water St., Peekskill, N. Y. Phone: (914) 737-4100.

Booth 758 (HP) Circle No. 381

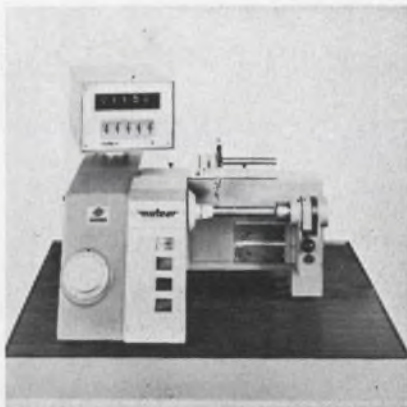

Bobbin coil winder

This automatic coil winding machine accepts #47 to #23 AWG. Winding speed is 5000 or 10,000 rpm at 15 to 800 turns/layer. Coil sizes may be to 3-in. diameter and to 3-in. wide.

Associated American Winding Machinery Inc., 750 St. Ann's Ave., Bronx, N. Y. Phone: (212) 292-5050.

Booth 750 (HP) Circle No. 359



Portable ball-bonder

A single-station thermocompression bonder has a steady constant flame (to 500°F) which severs wire to form a perfect ball. During bonding, the flame is intercepted by a baffle device. When the operator triggers the lever for cut-off, the baffle permits the flame to touch the wire. The machine will handle gold wire for ball-bonding and either gold or aluminum wire for stitch-bonding. Acceptable diameters range from 0.7 to 0.0002-in.

Sola Basic Industries, 304 Hart St., Watertown, Wis. Phone: (414) 261-7000.

Booth 543 (HP) Circle No. 363

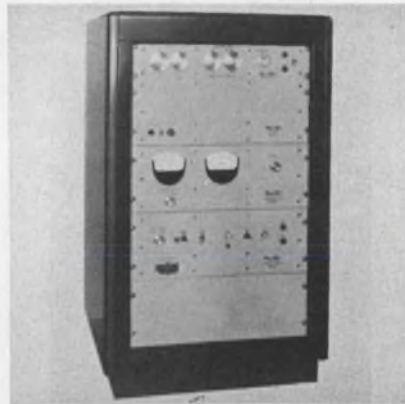

Resistor noise tester

Model 5003 sorts 10-Ω to 1-MΩ resistors by noise index. An automatic signal indicates rejection of any resistor which exceeds a preset noise figure. The system sorts up to 6000 per hour at ±3-dB tolerance. Higher speeds are accomplished by the addition of more channels. Applied voltage is 1 to 400 Vdc. Noise index reject level ranges from 0 to -40 dB.

Price: \$12,900. Quan-Tech Labs., 43 S. Jefferson Rd., Whippany, N. J. Phone: (201) 887-5508.

Booth 303 (HP) Circle No. 365

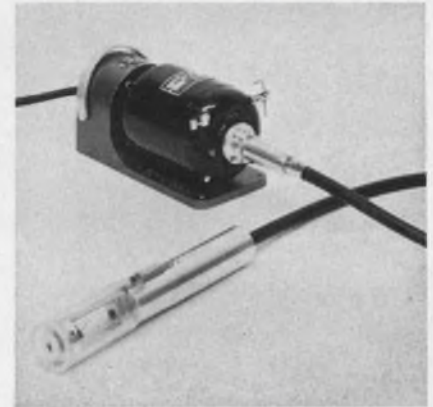

Portable wire stripper

This twin-blade wire stripping machine handles shielded cable, thin wall, non-concentric primary insulations and other hard-to-strip wires. The spring-loaded swing blades are independently adjustable to any desired gap. Simultaneous opening and closing of the blades is synchronized by a floating plunger bushing which slides in an oilite bearing.

Price: \$295. Carpenter Co., Fairgrounds Dr., Manlius, N. Y. Phone: (315) 682-9176.

Booth 569 (HP) Circle No. 351



Ultrasonic ring welding

Ultrasonic ring welding equipment for encapsulating semiconductors use solid-state frequency converters and ceramic acoustic transducers with 85% efficiency. Hermetic welding of similar or dissimilar metals in 360° ring diameters ranging from 1/8 to 2-1/2-in. is achieved without heat. Welding can be carried out in special atmospheres and in vacuum. For most materials an inert atmosphere is not necessary.

Sonobond Corp., 310 E. Rosedale Ave., West Chester, Pa. Phone: (215) 696-4710.

Booth 745 (HP) Circle No. 281

Challenge from Westinghouse:

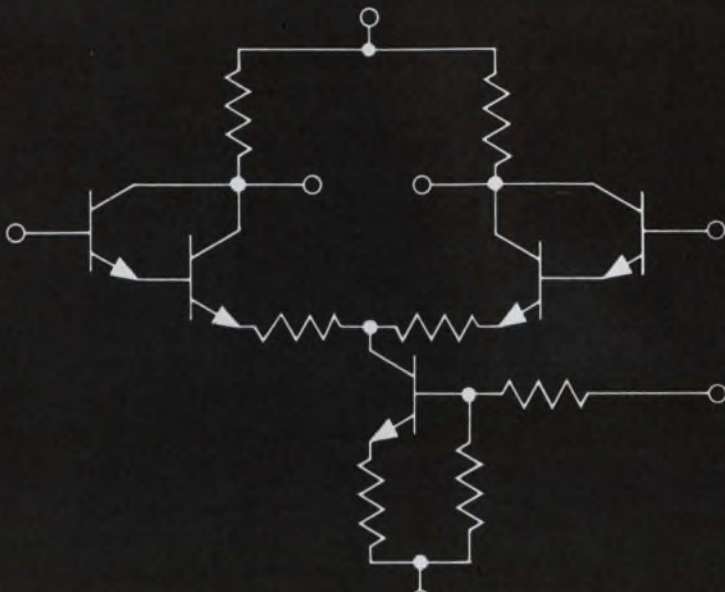

Input impedance	500 K Ω
Output impedance	8 K Ω
Output voltage swing	14 volts P/P
Differential gain	50 V/V ^o
Frequency response	150 KHz
Common mode rejection ratio	80 db
Drift	10 μ V/ $^{\circ}$ C
Supply voltage	+ 12 V, - 9 V

try to find another IC differential amplifier like this for \$7.50

WC 115 T directly replaces IC's costing much more

This universal differential amplifier gives you two Darlington pairs in a differential connection with a constant-current source. Manufacturer's price in 50-499 quantities: \$7.50. For smaller orders: \$10.50.

How does Westinghouse do it? Having the most modern IC plant in the industry helps. But mostly, it's a product of Westinghouse research leadership in linear IC's.

This differential amplifier design gives you top performance in these parameters: input impedance, input current, source to load isolation, temperature stability, and DC drift. You can use it as either a differential or single-ended input and output amplifier. It gives both inverting and non-inverting operation. Frequency response exceeds 150 KHz.

For immediate delivery, call your Westinghouse electronic distributor*. Or for complete specs, write Westinghouse Molecular Electronics Division, Box 7377, Elkridge, Maryland 21227.

*Distributors determine resale prices

You can be sure if it's Westinghouse

J-09131



ON READER-SERVICE CARD CIRCLE 823



No loss of gain above 30 MHz with high-Z FET scope probe

A FET is the active element in the nose of this oscilloscope probe. High impedance, good high-frequency performance, no loss of gain and smaller size are all advantages attributable to the FET. (Passive probes involve a basic compromise of input impedance and gain.) The P6045 probe will operate into any standard 1-M Ω scope input and is also capable of driving external 50- Ω loads, as in sampling scopes. It is designed for low-amplitude work in the 30-MHz range.

The FET and two emitter-followers form the probe's impedance transformer, which drives a 93- Ω cable. (One good impedance transformer is the vacuum tube, but its size and dc instability are drawbacks.) The cable terminates in a compensating amplifier, which is attached to the scope's input connector.

The compensating amplifier operates in two modes. With the 50- Ω load resistor switched out, a 50- Ω external load is necessary, and a 3-in., 50- Ω cable extends the 50- Ω Z_o from the connector to the output transistor. With the load resistor switched in for use with high-Z inputs, the 3-in. cable acts as an 8-pF internal-load capacitance.

Input resistance of the probe consists of a 10-M Ω shunt resistor. Input capacitance consists of the

FET's capacitance plus the environmental capacitance of the 10-M Ω resistor, the gate protection circuit and the nose of the probe. Total is about 4 pF.

Rise time is limited by the bandwidth of the compensating amplifier and impedance transformer, the input time constant of the 25- Ω generator and 4-pF input capacitance (0.2 ns) and the output time constant of the amplifier load impedance and cable capacitance plus the scope's input capacitance (1.3 ns for 15 pF). The total rise time for a sampling scope is 1.5 ns max, and for a real-time scope 1.86 ns. The compensating amplifier can be adjusted for specific real-time scopes to reduce rise time.

The probe has X10 and X100 attenuators to extend dynamic range while reducing input capacitance (2.6 pF for X10, 2.0 pF for X100). The probe input may be offset ± 1 V and any 1-V window within ± 1.5 V utilized. An RC circuit protects the gate. The circuit has been tested to 100 V for 1- to 3-s transients and to 200-V for 0.5-s transients. Overload capability is 12 Vdc plus peak ac.

P&A: \$275, \$375 (with power supply); stock. Tektronix Inc., P. O. Box 500, Beaverton, Ore. Phone: (503) 644-0161.

Booth 428 (HP) Circle No. 528

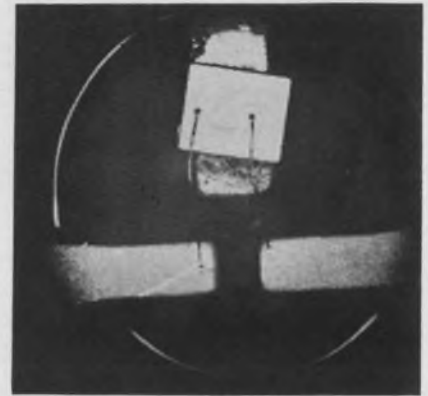

Silicon FETs go to uhf for mixers, amplifiers

A pair of silicon planar field-effect transistors are designed for uhf amplifier and mixer applications. Types UC150 (TO-72 can) and 150W (ceramic package) are capable of operation from dc to 800 MHz. Lower noise and capacitances and increased small-signal power gains are reported to result in a 30% improvement in gain-bandwidth product.

Both devices are characterized by a drain-to-gate voltage (V_{DGO}) and source-to-gate voltage (V_{SGO}) of 30 V and a gate current of 10 mA. Power dissipation is 300 mW at 25°C free-air temperature derating linearly at 1.7 mW/°C. Common source noise figure at 15 V, 5 mA and 1 k Ω is 4.5 dB at 400 MHz and 2 dB at 100 MHz. Reverse transfer capacitance (C_{rss}) does not exceed 0.8 pF at 1 MHz, input capacitance (C_{iss}) does not exceed 4 pF (3.5 pF for ceramic package) and output capacitance does not exceed 2 pF (1 pF for ceramic package). Common-source power gain at 15 V and 5 mA is 12 dB at 400 MHz and 18 dB at 100 MHz.

Gate breakdown voltage ($V_{(BR)GSS}$) is -30 V at -1 μ A. Total gate leakage current at -20 V is -100 pA ($\pm 25^\circ\text{C}$) and -100 nA ($\pm 150^\circ\text{C}$). Drain saturation current (I_{DSS}) ranges from 5 to 15 mA at 15 V and pinch-off voltage is 6 V at a 1-nA drain current.

Transconductance (Y_{FS}) ranges from 4500 to 7500 μ mhos at 1 kHz and output conductance (Y_{OS}) is 50 μ mhos.

Storage temperature range for both devices is -65 to 200°C.



Union Carbide Electronics, 365 Middlefield Rd., Mountain View, Calif. Phone: (415) 961-3300.

Booth 1721 (SA) Circle No. 567

For any capacitor requirement ... fixed or variable ... glass, quartz, air or ceramic dielectrics

Write



JFD ELECTRONICS CO. / COMPONENTS DIVISION
15th Ave. at 62nd St.
Brooklyn, N. Y. 11219

Please send me
VAM Air Variable Capacitor Bulletin VAM-65

Name _____
Title _____
Company _____
Address _____



JFD ELECTRONICS CO. / COMPONENTS DIVISION
15th Ave. at 62nd St.
Brooklyn, N. Y. 11219

Please send me Modutrim Ceramic
Variable Capacitor Bulletin MT-66

Name _____
Title _____
Company _____
Address _____



JFD ELECTRONICS CO. / COMPONENTS DIVISION
15th Ave. at 62nd St.
Brooklyn, N. Y. 11219

Please send me Uniceram Ceramic
Fixed Capacitor Bulletin UNM-65-2

Name _____
Title _____
Company _____
Address _____

JFD ELECTRONICS CO. / COMPONENTS DIVISION
15th Ave. at 62nd St.
Brooklyn, N. Y. 11219

Please send me Stangard Ceramic
Variable Capacitor Bulletin STD-65

Name _____
Title _____
Company _____
Address _____

JFD VAM air variable capacitors maintain highest Q at high frequencies, offer ultra stability, smallest size. Request Bulletin VAM-65.

Modutrim ceramic variable capacitors feature wide Δ 'C in extremely small and ultra stable circuits. Now 9 models in 4 configurations. Request Bulletin MT-66.

Uniceram High-Q Ceramic Fixed Capacitors combine exceptional stability, small size with minimum Q of 5000. Send for Bulletin UNM-65-2.

Low-cost Stangard miniature ce-

ramic variable series for commercial and industrial applications provide 8 wide Δ 'C in 4 versatile configurations. Write for Bulletin STD-65.

And remember JFD also offers industry's widest line of piston trimmer capacitors... over 3500 standard and special panel-mount and printed-circuit units. They're available with glass, quartz, air and ceramic dielectrics, with a wide variety of drive mechanisms for every requirement. Here are two examples.

For tuning and trimming applica-

tions, JFD's Super Max-C Extended Range EMC series offers unusually wide Δ 'Cs—as wide as 1.5 to 300 pf with a single standard unit.

If space is highly limited, the miniature 950 series offers capacitance ranges as wide as 1.2 to 16 pf in a unit only 5/16" long.

These and many others are fully described in Catalog C-66. To obtain a copy, just add "and C-66" to any of the coupons above.

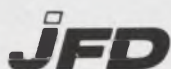

"TODAY'S COMPONENTS BUILT FOR TOMORROW'S CHALLENGES"

JFD ELECTRONICS CO. / COMPONENTS DIVISION • 15th Avenue at 62nd Street • Brooklyn, New York 11219 / Phone 212-331-1000
Sales Offices — Arcadia, California / Chicago, Illinois / Baltimore, Maryland / Saxonville, Massachusetts / Brooklyn, New York
New Hartford, New York / Cincinnati, Ohio / Philadelphia, Pennsylvania / Pittsburgh, Pennsylvania / Paris, France / Azor, Israel

Speed Inquiry to Advertiser via Collect Night Letter
ON READER-SERVICE CARD CIRCLE 824

Low-current transformer

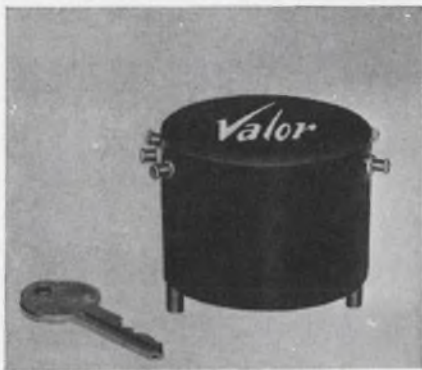

A high-voltage, low-current transformer is specifically designed for photomultiplier applications. The transformer is potted with a corona-resistant silicone compound in a diallyl phthalate case. The unit will operate in temperatures up to 130°C at altitudes up to 200,000 ft.

P&A: \$20; 1 to 8 wks. Valor Electronics Inc., 13214 Crenshaw Blvd., Gardena, Calif. Phone: (213) 321-2280.

Booth 1408 (SA) Circle No. 340

Active low pass filters

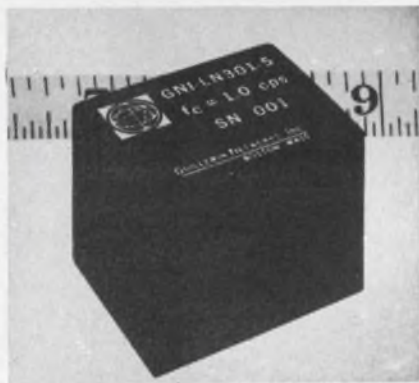

Three-pole, active, elliptic low pass filters require approximately 1-in. and will accommodate a wide range of terminating impedances. Output noise with input shorted is 10 μV rms typical. Insertion loss is dB ±0.5 dB. Operating temperature is 0 to 70°C. Filters may be used singly, in parallel or cascaded.

Guillemin Networks, Inc., 170 Brookline Ave., Boston. Phone: (617) 536-5810.

Booth 1627 (SA) Circle No. 354

100-V FET op-amp

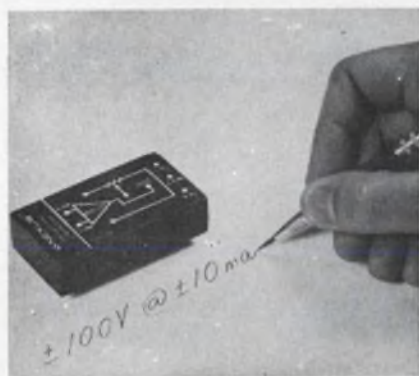

The encapsulated pack of this 100-V op-amp permits use in high stock, vibration and humidity environments, FETs give an input impedance of 10¹⁰ Ω min. The circuit is chopperless. Output voltage range is ±100 V at ±10 mA and supply voltage is ±120 V. Supply current is 10 mA quiescent and 20 mA full output. Dc gain is 200,000.

P&A: \$125 (1 to 9); 2 to 4 wks. Nexus Research Laboratory, Inc., 480 Neponset St., Canton, Mass. Phone: (617) 828-1022.

Booth 1805 (SA) Circle No. 509

RFI shielded fuseholder



A shielded fuseholder prevents circuit disturbance from RFI and prevents RF radiating interference to nearby circuits. The device accomplishes shielding and grounding when the holding nut is drawn up and the chain-attached metal cap is screwed down to seal the collar. Rated 30 A, 250 V, it is available in two sizes to receive 1/4 x 1-1/4 and 1/4 x 1-in. fuses.

McGraw-Edison Co., Bussmann Mfg. Div., St. Louis. Phone: (314) 421-1740.

Booth 1446 (SA) Circle No. 279

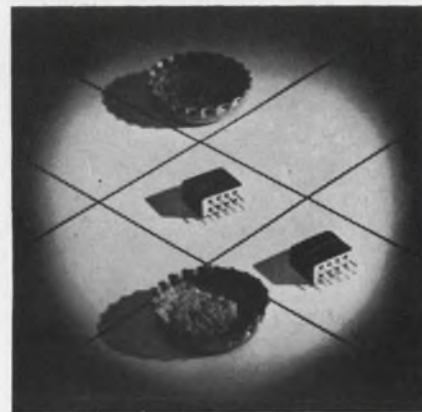

1-A dpdt relay

This dpdt relay measures 0.04-in.³. Voltage ranges are 6, 12 and 24 Vdc, and corresponding coil resistances are 100, 400 and 1600 Ω. Minimum operating life is 150,000 operations, and insulation resistance is 1000 MΩ at 25°C. The relay operates over -65 to 125°C, withstands 30 G at 10 to 300 Hz vibration, withstands 100 G shock for 11 ms and is not damaged by 150 G acceleration.

Branson Corp., P. O. Box 845, Denville, N. J. Phone: (201) 625-0600.

Booth 1715 (SA) Circle No. 324

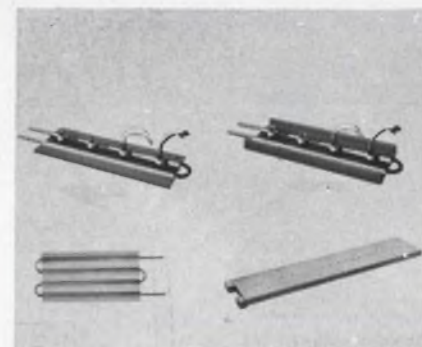

Liquid cooled plates

Power dissipation in high current rectification and regulation systems often reaches levels which make these aluminum liquid-cooled plates more desirable than forced air cooling systems. Used to mount power transistors, rectifiers and SCRs with custom mounting holes, the plates may be considered an integral portion of the high current buss work and run at higher current densities than open uncooled bussing. Isolation can be achieved by using plastic or rubber hose.

Wakefield Engineering Inc., Wakefield, Mass. Phone: (617) 245-5900.

Booth 1104 (SA) Circle No. 376

KLYSTRONS

Reflex
CW Amplifiers
Pulse Amplifiers

MAGNETRONS

Conventional
CEM/ICEM
Voltage Tunable

CROSSED FIELD AMPLIFIERS

POWER GRID TUBES

Rectifiers
Triodes
Tetrodes
Pentodes

TRAVELING WAVE TUBES

Low-noise
CW
Multi-Megawatt

BACKWARD WAVE OSCILLATORS

NOISE SOURCES

CERAMIC SEALS

GAS SWITCHING TUBES

TR's, ATR's, and pre-TR's
Thyratrons
Ignitrons

CAVITIES

Stabilizing
Oscillator
Amplifier

MIXERS AND MODULATORS

MIXER-PREAMPLIFIERS

THERMAL AND VACUUM SWITCHES

I-F CIRCUITS AND COMPONENTS

**STRIP TRANSMISSION LINE
COMPONENTS**

SOLID STATE PRODUCTS

Varactor Diodes
Power Sources
Frequency Multipliers
Silicon Controlled Rectifiers

**INDUSTRIAL PROCESSING
EQUIPMENT**

AEROSPACE COMPONENTS

HYBRID AMPLIFIERS

Twystrons®

CUSTOM ELECTRONIC PACKAGES

POWER SUPPLIES

FILTERS AND WATER LOADS

MICROWAVE PLUMBING

READOUT TUBES



Again...
years-ahead
developments
from

varian
electron tube
and device group

Booths
1349-50-51-52-53
54-55-56-57-58

WESCON/66

Sports Arena

CIRCUIT COMPONENTS

Micromin 5-ns switch

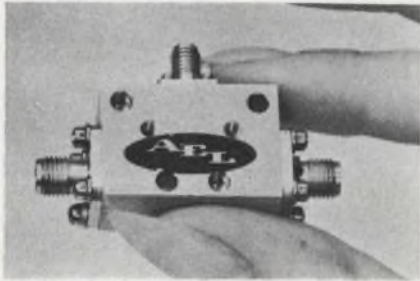

For operation over 0.1 to 4.2 GHz, this solid-state switch has a switching speed of 5 ns. The 1.8- x 1.2- x 0.5-in. device has 45-dB isolation and insertion loss of 1.2 dB max across the band. Vswr is 1.2 and RF power averages 0.25 W. Operating temperature range is -54 to 110°C.

American Electronic Labs., P. O. Box 552, Lansdale, Pa. Phone: (215) 822-2929.
Booth 2079 (SA) Circle No. 356

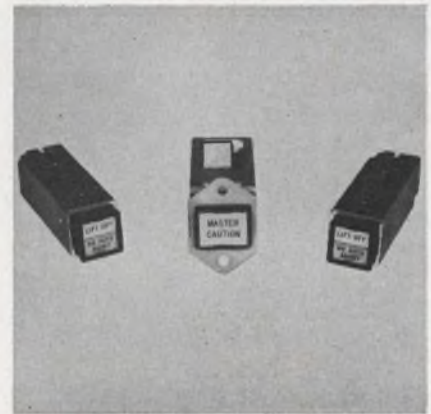

Pushbutton switches

Hermetically sealed, illuminated pushbutton switches for spacecraft applications measure 0.812-in.² by 3.5-in. and 1- x 0.76- by 3.5-in. with 2- and 4-lamp incandescent illumination. The two types feature removable 2pdt switch packages in momentary actions. Lamp test diodes are included. Contact ratings are 28 Vdc, 7 A resistive 4 A inductive. Operating range is -67 to ±248°F.

Jay-El Products Inc., 1859 W. 169th St., Gardena, Calif. Phone: (213) 323-7130.
Booth 1020 (SA) Circle No. 522

Miniature High Q Air Capacitors

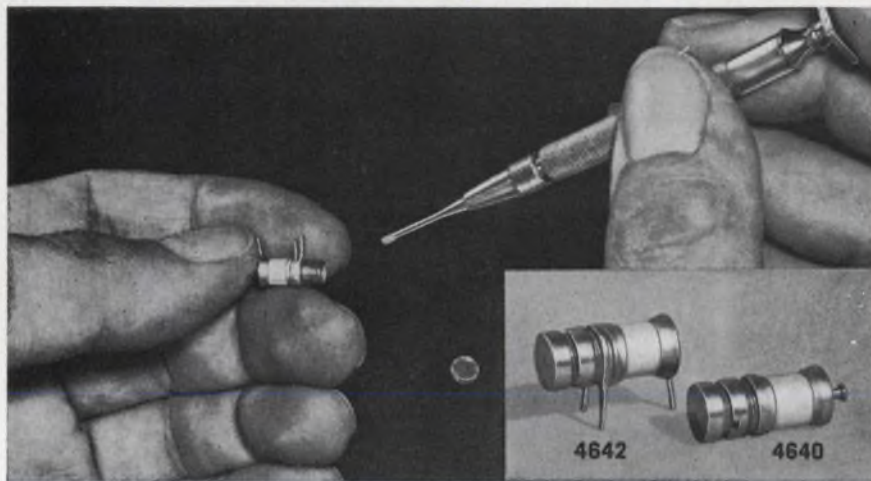

**Small Size • High Q • Rugged
High Selectivity • High Sensitivity**

- Size: .220" dia. 15/32" length
- Q @ 100 mc: > 5000
- Capacitance Range: 0.4 — 6 pf
- Non-Magnetic

New miniature series features high quality materials and workmanship typical of all Johanson Variable Air Capacitors.

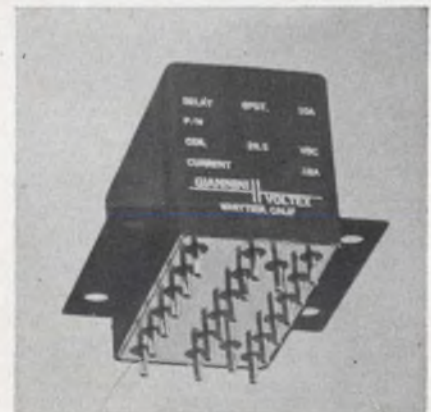
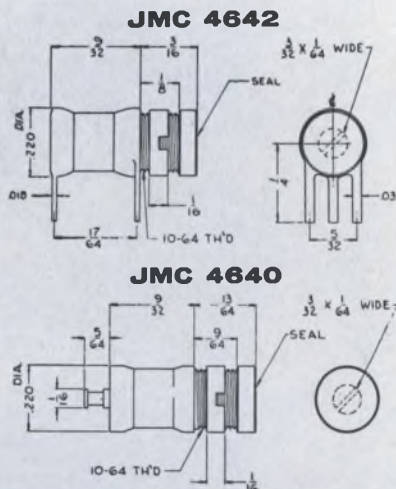

6-pole relay

With welded internal construction, this 6-pole miniature power relay meets MIL-R-6106. The relay has double-make double-break contacts incorporating silver cadmium oxide and silver magnesium nickel contacts. The unit has multi-pole applications in airborne or ground support equipment.

Giannini Voltex, 12140 E. Rivera Rd., Whittier, Calif. Phone: (213) 698-1245.
Booth 1444 (SA) Circle No. 390

Write or Phone for Details, Prices

Johanson MANUFACTURING CORPORATION
400 Rockaway Valley Road, Boonton, N. J. 07005 • Phone (201) DEerfield 4-2676

See the Johanson line at Booths 1449 and 1450, Wescon, Los Angeles

ON READER-SERVICE CARD CIRCLE 825



HUDSON'S ELECTRI-CITY... U.S.A.

During the past 25 years, our community has grown into a fully developed metropolis, populated by the nation's leading "electri-citizens". Some of our prominent families like the Relays, the Transformers and the Filters have been conducting business in our custom-built "standard" models for years.

The current census report includes over 5,000 varied shape units in every size and building material, available for immediate occupancy.

With Hudson's construction "know-how", you'll find housing costs at an absolute minimum so that moving into a precision built efficiency model is quite economical.

Looking at our city, you can see we appreciate individuality. So, if you don't see precisely what you want, Hudson will build it to your exact specifications . . . after all, this is how Hudson's Electri-City came to be.



HUDSON
TOOL & DIE COMPANY, INC.

Enclosures, Stampings and Assemblies

NEWARK, NEW JERSEY — U.S.A.



Johnson brings you a long line of connectors

No matter what kind of application, Johnson's long line of jacks and plugs will supply your design needs. Whether it's military or commercial, whether it's sub-miniature or standard, there's a rugged polyamide insulated or un-insulated connector for your job. Johnson has a full line of tip and banana plugs, tip jack and sleeve assemblies, metal-clad and rapid mount tip jacks, dual banana plugs and the unique, patented Johnson binding post in three sizes. Insulated connectors color coded to federal color standards. Voltage breakdown ratings up to 11,000.



Get complete information on JOHNSON'S full line of connectors. Write today on company letterhead for free, detailed Johnson components catalog.

E. F. JOHNSON COMPANY

WASECA, MINNESOTA 56093



HERE'S A CONNECTOR FOR YOUR PROJECT, CONSTRUCTED OF TOUGH, LOW LOSS POLYAMIDE

FOR RELIABLE PERFORMANCE UNDER ADVERSE CONDITIONS. TURN PAGE FOR DETAILS.



**Look to Johnson for
all your component needs**

CONNECTORS

SUB-MINIATURE INSULATED TYPES — Designed for printed circuit applications. Operating voltages to 1500 volts RMS . . . 5 amperes current carrying capacity . . . contact resistance less than 2 milliohms. Capacitance between two adjacent jacks less than one pf at 1 Mc. 10 colors available. Test-Point Strip/Handle — rapid-mounting polyamide body contains 12 test points each rated at 5 amps., maximum current capacity. Operating voltage 1500 volts RMS at sea level, 350 volts RMS at 50,000 feet. Contact resistance less than 2 milliohms.

STANDARD INSULATED CONNECTORS — A complete line of connectors molded of tough, low-loss, shock-proof polyamide in 10

colors meeting Fed. Std. 595. Tip, Banana and Dual Banana Plugs; Tip and Banana Jacks; Metal-Clad Tip Jack, Military; Jack and Sleeve; Binding Posts.

RIB-LOC TERMINALS — A new line of miniature, one-piece, insulated terminals with a unique serrated conical design, which resists loosening and turning. Provides an inexpensive approach to convenient press-in type terminals. Six colors conforming to Federal Color Standard No. 595. Terminal styles include single and double turret feed-thrus and stand-offs, .040" dia. tip plug and mating jack for .040 plug.

CAPACITORS

MACHINED PLATE TRIMMER AND TUNER TYPES — U, UA, UB, U-LC, V, AND W — Available in both printed circuit and chassis mounting types. U types available in differential and butterfly printed circuit mounting types in addition to single section types. V and W capacitors available in single section type only. Maximum capacities of up to 54 pf. Tuners consist of a machined plate trimmer and high Q air wound silver plated inductor, in resonant frequencies of 100 to 750 Mc.

SOLDER PLATE TYPES — Type M: Capacity values to 30 pf. Voltage ratings to 1250 volts peak. Available in single section, differential and butterfly types.

Type S: Capacity values to 100 pf. Voltage ratings to 3000 volts peak. Available in single section, differential and butterfly types.

Type K: Capacity values to 150 pf. Voltage ratings to 3800 volts peak. Available only in single section types. May be furnished in production quantities in full compliance to MIL-C-92A.

Type R: Capacity values to 340 pf. Voltage ratings to 4400 volts peak. Available only in single section type.

Type L: Capacity values to 200 pf. Voltage ratings to 3500 volts peak. Available in single section differential, butterfly and dual section types.

SPACER TYPES — Type C: Capacity values to 1500 pf. Voltage ratings to 13,000 volts peak. Available in single section and dual section types.

Type D: Capacity values to 1700 pf. Voltage ratings to 9000 volts peak. Available in single section and dual section types.

STAKED PLATE TYPES — Type E: Capacity values to 1000 pf. Voltage ratings to 4500 volts peak. Available in single section and dual section types.

Type F: Capacity values to 400 pf. Voltage ratings to 3000 volts peak. Available in single section and dual section types.

TUBE SOCKETS, INSULATORS, PILOT LIGHTS AND HARDWARE

ULTRA HIGH FREQUENCY SOCKETS — Continuous heat resistance to 500°F. with low loss, glass filled silicone base and heat treated beryllium copper contacts. Low inductance screen bypass capacitor available for VHF and UHF operation.

KEL-F SERIES — Molded of low dielectric loss-factor Kel-F plastic — designed for use with a wide selection of high power transmitting tubes.

STEATITE WAFER TYPES — Available in 4, 5, 6, 7, and 8-pin standard socket types, as well as Super Jumbo 4-pin types. Also giant 5 pin, and 7 pin Septar and VHF Septar Sockets.

SPECIAL PURPOSE TYPES — Includes sockets for special purpose tubes.

Note: For detailed specifications, request Socket Standardization Booklet 536 on your company letterhead.

INSULATORS — Low loss, high-voltage breakdown in either steatite or porcelain. Complete line includes Thru-panel Bushings and Insulators, Antenna Strain and Feeder Types, Cone and Stand-off Insulators, Lead-in Bushings and Feed-Thru Bowl Assemblies.

PILOT LIGHTS — Over 47 separate assemblies. Continuous indication neon types, models for high and low voltage incandescent bulbs, standard or wide angle glass, and lucite jewels. Specials, including types meeting military specifications, also available in production quantities.

PANEL BEARINGS — For use on ¼" shafts and panels up to ¾" thick. **CRYSTAL SOCKETS** — For low capacity, high voltage and high temperature operation. Glazed steatite, Grade L-423 or better. DC-200 impregnated. **RF CHOKES** — High quality construction. For 1.7 to 30 Mc range.

Johnson also offers a complete line of heavy-duty RF components for broadcast transmitting, RF heating, antenna phasing and other commercial applications.

Equipment in this line includes fixed and variable inductors, antenna phase sampling loops, isolation filter inductors, feed-thru bowl insulators, static drain chokes, RF contactors, and heavy duty make-before-break switches.



E. F. JOHNSON COMPANY
W A S E C A . M I N N E S O T A 5 6 0 9 3

ACTON 6-WAY PRECISION DIGITAL PHASE METER 331

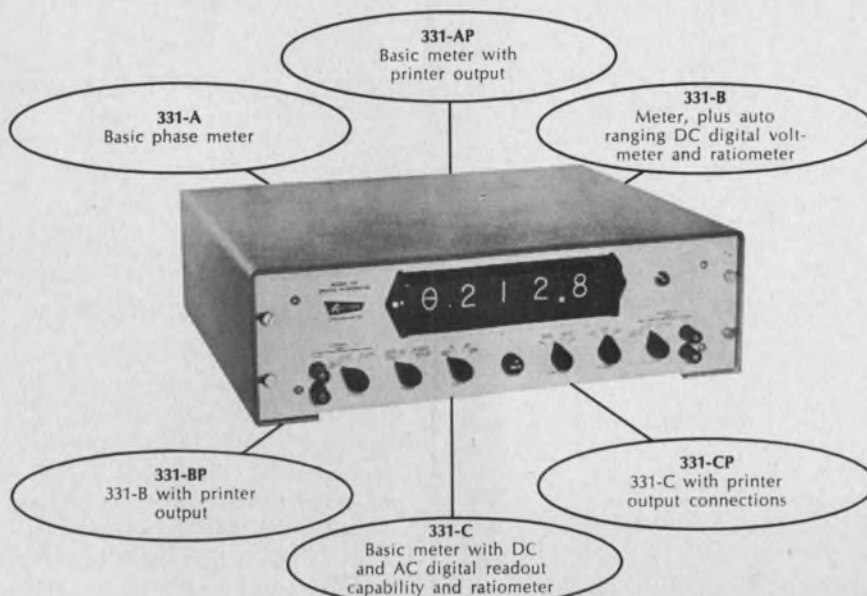

ELECTRICAL SPECS: Reads 000.0° to 360.0° in frequency range from 30Hz to 500KHz; accurate to $\pm 0.5^\circ$ 200Hz to 35KHz; Reads DC (when provided) 0.001-600 volts, and AC (when provided) 0.1-300 volts.

ON READER-SERVICE CARD CIRCLE 71

Six variations provide the Acton 331 precision digital phase meter with almost unlimited functional and application versatility, now and in years ahead. Ideally designed for laboratory and service work with servo components and assemblies, audio systems, communications equipment, and for quality control and production checkout applications.

COMPLETE DATA ON REQUEST

© 1966



Laboratories, Inc.

531 Main Street, Acton, Massachusetts
A Subsidiary of Bowmar Instrument Corporation

With EASTMAN 910® Adhesive... Fast, strong nylon-to-metal bonds

General Electric Company needed a rapid-setting adhesive for production line assembly of its electronic consoles. One that would give quick joint strength without use of jigs and be able to withstand operating temperatures of 160° F. without loosening.



EASTMAN 910 Adhesive met these requirements.

GE people apply a few drops of EASTMAN 910 Adhesive to the edge of the console's metal harness assembly outlet. Then a nylon grommet is pressed in place. In seconds, the bond is set.

EASTMAN 910 Adhesive will form bonds with almost any kind of material without heat, solvent evaporation, catalysts, or more than contact pressure. Try it on your toughest bonding jobs.

For technical data and additional information, write to Chemicals Division, EASTMAN CHEMICAL PRODUCTS, INC., subsidiary of Eastman Kodak Company, Kingsport, Tennessee. EASTMAN 910 Adhesive is distributed by Armstrong Cork Company, Industry Products Division, Lancaster, Pa.

Here are some of the bonds that can be made with EASTMAN 910 Adhesive

Among the stronger: steel, aluminum, brass, copper; vinyls, phenolics, cellulose, polyesters, polyurethanes, nylon; butyl, nitrile, SBR, natural rubber, most types of neoprene; most woods. Among the weaker: polystyrene, polyethylene (shear strengths up to 150 lb./sq. in.).

ON READER-SERVICE CARD CIRCLE 72

◀ ON READER-SERVICE CARD CIRCLE 248



There is no adhesive like EASTMAN 910® Adhesive

- SETS FAST**—Makes firm bonds in seconds to minutes.
 - VERSATILE**—Joins virtually any combination of materials.
 - HIGH STRENGTH**—Up to 5,000 lb./in.² depending on the materials being bonded.
 - READY TO USE**—No catalyst or mixing necessary.
 - CURES AT ROOM TEMPERATURE**—No heat required to initiate or accelerate setting.
 - CONTACT PRESSURE SUFFICIENT.**
 - LOW SHRINKAGE**—Virtually no shrinkage on setting as neither solvent nor heat is used.
 - GOES FAR**—One-pound package contains about 30,000 one-drop applications. (Or in more specific terms, approximately 20 fast setting one-drop applications for a nickel.)
- The use of EASTMAN 910 Adhesive is not suggested at temperatures continuously above 175°F., or in the presence of extreme moisture for prolonged periods.

See Sweet's 1966 Product Design File 8a/Ea.

Now available! EASTMAN 910 Surface Activator. When certain surface conditions inhibit rapid bond formation, use of EASTMAN 910 Surface Activator is suggested to restore the rapid polymerization of EASTMAN 910 Adhesive.

U129

The Victor Imperial Digit-Matic can do anything other serial entry printers do. Only Victor does it for less.

For \$335 it lists 8-column figures from remote sources. It can do this on either 24 or 48 volt solenoids. Solenoid pulse timing: .025-.050 sec. "on" time; .025 sec. minimum "off" time.

And because it operates on printing press action, it reduces wear, eliminates parts, and assures uniform, clear printing.

For only \$50 more, the Digit-Matic will add and subtract as well. O.E.M. and quantity discounts available.

There are Victor service representatives covering every county in the United States.

Can the Victor Imperial Digit-Matic do anything at all? Just about. Write: Victor Comptometer Corporation, Business Machines Group, 3900 North Rockwell Street, Chicago, Illinois 60618.

VICTOR



**Only \$335?
Can it do
anything at all?**

CIRCUIT COMPONENTS

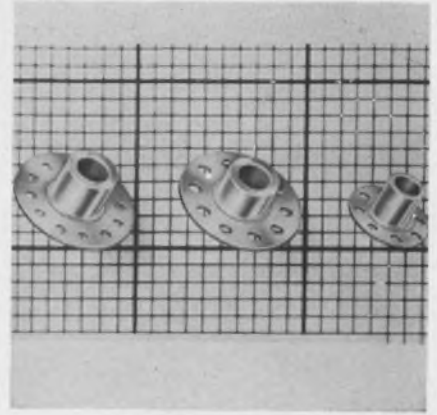

Multi-tie terminals

MIL-T-55155/26 circular stud ground terminals provide 8, 10 and 12 tie points. Measuring 3/8 in. above board, the terminals are mounted by drilling a panel hole, aligning the stud portion and securing the terminal to panel. Counter-bore construction at the tie-point flange end of the terminals permits stacking of two or more terminals.

P&A: \$0.19 (500 to 999); stock. Cambridge Thermionic Corp., 445 Concord Ave., Cambridge, Mass. Phone: (617) 876-2800.

Booth 1748 (SA) Circle No. 387

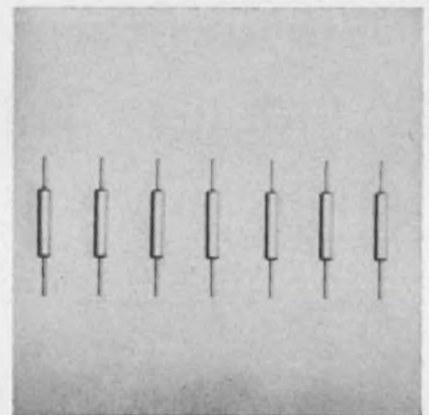

Connector pin filters

Connector pin filters make it possible to retain original pin spacing in miniaturized connectors. A typical unit has a pin diameter of 0.015-in., filter diameter of 0.05-in. and a filter length of 0.35-in. Temperature range is -55 to $\pm 125^{\circ}\text{C}$ without voltage derating. Minimum attenuation ranges from 55 to 90 dB at 200 to 1000 MHz. Insulation resistance is 20,000 M Ω min at 25°C and 5000 M Ω min at 125°C .

Denesco, Inc., 2408 San Mateo Pl. N. E., Albuquerque, N. M.

Booth 2045 (SA) Circle No. 320

Reducing a connector's length is one thing. Reducing its weight is another. Bendix Solder and Hermetic-Type "Pancake" connectors do both.

One thing you can say about Bendix® JT Pancake connectors: they reduce connector length by up to 50% and weight up to 60%, making them the smallest, lightest models available.

Equally impressive is the wide range of types we've got on hand, all ready to be delivered in rapid, off-the-shelf fashion. Among them are wall mount,

box mount, jam nut, straight plug and 90° plug; nine different sizes; 34 different insert patterns; 16-, 20-, 22- and 24-contact sizes that will accept a wire range of 16 through 28 gage.

(You'll find most of these types available in our crimp-type JT Pancake connector line, too.)

What about performance? These light-

weights have nine major design improvements. There are provisions for up to 128 contact pins, increased resistance to pin bending, greater contact retention, temperature capabilities to 392°F, and improved electrical characteristics through rigid, glass-filled epoxy inserts, to name a few. For complete information, write us in Sidney, New York.



Scintilla Division



Less than 60 milliwatts
operates these—

NEW, MINIATURE SENSITIVE RELAYS

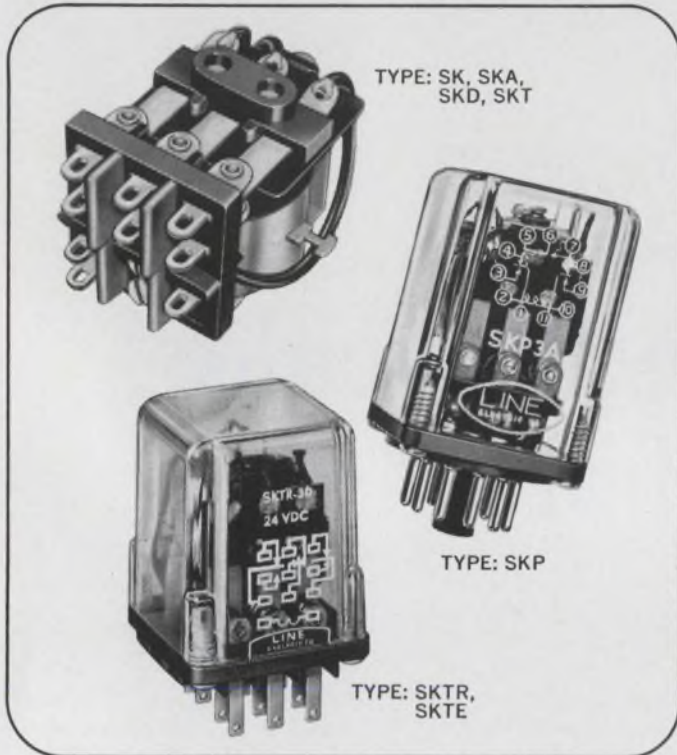

TYPE: SK, SKA,
SKD, SKT

TYPE: SKP

TYPE: SKTR,
SKTE

Our new Series SK low sensitivity, low profile, low cost relays are identical in construction to our Series MK miniature relays with one essential difference — the special alloy used in pole and frame increases the magnetic flux several times enabling the relays to respond to very low power levels — less than 60 milliwatts per pole pull-in.

This widens the voltage operating range considerably e.g., a 10,000 ohm coil generally rated at 110 VDC can be used in circuits as low as 26 VDC. And in the case of solid state circuitry the extremely low power consumption fills a great need for small drain combined with miniaturization.

7 types comprise the Series SK relays . . . all have 5 amp. contacts and are available in a range of coil resistances from 15 ohms up to 20,000 ohms. Prices start from \$4.15 (SK-1.SPDT) with volume discounts applying to quantity orders. Ask for Bulletin 301 and price list.

OPEN TYPE

- Series SK Solder Lugs
- Series SKA .110 Quick Connect Lugs
- Series SKD .187 Quick Connect Lugs
- Series SKT Printed Circuit Pins

ENCLOSED TYPE

- (Metal or Plastic Housing)
- Series SKP Plug-in Octal
- Series SKTR Low Cost (Plug-in)
- Series SKTE Printed Circuit



For a prototype specify coil and contact requirements

LINE ELECTRIC COMPANY
Division of Industrial Timer Corporation
205 U.S. Highway 287, Parsippany, N. J.
In Canada: Sperry Gyroscope Ottawa Ltd., Ont.

Speed Inquiry to Advertiser via Collect Night Letter
ON READER-SERVICE CARD CIRCLE 74

CIRCUIT COMPONENTS

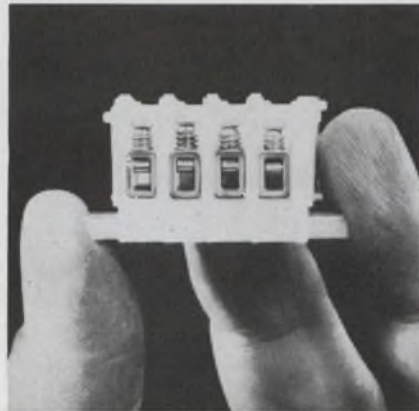

300-V miniature block

A miniature 300-V sectional terminal block with 1/4-in. center-to-center contact spacing handles wire ranges up to #12 AWG. It is rated at 300-V NEMA General Industrial Control Devices and 600-V NEMA Limited Power Circuits. Contact sections are 49/64-in. wide.

Buchanan Electrical Products Corp., 1099 Floral Ave., Union, N. J. Phone: (201) 289-8200. Booth 1359 (SA) Circle No. 345

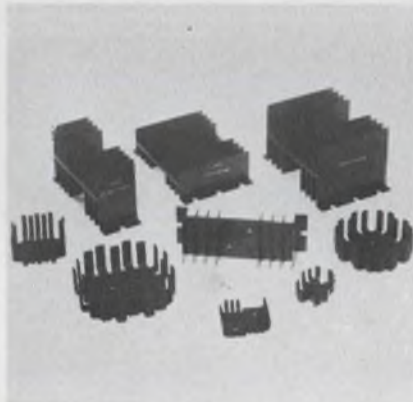

TO-66 heat sinks

Heat dissipators cover the full range of power requirements for TO-66 transistors. The smallest dissipator maintains case temperature below its maximum while the transistor is dissipating 8 W in natural convection on a PC board at 25°C ambient. In a forced air environment, it dissipates 15 W. With the medium size unit, case temperature is held to a safe level at dissipations exceeding 12 W in natural convection and 18 W in forced air. All are made of black anodized aluminum.

International Electronic Research Corp., 135 W. Magnolia Blvd., Burbank, Calif. Phone: (213) 849-2481. Booth 564 (HP) Circle No. 500

WESCON

Booths 414-416

439-441

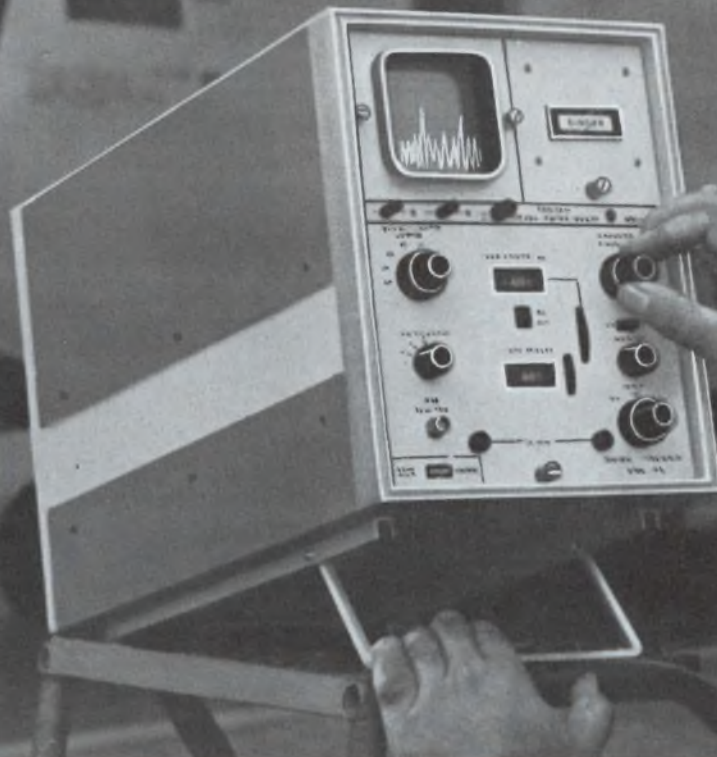

Battery- or line-powered Portable TA-2 analyzer main frame

THE STANDARDS

Panoramic* UNIVERSAL SPECTRUM ANALYZERS 20 cps to 27.5 Mc

Portable TA-2 and Rack or Bench Mount RTA-5 with 4 Solid State Interchangeable Modules



Rack- or bench-mount RTA-5 Analyzer main frame

Make precise, rapid swept band analyses anywhere! Check out and pinpoint troubles in communications signals, sound, vibration, noise and RFI.

The standard—feature-by-feature AC/DC or internal battery operation Bright, easily read calibrated spectrum displays Digital frequency readout of scanned band Calibrated linear and 40 db log level scales Built-in Xtal markers for self-checking Simplified — few controls, many preset for optimum results.

4 solid state plug-in modules feature digital center frequency and sweep width controls "Quick-look" overall analysis and highly resolved narrow scans are quickly set up Advanced design provides excellent dynamic range, sensitivity, resolution and sweep repeatability.

Choice of analyzer main frames for all modules Compact RTA-5 main frame is only 19" wide, 7" high, and 18½" deep — ideal for space saving, rack- or bench-mounting Portable, solid-state TA-2 weighs only 40 pounds, complete with module and internal rechargeable battery pack — also operates from almost any AC or DC source.

Modules For TA-2 & RTA-5 Main Frames	OFF SHELF DELIVERY			NEW
	AR-1 (Sonic)	AL-2 (log-scan sonic)	UR-3 (Ultrasonic)	VR-4 (Video)
Frequency Range	20-35,000 cps	20-35,000 cps	100 cps-700 kc	1 kc-27.5 mc
Sweep Widths	0.2, 1, 5, 20 kc	0.2, 1, 5, 20 kc; 25-25,000 cps log	adjust. to 0-400 kc	adjust. to 0-5 mc
Resolution	Automatic optimum to 25 cps		adjust. to 100 cps	adjust. to 200 cps
Residual distortion	All unwanted products at least 60 db down			-50 db
Sensitivity	30 μv full scale deflection			
Marker Spacing	0.02% Accuracy-Fundamentals shown-Harmonics Usable			
	2.5 kc	2.5 kc	25 kc	25 kc, 500 kc, 100 Mc

Write for brochure, or contact your local Singer Instrumentation representative



*A Trademark of THE SINGER COMPANY

EMPIRE • GERTSCH • PANORAMIC • SENSITIVE RESEARCH

SINGER
INSTRUMENTATION

THE SINGER COMPANY, METRICS DIVISION • 915 Pembroke St., Bridgeport, Conn. 06608, U. S. A. • PHONE (203) 366-3201

1/6 SIZE LATCHING RELAY

BY **BRANSON**

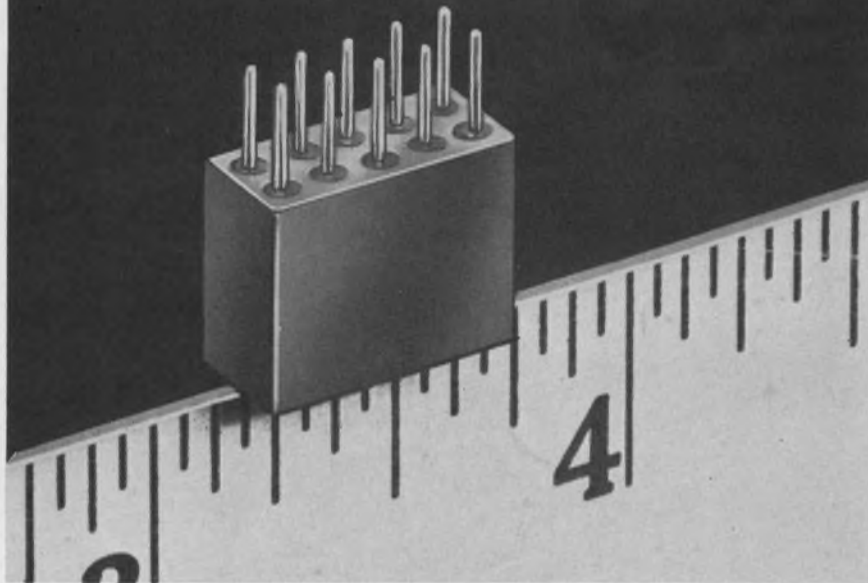

NEW FROM BRANSON...

The new Type LJ is a magnetic latching relay with DPDT contacts rated at 1 amp resistive at 28 VDC. Contacts are actuated by a low-power pulse, and remain in either position after removal of power. Physical dimensions are only .2" x .4" x .5"! Meets or exceeds applicable sections of MIL-R-5757D.

Send for technical details.

OTHER BRANSON PRODUCTS...



1/2 CRYSTAL-CAN
4PDT RELAY



TRANSISTOR SIZE
SPDT RELAYS



MICRO-MINIATURE
RELAY SOCKETS



6PDT CRYSTAL
CAN RELAYS

Relays...Our Only Business

BRANSON CORP.

VANDERHOOF AVENUE • DENVILLE, NEW JERSEY • (201) 625-0600

See us at Wescon—Booth #1715 Sports Arena

ON READER-SERVICE CARD CIRCLE 75

U134

CIRCUIT COMPONENTS

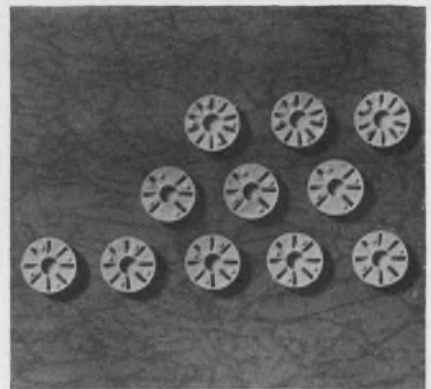

Mounting insulators

For mounting TO-5 micrologic packs on PCs, these insulators convert the leads to a 0.4-pin circle breakout at the PC board. Feet are located on the top and bottom of the insulator for convection air flow, inspection of solder fillets and flush cleaning of solder flux residues from the circuit board after soldering. Insulators are molded of Acetal resin.

P&A: \$0.01 to \$0.08; stock. Robinson Electronics, Inc., 3636 W. 139 St., Hawthorne, Calif. Phone: (213) 679-0351.

Booth 1536 (SA) Circle No. 537

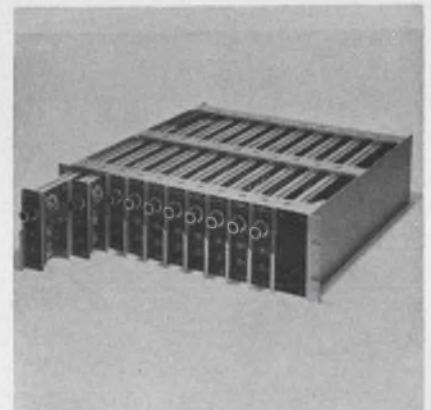

Differential dc amplifier

This narrow-band amplifier isolates, filters and amplifies low-level signals. Ten channels of amplification share a common power supply. Input signals are modulated by 2 FETs operating at 1.1 kHz. Gain steps of 5 to 1000 are available with accuracy of $\pm 0.5\%$ or better. Isolation is $10^9 \Omega$ and source impedance is 1000Ω max in either input line. Input impedance is $1 M\Omega$ shunted by $0.01 \mu F$ and output impedance is 0.3Ω max, dc to 1 kHz.

Neff Instrument Corp., Duarte, Calif. Phone: (213) 357-3002.

Booth 1712 (SA) Circle No. 515

ELECTRONIC DESIGN, August 16, 1966

Be sure to see CEC's Galaxy of Stars

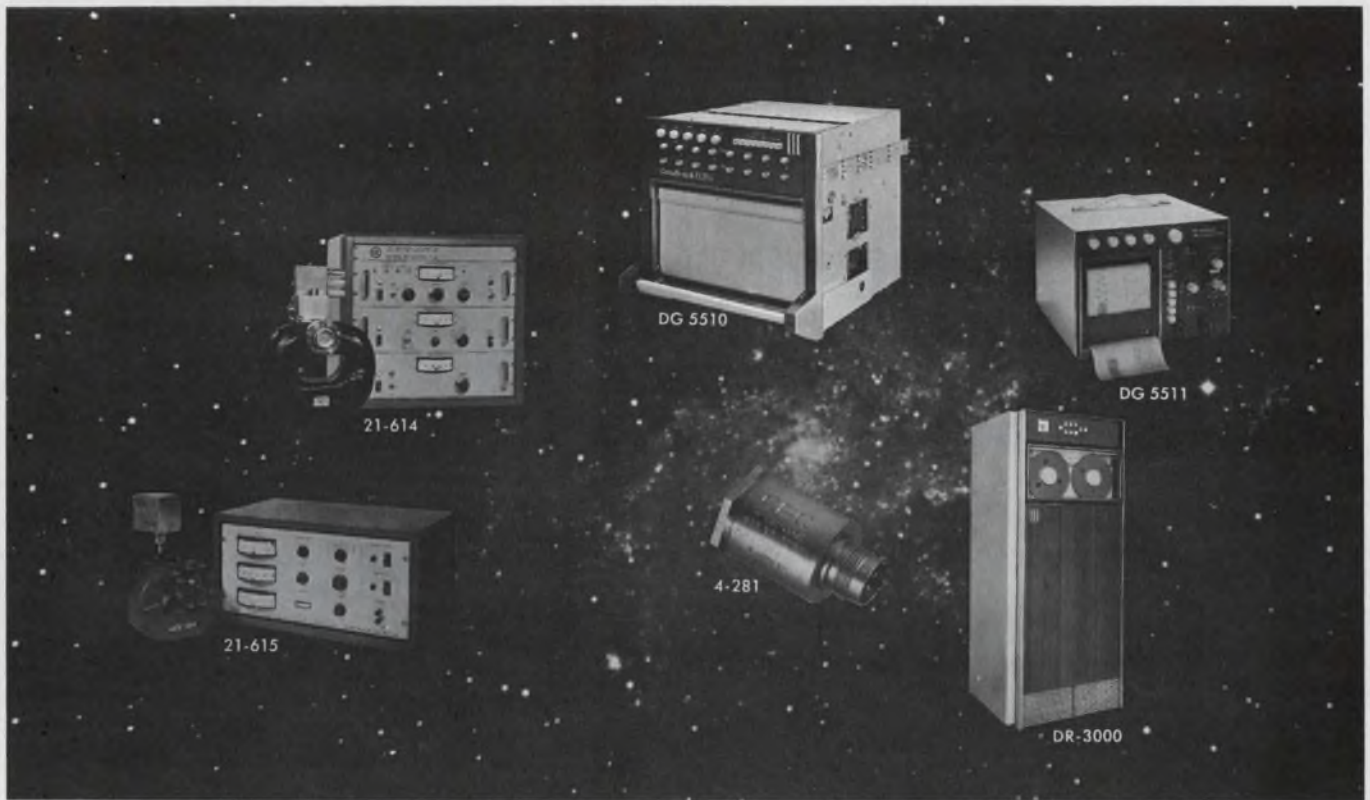

The place: Booths 214 thru 219

Concerned with recording, sensing or analyzing? Then CEC has some surprises in store for you — plus some positive answers to perennial problems.

We will introduce you to the latest techniques in data recording and research. And you will be able to inspect and evaluate such recent achievements as CEC's...

DR-3000 Digital Recorder. Commonly referred to as the "universal recorder", this instrument provides unequalled versatility and performance—at the lowest cost of any comparable digital tape system. New advantages include a standard choice of any tape speed from 37½ to 112½ ips. See this straight-line-loading IBM compatible 7- or 9-track system.

DG 5510 Thermal Writing Recorder. The DG 5510 is the most advanced instrument of its type available today. Basically, the recorder is a solid-state, 8-channel, self-contained unit with driver amplifiers and power supply capable of accepting a broad selection of high-level signals. Automatic Elec-

trical Signal Limiting assures that the stylus motor and writing assembly cannot be damaged by transient or other high-level signals.

DG 5511 Portable Recorder. This is the first low-cost thermal writing recorder to provide the capability formerly achieved only through multiple instruments. *Two* plug-in signal conditioners accommodate a wide range of voltage inputs. *No* preamp is needed for high-level signals. Automatic Electrical Signal Limiting is included.

4-281 Piezoelectric Accelerometer. A unique addition to CEC's famed piezo family, the 4-281 eliminates these six major problems in vibration measurement: (1) Impedance Matching. (2) Cable Capacitance. (3) Sensitivity Variation. (4) Mass Loading. (5) System Noise. (6) Case Sensitivity.

21-614 Cycloidal Residual Gas Analyzer. Unmatched for performance, versatility and convenience of operation, this instrument is capable of making both qualitative and quantitative measurements of minute quantities of

ON READER-SERVICE CARD CIRCLE 76

gases with molecular weights as high as m/e 200. Two versions are on display —the standard model, and the 21-614 (shown above) which has been modified to sample from atmospheric pressure through *true* differential pumping.

21-615 Residual Gas Analyzer. This unit provides greater sensitivity, range and resolution—for *less cost*—than any comparable instrument. Features include capability of scanning the full mass range from 2 to 100 in a single sweep; automatic repetitive scanning of any portion of the mass range; automatic filament protection; and an analyzer that is bakeable to 450°C.

Want more reasons for dropping by? We'll be proud to show them to you.

CEC

CONSOLIDATED ELECTRODYNAMICS
A SUBSIDIARY OF BELL & HOWELL/PASADENA, CALIF. 91105
INTERNATIONAL SUBSIDIARIES: WOKING, SURREY, ENGLAND
AND FRIEDBERG (HESSSEN), W. GERMANY



today's most reliable thermal time delay relays—bar none!

Choose G-V for thermal time delay and you have a relay that's been reliability-proved through years of rigorous service and millions of operating hours. Rugged! Simple! One heater, one pair of contacts, one type of metal, one husky mechanical structure. G-V can help you solve design problems and make substantial savings. For selection data (Bulletin PD-1006) or assistance of a G-V field engineer, phone or write today.

R TYPE Time Delay Relays

- Metal sheathed heaters
- Hermetically sealed, still adjustable
- Meet military requirements
- Miniature Flanged, Miniature Plug-in or Octal Size
- For time delays of 12 to 240 seconds
- Heater voltages up to 230 volts AC or DC



T TYPE Time Delay Relays

- Ribbon heaters
- Medium delays—faster recovery
- Hermetically sealed, still adjustable
- Meet military requirements
- Miniature Flanged, Miniature Plug-in or Octal Size
- For time delays of 2 to 12 seconds
- Heater voltages up to 160 volts AC or DC



H TYPE Time Delay Relays

- Hot wire heaters
- Short delays—rapid recovery
- Hermetically sealed, still adjustable
- Meet military requirements
- Miniature Size, Flanged or Plug-in
- For time delays of 1/10 to 4 seconds
- Heater voltages up to 32 volts AC or DC



LT SERIES Subminiature Thermal Timing Relays

- Height above mounting panel only 40% that of standard miniature relays
- For time delays of 2 sec. to 75 sec. factory set
- Heater voltages 6.3 to 115 v
- Contacts NO or NC



PT SERIES Thermal Relays

- The most precise, sturdiest thermal relay ever built
- Operates up to 2,000 cps, 20 g vibration and 50 g, 11 ms shock for delays up to 90 seconds. Above 90 seconds, vibration is 20 g, 1200 cps
- Time delay: 3 to 180 seconds. Tolerance $\pm 5\%$ factory set
- Heater voltages: 6.3 to 115 v. for delays up to 12 sec.; to 230 v. for longer delays



G-V CONTROLS INC.

Okner Parkway • Livingston, New Jersey
(201) 992-6200

CIRCUIT COMPONENTS

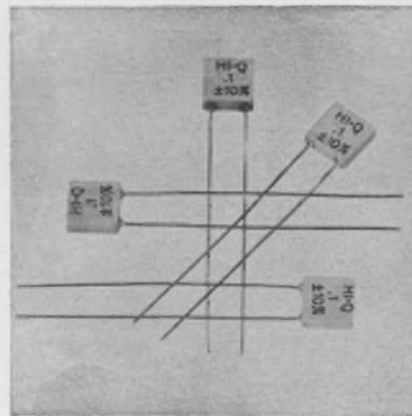

Hermetic capacitor is unencapsulated

The hermetic seal of these unencapsulated all-ceramic monolithic capacitors meets MIL-C-23269 long-term moisture tests. The construction eliminates organic encapsulation. Degradation of encapsulation as well as of the capacitor as a unit by solvents, high temperature exposures, shelf life, flammability tests and radiation is also eliminated. The CKR06 case style is available at 200 Vdc from 1200 to 10,000 pF and at 100 Vdc from 0.012 to 0.1 μ F. The 0.25-in. x 0.1-in.² CKR12 style is available at 100 Vdc from 10 to 10,000 pF.

Aerovox Corp., Olean, N. Y.
Phone: (716) 372-6611.
Booth 1701 (SA) Circle No. 559



Ac tach generators

Meeting MIL-G-5413B, these 4-pole ac tachometer generators have 20-Vac, 41.7-Hz outputs when driven at 1250 rpm. Models 22A550 and 22A553 weigh 4.5 and 2.1 lbs. The units have permanent magnet rotors and aluminum-alloy housings.

Globe Industries, Inc., 2275 Stanley Ave., Dayton, Ohio. Phone: (513) 222-3741.

Booth 1013 (SA) Circle No. 397

NOW!

Solid State Time Delay Relays for as little as

\$17⁵⁰

(P&B QUALITY,
OF COURSE)

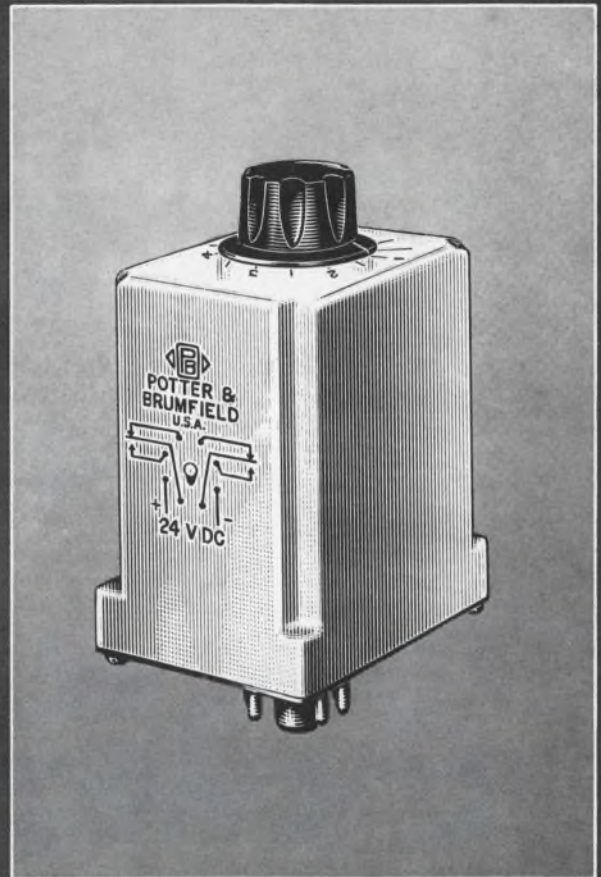

why pay for operating characteristics you don't need?

Here is a practical cost-saving answer to many timing applications which do not require the extreme precision of much more expensive relays. CH Series solid state time delay relays are quality-built to perform dependably in most industrial applications. Where more critical parameters are required, we recommend our CD Series.

SAVE UP TO 60%—You can save up to 60% of your time delay relay costs with our new CH Series. Adjustable or fixed models are available with delays on operate or release as well as "interval on".

ACCURACY $\pm 10\%$ —Accuracy is $\pm 10\%$ over the -10° to 55°C temperature range for adjustable time delays. Fixed delays have an accuracy of $\pm 5\%$ at 25°C ambient temperature. Reset time is 100 milliseconds.

INTERNAL RELAY RATED 10 AMPERES—An internally-mounted DPDT relay is rated at 10 amperes, 115 VAC, resistive. Both AC and DC models are available and all come in a white nylon case with octal plug. CH relays for DC operation have an internal protection against damage by reversal of input polarity. Relays will not operate falsely nor be damaged by a transient input voltage having a magnitude up to twice rated input voltage and a duration of eight milliseconds.

Write for the complete catalog of P&B Time Delay Relays. You can get CH Series relays from your local electronic parts distributor.

SPECIFICATIONS CH and CD Series Comparison

	CH SERIES	CD SERIES
Dial Setting	Reference scale	Time-calibrated $\pm 5\%$ of full scale
Temperature Range	-10°C to $+55^\circ\text{C}$	-40°C to $+55^\circ\text{C}$
Accuracy Over Temperature and Voltage Range	$\pm 10\%$ of nominal	$\pm 5\%$ of nominal
Transient Protection	Twice rated input voltage for 8 milliseconds	Tested to 1000V— $\frac{1}{2}$ cycle surges (on all 115V AC models)
Inherent False Operation	Contacts may transfer momentarily if timing interval is interrupted	None
Reset Time	100 milliseconds	60 milliseconds
Repeatability	$\pm 2\%$	$\pm 1\%$
Polarity Reversal Protection (on DC)	Yes	Yes



POTTER & BRUMFIELD

Division of American Machine & Foundry Co., Princeton, Ind.
Export: AMF International, 261 Madison Ave., New York, N.Y.

Speed Inquiry to Advertiser via Collect Night Letter
ON READER-SERVICE CARD CIRCLE 78

actual size

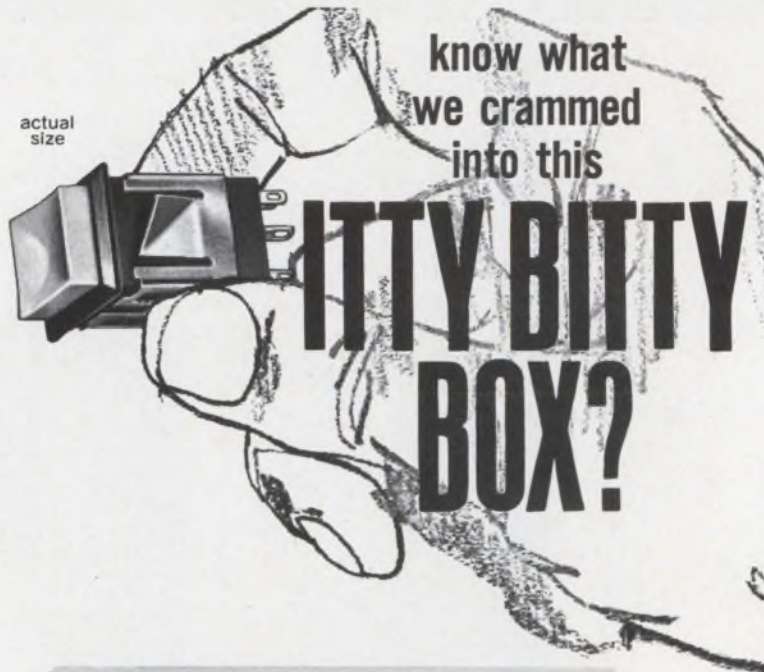

ALL THIS
IN THE SERIES BX

BOX SWITCH

● UP TO 4 POLES OF SWITCHING

1-A, 1-C, 2-C & 2-A in this MOMENTARY ACTION pushbutton Switch (or D, F or G contact forms on special order).

● INTEGRAL SLIDE CONTACTS

Silver-plated spring-tempered phosphor bronze contacts rated 250 ma., 30 watts max., A.C. non-inductive load.

● ADJUSTO-CLIP* PUSH-IN MOUNTING

Instantly adjustable clips for front-of-panel "snap-lock" mounting; for panels 3/64" to 17/64" thick.

● BEST LOOKING BEZEL IN THE BUSINESS

Low silhouette bezel pleasingly frames switch button; acts as an attractive escutcheon plate.

● SUPER SPACE SAVING SIZE

Mounts in matrixes on 11/16" centers in either of two planes. Takes only 1 1/8" behind panel depth.

● CYBERNETICALLY DESIGNED BUTTONS

Handsome finger-fitted concave design: choice of white, black, red, green — other colors and/or identifying legends on special order. 7/64" button stroke.

● MOLDED BODY ENCLOSES CONTACTS

Protects against dust and dirt . . . prevents bending or disfiguring contacts caused by excessive handling. Terminal identification molded into case.

● AND INCOMPARABLE QUALITY, TOO!

Built with the very finest materials manufactured in perfectly matched molds . . . with the "solid" feeling action you expect only from the most precisely engineered switches! Ideal for computers, data processors, telephones and telephone equipment, etc. * Patent applied for

WRITE FOR BULLETIN 169

SWITCHCRAFT®

5529 Elston Avenue
Chicago, Illinois 60630



see it at Wescon
booth 1645

ON READER-SERVICE CARD CIRCLE 79

CIRCUIT COMPONENTS

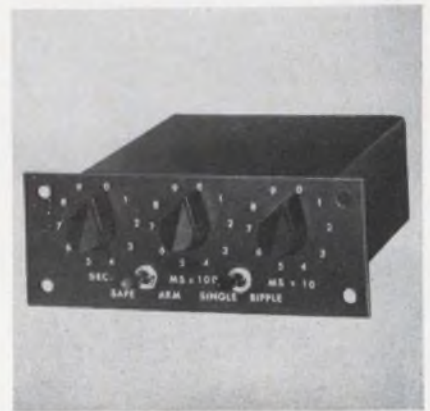

Repeat cycle timer

Pulse signals vary from 30 ms to 9.9 s in increments of 10 ms with this intervalometer. The unit can be used as a pulse source or coupled to a switch to provide timed distribution of sequential programs. Timing tolerance is $\pm 5\%$ over a range of 18 to 32 V from -55 to 85°C . The pack includes built-in suppression to protect circuitry from inductive loads.

P&A: \$355 (1 to 4); 10 wks. Leduc Inc. 123 Webster St., Dayton, Ohio. Phone: (513) 224-9891.

Booth 1006 (SA) Circle No. 266

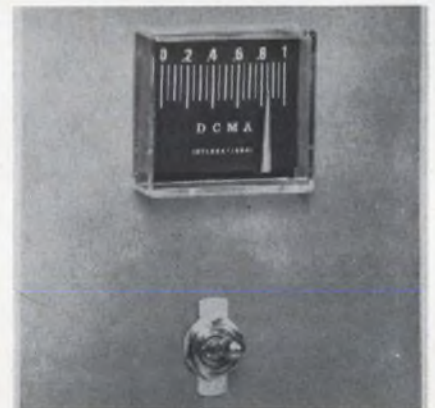

Panel meter

With a pointer that moves in a line across the face rather than in an arc, this meter has the basic format of a 1-1/2-in.² panel meter. Scale length is 1.3 in. Initial accuracy is $\pm 2\%$ (dc) and $\pm 3\%$ (ac). Standard models include 16 dc ranges from 0 to 100 μA up to 0 to 3 A, seven dc ranges from 0 to 50 mV up to 0 to 100 V, and three rectifier ac voltage ranges.

Price: \$15.10. International Instruments Inc., 8815 Marsh Hill Rd., Orange, Conn. Phone: (203) 795-4711.

Booth 570 (HP) Circle No. 294

Why IEE rear-projection readouts make good reading

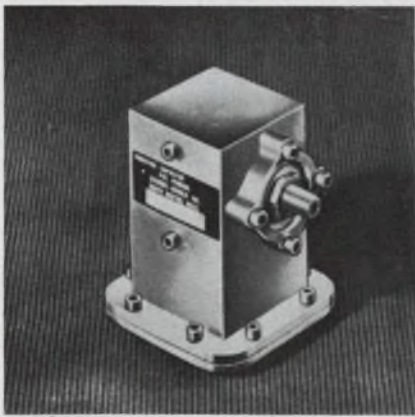

Vibrating reed capacitor

This vibrating capacitor is a modulator of the vibrating reed type which varies its capacitance sinusoidally to modulate a dc signal. Under constant temperature, drift is 0.1 mV/24 hours. Capability is 0.05 mV. Temperature coefficient of drift is 0.03 mV/°C. Static capacitance is 10 pF/channel. Available frequencies range from 60 to 600 Hz.

P&A: \$85 to \$120 (over 50): stock. Stevens-Arnold Inc., 7 Elkins St., South Boston, Mass. Phone: (617) 268-1170.

Booth 1451 (SA) Circle No. 284



Resonant reed decoder

Built in a tuning fork configuration, the tines of this 3/16-in.³ decoder vibrate in response to a specific frequency input. It is a high Q, narrow bandwidth ($\pm 0.25\%$) device, available with frequencies tuned from 300 to 1200 Hz. Response time is 100 ms max with less than 5 mW input signal. Coil resistance is $210 \Omega \pm 10\%$ and contact ratings are 10 mA peak at 1.5 Vdc.

Ledex Inc., College & South Sts., Piqua, Ohio. Phone: (513) 773-8271.

Booth 1006 (SA) Circle No. 548

Not the kind of good reading you'd curl up with on a rainy night. But a more important kind if you're designing equipment that requires message display. Reason is that IEE readouts are the most readable readouts around. If you've seen them, you know this to be fact. If you haven't as yet, here is why our readouts make such good reading:



SINGLE-PLANE PRESENTATION

No visual hash of tandem-stacked filaments. IEE readouts are miniature rear-projectors that display the required messages, one at a time, on a non-glare viewing screen. Only the message that's "on" is visible.



EASY-TO-READ CHARACTERS

Since IEE readouts can display anything that can be put on film, you're not limited to thin wire filament, dotted, or segmented digits. Order your IEE readouts with familiar, highly legible characters that meet human factors and Mil Spec requirements. This section from our sample type sheet gives you an idea of the styles available that offer optimal stroke/width/height ratio for good legibility.

BALANCED BRIGHTNESS/CONTRAST RATIO

The chart below is a reasonable facsimile of character brightness and how



it affects readability. The background is constant, but the brightness increases from left to right. You can draw your own conclusions, armed with the fact that IEE readouts give you up to 90 foot lamberts of brightness. Brightness, however, isn't the sole factor in judging readability. Background contrast is equally important—a fact we've simulated below, reading from left to right.



Obviously, brightness without contrast or vice versa, doesn't do much for readability. A balanced ratio of both gives you the crisp legibility of IEE readouts.



WIDE-ANGLE READABILITY

IEE's unique combination of single-plane projection, flat viewing screen, balanced ratio of brightness/contrast, and big, bold characters makes for wide-angle clarity and long viewing distances.

OTHER WAYS IEE READOUTS MAKE GOOD SENSE

As if the superior readability of our readouts weren't enough, here are a few reasons why IEE readouts make good sense in other areas:

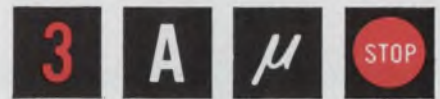

INFINITE DISPLAY VERSATILITY

Because our readouts use lamps, lenses, film, and a screen, they can display literally anything that can be put on film. That means you have up to 12 message positions with each readout to display any combination of letters, words, numbers, symbols, and even colors!



FIVE SIZES TO PICK FROM

IEE readouts now come in five sizes providing maximum character heights of $\frac{3}{8}$ ", $\frac{1}{2}$ ", 1", 2", and 3". The smallest is the new Series 340 readout that's only $\frac{3}{4}$ " H x $\frac{1}{2}$ " W, yet can be read from 30 feet away. The largest, the Series 80, is clearly legible from 100 feet away.

EASY TO OPERATE

IEE readouts are available with voltage requirements from 6 to 28 volts, depending on lamps specified. Commercial or MS lamps may be used, with up to 30,000 hours of operation per lamp. Lamps may be rapidly replaced without tools of any kind.

Our readouts operate from straight decimal input or will accept conventional binary codes when used with IEE low-current driver/decoders.

For more proof why IEE rear-projection readouts make good reading, send us your inquiry. You'll see for yourself why they've been making the best seller list, year after year!

IEE INDUSTRIAL ELECTRONIC ENGINEERS, INC.

7720 Lemona Avenue, Van Nuys, California
Phone: (213) 787-0311 • TWX (910) 495-1707
Representatives In Principal Cities

SEE US AT WESCON, BOOTH 318 HOLLYWOOD PARK

ON READER-SERVICE CARD CIRCLE 80

THIS IS NO GIMMICK...

and it's not etched!

The increased acceptance and use of aci Signaflo Systems is partially a result of this unique aci advancement, "Spread-Pitch", for interconnection adaptability and versatility.

It is another reason for aci's leadership and ability to solve interconnection problems.

... new connective dimensions



DIVISION OF KENT CORPORATION
206 Industrial Center, Princeton, N. J. 08540

WESCON
BOOTH
1003-
1004

aci has developed a manufacturing technique, "Spread-Pitch", which can change the pitch dimension of conductors wherever required.

Thus, narrow pitch dimension cable can be used on aci Signaflo Systems and yet match hardware contact with various dimensions for interconnection simplicity without loss of any inherent characteristics, such as flexibility, strength, low total cost, weight and space savings.

INFINITELY VARIABLE

.075 to .150

.075 to .100

.025 to .100

.050 to .125

CIRCUIT COMPONENTS

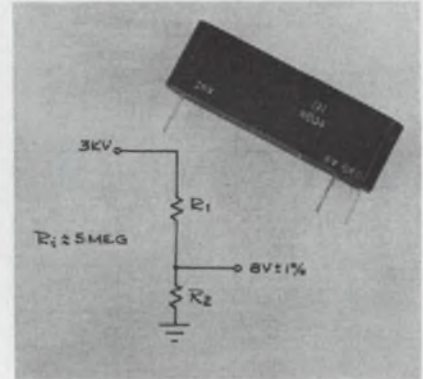

Voltage divider networks

Voltage dividers with 1% accuracy provide 8 V from -55 to $\pm 85^\circ\text{C}$ with a 3-kV input. Power dissipation exceeds 2 W with a thermal insulator. Input resistance is approximately 5 M Ω and output resistance is 13 k Ω . The wirewound resistor network measures 0.375 x 0.625 x 2-in. and is designed for PC mounting.

Tri-King Industries Inc., 8933 Quartz Ave., Northridge, Calif. Phone: (213) 882-1500.

Booth 1819 (SA) Circle No. 561

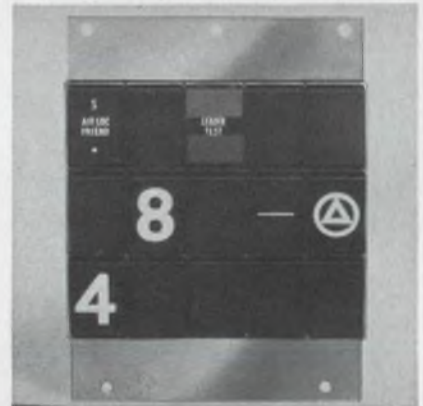

Readout switch

Readout-switches combine 12-message rear-projection readouts with pushbutton switch capability. The modular devices accept decimal input and provide a visual display. Each of the 12 optical systems projects through film reticles, permitting a choice or combinations of colors. To produce compound messages, as many as 6 optical systems can be energized simultaneously. Housings are fitted with a 2pdt or 4pdt momentary or alternate switch.

P&A: from \$45; 3 wks. Shelly Associates, 111 Eucalyptus Dr., El Segundo, Calif. Phone: (213) 322-2374.

Booth 2144 (SA) Circle No. 550

ON READER-SERVICE CARD CIRCLE 81

Capacitor reliability makes the grade

$$F(x) = 1 - \exp\left[-\frac{x^B}{\alpha}\right]$$

Graded reliability: exclusive with KEMET KG solid tantalum capacitors. Through accelerated test techniques, we establish reliability data covering your specific order. Graded failure rates range as low as 0.001% per thousand operating hours.

This failure rate prediction comes from an adaptation of the Weibull distribution function, in a special control test sequence and chart form. Its validity has been confirmed by test data covering billions of capacitor hours.

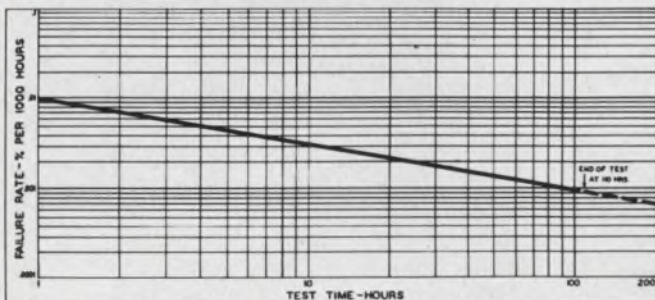

REGIONAL SALES OFFICES. East Coast: J. G. Egan, 1341 Hamburg Turnpike, Wayne, New Jersey 07472. Phone: 201-696-2710. **Mid-Atlantic:** R. H. Robecki, 1341 Hamburg Turnpike, Wayne, New Jersey 07472. Phone: 201-696-2710. **Mid-West and South:** K. S. Collart, P. O. Box 6087, Cleveland, Ohio 44101. Phone: 216-221-0600. **West Coast:** B. G. Bryant, 701 East Whittier Blvd., Whittier, California 90605. Phone: 213-698-8077.

KEMET is a registered trade mark of Union Carbide Corporation.

KEMET KG solid tantalum capacitors with predicted reliability are available from 0.0047 to 330 microfarads, 6 to 100 VDC, for continuous operation from -55 to 125°C . Standard tolerances 10 and 5%. Closer tolerances on request.

Graded reliability: another reason to think of KEMET capacitors. For details on these, or our other tantalum capacitors, call our nearest office, or mail the coupon.

Clip, fill in name and title, attach to letterhead

Union Carbide Corporation
Linde Division, Dept. ED-83
270 Park Avenue, New York 10017

Please send details on High-Reliability
KEMET Solid Tantalum Capacitors

Name _____

Title _____



ON READER-SERVICE CARD CIRCLE 82

**UP TO
200 MILLION
OPERATIONS!**

doranic[®]

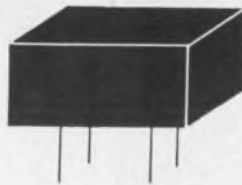

Reed Relays

Logic Modules

Mercury Wetted Contact Relays

Economical Doranic products simplify your circuit design, production and assist you in obtaining system reliability. Life up to 200 million operations is achievable at nominal loads.

Douglas Randall's design team is experienced in custom circuit packaging; and special relay design and production. They will assist your design engineers in component selection and specifications.

For a comprehensive catalog of our complete line of standard relay products, write:

douglas randall, inc.



A SUBSIDIARY OF WALTER KIDDE & COMPANY, INC.

6 Pawcatuck Avenue, Westerly, Rhode Island 02891

Tel.: Area Code 203 599-1750 (Pawcatuck, Conn.)

ON READER-SERVICE CARD CIRCLE 83

CIRCUIT COMPONENTS

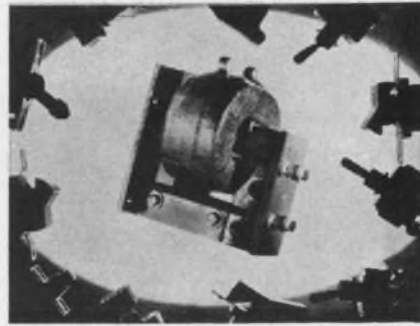

28 Vdc test inductor

A 25-A, 28-Vdc iron-core test inductor is applicable as lab test equipment for military switches and relays with inductive current ratings from 2 to 100 A. The inductor can be used for any current rating between 2 and 25 A. Current ratings between 25.1 and 100 A are obtained by combining a group in parallel.

Cutler-Hammer Inc., Milwaukee.
Phone: (414) 442-7800.

Booth 1610 (SA) Circle No. 311

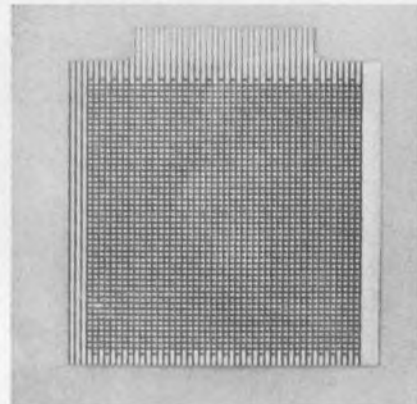

Breadboard kit

Five breadboards pierced on a 0.05 x 0.05-in. center are offered for IC prototyping and production. A series of parallel copper strips corresponding to the hole matrix can be broken at any point to form any circuit. Both single-sided copper-clad boards and double-sided matrix boards with strips at right angles are included. Two plug-in boards, single- and double-sided with 30 gold-plated contacts, two fully pierced 6 x 6-in. single- and double-sided and one plain board make up the introductory pack together with a spot face cutter.

P&A: \$22.95; stock. Vero Electronics Inc., 48 Allen Blvd., Farmingdale, N. Y. Phone: (516) 694-6550.

Booth 1833 (SA) Circle No. 327

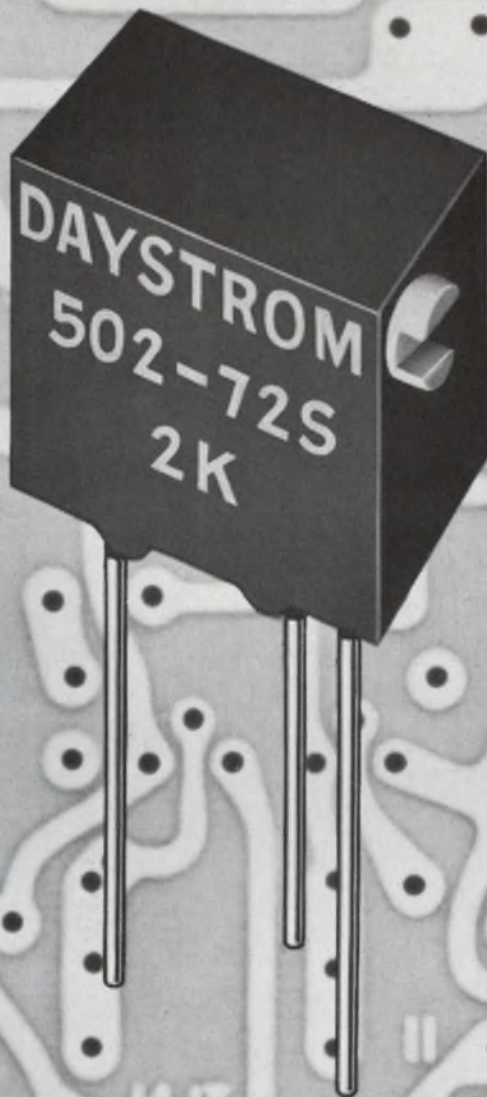

New Chairman of the Board cuts costs, creates openings

Look at the specs and you'll see why so many large users already have turned to the new Weston-Daystrom 501 & 502 5/16" commercial Squaretrim® pots. They save up to 80 per cent of the PC board space formerly required—and no extra cost. Notice the extra dividends:

Convenience 3 different configurations with adjusting screw on top, side or end • **Tolerance** $\pm 5\%$
• **Adjustability** 15 mechanical turns • **Slip Clutch** eliminates wiper damage, cuts production delays
• **Soldered Terminations** for better protection against vibration, shock and humidity—
no pressure taps • **Superior Resolution** 0.125% or less • **Wide Range** 10Ω to 20K • **High Power**
0.6 watt in still air at 70C • **Wide Temperature Range** $-55C$ to 150C • **Low Temperature**
Coefficient 70 ppm max. • **Low Noise** 100 ohms max. ENR • **Small Size** $\frac{5}{16}" \times \frac{5}{16}" \times \frac{3}{16}"$

Weston Instruments, Inc. • Archbald Division • Archbald, Pa. 18403

WESTON® *prime source for precision... since 1888*

ON READER-SERVICE CARD CIRCLE 231

IT'S HARD TO CONTACT YOU IF YOU DON'T CONTACT US.

It isn't that we don't have a phone or men out beating the bushes. It's just that, if you don't let us know about any electrical contact or sub-assembly problem you might have, we may not find you. And that would be a shame. You'd be depriving yourself of the opportunity of dealing with people who have seen enough contact problems to realize that yours may well be different from all the others. And, people who know what to do about your problem!

Once a solution is reached, it is executed with the finest, most modern, and in many cases, exclusive facilities in our industry. That's another reason it would be a shame not to get in touch with us. Two more are service (and our eager approach to it) and delivery (we break our necks to be prompt). So do us a favor by doing yourself a favor. Next time the subject of contacts comes up, contact Deringer. It's your best bet for quick, economical service.



METALLURGICAL CORPORATION

1250 Town Line Road - Mundelein, Illinois 60060

ON READER-SERVICE CARD CIRCLE 84

CIRCUIT COMPONENTS

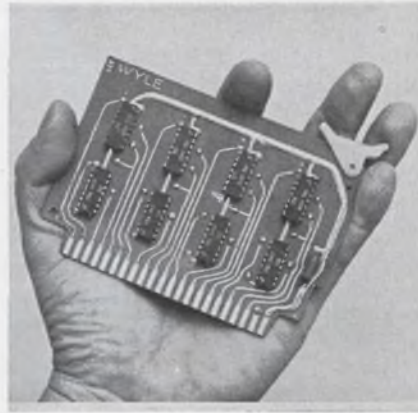

IC logic modules

More than 20 basic types of modules use discrete components to complement ICs where cost advantages are gained. Modules include several NAND gate cards, one of which provides twelve 2-input gates. Among the flip-flop cards, type MUF-5 provides 5 universal (JKRST) flip-flops. Type MGF-8 affords 8 set-reset flip-flops with input gating. Other modules are BCD presettable counters, lamp drivers, AND gates, one-shot multivibrators, Schmitt triggers, crystal oscillators, and BCD-to-decimal decoders. The modules feature monolithic silicon DTL NAND saturated logic in a 14-pin dual-in-line package. Inputs are diode-coupled and isolated and outputs use saturated transistors for logic zero, with a fan out of 8 for gates, 7 for flip-flops and 25 for buffers.

Wyle Labs., 133 Center St., El Segundo, Calif. Phone: (213) 322-1763.

Booth 2031 (SA) Circle No. 275

Tuning fork filter

Tuning fork filters for doppler radar operate in the 60-Hz to 20-kHz range. Normal single element bandwidth is 0.001 to 0.0002 times the center frequency at the 3 dB points. Accuracies of 0.1% to 0.002% vary with temperature range. Insertion loss with all-electromagnetic transducers is 10 dB. With all-piezoelectric units, loss is about 6 dB. All units are hermetically sealed.

Varo Inc., 402 E. Gutierrez, Santa Barbara, Calif. Phone: (805) 963-2055.

Booth 1716 (SA) Circle No. 276



Performance is going up...

Nexus prices are still coming down



Here's a good example: The SQ-10a* solid-state, general-purpose operational amplifier started at \$24 6 months ago dropped to \$19 **NOW ONLY \$17!**

Now the versatile Nexus SQ-10a costs you less than ever before . . . in spite of the fact that it is better than ever before. Its new unit price — \$17 — is the lowest in the industry for a quality, encapsulated operational amplifier.

This should interest many . . . but surprise no one.

Ever since we developed the first encapsulated operational amplifier, Nexus has been improving product quality and reducing prices.

Actually, one is a direct result of the other. When the product is better, you buy more. When the volume goes up, costs come down, and everybody wins. That has been the unvarying trend at Nexus since we first opened our doors.

The SQ-10a is a widely-used moderate-performance, general-purpose amplifier. As its performance has improved, its price has dropped, as indicated by the comparative characteristics.

If you would like to know more about the remarkable, low-cost SQ-10a, or its performance counterpart the low profile (.375" high) SF-10 at only \$22.00, write for complete data today.

*An improved version of the SQ-10

WESCON BOOTH # 1805-1806 — ISA BOOTH # 1440

COMPARATIVE PERFORMANCE — TYPICAL CHARACTERISTICS		
	SQ-10	SQ-10a
Supply Voltage	± 15 volts	± 15 volts
Open-Loop Gain (@ D. C.)	20 K	100 K
$\Delta I_{OS} / \Delta T$	3 nA/°C	1.5 nA/°C
$\Delta E_{OS} / \Delta T$	20 μ V/°C	5 μ V/°C
f _t	1.5 mc	2 mc
Output Current Range	± 2 ma	± 5 ma
I _{OS}	± 100	± 30
I _p	15 KC	25 KC
Operating Temperature Range	—5° to +70°C	—25°C to +85°C



NEXUS

RESEARCH LABORATORY, INC.
480 NEPONSET STREET, CANTON, MASS. 02021
TEL: (617) 828-9000 TWX (617) 828-1022

TERMINAL BLOCKS

CURTIS

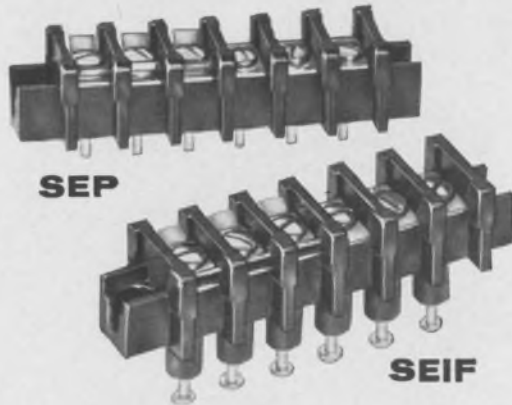

- SEP** - for connections to printed circuits
- SEIF** - for miniature insulated feed-thru
- SEF** - for miniature feed-thru
- SES** - for miniature surface contacts

All types of "SE" blocks include:

- Only 1/4" center-to-center terminal spacing
- Bright tin plated screw machine inserts
- #2-56 terminal screws for up to 16 #AWG wire
 - Molded black phenolic base
 - Choice of 1-18 poles
 - 300 volts — 5 amps



Send Today for Further Information
CURTIS DEVELOPMENT & MFG. CO.
 3236 N. 33rd St. • Milwaukee, Wis. 53216

SEE US AT WESCON SPORTS ARENA—BOOTH 1810
 ON READER-SERVICE CARD CIRCLE 85



**LOOK WHAT'S HATCHED AT
 LITTELFUSE**

**The world's smallest fuse—Picofuse.
 1/8 thru 5 amps...1/6 gram...125 v.**

LITTELFUSE

DES PLAINES, ILLINOIS

ON READER-SERVICE CARD CIRCLE 86

CIRCUIT COMPONENTS

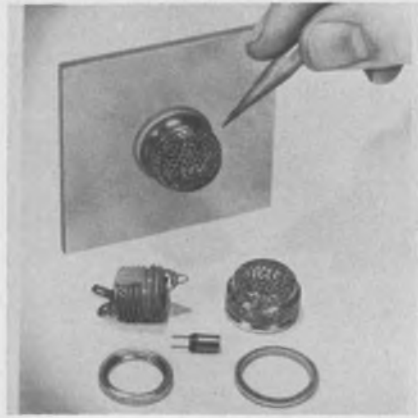

Shielded fuse holder

Front panel mount overload-indicating fuse holders have shielding designed to eliminate RFI from passing through or coming out of the fuse post opening. Shielding is accomplished by a mesh-impregnated see through molded plastic lens and a mesh-imbedded silicon gasket that fits between the lens and the mounting surface. The holders are available in ratings from 2-1/2 to 130 V.

P&A: \$5; stock to 8 wks. Littelfuse, 800 E. Northwest Hwy., Des Plaines, Ill. Phone: (312) 824-1188. Booth 1111 (SA) Circle No. 355

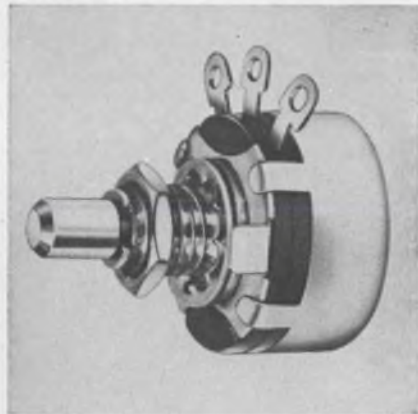

Hot-molded 5/8-in. pot

Operable through 50,000 rotational cycles, hot-molded 5/8-in. pots are available in a 100-Ω to 5-MΩ range with tolerances of ±10% to 100 kΩ and ±20% above 100 kΩ. Power rating for the military units is 1 W at 70°C and 350 Vdc max derated to 0 W at 120°C. Commercial units are rated at 3/4 W at 40°C and 500 Vdc max.

Clarostat Mfg. Co., Dover, N. H. Phone: (603) 742-1120. Booth 1106 (SA) Circle No. 307

ON READER-SERVICE CARD CIRCLE 229 ➤

INCREMAG[®] the precision counter with a memory

Low-cost, low-power precision counting. Frequency division, programming, timing, memory storage, pulse delay and pulse shaping. These and many other assignments can be performed by designers in industrial applications with INCREMAG Series QC-10.

And what's more, you get greater simplicity, reliability and flexibility compared with standard binary circuitry. Only 8 transistors instead of 20 are needed for a count ratio of 1,000:1 and fewer associated components, much less power. Plan for continuous information storage without a power supply. The higher the count ratio, the more you can save.

Then there's HAYDON performance benefits – dependable application assistance. For the full story on INCREMAG Series QC-10, write HAYDON Products/Industrial Controls Division, General Time Corporation, Thomaston, Connecticut.

- ### Outstanding Features
- Magnetic counting/dividing circuit delivers output pulse after receiving pre-set number of inputs
 - No delay; automatic reset during delivery
 - Handles odd or even numbers
 - All solid state circuitry—two transistors per stage
 - Low voltage—6VDC ± 15% @ 380 ma maximum
 - Count memory—no loss of prior count even with power failure
 - Not limited to binary logic—any count from 1 to 12, multi-staged units for counts over 12
 - Cascaded single stages give composite count equal to product of fixed count stage. Counting rate from 10,000 cps to repetitive pulse one/day or lower. Plug-in to fit standard octal socket for rapid assembly
 - 1.60 cubic inches per stage permits smaller end product design. Long life, high reliability, low cost.

INCREMAG Series shown actual size

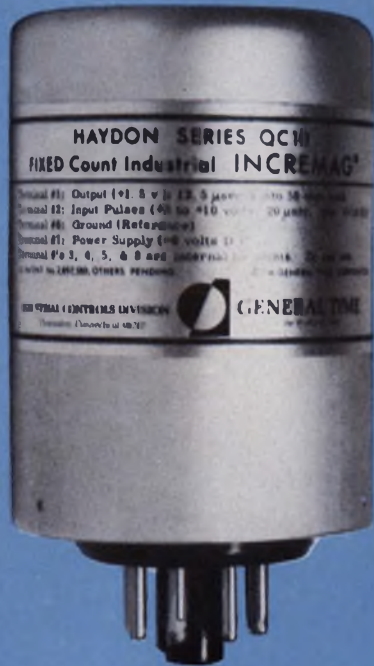

QC 13 1,000 : 1
Counts any number resulting from 3 numbers, between 2 and 12, multiplied together, e.g.
 $2 \times 10 \times 8 = 160$
 $9 \times 7 \times 4 = 252$
 $12 \times 12 \times 12 = 1,728$



QC 12 100 : 1
Counts any number resulting from 2 numbers, between 2 and 12, multiplied together, e.g.
 $2 \times 10 = 20$
 $12 \times 9 = 108$
 $9 \times 7 = 63$



QC 11 10 : 1
Counts any numbers from 2 to 12.

QC-10 DIMENSIONAL DETAILS AND EXTERNAL CONNECTIONS

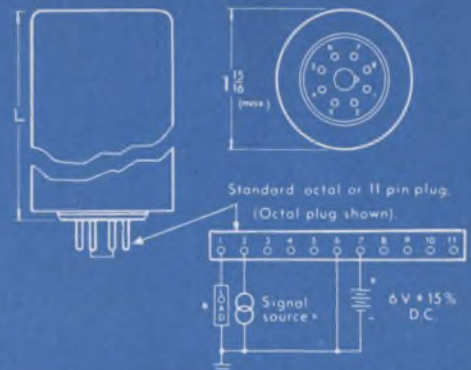

QC-10 BLOCK DIAGRAM SHOWING MULTIPLE COUNTING STAGES CONNECTED IN CASCADE



QC-10 FIXED COUNT INCREMAG [®] Physical Details				
Model No.	Count Ratio	Axial Length "L" ± 0.030"	Socket Type	Weight (approx.)
QC 11	10:1	1.5"	Octal*	3.9 oz
QC 12	100:1	2.1"	Octal*	5.3 oz
QC 13	1,000:1	2.7"	11 pin**	6.7 oz
QC 14	10,000:1	3.2"	11 pin**	8.0 oz
QC 15	100,000:1	3.8"	11 pin**	9.3 oz

*e.g. Amphenol #77MIP8 ** e.g. Amphenol #77MIP11



METALIZED MYLAR CAPACITORS



to your exact
specifications...
at stock prices

METALIZED MYLAR CAPACITORS

Unique, self-healing units that remain in circuit during voltage surges with little or no loss of electrical properties. Use the M2W's where size and weight are limiting factors and long life and dependability are required. The units utilize metalized Mylar* Dielectric with film wrap and custom formulated epoxy resin end fill. Available in round and flat styles.

*Du Pont Trademark for Polyester Film

Samples available on your letterhead request

Standard

**CONDENSER
CORPORATION**

DEPT. ED-8, 3749 N. CLARK STREET, CHICAGO, ILLINOIS 60613

ON READER-SERVICE CARD CIRCLE 87

CIRCUIT COMPONENTS

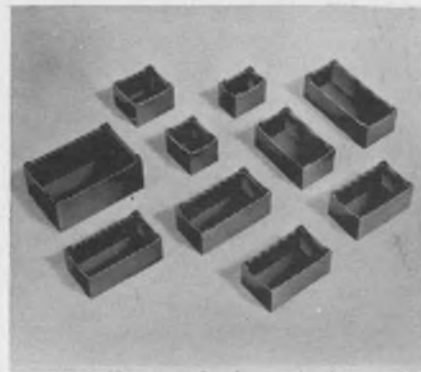

Encapsulating shells

Flame-proof, glass-filled diallyl phthalate shells are available in sizes from 0.4 x 0.6 x 0.48-in. to 0.9 x 1.4 x 0.48-in. They have an inner step that accepts a header and elevates the assembly from the circuit board. This allows solder fillet formation under the components, flush cleaning of flux residues and improved convection cooling.

P&A: \$0.15 to \$0.60; stock. Robinson Electronics Inc., 3636 W. 139th St., Hawthorne, Calif. Phone: (213) 679-0351.

Booth 1536 (SA) Circle No. 367

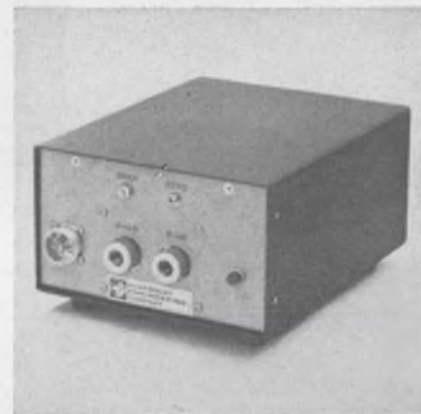

Pressure transducer

Repeatability error of 0.01% full scale and hysteresis error of 0.015% are featured in this capacitive pressure transducer. The sensor uses a single capacitor plate on the reference side of the diaphragm to measure psia or psig in liquid, gas or vapor. Differential measurements may be made in a dry-gas reference medium. Full scale pressure range is 0.1 to 5000 psi. Output is 0 to 5 Vdc or 0 to 1 mA and linearity is 0.05% full scale.

Rosemount Engineering Co., 4900 W. 78 St., Minneapolis. Phone: (612) 927-7711.

Booth 170 (HP) Circle No. 399



In designing a low-noise TWT, the real problem is keeping it small and light.



Our new L-5088 weighs only 1.8 pounds.

Small, light and rugged, it's ideal for airborne applications. Noise figure is less than 10 db across most of the band (conservatively rated at 12 db maximum between 2.0 and 4.0 Gc). Construction is metal/ceramic to MIL-E-5400; focus is by PPM Alnico magnets. Minimum saturation power output is 7dbm; minimum small signal gain is 33 db. Conservative cathode design assures long life.

Something else to think about. Our new L-5088 comes as a compatible package, if you like — TWT plus matching integral solid state power supply. Find out more about Litton's lightweight TWT. Send for Data Package. Electron Tube Division, 960 Industrial Road, San Carlos, Calif. 94070. (415) 591-8411.

 **LITTON INDUSTRIES**
ELECTRON TUBE DIVISION

Speed Inquiry to Advertiser via Collect Night Letter
ON READER-SERVICE CARD CIRCLE 88

Yes, you can



YOU CAN BUILD
AN ARTISAN
TRANSISTORIZED
ORGAN WITH KITS
AND SUB-ASSEMBLIES

save \$2000 or more

Relax with one of the world's most rewarding hobbies . . . build a full-size, concert quality transistorized organ. The Artisan Kit Organ has the same rich pipe-like tones, the same features, as the famous Artisan Custom Organ. There's not one bit of difference in tonal beauty, console style, high quality.

10 styles for home, church, school.



Write for brochure
2476 ED No. Lake Ave.
Altadena, Calif. 91001
Phone: 798-0888

ON READER-SERVICE CARD CIRCLE 89

DISCOVER
THIS
FASTER,
MORE
ACCURATE,
DISTORTION-FREE
"PRESS and PEEL"
METHOD
for making
printed circuit
master
drawings

BY-BUK

"TAPE-LIFT"

PRINTED CIRCUIT DRAFTING AIDS in flat 8" strips packaged in handy slip-pack boxes. Featuring our NEW Black Matte Finish, Clear Adhesive Centerless Donuts, Teardrops and Oval Pads in many new stock sizes, also Tees, Elbows, Fillets, Adapters, Register Marks, Drafting Film and Grids, Conductor line tapes in Matte or Creped finish in widths from 1/4" up.

Write for our NEW **CROSS-REFERENCE DRAFTING AIDS GUIDE & PRICE LIST NO. P-41** - FREE SAMPLES.

BY-BUK COMPANY

4326 W. Pico Blvd., Los Angeles, Calif. 90019 • (213) 937-3511

Visit Booth #637—Wescon Show—Hollywood Park

ON READER-SERVICE CARD CIRCLE 90

CIRCUIT COMPONENTS

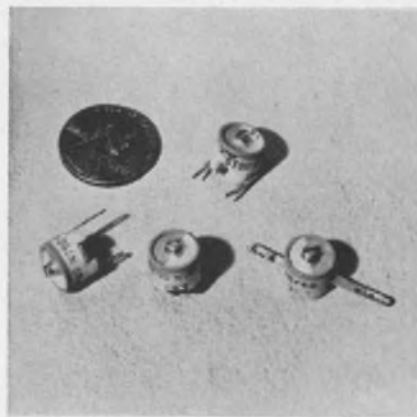

Trimmer capacitors

Disc ceramic-dielectric trimmer capacitors are available in ranges of 2 to 8, 2.5 to 11, 3 to 10, 3 to 15, 5.5 to 18, 7 to 25, 8 to 25 and 9 to 35 pF. This range is covered with a 180° screwdriver adjustment. Q is 500 min at 1 MHz. Working voltage is 350 Vdc from -55 to 85°C derated to 200 Vdc at 125°C and 200 Vdc up to 85°C, derated to 100 Vdc at 125°C.

JFD Electronics Co., 15th Ave.
at 62nd St., Brooklyn, N. Y. Phone:
(212) 331-1000.

Booth 1418 (SA) Circle No. 315

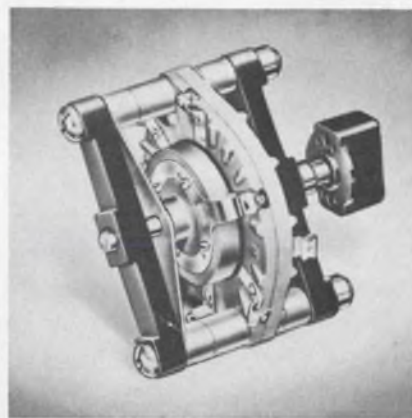

15-kV switches

Featuring high voltage breakdown, these switches have self-cleaning and wiping action. With 60° indexing, these switches have changeable stop buttons for selecting the number of positions. Contacts have a current carrying capacity of 20 A. The 15-kV switches are intended for RF use to 30 MHz.

P&A: \$8.75; stock. James Millen Mfg. Co., 150 Exchange St., Malden, Mass. Phone: (617) 324-4108.

Booth 1714 (SA) Circle No. 342

Only Varian delivers low-noise TWT amplifiers that have...



lowest noise figure,
smallest size,
lightest weight,
highest saturation power,
single-reversal
permanent-magnet focusing,
integral power supply,
broad band frequency range,
narrow band frequency range,
S-band performance,
C-band performance,
X-band performance.

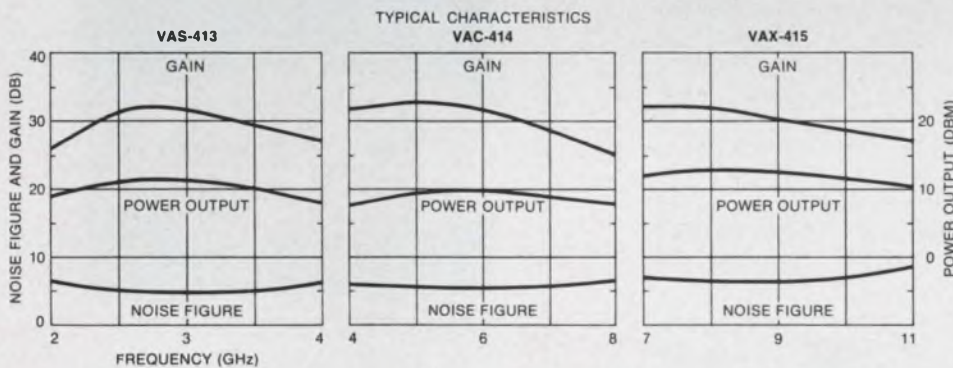

See them at Wescon:
Varian Booths 1349-1358,
Sports Arena—
along with all of our
other years-ahead
developments.

For more information on these 3-inch TWT amplifiers,
covering the complete spectrum of applications, write Palo
Alto Tube Division, 601 California Avenue, Palo Alto, Calif.

In Europe: Varian A.G., Zug, Switzerland.

In Canada: Varian Associates of Canada, Ltd., Georgetown, Ontario.



Speed Inquiry to Advertiser via Collect Night Letter
ON READER-SERVICE CARD CIRCLE 91



WE'VE GOT A BABY FIREFLY THAT REALLY PERFORMS!



T-3/4 T-1

NO FOOLING! ONE OF OUR competitors is telling about a lamp that is as big as a firefly — claims it flies, too! Says it's dependable and if you want a smaller lamp than theirs you'll have to consider *baby fireflies*. How droll!

LOOK NO FARTHER!

We've got baby fireflies *and* the mother too! Our babies are every bit as *dependable* as the parent — real performers. Hudson's T-3/4 lamps actually have the same electrical ratings as *our* famous, but bigger, T-1 lamps. They're just as bright and also have design lives exceeding 100,000 plus hours.

Where you have the space, Hudson's T-1 lamp will do a great job. *If* your space is limited, the Hudson T-3/4 lamp will do the job equally well. Regardless of which size you need, why not get them from Hudson the next time?



We make no claim that our fireflies fly. Unless, of course, they get an assist from an airplane. And many of them do.

Write for new catalog.

Hudson LAMP COMPANY
Miniature Lamp Specialists



518 ELM STREET, KEARNY, NEW JERSEY 07032

ON READER-SERVICE CARD CIRCLE 92

CIRCUIT COMPONENTS

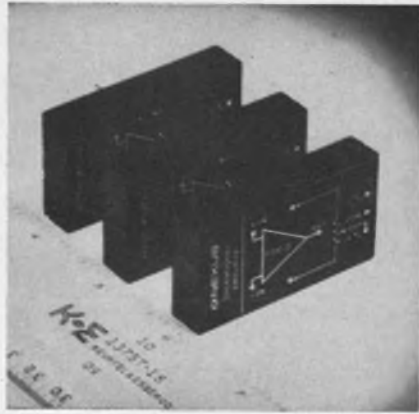

High-speed op amp

A high-speed inverting amplifier is designed for applications requiring a fast slewing rate, μ s settling time, high dc gain and low offsets. The amplifier is damped by the equivalent of a single resistor/capacitor network so that a -20 dB/decade amplitude response and a phase shift of -90° is controlled to beyond 10 MHz. Full output frequency is 1 MHz and unity gain frequency 30 MHz. Dc gain is 10^5 . Output is ± 10 V at 20 mA.

P&A: \$90 (1 to 9); 2 wks. Nexus Research Lab. Inc., 480 Neponset St., Canton, Mass. Phone: (617) 828-9000.

Booth 1805 (SA) Circle No. 338

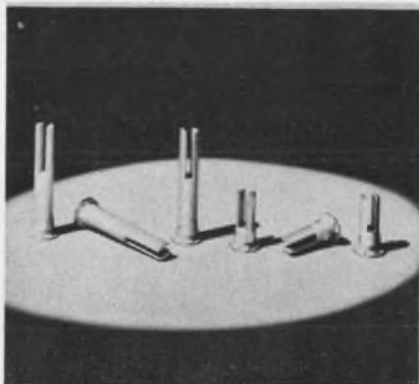

Solder terminals

Permanent solder joints on aluminum are made with this self-clinching solder terminal. The terminal is tinned bronze for soldering purposes and may be installed in panels 0.04-in. and thicker with hardness of Rockwell B-50 or less. The terminals measure 5/16- or 9/16-in. long with 1/8-in. diameter.

Penn Engineering & Mfg., P. O. Box 311, Doylestown, Pa. Phone: (215) 766-8853.

Booth 645 (HP) Circle No. 321

BRIEF SPECIFICATIONS: Power rating—2 Watts ■ Working Voltage—500Vdc ■ Resistance Range—50 ohms to 10 megohms linear, 250 ohms to 5 megohms tapered ■ Available with shaft seals, mounting seals, switches, high torque, ganging, non-metallic shafts, L & T Pads, concentric shafts, high-voltage standoffs, backlash assemblies, encapsulated units and locking bushings ■ Meets specifications of MIL-R-94—Style RV-4.

when you're being critical
the design and the

SERIES 53

Hardness of contact
optimum compatibility

low noise and long life. Backlash is zero. Total enclosure protects against moisture and other environmental hazards. No matter how critical your application—computer, space, military systems, etc.—you can count on the Series 53 potentiometer because you know it's by

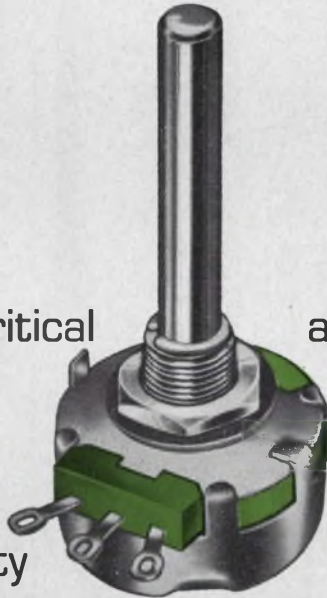

about quality, nothing matches
construction reliability of our

POTENTIOMETER

materials are selected for
to assure minimum wear,

CLAROSTAT

CLAROSTAT MFG. CO., INC. DOVER, NEW HAMPSHIRE

Visit CLAROSTAT at WESCON BOOTH 1106

ON READER-SERVICE CARD CIRCLE 159

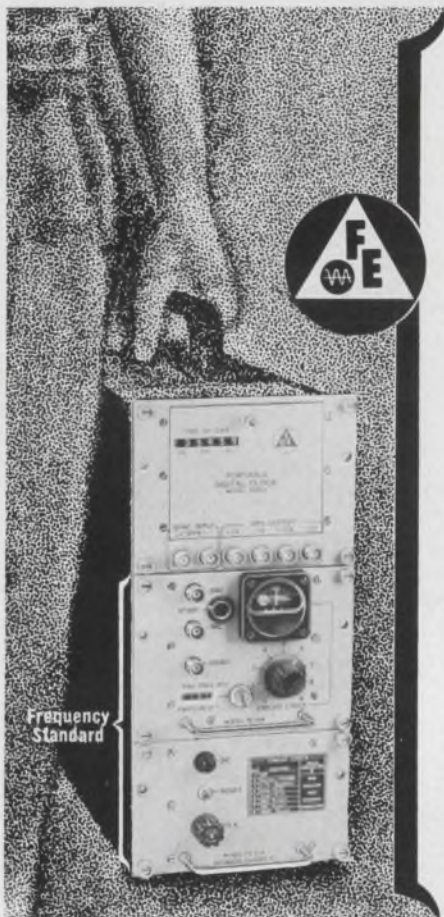

digital dexterity!

"militarized" HIGH STABILITY PORTABLE CLOCK

- Outputs: 1 PPS, 100 KC, 1 MC, 5 MC
- 2 usecs time accuracy per day
- 5 PP10¹¹ frequency drift per day
- Portable—18 hours full operation on internal rechargeable batteries
- 1 usec setting resolution

"militarized" HIGH STABILITY FREQUENCY STANDARDS

- Output frequencies: 5 MC, 1 MC, 100 KC
- 5 PP10¹¹ per day
- Portable—24 hours full operation on internal rechargeable batteries
- MTBF of 15000 hours minimum
- Automatic battery cut-out

FREQUENCY ELECTRONICS, INC.

55-11 Queens Blvd., Woodside, N.Y. 11377
(212) 458-4747

SEND FOR OUR COMPLETE CATALOG ED

Manufacturers of: High Performance Distribution Amplifiers • Digital Phase Comparators • High Stability Crystal Oscillators • Proportional Ovens • Linear Discriminators

ON READER-SERVICE CARD CIRCLE 93

Not all Knobs are Rogan KNOBS



...just the
better
Knobs

World's finest knobs available from stock molds. Hundreds of exclusive designs. Wide range of sizes, shapes and colors. No tool costs. Preferred by leading design engineers everywhere. Write for new Rogan catalog today.

Rogan
BROTHERS, INC.

8025 N. Monticello Ave.
Skokie, Illinois 60076

Specializing In Stock Molded Knobs Since 1939

ON READER-SERVICE CARD CIRCLE 94

CIRCUIT COMPONENTS

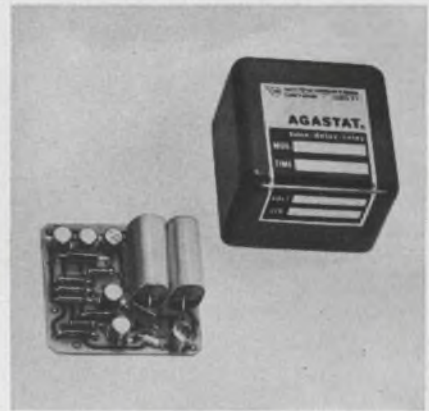

High-accuracy oscillator

Oscillators with 100:1 adjustment ratios utilizing non-tantalum RC networks achieve accuracy of $\pm 0.25\%$ to $\pm 1.5\%$. They eliminate the UJT as a level detector and substitute a sawtooth differential amplifier. Stable plastic film capacitors are used with the time discriminator circuit. Available in ranges of 2 to 200 Hz, 20 to 2000 Hz and 200 to 20,000 Hz, the units have repeat accuracy of $\pm 0.1\%$.

P&A: from \$70; stock. Agastat Div. of ESNA, 1027 Newark Ave., Elizabeth, N. J. Phone: (201) 352-2900.

Booth 1361 (SA) Circle No. 544



Rotary switch

Series 50 rotary switches fit behind a panel envelope 1/2-in. in diameter and 13/16-in. deep. The entire switch from shaft to terminals is 1-3/8-in. long. It has 36° indexing and comes with one or two poles. The switching element is completely enclosed. Adjustable or factory set stops and optional shaft and panel seal are featured.

Grayhill Inc., 561 Hillgrove Ave., LaGrange, Ill. Phone: (312) 354-1040.

Booth 1206 (SA) Circle No. 375

ELECTRONIC DESIGN, August 16, 1966

"a relay handbook to rely on"

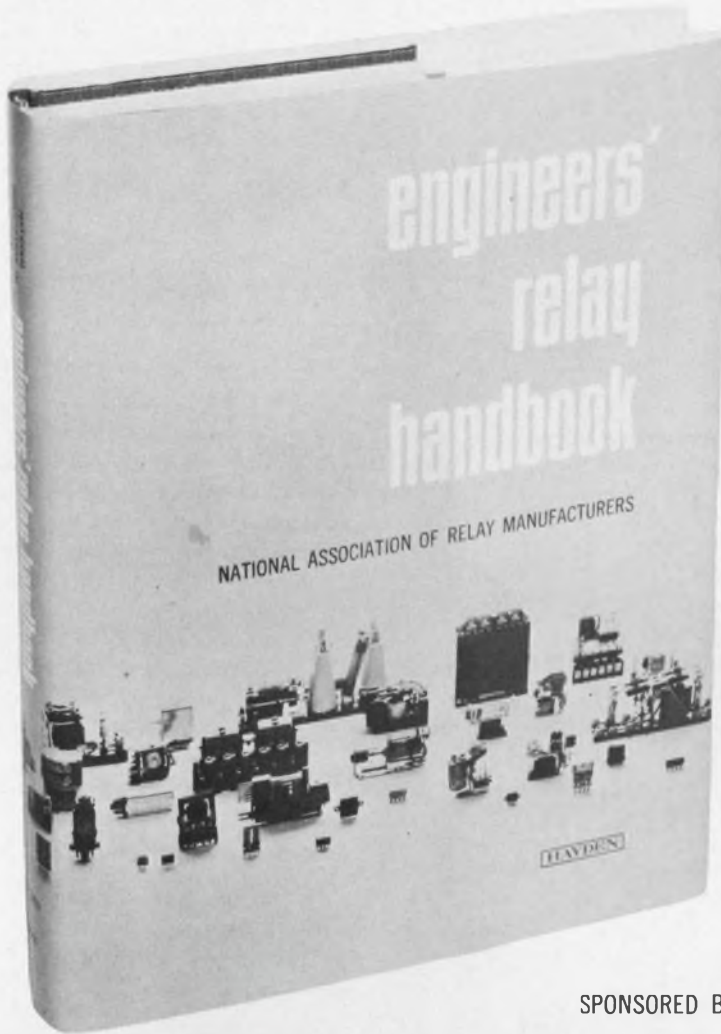

That's how *Product Engineering* described the *Engineers' Relay Handbook*, just published by Hayden. And with good reason. It was sponsored and produced by the National Association of Relay Manufacturers to provide the relay user with a complete guide to all aspects of relay technology. This is a book the design or systems engineer can't afford to miss. Whether you seek information on the types, reliability, economics, or government specifications of relays, the answer is clearly and thoroughly presented in this invaluable reference.

engineers' relay handbook

SPONSORED BY THE NATIONAL ASSOCIATION OF RELAY MANUFACTURERS

- the first complete roundup of objective relay information
- specifically prepared for the relay user
- detailed coverage of specification parameters
- clarification of performance terminology
- practical emphasis maintained throughout
- complete bibliography of relay literature
- 300 pages, Fully illustrated, Clothbound, \$11.95.

CONTENTS

Relay Terminology • Classes of Service • Relay Classification • Principles of Relay Operation • Relay Application Considerations • Relay Reliability • How to Specify a Relay • Testing Procedures • Government Specifications • Appendices • Bibliography

SEND FOR YOUR 10-DAY FREE EXAMINATION COPY NOW!

Or see it at the Hayden Book Co. Exhibit at the WESCON Show Booth 2119

Dept. ED-82, Hayden Book Company, Inc., 116 W. 14 St., New York, N.Y. 10011

Send me the "Engineers' Relay Handbook" for a free examination. At the end of ten days, I will either remit \$11.95 plus postage or return the book with no further obligation.

Name _____ Title _____

Company _____

Address _____

City _____ State _____ Zip _____

- Check here if payment enclosed. Publisher pays postage with same return guarantee. (Foreign orders, except Canada, must include payment in \$ U.S.)

Need Cables

of SPECIAL CONSTRUCTION

500 Feet to ONE MILLION Feet

Columbia has the facilities to manufacture cables up to one inch in diameter with almost any number of conductors of various gauges, solid and stranded, bare or tinned copper. Wire and cable can be made from single conductors to pairs, triplets, quads, etc. Shielding where required can be braided, spiral wrapped, aluminum mylar or the new conductive vinyls and polyethylenes. Outer coverings are available in a broad temperature range. Also included are extremely flexible and weatherproof compounds. Steel support wires with tensile strengths of from 900 lbs. to 5,000 lbs. can also be furnished as part of the cable.

For a prompt quotation on your special cable write us giving full information regarding your requirements.

Send for our Catalog No. 111 describing "America's Most Complete Wire Line".



Columbia
WIRE & SUPPLY CO.
2850 Irving Park Road • Chicago 18, Ill.

AUDIO, TV, & AUTOMATIC CONTROLS



Video tape recorder

A cross-field bias head longitudinal recording system is employed by this dual-, audio- and video-channel recorder. It uses 1/4-in. audio magnetic tape and records at 30 ips. Video bandwidth is 60 Hz to 1 MHz ± 6 dB. Signal to noise ratio is greater than 34 dB. Input and output TV signal is 1.4 V p-p into 75 Ω . The recorder consumes 100 VA.

Akai Electric Co., Ltd., 12, 2-Chome, Higashi-Kojiya-cho, Ohtaku, Tokyo, Japan. Phone: 741-1426. Booth 2164 (SA) Circle No. 357

Stepping motor

Converting dc pulses into a rotary output of 10 discrete increments per revolution, this stepping motor consists of a solenoid, a spring-loaded armature and a ratchet-and-pawl actuator that drives an output drive element. Torque output is 0.1 in.-lb. Lateral shaft movement compensation is unnecessary because there is no axial thrust motion. Nominal stepping speed is 500 operations per minute. The unit can be supplied to operate on 6, 12, 24, 48 or 110 Vdc or on 24, 115, or 240 V full-wave rectifier-produced dc. Power consumption is 6 W. The 10-step operation lends the device to uses in visual read-out counters, rotary switches and other light-duty decimal applications. Gearing can be provided to give counts in units other than 10.

Price: about \$10. Heinemann Electric Co., 248 Magnetic Dr., Trenton, N. J. Phone: (609) 882-4800.

Booth 1438 (SA) Circle No. 287

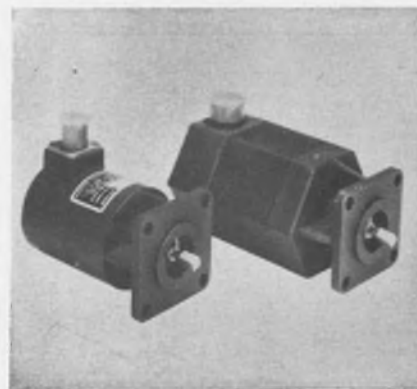

Induction motors

Rated up to 24 oz-in. full load torque at 3200 rpm, these induction motors operate from 15 or 208 Vac, 60 Hz, 1 or 3 phase. Input is 95 W max for a unit rated at 24 oz-in. and 3200 rpm, and lower for motors with lower torque ratings. Meeting MIL specs, these 5-lb motors measure 3.75 x 3.843 in.

Globe Industries, Inc., 2275 Stanley Ave., Dayton, Ohio. Phone: (513) 222-3741.

Booth 1013 (SA) Circle No. 562



8-channel recorder

The basic recorder of this thermal write/record system has driver amplifiers and power supply. Varying ac and dc signals can be conditioned by an attenuator, medium gain and medium low gain preamp. Driver amplifiers provide compensation and damping to the stylus motors. The amplifiers have signal limiting adjustable to 125% of full-scale deflection. Sensitivity is 25 mV to 500 V full scale, linearity is better than 1%, frequency response is dc to 150 Hz and calibrated zero suppression is ± 100 V max.

Consolidated Electrodynamics Corp., 360 Sierra Madre Villa, Pasadena, Calif. Phone: (213) 796-9381.

Booth 214 (HP) Circle No. 563

STEP IN THE RIGHT DIRECTION WITH KEARFOTT STEPPER MOTORS

The logical step is to think of Kearfott for a wide variety of permanent magnet and variable reluctance stepper motors.

You get — • High Speed • High Quality • High Reliability • Variety of Stepping Angles • Non-resonant VR types which need no external electrical or mechanical damping devices.

It's even more logical when you're looking for logic components. Ask for Kearfott's completely transistorized driver and

logic circuits — • Rugged • Compact • Lightweight • Easily Mounted • Wide Operating Temperature Range • Pulse Shapers and Inverters Available.

Or how about these special stepper motors, which are typical of Kearfott's forward thinking in design — • Separable Rotor & Stator Stepper Motor for Gimbal Drive Applications • Special Stepper Motor for Space Applications.

Now look at the wide variety of standard steppers we offer:

PERMANENT MAGNET AND VARIABLE RELUCTANCE STEPPER MOTORS

TYPE	SIZE	HOLDING TORQUE (in. oz.)	MAXIMUM STEPPING RATE (steps/sec.)	TOTAL POWER INPUT (watts)	WINDING RESISTANCE (ohms)	PHASING SEQUENCE TABLE NUMBER (for ccw rotation)	WEIGHT (oz.)	STEPPER MOTOR PART NUMBER	LOGIC-DRIVE CIRCUIT PART NUMBER
P.M. 90° Step Angle	5	.2	270	4.9	160	2	.7	CJ0 0191 750	C70 3531 301
	8	.6	320	5.2	600	1	1.5	CM4 0191 007	C70 3531 001
	8	.6	320	4.4	180	2	1.5	CM4 0191 012	C70 3531 301
	11	1.8	220	7.0	450	1	2.9	CR0 0191 750	C70 3531 001
	11	2.0	250	7.8	200	2	2.9	CR4 0191 002	C70 3531 302
	15	4.5	125	13.0	65	2	8.0	CT4 0191 001	C70 3531 302
P.M. 45° Step Angle	11	1.5	400	7.1	220	1	3.0	CR0 0193 750	C70 3531 001
	15	3.5	220	13.0	60	2	8.0	CT0 0193 750	C70 3531 302
	18	6.0	270	13.0	60	2	13.0	CV0 0193 750	C70 3531 302
V.R. 15° Step Angle	8	.5	1000	6.3	250	1	1.5	CM4 0192 001	C70 3531 104
	11	1.1	700	7.1	220	3	2.9	CR0 0192 750	C70 3531 201
	11	1.6	600	7.1	110	4	2.9	CR4 0192 001	C70 3531 402
	15	6.5	660	17.0	90	1	8.0	CT0 0192 750	C70 3531 103
	18	8.5	600	23.0	70	1	13.0	CV0 0192 750	C70 3531 103

NOTE: Operating voltage for all units is 28 volts dc. Temperature range for all motors is -54°C to +165°C (ambient + temp. rise). Duty for all units is continuous.

STEPPER MOTOR DRIVER AND LOGIC ELECTRONICS

PART NUMBER	OUTPUT SEQUENCE	CURRENT OUTPUT MAX./LEG (amp)	DC POWER REQ. (+ volts)	NEGATIVE BIAS REQ. (- volts)	INPUT PULSE POLARITY*	INPUT PULSE AMPLITUDE (volts)	INPUT PULSE RISE TIME (μ sec max.)	PULSE WIDTH (μ sec min.)	WEIGHT (oz.)	TEMPERATURE RANGE (°C)	TYPICAL KEARFOTT MOTOR
C70 3531 001	Table 1	.2	28	12	Negative	15 to 30	5	10	2.0	-55 to +125	CR0 0193 750 CM4 0191 007
C70 3531 002	Table 3	.2	28	15	Positive	2.3 to 15	10	10	1.8	-55 to +95	CR0 0192 750
C70 3531 004	Table 3	.5	28	None	Negative	3 to 15	5	10	2.8	-55 to +125	CR0 0192 750
C70 3531 101	Table 1	.2	28	12	Positive	2.5 to 6	5	10	3.0	-55 to +125	CR0 0193 750
C70 3531 102	Table 1	1.0	28	12	Negative	2.5 to 6	5	10	3.5	-55 to +125	Multiple Loading (e.g. up to 5 CR0 0193 750 in parallel)
C70 3531 201	Table 3	.2	28	12	Positive	2.5 to 6	5	10	2.2	-55 to +125	CR0 0192 750
C70 3531 103	Table 1	.5	28	12	Negative	2.5 to 6	5	10	3.5	-55 to +125	CT0 0192 750 CVO 0192 750
C70 3531 301	Table 2	.2	28	12	Negative	2.5 to 10	5	10	3.5	-55 to +125	CM4 0191 012
C70 3531 302	Table 2	1.0	28	12	Negative	2.5 to 10	5	10	4.5	-55 to +100	CT4 0191 001 CT0 0193 750
C70 3531 401	Table 4	.2	28	12	Negative	2.5 to 10	5	10	3.5	-55 to +125	Reduced Power (drives CR0 0192 750, for reduced torque applications)
C70 3531 402	Table 4	1.0	28	12	Negative	2.5 to 10	5	10	4.5	-55 to +100	CR4 0192 001
C70 3531 104	Table 1	.2	28	12	Positive	2.5 to 6	5	10	3.0	-55 to +125	CM4 0192 001

*Pulses with polarity reversed from that specified will also drive circuits, but with trigger occurring on trailing edge.

NOTES: 1. Units can be operated over a limited temperature range without applying a negative bias. Details on each unit will be supplied on request.
2. Units also available which do not require a negative bias supply. Part numbers available on request.

ELECTRICAL PHASING SEQUENCES

TABLE 1				TABLE 2				TABLE 3				TABLE 4					
Step	Yel.	Wht.	Red	Blk.	Step	Yel.	Blk.	Wht.	Red	Step	Red	Blk.	Yel.	Step	Red	Blk.	Yel.
1	0		0		1	0				1	0	0		1	0		
2	0			0	2		0			2		0	0	2		0	
3		0		0	3			0	0	3	0		0	3			0
4		0	0		4				0	4				4			
1	0		0		1	0				1	0	0		1	0		

"0" designates polarity of dc supply voltage.

Send for new stepper motor catalog and wall chart describing these motors in greater detail.

KEARFOTT PRODUCTS DIVISION

GENERAL PRECISION INC.

AEROSPACE GROUP
LITTLE FALLS, NEW JERSEY

ON READER-SERVICE CARD CIRCLE 96

AUGAT

Low Cost • High Performance • Wide Application

14 CONTACT DUAL-IN-LINE SOCKET

for testing and packaging Monolithic Circuits

Accepts packages with flat or round leads. Has large contoured entry holes for easy insertion. Gentle wiping action of spring contacts prevent lead damage.

Can be used in panel mount or printed circuit applications. Wire-wrap® termination also available.

Fast, easy, damage-free release of circuit. Unique ejector key, as integral part, speeds up testing programs. Simple extractor tool facilitates handling in close packaging production.

Unit has molded diallyl phthalate body with gold-plated, beryllium copper contacts. Dimensions: .8L x .5W x .37H. 16 and 20 DIL sockets under development.

Write for Data Sheet 166.

© Trade Mark Gardner-Denver Co.

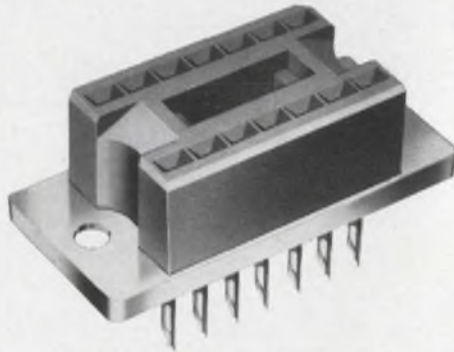

AUGAT INC.

31 PERRY AVE., ATTLEBORO, MASS. 02703

WESCON
Booth 1643

ON READER-SERVICE CARD CIRCLE 97

CONTROL SYSTEM AIR & SPACE



2-axis free gyro

As an inertial reference in environmental extremes, this torqueable 2-axis free gyro has high angular momentum-to-weight ratio. A $\pm 2^\circ$ gimbal freedom permits use of a momentum wheel larger than supporting gimbals. Fluid flotation is eliminated through use of ball-bearing suspension. Flex leads are used for power and signal transfer. Low gimbal mass results in minimum anisoelastic and bearing junction effects under high-G environments. Mass unbalance is less than $0.30^\circ/\text{minute}/G$ about each axis. The 12-in.³ package weighs 1 lb.

General Precision Inc., 1150 McBride Ave., Little Falls, N. J. Phone: (201) 256-4000.

Booth 2155 (SA) Circle No. 328

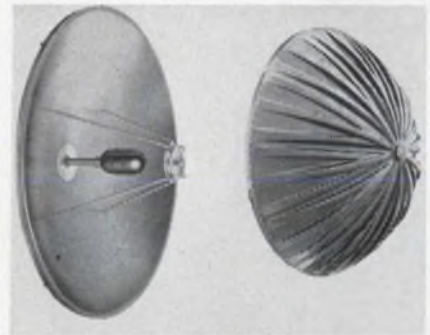

4-port antenna

A 4-port (dual-frequency/dual polarized) cassegrain antenna provides 5925 to 6425-MHz and 10.7 to 11.7-GHz coverage, with horizontal and vertical polarization modes. Models are available in both 6 and 10-ft. sizes. Features include low side lobe level, low loss radome design, high cross-polarized isolation, dual band/dual polarized capacity and center mounted feed.

Jerrold Electronics Corp., 401 Walnut St., Philadelphia. Phone: (215) 925-9870.

Booth 233 (HP) Circle No. 274

America's Foremost

COMPACT

HIGH VOLTAGE POWER SUPPLIES

Unregulated—Series "S"
Output: 1 KV to 60 KV up to 10 MA DC
input: 115 V, AC—60/400 cycles
From Stock

Regulated—Series "TRHV"
Output: 1 KV to 30 KV up to 5 MA DC
Input: 115 V, AC—60/400 cycles
From Stock

Both Del models represent the ultimate in quality. Their design and manufacture incorporate only the finest materials and workmanship to assure reliable and dependable service.

Other instrumented power supplies available up to 250 KV ratings.

WRITE FOR DATA

Applications

- Missile Ground Support Equipment
- Radar Displays
- Image Intensifiers
- Storage Tubes
- Electron Optical Devices
- Nuclear Applications
- CRT Applications
- Electrostatic Precipitation Equipment



DEL ELECTRONICS CORPORATION

250 E. SANDFORD BLVD., MOUNT VERNON, N.Y. • (914) 699-2000
Visit us at Booth 1211 at WESCON

ON READER-SERVICE CARD CIRCLE 98



FROM THE INDUSTRY'S MOST COMPREHENSIVE LINE...

OPERATIONAL AMPLIFIER 'FIRSTS' BY ZELTEX

100 Volt Chopper Stabilized Diff Amp □ 150 Volt Output Op Amp in Production □ FET Op Amp in Production □ $0.5 \mu\text{V}/^\circ\text{C}$ Drift for under \$200 □ 100 Volts Output for under \$100 □ 100 Volt low-error multiplier □ 100 Volt low-error sine/cos Generator

Zeltek announces industry firsts time-after-time... because of a company-wide dedication toward filling specific industrial needs. Zeltek is also well known to its customers for helping them out of tight design spots with modifications of existing standard units.

These, in turn, often become standards. Whatever your operational amplifier or computer element requirements... check with Zeltek first. The Zeltek products briefly described below are just a small sample. Write for our latest short-form catalog.



MODULAR OP AMP MODEL 145 with low noise chopper features $0.5 \mu\text{V}/^\circ\text{C}$ and $1 \text{ pa}/^\circ\text{C}$ drift, 100 $\text{V}/\mu\text{sec}$ slew rate and 10 V, 25 ma output. All in a new and rugged diecast aluminum case.



150 VOLT OP AMP MODEL 140B-HV with chopper allows 100 V rms D/A conversion and gives 50 ma output at 100 V level without booster.

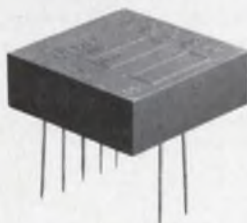

FET DIFFERENTIALS - 132 SERIES offers 10,000 megohm input impedances, 100 picoamp input current, and $10 \mu\text{V}/^\circ\text{C}$ drift in convenient $0.4''$ high flat pack at low cost.

BOOSTER MODEL B-10 increases the output of standard amplifiers to 200 ma for driving capacitive or low resistance loads.

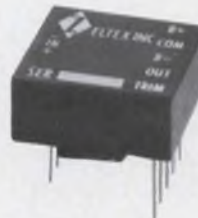

ECONOMY DIFFERENTIAL OPAMP MODEL 115D is designed for medium performance applications where dependability is important. A variety of units available with prices starting from \$19.



ELECTRONIC MULTIPLIER MODEL 503 is typical of a variety of Zeltek non-linear computer elements offering state-of-the-art performance. This one has a maximum static error of 25 mV over the 100 Volt range. It is available in card form or as a completely wired system.



CHOPPER STABILIZED DIFFERENTIAL AMPLIFIER MODEL 111 offers very low drift and high gain in differential form. Six standard versions available with output ranges from 10 V to 100 V.



ZELTEX, INC.
1000 Chalomar Road
Concord, California 94520
Phone (415) 686-6660

ON READER-SERVICE CARD CIRCLE 99



960-bit card reader

A static card reader is capable of reading 960 bits from a 12 x 80 IBM card. Remote electrical contacts are actuated by mechanical sensing of the punched hole. Maximum switching voltage is 100 V resistive, power dissipation is 50 W and current carrying capacity per switch is 1.5 A static. Capacitance between any two switches is 1 pF max and across open contacts 0.5 pF max at 1 kHz.

Sealectro Corp., Mamaroneck, N. Y. Phone: (914) 698-5600.
Booth 1024 (SA) Circle No. 301

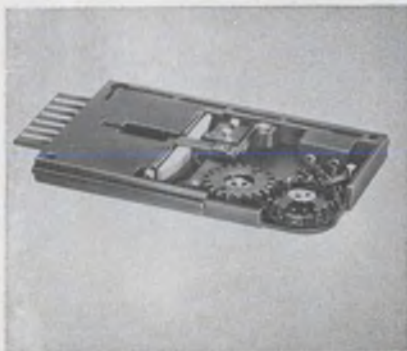

Count-printout units

The "Uniprint" module and platen are companion components for printing readout counting systems. Count speed for the module is 50 Hz. Maximum impact force on the platen is 0.8 in.-oz and impact time is 10 ns. The module has a minimum count life of 10^6 and print life of 10^7 . The components operate from 12- or 24-Vdc pulses $\pm 10\%$.

Durant Mfg. Co., 693 N. Cass St., Milwaukee. Phone: (414) 271-9300.
Booth 2112 (SA) Circle No. 302

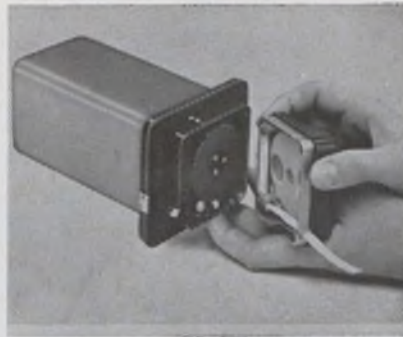

Alphanumeric printer

A compact 60-in.³ alphanumeric strip printer meets MIL-E-5400 and E-5272. Printout capacity is 9000 characters per 75-ft spool of tape. The printer has a full 64-character selection. Printing speed is up to 30 characters per second. Input is 6-bit parallel BCD. Input power is 28 Vdc plus dc logic voltages. Data are printed on 5/16-in. pressure sensitive tape.

Price: \$1900. Clary Corp., San Gabriel, Calif. Phone: (213) 287-6111.

Booth 2052 (SA) Circle No. 277



Photoelectric keyboard

This photoelectric keyboard has application in CRT terminals for remote inquiry stations and special computer input/output stations. The 3-row communications keyboard generates a 5-bit Baudot code and the 4-row keyboard with 60 keys and a space bar generates an 8-bit ASCII code. The 4-bank keyboard handles any 8-bit code assignment scheme and any keytop character assignment with a max of 3 independent shift positions.

Price: from \$100. Friden Inc., 2350 Washington Ave., San Leandro, Calif. Phone: (415) 357-6800.

Booth 2036 (SA) Circle No. 543

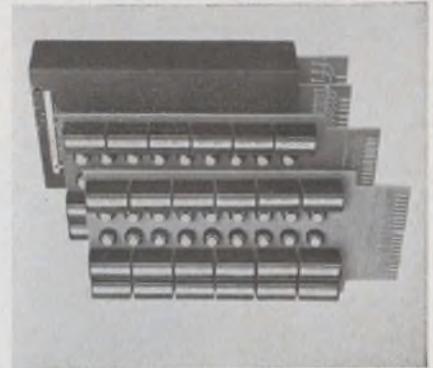

Digital/rotary converter uses inductive dividers

Accuracy of 0.1 ppm, equivalent to over 11 binary bits, is characteristic of this digital-to-shaft-position converter. A method for switching ac inductive dividers with semiconductor switches is employed. The dividers operate at low impedance levels and are virtually immune to errors caused by strays. The low output impedance permits appreciable output currents to be supplied without undue loading errors. Up to 1/2 A can be fed into 10- Ω loads without intermediate amplification. The same unit can power two standard resolver- or synchro-positioners simultaneously.

The resolvers are electromechanical transducers whose shaft angle varies in response to the ratio of two input voltages applied to mutually perpendicular coils. The resolver is connected to digital commands by the two dividers. The dividers are continuously 90° out-of-phase.

This conversion is entirely passive and requires no loop-closing feedback controls. Open-loop torque developed by the shaft is adequate to position light-duty mechanical loads. This method also lends itself to closed-loop position control where power applications require high torque and position accuracy.

The converter is an 11-bit interface unit with logic, switching and drivers mounted on three 7-1/2- x 4-1/2-in. PC cards. Resolver/synchro output is 400 Hz and conversion time is 1 ms max. Output accuracy is 0.1° no load. Digital signals with up to 18-bit resolution can be handled.

P&A: \$1500; stock to 90 days. North Atlantic Industries, Inc., 200 Terminal Dr., Plainview, N. Y. Phone: (516) 681-8600.

Booth 329 (HP) Circle No. 503

An Eight-Second Review.

- 8** CDE makes timers and time delay relays.
- 7** With rugged solid state circuitry.
- 6** repeatability of $\pm 2\%$.
- 5** 25 millisecond reset time, maximum.
- 4** 200 millisecond to 300 second range.
- 3** high volumetric efficiency.
- 2** design flexibility and
- 1** long, dependable life built right in.
- 0** standard stock ratings available.

If you like the subject, do some research with the CDE field engineer or authorized distributor in your area. He will gladly discuss your application requirements at no obligation.

CDE **CORNELL-DUBILIER**

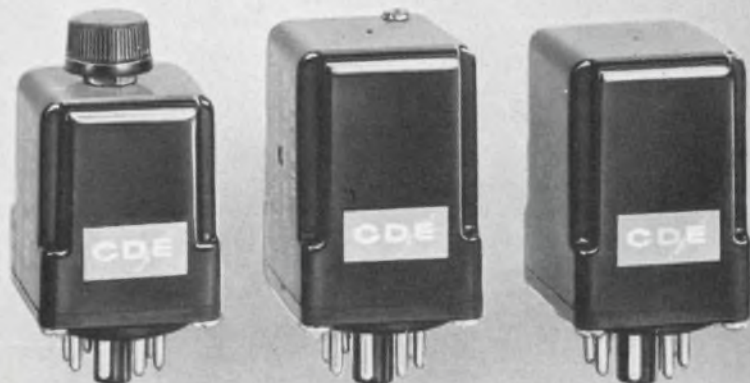

STANDARD FREQUENCY RECEIVERS

FREQUENCY STANDARDIZATION TO THE
NATIONAL BUREAU OF STANDARDS



Model T-60 60 KHZ Time Code Receiver
Round The Clock WWVB 60 KHZ Binary Time Code Broadcasts • Most Accurate Time Signal Available • Can Be Recorded Continuously
Radio Station WWVB is broadcasting complete time information using a level shift carrier time code (10 db level changes). This code, which is binary coded decimal (BCD) is broadcast continuously and is synchronized with the 60 khz carrier signal. \$480.00

Model T-60A Rack Model (3½" H x 19" W x 5" D)



Model SR-60 Price: \$850.00
Model SR-60. WWVB-60 khz. Will calibrate any local standard up to 5-10¹⁰ within a short period. Can be easily operated by any technician and performs in any part of the Continental United States.



Model SFD-6R Modular Construction:
A complete system for distribution of standard frequency throughout a plant. All solid State—fail safe—reasonably priced. Price depends upon Modules selected (\$90.00 each). Several Modules available.



Model WVTR Mark II All Silicon Transistor
Five different models of Receivers for WWV and WWVH are available. They receive all frequencies transmitted by WWV and are all crystal controlled double conversion superheterodynes. \$590.00

Special Antenna Assemblies for both VLF and HF are in stock.

Model WWVT \$590.00

Mark II
All Silicon Transistor
Over All Size
7¼" x 9½" x 5"
Approx. Weight
7 lbs.



Model 45 \$98.50
A pocket size battery powered Time Base Calibrator, complete with internal battery.

Send for complete specifications. Prices and specifications subject to change without notice. F.O.B. Woodland Hills, Calif.

SPECIFIC PRODUCTS

P.O. Box 425 / 21051 Costanzo Street
Woodland Hills, California
Area Code: 213 340-3131



BOOTH 127 (Hollywood Park)

ON READER-SERVICE CARD CIRCLE 100

U162

DATA PROCESSING

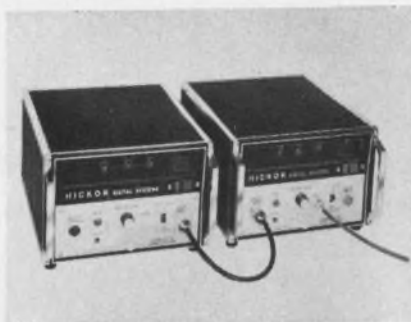

Event counter plug-in

This solid-state event counter and slave plug-in extends the manufacturer's digital measuring system. A single plug-in/main frame combination provides a 3-digit display and cascade combinations provide a 6-, 9-, or 12-digit display. Up to 10⁶ pulses per second can be counted. Operation may be remotely controlled to "start count," "stop count," "resume count" or "reset." Sensitivity is 100 mV.

P&A: \$75; September. Hickor Electrical Instrument Co., 10514 Dupont, Cleveland. Phone: (216) 541-8060.

Booth 319 (HP) Circle No. 353

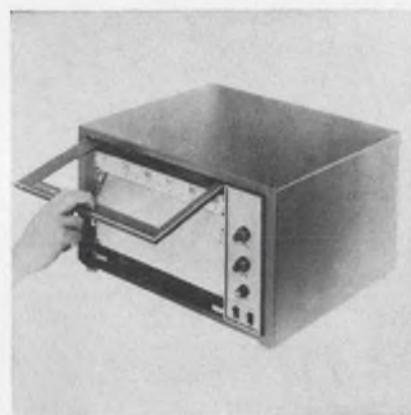

Strip chart recorder

Using a 12-in. wide strip chart, series 550 recorders have a two-position (30° and 45°) tilt-out chart plate, a removable chart-leading mechanism and plug-in range spool cards. The amplifier is solid state and the measuring circuit is isolated and guarded. Accuracy is ±0.25% of span or ±10 μV, dead-band is less than 0.1% of span and minimum span is 1 mVdc.

The Bristol Co., Waterbury, Conn. Phone: (203) 756-4451.

Booth 1305 (SA) Circle No. 262



Serial entry printers

A choice in data input and print command solenoid voltages (24 or 48 V) is offered in these serial entry printers. These units are compatible with systems requiring up to 8 columns printing capacity such as nuclear instrumentation readout systems, flow-meters, digital counters and production scales. Drive motor voltage requirement is 115 Vac or 115 Vac/dc.

P&A: \$335 to \$385; 45 days. Victor Comptometer Corp., 3900 N. Rockwell St., Chicago. Phone: (312) 539-8210.

Booth 2042 (SA) Circle No. 332



Electronic calculator

This calculator has an automatic floating decimal system. The capacity of the 240SR enables it to handle computations involving two 12-digit numbers, calculating the 24 most significant digits. With the automatic decimal, this feature gives the product register a 52-place capacity. Computations are displayed along with the three visible working registers on a CRT.

Price: \$2395. SCM Corp., 410 Park Ave., New York. Phone: (212) 752-2700.

Booth 2070 (SA) Circle No. 549



Magnetic core counters

Highly stable magnetic core counters, offering multi-function output configurations, provide low power drain since they are non-conducting during non-counting periods. They are immune to random noises and retain memory even with total power loss. The counters operate on 18 to 32 Vdc.

P&A: from \$120; stock. Agastat Div. of ESNA, 1027 Newark Ave., Elizabeth, N. J. Phone: (201) 352-2900.

Booth 1361 (SA) Circle No. 539



Impulse counters

Employing the same solenoid mechanisms for counting and resetting, these 2- and 3-digit reset impulse counters are self-returning to zero. A reset start signal of 12 to 125 ms initiates the reset cycle, complete in 160 ms and signalled by a switch opening for each digit. Maximum power consumption is 4 or 6 W for the 2 or 3 digit counter. Counting rate is 25 Hz.

Presin Co. Inc., 226 Cherry St., Bridgeport, Conn. Phone: (203) 333-9491.

Booth 2057 (SA) Circle No. 288

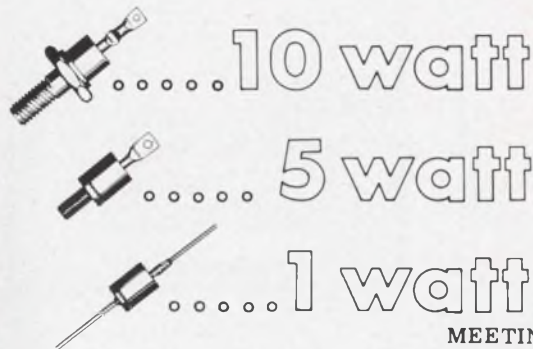

...ZENER DIODES

MEETING MIL. SPECIFICATIONS
THREE ADDITIONAL QUALITY ITEMS
WITH OFF THE SHELF DELIVERY AT A
MINIMUM COST FROM...



TEN WATT

1N1351A - 1N1375A
1N2971B - 1N3005B
1N3007A - 1N3015A

MILITARY TYPES
JAN1N2972B - JAN1N3004B

FIVE WATT

1N1891 - 1N3105
1N4016B - 1N4042B

ONE WATT

1N1875 - 1N1888
1N3098 - 1N3101
1N3017B - 1N3044B
1N3045A - 1N3051A

MILITARY TYPES
USN1N3017B - USN1N3043B



DIVISION OF COMPONENTS, INC.
3540 WEST OSBORN ROAD / PHOENIX, ARIZONA 85019
PHONE: 602-272-1341

VISIT US AT BOOTH 1107,08, WESCON

ON READER-SERVICE CARD CIRCLE 101

NEW BLILEY COMPONENT OVENS

WITH PROPORTIONAL
TEMPERATURE CONTROL



New type BPCO ovens maintain cavity temperature within $\pm 0.1^\circ\text{C}$ with solid state noise-free circuitry. Ovens mount flat on PC board and provide eight wire lead connections for components.

STANDARD MODELS

Model	Heater	Cavity Size
BPCO 30-1	27VDC	1.25 cubic inches
BPCO 31-1	12VDC	1.25 cubic inches
BPCO 40-1	27VDC	2.25 cubic inches
BPCO 41-1	12VDC	2.25 cubic inches

Request Bulletin 544 for complete information

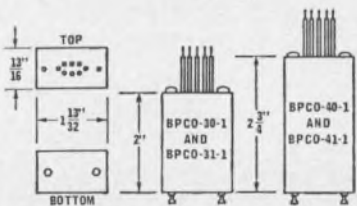

Bliley If you buy quality

BLILEY ELECTRIC COMPANY
Union Station Bldg., Erie, Pennsylvania

DATA PROCESSING

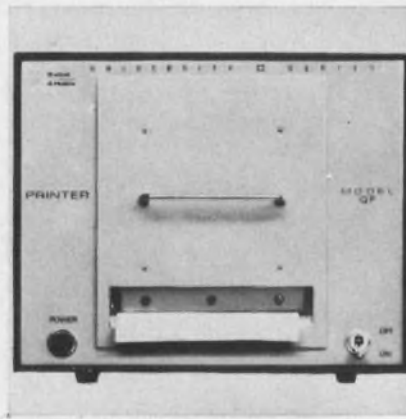

Digital printer

This digital printer has 12-column parallel input printer. Each column is capable of printing 0 to 9. The input code is BCD 1-2-4-8 with a printing rate of 2 lines/s max. An available multiplexer option permits two 12-digit instruments to be printed out.

Baird-Atomic, 33 University Rd., Cambridge, Mass. Phone: (617) 864-7420.

Booth 101 (HP) Circle No. 331



Digital tape system

A number of input/output logic levels is available with this digital system. Both horizontal and vertical mountings of the transport are available. Operate time is 10 seconds max. With absolute straight-line loading, the transport of the DR-3000 operates at 200, 556 or 800 bits/in. Dual capstans with positive drive preclude tape slippage and eliminate tape contact and wear in the storage area.

Consolidated Electro-dynamics Corp., 360 Sierra Madre Villa, Pasadena, Calif. Phone: (213) 796-9381.

Booth 214 (HP) Circle No. 533



Desk-top computer

Data storage registers and program storage have been added to the manufacturer's basic computer. The extended system can handle word lengths up to 24 decimal digits, and handle techniques such as branching, looping and conditional transfer. Additional elements consist of a punched card programmer, patch board programmer, supplemental memory unit and peripheral input keyboard. The programmer provides storage for up to 512 program steps. In addition to the 72-decimal digits provided by the arithmetic registers, 648 decimal digits of storage are available.

Wyle Labs., 133 Center St., El Segundo, Calif. Phone: (213) 322-1763.

Booth 2031 (SA) Circle No. 524



Bidirectional counter

An internal supply for powering remote pickup heads is featured in this bidirectional counter. The CF-400R accepts add/subtract information from two different sources, from the same source on separate lines or from quadrature signals. It is available with 4, 5 or 6 wide-angle nixie displays with polarity sign. The unit requires 105 to 125 V rms, 50 to 60 Hz, 25 W. The internal supply affords ± 6 or ± 12 Vdc.

P&A: \$995; 4 wks. Anadex Instruments Inc., 7833 Haskell Ave., Van Nuys, Calif. Phone: (213) 782-9527.

Booth 208 (HP) Circle No. 518



Thermal writing recorder

Two channels of analog information are recorded from dc to 125 Hz on 50-mm-wide channels by this recorder. The 36-lb unit with heated stylus can be used with or without attenuator plug-ins for high-level signals or with pre-amp plug-ins for low-level signals. Frequency response is dc to 70 Hz ± 1.5 dB at 50-mm amplitude and dc to 125 Hz ± 2.0 dB at 10-mm.

P&A: \$1165; 60 days. Consolidated Electrodynamics Corp., 360 Sierra Madre Villa, Pasadena, Calif. Phone: (213) 796-9381.

Booth 214 (HP) Circle No. 525

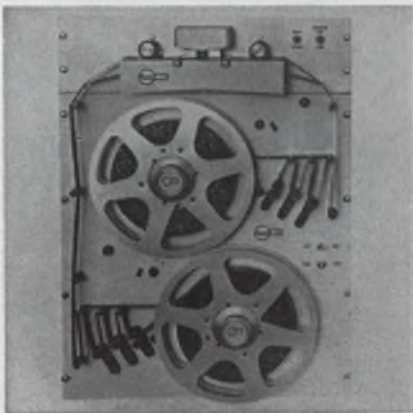

Paper tape spooler

This 1000-character/s paper tape spooler provides full proportionate servo operation of the reeling speed. Models are available with up to 10-1/2-in. diameter reels. High speed bidirectional rewind is independent of the associated reader. The unit operates on 50 to 400 Hz, 115-V input over a range from 0 to 70°C.

Availability: 8 wks. Ex-Cell-O Corp., Rheem Electronics Div., 5250 W. El Segundo Blvd., Hawthorne, Calif. Phone: (213) 772-5321.

Booth 2005 (SA) Circle No. 531

NEW CAPACITOR TESTER SAYS EXACTLY WHAT IT MEANS



MODEL 5340 DIGITAL CAPACITOR TESTER

- Measures true series capacitance
- Direct digital display with long-life Nixie® tubes
- Tests capacitance, leakage, DF, and ESR
- Test frequencies of 120 cps and 1 kc
- Internal dc bias supply with electronic current limiting

The dual-frequency 5340 provides an exceptionally flexible instrument for accurately measuring a wide range of capacitance, leakage, dissipation factor and equivalent series resistance values. Results (in picofarads, nanofarads, microfarads) are displayed immediately on a 4-digit Nixie® readout, with a separate 3-digit readout of DF or ESR. Five terminal guarded measurements prevent stray capacitance and lead resistance errors. A 25% over-range capability facilitates test operation procedures. Since capacitors are always specified in terms of series capacitance by the manufacturer, direct series capacitance measurements on the Model 5340 DCT are therefore much faster and easier. No need for conversion formulae. No table look-ups. Reduced operator error. Priced at \$4500.00. Single frequency capacitor testers from \$1995.00.

For complete information, including a new 4-page technical paper entitled "Theory and Application of Capacitance Measurements", contact the Micro Instrument representative near you or write directly to us.



12901 Crenshaw Blvd., Hawthorne, California 90250
Phones: (213) 679-8237 & 772-1275/TWX (213) 647-5133

ON DEMONSTRATION AT WESCON—HOLLYWOOD PARK—BOOTH 133

ON READER-SERVICE CARD CIRCLE 103

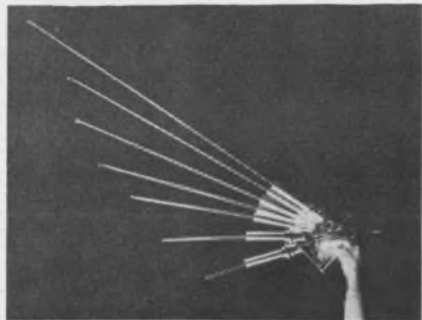

Self-generating antenna pops-up from coil

A self-erecting tubular structure for antennas, probes and supports is available in lengths up to 100 ft. When retracted, the tubes are stored as a rolled-up coil no taller than the width of the strip from which they are made. When controlled erection and retraction are required, maximum dimension of the stored tubes and guide members is about 2-1/2 times material width. There are two forms of the basic design. In one, the material is compressed into a cavity to form a flat coil. The other stores the material on a drum, which, when allowed to revolve, generates the structure progressively. Speed of erection may be governed by an escapement, centrifugal or friction devices or an electric motor. The tubular structures are designed for use as antennas in portable communications equipment, in unattended radio applications, citizens' band and amateur radios and rocket telemetry.

Ametek Inc., Hunter Spring Div., Hatfield, Pa. Phone: (215) 822-2971.

Booth 649 (HP) Circle No. 502

NBS frequency receiver

Calibration of local equipment to the accuracy of the primary time and frequency standards of the NBS radio stations WWV and WWVH is accomplished by this all-silicon transistor, crystal-controlled receiver. Units have double-shift superheterodyne, ceramic filters and 1- μ V sensitivity. Model WVTR measures 3-1/2 x 19 x 5-in.

Specific Products, 21051 Costanzo St., Woodland Hills, Calif. Phone: (213) 340-3131.

Booth 127 (HP) Circle No. 316



One micron laser system

Model 513 "Biolaser" provides a flux density on stage of up to 10^4 joules/cm². The instrument contains a high-intensity monochromatic source that produces a coherent beam which can be focused to spot sizes as small as one micron. The X-Y control permits precise positioning of the laser beam on the specimen. Spot size is varied by changing the power of the microscope objectives.

TRG Control Data Corp., Rte. 110, Melville, N. Y. Phone: (516) 531-0600.

Booth 178 (HP) Circle No. 350

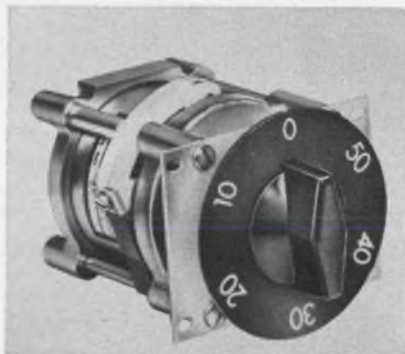

Turret attenuators

From dc to 1200-MHz, these units have attenuation of 0 to 50 dB. Model ATV-50 ranges from 0 to 50 dB in 10-dB steps with accuracy of ± 0.5 dB at 1.2 GHz. Model ATV-9 ranges from 0 to 9 dB in 1-dB steps and model ATV-1 ranges from 0 to 0.9 dB in 0.1 dB steps. Typical insertion loss at 1.2 GHz is 0.1 dB max.

Price: \$195 to \$275. Jerrold Electronics Corp., 401 Walnut St., Box 1467, Philadelphia. Phone: (215) 925-9870.

Booth 233 (HP) Circle No. 534



Balanced mixers

Series 20800 balanced mixers use miniature, easily replaceable diodes. Dc returns are included. The IF output capacitance is approximately 12 pF per output. Finish is gold plate. Models are available from 1 to 12.4 GHz in octave bands.

P&A: \$285; 4 wks. Omni Spectra Inc., 19800 W. Eight Mile Rd., Southfield, Mich. Phone: (313) 444-8890.

Booth 2076 (SA) Circle No. 346



Coax diode limiter

A range of 0.1 to 8 GHz is covered by this coax diode limiter. The passive semiconductor device provides receiver protection over a multi-octave range with insertion loss of 1.5 dB max, flat leakage of 100 mW max and recovery time of 100 ns max. Peak RF input power is 20 W and average RF input power is 0.2 W. The 2-oz receiver protector is designed for ECM, broadband tracking and navigational radar or ferrite duplexing networks.

Microwave Assoc., Inc., Burlington, Mass. Phone: (617) 273-3000.

Booth 2065 (SA) Circle No. 378

Tektronix is building spectrum analyzers

↓
smaller

ONLY 7" HIGH x 12" WIDE x 22" DEEP

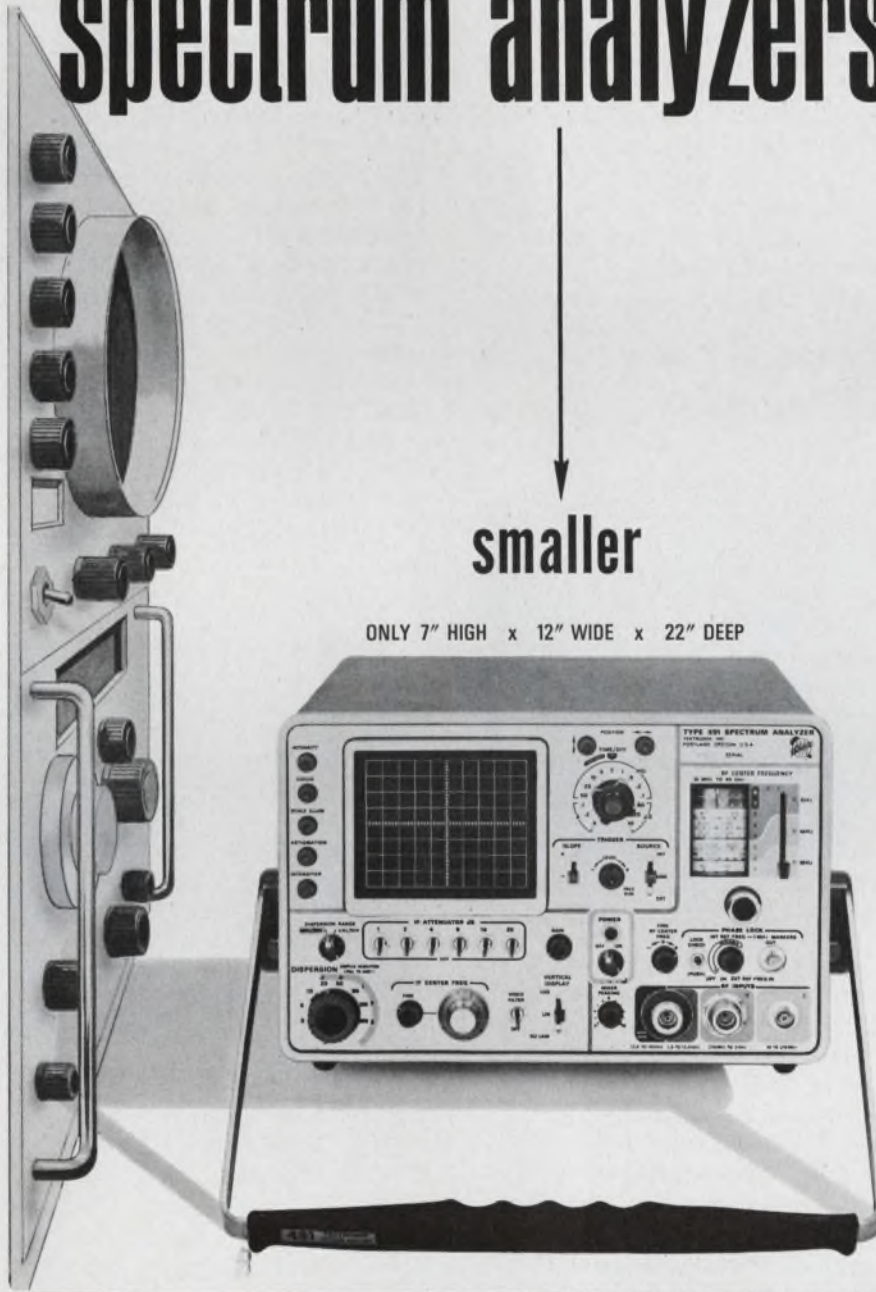

it's the new Type 491 10 MHz - to - 40 GHz

You can judge its performance by these features . . . internal phase lock for stable displays even at 1 kHz/div dispersion . . . resolution range of 1 kHz to 100 kHz coupled to calibrated dispersion for operational simplicity . . . dispersion range of 10 kHz (1 kHz/div) to 100 MHz (10 MHz/div) for direct readings of relative frequency from the display . . . CW sensitivity of -110 to -70 dBm depending on frequency . . . and display flatness of ± 1.5 dB over 100 MHz dispersion.

With oscilloscope-type triggering and sweep circuitry, you can trigger from internal, external or line sources, and have wide choice of sweep rates from 0.5 s/div to 10 μ s/div in a 1-2-5 sequence. Other features include EMI (RFI) suppression . . . trace intensification of high speed segments of the waveform . . . camera compatibility with the Tektronix Type C-30 for easy, high quality photographs . . . bright display, small spot size, long persistence (P-7) phosphor on a new 4-inch rectangular CRT with 8x10 div (1 div equals 0.8 cm) display . . . and DC-coupled recorder output.

The Type 491 is only 7" high by 12" wide and 22" deep, weighs less than 40 pounds and requires only 55 watts. Yet it has the broad frequency range and high performance you need for most applications. And setup is easy even at waveguide frequencies—just mount one of the external waveguide mixers to your source and couple it to the Type 491 with a flexible cable.

As shown, the carrying handle adjusts for various tilt positions and provides a sturdy support stand. The front panel cover serves as a storage case for the included accessories such as adapters, cables, waveguide mixers and coax attenuators. And the rugged construction of the Type 491 lets you carry it on the toughest industrial and military assignments.

Type 491 (with accessories) . . . \$4200

U.S. Sales Price f.o.b. Beaverton, Oregon

Tektronix, Inc.



For complete information, contact your nearby Tektronix field engineer or write:
Tektronix, Inc., P.O. Box 500, Beaverton, Oregon 97005

SEE THE LATEST TEKTRONIX INSTRUMENTS AT WESCON — BOOTH 428-433

ON READER-SERVICE CARD CIRCLE 104

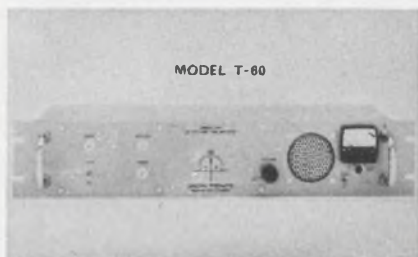

Time code receiver

Model T-60 time code receiver receives WWVB 60-kHz binary time code broadcasts. Radio station WWVB broadcasts time information using a level shift carrier time code (10-dB level changes). This BCD code is broadcast continuously and is synchronized with the 60-kHz carrier signal. The station identification is provided by a phase shift of 45° forward at exactly 10 minutes after each hour and the reverse shift at exactly 15 minutes after each hour. The Schmitt BCD output can be completely automated for continuous monitoring of real time and time interval information.

P&A: \$480; 30 to 40 days. Specific Products, 21051 Costanzo St., Woodland Hills, Calif. Phone: (213) 340-3131.

Booth 127 (HP) Circle No. 317

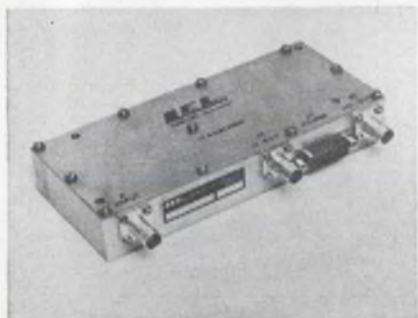

IF amplifier

For microwave receiving systems, this amplifier furnishes outputs at IF and video. Center frequency is 30 or 60 MHz, bandwidth is 3 or 8 MHz and input is from a 50-Ω source or microwave mixer. IF gain is 75 dB and gain to video output is 80 dB. Maximum input for linear operation is 10 dBm. External agc range is 50 dB and noise figure is 7 dB max.

P&A: \$375; 2 wks. Varian Assoc., LEL Div., Akron St., Copiague, N. Y. Phone: (516) 264-2200.

Booth 1349 (SA) Circle No. 269

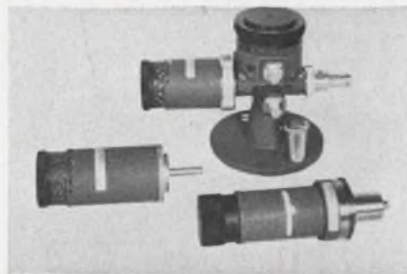

Standing wave detector

Replacing coax slotted lines, this standing wave detector measures vswr and impedance from 20 MHz to 2.3 GHz in coax systems. The detector consists of a coax tee junction, pickup probe assembly and a normalizing calibrated susceptance. Frequency ranges available are 20 to 100 MHz, 100 to 1000 MHz, 0.95 to 2 GHz and 0.95 to 2.3 GHz. Ranges can be extended by changing the calibrated susceptance.

Price: \$695 to \$895. PRD Electronics, Inc., 1200 Prospect Ave., Westbury, N. Y. Phone: (516) 334-7810.

Booth 459 (HP) Circle No. 290



Power line RFI filters

Power line filters are offered in three types of assemblies. Series GFP7100 is a filtered panelboard assembly with filters, an RF-tight compartment and shielded circuit breaker panelboard for distribution, series GF6425 is for use in shielded rooms and in non-distribution installation and series GFP7101 is a shielded panelboard assembly without RF filters. All are rated for 30 to 200 A, 120 to 250 V single or three-phase. Insertion loss is 100 dB over a 14-kHz to 100-MHz range.

Genisco Technology Corp., 18435 Susana Rd., Compton, Calif. Phone: (213) 774-1850.

Booth 1128 (SA) Circle No. 545

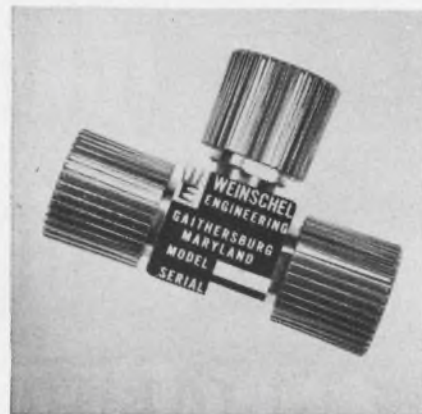

Coax power dividers

Covering dc to 18 GHz, series 1506 power dividers use a resistive film deposited on a ceramic base. The balance of power division on the two output arms is 0.5 dB. Stainless steel N connectors or 7-mm connectors are provided. Vswr is 1.25 max from dc to 10 GHz and 1.35 max from 10 to 18 GHz. Maximum asymmetry of power division is 0.2 dB to 4 GHz, 0.35 dB to 10 GHz and 0.5 dB to 18 GHz.

P&A: \$150 to \$285; Nov. Weinschel Engineering, Gaithersburg, Md. Phone (301) 948-3434.

Booth 189 (HP) Circle No. 383



230- to 870-MHz receiver

A fully transistorized single-conversion receiver covers 230 through 870 MHz. Model 9905 provides facilities for the reception of fm and am signals. Am bandwidths are 1 and 6 MHz and fm bandwidth is 1 MHz with a discriminator to accept deviations of up to 250 kHz. The unit operates from 12 Vdc for field use as well as from 110 Vac 60 Hz.

P&A: \$1365; September. Marconi Instruments, Englewood, N. J. Phone: (201) 567-0607.

Booth 370 (HP) Circle No. 555

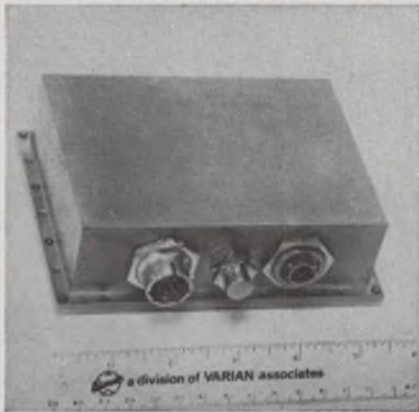

S-band transmitter

Rated at 20-W output, this S-band telemetry transmitter operates at 2.2 to 2.3 GHz. Frequency stability is $\pm 0.0025\%$ provided through a crystal-referenced afc servo loop. Efficiency is more than 13%. The system includes an exciter, power amplifier and pre-regulated dc to dc converter. Spurious radiation is avoided by generation of RF power directly at the output frequency.

Varian Assoc., Eimac Div., 301 Industrial Way, San Carlos, Calif. Phone: (415) 592-1221.

Booth 1349 (HP) Circle No. 270

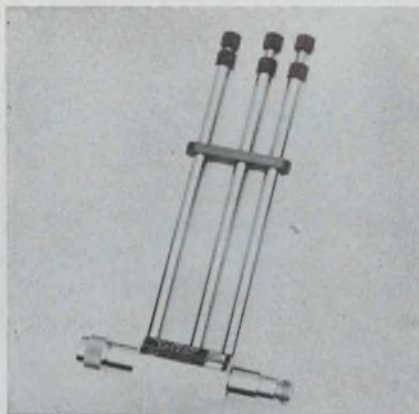

Coax triple-stud tuner

For operation from 0.9 to 12.4 GHz, these coax triple-stud impedance tuners have N-type connectors. They match lead impedances or introduce a mismatch into a matched system. Heat-treated beryllium-copper fingers are used. Nominal impedance is 5Ω and vswr is up to 5 min, correctable to 1.01. Insertion loss is 0.2 dB max (matched system).

P&A: \$142.50 or \$157.50; stock to 4 wks. Maury Microwave Corp., 10373 Mills Ave., Montclair, Calif. Phone: (714) 626-0441.

Booth 2035 (SA) Circle No. 379

Organized for your purpose and satisfaction!

NEW SUBMINIATURE SWITCH SERIES

Provision for Illumination
with Replaceable Lamp



Unlimited Code
Capability

1-2-2-4
(COM) DECIMAL BCD
DIODE ETC.

Designed to Meet or Exceed
Requirements of MIL-S-22710

6000
Family
--Sealed--

5000
Family
--Unsealed--

Cable Termination



6100 SERIES

P. C. Board Termination



5300 SERIES

Wire Loop Termination



6200 SERIES

EECoSWITCH[®]
ROTARY THUMBWHEEL SWITCHES

*A leader
at any level!*

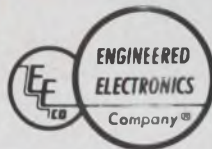

Digital Circuit Modules ■ Custom Welded and Packaged Circuits ■ Systems
Area Phone Numbers: Boston (617) 275-0540 ■ New York City (201) 444-3220
Washington, D.C. (301) 779-3636 ■ San Francisco (408) 253-5951

ENGINEERED ELECTRONICS Company
1441 EAST CHESTNUT AVENUE, SANTA ANA, CALIFORNIA 92702
PHONE: (714) 547-5651 TWX: 714-531-5522 CABLE: ENGELEX

See EECo at Wescon, booths 2016-2019

ON READER-SERVICE CARD CIRCLE 105

INDUSTRIAL DESIGN AWARDS

Blue-ribbon products vie for honors

Four experts sized up 160 Industrial Design entries. These 18 are the finalists in this eighth annual awards competition. All products will be on display at the show, where the final winners will be announced.



Videotrainer for school use contains video tapedeck, audio and video amplifiers, pop-up monitor and plenty of room for mikes, tripod, splicer and cables. Everything folds into a unit which can be secured with a single lock.

Company: Ampex Corp.
Designers: Harry K. Matsuda, Mervin W. LaRue, Edward R. Bach

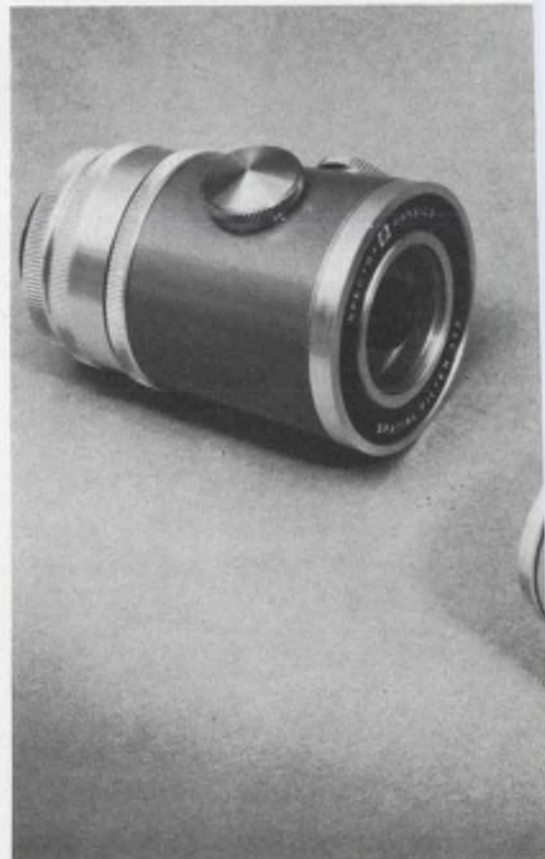

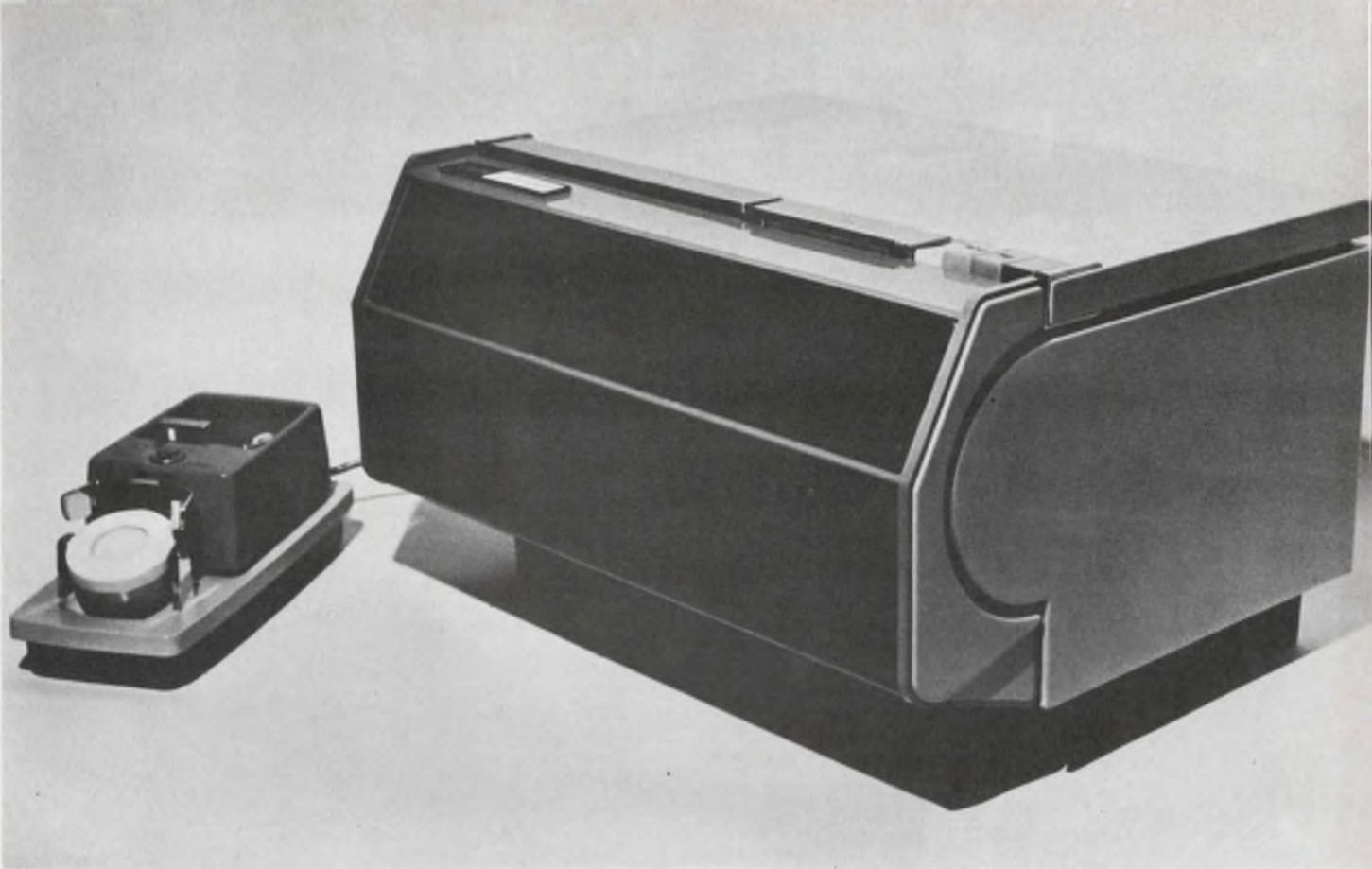

Xerox Magnafax telecopier transmits via existing telephone lines. The 110-V ac, 46-lb portable has its own acoustic coupler. Scanner and printer are positioned by a 322-tooth gear synchronization clutch.

Company: Latham, Tyler, Jensen, Inc.
Designer: Donald L. McFarland

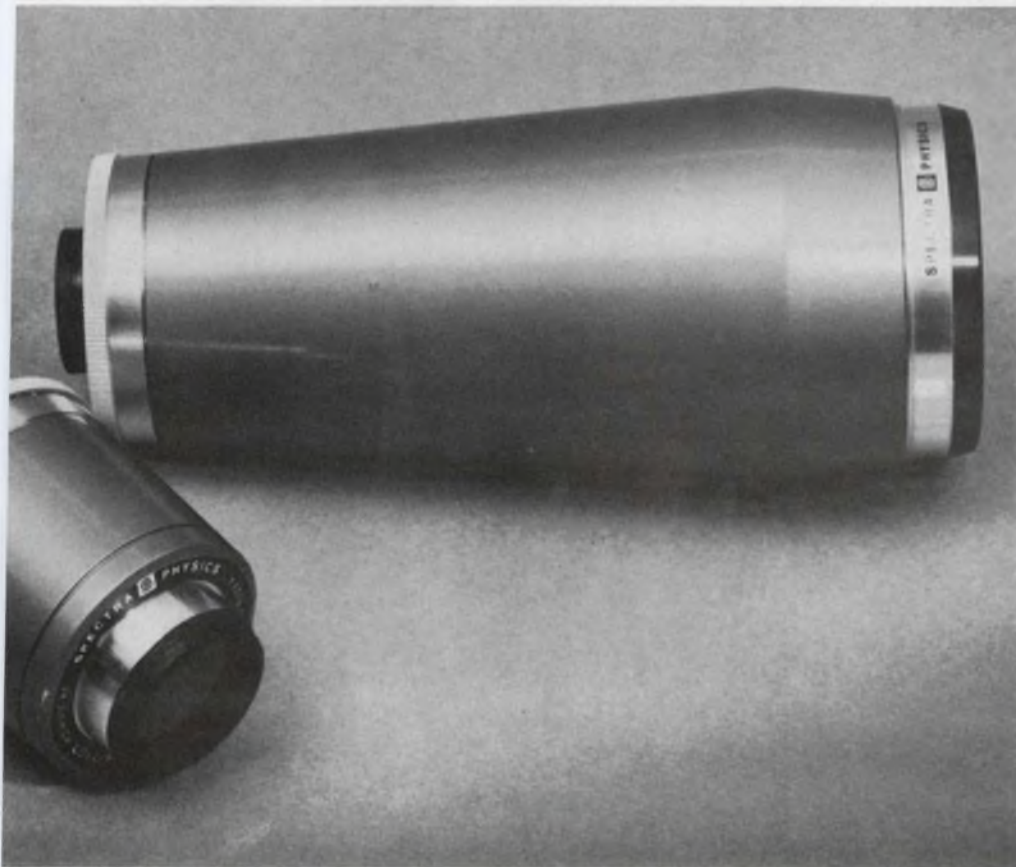

Spatial filter and lens family uses "parent" filter housing to accommodate all other elements. Positioning stages remain with housing and are controlled by radial knobs (x and Y) and coax ring (z).

Company: Spectra-Physics, Inc.
Designer: Carl J. Clement



Direct access storage facility. Each section slides out providing easy access for removal of its magnet drum.

Company: IBM / Systems Development
 Designers: Donald A. Wood, Donald A. Moore, Eliot Noyes

Solid-state amplifier/preamp for free-standing, table-top or built-in use. Lever switches employ available rocker switch mechanisms. Back-panel aluminum casting doubles as heat sink.

Company: James B. Lansing Sound,
 Designer: Arnold Wolf, Lamont J. Seitz



Microcalorimeter detects changes to 5 millicalories at $\pm 3\%$ accuracy. Twin-thermopile unit has integral programmer and recorder amplifier.

Company: Beckman Instruments, Spinco Div.
 Designer: Charles W. Dodgø

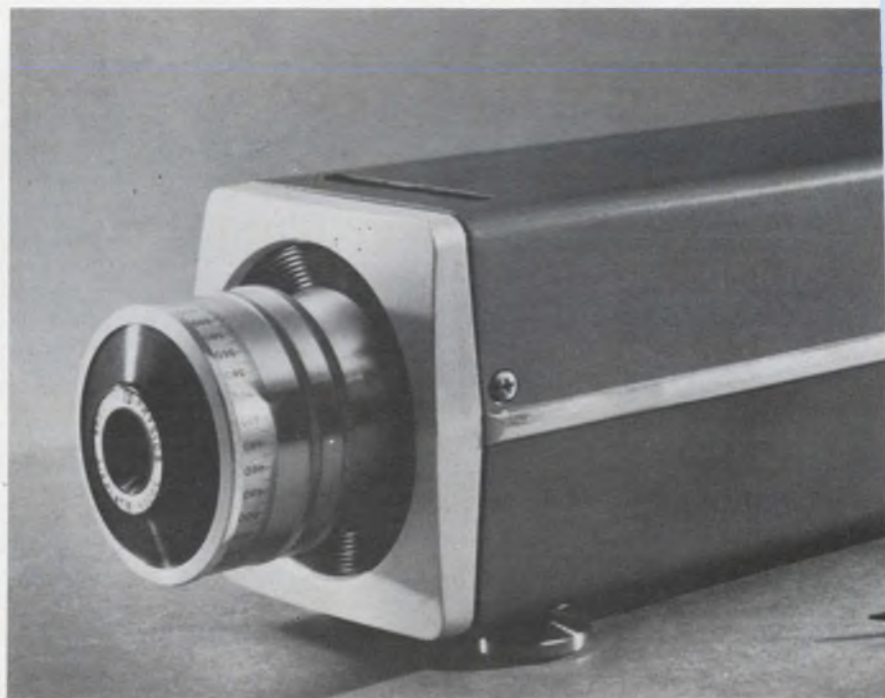

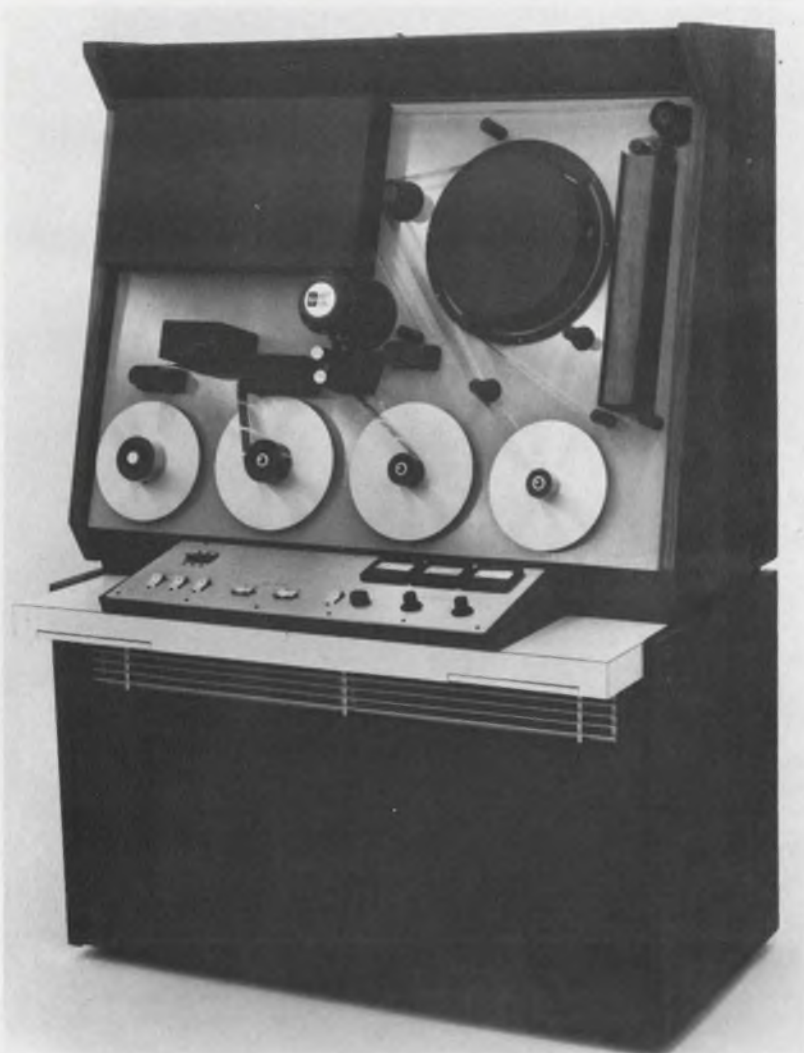

Multimode microfilm copier is world's quickest (1000 ft in 5-1/2 minutes). Pre-programable dry process unit uses light and heat on 16- or 35-mm Kalvar low-, medium- or high-contrast film.

Company: Litton Industries/Electron Tube Div.
Designer: Harold Lakin



Dynamic microphone holds either of two coils in its barrel for high- or low-impedance inputs. Barrel unscrews for easy access to coils.

Company: Ampex Corp.
Designers: Terrence N. Taylor, Arden Farey, Sandy Schroeder

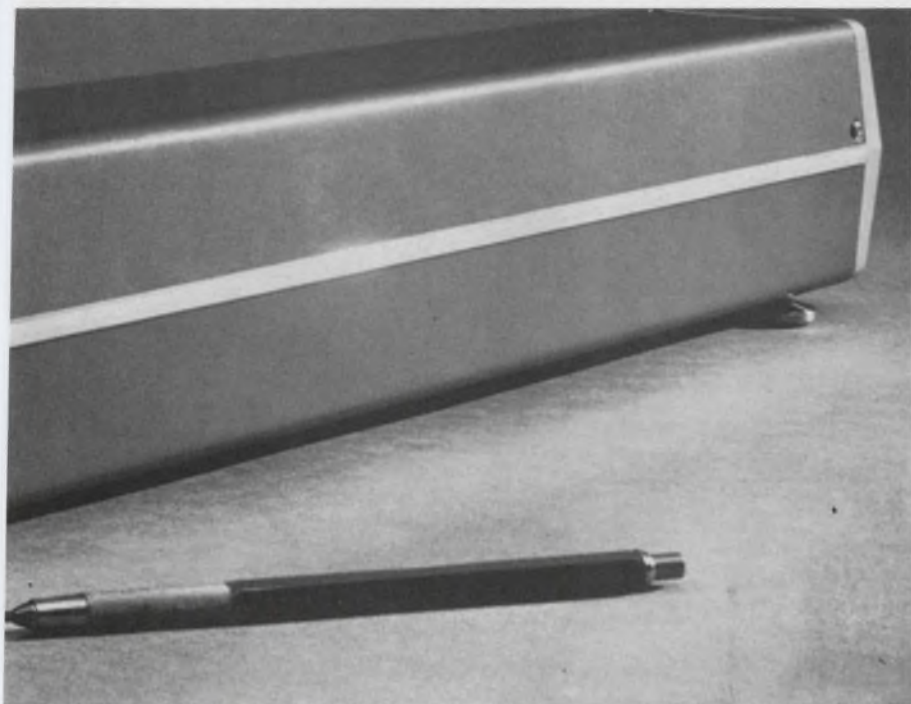

Helium-neon laser has resonator structure decoupled from stresses via a heat-shielding envelope secured through three spherical bearings. Cone-pointed set-screws at right angles to diaphragm in housing permit simple mirror adjustment.

Company: Spectra-Physics, Inc.
Designer: Carl J. Clement

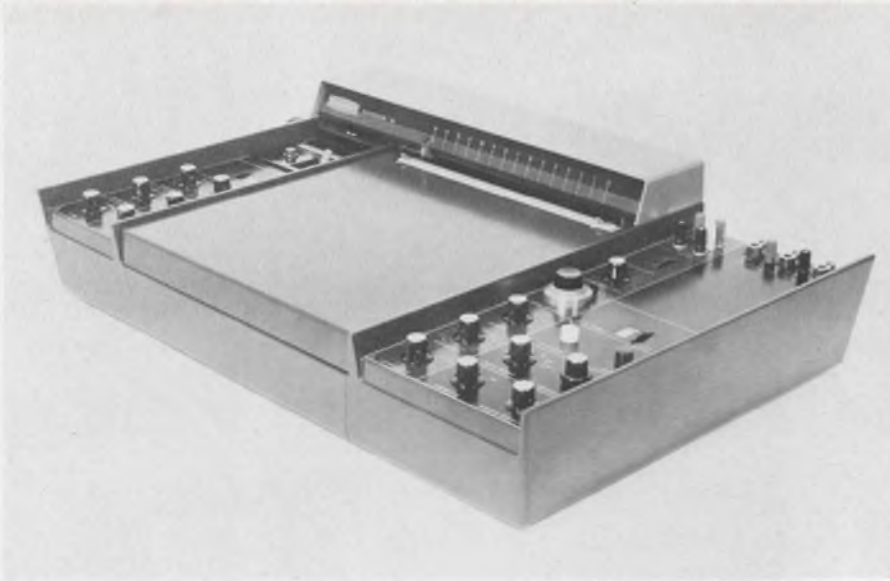

Electroscan 30 is a controlled voltage recorder operable in galvanostat and potentiostat modes. The unit is designed for recording at least 15 electrochemical analytical techniques.

Company: Beckman Instruments/
Spinco Division
Designer: Industrial Design Staff



Data station transmits 8-bit ASCII at 120 characters/second. Design modularity allows system flexibility. Input/output capabilities include paper tape, punched cards, printer and keyboard-teleprinter units and an optical scanning input device.

Company: Honeywell/EDP Division
Designers: W. H. Harkins, J. F. Graham

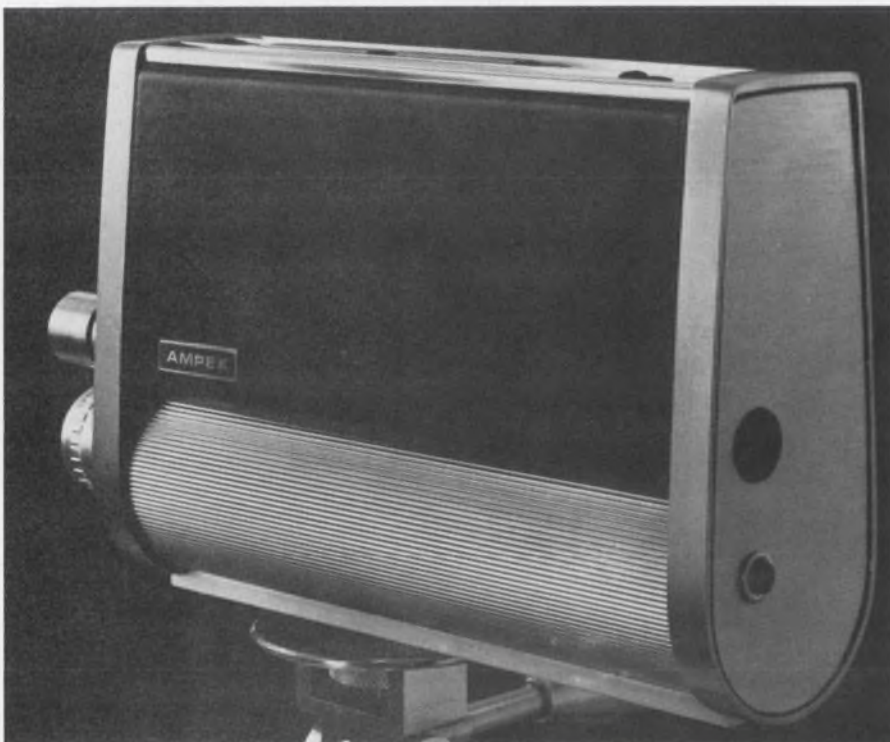

Hand-held vidicon camera sports optical viewfinder and fluted grip. A single cable carries input power, audio and video outputs and provides remote control of video tape.

Company: Ampex Corp.
Designers: Donald E. Leman, Arden Farey, Mervin W. LaRue

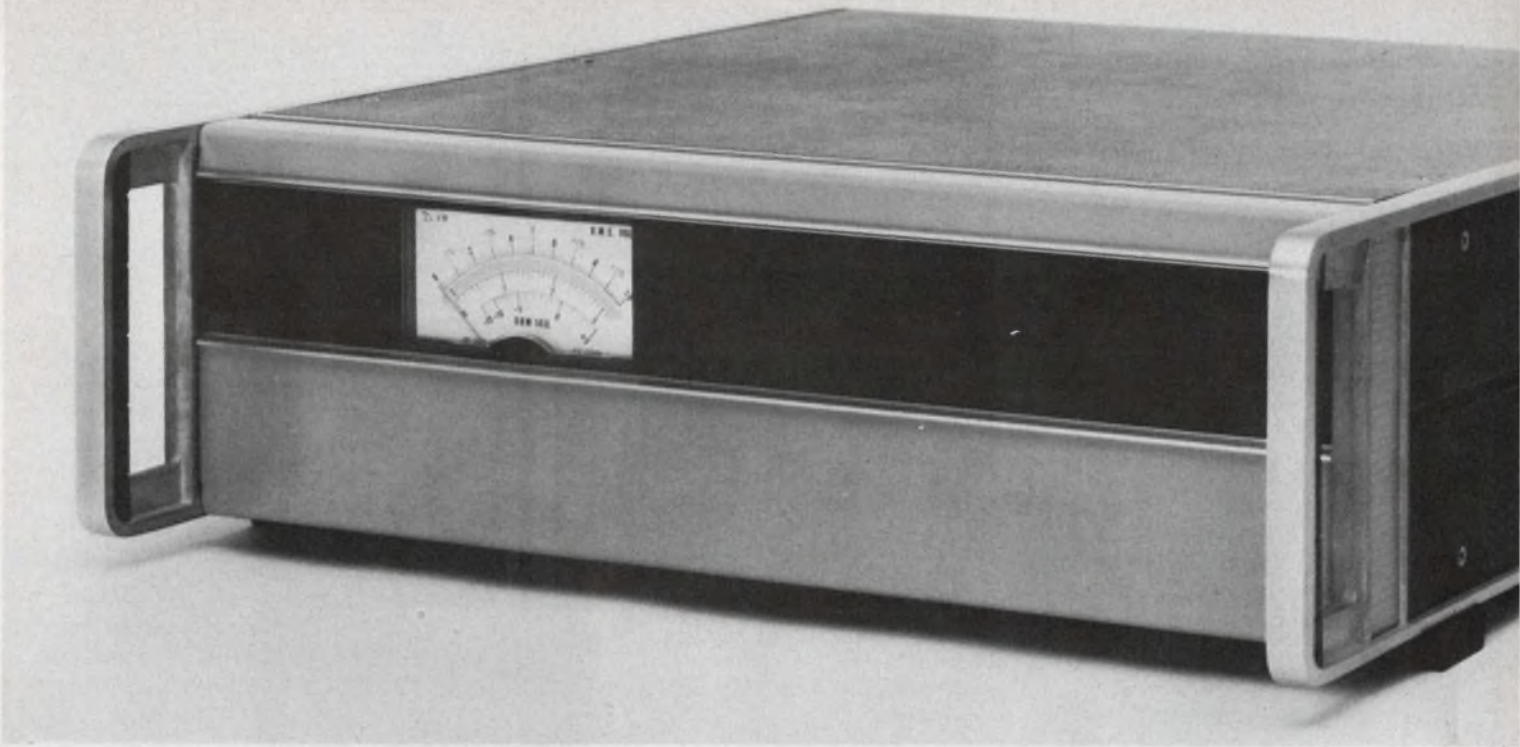

This meter snaps on to the front of equipment. Zero-adjust is made with ball-point pen.

Company: Hewlett-Packard
 Designers: Allen Inhelder, Don Pahl, Roy Ozaki, John Lark, Dale Jones

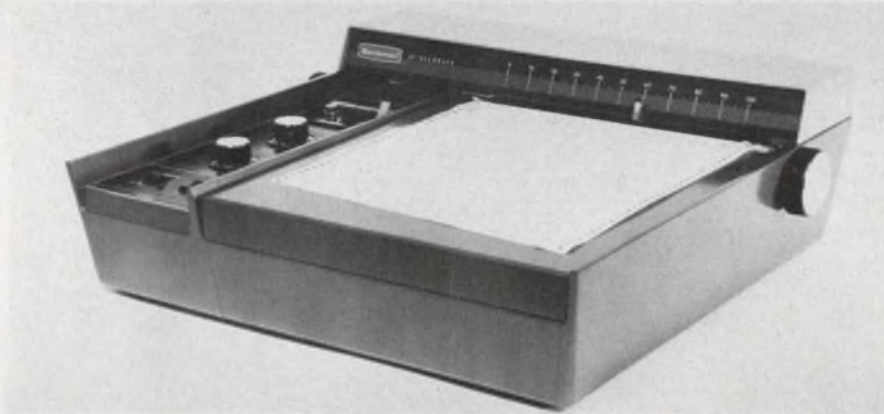

Ten-inch laboratory strip chart recorder uses sprocketed paper. Pen lift, chart speed, zero and range controls are conveniently grouped.

Company: Beckman Instruments
 Designer: Industrial Design Staff

Susceptance standard sports sand-cast aluminum base and photographically deposited dial artwork.

Company: Hewlett-Packard
 Designer: Thomas C. Lauhon

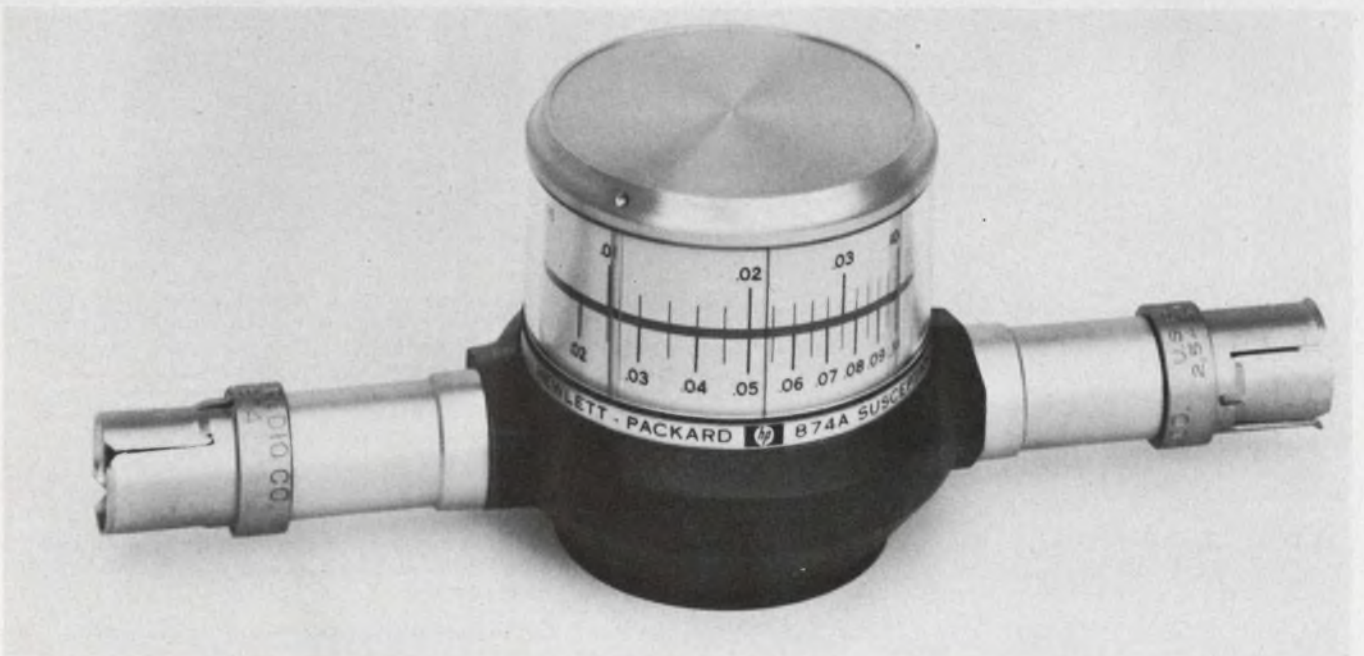

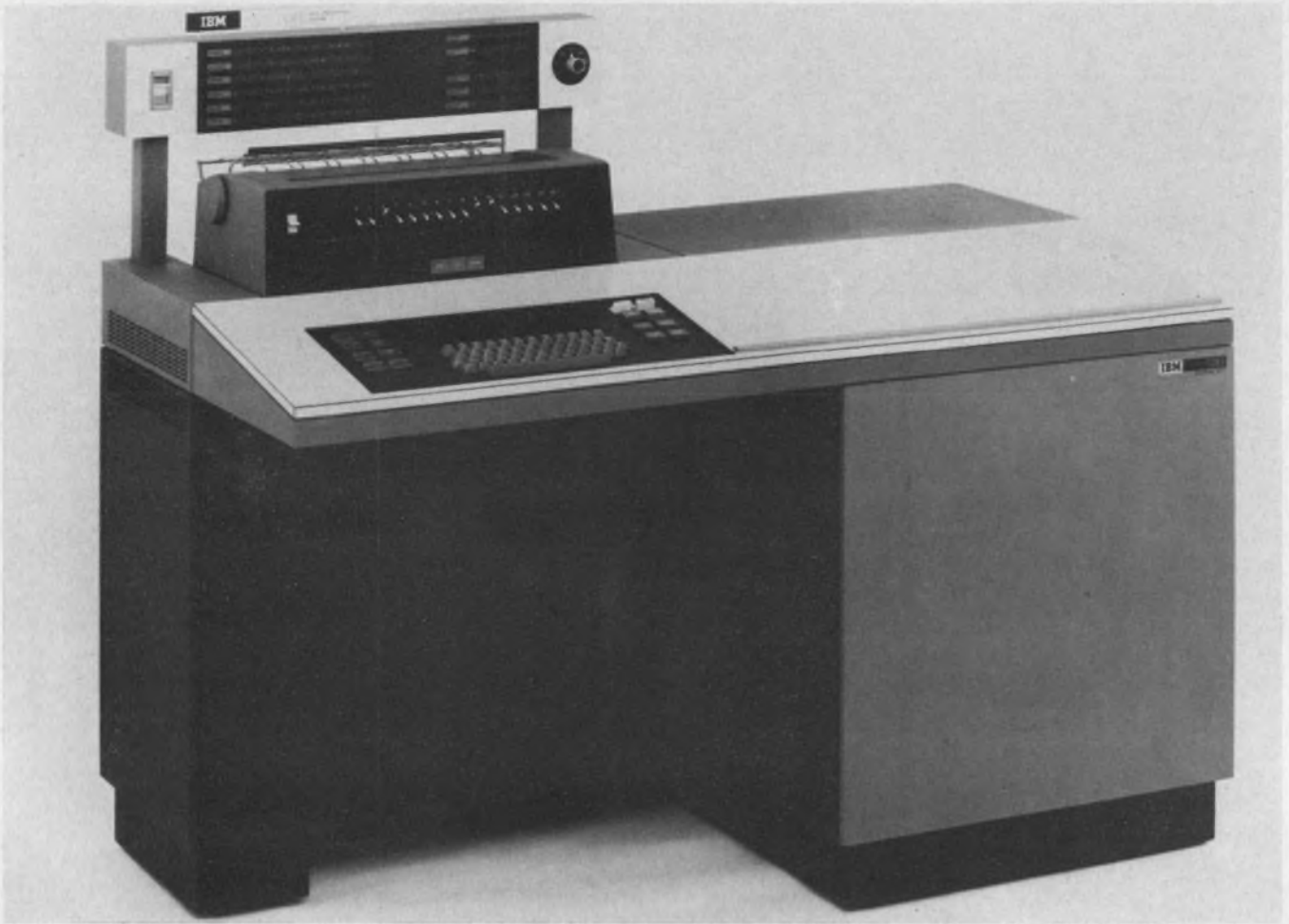

Computing system

Company: IBM / Systems Development Division
 Designers: Donald A. Moore, Donald A. Wood, Eliot Noyes

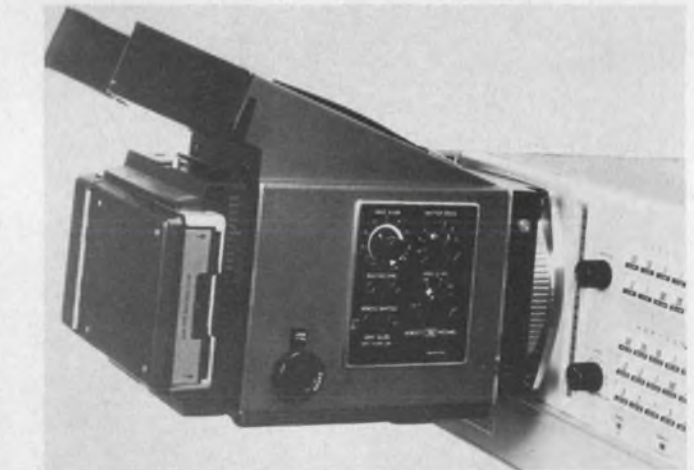

Oscilloscope camera clusters color-coded controls on outside. The f/1.9 lens has low vignetting and high transmission. Shutter is electronically controlled. The camera has remote and parallel operating capability.

Company: Hewlett-Packard/Colo. Springs Division
 Designer: Andi Are

Visual analysis console has stored program logic and combined electronic/photographic CRT display. Updating, editing or adding to information in the memory is accomplished through the keyboard. A light gun and cursor complete the communications system.

Company: The Bunker-Ramo Corp.
 Designer: Richard L. Ketcham

The best thing that's
happened to capacitors
since metal joined film!



NEW PAKTRON MF
CAPACITORS OF METALIZED MYLAR*



PAKTRON

DIVISION ILLINOIS TOOL WORKS INC.
1321 LESLIE AVENUE • ALEXANDRIA, VIRGINIA 22301

"Remember, you're never more than a few feet away from a product of ITW"®

*A DuPont Registered Trademark

PAKTRON® MF CAPACITORS OF METALIZED MYLAR®*... PROVIDE GREATER VALUE!

- Superior performance • High reliability lead assembly process • Epoxy coated for superior environmental protection • Radial leads for efficient P.C. board use

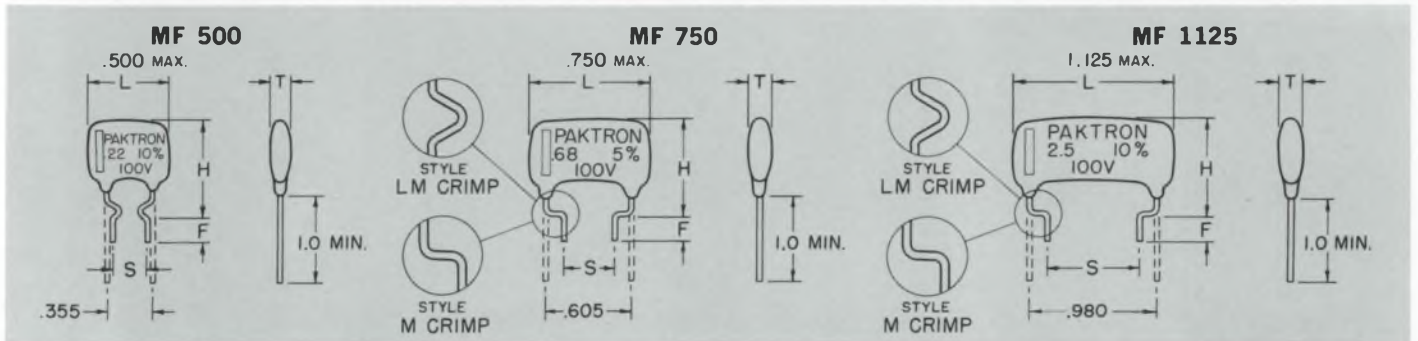

STANDARD VALUES AND SIZES:

MF 500

VALUE MFD.	T DIM. IN. MAX.	H DIM. IN. MAX.
.1	.200	.440
.12	.220	.470
.15	.250	.550
.18	.270	.610
.22	.300	.660

MF 750

VALUE MFD.	T DIM. IN. MAX.	H DIM. IN. MAX.
.22	.250	.550
.33	.300	.660
.47	.350	.690
.50	.360	.700
.68	.400	.740

MF 1125

VALUE MFD.	T DIM. IN. MAX.	H DIM. IN. MAX.
.68	.300	.600
1.0	.350	.660
1.5	.400	.720
2.0	.450	.770
2.5	.500	.820

NOTE: H Dim. shown for M style crimp or long lead, add .075 for H Dim. with LM style crimp.

STANDARD CRIMPS:

MF 500

STYLE	S DIM. ± .032	F DIM. + .01 - .04
M	.250	3/16
LM	.250	or
LM	.312	3/16

MF 750

STYLE	S DIM. ± .032	F DIM. + .01 - .04
M	.312	3/16
M	.375	or
M	.400	3/16
M	.437	or
LM	.500	3/16
LM	.562	3/16

MF 1125

STYLE	S DIM. ± .032	F DIM. + .01 - .04
M	.625	3/16
M	.718	or
M	.843	3/16
LM	.937	3/16

PERFORMANCE CHARACTERISTICS

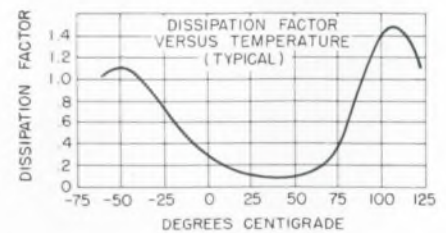
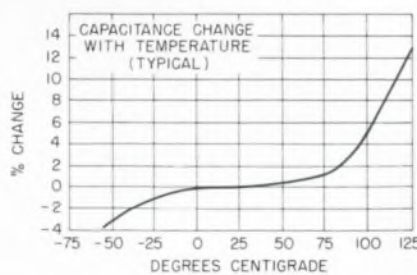
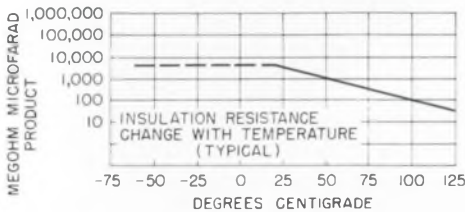

SPECIFICATIONS

PHYSICAL • Case high grade epoxy, marked: Paktron, value, voltage, tolerance and ground bar • Leads #20 heavily tinned, 5 lbs. Pull min., solderability exceeds EIA std. RS 178

ENVIRONMENTAL • Thermal life exceeds 500 hrs. @ 85° C 150% W V DC • Temperature range -55° C to +85° C 100 W V DC • Degrade linearly from +85° C to 50 W V DC at +125° C • Moisture resistance exceeds EIA std. RS 164 Paragraph 2.3.8

ELECTRICAL • Tolerance ± 5%, ± 10%, ± 20% standard, others available on request • Dissipation factor less than 1% @ +25° C, 1Kc • Insulation resistance 3 x 10⁴ megohm x microfarad, 2 minutes at W V DC • Temperature stability, from -25° C to +85° C, less than 3% deviation from 25° C value • Dielectric strength, 200 V DC, 1 min. @ +25° C.

REQUEST MORE DETAILS AND ASK FOR FREE SAMPLES

*DuPont Registered Trademark



PAKTRON

DIVISION ILLINOIS TOOL WORKS INC.
1321 LESLIE AVENUE • ALEXANDRIA, VIRGINIA 22301

THE FIRST

± 40 VOLT ALL SILICON DEFLECTION DRIVER



MODEL RDA-PP6N-1R

Amplifier and Regulated
Quadru-Power Supplies
with Safety Current Limiting



12 Amp Change in less than 9 μ sec
0.02% linearity

- Direct Conversion: E_{in} to I_{out}
- dc to Pulses and Complex Waveforms
- Compatible with Single-Ended Yokes
- No Synthesizing Networks Required
- Self Contained, Needs only 115 Vac
- Minimum Crosstalk

Constantine Engineering Laboratories Co.

MAHWAH, N. J.

UPLAND, CAL.

ON READER-SERVICE CARD CIRCLE 138

DIGITAL INSTRUMENTATION



Model 201



Model 500



Model 610-620

WESCON/66

See us at Booth
206-207 at the track

DIGITAL DC VOLTMETERS

• 9 Models offering F.S. ranges of 10 MV to 1000 V • Certified accuracy to .1% F.S. • Floating or grounded input • Reliable silicon transistor circuitry • Individually calibrated and certified • Available options include BCD output, retransmitting pot., auto-polarity, minimum or maximum retention.
From **\$315.00**

DIGITAL PRINTERS

• BCD 1-2-4-8 low level parallel input • Prints 8 columns in 2 banks of 4 • 45 line/minute print rate • Uses standard 2 1/4" paper tape • Remotely programmable • Designed for use on all "DigiTec" instruments with BCD coded output and other instruments with compatible coding.
• Time, Identification and Scanning Accessories available.
From **\$750.00**

DIGITAL THERMOMETERS

Precision digital measurement of temperature reading directly in degrees C or F.

THERMISTOR BASED (Series 500)

• Ranges covering -50 to +100° C.
• Accuracy to 0.15° 18 interchangeable probes.

PLATINUM BULB (Series 530)

• Ranges covering -390° to +1000° F. • Accuracy to 0.70° F.
• Interchangeable probes.

THERMOCOUPLE (Series 560)

• Ranges covering -300° to +2000° F. • Accuracy to 1.5° F.
• Reading resolution to 0.05°.
• For use with ISA Type "J," "K" and "T" thermocouples.
From **\$345.00**

DIGITEC

UNITED SYSTEMS CORPORATION

918 Woodley Road Dayton, Ohio 45403

Stocking representatives throughout the world

ON READER-SERVICE CARD CIRCLE 139

Unexcelled 30 ohm FET Switch

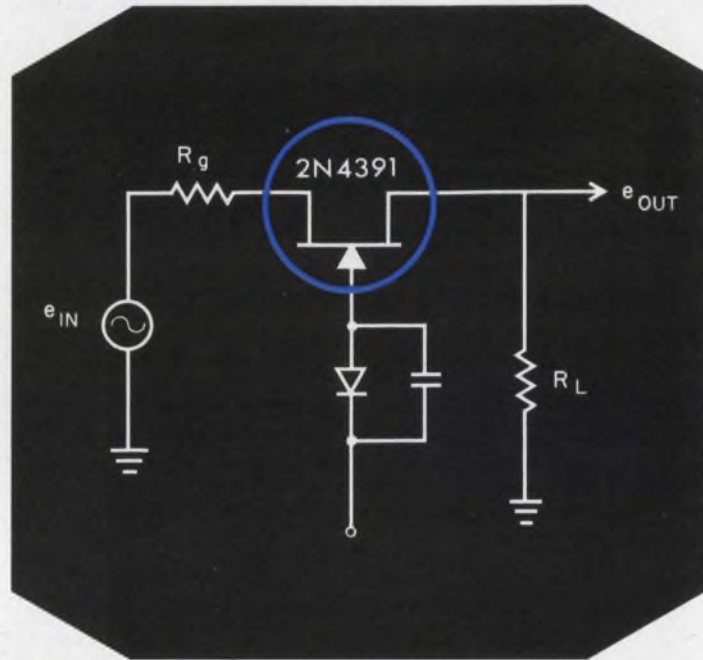

Unequaled Performance/Price

COMPARE!

	2N4391	2N4392	2N4393	2N4091	2N4092	2N4093	Units
ON Resistance, R_{ON}	30	60	100	30	50	80	ohms
Leakage, $I_{D(OFF)}$	100	100	100	200	200	200	pA
Capacitance, C_{rss}	3.5	3.5	3.5	5.0	5.0	5.0	pf
Capacitance, C_{iss}	14	14	14	16	16	16	pf
Turn On Time, t_{on}	10	10	15	15	15	20	nsec
Turn Off Time, t_{off}	15	30	40	40	60	80	nsec
Price, 1-99	16.50	15.50	9.00	18.00	16.50	9.70	\$

Another advancement from the leader in Field Effect Transistor technology — UNION CARBIDE ELECTRONICS. Select the performance/price for your application and call your UCE distributor today.



ELECTRONICS

Technology

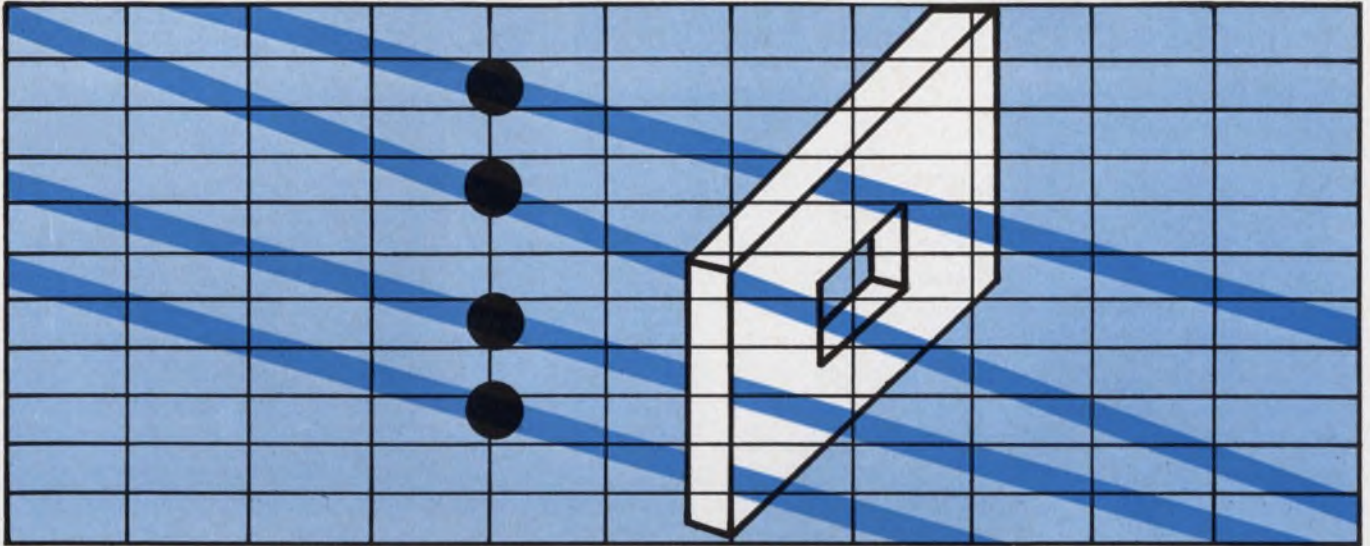

Spurious signals in any frequency band may be eliminated from mixers by application of

cross-product traces. These will disclose the signals' position and significance. Page 210

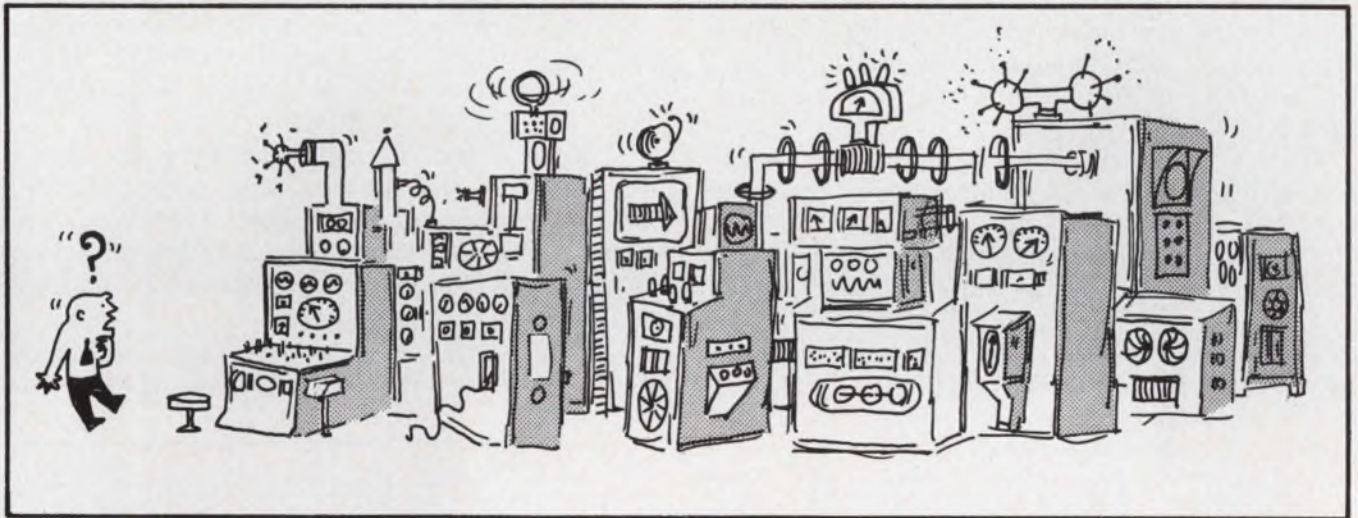

Man and machine will work together efficiently only if the electronic-equipment designer

takes human factors into account. Heed these tips and don't baffle the operator! Page 218

Also in this section:

Stabilize gain in dc amplifiers. Page 180

Cure switching-system noise problems by a simple procedure. Page 186

Cut transistor-replacement costs by using safe-operating-area (Soar) principles. Page 192

Check pad parameters graphically with a set of charts. Page 200

Stabilize gain in a dc amplifier by making it depend solely on power supply voltage and temperature. Low input current and high collector resistance are needed.

Under certain operating conditions, the open-loop voltage gain of a transistorized differential dc feedback amplifier can be made independent of circuit parameters. The gain will depend solely on the power supply voltage and the temperature.

The amplifier's closed-loop voltage gain, which depends on the magnitude and stability of the open-loop gain, can thus be made extremely stable. Specially selected components or circuit-compensating techniques, furthermore, are unnecessary.

In the experimental circuit, Fig. 1, the open-loop gain is virtually independent of the transistors so long as the input current is low ($< \mu\text{A}$) and the collector resistance is high ($> \text{M}\Omega$). It depends only on $qV_1/2kT$, where q is the electron charge, k is Boltzmann's constant and T is the temperature in degrees Kelvin.

The circuit also has a low drift rate with temperature ($\mu\text{V}/^\circ\text{C}$), a closed-loop frequency response flat to about 100 kHz and an output impedance less than 200 ohms.

With dc amplifiers, the differential input stage is most often used when high sensitivity is needed and drift, common-mode interaction and the effect of varying transistor parameters must be minimized.^{1,2,3,4,5} A differential input keeps the drift

Charles K. Wilk, Research Electronic Engineer, Air Force Systems Command, APO, New York, N. Y.

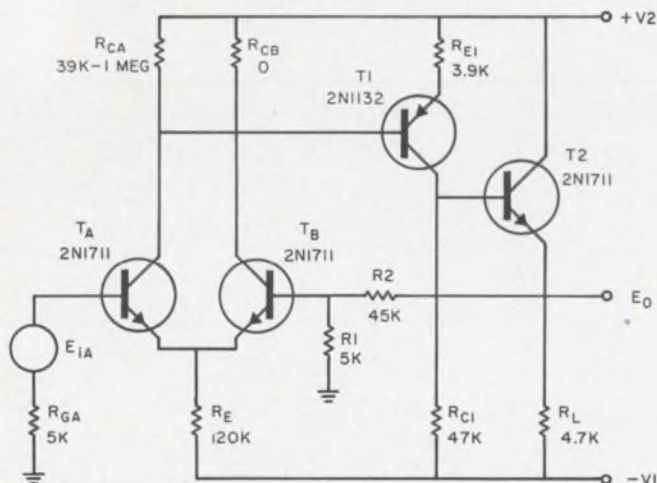

1. Open-loop gain of this differential dc feedback amplifier approaches $qV_1/2kT$ when the input current is low ($< 1 \mu\text{A}$) and the collector resistance is high ($> 1 \text{M}\Omega$).

low. Closed-loop gain is stabilized by designing for a much greater open-loop gain.

Unfortunately, in the usual approach, acceptable values for both drift and gain stability call for additional circuitry or, at least, a fair amount of sophistication. The comparatively simple circuit of Fig. 1 will, under the given operating conditions, provide excellent drift and gain-stability characteristics.^{6,7}

The ratio of A_{VOL}/H , where A_{VOL} is the open-loop gain of the amplifier and H is the input voltage divider ratio ($R1/[R1 R2]$), is plotted in Fig. 2 with input current I_{BA} as a parameter.

Not that as $R_{CA} \rightarrow \infty$ and with I_{BA} small enough:

$$\lim_{R_{CA} \rightarrow \infty} A_{VOL}/H = qV_1/2kT. \quad (1)$$

This is a value of about 200 for the circuit values of Fig. 1 and for T about 290°K . The transistors used in the tests were unselected. (The derivation of this equation is shown in the accompanying box).

Eq. 1 is devoid of transistor parameters and operating-point dependence. The term $qV_1/2kT$ comes from the base-to-emitter junctions of the input differential transistors. It is however, composed solely of physical constants, a power supply voltage and a temperature.

Power supply voltages are often deliberately made small to minimize voltage-dependent noise

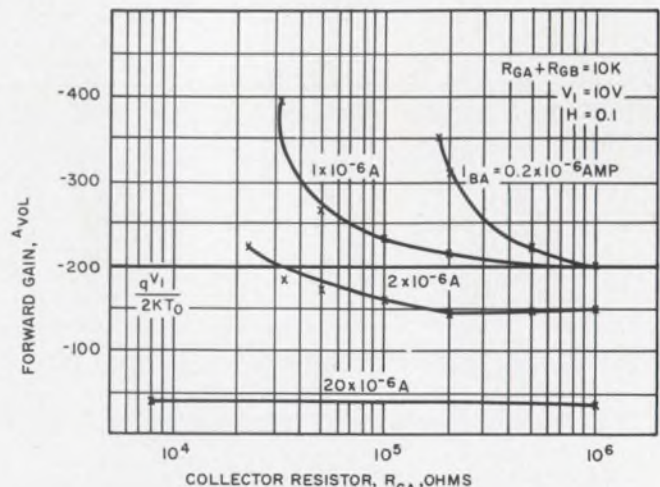

2. Limit of $qV_1/2kT$ for open-loop gain is approached in this experimental plot for the amplifier of Fig. 1 made under the given operating conditions.

and drift. At the same time, base current of the input stage is often held to the order of microamperes to minimize noise. Hence, the direct dependence of the open-loop gain on the magnitude of the supply voltage limits the maximum gain that is practical but does not seriously compromise drift and noise performance.

Even with moderate values of open-loop gain, the closed-loop gain can still be held stable if the open-loop gain is stable. The relative change in the closed-loop voltage gain of the circuit, A_{VCL} , over a temperature range and with supply voltage variations of 1, 0.1 and 0% are plotted in Fig. 3 for the case established by Eq. 1. From this equation:

$$A_{VOL} = -qV_1/2kT = f(T, V); \quad (2)$$

$$\Delta A_{VCL} = (\partial A_{VCL}/\partial T) \Delta T + (\partial A_{VCL}/\partial V_1) \Delta V_1; \quad (3)$$

$$\Delta A_{VCL}|_{MAX} = |(qV_1/2kT_0)/(1 - HqV_1/2kT_0)| (|\Delta T/T_0| + |\Delta V_1/V_1|). \quad (4)$$

The closed-loop gain stability for the worst case is:

$$|\Delta A_{VCL}/A_{VCL}|_{MAX} = (|\Delta T/T_0| + |\Delta V_1/V_1|)/(1 - HqV_1/2kT_0). \quad (5)$$

The plot in Fig. 3 is based on Eq. 5.

The change in stability with temperature, for any particular power supply tolerance, is quite small. Temperature stability improves, however, with the power supply stability and with larger feedback ratios. The feedback ratio, H , is the inverse of the closed-loop voltage gain, A_{VCL} , provided $H \gg 1/A_{VOL} = 2kT/qV_1$.

The circuit, with the constraints previously mentioned, can provide a gain stability better than 0.026%/°K over the temperature range of 300 to 400°K, with $H = 0.10$ (or a gain of 10), and with a 10-volt $\pm 0.1\%$ power supply. ■ ■

References:

1. D. W. Slaughter, "The Emitter-Coupled Differential Amplifier," *IRE Trans. on Circuit Theory*, Mar., 1956.
2. J. R. Biard and W. T. Matzen, "Drift Considerations in Low-Level Direct-Coupled Transistor Circuits," *Electronics*, No. 32 (Jan., 1959).

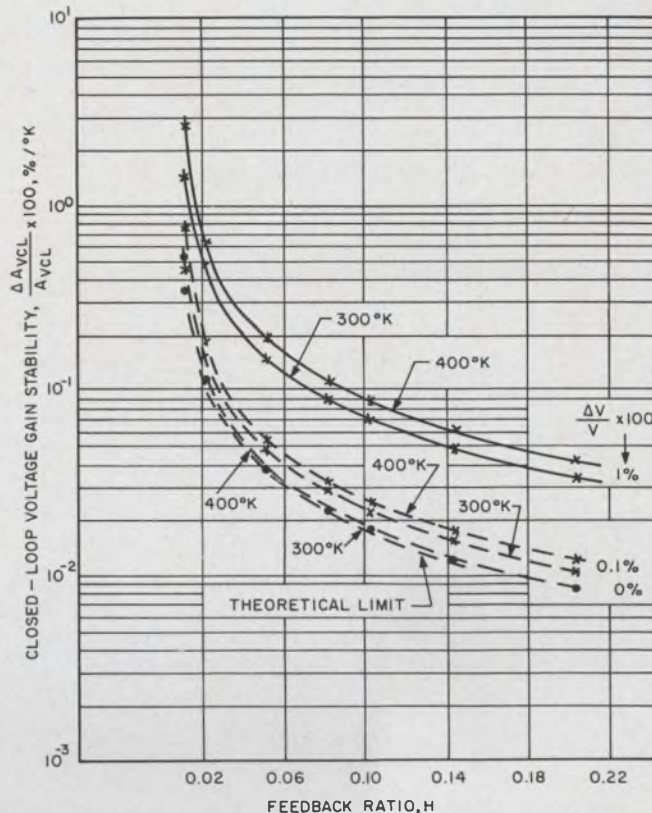

3. Closed-loop gain stability plot for the dc amplifier of Fig. 1 shows gain stability better than 0.026%/°K over the temperature range of 300 to 400°K for typical conditions of $H = 0.10$ and a 10-volt $\pm 0.1\%$ power supply.

3. D. F. Hilbiber, "A New Transistor Differential Amplifier," *IRE Trans. on Circuit Theory*, Dec., 1961.
4. D. F. Hilbiber, "Stable Differential Amplifier Designed without Choppers," *Electronics*, Jan., 1965.
5. R. D. Middlebrook, *Differential Amplifiers* (New York: John Wiley & Sons, Inc., 1963).
6. C. K. Wilk, "A Low-Drift Constant-Gain Transistor dc Amplifier for Rocket Instrumentation" (Master's thesis, Penn. State Univ., Mar., 1964).
7. L. C. Hale, J. S. Nisbet and C. K. Wilk, "Simple, Stable and Reliable Transistorized dc Amplifiers," *IEEE Trans. on Instr. and Meas.*, Sept., 1965.

Deriving the limiting-gain equation

The circuit of Fig. A is used to calculate the open-loop voltage gain A_{VOL} . Defining:

$$A_{VOL} = E_o/E_{ib} = H \cdot A_{VAB} \cdot A_{V1} \cdot A_{V2}, \quad (1)$$

where

$$A_{VAB} = E_{CA}/E_{ib} = -E_{CA}/E_{iA}, \quad (2)$$

$$A_{V1} = E_{C1}/E_{CA}, \quad (3)$$

$$A_{V2} = E_o/E_{C1}, \text{ and} \quad (4)$$

$$H = R_1/(R_1 + R_2). \quad (5)$$

Making use of the Giacoletto hybrid-pi equivalent circuits of Fig. B and the low-frequency approximations:

$$Z \approx r_{be} = kT/qI_b,$$

$$g_m = (q\beta)/kT,$$

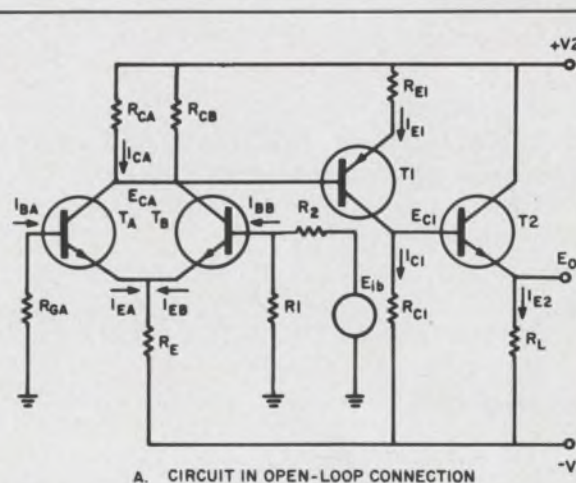

A. CIRCUIT IN OPEN-LOOP CONNECTION

$$1 + \beta = (1 + g_m Z),$$

where

k = Boltzmann's constant,

q = electron charge, and

T = temperature, °K.

The stage gains may be written as:⁶

$$A_{VAB} = \frac{(1)}{[(r_{b'B} + R_{GB} + kT/qI_{BB})(1 + \beta_A)/(1 + \beta_B)] \dots} \dots \frac{\beta_A R'_{CA}}{r_{b'A} + R_{GA} + kT/qI_{BA}}, \quad (6)$$

provided that

$$R_E \gg (r_{b'A} + R_{GA} + Z_A)/(1 + g_{mA} Z_A);$$

$$A_{V1} \approx \frac{[r_{b'2} + kT/qI_{B2} + R_L(1 + \beta_2)]}{[r_{b'1} + kT/qI_{B1} + R_{E1}(1 + \beta_1)]} \dots \frac{[-\beta_1 R_{C1}]}{[R_{C1} + r_{b'2} + kT/qI_{B2} R_L(1 + \beta_2)]}; \quad (7)$$

and

$$A_{A2} \approx \frac{R_L(1 + \beta_2)}{r_{b'2} + kT/qI_{B2} + R_L(1 + \beta_2)}; \quad (8)$$

where

R'_{CA} = equivalent impedance in collector circuit of T_a .

A number of reasonable assumptions considerably simplify the gain expressions without imposing undesirable constraints. With the above approximations, the gain expressions become:

$$r_{b'2} + kT/qI_{B2} \ll R_L(1 + \beta_2), \quad (9)$$

$$R_{C1} \ll R_L(1 + \beta_2), \quad (10)$$

$$\beta_A \approx \beta_B. \quad (11)$$

Furthermore, the case of balanced emitter currents,

$$I_{EA} = I_{EB}, \quad (12)$$

is of particular significance. The balanced, or nearly balanced, condition is usually required for good temperature stability.

With the above approximations, the gain expressions become:

$$A_{VAB} \approx \frac{\beta_A R'_{CA}}{r_{b'A} + R_{GA} + r_{b'B} + R_{GB} + 2kT/qI_{BA}}, \quad (13)$$

provided that

$$I_{EA} \approx I_{EB}, \text{ and } \beta_A = \beta_B;$$

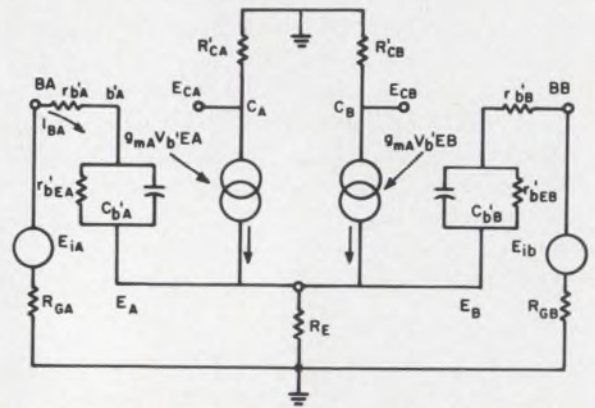

B (a) DIFFERENTIAL STAGE

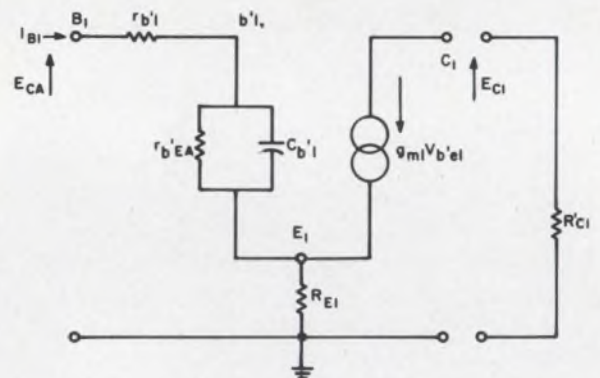

(b) COMMON EMITTER STAGE

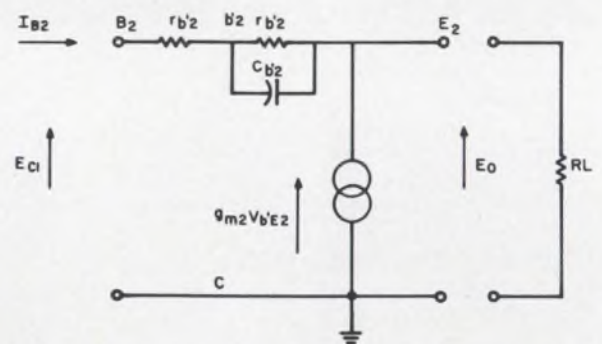

(c) COMMON-COLLECTOR STAGE

$$A_{V1} \approx \frac{-\beta_1 R_{C1}}{r_{b'1} + kT/qI_{B1} + R_{E1}(1 + \beta_1)}; \quad (14)$$

$$A_{V2} \approx 1. \quad (15)$$

And therefore, from Eqs. 1 and 13 through 15:

$$A_{VOL} \approx \frac{H\beta_A R'_{CA}}{\{[-\beta_1 R_{C1}]/[r_{b'1} + kT/qI_{B1} + R_{E1}(1 + \beta_1)]\} \dots} \dots \frac{(1)}{\{r_{b'A} + R_{GA} + r_{b'B} + R_{GB} + 2kT/qI_{BA}\}} \quad (16)$$

Note that:

$$\frac{1}{R'_{CA}} = \frac{1}{R_{CA}} + \frac{1}{r_{b'1} + kT/qI_{B1} + R_{E1}(1 + \beta_1)} \quad (17)$$

A limitation on open-loop gain is set. If $R_{CA} \rightarrow \infty$ (i.e., open circuit), then $I_{BA} \rightarrow V_1 / (\beta_A \beta_1 R_{C1})$. Therefore:

$$\lim_{R_{CA} \rightarrow \infty} \frac{A_{VOL}}{H} = \frac{-\beta_A \beta_1 R_{C1}}{r_{b'A} + R_{GA} + r_{b'B} + R_{GB} + 2kT/qI_{BA}} \quad (18)$$

$$= \frac{-V}{I_{AB}(r_{b'A} + R_{GA} + r_{b'B} + R_{GB}) + 2kT/q}$$

And finally:

$$\lim_{R_{CA} \rightarrow \infty} \frac{A_{VOL}}{H} = \lim_{R_{CA} \rightarrow \infty} A_{VAB} \cdot A_{V1},$$

$$\leq -qV_1/2kT,$$

$$I_{BA} << \frac{2kT}{[q(r_{b'A} + R_{GA} + r_{b'B} + R_{GB})]}. \quad (19)$$

Deriving the closed-loop gain stability from the Nyquist equation:

$$A_{VCL} = A_{VOL} / (1 - H A_{VOL}), \quad (a)$$

where

A_{VOL} = open-loop voltage gain, and

A_{VCL} = closed-loop voltage gain.

And:

$$\Delta A_{VCL} = \frac{\partial A_{VCL}}{\partial T} \cdot \Delta T + \frac{\partial A_{VCL}}{\partial V_1} \cdot \Delta V_1; \quad (b)$$

$$\frac{\partial A_{VCL}}{\partial T} = \frac{\partial}{\partial T} \left(\frac{A_{VOL}}{1 - H A_{VOL}} \right),$$

$$= \frac{\partial}{\partial T} \left[\frac{qV_1/2kT}{1 - (HqV_1/2kT)} \right],$$

$$= \frac{-qV_1/2kT_o^2}{[1 - (HqV_1/2kT_o)]^2}; \quad (c)$$

$$\frac{\partial A_{VCL}}{\partial V} = \frac{\partial}{\partial V} \left(\frac{A_{VOL}}{1 - H A_{VOL}} \right),$$

$$= \frac{\partial}{\partial V} \left[\frac{qV_1/2kT}{1 - (HqV_1/2kT)} \right],$$

$$= \frac{q/2kT}{[1 - (HqV_1/2kT)]^2}. \quad (d)$$

Substituting (c) and (d) into (b):

$$\left| \Delta A_{VCL} \right|_{MAX} = \frac{(qV_1/2kT_o) (-\Delta T/T_o + \Delta V_1/V_1)}{[1 - (HqV_1/2kT)]^2}, \quad (e)$$

and

$$\left| \frac{\Delta A_{VCL}}{\Delta A_{VCL}} \right|_{MAX} = \frac{\Delta T/T_o + \Delta V_1/V_1}{[1 - (HqV_1/2kT_o)]^2},$$

$$= \text{Eq. 5 in the text.}$$

What happens when you insulate with HYGRADE SLEEVING?

No cracking, no corrosion, no wicking, no dielectric breakdown . . . nothing! It just sits there . . . preventing trouble the way it's supposed to. In fact, you can forget it! Isn't that what you want in insulating sleeving? Just tell us where you plan to use it, under what conditions. We'll recommend the right material. You can take our word for it . . . because we've been insulation specialists for 44 years.



HYGRADE[®] INSULATING SLEEVINGS

Markel HYGRADE Sleevings are constructed of carefully braided fiberglass yarn, impregnated and coated with specially formulated varnishes, vinyls, resins, or silicone rubber compounds. A wide range of types, grades and sizes meet virtually every conceivable requirement for dielectric and mechanical strength under all kinds of operating conditions . . . at continuous temperatures from -70°F to 1200°F . We'll be glad to send you specifications and Sample File on the entire HYGRADE Sleevings line. Just write. No charge or obligation.

L. FRANK MARKEL & SONS

Norristown, Pa.

215-272-8960

INSULATING TUBINGS & SLEEVINGS • HIGH TEMPERATURE WIRE & CABLE



Reduce system costs with TI

TI linear integrated circuits mean fewer system components, less assembly and test time, increased manufacturing efficiency. In short — reduced system costs. Now you get improved performance and increased reliability, too, in such circuits as the Series 75 and Series 72 amplifiers described here.

Series 75 magnetic-core sense amplifiers

Each of these new amplifiers for magnetic core memories replaces a whole circuit board of transistors and passive components. The SN7501 circuit shown in Figure 1, for example, contains 18 transistors, 25 resistors, four diodes and one capacitor in a single tiny chip of silicon. Cost is only about 80 percent of a comparable discrete-components circuit. Soldered connections are reduced by more than 90 percent — resulting in greatly improved reliability.

Performance is excellent, as shown in Figure 2. Series 75 sense amplifiers are recommended for core memory applications with cycle time as low as 0.7 μ sec.

The SN7500 is a complete monolithic sense amplifier that includes both strobe gate and pulse-shaping output circuits as shown in Figure 3. It detects low-level bipolar differential input signals, discriminates between those representing logical "1" and logical "0", and converts them to logic levels compatible with standard integrated circuit logic, including TI's Series 54 TTL.

The amplitude-discriminating sense amplifier incorporates a threshold circuit with a narrow region of uncertainty. A strobe input is provided so the threshold detector can be activated when the signal-to-noise ratio is at maximum during the system read cycle, and is inhibited during the write cycle.

The SN7501 performs a similar sense amplifier function, but also includes an externally adjustable threshold voltage and a flip-flop output. Since the flip-flop is externally set at zero, the output pulse width can be accurately controlled. The flip-flop can be used for temporary data storage.

The SN7502 sense amplifier includes an internal one-shot multivibrator, providing a negative-going output pulse when triggered by the threshold detector. The single-ended output lends itself readily to performing DOT-OR logic.

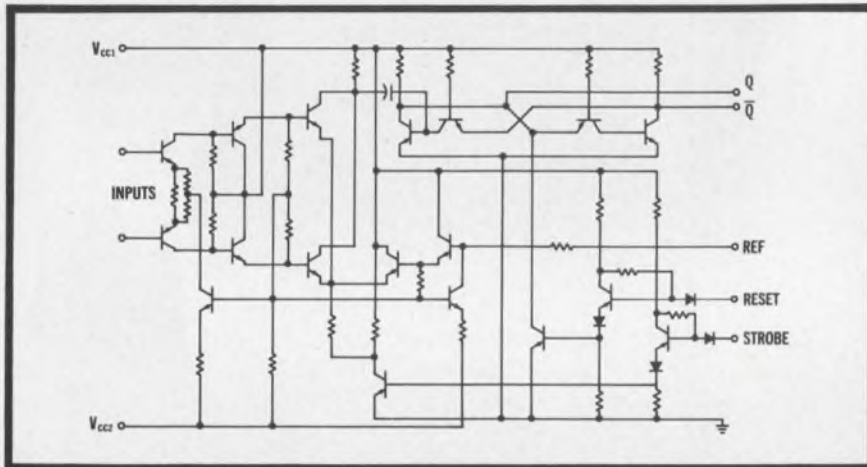

Figure 1. Circuit diagram of the SN7501 sense amplifier.

TYPICAL CHARACTERISTICS	
Input threshold voltage level	10-30 mV
"Off" output level	3.2 V
"On" output level	0.3 V
Input threshold offset	2 mV
Input impedance	3000 ohms
Propagation delay	60 nsec
Overload recovery	100 nsec
Common-mode rejection	
SN7500	2 V
SN7501	1 V
SN7502	1½ V
Temperature range	0° to + 70°C

Figure 2. Series 75 sense amplifiers.

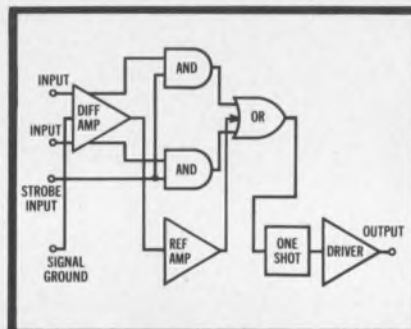

Figure 3. Functional block diagram of SN7500

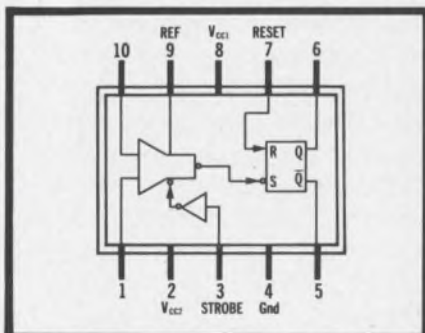

Figure 4. SN7501 incorporates flip-flop

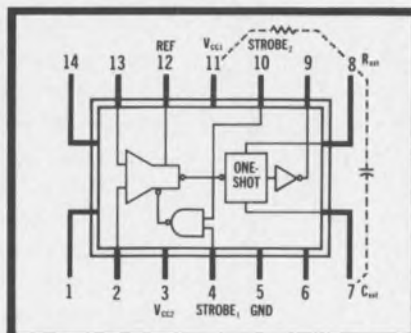

Figure 5. SN7502 includes one-shot.

linear integrated circuits

Series 75 circuits are available in the standard TO-84 flat pack, or the transistor-type TO-100 package shown in Figure 6. The SN7500 is also available in a military version (SN5500) for operation in environments of -55° to $+125^{\circ}\text{C}$. Severe temperature versions of the SN7501 and SN7502 are also available.

Circle 25 on Reader Service card for product bulletins.

Series 72 high-performance differential/operational amplifiers

Now you can get both discrete-component performance and integrated circuit reliability in differential/operational amplifiers from Texas Instruments. Figure 7 shows that performance of SN725 and SN726 integrated circuits are comparable to discrete-component amplifiers.

The SN725 differential amplifier features an open-loop gain of 88 dB, yet it is unconditionally stable when used with two external capacitors in the frequency-response-shaping network.

The SN726 high-performance operational amplifier features a class-B output stage to give a 10 V swing with a 600-ohm load. A Darlington-connected transistor pair gives an extremely high input impedance.

In both circuits, transistor pairs are close together for improved differential-input voltage offsets and temperature-drift characteristics. Improved collector saturation resistance provides high output current and voltage capability. Both amplifiers allow ± 5 V common-mode input signals before overloading, and there is no danger of latch-up from noise or output feedback.

For less demanding applications, the SN723 differential amplifier or SN724 operational amplifier may be used at a considerable saving in cost.

TI differential and operational amplifiers are available for two temperature ranges. Series 72 is recommended for 0° to $+70^{\circ}\text{C}$, while Series 52 covers the full military range of -55° to $+125^{\circ}\text{C}$.

Circle 26 on Reader Service card for more information on Series 72 and 52 integrated circuits.

Choice of Packages

TI linear integrated circuits are available in either of the package types shown in Figure 6 — The time-proven TO-89 flat pack or the transistor-type TO-100 package. Both packages feature hermetic seals for high reliability in severe environments.

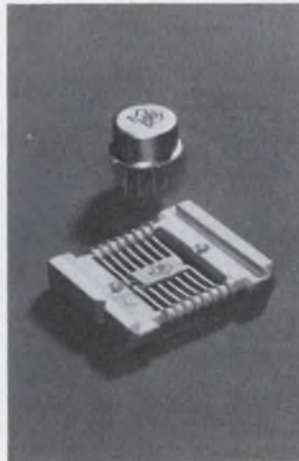

Figure 6. Package types for TI linear integrated circuits.

Characteristic	SN725	SN726
Gain, Open-loop, dB	88	60
Input-voltage Offset, mV	1	3
Temp. Coefficient Input-voltage Offset, $\mu\text{V}/^{\circ}\text{C}$	5	10
Input-current Offset, μA	0.3	0.03
Common-mode Rejection, dB	100	80
Output-voltage Swing, V	± 8	± 5
Output-current Peak, mA	1	10
Input Impedance, megohm	0.1	2

Figure 7. Typical Performance of integrated differential/operational amplifiers.

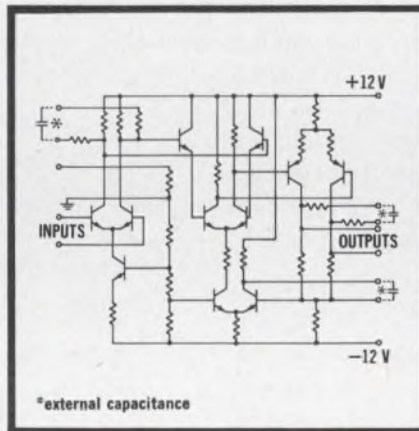

Figure 8. Circuit diagram of SN725 differential amplifier.

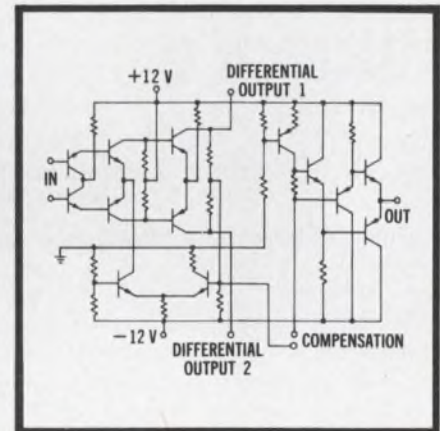

Figure 9. Circuit diagram of SN726 operational amplifier.



TEXAS INSTRUMENTS
INCORPORATED
13500 N. CENTRAL EXPRESSWAY
P. O. BOX 5012 • DALLAS 22, TEXAS

Cure switching system noise problems with this straightforward procedure for isolating switching circuits from power line noise.

Any engineer who has worked on high-speed switching systems, such as integrated circuit computers, knows that one of the first places to look in case of noise trouble is the power and ground distribution system. This troublesome circuitry is often "designed" with a cut-and-try approach. If trouble appears, a decoupling capacitor is hung somewhere along the line and through trial and error the noise is eventually cleared up.

Why not determine decoupling requirements exactly before the system is turned on? Here's an exact procedure that you can use to determine:

- The proper type of decoupling capacitor.
- The value of the capacitors.
- The spacing of the capacitors along the power line.

The decoupling capacitors are used to simulate closely a low-characteristic-impedance power-distribution line. This is a valuable technique when a bus-bar configuration is found to be too bulky or expensive (see Table 1). Printed-wiring boards commonly employ decoupling capacitors on the power conductors. Usually the capacitors take up less space than the wide printed conductors needed to obtain a low characteristic impedance.

Switching time, line impedance are factors

The type of capacitor is mainly determined by the rise and fall times of the circuits. The highest frequencies on the power-distribution lines are a function of the rise and fall times, and not of the clock rate of the system. Transmitting a signal from a digital circuit with a rise time of 5 ns is approximately equivalent to transmitting a 100-MHz sine wave. The fact that the circuit may switch only once per hour does not change the fast rise and fall times and the interaction with the transmission line.

Curves of dissipation vs frequency, impedance vs frequency, or capacitance drop-off vs frequency should be consulted to determine if a particular type of capacitor is suitable for the rise and fall times of the circuits.

The method of determining the value of the

capacitor depends on why it is being used. There are two reasons for using decoupling capacitors:

- Capacitors may be placed along the transmission line that leads from the power supply to the circuits to reduce the line's characteristic impedance and thus reduce the possibility of voltage transients due to current changes. The lower characteristic impedance of the line will be a closer match to the low output impedance of the supply, thus eliminating reflections and "ringing" (i.e., damped oscillations) in the line.

- A capacitor may be added to the transmission line near a circuit, as in Fig. 1, to supply the high-frequency portion of the current needed when the circuit changes state. The intent is not to decrease the characteristic impedance seen by the power supply, but rather to shorten the path of the high-frequency current.

In order to compensate properly for characteristic impedance, its value must be known.

The general expression for the characteristic impedance of two conductors is:

$$Z = (R + j\omega L) / (G + j\omega C), \quad (1)$$

where R , G , L and C are distributed parameters of the conductors and ω represents frequency.

For high frequencies the terms $j\omega L$ and $j\omega C$ will be large in respect to R and G . Equation (1) then becomes:

$$Z_0 = (L/C)^{1/2}. \quad (2)$$

Thus, the impedance of the line at high frequencies is totally dependent on the ac parameters, which in turn depend on the geometries and dimensions of the conductors.

The value of these capacitors may be calculated from Eq. 3 which is derived from the equation for characteristic impedance, $Z_0 = (L/C)^{1/2}$.

$$C_D = (L/Z_0^2) - C_L, \quad (3)$$

where

C_D = decoupling capacitance in farads per unit length,

C_L = distributed line capacitance in farads per unit length,

L = distributed line inductance in henries per unit length, and

Z_0 = desired characteristic impedance, ohms.

Roger J. Feulner, Staff Supervisor, Industrial Systems Development, Automatic Electric Laboratories, Inc., Northlake, Ill.

Comparison of three power distribution techniques.

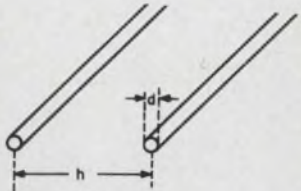
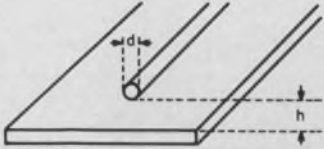
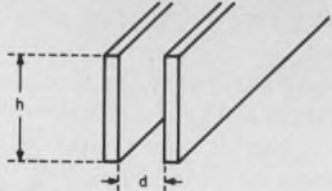
Type	Characteristic impedance	Remarks
 <p>Two-wire line</p>	$Z_0 \cong \frac{120}{\sqrt{\xi_r}} \log_e \frac{2h}{d}$	Has highest characteristic impedance of three types shown.
 <p>Single wire near a ground plane.</p>	$Z_0 \cong \frac{138}{\sqrt{\xi_r}} \log_{10} \frac{4h}{d}$ <p>For $d \ll h$</p>	Compromise between two-wire and bus-bar. Can be fabricated with multilayer printed wiring.
 <p>Bus-bar</p>	$Z_0 \cong \frac{377}{\sqrt{\xi_r}} \frac{d}{h}$ <p>For $\frac{d}{h} < 0.1$</p>	Lowest characteristic impedance of three types shown. Also the bulkiest.

ξ_r = Dielectric constant of the material surrounding the conductors. $\xi_r = 1$ for air

The first step in the calculation of the capacitor value for this case is to determine the minimum current rise time that the power-distribution line can supply without producing reflections and voltage transients. All higher frequencies will have to be supplied by the charge on the capacitor.

Two restrictions determine the minimum rise time:

- The rise time must be larger than twice the propagation delay on the line from circuit to power supply in order to prevent reflections.

$$t_{min} > 2d_1/v_p \tag{4}$$

where

t_{min} = minimum rise time in seconds, of current that the distribution line can supply,

d_1 = length of line from the circuit to the power supply, and

v_p = velocity of propagation on the line in units of length per second [$v_p = 1/(LC)^{1/2}$].

- The rise time must not produce a voltage transient across the power line greater than the

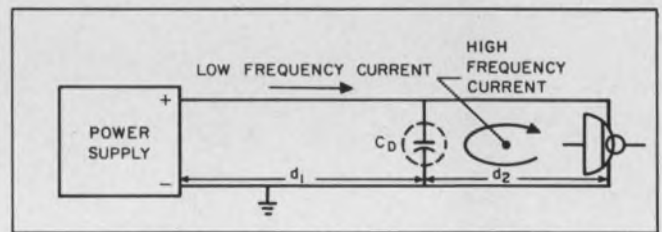

1. The decoupling capacitor, C_D , supplies the high-frequency portion of the current required when the switching circuit changes states, thus damping any transients that may appear on the power line.

circuit specifications allow. Since the rise time must be large compared with the propagation delay, the distributed parameters may be approximated by lumped parameters. The important parameter for this situation is the total series inductance of the line:

$$\Delta v > (L \times d_1) \Delta I / t_{min}, \tag{5}$$

$$t_{min} > (L \times d_1) \Delta I / \Delta V, \tag{6}$$

where

L = distributed series inductance of the line in henries per unit length,
 ΔI = change in current required by the circuit in amperes, and

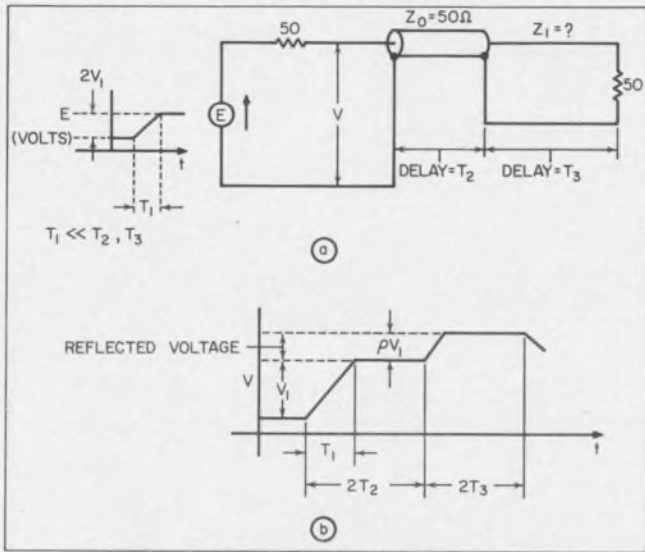

2. Normal current supplied to a switching circuit (a) may not change level fast enough to meet change-of-state current requirements (b). A decoupling capacitor can supply the charge needed for the steeper rise time (c).

ΔV = maximum allowable voltage drop across the line in volts.

The rise time of the current supplied by the distribution network, t_{min} , must satisfy inequalities (4) and (6).

The difference between t_{min} and the rise time of current required by the circuit, t_r , determines the charge that must be supplied by the capacitor. Figure 2 shows the two currents separately and superimposed. The shaded area between the superimposed currents (Fig. 2c) represents the charge that must be supplied by the decoupling capacitor. The equation for the charge is:

$$Q_c = \int_0^{t_{min}} i_{circuit} dt - \int_0^{t_{min}} i_{line} dt, \quad (7)$$

$$Q_c = [1/2 \times \Delta I \times t_r + \Delta I(t_{min} - t_r)] - 1/2 \Delta I t_{min}, \quad (8)$$

$$Q_c = 1/2 \times \Delta I \times (t_{min} - t_r). \quad (9)$$

The charge required and the maximum allowable voltage drop across the power line, ΔV , determine the capacitor value:

$$C_D = Q_c / \Delta V. \quad (10)$$

Substituting Eq. 9 for Q_c :

$$C_D = \Delta I (t_{min} - t_r) / 2\Delta V. \quad (11)$$

If a decoupling capacitor is located too far from a circuit, or if the distance between capacitors on the power distribution network is too long, the effectiveness of the capacitors will be reduced, because the impedance of the connecting conductors now becomes a factor.

Decoupling capacitors can be located either on the length of transmission line between capacitors, if they are being used to reduce the characteristic impedance of the line, or on the length of

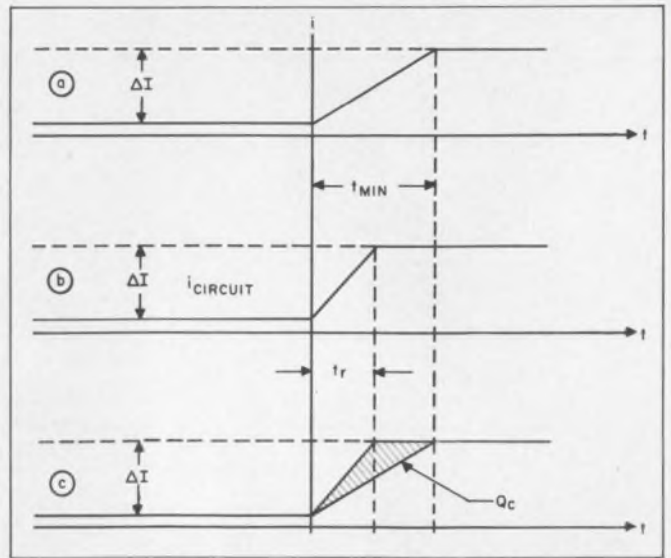

3. Calculation of propagation velocity and characteristic impedance is simplified with the test setup (a). The voltage across the 50-ohm resistor (b) is monitored on a high-speed oscilloscope.

transmission line between the circuit and the capacitor, if the capacitor is being used to supply transient currents.

To calculate capacitor separation, the same two restrictions are used as were used for determining t_{min} . In this case, however, the transmitted current ramp has a rise time equal to the rise time of the circuit, t_r , and the length of transmission line is the distance from capacitor to capacitor or from the capacitor to the circuit. The following inequalities result from these two substitutions:

$$t_r > 2 \frac{d_2}{v_p} \text{ or } d_2 < (1/2) \times t_r \times v_p, \quad (12)$$

$$t_r > L \times d_2 \Delta I / \Delta V \text{ or } d_2 < (t_r / L) (\Delta V / \Delta I), \quad (13)$$

where

d_2 = the distance from the circuit to the capacitor (or capacitor to capacitor),

t_r = the rise time of the circuits in seconds,

L = the distributed inductance of the line in henries per unit length,

v_p = velocity of propagation of the line in units of length per second
 $[v_p = (1/LC)^{1/2}]$,

ΔV = maximum allowable voltage drop across the line in volts, and

ΔI = change in current required by circuit in amperes.

How to measure line parameters

The formulas developed above require that the parameters of the line be known. A relatively uncomplicated and accurate test setup that can be used to determine the velocity of propagation and

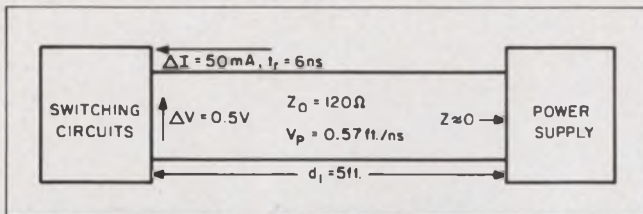

4. The design techniques described can be used to isolate the switching circuits from the power supply in this typical circuit.

the characteristic impedance is shown in Fig. 3a. The measured values can, in turn, be used to calculate the distributed inductance and capacitance.

A voltage step with a rise time much faster than the propagation times of interest is applied to a 50-ohm coaxial cable. The unknown line is fed from the cable and the voltage at point A is observed with a high-speed oscilloscope.

If the characteristic impedance of the line under test is greater than 50 ohms, a positive reflection will appear at point A (Fig. 3b). If the line has a characteristic impedance less than 50 ohms, a negative reflection will occur (not illustrated) and the fraction of the applied voltage that is reflected, ρ , will be negative. The time interval to the reflection is twice the delay of the 50-ohm coaxial cable. The duration of the reflected voltage is twice the delay of the transmission line under test. The fraction of the applied voltage that is reflected, ρ , determines the line impedance:

$$v_p = \text{length of line under test}/T_s, \quad (14)$$

$$Z_1 = (50\Omega) \times (1 + \rho)/(1 - \rho). \quad (15)$$

The distributed inductance and capacitance per unit length can be calculated from the formulas:

$$Z_1 = (L/C)^{1/2} \text{ and } v_p = (1/LC)^{1/2}.$$

Design example illustrates technique

Assume that power to a group of switching circuits is delivered by two 20-gauge wires (see Fig. 4). The length of wire (d_1) to the power supply is five feet. The characteristic impedance (Z_0) and velocity of propagation (v_p) are measured to be 120 ohms and 0.57 feet per nanosecond, respectively. The maximum change in current that the circuits require (ΔI) is 50 milliamperes. The current rise time (t_r) is 6 nanoseconds. The maximum allowable change in supply voltage (ΔV) is 0.5 volts.

The distributed inductance and capacitance per unit length of wire can be calculated from the formulas for characteristic impedance and velocity of propagation.

$$(L/C)^{1/2} = Z_0 = 120 \Omega,$$

$$(1/LC)^{1/2} = v_p = 0.57 \text{ ft/ns},$$

$$L = 0.21 \mu\text{H/ft},$$

$$C = 15 \text{ pF/ft}.$$

The following two checks verify that decoupling capacitance is needed:

1) Twice the propagation delay of the line, $2d_1/v_p$ (i.e., $2 \times 5/0.57 > 6$ ns), is greater than the current rise time. Therefore, the line must be treated as a transmission line and the circuit sees an impedance of 120 ohms.

2) The voltage drop produced by a current change of 50 mA through 120 ohms is much larger than the maximum allowable drop (i.e., $0.05 \times 120 > 0.5$ V).

In order to obtain the most effective solution we can compare the results of both decoupling techniques as follows:

Technique 1: Several capacitors are placed along the line to reduce the characteristic impedance seen by the circuit. To find the length of line between capacitors, calculate maximum separation from Formulas (12) and (13):

$$d_2 < 1/2 (t_r) (v_p) = 1/2 (6 \times 10^{-9}) (0.57 \times 10^9) = 1.71 \text{ ft},$$

$$d_2 < (t_r/L) (\Delta V/\Delta I) = [(6 \times 10^{-9}) / (0.21 \times 10^{-6})] (0.5/0.05) = 0.285 \text{ ft} \approx 3 \text{ in}.$$

The capacitors will be placed along the line, one every three inches, making a total of 19.

To find the proper capacitance value, calculate the desired line impedance: $\Delta V/\Delta I = 0.5/0.05 = 10$ ohms. Then substitute this value into Eq. (3):

$$C_D = (L/Z_0^2) - C_L = [(0.21 \times 10^{-6})/10^2] - 15 \times 10^{-12} = 0.0021 \mu\text{F/ft}.$$

The value of the individual capacitors is: $(2100 \text{ pF/ft}) (5 \text{ ft})/19 \text{ capacitors} = 552 \text{ pF/capacitor}.$

Technique 2: A single capacitor is placed near the circuits to supply the high-frequency portion of ΔI . The length of line between circuit and capacitor is three inches. The calculations are the same as for *Technique 1*. To calculate capacitance value, use formulas (4), (6) and (11).

$$t_{min} > 2d_1/v_p = 2(5)/(0.57 \times 10^9) = 17.5 \text{ ns},$$

$$t_{min} > (L \times d_1) \Delta I/\Delta V = (0.21 \times 10^{-6}) (5) (0.05/0.5) = 0.105 \mu\text{s},$$

$$C_D = \Delta I (t_{min} - t_r)/2\Delta V = 0.05 (0.105 \times 10^{-6} - 6 \times 10^{-9})/2(0.5) = 0.005 \mu\text{F}.$$

For this example the second technique is more efficient since a single 0.005- μF capacitor provides the same simulated line impedance as a string of nineteen 552-pF capacitors. ■ ■

Bibliography:

- Jarvis, D. B. "The Effects of Interconnections on High-Speed Logic Circuits," *IEEE Trans. on Electronic Computers*, Oct., 1963.
- Moffitt, L. R. "Time-Domain Reflectometry—Theory and Applications," *EDN*, Nov., 1964.

Siemens components

are

developed and produced by one of the world's leading electrical organizations, employing 257,000 people—15,000 in R & D alone—manufacturing in 33 countries and represented in over 100.

include

Ferrite materials
Capacitors
Electron tubes
Microwave tubes
Rectifiers

offer

advanced design,
reliability,
long life,
versatility



SIEMENS

FERRITE POT CORES

Precision-engineered for adjustable high-stability, high-Q coils. Siemens pot cores meet the most critical requirements for filters used in multiplex and other carrier-frequency applications, achieved with properties like: easy adjustment, highest stability, high Q, low distortion, and self-shielding.

Uniformity of characteristics. Siemens pot cores are known for consistent electrical characteristics month after month.

Wide range of materials and sizes. With 8 different materials, 18 different sizes (from .22 to 2.75 inches diameter) and a total of more than 250 different stand-

ard types, optimum properties are obtainable for all filter, oscillator and transformer applications.

Stability. Less than 0.2% change in permeability in 10 years at temperatures up to 70° for typically gapped cores used in filter coils.

High Q value with high stability is typical. For example, a 26 x 16 core of N22 or N28 material AL 315 at 100 kc/s shows a Q value of approximately 950.

Off the shelf delivery. Write now for complete information on Siemens pot core application.

SIEMENS AMERICA INCORPORATED
Components Division
230 Ferris Avenue,
White Plains, N.Y. 10603

In Canada: SIEMENS CANADA LIMITED
407 McGill Street, Montreal 1, P.Q.

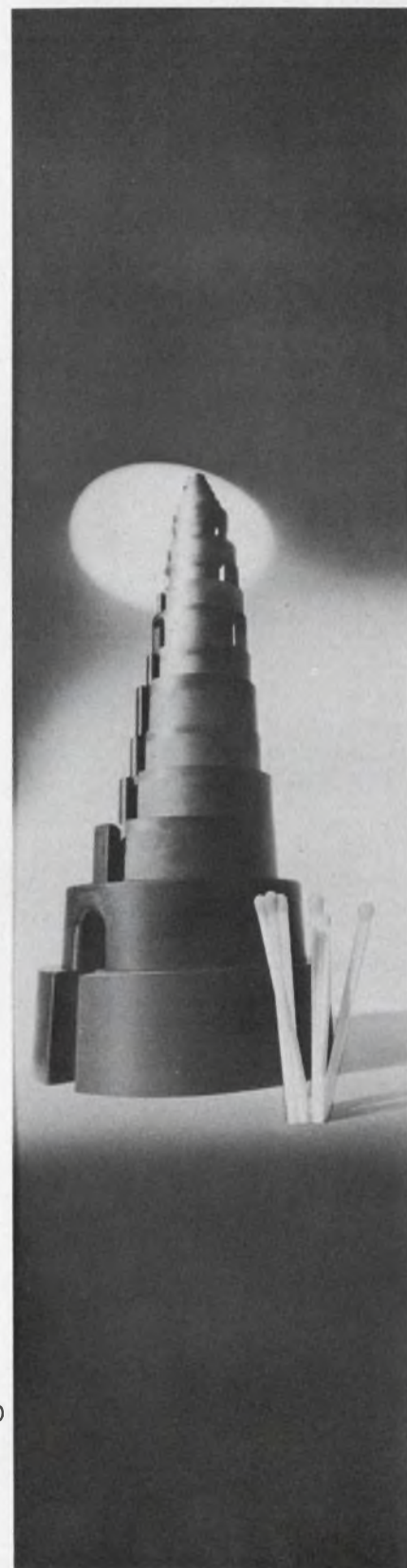

Cut transistor-replacement costs due to device failure. Use safe-operating-area principles to design power-transistor switching circuits.

Part 2 of a two-part article

Designers will surely welcome a solution to the problem of transistor failure in power-switching and amplifying circuits. If a network design is patterned according to Soar (safe operating area) principles, both questionable safety margins and the high cost of device replacement will be avoided.

Soar, an area plot on the device's I_C - V_{CE} characteristics, is tailored to the specific application at hand. It embraces the governing design parameters, emphasize the design stresses peculiar to the application and accounts for worst-case thermal effects.

In effect, Soar is a complete, graphical representation of the combined effect of the absolute maximum ratings that appear on device specification sheets. It is more comprehensive in that it supplies design guidelines for operating conditions that are beyond the scope of data-sheet information.

The remaining* areas of major application for power transistors are resistive and clamped inductive switching networks, unclamped inductive switching circuits and Class-B amplifiers. The areas of safe device operation will be developed through examination first of the current-voltage relationships peculiar to each application.

Separate drive and collector networks

The first step in establishing Soar for resistive and clamped inductive switching circuits is to separate the drive and collector network portions. A Soar is easily developed for the latter circuit; the drive section is reviewed in terms of its adherence to the specified absolute maximum ratings of the parameters.

The key ratings for the drive circuit, drawn from the transistor specification, are $I_{B\ MAX}$ and $V_{BE0\ MAX}$. If not otherwise specified, it can be assumed that $I_{B\ MAX}$ is the maximum base current in the forward direction. The reverse base

*The other major application categories, dc and pulse operation, were examined in Part 1 of this article (see ED 18, Aug. 2, 1966, pp. 52 to 56).

Peter P. Balthasar, Manager of Applications Engineering, Bendix Semiconductor Div., Holmdel, N. J.

current during collector-current turn-off (stored charge) should also not exceed the value of $I_{B\ MAX}$. The driving source voltage, V_{BB} , should generally be smaller than V_{BE0}^\dagger

Turning to the collector circuits, the following are the governing design parameters:

- $T_{J\ MIN} \leq T_J \leq T_{J\ MAX}$, based on average power dissipation and θ_{JC} .
- V_{CES} , V_{CRO} , V_{CER} and V_{CEX} ; each is used for the highest collector voltage at which a resistive load can be switched off.
- $V_{CEO\ (SUS)}$; this value should be multiplied by a factor of 0.5 for high-frequency devices and by 1.0 for others. The net product in both cases is the maximum clamping voltage at which the maximum collector current can be switched.

Furthermore, it is good practice to limit the maximum allowable rise and fall times: 50 μs is a

† For diffused germanium transistors, however, V_{BB} can be, and in most applications actually is, higher than V_{BE0} . For these cases a maximum base-emitter dissipation should be given.

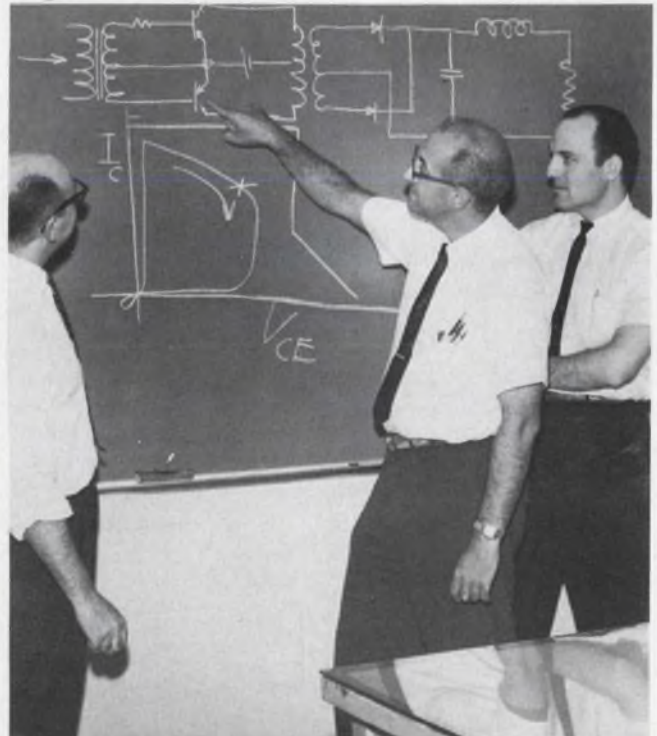

Pointing out the device under stress, an applications-engineering associate (center) of Author Balthasar (extreme left) makes an inquiry about the Soar inverter plot.

reasonable number, one which is seldom exceeded in most designs.

Use Soar to cut conjecture

Conclusions based on this temperature, voltage and time information compel the circuit designer to be very conservative, even though he does not actually know the safety margin of the design. To eliminate any additional guesswork, a Soar with specific conditions for derating should be used.

Figure 1 shows a safe operating area (delineated by the crosshatching) for clamped inductive switching circuits. Here the collector current has to be drastically decreased at high collector voltages for transistors exhibiting high negative resistance on their open-base breakdown characteristic. If the two test points are near the same voltage level, it is practical to test only the high-current point and simplify the Soar by using only the shaded area. A similar simplification can be achieved by switching the maximum collector-current on a resistive load line. In all other cases, both test points must be used. A high value of either V_{CES} or V_{CEX} may be tolerated, provided the Soar is modified so that the load line reaches the collector leakage current at V_2 (Fig. 1b).

Test circuit establishes Soar

Let us now go through the step-by-step proce-

cedure for the Soar testing of these circuits. As in Part 1 we use a typical silicon power transistor unit—the B170008. The conditions are as follows:

$$T_J = (T_C + \theta_{JC} P_{C\text{ AVG}}) \leq T_{J\text{ MAX}} = 200^\circ\text{C}, \quad (1)$$

$$P_{C\text{ AVG}} = \frac{1}{0.1\tau_J} \int_0^{0.1\tau_J} i_c V_{ce} dt \leq P_{dc} \text{ at highest}$$

$$V_{CE(dc)} = 40 \text{ W}, \quad (2)$$

$$I_C = f(V_{CE}) \text{ (Soar Area E)}, \quad (3)$$

$$\text{Allowable rise or fall time, } t_r = t_f \leq 50 \mu\text{s}, \quad (4)$$

$$I_B \leq I_{B\text{ MAX}} \leq 7 \text{ A}, \quad (5a)$$

$$I_{B\text{ REV MAX}} \leq 1 \text{ A}, \quad (5b)$$

$$V_{BB2} \leq V_{BEO} = 5 \text{ V and } R_{source} \leq 5 \Omega. \quad (6)$$

For the resistive loadline, $L=0$ and $V_{CC}=V_2$ in the circuit (Fig. 2a). Note that the test circuit can be used for both clamped inductive and resistive switching. The switch itself can be a 60-Hz mercury relay, or a transistor driven by a pulse generator as shown in Fig. 2b. Where high values of base current are required, the circuit in Fig. 2a has very high currents in the switch. Therefore the modified driver (Fig. 2c) may be used instead.

It operates as follows: When the switch is closed, forward base current is supplied and current starts to build up in the inductor. Opening the switch breaks the forward current. At the same time, the inductive current is forced in the reverse

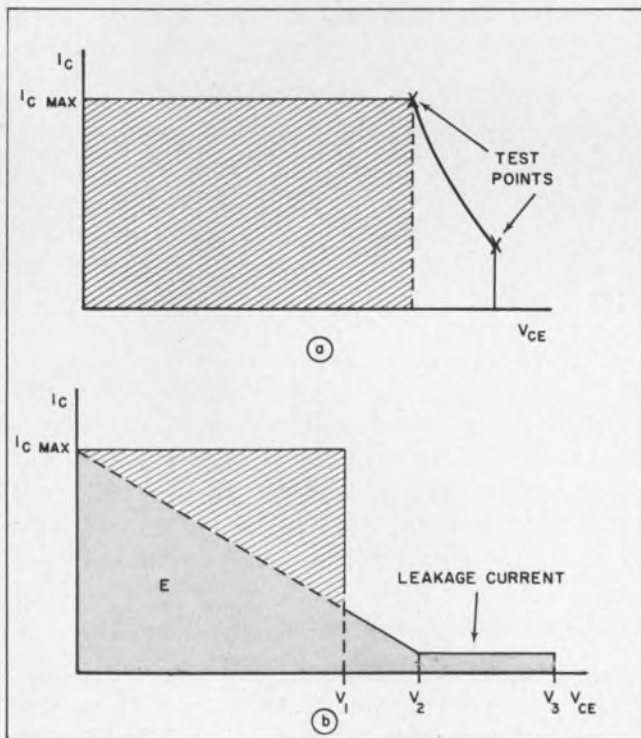

1. Safe operating area (Soar) for power transistors in clamped inductive switching applications is denoted by the crosshatched portion on the I_C - V_{CE} characteristic (a). If the load is resistive a modified Soar (b) is used—area E under the triangular portion.

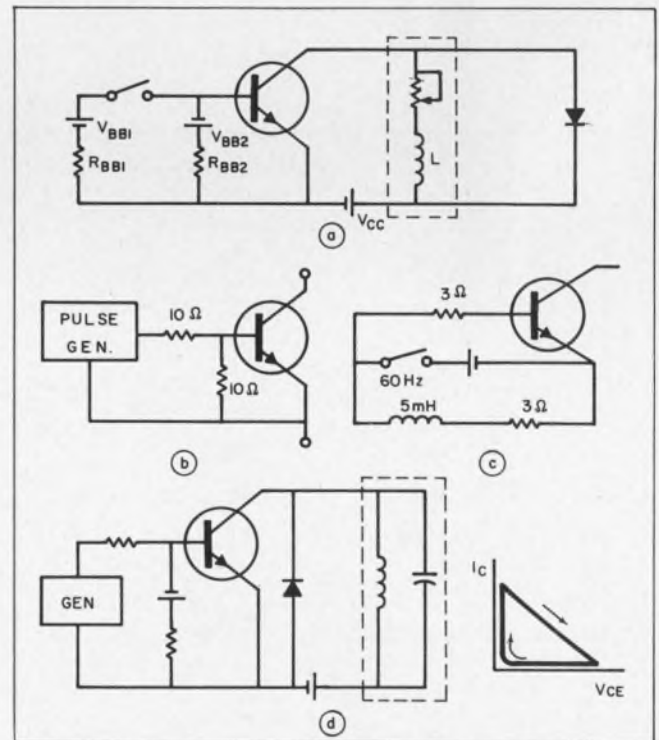

2. Test circuit determines Soar I and V parameters for resistive and clamped inductive switches (a). Pulse generators may be more convenient in base-drive section (b). For high base drive values, a larger signal generator (c) is used. For tuned loads, use modified circuit (d).

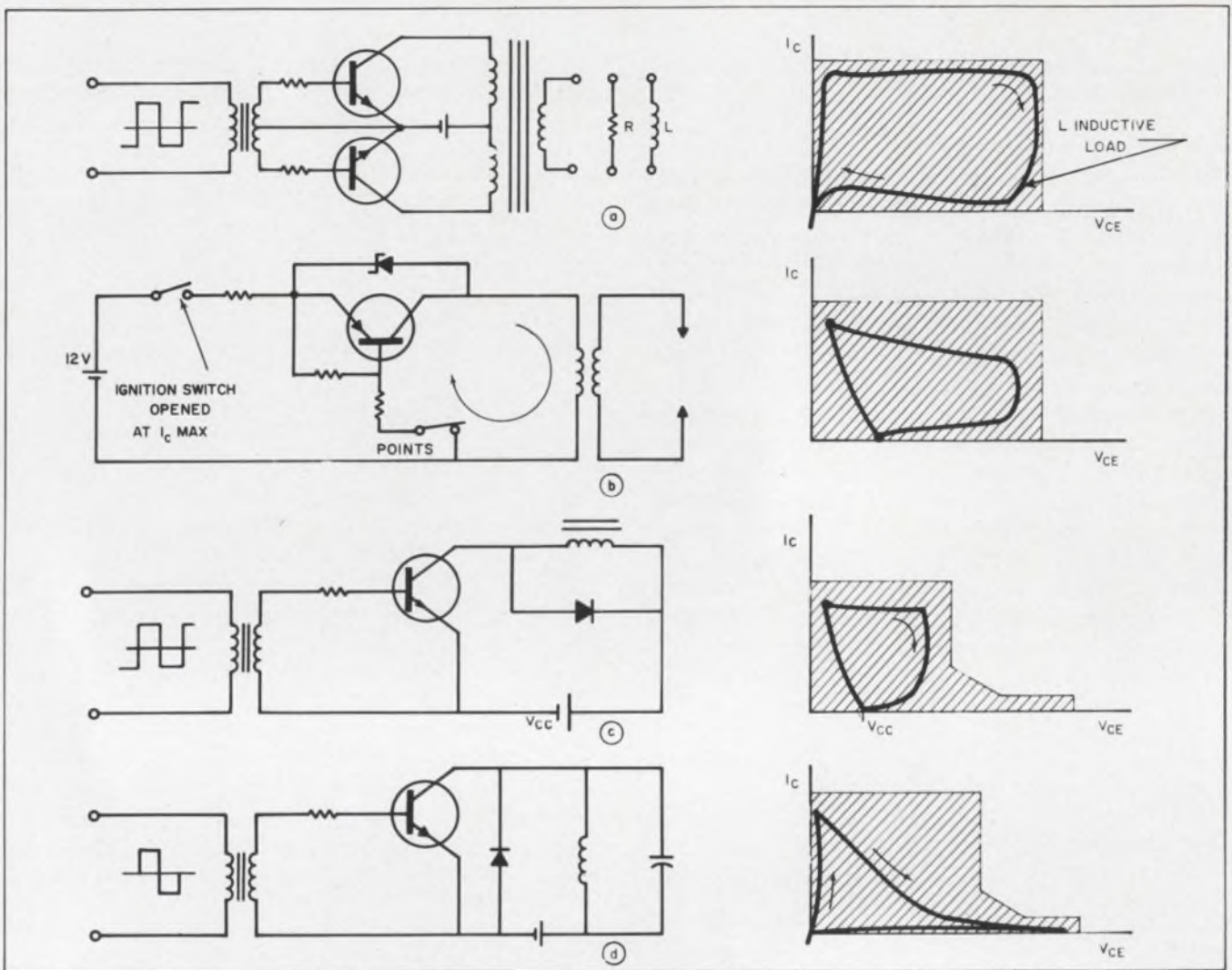

3. Common resistive and clamped inductive switching networks and their associated Soars: inverter (a), ignitor (b),

relay-driver (c) and TV horizontal-output stage (d). In each case the Soar is the area bounded by the enclosed curves.

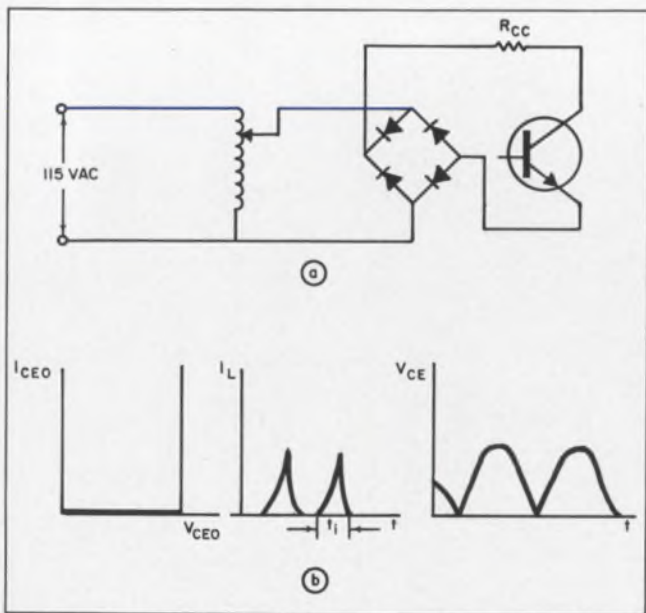

4. Unclamped inductive switching circuits (a) present a number of variables to the power device, not the least of which is an indefinite inductance. The resulting device characteristic (b) is more complex than the simple $I_C - V_{CE}$ relationship.

direction through the emitter-base diode, turning off the transistor. To verify worst-case conditions, the highest reverse base current should be used. A tuned load can be used to sweep V_{CE} to V_3 of Fig. 1b. Figure 2d shows the circuit of Fig. 2a modified with a tuned load, and the resulting $I_C - V_{CE}$ characteristic.

The Soar procedure described in the preceding paragraphs can be fitted to a number of resistive and clamped inductive switching systems. Among the most widely used of these are inverters (Fig. 3a), ignitors (Fig. 3b), relay drivers (Fig. 3c) and TV horizontal-output stages (Fig. 3d). The $I_C - V_{CE}$ graph is given beside each circuit.

Avoid unclamped L-switches

On conventional data sheets there are few guides to what kind of inductive currents can be switched successfully. This is one good reason to avoid switching unclamped inductors whenever possible. Nonetheless, such applications do crop up and Soar must be developed. The following test circuit paves the way.

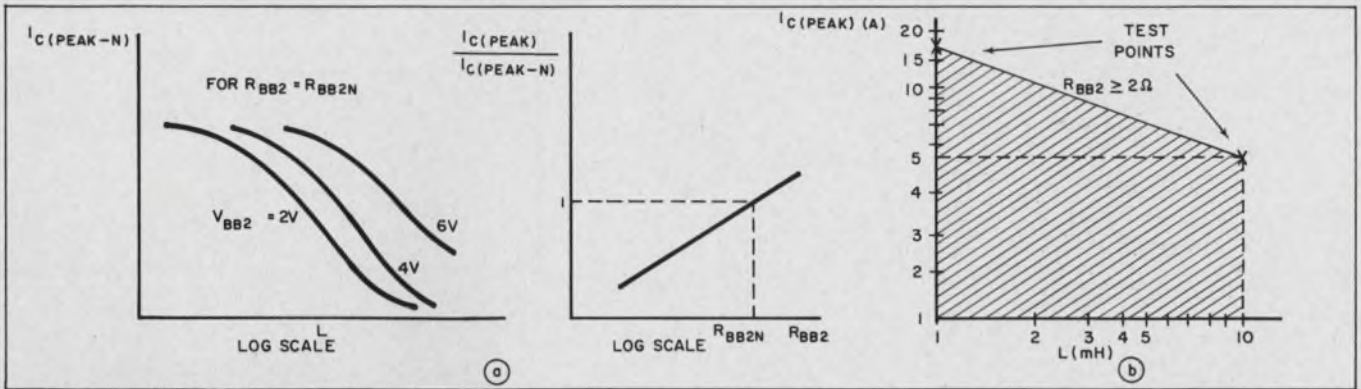

5. Transistor capability is basis for establishing Soar in unclamped inductive switching networks. Collector current

vs inductance as functions of base resistance and base bias (a) determine the Soar curve (b).

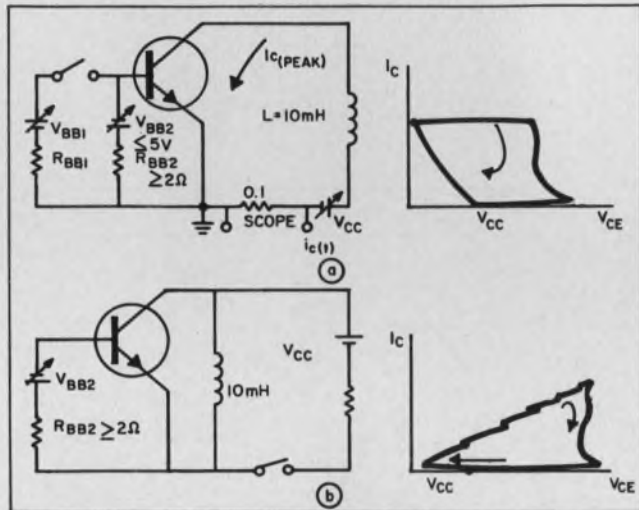

6. Test circuits for measuring the Soar parameters for unclamped inductive switching circuits: common-emitter network (a) and common-collector version (b).

A V_{CE0} specified at 0.5 A on full-wave rectified 60-Hz current in the test circuit of Fig. 4a would indicate that an inductive current of half an ampere can be turned off by opening the base. It is, however, difficult to determine the exact amount of inductance. (It, in fact, varies between 0.5 and 200 mH in the circuit.)

The following estimate makes clear the problem of indefinite loads: A transistor characteristic as shown in Fig. 4b would be able to switch off 0.5 A if inductor L were smaller than $t_1 V_{CE0 MIN}/0.5$ A. If $V_{CE0 MIN} = 50$ V and $t_1 = 0.2$ ms, $L = 20$ mH.

A similar estimate could be made if either V_{CES} or V_{CER} (instead of V_{CE0}) were specified at an appreciable collector-current level. Moreover, these calculations would be just as valid. To draw any conclusions from this information for even higher collector currents and for the various base reverse-biased conditions is therefore extremely difficult. Fortunately, however, an accurate Soar can still be developed. Only four variables are of prime importance for circuits that switch an unclamped inductive load. These are:

- The current to be switched, $I_{C PEAK}$.
- The inductance of the load, L .
- The OFF driving base voltage, V_{BB2} .†
- The output impedance, R_{BB2} , of the driving circuit.

Figure 5 shows a transistor's capability for unclamped inductive switching. If we again use B170008 and $R_{BB2} > 2.0 \Omega$, we can simplify Fig. 5a. If the load has a series resistive component, the energy absorbed in the resistor during collector current turn-off can be subtracted from the energy stored in the inductor. However, calculating the energy absorbed by the resistor is difficult when the highest breakdown voltage of a transistor type is unknown. Within a given transistor type, the unit with the highest voltage absorbs more energy than any with a lower voltage. All specifications give a minimum but no maximum value for this voltage. Therefore, the safest procedure is to assume that all load energy must be absorbed by the transistor (Fig. 5b).

Power pulses used in test circuit

The thermal consideration is based on power pulses with small time durations compared with the thermal time constant of the device. The following conditions apply to the Soar representation (Fig. 5b):

$$T_J = T_C + \theta_{JC} P_{AVG} \leq T_{J MAX} = 200^\circ C, \quad (7)$$

$$P_{AVG} = \frac{1}{0.1\tau_J} \int_0^{0.1\tau_J} i_c V_{CE} dt \leq 40 \text{ W}, \quad (8)$$

$$V_{BB2} \leq V_{EBO MAX} = 5V, \quad (9)$$

$$(1/2)LI_c^2 \leq 125 \text{ milliwatt-seconds}. \quad (10)$$

Two test circuits which verify that the Soar of Fig. 5b is accurate are presented in Fig. 6. Used in the testing of unclamped inductive-loaded circuits, they represent the extremes of the $I_C - V_{CE}$ characteristic. Note that the Soar of Fig. 5a falls

†Punch-through limited devices, compared with avalanche-breakdown limited devices, are less sensitive to an increase of reverse-bias V_{BB2} . They withstand the switching of high-energy levels better.

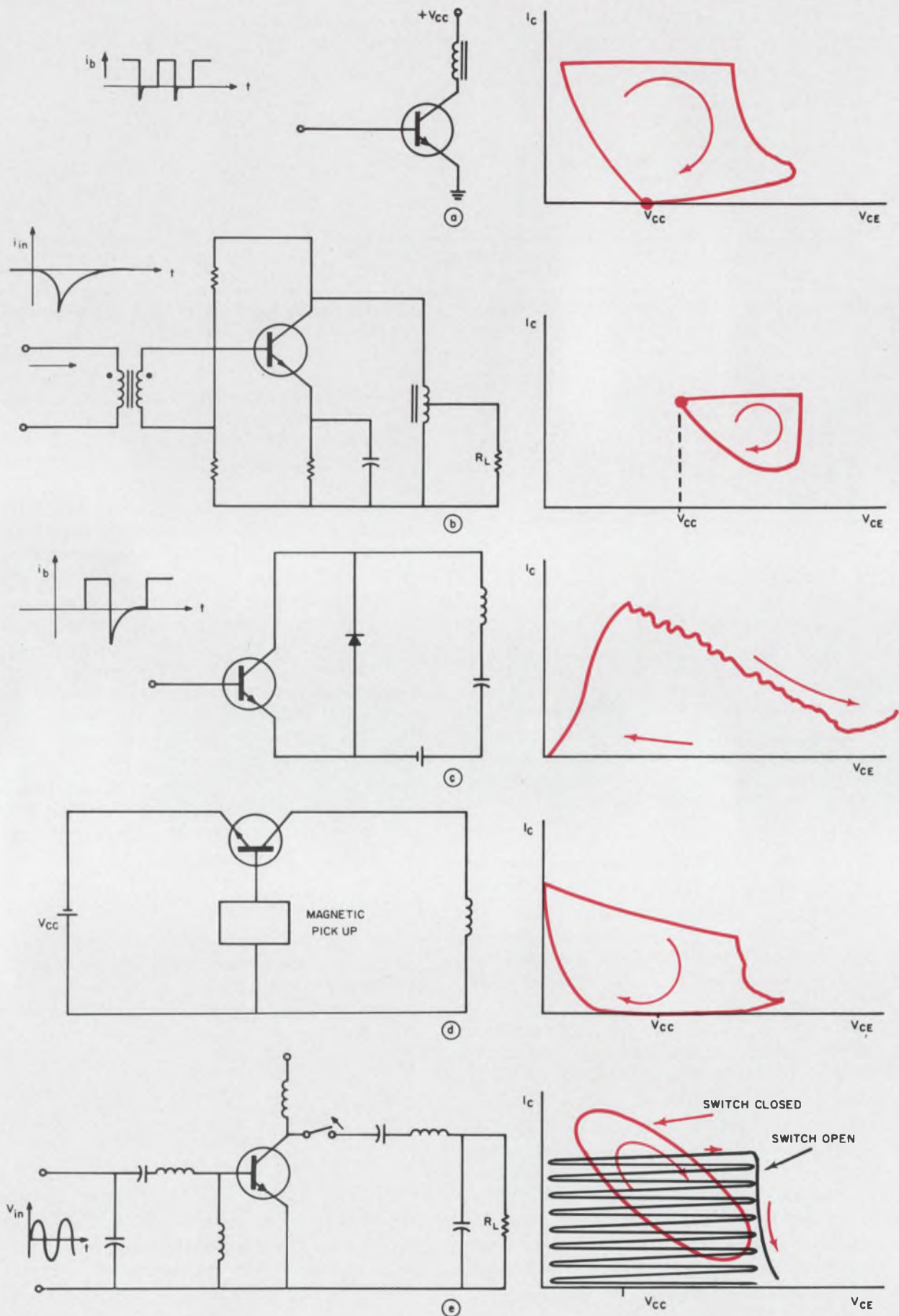

7. Soar plots for a number of unclamped inductive switching applications include a relay driver (a), a Class-A audio amplifier with a large inductive transient (b), a TV horizontal-output stage with high-voltage arcing (c), an ignition system with an open secondary (d) and a high-frequency, Class-B amplifier with the load removed (e).

zontal-output stage with high-voltage arcing (c), an ignition system with an open secondary (d) and a high-frequency, Class-B amplifier with the load removed (e).

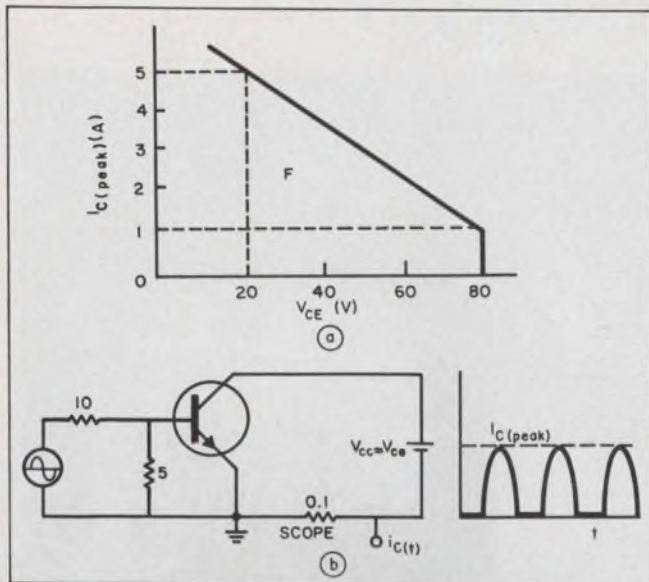

8. When a Class-B stage is shorted, the current-handling capabilities of the device are severely tested. The resulting Soar (a) for a specific device (the B170008 power transistor) was established by the test circuit (b) for one class of applications—audio stages.

within the enclosed area of Fig. 6a.

Similar Soars can be developed for a host of specific unclamped inductively loaded circuits. Some of the more common systems and their representative $I_C - V_{CE}$ characteristic appear in Fig. 7. These are the relay-driver (Fig. 7a), a Class-A audio amplifier in which the inductive-coupling produces a transient (Fig. 7b), a TV horizontal-output stage with high-voltage arcing (Fig. 7c), an ignition system with an open secondary (Fig. 7d) and a high-frequency, Class-B amplifier with the load removed (Fig. 7e).

Data lacking for shorted Class-B stages

One of the questions that transistor specification sheets fail to answer directly is how much current a Class-B stage can handle under short-circuited conditions. By testing one type, we have developed a Soar from the results. The B170008 device was again used, although the shape of the Soar curve is equally applicable to all other power transistors in this application (Fig. 8a). The test circuit itself is shown in Fig. 8b.

Safe operation is guaranteed for any operation within Area F when the following conditions are met:

$$T_J = T_C + \theta_{JC} P_{C\text{ Avg}} \leq 200^\circ\text{C}, \quad (11)$$

$$T_C \leq 100^\circ\text{C}, \quad (12)$$

$$f \geq 20 \text{ Hz}, \quad (13)$$

$$I_{C\text{ PEAK}} \leq f(V_{CE}) \text{ (Area F)}. \quad (14)$$

The limits of 20 Hz and 100°C were chosen because they satisfy a majority of the conditions common to audio applications. ■ ■

Can you get high-speed complementary transistor design in IC's —without compromise?

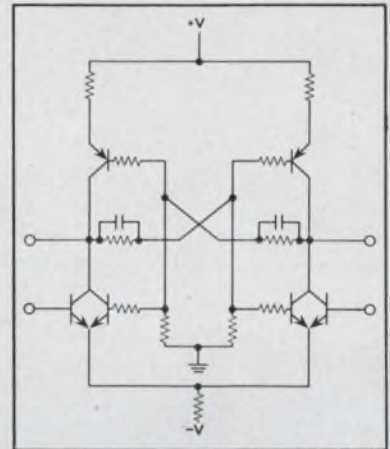
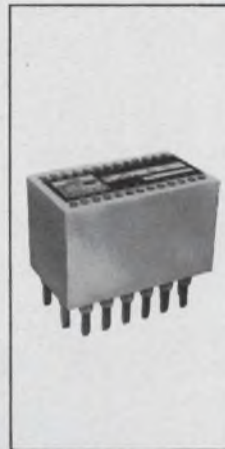

Look at Philco's hybrids.

Suppose you want your circuit design to take full advantage of complementary transistor techniques—with low standby power requirements, high speed, the ability to drive high currents and high capacitive reactance loads. Yet you'd like the advantages of integrated circuitry, too—miniaturization, reliability and cost reduction.

This is where our hybrid microcircuits can help. The CTL flip-flop microcircuit shown above, for example, has a stage propagation delay of less than 5 nsec at 100 ma. It is easily fabricated at minimum cost by hybrid techniques—requiring no compromises in achieving simultaneous NPN and PNP action.

In addition, our hybrid techniques permit the simple construction of complementary linear IC's, RF/IF amplifiers with center frequencies in excess of 100 MHz, and FET input operational amplifiers. Of course, the same advantages of high power capability and moderate cost still apply.

The examples above indicate only one or two problem areas that yield to the hybrid approach. High power and voltage requirements can also be easily met in hybrid IC's. A call to your local representative or to Philco's Marketing Department, Spring City, Pa. (215-948-8400), will bring you further information—and an invitation to submit discrete circuit plans for a quick quote on hybridization costs!

SOLID-STATE PRODUCTS OPERATION

PHILCO

A SUBSIDIARY OF Ford Motor Company,
LANSDALE DIVISION · SPRING CITY, PA.
In Canada, Don Mills Road, Don Mills, Ontario, Canada

Speed Inquiry to Advertiser via Collect Night Letter
ON READER-SERVICE CARD CIRCLE 143

VOLTAGE-TO-FREQUENCY

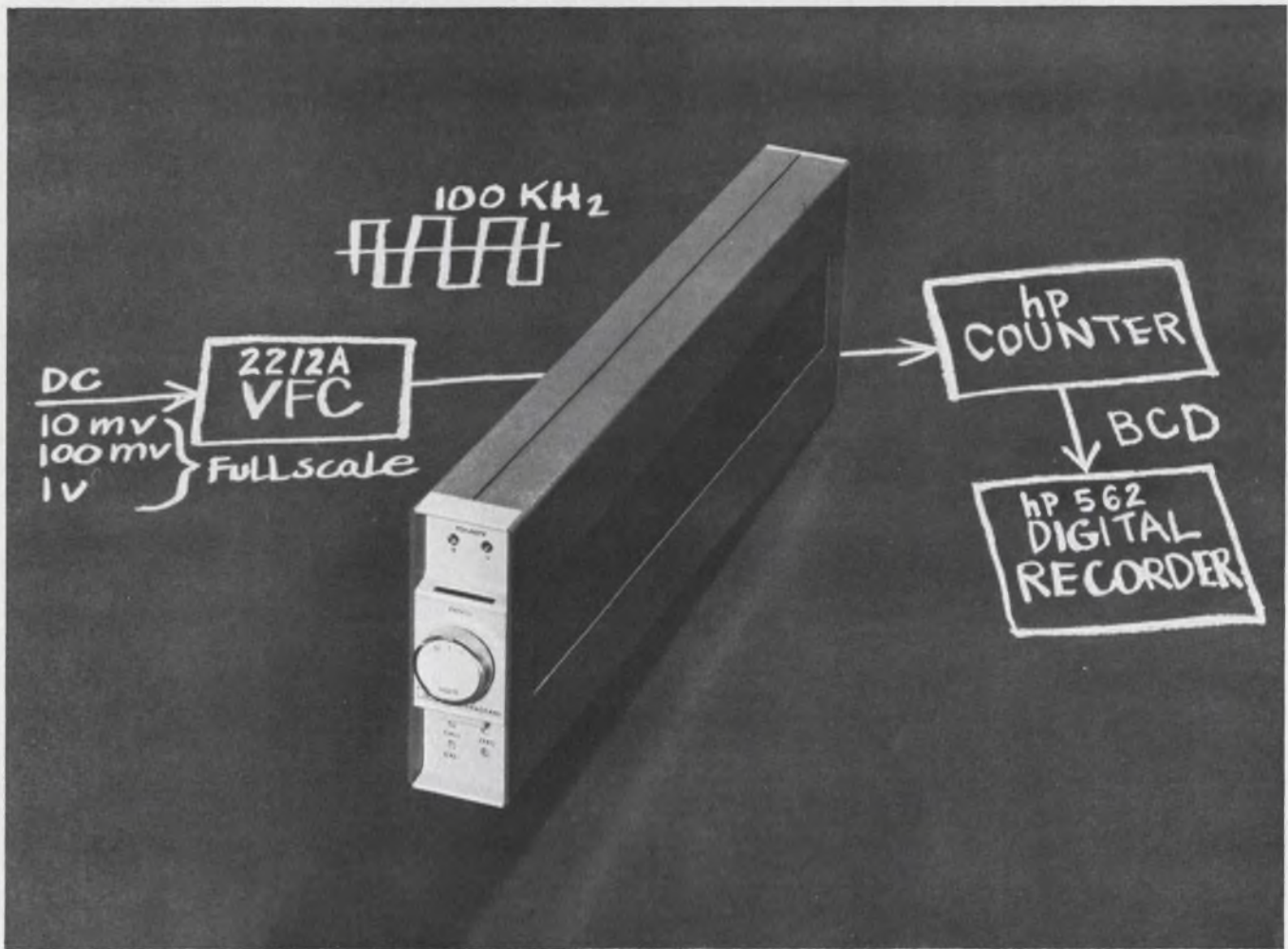

CONVERTER

High-performance low-level analog-to-digital conversion

The Hewlett-Packard 2212A Voltage-to-Frequency Converter delivers an output pulse train with rate directly proportional to the magnitude of a dc input signal. Full-scale inputs of 10 mv, 100 mv and 1 v produce an output frequency of 100 kHz; 150% overranging on all ranges. Other ranges, precision vernier control and internal calibration source are optional.

Here's a converter ideal for all types of low-level analog-to-digital conversion applications. Used with an electronic counter it tracks an input voltage by repetitive sampling to form a noise rejecting integrating digital voltmeter. The VFC responds to both positive and negative input voltages; used with a reversing counter it tracks around zero with no crossover error. Provides polarity indication and output signal.

Differential input for low drift, high cmr (120 db all ranges); true integration averages out noise superimposed on signal. Input impedance is 1000 megohms all ranges for minimum circuit loading; input and output circuits are isolated by internally driven guard shields. Fast 100 μ sec settling, 100 μ sec overload recovery gives maximum usefulness in multi-channel system applications.

The 2212A MTBF is predicted in excess of 10,000 hours. Hermetically-sealed silicon transistors are used throughout, and passive and active components are selected for reliability, as well as performance. VFC speci-

fications are guaranteed at 95% relative humidity at 40°C. A factory 100-hour "run-in" test at elevated temperature assures reliable operation.

A rugged, unique molded dielectric case encloses VFC circuitry and built-in power supply...all in a package less than 5 $\frac{1}{4}$ " high. A combining case is available to hold 10 instruments side-by-side in a rack-width module. The 2212A VFC costs \$900.

Call your Hewlett-Packard field engineer for complete information or write the Dymec Division of Hewlett-Packard, 395 Page Mill Road, Palo Alto, Calif. 94306, Tel. (415) 326-1755; Europe: 54 Route des Acacias, Geneva.

Data subject to change without notice. Price f.o.b. factory.

See New hp Instruments
Attend Measurement Seminars
WESCON - Hollywood Park

**HEWLETT
PACKARD**  **DYMEC
DIVISION**

1317

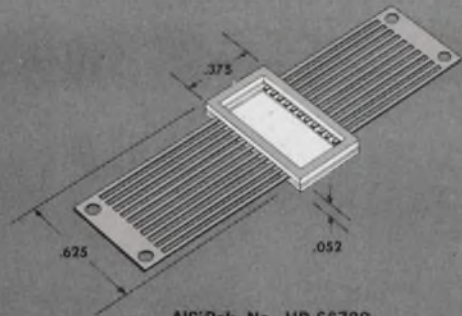

AISiPak No. HP-66788
22 Leads

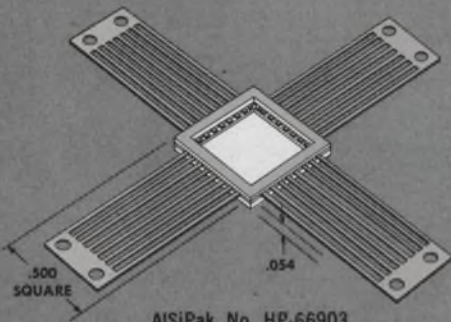

AISiPak No. HP-66903
16 or 32 Leads

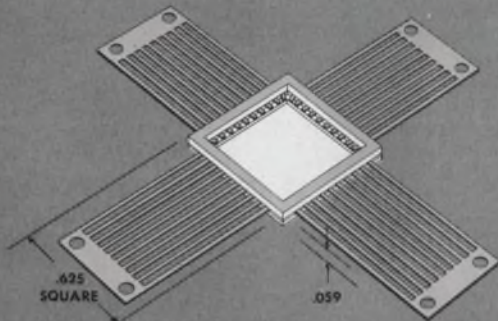

AISiPak No. HP-66907
20 or 40 Leads

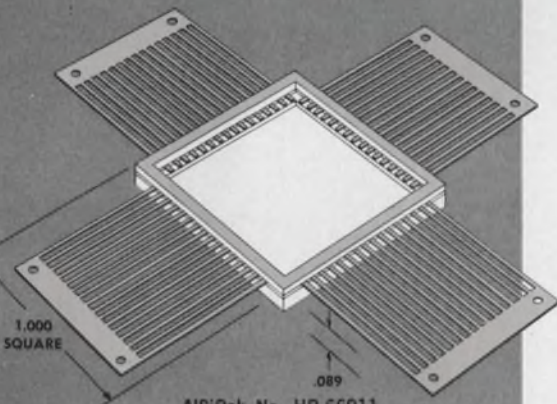

AISiPak No. HP-66911
30 or 60 Leads

ALSiPAK CERAMIC PACKAGES

Four New Preferred Styles

The **RELIABILITY** of AISiPak CERAMIC PACKAGES for electronic circuits is thoroughly proven. The use of these ceramic packages has grown rapidly and continues to rise.

As a service to the electronic industry, American Lava Corporation introduced seven "preferred style" packages early in 1965. They involve no tooling charges, are more promptly available and permit several low cost or no charge options on leads, inside depth, pads, etc., to readily adapt these preferred styles to an individual need.

As new requirements in volume are established, American Lava moves promptly to meet them. Shown are four new AISiPak packages which have been added to the original Preferred Style packages introduced in American Lava Bulletin No. 655. We believe this bulletin is the most inclusive technical publication presently available on ceramic packages.

CUSTOM PACKAGES. AISiPak ceramic packages can be custom made for your specific requirements. Our technical people with special experience on package design will make suggestions if you request them.

NEW CHIP MOUNTING PAD PACKAGES.

Recent advances on chip mounting pad package designs now permit AISiPak packages with nickel-iron-cobalt pad brought directly off one lead down onto the floor of the package.

Bulletin No. 655 Available on Request



American Lava Corporation **3M**
A SUBSIDIARY OF COMPANY

PHONE 615 265-3411, CHATTANOOGA, TENN. 37405

For service, contact American Lava representatives in Offices of Minnesota Mining and Manufacturing Company in these cities (see your local telephone directory): Atlanta, Georgia • Boston: Needham Heights, Mass. • Chicago: Bedford Park, Illinois • Cleveland, Ohio • Dallas, Texas • Laurens, South Carolina • Los Angeles, Calif. • Metropolitan New York: Ridgefield, N. J. • Up-State New York and Canada: Baldwinsville, New York • Philadelphia, Penn. • Roanoke, Va. • South San Francisco, Calif. Troy, Michigan • 3M International: c/o American Lava Corporation, Chattanooga, Tenn. 37405, U.S.A., Phone 615/265-3411.



Check the parameters of pads graphically

with a set of charts that show the errors in terms of percentage errors of the pad resistors.

Four-pole resistance networks, or pads, are essential components in transmission circuits. If the resistors are not accurate, the pads will not provide the required impedances and attenuation, and errors will be introduced into the system.

Here is a set of nomographs that give the return loss and the error in input impedance, attenuation and insertion loss for T- and Π -type pads that are due to errors in the values of their component resistors.

It is possible to calculate the parameters once the percentage errors in the resistors are known. The math, however, is tedious and time-consuming.

The charts, on the other hand, can be used to find all these parameters for symmetrical pads from 0.1 to 100 dB rapidly and easily. Knowing the required accuracy of the pad the designer can also select suitable standard resistors of known tolerances.

Mathematics is complex

The components of a T-pad may be evaluated from the given impedance requirements:

$$R1 = Z1 (K^2 + 1)/(K^2 - 1) - R3 \quad (1)$$

$$R2 = Z2 (K^2 + 1)/(K^2 - 1) - R3 \quad (2)$$

$$R3 = 2K (Z1Z2)^{1/2}/(K^2 - 1) \quad (3)$$

where:

$Z1$ = input impedance,

$Z2$ = output impedance,

K = required attenuation ratio,

For symmetrical pads, where $R1 = R2$:

$$R1 = R2 = R(K - 1)/(K + 1)$$

$$R3 = 2RK/(K^2 - 1)$$

(It has been assumed that $Z1 = Z2 = R$ for symmetrical pads.)

The pertinent equations for a T-pad are:

Attenuation (dB):

$$20 \log \left\{ \frac{R1(R + R1 + R3) + R3(R + R1)}{RR3} \right\}, \quad (4)$$

Error in attenuation (dB):

$$20 \log \left\{ 1 + \frac{(3K^2 + 1)(K - 1)}{2K^2(K + 1)} \frac{a}{100} - \frac{(K - 1)^2}{K(K + 1)} \frac{c}{100} \right\} \quad (5)$$

Insertion loss (dB):

$$20 \log \left\{ \frac{(R + R1)(R + R1 + 2R3)}{2RR3} \right\} \quad (6)$$

Error in insertion loss (dB):

$$20 \log \left\{ 1 + \frac{1}{100} \frac{K - 1}{K + 1} (a - c) \right\}, \quad (7)$$

Error in input impedance:

$$\left\{ \frac{(K^2 + 1)(K - 1)}{K^2(K + 1)} \frac{aR}{100} + \frac{2(K - 1)}{K(K + 1)} \cdot \frac{cR}{100} \right\} \quad (8)$$

Return loss (dB):

$$20 \log \left\{ 1 + \frac{200}{K^2(K + 1)} \frac{a}{100} + \frac{2(K - 1)}{K(K + 1)} \frac{c}{100} \right\}, \quad (9)$$

where a and c are the percentage errors in the values of $R1$ and $R3$ respectively, and R is the terminating resistance.

The similar expressions for a Π -pad are:

Attenuation (dB):

$$20 \log \left\{ \frac{R3(R + R1) + RR1}{RR1} \right\}, \quad (10)$$

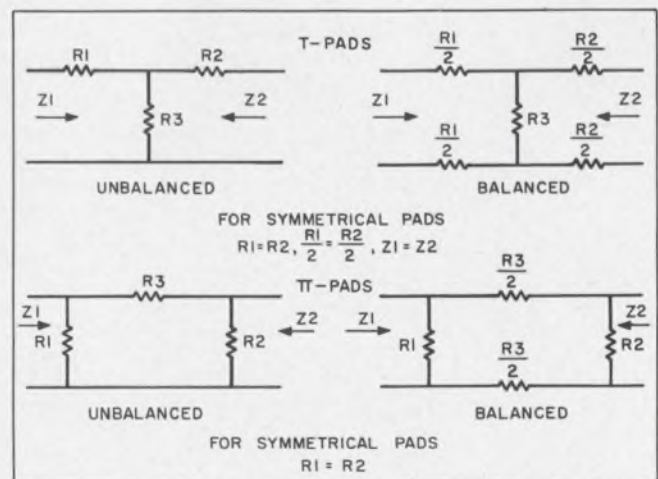

1. T and Π pads are the most widely used four-pole resistive networks in transmission-line circuits.

Error in attenuation (dB):

$$20 \log \left\{ 1 - \frac{(K-1)^2 a}{2K^2 \cdot 100} + \frac{K-1 c}{K \cdot 100} \right\}, \quad (11)$$

Insertion loss (dB):

$$20 \log \left\{ \frac{(R+R1)(RR3+R1R3+2RR1)}{2RR1^2} \right\}, \quad (12)$$

Error in insertion loss (dB):

$$20 \log \left\{ 1 + \frac{1}{100} \frac{K-1}{K+1} (c-a) \right\}, \quad (13)$$

Error in input impedance:

$$\left\{ \frac{(K-1)(K^2+1)}{K^2(K+1)} \frac{aR}{100} + \frac{2(K-1)}{(K+1)} \frac{cR}{100} \right\}, \quad (14)$$

Return loss (dB):

$$20 \log \left\{ 1 + \frac{200}{\frac{(K-1)(K^2+1)}{K^2(K+1)} a + \frac{2(K-1)}{K(K+1)} c} \right\}, \quad (15)$$

where a and c are the percentage errors in the

values of $R1$ and $R3$ respectively, and R is the terminating resistance.

The component values for the Π -pad are:

$$1/R1 = (K^2 + 1)/Z1(K^2 - 1) - 1/R3, \quad (16)$$

$$1/R2 = (K^2 + 1)/Z2(K^2 - 1) - 1/R3, \quad (17)$$

$$R3 = (K^2 - 1) (Z1Z2)^{1/2} / 2K. \quad (18)$$

For symmetrical pads:

$$R1 = R2 = R (K + 1) / (K - 1),$$

$$R3 = R (K^2 - 1) / 2K.$$

How to use the charts

To illustrate the use of the charts, let the required value of a T-pad be 10 dB and let the percentage errors in the values of the resistors $R1$ and $R3$ be +10 and +5 respectively. That is, $a = +10$, and $c = +5$. Then attenuation error can be determined from the graph of Fig. 2. Find the values of A and C for a 10-dB pad, corresponding to $a = 10$ and $c = 5$. The signs of A and C should be the same as those of a and c , respectively. Here $A = +0.081$ and $C = +0.018$. In the figures, N rep-

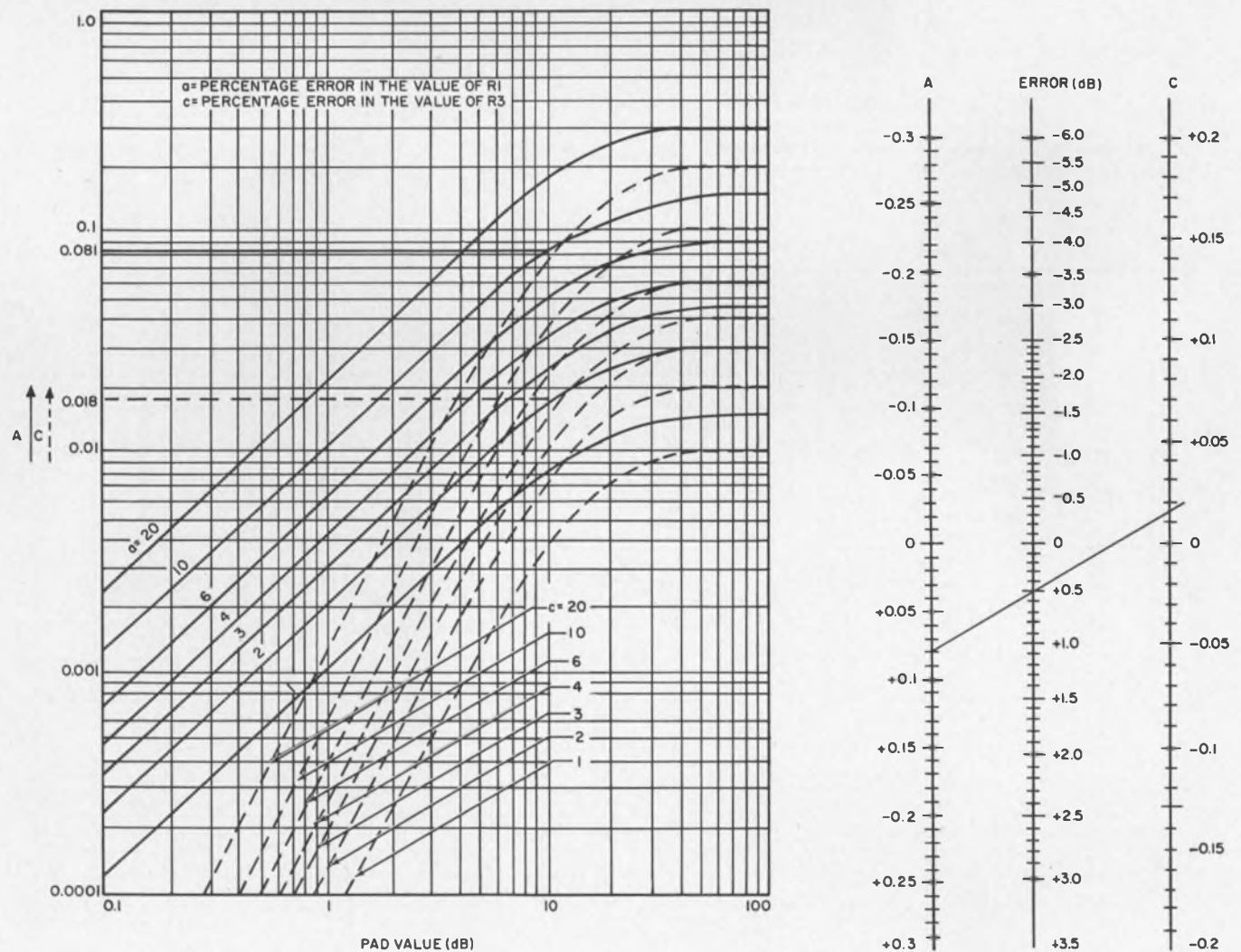

2. Errors in attenuation caused by percentage errors in the resistors may be read off in two steps from the graph

and from the nomograph. The curves are valid for symmetrical T-pads, balanced or unbalanced.

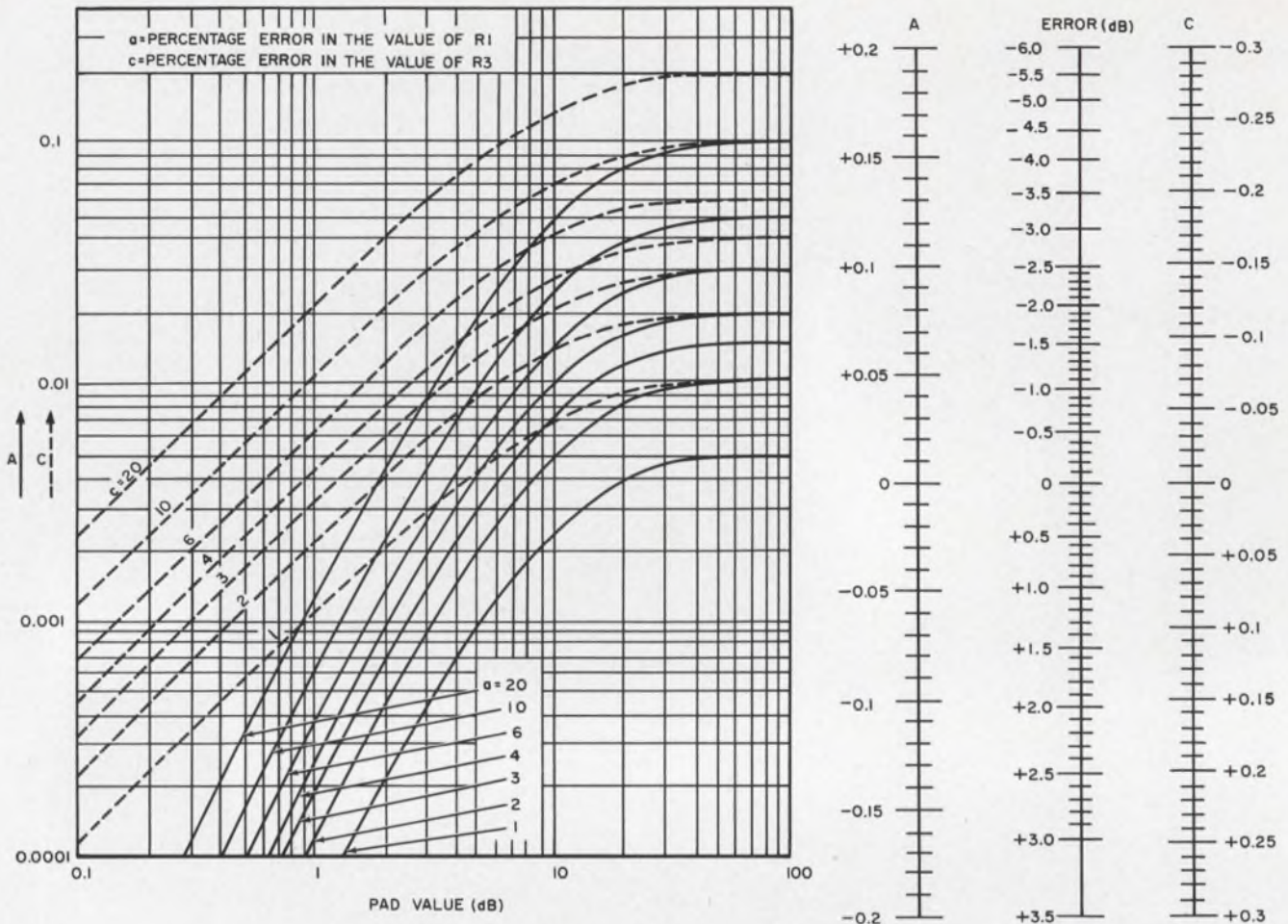

3. For symmetrical Π -pads, balanced or unbalanced, use this chart and nomograph to find the error in attenuation

resulting from variations in the values of the resistors due to aging or changing tolerances.

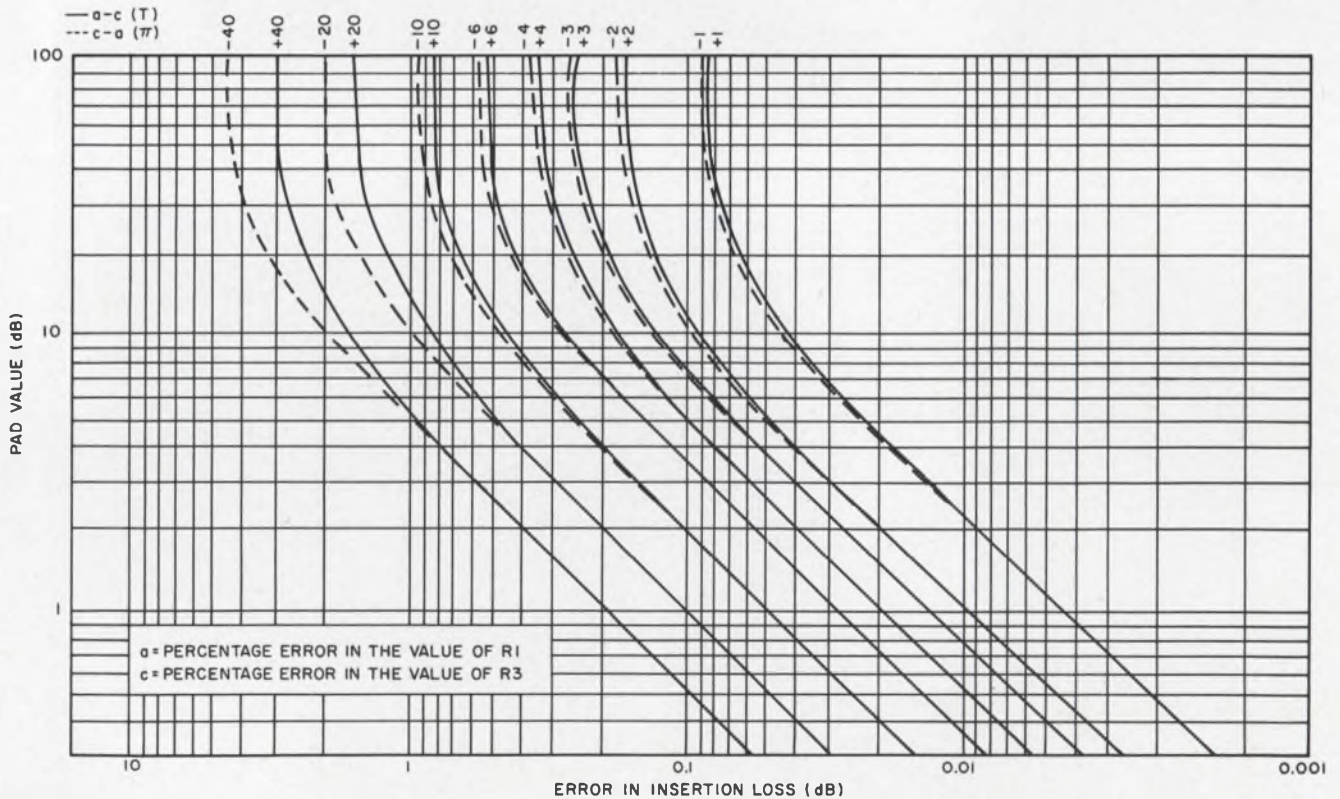

4. Errors in the insertion loss for both symmetrical T- and Π -pads are plotted here as a function of percentage errors

of the resistors. The worst-case tolerances for the resistors may be found also.

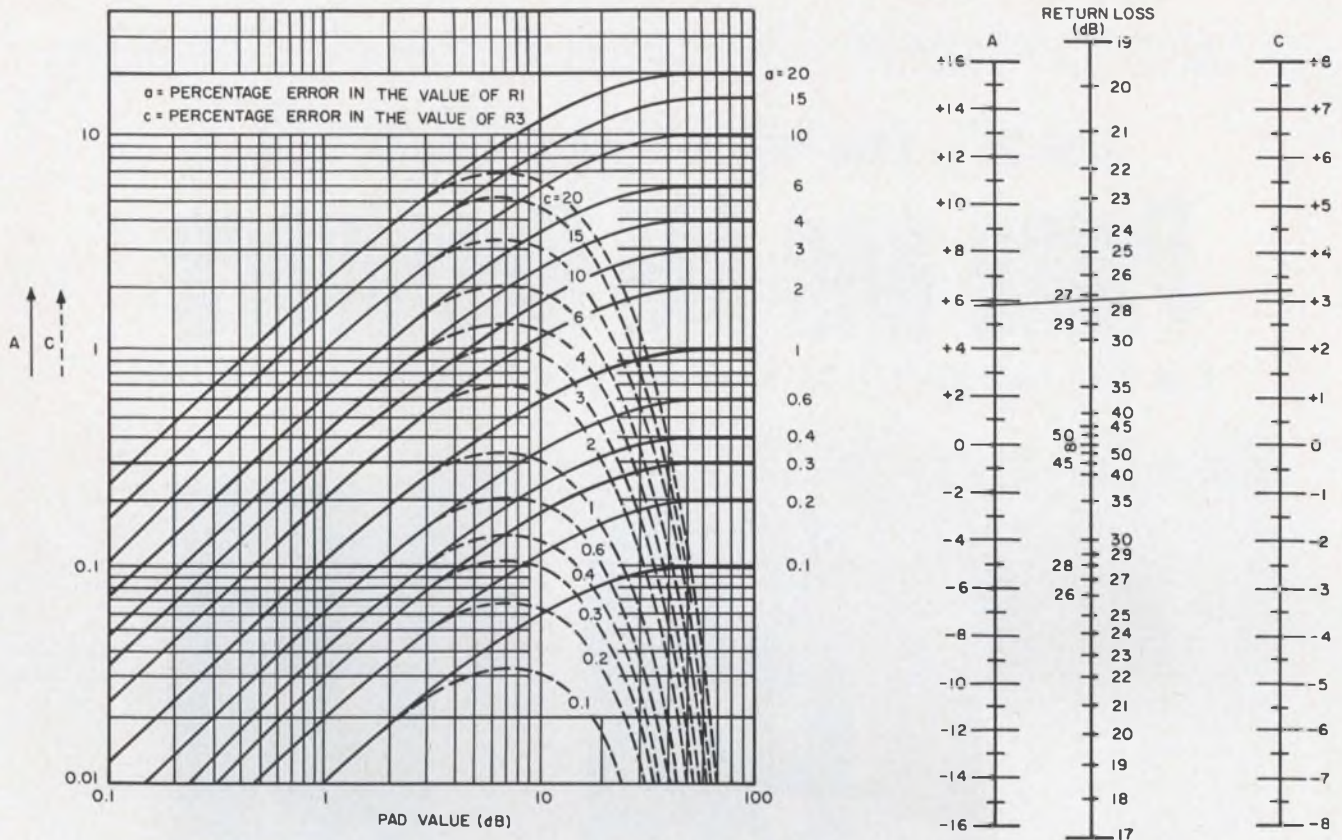

5. Return losses or symmetrical T- and Π -pads may be checked with the aid of this chart and nomograph.

resents the required attenuation in dB.
 Next, on the nomograph of Fig. 2, draw a straight line through the points $A = +0.081$ and $C = +0.018$. The point of intersection of this straight line and the middle line gives directly the error in attenuation of the pad. In this case, the error is $+0.50$ dB.

The error in attenuation for Π pads may be found similarly with the aid of Fig. 3.

To find the insertion loss, let the pad (T- or Π -type) value be 10 dB. Let the percentage errors in the values of the resistors $R1$ and $R3$ be $+15$ and $+5$, respectively. Hence $a = +15$ and $c = +5$.

For a T-pad, find the value of $a-c$ from Fig. 4. Here, $a-c = +10$. Corresponding to $a-c = 10$, the error in insertion loss of a 10-dB pad is 0.45 dB. The sign of the error is the same as that of $(a-c)$ thus the error is $+0.45$ dB.

Similarly, for a Π -pad, find the value of $c-a$ from Fig. 4. If $a = +15$ and $c = +5$, then $c-a = -10$. Corresponding to $c-a = -10$, the error in insertion loss of the 10-dB pad is -0.46 dB.

Thus for a T-pad, if $a-c$ is positive, the error is positive; and if $a-c$ is negative, the error is negative. Analogously, for a Π -pad, if $c-a$ is positive, the error is positive; and if it is negative, the error is negative.

To determine return loss let the pad (T- or Π -type) value be 10 dB and the percentage errors in the values of resistors $R1$ and $R3$ be $+10$ and $+10$, respectively: $a = +10$ and $c = +10$.

From the graph of Fig. 5, find the values of A

and C corresponding to the values $a = 10$ and $c = 10$. The signs of A and C should be the same as those of a and c , respectively: $A = +5.8$, $C = +3.15$.

Then, on the nomograph, draw a straight line through the points $A = +5.8$ and $C = +3.15$. The reading at the point of intersection of this straight line with the middle line gives the return loss of the pad: The return loss is 27.3 dB.

Graphs expedite component selection

The graphs help the designer to choose standard components instead of expensive custom-made ones. For example, could standard resistors be used in a T-pad that should have a 6 ± 0.2 dB attenuation, an impedance of 600 ohms and a return loss above 30 dB?

The calculated values of its resistors are $R1 = 199.3$ ohms and $R3 = 803.4$ ohms. If we use standard resistors [i.e., 200 ohms ($\pm 1\%$) for $R1$ and 806 ohms ($\pm 1\%$) for $R3$], we can see from Figs. 4 and 5 that the error in insertion loss of the pad is within ± 0.06 dB and the worst return loss is 44 dB. These values are well within the specified limits. To boot, the cost of the pad is reduced, since standard resistors can be used, instead of wire-wound resistors. ■ ■

Acknowledgements:

I am grateful to Shri H. J. Mirchandani, Chief Engineer, Transmission Engineering & Development Department, for his guidance and encouragement. I also wish to express my thanks to Shri A. A. Patankar, engineer, for his suggestions.

From CEI . . . a New Family of Pre-Tuned, Crystal-Controlled

Pulse and AM Receivers

• 4 AM AND 4 PULSE MODELS • COVER 60 MHz TO 150 MHz • COMPACT, ALL SOLID STATE



TYPE 415 AM RECEIVER

TYPE 416 PULSE RECEIVER

Introducing two new series of top-performing CEI receivers . . . the Type 415 for AM and Type 416 for Pulse reception. Both series cover the 60-150 MHz range using standard tuners.

Each receiver is a completely transistorized, fixed-tuned unit allowing the selection of any of four preset channels within its frequency range (see table at right for ranges of individual receivers). The four channels are factory-set to your requirements and may be easily and swiftly reset, when necessary, by field maintenance personnel.

The AM units are available with a choice of 50 or 100 kHz bandwidth. Compact and lightweight, all these receivers offer high sensitivity and reliability and require very little power—just 3½ watts.

Signal monitor outputs of 21.4 MHz have been provided, and a matching signal monitor (CEI Type SM-4301) may be mounted alongside one or more of the receivers to provide a visual display around the tuned frequency.

Special rack-mount equipment frames are also available, designed to accommodate two, three or four of the Type 415, 416, and/or SM-4301 units.



RACK-MOUNTS & SIGNAL MONITOR AVAILABLE— Shown here is a Type 416 Pulse receiver and matching Type SM-4301 signal monitor in an EF-402 equipment frame. Equipment frames are available to mount two, three or four units.

Table of Standard Tuning Ranges
(other frequency combinations on request)

Receiver Type		Overall Frequency Range (MHz)	Band A Frequency Range (MHz)	Band B Frequency Range (MHz)
AM	Pulse			
415-1	416-1	60-90	60-75	75-90
415-2	416-2	75-110	75-90	90-110
415-3	416-3	90-130	90-105	105-130
415-4	416-4	110-150	110-125	125-150



For complete information and specifications, please contact:
COMMUNICATION ELECTRONICS INCORPORATED

6006 Executive Blvd., Rockville, Md. 20852 · Phone: (301) 933-2800 · TWX: 710-824-9603

WESCON/66

Meet us at booths 633-634



Mallinckrodt
Transistar® Chemicals

**the
latest
dope
on
dopants...**

... single crystal silicon, solvents, etchants (including new premixed types) and all the other Mallinckrodt Transistar® chemicals for the electronics industry.

More semiconductor devices have been processed with Transistar chemicals than with any other brand.

That's why this new Mallinckrodt catalog belongs in your file. Send for a copy. Write Mallinckrodt, Industrial Chemicals, St. Louis, Mo. 63160

Mallinckrodt[®]

Mallinckrodt Chemical Works / Electronic Chemicals / St. Louis / New York / Los Angeles

ON READER-SERVICE CARD CIRCLE 146

Measure thermal resistances to find the maximum power that your integrated circuit or discrete transistor can handle.

In determining power-handling capabilities for semiconductor devices, it is important to know accurately the thermal resistance of the device. Unfortunately, especially with integrated circuits, this value is often unknown. To overcome this problem, a simple and inexpensive test setup can be built to determine the thermal resistance of any semiconductor package.

In the test circuit, a known power pulse is applied to the selected test device for a specified length of time. When the pulse is removed, the base-to-emitter voltage (V_{BE}) of the transistor (or one of the transistors, for an integrated circuit) is measured. Since V_{BE} is directly proportional to temperature, and a calibration curve may be initially drawn for the device, it is possible to determine immediately the junction temperature (T_j) resulting from a known power dissipation.

The V_{BE} versus T_j calibration chart can be plotted by:

- Placing the test device in a temperature-controlled oven.
- Supplying a limited amount of current to the base of the transistor ($100 \mu A$).
- Measuring V_{BE} with a digital voltmeter.
- Increasing the oven temperature in specified steps.

Since power dissipation in the device is on the order of microwatts, the temperature of the oven is for all practical purposes the temperature of the junction. By using a thermocouple, an accurate plot of V_{BE} versus junction temperature can be made. The calibration graphs for the devices described in this article are shown in Fig. 1.

Once this is done, the test circuit, consisting of a "pulser," an oscilloscope, a few batteries and a couple of meters, can be put to use.

Pulser uses mercury relays

In the circuit shown in Fig. 2, the two 1N649 diodes allow both relays to operate only on the positive half cycle of the input voltage. The resistors are used to limit the peak coil current, and the

2-K Ω potentiometer allows slight adjustment of the duty cycle when the turn-on and turn-off operating points of relay K_2 are changed with respect to relay K_1 . Relay K_1 is a Western Electric Type-275D (bridging type) and relay K_2 is a Clare Type-HGP-2004 (non-bridging type). The three 1N540 diodes, in parallel across the relay coil of K_2 , act as an electronically variable capacitor. Since these are diffused, the relationship between junction capacitance and reverse-bias voltage is given by:

$$C = \frac{K}{(V)^{1/3}}, \quad (1)$$

where K is a constant and V is the reverse bias voltage. Hence, as the reverse bias increases, the junction capacitance decreases. As a result, the diode capacitance causes the coil current of K_2 to be initially delayed, and then to increase rapidly causing K_2 to energize quickly, with a high degree of repeatability.

The relay contact connections are shown in the

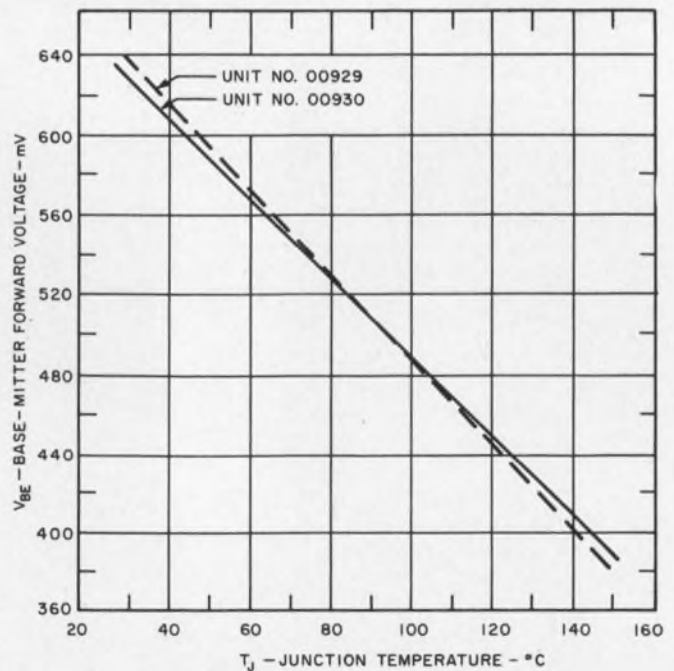

1. Knowing the base-emitter voltage of the device under test, one can quickly find the actual junction temperature by using this V_{BE} versus T_j calibration chart.

J. B. Kops, Product Engineer, Custom Products Section, Westinghouse Electric Corp., Elkridge, Md.

circuit of Fig. 3a. The voltage pulse across R_1 is given in Fig. 3b, as well as the sequence of operation of relays K_1 and K_2 . The first OFF condition is the result of the non-bridging time of relay K_2 . As relay K_2 is energized, the wiper arm moves from contacts 4 and 5 to contacts 1 and 2. During this wiper arm movement, there is a period of time that occurs in which the wiper arm does not make contact with either contacts 4 and 5 or 1 and 2. The second OFF condition is the result of relay K_1 remaining energized for a short period of time after relay K_2 has de-energized. The resulting power duty cycle for the pulse waveshape of Fig. 3b is 94%.

To achieve accuracy, only a very narrow portion of the pulse should be used for the temperature-varying parameter measurement; this allows the measurement to be made before one cooling thermal time constant of the device under test has elapsed. It is also desirable to have the test device reach thermal equilibrium at high temperature during the power pulse prior to the measurement portion of the pulse. For these reasons, the 0.2-msec OFF portion of the waveshape (Fig. 3b) is selected for measurement of the temperature-varying parameter.

The testing of discrete transistors is straightforward and power levels as high as one watt were successfully pulsed with this mercury relay pulser. However, in testing integrated circuits, the engineer must decide what transistor is to be used for the temperature measurements. In the tests described here, for a two-transistor integrated circuit, the V_{BE} of the transistor closest to the geometric center of the chip was measured.

The circuit tested was the Westinghouse WM1106, a video amplifier. The test circuit is given in Fig. 4. Switch S_2 and microammeter M_2 allow for calibration of the base current of Q_2 for the V_{BE} measurement. Switch S_1 and peak-reading voltmeter M_1 allow measurement of the voltage, V_{1-4} . Note that:

$$V_{1-4} = |V_{1-6}| + |V_{4-6}|, \quad (2)$$

and that I_{1-4} can be calculated from:

$$I_{1-4} = \frac{V_{AA} - V_{1-4}}{993.5}. \quad (3)$$

The total power dissipated is given by:

$$P_T = (V_{1-4})(I_{1-4})(0.94), \quad (4)$$

where (0.94) is the power duty cycle. With this information, the junction-to-ambient thermal resistance of the video-amplifier integrated circuit is then determined by the following procedure:

- 1) Measure the ambient temperature, T_A ;
- 2) Apply power and measure V_{1-6} , V_{4-6} , V_{AA} and V_{BE} ;
- 3) Calculate the power dissipation, P_T ; and

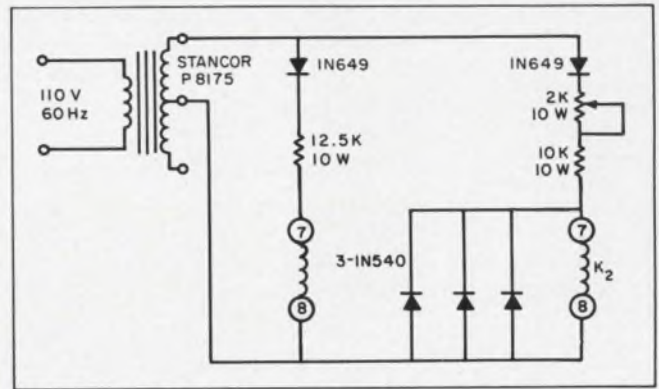

2. Simple pulser unit operates from the 110-volt line. The three diodes, across relay K_2 , act as a variable capacitor which initially delays the current flow through the relay and then allows it to increase rapidly. This results in fast action and high repeatability.

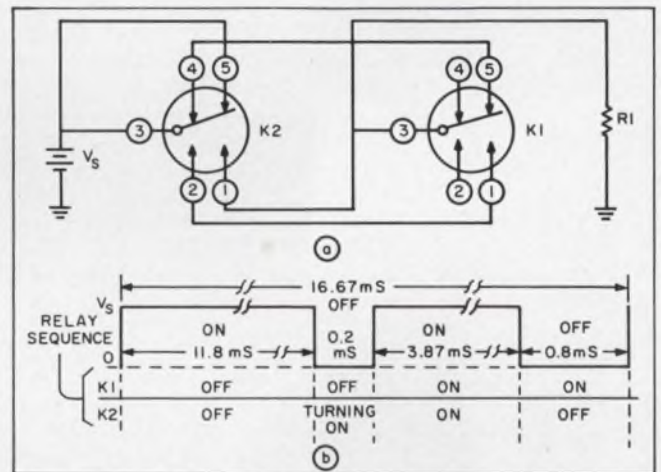

3. Relay contact connections illustrate how the voltage pulses are applied to the load. K_1 is a bridging-type relay and K_2 is a nonbridging type. The resulting voltage pulse and its relation to the relay logic is shown in (b).

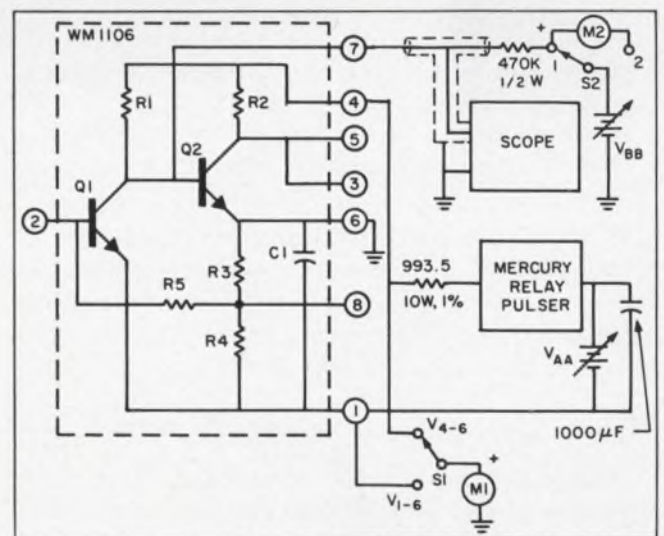

4. Thermal resistance test setup uses Tektronix 535 oscilloscope (Type Z plug-in) for V_{BE} measurements. Meter M_2 is used to calibrate the drive current to the base of transistor Q_2 , where V_{BE} is monitored.

Table 1. Test results for 2N1893 with and without heat sinks.

		Unit no. 1			Unit no. 2		
Vendor	Part no.	V _{BE} (mV)	*T _J (°C)	Θ _{JA} (°C/W)	V _{BE} (mV)	*T _J (°C)	Θ _{JA} (°C/W)
No heat sink	—	251	151.0	247	250	150.0	245
Wakefield	207	388	94.5	133	380	97.8	139
Vemaline	6049	345	112.0	168	355	108.0	160
P.S.I.	11	405	87.5	119	410	85.5	114
Thermalloy	1101A	395	91.5	127	385	95.6	135
Wakefield	X	375	100.0	144	370	101.8	147

Note: T_A = 29°C, I_C = 42 mA, V_{CE} = 12.5 V, and P_T = 494 mW for all tests.

*From V_{BE} vs T_J curve

Table 2. Test results for WM 1106 IC video amplifier.

Junction to ambient							
Unit No.	V _{BE} (mV)	V ₁₋₄ (V)	I ₁₋₄ (mA)	P _T (mW)	T _A (°C)	*T _J (°C)	Θ _{JA} (C/W)
00929	625	8.00	2.70	20.2	29.0	35.5	322
00929	615	12.00	3.72	41.8	29.0	40.3	270
00929	604	15.18	4.91	69.7	29.8	45.5	250
00930	618	8.00	2.55	19.1	30.0	36.7	351
00930	605	12.00	3.53	39.7	30.3	42.9	317
00930	596	15.18	4.46	63.3	29.0	47.5	292
Junction to case							
					T _B (°C)		Θ _{J-C} (°C/W)
00929	459	16.0	3.72	55.7	109.4	113.4	71.8
00930	478	16.0	3.62	54.2	100.8	105.0	79.3

*From V_{BE} vs T_J curve

- 4) Calculate the junction-to-ambient thermal resistance from the equation:

$$\Theta_{JA} = \frac{T_J - T_A}{P_T} \quad (5)$$

The junction-to-case thermal resistance can be determined in a similar manner except that the device must be placed in a bath. The ambient temperature in the above equation is then replaced by the bath temperature (T_B).

Discrete and integrated devices are tested

Test results of junction-to-ambient thermal resistances of two 2N1893 transistors at T_A = 29°C and P_T = 494 mW, with and without various heat sinks attached, are given in Table 1.

Test results of junction-to-ambient and junction-to-case thermal resistances of two WM1106

integrated video-amp devices are presented in Table 2. The dV_{BE}/dT of units 00929 and 00930 were 2.15 and 2.05 mV/°C, respectively. The measured values given for each of the tests in the table represent the average of five readings. To make the junction-to-case thermal-resistance tests, an agitated bath of 600 ml of Dow Corning Type DC 331 silicon oil heated to approximately 100°C was used. The bath was heated to this high temperature to eliminate bubble formation due to bath agitation, and to take advantage of the lower bath thermal resistance due to the lower viscosity of the silicon oil at the elevated temperature. ■ ■

Acknowledgment:

The author wishes to acknowledge the assistance of T. L. Sachs and D. S. Hirakis of the Aerospace Div. Westinghouse Electric Corp., who aided in performing the experiments. These tests were done while the author was with the Aerospace Div.

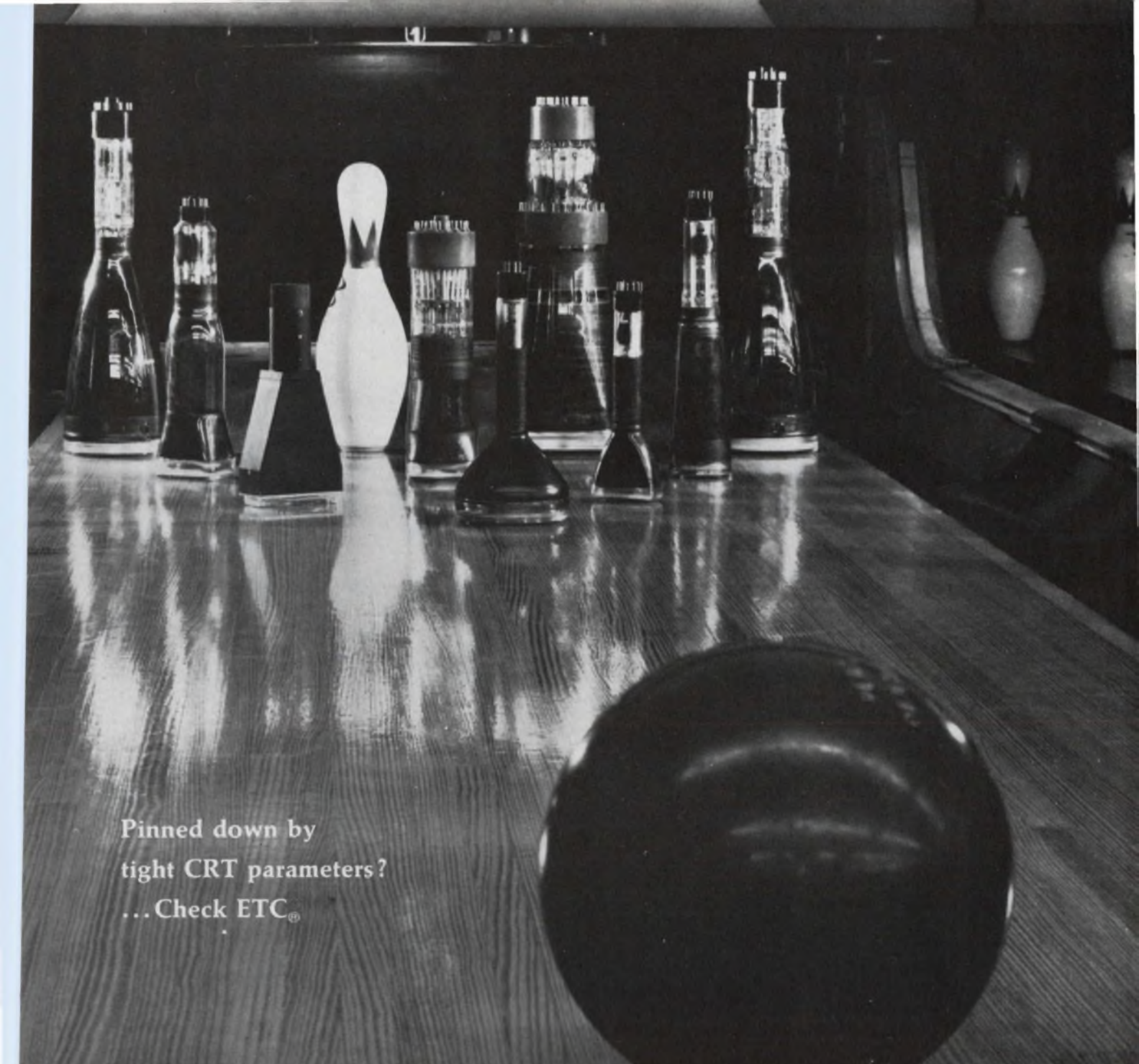

Pinned down by
tight CRT parameters?
... Check ETC[®]

Tube capability is right down our alley

Challenge has been our game for nearly 30 years . . . the challenge of designing, building, and testing special CRT's for special applications. We meet this challenge, continually, through the know-how and creativity of our champion CRT research team, comprising some of the most advanced minds in the technology.

From our modern research and development facilities have come many "firsts" in CRT development. Electrostatic deflection plates, aluminized screens, reticular optics,

and flying spot scanners are some of our pioneering achievements. And our contributions to industry, science and the military have earned us a reputation for solving particularly difficult tube problems.

Today, in addition to virtually unlimited capability in special CRT design, we offer the largest variety of off-the-shelf tubes in the industry. Each has undergone the quality-controlled product engineering and stringent testing required as a custom fabricated item. And each will provide more display per dol-

lar in the application for which it was designed.

Try pinning us down to your individual CRT needs, whether they involve multi-layer phosphors, special shapes, ultra high resolution, or multi-guns. You'll find us "right down your alley" when it comes to meeting your specs. Why not call us today . . . or write for our complete capability story.

**GENERAL
ATRONICS**
ELECTRONIC TUBE DIVISION
PHILADELPHIA • PENNSYLVANIA 19118

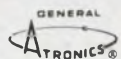

Rid mixers of spurious signals with the aid of cross-product traces that reveal the position and significance of all signals within the band.

Unexpected spurious signals in mixers have foiled many good designs and forced engineers to come up with make-shift suppressing devices. But cross-product (C-P) traces can take the guess-work out of the design procedure.

These data, shown in the accompanying tables and plots, predict the performance limits of the design, help engineers to shape the bandwidth characteristics and pinpoint the best design approach.

The unexpected signals are usually beat frequencies, resulting from the mixing of the harmonics of the local oscillator with some unwanted but known input. Called spurious cross-products, they can be plotted as C-P Loci or traces. They have been generated with the aid of a digital computer in a form that permits identification and plotting of only those lines that are relevant to the particular mixing mode and mixing ratio.

In a typical mixer a desired signal, F_s , mixes with a pump signal of the local oscillator, F_p , to produce an output signal, F_o (Fig. 1). A spurious signal, F_x , falling in the input bandpass, is also present. It is the multiple of F_x that combines with a multiple of the pump frequency to produce an output at, or very near to, the desired output.

Suppose, for example, a receiver having a 30-MHz IF output is set to receive 150 MHz. The local oscillator operates at 120 MHz. An unwanted signal is present at the antenna at 165 MHz, and may also be present at the first mixer because of the broadness of the RF amplifier (the result of design limitations or mistuning). The second harmonic of the 165-MHz signal beats with the third harmonic of the local oscillator's frequency to produce 30 MHz:

$$\begin{aligned} -2 F_x + 3 F_p &= -2 \times 165 + 3 \times 120 \\ &= -330 + 360 = 30 \text{ MHz.} \end{aligned}$$

No amount of IF selectivity can discriminate against this spurious output, since it falls directly on the desired output. Hence, a remedy must be sought elsewhere. This particular odd-order cross-product (fifth-order, determined by adding the absolute values of the coefficients of F_x and F_p) is only one of many. However, it is a particularly serious one, since it is close to the desired signal, and it is likely to be about 50 dB below the desired signal against a typical military specification of -60 dB minimum. The usually stronger image frequency, which is separated from the desired

signal by a frequency equal to twice the IF, is often less difficult to eliminate than this close-in spurious signal.

Several courses of action are possible to reduce or eliminate this fifth-order spurious signal:

- The mixing ratio can be increased to move the response outside the RF bandpass.
- The RF bandpass can be narrowed to reduce the spurious signal before it enters the first mixer.
- A mixer can be chosen that has fewer non-linearities above the second-order harmonic signal so that higher-order harmonics are not generated.

The fifth-order example brings up a specific spurious frequency and the measures that may reduce it. However, these measures may well accentuate a fourth-order harmonic signal. Hence the locus of each spurious signal must be known and must be plotted relative to the design signal, before an effective suppression method can be evolved. This is accomplished by the C-P trace technique.

Two equations describe signal relations

Five readily identifiable mixer modes are available. The choice depends on whether local oscillator's frequency is above or below the desired signal and whether the output is the result of either the sum or difference of the input signals. The five mixer modes are:

- low side-injection /down-converter (LSI/DC) difference mixing,
- high side-injection /down-converter (HSI/DC) difference mixing,
- lower sideband /up-converter (LSB/UC) difference mixing,
- low side-injection /up-converter (LSI/UC) sum mixing,
- high side-injection /up-converter (HSI/UC) sum mixing.

Each case may be quickly identified through the graphical representation of the mixer modes in Fig. 2. The rectangular blocks in Fig. 2 represent the mixer and the relative elevation of the horizontal lines indicate the frequency relationship among the various signals. The generalized mixer equation may be written:

$$N_1 F_s + M_1 F_p = F_o, \quad (1)$$

where

- F_s = signal frequency,
- F_p = pump or local oscillator frequency,
- F_o = output frequency, and

David H. Westwood, Manager, RF Communications Development, RCA, Camden, N. J.

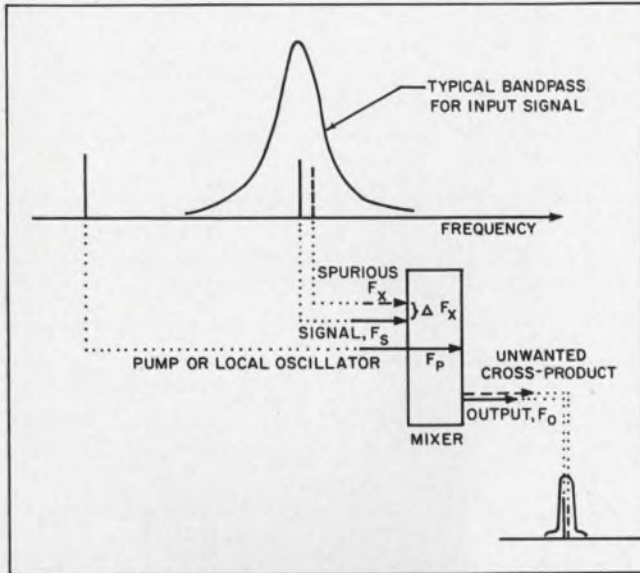

1. Spurious signals in the output of mixers are cross-products of the spurious inputs and the harmonics of the local-oscillator signals. The multiple of F_x combines with a multiple of the pump frequency.

$$\begin{aligned} N_1 = \pm 1 \} & \text{defines the mixer mode.} \\ M_1 = \pm 1 \} & \text{ " " " " " " } \end{aligned}$$

The generalized expression for spurious signals is:

$$N F_x + M F_p = F_o, \quad (2)$$

where

$$\begin{aligned} F_x &= \text{spurious frequency,} \\ N &= \pm \text{integer from 0 to } R_{\text{max}}, \\ M &= \pm \text{integer from 0 to } R_{\text{max}}, \end{aligned}$$

and both N and M cannot be negative simultaneously. R , the order of the spurious signal, is expressed as:

$$R = |N| + |M|, \quad (3)$$

and

$$\Delta F_x = F_x - F_s. \quad (4)$$

Equations 1, 2 and 4 may be combined to yield a single expression in several different ways. Two expressions for F_s are needed, one having the output frequency, F_o , as the independent variable, and the other having the pump frequency, F_p , as the independent variable. By elementary algebra, these expressions have been derived and are:

$$F_s = \frac{M_1 N}{N_1 M - M_1 N} \Delta F_x + \frac{M - M_1}{N_1 M - M_1 N} F_o, \quad (5)$$

$$F_s = \frac{N}{N_1 - N} \Delta F_x + \frac{M - M_1}{N_1 - N} F_p. \quad (6)$$

Both expressions, Eqs. 5 and 6, are straight lines of the form $y = mx + b$, and define the loci of all spurious frequencies that satisfy Eqs. 1, 2 and 4. The general rule is that when F_o is fixed, for example, in the case of a tunable receiver having a fixed IF as the output of the mixer, Eq. 5 should

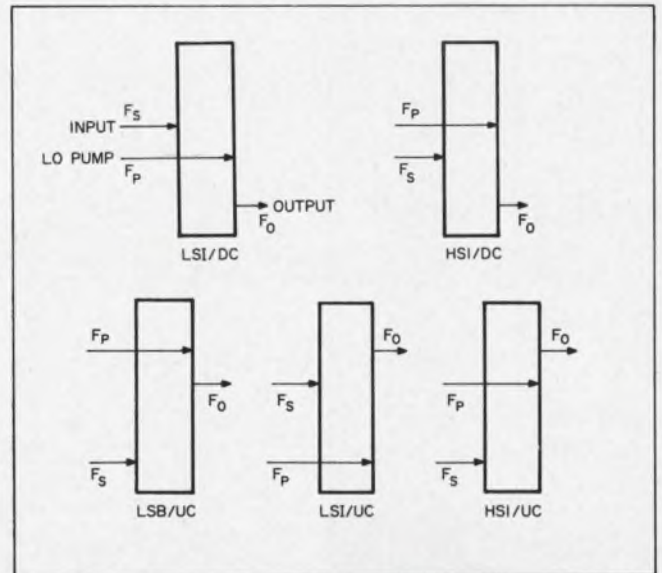

2. Five widely used mixer modes are shown graphically. The boxes are the mixers. The elevation of the horizontal lines indicates the frequency relationship among the input, the LO pump and the output signals.

be used. When the pump frequency is fixed, as in the case of up-converting a band of input frequencies to a band of output frequencies, Eq. 6 is preferred. A more useful set of equations can be obtained by normalizing both expressions with respect to the independent variable, thereby achieving a universal set of equations:

$$\begin{aligned} F_s / F_o = \frac{M_1 N}{N_1 M - M_1 N} \Delta F_x / F_o \\ + \frac{M - M_1}{N_1 M - M_1 N}, \quad (7) \end{aligned}$$

$$F_s / F_p = \frac{N}{N_1 - N} \Delta F_x / F_p + \frac{M - M_1}{N_1 - N}. \quad (8)$$

These normalized equations have been programmed in a digital computer with solutions for the following parameters: Y-axis intercept (Y_o), X-axis intercept (X_o), and slope (S_o).

The information, printed out for each value of N_1 , M_1 , N and M as R ranges from 1 through 16, includes all possible cross-products through the sixteenth order, for all possible mixer modes. The computer was programmed to discard all solutions which are not physically realizable or are not relevant to the particular mixer mode.

Because of space limitations, only one set of tabulated data, for the LSI/DC, is included, to illustrate the nature of such tables (Table 3). A complete set of tables that includes all harmonics up to the 16th for the five mixer modes is available. To obtain a set, please circle Reader Service number 782.

The printed data may be converted to graphs for each mixer mode, as in Figs. 3, 4, 6 and 7. In these figures only the first six orders of spurious signals are included. The circled numbers (2 through 6), appearing on the C-P traces, show the

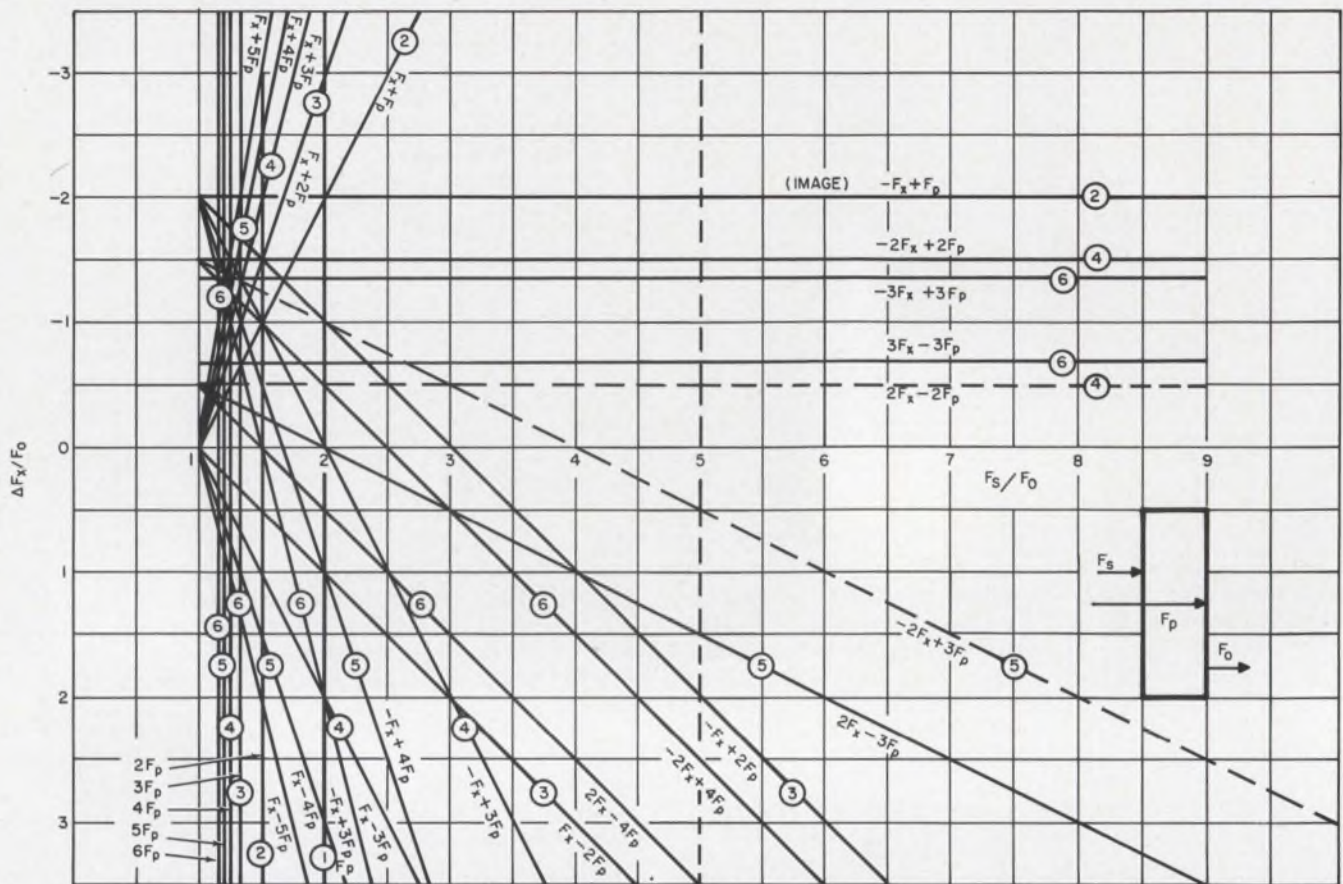

3. Cross-product traces for low-side injection/down-converter are normalized with respect to the output frequency, F_o . These graphs are useful in systems where the output is fixed, as in tunable receivers. The relevant

spurious frequencies in a specific case are found by drawing a horizontal line at F_s/F_o (dashed) and checking the intercepting lines. The ones closest to the X-axis are the most significant (dashed).

order of the spurious signal. For example, the cross-product trace, $5F_x - F_p$, is a sixth-order spurious frequency and the circled number is a 6. These identifications help the designer to assess quickly the order and the relative magnitude of the spurious signal and also to:

- Locate and identify all spurious frequencies.
- Determine the relative merits of the different mixer modes as they apply to this problem.
- Make tradeoffs between large versus small mixing ratios.
- Graphically construct required input band-pass characteristics.

Find spurious signals for given specs

The illustrative example for a low side-injection/down-converter, discussed earlier, has an input at 150 MHz, a pump frequency at 120 MHz and an output at 30 MHz.

The relevant spurious frequencies are determined by constructing the vertical line, $F_s/F_o = 150/30 = 5$, on the C-P trace chart of Fig. 3, as shown in a dashed line. The C-P traces that intersect the 5.0 line and are nearest to the X-axis present the greatest danger. These are:

- (a) $2F_s - 2F_p$, a fourth-order line, located below the signal by one-half of the IF ($0.5 F_o$), at $150 - (0.5 \times 30) = 135$ MHz; and
- (b) $-2F_x + 3F_p$, a fifth-order line intersecting

the signal line at a mixing ratio of 4. It creates a spurious frequency that appears above the signal by one-half of the IF at $150 + (0.5 \times 30) = 165$ MHz.

The image and a total of nine spurious frequencies of sixth order and below can be identified by the intersections of the C-P traces with the vertical line.

A similar vertical line ($F_s/F_p = 150/120 = 1.25$) may be drawn on Fig. 4 and the same spurious frequencies may be identified. It should be observed that, since the normalization is to the pump frequency, F_p , in Fig. 4, the actual spurious frequency is derived from the intersection of this C-P trace with the horizontal line of $F_x/F_p = 1.25$. This occurs at $\Delta F_x/F_p = 0.125$. Thus:

$$F_x = F_s + \Delta F_x = 150 + (0.125 \times 120) = 165 \text{ MHz.}$$

Band conversion maintains constant output

Most receivers do not have just a single input frequency, as in the previous example, but are required to frequency-convert any signal within a given band. The pump is generally tracked to the input signal to produce a constant IF output.

Consider a low side-injection/down-converter. The input is at 13.5 MHz, the output is at 2.5 MHz and the frequency of the local oscillator is 11 MHz. Assume that this mixer must operate over either of the following input signal ranges: ± 0.5

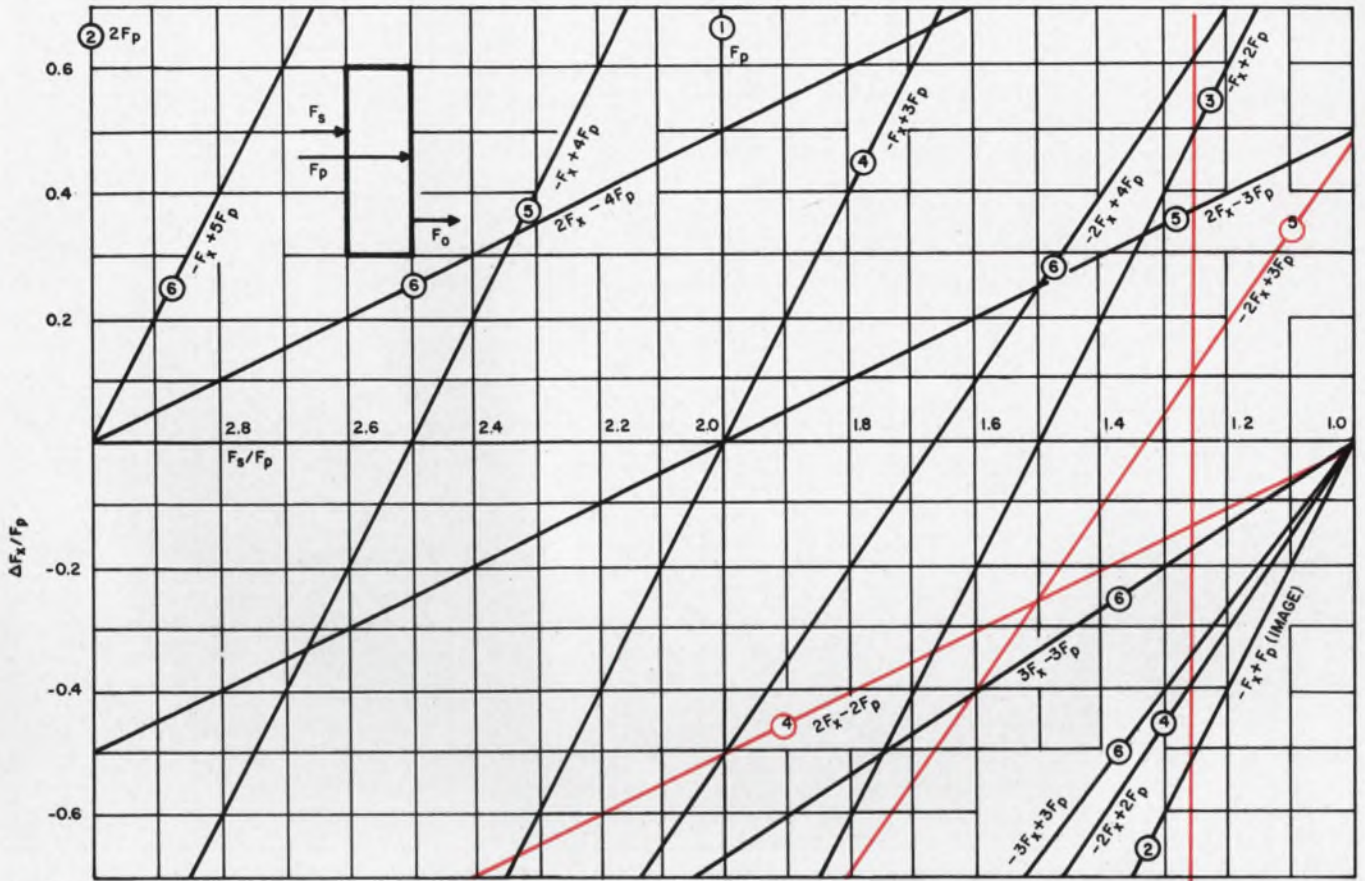

4. Cross-product traces, normalized to the pump frequency, F_p , are useful when F_p is the independent variable, as in the case of up-conversion. The traces are valid

for low-side injection/down-conversion. The colored lines represent the example shown in Fig. 3. The spurious frequency is derived from the intersection of F_p with F_x/F_s .

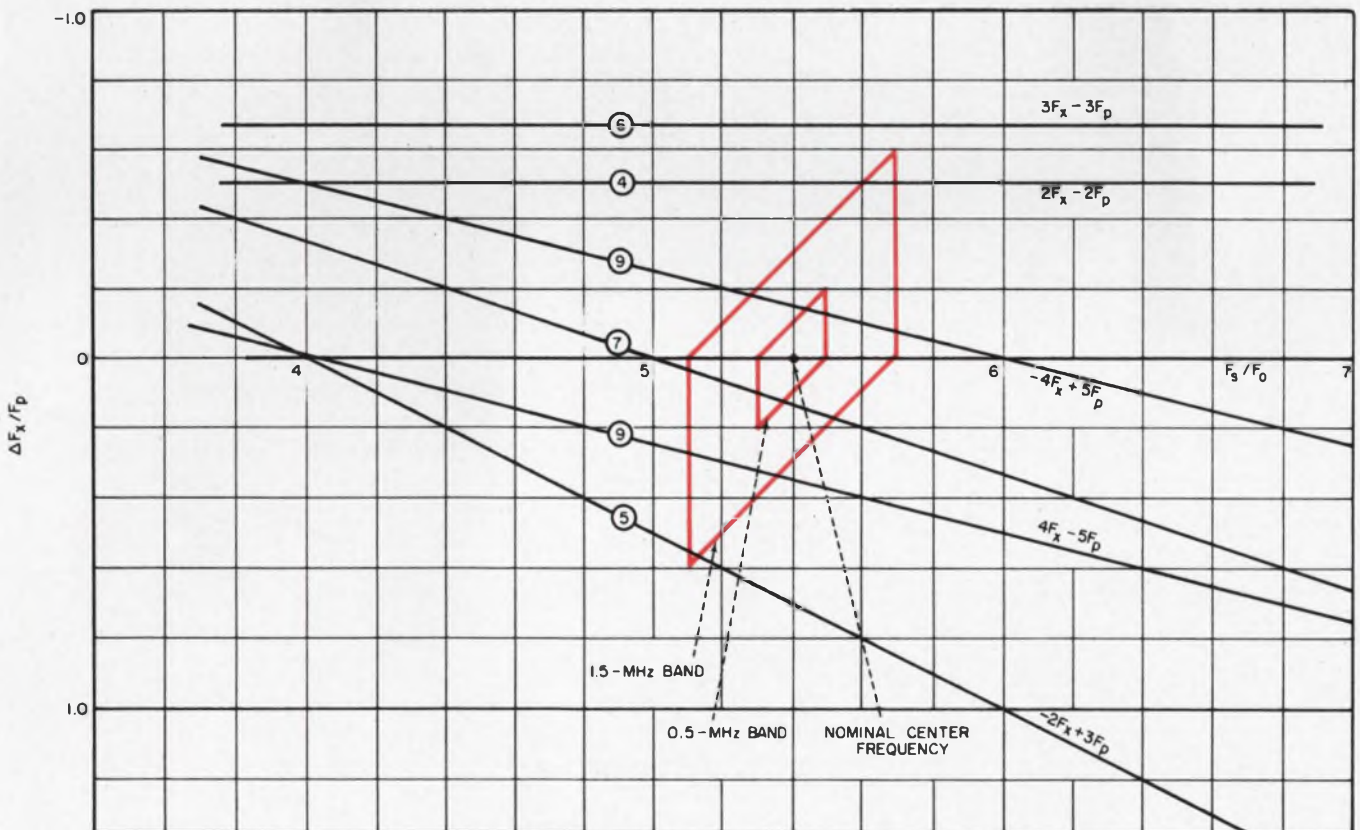

5. Bandpass plots yield parallelograms, intercepted by the spurious signals. The graphs give an instantaneous evaluation of all spurious signals and their position within

the band. Any 45° side of the parallelograms (color) represents a single frequency. The graph was plotted with the aid of Table 3 and rotated clockwise by 90°.

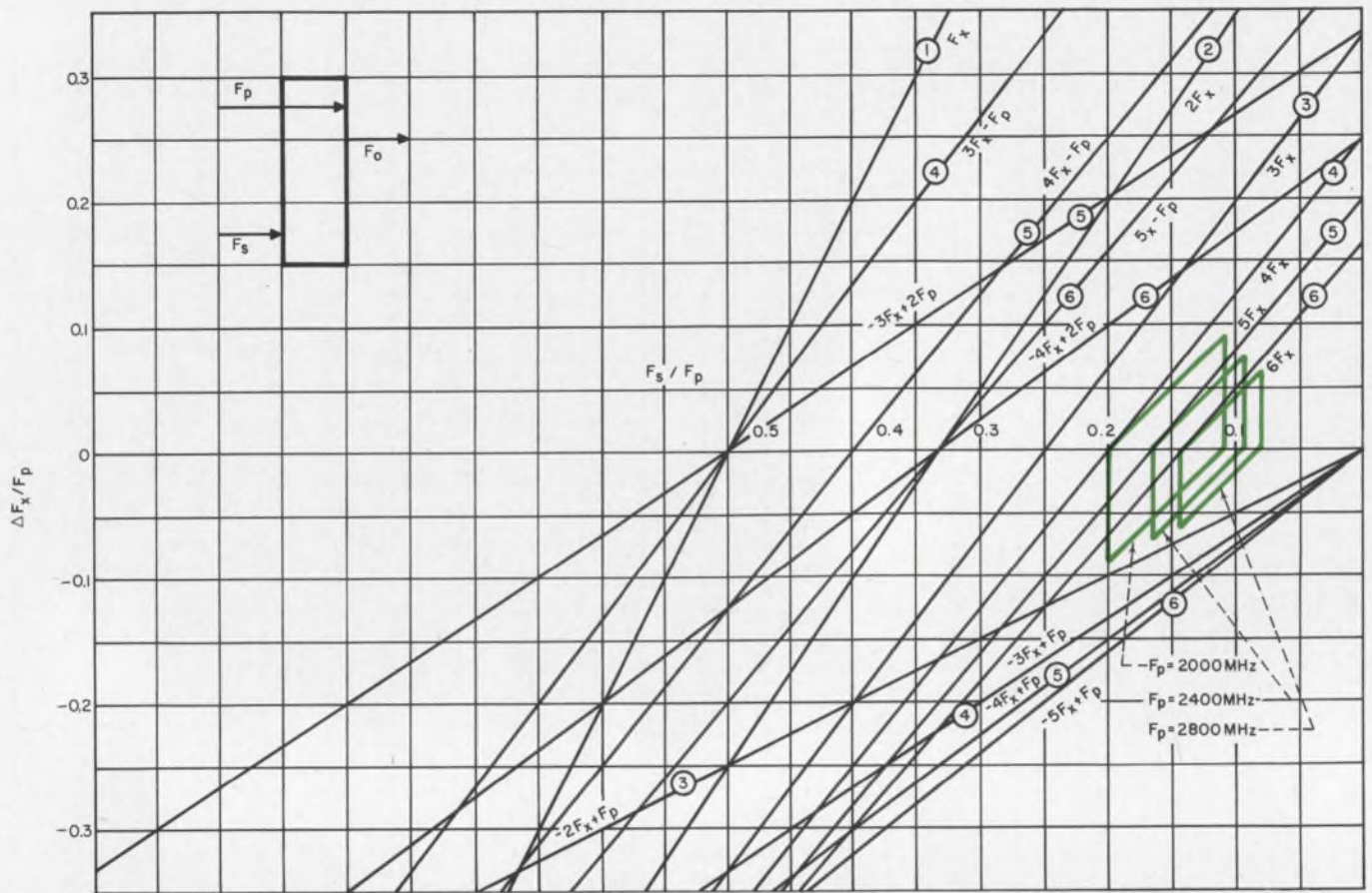

6. Bandpass parallelograms for lower-sideband/up-converter (color) compare the three possible pump frequen-

cies. (The graph is normalized to F_p). A pump frequency of 2800 MHz yields a clean bandpass.

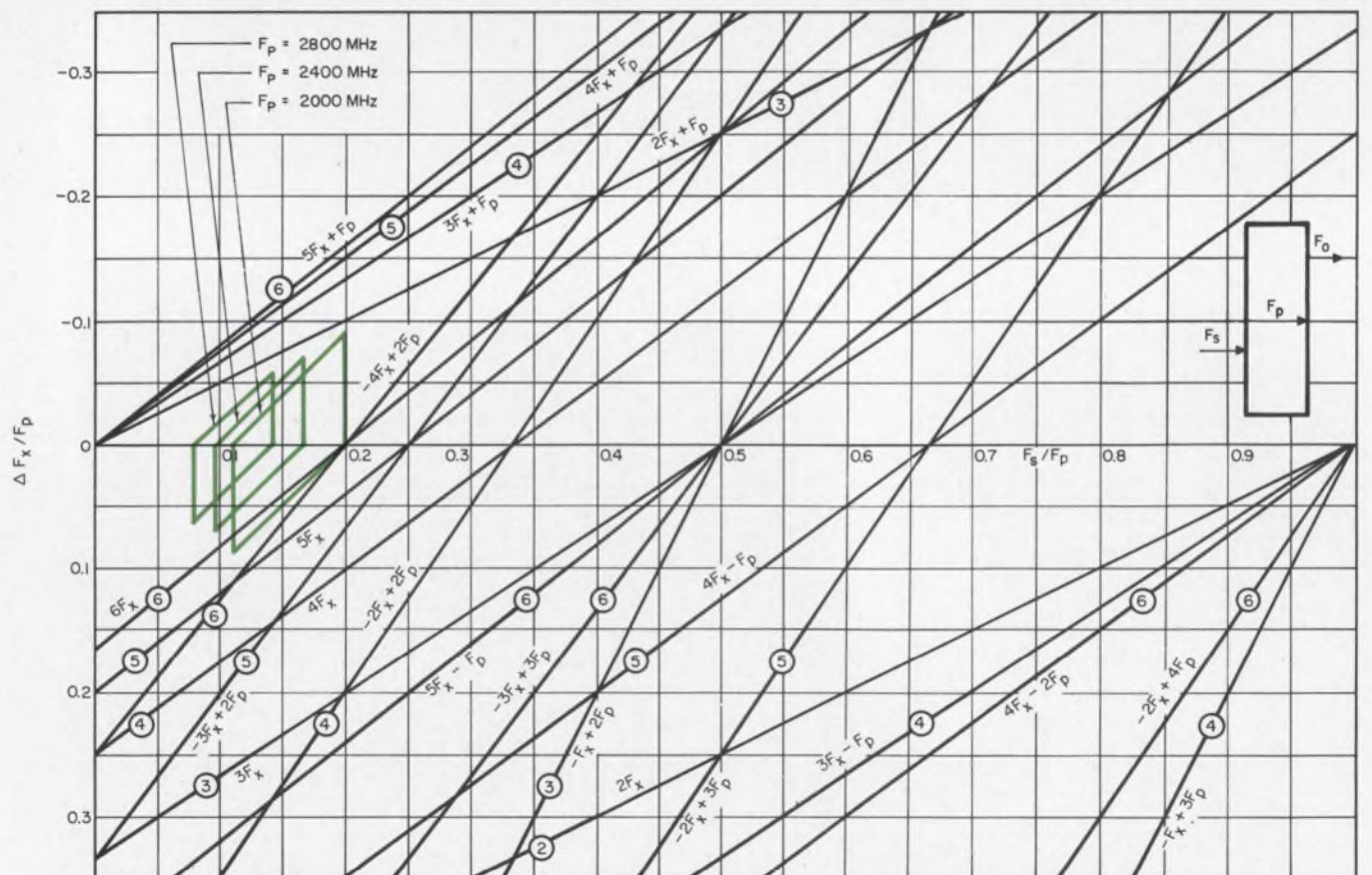

7. Less spurious frequencies are encountered in a high-side injection/up-converter at the pump frequencies used in Fig. 6, according to the bandpass parallelograms

(color). The graph is normalized to F_p . A comparison of the parallelograms in this figure and in Fig. 6 helps designers to choose the best approach.

Table 1. Spurious lines and intersections

Spurious	Order	Y_o	Spurious frequency F_x (MHz)
$2 F_x - 2 F_p$	4	∞^*	12.25
$-2 F_x + 3 F_p$	5	4.0	15.25
$3 F_x - 3 F_p$	6	∞^*	11.83
$-3 F_x + 4 F_p$	7	5.0	13.83
$4 F_x - 5 F_p$	9	4.0	14.375
$-4 F_x + 5 F_p$	9	6.0	13.125

*Vertical line, parallel to the Y-axis.

Table 2. Uhf broadband/up converter computations

Pump F_p (MHz)	Input F_s (MHz)	Normalized input F_s/F_p	LSB/UC output F_u (MHz)	HSI/UC output F_o (MHz)
2000	225	0.112	1775	2225
	400	0.2	1600	2400
2400	225	0.094	2175	2625
	400	0.167	2000	2800
2800	225	0.08	2575	3025
	400	0.143	2400	3200

MHz (3 dB points) centered at 13.5 MHz, or ± 1.5 MHz (3 dB points) centered at 13.5 MHz.

The local oscillator's frequency setting is such that a 2.5-MHz output is maintained. Note that an input band of frequencies is a separate case from "a single-frequency input which has an input bandpass." The single frequency is evaluated along a single vertical line as in the first example, whereas a band of operation results in a parallelogram, as developed below.

The 0.5-MHz band has the following F_s values:

$$(F_s)_{min} = 13.25 \text{ MHz,}$$

$$(F_s)_{max} = 13.75 \text{ MHz.}$$

The 1.5-MHz band has the following F_s values:

$$(F_s)_{min} = 12.75 \text{ MHz,}$$

$$(F_s)_{max} = 14.25 \text{ MHz.}$$

These values are then normalized with respect to F_o . For the 0.5-MHz band, F_s/F_o becomes 5.3 and 5.5. For the 1.5-MHz band, F_s/F_o becomes 5.1 and 5.7.

The graphical solution requires establishment of an expanded coordinate system around the ratio, $F_s/F_o = 5.4$, the normalized center frequency. Plotting all possible C-P traces that appear in Table 3 is time-consuming and unnecessary. The relevant lines may be identified by scanning the Y_o column in Table 3 and noting the intersection of spurious lines that occur near 5.4, that is, between approximately 4 and 7. These lines are readily plotted (Fig. 5) by drawing a straight line through the Y_o value on the Y-axis at a slope equal to the corresponding S_o value. (The slope expressed as a ratio in Table 3 enables the user merely to count horizontal and vertical squares on the graph paper in order to draw the

line). Table 1 summarizes the data obtained by extracting the Y_o cross-overs between 4.0 and 7.0 from Table 3, graphically deriving the $\Delta F_x/F_o$ values along the vertical 5.4 line and computing ΔF_x from the value of $\Delta F_x/F_o$ read from the chart.

Parallelograms show bandwidths

Plotting the bandwidth points on this C-P trace coordinate system results in 45° parallelograms, as shown in Fig. 5. A moment's study of this coordinate system will show that a 45° line represents a single frequency. Consider, for example, the 45° line that begins with 5.1 and passes through a point opposite 5.7 at 0.6 units up. That point represents a negative delta from 5.7. This point is obviously at $5.7 - 0.6 = 5.1$, which is the same as 5.1 on the F_s/F_o axis.

It may be noted in Fig. 5 that of the six spurious lines, two fall within the 0.5-MHz band and five within the 1.5-MHz band. The strongest spurious signal will be the fifth order, touching the lower corner of the 1.5-MHz band. The position of the spurious lines within the band is readily apparent. If a particular spurious frequency is suspected of causing trouble it can be scaled off or filtered out. If all spurious lines were to be avoided in this example, it would be necessary to reduce the effective bandpass to approximately one-third of the 0.5-MHz band, or to 0.17 MHz. This would result in a smaller parallelogram that encloses the nominal center-frequency point but does not touch any of the spurious lines.

Pick the best approach graphically

In a particular design, it is desired to up-convert the 225-to-400-MHz uhf band to S-band. An output frequency in the general vicinity of 2200 ± 600 MHz is desired for this design. It is also necessary to choose between the two possible up-converting modes, that is, lower side-band/up-converter and high side-injection/up-converter. One further restriction on the system is that the choice of pump frequency is restricted to one of the following three values: 2000, 2400 or 2800 MHz.

Table 2 presents a summary of the simple computations necessary to plot the parallelogram bandpass characteristics shown in Figs. 6 and 7.

With the limitations placed on this up-converter, the bandpasses of Fig. 7 intercept fewer spurious lines of sixth order and below than those of Fig. 6. It appears from the diagrams that a pump frequency of 2400 MHz or 2800 MHz with the high side-injection/up-converter would be a good choice. A pump frequency of 2800 MHz for the lower side-band/up-converter shows a bandpass free of spurious lines. However, the sixth-order line, $6 F_x$, touches the upper edge of the band.

In this example the lower side-band/up-converter would invert the up-converted signal which, in an actual problem, may add more design constraints. ■ ■

(continued on p. 216)

Table 3. Low-side injection/down-converter

Coeff. of F_x	Coeff. of F_p	Spur. order	F_0 normalized			F_p normalized		
			axis intercepts		Slope	axis intercepts		Slope
			Y	X		Y	X	
0.	1.	1	2.000	N*	0./ 1.	2.000	N*	0./ 1.
1.	0.	1	1.000	1.000	-1./ 1.	N*	-1.000	-1./ 0.
0.	2.	2	1.500	N*	0./ 2.	3.000	N*	0./ 1.
1.	1.	2	1.000	2.000	-1./ 2.	N*	-2.000	-1./ 0.
1.	-1.	2	N*	0.000	1./ 0.	N*	0.000	-1./ 0.
-1.	1.	2	N*	-2.000	-1./ 0.	1.000	2.000	-1./ 2.
0.	3.	3	1.333	N*	0./ 3.	4.000	N*	0./ 1.
1.	2.	3	1.000	3.000	-1./ 3.	N*	-3.000	-1./ 0.
1.	-2.	3	1.000	-1.000	1./ 1.	N*	1.000	-1./ 0.
-1.	2.	3	3.000	-3.000	1./ 1.	1.500	3.000	-1./ 2.
0.	4.	4	1.250	N*	0./ 4.	5.000	N*	0./ 1.
1.	3.	4	1.000	4.000	-1./ 4.	N*	-4.000	-1./ 0.
1.	-3.	4	1.000	-2.000	1./ 2.	N*	2.000	-1./ 0.
-1.	3.	4	2.000	-4.000	1./ 2.	2.000	4.000	-1./ 2.
2.	-2.	4	N*	-0.500	2./ 0.	1.000	0.500	-2./ 1.
-2.	2.	4	N*	-1.500	-2./ 0.	1.000	1.500	-2./ 3.
0.	5.	5	1.200	N*	0./ 5.	6.000	N*	0./ 1.
1.	4.	5	1.000	5.000	-1./ 5.	N*	-5.000	-1./ 0.
1.	-4.	5	1.000	-3.000	1./ 3.	N*	3.000	-1./ 0.
-1.	4.	5	1.667	-5.000	1./ 3.	2.500	5.000	-1./ 2.
2.	-3.	5	2.000	-1.000	2./ 1.	2.000	1.000	-2./ 1.
-2.	3.	5	4.000	-2.000	2./ 1.	1.333	2.000	-2./ 3.
0.	6.	6	1.167	N*	0./ 6.	7.000	N*	0./ 1.
1.	5.	6	1.000	6.000	-1./ 6.	N*	-6.000	-1./ 0.
1.	-5.	6	1.000	-4.000	1./ 4.	N*	4.000	-1./ 0.
-1.	5.	6	1.500	-6.000	1./ 4.	3.000	6.000	-1./ 2.
2.	-4.	6	1.500	-1.500	2./ 2.	3.000	1.500	-2./ 1.
-2.	4.	6	2.500	-2.500	2./ 2.	1.667	2.500	-2./ 3.
3.	-3.	6	N*	-0.667	3./ 0.	1.000	0.667	-3./ 2.
-3.	3.	6	N*	-1.333	-3./ 0.	1.000	1.333	-3./ 4.
0.	7.	7	1.143	N*	0./ 7.	8.000	N*	0./ 1.
1.	6.	7	1.000	7.000	-1./ 7.	N*	-7.000	-1./ 0.
1.	-6.	7	1.000	-5.000	1./ 5.	N*	5.000	-1./ 0.
-1.	6.	7	1.400	-7.000	1./ 5.	3.500	7.000	-1./ 2.
2.	-5.	7	1.333	-2.000	2./ 3.	4.000	2.000	-2./ 1.
-2.	5.	7	2.000	-3.000	2./ 3.	2.000	3.000	-2./ 3.
3.	-4.	7	3.000	-1.000	3./ 1.	1.500	1.000	-3./ 2.
-3.	4.	7	5.000	-1.667	3./ 1.	1.250	1.667	-3./ 4.
0.	8.	8	1.125	N*	0./ 8.	9.000	N*	0./ 1.
1.	7.	8	1.000	8.000	-1./ 8.	N*	-8.000	-1./ 0.
1.	-7.	8	1.000	-6.000	1./ 6.	N*	6.000	-1./ 0.
-1.	7.	8	1.333	-8.000	1./ 6.	4.000	8.000	-1./ 2.
2.	-6.	8	1.250	-2.500	2./ 4.	5.000	2.500	-2./ 1.
-2.	6.	8	1.750	-3.500	2./ 4.	2.333	3.500	-2./ 3.
3.	-5.	8	2.000	-1.333	3./ 2.	2.000	1.333	-3./ 2.
-3.	5.	8	3.000	-2.000	3./ 2.	1.500	2.000	-3./ 4.
4.	-4.	8	N*	-0.750	4./ 0.	1.000	0.750	-4./ 3.
-4.	4.	8	N*	-1.250	-4./ 0.	1.000	1.250	-4./ 5.
0.	9.	9	1.111	N*	0./ 9.	10.000	N*	0./ 1.
1.	8.	9	1.000	9.000	-1./ 9.	N*	-9.000	-1./ 0.
1.	-8.	9	1.000	-7.000	1./ 7.	N*	7.000	-1./ 0.
-1.	8.	9	1.286	-9.000	1./ 7.	4.500	9.000	-1./ 2.
2.	-7.	9	1.200	-3.000	2./ 5.	6.000	3.000	-2./ 1.
-2.	7.	9	1.600	-4.000	2./ 5.	2.667	4.000	-2./ 3.
3.	-6.	9	1.667	-1.667	3./ 3.	2.500	1.667	-3./ 2.
-3.	6.	9	2.333	-2.333	3./ 3.	1.750	2.333	-3./ 4.
4.	-5.	9	4.000	-1.000	4./ 1.	1.333	1.000	-4./ 3.
-4.	5.	9	6.000	-1.500	4./ 1.	1.200	1.500	-4./ 5.

*The line does not intercept the axis, it is parallel to it.

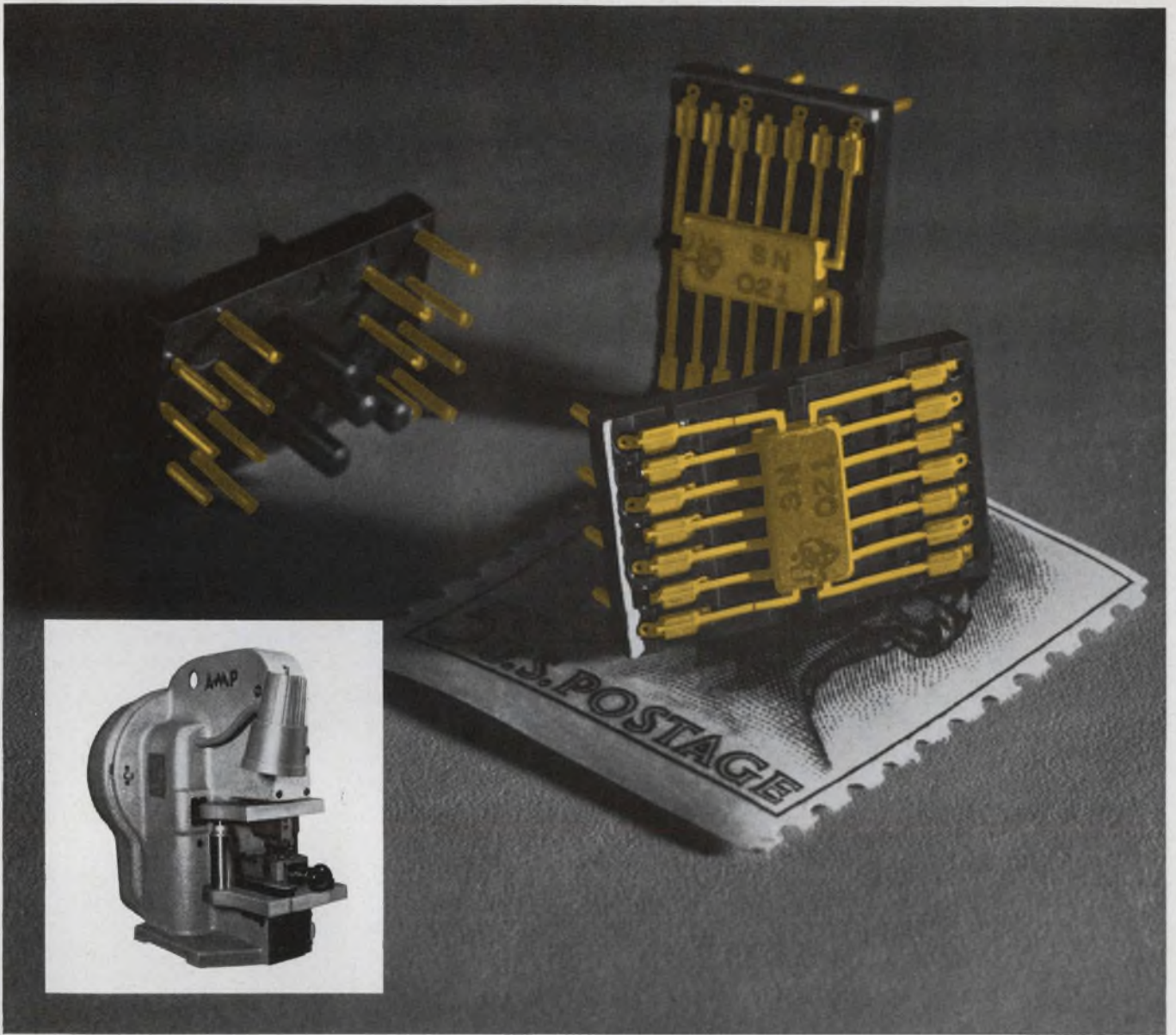

GANG CRIMPING

A new breakthrough in integrated circuits

All 14 ribbon leads of the flat pack above were crimped simultaneously to pins on our new AMP-CRIMPAC* Header . . . a feat of engineering that only a leader in crimping techniques would attempt.

Frankly, it wasn't easy—even for us.

For one thing, we had to use plastic as the anvil for the crimping dies. Nobody had ever done that before. Then, we had to make the pack's .050" mounting centers compatible with existing wiring techniques. And, to top it off, the whole system had to be completely trouble-free and uniformly reliable.

Here's how we did it. We made the AMP-CRIMPAC Header of sturdy phenolic and molded in 14 pins, staggered so that they come through on .100" centers. We designed a precision automatic machine to gang crimp all 14 of the pack's leads at once. After encapsulation, the pack assembly is as rugged as a transistor can or other plug-in component. It can either be plugged and soldered directly onto printed circuit boards, or plugged into an AMP-CRIMPAC Receptacle.

The receptacle attaches to the system panel and is provided with posts that accept AMP's TERMI-POINT* clips for automatic or manual back-panel wiring. Both the header and its mating receptacle are color-coded,

polarized, and keyed for optimum control during production and in field maintenance.

Why go to crimping in integrated circuits? Consider the evidence:

- Reliability is controllable and repeatable
- No heat damage to the circuit function
- No need for bending or pre-forming pack leads
- Exceptionally fast assembly
- Less capital outlay for equipment
- Available for all 1/4" x 1/4" or 1/4" x 1/8" flat pack applications

Now you can enjoy system maintainability right down to the single flat pack circuit. Write for more information on AMP-CRIMPAC Headers and Receptacles today.

*Trademark of AMP INCORPORATED



AMP* products and engineering assistance available through subsidiary companies in: Australia • Canada • England • France • Holland • Italy • Japan • Mexico • Spain • West Germany

Visit us at the Wescon Show, Booths 1333-1335, August 23-26, 1966

Speed Inquiry to Advertiser via Collect Night Letter

ON READER-SERVICE CARD CIRCLE 147

Check off the human factors design of your electronic system – big or small – by using this conveniently classified compilation.

Often, an engineer has designed an excellent system only to see it perform poorly because he forgot one basic thing: people must operate it. Controls that are easy to see, simple to use and readily accessible for repairs are goals of human-factors engineering. Military publications are crammed with reminders on how to build equipment that won't baffle operators.^{1,2} Here, in one checklist, is a compilation of these tips. While they are the standards expected in modern military equipment, they are equally useful in all nonmilitary applications.³

Labels

Make numerals and letters simple in design, similar to Leroy lettering guides. Avoid extra flourishes.

Use capital letters for labels, but use standard capitalized and lower-case type for extended copy.

Scale numbering systems to increase from left to right or bottom to top whenever possible.

Relate the coding or labeling on the display and its control to tell which control affects which display.

Use arrows to indicate direction of operation of control.

Minimize mental translations of units and symbols on controls and dials.

Meters and dials

Use scale graduations no finer than necessary, within the accuracy of the instrument itself.

Separate indices and numerals on a dial sufficiently for accurate reading.

Design instrument pointers to reduce parallax. They should not overlap numerals or indices.

When several instruments must be read at once, orient the instruments so that the normal operating positions of all pointers are aligned, preferably at the 9- or 12-o'clock position.

Use similar numbering and scale progressions for dials which may appear on the same panel.

Use color code techniques to define operating and danger ranges, or to simplify check-reading.

Use scale breakdowns of units, fives or tens when possible; avoid fractions or decimals.

Orient scales to make critical ranges appear in the left or upper quadrants.

For multirevolution dials, orient the zero position at 12-o'clock.

For dials which have a noncontinuous scale, provide a definite scale break between the end of the scale and the zero position.

Avoid the use of more than two pointers on a single dial.

Provide even illumination of all parts of a dial, including the pointer.

In dial-scale design, the fixed scale with moving pointer is preferred over the fixed-index, moving-scale design.

Because numeral and scale index sizes are dependent upon the reading distance, use optimum height-width ratios.

When reciprocal readings are necessary from a single pointer, make sure the two ends of the

Arnold T. Lloyd, Lockheed Aircraft Service, Ontario, Calif.

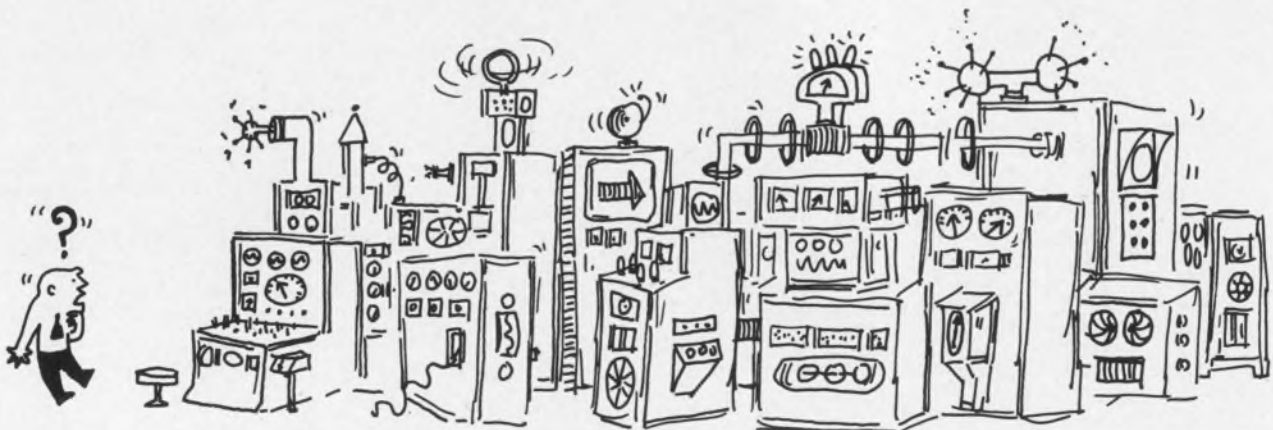

pointer are identifiable.

Make the opening for open-window dial display large enough to permit viewing of at least two numbers.

Counters

Select counters in which the numbers "snap", rather than drift, into place.

Avoid counter designs which have too much space between numerals when they must be read as one value.

Mount counters close to the panel so that numbers are not obscured by bezel openings.

Warnings

When selecting warning lights, make sure they are compatible with the ambient illumination levels expected. Use dimmer controls if necessary.

When dark-adaption is necessary, use red light only (wavelengths longer than 620 millimicrons).

Vary flash rates for flashing warning lights from 3 to 10 per second. ON-time should be at least 0.05 second.

Allow warning signals to be visible no longer than necessary to attract attention. Never design a device meant to provide a specific warning to actuate during any part of normal operations.

Isolate warning lights conspicuously from normal-operation lights for greatest effectiveness.

Visual displays

Maintain ambient illumination surrounding a CRT display for detection tasks at about 0.1 millilambert.

Hold vibration of visual displays to a minimum. Any display movement requires higher illumination levels and longer reading time.

Provide a display to show when an instrument is not operating properly.

Design changes in visual indications to be obvious enough to be detected easily.

Control operation

Position controls which must be located "blind" ahead of the operator rather than to the side or behind him.

Place often used controls between elbow and shoulder height.

Provide control movement in the expected direction; that is, increases should be to the right or upward.

Design control movements and locations parallel to the axis of the display motion which they affect.

Design and position cranks with respect to the speed or load that they govern; that is, small cranks at elbow height for fast action and light loads; large cranks for full arm motion for heavy loads.

Use adjustment-type knobs no more than two inches in diameter and only for very light torques.

Use round knobs for controls requiring smooth continuous movement; use bar- or pointer-type knobs for detent-type switching.

Provide toggle or bat-handle switches with at least 30° throw to each side of center to give good visual indication of displacement.

Pedals

Mount brake pedals so that the knee angle (between the upper and lower leg) of the operator is somewhere between 105° and 135°.

Pivot pedals so that control action is similar to the limb or foot motion (near the heel of the foot for ankle action on an accelerator pedal, or above the foot for leg motion as in the case of the brake).

Design control actions to be positive without being sticky or stiff.

Allow joystick movement to be equally free in all directions. Small joysticks on table- or desk-top installations should be mounted so that the hand has a resting place for steadying the control movement.

Panel layout

Design panel layout to be as functionally simple as possible. Trade-offs of primary position for controls and displays should be considered as a whole in order to relate functions.

Conceal beneath a lid those displays and controls which are not necessary to normal operation.

Make sure the operator cannot cover a display while manipulating a control.

Provide clear labels using standard abbreviations. Provide illumination where necessary and be consistent in placing labels either above or below controls or displays.

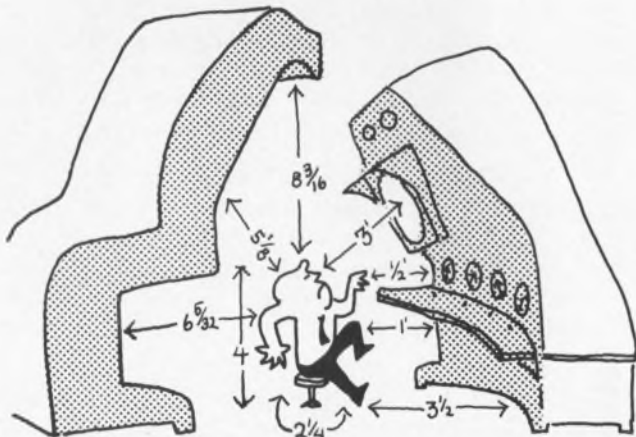

Avoid glossy surfaces or highly polished metals. Use anti-glare coating on transparent instrument covers when possible.

Console dimensions

Design cabinets, racks, and consoles with the dimensional statistics of the human operator in mind. Although static dimensions are available to the designer,¹ common sense may be more valuable in adjusting these figures to the dynamic situation.

Mount vertical displays 50 to 70 inches above the floor when they are to be viewed from a standing position.

Use a 30-inch seat-to-eye height reference to locate visual displays used by a seated operator.

For a comfortable display-mounting angle, use the following rule of thumb: 60° from horizontal for seated operators; 45° for a combination of sit and stand; 30° for a straight standing position.

Use a 28-inch arm reach, measured from the operator's shoulder, as a limiting figure for the placement of controls which are to be used often.

Console organization

When possible, arrange controls sequentially with respect to the expected or required order of operation. Activity for both hands should be evenly distributed.

Generally, organize control-display combinations so that visual displays occupy central areas, and controls occupy peripheral areas, to avoid hand and arm interference with visual tasks.

Emphasize functional groupings of displays and controls by using such techniques as color coding, marked outline, symmetry of grouping, and/or differential plane of mounting.

When desk positions are required, consider height of writing surface, working width and depth, knee and foot room, and elbow room if more than one operator is involved.

Design storage space with man's physical dimensions in mind; consideration should be given to reach-distance, eye height when stored items must be seen, and depth of bin (for articles pushed to the rear).

System layout

When men and machines are grouped for system or team operations, consider not only the individual needs but also the equitable flow of human traffic and aural and visual communication links.

When group activity demands use of a central visual display, make sure that lines of sight to the display are not blocked by poor arrangement of people or equipment.

Provide sufficient space in corridor and passageway design for people to pass each other, and

room for doors to open into passageways without hindering the flow of traffic.

Give special consideration to passageways and doorways used by personnel who are encumbered by special clothing or equipment.

Operational environment

Good illumination should include the following considerations: (a) suitable brightness for the task at hand, (b) uniform lighting on the task, (c) suitable contrast between task and background, (d) freedom from glare from either the light source or the work surfaces, and (e) suitable quality and color for the illuminants and surfaces.

For aircraft cockpits or other specialized military applications, consult recommended lighting-level tables for both the ambient and specialized lighting.¹

Do not assume that general ambient illumination will be adequate for individual tasks. A careful analysis of the entire lighting system will prevent later make-shift remedies.

Consider the environmental conditions under which the man-machine combination must work. If these conditions cannot be controlled directly, it is necessary to provide other safeguards. Temperature, ventilation, and noise are the major considerations, and modern protective measures should be used by the designer.

Ease of maintenance

Design and use displays that will indicate marginal or substandard performance to the maintenance technician. Although it is obvious when most equipments are inoperable, it is often difficult to determine when they are functioning poorly or below effective levels.

Consider the matter of maintenance simplification as well as operational simplification. Use modular techniques, go-no-go indicators, and disposable packages when feasible.

Follow good display and control practices when providing these functions for the maintenance technician. Poor meter display, screwdriver controls which are too sensitive, or poor use of color coding hinder maintenance.

Avoid large cumbersome back-access doors on cabinets or racks. These create a nuisance and a hazard. Use quickly removable or small double-hinged doors which do not complicate the space problem.

Avoid cable entrances on the front of cabinets.

Screwdriver calibration adjustments are unsatisfactory from the standpoint of human manipulation. Use knobs whenever possible, and if these shouldn't be disturbed except in special cases, cover them or provide a special seal or danger code.

Provide a record for adjustment controls. It is difficult to remember settings without some mark-

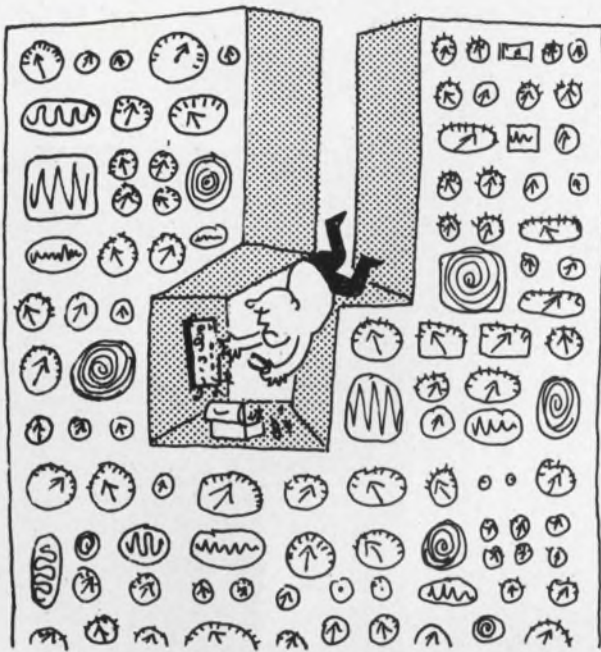

ing, and this record may reveal gradual deterioration in performance as settings need changing.

Mark keyways for plug-in components so that the technician does not rely on "feel" to find the proper position. Tube labels should also be oriented so they can be seen from the maintenance position.

In mounting parts on chassis and chassis in racks, allow for access to both sides of a chassis. Leave sufficient hand room for the technician to remove and replace parts without danger. Provide hand grips for lifting.

Avoid mounting parts and assemblies so that several intermediate pieces have to be removed to get to one that requires frequent servicing.

Use sturdy, smoothly operating drawer slides; make sure they will hold the unit firmly in the open position, and that the technician does not need three hands to manipulate fasteners or guide flexible cables.

Reduce the number of part types required, and use common parts where possible to simplify maintenance and storage.

Affix legible, permanent tuning instructions, calibration graphs, labeling and dial markings to cabinets: loose instructions get lost.

Provide routine check points which are available without removing the chassis from the cabinet. ■ ■

References:

1. *General Specification for Electronic Equipment* (U.S. Mil. Spec. MIL-E-16400) and *Human Factors Design Criteria for Aerospace Systems and Equipment* (U.S. Mil. Spec. MIL-STD-803). (These two military specifications offer a starting point for more detailed information in general or relative to specific areas.)

2. *Suggestions for Design of Electronic Equipment* (San Diego, Calif.: U.S. Navy Electronics Lab. pamphlet).

3. "A Special Report on Industrial Design," *ELECTRONIC DESIGN*, XIII (Nov. 8, 1965), 21-35.

who said you can't design a plugboard programming system to withstand severe shock?

MAC Panel has done it!



NEW SERIES 140

MAC Panel's Series 140 Plugboard Programming Systems are available in a wide range of sizes . . . each designed and engineered to withstand the severest shock and vibration under operating conditions. Tested to 50G without self-generated contact noise. And life tested to 10,000 cycles with only random variation in contact voltage drop.

Not enough facts? Here are more: You can only insert plugboards one way. Receptacles are available for standard taper pins or series 53 pins. Contacts are spaced on $\frac{1}{4}$ " x $\frac{1}{4}$ " grid to allow more positions in a minimum of space.

How about plugwires? The new Series 140 Plugwires are interchangeable with most existing systems. Ball-D-Tent design prevents accidental dislodging, won't mar the surface.

Want more facts? Write today . . . outline your specific needs and let MAC engineers come up with the answers. They usually do.

MAC
O.E.M. DIVISION

MAC PANEL CO. High Point, N.C.

ON READER-SERVICE CARD CIRCLE 148

A new feather in our old hat



ACE Digital Test Command System

Motorola's leadership in Integrated Circuits has been extended by another state-of-the-art achievement — the design and production of the First Integrated Circuit Automatic Checkout Equipment, used at Cape Kennedy for compatibility testing of Apollo systems prior to launch. This DTCS, (shown above) processes command messages to produce and channel test stimuli to various spacecraft systems under test. Each DTCS contains some 8,000 Motorola MECL Integrated Circuits.

This is but one example of Integrated Circuit Applications. New technology is being applied daily to advanced analog, RF, and digital circuitry in sophisticated system configurations. We have projects ready and waiting for qualified circuit design engineers and system analysts.

If a challenge like this interests you, contact Phil Nienstedt, Manager of Recruitment, Department 628.

At WESCON: The DTCS shown above will be displayed at Motorola's Integrated Circuits Applications Suite during the show.



Government Electronics Division • Aerospace Center • P.O. Box 1417, Scottsdale, Arizona
MOTOROLA ALSO OFFERS OPPORTUNITIES AT CHICAGO, ILLINOIS — AN EQUAL OPPORTUNITY EMPLOYER

ON CAREER-INQUIRY FORM CIRCLE 901

Book Reviews

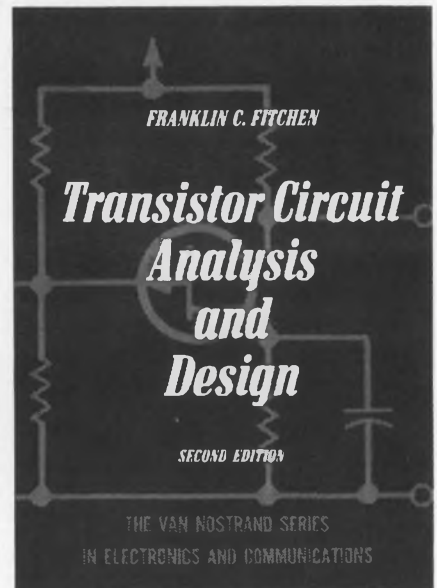

Transistor Circuitry

This text, devoted to the characteristics, analysis and application of semiconductor devices, has a "hole card." It is one of the most up-to-date treatments of solid-state components.

The contents examine the junction-FET, insulated-gate FET (IG-FET or MOS-FET), unijunction transistor (UJT) and microelectronic devices, as well as providing a thorough study of bipolar devices and popular diodes. An updated version of a textbook geared for the advanced university student, the book also serves as a "bible" for the practicing engineer.

The first three chapters deal with the nature of semiconductors—their properties, the physics involved in understanding them, and how to go about choosing operating points and biasing networks to put them to work.

The next three chapters are design-oriented analyses. They delve into the various devices' parameters and equivalent circuits, representative circuit models and black-box design considerations.

The work proceeds to basic application information (how-to-design) in five fundamental use areas: large-signal amplifiers, multi-stage amplifiers, communications amplifiers, circuits and systems,

(continued on p. 230)

CAREER INQUIRY – confidential

19

Respond to the career opportunities advertised in this issue. Fill out and send us this handy resume. **Electronic Design** will do the rest – neat copies of this form will be mailed to the companies of your choice, indicated by the circled Career Inquiry Numbers at the bottom of this page.

Name		Home Phone	
Home Address (Street)		City	State
			ZIP Code
Age	U.S. Citizen <input type="checkbox"/> Yes <input type="checkbox"/> No	Security Clearance	

Prime Experience	Secondary Experience

Desired Salary	Availability Date
-----------------------	--------------------------

Employment History – present and previous employers

Company	City, State	Dates	Title
		to	
		to	
		to	

Education – indicate major if degree is not self-explanatory

Degree	College	City, State	Dates
			to
			to
			to

Additional Training – non-degree, industry, military, etc.

Professional Societies

Published Articles

Career Inquiry Numbers:

900	901	902	903	904	905	906	907	908	909
910	911	912	913	914	915	916	917	918	919

ELECTRONIC DESIGN
 850 Third Avenue
 New York, New York 10022



To
**ELECTRONIC
ENGINEERS**
with a sense
of timing...

BENDIX (KANSAS CITY DIV.) **IS ON THE MOVE!**

This is the opportune moment to investigate your career potential at Bendix, Kansas City Division. As prime contractor for the AEC, we have enjoyed an enviable, orderly 16-year growth. Now we are entering a unique developmental phase, opening new fields of activity in microminiaturization, microwave and logic circuitry. This situation adds up to a ground-floor opportunity in a well-established corporation noted for advanced engineering. Cooperative, professional atmosphere, plus excellent living conditions. Let us hear from you promptly so we may detail more clearly the many advantages we can offer you.

Please mail résumé at once to:

Mr. E. C. McGurran, Tech. Personnel Repr.
THE BENDIX CORPORATION, Box 303-HE
Kansas City, Missouri 64141



AN EQUAL OPPORTUNITY EMPLOYER

ON CAREER-INQUIRY FORM CIRCLE 902

Fold here, staple and Mail.

FIRST CLASS
Permit No. 725
New York, N.Y.

BUSINESS REPLY MAIL

No Postage Stamp Necessary if Mailed in the United States

POSTAGE WILL BE PAID BY

ELECTRONIC DESIGN

READER SERVICE

850 THIRD AVENUE

NEW YORK, NEW YORK 10022



If you hesitate

until the RFPs come out and the airplanes are named,
you'll be reporting to those reporting to those
who answer this ad today.

Insure that your ideas and talents are reflected in the design of the fighters and transports and spacecraft and missiles that will fly in the decade of the Seventies. Join the design team at McDonnell where the lines for those aircraft, spacecraft, and missiles are being drawn right now.

At McDonnell you'll have the security of a backlog of manned and unmanned spacecraft, a variety of Phantom fighters and reconnaissance craft, medium assault tactical missiles, lifting bodies and escape systems, automation and airborne collision avoidance systems.

You'll find projects staffing-up to meet the spacecraft demands of planetary environments and Earth-orbital systems. You'll find STOL a magic word at McDonnell in both fighter and transport design groups. You'll find the application of precise time reference an opportunity with open-ended potential.

You'll find reentry designs advanced beyond brute force concepts, and you'll find tactical weapon systems in study that exhibit the advantages of creative departure from convention. You'll find metals technology developments advanced to meet supersonic and hypersonic design requirements. You'll find a history of corporate achievement and the continuing stimulus that turns creative ideas into practical hardware.

If you are a degree-holding engineer, physicist, mathematician or have specialized in other related fields of science, take the positive approach to the next decade. Don't hesitate. Investigate opportunities at McDonnell, today.

Mail This Form To: W. R. Wardle, McDonnell Employment, Dept. R-815 Box 516, St. Louis, Mo. 63166

Name _____ Phone _____ Age _____

Home Address _____ City & State _____ Zip _____

Education: BS _____ MS _____ PhD _____ Major Field: _____
Date Date Date

Primary Experience Area: _____

Present Position: _____

Number of Years _____ I would like to receive application form

MCDONNELL

An Equal Opportunity Employer

ON CAREER-INQUIRY FORM CIRCLE 903



*Look into the vehicles
of opportunity
at Lockheed...*

**FOR CIRCUIT
DESIGNERS.**

Opportunity broad enough to interest every circuit designer, that's the sweep of electronics assignments at Lockheed. Big, wide-ranging programs that extend from deep sea to deep space. And with ever-growing commitments comes an increasing need for new concepts and major technical advances in flight controls, communications, antennas and state-of-the-art electronics check-out equipment in both spacecraft and fleet ballistic missiles. In addition to its major vehicle programs... Agena, Poseidon, and Polaris, Lockheed is involved in deep submersibles; unique advanced land vehicles; information systems for states and hospitals; and many other technically alluring programs. For complete information, write Mr. K. R. Kiddoo, Professional Employment Manager, P. O. Box 504, Sunnyvale, California. Lockheed is an equal opportunity employer. *Engineers and scientists attending Wescon are invited to visit Lockheed's booths 2102A and 2103A.*

LOCKHEED
MISSILES & SPACE COMPANY
A GROUP DIVISION OF LOCKHEED AIRCRAFT CORPORATION

ON CAREER-INQUIRY FORM CIRCLE 904

you think combinations and permutations an do great things for a company,

ou should see
hat they can do
or a career.

At Light Military we're proving that crossing two or more technical specialties is a most prolific way to come up with new ideas, new products and new directions.

This diversification of ours already covers a lot of ground (to say nothing of space).

Right now we're putting the advanced technologies we're developing to work in next generation programs that range from Early Warning radar to attack radar to low light-level sensing systems and that include television, and infra-red sensors, digital data processing, and weapons and flight control systems.

Nothing but diversification this broad could do so much for so many so well. For example, because of it the Department has a basis for growth that would be hard to top. And because of it our engi-

neers are constantly presented with multi-avenue and multi-specialty opportunities for professional growth.

It might well be that crossing your experience and capabilities with ours could lead to some pretty rewarding results all around. The first step couldn't be easier. Just put an "X" next to the technical skills itemized below that are in line with your interests and experience. Then fill out the coupon. We'll get back to you promptly with information on current openings. If you have a resume handy, send it along.



LIGHT MILITARY ELECTRONICS DEPARTMENT

GENERAL ELECTRIC

An Equal Opportunity Employer

ANALOG CIRCUITRY

- LOW LEVEL LINEAR AMPLIFIERS**
Direct Current
Low Frequency
High Frequency
Operational
Buffer
Low Noise
Other
- NONLINEAR SINUSOIDAL CIRCUITS**
Frequency Multipliers
Frequency Dividers
Mixers and Converters
Modulators
Demodulators
Other
- AMPLITUDE OPERATORS**
Amplitude Selection
Amplitude Discrimination
Amplitude Comparison
Level Setting
Other

DIGITAL CIRCUITRY

- LOGIC CIRCUITS**
Logical Gates
Counters and Digital Frequency Dividers
Registers and Memory Circuits
Digital Arithmetical Circuits
Other
- GENERATORS**
Pulse
Square Wave
Time Base
Other
- AMPLITUDE OPERATORS**
Amplitude Comparison
Level Setting

SYSTEMS ANALYSIS

- RADAR**
AEW Radar
Multi-Mode Radar
- PHOTICS**
- GUIDANCE**
- ECM**
- LOGIC**

RELIABILITY

- RELIABILITY DESIGN (CIRCUITS)**
- COMPONENTS**
- STATISTICS**
- RELIABILITY PROGRAMS**

CONTROL AND SERVO CIRCUITRY

- CONTROL AND SERVO MECHANISM CIRCUITS**
Automatic Gain Control
Automatic Frequency Control
Servomechanism, Position
Other
- POWER SUPPLY CIRCUITS**
Regulators, AC and DC
Regulated Power Supplies, AC to DC

ANTENNA AND MICROWAVE CIRCUITS AND RF POWER

- POWER AMPLIFIERS**
Direct Current
Low Frequency
High Frequency
Low Distortion
Other

TEST EQUIPMENT DESIGN

- MANUAL**
- SEMI-AUTOMATIC**
- FULLY-AUTOMATIC**
(these test positions for all categories listed above)
- SYSTEMS TEST POSITIONS**

TECHNICAL WRITING

- TECHNICAL MANUALS**
- TECHNICAL REPORTS**

MANUFACTURING ENGINEERING

- PROCESS DEVELOPMENT ENGINEERING**
- PRODUCIBILITY ENGINEERING**
- FACILITIES ENGINEERING**

OTHERS (Fill in your specialty if you don't see it here.)

GENERATORS

- Fixed Frequency Sinusoidal**
- Variable Frequency Sinusoidal**
- Precise Frequency Sinusoidal**
- Pulse**
- Square Wave**
- Time Base**
- Other**

- POWER SUPPLY CIRCUITS**
Unregulated Power Supplies AC to DC
Power Converters, DC to DC
Power Converters, DC to AC
Voltage Multipliers
Other

- FREQUENCY OPERATORS**
Frequency Selection
Frequency Discrimination
Other

- TIME OR PHASE OPERATORS**
Time Selection
Time Discrimination
Time Comparison
Time Delay
Phase Shifting
Other

MECHANICAL DESIGN

- PACKAGING DESIGN**
Space
Missile
Aircraft
Ground
- ENVIRONMENTAL ANALYSIS AND TEST**
Thermal
Dynamics
RFI/EMI

FIELD SERVICE

Name: _____

Home Address: _____

Home Telephone: _____

Job Title: _____

Years Experience: _____

Degree: _____ Year Received: _____

Mail this ad to William H. Gilmore, Light Military Electronics Department, General Electric Company, Sect. 59S, French Road, Utica, N.Y. All replies will be held in strict confidence.

Electronic engineers:

I'm interested. Please phone me at home with details. I'm usually available after _____ (AM) (PM) on _____ (days).	
Name _____	
Phone (incl. area code) _____	
Address _____	
City _____	State _____
Degree _____	
Field of interest _____	

This can be the start of something...

Electrical/electronics assignments of unusual scope and growth potential are immediately available at Boeing, for work on some of the nation's most important missile and space programs.

For example, as an Apollo/Saturn V support contractor to the National Aeronautics and Space Administration, Boeing is performing major systems engineering and integration functions. Responsibilities include design, fabrication, assembly and test of the first stage of the Saturn V.

In addition, Boeing is weapon system integrator for the USAF Minuteman ICBM program. And it's building the USAF "Burner II," a solid fuel upper

stage to be used initially atop the Thor launch vehicle. NASA's Lunar Orbiter, designed and built by Boeing, is yet another example of the kind of challenging assignments awaiting you.

Openings cover all levels of experience, responsibility and income. You have a wide choice of geographical locations, from the Pacific Northwest evergreen playground to the famous resort and culturally rich aerospace centers of the Southeast.

Requirements for these assignments include a B.S.E.E. or advanced degree and related experience. Boeing is an equal opportunity employer.

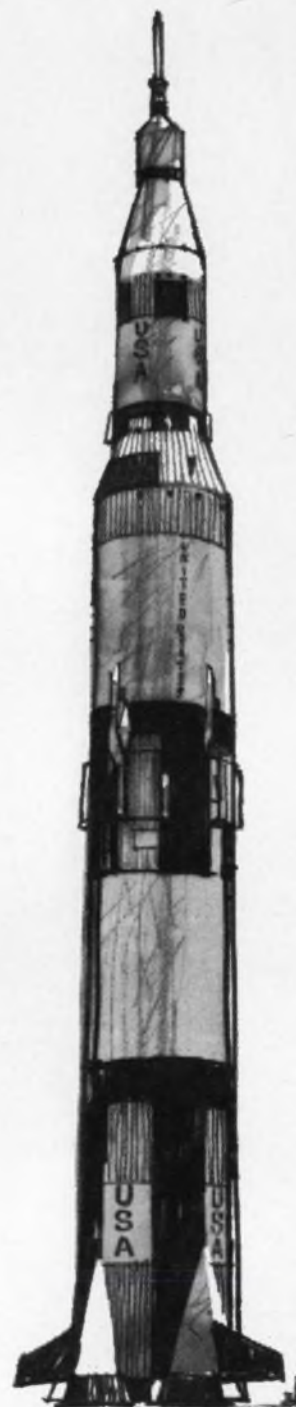

big.

Send the above coupon today, to the Employment Manager at the facility of your choice; he'll call you shortly. Address your letter to the Boeing Employment Office at one of the following addresses: Cape Kennedy: C. K. McConnell, P.O. Box 1698-EDC, Cocoa Beach, Florida 32931; Huntsville: A. J. Wraspir, P.O. Box 1680-EDC, Huntsville, Alabama 35807; New Orleans: R. A. Garinger, P.O. Box 29100-EDC, New Orleans, Louisiana 70129; Seattle: R. R. Laurie, P.O. Box 3822-EDC, Seattle, Washington 98124.

BOEING

AEROSPACE GROUP

MISSILE & INFORMATION SYSTEMS DIVISION
SPACE DIVISION

DISCOVER THE WIDENING WORLD OF WESTON



**WE HELP FORD
BUILD BETTER
CARS**



**WE HELP BOEING
CREATE SAFER
JETS**



**WE HELP NASA
EXPLORE
SPACE**



**WE HELP YOU
TAKE BETTER
PICTURES**

From 1888 (when we developed the first practical yardstick for measuring electrical current) to the present, Weston has been the nation's prime source for precision.

Our six integrated divisions are currently keeping pace with the needs of industry and government through thousands of different products, programs and projects.

We developed the Xact-Ray gauge to help Ford get uniform fender thickness, and indicators for Boeing to create safer jets. We designed and developed 27 indicator displays for

NASA's Apollo spacecraft. We are also nationally known for the famous Master V and Ranger 9 exposure meters, first choice of amateur and professional shutterbugs.

These examples are just a minute part of the Weston spectrum. We provide precision measuring devices for use under every conceivable condition.

If you're an engineer, looking for new challenges, we invite you to discover the widening world of Weston. *And widen your personal world, too!*

Write in confidence to Corporate Personnel Manager

WESTON

INSTRUMENTS, INC.

614 Frelingheusen Avenue, Department E.D.-1, Newark, New Jersey

PLANTS AND DIVISIONS

Weston-Newark
Newark, N. J.

Weston-Archbald
Archbald, Penna.

Weston-Poughkeepsie
Poughkeepsie, N. Y.

Weston-Transcoil
Worcester, Penna.

Weston-Rotek
Watertown, Mass.

Weston-Boonshaft & Fuchs
Halboro, Penna.

Weston • Prime Source for Precision . . . Since 1888

An Equal Opportunity Employer

ON CAREER-INQUIRY FORM CIRCLE 906

Radar Equipment Design Engineers

The Hughes Radar & Space Electronics Laboratories have important opportunities available for experienced Engineers.

Product design

Engineering assignments exist which involve the design and conceptual development of transmitters, modulators and power supplies employing BWO, CFA, Magnetron, Klystron and Traveling Wave Tubes. Desirable background would include a working knowledge of fabrication techniques, stress and thermal analysis, cooling, encapsulation, microminiaturization or high-voltage design.

Openings are available on nearly all levels—from those with a minimum of two years of applicable, professional experience through those who are interested in and qualified for senior supervisory positions.

Accredited degree and U.S. citizenship required.

For immediate consideration, please airmail your resume to:

MR. ROBERT A. MARTIN
Head of Employment
Hughes Aerospace Divisions
11940 W. Jefferson Blvd.
Culver City 2, California

HUGHES

HUGHES AIRCRAFT COMPANY
AEROSPACE DIVISIONS

An equal opportunity employer — M & F



BOOK REVIEWS

(continued from p. 222)

and pulse circuits. Supplementing this are detailed sections devoted to amplifier circuit design itself. These cover gain stability considerations, the role of feedback and noise behavior.

Another strong point of the text is the choice of problems following each of the 13 chapters. Instead of merely serving as academic exercises, these problems relate to actual design situations faced by the practicing engineer.

Transistor Circuit and Design. Franklin C. Fitchen (D. Van Nostrand Co., Inc.: New York). 412 pp., \$8.50.

—Mark B. Leeds

Physical measurement

The major systems of measurement are described, analyzed and inter-related in this concise volume. It includes systems of mechanical units, units of measurement of acoustic quantities and of quantities used in molecular physics, and systems of measurement of electromagnetic radiation.

Two appendices include tables, constants and conversions for each individual system.

Units of Measurement of Physical Quantities. A. G. Chertov (Hayden Book Company, Inc.: New York). 165 pp., \$4.75.

Computer system

The construction, operation and expansion of the OPS-3 system, developed in a graduate seminar at MIT, are explained in terms which a novice in the computer field can understand. The book describes the basic system, input and output, conditional and unconditional branching, polynomial processing and other aspects of the system. Procedure for defining and processing variables, vectors and matrices are described to make simple applications of the system possible after a brief reading.

On-line Computation and Simulation: the OPS-3 System. M. Greenberger, M. Jones, J. Morris, Jr. and D. Ness (The MIT Press: Cambridge, Mass.). 126 pp., \$4.50 (paperback).

Transistor design handbook

The basic techniques of circuit design are discussed and the circuits analyzed in detail to enable the reader to apply them to any circuit of a known mode of operation.

Part I explains the principle of operation of certain circuits, giving typical values of transistor parameters and specific examples of design. Part II shows synthesized designs in practical form. Part III examines some of the difficulties of design and testing and offers hints on the current testing of prototypes.

An appendix contains the mathematical justification for the expressions and approximations used in the text.

Electronic Designer's Handbook: a Practical Guide to Transistor Circuit Design. T. K. Hemingway (Business Publications Limited: London). 296 pp., about \$8.75.

Control systems

The application of modern control theory is discussed, including such topics as the analysis and synthesis of multiple input-multiple output control systems, application of fundamental concepts in functional analysis to control systems problems, and new topics in Lyapunov function techniques. Applications are geared to electrical, aerospace, mechanical and chemical engineers and to graduate students in those areas.

Modern Control Systems Theory. C. Leondes, ed. (McGraw-Hill Book Company, Inc.: New York). 486 pp., \$17.50.

Semiconductor devices

This text is primarily devoted to the use of semiconductors as switching devices in digital systems. A large part of the book involves semiconductor data, including standardization, rationalization, life-expectancy and serviceability of components. Extensive circuit and logic diagrams illustrate the text.

Transistor Electronics: Use of Semiconductor Components in Switching Operations. K. Rumpf and M. Pulvers (Pergamon Press: New York). 282 pp., \$10.

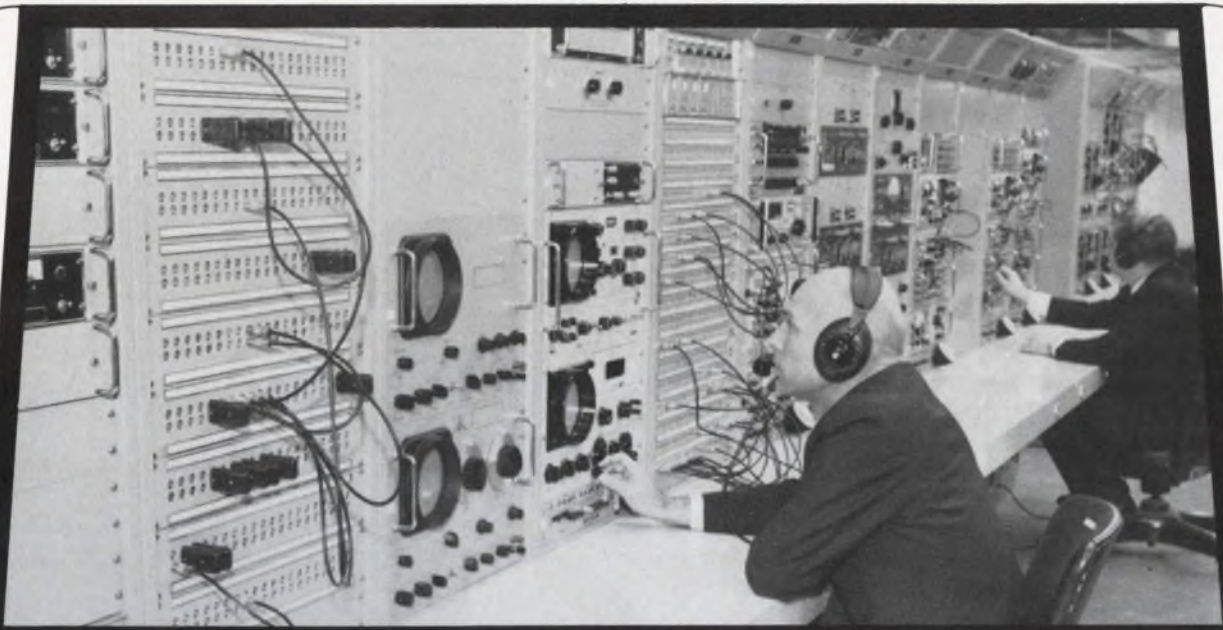

Top—For quick reaction in airborne and ground based electronic systems, LTV ElectroSystems' Greenville Division is the experienced leader. Range instrumentation and tracking, ground-based satellite tracking stations, command and control systems — all are in production or in use.

Right—Designer and builder of the world's most powerful transmitting equipment, Continental Electronics, an LTV ElectroSystems subsidiary, was the prime contractor for the NATO VLF installation at Anthon, England. Continental is the Free World's most experienced organization specializing in super-power electronics.

Left—Powerful, compact units such as the ESC 1000 Long Range Ground/Air/Ground Secure Digital Communications System demonstrate only one phase of LTV ElectroSystems' Garland Division's experience and capability in systems design. The ESC 1000 system will communicate up to 6000 miles in conventional applications and up to 12,000 miles in conjunction with a satellite.



complete spectrum of opportunity for creative challenge

At LTV ElectroSystems, Inc., talented electronic systems oriented engineers know the excitement of creativity, the satisfaction of personal and professional advancement and contribution in an expanding organization, the flexibility and creative freedom of small product groups. Still they enjoy big company growth and opportunity.

LTV ElectroSystems is an organization delivering highly complex new electronic systems to meet defense and space

demands of today and the future. Major fields of capability include: space/air/ground electromagnetic reconnaissance and surveillance systems; command and control systems; high-power radar and radio; nuclear detection and surveillance equipment; information processing and display systems; super power equipment; VLF transmitters; commercial radio transmitters; guidance systems; antennas; electronic warfare systems; satellite tracking systems . . . and more.

These vital programs offer exceptional career positions to engineers in the following disciplines: **RF SYSTEMS ANALYSIS / RF CIRCUIT DESIGN / DIGITAL CIRCUITS DESIGN / DIGITAL SYSTEMS ANALYSIS / WEAPONS SYSTEMS ANALYSIS / GUIDANCE SYSTEMS / RADAR SYSTEMS / ANTENNA SYSTEMS DESIGN / ELECTRO-MECHANICAL PACKAGING / AIRCRAFT ELECTRICAL INSTALLATION DESIGN / AIRCRAFT STRUCTURES DESIGN / MECHANICAL SYSTEMS / ELECTRO-OPTICS / STRESS ANALYSIS / SCIENTIFIC PROGRAMMING . . . plus others.**

For complete information write: Professional Placement, Dept. 676A, P. O. Box 6118, Dallas, Texas 75222. Opportunities exist in Greenville, Dallas, Garland, Texas and Greenville, S. C. LTV is an equal opportunity employer.

LTV
ELECTROSYSTEMS, INC.

A SUBSIDIARY OF LING-TEMCO-VOUGHT, INC.

ON CAREER-INQUIRY FORM CIRCLE 907

Design Engineer looking for a unique CREATIVE CHALLENGE?

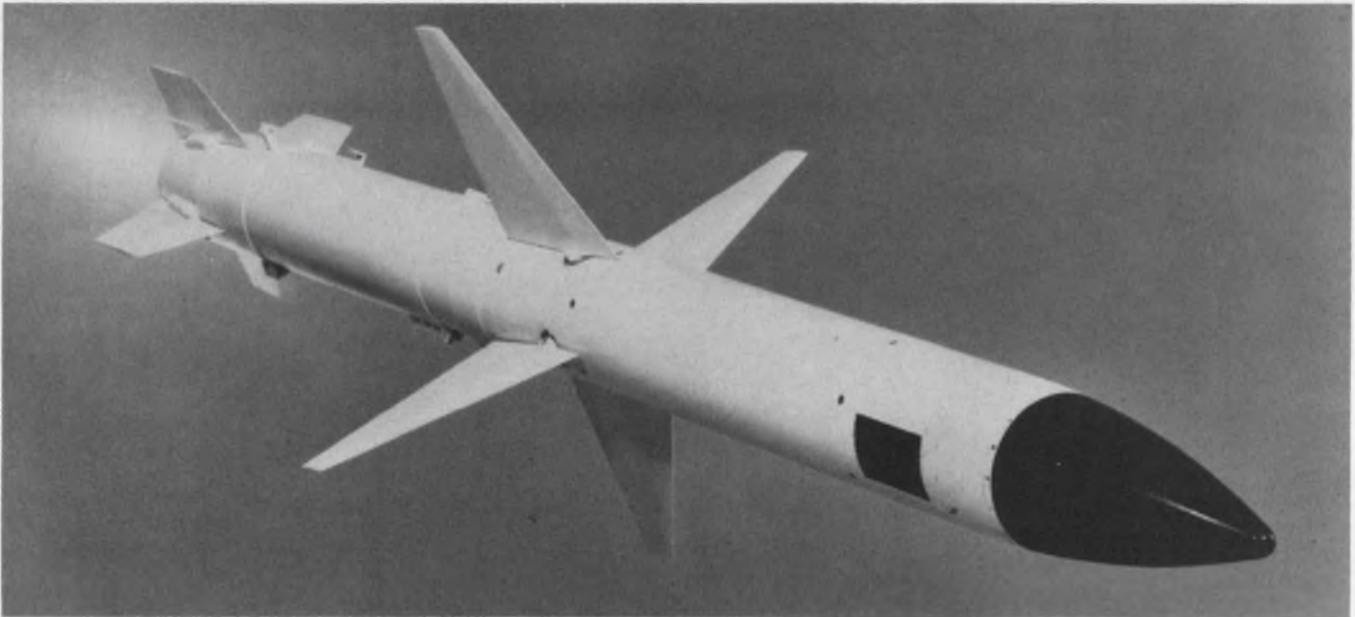

We have a small team of highly skilled scientists and engineers engaged in developing advanced weapons and fire control systems. Their job is to go beyond present technologies . . . to explore exciting new design ideas. If such work appeals to you, we have a limited number of current openings on this team.

Texas Instruments is a growing company of more than 37,000 people engaged in many science-based activities throughout the

RIDGECREST, CALIFORNIA is a small desert town about three hours drive from Los Angeles. It's also only a short drive from several of the West's and Southwest's

world. If, however, you are a design engineer who likes particularly creative work, who prefers non-routine assignments, and who works best with the fewest possible restrictions, we believe you will be especially interested in the professional opportunities at our relatively small Ridgecrest laboratory.

While we are primarily interested in personnel with advanced degrees, openings exist also for qualified BS graduates in mechan-

ical or electrical engineering. You should have directly related experience in: Radar Guidance; RF Circuits; Systems Analysis; etc. More important, though, you should have a strong interest in design work of an innovative nature.

Please send confidential resume to Tom Milner, advance design manager, Texas Instruments Incorporated, P. O. Box 997, Ridgecrest, California.

an hour or so from some of the finest fish and game areas in the world.

MATERIALS
COMPONENTS
CIRCUITS
EQUIPMENTS
SYSTEMS
SERVICES



TEXAS INSTRUMENTS INCORPORATED

An Equal Opportunity Employer

ON CAREER-INQUIRY FORM CIRCLE 908

Universal waveform comparator uses UJT relaxation oscillators

Even though it is more commonly employed as an oscillator, switch, or triggering source, the unijunction transistor (UJT) makes for a precise voltage comparator or level detector. This esoteric capability enables it to be used in a simple, inexpensive, universal circuit capable of distinguishing between digital, linear and nonlinear waveforms.

Few engineers realize that the UJT actually compares two voltage levels as its main function. Moreover, in a majority of cases this comparison is independent of the shape, speed or nature of the voltages placed on its base 2 and emitter terminals with reference to base 1.

Its trigger output should be viewed as a response to these levels, one that is finite whenever the ratio of the voltages equals or exceeds some fixed proportion (see Fig. 1). This output, a pulse, can then be put to use to perform some command function—such as triggering an alarm, switching in another circuit, or effecting a change (in level, duty cycle, etc.) via a feedback connection.

The basic circuit compares two dc levels as follows: When the voltage supplied to C_T reaches, say, 0.6 of the bias across the base terminals, an output results. Until the 60% level is reached, no output is generated. The dc signals may represent power supply levels, other bias voltages, rectified ac waveforms, etc. The output may be used to regulate or modify these levels by means of SCR phase-control or through some other triggered semiconductor power device. Moreover, even the ripple content on the capacitor supply may be sensed, for it may just bring the emitter up to the 60% level if desired.

Two UJTs are employed in the universal waveform comparator (Fig. 2a), which is basically a double version of the basic circuit. In one application a pulse train may be compared to a dc value. The former serves as the command or "tracked" level; the latter is the bias. By choice of appropriate components, pulse amplitude, width, or even duty cycle may be monitored. If the value of any one, or any preset combination, of these three variables exceeds some predetermined level, an

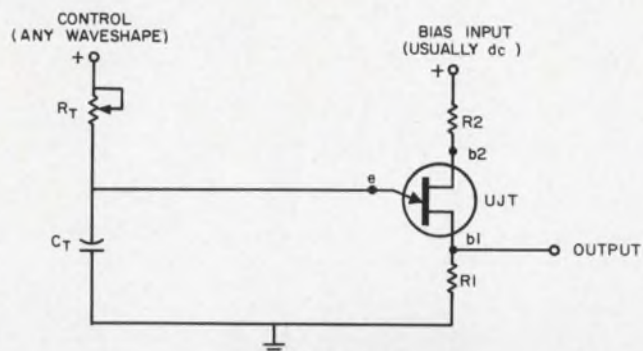

1. **UJT relaxation oscillator** is more appropriately a waveform comparator. When the voltage from emitter to base-1 reaches a fixed proportion of the voltage between base-2 and base-1 (typically 60%), an output is generated. Main function of UJT is thus voltage comparison; output pulse is a result which can be put to triggering, switching or feedback-mechanism usage.

output appears across the pulse transformer in the base-1 leg of Q_B . The sampling here is periodic, and until the threshold is reached, each "under-value" sample is dissipated at the termination of the pulse across the resistor in the base-1 section of Q_A .

Here's how the level-detecting works: Just prior to the trailing edge of the pulse input, the common-emitter terminal is positively biased. The voltage across C_T , however, is insufficient to fire either of the UJTs, because the 60% level has not been reached. The bias is slightly less than the tracking-level amplitude (a one-volt margin suffices) and the timing network (R_T - C_T) is chosen to prevent C_T from reaching 60% of the bias level. The tendency (with both signals present) is for Q_B to always fire before Q_A . The key is the charging network. If the pulse is too short in width (or too small in amplitude) to permit C_T to reach the 60% threshold of Q_B , Q_B will never fire.

When the trailing edge occurs, Q_B remains back-biased—it cannot fire. But the bias across Q_A is now rapidly approaching zero. Q_A is then forward-biased—it fires. The capacitor discharges into R_A and is then ready for the next sample (Fig. 2b). However, if the pulse duration is long enough for C_T to reach the firing threshold of Q_B , Q_B is triggered and C_T discharges into its base-1 section before the trailing edge occurs.

Figure 3 displays a circuit for the comparison of two pulse trains. The fixed one (multivibrator output) serves as the bias source; the tracked waveform (variable pulse widths) is the bias for Q_A and the charge source for C_T . Operation here

VOTE! Circle the Reader-Service-Card number corresponding to what you think is the best Idea-for-Design in this issue.

SEND US YOUR IDEAS FOR DESIGN. Submit your IFD describing a new or important circuit or design technique, the clever use of a new component, or a cost-saving design tip to our Ideas-for-Design editor. If your idea is published, you will receive \$20 and become eligible for an additional \$30 (awarded for the best-of-issue Idea) and the grand prize of \$1000 for the Idea of the Year.

IDEAS FOR DESIGN

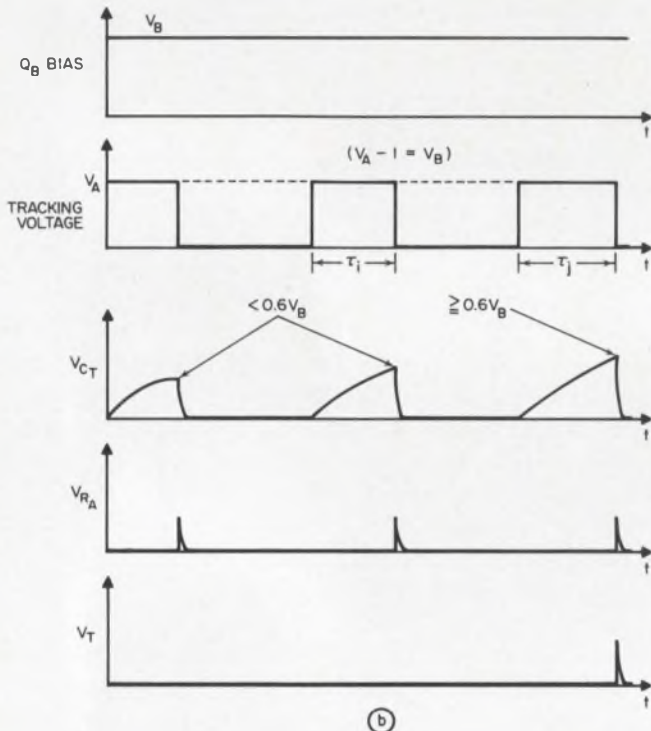
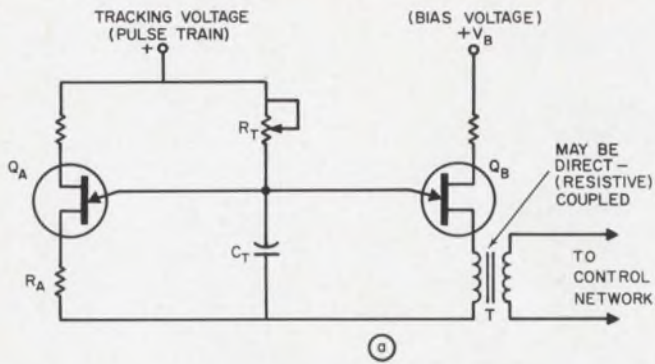

2. **Basic universal waveform comparator** uses 2 UJTs (a). Here a pulse train is compared to a dc level. When pulse width is long enough to permit C_T to reach $0.6 V_B$, Q_B fires (b). With insufficient pulse widths, capacitor voltage sample is dissipated across R_A at termination of pulse.

is the same as in the circuit of Fig. 2a, but if a decreasing pulse-width train were being tracked, these two signals would be interchanged.

This network was built and installed in a guidance system. The sources were analog representations of input data; the output was used to fire SCR power controls in a digitized subsystem. This same basic circuit was also used to compare ramps, sinusoid (half-wave), triangles, and other wave forms in additional applications.

In all cases the following design principles must be observed:

- For fast pulses, coils should be placed in the base-2 sections to prevent UJT firing upon turning on (application of input pulses).
- The power rating of the base-1 sections must be adhered to carefully. Zeners and voltage dividers

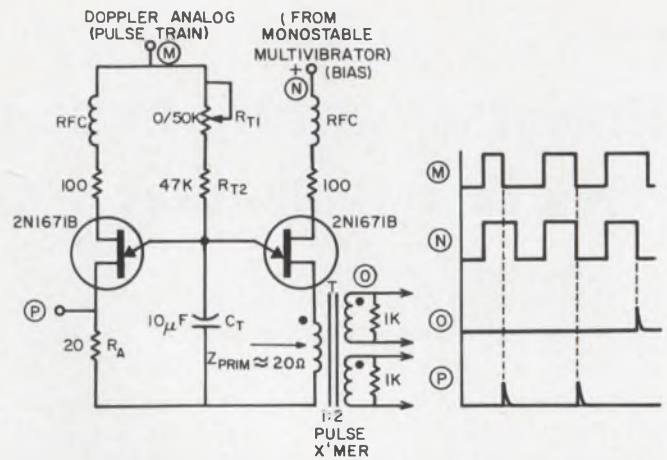

3. **Pulse comparison circuit** contrasts varying pulse train with a fixed pulse waveform (multivibrator output). An output appears across the pulse transformer whenever the tracked pulse width exceeds the monostable pulse width. This same circuit, with little or no modification, may be used to compare ramps, triangles, dc, rectified sinusoids and other basic waveforms. In some cases the multivibrator source and tracking signal are interchanged to fit the design need.

may be necessary to step down the capacitor source voltage.

- R_T actually consists of a fixed resistor in series with a potentiometer for safer charging control.
- Synchronization must be employed between bias and tracking sources by use of a clock.
- The R_T-C_T constant must be such as to prevent mistripping, dual-firing, etc. For example, the R_A output may be used as a synchronous control to prevent dual-firing.
- Since the resistance between bases of a UJT is nominally $7 \text{ k}\Omega$, a small dc level is present at the output (base-1). Care should thus be taken to prevent coil saturation (if T is used) or inadvertent SCR firing (if a resistor is the output-coupling).
- The bias level (Q_B source) should be lower than the Q_A source by at least 0.5 volt.

This circuit concept has also been applied to Doppler systems with success. Incidentally, it is very temperature-stable, largely because of the UJT parameters and its designed-in (via R_1 , R_2 values) temperature compensation.

Andrew F. Cooper, Computer Engineer, Paragon Div. of Texaco, Long Island City, N. Y.

VOTE FOR 110

Circuit gives 100:1 range for pm motor speed control

This circuit will operate a 3.5-W, 28-Vdc, 60-rpm (rated) permanent-magnet motor from greater than 60 rpm to less than 0.5 rpm before stopping. Moreover, it provides a speed variation that is reasonably linear.

A typical speed range of 10:1 may be achieved

ON READER-SERVICE CARD CIRCLE 224 ➤

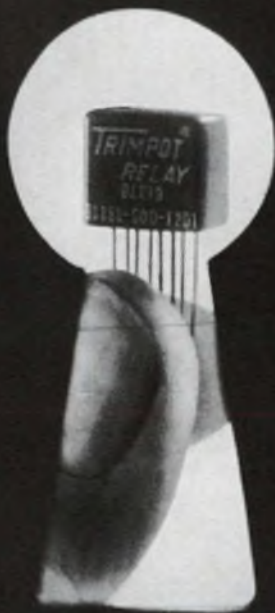

What design doors can you open with the world's smallest industrial relay?

Our new Model 3118 TRIMPOT® DPDT Relay weighs in at 1.8 grams, yet switches a one-amp load along with the heavy-weights. Only 1/6 the size of a conventional crystal-can unit, it's the smallest industrial relay in existence. It brings high quality and performance to your applications at low cost.

Designed specifically for industrial use, the Model 3118 clearly reflects Bourns' long experience in military relays. It has the same type motor assembly and structure as the highest quality MIL unit and provides the same 100,000-cycle life. Also, it undergoes the same 5000-operation run-in as well as the rigorous final inspection for coil resistance, dielectric strength, operate and release time, pickup and dropout values, contact resistance and contact bounce. In addition, its damped return spring and balanced armature design assure excellent resistance to shock and vibration.

The 0.1" grid spaced pins let you plug the Model 3118 right into your printed circuits. Units are available immediately from the

factory with operating voltages of 6, 12 and 26.5 VDC, and in three terminal types. Write today for complete technical data.

Size:	0.26" x 0.53" x 0.43"
Pick-up sensitivity:	200 mw, max.
Contacts: DPDT; rating:	1.0 amp resistive at 28 VDC
Operating temp. range:	-55 to +85°C
Shock:	50 G, 11 ms
Vibration:	10 G, 5-3000 cps
Std. coil resistances:	60Ω to 1200Ω
Life:	100,000 cycles at rated load
Pin spacing:	0.10" grid



TRIMPOT means BOURNS—BOURNS means QUALITY
TRIMPOT is a registered trademark of Bourns, Inc.

BOURNS, INC., TRIMPOT DIVISION, 1200 COLUMBIA AVE., RIVERSIDE, CALIF.
PHONE 684-1700 • TWX: 714-682 9582 • CABLE: BOURNSINC

TRIMPOT® AND PRECISION POTENTIOMETERS — RELAYS — MICROCOMPONENTS: TRANSFORMERS, INDUCTORS, RESISTORS AND CAPACITORS

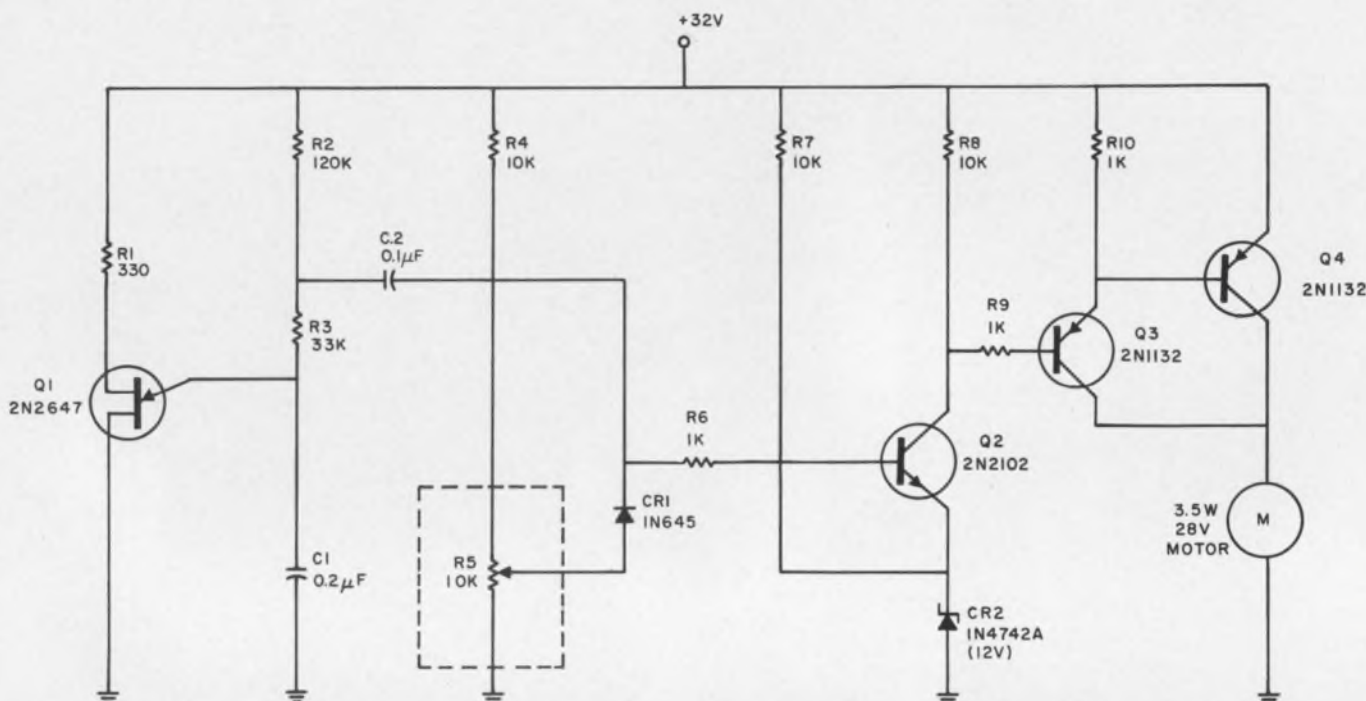

Speed range of 100:1 in a pm motor is provided by this UJT-bipolar motor-speed control circuit. Potentiometer

R5 determines the speed setting; over-all variation is fairly linear.

by varying the voltage across a miniature dc permanent-magnet motor. Since the torque is a function of the applied voltage, as the voltage is reduced a point is reached where the torque is no longer sufficient to overcome the friction—in the vicinity of 10% of maximum voltage for the 3.5-watt motor in this application.

This range may be extended by a circuit (see schematic) which produces variable-width pulses of 30 volts' amplitude to run the motor at a speed proportional to the average current. In the circuit Q1 is a UJT sawtooth generator whose output is attenuated by R2 and R3 to be 10 volts peak-to-peak. The sawtooth waveform is clamped by CR1 to a variable dc voltage established by R5.

The setting of R5 determines how much of the sawtooth waveform will exceed the 12-volt threshold established by CR2. The portion of the sawtooth exceeding this threshold saturates Q2, generating a rectangular pulse which is coupled through Q3 and Q4 to the motor. Variation of R5 permits adjustment of the sawtooth from completely below the 12-volt threshold to completely above. Maximum speed is achieved when full dc voltage is applied to the motor. Since Q4 is either cut off or saturated, the power dissipation is low and a heat sink is not required.

D. G. Greenly, Sr. Research Engineer, HRB-Singer, Inc., State College, Pa.

VOTE FOR 111

Linear width-amplifier doesn't attenuate pulses

A solution to the pulse-stretching problem associated with the tracking of narrow pulses is the linear pulse-width amplifier. This amplifier eliminates excessive attenuation, the main drawback of the commonly used low-pass filter.

The output of the linear pulse-width amplifier is the same amplitude as the input and its pulse width is a fixed multiple of the input pulse width. The pulse-width amplifier can respond to changes in input pulse width from one pulse to the next, thus it can track rapidly changing pulses.

In many phase-locked loop systems, electronic servos have to track extremely narrow pulses. Operational amplifiers associated with these electronic servos generally have narrow bandwidths for stability and memory purposes, therefore the narrow pulses have to be stretched in order to bring them within the bandwidth of the amplifiers. Pulse stretching is usually accomplished by forcing the narrow pulse through a low-pass filter. The disadvantages of this method are the tremendous attenuation in the filter and its slow response to changing input conditions.

The circuit diagram of the linear pulse-width amplifier and its associated waveforms are shown

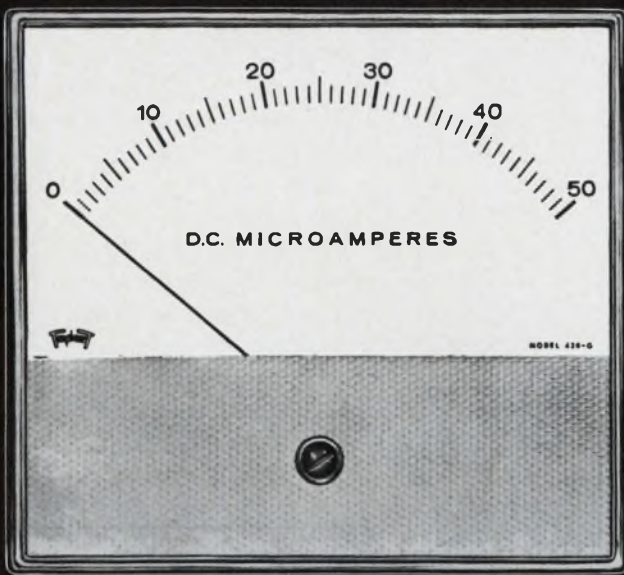

now you see it

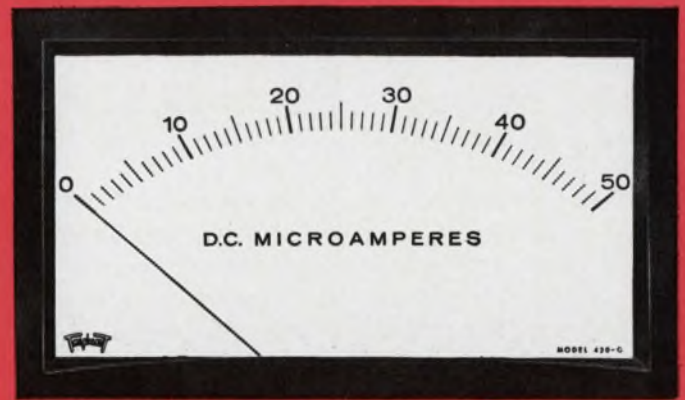

now you don't



THE PANEL INSTRUMENT WITH BUILT-IN FLEXIBILITY

New Triplet G-Series Panel Instruments offer a modern design that features a greater degree of flexibility and interchangeability.

- 1** Two types of mounting are available—conventional flush type or behind-the-panel with a bezel for modern picture window appearance.
- 2** The insert shield on the front of the meter can be custom painted or printed to meet customer's requirements.
- 3** Triplet's famous self-shielded Bar-Ring magnet, with one-piece die-cast frame, all DC and DC suspension type instruments.

Available in three popular sizes: 2½", 3½" and 4½" models with black molded dustproof cases and clear molded plastic fronts.

TRIPLET

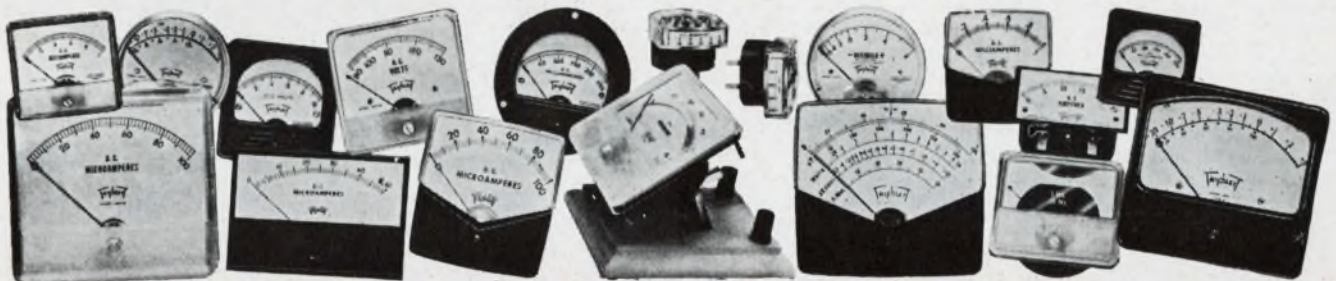

TRIPLET ELECTRICAL INSTRUMENT COMPANY, BLUFFTON, OHIO

in Fig. 1. The letters in the waveform diagram are keyed to the indicated junctions in the circuit schematic.

Here is how the amplifier operates: Normally, the input is at zero volts. The pulse-amplitude standardizer is a level translator and high-accuracy clamp. With the input at zero volts, the output of the standardizer is a few volts negative with respect to ground. Diode D_3 is conducting and holding the capacitor negative. All other diodes are cut off and the output of the zero-crossing detector is at zero volts.

When the input goes positive, the output of the pulse-amplitude standardizer goes positive and is clamped to a precise voltage. Diodes D_1 and D_2 start conducting, while diodes D_3 and D_4 are OFF. As soon as the input goes positive, D_1 places a positive potential at the input of the zero-crossing detector and the output of the detector immediately goes positive. Since at this time C_1 is at a negative voltage, the anode of D_4 is negative with respect to its cathode and D_4 is out of the circuit. The positive output of the pulse-amplitude standardizer starts to charge C_1 positively through D_1 and R_1 . If the input voltage is high enough, the resistor will act as a constant-current source for a fraction of the charging time constant, and the capacitor voltage will be linearly proportional to the input pulse width.

As soon as the input pulse drops back to zero, the output of the pulse-amplitude standardizer goes back to its original negative level. Diodes D_1 and D_2 turn off, while D_3 and D_4 conduct. Diode

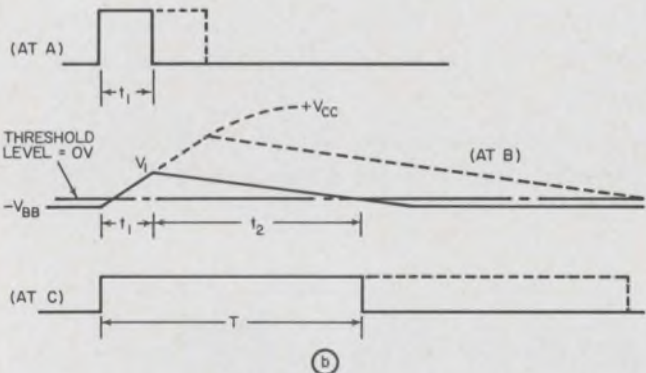
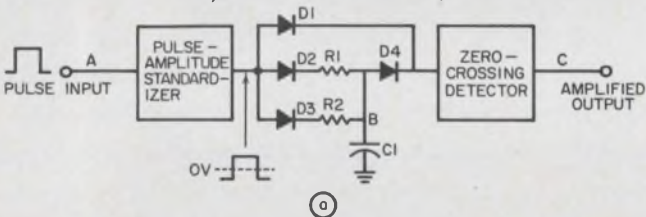

Linear pulse-width amplifier does not attenuate input signal amplitudes (a). Used for tracking very narrow pulses (such as in phase-locked loop systems), the circuit is basically a pulse-stretcher. Key waveforms (top—input pulse; middle—capacitor voltage; bottom—output pulse) appear in (b).

D_4 maintains the positive voltage, which is across the capacitor, at the input of the zero-crossing detector and maintains a positive output at the detector. The input impedance to the zero-crossing detector must be very high in order not to affect the discharge time of the capacitor. Timing capacitor C_1 is discharged through D_3 and R_2 . If the negative voltage toward which the capacitor is discharged is large, R_2 will act as a constant-current source. The voltage across the capacitor diminishes linearly, and when it reaches zero, the output of the zero-crossing detector drops back to zero. After crossing the zero-voltage line, it does not matter whether the capacitor discharge is linear or nonlinear.

The voltage to which the capacitor charges depends on the positive voltage to which the output of the pulse amplitude is clamped, on the input pulse width and on the R_1 - C_1 time constant. This is expressed as:

$$V_1 = V_{CC} - (V_{CC} + V_{BB})e^{-t_1/R_1C_1} \quad (1)$$

The time it takes to discharge the timing capacitor depends on V_1 and the discharge time constant R_2C_1 , given by:

$$t_2 = R_2C_1 \ln [(V_{BB} + V_1)/V_{BB}] \quad (2)$$

If R_2C_1 is made much larger than R_1C_1 , then large pulse-width amplification results. The output pulse width is equal to $T = t_1 + t_2$ and the pulse width amplification factor is:

$$A_{pw} = T/t_1 \approx 1 + (V_{CC}R_2/V_{BB}R_1) \quad (3)$$

Theoretically, there is no limit to the pulse-width amplification factor; however, nonlinearities due to very short R_1C_1 time constants or very wide input pulse widths will result.

George P. Klein, Sr. Engineer, Reeves Instrument Co., Garden City, L. I., N. Y.

VOTE FOR 112

Tunnel-diode amplifier improves emitter-follower logic

A nonlinear, tunnel-diode voltage amplifier combined with emitter-followers can be used to yield high-speed computer logic circuits. The tunnel diode overcomes the less-than-unity gain characteristic of the emitter-follower. Emitter-followers used to perform binary logic offer a number of advantages, such as high speed, no polarity inversion, high input impedance, and current gain.*

The complete circuit is shown in Fig. 1 with the tunnel diode amplifiers inserted between the emitter-follower AND and OR gates. The resistors R in the collector circuits of the input emitter-

*Work performed under the auspices of the U.S. Atomic Energy Commission.

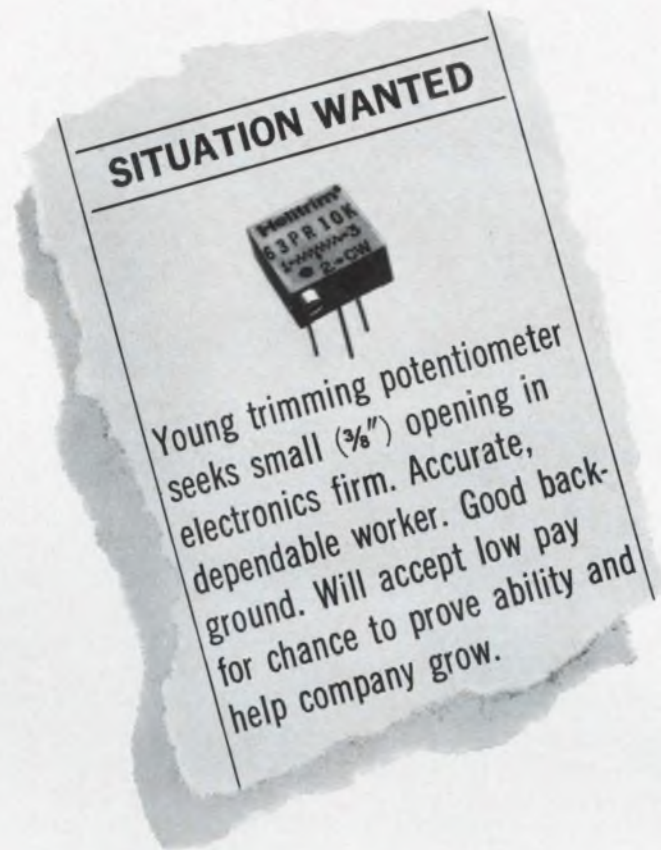

Hire Helipot's 3/8" cermet trimmer for the jobs too tough for wirewounds

Got a big job for a small, square trimmer? Sign up the new Helitrim® Model 63P trimming potentiometer. Smallest of its class in size and price, the tough little 63P offers essentially infinite resolution, with ruggedness and reliability twice as high as you'd expect.

No wonder. Beneath its sealed 3/8" x 3/8" x 3/16" molded plastic housing, the 63P has a heart of cermet. No other resistance element can match its combination of high power rating, essentially infinite resolution, freedom from sudden failure, resistance stability, and wide 10 ohm to 2 megohm resistance range. Wirewounds or carbon won't even come close.

References? This new trimmer just graduated from Helipot. It's been thoroughly checked out and tested again and again.

It meets or exceeds requirements of MIL-R-22097B. We'll vouch for it... and so will you, once you've tried it. Send now for full details, or ask a Helipot sales rep to introduce you.

RESUME

GENERAL

Ambient temp. -65 to +150°C
 Power rating, watts.... 0.5 at 85°C, derating to 0 at 150°C
 Adjustment turns, nominal..... 20

ELECTRICAL

Standard res. range, ohms..... 10 to 2 meg.
 Resistance tolerance ±20%
 Resolution essentially infinite

MECHANICAL

Stop..... clutch action, both ends
 Starting torque, max..... 5.0 oz.-in.
 Weight, approx. 1 gm.

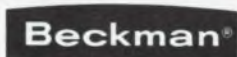

INSTRUMENTS, INC.

HELIPOT DIVISION

FULLERTON, CALIFORNIA • 92634

INTERNATIONAL SUBSIDIARIES: GENEVA; MUNICH; GLENROTHES, SCOTLAND; TOKYO; PARIS; CAPETOWN; LONDON; MEXICO CITY

Speed Inquiry to Advertiser via Collect Night Letter
 ON READER-SERVICE CARD CIRCLE 149

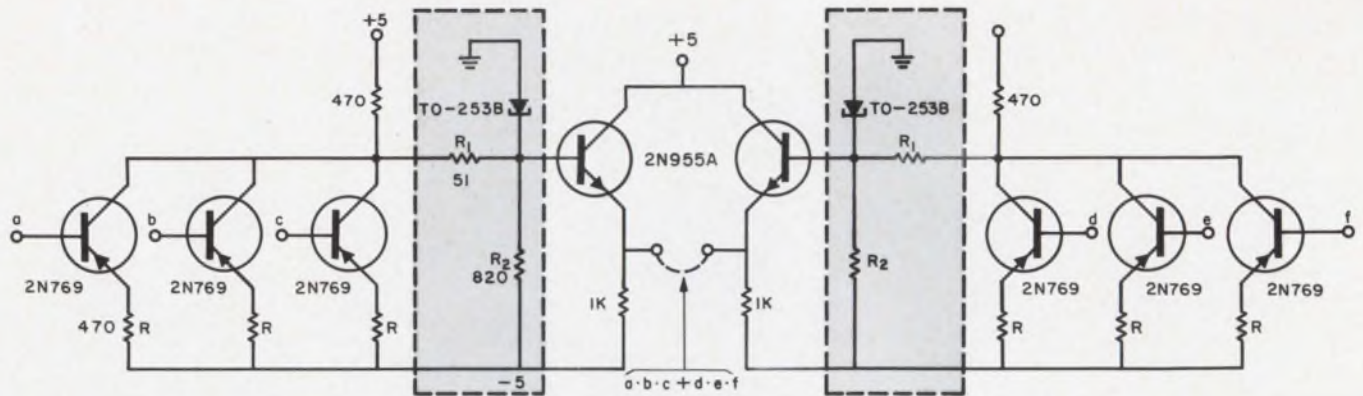

1. Complete logic circuit uses emitter-followers for high speed, noninversion and high input impedance. Tunnel-

diode amplifiers raise common-emitter gain above unity and also provide noise immunity.

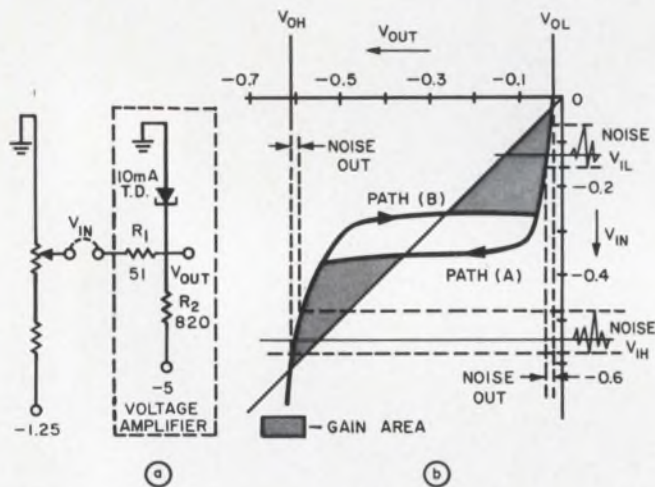

2. Tunnel-diode amplifier is simple and uncluttered (a). Shaded areas (b) of characteristic indicate voltage gain for logical 1 and 0.

current of the tunnel diode is exceeded and the tunnel diode flips to its high-voltage state, as shown in Fig. 2b by path A. At the point where the peak current is exceeded, tunnel-diode impedance is suddenly increased and voltage at the output becomes more negative than at the input; thus the current through R_1 is reversed, allowing voltage gain. The shaded areas in Fig. 2b that appear on either side of the 45° unity gain line indicate voltage gain for both 1 and 0. As the input becomes less and negative (follow path B in Fig. 2b), current flows from left to right in R_1 and passes through R_2 to the minus supply, taking the place of current previously supplied by the tunnel diode. If the current in the tunnel diode falls below the valley current (I_V), it will revert to its low-level voltage and the current through R_1 will again reverse, giving the desired level regeneration.

follower AND gates limit the current in TD_1 , so that a malfunction in some other circuit will not cause the input to go too negative. The propagation delay through two levels of logic, AND-OR, can be as low as 1.5 ns for a fan-out of 1, and 1.75 ns for a fan-out of 4. Slight modification of the input to this circuit will allow it to be used as a set-reset toggle.

Note that the amplifier has hysteresis, which provides good noise immunity. As indicated graphically in Fig. 2b, noise signals superimposed on the two input levels V_{IL} and V_{HI} have very little effect on V_{OL} and V_{OH} . Although this amplifier may have a possible gain of 2, it supplies enough gain only to re-establish two levels set by the tunnel diode, which for this requirement would be less than 1.02 gain.

Voltage offset is reduced by using both pnp and npn transistors arranged in such a manner that a positive shift in voltage, caused by the base-emitter rise, can be offset by a negative shift in the opposite polarity transistor. The 2N769 (pnp) and 2N955A (npn) are germanium transistors selected for their high speed. Since the gain in each emitter-follower is about 0.99, it is necessary to provide a voltage gain of approximately 1.02.

The logic element described has the advantages of high speed, AND-OR logic in one block, good noise immunity, and high fan-in and fan-out.

The General Electric TO-253B, 10-mA tunnel diode with a rise time of 68×10^{-12} seconds was selected as the voltage amplifier. The basic tunnel-diode amplifier circuit is shown in Fig. 2a and its gain characteristics in Fig. 2b.

The circuit may tend to oscillate if input leads are too long but this is easily corrected by using 1-k Ω resistors to ground on inputs, or by keeping input leads short).

Operation of the voltage amplifier circuit is as follows: As the input to the amplifier is pulled more negative, the current through R_1 increases, adding to the bias current ($1/2 I_P$) until the peak

Forrest Salter, Design Engineer, Argonne National Laboratory, Argonne, Ill. VOTE FOR 113

IFD Winner for May 10, 1966

Howard F. Stearns, Principal Engineer, Fairchild Hiller Corporation, Rockville, Md.

His idea, "Low-voltage supply replaces small batteries," has been voted the \$50 Most Valuable of Issue Award.

Cast Your Vote for the Best Idea in this Issue.

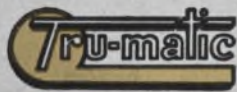

MACHINE & TOOL CO., INC.

Phone: 421-5000
421-5001

*Mltg
Parts Dept*
Paradise Road
EAST STROUDSBURG, PA. 18201

April 13, 1966

Tally Corporation
1310 Mercer Street
Seattle 9, Washington

Gentlemen:

We have an NC-425 Wiedemann punch press with a Pratt & Whitney tape control. The control has a Tally reader, Model 424-PR, Serial No. 409-0274.

We have had the machine two years. Usually we run two 9-hour shifts. The other day the motor froze fast. Actually what happened was the corrugated belt was too tight and it caused the Oilite bearings on the drive shaft to become out of round and bind.

If possible I would like to get a Parts List for the reader and two bearings.

Congratulations on producing a good piece of equipment. This is the first trouble we have had. Under normal working hours, the Tally reader would work without fail for over four years.

Very truly yours,

TRU-MATIC MACHINE & TOOL CO., INC.

James Staples

James Staples,
Plant Superintendent

JB:mk

ELECTRONIC CHASSIS & ASSEMBLIES, CABINETS, AIRCRAFT MACHINED PARTS, FINISHING, WELDING

All tape readers break down. Only ours don't break down very often!

We're grateful for Mr. Staples' letter telling us about the built-in reliability of Tally equipment. Needless to say, the parts list and two bearings have been sent long ago. Mr. Staples tells us the machine was quickly restored to 18-hour-a-day service. Now that the drive belt has been properly adjusted, he expects his N.C. System to run with little or no trouble for many years.

Pleased as we were to hear from Mr. Staples, we are even happier that our correspondence from the user is minor compared to the number of perforators and readers we've shipped in the past few years. For as you know, in our business, no news is good news.

There are a lot of good solid engineering reasons why Tally readers are extraordinarily reliable. For all of them, please address Ken Crawford, Tally Corporation, 1310 Mercer Street, Seattle, Washington 98109. In the U.K. and Europe, address Tally Europe, Ltd., Radnor House, 1272 London Road, London, S.W. 16, England.

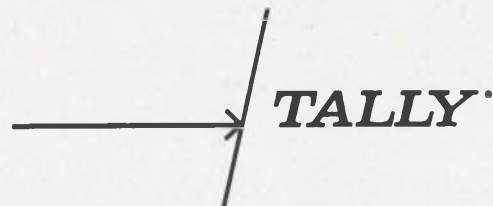

Speed Inquiry to Advertiser via Collect Night Letter
ON READER-SERVICE CARD CIRCLE 150



What's the
charge?

GLASKYD[®]

ALKYD

the
better
molding
compound
for
electrical—
electronic
products

Here's why GLASKYD glass-reinforced alkyd compounds in continuous rope and cut slug form gain wider acceptance every day:

- excellent dielectric strength
- dimensional stability
- resistance to heat, flame and moisture
- wide choice of colors.

GLASKYD offers economy through new, automated cold plunger molding— with fast cure, short cycles, high production rates. This alkyd also can be molded by compression or transfer techniques.

Widely used in such applications as electrical housings, connectors, coil bobbins and strips, switches and collector rings, GLASKYD also is ideal for arc-less switches, phase barriers, brush holders and tuner strips.

Rope in new markets, new product quality — with GLASKYD.

For details, write:

CYANAMID

American Cyanamid Company, Plastics & Resins Division, Wallingford, Conn.

Sales offices in: Charlotte • Chicago • Cincinnati • Cleveland • Dallas • Detroit • Los Angeles • Minneapolis • New York
Oakland • Philadelphia • St. Louis • Seattle • Wallingford. Also available in Canada.

Products



Series capacitance and dissipation factor measured. Strays have no effect. Page 250

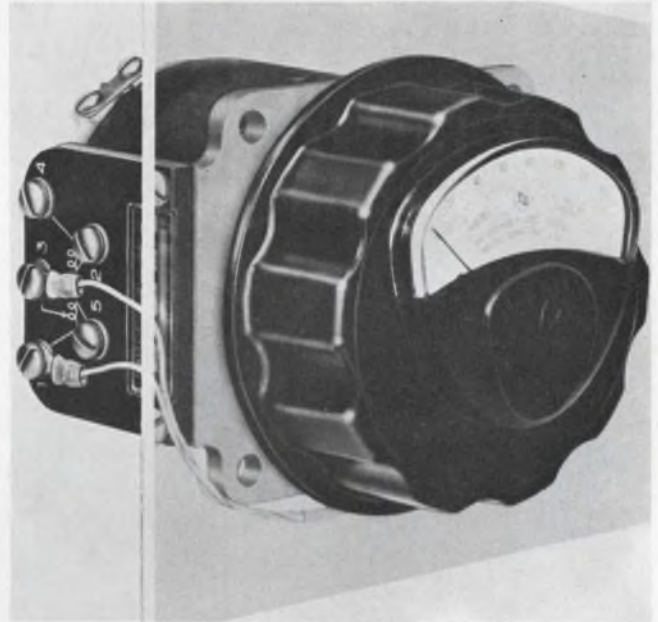

Variable transformers (to 4 kVA) incorporate 120- or 240-V voltmeter in knob. Page 244

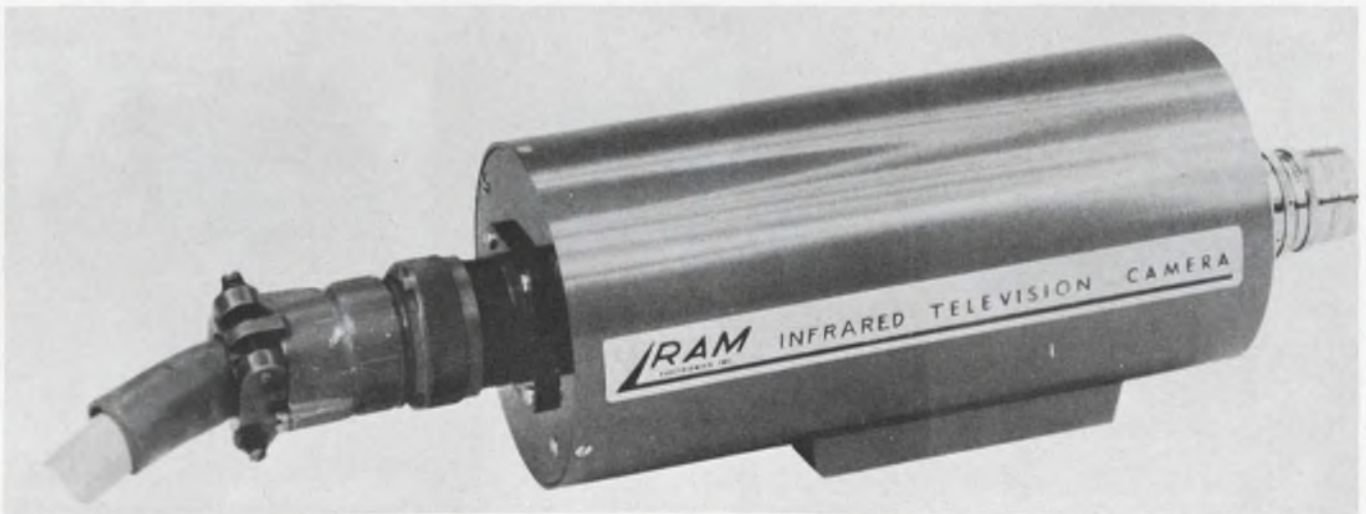

Vidicon TV camera views visible and IR spectrums exceeding 2 microns. Unit can

image objects by their own thermal radiation at 250°C. Page 264

Also in this section:

Variable band-pass filter offers choice of Butterworth or transient-free response. Page 254

Micromin coax switches are usable to 4 GHz. Page 272

Silicon npn transistors designed for nuclear radiation environments. Page 278

What do
you mean...
"or equal?"



Robinson MET-L-FLEX mounts have no equal...!

Only Met-L-Flex mounts are completely impervious to the elements—extreme high or low temperatures, oils, chemicals, fuels, whatever—our mounts will withstand them all! Met-L-Flex mounts are **all metal**—they incorporate a resilient cushioning material of fabricated, knitted stainless steel wire. It isolates your product from vibration and shock, and we're the only ones that have it!

Perhaps your product doesn't require a mount this great? Fine, we also have a **complete line** of elastomeric mounts to meet any vibration or shock problem... so whether you're mounting electronic gear, little "black boxes," heavy machinery, or complete computer systems, we have the mount to solve the problem.



Met-L-Flex unit isolator for Airborne, Vehicular and Industrial applications.



High Frequency engineered mounting systems for missile applications.

VibraShock

ROBINSON TECHNICAL PRODUCTS, INC.
3310 Vanowen Street, Burbank, California 91504
(213) 849-7181 TWX 910-498-2217

ON READER-SERVICE CARD CIRCLE 151

COMPONENTS

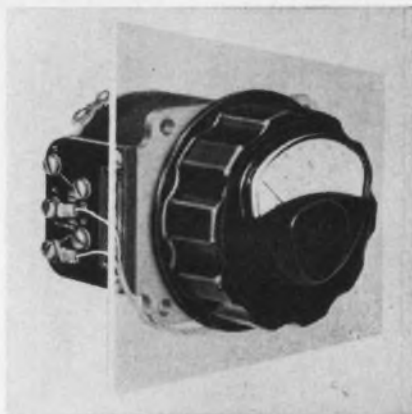

Meter knob transformers

Offered with metered knobs, these variable transformers have a voltmeter which remains stationary inside the knob rim. Single units with enclosed construction are available for single phase service in ratings up to 4 kVA. 120-V meters have 0- to 50-V scales and 240-V meters have 0- to 300-V scales. Meter accuracy is $\pm 2.5\%$ of full scale.

P&A: \$56 to \$132; 30 days. Superior Electric Co., Bristol, Conn. Phone: (203) 582-9561.

Booth 1752 (SA) Circle No. 298

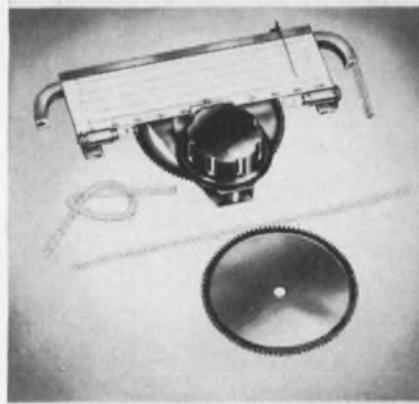

Dial assembly

This dial assembly provides positive pointer travel and resetability. The drive mechanism has 180° rotation of the output shaft. 5-1/2 turns of the knob move the pointer 6-1/2-in. Dial face has one 0 to 100 scale plus blank scales. The dial has adjustable zero-set and anti-parallax pointer.

James Millen Mfg. Co., 150 Exchange St., Malden, Mass. Phone: (617) 324-4108.

Booth 1714 (SA) Circle No. 333

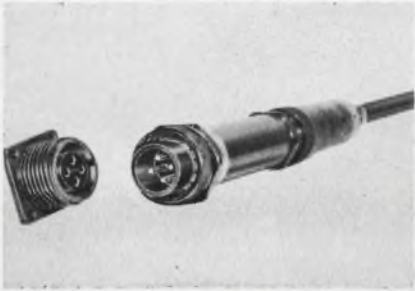

EMI shielded connector

Providing noise suppression for power and control circuits on ground-support equipment, these electromagnetic connectors have a peripheral shielding system designed so that all points of ground continuity are made within the sealed connector. 360° shielding, with multi-point ground continuity from cable braid to mounting panel, provides maximum dB interference attenuation over a wide frequency range.

P&A: \$25; 4 wks. Pyle-National Co., 1334 N. Kostner Ave., Chicago. Phone: (312) 342-6300. Booth 1430 (SA) Circle No. 330

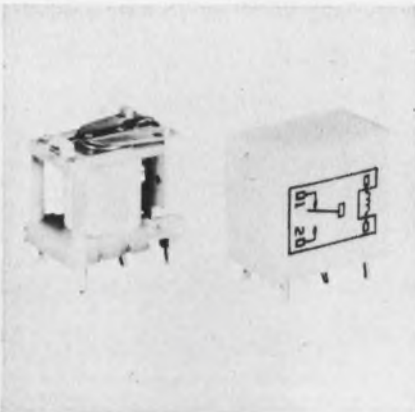

Miniature relay

A miniature relay with PC terminals, series 600 has coil and contact terminals set at right angles. Center terminal forming provides a spring-loaded effect, securing the unsoldered relay to PC board for handling, insertion of other components and inspection. Contacts are rated from dry circuit to 5 A, 115 Vac resistive. The integral one-piece glass-filled nylon bobbin and deck mounts up to 8-kΩ coils for dc applications.

Cornell-Dubilier Electronics, 50 Paris St., Newark, N. J. Phone: (201) 624-7500. Booth 1825 (SA) Circle No. 377

ELECTRONIC DESIGN, August 16, 1966

if you want... PRECISE POSITIONING



- RAPID ACCELERATION
 - IMMEDIATE RESPONSE
- IN YOUR TAPE TRANSPORT
CAPSTAN DRIVE

INLAND MOTOR has the answer in its DC DIRECT DRIVE TORQUE MOTORS

Precise Positioning... No gears — No backlash. The direct-drive torque motor shaft IS THE capstan itself... ensures high coupling "stiffness." It gives high mechanical resonant frequency offering design capabilities of an extremely wide servo bandwidth.

Rapid Acceleration and Deceleration... Produces more torque, size for size, than any other electro-mechanical device. As a capstan drive it has the highest, practical torque-to-inertia ratio.

Immediate Response... Since its torque is a direct function of applied current, independent of speed, response is positive and instantaneous at all operating speeds — limited only by the characteristics of the tape.

Direct Coupling = Precise Positioning

High Torque - Low Inertia = Rapid Acceleration

DC Control = Immediate Response



TORQY SAYS:

If you would like full information on Inland's Torque Motors used as a capstan drive in a tape transport application or engineering assistance on a particular servo design problem, let us know... we'll be glad to help.



INLAND MOTOR

CORPORATION
RADFORD, VIRGINIA
703-639-3973

SUBSIDIARY OF **KOLLMORGEN**
BOOTH #2149 WESCON SHOW

ON READER-SERVICE CARD CIRCLE 152

The easiest way to cut component costs.

Farm them out!



Read why in Art Wire's New Bulletin 501

Learn why Art Wire consistently produces wire forms, small parts stampings and cut tubing at considerable savings over your in-plant costs. And how we can go into high-speed automatic production even faster. For your copy use the inquiry card. If you're in a hurry, call 201-621-7272.

ART WIRE & STAMPING CO.

17 Boyden Place, Newark, N. J. 07102

COMPONENTS



Input filters

Power line frequencies of 50 or 60 Hz are rejected by more than 60 dB when these direct-mating filters are connected to dc strip-chart recorders. Inserted in series with the input, the filters reduce the effects of superimposed noise. Input signals up to 200 V may be applied. The 17106A mates with the front panel input, while the 17107A is used with the rear input connector.

P&A: \$35; one wk. Hewlett Packard, 1501 Page Mill Rd., Palo Alto, Calif. Phone: (415) 326-7000. Booth 305 (HP) Circle No. 295

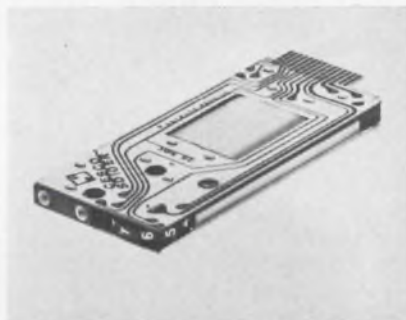

Counter/printer

An electromechanical printer/counter combines recessed indicating characters, block raised-type printing characters and electrical position readout contacts on a single wheel. Standard 12- or 24-Vdc counters may be positioned in excess of 3000 steps/minute by means of half-wave rectified 60-Hz ac pulses. Dc power supplies, multivibrators or one-shots are eliminated.

P&A: \$12 to \$40; stock. California Electro Scientific Corp., 2203 S. Grand Ave., Santa Ana, Calif. Phone: (714) 546-9550.

Booth 2048 (SA) Circle No. 541

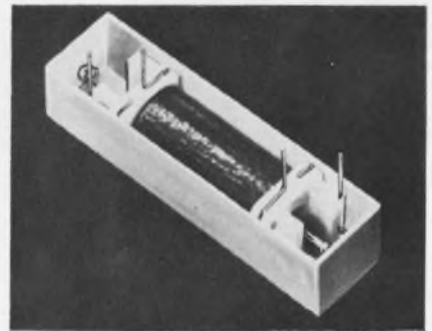

Low-cost reed relay

With switch contacts rated at 15 VA resistive, D-88 reed relays have a life expectancy of 20,000,000 cycles. They are available in 6, 12 and 24 Vdc (nominal).

P&A: \$0.88; stock. Dormeyer Industries, 3418 N. Milwaukee Ave., Chicago. Phone: (312) 283-4000. Booth 1820 (SA) Circle No. 371

Compensating resistors

Transistor circuitry requires the use of controlled positive temperature coefficient resistors. These 0.1-in. diameter resistors have a change of $+0.5\%/^{\circ}\text{C}$. Any value between $1\ \Omega$ and $5\ \text{k}\Omega$ is available. Standard wattages are 1, 0.5, 0.25, 0.1 and 0.04.

P&A: \$1.40 (over 100); stock to 3 wks. On Mark Engineering Co., 11728 Vose St., North Hollywood, Calif. Phone: (213) 875-0610.

Circle No. 568

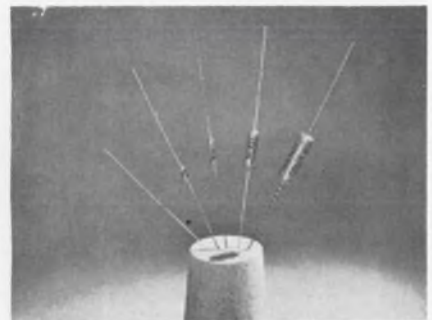

50-MΩ metal film resistor

These metal film resistors available up to 50 MΩ have temperature coefficients of ± 25 , ± 50 or ± 100 ppm/ $^{\circ}\text{C}$ min. Meeting MIL-R-10509F, the units come in 1/20-, 1/10-, 1/8-, 1/4-, 1/2- and 1-W sizes. Standard tolerance is 1%.

Pyrofilm Resistor Co., Inc., 3 Saddle Rd., Cedar Knolls, N.J. Phone: (201) 539-7110.

Circle No. 569

AT WESCON: CATCH 22!

ELECTRONIC DESIGN'S CONTRIBUTED SESSION

Zero-in on semiconductor amplifier design. Learn the why, where, how of solid-state devices in high-frequency applications by attending the Electronic Design - sponsored WESCON session.

Bipolars (such as this low-noise RF unit), FETs, MOSs and varactors, as they should properly be used in 0.5 MHz-5.0 GHz amplifiers, are the program targets. Also—design hints and trade offs.

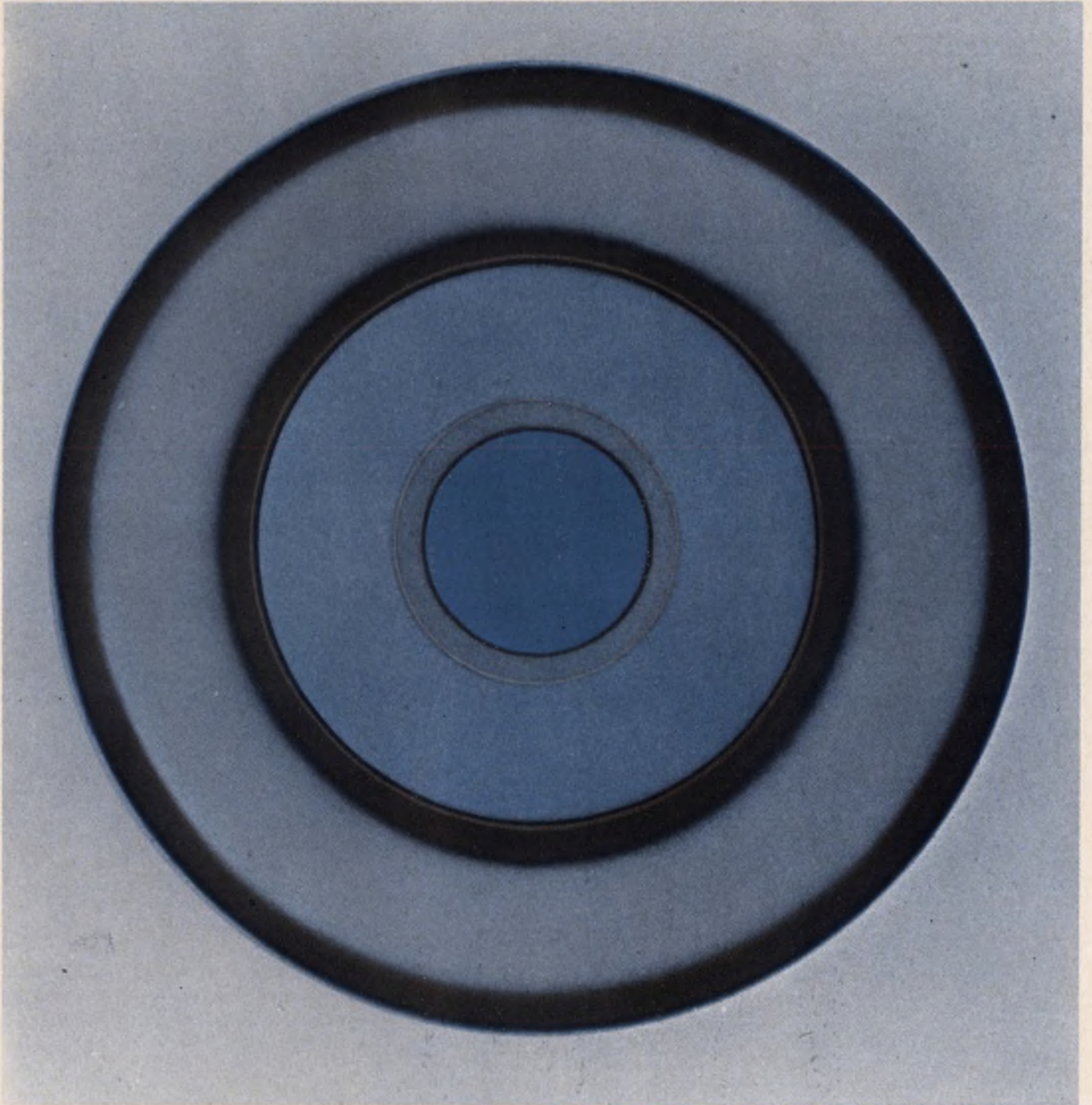

PARTICIPANTS: R.Q. Lane, **Fairchild Semiconductor**, "Small-signal design." Roy Hejhall, **Motorola Semiconductor**, "Large-signal design." J.B. Compton, **Siliconix**, "J-FET high-frequency amplifiers." Paul E. Kolk, **KMC Semiconductor**,

"MOS high-frequency amplifiers." George Johnson, **Texas Instruments**, "Low-noise amplifier design." R. Minton, **RCA**, "High-frequency amplifier design trade-offs. **CHAIRMAN:** Dr. John Moll, Dept. of Electrical Engineering, Stanford University.

TIME: Friday, Aug. 26, 9:30 A.M.

PLACE: Biltmore Music Room, Los Angeles, California

WESCON SESSION 22—SEMICONDUCTOR HIGH-FREQUENCY AMPLIFIERS

WRAP-AROUND MAGNETIC SHIELDS

APPLIED IN SECONDS

Cut to any size or outline
with ordinary scissors



Co-Netic and Netic foils are ideal for initial laboratory or experimental evaluation . . . also for production applications and automated operations. Dramatically enhance component performance by stopping degradation from unpredictable magnetic fields. When grounded, foils also shield electrostatically. They are not significantly affected by dropping, vibration or shock, and do not require periodic annealing. Available in thicknesses from .002" in rolls 4", 15", and 19-3/8" wide. High attenuation to weight ratio possibilities. Every satellite and virtually all guidance devices increase reliability with Netic and Co-Netic alloys, saving valuable space, weight, time, and money.



CRT

Audio Transformer

Cable Shielding

Printed Circuit Module

Automated Operation

MAGNETIC SHIELD DIVISION

Perfection Mica Company

1322 N. ELSTON AVENUE, CHICAGO 22, ILLINOIS

ORIGINATORS OF PERMANENTLY EFFECTIVE NETIC CO-NETIC MAGNETIC SHIELDING

ON READER-SERVICE CARD CIRCLE 155

WIDEST RANGE OF MINIATURE (TO-18) PHOTOCELLS



Clairex now offers the broadest selection of miniature CdS and CdSe Photoconductive Cells available anywhere. 23 types of CL 900 series offer:

- Resistance values from 2K to 1.4 megohms at 2 ftc
- Voltage ratings from 100 to 250 volts
- All cells hermetically sealed in low-profile TO-18 transistor case. If you need a miniature, high-reliability photocell, send for new Photocell Design Manual.

CLAIREX

"The LIGHT Touch in Automation and Control"
1239 Broadway, New York, N.Y. 10001
212 MU 4-0940

CL 108

ON READER-SERVICE CARD CIRCLE 156

COMPONENTS

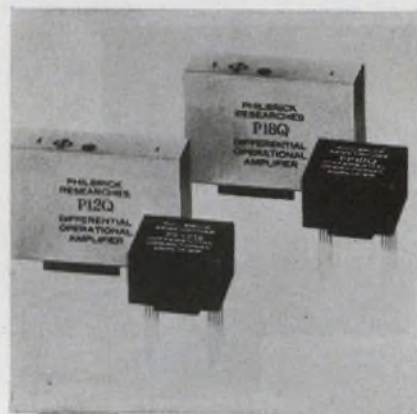

Battery-powered op-amp

Operating from two 1.35-V mercury cells, these op-amps have a battery life of 200 to 5000 hours. The units are rated at ± 1 V max output with a 500- Ω load at ± 2 mA. Offset is 100-pA. The units are in an epoxy-molded pack and mounted in a plug-in case measuring 2-1/4 x 1-1/2 x 3/4 in.

Philbrick Researches, Inc., Allied Drive, Dedham, Mass. Phone: (617) 262-9279.

Circle No. 570



40-kW relay

Loads up to 40 kW can be controlled by signals of less than 0.25 mA with this solid-state relay. The epoxy-encapsulated control circuit actuates a mercury-to-mercury plunger relay with sealed contacts which renew themselves on each "make" and "break." Mercury plunger relays come rated from 25 to 100 A in 1-, 2- and 3-pole configurations.

Ebert Electronics Corp., Floral Park, N. Y. Phone: (516) 437-7777.

Circle No. 571

Linear bridge

Data reduction in temperature measuring systems employing Pt resistance temperature sensors is eliminated by this linear bridge. The linear mV output corresponds directly to °F or °C. Deviation from linearity over a range of 0 to 500°F is $\pm 0.04\%$. Bridge limits are -350 to 1350°F. Integral pots allow the unit to be matched to any platinum resistance sensor. 28-Vdc, 23- or 115-Vac models are available.

P&A: \$165; 3 wks. Rosemount Engineering Co., 4900 W. 78 St., Minneapolis. Phone: (612) 927-7711.

Booth 170 (HP) Circle No. 398

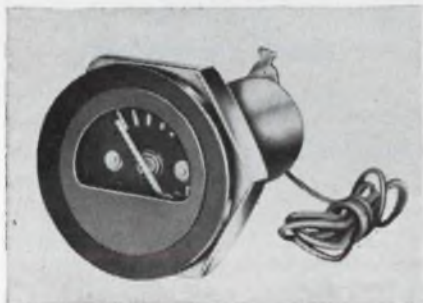

1/2-in. panel meter

An external-pivot d'Arsonval movement and high flux-density Alnico magnet are included in these micromin meters. Model SC-031 has optional mounting and model SC-030 has face plate and hex nut for front mounting. Accuracy is 5% of full scale. Each unit has magnetic and non-magnetic panels, lance pointer, magnetic shielding, an internal zero adjuster and steel housing.

Ideal Precision Meter Co., Inc., 214 Franklin St., Brooklyn, N. Y. Phone: (212) 383-6904.

Circle No. 572

Indicator lamp

Available in 3 V and 0.008 A or 5 V and 0.063 A with a 10⁴-hr life, this indicator lamp has a heat-resistant polycarbonate base. Transparent or translucent plastic caps are available in round, square or lens-end styles. The indicators can be mounted on 1/4-in. centers.

Chicago Miniature Lamp Works, 4433 N. Ravenswood, Chicago. Phone: (312) 784-1020.

Circle No. 573

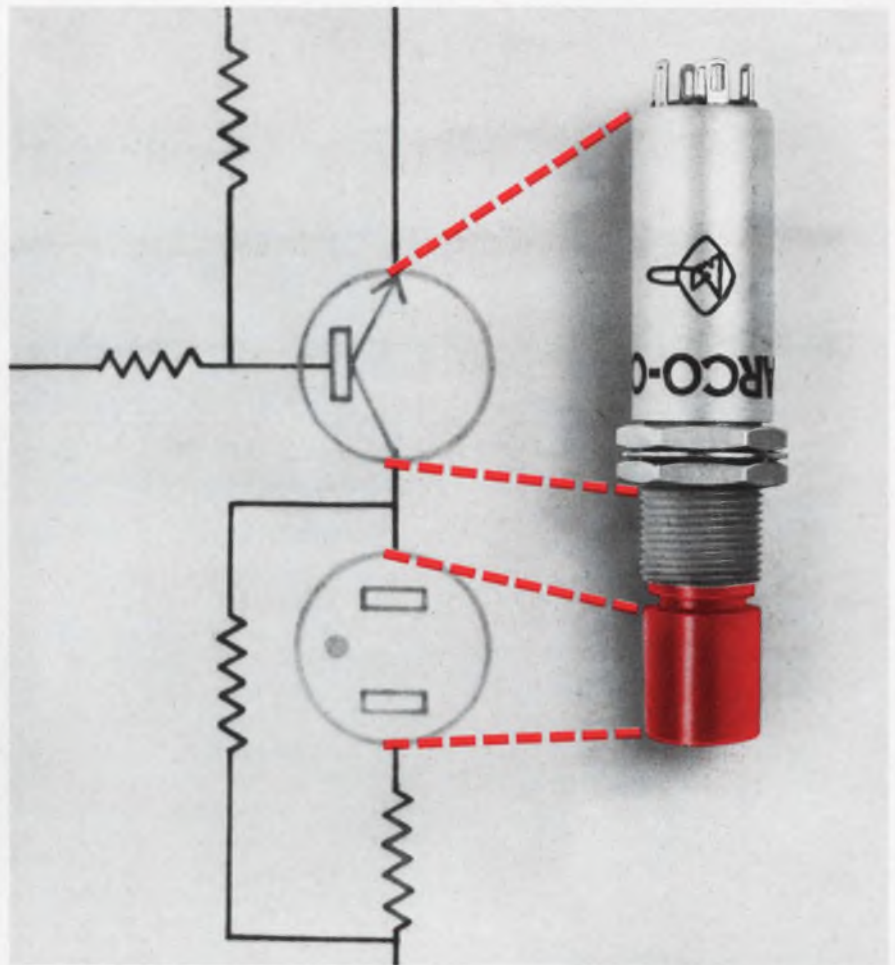

ONE COMPACT UNIT FILLS TWO GAPS IN THIS CIRCUIT

Marco-Oak subminiature transistorized indicator lights do a big job for their size. They combine a neon or incandescent lamp with means for transistor switching where voltage changes are small. High voltage series is designed for connection to power at 90 volts or more, low voltage series for circuits of 6 or more volts.

They are adaptable to a full range of transistorization from high-quality micrologic to commercial units, mounting from back of panel.

Many options are available in dimensions, terminals, circuits, caps (shape, finish, color) . . . more features relating to components and circuitry than could possibly be described here. Write today for full details in the new T66 descriptive bulletin.



MARCO-OAK INDUSTRIES

A DIVISION OF OAK ELECTRO/NETICS CORP

207 SOUTH HELENA STREET, ANAHEIM, CALIFORNIA 92805

PHONE: 714-535-6037 • TWX: 714-776-8111

ON READER-SERVICE CARD CIRCLE 157



the
fitting
is easy

MORE
CAPACITANCE
IN LESS SPACE

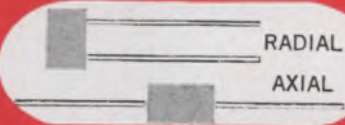

MUCON
HI-PuFs
SUB-MINIATURE CERAMIC
MONOLITHIC CAPACITORS

NPO CERAMIC

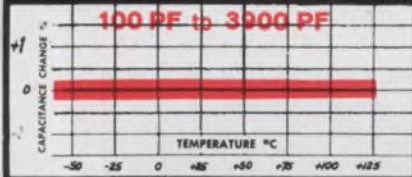

STABLE-K CERAMIC

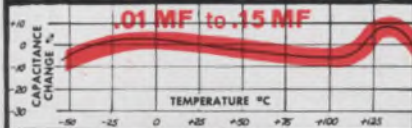

SUPER-K CERAMIC

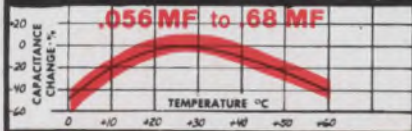

IN 3
SIZES

3/16" W x 5/16" L x .120" T
1/4" W x 7/16" L x .120" T
5/16" W x 17/32" L x .125" T

For complete information on Hi-PuFs and other Mucon Sub-miniature ceramic capacitors, write

REPUBLIC ELECTRONICS CORP.
176 E. 7th ST., PATERSON, N. J. 07524
201-279-0300

ON READER-SERVICE CARD CIRCLE 158

TEST EQUIPMENT



Capacitance limit bridge

Series capacitance measurements may be made by this limit bridge. All effects of stray capacitance measurements are eliminated. The go-no-go bridge provides simultaneous limit decisions for series capacitance and dissipation factor at 120- or 1000-Hz test frequencies and eliminates stray effects due to bias supplies, capacitance to ground or shielded leads. A 0- to 300-V bias supply can be used. Model 5350 makes a limit decision in 250 ms with 0.25% accuracy on capacitance and 1% accuracy on dissipation factor. It provides one accept and three reject categories. A 2-, 3-, 4- or 5-terminal measurement allows guarding and sensing for the test capacitor. Capacitance ranges are 0 to 1199.9 μ F at 120 Hz, and from 0 to 11.999 μ F at 1000 Hz. Capacitance limits are: lower, 0 to 9999; upper, to 11,999. Limits are set in with 4- and 5- digit in-line thumb-wheel switches. Dissipation factor is from 0 to 0.9999.

P&A: \$2000, \$3000 (oscillator); 8 wks. Micro Instrument Co., 12901 Crenshaw Blvd., Hawthorne, Calif. Phone: (213) 772-1275.
Booth 133 (HP) Circle No. 527

Calibration standard

Employing "go no-go" circuitry for warning against control mis-settings or overloads, this ac-dc standard calibrates analog, differential and digital instruments with $\pm 0.1\%$ max accuracy. Ranges are 0.001 to 1000 V, 0.1 mA to 20 A dc and ac and 0.01 W to kW. The standard has a Wheatstone bridge with measurement capability from 0.001 Ω to 11 M Ω and a sine wave

oscillator/power amplifier which calibrates from 50 to 1000 Hz.

Price: \$8450. Radio Frequency Labs. Inc., Powerville, Boonton, N. J. Phone: (201) 334-3100.
Booth 255 (HP) Circle No. 347

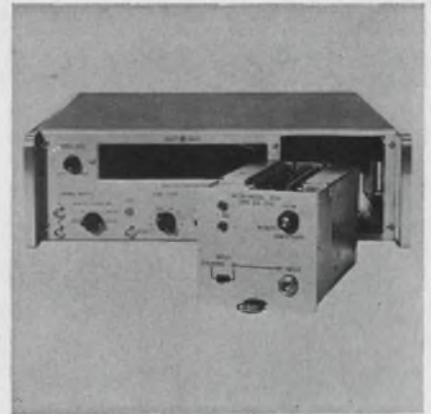

Frequency extenders

A series of high frequency plug-ins for the manufacturer's 50- and 100-MHz counters and the Hewlett-Packard 5254L counter extend frequency ranges to 12.4 GHz. Accuracy of the basic counter is retained. The three plug-ins cover 0.3 to 3 GHz, 2.96 to 8.2 GHz and 8.2 to 12.4 GHz. Input signals are cw, with or without am. Signal input sensitivity is better than -7 dBm (100 mV rms). Resolution is ± 0.1 Hz to ± 100 kHz selectable in decade steps by counter time base switch.

P&A: \$975, \$1950 and \$1975; 45 days. Systron Donner Corp., 888 Galindo St., Concord, Calif. Phone: (415) 682-6161.
Booth 147 (HP) Circle No. 554

D-to-A converter

Better than 0.1% resolution with a full-scale output of 1.5 V into 1500 Ω is provided by this digital-to-analog converter. A front-panel column switch selects any single digit for conversion or any two or three adjacent digits. The selected digits provide full scale output without further adjustment. A rear-panel connector accepts 4-line BCD signals from 9 digits. Positive-true-negative-level logic, with a 3-V swing, operates the converter.

Price: \$1100. Atec, Inc., Box 19426, Houston, Texas. Phone: (713) 468-7971.
Booth 126 (HP) Circle No. 512



Technical achievement for you... better living for you and your family

We are particularly anxious to meet you if you are a Circuit Design Engineer; Packaging and Mechanical Engineer; Electron Optics, Vacuum Technology or Materials and Process Specialist. But whatever your technical strengths, if "roll-up-the-sleeves" engineering appeals to you, we'd like to hear from you.

Here you'll find an environment that emphasizes the individual, and his personal contribution to technical development—contribution by working on projects, not writing about them. Your work will benefit advanced engineering throughout the world. *You* will benefit from technical association with specialists experienced in developing state-of-the-art instrumentation, components and devices.

All Tektronix R & D—financed entirely from our annual sales of over \$100 million—is directed toward *commercial* products. Our community is prosperous, balanced, with a stability of employment not typical of every industrial center. And as for the Green Land we live in—it speaks for itself.

If you're seeking technical advancement and better living for you *and* your family, why not investigate Tektronix?

Write to D. A. Thompson, Tektronix, Inc., P. O. Box 500B, Beaverton, Oregon 97005, or send in the coupon.

Professional Placement Mgr., Tektronix, Inc.

P. O. Box 500B, Beaverton, Oregon 97005.

Please send me your Booklet, "Tektronix" Application Form

NAME: _____

ADDRESS: _____

CITY: _____

STATE: _____

I am interested in: _____

Tektronix, Inc.

An Equal Opportunity Employer.



A vacuum relay:

- Carries high rf currents due to large surface area of contacts.
- Smallest size for its power rating.
- Operates faster than other high voltage relays due to small contact separation.
- Will interrupt high dc power.
- Has highest voltage ratings due to vacuum dielectric.
- Has long contact life.
- Low and stable contact resistance from dc through 30 mc.
- Requires no contact maintenance.

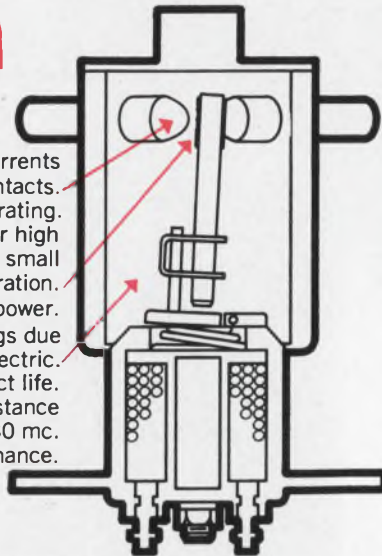







Jennings vacuum relays:

Have the additional benefit of 18 years of constant development effort and manufacturing experience. All Jennings vacuum relays have been field tested and proven successful in countless applications.

consequently:

Jennings vacuum relays are unexcelled for use in high voltage communication systems particularly in aerospace, land, or marine vehicles that cannot tolerate heavy weight and have limited space. Within their size and voltage range they also have no equal for switching dc or pulse forming networks.

Thorough knowledge of the characteristics of vacuum relays is a most useful tool in any electronic engineer's hands. It can easily be obtained by requesting Jennings new vacuum relay catalog No. 103. Jennings Radio Manufacturing Corporation, a subsidiary of International Telephone and Telegraph Corporation, 970 McLaughlin Avenue, San Jose, California 95108.

	 RJ1A	 RJ2A	 RF10	 RB7A	 RB1E	 RB4
Contact Arrangement	SPDT	SPDT	SPDT	DPDT	SPDT	4PDT
Test Voltage (Peak KV)	5	18	20	9	18	17
Operate Voltage (Peak KV) (16 mc)	2	8	10	3	8	10
Continuous Current Amps RMS (16 mc)	7	15	30	4	6	6
Interrupt DC Power (KW)	N/A	1	50	1	1	1
Contact Resistance (Max. ohms)	.010	.012	.012	.020	.012	.010

ITT Jennings

ON READER-SERVICE CARD CIRCLE 160

TEST EQUIPMENT



Resistance tester

Resistances under dry circuit conditions where dissipated power is less than 1 pW are measured by this tester. Accuracy and stability are 3% full scale for 8 hrs. Model 1200 has a front panel calibrator switch and limit adjust for go no-go measurements. Ranges are from 1 mΩ to 1 mΩ full scale.

P&A: \$985; 30 days. Lear Siegler, Inc., Cimron Div., 1152 Morena Blvd., San Diego, Calif. Phone: (714) 276-3200.

Booth 368 (HP) Circle No. 389



Wave analyzer

Line- or battery-operated, this portable audio frequency wave analyzer has a 1% bandwidth. Attenuation is 75 dB min at two times and at 1/2 center frequency. Sensitivity is from 100 μV to 300 V full-scale. At 20 Hz, model 1568-A has a bandwidth of 0.2 Hz between 3-dB points. The unit is housed in either a portable case or a relay-rack cabinet.

Price \$1350. General Radio Co., West Concord, Mass. Phone: (617) 369-4400.

Booth 348 (HP) Circle No. 201



RF directional wattmeter

For measuring pulsed RF systems or cw average power, model 4311 is a portable peak or average reading directional wattmeter. Amplifier and power supply are self-contained. As an average (cw) power wattmeter, frequency range is 45 to 2300 MHz. Power range is 1 to 10 kW. As a peak pulse or envelope power meter, frequency range is the same and power range is 1 W to 25 kW.

P&A: \$575; 90 to 120 days. Bird Electronic Corp., 30303 Aurora Rd., Cleveland. Phone: (216) 248-1200. Booth 201 (HP) Circle No. 348



Tera-ohmmeter

With a range of 10^5 to 10^{16} Ω , this solid-state ohmmeter has a current range of 10^{-13} to 10^{-5} A and continuously variable test voltage of 0 to 1000 Vdc. Measurements require less than 2 s. Accuracy is 3% of reading. The TO7A can measure insulation resistance of components such as switches, pots, sockets or transformers.

Rohde & Schwarz Sales Co. Inc., 111 Lexington Ave., Passaic, N. J. Phone (201) 773-8010. Booth 301 (HP) Circle No. 263



Our pin encoders offer greatest reliability—for 89 good reasons.

After original qualification, we randomly selected 89 pin encoders from production shipments and duplicated the qualification life test. Every one passed.

Only a pin contact encoder can offer this reliability. That's because the pin encoder eliminates cantilevered wire brushes and substitutes multiple discrete contacts. Thus achieving true contact redundancy for the first time.

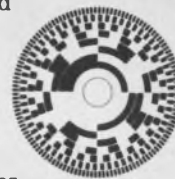

Versions of Litton's new pin encoders have been qualified to levels in excess of MIL-E-5272. They have also been subjected to 30g vibration, 5-2000 cps, and repeated shocks of 150g with no adverse effects on the encoders tested.

By the way, we also guarantee our pin encoders to 10,000,000 revolutions. And justify it. For information, write Encoder Division, 20745 Nordhoff Street, Chatsworth, Calif. 91311, or telephone 213 341-6161.

Europe: Schwamendingenstrasse 5, Zurich 8050, Switzerland.

ENCODER DIVISION
LITTON INDUSTRIES

ON READER-SERVICE CARD CIRCLE 161

MINIATURE TEST ACCESSORIES 1/3 smaller...

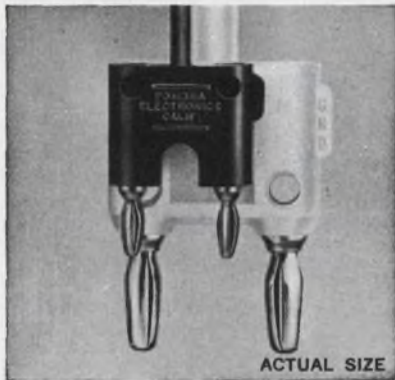

1/2" SPACING for the new generation of miniaturized test equipment

Pomona created a complete line of 1/2-inch spaced Banana plugs, jacks, cable assemblies, patch cords, adapters, and binding posts to meet the industry's continuing demand for miniaturization.

Banana plug springs formed of one piece Beryllium copper (per QQ-C-533), heat treated for long service life and low contact resistance. Tough, molded thermoplastic bodies provide maximum strength and insulation. Available in a wide selection of colors.

WRITE FOR FREE CATALOG 11-66

Lists over 230 molded test accessories, all designed to meet rigid industrial and military specifications—and built by the quality leader...



MODEL 2440
MINIATURE INSULATED
DOUBLE BINDING POST



MODEL 2244
MINIATURE DOUBLE
BANANA PLUG WITH
SET SCREWS



MODEL 2142
MINIATURE
INSULATED
BANANA JACK

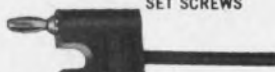

MODEL 2247
MINIATURE PATCH CORD
DOUBLE BANANA PLUG
BOTH ENDS

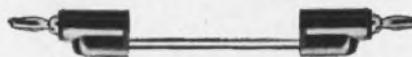

MODEL 1081
MINIATURE PATCH CORD
BANANA PLUG, STACK UP

POMONA
ELECTRONICS CO., INC.
1500 East Ninth Street, Pomona, California 91769
Telephone (714) 623-3463

SEE US AT WESCON—Booth No. 1455
ON READER-SERVICE CARD CIRCLE 162

TEST EQUIPMENT



Band-pass filter covers subsonic to low RF

The need for overlapping filters to secure continuous coverage from subsonic frequencies to low RF is eliminated by this variable band-pass filter. Model 3100 permits a choice of response either in sharp-cutoff frequency filtering or in noise rejection for critical waveform studies. Both cutoffs are independently tuneable from 10 Hz to 1 MHz. Attenuation rate is 24 dB/octave and maximum attenuation is 80 dB. A switch selects either a maximally flat (Butterworth) characteristic, or a 4-element RC characteristic. Circuitry is silicon solid-state.

P&A: \$525; October. Krohn-Hite Corp., 580 Massachusetts Ave., Cambridge, Mass. Phone: (617) 491-3211.

Booth 151 (HP) Circle No. 368

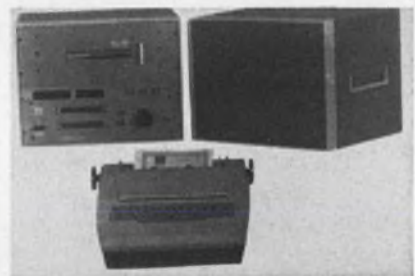

Programable calibrator

Meter calibration time is cut to 5 minutes per instrument. Model 70 will handle a variety of deflection-type instruments: multimeters, dc and ac ammeters, ohmmeters and dc and ac voltmeters. Programming is by a single IBM card for each instrument type. Voltages, currents, and resistance are automatically produced and applied to the instrument under test. A readout subsystem prints results on an 8-1/2 x 11 sheet showing error at all points.

Electro Scientific Industries Inc., 13900 N. W. Science Park Dr., Portland, Ore. Phone: (503) 646-4141.

Booth 401 (HP) Circle No. 323



Sweep generator

For production testing of AM and FM circuits, this swept frequency generator has a rotary selector that can be switched to any of 13 test frequencies. The selector has a capacity of 5 AM or FM frequencies, a crystal-controlled RF/IF channel, a swept FM/IF channel and a swept AM/IF channel. Operating mode selection of the generator is made by switches for cw, modulated cw or swept operation.

Telonic Industries, Inc., 60 N. First Ave., Beech Grove, Ind. Phone: (317) 787-3231.

Booth 448 (HP) Circle No. 271



RF millivoltmeter

A solid-state, RF millivoltmeter has frequency range and accuracy of 10 kHz to 100 MHz $\pm 4\%$, 100 to 700 MHz $\pm 5\%$, 700 MHz to 1 GHz $\pm 10\%$ and 1 to 1.2 GHz $\pm 22\%$. Seven voltage ranges cover 3 mV to 3 V or to 300 V with 100/1 divider. Sensitivity is 200 μ V on 3 mV range. Input impedance is 2.6 pF and 150 k Ω . Response is true rms up to 30 mV, peak above 30 mV, true rms up to 3 V with divider.

P&A: \$395; stock to 4 wks. Millivac Instruments Inc., P.O. Box 997, Schenectady, N. Y. Phone: (518) 372-4781.

Booth 139 (HP) Circle No. 300

EMR image tubes convert ultraviolet to visible light with high resolution

New ultraviolet image converter tubes from EMR photoelectric laboratories offer exceptional resolution for applications such as astronomy and space surveillance. Precision of EMR image converters permits quantitative contrast measurements at any point on the output field. To preserve inherent resolution, tubes can be made available with fiber optics output windows for direct nonparallactic coupling to film or TV scanning type tube.

Magnetically focused image converters can provide limiting resolution up to 90 line-pairs per millimeter, ultraviolet-to-visible light photon gain of 55, and noise of less than one thermal event per second. Both electrostatically and magnetically focused units are available with end-windows of nominally one-inch useful diameter.

The wide selection of UV sensitive photocathodes and UV transmitting windows developed by EMR technology is unmatched in industry. Judicious combinations of these in EMR image tubes assure that any portion of the UV spectrum above 1050 Å can be made visible. For a scientific answer to your image converter problem, write or call EMR.

**Photoelectric Division
Electro-Mechanical Research, Inc.
P. O. Box 44
Princeton, New Jersey 08540**

PHOTOELECTRIC DIVISION

EMR

ON READER-SERVICE CARD CIRCLE 163

ANOTHER "ADVANCED" CONCEPT FROM DSE

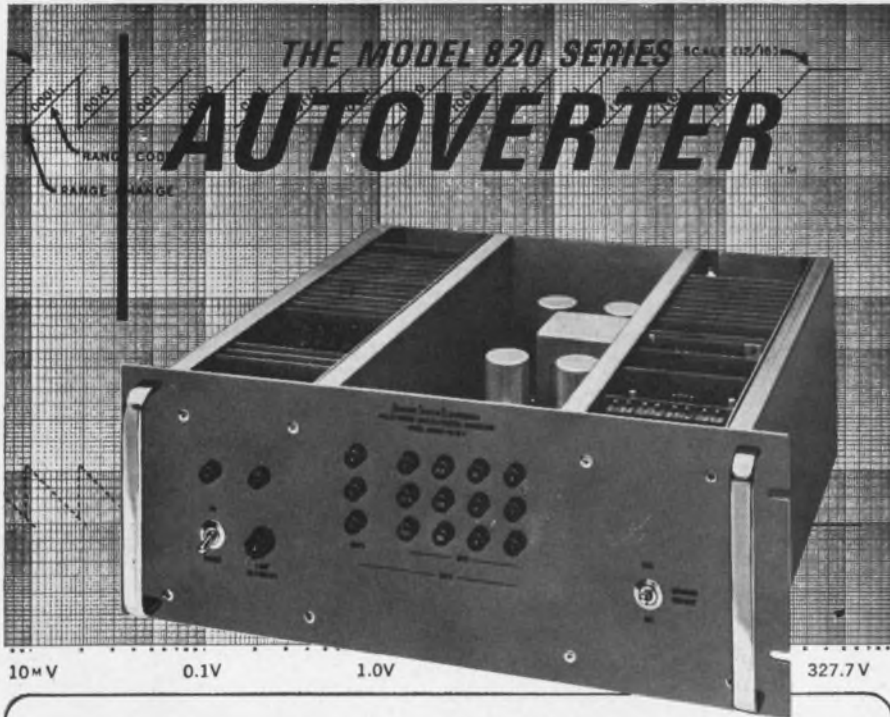

ANNOUNCING... A NEW MULTIRANGE ANALOG-TO-DIGITAL CONVERTER

The Model 820 Series AUTOVERTER—designed and developed by DSE—is an automatic ranging, general purpose, solid state, analog-to-digital converter. It is especially ideal for a broad spectrum of applications requiring the conversion of raw information into computer input data. Application requirements of wide dynamic ranges, such as, testing and checking out laboratory equipment, monitoring aircraft on the flight-line, measuring public utility system data, converting geophysical field expedition data, on-board airborne telemetry systems, and others.

The DSE AUTOVERTER exhibits an input dynamic range in excess of 160 db. Providing an actual reading accuracy and resolution $\pm 0.1\%$, over a dynamic range in excess of 100 db, the Model 820 Series offers the equivalent range and resolution of a 26 binary bit converter—using only 16 bits of data.

Available in four models, with a dynamic range from ± 10 mv to ± 327.7 V, the DSE AUTOVERTER is convenient for measuring a single test parameter which has a wide dynamic range, or measuring many channels of analog data which together have an extremely wide range.

The AUTOVERTER is another "state of the art" original concept from DSE to add to its data conversion capabilities in the GSE and airborne fields. Complete information and specifications are available upon request. Simply write, wire or telephone today.

Engineers: If your field is data conversion, an exceptional opportunity is available at DSE. Write to personnel director. An equal opportunity employer.

'performance'

DSE

2321 East Washington Street

Phoenix, Arizona 85034 | (602) 275-6229

DYNAMIC SYSTEM ELECTRONICS

ON READER-SERVICE CARD CIRCLE 164

TEST EQUIPMENT

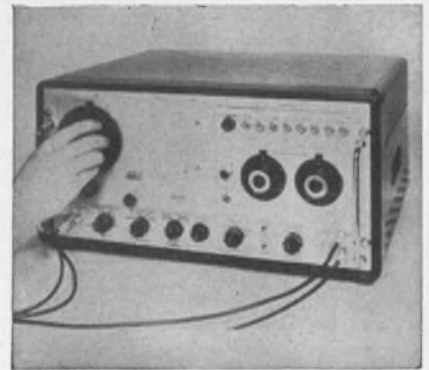

Sweep oscillator

Covering 460 to 960 MHz, this solid-state sweep oscillator has a sweep width of 5 to 500 MHz. The 3005 can show frequency response over a narrow spectrum or its entire range. Scanning may be internally or externally controlled from 0.01 to 100 Hz. Leveled output is 0.3 V rms. Flatness is better than ± 0.75 dB at max sweep width.

P&A: \$750; 30 days. Telonic Industries, Inc., 60 N. First St., Beech Grove, Ind. Phone: (317) 787-3231. Booth 448 (HP) Circle No. 267

Frequency monitor

The deviation of a 1-MHz signal being calibrated to a 1-MHz lab standard is monitored by this digital monitor with a 1-s gate time. The reference standard and the unknown are connected to front panel jacks and the deviation with polarity is read on the 3-digit in-line display. Five front panel pushbutton switches allow a reading of the deviation in parts per 10^6 , 10^7 , 10^8 , 10^9 or 10^{10} . The direct digital readout is also connected to a rear panel recorder socket for permanent recordings on a digital printer. Drift plots may be made on strip chart recorders using a digital-to-analog converter. An optional feature is available to permit deviation measurements of two 100-kHz as well as two 1-MHz frequencies. Model 1011A includes storage memory for both the visual display and electrical output and 1-M Ω input impedance.

Price: \$1875. Atec, Inc., P.O. Box 19426, Houston. Phone: (713) 468-7971.

Booth 126 (HP) Circle No. 392



*You'd figure
500 volts at
60 cycles
would darn near
vaporize this
M.A. Bobbin Core,
right?*



Wrong! Its got GVB*. Even at more than 1500 volts, tests show no breakdown on M.A. bobbin cores with GVB. In addition to guaranteeing the core's ability to withstand at least 500 volts between bare winding and bobbin, GVB finish also seals the bobbin to withstand a ten-inch mercury vacuum.

It seals against potting material, provides a resilient, non-slip base for winding, and its epoxy skin protects the core against wire cuts. Abraded wire problems are eliminated and no prior taping is required.

GVB has proven itself on thousands of cores . . . and now Magnetics has applied it to the bobbin core, the

miniature workhorse of computers, high frequency counters, timers, oscillators, inverters and magnetic amplifiers.

Made from ultra-thin permalloy 80 and Orthonol® (0.001" to 0.000125"), Magnetics' bobbin cores are available in tape widths from 0.023" to 0.250" or wider on request. Core diameters range down to less than 0.100" with flux capacities down to several maxwells.

For more information on GVB Bobbin Cores, write Magnetics Inc., Dept. ED-42, Butler, Pa. 16001.



**Guaranteed voltage breakdown*

Blue chip.

RNAL

16

42% Return on investment

College Yield to Stay High, If Business Helps

It's called one of the shrewdest investments business ever made—the college contribution.

It has paid the best dividends business ever got—the 42% of college-educated leaders that business employs, every year.

A real human potential. Leader stuff. Bright with brainpower, brimming with skills. Able to fill management posts.

But can it go on, can the colleges guarantee the supply?

Higher education is in

trouble. Costs are skyrocketing. On the average, tuition fees cover only about 1/3 of the educational cost.

What is needed? More business giving. Unrestricted giving. Business can gain even more by raising the quality of education to an all-time high.

If business wants college talent, it must help keep the colleges in business.

Your aid-to-education program is an aid to yourself.

stant

COLLEGE IS BUSINESS' BEST FRIEND

Published as a public service in cooperation with The Advertising Council and the Council for Financial Aid to Education.



SPECIAL TO CORPORATE OFFICERS—A new booklet of particular interest if your company has not yet established an aid-to-education program.

Write for: 'HOW TO AID EDUCATION—AND YOURSELF,' Box 36, Times Square Station, New York, N. Y. 10036.



Mix these signal, power and coax leads in any combination.

ON READER-SERVICE CARD CIRCLE 880

Burndy Trim Trio Connectors—available in many shapes—accept three contact styles, all crimp-removable, for signal and power leads #16 thru #24, twisted pair #24 and #26, and subminiature coaxial cables.

Changing conductors is fast and simple, whether for lower voltage drop or better shielding or mechanical reasons. This makes Trim Trio Connectors ideal for breadboard and prototype work as well as

production. For large production runs you can take advantage of the economies offered by the automatic Burndy Hyfematic™ with a crimp rate of up to 3000 contacts per hour.

Get more details on how you can take advantage of the Burndy Trim Trio System—THE ACCEPTED METHOD OF INTERMIXING CONTACTS.

BURNDY
Norwalk, Connecticut

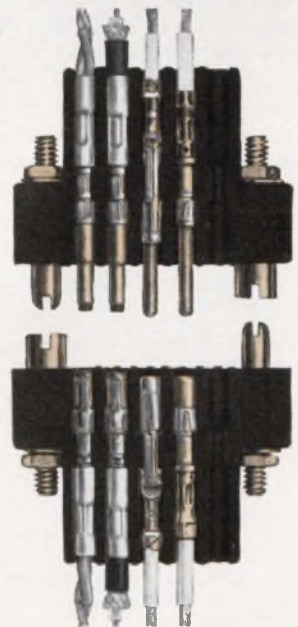

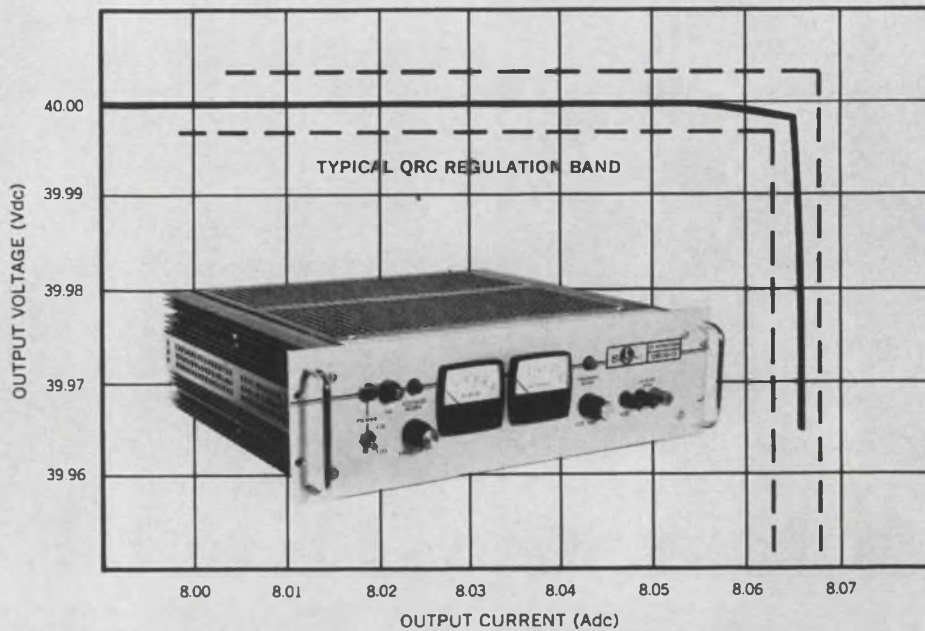

Automatic crossover between constant voltage and constant current modes

Sorensen QRC Power Supplies offer $\pm .005\%$ regulation

ON READER-SERVICE CARD CIRCLE 879

The Sorensen QRC series—wide range, transistorized power supplies—provide constant voltage/constant current regulation so sharp the units operate without ever leaving the specified regulation band. Voltage regulation is $\pm .005\%$ for line and load combined. The QRC's are provided with front panel dial set adjustment of voltage and current limits, as well as voltage/current mode indicator lights. Other design features include: Low ripple . . . 1 mV rms • No turn-on/turn-off overshoots • Remote sensing and

programming • Series/parallel operation • Input voltage 105-125 or 201-239 Vac, 50-400 c/s • Temperature capability to 71°C • RFI spec meets MIL-I-26600 and MIL-I-6181D. All Sorensen power supplies conform to proposed NEMA standards. For QRC details, or other standard/custom power supplies, AC line regulators or frequency changers, contact your local Sorensen rep, or write: Raytheon Company, Sorensen Operation, Richards Ave., Norwalk, Connecticut 06856 Tel: 203-838-6571.

ELECTRICAL & MECHANICAL SPECIFICATIONS

MODEL NUMBER	OUTPUT VOLTAGE RANGE (Vdc)	CURRENT OUTPUT RANGE (A dc)	VOLTAGE REGULATION (LINE & LOAD COMBINED)	RIPPLE VOLTAGE (rms)	CURRENT REGULATION	RIPPLE CURRENT (rms)	RACK HEIGHT (INCHES)	PRICE
QRC20-08A	0-20	0-8	$\pm .005\%$ or ± 1 mv	1 mv	$\pm .05\%$ or ± 4 ma	1 ma	3½	\$410.00
QRC20-15A	0-20	0-15	$\pm .005\%$ or ± 1 mv	1 mv	$\pm .05\%$ or ± 8 ma	2 ma	5¼	525.00
QRC20-30A	0-20	0-30	$\pm .005\%$ or ± 1 mv	1 mv	$\pm .05\%$ or ± 16 ma	4 ma	7	700.00
QRC40-4A	0-40	0-4	$\pm .005\%$ or ± 1 mv	1 mv	$\pm .05\%$ or ± 3 ma	1 ma	5 †	315.00
QRC40-8A	0-40	0-8	$\pm .005\%$ or ± 1 mv	1 mv	$\pm .05\%$ or ± 4 ma	1 ma	3½	450.00
QRC40-15A	0-40	0-15	$\pm .005\%$ or ± 1 mv	1 mv	$\pm .05\%$ or ± 8 ma	2 ma	5¼	575.00
QRC40-30A	0-40	0-30	$\pm .005\%$ or ± 1 mv	1 mv	$\pm .05\%$ or ± 16 ma	4 ma	7	775.00

†Half rack

SEE US AT WESCON BOOTHS 145 & 146 HOLLYWOOD PARK



Sorensen represented in California by Ward-Davis Assoc., 770 S. Arroyo Parkway, Pasadena. Phone 213-684-2840; 3921 E. Bayshore, Palo Alto. Phone 415-968-7116; 3492 Pickett Street, San Diego. Phone 714-297-4619.

FOR FOREIGN SALES AND PRICES consult nearest facility. CONTINENTAL EUROPE: Sorensen-Ard-ag AG, 8045 Zurich, Switzerland, Binzstrasse 18. FRANCE: Sorensen-France, 25 A Rue du Chablais, 74 Annemasse; GERMANY: Sorensen G.m.b.H., 6 Frankfurt am Main, Wilhelm-Leuschnerstrasse 93. UNITED KINGDOM: Cossor Instruments Ltd., The Pin-

TEST EQUIPMENT



Light signal monitor

For measuring continuous and pulsed light signals from GaAs sources, lasers, flash equipment and flashtubes, the "Lite Mike" uses a calibrated photodiode as its detector. Encompassing a spectral range from 0.35 to 1.13 microns, the instrument has a peak sensitivity at 0.9 microns of $0.5 \mu\text{A}/\mu\text{W}$ (70% quantum efficiency). Capable of rise times to 4 ns, it can be used up to 100 MHz.

P&A: \$375; stock. EG&G Inc., 160 Brookline Ave., Boston. Phone: (617) 267-9700.
Booth 1626 (SA) Circle No. 361

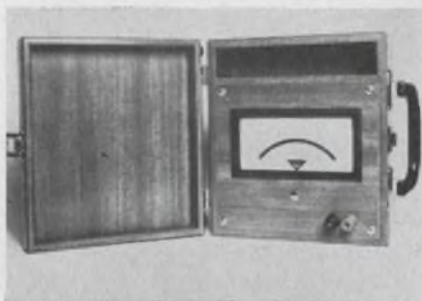

Lab voltmeter standard

Measurement accuracies to 0.1% ac or dc are achieved by this 6-lb portable meter. Ac units operate over a frequency range of 45 to 1800 Hz or fixed frequencies of 60 or 400 Hz. Stock ranges include 110 to 125, 100 to 130, 198 to 218 and 430 to 470 Vac and 5.5 to 6, 11 to 13, 23 to 25, 27 to 29, 145 to 155 and 290 to 310 Vdc. The meters have taut-band movements and fully encapsulated solid-state circuitry.

Availability: 6 wks. American Machine & Foundry Co., 1025 N. Royal St., Alexandria, Va. Phone: (703) 548-7221.

Circle No. 574

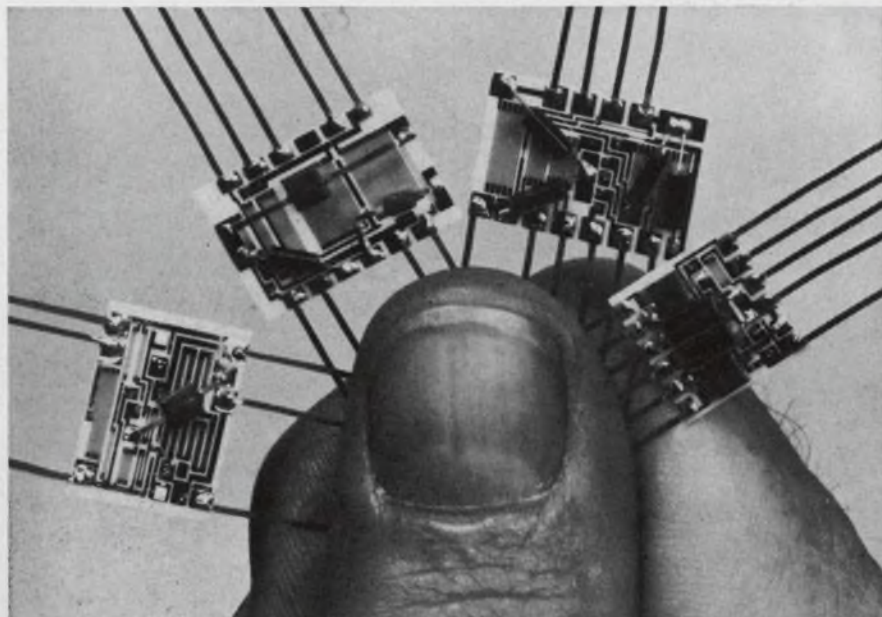

High reliability circuits produced for the Lunar Excursion Module

BUNKER-RAMO CUSTOM HYBRID MICROCIRCUITS

DESIGN AND PACKAGING FREEDOM

Mix integrated circuits, precision resistors, tunnel diodes—whatever you need to get the function you want in the package you want.

SPEED

Digital logic circuits to 250 megacycles; other circuits to microwave frequencies.

POWER

Up to 40 watts per square inch of resistor area without heat sink.

LOW COST, QUICK DELIVERY

Simplified processes mean lower tooling and start-up costs even for short runs or prototypes; faster delivery, too.

PRECISION RESISTORS

Production-run thin-film resistor tolerances to $\pm 0.01\%$ initial adjustment, with $\pm 0.05\%$ tracking accuracy at full load for 10,000 hours; $\pm 5\text{ppm}/^\circ\text{C}$ temperature coefficient control.

APPLICATION ENGINEERING

To explore solutions to your circuit problems, call or write our application engineers.

See us at WESCON—Booth 2140



THE BUNKER-RAMO CORPORATION
DEFENSE SYSTEMS DIVISION

8433 FALLBROOK AVENUE · CANOGA PARK, CALIFORNIA 91304 · (213) 346-6000, EXT. 546

ON READER-SERVICE CARD CIRCLE 165



Please send me the latest Acopian catalog that lists

**62,000
DIFFERENT
POWER
SUPPLIES**

available
for shipment
in 3 days.

Name _____

Title _____

Company _____

Address _____

City _____

State _____

ZIP _____

ACOPIAN CORP.
EASTON, PENNSYLVANIA
TEL: (215) 258-5441



ON READER-SERVICE CARD CIRCLE 166

TEST EQUIPMENT



Low-pass amplifier

Serving as signal amplifier or preamp or as a fast rise time pulse amplifier, this unit has a 100-kHz to 225-MHz bandwidth with a 15-V p-p output into 75 Ω . Gain is switchable in steps of 20, 40 and 60 dB with a 6-dB continuous adjustment. Input and output impedance is 75 Ω brought to BNC coaxial receptacles. Noise figure is 11.5 dB.

P&A: \$995; 30 days. C-Cor Electronics Inc., 60 Decibel Rd., State College, Pa. Phone: (814) 238-2461.

Circle No. 575



FM signal generator

The FM signal generator can test and calibrate telemetering systems in the 2200- to 2300-MHz range. With 200-Hz peak residual FM characteristic, the unit can work into receiver bandwidths of 10 kHz min. Output is calibrated from -10 to -130 dBm into 50- Ω load. An internal rate generator provides eight telemetry rate frequencies at deviation amplitudes up to 1 MHz peak. External modulating signals can be contained in a frequency spectrum from dc to 1 MHz.

Astro Communication Laboratory, Inc., 801 Gaither Rd., Gaithersburg, Md. Phone: (301) 948-5210.

Circle No. 576

Nobody
gets a
charge
out of
Fluorglas*

We like it that way.

Because every day, electrical engineers are finding new applications using the insulating properties of FLUORGLAS* adhesive tapes and laminates.

They have extremely low dielectric constants and exceed Class H temperature requirements. They never carbonize when burned or exposed to an electrical arc and do not absorb moisture, so they never become conductive.

FLUORGLAS* insulating materials are unaffected by solvents, chemicals and corrosive gases and withstand extremes of heat and cold.

Fact is, we haven't found an insulating problem that a FLUORGLAS* tape or laminate couldn't solve.

Think you can? Write for full electrical specifications and give us a brainbuster.

*Registered trademark, Dodge Fibers Corp.

**Dodge Fibers
Corporation**

Hoosick Falls, N.Y. 12090

See us at Booth 573-574 Wescon Show

ON READER-SERVICE CARD CIRCLE 167
ELECTRONIC DESIGN, August 16, 1966

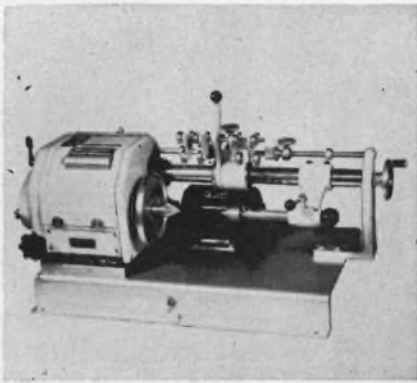

Coil winders

Coil winding machines vary in coil length capacity and are suitable for winding medium and small gauge at high speeds. Feed rates are set on a dial indicating wire diameter in thousandths of an inch. The length of the traverse is adjustable by stop-collar settings. Fine adjustment on layer length is made by micrometer type screw adjustments at each end of the coil. The machines accept #24 to #50 AWG, with 8-in. between centers.

Price: \$700 and \$730. Coil Winding Equipment Co., Railroad Plaza, Oyster Bay, N. Y. Phone: (516) 922-5660.

Booth 703 (HP) Circle No. 374

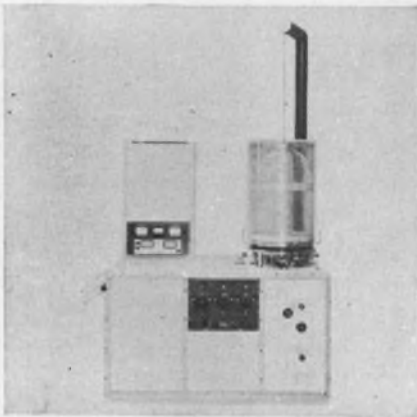

Vacuum evaporator

With a pumping speed of 500 liters/s at the port, this steel manual vacuum system can reach the 10^{-7} torr range in 5 minutes after high vacuum crossover. Ultimate pressure in the VER-775 is 10×10^{-8} torr at the port and 5×10^{-8} torr at the stub. Plug-in connectors are provided on the side of the cabinet for control of the unit.

Veeco Instruments Inc., Plainview, N. Y. Phone: (516) 681-8300. Booth 1632 (SA) Circle No. 268

CREATIVE STYLING . . . DISTINCTIVE QUALITY

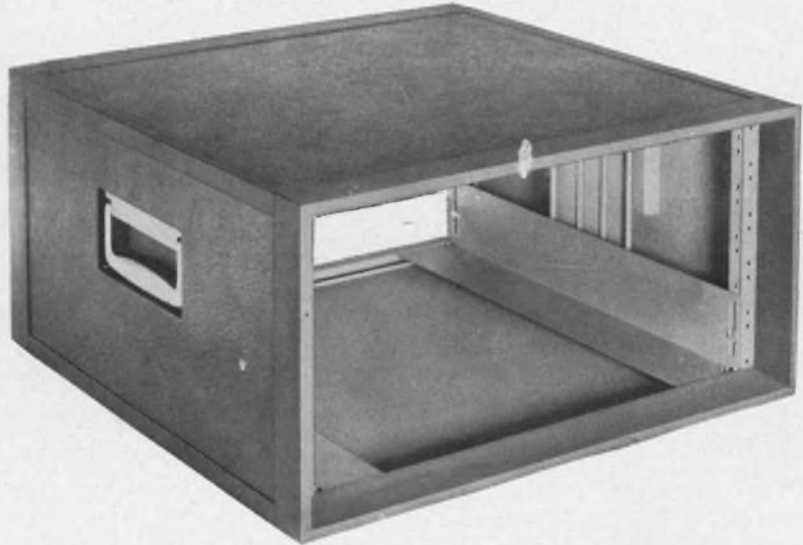

CLASSIC CABINETS

Another outstanding series of enclosures from the skilled hands of the Bud designers. Both in appearance and construction, the CLASSIC line of cabinets presents an unusual opportunity for builders of electronic equipment and systems to house their products to the best advantage.

This new line of standard cabinets has a sturdy welded frame composed of aluminum extrusions. The panels forming the sides, top and bottom are of distinctive patterned aluminum.

CLASSIC cabinets are available in 15 sizes ranging from $3\frac{1}{2}$ " x 19" panel space to 28" x 19" panel space. Beautifully finished in vinyl textured charcoal gray or sand.

Write us for literature about CLASSIC cabinets or see them at your Authorized Bud Distributors showroom.



BUD RADIO, INC.
Willoughby, Ohio

Heat exchanger



Designed to maintain 80°F max with a 1-kW heat dissipation, this heat exchanger employs chilled water from 66 to 70°F. Air is recirculated within the enclosure and cooled by the heat-exchanger in the blower case. More cooling may be obtained by using refrigerated water or direct refrigerant expansion. A higher ambient temperature may be maintained by the use of warm or hot water.

McLean Engineering Labs., P. O. Box 228, Princeton, N. J. Phone: (609) 799-0100.
Booth 445 (HP) Circle No. 329

Cable-tying gun



This tool has a tension indicator on the side of the handle to adjust tension to wire insulation. There is a provision for locking the tension at any setting. The tool tightens, locks, cuts off and ejects the strap at the preset, calibrated tension. It accepts all self-clinching types of standard and miniature ties, clamps and identification markers.

Panduit Corp., 17301 Ridgeland Ave., Tinley Park, Ill. Phone: (312) 532-1800.
Booth 505 (HP) Circle No. 336



Water purity meter

Resistivity of final rinse water for ICs and components is checked by this PM-20 high purity meter/monitor. Purity scale is calibrated 0 to 18 MΩ/cm in increments of 0.2. The dual temperature compensator scale is calibrated from 10 to 100°C and 50 to 212°F. The meter operates on 115 Vac and requires a conductivity cell of 0.01 constant.

Price: \$118 (meter), \$95 (conductivity cell). Barnstead Still & Sterilizer Co., 2 Lanesville Terrace, Boston. Phone: (617) 522-8490.
Booth 744 (HP) Circle No. 396

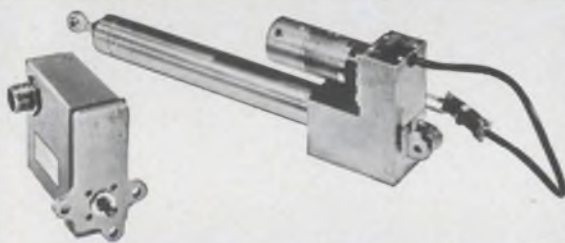

rotary & linear ACTUATORS custom tailored

Because Globe is the largest manufacturer of precision miniature a.c. and d.c. motors and compatible stock gear trains, we can design and deliver an actuator to meet your requirement in a short time. Gain the lead time advantages of Globe's thoroughly proven modular design and large inventory. A refined design can be adapted to your needs for rotary torque to 1000 in. lbs., including all necessary take-off and control elements such as limit switches, potentiometers, etc. No matter what your special requirements may be, a Globe linear actuator will combine maximum thrust in the smallest possible package. Our application specialists will recommend the optimum unit. We routinely handle actuators that must meet MIL specs, specified reliability, high shock and vibration. Request Bulletin A-1 from Globe Industries, Inc., 2275 Stanley Ave., Dayton 4, Ohio.

GLOBE

Visit our Booth 1014
WESCON Show

IDENTIFY WIRES AND CABLES WITH INDESTRUCTIBLE PVC

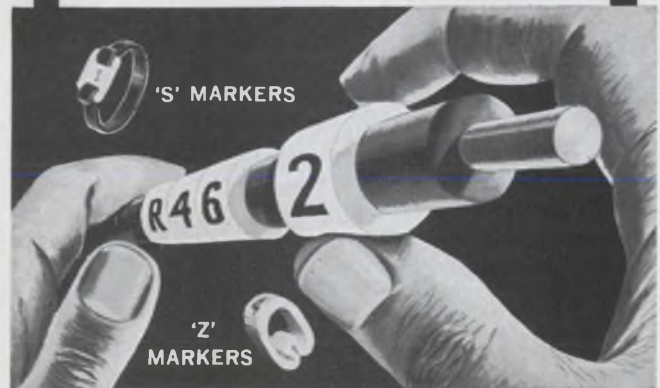

'Z' and 'S' MARKERS

Here are marking systems that will last the life of wire and cable under all conditions. Can't rub-off, peel-off or fall-off...can't slip or slide, yet are easily removed when necessary...are guaranteed to resist abrasion, grease, oil and chemicals!
"Z" markers for wires up to 1/8" diameter and "S" markers for bundles of wires or cable over 1/8" diameter. Write for free samples today.

OTHER ELECTROVERT PRODUCTS: wire and cable harnessing systems; grommet strip, wavesoldering systems.

Sold Coast-to-Coast through Authorized Distributors.



ELECTROVERT INC.

86 Hartford Ave., Mt. Vernon, N.Y. 10553
Burbank, California; Milwaukee, Wisconsin

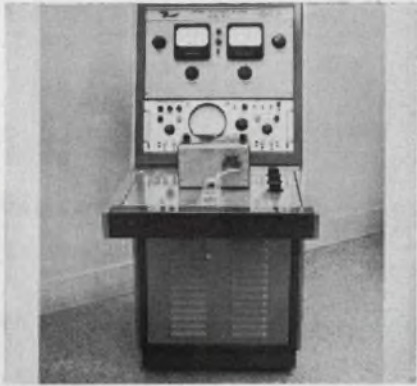

Resistance analyzer

Capable of testing 1000 semiconductors per hour, this thermal resistance analyzer indicates power dissipation capacity in terms of thermal resistance or as junction temperature versus time. 0 to 200 W are provided by stepless control of voltage (0 to 20 V) and current (0 to 10 A). Junction temperature is measured as a function of forward voltage drop in the collector-base junction.

Bendix, Semiconductor Div., Holmdel, N. J. Phone: (201) 946-9400.

Booth 1651 (SA) Circle No. 286



Thin-film evaporator

Model BA-510 is a high-speed system for producing thin-film deposition coatings in a high vacuum environment. Optional accessories include single or multiple electron beam sources, 8-position mask-substrate changer, optical and conductance thin-film monitors, glow discharge and rotary cage. Cycling time with liquid nitrogen to less than 5×10^{-8} torr is achieved in the 20-in. bell jar.

Price: \$7000 to \$10,000. Bendix Balzers Vacuum Inc., 1645 St. Paul St., Rochester, N. Y. Phone: (716) 342-0400.

Booth 1649 (SA) Circle No. 280

NEW! HIGH PRECISION INSTRUMENTATION HEADS!!

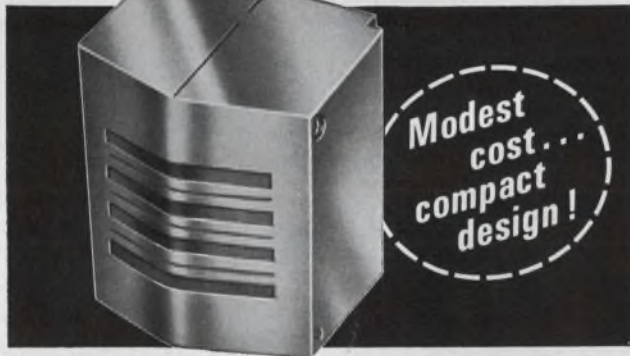

Now... for Analog and FM instrumentation applications... Nortronics offers two new 3-channel and 4-channel magnetic record and reproduce tape heads. Format follows the standard IRIG 7-channel interlace for 1/2-inch tape—Track width is 0.050 inches; tracks spaced 0.140 inches center-to-center across the head and .070 inches center-to-center across the tape when the two heads are interlaced. All channels within heads located within 0.002 inches of the nominal position required to match this track location. Heads feature deposited quartz gaps down to one micron, and without mounts measure only 0.700 inches wide by 0.830 inches high by 0.665 inches deep. Mounts, terminal connections, impedances and resolution can be tailored to fit individual requirements.



ADDITIONAL FEATURES: Fine laminated, precision lapped low-loss core structures; hyperbolic face contour for intimate tape-to-gap contact; and highly polished, all metal faces which greatly reduce oxide buildup and the need for frequent head cleaning.

For additional information, write:

Nortronics®

8185-L 10th Ave. No. • Minneapolis, Minn. 55427

**THE DESIGNER
OF THIS
HEATED SHANK***



**SELECTED
SUPRAMICA® 500
ceramoplastic
FOR
TOTAL DIMENSIONAL
STABILITY
AND
PRECISE
MACHINABILITY**

These other advantages are inherent in SUPRAMICA® ceramoplastics and MYCALEX® glass-bonded mica:

- High dielectric strength
- High arc resistance
- High temperature resistance
- Thermal expansion close to that of stainless steel
- Inorganic formulations
- Low specific gravity
- True hermetic seals
- Machinable to precision tolerances
- Moldable with metal inserts

Solve your design problems with the world's most nearly perfect insulation materials.

*TEMPRESS RESEARCH CO. Sunnyvale, Calif.



**MYCALEX
CORPORATION OF AMERICA**

World's Largest Manufacturer of ceramoplastics, glass-bonded mica and synthetic mica products.

Send today for comprehensive 36-page color catalog.

125 Clifton Boulevard, Clifton, N.J.

ON READER-SERVICE CARD CIRCLE 184

SYSTEMS

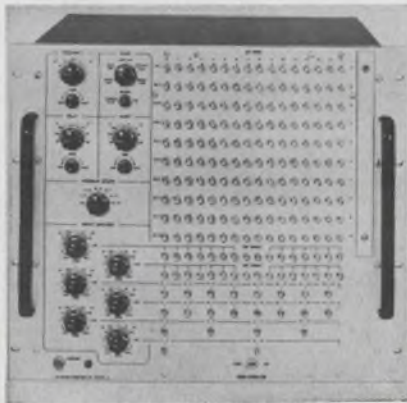

5-MHz word generator

For design and testing of memory elements and memory systems, telemetry systems or digital logic systems, model 1623 word generator uses high-speed ICs for stepping frequencies up to 5 MHz. Complex test programs are achieved by 10 output channels, each providing 16 bit-times, and with the 160-toggle switch matrix which establishes the basic program format. Six independent repeat generators (2 step-repeat, 2 pair-repeat, 1 quad-repeat and 1 octet-repeat) provide repeat durations from 1 μ s to 1 s. Word length can be selected for each of the 4 quads or 2 octets.

Price: \$5975. E-H Research Labs. Inc., 163 Adeline, Oakland, Calif. Phone: (415) 834-3030.

Booth 220 (HP) Circle No. 558



20-W CO₂ laser

A 20-W, cw, CO₂ laser system has beam divergence of 2 milliradians max. Model LG-14 includes laser head, power supply, gas source, metering valves, vacuum pump and output meter. Output is distributed over several vibrational-rotational transitions spaced 200 Å apart around 10.6 microns. The dc-excited discharge tube is water cooled. A remotely controlled beam shutter directs output into a power detector for monitoring and provides exposure time control.

P&A: \$8900; 60 days. Raytheon Co., 130 Second Ave., Waltham Mass. Phone: (617) 899-8080.

Circle No. 577

“9 years ago we had a great idea that put us in the high-rel relay business.



It's still a great idea, and now we've put it in a one-inch package!”

Wedge-action* was the great idea. By combining long precious-metal contact wipe with high contact force, it gives Electro-Tec relays the highest dry-circuit confidence level ever reached. (90%, based on a failure rate of only .001% in 10,000 operations.)



Packing wedge-action into a one-inch envelope wasn't easy. But it was worth it. It gives you maximum reliability in minimum space. And it's available for both 6PDT and 4PDT operations, in relays that exceed all requirements of MIL-R-5757/1 and /7.

The one-inch relay is just one of our family of wedge-action relays, which cover almost every dry-circuit to 2 amp application. When you need a high-rel relay that really works, remember our great idea, and put it to work for you.

•U.S. Patent No. 2,886,046 and others pending.



Electro-Tec Corp.

SLIP RINGS • RELAYS • SWITCHES • OPTICS

P. O. Box 667 • Ormond Beach, Florida (804) 677-1771 • TWX 810-857-0305

Manufacturing Facilities:
Ormond Beach, Fla. • Blacksburg, Va.

ON READER-SERVICE CARD CIRCLE 185
ELECTRONIC DESIGN, August 16, 1966



Electronic calculator

Operating in milliseconds, this desk-top calculator has a key for square root computations. The solid-state counter has an 11-key keyboard, automatic decimal control from 0 to 13 places and multiple registers. A second constant can be held in the top register. Automatic transfer of terms or intermediate answers permits a logical flow of calculations.

Price: \$1950. The Singer Co., Friden Inc. Div., 2350 Washington Ave., San Leandro, Calif. Phone: (415) 357-6800.

Booth 2036 (SA) Circle No. 532

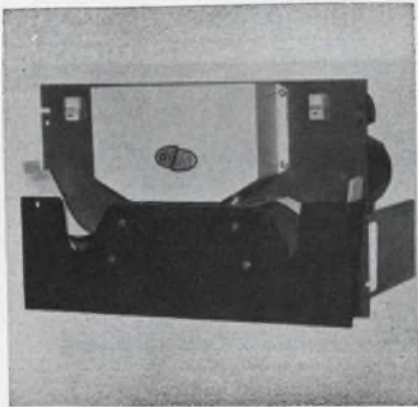

Lister/printer

A high-speed lister/printer for data logging applications is capable of speeds up to 40 numeric or 20 alphanumeric lines per second. Line widths are expandable in 4-column increments up to 16 columns. Series DL units use a continuous, rotating type-drum which is cantilevered beyond the front panel. The all-silicon circuits have an average calculated MTBF of 3500 hours.

Price: \$2500 to \$5000. Di/An Controls Inc., 944 Dorchester Ave., Boston. Phone: (617) 288-7700.

Booth 2007 (SA) Circle No. 560

In the face of rising costs, these new power modules bring the cost per watt of 0.05% regulated DC to an all-time low!

MC-65 SERIES is a new line of all-silicon AC-DC power modules — specifically designed to give you more watts per dollar. A wide range of different voltage and current models is available. So, if you're interested in better power supplies at budget prices — and who isn't — write for information on these new Technipower modules today!

- 314 models, outputs 3 to 152VDC, up to 750 watts.
- Regulation $\pm 0.05\%$.
- Temperature coefficient 0.015%/°C typical.
- Ripple 2mV RMS.
- Temperature rating 65°C.
- Not damaged by output shorts or overloads.
- No turn-on/turn-off overshoot.
- Designed to meet MIL specifications.



Portrait of a Hero

Your inquiry will also bring you a copy of the latest Technipower catalog, giving complete data and prices for more than 4000 power modules and lab supplies.

SEE THESE AT WESCON — BOOTHS 116-118



TECHNIPOWER

A BENRUS SUBSIDIARY

18 MARSHALL STREET, NORWALK, CONNECTICUT 06854

ON READER-SERVICE CARD CIRCLE 186

SYSTEMS



IR vidicon camera

The vidicon TV camera views visible and IR spectrums in excess of 2 microns. The CH-1070 can simultaneously detect a hydrogen flame in bright sunlight and provide visible spectrum coverage of the area. The camera can image objects by their own thermal radiation at 250°C and observe objects in total darkness when illuminated by IR radiation. On a standard EIA pattern the camera's horizontal resolution is 600 lines.

Canoga Electronics Corp., 1510 W. 228 St., Torrance, Calif. Phone: (213) 325-5244.

Circle No. 578



High frequency recorder

This transportable instrumentation tape recorder/reproducer has a frequency response of 1.5 MHz. Model SP-600 provides 4 tracks with azimuth controls. Recording time is 19 minutes at 120 ips with 1/2-mil tape. Twelve 1/2-in. reels hold 11,500 ft of tape. Flutter is below 0.5% p-p from 0.2 Hz to 10 kHz. An automatic tape lifter removes the tape from heads. When in motion, the tape is continually cleaned by two built-in cleaners.

Price: \$7000. Ampex Corp., 401 Broadway, Redwood City, Calif. Phone: (415) 367-2011.

Circle No. 579

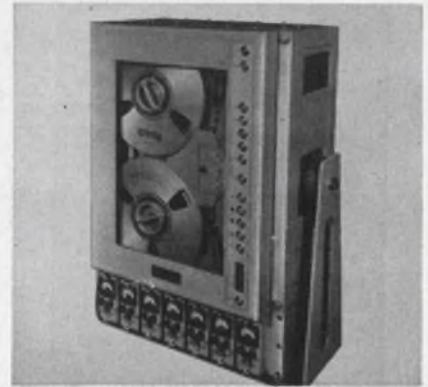

Shipboard recorder

A system to record variations in typical sound spectrums picked up by hydrophones has been developed for use aboard ships and submarines. The data recording system will provide better than 55-dB broadband and 75-dB single-cycle signal-to-noise performance. The unit will record and/or reproduce 7 channels of direct or FM data in accordance with IRIG standards. It will record signals as low as 400 μV without degradation.

Leach Corp., 717 N. Coney Ave., Azusa, Calif. Phone: (213) 334-8211.

Booth 1515 (SA) Circle No. 542

1/4" Mechatrim Trimmer Pot

The only one like it on the market ... Electro-Techniques' 1.5 gr. 1/4" Type HT-250 Mechatrim® Metal Film Trimmer Pot in a TO-5 can; also panel and side adjustment mounts. It takes superlatives to describe its features and functions, which meet or exceed existing mil-specs. ■ +30 PPM/°C temperature coefficient ■ Non-wirewound reliability ■ Infinite resolution ■ Resistance maintained well into 150 MC ■ Humidity proof ■ Setting stability unaffected by acceleration, shock and vibration ■ Long life ■ Low cost ■ Immediate delivery.

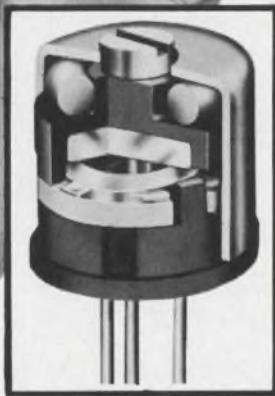

ELECTRO TECHNIQUES
11301 E. Ocean Ave., La Habra, Calif. 90631/(213) 691-0741
MFRS. OF LINEAR AND NON-LINEAR PRECISION POTENTIOMETERS SINCE 1959

Write or phone for Technical Bulletin 109 or HT250 Test Report, or both

ON READER-SERVICE CARD CIRCLE 187

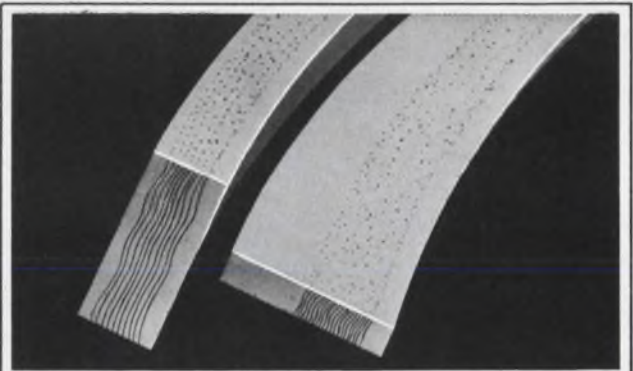

U. S. Patent 82,674,644

POLASTRIP...

seals and shields with a single material

Polastrip consists of oriented wire (typically monel or aluminum wire) imbedded in a matrix of silicone rubber. It is available as a standard item in several thousand cross-sections and types. Polastrip has proven itself

to be the most effective shielding material available for solving many difficult shielding problems. Cost is comparable to conventional, combination materials. Write for free samples, prices, and literature!

METEX Corporation

Walnut Avenue, Clark, New Jersey 07066
(201) FU 1-7272 • TWX 710-744-4530
West Coast: 5057 W. Washington Blvd., Los Angeles



ON READER-SERVICE CARD CIRCLE 188

ELECTRONIC DESIGN, August 16, 1966

36-channel oscillograph

With up to 36 active data channels, this light beam recording oscillograph is capable of recording up to 15 kHz. The unit can accept up to 200 ft of 8-in. wide recording paper. Model 801 has 10 speeds up to 128 ips, millimeter or decimal grid lines, trace numbering, grid line intensity control, flash timing lines and individual input connectors.

P&A: about \$2000; 90 days. Midwestern Instruments, 41 & Sheridan Rd., Tulsa, Okla. Phone: (918) 627-1111.

Booth 141 (HP) Circle No. 391

Ferrite tester

Testing of coincident-current core memory mats under speeds simulating computers is made possible with type 1527 ferrite tester. It includes a timing and control section, 4 current drivers, high-speed switching for mats up to 64 by 64, a difference amplifier and a 4-channel discriminator. Address-to-address cycle time is 10 μ s. Testing patterns are single-checkerboard and 4 double-checkerboards. Front panel switches and a diode plugboard permit program modification. Testing modes are continuous, stop on error and automatic re-start.

P&A: \$33,000; 10 wks. Digital Equipment Corp., 146 Main St., Maynard, Mass. Phone: (617) 897-8821.

Circle No. 580

Uhf transponder

Local or remote controlled, the uhf transponder has a 225- to 399.95-MHz range. The unit provides AM communications on 3500 channels. The transmitter subassembly provides 100-W min RF carrier output with 50- Ω load. It consists of a 10-W driver and 100-W amplifier. The modulator can amplify signals from 0.3 to 3 kHz and accept an external broadband input from 3 to 25 kHz. The main receiver has a 3- μ V sensitivity. Synthesizer frequency range is 85 to 143 MHz in 16.66-kHz steps.

Hallicrafters, 5th and Kostner Ave., Chicago. Phone: (312) 826-6300.

Circle No. 581



REMEMBER PAPER TAPE?

People recorded data on it. It was full of holes that were hard to make and even harder to read. Small wonder that it went the way of high-button shoes and nickel beer.

Incremental magnetic recording directly in computer compatible format is the modern way.

KENNEDY INCREMENTAL RECORDERS are far more

Reliable	Almost no moving parts instead of complicated cams, punches and clutches
Speedy	Asynchronous writing rates to 500 characters per second
Compact	One foot of magnetic tape equals 20 feet of paper tape at 200 BPI; more at 556 BPI
Silent	No noisy mechanism
Compatible	Tapes produced may be read on any IBM compatible transport
Economical	No conversion required re-usable tape minimum maintenance

Models are available for every requirement, reading as well as writing.

Look to Kennedy to provide the incremental recording equipment to modernize your data system.



MODEL DS 370 MODEL 1400 MODEL 1500 MODEL 2200

See us at Wescon '66
Booth 152
Hollywood Park

Kennedy Co.

275 N. Halstead Ave., Pasadena, Calif. 91109 (213) 681-9314

ELGENCO Noise Generators



Model 610A

SOLID STATE NOISE GENERATORS

Model 602A 5 cps to 5 mc, 3 Ranges \$ 290
 Model 603A 5cps to 5 mc, 3 Ranges \$ 495
 Model 610A 5 cps to 5 mc, 8 Ranges \$1,175
 Series 624 (Fixed frequency) 5 cps to 500 kc
 \$245 to \$490. Write for details on frequency
 ranges and spectral flatness.



Model 312A

VACUUM TUBE NOISE GENERATORS

Model 301A DC to 40 cps. \$1,995
 Model 311A Two outputs DC to
 40 cps and 10 cps to 20 kc. \$2,395
 Model 312A Two outputs DC to
 120 cps and 10 cps to 20 kc. \$2,495
 Model 321A DC to 120 cps. \$2,095
 Model 331A 10 cps to 20 kc. \$1,275

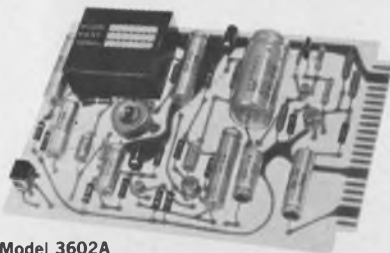

Model 3602A

NOISE GENERATOR CARDS

Series 3602, 3603, and 3606 \$144 to \$389
 Various frequency ranges and output flat-
 ness available. Size: 4½" x 6½" x 1". Write
 for details.

ENCAPSULATED NOISE SOURCE MODULES

Series 1602, 1603, and 1606. . \$95 to \$340
 Various frequency ranges and output flat-
 ness available. Size: 1¾" x 1½" x ¾". Write
 for details.

ELGENCO INCORPORATED



1550 Euclid Street
 Santa Monica, California
 Phone: (213) 451-1635
 TWX: (213) 879-0091

DEMONSTRATOR MODELS AVAILABLE
 See EEM or Write for Name of Nearest Rep
 ON READER-SERVICE CARD CIRCLE 193

POWER EQUIPMENT



4- to 20-kV supplies

These supplies withstand space environments and continued exposure to reduced atmospheric pressure or high vacuum environment. The "Kilo-Pac" has been encapsulated to eliminate corona in the region from 10,000 ft to outer space. Units connected back-to-back (as negative output unit and positive output unit with a common ground) may be used at 40 kV. Outputs are 4 to 7 kV at 30 μ A, 7 to 12 kV at 20 μ A and 12 to 20 kV at 10 μ A. Line and load regulation are $\pm 0.4\%$ and $\pm 1.5\%$. The units are used to operate image intensifiers, nuclear particle detectors, low-power electrostatic deflection plates and for other high-voltage low-current applications.

Price: \$795 to \$1195. Pulse Engineering Inc., 560 Robert Ave., Santa Clara, Calif. Phone: (408) 248-6040.

Booth 442 (HP) Circle No. 551

10-V reference source

Remote voltage sensing provisions and self-restoring overload and short protection are featured in this reference source. Output is nominally 10 Vdc adjustable over ± 50 mV by a multi-turn pot with a resolution of 25 μ V min. Load regulation is 10 μ V min for a 10-mA step change. Temperature coefficient is 2.5 ppm/ $^{\circ}$ C and stability is 0.005%/month.

Source impedance is 0.5 m Ω and current rating is 25 mA max. The unit operates from a 115-V $\pm 10\%$, 60-Hz input.

P&A: \$275; 3 to 4 wks. Power Designs Inc., 1700 Shames Dr., Westbury, N. Y. Phone: (516) 333-6200.

Booth 210 (HP) Circle No. 526

Need a small 1, 5 or 10 mc crystal oscillator for use in synthesizers, timing systems, counters, communication systems, time-code generators, tape systems, or some other small black box?

Think **TRACOR**[®]



Shown half actual size

TFA 766

Volume 19.1 in.³
 That's about the size of it.

For further information:
 TRACOR, Inc.
 General Sales Office
 6500 Tracor Lane
 Austin, Texas 78721
 Phone: 512-926-2800



**SULZER
 DIVISION**

REPRESENTATIVES IN PRINCIPAL CITIES

We are looking for EE's, ME's and Physicists for design consultation or systems development in ASW and undersea problems—experience in penetrations aids—design studies, tests, analysis and reports on electronic and mechanical systems. Your reply strictly confidential.

ON READER-SERVICE CARD CIRCLE 194
 ELECTRONIC DESIGN, August 16, 1966

MATERIALS

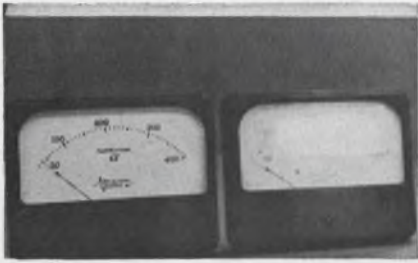

Conductive coating

Eliminating static charges and ambient light glare from instrument cover glasses, this vacuum-deposited coating combines an anti-reflection and a conductive coating. Reflections are decreased by a factor of 10. This coating meets humidity, durability and solubility requirements of MIL-C-657A and will withstand temperatures ranging from -260 to 200°C .

Optical Coating Laboratory, Inc.,
2789 Giffen Ave., Santa Rosa, Calif.
Phone: (707) 545-6440.

Booth 2041 (SA) Circle No. 265

EMI/RFI shielding

A woven magnetic shielding protects against electromagnetic and radio frequency interference. The light weight shielding can be supplied on single and multi-conductor cables and as an overall cable shield. Conventional termination methods are used and no special tooling is required. "Magna-Shield" can be soldered or crimped. Various voltage wire can be supplied but 600 V is standard.

B&B Electronics Corp., 17360
Gramercy Pl., Gardena, Calif.
Phone: (213) 321-1956.

Booth 578 (HP) Circle No. 285

Dielectric materials

Combining the thermal conductivity of beryllium oxide with the flexibility and workability of organic insulating resins, these dielectric materials, E-30 series, have heat conductivities between 5 and 18 BTU/ft-2-hr- $^{\circ}\text{F}$ -ft. Dielectric strength is 350 to 400 V/mil. Dielectric constant is 4.8 to 5.4 at 1 MHz. Volume resistivity at 25°C is 10^{14} Ω cm.

National Beryllia Corp., First &
Haskell Aves., Haskell, N. J.
Phone: (201) 839-1600.

Booth 752 (HP) Circle No. 326



**Varo,
you sure
know
how to
give
a guy a
workout!**

Be glad we do.

If we didn't you might have to find out the hard way just what the environmental limitations of your small components and systems are.

But you don't have to take that chance. Not where temperature is concerned.

Our new, portable temperature chamber, the TC4 shown above, can provide plenty of answers. (We also make this equipment in a vertical configuration, the TC2.)

You can test small components and systems in this chamber at temperatures ranging from -100°F to $+400^{\circ}\text{F}$.

It gives you a control accuracy of better than $\pm 1/4^{\circ}\text{F}$ by using an anticipatory controller which predetermines temperature trends and compensates for them in advance.

Both these chambers are lightweight, easy to carry around. The TC4 weighs only 20 lbs., the TC2, 15 lbs. And their complete portability lets you bring the chamber to the project with an ease never before possible.

Or with an economy never before possible. Our solid state circuitry, control simplicity, easy access, low CO_2 and power consumption and low price add up to a cost story worth looking into.

Temperature testing is one of our capabilities. Ask us about our complete line of centrifuges and processing equipment for the electronic industry.

Call or write today.

20 Years of Meeting Challenge With Achievement

See us at Wescon Booth 1716-1717



GYREX PRODUCTS
3003 PENNSYLVANIA AVE., SANTA MONICA, CALIF. 90406. (213) 393-0462

ON READER-SERVICE CARD CIRCLE 195

VECO THERMISTORS

BEADS • BULBS
DISKS • WASHERS
GLASS PROBES • RODS
CRYOGENIC THERMISTORS
SENSOR ASSEMBLIES
THERMISTOR CATHETERS
MILITARY GRADE
THINISTORS®
Thin film thermistors

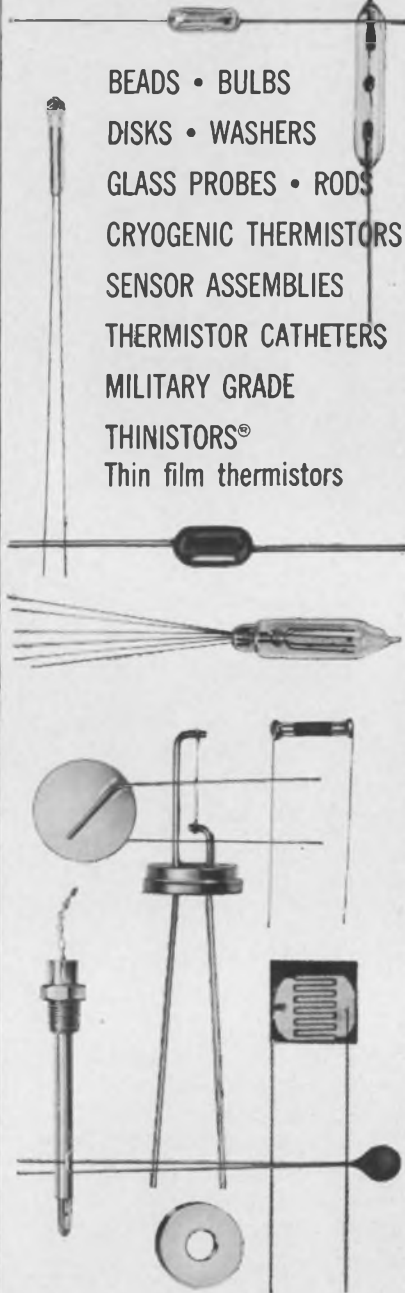

Specify VECO Thermistors whenever accuracy, stability and reliability are required. VECO stocks a wide range of thermistor types in a variety of resistance values for immediate delivery. Remember—the most reliable thermistors are VECO thermistors.

Write for VECO Literature Catalog SB53-1
VECO First in Progress • First in Service

J-6907

VECO VICTORY ENGINEERING CORP.
124 Springfield Ave., Springfield, N.J. 07081
Tel: 201 • 379-5900 TWX: 710-983-4430

MATERIALS



IC drafting symbols

IC and other multi-pad configuration drafting symbols eliminate positioning of individual pads. Configurations such as TO-5, TO-18, dual transistor and 8-, 10- or 12-pin micrologic elements are available. The opaque drafting symbols are individually die cut and printed on adhesive-backed matte acetate film. These symbols are accurate to ± 0.001 in. Availability is 2X and 4X scale.

Bishop Industries Corp., 10757 Magnolia Blvd., North Hollywood, Cal. Phone: (213) 763-7317.

Circle No. 605

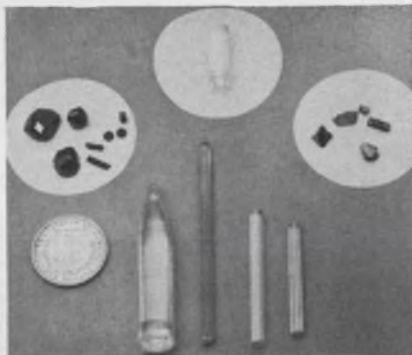

Oxide crystals

This line of 20 standard oxide crystals includes three basic groupings available in raw forms and standard shapes. Magnetic oxide single crystals include YIG, GaYIG, lithium-ferrite and nickel-ferrite. Magnetic oxide polycrystals include Ni-Al-ferrite, YIG, Mg-Mn-ferrite and Mg-Mn-Al-ferrite. Laser and other non-magnetic oxide signal crystals include YAG, calcium-tungstate, beryllium-oxide, sapphire and quartz.

Aremco Products Inc., P. O. Box 145, Briarcliff Manor, N. Y. Phone: (914) 762-0685. Circle No. 606

PORTABLE TYPE 32MHz FREQUEN- CY COUNTER -TR- 3666 GIVES INSTANT AND HIGH MEASURING ACCURACY



■ Greater portability ■ Compact—12.0" wide \times 6.0" high \times 14.6" deep
■ Lightweight—24.5 lbs ■ Durable
■ Power—DC 12/24V and AC 115 V
■ Withstands use under rugged conditions ■ Low power consumption—34 W
■ Built-in power line noise filter ■ Built-in WWV receiver—5/10MHz
■ High input sensitivity—50mV rms/min ■ High degree of measuring accuracy available instantly. No waiting for crystal oscillator oven temperature to build up.

Specifications:

Range: 10Hz to 32MHz Input Sensitivity: 50mV rms minimum, 140mV rms maximum Accuracy: ± 1 count \pm time base accuracy
 Registrations: 6 digits in-line digital display tubes with display storage Time Base Accuracy: 1×10^{-7} or less adjustable after calibrated by WWV WWV Receiver: Sensitivity; 3 μ V, 5MHz and 10 MHz optional changeover
 Power Requirements: DC 24V \pm 4V, approx. 24W; DC 12V \pm 2V, approx. 36 W; AC 100V \pm 20V, approx. 34 W Operating Temperature Range: -10°C \sim $+50^{\circ}\text{C}$
 Weight: Net 24.5 lbs Dimensions: 12" wide, 6" high, 14.6" deep

See for yourself by visiting Booth No. 158, WESCON/66, Hollywood Park, Los Angeles

For further details, write to:

Takeda Riken Industry Co., Ltd.

285, Asahi-cho, Nerima-ku, Tokyo, Japan
Cables: TRITRONICS TOKYO Phones: 930-4111

ON READER-SERVICE CARD CIRCLE 197
ELECTRONIC DESIGN, August 16, 1966

INSULTITE

heat-shrinkable tubing

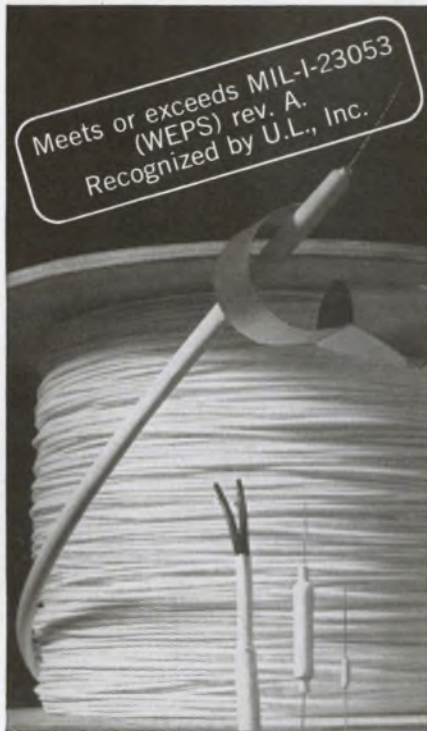

first of the INSULRAD family of irradiated polyolefins from E.C.C.

Now there's an important new source of heat-shrinkable tubing—INSULTITE from Electronized Chemicals Corporation.

INSULTITE meets competitive heat-shrinkable tubing requirements spec for spec—outperforms other shrinkables in volume resistivity, longitudinal change, water absorption, and resistance to solvents.

INSULTITE is the answer wherever skin-tight packaging or encapsulating covers are needed. Apply heat: INSULTITE molds itself around smooth or irregular shapes to form a tight protective jacket. INSULTITE is available in standard colors and sizes and is supplied in four-foot or specified lengths... all competitively priced and available now. For more information on this new product, write, wire or call Electronized Chemicals Corporation, Burlington, Mass. Tel. 617-272-2850. Dealer inquiries are invited.



**ELECTRONIZED
CHEMICALS
CORPORATION**
a subsidiary of

HIGH VOLTAGE ENGINEERING

See us at the Wescon Show
in booths 728, 729.

ON READER-SERVICE CARD CIRCLE 198
ELECTRONIC DESIGN, August 16, 1966

Microwave materials

Magnetic saturation moments of 1000 and 1200 gauss are characteristic of G-1010 and G-1210 microwave garnets. Both exhibit dielectric losses of 0.00025 and may be utilized successfully in Y-junction circulators and phase-shifting devices.

The G-1010 can be used at a frequency of 400 MHz. Low-loss dielectric materials, D-13 and D-16 magnesium-titanate have dielectric constants of 13.0 and 16.0 respectively at 10 GHz.

Trans-Tech Inc., 12 Meem Ave., Gaithersburg, Md. Phone: (301) 948-3800.

Circle No. 607

Urethane solvent

Components which have been encapsulated or potted with urethane compounds may be depotted for repair or retrieval purposes by soaking or brushing with "Uresolve." A 1-in. cube of rigid or flexible urethane foam will dissolve completely within 1 hour at room temperature. The solvent will not cause any significant swelling, discoloration, or chemical attack of most polymers and it will not attack magnesium, beryllium, aluminum, steel, copper or their alloys.

Amicon Corp., 280 Binney St., Cambridge, Mass. Phone: (617) 864-8710.

Circle No. 608

Precious metal crystals

Crucible-grown single crystal rods with 1/4 to 1-1/2-in. diameters, lengths of 1, 2, 4 and 6 in. and random orientation have purities to 99.9999%. A spark erosion cut-off process produces accurate strain-free crystals. Specific orientations within 3° of major axis 100, 110 and 111 are available at additional cost. Crystals are presently offered in gold, platinum, palladium and silver.

P&A: about \$620; 4 to 6 wks. Aremco Products, Inc., P. O. Box 145, Briarcliff Manor, N. Y. Phone: (914) 762-0685.

Circle No. 609



... 35 YEARS LEADERSHIP
IN ROTARY SWITCHES

Moduline
rotary switches...
one week delivery
on 2 million
variations!

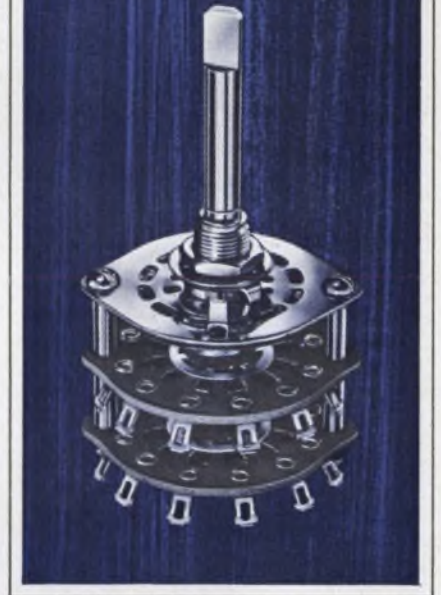

How does Oak® do it? Simple. We break a rotary switch down to four basic elements. Then we stock all possible variations of each element in our Moduline assembly room... ready and waiting for your order. Your order comes, we start assembling—from 1-99 switches to your precise specs. Over 2 million variations with one week delivery.

Only Oak offers you Moduline™ switches—made with the same precision quality to military specs as custom-made. Will break 1 amp @ 28 vdc, 0.5 amp @ 110 vac or carry 5 amps.

For full details, write for Bulletin SP-205.

OAK MANUFACTURING CO.

A DIVISION OF OAK ELECTRO/NETICS CORP.
CRYSTAL LAKE, ILLINOIS 60014 • Telephone: 815-459-5000
TWX: 815-459-5628 • Cable Address OAKMANCO

ON READER-SERVICE CARD CIRCLE 199

You name the meter. Ideal has it.

(or we'll make it for you)



If one concentrates long and hard enough on panel meter development and engineering, one becomes expert.

IDEAL meters are used by all the Military and by leaders in defense and industry. For everything in meters—ruggedized or commercial, custom and stock, 1/2" to 7"—you can count on IDEAL, the proven leader.

Write for free 32-pg. catalog. Ideal Precision Meter Co., Inc., 218 Franklin St., Brooklyn, N.Y. 11222. (212) EVergreen 3-6904.

ON READER-SERVICE CARD CIRCLE 200

PACKAGING PANELS

CUSTOM DESIGNED • FAST DELIVERY • MINIMUM COST

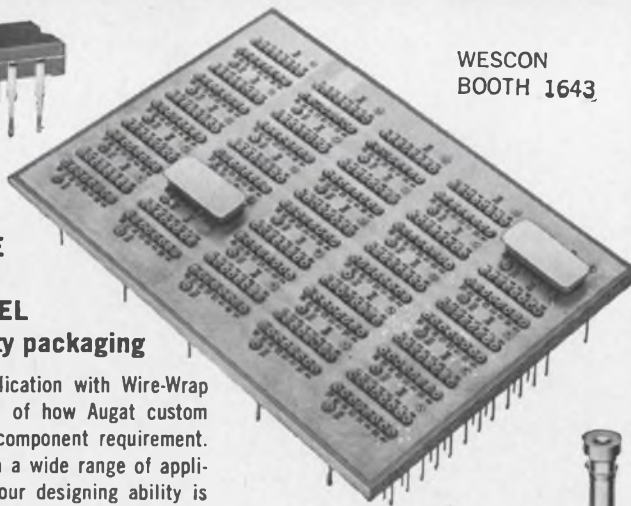

WESCON
BOOTH 1643

DUAL-IN-LINE WIRE-WRAP® SOCKET/PANEL

for high density packaging

This packaging application with Wire-Wrap terminals is typical of how Augat custom designs to fit any component requirement. Because we work in a wide range of applications every day, our designing ability is uninhibited. Due to complete in-house facilities, our delivery is fast and at lowest possible cost.

Wide selection of Socket/Terminals with brass sleeves and beryllium copper, gold plated contacts available. May be purchased separately.

Write for data sheet 266.

AUGAT

INC. 31 PERRY AVE., ATTLEBORO, MASS. 02703 ©Trademark Gardner-Denver Co.

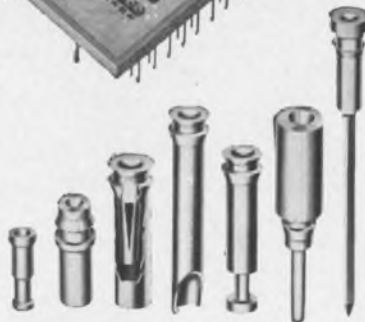

ON READER-SERVICE CARD CIRCLE 201

MICROWAVES

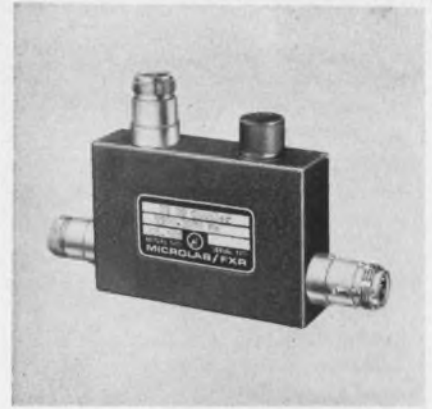

Low-cost coax couplers

A series of highly directive coaxial couplers is designed to sell at 30% below the industry average. Model CB 3- and 4-port couplers offer 25-dB directivity over a full octave frequency range. 10-, 20- and 30-dB models are available with a vswr of 1.15 and type N and TNC connectors.

P&A: \$90; stock. Microlab/FXR, 570 W. Mt. Pleasant Ave., Livingston, N. J. Phone: (201) 992-7700. Booth 204 (HP) Circle No. 322



200-W cw klystrons

200-W cw output at 2115 ±5 MHz is produced by these power amplifier klystrons at 40% efficiency. The 5-cavity tube is available in heat-sinked or air-cooled models rated at 500 W cw and 1 kW cw. Beam current transmission figure is 95%. The electrostatically-focused tubes produce no stray magnetic fields and are free of thermal drift.

Varian Assoc., Eimac Div., 301 Industrial Way, San Carlos, Calif. Phone: (415) 592-1221.

Booth 1349 (SA) Circle No. 516

ELECTRONIC DESIGN, August 16, 1966

Hz

There are many ways to measure frequency. This one was shown in my Father's high school text book:



Today, we do it electrically in less than two cubic inches, for you to use in your airplanes and other flying machines. The range: 50 Hz to 3600 Hz.

We also make *voltage* sensors, 25 millivolts to 440 volts AC and DC.

E

I Current sensors ranging from 2.5 milliamperes to 250 amperes DC and to 500 amperes AC.

Phase sequence or open phase detectors for systems up to 400 volts.

Ø

T Time interval sensors from fifty milliseconds to minutes, hours, or days.

We also make *special* sensors for values such as R.P.M., temperature and others. If any of these interest you, please write us.

Gabriel M. Giannini

GIANNINI | **VOLTEX**

12140 E. RIVERA RD., WHITTIER, CALIF. 90606
PHONE: 213-723-3371, TELETYPE: 213-685-6261

An Independent Company/An Equal Opportunity Employer

ON READER-SERVICE CARD CIRCLE 202
ELECTRONIC DESIGN, August 16, 1966

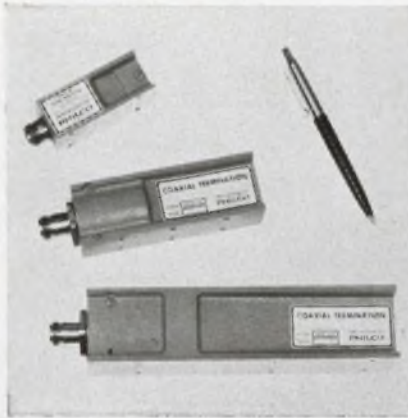

Dry coax terminations

Capable of dissipating up to 1000 W from dc to 4 GHz, these dry coax terminations are conduction-cooled. They provide low-reflection termination of a 50-Ω flexible or rigid coax line. Series 460A is available for 150-, 400- or 1000-W levels. The 150-W version has a type N or TNC RF connector. Larger units have N, C, BNC, TNC, HN, LC or 1-5/8-in. rigid line connectors.

Price: \$235 (150 W), \$325 (400 W), \$450 (1000 W). Philco, Sierra Electronic Div., 3885 Bohannon Dr., Menlo Park, Calif. Phone: (415) 322-7222.

Booth 453 (HP) Circle No. 388



Pulse modulator

Designed for pulse magnetrons, this solid-state magnetic pulse modulator has applications in airborne weather radar systems. RF output is 15.5 GHz ±85 MHz. Pulse length is 1.5 ms, pulse repetition rate is 800-Hz and input voltage is 115 V, 400 Hz single phase.

Litton Industries, Electron Tube Div., 960 Industrial Rd., San Carlos, Calif. Phone: (415) 591-8411.

Booth 1507 (SA) Circle No. 343



... 35 YEARS LEADERSHIP
IN ROTARY SWITCHES

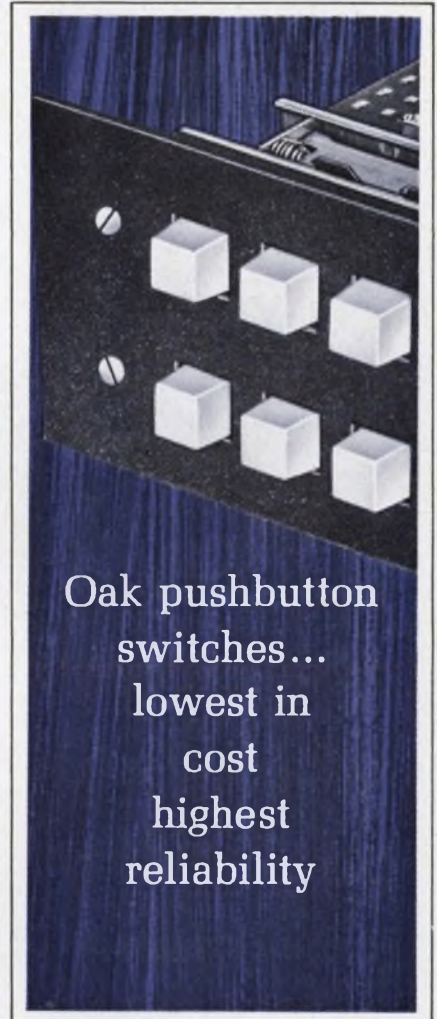

Oak pushbutton
switches...
lowest in
cost
highest
reliability

Built-in economies reduce costs and maintenance. Modern Oak® styling gives smart appearance for simplified or complicated arrangements. More flexible circuit design than provided by many rotary switches because of the large number of blade shapes combined with plunger actions. Oak-pioneered double-wiping action contacts are used in push-button switches. Special frames for lamps prevent vibration and shock, give long lamp life. Lighted push-buttons use one lamp to illuminate 1, 2 or 4 buttons. Unlighted pushbutton switches also.

For full details, write for Bulletin SP-165.

OAK MANUFACTURING CO.

A DIVISION OF OAK ELECTRO/NETICS CORP.
CRYSTAL LAKE, ILLINOIS 60014 • Telephone: 815-459-5000
TWX: 815-459-5628 • Cable Address OAKMANCO

ON READER-SERVICE CARD CIRCLE 203

SWITCH TO G-E SILICONE RUBBER INSULATION ELIMINATES COSTLY BAKE CYCLE

Many relay and contactor operating coils for locomotive and rapid transit car control systems are varnish impregnated, then baked to cure the varnish. Some of these coils have lead wires connected internally and extending through the coil surface insulation.

A typical production cycle includes two varnish dips and two bake cycles at 150°C for 12 to 14 hours — tough treatment for any insulation.

One coil manufacturer had these problems when using lead wire with conventional insulation:

1. Lead wire insulation hardened during bake cycle.
2. Lead wire insulation cracked at extension point.
3. Considerable difficulty in cleaning varnish off lead wires after impregnation.

In 1960, this manufacturer switched to G-E silicone rubber insulation. And in the six years since, the problems have not recurred.

Lower costs, fewer rejects

The switch to silicone was primarily made to improve product quality for customers. But because the baked varnish did not adhere tightly to the silicone rubber, it was easily removed. So the manufacturer also got two cost-saving bonuses: fewer rejects and lowered labor costs.

FREE NEW DATA BOOK



For more ways on how G-E silicone rubber insulation can save money, get Technical Data Book CDS-592, a comprehensive 36-page guide to high performance wire and cable.

Write to Section L8207, Silicone Products Dept., General Electric Co., Waterford, New York 12188.

GENERAL ELECTRIC

ON READER-SERVICE CARD CIRCLE 204

MICROWAVES

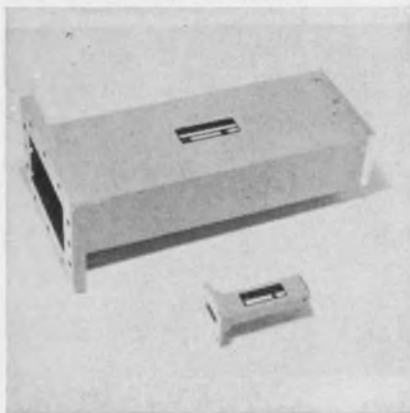

Waveguide terminations

Designed to cover 1.12 to 40 GHz, these fixed terminations exhibit a typical vswr of 1.02. They consist of a waveguide section terminated in a tapered dissipative material which absorbs applied power in the waveguide. Terminations from L-through S-band are constructed in aluminum waveguide. E-through U-band terminations are fabricated from copper alloy or silver waveguide.

P&A: \$35 to \$250; stock to 8 wks. Maury Microwave Corp., 10373 Mills Ave., Montclair, Calif. Phone: (714) 626-0041.

Booth 2035 (SA) Circle No. 517



Micromin coax switch

Microminiature (29/32 x 13/32-in.) coaxial switches cover dc to 2.5 GHz (usable to 4 GHz). Pressurized and hermetically sealed, the switches are reported to be the smallest high frequency coaxial switches on the market. Vswr is 1.3 and crosstalk is -80 dB. The switch withstands 100-G shock for 11 ms.

Automatic Metal Products Corp., 315-323 Berry St., Brooklyn, N. Y. Phone: (212) 388-6057.

Booth 1016 (SA) Circle No. 358

NCC

to be Sure

Here is a high quality capacitor "NCC" for space saving equipment and it costs no more than the one you are using!

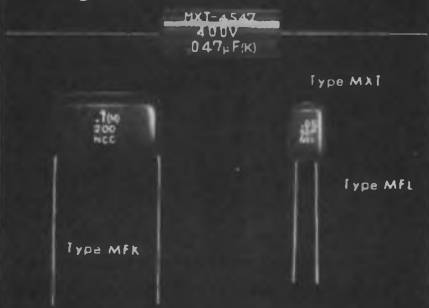

POLYESTER FILM CAPACITORS.

Type MXT In Plastic Tube
Capacitance Range: .001 MFD to .22 MFD
Voltages: 100v, 200v, 400v, 600v DC.

Type MFK Dipped Flat Shape NON-Inductive Construction
Capacitance Range: .01 MFD to .22 MFD
Voltages: 100v, 200v, 400v, 600v DC.

Type MFL Dipped Flat Shape
Capacitance Range: .001 MFD to .47 MFD
Voltages: 35v, 50v, 100v, 200v DC.

METALLIZED POLYESTER FILM CAPACITORS.

Type FNX-H Mylar Wrapped Semioval with Epoxy End Seal
Capacitance Range: 1 MFD to 10 MFD
Voltages: 50v DC.

Type TAX

Type TSL

SOLID TANTALUM CAPACITORS.

Type TAX Capacitance MIL-C-26655A Hermetically Sealed. Range: 1 MFD to 220 MFD.

Type TSL. Voltages: 3v, 6v, 10v, 15v, 20v, 25v, 35v DC.
Sealed with Epoxy Resin.

for full details, contact:

**MATSUO
ELECTRIC CO., LTD.**

3-chome, Sennari-cho, Toyonaka-shi, Osaka, Japan
Cable Address "NCC MATSUO" OSAKA

ON READER-SERVICE CARD CIRCLE 205

NO BRUSH FAILURES IN THESE SYNCHROS

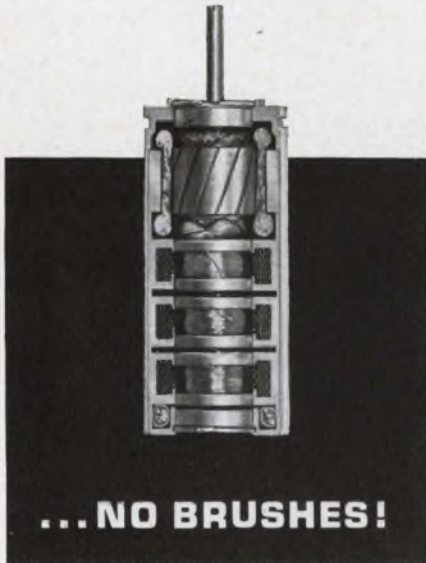

Rotary transformers couple power into rotors without contact, eliminating the number-one cause of early synchro failure. Without brushes, synchro life depends on bearing life alone—normally at least 5 or 6 times average brush life.

Harowe brushless synchros are available for all functions: control and torque transmitters, control transformers, differentials, resolvers. Sizes 5, 8, 10, and 11 are standard; larger sizes available. Use them to boost life expectancy of new systems; upgrade existing systems. Write for complete specs—



HAROWE SERVO CONTROLS, INC.
24 Westtown Road
West Chester, Pa. 19380
(215) 692-2700

SERVO, SYNCHRONOUS AND STEPPER MOTORS
MOTOR GENERATORS • SYNCHROS • RESOLVERS
PANCAKE SYNCHROS • GEARHEADS

ON READER-SERVICE CARD CIRCLE 206
ELECTRONIC DESIGN, August 16, 1966

TWT X-band amplifier

This amplifying device is a pulse-position modulated TWT covering 7 to 9 GHz with a minimum small-signal gain of 60 dB. Minimum saturation power output is 2 W, continuously variable over a 10-dB range. The unit features an automatic 2-minute time delay to allow for tube warm-up and an automatic shutoff to 0 gain for standby. Power consumption is 75 W.

P&A: \$4200; 60 days. Huggins Labs. Inc., 999 E. Arques Ave., Sunnyvale, Calif. Phone: (408) 739-9330.

Booth 1725 (SA) Circle No. 552

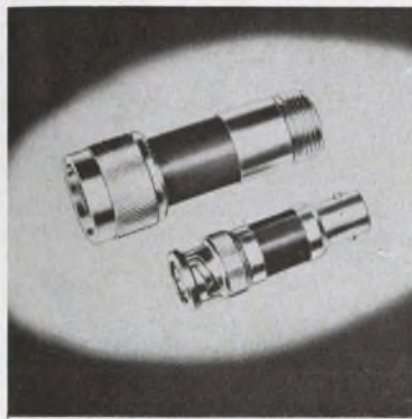

Coaxial attenuator

With ranges of 1, 2, 3, 6, 10, 12, 14 and 30 dB, this coax attenuator is available in series N, BNC and TNC connector interfaces. The bodies are silver-plated brass with impedance matching sleeves. Impedance is 50 or 75 Ω and frequency range is dc to 4 GHz. Resistance tolerance is $\pm 1\%$ or 0.1 dB. Vswr is 1.05 max at 1 GHz and 1.20 max at 4 GHz. Maximum power is 1 W continuous.

Greenpar Engineering Ltd., Station Works, Harlow, Essex, England.

Circle No. 582

Parametric amplifier

A low-noise nondegenerate parametric amplifier, the VCA/C12 operates in the 4- to 5-GHz range. The balanced idler circuit operates in push-pull at 13 GHz. The combined noise figure for the amplifier and ferrite circulator is 2.3 dB max. For a 20-dB gain the 3-dB bandwidth is 40 MHz max.

Ferranti Ltd., Gem Mill, Chadderton, Oldham, England.

Circle No. 583



...35 YEARS LEADERSHIP
IN ROTARY SWITCHES

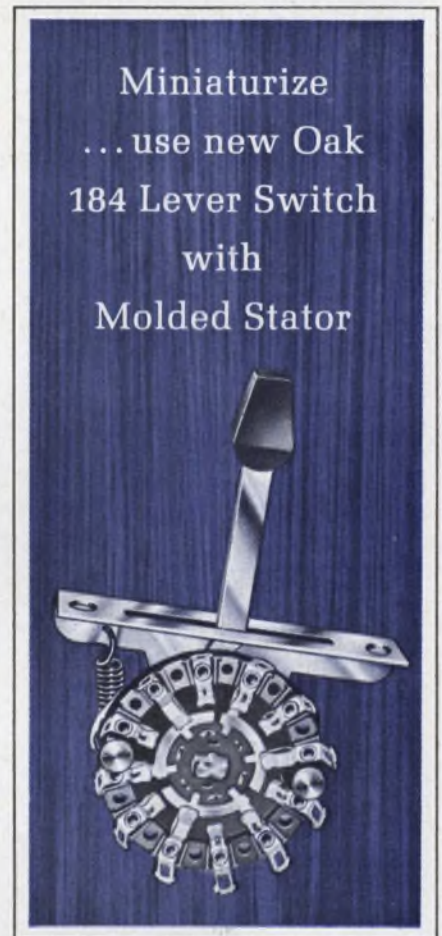

This new switch gives versatility in a small area. Available with one or several sections, optional spring return. Lever switch design and construction provide for long life. Also offers advantages of molded "A" stator... more clips per stator, recessed clips provide secure mounting and minimize electrical leakage. Diallyl Phthalate Stator provides improved or equal dielectric characteristics at no extra cost. Made with Oak-pioneered double-wiping action contacts.

Only Oak® offers you this compact lever switch with molded "A" stator. Breaks 1.0 amp @ 28 vdc, 0.5 amp @ 110 vac. Carries 5 amps. For full details, write for Bulletin SP-199.

OAK MANUFACTURING CO.

A DIVISION OF OAK ELECTRO/NETICS CORP.
CITY LAKE, ILLINOIS 60014 • Telephone: 815-459-5000
TWX: 815-459-5628 • Cable Address OAKMANCO

ON READER-SERVICE CARD CIRCLE 207

MICROWAVES

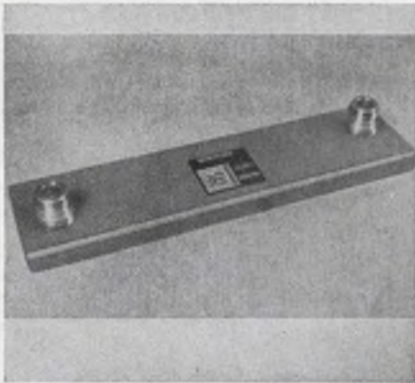

Stripline bandpass filter

Typical for these 5-section stripline bandpass filters is a 1.5 to 5-GHz center frequency with 3 to 20% bandwidth. Insertion loss is 0.6 dB passband and 60 dB stopband. Max passband ripple is 0.2 dB and max passband vswr is 1.5. Impedance is 50 Ω, average power is 100 W and peak power is 100 kW.

Elpac Inc., 3760 Campus Dr., Newport Beach, Calif. Phone: (714) 546-8640.

Circle No. 584

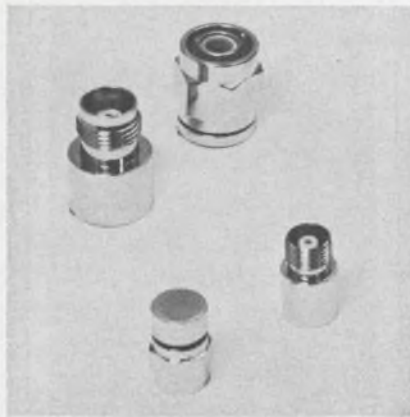

Terminations and shorts

With a nominal impedance of 50 Ω, terminations and shorts are available in a variety of configurations. Frequency range is dc to 12.4 GHz. Vswr is 1.1 and average power rating is 1/2 W. The units have steel bodies and coupling nuts, Teflon insulators and beryllium-copper contacts.

General RF Fittings, Inc., 702 Beacon St., Boston. Phone: (617) 267-5120.

Circle No. 585



2-kW fixed attenuator

With flat attenuation over a dc to 12.4 GHz range, this fixed attenuator has a handling capacity of 5 W average and 2 kW peak. Model 20 is calibrated at dc, 4, 8, and 12 GHz. Vswr is 1.2 max from dc to 4 GHz and 1.35 max from 4 to 12.4 GHz. Power sensitivity is 0.0003 dB/dB/W.

Price: \$60. Weinschel Engineering, Gaithersburg, Md. Phone: (301) 948-3434.

Circle No. 586

**-55°C to +120°C
±.03°C control stability**

Tenney's new mechanically refrigerated, multi-range bath is ideal for instrument calibration, biochemical work, checking critical components and ASTM tests. Additionally, the fluid may be circulated to cooling condensers, refractometers, spectrophotometers and special systems.

For complete information, write to:

Tenney
ENGINEERING, INC.

1090 SPRINGFIELD ROAD, UNION, N.J.
Western Div.: 15700 S Garfield Ave.
Paramount, Calif. 90723

New Tenney MR-1
Multi-Range Precision
Temperature Bath

334

ON READER-SERVICE CARD CIRCLE 208

**SPELLMAN HIGH VOLTAGE
RF POWER SUPPLIES**

**TRANSISTORIZED HIGH VOLTAGE STEP-UP
COIL—OUTPUT 10 KV DC @ 1 ma.**

- Coil driven by single self-oscillating transistor
- Input voltage 24 V DC approx. 1 amp.
- Coil height—4 1/4"
- Diameter—3"
- Approx. operating frequency—120 KC

MODEL TRF-10
Complete with operational circuit diagram and data
\$15.00 net

**DC to DC COMPLETELY SOLID STATE
10 KV HIGH VOLTAGE POWER SUPPLY**

- Input—24 V DC approx. 1 amp.
- Output—10 KV DC @ 1 ma.
- Ripple less than 0.05%
- HV output may be varied from 1 KV to 10 KV by controlling the DC input voltage. For example: for a 5 KV output @ 1 ma., an input voltage of 14V is required.
- High frequency unit—frequency approx. 130 KC
- Completely shielded in an enclosed housing
- Dimensions—6" W x 6" H x 5" D

MODEL TR-110 \$65.00 net SHOWN LESS HOUSING

**5-35 KV TRANSISTORIZED COMPLETELY SOLID STATE
DC POWER SUPPLY**

Continuously variable 5-35 KV regulated power supply with regulated focus voltage tap 4-9 KV.
A continuous duty DC supply with highly filtered outputs and regulated against line and load better than 0.05% at 1 ma. Ripple less than 0.05%. Input: 117V 60 cycles. Dimensions: 19" W x 8 3/4" H x 15" D.

MODEL TR-135 Complete with HV and Current Meters \$575 Net

SPELLMAN HIGH VOLTAGE CO., INC.
1930 Adeo Ave., Bronx, N.Y. 10469 (212) KI 7-0306

ON READER-SERVICE CARD CIRCLE 209

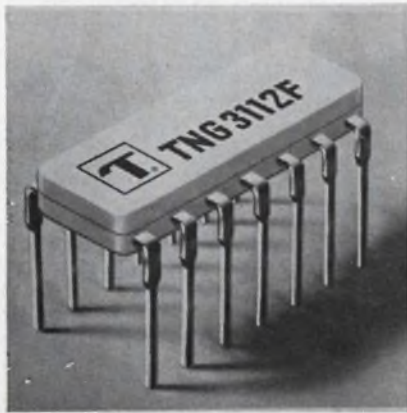

HLTTL J-K flip-flops

Charge storage flip-flops include 30- and 40-MHz versions of "ENABLE OR", "OR" and "AND" input units. All are suited for arithmetic shift register applications. They are available in 14-lead flat-pack or dual-in-line packages. Fan out is 15, noise immunity is 1 V and capacitance drive capability extends to 300 pF. Clock pulse width requirement is 12 ns.

Transitron Electronic Corp., 168 Albion St., Wakefield, Mass. Phone: (617) 245-4500.
Booth 1741 (SA) Circle No. 521

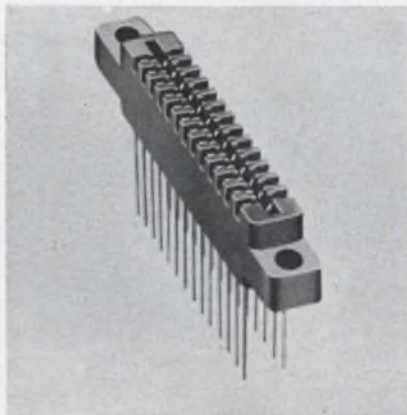

Miniature PC connector

This 0.025-in. square tail miniature PC board connector features cantilevered contacts on 0.125-in. centers. It can be wired at a rate up to 750 wires per hour on an automatic wire wrap machine. A comb contact assembly provides the gap uniformity of preloaded cantilevered construction. Contact pressure is independent of board insertion depth.

Cinch Mfg. Co., 1026 S. Homan Ave., Chicago. Phone: (312) 632-2000.
Booth 1312 (SA) Circle No. 366



M 306

Bendix magnetic electron multipliers offer you the largest current gains with the smallest packages.



M 308



M 310

Midget dimensions and current gains of 10^7 make Bendix® electron multipliers tops in the industry. These versatile detectives can handle jobs to the extreme end of the electromagnetic spectrum: photon and particle counting; ultraviolet and soft x-ray detection; high altitude solar radiation; nuclear radiation and ion detection.

Bendix multipliers are even sensitive to the hard ultraviolet range. And exposure to ambient atmosphere does not deteriorate their performance.

What about a power supply? Bendix multipliers and our model PS-304 power supply were just made for each other. It assures constant voltage differentials while levels are varied.

More information? Get in touch with us at 3625 Hauck Road, Cincinnati, Ohio 45241.

Specifications	Model M 306	Model M 308	Model M 310
Direction of view	side	end	side
Aperture (in mm)	18.3 x 15.5	10.4 x 5.3	12.5 x 12.5
Spectral response	10^7	10^7	10^7
Operating press. max. torr	5×10^{-4}	1×10^{-4}	1×10^{-4}
Length, max. inches	4	2½	2½
Height, max. inches	.81	.93	.80
Width, max. inches	1.32	1.29	.69
Weight, nom. oz.	4½	2	2½

Bendix Cincinnati builds mass spectrometers, polarimeters, polarographic systems, viscometers and other scientific instruments for over 100 areas of research and analysis.

Cincinnati Division



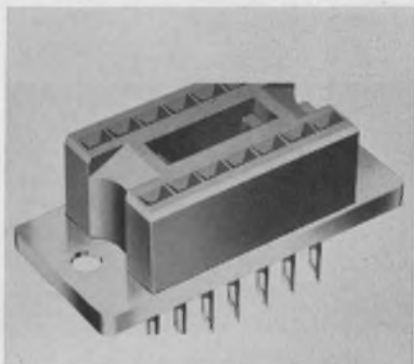

Dual in-line sockets

For testing and packaging plug-in ICs, this 14-contact dual-in-line socket accepts flat or round leads (100-mil lead spacing and 300-mil row spacing). Body is molded diallyl phthalate with gold-plated beryllium copper contacts. Sockets are available with a steel saddle for panel mounting or without saddle for PC applications.

P&A: \$0.35 to \$0.84 ea.; 4 to 5 wks. Augat Inc., 33 Perry Ave., Attleboro, Mass. Phone: (617) 222-2202.

Booth 1643 (SA) Circle No. 319

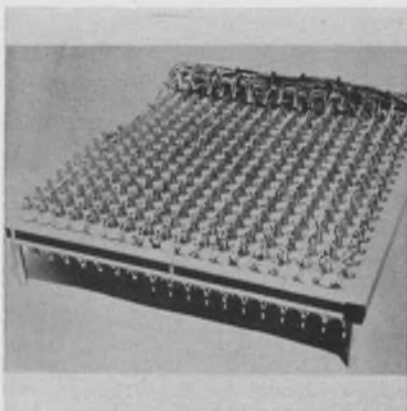

Latching relay matrix

This signal switching selector provides permanent memory for input-output programming in communications, telemetry and data processing. When shielded, the matrix switches audio and MHz communication signals. Switching requires less than 10 mW-seconds. Permanent magnetic latching eliminates holding current. Crosstalk is -75 dB at 10 MHz.

McKee Automation Corp., 7315 Greenbush Ave., North Hollywood, Calif. Phone: (213) 983-1193.

Booth 2011 (SA) Circle No. 339



Flat-pack carriers

Accommodating short and preformed leads, these carriers facilitate marking and automatic handling of flat packs. The units have an identification of the #1 lead position and a snap-on clip that holds the flat pack. The contacts exert a 50-gram force per lead, keeping contact resistance less than 0.01 Ω. Life is 50,000 insertions. The carrier-contractor can be used over a range of -65 to 150°C.

Barnes Development Co., Lansdowne, Pa. Phone: (215) 622-1525.

Circle No. 587

Self-coiling NEG'ATOR® metal readout scales simplify instrument design

The NEG'ATOR, a flat strip of prestressed spring steel, tends to coil at each end and resists uncoiling uniformly over the entire length of the strip.

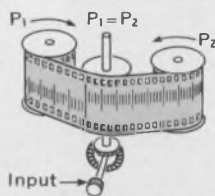

When used as a printed metal readout scale, both ends are curled on bushings of equal size. Since the opposing forces (coils) are always in balance, the span between is held taut.

With its own built-in recoiling energy, the NEG'ATOR replaces large dial scales, long strips or drum scales, expanding readability while saving space!

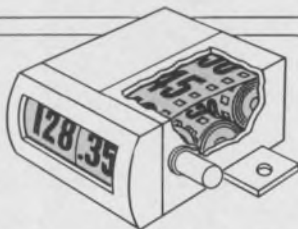

Ask for Bulletin 310T containing full details.

HUNTER SPRING

AMETEK®

A DIVISION OF AMETEK, INC.

27 SPRING AVENUE, HATFIELD, PENNSYLVANIA 19440

ON READER-SERVICE CARD CIRCLE 121

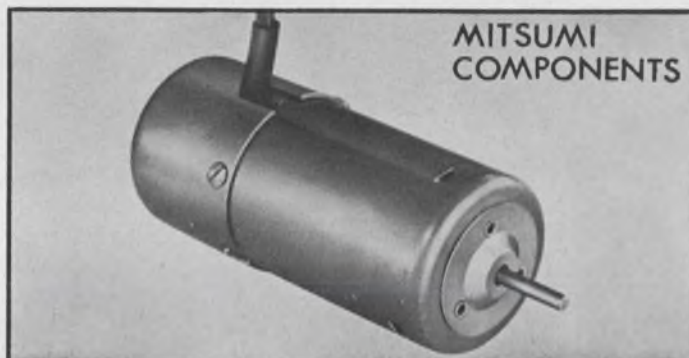

MITSUMI COMPONENTS

NEW MICRO-MOTOR

The most excellent characteristics of Mitsumi micro-motor is in its extremely high efficiency. Formerly it has been considered impossible to attain an efficiency of more than 50% for micro-motors with a diameter of 20mm or less. We have, however, succeeded in breaking through this common concept through the adoption of a new system in the magnetic circuit. We serves many types of micro-motors to our customers with automated and quality-controlled mass production.

Main Products

Polyvaricon · IFT · Oscillator coil · Antenna coil · Composite coil · Special coil · Micro motor · Synchronous motor · Variable resistor · Trimming potentiometer · FM tuner TV tuner · Various sockets · CdS photoconductive cell.



MITSUMI ELECTRIC CO., LTD.

New York office: 11 Broadway, New York, N.Y. 10004, U.S.A. Phone: HA-5-3085, 3086
Main office: 1056, Koadachi, Komae-machi, Kitatama-gun, Tokyo, Japan. Phone: Tokyo 415-6211/23

ON READER-SERVICE CARD CIRCLE 122

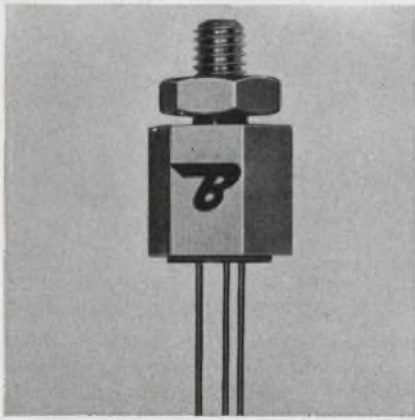

5- and 10-A transistors

Seventy-five 5- and 10-A silicon npn power transistors are designed for hf power amplifier and high power switching applications. Package configurations are TO-5, MT-27, TO-59, TO-60, TO-61 with isolated collector and TO-61 with collector connected to case. V_{CE0} is 40 to 80 V and RF power output is 25 W at 50 MHz. Dc current gain is 120 to 240 at 3 A and 10 V and gain-bandwidth product is 275 MHz. At 3 A, switching time is 40 ns (on) or 300 ns (off).

P&A: \$2.86 to \$20.75 (100-999); stock. Bendix Semiconductor Div., Holmdel, N. J. Phone: (201) 747-5400.

Booth 1651 (SA) Circle No. 546



Overlay transistor

Mounted in a TO-18 grounded emitter case, the V408 overlay transistor delivers in excess of 20 W at 400 MHz into a 50- Ω load. Minimum gain is 6 dB. Collector efficiency is 50%.

P&A: \$150; 12 wks. United Aircraft Corp., Vector Div., Southampton, Penn. Phone: (215) 355-2700.

Booth 1130 (SA) Circle No. 380

ULTRADEX[®]

AUTOMATIC INDEXING TABLES ACCURATE WITHIN 1/4 SECOND OF ARC

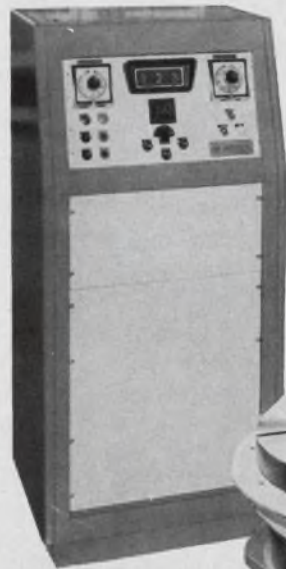

Designed for programming directly into any machine for completely automatic production where extreme accuracy in radial indexing is required.

ULTRADEX 12" and 24" diameter tables are available in models to index to any full, half, or quarter degree. Horizontal or vertical tables available. All-electric lifting mechanism, or electro-pneumatic for heavier loads.

24" ULTRADEX with visual read-out remote control console for automatic indexing.

AA INDUSTRIES, INC.

350 FAIR STREET

DETROIT, MICHIGAN 48220

ON READER-SERVICE CARD CIRCLE 123



Look to the Leader

PERMACOR[®]

For Every Electronic Powdered IRON CORE Need!...

As the world's largest producer of iron cores, Permacor has the capability and facilities to supply any requirement or meet any specification you may have.

Write for Complete Information

PERMACOR[®]

A Division of Radio Cores, Inc.

9540 Tully Ave., Oak Lawn, Ill.
Phone: 312-Garden 2-3353

ON READER-SERVICE CARD CIRCLE 124

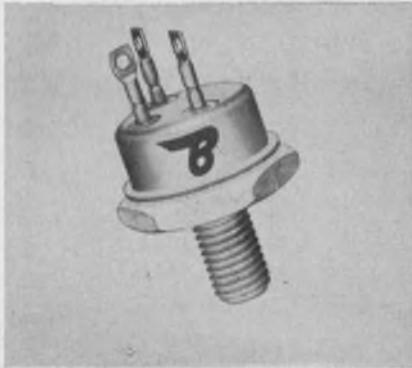

Radiation-resistant npn transistor rated at 35-W

Silicon 5- and 10-A npns have base transit times of 0.5 ns at 1-A collector current. The devices are designed for radiation environments having exposure levels as great as 5×10^{14} NVT (total integrated neutron flux with energy levels greater than 10 KeV). Typical gain-bandwidth product is ± 500 MHz at 28 V and 0.5 A. V_{CE0} is 40 to 75 V.

Price: \$40 to \$200 (1 to 99). Bendix Corp., Holmdel, N. J. Phone: (201) 747-5400.

Booth 1649 (SA) Circle No. 369

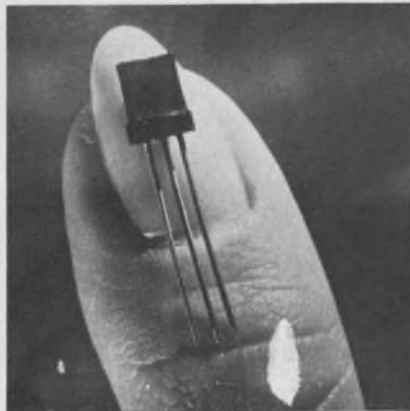

Voltage reference diode

For voltage reference and regulator applications at up to 15 mA, this two-diode, common-anode device exhibits a reference voltage temperature coefficient of less than 0.25% /°C. Reference voltage is from 5.6 to 6.8 V at 5 mA bias. Capacitance is typically 19 pF at zero volt bias and frequency of 1 MHz. A third lead is available located at a common point between the diodes.

P&A: \$0.40 (production quantities); 30 days. General Electric, Schenectady, N. Y. Phone: (518) 374-2211.

Booth 1322 (SA) Circle No. 296

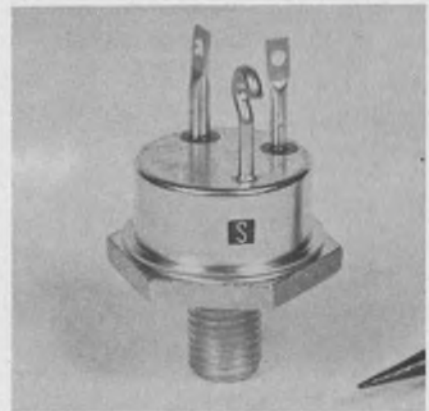

Npn power transistors

Capable of collector-to-emitter sustaining voltages up to 300 V with 10-A gains of 15 to 45, these silicon planar power transistors have a flat gain curve from 10 mA to 2 A. Saturation voltage collector-to-emitter is 0.6 V at 10 A with f_t of 40 MHz. Switching times are in the ms range. The devices are capable of dissipating 100 W at 100° C case temperature.

Solitron Devices, Inc., 1177 Blue Heron Blvd., Riviera Beach; Fla. Phone: (305) 848-4311.

Circle No. 610

Today... the switch is to TECH LABS

Thumbwheel Switches

Tap Switches

Heavy Duty Control Switches

Special Switches

Stepping Switches

Attenuators

FREE

Send for catalog

Telephone: 201-944-2221 • TWX: 201-947-4730

TECH LABORATORIES, INC., Palisades Park, N. J.

ON READER-SERVICE CARD CIRCLE 125

PERFORATED SCREENS FOR CENTRIFUGES

Stainless steel etched screens for extracting juices and crystals are resistant to acids, easy to clean, long lived — may be used wherever centrifuge requires small regular holes. Openings may be as small as .005 inches, on centers to your specification. *** Also available, back up plates for filter particle determination. Send us your problem in etched or formed metal — we produce to tolerances of $\pm .000039$ inches.

BUCKBEE MEARS CO.

245 E. 6th ST., SAINT PAUL, MINN.

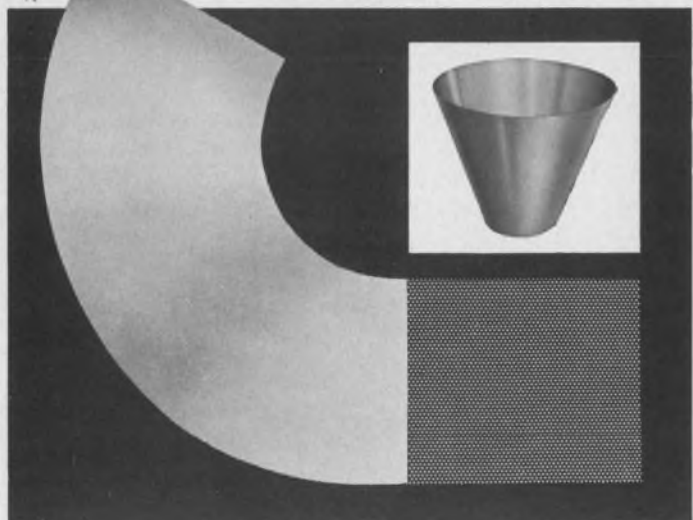

ON READER-SERVICE CARD CIRCLE 126

ELECTRONIC DESIGN, August 16, 1966

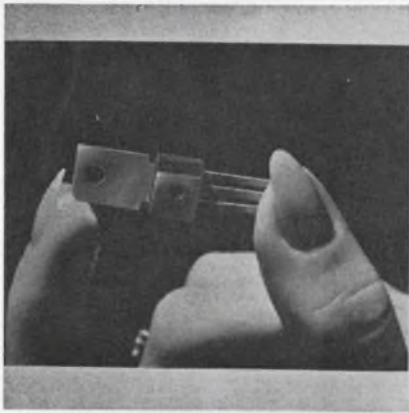

High-voltage power transistor for 40 cents

High-voltage plastic-encapsulated silicon power transistors are priced at 40 cents in large volume. Designated 2N4054 through 2N4057, the passivated npn silicon transistors will deliver 1 W when used as a Class A audio output. Rated dissipation is 4 W at 70°C case. Junction-to-case thermal resistance is less than 20°C/W. Four different voltage groups, from 150 to 300 V, are available. Operating junction temperature ranges from -55 to -150°C. Beta is between 30 and 90 at 50 mA and 10 V. Minimum f_t is 15 MHz. Standard lead configuration is in-line and a formed configuration similar to a TO-5 is optional. Industrial applications include high-voltage differential and op-amps, Nixie drivers and high-voltage power supplies.

P&A: \$0.40 to \$0.59; stock to 60 days. General Electric, Semiconductor Products Dept., Electronics Park, Syracuse, N. Y. Phone: (518) 374-2211.

Booth 1322 (SA) Circle No. 303

2-W silicon zeners

Silicon molded zener diodes are low-cost replacements for 0.25-W and 400-mW glass units and 1-W metal zener diodes. The molded, non-conductive, epoxy body withstands environmental requirements of MIL-S-19500. The zener has a full 2-W rating. The zeners are 0.195-in. long x 0.114-in. in diameter.

Components Inc., Smith St., Biddeford, Maine. Phone: (207) 284-5956.

Booth 1107 (SA) Circle No. 529

SPIN YOUR DISHES WITH MECATORN[®]

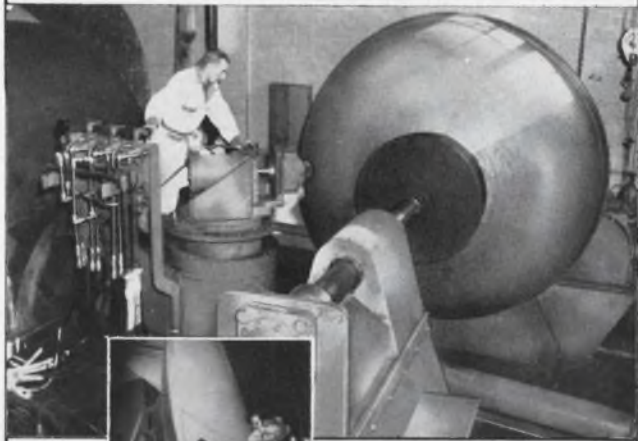

Torngren "dishes" span the nation, contributing to the efficient operation of many communication networks both military and commercial.

Our Mecatorn process can mean substantial savings in your program cost while actually increasing the overall efficiency of your system. Reflectors can be Mecatorn spun from 4" to 16 feet diameter.

Metallurgical advantages such as refined grain structure with flow line pattern matched to part configuration, elimination of porosity and occlusions in the metal, automatic self-inspection of work in progress, are all primary benefits attained through the Mecatorn spinning process.

Before you spec, check with Torngren — for parabolic reflectors of superior quality at considerable dollar savings.

Send for a free copy of our new capabilities brochure and current price list #466.



C.W.

TORNGREN

236 PEARL STREET

SOMERVILLE, MASSACHUSETTS

AREA 617/ MO 6-3250

ON READER-SERVICE CARD CIRCLE 127

New Literature

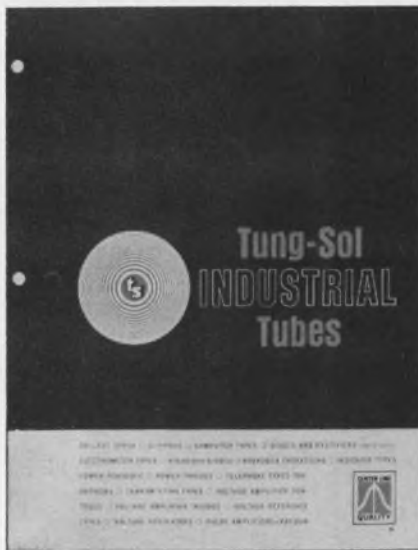

Tube reference manual

A quick-reference guide to special-purpose industrial and military tubes is offered. Listing 165 types, the manual contains a brief description of high-performance tubes in 21 categories. Tung-Sol Electric Inc.

Circle No. 588

Strobe handbook

The "Handbook of Stroboscopy" describes modern electronic stroboscopes and their accessories and discusses their use in speed measurement, motion observation, and high-speed photography. An applications section describes uses in industry and education. The 116-page manual assumes no prior experience of the reader with stroboscopy.

Available for \$1 from General Radio Co., West Concord, Mass.

Single- and multi-turn pots

A line of single- and multi-turn pots for linear and nonlinear functions is described in this 4-page brochure. Data are grouped in tabular form by type with characteristics, dimensions and performance specs. Modified and special designs are described. Trans-America Dynamics Corp.

Circle No. 589

Avalanche silicon rectifiers

This 48-page book contains information on semiconductor theory, rectifier manufacturing methods and characteristics and test circuits. In addition, there are chapters on rectifier and filter circuit design and application techniques. Detailed electrical and physical specs are given on 18 different series of avalanche silicon rectifiers. Also included is data on tube replacement silicon rectifiers and high voltage silicon rectifiers. Sarkes Tarzian Inc.

Circle No. 590

Diode reliability

Achievements in production of high-reliability silicon annular transistors and zener diodes are detailed in this pair of reliability reports. The reports cover data summarizing a year of testing. Power ratings of the devices included in the zener report include 400 mW, 1, 10 and 50 W. Stability curves and histograms show initial and final parameter distributions and typical shifts in distributions. Summarized test results for each power rating are charted separately and environmental test results are reflected in one chart showing all four power ratings. Motorola Semiconductor Products Inc.

Circle No. 591

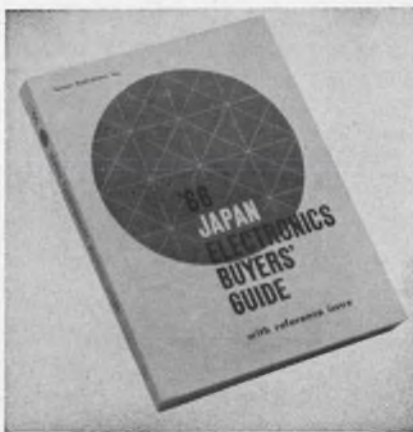

Japan electronics guide

Containing over 400 pages, this guide is a complete listing of all Japanese electronic companies. Each firm's address, products, and key personnel are tabulated. An alphabetized listing of all electronic products and individual manufacturers for these items is presented.

Available for \$10 from Starne-tics, 10639 Riverside Dr., N. Hollywood, Calif.



Electrolytic capacitors

A 112-page "Twist-Prong Electrolytic Reference" catalog presents replacements for original equipment capacitors. The electrolytic line defined in this replacement catalog and cross-reference covers 230 can numbers. Cornell-Dubilier Electronics.

Circle No. 592

Flux cored solder

Solder alloys, flux core percentages, and wire sizes are described and illustrated in this catalog to facilitate selection and specification. A liquid flux line is shown with chemilurgical data on water-white rosin, activated rosin, organic and acid fluxes. Gardiner Solder Co.

Circle No. 593

Component catalog

A 60-page full-line catalog contains data sheets on trimmers, miniature pots, switches and turn-counting dials. The catalog also incorporates a wirewound precision potentiometer handbook. Spectrol Electronics Corp.

Circle No. 594

Logic modules

A line of off-the-shelf micrologic modules is described in this 36-page catalog. The book includes specifications on micrologic chips, design aids, hardware and accessories and power supplies. A section discusses the choice between DTL and TTL logic schemes, pointing out advantages and disadvantages. The opening pages provide a reference source of general specs for logic circuits. Included are descriptions and diagrams covering maximum ratings, the standard load concept, logic levels, noise immunity, measurement and waveform definition, waveform characteristics and the wired-OR configuration. Data Technology Corp.

Circle No. 595



New EI-85 Digital Multimeter* In one encoding makes $\pm .005\%$ measurements In 10 ms ! and it stays there ■

Accurate, full 5 digit measurements are now possible in 10 msec with the EI-85's successive approximation logic.

Why the "one encoding"? Because unlike other high speed instruments which are allowed to encode before their input circuitry settles to full accuracy, the EI-85 contains a sensing circuit which acknowledges settling of its high impedance input section to $\pm .001\%$ of final value before allowing its logic circuitry to encode. All *within* 10 msec! Repeat encodings are not necessary to obtain that "last digit of accuracy" with this high speed DVM. This assures you consistent repetitive readings.

Noise Rejection—Not forgetting the effect of noise, the EI-85's guarded differential input and active Bessel filter provides 160 db of CMR and 60 db NMR at 60 Hz while maintaining a *constant* high input impedance of greater than 10,000 megohms to 10

volts F.S. This means, of course, no loss of accuracy due to noise or source loading during encoding!

Whether your need is for accurate high speed measurements of dynamic fast changing signals, high speed system operation (100 readings/second) or a versatile accurate multimeter for general purpose use, the EI-85 fills the bill!



* DC, Ratio, AC, Resistance, Pre-Amplifier

Other Features—Complete multimeter capability utilizing plug-in card accessories • DC and Ratio comprise the basic instrument • 10 μ volts basic resolution without preamplifier (1 volt F.S.) • Differential guarded input on *all* modes of operation • Autorange and polarity in *all* modes • Storage in read-out prevents "blinking" • Storage in

electrical outputs allows time sharing operation • Isolated BCD and 10-line decimal outputs and remote control are standard • AC converter—5 digit, 10 μ volt resolution, 10 Hz to 100 KHz • Resistance converter—.01 ohms to 10 megohms • Preamplifier—for 1 microvolt resolution • Priced from \$5000.00.

Complete EI-85 High Speed System—EI system modules for signal conditioning, scanning, comparison, timing, automatic programming, and peripheral outputs such as computer compatible paper or magnetic tape can be easily added to your EI-85. Contact your Honeywell Sales Office or write: Honeywell, Test Instruments Division, San Diego Operation, 8611 Balboa Ave., San Diego, California 92112.



DATA HANDLING SYSTEMS

Honeywell

DIGITAL VOLTMETERS

HONEYWELL IS WORLDWIDE • Sales and service offices in all principal cities of the world. Manufacturing in Brazil, Canada, France, Germany, Japan, Mexico, Netherlands, United Kingdom, United States.

ON READER-SERVICE CARD CIRCLE 128

BURR-BROWN operational amplifiers

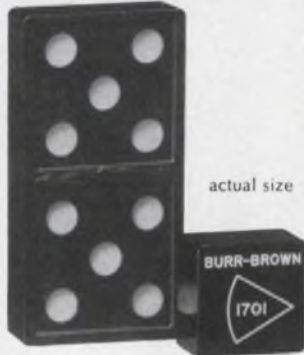

less than
2/10 cubic inch
in size

This new family of Burr-Brown general purpose operational amplifiers is just the ticket for thousands of applications where space is at a premium. Each one is a complete solid-state amplifier, requiring only external power to operate. Features include: built-in frequency compensation, input-output protection and output booster stage for ± 10 V at 10 mA.

Model 1701 — Integrated Circuit Operational Amplifier, state-of-the-art performance

Model 1706 — Discrete Component Operational Amplifier, low current offset and drift

Model 1572 — FET Input Operational Amplifier, high input impedance

Model 1719 — 50 mA Power Booster for use with above models



These amplifiers may be used in any of the typical circuits shown in Burr-Brown's Handbook on Operational Amplifier Applications and the Handbook of Active RC Networks.

For complete information visit
Wescon Booth #1102-3 or write for
special Wescon new product packet

BURR-BROWN

RESEARCH CORPORATION
INTERNATIONAL AIRPORT INDUSTRIAL PARK
BOX 11400, TUCSON, ARIZONA 85706
PHONE: 602-294-1431 • TWX: 910-952-1111

NEW LITERATURE

Alloy properties

Data on physical constants and thermal properties of heat- and corrosion-resistant nickel-iron-chromium alloy are given in this 20-page brochure. Included are mechanical properties, information on metallography, corrosion resistance and working instructions. International Nickel Co.

Circle No. 596



Radio electronics

Stereo hi-fi, citizens band 2-way radio, tape recorders, ham gear, test equipment, radios, TVs and accessories are covered in the 1967 radio electronics catalog. The 512-page book covers all major manufacturers. Lafayette Radio Electronics Corp.

Circle No. 597

Thin-film networks

Thin-film passive networks are fully described in this 4-page color brochure. The bulletin considers how, why and when to design with these passive networks along with economic factors. Electra Mfg. Co.

Circle No. 598

Computer applications

Application notes describe how a digital computer solves 10 typical engineering problems. They include RLC circuit impedance and phase angle, least squares curve fit, RC filter response, Chebyshev filter response, numerical solution of a first-order differential equation, RC filter step response, Butterworth filter attenuation curve, Gaussian error curve and RL circuit analysis. Each note contains a definition of the problem, a flow chart and a problem solution sheet. Pacific Data Systems.

Circle No. 599

Digital and linear ICs

Schematics, design features and complete model designations of more than 60 digital and linear ICs are given in this 8-page quick-reference guide. The digital line includes such as NAND gates, flip-flops, pulse binary counters, line drivers, level-detector/Schmitt triggers, diode arrays, monostable multivibrators, AND or NAND gates, interface circuits, level shifters and destructive readout bit drivers. The linear line includes operational and differential amplifiers and power circuits. Amplifiers and pre-amps for audio, video and servo applications are included. Westinghouse Molecular Electronics Div.

Circle No. 600

Planar power transistors

This 8-page brochure catalogs and describes the company's planar power transistors and planar SCRs and illustrates power packages. The selection guide contains complete tabular specs and also details planar power advantages. Fairchild Semiconductor.

Circle No. 601



Wire stripping

Special-purpose powered wire strippers and twistors to process solid and stranded wire are described in a 12-page brochure. The basic uses of the four types of wire strippers—swing blade, rotary collet, wheel type and shield strippers—are defined. Carpenter Mfg. Co.

Circle No. 602

Microwave tubes

To aid in choosing microwave tubes, this catalog lists klystrons, TWTs and BWOs by frequency and power level. Ratings range from 0.75 to 100 GHz and up to 21 MW. Frequency/power combinations are also given. Sperry, Electronic Tube Div.

Circle No. 603

SILVER PLATING



EASILY APPLIED

Cool-Amp can be applied on the job. The only equipment needed is a clean rag, a wire brush and some water. Cool-Amp contains no cyanide and can be used in underground vaults, substations and hard to get at places by several persons at the same time.

REDUCES RESISTANCE

Cool-Amp Powder deposits a genuine coat of silver that will not peel off. It prevents oxidation, minimizes overheating, thereby reducing maintenance. Provides cool maximum conductivity for all copper, brass or bronze current-carrying connections.

FREE SAMPLE—Write today for informative folder and free sample of Cool-Amp. One pound will silver plate approximately 6,000 square inches. \$14.75 per pound—Shipped F.O.B. Portland.

The COOL-AMP Co.

8629 S.W. 17th Avenue, Portland 19, Oregon

ON READER-SERVICE CARD CIRCLE 130

give...so more will live
HEART FUND

Designed for Advanced Data Systems...



The Series 400 TELCOM Receiver

Look at these features...

- All solid state design
- Superior performance
- Completely modular, plug-in construction
- RF heads for VHF and S-Band telemetry, sweep tuned and wide band heads for surveillance applications
- Plug-in pulse-detection recording converter, spectrum display, electrically switchable IF Filters

Interested? Get the detailed specifications. Write for your free copy of the DCS Series 400 TELCOM Receiver brochure.

Would you like an appointment to see a TELCOM Receiver for yourself? Just call the DCS office below nearest you...

Dept. EDB-6, East Liberty Street, Danbury, Conn. 06813
Telephone: 203-743-9241 • TWX 744-1990



DATA-CONTROL SYSTEMS INC.
Instrumentation for Research

Sales Offices
Silver Spring, Md., Huntsville, Winter Park, Long Beach, Santa Clara,
Albuquerque
Copenhagen London Rome Paris Munich Amsterdam

DCS 6-66

ON READER-SERVICE CARD CIRCLE 132

Glass capacitor guide

An 8-page brochure describes in detail a line of glass capacitors. The illustrated guide lists complete parameters in a 2-page spread and gives a table comparing performance of glass dielectric with ceramic mica, paper and paper plastic and tantalum dielectrics. Also included are applications, performance curves and a failure rate chart. Corning Glass Works.

Circle No. 604

Reprints Available

The following reprints are available free and in limited quantities. To obtain single copies, circle the number of the article you want on the Reader-Service Card.

Collector Tap Improves Logic Gating (No. 740)

Guidelines for Selecting Laser Materials (No. 741)

Tools for Design of Adaptive Control Systems (No. 742)

Can Logic Arrays Be Kept Flexible (No. 743)

Hall Effect Multiplier Simplifies Polar Display (No. 744)

Thin Film/Monolithic Circuits—How and When to Use Them (No. 745)

Subscription Policy

ELECTRONIC DESIGN is circulated free of charge to qualified design engineers in the U.S., Western European Continent and Britain. To establish your qualifications, send ELECTRONIC DESIGN the following information on your company's letterhead: Your name, engineering title, description of your design duties and a list of your company's major products. The letter must be signed by you personally.

Subscription rates for nonqualified subscribers—\$25 a year in the U.S., \$35 in all other countries. Single copy, \$1.50.

Change of Address

A subscriber's change of address requires a restatement of his qualifications. To expedite the change, and to avoid missing any issues, send along a label from a back copy.

Microfilm Copies

Microfilm copies of all 1961, 1962, 1963, 1964 and 1965 issues of ELECTRONIC DESIGN are available through University Microfilms, Inc., 313 N. First Street, Ann Arbor, Mich.

Design Data from

Miniature Film Resistors

CADDOCK ADVANCED STATE OF THE ART
MICROMINIATURE FILM RESISTORS

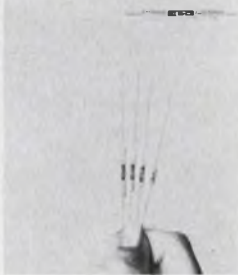

A new catalog describing miniature film resistors produced with proprietary Micronox* films is now available. Design data for three basic types is included:

1—Miniature Megohm resistors, one-fifth conventional size in 1 to 20 megohm range.

2—Miniature Precision Film resistors, 10 ohms to 5 megohms, 1/2 conventional size.

3—Miniature Power Film Resistors operating to +275°C.

*MICRONOX—Trade Mark.

CADDOCK ELECTRONICS

6151 Columbus Ave.
Riverside, California 91769

171

Circuit Selector Switch Catalog

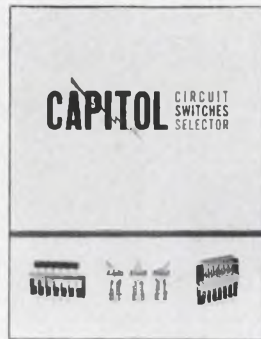

24 page catalog gives full specifications on complete line of high quality, precision switches: illuminated single and multiple position, interlocking push button, push-lock push-release, momentary, telephone lever, push-turn-lock, single hole mounting, accumulative locking and special switches. With contacts rated at 3 amp., 110 v. AC, switches described are manually operated units, featuring selective control of one or more groups of circuit combinations. Modifications to designers' needs also shown: i.e., banking, solenoid release.

The Capitol Machine & Switch Co., Inc.

87 Newtown Rd.
Danbury, Connecticut 06810

173

Your Micro-Electronics Tool Catalog



—BY RETURN MAIL!

The finest SWISS TWEEZERS for handling miniature and micro-miniature parts . . . all alloys in 42 patterns • PLIERS with miniature heads featuring the famous Lindstrom "Box Joint" Swedish pliers, perfect for precision work. • CUTTING NIPPERS . . . regular edges, semi-flush edges and full-flush edges. • CUTTING TWEEZERS for difficult and special wire cutting problems in confined areas. • SCISSORS for ribbon wire and light sheet metals made of Solingen Steel.

Write Today—Ask for Catalog No. 423.

Hammel, Riglander & Co., Inc.

P. O. Box 222
New York, N. Y. 10014

175

Manufacturers

Advertisements of booklets, brochures, catalogs and data sheets. To order use Reader-ServiceCard.

The Q Meter In Theory And Practice



This booklet is available from Marconi Instruments of 111 Cedar Lane, Englewood, New Jersey. It describes measurements possible using Q Meter and discusses in detail, the mathematical relationship underlying such measurements as self-capacitance of inductors, capacitance, $\tan \delta$ and resistance, measurement of R and C on resistors at RF and the calculation of transmission line constants

Marconi Instruments

111 Cedar Lane, Englewood, New Jersey

172

Terminal Board Engineers' Guide

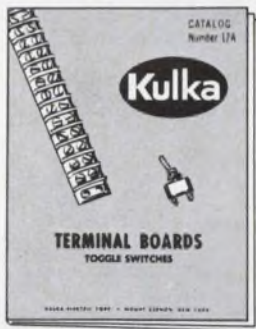

"Broadest Line of Terminal Boards in the Industry" —the new Kulka Catalog 17A is designed for the Specifying Engineer and Purchasing Agent. It contains 56 pages of exhaustive data on every type of terminal board in current use, including "Kliptite," High Heat, Closed Back, High Barrier, Stud and Turret, Pressure Contact, Wire-Wrap, Screw Clamp, and Military Terminal Boards. Free copy on request.

Kulka Electric Corporation

520 South Fulton Ave.
Mount Vernon, N. Y. 10551

174

Bus Bars For Noise Reduction



A 10 page Technical Bulletin is now available, describing a new concept in power or signal distribution. Basic mechanical and electrical design principles, along with descriptive pictures and diagrams, are included in this bulletin. These compact buses can replace bulky cable harnesses and repetitive wiring for computer or modular application. This method of construction satisfies the demanding requirements of low inductance and resistance of high speed, solid state systems, while controlling electrical noises.

Eldre Components, Inc.

1239 University Avenue
Rochester, New York 14607

176

Electronic Design

Advertising Representatives

New York 10022

Robert W. Gascoigne
Thomas P. Barth
Samuel M. Deitch
Richard W. Nielson
850 Third Avenue
(212) PLaza 1-5530
TWX: 867-7866

Philadelphia 19066

Fred L. Mowlds, Jr.
P. O. Box 206
Merion Station, Pa.
(215) MO 4-1073

Marblehead 01945

Richard Parker
7 Redstone Lane
(617) 742-0252

Chicago 60611

Thomas P. Kavooras
Berry Conner, Jr.
720 N. Michigan
(312) 337-0588

Cleveland 44107

Robert W. Patrick
8410 Treetower Drive
Chagrin Falls, Ohio
(216) 247-7670

Los Angeles 90303

Stanley I. Ehrenclou
Terrence D. Buckley
W. James Bischof
2930 W. Imperial Highway
Inglewood, Calif.
(213) 757-0183

San Francisco

Ashley P. Hartman
P. O. Box 1106
Los Altos, Calif. 94022
(415) 327-6536

Southwestern 75206

Tommy L. Wilson
6200 North Central Expressway
Dallas, Tex.
(214) EMerson 1-2311

London W. 1

Brayton C. Nichols
44 Conduit Street

Tokyo

Yoshihiro Takemura
International Planning
Service, Inc.
Room No. 512 Nikkoh
Mita Building
1, Nishidaimachi, Shiba-
Takanawa
Minato-ku, Tokyo



Advertisers' Index

*PARTICIPANTS IN NIGHT LETTER PROGRAM

Advertiser	Page	Advertiser	Page	Advertiser	Page
AA Industries, Inc.	277	Erie Technological Products, Inc.	9	Paktron Division, Illinois Tool Works Inc.	U176 A-B
ACI Division, Kent Corporation	U140	Fairchild Semiconductor, A Division Fairchild Camera and Instrument Corporation	27, 58	Pamona Electronics Co., Inc.	254
*AMP, Incorporated	217	Frequency Electronics, Inc.	U154	Parker Instrument Corporation	U84
Acopian Corporation	258	G-V Controls, Inc.	U136	Perfection Mica Company	248
Acton Laboratories, Inc.	U129	Gardner-Denver Company	U119	Philbrick Researches, Inc.	29
*Agastat Timing Instruments, Elastic Stop Nut Corporation of America	44	General Atronic Inc.	209	*Philco, Lansdale Division	197
Aladdin Electronics, A Div. of Aladdin Industries, Inc.	U120	General Electric Company, Electronic Components	30	*Potter & Brumfield, Division of American Machine & Foundry Company	U137
Allen-Bradley Co.	32A-B	General Electric Company, Silicone Products Department	272	Princeton Applied Research Corp.	16
Aluminum Company of America	U74, U75	General Instrument Corporation	U111	*RBM Controls Division	49
American Cyanamid Company, Plastics & Resins Division	242	General Precision, Kearfott Division	U157	RCA Electronic Components and Devices	Cover IV
American Lava Corporation	199	General Precision, Librascope Group	51	*Radiation, Incorporated	U115
Amperex Electronic Corporation	47	Giannini-Voltex	271	Radio Cores, Inc.	277
Art Wire & Stamping Co.	246	Globe Industries, Inc.	260	Randall, Inc. Douglas	U142
Artisan Organs	U150	Gudebrod Bros. Silk Co., Inc.	50	Republic Electronics Corp.	250
Augat, Inc.	U158, 270	H. P. Associates	Cover III	Robinson Technical Products Inc.	244
Bausch & Lomb, Electronics Division	46	Hamilton Standard Division, of United Aircraft Corporation	6	Rogan Brothers, Inc.	U154
*Beckman Instruments, Inc., Helipot Division	239	Hammel Riglander & Co. Inc.	284	Scientific Data Systems, Inc.	8
Belden Manufacturing Company	U100	Harowe Servo Controls, Inc.	273	Siemens America, Incorporated	190, 191
Bendix Corporation, The Cincinnati Division	275	Hayden Book Company, Inc.	U155	Signetics Integrated Circuits, A Subsidiary of Corning Glass Works	55
*Bendix Corporation, The, Scintilla Division	U131	Haydon Company, A. W.	288	Simpson Electric Company	35
Bliley Electric Co.	U164	Haydon Products/Industrial Controls Division, General Time	U147	Singer Company, The—Metrics Division, Panoramic	U133
*Bodine Electric Company	61	Hewlett-Packard, Dymec Division	198	Specific Products	U162
*Bourns, Inc.	25, 235	Hewlett-Packard, Loveland	57	Spectral Electronics Corporation	7
Branson Corp.	U134	Hewlett-Packard, Sanborn Division	15	Spellman High Voltage Co., Inc.	274
Buckbee Mears Co.	278	Hewlett-Packard, Moseley Division	1	Sprague Electric Company	10, 12, 20
Bud Radio, Inc.	259	Hewlett-Packard	23, 45, 52, 53, 64	Standard Condenser Corporation	U 48
Bunker-Ramo Corporation-The	257	Hoffman Semiconductor, a Division of Hoffman Electronics Corporation	60	Switchcraft, Inc.	U138
*Burr-Brown Research Corporation	282	Honeywell Test Instrument Division	281	Syntro Company	43
*Burroughs Corporation	U117	Hudson Lamp Company	U152	Systron-Donner Corporation	U80 A-B
By-Buk Company	U150	Hudson Tool & Die Company, Inc.	U128-A-B	TRW Semiconductors	62
CTS Knights Inc.	U118	Hunter Spring, A Division of Ametek, Inc.	276	Takeda Piken Industry Co., Ltd.	268
Caddock Electronics	284	IRC, Inc.	U91, U93, U95	*Tally Corporation	241
Capitol Machine & Switch Co., Inc., The	284	ITT Cannon Electric, Inc.	2	Tech Laboratories, Inc.	278
CELCO Constantine Engineering Laboratories Co.	177	ITT Semiconductors	U105, U107, U109	Technipower Inc. A Benrus Subsidiary	263
Clairex Corporation	248	Ideal Precision Meter Co. Inc.	270	Technical Wire Products, Inc.	U92
Clarostat Mfg. Co., The	U153	Industrial Electronic Engineers, Inc.	U139	Tektronix, Inc., Oscilloscopes	U167, 251
Cohu Electronics, Inc.	39	Inland Motor Corporation	245	Tenney Engineering, Inc.	274
Columbia Wire & Supply Co.	U156	*JFD Electronics Co.	U125	Texas Instruments Incorporated, Semiconductors-Components Division	184, 185
Comar Electric Company	U94	Jennings Radio Mfg. Corp.	252	Torngren Co., Inc., C. W.	279
Communication Electronics, Incorporated	204	Johnson Manufacturing Corp.	U128	Tracor, Inc.	266
Components, Inc.	U163	Johnson Company, E. F.	U128 C-D	Triplett Electrical Instrument Company	237
*Computer Measurements Company	U82, U83	Kennedy Co.	265	Union Carbide Corporation, Linde Division	U141
Consolidated Electrodynamics, A Subsidiary of Bell & Howell	U135	Kidde & Company, Inc., Water	U121, U142	*Union Carbide Corporation	178
Constantine Engineering Labs. Co. (CELCO)	177	Kulka Electric Corp.	285	United Systems Corporation	177
Continental Connector Corporation	48	LFE Electronics, Division of Laboratory of Electronics, Inc.	36	United Transformer Corp.	Cover II
Cool-Amp, Inc., The	283	Lambda Electronics Corp.	U113	*Varian Associates	U127, U151
Coors Porcelain Co.	U101	Leach Corporation	287	Varo Inc.	267
Cornell-Dubilier Electronics	U161	*Line Electric Company	U132	Victor Comptometer Corporation	U130
*Corning Electronics	U98, U99	Little Use	U146	Victory Engineering Corporation	268
Curtis Development & Mfg. Co.	U146	*Litton Industries, Electron Tube Division	U149	Westinghouse Molecular Electronics Division	U123
Cutler-Hammer, Inc.	U66	Litton Industries, Encoder Division	253	Weston Instruments, Inc. Archbald Division	U143
*Damon Engineering, Inc.	22	Mac Panel Company	221	Zeltex, Inc.	U159
Data Control Systems, Inc.	283	*Mallory & Co., Inc., P. R.	19	Regional Advertising	
Del Electronics Corporation	U158	Mallinckrodt Chemical Works, Electronic Chemicals	205	Burndy Corporation	256C
Delco Radio, Division of General Motors	38	Marco-Oak Industries/Division of Oak Electro/Metrics Corp.	249	*Magnetics, Inc.	256A
Deringer Metallurgical Corp.	U144	Marconi Instruments	285	Sorensen Operation, Raytheon Company	256D
Dodge Fibres Corporation	258	Markel & Sons, L. Frank	183	Career Advertising	
*Dow Corning Corporation	40, 41	Matsuo Electric Co., Ltd.	272	Bendix Corporation, The	224
Dynamic System Electronics	256	Metex Corporation	264	Boeing Aerospace Group	228
ESI/Electro Scientific Industries, Inc.	59	Micro Instrument Company	U165	General Electric Company Light Military Electronics Dept.	227
Eagle Signal, a Division E. W. Bliss Company	4, 5	Mitsumi Electric Co., Inc.	276	Hughes Aircraft Company Aerospace Division	230
Eastman Chemical Products, Inc.	U129	*Motorola Semiconductor Products, Inc.	U85	LTV—Electrosystems, Inc.	231
Eldre Components, Inc.	285	Mycalex Corporation of America	262	Lockheed Missiles & Space Company	226
*Electro-Mechanical Research, Inc.	255	Nexus Research Laboratory, Inc.	U145	McDonnell Aircraft	225
Electro Tec Corp.	262	Norden Division of United Aircraft Corporation	42	Motorola Government Electronics Division Aerospace Center	222
Electro Techniques	264	Nortronics, Inc.	261	Texas Instruments, Incorporated	232
Electronic Design	247	*Oak Manufacturing Co.	269, 271, 273	Weston Instruments, Inc.	229
Electronic Research Associates, Inc.	37				
*Electronic Specialty Co.	33				
Electronized Chemicals Corporation	269				
Electrovert, Inc.	260				
Elgenco, Inc.	266				
Engineered Electronics Company	U169				



Upset? Power contactor deliveries rescheduled again? Next time call Leach!

We've got hundreds of power contactors in stock throughout the country. Contactors like the models 9324 (20 amp), 9123 (25 amp), and the 9124 (50 amp).

These new units are the smallest, lightest power contactors meeting MIL-R-6106E. True balanced armature construction lets them take up to 50g shock and 25g vibration with a contact opening of less than 10 microseconds.

The Model 9324 (MS27418) is a 20 amp, 3PST/NO contactor. Under motor load, its rating is 15 amp break and 75 amp make at 115 VAC, 3 phase. Operate time 20 milliseconds, with release at 10 milliseconds.

The 25 amp model 9123 (MS27997) and 50 amp 9124

(MS27222) meet the latest requirement of the aircraft and aerospace industries. Basic models are 3PST/NO and 3PST/NO with 5 amp auxiliary contacts. Industry standard mounting makes them interchangeable with older, larger, top-hat type MS24143 and MS24376.

Interested? Then ask for our new Power Contactor Brochure, or better still, send us your purchase order. You'll have your power contactors by return mail. Leach Corporation, Relay Division, 5915 Avalon Bl. Los Angeles, California; 90003
Phone (Area code 213) 232-8221
Export: LEACH INTERNATIONAL S. A.



LEACH

BOOTH 1515-16 WESCON

Can you take advantage
of this cost breakthrough in
time code generators?



If you're paying for exotic levels
of precision you don't really need
and can't use, this remarkable new
electromechanical unit may cut
your costs in half!

Here's a precision electromechanical time code generator specifically designed to fill many applications at about half the cost of comparable electronic units!

If you've had to buy costly code generators with fancy specifications because nothing else fit your application, this new development can save you real money. It's designed around standard A. W. Haydon Company components and on a modular basis that allows us to customize it to your exact requirements. The time base is established by a synchronous motor-driven repeat cycle timer which rapidly steps a preset code pattern of output switches. Standard output codes available are straight decimal or binary coded decimal.

Typical applications include computers, data handling system, illuminated time displays, direct printout devices, checkout equipment, telemetry systems, and tape punching devices. These units should be carefully considered for any commercial/industrial equipment requiring a time code. This versatile instrument can be arranged to supply readings in days, hours, minutes, and seconds. It can be used as a master clock to drive slave units. It can be custom adapted to handle special codes. Code output is displayed on the front panel, and setting is by convenient knurled wheels. Standard models are available with time outputs from 59 minutes, 59 seconds, to 369 days, 23 hours, 59 minutes, 59 seconds. Panel fits standard 19" racks. Electrical requirement is 105-125 VAC, 58-62 CPS. Send for further information.

AWH HAYDON
THE COMPANY

232 NORTH ELM ST., WATERBURY, CONN. 06720
Tel: 203-756-4481 TWX: 203-753-3179

4060 INCE BLVD., CULVER CITY, CALIF. 90231
Tel: 213-UPton 0-5461 TWX: 213-836-0444

Timing & Stepper Motors • Electromechanical & Electronic Timing Devices & Systems

ON READER-SERVICE CARD CIRCLE 133

Designer's Datebook

AUGUST						
S	M	T	W	T	F	S
	1	2	3	4	5	6
7	8	9	10	11	12	13
14	15	16	17	18	19	20
21	22	23	24	25	26	27
28	29	30	31			

SEPTEMBER						
S	M	T	W	T	F	S
	1	2	3	4	5	6
7	8	9	10	11	12	13
14	15	16	17	18	19	20
21	22	23	24	25	26	27
28	29	30				

August 17-19

Joint Automatic Control Conference (Seattle, Wash.) Sponsor: AACC; Prof. Arthur Bryson, Dept. of A&A, MIT, Cambridge, Mass.

August 23-26

WESCON (Western Electronic Show & Convention) (Los Angeles, Calif.) Sponsor: IEEE; Don Larson, WESCON, 3600 Wilshire Blvd., Los Angeles, Calif.

August 29-31

International Congress on Instrumentation in Aerospace Simulation Facilities (Stanford University) Sponsor: IEEE, G-AES; R. K. Hallett, Jr., NASA, Ames Research Center, Moffett Field, Calif.

August 29-31

Annual Conference on Electronic Materials (Boston, Mass.) Sponsor: AIME; Leonard R. Weisberg, the Metallurgical Society of AIME, 345 East 47th St., New York, N.Y. 10017.

Sept. 15-16

Computer Aided Solid-State Design Institute (Santa Clara, Calif.) Sponsor: University of Santa Clara, Department of Electrical Engineering, Santa Clara, Calif. 95053.

Sept. 20-22

Eighth Annual Conference on Tube Techniques (New York City) Sponsor: IEEE, G-ED; R. J. Bondley, General Electric Company, Schenectady, N. Y.

Sept. 22-24

IEEE Broadcast Symposium (Cedar Rapids, Iowa) Sponsor: IEEE, G-B; Serge Bergen, 10828 Fairchester Drive, Fairfax, Va.

Sept. 26-27

Joint Engineering Management Conference (Wash., D. C.) Sponsor: IEEE, G-EM et al; Homer Sarason, IBM, Armonk, N. Y.

ULTRA FAST

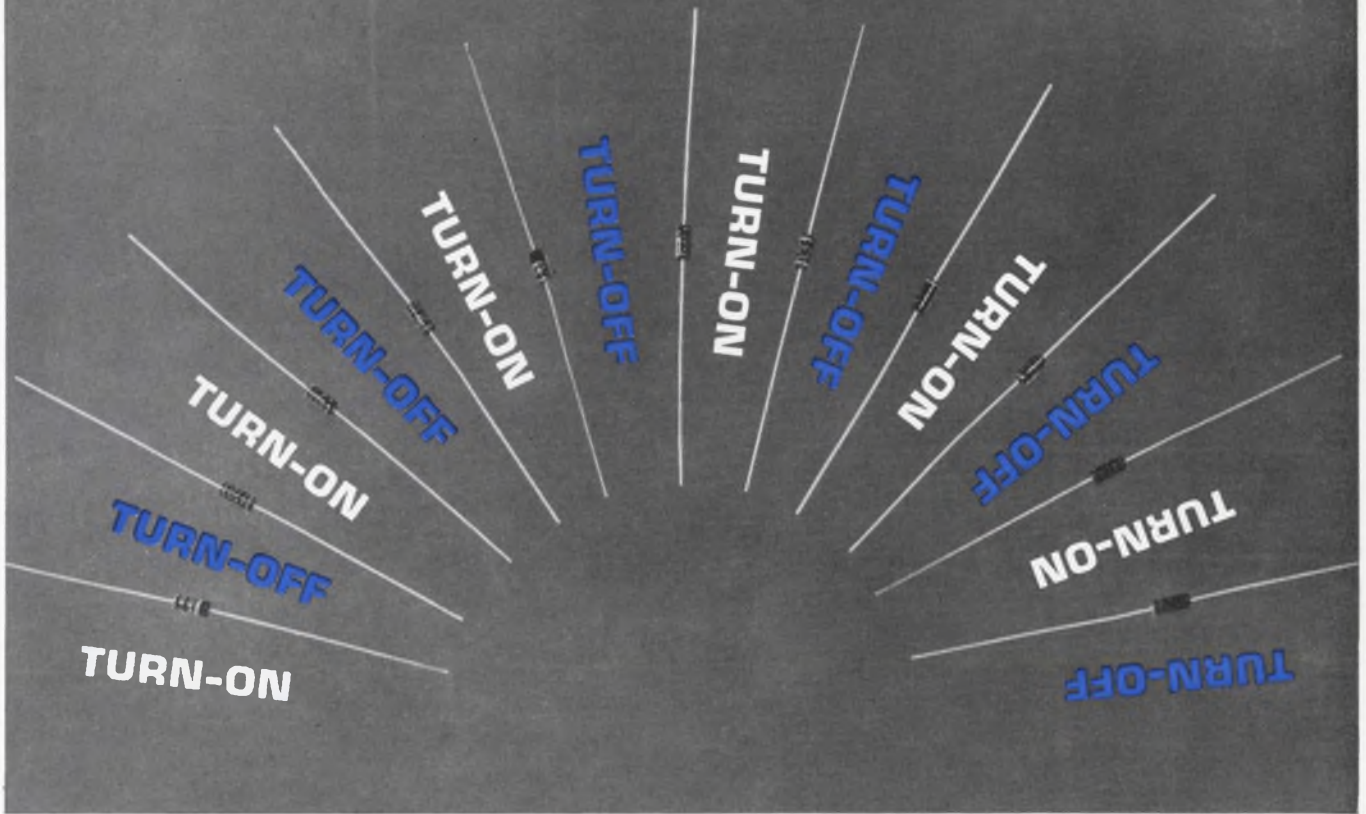

specify hot carrier diodes from hpa

For high-speed switching in ultra-fast computers, sampling circuits, test equipment or UHF and VHF mixers and detectors, you owe it to yourself to investigate low-noise, high-reliability 2300 Series Hot Carrier Diodes from hp associates. All devices in this series have minority carrier lifetimes of less than 100 picoseconds. Using the latest advances in metal-silicon technology, these devices offer increased forward current and higher breakdown voltage. Operating and storage temperature range -60°C to $+125^{\circ}\text{C}$. Power dissipation at 25°C is rated at 125 mw. Peak pulse power rating is 5 ergs. They also meet the requirements of MIL-S-19500C.

Write today for application information and complete data, including life test data, hp associates, 620 Page Mill Road, Palo Alto, California 94304, Tel. (415) 321-8510.

TYPICAL DEVICE SPECIFICATIONS

Device	Forward Current I_{F1}	Forward Current I_{F2}	Breakdown Voltage BV_R	Leakage Current I_R	Capacitance C_0	Effective Minority Carrier Lifetime ^a τ	Price 1 to 99 100 to 999
hpa 2301 Min. Max.	50 mA	1 mA	30 V	300 nA	1 pf	100 ps	\$8.50 ea. 6.35 ea.
hpa 2302 Min. Max.	35 mA	1 mA	30 V	300 nA	1 pf	100 ps	7.75 ea. 5.80 ea.
hpa 2303 Min. Max.	35 mA	1 mA	20 V	500 nA	1.2 pf	100 ps	7.15 ea. 5.35 ea.
Test Conditions	$V_F = 1\text{ V}$	$V_F = 0.4\text{ V}$	$I_R = 10\ \mu\text{A}$	$V_R = 15\text{ V}$	$V_R = 0$ $f = 1.0\text{ MHz}$		

^aThese diodes are too fast to measure in conventional circuits utilizing standard reverse recovery time measurements. Therefore, the effective minority carrier lifetime is specified as τ instead of T_{rr} . Devices are hermetically sealed in a miniature glass package 0.160" long, 0.070" in diameter, color coded.

See New hp Instruments
Attend Measurement Seminars
WESCON—Hollywood Park

HEWLETT
PACKARD



HP
ASSOCIATES

From bright sunlight to overcast starlight

**RCA thin-film
semiconductive
targets in Image Orthicons
offer exceptionally stable
performance in B/W
and color TV**

The RCA line of camera tubes includes three Image Orthicons—7629A, 7967, and 8092A—equipped with RCA's latest advance in TV technology, thin-film semi-conductive targets. They offer the high gain and tube sensitivity that can be equivalent to photographic film with an ASA exposure index of more than 10,000,000.

RCA-7629A. Easy to set up and simple to operate, this Image Orthicon makes possible very low-light-level studio operation and remote pickup. It is excellent for industrial service, taking good black-and-white pictures with scene illumination as low as 2 to 3 lm/ft² equivalent to film with an ASA index of 20,000.

RCA-7967. This Image Orthicon, with a multialkali photocathode features low target-to-mesh capacitance, reduced microphonics, and S-20 spectral response. It can reproduce black-and-white scenes under extremely low-light-level conditions. Its sensitivity is equivalent to photographic film having an ASA index of ten million or more!

RCA-8092A. An Image Orthicon with field mesh, this tube makes possible full color pickup with scene illumination as low as 40 lm/ft². A quality tube noted for high resolution over a wide range of incident light levels, 8092A is available in sets of 3 with color-mated characteristics, with the designation 8092A/S.

If you are designing TV cameras, check into RCA's line of Image Orthicons. You'll find the one that's right for your special application. See your RCA Representative. For technical data, write RCA Commercial Engineering, Sect. H-18Q-3, Harrison, N.J. ALSO AVAILABLE THROUGH YOUR RCA INDUSTRIAL TUBE DISTRIBUTOR.

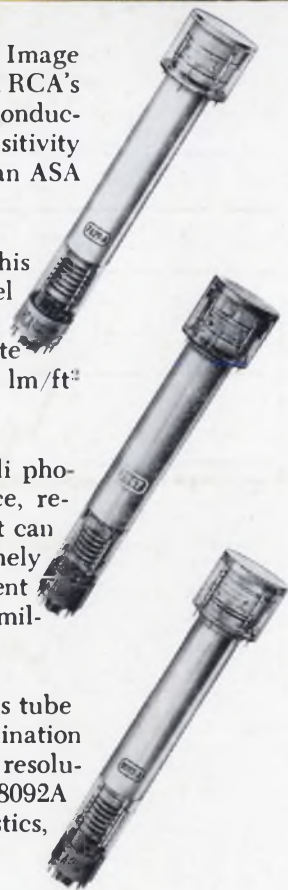

RCA Electronic Components and Devices

The Most Trusted Name in Electronics