

Electronic Design

THE MAGAZINE OF ESSENTIAL NEWS, PRODUCTS AND TECHNOLOGY

VOL. 14, NO. 3
FEB. 1, 1966

The trace won't drift in this 25 MHz oscilloscope. With push-button control, automated tests are possible even when accurate waveform monitoring is needed.

Used as a precision lab instrument, the scope will eliminate errors resulting from dc drift while reducing set-up and calibration time. (See page 90.)

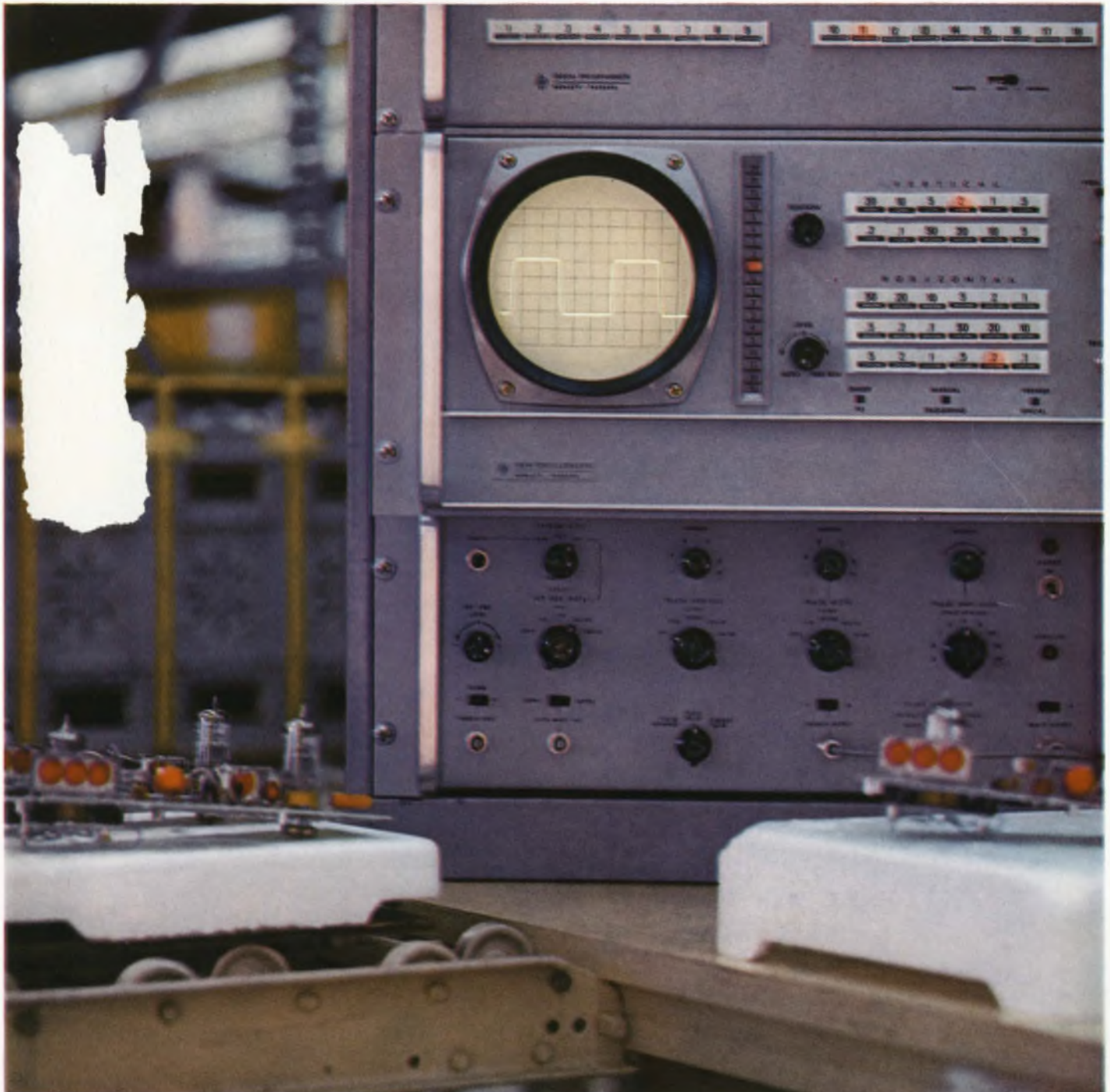

To make it solder right, you need the right kind of gold for the job.



Good soldering techniques work better when best-for-the-job gold deposits are present. Sel-Rex can supply the right gold plating process for each specific application. For example: the deposit structures of several Type I and Type II patented Sel-Rex formulations aid the capillary flow of solder materials. And one unique Sel-Rex gold deposit offers exceptional hardness along with excellent solderability.

Detailed knowledge of gold plate characteristics—electrical, chemical, mechanical—stems from long term research. Sel-Rex leads not only in research, but also in the diversity of gold processes available to match the formulation to the job.

Write for your free copy of a paper on our soldering study and details on Sel-Rex processes. Sel-Rex Corporation, Department A-2, 75 River Road, Nutley, New Jersey, 07110.

Sel-Rex
Sel-Rex logo featuring the brand name in a bold, sans-serif font above a downward-pointing arrow.

NEW

Hewlett-Packard Multi-function Meter

For Just
\$195

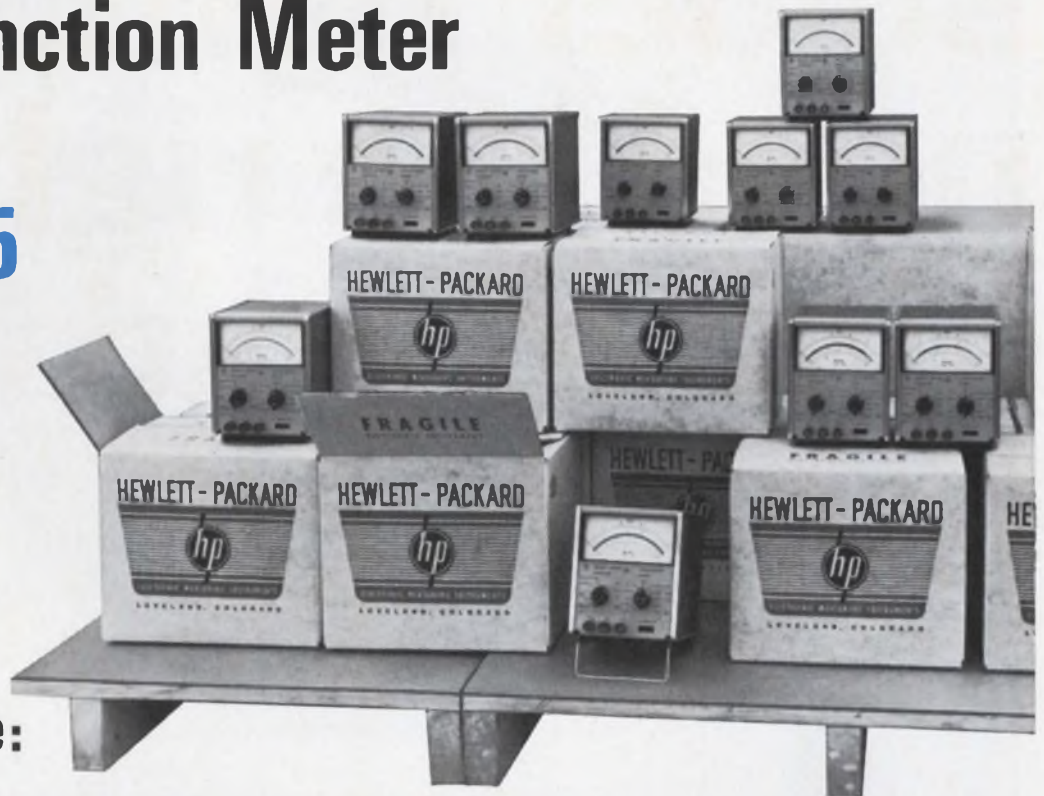

Accurately Measure:

DC Voltage ± 100 mv to ± 1000 v full scale ($\pm 2\%$ accuracy)

AC Voltage 10 mv to 300 v rms full scale, 10 Hz to 1 MHz ($\pm 2\%$ accuracy)

Resistance 10 ohms to 10 megohms center scale ($\pm 5\%$ of midscale reading accuracy)

Here's Hewlett-Packard quality in a low-cost, solid-state, battery-operated multi-function meter, the new hp 427A!

And you can get it for the lowest cost—check it against *any* comparable instrument!

Minimum zero drift. For dc measurements you get 1 mv resolution. The ac meter is average-responding, calibrated in rms volts. Only one zero set for dc and resistance measurements... no need to re-zero when switching from dc to ohms measurements... seldom "zero" on the 1 v range and above.

Long battery life. Basically battery operated (battery supplied), the 427A uses a dry-cell battery with a regulator; front-panel battery check provided, reads under load regardless of range switch setting. 300 hours' typical operation per battery. AC-battery operation, 115/230 v, 50-1000 cps, optional for \$35 additional.

Floating input. Performance is the story: Broad measuring capability, high accuracy, at low cost. Floating input, 10-megohm input impedance and common ter-

minals for ac and dc, high resolution with 9 ranges for dc coverage, 10 ranges for ac, 7 for resistance. Individually calibrated taut-band meter. Has overload protection for all functions.

Highest value. The hp 427A is a *real buy*... the best instrument of its type you can find... at a price that gives you the best available performance at the lowest available price (\$195). There's no other meter to match it.

If you *need* a demonstration, call your Hewlett-Packard field engineer. If you merely need to know complete performance specifications in order to get this low-cost measurement tool working for you, write Hewlett-Packard, Palo Alto, Calif. 94304, Tel. (415) 326-7000; Europe: 54 Route des Acacias, Geneva.

1051

HEWLETT  PACKARD
An extra measure of quality

Data subject to change without notice. Price f.o.b. factory.

ON READER-SERVICE CARD CIRCLE 2

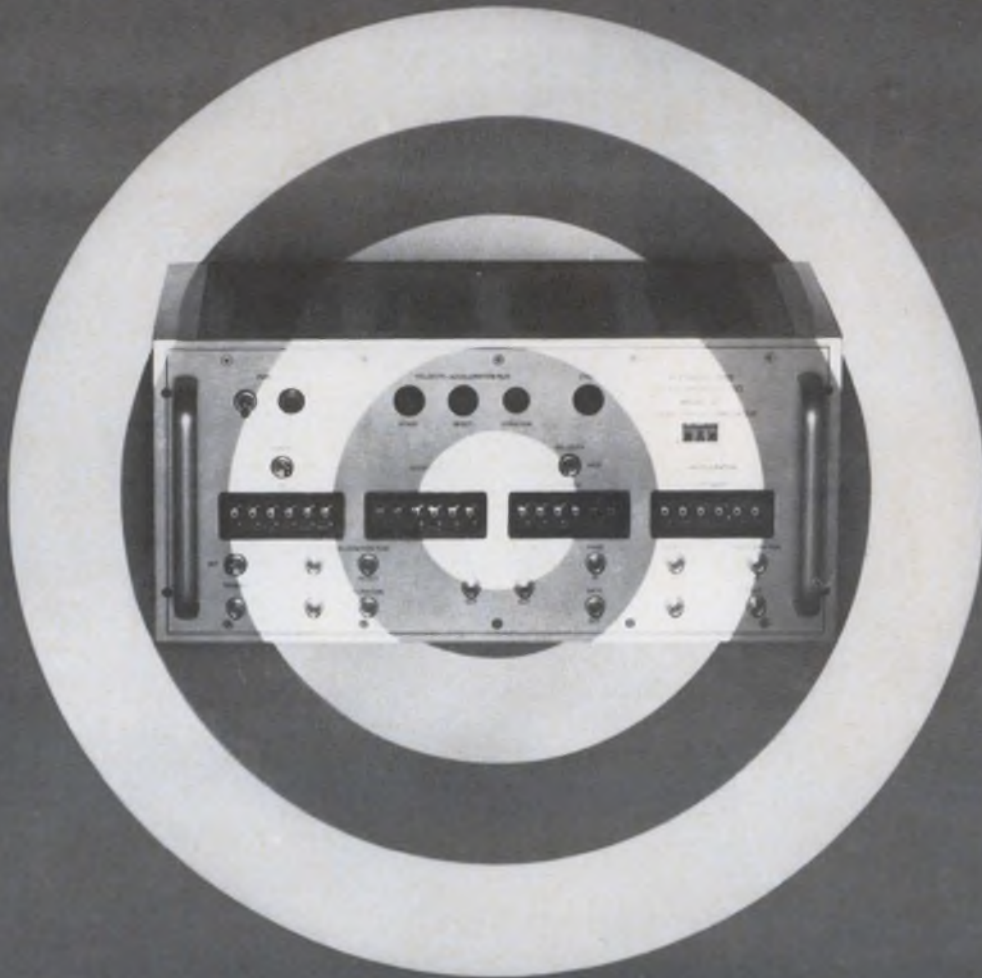

We make enemies

Simulated enemies are available in a compact package labeled the RUTHERFORD S1 Dynamic Range Simulator. It is the most accurate, reliable, stable video target simulator ever developed. With it you can evaluate, check, and calibrate range, range rate, target tracking, and tracking memory of the most sophisticated weapons control and tracking systems. Forget the limitations and problems built into old-fashioned analog simulators.

Check these parameters: Target Range in one-foot increments from 0 to 1 million feet. Target Velocity

from 0 to 100,000 ft/sec in 0.1 ft/sec increments. Target Acceleration from 0 to 10,000 ft/sec/sec with 0.01 ft/sec/sec resolution. Check all the specs. They meet or exceed the rigid performance requirements of any known weapons control system or tracking system used for air traffic control, satellite surveillance, etc. The Rutherford S1 is an example of



the advanced design that has established Rutherford as the leader in pulse and time delay instrumentation. Other sophisticated instruments will soon be developed by the new CMC/Rutherford team. Our intent is to give you a wide range of instruments that are always the best quality and best buy.

So join the Rutherford Rampage (a division of the CMC Crusade) and write today for the complete specs on the S1. Learn how you can earn your own glorious Crusading Engineers medal with special Rutherford stripe. You'll look so handsome!

12982 Bradley • San Fernando, California • Phone (213) 772-6321 • TWX 213-647-5170

THE RUTHERFORD DIVISION OF CMC IS A LEADING DESIGNER AND MANUFACTURER OF PULSE GENERATORS, TIME DELAY GENERATORS, AND DYNAMIC RANGE SIMULATORS.
ON READER-SERVICE CARD CIRCLE 3

NEWS

- 13 News Report
- 17 **Showdown near on airborne phone system**
The FCC may authorize field tests soon on an overdue radiophone for commercial aircraft; but a proposed ssb system is meeting industry objections.
- 21 **Navy elevates deep-submergence program**
Sealab III, due next year, should incorporate electronic solutions to communications, other problems found in Sealab II, as reported at a recent conference.
- 26 Batch diodes apply beam-lead method
- 28 Lithium batteries promise high yield
- 31 Washington Report
- 32 Letters
- 41 **Editorial:** We're indebted to you

TECHNOLOGY

- 44 **Design efficient multipliers** with step-recovery diodes. For high-order harmonic generation, it's efficient, simple and has low noise.
- 48 **Complement of exclusive-OR** can be obtained with a simple and reliable circuit that restores signal levels and has high fan-out, as an extra bonus.
- 52 **Small-capacitor measurements** pose formidable problems. Here is a method for measuring temperature coefficient and drift to an accuracy of 1%.
- 56 **Avoid over-integration** by designing linear circuits with off-the-shelf items. External discrete parts may be added whenever needed.
- 64 **Simplify dc amplifier design** by using FETs. Their high-input-impedance and zero-temperature-coefficient attributes also improve performance.
- 70 **Try designing your career.** You can get to the top without a plan, but it's unlikely. Here are some ideas to help smooth your way.
- 76 **Ideas for Design**

PRODUCTS

- 90 **Test Equipment:** A 25 MHz oscilloscope with zero dc drift—a first in the technology that pays dividends in both lab and production line applications.
- 114 **Microelectronics:** Flat-pack carrier speeds production
- 122 **Systems:** 48 column high-speed alphanumeric printer
- 97 Components
- 111 Microwaves
- 130 Power Equipment

Departments

- 142 Advertisers Index
- 138 Application Notes
- 144 Designer's Datebook
- 132 New Literature

Engineers and Scientists:

*The Hughes Aircraft Company
is proud to announce the establishment of*

THE HUGHES PROFESSIONAL CAREER DEVELOPMENT PROGRAM

This new Program emphasizes individual career growth through a sequence of selected work assignments for graduate engineers who have acquired between two and eight years of professional experience. It is designed primarily for two types of development:

1. Specialized, in-depth assignments to develop unusual proficiency in a specific area of interest.

2. Broad, systems-types of assignments to prepare for system and project engineering responsibilities.

There will be a maximum of three assignments which will be determined jointly by the participant and the Professional Development Section. The assignments, which are flexible in length would normally extend for one year each. They may be selected from a broad spectrum of aerospace electronics hardware and systems-oriented programs and will be designed to provide optimum backgrounds in specialized areas of interest.

The Program will be limited to 50 participants in 1966. These will be selected from candidates who are graduates in E.E., M.E. or Physics from fully-accredit-

ed universities and who have acquired from two to eight years of professional-level technical experience. U.S. citizenship is required.

Those in the Program will receive salaries commensurate with levels established by their overall experience and qualifications.

We invite interested Engineers and Physicists to submit their qualifications for consideration.

Please forward your resume including details of your educational and experience background to:

Mr. Robert A. Martin
Head of Employment
HUGHES Aerospace Divisions
11940 W. Jefferson Blvd.
Culver City 27, California



An equal opportunity employer

FAIRCHILD HYBRID CIRCUITS

Fairchild hybrids are made using the widest array of products in the industry. You can get a custom logic function, in any of four integrated circuit families, combined with any of our catalog transistors and diodes. We use nichrome thin-film resistors and MOS

capacitors. In TO-5 cans or Flat-Paks. Here are five of our standard, off-the-shelf circuits. You can also design your own: contact our sales force for data sheets, Hybrid Design Handbook, design assistance, and prices.

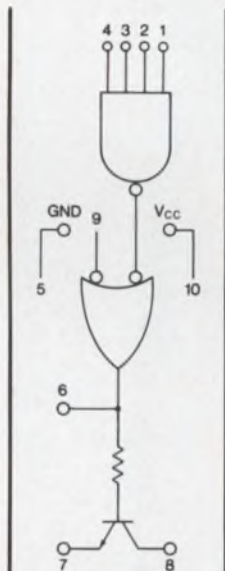

FSH2001 - HIGH CURRENT DRIVER (250mA)
Compatible with DT μ L* diode-transistor logic circuits.
APPLICATIONS:
Interface to faster logic or higher voltage levels.
Lamp driver with input decoding (latchable).
Relay driver with input decoding (latchable).
Memory driver with input decoding.
Coaxial cable driver.

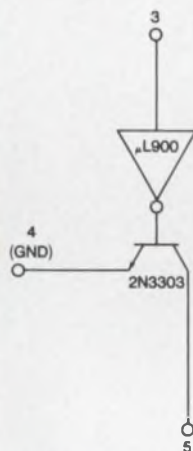

FSH2100 - HIGH CURRENT DRIVER (250mA)
Compatible with μ L* standard resistor-transistor integrated circuits.
APPLICATIONS:
Interface directly with DT μ L diode-transistor logic circuits. Fan-out = 150.
Relay drivers.
Magnetic core drivers.
Interface with discrete circuits.

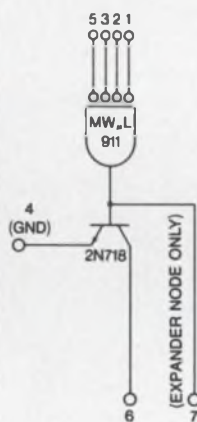

FSH2101 - HIGH VOLTAGE BUFFER (100V)
Compatible with MW μ L* milliwatt integrated circuits.
APPLICATIONS:
Interface with μ L standard resistor-transistor integrated circuits and DT μ L diode-transistor logic circuits.
Neon tube driver.
Nixie tube driver.
Interface with discrete circuits.

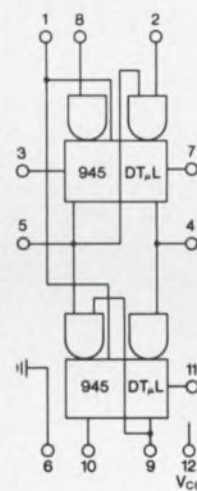

FSH2500 - DUAL FLIP-FLOP
Compatible with DT μ L diode-transistor logic circuits.
APPLICATIONS:
Shift register.
Shift counter.
Temporary memory storage.

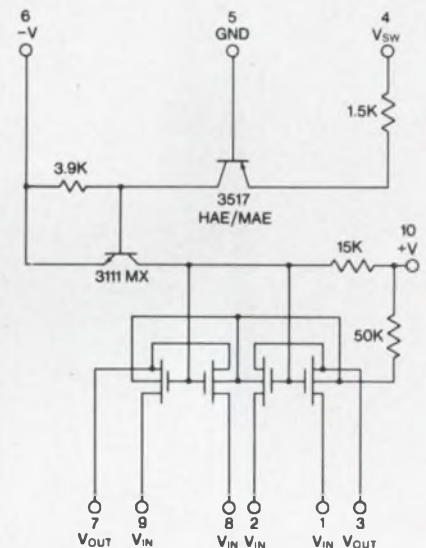

FSH3001 ANALOG SWITCH
Compatible with μ L standard resistor-transistor integrated circuits, MW μ L milliwatt integrated circuits, and DT μ L diode-transistor logic circuits.
APPLICATIONS:
High level signal switching.
Scanning.
Multiplexing.
A-D conversion.
Pulse coded modulators.
Four-pole single throw switch.

FAIRCHILD
SEMICONDUCTOR

* μ L, MW μ L, and DT μ L are Fairchild trademarks.

SELECTED for MAJOR AEROSPACE SYSTEMS because of
 DRAMATIC SIZE REDUCTION and INHERENT RELIABILITY...

ERIE SUBMINIATURE BROAD BAND RFI FILTERS



Actual Size



Exclusive! **High Attenuation • Hermetically Sealed
 Subminiature • Reliable**

Only one-fourth the size of conventional filters, Erie subminiature Broad Band RFI Filters provide excellent attenuation performance in the 10KC to 10KMC frequency range as shown in the attenuation curves below.

The problem of Electro-Magnetic Interference caused by switches, relays, motor commutators, SCR and transistor switching is efficiently eliminated by the use of Erie's hermetically sealed Broad Band EMI Filters. No longer is it necessary to use bulky paper capacitor-coil combinations . . . or large conventional filters. Erie filters provide better attenuation *in a fraction of the space*.

These reliable Broad Band Filters are selected for major aerospace systems as well as for use in industrial and commercial communication circuitry because of their small size (.375 dia. x .720 long) and high performance. Mounting arrangements and hardware to suit the application.

Consider the advantages of Erie Broad Band EMI Filters in your equipment. Write TODAY for literature and samples . . . Erie Technological Products, Inc., Erie, Pennsylvania.

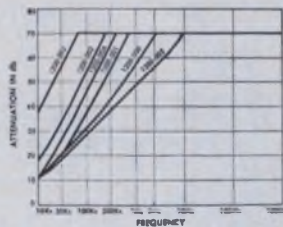

TYPICAL
 ATTENUATION
 CURVE

Another series of components in Erie's Project "ACTIVE."
 Advanced Components Through Increased Volumetric Efficiency.

ERIE
TECHNOLOGICAL
PRODUCTS, INC.

Formerly
 Erie Resistor
 Corporation

644 West 12th Street
 Erie, Pennsylvania

Like to see our new T Series modules perform?

Warm up your scope, we'll be right over.



Our new T Series integrated circuit logic modules are so fast and flexible that we can hardly blame you if you doubt the

amazing specs: Fan out of 14. Noise rejection up to 1.8v. 18 nanosecond gates. 40 nanosecond flip-flops.

So we've given our men demonstration kits and you can see for yourself.

Each kit contains an assortment of module cards and has its own power supply and timing source. You furnish the problems and the oscilloscope.

Our man may even leave the kit a few days for you to play with. Fun.



Scientific Data Systems

1649 Seventeenth Street, Santa Monica, California
U.S. sales offices in New York, Boston, Washington, Philadelphia, Pittsburgh, Huntsville, Orlando, Chicago, Houston, Dallas, Albuquerque, Denver, Seattle, San Francisco, St. Louis, Detroit.

The logo for Scientific Data Systems, consisting of the letters 'SDS' in a bold, sans-serif font, enclosed within a dark rectangular border.

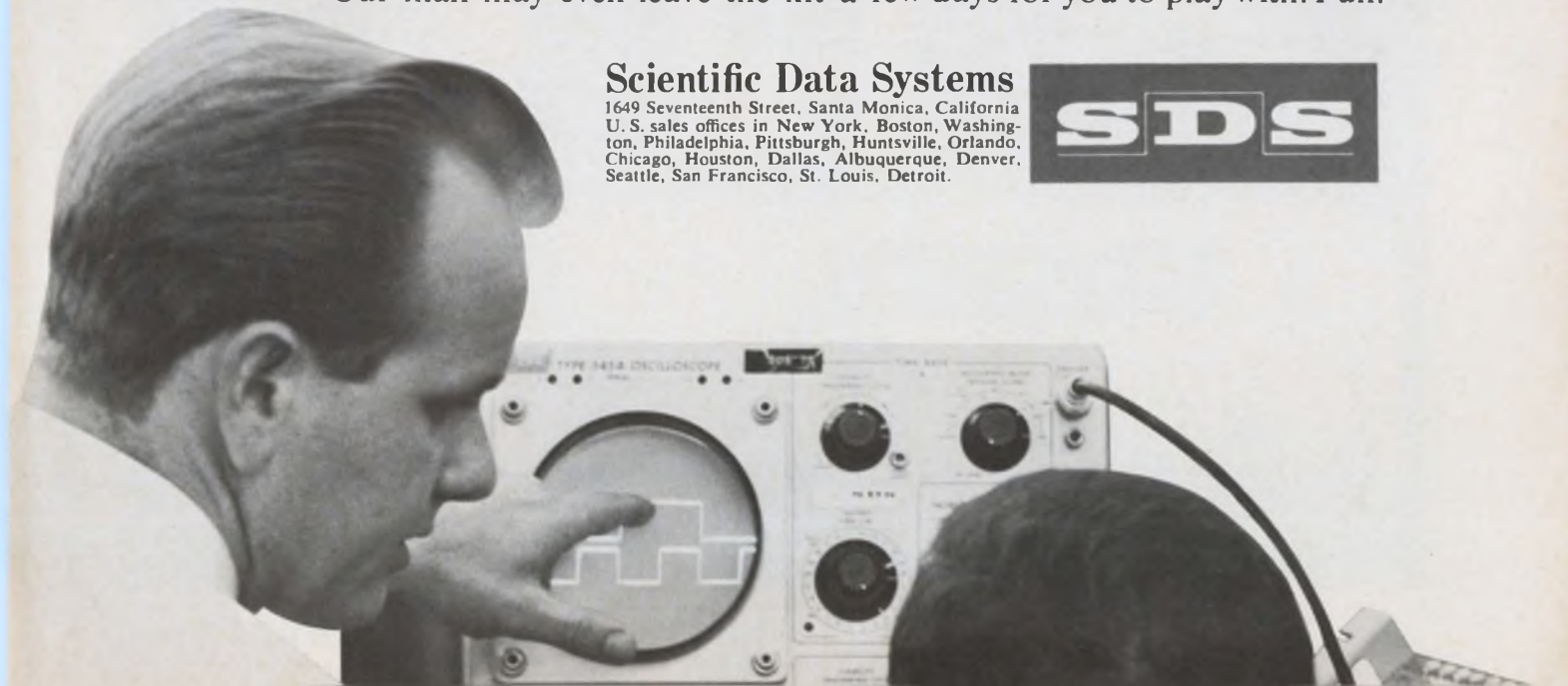

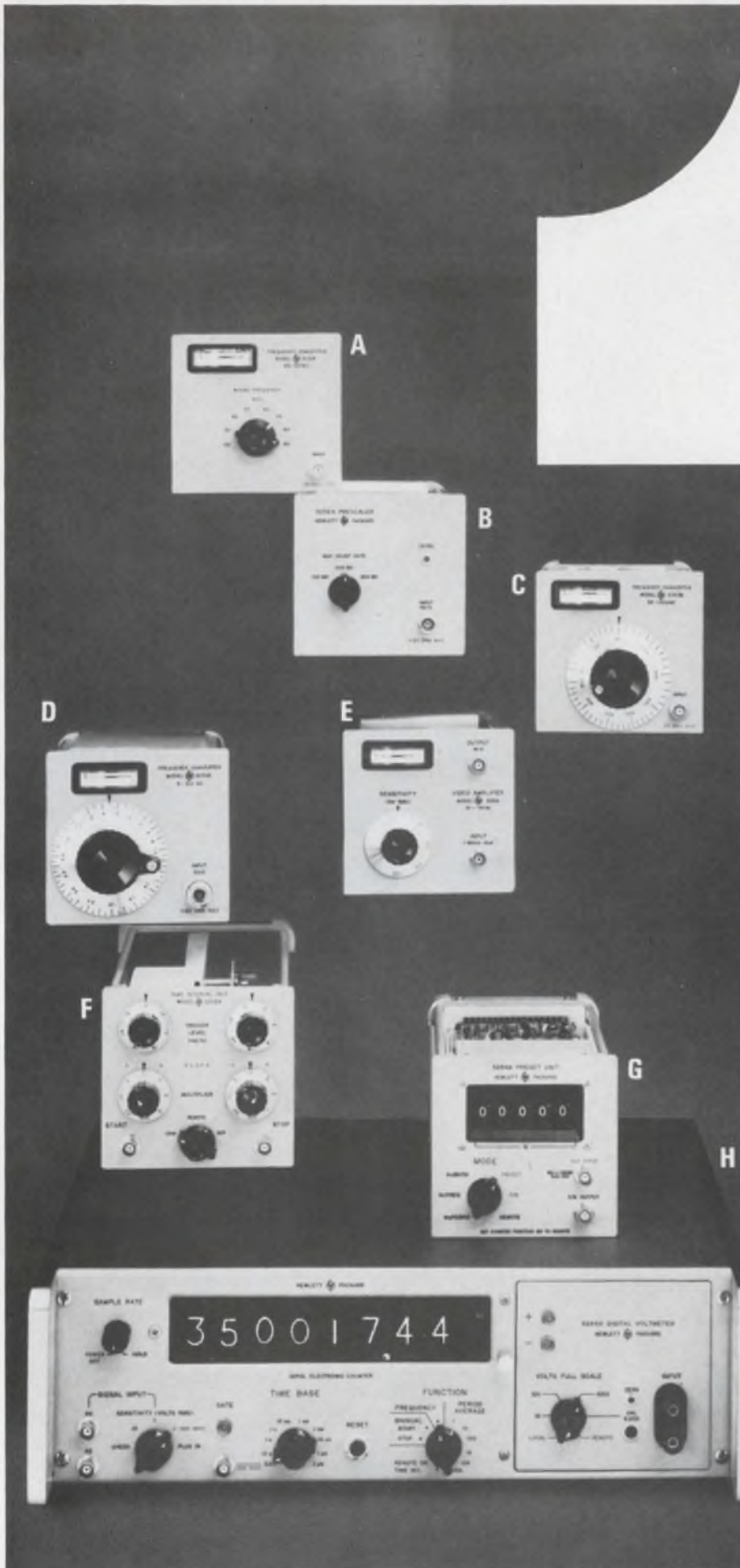

Plug-ins of your choice—to meet your need:

- A** 20-100 MHz frequency converter, to increase the basic 50 MHz counting rate of the 5245L; 5251A, \$300.
- B** DC to 350 MHz prescaler, direct readout, no tuning, multiple scale factors for faster readings in lower ranges; 5252A, \$685.
- C** 50 MHz to 500 MHz frequency converter, to increase the basic counting rate of the 5245L; 5253B, \$500.
- D** 300 MHz to 3000 MHz frequency converter; as with other hp converters, just add the tuning indication to the counter measurement; 5254A, \$825.
- E** 1 mv to 300 mv rms video amplifier, to increase counter sensitivity; 5261A, \$325.
- F** Time interval unit, measure time interval 1 μ sec to 10⁴ sec, resolution of 0.1 μ sec; 5262A, \$300.
- G** Preset unit, normalizes measurements to engineering units, divides input frequency by N, counts N events (1 to 100,000); 5264A, \$650.
- H** Digital voltmeter, 6-digit measurement of 10, 100 and 1000 v full scale, 0.1% accuracy, 5% overranging; 5265A, \$575.

Accessories to increase usefulness, value:

- *2590B Transfer Oscillator for reliable, rapid measurement to 15 GHz, \$1900
- *580A, 581A Digital-to-Analog Converters, for conversion of output for x-y recording, \$525
- *562A Digital Recorder, about \$1600, depending on options
- *2514A Digital Scanner, for systems applications, \$2500
- *2545 Tape Punch Set, \$3900
- *2526 Card Punch Set, \$3100
- *2546 Magnetic Tape Recorder Set, \$8565

Data subject to change without notice. Prices f.o.b. factory.

ONE COUNTER FOR ALL YOUR NEEDS:

hp 5245L!

Can't be obsoleted—just plug in new capabilities as you need them

Today! direct counting to 350 MHz, converter measurements to 3000 MHz!

Eight plug-ins, available now!

More plug-ins to come!

Convenient, easy-to-read controls!

Superior readability, electrical output!

Value-priced at \$2950!

The Hewlett-Packard 5245L 50 MHz Electronic Counter is unmatched in performance capabilities, convenience features and plug-in versatility. Your \$2950 investment in the basic counter gives you the measuring capability you need today, an investment in your expanding needs for greater frequency range, sensitivity and special measurements, plus a guarantee that new state-of-the-art measurements will be available as they're developed.

The basic 5245L gives you a highly stable time base for accuracy, BCD output for recorders and accessories, capability for fre-

quency, period, multiple period average, ratio and multiples of ratio measurements, plus the ability to scale a signal by decades. Such hp features as display storage, rectangular digital readout tubes for measurements at-a-glance, solid-state modular construction for reliability and easy maintenance . . . are standard.

The plug-ins tell their own stories. Ask your Hewlett-Packard field engineer for a demonstration or write for complete specifications to Hewlett-Packard, Palo Alto, California 94304, Tel. (415) 326-7000; Europe: 54 Route des Acacias, Geneva.

HEWLETT  **PACKARD**
An extra measure of quality

603

New from Sprague!

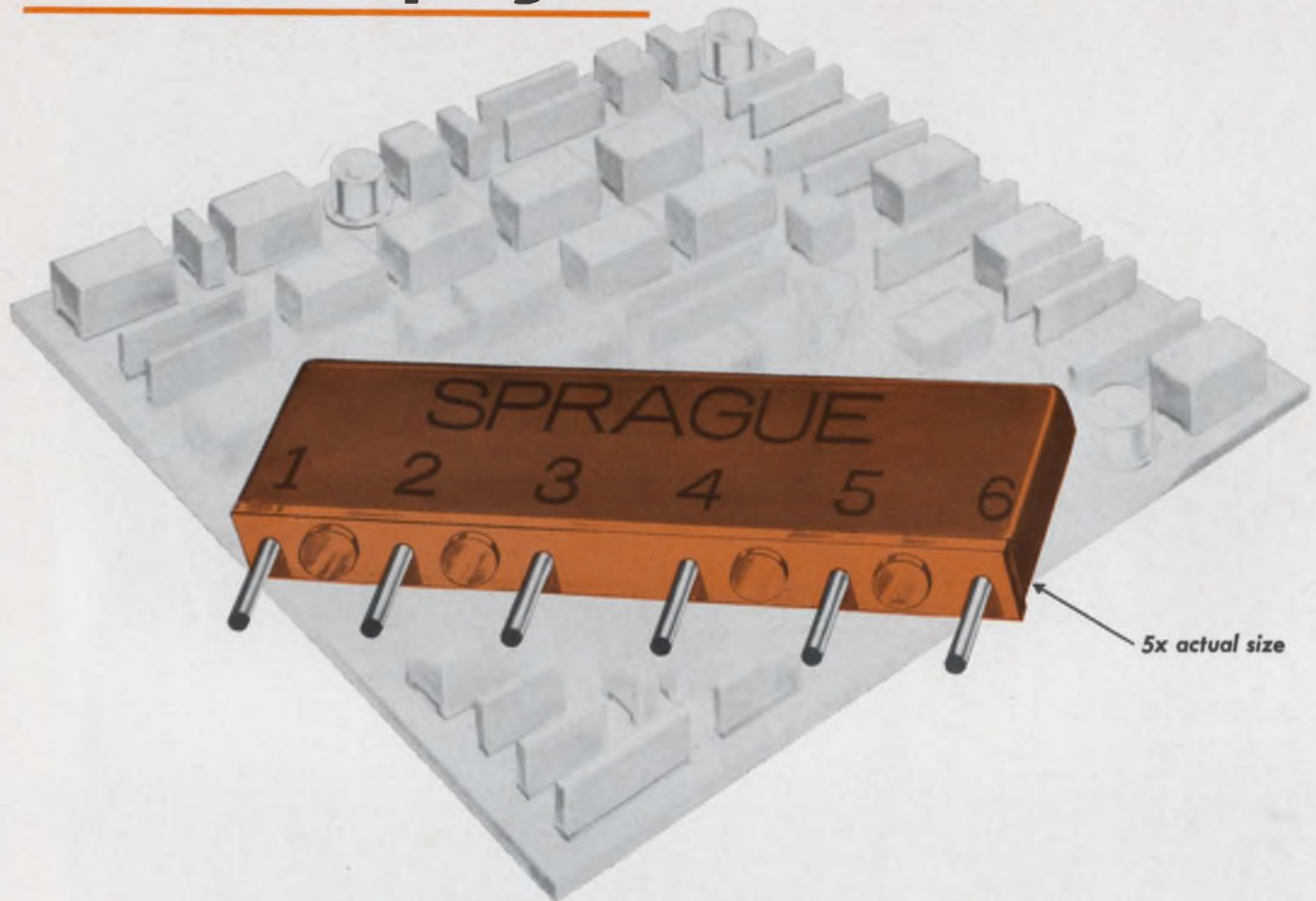

METANET[®] TRUE METAL-FILM NETWORKS **PRECISION RESISTOR**

Save Space, Time, and Money

High packaging density—4 to 8 times that of individual components.

Fewer components to stock, handle, inspect, install. Entire module can be hand-inserted faster than one axial-lead component.

Permit substantial savings over equipment assembled with individual components.

Epoxy terminal board keeps pin terminals free of resin coating, unlike conventional dipped components, and provides uniform lead spacing.

Stand-off bosses permit efficient flux removal after soldering. Also prevent dirt and moisture traps around leads.

Extremely stable and reliable. Meet performance requirements of MIL-R-10509E. Resistance tolerances to $\pm 1\%$.

Ceramic capacitors can be incorporated for further savings and size advantages over individual components

For complete information write to Integrated Circuit Application Engineering Dept., Sprague Electric Company, 347 Marshall St., North Adams, Massachusetts 01248

SPRAGUE COMPONENTS

RESISTORS
CAPACITORS
TRANSISTORS
INTEGRATED CIRCUITS
THIN-FILM MICROCIRCUITS

PULSE TRANSFORMERS
INTERFERENCE FILTERS
PULSE-FORMING NETWORKS
TOROIDAL INDUCTORS
ELECTRIC WAVE FILTERS

CERAMIC-BASE PRINTED NETWORKS
PACKAGED COMPONENT ASSEMBLIES
BOBBIN and TAPE WOUND MAGNETIC CORES
SILICON RECTIFIER GATE CONTROLS
FUNCTIONAL DIGITAL CIRCUITS



"Sprague" and "®" are registered trademarks of the Sprague Electric Co.

ON READER-SERVICE CARD CIRCLE 6

ED News

Showdown near on airborne phone system PAGE 17

Navy elevates deep-submergence program PAGE 21

Batch diodes apply beam-lead method PAGE 26

Lithium batteries promise yield PAGE 28

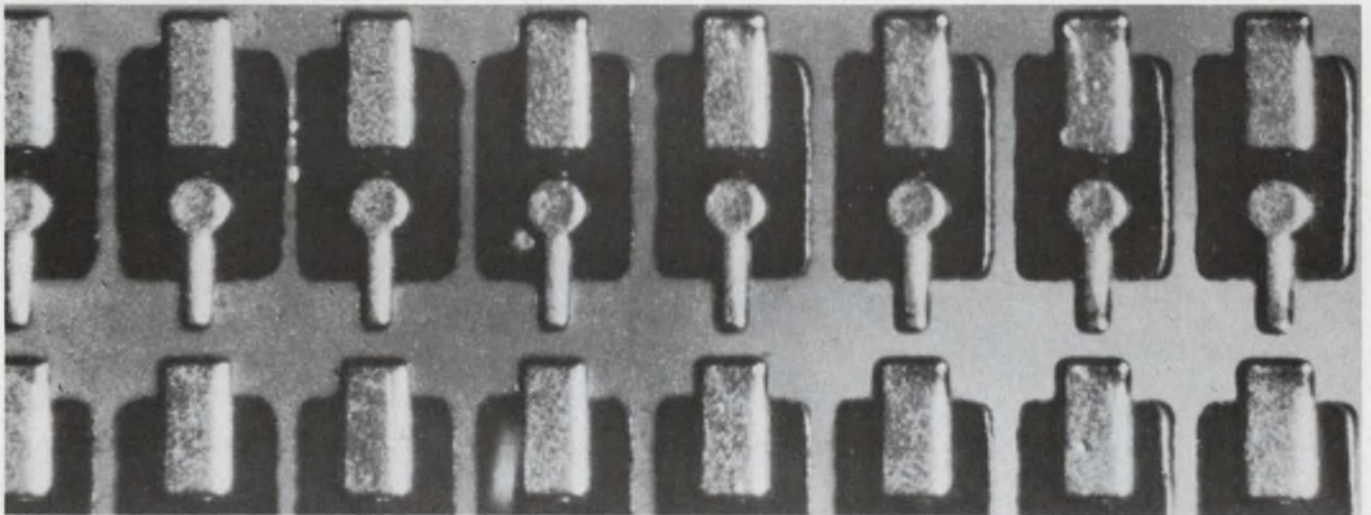

Batched beam-lead diodes . . . 26



Astronaut and his stroller . . . 26

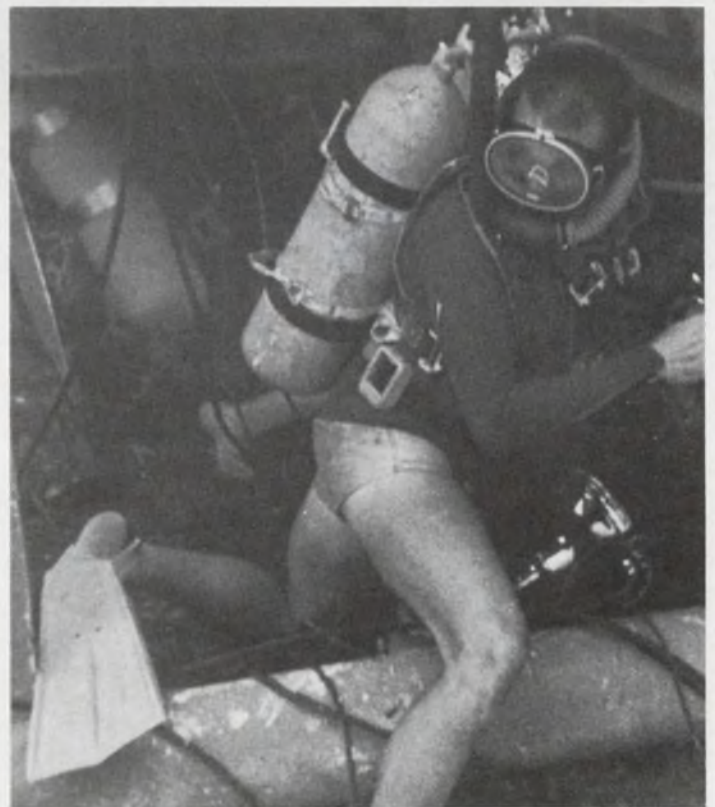

Aquanaut and his Sealab . . . 21

Now from Sprague!

LOW-COST, HERMETICALLY-SEALED

SEPT[®]

SILICON EPITAXIAL PLANAR TRANSISTORS

**A NEW LINE OF NPN QUALITY TRANSISTORS
IN TO-5 AND TO-18 CASES!**

**SUPERIOR TO EPOXY-ENCASED TRANSISTORS IN
MOISTURE RESISTANCE AND POWER CAPABILITY!**

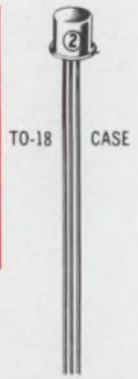
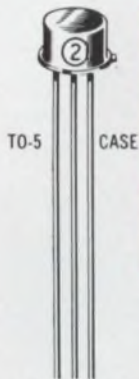

TYPE NO.		APPLICATION	BV _{CBO}	BV _{CEO}	h _{FE}	f _T
TO-5 CASE	TO-18 CASE					
TN53	TN54	High Voltage Switch, Amplifier, Gen. Purpose	75V	45V	50 min.	100 Mc
TN55	TN56	Low-level, Low-noise	40V	30V	60 min.	30 Mc
TN59	TN60	High Speed Switch High Speed Amplifier	40V	30V	100 min.	100 Mc
TN61	TN62		40V	30V	50 min.	100 Mc
TN63	TN64		20V	20V	25 min.	20 Mc

For complete information, write to Technical Literature Service, Sprague Electric Company, 347 Marshall Street, North Adams, Mass. 01248

SPRAGUE COMPONENTS

TRANSISTORS
CAPACITORS
RESISTORS
INTEGRATED CIRCUITS
THIN-FILM MICROCIRCUITS

PULSE TRANSFORMERS
INTERFERENCE FILTERS
PULSE FORMING NETWORKS
TOROIDAL INDUCTORS
ELECTRIC WAVE FILTERS

CERAMIC-BASE PRINTED NETWORKS
PACKAGED COMPONENT ASSEMBLIES
BOBBIN and TAPE WOUND MAGNETIC CORES
SILICON RECTIFIER GATE CONTROLS
FUNCTIONAL DIGITAL CIRCUITS



"Sprague" and "SE" are registered trademarks of the Sprague Electric Co.

ON READER-SERVICE CARD CIRCLE 7

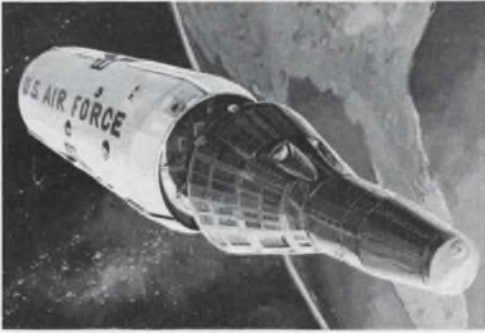

MOL, post-Apollo are budget victims

The Air Force MOL and NASA's post-Apollo applications programs are major victims of Vietnam war surgery in the President's \$112.8 billion budget request for Fiscal 1967, announced just last week. Instead of vast increases, both projects are likely to end up with the same funds they have in the current year—\$150 for MOL and \$100 million for post-Apollo.

When questioned on the conspicuous absence of additional funds for these big projects, both DOD and NASA officials replied that they were "effectively extending the definition phases for another year."

Total government expenditures for R&D are estimated to total \$15.939 billion in the new fiscal year, down slightly from last year's 15.961 billion. Research funds will increase from \$5.1 to \$5.3 billion.

The defense budget picture is clouded by amended and supplemental requests for Vietnam. At first glance the department's \$59-billion request seems to be a drop from last year's \$63 billion, with cuts in just about every area. However, supplemental Vietnam expenditures for FY '66 have been estimated at \$4.6 billion, and more than double that amount—\$10.3 billion—for FY '67. Secretary McNamara's "Defense Posture Statement" to Congress this week is expected to clear some of the fog, as well as go into more detail on budgeted projects.

The DOD had expected MOL funds to go up as high as \$250 million in this budget. (E/D, Jan. 18, p 31) Though they will just about hold the line instead, a DOD official stated: "We still consider MOL a very important program . . . but it is a difficult program, with substantial technical problems."

Military RDT&E will stay at about \$6.9 billion. On the plus side are "strong emphasis" on the Navy's Poseidon missile. "continued development" of Nike X, and "increased emphasis" on a battlefield SAM-D surface-to-air missile. On the negative side are the MOL cuts and the phasing into production of the F-111 fighter. C5A transport and Minuteman III missile programs.

News Report

Significant procurement items include the Navy's nuclear carriers, 210 FB-111s, 1000 Minuteman IIIs and an undisclosed number of C5As. The total procurement bill is nearly \$18 billion, down from last year's \$22 billion.

NASA's shaved request of \$5.012 billion indicates a drop-off in scientific goals in deference to continued emphasis on the manned lunar mission. The Apollo-applications program—using Apollo techniques and hardware for unmanned scientific missions beyond the manned lunar landing—appears to be in real trouble. The study program is being phased out of the budget, and nothing has appeared to utilize the study results. Though the agency had hoped to double the \$100 million spent on post-Apollo in FY '66 and wound up, like DOD with its MOL, with the same amount for FY '67, a NASA official said: "We have preserved the option to go ahead for the 1968 budget." (See E/D, Jan. 18, p 13, 31)

The recent released report of the National Academy of Sciences on Apollo applications was supposed to bolster NASA's budget request. But the report did not spell out specific-enough scientific objectives. The agency still has hopes that the influential academy will be able to convince Congress of the importance of further scientific missions that make use of Apollo experience and hardware. The Apollo program itself has not been affected, with this year's request for nearly \$3 billion by far the biggest item on NASA's list. The agency still hopes to land a man on the moon "in this decade."

Other developments of significance in the NASA budget request:

- A stretchout of the Voyager Mars program from 1971 to 1973 and the Advanced Orbiting Solar Observatory cancellation further illustrate cutbacks in scientific goals.
- In advanced research and technology, electronic systems show the only real increase, from \$32.3 million to \$36.8. Expensive propulsion-system research has fallen off in all three areas, but still totals \$132 million.

- Weather satellites show an area of more attention, led by the Nimbus. The budget here is up from \$39 to \$44 million.

- The new Cambridge Electronics Research Center is expected to be started by July. Two main activities there will be in optical communications and component qualifications and standards. The new budget includes \$10 million for the ERC.

Significant items from other department budgets show some gaps. The Federal Aviation Agency expects to complete this year the \$220-million design phase of its **supersonic aircraft** (SST) development program. But absent in the budget request are SST appropriations beyond the design phase. The FAA budget will also allot \$30 million for continued development of air traffic control systems and landing aids.

The Department of Commerce will spend more money for **computers** for the Census Bureau and Patent Office. **High-speed rail transit** programs—mainly the Northeast Corridor demonstration—will get \$13 million to spend in FY '67. The new Environmental Science Service Administration (former Weather Bureau, Geodetic Survey and Radio Propagation Lab and the new Institute of Oceanography) will get more money for R&D (3 million) and for **weather satellites** (\$8.5 million).

The Atomic Energy Commission request has no mention of the long-talked-about **200 Bev accelerator** project. This may have been held off for a supplemental request coincident with site selection, due for announcement "soon."

Philco buys General Micro-electronics

Continuing expansion of its microelectronics activities, Philco Corp. last week announced the purchase of General Micro-electronics from its parent company, Pyle-National, of Chicago. The reported sale price was \$4.3 million. Another \$4.8 million was paid to Pyle-National to repay its loans to GME, Philco said. The company plans to continue operation of GME, a leader in metal-oxide-silicon device technology, at its plant in Santa Clara, Calif.

Western industry group expands

In an annual statement to members, the Western Electronic Manufacturers Association has reported an increase in councils and active members in 1965. The active membership now stands at 367 companies, a growth of

18% since January, 1965. A sixth council of the association was formed in Colorado. The new council already has 17 member companies.

Growth in other WEMA councils includes a 50% gain in members in Arizona and more than 10% each in the Los Angeles and San Francisco units. The association serves the Western electronics industry from two offices, one in Los Angeles and the other in Palo Alto.

Essa I, II weather satellites blastoff

The first weather satellite in the Tiros Operational Satellite system (TOS) is due for launch this week, to be followed by Essa II later this month. The Essa (environmental survey satellite) will be virtually identical to the Tiros IX in design and planned orbit. The Tiros series was considered an interim operational system.

Developed by RCA's Astro Electronics Division, in conjunction with Goddard Space Flight Center, the Essa I will carry two half-inch Vidicon cameras which have a resolution of about two miles. The second in the Essa series will carry two automatic picture transmission cameras.

The third satellite in the Essa series, due for launch in early summer, will carry the advanced Vidicon camera system that was used in the Nimbus weather satellite.

W. G. Shepherd, University of Minnesota vice president, has been elected president of the IEEE for 1966, succeeding Bernard M. Oliver. W. K. MacAdam, AT&T vice president was elected vice president.

An Association for the Advancement of Medical Instrumentation, recently formed in Cambridge, Mass., hopes to improve communication between medical and instrument people. The AAMI can be contacted at PO Box 314, Harvard Square, Cambridge, Mass., 02138.

Oceanographic studies from space may be carried out by the Naval Oceanographic Office, in conjunction with NASA, possibly under the space agency's Apollo applications program. The Navy and NASA recently reached agreement on preliminary plans, but the gloomy future of post-Apollo funding may harm plans.

A data acquisition system for the Concorde supersonic airliner—an English-French project—will be built by Radiation, Inc., under a contract that will probably bring about \$2 million. First flight tests for the Concorde are scheduled for 1968, but the craft will probably not fly until 1972.

RCL INTRODUCES COMPLETELY FOOLPROOF 1/2" ROTARY SWITCHES

WITH REVOLUTIONARY, NEW WireEasy CONSTRUCTION.
WIRING TO SWITCHES NOW POSSIBLE "IN-THE-FLAT"

Up to 12 positions per deck . . . up to 6 poles per deck . . . shorting and non-shorting poles can be grouped in any combination on one deck . . . individual deck parts self-contained and permanently molded into place. Extremely low and uniform contact resistance: $.0025\Omega$ average. Life expectancy: 100,000 mechanical operations.

RCL

Write for complete engineering information

ELECTRONICS, INC.

General Sales Office: One Hixon Place, Maplewood, New Jersey

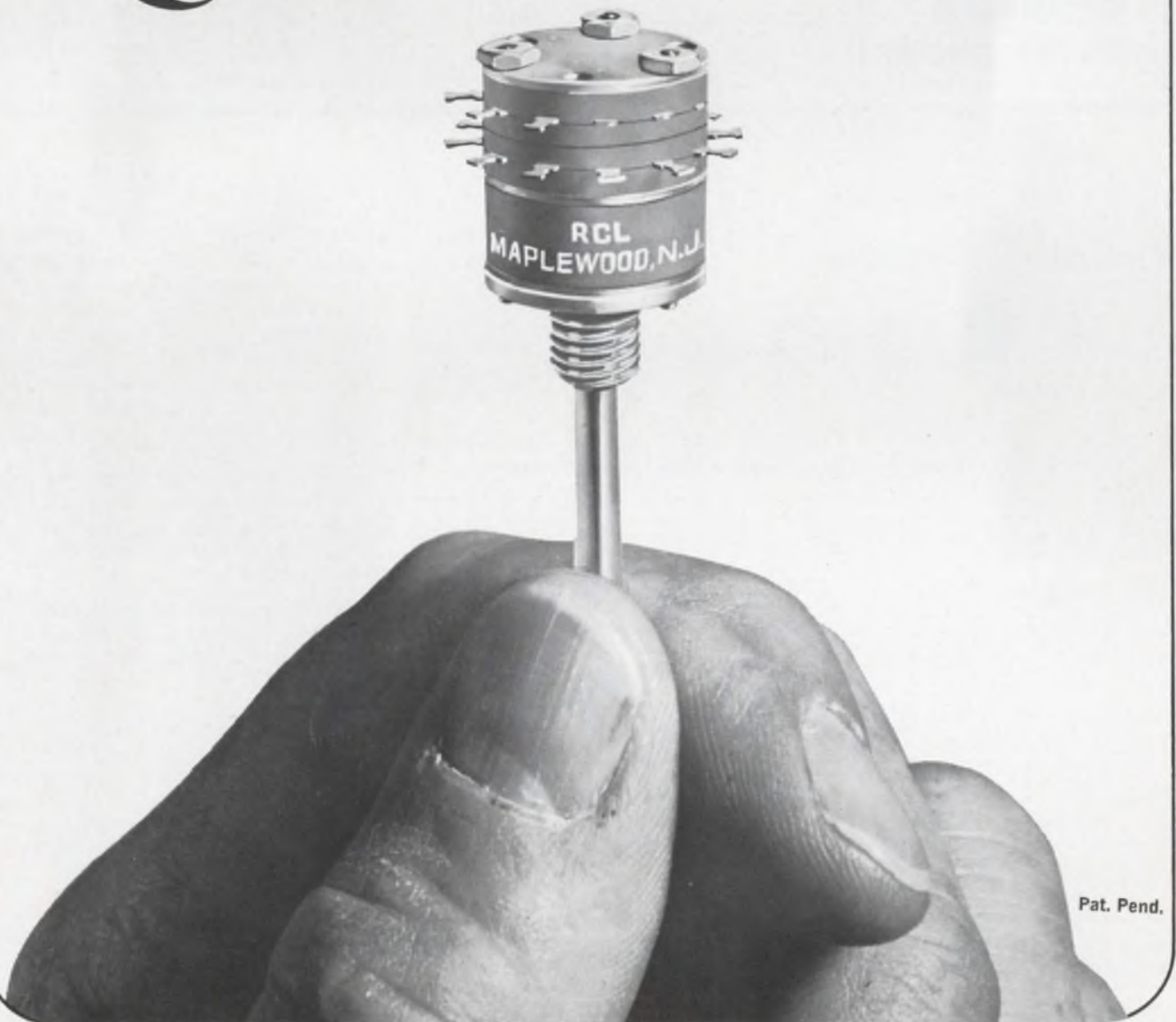

Pat. Pend.

Speed Inquiry to Advertiser via Collect Night Letter
ON READER-SERVICE CARD CIRCLE 8

PAR offers a line of superior precision voltage/current reference sources

**.001%
STABILITY**

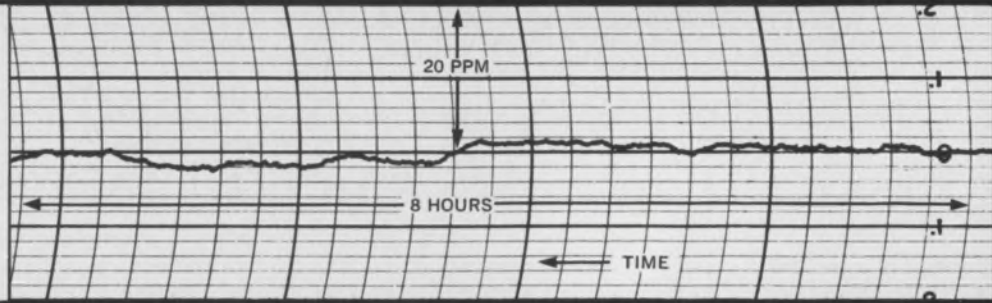

**.0001%
LINE & LOAD REGULATION**

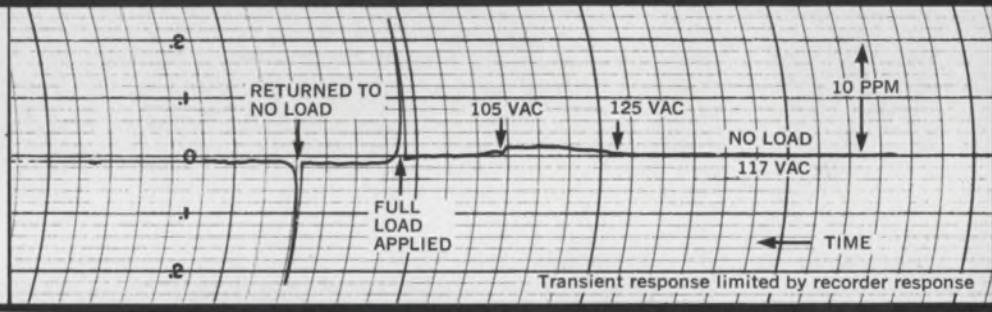

Model TC-100.2BR

INDEX OF PAR REFERENCE SOURCES

MODEL NO	OUTPUTS		ACCURACY		RESOLUTION		8 HOUR STABILITY		PRICE
	CONST. V.	CONST. I.	CONST. V.	CONST. I.	CONST. V.	CONST. I.	CONST. V.	CONST. I.	
TC-602R	0 to 60 V @ 2 A max.	0 to 2 A @ 51 V max. (Requires Ext. Resistors)	0.1% of F. S.	Determined by Ext. Resistors	10 mv	Determined by Ext. Resistors 400 μ a max.	.001%	.001% \pm stability of external resistors	\$1,185.
TC-100.2R	0 to 100 V @ 200 ma max.	0 to 100 ma* @ 100 V max.	0.01% of F. S.	0.02% of F. S.	1 mv	1 μ a	.001%	.002%	\$1,500.
TC-602CR	0 to 6 V 0 to 60 V @ 2 A max.	0 to 60 ma 0 to 600 ma 0 to 2 A @ 60 V max.	0.01% of F. S.	0.03% of F. S.	1 μ v min.	10 m μ a min.	.001%	.002%	\$1,750.
TC-100.2AR	0 to 100 V 0 to 10 V 0 to 1 V @ 200 ma max.	0 to 100 ma* 0 to 10 ma 0 to 1 ma @ 100 V max.	0.01%	0.02%	10 μ v min.	10 m μ a min.	.001%	.002%	\$1,800.
TC-100.2BR	0 to 100 V 0 to 10 V 0 to 1 V @ 200 ma max.	0 to 100 ma* 0 to 10 ma 0 to 1 ma @ 100 V max.	0.01%	0.02%	100 m μ v min.	100 μ a min.	.001%	.001%	\$2,200.
SF-Series (Fixed)	Any fixed voltage to 100 V @ 2 amps max.	Any fixed current to 2 amps @ 100 V max.	Within setting resolution		Up to 1 ppm of adjustable range about nominal		.001%	.001%	By quotation only.

*Available to 200 ma (at extra charge).

Princeton Applied Research Corporation offers a sophisticated line of power supplies providing extremely stable voltage and current outputs whose accuracy is traceable to N.B.S. All models are completely solid state and feature a careful, conservative design leading to highly reliable operation. Indicative of the features found in these units is a unique chopper-stabilized amplifier with a DC open-loop gain of 5×10^6 , falling off no faster than 6 db/octave to unity gain. This insures extremely low output impedance (less than 10 micro-ohms at DC) and fast transient response without ringing.

PAR Reference Sources permit considerable operational flexibility, having been used in such diverse applications as serving as the reference voltage in analog computers to providing the constant current required in "bucking" coils in elaborate magnetometer systems. All units feature digital output selectors, complete short circuit protection, and low ripple and noise. Write for Bulletin No. 112.

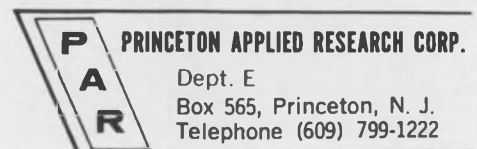

ON READER-SERVICE CARD CIRCLE 9

Showdown near on airborne phone system

An ssb facility is proposed for airline travelers, but the plan is meeting objections in industry. But the FCC may authorize field tests by summer.

Peer Fossen
West Coast Editor

It is early morning. Your jet got off on time, you have had your in-flight breakfast, and have gone over the documents in your briefcase at least three more times. You are on your way to Procurementville to present an important proposal for your company.

Then it happens. Your flight is put into a holding pattern over the terminal area, and it becomes clear that you will not be able to make that all-important 10:00 meeting.

What can you do? Nothing. Absolutely nothing but sit back, wait for your plane to land, hope that your company presentation will eventually be given another chance, and perhaps curse the lack of a public air-ground radiotelephone system.

That, unfortunately, is today's situation, despite the long-established need for such a communications system. The only way an in-flight commercial passenger can now get in touch with the ground is through the aircraft's operational radio system. For obvious reasons, such use is limited to dire emergencies.

But if today's situation is bleak, there is hope for the air traveler of tomorrow. Having evaluated an FM system that operates in the 450 MHz range and that has been in developmental operation in private aircraft for some years, the Federal Communications Commission is taking a close look at single-sideband (ssb) emission within the allotted frequency spectrum. It hopes to come up with a solution to the public air-ground radiotelephone problem.

A proposed ssb system is being pushed by the Radio Technical Commission for Aeronautics (RTCA), and the FCC has been asked to authorize field tests of it by late

summer. Despite a good deal of disagreement in the communications industry over the RTCA's proposed specifications for the system and its time schedule for development, most industry observers believe that the FCC will approve the ssb tests.

Industry blamed for delay

In a nutshell, there has been no public ground-air radiotelephone service so far because the electronics industry has failed to develop a system that can be of wide operational value within the limited FCC frequency allotment. Obstacles remain, despite many years of discussions and planning on the part of the electronics industry, airline and private aircraft owners and operators, aeronautical organizations and the Government.

The development FM system has been in use in some 300 private aircraft, supported by ten ground stations servicing aviation's "golden triangle," whose vertices are New York, Washington, D. C., and Chicago. However, the system is limited to six channels, with only a single channel serving the New York City area.

But the system is cumbersome, with no provisions for hookswitch supervision, which is necessary for automatic call completion. Moreover, an in-air "push-to-talk" requirement is confusing to the party on the other end of the call. Even if an industry-claimed optimized FM system, with 24 to 30 channels within the frequency allotment, were to become a reality, it would not satisfy the FCC.

FCC asks end to FM system

Responding to petitions by the American Telephone and Telegraph Co. and the General Motors Corp. (AC Spark Plug Division) aimed at making the FCC reconsider its

June, 1963, proposal to terminate the FM developmental service—the FCC in a Memorandum Opinion and Order (Docket No. 14615, June 30, 1965) stated in part: ". . . we have found that the present developmental air-ground system cannot provide an adequate service to the public within its present frequency allotment. We have also determined that, in view of the congestion prevalent in the land mobile services, no additional frequency space can be made available in which to expand this service in the vicinity of its present allotment. Consequently we have decided to terminate the present developmental operation within five years."

Simultaneously the commission issued a Notice of Proposed Rule Making (Docket No. 16073), stating: "We are willing to adopt an air-ground radiotelephone system which can provide an adequate public service within the present frequency allotment."

FCC criteria. . . .

The operating criteria for the ssb system set forth by the FCC are:

- Spectrum: 454.675-455.000 and 459.675-460.000 MHz.
- Voice channels: At least 60 2-way channels.
- RF bandwidth: Not exceeding 5 kHz per 1-way channel.
- Emission: Single sideband.

Docket. No. 16073 also poses three questions:

1. Would a 60-channel air-ground system be adequate to accommodate both national and international air travelers in the vicinity of major U. S. air terminals?

2. How many simultaneous radiotelephone conversations should the equipment aboard passenger aircraft be capable of handling?

3. What technical standards should be specified for providing selective signaling in the air-ground radiotelephone service?

The docket goes on to state that if constructive results are produced, a further FCC notice, specifying rules and standards, will be issued; otherwise this docket may be termi-

(airborne phone, continued)

nated and the frequencies made available for other purposes.

. . . and RTCA answers

Responding to the FCC notice, the Radio Technical Commission for Aeronautics recently issued its Report Do. 130, setting forth systems characteristics intended to meet the FCC criteria. The report was prepared by a special RTCA committee (SC-114), consisting of representatives from the electronics industry, FCC, National Business Aircraft Association, Aircraft Owners and Pilots Association, and Air Transport Association of America. E. D. Hart of the Bendix Radio Division was chairman of the committee, Frank White of the Air Transport Association was vice chairman, and C. J. Moncavage of RTCA was secretary. C. A. Rypinski, an independent communications consultant to the committee, was a major contributor to the system presented in the RTCA report. (The basic systems characteristics recommended are shown in the accompanying listing).

In response to the three FCC questions, RTCA's report offers these comments:

1. "The adequacy of 60 channels would be dependent upon customer acceptance and upon the division between private and commercial aircraft. Customer acceptance, particularly in large segments of the private aircraft market, would depend upon the cost, size and weight of the airborne unit, grade of service and the rates. Since telephone traffic generated by an air carrier would be several times that generated by a private aircraft, the mix between private and commercial craft would be a controlling factor in the over-all traffic pattern. It is expected that satisfactory service might be provided to the projected market at most of the major hubs for a five to eight year period.

"The system proposed in this report provides three significant improvements over the present developmental system, as follows: (a) It provides 60 operating channels in lieu of six; (b) It provides 10-channel trunking at each station; (c) It minimizes the need for manual routing—that is, operator intervention.

"It is considered, therefore, that when average demands are considered, the 60 channels will be adequate for some time.

2. "The plan permits the utilization of airborne equipment capable of providing from one through ten simultaneous full-duplex channels. If the system is adopted and imple-

mented, manufacturers would provide airborne equipment with capabilities falling within this range, depending entirely on user demands for simultaneous air-ground circuits.

3. "The plan provides for signaling of various types, including selective signaling. Field trials are necessary to provide confidence for the technique offered."

The RTCA report goes on to urge prompt FCC authorization for field tests of its ssb system, and it suggests that such tests be conducted in an area not serviced by the developmental FM system. Two possible areas mentioned are the West Coast and Fort Worth-Dallas.

Finally, the committee urged the FCC not to terminate the interim six-channel system, "unless and until there is evidence that it would interfere with the adoption, field trial and implementation of a suitable 60-channel ssb system."

Disagreement blocks progress

The forward of the RTCA report states that the association's objective is the solution of problems of air-ground telecommunications "by mutual agreement of its member and participating organizations." But while a specific ssb system is proposed in the report, there is strong evidence of disagreement among the committee members, both

RTCA-proposed specifications for ssb system.**Airborne system**

- Full duplex ssb operation on 60 voice channels (or fewer in the case of limited-range aircraft)
 - Nominal power; 10 watts PEP per channel.
 - An IF shape-factor of 1.25-1, measured at the 60 dB point.
 - Voice bandwidth of 300-3000 Hz.
 - Long-term frequency stability of two parts in 10 million.
 - Receiver sensitivity: 10 dB noise figure or 0.2 μ V.
 - Acceptance bandwidth of 590 Hz for group pilot carrier (\pm 500 Hz doppler shift +90 Hz frequency error).
 - No squelch required.
 - Radiation at upper side-

band frequency.

- Out-of-band spurious emission 40 dB down.
- Airborne logic unit to decode signaling, provide channel designation or search, unit ground station identification, frequency-correction decoding, RF output level command decoding, etc.
- 20-pound unit, to operate at -10°C to $+40^{\circ}\text{C}$ at a cost of about \$4000.

Ground system

- A group center-frequency reference pilot carrier accurate to \pm 10 Hz of assigned frequency.
- Power: 50 watts PEP per channel.
- Sensitivity, bandwidth, intermodulation and out-of-

band emission figures the same as in airborne system.

- System voice frequency translation error of less than \pm 5 Hz within 0.25 μ s.

Anticipated problem areas

- Maintenance of frequency stability of the airborne reference.
- Modulation of signal by multipath signals.
- Power requirement for various command functions and voice circuits.
- Frequency-locking in 450 MHz environment.
- Adjacent-channel and co-channel interference and required co-channel protection ratios.
- Level variation of incoming telephone path.

OUR CUSTOMERS HAVE NEVER SEEN THE LIGHT

and the day they do will be the day we lose business

Rolling metals to uniform standards is a specialty. Rolling metals for ultra-thin gauge foils for photo etching, shims, strain gauges, honeycomb structures, capacitors, etc; and rolling them virtually free of pin holes is a dedication.

We, at Arnold Engineering have the dedication and capability of precision rolling more than fifty-five metals. We've already rolled alloys and metals as soft as copper to a "thinness" of 0.000069"—alloys as hard as

Type 302 stainless and Elgiloy to 0.0002" and less. All of our mills, slitters and centerless grinding facilities are housed in a separate air conditioned filtered and pressurized clean room to minimize foreign particles which could cause pin holes in finished work. With dual source, non-contacting beta-ray gauges, we have held tolerances totalling 0.000017" on a week's run of .0011 ga. When you're ready to roll, give us the nod. We would like to show you how we can keep you in the dark.



THE ARNOLD ENGINEERING COMPANY Main Office: MARENGO, ILL.
BRANCH OFFICES and REPRESENTATIVES in PRINCIPAL CITIES

Speed Inquiry to Advertiser via Collect Night Letter
ON READER-SERVICE CARD CIRCLE 10

Did You Know Sprague Makes 32 Types of Foil Tantalum Capacitors?

125 C TUBULAR TANTALEX® CAPACITORS



Type 120D polarized plain-foil
Type 121D non-polarized plain-foil
Type 122D polarized etched-foil
Type 123D non-polarized etched-foil

ASK FOR BULLETIN 3602C

ON READER-SERVICE CIRCLE 821

85 C TUBULAR TANTALEX® CAPACITORS

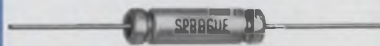

Type 110D polarized plain-foil
Type 111D non-polarized plain-foil
Type 112D polarized etched-foil
Type 113D non-polarized etched-foil

ASK FOR BULLETIN 3601C

ON READER-SERVICE CIRCLE 822

RECTANGULAR TANTALEX® CAPACITORS



Type 300D polarized plain-foil
Type 301D non-polarized plain-foil
Type 302D polarized etched-foil
Type 303D non-polarized etched-foil

ASK FOR BULLETIN 3650

ON READER-SERVICE CIRCLE 823

TUBULAR TANTALUM CAPACITORS TO MIL-C-3965C



CL20, CL21 125 C polarized etched-foil
CL22, CL23 125 C non-polarized etched-foil
CL24, CL25 85 C polarized etched-foil
CL26, CL27 85 C non-polarized etched-foil
CL30, CL31 125 C polarized plain-foil
CL32, CL33 125 C non-polarized plain-foil
CL34, CL35 85 C polarized plain-foil
CL36, CL37 85 C non-polarized plain-foil

ON READER-SERVICE CIRCLE 824

RECTANGULAR TANTALUM CAPACITORS TO MIL-C-3965C



CL51 polarized plain-foil
CL52 non-polarized plain-foil
CL53 polarized etched-foil
CL54 non-polarized etched-foil

ON READER-SERVICE CIRCLE 825

For comprehensive engineering bulletins on the capacitor types in which you are interested, write to:

Technical Literature Service
Sprague Electric Company
347 Marshall Street
North Adams, Mass. 01248

49C-5181

SPRAGUE®

THE MARK OF RELIABILITY

*Sprague® and ® are registered trademarks of the Sprague Electric Co.

NEWS

(airborne phone, continued)

with regard to selection of the system and to its implementation. The disagreement is reflected in the report itself, as well as in the multitude of comments and replies to comments filed with the FCC in response to Docket No. 16073.

For example, the report contains a step-by-step time schedule for the adoption, field test and implementation of the system. It discusses, with careful wording, the fact that the achievement of any schedule is subject to variables, many of which are unknown. "However," the report goes on, "in an atmosphere of cooperation and in an effort to set forth general guidelines, the following schedule was established as being representative of an optimistic (fast) schedule." In brief, the schedule shows these dates:

- July, 1966—FCC rules permitting start of field tests.

- August, 1966—Availability of first airborne and ground systems for flight test and evaluation.

- Spring, 1969—Terminal equipment to link ground RF systems with the public telephone network.

- Starting in 1971—Final configuration implementation.

Industry objections are strong

AT&T questions the practicality of the ssb system. In the RTCA report the company states: "Based on theoretical studies conducted by our laboratories, there is substantial reason to doubt the feasibility of developing a commercially workable ssb air-ground system meeting the design criteria specified by the commission. How far the present state-of-the-art and accompanying economic considerations would permit approaching these design criteria could only be determined by an extended development program, requiring an estimated three to five years. In our opinion, the chances of achieving the major objectives specified are not sufficient to warrant launching such a program at this time."

Also included in the report are separate views by Motorola, Inc., on a system utilizing FM techniques within the uhf spectrum. These views are concurred in by the General Electric Co., General Motors

(continued on pg 24)

Navy elevates deep submergence effort

Now under Chief of Naval Material, project looks to electronics to solve problems encountered in Sealab II. Sealab III, due next year, is one of five programs.

S. David Pursglove
Washington Editor

The Navy has given its undersea exploratory work—involving rescue, salvage and habitation of the deep—a more promising future by making the program a fully recognized "project" under the Chief of Naval Material. The effort—called Deep Submergence Systems Project (DSSP) had theretofore been just one of several miscellaneous ones under the wing of the Special Projects Office.

The announcement came as 1400 oceanographers, underwater engineers and antisubmarine warfare specialists—400 more than expected—overflowed a Washington hotel recently to hear a two-day report on one of the Deep Submergence Pro-

gram's more widely publicized projects, Sealab II. Plans for Sealab III were also outlined.

Project comprised of 5 activities

The Deep Submergence Systems project, stemming from a desire to avoid a repetition of the Thresher submarine tragedy, now consists of five activities:

- **Submarine Rescue**—includes development of techniques and equipment for locating disabled submarines and improvement of escape systems. Although development of instruments is a significant R&D activity, the major effort here is development of small deep-sea rescue vehicles.

- **Small-Object Recovery**—aims

to develop ways to search the seas down to 6000 feet for missile war heads, practice torpedoes and abandoned aircraft. A search vehicle is to be built to test the techniques. Based on experience with the test vehicle, the project will then design and build two operational craft capable of finding and retrieving objects down to 20,000 feet.

- **Large-Object Salvage**—aims to develop a collapsible pontoon system to lift sunken ships and other objects from as deep as 800 feet. Attachment of pontoons and preparation of the object for salvage will be done by divers.

- **Man-in-Sea Activity**—Designed to enable man to live and work in a deep-sea environment at ambient pressure. Sealab is one aspect of the research. Working for weeks at a time from permanent sea-bottom dwellings and mobile quarters open to the sea, swimmers will participate in rescue and recovery operations, maintain bottom-mounted equipment, conduct scientific studies, and take part in military operations of the sort that might be associated with mine defense, amphibious assault or espionage.

- **A Nuclear-Powered, Deep-Diving Research Vehicle (NR-1)**—Design, development and construction of a nuclear power plant—a small pressurized water type reactor—will be carried out by Vice Adm. Hyman G. Rickover's Naval Reactors Division of the Atomic Energy Commission. Development of the craft itself, however, and of its equipment and instrumentation will be done by the Deep Submergence Systems Project. The NR-1 will be equipped with a small laboratory and facilities for ocean-floor mapping. This activity is believed by many observers to be the one that will prove to be the project's major effort.

In announcing the "fundamental changes in the management of our ocean technology program," Navy Undersecretary Robert H. B. Baldwin made it clear that as a separate project, DSSP would receive "in-

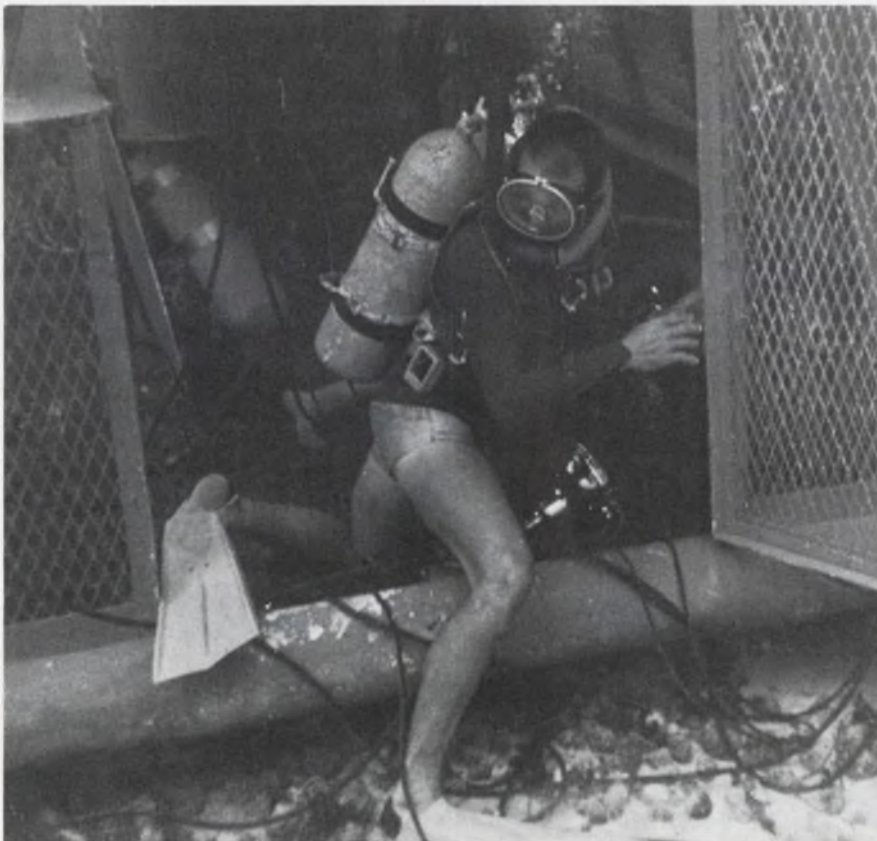

Not James Bond, but a Navy Sealab II aquanaut enters the deep-submergence research vehicle, which was under 200 feet of the Pacific Ocean for 30 days.

D
DAMON

VCXOs

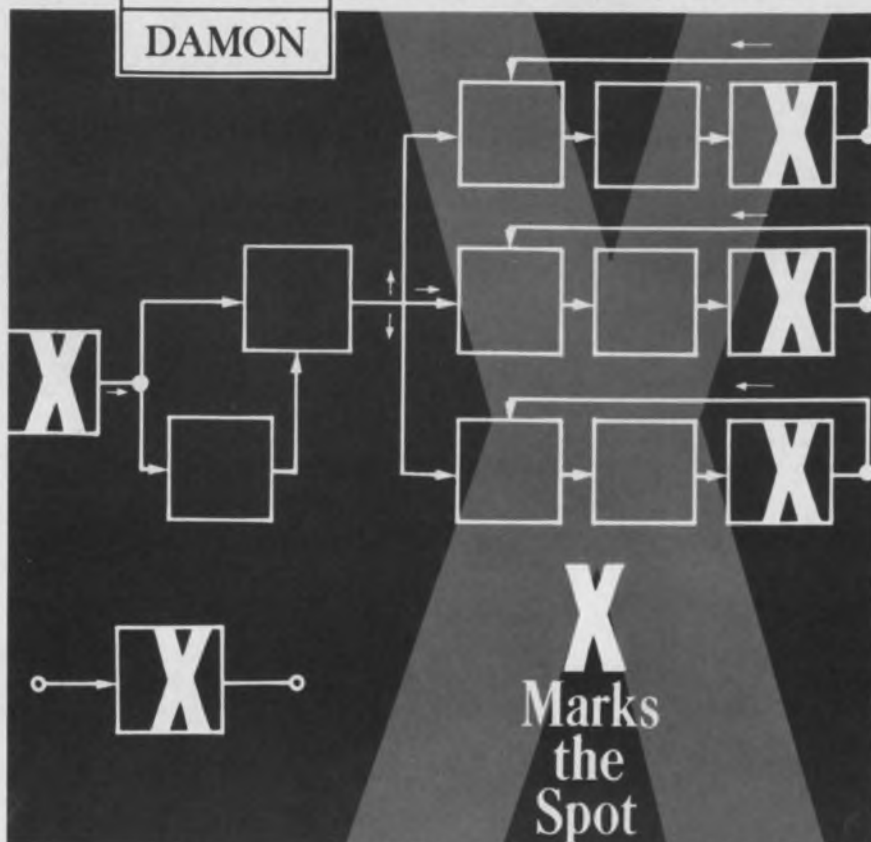

X
Marks
the
Spot

where
Precise
Control of
Frequency
begins

If you are involved in applications requiring electronic frequency control, the new Damon VCXO Brochure can help you. This Brochure is packed with technical data on applying Damon VCXOs to many modern electronic systems such as AFC, Coherent Radar, Phase Locked Receivers and Transmitters, Doppler Trackers, FM Generators Exciters, Frequency Synthesis and STALO. Damon VCXOs are available with peak frequency deviations from 20 cps to 2 mc and with center frequencies spanning 100 cps to 300 mc.

Write for this New Damon VCXO Brochure



DAMON ENGINEERING, INC.

240 Highland Ave., Needham Heights, Mass. 02194 Tel.: (617) 449-0800

Speed Inquiry to Advertiser via Collect Night Letter
ON READER-SERVICE CARD CIRCLE 11

NEWS

(Sealab, continued)

tensified management and focus of effort."

The Navy got the reorganization off to a good start by assigning its respected Chief Scientist for Special Projects, Dr. John P. Craven, as acting manager until a senior officer is appointed in June.

Simultaneously Dr. Robert Morse, Assistant Secretary of the Navy for R&D, has been designated the focal point for department-wide policy supervision of all ocean engineering. He will become chairman of the new Navy Oceanographic Policy and Programs Board in addition to his other offices.

Under the changes, DSSP will assume the status and acquire the prestige of such projects as Polaris, Antisubmarine Warfare, F-111B (Navy version of TFX) and the all-weather carrier landing systems project.

Communications problem critical

The Sealab II demonstration took place last fall off LaJolla, Calif. Aquanauts lived and worked in the deep ocean for 15 to 30 days. As in the case of Sealab I (off Bermuda), the living quarters were in a tank, with a bottom entrance to the ocean. The crew lived in highly pressurized "air"—largely helium—trapped in the upper portion of the tank. The helium replaced nitrogen and thus prevented nitrogen narcosis.

But it was the helium content of the atmosphere that created many of the communication problems that were widely publicized. Because of the much higher speed of sound in helium, human speech acquired characteristics that were described as "Donald Duck-like." Even after 15 days (and in the case of Aquanaut-Astronaut Scott Carpenter, 30 days), the crew could not adjust to the strange speech to the extent that critical instructions could be issued verbally. This was especially true of diver-to-diver instructions outside of the Sealab shirt-sleeve atmosphere. The aquanauts had to fall back on finger sign language and rapping on their oxygen tanks, and this held their total vocabulary to less than a dozen words. Commander Carpenter had some bitter words on this count:

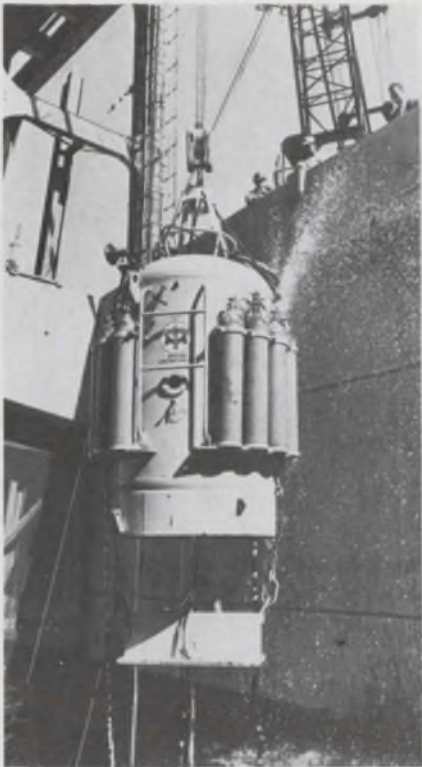

Dam repair work was done using a Westinghouse-built chamber under 200 feet of river water. Workers lived under pressure in the hoisted chamber for a week.

"We desperately need a research program to develop a reliable diver-to-diver communication system that does not encumber him with wires and does not compromise the performance of his breathing apparatus."

Carpenter contrasted the jerry-built, "gee-whiz, it worked" man-in-sea program with the well-funded man-in-space program and summed up the difference in possible emergencies this way:

"A diver's most urgent cry—mayday—can be uttered only with four fingers or four raps. And the raps don't carry very far."

Sealab III due in early '67

Acting Manager Craven indicated that several improved pieces of equipment were under study and likely would be tested in Sealab III, which he announced would get underway "early in 1967." However, no new concepts are involved. Primarily the tests will involve rearrangement of communication equipment.

Dr. Craven also expects to test new suits in Sealab III. A unanimous complaint of the Sealab II crew was that of bitter cold in con-



hp 3439A Plug-in Digital Voltmeter

versatile, 4-digit DVM—for only \$950
 accuracy better than $\pm 0.05\%$ of reading ± 1 digit, $\pm 15^\circ\text{C}$ to $\pm 40^\circ\text{C}$
 with line voltage variation of $\pm 10\%$
 5% overranging, high ac rejection (30 db at 60 Hz)
 signal common floatable up to 500 v dc from chassis ground
 automatic ranging

Use it for:

mv to kv dc autoranging voltage measurements: thermocouple, bridge measurements, production and maintenance testing
 μa to a dc current measurements: power supply currents, collector and base currents, leakage currents
 mv to kv ac voltage measurements: average responding (rms with hp 3440A), servo measurements, turns ratios
 ohms to megohms resistance measurements
 programmable ac, dc voltage ranges

Plug-in capability makes this DVM an economical bench instrument with a wide range of uses. The basic instrument, priced at \$950, offers high accuracy, dc isolation, speed (readings in a fraction of a second), ac rejection, economy, reliability. Plug-ins permit manual range selection 10 v to 1000 v full scale (3441A); automatic range selection with remote range feature (3442A); measurement ranges 100 mv to 1000 v full scale, with automatic and remote ranging (3443A); voltage (100 mv to 1000 v), current (100 μa to 1 amp) and resistance (1000 Ω to 10 M Ω) measurements (3444A); ac/dc measurements, 10 v to 1000 v full scale with manual, automatic

and remote ranging (3445A), and remote function and/or ranging (3446A). Plug-ins priced from \$40 for the manual ranging unit (required) to \$525 for the ac unit and \$575 for the multi-function unit.

Your Hewlett-Packard field engineer will give you a demonstration of the voltmeter and the plug-ins most useful for your application. Just give him a call. Or write for complete specifications to Hewlett-Packard, Palo Alto, California 94304, Tel. (415) 326-7000; Europe: 54 Route des Acacias, Geneva.

Data subject to change without notice. Prices f.o.b. factory.

HEWLETT  PACKARD
 An extra measure of quality

908

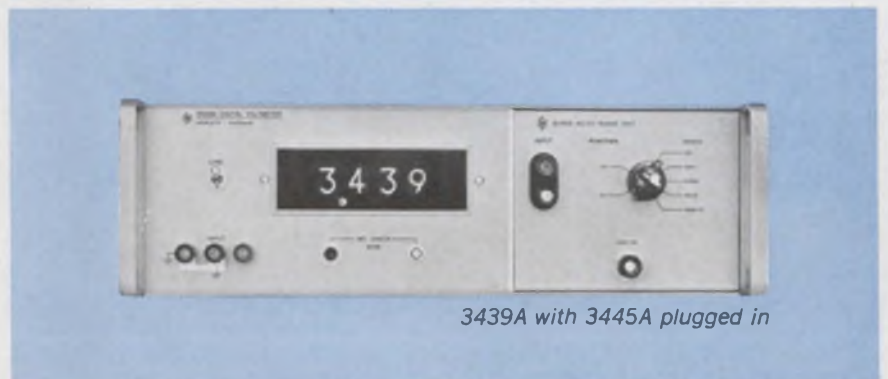

3439A with 3445A plugged in

ON READER-SERVICE CARD CIRCLE 12

(Sealab, continued)

ventional diving suits. The crewmen want suits heated either by circulating warm water or by embedded wiring. A Sealab-like crew that repaired a Virginia dam recently wore suits heated by warm water circulated from a surface source. Dr. Craven indicated that a similar suit would be tried by his men. The suit may use water heated by an isotope source that would replace one weight on the diver's belt.

Visibility nearly impossible

Sealab II divers found the visibility below 200 feet to be almost too poor for effective work, even with the best available lighting. When bottom conditions were good, the best lighting was effective only up to about 20 feet. However, when the divers were trying to work, and stirring up sediment, visibility was often less than five feet. It was virtually impossible to leave the immediate sealab vicinity for exploration, although some excursions were made with long lines to guide the divers back. However, long lines are considered not reliable and not practical for working divers.

Dr. Craven revealed that a program to improve the lighting was under way, based on better use of existing lighting. Capitalizing on the light-wavelength "window" in underwater visibility at 4800Å,

(airborne phone, continued)

Corp. and AT&T, except that the latter does not go along with Motorola's claim that FM can give 24 to 30 channels, with provision for a 900-Hz doppler shift and a 900-Hz frequency error at Mach 1 speeds.

Meanwhile, sentiment in the electronics and aeronautical industries, both among RTCA members and non-members, is mixed. Here is a sampling of views expressed (off the record) to ELECTRONIC DESIGN:

"The present FM system is totally inadequate for airline use."

"The present system is of great use to private aircraft and should be continued and expanded, at least until something better comes along."

"FCC does not want to expand the FM system usage. They are

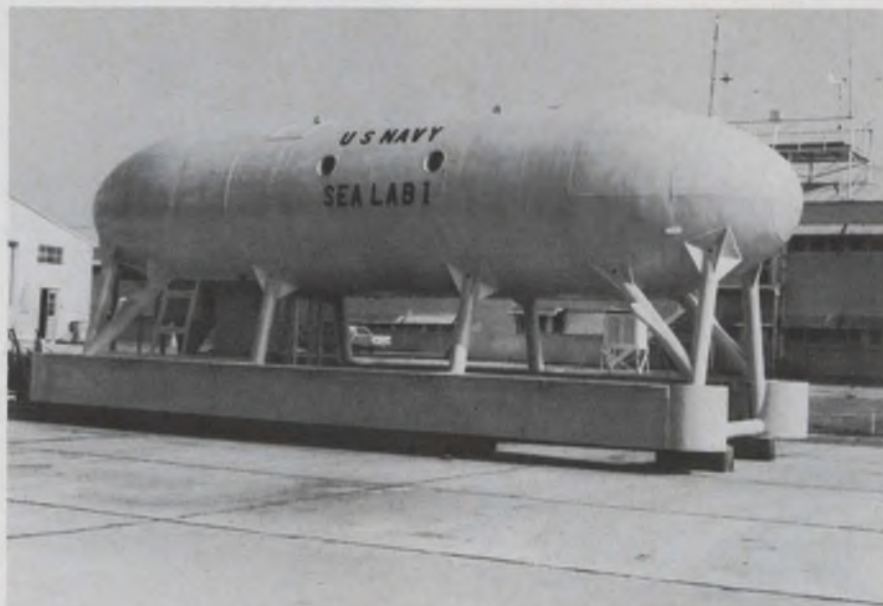

Sealab I has not undergone extensive external changes in the new configuration. Bermuda was the scene of the first eight-day undersea living experiment.

Sealab III is expected to feature a rotating green beacon to help guide its divers back home. In addition battery-powered green markers will be set out and anchored to light paths from the underwater tank to work areas.

Dam work uses same technique

Private industry has a stake in what is being learned in the Sealab program and already is capitalizing on it. Marine Contracting, Inc. of Connecticut used the Sealab technique of underwater living to repair Smith Mountain Dam near Roanoke, Va. Using a system devel-

oped by Westinghouse, divers working 200 feet underwater lived in a pressure chamber atop the dam and were transported in a pressurized capsule. (See photo on p 23). They were able to work normal shifts for a week, and they underwent long decompression only once, at the end of their week.

Decompression time varies only with the depth to which the diver has descended and is not a function of the length of his stay. A diver who has descended to 200 feet needs about six days to decompress, whether he was there for a half-hour or for a week, the Navy has learned. ■ ■

afraid it will become too firmly implanted."

"The RTCA time schedule for implementing the ssb system is too pessimistic. Everything needed is in operation in one form or another. It's just a matter of putting it together."

"Let's expedite the system to make FCC look favorably on ssb."

"The determining factor is getting an operational ssb system. It is not a technical one. It is of a political or financial nature."

"Think of what would happen if telephone companies decided to drag their feet."

"The big electronics companies are just stalling for time. They have their own ssb systems under development and do not want us little guys—who are ready to go now

—in on the kill."

"If and when the FCC ruling on the ssb system comes, it must be written in such a manner that every company with a capability in the field gets a chance."

The FCC is under pressure from many quarters to make up its mind. Waiting eagerly for that decision are the land and marine mobile communications industries, which want the frequency spectrum now allotted to air-ground radiotelephone, to widen their own markets. And, as if the external pressures were not enough, there is disagreement even within FCC. Three commissioners—Rosel H. Hyde, Robert T. Bartley, and Robert E. Lee—dissented when the Notice of Proposed Rule Making for the ssb system was drafted. ■ ■

HERE'S WHAT THIS 5 WATT ZENER DID FOR ONE COMPANY!



- Reduced weight 93%
- Reduced size 90%
- Reduced cost 73%

IMPRESSIVE? Read on so you can achieve similar savings.

CASE HISTORY

This company has a design engineer-- let's call him Bill--who had a problem. Line spikes were causing high base to emitter voltages that were destroying a transistor in the emitter-follower of Bill's solid state amplifier. Transistors with high base to collector voltages were both expensive and difficult to get.

The 24 volts of power for Bill's amplifier came from a high current, low voltage supply that also fed several other sub-assemblies. Bill found that when he inserted sufficient limiting impedance to protect the transistor, the circuit wouldn't operate satisfactorily.

What Bill needed was a line voltage transient clipper that would conduct high current during transient surges while having no steady state power consumption--a 36-volt zener!! Now he had a choice--a bulky 50 watt stud (1N3326), or an equally bulky 50 watt T03 (1N2885).

or

a Unitrode UZ5836, miniature axial leaved zener with a comparable surge rating. He chose the latter and saved in weight, size, and cost.

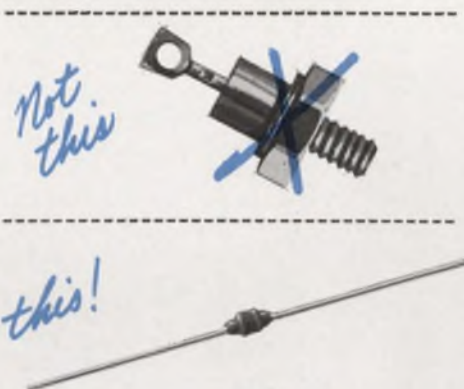
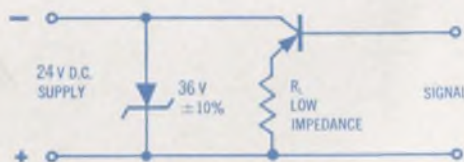

YOU CAN DO THE SAME. Contact the factory, call your local COMPAR office, or circle the reader service number on the magazine's reply card. All will insure your receiving data sheets and samples of Unitrode Zeners as well as information on other semiconductor devices immediately.

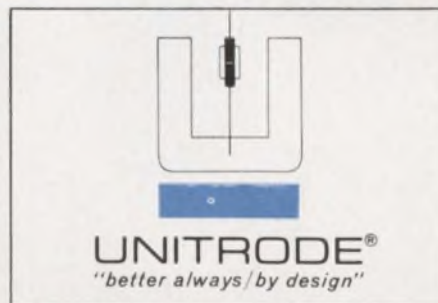

580 Pleasant Street, Watertown,
Mass. 02172 Telephone (617) 926-0404
TWX (710) 327-1296

Speed Inquiry to Advertiser via Collect Night Letter
ON READER-SERVICE CARD CIRCLE 13



"BLUE CHIP" TRANSFORMERS for printed circuit applications FROM STOCK!

OFF THE SHELF—These versatile transformers are available in five different sizes (.10 to 1.2 cubic inches) and a total of 62 new ratings. This wide choice of power ratings allows designers to select an optimum design, the one best suited for their particular electrical and mechanical requirements. These tiny, plastic cased transformers meet Mil-T-27B, grade 5, class S specifications and are 100% production tested.

Write for complete electrical and mechanical specifications.

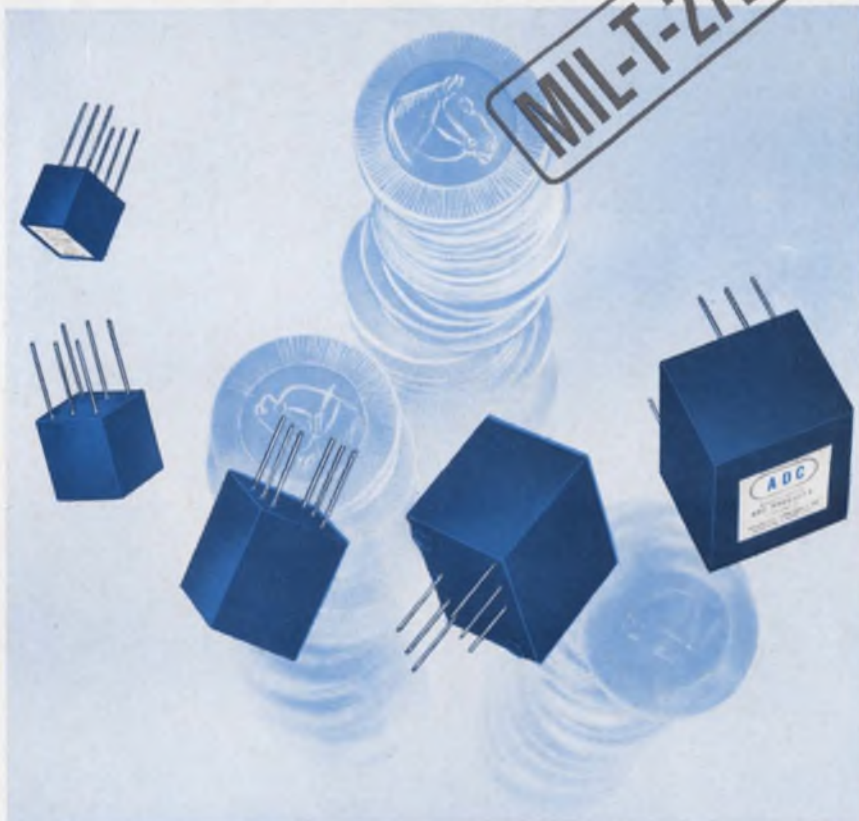

ADC PRODUCTS INC.

6325 CAMBRIDGE STREET ■ MINNEAPOLIS, MINNESOTA 55416

ON READER-SERVICE CARD CIRCLE 14

NEWS

Batch diodes apply beam-lead method

Batch fabrication of semiconductor devices—diodes now and transistors and integrated circuits in the future—has been advanced by application of the beam-lead technique.

The fabrication method, developed at Bell Telephone Laboratories about a year ago, will be used first in a line of diodes put out by the General Instrument Corp. of Newark, N. J. The major benefit of the beam-lead approach is a potential cost savings. So far, however, General Instrument has not disclosed its immediate pricing plans.

A spokesman at General Instrument says that the technique increases reverse breakdown voltage as much as 10-15 volts in the 100-volt region.

Samples of the "Herculead" beam-lead diodes are available from the manufacturer. ■ ■

Stroller for astronauts



Astronaut Maneuvering Unit for Gemini 9 (under test above) will permit astronauts to venture up to 1000 feet from their spacecraft and remain outside for up to an hour. Developed by Ling-Temco-Vought Corp., Dallas, Tex., the 160-lb backpack includes self-contained life-support, communications, telemetry, propulsion and both manual and automatic stabilization systems. The astronaut will maneuver on a long tether but otherwise will not be dependent on the mother ship.

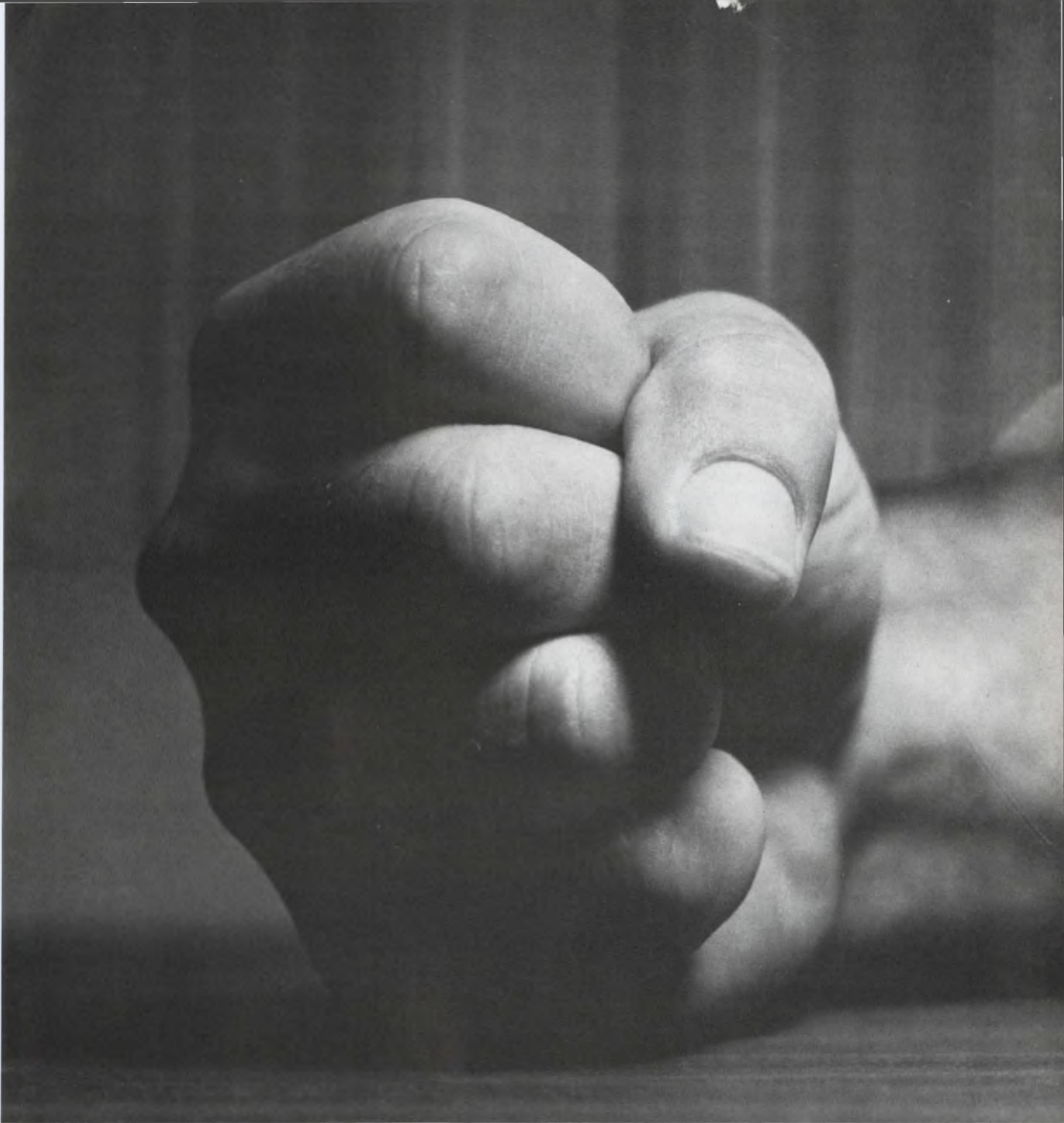

If you felt like this the last time your subminiature relay order was rescheduled, next time call Leach



We've got over 7,000 subminiature relays in stock at key locations throughout the country. Ready for immediate delivery. Relays like our **SERIES E**, a half-size unit rated for top performance in dry circuit to 2 amp switching. Designed for printed circuit and high environmental applications, this

subminiature relay offers space and weight economies of better than 50% over full size crystal can types. Available in voltages from 6 to 26.5 vdc, the **SERIES E** has an operate and release time of less than 4 milliseconds maximum, including bounce. It will withstand 100g shock, 30g vibration and operating temperatures from -65 to $+125^{\circ}\text{C}$. Rated life is 1,000,000 cycles, dry circuit.

Need one tomorrow? A dozen, a hundred? Then call us today. You'll have them. Right on time.

Leach Corporation, Relay Division;
5915 Avalon Blvd., Los Angeles,
California; Phone: (213) 232-8221;
Export: LEACH INTERNATIONAL S. A.

LEACH CORPORATION



WOOD ELECTRIC

CIRCUIT BREAKERS



When the specs say . . .
"Meet Requirements of
MIL Standard 202B"

You can depend on us!

The above photograph shows Circuit Breakers at Wood Electric being tested for temperature and humidity requirements of MIL Standard 202B. Units undergo temperature changes from 14 to 160° F during a 10 day cycle while relative humidity is held constant at 50%. Test chamber is controlled within $\pm 2^\circ$ F and $\pm 2\%$ humidity.

There are other specs and other tests, lots of them, but they all have one purpose in common—to assure the most reliable performance in the industry. If it's by Wood Electric—you can depend on it!

Choose from a wide variety of proven commercial and military Circuit Breakers to meet the specific needs of your application—Thermal types with time delays from 0.5 to 90 seconds and Magnetic types with temperature-stable trip points from instantaneous to 10 seconds. Models are available with ratings from 1/2 to 50 amps . . . AC or DC . . . single pole, two pole and three pole.

Write for Circuit Breaker Catalog CB-10-65



**WOOD ELECTRIC
CORPORATION**

244 Broad St. Lynn, Massachusetts (617) 598-5313

ON READER-SERVICE CARD CIRCLE 15

NEWS

Lithium batteries promise high yield

A lithium electrode has been used with success in a prototype battery of potentially striking capacity.

The battery reportedly yields 100 Wh/lb—four times the capacity of nickel-cadmium batteries. The yield is higher than today's highest-capacity silver-zinc types. And the 10 amp-hour prototype has exhibited only one-sixth of its theoretical capacity, according to Dr. Robert Shair, vice president of research and development for Gulton Industries, Metuchen, N. J.

Lithium cannot be kept in air, and it reacts strongly with water, so a propylene carbonate electrolyte must be hermetically sealed into the battery. A good electrode consists of a lithium paste applied to a nickel mesh, according to Dr. Shair.

In this prototype the positive electrode is a mixture of nickel fluoride, carbon and powdered metal. Gulton designers included the two latter substances to lower the resistance of the electrode. Further investigation may uncover better positive electrode materials, among the other halides, Dr. Shair said.

Although the developers have successfully recycled the batteries hundreds of times, they have observed some deterioration of the electrodes. Dr. Shair feels that even though a good deal of engineering must yet go into the battery, Gulton should be able to market a commercial lithium battery within two years.

"We foresee a lithium battery so efficient that it will compete with fuel cells for supplying power for a long time in inaccessible equipment," He said. ■ ■

Accuracy is our policy

Equation 2 for "Graph speeds calculation of skin effect" by L. D. Jambor in the November 8 issue, page 51, which also appeared in an accuracy statement in the November 22 issue, should be corrected by

a factor of $\frac{1}{2\sqrt{\pi}}$ to read:

$$\delta = \frac{1}{\sqrt{\pi f \mu \sigma}}$$

Also in the accuracy statement, $1/\epsilon$ —should merely be $1/\epsilon$.

For Any Operational Amplifier Requirement Philbrick Is The Source

If you're looking for:

economy



*Model P55AU & PP55AU — \$20.00
(less in quantity)*

speed



Model P45A & PP45 — 100 MHz Gain-Bandwidth

**miniature
packaging**



*Models Q25AH & Q85AH — in low profile
TO-8 transistor case*

drift stability



Model SP656 — $< 1 \mu V$ per day

low offset current



Model P2A — $< 10^{-12}$ A.

high output voltage



Model SP102 — $\pm 100V$ at ± 10 mA.

high impedance



Model P25A & PP25A — $10^{12} \Omega$

reference material



*New Applications Manual — Write on
letterhead for free copy.*

**application
engineering**

*Qualified consulting services available on
a world-wide basis.*

See Philbrick for: the widest range of models . . . the most extensive application assistance. Write, wire or phone . . . find out why more engineers than ever before rely on high-performance Philbrick Operational Amplifiers. Philbrick Researches, Inc., 46-F Allied Drive at Route 128, Dedham, Massachusetts 02026. Telephone (617) 329-1600.

Engineering Representatives

Ala.: Huntsville (205) 536-8393, Mobile (205) 954-9298; Ariz.: Phoenix (602) 265-3629; Cal.: Los Angeles (213) 937-0780, Palo Alto (415) 326-9800, San Diego (714) 222-1121; Colo.: Denver (303) 733-3701; Conn.: West Hartford (203) 233-5503, Greenwich (203) 661-5140; Fla.: Ft. Lauderdale (305) 564-8000, Orlando (305) 425-5505; Ill.: Chicago (312) 676-1100, (312) 676-1101; Ind.: Indianapolis (317) 356-4249; La.: New Orleans (504) 242-5575; Md.: Baltimore (301) 727-1999; Mass.: Wakefield (617) 245-5100; Mich.: Detroit (313) 838-7324; Minn.: Minneapolis (612) 545-4481; Mo.: St. Louis (314) 741-3779; N. M.:

Albuquerque (505) 268-3941; N. Y.: Buffalo (716) 835-6168, DeWitt (315) 446-0220, Lancaster (716) 835-6188, Valley Stream (516) 561-77 1; N. C.: Winston-Salem (919) 725-5384, (919) 725-5385; Ohio: Dayton (513) 298-9964, Westlake (216) 871-8000; Okla.: Tulsa (918) 627-6199; Pa.: Philadelphia (215) 277-0559, Pittsburgh (412) 371-1231; Tex.: Dallas (214) 526-8316, Houston (713) 781-1441; Utah: Salt Lake City (801) 466-4924; Va.: Alexandria (703) 836-1800; Wash.: Seattle (206) 723-3320.
EXPORT: N.Y.: New York (212) 246-2133.
CANADA: Quebec: Montreal (541) 482-9750, Ontario: Toronto (416) 789-4325.

ELECTRONIC ANALOG COMPUTING EQUIPMENT for MODELLING, MEASURING, MANIPULATING and MUCH ELSE



PHILBRICK

ON READER-SERVICE CARD CIRCLE 16



**■ WHO EVER HEARD OF
A WATER-COOLED SCR?**

We have. It's the newest thing in G.E.'s big family of power-rated semiconductors!

No, we're not putting you on. Technically speaking, it's two SCR's placed back-to-back in an integral water-cooled assembly. This compact, high performance switch is the highest current-rated unit ever assembled and commercially offered in a single component package.

The rating of this SCR switch, the C500X1, is 1200 Amperes RMS, 1800 volts peak in both directions. It can be used directly on 440 or 550 volts a-c service. The all-important surge rating is 4000 Amperes peak for 10 cycles.

You'll find it ideal in severe switching applications such as contactor re-

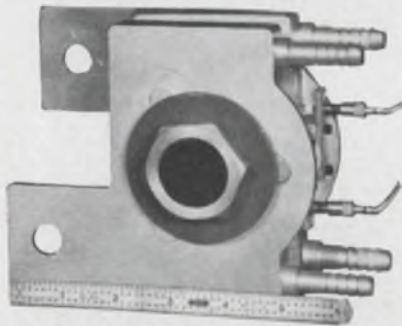

G-E Water-cooled AC Solid-state Switch

placement, primary phase control for plating, battery charging, welding, induction heating, and power supplies as well as for a-c motor speed control.

**■ FOR EXAMPLE, TAKE
RESISTANCE WELDING**

The solid-state switch offers improved performance, and you save space to reduce the size of your equipment.

Another obvious advantage of solid-state is the fact that it is insensitive to position. You can mount it to suit your

**Using Shunt-wound D-C Motors?
Try This Low-cost Speed Control Circuit**

Notice the G-E C22B SCR in this circuit. Its phase-controlled trigger signal is derived from the voltage across it so that the SCR output reacts to both the speed of the motor and its loading conditions. This gives you a form of feedback that's excellent for motor speed regulation. The control

circuit is reset at the end of each half cycle by resistor R₁ and diode D₁. Circle Number 813.

More detailed information on this and several other d-c motor control circuits may be obtained by writing your G-E representative for our Application Note 200.44.

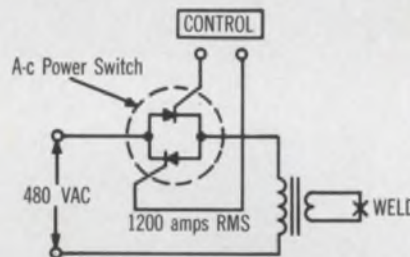
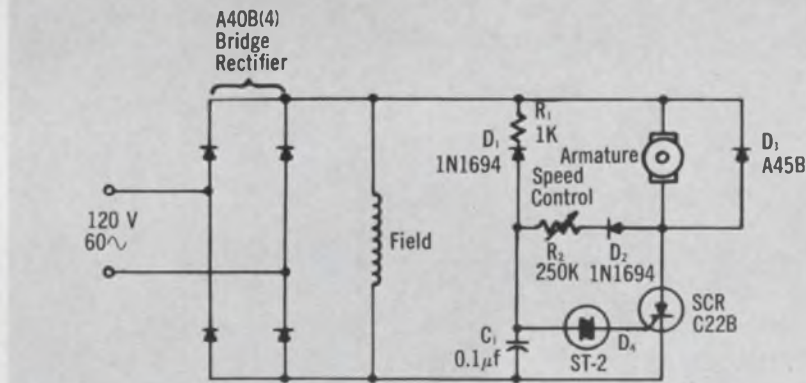

Switch Used in Welding Application

design. Circle Readers' Service Card Number 811 for more details.

**■ SPEAKING OF ECONOMY
SEMICONDUCTORS, HAVE YOU
SEEN ONE OF OUR NEW
"TRY-THEM-YOURSELF" KITS?**

Naturally, you'll want to test our economy transistors before you buy them, just as you do with all semi-

conductors. So we've packed 4 each of 25 different types in a reasonably-priced kit you can purchase from your local G-E electronic components distributor. Just ask for the G-E 16KT1300 kit. Models include our latest 2N2923-25, 2N3392-94, 2N3973-76, 2N3877, 2N3414-17, 2N3605-07, 2N3854-56, 2N2926, 2N3973-76, 2N3391-94, 2N3662-3, 2N3855-6, 2N3414-7, 16U3-4, 2N3877 and 77A, and 2N3605-7 transistors. Find out for yourself what their economies can add to your profits. Circle Number 812.

See your G-E engineer/salesman or electronic components distributor for more information. Or write to Section 220-26, General Electric Company, Schenectady, New York 12305. In Canada: Canadian General Electric, 189 Dufferin St., Toronto, Ont. Export: Electronic Component Sales, IGE Export Division, 159 Madison Ave., New York, N. Y. 10016.



First the moon, then what?



Academy proposals upset NASA

National Aeronautics and Space Administration officials are privately disturbed by the National Academy of Science's recommendations for the space program in the 1970's and early 1980's. NASA had looked forward to the report—"Space Research: Directions for the Future"—as an outline of post-Apollo programs backed by the most influential elements of the scientific community. The space agency still does not have any approved major programs beyond the landing of Americans on the moon. The academy report, which has just been released, was looked to as a guide that would support the agency's funding requests. However, the report plays down manned programs. Its emphasis is on unmanned scientific probes.

The report affirms the Space Science Board's earlier recommendations that the unmanned exploration of Mars should have first priority in the post-Apollo period, with more detailed investigation of the moon's surface and the unmanned exploration of Venus playing secondary roles during that period. However, the new report goes further by completing the priority list in this order: other major planets; comets and asteroids; Mercury; Pluto; interplanetary dust. The academy envisions the use of NASA's large rocket boosters to send instrumented probes to the farther planets, but it fails to dwell on any manned flights other than a continuation of manned lunar surface studies.

MOL in danger

NASA has found some consolation in indications of the Administration's apparent downgrading of the Air Force MOL (manned orbiting laboratory) program. The funds cut from MOL will not go to NASA; however, a slowed or terminated MOL program keeps NASA supreme as manager of America's space activities. A successful Air Force MOL program and a NASA without major national goals beyond Apollo could conspire to turn the total U.S. manned space effort to the Air Force. Although NASA is grateful for the reprieve represented by the MOL slowdown, some observers believe

Washington Report

S. DAVID PURSGLOVE,
WASHINGTON EDITOR

the civilian agency may yet be required to bow to the Air Force in the area of manned space programs.

Safe car buffs staggered by Staggers

Administration supporters of President Johnson's planned program of centralized research on highway safety are somewhat glum over recent remarks of the new chairman of the House Commerce Committee, Rep. Harley O. Staggers (Dem., W. Va.). He spoke at a Washington breakfast given by the Ford Motor Co. at a time when newspaper criticism of alleged unsafe automobile design was at a peak. Ford sponsored the breakfast to announce a newspaper advertising campaign to urge motorists to drive more safely and to publicize the automobile industry's design advances. Congressman Staggers spoke only briefly, but long enough to discourage officials who had hoped the House Commerce Committee would continue the push begun under its retired chairman, Rep. Oren Harris, to persuade the industry to design safer vehicles and to incorporate advanced safety devices. Rep. Staggers' theme: "The human factor in auto accidents is the great problem." The comment has cooled hopes that the current session would see passage of bills promoting research on new roadside and car-mounted warning devices.

Does war promote plowshare business?

Analysts of the defense industry in the many Washington-based "thinking factories" are pondering a viewpoint that emerged from the recent Paris meeting of science advisors to the member governments of the Organization for Economic Cooperation and Development. A study submitted to the meeting by Europeans showed that while there is some spin-off from military R&D to civilian technology, the same result could be achieved more efficiently by pumping the money directly into civilian R&D in the first place. U.S. Presidential Science Advisor Donald Hornig believes that many civilian industries that otherwise would remain in the distant future are actually created now by military and space programs. A new round of high level studies on the impact of military R&D on civilian industry is expected.

RADAR

... systems, missile guidance and communication systems.

Assignments in advanced radar technology are available with one of the country's outstanding research organizations.

IIT Research Institute, located on the campus of the Illinois Institute of Technology in Chicago, has every professional asset you may desire: a superb complex of facilities, exceptional opportunities for graduate study, a fine technical staff who published over 600 papers last year. It is a highly successful contract research operation, with a gross annual volume of over \$25 million in 1965.

Current positions are in the design, experimental evaluation and analysis of radar and missile guidance and communications systems. They require 3 - 7 years of experience related to this work, a minimum of BSEE, and an above-average academic record.

Interested candidates are invited to write, in strict confidence, to Mr. Ron Seipp.



10 West 35th Street
Chicago, Illinois 60616

An equal opportunity employer
M&F

Letters

Licensing exams for engineers? Readers are split on the issue

Sir:

Our attention has been called to the editorial in your issue of Nov. 8, 1965: "The Engineer's License—Is it Worth It?" We are always pleased to observe the attention given to engineering registration in the many technical publications of this country, but we regret that in this case there are a number of misstatements.

The purpose of registration laws is only secondarily to uphold a high standard of qualification and ethical practice, except to the extent that these virtues are necessary to carry out the real purpose of the law, which is to protect the public health and safety.

Admittedly registration laws are not perfect in eliminating the incompetent—whether doctors, lawyers, CPA's or other professionals. Certainly, however, experience demonstrates that an examination and licensing procedure to protect the public health and safety are necessary. We hope that you do not suggest that "Tom, Dick or Harry" be allowed to perform engineering services for the public without any proof of qualification. And if the state does not administer the licensing procedure, who should do it?

Before a person can be a specialist in any field he must acquire a knowledge and understanding of the basics of his calling—specialization comes later. . . . The registration boards have wide discretion in formulating the examinations, and in every case the state board provides a variety of examinations to cover particular fields of knowledge and experience.

The suggestion that the various engineering disciplines be noted on each license is a step backward by about 20 years, at least. This was the practice in the early days of registration, but the profession

has rather uniformly come to the conclusion that engineering is one profession and should be so identified on the certificates. In our present complex engineering world, it would be impossible to designate every field and branch—in one jurisdiction the board lists some 118 fields of engineering knowledge and practice for examination purposes—but those who pass the examination selected are identified on their certificates as "professional engineer."

None of these comments is meant to imply that registration has reached the point of perfection—far from it. The profession can stand, and sorely needs, all the constructive help it can obtain to improve the registration laws, examinations and procedures. To that end, we warmly welcome your continued interest.

Paul H. Robbins, P.E.
Executive Director
National Society of Professional Engineers
Washington, D. C.

Sir:

Re: Nov. 8 editorial by Maria Dekany. Today is the age of specialization. It becomes more apparent each day that highly specialized skill in a particular area is more valuable than generalized knowledge over a large area. Why should the Electrical Professional Engineer (EPE) be concerned about the stress and strain characteristics of beams, the work of the MPE (Mechanical Professional Engineer)? Or fluid mechanics, the work of the Civil Professional Engineer (CPE)?

Thanks again for airing a subject that needs to be reworked, rearranged and revitalized.

William K. Lacy
General Electric Co.
Huntsville, Ala.



take as needed

for severe temperature applications

These new, smaller, more efficient Uni-Sel selenium rectifiers bring relief to circuits troubled with high temperature bugs.

The Uni-Sel provides continuous DC current ratings, amperes for 26 and 33 volt RMS cells — plus greater reduction in cell sizes and lower unit cost than previous selenium rectifiers.



SYNTRON COMPANY

283 LEXINGTON AVENUE • HOMER CITY, PA.

66R7

This 20-joule High-Q CAPACITOR has inductance of ONLY 1 NANOHENRY

- Q is 250 at 5 mc
- 0.1 microfarad
- 20 kilovolts



\$172

The Model ESC 247B coaxial disc capacitor is one of a series whose inductance is essentially that of the terminal. Its coaxial construction results in maximum self-inductance of only one nanohenry for any capacitance from 250 pf to 0.5 μ fd.

Capacitors in this configuration can be furnished in 50kv rating or, at lower voltage, to 500 joules. They can also be constructed to operate at high repetition rates.

Units available at ratings to 50 kv will permit coaxial mounting of spark-gap switches.

The through-hole in the center of the terminal permits efficient installation of circuit components.

Ask for Bulletin EB365-20; it gives detailed information about the physical structure and electrical characteristics of coaxial disc capacitors.

And write or call us whenever you have a special or unusual requirement for capacitors.



TOBE DEUTSCHMANN

LABORATORIES

CANTON, MASSACHUSETTS 02021 Telephone (617) 828-3366

ON READER-SERVICE CARD CIRCLE 19

LETTERS

(License exams continued)

Sir:

I wholeheartedly concur with your analysis of the engineer's license situation, as stated in the Nov. 8, 1965, issue of *ELECTRONIC DESIGN*.

But in addition to writing editorials, what can you or the nonlicensed engineers do about this?

Howard H. Manko

Director

Solder Research & Development
Alpha Metals, Inc.
Jersey City, N. J.

Sir:

I read with interest your editorial, "The Engineer's License—Is It Worth It?" (*ELECTRONIC DESIGN*, p 18, Nov. 8, 1965). . . . However, I must say that I take exception to the statements you make about facts concerning the professional engineering examination.

The basic reason for the licensing procedures is not to "reward long experience" nor to "favor new graduates" but to protect the public safety. The reasons for the engineering license are exactly analogous to the reasons for licensing physicians and lawyers; the same New York State Board of Examiners administers these licenses as well as the license for engineers. In most cases no one will fail to agree that a written examination will tend to favor new graduates, who are closer to the fundamentals of the subject matter than are men who have been out of school for some time and have not kept themselves informed on these fundamentals.

The professional engineering license is not granted solely on the basis of the performance given on a written examination but, in general, by the following procedure (I give only the salient points):

1. Passing Parts I and II of a written examination based on a general knowledge of structures and a selection of questions from at least two areas of the engineering field.

2. The candidate must then show evidence of having per-

(continued on p 38)

NEW General Electric Indicating Lights

colorful Lexan* lenses for brighter light, new lens shapes for wider visibility

Four new lines of indicating lights—CR103 Type H—for countless commercial and industrial applications. Three mounting hole diameters— $\frac{1}{16}$ ", $\frac{1}{32}$ " and 1".

Five vivid lens colors—yellow, blue, green, red, white and also clear.

Glare-free illumination—Lexan (polycarbonate resin) lenses diffuse the light, eliminate "hot spots" and are virtually unbreakable.

*Registered trademark of General Electric Company

Three new lens shapes (crown, spherical and torpedo) each designed for wide-angle visibility—even from the side of the equipment.

Ease of installation—Lamps and lenses are installed from the front without removing base assembly or opening the panel.

For more information, write Section 811-62, General Electric Co., Schenectady, N. Y.

GENERAL  ELECTRIC



CR103 Type HC



$\frac{1}{32}$ " dia. mtg. hole,
crown lens

CR103 Type HB



$\frac{1}{16}$ " dia. mtg. hole,
spherical lens

CR103 Type HA



1" dia. mtg. hole, crown lens

CR103 Type HD

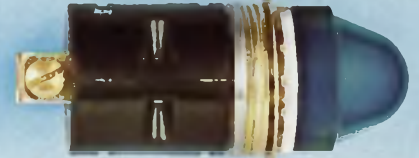





1" dia. mtg. hole, torpedo lens

MOTOROLA PNP/NPN SILICON ANNULAR

Twins*

MULTIPLE-DEVICE TRANSISTORS

the **full** line from low-level  
to high-current   transistors
...with built-in **design flexibility**
to meet many special applications—



LOW-PROFILE
TO-5 PACKAGE



CERAMIC 6-LEAD
FLAT PACKAGE

Motorola TWINS* let you make maximum use of space . . .

Motorola Twins put two transistors in the space of one. Each compact device—in 6-lead, low-profile TO-5, TO-18, or ceramic flat pack — holds dual PNP, NPN, or complementary transistors in one common environment, permitting better parameter uniformity during wide temperature swings.

Motorola's Annular Process Achieves New Performance Characteristics, New Levels of Reliability



The unique Motorola annular process has made it possible to design and produce the broadest available range of PNP or NPN silicon transistor and complementary pairs. For the annular process permits true silicon oxide surface passivation — thus eliminating uncontrolled "channeling" and leakage to the edges of the transistor die.

*Trademarks of Motorola Inc.

FOR HIGH-SPEED SWITCHING CIRCUITS AND DC TO VHF AMPLIFIER APPLICATIONS: DUAL TRANSISTORS

LOW-LEVEL AND HIGH-FREQUENCY

Dual PNP MD3250 and 51, featuring minimum f_T of up to 250 MHz and C_{obo} of 6 pf maximum; current gain specified from 10 μ A to 50 mA; high breakdown voltage — up to 50 V minimum; wide band noise figures as low as 3 db maximum.

LOW-NOISE/LOW-LEVEL/HIGH-GAIN AT μ A LEVELS

Dual PNP 2N3800-01 and 2N3806-07, featuring noise characteristics as low as 1.5 db maximum at $f=1$ kc and 10 kc; wide band noise figures as low as 2.5 db; high breakdown voltage $BV_{CEO}=60$ Vdc minimum; high beta guaranteed from 10 μ A to 10 mAdc.

LOW-LEVEL AND LOW-NOISE

Dual NPN 2N2913-14 and 2N2972-73, featuring high breakdown voltage $BV_{CEO}=45$ Vdc minimum; very high beta guaranteed from 10 μ Adc to 1.0

mAdc — h_{FE} up to 150 minimum at 10 μ Adc; excellent noise characteristics — as low as 3.0 db maximum at $f=1$ kc.

HIGH SPEED SWITCHING AND DC TO VHF AMPLIFICATION

Dual PNP Stars* MD2904/A-05/A, featuring high-voltage rating — BV_{CEO} to 60 Vdc minimum; high uniform beta over the current range from 0.1 mA to 300 mA; high current-gain bandwidth product — $f_T=200$ MHz minimum; low saturation voltage — 0.4 volt maximum at 150 mA.

Dual NPN Stars MD2218/A-19/A, featuring current gain specified from 0.1 to 300 mAdc; high current-gain bandwidth product — $f_T=300$ MHz minimum for MD2219/A; switching limits specified — t_d, t_r, t_s, t_f ; all leads electrically isolated.

COMPLEMENTARY PAIRS

HIGH SPEED SWITCHING / DC TO VHF AMPLIFICATION AND COMPLEMENTARY CIRCUITRY

Dual Stars NPN/PNP MD6001-02 (NPN type similar to the 2N2218 and 2N2219; PNP type similar to the 2N2904 and 2N2905), featuring beta specified at five current levels from 0.1 mAdc to 300 mAdc; switching limits specified — t_d, t_r, t_s, t_f ; all leads electrically isolated.

FOR APPLICATIONS REQUIRING A MATCHED PAIR OF DEVICES WITH HIGH UNIFORMITY UNDER VARYING CONDITIONS:

DIFFERENTIAL AMPLIFIERS

LOW-LEVEL AND HIGH-FREQUENCY

Dual PNP MD3250A and MD3251A, featuring minimum f_T of up to 250 MHz and C_{obo} of 6 pf maximum; current gain specified from 10 μ A to 50 mA; high breakdown voltage — $BV_{CBO}=50$ V minimum; low base voltage differential — 3 mV maximum at $I_C=100$ μ Adc — held within 1.8 mV from -55°C to $+125^\circ\text{C}$; wide-band noise figures as low as 3 db maximum.

LOW-LEVEL AND LOW-NOISE

Dual NPN 2N2915-20 and 2N2974-79, featuring high breakdown voltage $BV_{CEO}=45-60$ Vdc minimum; very high beta guaranteed from 10 μ Adc to 1.0 mAdc; beta match as tight as 0.9 to 1; base voltage differential as low as 3 mV maximum at $I_C=100$ μ Adc; excellent noise characteristics — as low as 3.0 db maximum at $f=1$ kc.

LOWEST NOISE/LOW-LEVEL/HIGH GAIN AT μ A LEVELS

Dual PNP 2N3802-05 and 2N3808-11, featuring minimum gains as high as 300 at 100 μ A; noise characteristics as low as 1.5 db maximum at $f=1$ kc and 10 kc; wide-band noise figures as low as 2.5 db; device-to-device V_{BE} (base voltage differential) as low as 5 mV over complete current range from 10 μ A to 10 mA; differential changes with temperature as low as 10 $\mu\text{V}/^\circ\text{C}$ from -55°C to $+125^\circ\text{C}$.

HIGH UNIFORMITY OVER WIDE TEMPERATURE RANGE

Dual NPN Stars 2N2060/A, 2N2223/A and 2N2480/A, featuring BV_{CBO} as high as 100 V; $\Delta(V_{BE1}-V_{BE2})$ as low as 0.9 mVdc = 100 μ Adc from -55°C to $+125^\circ\text{C}$; maximum base-emitter voltage differential as low as 3 mVdc; low capacitance values ($C_{ob}=8$ pf typical; $C_{ib}=20$ pf typical); all leads electrically isolated.

FOR SPECIAL APPLICATIONS CUSTOM-TAILORED TO SPECIFIC OEM REQUIREMENTS:

DARLINGTON AMPLIFIERS

Motorola has a complete custom capability for fabricating "one-of-a-kind" Darlington amplifiers to go with any given circuit.

GET IN TOUCH with your Motorola field sales representative or local Motorola semiconductor distributor to get sample devices for testing. For complete technical details, write: Motorola Semiconductor Products Inc., Technical Information Center, Box 955, Phoenix, Arizona 85001. Act today.



MOTOROLA
Semiconductors

Speed Inquiry to Advertiser via Collect Night Letter
ON READER-SERVICE CARD CIRCLE 20

Vector Solid State Laboratories

Now available in
production quantities...

2N3866

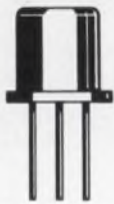

- NPN silicon transistor designed for high-level broad-band VHF-UHF amplification
- f_T to 1000 mc measured at 15 V, 50mA
- Economical
- Can be supplied in a variety of cases

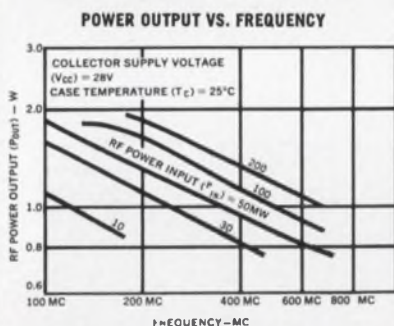

Contact your local representative for
data sheets, price and delivery
or phone Vector Solid State Laboratories
(215) EL 7-7600

Vector
U
DIVISION OF UNITED AIRCRAFT CORPORATION
A
SOUTHAMPTON, PENNSYLVANIA

ON READER-SERVICE CARD CIRCLE 21

LETTERS

(License exams continued)

formed a high standard of engineering work for at least four years (graduate studies may be counted toward this). The acceptability of the work is judged by the board of examiners, and, if acceptable, the candidate is permitted to take Part III of the examination. Part III requires a knowledge of engineering economics and a fairly deep knowledge of some engineering specialty.

If one examines the component problems which are involved in the design of even an elementary structure—such as, say, a small residence—it will be noted that they are structural, electrical, thermal and chemical in nature. Does it not, therefore, seem reasonable that the engineer who is to accept the responsibility of signing the design plan should be “familiar with a wide variety of subject matter,” even though he cannot be expected to be expert in more than one or two areas of specialty?

A simple perusal of the examinations given in past years will indicate that they have, in fact, been brought up-to-date in terms of the problems that have to do with facilities wherein the public safety is concerned. The examination does not pretend to qualify candidates for high-level research positions or for advanced degrees in engineering.

A chief reason why many fail the professional engineering licensing examination is the lack of serious preparation. Too much dependence is placed on the fact that the examination is an open-book type, and, as a result, many candidates spend too little time actually studying the pertinent subject matter. Those of us who concern ourselves with this problem are constantly urging students to prepare adequately for what is actually not an easy examination for the average engineer (even those just fresh from the classroom).

To aid those who have been out of school for some time, the engineering societies run an entire se-

quence of review courses designed specifically to prepare candidates for the exam. I was therefore very disturbed to see your editorial dismiss the examination as a hodge-podge and, in the case of the electrical field (traditionally one of the most difficult subjects for students), one which “can be passed with a knowledge of Ohm’s law—etc.” You will have done any potential candidate for the exam, who believes this, a great disservice if he uses this information to convince himself that he need not prepare to any great extent for the exam; this will be especially true in the case of new students. What student does not reach out for any statement which he can use to rationalize his inattention to a program of study?

In closing, I will mention that I do agree with you in that the engineering license ought to state the specialty of the licensee, although I would personally not like to see the examination itself become less broad in scope than is presently the case.

Velio A. Marsocci
Associate Professor of
Engineering
State University of New York
Stony Brook, L. I., N. Y.

NSPE: our readers answer our readers

Sir:

Mr. Freeman and I were pleased to have provoked the criticism in Mr. Biega’s letter to *ELECTRONIC DESIGN* (Dec. 20, p 19).

We readily agree that the National Society of Professional Engineers works to elevate the image and professional standing of engineers. The trouble with NSPE is that it admits only professional engineers (PEs). When Mr. Biega refers to the “low level of support [given to NSPE] by the engineers themselves,” he overlooks the fact that engineers are unlikely to support NSPE when they are not even entitled to membership. What support should a non-member give? Should he write encouraging letters, or send donations, or perhaps attend meetings and applaud?

The real question is which of these two alternatives is feasible:

1. 80% of American engineers should spend a semester reviewing academic material that is otherwise useless, just to take the PE exam and join NSPE; or,

2. NSPE should alter its membership requirements to admit unlicensed engineers.

The answer is clear, because NSPE is now considering admitting unlicensed engineers. Thus the onus is *not* on the engineers for failing to support NSPE.

There is a period in every engineer's career when he is much in demand. This is when he has between two and ten years of experience. The average engineer in this country is about 40 and has over 15 years of experience. Most companies would be reluctant to fill their ranks with senior engineers at over \$12,000 each. This would be "too many chiefs and not enough Indians."

How do companies assure an ample supply of young engineers? By publicizing the alleged shortage of engineers, thus hoping to attract greater numbers of youths into engineering college. In six years these youths will have B.S.'s and two years of experience, and they'll alleviate the "shortage." But what about 20 years later—where will they be then? There's no shortage of 40-year-old engineers, except men with certain specialties on the frontier of R&D. The average engineer of 40 has far less demand for his skills, and at 50 he has almost none. Apparently the best security is to find some way of remaining 30 years old until retirement. A practical alternative is for engineers to form a strong professional association.

Any organization which seeks to improve the professional standing of the engineer must disillusion the general public by publicizing the complete story about the shortage of engineers. We sincerely hope that NSPE will exert effort in this direction.

We are also grateful to ELECTRONIC DESIGN for providing a forum for these ideas, which do not necessarily reflect the ideas of our employers or co-workers.

Robert Bruce
Jay Freeman

Great Neck, N. Y.

February 1, 1966

REDUCE 3RD ORDER SPURIOUS 40 db WITH AVANTEK +20 dbm PREAMPS



¼ Actual Size

MEASURED DATA ON MODELS AP-20 & AL-20, 200 TO 400 MHz

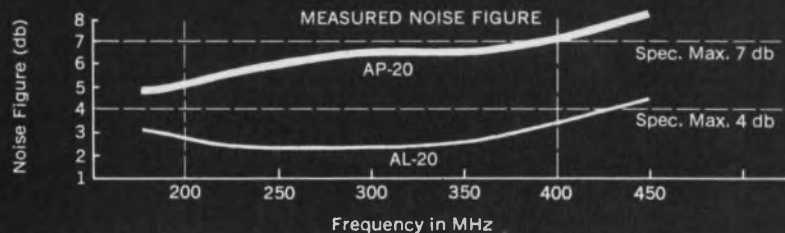
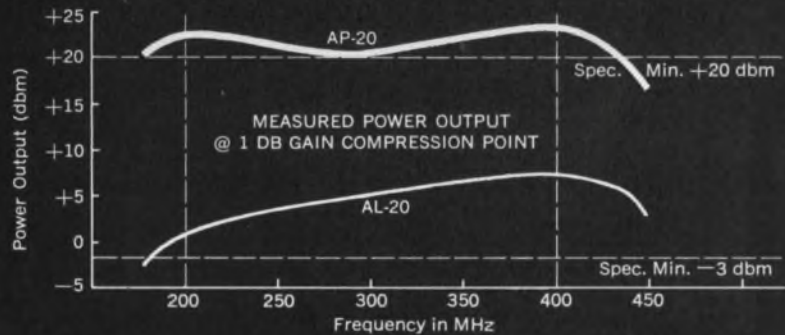

If your receiver is plagued by strong in-band signals which are generating 3rd order intermodulation products and limiting your dynamic range—then consider Avantek AP series preamplifiers. They are guaranteed to have +20 dbm output at the 1 db gain compression point, combining wide dynamic range with excellent sensitivity.

For example, if two strong signals produce -20 dbm outputs in a 0 dbm preamp, then the third order products appear at -60 dbm*. When an AP +20 dbm model is substituted, the spurious will appear at -100 dbm. Thus the AP model yields a 40 db reduction of 3rd order spurious.

If you need the lowest possible noise figure in a low level preamp, consider the Avantek AL series. These are available in octave bands from 100 through 1000 MHz, with special models for coverage below 100 MHz. For details, contact Avantek or any of the sales offices listed below.

*With two equal output signals "S" db below the 1 db gain compression point or intercept compression reference of an amplifier, then 3rd order products will appear "2S" db below output signal level.

AP-20	Guaranteed Performance Data
frequency	200 to 400 MHz
noise figure	7 db max.
minimum gain	24 db
gain flatness	±1 db
Pout @ 1 db compression	+20 dbm
weight	10 oz.
input power	4 watts max.

Avantek

3001 Copper Road, Santa Clara, Calif. (408) 739-6170
Los Angeles (213) 937-0790 • Dallas (214) 631-5440
Wash., D.C. (202) 783-7319 • Phoenix (602) 264-5878
New Jersey (201) 226-4545 • Boston (617) 862-7782
Baltimore (301) 825-2385 • San Diego (714) 298-8385

ON READER-SERVICE CARD CIRCLE 22

TRW CAPACITORS ARE SMUG



... especially our new metallized polycarbonates!

TRW has now extended its leadership in film capacitors to include metallized polycarbonate types. Two features of the X463UW are outstanding. Precise processing assures low TC through temperature ranges to 125° C. Metallized construction reduces size to less than one half that of film-foil designs. Other features of the line include:

- Capacity range from .01 to 10.0 mfd
- Low dielectric absorption
- Available in tolerances to $\pm 1\%$
- Humidity resistance per MIL-C-27287

For full information contact: TRW Capacitors, Box 1000, Ogallala, Nebraska. Phone: 308-284-3611 • TWX: 910-620-0321.

TRW CAPACITORS

ON READER-SERVICE CARD CIRCLE 23

Co-Publishers

James S. Mulholland, Jr.
Robert E. Ahrens Dorf

Editorial Director

Edward E. Grazda

Editor

Howard Bierman

Managing Editor

Robert C. Haavind

Technical Editors

Maria Dekany
Frank Egan
Mark B. Leeds
Rene Colen
Joseph J. Casazza

News Editors

Roger K. Field
Richard Harnar
Alfred Rosenblatt

West Coast Editors

Ralph Dobriner
Peer Fossen

New Products Editors

Ronald A. McGee
Patrick Cook

Washington Editor

S. David Pursglove

Editorial Production

Dollie S. Viebig
Anne T. Lombardi

Art Director

Clifford M. Gardiner

Technical Illustrators

William Kelly
Lewis D. Hill
Cheh Nam Low
Leonard P. Levenson

Production Manager

Thomas V. Sedita

Asst. Production Manager

Helen De Polo

Production Assistants

Bernard Wolinsky
Carl Merkin

Circulation Manager

Nancy L. Merritt

Reader Service

Diane Pellechi

E/D EDITORIAL**We're indebted to you . . .**

We're happy. Why shouldn't we be? You all but overwhelmed us. We asked you, Do you like ELECTRONIC DESIGN's new format? Your answer: Emphatically, yes. More than 4300 reader-reaction cards were returned to us within 10 days of delivery of the January 4 issue. A majority of more than 100 to 1 expressed enthusiastic approval of the timeliness and quality of our "new product". Many sound observations and suggestions were made. Let me review our initial analysis of your comments and how we are reacting to your suggestions:

■ **SIZE AND FORMAT.** A comment from a subscriber at Sperry Gyroscope Co. was echoed by the thousands—"New size and format easier to hold, easier to read, easier to clip and file, and looks more professional." Of the 4346 cards received, 4308 readers expressed satisfaction while 38 felt that we lost identity and thus made it difficult to quickly sort ELECTRONIC DESIGN from a pile of magazines.

■ **ADS BETWEEN TECHNICAL ARTICLES.** Most readers pinpointed the functional interspersing of ads between articles in the Technology section, typified by a comment from a Union Carbide engineer—"Appreciate not losing the first page of an article following previous one." However, a number of readers indicated a preference for ads grouped at the front and back of the issue, with news and articles in between.

By placing ads between feature articles and technical departments, it is possible to clip one story without destroying its neighbors. We intend to follow this approach for all you "cut and file" readers (and who doesn't cut and file?).

■ **INSERTS.** Although the number of objections to inserts was low, the intensity was quite volatile. Said one reader from HRB-Singer Inc., "Don't like heavy sheets between articles, makes it hard to read."

Hereafter, inserts will be positioned to minimize reader inconvenience.

■ **WIDE MARGIN TO ALLOW HOLE PUNCHING.** Many readers file their articles in loose-leaf binders and, as a subscriber from The Martin Co. suggested, "Keep the inside margin wide enough for punching".

This factor was considered in the redesign. If you carefully tear or clip each page at the inside edge, there is sufficient space for binder holes. Try it and see. Also note the use of a "perfect binding" process (use of glue on each individual page) to simplify page removal.

These are just for openers. You have stirred us with your laudatory remarks, alerted us to your very specific needs and enlightened us to our failings.

To the thousands of you who took the time to write, sincerest thanks from all of us.

HOWARD BIERMAN

Operational Amplifiers

Price = \$24

High Performance

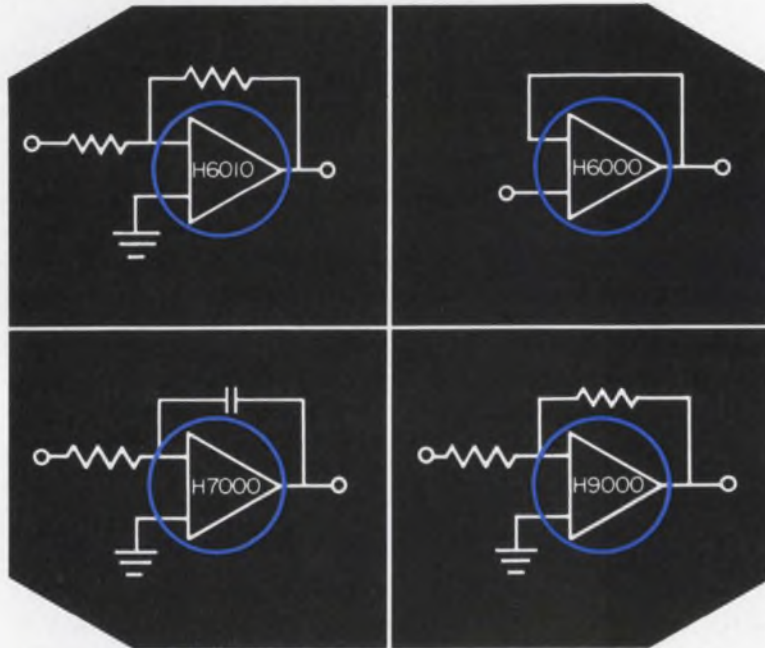

$R_{IN} = 10^6 M\Omega$

$f_T = 15 mc$

Select-Performance/Price

UNION CARBIDE ELECTRONICS AMPLIFIERS

SPECIFICATIONS	H6010	H6000	H7000	H9000	Units
OPEN LOOP GAIN (min)	86	90	86	95	db
GAIN BANDWIDTH PRODUCT	6.5	2.0	2.5	15.0	mc
INPUT IMPEDANCE	0.25	10	10^6	1.0	$M\Omega$
VOLTAGE DRIFT (max)	10	10	25	5	$\mu V/^\circ C$
CURRENT DRIFT (max)	5.0	1.0	*	0.5	nA/ $^\circ C$
OPERATING TEMPERATURE (max)	-25 to +85	-55 to +125	-55 to +125	-55 to +125	$^\circ C$
OUTPUT (min)	$\pm 10/3$	$\pm 10/2$	$\pm 10/2$	$\pm 10/30$	V/mA
PRICE (1-4)	\$24	\$89	\$119.50	\$99.50	

*50pA @ 25°C varies exponentially

Select the amplifier to give you best performance/price and call your UNION CARBIDE ELECTRONICS Distributor today.

**UNION
CARBIDE**
ELECTRONICS

UNION CARBIDE CORPORATION 365 Middlefield Road, Mountain View, California 94041 TWX: 415-969-9166; Telephone: (415) 961-3300

Speed Inquiry to Advertiser via Collect Night Letter
ON READER-SERVICE CARD CIRCLE 24

ED Technology

Design efficient multipliers with step recovery diodes PAGE 44

Complement of exclusive-OR simply obtained PAGE 48

Small capacitor measurements of drift and TC PAGE 52

Avoid over-integration by using off-the-shelf IC's PAGE 56

Simplify dc amplifier design using FETs PAGE 64

Design your career and get to the top PAGE 70



Get to the top, faster . . . 70

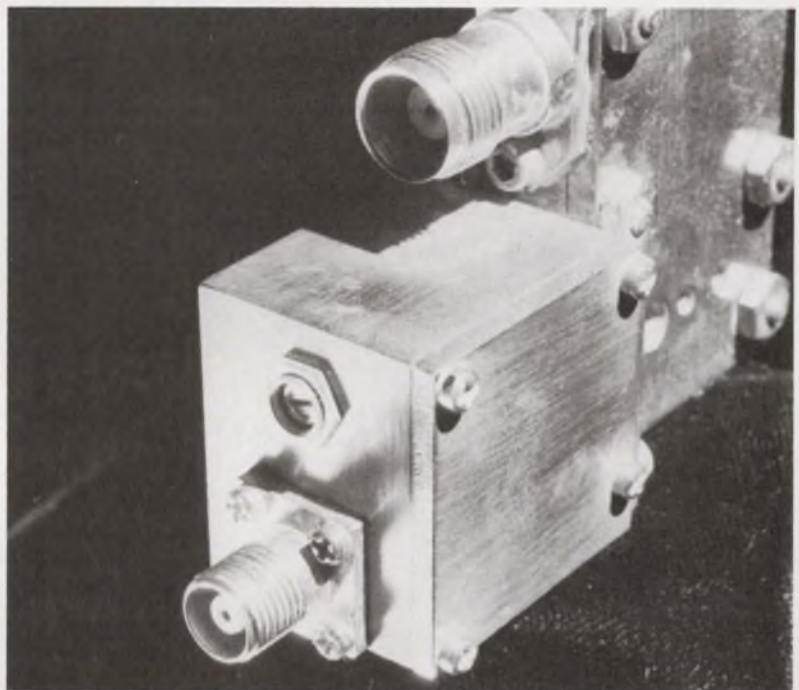

Up frequency with step-recovery diode . . . 44

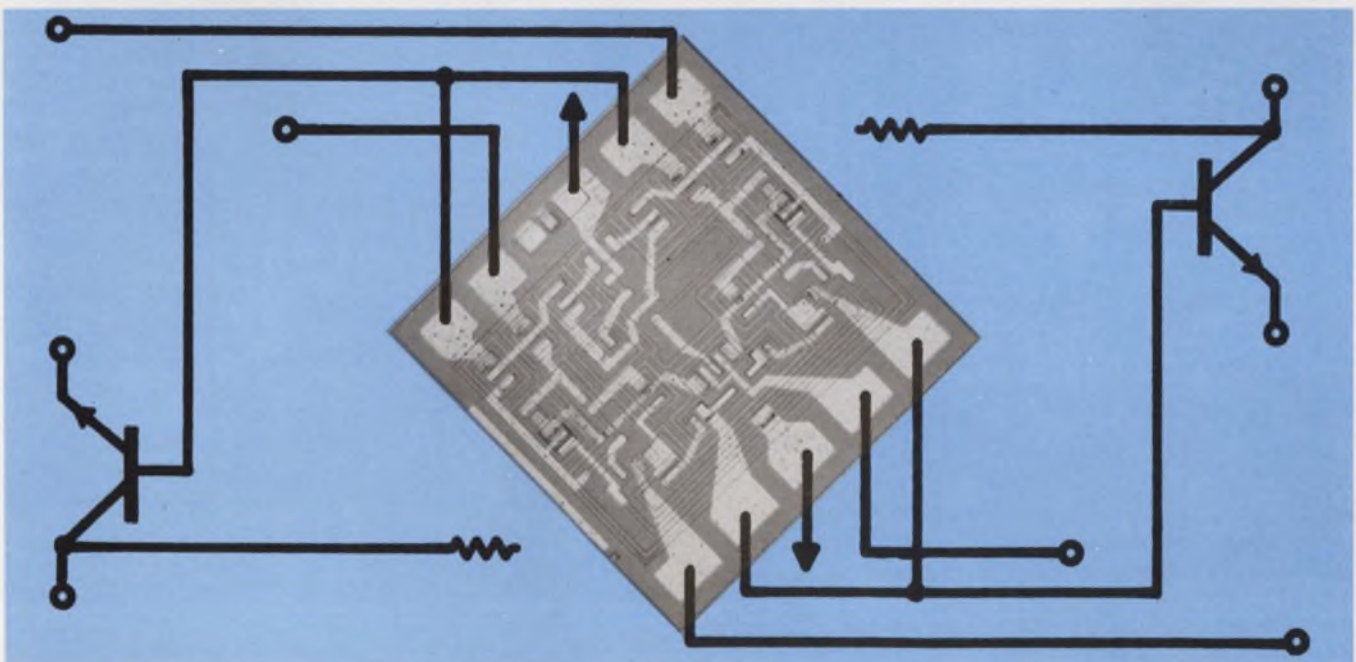

Discrete components modify off-the-shelf ICs . . . 56

Design efficient multipliers with the step-recovery diode. For high-order harmonic generation, it's efficient, simple and has low noise.

For high-order frequency multiplication, step-recovery diodes prove to be the all-around champions. Multipliers designed with this type of diode turn out to be more efficient,¹ less noisy, simpler to build and more adaptable to integrated circuits than multipliers using varactor diodes.

There is no need for idler circuits, and many of the possible modes of parametric oscillation are eliminated.

These compact multipliers, when combined with a stable oscillator, are especially suited as local oscillators in transponders and in other miniaturized microwave receivers. Another major area of application is as low-power transmitters.

The design of step-recovery-diode multipliers is straightforward once the proper diode has been selected.

The primary reason for the effectiveness of this diode is that it is a charge-storage device, with characteristics that closely approximate a perfect nonlinear capacitor.² When conducting in the forward direction, the diode stores charge. When the applied signal reverses, the diode conducts for

a brief period and then abruptly ceases conduction, producing a waveform rich in harmonic content.

Now the primary limiting factor of the step-recovery diode is its power-handling capability. Most available diodes are in the 70 to 100 mW range, with a few having a 1-watt upper limit. Devices with a 2-watt power-output capability at S-band are expected to be commercially available soon.

What are the basic building blocks?

An efficient step-recovery-diode multiplier circuit consists of five basic subsystems:

1. A low-pass or bandpass input filter at the fundamental frequency.
2. A coupling network to transfer the source impedance (normally 50 ohms) down to the impedance presented by the diode (normally 1-10 ohms).
3. The diode and associated bias network.
4. A coupling network to transform the diode impedance to the level of the output circuit.
5. A bandpass output filter at the output frequency.

The input filter and input impedance transformer prevent the harmonic frequencies generated in the diode from coupling back to the primary oscillator and provide conjugate match to the primary oscillator source at the desired input frequency.

The combined effect is the isolation of the nonlinear load reactance of the diode from the primary oscillator. Hence, the primary oscillator will not generate harmonically related ac components.

The output impedance transformer and the bandpass filter must provide high-Q energy storage at the output frequency, match the diode's impedance to the load and provide a reactive termination to unwanted harmonics.

The design of the filters and the impedance transformers is conventional and therefore does not require discussion. Selecting the best diode for the job, however, is not so simple.

The significant device characteristics that should be evaluated when selecting a step-recovery diode are:

- R_s , the series resistance of diode.

Nick Jansen, Senior Engineer, Motorola Military Electronics Div., Scottsdale, Ariz.

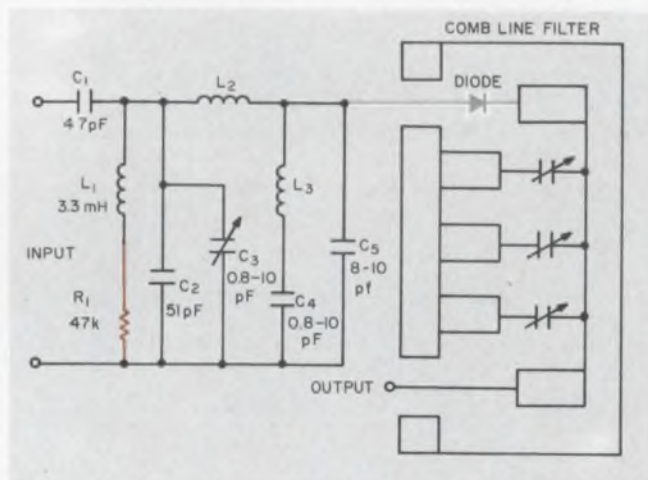

Multiplier circuit is designed for an input frequency of 131 MHz and an output frequency of 2096 MHz. Finding the optimum value of bias resistor R_1 proved to be essential. Even minor deviations from the experimentally found optimum of 47k noticeably reduced the multiplier's conversion efficiency.

- C_j , the junction capacitance.
- τ , the minority carrier lifetime.
- T , the transition time.

Primarily, efficient frequency multiplication depends upon τ and T . However, the selected diode should have a low R_s , and C_j should be low enough so that the diode will self-resonate above the desired output frequency.

The storage time should be as large as possible, since it determines the amount of stored charge during forward bias.

The transition time—the time needed for the diode to recover from a stored-charge condition to a reverse-biased condition—limits the frequency of operation.

For efficient operation, the following conditions must be satisfied:

$$\tau > \frac{1}{f_{in}}, \text{ and } T < \frac{1}{f_{out}}, \quad (1)$$

where f_{in} is the input frequency and f_{out} is the output frequency.

To assure good conversion efficiency, the minority-carrier lifetime, τ , should exceed the input frequency period by a factor of three.² For example, if the product of $Tf_{out} < 0.2$, a conversion efficiency of approximately 40% can be approached. To illustrate the sensitivity of the design, if Tf_{out} is 0.35, the harmonic power output will be 6 dB down from the input amplitude and will be further attenuated 6 dB per octave above f_{cut} .

Let's take as a practical example, the design of a 16X multiplier (see illustration). The fundamental frequency is at 131 MHz, the output frequency is to be 2096 MHz. The diode we selected for this multiplier (hp associates, Type 0116), has a minority-carrier lifetime of 30 ns and a transition time of 100 ns.

Applying the previously established criteria, we find that:

$$\tau f_{in} = (30 \times 10^{-9})(131 \times 10^6) \approx 4.0,$$

and:

$$T f_{out} = (100 \times 10^{-12})(2096 \times 10^6) \approx 0.21$$

Therefore, theory predicts high conversion efficiency for this particular set of conditions.

Circuit design based on experiments

The input circuit of the multiplier is comprised of a 131-MHz lumped-constant bandpass filter (L_2, C_2, C_3), a line-to-diode impedance-matching network (L_3, C_4, C_5) and a bias circuit (L_1, R_1). We experimentally found the optimum value of the bias resistor to be 47k. Relatively minor deviations from this optimum value noticeably reduced the conversion efficiency.

To determine the optimum value of R_1 , two variable resistors were connected in series. One provided a coarse adjustment, the other a fine adjustment. These potentiometers were adjusted for maximum power output at the desired harmonic frequency, consistent with a signal clear of spurious noise and parametric oscillations.

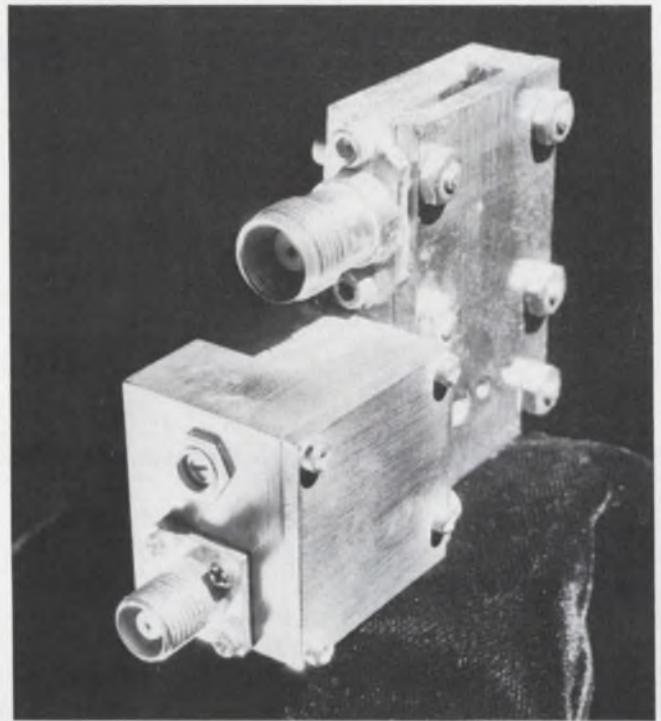

Multiplier package has an output frequency of 2096 MHz with an input at 131 MHz.

Since miniaturization was of importance, a comb line filter with a pass band of 40 MHz, centered at 2100 MHz, was selected for the output filter. The resonating elements of the comb line filter are only $\lambda/8$ long; hence, this filter is considerably smaller than an equivalent coaxial cavity or an interdigital filter. The measured insertion loss of the output filter was 1.9 dB, as compared with the theoretical loss of 0.8 dB. However, the walls of the filter were not polished or silver-plated, which would have reduced filter loss.

We obtained a conversion efficiency of -8.75 dB (13%), including the 1.9 dB loss in the output filter. Input signal levels up to 50 mW were applied without affecting the linearity of the output signal. The saturated power output of the Type 0116 diode is estimated by the manufacturer to be in the 60-70 mW range.

The measured 3-dB bandwidth is 40 MHz, which is identical to the pass band of the comb line filter. At the output terminal, the fifteenth harmonic is down 39 dB from the sixteenth. All other harmonics are 45 dB or more below the sixteenth. Harmonic content, generated by the multiplier at the input terminal, was measured for the second through the twentieth harmonic and was found to vary from a minimum of 28 dB (fourth) to a maximum of 63 dB (eleventh) below the applied 50-mW signal. ■ ■

References:

1. R. B. Mouw and F. S. Coals, "Microwave Applications of the Step Recovery Diode," Paper V-8, 1964 PTGMTT International Symposium, New York, May, 1964.
2. R. Hall, "Harmonic Generation with Step-Recovery Diodes," HPA Application Note No. 2.
3. S. M. Krakauer, "Harmonic Generation, Rectification, and Lifetime Evaluation with the Step-Recovery Diode," *Proc. IRE*, July, 1962, p 1665.



Six Semiconductor Innovations Help

1. New tetrode FET attains 8000 μ mhos

Very high transconductance, frequency capability into the uhf range—these are the major advantages you get with TI's new TIXS35 N-channel tetrode field effect transistors. These represent a two-to-one improvement over currently available tetrode FETs.

Transconductance is typically 8000 μ mhos with substrate gate connected to source, and 10,000 μ mhos minimum with gates connected together. Other characteristics: $V_{(BR)GSS} = 30$ V min; $C_{rssl} = 1.4$ pF max; $C_{issl} = 8$ pF max.

Isolation between gates minimizes "pulling" in mixer applications and greatly reduces skewing problems in AGC applications at IF. In autodyne mixer circuits like the one at left, the TIXS35 reduces circuit components. Circle 71 on Reader Service card for data sheet.

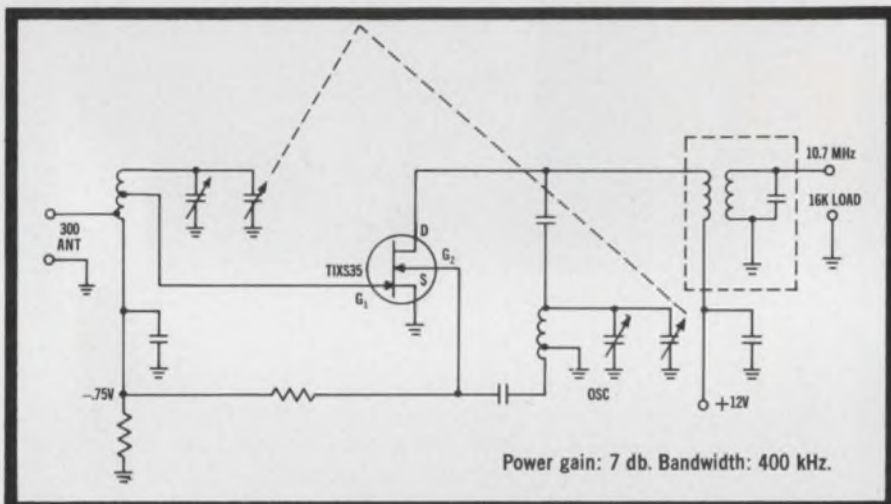

1. Unique autodyne mixer employs TIXS35 FET which functions as both mixer and local oscillator.

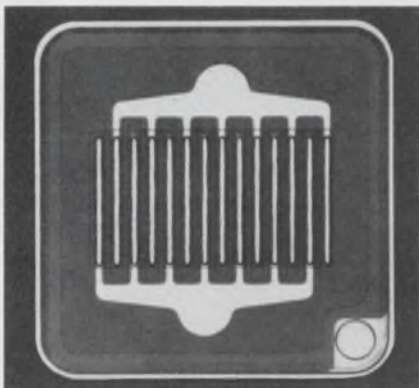

2. Symmetrical geometry of TIXS33 FET.

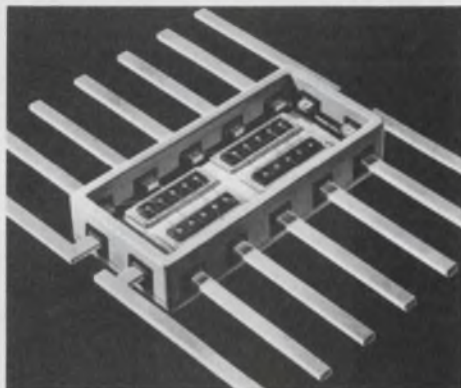

3. Up to 20 diodes may be packaged in a single case.

2. New N-channel FET features 60 ohms R_{DS} (ON)

TI's new TIXS33 field-effect transistor features a very low drain-source resistance of 60 ohms maximum. This makes it ideal for a wide range of switching applications such as low-level choppers and commutators as well as low- and medium-frequency amplifiers.

This planar epitaxial device offers high transconductance ($Y_{fs} > 12,000$ μ mhos), high drain current (> 25 mA), low leakage ($I_{GSS} < 1$ nA), and low capacitance ($C_{DG} < 5$ pF and $C_{ISS} < 20$ pF).

Symmetrical geometry makes drain and source leads interchangeable. This permits use in multiplex and sample-hold circuits and allows replacement of older devices with non-standard lead configurations. Package is the TO-72 (four-lead version of the TO-18). Circle 72 on Reader Service Card for data sheet.

3. High-density diode arrays save space, improve product

Custom monolithic and discrete diode arrays, combining up to 20 diodes in standard flat-pack, low-profile TO-5 and TO-18 packages, are available from TI.

Benefits include high-density packaging, compatibility with integrated circuits, uniformity of parameters, and close thermal tracking. Core drivers, diode AND gates, common-anode and common-cathode arrays are typical of devices that are available. Circle 75 on Reader Service Card for information.

TI cannot assume any responsibility for any circuit shown or represent that they are free from patent infringement.

You Improve Performance, Reduce Cost

4. New diodes employ oven for high stability, low cost

TIXD746 - 759 temperature-compensated reference diodes offer temperature coefficients as low as 0.001%/°C and voltage ratings from 3.3 to 33 volts. Cost is less than conventional multi-junction reference diodes.

The unique unit comprises a Moly/G® diode within a self-regulating polycrystalline semiconductor oven as shown at right. The oven holds 120°C within ±8°C from -55°C to +100°C and within ±2°C from -10°C to +50°C. Temperature is held within 1°C over a 10% voltage change. The oven operates on 24 V ac or dc.

Typical applications include regulated power supplies, high-frequency crystals, differential amplifiers, and instruments requiring voltage reference. Circle 73 on Reader Service Card for data sheet.

5. Simplify assembly with TI customized light sensor arrays

Now you can reduce manufacturing costs, increase reliability, improve performance, and minimize optical crosstalk with PC-board light sensor and light emitter arrays from TI.

You can reduce assembly, testing and inventory costs because TI arrays are preassembled and pretested units ready for installation. Reliability is improved because PC-board design is inherently more rugged than individually wired sensing devices. All components are hermetically sealed for long life.

LS600 planar light sensors give high, uniform sensitivity. Typical output is 1 mA, light, and 0.01 μA, dark, at 25°C. Sensitivity can be matched to ±20% across arrays. Lens confines admission angle to 10° off axis, minimizing optical crosstalk with close sensor spacing. Circle 74 on Reader Service Card for information.

6. 400 V power transistors permit simplified circuitry

TIP04 NPN silicon transistors feature 400 volt minimum $V_{(BR)CBO}$ — permitting simplified circuitry for high-power line-operated equipment and circuits with inductive or capacitive loads.

Low saturation voltage (1V max at 2A) gives high efficiency. Low leakage ($I_{CEX} = 10$ mA max at 400 V and 100°C T_C) permits high-impedance bias circuitry for high gain. Other features include an f_T of 3 MHz and fast switching speed. Circle 76 on Service Card for data sheet.

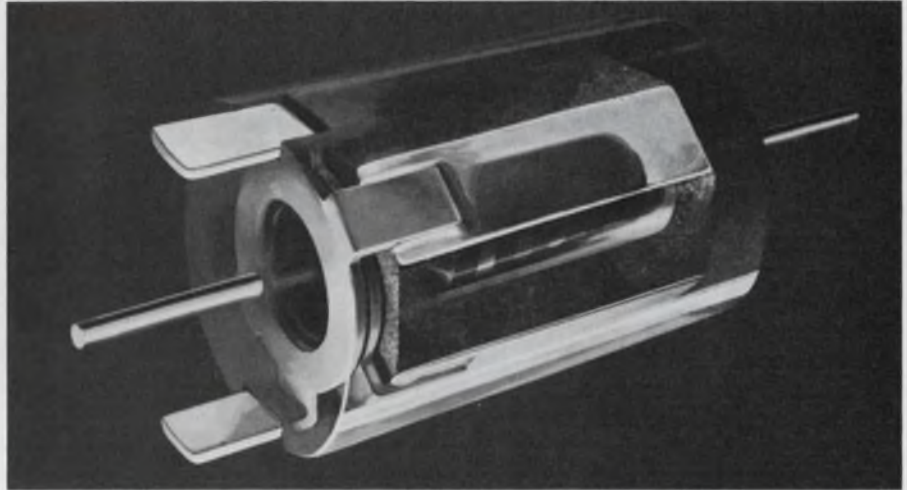

4. Unique construction of TIXD746 — 759 series temperature-compensated reference diodes.

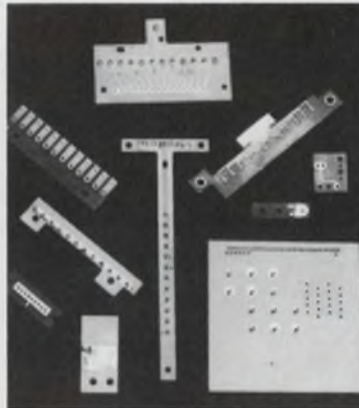

5. Typical light sensor arrays produced by TI.

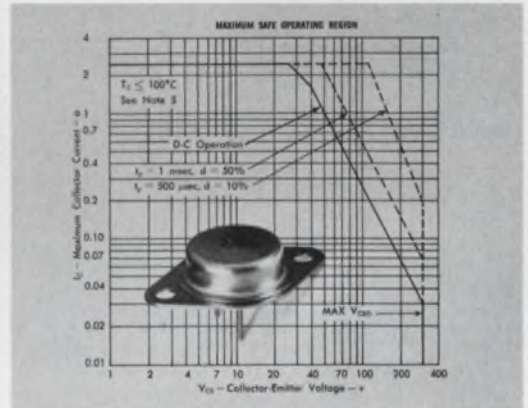

6. High voltage capability of TIP04 permits simple circuitry.



TEXAS INSTRUMENTS
INCORPORATED
13500 N. CENTRAL EXPRESSWAY
P. O. BOX 5012 • DALLAS 22, TEXAS

Design coincidence detectors that are simple, yet reliable; that restore signal levels and provide the complement of the exclusive-OR.

In designing exclusive-OR circuits, it has always been considered essential to have the complement of the input signal. When it was not readily available, it was created by added circuitry. This approach to the design of exclusive-OR circuits can increase cost considerably, especially if many such circuits are needed.

The solution to this problem is a simple and reliable circuit, shown in Fig. 1 and in the photo.

It provides the complement of the exclusive-OR economically, restores signal levels and has high fan-out.

Basically the exclusive-OR circuit produces an output of a logic "1" when one and only one input is a logic "1," or:

$$Y = A\bar{B} + \bar{A}B$$

When there are more than two inputs, the exclusive-OR is commonly referred to as a modulo-2 adder. In this case the output is a logic "1" when there is an odd number of logic "1" inputs.

The truth table in Fig. 2 shows the operation of an exclusive-OR circuit and of the circuit in Fig. 1. It is clear from this table that a circuit providing the complement of an exclusive-OR is really a coincidence detector, since only when both inputs are identical will there be a logic "1" output.

Operation is simple

The logical "0" and "1" are assigned respectively to ground and to $+V$.

The technique is based on voltage division. The critical components in the circuit are R_3 , R_1 , R_5 and R_6 . Resistors R_1 and R_2 are made equal.

When inputs A and B are at a logic "0", Q_1 and Q_2 are cut off and the output is $+V$. When one of the inputs is a "1" and the other is a "0," the input is a voltage source of $+V/2$ in series with $0.5 R_1$.

R_3 , R_1 , R_5 and R_6 are selected so that point D becomes sufficiently positive to drive Q_1 into saturation, but Q_2 remains cut off. The output is now clamped to ground through Q_1 .

If both A and B are at $+V$, then the driving source is a voltage of $+V$, through an equivalent resistance of $0.5 R_1$. The voltage at Q_2 is now sufficiently positive to drive it into saturation.

When Q_2 is in saturation, point D is clamped to ground through CR_1 and Q_2 . If Q_1 and Q_2 are high-quality-silicon switching transistors and CR_1

is a germanium diode, then the voltage at point D will be approximately 0.4 volt ($V_{CR_1} = 0.2$ V, $V_{CE} = 0.2$ V).

Since the required V_{BE} to drive Q_1 into saturation is approximately 0.8 volt, Q_1 will be cut off and the output voltage will be $+V$. A V_{BE} of 0.4 volt might be sufficient to cause a small collector current to flow, thus degrading the output signal when A and B are logic "1"s.

Several remedies are shown in Fig. 3. All of these methods effectively raise the voltage difference between the required turn-on voltage of Q_1 and the clamped voltage at point D when Q_2 is in saturation. These modifications further increase the reliability of the circuit.

Note that in Fig. 3, only those portions of Fig. 1 are repeated which are modified by the added components, shown in white.

If there are more than two inputs, the circuit is readily usable as a multi-input coincidence detector. However, the input resistors must be carefully evaluated, to provide clear-cut voltage differences for the logic states.

To fully appreciate the advantages of the circuit in Fig. 1, let us introduce more conventional circuits used to generate the exclusive-OR.

Even if the complement of the input is available, the circuits are complex, as shown in Fig. 4. If the complement has to be provided through additional circuits, shown with the dashed lines in Fig. 4, then expenses can really mount up.

With integrated circuits, Figs. 4b and c are somewhat more economical than 4a and d, because two types of cans will supply all the circuitry. For Figs. 4a and d, three different types of cans are needed, even though the circuits are simpler. Besides, the latter ones do not restore the signal level and have low fan out. Amplifiers are then advisable if they are to drive several circuits. ■ ■

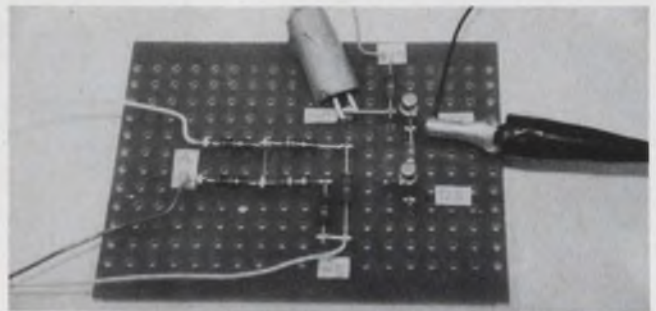

Complement of exclusive-OR is provided by this simple circuit. Clamps tie components to test setup.

Exclusive-OR and its complement

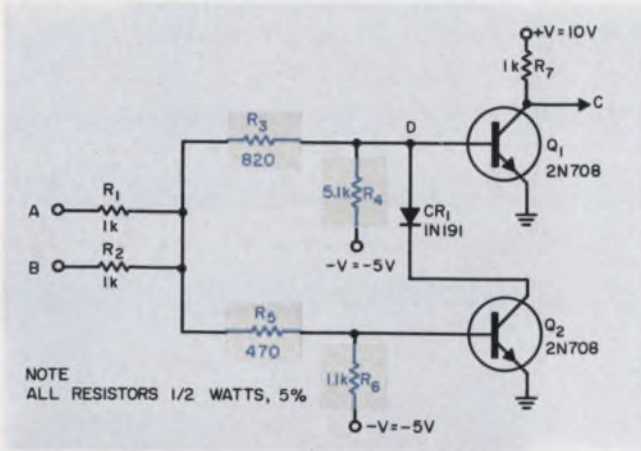

1. **Economical and reliable circuit** functions as the complement of an exclusive-OR with the minimum number of components. Ground potential represents a logic "0"; +V represents a logic "1." Components critical to the operation of the circuit are shown in color.

A	B	C
0	0	0
0	1	1
1	0	1
1	1	0

(a)

A	B	C
0	0	+10
0	+10	0.2
+10	0	0.2
+10	+10	+9.7

(b)

2. **Exclusive-OR** circuits produce an output of "1" when one of the two inputs is a "1" (a). The circuit in Fig. 3 has an output of +V, or logic "1," when both inputs are identical. This is the complement of the exclusive-OR. The circuit may also be used as a coincidence detector.

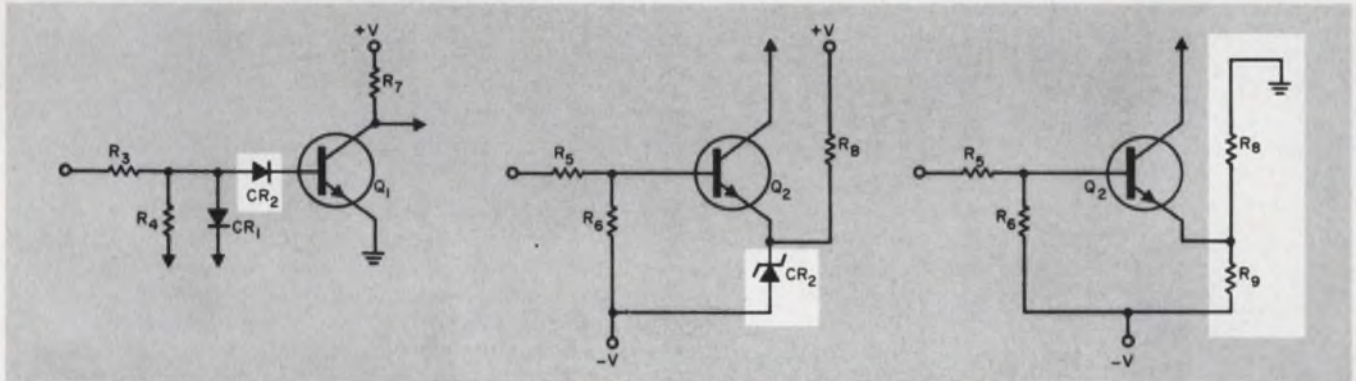

3. **Voltage difference** between the turn-on voltage of Q_1 and the saturation voltage of Q_2 can be increased with

either one of these circuits. This modification, indicated in white, increases the reliability of the circuit in Fig. 1.

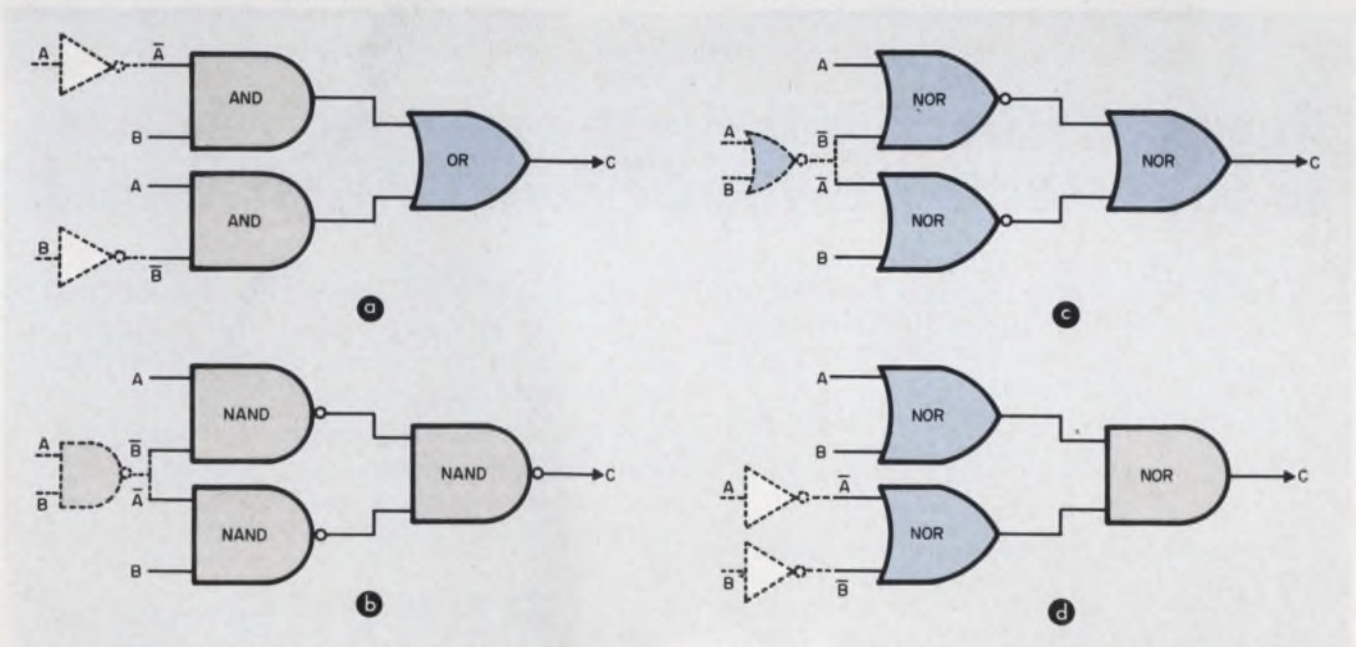

4. **Exclusive-OR** circuits use both the signal and its complement. If the complement is not available, up to two inverters may be needed—shown with dashed lines. The configurations of (b) and (c) are the most economical if

integrated circuits are used—only two types of cans are needed. Circuits (a) and (d) are simple but do not improve the signal level, have low fan out and need three types of IC cans. These may also need output amplifiers.

ZERO DEFECTS



Albert Canning (left) presents Martin's Quality Supplier Award to Horace Potter, president of Reeves-Hoffman.

Reeves-Hoffman is the first crystal manufacturer to earn Martin's coveted "Zero Defects" award!

With delivery of over 1,000 defect-free crystal-controlled filters for the highly reliable Bullpup missile, Reeves-Hoffman becomes the first and only crystal manufacturer to earn Martin-Orlando's Zero Defects Award.

The product that won the award was a complex miniature network package, which consists of crystals, glass-to-metal seals, temperature controlling and other circuitry.

In making the presentation, Mr. Albert J. Canning, technical requirements chief, quality, of Martin-Orlando, said in part: "This award from the Martin Company for Zero Defects is intended to reflect the thousands of systems components that Reeves-Hoffman has previously delivered. . . . It represents excellence in performance."

We think it is important to note that the award is also based on management cooperation and the meeting of scheduled delivery dates. Shipping defect-free products merely qualifies a supplier for the award, but does not guarantee it.

Whether our products are for outer space, undersea or "down-to-earth" applications, we do our utmost to deliver "zero defects" shipments on time. We invite your inquiries.



REEVES-HOFFMAN
DIVISION OF **DCA**



400 WEST NORTH STREET, CARLISLE, PENNSYLVANIA 17013

ON READER-SERVICE CARD CIRCLE 25



This 5 MHz counter/timer from Monsanto is only 3½ inches high, and weighs just 16 pounds. Yet it gives you a time base range from 1 μ second to 100 seconds in decade steps, and resolution for frequency measurement of 0.01 Hz.

HOW COME? Integrated circuits. In 90% of the active circuits. That's how Monsanto builds big performance into a small package. Plus speed, accuracy, reliability, low power consumption, low heat generation and easy maintenance. Six of the 13 printed circuit boards are interchangeable.

HOW MUCH? Just \$1575. And that low selling price

goes with these "high-priced" specs:

- Measures average frequency: 0–5 MHz • Measures average periods: 0.2 μ sec. to 1 sec. • Measures single periods: 1 μ sec. to 10⁶ sec. • Measures frequency ratios: 10⁻⁶ to 10⁶ • Measures time intervals: 1 μ sec. to 10⁶ sec. • Counts: random or uniformly spaced signals.
- Want to know more? Just clip the coupon.

MONSANTO, ELECTRONICS DEPT. 800 NORTH LINDBERGH BLVD. • ST. LOUIS, MO.

Details, please, on the Model 1010 5 MHz Counter/Timer
 Model 1000 20 MHz Counter/Timer

Name/Title _____

Firm _____

Address _____

City/State/Zip _____



ON READER-SERVICE CARD CIRCLE 26

Small-capacitor measurements pose formidable problems. Here is a method for measuring temperature coefficient and drift to an accuracy of 1%.

Ever try to measure temperature coefficient and drift for a low-value capacitor? If so, you know that stray capacitance in the measuring set-up may well turn out to be larger than the value being measured.

In spite of this, the measurements must often be made accurately, because proper operation of the circuit may hinge on keeping the capacitance value within small limits despite wide temperature swings.

The following method will yield temperature coefficient and drift measurements that are accurate to within 1%.

Measurement section uses bridge

The measurement portion of the test set-up is a commercial capacitance bridge. Its design allows for the extension of the measurement terminals as well as the exclusion of all capacitances to ground without sacrificing accuracy. Since the final bridge measurement includes the capacitance of the test specimen plus the open-terminal capacitance of the specimen mounting terminals, the design objective was to reduce the level of the open-terminal capacitance so that it becomes insignificant. The factors that determine the open-terminal capacitance are:

- The capacitance of the bridge terminals.
- The capacitance of the extension leads.
- The rigidity of the extension leads and terminations.
- The measurement frequency.

The measurement frequency is always defined, but the other factors are a function of the test set-up's physical design. In the set-up employed (Fig. 1), a rigid coaxial cable pair is used to connect from the bridge input to a specially designed feedthrough panel assembled to the door of a temperature chamber. The front of the feedthrough panel contains standard BNC receptacles, with their center conductors wired through and terminated at the back of the panel with solder standoffs.

Fig. 2 shows the back of the panel, with its standoffs, an oil tank and a thermocouple probe. Mounted test capacitors are shown soldered to the standoffs. The final design of the panel was influenced by the knowledge that if any portion of the bridge extension leads is within the tempera-

ture chamber, an inaccurate measurement could result. This is because of the change in cable capacitance introduced by a temperature change.

To determine the extent of such temperature-induced errors, the capacitance of an eight-foot length of coaxial cable was measured at an ambient temperature of +25°C. Another measurement was made with two feet of the cable inside a temperature chamber stabilized at +125°C. The cable capacitance was 4 pF less than at +25°C. The same measurement was also made at -55°C, and the cable capacitance was found to be 13 pF more than at +25°C. These differences are significant and can completely mask the actual temperature coefficient and drift of low-value capacitors.

Changes in the routing of the cable also caused variations in cable capacitance. This indicated that the test set-up must be identical for all measurements (system rigidity) to ensure repeatable results.

With the test system used, the average open-terminal capacitance for a terminal pair is 0.022 pF at +25°C, and the greatest change over the temperature range of -55°C to +125°C is 0.003 pF. The open-terminal capacitance is thus reduced to an insignificant value and may be disregarded.

Environmental-control is important

Reducing the open-terminal capacitance of the test-specimen terminals does not in itself insure accurate test results. The environment sur-

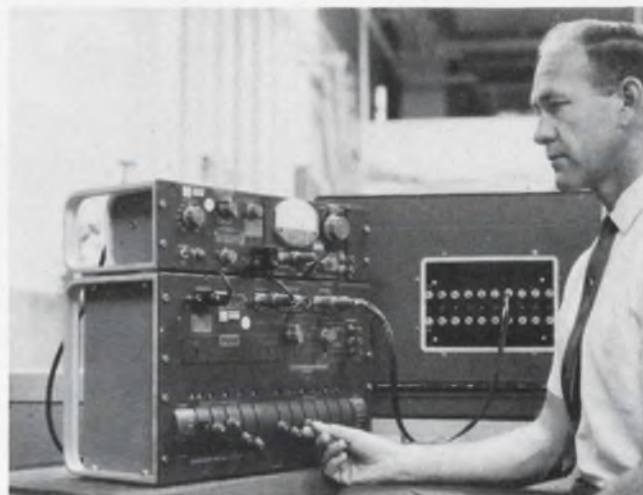

Small capacitors can present big problems, says author Ray as he sets up a capacitance bridge.

James A. Ray, Senior Research Engineer, Lockheed Missiles and Space Co., Sunnyvale, Calif.

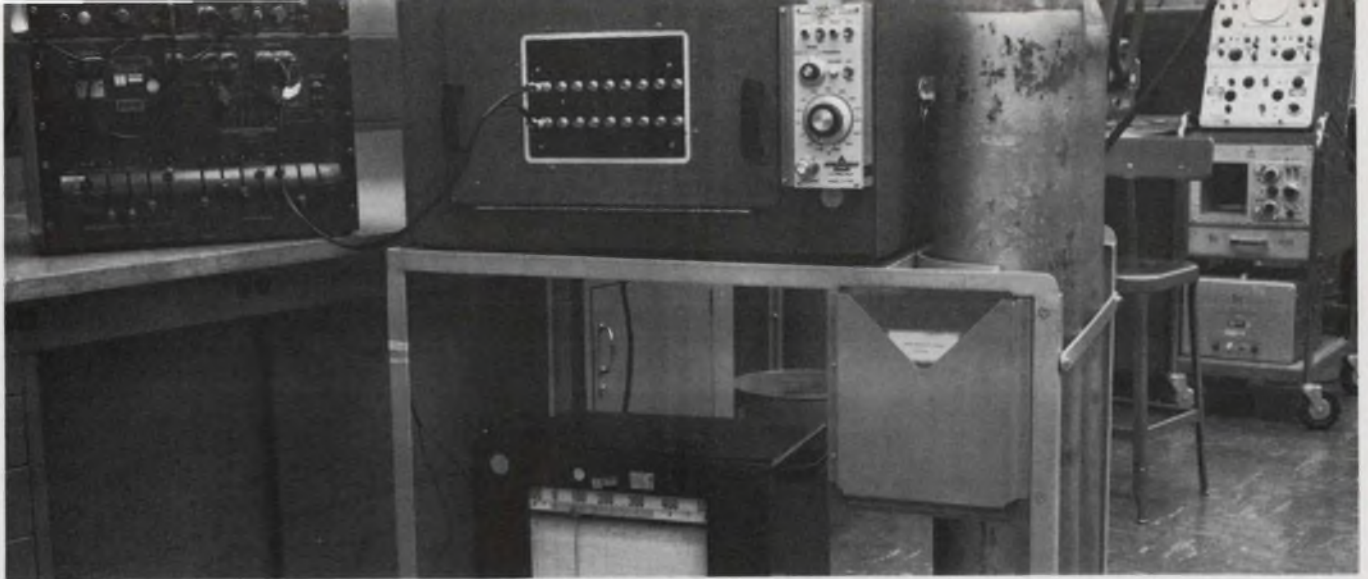

1. Test system consists of a capacitance bridge, a temperature chamber with a special feedthrough panel and a

temperature recorder. A rigid coaxial cable pair connects the bridge input to the feedthrough panel.

rounding each test specimen must also be closely controlled. It was found that the geometry of a part can cause inconsistent test results in a forced-airflow environment. This was demonstrated by using a feedthrough panel that permitted test specimens to be mounted in a forced-airflow temperature environment.

Temperature gradients measured before the test specimens were mounted to their standoffs were found to be no more than 0.7°C in any direction. The test specimens were then mounted, and the gradient measurements repeated. Drastic changes were observed. It was found that each specimen acted as an airflow barrier, creating air turbulences which altered the gradients in the mounting area. This condition is over-come by mounting the test specimens in an oil bath.

Fig. 2 shows the rear of the feedthrough panel with capacitors mounted in the oil tank, which is filled with chemically inert silicon oil to a depth that completely immerses the capacitors. The thermocouple probe senses the oil temperature and transmits an output to the calibrated temperature recorder (Fig. 1). Temperature gradients in

the oil-filled tanks are less than 0.5°C , and sensing with a single thermocouple is satisfactory. The gradient changes experienced in a forced-airflow environment are not present in the oil bath, even with changes in specimen orientation, location or geometry.

Using the system

Temperature coefficient and drift of test capacitors are determined by a series of measurements and calculations. Test specimens are soldered to the standoffs and immersed in silicon oil, and the capacitance of each is measured after temperature stability is reached. Stability is attained when two capacitance measurements, taken at 15-minute intervals, show no significant difference. The same procedure is repeated at the temperatures of interest. Typical temperatures and their test sequence are: $+25^{\circ}\text{C}$, -55°C , $+25^{\circ}\text{C}$, $+125^{\circ}\text{C}$ and $+25^{\circ}\text{C}$. The first $+25^{\circ}\text{C}$ measurement and that made at -55°C are used to compute the low-temperature coefficient. The second $+25^{\circ}\text{C}$ measurement and that made at 125°C are used to compute the high-temperature coefficient. The three $+25^{\circ}\text{C}$ measurements together are used to compute the capacitance drift.

After the measurements have been made, the temperature coefficient is computed as follows:

$$TC = \frac{(C_2 - C_1) \times 10^6}{C_1(T_2 - T_1)},$$

where TC = temperature coefficient in parts per million per degree centigrade.

C_1 = capacitance, in picofarads, at $+25^{\circ}\text{C}$.

T_1 = $+25^{\circ}\text{C}$.

C_2 = capacitance, in picofarads, at the low (or high) temperature.

T_2 = low (or high) temperature in degrees centigrade.

The capacitance drift is then calculated by taking the greatest single difference between any two of the three $+25^{\circ}\text{C}$ measurements and dividing it by the intermediate $+25^{\circ}\text{C}$ measurement. ■ ■

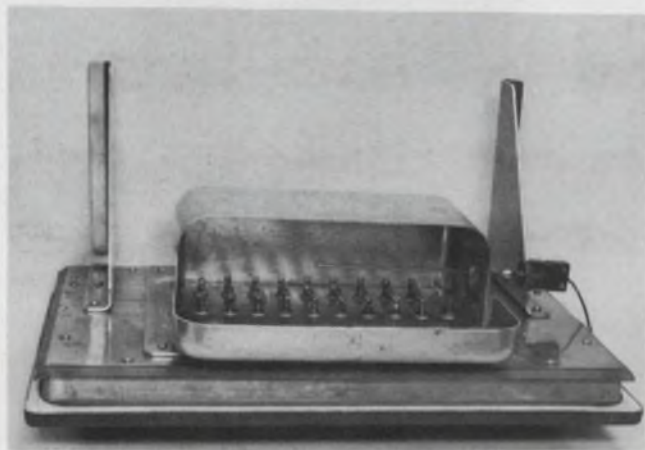

2. Back of feedthrough panel holds the standoffs for mounting the test capacitors, an oil tank and a thermocouple probe. Temperature gradients in the oil bath are less than 0.5°C in any direction.

Try to find a connection

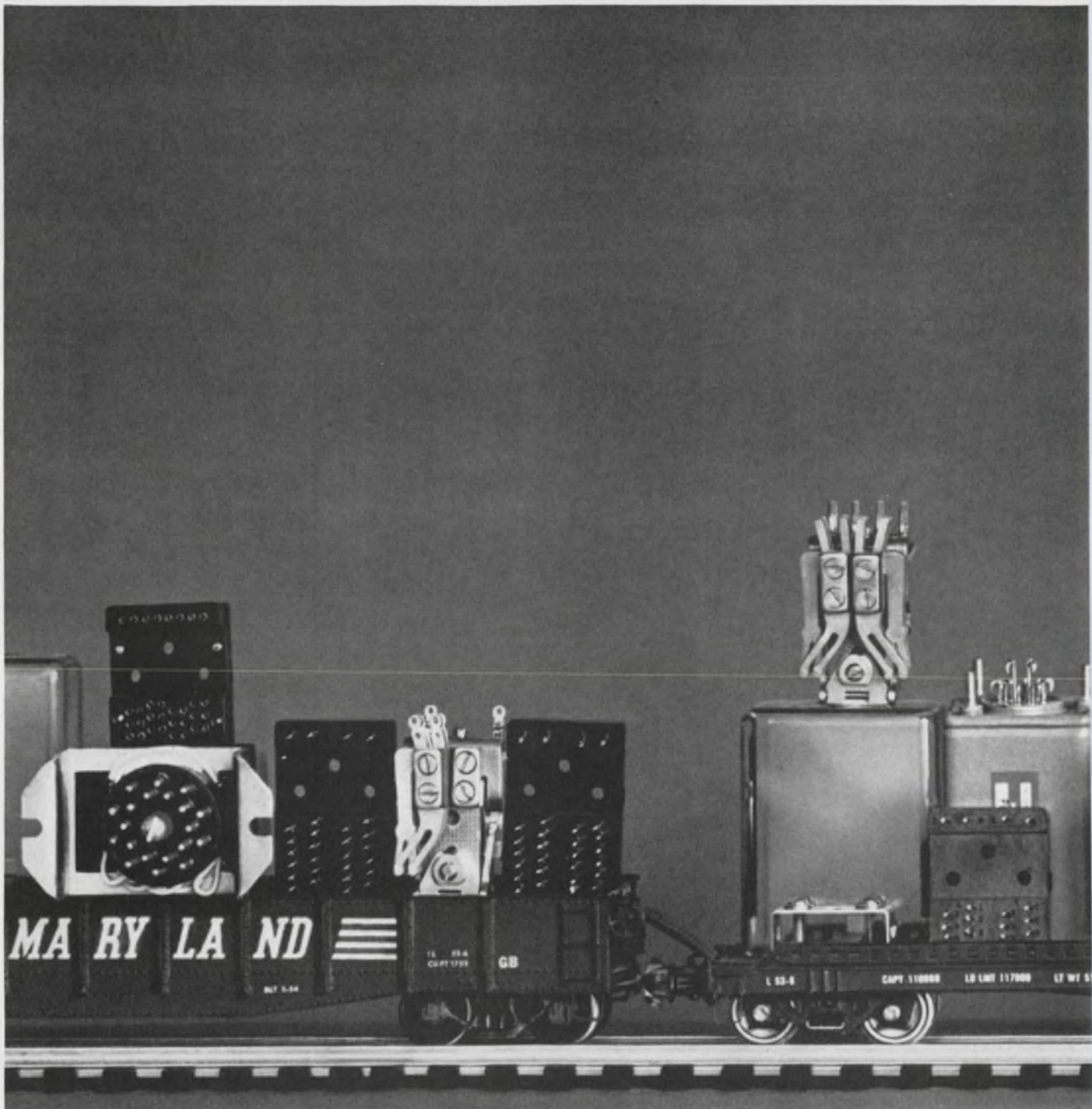

The growing popularity of AE's Class E Relay as the "workhorse of the industry" has set off a demand for a wide variety of mounting techniques.

Now AE can accommodate virtually every type of circuit connection or mounting used in electrical and electronic equipment designs.

Wherever designs call for "wiring in," AE Class

E Relays are available with solder-type, wrapped-wire, taper-tab and printed-circuit terminals.

AE has also developed special sockets for chassis or printed-wiring board mounting, that accommodate Class E Relays with PC or taper-tab terminals. And prewired types with octal plug-in bases.

Where extra protection is required, AE Class

you can't make with

AE Class E Relays

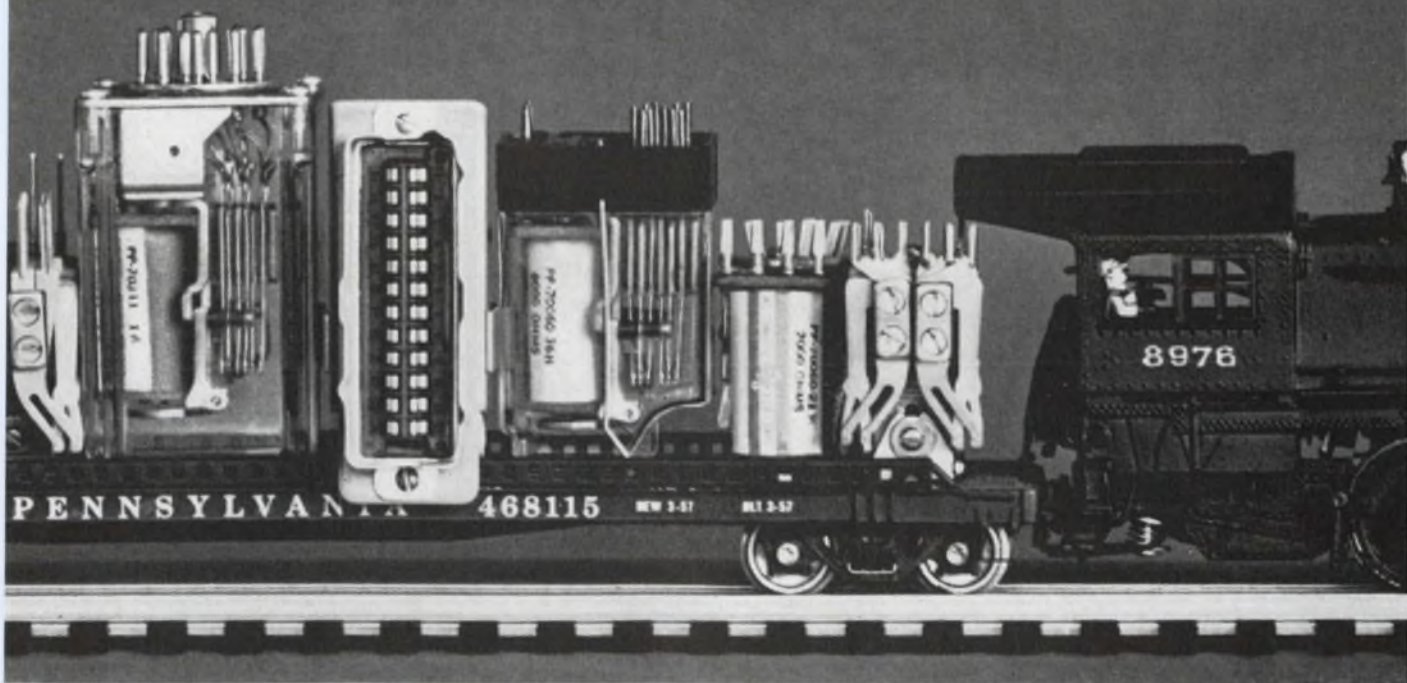

E Relays are available in hermetically sealed enclosures with either hook terminals or plug-in headers. Or plastic dust covers that snap on to the chassis- or printed-circuit type of socket.

For full information on the limitless variations in mounting and connections for AE Class E

Relays, ask for Circular 1942-C. Write to the Director, Relay Control Equipment Sales, Automatic Electric Company, Northlake, Ill. 60164.

AUTOMATIC ELECTRIC

SUBSIDIARY OF

GENERAL TELEPHONE & ELECTRONICS GTE

ON READER-SERVICE CARD CIRCLE 27

Avoid over-integration by designing linear circuits with off-the-shelf items. External discrete parts may be added whenever needed.

If you're out to put monolithic integrated microcircuits into your analog equipment, your best approach is *not* to try to integrate the system totally.

Instead, you'd be better off designing around off-the-shelf linear microcircuits and including external discrete components where they're needed. In this way, you'll benefit not only from the low cost of off-the-shelf units, but the discrete parts will provide operating flexibility and allow you to accomplish functions which could not be integrated economically.

This article covers the design of eight types of commonly used circuits around off-the-shelf linear microcircuits:

- Sine-wave oscillator.
- Voltage-to-frequency converter.
- Logarithmic amplifier.
- Multiplier.
- Servo current driver.
- Voltage comparator.
- Positive peak detector.
- Double-ended limit detector.

The microcircuits used are the μ A702A wideband dc amplifier,^{1,2,3,4} the μ A709 high-performance operational amplifier,⁵ the μ A710 high-speed

differential comparator,⁶ and the μ A711 dual comparator,⁷ all available from Fairchild Semiconductor. Tables 1 and 2 briefly summarize the characteristics of these devices. Similar design techniques can be used with other available linear microcircuits, although values will differ.

Sine-wave oscillator has stable gain

A μ A702A wideband dc amplifier is the central element of the phase-shift oscillator shown in Fig. 1. Negative feedback is applied through R_3 to the inverting input of the amplifier. The feedback stabilizes the gain and makes it essentially independent of the integrated-circuit's characteristics. The RC network (R_1 , C_1 , R_2 and C_2) applies positive feedback to the non-inverting input.

The circuit will oscillate at the frequency at which the phase shift through the RC network is zero if the positive feedback is equal to, or greater than, the negative feedback. However, it is desirable to hold the positive feedback exactly equal to the negative feedback. If the positive feedback is greater, the output of the oscillator will build up until it becomes nonlinear, distorting the output sine wave.

R. J. Widlar, Application Engineer,
J. N. Giles, Application Engineer, Fairchild Semiconductor, Mountain View, Calif.

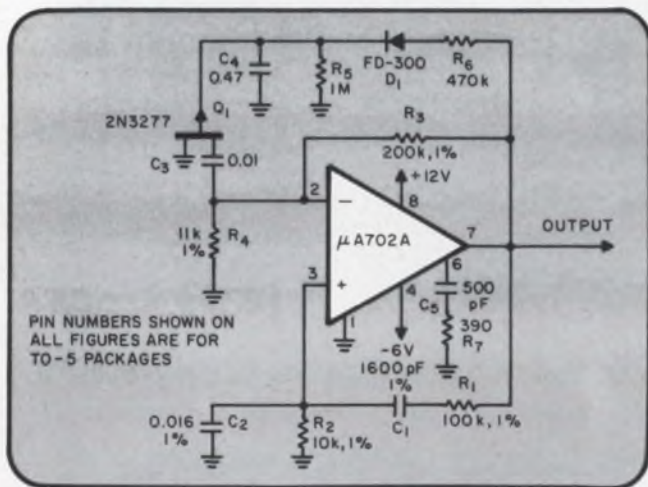

1. One kHz sine-wave oscillator applies negative feedback to the inverting input of the IC amplifier to stabilize the gain and make it independent of the integrated-circuit characteristics.

Table 1. Typical characteristics

	μ A702	μ A709
Input offset voltage	2	1 mV
Input offset current	0.7 μ A	50 nA
Input bias current	4 μ A	200 nA
Temperature coeff. of input offset voltage	5 μ V/ $^{\circ}$ C	—
Common-mode rejection	80	90 dB
Input voltage range		\pm 8 V
Voltage gain	2600	45,000
Output resistance	200	150 Ω
Input resistance	25	400 k Ω
Output voltage swing	\pm 5.3 V	—
$R_L = 10$ k Ω	—	\pm 14 V
$R_L = 2$ k Ω	—	\pm 13 V
Power consumption	70	80 mW
Power supply sensitivity	50	25 μ V/V
Open-loop bandwidth	1 MHz	

μ A709: High performance operational amplifier
($T_A = 25^{\circ}$ C, $V_B = \pm 15$ V)

μ A702: Wideband dc amplifier
($T_A = 25^{\circ}$ C, $V^+ = 12.0$ V, $V^- = -6.0$ V)

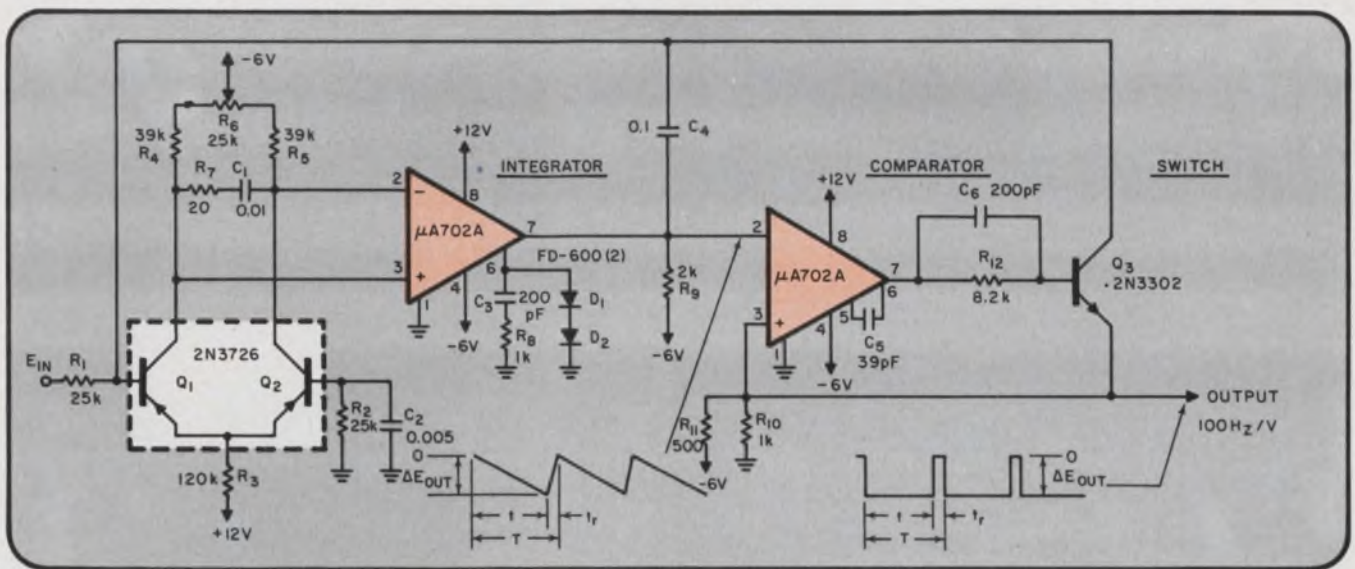

2. **Voltage-to-frequency converter** overcomes low gain and high input-current requirements of the $\mu A702A$

wideband dc amplifier by adding a discrete pnp matched pair at the front end.

The positive and negative feedbacks cannot be made equal with a simple adjustment. Any small component change will either stop the oscillation or distort the output. This difficulty is overcome by using an agc circuit, composed of a diode detector and FET amplifier, to hold the gain at the precise value required to sustain oscillation at the desired output level.

If $R_1 C_1 = R_2 C_2$, the frequency at which the phase shift through the RC network is zero (and therefore the frequency of oscillation) is given by:

$$f = \frac{1}{2\pi R_1 C_1} \quad (1)$$

The attenuation through the network at this frequency is:

$$\eta = \frac{1}{1 + 2\left(\frac{R_1}{R_2}\right)} \quad (2)$$

For oscillation to be possible, the amplifier gain must make up for this loss. For $R_1 = 10 R_2$, the amplifier gain must be exactly 21. Such a large ratio of R_1 to R_2 is chosen to keep the signal level across the FET low enough to avoid distortion.

The output of the amplifier is rectified by D_1 and filtered by C_1 . This voltage, which varies as the ac output of the amplifier, is fed to the gate of the FET and controls its drain-to-source resistance. Thus the output of the amplifier is held at a constant level. The filter capacitor, C_4 , must be large enough for the agc loop to be stable. The value of C_3 is also important for agc stability. To change the frequency of oscillation, C_1 , C_2 , C_3 and C_4 should all be changed proportionally. The ac output level is determined by the ratio R_4/R_5 and the characteristics of the FET.

With the component values shown, the frequency of oscillation is 1 kHz and the peak-to-peak output voltage is about 8 volts. The stabilization time from initial turn-on is approximately 50 ms.

Table 2. Typical characteristics

	$\mu A710$	$\mu A711$
Input offset voltage	1	1 mV
Input offset current	0.5	0.5 μA
Input bias current	25	25 μA
Temperature coeff. of input offset voltage	5	3 $\mu V / ^\circ C$
Input voltage range	± 5	± 5 V
Differential input voltage range	± 5	± 5 V
Voltage gain	1200	1500
Output resistance	200	200 Ω
Positive output level	+3.1	+4.5 V
Negative output level	-0.5	-0.5 V
Power consumption	110	130 mW
Response time	40	40 ns
Strobe release time	—	12 ns

$\mu A710$: High speed comparator
($T_A = 25^\circ C$, $V^+ = 12.0$ V, $V^- = -6.0$ V)

$\mu A711$: Dual comparator
($T_A = 25^\circ C$, $V^+ = 12.0$ V, $V^- = -6.0$ V)

Voltage-to-frequency converter uses transistors

An excellent example of the design approach involved in adapting an off-the-shelf microcircuit to a special need is the voltage-to-frequency converter in Fig. 2. The circuit consists of an integrator, a voltage comparator and a switch.

The output voltage of the integrator is a negative-going ramp which falls at a rate directly proportional to the dc input signal. When the ramp reaches a pre-determined negative level, it is sensed by the comparator which drives the switch to reset the integrator output to zero.

The time for the integrator output to go from zero to the preset level is inversely proportional to the input voltage. Thus, the operating frequency will be proportional to this voltage.

The $\mu A702A$ was chosen for the integrator because of the fast slewing rate required during the reset interval. However, this amplifier by itself does not have enough gain to make the integrator function properly over a wide dynamic range. In addition, this application frequently requires lower input currents than are practical with the $\mu A702A$.

Both these limitations were overcome by using a discrete *npn* matched pair (Q_1 and Q_2) in front of the amplifier. This composite amplifier has a gain greater than 25,000 and input currents less than $0.5 \mu A$. The offset voltage of the input transistors is conveniently balanced out with the potentiometer (R_6).

Because of the high gain of the complete amplifier, frequency compensation is done at two points, with R_7 , C_1 and R_8 , C_3 . The integrating capacitor is C_1 . The clamping diodes (D_1 and D_2) prevent overloading of the comparator under abnormal operating conditions.

A second $\mu A702A$ is used as a voltage comparator at the output of the integrator. A threshold voltage of -4.0 volts is supplied to the non-inverting input of the comparator from a resistive divider (R_{10} and R_{11}). When the output of the integrator falls to -4.0 volts, the output of the comparator rises rapidly from -5.0 volts, turning on Q_3 , which supplies positive feedback to the non-inverting input of the comparator. Q_3 saturates and drives approximately 11 mA into the summing node of the integrator. It also holds the non-inverting input of the comparator very near to ground potential.

When the integrator output, which is being driven positive by the switch current, reaches zero, the comparator output swings negative and turns off Q_3 . The cycle is then repeated. In Fig. 2, R_{12} limits the base drive of Q_3 , while C_5 and C_6 decrease the on and off times of the switch.

The time required for a given change in the output voltage of the integrator is given in terms of the input voltage and circuit values by:

$$t = R_1 C_4 \frac{\Delta E_{OUT}}{E_{IN}} \quad (3)$$

Similarly, when Q_3 is turned on, the reset time is:

$$t_r = C_4 \frac{\Delta E_{OUT}}{I_{C3}} \quad (4)$$

or:

$$t_r \cong R_{11} C_4 \frac{\Delta E_{OUT}}{V^-} \quad (5)$$

The output of the integrator swings from zero down to a voltage determined by the resistive divider, R_{10} and R_{11} , so:

$$\Delta E_{OUT} = \frac{R_{10} V^-}{R_{10} + R_{11}} \quad (6)$$

Therefore, the period for one cycle of operation is:

$$T = \frac{C_4 R_{10} V^-}{R_{10} + R_{11}} \left(\frac{R_1}{E_{IN}} + \frac{R_{11}}{V^-} \right) \quad (7)$$

Since $\frac{R_1}{E_{IN}} \gg \frac{R_{11}}{V^-}$,

$$f \cong \frac{(R_{10} + R_{11}) E_{IN}}{C_4 R_1 R_{10} V^-} \quad (8)$$

which gives a conversion factor of 100 Hz/V.

Logarithmic amplifier has wide dynamic input range

An excellent logarithmic amplifier may be designed by utilizing the highly predictable and non-linear characteristics of bi-polar transistors. If V_{BE} is greater than $4kT/q$, where q is the charge of an electron, k is Boltzmann's constant and T is the absolute temperature, the variation in collector current with emitter-base voltage for a bi-

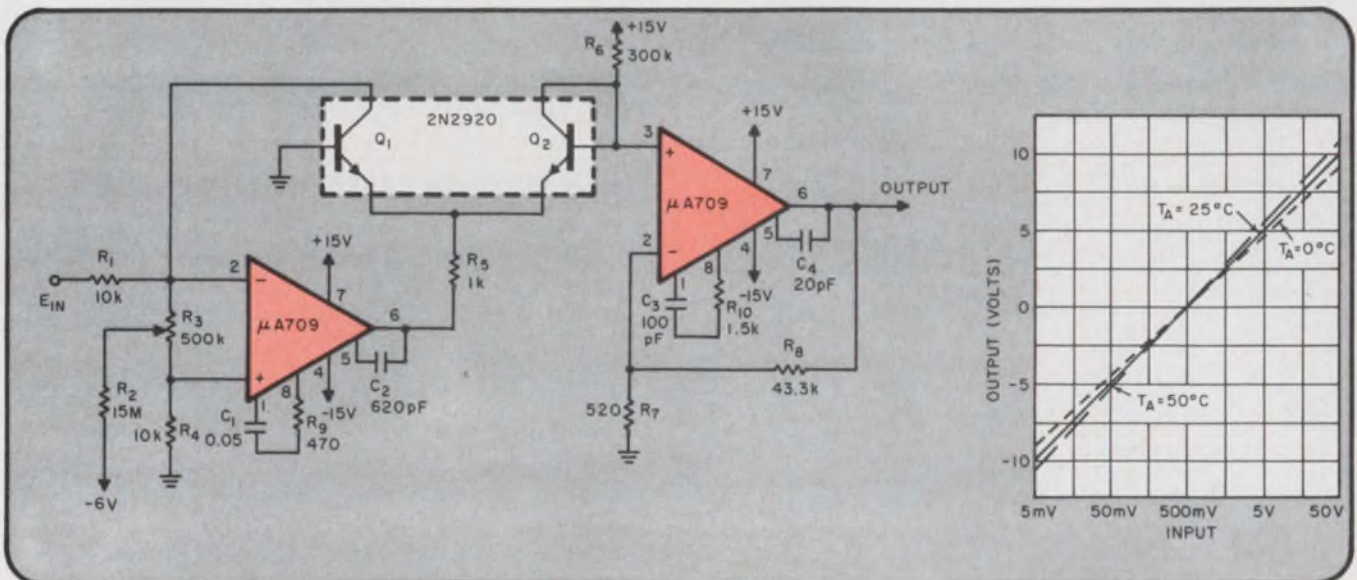

3. Logarithmic amplifier adds matched transistor pair to $\mu A709$ amplifier. Emitter-base voltage differential between

the transistors is proportional to the log of their collector currents with Q_1 used as a feedback element.

polar transistor is given by:⁸

$$I_C \propto \exp\left(\frac{qV_{BE}}{kT}\right) \quad (9)$$

This expression holds for high currents where emitter-contact and base-spreading resistances become important and for low currents where collector-leakage currents cause inaccuracy. The expression is valid for operation over at least six decades of collector current with well-made silicon transistors.

Using the expression given above, it can be shown⁹ that the emitter-base voltage differential between two matched transistors operating at different collector currents is:

$$\Delta V_{BE} = \frac{kT}{q} \ln\left(\frac{I_{C1}}{I_{C2}}\right) \quad (10)$$

In the circuit of Fig. 3, transistor Q_1 is used as the feedback element around a $\mu A709$ operational amplifier. The negative feedback forces the collector current of Q_1 , or I_{C1} , to equal the current flowing into the summing node of the amplifier. Hence:

$$I_{C1} = \frac{E_{IN}}{R_1} \quad (11)$$

The collector current of Q_2 is determined by the positive supply voltage and R_6 as:

$$I_{C2} = \frac{V^+}{R_6} \quad (12)$$

If Q_1 and Q_2 are a matched pair of transistors, Eq. 10 can be used to give:

$$\Delta V_{BE} = \frac{kT}{q} \ln\left(\frac{R_6 E_{IN}}{R_1 V^+}\right) \quad (13)$$

Since the base of Q_1 is grounded, this voltage is presented to the input of the second amplifier. The gain of this stage is $(R_7 + R_8)/R_7$, so that:

$$E_{OUT} = \frac{kT(R_7 + R_8)}{qR_7} \ln\left(\frac{R_6 E_{IN}}{R_1 V^+}\right) \quad (14)$$

This shows that the output voltage is proportional to the logarithm of the input voltage. It can be seen from Eq. 14 that the coefficient of the log term is proportional to absolute temperature, which gives it a thermal sensitivity of 0.3%/°C. The over-all transfer function of the amplifier is given for various operating temperatures in Fig. 3. The dynamic range of the amplifier is 80 dB.

Resistors R_2 and R_1 in Fig. 3 are used to provide an offset adjustment, which increases the dynamic range for small input signals. R_2 is used to limit the loop gain of the input amplifier so that it can be frequency compensated. R_7 is chosen to be equal to the diode impedance of Q_2 to minimize the effect of the input bias current of the output amplifier. The slope of the log characteristic is determined by R_8 , while R_6 determines the zero crossing.

Multiplier with transistor pair

Another interesting use for the nonlinear properties of the bipolar transistor is in the multiplier circuit in Fig. 4. The basic multiplying element is the transistor pair, Q_1 and Q_2 . Its operation can be understood from the following.

The small signal transconductance of a transistor can be obtained by differentiating Eq. 9:

$$\frac{dI_C}{dV_{BE}} = \frac{qI_C}{kT} \quad (15)$$

Next, let's consider a matched transistor pair in a differential configuration as shown in Fig. 4. With the differential input voltage at zero, the input current supplied to the emitters will split equally between the two transistors; the differential output current will be zero. Hence, Eq. 15 can be rewritten in terms of the differential

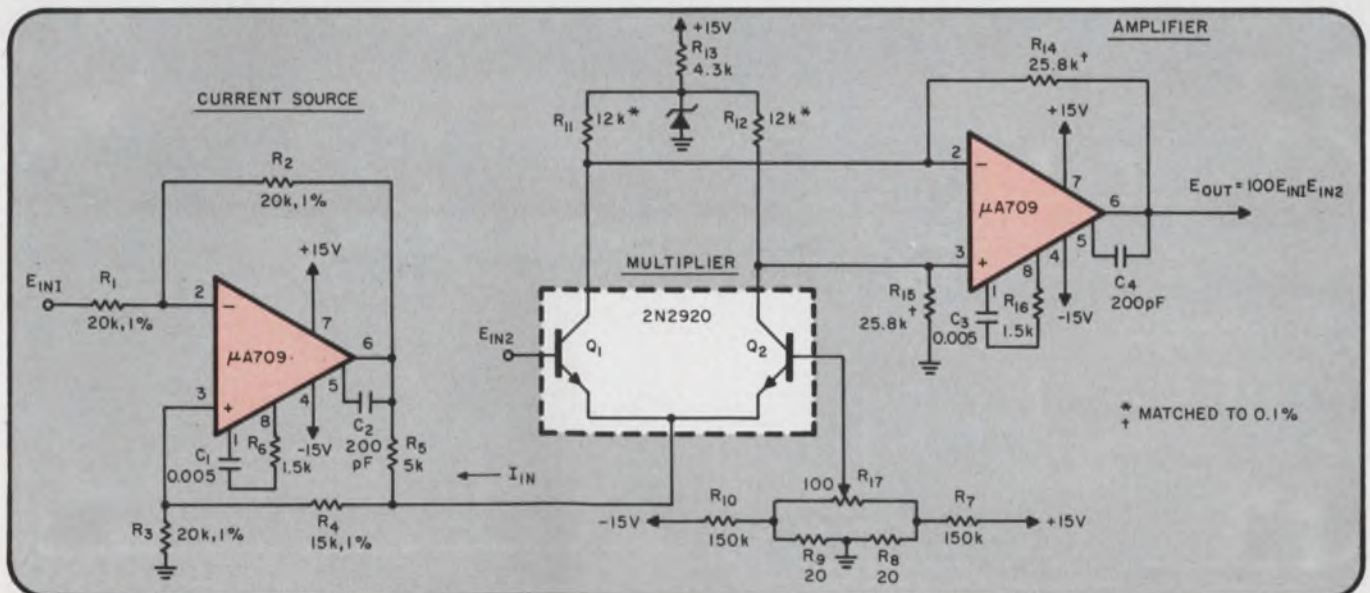

4. Multiplier circuit also uses an external transistor pair, Q_1 and Q_2 —this time as the basic multiplying element.

The output of the current source is proportional to a positive input voltage at E_{IN1} .

output current, the input current to the emitters and input voltage as:

$$I_{OUT} = \frac{q}{2kT} I_{IN} E_{IN2} \quad (16)$$

The differential output current is proportional to the product of the differential input voltage and the current supplied to the emitters.

In Fig. 4, the first $\mu A709$ supplies a current proportional to a positive input voltage to the emitters of Q_1 and Q_2 . Using standard operational amplifier theory, this current can be shown to be:

$$I_{IN} = \frac{E_{IN1} R_2}{R_5 R_1} \quad (17)$$

A second input voltage is supplied to the differential pair. Combining Eqs. 16 and 17 and setting $R_1 = R_2$, the output current of the differential pair is:

$$I_{OUT} = \frac{q}{2kTR_5} E_{IN1} E_{IN2} \quad (18)$$

The output of the pair is connected to a second $\mu A709$, which converts the differential current to a single-ended, zero-referenced voltage. The output

voltage of this amplifier will be $E_{OUT} = R_{14} I_{OUT}$, for $R_{14} = R_{15}$ and $R_{11} = R_{12}$. Hence:

$$E_{OUT} = \frac{qR_{14}}{2kTR_5} E_{IN1} E_{IN2} \quad (19)$$

which shows that the output voltage is proportional to the product of the two input voltages.

There are several details that help make the circuit work right. One is that the resistor pairs, $R_{11} - R_{12}$ and $R_{14} - R_{15}$, must be very closely matched (to within 0.1%). An adjustment is provided for nulling the offset of Q_1 and Q_2 . This adjustment should be made when the current-source is at its maximum value. It should also be noted that Eq. 16 is a small-signal approximation. Thus, the voltage input to the differential pair should be kept small. Restricting the input voltage to ± 20 mV gives linearity acceptable for most applications. Note that E_{IN2} can be a bipolar signal and E_{IN1} must be a positive voltage.

Servo current driver uses a $\mu A702A$

A fairly typical example of an application where an operational amplifier would normally not be considered, but where a $\mu A702A$ can be used

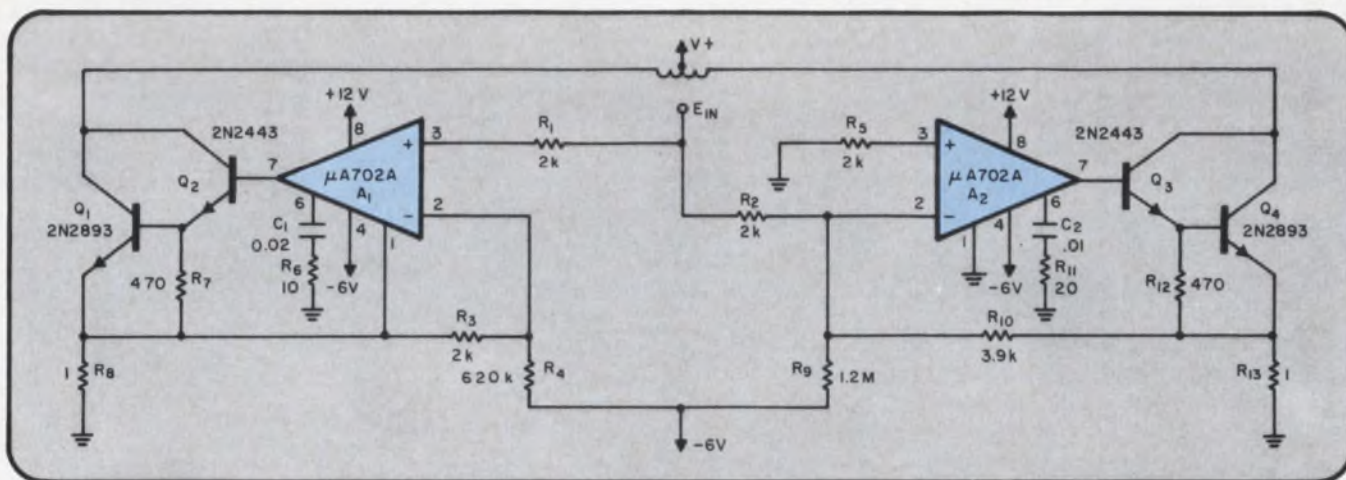

5. Servo current driver obtains push-pull phase inversion by using one operational amplifier for positive input signals and the other for negative ones. The $\mu A702A$

permits the output stage to be biased at very low quiescent currents with no risk of thermal runaway over a full temperature range.

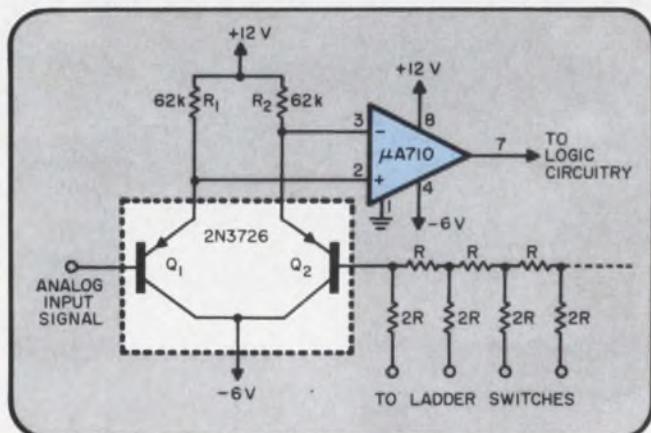

6. Voltage comparator reduces input current requirements by adding pnp pair in front of $\mu A710$ differential comparator element.

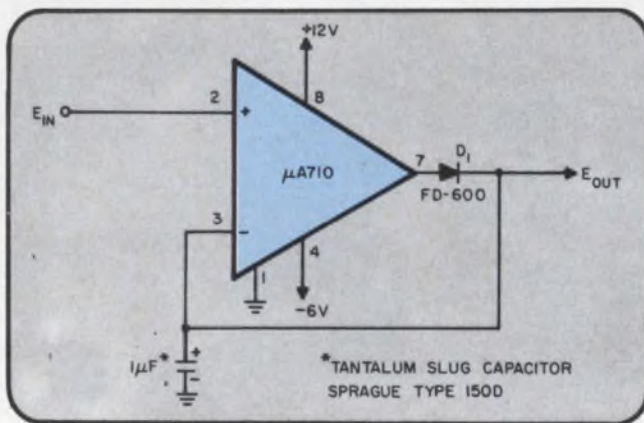

7. Positive peak detector measures peaks of very fast pulses with an externally modified $\mu A710$ differential comparator element.

effectively, is shown in Fig. 5. This is a push-pull class-B servo current driver.

The output current of opposite sides is sensed across R_1 and R_2 . One $\mu A702A$ (A_1) functions as a unity-gain, non-inverting amplifier which makes the voltage across R_1 equal to the input voltage for positive input signals. For negative input signals, A_2 functions as a unity-gain, inverting amplifier which forces the voltage across R_2 to equal the input voltage. Thus, phase inversion for the push-pull amplifier is obtained.

The quiescent output current of the amplifier is determined by R_1 and R_2 ; the values shown give a quiescent current of approximately 20 mA on each side. The circuit will give a ± 2 -A output current for a ± 2 -volt input signal. Input resistance is 4k.

The excellent dc characteristics of the $\mu A702A$ permit the biasing of the output stage at very low quiescent currents, without running the risk of thermal runaway or of encountering a dead zone—even for full temperature-range operation. Also, the low offset and high gain allow good accuracy without wasting an excessive amount of the supply voltage across the current-sensing resistors. Since the output transistors are included within the feedback loop, their characteristics have a negligible effect on over-all performance.

One unusual aspect of this circuit is that the ground terminal of A_1 (pin 1) is connected to the current-sensing resistor, R_1 . This provides bootstrapping on the common-mode range of the amplifier so that it can be operated above its usual common-mode limit of +0.5 volt without exceeding the ratings.

Voltage comparator for all logic forms

Basically, a voltage comparator does the same job as an operational amplifier. Operational amplifiers are, in fact, used frequently as comparators. However, in many applications, the comparator is expected to recover rapidly from saturation, which is its normal operating state. Additionally, the large output swing desired for operational amplifiers is often a disadvantage when the comparator must drive low-level logic circuits. The $\mu A710$ is a differential comparator designed to

overcome such limitations of operational amplifiers. It features extremely fast recovery from saturation and its output is compatible with practically all integrated logic forms.

One of the most obvious applications for this device is as the voltage comparator in an A/D converter. For very high-speed systems in which the ladder network has a low impedance, it can be used alone. However, when speed is not the prime objective, the ladder impedance is generally high enough so that the $\mu A710$ introduces significant error due to loading. In this case, a transistor pair can be used in front of the $\mu A710$ to reduce the input current. This is shown in Fig. 6. A *pn*p pair is used here so that the full ± 5 -volt input range will still be available.

The speed of the comparator is affected somewhat by the addition of the input stage. This is due primarily to the collector-base capacitance of the input transistor loading the ladder network. The transistors selected for this application have a low collector-base capacitance and should load the ladder with a total capacitance of less than 10 pF.

Peak detector measures fast pulses

One difficult problem that can be solved with the $\mu A710$ is the accurate measurement of the peak amplitude of very fast pulses. A peak detector which does this is shown in Fig. 7. The input signal is applied to the non-inverting input of the $\mu A710$. The output is taken from a large capacitor connected to the inverting input.

If the voltage on the input terminal is greater than that on the output, the comparator output will swing positive and charge the capacitor rapidly through D_1 . When the input voltage drops below the voltage on the capacitor, the output of the $\mu A710$ swings negative and the diode becomes reverse biased. This leaves the capacitor charged to the peak value of the input signal.

Because of the low offset and fast response of the $\mu A710$, this circuit can measure the amplitude of pulses less than 100 ns wide with a 5mV accuracy. The decay time of the voltage developed across the capacitor is determined by the input bias current of the comparator and is approximately 20 ms/volt. If the peak detector is to follow more rapidly varying signal, a resistor can be inserted between the output and the negative supply voltage. The peak detector barely loads the signal source since the maximum load current is about 25 μA , and this only occurs at the peak of the signal.

The circuit functions as a unity-gain feedback amplifier at the peak of the input signal, with C_1 providing frequency compensation. Hence, C_1 cannot be made much smaller than the 1 μF indicated, or the circuit will oscillate at the peak of the input signal, giving erratic operation. Larger values of capacitance can, however, be used.

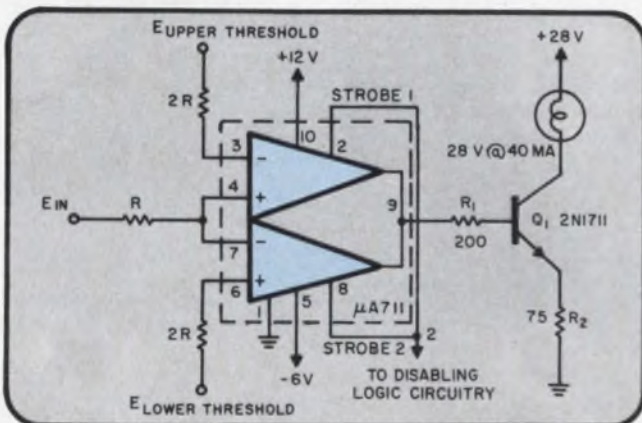

8. Double-ended limit detector uses integrated-circuit dual comparator. The circuit is designed for automatic go/no-go test equipment.

Double-ended limit detector is sense amplifier

The $\mu A711$ dual comparator was designed pri-

OSCILLATORS

< 1 cps to 20 mc



ACCUTRONICS, INC.
ANNOUNCES A COMPLETE
OSCILLATOR LINE
COMPATIBLE WITH I.C.
APPLICATIONS

If your new system is utilizing integrated circuits, let Accutronics assist you with your oscillator requirement. Operating on voltages as low as 3 volts the I.C. series can provide an output level to drive all forms of gates, flip-flops, multivibrators, etc. Typical output levels would be 2 volts to 2.8 volts peak to peak with a 3 volt supply. Rise and fall times of <20 nanosec. are typical. Sine wave outputs can be provided with <5% distortion and frequency stabilities from $\pm 0.0001\%$ to $\pm 5\%$. Size of the oscillators vary with frequency and output characteristics. "Worst case" design coupled with advanced production techniques insures a long life with trouble free performance. The Accutronics oscillator is guaranteed for 2 years! Can we be of service? Call collect Area 312, 879-1000.



FF41 Series

FREQUENCY: <400 cps to 20 mc
FREQUENCY TOLERANCE: $\pm 0.015\%$ or better over temperature range
TEMPERATURE RANGE: -25°C to $+70^{\circ}\text{C}$
SUPPLY VOLTAGE RANGE: 3V dc to 30V dc as specified
LOAD IMPEDANCE: $1\text{K}\Omega$ to $10\text{K}\Omega$
OUTPUT WAVEFORM: Sine or Square as specified
OUTPUT VOLTAGE: Square wave 3.5 to 4V p/p with <20 ns Sine Wave 1.2 rms with <5% distortion
Note: The above outputs are typical with a supply voltage of 3.5 volts and frequency of 1 kc

PRICE: \$87.50 to \$118.75

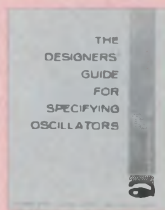

FREE: "The Designers' Guide For Specifying Oscillators"

This new brochure takes the guess work out of oscillator specifying. It covers in detail all of the many parameters involved and their importance to your overall system design. Order your free copy by circling the reader service number or writing to Accutronics, Inc.

accutronics, inc.

12 S. Island Ave., Batavia, Illinois

ON READER-SERVICE CARD CIRCLE 28

marily as a core-memory sense amplifier. However, it is versatile enough to be used in a number of other applications.

In one of these, Fig. 8, the circuit gives a positive output for input signals below a preset threshold or above a second, independently adjustable voltage threshold. This output is fed to a lamp driver, so that whenever the input signal goes outside the tolerance limits, the lamp will light. A feature of the circuit is that the limit detector can be disabled when it is not being used by applying a zero-logic signal to the strobe terminals. In addition, up to eight dual comparators can be wired with common outputs and be used to feed a single lamp driver.

To make the accuracy dependent only on offset currents rather than on bias currents, the relative values of the source resistances for the signal and reference voltages should be as indicated in the schematic. Ideally, these resistances should be as low as possible. The lamp driver is designed so that its peak output current is limited during the initial turn-on of the bulb when the filament resistance is low. This is accomplished with R_2 . Series resistor R_1 limits the output current of the comparator when the lamp driver saturates.

Off-the-shelf philosophy

These applications demonstrate the practical use of off-the-shelf integrated circuits in linear circuit design. The intent here is to show that the possibility of using these devices in a wide variety of applications should not be overlooked in fear of having to design and buy a custom package.

Low cost, through the inherent high-volume process involved, is the most significant advantage of monolithic integrated circuits. In addition, the use of integrated circuits can reduce the expense of assembly and testing. For the low volume user this cost edge can be acquired through the use of already standardized packages which are then modified to perform a specific function by the use of external discrete components. ■ ■

References:

1. R. J. Widlar, "A Monolithic Operational Amplifier," Fairchild Semiconductor APP-105/2.
2. R. J. Widlar, "The Improved $\mu\text{A}702$ Wideband DC Amplifier," Fairchild Semiconductor APP-111/2.
3. "A702 Circuit Design Ideas," Fairchild Semiconductor APP-114.
4. J. N. Giles, "Frequency Compensation Techniques for an Integrated Operational Amplifier," Fairchild Semiconductor APP-117.
5. R. J. Widlar, "A Unique Circuit Design for a High Performance Operational Amplifier Especially Suited to Monolithic Construction" Fairchild Semiconductor TP-32.
6. R. J. Widlar, "A High Speed Differential Comparator," Fairchild Semiconductor APP-116.
7. R. J. Widlar, "Core Memory Sense Amplifier Designs Using an Integrated Dual Comparator," Fairchild Semiconductor APP-123.
8. C. T. Sah, "Effect of Surface Recombination and Channel on P-N Junction and Transistor Characteristics," *IRE Trans. on Electron Devices*, Vol. ED-9, pp. 94-108, January, 1962.
9. R. J. Widlar, "Some Circuit Design Techniques for Linear Integrated Circuits," *IEEE Tran. on Circuit Theory*, December, 1965, to be published.

this trademark found in your scientific apparatus automatically rates you as a "quality" manufacturer

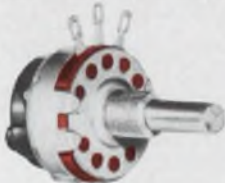
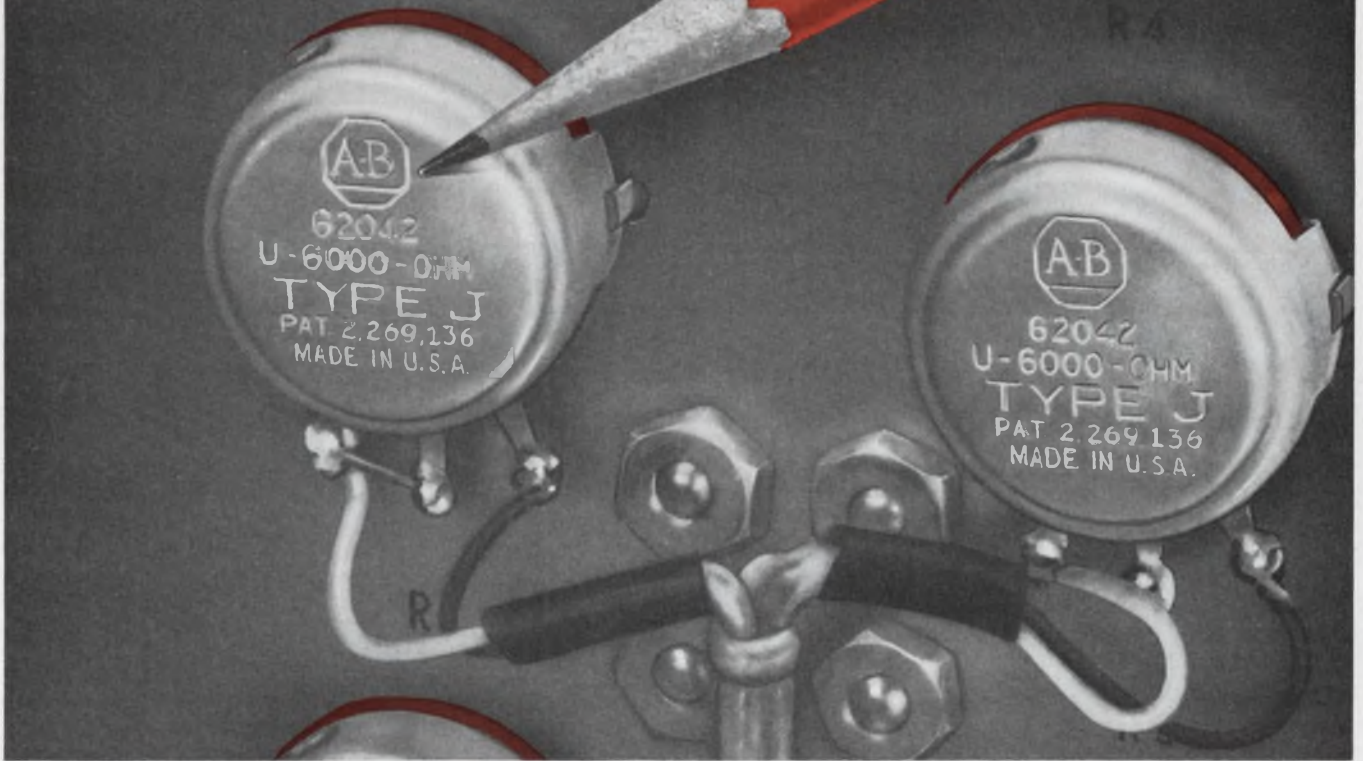

Type JS single unit with line switch



Type JJC dual unit with concentric shaft



Type JJJ triple unit



Type JL single unit with lock bushing



Type JJ dual unit



Type JJV dual unit with vernier adjustment

■ The A-B trademark on variable resistors is proof of design integrity — you have resisted the temptation of saving pennies by substituting marginal performing "entertainment type" controls. By thus assuring your customers of the "quality" of your apparatus, the extra price you pay becomes a good investment.

Allen-Bradley Type J variable resistors have a solid molded resistance element made by A-B's exclusive hot molding process. Operation is always smooth — there are never any sudden jumps in resistance during adjustment. Furthermore, the Type J exhibits an exceptionally low noise level when new — it becomes even lower with use. On life tests, the Type J will provide well over 100,000 complete rotational cycles with less than a 10% resistance change at the completion of the test.

For more details on the complete line of A-B quality electronic components, please write for Publication 6024: Allen-Bradley Co., 1344 South Second Street, Milwaukee, Wisconsin 53204. Export Office: 630 Third Avenue, New York, N.Y., U.S.A. 10017.

1165-3AB



ALLEN-BRADLEY

QUALITY ELECTRONIC COMPONENTS

ON READER-SERVICE CARD CIRCLE 29

Simplify dc amplifier design by using FETs. Their high-input-impedance and zero-temperature-coefficient attributes also improve performance.

Dc amplifiers have traditionally been plagued by stability problems. But if the amplifier uses a field-effect transistor (FET) as the active element, performance variations with temperature are no longer a risk.

This is largely due to the zero-temperature-coefficient property of the FET. To take advantage of it, you must know how to arrange the biasing. Once the biasing conditions are understood, the FET can be used to provide stable performance in a host of dc amplifier circuits. These include simple amplifiers, memory stages, electrometers and source-followers.

In addition, the high-input impedance of the

FET simplifies the amplifier design. The engineer need not bother with costly, complex multi-stage networks to achieve high R_{in} . Thus, this impedance property and the temperature coefficient attribute give the FET distinct advantages over bipolar transistor and tube dc amplifiers.

Zeroing-in on temperature effects

Consider the transfer characteristic of a typical FET taken at three temperatures (Fig. 1). Note that the drain current for this unit varies for every possible gate bias voltage except that corresponding to point A. For higher gate voltages, the drain current increases with increases in temperature to produce a positive temperature coefficient. Smaller values of gate voltage produce a negative temperature coefficient where the drain current decreases with increases in operating temperature. At point A, however, the drain current remains constant as temperature is varied and the

Carl David Todd, Applications Consultant, Dickson Electronics Corp., Scottsdale, Ariz.

(This article is a condensation of a Dickson Applications Note, "FET DC Amplifiers." The complete article may be obtained by writing to Dickson at the above address and requesting Vol. 1, No. 6 of its Application Note Series.)

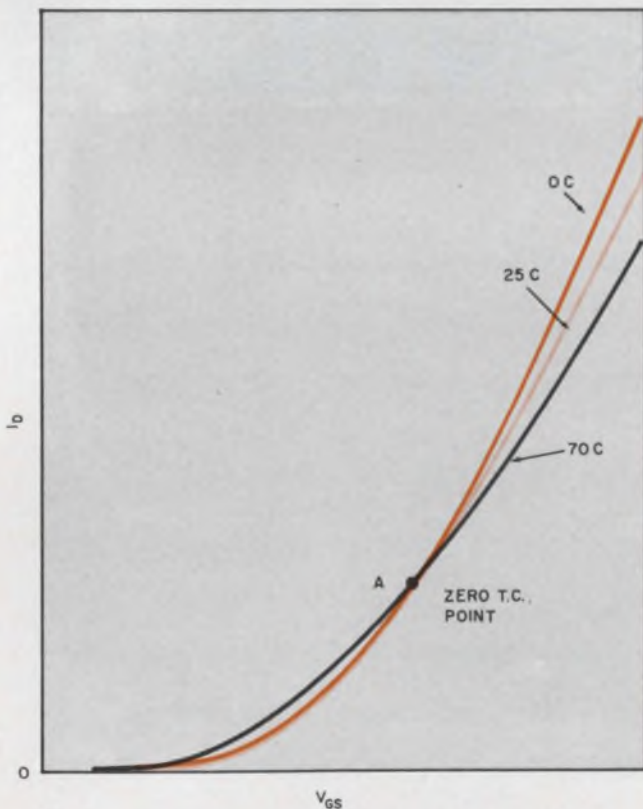

1. FET transfer characteristic (drain current verses gate bias voltage) shows the effect of temperature variations. Note the zero temperature coefficient point (A) for one value of gate bias.

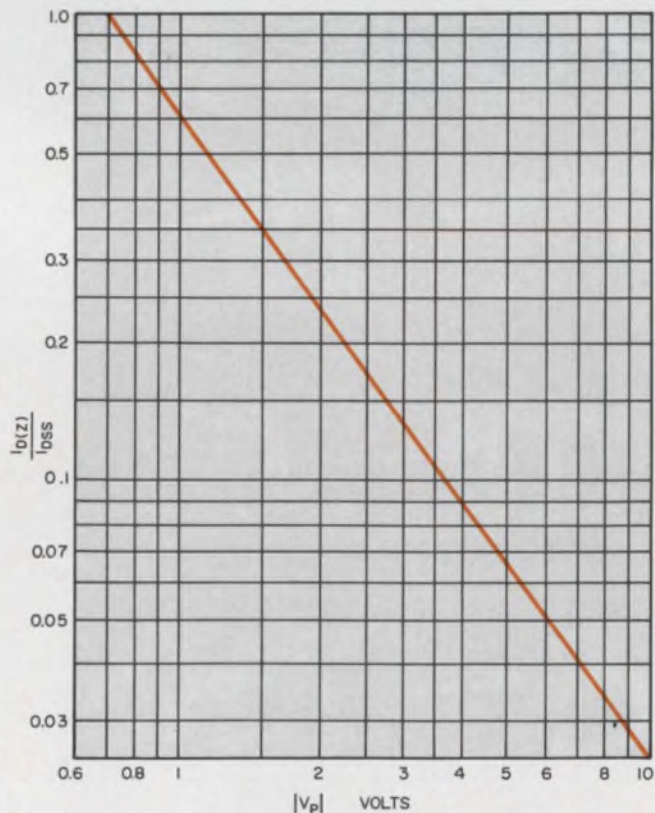

2. Optimum bias is determined by measuring the drain characteristic at different temperatures. This yields the normalized value of drain current at a given pinchoff voltage to yield the most stable temperature performance.

temperature coefficient is essentially zero.

Two opposing effects are present which affect the temperature coefficient in opposite ways. The first effect is due to a variation in the barrier or contact potential, which has a negative temperature coefficient of about 2.2 mV/°C, thus resulting in a positive temperature coefficient for I_D when the gate voltage is held constant.

The percentage change in I_D due to barrier-potential variation would be a function of g_{fs}/I_D and would be greatest for FETs having a low pinchoff voltage. For FETs with a very low value of V_p , this effect dominates, and the net temperature coefficient of I_D will be positive.

If the value of V_p for a FET is very high, then the changes in barrier potential will produce very little variation in I_D , and the net effect will be dominated by the change in resistivity. (The resistivity variation is the second temperature effect.) This will result in a net negative temperature coefficient.

FETs having an intermediate value of pinchoff voltage may have a temperature coefficient for I_D which is either positive or negative. It depends upon the bias condition. At one critical value of V_{GS} , the temperature coefficient is zero. A theoretical analysis indicates that this zero temperature-coefficient bias point occurs when the ratio I_D/g_{fs} is equal to approximately 0.32 volt.

Combining the above requirements with the normal theoretical characteristic equations for FETs, the theoretical values of the gate voltage and drain current required to yield the optimum bias point for n -channel FETs are derived. Thus,

$$V_{GS(z)} \approx V_p + 0.64, \quad (1)$$

$$I_{D(z)} \approx I_{DSS} \frac{0.64^2}{V_p}, \quad (2)$$

where $V_{GS(z)}$ and $I_{D(z)}$ are the gate voltage and drain current, respectively, that produce the zero coefficient. V_p is the pinchoff voltage and I_{DSS} is the drain current at zero gate bias.

Several n -channel FETs (five different types) exhibiting a wide spread in parameters were tested to determine the optimum bias point. This was done by plotting the characteristic curves at different temperatures, as shown in Fig. 1, and then reading the bias-condition values from the resulting intersection point. Figure 2 illustrates the results for the optimum drain current normalized to the I_{DSS} value.

The empirical results indicate that the zero-temperature-coefficient bias point will occur at I_D equal to I_{DSS} or at a V_{GS} of zero for an n -channel FET with V_p equal to -0.7 volt.

The results of a plot of the measured gate voltage for zero temperature coefficient as a function of the pinchoff voltage are given in Fig. 3. The theoretical Eq. 1 is plotted as a dotted line. The empirical relationship is not as well-behaved and as predictable as one would like. One observation would be that the actual gate voltage required to give a zero temperature coefficient usually seems to be nearer to zero than theoretical predic-

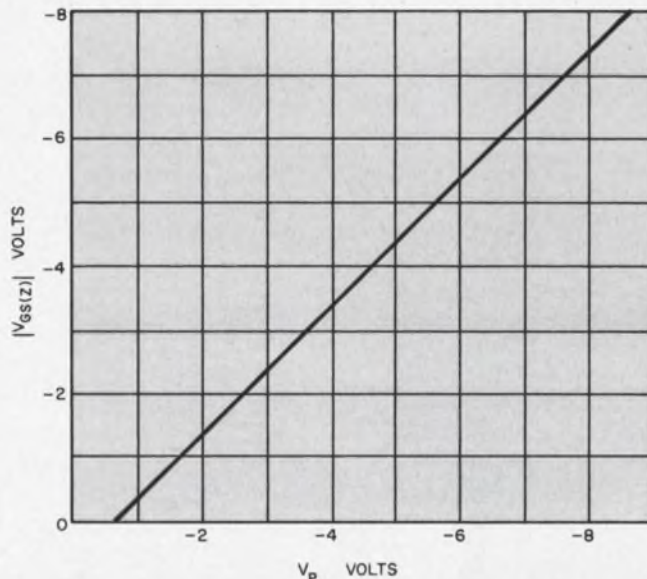

3. The FET gate voltage required to produce a zero temperature coefficient for the drain current varies as a function of the pinchoff voltage.

tions would indicate.

Measurements on a number of n -channel FETs indicated that the actual magnitude of drift in equivalent V_{GS} was within about 15% of the value predicted by:

$$D = 2.2 [1 - \sqrt{I_D/I_{D(z)}}] \quad (3)$$

Bias makes the difference

We will now consider several basic dc amplifier circuits and discuss their component and bias requirements along with the characteristics typically achievable. In some circuits it will be assumed that the source providing the input signal establishes a dc return path to ground for the gate. In the other circuits, the assumption is that a resistor of between 1 and 10 meg is connected across the input terminals.

Source-followers. Since one of the primary reasons for the use of a FET in dc amplifiers is the very high resistance, the source-follower circuit is fairly common. Fig. 4a illustrates the simplest form of a FET source-follower. The output load resistor provides the bias conditions that may be chosen to provide a negligible temperature drift, and, in turn, the critical gate voltage and the critical drain current are given by:

$$R_1 = V_{GS(z)}/I_{D(z)} \quad (4)$$

Note that Eq. 4 tells us—for FETs with a relatively low value of pinchoff voltage—that the load resistance value required to give temperature stability may well be too low to give adequate voltage gain for the stage.

For this circuit, the typical voltage gain for the temperature-stabilized source-follower will be less than 0.5. It works best with FETs having an intermediate value of V_p . There will be a dc offset between the output and input voltages even with the input made zero. This will be equal to $V_{GS(z)}$ and may be eliminated by the use of a differential

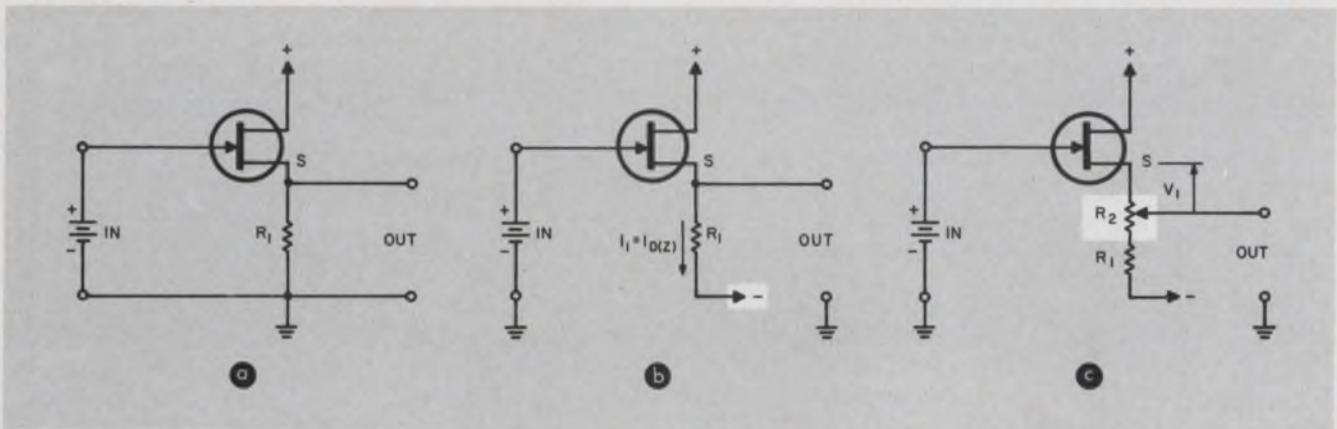

4. The FET makes a simple source-follower because of its high input impedance (a). When unity gain is desired, the source uses a separate negative supply to obtain the

proper current biasing (b). By placing a potentiometer in the source leg (c), the offset voltage becomes adjustable through zero.

amplifier as the succeeding stage.

Better performance may be obtained from the source-follower circuit in Fig. 4b, where a separate negative power supply provides the critical bias current which is made equal to $I_{D(z)}$. The value of R_1 in this case will be much greater than before, and hence the voltage gain may easily approach unity.

This circuit may be used with FETs having pinchoff voltages close to the -0.7 volt ideal. This will yield a zero temperature coefficient for zero gate voltage and thus have negligible offset voltage in the source-follower.

A simple circuit modification (Fig. 4c) will allow the removal of the offset voltage for non-ideal FETs and yet retain negligible drift and a voltage gain which is close to unity. The value of $V_{GS(z)}$ here, however, must be small in comparison with the negative supply voltage to prevent any loss in voltage gain.

Common-source dc amplifiers. The FET may be used in the common-source mode to give a voltage gain greater than unity and yet have the capability of negligible drift. Fig. 5 shows a typical circuit arrangement to achieve this.

Potentiometer R_2 provides an adjustable gate bias voltage, which may be set equal to $V_{GS(z)}$ for minimum drift. Variable resistor R_1 used for the drain load will allow the adjustment of the dc output level. The output cannot be made equal to zero without additional circuitry, but this adjustment will assure that the same offset is obtained.

The voltage gain of the common source FET amplifier is approximately equal to $g_{fs} R_1$ if the drain resistance of the FET is much greater than R_1 , and if the dc resistance seen between the source and ground is negligible. Voltage gains of 10 or more are practical.

Putting FETs to work

Two FETs may be connected together in a differential-amplifier mode as shown in Fig. 6a. While one of the main reasons for going to a differential pair with bipolar transistors is to reduce the net drift, the typical drift that may be

achieved with FETs in the differential mode is often worse than that which may be obtained from a single stage whose bias point is carefully set at the optimum condition.

Balanced operation of the FET differential amplifier requires matched FETs having approximately equal g_{fs} and I_{DSS} and optimum bias conditions. This approach is economical, therefore, only if high input resistance is required along with substantial common-mode rejection. The common-mode rejection may be improved by replacing R_s with a current source. Some dc return from the gates to ground must be present and is simulated in Fig. 6a by R_1 .

The FET source-follower may be followed by a bipolar matched differential pair as shown in Fig. 6b. The over-all drift may be controlled by varying the bias current for the FET, which is normally operated near its optimum bias condition. This approach has the benefit of a possible zero voltage offset between input and output.

Electrometer-type circuits. The limiting value of the FET's input resistance is due to the various leakage currents which flow out of the gate. These develop an error signal across the

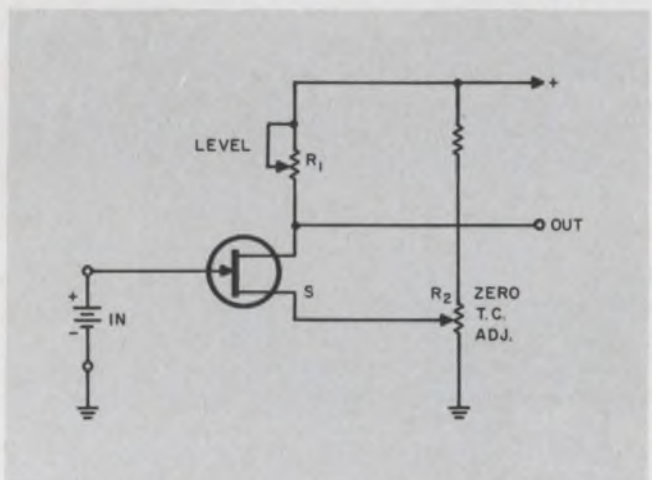

5. Voltage gains of 10 or more are practical in the common-source FET dc amplifier. This circuit (shown simplified) also exhibits negligible drift.

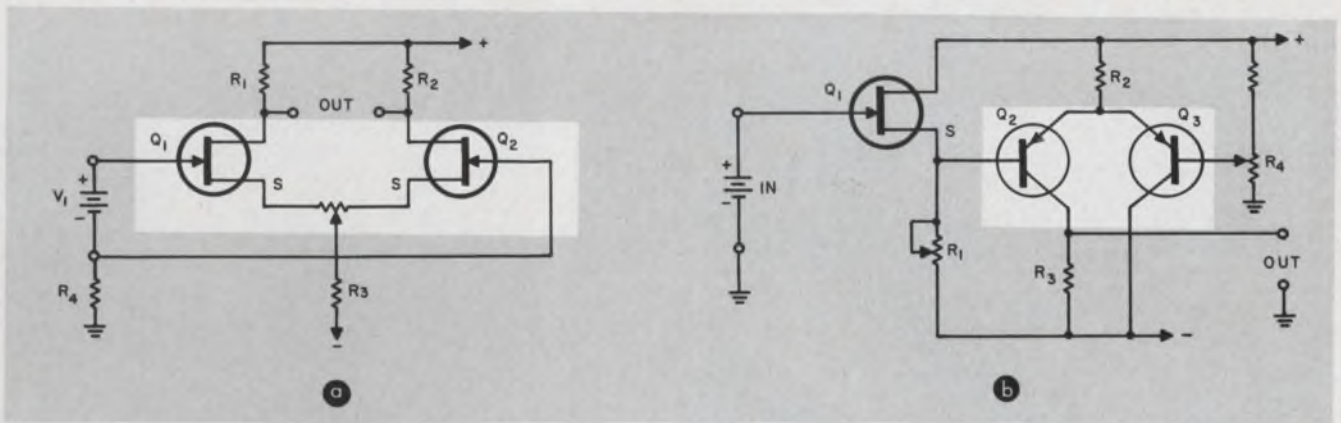

6. In the basic FET differential amplifier (a), care must be taken to match the g_{fs} , I_{DSS} and biasing. Otherwise, the circuit will be less stable with temperature variations than

single-ended amplifiers. Zero offset voltage between input and output is achieved by going to a bipolar differential pair preceded by a FET source-follower (b).

source (generator) resistance with fluctuations in operating temperature. This variation is somewhat exponential, as is the case with most leakage currents associated with reverse-biased semiconductor junctions. Hence, it may not be balanced out with the control of the drain current, which produces a relatively linear temperature coefficient.

The problem is usually not too severe unless the generator resistance of the source is quite large or unless the maximum operating temperature is high. Under either of these conditions, compensation of the drift due to leakage currents is required and may be accomplished to a respectable degree.

One simple way is to add another source of leakage current which is equal in magnitude but opposite in polarity. This is done in Fig. 7, where the reverse-leakage current of diode D_1 is matched with the sum of the I_{D0} and I_{S0} leakage currents of the FET.

The simple compensated FET source-follower amplifier may be extended a step further as shown in Fig. 8 to allow the measurement of very small dc currents. An operational amplifier, connected in a negative-feedback servo loop, attempts to

maintain the net input current into the FET gate equal to zero. This is achieved by developing a current through R_2 that will be exactly equal in magnitude but opposite in polarity to that provided at the input terminal. Resistor R_1 is set to give zero voltage offset between the input terminal and the output of the FET source-follower. It is adjusted with the input shorted to ground.

A second zero adjustment is provided by R_3 , which may insert a small positive or negative input current through R_1 to compensate for any small net current flowing in the gate circuit. This yields zero voltage at the output of the operational amplifier when no current is supplied to the input. This arrangement is capable of current measurement down to and beyond the picoampere range.

Analog memory circuits. High-input-resistance dc amplifiers may be modified slightly to provide an analog memory capable of rather long memory times. The leakage-current-compensated source-follower in Fig. 7 is used in conjunction with a low-leakage memory capacitor, C_1 , placed across the input terminals (Fig. 9a).

Switch S_1 , as shown, connects the voltage to be remembered to the memory capacitor during

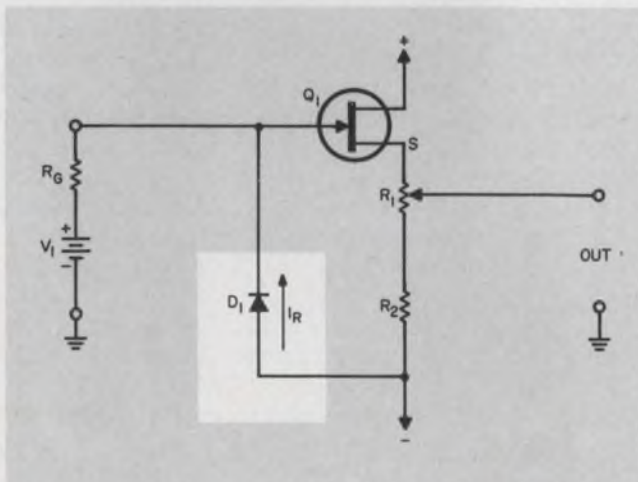

7. The FET may be used as an ultra-high input-resistance voltage amplifier. Diode D_1 provides leakage-current compensation for the FET.

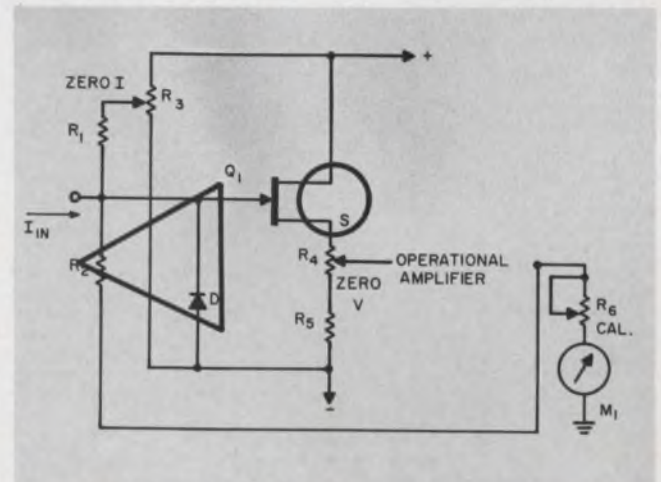

8. Very low currents, down into the picoampere region, may be measured by using a FET followed by an operational amplifier with a negative-feedback servo loop.

The Industry's Most Stable Oscillators

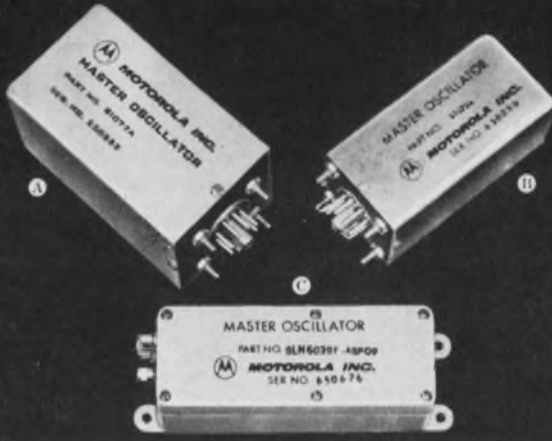

(A) HIGH PERFORMANCE PLUG-IN Type S1077A

- $1 \times 10^{-9}/C^{\circ}$ from -20° to $+55^{\circ}C$
- 1×10^{-9} Short Term Stability
- Less Than 1×10^{-9} /Day Aging
- 1 MC Model S1077A . . . \$450

(B) LOW COST PLUG-IN Type S1072A

- Less Than 2×10^{-9} /Day Aging
- 5×10^{-9} from -55° to $+71^{\circ}C$
- 60 KC to 12 MC Output Available
- 1 MC Model S1072A . . . \$345

(A) & (B) All silicon solid state design using proportional ovens with glass-enclosed crystals assures unexcelled performance—with *guaranteed specifications*—in frequency and time applications. Ideal for use in digital frequency counters, phase-locked receivers, synthesizers, SSB systems, missile guidance and satellite tracking systems, navigation, computer and communications equipment.

(C) HIGH PERFORMANCE MILITARY Type SLN6039

- Fast Warm-Up within 5×10^{-9} in 1 hour
- 5×10^{-9} or 1×10^{-9} /Day Aging
- 60 KC to 12 MC Output Available
- 3 MC Model SLN6039D . . . \$540

(C) This oscillator with its wide dynamic range proportional oven and glass-enclosed precision crystal meets many MIL specifications for both airborne and ground equipment.

For full specifications call or write: Motorola Communications & Electronics, Inc., 4501 Augusta Blvd., Chicago, Illinois 60651. (312) 772-6500. A Subsidiary of Motorola Inc.



MOTOROLA
Precision Instrument Products

ON READER-SERVICE CARD CIRCLE 30

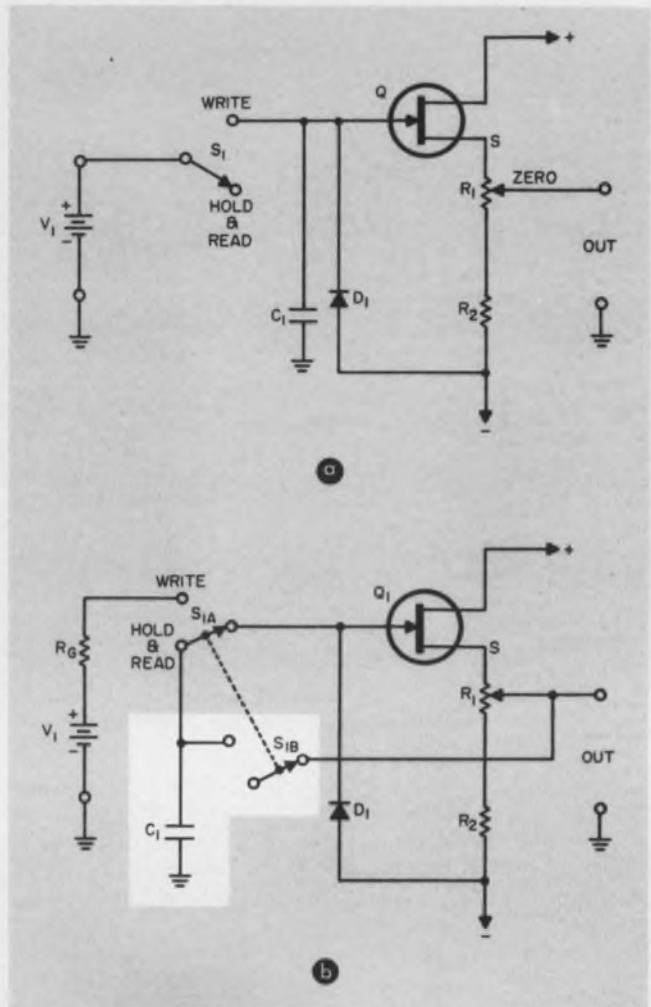

9. Analog memory circuits capable of very long memory times are achieved by using a compensated FET source-follower (a). Addition of another switching function (b) prevents memory capacitor *C*, from loading the input.

“write” and then disconnects the input during memory “hold” and “read.” The action of *S*, may be accomplished by a low-leakage mechanical switch, reed relay or by a carefully designed solid-state switch using FETs in a chopper mode.

The memory time may reach several minutes with a reasonable match in leakage currents. Even longer periods are possible with very careful matching and some degree of temperature control.

In certain applications, the relatively large memory capacitor, which may be $1 \mu F$ or so, may severely load the input source or may demand too long a time for accurate “write” operations. This problem is easily remedied by the addition of another switching mode, as shown in Fig. 9b.

The memory capacitor is connected to the output of the source-follower during “write.” Thus, the relatively low output resistance will charge *C*, rapidly and without loading the input source at all. Then, for memory “hold” and “read” operations, the memory capacitor is switched to the input of the source-follower, which is now removed from the input voltage. In either of the above memory circuits, the outputs may be monitored during “write,” “hold” and “read” without affecting the memory accuracy. ■ ■

Another great idea from Daven...

When
there's no room
in here...



put your
rotary switch
out here!

The new Daven Switch-in-knob



ACTUAL SIZE

Tight squeeze behind the control panel? Use the brand new Daven Switch-In-Knob . . . the world's smallest rotary selector switch built right into the knob. Now the switch is *outside* your instrument . . . *inside* the knob.

And all you need is $\frac{3}{16}$ " behind the panel, eliminating $\frac{7}{16}$ " from the overall length of the standard Series G and K switches.

Yet for all its compact advantages, the Switch-In-Knob includes *all* the features of the popular military Series G or the new commercial

Series K switch.

The Series G has high reliability, superior dielectric strength, and longer life. It is built in a clean room environment to meet applicable Mil specs on temperature, humidity, corrosion, vibration, acceleration, shock and immersion. And it is both explosion-proof and waterproof.

The Series K was developed for instrument and commercial applications where the same size, quality and electrical specs as the Series G were needed . . . at a lower cost.

Although the Series K (without knob) costs only \$4.85 to \$3.85 each (depending upon quantity), it is a completely enclosed unit offering long life, low contact resistance, high dielectric strength, wide operating temperature range, positive detent action and resistance to corrosion, shock and vibration. Both the Series G and K come in single deck, shorting and non-shorting . . . in various combinations up to 4 poles and 10 positions.

Write today for complete specs and prices on the new Switch-In-Knob!

DAVEN 
LIVINGSTON, NEW JERSEY

(201) WYman 2-4300 • TWX 201 992-7356 • Cable: DAVEN LIVINGSTON N J

Speed Inquiry to Advertiser via Collect Night Letter

ON READER-SERVICE CARD CIRCLE 31

Try designing your career.

You can get to the top without a plan, but it's unlikely. Here are some ideas to help smooth your way.

Last month the fellow in the seat next to me on a plane from Chicago to Cleveland told me of a plan he had laid out for his career. He would stay just so long on his present job, then he would move to a better job, spend so much time on that, then to the next step up and stay so long there. Eventually he expected to land in the top echelons of his company. This was no company training plan, his company had no such plan. This was a plan he had worked out for himself.

"You're assuming a lot in that plan, aren't you?" I asked.

"Certainly I am," he agreed, "but it's better than drifting, don't you think?"

I did think it was better than drifting, but, I said, "You'll get mixed up in company politics."

"I know that, but I'd be in politics no matter what I did, wouldn't I? So why not use the company's political set up to help me get ahead?"

You may say, "Why should this interest me, our company has no politics?" I have been told that hundreds of times, but each time I explain that I am not speaking of the dirty, sticking a knife in your back stuff, the man agrees that politics do figure in the promotions in his company.

Just ask yourself, "Why was my boss given his job?" Then, "Weren't some other men considered for the job? Why weren't they chosen?" When you have answered those questions, you will know what I mean by company politics. It's all those human factors that influence decisions affecting people and projects in your company. If you know what these factors are, you can put company politics to work for you. Your gain is that you will be considered for promotions when you should be considered.

How much career planning have you done? You may say, "I'm doing it every day by my ideas, my designs, my work." That's fine, but are you doing the other things that can help you advance in your company? A career can and should be planned step by step with the same care you use on any of your project designs. Thousands of engineers have

done it, and they have found it much more profitable than drifting.

Your plan for advancement.

In planning any advancement within your company, here are the points you should consider:

1. **There are politics in all companies**, some good and some bad. Most are part of normal competition and good management.

2. **Analyze how far you want to go** in your company and what jobs ahead are possible for you. Analyze your own capabilities. Then decide what you want and go after it.

3. **Start training yourself** for the job ahead, since you advance one job at a time.

4. **Do a good job where you are**, an outstanding one if possible. Any advancement will come from what you do on the job you now hold.

5. **Know your competition**—the men who are capable of being advanced to the job you want. Respect this competition, cooperate with it and associate with it.

6. **Find the people who control promotions** in your company. Try to impress them.

7. **Be loyal to the boss**, the department and the company. Instead of complaining about rules, work regulations or management decisions, try to figure out why they are justified.

8. **Make the best possible first impression**. In all your contacts, present an image of competence.

9. **Make friends of everybody**—those above you, those at your level and those among the supporting troops.

10. **Conform**. Most managements are afraid of the radical in looks, in dress and in actions. Let someone else carry the placards in the protest line.

11. **Reconcile yourself to the tradeoffs**. Each time you move up, you'll find the bigger job more demanding. Face the fact that you have to trade some freedom for the extra pay the job brings.

Do you have what it takes?

Do you think you have what it takes to be promoted? You may say: "I have seniority. I have as much education and experience as anyone."

Both of these may be good qualifications, but in your company are these the qualifications that push a man ahead? It might be smart to check on what has counted in past promotions in your company.

Ed J. Hegarty, Consultant, Mansfield, Ohio

This article is based upon material appearing in Mr. Hegarty's latest book, "How to Succeed in Company Politics" (McGraw-Hill Book Co., 256 pages, \$5.95). He is the author of 10 other books dealing mainly with personal development, sales and sales training.

Usually, you'll find that the man who got promoted was doing a good job where he was. I ask men how the boss feels they are doing on the job. They say, "I must be doing all right, he never says anything." I'd suggest you ask him. You may think you are doing all right, but the boss may see a number of ways in which you can improve. If he does and tells you so, you can act accordingly.

Next, how do you stand on education? Do you have the training needed for the jobs ahead? The training of an executive is a continuous process. You should be learning more every day, and this learning should not be confined to what you learn on the job. Ask your boss what training he suggests for you. By asking how you are doing, he sees that you want to do better and that you want to get ahead. But to hold any higher job, you have to prove that you can handle the one you are doing. On any higher job, you can assume you will need more education and training. One trainer put it this way, "On the basis of the job you are doing, would you promote you?"

What are the jobs ahead?

You advance one job at a time. This is the rule in most companies. Why not make a list of the jobs to which you might advance. Then take a look at the next step up. Suppose that you'd have to supervise the work of several men. (This is probably the toughest task for a man who has had only his own job to worry about and now is asked to supervise the work of others.) What do you know about supervision? Every year hundreds of helpful books are written on supervision. Have you read any of them? Such books are full of ideas to help you hold your next job—the one in which you may have to direct several men. If you are successful with them, management may give you a job that calls for managing more men.

How far do you want to go?

Every man has or should have a goal to shoot for in his company. What's yours? Is it the top job? This is the first question to ask in any career planning. Do you need to get to the top job to be happy? Some men do and some don't. Is your goal to be the vice president in charge of engineering in your company? Perhaps you don't want to shoot that high. In selecting, aim at a job that's possible for you. You may never make out in that

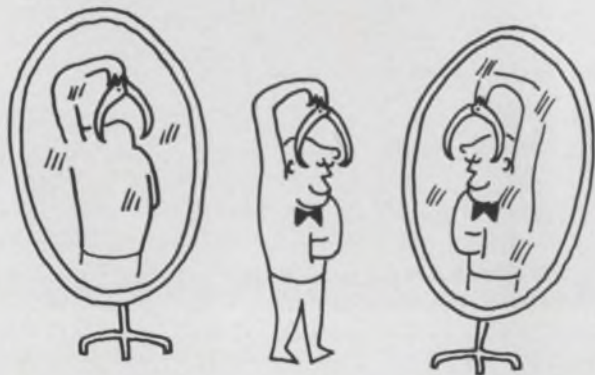

top spot, but you might be excellent in a number of jobs one step below the top. Perhaps you are already satisfied and want to stay where you are. This too calls for planning. Your company may consider the job you have now as a training job, and it may want to move another man into it so he can get the experience you are now getting. In maneuvering to stay on your present job, you may give the impression that you do not have the ability to advance to a better job.

Who is your competition?

As you move up in your company, you will have competition. Others might want that top job too. Make a list of these fellows and analyze them. Try



to rate them, not on your likes or dislikes, but on their ability to get ahead. These are the men who will also be considered for the jobs you get as you move up the ladder. What have they got that you haven't? You will probably be able to cross off some men because they lack the ambition or desire to advance. This will leave you with a smaller list. These men are your competition.

It's good company politics to know these men, to work with them and to cooperate with and speak well of them. When one man read this in my book, he wrote me, "That's sure good advice, some day one of these jokers may be your boss." Today they are competition. By working cooperatively with them, you impress management with your ability to get along with others.

Who does it pay to impress?

The key to any advancement is the list of men above you. If your company has the right men, it can go on to greater success. Without them, it has to struggle to stay alive. Thus, every company wants men who are ambitious and who will train themselves to handle top jobs. But to move up to a more important job, you have to impress someone that you are one of those ambitious men.

Who is this someone—or is it more than one person? Someone above you has the power to recommend you for a better job, and it will pay you to know who that is. Then you can go out of your way to impress that man or group.

What counts in promotions?

Performance, achievement and ability—are these the only factors that count in promotions, or are other factors also involved, subtle and personal factors never overtly mentioned but neverthe-

less important in determining who will progress and who will not? Is there any friendship or clannishness involved—school ties, loyalty, family or other such factors that help determine who is promoted? All of these factors are important in some companies. What is important in yours? It pays to find out and include these factors in your career plan.

Your image is important.

In moving about in your company, you are broadcasting two images: the image of first impression and the image of competence.

Keep in mind that first impressions are very important. You look at me and form an opinion. I look at you and form another. Of course, further acquaintance can change that first impression, but why not make that first impression as good as possible? Little things like shined shoes, a hair cut, neat or sloppy dress can mean a lot the first time you meet the man who has the power to promote you. There are things you can't change



about your looks: whether you're tall, short, thin, fat, etc. But you can try to make the most of what you have. You might ask, "What has my appearance to do with my ability as an engineer?" Nothing, maybe. But it has a lot to do with what a stranger thinks of you.

Check the executives in your company as to looks and dress. Why not try to make an impression on them by dressing appropriately. One executive told me of an engineer he sent back to the office to get a coat, a shirt and a tie. "Here we were going before the operating committee to get approval of our year's budget," he explained, "and this joker shows up in a sport shirt." The executive did not want that sport shirt to make the wrong impression on the committee. You can't look like an expert in a sport shirt.

Remember that as you move about in your office, in the cafeteria and through the halls or aisles of the office and factory, people see you and form this first impression. Some of these eyes belong to the men who have some say about your

promotion. You may say, "I hate this conformity." Okay, hate it, but go along with it, if you want to advance toward the top.

You also advance your personal stock by broadcasting an image of competence. You build this image by your performance on the job, by appearing willing and anxious to learn, by listening to suggestions and by stating your ideas clearly so that the other fellow understands them. Building this image among those who count takes time and constant effort. Without it you are lost in the competition. So why not ask yourself now, "What is my image of competence today, and what can I do to make it better?" One fellow might improve his image of competence by keeping his big mouth shut and listening more. Another might improve his if he stopped criticizing others and their work.

The ability to make decisions, to bring to the boss problems with suggested solutions instead of just problems, to present ideas so they can be understood are all factors in building this image of competence.

Choose your friends wisely.

Pal around with the "comers." In making up your list of competitors for promotion, you checked off some you felt destined to be executives of the future. Make these men your friends, the ones with whom you go to lunch, play golf and discuss ideas. You are judged by the company you keep, so keep company with the group on the way up.

What does the bigger job cost?

On every job you move up to, you have to give up a little of something you have now. As you get into the upper echelons you have to give up more and more. You'll have less free time, you'll see less of the wife and kids. More of your time will be demanded by that big job.

The other evening, a wife of a big executive told me, "I seldom see him any more, he's got that company for a wife." She has her own car, she belongs to the country club, her children are in better schools. Most of these advantages come because of his job and the money it brings in. If you aim for one of these top jobs, it may save trouble later if you explain all this to the wife and get her on your side. For if you are to go up to the bigger job, you have to forfeit some of the freedom you have now.

You don't have to play.

You don't have to accept any of these ideas, but they are the "rules of the game." You won't advance in your company if you refuse to play according to the rules. You may make some small advancement, but you'll never get up near the top. In deciding what to do, you are the key man, your wants and desires come first. Follow these suggestions, and your road to the top will be easier. Buck them and you may get nowhere. ■ ■

INSTRUMENTATION SPECS in 250 KC tape recording

...now start at under \$9966

(7 CHANNELS, 6 SPEEDS, DIRECT MODE)

The design approach that made possible Sanborn true IRIG instrumentation performance at lower cost in low bandwidth tape recording is now available in intermediate band systems. Sanborn Models 3917B and 3924B 7- and 14-channel systems record and reproduce data up to 250 kc in direct mode, to 20 kc in FM mode. Pulse mode enables digital information as short as 2 μ sec wide to be recorded and reproduced. A complete 6-speed system ready for direct recording/reproducing costs \$9966 for 7 channels, \$15,977 for 14 channels. (Same systems may be ordered with fewer tape speed plug-ins, at correspondingly lower costs.)

These new systems have the same improvements in performance, reliability and operating ease as the low bandwidth models, for instrumentation tape recording with complete IRIG compatibility. The tape transport, key to superior system performance, is of a rugged and simple Hewlett-Packard design which reduces costs without sacrificing uniform tape motion; six electrical speeds are pushbutton-selected (1 $\frac{1}{8}$ to 60 ips) without idler or capstan change. Other standard features include provision for edge track for voice commentary, adjustable input/out levels, built-in 4-digit footage counter accurate to 99.95%, and easy snap-on reel loading. The transport needs no maintenance except occasional cleaning of the tape path.

Check the system specifications here and call the H-P Field Engineer in your locality for complete technical data and application engineering assistance. Offices in 48 U.S. and Canadian cities, and major areas overseas. Sanborn Division, Hewlett-Packard Company, Waltham, Massachusetts 02154. Europe: Hewlett-Packard S.A., 54 Route des Acacias, Geneva, Switzerland.

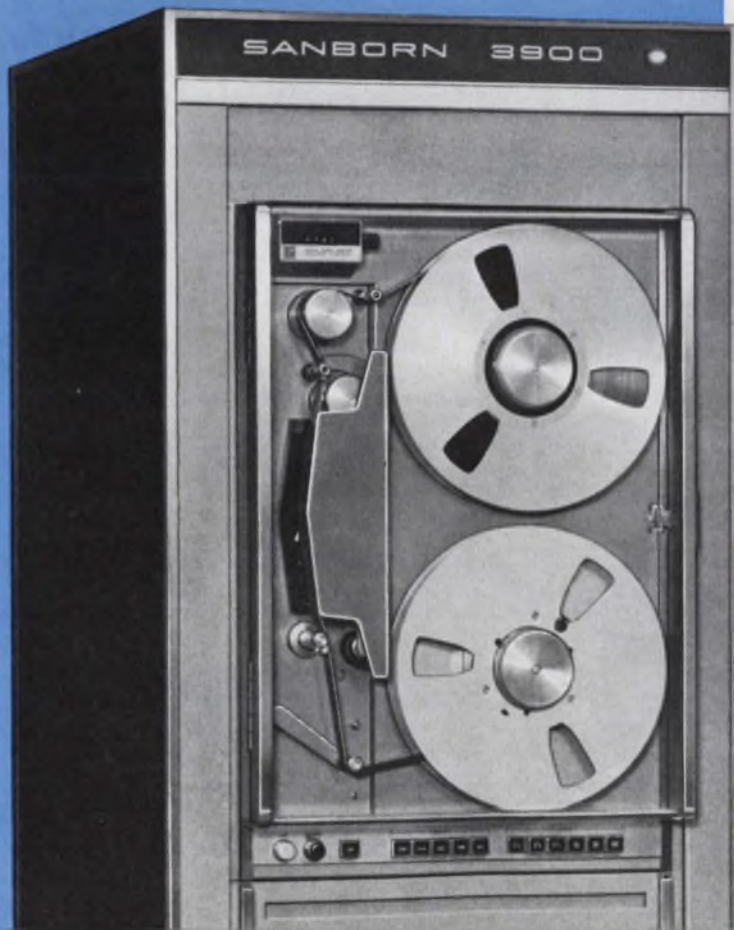

representative specifications

DIRECT MODE

Tape Speed	Bandwidth	Frequency Response	S/N Ratio Filtered	Minimum RMS Unfiltered
60 ips	300-250 KC	± 3 db	35 db	29 db
15 ips	100-62.5 KC 300-44 KC	± 3 db	32 db 38 db	27 db
1 $\frac{1}{8}$ ips	50-7 KC 300-5 KC	± 3 db	30 db 39 db	26 db

*Measured with bandpass filter at output with an 18 db/octave rolloff

FM MODE

Tape Speed	Bandwidth	Frequency Response	FM Center Carrier Frequency (Nominal)	S/N Ratio* Without Flutter Comp.	Total Harmonic Distortion
60 ips	0-20 KC	+0, -1db	108 KC	45 db	1.5%
15 ips	0-5 KC	+0, -1db	27.0 KC	45 db	1.5%
1 $\frac{1}{8}$ ips	0-625 cps	+0, -1db	3.38 KC	40 db	1.8%

*Noise measured over full bandwidth, min. rms at zero freq. dev., with lowpass filter placed at output. Filter has 18 db/octave rolloffs.

TAPE TRANSPORT

Maximum Interchannel Time Displacement Error: ± 1 microsecond at 60 IPS, between two adjacent tracks on same head.

Tape Speeds: 60, 30, 15, 7 $\frac{1}{2}$, 3 $\frac{3}{4}$, 1 $\frac{1}{8}$ ips standard; 0.3 to 120 ips optionally available.

Tape: 3600 feet, 1.0 mil, $\frac{1}{2}$ " (7 channel), 1" (14 channel).

Controls: Line (Power), Stop, Play, Reverse, Forward (fast) and Record are pushbutton relays. A receptacle at the rear of the transport is provided for remote control operation.

Drive Speed Accuracy: $\pm .25\%$.

FLUTTER

Speed	Bandwidth	Flutter (p-p)
60 ips	0-200 cps	0.2 %
	0-10 KC	0.6 %
30 ips	0-200 cps	0.2 %
	0-5 KC	0.8 %
15 ips	0-200 cps	0.25 %
	0-2.5 KC	0.6 %
7 $\frac{1}{2}$ ips	0-200 cps	0.5 %
	0-1.25 KC	0.65 %
3 $\frac{3}{4}$ ips	0-200 cps	0.5 %
	0-625 cps	0.8 %
1 $\frac{1}{8}$ ips	0-200 cps	0.8 %
	0-312 cps	1.2 %

HEWLETT
PACKARD  SANBORN
DIVISION

Senior Computer Engineers

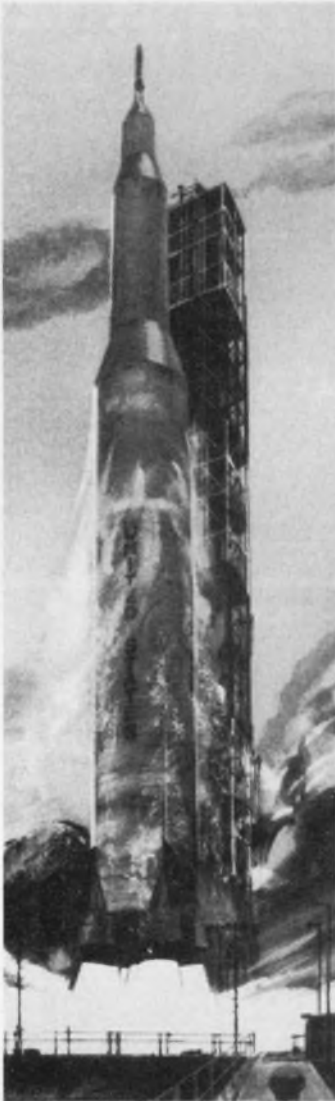

NASA Apollo/Saturn V

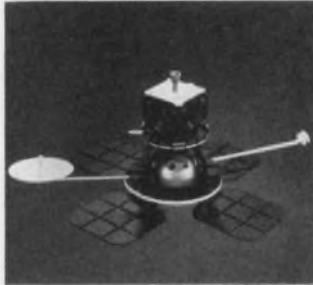

NASA Lunar Orbiter



USAF Minuteman II



Computer Center, Seattle

The Boeing Aerospace Group has immediate openings for senior engineers with its Advanced Electronics organization in Seattle, Washington. These assignments, which include lead positions, involve advanced computer and display development in connection with some of the nation's most important defense and space programs.

Requirements include an MSEE, or BSEE plus 3 to 5 years, with directly related experience in computer design, computer logic design, analysis of computer controlled checkout equipment, or complex weapon systems simulations. Positions are available for:

Computer Systems Engineers—Responsibilities include conducting system studies and analyzing and translating overall system requirements into associated sub-system specifications covering both hardware and software. Duties involve providing technical support in the development and integration of digital computers for research and project programs of deep space, missile, and airborne systems, and their associated checkout equipments.

Computer Research Engineers—Assignments involve supporting planetary and missile system efforts by application of logic design optimization procedures, adaptive techniques, Boolean analysis, and hybrid functions in performing research, conducting studies, and directing development of unique special purpose and advanced general purpose computers. Duties include the development of special logic circuit designs and the utilization of integrated microcircuits required for advanced and unique computer implementation.

Data Processing and Display Engineers—Responsibilities include analyzing overall systems objectives and defining requirements for communications, display and advanced data processing sub-systems and resolving difficult system integration problems employing microelectronic techniques. Additional duties include the simulation of complex systems by hybrid equipment, and the development of new processing and display techniques relating to sensors, instrumentation, communications, guidance and control. Positions are also available to perform advanced memory and display research.

Information Systems Simulation Engineers—Position requires applying simulation techniques to information systems in order to validate accuracy and adequacy of functional system design prior to physical implementation. Applicants must have a broad background in computer-oriented problem areas, and be capable of assuming major responsibilities involving both computer software and computer hardware.

Salaries are competitively commensurate with experience and educational background. Moving and travel allowances are paid to newly hired personnel. Boeing is an equal opportunity employer.

Send your resume to Mr. Lawrence W. Blakeley, Aerospace Group, The Boeing Company, P.O. Box 3822-EDA, Seattle, Washington 98124.

BOEING
AEROSPACE GROUP

Missile & Information Systems Division • Space Division

Terminal Block Selector

These represent a cross section of the broad Curtis terminal block line. Moldings are of black thermosetting phenolic.



Track-type system utilizes snap-in modular assemblies for unlimited build-up combinations. Rated at 600 volts, 25, 50 or 75 amperes, depending on type. Available (two or three poles per assembly) with terminal bar and #6-32 screws or tubular connectors, with or without captive pressure pads on screws. Also single pole, high current tubular connector and fuse holder assemblies. Rubber covers and white fiber marking strips available. System requires no end pieces or mounting clamps—only two parts required to make up any length of block. Track prepunched and plated.

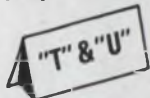

Rugged, heavy-duty, high current, factory assembled modular build-up blocks. Type "T" rated 600 volts, 125 amperes, has 1 to 6 terminals with high pressure, solderless connectors for AWG No. 16 to No. 1/0 wire. Type "U" rated 600 volts, 250 amperes, has 1 to 4 terminals with high pressure, solderless connectors for AWG No. 6 to 250 MCM wire. Aluminum mounting brackets. White fiber marking strips. Also longer lengths.



Compact, modular build-up concept for control of power circuits. Rated at 600 volts, 30 amperes. Brass terminal bars with No. 10-32 washer head screws take up to AWG No. 10 wire. Available 1 to 50 terminals per block, factory assembled with aluminum mounting brackets and white fiber marking strips. Also available with male .250" x .032" quick-disconnect tab terminals in various configurations with 2 or 3 tabs replacing one or both terminal screws.



Popular, fully insulated feed thru series for compact, neat chassis mounting. Rated at 300 volts, 20 amperes with terminals on $\frac{7}{16}$ " center to center spacing. Available in lengths of 1 to 18 poles with internal screws, printed circuit pins, or turret-type solder (with or without axial taper pin receptacle) connections.



Quick-disconnect tab terminals with choice of 2, 4 or 6 .110" x .020" tabs per pole. Rated at 300 volts, 7 amperes for 2 tabs, 15 amperes for 4 or 6 tabs. Available with 1-22 terminal poles per block with integral mounting brackets. Also with .062" dia. feed thru pins for soldering to printed circuit boards.



Miniature, compact series (terminals on $\frac{1}{4}$ " center to center spacing) rated at 300 volts, 5 amperes. Available in lengths of 1 to 18 poles with #2-56 screws, clamps, or 2, 4 or 6 .110" quick-disconnect tab terminals per pole. Variations include surface mount, feed thru, or insulated feed thru with internal turret-type solder connections or printed circuit pins.

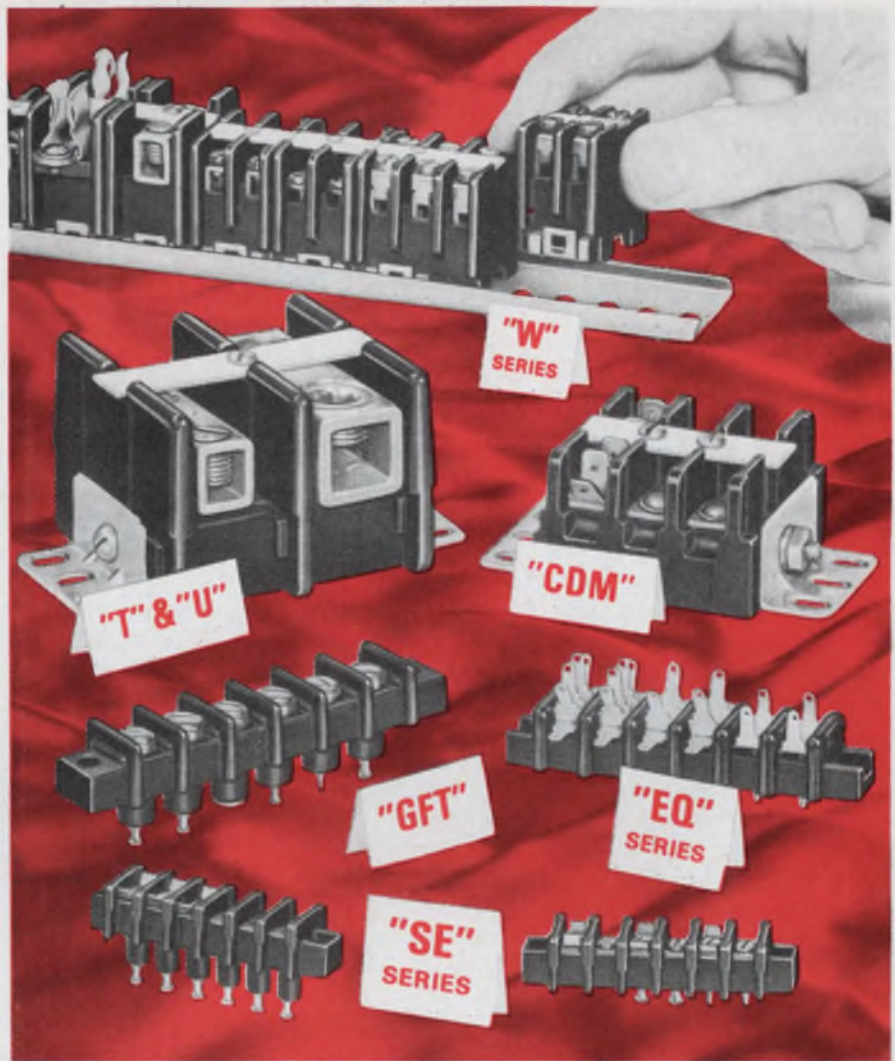

CURTIS

YOUR COMPLETE, DEPENDABLE SOURCE TERMINAL BLOCKS

The extremely wide choice of Curtis terminal blocks in various sizes, types, ratings and configurations is a result of progressive engineering and manufacturing to meet your particular terminal block requirements.

Since 1933, Curtis has engineered and manufactured quality electrical components for various industries throughout the world.

If you're looking for a source of quality, off-the-shelf terminal blocks which can be supplied in a variety of types to meet your exact requirements, remember . . . Curtis can.

FREE! CURTIS
24-page Terminal Block
Selector Catalog



CURTIS DEVELOPMENT & MFG. CO.
3236 North 33rd Street • Milwaukee, Wisconsin 53216

See us at Booth 2C39, IEEE Show
ON READER-SERVICE CARD CIRCLE 34

MOS-FET circuit stores input voltage peaks as dc

When a high-input impedance MOS-FET is used in shunt with a sampling capacitor, the result is a stable, linear detector that converts input peaks to a dc level. The circuit also provides a fast response and a low output impedance.

The conventional diode-capacitor combination used to store the peak amplitude of incoming signals has several inherent limitations. When a relatively small capacitor is used, the loading effect of the sampling circuitry will result in a short time constant. With a larger capacitor, the circuit is hard-pressed to reach the full-charge level when short-duration input pulses are sampled. Furthermore, diode nonlinearity adversely affects the results in both cases.

In the MOS circuit shown, Q_1 initially has both its emitter and base at zero volts. When the base goes positive by a voltage greater than the emitter-base voltage drop of the transistor, Q_1 becomes forward biased. When the input voltage is

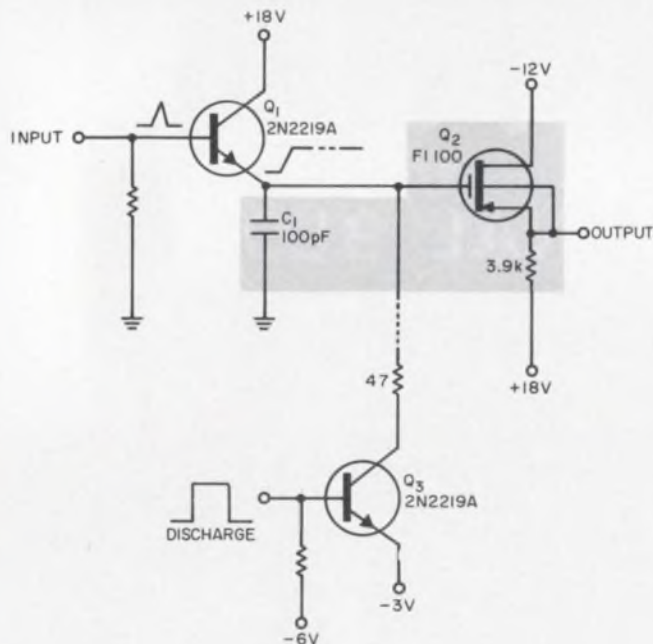

MOS stage and shunt sampling capacitor is used to store input peaks as dc levels.

either removed or reduced, the transistor becomes back-biased, due to the voltage stored in C_1 . The emitter returns to its initial point at the rate by which C_1 is discharged. This is determined by the leakage of C_1 , Q_1 , Q_3 and the gate current of Q_2 .

C_1 must be small in order to insure that the emitter-base drop remains constant for the range of charging currents required. But the very high impedance of the MOS yields a relatively long time constant (over 10 seconds) that is limited almost entirely by leakage. Thus the capacitor-size restriction is largely obviated. Since the source-follower does not permit unity gain, $V_{out} < V_{in}$. However, the two are proportional, and a 1:1 relationship can easily be restored if required.

By turning on Q_3 , which is normally off, the circuit can be quickly discharged. Q_3 may also be used to block transient reception at the input.

Transistor Q_1 must have a low I_{cbo} at relatively high BV_{cbo} levels. Since Q_2 operates in a linear mode, it may be either a p -channel or n -channel device. The linearity is within 1% over a 10:1 range (from 0.5 to 5.0 volts) for the component values shown.

Thomas Skopal, Associate Engineer, Computer Test Corp., Cherry Hill, N.J.

VOTE FOR 110

Neon lamp arrangement forms 60-Hz divider

A simple, compact, line-synchronized trigger source providing 60-Hz pulses is obtained when two neon lamps are used in the timing network. Employed as a test device for pickup, display and storage systems, this stable circuit (source) also has a division capability by factors two through six.

The 60-Hz rate is of great importance because of its relationship to the vertical scan rate of TV-type equipments with which the circuit is used. The field rate in these equipments is normally 60 per second and, therefore, the trigger source becomes a fundamental timing device. The schematic of the trigger source appears in Fig. 1a.

The instability usually associated with simple neon circuits has been circumvented by the rectifying and reference elements. The large sawtooth ripple excursion (Fig. 1b) is vital in maintaining synchronism of the neon firing with the

IDEAS FOR DESIGN: Submit your Idea for Design describing a new or important circuit or design technique, the clever use of a new component, or a cost-saving design tip to our Ideas for Design editor. If your idea is published, you will receive \$20 and become eligible for an additional \$30 (awarded for the Best of Issue Idea) and the grand prize of \$1000 for the Idea of the Year.

ON YOUR MARK...



Kay 154: 50 KHz to 100 MHz

Kay 159: 1 MHz to 300 MHz

**PM 7650 Plug-in:
Pulse Markers
0.5 to 100 MHz**

**PM 7660 Plug-in:
Harmonic & CW Markers
1 to 300 MHz**

These solid-state sweep and marker generators cover the range in a single sweep; provide a continuously-variable narrow sweep.

Performance characteristics include line-lock, cw, manual and variable sweep rates, and external input.

PM 7650 and PM 7660 plug-in marker heads offer up to eight optional, individually-switched crystal plug-in markers per head.

A variable birdie marker provision is standard. All plug-in marker heads may be changed or added as required.

External modulation from dc up to more than 15 KHz, a built-in detector and switched attenuator are standard features. Sweep high-to-low or low-to-high.

For literature and prices write:

KAY ELECTRIC COMPANY

Pine Brook, Morris County, New Jersey • (201) 227-2000

Wide-Sweep Generator

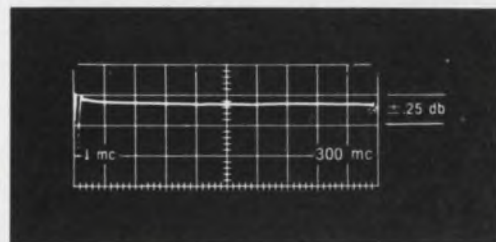

Full 300 MHz Wide Video Sweep

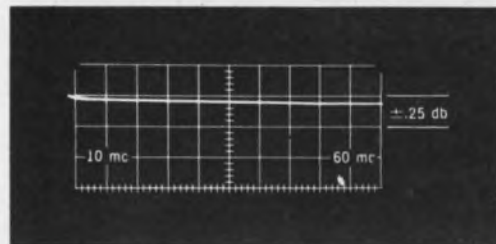

Programmable, Voltage Controlled Oscillator

Marker Generator

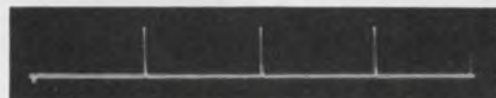

Pulse-Type Markers



Harmonic (or Comb) Birdie Markers



Single-Freq. Type Birdie Markers

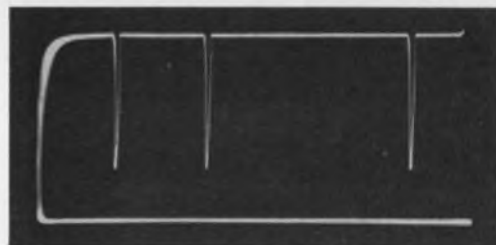

Detected Turn-Off Markers

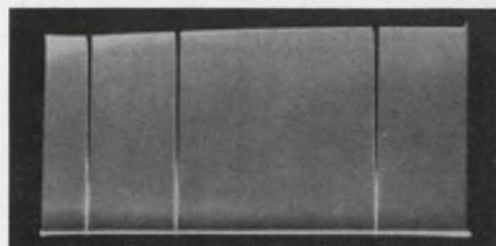

Undetected Turn-Off Markers

Visit Kay at the IEEE Show, Booths 3C11 - 3C17

ON READER-SERVICE CARD CIRCLE 35

IDEAS FOR DESIGN

60-Hz line. The positive extreme of the sawtooth is limited by zener diode CR_2 , thus providing a constant peak voltage for timing capacitor C_2 . CR_2 also makes the circuit insensitive to normal line voltage fluctuations.

Unstable operation of the neon at the higher division rates is usually caused by the dark environment within the small minibox. Elimination of this problem is accomplished by the addition of neon lamp L_2 . This second lamp is placed in close physical proximity to L_1 , and continuously pulsed with the 60-Hz sawtooth, thereby exerting sufficient influence on L_1 to stabilize it.

The upper narrow portion of the current pulse

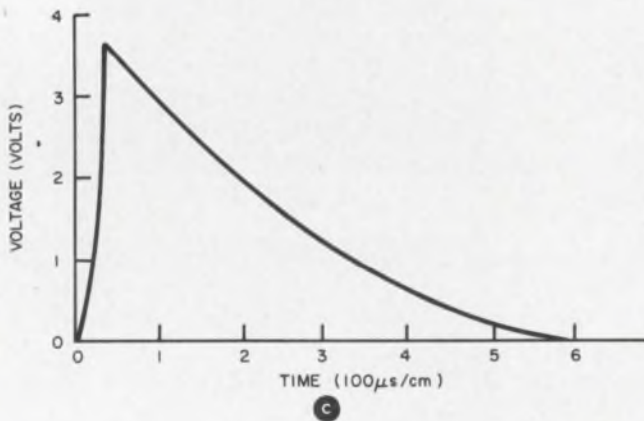
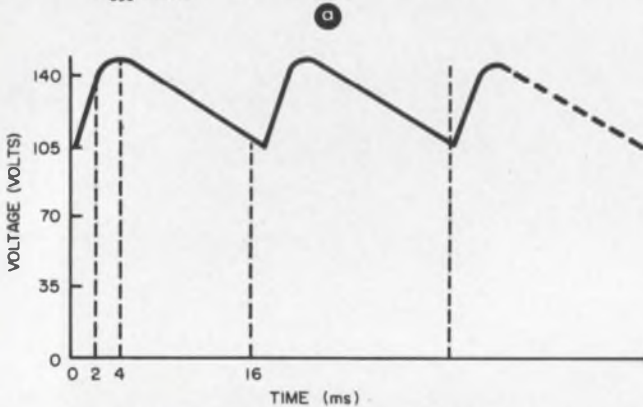
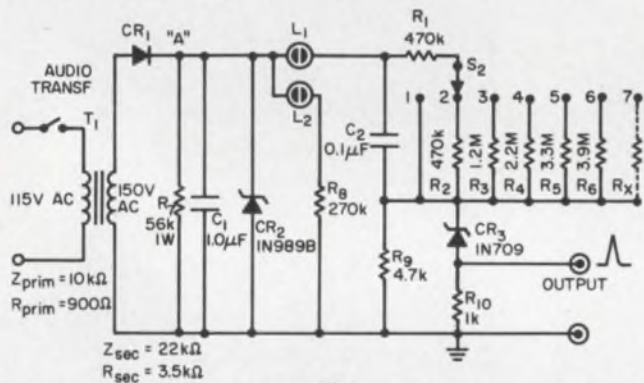

Stable synchronized 60-Hz trigger source and divider are formed by neon lamp timing circuit (a). Rectified line voltage at point A maintains synchronism of lamp with line because of its large sawtooth ripple (b). Output is derived from current pulse across R_9 (c).

appearing across R_0 is made available at the output (Fig. 1c) through the divider arrangement of CR_3 and R_{10} . The frequency, or the division rate, is determined by the positioning of selector switch S_2 . An additional position (7) on the switch will provide stable division by a factor of 10 by simply adding a 6.8 M Ω timing resistor.

O. R. Harper, Engineer, U.S. Army Electronics Command, Fort Monmouth, N. J.

VOTE FOR 111

Iron mightier than pen for polaroid data marking

The very common soldering iron can be put to advantage in the recording of data on polaroid pictures. It can be used for writing, retracing, drawing or labeling purposes.

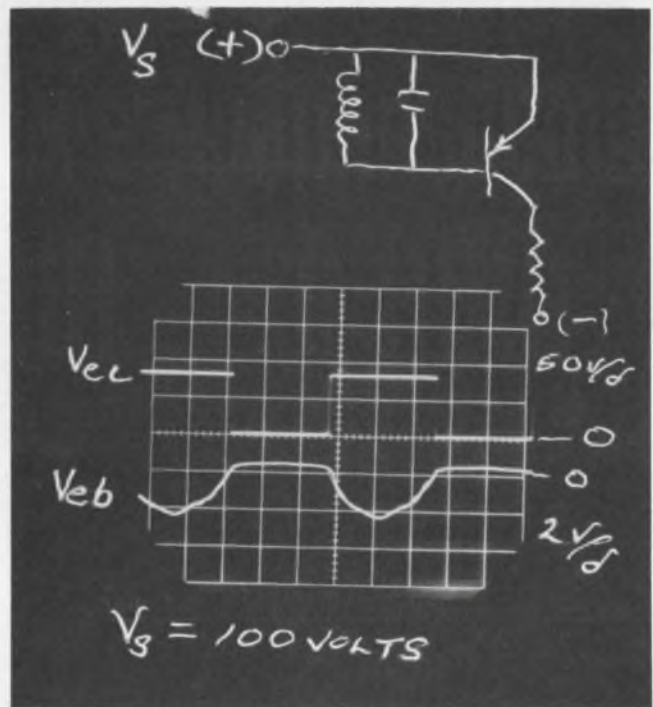

Writing on polaroid pictures is a snap when a soldering iron is used instead of the pen. A hot, fine-point tip quickly and easily produces clear linework on the laboratory photograph.

The results (see photograph) are especially clear when a very hot, fine point iron is used. They are quickly and easily obtained and are superior to results achieved with other makeshift schemes.

Dan R. Cole, Research Technician, Skil Corp., Chicago, Ill.

VOTE FOR 112

Transistor bridge circuit monitors two voltage sources

Two transistors and two diodes in a bridge configuration provide a simple means of monitoring two voltage sources. Both the amount and direction of any unbalance between the sources



STANDARD DEFLECTION YOKES

AND CRT COMPONENTS

 <p>Low cost stator type yoke for high grade commercial applications</p> <p>TYPE KY</p>	 <p>Low LI², high sensitivity for 42°, 52°, 70° and 90° 1 7/16" CRT neck</p> <p>TYPE FY</p>	 <p>High quality general purpose, moderate resolution low residual, for 52°, 70° and 90° 1 7/16" CRT neck</p> <p>TYPE AY</p>
 <p>Fast core general purpose, moderate resolution, for 52°, 70° and 90° 1 7/16" CRT neck</p> <p>TYPE HY</p>	 <p>Deflectron®, general purpose for 42° 1 7/16" CRT neck</p> <p>TYPE HD</p>	 <p>Fast core, low LI², low distributed capacity for 52° 1 7/16" CRT neck</p> <p>TYPE GD</p>
 <p>Deflectron® for high resolution recording storage tubes Scan converter applications</p> <p>TYPE QD</p>	 <p>Recording storage tube yoke Scan converter applications</p> <p>TYPE QY</p>	 <p>Writing yoke for high frequency beam modulation Celcaloy, ferrite and air core for 1 7/16" CRT neck</p> <p>TYPE AW</p>
 <p>General purpose yokes for 7/8" CRT neck BY 1" storage tube CY for 1 1/8" storage tube CYT</p>	 <p>Miniature yoke for 7/8" CRT neck and special unit construction</p> <p>TYPE MY</p>	 <p>Rotating yoke for 52° and 70°, 1" and 1 1/8" CRT necks Includes bearings, gear and sliprings</p> <p>TYPE RY</p>
 <p>Low resistance version of type BY Available for types CY and CYT</p> <p>TYPE YY</p>	 <p>Character and storage tube yoke for 2" CRT neck Type DY 2 1/4" CRT neck Type DJ</p> <p>TYPE DY</p>	 <p>Coils for centering and beam alignment, aiming, flooding for 1 7/16" CRT neck</p> <p>TYPE KC</p>
 <p>Pincushion corrector, electromagnetic, low cost, general purpose</p> <p>TYPE L</p>	 <p>Pincushion corrector, permanent magnet Specials available</p> <p>TYPE M</p>	 <p>Focus coil, dynamic for high resolution Many other standard types available</p> <p>TYPE HLF</p>
 <p>Vidicon yoke, focus and alignment coils 1" For slow scan, high resolution</p> <p>TYPE WV</p>	 <p>Hybrid vidicon yoke, 1" Magnetic deflection coil with shielding</p> <p>TYPE HV</p>	 <p>Vidicon yoke, focus and alignment coil 1" For standard TV applications</p> <p>TYPE TV 129</p>
 <p>Image Orthicon yoke, focus and alignment coils 3" For high resolution, slow scans</p> <p>TYPE AV 172</p>	 <p>Image Orthicon yoke, focus and alignment coils 3" For standard TV applications</p> <p>TYPE TV 172</p>	 <p>Static astigmatic corrector and dynamic focus coil For high resolution 42° CRT</p> <p>TYPE NC</p>



Constantine Engineering Laboratories Company

MAHWAH, N. J.
201-327-1123
TWX 201-327-1435

UPLAND, CAL.
714-982-0215
TWX 714-556-9550

ON READER-SERVICE CARD CIRCLE 36

WANT TO SAVE MONEY BY
 USING **GUDEBROD**
 LACING TAPE? . . .



YOU DO IT HERE!

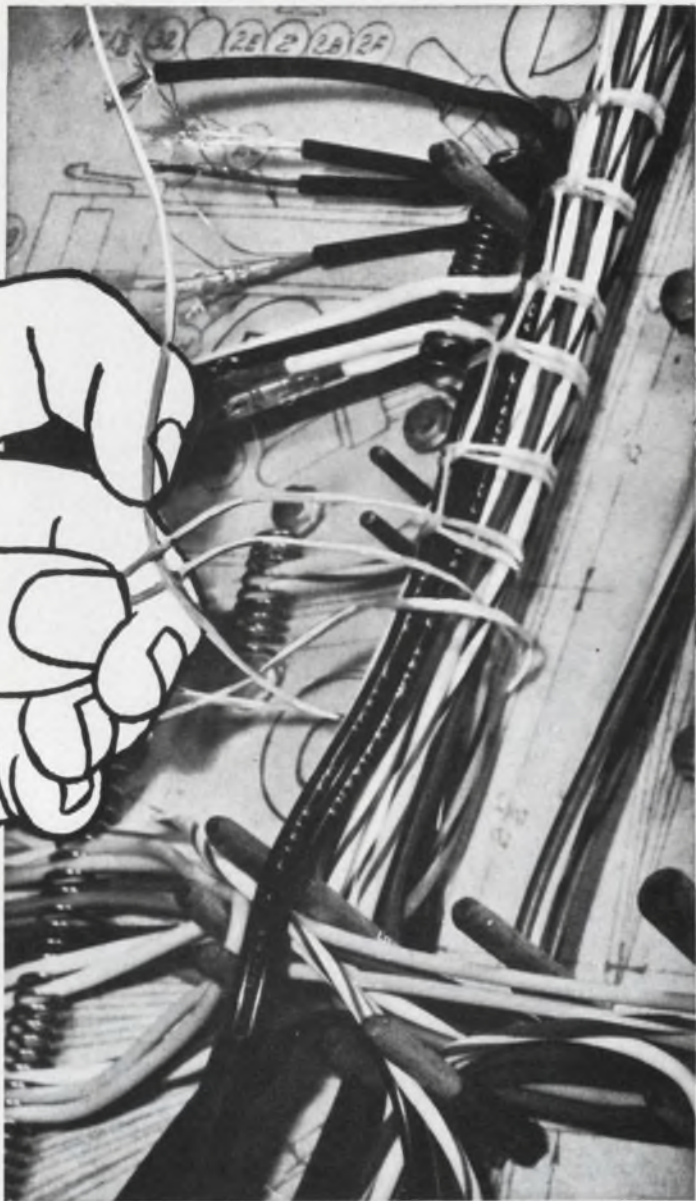

Harness tying may be a relatively minor operation. But it also can be a major cost drain. Lacing tape is one of the smallest costs in the harnessing operation but with Gudebrod Tape you can save dollars in making harnesses. Knots tie easier, workers say they almost tie themselves, knots stay tied, the harness workers can go right on with the harnessing without having to go back for re-tightening. Workers like to use Gudebrod Tape. You cut harnessing time—you have fewer rejects. All of this works for you in saving money on cable harnesses—that's why it pays to specify Gudebrod Lacing Tape, the original flat braided tape. Prove these statements in your own harnessing department—give Gudebrod Tape a comparative test.

**GUDEBROD
 CABLE-LACER**



—ANOTHER MONEY SAVER

The first hand tool specifically engineered for continuous wire harnessing. Handle holds bobbin, feeds tape as needed, grips tape for knotting. Speeds, eases harnessing. Has paid for itself in a day in many plants.

CABLE LACING INFORMATION:

When you need help on knots, on spacing, on the type of tape to use—Gudebrod is your one best source for information. We have over 200 different lacing tapes in stock, for temperatures up to 1500° F. or down to -100° F., burn proof

tapes, tapes that do not outgas in vacuum, color coded tapes, cut lengths, tapes of nylon, Dacron*, Teflon*, spun glass, silica fiber. Ask for a copy of our Product Data Book.

*Du Pont Registered Trade Mark

Area Code 215, WA 2-1122



GUDEBROD BROS. SILK CO., INC.

FOUNDED IN 1870

Electronics Division

12 SOUTH 12th STREET, PHILADELPHIA, PENNSYLVANIA 19107

ON READER-SERVICE CARD CIRCLE 37

are indicated by a meter-lamp arrangement.

The circuit (Fig. 1a) operates as follows: with $V_1 > V_2$, current flows through the base-emitter junction of Q_1 , the milliammeter, M , and CR_2 . M therefore indicates the amount of unbalance. When $V_1 - \Delta V = V_2$, where ΔV is the voltage necessary for lamp indication, lamp L_1 turns on and indicates the unbalance direction. An unbalanced $V_2 > V_1$ produces a similar meter deflection and indication on lamp L_2 .

The magnitude of ΔV depends on the meter resistance, R , and the type of semiconductors (germanium or silicon) in the bridge legs. For

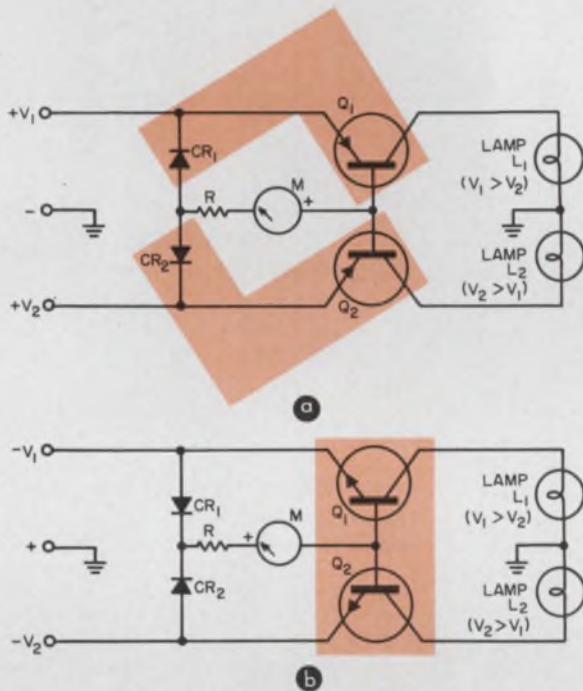

Transistor-diode bridge arrangement (color) monitors two voltage sources with respect to negative ground (a). Meter M and lamps L_1 and L_2 indicate unbalance amplitude and direction. Npn's are used in positive system (b).

$R < 100$ ohms, ΔV can be reduced to approximately 0.7 volts by using germanium-type transistors and diodes. R , however, must be chosen to limit the base current in the maximum-unbalance case.

Meter scaling can be achieved by the proper choice of a meter shunt. Fig. 1b depicts the circuit for the monitoring of voltage sources referenced to a negative ground. The only major differences are the substitution of npn for pnp type transistors and the reversal of the diodes and the meter.

R. W. Stinson, Design Engineer, Western Electric, New York, N. Y.

NOTE FOR 113

Modified monostable flip-flop has improved duty cycle

The replacement of the output resistor by a transistor in the basic monostable flip-flop results

PROBLEM: How To Reduce Linear Circuits To Microelectronic Packages?

PROBLEM: How To Lower Costs Of Procuring Present Microelectronic Packages?

SOLUTION: **Soliton** DEVICES, INC.

Why Specify Soliton As A Source For Linear Microcircuits?

From micro chips to micro modules, Soliton has full capabilities for production of linear microelectronic packages. Soliton can convert your linear circuit to a microelectronic package and produce it in small or large quantities. Or we can economically produce packages that are presently being supplied to you.

Three Examples of Linear Module Designs Now Available As Standard Catalog Items.

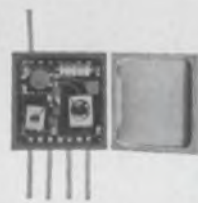

Microelectronic High Impedance Preamp TMS-101

- Impedance: 4 megohms from 2 kc to 10 kc
- Gain: 20 volts/volt
- Output Impedance: 500 ohms maximum
- Phase Shift: $\pm 3^\circ$ for inputs to 25 mV
- $\pm 5^\circ$ for inputs from 26 to 100 mV
- Size: 0.5" square x 0.150" high

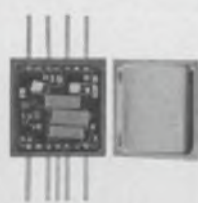

Microelectronic Amplifier-Demodulator TMS-102

- Input Impedance: 35,000 ohms $\pm 25\%$
- Gain: 2.6 volts DC/volt RMS
- Quadrature Rejection Ratio: -26 db
- Output Noise Level: 20 mV RMS max. (with input shorted)
- Size: 0.5" square x 0.150" high



Microelectronic Power Amplifier for Servo Control TMS-501

- Power Output: 5 watts from -55° to $+71^\circ\text{C}$, derating to 3.5 watts at 100°C
- Power Input Requirements: 11 watts
- Gain: adjustable from 100 to 1000
- Size only 0.400 cu. in. volume

SERVICE — SOLITRON answers promptly all inquiries regarding applications, prices and delivery.

COMPETENCE — As a major semiconductor manufacturer SOLITRON offers a meaningful guarantee that all active semiconductor components are tested to the customer's exacting specifications.

CONFIDENCE — SOLITRON is a component manufacturer only. Discussions regarding systems application can be carried on with the assurance that company-confidential proprietary projects will not be compromised.

Soliton DEVICES, INC.

Leader in Power Transistors, Solid-State High Voltage Rectifiers, Temperature Compensated Zeners, Voltage-Variable Capacitors, and Random/White Noise Components.

256 Oak Tree Road • Tappan, New York 10983 • Tel: 914-359-5050

ON READER-SERVICE CARD CIRCLE 38

who said
quality
plugboard
programming
systems
have to be
expensive?

not
MAC Panel
engineers!

All they say is that they have to be better than all the others at less cost. And they are—all seventeen standard sizes of them.

MAC design engineers take pride in designing flexible and fixed plugboard programming systems that perfectly mate with your racks, that give you the most reliable program control of your electronic equipment.

Special attention is given to the design and engineering of each component in MAC systems: receivers, plugboards and plugwires. Meeting your precise requirements for number of circuits, installation space limitations, environmental conditions, signal levels, frequency range, and reliability is their prime objective.

Whether one of the standard systems meets your needs or you require a custom designed system, MAC Panel is the source. See your MAC representative, or write for MAC's full line catalog today.



MAC
O.E.M. DIVISION

MAC PANEL CO. High Point, N.C.

ON READER-SERVICE CARD CIRCLE 39

IDEAS FOR DESIGN

in the improvement of the multivibrator's on-time to off-time ratio. This low-impedance substitute provides faster charging and requires less input trigger power.

In the conventional flip-flop (Fig. 1a), the output (collector of Q_2) contains an RC function primarily determined by the R_3C product. The

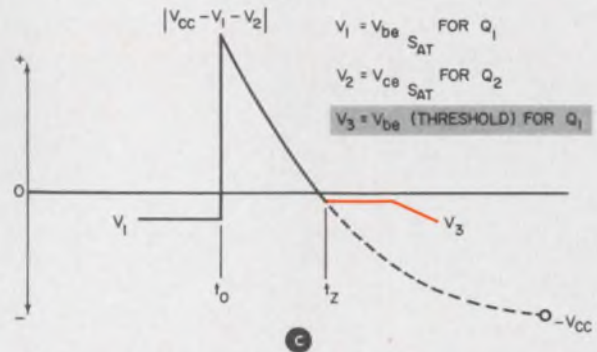
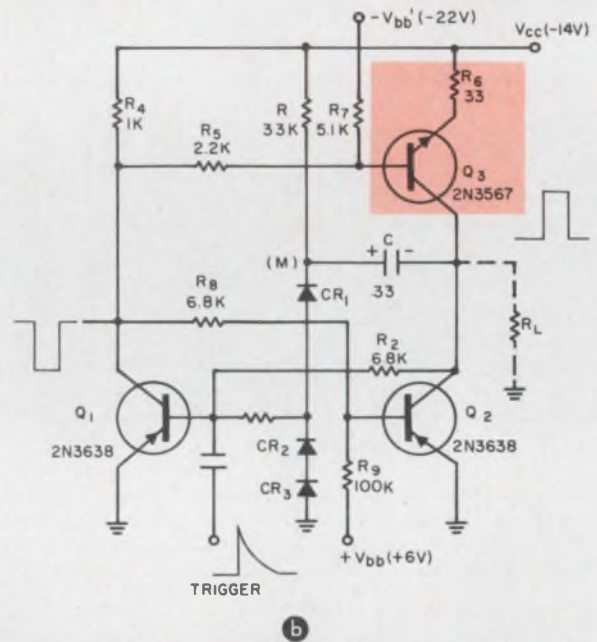
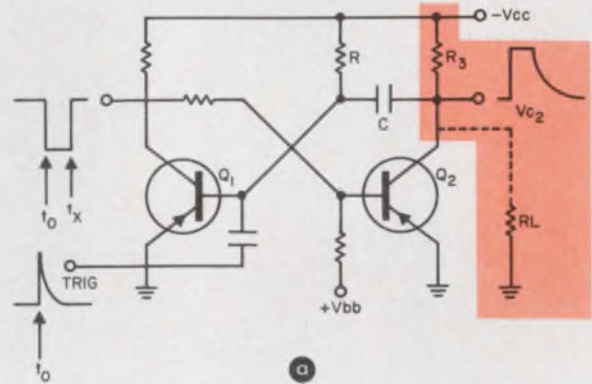

Duty cycle of basic monostable flip-flop (a) is limited by load placed on collector of Q_2 and by the presence of R_3 (when a trigger occurs before V_{c2} has reached V_{cc}). The modified flip-flop (b) replaces R_3 with a low-impedance source ($Q_3 - R_6$) to overcome the duty-cycle limitation. The trigger turns Q_1 and Q_3 off, thus turning Q_2 on and establishing the switching threshold at point M (c).

ON READER-SERVICE CARD CIRCLE 216 ➤

POWER- RATED SCR's AT ECONOMY PRICES



2N3873
600V Press Fit—\$7.24*

2N3899
600V Stud—\$7.40*

RCA 35-amp types, rated for 120V and 240V line operation, provide a new, more economical way to control 8 kw.

New RCA 35-amp power-rated Silicon Controlled Rectifiers make solid-state control an affordable selling feature for products such as space heaters, dc motor drives, regulated power supplies and battery chargers. And, RCA's new SCR's make circuitry more economical and more reliable, too. Check these features:

- 35 amps I_{FRMS} at 65°C case temperature.
- 350 amps single-cycle surge capability.
- 200 amps/ μ sec di/dt rating in a 35-amp I_{FRMS} device, means low turn-on dissipation that formerly required substantial derating. You don't have to over-design. Result: New Economy.
- 120V and 240V line operation ratings, with plenty of voltage cushion for transients, suits these devices to home appliances and standard industrial controls.
- New gate characterization—made possible by RCA concentric-gate geometry and

shorted-emitter technique—opens new design doors to mass-produced economy SCR circuits.

Evaluate new RCA power-rated SCR's for your projects. Call your nearest RCA Sales Office. For technical data on these new types and a copy of RCA Application Notes: SMA 39 (Gate Characteristic Profile) and SMA 38 (SCR Motor Speed Control), write: RCA Electronic Components and Devices, Commercial Engineering, Section R-G2-1, Harrison, New Jersey.

RCA Power-Rated Types available in both Press Fit and Stud Packages.		
Type	Line Operation	V_{B00} and V_{RM} (rep)
2N3870		100V
2N3871	120V	200V
2N3872	240V	400V
2N3873		600V
2N3896		100V
2N3897	120V	200V
2N3898	240V	400V
2N3899		600V

AVAILABLE
THROUGH YOUR
RCA DISTRIBUTOR



The Most Trusted Name in Electronics

*Price in quantities of 100-999

IDEAS FOR DESIGN

output pulse width varies as a function of the voltage here (V_{c2}) when the input trigger is applied before V_{c2} reaches V_{cc} . Moreover, when the output stage is loaded by R_L , V_{c2} is lowered and the pulse width (and duty cycle) decreases.

Thus, where the duty cycle varies or otherwise does not allow V_{c2} to reach V_{cc} , or when a load is placed on Q_2 , substantial advantages are offered by the modified circuit (Fig. 1b). The principal modification is the replacement of R_3 (Fig. 1a) with Q_3 and R_6 . Q_3 is off when Q_2 is on. During the period that the monostable is switching back to its stable state, it is likely that all transistors are conducting in some fashion. R_6 must then be by the modified circuit (Fig. 1b). The principal large enough to prevent the flow of disastrous collector currents and thermal runaway in Q_2 .

A positive trigger turns Q_1 and Q_3 off. Q_2 comes on, producing approximately the waveform of Fig. 1c at the junction of R and C . This condition exists for a period τ when the threshold voltage of CR_1 and V_{be} (of Q_1) is reached. Q_1 starts conducting. When Q_3 begins to conduct, the switching action is hastened by the positive feedback provided by R_5 . R_5 also allows R to be larger, since R need not furnish a saturating base current to Q_1 . The extra power supply, $-V_{bb}$, can be avoided by diodes placed in series with R_6 and R_5 . CR_1 can be replaced by a transistor that features a low saturation resistance. The transistor substitute can be turned on by Q_3 . A waveform at the collector of Q_2 will not have the RC-decay limitation because C is charged through R_5 and r'_{sat} of Q_3 . This combination is typically of the order of 50 ohms. The fast charging of C allows a considerable variation of duty cycle without sacrificing pulse-width repeatability. The low effective resistance of Q_3 and R_5 tolerates the presence of either a lower R_L or a changing R_L without affecting the pulse width ($R'_L + R_5 + r'_{sat}$).

The equation for the pulse width can be shown to be:

$$t = RC \ln \frac{V_{cc} + V_{c2} - V_4 - V_5}{V_{cc} - V_6}, \quad (1)$$

where $V_4 = CR_1 r'_{sat} + V_{be sat}$ (of Q_1), $V_5 = V_{ce sat}$ (of Q_1) and the threshold $V_6 = V_{be} (Q_1) + CR_1$.

The circuit is used as a 5:1 frequency divider in a 600 pps line. The pulse width is approximately 7.5 ms, which provides a one-half cycle period before the monostable is reset. In this time, C can charge to within 1% of the value to which it would charge if it weren't retriggered. Thus the output pulse width is very nearly $0.69 RC$.

David E. Smead, Project Engineer, Auto Data, Inc., San Diego, Calif.

VOTE FOR 114

Difference amplifier forms short-circuit detector

A single-ended differential amplifier and a relay-driver stage combine to function as a go-no-

go detector. It is suited for detecting terminal shorts in small, nonfunctional printed-circuit boards that may contain semiconductors.

These boards, which are commonly found in production-line setups, occasionally pose an additional need for a resistance-limit check. The detector also fulfills this requirement. Moreover, it exhibits a sharp transition between the go and no-go conditions and does not induce any harmful currents into the device being checked.

In the detector (see illustration), Q_1 and Q_2 form a differential amplifier with a single-ended output. Zener diode CR_1 provides the reference voltage for the amplifier as well as the voltage for the test terminals. When the terminals are open, Q_1 is turned off and the voltage at the collector of transistor Q_2 is -4.5 volts. Also, zener diode CR_2 is nonconducting, and the output (Q_3) is turned off.

With a short across the test terminals, transistor Q_1 conducts heavily and thereby increases the current through feedback resistor R_5 . This results in a shift of the voltage at the collector of Q_2 to -8.5 volts. This voltage is sufficient to break

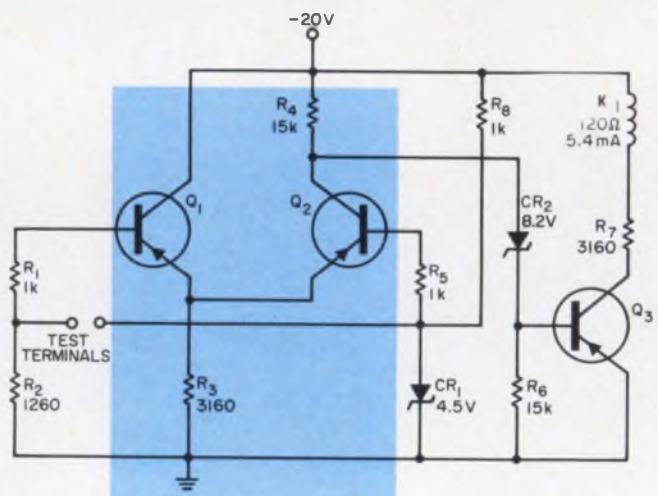

Differential amplifier forms the heart of a go-no-go short-circuit detector. Relay K_1 is energized when the test terminals exhibit zero potential.

down diode CR_2 . With CR_2 conducting, a current high enough to saturate transistor Q_3 flows. As a consequence, relay K_1 is operated. It may trigger an audio or visual indication of the short circuit or may actuate a stepping switch.

The detector uses germanium alloy, medium-gain, low-frequency, switching-type transistors. It indicates shorts for resistances of up to 5 ohms with a transition range (at that point) of about one-tenth ohm. The upper limit may be altered by varying the value of R_5 . Using the component values shown, the circuit limits the maximum current through the test terminals to 4 mA, a value which is safe for most semiconductors.

It is of interest to note that this detector can also be used in a complementary fashion; that is, to check that the resistance of certain electrical paths is not above a pre-calibrated, nominal value.

J. R. Fallon, Planning Engineer, Western Electric Co., Inc., New York, N. Y.

VOTE FOR 115

Low Cost Test Signals

10 MHz to 1000 MHz

—with the 3200B VHF OSCILLATOR



Using the new
Frequency Doubler
Probe 13515A

Features:

- ±0.002% Frequency Stability
- External AM and Pulse Modulation
- Waveguide-Below-Cutoff Output Attenuator
- Solid-State Power Supply

Data subject to change without notice.

The VHF Oscillator Model 3200B is designed for general purpose laboratory use including receiver and amplifier testing, driving bridges, slotted lines, antenna and filter networks, and as a local oscillator for heterodyne detector systems in the frequency range from 10 to 500 mc.

The push-pull oscillator is housed in a rugged aluminum casting for maximum stability and extremely low leakage; six frequency ranges are provided for adequate bandspread on the slide-rule dial. Internal CW operation is provided; AM and pulse modulation may be obtained through the use of a suitable external source. The RF output is coupled through a waveguide-below-cutoff variable attenuator; in addition, an electrical RF level vernier is included as a front panel control.

An optional accessory Frequency Doubler Probe, Model 13515A incorporates a solid-state doubler circuit and provides additional frequency coverage from 500 to 1000 mc.

SPECIFICATIONS 3200B

- | | |
|--|--|
| <p>Frequency range: 10 to 500 Mc (MHz) in six bands: 10 to 18.8 Mc; 18.5 to 35 Mc; 35 to 68 Mc; 68 to 130 Mc; 130 to 260 Mc; 260 to 500 Mc.</p> <p>Frequency accuracy: within ±2% after ½ hour warmup (under 0.2 mw load).</p> <p>Frequency calibration: increments of less than 4%.</p> <p>Frequency stability (after 4-hour warmup under 0.2 mw load): short term (5 minutes) ±0.002%; long term (1 hour) ±0.02%; line voltage (5-volt change) ±0.001%.</p> <p>RF output:
Maximum power (across 50-ohm external load):
>200 mw (10 to 130 Mc);
>150 mw (130 to 260 Mc);
>25 mw (260 to 500 Mc).</p> <p>Range: 0 to >120 db attenuation from maximum output.</p> <p>Load impedance: 50 ohms nominal.</p> <p>RF leakage: sufficiently low to permit measurements at 1μv.</p> | <p>Amplitude modulation: externally modulated.
Range: 0 to 30%.
Distortion: <1% at 30% AM.</p> <p>External requirements: approximately 15 volts rms into 600 ohms for 30% AM, 200 cps to 100 Kc.</p> <p>Pulse modulation: externally modulated.
External requirements: 1 volt peak pulse into 2000 ohms. 5-volt rms sine wave will provide useable square-wave modulation.</p> <p>Power: 105 to 125 v or 210 to 250 v, 50 or 60 cps, 30 w.</p> <p>Dimensions: 7½½" wide, 6½" high, 12½" deep (198 x 165 x 318 mm.)</p> <p>Weight: net 15 lbs. (6, 8 kg), shipping 19 lbs. (8, 6 kg).</p> <p>Accessories available: 13515A Frequency Doubler Probe; 501B, 514B, 517B Output Cables; 502B, 506B Patching Cables.</p> <p>Price: Model 3200B, \$475.
F.o.b. factory.</p> |
|--|--|

13515A FREQUENCY DOUBLER PROBE

- | | |
|--|---|
| <p>Frequency range: 500 to 1000 Mc (MHz) with the 3200A/B operating at 250 to 500 Mc.</p> <p>Harmonic suppression: (at 4 mw output):
fundamental: >16 db down;
higher order: >16 db down (500 to 800 Mc);
>14 db down (800 to 1000 Mc).</p> | <p>RF output: more than 4 mw across external 50-ohm load, controlled by probe depth.</p> <p>Weight: net 4 oz. (110 gms), shipping 8 oz. (220 gms).</p> <p>Price: Model 13515A, \$95.
F.o.b. factory.</p> |
|--|---|

For more information contact your local Hewlett-Packard field engineer or write Hewlett-Packard, Green Pond Road, Rockaway, N. J. 07866; Europe: 54 Route des Acacias, Geneva.

HEWLETT  PACKARD
An extra measure of quality

What happens when you insulate with HYGRADE SLEEVING?

No cracking, no corrosion, no wicking, no dielectric breakdown . . . nothing! It just sits there . . . preventing trouble the way it's supposed to. In fact, you can forget it! Isn't that what you want in insulating sleeving? Just tell us where you plan to use it, under what conditions. We'll recommend the right material. You can take our word for it . . . because we've been insulation specialists for 44 years.



HYGRADE[®] INSULATING SLEEVINGS

Markel HYGRADE Sleevings are constructed of carefully braided fiberglass yarn, impregnated and coated with specially formulated varnishes, vinyls, resins, or silicone rubber compounds. A wide range of types, grades and sizes meet virtually every conceivable requirement for dielectric and mechanical strength under all kinds of operating conditions . . . at continuous temperatures from -70°F to 1200°F . We'll be glad to send you specifications and Sample File on the entire HYGRADE Sleevings line. Just write. No charge or obligation.

L. FRANK MARKEL & SONS

Norristown, Pa.

215-272-8960

INSULATING TUBINGS & SLEEVINGS • HIGH TEMPERATURE WIRE & CABLE

ON READER-SERVICE CARD CIRCLE 41

IDEAS FOR DESIGN

UJT, flip-flop form stable, 20-second one-shot

A twenty-second one-shot multivibrator, stable to within one second from -55°C to $+125^{\circ}\text{C}$, can be made by combining a conventional set-reset flip-flop with an inverter and unijunction transistor (UJT). A potentiometer in the UJT charging network provides for variable reset adjustment.

Referring to the circuit diagram, the closing of S_1 sets the flip-flop and turns off Q_1 . When Q_1 is turned off, C_1 begins to charge to +25 volts through resistors R_1 and R_1 . When the breakdown voltage of Q_2 is reached, the UJT discharges C_1 and resets the flip-flop through C_2 .

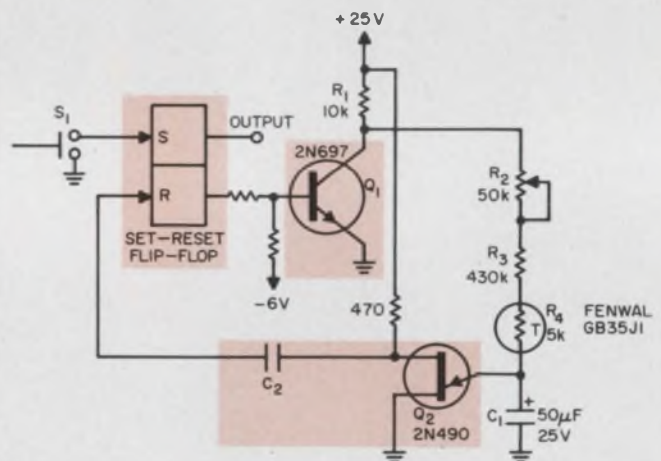

Set-reset flip-flop, inverter and UJT combine to form stable time-delay network. Output of one shot is 20 seconds in duration and is held to ± 1.0 second over temperature range -55°C to $+125^{\circ}\text{C}$.

The time-delay stability is attributed to the careful selection of R_1 , R_1 and C_1 . R_1 must be chosen such that the $I_{cbo(mar)}$ (of Q_1) voltage drop across it will be negligible. The choice of C_1 is critical in that its leakage current at high temperatures must be small in comparison to its charging current (the Sprague type-137D used has a maximum leakage current of only $5 \mu\text{A}$ at 125°C). Thermistor R_1 compensates for the change in capacitance with temperatures and for the slight leakage of C_1 .

Aaron Mall and Jack Shaul, Development Engineers, Bendix Corp., Baltimore, Md.

VOTE FOR 116

IFD Winner for Oct. 25, 1965

Carl Andren, Associate Engineer, Applied Physics Laboratory, Silver Spring, Md.

His idea "Symmetry amplifier compensated by FET current-source diodes" has been voted the \$50.00 Most Valuable of Issue Award.

Cast Your Vote for the Best Idea in this Issue.

ON READER-SERVICE CARD CIRCLE 217 >

1,000,000,000,000

TRACE WIDTHS PER SECOND

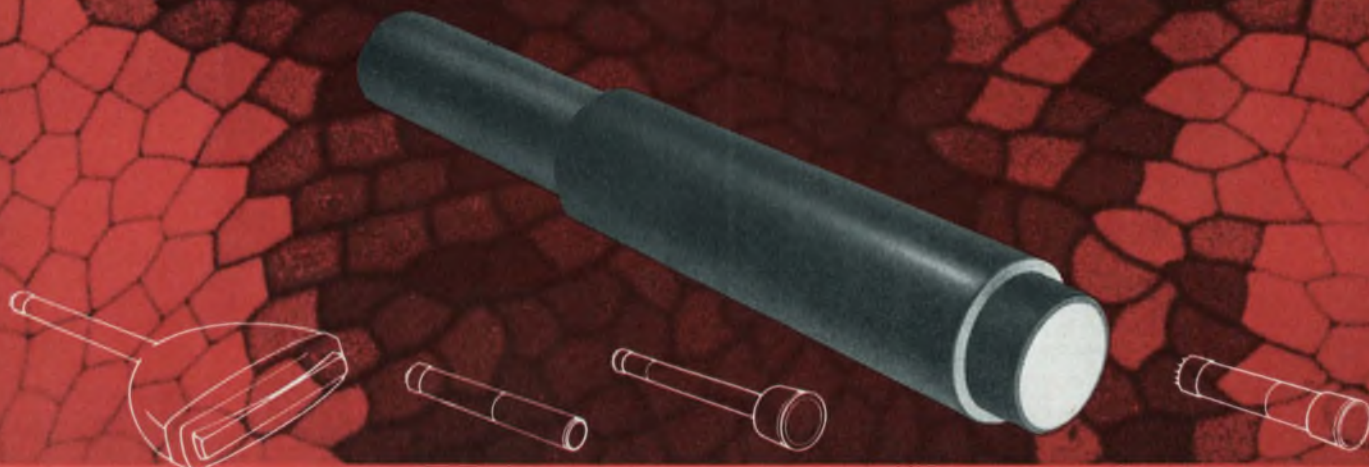

Tube #	Screen Size	Feature	Focus	Deflection	Resolution	Trace-width	Fiber Dia. Microns
KC 2486P	8 ³ / ₈ " x 1 ³ / ₈ "	Large presentation in-line scan tube	Electrostatic	Magnetic	200 li./in.	.005	15
K 2252P	2 ¹ / ₂ "	High-resolution, Electrostatic deflection	Electrostatic	Electrostatic	800 li./in.	.0012	10
KC 2287P	3"	Uniform-scan high resolution	Electrostatic	Magnetic	1500 li./in.	.0007	5
K 2226P	3"	High resolution	Magnetic	Magnetic	1000 li./in.	.001	8
KC 2474	12"	Direct plotting High brightness, contrast	Electrostatic	Electrostatic	100 li./in.	.01	50

Background above: Microphoto of fiber-optics bundle mosaic.

(and it's recordable — thanks to DuMont's Fiber-Optics Leadership!)

DuMont's leadership in fiber-optics technology has resulted in a whole family of CRTs having significant advantages over conventional means of display: up to 30 times more efficient presentation of spectral information, superior resolution and contrast, curved-field compensation, elimination of parallax, to name a few.

Take our new KC2427P, the 3", high-resolution CRT shown above (it's the CRT used in the world's first fiber-optics 'scope). In addition to one-shot writing speed of 10^{12} trace widths/sec, this new CRT has 1.0 mv/trace fs sensitivity (2.0 mv/trace sensitivity with a gain-of-8 amplifier), 500 lines/in resolution, 2.5 ns risetime at 100 mHz, a 1000-mHz band-width capability with unlimited scan rate, distributed de-

flected structure to capture broad-band transients, electrostatic focus and deflection, and a faceplate held within 1 mil of absolute flatness.

DuMont offers fiber-optics CRTs with a variety of options: Screens to 12" for large-screen presentation or for direct plotting or recording. You can have a choice of phosphors (including high-UV types) on aluminized or unaluminized screens, clad or unclad fibers ranging in diameter down to 4 microns.

For whatever application—high-speed, high-resolution direct recording, image coding, large-screen presentation, direct plotting, or direct coupling to other optical devices — DuMont is sure to have the right fiber-optics CRT for you.

Happy surprise—you'll find fiber-optics CRTs significantly *smaller* and *less expensive* than their conventional counterparts.

Write or call for informed applications assistance, or to ask for our new 1966 48-page Catalog listing over 4000 tubes that we make.

WORLD'S LEADING MANUFACTURER OF DISPLAY TUBES

FAIRCHILD

DU MONT ELECTRON TUBES
A DIVISION OF FAIRCHILD CAMERA AND INSTRUMENT CORPORATION
CLIFTON, N. J.

QUALITY, VARIETY SERVICE

...that's the story of "Ohmitran" v. t.[®] variable transformers

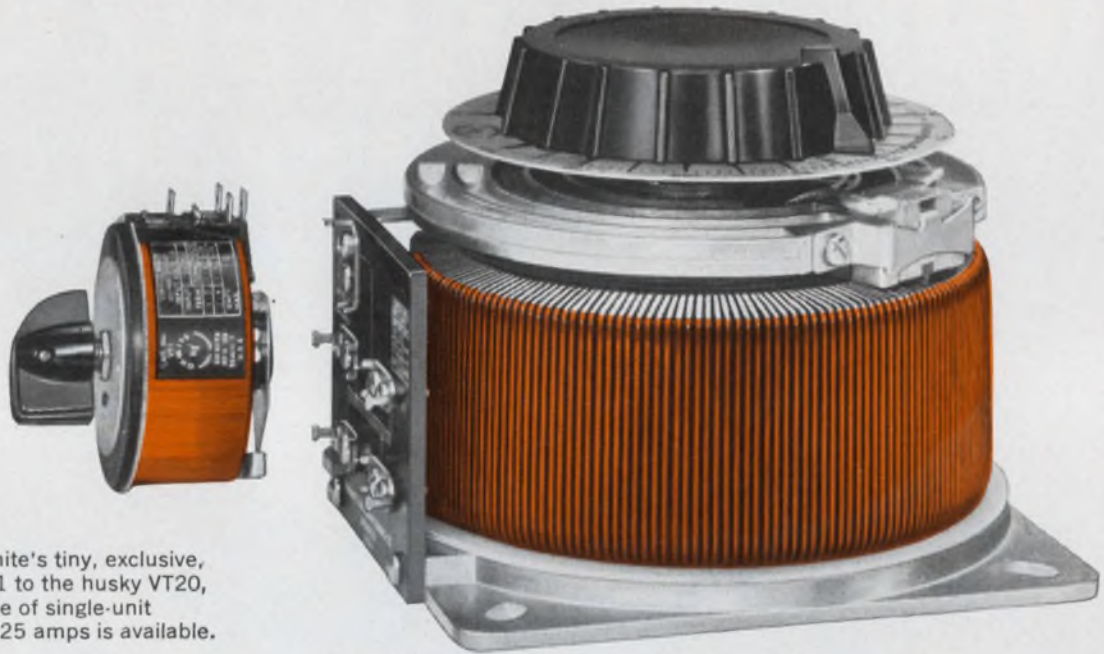

From Ohmite's tiny, exclusive, 1-amp VT1 to the husky VT20, a full range of single-unit ratings to 25 amps is available.



SATISFY yourself . . . eliminate irritating variable transformer difficulties with Ohmite's famed reliability and long service life. In any piece of equipment, an Ohmite component indicates that there has been no compromise with quality.

MEET virtually all your requirements from Ohmite's big selection. Single units start with a tiny (and exclusive) 1-amp model, extend through heavy-output models of 25 amps. For single and/or ganged models,

voltage inputs begin below 40 volts, run to 480 volts. There are assemblies for 3-phase applications, too, plus models in stationary or portable cases—with meters if you like. Most are stocked for fast delivery.

EASE engineering headaches by taking advantage of Ohmite's ready-to-ship stock of standard units, or willing advice and service on units for special applications. Bone up on the broad aspects of Ohmite's complete variable transformer service by requesting *Catalog 500*.

**RHEOSTATS • POWER RESISTORS • PRECISION RESISTORS • VARIABLE TRANSFORMERS • RELAYS
TAP SWITCHES • TANTALUM CAPACITORS • SEMICONDUCTOR DIODES • R.F. CHOKES**

OHMITE

MANUFACTURING COMPANY
3643 Howard Street • Skokie, Illinois 60076
Phone: (312) ORchard 5-2600



ON READER-SERVICE CARD CIRCLE 42

ED Products

25 MHz oscilloscope for lab or production line PAGE 90

Crimp-connector speeds flat-pack mounting PAGE 114

Flat-pack socket aids IC production testing PAGE 114

Alphanumeric printer gives 20 lines per second PAGE 122

Single computer tests all 2- and 3-lead devices PAGE 122

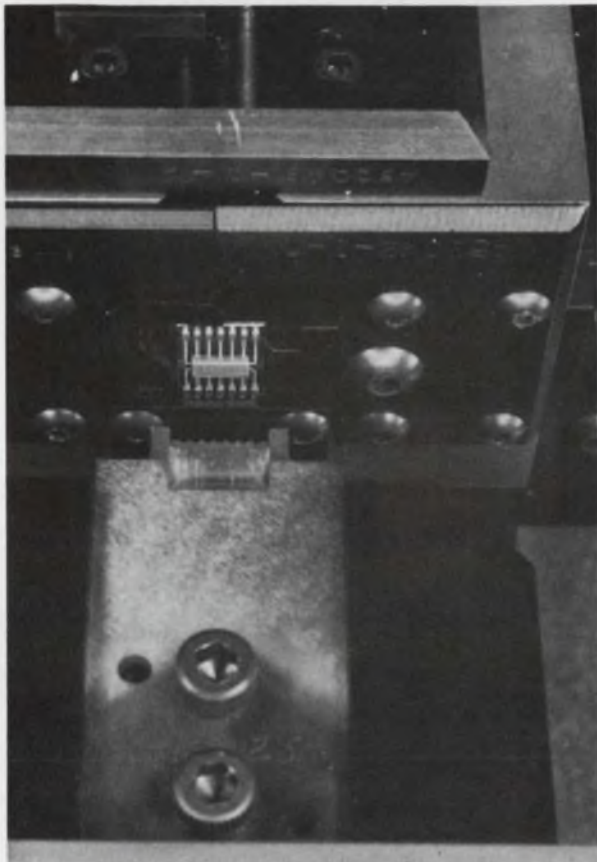

A faster way to mount flat-packs . . . 114

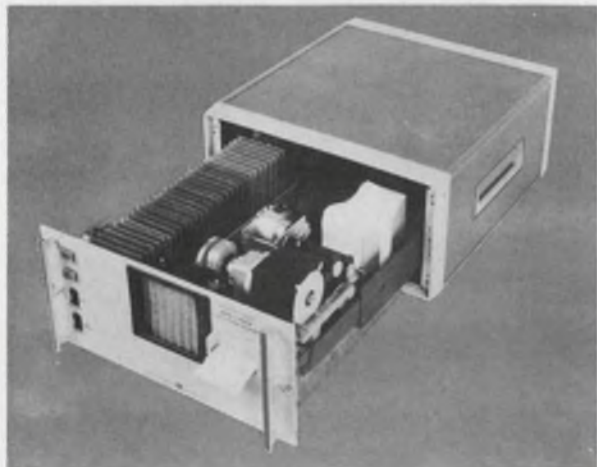

Forty-eight columns of alphanumeric soup . . . 122

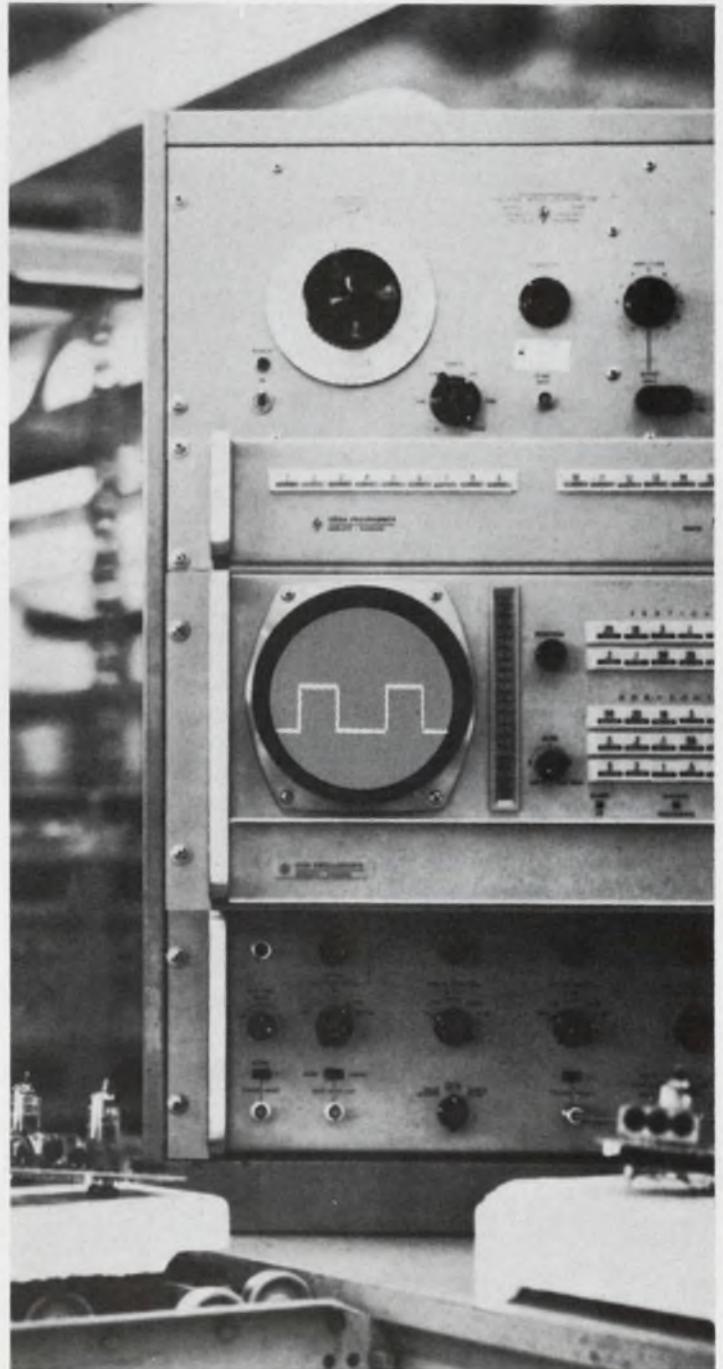

For production or lab work, you don't need dc drift . . . 90

No dc drift in pushbutton scope, programmed operation now possible

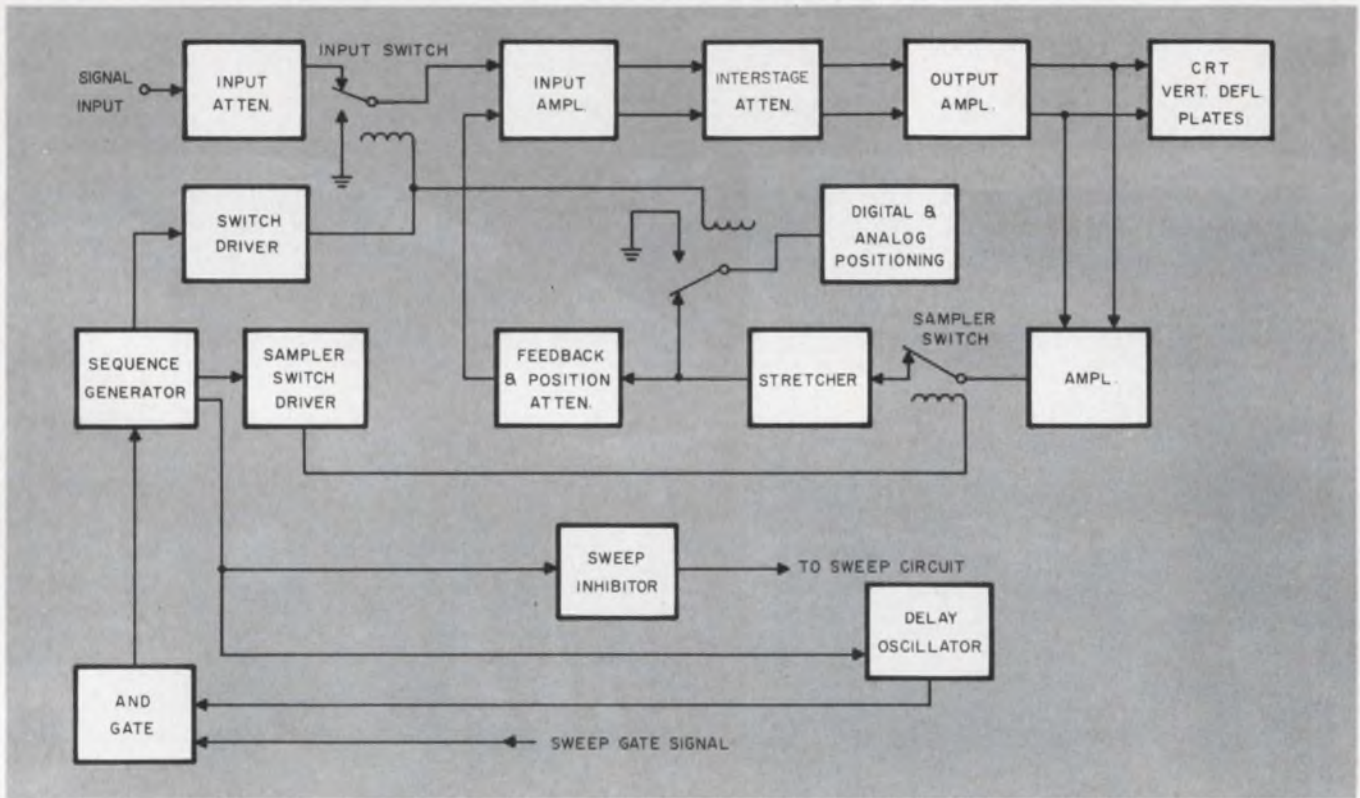

At best, dc drift in an oscilloscope is a bother, at worst it can be a disaster. In eliminating this drift in the new Model 155A oscilloscope, Hewlett-Packard of Colorado Springs offers more convenience in laboratory scope measurements and fully programmable operation on the production line. Beyond the stabilization circuitry shown above, and the programming boards and cables, the 155A is a standard 25 MHz instrument with specs generally comparable, if not superior to others in its price range. The pushbutton controls are also a handy extra.

The effects of driftless operation will be particularly valuable in measurements at dc levels. When this is required, as in pulse analysis for instance, the drift introduced by the amplifiers and controls of a conventional scope can make life pretty difficult. In some cases the error caused by drift can become great enough to drive the trace completely off the face of the scope.

With the drift eliminated, the trace stays put indefinitely. And, in a programmed system, it can be recalled to the same position at any time. The operator can make detailed waveform measurements by simply selecting the proper program.

Front-panel controls of the 155A include illuminat-

Drift stabilizer operation

The stabilizer circuitry corrects for oscilloscope drift through a feedback loop. The delay multivibrator changes state, activating one leg of the "AND" gate 350 ms after completion of the previous correction. When the sweep in progress ends, the other side of the "AND" gate is armed, triggering the sequence generator.

The sequence generator grounds the oscilloscope input and removes positioning voltage, commands that a sample be taken, and inhibits the sweep. With the input grounded, each side of the amplifier should be at the same voltage. If not, drift has occurred and correction is made.

The sampler circuit senses the drift and feeds this voltage back to the amplifier input to correct the difference. The sampled voltage difference is also stored on the stretcher to maintain the correction. At the end of the 2 ms sampling period the sampler switch is opened and 1 ms later the input is reconnected. Simultaneously, the position voltage is reestablished and added to the drift correction voltage which has been stored on the stretcher. The sweep is inhibited for two more ms and then is allowed to return to normal operation.

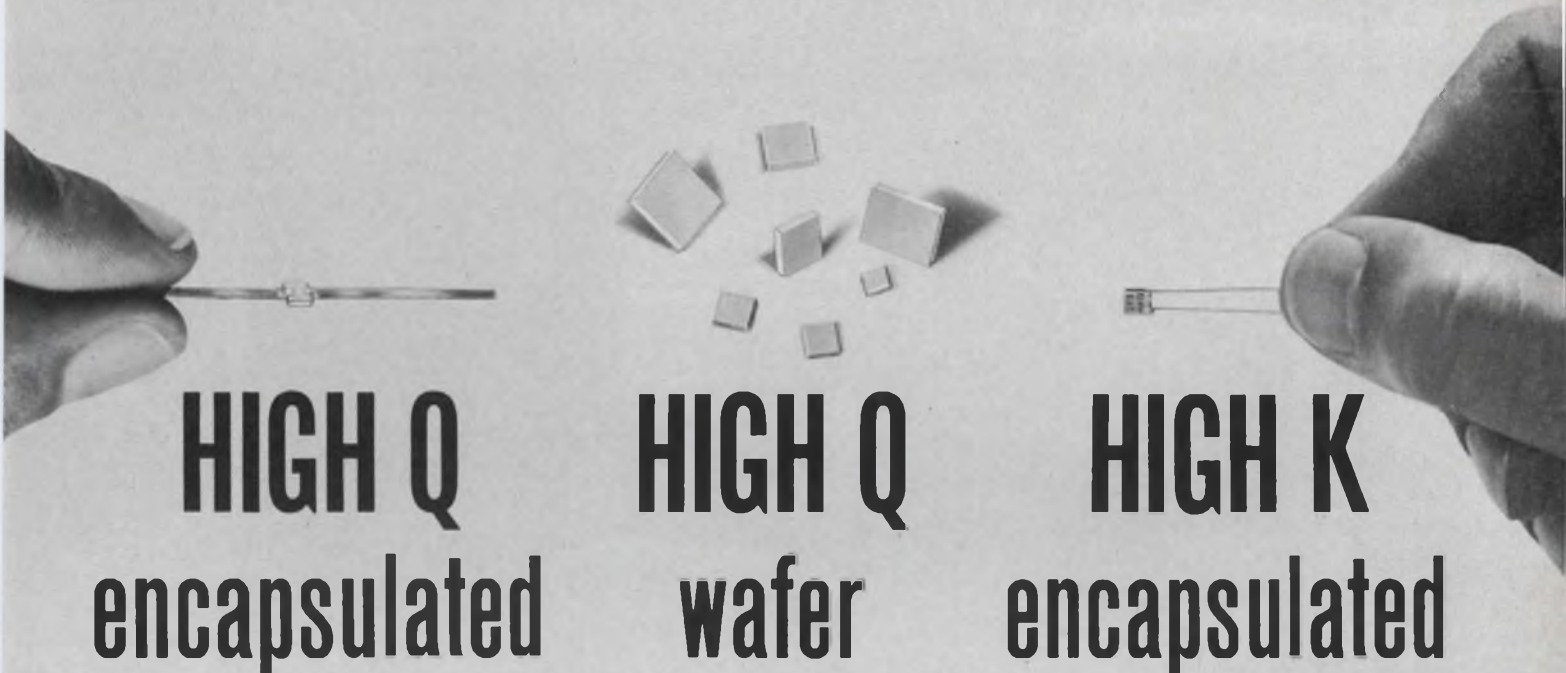

Now, JFD Uniceram® Fixed Capacitors Come THREE ways

High Q Uniceram High Q ceramic fixed capacitors offer a unique combination of small size, exceptional stability and a guaranteed minimum Q of 5000 . . . with up to ten times more capacitance per unit volume than competitive units . . . up to .206 mfd/in³.

GLASS ENCAPSULATED—105 models, with capacitance values from 0.5 to 3000 pf, provide the ultimate in High Q, reliability and stability. All models meet or exceed requirements of MIL-C-11272B.

WAFERS—Uniceram High Q capacitors are also available as unencapsulated wafers with metalized edges. 88 low-cost units, with capacitance values from 0.5 to 3000 pf,

offer the same outstanding electrical properties. These wafers are ideally suited for hybrid integrated circuits, can be soldered directly to printed circuit boards or used as discrete components.

High K ENCAPSULATED—A High K series of Uniceram ceramic fixed capacitors with up to 1 mfd capacitance per unit volume is also available. These glass encapsulated units meet or exceed requirements of MIL-C-11015C. Volumetric efficiency . . . up to 48 mfd/in³.

WAFERS—Uniceram High K capacitors will soon be available as unencapsulated wafers, also.

WRITE FOR CATALOG UNM 65-2

ON READER-SERVICE CARD CIRCLE 141

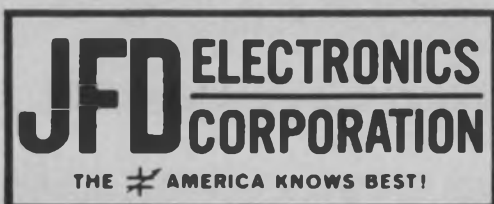

Components Division
JFD ELECTRONICS CORPORATION, 15th Ave. at 62nd St., Brooklyn, N. Y. 11219
Tel: 212 DE 1-1000
JFD NORTHEASTERN, Ruth Drive, P. O. Box 228, Marlboro, Mass. 07152
JFD NEW YORK-NORTHERN, Damiano Pl., P. O. Box 96, New Hartford, N. Y. 13503
JFD MID-ATLANTIC, P. O. Box 5055, Philadelphia, Pa. 19111
JFD MID-ATLANTIC-MARYLAND, P. O. Box 7676, Baltimore, Md. 21207
JFD MIDWESTERN, 6330 W. Hermione St., Chicago, Ill. 60646
JFD MIDWESTERN-OHIO, P. O. Box 8086, Cincinnati, Ohio 45208
JFD WESTERN, 9 Morlan Place, Arcadia, California 91006
JFD ISRAEL LTD., Industrial Area B, Bldg. 23, Azor, Israel
JFD ELECTRONICS, EUROPE S A, 7 Rue de Rocroy, Paris, 10, France

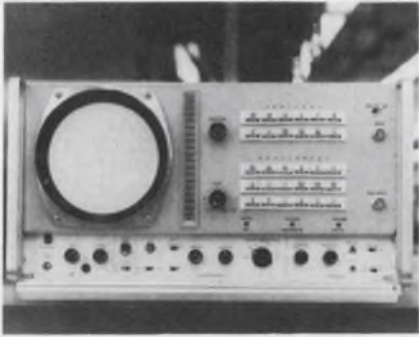

ed pushbuttons for sweep and sensitivity control, level and position verniers, as well as the conventional horizontal and vertical controls.

Pertinent specifications are as follows:

Sensitivity: 12 calibrated ranges from 5 mV/cm to 20 V/cm. Vernier allows continuous adjustment and extends sensitivity to 50 V/cm.

Bandwidth: Dc coupled, dc to 25 MHz; ac coupled, 2 Hz to 25 MHz.

Dc stability: Dc stabilization maintains zero offset base line within ± 0.1 cm.

Input impedance: 1 megohm shunted by approximately 50 pF.

Internal sweep: 18 calibrated ranges from 0. μ s/cm to 50 ms/cm. Accuracy is typically within 1%, always within 3%. Vernier allows continuous adjustment and extends slowest sweep to 0.25 sec/cm.

Position: Base line can be offset ± 5 cm in 1 cm steps and ± 25 cm in 5 cm steps. Accuracy is $\pm 2\%$ on the settings. Vernier control allows continuous ± 2 cm adjustment.

Magnification: X5 expansion extends fastest sweep to 20 ns/cm. Times 0.1 slows 10 ms/cm, 20 ms/cm, 50 ms/cm decade to 0.1 sec/cm, 0.2 sec/cm, 0.5 sec/cm. Accuracy is typically within 3%, always within 5%.

Triggering: Internal or external at 40 Hz to greater than 25 MHz, also from line voltage. Base line displayed in absence of input signal.

Programmable functions include: Sensitivity, input coupling, vertical positioning, sweep time, trigger source, and trigger slope.

P&A: \$2150; May. \$2450 with programing capability. A companion programmer, Model 1550A, is \$600. Hewlett-Packard, 1900 Garden of the Gods, Colorado Springs, Colo. Phone: (303) 636-5111.

Circle No. 251

50-MHz oscilloscope

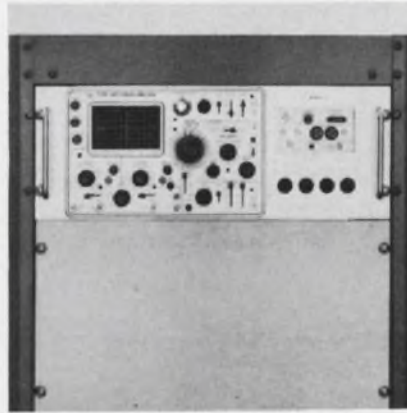

A new compact, 50-MHz, dual-trace rack-mount oscilloscope, type R453, was developed primarily for service in high-speed applications. The type R453 gives dual-trace sensitivity to 20 mV/div at 50 MHz, to 5 mV/div at 40 MHz, and the channels can be cascaded to obtain 1 mV/cm sensitivity at 25 MHz, single trace. Signal delay allows viewing the leading edge of the trigger waveform.

Price: \$2035. Tektronix, Inc., P.O. Box 500, Beaverton, Oregon. Phone: (503) 644-0161.

Circle No. 252

Audio generator



The Model 378 produces a very low-distortion sine wave signal over repeatable settings at discrete levels between 1 cps and 110 kilocycles. Frequency is selected by switching between 1% resistors and capacitors. The output level can be set between 0 and 10 volts rms (or between -70 and $+22$ dB) on a 4-1/2-in., D'Arsonval 2% full-scale accuracy meter.

Price: \$49.95 (kit), \$69.95 (wired). Electronic Instrument Co. Inc., 13101 39th Ave., Flushing, N. Y. Phone: (212) 762-6000.

Circle No. 253

Pulse generator



Model 110A pulse generator features a 4.0 ns rise-time and an external triggering provision. Pulse repetition rate is variable from 4 Hz to 40 MHz, pulse width from 10 ns to 5 ms. Simultaneous positive or negative outputs are available to 10 V with up to 70 dB attenuation in single or double modes.

Pulse delay settings range from 10 ns advance to 50 ms delay and transition times are variable.

Price: \$1250. Datapulse Inc., 509 Hindry Ave., Inglewood, Calif. Phone: (213) 671-7713.

Circle No. 254

Dual-scale thermometer



Five standard temperature ranges are available in the Model TM1004 Thermist-O-Meter, beginning with a low range of -58° to $+32^{\circ}$ F, up to a high range of $+212^{\circ}$ to $+302^{\circ}$ F, with both Fahrenheit and Celsius indications. Accuracy of 1% of full scale, mercury cell power for one year's operation, and battery check indication are specified.

P&A: \$120; stock. Rustrak Instrument Co. Inc., Municipal Airport, Manchester, N. H. Phone: (603) 623-3596.

Circle No. 255

Sigma slide rule

A new, 10-in. slide rule said to provide exceptionally smooth slide action, lasting hairline adjustment and extreme dimensional stability. The 1737 sigma slide rule is made of bamboo and laminated with white facings.

Eugene Dietzgen Co., 2425 N. Sheffield Ave., Chicago, Ill. Phone: (312) 549-3300.

Circle No. 256



Random noise generator

A three-band noise generator covers a range of 5 Hz to 5 MHz. Output flatness is ± 1 db from 10 Hz to 500 kHz and ± 3.5 dB from 500 kHz to 5 MHz at maximum RMS output of 3 volts.

P&A: \$495; stock to 30 days. Elgenco, Inc., 1550 Euclid St., Santa Monica, Calif. Phone: (213) 451-1635.

Circle No. 257

Squarewave generator

A compact, general-purpose square-wave generator provides simultaneous positive and negative-going pulses with a risetime of 1 ns or less. It can also provide a positive-going pulse of 0.5 V to 12V into a 50 ohm load or up to 130 V when unterminated. Risetime of the high amplitude pulses are below 12 ns.

Repetition rate of either output is selectable in decade steps from 10 Hz to 100 kHz. A continuously variable multiplier provides coverage between steps and extends the maximum rep rate to 1 MHz.

A trigger output produces both positive and negative triggers of 0.4 V into 50 ohm with a rise time of about 50 ns.

P&A: \$590; early 1966. Tektronix, Inc., Box 500, Beaverton, Oregon. Phone: (503) 644-0161.

Circle No. 258

Ballantine AC-DC Digital Voltmeter ...and DC/AC Voltmeter/Ohmmeter



Model 355
Price: \$590

Ever hear of so many features in a Digital Voltmeter such as this?

BALLANTINE'S MODEL 355 AC/DC DIGITAL VOLTMETER HAS THESE OUTSTANDING FEATURES: Measures full scale ac to 10 mV • Measures ac & dc from 0 to 1,000 V • $\frac{1}{4}$ % accuracy f.s. for ac & dc voltages up to 500 and for mid-band frequencies • Large, well-lighted readout with illuminated decimal point, mode and range information.



Model 345
Price: \$375

Or in a DC/AC Voltmeter/Ohmmeter like this?

BALLANTINE'S MODEL 345 DC/AC VOLTMETER/OHMMETER GIVES YOU THESE ADVANTAGES: Measures 0 - 1,000 V dc; 0 - 350 V ac (20 Hz to 1,000 MHz); 0 - 5,000 M Ω • One easy-to-read voltage scale instead of four as in many volt-ohmmeters • Unrivalled accuracy and high resolution: 1% of indication for dc; 2% of indication for ac; and 3% of indication for ohms • Built-in calibrator.

Write for brochures giving complete details

— Since 1932 —



BALLANTINE LABORATORIES INC.

Boonton, New Jersey

CHECK WITH BALLANTINE FIRST FOR DC AND AC ELECTRONIC VOLTMETERS/AMMETERS/OHMMETERS, REGARDLESS OF YOUR REQUIREMENTS. WE HAVE A LARGE LINE, WITH ADDITIONS EACH YEAR. ALSO AC/DC LINEAR CONVERTERS, AC/DC CALIBRATORS, WIDE BAND AMPLIFIERS, DIRECT-READING CAPACITANCE METERS, AND A LINE OF LABORATORY VOLTAGE STANDARDS FOR 0 TO 1,000 MHz.

Speed Inquiry to Advertiser via Collect Night Letter
ON READER-SERVICE CARD CIRCLE 43

Milliohmmeter

Model 502A portable milliohmmeter features 13 overlapping ranges from 10^{-3} - 10^3 ohms. Power through the sample is less than 2μ watts, and a voltage limiter holds the maximum voltage across the sample to 25 millivolts.

The unit can be set in the limiting mode where the maximum improper-range power is 65μ watts. Accuracy is $\pm 3\%$ full-scale.

P&A: \$425; 30 days. Kiethley Instruments, 12415 Euclid Ave., Cleveland, Ohio. Phone: (216) 795-2666.

Circle No. 259

Digital voltmeter

Accuracy of one part in twenty thousand is available on this digital voltmeter. Model 2025 converts analog to digital readings on a scale of 19999 without reducing accuracy.

Conversion time is constant at 20 ms. The unit has six operating modes, 2 built-in Standard Cell for checking performance, and greater than 25,000 Meg input impedance. Accuracy is specified at 0.01% of the reading \pm one digit.

IERC, Dynamics Corp. of America, 135 West Magnolia, Burbank, Calif. Phone: (213) 849-2481.

Circle No. 260

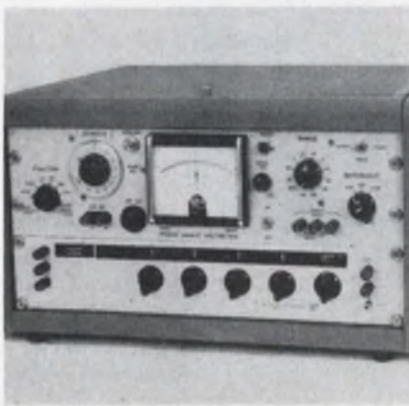
Synchro null detector

A combination of a synchro bridge and a phase angle voltmeter is said to permit the complete range of commercial synchros to be measured with 2 seconds of arc accuracy. The instrument is also available in a console with a combination of a phase angle voltmeter and any one of the following: Synchro, bridge simulator, resolver/synchro or resolver bridge.

P&A: From \$1800; 30-60 days. North Atlantic Industries, 200 Terminal Dr., Plainview, L. I., N. Y. Phone: (516) 681-8600.

Circle No. 261

Ohmic thermometers

A family of 11 resistance thermometers enables measurement and control of temperatures. Ranges cover -328°F to $+500^{\circ}\text{F}$, sizes from 0.125 to 12-in. long, and 0.125 to 0.278-in. diameter, in both body and tip-sensitive styles.

Designed for use with resistance measuring equipment, their high resistive change of several ohms per degree permits long, spliced leads with minimal loss of accuracy.

Price: \$11-\$59. Minco Products, 740 Washington Ave. N., Minneapolis, Minn. Phone: (612) 338-6753.

Circle No. 262

**Buy your ITT Red Caps
from any of the following
ITT authorized distributors**

ALABAMA

Gulf Semiconductors, Inc.
(205) 881-7737

ARIZONA

Moltronics of Arizona
(602) 278-5531
R. V. Weatherford Company
(602) 943-1966

CALIFORNIA

Capacitors, Inc.
(213) 682-3541
Electronic Components, Inc.
(714) 232-8951
Fortune Electronics
(415) 826-8811
Hollywood Radio and Electronics
(415) 322-3431
Perlmuth Electronics
(213) 931-1041
Santa Monica Bell Electronics
(213) 321-5802
Wesco Electronics
(213) 795-9161

CONNECTICUT

Cramer Electronics
(203) 288-7771

FLORIDA

Cramer Electronics
(305) 566-7511
Gulf Semiconductors, Inc.
(305) 887-6541

ILLINOIS

Semiconductor Specialists, Inc.
(312) 622-8860

MARYLAND

D & H Distributing Company, Inc.
(301) 539-6525
Frontier Electronics, Inc.
(301) 427-3300

MASSACHUSETTS

Cramer Electronics, Inc.
(617) 969-7700
Greene-Shaw Company, Inc.
(617) 969-8900

MINNESOTA

D. F. Countryman & Company
(612) 645-9151
Semiconductor Specialists, Inc.
(612) 866-3434

MISSOURI

Olive Industrial Electronics
(314) 863-4051

NEW JERSEY

Eastern Radio Corporation
(201) 471-6600
General Radio Supply
(609) 964-8560
Valley Electronics
(609) 662-9337

NEW YORK

Arrow Electronics, Inc.
(516) 694-6800
Electronic Supply Corporation
(212) 478-4000
Harvey Radio Company, Inc.
(516) 921-8700
Milo Electronics
(213) 233-2980

NORTH CAROLINA

Southeastern Radio Supply
(919) 828-2311

OHIO

Alpine Industries, Inc.
(513) 278-5861
Pioneer Standard Electronics
(216) 432-0010

PENNSYLVANIA

Philadelphia Electronics
(215) 568-7444

TENNESSEE

Electra Distributing Company
(615) 255-8444

TEXAS

Beta Electronics, Inc.
(817) 277-2231
Contact Electronics
(214) 631-9530
McNicol, Inc.
(915) 566-2936

VIRGINIA

Meridian Electronics
(703) 353-6648

CANADA

Prelco Electronics, LTD
(514) 389-8051

ITT

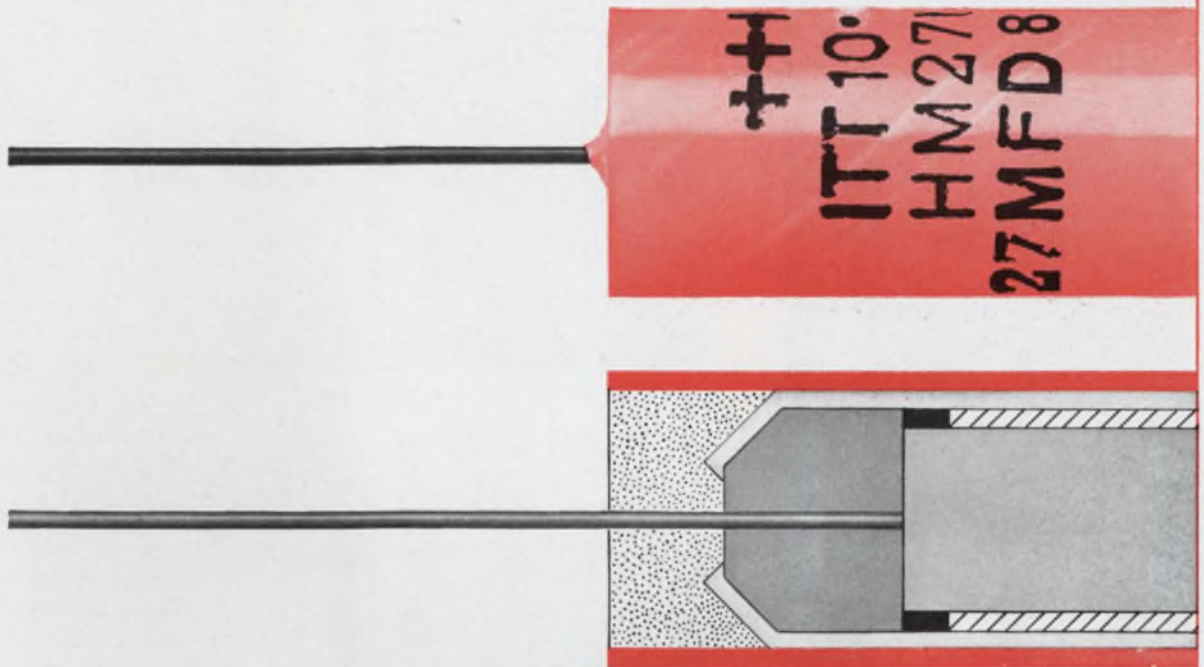

Why ITT wet tantalum capacitors can't leak

Every ITT Red Cap[®] wet tantalum capacitor gets a "total stress" seal that, unlike the ordinary single-crimp seal, positively prevents electrolyte leakage. To accomplish this, ITT inserts a teflon end seal, then spins down the open end of the can until end seal, anode and insulating washer are under a predetermined compressive force.

Seal integrity is further insured by the addition of an epoxy end fill. Since the epoxy's expansion coefficient is less than that of the can, temperature cycling cannot relax the spun seal.

If you're tired of electrolyte leaks and the problems that go with them, here's an easy solution. Order the ones that can't leak — the Red Caps[®] — from your ITT Capacitor distributor or from ITT Semiconductors, 3301 Electronics Way, West Palm Beach, Florida.

ITT

First Ever!



M-O V INTRODUCE THEIR FIRST DUAL-TRACE MESH P.D.A. C.R.T.

M-O V's wide range of precision instrument C.R.T.'s is now further extended by the introduction of a rectangular flat-face dual-trace oscilloscope tube with mesh P.D.A. This is the first time that such a tube has ever been produced. The M-O V range of dual trace C.R.T.'s now gives equipment designers the widest choice of high-brightness, high-sensitivity tubes in the world.

The new Dual-trace Tube has all these features:

- * 10 kV (Va4) operation for high brightness and writing speed.
- * High deflection sensitivities — 5y 5 V/cm, 5x 10 V/cm.
- * Deflection blanking.
- * Useful scan (each trace) — 6 cm x 10 cm.
- * Independent astigmatism adjustment.
- * Area of common scan (min.) — 5 cm x 10 cm.
- * Rectangular flat face to save panel space 12 cm x 9 cm.
- * Va3 — 1.5 kV.
- * Available to order with round screen — 13 cm diameter.

This new tube joins M-O V's other dual trace precision instrument C.R.T.'s to form the widest range of such tubes in the world.

For full details write to:

Genalex

THE M-O VALVE CO. LTD.

N. American Sales Manager: David LaFrenais,
9 Codeco Court, Don Mills, Ontario, Canada.
Phone: 416 — 447 — 5511

ON READER-SERVICE CARD CIRCLE 46

TEST EQUIPMENT

Dc measurement system



A new precision dc potentiometric measuring and calibration system has better than 10 ppm accuracy from 0-2.011,111 volts. Guideline Type 960-S has provision for remote digital readout, and features potentiometer resolution of 1 part in 2 million. Thermal emf generation is less than 0.1 μ V, and the system has auto calibration facilities.

P&A: \$4110; 45 days. Hallmark Standards, 1995 Palmer, Larchmont, N. Y. Phone: (914) 834-6630. Circle No. 263

Null microvoltmeter



A solid state null detector and microvoltmeter is available in either line or rechargeable battery versions. The new instruments, Models 845A and 845AB feature input impedance of 10 Meg on ranges of 1 microvolt to 1 millivolt and 100 Meg on ranges of 300 V to 1 kV.

Input isolation is 10^{12} ohms. Nineteen end-scale ranges cover 1 microvolt to 1000 volts.

P&A: \$350-\$395; stock—30 days. John Fluke, Box 7428, Seattle, Wash. Phone: (206) 776-1171. TWX: (910) 449-2850.

Circle No. 264

Coating measuring unit



The thickness of anodic and organic coating on aluminum, stainless and other non-ferrous alloys can be non-destructively measured by the Permascope type EC3. The instrument is direct-reading, calibrates in seconds and covers two standard ranges of 0 to 0.0015-in. and 0 to 0.005-in. Other ranges up to a maximum 0.080-in. are available on special order.

Twin City Testing Corp., 533 S. Niagara St., Tonawanda, N. Y. Phone: (716) 693-6303.

Circle No. 265

3 Gc frequency meter



The 331C operates as a frequency meter and a signal generator at frequencies up to 3000 MHz. Accuracy is ± 5 parts in 10^{10} , drift, better than 1 part in 10^9 per day.

The principle is that of a heterodyne wave meter. A comparison oscillator is controlled by a MHz crystal source. Frequency is displayed on three dials, for the last four Nixie tubes. Signals as small as 10 microvolts can be measured.

Data Instruments Div., Pennsauken, N. J. Phone: (609) 662-3031.

Circle No. 266



NEW

8960 ways
to switch your product
on and off in style

*And if these new Cutler-Hammer Designer-Line switches won't do
the job . . . we'll build one that will.*



RIGHT NOW you have 8 lever styles . . . a choice of 7 colors . . . ac or dc operated . . . screw, spade, lug or wire lead terminations . . . SPST, SPDT, 2-circuit, DPST or DPDT circuit arrangements . . . up to 6 amp ratings.

Here's design freedom at its best. Greater styling flexibility than ever before. Another major extension of industry's already most complete line of quality switches.

What's more, they're time-tested devices. With quick make-quick break contact action that reduces wear. Lengthens switch life.

And they're insulated for greater safety. High dielectric superstructure provides long insulating path. Result? No shocks from metallic tool, appliance and instrument housings.

GET A SAMPLE. Examine it. Try it out. See it add glamor to your product.

When you're ready to order, you can expect fast service from complete stocks of your nearby Cutler-Hammer distributor. For information, write on company letterhead to Cutler-Hammer, Milwaukee, Wisconsin 53201.



CUTLER-HAMMER DESIGNER-LINE SWITCHES / ENGINEERED FOR VALUE



Multiply phasors the easy way

Irving Karmin
Senior Project Engineer
Loral Electronics Co., N. Y.

This article was published in the August 2 Issue of *ELECTRONIC DESIGN*, page 34. Unfortunately one complete set of construction lines that was to illustrate the ease of vector multiplication was omitted from the graph. Since the absence of these lines somewhat hinders the understanding and appreciation of this graphical method, we are publishing the corrected graph, along with the example the author used to illustrate the multiplication of vectors.

Multiplication: We simply add the angles and add the magnitudes in the log scale. For example, multiply $20 \angle -60$ by $4 \angle +45$. The angle of the resulting phasor is $-60 + 45 = -15$.

To find the magnitude, locate Point $20 \angle -60$ (shown with broken black lines); then locate the point $4 \angle +45$. Measure the distance of Point 4 from the abscissa with a ruler. Add this distance to Point 20; the result is 80. Therefore, the final result is $80 \angle -15$.

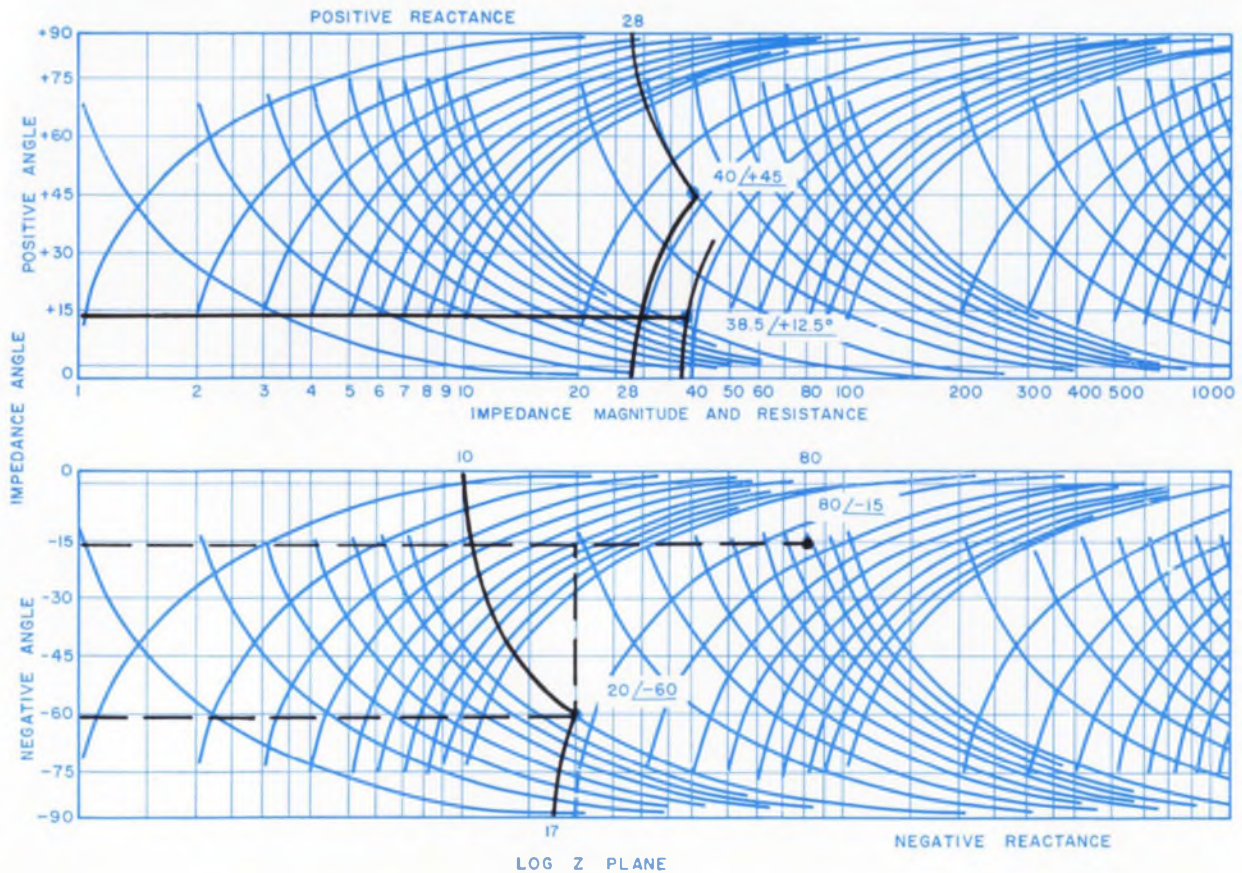



RELIABILITY

TOTAL CAPABILITY IN
PRECISION RESISTANCE



"DALE Metal Films
have sure solved
our reliability
problems, Ed."

"I like the price."

No need to scrap reliability for low price ...get both with DALE METAL FILM RESISTORS

LOW NOISE CONSTRUCTION. Maximum for standard resistance range: 0.10 micro-volt per volt over a decade of frequency. Low and intermediate values: below 0.05 micro-volt per volt. Terminating band of low-resistance metal alloy is deposited in same vacuum as metal film element resulting in oxide-free, low-noise contact area between film, terminating band and press-fit cap.

CONTROLLED T.C. Ten standard T.C. codes from $0 \pm 150 \text{ ppm}/^\circ\text{C}$ to $0 \pm 25 \text{ ppm}/^\circ\text{C}$ available in operating temperature range of -55°C to $+175^\circ\text{C}$. Close matching between pairs or sets available.

GOOD HF CHARACTERISTICS. Low reactance gives excellent stability at high frequencies. Non-helixed or laterally adjusted units supplied for extremely critical applications above 100 mc.



SPECIAL REQUIREMENTS. Special terminals, special matching, special pre-conditioning, special networks and mountings can be quickly supplied by our Special Film Products Department.

WRITE FOR CATALOG A

DALE ELECTRONICS, INC.

1328 28th Avenue, Columbus, Nebraska
Also Sold by Dale Electronics Canada, Ltd., Toronto, Ontario, Canada

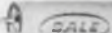

<p>MFF Epoxy coated. Meets electrical and environmental requirements of Char. B, C, D, E; MIL-R-10509E, but is dimensionally smaller.</p> 				
<p>MFH Hermetically sealed in ceramic tube. Meets requirement G; MIL-R-10509E.</p> 				
<p>MF Transfer molded in epoxy. Meets all requirements of Char. B, C, D, E; MIL-R-10509E.</p> 				
DALE TYPE	MIL TYPE	125° C RATING	RESISTANCE RANGE	DIMENSIONS (LxD.)
MF 50	RN-50 (Proposed)	1/20 watt	49.9 Ω to 60K Ω	.140x.065
MF-1/10	RN-55	1/10 watt	49.9 Ω to 200K Ω	.250x.093
MF-1/8	RN-60	1/8 watt	30 Ω to 550K Ω	.406x.140
MF-1/4	RN-65	1/4 watt	30 Ω to 1 Megohm	.593x.203
MFS-1/2	RN-70	1/2 watt	49.9 Ω to 2 Megohms	.750x.250
MF-1	RN-75	1 watt	49.9 Ω to 6 Megohms	1.093x.375
MF-2	RN-80	2 watts	100 Ω to 15 Megohms	2.188x.375
Tolerance: +1% standard; +5%, +.25%, +.1% available.				
ENVIRONMENTAL SPECIFICATIONS*				
Dale MF resistors are manufactured to the environmental specifications of MIL-R-10509E. Characteristics D, C or E apply depending on T.C. Code specified at purchase.		DALE T.C. CODE		Applicable Char. of MIL-R-10509E
		T-1 (100 P.P.M./°C)		D
		T-2 (50 P.P.M./°C)		C
		T-9 (25 P.P.M./°C)		E
*Specifications for MFF and MFH are similar, but vary dimensionally.				

Speed Inquiry to Advertiser via Collect Night Letter
ON READER-SERVICE CARD CIRCLE 801

**TOO SMALL
TO BE A
LIFESAVER?***



**NOT
IF YOU'RE DESIGNING
ELECTRICAL CIRCUITS**

In the race toward smaller circuits and higher density packaging, some electrical design engineers are sinking in a sea of overlarge components. Those in the know are being buoyed up by Magnetics' miniature powder core line—moly-permalloy cores as small as 0.110" I.D.

Designers involved with highly critical inductor stability factors are welcoming another Magnetics innovation—guaranteed temperature stabilization in miniature powder cores. The "D" type limits the change in inductance to $\pm 0.1\%$ from 0 to +55 degrees C. The "W" type limits the change from $\pm 0.25\%$ from -55 to

+85 degrees C. Our new "M" type limits the change to $\pm 0.25\%$ from -65 to +125 degrees C. A wide selection of core sizes and permeabilities broadens the engineer's design scope even more. And all of these sizes are designed so they can be wound on present miniature toroidal winding equipment.

If you are faced with a problem of compacting a circuit design, it will pay you to investigate the condensing potential of Magnetics' miniature powder cores line. For the complete story, write Dept. ED-30, Magnetics Inc., Butler, Pa.

**Actual size of Magnetics' 0.110" I.D. powder core*



Speed Inquiry to Advertiser via Collect Night Letter
ON READER-SERVICE CARD CIRCLE 802

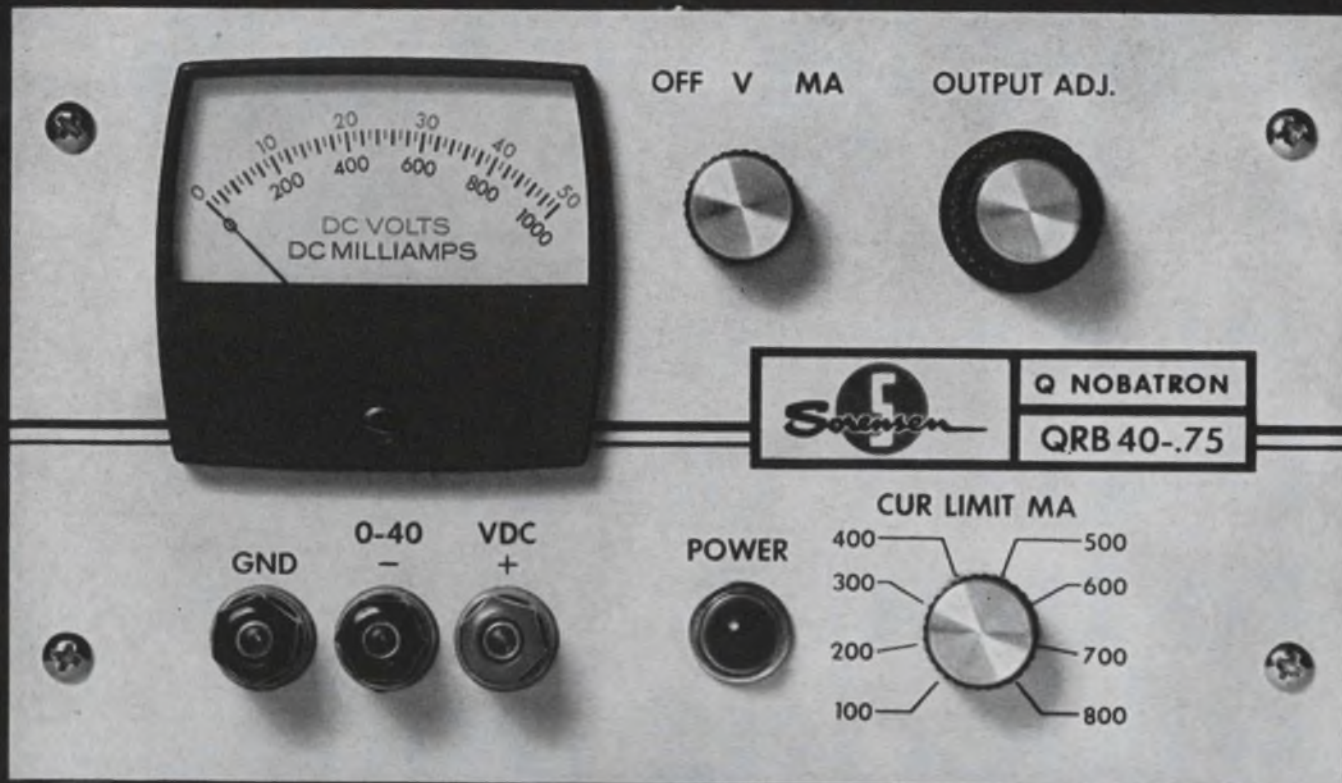

power supply close-up:



more watts per dollar

Check the specs and the price (\$145) and you will find: Sorensen's new QRB40-.75 "ranger" delivers 1½ times the watts per dollar of most competitive power supplies... with no stinting on performance.

CONSTANT CURRENT... Unit can be externally converted to a highly regulated (0.15%) constant current supply.

CURRENT LIMITING... Provides automatic protection against short circuit or overload. Also acts to provide automatic transfer from the normal constant voltage mode to a constant current mode whenever the load demands more current than the limiter has been set to supply.

RESOLUTION... Output can be finely adjusted to 4mv on the 40-volt model; 3mv on the 30-volt model; and 2mv on the 20-volt and 15-volt models. **OTHER QRB FEATURES** include programmability, series/parallel operation, and remote sensing.

For complete data on the QRB series and other Sorensen products send for the new, 140-page "Controlled Power Catalog and Handbook." Write Sorensen, Richards Avenue, South Norwalk, Connecticut. Or use reader service card number **200**.

ELECTRICAL & MECHANICAL SPECIFICATIONS

MODEL NUMBER	OUTPUT VOLTAGE RANGE (VDC)	OUTPUT CURRENT (AMPS.)	% REG. (LINE & LOAD COMB.)	RMS RIPPLE (MICROSEC.)	RESP. TIME (MICROSEC.)	TEMP. COEF. (%/°C.)	CABINET SIZE INCHES			RACK PANEL INCHES	WEIGHT (LBS.)
							WIDTH	HEIGHT	DEPTH	HEIGHT	
QRB15-2	0-15	0-2	±(0.01% + 1mv)	0.15mv	50	±0.015	8¼	5½	9	5¼	10.75
QRB20-1.5	0-20	0-1.5	±(0.01% + 1mv)	0.15mv	50	±0.015	8¼	5½	9	5¼	10.75
QRB30-1	0-30	0-1	±(0.01% + 1mv)	0.15mv	50	±0.015	8¼	5½	9	5¼	10.75
QRB40-.75	0-40	0-.75	±(0.01% + 1mv)	0.15mv	50	±0.015	8¼	5½	9	5¼	10.75

Sorensen represented in California by Ward-Davis Assoc., 770 S. Arroyo Parkway, Pasadena, Phone 213-684-2840; 1020 Corporation Way, Palo Alto, Phone 415-968-7116; 3492 Pickett Street, San Diego, Phone 714-297-4619.



ON READER-SERVICE CARD CIRCLE 803

Uniring® grounds a shielded cable in less time than it takes to heat a soldering iron.

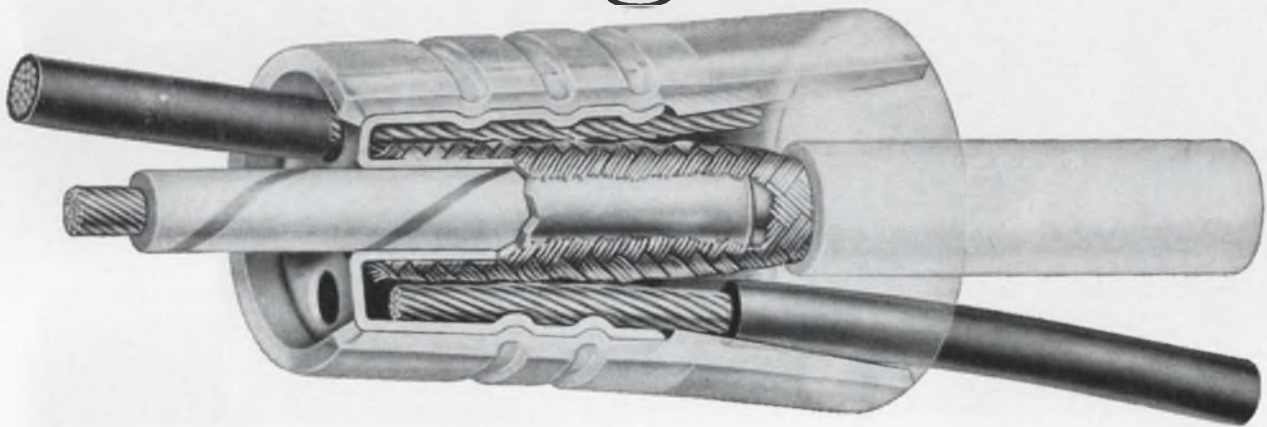

Uniring combines inner and outer ferrules in unitized construction. Simply insert a stripped conductor and tap wire, then crimp. One crimp does it. No heat. No burnt cables. Result: A vibration-resistant, noise-free connection that is mechanically and electrically stable. A uniform connection that takes virtually no time to make.

Uniring terminations are color coded for fool-proof size selection. And the insulated Uniring employs a nylon sleeve that's flared for fast, easy insertion of the shielding braid and tap. (These connectors are also available uninsulated.) No other type of connector is as fast, as reliable, or as low in cost to use. Time and labor savings offered

by the compression method of grounding and terminating shielded cable are recognized by the military and referred to in MIL-E-16400 and MIL-I-983. Burndy Uniring terminations conform in all details to MIL-F-21608 (dated 1/5/59). Send today for a free sample and catalog.

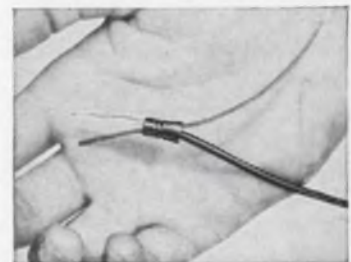

BURNDY

Norwalk  Connecticut



Control-panel relays

BF relays are developed for automatic machinery control panels. Easier wiring, protection against corrosive and contaminated environments, and simplified mounting procedures are featured. A timing range from 0.2 to 60 seconds is provided by mounting the BT timer on the BF relay. In addition to the BT 4-pole timer, two timed and two stationary contacts are standard.

Westinghouse Standard Control, Beaver, Pa. Phone: (412) 775-2000.

Circle No. 267

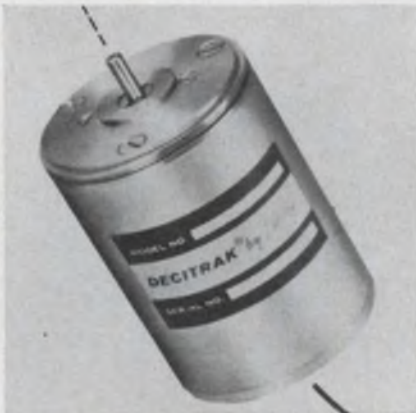

Decimal shaft encoder

Life expectancy of the Decitrak encoders is projected for 50×10^6 revolutions. Citing a figure of 2×10^6 as normal for brush encoders, the company attributes their extended life projections to changes in brush configuration, alloy and current/voltage control circuitry. Decimal output from this unit can be used to drive such display units as printers and lamp banks.

Theta Instrument Corp., Saddle Brook, N. J. Phone: (201) 487-3508.

Circle No. 268

NOW! COMPLETE DESIGN FREEDOM IN LIGHTING EFFECTS & SWITCHING FUNCTIONS

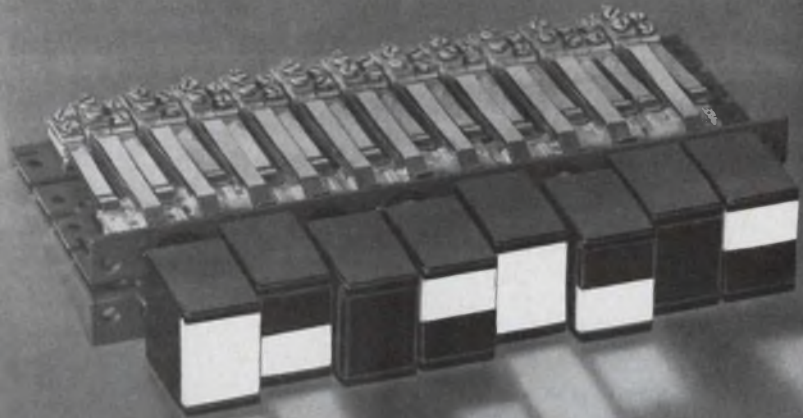

... IN ONE COMPACT UNIT

*littel "Multi-Switch" Patent Applied For

SWITCHCRAFT SERIES 37000, 38000

illuminated littel

"MULTI-SWITCH"

MULTIPLE STATION PUSH-BUTTON SWITCHES

YOU'RE THE BOSS. Now, you no longer need design switching functions and control panel lighting to accommodate what's available to you—because Switchcraft's revolutionary new illuminated littel "Multi-Switch" gives you virtually unlimited combinations of lighting effects and switching functions from stock, without a custom-built price penalty. Check these features:



Single Color



Split-Face

PICK A COLOR—ANY COLOR! Choose the kind of highly visible illumination that is cybernetically correct for your special application: single color buttons, dual colors or twin lamps (for redundancy). Red, Green, Blue, White, Yellow.

Transparent clear or translucent solid colors; or split-face inserts for "flip-flop" lighting (alternate lighting of top and bottom lamps). Lights can be "ON" when button is in either the "IN" or "OUT" position or permanently "ON" when button is in the "IN" and "OUT" positions. You can engrave or hot-stamp the large rectangular-shaped display screens—or as an added plus—behind-display screen legend inserts have a special matte surface for in-the-field identification. And, lighting

effects can be changed in seconds—even in the field. Unexcelled for prototypes!

UNLIMITED SWITCHING FUNCTIONS

Up to 6 PDT in only .6 sq. in. panel space! Positive inter-lock with fool-proof, fail-safe lock-out; or non-lock momentary action; or all-lock (accumulative lock); or push-to-lock, push-to-release . . . or any combination on a single frame! Combines lighting and switching—cuts installation costs and space requirements by 50% or more. 1 to 18 stations per row. Ganged and coupled matrixes, electrical lock-up and release, solenoid release available. Switching power range, up to 15 amps, 1½ HP, 125/250 V.A.C.

FOR EXPERT FACTORY-TRAINED ASSISTANCE

Switchcraft has a unique network of local factory-trained distributors to give you expert assistance in writing specifications, and supplying Multi-Switches from stock at factory prices. Write for the name of your Switchcraft Factory Trained Multi-Switch Distributor and/or Engineering Specification Catalog S-323.

SWITCHCRAFT®

5529 North Elston Avenue, Chicago, Illinois 60630

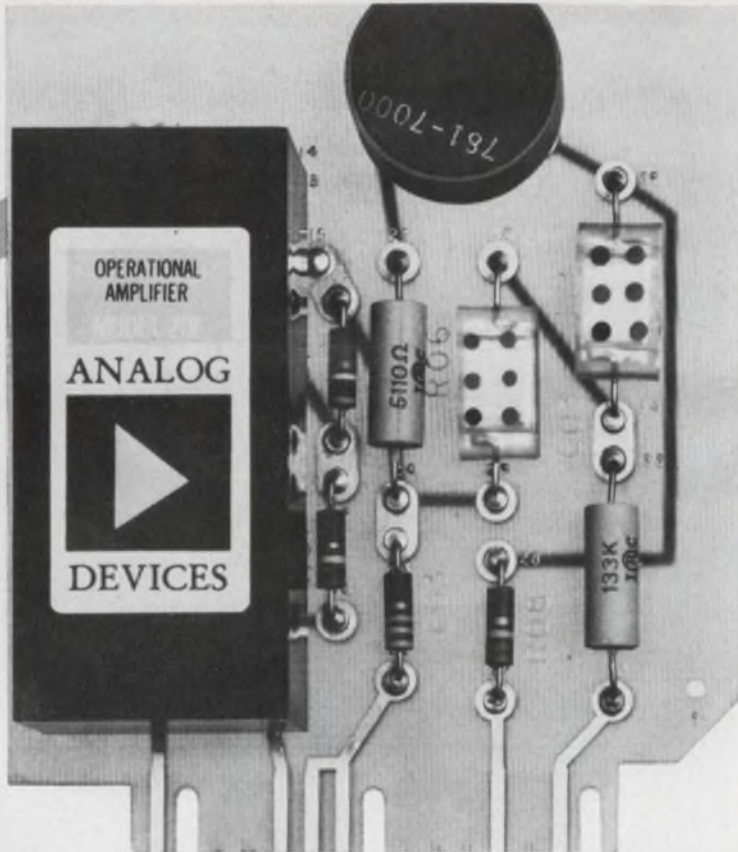

New operational amplifier with 10^9 gain and

DRIFT - $0.2 \mu\text{V}/^\circ\text{C}$
SIZE - 3 Cu. In.

Mounts alongside the summing components on your P-C board

What's more, current drift for Models 201, 202, and 203 is only $0.5 \text{ pa}/^\circ\text{C}$. . . a thousandfold improvement over conventional P-C mounting op amps. What a marvellous amplifier for integrators and other low-level input applications! Owing to the extremely low initial offsets, you can often dispense with the external offset potentiometer (and the time required to adjust it).

Although these amplifiers are chopper-stabilized types, each built-in chopper operates from the amplifier's $\pm 15 \text{ VDC}$ supply, thereby eliminating a common source of AC noise pickup. In addition, an internal $0.5\text{-}\mu\text{sec}$ overload recovery network saves the user the trouble of providing his own recovery circuit . . . and removes the possibility of degrading drift specs in the process.

All three amplifiers have short-circuit protection, low drift, fast slewing, and $\pm 11\text{-volt}$ output in common, but each Model has one or more characteristics deliberately enhanced. For example, Model 201 develops 100 ma continuous output, Model 202 has 10 Mc bandwidth, and Model 203 is designed for low $10 \mu\text{V}$ -peak noise level.

SPECIFICATIONS (Model 202)	
Min. DC Gain	180 db
Max. Voltage Drift	$0.2 \mu\text{V}/^\circ\text{C}$ $1.0 \mu\text{V}/\text{day}$
Max. Current Drift	$0.5 \text{ pa}/^\circ\text{C}$
Max. Initial Offset	$\pm 20 \mu\text{V}$, 50 pa
Bandwidth	10 Mc
Output	$\pm 11 \text{ Volt}$ 20 ma
Price (1 - 4)	\$235

APPLICATION MANUAL—Write for free Application Manual on operational amplifier theory and usage. We'll also send you data sheets on our complete op amp product line.



See us at the IEEE SHOW, Booth 4M19

ANALOG DEVICES, INC.

221 Fifth Street, Cambridge, Mass.

Phone 617/491-1650

ON READER-SERVICE CARD CIRCLE 48

COMPONENTS

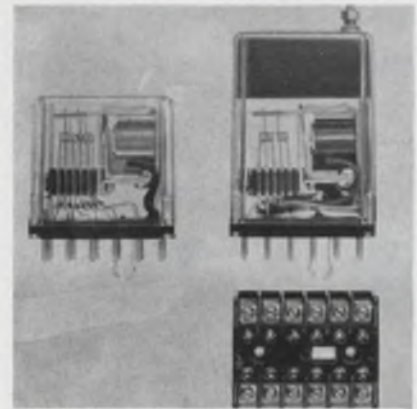

Plug-in relays

Bulletin 114 multi-pole plug-in relays come in three types: time delay, latching, and multi-pole/multi-purpose. The modular relays are guaranteed for 10 million operations. Measuring $2\text{-}19/32 \times 1\text{-}15/32 \times 2\text{-}5/8\text{-in.}$, and encased in Lexan, the relays are applicable to a variety of industrial control circuit uses.

Relay contacts are rated at 10 amps, 115 Vac. Standard coils are rated to 230 Vac.

Ward Leonard Electric Co., Mount Vernon, N. Y. Phone: (914) 664-1000. TWX: (914) 699-4997.

Circle No. 269



8-day timer

Model 4651 Magnetic sequence timer is designed for undersea operation. After eight days, this timer emits a signal—such as needed to separate an undersea buoy from its anchor, and eight hours later, another contact closes—to shut off all power, for example.

Output relay contact rating is 2 amps at 28 Vdc, the unit weighs 600 grams, and the black anodized aluminum case measures $4 \times 3\text{-}1/2\text{-in.}$

C & K Components, 103 Morse, Newton, Mass. Phone: (617) 926-0800. TWX: (617) 924-7970.

Circle No. 270



Voltmother

This self-calibrating system can tend your entire brood of dc voltage sources and measuring devices—with 5 ppm accuracy.

Our new 1045A DC Voltage Measuring System is designed to serve as your final authority on voltages ranging from above 1100 volts down to less than a volt. This range used to require two or more separate instruments.

The system's accuracy—5 ppm with 7 place resolution—is the best you can get. For all this range and accuracy, you don't have to be a fuss-budget with the 1045A. Even a fledgling technician can fly with six-place accuracy.

No external calibration is required to verify the system's accuracy. It functions as a voltage comparator, comparing voltages to saturated reference standard cells. As an added safeguard, the voltage of the standard cells is continuously monitored during the measurement.

Think of the many voltage devices used in your plant or lab that you rely on for consistently accurate readings: decade power supplies, potentiometric and digital volt-

meters, X-Y Recorders, pH meters, thermocouples, electrometers, reference voltage power supplies...

If the behavior of any of these instruments is open to question, consider how they might respond to the discipline of a good Voltmother. ESI, 13900 NW Science Park Drive, Portland, Oregon (97229).

The ESI 1045A Voltage Measuring System combines a direct-reading potentiometer, direct-reading standard cell comparator, and guarded voltbox. Price: \$4,200

	1000V	100V	10V	1V	0.1V
Limit of Error at Specified Voltages (in ppm)	11.7	4.1	3.6	4.6	21
Probable Error* (in ppm)	2.6	0.9	0.8	1.0	4.7

*At least one-half of all measurements will be more accurate than the probable error.

Electro Scientific Industries **esi.**



what gives?

less than 1/1000 of an inch!

That's why our line of Palomar Accelerometers is your best choice for military and aerospace applications.

Fast response, accuracy and reliability are key features.

The heart of the Palomar Accelerometer is a tiny jewel-pivot pendulum captured in a magnetic field. So sensitive that the smallest hint of a change in velocity causes it to send out a corrective signal; maximum pendulum movement is less than 1/1000 of an inch.

United Control Corporation offers an entire family of these closed-loop, servoed acceleration transducers. Choose from types to measure either angular or linear acceleration... analog or digital output... fluid or electronically damped.

For the solution to your acceleration measurement problem for instrumentation or control, call or write UCC. "Control" is our middle name.

UCC UNITED CONTROL CORPORATION

Overlake Industrial Park, Redmond, Wash. 98052
Phone 206-885-3711 or TWX 206-999-1874

ON READER-SERVICE CARD CIRCLE 50

COMPONENTS

Temp sensing resistors

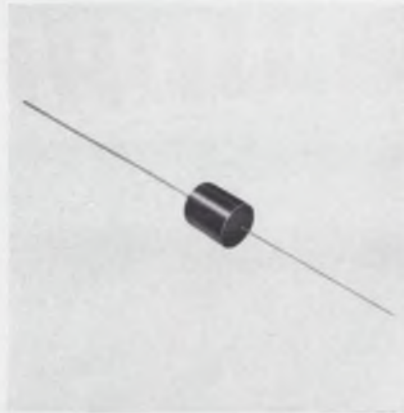

A miniature temperature sensing resistor has a temperature coefficient of 4500 PPM/°C. It is suggested as a replacement for silicon resistors. Any value between 1 ohm and 5 K, can be ordered in this type SM-04 TS resistor. The unit is rated at 0.04 watt, and measures 0.09 x 0.150-in. long.

P&A: about \$1.00 per hundred; 2 weeks. Riedon Division, On Mark Engineering, 11728 Vose, N. Hollywood, Calif. Phone: (213) 875-0610.

Circle No. 271

Differential amplifier

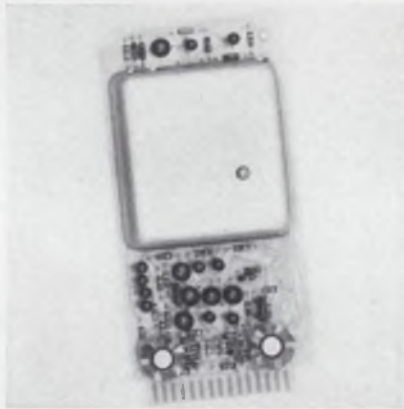

Model AD20 all-silicon amplifier provides dc gain of 2×10^5 and unity crossover at 5 MHz, for use in operational or potentiometric amplifier circuits. Full-scale output is ± 20 V, up to one watt at currents up to 100 mA. Output slewing limit is better than 15 volts per μ s. Input offset voltage has a stability of 2 μ V per °C.

Price: \$203 each, 10-29. Newport Laboratories, P. O. Box 2087, Newport Beach, Calif. Phone: (714) 646-9295.

Circle No. 272

Modular ladder networks

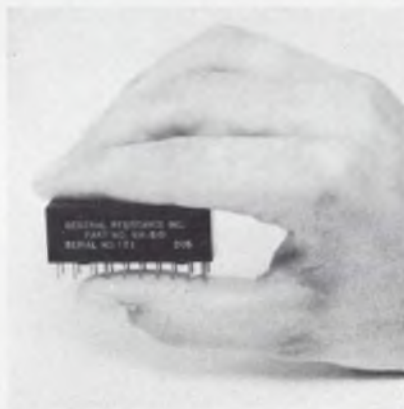

A series of miniature plug-in ladder networks use wirewound, film, and integrated components to achieve accuracy of better than half the least significant digit in ladders up to 14 bits. Response time is better than 1 μ s.

Each network is accompanied by a digital tape confirming its conversion accuracy.

General Resistance, Inc., 430 Southern Blvd. Bronx, N. Y. Phone: (212) 292-1500.

Circle No. 273

Switch systems

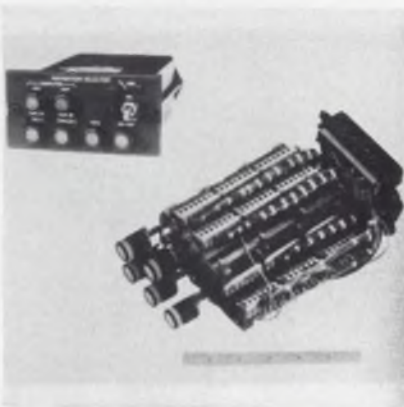

Control-panel mounted push-button switches replace relays or multiple displays, thus conserving space. The system design allows fewer display instruments, and selection of navigation equipment by priority, first pilot/copilot, then navigator—with each knowing what gear is on the line. It actuates up to 24 switch contacts simultaneously. Contacts carry up to 2 amps.

Transco Products Inc, 4241 Glencoe Ave., Venice, Calif. Phone: (213) 391-7291.

Circle No. 274

**In 1939,
Julius Schmidt
made
this
electric
toothbrush.**

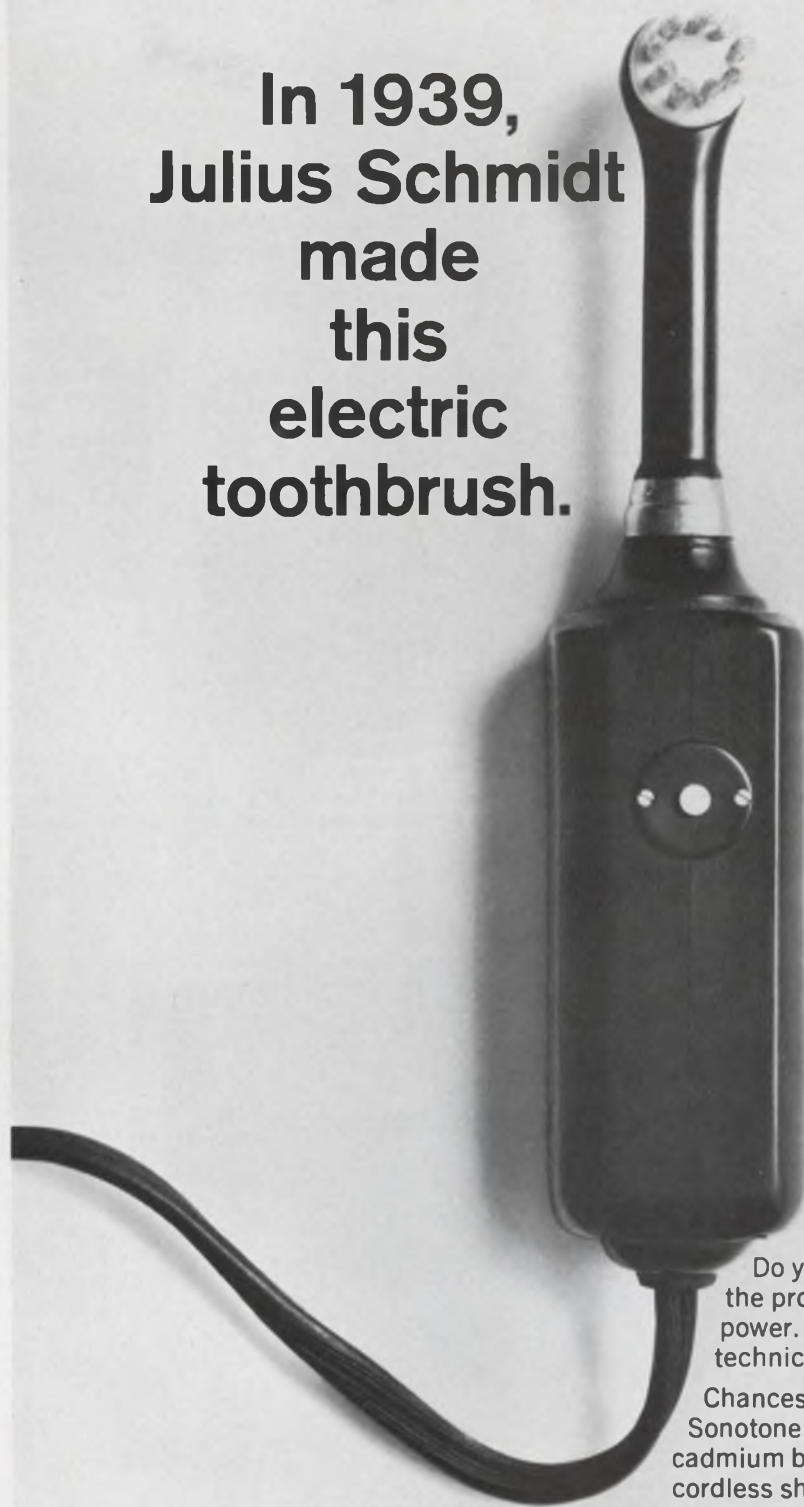

**Don't make
the same
mistake
he did.**

His mistake? He shelved his idea after listening to short-sighted criticism. ("Foolish!" "Kid's toy!" "Never sell!")

So his electric toothbrush went unpatented and unproduced.

Twenty years later, the power toothbrush was an overnight success. Sonotone, pioneer in the development of rechargeable batteries, helped make this possible.

Do you have a "foolish" product idea? Perhaps the profitable difference is Sonotone cordless power. Call us in. Give us all the necessary technical data and we'll dig right into it.

Chances are we'll come up with something. After all, Sonotone makes rechargeable sintered-plate, nickel-cadmium batteries for everything from Titan rockets to cordless shavers. This experience equips us to handle any special problem. Your special problem.

Please don't be shy about asking for help. Remember Julius Schmidt!

Sonotone Batteries  [®]
portable power for progress

Speed Inquiry to Advertiser via Collect Night Letter
ON READER-SERVICE CARD CIRCLE 51

Electrochemical timer



An electrochemical timer that weighs about 2 grams and sells for as little as \$14.85 is designed to meet the specifications of MS 90386 (WP). The unit consumes only 50 mW of power compared to 1.5 to 4 W for previous devices filling a similar need. The qualifications of MIL-I-81219 are met. Indication of current is provided by the transfer of mercury across an electrolyte gap.

Curtis Instruments, Inc., 351 Lexington Ave., Mount Kisco, N. Y. Phone: (914) 666-8051.

Circle No. 275



Rocker switches

Rocker-type switches in five circuit arrangements (spst, spdt, dpst, dpdt, and 2-circuit) have a snap-in mounting feature. These switches have silver-plated contacts and no exposed metal parts. Two and three-position types, with either maintained or momentary contacts are available. They are UL and CSA approved with ratings up to six amps, 125 Vac, and 0.5 amp at 30 Vdc.

Cutler-Hammer, 4201 N. 27, Milwaukee, Wis. Phone: (414) 442-7800.

Circle No. 277

High-Q inductors

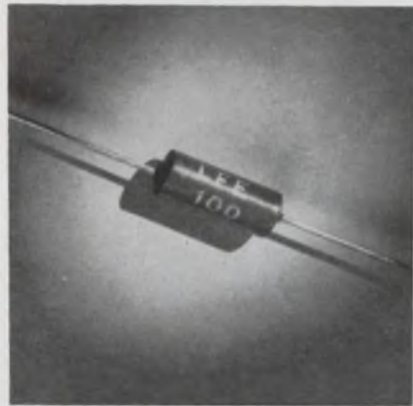

The "Micro-Red" subminiature shielded inductor in the envelope size 0.335-in. long by 0.125-in. diameter was specifically designed for high-density circuitry.

The unit has exceptional Q values, ranging from 40 to 85 over the inductance range of 0.10 μ H to 10,000 μ H. It is offered in 61 pre-designed values, and is engineered to meet MIL-C-15305, class 1, grade B.

Available from stock. Lenox-Fugle Electronics Inc., 475 Watchung Ave., Watchung, N. J. Phone: (201) 376-7300.

Circle No. 276

GLOBE

2-speed commercial motor & gearmotor widest exact speed/torque range

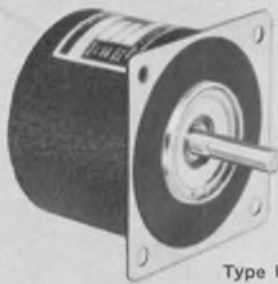

Type UC



Type UCF

Globe's new dual-speed gearmotor package gives you more synchronous speed/torque options than ever before at commercial motor prices.

You get two exact speeds from one hysteresis synchronous motor depending on how the leads are connected. Options of 1, 2, or 3 phase, 2, 4, or 6 pole, give several choices of dual output speeds. Thirteen standard geartrains offer 26 speed/torque options ranging from

0.2 to 10.0 lb. in. continuous torque, and speeds from 600 rpm to .8 rpm.

2-speed induction motors produce different but equally large sets of speed/torque options.

Start with Globe—a reliable prototype and production source—where you can get custom speeds in standard packages. Request Bulletin 4363. **Globe Industries, Inc., 2275 Stanley Ave., Dayton, Ohio 45404, U.S.A., Tel: 513 222-3741.**

Speed Inquiry to Advertiser via Collect Night Letter
ON READER-SERVICE CARD CIRCLE 52

The 4 rectifiers used
in this 10-amp bridge
cost \$4.57* — the bridge
takes 6 minutes to build...

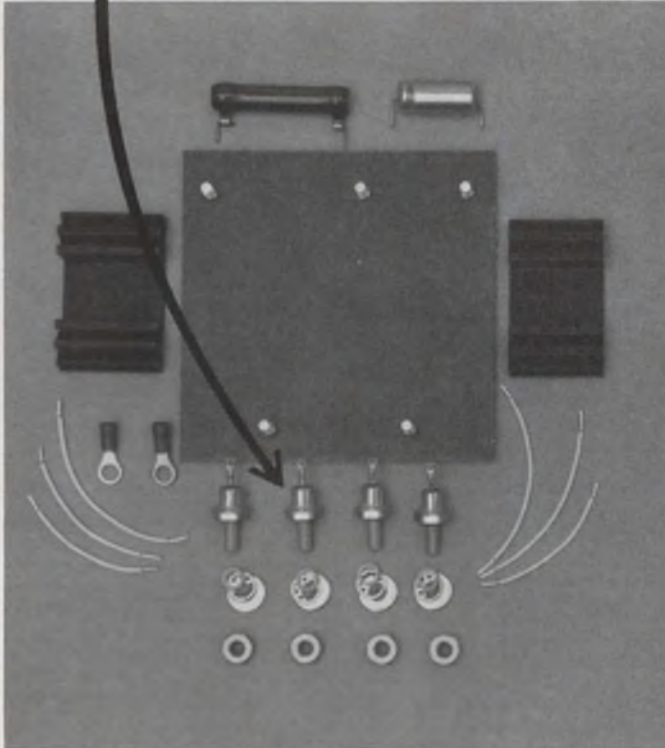

This Motorola 10-amp
bridge costs \$3.65† —
takes only 75 seconds
to install!

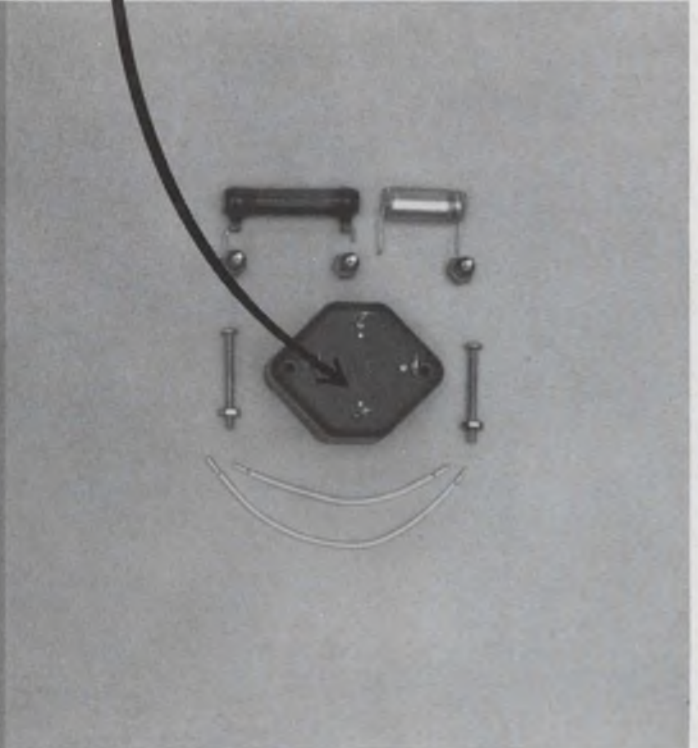

You, too, can simplify your designs, reduce costs and increase the reliability of your circuits with Motorola Molded Rectifier Bridges. They provide these advantages:

■ reduction of assembly-steps by up to 75%. ■ elimination of bridging "heat-sinks", mounting hardware, and intercomponent connections. ■ no dirt and grime-catching corners and crevices common to un-encapsulated or "finned-type" assemblies. ■ 3-step "source-tested" — (1) individual rectifiers tested and matched before assembly (2) bridge assembly tested before encapsulation (3) final molded bridge tested before shipment.

Now, with the addition of the MDA972 series, Motorola offers a complete molded bridge line up to

16-Amps, covering all your applications down to 1-amp, in a variety of case sizes, shapes and terminal configurations.

44 types immediately available in any quantity

- MDA920 series: 1A, 25-600 V
- MDA942 series: 1.5A, 50-600 V
- MDA952 series: 6A, 50-600 V
- MDA962 series: 10A, 50-600 V
- *New* MDA972 series: 16A, 50-600 V

Contact your franchised Motorola distributor now for evaluation units from his "off-the-shelf" stock — determine for yourself how these ready-to-use, easy-to-install rectifier bridges can save you **TIME AND MONEY**.

*Estimated average cost for 4 stud-rectifiers per current major manufacturers' published prices.

†Price for MDA962-3, 200 volts, in 100-up quantities.

POWER UP WITH . . .

MOTOROLA Semiconductor Products Inc.

BOX 955, PHOENIX, ARIZONA 85001

Speed Inquiry to Advertiser via Collect Night Letter
ON READER-SERVICE CARD CIRCLE 53

how to get your Pulse Generator "made to order" from TI



"Special" Pulse Generators are made to order at TI. Modular construction allows assembly of the right building blocks to meet your requirements. Now, "specials" cost you no more, frequently cost less than conventional pulse generators.

For example, the 6613 is an economical general-purpose unit with PRF from 15 cps to 15 mc, priced at only \$950. Another model, the 6325, is a ten-channel, word-bit programmable unit operating up to 25 mc. The single unit does the job of ten discrete generators, at half the cost, and fits in a cabinet 23 in. wide, 38 in. high, 18 in. deep.

TI Pulse Generators give you outstanding performance: PRF's to 100 mc, fast rise and fall times, variable pulse width and delay, variable rise and fall times, plus and minus outputs, pulse mixing, programmed and random word generation. You have your choice of portable or rack-mounting cases.

When you need special pulse generator performance, choose one of the thousands of standard pulse generator combinations from Texas Instruments. For more information, contact your nearest TI Authorized Representative or write to the Industrial Products Group in Houston.

INDUSTRIAL
PRODUCTS
GROUP



TEXAS INSTRUMENTS
INCORPORATED
P. O. BOX 66027 HOUSTON, TEXAS 77006
118 RUE du RHONE GENEVA, SWITZERLAND

ON READER-SERVICE CARD CIRCLE 54

COMPONENTS

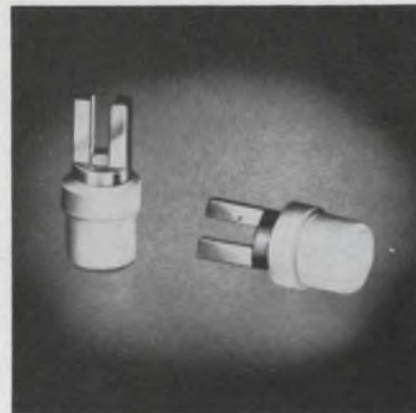

Slotted terminals

A subminiature Press-Fit stand-off incorporates a slotted terminal to aid in soldering leads. Designated ST-SM-750 SL, the terminal has a Teflon bushing with a major diameter of 0.172-in. and is designed for insertion into chassis of 0.085-in. maximum thicknesses. Bushings can be supplied in any of the 10 EIA colors for coded installations.

Sealectro Corp., 225 Hoyt St., Mamaroneck, N. Y. Phone: (914) 698-5600. TWX: (710) 566-1110.

Circle No. 278

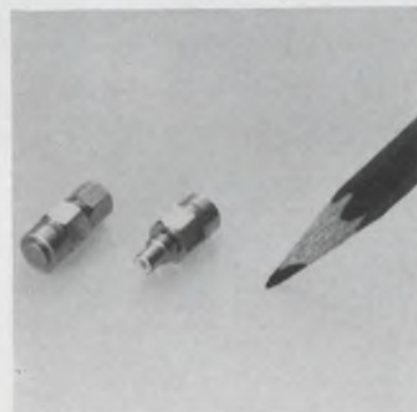

Coaxial terminations

Coax connectors of the 60-001-0000 line are designed to mate with any standard MIL-C-22557 components. The screw-on connector provides a vswr of 1.1 from dc to 4 GHz and is specified for operation from dc to 12.4 GHz with a max vswr of 1.20. The units are also available in snap-on, slide-on and screw-on jack configurations. They are said to reduce residual errors in testing applications.

Sealectro Corp., 225 Hoyt St., Mamaroneck, N. Y. Phone: (914) 698-5600. TWX: (710) 566-1110.

Circle No. 279

New low-cost Daystrom Model 333 commercial trimmer has knurled finger-tip adjustment knob. It also has an Allenhead for fine adjustment . . . 4 to 1 ratio, nominal. Designed for PC board use, it requires approximately 1/2 cubic inch of space. Price is another unusual feature—only \$1.45 in 100 lot quantities!

Model 333's unique resistance element is the same as used in MIL-type Squaretrim® pots for high resolution, linearity, and low noise. Also,

it is vibration and shock resistant.

This is just one of the special-purpose Daystrom units—from industry's broadest line of subminiature square-trimming potentiometers. Chances are that we can fill your most exacting requirements with a standard, off-the-shelf model.

See your Weston distributor for catalog, prices and evaluation units. **Weston Instruments, Inc., Archbald Division, Archbald, Pennsylvania 18403. Phone: (717) 876-1500.**

From Weston's broad trimmer line



actual size



Model 333 — 1/2" by 3/8" by 3/8". Dual adjustment: knurled finger-tip knob and Allenhead. For PC board mounting. Resistance: 50Ω to 10k, up to 50k on special order. Rating: 0.2w @ 40°C in still air.

Series 200 — 3/8" Square-trim, 0.150" thick, slotted or Allenhead adjustment screws. This is only one of a full line of 3/8" pots. Operation: from -55 to 150°C. Resistance: 10Ω to 50k. Rating: 1w @ 50°C in still air.

Only Weston's exclusive wire-in-the-groove offers **LOCKED-IN LINEARITY**

let your
fingers
do the
trimming

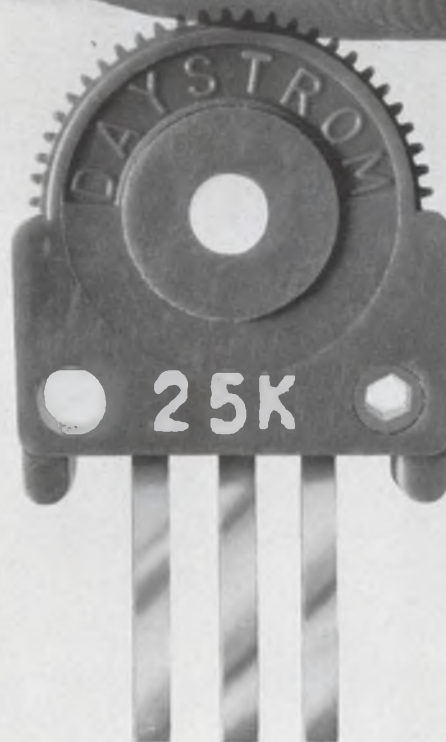

WESTON® prime source for precision... since 1888

ON READER-SERVICE CARD CIRCLE 55

LOOK TO



**FOR TEMPERATURE
MEASUREMENT
TAILORED
TO YOUR
NEED**

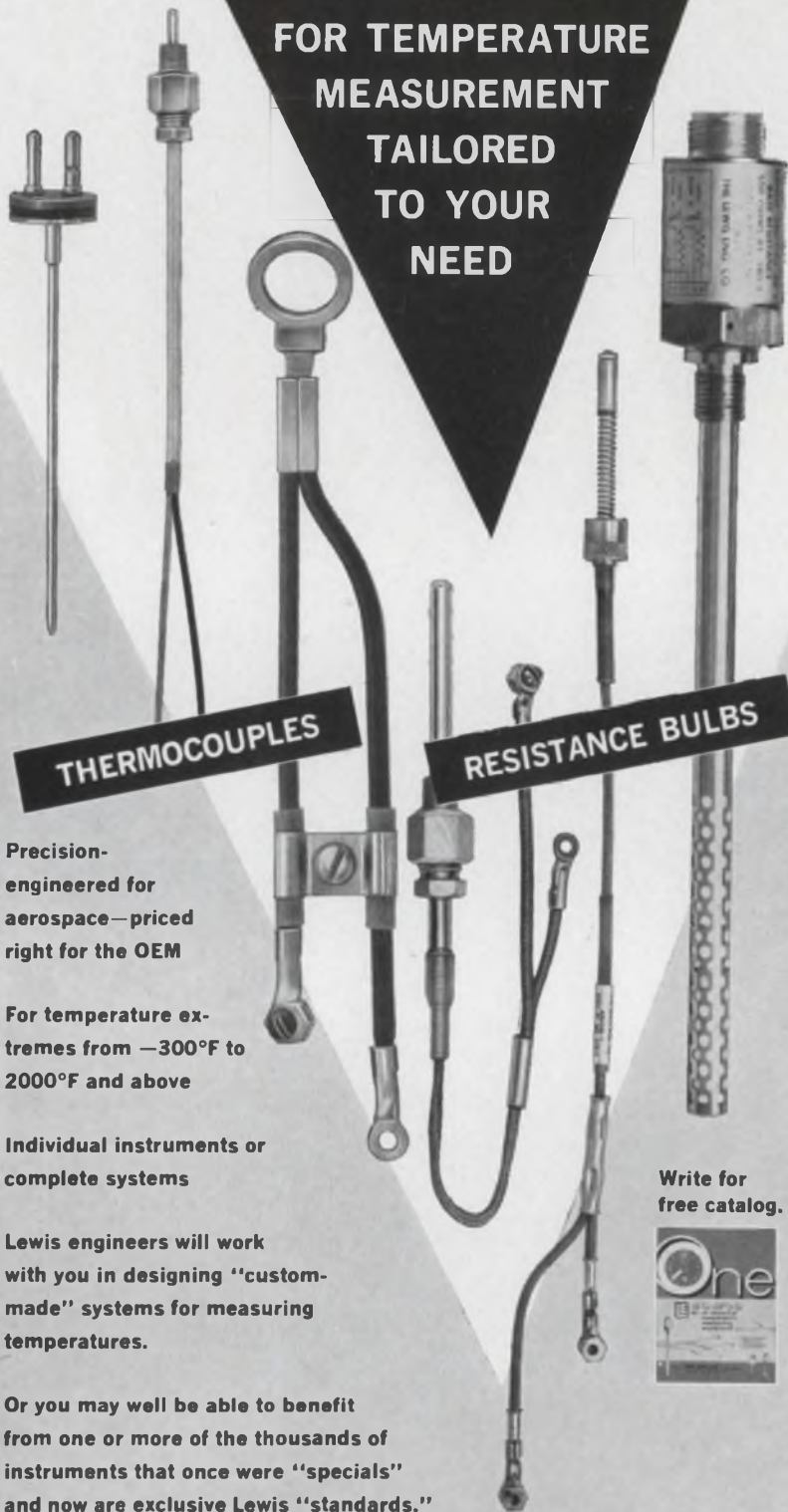

THERMOCOUPLES

RESISTANCE BULBS

Precision-engineered for aerospace—priced right for the OEM

For temperature extremes from -300°F to 2000°F and above

Individual instruments or complete systems

Lewis engineers will work with you in designing "custom-made" systems for measuring temperatures.

Or you may well be able to benefit from one or more of the thousands of instruments that once were "specials" and now are exclusive Lewis "standards."

Write for free catalog.



THE LEWIS ENGINEERING COMPANY

Naugatuck, Connecticut

Lewis—custom producer to industry and aircraft of electrical temperature measuring instruments and systems... high temperature thermocouple and extension wire... and multi-conductor cables.

ON READER-SERVICE CARD CIRCLE 56

COMPONENTS

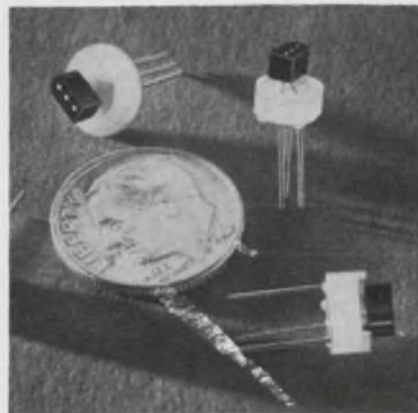

Transistor pads

New additions to the Transpad transistor mounting pad line include nylon pads for the recently introduced three-inline plastic molded transistors. Mounting to three holes at 90 degrees is aided by the #10170 and 10171 for 0.100 and 0.200-in diameter circles respectively. The 10218 accomplishes automatic lead conversion to TO-5 configuration. All are molded of natural-color nylon stock.

Milton Ross Co., 511 Second St. Pike, Southampton, Pa. Phone: (215) 355-0200.

Circle No. 280



Pressure transducer

Designated series 2201, a new instrument in the Teleflight line of pressure transducers is designed for airborne and ground support applications. The 2201 has a hysteresis error as low as 0.05% and a repeatability error less than 0.05%. The sensing element is four active 350-ohm foil strain gages in a Wheatstone bridge. Ranges are 200 to 5000 psis or psia.

Price: From \$350. Taber Instrument Corp., 107 Goundry St., North Tonawanda, N. Y. Phone: (716) 694-4000.

Circle No. 281

If you work with AC--work with ACton

PRECISION PHASE MEASUREMENT



PRECISION PHASE METER 329-B. Delivers almost unlimited use and application flexibility in measuring phase directly 0° - 360° full scale; twelve 30° scales for precision reading. Frequency range 30 cps-500kc. Three standard plug-in modules: Buffer amp—accuracies up to $\pm 0.5^{\circ}$; Hi-gain preamp-1mv sensitivity; Precision phase shift generator. Special plug-ins available. All solid state.



PRECISION DIGITAL PHASE METER 331. Large, four-digit presentation provides direct reading 0° - 360° to accuracy of $\pm 0.5^{\circ}$. Frequency range, 30cps-40kc. Provisions available for printer output, AC and/or DC outputs for voltmeter reading. Inputs directly usable, 0.2-150 volts. Solid state throughout.

PRECISION DELAY MEASUREMENT



PRECISION DELAY SET 460. Separate transmitter and receiver facilitate either open or closed loop uses. $\pm 5\mu s$ accuracy 0-4ms, in each of twenty $200\mu s$ ranges. Standard carriers 0.5-50kc, others available. Applicable to telephone and data transmission lines, filters, networks and many communications systems. Solid state throughout.



PRECISION DELAY EQUALIZER 475-A. Six cascadable modules each provide 0-2.5 ms of delay equalization and a series total of 15ms, continuously adjustable. Six standard frequencies are 1kc, 1.4kc, 1.6kc, 2.0kc, 2.4kc and 2.8kc. Others on special order. Applicable to most compensation requirements; ideal companion to 460-A Delay Set above.

PRECISION STANDARDS, ANALYZERS



PRECISION PHASE STANDARD 70N0. Self-calibrating instrument provides accuracy of $\pm 0.03^{\circ}$ in continuously variable phase settings 0° - 360° . Up to twelve standard crystal controlled frequency selections, 30cps-50kc; others available. For the comprehensively planned laboratory or standards department in calibrating all types of phase devices and instruments. All solid state.



RAYSPAN SPECTRUM ANALYZER SERIES 100. Real-time analysis of all types of physical, doppler and medical signals with analysis bandwidths to 100kc. Utilizes 100, 250 or 500 magnetostrictive filters with selectable 3db bandwidths. Up to 100,000 samplings per second; preserves all spectral events as they occur. Chart type recording illustrated; scope accessories equally applicable. All solid state.



... AND MAKING NEW HISTORY IN SCIENTIFIC INVESTIGATION • ELECTRON MICROPROBES, FAR INFRARED SPECTROMETERS. **ACton starts with AC.** If you work with it, call us.

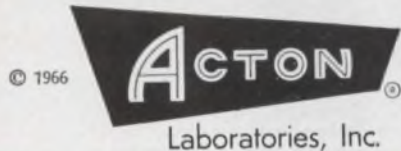

531 Main Street • Acton, Massachusetts
a subsidiary of BOWMAR INSTRUMENT CORPORATION

ON READER-SERVICE CARD CIRCLE 57

Sankyo Micro Motors and Time Switches...

guaranteed for reliable performance, uniformity and long life

TIME SWITCHES

Used with electric washing machines, dish washers, battery chargers, electric fans, refrigerators, etc.



DFC Automatic defrosting timer for refrigerator

60-U 60 minute spring wound remote control switch



DFS 4 Combination thermostat timer for automatic defrosting of refrigerator

MICRO MOTORS

Used for tape recorders, 8mm movie cameras, record players, shavers, electronic machines, etc.

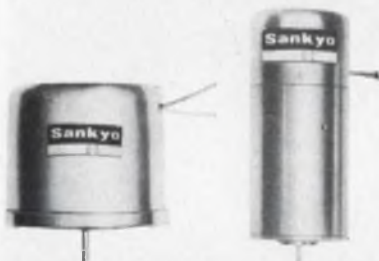

DMT1, DMY15, DMY50 MMS44, MMS51

SPECIFICATIONS FOR SANKYO MICRO MOTORS

	ϕ (mm)	Range of Voltage (V)	Rated Torque (g-cm)	Rated Speed (rpm)	Load Current (mA)	Starting Torque (g-cm)
DM11	42-37	4.5-6	9	2400	130	25-4.5V
DMY15	42-37	4.5-6	15	2400	200	50-4.5V
DMY50	42-37	6-12	25	2400	130	50-8V
MMS44	25-55.5	6-10	10	3000	140	20-6V
MMS51	25-55.5	4.5-6.3	7	2900	140	25-4.5V
MMP55	20-45	4-6	10	2900	290	60-4.5V
MM26	16-29	4-6	2	1750	120	15-4V

Sankyo

AMERICAN SANKYO CORP.

Rm. 808-10, 95 Madison Ave., N.Y.C.

Tel: LE-2-8020

SANKYO EUROPE

c/o DEUTSCHE MITSUBISHI, Dusseldorf

Zimmermann-Str. 6, West Germany

SANKYO SEIKI MFG. CO., LTD.

Shimbashi, Tokyo, Japan

COMPONENTS

Oscillators for ICs

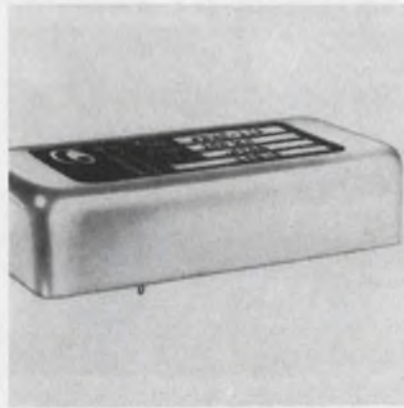

The FD41 series of oscillators are designed for use with integrated circuits. Operating voltages range as low as 3 Vdc with oscillator stabilities as high as $\pm 0.015\%$. Unit temperature range is 0° to 60°C at frequencies from 1 Hz to 50 MHz. Output voltage is 3.5 to 4 V square wave with less than 20 nsec rise or 1 to 2 V sine wave with a distortion of less than 5%.

P&A: \$87.50-\$227.50; 4-5 weeks. Accutronics, Inc., 12 South Island, Batavia, Ill. Phone: (312) 879-1000. *Circle No. 282*

2.5 MHz crystal

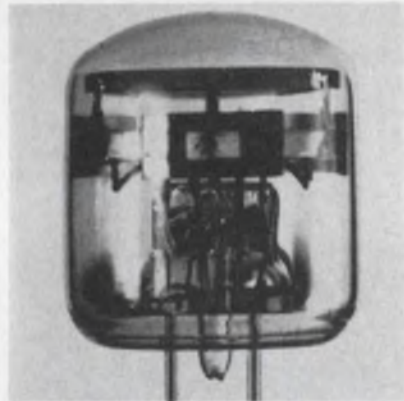

Operating at the fifth overtone, a 2.5 MHz precision crystal is suitable for use in secondary frequency standards. After 21 days, stability is 0.5×10^{-9} per day. Stability is effected less than 1×10^{-7} by a shock of 30 G's for 11 ms. Drive level is 50 to 75 μs and the unit's operating temperature range is $+42^\circ$ to $+57^\circ\text{C}$.

Availability: 8-10 weeks. CTS Knights Inc., Sandwich, Ill. Phone: (805) 786-2141. TWX: (805) 786-2130. *Circle No. 283*

Insulating wafers

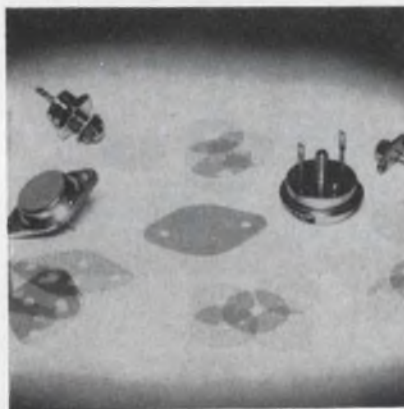

Pre-punched mica or Teflon wafers are available for insulating a transistor body from the heat sink. They are offered in configurations to fit all transistor base sizes. The relatively low thermal gradient of thin layers of mica or Teflon is said to give electrical isolation with little effect on heat transfer from transistor case to chassis.

P&A: \$8.00-\$50.00/thousand; 3 weeks. Perfection Mica Co., 1322 N. Elston Ave., Chicago, Ill. Phone: (312) 384-2122. *Circle No. 284*

Coax connector

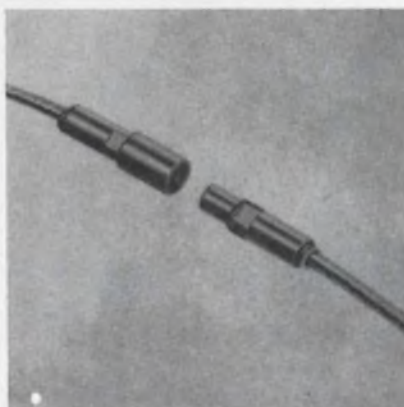

Protected spring fingers that cannot be over deflected is the leading feature of a new line of push-on coaxial connectors. The MD series are also said to be interchangeable with other competitive connectors now in use. Other features include collet-cable grip, crimped or soldered center contacts and provisions to avoid cold-flow trapping of a mating pin.

Tynax Engineering Co., 31 East Santa Clara St., Arcadia, Calif. Phone: (213) 445-2920. *Circle No. 285*



**Why sacrifice high speed
for low power in aerospace systems?**

**You can get both
in Signetics SE 400 series
integrated circuits.**



**Signetics SE 400 series provides:
40% to 70% less power consumption than comparable devices while
maintaining equal or greater speed and noise immunity,
50% reduction in flip-flop can-count with a new dual binary,
off-the-shelf delivery**

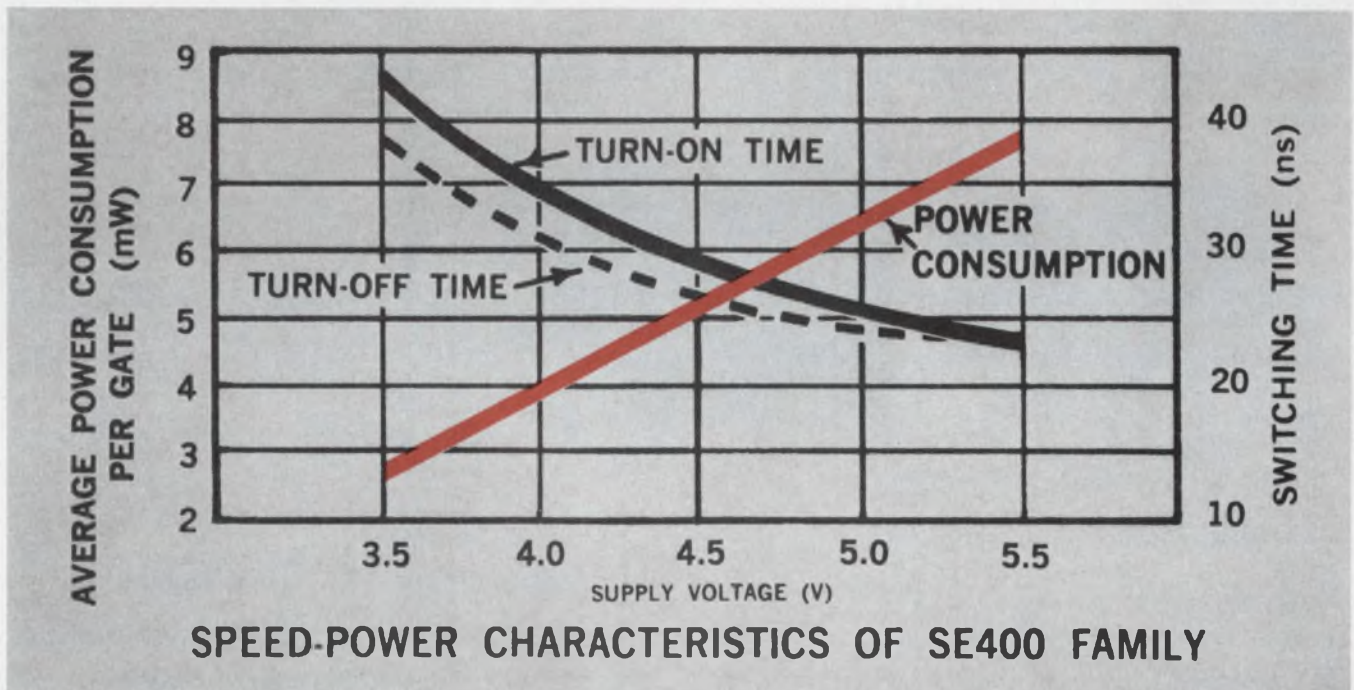

This family of four full MIL range integrated circuits features a dual 5 Mc Binary element operating on less than 9 mW per flip-flop. Like the other members of the family, it was designed for maximum speed consistent with low power operation. The

family is intended for use in applications where high density packaging and the ability to drive high capacitances associated with multilayer printed circuit boards are important considerations. For complete data and specifications, write today.

SIGNETICS INTEGRATED CIRCUITS

A subsidiary of Corning Glass Works,
811 East Arques Avenue, Sunnyvale, California
Tel.: (408) 739-7700 TWX: (910) 737-9965



Signetics SE 400 series elements include a Low Power Dual AC Binary, a Dual NAND Gate, a Dual Driver-Buffer, a Quad NAND Gate.

ON READER-SERVICE CARD CIRCLE 59

ELGENCO Noise Generators



Model 610A

SOLID STATE NOISE GENERATORS

Model 602A 5 cps to 5 mc, 3 Ranges \$ 290
Model 603A 5cps to 5 mc, 3 Ranges \$ 495
Model 610A 5 cps to 5 mc, 8 Ranges \$1,175
Series 624 (Fixed frequency) 5 cps to 500 kc
\$245 to \$490. Write for details on frequency ranges and spectral flatness.



Model 312A

VACUUM TUBE NOISE GENERATORS

Model 301A DC to 40 cps \$1,995
Model 311A Two outputs DC to 40 cps and 10 cps to 20 kc \$2,395
Model 312A Two outputs DC to 120 cps and 10 cps to 20 kc \$2,495
Model 321A DC to 120 cps \$2,095
Model 331A 10 cps to 20 kc \$1,275

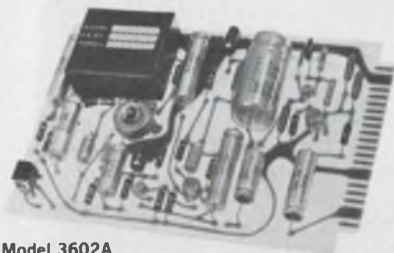

Model 3602A

NOISE GENERATOR CARDS

Series 3602, 3603, and 3606 \$144 to \$389
 Various frequency ranges and output flatness available. Size: 4½" x 6½" x 1". Write for details.

ENCAPSULATED NOISE SOURCE MODULES

Series 1602, 1603, and 1606 . \$95 to \$340
 Various frequency ranges and output flatness available. Size: 1¾" x 1½" x ¾". Write for details.

ELGENCO INCORPORATED



1550 Euclid Street
 Santa Monica, California
 Phone: (213) 451-1635
 TWX: (213) 879-0091

For a more complete listing, write for our short form catalog.

ON READER-SERVICE CARD CIRCLE 60

COMPONENTS

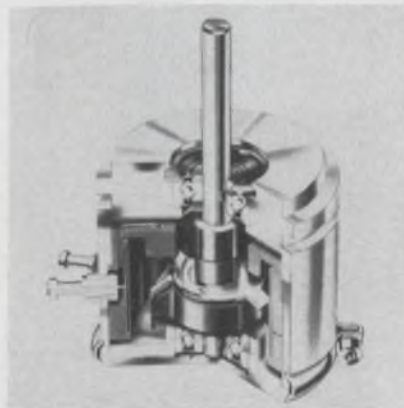

Mil-spec potentiometers

The requirements of MIL-R-12934D, RR0900 are met by the 2540 series potentiometers. The new servo-mounted pots offer a $\pm 0.5\%$ independent linearity and are gangable up to six units. Using a dual contact wiper design, they will withstand up to 50 G's shock. Power rating is 1.25 watts at 85°C. Resistances range from 10 ohms to 100 K.

Amphenol Controls, 120 S. Main St., Janesville, Wis. Phone: (608) 754-6616. TWX: (608)653-8321.

Circle No. 286

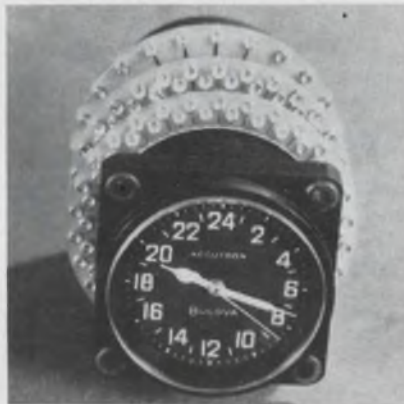

Self-powered timer

A modular digital-output timer is self-powered by a 1.3-volt mercury cell that lasts for a minimum of one year. Accuracy is guaranteed to ± 2 seconds per day. The basic timer module weighs about three ounces and is provided with electrical contacts rated at 25 mA at 28 Vdc. The timer can provide contact closures for any second, minute, hour or day in any combination.

Basic units priced from \$455. Bulova Watch Co., Inc., Bulova Park, Flushing, N. Y. Phone: (212) 335-6000. TWX: (212) 672-0344.

Circle No. 287

NEW FET OPERATIONAL AMPLIFIERS from BURR-BROWN

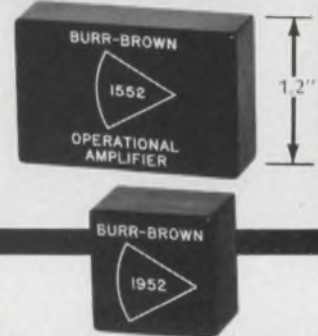

These new general purpose dc operational amplifiers employ matched junction FETs in the balanced input stage to achieve high input resistance and unusually low drift. Designed for ± 10 volt service, units have an operating temperature range of -40 to $+85^\circ\text{C}$. Model 1552 is supplied in a modular 1.8" x 1.2" x 0.6" package. Model 1952, designed for high density applications, is 1.0" x 1.0" x 0.7". Units are priced at \$145 and \$165.

	1552	1952
Input Impedance		
Differential	$10^{10}\Omega$	
Common Mode	$10^{10}\Omega$	
Voltage Gain	106 db	
Bandwidth @ 0 db	1.5 Mc/s	
Maximum Frequency for rated output	100 Kc/s	
Input Voltage Drift	$\pm 5 \mu\text{V}/^\circ\text{C}$	
Input Current Offset @ 25°C typical	$\pm 0.1 \text{ nA}$	
Input Current Drift	(offset doubles every 10°C)	

Two additional new FET amplifiers (Models 1553 & 1953) are also offered by Burr-Brown. Performance is similar to above except isolated-gate FETs are used to achieve $10^{12}\Omega$ input impedance with corresponding changes in offset and drift characteristics.

FOR COMPLETE TECHNICAL INFORMATION write, wire, or phone Burr-Brown, today.

BURR-BROWN

RESEARCH CORPORATION
 INTERNATIONAL AIRPORT INDUSTRIAL PARK
 BOX 11400, TUCSON, ARIZONA, 85706
 PHONE: 602 294-1431 • TWX: 910-952-1111

Speed Inquiry to Advertiser via Collect Night Letter

ON READER-SERVICE CARD CIRCLE 61
 ELECTRONIC DESIGN

MICROWAVES

Phase-shift circulators

Two new S-band differential phase-shift circulators provide maximum insertion loss of 0.5 dB and isolation of 20 dB minimum. The 30 Mw CSH32 operates 2.6 to 3.1 GHz with a maximum vswr of 1.15. The similar CSH24 operates 2.8 to 3.2 with a vswr of 1.2. Average power for the two units is 30 and 32 kW respectively based on a 2:1 mismatched load. Waveguide for both is RG-48/U.

Raytheon Co., 130 Second Ave., Waltham, Mass. Phone: (617) 899-8400. TWX: (617) 894-8591.

Circle No. 288

Frequency extender

A YIG-tuned frequency extender covers the 1 to 4.5 GHz range in two bands. The unit, designated FE 1-4.5 converts the input signal to a 60 MHz IF. Tuning is said to be re-settable to $\pm 0.5\%$. It uses its own YIG preselector to track across the range, avoiding mechanical drive and an image rejection of 70 dB min.

P&A: \$8500; 30 days. Communication Electronics Inc., 6006 Executive Blvd., Washington Science Center, Rockville, Md. Phone: (301) 933-2800. TWX: (301) 365-8667.

Circle No. 289

Ku-band circulator

A lightweight, differential phase-shift circulator provides protection of Ku band airborne radar systems. Average power is 100 watts and peak power 100 kilowatts across the CKuH5's frequency range of 15.9 to 17.1 GHz. Isolation is 30 dB or more, while insertion loss does not exceed 0.4. Maximum vswr is 1.15. The CKuH5 has UG541/U flanges and mates with a RG-91U waveguide.

Raytheon Co., Special Microwave Devices Operation, 130 Second Ave., Waltham, Mass. Phone: (617) 899-8400. TWX: (617) 894-8591.

Circle No. 290

VACUUM+ CERAMIC

RF10A



RJ2A



RJ1A



JENNINGS TYPE

Operating Voltage (16 mc)
Test Voltage (60 cycle)
Continuous Current (16 mc)
Interrupting Rating
(dc resistive loads)
Weight (oz.)

RF10A

10 KV Peak
20 KV Peak
30 Amps RMS
50 KW
(up to 5 amps or 10 KV)
16

RJ2A

8 KV Peak
18 KV Peak
15 Amps RMS
1 KW
(up to 1 amp or 1 KV)
3

RJ1A

2 KV Peak
5 KV Peak
7 Amps RMS
1

Vacuum plus ceramic adds up to a new line of Jennings vacuum relays that brings you (1) High voltage hot switching capability (2) Highest RF current carrying ratings (3) Shock resistance (4) Small size and light weight (5) Greater reliability (6) Low unchanging contact resistance.

These new relays eliminate the necessity to redesign circuits in order to avoid difficult switching problems. Now small lightweight systems can be designed in the sure knowledge that the new Jennings vacuum relays offer as much as or more reliability and high performance than any other component in the circuit.

The RF10A relay features high power dc interrupting capability up to 50 KW.

The RJ2A and RJ1A are essentially rf relays capable of withstanding high voltage and carrying high rf currents. Even so the RJ2A will interrupt a rather remarkable 1 amp at 1000 volts for many thousands of operations.

Jennings also offers many glass vacuum relays, each designed to provide maximum performance to the particular segment of the electronic field for which they were created.

Our new catalog 102 describing our complete line of vacuum relays is available at your request.

Jennings Radio Manufacturing Corporation — Subsidiary of International Telephone and Telegraph Corporation, 970 McLaughlin Avenue. P. O. Box 1278 San Jose, California 95108.



DUAL OUTPUT POWER SUPPLIES

**Guaranteed
3-DAY
Shipment!**



Dual output power supplies are housed in one case 3-5/16" x 4-5/32" x 4-11/16" high. Identical or different output voltages from 1.5 to 75 are available in 1 volt increments for each of the DC outputs. The graph below furnishes maximum current corresponding to output voltage. Select the two outputs needed and telephone Acopian for all the details — plus guaranteed 3-day shipment after receipt of your order.

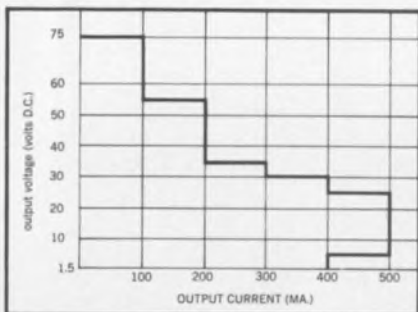

TYPICAL SPECIFICATIONS

Input Voltage: 105 to 125 VAC

Line Regulation: ± 0.5 to $\pm 0.05\%$
(depending on model)

Load Regulation: ± 1.0 to $\pm 0.05\%$
(depending on model)

Ripple: 5 to 1 mv (depending on model)

No additional external
heat sinking required.

Write for Acopian's 16-page catalog and price list to: Acopian Corp., Easton, Penna., or call collect (215) 258-5441.

Acopian

ON READER-SERVICE CARD CIRCLE 63

MICROWAVES

Klystron oscillators

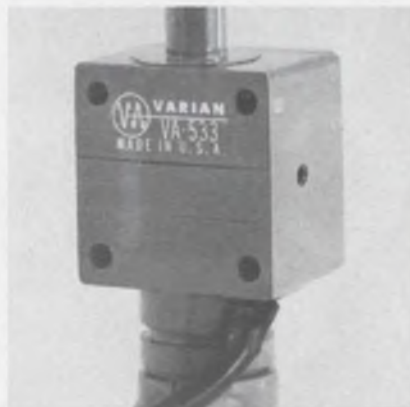

Designed primarily for pumping parametric amplifiers, the VA-533 two-cavity klystron oscillators are capable of providing 1 to 10 watts at any fixed frequency from 12.4 to 18 GHz.

These conduction-cooled units are also suitable for applications in doppler systems and for use in test-set power-sources.

P&A: \$2,000 or less; 60 days. Varian Associates, 611 Hansen Way, Palo Alto, Calif. Phone: (415) 326-4000.

Circle No. 291

Microwave attenuators

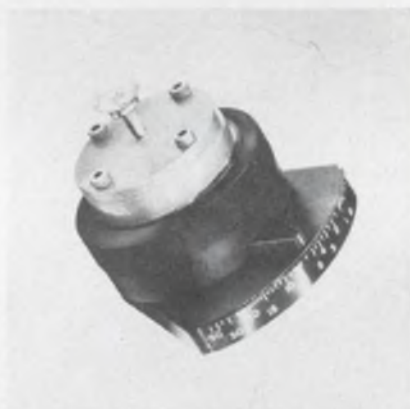

A line of semi-precision attenuators covers a full waveguide band with an 0-50 dB range. Called Model 511, these units have RF sections identical to the manufacturer's precision 510 series.

They provide flat attenuation proportional to the \cos^2 of the angle of rotation of the center circular sections. Accuracy is 5% or 0.25 dB across the 12.4 to 140 GHz region.

TRG, Control Data, Route 110, Melville, N. Y. Phone: (516) 531-0600.

Circle No. 292

Shielded BWO



Designated the WJ-2004, an X-band BWO features unsaturated magnetic shielding in a compact package measuring 2 x 2 x 6-in. Performance exceeds the environmental requirements of MIL-E-5400, Class II. Weight is under two pounds. It covers the frequency range of 9.5 = 13.0 GHz with a minimum power output of 10 mW.

Watkins-Johnson Co., 3333 Hillview Ave., Palo Alto, Calif. Phone: (415) 326-8830. TWX: (910) 373-1253.

Circle No. 293

Microwave reflector



The TM series of reflectors are tower-mounted flat units for periscope use to 13 GHz. The enclosed reflector panel is fabricated of solid aluminum, without perforations. A modified gimbal mounting structure (Omni Mount) is used. Five models are available with sizes from 4 x 6 feet to 12 x 17 feet. All mount to a 4-1/2-in. pipe or directly to tower members.

Microflect Co. Inc., 3575 25th St. SE, Salem, Oregon. Phone: (503) 363-1128.

Circle No. 294

EASTMAN 910® Adhesive...

bonds steel-to-phenolic-to-ceramic in minutes

In the manufacture of Motorola's lightweight Handie-Talkie radios, a miniature phenolic insulator is quickly bonded to a steel chassis with one drop of EASTMAN 910 Adhesive. Another drop of this versatile adhesive is then used to secure a tiny ceramic potentiometer to the plastic. Farther along the assembly line coil forms and plastic bushings are secured in place with clear, thin EASTMAN 910 Adhesive without danger of plugging adjacent terminals or through-holes. (Bonds remain intact through 5 seconds' immersion in molten solder at 475°F.)



bonds with almost any kind of material. Without heat, solvent evaporation, catalysts or more than contact pressure, this clear, thin adhesive forms strong bonds between well-mated surfaces in seconds to minutes. Try it on your toughest jobs.

For technical data write to the Chemicals Division, Eastman Chemical Products, Inc., subsidiary of Eastman Kodak Company, Kingsport, Tenn. EASTMAN 910 Adhesive is distributed by Armstrong Cork Company, Industry Products Division, Lancaster, Pa., and Loctite Corp., 705 N. Mountain Road, Newington, Conn.

EASTMAN 910 Adhesive will form

Here are some of the bonds that can be made with EASTMAN 910 Adhesive

Among the stronger: vinyls, phenolics, cellulose, polyesters, polyurethanes, nylon; steel, aluminum, brass, copper; butyl, nitrile, SBR, natural rubber, most types of neoprene; most woods. Among the weaker: polystyrene, polyethylene (shear strengths up to 150 lb./sq. in.).



- SETS FAST**—Makes firm bonds in seconds to minutes.
 - VERSATILE**—Joins virtually any combination of materials.
 - HIGH STRENGTH**—Up to 5,000 lb./in.² depending on the materials being bonded.
 - READY TO USE**—No catalyst or mixing necessary.
 - CURES AT ROOM TEMPERATURE**—No heat required to initiate or accelerate setting.
 - CONTACT PRESSURE SUFFICIENT.**
 - LOW SHRINKAGE**—Virtually no shrinkage on setting as neither solvent nor heat is used.
 - GOES FAR**—One-pound package contains about 30,000 one-drop applications. (Or in more specific terms, approximately 20 fast setting one-drop applications for a nickel.)
- The use of EASTMAN 910 Adhesive is not suggested at temperatures above 175°F., or in the presence of extreme moisture for prolonged periods.

See Sweet's 1966 Product Design File 8a/Ea.

Now available! EASTMAN 910 Surface Activator
When certain surface conditions inhibit rapid bond formation, use of EASTMAN 910 Surface Activator is recommended to restore the rapid polymerization of EASTMAN 910 Adhesive.

ON READER-SERVICE CARD CIRCLE 64

**YOUR
SHORTEST
ROUTE**

to what's new in Semiconductor Coolers WAKEFIELD DISTRIBUTOR PRODUCTS CATALOG

The latest designs in Heat Sinks are as near as your nearby authorized WAKEFIELD Electronic Distributor. His name is in our catalog along with the full line he stocks: milliwatt to high power coolers, circuit board coolers, extrusions, thermal joint compound, DELTA BOND 152 Thermally Conductive Adhesive.



NC-680-1.0

FOR YOUR COPY, WRITE

WAKEFIELD
ENGINEERING, INC.

DELTA
DIVISION

139 FOUNDRY ST. / WAKEFIELD, MASS. (617) 245-5900 • TWX 617-245-9213

ON READER-SERVICE CARD CIRCLE 65

February 1, 1966

NEW EASY-TO-TRANSFER

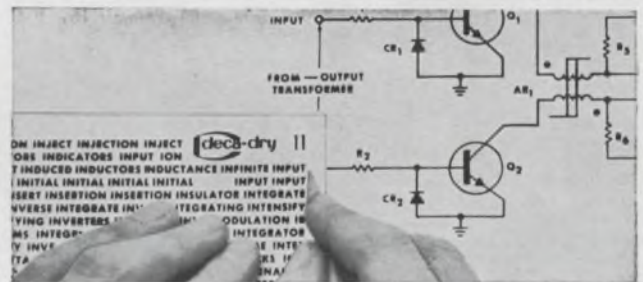

Titles, Codes, Words, Letters, Numbers in Seconds DECA-DRY ELECTRONIC MARKING KIT



Contains hundreds of standard titles, codes, words, letters and numbers in dry transfer form. Rub lightly with a pencil and instantly they transfer onto prototypes, control panels, printed circuit masters, schematics, drawings, electrical and mechanical components. Titles appear crisp, sharp, professional giving all drawings and equipment the look of quality printing. Won't move, crack or peel. Produces razorsharp copies in most reproduction processes. Find out more about it! Write today for a free sample.

SEND FOR FREE DECA-DRY SAMPLE



Chart-Pak, Inc.
630D River Road,
Leeds, Massachusetts

Send sample, literature and name of nearest dealer for Deca-Dry Electronic Marking Kit.

NAME TITLE

COMPANY

ADDRESS

CITYSTATE.....ZIP.....

ON READER-SERVICE CARD CIRCLE 66

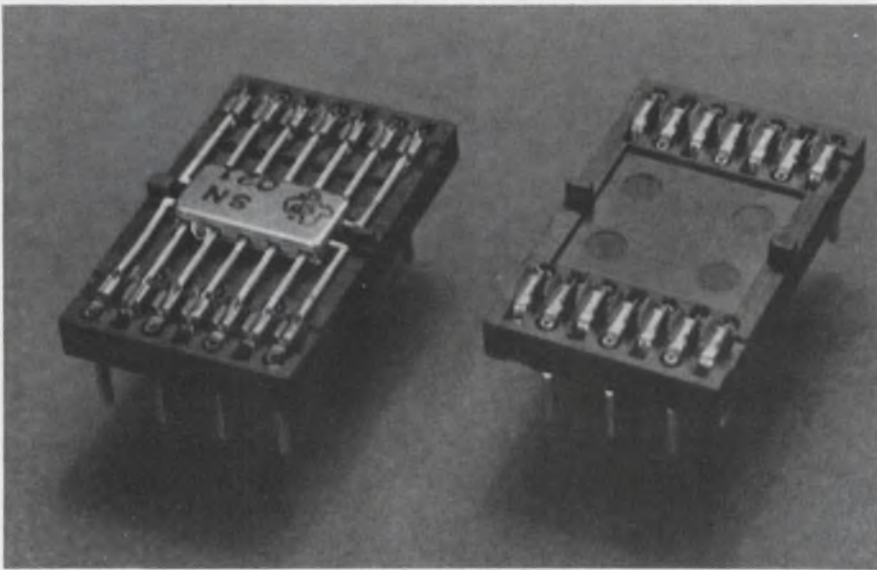

Crimp-type flat pack carriers allow semi-automatic production

There is still no fool-proof "easy" way to mount integrated-circuit flat packs but a new system from Amp, Inc., of Harrisburg, Pa., represents a long step in that direction. Many of the usual handling problems that, in the past, have limited flat pack usefulness are solved by a triple-function carrier and receptacle combination designed for crimped lead connections. The carrier prevents handling damage during production operations, serves as a test fixture for quality control and operational testing, and allows standard production-line connection techniques to be used.

Both speed and economy are cited

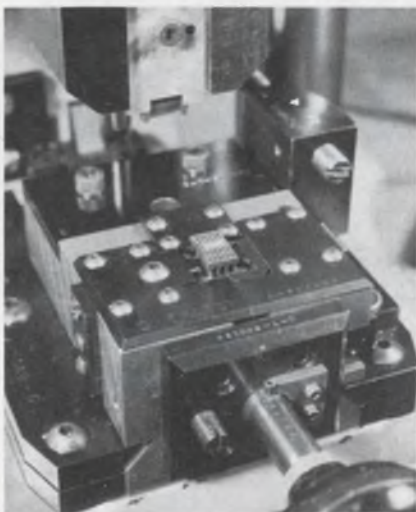

as advantages in this new mounting system. Production rates range up to 100 or more units per hour with a spoilage rate of virtually zero. In one application investigated by Amp engineers, a computer manufacturer was allowing 14 man-hours to mount and interconnect a system comprised of 90 flat-pack devices. Amp estimated that this job could be done in only one hour using their semi-automated system and Termapoint interconnection techniques.

A fully automated flat-pack assembly machine will probably await industry standardization in shipping containers. Some manufacturers now provide disposable carriers but there is no standardization. Some simply ship the devices loose. The new Amp process requires that the device be positioned on the carrier by hand before the assembly is placed on the assembly jig to be crimped. A crimping press is offered on a lease basis and a manual crimping tool will soon be available. Once on the jig, a single stroke crimps up to fourteen leads simultaneously.

From this point in a production schedule, usual modular engineering can be used. After any required testing, the carrier can be mounted directly on a PC board or mated with a special receptacle to

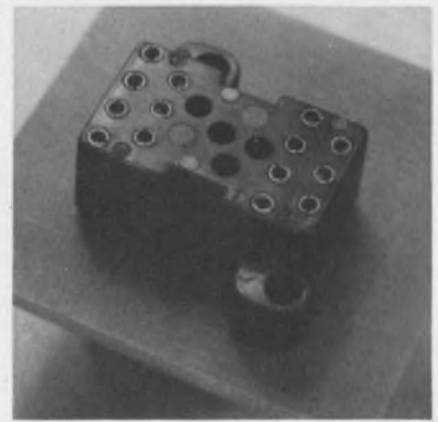

become a 14-pin functional module.

Carrier and receptacle design includes both polarizing and keying posts to make sure that the carrier is mounted in proper phase with the receptacle and that the carrier is plugged into the correct circuit board or receptacle.

Contact material is beryllium copper and the carrier body is of compression molded phenolic.

P&A: \$4-\$5, reducing to half in production lots; 2 weeks. Amp, Inc., Harrisburg, Pa. Phone: (717) 564-0101. TWX: (717) 564-4103.

Circle No. 295

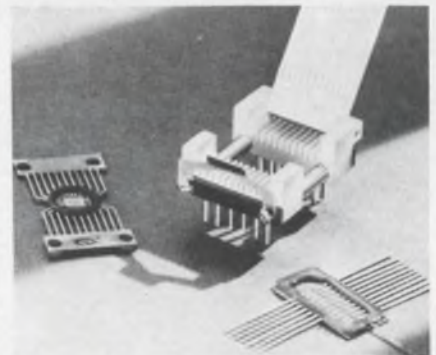

IC flat-pack test socket

A new test socket for integrated circuit flat packs features low capacitance and low contact resistance. High temperature Dialyl insulators permit accurate testing to 220°C. Spring tempered beryllium copper contacts are hard gold-plated over nickel, and are formed to provide wiping action on closing the socket lid.

These sockets accommodate up to 22 leads on 0.050-in. spacing. The design accepts any package size from 1/8 x 1/4-in or larger.

Available from stock. Azimuth Electronics, P. O. Box 463, Denville, N. J. Phone: (201) 361-0085.

Circle No. 296

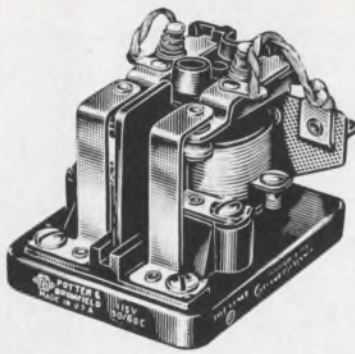

Here's why engineers have specified this heavy duty 25 amp relay by P&B for over 30 years

This is the granddaddy of all P&B relays. Our very first design. Many millions are in use throughout the world . . . starting motors, controlling elevators, switching high current and voltage loads, doing a multitude of heavy duty jobs, reliably. Year after year, the PR Series remains high on our best-seller list. Here are some reasons why.

EXCELLENT CONTACT WIPE ACHIEVED WITH FLOATING CONTACT CARRIER

PR relays are designed with a full floating carrier for the movable contacts. Beside providing sufficient contact pressures, the floating carrier builds-in an abundance of wipe to keep the contacts scrubbed on every operation. Large, $\frac{5}{16}$ " diameter contacts switch 25 ampere non-inductive loads or 1 HP at 115/230 VAC, single phase. A phenolic barrier between the contacts of multipole relays prevent flash-over between contacts.



SELECT FROM A VARIETY OF CONTACT ARRANGEMENTS

PR reliability is available in relays having the following contact arrangements: SPST-NO, SPST-NC, SPST-NO-DB, SPST-NC-DB, SPDT, DPST-NO, DPST-NC, and DPDT. Coil voltages range from 6 to 440 volts A.C., and 6 to 110 volts D.C. A vast number of special variations of these standard parameters have been engineered over the years.



AUXILIARY CONTACTS ADD TO VERSATILITY OF PR RELAYS

A single set of auxiliary contacts (Form A, B or C) can be supplied when the application demands. They are rated at 5 amperes at 115 VAC, 60 cycle resistive. Standard models of PR relays with auxiliary contacts are available from leading electronic parts distributors.

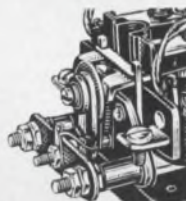

MANY STANDARD RELAYS ARE LISTED BY U/L AND CSA

A wide range of standard PR relays is listed by Underwriters' Laboratories (File E22575) and Canadian Standards Association (File 15734). CSA listing covers AC relays only. These listings can often save you time and extra expense when obtaining UL or CSA qualification for your products.

MAGNETIC ARC-QUENCHERS FURNISHED ON SOME MODELS

For DC loads over 28 VDC, PR relays with normally open contacts can be furnished with permanent magnets to quench arcs. These magnets increase the DC voltage rating to 220 volts resistive . . . and often increase the life of contacts handling DC inductive loads.



PR SERIES SPECIFICATIONS

GENERAL:

- Mechanical Life:** Single-pole, 1,000,000 (cycles); double-pole 10,000,000 (cycles).
- Contacts:** 100,000 cycles at rated load. Contact life increases at smaller loads or with appropriate arc suppression.
- Breakdown Voltage:** 1,500 volts rms minimum between all elements and ground.
- Ambient Temperature Range:**
DC: -55 to +80° C.
AC: -55 to +45° C.
- Weight:** Approximately 10 ozs.
- Pull-In**
DC: 75% of nominal voltage (approx.)
AC: 78% of nominal voltage (approx.)
- Terminals:** Heavy-duty screw type terminals are standard for coil and contacts. Available with printed circuit, plug-in, $\frac{1}{8}$ " quick connect and terminals for rear panel wiring.
- Enclosure:** PR dust cover.

CONTACTS:

- Arrangements:** Up to 2 Form C (DPDT.)
- Material:** $\frac{3}{16}$ " dia. silver standard. Other materials available for special applications.
- Load:** 25 amps non-inductive or 1 HP @ 115/230 volts AC, single phase. Special version—30 amp. non-inductive at 115/230 VAC; single phase available. (Consult factory)

COIL:

- Voltage:** AC: 6 to 440 volts.
DC: 6 to 110 volts.
- Power:** DC: 2.0 watts nominal.
AC: 9.8 volt-amps.
- Resistance:** 63,800 ohms maximum.
- Duty:** Continuous, AC or DC (DC coils will withstand 8 watts @ +25° C.)
- Mounting:** Two $\frac{3}{16}$ " diameter holes on $1\frac{1}{2}$ " centers.

LEADING ELECTRONIC PARTS DISTRIBUTORS STOCK 44 DIFFERENT PR RELAYS

Immediate delivery
at factory prices.

Ask your distributor
for a copy of Stock Catalog 100



POTTER & BRUMFIELD

Division of American Machine & Foundry Company, Princeton, Indiana
Export: AMF International, 261 Madison Avenue, New York, N.Y.

Speed Inquiry to Advertiser via Collect Night Letter
ON READER-SERVICE CARD CIRCLE 67



**LIGHT
TO FIGHT
BY...**

Portable military shelters require a very special kind of interior lighting.

WE MAKE THIS KIND.

Literature on request

BRUCE INDUSTRIES, INC. 1528 West 178th Street, Gardena, California

ON READER-SERVICE CARD CIRCLE 68

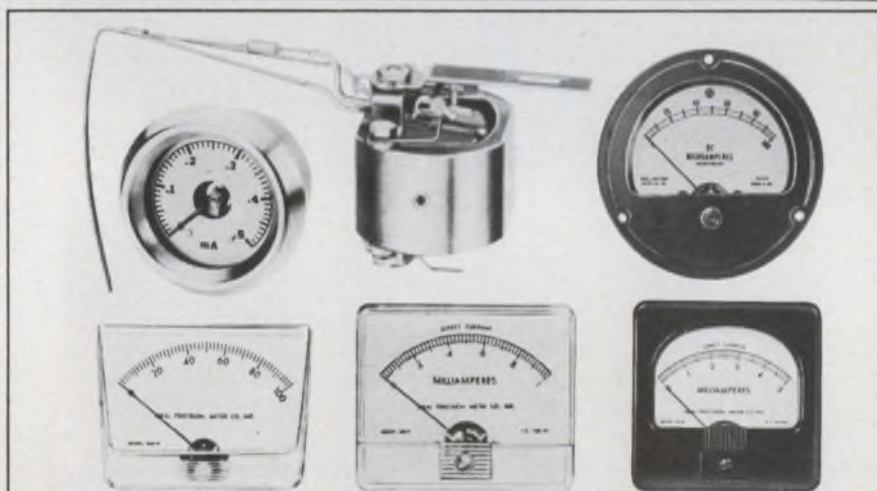

You name the shape, we have it—or we'll make it for you:

For everything in meters you can count on Ideal.

BRAND

Ideal is a specialist's specialist—a complete facility with 100% concentration on meter development and design exclusively. Ideal meters are used by every branch of the Military and by leaders in defense and industry. Whatever you need in meters—ruggedized or commercial, custom and stock, 1/2" to 7"—call Ideal, the proven leader.

Write for free 52-pg. handbook and catalog. Ideal Precision Meter Co., Inc., 218 Franklin St., Brooklyn, N.Y. 11222. (212) EVergreen 3-6904.

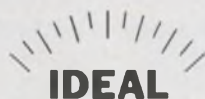

ON READER-SERVICE CARD CIRCLE 69

MICROELECTRONICS

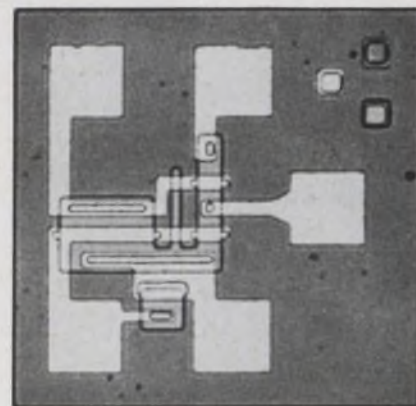

MOS ME family includes 15 units

A group of 15 MOS microcircuits includes a 90-bit shift register with 542 MOSTs on a single chip. Other circuits in the group are a 12-bit shift register, a four-stage binary counter, eight different multiplexer gate devices, a dual full adder, and more in the way of NOR circuits, emitter following drivers, and a new MOST series-shunt chopper.

The 90-bit MEM-4090 operates in computer memory systems at a clock memory frequency up to 1 MHz. It can be operated as two parallel 45-bit delays, or in series for the full 90 bits.

The 12-bit MEM-507 contains the equivalent of 200 MOSTs, and operates at a clock frequency of 500 kHz. The MEM-1050 is a four-stage binary up-down counter with a frequency range from dc to over 1 MHz and an input impedance of 10^{12} ohms. It also contains the equivalent of 200 MOSTs.

The multiplexer gates (MEM 2001 and MEM 5001-5007) are arrays of silicon p-channel, insulated gate enhancement mode FETS.

These units are joined by the less complex dual full-adder MEM-1000, a 3-input and 2-input NOR with buffer (MEM-901), and four emitter follower drivers (MEM-4000). Included in the lot is a new MOST series-shunt chopper (MEM-590).

Prices: (in 50-99 quantities) MEM-4090, \$46.80; (in 100-199 quantities) MEM-507, \$29.60; MEM-1050, \$37.50; MEM-2001, \$23; MEM-1000, \$18.90; MEM-901, \$7.10; MEM-4000, \$5.25; MEM-590, \$25.10. General Instrument Microelectronics Div., 600 W. John, Hicksville, N. Y. Phone: (516) 681-8000. TWX: (516) 433-9162.

Circle No. 297

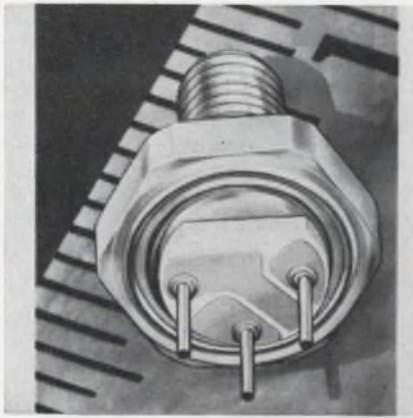

Be-to-metal assemblies

Intended for use in high frequency power transistors, a line of beryllia-to-metal assemblies is offered for a variety of semiconductor packages. Precise metallized patterns for semiconductor devices can be provided with definition between segments as close as 0.010-in. and a flatness of 0.001-in. Leads can be brazed in either radial or vertical configurations.

Advac Products Inc., 174 Richmond Hill, Stamford, Conn. Phone: (203) 325-3881.

Circle No. 298



Slip ring capsule

A subminiature slip ring capsule contains 60 circuits. Only 1.03-in. long by 1.125-in. diameter, the unit withstands shock and vibration in accordance with MIL-STD-202B.

Operating temperature is 0-85°C, non-operating from -55° to +100°C. Dielectric strength is 500 Vac at 60 Hz, insulation resistance is 500 Meg at 500 Vdc, and contact resistance variation (noise) is 15 milliohms. Current capacity is 2 A on 10 circuits, 500 mA on 50.

Electro-tec, Box 667, Ormond Beach, Fla. Phone: (305) 677-1771.

Circle No. 299

CHANGE PROGRAMS IN SECONDS!

NO TOOLS!

NO MEASURING!

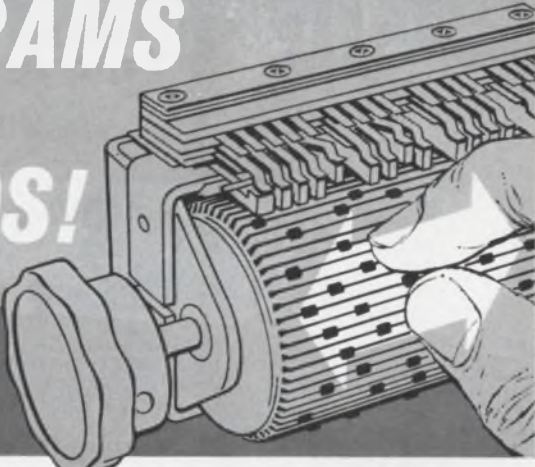

actan field-adjustable programming switches

TYPICAL ACTAN UNITS

BPO16A60MD-60 program positions with **16 controlled circuits for manual operation.** Detent is field removable for in-field motor or solenoid drive installation.



BPO32A60MD-60 program positions with **32 controlled circuits for manual operation.**



BPO19A60T-D-MINI-ACTAN 30 program positions, 19 controlled circuits, and time base, 1 RPM timing motor drive in a package just 5 1/2" x 2 3/4" x 3 1/4". Also offered with 10 contact positions.



BPO48A90T-90 program positions providing 4 1/2° accuracy or resolution at all times. Also available with 120 program positions and 3° resolution.



Actan programming switches offer a degree of versatility far beyond that of any other comparable programming switch and fill virtually limitless control and program application requirements including: sequencing... scanning... timing... code generation... and many more. And, this outstanding versatility is achieved for half the cost and in half the space of comparable devices. Check these features: Field Adjustable without special tools and with 100% reproducibility. Multiple ON/OFF or Cam Functions. Manual or Remote Operation. Pulsed or Time Based Function. 10,000,000 Operations Guaranteed. Transfer Speeds to 50 Milliseconds. Up to 48 Circuit Control in a Single Unit. Contacts Rated for Dry Circuit to 2 Amps, 24 VDC or 115 VAC. Optional U.L. Approved 10 or 20 Amp Contacts for 115 VAC. Many standard units are available from Sealectro Distributors for off-the-shelf delivery. Write for the complete ACTAN catalog.



PROGRAMMING DEVICES DIVISION

SEALECTRO CORPORATION

HOYT STREET • MANARONECK • NEW YORK
PHONE 914 698 5600 TWX: 710-566-1110

Sealectro Ltd., Portsmouth, Hants, England

ON READER-SERVICE CARD CIRCLE 78

1 KC to 600 KC Receiver from CEI



Receives AM, SSB, CW, MCW & FSK with digital frequency display

CEI's new Type 351 receiver covers ELF through MF frequencies, tuning 1 to 600 kc in a single band. Modes of reception include AM, SSB, CW, MCW and FSK, with tuned frequencies shown on a big, bright digital display. For increased versatility four IF bandwidths (150 cps, 1, 3 and 6 kc) can be selected with a front panel control. An input attenuator control (0, -20, -40 and -60 db) is also mounted on the front panel. The Type 351 features low noise, excellent sensitivity and good image and IF rejection. BFO can be adjusted ± 3 kc, while incidental FM is less than 10 cps peak deviation.

Using solid state circuitry throughout (except for the neon display tube), the Type 351 weighs 20 pounds and requires just 3½ inches of rack space. It operates from a standard 115 vac source.

For complete information about this or other CEI products, please write:

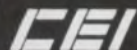

COMMUNICATION ELECTRONICS INCORPORATED

6006 Executive Boulevard, Rockville, Maryland 20852, Phone: (301) 933-2800

ON READER-SERVICE CARD CIRCLE 79

SEMICONDUCTORS

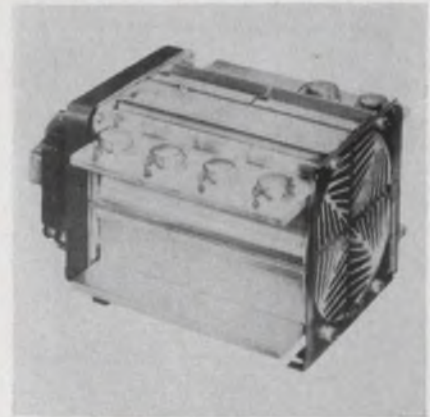

Semiconductor cooler

Series FCA-820 cooling package can accommodate up to 32 semiconductors, or more, if stacked. Increased fan size and a new fin extrusion design are said to increase efficiency.

These packages can eliminate ducting and baffling, and their low thermal resistance can cut down on the number of semiconductors needed in a regulatory circuit.

The units are factory assembled to the specifications. Two module types are available: the 820-A "shelf-type" and the 820-B to provide lower thermal resistance for stud-mounted rectifiers.

Wakefield Engineering, 139 Foundry, Wakefield, Mass. Phone: (617) 245-5900.

Circle No. 351

telephone quality components

There is no higher standard for switching components. Specify famous Stromberg-Carlson . . . known to telephony since 1894.

RELAYS: Types A, B, BB, C and E. All standard spring combinations are available. Send for Bulletin T-5000R3.

KEYS: Broad selection of push-button, cam and twist types. Send for Bulletin T-5002R2.

HANDSETS: High-efficiency instruments; standard or with switch assemblies. Send for Bulletin T-5017R.

Full-line data on request.

STROMBERG-CARLSON

A Subsidiary of General Dynamics

116 Carlson Road • Rochester, N. Y. 14603



ON READER-SERVICE CARD CIRCLE 80

Silicon mesa dice

Silicon mesa passivated dice have electrical characteristics encompassing the entire range of computer, zener, and silicon diode specifications.

Typical sizes are 0.02 x 0.02 x 0.007-in. Recovery and capacitance characteristics less than 2 ns and 2 pfd are obtainable. Dice meet, or exceed MIL-S-19500 and MIL-STD 202. Termination temperatures greater than 350°F will not alter characteristics. Substrate, thin film, and matrix configurations can be engineered.

P&A: \$1.50-\$0.50; stock. Micro Semiconductor Corp., 111250 Playa Court, Culver City, Calif. Phone: (213) 391-8271. TWX: (213) 871-5209.

Circle No. 352

Opens fresh design horizons...

microminiature solid cermet discrete resistor



Explore new design areas with these Ceradot[®] pellet resistor characteristics available only from CTS:

- ⑦ To $\pm 1\%$ tolerance.
- ⑦ 15 watts/cm³ power to size ratio.
- ⑦ Won't short out under any operating conditions.
- ⑦ Extreme stability under extreme environments.
- ⑦ 15 ohms to 200K ohms resistance range.
- ⑦ Not affected by radiation.
- ⑦ Operates at 175°C hot spot without leads.
- ⑦ Available with leads or terminating surfaces for soldering or welding.

Current CTS Ceradot applications include numerous aerospace, military and industrial microcircuits, such as discrete components inside transistor cans and flat packs, microwave loads, temperature compensated transistor circuits, load resistors, etc. How can Ceradot's unique characteristics help solve your design problem?

EXPERIMENT WITH CTS CERADOTS

Designers' Kit contains an assortment of pellet resistors in these sizes: .050" dia. x .030"; .050" dia. x .062"; .100" dia. x .030" and .100" dia. x .062" in random resistance values. Uses: in prototypes, development programs, testing and experimental microcircuits. Kit price \$10.00. Immediate delivery.



CTS CORPORATION
Elkhart, Indiana

Sales Offices and Representatives conveniently located throughout the world.

Principal Products

Variable Resistors
Selector Switches
Loudspeakers
Trimming Potentiometers
Fixed Resistor Micromodules
& Microelectronic Circuitry
Crystals, Filters,
Oscillators & Ovens

Subsidiaries

CTS of Asheville, Inc., Skyland, N.C.
CTS of Berne, Inc., Berne, Indiana
CTS of Paducah, Inc., Paducah, Ky.
Chicago Telephone of California, Inc.,
South Pasadena, Calif.
CTS of Canada, Ltd., Streetsville, Ontario
CTS Microelectronics, Inc., Lafayette, Ind.
CTS Research, Inc., Lafayette, Ind.
CTS Knights, Inc., Sandwich, Ill.

**SOLVE
YOUR
TESTING
AND
PRODUCTION
PROBLEMS**

with **BELL**
**HALL EFFECT DEVICES
AND MAGNETIC FIELD
INSTRUMENTATION**



Model 240 GAUSSMETER

Incremental • Measures One part out of 10,000 resolution • .1 gauss to 30,000 gauss, full scale • Single sensing device • Custom probes.



Model 350 A-C GAUSSMETER

First in direct scale reading to 30,000 cps • For time-varying fields from 10 to 30,000 cps • .1 to 3000 Gauss F.S. • Accuracy +2% • Magna-probe provides 100 Gamma F.S. sensitivity • Selectable high and low pass filters • Provision for spectrum analysis.

Many of our most enthusiastic customers are men who "didn't need" Magnetic Field Measurement or Hall Effect circuitry. Let us show you, too, how profitable these instruments and devices can be!

FW BELL INC.

1356 Norton Avenue
Columbus, Ohio, 43212
Phone (614) 294-4906
TWX 614-759-0193

ON READER-SERVICE CARD CIRCLE 82

SEMICONDUCTORS

Microcircuit transistor

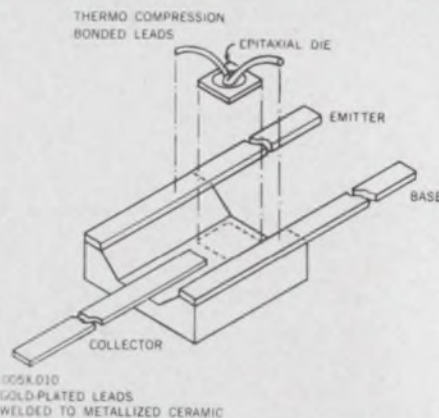

A new double-diffused *npn* silicon transistor is designed for thin-film and other micro-circuit packaging as a vhf-uhf amplifier. Performance figures are 14 dB gain at 450 MHz, noise figure less than 4 dB. Selected versions are available with noise figures down to 2.5 dB at 450 MHz.

Most of the manufacturer's other transistors are also available in the new packaging configuration.

P&A: from \$24.75; 10 days. KMC Semiconductor, Parker Road, R D #2, Long Valley, N. J. Phone: (201) 876-3811. *Circle No. 353*

Volt-variable caps

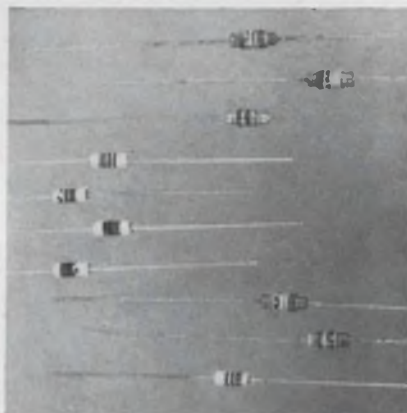

A series of all-epitaxial voltage variable diodes, the Varactron line, includes a total of 299 different devices. These include JEDEC types 1N4786-4815, 1N950-956 and V20G-100G plus the manufacturer's types VG107-339 and VM200-985. All use the P+NN+ construction with dc ratings as high as 150 volts.

P&A: From \$2.00; most from stock. Teledyne Inc., Crystalonics Div., 147 Sherman St., Cambridge, Mass. Phone: (617) 491-1670. TWX: (617) 499-9156.

Circle No. 354

Hybrid SCR bridge

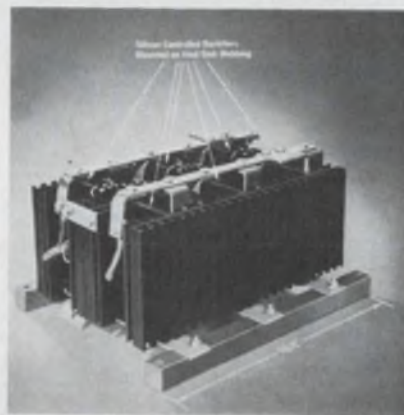

A new hybrid silicon-controlled rectifier bridge assembly for applications in motor controls and ac regulator power supplies functions under a wide variety of adverse environments. The assembly is available in single-phase or three-phase configurations and features outputs which are up to 140 amps and PRV ratings as high as 1.3 kV.

International Rectifier, 233 Kansas St., El Segundo, Calif. Phone: (213) 678-6281.

Circle No. 355

Commercial rectifiers

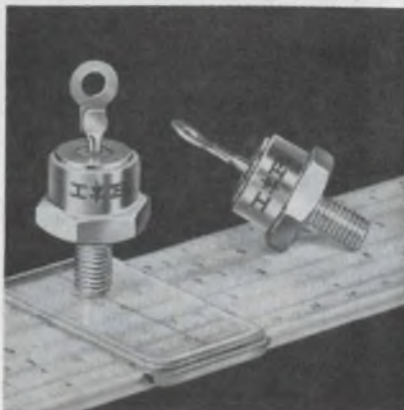

Having a 15 to 40 amp range, the 40HF series of rectifiers are rated from 100 to 400 volts PRV. Standard and reverse polarity, double diffused junction, hermetic sealing and hard-solder assembly are also featured in this series of rectifiers for industrial and commercial equipment. Other applications include battery chargers, motor drives, field control and motor armature control.

International Rectifier, 233 Kansas St., El Segundo, Calif. Phone: (213) 678-6281. *Circle No. 356*

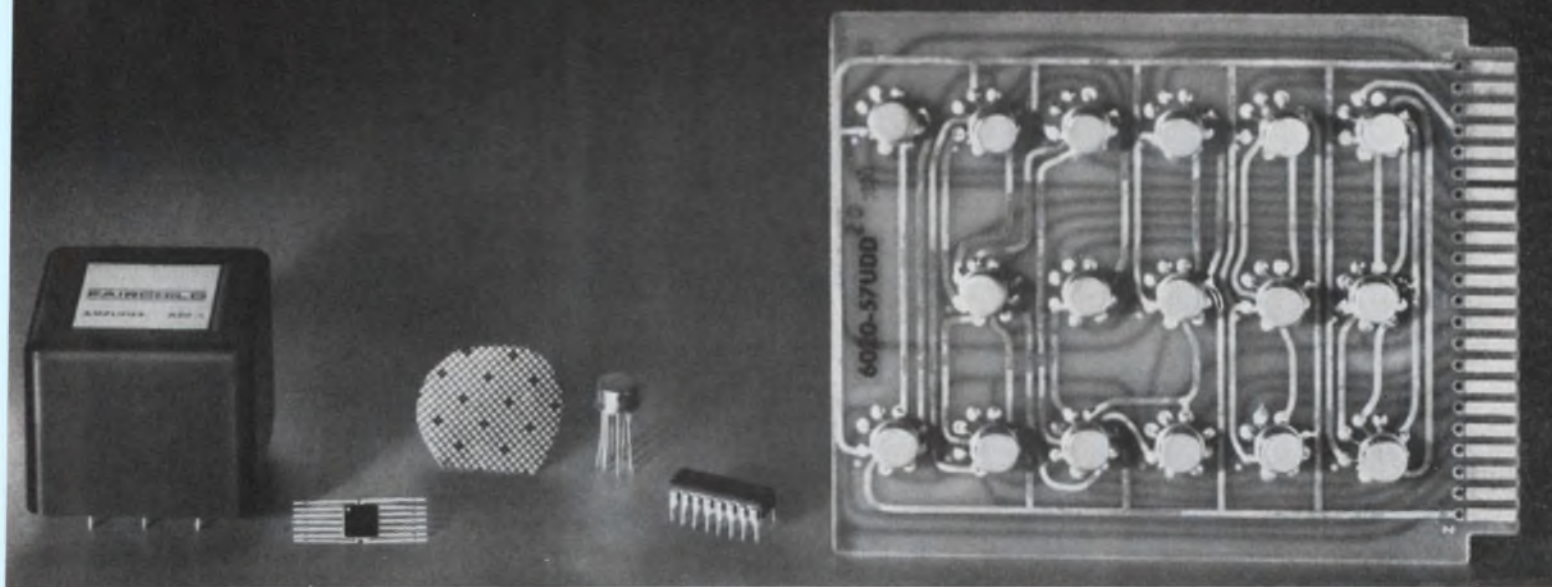

Test all these circuits five ways with one system:



Fairchild Series 4000MA

1. Function Check. Each test sequence includes logic performance check. If the circuit passes, the system will automatically switch to the next test mode.

2. DC Testing. The 4000 makes sixty tests per second with resolution of $\pm 0.1\text{mV}$ and $\pm 0.1\text{nA}$. Readout is Go/No-go with optional direct digital display or data logging.

3. Linear Measurements. The 4000 automatically measures: input offset voltage, input bias current, input common mode rejection ratio, open loop voltage gain, output impedance, output voltage swing, V^+ and V^- supply current, total device power, input common mode ratio, differential volt-

age gain, output common mode voltage, maximum voltage between V^+ and V^- terminals, BV_{CEO} at $10\mu\text{A}$ and up, differential input impedance and open loop voltage transfer function.

4. Switching Time. An automatically programmed switching time option measures storage time; propagation delay; pulse rise time, fall time and width; saturation voltage and pulse height and sag.

5. AC Voltage Measurements. Sinusoidal measurements can be made on a variety of circuits, with $\pm 1\%$ accuracy.

Economical Testing. The simple magnetic disc programming lets an inexperienced

operator switch to 36 different test programs on a single disc in just seconds. This means you can program and test printed circuit cards, integrated circuits, flat packs, dual in-line packs, potted modules and even micrologic wafers at a single test station.

For a complete list of options and the full range of Series 4000 capabilities, get in touch with your nearest representative or write Fairchild Instrumentation.

FAIRCHILD
INSTRUMENTATION

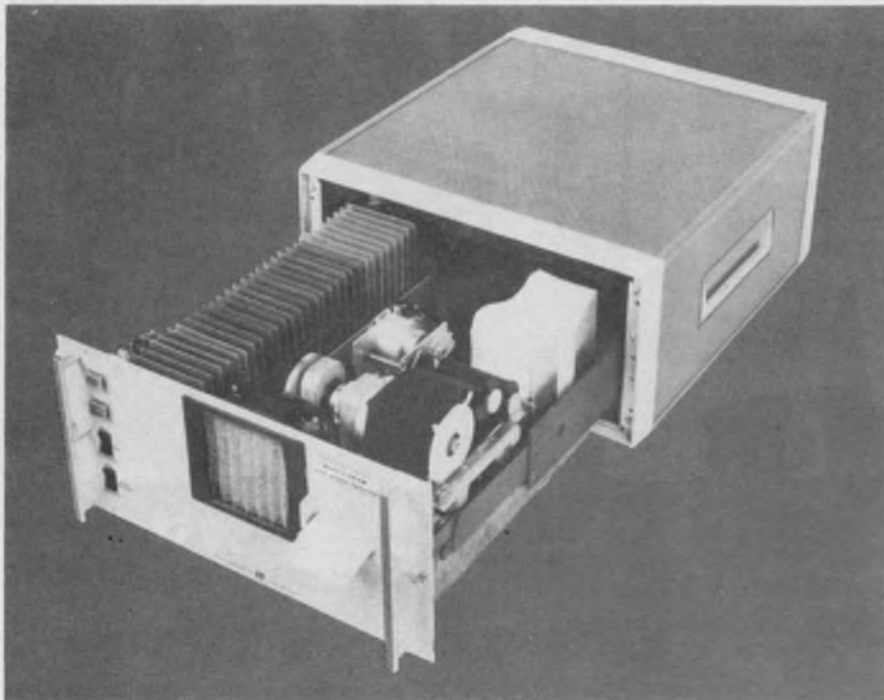

Alphanumeric printer gives 20 lines per second

The new "Minitype" high-speed printer handles up to 48 characters per line, at speeds of 20 lines per second, alphanumeric, or 40 lines per second, numeric.

Developed for the Polaris program, this unit handles telemetry, counter, computer, and similar printouts. It prints on any paper (no cogwheels). The unit accepts binary codes up to six digits with logic levels of any two positive or negative voltages having more than three volts difference.

The 8-3/4-in. high unit can be housed in a 19-in. rack-mount, or in

a table-top cabinet. It has modular solid-state electronics, and carries a one-year unconditional guarantee. Options include decimal point insertion, zero suppression, mixed input codes, special type, and expandable capacity (48 columns max).

Among the machine's points are no loss of speed from multiple-copy printing, and no guarantee voidance if the unit is run without paper.

P&A: 20 col, \$4480; 48 col, \$7280; 60 days. Shepard Labs, 480 Morris, Summit, N. J. Phone: (201) 273-5255.

Circle No. 357

3-lead testing computer

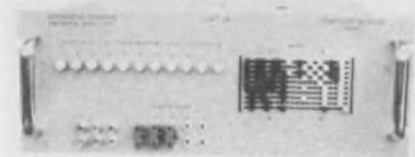

SCAT 26 is a testing computer for all two and three lead semiconductors and components. It makes up to 20 measurements in 400 ms, stores all results, sorts them against its program, and classifies them into 11 matrix categories.

All voltage and current tests, limit, saturation, breakdown, β , leakage, and such things as integrated circuit drain can be made as differential measurements in any order. Current mode, dc, and pulsed dc measurements are made within the range of 1 nA to 1/2 A, 0-300 V.

Applications include quality control, troubleshooting, and inspection.

P&A: \$12,000; 30-60 days. Continental Device, 12515 Chadron, Hawthorne, Calif. Phone: (213) 772-4551.

Circle No. 358



1 Microsec memory

The ICM-40 coincident current, random-access core memory features integrated circuitry, with operating speeds of 1 μ s full cycle, and access time of less than 500 ns.

The 5-1/4-in. high unit mounts in a standard relay rack, and permits word capacities to 16,384. Operating modes include clear/write, read/restore, and read/modify/write cycles, while outputs memory busy, information available, and end-of-cycle. Hold-address control is also available.

Operating ambient temperature range is 0-50°C. Separate power supplies contain power-failure sensing, non-volatile start/shut-down, over voltage, over load, and line-transient protection.

Computer Control Co., Old Conn. Path, Framingham, Mass. Phone: (617) 879-2600. Circle No. 359

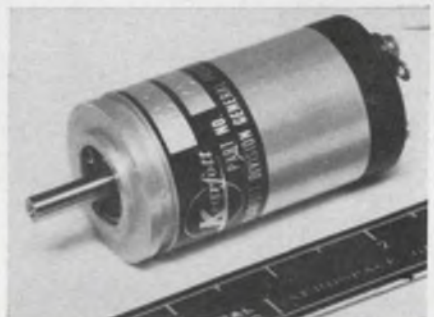

Low ripple dc tach

A size 8 DC tachometer-generator, CMO 9608 001, exhibits little variation in output despite temperature fluctuation. Speed-sensitive output voltage varies less than 0.01%/°C within operating range -54°C to +100°C. Output voltage is 3 v/thousand rpm, with output impedance of 225 ohms. Linearity is 0.5% to 3600 rpm, and bidirectional error is 0.2%. Max speed is 12,000 rpm, friction torque is 0.15 in. oz., rotor moment of inertia is 2 gm cm².

General Precision, Kearfott Div., Aerospace Group, Phone: (201) 256-4000. TWX: (201) 256-5926.

Circle No. 360



A DC VOLT-OHMMETER WITH NO RANGE SWITCH!

More time saved—Put an end to tedious, time-consuming manual range switching with the new Hewlett-Packard 414A Autovoltmeter. Just touch and read... range and polarity change automatically. You read range and polarity on the digital readout above the analog meter.

More accuracy—And the analog meter lets you measure ± 5 mv to ± 1500 v full scale, 12 ranges, with an accuracy of $\pm 0.5\%$ of full scale $\pm 0.5\%$ of reading; 5 ohms to 1.5 megohms, 12 ranges, accuracy 1% of reading $\pm 0.5\%$ of full scale.

All this for just \$650!

More uses—The 414A is the world's first "touch-and-read" analog volt-ohmmeter with accuracy anywhere approaching what you require for trouble shooting, tweaking, peaking and nulling, probing a circuit without a schematic. Use it for maintenance testing, on the production line, in the lab.

In the dc voltage function you simply touch the point to be measured and in less than 300 msec read the range and polarity on the digital display and the precise dc measurement on the individually calibrated, mirror-backed taut-band meter. Automatic ranges are selected and displayed for resistance measurements, too.

More noise rejection—Ranges also can be selected and held manually, and a Down Range control feature lets you drop to the next lower range merely by pushing a front-panel button.

Input resistance is 10 megohms on the 5 and 15 mv ranges, 100 megohms on 50 mv range and above. The 414A is insensitive to 60 cps signals with peak value less than 7 times the full-scale dc level of range in use in "Hold" position (rejection is 20% of reading when using Auto-ranging).

To get the true significance of this automatic instrument, you need to see it perform on your bench. Call your Hewlett-Packard field engineer for that convincing demonstration. Or write for complete information to Hewlett-Packard, Palo Alto, Calif. 94304, Tel. (415) 326-7000; Europe: 54 Route des Acacias, Geneva.

Data subject to change without notice. Price f.o.b. factory.

HEWLETT  PACKARD
An extra measure of quality

1033

ON READER-SERVICE CARD CIRCLE 85

FM multiplex



A solid-state, 48-channel FM voice multiplex unit is designed for microwave relay use. Designated MC-30, this equipment features toll quality performance, modular construction or battery operation. Power options permit 24 Vdc, 48 Vdc, or 120 Vac input. It is said by the manufacturer to be suited for applications requiring transmission of voice, vhf base station control, telemetering, data and facsimile.

Motorola Inc., 1450 N. Cicero Ave., Chicago, Ill. Phone: (312) 379-6700.

Circle No. 361

Broadband hf antennas

A line of 108 different transmitting and receiving antennas consist entirely of prefabricated parts. An antenna to satisfy highly individual requirements can be supplied quickly and at moderate cost.

Among the salient characteristics that can be supplied as specified are: frequency range (seven ranges from 6.5 to 32 MHz through 2.5 to 32 MHz), power capacity (20 kW average, 10 kW average or receiving capacity only), input impedance (50 ohms coaxial, 300 ohms balanced or 600 ohms balanced) and radiation pattern (for short, medium or long distances). The antennas, designated series 1700, range from 45 to 210 feet in height, depending primarily on the frequency range. The units are supplied in kit form for field erection. All parts of the radiating curtain are made to be assembled with nuts, bolts, and cotter pins. The assembled antennas will withstand 100 mph winds, and corrosive elements, such as salt spray.

Granger Associates, 1601 California Ave., Palo Alto, Calif. Phone: (415) 321-4175. TWX: (415) 492-9377.

Circle No. 363

Programing switch

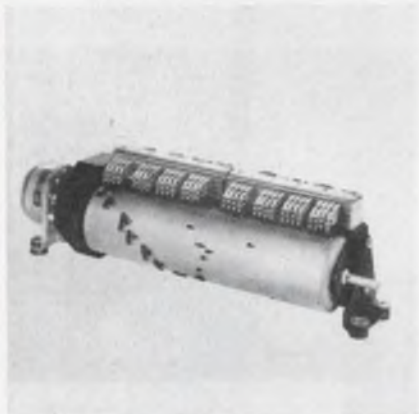

Designed for high density switching requirements, a new Actan programming switch features two and three tiers of contacts stacked on top of each other.

By stacking the banks of form C contacts up to three high, two or three times as many electrically discrete circuits as before may be simultaneously programed. The switch is available as either time-based, pulsed, or manual.

Sealectro Corp., 225 Hoyt St., Mamaroneck, N. Y. Phone: (914) 698-5600. TWX: (710) 566-1110.

Circle No. 362

WORLD'S LARGEST ELECTRONIC KIT CATALOG...FREE!

- Laboratory & Test Instruments
- Malmstadt-Enke Laboratory Educational & Research Instrumentation
- Radio-TV Repair Instruments
- World's Largest Selection Of Amateur Radio Equipment
- Citizens Band Radio Equipment
- Color And Black & White TV
- Stereo Hi-Fi Equipment
- Electronic Organs
- Marine Electronics
- Instrumentation For Biology & Physiology



Heath Company, Dept. 60-2
Benton Harbor, Michigan 49023
Please send FREE 1966 Heathkit Catalog.

Name _____ (Please Print)
Address _____
City _____ State _____ Zip _____

CL-234

ON READER-SERVICE CARD CIRCLE 84

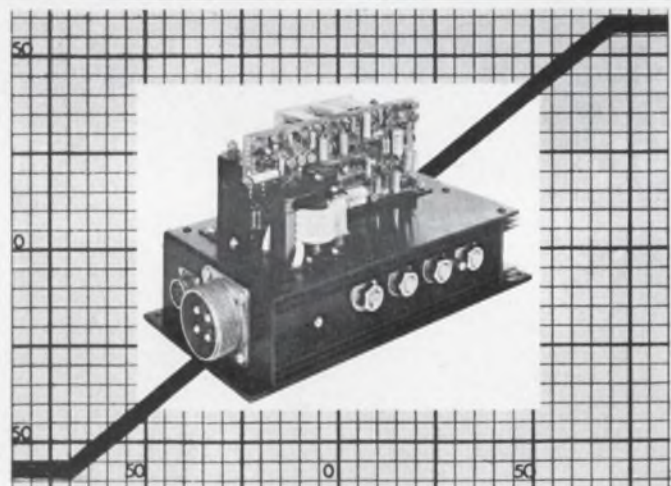

Bi-directional, Full wave MOTOR CONTROL

The new Model A480, 17 KW power output servo amplifier is designed to drive 1 to 8 HP DC motors in applications where superior performance is required. The output of the amplifier features smooth, full wave, bi-directional control with linear operation through null. Adjustable current limiting and three signal inputs with 100 K input impedance are standard features. The amplifier is 12 x 6 x 6 and weighs only 14 lbs.

Servo Amplifiers • Static Inverters • Power Supplies

WESTAMP

1542 15TH ST., SANTA MONICA, CALIF. 90404. 213-393-0401

ON READER-SERVICE CARD CIRCLE 85

ELECTRONIC DESIGN

Phantoms score victories in Viet Nam.

Geminis rendezvous in Space.

While these products make news, **MCDONNELL** has many new projects in progress.

McDonnell's wide-ranging aeronautic, astronautic, automation and electronic programs need talented and experienced personnel.

A 26-year history of growth and achievement has shown a year-by-year increase in employment levels without experiencing a major dip in the upward trend. *Planned* accomplishment sets McDonnell ahead of most companies in the industry.

McDonnell provides company benefits that are modern and contain many innovations. (For example, UN Day and NATO Day are paid holidays; educational assistance gets up to full sponsorship, reduced work weeks.)

Living in the St. Louis area is a gracious change of pace from the noise and clutter of the larger cities. Better living at less cost will inspire frequent visits to restaurants, shows and cultural centers that vie with heralded facilities on both coasts.

Schools are plentiful, *not overcrowded*, and have AAA ratings which put them above par with most schools in the nation.

Enjoy seasonal weather cycles that average 33.8° in winter and 77.4° in summer. The full range of recreation outlets provides an opportunity to enjoy living at a relaxed, unhurried pace.

These facts should satisfy the *inner* man. The professional in you will also be surprised at the way things have a way of getting done, without red tape, and they get done right. Whether launched before a watching world or in

secret on some far corner of the globe, it has become characteristic of products built by McDonnell that they work.

Join the McDonnell Team for professional growth, job potential, recognition and stability.

Requirements exist for the following positions:

OPERATIONS

Building Design Engineers
Tool Designers
Production Planners
Industrial Engineers
Numerical Control Programmers
Aircraft Systems Buyers
Procurement Price Analysts
Contract Coordinators
Management Information Systems (Pert)
Budget Analysts
Technical Writers
Aircraft Maintenance Engineers
Technical Data Engineers
Spares Planners
Field Service Representatives

ENGINEERING

Designers
Aerodynamics Engineers
Guidance & Control Engineers
Loads & Weights Engineers
Operations Analysts
Propulsion Engineers
Thermodynamics Engineers
Stress Engineers
Structural Dynamics Engineers
Electronic Systems Engineers
Reconnaissance Specialists
Flight Test Engineers

AGE—GSE Systems Engineers
Life Sciences Specialists
Materials & Processes Specialists
Reliability Engineers
Facilities Services Engineers
Producibility Engineers
Administrative Specialists
Engineering Services Specialists
Data Management Specialists

To arrange an interview in your area of interest, please send your resume with the completed coupon. *We will answer every inquiry.*

MCDONNELL, P. O. Box 516, St. Louis, Missouri 63166

Attn: W. R. Wardle, Engineering Employment Office, Dept. R-21

Name _____

Home Address _____

City & State _____

Phone _____

Present Position _____

Degree _____

A PLANS FOR PROGRESS COMPANY
AND AN EQUAL OPPORTUNITY EMPLOYER

**AT
MAC
THERE'S ONLY
ONE WAY TO GO
...UP!**



When You
Think of a
Wire Source for
"Specials"

... Think of
**Columbia Wire
and Supply Co.**

Columbia Wire can assure the finest service for special wire requirements. We are constantly producing products for the production lines of consumer and military oriented manufacturers. This includes braiding and shielding • harnesses • marked and numbered leads • extension cords and cables • cut leads with terminals • assemblies • automatic terminal attaching • wire stripping • power cord sets.

For fast delivery on stock items, Columbia stocks millions of feet of many products — including: air conditioner cable ■ automotive cable ■ coaxial cable ■ hi-temp wire ■ hi-voltage wire ■ hook-up wire ■ inter-com wire ■ juke box speaker cable ■ microphone cable ■ shielded cable ■ shielding-braided copper ■ shielded multi-conductor cable ■ speaker cable ■ television wire and cable ■ test lead wire ■ tinned copper-solid ■ U/L service cord ■ Teflon ■ mil-spec hook-up ■ mil-spec cables ■ heater cord breather tube cable.

For your next wire need, standard or special, ask Columbia... your order will be given prompt and careful attention.

Write for Catalog 111



Columbia
WIRE & SUPPLY CO.
2850 IRVING PARK ROAD
CHICAGO 18, ILLINOIS

ON READER-SERVICE CARD CIRCLE 87

SYSTEMS

Digital printer

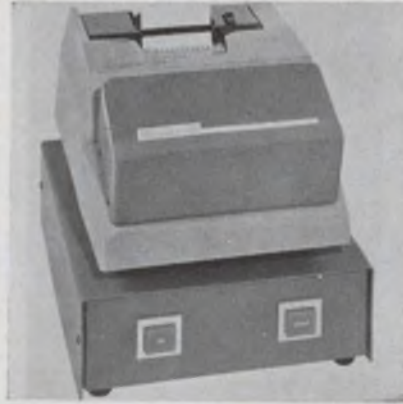

Model 610 digital printer and 620 printer-control comprise a paper-tape recording system for digital thermometers, counters, voltmeters, and other instruments. Readouts in two groups of four digits permit the reading of two instruments, or the identification coding of one.

Accessories are available to provide print identification and various input scanning functions.

Price: \$750. United Systems, 918 Woodley Rd., Dayton, Ohio. Phone: (513) 254-3567.

Circle No. 364

Closed-circuit TV



Third generation closed circuit TV cameras will fill a broad range of military, industrial, commercial, medical, and educational uses.

The remote-control TE-22-A and the local-control TE-20-A are 11-1/2 inches long, 5-1/2 inches in diameter, and weigh nine pounds without lenses.

Price: TE-20-A, \$1295; TE-22-A, \$1350. General Electric, Visual Communications Products, #7-315 Electronics Park, Syracuse, N. Y. Phone: (315) 456-2226.

Circle No. 365

Dynamic testing

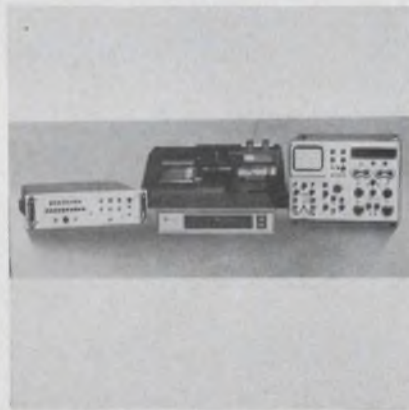

The Automatic Tester Interface enables users to combine standard test equipment to automatically record data from dynamic testing of integrated and semiconductor circuits.

When coupled with a Tektronix 567 scope, a Tektronix 262 programmer, and an IBM 562 card summary punch, Model 5320 lowers the cost of dynamic testing, while testing up to eight parameters.

Price: \$1275. Radiation Inc., P. O. Box 220, Melbourne, Fla. Phone: (305) 723-1511.

Circle No. 366

2 microsecond memory

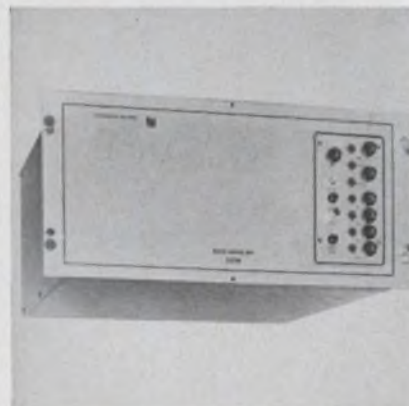

An integrated core memory system with full-cycle time of $2\mu\text{s}$ is designated MUA. Supplied in any of four access modes (random, sequential, random/sequential, and sequential interlaced), the user can select from a variety of circuits and features.

Word capacities range from 64 to 4,096, with two to 30 bits per word. Half cycle time is $1.25\ \mu\text{s}$, and access time is 950 ns.

Fabri-tek Inc., Amery, Wis. Phone: (715) 292-0900.

Circle No. 367

all Teflon* solenoid valves for epitaxial reactors



Join the companies who are already using these corrosion-proof valves in the production of micro-circuits. For complete information and specifications write today for Catalog 108CE.

Valcor Engineering Corp.
5382 Carnegie Ave., Kenilworth, N.J.
(201) CH 5-1885

VALCOR
SOLENOID VALVES

*duPont Company registered trademark

219

ON READER-SERVICE CARD CIRCLE 88

NEW High Voltage Reed Relay

Switches 5000 V

low cost

Reed relay
Reliability

Rated 50VA at 5000v
max. or 3 amps. max.

Life Expectancy—
20 million cycles at
rated load.

7/8" h (above mounting base)
1 1/16" w, 4 1/2" long.

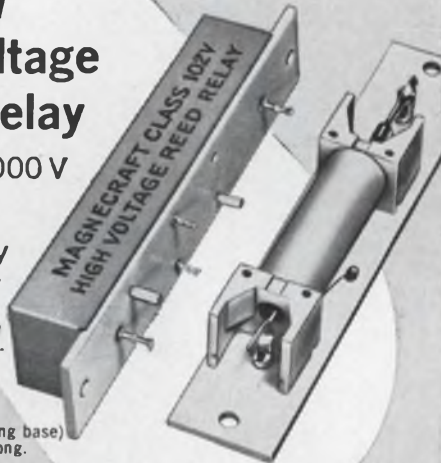

MAGNECRAFT 102V High Voltage Reed

Newest addition
to the largest
selection of
Mercury-Wetted
Contact and
Dry Reed Relays

Send for
Catalog.

- Contacts of special material, high vacuum sealed.
- Contact leads soldered to rigid terminal posts—prevents stresses that affect relay adjustment.
- Nylon bobbin and epoxy resin terminal board provide great dielectric strength and resistance to moisture absorption.
- Internally insulated metal cover provides electrostatic shielding; also protects relay from stray magnetic fields and mechanical injury.
- Stocked for immediate delivery with coils for standard operating voltages.

MAGNECRAFT Electric Co.

5571 N. Lynch, Chicago, Ill. 60630 (312) 282-5500

ON READER-SERVICE CARD CIRCLE 89

February 1, 1966

Do you need
an amplifier
to fit in this
space . . . today?

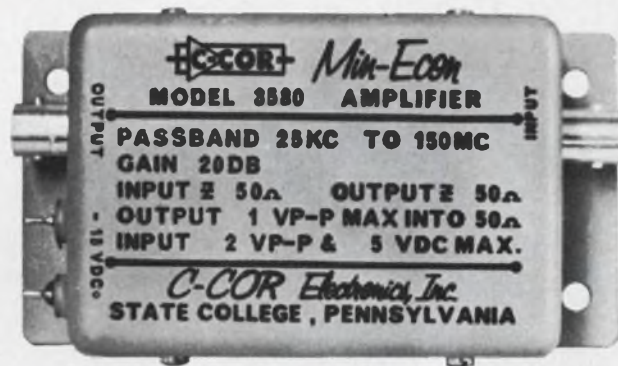

We have many . . .
The new *Min-Econ*

This is a full-size photograph of a typical Min-Econ amplifier. Each one in our new line is this small, and economically priced. Utilization of standardized packaging techniques and common parts wherever possible permits this approach. We have over a dozen designs **on the shelf** for immediate delivery. They will deliver sizeable linear output power, with good isolation between output and input. These units are not "flea-power" devices as are many so-called "amplifier modules." They are silicon solid-state units. The model 3580 picture here is a video amplifier, with a pass band of 25 kc to 150 mc, 20 db gain, and 1 volt p-p output capability. The price: \$150.

Among other video amplifiers are:

Model	Passband	Output	Price
3581	20 cps to 60 mc	1 v p-p	\$70.00
3582	20 cps to 10 mc	2 v p-p	80.00
3585	10 cps to 3 mc	55 v p-p	90.00

Bandpass models include 10% bandwidths at center frequencies from 100 to 500 mc. Prices around \$150.

Let us send you more information on this remarkable new line — and let us solve your special amplifier problem with units of any size. Amplifiers are our specialty.



C-COR Electronics, Inc.

60 DECIBEL ROAD • STATE COLLEGE PA. • 16801

We keep moving ahead . . .

to stay ahead in electronics

ON READER-SERVICE CARD CIRCLE 90

127

Magnetic tape heads

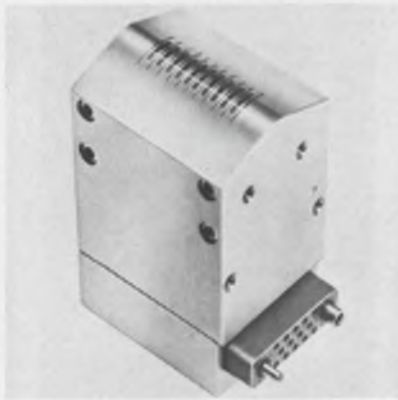

Magnetic tape playback heads with built-in amplifiers are designed for low-signal applications from 100 Hz to 2.5 MHz. These units are supplied with up to 20 channels per inch of tape width, with either differential or single-ended output.

Operational temperature range is between -55° and 85°C . Output impedance is 50 ohms maximum.

Western Magnetics Div., GJM Inc., 1733 Flower, Glendale, Calif. Phone: (213) 245-7311.

Circle No. 368

Servo motor-generator

Model 20023, 115-Vac servo motor-generator has one fixed, and one variable voltage phase, and can be supplied with alternate output shaft configurations.

The unit measures $5\text{-}3/8 \times 1\text{-}7/8$ -in., and meets MIL-E-5272, MIL-STD-202, and MIL-I-26600 environmental specs. The two-phase, 400-Hz motor has speeds from 10,300 to 11,750 rpm, and max. operating torque of 1.20-in./oz. The generator has an output voltage of $0.2\text{ V} \pm 10\%$ at 1,000 rpm, and pulse linearity of $\pm 0.5\%$ at 0 and 3000 rpm.

Electrokinetics Div., Varo, Inc., 402 E. Gutierrez St., Santa Barbara, Calif. Phone: (805) 963-2055. TWX: (805) 449-7200.

Circle No. 370

Voltage monitor

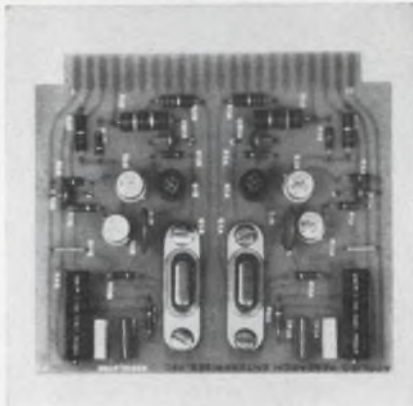

The model AVC-100 is designed to monitor both upper and lower limits of ac voltage in systems applications. When preset points are reached, the module will fire an internal solid-state switch. Both upper and lower limits of the voltage monitor are adjustable to $1/2\%$.

Price: \$150. Applied Research Enterprises Inc., 30 Park Row, Stamford, Conn. Phone: (203) 348-2302.

Circle No. 369

Accuracy is our policy

In the article, "Is 60-cycle pickup degrading the performance of your dc amplifiers?" [E/D, December 20, p 34], Fig. 1 was labeled incorrectly. The portion labeled "a" should have been "b," and vice versa.

CASTING RESINS FREE STYCAST® CHART



Over 20 Stycast® epoxies and urethanes are presented in tabular form.

*This valuable Folder is yours.
Write or use Reader Service Card.*



EMERSON & CUMING, INC.

- Canton, Massachusetts
- 604 W. 182d St., Gardena, Calif.
- 9667 Allen Ave., Rosemont, Ill.

Emerson & Cuming Europe N. V.
Oevel, Belgium

ON READER-SERVICE CARD CIRCLE 91

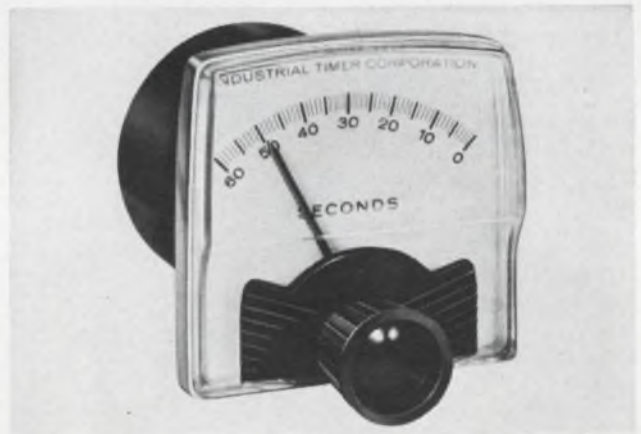

MTD

Bold new look in delay timers

Looks aren't everything—but the new MTD is a glamorous bit of time packaging. This is an automatic reset delay timer available in ten models cycling from 6 seconds to 3 hours. Harmonizes with all modern panel instruments. Write for Bulletin #304.



INDUSTRIAL TIMER CORPORATION

65 U. S. HIGHWAY 287, PARSIPPANY, NEW JERSEY
IN CANADA: SPERRY GYROSCOPE OTTAWA LIMITED, ONTARIO

ON READER-SERVICE CARD CIRCLE 92

ELECTRONIC DESIGN

Selector switch

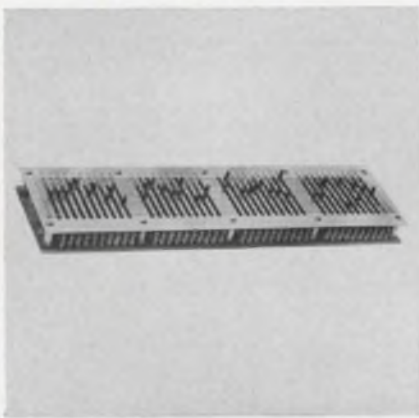

A manual crossbar-type selector switch provides 400 crosspoints between its 10-connector printed-circuit base, and 40 transverse slider rails.

Contact resistance is 0.05 ohms, maximum, while current carrying capacity is 3 amps, 125 V ac or dc. Make or break current is 1 amp at 15 Vdc; 150 mA, 125 Vac.

P&A: \$55.00 each; 25% discount on 25 units. Cherry Electrical Products Corp., P. O. Box 438, Highland Park, Ill. Phone: (312) 432-8182.

Circle No. 371

Punched card sensors

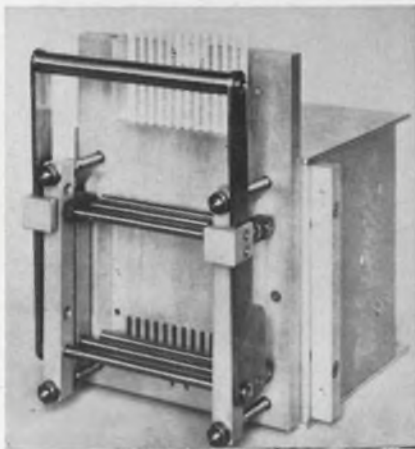

The JM3C reads from 1 to 40 columns of any punched card. Insert the card, close the handle, and individual switches read the card: closed for a hole, open for no hole. Other units can be made with as few as 24, or as many as 1400 switches, allowing programing and other automated functions. Military, commercial, and industrial applications are suggested by the manufacturer.

Taurus Corp., Academy Hill, Lambertville, N. J., Phone: (609) 397-2390. TWX: (609) 490-3063.

Circle No. 372

Solid-state scopes

Three solid-state, drift-free oscilloscopes include a computer-display scope, a monitor scope for low frequency data display, and another low-frequency scope for complex data.

The computer-display scope features high resolution and linearity. For alphanumeric and vector displays it has 12 μ s jump-scan time.

KM 402 monitor scope has 25 line/cm resolution, and 1% linearity. Direct-coupled amplifiers give full scale, undistorted vertical deflection to 7 kHz, down 3 dB at 50 kHz. A 14-in., aluminized CRT makes this scope applicable in telemetry, or other high-speed XY plotter applications.

Model KS707 is a 17-in. magnetically deflected scope with calibrated linear time base and provision for triggered or recurrent sweeps. Specs are similar to those of the KM402.

ITT, Industrial Products Div., 1591 Bledsoe St., San Fernando, Calif. Phone: (213) 367-2211. TWX: (213) 764-5911.

Circle No. 373



**LOOK WHAT'S HATCHED AT
LITTELFUSE**

**The world's smallest fuse—Picofuse.
1/8 thru 5 amps...1/6 grain...125 v.**

LITTELFUSE

DES PLAINES, ILLINOIS

ON READER-SERVICE CARD CIRCLE 93

February 1, 1966

High torque, Self-shielded

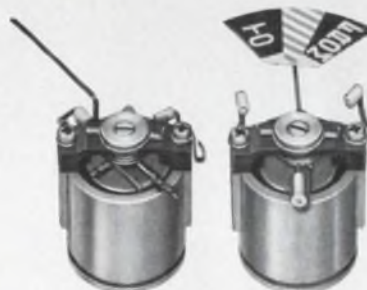

AI-2 (actual size)

moving coil mechanism

Versatile mechanisms for critical indicating and control systems have "On-off", "+, -", "Go-no go", null, left-right, or scale indicators. High torque, self-shielded core magnet design permits grouping of functions in small panel space. Moving coil weighs 100 mg less and provides at least 10% more torque than best previously available mechanism of this type. Wide choice of sensitivities; synchro or standard mounting.

AMMON

AMMON INSTRUMENTS, INC.
345 Kelley Street, Manchester, N. H. 03105

ON READER-SERVICE CARD CIRCLE 94

NCC

to be Sure

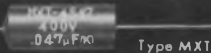

Type MXT

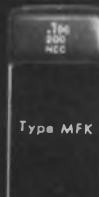

Type MFK



Type MFL

POLYESTER FILM CAPACITORS.

Type MXT

In Plastic Tube.

Capacitance

Range : .001 MFD to 22 MFD.

Voltages : 100v, 200v, 400v, 600v DC.

Type MFK

Dipped Flat Shape, NON-Inductive

Construction

Capacitance

Range : .01 MFD to 22 MFD

Voltages : 100v, 200v, 400v, 600v DC.

Type MFL

Dipped Flat Shape

Capacitance

Range : .001 MFD to .47 MFD.

Voltages : 35v, 50v, 100v, 200v, DC.



METALLIZED POLYESTER FILM CAPACITORS.

Type FNX-H

Mylar Wrapped Semoval with Epoxy

End Seal

Capacitance

Range : 1 MFD to 10 MFD.

Voltages : 50v DC.

Type SX



Type SFL



POLYSTYRENE FILM CAPACITORS.

Type SX

Capacitance

Range : 100 PF to 1000 PF.

Type SFL

Voltages : SX 125v, 250v DC.

SFL 35v DC.



Type TAX



Type TAS

SOLID TANTALUM CAPACITORS.

Type TAX

Capacitance

Range : 1 MFD to 220 MFD

MIL-C-26655A Hermetically Sealed

Type TAS

Voltages : 3v, 6v, 10v, 15v,

Sealed with Epoxy Resin

20v, 25v, 35v DC.

for full details, contact :

MATSUO
ELECTRIC CO., LTD.

3-chome, Sennari-cho, Toyonaka-shi, Osaka, Japan
Cable Address : **NCC MATSUO OSAKA**

POWER EQUIPMENT

Phase sensing converter

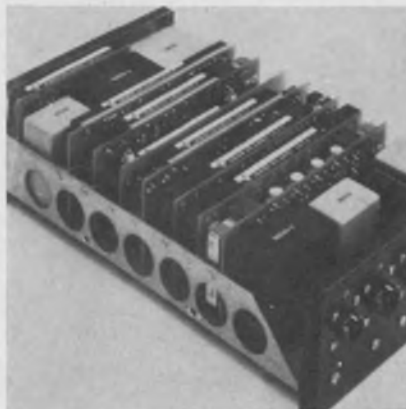

Transfer stability of 0.2% and linearity to 0.1% over a temperature range of -40° to $+75^{\circ}\text{C}$ are the leading features of the PSC-419 phase-sensitive converter. The unit is designed for a MTBF of 10,000 hours per MIL-HBK-217. It meets the requirements of MIL-T-21200 and provides a ± 10 -v output for an input of 10 mVac. Output impedance is 0.2 ohm.

North Atlantic Industries, 200 Terminal Dr., Plainview, N. Y. Phone: (516) 681-8600.

Circle No. 374

Dc power supply



A line of subminiature power supplies provide outputs at any fixed level from 3.3 to 28 Vdc, 40 mA. Package size is 1 x 3 x 1-1/4-in. The supplies are complete with transformers, rectifiers, filter and regulator and either single or dual outputs are available. Other features include floating outputs, allowing either positive or negative voltages to be tapped.

P&A: \$40-\$52; stock. Ferrotran Electronics Co., Inc., 693 Broadway, New York, N. Y. Phone: (212) 254-5810. Circle No. 375

Multiple TWT supply

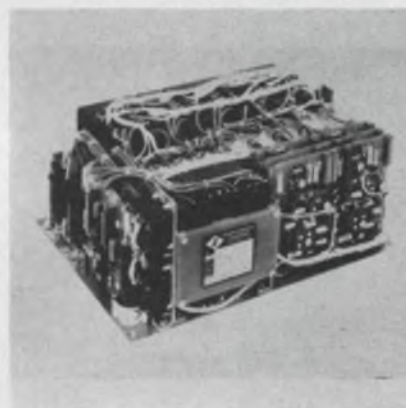

Four traveling-wave tubes can be driven by the Model PM 1414 programmable supply. Section #1 of the unit provides 2 kV at 1 amp and 8 kV at 0.1 amp with 5% duty cycles. Continuous 7.0 Vac and -100 Vdc is also provided. Section #2 provides 1.0 kV and 4.5 kV at 12% duty cycle as well as the continuous voltage. Supplies #3 and #4 are identical 1.0 kV, 7 Vac and -50 Vdc units.

Pioneer Magnetics Inc., 1745 Berkeley St., Santa Monica, Calif. Phone: (213) 393-0136.

Circle No. 376

Dual dc supply

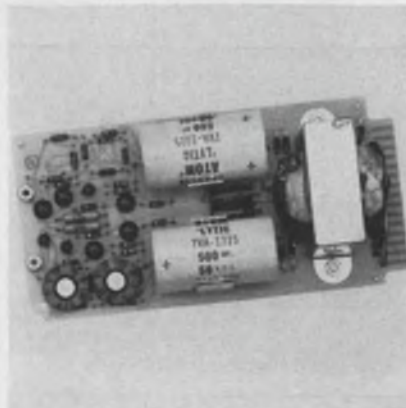

The model P100 all-silicon supply provides two independently adjustable voltage sources that have a 100 mA capability. Range of voltage adjustment for each source is from 8 to 18 volts. Ripple and noise are held to 0.05% for a $\pm 10\%$ line change and 0.2% from full-load to no-load. Voltage overshoot for a 100 mA step load change is less than 0.15 V.

Price: \$95. Newport Laboratories, P. O. Box 2087, Newport Beach, Calif. Phone: (714) 646-9295. Circle No. 377

**Speed, up to 150 characters per second,
bidirectional and asynchronous . . . fast front
loading . . . new simplified read head with fewer
parts for greater life and easier maintenance.**

NEW TALLY TAPE READERS GIVE YOU MORE BITS PER DOLLAR . . . LONGER



Tally "R" series readers mark an important advance in the evolution of perforated tape technology. Offering a new combination of speed, price, and performance unmatched by any remotely comparable device, they are your best value today—and tomorrow.

Here are some of the reasons why. Because of edgeless guiding and a four point

starwheel, these readers read tape longer and more accurately—even out-of-tolerance tape. Tape wear is virtually eliminated by starwheel reading. You can comfortably expect tape life to exceed 1,000 passes on any Tally reader. "R" series readers will read any tape material without regard to color, thickness, or opacity. They will read 5, 6, 7, or 8 level tapes without modification or adjustment.

New "R" series readers are available in either 75 or 150 character per second versions. They are offered in table top console without reeling or standard rack

mount with or without integral reel tape handling.

Let us send you the details. Address Mr. Ken Crawford, Tally Corporation, 1310 Mercer Street, Seattle, Washington 98109, Phone: (206) MA 4-0760. TWX: (910) 444-2039. In the U.K. and Europe, address our man in London, H. Ulijohn, Tally Europe Ltd., Radnor House, 1272 London Road, London, S.W. 16, England, Phone: POLLards 9199.

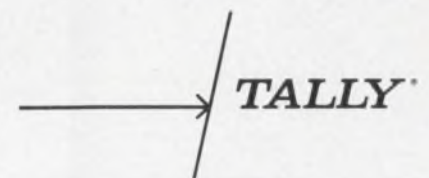

Speed Inquiry to Advertiser via Collect Night Letter
ON READER-SERVICE CARD CIRCLE 96

IF YOU BUY, USE OR
SPECIFY PRECISION RESISTORS,
JULIE RESEARCH HAS A FREE
ENGINEERING MANUAL FOR YOU.

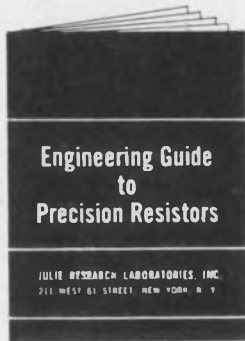

NEW!

WHAT'S IN THE MANUAL: ■ How to specify precision resistors. ■ Ten critical checkpoints in resistor specs. ■ Specify by application for best price-performance mix. ■ A chart for selecting precision resistors. ■ Can you use a standard resistor? ■ Four new types of precision resistors. ■ Complete engineering guide to Julie resistors.



JULIE RESEARCH LABORATORIES, INC.
211 WEST 61st STREET, NEW YORK, NEW YORK / (212) CI 5-2727

ON READER-SERVICE CARD CIRCLE 97

ULTRADEX[®]

**AUTOMATIC
INDEXING TABLES
ACCURATE WITHIN
1/4 SECOND OF ARC**

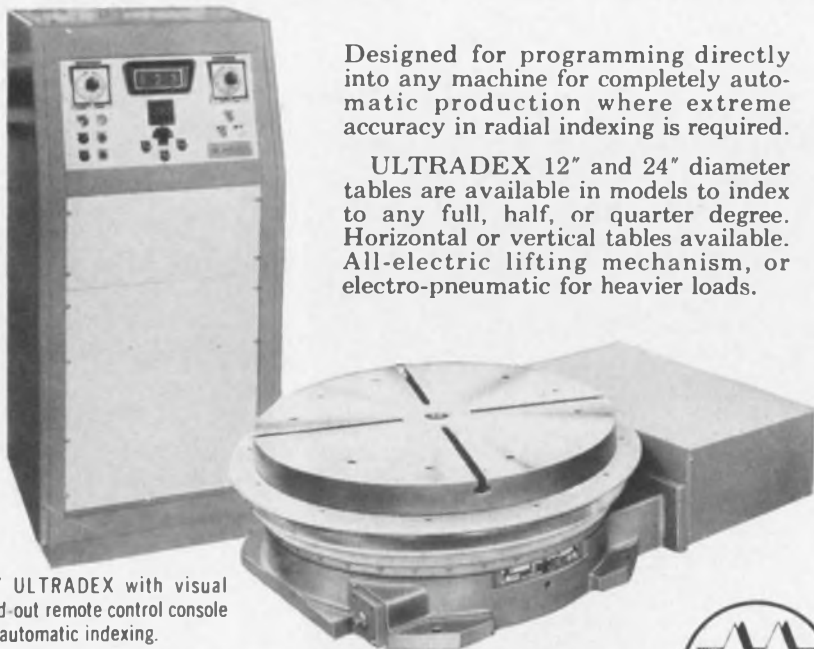

24" ULTRADEX with visual read-out remote control console for automatic indexing.

Designed for programming directly into any machine for completely automatic production where extreme accuracy in radial indexing is required.

ULTRADEX 12" and 24" diameter tables are available in models to index to any full, half, or quarter degree. Horizontal or vertical tables available. All-electric lifting mechanism, or electro-pneumatic for heavier loads.

AA INDUSTRIES, INC.

350 FAIR STREET

DETROIT, MICHIGAN 48220

ON READER-SERVICE CARD CIRCLE 98



New Literature

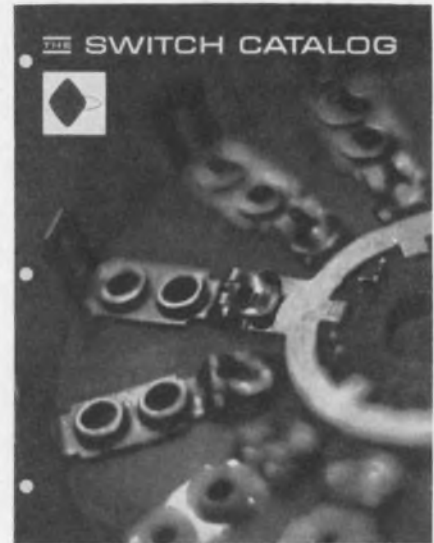

Switch catalog

Engineering information and specifications on the manufacturer's line of switches are included in this eighty-page catalog. Special functions, insulation, and MIL specs are included between the four-color covers. Oak Mfg.

Circle No. 378

Thermistor thermometers

Laboratory and industrial test thermometers using interchangeable thermistors sensors to achieve multi-point and multi-range systems are described in a 24-page catalog. Twenty-one standard probe designs are illustrated and priced with full specifications. Atkins Technical Inc.

Circle No. 379

Epoxy resins

Two types of epoxy resin are described in Bulletins SC:65-32 and SC:65-38. The first lists the typical properties, curing agents and laminate preparation and properties of resin 1045-A-80. The second contains a series of graphs illustrating the viscosity variation of resin 840 as well as property listings and casting procedure. Shell Chemical Co.

Circle No. 380

Filter manual

An 80 page technical brochure discusses fundamental design data of filters and multiplexers. Frequency ranges from dc to 12 GHz are considered, and sample specifications given. A copy of this *Filter Technical Manual, M-100*, may be obtained by letterhead request to: American Electronic Laboratories Inc., P.O. Box 552, Lansdale, Pa.

Flexible couplings

Miniature flexible couplings, universal joints, and allied power transmission accessories are listed in a 40-page catalog along with prices for the various models. The catalog is aimed at design engineers working with servomechanisms, automatic control, remote control or other power take-off drives from electromechanical equipment. Four-dee, Inc.

Circle No. 381

Interference reduction guide

A two-volume guide to interference reduction includes the background and techniques necessary to enable the engineer to minimize interference generation and susceptibility. Both Vol. 1 (AD 619 666D) and Vol. 2 (AD 619 667D) are illustrated.

Copies are available for \$7.00 (Vol. 1, 221 pp) and \$7.50 (Vol. 2, 364 pp) from Clearinghouse, U.S. Department of Commerce, Springfield, Va.

Diodes and transistors

Two catalogs describe germanium gold-bonded diodes and germanium transistors, both alloyed-junction and diffused alloyed-junction types. The transistor brochure, T-5001, gives specs for 145 types, including computer, HV, bilateral, drift, audio, and photo transistors. The diode catalog, T-4002, covers 200 types for all voltages and includes fast-recovery types. General Instrument.

Circle No. 382



One of the two slides supporting this man weighs less than the telephone!

Chassis-Trak ultra-thin aluminum slides are engineered for application where weight is a critical factor. Available in tilt, non-tilt, and lock slides . . . the Model D-600 extruded aluminum slide weighs only 4½ pounds, but readily supports up to 125 pounds . . . even when fully extended. That is why the telephone, weighing almost 5 pounds, is actually heavier than one slide.

All slides are coated with exclusive Poxylube 75 dry-film lubricant, providing permanent lubrication while protecting against atmospheric corrosion. For information on the Model D-600 extruded aluminum slides, call or write today.

A Package for Every Major Missile Project from . . .
525 South Webster Ave., Indianapolis, Indiana

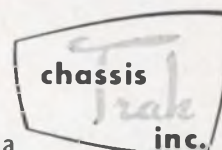

ON READER-SERVICE CARD CIRCLE 99

JUST CUT TO PATTERN

Netic & Co-Netic Magnetic Shields

HAND FORM IN SECONDS

A great convenience to design engineers, packaging engineers, R/D, etc. A fast inexpensive empirical tool to determine and shield the necessary components of systems. Use multiple layers if needed. Thicknesses from .002". Also widely used in automated or manual production line techniques.

Netic attenuates high intensity fields, Co-Netic low intensity fields. Permanently Pre-Annealed. Not affected by bending, vibration or shock. Minimum retentivity. Increases systems reliability.



MAGNETIC SHIELD DIVISION

Perfection Mica Company

1322 N. ELSTON AVENUE, CHICAGO, ILLINOIS 60622

ORIGINATORS OF PERMANENTLY EFFECTIVE NETIC CO-NETIC MAGNETIC SHIELDING

ON READER-SERVICE CARD CIRCLE 100

GETTING A CHICAGO CUT AND PLAYING A LOSING HAND?



Then Let's Talk Price!! Take a JEDEC type; any JEDEC type. One manufacturer's is pretty much like another's. You can't really go wrong... so why not go right!! Go Western. Western's new production facilities guarantee highest quality at the lowest price in the industry. Our huge distribution network puts any of our 6,000 different components in your hands almost immediately... when you need them. Yes, 6,000 types — more than any other three manufacturers combined. Certainly a most important factor to consider when playing the game to win!!

Lowest Cost...Highest Quality...Immediate Availability

Your Western Distributor...

The One Source for All Your Customers' Semi-Conductor Needs!!



WESTERN TRANSISTOR CORPORATION
DEPT. B-5 • 11581 FEDERAL DR. • EL MONTE, CALIF. 91731 • PHONE: 442-5507

ON READER-SERVICE CARD CIRCLE 101

NEW LITERATURE

Frequency changers

Twenty-four dc-to-ac inverter models, 20 ac-to-ac frequency changer models, plus 3 high-surge inverter models are described in catalog 138a. All units are solid state. The inverters and frequency converters have power ratings ranging from 15VA to 500 VA, and are available with either square wave or sinusoidal outputs. The high-surge inverters have surge ratings up to 1500 VA. Electronic Research Associates.

Circle No. 383

Medical power sources

An explanation of the Certified Cell Program and of the use of high-reliability power sources in medical electronics is given in this full-color booklet. Charts and graphs illustrate test results. The areas of study include cardiac situations involving the Stokes-Adams syndrome and electrical control of the bladder and urinary tract, among others. Mallory Battery Company.

Circle No. 384



Transformer catalog

Catalog P1065G describes characteristics, outline dimensions, connections, charts and illustrations of a complete line of manual and motorized 50/60 cycle variable transformers. Data also cover line connectors, 40-volt types, oil-cooled and explosion-proof models, multi-winding assemblies, positioner systems, full-range controllers, ac power supplies, packaged transformer primaries and slidewire resistors. Superior Electric Co.

Circle No. 385

REAL MEASURE OF PERFORMANCE:

Exclusive with the 175A Oscilloscope:

**20 MHz bandwidth at 1 mv/cm sensitivity, 50 MHz at 10 mv/cm, dual-channel!
4-channel 40 MHz bandwidth plug-in!**

Plug-in recorder, pushbutton trace recordings with 30 MHz bandwidth!

Plug-in trace scanner for high resolution recording on external x-y recorder!

Time mark generator plug-in for 0.5% accuracy time measurements!

Mixed sweep for error-free time interval measurements!

Measurement performance is what you get with the 175A 50 MHz Scope, performance not available elsewhere. The performance spotlighted above is yours with the 175A...high sensitivity and bandwidth for dual- or 4-channel broadband measurements, inexpensive recordings of signals (improves signal to noise ratio of noisy signals, plus it gives clear recordings of dim low-duty-cycle signals), the unique benefits of a delay generator plug-in...all exclusive with the 175A. And 14 plug-ins to choose from, for maximum versatility to match your specific application.

And every combination of scope and plug-ins gives you Hewlett-Packard design and manufacturing quality. Backed up, too, by your Hewlett-Packard field engineer, who can help solve your measurement problem with a scope or with other tools from the broad line of high-quality instrumentation he offers.

Give him a call. Take a look at the 175A Scope. A comparison with other scopes will show you the real measure of performance you get exclusively from Hewlett-Packard. Full specifications on the 175A are available by writing Hewlett-Packard, Palo Alto, California 94304, Tel. (415) 326-7000; Europe: 54 Route des Acacias, Geneva.

175A Oscilloscope, \$1325
1755A 50 MHz Dual-Trace Vertical Amplifier, \$575
1754A Four-channel Vertical Amplifier, \$595
1784A Recorder Plug-in, \$775
1782A Trace Scanner, \$425
1783A Time Mark Generator, \$130
1781B Delay Generator, \$325

Prices f.o.b. factory.

964

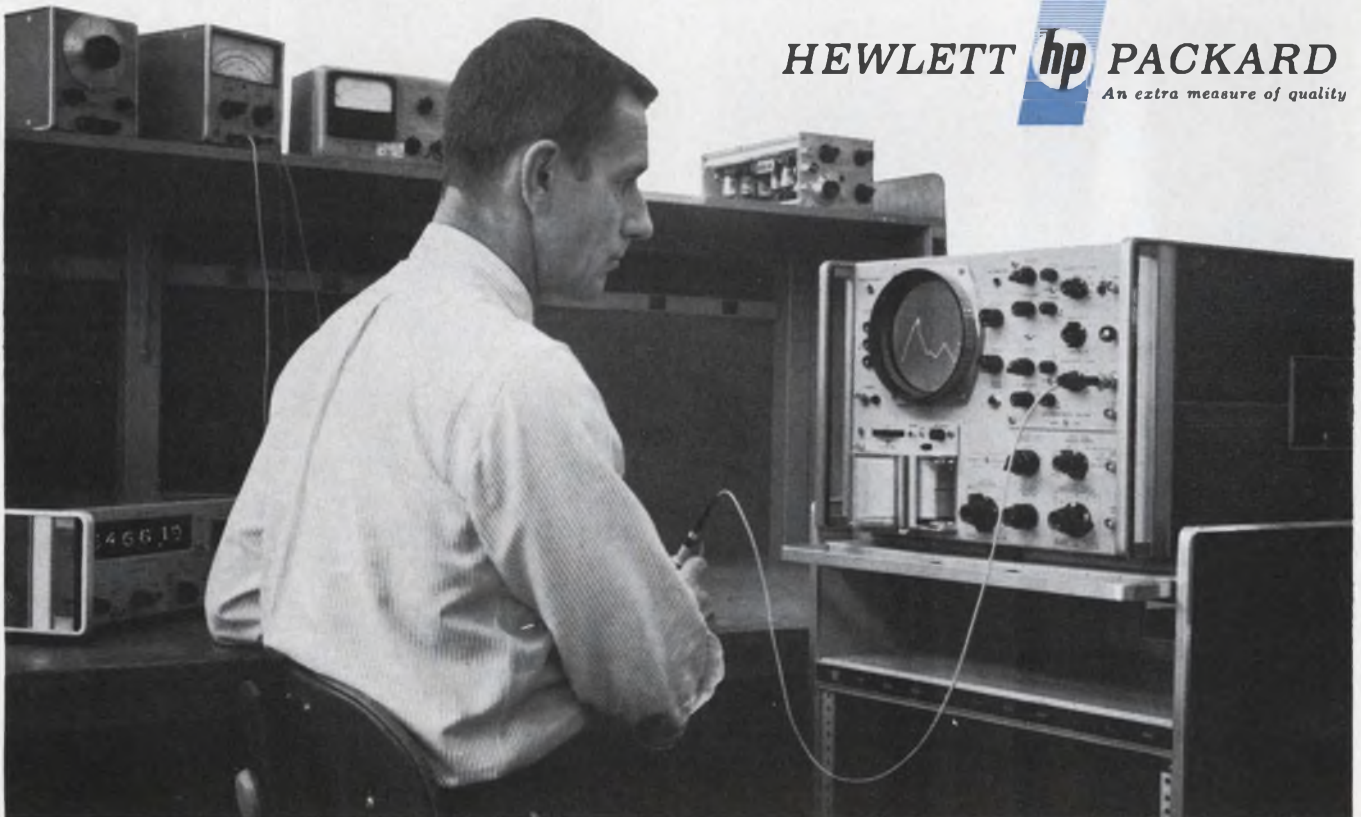

HEWLETT  PACKARD
An extra measure of quality

The 175A Scope, 1755A Vertical Amplifier Plug-in and 1781B Sweep Delay Generator give you the exclusive 20 and 50 MHz dual-channel performance listed above—for only \$2225!

ON READER-SERVICE CARD CIRCLE 102

Current regulators

Typical characteristics, complete specifications, and ordering information on two lines of current-regulating circuit components are contained in Catalog No. 1001. The four-page catalog deals with the "Currector" series of current regulating devices and the "Negistor" series of negative resistance units. Telonic Engineering Co.

Circle No. 386

Communications equipment

Radio equipment for high-frequency communications and the aviation services is described in a 16 page illustrated catalog. The publication covers a variety of broadband hf antennas, hf transmitter-to-antenna interface equipment, broadband hf power amplifiers and ionosphere sounders for communications and research. Granger Associates.

Circle No. 387

CRT scan recorder

A high resolution, intensity modulated recorder series is described in a new brochure. The trace image from the cathode ray tube is traced on photosensitive paper in real time. Federal Scientific Corp.

Circle No. 388

Operational amplifiers

Small quantity prices for solid-state encapsulated dc operational amps, accessories, and other standard items are listed in a newly lowered price list, PA-071-12/65. Nexus Research Laboratory.

Circle No. 389

Gyros

Application notes, general description, design features and performance characteristics of a wide variety of gyros are contained in a new 28-page brochure. Included is a description of a group floated rate integrated gyros as well as a series of degree-of-freedom ball bearing rate integrating gyros. General Precision, Inc., Kearfott Division.

Circle No. 390

Diode reliability

The results of a three-year diode reliability study program involving 15,700,000 diode hours of 100°C life test at rated conditions, are available in a 60-page report, TR-108. During the program 7,885 units were life tested. Unitrode Corporation.

Circle No. 391

Waveform display analyzer

Brochure No. LP-3607 describes a graphic input/output device called the Waveform Display Analyzer. The device provides the means for analyzing and evaluating a wide variety of data and can be coupled with any large digital computer, according to the manufacturer. Illustrations are included. General Precision Inc.

Circle No. 392

Relay catalog

A new 160-page catalog gives engineering and purchasing data on 11 major manufacturers' relay lines. Kierulff Electronics.

Circle No. 393

INSULATING- CAP. WIRE & CABLE TERMINAL END. MARKER TUBE

K.C.C.

ELECTRICAL CONSTRUCTION
WIRING, PANEL WIRING OF
HIGHEST QUALITY!

□ OUTSTANDING

FEATURES!

Electrical insulation
totally resists water,
oils, acid, cold, pressure
from packing.

Various colors
to indicate
wire size.



K.C.C SHOKAI LTD.

Head Office: No. 71, 4-chome Nadakita-dori, Nada-ku, Kobe, Japan
Tokyo Office: No. 212, 2-chome Nishi-Okubo, Shinjuku-ku, Tokyo, Japan
Cable: WMKCC KOBE
Telephone Kobe: (87) 0271-3 Tokyo: (369) 4111

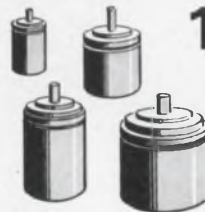

1001 uses for STEPPER MOTORS

Because their output is in discrete increments, Cedar stepper motors have many advantages over conventional motors for precise positioning applications. They are bi-directional and have high torque output. They can be run at high stepping rates or as slow as you wish. Because shaft rotation is incremental, damping is not required.

Some of the applications for which stepper motors have been used are: replace motor-tachometers in servo systems, control missile ailerons, shutter control on high-speed cameras, open loop positioner in checkout systems, high-speed counter in such applications as rapid firing weapons, replace ultra low-speed dc motors, incremental tape handlers, and digital-to-analog and analog-to-digital conversion equipment.

The uses for stepper motors are as unlimited as your imagination. New applications are constantly being discovered. What new use will you next make of stepper motors? Let us know about your ideas; we'll be happy to work with you.

Cedar Stepper Motors are available in sizes 5, 8, 11 and 15 in both permanent magnet and variable reluctance types, and with a wide variety of stepping angles. All meet the full requirements of MIL-E-5272. For free booklets on stepper motor application ideas, write or call:

CEDAR

ENGINEERING DIVISION

CONTROL DATA

CORPORATION

5806 West 36th Street, Minneapolis 16, Minnesota. Phone 929-1681

ON READER-SERVICE CARD CIRCLE 104



Hold the winning hand.

Triad deals out two new integrated circuit cards for breadboarding with TO-5's and flat packs—the 13540 and 13541. They give the engineer new flexibility in pre-design testing of discrete components.

Both cards are two-sided, 1/16" G-10 glass epoxy; gold plated, with flat pack mounting tabs on one side and TO-5 pads on the other. You can mount six TO-5's or six flat packs or a mixture of both. The only difference between the 13540 and 13541 is the connector pattern. Both are in stock now!

We're also offering the CE-5 card extractor to go with them, an unbeatable combination for development and prototype breadboarding of integrated circuitry.

Stock Triad, and come up winners every time. One way to make sure you have all the Triad transformers your customers need is to keep a copy of our catalog handy...over 1700 items immediately available, more added each month. Get it from your distributor or write us direct. Triad Distributor Division, 305 North Briant Street, Huntington, Indiana.



Triad Distributor Division

LITTON INDUSTRIES



ON READER-SERVICE CARD CIRCLE 105

NEW and Unique

The Lundey Clinch-Loc[®] HERMETIC TEFLON[®] TERMINAL

the ultimate in simplicity

IT'S DUAL-PURPOSE
... and economical

• Dupont Trademark

Use it as a moisture-proof terminal or a conventional panel feed-thru and get *low initial cost, fast and economical assembly, ruggedness and mechanical reliability*—plus the excellent thermal and electrical values of Teflon.

U.S. Patent 3,166,634
Canadian Patent Applied For

Designed to meet Mil-T-27
requirements



WRITE NOW FOR SAMPLE KIT
includes product samples and literature

another quality product in THE LUNDEY LINE

LUNDEY ASSOCIATES, INC.
694 Main St. Waltham, Mass. 02154

ON READER-SERVICE CARD CIRCLE 106

February 1, 1966

Cut costs with world's smallest, uniquely produced Silvered Mica Capacitors

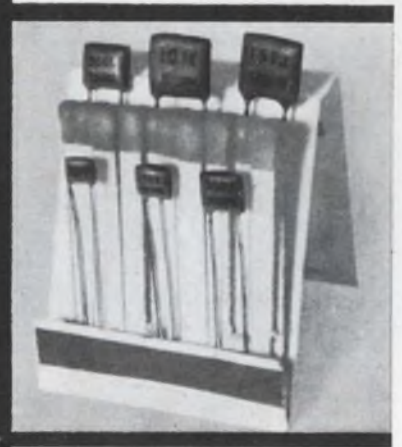

SOSHIN FMCON

- Smaller than and comparable in price to ceramic capacitors
- Excellent capacitance temperature characteristics

Type	Size (mm)			Maximum Capacitance (PF)	T. C.
	Area	Thickness (Max.)	Lead ϕ		
FM05	5 x 5	5.0	0.3	10	D
FM06	6 x 6	5.0	0.4	25	D
FM07	7 x 7	5.0	0.4	43	D
FM08	8 x 8	5.0	0.4	75	E
FM09	9 x 9	5.0	0.5	110	F
FM10	10 x 10	5.0	0.5	150	F

Various other types are also available.

SOSHIN

SOSHIN
ELECTRIC CO., LTD.

18-18, Nakamagome 1-chome,

Ohta-ku, Tokyo, Japan. Cables: SOSHINCAPACITOR TOYKO

ON READER-SERVICE CARD CIRCLE 107

**The
easiest way
to cut
component
costs.**

Farm them out!



**Read why
in Art Wire's
New Bulletin
501**

Learn why Art Wire consistently produces wire forms, small parts stampings and cut tubing at considerable savings over your in-plant costs. And how we can go into high-speed automatic production even faster. For your copy use the inquiry card. If you're in a hurry, call 201-621-7272.

ART WIRE & STAMPING CO.

17 Boyden Place, Newark, N. J. 07102

Application Notes

Designing with MOS FETs

Whether you prefer to call them MOS FETs, MOSTs, IGFETS or MOSFETs, the development of the metal-oxide field-effect silicon transistor is an important area to watch. In a paper called "Designing with MOS Semiconductors," Dr. J. Leland Seely, manager of integrated circuits engineering at the Microelectronic Division of General Instrument Corp., offers a solid but readable report on the basic design features of MOS FETs.

The paper covers basic structure, and operational theory, applications, integrations, the resistor problem and several complex circuits. The paper concludes with an operational description of a 21-bit shift register diffused on a single chip that Seeley describes as a "giant step" in the development of monolithic circuitry. He says, "It is significant and typical of the power of this new technology that such a complicated circuit can be made to economically acceptable yields."

Circle No. 394

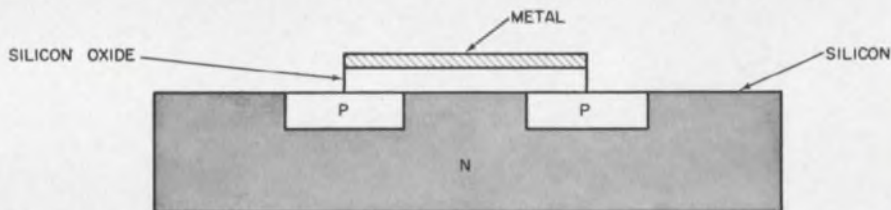

SCRs/power diodes

Application note 200.37 offers advice on increasing power and frequency with high speed SCRs and power diodes. The note, by Neville Mapham of the Rectifier Components Department of General Electric, covers a variety of important parameters and typical trouble spots in the use of these devices. General Electric Rectifier Components Dept.

Circle No. 395

VCXO brochure

Eight pages on voltage controlled crystal oscillators (VCXOs) include a graphic and theoretical discussion, block diagrams, frequency bandwidth graphs, and a specifications guide for the manufacturer's products. Damon Engineering.

Circle No. 397

Vswr detector

An 8-page note covers error analysis procedures and methods of determining vswr values instantly over a broad range of frequencies from 1 MHz to 4 GHz with the "Rho-tector" vswr detector. A nomograph gives the effect of cable attenuation on input and load vswr. Telonic Engineering.

Circle No. 398

Operational amps

This 17-page application note discusses advantages and disadvantages of the three principal Operational Amplifier configurations. Early conclusions show that inverting amplifiers provide highest accuracy and permit gains less than unity. The non-inverting configuration gives high input impedance, and the differential is ideal for push-pull outputs.

Also analyzed are input and output impedances, loop gain, gain errors, dc drift, common-mode limitations and more. Analog Devices.

Circle No. 396

ME components

An eight-page brochure gives performance characteristics of micro-circuit resistors and capacitors.

The brochure contains 13 charts, a nomograph and a table. Providing a wide range of design information. Corning Glass Works.

Circle No. 399



What's our line? Electronic Chemicals. Only Mallinckrodt makes such a complete line . . . just for the electronics industry. Look what's in it: Czochralski crystals ❶ up to 1¼ inches in diameter. TransistAR® Etchants ❷ including the first Ammonium Fluoride offered in convenient solution form. Dip, paint-on and diffusion dopants ❸ . . . quality found nowhere else. Solvents with unusually low particulate levels . . . such as Trichloroethylene TransistAR ❹, the industry's standard cleaning solvent. For higher device yields, be sure of the purity and compatibility of your chemicals. Rely on the technical competence of Mallinckrodt . . . a company that knows electronics, as well as electronic chemicals. It'll pay off. ❺ You can check it.

Mallinckrodt Chemical Works  Electronic Chemicals

St. Louis • New York • Los Angeles

**-120°F to +350°F
on a bench!**



The New Improved Tenney Jr. Bench Model, Mechanically Refrigerated, High-Low Temperature Test Chamber features wider temperature range with $\pm 1/2^\circ$ F control throughout with indicator. Full 1,400 cu. in. test area. New, faster pull down, greater load dissipation. New fan guard. 2¢ per hour average operating cost! Hermetically sealed inside and out. Weighs only 200 lbs. Simple plug-in operation.

Still priced at only \$990 complete. Available immediately.

To order, or for more information, write to



1090 Springfield Road • Union, New Jersey

Western div.: 15700 S. Garfield Ave. • Paramount, Calif. 90723

Oldest and Largest Manufacturer of Aerospace and Environmental Equipment 210

ON READER-SERVICE CARD CIRCLE 122

Performance Proves:

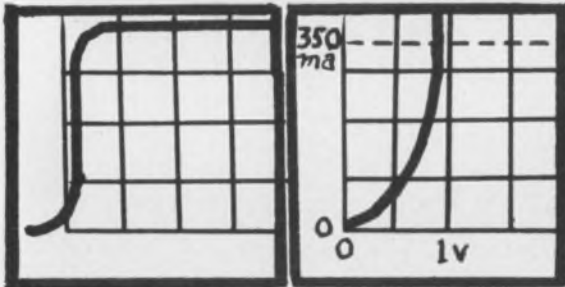

Fastest Switching Diode With High Forward Current

Test waveforms show that International Diode Corp.'s ID3-050T alloy junction diode has a reverse recovery time (left) in the picosecond range, with a 200-to-400 milliamperere forward conductance (right). IDC can provide more than 100 types to solve your design problems, including Q6-100, Q5-100, ID3-050, 1N3146. Price as low as 45 cents in quantities; delivery mostly from stock. Write or phone for details.

INTERNATIONAL DIODE CORP.

90 Forrest Street, Jersey City, N. J. 07304

201 - 432-7151

ON READER-SERVICE CARD CIRCLE 123

APPLICATION NOTES



Flow switches

Applications for flow switches in air conditioning, heating, water treatment, liquid transfer and air flow systems are discussed in this new guidebook FS-GB. McDonnell and Miller, Inc.

Circle No. 701



Varactor diode theory

The basic concepts of harmonic generation with non-linear reactances are presented in an application bulletin directed to communications design engineers. The report deals with the two basic circuit approaches: the series and the shunt configurations. Equations and formulas are included.

A discussion of filters devotes special attention to double-tuned bandpass filters for suppression of spurious responses.

In conclusion, as a specific example, a tripler design, is given in which a 1N4885/H4A varactor driven by an 8458 twin tetrode provides 22 watts at 450 MHz.

Copies of the report, S-124, can be obtained by writing on company letterhead to Amperex Electronic Corp., Hicksville, N. Y.

Reprints Available

The following reprints are available free and in limited quantities. To obtain single copies, circle the number of the article you want on the Reader-Service Card.

Basic Thin Film Techniques (No. 740)

Circuit Marriages Add Flexibility to Logic Design (No. 741)

A New Tool for Easier Network Synthesis (No. 742)

Binary Quinary Logic Improves Decade Counters (No. 743)

Simple IC Tester Handles Prototype Quantities (No. 744)

Trouble Spots in Circuits (No. 745)

Hall Effect Multiplier Simplifies Polar Displays (No. 746)

Designers Challenge (No. 747)

Reliability Terminology (No. 748)

Collector Tap Improves Logic Gating (No. 749)

Digital Computers (No. 750)

Thick Films—How and When to Use Them (No. 751)

Harmonic Generators—Is the Step Recovery Diode Best? (No. 752)

Keeping A CRT's Spot in Focus (No. 753)

Improving the Stability Measurement of Precision Oscillators (No. 754)

Slotted Antenna Arrays Can Be Smaller (No. 755)

Inside the Company Library (No. 756)

Stable Blocking Oscillators, They Can be Practical Part 1 (No. 757)

Subscription Policy

ELECTRONIC DESIGN is circulated free of charge to qualified design engineers in the U.S., Western free Europe and England. To establish your qualifications, send ELECTRONIC DESIGN the following information on your company's letterhead: Your name, engineering title, description of your design duties and a list of your company's major products. The letter must be signed by you personally.

Subscription rates for nonqualified subscribers—\$25.00 per year in U.S.A., \$35.00 in all other countries. Single copy, \$1.50.

Change of Address

An address change for a subscriber requires a restatement of his qualifications. To expedite the change, and to avoid missing any issues, send along a label from a back copy.

Microfilm copies of all 1961, 1962, 1963 and 1964 issues of ELECTRONIC DESIGN are available through University Microfilms, Inc., 313 N. First Street, Ann Arbor, Mich.



"George . . . if we still lived back East, you'd be shoveling snow now instead of lazing in this gorgeous Arizona sunshine."

"I'm not lazing — I'm working on my Masters."



MOTOROLA in PHOENIX

offers excellent career opportunities to qualified engineers. And when the pool and golf course get tiresome, nearby Arizona State University offers a full range of graduate engineering courses through the Ph. D. level. Specific opportunities are:

Antennas & Propagation
Solid State R F
Microwave Techniques
Missile & Space Instrumentation
Operational Support
Integrated Circuitry

Equipment Reliability Analysis
Parts Reliability
Data Acquisition, Processing
& Display
CW Transponders
Radar & Radar Transponders
Fuzes

Guidance & Navigation
Command & Control
Space Communications
Signal Processing
ECM, CCM & Surveillance
Tracking & Telemetry

Contact Phil Nienstedt, Manager of Recruitment, Department 621

MOTOROLA • Military Electronics Division

Western Center • P.O. Box 1417, Scottsdale, Arizona

MOTOROLA ALSO OFFERS OPPORTUNITIES AT CHICAGO, ILLINOIS — AN EQUAL OPPORTUNITY EMPLOYER

Same day shipment

ON 75 STOCK ITEMS



Chemtron*

REED RELAYS

OFFER YOU:

FAST DELIVERY

The large **CHEMTRON** line features prototype order shipment the **SAME DAY** on 75 STOCK ITEMS, plus an exclusive design flexibility that allows shipment the **SAME WEEK** on SPECIALS. This large stock and design flexibility also means fastest delivery on production quantities.

VACUUM ENCAPSULATION

A process developed specially for **CHEMTRON** relays insures maximum ruggedness and reliability.

0.1" PIN SPACING FOR PC MOUNT

Board layout for **CHEMTRON** reed relays is easier.

MAGNETIC SHIELDING

The attractive **CHEMTRON** outer case is a magnetic shield to prevent interaction between closely spaced relays.

HIGH SENSITIVITY COILS

These coils allow **CHEMTRON** reed relays to be driven with low power transistors to minimize drive circuit problems.

WRITE TODAY FOR YOUR FREE CATALOG



SELF-ORGANIZING SYSTEMS, INC.

P.O. BOX 9918 • DALLAS, TEX. 75214 • (214) 276-9487

PLANT: 1910 N. FIRST ST., GARLAND, TEX.

*TM SELF-ORGANIZING SYSTEMS, INC.

ON READER-SERVICE CARD CIRCLE 125

142

Advertisers' Index

*PARTICIPANTS IN NIGHT LETTER PROGRAM

Advertiser	Page	Advertiser	Page
AA Industries, Inc.	132	Lewis Engineering Company, The	106
ACI Division, Kent Corporation	144	Littelfuse	129
ADC Products, Inc.	26	Litton Industries, Triad Distributor Division	137
Accutronics, Inc.	62	Lundy Associates, Inc.	137
Acopian Corporation	112	M-O Valve Co., Ltd.	96
Acton Laboratories, Inc.	107	Mac Panel Company	82
Allen-Bradley Co.	63	Magnecraft Electric Co.	127
American Sankyo Corp.	108	Mallinckrodt Chemical Works	139
Ammon Instruments, Inc.	129	Marconi Instruments	143
Analog Devices, Inc.	98	Markel & Sons, L. Frank	86
*Arnold Engineering Company, The	19	Matsuo Electric Co. Ltd.	130
Art Wire & Stamping Co.	138	Monsanto, Electronics Dept.	51
Automatic Electric, A Subsidiary of General Telephone & Electronics	54, 55	Motorola Communications & Electronics, Inc.	68
Aventek	39	*Motorola Semiconductor Products, Inc.	36, 37, 103
*Ballantine Laboratories, Inc.	93	Ohmite Manufacturing Company	88
Bell, Inc., F. W.	120	Perfection Mica Company	134
Bruce Industries, Inc.	116	Philbrick Researches, Inc., George A.	29
*Brush Instruments, Division of Clevite	Cover III	Potter & Brumfield Division of American Machine & Foundry Company	115
Burr-Brown Research Corporation	110	Princeton Applied Research Corp.	116
C-Cor Electronics, Inc.	127	RCA Electronic Components and Devices	83, Cover IV
CTS Corporation	119	*RCL Electronics, Inc.	15
Cedar Engineering Division, Data Control Corporation	136	Reeves Hoffman Division of DCA	50
CELCO Constantine Engineering Laboratories Co.	79	Rutherford Division of CMC, The	2
Chart-Pak, Inc.	113	Scientific Data Systems, Inc.	7
Chassis-Trak, Inc.	133	Sealectro Corporation	117
Columbia Wire & Supply Co.	126	Sel-Rex Corporation	Cover II
Communication Electronics, Incorporated	118	Self Organizing Systems, Inc.	142
Constantine Engineering Labs. Co. (CELCO)	79	Signetics Integrated Circuits	109
Curtis Development & Mfg. Co.	75, 143	Soliton Devices, Inc.	81
Cutler-Hammer, Inc.	94A	*Sonotone Corporation	101
*Damon Engineering, Inc.	22	Soshin Electric Co., Ltd.	137
*Daven, Division of McGraw-Edison	69	Sprague Electric Company	10, 12, 20
ESI, Electro Scientific Industries	99	Stromberg-Carlson Corporation	118
Eastman Chemical Products, Inc.	113	Switchcraft, Inc.	97
Eldre Components, Inc.	143	Syntron Company	33
Elgenco, Inc.	110	TRW Capacitors	40
Emerson & Cuming, Inc.	128	*Tally Corporation	131
Erie Technological Products, Inc.	6	Tenney Engineering, Inc.	140
Fairchild Instrumentation, A Division of Fairchild Camera and Instrument Company	121	Texas Instruments Incorporated, Industrial Products Group	104
Fairchild Semiconductor, A Division of Fairchild Camera and Instrument Corporation	5	Texas Instruments Incorporated, Semiconductor-Components Division	46, 47
Fairchild Scientific Instruments, Du Mont Laboratories Division, Fairchild Camera and Instrument Corp.	87	Tobe Deutschmann Laboratories	34
General Electric Company	30	*Union Carbide Corporation	42
General Electric Company, General Purpose Control	35	United Control Corporation	100
Globe Industries, Inc.	102	*Unitrode Corporation	25
Gudebrod Bros. Silk Co., Inc.	80	Valcor Engineering Corp.	127
Heath Company	124	Vector Division of United Aircraft Corporation	38
Hewlett-Packard, Sanborn Division	73	Wakefield Engineering, Inc.	113
Hewlett-Packard, Boonton Division	85	Westamp, Inc.	124
Hewlett-Packard	1, 8, 9, 23, 123, 135	Western Transistor Corp.	134
ITT Semiconductors	94, 95	Weston Instruments, Inc.	105
Ideal Precision Meter Co. Inc.	116	Wood Electric Corporation	28
Industrial Timer Corporation	128	Regional Advertisers	
International Diode Corp.	140	Burndy Corporation	76D
*JFD Electronics Corporation	91	*Dale Electronics Inc.	76A
Jennings Radio Mfg. Corp.	111	*Magnetics Inc.	76B
Julie Research Laboratories, Inc.	132	Sorensen, A Unit of Raytheon Company	76C
K.K.C. Shokai Ltd.	136	Career Advertising	
Kay Electric Company	77	Boeing Company, The	74
*Leach Corporation	27	Hughes Aircraft Company Aerospace Divisions	4
		IIT Research Institute	32
		McDonnell Aircraft	125
		Motorola, Military Electronics Division	141

Advertising Representatives

New York 10022

Robert W. Gascoigne
Thomas P. Barth
George W. Fleck
John F. Gilbert, Jr.
Rick Brough
850 Third Avenue
(212) PLaza 1-5530
TWX: 867-7866

Philadelphia 19066

Fred L. Mowlds, Jr.
P. O. Box 206
Merion Station, Pa.
(215) MO 4-1073

Marblehead 01945

Richard Parker
7 Redstone Lane
(617) 742-0252

Chicago 60611

Thomas P. Kavooras
Berry Conner, Jr.
720 N. Michigan
(312) 337-0588

Cleveland 44107

Robert W. Patrick
8410 Treetower Drive
Chagrin Falls, Ohio
(216) 247-7670

Los Angeles 90005

Stanley I. Ehrenclou
Terrance D. Buckley
W. James Bischof
3275 Wilshire Blvd.
(213) DUnkirk 2-7337

San Francisco 94306

Ashley P. Hartman
541 Del Medio
Apt. #301
Mountain View, Calif.
(415) 327-6536

Southwestern 75235

Tommy L. Wilson
6200 North Central Express-
way
Dallas, Tex. 75206
(214) EMerson 1-2311

London W. 1

Brayton C. Nichols
44 Conduit Street

Tokyo

Yoshihiro Takemura
International Planning
Service, Inc.
Room No. 512 Nikkoh
Mita Building
1, Nishidaimachi, Shiba-
Takanawa
Minato-ku, Tokyo



Bus Bars For Noise Reduction



A 10 page Technical Bulletin is now available, describing a new concept in power or signal distribution. Basic mechanical and electrical design principles, along with descriptive pictures and diagrams, are included in this bulletin. These compact buses can replace bulky cable harnesses and repetitive wiring for computer or modular application. This method of construction satisfies the demanding requirements of low inductance and resistance of high speed, solid state systems, while controlling electrical noises.

Eldre Components, Inc.

1239 University Avenue
Rochester, New York 14607

171

Terminal Block Selector



A new 20-page, completely illustrated catalog contains photos, descriptions, ratings, engineering drawings, and prices of the complete line of Curtis terminal blocks. Included are printed circuit, insulated feed-thru, quick disconnect, track type, and high current terminal blocks. Handy selection chart quickly locates the perfect block for your particular requirements. Send today for your free copy.

Curtis Development & Mfg. Co.

3236 North 33rd Street
Milwaukee, Wisconsin 53216

172

The Sig Gen—Book I



The Sig Gen Book I is a new publication available from Marconi Instruments, 111 Cedar Lane, Englewood, New Jersey. It deals with the use of signal generators in testing receivers and covers such subjects as: Source Impedance of Feeder Connected Receivers, Coupling to Loop Aerials, Signal-to-Noise Ratio, Automatic Gain Control, Plotting Response Characteristics, Measurement of Adjacent Channel Suppression and Spurious Response. A handling and mailing charge of 50¢ is asked. For your copy write:

MARCONI INSTRUMENTS, Dept. WAB

111 Cedar Lane
Englewood, New Jersey

173

SIGNAFLO

... aci systems
employing advanced
interconnection
expertise...



Signals flow through "wiring that moves" in this retractile rack and panel aci Signaflo system of round wire to flat cable connections and memory coiled flat conductor cable.



SIGNAFLO SYSTEMS

Send for literature

aci DIVISION OF
KENT CORPORATION

206 INDUSTRIAL CENTER, PRINCETON, N.J. 08540

Let the aci engineering staff and its unique
problem solving capability design aci

SIGNAFLO

systems into your circuitry
cabling . . . whether you
require shielded or un-
shielded, fixed imped-
ance, minimum cross
talk, etc.

Signals flow by the millions through this multiple layered aci Signaflo system for computers. Narrow cable uses exclusive aci "spread pitch" development for connector compatibility.

Designer's Datebook

FEBRUARY						
S	M	T	W	T	F	S
6	7	8	9	10	11	12
13	14	15	16	17	18	19
20	21	22	23	24	25	26
27	28					

MARCH						
S	M	T	W	T	F	S
6	7	8	9	10	11	12
13	14	15	16	17	18	19
20	21	22	23	24	25	26
27	28	29	30	31		

Feb. 1-3

International Conference on Urban Transportation (Pittsburgh, Pa.)
Sponsor: Pittsburgh Chamber of Commerce; Bennett S. Chapple, Jr., Chamber of Commerce Bldg., Pittsburgh.

Feb. 2-4

Aerospace & Electronic Systems Winter Convention (Los Angeles)
Sponsor: IEEE, G-AES; IEEE Office, 3600 Wilshire Blvd., Los Angeles

Feb. 3-8

International Exhibition of Electronic Components (Paris, France)
Sponsor: F.N.I.E. (Electronic Industries Assn. of France); Gen'l Commissioner, Robert Foucault, 16 Rue de Presles, Paris.

Feb. 9-11

International Solid-State Circuits Conference (Philadelphia)
Sponsor: IEEE, University of Pennsylvania; J. D. Meindl, U.S. Army Electronics Command, Ft. Monmouth, N. J.

Mar. 21-25

IEEE International Convention (New York)
Sponsor: IEEE; IEEE, 345 East 47th St., New York, N. Y.

Mar. 21-23

Solar Energy Society Annual Conference (Boston)
Sponsor: Solar Energy Society; Dr. Peter Glaser, Arthur D. Little, Inc., Acorn Park, Cambridge, Mass.

Apr. 20-22

1966 InterMag (International Conference on Magnetism) (Stuttgart, Germany)
Sponsor: IEEE G-Mag; Dr. E. W. Pugh, IBM Corp., 1000 Westchester Ave., White Plains, N. Y.

Apr. 26-28

Spring Joint Computer Conference (Boston)
Sponsors: AFIPS, IEEE, ACM; Dr. Harlan Anderson, Digital Equip. Corp. Maynard, Mass.

Another Brush Innovation in Recording:

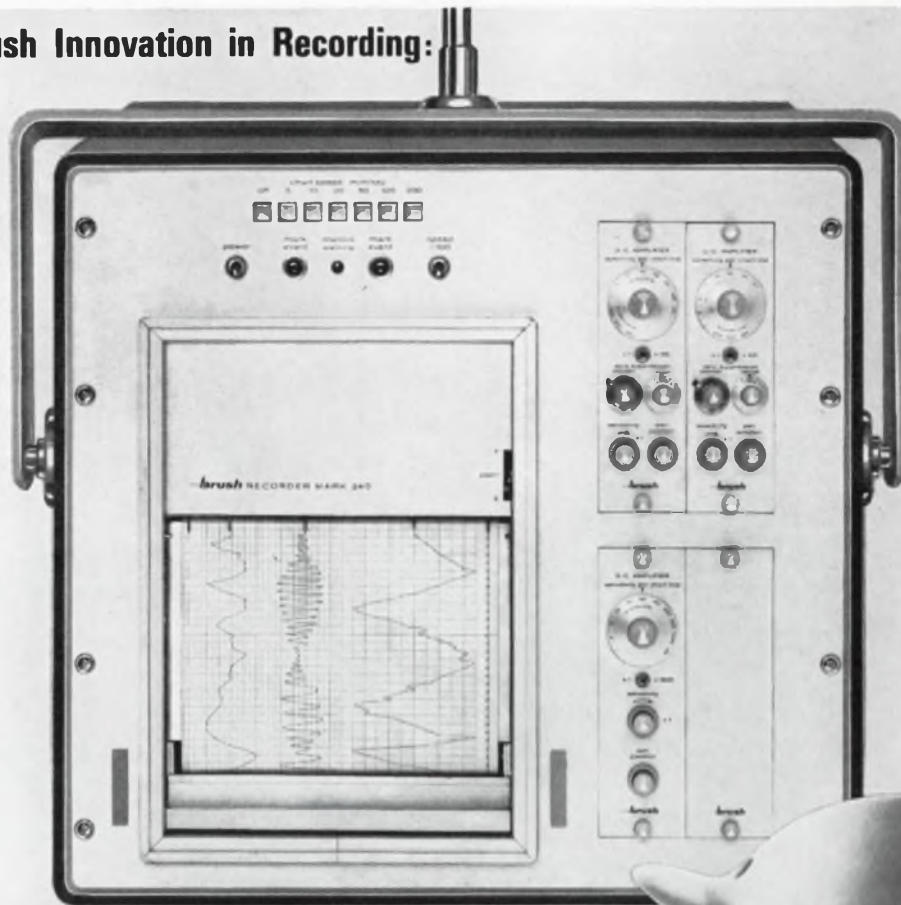

The Brush Mark 240

**If you can't record it
with this recorder,
chances are
it didn't happen!**



What we've done is this:

We took our famous Mark 200 Recorder and made a 'compact' version for general purpose and medical requirements. Performance? The new 240 will do everything the Mark 200 will do. And as Aerospace people will tell you, that's plenty: System linearity better than 1/2%. Pressurized fluid writing system assures incredibly crisp traces on low cost chart paper. Presentation is true rectilinear and there's push-button choice of 12 chart speeds.

Cost? The Mark 240 runs about

half as much as a Mark 200. Still, you have a choice of either four 40 mm analog channels, two 80 mm channels, or a combination* of two 40s and one 80. (You can also have 8-channel event-marker modules). There's a choice of 17 plug-in pre-amplifiers, too. High gain d-c units, straight-through couplers and strain-gage and demodulator types. The Mark 240 is just 17 1/2" high x 19" wide x 20 1/2" deep. Mount it vertically or horizontally in standard 19" racks to RETMA specs, on table-top carts or you name it!

If your kind of recording calls for the utmost in resolution, precision and recording flexibility, ask your Brush representative for complete details about the new Brush Mark 240. There's nothing else like it . . . anywhere! Brush Instruments Division, Clevite Corporation, 37th & Perkins, Cleveland, Ohio 44114. *Just out! Three information-packed booklets on strain recording, temperature recording and techniques of low-level recording. Write us today for your copies. They're yours for the asking!*

*see photo

CLEVITE

brush INSTRUMENTS DIVISION

Speed Inquiry to Advertiser via Collect Night Letter
ON READER-SERVICE CARD CIRCLE 220

Going strong after 30,000 hours



These RCA-7586 nuvistors have a demonstrated RELIABILITY of 99.901% per 1,000 hours out to 30,000 hours of operation—as revealed in continuing life tests that now exceed 2,000,000 tube-hours.

This exceptional reliability is but one reason why so many circuit designers choose nuvistors for sophisticated applications demanding high-level performance at practical costs. Other reasons include: essentially constant transconductance over a very wide temperature range, dependable performance in the presence of both pulse and steady-state nuclear radiation, low RF and sub-audio noise and 1000 g shock rating.

Be sure to evaluate nuvistors whenever you need an amplifier, oscillator, frequency multiplier, mixer, cathode follower or a general-purpose tube for commercial or military applications. For specifics, call your nearest RCA District Office or write to RCA Commercial Engineering, Harrison, N. J. 07029.

Nuvistor Life Test Conditions

Heater Volts	6.3
Heater-Cathode Volts	0
Plate-Supply Volts	75
Cathode Resistor—Ohms	100
Grid-Circuit Resistance—Megohm	0.5
Metal-Shell Temperature—°C.	150
Plate Dissipation—Watt	0.75

RCA DISTRICT OFFICES—OEM SALES: EAST, 2075 Millburn Ave., Maplewood, N. J. 07040, (201) 485-3900 • MID-ATLANTIC, 605 Marlton Pike, Haddonfield, N. J. 08034, (609) 428-4802 • MID-CENTRAL, 2511 East 46th St., Bldg. Q2, Aikman Square, Indianapolis, Ind. 46205, (317) 546-4001 • CENTRAL, 446 East Howard Ave., Des Plaines, Ill. 60018, (312) 827-0033 • WEST, 6363 Sunset Boulevard, Hollywood, Calif. 90028, (213) 461-9171 • INTERNATIONAL OPERATIONS, RCA International Division, Central and Terminal Aves., Clark, N. J. 07066, (201) 382-1000 • 118 Rue du Rhone, Geneva, Switzerland, 35 75 00.



RCA Electronic Components and Devices, Harrison, N. J.

The Most Trusted Name in Electronics