

C
DEC 27 1960
DESIGN
IN THE
60's
G

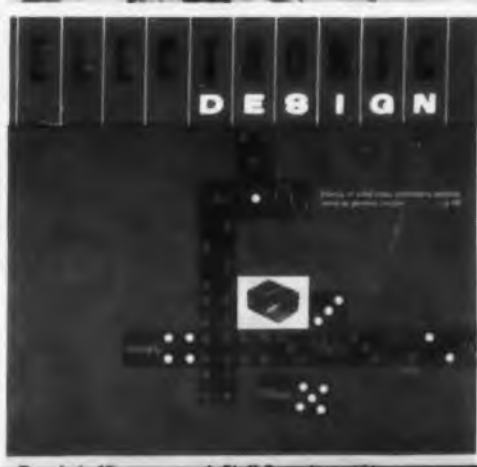

CLIFTON PRECISION OFFERS SIZE 8 SYNCHROS OF GUARANTEED 5' (MAX. ERROR) ACCURACY

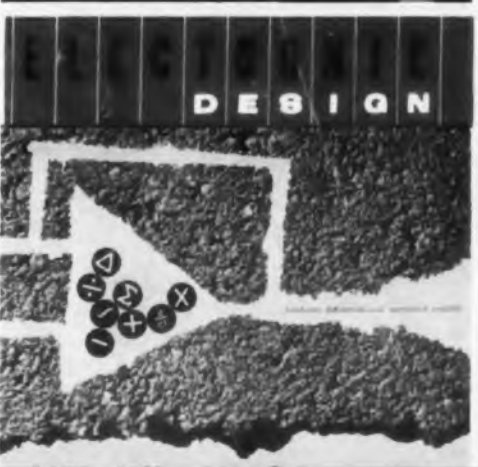
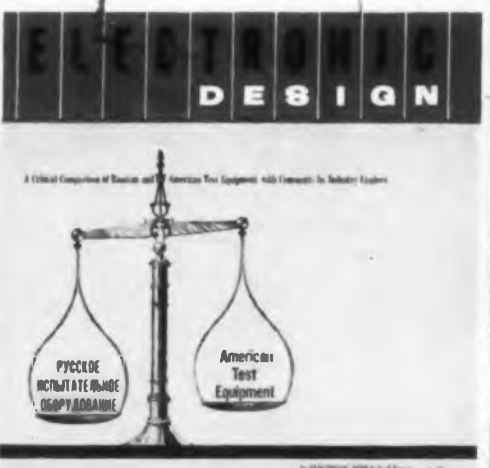
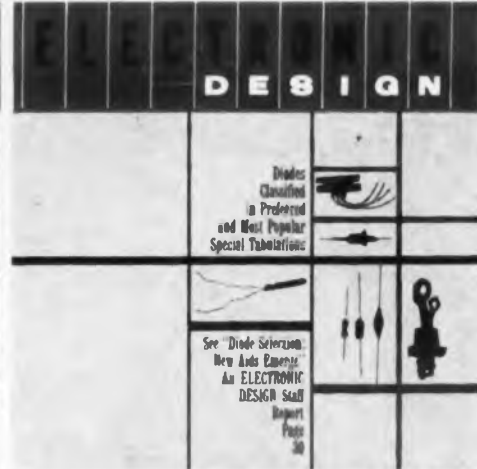
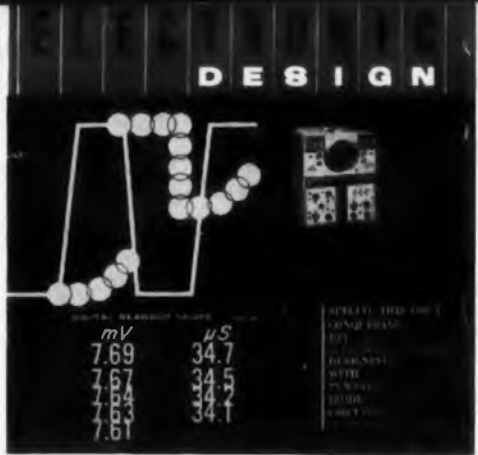

TYPICAL DISTRIBUTION CURVES ON LOT OF 1200 UNITS

Extreme uniformity and thermal stability are maintained in these premium synchros in all electrical characteristics—and especially accuracy.

They are high temperature resistant units and retain their stable characteristics over a temperature range of -55°C to $+125^{\circ}\text{C}$. Exposure to $+150^{\circ}\text{C}$ is feasible for short periods of time.

These are production line units—not selected. Delivery is in 45 days; prototype quantities immediately.

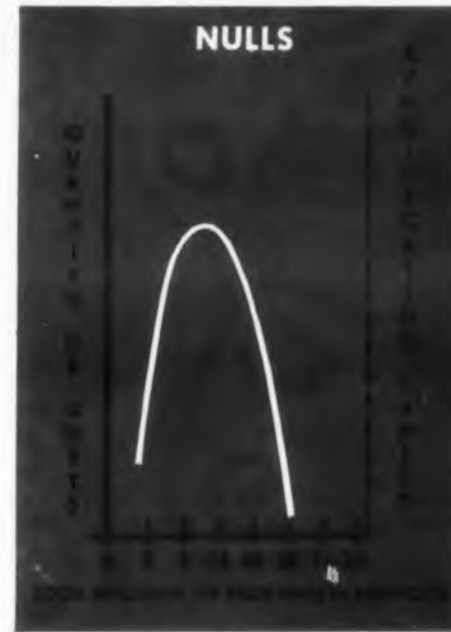

SYNCHRO FUNCTION	CPPC TYPE	ELECTRICAL CHARACTERISTICS										D.C. RESISTANCE			IMPEDANCE			ACCU- RACY		
		ROTOR AS PRIMARY					STATOR AS PRIMARY					Rotor (Ohms)	Stator (Ohms)	Z _{in} (Ohms)	Z _o (Ohms)	Z _{rs} (Ohms)	Max. Volt. (MV)	Max. Error (Min.)		
		Input Voltage (400~)	Input Current (Amps.)	Input Power (Watts)	Output Voltage (Volts)	Sensitivity (MV/deg.)	Phase Shift (deg. lead)	Input Voltage (400~)	Input Current (Amps.)	Input Power (Watts)	Output Voltage (Volts)								Sensitivity (MV/deg.)	Phase Shift (deg. lead)
Torque Transmitter	HGC-8-A-010	26	.120	.66	11.8	206	10.0	—	—	—	—	—	37	12	46+j210	11+j36.5	81.5+j24	30	5	
Control Transformer	HTC-8-A-010	—	—	—	—	—	—	11.8	.039	.092	22.5	393	10.5	365	64	400+j1420	60+j254	590+j176	30	5



For additional information, call or write our Sales Department, 5050 State Road, Drexel Hill, Pennsylvania, MAdison 2-1000, TWX LNSDWN, PA. 1122(U)—or our Representatives.

CLIFTON PRECISION PRODUCTS CO., INC.

Clifton Heights, Pennsylvania

ENGINEERS—Join a pioneer in the rotary components field. Write David D. Brown, Director of Personnel.

CIRCLE 1 ON READER-SERVICE CARD



COVER: For this year-end issue, Electronic Design's Art Department took the 25 covers which have run thus far in the year and arranged them in one cover.

Selected Topics In This Issue

Capacitors

Tantalum Capacitors: 33 Questions and Answers About Them 32

Computers

System Is Developed to Process Information for BMEWS 12
STRAD System Is Imported from U.K. 18

Consumer Electronics

Highlights of Recent Hi-Fi Shows 36

Medical Electronics

Companies Develop Monitoring Systems for Hospitals 4
Cardiotachometer Can Read Fetal Heartbeats 16

Microwaves

New Shapes in Antenna Designs 109
Multiresonator Directional Filter Uses Strip Transmission Lines 110
Design Approaches in Tomorrow's Microwave Sources 114
Five Approaches to Microwave Attenuators for Wide Frequency Coverage 120

Missiles and Rockets

New Energy Source Is Announced at ARS Meeting in Washington 4

Semiconductors

Silicon Transistor Circuits: How to Stabilize Them with Silicon Resistors 28

Test Equipment

Simulation Test Replaces Brute-Force Technique 38

Sidelights of the Issue

Stocktaking

Once again, the time has rolled around to close the editorial books for the year. Amid the hurly-burly of bi-weekly deadlines, most of the staff of **ELECTRONIC DESIGN** is inclined to view the operation as one heck of a lot of trees and underbrush with only occasional glimpses of a forest.

Now, however, comes the time to count the trees and see just how far our forest extends.

In the 26 issues of 1960, we gave our subscribers a look at some 4,500 new products, and featured major stories on 75 others. This represents virtually all new products which might be specified by engineers working original equipment.

During 1960, we also gave our readers 22 staff reports on major developments and analysis of the state of the art in various segments of the industry. Among these were reports on microminiaturization, designing for maintainability, the diode field, and RFI control. In addition, there were exhaustive reports on such widely diverse subjects as anti-submarine warfare and bionics.

Indeed, the index for 1960 shows that we covered in depth, through the News section, technical articles, and product stories, nearly two dozen major segments of the industry.

Lest, however, we be accused of indulging in a "numbers game," we hasten to add that all this would be meaningless if our reporting were meaningless. If the new products had not been checked out, if our staff reports had not been thoroughly researched, our figures would be as the sounding brass.

Happily, this is not the case; at least, according to our lights. Reader response has been, to put it mildly, gratifying.

A great editor with a reputation for being hard to please, once told a writer, "I am encouraged to go on." That, in most cases, is the way we feel about our readers.

On that note, this vague balance sheet closes, with the addition of ED's collective best wishes to its readers for a very merry Christmas and a happy and prosperous New Year.

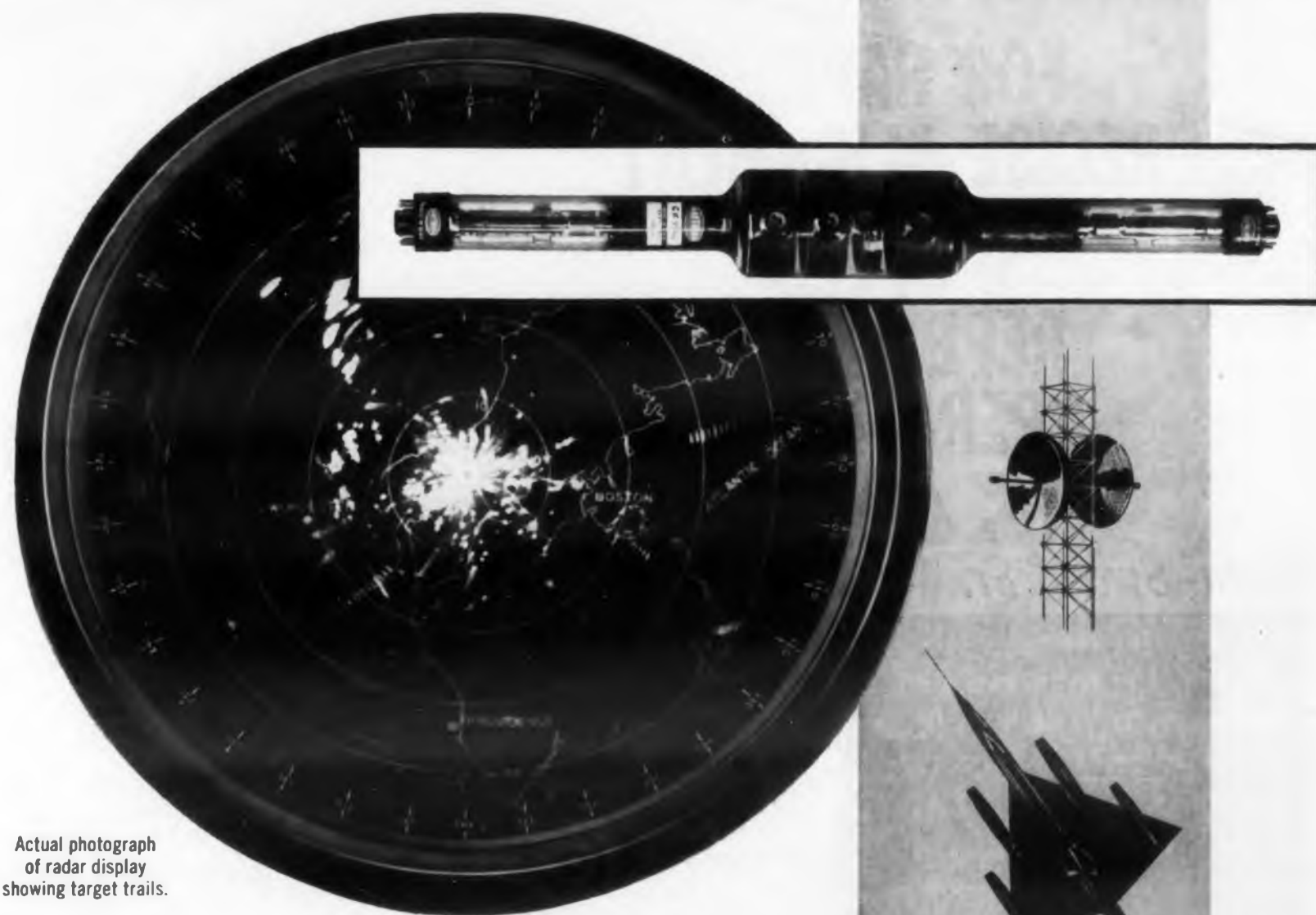

Actual photograph of radar display showing target trails.

Raytheon Recording Storage Tubes Add Greater Capabilities to Your Radar System Designs

The advanced design features of Raytheon Recording Storage Tubes offer designers of radar systems many new application possibilities.

For example, the CK7702, a dual-gun type, is capable of simultaneous writing and reading. It has a minimum resolution of 1200 TV lines per diameter—substantially higher than the resolution available from any other tube presently on the market!

As a result, the CK7702 enables bright video display with high resolution and adjustable automatic priming which can be used to generate target trails for electronic plotting of even high speed jet aircraft. Stored signals can be held for many hours, read several thousand times, or erased in a fraction of a second if desired.

Raytheon's full line of single and dual-gun storage tubes adds greater capabilities to new equipment designs

you may be contemplating, such as:

- Scan conversion for bright display and target trails.
- Slow-down video for transmission of still pictures over telephone lines or other communication channels.
- Stop motion to permit analysis of production machinery or to stop action in a sporting event.
- Signal-to-noise improvement of radar or other still pictures by integration.
- Conversion of television pictures from one transmission standard to another.
- Indication of moving targets by electronic comparison of pictures taken at different times.
- Storage of digital or analog computer data for rapid accessibility during readout.

Complete technical data can be obtained by writing to Raytheon, Industrial Components Division, 55 Chapel Street, Newton 58, Mass.

RAYTHEON COMPANY

INDUSTRIAL COMPONENTS DIVISION

RAYTHEON

FOR RAPID, PRECISE ALIGNMENT

(1-350 mc)

TO SPEED REPETITIVE OPERATIONS

KAY

Rada-Sweep® Sr. | Rada-Sweep® 300

The Sweeping
Oscillator-Frequency Marker which
Permits You to Complete Its Design
to Your Specific Requirements

CHOOSE:

- Center Frequencies exactly as required.
- Frequency markers at exact alignment points.
- Sweep widths • RF output

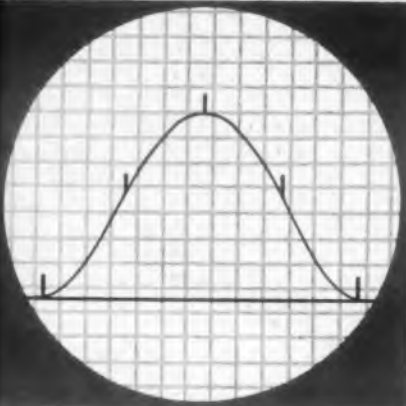

The Rada-Sweep Sr. and 300 provide all-electronic fundamental frequency sweeping oscillator signals with good wave shape and no spurious outputs. Precision, pulse-type crystal markers and highly stable, narrow and wide band sweeps provide ease of operation and highest accuracy. Select the specifications that solve your unique alignment problem.

FOR EXAMPLE:		
BAND	CENTER FREQUENCY	MARKING
1	2.2	2.1, 2.2, 2.3 mc
2	3.0	2.5, 2.875, 3.0, 3.125, 3.5 mc
3	28.8	28.8 mc
4	72.5	70, 75 mc
5	180	170, 190 mc
6	230	230 mc

GENERAL SPECIFICATIONS

KAY Rada-Sweep® Sr.

CATALOG NO. 385-A

• 24 Pulse-Type, Crystal-Controlled Markers Set to Your Specifications.

• Provides Fundamental Frequency Sweeps Over 6 Switched Bands . . . No Spurious Output.

SWEEP WIDTH: To 70% of center frequencies selected — 1 and 100 mc; 60 to 70 mc for frequencies — 100 and 260 mc.

SWEEP RATE: Variable around 60 cps; locks to line frequency.

RF OUTPUT: 0.5 volt rms into nominal 70 or 50 ohms. Higher for lower frequency units. Output held constant to within ± 0.5 db over widest sweep by AGC circuit.

ZERO REFERENCE: A true zero base line produced on oscilloscope during retrace time.

ATTENUATORS: Switched 20 db, 20 db, 10 db, 6 db, 3 db plus continuously variable 6 db.

MARKERS: Accurate to $\pm 0.05\%$. Groups of markers selected simultaneously with sweeps by main band switch.

PRICE: \$725.00 including cabinet, F.O.B. Factory (\$798.00 F.A.S. New York) Crystal Marks \$17.00 each extra.

KAY Rada-Sweep® 300

CATALOG NO. 388

SPECIALIZED SWEEPING OSCILLATOR SIMILAR IN SPECIFICATIONS TO RADA-SWEEP SR.

• 1 mc to 350 mc.

• Any 12 Fixed Center Frequencies Set to Your Specifications.

• Up to 30 Pulse-Type, Crystal-Controlled Markers Set to Your Specifications.

PRICE: \$925.00 F.O.B. Factory (\$1018.00 F.A.S. New York) plus markers at \$17.00 each.

WRITE FOR COMPLETE CATALOG INFORMATION

KAY ELECTRIC COMPANY

DEPT. ED-12 MAPLE AVE., PINE BROOK, NEW JERSEY CAPITAL 6-4000

CIRCLE 3 ON READER-SERVICE CARD

CONTENTS FOR DECEMBER 21, 1960 VOL. 8 NUMBER

26

ELECTRONIC DESIGN News	4
ARS Meeting Produces New Energy Source	4
Automated Patient Monitoring Gains Hospital Foothold	5
Pilot Navigation Aids Are Pushed	8
BMEWS Checkout Data Processor Detailed at EJCC	12
Ultrasensitive Cardiometer Records Heart Fluctuations	16
STRAD Data System Is Imported from U.K.	18
Washington Report	22

What Are We Buying?	27
An Editorial	

Silicon Transistor Circuits: How To Stabilize Them With Silicon Resistors	28
With graphs and equations, the authors show how to stabilize the dc-operating point of silicon transistor circuits—E. C. Wilson, G. W. Andrews	

Tantalum Capacitors: 33 Questions and Answers on Their Applications, Characteristics, Peculiarities	32
Everything from battery effect to reliability covered	

Highlights of Recent Hi-Fi Shows	36
A pictorial roundup of clever consumer items displayed at hi-fi shows in New York and Chicago	

Simulation Test Replaces Brute-Force Technique	38
New power supplies increase efficiency of semiconductor life tests	

MicroWaves	109
In this, the second section of a series devoted to microwave technology, ELECTRONIC DESIGN has assembled a balanced diet of advanced design theory, current design techniques and new microwave products. Without complementary progress in each of these areas, microwaves would be incapable of fulfilling the promised advances in performance and in penetration into new fields of technology.	

New Shapes Launch Microwaves	109
A photo story of the broad range of antenna designs recently in the news.	

Multiresonator Directional Filter Uses Strip Transmission Lines	110
Provides characteristics of directional coupler and filter—R. L. Steven, P. E. Dorato	

Design Approaches in Tomorrow's Microwave Sources	114
To achieve 500-megawatt peak and 1-megawatt cw in microwave power, tube designers are developing exotic new techniques—T. Bibbens	

Five Approaches to Microwave Attenuators for Wide Frequency Coverage	120
The variety of approaches taken by microwave designers to a common design problem are illustrated. This is followed by other types of microwave products.	

4	Index of Articles, July 6 through December 21	142
	Topics listing and cross-reference guide	
	New Products	40
	New Literature	130
	Careers	150
27	Your Career	150
28	Advertisers' Index	154

Coming Next Issue

For the first issue of the New Year, **ELECTRONIC DESIGN** has surveyed all the major and most of the minor segments of the electronic industry to come up with their predictions for 1961. An array of subjects is covered in this Staff Report, entitled "The Look Ahead for '61." For the report **ED's** editors have also added their own analyses of what the New Year will bring and have come up with some provocative predictions, based on both sound fact and sound observation.



ELECTRONIC DESIGN is published bi-weekly by Hayden Publishing Company, Inc., 830 Third Avenue, New York 22, N. Y. T. Richard Gascoigne, Chairman of the Board; James S. Mulholland, Jr., President; Edmund C. Grainger, Jr., Secretary. Printed at Hildreth Press, Bristol, Conn. Accepted as controlled circulation at Bristol, Conn. Additional entry New York, N. Y. Copyright © Hayden Publishing Company, Inc., 1960, 37,400 copies this issue.



To be frank, why pay for more than you need?

Canoga's MPS-26 instrumentation radar delivers accuracy to 0.5 mils, far more than necessary for almost all tracking purposes, yet only a fraction of the cost of huge units which deliver more (but so often un-needed) accuracy. Since more down range

locations are possible with this reduced cost, the MPS-26 provides absolute protection against catastrophic failure. Here, then, is the economical yet positive answer to mobile missile range instrumentation — to the complete satisfaction of both the engineer and the budget officer. For our complete specifications, please write or telephone Canoga Electronics. **CANOGA**



CANOGA ELECTRONICS CORPORATION VAN NUYS, CALIFORNIA FORT WALTON BEACH, FLORIDA

CIRCLE 4 ON READER-SERVICE CARD

Two Major Developments Highlight ARS Meeting

Reveal Details of 'Austin-Effect' Power Source, Proposed Communication Satellite at Conference

A POWER source described as completely new and a radically designed synchronous communication satellite were described publicly for the first time at the annual meeting of the American Rocket Society in Washington earlier this month.

Researchers at Westinghouse's Aircraft and Missile Electrical Power Systems Div., Lima, Ohio, have discovered that exotic vitreous enamels can be made to behave much like batteries by subjecting them to temperatures above 200 C. The company did not disclose the composition of the enamels being used.

The discovery may result in inexpensive power supplies with high specific power and long shelf life for special applications, according to B. O. Austin, company consultant who reportedly first noticed the effect. Such supplies would be able to operate above 1,000 C.

An "Austin-effect" battery consists of a coating of special enamel on a sheet of iron or other metal to which an electrode is attached. The enamel is then coated with a thin layer of silver, to which another electrode is attached. If the sandwich is heated to more than 200 C, and as high as about 1600 C, current will flow from the enamel to one of the metal layers. In experi-

mental devices made by Westinghouse, power densities of 16 mw per sq. in. have been measured at 600 C, indicating that devices could be made that would weigh as little as 5 lb per kw hr, Westinghouse says. Batelle Memorial Institute has reportedly confirmed the company's results.

Though the effect is not understood, the enamel is believed to operate like a battery, with excitation of either ions or electrons the source of the current flow. Mr. Austin believes that his special ceramics may contain a fixed amount of potential power at each temperature level. He also believes that the effect may be related to the one that causes enamel insulation to break down at high temperature. Establishing this link might help avoid system failures in many designs, he reports.

Heating and discharging a unit starts current flow, which continues at decreasing levels, until the enamel cools below its excitation point or its energy is depleted. In one experiment, two hours passed before a 10-ohm matched load discharged an Austin-effect unit sufficiently to reduce power output from 13 mw to 7.5 mw in a 650 C environment. Efficiency has not been established but is believed to be high.

Reheating is possible, Mr. Austin says, but each recycling operation must be at a higher temperature, and will result in lower power outputs. However, because there are apparently no internal short circuits, shelf life of actual units would be long.

Steel, iron, aluminum and other metals can be used for the sandwich, and lightweight magnesium is considered a good possibility. Units developed so far have proved very reliable. In all of them, output is proportional to area and temperature. The units can be cascaded; in series their voltages add arithmetically, in parallel they add in proportion to area. Mr. Austin believes miniature devices could be made as small as 10 mils thick and an eighth of an inch

square. He also believes they might be made to operate at temperatures considerably lower than 200 C.

Proposed Synchronous Satellite Would Use Phase Modulation

One of the surprises of the meeting was the announcement by Hughes Aircraft Co. of a synchronous, active communications-satellite system it has developed and proposed to ARDC and other agencies. The spin-stabilized payload would weigh about 32 lb, including only 5 lb of electronics, and would use a new type of if phase modulation to make modulation and detection linear for compatibility and to conserve power. This modulator, which Hughes is not describing in detail, uses two balanced limiters.

Also used in the payload, which would provide 600 two-wire voice channels, is a specially designed traveling-wave-tube power amplifier that operates with low filament drain and gives 2-w output. Efficiency goal was 33 per cent. ■ ■

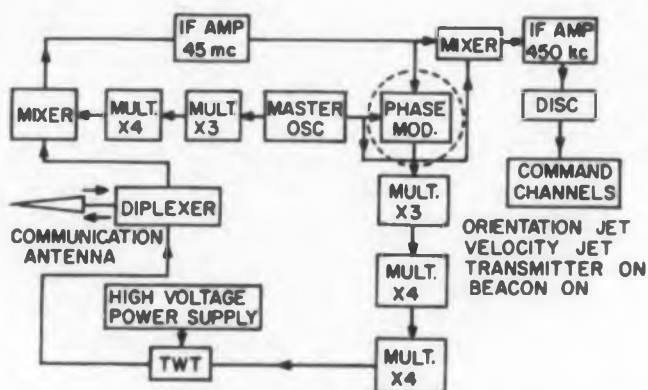

Payload of proposed communications repeater has no detector, uses linear, balanced if phase modulator that is essentially a balanced limiter.



New power source consists of iron sheet coated with special enamel. Enamel is coated with thin layer of silver. Toaster was used in Westinghouse demonstration to heat the sandwich, which give high specific power both in and out of hot environment.

Automated Monitoring Gains Hospital Foothold

17-Patient System in Operation; Many Companies Entering Field

AUTOMATIC monitoring of many special-care patients from a central console is being accomplished with a new 17-patient system recently installed at New York's Roosevelt Hospital.

The experimental system, which is being used for continuous observation of critically ill patients, may serve as a model for similar installations in hospitals across the country.

Although Epsco, Inc., Cambridge, Mass., has taken the lead in the automatic-monitoring field with the Roosevelt Hospital unit, several other companies are well advanced in development of similar systems.

The system developed by Epsco monitors body temperature, electroencephalograph (EEG) signals to derive heart rate, using a simple analog-computer circuit. Equipment for measuring respiration rate will be added later.

All measurements, except for temperature, are made using small voltage pick-ups attached to a few millivolts, are sent through a junction box at the head of each bed to the central console, for amplification and display, over carefully shielded cables. Rectal temperature is measured by a thermistor probe in a bridge circuit.

Other planned systems are generally similar in concept. Among systems in advanced stages of development are the following:

- A multi-patient unit, under development by Gulton Industries, Inc., Metuchen, N. J., will make measurements of blood pressure, blood-oxygen content, heart rate, respiration rate, and temperature. The first unit should be installed and in operation in a hospital within two months.

- A portable monitoring unit for doctors answering emergency calls, or riding in ambulances, is under development at Lockheed Electronics Co., Metuchen, N. J. This unit will be powered by mercury cells. Prototype units will probably be given to selected doctors, who will recommend further design change.

- A central nursing station for a 12-bed ward is being developed by Litton Industries' Medical Electronics and Bionics Laboratory in Woodland Hills, Calif. This unit will measure the following parameters: body temperature, blood pressure, heart rate EEG and EKG signals, respiration rate, and galvanic skin response. The recording and monitoring console is designed. A three-channel Biopack, for transmitting signals from the patient to the console, is nearing completion.

(continued on p 6)

(picture of a KIN TEL differential amplifier at work)

6 volts of 60 \sim common-mode noise and
6 millivolts of signal in here

2 microvolts of 60 \sim noise (equivalent input)
and 6 volts of signal out here

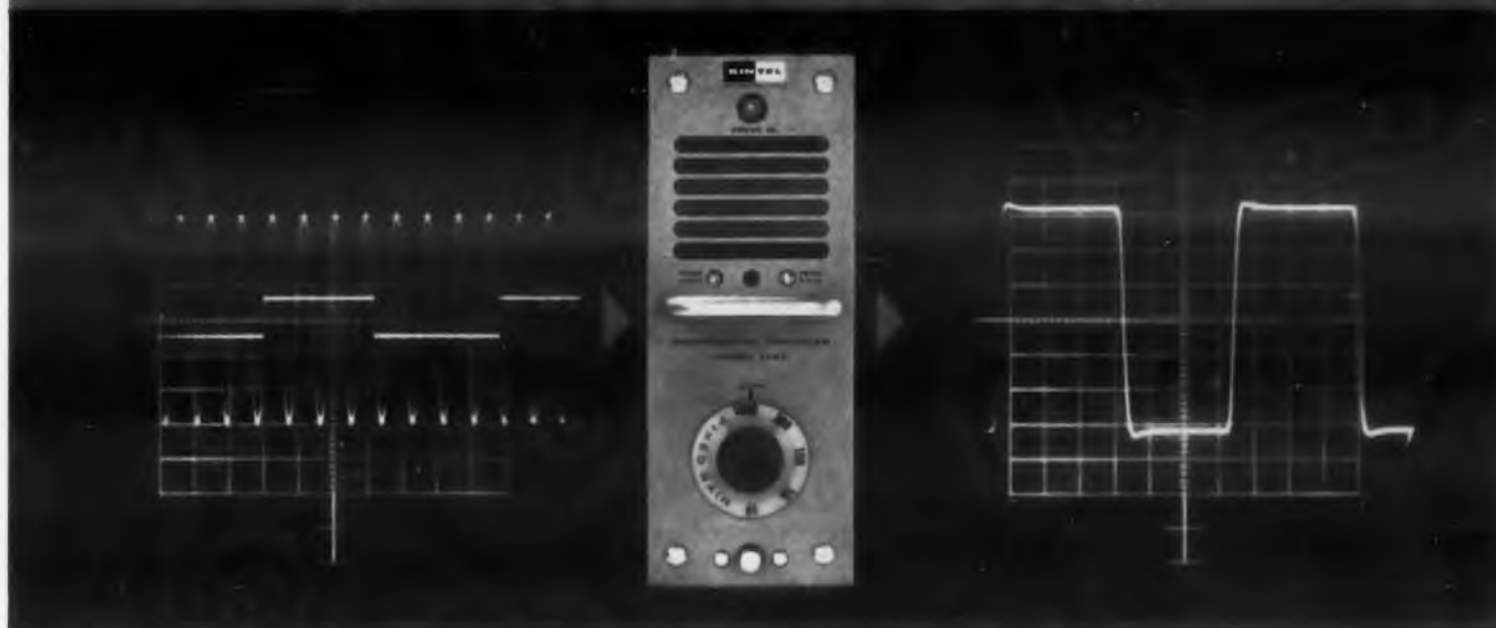

If you measure the output of thermocouples, and the thermocouples are bonded to a rocket engine or almost any other grounded object, and the distance between thermocouples and amplifiers is more than a few feet, you should consider the above illustration carefully. While we'll admit your thermocouples probably aren't producing square waves, nine chances out of ten you *do* have a problem with 60-cycle common-mode noise. Nearly everybody does.

What can be done about it? Well, KIN TEL differential amplifiers reject ruinous 60-cycle common-mode hum and noise by a factor of 3,000,000 to 1 with any unbalance up to 1000 ohms in series with either side of the input, 1,000,000 to 1 with 10,000 ohms unbalance. Rejection for DC is practically infinite and both input and output can be floated up to ± 300 volts DC or peak AC. The secret of this exceptionally high common-mode rejection in the presence of high input unbalance is isolation. Input signal terminals are isolated from chassis ground by 10,000,000 megohms and 0.6 micromicrofarads. Input and output signal terminals are completely isolated from each other. Output signal terminals are isolated from ground to almost the same extent as the input. With this virtually perfect isolation, you can rescue microvolt level signals from volts of common-mode noise, regardless of whether load and transducer are floating or grounded, balanced or unbalanced.

Before you send us that letter...the input scope photo is a double exposure. The square wave input signal was taken with the scope connected across points 1 and 2 (see drawing below) with 5 mv/division sensitivity. To show the noise, the scope was connected between points 2 and 3, and sensitivity was 1 v/division. The scope on the output was set for 1 v/division sensitivity and, of course, no noise is evident.

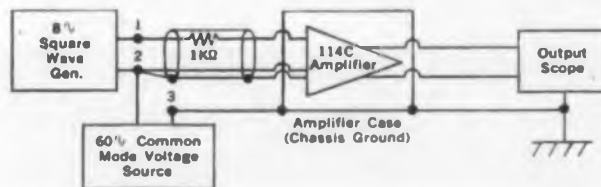

Specifications other than common-mode rejection are equally impressive. Linearity is 0.01% of full scale (10 volt) output for either polarity, 0.02% of full scale for plus-to-minus or minus-to-plus polarities. Equivalent input drift is less than $2\mu\text{v}$; noise at full amplifier bandwidth is less than $6\mu\text{v}$. Input impedance is 30 megohms, output impedance less than 0.25 ohms. Standard bandwidth is less than 3 db down at 80 cps, and the amplifier settles to within 99.9% of final value within 50 milliseconds for an output change of 5 volts. Plug-in input and output filters allow bandwidth options from 3 cps to 120 cps, transient response as good as 25 milliseconds. Gain is 10 to 1000 in 5 steps. A front panel vernier control provides 1 to greater than 3.3 times continuous adjustment of each gain step. Gain stability is $\pm 0.05\%$. Output capability is 10 volts at 10 milliamps. Amplifiers have integral power supplies. Enclosures include six-amplifier and single-amplifier 19-inch rack modules, and portable single amplifier cabinets.

To meet your exact requirements at minimum cost, two models are now available: the 114A at \$775, and the 114C (described) at \$875. Delivery on both models is currently from stock. Write for detailed technical data or a demonstration. Engineering representatives in all major cities.

KIN TEL
A DIVISION OF
COHU
ELECTRONICS, INC.

5725 Kearny Villa Road, San Diego 11, California
Phone: BRowning 7-6700.

CIRCLE 5 ON READER-SERVICE CARD

NEW



MODEL 801H

a GOOD
MEASURE of
user benefits...



NEW! 1MV FULL SCALE NULL SENSITIVITY—RECORDER
OUTPUT—AUTOMATIC LIGHTED DECIMAL—IN-LINE
READOUT—TAUT BAND SUSPENSION METER

precision DIFFERENTIAL DC VOLTMETER

PARTIAL 801 H SPECIFICATIONS

Voltage Ranges:	0.5, 5, 50 and 500V DC
Accuracy:	0.05% from 0.1 to 500V 0.1% or 50uv, whichever is greater, below 0.1V
Null Sensitivity Ranges:	10V, 1V, 0.1V, 0.01V and 0.001V
Maximum Meter Resolution:	5uv
Input Impedance:	Infinite at null
Dimensions:	Cabinet 9 $\frac{3}{4}$ " W x 13 $\frac{1}{2}$ " H x 14" D Rack 19" W x 8 $\frac{3}{4}$ " H x 13 $\frac{1}{4}$ " D
Weight:	Cabinet 25 lbs., Rack 28 lbs.
Price:	Cabinet \$555.00, Rack \$575.00 Prices F.O.B. factory, Seattle

Extreme accuracy and stability are achieved by advanced circuit design which incorporates a chopper stabilized null amplifier and a standard cell reference.

Using the same accurate principal to find the unknown as the beam balance, the Model 801H Differential Voltmeter gives you balanced accuracy, guarantees a "good measure for your money."

Like all jf differential voltmeters, the Model 801H provides infinite input impedance at null over the entire 0-500 Volt range. This jf feature is unique on today's voltmeter market and is of prime consideration when making precise DC measurements. The source loading of 1 to 10 megohms above a nominal 10 volts, which is inherent in other differential voltmeters now available, cannot be tolerated when 0.05% or better accuracy is to be maintained.

Prices and technical
data subject to change
without notice.

Write for complete specifications.
Also ask for information on the jf A-70 recorder,
companion to the 801H, and the Model 803.



JOHN FLUKE MFG. CO., INC.
P. O. BOX 7161 SEATTLE 33, WASH.

CIRCLE 6 ON READER-SERVICE CARD

NEWS

(continued from p 5)

The Roosevelt Hospital installation marks a significant step toward automation of patient observation in hospitals. In the last few years electronic monitoring equipment has been widely used in the operating room, and occasionally for one or two post-operative or critically ill patients.

The 17-patient experimental system designed by Epsco, however, is the most advanced step yet taken toward large-scale monitoring in the hospital ward.

A single nurse can gather data on many patients over a long period of time, giving doctors more information for making decisions. In addition, danger signs can be spotted early so that immediate steps can be taken in emergencies.

Further refinements of present systems will probably include circuits capable of responding to such danger signs, and automatic alarms.

Some measurement techniques for remote monitoring are fairly well developed, but most could stand much improvement.

Because of the new electronic measurement methods being developed intensive medical research is being done in many areas to take advantage of the information now available to a physician.

Temperature, for example, can now be determined anywhere on the body, according to John F. Moore, manager of product development at Lockheed Electronics. A medical researcher at Princeton is using this technique to determine the information that can be gained by local chilling of some portion of the body, and then measuring the time it takes for this point to return to normal body temperature, Mr. Moore said.

Intensive study has already been applied to detailed analysis of EKG signals, which represent voltage differences between selected points on the body. A complex voltage pulse is generated each time the heart beats. It has been found that many factors in a patient's condition can be de-



Nurse operates central console used to monitor continuously up to 17 patients in a special-care ward. A unit similar to this one has been installed by Epsco, Inc., at Roosevelt Hospital in New York.

terminated by studying the resulting waveforms.

The Epsco system uses voltages from the legs and the arms for this measurement, with the right leg taken as a reference. Electrodes inserted in the scalp are used to pick up the EEG voltages.

Respiration rate in the planned Gulton system will be measured by a nasal thermistor probe. Inhalation and exhalation can be sensed because of the temperature difference between inhaled and exhaled air.

Gulton will use a conventional red-infrared oximeter for measuring blood-oxygen content. Light shining through an ear lobe will be detected by red-sensitive and infrared-sensitive sensors. The IR signal acts as a reference, since IR transmission is not affected by blood oxygen. Transmission of the red light, however, is proportional to oxygen content, so that the output of the red detector indicates variations in blood oxygen.

Simple Operation, Effective Shielding Are Primary Design Considerations

Many important considerations must be satisfied in designing equipment for use in automated hospital systems. Simple operation and adequate shielding are primary hardware requirements, and patient comfort and some degree of maneuverability are desirable in an instrument concept. Long clinical testing periods are usually necessary before a new concept is accepted.

Simplicity is vital because nurses are usually too busy to spend much time making adjustments. An oscilloscope used with the Epsco system for displaying EEG and EKG waveforms, for instance, is operated by the nurse much as she would operate a TV set.

Focus, brightness, vertical position, the scale light, and a channel switch are about the only controls she must operate. When a preamplifier output is switched from the scope to a strip-chart recorder, the nurse must adjust amplitude properly before a switch is thrown.

Most other controls are operated with a screwdriver through access ports in the front of the console. This prevents unnecessary knob twirling by untrained people.

Epsco measured bed-to-console distances to compensate for varying cable impedances.

Because of the low level signals that must be detected, much care must be devoted to shielding and grounding practices. The frame or chassis is never used for a signal or power ground in Epsco's unity and all signal carrying leads are shielded.

Shield terminations are not chosen randomly, but are connected to the source or amplifier only after careful consideration of the possibilities of ground loops and noise. ■ ■

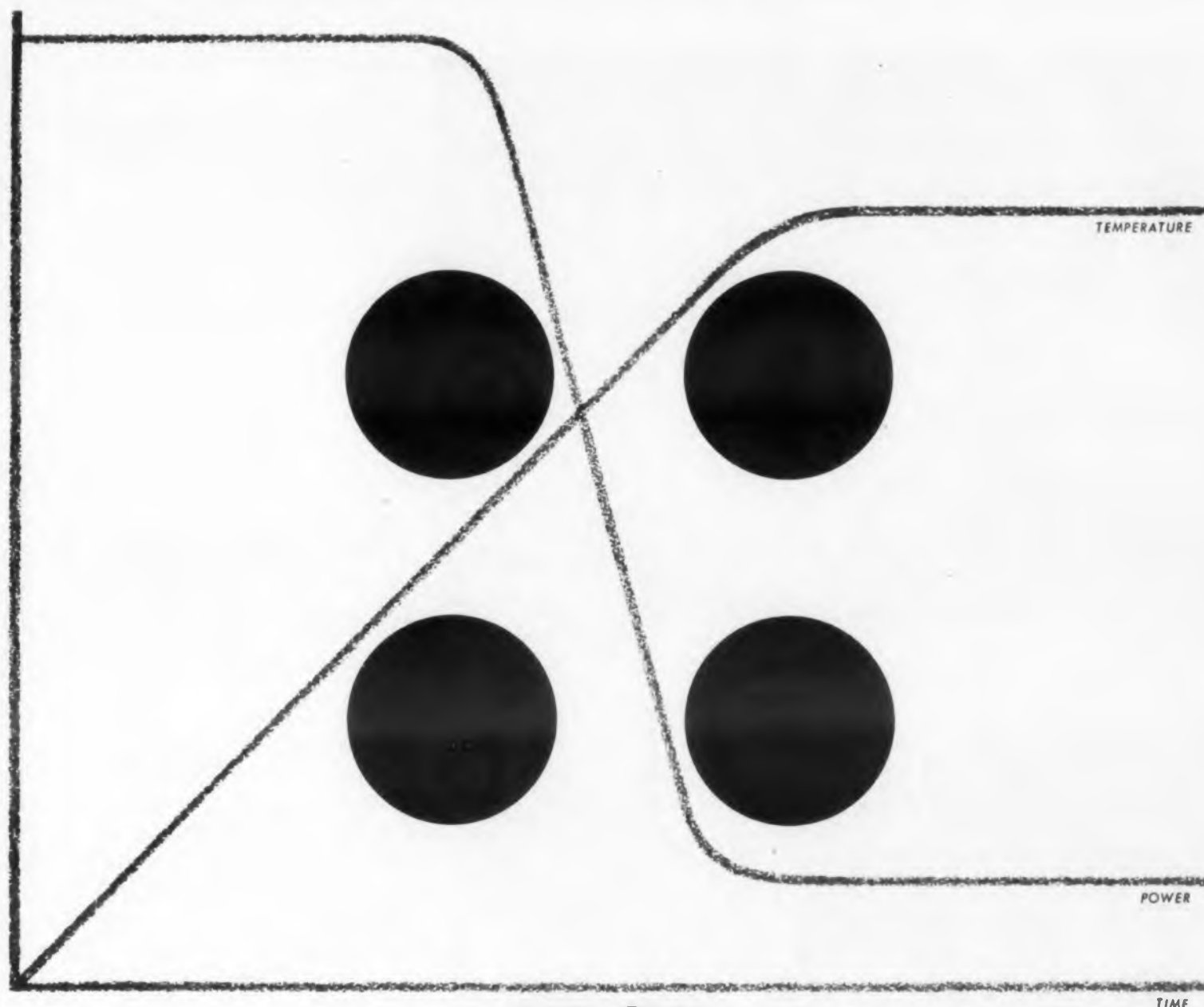

BULOVA PROPORTIONAL SILICON TRANSISTOR CONTROLLED OVEN



Where ever temperature variations affect the "percentage" of heat required to maintain efficient operation, the new Bulova proportional control oven eliminates temperature cycling, RF interference noise, surges of oven power, and the drift of temperature differential due to aging. The oven temperature can be set to an accuracy of $\pm 0.5^{\circ}\text{C}$ and has a range of $+40^{\circ}\text{C}$ to $+125^{\circ}\text{C}$.

The stepless control of the Bulova proportional system is accomplished by two highly stable Bulova developments: (1) a temperature sensitive bridge, and (2) a transistorized amplifier supplying

power proportional to the output of the bridge. Thus any unbalance created by resistance changes is amplified and conveyed to the heater . . . which receives only enough power to take care of heat loss with a $.01^{\circ}\text{C}$ stability or better. DC proportional control is employed to eliminate any interference of oven control circuitry with the internal circuitry.

If you'd like more information on how the Bulova proportional control oven can extend the life of your units to equal that of the solid state components used, write Department 1771, Bulova Electronics, Woodside 77, New York.

CIRCLE 7 ON READER-SERVICE CARD



"A Rutherford pulse generator is being used to test silicon rectifiers at the Clyde, N.Y., facilities of the G. E. Semiconductor Products Department."

Rutherford PULSE GENERATORS for TESTING

 **Semiconductors**

The Rutherford B-7B Pulse Generators are engineered to meet today's rigid standards of testing, research and development.

If your requirements are for high performance and wide versatility at low cost...specify the Rutherford Model B-7B.



SPECIFICATIONS

Rack mountable . . . single unit construction . . . variable time rise control . . . 50 volts into 50 ohms at 30% duty factor . . . rep. rate to 2 mc . . . widths .05 μ s to 10,000 μ s . . . delays to 10,000 μ s.

Low budget price: \$720.00 F.O.B. Culver City, California



Rutherford ELECTRONICS CO.

Dept. ED 4721 • 5944 Lindblade Street • Culver City, California • TWK-CVR-CY-4133

pulse generators / pulse systems / accurate time delay generators

CIRCLE 8 ON READER-SERVICE CARD

NEWS

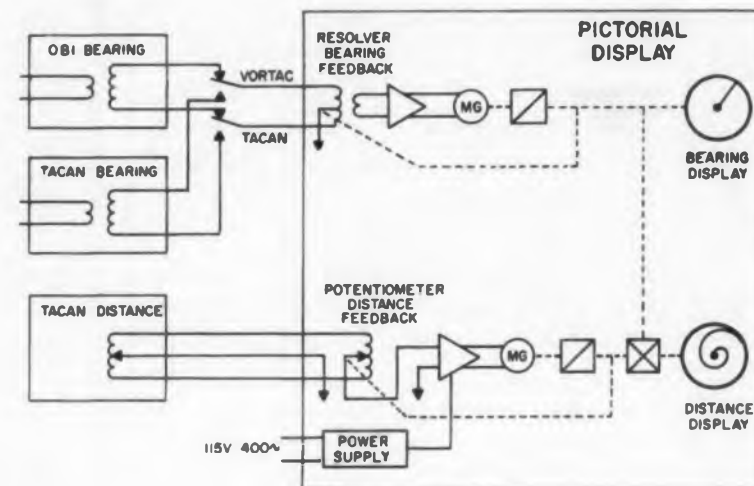

Pilot Navigation Aids Are Pushed

FAA Calling For Design of Displays; Course Computers, Combinations Pushed

ENCOURAGED by the Federal Aviation Agency, designers are developing a tangle of cockpit devices intended to help pilots navigate their aircraft. The lure is what happens to be a sizable and eager market, one the FAA would be pleased to see satisfied. Hence the agency's endorsement, both official and unofficial, of the current design effort.

Three types of units are under development:

- **Pictorial displays.** These devices show the aircraft as a symbol moving across a map of the terrain below. The symbol is driven by distance and bearing signals from VORTAC (or VOR) and DMET stations, or by signals from other sources. Companies developing this type of equipment include ACF Electronics, International Telephone and Telegraph Laboratories, and Butler Co.

- **Course-line computers.** These devices are programed by the pilot with bearing and distance data to a destination from a VORTAC station, and automatically compute and display left- and right-steering information. These data are shown numerically through windows. Units are being developed for commercial and private aircraft by ACF Electronics, Butler, Bendix Corp., and Collins Radio Co.

- **Combination Units.** In these devices, a course-line computer is combined with a pictorial display so pilots can see where they are in relation to a map and know what heading to steer at any given

time. Butler and ACF Electronics are developing combination units—ACF under a contract from the FAA.

The FAA, which has "high hopes" of seeing pictorial displays and course-line computers play useful roles in aircraft navigation and traffic control, is currently developing air-traffic procedures in which advantage would be taken of the new devices. The agency reports that it expects the devices to prove practical and is confident that they will fit into the air-traffic control system.

Tests have already been completed to determine the effectiveness of pictorial displays in a terminal area. The ACF unit was used for these tests. Scheduled now are tests to determine their suitability in an 80-mile diam terminal transition area, and in en-route situations. In addition to flight tests, computer-simulation tests are planned.

Later, the combination unit that ACF is developing for the FAA will be flight-tested—probably in the spring of 1961. The unit is reportedly scheduled for its company flight tests very early in 1961.

During this same period, the FAA will be testing compatibility of course-line computers with air-traffic-control procedures. The computer developed by Butler is said to be almost ready for testing.

A pictorial display already is being used in regular flights of the F-106 interceptor, where it is part of the integrated navigation and fire-control system. In

Latest pictorial display makes use of two rotating transparent disks to indicate position of aircraft. Plane's position is indicated by point on underlay map over which the spiral distance-indicating line and the straight bearing-display line cross. Diagram shows the test setup used to evaluate the unit in company tests. The device is being used with VORTAC, VOR-DMET, and TACAN equipment. This unit was developed by International Telephone and Telegraph Laboratories.



Two types of pictorial displays differ in way data is presented. ACF unit (top) uses transparent map through which circled dot can be seen. Dot is moved by rack and pinion operated by rho-theta information from VORTAC stations. Display area is 6 in. in diameter. The unit weighs either 4 or 5 lb, depending on model. In ITT unit (bottom), VORTAC signals rotate two scribed transparent disks, through which a map can be seen. Unit's housing contains transistorized plug-in modules. Display diameter is 12 in. Company is working on a 10-in. version. Weight is 10 lb, exclusive of maps, which may weigh up to 7 lb.

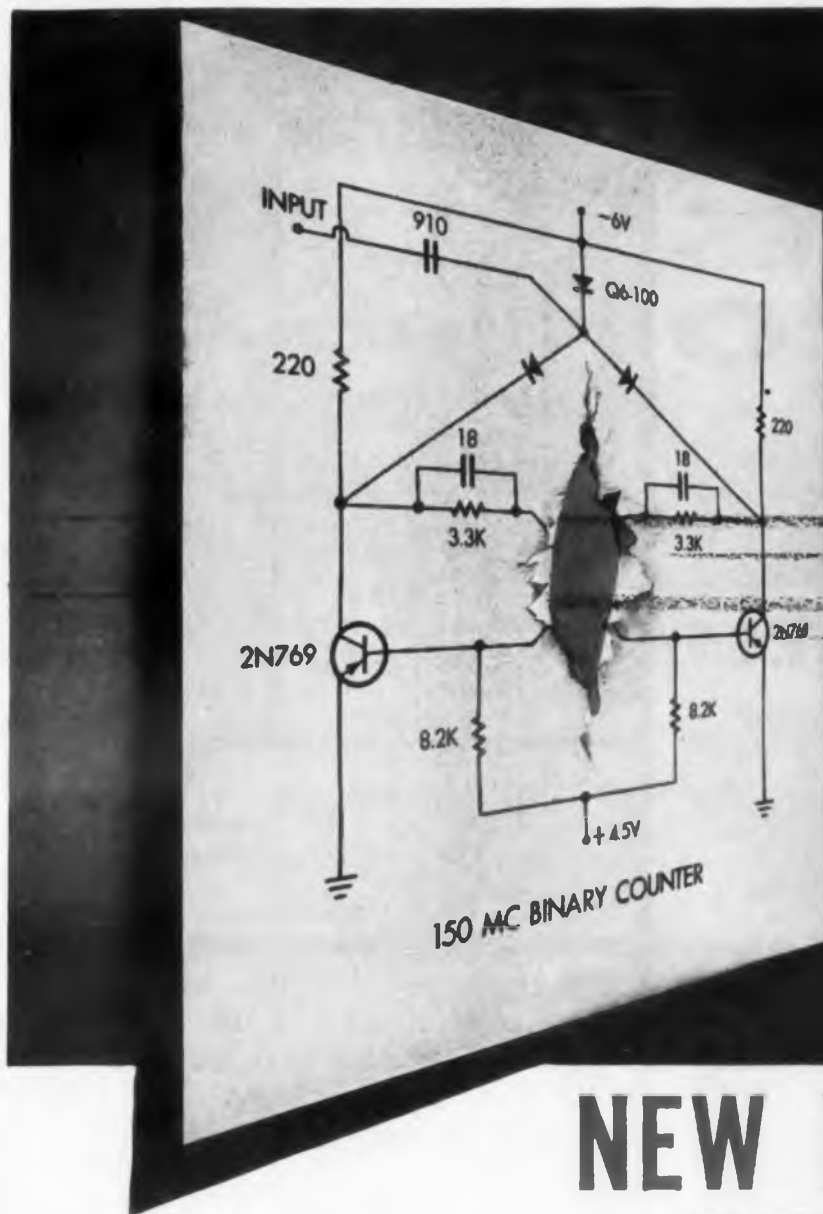

NEW PHILCO 2N769 (IN TO-18) CASE

THE TRANSISTOR FOR 100 mc COMPUTER CIRCUITS

Philco's new 2N769 is the world's fastest commercially available switching transistor! This new addition to the Philco line of MADTs features an 800 mc gain bandwidth product, low hole storage factor, and low emitter and collector diode capacities. It is intended for use in saturated switching circuits at switching rates up to 300 mc. For complete information, write Dept. ED122160

Immediately available from your Philco Industrial Semiconductor Distributor.

WORLD'S FASTEST SWITCH



ABSOLUTE MAXIMUM RATINGS

Storage Temperature	100°C
Collector Voltage, V_{CB0}	-12 volts
Collector Voltage, V_{CEs}	-12 volts
Collector Voltage, V_{CE0}	-7 volts
Emitter Voltage, V_{EB0}	-2 volts
Collector Current, I_C	-100 ma
Device Dissipation @ 25°C	35 mw

ELECTRICAL CHARACTERISTICS (T=25°C)

Characteristics	Condition	Min.	Typ.	Max.
Collector Cutoff Current, I_{CBO}	$V_{CB} = -5v$			-3 μa
Current Amplification Factor, h_{FE}	$V_{CE} = -0.5v, I_C = -20 ma$	25		
Collector Saturation Voltage, $V_{CE(SAT)}$	$I_C = -10 ma, I_B = -1 ma$			-0.24 volt
Base Input Voltage, V_{BE}	$I_C = -10 ma, I_B = -1 ma$	-0.30		-0.45 volt
Output Capacitance, C_{ob}	$V_{CB} = -5v, I_E = 0$		1.5	3 $\mu\mu f$
Gain Band-Width Product, f_T	$V_{CE} = -5v, I_E = 7 ma$	600	800	mc
Hole Storage Factor, $K's$	$I_B = -2 ma$		15	30 $m\mu sec$
Emitter Transition Capacitance, C_{TE}	$V_{EB} = -1v, I_C = 0, f = 4 mc$		5	8 $\mu\mu f$

PHILCO

Famous for Quality the World Over

LANSDALE DIVISION • LANSDALE, PENNSYLVANIA



CIRCLE 9 ON READER-SERVICE CARD



**TRANSISTORIZED
DESIGN GROUP**

MODEL	DC OUTPUT VOLTS	DC OUTPUT AMPS.	REGULATION
SC 32-0.5	0-32	0-0.5	0.01%
SC 32-1	0-32	0-1	
SC 32-1.5	0-32	0-1.5	
2SC 32-1.5	0-32	0-1.5	
Dual Output	0-32	0-1.5	
SC 32-2.5	0-32	0-2.5	
SC 32-5	0-32	0-5	
SC 32-10A	0-32	0-10	
SC 32-15A	0-32	0-15	
SC 60-2	0-60	0-2	
SC 60-5	0-60	0-5	
2SC 100-0.2	0-100	0-0.2	
Dual Output	0-100	0-0.2	
SC 150-1	0-150	0-1	
SC 300-1	0-300	0-1	

MODEL	DC OUTPUT VOLTS	DC OUTPUT AMPS.	REGULATION
SC 18-0.5	0-18	0-0.5	0.1%
SC 18-1	0-18	0-1	
SC 18-2	0-18	0-2	
SC 18-4	0-18	0-4	
SC 36-0.5	0-36	0-0.5	
SC 36-1	0-36	0-1	
SC 36-2	0-36	0-2	
SC 3672-0.5	36-72	0-0.5	
SC 3672-1	36-72	0-1	

MODEL	DC OUTPUT VOLTS	DC OUTPUT AMPS.	REGULATION
PSC 5-2	0-7.5	0-2	0.02%
PSC 10-2	7.5-12.5	0-2	
PSC 15-2	12.5-17.5	0-2	
PSC 20-2	17.5-22.5	0-2	
PSC 28-1	22.5-32.5	0-1	
PSC 38-1	32.5-42.5	0-1	

MODEL	DC OUTPUT VOLTS	DC OUTPUT AMPS.	REGULATION
HB-2	0-325	0-200 ma.	0.1%*
HB-4	0-325	0-400 ma.	
HB-6	0-325	0-600 ma.	
HB-8	0-325	0-800 ma.	

MODEL	DC OUTPUT VOLTS	DC OUTPUT AMPS.	REGULATION
SR 12-50	5-13	0-50	0.1%
SR 28-50	24-32	0-50	
SR 48-30	44-52	0-30	

MODEL	DC OUTPUT VOLTS	DC OUTPUT AMPS.	REGULATION
SM 14-30	0-14	0-30	0.1%*
SM 36-15	0-36	0-15	
SM 75-8	0-75	0-8	
SM 160-4	0-160	0-4	
SM 325-2	0-325	0-2	
SM 14-15	0-14	0-15	
SM 36-10	0-36	0-10	
SM 75-5	0-75	0-5	
SM 160-2	0-160	0-2	
SM 325-1	0-325	0-1	
SM 14-7	0-14	0-7	
SM 36-5	0-36	0-5	
SM 75-2	0-75	0-2	
SM 160-1	0-160	0-1	
SM 325-0.5	0-325	0-0.5	

*0.01% REGULATION AVAILABLE

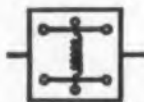

**MAGNETIC
DESIGN GROUP**

MODEL	DC OUTPUT VOLTS	DC OUTPUT AMPS.	REGULATION
KM236-15A	0.1-36	0-15	0.5%
KM236-30	0.1-36	0-30	
KM236-50	0.1-36	0-50	
KM 251	2-14	30A or 240 W.	±1%
KM 252	5-35	12A or 240 W.	
KM 253	20-60	6A or 240 W.	
KM 254	30-90	4A or 240 W.	
KM 255	60-180	2A or 240 W.	

VOLTAGE REGULATED DC POWER SUPPLIES KEPCO



MODEL HB-6M

COMPACTNESS



TWO 4 1/2" SC UNITS
MOUNTED IN RACK ADAPTER RA-2

WIDE VARIETY



MODEL 2SC32-1.5

VERSATILITY



MODEL 400B

FOR DETAILED SPECIFICATIONS
ON MORE THAN 150 STANDARD
MODEL POWER SUPPLIES
SEND FOR KEPCO CATALOG



131-36 SANFORD AVENUE
FLUSHING 52, N. Y.
IN 1-7000 • TWX #NY4-5196

CIRCLE 10 ON READER-SERVICE CARD



**VACUUM TUBE
DESIGN GROUP**

MODEL	DC OUTPUT VOLTS	DC OUTPUT AMPS.	REGULATION	
800B	#1 0-600 #2 0-600 Parallel 1 & 2 0-600 Series 1 & 2 0-1200	0-200 ma. 0-200 ma. 0-400 ma. 0-200 ma.	TO 0.01%	
430D	#1 0-450 #2 0-450 Parallel 1 & 2 0-450 Series 1 & 2 0-900	0-300 ma. 0-300 ma. 0-600 ma. 0-300 ma.		
2400B	#1 0-400 #2 0-400 #3 0-150 Bias Parallel 1 & 2 0-400 Series 1 & 2 0-800	0-150 ma. 0-150 ma. 0-5 ma. 0-300 ma. 0-150 ma.		
103	#1 0-300 #2 0-300 #3 -50 to +50 Parallel 1 & 2 0-300	0-75 ma. 0-75 ma. 0-5 ma. 0-150 ma.		unreg- ulated
400B	0-400 0-150 Bias	0-150 ma. 0-5 ma.		TO 0.02%
730B	0-350	0-3 Amp.		
720B	0-350	0-2.25 Amp.		
710B	0-350	0-1.5 Amp.		
700B	0-350	0-750 ma.		
780B	0-600	0-3 Amp.		TO 0.01%
770B	0-600	0-2.25 Amp.		
760B	0-600	0-1.5 Amp.		
750B	0-600	0-750 ma.		
605	0-600 0-150 Bias	0-500 ma. 0-5 ma.		
615B	0-600 0-150 Bias	0-300 ma. 0-5 ma.		
2500	0-2500	0-50 ma.	TO 0.004%	
1520B	0-1500	0-200 ma.		
1220C	0-1200	0-50 ma.		
1250B	0-1000	0-500 ma.		
KR16	0-150	1.5 Amp.	0.1%	
KR17	100-200	1.5 Amp.		
KR18	195-325	1.5 Amp.		
KR19	295-450	1.5 Amp.		
KR8	0-150	600 ma.		
KR5	100-200	600 ma.		
KR6	195-325	600 ma.		
KR7	295-450	600 ma.		
KR12	0-150	300 ma.		
KR3	100-200	300 ma.		
KR4	195-325	300 ma.		
KR10	295-450	300 ma.		
KR11	0-150	125 ma.		
KR1	100-200	125 ma.		
KR2	195-325	125 ma.		
KR9	295-450	125 ma.		

NEWS

(continued from p 9)

this system, designed by Hughes, Aircraft Co., plane position in relation to a map is projected from 35-mm film onto an 8-in.-diam frosted-glass viewer. But the complicated digital control system, optics, and integrated systems involved make this type of system impractical for private and commercial aircraft.

The new pilot aids would enable pilots to fly what would now be considered off-course. Parallel routes, dog-legs, and other routes could be flown. Commercial and private craft might someday have capability similar to that of military aircraft carrying doppler radar or inertial navigating systems.

The generation of devices under development, however, could not be used for navigating. They would not be accurate enough for present air-traffic control procedures, the FAA states. The government agency does not consider the devices flight instruments.

In the ITT pictorial display, a deck of 12-in. diam maps arranged in route order is stacked so that the one on top shows in a circular window. This window, which is edge-lit by a ring light and transparent light conductor, consists of two acrylic sheets each bearing a scribe line. The windows are turned by 13-in. ring gears in a driving arrangement to eliminate backlash.

A straight radius line on one transparent sheet walks through 360 deg as the sheet is turned. This shows bearing.

Spiral Indicates Distance As It Is Turned

The other sheet is scribed with a spiral that indicates distance as it is turned. At any moment the spiral and the straight line, cross somewhere over the map below, showing aircraft position. Scale of the lines and the map is such that the indication is not less accurate than the signal accuracy of the signals that operate the system.

The bearing indicator is fed by the aircraft's omnidirectional bearing indicator or TACAN system. The bearing circuit uses a low and a high-impedance resolver and a servoamplifier.

The distance-indicating spiral is driven by signals from DMET or TACAN equipment through a potentiometer circuit. ITT's project manager, M. A. Argentieri, reports that neither the bearing nor distance circuits degrade system accuracy.

The ITT unit is constructed of plug-in, transistorized modules mounted in the frame of the map holder. The unit is said to weigh 13 lb without maps, and to be mountable anywhere in a cockpit. In its current configuration it holds up to

20 maps, weighing 7 lb.

In the ACF display, a luminescent reticle is moved on a slotted, rotating disc and a rack and pinion in the slot. The reticle moves under maps printed on transparent mylar. Two models of the display have been produced, one using a roll map, the other using map slides.

As in the ITT display, VOR-DMET or VORTAC signals operate the driving transistorized servoamplifier system.

One characteristic described as a disadvantage of these systems—that they show only present location and leave no record of position—is reportedly eliminated in the Butler pictorial display. In this unit, a stylus inks a track on the route chart by touching it at 20-sec intervals.

Course-Line Computers Complement Pictorial Displays

Because a pilot wants to know not only where he is but which way he should head, computers have been developed to take bearing and distance data and calculate a recommended course. Most of these have been developed for the Air Force and are outgrowths of the course indicators now in wide use. These use meter movements and compass display to show course.

In course-line computers, data is set in by the pilot after he measures map-distance and bearing to a destination. The computer then uses data received via the aircraft's VORTAC equipment to compute left- and right-steering instructions. The pilot reads this information in the form of numbers in the computer's windows.

In many flight situations, these computers eliminate the need for pictorial displays, the FAA says. This is encouraging development of them. The agency has contracted with ACF Electronics to design a computer that would be combined with the company's pictorial display.

This computer is scheduled for delivery to the FAA next spring. The company has also developed a specialized digital computer that calculated slant-range correction when an aircraft bears a point directly over a VORTAC station. Above a station there exists a zone of uncertainty in which exact position is difficult to determine without special means. By solving the approach and departure triangle, ACF's digital unit is able to establish its position even in this zone, the company reports.

Collins, Bendix, and Butler are also developing course-line computers. The Collins and Bendix units will reportedly use high-impedance servoamplifiers; the Butler vector-analog computer uses two Wheatstone bridges and has no moving parts, the company states. Butler's present unit, which has been turned over to the FAA, weighs 8 lb. Future models will reportedly weigh about 4 lb. ■ ■

New Line of Precision Toroidal Inductors For Practically Every Application



Designed for use in commercial, industrial, and military apparatus, Sprague Precision Toroidal Inductors are customarily supplied to the close inductance tolerance of $\pm 1\%$. The broad line of Sprague inductors includes such styles as open coil, plastic-dipped, rigid encapsulated types with tapped or through-hole mounting, and hermetically-sealed inductors.

All styles, with the exception of the open-coil type, meet the requirements of Specification MIL-T-27A.

Several core permeabilities may be obtained in each of the five basic sizes of Sprague inductors to give the circuit designer the optimum selection of desired Q and current carrying abilities. Each of the core sizes is available with several degrees of stabilization. Inductors made with cores which have not been subjected to the stabilization process exhibit low inductance drift with time and have a low temperature coefficient of inductance. Where a greater degree of permanence of characteristics is required, cores with two different stabilization treatments can be used for most types of inductors.

Sprague toroidal inductors may be operated from -55°C to $+125^{\circ}\text{C}$. Temperature cycling of finished inductors is a standard production procedure in order to equalize internal stresses and insure permanence of electrical characteristics.

For detailed information on Sprague Precision Toroidal Inductors, write on company letterhead for portfolio of engineering data sheets to Technical Literature Section, Sprague Electric Company, 347 Marshall Street, North Adams, Massachusetts.

PULSE-FORMING NETWORKS

FROM WATTS

to
MEGAWATTS



... and everything in between!

When it comes to pulse capacitors and pulse-forming networks, many complexities in parameters and design factors must be considered. These specialized units must be designed and manufactured by a specialized organization. And because Sprague maintains a highly-technical special engineering section devoted exclusively to pulse capacitors and networks, it has been, from the very beginning, a major supplier of these complex units for radar equipment (ground, marine, aircraft, missile), tube testing, and similar pulse circuit applications.

This special engineering section performs four important functions: One group designs custom units in accord-

ance with required parameters. Another group builds pulse capacitors and networks to these precise specifications. In another area, a group of specially-trained field engineers provides application assistance wherever needed. And yet another independent group works toward the future developing new materials, new design concepts, and new techniques for manufacture.

This concentration on pulse capacitors and pulse-forming networks has enabled Sprague to introduce product improvements such as heliarc sealing of cases, rugged alumina bushing assemblies, Fabmika[®] dielectric, and improved hermetic sealing of closures.

Save time and money by working with Sprague from the start. Write for Engineering Bulletin No. 10,001 to Technical Literature Section, Sprague Electric Company, 347 Marshall St., North Adams, Massachusetts.

SPRAGUE
THE MARK OF RELIABILITY

CIRCLE 11 ON READER-SERVICE CARD

SOMETHING NEW IN A SUITCASE...

... Complete transistorized EECO Digital System Breadboard

Designers who want to go places fast systemswise can be sure of getting there on time with an EECO suitcase. It's packed with a complete and integrated breadboarding system designed around mutually compatible EECO T-Series Germanium circuit modules, N-Series transistorized decades, and R-Series Minisig® sensitive indicators.

Standard 19" amateur-notched panels have the necessary permanent wiring to accommodate any standard EECO Germanium circuit module, and all other circuit interconnections are made by patch cords or plugs, with unique, prepunched circuit cards to guide you. No soldering is required, and experimental arrangements of T-Series circuits can be quickly patched up, changed, or taken down without waste of time or materials.

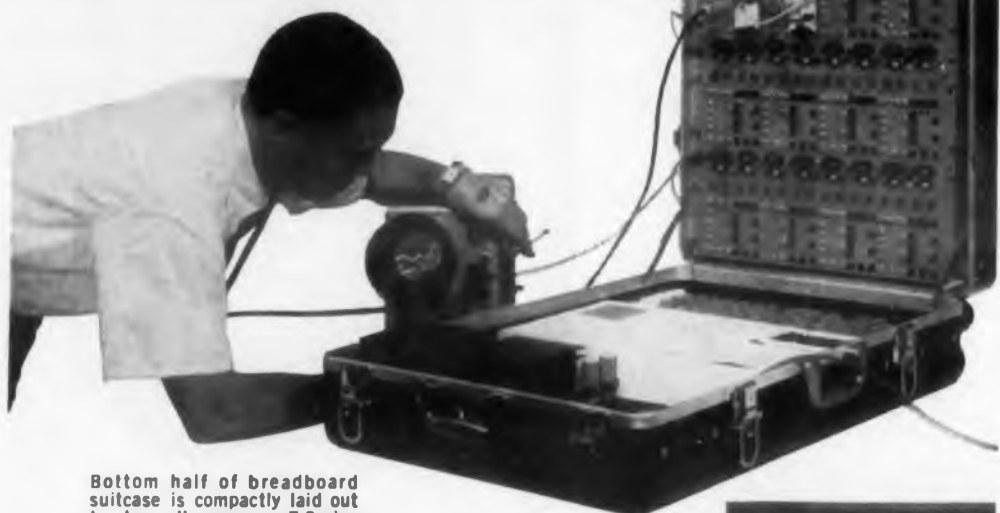

Bottom half of breadboard suitcase is compactly laid out to store all necessary T-Series circuit modules, circuit cards, patch cords, and compatible power supplies.

EECO T-Series breadboard equipment is available in both suitcase and rack-mounted types. Breadboard Kits of any degree of complexity can be built up in stages, according to the specific panels and number of circuits incorporated. Compatible interconnections between racks or suitcases further enable the designer to expand the equipment into a complete systems development console. Compatible solid-state, convection-cooled power supplies are also available in two different models: ZA-720 is a dual 12-volt, 5-amp supply; ZA-721 is a 12-volt, 1-amp plug-in power supply.

FEATURES

- Permits rapid formulation of digital electrical systems.
- System may be operated slowly to permit inspection of its mode of operation, or over-speed to indicate system derating.
- Operation may be analyzed with a minimum of test equipment.
- Provides a means for rapidly building and testing alternate ways of formulating a system.
- Minimizes wiring errors and the inclusion of defective parts.
- Circuit cards provide a means for rapidly visualizing the system, and facilitate drawing a circuit diagram.
- Circuit cards enable the designer to determine the elements involved, as well as the cost of the system.

A request, on your company letterhead, will bring detailed information on the flexibility of the EECO T-Series Breadboarding equipment, and a demonstration if desired.

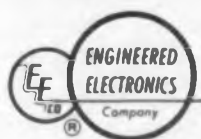

ENGINEERED ELECTRONICS COMPANY
1441 East Chestnut Avenue • Santa Ana, Calif.

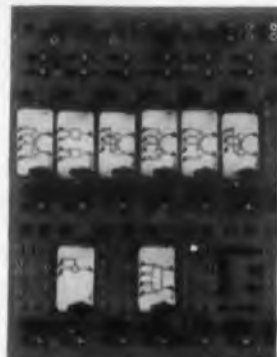

Circuit cards are selected according to the system it is desired to breadboard and placed on the panel in alignment with the jack pattern. Corresponding T-Series circuit modules are plugged in above each card.



Circuit interconnections are made by patching through holes in the circuit cards. Resulting pattern of symbol cards and patch cords shows a schematic and bill of materials for the system, once it is checked out.

NEWS

BMEWS Checkout Data Processor Detailed

Unit Described at EJCC Inserts Simulated Radar Returns To Accomplish On-Line, Real-Time System Monitoring

DESIGN details of an on-line, real-time checkout data processor for BMEWS were publicly revealed for the first time at the Eastern Joint Computer Conference in New York. Although only one operating mode of one checkout system included in BMEWS was described, much could be inferred about the organization and design of the long-range warning system.

The unit described is the Checkout Data Processor (CDP), the first of which is now in operation at Thule, Greenland. The unit was built by RCA-Moorestown as a part of its over-all BMEWS system contract. Auerbach Electronics, Philadelphia, were data-system consultants to RCA in the design of the data processors, program design and integration into BMEWS.

The Checkout Data Processor is the principal means of monitoring system of BMEWS. It subjects the entire system to a "realistic" missile attack by inserting simulated radar returns into the waveguides at the output of the radar antennas. The resultant outputs of BMEWS' radar-data correlators and missile-impact predictor (an IBM 7090) are then compared against expected values. Significant deviations from these values indicate system malfunction; other operating modes can then be initiated to locate the defective sub-sections of the system.

Thin-Film Memory Commercially Available; Access Times Are Measured in Nanoseconds

First news of a commercially available thin-film memory was disclosed by Remington Rand's Univac division at the Eastern Joint Computer Conference. The new memory, with access times measured in nanoseconds, will be included in the Univac 1107 computer, for which orders are being taken on an 18-month to two-year delivery basis.

The memory consists of metal dots, a few millionths of an inch thick, vapor-deposited on a glass substrate.

Connections are by etched, multilayer circuit grids placed on the dot array.

According to the Remington Rand announcement, the thin-film unit will form the control memory of the new computer. Additional storage will be by ferrite cores. Computer rental is estimated at \$40,000 to \$60,000 per month.

Additional details of the thin-film memory will appear in the Jan. 4, 1961, issue of ELECTRONIC DESIGN.

A MAJOR CAUSE OF FAILURE ELIMINATED BY BUILDING A TRANSISTOR INSIDE ITS OWN SHELL

Most transistor failure is not abrupt. It consists of surface changes causing a gradual shift in parameters. While the whole industry has sought answers, Fairchild has followed a research and development course of its own. We can now reveal a unique solution.

Called "PLANAR STRUCTURE," this Fairchild answer uses a passivated surface—a hard, passive coating of silicon oxide—not new in theory, but new in the way it is done. Fairchild oxidizes the surface first. Then the transistor's junctions are diffused **under the oxide**. Contaminants cannot reach them during process or after. Result: performance is unchanged by time, use, environment or even exposure to foreign matter.

Planar is the answer for system reliability where thousands of transistors must all be operative at an instant—for fast, simple circuits tightly packed in minimum space—for carefully matched pairs, triplets or quads that must stay exactly in balance—and for leakage reduction by a factor of one hundred. And planar is the answer even for simpler circuit requirements where high assurance has a value.

These advantages apply to planar diodes, too. Of course, Fairchild planar silicon transistors and diodes are available in production quantities. A new 12-page brochure explains the process and results more fully. May we send you a copy?

A wholly owned subsidiary of Fairchild Camera and Instrument Corp.

545 WHISMAN RD. • MOUNTAIN VIEW, CALIF. • YORKSHIRE 8 BT61



For each "test" missile inserted into the system, the CDP continually computes the simulated return for the many radar beams scanning through the BMEWS search pattern. Since a certain number of returns from the various search beams are required to compute a missile's trajectory, the CDP continues to generate and insert simulated moving targets until the impact predictor computes an output.

Each simulated return is "tagged" as such upon insertion into the system. Thus, a simulated attack by many missiles can be fed into BMEWS without impairing its ability to identify any real attack that might occur during a test period.

With checkout performed on an on-line basis, the CDP can "exercise" BMEWS at frequent intervals. Analysis of BMEWS' response to simulated targets also provides useful data on system noise, external interference and other important design factors. Deviations from expected response can be printed out as a permanent record for subsequent analysis.

Indirect Addressing Method, Different Memories Are Used

The CDP consists of five major subsystems:

- Wired-core memory
- Coincident-current memory
- Arithmetic and logic unit
- Input-output system
- Control system

The input system includes more than 180 addressable inputs which fall into 36 different classes of information. The CDP can communicate with more than a dozen other digital data-handling devices, including a pair of IBM 7090's. The output system has more than 75 addressable outputs which fall into 15 classes.

The wired-core memory stores the program and constants used by the CDP in 192 2.5 in. Lenite cores arranged in an 8x24 in. matrix. These cores are wired in the form of a Dimond ring translator to assure permanent storage and high speed. Each core is threaded by 512 wires giving a total storage capacity of 4,096 23-bit words.

The coincident-current memory has a capacity of 1,024 19-bit words. This memory stores reports from the radar data take-offs and the impact predictor, provides input and output buffering, and stores the results of intermediate computations.

(continued on page 14)

CIRCLE 12 ON READER-SERVICE CARD ➤



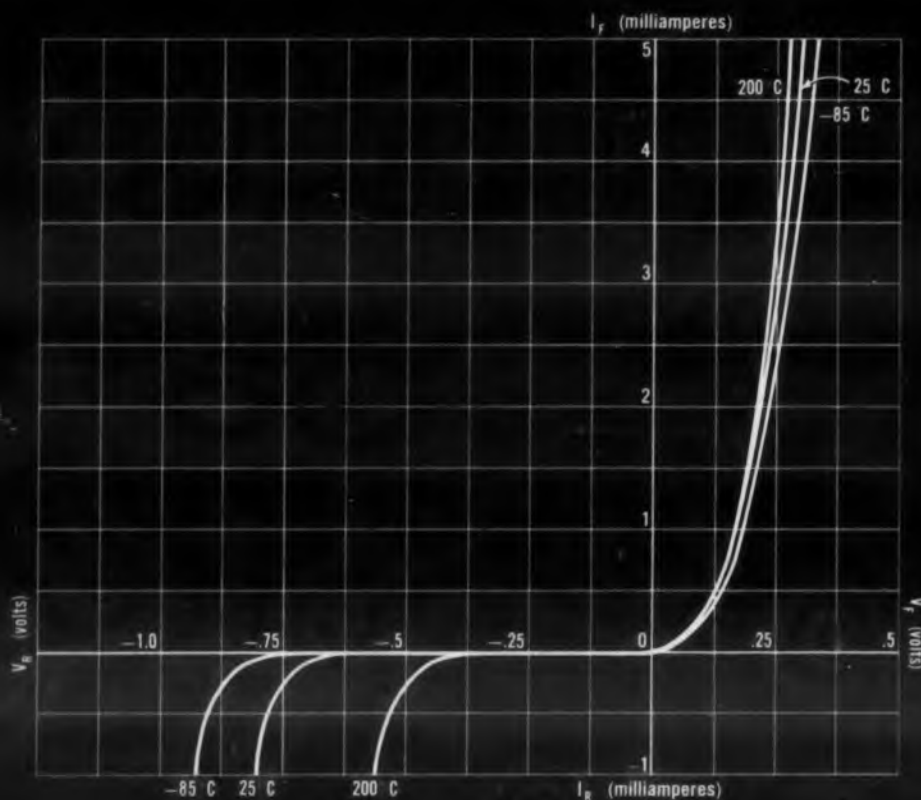

TYPICAL UNI-TUNNEL DIODE CHARACTERISTICS

HOW HOFFMAN UNI-TUNNEL DIODES SIMPLIFY AND IMPROVE MODULATOR CIRCUITRY DESIGN

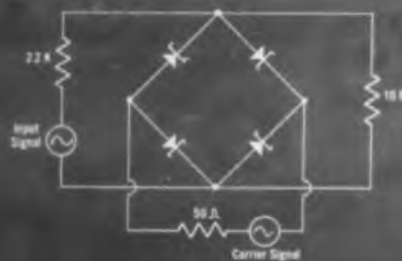

BRIDGE MODULATOR CIRCUIT UTILIZING FOUR HOFFMAN UNI-TUNNEL DIODES

These graphs illustrate typical operating characteristics of the modulator circuit above

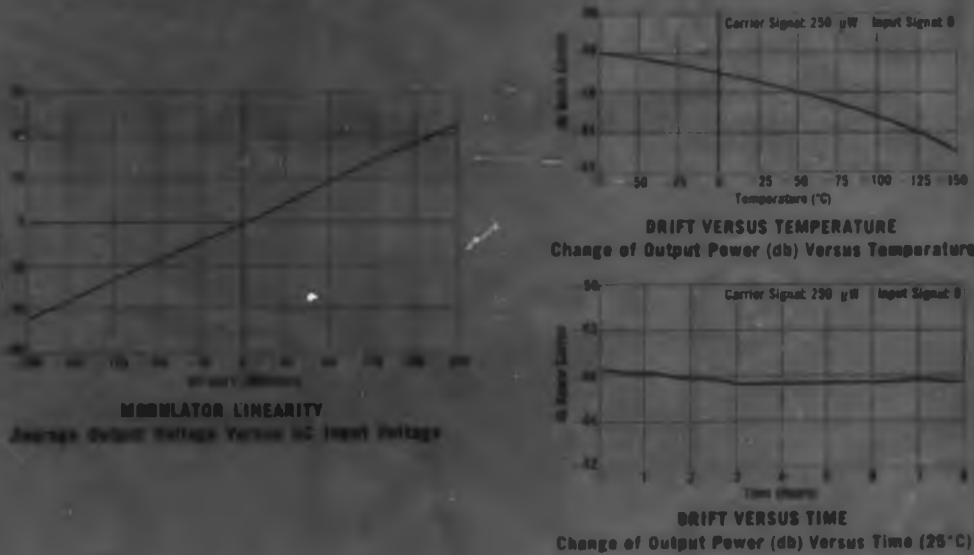

Write for output in Hoffman Application Notes - Volume II, Number 1

CIRCLE 13 ON READER-SERVICE CARD

Hoffman design-aid series



TO 18 Case

For unprecedented efficiency at low signal levels plus extreme temperature stability...

HOFFMAN NOW OFFERS YOU SILICON UNI-TUNNEL* DIODES

These unique devices, sometimes referred to as "backward" diodes, utilize the tunneling effect to achieve high forward conductance at very low voltage levels. When they are biased in the reverse direction, the familiar tunnel diode current characteristic appears as a leakage current measurable in microamperes.

TYPICAL APPLICATIONS

Ability of the Uni-Tunnel diode to operate efficiently at low voltage levels eliminates the complex circuitry previously required for low-level operations, resulting in lower cost, greater reliability and decreased space requirements (see modulator circuit at left). Benefits like these also make Hoffman Uni-Tunnel diodes ideal in:

- computer logic
- detectors
- choppers
- clippers
- tunnel diode circuitry

SPECIFICATIONS

Twelve types available with minimum forward currents as high as 10 mA (at .25V) and maximum reverse currents as low as 5.0 μ A (at 0 to 0.5V). Operating and storage temperature range is -85°C to $+200^{\circ}\text{C}$.

STANDARD AND CUSTOM-ENGINEERED UNITS AVAILABLE IMMEDIATELY IN QUANTITY

Contact factory, El Monte, California, or your local Hoffman sales office for further information. Ask for Technical Data Sheet 131-760 UTD.

Hoffman

ELECTRONICS CORPORATION
Semiconductor Division

1001 Arden Drive, El Monte, California

TWX: El Monte 9735

Plants: El Monte, California and Evanston, Illinois



*Trademark Hoffman Electronics Corporation

NEWS

(continued from p 13)

The coincident-current memory can be considered as the "working" memory of the CDP, while the wired-core unit serves as a permanent, "reference" memory. An indirect addressing scheme facilitates information transfer between the two memories. An "indirect jump" instruction specifies an address in the coincident-current memory which contains the location in the wired-core memory to which control should be transferred. Thus, variable linking can be accomplished by changing the contents of the coincident-current memory.

The CDP is mechanized by NOR-type transistor-diode logic. The computer contains about 8,000 transistors and more than 40,000 diodes. Clock rate is 625 kc. The numbering system is binary with a word length of 19 bits, including one parity bit. Processing speed, including access time, is 12.8 μ sec per instruction.

Operation of the CDP is controlled by three programs. These are the Executive, Simulation, and Evaluation programs. The programs are interleaved in time, and the data processor switches among these programs several times during each interval between main bangs of the radar.

This procedure is necessary because the evaluation program requires several main-bang intervals to complete its work. Also, BMEWS must correlate a number of returns from each target before it can predict the missile's impact. When a program is interrupted, its status is stored in the CDP and the program is continued or begun anew during the next go-around.

The simulation program is fed by missile trajectories stored on tape and by the positions of the radar beams. Each trajectory consists of 120 6-bit characters. During one interval between main bangs, the CDP computes the simulated returns to be fed into BMEWS during the next interval. Tape reading speed is 15,000 characters per second.

The simulated return contains information as to the missile's range, size and velocity. Thus, the simulation program must compute amplitude, time of insertion, and doppler shift of the return. These computations are performed simultaneously for many targets, and separate computation is necessary for each radar beam. Beam azimuth for the next main-bang interval is used by the simulation program to determine which targets will be detected by each particular beam during that cycle.

Digital-to-Analog Converters, VFO Simulate Targets for System

The calculated-return parameters are then transmitted to target generators (one for each

beam), which provide the actual simulated return. Digital-to-analog units convert these data into a form suitable for control of the signal source and modulator. Simulated doppler shift is introduced by a variable-frequency oscillator whose output is controlled by the data processor through a closed-feedback loop. The simulated signal is inserted into BMEWS at the proper instant (according to range) by means of a digital counter driving an And gate.

The simulation program also computes the parameters of the signals to be expected at the output of BMEWS. These parameters are for use by the evaluation program.

The evaluation program, unlike the simulation program, does not have to be synchronized with the events of each main-bang period. Once begun, it continues its work until interrupted by the executive program and resumes its work later.

Self-Checking Processor Used on Teaching, Acquisition Radar

The evaluation program is divided into three priority classes of routines. The first two routines process the data received from BMEWS, compare them with anticipated values from the simulation program, and printout the appropriate information. The third routine is a continuing self-check of the CDP itself. This last routine is a non-ending one which is sandwiched into whatever space is available after all other routines are completed.

The evaluation routine picks up the value for each of the parameters in the output of the impact predictor and radar data take-offs. These values are subtracted from the anticipated values and compared to specified tolerances for each parameter. If all deviations are within the tolerances, BMEWS is deemed to be operating satisfactorily. The criterion for printing out an alarm signal is that the deviation for at least one of the parameters is larger than the specified tolerances.

Typical parameters for evaluating the radar-data take-off include: range, range rate, azimuth, elevation, and signal strength.

Printout consists of 4-bit characters written at 20 lines per second. A 40-bit buffer controls the printing console. The buffer is addressable by the CDP and can order a total of 30 different printing instructions.

The authors of the EJCC paper describing the CDP are A. Eugene Miller of Auerbach Electronics and Max Goldman of RCA. Mr. Miller pointed out that the CDP was described entirely in terms of the over-all checkout mode for the acquisition radars of BMEWS. The CDP, however, also includes additional modes for locating faults in the acquisition radars and performs similar checkouts on the system and unit levels for the tracking radars of BMEWS. ■ ■

*the
"last word"
in
vitreous enamel
power resistors*

100*
PROOF
in every test

Greenohm "V"®
by CLAROSTAT

* In test after test conducted by independent evaluation laboratories, Clarostat GREENOHM "V" resistors have exceeded applicable military requirements *without a single failure*. These wire-wound power resistors are the newest in concept and quality—the development and product of the most experienced specialists in resistors, controls and resistance devices—CLAROSTAT.

Available in all commercial sizes from 5 to 200 watts, in tubular and stack-mounting styles. Also in all military types, Characteristics G, V and 'Y.



WRITE FOR COMPLETE TECHNICAL DETAILS

CLAROSTAT MFG. CO., INC.

DOVER, NEW HAMPSHIRE

In Canada: CANADIAN MARCONI CO., LTD., Toronto 17, Ont.

*direct
line
service*

**IMMEDIATE
DELIVERY!**

Phone your local Clarostat
Industrial Distributor

CIRCLE 14 ON READER-SERVICE CARD



YOUR BEST BUY FOR APPEARANCE AND PERFORMANCE... WESTON 301 PANEL METERS

*Now...modern 3½-inch meters
with time-tested Weston movements*

You'll find new design advantages in the familiar, reliable Weston 301 panel instruments. Case and mechanism are redesigned for modern needs—more reliable than ever before—at no increase in cost!

The exclusive **Cormag®** mechanism makes the 301 immune to the effects of stray magnetic fields. Instruments can be mounted on magnetic or nonmagnetic panels, close to other instruments, *without* special adjustments. Choose between round or rectangular case, modernistically styled in phenolic plastic.

Another design advantage...New 2½-inch Weston panel instruments—the 201 series—are designed with matching cases and incorporate the same advanced features!

For specifications...information...or the address of your nearest distributor, contact your local Weston representative, or write to: Daystrom, Incorporated, Weston Instruments Division, Newark 12, New Jersey.

*International Sales Division, 100 Empire Street,
Newark 12, New Jersey. In Canada: Daystrom Ltd.,
840 Caledonia Rd., Toronto 19, Ontario.*

Weston 301 Series is available in ac, dc, and RF types . . . voltmeters, ammeters, milli- and micro-ammeters . . . in dozens of ranges. Both round and rectangular meters are flush mounted. 301 Series requires 2.82" diameter cutout, 201 Series requires a 2.22" cutout.

DAYSTROM, INCORPORATED
WESTON INSTRUMENTS DIVISION

Reliability by Design

CIRCLE 15 ON READER-SERVICE CARD

NEWS

Thermoelectric Generator

Device's Nickel-Cadmium Batteries Will Replace Conventional Cells

POWER for an automatic weather station in the Gulf of Mexico will be supplied by a 30-w thermoelectric generator to be built by General Instrument Corp., Newark, N. J., under a National Bureau of Standards contract.

Other power sources already tested in the Gulf buoy include solar cells and wind generators (*ED*, July 6, p 36). These sources have been used to trickle-charge Coast Guard-type, long-life, lead-acid batteries. These batteries only operate for about six months without recharging, a severe handicap for remote ocean stations.

The General Instruments proposal calls for nickel-cadmium batteries to be trickle-charged by the thermoelectric generator in place of the conventional lead-acid cells.

Heat for the generator will be supplied by a flameless oxidation reaction, using propane as fuel and a catalyst to step up the reaction. Temperature in the 500 to 2,000 F range can be achieved, according to Melvin Barnat of General Instrument's Thermoplastic Div. A choice of



This housing for a 5-w thermoelectric generator was designed for off-shore Coast Guard buoys by General Instrument. Aluminum fins provide for heat dissipation, square housing on front holds generator, and the attachment to the generator housing holds propane fuel and acts as an air inlet. The stainless steel flanges are used to attach the generator to a tower. Three of these units are being delivered to the Coast Guard.

To Power Weather Buoy

operating temperature will depend on the semiconductor materials to be used for the thermopiles, according to Mr. Barnat.

NBS Finds Solar Cells Deteriorate, Wind Generators Can Be Becalmed

There are important drawbacks to the energy sources tested so far by NBS, according to William Hakkarinen, electronics engineer with the Bureau of Standards. Solar cells were found to deteriorate after about eight months at sea. Wind generators are promising, but they can only be used where there is an average wind speed of 10 knots or more, Mr. Hakkarinen said.

Weight is another factor that must be considered. The lead-acid batteries used on the present NBS buoy weigh about 5,000 lb. The thermoelectric assembly is expected to weigh about 600 lb, and about 500 lb of fuel should be enough to last for a year. Cost of the thermoelectric generator is expected to be about \$20,000 with delivery within a year, according to Mr. Hakkarinen.

Efficiency of the generator will probably be a little higher than usual because of the ability to get a larger temperature difference across the thermocouples by conduction from the water. This will provide a higher temperature difference than otherwise would be feasible.

Some provision for automatic restart in case of flooding will be made in the generator design. ■ ■



Gulf buoy which will carry the planned 30-w thermoelectric generator provided early warning of last summer's Hurricane Ethel. It transmits on 5,340 kc for 3 min every 6 hr. Use of such buoys is likely to increase as instrumentation and power sources are improved.



DIRECT READOUT

DU MONT CHARACTER DISPLAY TUBES...

DU MONT CHARACTER DISPLAY TUBES ARE USED IN SUCH APPLICATIONS AS:

- Target display and identification
- Air traffic control
- Reproduction of info from coded magnetic tape
- Harbor traffic control
- and many others

*Write for complete technical details
Industrial Tubes Sales*

enhance any system requiring versatility of rapidly formed characters for readout. A unique Du Mont CRT gun design enables alpha-numeric characters to be formed electrostatically in any size from $\frac{3}{8}$ " to over 1", and positioned electromagnetically anywhere on the screen — on any size screen from 5" to 19". Other background information, such as a separate radar display for target tracking, can be shown simultaneously through time sharing devices.

Du Mont tubes short-cut expensive system maintenance problems by permitting replacement of the *display* portion of a system *alone* — eliminating the necessity of replacing expensive integrated tube and character generator. For versatility, clarity and economy — look to Du Mont for character readout.

Available now at attractive prices!

DU MONT

ALLEN B. DU MONT LABORATORIES, Clifton, N. J.

DIVISIONS OF **FAIRCHILD**
CAMERA AND INSTRUMENT
CORPORATION

CIRCLE 16 ON READER-SERVICE CARD

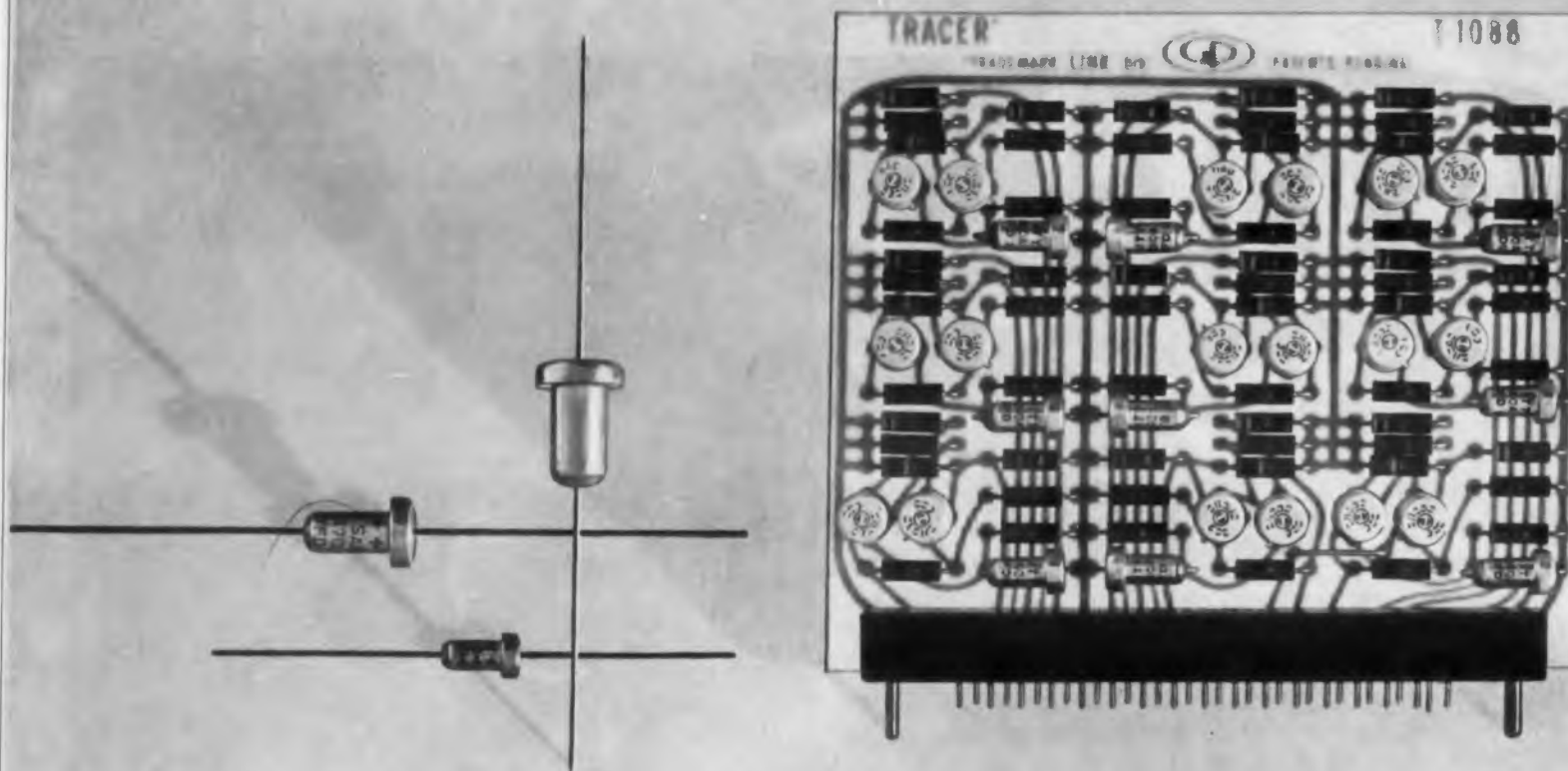

Link Division of General Precision, Inc. specified ITT capacitors for this vital portion of its Tracer Identification and Control System, which demands utmost reliability and long life expectancy from every component.

TOTAL PROCESS CONTROL AND DISCIPLINED PRODUCTION DELIVER

HIGH-RELIABILITY WET-ANODE TANTALUM CAPACITORS FROM ITT

ITT wet-anode tantalum capacitors meet MIL-C-3965B—a fact proved by independent laboratory qualifications tests on ITT capacitors. The reliability and long life expectancy of these competitively-priced capacitors are direct results of ITT's total process control and disciplined production procedures, above and beyond testing standards more stringent than normal industry practice—and backed by ITT's world-wide facilities and experience.



Phone these ITT-CD Capacitor Sales Offices:

Albuquerque AX 9-8013	Los Angeles HI 6-6325
Boston CA 7-2980	Miami MI 4-3311
Chicago SP 7-2250	Minneapolis WE 9-0457
Cleveland GR 5-3080	New York LO 5-1820
Dallas EM 1-1765	Philadelphia TR 8-3737
Dayton BA 8-5493	Phoenix WH 5-2471
Denver KE 4-5091	Rochester FI 2-1413
Detroit TO 8-3322	San Francisco LY 1-7321
Fort Wayne HA 0641	Seattle MA 2-5433
Kansas City JE 1-5236	St. Louis EV 2-3500

IN STOCK AT ITT DISTRIBUTORS:

- TWO TYPES—M-Type and P-Type, for applications from -55 to 85 and 125 C. respectively
- 29 VALUES—from 1.75 to 330 mfd's over a working voltage range to 125 VDC and maximum surge voltages to 140 VDC
- COMPACT AND RUGGED—sintered tantalum slug in fine-silver cases for 2000-hour life at maximum temperature and working voltage
- GUARANTEED—to 80,000 ft. and accelerations of 20 G's with a 0.1 in. excursion in 50-2000 cps range
- LONG STORAGE LIFE—tantalum-oxide dielectric is completely stable; assures trouble-free operation

COMPLETE SPECIFICATIONS ON ITT wet- and solid-anode tantalum capacitors are available on request. Write on your letterhead, please, to the address below.

ENGINEERS: Your ITT representative has a complete set of qualifications and quality control tests for your inspection.

NEWS

STRAD Data System

Telegraph, Data Switcher Can Handle 83,000 WPM

A LARGE-SCALE electronic telegraph and data-switching system developed in England has been introduced here by the Intelex Systems Division of ITT. The system, known as STRAD (Signal Transmission, Reception, and Distribution), is of the "store and forward" type employing a magnetic drum as the main storage element. Message-handling capacity is said to be 83,000 words per minute; up to 108 incoming lines can be accommodated by the system.

The design of STRAD features central message-storage tracks for economy of switching equipment. Incoming messages are recorded in sequence on one "incoming-line" track of the drum. This track is continuously freed for additional messages by re-recording its contents onto an available central storage track.

Two Switches per Line Needed for 108-Line Circuit

Thus, for a 108-line circuit, only two 108-contact switches are needed at the input end. One

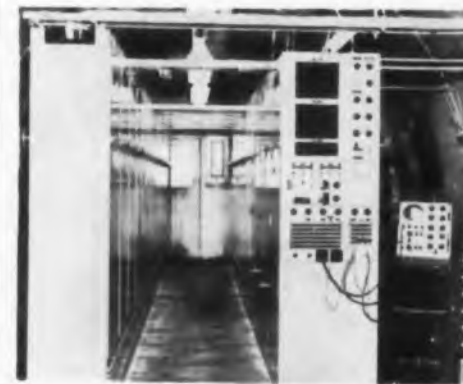

Prototype STRAD installation at the Admiralty in London. Equipment now being offered in the U. S. is solid state and modularized. System also features good possibilities for expansion to accommodate future growth. Large, multi-plant concerns having private communications systems and military are seen as likely customers for STRAD by ITT's Intelex Systems Division.

Imported from U.K.

switch connects the incoming lines to the "incoming line" track while the second switch connects that track to available central storage tracks. The more obvious approach of giving each incoming channel random access to any of the central storage tracks would require 108 switches, each having 108 contacts per switch.

STRAD can receive messages at rates of up to 2,400 bits per sec. Messages are transferred from the incoming line track to the central storage tracks at 50,000 bits per sec. A magnetic tape store for overflow is automatically patched into the system as needed.

At the output end, messages are transferred, in turn, from central storage to one "output line" track, by an identical two-switch system. Buffer-translators at each end serve a variety of input-output gear including computers, punched cards or tapes, magnetic tape, etc.

Control Circuits in System Record Pertinent Data

Control circuits within STRAD note and record message origin and destination, priority, message number and other pertinent data. Messages are automatically forwarded according to priority as soon as lines to the proper destinations become available.

STRAD will be marketed on a custom-built basis. Estimated cost for a large installation is on the order of \$20,000 per duplex channel. Two systems have been operating in England for several years. Standard Telephones & Cables, Ltd., the English manufacturer of STRAD, has received orders for seven additional units, including one for the American embassy in Paris. It has not been determined whether units ordered by U.S. firms will be made here or abroad. ■ ■

CIRCLE 18 ON READER-SERVICE CARD ➤

IN THERMISTORS

—the key name is **Keystone**

... whether you need **10** or **10,000,000** pieces—

STANDARD PARTS

SPECIAL ASSEMBLIES



Versatility Plus . . .

A partial list of small discs and rods, all with identical characteristics

Temperature Coefficient (25°C) -3.8% / °C
Beta Value (37.8°C / 104.4°C) 3500°K
Ratio (37.8°C / 104.4°C) 7.3

Resistance 25° C	Keystone Type Number	Diameter (Inches)	Thickness (Inches)
500	L0503-312-73	0.050	0.030
160	L0903-100-73	0.100	0.030
500	L0903-312-73	0.100	0.030
1000	L0909-623-73	0.100	0.100
100	L2003-62-73	0.200	0.030
180	L2006-112-73	0.200	0.060
200	L2006-125-73	0.200	0.060
230	L2006-143-73	0.200	0.060
270	L2008-168-73	0.200	0.080
300	L2008-187-73	0.200	0.080
100	L3006-62-73	0.300	0.060
200	L3008-125-73	0.300	0.080
250	L3008-156-73	0.300	0.080
300	L3018-187-73	0.300	0.180
270	L060637-168-73*	Rod, 0.060" square, 3/8" Length.	
5000	L060637-3120-73*		
10000	L060437-6234-73*		

Special Mounting Requirements

Thermistor applications often dictate special mounting requirements. As a result, Keystone units are supplied with many types of special lead assemblies, mounting tabs, heat dissipating fins. Units are mounted in probes and transistor type cans, attached to plates and metal parts of wide variety.

Keystone has the experience (over almost a quarter of a century), the knowledge and production capability to handle your thermistor requirements in any quantity—of any type and size.

Because of unsurpassed quality control, your tolerance specifications are acceptable to $\pm 2\%$ on resistance value and Beta value (in fact, we maintain a $\pm 2\%$ production tolerance on the material constant of *all* Keystone thermistors regardless of resistance tolerance). All parts can be supplied in pairs or sets matched closely in resistance-temperature or voltage drop characteristics.

We can supply discs, washers, rods, heads and special shapes including washer segments, square rods, rectangular wafers, square wafers, etc. Our experienced sales staff and engineering and research and development organizations are available for consultation. Write us or call today.

Keystone

CARBON COMPANY
RESISTOR DIVISION • St. Marys, Pa.
Telephone: Terminal 4-1591

NEWS

Frequency-Sweep Doppler System In Development for Space Use

A frequency-sweeping doppler system to measure velocities to 25,000 ft per sec and altitudes to 100 nautical miles is in development at Raytheon's Airborne Equipment Operation group, Sudbury, Mass. Work on the missile-borne system is being performed for the Air Force's Wright Air Development Division with a view towards ultimate use in navigation of Boost-Glide vehicles, orbit rendezvous, and landings on the moon.

A five-month study program was recently completed and laboratory breadboards are now being designed and assembled to determine feasibility of design. Successful development of the system would constitute a major advance in the capabilities of doppler navigation equipment. Units for the B-58 and B-70 bombers mark the velocity and altitude limits of existing designs.

The innovation in Raytheon's system is in the method chosen to improve signal-to-noise ratio at the receiver. Given the weight limitation of space electronics, relatively low transmitter power is available for the altitude at which the equipment is to operate. Signal propagation and return through the plasma sheath around the vehicle further complicates the problem. Raytheon's proposed solution involves "compression" of the returned signal by suitable variations in transmitted frequency.

The frequency of the returned signal varies according to the angle each portion of the beam makes with the vertical. At very high altitudes this effect would be apparent even with an extremely narrow beam. Hence, the returned energy is distributed in a relatively broad spectrum. A compensating variation of frequency within the transmitted beam should, however, result in a constant-frequency return signal. With the returned energy thus concentrated into a narrower band, a considerable improvement in signal-to-noise ratio is expected.

This design approach would require a closed-loop servo system to control the extent of frequency sweep according to vehicle speed and altitude. Transmitter power may have to be as high as 100 w, average, according to Raytheon engineers. Operation at lower powers would be preferable and will also be attempted. Frequency will probably be from 10 to 14 kmc or from 34 to 36 kmc.

It may be necessary to develop a special transmitting tube for the system, though existing types will be thoroughly evaluated.

NEW! MALLORY TAH 125°C TANTALUM CAPACITORS



New! A miniature 125°C tantalum capacitor—the Mallory TAH. The largest capacity per volt per cubic inch of any high temperature tantalum capacitor. Available in three case sizes and in 30 ratings from 2 mfd/60WVDC to 330 mfd/4WVDC. Same sintered pellet anode construction made famous by Mallory for reliability under extreme environmental conditions. High temperature seal and superior welded lead construction.

The Mallory TAH is specifically designed for medium voltage, low impedance transistorized circuits requiring small size, stability and long life characteristics.

FROM THE INDUSTRY'S WIDEST SELECTION

... seven high temperature sintered anode tantalum electrolytic capacitors

Type	Capacity Range mfd	W. Volts DC at 85° C	Temp. Range ° C	Body Length	Body Diameter	Bulletin Number
TAH	2-330	90-6	-55 to +125	.500 to .875"	.238"	4-57
MTF	11-140	90-6	-55 to +150	.500"	.287" (Body) .484" (Flange)	4-41
XTK	2-70	340-8	-55 to +175	.438 to 1.313"	.650"	4-49
XTM	4-140	340-8	-55 to +175	.566 to 1.800"	.650"	4-49
XTL	3.5-120	630-18	-55 to +200	.500 to 2.595"	.875"	4-31
XTH	7-240	630-18	-55 to +200	.688 to 4.065"	.875"	4-31
XTV	18-1300	630-30	-55 to +175	.563 to 2.750"	1.125"	4-39

HIGH RATINGS-SMALL CASE SIZES



... and six other types ... HAT, TNT, & TAP sintered anode liquid electrolyte; TAM & TAS sintered anode solid electrolyte; and 110 TAF foil ratings ... Metal case and encapsulated, from micro-miniature size upward. All produced in our new manufacturing facilities, the first in the industry specially designed for tantalum capacitor production.

Easier than ever to order. New 13-digit catalog numbering system lets you specify the exact Mallory tantalum capacitor you want, without writing out long, detailed specifications.

Write for complete technical data. For expert consultation on your circuit requirements, see a Mallory capacitor specialist.

Mallory Capacitor Co.
Indianapolis 6, Ind.
a division of



CIRCLE 19 ON READER-SERVICE CARD

Mallory Tantalum Capacitors Stocked by these distributors

Baltimore, Md.
Radio Electric Service
Binghamton, N.Y.
Stack Electronics
Boston, Mass.
Cramer Electronics, Inc.
DeMambro Radio Supply Co.
Lafayette Radio
Bridgeport, Conn.
Westconn Electronics
Buffalo, N.Y.
Wehle Electronics
Camden, N.J.
General Radio Supply Co.
Chicago, Ill.
Allied Radio Corp.
Newark Electronics Corp.
Cincinnati, Ohio
United Radio
Cleveland, Ohio
Pioneer Electronics
Dallas, Texas
Engineering Supply Co.
Dayton, Ohio
Allied Supply Co.
Denver, Colo.
Denver Electronics
Houston, Texas
Harrison Equipment Co., Inc.
Lenert Company
Indianapolis, Ind.
Graham Electronics
Los Angeles, Calif.
California Electronics
Kierulff Electronics, Inc.
Radio Product Sales
Minneapolis, Minn.
Northwest Radio
Montreal, Que.
Canadian Electrical Supply Co.
Mountainside, N.J.
Federated Purchaser, Inc.
Nashville, Tenn.
Electra Dist. Co.
Newark, N.J.
Lafayette Radio
New York, N.Y.
Harrison Radio Corp.
Harvey Radio Co., Inc.
Hudson Radio & TV Corp.
Lafayette Radio
Terminal Electronics
Oakland, Calif.
Elmar Electronics, Inc.
Zack Electronics
Orlando, Fla.
East Coast Radio
Ottawa, Ont.
Wackid Radio-TV Lab.
Palo Alto, Calif.
Zack Electronics
Pasadena, Calif.
Electronic Supply Corp.
Perth Amboy, N.J.
Atlas Electronics
Philadelphia, Pa.
Herbach & Rademan
Philadelphia Electronics
Pittsburgh, Pa.
Radio Parts Co.
St. Louis, Mo.
Olive Electronics
Seattle, Wash.
F. B. Connelly Co.
Tampa, Florida
Thurrow Distributors, Inc.
Toronto, Ont.
Alpha Aracon Radio Co.
Electro Sonic Supply
Wholesale Radio & Electronics
Tucson, Ariz.
Standard Radio Parts
Tulsa, Okla.
Engineering Supply Co.
Washington, D.C.
Electronic Industrial Sales
White Plains, N.Y.
Westchester Electric
Winston-Salem, N.C.
Dalton-Hege Radio



Complete line of aluminum and tantalum electrolytics, motor start and run capacitors

Minuteman Checker Records Test Results on IBM Cards

Resistors, capacitors, diodes, and Zeners, supplied by Minuteman subcontractors on component boards, are being tested on automatic component measuring and recording systems, according to a spokesman for Dymec Div. of Hewlett-Packard Co. About 100 components a minute are tested by the Dymec machine; data on each individual component, by serial number, is recorded on IBM punched cards.

Installed at Boeing Airplane Co., the automatic check-out gear gives two tests to resistors: resistance (range is 2 ohms to 20 meg) with an accuracy of ± 10 milliohms) and dissipation (test currents are low enough to test resistors with 1/8-w ratings). Three tests are given to capacitors. Capacitance is measured from 20 pf to 500 μ f; dissipation factor in four ranges from 0.3 to 10 μ a per μ f. Leakage is measured separately at a rate of 20 to 30 capacitors per minute over a range of 0.01-10.0 μ a per μ f with accuracy of 5 per cent.

Forward voltage of diodes is measured on two ranges—one and 10-v full scale, and reverse current is measured twice at separately selectable back voltages (six decade ranges from 0.1 μ a to 10-ma full scale). Zener voltage is measured in three ranges from 1 to 100-v full scale; impedance, with 2 per cent accuracy at 100-ohm full scale.

According to Don Loughry, Dymec project engineer for the system, the Boeing installation accepts the Minuteman-type etched circuit trays that hold up to 200 components. The tray is dropped into a drawer that is slid closed by the operator to shield the components from the effects of stray fields and ambient light. Closing the drawer aligns the tray and inserts it into the input receptacle, where it is automatically scanned by the machine. Output of the system energizes an IBM card punch.

Replacement-Capacitor Sales To Increase 50 Per Cent by 1965

The replacement-capacitor sales market will increase by 50 per cent over the next five years, it has been predicted by Gordon E. Burns, distributor sales manager for General Electric's Electronic Components Div.

The market, now reckoned at \$20 million, will grow to \$30 million annually, Mr. Burns said.

He made his prediction at the announcement of GE's entry into the replacement-capacitor market with a line of 275 twist-prong and tubular capacitors.

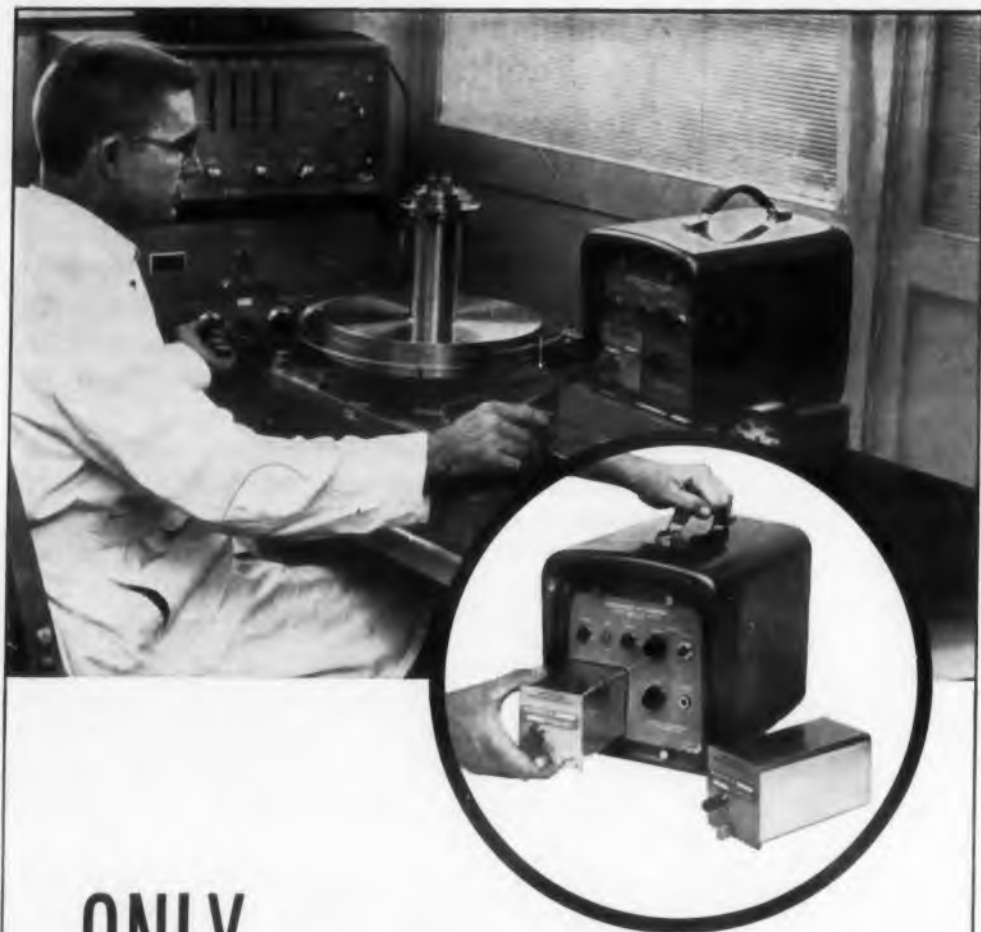

ONLY *wiancko offers a
portable secondary standard
with digital readout*

Q3403 exclusive features:

- ✓ Permits direct parameter measurements and calibration of transducers (pressure, force, accelerometers and temperature) in field, plant or laboratory.
- ✓ x2 and x4 plug-in frequency multiplier, coupled with bandwidth adjust provides greater accuracy due to increased resolution and real data capability—speedier testing and checkout.
- ✓ Readily interchangeable plug-in units for absolute, gage and differential pressure heads—ranges 5 to 10,000 psi.
- ✓ Head adapter permits use of Wiancko force rings, accelerometer, pressure pickups, or temperature bulbs—500 feet distant from Standard.

Accuracy: ± 0.05 percent full scale; ranges 0-2500 psi
 ± 0.08 percent full scale; ranges 3000-10,000 psi

For more information write for Product Bulletin 106A.

WIANCKO
ENGINEERING COMPANY



255 North Halstead Avenue • Pasadena, California

Precision with lasting reliability

CIRCLE 20 ON READER-SERVICE CARD

WASHINGTON REPORT



Ephraim Kahn

ARMY COST-CUTTING EFFORTS will be stepped up, in line with programs already undertaken by the Air Force and the Navy. Object is to be able to show Congress that fat has already been trimmed from military buying, and that a cut in funds can not be absorbed without a loss in defense potential. The Army's technical services will work with industry, at high levels. For electronic companies, most contact will be had with the Chief Signal Officer and the Chief of Ordnance. Representatives of industry will be asked to meet with these officers.

DESIGN CHANGES sponsored by the government and failure to deliver government-furnished equipment on time were the prime causes of delay in missile site construction, according to the Chief of Army Engineers, Lt. Gen. Emerson C. Itschner. Labor disputes on-site had only a minor role in the delays, but the 1959 steel strike was significant.

SCIENTIFIC AND ENGINEERING SKILL "of the highest professional caliber" is needed by the Air Force to manage its R&D programs, according to the head of the Air Research and Development Command, General Schriever. At present, Air Force officials believe that "dangerous levels" have been reached in the Air Force's technical personnel situation. Steps to reverse this trend will be taken. One big problem, according to Schriever, is that basic R&D is often slighted because high brass tends to overemphasize end products—weapons and systems.

IN THE NEAR FUTURE, the Air Materiel Command will start talks with manufacturers concerning replacement of its 17 computers with "second generation" devices that incorporate solid-state electronics. After these discussions, a federal specification will be drafted. Later, the question whether to lease or buy will have to be resolved. Now, the Air Force machines are leased at a cost of about \$31 million a year. If funds were available, the military would like to have more computers right now.

SPEED-UP OF R&D HAS ITS PRICE and is always a gamble, according to the Navy. Examining some of the practical effects of speeding the development of electronic equipment and pushing concepts to hardware faster than usual, the Navy notes that complex electronic systems for this Service may take from nine to 13 years for completion. A new radar was sought more rapidly, and concurrent development and testing was authorized. Time was cut to about seven and one-half years for the hardware phase, and early models had to be returned to the maker for service testing. Eventually, the originally planned reliability will be achieved, but "first ship installations have had serious trouble, and have gained a very poor reputation with operating

personnel." As the Navy sees it, these problems are primarily attributable to "overlapping schedules in each step in the hardware cycle" which "prevented elimination of design failures which would have been the case if normal test and evaluation feedback had been possible."

STRESS ON RELIABILITY is believed necessary by the Air Materiel Command even when it raises initial costs. The AMC will soon start to incorporate reliability clauses in all appropriate contracts, justifying it on the ground that lower maintenance often more than offsets any additional first cost. AMC will also adopt "value engineering" for general use. This saved over \$120 million in the first 9 months of 1960. It will ask contractors to take more responsibility in certifying and qualifying components for weapons systems under its Engineering Qualified Approval Procedures for production engineering.

BIG SAVINGS IN ELECTRON-TUBE BUYING are reported through the Air Force's adoption of a single-department buyer for electron tubes. In July-October, orders worth \$5.5 million are estimated to have resulted in savings of over \$1 million.

TWO BIG ELECTRONIC PROJECTS probably will be included in the Air Force's fiscal 1962 budget. It has long wanted funds for tracking and surveillance radar for the Ballistic Missile Early Warning System (BMEWS). They would be installed at Thule, Greenland, and Clear, Alaska. Tracking radars have already been authorized for the BMEWS station at Fylingdales Moor, England. Another \$15 million would be needed for these radars. Certain to require large amounts of electronic equipment would be the "hardened" underground operations center that the North American Defense Command (NORAD) wants to complete in Cheyenne Mountain near Colorado Springs, Colo. About \$10 million would be needed for the NORAD headquarters, where all air and space defense data would be evaluated and correlated.

MISSILE COSTS CAN BE CUT 25 PER CENT, says General Hurst, head of the Army Ballistic Missile Agency. Key to successful cost-cutting is use of value-analysis engineering as a "work habit," and Hurst wants both ABMA employees and contractors to use it.

CONTRACTING POLICY of the Air Materiel Command's Directorate of Procurement is veering toward more fixed-price pacts, and thought is being given to expanding the use of performance-incentive contracts. Annual purchases by AMC for the past few years have ranged between \$9 billion and \$10 billion.

BAN ON TELEGRAPHIC BIDS in an invitation can no longer be waived by contracting officers. About seven years ago, the General Accounting Office held that procurement officers could ignore this proviso in an invitation as an "informality," provided this did not confer any advantage on the bidder who submitted his offer by telegram. Whenever any question of this kind has arisen, the agency has required rejection of the telegraphic bid. Now, the General Accounting Office rules that it "will best serve the interests of the United States, as well as all potential suppliers" if strict observance is required when bid invitations ban telegraphic responses. If the invitations do not forbid telegraphic bids, then this ruling does not apply.

- Adjustable
- Subminiature
- Weighs only 1.3 oz.
- Ni-Span C pressure capsule
- Stainless steel housing



NEW BRISTOL PRESSURE SWITCH

Here's a subminiature pressure switch that incorporates the superb reliability characteristics of larger Bristol pressure switches. Yet, it's both miniature in size and it's adjustable.

It's the Bristol Type C2060... with six models covering ranges from 2-15 psi, absolute, to 20-200 psi gauge.

Easy pressure adjustment. You can change pressure settings easily and simply, without tools. Just turn the top portion of the switch. A strong ball detent holds settings positively even under severe vibration and shock.

Withstands shock, vibration, and acceleration in excess of MIL-E-005272B requirements. SPDT snap-action contacts are rated at 5 amps, 125vac, 60

cps; 2.5 amps d-c resistive load.

Get complete specifications on the new Bristol adjustable pressure switch today. Simply write for Bulletin AV 2015. The Bristol Company, Aircraft Equipment Division, 151 Bristol Road, Waterbury 20, Conn.

O.14

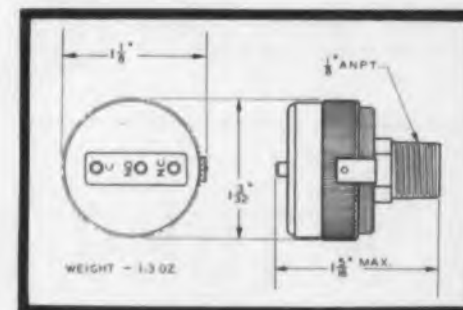

Dimensions

BRISTOL FINE PRECISION INSTRUMENTS
FOR OVER SEVENTY YEARS
CIRCLE 21 ON READER-SERVICE CARD

Tung-Sol Silicon Power Rectifiers

Diffused Junction and Alloy Junction

New freedom for designers

Designers who seek more freedom to use economical components while obtaining maximum equipment reliability should become thoroughly familiar with the Tung-Sol line of silicon rectifiers.

All Tung-Sol rectifiers are designed and manufactured to the same unexcelled standards of quality. At the very minimum, the entire line meets the toughest requirements laid down by military specifications. And you can be sure that wherever more rigid commercial specifications exist, Tung-Sol rectifiers will equal or exceed these higher performance and reliability demands. All in all, Tung-Sol rectifiers afford the widest design flexibility.

This select Tung-Sol line is available in production quantities immediately from stock and at conservative prices. Tung-Sol Electric Inc., Newark 4, N.J.

New
Interchangeability chart
available

Write for Tung-Sol silicon power rectifier interchangeability chart and catalog today. Forty-four Tung-Sol types replace more than 300 competitive types.



TUNG-SOL

Technical assistance is available through the following sales offices:
Atlanta, Ga.; Columbus, Ohio; Culver City, Calif.; Dallas, Texas; Denver,
Colo.; Detroit, Mich.; Irvington, N. J.; Melrose Park, Ill.; Newark, N. J.;
Philadelphia, Pa.; Seattle, Wash. CANADA: Toronto, Ont.

CIRCLE 22 ON READER-SERVICE CARD



NEWS

New Film-Coated Wire Described At Chicago Insulation Conference

Film-coated, 250-C magnet wire drew the attention of electronic engineers at the Third National Conference on the Application of Electrical Insulation in Chicago. The ML-type wire, as it is called, is only now becoming available in commercial quantities from a number of wire producers, including Anaconda Wire and Cable Co.

It was reported that the insulation will make possible more compact coil windings than those in current use at 250 C. At the present time, glass braiding is used at these temperatures. Engineers at the conference said they planned to investigate use of the new wires to design smaller high-temperature relays and motors. Some also said they were attracted by manufacturers' claims that the wire was suitable for encapsulation and hermetic sealing.

Industry sources said the chemical coating film appeared to be a super polyimide, although the developer, DuPont, has not revealed its composition. DuPont has a similar line of dipping compounds to be marketed under the trade name Herox.

High-Power Microwave Duplexer Uses Secondary Electron Resonance

A new duplexer, in which power-activated switching is accomplished by secondary electron resonance (multipactor) rather than by gas discharge, is reported to feature long life, low noise, and short recovery times of the order of an rf cycle.

The S-band duplexer capable of switching seven megawatts of incident peak power has been developed by General Electric Co. of Schenectady, N.Y.

Multipactor discharge consists of electrons in high vacuum which are driven back and forth between two electrodes by an rf electric field. In the prototype duplexer, the multipactor discharge occurs in an evacuated transmission type cavity, which performs the functions of a TR switch. Development work performed to date has resulted in design and operation of such TR cavities capable of switching 3.5 megawatts of incident power upon the cavity, and of providing isolation of 23 db, reports the company.

A dual TR cavity consisting of two similar resonators has been built which, in conjunction with two side-wall hybrids, constitutes a balanced duplexer capable of switching seven megawatts.

CIRCLE 23 ON READER-SERVICE CARD >

ELECTRONIC DESIGN • December 21, 1960

PUTTING MAGNETICS TO WORK

High-Vacuum Orbital Simulator Will Help Spacecraft Research

Lockheed scientists will bring a "chunk of space" down to earth here next summer when they activate a new High-Vacuum Orbital Simulator (HIVOS).

The huge piece of space test equipment will help tell what happens to satellites and spacecraft over long periods in orbit, reports Lockheed. It will be able to duplicate the heat absorbed from the searing radiation of the sun in space, and the freezing, near-absolute-zero cold of space in the earth's shadow.

Lockheed Will Use Facility To Test Agena, Other Vehicles

The new facility will be used by Lockheed Missiles and Space Div., satellite systems organization, to test various satellites and spacecraft, primarily Lockheed's Agena vehicle, under orbital conditions.

"Space-chamber" operations will be automatically programmed and controlled. The HIVOS will have a low-speed digital data-acquisition system for recording the thermal environment as well as monitoring vehicle functions. Checkout equipment similar to that used in conventional earthbound checkout of satellites will allow the satellite to be run electronically through its entire program under near-actual outer-space conditions.

Internal dimensions of the simulator space will accommodate a satellite 8-ft in diameter and 15-ft long. With expansion, it will be able to contain satellites up to 10-ft in diameter and 32-ft in length.

The space chamber, scheduled for completion in August 1961, will cost approximately \$3.5 million.



Open your eyes to new amplifier designs!

See how to combine tape wound cores and transistors for more versatile, lower-cost, smaller amplifiers

Tie tape wound cores and transistors into a magnetic-transistor amplifier, and open your eyes to new design opportunities.

To start with, these are static control elements—no moving parts, nothing to wear or burn out. Next thing you find is that you reduce components' size—your amplifier is smaller and costs less. That's because between them the core and the transistor perform just about every circuit function . . . and then some.

For instance? The core has multiple isolated windings. Thus you can feed many inputs to control the amplifier. The core also has a square hysteresis loop, and thus acts as a low loss transformer. That means you save power. In addition, the core can store and remember signals—so time delay becomes simple.

There's no need for temperature stabilization, either. The transistor acts only as a low loss, fast, static switch—and in this function it has no peer.

How do you want to use this superb combination? As a switching amplifier—or a linear one? In an oscillator? A power converter (d-c to d-c or d-c to a-c)? You'll have ideas of your own—and if they involve tape wound cores, why not write us? Ours are Performance-Guaranteed. *Magnetics Inc., Dept. ED-81, Butler, Pennsylvania.*

MAGNETICS inc.



Space simulator, as shown in architect's drawing, will be used by Lockheed to test satellites and spacecraft under near-actual orbital conditions.

CIRCLE 23 ON READER-SERVICE CARD

ELECTRONIC DESIGN • December 21, 1960

CIRCLE 24 ON READER-SERVICE CARD



**Quality control
engineer
with a
problem:**

"I can't test every relay!"

You shouldn't have to! Besides, quality can't be "tested into" relays—it has to be built in at every step of the production cycle. At General Electric it is.

Not simply individual tests for shock, vibration, etc., but *complete* quality control is what gives General Electric relays exceptional reliability.

Quality control begins with stringent material tolerances General Electric demands of its vendors, monitored by frequent appraisals on everything from tool calibration to their reporting procedures, and checked by G.E.'s careful processing of incoming materials. Result: less than 1% of incoming material must be rejected.

Quality control continues with equally exacting measures in our own plant:

- Of average relay manufacturing time, General Electric spends 30% in planned quality checks—much more for specials.
- More than 25% of total factory floor space is used to test relays.
- Advanced equipment and techniques are used, including the unitized testing console. This automatic, on-line testing center eliminates human error from production acceptance tests, eliminating another variable of relay reliability.

But, quality control doesn't end here. General Electric quality control even follows relays into the field to analyze

malfunctions and, if necessary, re-assess testing procedures, or design.

It all adds up to complete quality control—a highly developed monitor and feedback network that guides General Electric's manufacturing process through the consistent production of industry's most reliable sealed relays.

For information on our special customer-requested testing program, or more on quality control, see your G-E Sales Engineer. General Electric Co., Specialty Control Dept., Waynesboro, Va.

Progress Is Our Most Important Product

GENERAL  ELECTRIC

GENERAL ELECTRIC SEALED RELAYS—UNMATCHED FOR RELIABILITY

CIRCLE 25 ON READER-SERVICE CARD

General Electric sealed relays for the '60's



MICRO-MINIATURE

Small and light for military use, the General Electric Micro-miniature's dual-coil construction provides a highly efficient magnetic circuit, requiring minimum operating power. A balanced armature combined with extremely high tip forces gives the relay exceptional resistance to shock and vibration. It is available in current-calibrated and voltage-calibrated forms, SPDT or DPDT. Other specifications:

Operating Sensitivity: 200 milliwatts; 300 milliwatts.

Vibration: 20 G's, 55-2000 cps (except for certain mounting forms).

Shock: 50 G's per MIL-R-5757C.

Ambient Temperature: -65C to +125C.

Operating Time: (25C) 6 milliseconds maximum.

Release Time: 5 milliseconds maximum.

Contact Rating: 2 amps resistive at 28 VDC or 115 VAC.

Life: 100,000 operations minimum at rated load.

Dielectric Strength: 1000 V rms except 700 V across terminals.

Insulation Resistance: 1000 megohms minimum.

Contact Resistance: .05 ohms maximum at rated load.



MINIATURE: Long-life type; rated 5 amps at 28 VDC; in 2- or 4-pole double-throw and 6PNO forms. Ideal for ground applications.



4-POLE MICRO-MINIATURE: Welded construction, exceptionally long life. Rated 2 amps at 28 VDC, or 115 VAC resistive; requires only 10 milliwatts per pole.



GRID-SPACED MICRO-MINIATURE: Long-life crystal-can type, rated 3 amps at 28 VDC, operating sensitivity 300 mw; 16 mounting for ms; 30 G's vibration to 2000 cps.

General Electric Company
Section C792-17
Schenectady, New York

Please send me a free copy of the
1959-60 Sealed Relay Catalog.

Name _____

Address _____

City _____

State _____

GENERAL  ELECTRIC

CIRCLE 26 ON READER-SERVICE CARD

EDITORIAL

What Are We Buying?

The military is not buying enough when it specifies only equipment. It must also buy feedback information.

Just as important as the delivery of operational hardware by engineers is the transmittal of the vital information on the many conclusions and recommendations reached by those engineers while building the equipment. But when the emphasis is chiefly on equipment, when the contract payments are made on equipment, the contractor is necessarily going to deliver equipment. If he allows himself the luxury of doing otherwise, he will not make a profit.

Too frequently, the delivery of, say, a marginal missile is not consistent with real military objectives or national purpose. In these cases, it would be better to recognize that the missile being built should be modified or abandoned. But this cannot be done unless the contractor can deliver information which will influence design of present equipment and planning for the future. Indeed, engineers doing field testing report that the same mistakes are made time and time again.

The healthy competition of our profit system, coupled with current contracting practices have created this unhealthy situation. Both the time and money given to industry are in most cases insufficient for industry to make a profit (and thereby stay in business) and at the same time to take the long view on what is best for the country. But our system is not only in competition internally; it is in a race for survival with a system of state control which, because of its monolithic consumer-manufacturer structure, permits rapid and vital feedback.

Thus, the state-controlled political system may win the competition unless our procedures are modified. Our "control" or "review and evaluation" processes must be examined for the inadequacy to keep pace with the rapidly changing events of the day. The addition of feedback data, while costing slightly more, would provide economy through efficiency in the long run and would advance military objectives.

The military cannot afford to buy the wrong product. This means having more information and being able to act on it. To get the information, the military must specify it and pay for it.

James G. Koppke

YOURS
FOR THE
ASKING...
AC POWER
FROM
BEHLMAN



Behlman is offering this guide to AC power supplies as a service to those engineers who have a need for extremely accurate and exceptionally stable AC power — single, two and three phase. For your free copy, send the coupon below to: Behlman Engineering Company, 2911 Winona Ave., Burbank, Calif.

NAME _____
ADDRESS _____
COMPANY _____

BEHLMAN ENGINEERING a subsidiary of Electronic Energy Conversion Corporation
CIRCLE 27 ON READER-SERVICE CARD

Silicon Transistor Circuits: How To Stabilize Them With Silicon Resistors

One age-old problem with transistorized circuitry is compensating for temperature variations. In this article, the authors show (with graphs, equations and examples) how to use silicon resistors to stabilize the dc operating point of silicon transistor circuits.

Earl C. Wilson, George W. Andrews

Texas Instruments, Inc.
Dallas, Tex.

SINCE transistor electrical parameters are sensitive to temperature changes, some form of compensation is usually required to insure proper circuit performance over a broad temperature range.

The Sensistor[®] silicon resistor has a +0.7 per cent per degree C temperature coefficient of resistance; this article describes its use in stabilizing the dc operating point of silicon transistor circuits. It is assumed the reader has a working knowledge of the causes and effects of dc operating point instability, including the temperature characteristics of collector cut-off current, I_{CBO} , dc forward current transfer ratio, h_{FE} , and forward base-emitter voltage, V_{BE} .

Designing Circuits To Get Operating Point Stabilization

A circuit can be designed with operating-point stability, if the transistor's temperature-dependent quantities can be made to have very little effect on collector current. For low collector current values, the near exponential increase of I_{CBO} with temperature tends to swamp out the linear variation of V_{BE} and the effects on h_{FE} at high temperature. At low temperatures, I_{CBO} is very small in most silicon transistors, so instability caused by $\Delta V_{BE}/\Delta T$ and $h_{FE}/\Delta T$ becomes predominant.

Adequate compensation for h_{FE} variations can usually be achieved, using negative dc feedback.

[®] Trademark of Texas Instruments Inc.

Such feedback improves circuit stability and linearity at the expense of dc gain.

Changes in operating point caused by $\Delta V_{BE}/\Delta T$ can be corrected by placing a temperature-sensitive element with a positive temperature coefficient in the emitter circuit. The effect is voltage cancellation. Compensation for $\Delta V_{BE}/\Delta T$ is achieved if the rate at which the external base-emitter bias changes exactly cancels the $\Delta V_{BE}/\Delta T$ of the transistor. A silicon resistor offers an excellent means for $\Delta V_{BE}/\Delta T$ compensation. I_{CBO} changes with temperature, which present a more complicated problem, are considered in the following section.

Two Figures of Merit Used to Evaluate Stability Factors

Two figures of merit often used to evaluate operating point stability with regard to temperature changes are: the current-stability factor, S_I ; the voltage-stability factor, S_V . S_I is more important because, for a resistive load, S_V is a direct function of S_I .

The current stability factor evaluates the ability or inability of the external circuit to minimize collector current variations. S_I and S_V are usually defined as:¹

$$S_I = \frac{\partial I_C}{\partial I_{CBO}} \quad (1)$$

$$S_V = \frac{\partial V_{CE}}{\partial I_{CBO}} \quad (2)$$

For ideal stabilization, S_I (amplification of I_{CBO}) will be one. The circuit in Fig. 1 is used

to determine operating-point stability. The stability factor can be used for any connection of a single-stage amplifier.

Fig. 2 is a Thevenin equivalent circuit for Fig. 1.

$$R_B = R_1 (R_2) / R_1 + R_2 \quad (3)$$

$$V_{OC} = V_{CC} (R_1) / R_1 + R_2 \quad (4)$$

$$I_E + I_C + I_B = 0 \quad (5)$$

$$I_B = [I_C - I_{CBO} (1 + h_{FE}^*)] / h_{FE}^* \quad (6)$$

$$I_E = (I_{CBO} - I_C) (1 + h_{FE}^*) / h_{FE}^* \quad (7)$$

$$V_{OC} = I_B R_B + V_{BE} - I_E R_E \quad (8)$$

$$V_{OC} = \frac{I_C}{h_{FE}^*} [R_B + R_E (1 + h_{FE}^*)] - \frac{I_{CBO}}{h_{FE}^*} [(R_B + R_E) (1 + h_{FE}^*)] + V_{BE} \quad (9)$$

$$S_I = \frac{\partial I_C}{\partial I_{CBO}} = \frac{(R_B + R_E) (1 + h_{FE}^*)}{R_B + R_E (1 + h_{FE}^*)} \quad (10)$$

If $h_{FE}^* \gg 1$:

$$S_I \approx 1 + R_B/R_E = 1 + R_1 (R_2) / R_E (R_1 + R_2) \quad (11)$$

Eq. (11) shows: if a stability factor near 1 is desired, the emitter resistor must be much larger than the parallel combination of R_1 and R_2 . With an open base or a very high R_B , the cur-

¹ The IRE standard on letter symbols for Semiconductor Devices, 56 IRE 28.S1, states

$$h_{FE} = \frac{I_C}{I_B} \text{ and } h_{FB} = \frac{I_C}{I_E}$$

where I_C , I_B , and I_E are total dc currents flowing in the respective leads; h_{FE} is the parameter listed on almost every transistor data sheet. The superscript asterisk used herein, identifies the static value of the forward current transfer ratio, when I_{CBO} is not included in I_C .

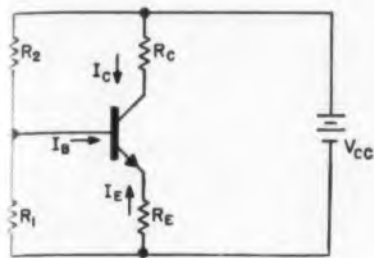

Fig. 1. General circuit used to determine stability factors.

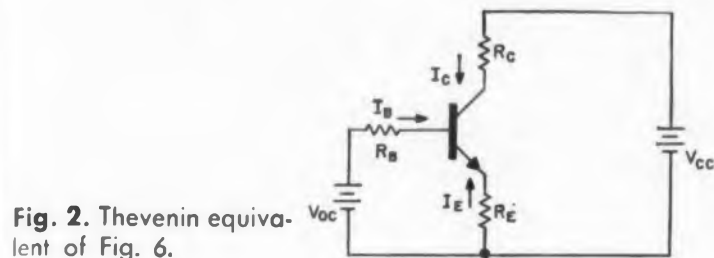

Fig. 2. Thevenin equivalent of Fig. 1.

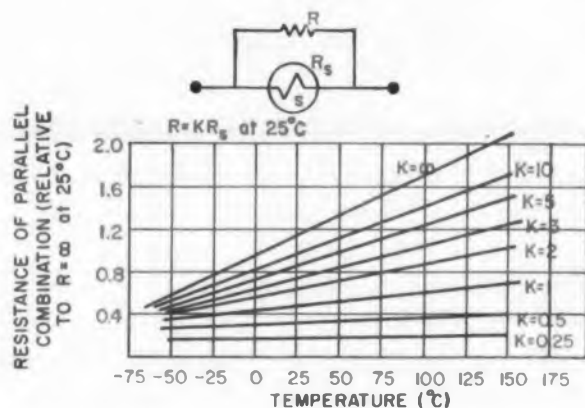

Fig. 3. Resistance vs temperature of parallel sensor silicon resistors and carbon resistors.

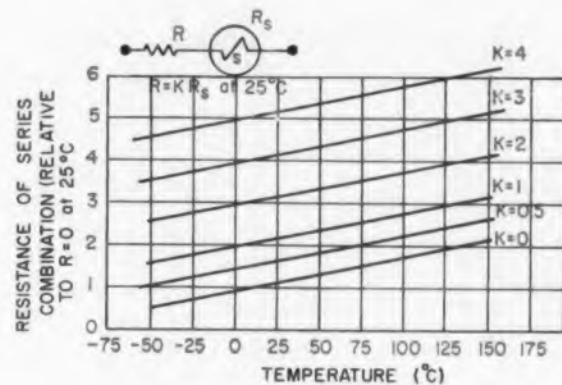

Fig. 4. Resistance vs temperature of series silicon resistor and carbon resistor.

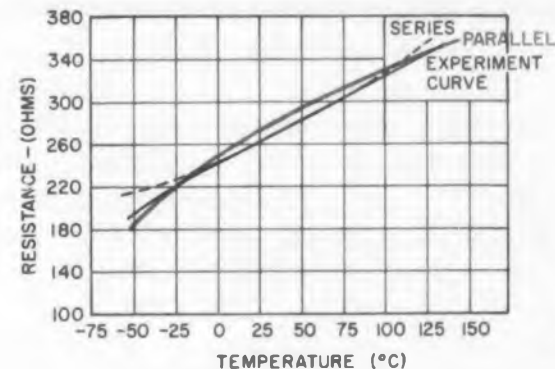
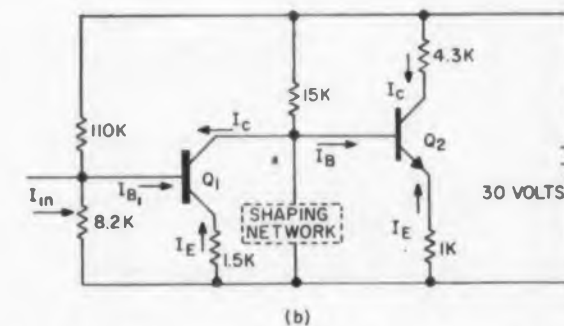
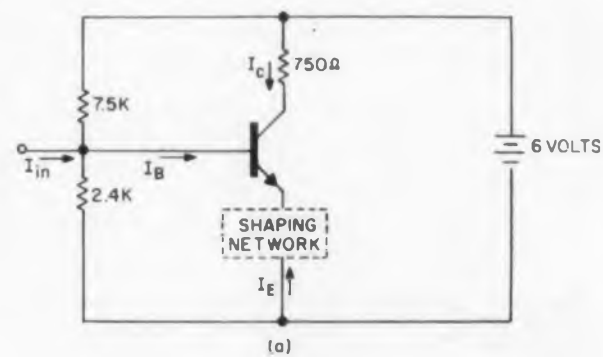

Fig. 6. Desired resistance of shaping network vs temperature for the circuit in Fig. 5a.



Figs. 5a and 5b. Circuits which determine shaping networks.

rent stability factor can approach the h_{FE}° of the transistor, and stability will be practically non-existent. Also, Eq. 11 assumes that I_{CBO} is the only variable with temperature; but since V_{BE} and h_{FE}° are critical quantities, the actual stability factor could be much poorer than that calculated.

To calculate the over-all stability, the following approach, using the circuits of Figs. 1 and 2, has been proposed.⁵

Starting from Eq. (9):

$$\frac{\partial I_C}{\partial V_{BE}} = \frac{-h_{FE}^{\circ}}{R_B + R_E (1 + h_{FE}^{\circ})} \quad (12)$$

$$\frac{\partial I_C}{\partial h_{FE}^{\circ}} = \frac{-I_E (R_B + R_E)}{(h_{FE}^{\circ} + 1) [R_B + R_E (1 + h_{FE}^{\circ})]} \quad (13)$$

$$\Delta I_C = \Delta I_{CBO} \left(\frac{\partial I_C}{\partial I_{CBO}} \right) + \Delta V_{BE} \left(\frac{\partial I_C}{\partial V_{BE}} \right) + \Delta h_{FE}^{\circ} \left(\frac{\partial I_C}{\partial h_{FE}^{\circ}} \right) \quad (14)$$

The total collector current change from Eq. (14) will be the result of changes in I_{CBO} , V_{BE} , and h_{FE}° . Since the three effects add, over-all

stability is poorer in many cases than the stability factor calculated using I_{CBO} variations alone.

Compensation with Shaping Networks Can Be Gained by Transistors

Although available silicon resistors offer a wide variety of characteristics, it is sometimes impossible to select a particular silicon resistor that exactly compensates for effects of temperature changes. In practice, it is sometimes desirable to use silicon resistors and carbon resistors in series or parallel combinations to form a shaping network.⁶

Fig. 3 shows the equivalent resistance vs temperature for a Sensistor silicon resistor alone at 25°C. Fig. 4 shows the equivalent resistance vs temperature for a Sensistor silicon resistor and carbon resistor in series, relative to the silicon resistor alone at 25°C. In both cases, resistor R was assumed independent of temperature changes. Symbol K is the ratio of the resistor value to the Sensistor silicon resistor resistance at room temperature (Eq. 15).

$$R = K R_s \quad (15)$$

The shaping network required to compensate

for temperature effects can be determined experimentally, as demonstrated with the circuits in Fig. 5a and 5b.

To determine the characteristics of the shaping network required for compensation, a variable resistor can be substituted for the shaping network and adjusted to maintain a constant collector current for a constant input current, as the operating temperature changes. After resistance values have been recorded, resistance vs temperature is plotted to show the characteristics required of the shaping network. The experimental method of temperature compensation provides a way to compensate for the variations of all components in the circuit. Note, however, the same procedure must be repeated each time a transistor or some other critical component is replaced.

Fig. 6 is a plot of resistance vs temperature required of the shaping network to maintain collector currents of 3 ma and 3.25 ma with input currents of 0 and 50 μ a, respectively, for the circuit of Fig. 5a.

If the shaping network exactly matches the desired characteristics, a change in temperature over the range of interest will not affect output

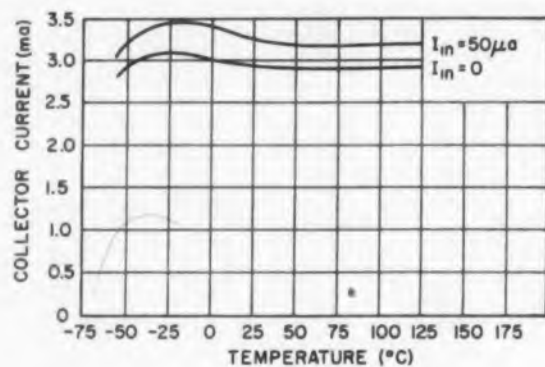

Fig. 7. Collector current vs temperature for circuit in Fig. 5a.

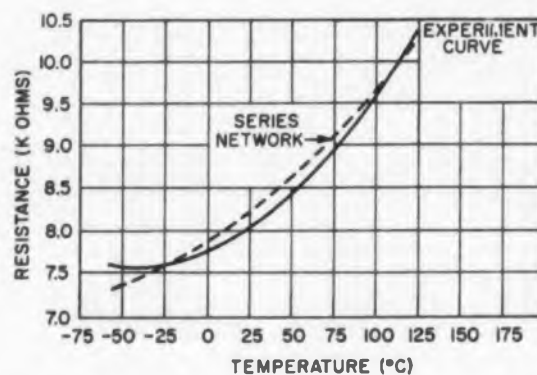

Fig. 8. Shaping network for circuit in Fig. 5b.

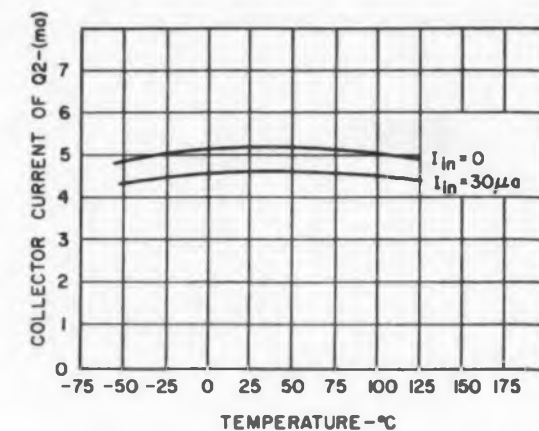
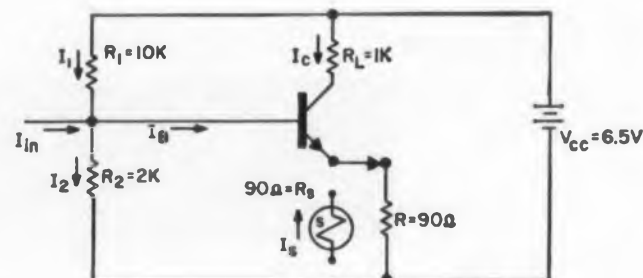

Fig. 9. Collector current vs temperature for circuit in Fig. 5b.

Fig. 10. Bias compensation test circuit.

current. Fig. 6 shows $\Delta R/\Delta T$, determined experimentally, is nearly constant at about $+0.8$ ohm per deg C. A silicon resistor used alone will not provide the required compensation for the circuit in Fig. 5a. The temperature coefficient of the silicon resistor is about $+0.7$ per cent per deg C. For a silicon resistor to provide adequate compensation by itself, the following relationship must be true: $0.007 R_S \approx 0.8$; $R_S \approx 110$ ohms.

The resistance change for changing temperature would be adequate, but the total resistance would be too small to compensate for the given conditions. A series or parallel combination of silicon resistors and carbon resistors can be used to get added resistance. Two points must be chosen that permit maximum compensation to be obtained from the elements used.

The series combinations can be approximated from Fig. 4, or calculated. The common points at -25 C and 100 C were chosen to get a shaping network for the circuit of Fig. 5a. With Fig. 6, these relationships are obtained: $0.68 R_S + R = 220$, $1.56 R_S + R = 320$; from which $0.88 R_S = 100$ and $R_S \approx 100$ ohms, $R \approx 150$ ohms. The curve resulting from these values of R and R_S is plotted in Fig. 6 along with the desired curve.

A parallel combination can be found in a similar manner. Assume common points at -50 C and $+100$ C.

$$\frac{0.57 R_S R}{0.57 R_S + R} = 198, \quad \frac{1.56 R_S R}{1.56 R_S + R} = 320$$

A simultaneous solution gives: $R_S = 1.15 R$.

Substituting in the previous equations: $R \approx 500$ ohms, and $R_S \approx 560$ ohms. The curve resulting

from these figures is also plotted in Fig. 6.

The parallel combination was chosen because it is more representative of the desired characteristics over the entire range from -55 C to 125 C. Fig. 7 is a plot of collector-current vs temperature for constant input currents of zero and $50 \mu\text{a}$, using the circuit in Fig. 5a.

Fig. 8 is a curve of resistance vs temperature required of the shaping network to maintain collector current of Q2 at 5 ma and 4.5 ma with input currents of 0 and $30 \mu\text{a}$ respectively for the circuit of Fig. 5b.

A series combination was used as the shaping network with common points at 25 C and 100 C.

$$\begin{aligned} \text{Then: } \quad 0.68 R_S + R &= 7,640 \\ 1.56 R_S + R &= 9,700 \\ R_S &= 2,340 \end{aligned}$$

Two 820 -ohm and one 680 -ohm silicon resistors were used: $R_S = 2320$ ohms; $R \approx 6$ K. R was obtained from 5.6 K and a 430 -ohm resistor; $R = 6.03$ K.

The collector-current vs temperature, for constant input currents of 0 and $30 \mu\text{a}$, is shown in Fig. 9.

Collector-current vs temperature curves in Figs. 7 and 9 show good compensation can be achieved with little effort, using the experimental method to determine shaping networks. If better compensation is required, the temperature coefficients of the resistors used in the shaping network must also be considered. The desired resistance curve can be matched with that of the shaping network at more points by adding more nonlinear elements in the shaping network. Figs. 3 and 4 show that a simple series combination of silicon resistors and carbon resistors provides

greater resistance change per degree change in temperature than a parallel combination.

Compensation for Base-Emitter Voltage Changes

The circuit in Fig. 10 compensates for changes in V_{BE} with temperature. The switch in the emitter circuit enables a measurement to be taken with either the silicon resistor or carbon resistor in the circuit. All calculations that follow are based on information presented in this article.

The nominal silicon resistor resistance, R_S , needed to compensate for $\Delta V_{BE}/\Delta T$ will be calculated. A dc collector current value must be chosen to determine R_S , using the circuit shown in Fig. 10 as an example: $V_{CC} = 6.5$; $I_S = 3$ ma. Assume that $h_{FE} \gg 1$, so $I_C \approx I_E = I_S$. Typically: $\Delta V_{BE}/\Delta T = -1.87$ mv per deg C at $I_C = 3$ ma.

To compensate for $\Delta V_{BE}/\Delta T$, this equation must be true:

$$\begin{aligned} (\Delta R_S/UT) I_S + \Delta V_{BE}/\Delta T &= 0 \\ \Delta R_S/\Delta T &= 0.007 R_S \text{ ohms per deg C} \\ 0.007 R_S \times 3 \times 10^{-3} &= 1.87 \times 10^{-3} \\ R_S &= 90 \text{ ohms} \end{aligned}$$

If the $\Delta V_{BE}/\Delta T$ of the transistor is exactly what is determined experimentally, a silicon resistor of 90 ohms will compensate $\Delta V_{BE}/\Delta T$ changes.

To maintain circuit efficiency, the current through the divider to the base should be much less than the collector current. In this case, 0.5 ma was chosen. With this, current stability factor can be calculated.

$$\begin{aligned} I_2 R_2 &= V_{BE} + I_S R_S \\ \text{Typically, } V_{BE} &= 0.69 \text{ at } 25 \text{ C, } I_C = 3 \text{ ma} \\ I_2 R_2 &= 0.69 + 3 \times 90 \times 10^{-3} = 0.96 \end{aligned}$$

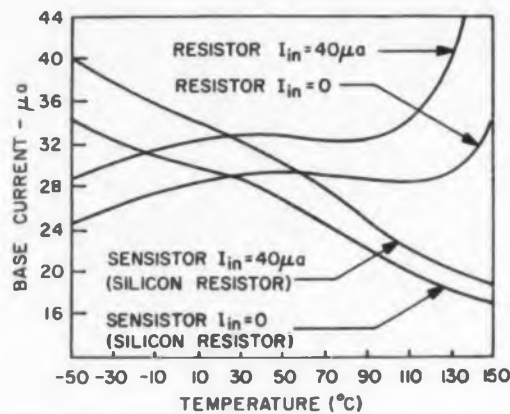

Fig. 11. Base current vs temperature for the circuit in Fig. 10.

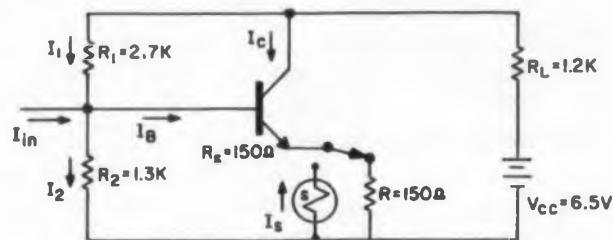

Fig. 13. Bias compensation circuit with large negative feedback.

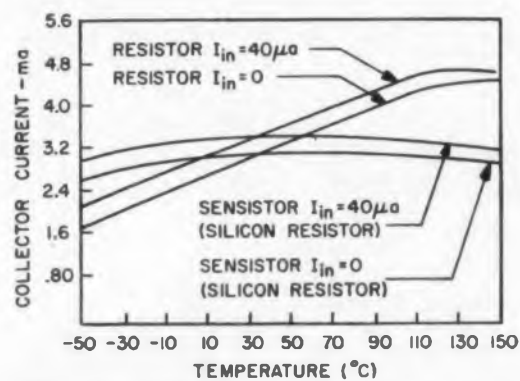

Fig. 12. Collector current vs temperature for the circuit in Fig. 10.

Fig. 14. Base current vs temperature for circuit in Fig. 13.

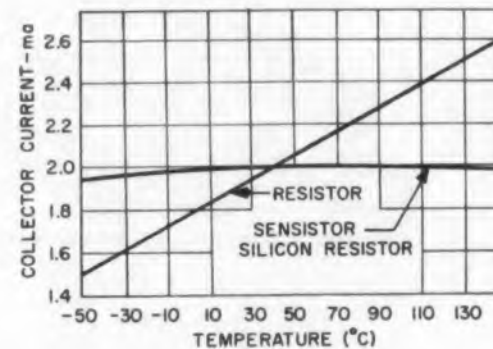
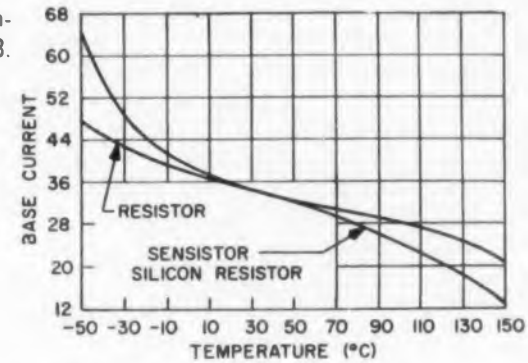

Fig. 15. Collector current vs temperature for the bias-compensation circuit in Fig. 13.

Assuming $I_2 \approx 0.5$ ma

$$R_2 \approx \frac{0.96}{5} \times 10^3 = 1,920 \text{ ohms}$$

$R_2 = 2$ K, the nearest standard value.

$I_2 = 0.96 \cdot 2 \times 10^{-3} = 0.48$ ma $I_1 = I_2 + I_B$

Typically, the 2N338 shows that

$h_{FE} = 50$ at -55 C and $I_C = 3$ ma

$$I_B = \frac{3 \times 10^{-3}}{50} = 60 \mu\text{a} \quad I_1 = 0.54 \text{ ma}$$

$$I_1 R_1 = 6.5 - 0.96 = 5.54$$

$$R_1 \frac{5.54}{0.54} \times 10^3 = 10.25 \text{ K}$$

$R_1 = 10$ K, the nearest standard value.

$$S_T = 1 + \frac{R_1 R_2}{R_S (R_1 + R_2)} = 19.3$$

Although the current stability factor is quite high, the contribution of ΔI_{CBO} toward instability for a collector current of 3 ma using a 2N338 is usually very small compared to the contribution from ΔV_{BE} . A method used to get a considerably smaller stability factor will be shown with the next circuit.

Figs. 11 and 12 show the results of temperature compensation using this approach on the circuit on Fig. 10. The circuit was tested with constant dc inputs of zero and 40 μa , using typical transistors rather than selecting units that had the same $\Delta V_{BE}/\Delta T$ characteristics as those used in the calculations.

Very good compensation was obtained as seen by comparing the related curves of Fig. 12. Fig.

11 shows the silicon resistor tends to adjust the base bias so that the output current will remain nearly constant for an increase in operating temperature. This effect is a compensation for $\Delta h_{FE}/\Delta T$ as well as $\Delta V_{BE}/\Delta T$.

Fig. 12 shows the noncompensated circuit became saturated when the operating temperature exceeded 110 C. It also indicates the circuit tested was a bit over-compensated at both temperature extremes. This means that a silicon resistor of a slightly smaller value would improve the degree of compensation.

A different value of R_S will be required to compensate for $\Delta V_{BE}/\Delta T$ for each value of I_E desired. The method of determining the correct value will be similar to that shown in the preceding example.

The circuit in Fig. 13 is similar to Fig. 10. The main difference: the circuit of Fig. 13 has a large negative feedback, and a special effort was made to get a reasonable stability factor. The result is nearly the same for the two circuits, except that the effects of I_{CBO} are not as apparent for Fig. 13 at high temperatures.

Example:

$$I_C I_E = I_S = 2 \text{ ma} \quad V_{CC} = 6.5 \text{ v}$$

$$\Delta V_{BE}/\Delta T = -1.95 \text{ mv per deg C,}$$

Typically $R_S \approx 140$ ohms

R_S was chosen to be 150 ohms, the nearest standard value.

$$I_1 \approx 0.75 \text{ ma} \quad V_2 = V_{BE} + I_S R_S$$

$$V_2 = 0.66 + 0.30 = 0.96 \text{ v}$$

$$R_2 \approx \frac{0.96}{0.75} \times 10^3 = 1.28 \text{ K}$$

$R_2 = 1.3$ K, the nearest standard value.

V_{CE} was chosen to be 3 v at 25 C

$$V_1 \approx 3 - 0.96 = 2.04 \text{ v}$$

$$R_1 = \frac{2.04}{0.75} \times 10^3 = 2.7 \text{ K}$$

$$R_L = \frac{V_{CC} - V_{CE}}{I_C + I_1} \quad R_L = 1.27 \text{ K}$$

$R_L = 1.2$ K, the nearest standard value.

Using the calculated resistor values, a stability factor can be determined.

$$S_T = 1 + \frac{3.51 \times 10^6}{150 (4 \times 10^3)} = 6.85$$

The results in Figs. 14 and 15 are quite similar to those obtained for Fig. 10. Note, however, that some compensation for $\Delta h_{FE}/\Delta T$ is accomplished without the silicon resistor when strong negative feedback is used. ■ ■

References

1. E. J. Angelo, Jr., *Electronic Circuits*, McGraw-Hill, New York, pp 194-196; 1958.
2. L. P. Hunter, *Handbook of Semiconductor Electronics*, McGraw-Hill, New York, pp 13-2 through 13-3; 1956.
3. D. Dewitt and A. L. Rosoff, *Transistor Electronics*, McGraw-Hill, New York, pp 155-57; 1958.
4. R. F. Shea, *Transistor Circuit Engineering*, John Wiley and Sons, New York, pp 55-6; 1958.
5. D. B. Hall, "Biasing Network Design for Silicon Tetra-rod Transistors," *Electrical Design News*, pp 46-51; April 1959.
6. E. Keonjian and J. S. Schaffner, "Shaping of the Characteristics of Temperature-Sensitive Elements," *Commun. and Electronics*, Vol. 14, pp 396-400; Sept. 1954.
7. "56 IRE 28.51 Standards on Letter Symbols for Semiconductor Devices, 1956," *Proc. IRE*, Vol. 44, pp 934-37; July 1956.



Tantalum Capacitors: 30 Questions And Answers On Their Applications, Characteristics, Peculiarities



Sprague Electric Co. recently arranged a symposium that gave engineers from many companies an opportunity to pose a multitude of questions on tantalum capacitors. These questions and Sprague's answers were recorded during the discussion period. Some of them are contained in this article.

Q. In the liquid-electrolyte tantalum capacitors, what happens to volatile constituents that pass off as life progresses? Are the vapors contained within the case? What happens if these units are encapsulated in an operating package? Does lead corrosion result?

A. The first question's answer: major by-products are hydrogen and oxygen. Oxygen is normally used in re-oxidation; hydrogen is normally absorbed on the surface of the tantalum, or it diffuses through the end seal. Vapors of the volatile components remain entrapped in the capacitor. What happens to encapsulated capacitors? Nothing—if the proper encapsulant is used.

Q. When solid tantalums are used as coupling capacitors, why do random breakdowns occur, even at much lower than rated voltage? What sort of short occurs?

A. This should not happen. This is not a phenomenon associated with the capacitor; it is quite strange to us.

Q. Do you use any rule-of-thumb criteria to determine pulse rating of tantalum capacitors?

A. No. There is no rule-of-thumb we know. Each application must be considered separately.

Q. What are the best tests—that is, easiest and cheapest—to determine reliability of units? Are there any simple tests, even up to 100 hours, that reveal weak units?

A. We don't know any.

Q. Is tantalum in short supply?

A. No.

Q. How much drift and what rate of drift can be expected in leakage current when a solid-electrolyte (or a liquid-electrolyte) type is used in a dc circuit at much less than rated voltage

(100 to 1 ratio or lower) to gain advantage of extremely low leakage current?

A. Generally, there is no drift to be expected in these operating conditions. A more specific answer: any minor drift depends on the rating of the capacitor and must be considered for the particular rating.

Q. Discuss methods used for charging the capacitance of a tantalum capacitor by operating it under controlled overrated conditions on a cut-and-try basis, such as, charging a 3- μ f capacitor to 2.7 μ f. Is this procedure permissible from a life standpoint? Our experience is: some makes of capacitors lend themselves to this technique, others do not.

A. This is a procedure we positively do not recommend. It is not permissible on any capacitor we make; we do not think it permissible on any capacitor that anybody else makes. Applying overvoltage beyond the rating that is sufficient to cause any change in the capacitance of the capacitor is an attempt to form it. It will generate gas and destroy the capacitor, probably by explosion, sooner or later.

Q. What is the statistical incidence of electrolyte leakage with factors such as temperature and vibration?

A. This depends on the capacitor's construction and the severity of test conditions. It must be considered for particular capacitors and particular applications.

Q. Because of tantalum capacitors' increased use in bypass and dc coupling applications, has thought been given to specifying and measuring parameters at 1 kc or 10 kc, instead of 120 cps?

A. Measurement at 1 kc is no problem. We can supply this data on request. Measurement at 10 kc is a definite problem. This requires special measuring apparatus. We don't normally do this: it is a straight measurement problem. We will do it where the application justifies it.

Q. Should you re-form solid tantalum capacitors after a lengthy shelf life before using?

A. No.

Q. Would there be any ill-effects from derating by 70 per cent or 80 per cent of rated voltage?

A. There is no disadvantage. Derating, however, improves the capacitor's reliability.

Q. Why can't anode-to-anode for back-to-back operation be used? Would the opposite arrangement change test results?

A. This is a mechanical problem only. So far there has been no mechanical advantage to putting two anodes in series in the same can. It is easier to connect two cathodes back-to-back.

Q. Ripple current ratings for sintered anode type wet tantalum capacitors are usually given for 120-cps operation. Is there a rule-of-thumb to determine ratings for 400 cps and higher?

A. No, yet. But we have data in preparation; we may be able to give guide lines later.

Q. What electrical effects can be expected during shock and vibration for each type of tantalum capacitor? What about microphonics?

A. A rule-of-thumb is: microphonic effects are least in solid-electrolyte types; second, in order of magnitude, in foil types; and greatest in the wet slug type of capacitor.

Q. Does encapsulation of wet or dry tantalum capacitors have any deleterious effects on their life? I have heard that encapsulation prevents breathing of the wet type during temperature variations and causes excessive stress or explosion of these units.

A. Potting compounds must be ones whose physical properties and curing procedures are such that the capacitor's seals are not excessively stressed or the mechanical integrity of the structure is not destroyed. There is no need for a wet capacitor to breathe.

Q. We've noticed on polar etched-foil units on lower frequency applications (less than 3 cps) that an apparent increase in capacitance occurs (about three times). This does not occur on plain-foil units. Can you explain this? We determined the capacitance value by measuring the RC time constant of the circuit.

A. This problem has arisen before; we have never been able to corroborate the fact that capacitance changes considerably at extremely low frequencies. It is difficult to measure. An adequate standard circuit should be used for correlation by the user and manufacturer.

Q. Would you care to comment on how far away the state of the art is from a truly symmetrical, dry, non-polar, oxide film dielectric capacitor? I'm not referring to back-to-back combinations of polar units, but rather to a unit whose basic design is non-polar.

A. Our company is not contemplating such a construction.

Q. Can the tantalum leads be bent smooth for mounting on PC boards without damage to the end seal or internal connections, if held with round-nose pliers?

A. Yes they can. We recommend a 1/32-in. minimum bending radius.

Q. In applications where induced random noise voltages (due to cabling, high gradient pulse environment, etc.) may impose undetermined levels of reverse voltages on either solid or wet slug types, do you recommend back-to-back applications of these capacitors?

A. We say, when in doubt, definitely yes. If there is any question about the reverse voltage that will be applied to the capacitor—when you want to be sure of your reliability, or if there is any doubt in your mind—put two units together in a non-polar configuration.

Q. Why a cylindrical shape? Volume efficiency of finished assembly is more important than component volume efficiency.

A. We agree with that, from a finished assembly or apparatus designers' standpoint. Up to this point, volume efficiency is greater for cylindrical structures; mechanical problems and seals are more readily solved in cylindrical units. This is a question of design and mechanics. Rectangular units are under consideration and may come in the future.

Q. What's the effect of time at reverse voltage on capacitors. We've had trouble with wets where reverse voltage is 2 to 3 v for a few milliseconds.

A. As on a solid, for example, 5 per cent continuously is not unheard of. You can go to higher percentages than this for intermittent duty. In the case of reversals, where you are exceeding recommended values, you should take each case in particular.

Q. What causes failure under reverse voltage conditions for each type, particularly for solid-electrolyte types? Is it loss of dielectric properties, deforming; over current or overheating problem; gas generation; other? For solid capacitors, can we apply milliamperes or ampere pulse of reverse current, if the duty cycle is such that internal capacitor heating is limited?

A. What you are doing when you apply a reverse voltage is to deteriorate, to some degree, the oxide layer. Then, when it is properly polarized, the leakage current is higher. It could possibly lead to a run-away condition.

Q. Are higher voltage ratings expected in the near future, particularly in the solids?

A. Yes.

Q. Could you add comparative cost data to the other points of comparison (for equivalent CV products)?

A. Based on a microfarad per cubic inch basis, the wet pellet has the lowest cost per microfarad/cubic inch. The solid is next; foil exhibits the highest.

Q. Is the maximum voltage of solid electrolyte capacitors limited by the manganese dioxide?

A. Yes.

Q. Why are measurements made at 120 cps? Why not 60 cps, 400 cps, or 1 kc?

A. Generally, 120 cps suits most users because most people use commercial bridges. Most commercial and laboratory bridges operate at 120 cps.

Q. Please specify methods of testing employed for capacitance, dissipation factor, equivalent series resistance.

A. A Wien type bridge is the most convenient way.

Q. What is the mechanism of operation of the solid-electrolyte manganese dioxide? Do we have ionic conduction? Do we have intense heat at a weak point in the dielectric causing the MnO_2 to decompose, releasing atomic oxygen? If ionic conduction or atomic oxygen is involved, how was this proved?

A. One could write a book on this one. This involves the whole completely. The function, first, of the solid electrolyte is to contact the surface of the oxide film, just as the surface oxide film of any electrolytic capacitor is contacted by the electrolyte. It is the ionically conducting electrolyte in the case of a normal so-called wet electrolytic capacitor. The solid electrolyte is manganese dioxide at present. Manganese dioxide is an n-type semiconductor. It is not manganese dioxide, it is manganese-something oxide. It is never MnO_2 exactly, it is MnO -something close to 2. The closer you get to 2, the better conduction you have.

Typical response curves indicating the various shape factors available in standardized Burnell Crystal Filters

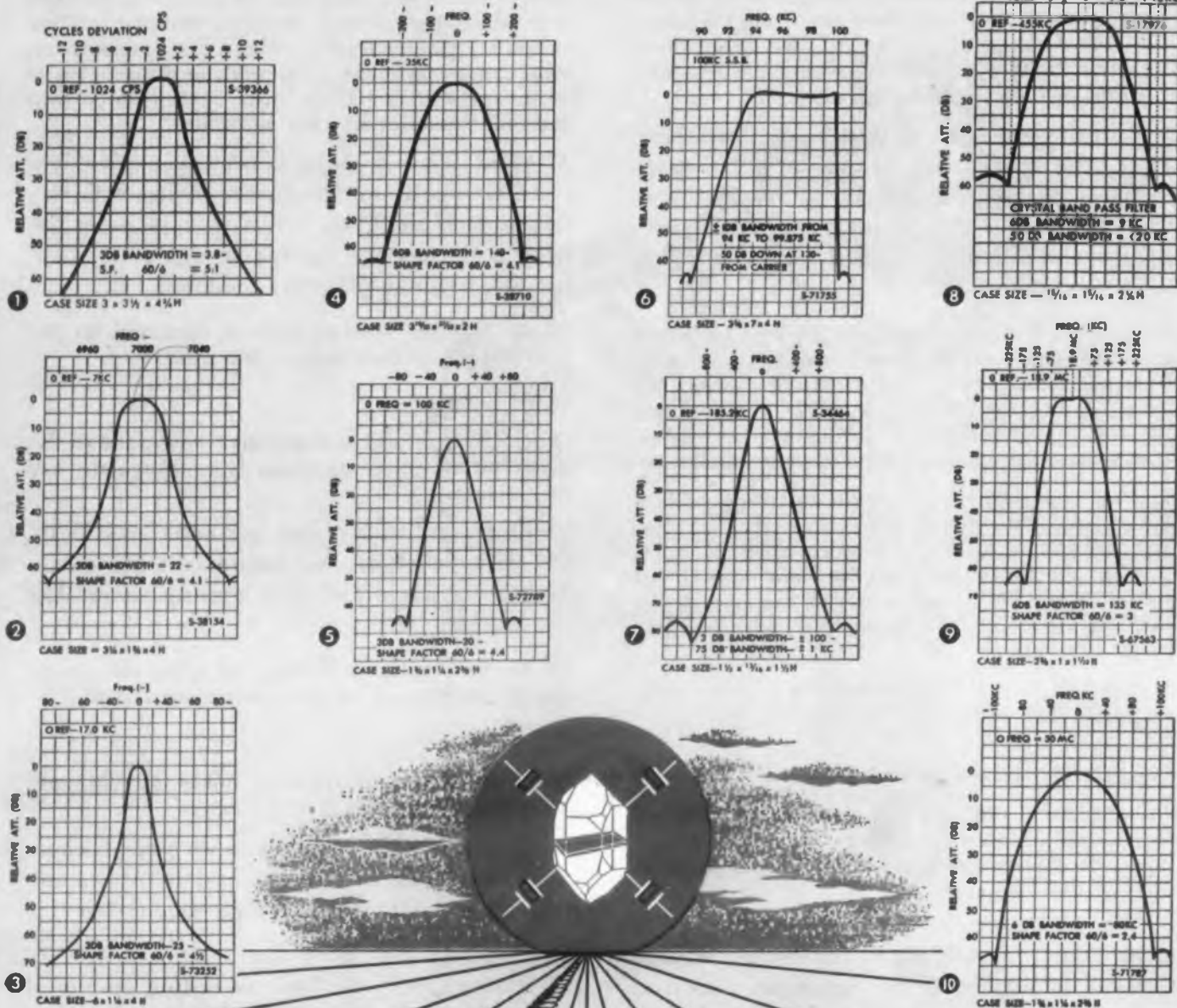

Running the gamut in crystal filters

BURNELL CRYSTAL FILTERS NOW COVER FULLEST RANGE YET POSSIBLE
1 kc to 30 mcs

To its notable achievements in advancing the electronic arts, Burnell & Co. now adds another—the development of moderately priced high attenuation crystal filters covering the extraordinary range of 1 kc. to 30 mc. This represents a range many times broader than previously thought practicable. In addition, the Burnell Crystal Filter line now includes several types heretofore considered impossible.

More than 15 years research, development and experience are represented in the designs illustrated in the response curves shown. Burnell & Co. has taken crystal filters out of the luxury class in applying its experience to their design and manufacturing without incurring developmental and engineering costs.

Whether your crystal filter needs are for standard units or those engineered to center frequency, band width, selectivity and impedance level, call on our Crystal Filter Division for quick delivery. Send now for Crystal Filter Catalog, XT455.

Burnell & Co., Inc.
PIONEERS IN MICROMINIATURIZATION OF TOROIDS, FILTERS
& RELATED NETWORKS

EASTERN DIVISION
DEPT. D41
10 PELHAM PARKWAY
PELHAM, N. Y.
PELHAM 8-5000
TELETYPE PELHAM 3633



PACIFIC DIVISION
DEPT. D41
720 MISSION ST.
SOUTH PASADENA, CALIF.
MURRAY 2-2841
TELETYPE PASACAL 7578

Mfd. in Canada by Edo (Canada) Ltd., Cornwall, Ont. • WELLINGTON 2-6774

CIRCLE 28 ON READER-SERVICE CARD



Q. Have you found that pre-aging or burn-in is necessary to weed out weak sisters and the units that would exhibit a high incidence of infant mortality? If yes, what would you recommend along these lines to achieve very low failure rates?

A. I think this would largely depend on the manufacturer and the type of capacitor he is producing. If his product is generally given to a large percentage of infant mortality, a very high infant mortality rate will be found, of course, and a burn-in is beneficial. We find it not applicable to our product.

Q. What produces the battery effect of tantalum capacitors, such as the retention of a small voltage even after a long discharge period? What output impedance is associated with this effect? It has been noted, also, that the voltage varies with temperature. Is there any correlation which has been found between this battery voltage and temperature?

A. We have noticed this; I guess everyone has. The Signal Corps has done some work on this. If you put any two materials together, you get a potential difference. I am talking about solid tantalum capacitors, because I think the others can be explained very readily. Wet types are merely exhibiting a battery action—you have concentration cells, different materials in an electrolytic cell. With solids, we have a different situation. I certainly would expect a potential to be generated. What we measure is generally of the order of a few tenths of a millivolt. We have measured these under various conditions. We have measured them and obtained a few tenths of a millivolt, put them in high-temperature ovens and left them in with no voltage applied for varying periods of time—and then taken them out. The few tenths of a millivolt would increase by a factor of maybe ten, maybe a hundred. I would increase to a few millivolts and even tens or twenties of millivolts. We have never seen anything too large. The Signal Corps has talked about considerably larger values. We have never seen any of these. Another interesting thing: it is possible for these things to exhibit different polarities. If we connect our meter with our positive probe to the so-called anode of the capacitor, this anode may be positive. But it is also possible for this anode to be negative. One important fact: these readings of millivolts were

measured with an extremely high impedance meter in series or across the terminals of these capacitors. This was an electrometer with something like 10^{12} or 10^{14} ohms of impedance. So, if you have any lower resistance or any circuitry at all across the capacitor of any much lower resistance, it would bleed off most of these voltages down to the very low microvolt region.

Q. Will the leakage currents for the solid tantalum decrease to that of the wet tantalum capacitor in the future?

A. The research and development program is certainly going to improve these things with time and experience, and we have every expectation of improving the leakage current conditions.

Q. Is a solid tantalum suitable for use as a coupling capacitor in high impedance circuits using published voltage ratings? We have had random failures of solid units in those cases where wet units did not.

A. Yes, solid tantalums are suitable for use as a coupling capacitor in high impedance circuits. We cannot say why wet slugs appear better than solids in your instance.

Q. What is the relative reliability of aluminum and tantalum electrolytics?

A. In general, when one considers continuous operation in excess of 10 to 20,000 hours, tantalum capacitors probably would prove more reliable than aluminums. However, the premium quality electrolytics will rival solids and wet slugs even on long-term testing.

Q. Sprague data indicates solid tantalum capacitors have lower failure rates when used in high impedance circuits. ASESAs conclusions from study contract recommends you eliminate applications of tantalum capacitors in high impedance circuits. What are your comments on this contradictory information?

A. ASESAs was talking about battery action, again. They ignored the characteristic of this capacitor having a lower failure rate under low impedance power supply conditions. They were saying capacitor terminals should be shunted by a resistance of not greater than some figure in the order of 5 meg. This may be true; I don't know. It varies with the capacitor and the capacitor manufacturer, certainly. But here, I want to point out that these are two different things. One is the elimination of the battery action that evidently concerns some people in certain applications. This is done by shunting the leads with a resistance of some value.

Q. Are there any adverse effects on life or reliability of foil tantalum capacitors when used under large derating conditions? For example, a 150 volts dc rated unit operated at 10 volts dc at room temperature.

A. No, there is no adverse effect. ■ ■

SPECIFY ARNOLD IRON POWDER CORES... COMPLETE RANGE OF SIZES AND SHAPES FOR YOUR DESIGNS

Arnold offers you the widest range of shapes and sizes of iron powder cores on the market.

In addition to toroids, bobbin cores and cup cores—typical groups of which are illustrated below—Arnold also produces plain, sleeve and hollow cores, threaded cores and insert cores, etc., to suit your designs. Many standard sizes are carried in warehouse stock for prompt shipment, from prototype lots to production quantities. Facilities for

special cores are available to order.

The net result is extra advantage and assurance for you. No matter what shapes or sizes of iron powder cores your designs require, you can get them from a single source of supply—with undivided responsibility and a single standard of known quality. And Arnold's superior facilities for manufacture and test assure you of dependably uniform cores, not only in magnetic properties but also in high mechanical

strength and dimensional accuracy.

● For more information on Arnold iron powder cores, write for a copy of our new 36-page Bulletin PC-109A. *The Arnold Engineering Company, Main Office and Plant, Marengo, Illinois.*

ADDRESS DEPT. ED-12

 **ARNOLD**
SPECIALISTS in MAGNETIC MATERIALS

BRANCH OFFICES and REPRESENTATIVES in PRINCIPAL CITIES • Find them FAST in the YELLOW PAGES 2841



CIRCLE 29 ON READER-SERVICE CARD

Highlights of Recent Hi-Fi Shows



Higher output power for amplifiers, more knobs for preamplifiers and higher sensitivity tuners were noted at the recent hi-fi shows held in New York and Chicago. Some of the less obvious items, including Far East imports, are shown to illustrate some trends in consumer product design.

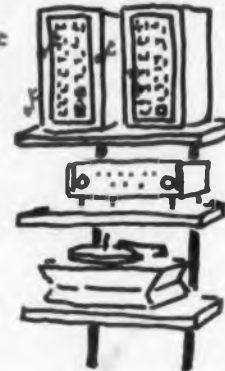

To minimize domestic squabbles between kit builder and spouse, H. H. Scott Inc., Maynard, Mass. supplies each hi-fi fm kit (LT-10) in a KIT-PAK, a carrying case that opens to a convenient work table. At any stage of construction, the KIT-PAK case can be neatly closed and put away; no mess is left on the kitchen table.



A one-inch crt, panel mounted on EMI's stereo preamplifier-amplifier model 555, can be used to balance channels, monitor output levels, evaluate frequency response with a test record and check turn-table rumble.

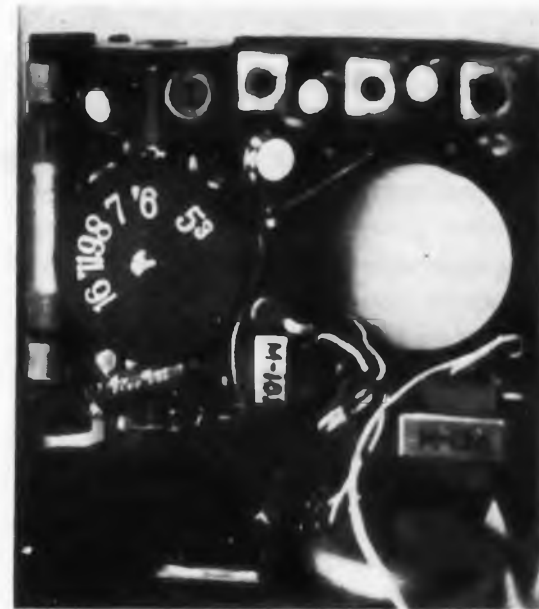

Although tightly packed in a case smaller than a pack of cigarettes, any component in Realton's six-transistor radio can be replaced without bending, cutting or disturbing neighboring parts. In short, a compact receiver designed with maintainability as a key consideration.



A Toshiba wall-mounted transistor radio, with a dangling chain on-off switch, is being marketed by Transistor World Corp. of New York.

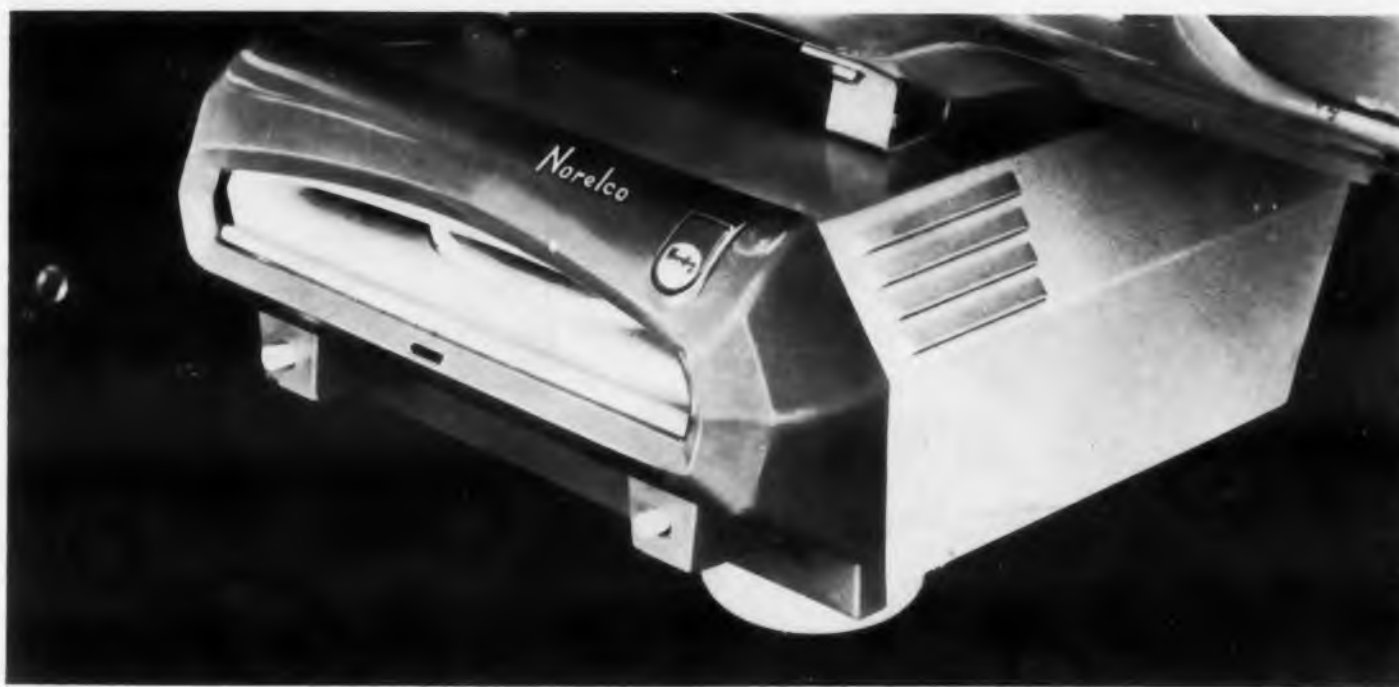

An automatic 45 rpm record player, for autos, requiring only record insertion and removal, is being marketed by North American Philips Co., Inc., Hicksville, N.Y. The "Auto Mignon" requires connection to the audio section of the car radio and draws only 50 mw from the car battery. Special shock absorbers prevent jarring of the stylus during sharp turns and sudden stops.

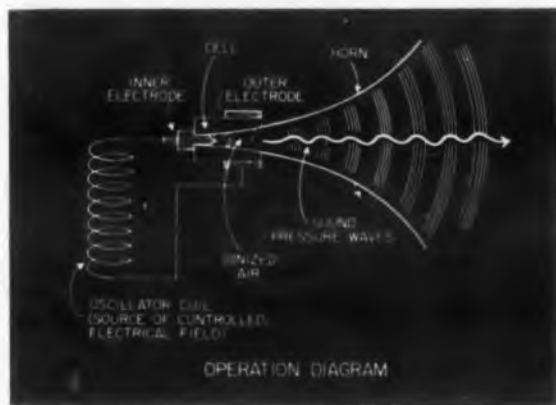

Transient distortion effects in conventional tweeters, due to mechanical inertia, are avoided by the use of a modulated ion stream directed through a horn. Developed by the Dukane Corp., St. Charles, Ill., the Ionovac consists of an ionic cloud chamber within a tiny quartz cell. Ionization is accomplished by means of a 27-mc oscillator supplying power to inner and outer electrodes of the cell structure. As the oscillator is modulated by an audio signal, ionization is increased or decreased, thus producing sound pressure waves. A horn is used to achieve efficient coupling to the outer air. The range of the high frequency speaker assembly, consisting of the power supply, modulator and horn with acoustic lens, extends from 3,500 to 20,000 cps.



A pre-assembled and factory aligned RF-converter cartridge, featuring a Nuvistor input stage, highlights Harmon-Kardon's Citation III fm tuner kit. Dual cascaded gated-beam limiters are followed by a wideband Foster-Seeley discriminator; a cathode follower is placed between the discriminator and de-emphasis network to prevent loading at high frequencies. Two panel-mounted meters are provided to permit periodic alignment.



A 14-tube, 8 in.-TV portable, distributed by Starlite Merchandise Co., New York, represents the first quantity import of Japanese TV products in the U. S.

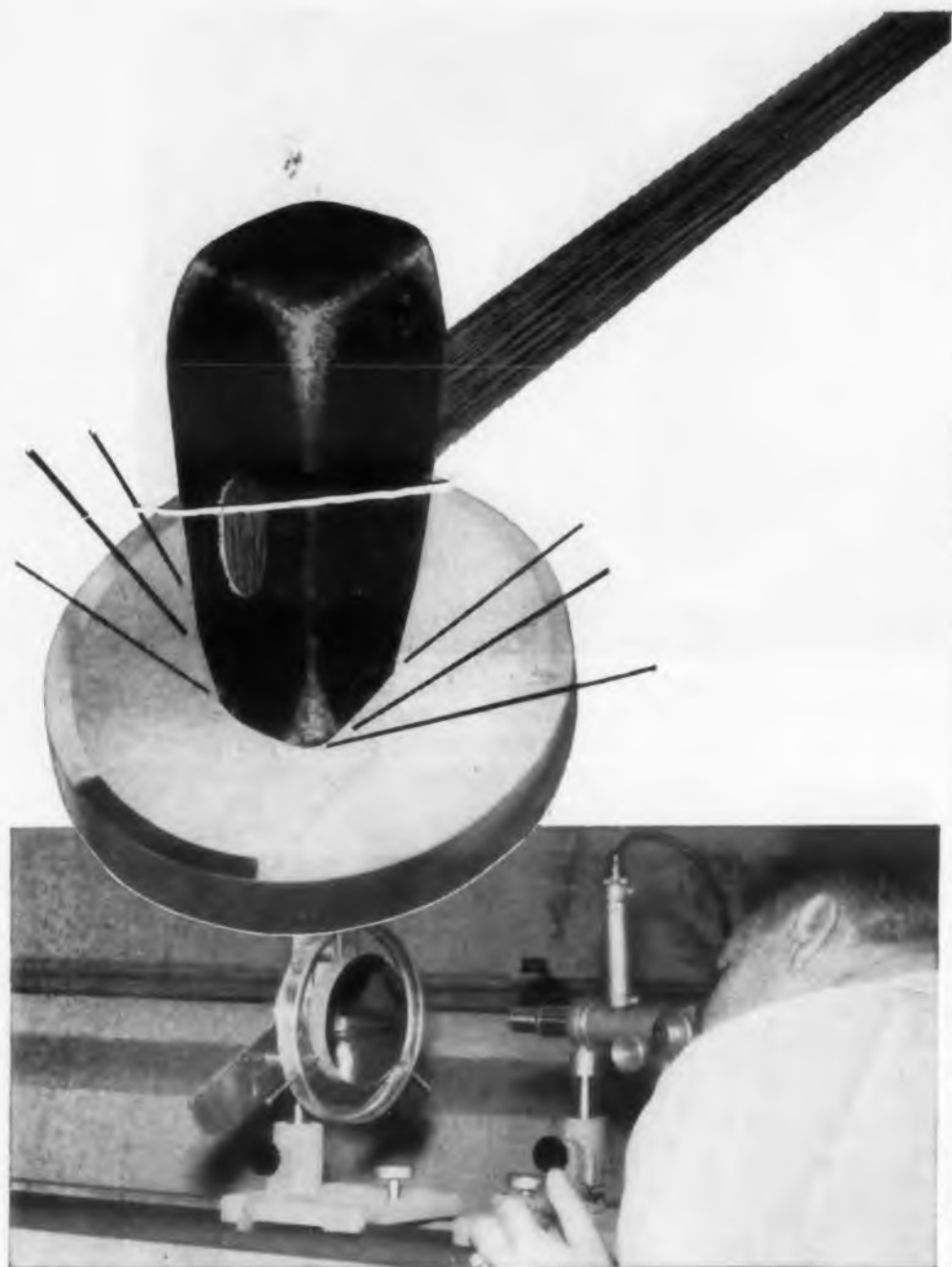

22,000 g's shock have been successfully applied to this plastic replica mirror at Singer-Bridgeport. Here an engineering physicist in the optics lab inspects test sample. These Singer plastic mirrors, called Repli-Kote, are an important contribution to the state of the optics art, providing a fast, economical method of duplicating polished glass mirrors from epoxy resins. Currently work is going forward in replica optics under Frankford Arsenal research and development contract.

Today Singer-Bridgeport's skills in precision machining and exacting assembly work are at the service of the Military. Anti-submarine devices, bomb rack assemblies are now in production.

Industry, too, depends on Singer-Bridgeport as a partner, not just a vendor, in engineering and producing electronic and electro-mechanical systems and components.

Singer-Bridgeport's comprehensive capabilities are detailed in a new illustrated brochure, yours for the asking.



SINGER-BRIDGEPORT

A DIVISION OF THE SINGER MANUFACTURING COMPANY
915 Pembroke Street Bridgeport 8, Conn.



*A Trademark of THE SINGER MANUFACTURING COMPANY

CIRCLE 30 ON READER-SERVICE CARD



Model 180A module is a building block for rectifier life-test systems.

Simulation Test Replaces Brute-Force Techniques

SIMULATION replaces brute force in a more efficient approach to the problem of semiconductor life testing. Modular life-test power supplies now incorporate the principles of simulator testing to provide a better method of testing a wide variety of rectifiers.

This is accomplished by the use of a high-current, low-voltage transformer to supply forward current and a low-current, high-voltage transformer to supply reverse voltage.

The major advantages of this method of testing include the independent adjustment of forward current and reverse voltages; a fixed load over a wide range of forward current; and savings resulting from reduced operating costs. Over the course of a 1,000-hr life test, operating costs may be reduced more than \$7 per rectifier, according to the manufacturer, Wallson Associates, Inc., 912 Westfield Ave., Elizabeth, N.J.

Mercury-Wetted Relays Switch Between Supplies

All modules use high-reliability, mercury-wetted relays to switch between forward current and reverse voltage supplies. The relays are driven in synchronism with the line frequency, and are phased to switch the rectifier being tested from one supply to another as the forward current (or reverse voltage) passes through zero.

Model 154D is a self-contained unit. Essentially it includes the switching

module and drive, forward current supply, reverse voltage power supply, and circuit resistors and fuses required to perform dynamic life testing on twenty 1-amp rectifiers. It is intended for use where small quantities of rectifiers are to be evaluated or when a large variety of operating conditions are required.

Reverse Voltage Is Adjustable From 0 to 1,500 V

The forward current output consists of twenty 1-amp circuits in a full-wave configuration. The reverse voltage is continuously adjustable from 0 to 1,500 v and is common to all of the output circuits.

Because each output circuit includes a forward-drop equalizing resistor, these circuits may be connected in parallel, as required, to a maximum of 10 per module, to test devices with ratings above 1 amp. The outputs are isolated in the forward direction by virtue of the action of the switching module. Individual reverse voltage fuses and indicating pilot lights provide reverse-voltage isolation, thus assuring that the failure of one rectifier will not affect the operation of the remaining devices on test. A number of suggested output connections are shown in Fig. 1.

Model 180 is a self-contained switching module intended for use as a "building block" in diode and rectifier life-test systems. It is capable of switching 20-amp average dc at up to 1,500 piv. Power supplies are not included; it is

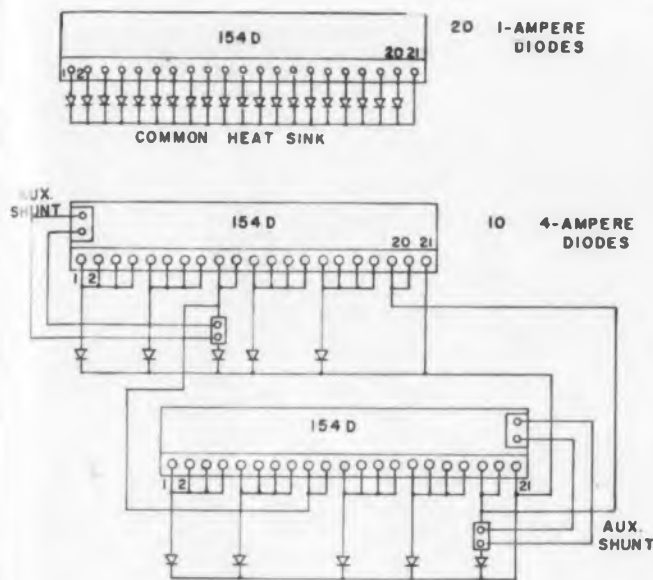

Fig. 1. Output connections suggested for the model 154D rectifier test power supply.

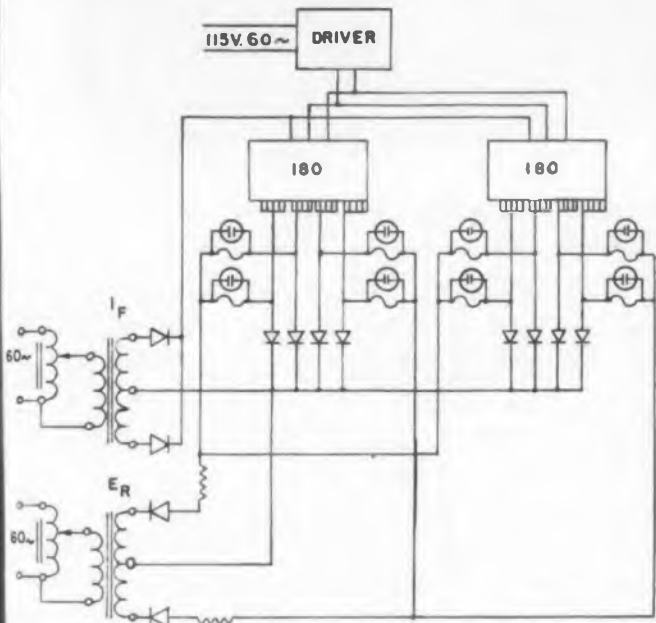

Fig. 2. Schematic for testing eight 5-amp diodes with two model 180 modules, illustrating a common heat-sink connection.

intended that several of these modules be connected to a common power supply to permit economical testing of large numbers of devices. The testing combinations possible are the same as for model 154D. Three different configurations of the model 180 are available. Typical usage is shown in Fig. 2.

The model 180 units are supplied without meters, power supplies, or relay drives. Standard rack adapters are available for mounting. Delivery for both model 154 and the model 180 units is two weeks. Model 154D is priced at \$800 while model 180 prices range from \$250 for the A module to \$300 for the C module.

For more information on these test power supplies turn to the Reader-Service Card and circle 251.

Bourns Trimpot® Puts the Proof in Humidity-Proof

Plunging a potentiometer into near-boiling water is just one of the ways Bourns puts the proof in humidity-proof. Every Trimpot unit made takes this 60-second bath with the water simmering at 90°C. Air expanded by the heat creates four pounds of pressure inside the potentiometer—enough to cause bubbles—if it leaks. Only if the unit is completely leak-free does it pass the test.

Bourns humidity proofing starts at the beginning—with original design and selection of materials. The plastic chosen for Trimpot cases, for example, displays the unusual properties of high insulation resistance and extremely low moisture absorption.

Further protection against humidity results from manufacturing procedures, such as internal potting of the resistance element and sub-components. Finally, Bourns samples all production for compliance to MIL-STD-202A, Method 106 as a routine part of a Reliability Assurance Program. As a result, Trimpot does more than "resist" moisture; it keeps moisture out.

For more information about the industry's largest selection of humidity-proof adjustment potentiometers—wirewound and carbon in a variety of sizes, power ratings, operating temperatures, etc.—write for new Trimpot summary brochure and list of stocking distributors.



Exclusive manufacturers of Trimpot®, Trimit®, and E-Z-Trim®. Pioneers in transducers for position, pressure and acceleration.
CIRCLE 31 ON READER-SERVICE CARD

NEW PRODUCTS

Covering all new products generally specified by engineers designing electronic original equipment. Use the Reader's Service Card for more information on any product. Merely circle number corresponding to that appearing at the top of each description.

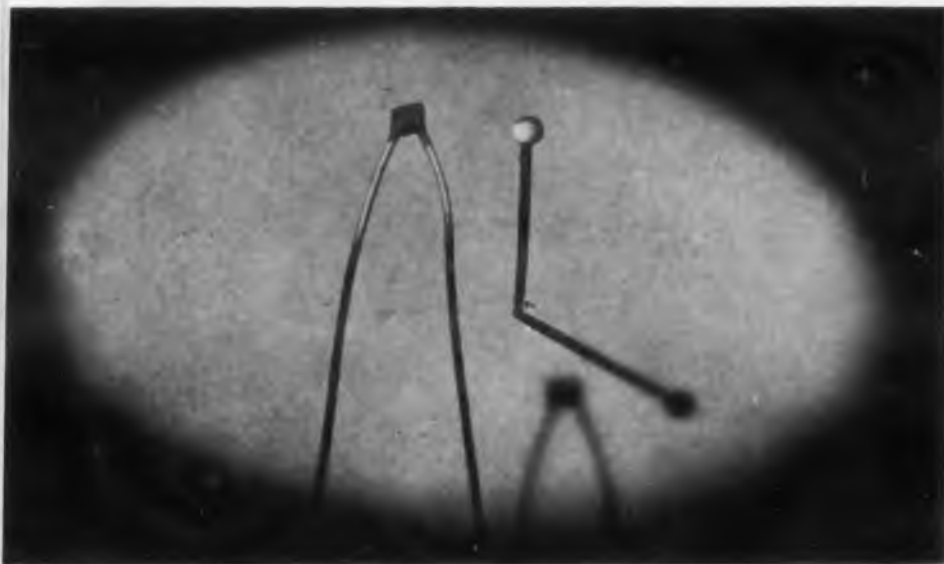

Microminiature Ceramic Capacitor 525 Is Rated At 30 Wvdc

The Series GL-10 microminiature ceramic capacitor is 0.1 in. square by 0.05 in. thick. Values range from 10 to 220 pf, with a rating of 30 wvdc. Coated with durez phenolic, the unit has a maximum capacitance change of $\pm 10\%$ from -55 C to 85 C. The capacitor meets or exceeds the requirements of MIL-C-1101B and is for use in miniature computers.

Gulton Industries, Inc., Dept. ED, 212 Durham Ave., Metuchen, N.J.

Price: $\pm 5\%$, 77 cents ea; $\pm 10\%$, 71 cents ea; $\pm 20\%$, 65 cents ea; \$325 to \$385 per 1,000.

Availability: From stock.

Beam-Switching Tubes Of Reduced Size, Weight, and Cost

526

Due to an increase in the field strength of their output electrode-magnets, these beam switching tubes are smaller, lighter, and less expensive than their predecessors. The high-current type BX-3000, with a constant output of 5.5 ma, is capable of lighting multiple indicator tubes or operating relays. The magnetically shielded type BX-2000, which provides 2.5 ma of constant output current, may be placed in contact in multiple installations without interaction. Both tubes use a four-electrode structure in each of ten positions for improved straight line switching and constant output characteristics. The tubes are insensitive to temperature and have a life potential of 50,000 hours. Electrically, the BX-2000 is identical to the general purpose BX-1000 shown in the photo for comparison.

Burroughs Corp., Dept. ED, P. O. Box 1226, Plainfield, N.J.

Price: Type BX-2000, \$29.50 ea; type BX-3000, \$27.50 ea.

Availability: Delivery after January 15, 1961.

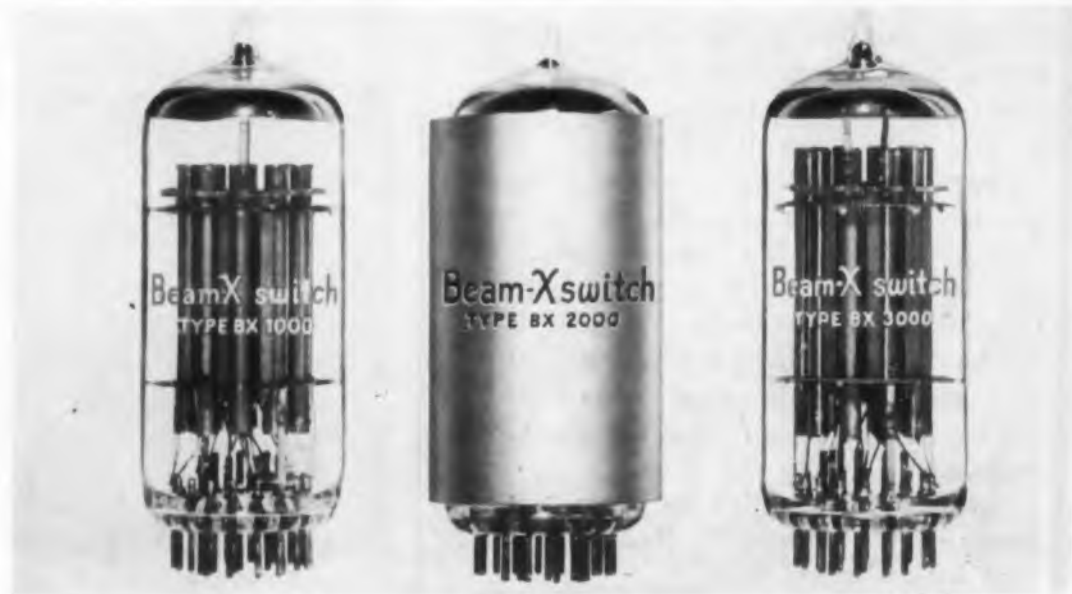

ELECTRONIC DESIGN • December 21, 1960



Primary Standard Resistance Oven 524 Provides Accuracy of 0.0008%

Model PRO-106 primary resistance oven comprises a set of precise and stable resistance standards. It is designed for the test and calibration of secondary standards and the calibration of non-temperature-regulated primary standards. Accuracy of 0.0008% is claimed; temperature coefficient is less than 0.05 ppm per deg from 15 C to 35 C ambient temperature. Six decade standards cover the range from 100 ohms to 10 megohms. The set, housed in a 10-1/4 x 15 x 14 in. mahogany cabinet, is protected from thermal and mechanical shock.

Julie Research Laboratories, Inc., Dept. ED, 603 W. 130th St., New York 27, N.Y.

Price: \$1,390.

Availability: 6 weeks.

M
W
lov
pli
cap
Vo
thr
1 μ
10%
ope
A c
shie
V
Wa
Pric
Ava
Micro
Comp
The
time
are w
rectly
interp
from C
per m
drawn
The te
Phys
P. O. B
Price:
A ailan
ELECT



Miniature Preamplifier 523 Weighs 3.5 G

Weighing 3.5 g, the model 8500 consists of a low-noise, 6-stage audio amplifier, a dc age amplifier, and associated age diodes. The epoxy-encapsulated unit measures 0.7 x 0.65 x 0.22 in. Voltage gain is 80-db minimum below age threshold, with equivalent input noise of less than 1 μ v. Harmonic distortion is said to be less than 10%; frequency response is 400 cps to 20 kc. The operating temperature range is -10 C to 55 C. A conductive overcoating provides electrostatic shielding. Supply voltage is 12 v.

Varo Manufacturing Co., Inc., Dept. ED, 2201 Walnut St., Garland, Tex.

Price: \$850 ea, 1 to 10 units.

Availability: 90-day delivery.



Microvolt Potentiometer 522 Compares Voltages to Within 1 μ v

The Goerz Model AE5075 microvolt potentiometer is designed to compare 2 voltages which are within 0.1% of each other, to within 1 μ v directly, or to within a fraction of that amount by interpolation on the galvanometer. Its range is from 0 to 1,100 μ v with a resistance of 100 ohms per mv. The potentiometer current of 10 μ v is drawn from a built-in saturated standard cell. The terminals are thermally shielded.

Physics Research Laboratories, Dept. ED, P. O. Box 555, Hempstead, N.Y.

Price: \$455.

Availability: From stock by February 1, 1961.

300% INCREASE IN RANGE NO INCREASE IN SIZE!



JFD TRIMMER
MODEL VC5G
.8-18 PF.

NEW JFD MAX-C SEALCAP
MODEL MC606
1.0-60 PF.

JFD



MINIATURE TRIMMER SEALCAP®

Now you can cut precious inches and ounces from your assemblies with space-saving, weight-saving MAX-C Sealcaps.

The surprising increase in range of the Max C trimmer capacitor is obtained by embedding the electrode band in the glass cylinder. This design provides the thin dielectric required for a large capacitance range while retaining the ruggedness and mechanical strength of a heavy wall glass tube.

Included in the Max C design is the Sealcap construction which provides the additional stability safeguard of a completely sealed interior.

The Max C retains all the advantages of glass tubular trimmers: Working voltage of 1000 VDC, Insulation Resistance of 10⁹ megohms, Q of 500 at 1MC, operating temperature range of -55°C to +125°C, and high stability. It meets or exceeds the applicable performance and environmental requirements of Mil-C-14409A.

Escape from the design limitations of conventional trimmers by specifying JFD MAX-C Sealcaps for your current and projected circuitry. Write today for the complete catalog describing MAX-C Sealcaps and other JFD precision electronic components. Other JFD components are...

FOR PANEL MOUNTS AND PRINTED CIRCUIT MOUNTING

SEAL CAP TRIMMER CAPACITORS	MINIATURE TRIMMER CAPACITORS
GLASS OR QUARTZ DIELECTRIC	LUMPED CONSTANT DELAY LINES
DISTRIBUTED CONSTANT DELAY LINES	PULSE FORMING NETWORKS
FILTERS	METALIZED INDUCTORS
LC TUNERS	

Detailed data sheets on any of these components selected from the extensive J.F.D. line are yours for the asking. Our engineering staff is at your service for consultation on your particular application.

MINIATURE PANEL MOUNT MAX-C SEALCAP SERIES

Model	Min.	Max. (PF)	Distance Beyond Panel	Maximum Diameter
MC601	1.0	14.0	29/64"	5/16"
MC603	1.0	28.0	11/16"	5/16"
MC604	1.0	42.0	29/32"	5/16"
MC606	1.0	60.0	1 5/32"	5/16"
MC609	1.0	90.0	1 3/4"	5/16"

Pioneers in electronics since 1929

JFD

JFD ELECTRONICS CORPORATION

6101 Sixteenth Avenue, Brooklyn 4, New York

WESTERN REGIONAL DIVISION
7311 Van Nuys Boulevard, Van Nuys, California

JFD CANADA LTD
51 McCormack Street, Toronto, Ontario, Canada

JFD INTERNATIONAL
15 Moore Street, New York, N.Y.

CIRCLE 32 ON READER-SERVICE CARD

NEW PRODUCTS

Accelerometer-Amplifier System

565

Measures shock and vibration

Model 50X2 accelerometer-amplifier system measures missile shock and vibration data. Gain is continuously variable from 0 to 50; maximum sensitivity is 2 v per g. Frequency response is from 5 cps to 4 kc for acceleration levels from 2 to 100 g at a gain of 1. Maximum output is 6.5 v rms; output impedance is less than 5,000 ohms. The unit stands vibrations up to 100 g at 2,000 cps and shock up to 500 g with a 10-msec rise time. Temperature range is -40 to +200 F. Power requirement is 3.8 ma at 28 v dc.

Columbia Research Laboratories, Dept. ED, MacDade Blvd. & Bullens Lane, Woodlyne, Pa.

Elapsed Time Indicator 575

Weighs 1.25 oz

Type SM-1 subminiature elapsed time indicator operates at 400 cps. Power consumption is 1.5 w at nominal voltage and frequency. Input voltage is 115 v, 28 v or 6.3 v, single phase. The unit measures 0.984 in. in diameter and 0.975 in. in length and weighs 1.25-oz. max.

Electro-Craft Corp., Dept. ED, 1015 S. Sixth St., Minneapolis 15, Minn.

Flip-Flops

578

Have speeds up to 5 mc

Model HF-2 plug-in module contains two flip-flops capable of speeds up to 5 mc. The flip-flops can be interconnected to form shift registers or counters with no external gating required. The flip-flops, compatible with the firm's standard sheffer stroke gates, can be used to build single-phase clocked systems operating at speeds up to 3 mc. Each flip-flop can drive seven stroke gates.

Abacus, Inc., Dept. ED, 3040 Overland Ave., Los Angeles 34, Calif.

GENERAL PURPOSE,
TYPE BX-1000

The original BEAM-X switch represents a breakthrough in electronic switching. It is the lowest cost, lightest weight, highest speed, smallest size, 10-position electronic switching device. It has found wide usage in Military Systems, Computers, Instrumentation, Industrial Control, Aircraft and Missiles.



SHIELDED,
TYPE BX-2000

The BX-2000 BEAM-X switch is completely shielded magnetically and still electrically identical to the BX-1000. The shielded construction permits direct stacking in applications where space conservation is vital. All BEAM-X switches are designed to drive NIXIE® tubes, printers and perform any decimal switching function.



**HIGH CURRENT,
TYPE BX-3000**

This High Current BEAM-X switch is specially designed for areas of heavier work. This switch provides more than twice the output current of the BX-1000, and is capable of driving multiple NIXIE indicator tubes, locally and remote. The characteristics of low cost, long life, ruggedness, high temperature operation and reliability remain the same in all BEAM-X switch



THREE

NEW

BEAM-X[®] SWITCHES

**FILL A
WORLD OF
DESIGN NEEDS**

In countless applications where switching functions exist — counting, distributing, multiplexing, coding, timing, matrixing, converting, and decoding — the BEAM-X switch has revolutionized circuit design. Now the Burroughs Electronic Tube Division has developed a new family of BEAM-X switches to fit varying application requirements. Each switch represents a real savings in cost, size and weight, and provides an increase in circuit performance and reliability.

ANOTHER ELECTRONIC CONTRIBUTION BY
Burroughs Corporation

ELECTRONIC TUBE DIVISION
Plainfield, New Jersey

Magnet Tester 569

Reliability is 0.25%

Model PMT-400 magnet tester measures magnetic flux. Repeatability is within 0.25%. As many as four levels of magnetic quality can be segregated by the tester in a given run of magnets. It provides visual indication of test results on a built-in indicator. Tolerances for each run are preset by the operator; test results are automatically flashed by the panel lights.

Indiana General Corp., Indiana Steel Products Div., Dept. ED, Valparaiso, Ind.

Price: On request.

Availability: Made on order only.

Broad-Band Balun 574

Range is 4 to 24 mc

Model Tr-2001 broad-band hf balun transforms the unbalanced output of hf transmitters to balanced antennae over the 4- to 24-mc range. The conventional version transforms an unbalanced impedance of 37.5 ohms to 600 ohms. Peak power output is 80 kw; average power output is 20 kw. The unit measures 13 x 9 x 11 in. and weighs 35 lb.

Industrial Transmitters & Antennas, Inc., Dept. ED, Lansdowne, Pa.

All-Glass Insulating Paper 579

Thickness as low as 0.0006 in.

This all-glass insulating paper solves electrical, thermal and electronic problems. Applications include: use as base for electroluminescent lamps, manufacture of bonded strain gages and as a component for printed-circuit materials. Melting temperature is above 1,200 F; thicknesses are from 0.0006 in. to 0.012 in.; dielectric is 370 to 2,370 v. This paper, designated Tissuglas, comes in any width up to 38 in. and in continuous rolls.

American Machine & Foundry Co., Amflex Products Dept., Dept. ED, Springdale, Conn.

◀ CIRCLE 33 ON READER-SERVICE CARD

End-of-line clipper

Clipper tube is connected across the far end of the pulse-forming network in series with a resistive load whose value approximates the network impedance. When the clipper tube is triggered, the pulse-forming network terminates in its characteristic impedance thereby reducing the inverse voltage to zero.

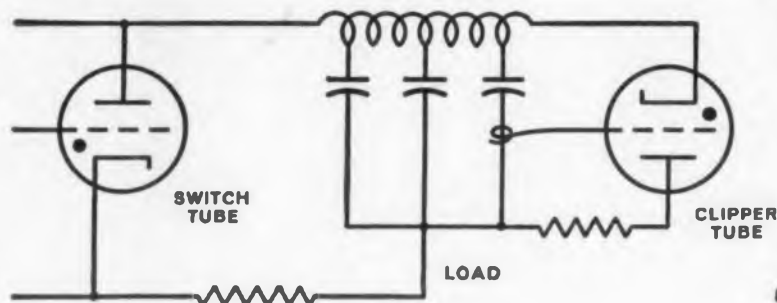

Positive protection against destructive voltages with Tung-Sol Clipper Thyratrons

Line-type radar modulators require clipper protection against excess inverse voltages, which can destroy costly components and increase equipment downtime. Clippers also perform valuable circuit service by regulating pulse amplitudes and reducing switch tube loading.

But until Tung-Sol developed these high-reliability hydrogen-filled clipper triodes previously used clipping devices brought some serious disadvantages to the job.

Now, however, you can be sure of perfect clipping action when you design Tung-Sol clippers into your equipment. More rugged and less costly than solid state devices, more efficient with a much lower dynamic impedance than vacuum clippers, and faster acting and more resistant to arc-back than gas diodes, the new Tung-Sol thyatron clippers are designed and built to deliver uncompromised performance.

The low "firing" voltage and the ability to carry large peak currents make these hydrogen clipper thyratrons ideal for this application. These tubes also feature hydrogen reservoirs which promote long life by providing an automatic mechanism for replenishing hydrogen lost by "cleanup".

Circuit requirements are simple whether the Tung-Sol thyratrons are used as "end of the line" clippers, "across switch" clippers or "tail biters".

Write for complete technical details on the new 7454 and 7455 Clipper Thyratrons. Tung-Sol Electric Inc., Newark 4, N. J. TWX:NK193.

Technical information available through ATLANTA, GA., COLUMBUS, OHIO, CULVER CITY, CALIF., DALLAS, TEXAS, DENVER, COLO., DETROIT, MICH., IRVINGTON, N. J., MELROSE PARK, ILL., NEWARK, N. J., PHILADELPHIA, PA., SEATTLE, WASH. IN CANADA: ABBEY ELECTRONICS, TORONTO, ONT.

CIRCLE 34 ON READER-SERVICE CARD



 **TUNG-SOL®**

NEW PRODUCTS

Medical-Electronics Instruments 589

Amplifier and transmitter



The B-30ATP Bio-pack incorporates type B-30A amplifier and B-30T fm transmitter operating on the band of 88 to 108 mc. The amplifier has an input impedance of 500 K, common mode rejection of better than 50,000:1, gain of 10,000, and an equivalent input noise level of 4 μ v, peak-to-peak. Frequency response is 0.4 cps to 10 kc between half-power points. The transmitter has a voltage sensitivity of 50 to 75 mv for 100% deviation, an input impedance of more than 100 K and a sensitivity to signals from dc to 10 kc. Power consumption is 4 ma at -9 v.

Computer Systems Laboratory, Litton Systems, Inc., Dept. ED, 5500 Canoga Ave., Woodland Hills, Calif.

Price: \$440.

Availability: 45 days.

Thermocouples

553

For millisecond response time



Model 479-C shielded thermocouple and model 452V spot-welded unshielded thermocouple are for use in applications where response time in milliseconds is required. The 479-C has 100-msec response, measured at 63% of temperature change from 32 to 190 F. The 452V measures 35 msec under the same conditions. Both thermocouples stand pressures to 5,000 psi and meet MIL-E-5272C specs.

Propulsion Development Laboratories, Inc., Press-Temp Products Div., Dept. ED, 1120 E. El Segundo Blvd., El Segundo, Calif.

Linear Voltmeter

581

Range is 0 to 50,000 v dc



Model 1170 electrostatic, linear voltmeter measures dc voltages as low as 0 to 10 v and as high as 0 to 50,000 v. Specifications include: input capacitance, less than 10 pf; input resistance, 10^{13} ohms min up to 100 v dc and 10^{10} ohms min up to 50,000 v dc; stability, better than 2% in 24 hr; repeatability, 1%; accuracy, $\pm 2\%$; resolution, $\pm 1\%$; life, up to 1,000 hr; and weight, 3-1/2 lb. Three probes available have ranges of 0 to 10, 0 to 50 and 0 to 100 v dc; 0 to 500 and 0 to 1,000 v dc; and 0 to 5,000 and 0 to 10,000 v dc. Applications of the portable, battery-operated unit include: dc voltage reader in high resistance and vacuum-tube grid circuits, reading capacitor voltage, reading the peak value of transient pulses, testing for electrostatic charge build-up and reading output voltages of charge devices.

B. K. Sweeney Manufacturing Co., Dept. ED, 6300 E. 44th Ave., Denver 16, Colo.

Price: voltmeter, \$239 ea; probes, \$35 to \$85.

Availability: From stock.

DC Power Supply

596

Has controlled output current



Model 722AR transistorized dc supply, having an output of 0 to 60 v at 0 to 2 amp, is suited for laboratory investigation of transistor circuits and characteristics. A special circuit limits the output current to a preset value. Output impedance is low and load regulation is better than 5 mv for a current change of 0 to 2 amp. Noise and ripple are less than 250 μ v. The unit is 5-1/4 in. high.

Hewlett-Packard Co., Dept. ED, 1501 Page Mill Road, Palo Alto, Calif.

Price: \$525.



To meet the most stringent requirements, where reliability is measured in life itself, ESC's Audio Delay Lines have been created as precision components in submarine Underwater Detection Systems. Characterized by long delay at low insertion loss, and high delay-bandwidth factors, ESC Audio Delay lines exhibit excellent phase linearity over a wide frequency range.

Delay—500 usec. to 5000 usec. and greater

Bandwidth (3db)—up to 35 KC and greater (delay-to-rise-time ratio—as high as 170 to 1)

Frequency Insertion Loss—less than 4 db

Construction—hermetically sealed in steel case and potted in epoxy resin for the most severe environmental applications.

Designed for minimum size and weight. Meets all applicable MIL Specs.



ESC

WRITE TODAY FOR COMPLETE TECHNICAL DATA.

exceptional employment opportunities for engineers experienced in computer components... excellent profit-sharing plan.

ESC ELECTRONICS CORP. 534 Bergen Boulevard, Palisades Park, New Jersey

Distributed constant delay lines • Lumped-constant delay lines • Variable delay networks • Continuously variable delay lines • Step variable delay lines • Video transformers • Filters of all types • Pulse-forming networks • Miniature plug-in encapsulated circuit assemblies

CIRCLE 35 ON READER-SERVICE CARD



Custom variations available to your exacting specifications

Precision
**FREQUENCY
STANDARDS
AND
FORK OSCILLATOR
UNITS**

OUR NEW HOME, DOUBLING OUR FORMER CAPACITY

Watch Master
ELECTRONICS



Our instruments, 40 to 30,000 cycles, are used extensively by industry and on government projects where enduring accuracy and maximum durability are required. Your inquiries on related products are invited.

PRECISION FORK OSCILLATOR UNITS

TYPE 2003



Size 1½" dia. x 4½" H. Wght. 8 oz.
Frequencies: 200 to 4000 cycles
Accuracies:—
Type 2003 (±.02% at -65° to 85°C)
Type R2003 (±.002% at 15° to 35°C)
Type W2003 (±.005% at -65° to 85°C)
Double triode and 5 pigtail parts required.
Input, Tube heater voltage and B voltage
Output, approx. 5V into 200,000 ohms

TYPE 2007-6



TRANSISTORIZED, Silicon Type
Size 1½" dia. x 3½" H. Wght. 7 ozs.
Frequencies: 360 to 1000 cycles
Accuracies:
2007-6 (±.02% at -50° to + 85°C)
R2007-6 (±.002% at +15° to + 35°C)
W2007-6 (±.005% at -65° to + 85°C)
Input: 10 to 30 Volts, D. C., at 6 ma.
Output: Multitap, 75 to 100,000 ohms

TYPE 2001-2



Size 3¾" x 4½" x 6" H., Wght. 26 oz.
Frequencies: 200 to 3000 cycles
Accuracy: ±.001% at 20° to 30°C
Output: 5V. at 250,000 ohms
Input: Heater voltage, 6.3-12-28
B voltage, 100 to 300 V., at 5 to 10 ma.

ACCESSORY UNITS FOR 2001-2



L—For low frequencies multi-vibrator type, 40-200 cy.
D—For low frequencies counter type, 40-200 cy.
H—For high freqs, up to 30 KC.
M—Power Amplifier, 2W output.
P—Power supply.

PRECISION FREQUENCY STANDARDS

TYPE 2005A

Size 8" x 8" x 7¼" High
Weight, 14 lbs.

Frequencies:
50 to 400 cycles (Specify)
Accuracy:
±.001% from 20° to 30°C
Output, 10 Watts at 115V
Input, 115V. (50 to 400 cy.)



TYPE 2121A

Size
8¾" x 19" panel
Weight, 25 lbs.

Output: 115V
60 cycles, 10 Watt
Accuracy:
±.001% 20° to 30°C
Input,
115V (50 to 400 cy.)



TYPE 2111C

Size, with cover
10" x 17" x 9" H.
Panel model
10" x 19" x 8¾" H.
Weight, 25 lbs.

Frequencies: 50 to 1000 cy.
Accuracy:
(±.002% at 15° to 35°C)
Output: 115V, 75W.
Input: 115V, 50 to 75 cy.



WHEN REQUESTING INFORMATION, PLEASE SPECIFY TYPE NUMBER

ATP
**American Time Products
Inc.**
61-20 Woodside Avenue
Woodside 77, N. Y.

NEW PRODUCTS

DC Power Supplies

603

For strain-gage application



Series 9160 and 9360 plug-in, transistorized power supplies are for strain-gage application and other applications requiring stable dc source. Voltage regulation is better than 0.01% for line variations of 100 to 130 v; load regulation is 0.3%. Output voltages are 12, 18 and 24 v with corresponding output currents from 400 to 200 ma (9160 series) and 1.2 to 0.6 amp (9360 series). Ripple is less than 0.05%; output isolation is 1,000 meg min. These hermetically-sealed units measure 2-3/8 x 2-1/4 x 4 in. and 3-3/16 x 2-15/16 x 4 in.

Mar-Cone Corp., Dept. ED, 44 Winn St., Woburn, Mass.

Price: Unit price for Series 9160, \$85; for Series 9360, \$100.

Availability: Five-day delivery.

Single-Sideband Strip Receiver 549

Range is 1.7 to 32 mc



Type 600 single-sideband strip receiver has a range of 1.7 to 32 mc. RF, IF and power supply modules are basic to the system. Modules are available for multiplexed voice signals, circuit testing, frequency shift multiplexed teleprinter signals, A F C, frequency synthesizer and rf module switching, and diversity combining. Stability is 1 part in 10 million per day. Audio output is constant within 2 db for input variations of 120 db above a 1-μv signal. Output levels are adjustable up to 10 dbm into a 600-ohm line.

Litton Industries, Westrex Corp. Div., Dept. ED, 540 W. 58th St., New York 19, N.Y.

CIRCLE 36 ON READER-SERVICE CARD

Pushbutton Switch**544**

Life is 25,000 operations per min



Series WC1500 pushbutton switch, designed to MIL-S-6743 specs, has a life of 25,000 operations min at rated load. It is rated at 2 amp inductive or 4 amp resistive, 28 v dc. The switch fits 5/8 in. holes.

Controls Co. of America, Control Switch Div., Dept. ED, Folcroft, Pa.

Control Synchros**558**

Size 8



These size 8 control synchros have high accuracy and stability from -55 to $+125$ C. Maximum electrical errors are ± 5 , ± 7 and ± 10 min for all synchros with standard 11.8-v input and synchro transmitters with 115-v input and 11.8-v output.

Vernitron Corp., Dept. ED, 123 Old Country Road, Carle Place, L.I., N.Y.

Price: \$50 to \$85.

Availability: From stock.

Trimmer Resistors**595**

Resistance range is 100 ohms to 1 meg

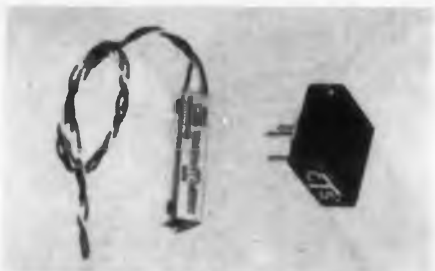

Series 170 trimmer resistors are 42-turn, 1/2-in. square units operating to 150 C. Power rating is 1 w at 50 C derated linearly to zero load at 150 C. Series 180 resistors are 25-turn rectangular units operating to 200 C. Power rating is 1 w at 125 C derated linearly to zero load at 200 C. Resistance range for both units is 100 ohms to 1 meg.

CTS Corporation, Dept. ED, Elkhart, Ind.

Bourns Trimpot® Instead of a Fixed Resistor?

Yes, these units meet the same Mil-Specs that fixed resistors meet and give you the added advantage of adjustability! Because of their design and construction, Trimpot potentiometers are virtually unaffected by the most severe shock and environmental conditions—a fact proven repeatedly in major missile and space programs.

Trimpot units offer several kinds of savings. They minimize the need to maintain stocks of close-tolerance resistors—you can adjust to compensate for the variances of fixed components. Production labor costs are cut, too, for Trimpot units eliminate

trial-and-error matching of fixed units to the system. Savings also carry over to maintenance because the technician can adjust equipment quickly in the field—no time and dollars spent to replace components.

Before you specify fixed units, investigate all the advantages offered by Trimpot potentiometers. Over 20 basic models (wire-wound and carbon)—in four terminal types and three mounting styles—are available on short notice from stocking distributors or factory. Get the facts...write for the new Trimpot brochure and list of distributors.

**BOURNS**

BOURNS, INC., TRIMPOT DIVISION
4135 MADONIA AVE., RIVERSIDE, CALIF.
PLANTS: RIVERSIDE, CALIF. AND AMES, IOWA

Exclusive manufacturers of Trimpot®, Trimit® and E-Z-Trim®. Pioneers in transducers for position, pressure and acceleration.

CIRCLE 37 ON READER-SERVICE CARD

NEW PRODUCTS

Germanium Transistors

563

Collector current is 200 ma

Types 2N1372 to 2N1381 pnp germanium-alloy transistors are designed for use in audio amplifiers, servo amplifiers, intercommunications systems and motor control applications. They have a maximum collector current of 200 ma, maximum power dissipation of 250 mw and a junction temperature of 100 C. They are suitable for medium-frequency switching in commercial and military equipment.

Sylvania Electric Products Inc., Dept. ED, 730 Third Ave., New York 17, N. Y.

Price: \$0.80 to \$1.88.

Availability: Through distributors.

Storage System

571

For use with Univac computers

This storage system is designed for use with Univac solid-state and step computers. Each storage unit is comprised of two drums that contain 24,000,000 digits and signs. The system can be expanded to as many as 10 storage drums. Searching, reading, writing, punching, processing and printing operations are performed simultaneously.

Sperry Rand Corp., Remington Rand Univac Div., Dept. ED, 315 Park Ave. S., New York 10, N. Y.

Price: \$3,500 for first drum and processing unit, synchronizer \$1,000, each additional drum \$1,900.

Availability: Delivery 1 year.

Control Modules

573

For audio-visual presentation

These control modules are designed to standardize remote-control power switching and triggering devices for audio-visual presentation systems. The module mount accommodates up to five control modules. The mercury relay types, models 30A-HG-1 and 30A-HG-2, are spst, high-current power switching devices for controlling



COMPLETE PANEL METER

BAR-RING TYPE MOVEMENTS (Exclusively Triplet)

- Self Shielded
- Not affected by magnetic panels or substantially by stray magnetic fields.
- More Torque
- Lower Terminal Resistance
- Faster Response
- Exceedingly Rugged and Accurate
- All Case Sizes

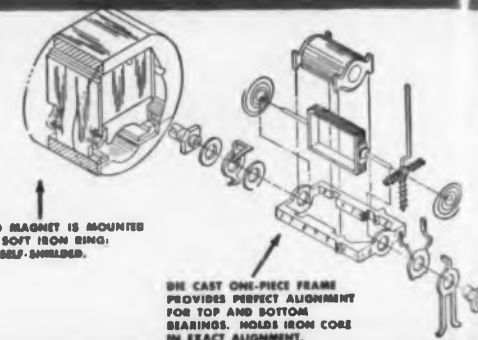

BURTON BROWNE ADVERTISING



Round Flush Mounting (2 1/4")
Model DC 321-T, AC 331-S, RF 341-T



Rectangular Flush Mounting (3 W")
Model DC 327-PL, AC 337-PL, RF 347-PL



Round Flush Mounting (3 1/2")
Model DC 321-T, AC 331-S, RF 341-T, Dyn. 361



Rectangular Flush Mounting (2 1/2")
Model DC 227-T, AC 237-S, RF 247-T



Rectangular Flush Mounting (4 1/4")
Model DC 420-PL, AC 430-PL, RF 440-PL



Rectangular Flush Mounting (2 1/2")
Model DC 227-PL, AC 237-PL, RF 247-PL



Rectangular Flush Mounting (6")
Model DC 626, AC 636, RF 646



Supplied in three sizes—1 1/2", 2 1/2" and 3 1/2"
In addition to the popular standard line of panel instruments, Triplet carries a complete line of specialized and special instruments designed to meet government specifications MIL-STD-1032A.



Round Flush Mounting (2 1/2")
Model DC 221-PL, AC 231-PL, RF 241-PL



Rectangular Flush Mounting (3")
Model DC 327-T, AC 337-S, RF 347-T, Dyn. 367-A

For complete details see your Electronic Parts Distributor, or write

TRIPLETT FULLY MEETS YOUR NEEDS

The name TRIPLETT has been on instruments of our manufacture for more than 55 years, and is regarded as a symbol of customer satisfaction to industrials and distributors in all parts of the world. Our instruments can be built to customer

specifications or provided from our large stocks of standard ranges in hundreds of sizes and types. We also carry in stock many semi-finished movements which can be converted readily to special customer needs.



Rectangular Flush Mounting (1 1/2")
Model DC 420, AC 430, BF 410

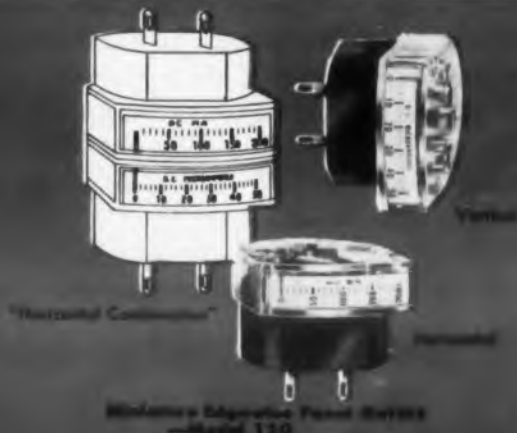

Model 327-U Unimeter 2 1/2"



Model 354 Relay



Tilting Case Portable
Model: 325 (DC), 335 (AC)



Model 420-U Unimeter 4 1/2"
with mirror scale



Model 234 Unimeter Stand



Round Flush Mounting (1 1/2")
Model DC 331-P, AC 331-P,
BF 341-P



Rectangular Flush Mounting
Model DC 724, AC 734, BF 784



Model 430 VS Meter
Type B Scale



1 1/2" Tilted Case 1 1/2" Depth Portable
Model 433 (DC), 433 (AC)

TRIPLETT

Quality...
First to last

TRIPLETT ELECTRICAL INSTRUMENT COMPANY
BLUFFTON, OHIO

the input power for projectors, lights and other group communications apparatus. The impulse relay type, model 10A-RA, is an spdt device that permits an electrical impulse or momentary contact to control on-off power to all types of audio-visual equipment. The power breaker type, model 30A-D15, is a 115-v ac, 30-amp equipment overload protection unit.

TelePrompTer Corp., Dept. ED,
311 W. 43rd St., New York 36, N. Y.

Germanium Transistor 566

For high current switching

Types 2N1073, 2N1073A and 2N1073B germanium pnp dap transistors are designed for high current switching at high frequencies. The units can switch up to 1,200 w. Maximum ratings for V_{CE} and V_{CB} are: 2N1073, 40; 2N1073A, 80; and 2N1073B, 120. When V_{CE} is 2 v dc and I_C is 5 amp dc, current gain is 20 min and 60 max. The transistors are suitable for use in horizontal output amplifiers, core drivers, hi-fi amplifiers, ultrasonics and power converters.

The Bendix Corp., Red Bank Div., Dept. ED, Holmdel, N. J.

Price: 2N1073, \$3.38 ea, 1 to 99 and \$2.25 ea, 100 and up; 2N1073A, \$7.35 ea, 1 to 99 and \$4.90 ea, 100 and up; 2N1073B, \$11.85 ea, 1 to 99 and \$7.90 ea, 100 and up.

Availability: From stock.

Digital-To-Analog Converter 580

For dual channel input

Model DA-102 digital-to-analog converter, for dual channel input, generates an analog output signal proportional to a binary-coded decimal input. Output ranges are 0 to 10 v full scale and 0 to 20 v full scale. The unit has 30 mercury relays and two ratio transformers.

Datex Corporation, Dept. ED,
1307 S. Myrtle Ave., Monrovia, Calif.

Price: \$950 single channel, \$1500 dual channel.

Availability: 30 to 60 days.

◀ CIRCLE 38 ON READER-SERVICE CARD



PRECISION SIZE 5 MOTORS NOW AVAILABLE FROM STOCK

Available for immediate delivery, these miniaturized Bendix® motors (type number CK 1066-40-A1) are designed for applications where space and weight requirements are at a minimum. So small that four can be packaged in a square inch, these motors are ideally suited for missile instrumentation and similar miniaturized applications. The motor has a tapered shaft; however, units may be obtained with other type shafts and with center tapped control windings.

TYPICAL MOTOR CHARACTERISTICS

Voltage	
Fixed phase	26 volts
Control phase	26 volts
Frequency	400 cycles
Stall Current*	
Fixed Phase	100 ma
Control Phase	100 ma
Stall Impedance*	
Fixed Phase	260 = 184.5 + j183.5 ohms
Control Phase	260 = 184.5 + j183.5 ohms
Stall Power Input* (Total)	3.69 watts
Stall Torque	0.138 oz.-in.
No Load Speed	9900
Torque-to-Inertia Ratio	44,400 rad/sec ² (Stall Acceleration)
Operating Temperature	
Range	-55°C. to +70°C.
Weight	0.88 oz.

*With rated voltage applied to each phase.

For information on these motors—
or similar motors in sizes 8, 10, 11, 15,
20, and 28—write:

Eclipse-Pioneer Division

Teterboro, N. J.



District Offices: Burbank, and San Francisco, Calif.; Seattle, Wash.; Dayton, Ohio; and Washington, D. C.
Export Sales & Service: Bendix International, 205 E. 42nd St., New York 17, N. Y.

CIRCLE 39 ON READER-SERVICE CARD

NEW PRODUCTS

Microminiature Latching Relay 584

For dry circuit, high-level switching



Model 76GB-N voltage-sensitive, microminiature latching relay is for dry circuit and high level switching. These dual-coil, balanced-armature relays stand vibrations of 30 g to 2,000 cps and shock of 100 g. Normal operating power is 90 mw. Contacts are rated at 10- μ amp resistance at 10 mv dc or ac for dry circuit and 2 amp resistive at 28 v dc or 115 v ac for high level. Contact life is rated at 5,000,000 operations min for dry circuit and 100,000 operations min for high level.

Iron Fireman Manufacturing Co., Electronics Div., Dept. ED, 2838 S.E. Ninth Ave., Portland 2, Ore.

Price: \$15.75 to \$26.40.

Availability: 30-day delivery from stock.

Voltage-Controlled Oscillator 598

Transmits research data



Model AOV-10 voltage-controlled oscillator transmits research data from the aircraft or missile to the control point. The airborne instrument weighs 5.5 oz and measures 1.87 x 1.44 x 1.63 in. Specifications include: intelligence frequency response, for modulation index of 5 or greater, it is within 0.2 db of dc response and is down less than 1 db at 1; input voltage, ± 10 mv for full deviation; common mode rejection, 100 db at dc and 94 db at 400 cps; linearity, $\pm 0.25\%$ max from best straight line; environmental temperature, continuous operation up to 100 C; power requirement, 18 or 28 v dc $\pm 10\%$ for stated specifications at 25 ma.

Data-Control Systems, Inc., Dept. ED, 39 Rose St., Danbury, Conn.



AUTOSYN® SYNCHROS

Dependable in miniaturizing
control circuitry



These Bendix® size 5 Autosyn synchros are well suited to the needs of missile instrumentation and similar applications requiring miniaturization and weight reduction. Typical characteristics are listed below. For additional information, including comprehensive data on transmitter, control transformer, and differential characteristics, write today.

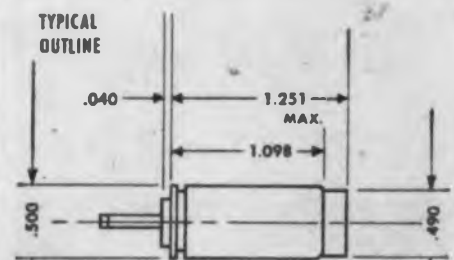

TYPICAL CHARACTERISTICS

Operating temperature range	-55°C. to 95°C.
Rotor moment of inertia	0.25 gm cm ²
Weight	0.8 oz.
Accuracy	± 15 minutes

Available as transmitter, control transformer and differential.

Manufacturers of

**GYROS • ROTATING COMPONENTS
RADAR DEVICES • INSTRUMENTATION
PACKAGED COMPONENTS**

Eclipse-Pioneer Division



Teterboro, N. J.

CIRCLE 40 ON READER-SERVICE CARD

ELECTRONIC DESIGN • December 21, 1960

TM Connectors

601

For use with 93-ohm cables



These miniaturized TM connectors are for use with 93-ohm cables up to 0.206 OD. Having low vswr, low insertion loss and low noise level, these connectors meet requirements for missile and airborne communications and telemetry systems.

General RF Fittings, Inc., Dept. ED, 702 Beacon St., Boston 15, Mass.

Availability: From stock.

High-Voltage Triode

559

For use up to 10 kv

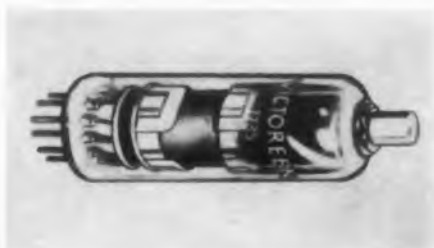

Type 7235 high-voltage, miniature triode is for use with plate voltages up to 10 kv. It can be used as a substitute for the 2C53. When used with the firm's Corotron, it provides a referenced series regulator for voltages up to 20 kv. It can be used as a voltage amplifier for electrostatic deflection circuits. Maximum diameter is 0.875 in.; maximum height is 2.75 in.

The Victoreen Instrument Co., Dept. ED, 5806 Hough Ave., Cleveland 3, Ohio.

Photoelectric Control Package

600

Operates on pulses of 0.015 sec.



Type 22LB5 photoelectric control package has spdt contacts. The transistorized unit is contained in a cylinder 7-1/2-in. long and 1-5/8 in. in diameter. With matching light source type 40CE1, relay operation with light impulses as short as 0.015 sec are possible at light beam ranges up to 20 ft.

Electronics Corp. of America, Dept. ED, 1 Memorial Drive, Cambridge, Mass.

From Allegheny Ludlum

NEW VALUES IN SILICON STEELS



In the intermediate silicon grades Allegheny Ludlum consistently furnishes the largest coils available—7000 to 9000 pounds. Wider widths open up opportunities for new applications using superior cold reduced electrical steel strip.

You can count on consistent magnetic results when you use A-L steels. Quality is checked and maintained in each coil to insure consistent results from shipment to shipment. Consistent gage uniformity is maintained throughout each coil.

Permeability is excellent—A-L processing gives you the maximum values consistent with AISI watt loss grades. Core loss guarantees are available according to AISI published values for as sheared or stress relief annealed samples.

In the grain oriented Silectron[®] grades Allegheny Ludlum carefully controls flatness—to insure minimum noise levels. Excessive noise levels and magnetostriction is held down to a minimum.

Because of the excellent gage consistency, A-L Silectron grades mean more uniformity in making stacked and wound cores.

The absence of brittle material is a must in making wound cores. You will appreciate the ductility of Allegheny Ludlum Silector grades.

For high quality electrical steels and the technical data you need in design and manufacture call your Allegheny Ludlum salesman, or write: *Allegheny Ludlum Steel Corporation, Oliver Building, Pittsburgh 22, Pennsylvania. Dept. ED 12-4.*



ALLEGHENY LUDLUM

PIONEERING ON THE HORIZONS OF STEEL

CIRCLE 41 ON READER-SERVICE CARD



2580

NEW PRODUCTS

Portable Potentiometer 562 Recorder

Has self-contained power source

This potentiometer recorder has chart speeds of 1/2 to 12 in. per hr as standard; other speeds can be furnished on request. The chart is driven by a clockwork motor with an eight-day movement. Full-scale deflection ranges available are between 0 to 5 mv and 0 to 100 mv. The instrument has an over-all accuracy of better than 0.5%. The input impedance is 15,000 ohms. The instrument is completely self-contained and is portable. It is transistorized and has a battery life of 250 hr.

Instrument Corp. of America,
Dept. ED, 516 Glenwood Ave.,
Baltimore 12, Md.

Price: \$995.

Availability: Two months.

Digital Comparator 567

For control systems

Model DK-100 digital comparator, designed for use in control systems, compares two binary or binary-coded decimal inputs and provides output positioning commands. It can be used directly for comparison of contact inputs, voltage-vs-contact inputs or voltage-vs-voltage inputs. Temperature range is -49 to +131 F. The unit measures 7 x 19 x 11 in. and weighs 20 lb.

Datex Corporation, Dept. ED,
1307 S. Myrtle Ave., Monrovia,
Calif.

Price: On request.

Availability: 60 days.

Printed-Circuit Connector 577

Has 22 contact positions

This 22-contact printed-circuit connector, called Taper-in, is for printed-circuit card applications in which frequent jumpering is necessary, or in which numerous circuitry changes must be made. It mounts all 0.07 to 0.055 printed-circuit

flying high

At one time this five section mica capacitor bank was considered "blue sky"; today it is flying high in General Electric's DJ 113 Fuel Flow Meter Indicator. The breakthrough in conventional mica shape limitations came because only CDE has its own complete mica fabrication facilities. The result: a yield several times more capacity per unit of volume than conventional capacitor designs. The main capacitor section delivers .125 plus or minus .00125 microfarads and has a temperature coefficient of 50 parts per million per degree centi-



grade. By combining the remaining four sections, the value of capacitance can be trimmed from .1255 microfarads to .1320 microfarads in thirteen incremental steps of 500 micro-microfarads. And all this in a disc less than .2" thick and under 2" in diameter! Today, as an integral part of fast-growing Federal Pacific Electric Company, CDE is ready and able to help you get your capacitor problems off the ground. Just a call will send us flying. Cornell-Dubilier Electronics Division, Mica Department, 55 Cromwell St., Providence, R. I.

CORNELL-DUBILIER ELECTRONICS DIV.



FEDERAL PACIFIC ELECTRIC COMPANY

growth through creative energy

• FILTERS • DELAY LINES • PULSE NETWORKS • SEMICONDUCTORS • VIBRATORS • POWER SUPPLIES • RELAYS • ANTENNA ROTORS

cards. The receptacles will receive the firm's series 53 taper-pin line. The connector permits 500 insertions and removals of the card without damage to the foil pads and without critical wear on the gold plating on the contacts.

AMP Incorporated, Dept. ED, Harrisburg, Pa.

Silicon Transistor Chopper 572

For high temperature-applications

Model 70 silicon transistor chopper, recommended for high-temperature applications, alternately connects and disconnects a load from a signal source. It can be used as a demodulator to convert an ac signal to dc. It can linearly switch or chop voltage from a fraction of a millivolt up to 10 v. Operating temperature is -55 to $+130$ C. Chopping frequency is dc to more than 100 kc. Driving voltage is square wave, 5 to 10 v peak-to-peak. Driving source and input resistances are 600 ohms. The unit stands 500-g shock for 11 msec, 30-g vibration from 0 to 2,000 cps and 700-g acceleration.

Solid State Electronics Co., Dept. ED, 15321 Rayen St., Sepulveda, Calif.

Price: \$133.

Availability: From stock.

Liquid Rosin Flux 568

For printed circuit dip soldering

Alpha 346-35, 346-60 and 346-20 liquid rosin flux are for printed circuit dip soldering. They all work well with brass, bronze, cadmium plate, copper, lead nickel plate, silver, solder plate, terne plate, hot-dipped tin, electrolytic tin plate, tin-zinc plate. Density for 346-60 is 0.958 g per ml, for 346-35 it is 0.901 g per ml and for 346-20 it is 0.866 g per ml. Solidity is 60%, 35% and 20%, respectively. All fluxes can be applied by dipping or brushing.

Alpha Metals, Inc., Dept. ED, 58 Water St., Jersey City 4, N. J.

Price: \$6 per gal, 4 gal; \$3.45 per gal, 216 gal.

Availability: From stock.

◀ CIRCLE 42 ON READER-SERVICE CARD

ANY SWITCHING COMBINATION FROM SPST to TPDT

with Centralab Switch Type Variable Resistors

CENTRALAB engineering took the conventional Model 2 composition variable resistor and developed these ingenious switching arrangements not available previously, with ratings up to 6 amps, 125 VAC. For use as single, dual concentric, or twin units, they are especially suitable for high fidelity and stereo, radio, television and phonograph applications. The use of these push-pull, push-push, and slide-switch units reduces the number of front panel controls, simplifies operation, and reduces component handling.

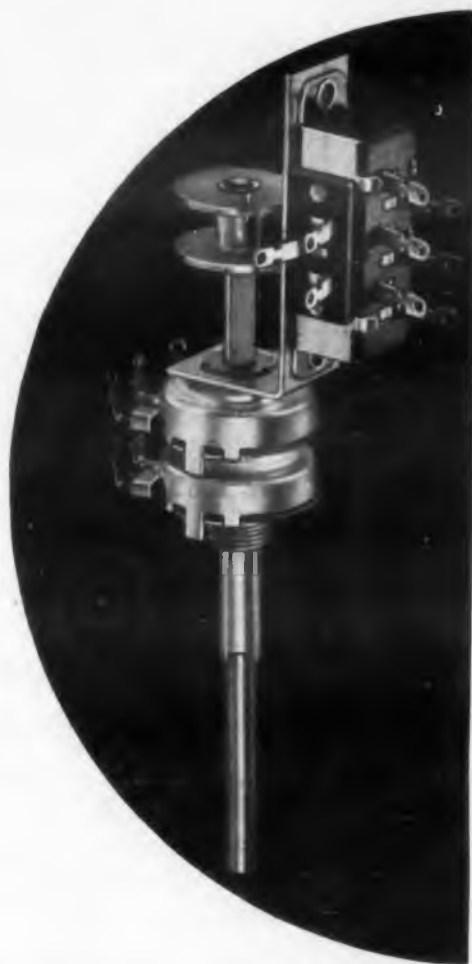

MODEL 2 VARIABLE RESISTOR SPECIFICATIONS

Rating 1/2 watt; Size 15/16" diam.
Resistances: 200 ohms to 10 megohms,
any taper



SLIDE SWITCH SPECIFICATIONS PUSH-PULL, PUSH-PUSH SPECIFICATIONS

Mounting Depth: 2 1/2" from control surface, in any desired radial position for easy assembly of leads
Switch: Positive or spring return styles, 1/2, 1, 3 or 6 amp, SPST to TPDT, 125 VAC

Mounting Depth: push-push; 2 1/2" from control surface
push-pull; 1 1/8" from control surface
Switch: SPST, 3 amp, 125 VAC

Industrial quantities of push-pull and push-push types available for immediate delivery at factory prices from your near-by CENTRALAB industrial distributor.

Centralab

B-6040 ®

The Electronics Division of Globe-Union Inc.
960M East Keefe Avenue • Milwaukee 1, Wisconsin
Centralab Canada Limited • Ajax, Ontario

ELECTRONIC SWITCHES • VARIABLE RESISTORS • CERAMIC CAPACITORS • PACKAGED ELECTRONIC CIRCUITS • ENGINEERED CERAMICS
CIRCLE 43 ON READER-SERVICE CARD

NEW PRODUCTS

PNP Germanium Transistor 582

For computer logic circuits up to 5 mc



Type 2N393 pnp germanium transistor is for computer logic circuits up to 5 mc. Absolute maximum ratings at 25 C are: collector-to-base and collector-to-emitter voltages, 6 v dc; emitter-to-base voltage, 5 v dc; collector current, 50 ma dc; dissipation, 25 mw; storage and junction temperature, -65 to +85 C. This micro alloy unit is hermetically sealed in the TO-24 package.

CBS Electronics, Dept. ED, Danvers, Mass.
Price: \$3.00 per unit in quantities of 1,000.
Availability: 2-week delivery from stock.

Rotary Switch 585

For use to 40 hp at 600 v



Type C-63 rotary switch is for motor control and power switching up to 40 hp at 600 v. Current rating is 63 amp at 600 v ac. It carries two isolated double-break silver-alloy contacts in each stage and provides up to 24 contacts within 12 stages. Standard contacts are for 90, 60, 45 and 30 deg throw. Mechanical life is 5,000,000 operations.

American Solenoid Co., Inc., Dept. ED, U. S. Highway 22, Union, N. J.
Availability: 10 to 20 days.

Linear Motion Potentiometers 551

Withstand 100 G shock



Types 3239 and 3209 linear motion potentiometers are for servo control systems and instrumentation transducers in aircraft and missile applica-

tions. The units resist vibration and shock loading in excess of 100 g without malfunction. Linearity is $\pm 0.5\%$ or better. Resistances range from 1 K to 20 K. The 0.5-in. diam units stand 1,000 v rms without dielectric failure. They can be used as feedback devices in rectilinear actuator servos, in airborne computers and as instrument transducers for fluid metering indicators and other direct read-out devices.

Markite Corporation, Dept. ED, 155 Waverly Place, New York 14, N.Y.

Availability: Made on order.

Pressure Transducers

561

Weight is 5 oz.



Type P2-300 variable-reluctance dc pressure transducers are designed for applications with critical weight limitations. Type P2-3076, for pressure ranges up to 5,000 psig, weighs 5 oz and needs 3 ma at 28 v dc for a dc output of 0 to 5 v. Output impedance is 1 K. Input, output and ground circuits are mutually isolated.

Daystrom-Wiancko Engineering Co., Dept. ED, 255 N. Halstead St., Pasadena, Calif.

Price: \$585.

Availability: From stock in January, 1961.

Plug-In Chopper

554

Is transistorized



Model 66 transistorized, line-driven, plug-in chopper can be driven from 115 v rms, 60 or 400 cps. Sinusoidal or square wave drive can be used from 20 cps to 12 kc sine wave or 30 cps to 5 kc square wave. The chopper can be used as a synchronous demodulator to convert an ac signal to dc. It can linearly switch or chop voltages down to a fraction of a millivolt and up to 5 v.

Solid State Electronics Co., Dept. ED, 15321 Fayen St., Sepulveda, Calif.

At Last—High Reliability in Carbon-Film Potentiometers!

Bourns Trimspot® carbon-film potentiometers now offer you twice the stability of any carbon unit heretofore available... at temperatures as high as 150°C. Now, for the first time, you can incorporate high-resistance, infinite-resolution potentiometers in your circuit without sacrificing reliability. The reason: Resiston®, a remarkable new carbon element that virtually eliminates the problems normally caused by extremes of temperature and humidity.

Thanks to this exclusive Bourns development, Trimspot carbon units can operate at temperatures



up to 150°C—with resistance shift only half that of ordinary carbon elements. In addition, they far exceed the requirements of Mil-Specs for humidity and MIL-R-94B.

Trimspot Resiston units are available from factory and distributor stocks with three terminal types... three mounting styles... and standard resistances ranging from 20K to 1 Meg. Resiston elements are available in most Bourns configurations. Write for the new Trimspot summary brochure and list of stocking distributors and representatives.

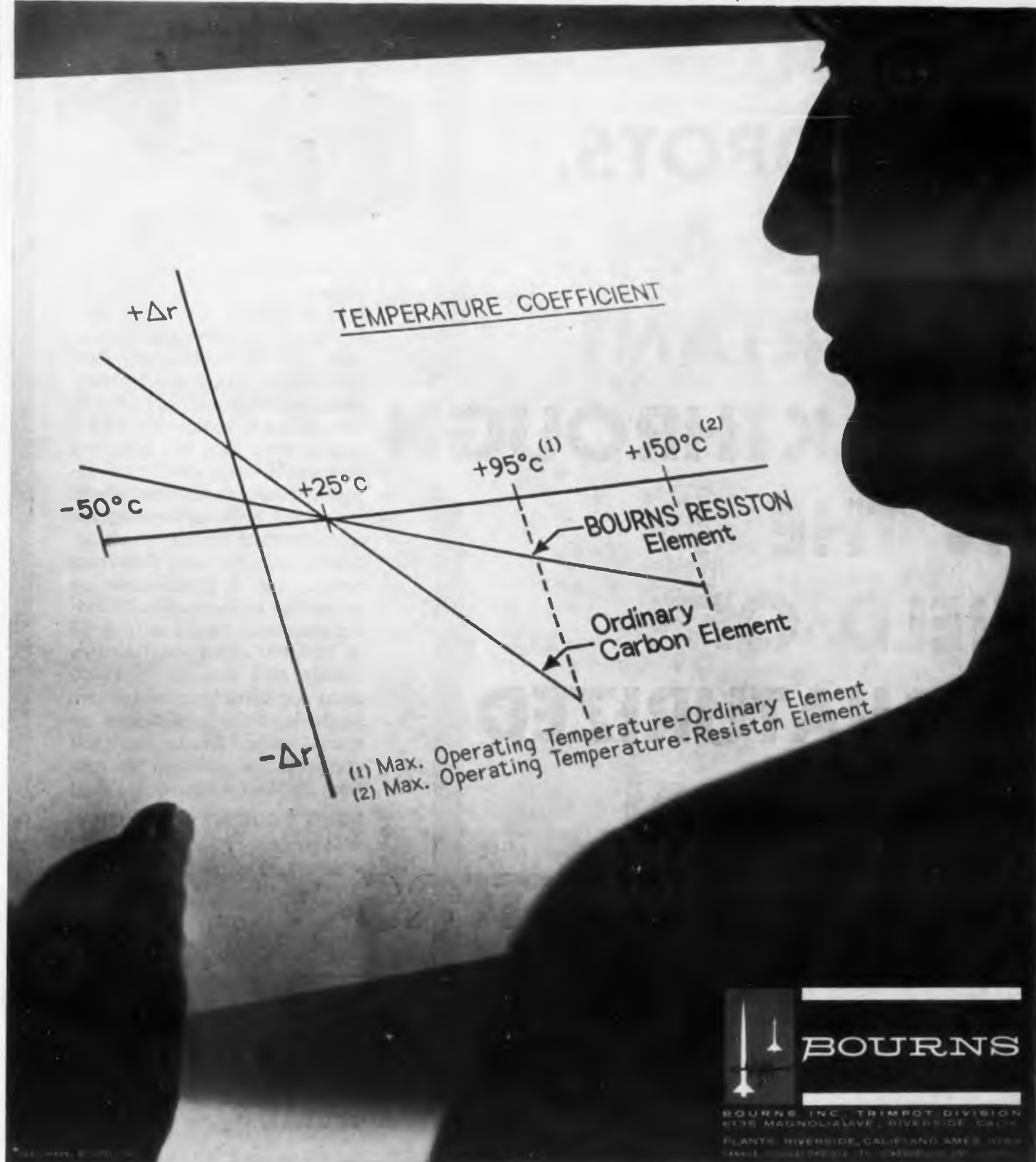

Exclusive manufacturers of Trimspot®, Trimit® and E-Z-Trim®. Pioneers in transducers for position, pressure and acceleration.

CIRCLE 44 ON READER-SERVICE CARD

NOW FROM BORG, MAKER OF FAMOUS MICROPOTS, COMES AN IMPORTANT BREAKTHROUGH IN THE FIELD OF MINIATURIZED PRECISION POTENTIOMETERS

Write for complete engineering data . . .
ask for Catalog Sheets BED-A160 and BED-A161

Mechanical Rotation ten-turn: $3600^\circ +5^\circ -0^{**}$; three-turn: $1080^\circ +5^\circ -0^{**}$
Electrical Rotation ten-turn: $3600^\circ +5^\circ -0^{**}$; three-turn: $1080^\circ +5^\circ -0^{**}$
Total Resistance Range ten-turn: 25 to 120,000 ohms^{**}; three-turn: 10 to 40,000 ohms^{**}
Standard Linearity $\pm 0.5\%$
Temperature Range -55°C to 125°C

*These tolerances are identical.
^{**}Tolerances: ten-turn — 25 to 50 ohms $\pm 10\%$; 100 to 120,000 ohms $\pm 3\%$; 120,000 ohms $\pm 5\%$.
three-turn — 10 to 30 ohms $\pm 10\%$; 100 to 40,000 ohms $\pm 3\%$.

CIRCLE 45 ON READER-SERVICE CARD

NEW BORG 2100 SERIES MINIATURE MICROPOTS

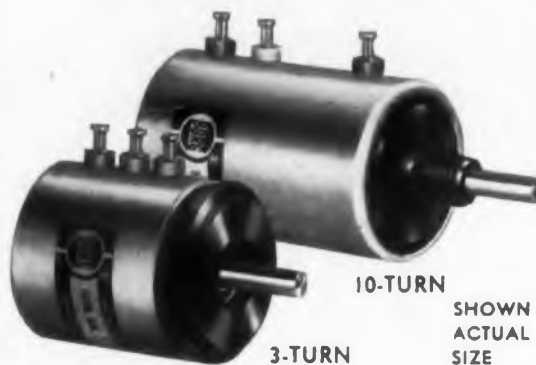

A new concept in the field of miniature precision potentiometers . . . Borg 2100 Series Micropots! Only $\frac{7}{8}$ " diameter, these new Micropots are wirewound, multiturn and linear. Housings are aluminum for maximum heat dissipation and are completely sealed against sand, dust and moisture. Permanent concentricity is assured. Terminals are gold plated for perfect solderability and are color coded to identify function! Available in ten and three-turn models, the 2100 Series can be ganged up to three units. Standard resistance ranges of from 25 to 120,000 ohms for ten-turn models, and from 10 to 40,000 ohms for three-turn models are available. Other resistances on special order. Let us send you complete information on new Borg 2100 Series Micropots today!

BORG EQUIPMENT DIVISION
Amphenol-Borg Electronics Corporation
JANESVILLE, WISCONSIN
Phone PLeasant 4-6616



NEW PRODUCTS

Transistor Test Sockets

548

For production testing

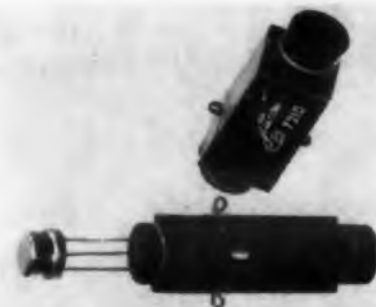

No. 72-101 transistor test socket is for the production testing of 3- or 4-lead transistors. It occupies a volume of $11/16$ in. square x $1-7/16$ in. long. Designed for $1/8$ -in. panel mounting, it may be mounted on 0.812 -in. centers. Frictional force exceeds 50 g on 0.017 -in.-diam lead wires.

Jettron Products Inc., Dept. ED, 56 Route 10, Hanover, N.J.

Price: On request.

Availability: From stock.

Resistance Probe

534

For semiconductor slices

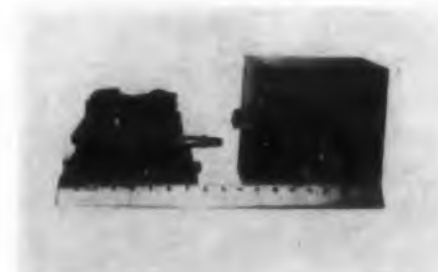

The Microprobe, a constant-tension four-point probe, is designed for resistivity measurements on semiconductor slices. Probe spacing is adjustable within 0.04 in. and is factory preset to a spacing of ± 0.0002 in. Probe tips are rhodium-plated, hard chrome steel. The device uses a four-way plug.

The Kemble Co., Dept. ED, 109 E. De la Guerra St., Santa Barbara, Calif.

Price: \$600.

Availability: Two to four weeks.

High-Density Delay Lines

529

Attenuation is 1%



Delay line type 2M1-5/5 has an attenuation of 1% or 0.008 db. Low-insertion loss is accoun-

plished by the use of subminiature toroidal inductors which enable large values of inductance to be achieved with a low dc resistance. Total delay is 0.2 μ sec. Other specifications are: rise time, 0.4 μ sec, impedance, 500 ohms; temperature coefficient, 0.03% per deg C; size, 0.25 x 0.4 x 1.75 in.

Valor Instruments, Inc., Dept. ED, 13214 Crenshaw Blvd., Gardena, Calif.

Price: \$12.35 in lots to 10.

Availability: From stock to two weeks.

Microminiature Relays

547

For printed circuit application



Series 4B microminiature relays are suited for printed circuit application. Contact rating is dry circuit to 2 amp, resistive. Temperature is -65 to $+125$ C. Dielectric strength is 1,000 v rms at sea level. Insulation resistance is 1,000 meg in. The units measure 0.8 x 0.8 x 0.875 in.

Hi-G, Inc., Dept. ED, Bradley Field, Windsor Locks, Conn.

Price: On request.

Availability: In sample quantities Dec. 15.

Rotary Tap Switch

602

Breaks 1 amp at 115 v ac



Series 45 rotary tap switch is rated to break 1 amp at 115 v ac, resistive. It carries 5 amp. Life expectancy is 100,000 cycles. It can be provided with 2 to 6 positions, with stops standard on 2 to 5 positions, and 6 positions supplied as continuous rotation. The switch incorporates 60-deg indexing, stop strength of 10 lb-in. and rotational torque of 12 oz-in. approx.

Grayhill, Inc., Dept. ED, 561 Hillgrove Ave., LaGrange, Ill.

Price: \$6 to \$6.40.

Availability: From stock in small quantities.

FROM .2 WATT TO 120 WATTS ...FROM 5 MC TO 225 MC

a PSI POWER AMPLIFIER FOR EVERY APPLICATION!

This Great New Line of Triple Diffused Silicon Mesas Provides a Transistor for Almost Every Communications Need!

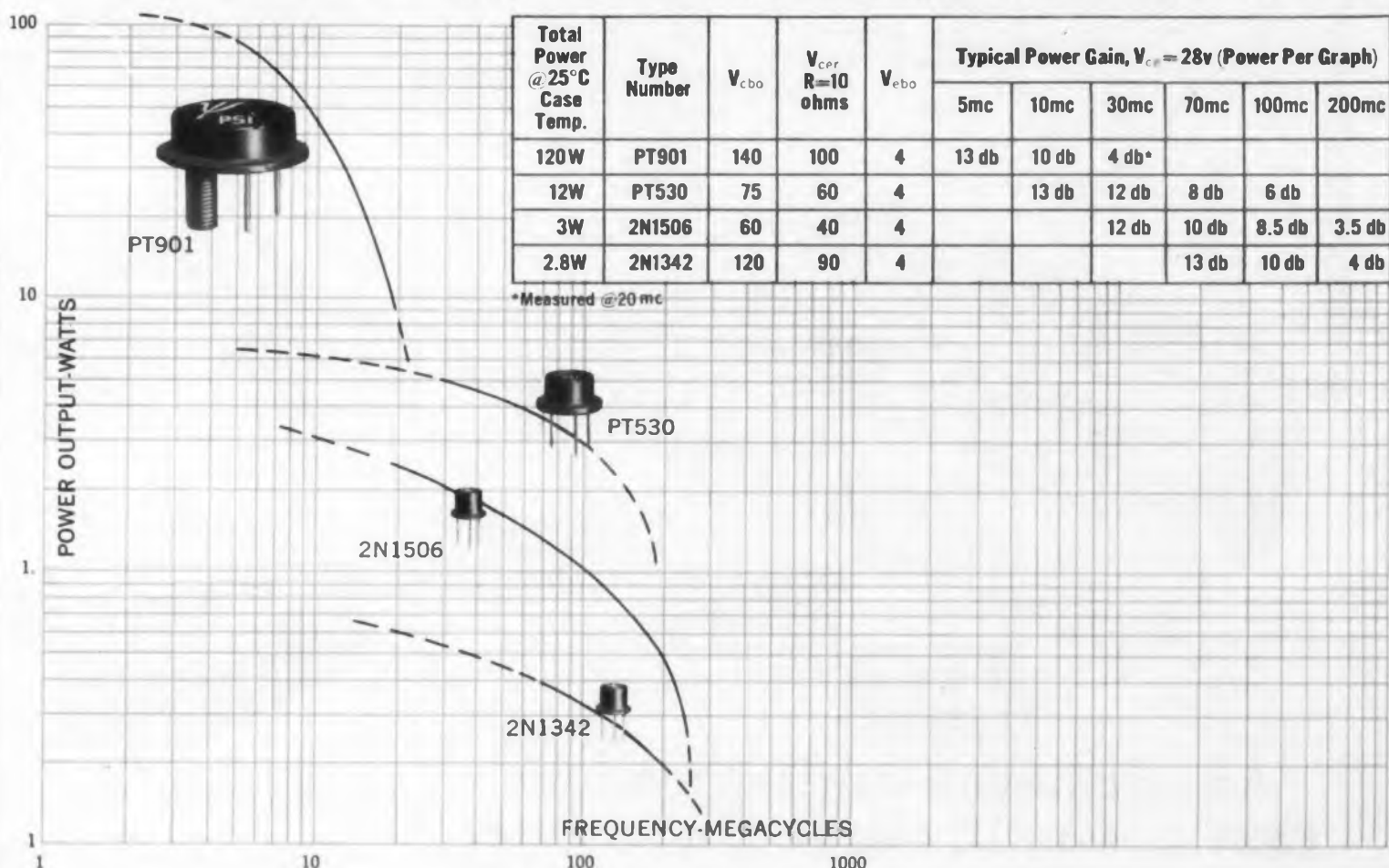

Designers of advanced communications equipment can now take a totally new approach to engineering of high performance transmitters in power and frequency ranges never before possible.

A PT530, for example, will furnish 5 watts RF power output at 30 mc (12 db power gain) or 3 watts at 70 mc (8 db power gain). It is the only silicon transistor capable of driving the PSI type PT901 power amplifier transistor to its full 100 watts output. The new 2N1342 furnishes a substantial amount of power for the designer working in the UHF region

... 200 mW RF output at 225 mc.

There are lower cost oscillator versions of the above types, too. The 2N1505 performs admirably in a circuit where you don't need the high gain characteristics of the 2N1506.

Immediate delivery is being made on evaluation quantities of types PT530 and PT901. Large quantity delivery is being made on all other PSI communications and switching transistors... including the remarkable new 2N1837 high performance switch.



PHONE, WIRE OR WRITE ANY PSI SALES OFFICE FOR FULL DETAILS.

Pacific Semiconductors, Inc.

A SUBSIDIARY OF THOMPSON RAMO WOOLDRIDGE, INC.

12955 CHADRON AVENUE • HAWTHORNE, CALIFORNIA • TWX: HAW CAL 4270
Facilities in Hawthorne, Culver City and Lawndale, California

CIRCLE 46 ON READER-SERVICE CARD



DIGITAL DATA SYSTEMS

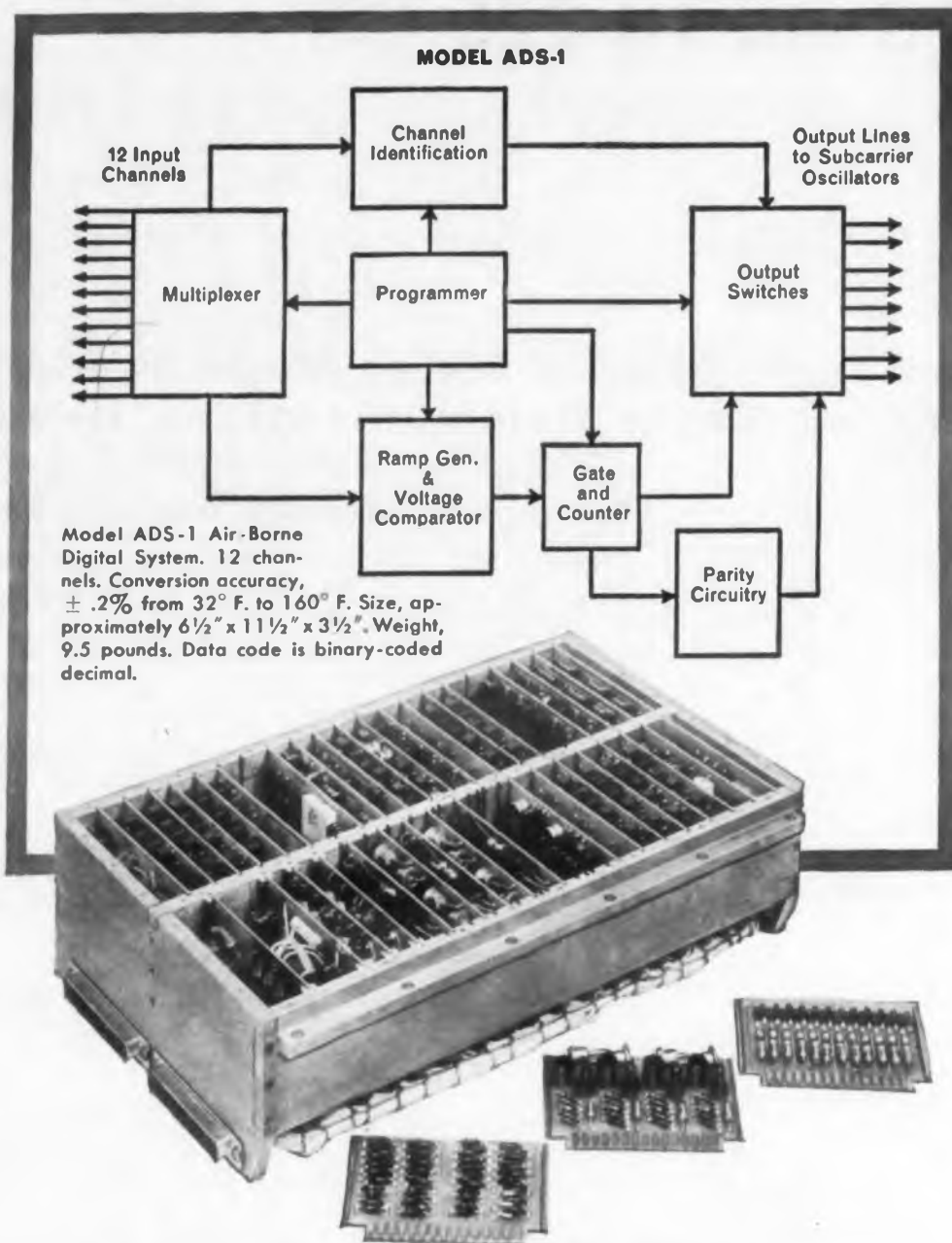

An air-borne digital system that is small, rugged, accurate, low in cost

Typical of Curtiss-Wright digital systems is Model ADS-1, designed primarily for missile use. It converts multiplexed analog voltages to a digital equivalent for use with FM-FM Telemetry Systems, magnetic or paper tape recorders. System includes input multiplexing, an analog to digital converter, output switching, channel identification and parity checking. Composed entirely of solid state components, except for 12 electromechanical input switching relays. Ideal also for ground instrumentation, industrial quality control, development laboratories. Special systems custom-designed to meet your specific requirements. Blueprint your problem and let us suggest an answer.

Inter Mountain Instrument Branch—Electronics Division

CURTISS WRIGHT

CORPORATION • P.O. Box 8324, Albuquerque, New Mexico

SOLID STATE RELAYS • SINGLE TRANSIENT PEAK READING VOLTMETERS • TRANSISTOR TEST INSTRUMENTS AND SYSTEMS • DIGITAL DATA ACQUISITION AND PROCESSING SYSTEMS
CIRCLE 47 ON READER-SERVICE CARD

NEW PRODUCTS



Crushable Ceramic

737

AlSiMag 714 crushable ceramic is for metal-sheathed cable and thermocouple insulation. This electrically-fused magnesium has a total impurity of less than 0.7%. It is normally furnished as a 1- to 4-in.-long tube. It meets AEC-Sr-10(ORO) and O-KPM 7-1 specs. American Lava Corp., Dept. ED, Manufacturers Road, Chattanooga 5, Tenn.



Nickel-Cadmium Battery

738

This nickel-cadmium battery is a hermetically-sealed cell of 4 amp-hr capacity. The 1.25-v, standard D size cell can be discharged at loads up to 50 amp and will supply hundreds of cycles of charge and discharge. It is for large current requirements, satellite and missile applications. Gould-National Batteries, Inc., Dept. ED, St. Paul 1, Minn.



Phase Sequence Indicator

749

Miniaturized, portable phase sequence indicators models 40A and 44A weigh only 11 oz. They are 2-7/8-in. wide x 1-5/8-in. deep and 4 in. high. Positive phase sequence indications are provided by model 40A for 60 cps power with adjustments possible for 120, 240 and 480 v. The model 44A is for use on 400 cps circuits. Associated Research, Inc., Dept. ED, 3777 W. Belmont Ave., Chicago 18, Ill.



Precision Switches

745

Series 2HL260 precision switches are spdt units operating at 2 hp, 250 v ac; 1 hp, 125 v ac; and 20 amp, 125 v ac. The basic switch measures $11/16 \times 1-15/16 \times 13/16$ in. It can be furnished with solder-log, screw-type or snap-on terminals. W. L. Maxson Corp., Unimax Switch Div., Dept. ED, Ives Road, Wallingford, Conn.



RF Switches

740

These switches are for critical rf switching applications and have other uses in dc- and low-frequency applications. Type 254-TX is one of the two dpdt units. Type 254-T is for use in attenuator applications. Current-carrying capacity exceeds 1,000 w. Kay Electric Co., Dept. ED, 14 Maple Ave., Pine Brook, N.J.



Transparent Insulation Sleeving

746

Temperature range of this transparent insulation sleeving starts at -67°F and extends to $+275^\circ\text{F}$ for continuous operation and is as high as 572°F for one hr. It is for use in environments where part numbers must be visible or repeated inspection is desirable. Rayclad Tubes, Inc., Dept. ED, Oakside at Northside, Redwood City, Calif.

Plastic Wire Ties and Cable Clamps 729

These polyethylene wire ties, designed for easy removal, are heat resistant and chemically inert. Breaking points are 45 to 95 lb. The clamps are effective from -60 to +300 F. Both devices employ Zytel 101.

Nylogrip Products, Dept. ED, 570 Pleasant St., Watertown 72, Mass.

Epoxy Resin 730

System G-07 displays good thermal conductivity for a low-density product. Its primary application is for embedding heat-generating electronic assemblies used in mobile or aircraft equipment.

Mitchell Rank Manufacturing Corp., Dept. ED, 51 Murray St., New York 7, N. Y.

Gaseous Diffusion Boats 731

Made of HT-2 ceramic, these diffusion boats are for doping silicon and germanium crystals for diffused-base diodes, rectifiers and transistors. They stand rapid processing in semiconductor diffusion oven at temperatures up to 1,300 C.

Duramic Products, Inc., Dept. ED, 426 Commercial Ave., Palisades Park, N. J.

Availability: Made to customer requirements with a delivery of two to three weeks.

Ceramics 732

The HT-1 series of high-aluminum-oxide ceramics have a heat resistance to 3,000 F, hardness in the range of carbides and dielectric strength as high as 250 v per mil. The material is available in three grades. Compressive strengths are to 400,000 psi.

Duramic Products, Inc., Dept. ED, 426 Commercial Ave., Palisades Park, N. J.

Availability: Parts are custom fabricated from this material.

Safety Pliers 733

These pliers are suited for electronic, radar and electrical applications. The line includes curved needle-nose, duck-bill, long-nose and diagonal cutting types. They are made of a special alloy of beryllium and copper. They are non-magnetic, non-corrosive and do not spark under severe use.

The Beryllium Corp., Dept. ED, P. O. Box 1462, Reading, Pa.

Availability: Through distributors.

Casting Resin 708

Type P-200 polyester resin is suited for small castings, potting electronic components and encapsulating miniature assemblies. It is of medium viscosity and cures without heat. Dielectric constant is 3.6 at 1 kc.

Melpar, Inc., Dept. ED, 3000 Arlington Blvd., Falls Church, Va.

Price: \$1.20 per lb in quantities of 45 lb.

Availability: From stock.

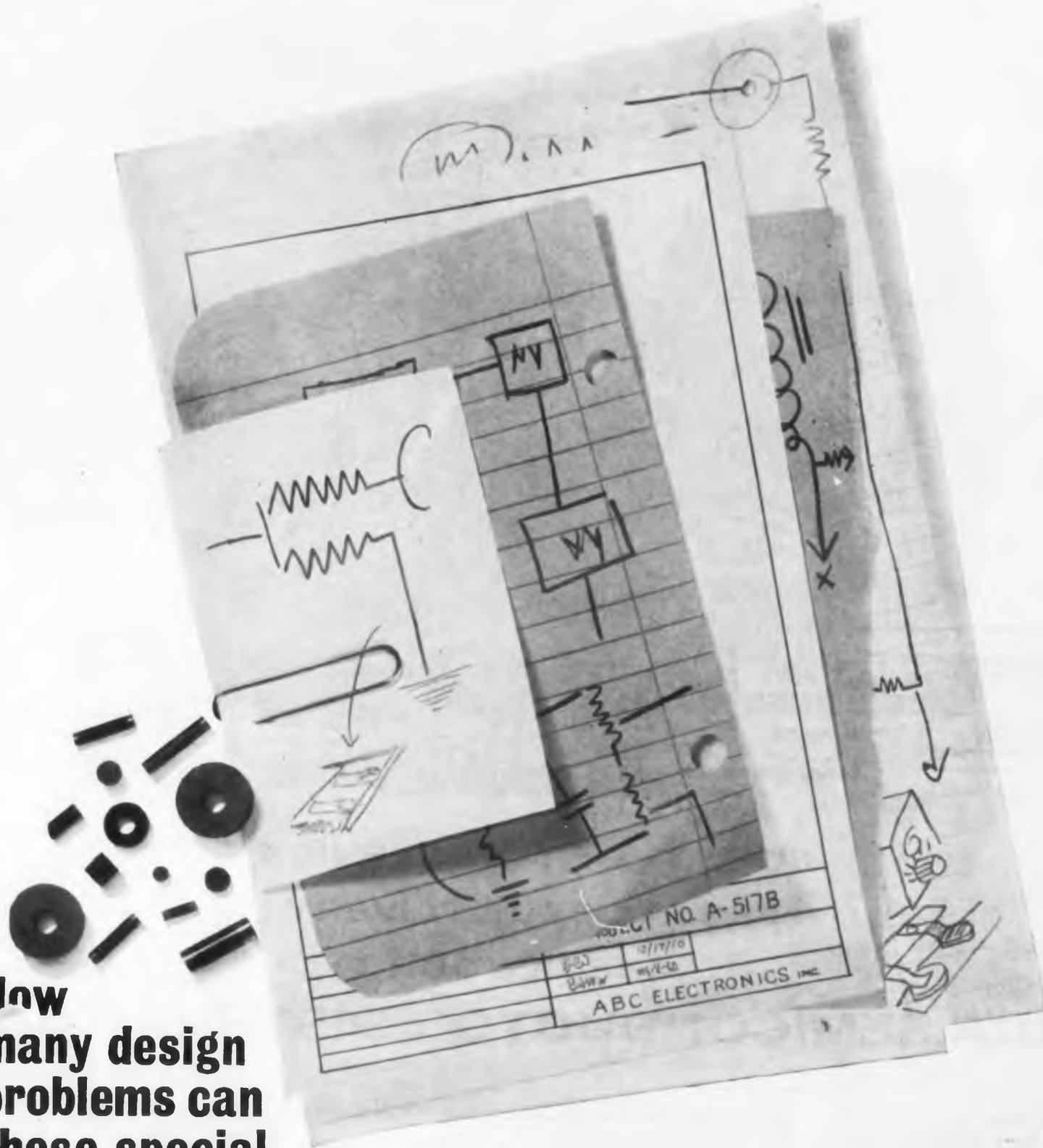

How many design problems can these special resistors solve for you?

Speer special resistors are made in a special way by a special process, but they solve many of the problems that are standard in electronics...problems of design...size...shape...fabrication.

Note the ends. Speer special resistors are made by a unique, patented* process whereby metal face ends are molded integrally with the resistor body to provide excellent contact. They can be made in many shapes...as tubes, rods, discs, thin plates...in circular or rectangular shapes, miniature in size, if desired. They are, in short, adaptable to many design requirements. The ends are made for easy solderability, but they can, of course, be provided for pressure connections or other modes of fastening.

Speer special resistors are presently being used for new design freedom by manufacturers of such varied items as automotive horns, fuses, electric blankets, lightning arrestors and control units. Perhaps they can solve your problems, too. Why not give us a call? We'll be glad to supply further details.

*U.S. PATENT # 2903668 CANADIAN PATENT # 699864

Other Electronics Divisions of Speer Carbon Company—Jeffers Electronics, Du Bois, Pa. • Onondaga Electronics, Syracuse, N. Y.



**SPEER
RESISTOR
DIVISION**

**Speer Carbon Company
Bradford, Pennsylvania**

CIRCLE 48 ON READER-SERVICE CARD



**FOR "ONE-STOP" SERVICE,
FAST LOCAL DELIVERY
CHECK YOUR
RCA SEMICONDUCTOR DISTRIBUTOR**

WHATEVER YOUR requirements in Transistors and Silicon Rectifiers...industrial, military, computer, entertainment...check first with your local RCA Semiconductor Distributor. His main objective is to offer superior-quality products and outstanding service—fast!

Your local RCA Semiconductor Distributor can offer all of these services:

- A comprehensive line of superior-quality RCA Transistors and Silicon Rectifiers.
- RCA Semiconductors for special projects or preproduction-run requirements from local stock—at *factory prices*.
- Prompt delivery of the latest RCA types for your evaluation.
- Orders filled from factory-fresh stock.
- Up-to-date practical product information.
- Valuable RCA technical assistance when it is needed.
- "One-stop" service on your orders.
- Specialists who understand your problems and your electronic needs.

Semiconductor Products
Distributor Sales
Harrison, N. J.



The Most Trusted Name in Electronics
RADIO CORPORATION OF AMERICA

NEW PRODUCTS

Punch Press

518

Heavy-duty type



Model BT-25 is a 25-ton punch press that can be set up for operations such as blanking, forming, shearing, riveting, drawing, cutting and crimping. Die space is 7-3/8 in. Distance from the center of ram to frame is 8 in. The machine is equipped with a single-pin, knife-type clutch; it can be easily changed from repeat to single-stroke action. It requires a 2-hp motor.

Alva Allen Industries, Dept. ED, 1001-15 North 3rd St., Clinton, Mo.

Price: \$1,097.50 job Clinton.

Availability: Units are in production.

Nuvistor Socket

485

This Nuvistor socket, No. 133-65-10-001, is fastened to the chassis by two tabs on the socket base which are rolled up against the underneath side of the chassis. The thickness of the chassis may vary between 0.032 and 0.082 in.

Cinch Manufacturing Co., Dept. ED, 1026 S. Homan Ave., Chicago 24, Ill.

Slide Switch

439

Type SW-742, useful in multiple switching applications related to audio systems, electronic measuring devices, and industrial controls, is a four-pole switch with all terminals in a common plane. Standard units have an over-all distance from mounting surface to extreme tip of terminal 0.575 in.

Continental-Wirt Electronics Corp., Dept. ED, 5221 Greene St., Philadelphia 44, Pa.

Price & Availability: Price is \$0.22 ea in quantities of 10,000; delivery time is 14 days.

Self-Aligning Chassis Slide

372

Slides automatically adjust to fit misaligned chassis and cabinets, eliminating need to shim. They meet mil specs for material and finish.

Grant Pulley & Hardware Corp., Dept. ED, High St., West Nyack, N. Y.

CIRCLE 50 ON READER-SERVICE CARD ►
ELECTRONIC DESIGN • December 21, 1960

UHF-VHF Beacon Transmitter 411

Measures 5-3/8 x 3-5/16 x 1-1/4 in.



Model BT-201 uhf-vhf transistor beacon transmitter measures 5-3/8 x 3-5/16 x 1-1/4 in. and weighs 1 lb 12 oz. These measurements include the batteries, which have a life of 20 hr. Power output is 250 mw at 121.5 or 243 mc. The transmitter is modulated class A2 by a 1,400-cycle tone, approximately 3 pps. It is designed to stand extreme conditions of shock, vibration and temperature.

General Antronics Corp., Dept. ED, 9036 Culver Blvd., Culver City, Calif.

Price: \$400 ea, 1 to 10; \$375 ea, 10 to 100; \$350 over 100.

Availability: 30 days, in sample quantities only, on order.

Infrared Operated Relays 538

Detects temperature changes

Model 5121 infrared relay is for detecting temperature changes. It can be used at a distance from hot forming processes to actuate water sprays, take-up reels and other equipment. The optical system and detector element provide a discriminate field of vision about 12 in. sq at a distance of 20 ft from the relay. Three relay contacts are provided: common, normally open and normally closed. The unit requires 115 v $\pm 10\%$, at 60 cps and 1 amp.

Weston Instruments Div., Daystrom Inc., Dept. ED, 614 Frelinghuysen Ave., Newark 12, N.J.



THIS IS A BETTER LATCHING RELAY

Better? Yes, in several ways. Bifurcated Contacts, for example, give improved reliability, especially in dry circuits. Contacts will not open during vibrations of 30Gs, 55 to 2500 cps. A special method of sealing cover to base eliminates flux contamination of the contacts. And there are more. Here is Potter & Brumfield's newest member of a distinguished family of micro-miniature relays: the FL Series.

Expressly designed for printed circuit applications, this DPDT, 3 amperes (@ 30V DC) latching relay lies parallel to the mounting surface. Its height, when mounted, is only .485", thus circuit boards may be stacked closer. Mounting can usually be accomplished without studs or brackets, simplifying installation.

The FL will remain firmly latched in either armature position without applied power, a significant advantage where power is limited and long relay "on" times are required. This relay may be operated by:

1. Pulsing each coil alternately (observing coil polarity), or
2. Connecting the coils in series and operating from a reversing (polarized) source.

Write for complete information or call your nearest P&B representative.

FL SERIES SPECIFICATIONS

Shock: 100 Gs for 11 milliseconds. No contact openings.

Vibration: .195", no contact openings. 10 to 55 cps. 30 Gs from 55 to 2500 cps.

Pull-In: 150 milliwatts maximum (standard) at 25° C. 80 milliwatts maximum (special) at 25° C.

Operate Time: 3 milliseconds maximum at nominal voltage at 25° C.

Transfer Time: 0.5 millisecond maximum at nominal voltage at 25° C.

Temperature Range: -65° C to +125° C.

Terminals: Plug-in pins.

Dimensions: L. 1.100" Max.—W. .925" Max H. .485" Max. Hermetically sealed only.



SC 11 D



SCG 11 DC

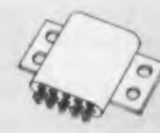

SL 11 DB
(Latching)

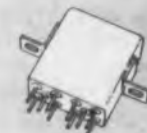

SLG 11 DA
(Latching)

Other P&B micro-miniature relays include conventional and latching models in crystal cases with a wide range of terminals and mountings. All are made in a near-surgically clean production area under the exacting requirements of our Intensified Control and Reliability program.

P&B STANDARD RELAYS ARE AVAILABLE AT YOUR LOCAL ELECTRONIC PARTS DISTRIBUTOR

YOUR BEST SINGLE SOURCE FOR ALL MICRO-MINIATURE RELAYS

 **POTTER & BRUMFIELD**

DIVISION OF AMERICAN MACHINE & FOUNDRY COMPANY • PRINCETON, INDIANA

IN CANADA: POTTER & BRUMFIELD CANADA LTD., GUELPH, ONTARIO

CIRCLE 51 ON READER-SERVICE CARD >

< CIRCLE 50 ON READER-SERVICE CARD

LAMBDA Transistorized Regulated Power Supplies

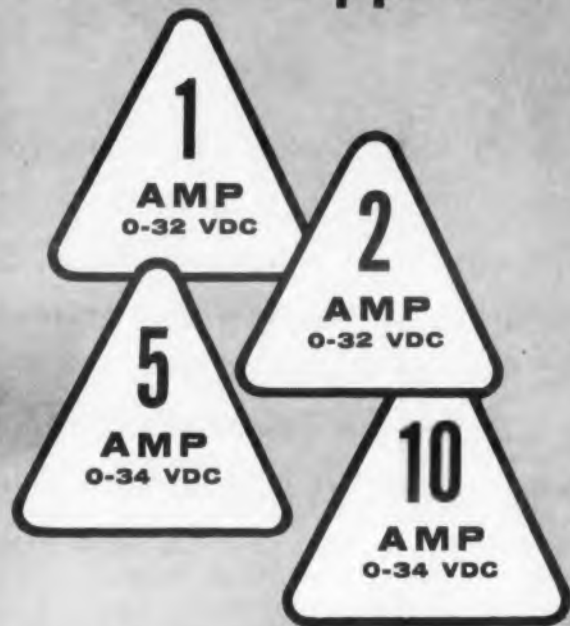

CONDENSED DATA ON LT SERIES

LT 1095M (with meters)	0-32 VDC, 0-1 AMP	\$315
LT 2095M (with meters)	0-32 VDC, 0-2 AMP	395
LT 1095 (without meters)	0-32 VDC, 0-1 AMP	285
LT 2095 (without meters)	0-32 VDC, 0-2 AMP	365

MODEL	VOLTAGE BANDS
LT 1095, LT 1095M	0-8, 8-16, 16-24, 24-32
LT 2095, LT 2095M	0-8, 8-16, 16-24, 24-32

Regulation: Line: Better than 0.15 per cent or 20 millivolts (whichever is greater). For input variations from 105-125 VAC. **Load:** Better than 0.15 per cent or 20 millivolts (whichever is greater). For load variations from 0 to full load.

AC Input: 105-125 VAC, 50-400 CPS.

Ripple and Noise: Less than 1 millivolt rms.

Ambient Temperature: 50°C—continuous duty.

Remote DC Vernier: Provision for remote operation of DC Vernier.

Remote Sensing: Provision is made for remote sensing to minimize effect of power output leads on DC regulation, output impedance and transient response.

Size:

LT 1095 3½" H x 19" W x 14⅞" D
LT 2095 3½" H x 19" W x 14⅞" D

- Convection cooled—no internal blowers to wear out.
- Guaranteed for a full 5 years.
- Compact. 1, 2, and 5 Amp only 3½" high, 10 Amp 7" high.
- Ambient temperature 50°C.
- Excess ambient thermal protection.
- Special, high purity foil, hermetically sealed long-life electrolytic capacitors.
- Hermetically sealed transformer designed to MIL-T-27A.
- Remote sensing and DC vernier.



CONDENSED DATA ON LA SERIES

LA 50-03A (with meters)	0-34 VDC, 0-5 AMP	\$425
LA100-03AM (with meters)	0-34 VDC, 0-10 AMP	540
LA 50-03A (without meters)	0-34 VDC, 0-5 AMP	395
LA100-03A (without meters)	0-34 VDC, 0-10 AMP	510

MODEL	VOLTAGE STEPS
LA 50-03A, LA 50-03AM	— 2, 4, 8, 16 and 0-4 volt vernier
LA100-03A, LA100-03AM	— 2, 4, 8, 16 and 0-4 volt vernier

Regulation: Line: Better than 0.15 per cent or 20 millivolts (whichever is greater). For input variations from 100-130 VAC. **Load:** Better than 0.15 per cent or 20 millivolts (whichever is greater). For load variations from 0 to full load.

AC Input: 100-130 VAC, 60 ± 0.3 cycle. This frequency band amply covers standard commercial power lines in the United States and Canada.

Ripple and Noise: Less than 1 millivolt rms.

Ambient Temperature: 50°C—continuous duty.

Remote DC Vernier: Provision for remote operation of DC Vernier.

Remote Sensing: Provision is made for remote sensing to minimize effect of power output leads on DC regulation, output impedance and transient response.

Size:

LA 50-03A 3½" H x 19" W x 14⅞" D
LA100-03A 7" H x 19" W x 14⅞" D

SEND TODAY FOR COMPLETE DATA.



LAMBDA ELECTRONICS CORP.

11-11 131 STREET • DEPT. 2 • COLLEGE POINT 56, N. Y. • INDEPENDENCE 1-8500

CIRCLE 52 ON READER-SERVICE CARD

NEW PRODUCTS

Low-Power Silicon Diodes

515

Rated for 150-mw dissipation



These hermetically-sealed, low-power silicon diodes are rated for 150-mw dissipation. They can be used as Zener diodes, general-purpose diodes and double-anode diodes. Applications include voltage regulation, voltage limiting in control circuits for ac-to-dc amplifiers and where surge protection is a requirement. Temperature range is from -65 to +175 C.

Controls Co. of America, Electron Div., Dept. ED, Tempe, Ariz.

Availability: From stock.

Wheatstone Bridge

588

For measuring very low resistances, this portable Wheatstone bridge can be furnished with extra terminals for inserting into the unknown arm a resistance equal to the resistance in the switches and the internal wiring of the series arm.

The Ealing Corp., Dept. ED, 33 University Road, Cambridge 38, Mass.

High Temperature Coaxial Cable

453

These high-temperature, miniature coaxial cables have extruded Teflon insulation and a fused Teflon tape jacket. The stranded conductor is silver-coated, copper-covered steel; the concentric conductor is a silver-coated copper braid.

General Electric, Chemical and Metallurgical Div., Dept. ED, Bridgeport 2, Conn.

DC Amplifier

381

Model E/DCA-10 type 100 A dc amplifier operates typical two-stage electrohydraulic servo valves. It produces a differential current in the valve torque motor coils that is proportional to the voltage applied at the input. Nominal servo valve torque-motor coil resistance is 1,000 ohms at each side. Frequency response with feedback is 0 to 1,000 cps. Dither amplitude is 0 to 3 ma, peak to peak. The unit is equipped with two power supplies.

Eastern Industries, Inc., Dept. ED, 100 Skiff St., Hamden, Conn.

Price: \$530.

Microwave Absorber

564

Operates at 800 C

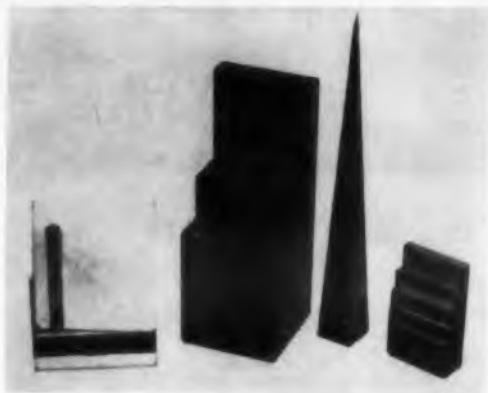

Type CMA 701 microwave absorber, a permeable dielectric, is capable of operation at 800 C. It has a dielectric constant of 50 at 20 mc, an attenuation of more than 38 db per cm at 8.2 kmc and more than 26 db per cm at 10 kmc, and a density of 4.05. The material can be machined or molded into shapes suitable for waveguide termination.

Custom Components, Inc., Dept. ED, Caldwell, N.J.

Availability: Immediate to 30 days.

Circuit Protector

433

Circuit breaker model MP1601 is manually re-closable, has visual trip indication on the reset plunger and can be calibrated to a definite ultimate trip. The snap-action thermal element is responsive to any dangerous increase in ambient temperature or current draw. It is available in ratings from 0.25 to 5 amp.

Mechanical Products, Inc., Dept. ED, Jackson, Mich.

Carbon-Deposited Resistors

576

These carbon-deposited resistors have a conformal coating called Aeroglaze that provides good performance and mechanical protection. The coating meets MIL-R-10509B. The resistors are 1/8, 1/4, 1/2, 1-, and 2-w types and are rated at 5 ohms to 50 mtg.

Hi-Q Div. of Aerovox Corp., Dept. ED, Olean, N.Y.

Thermal Wire Stripper

454

Model G thermal wire stripper features a continuously variable heat control for temperature adjustment. The unit can be hand-held or used as a bench tool. Absence of sharp cutting edges eliminates cut or nicked wires. No adjustment is needed for different wire sizes.

Western Electronic Products Co., Dept. ED, 2420 N. Lake Ave., Altadena, Calif.

Price & Availability: Price is \$69.50 fob Altadena. Available from stock.



HUGHES 2N1196 & 2N1197 DOUBLE-DIFFUSED MESA SILICON TRANSISTORS

These amplifiers can take it. Hughes 2N1196 & 2N1197 transistors were developed in conjunction with the U.S. Army Signal Corps on an IPS contract for military devices. They meet the exacting requirements of MIL-T-19500-A. ■ Among the ordeals these devices have undergone is a 5000-hour storage test at 200°C. But they re-prove their ruggedness and reliability every time. h_{fe} and leakage currents stay constant and uniform. They're guaranteed to do so. ■ All units are stabilized at 300°C during processing. ■ These PNP double-diffused mesa silicon transistors are outstanding in another way. They have an extraordinary combination of parameters. For instance: High alpha cutoff frequency, low collector shunt capacitance, low power requirements and low signal distortion, high gain at high frequency. And, as proven by the vigorous tests, for high-temperature operation these amplifiers can really take it. ■ For further information contact your nearest Hughes Semiconductor sales office or authorized distributor.

Or write Hughes Semiconductor Div., Marketing Dept., 800 Superior Ave., Newport Beach, Calif. For export, write Hughes International, Culver City, Calif.

SPECIFICATIONS @ 25°C		
ABSOLUTE MAXIMUM RATING	2N1196	2N1197 Units
$V_{CE} @ I_{CE} = -100 \mu A$	-70	-70 volts max
$V_{CE} @ I_{CE} = -100 \mu A$	-70	-70 volts max
$V_{CE} @ I_{CE} = -100 \mu A$	-4	-4 volts max
ELECTRICAL CHARACTERISTICS		
$G_v @ V_{CE} = -10V, I_C = -1mA$	28 @ 4.3Mc	22 @ 12.5Mc @ typ
$f_{\alpha} @ V_{CE} = -10V, I_C = -2mA$	45	55 Mc typ
$C_{cb} @ V_{CE} = -10V, I_C = -0.1-140Kc$	3	3 pf typ
$I_{CEO} @ -20V, T = 200°C$	-50	-50 μA max

350 mW dissipation in Free Air
Operating temperature range -65°C to +200°C



CREATING A NEW WORLD WITH ELECTRONICS
HUGHES
SEMICONDUCTOR DIVISION
HUGHES AIRCRAFT COMPANY

CIRCLE 53 ON READER-SERVICE CARD



OFF-THE-SHELF DELIVERY FROM THESE
FULLY-STOCKED TRANSITRON
INDUSTRIAL DISTRIBUTORS IN QUANTITIES
From 1-999

ARIZONA, Phoenix
Kimball Distributing Co.
1029 N. First St.
Alhambra 4-2539

CALIFORNIA, Gardena
Bell Electronic Corp.
306 East Alondra Blvd.
FACulty 1-5802

CALIFORNIA, Inglewood 1
Liberty Electronics Corp.
9817 Inglewood Ave.
OIlagon 8-7163

CALIFORNIA, Long Beach 6
Dean's Electronics
2310 Long Beach Blvd.
NEvada 6-9314

CALIFORNIA, Menlo Park
Bell Electronic Corp.
1070 O'Brien Drive
DAvenport 3-9431

CALIFORNIA, Palo Alto
Liberty Electronics Corp.
2443 Ash St.
DAvenport 1-1965

CALIFORNIA, San Diego
Western Radio & TV Supply
1415 India St.
BEImont 9-0361

CALIFORNIA, San Francisco
Fortune Electronics Corp.
1321 Mission St.
URDerhill 1-2434

CANADA, Montreal
Atlas Wholesale Radio, Inc.
4985 Buchan St.
REgent 3-7135

CANADA, Toronto Ontario
Alpha Arcon Radio Co., Ltd.
555 Wilson Ave.
Downsview Post Office
MEtrose 5-6181

COLORADO, Denver
Kimball Distributing Co.
1824 California St.
AComa 2-6208

D.C., Washington
Siberne Industrial Sales Corp.
3400 Georgia Ave., N.W.
TUckerman 2-5000

FLORIDA, Cocoa
Thurou Electronics, Inc.
540 St. Johns St.
NE 6-6331

FLORIDA, Miami
Thurou Electronics, Inc.
1800 N.W. 23rd St.
NE 5-0651

FLORIDA, Orlando
Thurou Electronics, Inc.
625 W. Central Ave.
CHerry 1-3695

FLORIDA, Tampa
Thurou Electronics, Inc.
121 So. Water St.
TAmpe 2-1885

FLORIDA, West Palm Beach
Goddard Distributors, Inc.
1309 N. Dixie
TEmple 3-5701

FLORIDA, Miami
Coddard Distributors, Inc.
4875 N.W. 37th Ave.
NEwton 4-4556

GEORGIA, Atlanta
Specialty Distributing Co., Inc.
763 Juniper St.
TRinity 3-2521

HAWAII, Honolulu
Industrial Electronics, Inc.
832 S. Queen St., P.O. Box 135
Tel 506-095

ILLINOIS, Chicago 44
Radio Distributing Co., Inc.
5144 West Madison St.
ESTebrook 9-2121

INDIANA, South Bend 24
Radio Distributing Co., Inc.
1212 High St.
ATLantic 8-4664

IOWA, Cedar Rapids
Iowa Radio Supply Co.
719 Center Point Rd., N.E.
EMpire 4-6154

KANSAS, Wichita
Radio Supply Co.
115 Laura St.
AlMherst 7-5218

MARYLAND, Baltimore 11
Kann-Ellert Electronics, Inc.
2050 Rockrose Ave.
TUredo 9-4242

MASSACHUSETTS, Boston
DeMambo Radio Supply Co., Inc.
1095 Commonwealth Ave.
ALgonquin 4-9000

MASSACHUSETTS, Worcester
DeMambo Radio Supply Co., Inc.
222 Summer St.
PLEasant 7-5626

MICHIGAN, Detroit 27
Radio Specialties Co., Inc.
12775 Lyndon St.
BRoadway 2-4200

MINNESOTA, St. Paul 1
Gopher Electronics Co.
370 Minnesota St.
CApital 4-9666

MISSOURI, Kansas City
Burslein-Appelbe Co.
1012-1014 McGee St.
BALtimore 1-1155

MISSOURI, St. Louis 16
Interstate Supply Co.
4445 Gustine St.
FLanders 1-7585

NEW HAMPSHIRE, Manchester
DeMambo Radio Supply Co., Inc.
1308 Elm St. NATIONAL 4-4006

NEW MEXICO, Albuquerque
Kimball Distributing Co.
1307 San Mateo, N.E.
AlMherst 5-0644

NEW YORK, Binghamton
Federal Electronics, Inc.
Vestal Parkway, East
Pioneer 8-8211

NEW YORK, Buffalo 3
Radio Equipment Corp.
147 E. Genesee St.
TL 6-1415

NEW YORK, Long Island City 6
M. L. Dais, Inc.
35-35 24th St. EMpire 1-1100

NEW YORK, New York 7
Harrison Radio Corp.
725 Greenwich St.
ARcley 7-7777

NEW YORK, New York 13
Milo Electronics Corp.
530 Canal St.
BEekman 3-2980

N. CAROLINA, Winston-Salem
Electronic Distributors
823 S. Marshall PARK 4-0541

OHIO, Cincinnati
Hughes-Peters, Inc.
1128 Sycamore St.
DUmbar 1-7625

OHIO, Cleveland 15
Radio & Electronic Parts Corp.
3235 Prospect Ave.
UTah 1-6060

OHIO, Dayton 2
The Stotts-Friedman Co.
108-112 N. Jefferson St.
BALdwin 4-1111

OKLAHOMA, Tulsa
Radio, Inc.
1000 S. Main St.
Gibson 7-9124

PENNSYLVANIA, Philadelphia
Radio Electric Service Co.
of Pa., Inc.
701 Arch St. WALnut 5-5840

RHODE ISLAND, Providence
DeMambo Radio Supply Co., Inc.
90 Broadway
JACkson 1-5600

TEXAS, Dallas 7
Contact Electronics, Inc.
P.O. Box 10393
2403 Farrington St.
Riverside 7-9831

TEXAS, Houston 19
Busacker Electronic
Equipment Co.
P.O. Box 13704
1216 W. Clay
JACkson 6-4661

UTAH, Salt Lake City
Kimball Distributing Co.
350 Pierpont Ave.
EMpire 3-5813

WASHINGTON, Seattle
C & B Electronic Co.
2221 3rd Ave.
MAin 4-4355

WASHINGTON, Tacoma
C & G Electronic Co.
2502 Jefferson Ave.
BRoadway 2-3181

NEW! CONTROLLED

4 TRANSITRON TYPES AUGMENT

Silicon Controlled Rectifiers / Switches



NEW! CONTROLLED SWITCHES

TSW31S - TSW201S PNP bistable switching devices in TO-18 packages, with maximum holding current of 1 ma.

- High gate sensitivity 20 μ A to fire
- Covers current range from 1 ma to 200 ma @ 75°C ambient
- Voltage ratings up to 200 volts available
- Temperature range: -65°C to +150°C

CIRCLE 811 ON READER-SERVICE CARD



NEW! TO-5 PACKAGE CONTROLLED RECTIFIERS

Two series of diffused silicon PNP bistable switching devices with very low triggering requirements and micro-second switching.

TCR251-TCR4001 series featuring:

- Low leakage: 100 μ A @ 125°C case
 - High gate sensitivity: 200 μ A @ 25°C
 - Low Holding Current: 5 mA maximum @ 25°C
 - Current rating: 1 amp at 80°C case or 600 ma at 25°C ambient
 - Voltage ratings: Up to 400 volts
- Plus 2N1595-2N1599 series with same current and voltage ratings

CIRCLE 812 ON READER-SERVICE CARD

Series	Package
TCR 550	1 $\frac{1}{2}$ hex base
TCR 520	1 $\frac{1}{2}$ hex base
TCR 510	1 $\frac{1}{2}$ hex base
TCR 505	3 $\frac{1}{2}$ hex base

Series	Package
2N1600	3 $\frac{1}{2}$ hex base
2N1595	TO-5
TCR 251	TO-5
TSW 31S	TO-18

① Maximum Holding Current Values

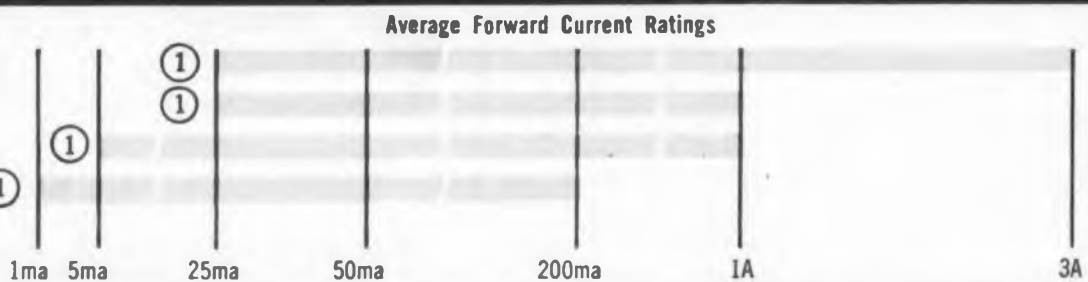
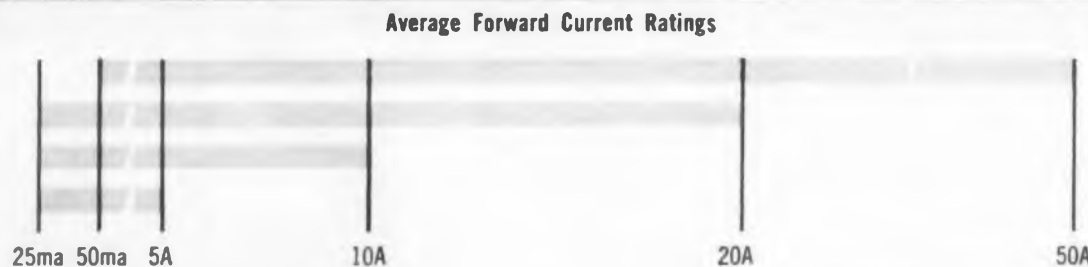

The complete Transistron line of Controlled Rectifiers and Controlled Switches includes the following higher current types:



NEW! 2N1600-2N1604 and TCR505-TCR4005 series diffused Silicon Controlled Rectifiers

- Current ratings: 3 amps at 80°C case; 1 amp @ 125°C case
- Voltage ratings: Up to 400 volts
- Package: 3 $\frac{1}{2}$ " hex base

CIRCLE 813 ON READER-SERVICE CARD



10 Amp Series 20 Amp Series

- Current ratings: 10 amps @ 25°C case; 5 amps at 100°C case
- Voltage ratings: Up to 400 volts
- Package: 1 $\frac{1}{2}$ " hex base
- Current ratings: 20 amps @ 25°C case; 10 amps at 100°C case
- Voltage ratings: Up to 400 volts
- Package: 1 $\frac{1}{2}$ " hex base

CIRCLE 814 ON READER-SERVICE CARD



NEW! 50 Amp Series

- Current ratings: 50 amps at 100°C case
- Voltage ratings: Up to 400 volts
- Package: 1 $\frac{1}{2}$ " hex base

CIRCLE 815 ON READER-SERVICE CARD

Transistron
electronic corporation

WAKEFIELD, MASSACHUSETTS

SALES OFFICES IN PRINCIPAL CITIES THROUGHOUT THE U.S.A.
AND EUROPE - CABLE ADDRESS: TRELCO

CIRCLE 810 ON READER-SERVICE CARD

RECTIFIERS & SWITCHES

INDUSTRY'S BROADEST LINE!

Binistors / Transwitches



THE BINISTOR (by-nis-tor)

Transitron's new silicon NPN Tetrode offers simpler, more reliable, more economical switching and storage circuitry. The key parameters of this bistable, negative resistance device are determined by external circuitry, providing remarkable stability and uniformity over wide temperature ranges. The signal and output swings are compatible with present transistor and diode circuits. Two series are available: The wide temperature range or military types and the commercial and industrial computer types. The stability and uniformity of each unit in the military series is absolutely guaranteed by the method of specification at critical temperatures (-65°C and +150°C).

CIRCLE 816 ON READER-SERVICE CARD
ABSOLUTE MAXIMUM RATINGS

	3N56	3N57
Collector to Emitter Voltage (V_{CE})	15 Volts	15 Volts
Collector Current @ 25°C (I_C)	30 mA	30 mA
Storage & Operating Ambient Temp. Range	-65°C to +150°C	-55°C to +100°C



THE TRANSWITCH

A PNP bistable silicon computer element that can be turned on and off with gate current. The device is available in the T0-18 package, and is designed for miniaturized memory circuits, ring counters, shift registers, controlled rectifier drivers, and flip flop equivalents. A 100 ma series (TSW-31A-TSW-201A) has been added to the Transwitch series. Both series (50mA and 100mA) are available in voltage ratings up to 200 volts. For commercial and industrial applications, the SW-30 type is now available. This unit, especially designed for lower temperature applications, features maximum collector current rating of 30mA and maximum voltage rating 30 volts.

CIRCLE 817 ON READER-SERVICE CARD
ABSOLUTE MAXIMUM RATINGS

	SW-30	TSW-31 thru TSW-201	TSW-31A thru TSW-201A
Forward current I_f	30 mA	50 mA	100 mA
Operating temp. range	-55°C to +85°C	-55°C to +125°C	-55°C to +125°C

SPECIFICATIONS (AT 25°C)

	SW-30	TSW-31 thru TSW-201	TSW-31A thru TSW-201A
Max. Saturation Voltage (V_s)	1.5 V @ 30 mA	1.5 V @ 50 mA	2 V @ 100 mA
Max. Forward "OFF" Current (I_{CGO})	10 μ A	10 μ A	10 μ A
Max. Reverse Current (I_R)	10 μ A	10 μ A	10 μ A
Max. Forward "OFF" Current (I_{CGO})	50 μ A @ 85°C	50 μ A @ 125°C	50 μ A @ 125°C
Max. Reverse Current (I_R)	50 μ A @ 85°C	50 μ A @ 125°C	50 μ A @ 125°C
Max. Gate Voltage to Switch "ON" ($V_{G ON}$)	1.0 V	1.0 V	1.0 V
Max. Gate Current to Switch "ON" ($I_{G ON}$)	1.5 mA	1.0 mA	1.0 mA
Max. Gate Voltage to Switch "OFF" ($V_{G OFF}$)	-5.0 V	-4.0 V	-6 V
Max. Gate Current to Switch "OFF" ($I_{G OFF}$)	-8.0 mA	-10 mA	-20 mA
Max. Holding Current (I_H)	10.0 mA	5.0 mA	7.0 mA

In writing for further information on all these devices, refer to the following bulletin numbers:

Controlled Rectifiers & Switches		Binistor & Transwitch	
TSW-31S series	Bulletin # TE-1356E	TSW-31A	Bulletin # TE-1357B-1
TCR-251 series	Bulletin # TE-1356D	TSW-31	Bulletin # TE-1357B
2N1595 series	Bulletin # TE-1356C	SW-30	Bulletin # TE-1357E
2N1600 series	Bulletin # TE-1356B-1	3N56	Bulletin # TE-1360A
TCR-505 series	Bulletin # TE-1356B	3N57	Bulletin # TE-1360B
10 amp series	Bulletin # TE-1356A-1		
20 amp series	Bulletin # TE-1356A		
50 amp series	Bulletin # TE-1356AA		

3N56 MILITARY TYPE SPECIFICATIONS & TYPICAL CHARACTERISTICS (At Noted Ambient Temp.)

TURN-ON	AMBIENT TEMP	MIN.	TYPICAL	MAX.	TEST CONDITIONS
D.C. Collector Saturation Voltage (V_{CE})	-65°C	—	0.46	1.0 V	$I_C = 10mA, I_b = +.5mA^*$ $V_J = 4V, R_J = 3K$ supply
	+25°C	—	0.7	1.0 V	
	+150°C	—	1.2	1.5 V	
Critical Injector Current (I_{crit})	-65°C	0	.38	.5 mA	$I_C = 10mA, I_b = -50\mu A$
	+25°C	0	.28	.5 mA	
	+150°C	0	.21	.5 mA	
	-65°C	0	1.10	1.5 mA	$I_C = 0.25mA, I_b = -50\mu A$
	+25°C	0	0.86	1.5 mA	
	+150°C	0	0.40	1.5 mA	
TURN-OFF Base Cutoff Current (I_{bo})	-65°C	—	—	—	$V_{CE} = 15$ volts, $V_{JE} = +13$ volts $V_{BE} = -.6$ volts
	+25°C	—	.020	0.2 μ A	
	+150°C	—	2.0	10.0 μ A	

3N57 COMPUTER TYPE SPECIFICATIONS & TYPICAL CHARACTERISTICS @ 25°C

TURN-ON	MIN.	TYPICAL	MAX.	TEST CONDITIONS
D.C. Collector Saturation Voltage (V_{CE})	—	0.7	1.0 V	$I_C = 10mA, I_b = +.5mA^*$ $V_J = 4V, R_J = 3K$ supply
Critical Injector Current (I_{crit})	0	.28	0.5 mA	$I_C = 10mA, I_b = -50\mu A$ $I_C = 0.25mA, I_b = -50\mu A$
	0	.86	1.5 mA	
TURN-OFF Base Cutoff Current (I_{bo})	—	.020	.2 μ A	$V_{CE} = 15$ volts, $V_{JE} = +13$ volts $V_{BE} = -.6$ volts

*Unit must switch on under the above conditions; however, actual V_{CE} measurement is made with $I_b = -50\mu A$



"Leadership in
semiconductors"

FOR TECHNICAL ASSISTANCE AND SERVICE
CONTACT THE TRANSITRON FIELD OFFICE
NEAREST YOU AS LISTED BELOW.

BALTIMORE, Maryland
2319 Maryland Ave.CHesapeake 3-3220

BOSTON, Massachusetts
168-182 Albion St.
Wakefield, Mass.CRystal 6-5640

CAMDEN, New Jersey
227 S. Sixth St.WOodlawn 6-2877

CHICAGO, Illinois
6641 W. North Av.
Oak Park, Ill.VIlIage 8-5556

CLEVELAND, Ohio
14625 Detroit Ave.
Lakewood, OhioACademy 1-9191

DALLAS, Texas
511 Braniff Airways Bldg.
Dallas 35, TexasFLeetwood 7-9448

DAYTON, Ohio
379 W. First St.BAldwin 4-9651

DENVER, Colorado
First National Bank Bldg.
621 Seventeenth St.AComa 2-1686

DETROIT, Michigan
2842 West Grand Blvd.TRinity 5-2440

KANSAS CITY, Missouri
Wirtham Bldg.
31st and Troost Sts.VAlentine 1-1819

LOS ANGELES, California
6362 Hollywood Blvd.
Hollywood 28, Calif.HOLlywood 2-2381

NEWARK, New Jersey
1060 Broad St.MArket 3-3151

ORLANDO, Florida
#10 Jacklind Bldg.
205 E. Jackson St.CHerry 1-4526

PHOENIX, Arizona
2727 North Central Ave.CRestwood 7-3366

ST. PAUL, Minnesota
Griggs-Midway Bldg.
1821 University Ave.MIddway 6-1891

SAN FRANCISCO, California
535 Middlefield Rd.
Palo Alto, Calif.DAVenport 1-2064

SEATTLE, Washington
3466 East Marginal WayMAIn 4-0783

SYRACUSE, New York
2360 James St.HOward 3-4502

WINSTON-SALEM, North Carolina
Nissen Building
310 W. Fourth St.PArk 3-0363

Transitron

electronic corporation
wakefield, melrose, boston, mass.



"Leadership in Semiconductors"

SEE YOUR AUTHORIZED DISTRIBUTOR FOR QUANTITIES FROM 1-999

Transitron

electronic corporation
wakefield, massachusetts

Sales offices in principal cities throughout the U.S.A. & Europe
cable address: Trelco

CIRCLE 818 ON READER-SERVICE CARD

◀ CIRCLE 811-817 ON READER-SERVICE CARD

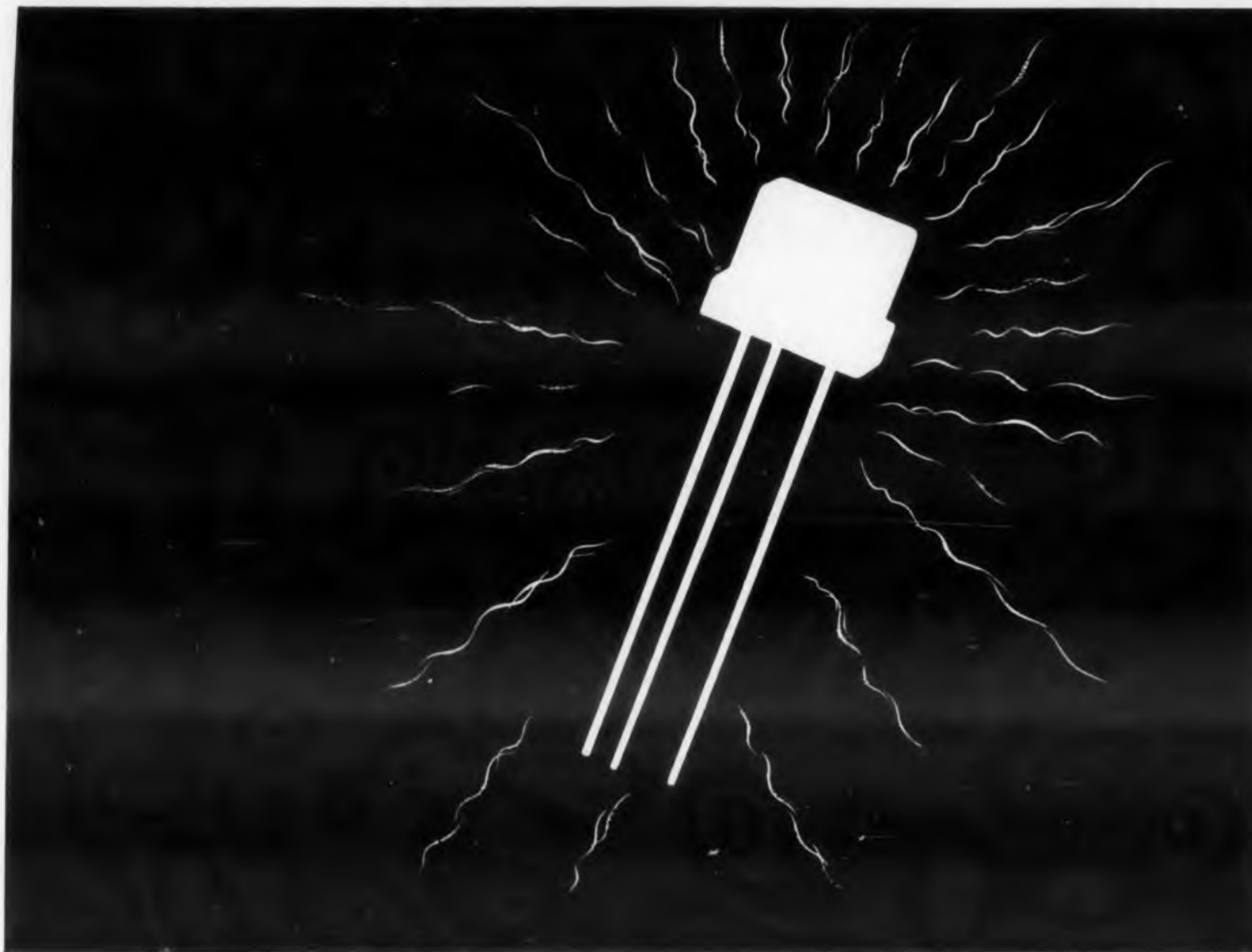

How to tame a "hot" transistor

Magnetic Materials Section reports on G-E thermistors . . . and how they may help you solve your temperature compensation problems

General Electric thermistors reduce their resistance substantially upon slight increases in temperature, making them especially suitable for temperature compensation of transistor circuits. Frequently, a thermistor or thermistor network is used in place of a base biasing resistor. Thermistors restrain transistors from running away at high temperatures, and often result in further economies.

For example, replacing an expensive uncompensated silicon transistor with a low-cost germanium transistor compensated with a thermistor permits savings of 80 per cent and more! Also, high-priced, low-temperature-coefficient resistors and capacitors may be replaced with inexpensive, high-temperature-coefficient units—

resulting in additional cost reductions. What's more, a higher gain in the circuit for given temperature variations may be achieved.

Because they are small and contain no moving parts, G-E thermistors are ideal for other temperature compensation applications, such as copper, magnetic amplifiers, and diodes. Other uses for thermistors include temperature measurement, time delay devices, voltage regulators, and current inrush suppressors.

Through new production facilities, General Electric can now design and manufacture thermistors to your specifications. For resistance values from 1 to 10,000,000 ohms, and with temperature coefficients of resistance from -1% to -5% at 25°C., there is a G-E thermistor for you. For further information, write: *Magnetic Materials Section, 7820 N. Neff Street, Edmore, Mich.*

MAGNETIC MATERIALS SECTION

GENERAL  ELECTRIC

CARBOLOY® CEMENTED CARBIDES • MAN-MADE DIAMONDS • MAGNETIC MATERIALS • THERMISTORS • THYRITE® • VACUUM-MELTED ALLOYS

CIRCLE 54 ON READER-SERVICE CARD

NEW PRODUCTS

Silicon Rectifiers

570

Handle up to 4 amp, half wave



Series 2R silicon-rectifier stacks handle up to 4 amp in half-wave and 20 amp in full-wave circuits. Having double diffused silicon-junction construction, the units are designed for magnetic-amplifier, power-supply and other medium-power applications. Forward voltage drop is 1 v max and reverse leakage is 1 v max at 25 C. Ambient temperature limit is 25 C.

Trans-Sil Corp., Dept. ED, 55 Honeck St., Englewood, N.J.

Availability: Immediate.

Index Insulator Coils

712

These index insulator coils have bobbin material thicknesses of 0.005 in. with index insulators. Mylar or Teflon can be used as bobbin material. Temperature range is -320 to +1,000 F.

Tur-Bo Jet Products Co., Inc., Dept ED., 424 S. San Gabriel Blvd., San Gabriel, Calif.

Connector

385

This rack-and-panel connector has aluminum die cast shells, cadmium plating and single-screw type engagement. Contacts handle up to 40 amp; contact arrangements are up to 156, 10-amp contacts.

Spec Electronics, Dept. ED, 10514 W. Pico Blvd., Los Angeles 64, Calif.

Price & Availability: In quantities of 1 to 9, \$45 ea; 10 to 49, \$39.30 ea. Delivery is 7 days after order received.

Transformer

377

Type 1210-C covers 20 kc to 10 mc. Impedance is 75 ohms, unbalanced, to 600 ohms, balanced. The unit handles 1 w. Uses include antenna matching, computer drive circuits, impedance matching.

North Hills Electronics, Inc., Dept. ED, Glen Cove, L.I., N.Y.

Price: \$14.95 to \$7.95 depending on quality.

Thermostat

444

Mounted in stainless steel well



Type SX339 Tempswitch is mounted in a stainless steel well for liquid immersion. The switch can be removed from the well without disturbing the fluid. Hermetically sealed, the unit meets MIL 5272A. It can be used in airborne and industrial applications.

Scaico Controls, Inc., Dept. ED, 210 Taylor St., Riverside, N.J.

Digital Logic Trainer

636

For digital circuit training

Model TDC digital logic trainer is for training in digital-circuit operation, logic design breadboarding and testing digital circuits. It demonstrates basic circuit operation and effects of loading and timing on circuit and network performance. The front panel has 50 pre-wired S100 digital circuits and logic symbols for each, clearly identifying input-output connections and their function. All connections can be made on a large patch-board front panel having pin jack jumpers.

Epsco, Inc., Components Div., Dept. ED, 275 Massachusetts Ave., Cambridge 39, Mass.

Price: With power supply, \$2,175 ea; without supply, \$1,795 ea.

Availability: From stock by Dec. 15, 1960.

Induction Motor

484

Drives an axial vane blower



Model DE-20-6 induction motor drives an axial vane blower and can be used in other military and commercial applications. Specifications include: horsepower, 3.4 hp; voltage, 200 v, 400 cps, 3-phase; speed, 11,500 rpm; weight, 9 lb, 6 oz. The motor is a continuous-duty unit.

General Precision Inc., Kearfott Div., Dept. ED, 1150 McBride Ave., Little Falls, N.J.

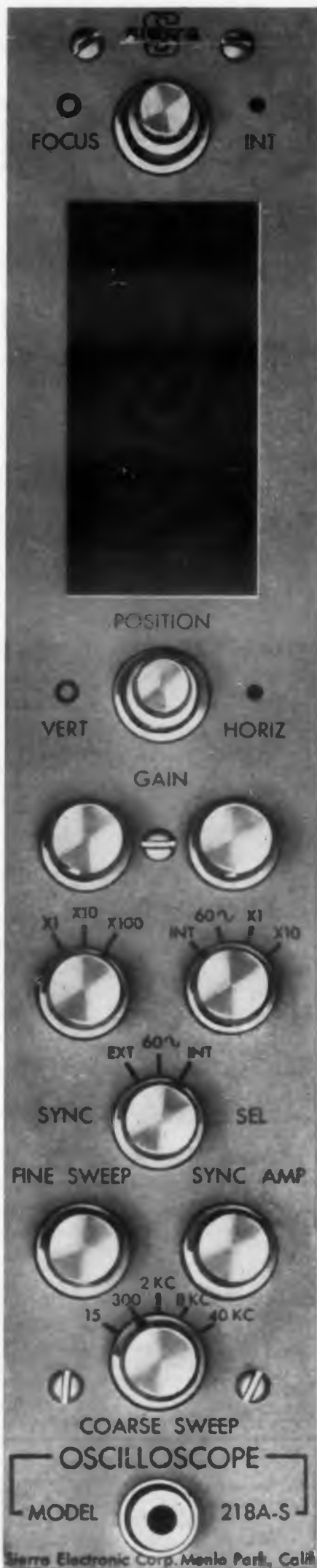

SIERRA MONITOR OSCILLOSCOPES



View up to
7 circuits simultaneously!

Sierra Model 218 Monitor Oscilloscopes provide, in the smallest possible package, a convenient and practical means for viewing and evaluating complex voltages. Up to seven oscilloscopes can be mounted side by side in a standard relay rack—units measure only 10½" high x 2½" wide (front panel). Thus seven circuits can be monitored simultaneously.

Designed primarily for tape recording and data handling systems, the Monitor Oscilloscopes are particularly suited for measuring and analyzing mechanical quantities through a transducer. Such quantities include stress, strain and vibration, pressure, displacement and acceleration.

Unusual design features include printed circuitry, broad bandwidth, smooth high frequency rolloff without overshoot and minimum heating (only 20 watts dissipation per scope unit, including filaments!) Request bulletin and demonstration.

sierra

SIERRA ELECTRONIC CORPORATION

A Subsidiary of Philco Corporation

5444A Bohannon Drive • Davenport 6-2060 • Menlo Park, California, U.S.A.

Sales representatives in all major cities

Canada: Atlas Instrument Corporation, Ltd., Toronto, Montreal, Vancouver, Winnipeg

Export: Frazer & Hansen, Ltd., San Francisco

CIRCLE 55 ON READER-SERVICE CARD

NEW PRODUCTS

Miniature Stepping Relay

Is rated at 3 amp, resistive

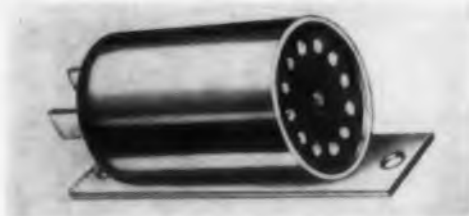

The Rotomite stepping relay has a contact rating of 3 amp, resistive, and 1 amp, inductive. It operates on continuous duty from 3 to 230 v dc with continuous rotation up to 30 steps per sec. Test life is over 1,000,000 operations. The unit measures 2-in. long and 1-3/16 in. in diameter. It weighs about 4 oz. Applications include computer circuits, automated devices and counting operations.

Guardian Electric Manufacturing Co., Dept. ED, 1550 W. Carroll Ave., Chicago 7, Ill.

Servo-Valve Monitoring System 701

Consists of three pressure transducers

Model 1000-7 monitoring system consists of a 3000-psi differential transducer, a 3000-psig transducer and a 300-psig transducer. Some specifications are: non-linearity and hysteresis combined, less than 0.25% of full scale; thermal zero and sensitivity drift, each less than 0.015% of full scale per deg F from -65 to +275 F; combined errors from all sources, less than 0.5% of full scale. A calibrating resistor of $40 K \pm 0.05$ ohm causes an electrical output within $\pm 0.25\%$ of half the full scale output.

Standard Controls, Inc., Dept. ED, 1130 Poplar Pl., Seattle 44, Wash.

Price: \$600 to \$1000, determined by specs.

Availability: 4 to 6 weeks.

Modular Cabinet Racks 504

For grouped arrangements

Designed for grouped arrangements, these panel racks are furnished with open side walls and detachable side panels. Type PL provides a rear door and type FL provides both front and rear doors. They come in these sizes: heights, 48-1/8, 67-3/8, 76-1/8 and 83-1/8 in.; depths, 18 and 24 in.; panel widths of 19 in. for units 18 and 24 in. deep; 24- and 30-in. panels for 24-in. racks.

Par-Metal Products Corp., Dept. ED, 32-62-49th St., Long Island City 3, N.Y.

Price: \$92 to \$274.

Availability: From stock.

SILICONE NEWS from Dow Corning

Engineer for Value



New Dielectric Gel Assures Protection Plus Easy Repairs

If value engineering is important to you, so is Dielectric Gel. This new "see-through" potting material offers all the advantages of other materials plus visual inspection and instrument testing . . . plus easy repair . . . plus fool-proof repotting.

A water white, medium viscosity liquid, Dielectric Gel readily surrounds components. It cures in place, forming a resilient mass with outstanding dielectric properties, good thermal stability and moisture resistance. No significant stresses are developed during or after cure. Serviceable from -60 to 200 C. Dielectric Gel protects potted components and circuits from

shock and vibration, other environmental extremes . . . is excellent for filling and impregnating capacitors, magnetic amplifiers, similar components and devices.

Circuits and components potted in Dielectric Gel can be checked both visually and by instrument. When probes are removed, Dielectric Gel heals itself. To replace a defective part you simply cut away the Dielectric Gel with a knife or scissors, replace the defective component and pour fresh Gel around the part. Result: Original high quality protection!

CIRCLE 800 ON READER SERVICE CARD

For 12-page manual, "Silicones for the Electronic Engineer", Write Dept. 3312.



Dow Corning

...Specify Silicones

No Heat-loosened Terminals Here

Repeated soldering does not loosen terminals mounted on silicone-glass laminate made with Dow Corning resins. Lightweight and rugged, silicone-glass laminates provide greater strength at elevated temperatures than many metals . . . keep their excellent dielectric properties despite storage, environmental aging, rapidly changing ambients, vibratory shock and high humidity. These are the reasons why Lear, Inc., Grand Rapids, Michigan selected silicone-glass laminate for the capacitor mounting board in their Stable Platform Model 2013J.



CIRCLE 801 ON READER SERVICE CARD

Easy Way to Repair Encapsulations

It's easy to replace defective parts encapsulated in Silastic® RTV, the fluid silicone rubber that cures without heat. First, you cut a slit in the Silastic RTV jacket; second, replace the component; third, patch the cut by pouring fresh Silastic RTV over the repair . . . there's no measurable loss in dielectric properties or physical strength. Encapsulation with Silastic RTV offers these advantages, too: resistance to moisture, fungus, corrosive atmospheres, corona and ozone, excellent dielectric properties, good heat dissipation and an operating temperature range of -60 to 250 C. Silastic RTV assures top value protection.



CIRCLE 802 ON READER SERVICE CARD

Heat-sink Sealant Ups Performance

When transistors and diodes are mounted with Dow Corning compound as the heat-sink sealant, heat dissipation improves up to 50%. That's because this grease-like silicone compound doesn't dry out, harden, melt or lose its initial properties from -70 to 200 C . . . even after long time exposure. Dow Corning silicone compound has excellent thermal conductivity and increases the heat transfer between diode-and-washer and washer-and-chassis . . . improves device performance. Applied to lead terminals and connector pins after soldering, Dow Corning compound protects against corrosion, corona and shorts.



CIRCLE 803 ON READER SERVICE CARD

DOW CORNING CORPORATION MIDLAND, MICHIGAN

branches: ATLANTA BOSTON CHICAGO CLEVELAND DALLAS LOS ANGELES NEW YORK WASHINGTON, D.C.
CIRCLE 800, 801, 802, 803 ON READER-SERVICE CARD

ELECTRONIC DESIGN • December 21, 1960

VHF Channel Preamp

441

Gain is 16 db

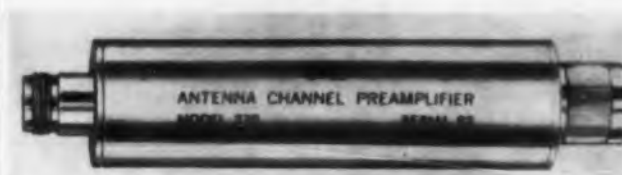

This TV and telemetering channel preamplifier is for use in the vhf spectrum. Having a flat response across 6 mc, the unit provides 16-db gain and has a noise figure of 9 db or less. It is packaged in a weatherproof cylinder. Over-all dimensions are 1-1/4 in. OD and length with connectors, 5-3/4 in. Total weight is 10 oz. Designated model 270, the unit comes equipped for all standard TV channels.

Spencer-Kennedy Laboratories, Inc., Dept. ED, 1320 Soldiers Field Road, Boston, Mass.
Availability: From stock.

Synthetic Mica Paper

613

Melting temperature is 1,365 C

Synthamica 202, synthetic mica paper, has a melting temperature of 1,365 C and an operating temperature up to 1,000 C. It is for use in high-temperature transformers, motors and capacitors. Dielectric constant is 3 to 4; dielectric strength is 600 to 1,000 v per mil. Dissipation factor is 0.0005 to 0.0020; volume resistivity is 5×10^{15} ohm per cm at room temperature. A tensile strength of 5,000 to 10,000 psi permits use as material for components for computers, radar and missile-guidance systems. The paper is available in continuous strips of 3-in. widths or sheets up to 6 in. in diam with a thickness range of 0.002 to 0.007 in.

Mycalex Corp. of America, Synthetic Mica Co. Div., Dept. ED, 20 Passaic Ave., Caldwell Township, N.J.

Price: Discs, \$3.50 ea; 3-in widths, \$21 for first 5 ft.

Availability: 14 to 21 days.

DC Gaussmeter

510

Measures flux densities to 30,000 gauss

Model D-874 gaussmeter measures flux densities up to 30,000 gauss with an accuracy of $\pm 3.5\%$. Five ranges are provided: 0 to 300, 0 to 1,000, 0 to 3,000, 0 to 10,000 and 0 to 30,000 gauss. The unit is equipped with a probe 0.025 in. thick and 0.2 in. wide. The active area is 0.0079 sq in. at the tip of the probe.

Dyan-Empire, Inc., Dept. ED, 1075 Stewart Ave., Garden City, N.Y.

Price: \$195.

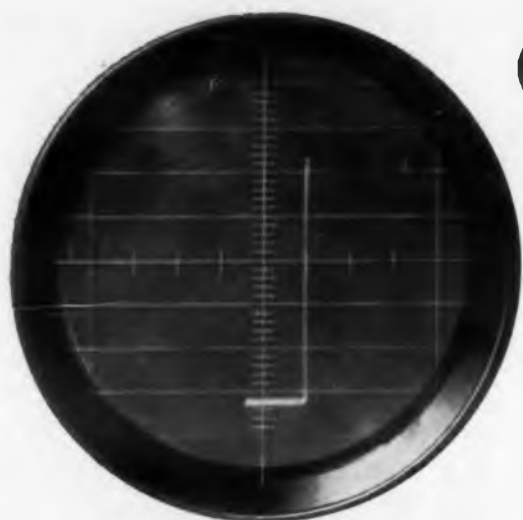

(before)

Reverse leakage tracing before immersion in H_2O_2 .

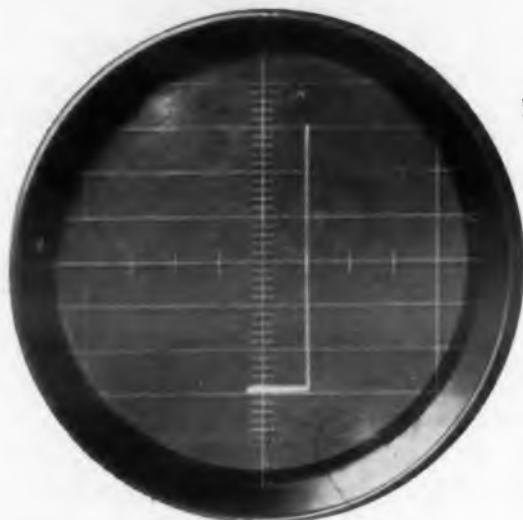

(after)

Reverse leakage tracing after immersion in H_2O_2 , dried without washing (virtually no change).

Here's proof !

No increase in reverse leakage when you etch diodes in

BECCO Hydrogen Peroxide!

To test the effect of impurity-free Becco Hydrogen Peroxide across an unsealed diffused silicon junction diode, the following "torure test" was performed: 600 volts AC were applied across the diode, and the reverse leakage current depicted on an oscillograph. Then, the diode was immersed in Becco 30% Reagent Grade Hydrogen Peroxide. The diode, without being washed in any way, was placed on a hot plate and the H_2O_2 was evaporated.

The voltage was re-applied and the tracing produced was virtually identical (see above)—proof that no impurities that could affect the diode exist in Becco Hydrogen Peroxide.

Of course, you'll use Becco H_2O_2 at a different stage—when you etch the diode. And, of course, good practice still dictates that you wash the diode in pure water following the etch. Nevertheless, this test proves that you need not be too concerned with your wash when you etch in Becco H_2O_2 , since the peroxide itself, made by an inorganic method, can not deposit any impurities of its own on the diode.

Becco packages its Reagent Grade H_2O_2 in returnable or non-returnable polyethylene containers to insure its purity when it arrives at your plant. Write us for further information or specifications, analysis, prices, etc. Address: Dept. ED-6.



BECCO[®]

BECCO CHEMICAL DIVISION
Food Machinery and Chemical Corporation
161 EAST 42nd STREET, NEW YORK 17, N. Y.
CIRCLE 56 ON READER-SERVICE CARD



NEW PRODUCTS

Electronic Integrator

442

Provides analog record of test data



Model PX590 or PX591 electronic integrator can be used for quantitative analysis of missile thrust curves, gas chromatograms, flow and power totalizing, spectroscopic-spectrographic analysis, illumination testing and other applications. The integrator-recorder hookup has an accuracy of 0.25% of full scale of readout. A manual-reset switch is used. The gain selector provides 10 steps, accurate to 0.1% over a 1,000:1 range.

Schlumberger Well Surveying Corp., Ridgefield Instrument Group, Dept. ED, Ridgefield, Conn.

Price: \$450 for basic unit.

Wire-Spring Relay

507

Transfers up to 51 circuits

Series WQA wire-spring relay is designed to transfer up to 51 circuits for 100,000,000 or more operations without readjustment. It is claimed to be the first unit of its kind to handle this many circuits at the same time. It is available in one, two or three levels of contact assemblies with up to 17 form C combinations each. Contacts are of palladium silver. Insulation resistance is 1,500 meg at 80 F.

Automatic Electric Laboratories, General Telephone & Electronics, Dept. ED, Northlake, Ill.
Price: About \$50.

Phenolic Laminate

508

Insulation resistance is 140,000 meg

Known as NEMA FR-2, this phenolic laminate has an insulation resistance of 140,000 meg in humid atmospheres. Dielectric strength is 90 kv per in. and impact strength is 0.5 ft-lb per in. It is designed to have outstanding self-extinguishing properties; flame-out is in less than 5 sec. Applications include computers, TV circuits and radio circuits.

General Electric Co., Laminated Products Dept., Dept. ED, Schenectady 5, N.Y.

Availability: Three weeks.

Vacuum-Tube Voltmeter

445

For ac use



This voltmeter meets applicable requirements of MIL-T-945A and environmental specifications of MIL-E-5272. Standard scales are: 0 to 10 mv, 0 to 30 mv, 0 to 100 mv, 0 to 300 mv, 0 to 1 v, 0 to 3 v, 0 to 10 v, 0 to 100 v and 0 to 300 v. Input impedance is 1 meg, frequency range is 20 cps to 50 kc and over-all length is 4-12/16 in. Two diameters are available in the meter movements, 3.5 and 4.5 in.

Jupiter Electronics, Inc., Reliability Controls, Inc., Dept. ED, 277 E. 144th St., New York 51, N.Y.

Chart Recorder

472

Has electric pen-lift mechanism



Model HR-93 X-Y chart recorder has an electric pen-lift mechanism that permits point plotting, family curve-tracing and rapid, non-recording pen indexing. It can be operated manually or automatically. Amplifiers are interchangeable and available in 10 mv per in. and 1 mv per in. sensitivity for either or both axes. Each axis contains its own power supply, attenuator and zero control and is independent both mechanically and electrically of the other. Accuracy is 0.5% with 7-1/2 in. per sec pen speed on both axes.

Houston Instrument Corp., P.O. Box 22234, Houston, Tex.

Price: \$670 to \$770 ea.

Availability: From stock.

Thermostat Anticipator

443

For use with heating elements



This thermostat anticipator was developed for use on the firm's high-watt-density heating elements. It is enveloped by the heating element itself; this virtually eliminates the time lag. The thermostat operates at the same temperature as the heating element during the transient.

Electrofilm, Inc., Dept. ED, 7116 Laurel Canyon Blvd., North Hollywood, Calif.

Availability: Made to customer specs.

Sheetmetal Nut

656

Type P-37 P-Nut, a press-in unit, is used for obtaining load bearing threads in thick or thin ductile sheetmetal for bolt and screw fastenings. The base provides a liquid tight seal between the nut and the walls of the drilled hole. Tensile strength exceeds that of a 200,000-psi bolt.

Hi-Shear Rivet Tool Co., Dept. ED, 2600 W. 247 St., Torrance, Calif.

Frequency Sensor

419

This 400-cps frequency sensor provides accurate and reliable frequency protection and indication. Accurate to $\pm 1\%$, this unit offers either a 2 or 5-amp dpdt output. Adjustable by 70 cps in both over and under trip points, the sensor uses a stable, magnetic frequency-to-voltage converter as the sensing element.

Crydom Laboratories, Inc., Dept. ED, 12850 Western Ave., Garden Grove, Calif.

Price and Availability: From stock; priced from \$151 to \$254 ea when ordered in quantities of 10.

Trimming Potentiometers

426

The TVR-150 series of trimming potentiometers is designed for printed circuit applications. They are available in two basic lead configurations for mounting convenience, and in 14 standard resistance ranges from 10 ohms to 100 K, with a basic power rating of 1 w.

Wells Industries Corp., Basic Electronic Controls Div., Dept. ED, 6880 Troost Ave., North Hollywood, Calif.



Librascope Shaft-to-Digital Encoders are highly accurate, reliable, shock-resistant, and versatile... ready to serve in a variety of applications including missiles, aircraft, machine control, computers, Doppler navigation and data processing. Accuracy that counts is the by-word of a Librascope Encoder... backed by the superior technology and reputation of one of the world's largest producers of Computers that Pace Man's Expanding Mind.

new noncontact magnetic encoder

MODEL NO. 807

FEATURES:

Long life, high reliability, high speed, natural binary V-Scan readout.

SPECIFICATIONS:

Output Code: natural binary
Resolution: (per input shaft turn) 128 counts
Full Scale Capacity: 7 bits*
Speed: operating from 0 to 10,000 rpm
Life Expectancy: 20,000 hours at 4,000 rpm; 4×10^9 revolutions
Starting Torque: 0.1 in.-oz. max.
Diameter: 2"
Length: 1 13/16"
Weight: 5 ounces

*ALSO AVAILABLE IN 13, 17, AND 19 BIT CAPACITIES.

NEW CATALOG AVAILABLE write today for your copy



new subminiature size 8 encoder

MODEL NOS. 787 & 793

FEATURES:

Low torque, low inertia, long life, high reliability, withstands severe environments.

SPECIFICATIONS:

Output Code: natural binary
Resolution: (per input shaft turn) 128 counts
Full Scale Capacity: 7 bits, 13 bits
Speed: operating 200 rpm, slew 600 rpm
Life Expectancy: 2×10^9 revolutions at 200 rpm
Starting Torque: 0.5 oz.-in. maximum
Diameter: .750"
Weight: 3 ounces

other popular Librascope encoders

Code	Model no.	Full scale capacity	Resolution per input shaft turn
Binary	773	13 bits	128 counts
	0-773	oil-filled unit for increased life	
Binary	710	10 bits	1024 counts
	707 (707D*)	7 bits	128 "
	713 (713D*)	13 bits	128 "
	717 (717D*)	17 bits	128 "
	719 (719D*)	19 bits	128 "
	0-713	oil-filled unit for increased life	
Self-Decoding Binary	740	10 bits	1024 counts
	723 (723D*)	2,000 counts	200 "
B/C/D	724 (724D*)	20,000 "	200 "
	733 (733D*)	3,600 "	200 "
	734 (734D*)	36,000 "	200 "
	735	360,000 "	200 "
Sine/Cosine	757-S**	4 quadrants per turn	7 bits per quadrant + limit 1
	758	4 quadrants per turn	8 bits per quadrant + limit 1
	758-S**	4 quadrants per turn	8 bits per quadrant + limit 1
Gray	708	8 bits	256 counts

*Contain isolation diodes for multiplexing

**Servo driven, hermetically sealed

BURBANK BRANCH
LIBRASCOPE DIVISION
GENERAL PRECISION, INC.
100 East Tujunga • Burbank, Calif.



For career opportunities, write John Schmidt Engineering Employment

CIRCLE 57 ON READER-SERVICE CARD

NEW PRODUCTS

Voltage-Controlled Crystal Oscillator 420

Has crystal stability over a 10-kc to 30-mc range



Model 10M-VX voltage-controlled crystal oscillator has crystal stability over the 10-kc to 30-mc frequency range. Specifications are: input voltage, ± 5 v dc; input impedance, greater than 100 K; linearity, $\pm 1\%$ of maximum deviation for narrow-band units and $\pm 2\%$ for wide-band units; output power, 1 to 10 mw into 100-ohm load. Applications include use in narrow-band telemetry, frequency tracking loops, and fm modulation techniques to eliminate multiple-conversions in transmitters.

Hermes Electronics Co., Dept. ED, 75 Cambridge Parkway, Cambridge 42, Mass.

Digital Voltmeters 661

Accuracies to 0.01%

Type V3 digital voltmeter has a display of three digits plus sign and an accuracy of 0.1% or 1 digit. Model V4 has a display of four digits plus sign and an accuracy of 0.01% or 1 digit. Model V3R digital volt ohmmeter has a display of three digits plus sign and an accuracy of 0.1% or 1 digit. All models have ranges of 10, 100 and 1,000 v dc, an input impedance of 10 meg and edge-lighted digital indicators. Other features are: automatic ranging and polarity, ac-dc conversion accuracy of 0.1% or 2 mv, punched paper tape and/or printed output and dc amplifier for low-level measurements.

Electro-Logic Corp., Dept. ED, 515 Boccaccio Ave., Venice, Calif.
Price: Model V3, \$995; model V4, \$1,295; model V3R, \$1,800.
Availability: 60 to 90 days.

PRINCETON ELECTRONICS

Announces!



THE FIRST SILICON DIODE WITH COMPUTER-PREDICTED RELIABILITY

YOU CAN'T ARGUE WITH COMPUTER LOGIC . . .

Computer processes applied to production and performance analysis by Princeton Electronics Corporation are establishing new standards of reliability in silicon diodes. PEC, manufacturers of silicon diodes for computers and other demanding applications, have developed the use of computer logic as a guide to production control and product quality.

The life history of every diode is computer recorded and available for analysis and evaluation — a major step forward in the over-all effort towards complete reliability in electronic systems.

Every design engineer understands the need for extreme reliability in electronic components, particularly for complex systems. No engineer could deny the advantages of this newest, most exacting method of manufacture, testing and evaluating potential performance.

Write today for complete information on the silicon diode with computer-predicted performance.

logically best

Electronics

P.O. BOX 127, PRINCETON, NEW JERSEY

Dynamic Test Set 412

Tests four rectifiers simultaneously



Model 164 200-amp dynamic test set simultaneously evaluates the characteristics of four silicon rectifiers in a full-wave circuit. Test capacity is four rectifiers in the 5- to 200-amp dc range, average forward current. Peak reverse voltage is adjustable between 0 to 1,500 v. Input is 208, 220 or 440 v, 60 cps. 32 kva, single phase.

Wallson Associates, Inc., Dept. ED, 912 Westfield Ave., Elizabeth, N.J.

Price: \$11,525 fob Elizabeth.

Availability: 8 to 10 weeks.

Germanium Tunnel Diodes 644

Have peak currents of 250 μ a to 250 ma

Developed for use in fm radio, uhf and vhf TV-broadcasting and receiving systems, these diodes operate at peak currents from 250 μ a to 250 ma. The units are housed in the standard TO-5 package.

U. S. Transistor Corp., Dept. ED, Syosset, L.I.

Availability: Sample units, by December 1st; production quantities, by about March 1st.

Tube Spacers 650

Are made of glass-ceramic

These tube spacers are made of Fotoceram glass-ceramic, a material which resists vibration and can be adapted to odd shapes and patterns. It can be used in various thicknesses. Tube spacers made so far have a tolerance of ± 0.0015 in.

Corning Glass Works, Dept. ED, Corning, N.Y.

Availability: Made to customer requirements.

◀ CIRCLE 58 ON READER-SERVICE CARD

Lavoie ROBOTESTER

FROM THE GROUND **up**



The Robotester's Failure Isolation capability puts it on the front line in the battle for absolute reliability. Up to 100 circuit tests per minute can be made with the basic unit. Robotester provides split second recognition, isolation and identification of abnormal functions between any two of 250 circuit points by high speed sampling and comparison. Automatic operation stops when out-of-tolerance value is met, and digital read-out identifies the isolated, faulty circuit.

Accuracy and high speed, with fast set-up and changeover, are the essence of Robotester. Tape-programmed acceptance standards guarantee versatility and flexibility. Robotester accessories extend test capabilities to meet complex problem configurations.

Measures: Resistance, Insulation Resistance
Voltages AC & DC
Impedance

Write for complete technical information and applications booklet.

Lavoie Laboratories, Inc.
MORGANVILLE, NEW JERSEY

NEW PRODUCTS

Multiconductor Cable 418

Cable is 0.012-in. thick



This multiconductor cable, called Contour Cable, is 0.012-in. thick. Connecting devices are supplied with the cable. Etched and continuous cable meets military performance specs for all types of harnesses and temperatures from -65 to $+250$ C. Rolls of unshielded, electrostatically or magnetically-shielded cable are available in widths up to 5-1/2 in. in conductor sizes from 20 to 28 gage. Up to 54 conductors per in. can be assembled in a single cable for micro-miniaturization application.

Hughes Aircraft Co., Industrial Systems Div., Dept. ED, International Airport Station, P.O. Box 90904, Los Angeles 45, Calif.

Standard-Frequency 646 Receiver

For reception of WWVL and NBA

Model LF-18-20 receiver is for the reception of standard-frequency stations WWVL and NBA on 20 and 18 kc. The unit provides frequency calibration of any secondary frequency standard having outputs of 100 kc or 1 mc. With the self-contained strip recorder, the frequency of a local standard may be adjusted to within a few parts in 10^{10} of absolute frequency. Standard output frequencies of 100, 20, 18, 10 and 2 kc are provided for auxiliary applications. A signal output of 2 kc is also provided for oscillographic comparison with the 2-kc output derived from the local standard.

RMS Engineering, Inc., Dept. ED, P. O. Box 6354, Station H, Atlanta 8, Ga.

Price: \$1,255 for rack mounting unit; \$1,300 for unit in cabinet.

Availability: Six to eight weeks.

◀ CIRCLE 59 ON READER-SERVICE CARD

Voltage-To-Digital Converter 436

Transistorized unit of modular design



This precision multiplex converter is a transistorized unit of modular design. Specifications include: input capacity, 1 to 100 channels; input voltage, 0 to ± 10 v; conversion speed, 5 μ sec per bit, 60 μ sec per channel; conversion rate, 16,667 channels per sec; precision, 0.048%. The unit measures 19 x 6-31/32 x 27 in. and weighs 40 lb plus 2 oz per channel.

General Precision Inc., Link Div., Dept. ED, Binghamton, N.Y.

Indicating Memory Switch 421

Switches 90 v at 10 ma, dc



This miniature, indicating memory switch will switch 90 v at 10 ma, dc. Available in various current and voltage ratings and several package styles, the unit plugs into a standard 9-pin oval socket. A 4-v negative pulse turns it on and a 4-v positive pulse turns it off. The unit can be used in information transfer circuits, logic circuits, test equipment, remote circuit, low-power control circuitry or as low-power circuit breaker.

United Engineers, Inc., Dept. ED, 824 E. Sixth St., Tulsa, Okla.

CIRCLE 60 ON READER-SERVICE CARD

here's why Amperex[®]

VHF P·A·D·T High-Gain Transistors ARE BETTER... for AM/FM, mobile communications, car radio, and instrumentation!

1 Maximum Uniformity and Interchangeability

By combining the best qualities of both the alloy and the diffusion approaches to transistor construction — and by means of special "self-jigging" techniques — the Amperex Post Alloy Diffusion Process achieves maximum yield and uniformity, virtually eliminating the need for "selection". From drawing-board to final quality control checkpoint, the PADT process rigidly maintains the specifications of each transistor you require, not only to provide hitherto unattainable uniformity, but also maximum interchangeability with competitive types — plus...

2 High Beta

The revolutionary PADT process provides a guaranteed *minimum* beta of 40... an average of 150... with resultant high power gain! Therefore, PADT transistors can now guarantee...

3 Maximum Design Freedom for Engineers

The unprecedented characteristics of PADT transistors provide easier temperature stabilization, lower bias circuit loss, higher dissipation reserve, superior K factor, high alpha cut-off frequencies and safe, extremely conservative collector voltage ratings.

7 NEW P·A·D·T PNP TYPES specifically designed for specific applications — and now in mass production at the new Amperex semiconductor plant in Slatersville, Rhode Island

APPLICATION	TYPE NO.	FUNCTION	FEATURES
CAR RADIO	PADT-23	RF amplifier in 6 or 12 volt car radio applications from .5 to 1.5 mc, or in portable broadcast receivers.	Low leakage and high current gain minimizes AGC current requirements. Improved noise figure. High base-to-emitter voltage rating minimizes danger of breakdown.
	PADT-24	IF amplifier (455 or 262.5 kc), or in mobile communication receivers; at 6 or 12 volts.	Low collector-to-base capacitance; plus extremely small collector cut-off current. Minimum Beta of 40 to facilitate the design of AGC circuits.
	PADT-27	Mixer, oscillator or converter, 455 or 262.5 kc; at 6 or 12 volts.	Low mixer noise averaging only 3 db at 1 mc. Low leakage, less than 50 μ a at 60°C.
MOBILE COMMUNICATIONS	PADT-25	High frequency IF amplifier in mobile communication and airborne receivers.	Unusually high output resistance for improved receiver selectivity. Less than 50 μ a leakage at 60°C improves AGC operation.
	PADT-26	RF or IF amplifier, or mixer, in receivers operating up to 100 mc.	Typical power gain greater than 14 db at 100 mc, with a noise figure less than 9 db. High base-to-emitter breakdown voltage for extreme safety.
	PADT-28	RF amplifier for service in the 175 mc region.	Typical gain of 14 db at 200 mc. Noise figure, 5.8 db. Maximum frequency of oscillation, 700 mc. Extremely low base resistance.
	PADT-31	Mixer, oscillator, or frequency multiplier at frequencies up to 60 mc.	High output resistance (30,000 ohms typical at 10.7 mc). Power gain — more than 14 db at 60 mc. Conversion gain 20 db min. at 27 mc.

In stock at the following Amperex distributors and others:

ADLETA COMPANY
DALLAS 1, TEXAS
FORT WORTH, TEXAS

MIL0 ELECTRONICS
NEW YORK, N. Y.

BRILL SEMICONDUCTOR CORP.
OAKLAND 6, CALIF.

NEWARK ELECTRONICS CORP.
CHICAGO, ILL.

ELMAR ELECTRONICS INC.
OAKLAND 7, CALIF.

RADIO SHACK CORP.
BOSTON, MASS.
STAMFORD, CONN.
W. HARTFORD, CONN.
NEW HAVEN 10, CONN.

INTERSTATE RADIO & SUPPLY
DENVER 4, COLORADO

R. V. WEATHERFORD COMPANY
GLENDALE 1, CALIF.

ask **Amperex**

for detailed data and applications assistance (including complete circuits designed to your specifications)



AMPEREX ELECTRONIC CORPORATION

230 DUFFY AVENUE, HICKSVILLE, L. I., NEW YORK

In Canada: Rogers Electronic Tubes & Components, 116 Vanderhoof Ave., Toronto 17, Ont.

P·A·D·T TRANSISTORS 'COMPARISON-TESTED' WITH COMPETITIVE CAR RADIO BRANDS

Stage	Parameter	Amperex PADT Transistor	Brand X	Brand Y
ALL	$f_{osc}(mc)$	70 typ	42 typ	Approx 12.8 min ⁽¹⁾
	$h_{fe}(f=1 kc)$	40 min 150 typ	80 typ	RF 20-80 CONV 20-200 IF 20-100
	$f_{max}(mc)$ $P_c(mw \text{ at } 45^\circ C)$ $I_{cbo}(25^\circ C)$	202 ⁽²⁾ typ 67 8 μ a max 1.5 μ a typ	60 ⁽³⁾ 7 typ	90 min 30 10 max
RF	Maximum Available Power Gain 1.0 mc	47.5 db ⁽⁴⁾	47.5	—
IF	Maximum Available Power Gain 455 kc	60.6 db ⁽⁴⁾	54.5 db	55

(1) Calculated on the basis of $f_{max} = 50$ mc and $r_b \cdot C_c = 200 \mu$ substituted in the following equation: $f_{osc} = \frac{1}{2\pi} \sqrt{\frac{1}{L C_c}}$
 (2) Calculated value based on a maximum available power gain of 28 db at 10.7 mc and a power fall of 6 db per octave.
 (3) Based on P_c at 25°C of 80 mw, P_c at 55°C of 50 mw and a linear derating factor which is 1 mw/°C.
 (4) Calculated by the following equation: $PG_{max \text{ avail}} = \frac{|Y_{12}|^2}{4R_{ie}R_{oe}}$

Coming soon! New P·A·D·T Switching, UHF and Power types!

NEW PRODUCTS

Resistance Bridge

480

For field applications



Model ZM-40 ()/MPM militarized resistance bridge is for field applications. It is designed to measure resistors or make other similar resistance measurements. It can be used as a limit bridge to compare resistors against an internal or external standard, a calibrated meter indicating the deviation in per cent. It can also be used as a null balance bridge to match pairs of resistors. The unit operates on 115 v $\pm 10\%$ from 50 to 420 cps. It measures resistances from 1 ohm to 2 meg with 0.25% accuracy. Temperature range is from -50 to $+65$ C.

American Electronic Laboratories, Inc., Dept. ED, 121 N. Seventh St., Philadelphia 6, Pa.

Price: On request.

Bake-Out Oven

520

For use in component manufacture

This bake-out oven modifies the ten-port manifold made by Consolidated Vacuum Corp. to meet the requirements of mass production of components. The ovens remove moisture from the products during the vacuum cycle. They produce temperatures of 120 to 320 C for transistor processing and to 400 C for planar-triode production. Temperature control is to ± 5 C. The ovens fit over the product and are raised and lowered pneumatically.

Trent, Inc., Dept. ED, 211 Levering Ave., Philadelphia 27, Pa.

Optical Material

499

Transmits infrared from 2.5 to 10 microns

Irtran-2 material transmits more than 70% of impinging energy from 2.5 to about 10 microns through a thickness of 2 mm. There is virtually no scattering or absorption loss due to thickness of material in the 3 to 9 micron region. An anti-reflection coating may be applied to increase transmittance characteristics. The refractive index is about 2.25 which makes the material useful for IR refractive optics.

Eastman Kodak Co., Dept. ED, Rochester 4, N.Y.

A
CUSTOMER
SAYS:
"SHOW ME!"



...We like customers who say "show me" because we can prove that Fansteel does more than just talk reliability. We can prove that Fansteel *does something about it!* Paul Weirich, Assistant General Manager, Rectifier-Capacitor Division, directs the customer "from Missouri" on a tour highlighting the Fansteel equipment, facilities, methods and skills which contribute to reliability in rectifiers and capacitors.

"... Show Me the Secret of



Here's the man who helped this miniaturization age get its start—Glen Ramsey, V.P. and General Manager, R-C Division, who developed the first porous tantalum anode back in 1936. Holding a new tantalum capacitor, he explains why the original Fansteel shoulder and curl design* is still the *best* ever developed—proved by millions of applications in the field.

*Patent No. 2,744,217



The customer "from Missouri" is introduced to Fansteel's new 240 amp. silicon rectifier by Bill Brown, Chief Engineer. Bill's staff of engineers, whose experience dates back to the beginning of the tantalum capacitor and the earliest selenium rectifier, is recognized as one of the most capable, creative teams in the electronic component field. (Incidentally, Bill Brown and staff promise more important product news soon.)



Hours and hours of vibration testing form just one phase in our reliability program. Consider our Gold-Cap** line of capacitors, for example. It takes almost 8000 readings, calculations, examinations and comparisons...and 27 days of testing...to certify each 100 Gold-Caps for pre-tested reliability.

**Trademark

Howard Brauer, Manager of Quality Control, gives a quick run-down on this 2500-unit tantalum capacitor life test chamber. "It's where we separate the 'men' from the 'boys'. 1000 hours of rugged electrical and thermal torture tells us how all units in each lot measure up to approved specs."



EC6012

Here's an operation that'll either make or break a silicon rectifier. As you know, the silicon slices in rectifier junctions must be perfect in every respect... uniformity in flatness, finish and parallelity is positively essential! Florian Schardt, Superintendent, Rectifier Plant, puts the 'mike' to a silicon slice to demonstrate the accuracy possible from the automatic lapping machines handling this job.



OF FANSTEEL Reliability!"



Using what he calls "the world's fastest shoe shine machine", Technical Director Stan Fry prepares for work in the "white room"—silicon rectifier assembly area. Besides dustless shoes, precautions for all authorized personnel include special, lint-free clothing, personal vacuum cleaning and removal of cosmetics.

Dust, dirt and other contaminants simply can't penetrate "white room" barriers. Because it takes only one microscopic dust speck to destroy a rectifier's reliability, a special air system filters out foreign matter actually 1000 times smaller than the thickness of human hair. This near-sterile atmosphere alone almost guarantees high reliability... automatic equipment and skilled operators do the rest.



The "white room" must have a constant supply of super-clean water for cleaning rectifier junctions. Here's where that water is processed. This is one of the filters in the system. It can "weed" out matter even as small as virus from the water. This water becomes so pure that we've measured its electrical resistivity at 18 million ohm-centimeters!



What you saw here is typical of the over-all Fansteel reliability picture. The real secret—if there is one—is found in the *attitude* of our people towards our reliability efforts. They believe in it. They work hard to make it a success. Another factor—care and stubborn attention to detail every step of the way, from raw material ordering to packaging. No detail is too small to risk half-way measures or compromise of any sort.

When we state that **reliability dictates our standards**, we mean just that. And when we say Fansteel capacitors and rectifiers are reliable, we mean they rank second to none! Meanwhile, we're exploring ways to do even better. FANSTEEL METALLURGICAL CORPORATION, North Chicago, Illinois.



WHERE RELIABILITY DICTATES STANDARDS

Rotating Electrical Connector 447

Permits continuous rotation



This rotating electrical connector permits intermittent or continuous free rotation of electrical lines and conduit without twisting or tangling. The standard model is a 5-hp unit operating on 220 v at 15 amp. It measures 2-1/2 x 5 in.

Ward-Riddle Co., Dept. ED, 241 Myrtle St., Ravenna, Ohio.

Price: \$75 ea.

Availability: From stock.

Modular Amplifier 509

For afc circuits

Designed for afc circuits, this modular amplifier is primarily for use in breadboard applications. Specifications include 10 db gain, bandwidth of 6 to 20 mc, power output of 5 to 300 mw and operating temperature range of -55 to +85 C.

Orion Electronic Corp., Dept. ED, 108 Columbus Ave., Tuckahoe, N.Y.

Price: \$125 to \$150.

Availability: Two to four weeks.

Bandpass Filters 466

Occupy from 0.125 to 0.625-cu. in.

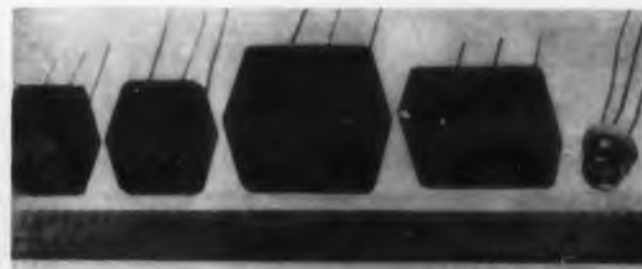

Designed for use in transistorized, subminiature telemetering oscillators, these filters range in volume from 0.125 to 0.625 in. Each is encapsulated in epoxy and has leads for etched-circuitry mounting.

Datafilter Corp., Dept. ED, 5921 Noble Ave., Van Nuys, Calif.

CIRCLE 61 ON READER-SERVICE CARD

SOLVING MATERIAL DESIGN PROBLEMS FABRICATING



Buy the parts not the problems. From large and unusual shapes to parts so small you inspect with a jeweler's glass... CDF's special fabricating facilities can do your job faster, more economically. Every part shown above is fabricated by CDF, except the etching of the printed circuits.

There's an excellent chance you can save on set-up and production time, and reduce unit costs by asking CDF to give you an estimate on final fabrication of laminated plastics, vulcanized fibre and electrical insulating materials.

Our machines, all 2,000 of them, are set up for just one purpose—the forming, machining and molding

of the many types of materials that we produce. Most important of all, you can combine economy with the exact properties you're looking for. CDF offers you a choice of materials from the industry's widest selection of laminated plastics, vulcanized fibre and electrical insulating materials. Check your Sweets PD file or write for General Folder 60.



CONTINENTAL-DIAMOND FIBRE

A SUBSIDIARY OF THE *Budd* COMPANY • NEWARK 107, DEL.
In Canada, 46 Hollinger Road, Toronto 16, Ont.



Machining low-cost tracks for sliding glass doors. Made by CDF from Diamond vulcanized fibre. It's tough, yet light in weight.

Molding automobile timing gear blanks made from CDF's Celoron molding material for maximum wear and a minimum of noise.

Postforming back-up disc for a sander. Made from a Dilecto laminated plastic to get maximum toughness and resiliency.

CIRCLE 62 ON READER-SERVICE CARD

NEW PRODUCTS

Polarographic Analyzer

448

Available in 23 current ranges



This polarographic analyzer can be furnished in 23 current ranges from 0.5 to 300 μ amp, full scale. There are 10 polarizing ranges from $\pm 1\frac{1}{2}$ to -5 v. Accuracy of the unit is 1/2% current and voltage; repeatability is 1/4%. The recorder has a chart width of 5 in. and a chart speed of 1/2 in. per min. Bridge drive is synchronous with a rotation time of 10 min.

Nesco Instruments, Inc., Dept. ED, 638 W. 17th St., Costa Mesa, Calif.

Price: \$795.

Availability: 4 to 6 weeks.

Mounted Temperature Probes

387

These resistance temperature measuring probes have integral pipe threads for easy assembly into equipment. Types 3129 and 4105 have minimum protection for the sensitive winding to provide the shortest time constant. Type 3119 is provided with a stainless steel sheath so it will operate in corrosive fluids and at pressures up to 150 psi. All will operate up to 250 F.

Arthur C. Ruge Associates, Inc., Dept. ED, Hudson, N.H.

Price: Type 3129 ranges from \$21 to \$32 ea; type 3119 ranges from \$32 to \$49 ea; type 4105 ranges from \$49 to \$74 ea; depending on quantities ordered.

Epoxy Casting Powder

376

This dry, non-toxic epoxy comes in single-component form and is for use with metals, glass and plastics. It has moisture and chemical resistance, and high electrical characteristics when cured.

Joseph Waldman & Sons, Epoxy Products Div., Dept. ED, 137 Coit St., Irvington, N.J.

Electric Counter

369

Model 4-Y-9434 four-figure counter can be furnished for base, top, or panel mounting. It operates at speeds to 600 counts per min. Input is 115 v ac.

Durant Manufacturing Co., Dept. ED, 1993-IS N. Buffum St., Milwaukee 1, Wis.

Price: \$4.

Video Distribution Amplifier 449

For color and black-and-white service



Type VA-R-201 video distribution amplifier is for color and black-and-white service. It provides three isolated 75-ohm outputs and requires 125 ma from a 285-v regulated source. By changing two resistors the nominal gain can be set at unity, ± 3 or $+6$ db, permitting one type of amplifier to be used for general-purpose video distribution, coax-line equalization, simultaneous line-feed and monitoring, or as a splitting amplifier in various types of video switching systems. Specifications include: output regulation, ± 0.1 db at 3.6 mc; isolation, 50 db at 15 kc; bandwidth, flat $\pm 2\%$ to 8 mc.

The Daven Co., Dept. ED, Livingston, N.J.

Voltage Calibrator 497

For checking dc voltmeters

Model SV-194 voltage calibrator is for checking the calibration adjustments of dc voltmeters. Output voltages of 0.5, 5, 50 and 500 v are provided. The calibration data is accurate to better than $\pm 0.005\%$ at 25 C. Stability is 0.005%. Long-term accuracy is 0.01% over the temperature range of 22 to 28 C.

Electro Scientific Industries, Dept. ED, 7524 S. W. Macadam, Portland 19, Ore.

DC Power Supply 468

Furnishes two independent outputs



Model 2536-1.5 dual-output, transistorized power supply furnishes two independent outputs of 0 to 36 v at 0 to 1.5 amp. Regulation is 0.01%; ripple is less than 1 mv. Operating ambient temperature is up to 50 C and storage temperature is up to 85 C.

Trygon Electronics Inc., Dept. ED, 111 Pleasant Ave., Roosevelt, L.I., N.Y.

Price: \$890 ea.

Availability: 4 weeks.



First commercially priced silicon rectifier

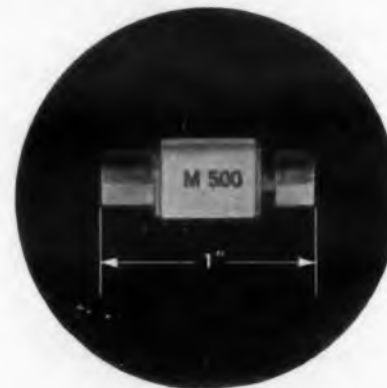

More in use than any similarly rated unit

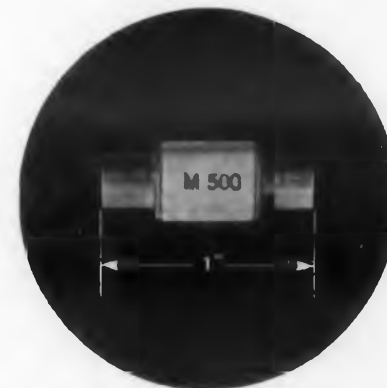

One of the first silicon rectifiers in volume production

TARZIAN M-500 Silicon Rectifier

The Sarkes Tarzian M-500 silicon rectifier is rated at 500 milliamperes dc, with a peak inverse voltage rating of 400 volts. This was the first commercially priced silicon rectifier, and more M-500's are now in use than any similarly rated unit.

The Tarzian M-500 is a cartridge type rectifier with end ferrules that snap quickly and easily into standard clips. The M-500 is made by a special Tarzian process that provides optimum forward to reverse ratios and long, useful life.

For additional information, practical application assistance, and prices on the M-500, write Sarkes Tarzian, Inc., Semiconductor Division, Bloomington, Indiana

DC amps (100° C)	Peak Inv. Voltage	Tarzian Type	Max. RMS Volts	Max. Recurrent Peak Amperes (100° C)	Max. Surge Amps 4MS	JEDEC No.
0.5	400	M-500	280	5	30	1N1084

Other voltage and current ratings also available in this style.



SARKES TARZIAN, INC.

World's Leading Manufacturers of TV and FM Tuners • Closed Circuit TV Systems • Broadcast Equipment • Air Trimmers • FM Radios • Magnetic Recording Tape • Semiconductor Devices

SEMICONDUCTOR DIVISION • BLOOMINGTON, INDIANA

In Canada: 700 Weston Rd., Toronto 9 • Export: Ad Aurlema, Inc., New York

CIRCLE 63 ON READER-SERVICE CARD



Model PS4232M
115-325 volts DC out
at 1.5 amp maximum

30 DAY DELIVERY

on all
models



Model PS4315M 0-36 volts DC out at 15 amp maximum

NEW TRANSISTOR - REGULATED POWER SUPPLIES

- *Five-Year Warranty*
- *Transient-Free Output*
- *Exclusive Regulator Circuit*

Two new lines of power supplies — one high and one low voltage line — are available now from POWER SOURCES, INC. Both lines feature the exclusive POWER SOURCES regulator circuit that provides full protection for the transistors *without* DC fuses. Both lines are warranted for *five full years*. Warranty includes all semi-conductor components. Cooling systems of advanced design insure long life and trouble-free operation.

For prices and complete specifications on POWER SOURCES high and low voltage solid state power supplies, write, wire or phone today.



Specify POWER SOURCES BY

POWER SOURCES, INC. Burlington, Massachusetts

High Voltage Supply Specifications

	PS4222	PS4230	PS4232
DC Output Range	35-215 volts 0-1.5 amps	90-300 volts 0-1.5 amps	115-325 volts 0-1.5 amps
AC Input	105-125 volts, 50-60 cps*, all models		
Regulation (line)	Better than 0.1% or 0.2 volts over entire input range (whichever is greater)		
Regulation (load)	Better than 0.1% or 0.2 volts for no-load to full load (whichever is greater)		
Transient Response	Output remains within regulation limits for step-function change of ± 10 volts in 105-125 volt input range Output remains within regulation limits for changes from no-load to full-load or full-load to no-load		

Low Voltage Supply Specifications

	PS4305	PS4315	PS4330
DC Output Range	0-36 volts 0-5 amps	0-36 volts 0-15 amps	0-36 volts 0-30 amps
AC Input	105-125 volts, 50-60 cps*, all models		
Regulation (line)	Better than 0.025% or 3 mv over input range (whichever is greater)		
Regulation (load)	Better than 0.05% or 5 mv, no-load to full-load variation (whichever is greater)		
Transient Response	Output remains within regulation limits for line voltage steps of ± 10 volts within input range Output recovers in 100 usec for no-load to full-load or full-load to 50% load step changes.		

*400 cps available on order

NEW PRODUCTS

Induction Potentiometers

450

For process-control applications



Models UH-16 and UH-18 induction potentiometers are designed for process-control applications. Specifications include: linearity, $\pm 0.5\%$ of full range; hysteresis, $\pm 0.5\%$ of full range; life span, 1 million cycles; ranges, 0 to 600 psia or psig to 0 to 20,000 psia or psig. The units are available for 26 v and 115 v, 400 or 60 cps operation.

Servonic Instruments, Inc., Dept. ED, 640 Terminal Way, Costa Mesa, Calif.

Switching Transistors

501

Four types offered

These germanium pnp switching transistors are for military and industrial data-processing applications. Types 2N794, 2N795 and 2N796 have a maximum dissipation of 150 mw and minimum betas of 30, 40 and 50. These units have the same performance characteristics as types 2N1300, 2N1301 and 2N1683 and are housed in TO-18 packages. Type 2N1319 bidirectional unit, also offered, is for use in core-driver and ac relay circuits in military and industrial switching applications. It has a collector-to-base voltage and collector-to-emitter voltage rating of -20 v max.

Radio Corp. of America, Semiconductor & Materials Div., Dept. ED, Somerville, N.J.

Gear Heads and Speed Reducers

491

Maximum torque variation is 2%

These gear heads and speed reducers are available in a wide variety of ratios and in sizes 8, 10, 11, 15 and 18. They have internal, preset mechanical slip clutches. Maximum torque variation is 7% over the temperature range of -55 to $+150$ C. At constant temperature, torque variation is 2% max. The clutches slip for 150 hr of continuous duty. The torque may be set from 3 to 200 oz-in., depending on size of gearhead.

Kinetic Instrument Corp., Dept. ED, 1070 Linwood St., Brooklyn 8, N.Y.

Availability: Production quantities, four to six weeks.

AC Reference Standard

Accuracy is 0.035% of reading ± 1 mv



Model 146A is a completely transistorized ac reference standard. At 25 C, with moderate loading, it has an accuracy of 0.035% of reading ± 1 mv. Because it is designed to meet MIL-E-4158, it may be used in the field for an-the-spot calibration of systems and missile checkout stations. Specifications are: range, 0 to 511.110 v ac rms; harmonic distortion, 0.015%; output frequency, 45 to 55, 54 to 66, 36 to 440 and 900 to 1,100 cps in selectable steps; frequency accuracy, 0.5%. Power output is 10 va from 10 to 511 v, 1 amp from 1 to 10 v, and the reference current is 0 to 1 v.

Rotek Instrument Corp., Dept. ED, 733 Concord Ave., Cambridge, Mass.

Price: \$4,975.

Availability: From stock to 10 weeks.

Wirewound Resistors

For high-reliability use

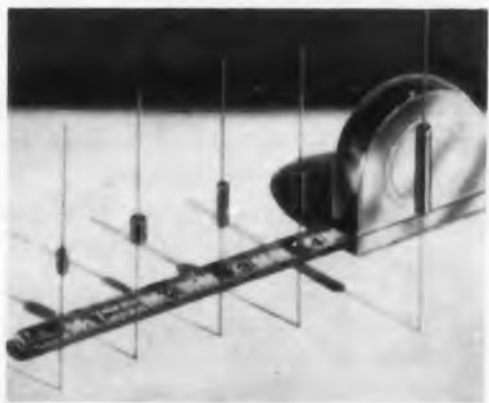

These wirewound resistors are designed to meet the needs of computers, missiles and other high-reliability applications. Special internal flanges are used to fasten the axial wire leads to the resistor body to guard against structural failure. Designed to MIL-R-93B specs at ambient temperatures of 125 C, the units are encapsulated in epoxy resin. Sizes are 1/8 to 3/16 in. in diameter and 1/4 to 1 in. in length. Power dissipation is from 1/20 to 1/2 w.

Shallcross Manufacturing Co., Dept. ED, Selma, N.C.

Availability: Varies according to style.

458

General Instrument Semiconductor... Design Breakthrough

NEW G 2N1678 "DYNAMIC DRIFT"

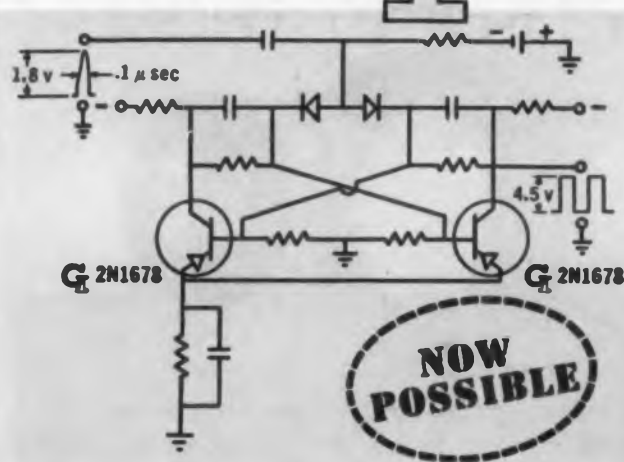

General Instrument proudly presents the 2N1678 "Dynamic Drift"... ideally suited for high speed, high voltage saturated circuit applications. The 1 Mc bistable multivibrator, above, is only one example of the multitude of applications for this attractively-priced transistor family.

Life test data proves reliability of the new General Instrument 2N1678 "Dynamic Drift". Close quality control guarantees extremely high electrical uniformity, shipment to shipment.

High Voltage
High Speed
Saturated Circuitry
At Low Cost



2N1678 PNP Germanium "Dynamic Drift"				
Parameter	Conditions	Min.	Typ.	Max.
T_c		-65°C		+85°C
P_c	$T_c = 25^\circ\text{C}$			120 mw
$V_{CE(s)}$	$I_c = 100 \mu\text{a}$	60 v		
V_{CEO}	$I_{CBO} = 25 \mu\text{a}$	60 v		
V_{EB0}	$I_{EBO} = 100 \mu\text{a}$	4 v		
f_{β}	$I_c = 20 \text{ ma}; V_{CE} = 0.25 \text{ v}$	25	40	
I_{CBO}	$V_{CE} = 10 \text{ v}$			5 μa
V_{BE}	$I_c = 20 \text{ ma}; V_{CE} = 0.25 \text{ v}$			0.6 v
f_{β}	$I_c = 1 \text{ ma}; V_{CE} = 5 \text{ v}$	25 Mc	35 Mc	
f_{α}	$I_c = 1 \text{ ma}; V_{CE} = 10 \text{ v}$		50 Mc	
h_{FE}	$I_c = 1 \text{ ma}; V_{CE} = 5 \text{ v}; f = 1 \text{ kc}$		30 Ω	
h_{FB}	$V_{CE} = 5 \text{ v}; I_c = 1 \text{ ma}; f = 1 \text{ kc}$		0.5 $\mu\text{ mho}$	2 $\mu\text{ mho}$
C_{ob}	$V_{CE} = 5 \text{ v}; I_c = 1 \text{ ma}; f = 5 \text{ Mc}$		3.5 pf	5 pf
$t_r + t_f$	$I_c = 20 \text{ ma}; I_B = I_{BE}$		0.4 $\mu\text{ sec}$	
$t_r + t_f$	$I_c = 1 \text{ ma}; R_L = 1 \text{ K}$		0.4 $\mu\text{ sec}$	

FULL LINE OF QUALITY G COMPUTER SEMICONDUCTORS

General Instrument is your major source for high quality computer semiconductors... transistors, as well as companion diodes, rectifiers and logic encapsulations for every type of circuit application. The transistor families shown below indicate the broad range of superior quality units offered by General Instrument.

Write General Instrument for complete engineering and life test data, design curves, and typical circuitry which takes advantage of the unique combination of characteristics offered by the new G 2N1678. Data is available, of course, on our full line of computer semiconductors. Our engineers will gladly discuss your specific circuit requirements

All speeds shown have been attained with conventional saturated circuitry. Total bar length represents rate (period) using speed-up capacitors; broken bar indicates maximum speed without capacitor.

Representative transistors shown are alloyed-junction devices. Types 2N501A, 2N604, and 2N1678 are MADT, Drift, and High-Voltage Drift, respectively.

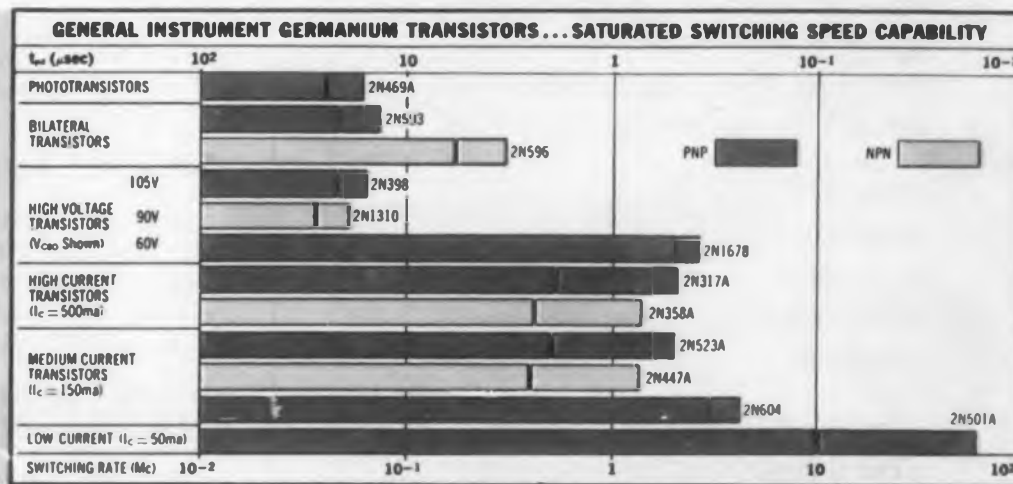

GENERAL INSTRUMENT
GENERAL TRANSISTOR
TRANSISTORS, DIODES, RECTIFIERS



SEMICONDUCTOR
DIVISION OF GENERAL INSTRUMENT CORPORATION
65 Gouverneur Street, Newark 4, New Jersey



IN CANADA: General Instrument—F. W. Sickles of Canada Ltd., P.O. Box 408, 151 S. Weber Street, Waterloo, Ontario, Canada. Sherwood 4-8101.

CIRCLE 65 ON READER-SERVICE CARD



High and Medium Temperature MULTI-CONDUCTOR CABLE

For Critical Applications

TIMES' experience in designing and manufacturing R.F. coaxial cable, data transmission cable, and low frequency control cable adds up to multi-conductor versatility to solve *your* problems.

As a "one source" manufacturer of all multi-conductor cable components, TIMES can produce round and ribbon cables utilizing almost infinite combinations of coaxial cable, Teflon®, PVC and polyethylene hook-up wire, and low capacitance cable.

Choose from TIMES *standard* engineered multi-conductor cables, or let our Engineering Service assist you in designing cables and *cable assemblies* to meet your specific requirements. © DuPont

TIMES WIRE & CABLE DIVISION
The International Silver Company
WALLINGFORD, CONNECTICUT, U.S.A.

Clip This Coupon To Your Calling Card or Letterhead

Please rush FREE literature on.

- Coaxial Cables
- Data Transmission Cables
- Multi-Conductors & Hook-up Wire
- For Info Only Have Rep Call



CIRCLE 66 ON READER-SERVICE CARD

NEW PRODUCTS

DC Torque Motors

464

For use as high-performance torquers



These dc torque motors are for use as high-performance torquers or direct-drive servo motors. These motors are pancake-type, multi-pole, permanent-magnet units. A typical unit with 3-3/4 in. OD and 1-5/8 in. ID has 2.2 oz-in. of torque per watt and a peak torque of 165 oz-in. A 1-7/8-in. OD motor has 0.35 oz-in. of torque per watt and a peak torque of 20 oz-in. When modified for higher speed operation, this unit has 0.034-w starting power and life exceeding 200×10^6 revolutions.

Giannini Controls Corp., Dept. ED, 1600 S. Mountain Ave., Duarte, Calif.

Dehydration Cartridges

368

These instrument-type units are designed for connection directly into the system line to protect sealed instruments, relays, and similar components. Sizes are 1.125 to 2.81 in. in diameter and 2.25 to 9.72 in. in length.

Robbins Aviation, Inc., Dept. ED, 2350 E. 38th St., Los Angeles, Calif.

Solderless Banana Plug

471

This solderless, molded, single banana plug has top stacking features. It is made of molded plastic with a beryllium copper, heat-treated, single spring contact. It is available in ten different colors.

Pomona Electronics Co., Inc., Dept. ED, Pomona, Calif.

Price and Availability: Price is \$0.50 ea.; \$0.43 ea. in quantities of 50 to 149; \$0.37 ea. in quantities of 150 to 249. Available from stock.

Rack and Panel Connectors

384

The Recon connectors are available in layouts with 7 to 104 pins. Inside pin terminations are flattened or pierced for wire soldering or straight for double-socket mating. Finish is applied to meet customer requirements.

Hermetic Seal Corp., Dept. ED, 43 River Road, North Arlington, N. J.

Availability: Two weeks.

Voltmeter

455

Range is 1 mv to 300 v



Type D-930-A voltmeter has a voltage range of 1 mv to 300 v and a frequency range of 5 cps to 100 kc. Over most of these ranges, the instrument has a measurement accuracy of 0.05%, even at the supply frequency. Automatic protection circuits are provided.

Muirhead Instruments Inc., Dept. ED, 441 Lexington Ave., New York 17, N.Y.

Frequency Transducer

621

Has an integral indicating meter

Model MM-1000-D frequency-to-analog transducer, called the Magacycler-Meter, has an integral indicating meter. Ranges are 0 to 250 cps and 0 to 1,000 cps. Full scale deflection can be obtained at any frequency between 250 and 1,000 cps. The unit is available with three standard input signal strengths of 2 w, 100 mw and 0.1 μ w. Applications include frequency monitoring, wave meters, telemetering, pulse-rate indicators, flow measurements and heart rate monitoring. Seven standard models cover the audio range from 15 to 12,000 cps (to 100 kc on request).

Pioneer Magnetics Inc., Dept. ED, 850 Pico Blvd., Santa Monica, Calif.

Price: \$79 to \$375 ea.

Availability: 15 to 30 days.

Impulse Generators

496

Can be supplied for up to 3,500 kv

These impulse generators can be supplied for 700, 1,400, 2,100 or 3,500 kv for use in testing cables, insulating materials, and electrical equipment. Each unit consists of four columns of capacitors which are separated by insulating rings. Standard execution provides 1/50- or 3/80- μ sec waves; accessories for other waveforms can be furnished. The generators are made in the Netherlands.

Phillips Electronic Instruments, Dept. ED, 750 S. Fulton Ave., Mount Vernon, N.Y.

DC Amplifiers

467

For analog computers

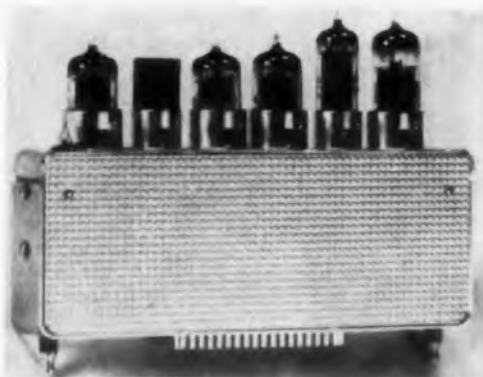

Models 3A and 3AM dc amplifiers are high-gain operational instruments for use in analog computing systems. Specifications include: open loop gain, 200 million at dc; offset, 100 μ v max at summing junction; drift, 0.36 v per hr max as an integrator; output, ± 100 v dc at 35 ma; frequency response, 100,000 cps min at -3-db point, 60,000 cps at gain of 100.

General Computers, Inc., Dept. ED, 9000 W. Pico Blvd., Los Angeles 35, Calif.

Price: Model 3A, \$135 ea; model 3AM, \$150 ea.

RF-Power Bridge

502

Accuracy is 1/4%

An accuracy of 1/4% of substituted dc power above 500 μ w can be obtained with model PB-1 rf-power bridge. It is designed for use with 200-ohm bolometer mounts using 4.5 or 8.75 ma barretters or a pair of 13-ma transistors.

Weinschel Engineering, Dept. ED, 10503 Metropolitan Ave., Kensington, Md.

Price: \$2,500 fob Kensington.

Availability: 90-day delivery.

Multiple Power Supply

482

For use in custom digital systems



Model B multiple power supply is for use in custom digital systems. The data power unit provides all voltages required for the operation of most medium-size digital systems. It is designed for 19-in. standard relay rack mounting.

Harvey-Wells Electronics, Inc., Dept. ED, 14 Huron Dr., Natick, Mass.

Price: \$598 ea.

Availability: From stock.

INDUSTRY'S MOST COMPLETE STANDARD LINE



E-I Glass-to-Metal SEALS

E-I SEALED TERMINALS AND HEADERS provide you with the widest possible design latitude. E-I offers the engineer/designer the industry's most complete line of sealed terminals and miniature components at prices that reflect the economies derived from standardized production. E-I seals are specified industry-wide for today's most critical military and commercial equipment... proof of their complete reliability in the most severe environments.

Multi-Lead Headers

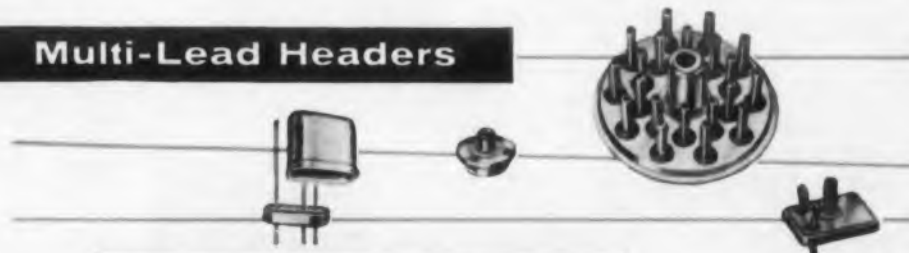

Condenser Seals



Individual Terminals

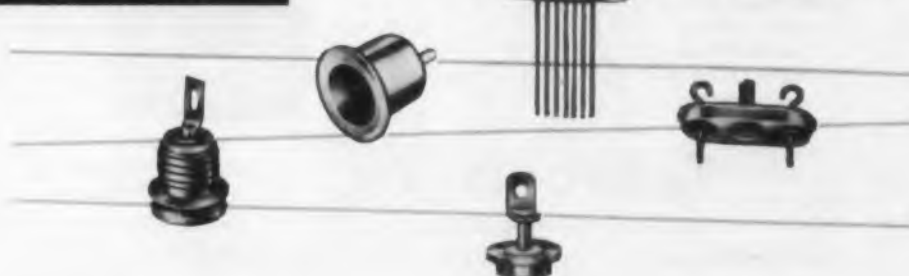

IF YOU HAVE A SEALING PROBLEM... call or write for complete information on the E-I standard line, or ask an E-I field engineer to make recommendations on your application.

Patented in Canada, No. 803,390;
in United Kingdom, No. 734,563;
licensed in U.S. under No. 2561520



ELECTRICAL INDUSTRIES

MURRAY HILL, NEW JERSEY, U. S. A.

A Division of Philips Electronics and Pharmaceutical Industries Corp.

CIRCLE 67 ON READER-SERVICE CARD

Traveling-Wave Tubes

For S-band use

474



Type IIA-76 traveling-wave tube is for applications from 2.3 to 2.9 kmc and has a maximum noise figure of 6 db. Small signal gain is 30-db min and saturation power output is 0-dbm min. The unit weighs 1.5 lb, without solenoid, and measures 1 in. in diam x 22.5-in. long.

Huggins Laboratories, Dept. ED, 999 E. Arques Ave., Sunnyvale, Calif.

Analog-Events Recorder

490

Has 6-in. chart

The analog-events recorder is a combination of two types of instruments with the recordings placed on one 6-in. strip chart. The center part of the chart is an analog measurement usually made by a basic permanent-magnet moving coil movement which can be equipped to measure dc microamperes, milliamperes, millivolts, volts; ac volts and amperes. Six chronograph pens showing on-off time of related events or timing pulses can be synchronized with the analog record by marking in the enlarged margins of the same chart.

Esterline-Angus Instrument Co., Dept. ED, P. O. Box 596, Indianapolis 6, Ind.

Availability: 15 days.

Test Chambers

513

Temperature range is -120 to +300 F

Model SU-120-1-HCR test chamber has a temperature range of -120 to +300 F. It is designed for use with standard tensile-test equipment. The cabinet is self-contained and the height of the chamber is hydraulically controlled for different levels of operation within the crossheads, without physical contact between the temperature chamber and the testing machine. Net test area is 22 x 7 x 8 in.

Cincinnati Sub Zero Products, Dept. ED, 3932 Reading Road, Cincinnati 29, Ohio.

Availability: 30 days.

Electronic Products **NEWS**

by **CARBORUNDUM**[®]

Temperature Compensation in Electric Eye Movie Camera provided by GLOBAR[®] Thermistor

Energy from a built-in photoelectric cell automatically sets the lens opening for correct exposure in the Bell & Howell "Electric Eye" movie camera. The high standard of

accuracy usual in Bell & Howell products is indicated by the use of a GLOBAR Type 479H Thermistor for temperature compensation.

The output current of the photo-cell varies with temperature. In addition, the resistance of the coil in the operating mechanism varies with temperature because of copper's positive temperature coefficient. A negative coefficient thermistor, in parallel with a fixed resistor, provides the necessary compensation.

GLOBAR thermistors are your answer to a variety of problems where a temperature-sensitive resistor is required. Disc and rod shaped bodies are available in a wide range of sizes, providing desired resistance values, thermal time and dissipation constants and temperature coefficients. For information, write to GLOBAR Plant, Refractories Division, Dept. EDT-120, Carborundum Co., Niagara Falls, N. Y.

CIRCLE 804 ON READER-SERVICE CARD

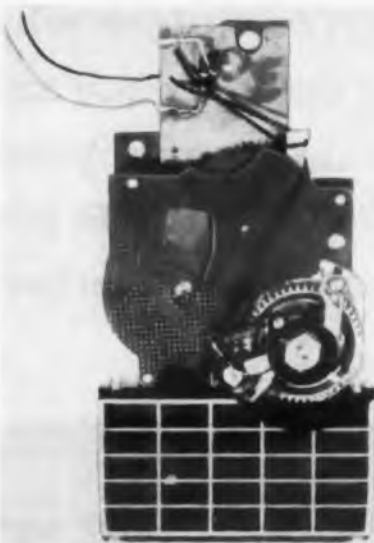

ALUMINA BUBBLES... new transformer potting material can withstand temperatures over 1000° C.

Trends to higher temperatures and upgrading of insulation systems have spurred the search for new potting materials for metal-encased electronic power transformers.

Research by Bell Telephone Laboratories suggests unusual possibilities in a special form of aluminum oxide developed by Carborundum's Refractories Division. The material is made by a process which converts alumina powder into microscopic, light-weight, free-flowing, non-abrasive bubbles. Ordinary granular alumina won't serve the purpose.

Since the material can withstand over 1000° C., all practical temperature limitations are removed. Electrical insulating properties are excellent. A particular advantage is the simplicity of the potting operation. The powder is simply poured into the transformer case and tapped or vibrated so that it fills all cavities. No curing or heating facilities are necessary. Because of these factors, the material may merit consideration even in applications where high temperature is not involved. For more information, write Refractories Division, Dept. EDP-120, Carborundum Co., Perth Amboy, N. J.

CIRCLE 805 ON READER-SERVICE CARD



Metallized Ceramics permit high-temperature soldering or brazing

Carborundum's Latrobe Plant can supply metallized steatite which can be used with any soft solder including those melting at approximately 600° F. Re-soldering can be done without adverse effects. This offers advantages over the usual silver or platinum firing of steatite material, which requires a silver bearing tin-lead eutectic solder melting at about 360° F. These joints cannot be re-soldered without dissolving the metallizing. Further, top use temperature is only 320° F. With the Carborundum metallizing, use temperature is determined only by the solder alloy used.

This type of metallizing is also used with high-alumina material for brazing. When assemblies are copper brazed, installations can be made with comparable hard solders.

For information, write Latrobe Plant, Refractories Div., Dept. EDC-120, Carborundum Co., Latrobe, Pa.

CIRCLE 806 ON READER-SERVICE CARD

NEW BOOKLET AVAILABLE ON GLOBAR[®] TYPE BNR VARISTORS



Non-linear, voltage sensitive resistors are finding many electronic applications. This booklet gives full information on characteristics and sizes of GLOBAR Varistors.

For your copy, write GLOBAR Plant, Refractories Division, Dept. EDV-120, Carborundum Co., Niagara Falls, N. Y.

CIRCLE 807 ON READER-SERVICE CARD



For ceramic parts and metallized assemblies, Kovar alloy, ceramic resistors, varistors and thermistors... count on **CARBORUNDUM**[®]

CIRCLE 804, 805, 806, 807 ON READER-SERVICE CARD

NEW PRODUCTS

Digital Clocks

456

Display 4, 5, 6 or 7 digits



The DC-151 series digital clocks provide a visual display of 4, 5, 6 or 7 digits, together with contact closure outputs. Time pulses are generated in the clock by a synchronous motor-operated switch. A mercury relay drives the time-generating rotary stepping switches. Contact closure outputs can be parallel or serial. The chassis is designed for standard rack mounting and contains an integral projection-type lamp bank.

Datex Corp., Dept. ED, 1307 S. Myrtle Ave., Monrovia, Calif.

Price: \$1,000 to \$1,865.

Availability: 30 to 60 days.

Temperature Control System 516

For missile use

This temperature control is designed to match space limitations found in missiles. It is housed in a box occupying less space than a 4-in. cube; half the box is a power amplifier and the other half is a preamplifier connected to a miniature sensing element. Temperatures can be controlled to within ± 0.03 F. A transistorized circuit is used.

Barber-Colman Co., Dept. ED, Rockford, Ill.

Clamping System 519

For servo mounts

This clamping system may be used to hold all types of servo-mount components for experimental and production uses. The package includes all necessary hardware. An adjustable clamp wrench can also be furnished. The system is suited for fast changing in production testing.

Angler Industries, Dept. ED, Metuchen, N.J.

Price: Kit with clamping wrench, \$15.50; kit of clamps and clamping hardware, \$2.45.

Availability: One week.

In Computers and Data Processing Consoles . . .

Every touch of a Switch is a test of your equipment!

The design of switches for complex electronic equipment is a specialty, one place where you can save valuable engineering design time and insure reliable input. But, don't stake your reputation on less than the finest. MICRO SWITCH precision and reliability will safeguard your performance standards.



75TH HONEYWELL
YEARS OF ENGINEERING THE FUTURE

Consult the Yellow Pages for the location of the nearby MICRO SWITCH branch office. Engineering assistance is available without obligation.

See our exhibit at the Eastern Joint Computer Conference

ELECTRONIC DESIGN • December 21, 1960



New MICRO SWITCH Synchronized One-Shot switch circuit assemblies save engineering time and equipment rack space

New Synchronized One-Shot push-button switch circuit assemblies for use in pulse and digital systems save design time required to develop flip-flop and gating networks.

The new MICRO SWITCH "1PB700" series assemblies have a special electronic circuit that generates a single square wave output pulse in synchronism with an external clock pulse with each operation of the push button. They can be used with clock pulse frequencies from 4 kc to 500 kc.

The electronic circuit is an integral part

of the push-button switch, resulting in a saving of equipment rack space. All circuit components are sealed in resilient potting material to insure protection from physical damage.

Three assemblies in the new series are patterned to fit a wide variety of d-c supply voltages and clock pulse rise times, voltages and frequencies. They can be applied to manual loading of magnetic drums, setting and resetting flip-flops, and checking ring counters. Ask for Data Sheet 172.

MICRO SWITCH modular lighted push-button switches can be customized for complete design flexibility

Give your control panel the finest in styling with the customizing that will precisely fit your control and display functions.

MICRO SWITCH "Series 2" lighted push-button switch modules simply snap together to match your styling requirements, then snap into slots in the mounting panel—all without

tools. They perform both control and indicator jobs to save panel space.

Select from 48 different units and 16 mounting barriers. Forty color display screens include lateral and longitudinal divisions. Available as operator-indicator switch units or indicator units only. Ask for Catalog 67.

MICRO SWITCH precision toggle switches offer you the exact control arrangements you need

MICRO SWITCH manufactures hundreds of different toggle switches and toggle switch assemblies. They are available with 2 or 3 operating positions, 1 or 3-hole mounting and a variety of circuitry and electrical rat-

ings. All have enclosed type contacts. Ask for Catalog 73.

A new "400" Series Toggle Switch is now available with a paddle-shaped tab which can be numbered or color-coded as an indicator.

MICRO SWITCH door interlock switches assure maximum safety during maintenance

MICRO SWITCH door interlock switches are installed on high voltage cabinets to automatically cut the power circuit when the cabinet door is opened for repairs or testing.

Safety position adds protection against "tying down" or wiring around a conven-

tional switch which might be forgotten after service is completed. By manually pulling the plunger out to the maintained-contact position, you close circuit for checking. When door is closed, plunger automatically returns to normal operating position. Ask for Catalog 63.

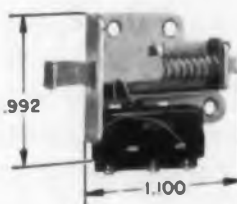
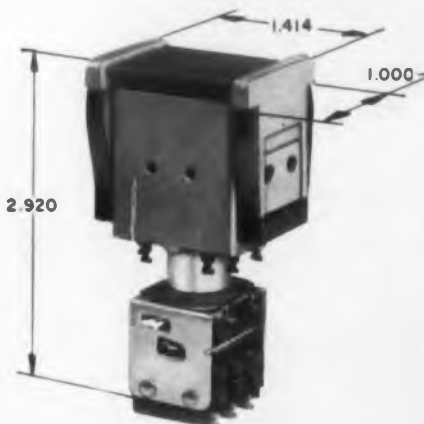

Transolver Synchro

459

Size 8



Type 4255-01 is of unique design in that the rotor is used as primary instead of the stator. The error variation is ± 7 min checked as a control transformer with rotor excited using main stator winding. Specifications are: input voltage, 11.8 v using rotor as primary; input current, 0.036 amp; output, 22.5 v; lead-phase shift, 12.3 deg; rotor resistance, 86 ohms; and stator resistance, 310 ohms.

John Oster Manufacturing Co., Avionic Div., Dept. ED, Racine, Wis.

Silicone Dielectric

391

For potting transistors, Sylgard 81 compound is serviceable from -70 to $+200$ C. It protects transistors from mechanical shock and vibration. It can be dispensed manually or with automatic metering devices.

Dow Corning Corp., Dept. ED, Midland, Mich.

Alkyd Bases and Sockets

462

Plaskon 540 is for plug-in use and for digital computers and other electronic machinery. With this alkyd, molded parts hold their tolerances during rapid production cycles. They are available in 20- and 11-pin design and 7- and 9-pin bases and sockets.

Alden Products Co., Dept. ED, 117 N. Main St., Brockton 64E, Mass.

High-Fidelity Output Transformer

498

This 65 w, high-fidelity output transformer is designed for use in the construction of a 60 w, high-fidelity amplifier with tertiary feedback. The amplifier has a total harmonic distortion of less than ± 1 db from 20 to 10,000 cps, power response is ± 1 db from 20 to 20,000 cps.

Chicago Standard Transformer Corp., Dept. ED, 3501 W. Addison St., Chicago 18, Ill.

Subminiature Switch

357

This subminiature switch with roller actuator is available in spdt or dpdt configurations. The unit breaks 5-amp resistance for a minimum of 150,000 cycles. It meets military specifications.

Crown Electric, Dept. ED, Box 171, Orange, N.J. Price: From \$1.80 ea, 1 to 9 units.

MICRO SWITCH . . . FREEPORT, ILLINOIS

A division of Honeywell

In Canada: Honeywell Controls Limited, Toronto 17, Ontario



Honeywell
MICRO SWITCH Precision Switches

CIRCLE 70 ON READER-SERVICE CARD

*For your Telemetry needs
a new Subcarrier Oscillator with...*



Universal-Millivolt Level Subcarrier Oscillator

Flexibility of application has been a prime design objective in the development of this new low-level transistorized subcarrier oscillator. Tele-Dynamics' Type 1254A directly replaces the combination of pre-amplifier and high-level subcarrier oscillator now used in FM telemetry. Eliminating the need for preamplification insures more reliable operation through your whole telemetry system. The differential inputs of the new 1254A may be biased at any DC level within 50 volts of power ground. All grounds are inde-

pendent, including signal ground, power ground, output return and case ground. This oscillator is only one of a family produced by Tele-Dynamics for your specific system needs, along with a companion transistorized wideband amplifier and mount. For detailed technical bulletins, call the American Bosch Arma sales offices in Washington, Dayton or Los Angeles. Or write to Tele-Dynamics Division, American Bosch Arma Corporation, 5000 Parkside Avenue, Philadelphia, Pa.

- True Differential Input
- Direct Actuation from Outputs of Grounded or Ungrounded:
 - Thermocouples • Strain gage bridges
 - Any transducer with millivolt level differential output
- Isolated Input and Output
- High Common Mode Rejection with no D.C. Level Restrictions
- All Silicon Semiconductors

TELE-DYNAMICS

DIVISION

AMERICAN BOSCH ARMA CORPORATION

CIRCLE 71 ON READER-SERVICE CARD

NEW PRODUCTS

Pressure Transducer

461

Has 1-in. diam



Model TP-1000 pressure transducer has a 1-in. diameter. It measures gaseous or liquid media in the 0-400 to 0-10,000-psi range, gage or absolute. The potentiometer output elements can be wirewound or deposited-metal-film. The unit stands overpressure of 25% above rated. Static error band is $\pm 1\%$ maximum deviation. Total resistance values are 500 to 20,000 ohm, $\pm 5\%$. Resolution is 0.25%.

Fairchild Controls Corp., Components Div., Dept. ED, 225 Park Ave., Hicksville, N.Y.
Price: Determined by customer requirements.
Availability: 60 to 90 days.

Modular Console Cabinets

371

A sloped front console has been added to the Prem-O-Rak modular console cabinet line. Front area is a 17-1/2-in. panel, sloped 19 deg from the vertical. Mounting angles are adjustable to any desired position.

Premier Metal Products Co., Dept. ED, 337 Manida St., New York 59, N. Y.

Nuclear Radiation Survey Meter

390

For survey and monitoring uses, this portable unit operates from a built-in battery. Meter indication is in three ranges: 0 to 10,000, 0 to 100,000, and 0 to 1,000,000 counts per min. The detector is a plastic scintillator measuring 7 in. in diameter.

Franklin Systems, Inc., Dept. ED, 2734 Hillsboro Road, West Palm Beach, Fla.

Synchro Dials and Weights

354

The F-100 series synchro dials and weights are for friction torque tests, synchronizing tests and spinning tests per MIL-S-20708, and for environmental testing of synchros from size 11 to 37.

Angler Industries, Dept. ED, 3 Lexington Drive, Metuchen, N.J.

Military Closures

358

Precision drawn cases and covers, from AF to OA, meet MIL-T-27A. All sizes are available.

Hudson Tool & Die Co., Inc., Dept. ED, 18-38 Malvern St., Newark 5, N.J.



SYSTEMS INTEGRATION

Systems Integration, a major endeavor at Lockheed, involves the responsibility of establishing and maintaining composite system and subsystem characteristics within the parameters necessary for a successful development of weapon and satellite systems.

An outstanding example of this system's engineering approach is illustrated by the Navy POLARIS Fleet Ballistic Missile Weapon System. The Navy gave Lockheed Missiles and Space Division the basic overall weapon system requirements and the required operational date, and requested Lockheed to develop a missile system compatible with the other systems of the weapon system. This demanded an entirely new procedure in missile development: 1) The design had to be based on anticipated advances in the state-of-the-art to meet performance requirements. 2) Simultaneous development of missile subsystems in an independent fashion was required to meet time scale requirements. Not only is Lockheed meeting these requirements — it is delivering an operational missile system three years ahead of the original schedule.

Detailed functions of successful systems integration activities include: Establishment of basic system characteristics through use of preliminary

design and parametric study techniques; sectionalizing the missile and defining interfaces and performance requirements for each subsystem; monitoring and counseling the design activities of subsystems and establishing interfaces and subsystem design parameters and tolerances; assuring and maintaining design compatibility of subsystems throughout the entire development of the missile into the weapon system.

From the development of advanced system proposals into the preliminary design and system requirements, on through to final missile production, demands highly trained engineers and scientists in missile and space technology concerned with the overall systems problems.

Engineers and Scientists: Work in the broad spectrum of systems integration functions provides a constant challenge at Lockheed Missiles and Space Division. If you are experienced in this area, you are invited to write: Research and Development Staff, Department L-21, 962 W. El Camino Real, Sunnyvale, California.

U. S. citizenship or existing Department of Defense industrial security clearance required.

Lockheed / MISSILES AND SPACE DIVISION

Systems Manager for the Navy POLARIS FBM; the Air Force AGENA Satellite in the DISCOVERER, MIDAS and SAMOS Programs

SUNNYVALE, PALO ALTO, VAN NUYS, SANTA CRUZ, SANTA MARIA, CALIFORNIA • CAPE CANAVERAL, FLORIDA • HAWAII

NEW PRODUCTS

Overload Relay 417

Compensates for heat and cold



This overload relay compensates automatically for heat and cold from -20 to $+165$ F. Base size of the unit is the same as the firm's standard overload relays. Ratings are from 25 to 300 amp, continuous current. The units are for indoor control installations near boilers, furnaces, heating units or refrigeration equipment and subjected to wide daily changes in ambient temperature.

The Arrow-Hart & Hegeman Electric Co., Industrial Control Div., 103 Hawthorn St., Hartford 6, Conn.

Capacity Measuring Instrument 434

Measures up to 1,000 pf



Model 402 Micro-Miker measures capacity from 0 to 1,000 in three ranges and inductances from 0 to 240 μ h in one range. Accuracy is $\pm 2\%$ of the reading for capacity and $\pm 3\%$ for inductance. The resolution is 0.1% full scale. Measuring frequency is 1 mc. A stable zero and a 6-in dial are the only controls.

C. E. S. Electronic Products, Inc., Dept. ED, 5026 Newport Ave., San Diego 7, Calif.

Price: \$785 fob San Diego.

Availability: 60 to 90 days.

new μ mesa* transistors...

*450-mw free-air dissipation
in one-tenth the volume
of a TO-18 package*



*Trademark of Texas Instruments Incorporated

TI 450/451

silicon transistors give you more power per package volume than any other silicon transistor

Use these TI *second generation* transistors to complement your *second generation* high-speed computers.

Check the outstanding advantages of the TI 450 and TI 451 . . .

- 1/10 the volume of a TO-18 package
- 450-mw free air dissipation @ 25°C
- hermetically-sealed-in reliability
- backed by a full year's warranty
- electrically the same as 2N706A and 2N753
- ribbon leads for "two-dimensional" mounting
- 1/5 the weight of a TO-18 package — only 0.07 gms
- heat sinking simplified by electrically isolated case

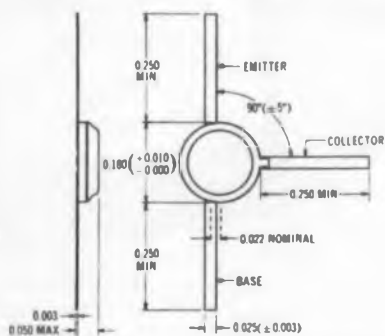

SUGGESTED MOUNTING METHODS

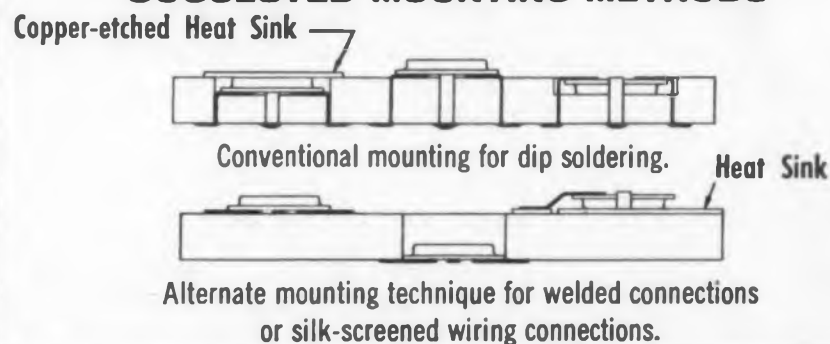

Electrical characteristics @ 25°C ambient

Symbol	Parameter	Test Conditions	Type	Min	Max	Units
t_{on}	Turn-On Time	$I_{B1} = 3 \text{ ma}, I_{B2} = 1 \text{ ma}$ $V_{CC} = 3 \text{ v}, R_L = 270 \Omega$			40	nsec
t_{off}	Turn-Off Time	$P. W. \leq 400 \text{ nsec}$, less than 2% duty cycle			75	nsec
$V_{CE(sat)}$	Collector-Emitter Saturation Voltage	$I_C = 10 \text{ ma}, I_B = 1 \text{ ma}$ (Pulse Test)			0.6	v
h_{FE}	DC Forward Current Transfer Ratio	$V_{CE} = 1 \text{ v}, I_C = 10 \text{ ma}$	TI 450 TI 451	20 40	60 120	

Specify TI for all your silicon transistor requirements—
signal • switching • medium power • power



SEMICONDUCTOR-COMPONENTS DIVISION

TEXAS INSTRUMENTS

LIMITED INCORPORATED

DALLAS ROAD • BEDFORD, ENGLAND • 13500 NORTH CENTRAL EXPRESSWAY • DALLAS, TEXAS

CIRCLE 73 ON READER-SERVICE CARD

ELECTRONIC DESIGN • December 21, 1960

Strain-Gage Plotters

457

Multi-channel types



Model 114 multi-channel recording and plotting instruments are for strain-gage use and can be furnished with 48 or 96 channels. No manual plotting or reading is required. There are three zero positions per channel, individual graphs for each channel and a portable motor-driven zero balance gun. The units are used for aircraft structural tests as well as other applications.

Gilmore Industries, Inc., Dept. ED, 13015 Woodland Ave., Cleveland 20, Ohio.

Availability: Immediate delivery from stock.

Cathode-Ray Tubes

494

Safety panel is bonded to face plate

These military and industrial cathode-ray tubes have a safety panel bonded to the face plate. The "Bonded Shield" design can be incorporated in industrial cathode-ray tubes in sizes of 3 to 27 in. The one-piece design is claimed to improve image visibility, reduce the reflecting surfaces and increase tube strength. These cathode-ray tubes are for use in oscilloscopes, closed-circuit TV, TV monitor tubes and radar indicators.

Sylvania Electric Products Inc., Dept. ED, 730 Third Ave., New York 17, N.Y.

Latch Relay

512

Can be spdt or dpdt

Suitable for printed-circuit application, this microminiature, sensitive latch relay maintains an actuated condition without continuous power drain. It uses rotary-balanced armature construction, allowing the relay to stand vibration and shock. The spdt unit has a sensitivity of 25 mw at pull-in at 25 C. The dpdt unit has a sensitivity of 40 mw or better. Contact rating is dry circuit to 2 amp, resistive at 32 v dc. Dielectric strength is 1,000 v rms at sea level and insulation resistance is 1,000 meg min.

Hi-G, Inc., Dept. ED, Bradley Field, Windsor Locks, Conn.

Availability: Samples, 60-day delivery; production qualities can be furnished after Jan. 30, 1961.

**ALLIED'S
NEW
6 POLE
Sub-Miniature Relay
with
0.2 Inch Grid Spaced
Terminals***



ACTUAL SIZE
TYPE JH-18D (6PDT)

OPERATING CONDITIONS

CONTACT RATING:

2 amperes non-inductive or 1 ampere inductive
at 29 volts d-c or 115 volts a-c
Low level contacts are available on request

AMBIENT TEMPERATURE:

— 65°C to + 125°C

VIBRATION:

5-28 cps at 0.5 inch double amplitude
28-2000 cps at a constant 20g

SHOCK:

50g operational

WEIGHT:

1.8 ounces maximum

*Also available with straight pins for printed
circuit application

Write for Bulletin JH-18D #25

ALLIED CONTROL

ALLIED CONTROL COMPANY, INC.

2 EAST END AVENUE, NEW YORK 21, N. Y.

CIRCLE 74 ON READER-SERVICE CARD

AL308

NEW PRODUCTS

Nude Ion Pressure Gage

469

Stands up to 500 C

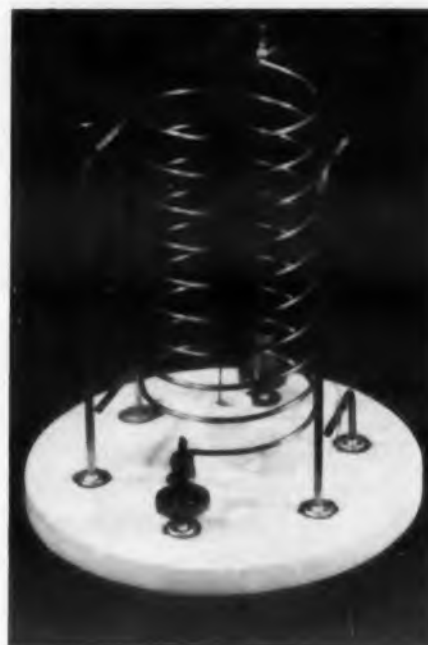

Type NIG nude ion pressure gage is designed to stand the high temperatures (up to 500 C) required for ultra-high vacuum applications. The Bayard-Alpert structure permits accurate pressure measurements down to 10^{-10} mm Hg and lower. Sensitivity is 100 μ amp per micron of pressure (calibrated for dry nitrogen) for 6-ma emission.

Vactronic Lab. Equipment, Inc., Dept. ED, 21 Monmouth Court, East Northport, L.I., N.Y.

Price: \$59.50 ea.

Availability: From stock.

Armored Tow Cable

495

This underwater, armored tow-cable is used to support sonar, target buoys and submarine research gear. The flat, flexible, stainless-steel braid is non-kinking and designed for breaking strengths up to 3,000 lb. Signals of all types and levels are transmitted by 20 conductors and permit control of the underwater unit by surface craft. A neoprene jacket makes the cable watertight and abrasion resistant.

Boston Insulated Wire and Cable Co., Dept., ED, 65 Bay St., Dorchester, Mass.

Printed-Circuit Connectors

364

Series 600-120 connectors have dual terminations and bifurcated beryllium copper contacts for 1/16-in. printed-circuit boards or tape cable. Dual contact sizes are 6, 10, 15, 18, 22, 28, 43, 58 and 105. Wire sizes include wire-hole solder lug for two No. 20 AWG wires, dip-solder lug and slotted-solder plug.

Continental Connector Corp., Dept. ED, 34-63 56th St., Woodside 77, N.Y.

a measure of
perfection...
**IDEAL
PRECISION**
Panel Meters
*the complete line
for every application*



Model 350 P
Clear Plastic
3 1/2 Inch

Model 275 PR
Clear Plastic
2 3/4 Inch



Model 460 P
Clear Plastic
4 1/2 Inch



Model 460 B
Bakelite
4 1/2 Inch

Here's the demand line that's setting sales records across the nation . . . engineered and produced to the highest standards . . . assembled in controlled atmospheric and climatic conditions . . . 100% inspected at every step of production to ensure highest quality and dependability.

- Accurate to within 2% of full scale
- All sizes and types available
- Scales to customers specifications

For complete information, write to

IDEAL

IDEAL PRECISION METER CO., INC.
214 Franklin Street, Brooklyn 22, N. Y.

Sold to Electronic Parts Distributors
exclusively through

WALDOM

WALDOM ELECTRONICS, INC.
4625 W. 53rd Street, Chicago 32, Ill.

CIRCLE 75 ON READER-SERVICE CARD

Take a close look
at today's foolproof
termination method...



Then put it to the test!

This blow-up of the unique GAMEWELL High Pressure Spring Contact Potentiometer Design tells the story. It's shockproof, snake-proof, foolproof!

Precious metal spring contacts with unit pressure in excess of 10,000 pounds per square inch assure positive, trouble-free contact at both tap and terminal. This advanced High Pressure Spring Contact Design provides extremely low end resistance... without excessive linearity distortion at taps. In addition, pressure is well within the spring's elastic limit... and there are none of the fatigue factors inherent in welded joint construction. It's truly a long-life design... and meets MIL specifications.

Thousands of GAMEWELL Pots incorporating this High Pressure Spring Contact Design are operating in all kinds of service. Exhaustive GAMEWELL and user tests have confirmed the superiority of this design under severe environmental conditions of shock and vibration... over temperature ranges from -65°C to +200°C. Put this method to the test in your lab.

For applications requiring utmost dependability, specify GAMEWELL High Pressure Spring Contact Design. Write for additional information and send specification requirements to THE GAMEWELL COMPANY, 1397 Chestnut St., Newton Upper Falls 64, Massachusetts.

A Subsidiary of E. W. Bliss Co.

GAMEWELL Series RL-270A Potentiometers are available with High Pressure Spring Contacts. They also feature dimensionally stable housings, closer tap spacing, advanced design shaft and-slip ring for low noise and minimum wear.



BLISS
GameWell
Precision Potentiometers
"Integrals of High Performance"

CIRCLE 76 ON READER-SERVICE CARD

Tapped Delay Lines

476

Designed for printed-circuits



Series L delay lines, designed for printed-circuit mounting, measure 1/2-in. thick and are of cast-epoxy construction. Tested at 800 v dc, the units are rated at 400-v continuous working voltage. Delay can be as small as 0.1 μsec; rise time of 7% to 8% of delay time. Temperature coefficient of delay is 0.005% per deg C. Standard tolerance is 2%; military tolerances can be furnished on special order.

Artronic Instrument Co., Dept. ED, 11232 Triangle Lane, Silver Spring, Md.

Multimeter

648

Assembled in the shape of and operating like a revolver, this multimeter, model No. 400 Transclip, comes with a leather carrying case. A pocket on the case holds the test leads and voltage probe holder. The unit measures 5-1/8 x 5-3/4 x 1 in. and weighs 17 oz.

Rowan Controller Co., Dept. ED, Red Bank, N.J.
Price: List price is \$39.95, complete with carrying case and voltage probes.

Electronic Equipment Wiring Tester

493

This electronic-equipment wiring tester, known as "Nifte", is designed to verify wiring locations in digital computers. The tester requires no programming or special skills; unskilled personnel have been trained to operate it in as little as two hours, according to the manufacturer. It is of modular construction and can be used for as few as 50 circuits and as many as 18,000.

North American Aviation, Inc., Autonetics Div., Dept. ED, 9150 E. Imperial Highway, Downey, Calif.

Differential Scanner

374

Model VLS differential scanner is a gamma-counting radiometric probe which permits separation of extraneous or background radiation from that radiation to be measured. Leaks which might occur in nuclear devices can be detected and evaluated by the scanner. It can be used with a portable counting ratemeter or a scaler as the readout instrument.

Uranium Instruments Co., Dept. ED, 126 N. Seventh, Box 1191, Grand Junction, Colo.

Price: \$221 ea.

Availability: From stock.

High selectivity,
attenuation and precision matching of...

NEW HILL FILTERS ASSURE FAST, PRECISE MEASUREMENT OF INTER-MODULATION DISTORTION

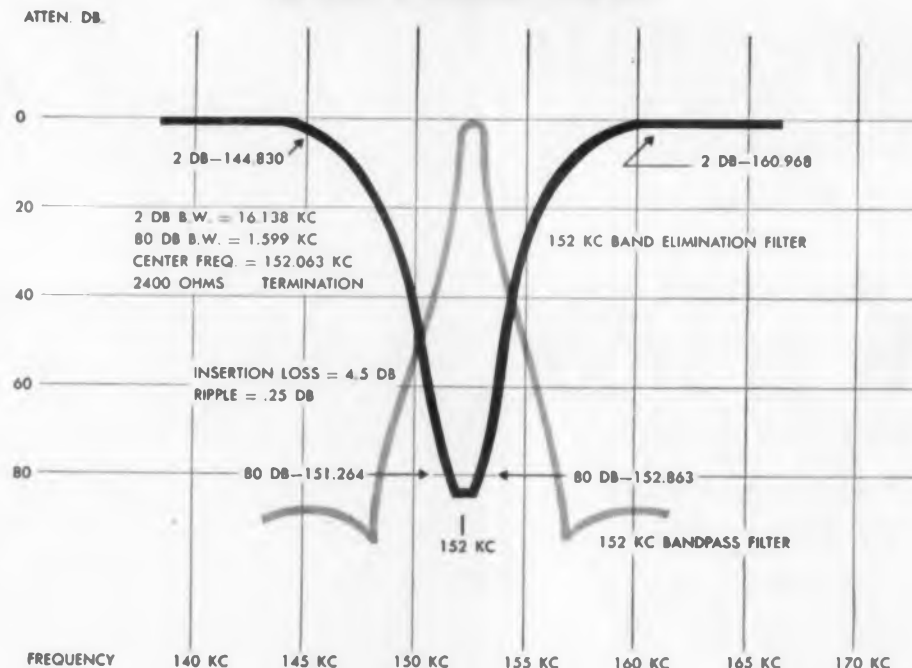

Actual operational curves, obtained from point-to-point readings, from Hill 34900 and 34800 filters developed to fulfill customers' specific requirements.

These two highly stable, precision-matched Hill Electronic filters permit fast, exceptionally accurate measurement of inter-modulation distortion in communications systems. A band elimination filter places a narrow, deep notch in the white noise being passed through the equipment under test. Distortion generated in the notch is then isolated for measurement by the narrow band filter.

The high degree of selectivity and attenuation of these filters, and the excellent alignment of one within the other are demonstrated in the actual operational curves shown above. Used together, these filters provide 80 db attenuation from 6 to 252 kc.

This is a typical example of Hill's creative engineering that develops outstanding solutions to customers' specific problems involving LC and crystal control filters as well as precision frequency sources and other crystal devices.

WRITE FOR BULLETINS 34800/900

They contain details and specifications concerning the filters described above.

HILL ELECTRONICS, INC.

MECHANICSBURG, PENNSYLVANIA

CIRCLE 77 ON READER-SERVICE CARD



Westinghouse

SILICON POWER
RECTIFIERS
AND
TRANSISTORS

NOW IN STOCK

YOU CAN OBTAIN
UP TO 1000 PIECES
OF MOST TYPES
AT
FACTORY PRICES
FROM

Schweber

ELECTRONICS

60 HERRICKS ROAD,

MINEOLA, L. I., N. Y.

PIONEER 6-6520.

TWX G-CY-NY-580U



CIRCLE 78 ON READER-SERVICE CARD



New high power silicon rectifier cells

Ratings to 600 volts... Currents to 240 amps!

Designed specifically for high-power applications, this new Type 439 Westinghouse rectifier cell features a peak reverse voltage rated at 600 volts. Another Westinghouse exclusive is the fused ceramic-to-metal construction that is hermetically sealed for extra reliability, extra ruggedness, extra-long life. Other features include:

- Lightweight (8 oz.), small size
- Hard soldered connections
- Junction temperatures to 190°C.
- No thermal fatigue

High current, high voltage applications include: Electro-chemical refining / Plating / Elevators / Cranes / D-C motors / Battery chargers / Railway traction / Welders.

For more information, call your nearest Westinghouse representative or semiconductor distributor. Or write: Westinghouse Electric Corp., Semiconductor Dept., Youngwood, Penna.

When it comes to semiconductors . . . you can be sure . . . if it's Westinghouse.

SC-1010

Westinghouse



CIRCLE 79 ON READER-SERVICE CARD

ELECTRONIC DESIGN • December 21, 1960

For immediate "off-the-shelf" delivery, order from these Westinghouse Distributors:

EASTERN

ACK SEMICONDUCTOR, INC.
Birmingham 5, Ala./FA 2-0588
CAMERADIO Pittsburgh, Pa./EX 1-4000
CRAMER ELECTRONICS, INC.
Boston, Mass./CO 7-4700
ELECTRONIC WHOLESALERS INC.
Melbourne, Florida/PA 3-1441
GENERAL RADIO SUPPLY CO., INC.
Camden, N. J./WO 4-8560
GENESEE RADIO PARTS CO.
Buffalo, N. Y./DE 9661
KANN-ELLERT ELECTRONICS, INC.
Baltimore, Md./TU 9-4242
MILGRAY ELECTRONICS
New York, N. Y./RE 2-4400
RADIO & ELECTRONIC PARTS CORP.
Cleveland, Ohio/UT 1-6060
SCHWEBER ELECTRONICS
Long Island, N. Y./PI 6-6520

MIDWESTERN

ELECTRONIC COMPONENTS FOR
INDUSTRY CO. St. Louis, Mo./WO 2-9917
INTER-STATE RADIO & SUPPLY CO.
Denver 4, Colo./TA 5-8257
LENERT CO. Houston, Texas/CA 4-2663
RADIO DISTRIBUTING CO.
Indianapolis, Ind./ME 7-5571
SEMICONDUCTOR SPECIALISTS, INC.
Chicago, Ill./NA 2-8860
S. STERLING CO. Detroit, Mich./BR 3-2900
UNITED RADIO, INC.
Cincinnati, Ohio/MA 1-6530
WHOLESALE ELECTRONICS SUPPLY
Dallas, Texas/TA 4-3001

WESTERN

ELMAR ELECTRONICS
Oakland, Calif./TE 4-3311
HAMILTON ELECTRO SALES
Los Angeles, Calif./BR 2-9154
NEWARK ELECTRONICS CO.
Inglewood, Calif./OR 4-8440



Westinghouse

SILICON POWER
RECTIFIERS
AND
TRANSISTORS

NOW IN STOCK

YOU CAN OBTAIN
UP TO 1000 PIECES
OF MOST TYPES
AT
FACTORY PRICES
FROM

Schweber

ELECTRONICS

60 HERRICKS ROAD,

MINEOLA, L. I., N. Y.

PIONEER 6-6520.

TWX G-CY-NY-580U



CIRCLE 80 ON READER-SERVICE CARD

CORNING STANDARD INDUCTORS



DELIVERED OFF THE SHELF 27 values ranging from 0.05 uh to 2.0 uh. High Q. 120 to 250. Frequency range from 10 MC to over 250 MC. High reliability under shock and vibration, since conductor is fired into glass, cannot shift. Low TC: 0 to +20 ppm/°C. Operation range from -55°C. to +125°C. No drift even under drastic dT. For panel or printed board mounting. Standard tolerance is ±10%. ±5% also available above 0.25 uh.

NEW KIT for prototype work contains 10 different inductors with four tuning cores and other accessories, along with 50-page brochure of performance charts. Contact distributor serviced by Erie Distributor Division.



CORNING TRIMMER CAPACITORS



ROTARY in three models for high-frequency tuned circuits. Standard: to 12.0 mmfd; Split bushing: to 12.0 mmfd; Precision: to 4.0 mmfd; Full rating from -55 to +125°C., TC: +50 ±50ppm/°C. Nonporous silver plating for corrosion resistance available on request.

DIRECT TRAVERSE for linear tuning. Full rating from -55°C. to +125°C. TC: +50 ±50 ppm/°C.; 0.5 to 3.0 mmfd; 1.0 to 7.5 mmfd; 1.0 to 8.0 mmfd; 1.0 to 12.0 mmfd.

MINIATURES for ultrafine tuning. .40 uufΔ/turn. Fixed cavity tuning. Silver-plated hardware for highest Q and corrosion resistance. Zero derating at 125°C. No backlash. Complete circumference thread contact with direct traverse motion. Panel mount or printed board. 1 to 4 mmfd; 1 to 8 mmfd; 1 to 12 mmfd; 1 to 18 mmfd.

CORNING ENCLOSURE TUBES



Both rectifier tubes and bushings. Made from selected glass for maximum mechanical and thermal strength. High temperature operation. High metallized bond strength: 1200 to 1500 psi. Impervious to moisture, fungi, dust, etc. Transparent, so you can inspect inserts visually. Also available with frosted glass. Made to your specifications.

DELAY-LINE COIL FORMS



For distributed constant delay lines on low loss forms. Scribe gap: 0.0040" ±0.0010" wide. O.D.: 0.200; 0.230; 0.240; 0.250. Up to 8" lengths with up to 40 lines. Forms can be produced to your specs. Short delivery time.

WHY CORNING MAKES THE MOST STABLE METALLIZED COMPONENTS

When we started fusing silver onto glass, there were roughly 60,000 glass formulae to choose from. Result: glass and metal matched perfectly for compatibility and operational characteristics.

When we fire metal to glass, it stays put. Even through tremendous thermal and mechanical shocks.

When we deposit metal, we are sure of a uniform, thin film, completely free from breaks.

Glass is chemically inert, cannot react with metal to alter properties.

Glass is non-hygroscopic. It will not warp or change its shape. Its coefficient of expansion is much lower than that of most other materials used for metallizing.

Add to all this the fact that we practically invented metallizing. This early start has helped raise metallizing from an art to a science with which we can beat your tightest specifications in mass quantities at low prices.

For more information, send for data on any of the components shown above. Check the literature card in this magazine or write direct to 540 High Street, Bradford, Pa.



CORNING ELECTRONIC COMPONENTS

CORNING GLASS WORKS, BRADFORD, PA.

CIRCLE 81 ON READER-SERVICE CARD

NEW PRODUCTS

Circuit Breaker Gang Assemblies 465

Protect three- and two-phase systems



Series 600 and 700 explosion-proof circuit breakers protect three- and two-phase systems. These hermetically-sealed units stand 50 g shock and operate from -55 to +100 C. Continuous duty ratings are from 50 ma to 15 amp. Contacts are rated for 50 v dc or 120 v rms at 60 or 400 cps. The units have a life of at least 10,000 operations at rated current.

Airpax Electronics Inc., Cambridge Div., Dept. ED, Cambridge, Md.

Price: On request.

Availability: From stock.

Slides

379

This new line offers models with capacities of 50, 100, 175, 250, and 275 lb. Seven lengths from 12 to 24 in. are available. They are made of cold-rolled steel, cadmium plated, and coated with a film of molybdenum.

Chassis-Trak, Inc., Dept. ED, 525 S. Webster Ave., Indianapolis 19, Ind.

Nylon Component Holders

446

Cap-Sure nylon component holders provide compact protection for tantalum capacitors and similarly shaped devices. Units mount by pressing into mounting board. They hold 9/32 or 3/8 in. diam components.

Industrial Devices, Inc., Dept. ED, 982 River Road, Edgewater, N.J.

Price & Availability: 8.5 to 10.5 cents each in production quantities; delivery from stock.

Silver Zinc Battery

662

Designed as a primary battery for missile auxiliary power units, Model P81A battery provides full current within 1 sec with a capacity of 4 amp-hr. The unit stands 30-g vibration, 10-g acceleration and 50-g shock along all three major axes. Temperature resistance is from 60 to 100 F, ambient with special models available for -65 to +165 F ratings. It will activate and operate in any position.

Cook Batteries, Dept. ED, 3850 Olive St., Denver 7, Colo.

Availability: Delivered 60 days after order received.

Universal Bridge

479

Employs Wheatstone circuit



This universal bridge is for measuring resistance, inductance and capacity. Measurement specifications are: dc resistance, 0.05 to 50,000 ohms; ac resistance, 50 ohms to 5 meg; capacity, 5 pf to 50 μ f; inductance, 5 mh to 50 h. Maximum error over the middle 2/3 of the scale is: on the 0.1 to 10-ohm ranges when using dc, 2%; on all other resistance ranges when using ac or dc, 1%; on all capacity and inductance ranges, 1%.

Physics Research Laboratories, Dept. ED, Uniondale, N.Y.

Price: \$199 ea.

Gold Powder and Sheets

663

Available in powder and sheet form in lots of from 1/2 troy oz and up, this gold material is 99.999% pure. The powder is 100 mesh and finer; the sheets are available in 4-in. widths with thicknesses down to 0.0005 in. It can be used to form ohmic junctions in semiconductors.

High Purity Metals, Inc., Dept. ED, 340 Hudson Street, Hackensack, N. J.

Switch Section

378

These etched-circuit switch sections with a no-clip design have a life of more than 1,000,000 operations. They pass Mil tests for insulation, breakdown, temperature and vibration. A wide range of contact combinations is offered.

Centralab, Div. of Globe-Union, Inc., Dept. ED, 900 E. Keefe Ave., Milwaukee 1, Wis.

Availability: Made to customer specs.

Electronic Relay

487

This electronic relay is design to actuate any electrically controlled function of a process or a machine. It can be used as a liquid, a size or a position control. 50 μ a are required to operate the unit, response is 0.02 sec. Unshielded leads up to 100 ft in length can be used. The relay is actuated by grounding an external probe, and grounding material can be of low conductivity.

The Clark Controller Co., Dept. ED, 1146 E. 152 St. Cleveland 10, Ohio.



MINIATURE MOTOR PROTOTYPES 24 HOUR DELIVERY

We now stock small quantities of the most popular sizes and types of Globe precision miniature motors—both a.c. (60 and 400 cycle) and d.c., plain and gear reduced, for immediate shipment off the shelf. Get the motor you need tomorrow!

Understandably we can't guarantee to meet every requirement that fast: the Globe line is the broadest available today with literally millions of combinations—stocks change day to day. But we are almost sure our inventory contains a motor that comes close to your prototype requirements—to tide you over until we can furnish the exact motor you need. (Most unstocked prototypes normally can be built and delivered in 4 weeks or less.)

Your Globe engineering representative has the latest stock lists. Contact us when you need a miniature motor immediately. For details about 24-hour prototypes, write for Bulletin 24. Globe Industries, Inc., 1784 Stanley Avenue, Dayton 4, Ohio, or telephone direct: BALDWIN 2-3741.

GLOBE INDUSTRIES, INC.

PRECISION MINIATURE A.C. & D.C. MOTORS, ACTUATORS,
TIMERS, STEPPERS, BLOWERS, FANS, MOTORIZED DEVICES

GLOBE

CIRCLE 82 ON READER-SERVICE CARD

WAIT A MINUTE... or a μ SECOND

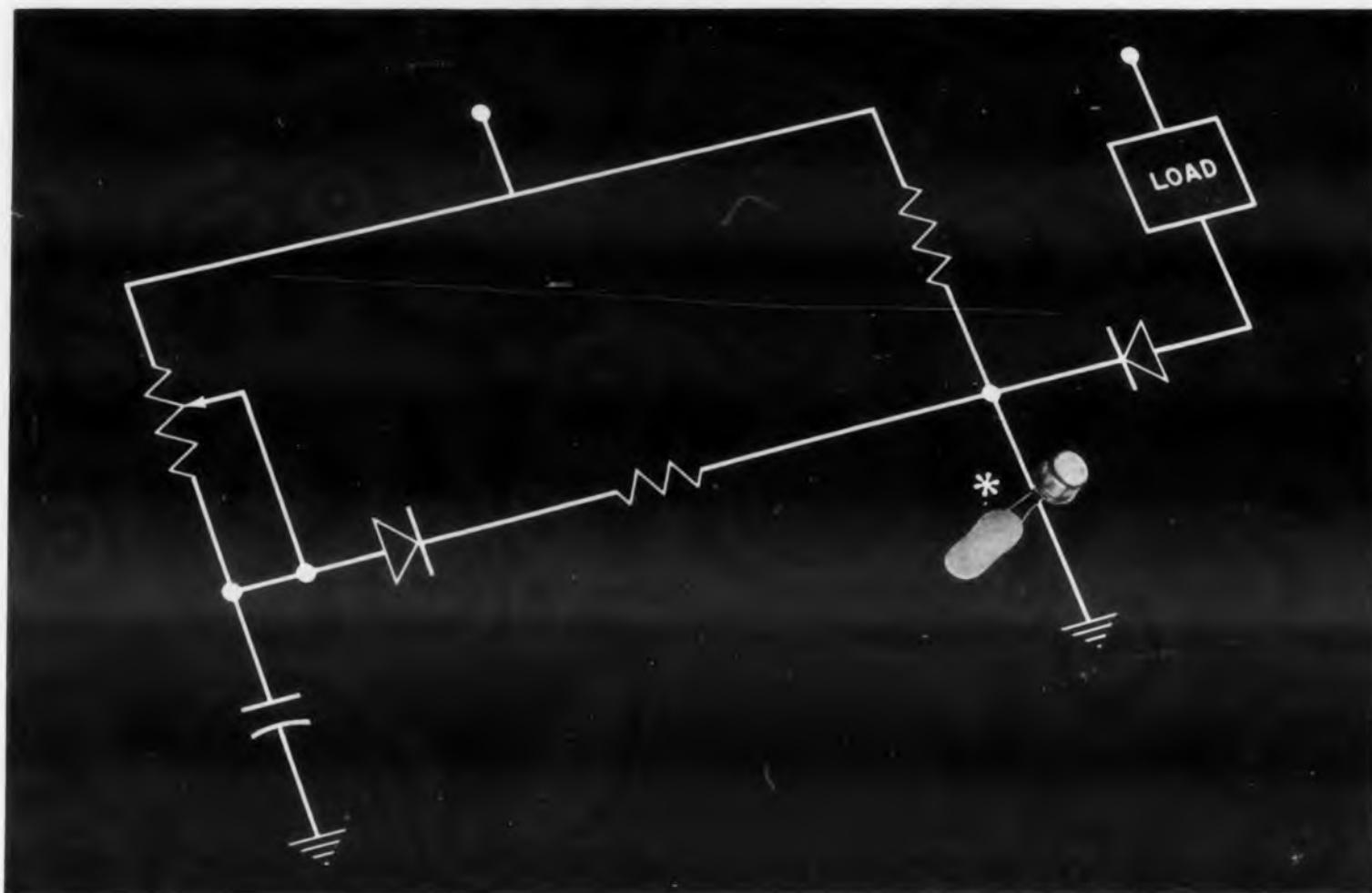

SHOCKLEY 4-LAYER DIODE* gives minutes or μ s time delays with a single circuit.

A wide variety of time delays from fractions of a microsecond to several minutes have been made possible by the Shockley 4-layer diode. Now you have the advantages of solid state circuitry for a wide range of industrial and military time delay or time cycle applications.

You'll see in the schematic drawing above that only one active element is needed in this circuit: the Shockley 4-layer diode. The Type AD shown will carry 300 ma continuously. Higher power diodes are available. Contact bounce and chatter are entirely eliminated since mechanical devices are no longer necessary.

If you are developing a circuit where a variable time delay is needed (to energize relays, to activate a power supply or to obtain timing pulses), contact our local engineering sales representative for details, or write to Shockley Transistor, Palo Alto.

Shockley TRANSISTOR
 UNIT OF CLEVITE TRANSISTOR
 STANFORD INDUSTRIAL PARK, PALO ALTO, CALIF.

CLEVITE
 CORPORATION

CIRCLE B3 ON READER-SERVICE CARD

NEW PRODUCTS

Fixed Attenuator

451

Frequency range is dc to 10 Gc



Model A-13 precision coaxial attenuators are for the range of dc to 10 Gc. Units can be supplied in attenuation values of 0 to 60 db. Accuracy up to 30 db, including absolute accuracy and variation of attenuation as a function of frequency, is 1/2 db; accuracy from 30 to 60 db is 3/4 db. The vswr of these units with type N connectors is 1.3 max from dc to 10 Gc. Power rating is 1 w. Units are calibrated as 2.8 Gc and at 0.5 Gc. They can be furnished with N, C, and TNC connectors.

RLC Electronics, Inc., Dept. ED, Mamaroneck, N.Y.

Price: \$155 to \$175.

Availability: Stock to two weeks.

Single-Component Epoxy Coating

475

Humiseal type 1F56 single-component epoxy coating requires no mixing and may be used directly from the shipping container. It is a high-temperature, rigid epoxy system curable at elevated temperature for a short period of time. Viscosity may be adjusted to yield builds of 10 mils and thicker. It may be applied by dip or brush. It is capable of continuous operation up to 155 C.

Columbia Technical Corp., Dept. ED, 24-30 Brooklyn-Queens Expressway West, Woodside 77, N.Y.

Printed-Circuit Toroids

362

These molded, printed-circuit toroids have an inductance range to 4 h, with Q values to 220, depending on frequency. Size is 5/8 x 5/8 x 3/8 in. high plus 0.025 in. boss. Cores 45, 50 and 51 are available in this package.

Torotel, Inc., Dept. ED, 5512 E. 110 St., Kansas City 37, Mo.

Availability: Immediate delivery.

Servo Control

367

The Microjuster permits precise manual knob adjustment of the electrical output of rotating electrical elements such as synchros or pots. It can be used in servo or similar systems to introduce settings such as altitude, heading, speed and elevation. It meets Mil specs.

Servo Development Corp., Dept. ED, 567 Main St., Westbury, N. Y.

Remote-Control Unit

483

For a central graphic display panel



This remote-control unit is packaged with a graphic symbol front cover, ready for use in a central display panel. It is designed to provide remote open-stop-close or on-off control and status indication of valves, motors, blowers, pumps and similar devices. Maximum loop line resistance may be as high as 100 ohms for incandescent indications or 2,000 ohms for neon indicators. The standard field unit is suitable for controlling up to 2-amp coils at 480 v.

Texas Instruments, Inc., Dept. ED, 3609 Buffalo Speedway, Houston 6, Tex.

Four-Pole Subminiature Relays 505

Occupy less than 0.5 cu in.

These 4 pdt relays occupy less than 0.5 cu in. and weigh less than 1 oz. Standard rating is 26.5 v dc. They are suitable for power or low-level switching and have a minimum rated life of 200,000 operations at rated load and 10,000,000 mechanical operations. Current rating is 2 amp at 26.5 v and 1 amp at 115 v ac. Units stand 30-g vibration and are rated for operation at 125 C. They can have solder lug, plug-in, or printed circuit headers with end bracket, side bracket, stud or socket mounts.

General Electric Co., Specialty Control Dept., Dept. ED, Schenectady 5, N.Y.

Availability: Immediate.

Chassis Slide 517

Has tilting design

SS-300-T chassis slide for rack-mounted equipment is for applications where the chassis must tilt up for quick access to circuitry. It is constructed on controlled temper cold-rolled steel and has a solid bearing to stand shock and vibration. It has a capacity of 185 lb at full extension and will mount a full 17-in. wide chassis in any 19-in. cabinet. Height is 3 in. and lengths are 14 and 24 in.

Christman Industries, Inc., Dept. ED, 1562 61st St., Brooklyn 19, N.Y.

Price: \$20.24 per unit.

Availability: From stock to 15 days.

Highly Reliable HITACHI "SEMI-CONDUCTORS"

For Industrial Use
Switching Transistors and Diodes

2SA18
2SA41
2SA42
2SA86
2SA208
2SA209
2SA210
2SB66
2SB67
2SB68
2SB81
2SB82
2SC89
2SC90
2SC91

Hitachi semi-conductors provide the basis for the excellent capacity of the Hitachi Electronic Computer HITAC 103.

1N34A
1N35
1N38A
1N56A
1N60
1S77
1S78
1S79
1S84

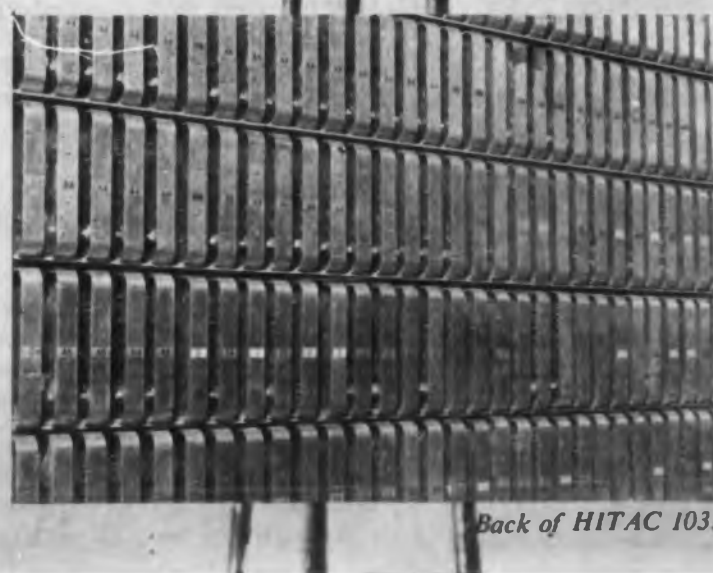

Back of HITAC 103.



Hitachi, Ltd.

Tokyo Japan

Cable Address: "HITACHY" TOKYO

CIRCLE 84 ON READER-SERVICE CARD



WHAT DEPENDABLE SLIDE SWITCHES

CAN DO FOR YOUR PRODUCTS

ADD COLOR—Trigger knobs in 10 attractive colors add decorative and functional touches to switching operations.

CUT COSTS—Low in initial cost, Stackpole Slide Switches often reduce costs up to 50% over other type switches.

SAVE SPACE—Stackpole Slide Switches take less panel area, often less depth than conventional switches.

SIMPLIFY PRODUCTION—Choice of solder lug or printed wiring terminals, clearance or tapped-extrusion mounting holes.

HANDLE HIGHER LOADS—0.5- to 1-amp types for electronic equipment. 1-, 3-, and 6-amp types for appliances and power tools.

SWITCH COMPLEX CIRCUITS—1- to 3-poles, 2- to 4-positions for real switching versatility.

FACILITATE OPERATION—Trend-setting slide action available with or without detents and spring returns. Plunger-operated and matching pushbutton styles also available.

Write for Slide Switch Bulletin

STACKPOLE

ELECTRONIC COMPONENTS DIVISION
STACKPOLE CARBON COMPANY, St. Marys, Pennsylvania

CIRCLE 85 ON READER-SERVICE CARD

NEW PRODUCTS

Silicon Diodes

481

For ultrasonic applications



Types 1N53D and 1N53RD silicon microwave-mixer diodes are for use in ultrasonic aircraft and missile applications. These 34,000-mc units have a maximum operating temperature of 150 C, an over-all noise figure of 9 db and an amplifier noise figure of 1.5 db. The matched pair of diodes have a maximum vswr of 1.5 at 34,860 mc and 2.5 max at $\pm 6\%$. Use of the pair eliminates local oscillator noise.

Sylvania Electric Products Inc., Semiconductor Div., Dept. ED, 730 Third Ave., New York 17, N.Y.

Price: 1 to 99 units: type 1N53D, \$75 ea; type 1N53RD, \$110 ea.

Connectors

360

No. AT-160-N and No. AT-180-N self-positioning connectors fit the firm's No. 6 and 8 size studs. They can be used as permanent connectors or as tools for use with production circuit checking equipment. The units can be attached to test harnesses and cables such as are used in aircraft and missile production.

Autotron, Inc., Dept. ED, 2413 Main St., Santa Monica, Calif.

Bamboo Slide Rule

427

This laminated bamboo slide rule provides self-lubricating qualities, shrink and warp resistance. It is 10 in. long and has log-log and overlapping scales. It is provided with a leather case and an instruction booklet.

Texas-Asiatic Import Co., Dept. ED, 2127 Fort Worth Ave., Dallas 11, Tex.

Infrared Filters

492

Pass 60% of Desired Radiation

These interference filters pass an average of at least 60% of the desired radiation but less than 1% of the radiation in the rejection band. The cut-on point can be placed anywhere between 1.5 and 8.0 microns. The cut-on slope of the filter can be made better than 13% of the cut-on wavelength. Infrared radiation out to 25 microns in wavelength may be isolated with their filters, the manufacturers claim.

Spectracoat, Inc., Dept. ED, Belmont, Calif.

THE CROTCHETY DIODE BUYER'S REVENGE



"Ho, ho," his fellow employees would jape, "some purchasing agent we have. He's so busy trying to find bargain diodes that he has little time for aught else."

"You'll see!" he would say, shaking his fat little fist. "It's folly to pay prodigious prices for MIL-spec diodes to go in our hi-fi sets, when more modest parameters are adequate. For weeks I've been writing letters to an alphabetical list of semiconductor manufacturers."

That very day he got to the X's. He wrote to Xytan. Xytan, you know, is the company that sells top-grade diodes for a fraction of their original cost. The products were made to meet very exacting MIL specs, but maybe just barely missed a parameter or two.

Happily, our friend found exactly what he wanted at Xytan: rugged glass-packaged diodes—plainly marked and classified. With a quantity purchase he bought them for only 16¢ each. They worked so well in the company's hi-fi sets that you would think that Lawrence Welk and the Champagne Lady were right in the same room with you.

The Crotchety Diode Buyer's brilliant coup brought him unanimous election to the company's board of directors. The very next day he fired all the loud-mouth malcontents.

If you're looking for top-grade semiconductors at tremendous bargains, write:

XYTAN

1755 Placentia Ave.
Costa Mesa, Calif. Midway 6-5097

CIRCLE 86 ON READER-SERVICE CARD

TAURUS TERMINALS OF TEFLON*

We are specialists in manufacturing STANDOFF & FEEDTHRU TERMINALS insulated with Teflon*. Simplest terminal to install by forcing into undersize chassis hole.

Taurus Terminals are accepted and approved by major users. Taurus is a completely integrated, experienced and quality minded manufacturer of terminals.

TAURUS PUNCHED CARD SENSORS

Read Entire
Punched Card
Statically



FOR
SIMPLE SWITCHING USING
STANDARD PUNCHED CARDS

The Sensor statically reads entire standard I.B.M. or Remington Rand punched cards. Each hole position has a corresponding closed switch, and each unpunched hole position has a corresponding open switch when the Sensor is actuated.

Used for automatic test equipment and other automatic devices.



TAURUS CORPORATION

8 Coryell Street
Lambertville, New Jersey

CIRCLE 87 ON READER-SERVICE CARD

Uninterrupted Power Supply

478

For microwave communications



Series 705 power sets are suited to military ground installations, aeronautical ground sites, computer installations and other applications where power-line failure cannot be tolerated. The system consists of a 7.5-hp ac motor driving a 6.5 kva alternator which is coupled to an 8.5 hp dc motor. Transfer from ac to dc drive is in less than 0.2 sec; frequency is held within 5%. A standby battery is used in the event of power-line failure. Units are available with permanent-magnet and trans-diode alternators from 2.5 to 30 kva or up to 25 kw in dc systems.

Electric Specialty Co., Dept. ED, 211 South St., Stamford, Conn.

Test Sockets

375

The AS test sockets eliminate the need for solder joints or clip leads in testing solder-terminal components. Dual insulated contacts provide a double connection to each pin.

Electronic Engineering Co. of Calif., Dept. ED, 1601 E. Chestnut Ave., Santa Ana, Calif.

Availability: Immediate.

Telephone Repeater Coils

361

These coils contain up to 20 wire connections to 10 layer-wound coils on a 1-in. impregnated coil form. The coils are U-I laminated. Breakdown potential between coil connections is 1,000 v.

Ferrotran Electronics Co., Inc., Dept. ED, 693 Broadway, New York 12, N.Y.

Price: \$20 to \$30.

Solid-State Ultrasonic Cleaners

355

These miniaturized, 20-kc cleaners provide 250- to 1,000-w power in unit combination. Systems providing up to 25,000-w power use modular-form, transistorized generators.

Acoustica Associates, Inc., Dept. ED, 10400 Aviation Blvd., Los Angeles 45, Calif.

Superdense Ceramic Material

356

Glennite HT-8 ceramic material made from hyperpure barium titanate, has a specific dielectric constant of 4,300 at room temperature. Density is greater than 8.

Gulton Industries, Inc., Dept. ED, 212 Durham Ave., Metuchen, N.J.

CHOOSE FROM THE INDUSTRY'S WIDEST SELECTION OF HIGH-CURRENT (TO 600 AMP) TRANSIENT-SUPPRESSED DC POWER SUPPLIES

Response time adjustable to 20 milliseconds . . .

Excellent dynamic load regulation . . . low ripple

Proven in production
use in the . . .

THOR . . . BOMARC . . . ATLAS . . .

JUPITER . . . POLARIS . . .

VANGUARD AND LA CROSSE

MISSILE PROGRAMS



SPECIFICATIONS

A.C. INPUT: 208/230/460 volt $\pm 10\%$, 3 phase, 60 cycle.

RIPPLE: Less than 1% RMS.

RESPONSE TIME: A special control internally mounted in the Power Supplies handles adjustment of response time. The "load on" response time is adjustable from 20 to 200 milliseconds, and the "load off" from 40 to 400 milliseconds. An important advantage of this adjustable response is when used with inductive loads, such as inverters; recovery can be adjusted to avoid interaction between inductive load and power supply.

RATINGS AVAILABLE:

Model Number	D.C. Output		Regulation		Dimensions W" x H" x D"	Weight Lbs.
	Volts	Amps	Static-Line or Load	Dynamic-Load*		
MRST28-100	24-32	100	$\pm 0.1\%$	$\pm 6V$	27" x 17" x 17"	230
MRST28-200	24-32	200	$\pm 0.1\%$	$\pm 6V$	22" x 36" x 22"	550
MRST28-300	24-32	300	$\pm 0.1\%$	$\pm 6V$	22" x 36" x 24"	700
MRST28-400	24-32	400	$\pm 0.1\%$	$\pm 6V$	26" x 66" x 30"	1250
MRST28-500	24-32	500	$\pm 0.1\%$	$\pm 6V$	22" x 68 1/2" x 32"	1650
MRST28-600	24-32	600	$\pm 0.1\%$	$\pm 6V$	22" x 68 1/2" x 32"	1650
MRST2440-250	24-40†	250	$\pm 0.1\%$	$\pm 2V$	26 1/4" x 69" x 38"	1650

* For Full Load Charge
† In 2 Ranges

Write for literature or recommendations based on your specifications.
Representatives throughout the United States.

PERKIN



PERKIN ELECTRONICS CORPORATION

345 Kansas St., El Segundo, Calif. • EAstgate 2-1375

CIRCLE 88 ON READER-SERVICE CARD

RCA

ELECTRONIC INSTRUMENTS

...bring RCA reputation, reliability and precision measurements to industry

Specify the V-O-M with the Extras!



Only \$43.95*

Complete with batteries, instruction book and all probes, clips and cables. (RCA V-O-M Kit, WV-38A(K), only \$29.95*). Rugged, scuff-proof, stain-resistant laminated vinyl carrying case, only \$4.95* extra!

WV-38A VOLT-OHM-MILLIAMMETER

Compare this superlative RCA V-O-M against the model you may have been thinking of buying. See if it doesn't check out better in these extra features:

- EXTRA! 1.0 volt and 0.25 volt DC ranges!
- EXTRA! Big easy-to-read 5 1/4" meter!
- EXTRA! Non-breakable plastic case; no glass to crack or shatter!
- EXTRA! Red test lead has probe and slip-on alligator clip for added versatility!
- EXTRA! Convenient location of jacks permits switching without interference from leads!
- EXTRA! Spring clips on the handle to hold test leads!
- EXTRA! DB scales clearly marked: no squinting!



NEW!

WA-44C

AUDIO GENERATOR

Generates sine and square wave signals for testing audio systems. Frequency range: 20 cps to 200 Kc. Total Harmonic Distortion 0.25% from 30 cps to 15 Kc. Used in measurement of intermodulation distortion, frequency response, db and dbm, input and output impedances, speaker resonance, transient response and phase shift. Also used to check tone controls, phonograph equalizers, resonant frequency of AC circuits, locate speaker and cabinet rattles, and to determine unknown frequencies.

Only \$98.50* (With cable and instructions.)



NEW PRODUCTS

Strain Gage

463

For repetitive measurement



Model SG2 versatile-resistance strain gage is for repetitive measurement of strain or unit elongation. It has applications in aircraft test certification, structural steel column loading and concrete specimen studies. Specifications include: strain range, ± 0.003 in. per in.; gage length, 1.25 in.; weight, 1 oz approx; size, 1.77 x 1 x 0.62 in. This unit has infinite resolution; combined error is less than $\pm 1\%$ of full scale. Model BCR1-0 bridge control readout provides a combined power supply, bridge balance and electrical readout meter. It is for operation on 110 v ac or with battery power for portable requirements.

Statham Instruments, Inc., Dept. ED, 12401 W. Olympic Blvd., Los Angeles 64, Calif.

Level Trigger

514

High-speed type

The LT-1 10-mc level trigger occupies only 0.35 cu in. and weighs 9 g. It operates from -55 to $+55$ C. The output rapidly assumes one level when input voltage is raised above critical triggering level and quickly changes to zero level when the input falls below turn-off level. If the input is open circuited at any time, the output remains at the value corresponding to the last input voltage applied. The standard 7-pin base permits easy insertion into sockets for development work, dip-soldering in printed-circuit boards and incorporation into finished computers.

Cambridge Thermionic Corp., Dept. ED, 445 Concord Ave., Cambridge 38, Mass.

Price: \$130 in quantities to 10.

Availability: From stock in quantities to 10.

Digital Display

489

Employs stroboscopic principle

The digital display known as Digistrobe, uses the stroboscopic principle to provide an in-line, in-plan, high-definition, white-on-black display. A single diode-encoding matrix is shared by all columns resulting in a reduced number of electronic



WT-100A ELECTRON-TUBE MICROMHOMETER

Precision laboratory instrument for measuring: true transconductance (accuracy better than $\pm 3\%$) — control-grid-to-plate (gm) and suppressor-grid-to-plate; electrode currents — plate, suppressor-grid, screen-grid, and control-grid; heater-cathode leakage current; voltage drop across low-voltage rectifier types; forward and reverse currents in small dry-disc rectifiers, and crystal diodes. For production-line testing, equipment design and development, quality control programs, preventive maintenance. Accommodates variety of bases and envelopes. Test tubes at published ratings or at ratings under which the tube is expected to operate.

\$1,075.00*



WO-91A 5-INCH OSCILLOSCOPE

A high-performance, wide-band oscilloscope ideally suited for servicing broadcast or closed-circuit TV (color or black and white), industrial and commercial signaling and communications systems, and general electronics applications. 5" graph screen provides good resolution. Dual bandwidth (4.5 Mc at 0.053 volts rms/in. sensitivity and 1.5 Mc at 0.018 volts rms/in. sensitivity). Internal calibrating voltage and calibrated graph screen. Includes special direct/low cap shielded probe and cable.

\$239.50* (Complete with ground cable, insulated clip, instruction book.)

ALSO AVAILABLE . . . WO-33A--3-INCH SUPER-PORTABLE OSCILLOSCOPE Only \$129.95* complete with low-cap direct input probe, cable, power cord, cord-carrying brackets, instructions. (RCA Super-Portable Oscilloscope Kit, (WO-33A(K), only \$79.95*.)

WV-84C ULTRA-SENSITIVE DC MICROAMMETER



Battery-operated vacuum-tube microammeter measures down to 0.0002 microampere. Designed for general industrial, chemical, and critical laboratory applications. Especially useful in measuring "dark currents" in vidicons and phototubes, as well as minute currents in image orthicons.

\$110.00*



WV-77E VOLTOHMYST®

To measure AC and DC voltages, 0 to 1,500 volts; resistances from 0.2 to 1,000 ohms. Famous RCA VoltOhmyst quality at a low price! Separate scales, 1 1/2 volts rms and 4 volts peak-to-peak, for accuracy in low-voltage ac measurements. Fuse-protected ohms-divider network. Complete with ultra-slim probes, long flexible leads.

Only \$43.95* (Easy-to-assemble kit, WV-77E(K), only \$29.95*)



NEW! WV-98B SENIOR VOLTOHMYST®

For making accurate AC and DC voltage measurements as well as measuring resistances from 0 to 1,000 megohms. Measures peak-to-peak values of complex wave forms. Rugged, die-cast aluminum case. Easy-to-read 6 1/2-inch meter! A fine VTVM for electronic engineers and technicians! Includes special dc/ac-ohms shielded probe and cable.

\$79.50* (Complete with ground lead, alligator clip, instruction booklet.)

See them at your
Authorized RCA Test
Equipment Distributor.



The Most Trusted Name in Electronics
RADIO CORPORATION OF AMERICA

*User Price (Optional)

components and circuitry. A single display can be used to sample several inputs on command. This unit operates directly from the output register of a computer, counter or allied equipment. Maximum transition time from display quantity to display quantity is 56 msec. Power requirements are single phase, 60 cps, 115 v ac $\pm 10\%$. A minimum strobe tube life of 2,000 hr is claimed.

General Precision, Inc., Kearfott Div., Dept. ED, 1150 McBride Ave., Little Falls, N.J.

Pulsing Power Supply 473

For tunnel-diode programming

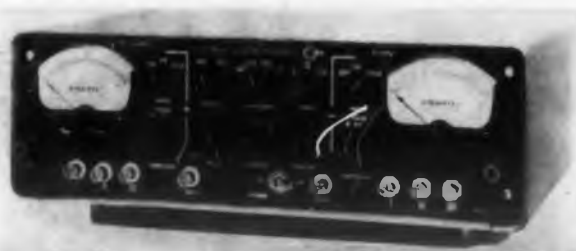

Model PS-2001 pulsing power supply is for programming tunnel-diode or parametron-logic networks. It provides pulsed outputs in a variety of pulse and regulated combinations. The pulses are phase-locked to an external or internal clock that is variable from 500 kc to 2 mc. Pulse amplitudes can be varied simultaneously from 0 to 1 v at 100 ma. Included are two dc supplies independently variable from 0 to 20 v and from 0 to -20 v at 100 ma upon which the pulses can be superimposed. Rise and fall times are 0.1 μ sec approx.

Straza Industries, Electronics Div., Dept. ED, 790 Greenfield Drive, El Cajon, Calif.

Load-Spectrum Programmer 511

Simplifies fatigue tests

This automatic programmer simplifies material fatigue testing. The engineer using the unit charts the amplitude and frequency of load cycles for one complete spectrum, attaches these charts to two rotating drums in the instrument, and sets a count-down type counter at the total number of cycles or spectrum repetitions and presses a starting switch. Two function generators read the charts and guide the programmer through the entire test spectrum. A typical frequency range is 0.1 to 3 cps; the spectrum repetition rate is adjustable from 200 to 10,000 sec per spectrum.

Research, Inc., Dept. ED, P.O. 6164, Minneapolis 24, Minn.

Price: \$6,500 to \$8,000.

Availability: 60 days.

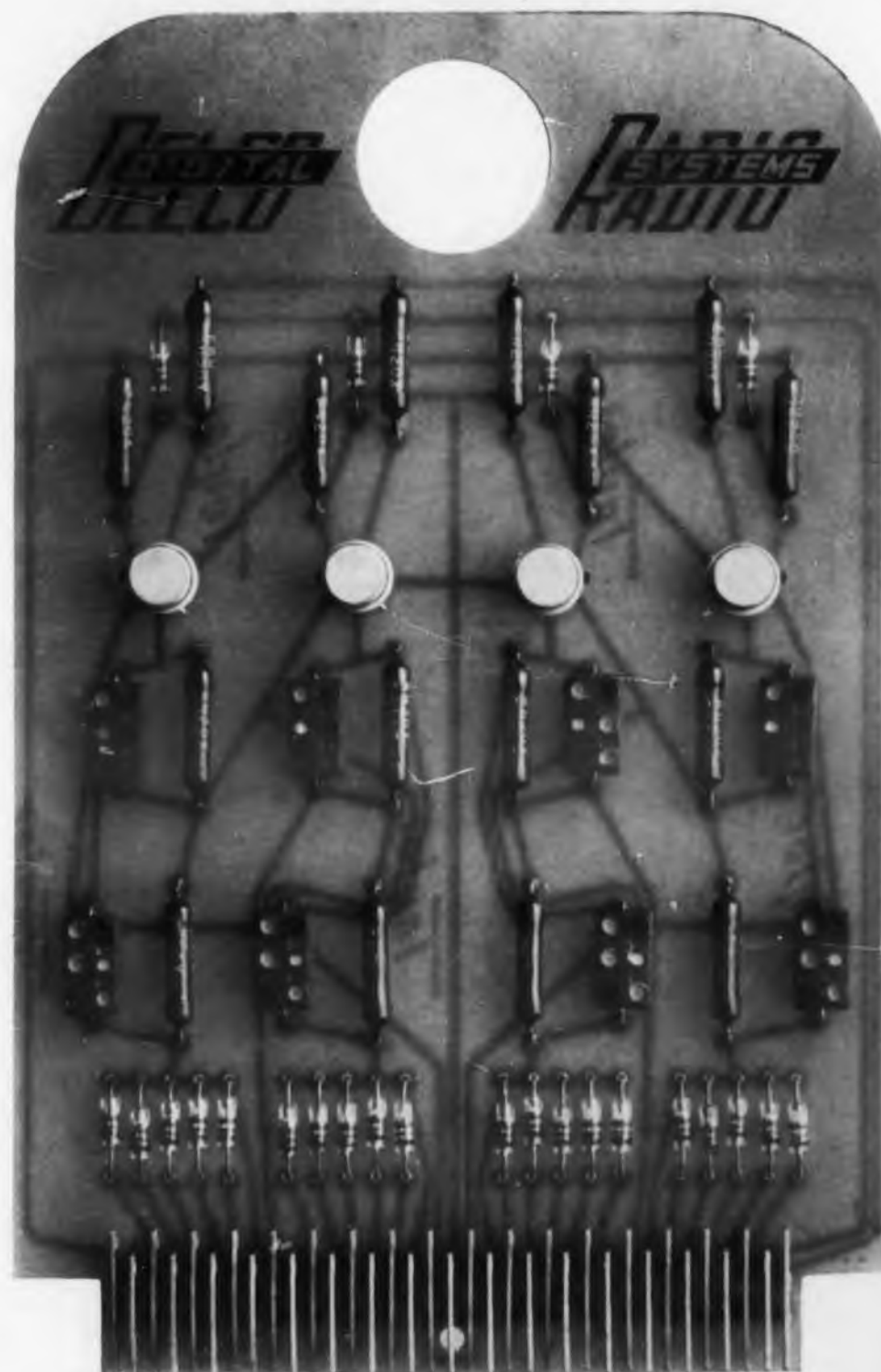

DIGITAL MODULES

... building block or plug-in card

Which package fits into your design? Packaged either way, Delco Radio Digital Modules meet or exceed all MIL-E-5272D (ASG) environmental requirements. Continuing life tests on these computer circuits now exceed four and one-half million transistor hours *without a failure*. The modules perform all the standard logic functions and come in many basic types and variations. Delco modules in the transistorized building block package are ideally suited for airborne guidance and control because of their extreme ruggedness, compactness and reliability. All miniature building block modules employ three dimensional welded wiring techniques and are vacuum encapsulated in epoxy resin. Delco Radio can offer you off-the-shelf digital circuits packaged as building blocks or plug-in cards, or can supply circuits to meet your specific needs. Our Sales Department will be happy to send you complete engineering data. Just write or call. ■ *Physicists and electronics engineers: Join Delco Radio's search for new and better products through Solid State Physics.*

PIONEERING ELECTRONIC PRODUCTS THROUGH SOLID STATE PHYSICS

Division of General Motors • Kokomo, Indiana

CIRCLE 90 ON READER-SERVICE CARD

DELCO
RELIABILITY
RADIO
RELIABILITY

ANOTHER G-C SPACE SAVER!

Threaded Cup Core and Bobbin for Miniaturized IF Transformer and Coil Applications

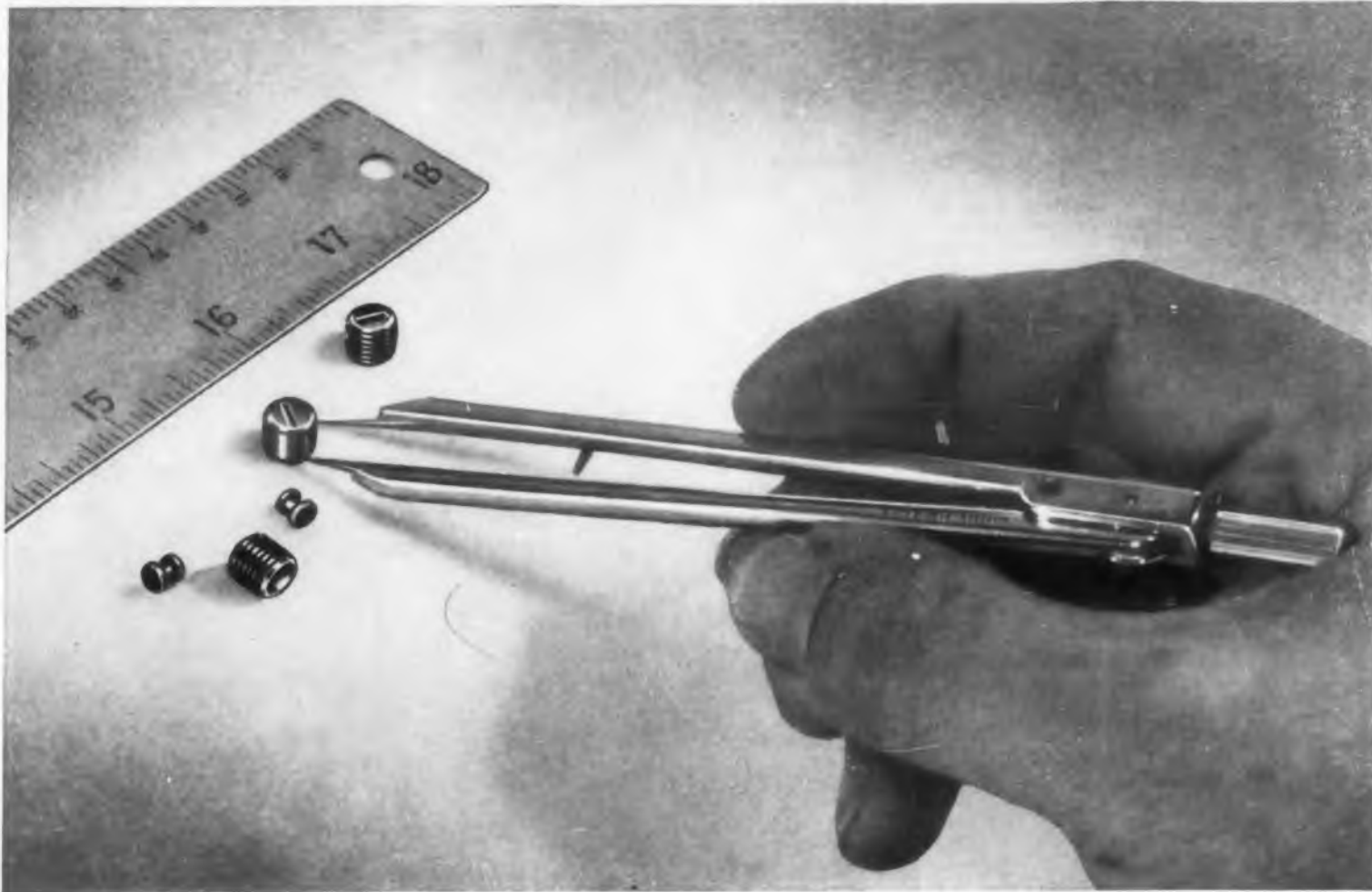

Now you can design miniaturized IF transformers and coils for AM-FM radio and television applications, and maintain high "Q" and effective permeability factors.

This new G-C threaded cup core and ferrite bobbin assembly has closely held mechanical tolerances for precision screw adjustment, and allows close cou-

pling factor between the coil and core.

For RF coil applications, G-C offers a complete line of threaded cores operating in frequency ranges up to 65 mcs. G-C threaded cores are available from stock in Q-1 and Q-2 material; pitch sizes from 1/4-28, 10-32 and 8-32; lengths from 1/4" to 1 1/8" with hex, square or screw-driver holes.

Write for additional information on the miniaturized threaded cup core F1266 and bobbin F1270 and data on G-C stock cores. Please address inquiries to Section ED.



GENERAL CERAMICS

KEASBEY, NEW JERSEY, U.S.A.

TECHNICAL CERAMICS, FERRITE AND MEMORY PRODUCTS
CIRCLE 91 ON READER-SERVICE CARD

NEW PRODUCTS

Ferrite Isolators

477

For signal source stability



This line of broadband waveguide ferrite isolators is for maintaining signal source stability, and eliminating long-line and frequency-pulling effects in all types of low-power microwave signal sources. Isolation is 20-dB min in C band (3.95 to 5.85 kmc) and X_y band (5.4 to 8.2 kmc); it is 30-dB min in X_u band (7.05 to 10 kmc) and X band (8.2 to 12.4 kmc). Insertion loss is 0.75, 0.7, 0.5 and 1-dB max in these respective bands. Minimum front-to-back ratio ranges are from 26:1 in the C band to 60:1 in the X_u band.

Narda Microwave Corp., Dept. ED, 118-160 Herricks Road, Mineola, L.I., N.Y.

Price: \$220 to \$250 ea.

Availability: From stock.

Packaging Paper

500

Daubrite packaging papers are sulfur-free and inhibit oxidation in non-ferrous metals. They are said to protect copper, brass, bronze, and cadmium from tarnishing over a period of years. The paper is available in a variety of weights and finishes, in widths up to 60 in., in sheets or continuous rolls.

Daubert Chemical Co., Dept. ED, 4700 S. Central Ave., Chicago, Ill.

Miniature Components

373

Having Precision 1, 2 and 3 tolerances, these miniature components include gears, shafts, differentials, ball bearings, couplings, collars, gear plates and others. Shaft sizes are 5/64, 3/32 and 1/8 in.

PIC Design Corp., Dept. ED, 477 Atlantic Ave., East Rockaway, L.I., N.Y.

Price & Availability: \$45 to \$75 less quantity discounts; 10 days.

Synthetic Resin-Type Adhesive

388

Adhesive type 7008 is a non-porous material for speaker coils, laminated circuits, multiple contact assemblies and other applications. It bonds at room temperature; a thermosetting reaction occurs at 250° F to provide maximum film strength.

B.B. Chemical Co., Dept. ED, 784 Memorial Drive, Cambridge, Mass.

Price: \$4.80 per gal in 50-gal drums.

Availability: From stock.

Phase Meter-Shifter

736

For 400-cps operation

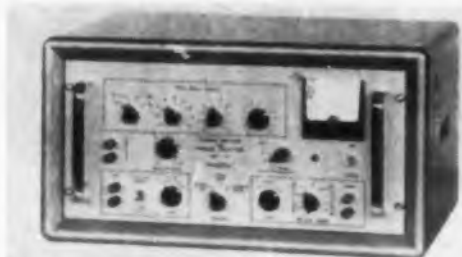

Model 341 combination phase meter and phase shifter is designed for phase measurements between fundamental components in the presence of severe harmonic distortion. For example, it measures the phase difference between two signals with an absolute accuracy of 0.1 deg. in the presence of 200% third-harmonic content. All harmonics are rejected by more than 80 db. The instrument performs with full accuracy and resolution at signal levels as low as 10 mv with useful operation at 1 mv. The null meter sensitivity may be set for 1, 10 or 100 deg for full scale indication.

Dytronics Co., Dept. ED, 5485 N. High St., Columbus 14, Ohio.

Price: \$850.

Availability: Three weeks.

Germanium Switching Transistors

503

For high-speed applications

Type 2N1605 npn, high-speed transistor has the following specifications: collector-to-base voltage, 40 v max for high-voltage circuitry; reverse-leakage current, 10 μ a max at 40 v; maximum power dissipation, 200 mw at 25 C; junction-temperature ratings, -65 to +100 C. It is housed in a TO-5 JEDEC package with the base connected to a metal case.

Sylvania Electric Products Inc., Dept. ED, 730 Third Ave., New York 17, N.Y.

Price: \$2.44 for 1 to 99 units; \$1.63 for 100 to 999.

Availability: Immediate.

Cord Reels

521

Hold electric cords

Electric cords can be wound on these miniature reels, eliminating the hazard of a dangling cord and portable equipment. The reels measure 1.25 in. wide, without the housing, and come in diameters of 3.25, 4, and 5 in. They accommodate cords measuring from 4 to 10 ft long. Heavy-duty types can also be furnished.

Cordomatic, Dept. ED, 17th and Indiana Ave., Philadelphia 32, Pa.

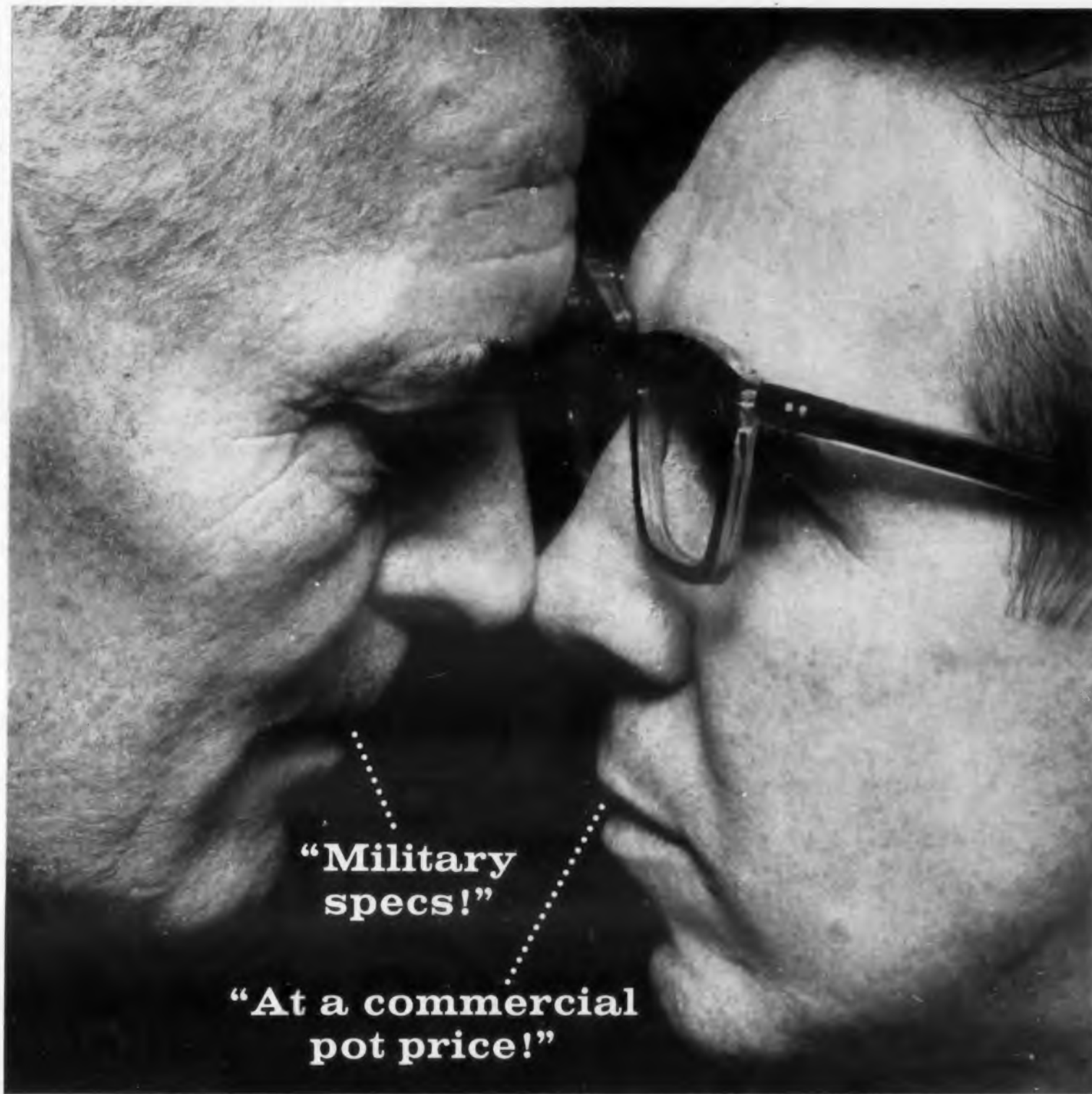

"Military specs!"

"At a commercial pot price!"

Waters new sealed PT^{3/4} potentiometer

Dust! Corrosion! Moisture! Vapors! All are foes of potentiometer reliability, yet ordinarily costly to keep out. Now, however, Waters introduces a new $\frac{3}{4}$ " plastic case pot, the PT $\frac{3}{4}$, meeting military sealed pot specs (MIL-R-19A, MIL-R-19/1A), yet priced no higher than many commercial grade pots! "O" ring shaft seal and complete internal sealing virtually eliminate environmental problems. Provides the same protection as encapsulation in less space. Resistance element is a copper mandrel wound with wire alloy which has a temperature coefficient of 20 P.P.M. per degree C. Resistance range 1 to 70,000 ohms. Dissipates 1.5 watts at 40°C. Available with split or plain bushings. Write for Bulletin PT 760.



WATERS MANUFACTURING, INC. • WAYLAND • MASS.

POTENTIOMETERS • COIL FORMS • POT HOOK® PANEL MOUNTS • TORQUE WATCH® GAUGES • C'TROL® METER/CONTROLLER • INSTRUMENTS
CIRCLE 92 ON READER-SERVICE CARD

50-G WHIZ!

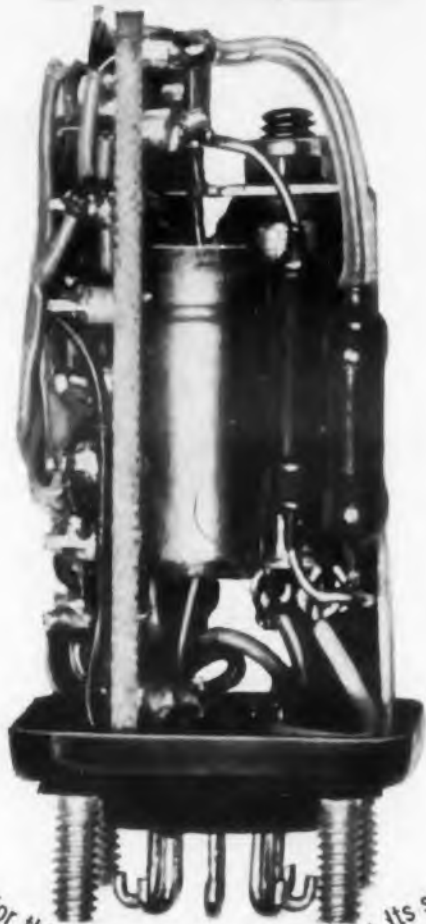

RUGGED IS THE WORD for this A. W. Haydon time delay relay. Its sealed relay will withstand shock up to 50 g for 11 milliseconds, and vibration up to 2000 cps at 20 g. It is also precise... with delays up to 120 seconds before starting or stopping. This little giant is our Series 31300 electronic time delay relay and you ought to know about it, particularly if you're in the missile field. ■ Every favorable adjective in the book has been used by our customers to specify one or another of our electronic time delay relays. Fixed or variable delays from a few milliseconds to days, weeks or months. Our solid state switches resist up to 150 g shock, vibrations up to 3000 cps at 100 g... accuracies run to 0.05% or better. We could go on. But if you will simply write for information about the Series 31300 or any other timing devices you need, whether electronic or motor driven, we will be happy to tell all.

AWHAYDON
THE COMPANY
4027 INCE BLVD., CULVER CITY, CALIFORNIA
CIRCLE 93 ON READER-SERVICE CARD

NEW PRODUCTS

Transistorized Preamplifiers 735

Noise figure is less than 2 db



Compensated from -5 to $+125$ F, these preamplifiers have a noise figure of less than 2 db. They operate with self-contained batteries. Model TA-4 is for use with a source impedance ranging from 5 to 24 ohms or 25 to 100 ohms and provides a maximum gain of 50,000 over a bandwidth of 10 cps to 50 kc. Model TA-5 is used with source impedance of 100,000 ohms or less and provides a maximum gain of 1,000 over a bandwidth of cps to 1 mc.

Radiation Electronics Co., Div. of Comptometer Corp., Dept. ED, 5600 Jarvis Ave., Chicago 48, Ill.

Price: Model TA-4, \$200; model TA-5, \$150.

Availability: Two weeks.

Glass Plug-In Base 370

Made to fit 7- and 9-pin sockets, this base can be used for miniature relays, molded miniature pulse transformers, plug-in modules and resistor networks. They can be molded directly into epoxy shells or can be cemented to glass or metal types.

Clairtron, Dept. ED, P.O. Box 171, Orange, N. J.
Price: From 6 cents in lots of 5,000 to 12 cents in lots of less than 100.

Magnetic Tape Cleaner 352

Model T-7070 magnetic tape cleaner is designed for the automatic cleaning of magnetic recording tape. Speed is adjustable from 0 to 300 ft per min. Units are available for 3/4-in., 1-in. and 2-in. tape.

Computer-Measurements Co., Dept. ED, 12970 Bradley Ave, Sylmar, Calif.
Price: \$6,575 ea.

Servo Mounting Clamps 359

These servo mounting clamps are for synchros, servomotors and potentiometers. Two clamp sizes can be used on six different housing sizes.

Theta Instrument Corp., Dept. ED, 520 Victor St., Saddle Brook, N.J.

Price: 19¢ ea, 1 to 100; 15¢ ea, 100 to 500; 10¢ ea, 500 to 1,000.



**pick the
best pilot light
for your application
in seconds!**

Johnson pilot lights
immediately available
for original equipment
or in-the-field replacement!

Choose your next group of panel indicators from E. F. Johnson's "preferred" line—over 47 separate assemblies carefully selected from Johnson's standard line by many of the nation's top design and development engineers. Available in a wide variety of types, these "preferred" units may be obtained from stock at parts distributors throughout the country for original equipment or in-the-field replacement. Write for your free copy of Johnson's newest pilot light specification catalog—see how easy it is to select the right pilot light... fast!

Select the right pilot light...fast!

Complete pilot light catalog 750a contains detailed specifications, prices, and technical data... everything you need to select the best unit for your particular application. Write for your free copy of Catalog 750a today!



Available types include: continuous indication neon types; models for high and low voltage incandescent bulbs; standard or wide angle glass; and lucite jewels in clear, red, green, amber, blue, or opal. Specials, including those meeting military specifications, also available in production quantities.



E. F. Johnson Company
2211 Second Ave. S.W. • Waseca, Minnesota

CIRCLE 94 ON READER-SERVICE CARD

ELECTRONIC DESIGN • December 21, 1960

Requires less than
0.2 sq. in. for panel
or chassis mounting!

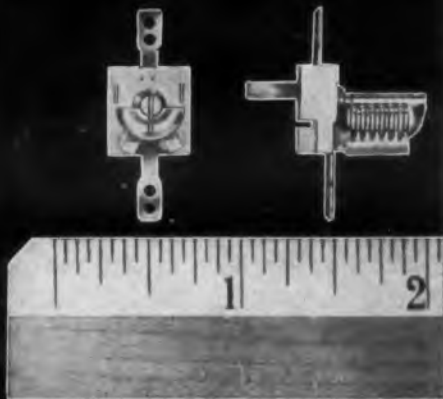

JOHNSON TYPE "U" AIR VARIABLES

Designed for use in extremely compact equipment, this tiny Type "U" air variable capacitor requires less than 0.2 square inch of space for panel or chassis mounting! Rotor and stator are precision-machined from one piece of solid brass for outstanding mechanical stability and uniformity. High "Q", high torque-to-mass ratio, low temperature coefficient — provides absolute freedom from moisture entrapment found in trimmer capacitors of the enclosed or solid dielectric type. All metal parts silver-plated—ceramic is steatite Grade L-4 or better. Breakdown ratings: 850 volts DC on .010" plate spacing; 1300 volts DC on .016" spacing. Available in special types and variations in production quantities. For detailed specifications, write your copy of our newest components catalog.



NO SPECIAL TOOLS REQUIRED FOR INSTALLATION
—Simply bend LocTabs into position. Double pierced, wide terminals facilitate wire or printed circuit use.

New Catalog

Write today for our newest electronic components catalog — complete specifications, engineering prints and current prices on:

• Capacitors • Tube sockets • Connectors • Pilot lights • Insulators • Knobs, Dials • Inductors • Hardware

E. F. JOHNSON CO.
1811 2nd Ave. S.W. • Waseca, Minn.

CIRCLE 95 ON READER-SERVICE CARD

Vibration Monitor

470

Senses excessive vibration



This resonance-type vibration monitor is for protecting equipment and processes against damage from excessive vibration. It is sensitive to vibrations two-millionths of 1 in. in amplitude. Applications include protection of gas turbine engines, pumps and motors at remote locations, fans, impellers and blowers. Another application is as a go/no-go gage for testing equipment with rotative parts having a vibration limit.

Stewart-Warner Corp., Dept. ED, 1826 Diversey Parkway, Chicago 14, Ill.

Price: Monitor, \$550 ea; plug-in attachment, \$300 ea.

Availability: From stock.

"T" Handle For Electronic Equipment 351

Model HP-5 "T" handle provides pushbutton control and positive latching for electronic drawers, instrument panels, cabinets and doors. The cast-aluminum handle measures 3/4-in. wide x 3-1/4-in. high and protrudes 1-3/8 in. from front of panel.

Chassis-Trak, Inc., Dept. ED, 525 S. Webster Ave., Indianapolis, Ind.

Price: \$5.75 per pair, 1 to 9; \$5.60 per pair, 10 to 49.

Availability: From stock, in small quantities.

Metal Alloy For Semiconductors 734

Foil and preforms fabricated of up to 5% germanium, alloyed with indium-gallium are available in several forms and sizes. Included are: spheres, from 0.005 in.; foil, from 0.0005 in. thickness; discs, from 0.005 in.; squares, from 0.020 in.; washers, from 0.020 in. ID with a land area as small as 0.005 in.

Alpha Metals, Inc., Dept. ED, 56 Water St., Jersey City 4, N.J.

Silicone Glass Laminate 353

Lamicoid grade No. 4053-3, a silicone-glass laminate, is designed for use as an axial spacer in 180-C transformers. The laminate stands continuous exposure to 200 C. Arc resistance is 180 sec. It is available in thicknesses of 1/32 in. to 3/8 in. in sheet size 36 x 42 in. and 3/8 in. to 2 in. 18 x 36 in. sheet size.

Minnesota Mining & Manufacturing Co., Mica Insulator Div., Dept. ED, Schenectady 1, N.Y.

Price: \$4.40 per lb in thicknesses of 0.050 and over.



Gertsch Ratio Standards 1000 Series NBS Certified AC ratio accuracy to 0.0001%

—certification provided in terms
of a Gertsch standard traceable
to the National Bureau of Standards

Three basic ratio sections are available: high frequency AC, low frequency AC, and DC, supplied in a variety of combinations.

You can obtain maximum AC ratios up to 1.111111, or minimum down to .111111. AC sections feature transient suppression, 6- or 7-place resolution, and terminal linearity of .0001%.

DC sections employ a Kelvin-Varley resistive divider with 6-place resolution and terminal linearity of .001%. All units available for case or rack mounting. Request Bulletin 1000.

If you require NBS traceability on your present RatioTran®, we will calibrate your unit and supply certification, for a nominal charge.

Gertsch

GERTSCH PRODUCTS, Inc.

3211 S. La Cienega Blvd., Los Angeles 16, Calif. • Upton 0-2761 • Vermont 9-2201

CIRCLE 96 ON READER-SERVICE CARD

**Wherever heat
is needed for
electronics research
or production
Lindberg equipment
can provide it**

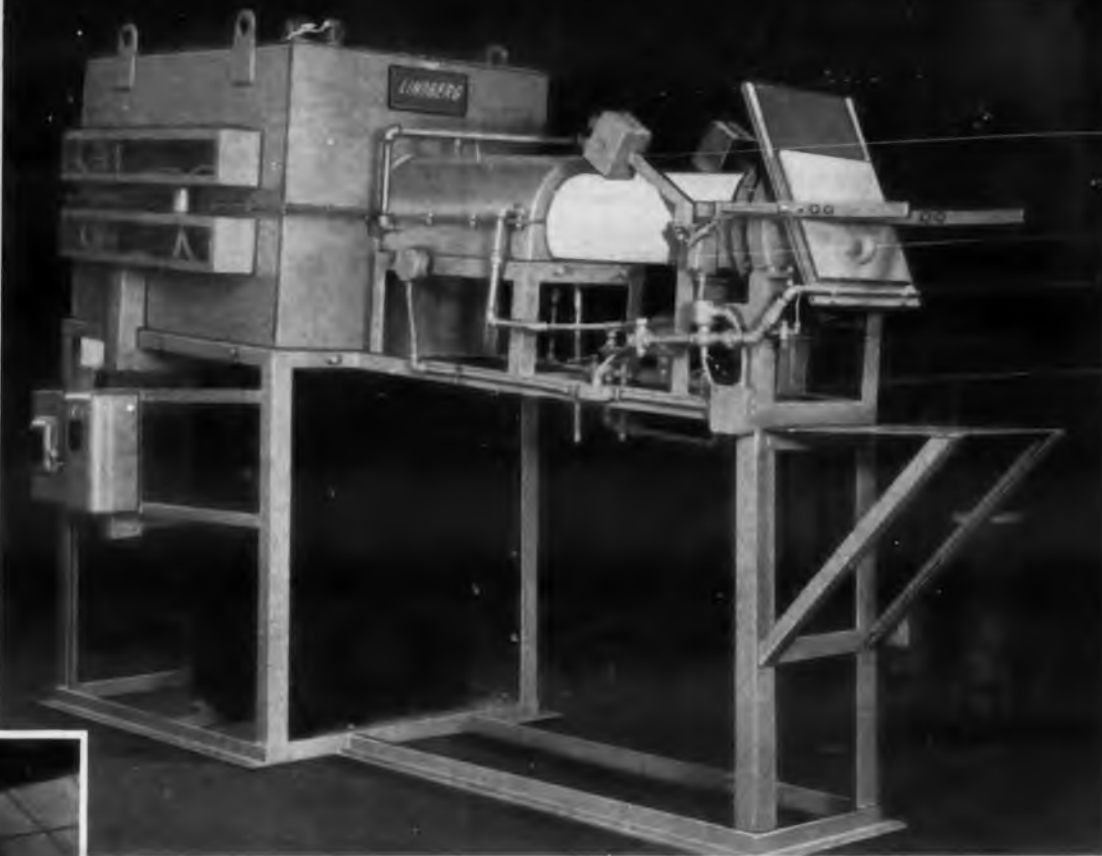

This Lindberg Hydrogen Atmosphere Furnace is designed for the reduction of germanium oxides and other materials. Model illustrated is a hand pusher type but this furnace is also available for continuous, automated operation.



Newly-designed Lindberg Horizontal Zone Scanner provides zone purification of metallic germanium and other metallic and organic materials. Lindberg can also furnish Floating Zone Scanners for the purification of silicon.

Electronics manufacturers now have available from one responsible source, a complete line of industrial heating equipment for research and production. For many years Lindberg has been a leader in all phases of the application of heat to industry. This background of experience has helped us pioneer the development of efficient equipment for the electronics and semi-conductor industries. Our design staff, the best in the business we believe, is available to help you find the right answer to any equipment requirements your research or manufacturing processes may require in these important fields. Just get in touch with your Lindberg local Field Representative (see your classified phone book) or write us direct. Lindberg Engineering Company, 2456 West Hubbard Street, Chicago 12, Illinois, Los Angeles, 11937 South Regentview Ave., Downey, California, Canada, Birleco—Lindberg Ltd., Toronto.

LINDBERG
heat for industry



This is one of a line of Lindberg Solid and Gaseous Diffusion Furnaces especially designed for research, pilot plant study, and production of quality transistor and semi-conductor devices. They can be had in single and multiple zone models. Encapsulation furnaces also available.



Lindberg Three-Tube Electric Rotary Calciner for calcining ferrite powders. This model is equipped with Lindberg CORRATHERM heating elements. Lindberg Calciners can be supplied with either fused quartz or alloy tubes. When required, gas-fired models are also available.

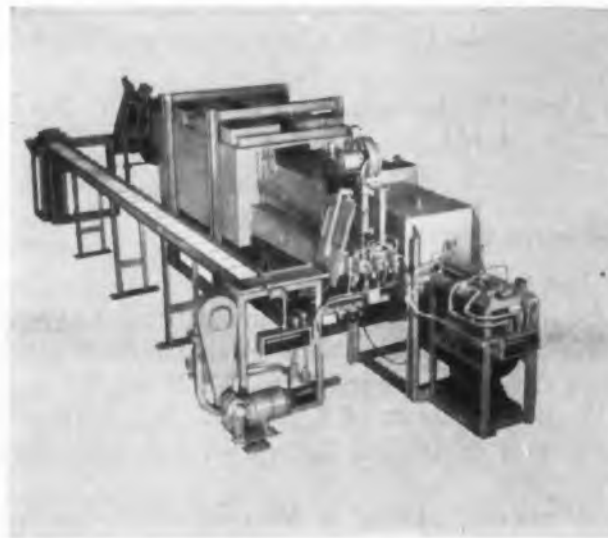

An automatic Lindberg Pusher Slab Tunnel Kiln, ideal for production of electrical ceramics, ferrites, and other electronic materials. This model is fully automatic, atmosphere-controlled. Maximum temperature 2650°F. Overall length 22 feet. Other Lindberg Kilns also available.

NEW PRODUCTS

DC Power Supply 413

Is continuously variable



Model 520A dc power supply, a 25-amp unit, is continuously variable from 0 to 36 v at any current from 0 to 25 amp. Regulation for line and load is less than 0.5% of maximum output. Ripple is less than 1%. Input is 105 to 125 v ac, 60 cps. The unit measures 7 x 16-3/4 x 19 in.

Harrison Laboratories, Inc., Dept. ED, 45 Industrial Road, Berkeley Heights, N.J.

Price: \$575 ea.

Availability: 30 to 60 days.

30-KW Generator 537

Produces both low and high frequencies

The Ther-monic 30-kw generator can be operated at frequencies of 250 to 450 kc as well as at 1 to 7 mc. It can be used for soldering, brazing and annealing applications. All controls are built into the unit. External grid adjustments are possible on both frequency ranges.

Induction Heating Corp., Dept. ED, 181 Wythe Ave., Brooklyn, N.Y.

Sealant 647

For use to 1,000 F

Raiseal 300 is a rigid, non-ceramic, structural adhesive which can be used at temperatures up to at least 1,000 F for moderate periods of time. Cure cycle is 2 hr at 300 F, post cure for 15 hr at 480 F. It can be used for metal-to-metal bonding.

Radiation Applications Inc., Dept. ED, 36-40 37th St., Long Island City 1, N.Y.

Price: \$110 per gal.

Availability: From stock.

◀ CIRCLE 97 ON READER-SERVICE CARD

M I C R O W A V E S

13

, a
ari-
ent
for
of
less
ac,
x

nc.,
ad,

37

tor
of
p 7
ng,
ons.
nit.
os-

pt.
yn,

47

ce-
ich
to
eri-
at
F.
tal

pt.
nd

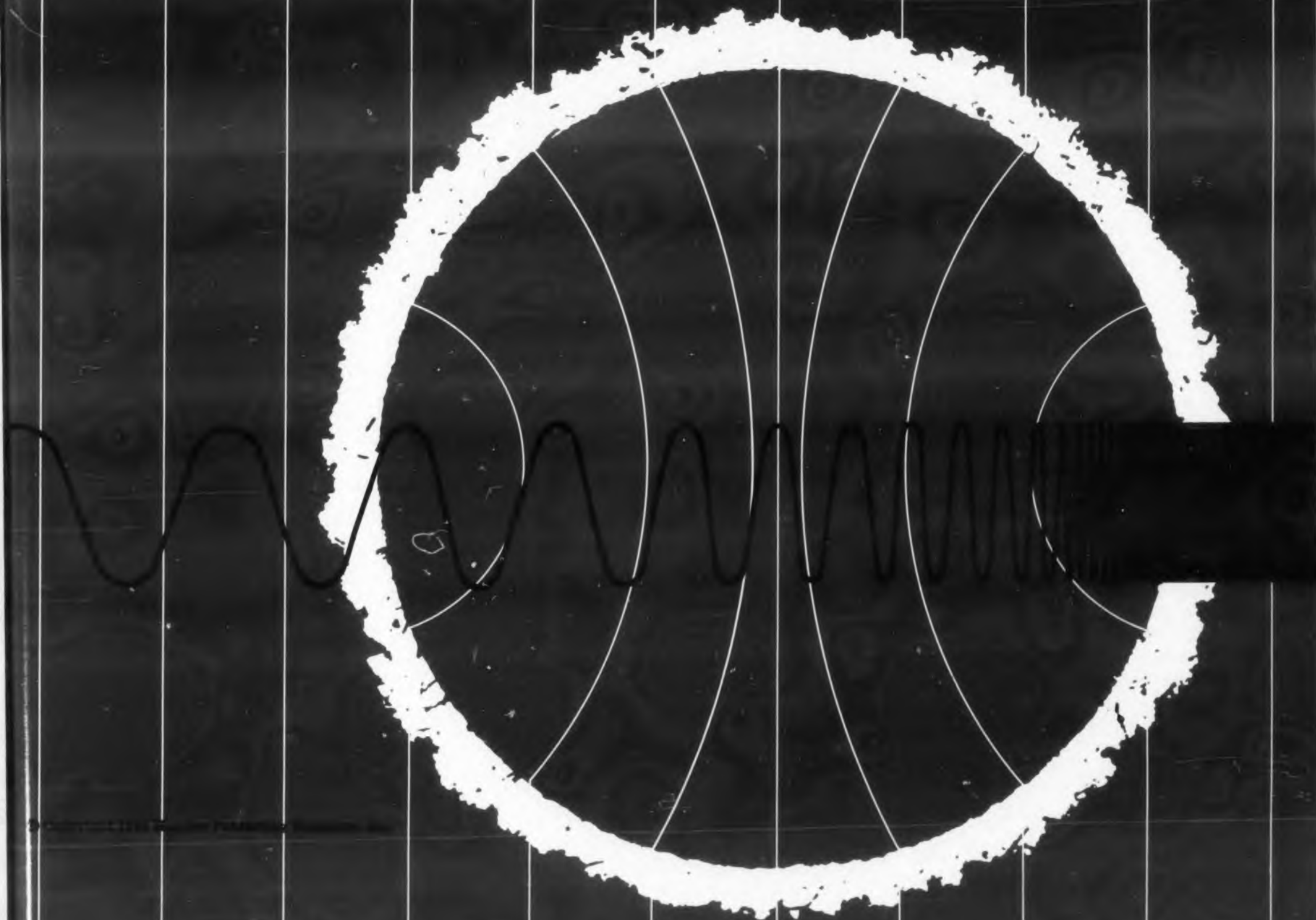

HUGHES LINE OF K_u-BAND BWO'S

Hughes K_u-band backward-wave oscillators are all permanent-magnet tubes with the compact, light-weight Hughes design that has proved so reliable. They are ideally suited for use in microwave signal and sweep generators, panoramic receivers, spectrum analyzers, frequency scan and navigational radars and countermeasures equipment. They feature low spurious output and narrow spectrum width. They are designed to give you thousands of hours of trouble-free life.

The new 326H, shown here, is of particular interest. It is specifically designed for use in test equipment and other strictly commercial instrumentation—and priced for that market. It is a small, streamlined tube with excellent operating characteristics.

All the tubes shown here are production products. Hughes will ship to meet your immediate requirements. For prices and full particulars, write today to Hughes Microwave Tube Division, 11105 Anza Avenue, Los Angeles 45, California.



CREATING A NEW WORLD WITH ELECTRONICS

HUGHES

HUGHES AIRCRAFT COMPANY
MICROWAVE TUBE DIVISION

THE 326H For commercial applications. Minimum output: 10 mw over 12.4 to 18 kmc band with power rising to 65 mw in the center of the band. Like all Hughes BWO's, the Hughes 326H requires no external cooling. All electrodes are isolated from each other and from the case.



THE 315H Covers the entire K_u band. Average power: 50 mw. Frequency range: 15.8-17.2 kmc. Total weight of tube and magnet: 11.5 lbs.



THE 316H Full band. Average power: 10-60 mw. Frequency range: 12.4-18.0 kmc. Total weight of tube and magnet: 11.5 lbs.



THE 317H Average power: 60 mw. Frequency range: 13.5-15.5 kmc. Total wt., tube and magnet: 10 lbs.



THE 318H Average power: 30 mw. Frequency range: 17.5-19.5 kmc. Total wt., tube and magnet: 10 lbs.

CIRCLE 89 ON READER-SERVICE CARD



MICROWAVES

Section on Microwaves

The response received to the MicroWaves section of *ELECTRONIC DESIGN*'s Nov. 23 issue at the Northeast Research and Engineering Meeting (Nov. 15-18) has been most gratifying. In the microwave center of Boston, it is not surprising that one out of five exhibitors was a microwave company. In talking about the prospects of electronics in 1961, the most optimistic predictions were voiced in the microwave booths.

These and other indications confirm our opinion that the microwave laboratories will continue to be among the most productive of new designs, new techniques and new products. For this reason, *ELECTRONIC DESIGN* has scheduled a section covering microwaves every second issue.

In the section for this issue, the editors have assembled further evidence of the variety and imagination characteristic of microwave products.

The range of antenna designs, recently in the news, is presented in

**New Shapes
Launch Microwaves p 109**

A down-to-earth design article describing the problems encountered when extending existing microwave techniques is the subject of

**Multiresonator Direction Filter
Uses Strip Transmission Line . . p 110**

The trends exhibited in upcoming power tubes, under development in laboratories across the country, are sampled in

**Design Approaches In Tomorrow's
Microwave Sources p 114**

Five companies approaches to microwave attenuators for wide frequency coverage, plus the latest of products of a wide variety of types are described in

**Microwave
Products p 120**



New Shapes Launch Microwaves

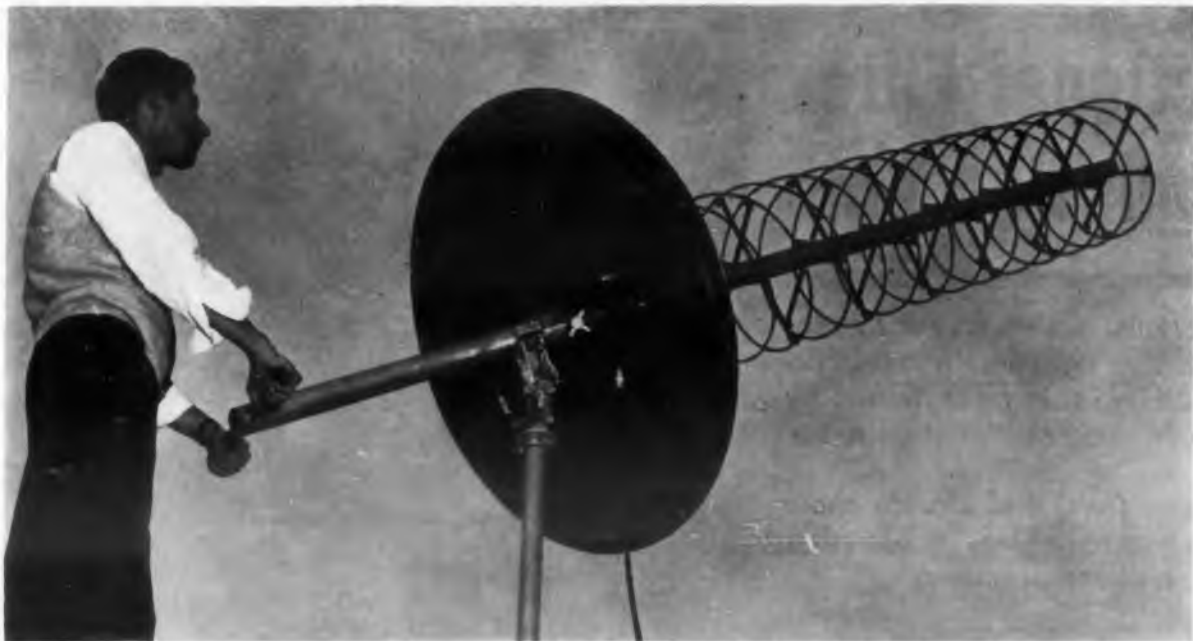

Fig. 1. Design ingenuity in the small antenna field is exemplified by this Andrew bi-filar helix. By interweaving two helices, the gain is increased by 1 to 4 db over conventional single-helix configurations, with no increase in size, little increase in weight.

A considerably expanded spectrum of antenna designs has been appearing on the microwave scene recently. From the variety of philosophies involved and the wide range of configurations, several conclusions can be drawn.

The first is that the range of functions served in radiating microwave energy into the air has increased in variety. This, in turn, is placing new emphasis on scan-speed, size, weight, and data-generating rate. The second is that the level of the component art has reached a meaningful point. Availability of the components needed is allowing antenna theory, built up over the years to be reduced to hardware.

In a survey article (*ED*, Nov. 23, p 166) some of the dramatic breakouts in phased-array antenna design were described by three experts at Hughes. Here, in pictorial form, we present some exotic antenna shapes that have recently made the news.

Long a matter of optics with traditional point source and parabola, antenna design is more and more based on non-geometric principles of focusing energy. Included here are examples of a bifilar helix, a retarded wave structure, an end-fire, swept-volume efficiency antenna and a maltese cross capable of operating in four different modes. ■ ■

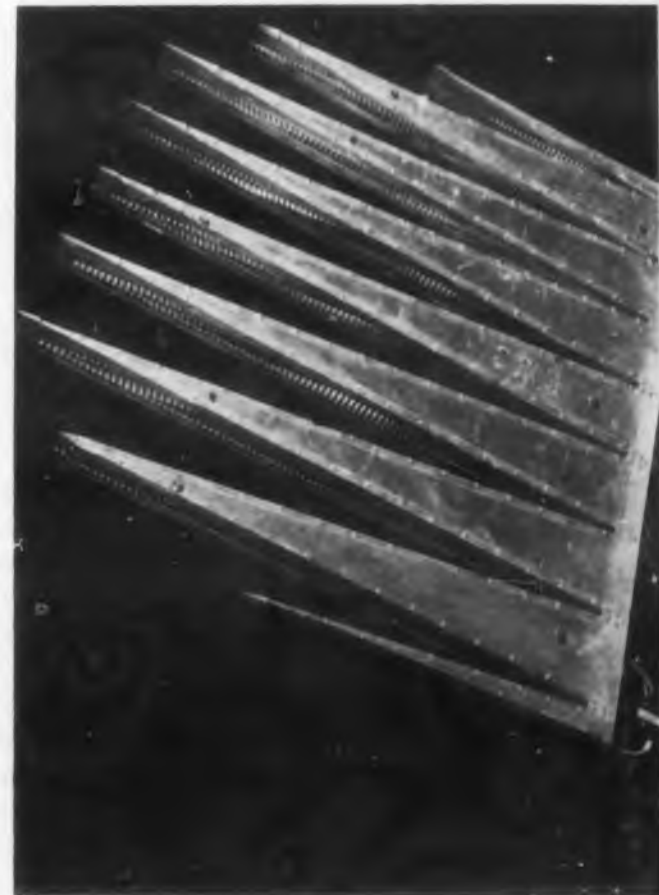

Fig. 2. One solution to the problem of large frontal area of airborne radomes is this swept-volume efficiency (SVE) antenna of GB Electronics, based on multiple end-fire-array principle.



Fig. 3. This Maltese-cross Chance-Vought antenna, for service with space vehicles, functions as a vertically or horizontally polarized antenna, or as a clockwise or counterclockwise helical antenna.

Fig. 4. An impressive reduction of radome height is achieved through this airborne retarded-surface-wave (RSW) antenna. The space between the "tines" form the radiating elements. Non-resonant slots on the surface of the tines generate the retarded wave.





Multiresonator Directional Filter Uses Strip Transmission Line



Development of the single-element directional filter seemed to provide an ideal multiplexing device—no branching attenuation and near-perfect isolation. Moreover, it seemed selectivity could be increased by simply adding more resonators in each branch—only that's not quite the way it works out.

Working from basic theory, authors Sleven (left) and Dorato show why it isn't that simple. They go on to show how to achieve an optimum multi-element unit by proper design choices and compromises.

Robert L. Sleven, Peter E. Dorato

Airborne Instruments Laboratory
Division of Cutler Hammer Inc.
Deer Park, N. Y.

A DIRECTIONAL filter combines the characteristics of a directional coupler and a band-pass filter. Ideally, the response at each of the four ports is:

P_1 is reflectionless

P_2 has a band-pass filter response with respect to Port 1

P_3 is isolated from Port 1

P_4 has a band-reject filter response complementary to the response of Port 2

Matrix Analysis Uses Two-Port Equivalent

There are several types of directional filters applicable for a range of frequency and size requirements. The directional filter configuration considered here is the branch line type, Fig. 1. Other types are reported in the literature.^{1,2} The branch-line directional filter can be represented by a four-port network (Fig. 2). By taking advantage of the symmetry about the dashed line the network can be reduced to an equivalent two-port network.³ This network can be described as the product of three ABCD matrices. One of these matrices is for the filter network in each branch of the directional filter. The other two matrices are for lengths of transmission line correspond-

ing to the spacing of the branches along the main transmission lines.

The two-port equivalent directional filter consists of a shunt admittance A_1 , a filter network N , and a shunt admittance A_2 . The ABCD matrices of the over-all network are the product of three matrices:

$$\text{Shunt admittance } A_1 = \begin{bmatrix} 1 & 0 \\ Z_o Y_1 & 1 \end{bmatrix} \quad (1)$$

$$\text{Filter Network } N = \begin{bmatrix} a & b/Z_o' \\ cZ_o & d \end{bmatrix} \quad (2)$$

$$\text{Shunt admittance } A_2 = \begin{bmatrix} 1 & 0 \\ Z_o Y_2 & 1 \end{bmatrix} \quad (3)$$

where Y_1 and Y_2 are functions of ϕ_1 and ϕ_2 , the spacing of the branches (Fig. 2), Z_o is the characteristic impedance of the feedlines and Z_o' is the impedance feeding and terminating the filter network.

The quantities a , b , c , d , ϕ_1 , ϕ_2 , Z_o and Z_o' are chosen to realize the ideal directional filter response. For Port 3 to be isolated, restrictions are placed on the filter network N and the spacing of the branches.

Three Basic Equations Restrict the Matrices

Perfect isolation of Port 3 from Port 1 occurs when the filter network has forward-to-back

symmetry. In addition, the branch spacings are chosen to make ϕ_1 an odd multiple of a quarter wavelength and ϕ_2 equals the length of ϕ_1 plus one-half wavelength. From the matrix viewpoint, symmetry of the filter network means that:

$$a = d \quad (\text{Port 3 isolated}) \quad (4)$$

In order for Port 1 to be reflectionless:

$$c = 0 \quad (\text{Port 1 reflectionless}) \quad (5)$$

By utilizing some of the properties of the ABCD matrix, the expressions for the responses at Ports 2 and 4 can be simplified. For a reciprocal network:

$$ad - bc = 1 \quad (\text{reciprocity}) \quad (6)$$

From Eq. (3) and (4), the expressions for the voltages at Ports 2 and 4 are then:

$$V_2 = \frac{1}{1 + b/Z_o} \quad (7)$$

$$V_4 = \frac{jb/Z_o}{1 + b/Z_o} \quad (8)$$

The requirements for ideal directional-filter performance have restricted the ABCD matrix of the N network to:

$$\begin{bmatrix} 1 & b/Z_o \\ 0 & 1 \end{bmatrix} \quad (9)$$

This matrix represents a network with identical

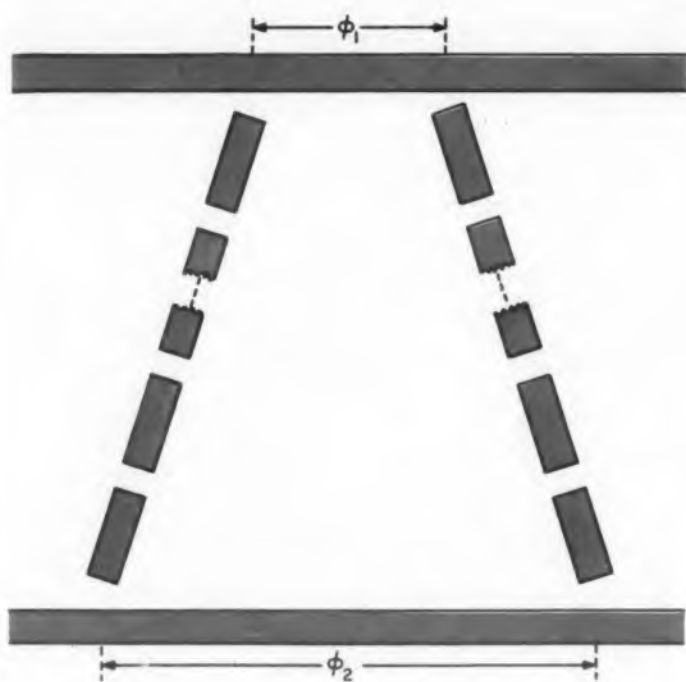

Fig. 1. Basic branch-line directional filter connects main signal line (lower) to selected signal line (upper) via symmetrical strip transmission line filters.

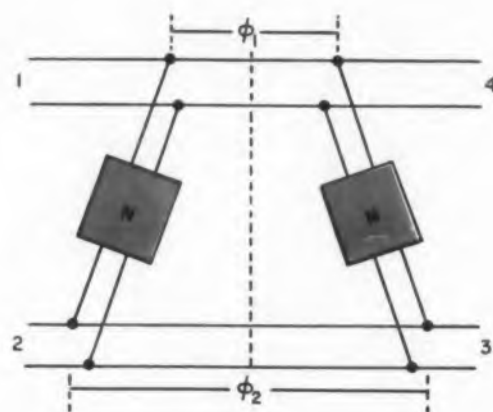
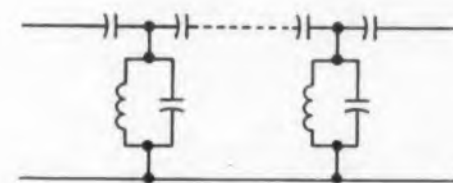

Fig. 2. Equivalent circuits of strip-line directional filter, indicating symmetry used in analysis.



A. STRIP TRANSMISSION LINE FILTER



B. EQUIVALENT CIRCUIT

Fig. 3. A lumped-parameter equivalent of one filter portion of the directional filter.

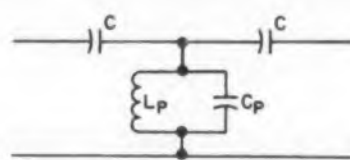

$$\begin{bmatrix} a & b/Z_o \\ Z_o c & d \end{bmatrix} = (j)^2 \begin{bmatrix} 1 & jF \\ 0 & 1 \end{bmatrix}$$

A ONE ELEMENT

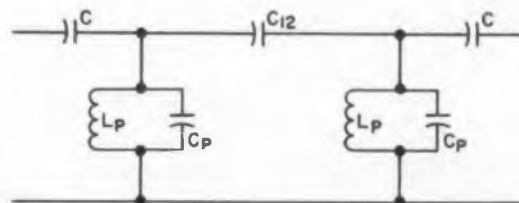

$$\begin{bmatrix} a & b/Z_o \\ Z_o c & d \end{bmatrix} = (j)^3 \begin{bmatrix} jF/k & (jF)^2/kd_1 + k/d_1 \\ d_1/k & jF/k \end{bmatrix}$$

B TWO ELEMENTS

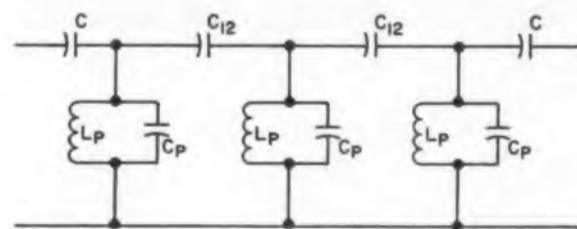

$$\begin{bmatrix} a & b/Z_o \\ Z_o c & d \end{bmatrix} = (j)^4 \begin{bmatrix} 1 + (jF)^2/k^2 & (jF)^3/k^2 d_1 + 2(jF)/d_1 \\ d_1(jF)/k^2 & 1 + (jF)^2/k^2 \end{bmatrix}$$

C THREE ELEMENTS

Z_o = impedance feeding and terminating each network

$$\text{where } \begin{cases} d_1 = \frac{(\omega_o C)^2 Z_o}{\omega_o C_p} & k = \frac{C_{12}}{C_p} & F = \frac{\omega}{\omega_o} - \frac{\omega_o}{\omega} \\ \omega_o = \sqrt{\frac{1}{L_p C_p}} & C_p = \text{total capacitance at each node.} \end{cases}$$

Fig. 4. Matrices are set up for one-, two- and three-element filters.

driving point and transfer functions. For a band-pass response at Port 2 this requirement can only be fulfilled when each branch of the directional filter contains only one resonator. Therefore, no complexity of the N network can yield maximally flat or equal ripple type responses of an order higher than 1. However, as will be shown, compromises in the obtainable responses at Ports 1 and 4 will result in a response at Port 2 resembling that of a multi-section band-pass filter.

In designing the directional filter, the decrements and coefficients of coupling for the filter network N are related to the terms in the ABCD matrix. To find the ABCD matrix of network N , an equivalent circuit is set up (Fig. 3). Similar matrices for one, two and three section filters are shown in Fig. 4.

If the resonators are lossy, each parallel-tuned circuit is shunted with a conductance G_p . This results in modifications for the expressions in Fig. 4: each (jF) is replaced by $(jF + d_o)$ and each (d_1) term is replaced by $(d_1 - d_o)$, where

$$d = \frac{G_p}{\omega_o C_p} = \frac{1}{Q_p} \quad (10)$$

Applying Design Approach To Units of Differing Elements

The ABCD matrix for the one-element filter shown in Fig. 4 satisfies the requirements of Eq.

(continued on p 112)

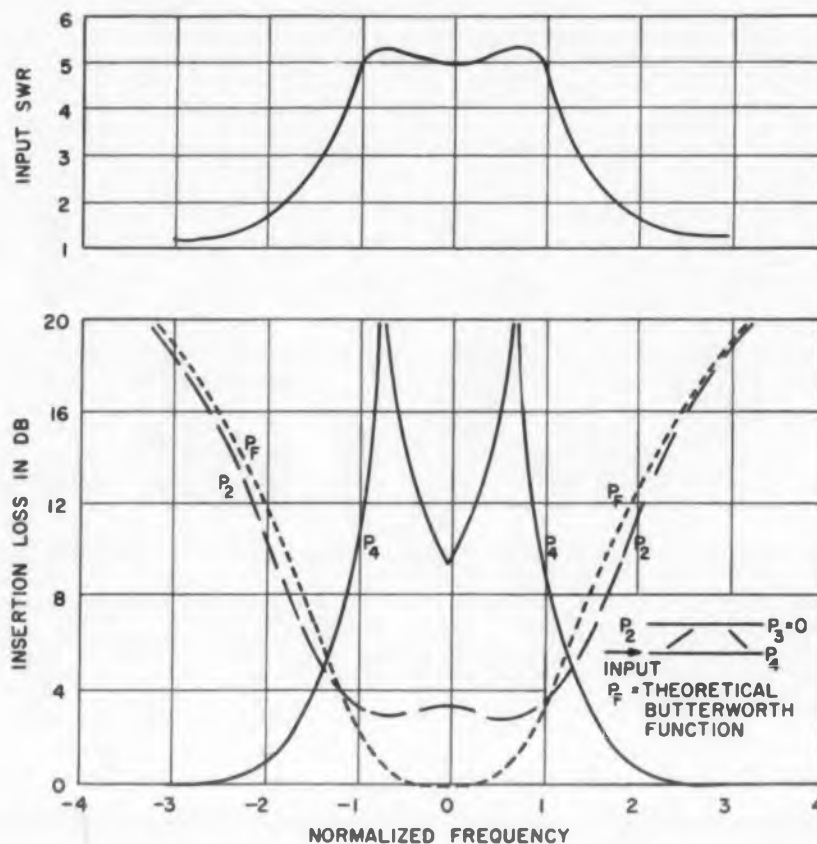

Fig. 5. Input SWR and insertion loss for a two-element directional filter, where $Z_o = 2Z'_o$. Insertion loss never drops below 3 db regardless of the value of Z_o chosen.

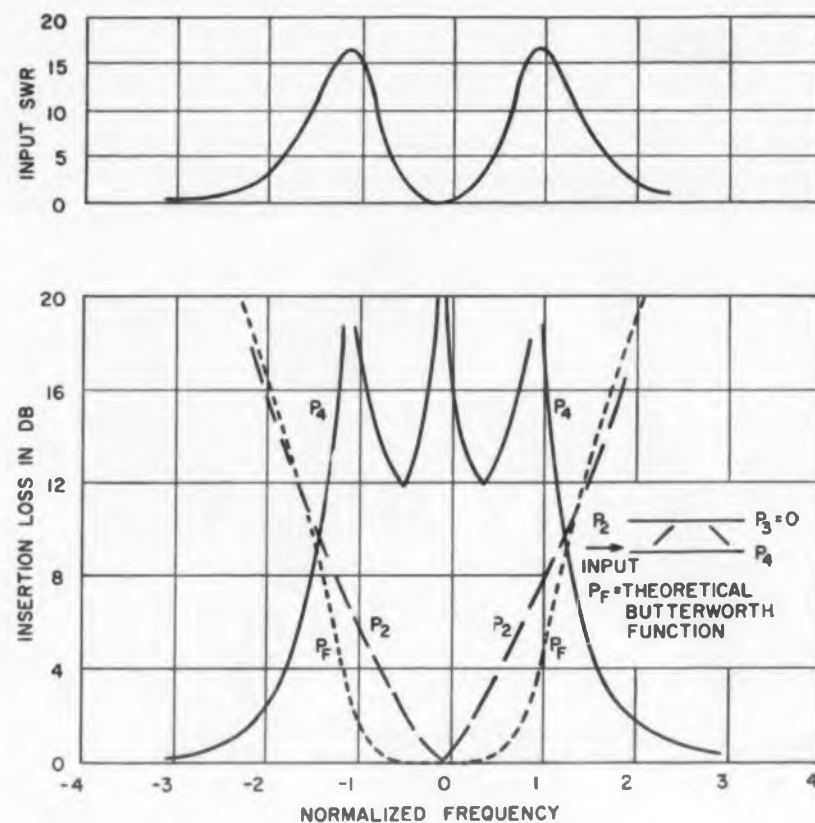

Fig. 6. Characteristics of three-element directional filter, once again with Z_o optimized at the value $Z_o = 2Z'_o$. Note that both P_2 and P_4 approach 0 at ω_o .

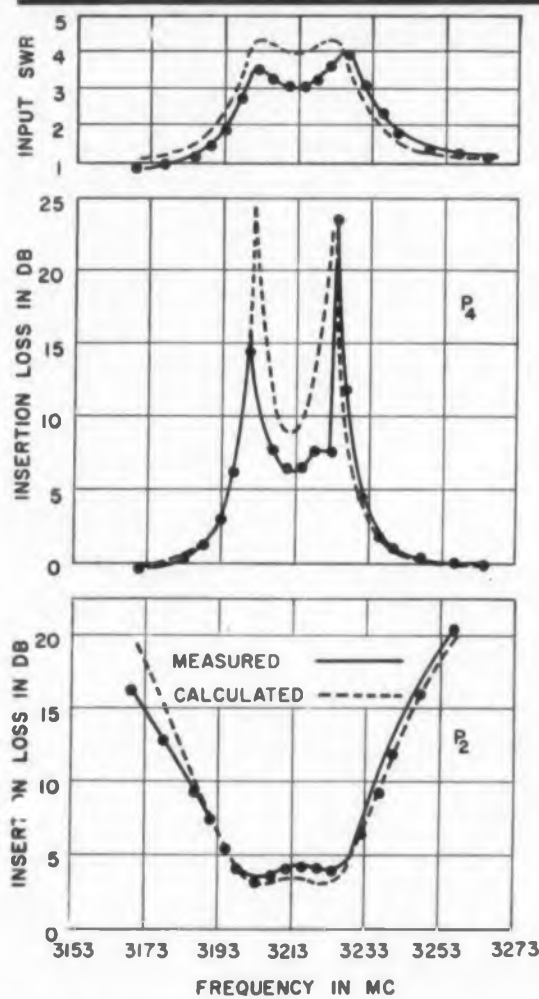

Fig. 7. Measured response of a two-element directional filter corresponds closely to theoretically derived values.

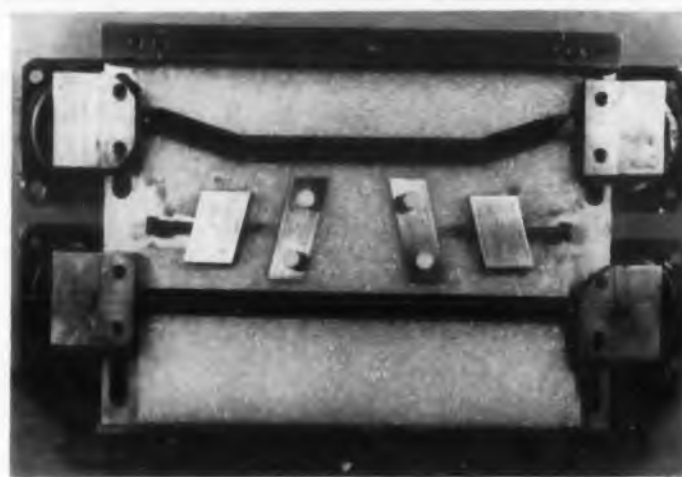

Fig. 8. Breadboard two-element unit indicates simplicity of design.

(4), (5) and (6). The power output at each port of the directional filter is:

$$P_1 = 0 \quad (11)$$

$$P_2 = \frac{1}{1 + \left(\frac{F}{d_1}\right)^2} \quad (12)$$

$$P_3 = 0 \quad (13)$$

$$P_4 = \frac{\left(\frac{F}{d_1}\right)^2}{1 + \left(\frac{F}{d_1}\right)^2} \quad (14)$$

where F is the frequency variable equal to $\frac{\omega - \omega_o}{\omega_o}$ and d , the filter decrement, is equal to $\frac{B\omega_{3db}}{f_o}$.

The band-pass response of the directional filter will be the same as that of a conventional filter with identical resonators and coupling capacitors when:

$$Z_o = 2Z_o' \quad (15)$$

where Z_o is the directional filter feedline impedance and Z_o' is the impedance feeding and terminating the conventional filter.

When the N network is a two-element filter, c cannot equal zero, and Eq. (5) cannot be satisfied. Furthermore, there is no value of Z_o that

can produce ideal directional filter characteristics with two elements. Nevertheless, the choice of Z_o affects the response. The best compromise between input SWR, Port 2 band-pass response and Port 4 band-reject response occurs with

$$Z_o = 2Z_o' \quad (16)$$

This case is shown in Fig. 5. Note that the midband insertion loss at Port 2 is 3.5 db. No value of Z_o will result in a midband loss at Port 2 of less than 3 db. The three-element directional filter behaves as an ideal directional filter at resonance ($jF = 0$). This is true because the restrictions on the ABCD matrix of the N network. Eq. (4), (5) and (6) are fulfilled at resonance. Off resonance, however, when $|F| > 0$, the restrictions are not met. As in the two-element case, the choice $Z_o = 2Z_o'$ appears to be the best compromise in the responses at all ports. These responses are shown in Fig. 6.

Theory Developed Is Verified In Breadboard Performance

Breadboard directional filters with one, two, and three resonators in each branch were tested. In all cases the experimental results for a two-element resonator directional filter, are shown in Fig. 7. The two-resonator filter (Fig. 8) in each branch was designed for a 3-db bandwidth of approximately 40 mc at 3,200 mc. The resonator's unloaded Q 's were approximately 2,000. A conventional maximally flat filter of this design would have a resonant loss of about 0.5 db.

Having chosen Z_o , the quantities remaining to be determined are:

1. The input (or output) gap between feedlines and the resonators.
2. The coupling gaps between resonators.
3. The spacing of the filters along the feedlines.

For the compromise case $Z_o = 2Z_o'$, the input, output, and inter-element coupling gaps are set to obtain the same decrements and coefficients of coupling that are required in the design of a conventional, symmetrical filter. The two branch filters are then spaced along the feedlines so that the separation along one line is $(2m + 1) \frac{\lambda_o}{4}$ and the separation along the other line is $(2m + 3) \frac{\lambda_o}{4}$. ■ ■

References

1. S. B. Cohn and F. S. Coale, "Directional Channel-Separation Filter," *Proc IRE*, Aug. 1956.
2. C. E. Nelson, "Circularly Polarized Microwave Cavity Filter," *IRE Transactions*, Vol. MTT-5, April 1957.
3. J. Reed and G. T. Wheeler, "A Method of Analysis of Symmetrical Four-Port Networks," *IRE Transactions*, Vol. MTT-4, Oct. 1956.

PRD previews/reviews/design notes

Bolometers, Barretters, and Thermistors

We have often been asked, "What is the difference between a bolometer, a barretter, and a thermistor?" At PRD the following is generally accepted: *Bolometer* is a general term which describes a temperature-sensitive element whose resistance changes as it dissipates microwave power. Bolometers include (a) thin short lengths of Wollaston wire, (b) evaporated metallic film, (c) small beads of semiconductors. The wire and film types are called "bolometers" or "barretters" and have a positive temperature coefficient. The semiconductor is called a "thermistor" and has a negative temperature coefficient.

Power Measurement Equipment

The bolometer, plus appropriate mount, provides us with an accurate, dependable means of measuring microwave

power. Each bolometer has a nominal operating resistance of 200 ohms when biased. For low power (1 mw max.), the PRD 631-C uses short lengths of

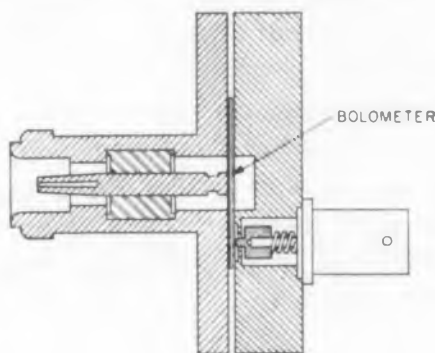

BOLOMETER MOUNT

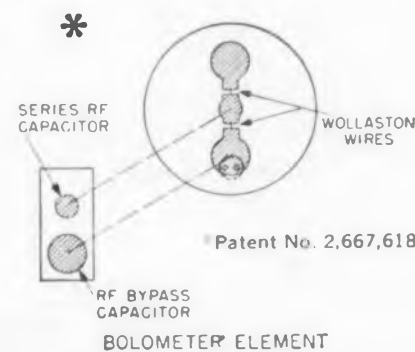

BOLOMETER ELEMENT

power. In itself, of course, the bolometer is a temperature-sensitive resistor, and gives no indicator reading. The most commonly used instrument for direct reading of microwave power is the self-balancing bridge. The PRD 650-B Universal Power Bridge can



PRD 631-C

accommodate bolometers, barretters, or thermistors and reads power directly to 100 milliwatts.

Design Details

The drawing above is the PRD 627-A Broadband Coaxial Bolometer and Thermistor Mount which houses the PRD 631-C (wire type), PRD 631-D (film type), and PRD 631-G (thermistor). The two general types of bolometers manufactured by PRD are Wollaston wire and evaporated metallic film applied to thin mica discs. The PRD 631-G Thermistor uses two semiconductor bead elements and has excellent stability characteristics.

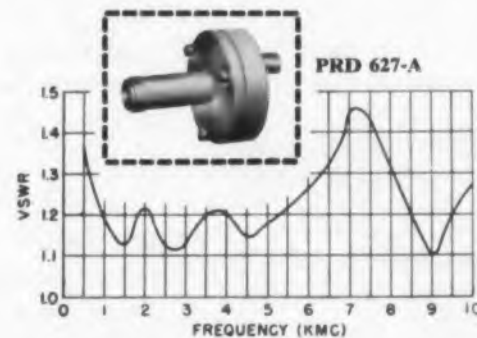

entire band and allows for easy replacement of bolometer elements without retuning. A typical VSWR curve is shown.

PRD produces a variety of mounts

CIRCLE 98 ON READER-SERVICE CARD



and bolometers. These include coaxial, waveguide, tunable, and broadband. Shown are, from top to bottom, a Waveguide Bolometer Mount (PRD 618) which operates from 26.5 to 40 KMC/S, a Waveguide Thermistor Mount (PRD 643-A) for 8.2 to 12.4 KMC/S, and a Coaxial Crystal and Bolometer Mount (PRD 613) for 1 to 12 KMC/S.

Precision in Production

PRD offers as standard catalog items some 34 different mounts and seven types of bolometers and thermistors. Our assembly line turns out several hundred bolometers alone in a week, all of which undergo rigorous stability and humidity tests after construction. PRD also produces, of course, all necessary associated equipment for power measurement. For more theoretical information, write for PRD Report Vol. 1, No. 4, "Microwave Power Measurements" or contact our Applications Engineering Department.

We have many interesting openings for engineers...contact Mr. John R. Zabka

PRD
ELECTRONICS, INC.
A Subsidiary of Harris-Intertype Corporation
Formerly Polytechnic Research & Development Co., Inc.

202 Tillary Street, Brooklyn 1, N. Y.
ULater 2-6800
1608 Centinela Ave., Inglewood, Cal.
ORegion 8-6022

HARRIS
INTERTYPE
CORPORATION

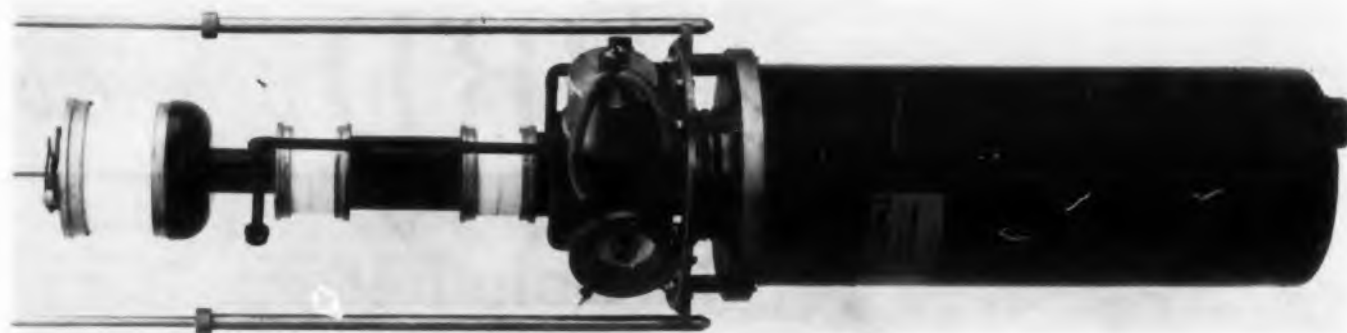

Fig. 1. Beryllia ceramic is used in the cavities and output windows of this 50-kw cw developmental Eitel-McCullough type 3K210,000LQ klystron and a family of similar tubes.

Design Approaches in Tomorrow's Microwave Sources



In a recent article (ELECTRONIC DESIGN, Nov. 23, 1960, p 172) state-of-the-art microwave tubes were sampled which are capable of 100 kw cw and 30 megawatts, pulse power. In 5 to 10 years, cw power of more than 1 megawatt and pulsed power of 100 to 500 megawatts will be available. In this article, author Bibbens describes new approaches now embodied in developmental tubes across the country that will help to make these ambitious goals a reality. Along with these tubes, some unorthodox microwave sources (not utilizing electron beams) are evaluated.

Terry Bibbens

Applications Engineer
Microwave Marketing
Eitel-McCullough, Inc.
San Carlos, Calif.

THEORETICALLY, there is no limit to the power that may be produced by a klystron, magnetron, or traveling wave tube. If the cathode area is increased, sufficient cooling is provided and a proper output window is used, greater output power may be obtained. However, these very large "ifs" are destined to be the object of development for some years to come.

High Power Output Windows Graduate to Beryllia Ceramic

An excellent example of the magnitude of these problems is the design of the output window. This window must maintain the vacuum in the tube while permitting the efficient transfer of the rf energy. For a number of years, glass enjoyed almost exclusive use in this application. Unfortunately, glass is easily broken, either by mechanical abuse, or by the thermal stresses. For this reason, power tube manufacturers soon searched for a new material.

The first answer was aluminum oxide ceramic.

The first production tubes to use all metal and ceramic construction were the Eimac 3K20.000-series klystrons of 1952. The alumina ceramic used in the windows was mechanically strong and could withstand the thermal stresses encountered. Power levels are increasing, however, and even alumina ceramic, now popular, has its limitations.

One of the most outstanding recent developments is the production of beryllia ceramic. This material has electrical properties exceeding that of most glasses, and has a thermal conductivity ten times greater than any material in use today. Thus, the heat generated by the rf energy is quickly conducted to the metal walls of the tube or output circuit, relieving the thermal stresses. This material is now incorporated in the high-power klystron family produced by Eimac, as in the 3K210,000LQ klystron (Fig. 1). This tube is capable of delivering a cw output power of more than 50 kw over the frequency range of 755 to 985 mc. Undoubtedly, beryllia ceramic will soon be used in other tubes throughout the industry.

Scaled-Up Standard Gun Replaced By Hollow-Beam Structure

Another major problem that has received considerable attention in recent years is the design

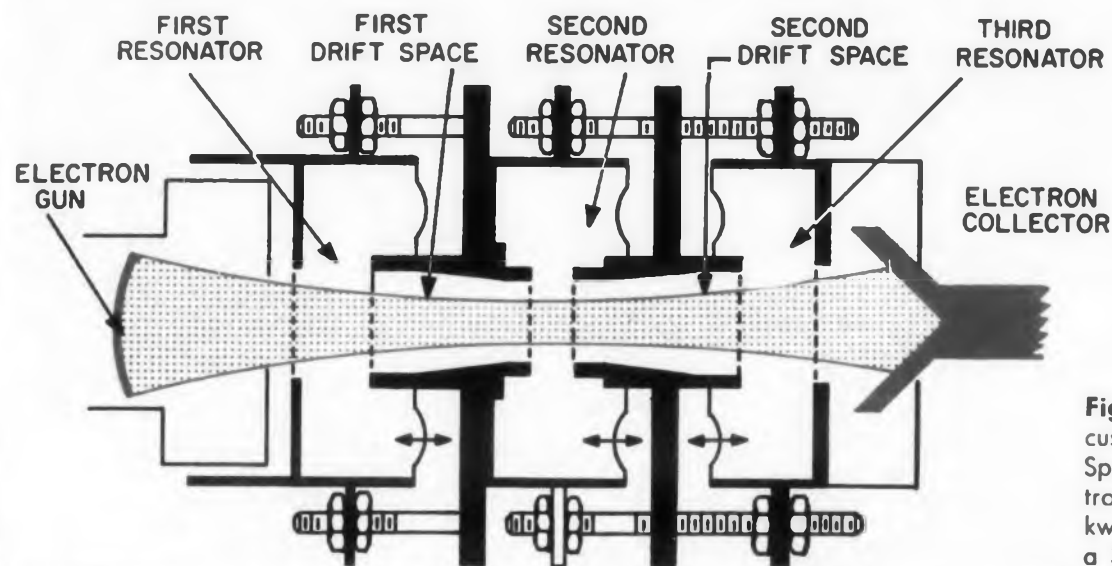

Fig. 2. Space-charge focusing, employed in this Sperry SAL-39 pulse klystron makes possible 25 kw at 1 Gc region from a 30-lb tube.

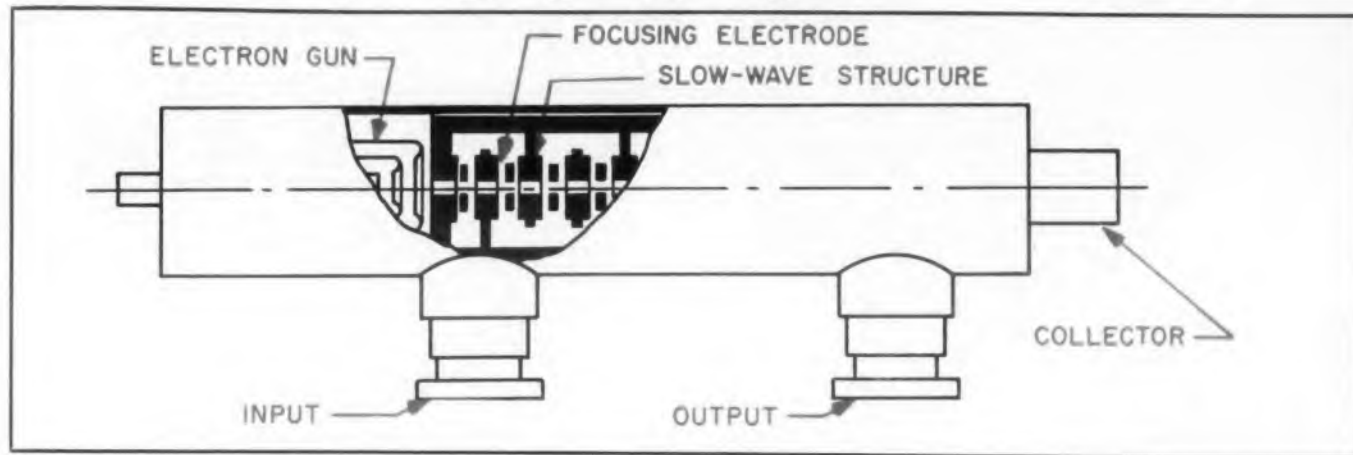

Fig. 3. Considerable promise for efficient high-power TWT operation is credited to this RCA Estiatron.

of cathodes or guns for super power klystrons and TWT's. Merely increasing the size of the electron gun when greater power is desired isn't a practical solution.

If the beam density is too great, and the beam diameter too large, the electrons will not be emitted evenly from the cathode surface. The space-charge cloud will reduce the number of electrons drawn from the center of the cathode, causing a considerably greater emission from the edges. In addition, the center electrons in a thick beam do not interact efficiently with the rf fields of either the cavity gaps, or the slow-wave structure. For these reasons, a hollow-beam cathode design for high perveance guns has been investigated by a number of tube manufacturers.^{1,2} By means of this design, it is possible to achieve greater efficiencies at high power, by eliminating the "inefficient" electrons.

An additional advantage of using the hollow-beam, high-perveance gun is the greatly increased bandwidth obtained. The higher beam current and more efficient coupling between beam and circuit increase the loading effect of the electron beam on the cavity or slow-wave structure. This, of course, results in a lower "Q", or shunt resistance, and a correspondingly greater bandwidth.

The hollow-beam, high-perveance gun design also permits a simplification in the power-supply design by lowering the anode voltage requirements for a given power input. For an average power input of 3 megawatts (corresponding to, perhaps, 1 megawatt cw output), standard-gun design requires an anode voltage of 100 kv and a cathode current of 30 amp. The advantages of high-perveance guns become even more obvious if the problems of insulation and X-ray shielding associated with the design and construction of a 100-kv power-supply are considered.

A recent example of a tube utilizing the hollow-beam gun design is the high-power traveling-wave amplifier developed by the Hughes Microwave Tube Div. This tube, the HAX-7, is capable of delivering a peak output of 100 kw, with a gain of 10 db. It provides a 10 per cent bandwidth at X-Band and a 25-kw average power capability.

Space-Charge-Focused Klystrons Eliminate Focusing Magnets and Electrodes

After the electron beam has been produced and launched by the gun, it must then be confined by some focusing structure to permit interaction. This problem is of particular importance to the power-klystron and traveling-wave-

tube designer because of the extended linear beam required for the operation of these devices. These two tube types are normally focused by means of an axial magnetic field—which may be formed by an electromagnet, permanent magnet, or periodic permanent-magnet stack.^{3,4,5} However, these magnets are heavy, bulky, and expensive. Therefore, considerable effort is being expended in the development of a better method of focusing.

One of the simplest techniques is that used by the Sperry Electronic Tube Div. in a number of their high power klystrons. This technique, often referred to as space-charge focusing, or ion focusing, requires no magnets or focusing electrodes. The beam is initially focused by the convergent gun and then allowed to spread during its travel. The drift-tube and gap-tip sections are machined to follow the contours of the beam, thus achieving a relatively high beam transmission.

The Sperry SAL-89 (Fig. 2) is an excellent example of the practicality of this focusing technique. This tube is capable of providing an output power of over 25 kw at 0.36 to 1.215 Gc with an efficiency of better than 27 per cent; yet it weighs less than 30 lb and requires no focusing power.

Floating Drift Tube Klystron Being Pushed Toward Kilowatt Region

A focusing technique that appears similar to the space-charge method is that employed by Eimac in the design of the Floating Drift Tube Klystron. However, there is considerable difference between these ideas. The FDTK uses the Heil gun to initially launch the beam and then relies on the rf fields across the gap-tips to aid in the focusing. For this reason, it is one of the few devices that maintain a nearly constant beam transmission when the tube operation changes from dc to rf conditions as oscillation begins. Laboratory models of this device have produced output powers of over 80 w cw at C-band with an efficiency of over 25 per cent. Investigations are now under way to extend this power level into the kilowatt range.

Unique Focus Electrodes of Estiatron Draw Little Focus Power

A more recently developed focusing technique^{6,7,8} that appears to have considerable promise for high power traveling-wave-tubes is that incorporated in the RCA Estiatron. In this tube design, the focusing electrodes are insulated from the main body of the rf structure and are located at the centers of the interaction regions of the rf circuit, as shown in Fig. 3. The beam



Fig. 4. Crossed-field forward-wave amplifier, type L-3280, developed by Litton, preserves magnetron efficiency without usually attendant frequency instability.

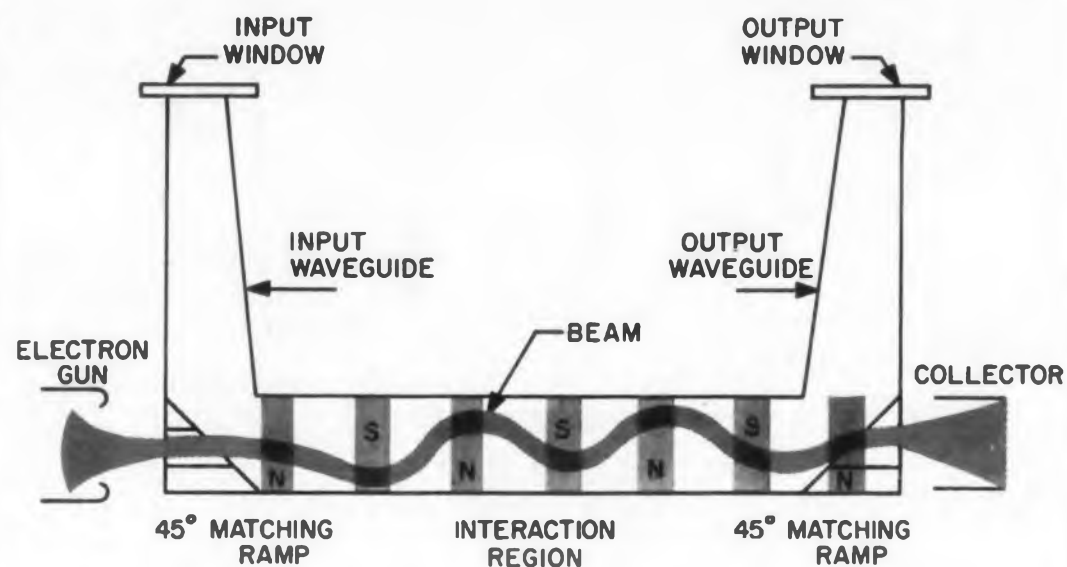

Fig. 6. Fast-wave structure tubes, such as this undulating-wave Ubitron developed by General Electric, may produce a megawatt cw at 50 or 60 Gc.



Fig. 5. Tapered slow-wave structure, used in Varian's VA-125A, makes possible 2-megawatts pulse power at over 45 per cent efficiency.

is then focused by applying different dc potentials to the two focusing electrodes. Because the beam interception is relatively low, the focus voltage supply need deliver only a minimum of power.

A development model of this tube, the RCA A-1156, has delivered a pulse output power of 10 kw in X-band, at a duty cycle of 0.001, with an efficiency of 30 per cent. This design is being improved to provide bandwidth capabilities of over 23 per cent and duty cycles of more than 0.025.

In addition to having the obvious advantage of light weight, the Estiatron can also be operated over a wide temperature range because of the absence of temperature-sensitive magnets. It is also expected that the life of the tube will be greater than that of a similar magnetically focused tube because electrostatic focusing continually drains ions from the beam and minimizes back-bombardment of the cathode.

Crossed-Field Amplifiers Combine Magnetron Efficiency with Frequency Stability

One of the most important microwave tubes in past years has been the magnetron oscillator. It was capable of delivering high peak powers at high efficiencies; it was small, and it could be produced in large quantity at a relatively low

cost. Unfortunately, it did not possess the degree of frequency stability required in many of the new radar systems.

To surmount this problem (and still retain the advantages of the magnetron), investigations of a cross-field amplifier were initiated. This work has resulted in a number of forward-wave and backward-wave amplifiers, each with their own unique advantages and limitations.^{10,11,12}

One of the most recent developments in this field is the crossed-field forward-wave amplifier produced by Litton (Fig. 4). This family of tubes is capable of producing multi-megawatts of peak power and multi-kilowatts of average power in the X-Band region. The details of frequency range and power level are classified. These tubes are of the non-reentrant, injected beam type, and have a currentless beam control electrode, which may be used as a convenient low-power modulating electrode. This design permits the construction of highly efficient amplifier tubes which have no internal electronic feedback-mechanism, and are therefore stable, low-noise devices.

TWT Efficiency Upped Considerably By Tapered Slow-Wave Structure

Although the traveling-wave-tube has proved to be an excellent amplifier, it has the disadvantage of being less efficient than other devices.

MICROWAVES

Typical efficiencies of 25 to 30 per cent are achieved by high power traveling-wave-tubes as opposed to 35 to 50 per cent for klystrons and 60 to 80 per cent for crossed-field amplifiers. However, it has been known for some time that by tapering the slow-wave structure, higher efficiencies could be achieved by extracting more energy from the electron beam in the output.

The fabrication of a tapered circuit is somewhat difficult, and this technique has not been applied to any great extent in production tubes until recently. One of the outstanding exceptions is in the VA-125A pulse traveling-wave-tube by Varian Associates, shown in Fig. 5. This tube is capable of providing a peak output power of 2 megawatts over the frequency range of 2.65 to 2.97 Gc with an efficiency of over 45 per cent. This performance is the result of reducing the spacing between the cloverleaf loading structures in the last four cavities of the slow-wave circuit. By tapering this spacing from normal to one-half normal in these four sections, the electron beam is slowed and considerably more power is extracted.

Unconventional Fast Wave Structure Used in Undulating-Beam Ubitron

Conventional microwave power tubes require a slow-wave structure, or periodic gaps, to provide interaction between the beam and rf wave. A new, unconventional device that has received considerable attention is the fast-circuit-wave traveling-wave amplifier. In this device, the wave propagates on an unloaded circuit with a phase velocity greater than that of light. The beam is made periodic to provide the coupling mechanism to the fast wave.

An example of this class of device is the Ubitron,^{13,14} developed at the General Electric Microwave Laboratory. The undulating beam of this tube (Fig. 6) provides the periodic interaction between beam and circuit wave by moving the electrons into or away from the center of the waveguide.

This undulating beam interacts with the normal TE_{01} mode to provide a cumulative bunching effect. To produce cumulative bunching, the beam must have maximum interaction with the circuit when energy is transferred from the beam to the circuit, and minimum coupling when the converse is true. Synchronism is maintained when the beam velocity is adjusted so that the electrons travel through one cycle of undulation while the wave travels one period plus one rf wavelength. Thus the wave "slips by" the beam one wavelength every period of undulation.

Laboratory models of this tube have produced peak powers of 1.2 megawatts with an efficiency



**QUADRUPLED POWER
IN THE SAME CUBE
THE CAPITRON
RADAR PULSE
MODULATOR**



**HA/HV LEADS AND
TERMINALS**

Insulated and corona free to 23 KV peak pulse, the AMP shielded magnetron cable assembly #836547 is a high voltage, high temperature unit that fits exceptionally confined spaces.

To see through peaseoup fog or moonless night, the Navy F8U2N Jet interceptor required a quadruple-power radar modulator that would fit in the same volume as the original power units.

The problem was a natural for AMP's Capatron personnel and facilities. New transformer design standards were developed, new high temperature insulations tested, new components created. The unit was packaged and tested in record time. Capatron is now in volume production of this unit . . . the AMP #855053.

Specifications: delivers 600 KW of pulse power to transmitter . . . 22,000 volts . . . requires only three inputs—DC voltage, system triggers, and AC for filaments . . . internal temperature range from -70°C to $+150^{\circ}\text{C}$. . . conforms to mil specs.

Complete specifications available. Send for them today.

**CAPITRON DIVISION
AMP INCORPORATED**
Elizabethtown, Pennsylvania

Capatron products and engineering assistance are available in Canada through Aircraft-Marine Products of Canada, Ltd., Toronto, Canada

CIRCLE 99 ON READER-SERVICE CARD

Developing the Right Attitude...

Orbiting space vehicles which will allow extensive scientific experiments in the fields of meteorology, astronomy and radiation require the most accurate attitude stabilization. In order to observe stellar nebulae and the solar weather, the orbiting telescopes must be pointed at the heavenly bodies with accuracies between one minute to one-tenth of a second of arc.

To study the problems of attitude control for future scientific space vehicles Grumman Engineers are presently designing a space vehicle simulator for the evaluation of such control systems. This nearly frictionless three degree of freedom platform will allow investigation of attitude control system parameters such as the minute disturbance torques caused by magnetic fields, gravity gradients and solar pressure. This simulator, to be housed in an environment controlled enclosure located in our new, five-million-dollar Avionics System Center, serves to illustrate just one facet of the absorbing work available to electronics engineers at Grumman.

Grumman offers diversified activity in electronics. We invite your inquiry for any of the following positions.

DIGITAL COMPUTER SYSTEMS ENGINEERS
BSEE with a minimum of 5 years' experience in the design, development and analysis of digital computers. Should be thoroughly familiar with logical design, circuit techniques, encoders, decoders, magnetic storage devices and programming. Must be capable of integrating the computer system with the entire Avionics System.

RADAR SYSTEMS ENGINEER. EE or Physics degree with a minimum of 5 years' experience in the design, development or analysis of advanced radar systems. Work will consist of the analysis; preparation of specifications; vendor liaison; test and evaluation; flight development of the latest airborne radar equipment and systems. Responsibilities include the development of support equipment for these systems.

IN-PLANT AVIONICS LIAISON ENGINEER
To work with and instruct technicians in test and servicing of advanced airborne electronic equipment including digital computers, radar data processing equipment and data link systems both in laboratory and after installation in aircraft. Minimum of 8 years' combined technical education and experience is required. Work

experience must include digital computers, data processing equipment or data link systems plus one or more of the following: radar, inertial guidance, electronics countermeasures, aircraft instruments, aircraft power systems, automatic flight control systems, doppler navigation equipment.

AUTOMATIC FLIGHT CONTROL SYSTEMS ENGINEERS. EE or Physics degree with a minimum of 5 years' experience in the design and development of autopilot and flight simulators. Work will involve the development of airborne flight control systems and the establishment of military automatic test equipment requirements.

LABORATORY EQUIPMENT ENGINEERS. BSEE with 7-10 years' experience in laboratory test program of airborne Avionics equipment. A working knowledge is required in a majority of the fields of airborne communication, detection, electrical systems, automatic flight control and navigation. An understanding of commercial power systems, electrical distributions, building design and electronic test instrumentation of all types is also necessary.

To arrange an immediate interview, send your resume to Mr. W. Brown, Manager Engineering Employment, Dept. GR-75. (U.S. citizenship required.)

GRUMMAN AIRCRAFT ENGINEERING CORPORATION

Bethpage, Long Island, New York



CIRCLE 910 ON CAREER INQUIRY FORM, PAGE 151



MICROWAVES

of 10 per cent at 2.5 Gc. Because the beam diameter need be only slightly smaller than the waveguide height, this device will permit much higher beam currents than conventional klystrons or traveling-wave tubes at the same frequency. It has been estimated that cw powers of over one megawatt could be produced by these devices at 50 to 60 Gc.

Microwave Solid-State Devices Moving Up in Power, Frequency

A new method of producing microwave energy is presented by the solid-state device. While it is not yet competing with high power sources, the solid-state source is of definite interest in local oscillator applications.

It is now possible to obtain powers of 1 or 2 w at 1 Gc with standard transistor oscillators. By using varactor diode frequency multipliers, powers of a few milliwatts can be obtained at frequencies in X-band. It has been reported by Microwave Associates that multiplication efficiencies much above the normal $1/n^2$ have been obtained (40 per cent for $n = 2$, and 25 per cent for $n = 3$). Microwave Associates has obtained powers of 10 mw at 10 Gc and 3 or 4 mw at K-Band with 6-v varactor diodes. (See also Texas Instruments, ELECTRONIC DESIGN, Nov. 23, 1960, p 66.)

In addition, powers of 100 μ w to one mw have been produced at X-Band by Esaki diode oscillators. It is anticipated that these power levels will be increased at least one order of magnitude within the next few years.

Molecular Oscillators, Many Others, Coming From Microwave Source Designers

A newer source of microwave energy is the molecular oscillator. This device and other oscillators utilizing atomic or sub-atomic particles (other than electron beams) are being investigated primarily as sources of ultra-stable frequencies (for clocks and frequency standards).^{15,16} Their energy can certainly be used wherever a few microwatts of power are sufficient. It is not expected that these devices will be competitive for a number of years to come. However, they will most likely be very strong contenders whenever precise frequency control is required at K-Band or above.

The microwave tube industry is investigating a number of techniques to obtain megawatts and multi-megawatts of rf energy. These include the

production of larger tubes of a conventional design, and the manufacture of new devices not presently in commercial use. A number of these products will be appearing within the next two or three years. The newer, more exotic devices mentioned here will not be in production for a few years. Because much of the development work is of a proprietary or classified nature, for additional information concerning a specific requirement, the equipment designer should consult the appropriate manufacturer. ■ ■

Acknowledgment

The author is greatly indebted for their excellent cooperation to the tube manufacturers who contributed to this article.

References

1. C. C. Johnson, *Periodic Electrostatic Focusing of a Hollow Electron Beam*, Trans. IRE, Vol. ED-5, No. 4, pp 233-243, Oct. 1958.
2. L. A. Harris, *Triode Electron Injection Systems for Hollow Beam*, Trans. IRE, Vol. ED-7, No. 1, pp 43-54, Jan. 1960.
3. J. R. Pierce, *Theory and Design of Electron Beams*, Bell Lab. Series, D. Van Nostrand Co., Inc., New York, N. Y., 1954.
4. J. R. Pierce, *Electron Beams in Strong Magnetic Fields*, Physical Review, Vol. 68, pp 229-230, Nov. 1954.
5. L. A. Harris, *Axially Symmetric Electron Beam and Magnetic-Field Systems*. Proc. IRE, Vol. 40, pp 700-708, June 1952.
6. D. J. Blattner, F. E. Vaccaro, C. L. Cuccia, and W. C. Johnson, *Medium Power L-and S-Band Estiatrons*, RCA Review, Sept. 1959.
7. W. W. Siekanowicz and F. E. Vaccaro, *Periodic Electrostatic Focusing of Laminar Parallel-Flow Electron Beams*, Proc. IRE, Vol. 47, pp 451-452, March 1959.
8. E. F. Bolohoubek, *Slow-wave Structures for Electrostatically Focused High-Power Traveling-Wave Tubes*, RCA Review, Sept. 1960.
9. RCA Trademark.
10. D. J. Harris and H. Heffner, *An Investigation of Amplification Along Electron Beams Under Crossed-Field Conditions*, Stanford Electronics Laboratory Technical Report No. 385-1, Nov. 1956.
11. George E. Dombrowski, *Theory of the Amplitron*, Trans. IRE, Vol. ED-6, No. 4, pp 419-428, Oct. 1959.
12. W. C. Brown, *Design and Development of the Platinotron, Amplitron and Stabilotron*, Magnetron Study Project; Final Engineering Report, Vol. 1, Raytheon Manufacturing Co., Waltham, Mass., 1957. (Contract No. DA-36-039-sc-56644).
13. General Electric Trademark.
14. R. M. Phillips, *The Ubitron, a High-Power Traveling-Wave Tube Based on a Periodic Beam Interaction in Unloaded Wave-Guide*, General Electric Microwave Laboratory Report, No. R-60-ELM-188, Palo Alto, Calif., 1960.
15. J. R. Singer, *Proposal for a Tunable Millimeter Wave Molecular Oscillator and Amplifier*, Trans. IRE, Vol. MTT-7, No. 2, pp 268-272, April 1959.
16. D. I. Bolef and P. E. Chester, *Some Techniques of Microwave Generation and Amplification Using Electron Spin States in Solids*, Trans. IRE, Vol. MTT-6, No. 1, pp 47-52, Jan. 1958.



Down in Lubbock, Texas he hasn't missed a shot for over 12,800 hours!

Every time he pulls the trigger the sound is brought faithfully to KDUB-TV viewers by a pair of Eimac 4W20,000A tubes. According to KDUB's Chief Engineer Rudy Starnes, each tube has more than 12,800 hours in aural power output under its belt and is *still going strong!* At the same station, two other Eimac 4W20,000A's have each delivered over 8,000 hours in visual service and are *still going great guns!* Records to shoot for—but typical of what you can expect from Eimac... the most advanced name in negative grid tubes, microwave tubes, amplifier klystrons. Eitel-McCullough, Inc., San Carlos, California.



Typical Operation Eimac 4W20,000A. The water-cooled, ceramic and metal 4W20,000A has coaxial terminals and a long-life unipotential thoriated tungsten cathode heated by electron bombardment. Its maximum plate dissipation rating is 20kw. You'll also find it ideal for use in radar picket-ship duty delivering 750kw (¾ megawatt) pulse output.

Service	Frequency	Plate Voltage	Plate Current	Useful Power Output
FM Amplifier	220	7 kv	3.4 amps	13 kw
TV Amplifier	216	7 kv	6.0 amps*	25 kw*
Pulse RF Amp (Radar)	230	25 kv	60 amps	750 kw
Pulse Modulator		20 kv**	200 amps	3 Mw

*Peak Sync

**30kv in oil

negative grid tubes • microwave tubes • amplifier klystrons



CIRCLE 101 ON READER-SERVICE CARD



MICROWAVES

PRODUCTS

Five Approaches to Microwave Attenuators For Wide Frequency Coverage



Attenuator Set

256

For standards laboratories

Model AS-1 precision attenuator set consists of eight coaxial attenuators. The following types are included: model 210 having a frequency range of 1 to 12.4 Gc in values of 3, 6, 10 and 20 db and model 50 having a frequency range of dc to 1 Gc in values of 3, 6, 10 and 20 db. All eight have stainless steel bodies with Type N, male/female connectors.

Weinschel Engineering, Dept. ED, 10503 Metropolitan Ave., Kensington, Md.

Price: \$475 fob Kensington, Md.

Availability: From stock.



Switch-Modulator- Attenuators

409

For microwave applications

Series SMA switch-modulator-attenuator is suitable for applications such as amplitude modulation of CW carriers, a square-wave chopper or microwave limiter, microwave rf switching and as a building block for various kinds of microwave equipment. Type WR-90 has these specifications: switching time, less than 10 nsec; frequency range, 8.2 to 12.4 Gc; insertion length, 1 in.; rf controlled power, at least 100 mw; dynamic attenuation range, 14 db at 10,000 mc; waveguide connections, UG-39/U cover flange. Continuous reverse working voltage is 50 v, recurrent peak-anode current is 150 ma and the average anode current is 50 ma.

Somerset Radiation Laboratory, Inc., Dept. ED, 192 Central Ave., Stirling, N. J.

Price: \$60, polished brass; \$72, silver-plated, rhodium-flashed.

Availability: From stock.

C-Band Attenuator

255

Motor actuated from 0 to 100 db

This direct-reading, C-band attenuator is motor-actuated from 0 to 100 db in less than 50 sec. It has coaxial type N connectors. The direct-reading dial is accurate to 0.1 db or $\pm 1\%$ of dial reading at calibration frequency. Insertion loss is 1 db max; vswr is under 1.5 from 5 to 5.8 kmc.

Transco Products, Inc., Dept. ED, 12210 Nebraska Ave., Los Angeles 25, Calif.

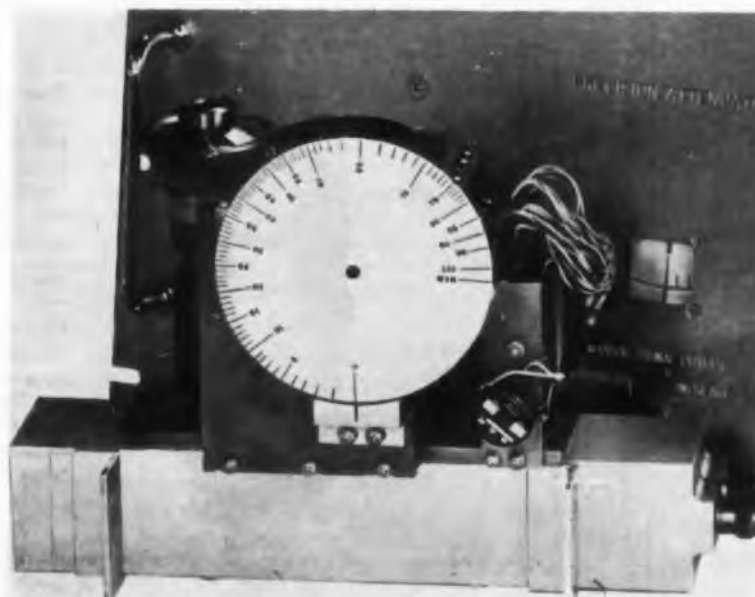

**Turret Attenuator****258**

Covers 0 to 50 db

Type TAB-50 turret attenuator, designed for use in the frequency range of dc to 1,250 mc, covers 0 to 59 db in 1-db steps. Adjustment is by a knob and dial. From 0 to 10 db, accuracy is from ± 0.2 db at 200 mc to ± 0.5 db at 900 mc. Above 10 db, accuracy is $\pm 2\% \pm 0.2$ db up to 200 mc and $\pm 5\% \pm 0.3$ db at 900 mc. At the 0-db position, there is 0.1-db loss up to 300 mc and 0.4-db loss at 900 mc. Power rating is 1 w. Input impedance is 50 ohms. The vswr is 1.2 up to 300 mc and 1.35 at 900 mc.

Telonic Industries, Inc., Dept. ED, Beech Grove, Ind.

Price: \$225 in single-unit lots.

Availability: Units are now in production.

**Calibrated Attenuator****257**

L-band, variable unit

Model 1001 calibrated attenuator is an L-band, variable unit using type BNC connectors. Specifications include: linearity, -0.1 db per 30 db; attenuation, adjustable over 100-db range; insertion loss, approximately 25 db; power dissipation, to 5-kw peak; frequency range, 925 to 1,225 mc.

General Communication Co., Dept. ED, 677 Bracon St., Boston 15, Mass.



Photos Courtesy Westinghouse Air Arm Division

Congratulations!

to **WESTINGHOUSE** for
an exciting breakthrough.

A RADAR RECEIVER NOISE FIGURE of 2.8 db at an X-band operating frequency has been achieved by engineers of the Westinghouse Air Arm Division. Dr. Robert Rampolla (left), and Mr. Thomas Hollis (right), using a true non-degenerate X-band parametric amplifier and a Microwave Associates "pill" varactor (MA-4253), achieved a 20 db gain with excellent stability and ample bandwidth.

This remarkable accomplishment in low-noise amplification at X-band resulted from research on a program sponsored jointly by Westinghouse and the U. S. Navy.

Sophisticated Varactor technology at Microwave Associates which made these results possible has produced the most complete line available of advanced varactors in standard, miniature "pill", and glass packages.

Write for detailed information and performance data on varactor techniques.

MICROWAVE ASSOCIATES, INC.

BURLINGTON, MASSACHUSETTS
Western Union FAX
TWX — Burlington, Mass. 942
Phone BRowning 2-3000

In PRECISION FILM RESISTORS

if it's news, expect it first from IRC

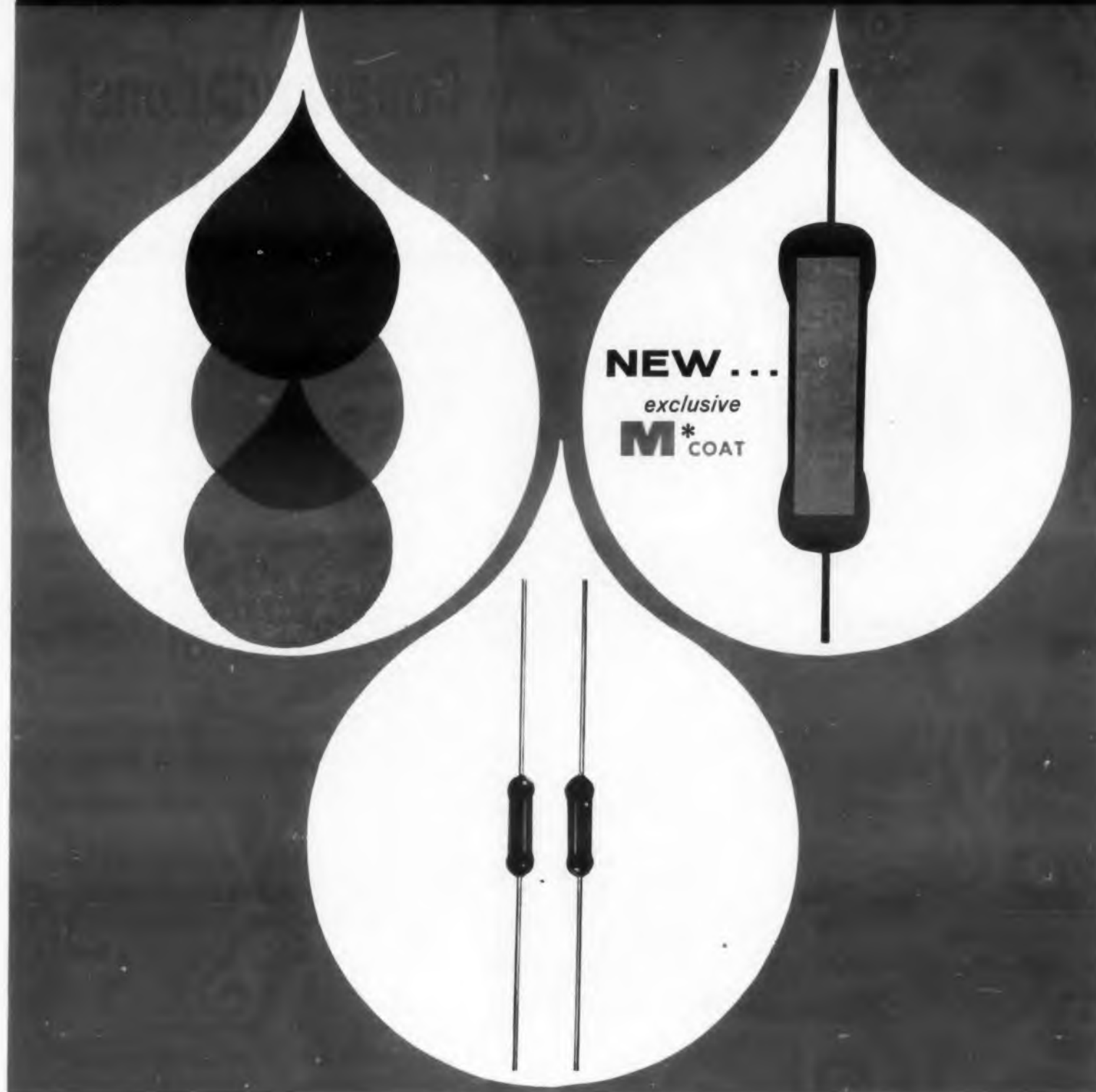

Most moisture-resistant coat ever achieved... withstands 30 cycles of MIL moisture!

IRC precision film resistors with M Coat take 30 cycles of moisture, 300% of the MIL-R-10509C Characteristic B requirement, tested in accordance with MIL standard 202.

M Coat adds greater protection for the resistance element, eliminates handling and assembly damage. Insulation resistance after 30 cycles of moisture is over 100 megohms.

Rating: $\frac{1}{2}$ watt at 70°C ambient. Standard tolerance: $\pm 1\%$. Range: 10 ohms to 2.49 megohms. Maximum continuous working voltage: 350.

Write for Bulletin AE-15, International Resistance Co., 401 N. Broad St., Philadelphia 8, Pa.

*Trademark exclusive IRC moisture-proof coating



Leading supplier to manufacturers of electronic equipment

CIRCLE 103 ON READER-SERVICE CARD



MICROWAVES
PRODUCTS

Clutches, Brakes, Clutch-Brakes 397

Precision size 8 units



Model F-1 clutch, F-2 clutch-brake and F-3 brake are magnetic, precision size 8 units. At 24 to 28 v dc, the units have a power consumption of 4 w. The F-1 has a clutch torque of 9 oz-in. min, the F-2 has a clutch torque of 7 oz-in. min and a brake torque of 4 oz-in. min, and the F-3 has a brake torque of 10 oz-in. min.

Fae Instrument Corp., Dept. ED, 42-61 Hunter St., Long Island City 1, N.Y.

Twin Power Pentode 407

For use in communications equipment

Type 6939 9-pin twin power pentode is for use in communications equipment operating at frequencies up to 500 mc. It is designed for use as a push-pull rf power amplifier tube or as a frequency-multiplier tube in mobile or fixed-station communications equipment. At 500 mc it delivers a useful power output of 5 w Continuous Commercial Service or 6 w Intermittent Commercial and Amateur Service.

Radio Corp. of America, Electron Tube Div., Dept. ED, Harrison, N.J.

Amplifier Klystron 400

Cw power is 1 kw



Type VA-834B amplifier klystron gives 1 kw of cw power tunable from 4.4 to 5 Gc. Designed for

MICROWAVES

tactical and transportable field equipment, it is suited to tropospheric forward scatter communications and radar transmitters. The tube tunes over a 600-mc range. When synchronously tuned at 4.4 Gc, gain is 57 db; when tuned for wide-band use, bandwidth is 12 mc. Maximum weight, including magnet, is 60 lb. Maximum dimensions are 12 x 13 x 15-1/2 in.

Varian Associates, Tube Div., Dept. ED, 611 Hansen Way, Palo Alto, Calif.

Price: \$9,980 in small quantities.

Availability: From stock.

L-Style Rotary Joints

399

Available in WR90 EIA, WR112 and WR187 sizes



These L-Style rotary joints are available in WR90 EIA waveguide sizes for 8.5 to 9.6 Gc and 8.5 to 10 Gc ranges, in WR112 sizes for 8.5 to 9.6 Gc range, and in WR187 sizes for 5.4 to 5.9 Gc range. Units are available in aluminum or copper alloy, non-pressurized or 30-psig pressurized, and with rotating in-line arm or rotating 90-deg arm. Each joint is tested before shipment and is accompanied by a written certificate of electrical performance.

Microwave Development Laboratories, Inc., Dept. ED, 92 Broad St., Babson Park 57, Wellesley, Mass.

Price: \$400 to \$700 ea.

Availability: Stock to 45 days.

Microammeters and Milliammeters

405

Basic research and production tools

These dc microammeters and milliammeters are basic research and production tools that meet all requirements of applications demanding recorder sensitivity, linearity and reliability. Standard chart speeds are 0.75 in. per hr through 12 in. per min. The 0- to 50- μ amp range requires 120 v, 60 cps and has a 200-ohm input resistance. The 0- to 1-ma range has an input resistance of 1,400 ohms. Response is 1 sec and 0.5 sec, respectively.

Esterline-Angus Co., Dept. ED, Box 596, Indianapolis 6, Ind.

EPSCO DELIVERS ITS SPECIFICATION: 30 MILLION CONVERSIONS PER SECOND



WORLD'S FASTEST A/D CONVERTER

Epsco's new VideoVerter combines unprecedented speed — up to 30 million conversions per second — with maximum simplicity of operation. Modular construction adapts easily to such manifold military, industrial and medical uses as:

- Digitization and reconstruction of television and radar video
- Precision measurement of asynchronous, fractional-microsecond, radar pulse returns
- Electro-neurological studies
- Digital computer analysis of any wide-bandwidth analog phenomena
- Space communications
- Wide band-narrow band-wide band communications
- High-speed transient pulse analysis



Available in 3 standard models with numerous optional features. Write for bulletin describing the standard 5-megacycle models: AV-6B (6-bit binary), AV-7B (7-bit binary) and AV-8B (8-bit binary). 30 mc units, modifications of these 3 models, are available on special order. Binary coded decimal units also available. All models available for quick delivery.

SPECIFICATIONS:

MODELS AV-6B, AV-7B, and AV-8B — The electrical specifications of these instruments are the same except for the number of binary bits in the output. The AV-6B is a 6 bit instrument, the AV-7B, 7 bit, and the AV-8B, 8 bit.

Analog Input Voltage Range:	0 to +10 V full scale
Analog Input Current Range:	0 to +100 ma full scale
Analog Input Impedance:	100 ohms (to match cables)
Conversion Accuracy:	$\pm 0.5\%$ or 50 mv, whichever is greater $\pm \frac{1}{2}$ the least significant digit
Conversion Time:	0.20 μ s* (200 millimicroseconds!)
Digital Output Form:	Parallel, semi-static for 0.1 microsecond (minimum)
Digital Readout Voltage levels:	0V = Binary one -6V = Binary zero
Digital Output Source Impedance:	600 ohms
Operating Controls:	Power Switch
Size:	Rack Mounting — 5 1/4" h x 19" w x 12" d
Weight:	Cabinet and Rack Models — 15 lbs. Special Package — Approximately 3 1/2 lbs.
Power Input:	105 to 125 V a.c., 55 to 65 cps, 50 watts
Operating Temperature Range:	-10 to +50°C
Indicators:	Power On Binary Code Readout

*AV-7B add .030 μ sec for AV-8B and subtract same for AV-6B

Epsco  **INSTRUMENTS**

A division of Epsco, Incorporated • 275 Massachusetts Avenue, Cambridge 39, Mass. • UNiversity 4-4950
CIRCLE 104 ON READER-SERVICE CARD

A-L Silectron Steels

←
For Easier Magnetization

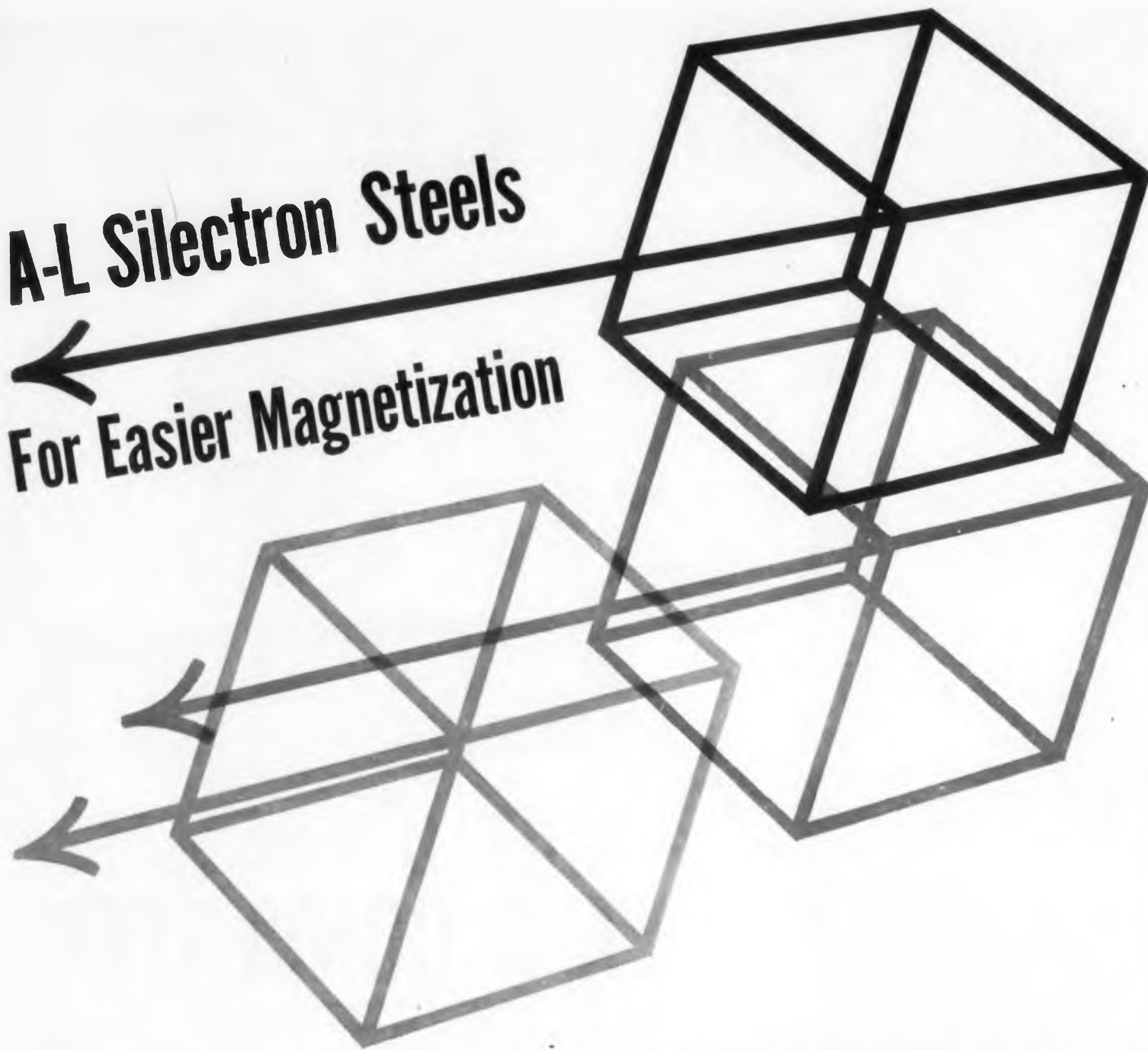

In A-L Silectron® (iron-silicon alloy) steels the grains are oriented so that magnetization is easiest in the direction of rolling. For example, the core loss of .014 inch thick Silectron, Grade 66 (AISI M-6), is only .659 watts per pound measured in the direction of rolling compared to 1.11 watts per pound of non-oriented transformer grade steel. (Both measurements made at 15 kilogausses and 60 cycles per second.)

While core designs should minimize the length of flux paths which are not parallel to the rolling direction, Allegheny Ludlum Silectron is so superior to all non-oriented grades that you can achieve better results with it even when 20 percent or more of the flux path is cross grain. Small scrapless EI Silectron laminations in which only the back of the E is cross grain are superior to the best conventional grades of silicon steels.

A-L Silectron is available in wide coils or in slit widths as narrow as 1/2 inch. For large power transformers use 14 mil Silectron. It's heat flattened to eliminate coil set and has very good (C-10) insulation. For wound cores unflattened 12 mil Silectron is a good choice. Its natural insulating coating, developed in a high temperature hydrogen anneal, is well suited for narrow widths. The 12 mil Silectron is also available with the same flattening and insulation as 14 mil.

Cores are more uniformly stacked and wound when you use Silectron because of its excellent gage uniformity. Magnetostriction is held to a minimum to prevent excessive noise levels.

Allegheny Ludlum Silectron is quality processed to give you consistently low core losses. For more technical information, contact your A-L salesman, or write: *Allegheny Ludlum Steel Corporation, Oliver Building, Pittsburgh 22, Pennsylvania. Dept. ED 12-3.*



ALLEGHENY LUDLUM

PIONEERING ON THE HORIZONS OF STEEL

CIRCLE 72 ON READER-SERVICE CARD



MICROWAVES
PRODUCTS

Klystron Power Supply 402

For beam voltages to 700 v



Model 62A3 klystron power supply is for klystrons requiring beam voltages up to 700 v. Beam is continuously adjustable from -200 to -700 v at 0 to 70 ma. Line regulation is ± 1 v; ripple is 5 mv max. Reflector voltage is 0 to 1,000 v, 0.1% regulation, 5 mv max ripple. Filament voltage is 6.3 v ac at 0 to 2 amp. Power requirement is 105 to 125 v, 50 to 60 cps, 220 w approx. The unit measures approximately 8 x 12 x 16 in.

Sperry Microwave Electronics Co., Div. of Sperry Rand Corp., Dept. ED, Clearwater, Fla. Price: \$550 ea.

Traveling-Wave Tube 403

Frequency range is 10 to 20 G

Model HA-82 K_u -band traveling-wave tube amplifier has a frequency range of 10 to 20 Gc and a small-signal gain of 25 db min. Saturation power output is 1 mv min; saturation gain is approximately 6 db below small-signal gain. The tube measures 15-3/4-in. long, 1-1/16-in. in diameter and weighs 1-3/4 lb.

Huggins Laboratories, Dept. ED, 999 E. Arques Ave., Sunnyvale, Calif.

Microwave Attenuators 393

Fixed, coaxial type

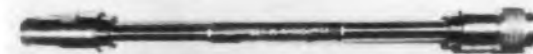

Series AL attenuators are designed for use in the range of 1,000 to 4,000 mc and can also be used up to 10,000 mc. Attenuation values are 0 to 20 db, vswr is 1.2 max under 10 db and 1.3 max

2990

ELECTRONIC DESIGN • December 21, 1960

for over 10 db. They can be furnished with type N or C connectors. Other specifications are: 50-ohm nominal impedance, power handling of 1 w cw and 1 kw peak. The units are bidirectional and are able to stand humidity and temperature changes.

Maury & Associates, Dept. ED, 10373 Mills Ave., Pomona, Calif.

Price: \$45 to \$50.

Availability: Two to four weeks.

Microwave Rotary Joint 392

Frequency range is 1,700 to 1,850 mc



Model RJSL-2A high-power, in-line waveguide incorporates transitions on each end to convert the TE_{10} mode in the waveguide to the TEM mode in a coaxial line. The vswr is 1.1, power handling capacity is 5 megawatts peak and 35 kw avg, flanges are type UG-435A/U and insertion loss is 0.02 db. An O-ring pressurizing seal is used.

Canoga Corp., Dept. ED, Van Nuys, Calif.

Price: \$2,500.

Availability: 60 days.

Hybrid Junction Tees 398

Matched and unmatched units



These matched and unmatched hybrid junction tees have an isolation greater than 35 db over the applicable frequency range. Frequency ranges are 2.6 to 3.95 Gc, 3.95 to 5.85 Gc, 5.85 to 8.2 Gc, 7.05 to 10 Gc, 8.2 to 12.4 Gc, 12.4 to 18 Gc, 18 to 26.5 Gc and 26.5 to 40 Gc. Flange and waveguide types are available.

Waveline, Inc., Dept. ED, Caldwell, N.J.

why

did **ZENITH** select
ELCO'S E-Z MATE SOCKETS
for its new television line?



ZENITH's reputation rests on thru-and-thru quality; and ELCO's patented E-Z MATES fortify that quality with unequalled advantages. E-Z MATES may be designed into "inaccessible" locations; permit "blind" tube insertion without pin damage; speed-up assembly; eliminate service problems. E-Z MATES are available in 7- and 9-pin miniature models, per Signal Corps Spec. SLC 6315/2, 3; and MIL Spec. S-12883-A.

SO find out how you can save time, tubes, temper and money with E-Z MATES, too. Send for Bulletin 117-A at once!

E-Z MATES available at no increase in prices!

if it's new... if it's news... it's from



"M" BELOW ERIE, PHILA. 24, PA., CU 9-5500
Elco-Pacific: 2200 Centinela, W. Los Angeles, GR 8-0671

CIRCLE 105 ON READER-SERVICE CARD

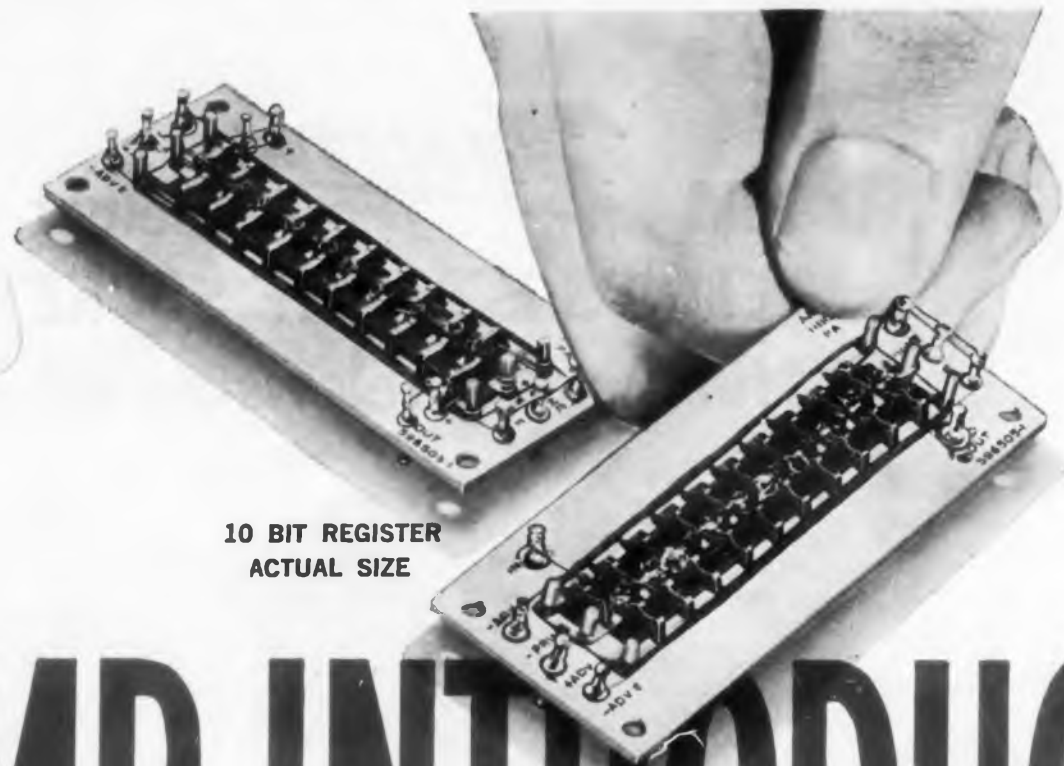

10 BIT REGISTER
ACTUAL SIZE

AMP INTRODUCES

A COMPLETELY NEW KIND OF SHIFT REGISTER USING MAGNETIC ELEMENTS ONLY...

Here is the first commercially available line of all-magnetic shift registers. Now you can have both non-destructive dynamic and static output in the same register. Now you can have the minimum number of components, the minimum number bit to bit interconnections and any serial/parallel input and output combination. Made with AMP multiaperture ferrite cores and copper wire only (see schematic below),

the AMP Shift Register line has a number of other useful features:

- -40°C to $+75^{\circ}\text{C}$ temperature operating range
- minor aperture output level up to 100 mw at several volts
- immune to nuclear radiation
- small size—ideal for miniaturization requirements
- ultimate in reliability and simplification

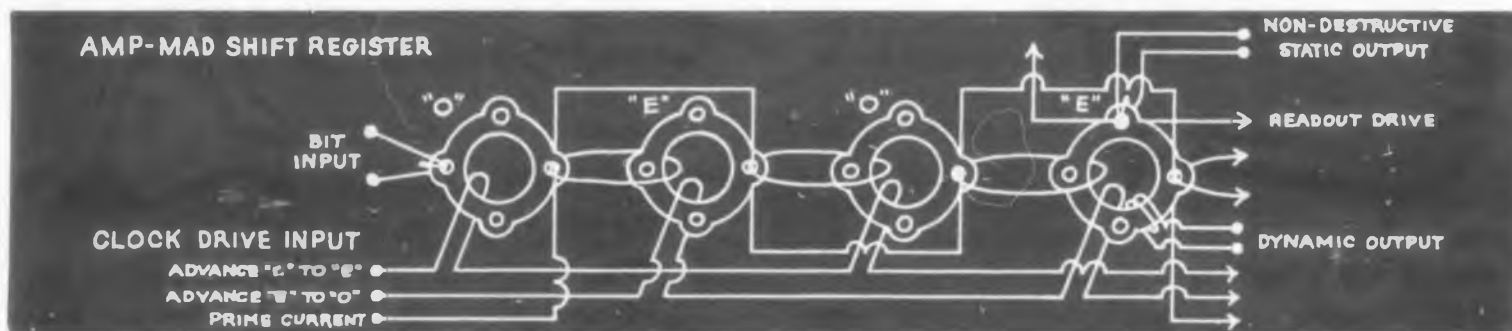

For complete information, including operating data, send for our AMP-MAD* Shift Register brochure.

AMP INCORPORATED

GENERAL OFFICES: HARRISBURG, PENNSYLVANIA

AMP products and engineering assistance are available through subsidiary companies in: Australia • Canada • England • France • Holland • Italy • Japan • West Germany

CIRCLE 106 ON READER-SERVICE CARD



MICROWAVES
PRODUCTS

Microwave Attenuators

394



For dc to
2,000 mc

Models AT-57 and AT-58 power attenuators are for the frequency range of dc to 2,000 mc. Model AT-57 is rated at 10-w continuous and 5-kw peak; model AT-58 dissipates 15-w continuous and 5-kw peak. The units isolate power sources from low-power measuring devices such as bolometers. The vswr for both units is 1.2:1; accuracy is ± 0.25 db up to 1,000 mc and ± 0.5 db from 1,000 to 2,000 mc. Input and output impedance is 50 ohms.

Empire Devices Products Corp., Dept. ED, Amsterdam, N.Y.

Directional Couplers

401

Ranges are 250 through 4,000 mc



The RDC series of directional couplers have ranges of 250 through 4,000 mc. The units allow modification to types C, BNC, TNC and LT connectors. Each unit covers a 2 to 1 frequency range. Couplings of 10, 20 and 30 db are available in any range.

Radar Design Corp., Dept. ED, Pickard Dr., Syracuse 11, N.Y.

Price: Unit having 1,000 to 2,000 mc, 20-db coupling and type C connectors, \$250 ca.

Availability: 5 weeks.

X-Band Magnetron

404

Minimum cw output is 1 mw

Type Z-5429 X-band, voltage-tunable magnetron has a minimum cw power output of 1 mw over the 8,500 to 11,000-meg range. It can be used as a driver or local oscillator tube in space telemetry, electronic counter-measures, rapidly-tuned radar, doppler radar and similar applica-

MICROWAVES

tions. Anode voltage is 1,250 v at 9,000 mc; anode current is 10 to 20 ma; filament voltage is 2.5 v; filament current is 3 amp. Maximum ratings are 2,000 v, 30 ma and 3.2 amp. It can operate at 50 C max. The tube weighs 4 lb.

General Electric Co., Power Tube Dept., Dept. ED, Schenectady 5, N.Y.

Price: \$1,300 ea.

Availability: In sample quantities.

Microwave Coaxial Isolators 406

Cover frequency ranges from uhf to X-band



Models CL-140 and SL-140 microwave coaxial isolators cover frequency ranges from uhf to X-band. Specifications of the CL-140 are: frequency range, 4,000 to 7,000 mc; insertion loss, 1 db max; vswr, 1.15 max. Specifications of the SL-140 are: frequency range, 1,900 to 2,300 mc; insertion loss, 0.6 db max; vswr in and out, 1.10 max. Both units have 20-db minimum isolation and use type N connectors.

Micromega Corp., Dept. ED, Venice, Calif.

Price: \$240 ea.

Availability: 30 days, sample quantities.

Band-Pass Filters 410

For missileborne applications



Series BP type 2 band-pass filters are for missile-borne applications. Length of cavities at 100 mc is 3.26 in. max. The filters are available in center frequencies from 100 to 4,000 mc. They are supplied with type BNC, TNC, N or C connectors. Specifications include: insertion loss, 1 db max; vswr, 1.10 max at center frequency; impedance, 50-ohm nominal.

Maury & Associates, Dept. ED, 10373 Mills Ave., Montclair, Calif.

Price: \$250 to \$350 ea, 1 to 10.

Availability: 4 to 7 weeks.

NEW DEPARTURES IN MINIATURE



ULTRA-CLEAN INCUBATORS FOR M/I* BALL BEARINGS N/D'S NEW WHITE ROOM PROVIDES ULTRA-CLEAN ENVIRONMENT FOR M/I BALL BEARING ASSEMBLY

N/D announces a new White Room at Sandusky, Ohio incorporating the latest technological advances available today. This new room provides a virtually dust-free atmosphere so necessary for the production of Miniature and Instrument Ball Bearings of high reliability.

Environmental controls within the room hold temperature to plus or minus 1°... with maximum humidity only 40%. Final air filtration into room removes particles smaller than 3/10 micron. A complete air change is made every three minutes. Engineers and technicians entering the room are thoroughly bathed by air showers in two successive deduster chambers.

You can benefit from New Departure's 25 years of experience in M/I ball bearing production by calling your nearby N/D Sales Engineer. Or write Department L.S., New Departure, Division of General Motors Corporation, Bristol, Conn.

*Miniature and Instrument Ball Bearings.



SEND FOR NEW DEPARTURE'S
M/I BALL BEARING CATALOG
TODAY. WRITE DEPT. L.S.

NEW DEPARTURE

MINIATURE AND INSTRUMENT BALL BEARINGS

CIRCLE 107 ON READER-SERVICE CARD

New ESNA CLINCH NUT HANDBOOK



Here's a brand new design manual giving full information on ESNA's line of self-locking clinch type Elastic Stop® nuts. The manual covers such points as:

Applications
Design Features
New Flush mounting Types
Insertion methods
Correct part selection
Plus: Materials, finishes and complete dimensional data

SEND TODAY for your copy.
Write Dept. 519-1257, Elastic Stop Nut Corporation of America, 2330 Vauxhall Road, Union, New Jersey.

This new flush mounting, miniature ESNA Clinch nut is easily installed by a simple flaring operation—becomes a permanent fastener.



actual size



ELASTIC STOP NUT CORPORATION OF AMERICA

CIRCLE 108 ON READER-SERVICE CARD

PILOT LIGHT AND PUSH BUTTON COMBINED

Grayhill Series 40 Miniature Lighted Push Button Switch was designed for Digital Computers, Hotel Call Systems, Reset Switches Warning Indicators, etc.

- Normally open, momentary contact switch
- Rated 1 amp, 115 VAC
- Independent neon or Incandescent Lamp Circuit
- 7/16" dia.—1 1/4" behind panel length
- Life expectancy 500,000 operations

Write for Complete Details



Actual Size

Grayhill Series 40 Miniature Lighted Push Button Switch



Phone: Fleetwood 4-1040
565 Hillgrove Avenue,
LaGrange, Illinois

"PIONEERS IN MINIATURIZATION"
CIRCLE 109 ON READER-SERVICE CARD



MICROWAVES PRODUCTS

Single Diode Switch

395

For K-band applications

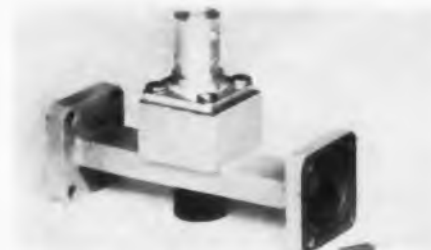

This single diode switch for K-band applications can switch more than 0.2 w at speeds of several millimicroseconds. Total modulation voltage needed is 1-v peak. The on-off ratio is 20 db; insertion loss is 2 db. The unit measures 2-1/2 x 1-3/4 x 7/8 in. It has been used in transmitters and test equipment.

The Bendix Corp., York Div., Dept. ED, York, Pa.

Hydrogen Thyatron Tube

396

Designed as radar pulse modulator



Type 5C22/HT415 hydrogen thyatron tube was designed as a radar pulse modulator. It produces pulse outputs in excess of 2 megawatts at an average power level of 1.6 kw. The manufacturer claims high peak voltage and high current ratings, high repetition rate, short deionization time and low jitter for the tube.

Electronic Enterprises, Inc., Dept. ED, 65 Seventh Ave., Newark 4, N.J.

Microwave Amplifier

408

Power output rating is 1 w min

Model M2405-A K_u-band traveling-wave amplifier has a power output rating of 1 w min. Standard frequency range is 12 to 18 Gc; small-signal gain is 30 db min. Small-signal gain variation over the band is less than 8 db. Test capabilities up to 6 w output in the center of the

NEW NEON INDICATOR LIGHT

FACTS!

- **Reliable:** 25,000 hrs. min. for NE-2H @ .5 ma lamp current
- **Neon:** low power consumption—120 mW nominal
- **Low voltage operation:** supply 24V DC nominal signal—6V DC to trigger
- **Miniaturized:** hole diameter 3/8"; behind panel required, 1 1/2"
- **Encapsulated:** moisture-fungus proof; withstands vibration, thermal and mechanical shock
- **Terminals:** signal, positive supply, common ground



TELEX miniaturized neon lights indicate visually the logical condition of high speed computer "flip-flop" modules. Countless other applications on portable, battery operated or low voltage equipment.

Transistor driven, combines advantages of low current drain with low voltage operation. Can operate direct from basic power supply or controlled by high impedance signal. Standard model 24V DC supply polarity with -6V DC switching polarity.

Variations of the terminal configurations and voltages designed to specification.

More detailed specifications and information are available on request. Write to Sales Manager,



SPECIAL PRODUCTS DIVISION
Telex Park • St. Paul 1, Minnesota
Dept. SP-403

Superior communication accessories for every need—TELEX Communications Accessories Division

CIRCLE 110 ON READER-SERVICE CARD

ELECTRONIC DESIGN • December 21, 1960

MICROWAVES

frequency band are possible. The tube is 1-1/8 in. in diameter, 14-3/4 in. long and weighs 1-3/4 lb.

Microwave Electronics Corp., Dept. ED, 4061 Transport St., Palo Alto, Calif.

Price: \$3,000 ea in small quantities.

Availability: 30 days.

Coaxial Mixer-Preamplifier 414

Provides low-noise coverage



Model MMC-3 coaxial mixer-preamplifier provides a low-noise coverage over the 4- to 8-kmc spectrum. Over-all gain is 25 db min; typical noise figure is 7.5 db. IF bandpass is 8 mc in 30- or 60-mc center-frequency versions.

LEI, Inc., Dept. ED, Akron St., Copiague, N.Y.

Price: \$825 ea.

Availability: 30 to 60 days.

Reflex Oscillator 415

For remote tuning applications



The SRU-266 reflex oscillator klystron is for remote tuning applications. It can be operated over large tuning ranges with no change in repeller voltage. The tube operates over a frequency range of 15 to 17 kmc without variation in reflector voltage. Some specifications are: constant repeller-voltage tuning range, 10% of center frequency; repeller voltage, 100 v nominal; output power, 20 mw min; beam voltage, 300 v nominal; heater voltage, 6.3 v.

Sperry Rand Corp., Electronic Tube Div., Dept. ED, Gainesville, Fla.

Price: On request.

Availability: On request.

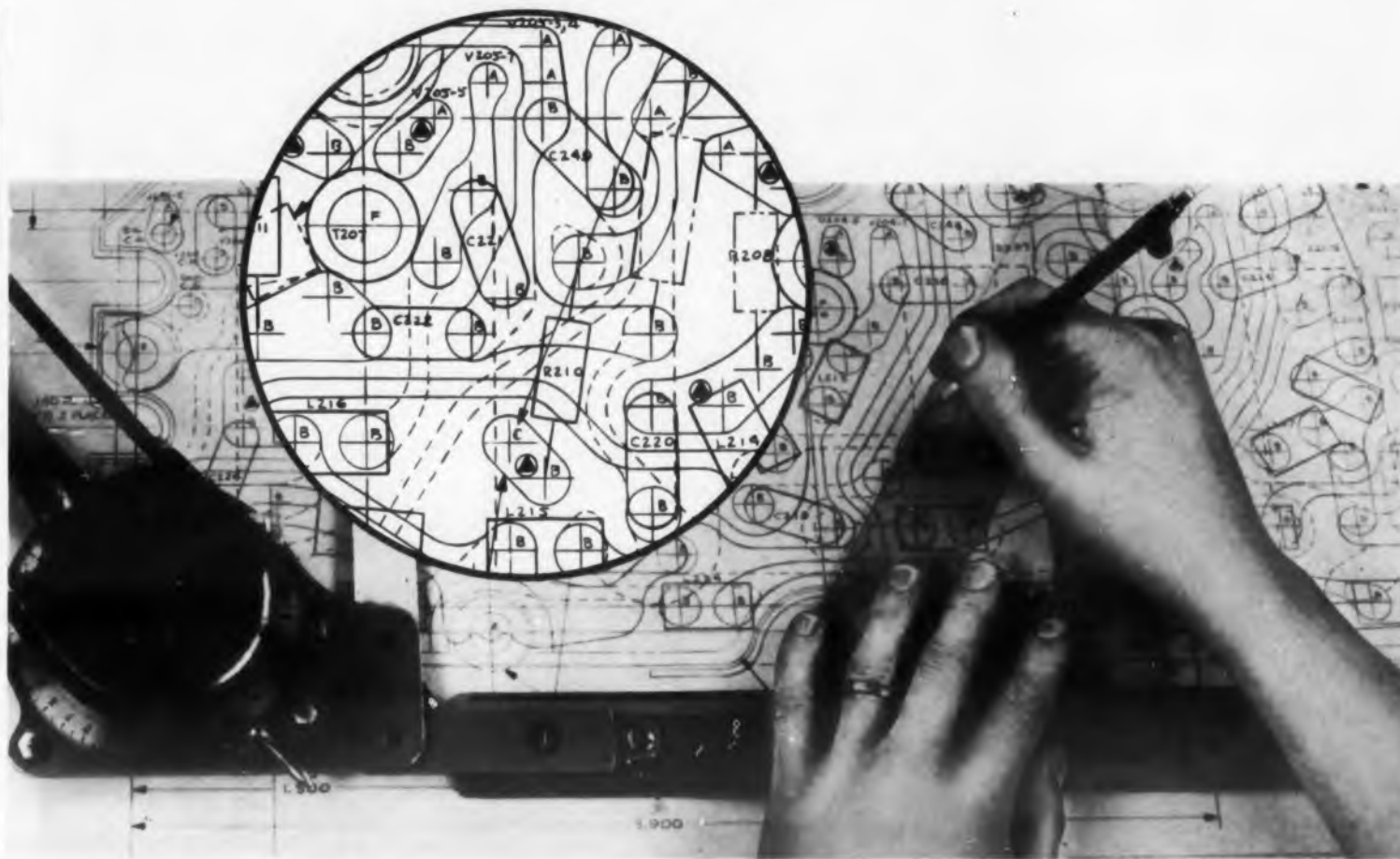

Designer drafts master layout of printed circuit design on dimensionally stable CRONAFLEX. Inset shows detail: solid lines indicate circuitry on component side of board; broken lines, circuitry on reverse side.

At Bendix-Pacific...

CRONAFLEX® CUTS COSTS, SPEEDS PREPARATION OF PRINTED CIRCUITS

Versatile CRONAFLEX Engineering Reproduction and Drafting Films have made possible a new, simplified method of preparing printed circuits at Bendix Corporation's Bendix-Pacific Division. Not only has it proven much more efficient and economical, it also assures uniform quality of finished boards and steps up the entire production cycle.

Commenting on the procedure, Edward E. Benjamin, Method and Design Standards Engineer, says: "CRONAFLEX lets us do a better, faster job, at lower cost, all along the line. For master layouts, where basic design begins, CRONAFLEX Drafting Film is ideal. It holds its size under varying temperature and humidity conditions, takes erasures and handling without damage, and has a far superior matte surface.

"From the master layout we make our master transparency, machine board drawing and assembly board drawing, using CRONAFLEX Direct Positive. Here again results are phenomenal. In the assembly drawing alone, for example, we've cut drafting time from 3-5 days to 4-8 hours! Add to this elimination of the negative step, fast printback

and excellent halftone quality, and you'll see why we're sold on CRONAFLEX!"

For a FREE booklet that describes this new method in detail, plus information on the many ways CRONAFLEX can help your firm cut costs and increase efficiency, clip and mail this handy coupon now.

E. I. du Pont de Nemours & Co. (Inc.)

Photo Products Department ED-12

Wilmington 98, Delaware

Please send me without obligation:

- Free booklet, "A Photographic Method for Preparing Printed Circuits."
 Information on the Full Line of CRONAFLEX Engineering Reproduction and Drafting Films.

Name _____

Firm _____

Address _____

City _____ Zone _____ State _____



BETTER THINGS FOR BETTER LIVING... THROUGH CHEMISTRY

CIRCLE 111 ON READER-SERVICE CARD

finding the golden needle in the haystack

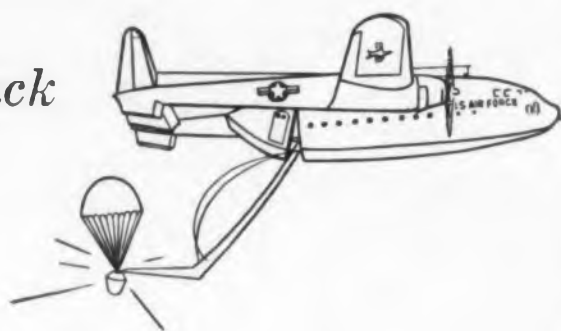

(Top right) sketch illustrates mid-air catch of returning Discoverer XIV nose cone snagged by an airplane-towed "skyhook." (left) A captured practice capsule is slowly reeled towards the rear opening of airborne C-119 Recovery Plane.

NOSE CONES PLATED WITH SEL-REX BRIGHT GOLD* RECOVERED FROM SPACE ORBITS!

Orbiting the globe, then returning earthward upon signal, Discoverer XIV's space capsule plummeted home to be snatched from the heavens in an historic mid-air catch!

U.S. teamwork had plucked the nose cone from a million miles of firmament—marking a significant stride forward in the Free World's space program.

The returning space capsule was plated with Sel-Rex Bright Gold. So was its predecessor, Discoverer XIII, which had been rescued earlier from the Pacific Ocean.

This patented plating process was applied by Philadelphia Rust-Proof Co., Inc. to provide maximum heat reflectivity and emissivity, under sub-contract from General Electric Company, Missile and Space Vehicle Department. Sel-Rex precious metal plating processes, in fact, are included in the original specifications of many advanced Space Age projects.

As producer of the world's largest selection of precious metal processes, Sel-Rex offers unique dependability to users of its plating systems. For, Sel-Rex engineers have removed the guess work, instead assure you of consistent plating quality, the quality that counts in critical areas.

Sel-Rex sales and service technicians throughout the Free World are ready to serve you with unmatched professional precious metal plating services.

Technical literature free on request. Specify precious metal(s) and your application.

Patented processes for plating with Gold, Rhodium, Platinum, Palladium, Silver, and to produce "custom alloys" for your particular requirements.



SEL-REX CORPORATION

MUTLEY 10, NEW JERSEY

World's largest milling precious metal plating processes



(Above) President Eisenhower holds American flag which was in recovered capsule during its flight through space. Capsule shown was electroplated with patented Sel-Rex Bright Gold Process. With the President are General Thomas D. White, Air Force chief (center) and Col. Charles G. Mathison, who directed the "capsule chase."

*Patented

NEW LITERATURE

PDM Telemetry Components 261

This 12-page, illustrated brochure, No. 935, describes the firm's commutator, transistorized pulse-width modulator, and crystal-stabilized transmitter designed for airborne PDM telemetry systems. The brochure includes detailed electrical, environmental and physical characteristics in addition to outline drawings. Tele-Dynamics Inc., 5000 Parkside Ave., Philadelphia 31, Pa.

Insulation Blankets 262

This four-page technical bulletin, No. 6019, "Custom Insulation Blankets," lists the thermal conductivity ("K" values) of various metals, insulating materials and miscellaneous materials. A simple method of calculating the thickness and material appropriate for a given insulation and the amount of heat in watts per square inch necessary to maintain a given temperature is explained. Various covering materials are categorized by thickness, weight and maximum surface temperature. Electrofilm Technical Service, 7116 Laurel Canyon Blvd., North Hollywood, Calif.

Plastics 263

This table shows significant physical, electrical, chemical and optical properties of acrylics, acetate, butyrate, Teflon and Kel-F fluorocarbons, nylon, polyethylene and vinyls. Properties shown include tensile, impact flexural and compressive strength, resistance to sunlight, water, acids and alkalis, dielectric constants, power factors, machining qualities, hardness, flexibility and thermal properties. Cadillac Plastic and Chemical Co., 15111 Second, Detroit 3, Mich.

Coaxial Cables 264

The development of Spirafil coaxial cable for use at 300 and 500 C is described in this 27-page paper. Development of the conductor and dielectric, manufacturing and testing procedures, and behavior of the cable under nuclear radiation are among the topics discussed. Tables and graphs give physical and electrical characteristics, particularly functions of temperature. Phelps Dodge Copper Products Corp., 300 Park Ave., New York 22, N.Y.

Industrial Plastics 265

This 16-page booklet outlines chemical, electrical, physical and thermal properties, suggests applications and lists available sizes of the firm's lines of nylons and plastics suitable for machining, molding, coating and tubing. The Polymer Corp., 2120 Fairmont Ave., Reading, Pa.

Pulse Camera

266

This two-page data sheet gives specifications for the firm's Model 370, 16-mm pulse camera. The Slip-Sync system, using stroboscopic illumination, is outlined. Application in slow-motion movies of destructive resonance in vibration tests as fast as 10,000 cps is described. Chadwick-Helmuth Co., 472 E. Duarte Road, Monrovia, Calif.

Azimuth Alignment Theodolites

267

Operation of the firm's alignment theodolites, used for setting and monitoring missile internal guidance systems, is described in this eight-page brochure. The optical systems of the theodolites are described and diagramed. Specifications of four of the firm's models are tabulated. Perkin-Elmer Corp., Norwalk, Conn.

Laminated Plastics

268

This eight-page, illustrated publication provides engineering data, product descriptions and suggested applications for Insurok laminates. Grades, physical, electrical and mechanical properties, and sizes of laminated plastic sheets, rods, tubes and fabricated parts are tabulated. The Richardson Co., 2731 Lake St., Melrose Park, Ill.

Digital Instruments

269

In 19 pages Bulletin No. 20-1 describes construction, operation and application of the firm's Series 20 digital instruments suitable for missile checkout applications. Accuracy, speed, and versatility of the machines for measuring ac and dc voltages, voltage ratios and resistances are discussed. Specifications, dimensional, and wiring diagrams are included. Available accessories are described. Non-Linear Systems, Inc., Del-Mar, Calif.

Guidance Test Equipment

270

In 22 pages this catalog, No. 153, lists the T8 series of precision test turntables, rate turntables, gyro test sets and consoles, modular test equipment and accessories, and other components. Illustrations, specifications, possible applications, and modifications are given. Sterling Precision Corp., Instrument Div., 17 Matinecock Ave., Port Washington, N.Y.

Transducers

271

The firm's line of Micro-ducers are listed in data-sheet No. 294. Size and range of miniature force transducers, gas and liquid precision pressure transducers, altimeter transducers and a strain gage are given. Clark Electronic Laboratories, Box 165, Palm Springs, Calif.

RCA-60FX5 power pentode with high sensitivity, used as audio output amplifier.

RCA-18FW6 remote-cut-off pentode used as rf or if-amplifier.

RCA-34GD5 beam power tube similar to 50C5.

RCA-20E27 high-mu twin-triode used in high-gain audio amplifier stages. Excellent stereo channel isolation.

RCA-50FK5 power pentode with high-sensitivity, used as audio output amplifier.

RCA-18FX6 pentagrid converter similar to 12BE6.

RCA-18FY6 twin diode high-mu triode used as detector, avc, first audio amplifier.

RCA-36AM3-A half-wave vacuum rectifier with tapped heater. Tapped section is used as a current limiter.

RCA-20EQ7 diode remote-cut-off pentode used as AM detector and if-amplifier.

100-MA
120-VOLT

New Tube Complements Make Your High-Quality Low-Cost Home Radio.

New RCA complements of 100-milliamper heater tubes for 120-volt series-heater complement, bring important sales advantages to your ac-dc radio and phonograph designs.

NEW 100-MA HEATER TUBE COMPLEMENTS

5-Tube Radio Complement
18FX6, 18FW6, 18FY6, 34GD5, and 36AM3-A. Performance equals 150-MA heater tube complements! Yet 100-MA complement dissipates much less heat.

4-Tube Economy Radio Complement
18FX6, 20EQ7, 50FK5, 36AM3-A. Top performance for a 4-tube complement.

2-Tube Stereo Complement
Two 60FX5's can provide 1.3 watts output per channel using a high-output stereo cartridge.

3-Tube Stereo Complement
20E27, two 50FK5's. 20E27 permits use of stereo cartridges with moderate output.

4-Tube Stereo Complement
36AM3-A, 20E27, two 34GD5's. Capable of delivering 1.4 watts per channel with a B+ supply voltage of 110 volts.

RCA FIELD OFFICES
EAST: 744 Broad St., Newark 2, N. J. MU 5-3900. MIDWEST: Suite 1154, Merchandise Mart Plaza, Chicago 54, Illinois, WH 4-2900. WEST: 6355 East Washington Blvd., Los Angeles 22, Calif. RA 3-8361.

RCA The Most Trusted Name in Electronics
RADIO CORPORATION OF AMERICA

The New Standard Of STABILITY At 5 mc...



BLILEY TYPE: BG61AH-5

ONE PART PER BILLION

(with temperature control)

Bliley BG61A-5 units have long been the unanimous choice for stability at 5 mc. Now, this outstanding crystal has been **RUGGEDIZED** for applications that demand high stability under shock and vibration. The

ruggedized unit, Bliley type BG61AH-5, will withstand vibration from 10 to 200 cps at 10G and acceleration of 50G with frequency change less than 1×10^8 . Request Bulletin 519A.

BLILEY ELECTRIC COMPANY

UNION STATION BUILDING
ERIE, PENNSYLVANIA

CIRCLE 113 ON READER-SERVICE CARD



Mystik Mylar Tape is composed of a smooth, thin, highly flexible polyester film backing and an instant adhering silicone adhesive. Consistent performance under exacting electrical, and limited space conditions. (Thermal limits, -80 to +325°F.). One of the most

effective electrical insulating tapes.

Other Mystik Brand electrical tapes:
7000-G: For extreme temperature demands (-110 to plus 550°F.). Tightly woven Fiberglas® backing. Superior electrical qualities.

7100-G: Same characteristics as 7000-G; with silicone adhesive on two sides.



Write for complete information
Mystik Adhesive Products, Inc.
4234 W. Drummond Pl., Chicago 39

CIRCLE 114 ON READER-SERVICE CARD

NEW LITERATURE

Servos 272

The use of Servolab instruction kits for teaching the theory and application of servo systems is outlined in this eight-page, illustrated report, SR-3. Several demonstrations are outlined and diagrammed. A power supply system, breadboard unit, synthesizer unit and analyzer unit are described. Servo Corp. of America, 111 New South Road, Hicksville, L.I., N.Y.

Miniature Power Supplies 273

This data sheet, No. NPB-104, gives electrical and mechanical characteristics and environment conditions for Models PAI-012 and PAI-040 miniature power supplies. The PAI-012 provides 100 v dc output, satisfying MIL-E-5400 and -5272. The PAI-040, designed to operate from an auxiliary source such as an unmanned microwave station, supplies 200 v dc at 100 to 200 ma. Hermetic Seal Transformer Co., Special Products Div., 2925 Merrill Road, Dallas, Tex.

Temperature Measuring Devices 274

Several thermometer elements and probes, a direct-reading temperature indicating instrument, a comparison bridge, a conversion bridge, and other related devices with temperature measurement applications are described and illustrated on this two-page bulletin, No. T-60. Arthur C. Ruge Association, Inc., Hudson, N.H.

Multi-Contact Connectors 275

This 12-page illustrated booklet, No. 4004B, depicts multi-contact connectors. Brief descriptions accompany the photographs. Consolidated Electrodynamics Corp., 360 Sierra Madre Villa, Pasadena, Calif.

Test Instrument Catalog 276

This 28-page catalog covers a line of test instruments available in kit and wired form. Items are illustrated; specifications and prices are included. Electronic Instrument Co., Inc., 33-00 Northern Blvd., Long Island City 1, N.Y.

Wirewound Potentiometers 277

This catalog gives electrical and mechanical specifications of a line of single-turn, wirewound precision potentiometers intended for aircraft, missile, and ground support applications. Maurey Instrument Corp., 7924 S. Exchange Ave., Chicago 17, Ill.



Capacitors for NO COMPROMISE Circuit Design

Unusual requirements in capacitance, tolerance, case size or configuration no longer need compromise your circuit designs. SOUTHERN ELECTRONICS' engineers are experienced in solving these problems to the extent that non-standard capacitors have become routine at SEC.

SEC has developed multiple block capacitors that are now saving space and weight in a production missile. Two 12mfd capacitors were designed to take less space than one, with improved electrical characteristics. In another application, SEC eliminated 6 tubular capacitors, utilizing a single can, 6 terminals and a common ground. Result: Room for additional components, easier wiring, and a less expensive component.

SEC, in addition to designing special capacitors to save weight and space, has developed dual-dielectrics to solve unusual temperature coefficient problems, and has introduced special dielectrics and oils for extreme high temperature and high voltage applications.

This engineering know-how has resulted in the use of SEC capacitors in twelve U.S. missiles, analog computers, and many radar and communications services.

SEC capacitors are manufactured in a wide range of capacitance to meet your needs from 100mmf to any higher value, with tolerances as low as 0.1%. They are made under unusually critical quality control standards, and meet or exceed the most rigid MIL-SPECS.

Write today for detailed technical data and general catalog.



Pioneers in custom precision capacitor engineering

SOUTHERN ELECTRONICS Corporation

150 WEST CYPRESS AVENUE
BURBANK, CALIFORNIA

CIRCLE 115 ON READER-SERVICE CARD

CIRCLE 69 ON READER-SERVICE CARD

Lab setup shows SB-15a versatility. (1) FM display measures dynamic deviation. (2) and (3) are AM and SSB signals, respectively, with sine wave modulation.

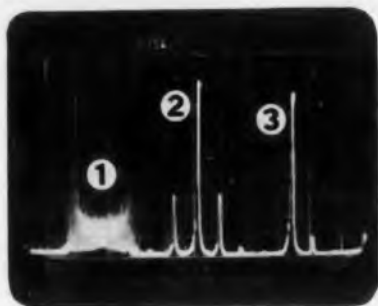

MORE ULTRASONIC ANALYSES *faster easier high accuracy*



PANORAMIC'S NEW, IMPROVED SB-15a spectrum analyzer 0.1 kc to 600 kc

Find, identify and analyze more types of ultrasonic signals with Panoramic's advanced Model SB-15a . . . economical, compact and completely self-contained.

• Noise, vibration & harmonic analysis • Filter and transmission line checks • Telemetry analysis • Communication System Monitoring . . . and more—Power Spectral Density Analysis and Frequency Response Plotting (with companion equipment).

SB-15a specifications:

• Frequency Range: 0.1 kc to 600 kc • Sweep-width: variable, calibrated from 1 kc to 200 kc • Center Frequency: variable, calibrated from 0 to 500 kc • Markers: crystal controlled at 10 kc and 100 kc intervals • IF Bandwidth: variable, 100 cps to 4 kc • Sweep rate: variable, 1 cps to 60 cps • Amplitude Scales: Lin, 40 db log (extendable to 60 db), 2.5 db expanded • Sensitivity: 200 μ v to 200 v full scale • Accuracy: \pm 0.5 db.

Write today for detailed technical data on the SB-15a . . . NEW CATALOG DIGEST . . . and regular mailing of THE PANORAMIC ANALYZER, featuring application data.



Sec. 2900
524 So. Fulton Ave., Mt. Vernon, N.Y.
OWens 9-4600 • TWX: MT-V-NY-5229
Cables: Panoramic, Mt. Vernon, N. Y. State

CIRCLE 116 ON READER-SERVICE CARD

◀ CIRCLE 69 ON READER-SERVICE CARD

UHF Parametric Amplifier 278

A uhf parametric converter designed as a low-noise input to conventional if amplifiers is described in this eight-page brochure. Principles of operation, a description of the parametric diode, a technical outline and specifications of the instrument are included. International Telephone and Telegraph Corp., Federal Div., 100 Kingsland Road, Clifton, N.J.

Circuit Breakers 279

Circuit breakers, rated from 1 to 50 amp and intended for aircraft and industrial electronic systems, are described in this eight-page catalog. Wood Electric Corp., 244 Broad St., Lynn, Mass.

Teflon Wire and Cable 280

Specifications for Teflon-insulated hook-up wire and transmission cable are tabulated in this four-page data sheet, No. DM-S-6001. Wire for 600 and 1,000 v operation in AWG sizes 10 through 32 are listed, along with 14 styles of two-conductor cable. Sequoia Wire and Cable Co., 2201 Bay Road, Redwood City, Calif.

Tape Transports 281

The firm's series 3160 magnetic tape transports are described in Data Sheet No. DS-3160. Operations and applications are described; specifications are tabulated, and characteristics curves are included. Minneapolis-Honeywell, Inc., Industrial Systems Div., 10721 Hanna St., Beltsville, Md.

DC Power Supplies 282

Bulletin No. SE-102, two pages, describes a line of magnetic-amplifier-controlled dc power supplies. Units are rated at 100 to 1,500 amp from 14 to 36 v. Design information and electrical ratings are given. Sprague Engineering Corp., 19300 S. Vermont Ave., Gardena, Calif.

Automatic Checkout Equipment 283

Eleven pieces of automatic checkout equipment suitable for missile, aircraft, or other weapons systems are described in this series of data sheets. General descriptions of construction, operation and application of the instruments are included. A block diagram of an entire checkout system shows the functions of the various devices. All data sheets are enclosed in a file folder. Packard Bell Electronics, Technical Products Div., 12333 W. Olympic Blvd., Los Angeles 64, Calif.

PRECISION IS SYNONYMOUS WITH BOEHME CRAFTSMANSHIP



Precision is our business. We have been pioneers in the engineering, design, and manufacture of the precision demands in the field of Instrumentation and Automation.

The parts shown in the figure, held to the tolerances indicated, are typical examples of Boehme skill in precision craftsmanship.

Any or all of our precision production facilities are available to you. Write or call us, there is no obligation.

H. O. Boehme, Inc.

Contractors, Designers, Manufacturers of Precision Electrical, Electro-Mechanical and Electronic Equipment since 1917
915 Broadway
New York 10, N. Y.



CIRCLE 117 ON READER-SERVICE CARD

51% * OF ALL ELECTRONIC FIRMS USE KRENGEL ENGRAVED DEEP-KUT® STAMPS

*Based on a survey of the 153 leading, publicly-owned electronics firms. Names of customers available on request.



Razor-sharp, permanent impressions every time on any surface, any shape.

Write for FREE SAMPLE and literature TODAY. Tell us your marking problem.

KRENGEL Manufacturing Co., Inc.
227 Fulton St., New York 7, N. Y.
Please send FREE ENGRAVED Deep-Kut Sample & Price List.

Name _____
Company _____
Street _____
City _____ Zone _____ State _____

KRENGEL Manufacturing Co., Inc.
227 Fulton St., New York 7, N. Y.
COrtlandt 7-5714

CIRCLE 118 ON READER-SERVICE CARD

**GUDELACE
TAKES THE
SLIPS
OUT OF
LACING**

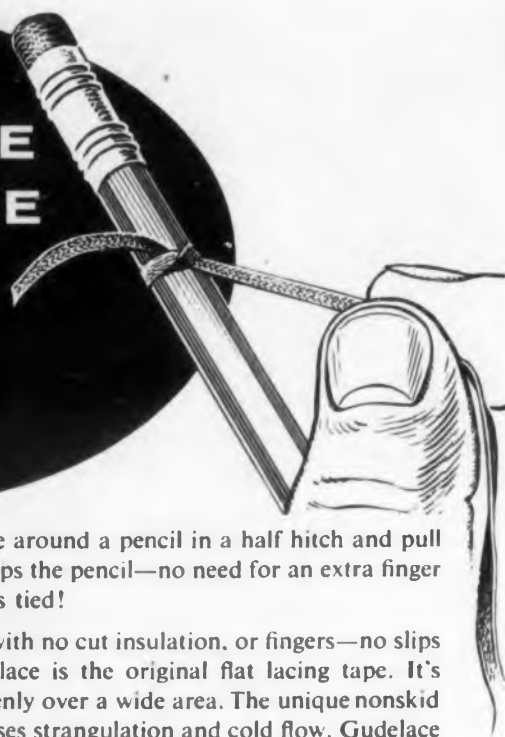

Try this simple test. Tie a piece of Gudelace around a pencil in a half hitch and pull one end. Gudelace's flat, nonskid surface grips the pencil—no need for an extra finger to hold Gudelace in place while the knot is tied!

Gudelace makes lacing easier and faster, with no cut insulation, or fingers—no slips or rejects—and that's *real* economy. Gudelace is the original flat lacing tape. It's engineered to *stay* flat, distributing stress evenly over a wide area. The unique nonskid surface eliminates the too-tight pull that causes strangulation and cold flow. Gudelace is made of sturdy nylon mesh, combined with special microcrystalline wax, for outstanding strength, toughness, and stability.

Write for a free sample and test it yourself. See how Gudelace takes the slips—and the problems—out of lacing.

GUDEBROD

Electronic Division
225 West 34th Street
New York 1, N.Y.

BROS. SILK CO., INC.

Executive Offices
12 South 12th Street
Philadelphia 7, Pa.

CIRCLE 119 ON READER-SERVICE CARD

**SWITCHCRAFT'S
Precision Construction
IS YOUR GUARANTEE OF
Dependability**



SWITCHCRAFT (SERIES 16000) "TELEVER-SWITCH"

(Telephone Type Lever or Key Switch)

- T-BEAM FRAME—provides rugged assembly.
- SINGLE HOLE MOUNTING—in panels up to 1/4" thick.
- STANDARDIZED NON-TURN DEVICE.
- POSITIVE STOPS—stop is not a part of mounting plate.
- FURNISHED—2 or 3 position actuators either locking, non-locking or a combination of the two.

See Catalog No. S-58 or write for special Catalog S-302.

SWITCHCRAFT
INC.

5529 N. Elston Ave.
Chicago 30, Ill.

Canadian Rep: Atlas Radio Corp., Ltd., 50 Wingold Ave., Toronto, Canada

AVAILABLE AT ALL LEADING RADIO PARTS JOBBERS •

CIRCLE 120 ON READER-SERVICE CARD

NEW LITERATURE

Drum Heads 284

The firm's series 3400 drum heads are described on this two-page data sheet. Capabilities of the devices are outlined with physical and electrical specifications and illustrations. Minneapolis-Honeywell Regulator Co., 10721 Hanna St., Beltsville, Md.

Electrical Contacts 285

Strip and fabricated Top-Lay electrical contacts are described in this four-page brochure. Properties of various conducting materials available are tabulated. Construction and design requirements are considered. Outline drawings of some available fabricated contacts are given. Texas Instruments Inc., Metals and Controls Div., 34 Forest St., Attleboro, Mass.

Shock Absorbing Mounts 286

Over 20 types of bonded rubber mountings and flexible mounting systems are described in this eight-page bulletin, No. 905. Mounts are designed to isolate equipment from vibration, shock and noise. Descriptions and load ratings, illustrations and mounting diagrams are included. Lord Manufacturing Co., Erie, Pa.

Speed Reductors 287

Eight- and ten-speed step-function speed reducers are described in these two-page data sheets. Bulletin No. 262 describes the units, giving electrical and mechanical specifications with outline drawings. Data sheet No. 1 describes applications of the units in chart drives on strip recorders. Inco Co., Div. Barry Controls, Inc., Hollis St., Groton, Mass.

Variable Power Transformers 288

Four-page data sheet No. 1 describes and illustrates the firm's series H-C Powerstat variable power transformers. Applications, ratings, and outline drawings are given. The Superior Electric Co., Bristol, Conn.

Dictionary of Computer Terminology 289

This 24-page dictionary entitled "Do You Talk 'Computese?'" defines over 80 terms common in computer terminology. The booklet is intended to clarify the technical jargon for the layman. Minneapolis-Honeywell Regulator Co., Industrial Div., 7th and Grange Sts., Philadelphia 44, Pa.



- a wide range of standard sizes
- colored tubing and special sizes
- a widerange of wall thicknesses
- prompt deliveries of

**SPAGHETTI TUBING
MADE FROM**

TEFLON*

by Pennsylvania Fluorocarbon

To obtain outstanding results from sheathing for wires, slip-on insulation and bushings, use the unique electrical properties of spaghetti tubing made from Teflon plus the outstanding engineering and manufacturing techniques developed by Pennsylvania Fluorocarbon.

The unique electrical properties of spaghetti tubing made from Teflon include: good dielectric strength (1000-2000 volts/mil); lowest dielectric constant (2.0) and dissipation factor (0.0002) of any solid dielectric; no change of electrical properties with temperature (-25°C. to +250°C.), or frequency (60 cycles to 100 mc.); unaffected by moisture. In addition, PF Teflon is not harmed by the hot soldering iron so assembly work is speeded up considerably.

The outstanding engineering and manufacturing techniques developed by Pennsylvania Fluorocarbon include: the tailoring of Teflon with colors for identification or with modifications for improved texture and mechanical properties; stress relieving spaghetti tubing for minimum shrinkage; cleaning and 100% inspection; the manufacture of a wide range of wall thicknesses and special sizes.

Write, wire or call and let us quote on your requirements. We can provide overnight delivery of standard sizes and many special sizes at competitive prices.

**PENNSYLVANIA
FLUOROCARBON CO., INC.**

1115 N. 38th Street, Phila. 4, Pa.
EVergreen 6-0603 TWX: PH 252

*DuPont registered trademark

CIRCLE 121 ON READER-SERVICE CARD

ELECTRONIC DESIGN • December 21, 1960



Anywhere . . .

At sea, in the icy cold of the antarctic! S.S. WHITE Molded Resistors in values up to 50,000 megohms retain their characteristics.

in Any Weather

Airborne, in the steaming heat of the tropics! S.S. WHITE Molded Resistors are made of coated, non-hygroscopic material that resists moisture.



S.S. White

"ALL-WEATHER"

**Molded Resistors
Withstand Temperature
and Humidity**

FIXED RESISTANCE VALUES RANGE
FROM 1000 OHMS TO 10,000,000
MEGOHMS!

65X Molded Resistor — 1 watt
80X Molded Resistor — 3 watts

While bargain buys in resistors are wearing out and being replaced, durable S.S. WHITE "All-Weather" Molded Resistors are still giving top performance in hundreds of commercial, industrial and scientific applications.

Our resistors are characterized by low noise level . . . precision . . . stability . . . have negative temperature and voltage coefficients. Compact . . . excellent stability and mechanical strength . . . values do not deteriorate due to age.

We'll be glad to cooperate with you in applying these high-quality resistors to your product. For our Bulletin 5409, just drop a line to Dept. 28R.

S.S. White

INDUSTRIAL DIVISION

10 East 40th Street
New York 16, New York

CIRCLE 122 ON READER-SERVICE CARD

Plugs and Connectors 290

A line of molded electrical plugs and connectors is described and illustrated in six-page Bulletin No. 5M-BA-660. Patch cords and custom moldings are briefly described. Components Manufacturing Service, Inc., West Bridgewater, Mass.

Trisulfide Glass 291

Servofram arsenic-trisulfide glass used in the fabrication of the optical elements for infrared detection and control devices is analyzed in this eight-page brochure. The glass can also be made into special lenses, correction plates, prisms, domes, wedges, or windows. Drawings and specifications are included on standard cell windows for use with Beckman, Baird Assoc., and Perkin-Elmer IR cells. Sections on meniscus and achromatic lenses are included. Servo Corp. of America, 111 New South Road, Hicksville, L.I., N.Y.

Miniature Relays 292

Electrical and mechanical specifications, dimensional diagrams and engineering data for type AR four-pole and two-pole microminiature relays and the MTRH time delay relays are given in this bulletin. Branson Corp., Whippany, N.J.

Plastics Products Booklet 293

Bulletin No. D400, eight pages, gives data on the physical, mechanical, and electrical properties and applications of Durez thermosetting phenolic and diallyl-phthalate molding compounds, Durez phenolic bonding and coating resins, and Hetron fire-retardant polyester resins. Application and materials-selection guides are given. Hooker Chemical Corp., Durez Plastics Div., 8 Walck Road, North Tonawanda, N.Y.

Mylar and Foil Film Capacitors 294

This two-color, eight-page brochure describes a line of Mylar capacitors. Nearly 300 wrapped and hermetically sealed units are tabulated with their capacitances, voltages and dimensions. Also included are characteristic curves of capacitance, insulation resistance, and power-factor versus temperature. Hopkins Engineering Co., 12900 Foothill Blvd., San Fernando, Calif.

Soldering Tools 295

This 12-page catalog, No. VG-250, on soldering tools contains prices, descriptions, and illustrations of a line of electric soldering irons, soldering pencils, safety toolholders, solder pots, wax pots, glue pots, and branding irons. Vulcan Electric Co., 88 Holten St., Danvers, Mass.

1 DIGITAL DISPLAY DOES THE WORK OF 15



NEW KEARFOTT DIGISTROBE* DISPLAY

Kearfott's new, highly compact Digistrobe digital display utilizes the stroboscopic principle to produce an exceptionally high-definition readout in the actual size shown here. Through the use of a unique shutter arrangement, a single diode-encoding matrix is shared by all columns (5 in the standard model), resulting in substantial savings in electronic components and circuitry. The fast response time of the Digistrobe (56 milliseconds transition from one five-digit quantity to a totally different one) permits a single unit to sample several different inputs on command through an input selector switch. Up to 15 individual displays of existing types can thus be replaced by a single Kearfott Digistrobe!

Incorporating only two moving parts and exclusively solid-state switching circuitry, the Digistrobe has extremely long life expectancy and requires minimum maintenance and service. Operation is directly from the output register of a computer, counter or allied equipment, eliminating the cost of intervening circuitry. Two years of extensive laboratory tests assure compliance with Kearfott's rigid standards of quality. For complete data and specifications, write for Digistrobe bulletin.

*Kearfott Trademark



**KEARFOTT DIVISION
GENERAL PRECISION, INC.**

Little Falls, New Jersey

CIRCLE 123 ON READER-SERVICE CARD

D-C MICROMULTIMETER

ALL-TRANSISTOR CIRCUIT
NICKEL-CADIUM BATTERY
WITH AUTOMATIC RECHARGE

CURRENT

($\pm 1\%$ fs)
 $\pm 100 \text{ m}\mu\text{a}$
to $\pm 1.0\text{a}$

D-C MICROVOLT METERS AND
D-C MICROVOLT/AMMETERS ARE
ALSO AVAILABLE, IN BOTH RACK
AND PORTABLE MODELS, FOR THOSE
WHO DO NOT REQUIRE THE RESISTANCE BRIDGE.

COMPLETE SPECIFICATIONS ARE AVAILABLE ON REQUEST.

VOLTAGE ($\pm 1\%$ fs)
 $\pm 100 \mu\text{v}$ to $\pm 1000\text{v}$

totally isolated from power line



Model 4132

Price \$785.00

RESISTANCE

10 ohms (fs)
to 100M (fs)

WHEATSTONE BRIDGE.
CURRENT THROUGH UNKNOWN
ALWAYS LESS THAN 1mA.
3-DIGIT ACCURACY.

DYNAMICS
INSTRUMENTATION COMPANY

583 MONTEREY PASS ROAD, MONTEREY PARK, CALIF.

CIRCLE 124 ON READER-SERVICE CARD

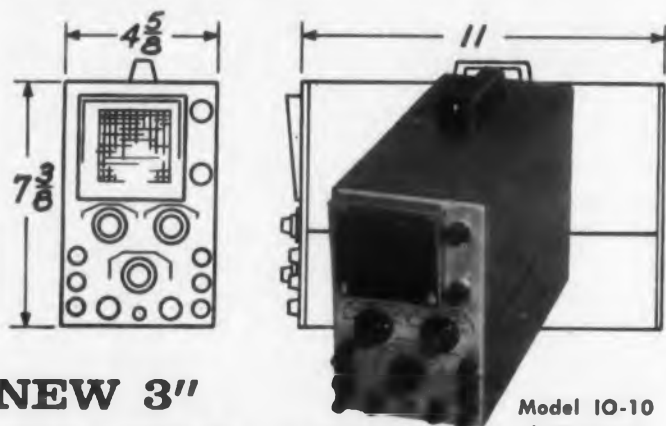

NEW 3" "SPACE SAVER" DC OSCILLOSCOPE

Model IO-10
\$7995

The little IO-10 has big applications. Use it in industrial, medical and general service fields for computer "read out" and for voltage, frequency and phase shift measurement. It features identical vertical and horizontal AC or DC coupled amplifiers, external sync terminal, external capacity binding posts for sweep rates lower than 5 cps, transformer-operated power supply, voltage-regulated B+ and bias and excellent specifications. 3RP-1 CR tube included. Send for free Heathkit catalog or see your nearest Heathkit dealer.

HEATHKIT DAYSTROM

HEATH COMPANY Benton Harbor 60, Michigan
Please send the Free Heathkit catalog.

NAME _____
ADDRESS _____
CITY _____ ZONE _____ STATE _____

CIRCLE 125 ON READER-SERVICE CARD

PACE PANEL METERS for EQUIPMENT MANUFACTURERS

CUSTOM METERS... acrylic cases, phenolic cases... 2-inch through 7-inch sizes... produced in quantity, to your specifications, for use in highest quality electrical and electronic instruments and equipment. Prices quoted promptly upon receipt of your specifications.

STOCK METERS... in all standard sizes and ranges... acrylic and phenolic cases... available promptly for your laboratory models, prototypes and production test gear. Inquire at leading Electronic Parts Distributors... or write directly to PACE.

PACE Panel Meters are engineered for rugged, trouble-free performance:

FULL DOUBLE-BRIDGE D'ARSONVAL MOVEMENT
HIGH-DENSITY SINTERED POLE PIECES
COINED, SOFT-IRON POLE FACES
HIGH TORQUE/MASS RATIO

Write for new, 1960 Catalog

PACE ELECTRICAL INSTRUMENTS CO., INC.
70-31 84th St., Glendale 27, L.I., N.Y.

Meter Division of **PRECISION Apparatus Co., Inc.**



CIRCLE 126 ON READER-SERVICE CARD

NEW LITERATURE

Microwave Equipment

296

This catalog describes traveling wave tubes and backward-wave oscillators. It contains frequency, gain, helix-voltage, and other data on 17 types are included. Two S-band periodic permanent-magnet and solenoid-focused types are included. Two S-band periodic permanent-magnet tubes, types TW-4002F and TW-956H, are listed. The backward-wave oscillator, type BW-1779, is described. Sylvania Electric Products Inc., 1100 Main St., Buffalo 9, N.Y.

Replacement Parts

297

This 48-page illustrated catalog lists available replacement parts for the radio, television and electronic industries. Specifications and other data on resistors, diodes, fuse resistors, and potentiometers are included. Carbon composition, wirewound, power, and precision resistors are included. International Resistance Co., 401 N. Broad St., Philadelphia 8, Pa.

DC Power Supplies

298

This 16-page catalog illustrates a line of dc power supplies, including transistorized, regulated types, types for missile test and launching, semi-regulated units, high-voltage radar supplies, and filter packs. Electrical specifications are given. Perkin Engineering Corp., 345 Kansas St., El Segundo, Calif.

Semiconductor Power Supplies

299

This two-page data sheet, No. 23, describes external connections required to convert Regatran programmable power supplies from voltage-regulated to current-regulated output, and explains control methods. Electronic Measurements Co., Red Bank, Eatontown, N.J.

Trimmer Potentiometers

300

The firm's series 70 and 71 trimmer potentiometers are described in four-page Data Sheet No. 60271. Photographs, outline drawings, and environmental, electrical, and mechanical characteristics are included. Helipot Technical Information Service, Fullerton, Calif.

Miniature Fan and Blower Selector

301

This four-page bulletin is a guide to determining cooling requirements for electronic applications and for selecting the proper type and capacity miniature fans and blowers. Globe Industries, Inc., 1784 Stanley Ave., Dayton 4, Ohio.

DC Capacitors

302

This four-page bulletin contains physical and electrical characteristics of metal-cased, hermetically sealed, oil-impregnated dc capacitors. Outline drawings and temperature curves are given. Aerovox Corp., New Bedford Div., New Bedford, Mass.

Electronic Test Equipment

This 20-page illustrated catalog, No. 28/Industrial, describes electronic test equipment and panel meters for industrial and communications applications. It includes electrical and mechanical specifications for voltmeters, tube and transistor testers, generators, oscilloscopes, and panel meters. Write on company stationery to: Precision Apparatus Co., Inc., 70-31 84th St., Glendale 27, L.I., N.Y.

Magnetic Amplifiers

303

This four-page bulletin, No. 260, uses characteristic curves, photos, and circuit diagrams to describe custom-designed magnetic amplifiers. A three-phase magnetic amplifier, a static exciter, and other basic types of magnetic amplifiers are used to illustrate the design principles involved. Polyphase Instrument Co., Bridgeport, Pa.

Electronic Hardware

304

This 32-page catalog, No. 32, describes electronic terminals and hardware. Included are more than 380 standard part numbers. Specifications and dimensional drawings are contained for standard and molded insulated terminals, terminal boards, eyelets, stand-offs, shaft locks and miscellaneous hardware, handles and control knobs. A line of instrument control knobs designed to MS-91528 specifications is included. Lerco Electronics, Inc., 501 S. Varney St., Burbank, Calif.

Direct-Printed Silver Circuits

305

This two-page bulletin describes the application of insulation and direct-printed silver circuits on curved irregularly shaped metallic, ceramic, and glass surfaces. J. Frank Motson Co., Flourtown, Pa.

Switches

306

Four-page Data Sheet No. 175 covers three series of miniature gold-contact precision switches for low-power applications. Photographs, mounting dimension drawings, mechanical characteristics, electrical ratings, and prices are included. Micro Switch, Freeport, Illinois.

A COMPLETE STOCK

OF 3 DIFFERENT TYPES

OF SHIELDING & BRAIDING!



Write for your Catalog B-1 describing Alpha's complete Shielding & Braiding line, listing full technical descriptions of dozens of sizes and featuring an Engineering Glossary. And Alpha Shielding is available for immediate delivery through your local Alpha Wire Electronic Parts Distributor.

ALPHA electronic WIRE

ALPHA WIRE CORPORATION
Subsidiary of LORAL Electronics Corporation
200 VARICK STREET, NEW YORK 14, N. Y.
Pacific Division:
1871 So. Orange Dr., Los Angeles 19, Calif.

FLAT... Woven, flexible, tinned copper braid, generally used as a high current conductor at low voltages, and as a bonding strap in vehicles and aircraft to eliminate ignition interference.

OVAL COMMERCIAL... Woven, tinned copper tubular braid, used as an electrostatic shield to cover conductors, cables, or other components, since it slips over them easily, due to its oval shape and flexibility.

TUBULAR... To Mil Spec QQ-B-575. Woven, tinned copper round braid, used in military applications requiring maximum shielding against electrostatic interference, mechanical abrasion and stresses. Construction has self-supporting characteristics enabling it to maintain its round configuration. Percentage of shielding coverage is 95% or more.

Special Constructions are available to order in the flat, oval, or tubular braid.

CIRCLE 127 ON READER-SERVICE CARD

NEW NYLON & THERMO-PLASTIC parts from GRC

Economically mass produced on fully automatic patented machines, GRC nylon parts are available from stock in many sizes and types. GRC uses single cavity techniques, molds in one automatic cycle, gets accurate, uniform parts.

These advantages, these economies, apply too, to tiny made-to-order parts to your specifications... in quantities of 25,000 to many millions. Write for bulletin describing GRC's unique method for injection molding small plastic parts or send prints for quotations. Ask about our zinc alloy die castings tool

NO SIZE TOO SMALL

Maximum: 1 1/4" long
— .03 oz.



NYLON SCREWS AND NUTS

GRC's complete line of high quality, close tolerance molded nylon screws and hex nuts include screws in standard commercial heads—Phillips or slotted types—in sizes from #4 thru 1/4"; hex nuts in ten sizes (#2 thru 5/16") GRC molded nylon miniature machine screws—half the weight of aluminum—in sizes as small as #0—make more compact designs possible. GRC's single cavity molding technique adds exceptional uniformity, accuracy, economy to nylon's high strength-to-weight ratio, built-in electrical insulating qualities, stability, resilience and elasticity. GRC's molded fasteners are available in Nylon or Delrin in a wide range of types, sizes and lengths.

Write for samples, prices and GRC's New Detailed Industrial Fastener Catalog.



GRIES REPRODUCER CORP.
World's Foremost Producer of Small Die Castings
40 Second St., New Rochelle, N. Y. NEW Rochelle 3-8600

CIRCLE 128 ON READER-SERVICE CARD

KPR* shortest way to sure circuits

*Kodak Photo Resist

With this simple, 6-step routine you'll etch circuits which will pass any inspection. Even inexperienced people will catch on quickly to this KPR method, quickly permitting you to enjoy every economy it allows.

(1) Start with clean metal. Power brush is fastest way. Always short exposure regardless of temperature, humidity, or storage.

(2) Quick acid rinse will assure unquestionable KPR adhesion. (5) Develop. Fastest way: vapor-spray degreaser. Also may use tray or tank.

(3) Coat plates (Dip, whirl, or spray in advance during slack time. KPR is so stable you can store plates till needed, even months, with no effect on KPR exposure times.) (6) Etch, using standard techniques. You'll have fewest rejects ever, for KPR protects circuit image during assembly of components, strips off clean when panel is skated on tin-lead solder.

(4) Expose to high intensity arcs.

Write for Industrial Uses of Kodak Photo Resist. No statement or suggestion in this advertisement is to be considered a recommendation or inducement of any use, manufacture, or sale that may infringe any patents now or hereafter in existence.

EASTMAN KODAK COMPANY
Rochester 4, N. Y.

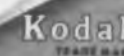

CIRCLE 129 ON READER-SERVICE CARD

CAN YOU READ THIS AT 6 FEET?



ACTUAL SIZE

*Get "Giant Size" Readability
In a "Pint Size" Package*

SPECIFY *Bowmar* ELAPSED
TIME INDICATOR **MODEL 1440**

- DIGITAL READOUT to 9999 hours in one hour increments
- SUBMINIATURE - Only .670 OD; 1.670 L
- FEATHERWEIGHT - Less than 2 ounces
- 115 V 400CPS OPERATION
- MINIMUM POWER DRAIN
- HERMETICALLY SEALED
- MOUNTS TO ANY PANEL THICKNESS
- MEETS REQUIREMENTS OF Mil-M-26550

IMMEDIATE DELIVERY

SEND FOR ETI DATA PAGE 2000-C1



BOWMAR INSTRUMENT CORPORATION
8000 Bluffton Rd., Fort Wayne, Ind.

FOR CONTROL OF THE FUTURE
CIRCLE 130 ON READER-SERVICE CARD

NEW LITERATURE

Coatings 307

This 12-page brochure describes thin-film coating materials. It contains information on the properties of fluorocarbon coatings, silicones, epoxy resins, and other coatings. Described are examples of industrial applications in such fields as missiles, aircraft, and electronics. Industrial Coatings Div., National Glaco Chemical Corp., 1949 N. Cicero Ave., Chicago 39, Ill.

Insulation Materials Testing 308

This 30-page manual, No. G-65, contains a series of bulletins on insulation materials testing methods and equipment. High-voltage breakdown testing, automatic rate of rise control, determination or resistance to arcing, and corona leakage detection are among the subjects covered. Associated Research, Inc., 3777 W. Belmont Ave., Chicago 18, Ill.

Trigistor 309

Bulletin AS-100 describes the combining of low-level logic operations and high-level output in a single circuit with a Trigistor. Solid State Products, Inc., 1 Pingree St., Salem, Mass.

Rate Gyroscopes

Theory and application of engineering principles involved in the development of rate gyroscopes are discussed in this 55-page booklet. Principles of gyroscopics, dynamic response, gyro motors, and pickoff are among the topics considered. Sections on the testing of rate gyros and on terminology encountered in the field are included. Send \$3.00 to R. C. Allen Business Machines, Inc., Aircraft Instrument Div., 333 Commerce, S. W., Grand Rapids, Mich.

Magnetic Particle Clutch 310

A dry magnetic particle clutch with a rated torque of 10 ft-lb is described in this four-page bulletin, No. EPD 6106-5. Operation data, specifications, slip and torque curves, and dimensional drawings are included. Vickers Inc., Electric Products Div., St. Louis 3, Mo.

Pulse Synchronizing Generator 311

This two-page data sheet describing a high-voltage synchronizing generator includes a system description, application suggestions, specifications and typical pulse and wave form illustrations. Electro-Optical Instruments, Inc., 2612 E. Foothill Blvd., Pasadena, Calif.

STRAITS TIN REPORT

News of developments
in the production
and uses of tin



Rubber tin—A tin compound that stretches like rubber and can be vulcanized has been developed by the Army. Tin is substituted for carbon, the usual base of rubber. The new polymer, alkyl tin methacrylate, is a "stretchable" high-temperature material with greater resistance to chemical fuel than conventional rubber. This may lead to a series of carbon-replacement materials similar to boron chemical fuels.

New tinplate that is lighter, stronger and thinner than any ever made is being researched by major steel producers. It shows great promise and is expected to offer important economic advantages to canners and other tin plate users, for shipping and product protection. No change in tin content of the new plate is indicated.

Nonspattering flux is the result of experiments by Tin Research Institute. The new soldering process uses polyethylene glycol instead of acidified water as a vehicle for acid fluxes. It has a low boiling point—flux won't spatter when it contacts molten solder or soldering bit. Spreads smoothly over large area. Won't rust or corrode; residue washes off easily. Low volatility prevents evaporation; high flashpoint eliminates fire risk. No unpleasant odors or harmful fumes.



Write today for more data on these items or for a free subscription to TIN NEWS—a monthly bulletin on tin supply, prices and new uses.

The Malayan Tin Bureau
Dept. 12M, 2000 K Street, N.W., Washington 6, D.C.
CIRCLE 131 ON READER-SERVICE CARD

ELECTRONIC DESIGN • December 21, 1960

“
 Say,
 what's this
 I hear
 about LFE
 making
 read/write
 heads for
 magnetic drums
 and
 tape?”

“They have been
 making them
 for years
 for their own
 systems!
 Now they're
 available
 to the industry.
 Why don't you
 write for
 further info?”

LFE

LABORATORY FOR ELECTRONICS
 MAGNETIC DEVICES OPERATIONS
 COMPUTER PRODUCTS DIVISION
 1079 COMMONWEALTH AVENUE
 BOSTON 15, MASS. DEPT. 12-21E

Please send me complete data on
 your magnetic read/write heads.

Name _____

Title _____

Company _____

Division _____

Address _____

CIRCLE 132 ON READER-SERVICE CARD

ELECTRONIC DESIGN • December 21, 1960

Mesa Transistors 312

Types 2N695, 2N705, 2N710 switching mesa transistors, types 2N700 and 2N741 uhf-vhf amplifier mesas, and types 2N1561 and 2N1562 rf mesa transistors are described in this series of data sheets. Ratings, typical characteristics, operating curves, and applications are included. The devices are said to have a reliability of 99.9993% per thousand hours of operation. Motorola Semiconductor Products, Inc., 5005 E. McDowell Road, Phoenix, Ariz.

Shipping, Storage Containers 313

A modular packaging technique for shipping and storage to Mil specifications is described in this 16-page catalog, No. E-59. Illustrations of assembly of standard components into modules are provided. Interior modifications, shock isolation techniques, exterior modifications and closures are covered. Specifications of materials and components are given. Zero Mfg. Co., 1121 Chestnut St., Burbank, Calif.

Coaxial Connectors 314

A line of connectors designed for use with Foamflex coaxial cables is described in this six-page brochure. Connectors are illustrated; intended applications are indicated. Attenuation curves are included. Kings Electronics Co., Inc., 38 Marbledale Road, Tuckahoe, N.Y.

Strip Coating 316

The firm's Isochemwax 1812 strip coating which temporarily protects components during casting and dip-coating operations is described in this one-page bulletin. Physical properties and application instructions are included. Isochem Resins Co., 221 Oak St., Providence 9, R.I.

Choppers 317

The firm's models 80, 81, 90, and 91 Vibrochoppers are described and illustrated in this four-page data sheet. Application circuits and descriptions are included. Electronic and mechanical specifications and curves appear. Solid State Electronics Co., 15321 Rayen St., Sepulveda, Calif.

Pulse Generator 318

Bulletin No. PG760, two pages, describes a transistorized pulse generator, model PG401, with low output impedance suitable for transistorized circuitry. Application suggestions and electrical specifications are provided. Valor Instruments, Inc., 13214 Crenshaw Blvd., Gardena, Calif.

NEW MULTIPLE ARRAY SWITCH

FACTS!

- **Reliable:** life expectancy 500,000 operations
- **Versatile:** 8 pole single or 4 pole double throw per button—eliminates need for relays in many applications
- **Wiping:** thorough action with noble metal alloy crossbar
- **Pure contact resistance:** .006 ohms nominal
- **Modular:** ANY number of buttons
ANY number of arrays
- **Miniaturized:** behind panel dimensions: 1¹⁹/₃₂" x 3/4"

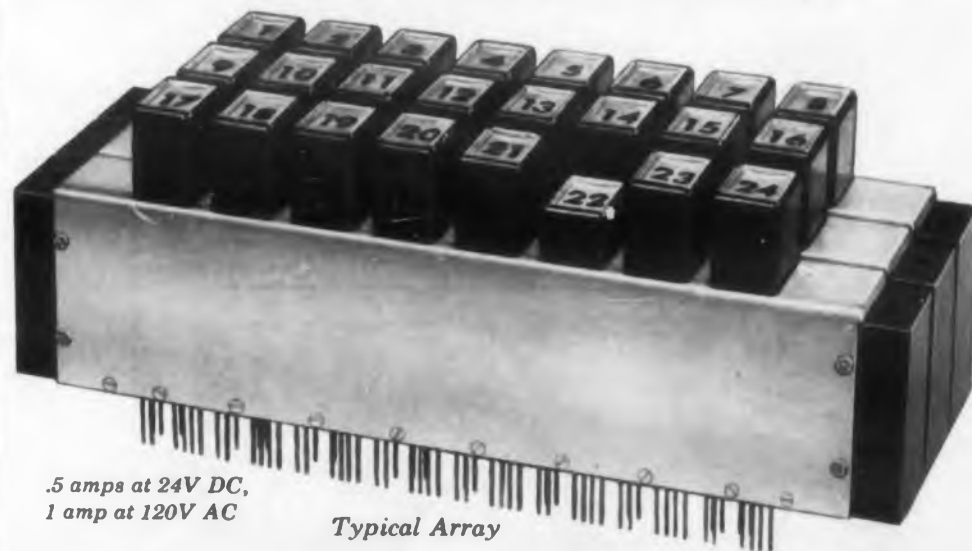

Design simplicity and special modular construction of these TELEX switches allow more circuits than other units approximately the same size and weight. Each button is 8-pole single throw—normally opened or closed—or 4-pole double throw or any combination. Magnetic detent assures longer life.

All or any buttons may be interlocked but the complicated multiplicity of parts required by conventional switches for latching and releasing and preventing multiple actuation has been eliminated. Also available in momentary make configurations.

Exceptionally versatile, this switch may be used with printed circuits or plugged into standard wire harness to perform for test equipment, binary coding problems, digital coding problems and standard keyboard or countless other custom uses. Switch resistance is .070 ohms nominal. Insulation resistance @ 500V DC between adjacent switch contacts and open is 40,000 megohms. Choice of colored buttons and numerals and optional light indicators. Variations designed to meet individual specifications.

More detailed specifications and information are available on request. Write to Sales Manager,

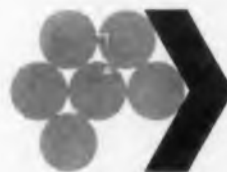

TELEX

SPECIAL PRODUCTS DIVISION • Telex Park, St. Paul 1, Minn., Dept. SP-402

Superior communication accessories for every need—
 TELEX Communications Accessories Division

CIRCLE 133 ON READER-SERVICE CARD

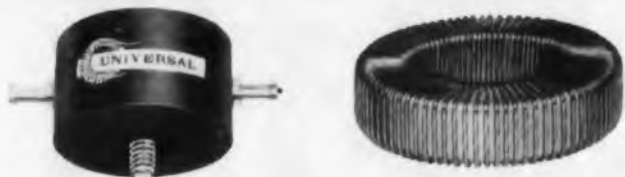

TOROIDS

We specialize in heavy wire TOROIDAL COMPONENTS—magamps, transformers, etc.

Equipped with the largest selection of winding machines, **UNIVERSAL** offers coils from 1/16" Fin. I.D. up to 30" O.D.

WIRE RANGE FROM #2—#50.

We also offer "Pot" Windings and Encapsulated Construction to MIL T-27A.



WRITE FOR FURTHER INFORMATION

UNIVERSAL TOROID COIL WINDING, INC.

171 Colt Street
Irvington 11, N. J.
ESsex 4-9804

The most COMPLETE line of TOROIDAL equipment in the world.

CIRCLE 134 ON READER-SERVICE CARD

GEE-LAR KNOBS FOR IMMEDIATE DELIVERY

Fast Service is the big "plus" you get at GEE-LAR—the House of Knobs. Hundreds of styles, sizes and types, including deluxe Gold Inlay Knobs, are stocked . . . quickly shipped to you in any quantity. Best of all, your costs are always moderate . . . there's no charge for tooling or molds.

FAST SERVICE
Gee-Lar is geared for immediate deliveries. Get the facts today.

KNOBS FOR
Television • Home Radios
Phonographs • Clock Radios
Auto Radios • Instruments . . . many others.

G-C ELECTRONICS CO.
Division of Textron Electronics, Inc.
West Plant: Los Angeles 18, California
Main Plant: Rockford, Illinois, U.S.A.
WRITE today for your big, free illustrated Gee-Lar Catalog. No obligation!

CIRCLE 135 ON READER-SERVICE CARD

NEW LITERATURE

Klystron and Traveling-Wave Tubes

Electronic and physical data on klystron and traveling-wave tubes are contained on color-coded cards sorted according to frequency band in a 4 x 6 in. metal file box. The file is available free to engineers and others engaged in the selection and specifications of microwave tubes. Write on company letterhead to: Sperry Electronic Tube Div., Sperry Rand Corp., Gainesville, Fla.

Connectors 319

Details of 26-contact electrical connectors are presented in two-page bulletin No. 4004-5. Photos, dimensional drawings, and charts describe the various configurations of plugs and receptacles available. Consolidated Electrodynamics Corp., Subsidiary of Bell & Howell, 360 Sierra Madre Villa, Pasadena, Calif.

High-Voltage Pentode 320

A high-voltage pentode designed for use with plate voltages up to 4 kv is the subject of four-page bulletin No. 2157-9. Illustrated with schematic diagrams showing typical circuits, the bulletin provides electrical and mechanical data, maximum ratings, and transfer, screen and plate characteristics. The Victoreen Instrument Co., 5806 Hough Ave., Cleveland 3, Ohio.

Temperature Controllers 321

This four-page, illustrated brochure describes electronic-indicating temperature controllers. Thermistor probe specifications, modifications, special features, and a "how to order" section are included. Fenwal, Inc., Pleasant St., Ashland, Mass.

Lead-Sulfide Photoconductors 322

Bulletin No. 7, four pages, tabulates specifications and gives typical performance characteristics curves for lead-sulfide infrared photoconductors. Infrared Industries, Inc., P.O. 42, Waltham 54, Mass.

Miniature Insulated Thermostats 323

This two-page bulletin describes the firm's new series of miniature, insulated thermostats available with contacts that open or close with temperature change. In addition to specifications and a part-numbering system, an actual size cut-away photograph for each of the four models is included. Chatham Controls Corp., 102 River Road, Chatham, N.J.



"There's a guy here from McLean, says he can cool anything!"

. . . anything electronic that is, but we're glad to see that our reps get around. McLean specializes in packaged cooling systems. They're rack mounted for easy installation and service.



McLEAN MODEL 2E408

The industry's standard . . . over 15,000 in use all over the world. High velocity, fast cooling. (7" x 19", 300 cfm).

Extend the life of sensitive tubes, transistors and other components with McLean packaged cooling units. Prevent system failure . . . maintain calibration and accuracy. Over 100 models in various panel heights and CFM's. Mil.Spec. equipment for packaged cooling also available.

WRITE TODAY

44 Page Packaged Cooling Catalog



McLEAN ENGINEERING LABORATORIES

World Leader in Packaged Cooling

Princeton, N. J. • WALnut 4-4440

TWX Princeton, New Jersey 636

CIRCLE 136 ON READER-SERVICE CARD

ELECTRONIC DESIGN • December 21, 1960



a good way to measure 0.00003 ohm

The Keithley 502 Milliohmeter offers speed, ease, and accuracy in the measurement of low resistances. Typical uses are corrosion tests, checking resistivity of metals, semi-conductors, printed circuits, switch and relay contacts.

Battery operation, a ruggedized meter, and protective cover make the 502 ideal for field tests of squibs, carbon bridges and other explosive devices. Features include:

- 13 overlapping ranges from 0.001 ohm to 1000 ohms full scale.
- accuracy within 3% of full scale; a four-terminal measuring system eliminates errors due to clip and lead resistance.
- 2 microwatts maximum dissipation across sample.
- no calibration or zero adjustments.
- instantaneous indication of resistance without zero drift or errors due to thermal EMF's.
- lightweight and portable. Furnished with protective cover and set of four test leads.
- price, \$375.00.

Write for complete details



**KEITHLEY
INSTRUMENTS**

12415 EUCLID AVENUE
CLEVELAND 6, OHIO
CIRCLE 137 ON READER-SERVICE CARD

ELECTRONIC DESIGN • December 21, 1960

Capacitors 324

A line of general-purpose disk and tubular ceramic capacitors is described and illustrated in this 20-page booklet. Specifications, temperature compensating curves, tolerance charts, color code tables, and photographs are included. Centralab, Div. of Globe-Union Inc., 900 E. Keefe Ave., Milwaukee 1, Wis.

Tape Perforator 325

The mechanical components, circuit design considerations, mechanical and electrical characteristics, and theory of operation for a super-speed tape perforator are covered in this 24-page booklet. Illustrations of the perforator, tape-feed mechanism, and tape spooler, and a dimensional diagram of a punch and motor mount also appear. An ordering questionnaire is included. Soroban Engineering, Inc., Box 1717, Melbourne, Fla.

Wire and Cable Booklet 326

This booklet contains engineering information on wire and cable. A coded numbering system for identifying cables is included. Tensolite Insulated Wire Co., Inc., W. Main St., Tarrytown, N.Y.

Miniature Connectors 327

This two-color, four-page brochure describes and illustrates Cannon Electric Company's series K and D miniature cable connectors. Schweber Electronics, 60 Herricks Rd., Mineola, L.I., N.Y.

Components Catalog 328

This four-page components catalog contains contact charts, diagrams, specifications, and photographs of a line of telephone-type relays, solenoids, and key switches. Hanell, Inc., 4114 W. 63rd St., Chicago 29, Ill.

High-Temperature Resistors

High-temperature, non-inductive resistors, available in three sizes, are described in Bulletin No. CE-2.07. Devices operate to 350 C. Write on company letterhead to Corning Glass Works, Electronic Components Dept., Bradford, Pa.

Differential Transformers 329

Four-page Catalog No. SE-60-2 describes and illustrates instruments for use with linear variable differential transformers. Included are servo amplifiers, strip-chart recorders, reference transformers and filters. Schaevitz Engineering, P.O. Box 505, Camden 1, N.J.

DIMCO-GRAY

SNAPSLIDE FASTENERS

**PROVIDE VIBRATION-PROOF HOLDING
AND QUICK, FOOL-PROOF RELEASE!**

APPROVED UNDER ARMY-NAVY STANDARDS

Here's a simple, easy means of securely fastening assemblies to withstand shock or vibration, and yet allow quick removal for inspection or repair. Instant snap action engages or releases fastener . . . no tools are required! After installation, fasteners never need adjustment . . . even with repeated use.

Three sizes available for different load requirements. Large and medium sizes are made of corrosion-resistant stainless steel. Small size is made of nickel-plated brass. Stock parts fit various thicknesses of flanges and mounting plates . . . special parts can also be supplied.

WRITE FOR FULL DETAILS TODAY!

DIMCO-GRAY COMPANY

201 E. SIXTH STREET DAYTON, OHIO
CIRCLE 138 ON READER-SERVICE CARD



for tomorrow's
applications **TODAY!**

**DOUBLE
DIFFUSED**

2200 PIV

**SILICON RECTIFIERS
IN A SINGLE UNIT**

Another scientific achievement from Britton Electronics is now available to you in hermetically sealed silicon rectifiers manufactured by the DOUBLE DIFFUSION process—offering up to 2200 PIV in a single unit.

This new development eliminates the necessity of voltage divider networks across lower voltage devices in series to secure equal voltage distribution.

Write and ask for Bulletin SC101 describing our full and diversified line of silicon power rectifiers.

BRITTON Electronics Corporation
19 WARREN PLACE, MT. VERNON, N. Y.

CIRCLE 139 ON READER-SERVICE CARD

AIRPAX

EXPANDED-SCALE FREQUENCY METERS



TYPE 5907 for use on
400 CPS supply sources

TYPE 5908 used on
60 CPS power source



These highly accurate, dependable Frequency Meters by Airpax, are completely self-contained. Connection is simple. Two meter terminals protruding from back of case connect directly across 100 - 130 volt source. Airpax MAGMETER® frequency sensing circuit is insensitive to voltage variations, responding only to frequency changes.

The 4½ inch meter, with mirror scale and combination pointer permits "quick look" indication at a distance and precise "close up" readings. Extension behind panel is approximately 2½ inches. Power consumption is less than 5 watts. Overall accuracy of frequency reading is 0.1% or .4 cycle in the 400 CPS model.

Ask for Bulletin F-06

AIRPAX
ELECTRONICS
INCORPORATED

5B23

SEMINOLE DIVISION • FORT LAUDERDALE, FLA.
CIRCLE 140 ON READER-SERVICE CARD

INDEX OF ARTICLES

July 6 through December 21, 1960

All articles are indexed under one or more of the basic categories listed below:

- | | |
|----------------------------------|----------------------------------|
| Automatic Control, Servos | Measurements, Instrumentation, |
| Circuits, Mathematical Analysis | Test Equipment |
| Communications, Methods and | Microwave Components, Techniques |
| Equipment | Navigation and Guidance Tech- |
| Components (except microwave | niques |
| components, tubes and semicon- | Nuclear Science |
| ductors) | Packaging Techniques, Electrome- |
| Computers, Data Processing, Aux- | chanical-Thermal Design, Pro- |
| iliary Devices | duction Processes and Equipment |
| Detection, Techniques and Equip- | Power Sources |
| ment | Radio Frequency Interference |
| Human Factors | Reliability |
| Industry, General | Systems |
| Materials | Tubes, Semiconductors |

The kind of article is identified by the following reference keys:

ART	Article (bylined by an authority)
DD	Design Decision
DIG	Digest
DYF	Designing Your Future
ED	Engineering Data
EDN	ELECTRONIC DESIGN News
GA	German Abstract
IFD	Idea for Design
PF	Product Feature
RT	Russian Translation
S & S	Standards and Specs

AUTOMATIC CONTROL, SERVOS

Automation, Russians seen catching up EDN p4 Sept 28
Control motor speed with centrifugally switched transistor DD p203 Aug 3
Gas bearing employed by Honeywell ceramic gyro ... EDN p21 July 6
Guidance system uses micromodules EDN p18 July 6
Operational amplifier, solid state, features fully floating, low-current input PF p98 Nov 9

CIRCUITS, MATHEMATICAL ANALYSIS

All-pass networks—Part 1: The anatomy of networks ART p36 Oct 12

All-pass networks—Part 2: Using the networks to shape transient response ART p70 Oct 26
Amplifier, feedback, generates narrow pulses IFD p144 Aug 17
Amplifier, two-stage, high-gain, formed with complementary transistors IFD p192 Nov 9
Biased base clipper isolates WWV "tick" tone IFD p155 Sept 28
Boolean algebra, putting it to work ART p76 Sept 14
Capacitors, holding, fires neon on short pulses IFD p213 Aug 3
Cascaded transistors with negative feedback make ideal amplifier building blocks . ART p52 Nov 23
Cascading identical two-port networks GA p210 Nov 23

Calculating the emitter capacitance of a tuned amplifier RT p196 Dec 7
 Cascade amplifier stage extends receiving tube use ...
 IFD p 154 Sept 28
 Choosing optimum dc supply voltage minimizes power
 dissipation ART p48 Nov 9
 Circuit, "double-dabble" rapidly converts n-bit binary
 to decimal ART p34 Dec 7
 Circuit, quotient, substitutes for difference variable
 IFD p194 Dec 7
 Combined double tee RT p200 Nov 9
 Conventional resistance networks and crt generate
 characters as a series of dots ... DD p180 Nov 9
 Decade-counting circuit RT p156 July 20
 Delay line added for constant-width pulse
 IFD p194 Dec 7
 Design considerations for nonlinear function genera-
 tors ART p56 July 20
 Designing hard tube delay multivibrators
 ART p52 July 20
 Designing 175-mc amplifier using silicone mesa trans-
 istors DIG p218 Oct 12
 Designing phase-sensitive transistor circuits
 RT p176 Sept 14
 Difference counters GA p168 Sept 28
 Digital circuit flexibility yielded by summing-core
 logic ART 48 Oct 12
 Digital fm technique delays analog signal on mag-
 netostriptive line IFD p146 July 20
 Diode forward voltage drop clamps outputs to zero ...
 IFD p156 Sept 28
 Diode, Zener, helps shift pulse levels
 IFD p197 Nov 23
 Driver closes relays rapidly with almost bounceless
 contacts IFD p156 Sept 28
 Dual frequency oscillator built with GEZ8 tube
 IFD p138 Oct 26
 Eliminate slide-rule step with simplified conversion ..
 IFD p164 Sept 14
 Filters, twin tee GA p214 Oct 12
 Generate variable delays with dc-controlled flip-flops
 ART p50 July 20
 Graphs plot coil resistance as a function of tempera-
 ture ED p183 Nov 9
 Increase voltage switched to load with series-connected
 transistors RT p218 Aug 3
 Information and human memory ... GA p159 July 20
 Initial multivibrator state set automatically by silicon
 controlled rectifier ART p104 July 6
 "Inside-out" limiter supplies constant amplitude
 square waves IFD p159 Sept 28
 Limiting values of active resistance in RC phase shift
 generators RT p142 Oct 26
 Line-type modulator gives variable pulse width
 ART p62 Sept 28
 Low-impedance transistor circuit drives coaxial line
 IFD p201 Oct 12
 Modified circuit limits pulse amplitude more effectively
 IFD p162 Sept 14
 Multi frequency against I_{c0} stabilized by blocking
 diodes IFD p158 Sept 28
 Multivibrator applications to gated-beam tube novel ..
 IFD p140 Aug 17
 Multivibrator gives nanosecond pulses with variable
 width, high-duty cycle ART p72 Sept 14
 Networks, ultra-flat, designed with computer-prepared
 tables ART p48 Aug 31
 Parametric amplifier, one-mc GA p220 Aug 3
 Polynomial expression evaluated by desk calculator ..
 IFD p144 Aug 17
 Potentiometer linearity determined with help of meth-
 od of least squares ART p60 Sept 28
 Primary screen grid emission, measuring
 IFD p164 Sept 14
 Selecting minimum time constants for time-base func-
 tions, a quick method ART p52 Nov 9
 Selecting transistors and diodes for logic applications
 ART p46 July 6

Signal flowgraphs simplify microwave measurements...
 DIG p222 Aug 3
 Simple circuit gives 3-dimensional scope display
 DIG p174 Sept 28
 Simple equations for rapid pi-network design
 ART p94 Aug 3
 Step functions, low level, generated by pulsed relay ..
 IFD p141 Aug 17
 Time-delay drop-out uses a thermal relay, inexpensive
 IFD p143 Aug 17
 Transfer function of a first-order element with line-
 arly varying coefficients RT p166 Sept 28
 Transformer senses filament fault current
 IFD p195 Nov 9
 Transistor circuit analysis speeded by flowgraph
 ART p54 Aug 31
 Transistor parameter converter, make your own
 ART p80 Sept 14
 Tuning-fork Q determined with aid of visual display
 IFD p160 Sept 14
 Two relay contacts clear integrator for rapid opera-
 tion IFD p198 Nov 23
 Video amplifier design uses mesa transistors
 ART p46 Aug 17
 Voltage comparisons, universal ratio set is suitable for
 IFD p142 Aug 17
 Voltage drops in conducting logic diodes, accounting
 for ART p56 Sept 28
 Wavelength frequency conversion chart for coherent
 light applications ED p187 Dec 7
 Zener current measured by voltmeter variable resistor
 IFD p163 Sept 14

COMMUNICATIONS: METHODS, EQUIPMENT

Facsimile mail system beats privacy-rule problem
 EDN p10 Nov 9
 GlobCom system choice mired in studies
 EDN p4 Aug 17
 GlobCom system to use orbital scatter
 EDN p30 Oct 12
 Iono- and tropo-scatter used in transpacific communi-
 cations EDN p26 Aug 17
 Maser, optical, developed by Hughes gives 10-kw co-
 herent light output EDN p11 July 20
 Maser, optical, research programs nearing success ...
 EDN p14 Aug 3
 Pulse code modulation terminal and repeater methods
 —Part 3 ART p98 July 6
 Record antenna patterns using off-the-shelf test equip-
 ment ART p78 Aug 3
 Transmission line computations speeded by reflection
 table ED p131 Aug 17
 Underground radio passes test EDN p4 Aug 17

COMPONENTS

Bridge circuit temperature stabilizes relay operation
 IFD p195 Dec 7
 Capacitors, tantalum GA p202 Nov 9
 Components, advanced, army systems research to use
 EDN p16 Dec 7
 Cut transformers' size and weight with U-shaped
 laminations PF p72 July 20
 Dc motors of brushless type use transistor switching
 EDN p36 Nov 23
 Designing electronic relays RT p208 Oct 12
 Equalizer extends transducer range . PF p90 Sept 14
 Female PC cards improve computer maintainability ..
 DD p141 July 20
 Ferrite devices in system applications
 Book p168 Sept 14
 Gyro of ceramic type by Honeywell employs gas bear-
 ing EDN p21 July 6
 Help determine potentiometer linearity by method of
 least squares ART p60 Sept 28
 High-sensitivity accelerometers sought by AF
 EDN p8 Sept 14
 Impedance of carbon film resistors . GA p208 Nov 23



Complexities to Simplicities

with HRB-SINGER's Multicoupler,
 one antenna feeds FOUR receivers

A military requirement for a multicoupler to meet a restricted space antenna installation problem was solved by HRB-SINGER's Model 330-M4 amplifier-multicoupler.

HRB's distributed bandpass amplifier techniques provided a 30 to 300 mc response with low noise characteristics and a high degree of reliability. A multiple position requirement was fulfilled by a single antenna and four output multicoupler incorporated with the low noise amplifier, thus eliminating the need for multiple antenna installations.

This is only one of many instances where HRB-SINGER research has been applied in the development of a custom amplifier line. The company has a complete capability to meet customer special performance and environmental specification or design requirement problems for specific UHF and VHF application. Direct your inquiries to Dept. G-10. A comprehensive series of data sheets describing this capability is yours for the asking.

ELECTRONIC RESEARCH AND DEVELOPMENT in the areas of: Communica-
 tions • Countermeasures • Reconnaissance • Operations Research • Human Factors
 • Intelligence • Weapons Systems Studies and Analysis • Nuclear Physics • Astro-
 physics • Antenna Systems



HRB-SINGER, INC.
 A SUBSIDIARY OF THE SINGER MANUFACTURING COMPANY
 Science Park, State College, Pa.



CIRCLE 141 ON READER-SERVICE CARD

ANNOUNCING

ANOTHER FIRST!



The Model 230 TAPE-PROGRAMMED CABLE HARNESS ANALYZER

- Automatic Testing by Tape Control
- Search and Fault Print-Out
- Capacity up to 9600 Wires
- Each Leakage Circuit Tested to All Others
- 100% Branch Testing Capabilities

CTI has scored another successful breakthrough in the challenging problem of cable harness testing . . . with the Model 230 Tape-Programmed Cable Harness Analyzer. This is the most flexible testing unit yet designed for programming and performing accurate tests on cable harnesses. Operation is fully automatic and unattended. Simultaneous programmable continuity and leakage measurements with go/no-go precision bridge tests assure accurate analysis. Any combination of branch or standard circuits can be selected. A unique "Search-Out" feature provides a printed record of test failures and the actual location of all circuits associated with each failure. Test circuit capacity of up to 9600 wires is available in 600 wire switch unit increments. Engineering changes in the cable harness under test are quickly handled by paper tape programming. Programming costs are minimized. The CTI Tape-Programmed Cable Harness Analyzer enhances competitive position by speeding testing operations and by assuring the quality of products.

Write for full information



CALIFORNIA TECHNICAL INDUSTRIES

DIVISION OF TEXTRON INC.
BELMONT 5, CALIFORNIA

Foremost in Automatic Testing

CIRCLE 142 ON READER-SERVICE CARD

INDEX OF ARTICLES

Indicator, servo-operated, gives analog and digital readout DD p128 Aug 17
 Induction motor and widerange speed controller combined in one machine PF p76 Aug 17
 Magnetostrictive line uses digital fm technique for delaying analog signal IFD p146 July 20
 Micromodules used in guidance system EDN p18 July 6
 Panel meter made super-thin by using PC rotor, nylon pointer DD p185 Nov 23
 Pilot lamp requires no power; glows even in bright daylight DD p140 July 20
 Potentiometers, wirewound trimming, for printed circuit application PF p88 Sept 14
 Relay driver closes contacts rapidly with almost no bounce IFD p156 Sept 28
 Relay generates low level step functions with pulsing IFD p141 Aug 17
 Relay of permanent magnet type for printed-circuit applications PF p64 Sept 28
 Resistors, highly reliable, result from rigid tests EDN p50 Aug 3
 Rubber grommet holds on tube hats . IFD p150 July 6
 Solid state pressure transducer represents a 10-fold increase in the state of the transducer art PF p58 Aug 31
 Standard rotary switch used by four-resistor decade IFD p149 July 20
 Tantalum capacitors: 33 questions and answers on their applications, characteristics, peculiarities ART p32 Dec 21
 Thermal relay, inexpensive time-delay drop-out uses IFD p143 Aug 17
 Vtvm range divider of simple type . IFD p196 Nov 23

COMPUTERS, DATA PROCESSING, AUXILIARY DEVICES

Analog circuit, simply designed, solves heat flow problem ART p60 July 20
 Analog computer helps in man-machine study EDN p38 Nov 9
 Analog computer to "remember" with initial condition circuit DD p186 Nov 23
 Analog-digital machine being built by NBS EDN p8 Aug 17
 Analyzer, 2000-channel, electrostatic and magnetic-drum storage combined DIG p216 Oct 12
 Assuming majority of computers is right, reliability is enhanced DD p182 Oct 12
 Boolean algebra, putting it to work—how to state a problem in Boolean algebra and extract a solution in hardware ART p76 Sept 14
 Character reader, lenticular, promises low cost EDN p8 Nov 9
 Computer capabilities of Russian seen in second place by '65 EDN p12 Oct 12
 Computer designs keyed by maintainability EDN p8 Sept 28
 Computers, general purpose to direct communications EDN p32 Nov 9
 Computer makes weather map for Navy EDN p12 Sept 28
 Computer memory, made by RCA, uses super-conductivity EDN p32 July 20
 Computers may use neuron information theory EDN p10 Sept 28
 Computer will count election ballots EDN p30 Aug 17
 Data processing systems edited with Datacom EDN p40 Nov 9
 Design consideration for nonlinear function generators ART p56 July 20
 Designing with digital computers—An ELECTRONIC DESIGN Staff Report ART p28 Aug 31
 Digital computer, shipboard, is keystone of ASROC system EDN p20 July 20
 Electronics in process control stressed at ISA meeting EDN p4 Oct 12
 Function generator has high accuracy PF p56 Dec 7
 Navy data system begins sea duty EDN p20 Sept 14
 N-bit binary to decimals, converted rapidly with "double-dabble" circuit ART p34 Dec 7
 Point plotter provides accuracy of 0.0015 in. PF p108 July 6
 Punched cards program diode function generator DD p140 July 20

Reader described at AIEE meeting uses rotating rasters EDN p10 Aug 31
 Selecting transistors and diodes for logic applications ART p46 July 6
 Space computer designed at MIT EDN p26 July 6
 Summing core logic yields digital-circuit flexibility ART p48 Oct 12
 Teaching a computer to think for itself DIG p172 Sept 28
 Telex random-access desk file reduces access time one-third EDN p32 Aug 17
 Voltage drops in conducting logic diodes, accounting for ART p56 Sept 28

DETECTION, TECHNIQUES AND EQUIPMENT

Airborne IR seeker-tracker nears completion EDN p26 Oct 12
 Approximate radar range equation causes errors in low-noise system calculations ED p183 Oct 12
 Army's new HiPar radar aids Nike effectiveness EDN p28 Sept 28
 Balloon-borne satellite detector, ultra-miniature preamps for EDN p10 Oct 26
 CW, non-doppler ranging system for Samos EDN p8 July 20
 Dual infrared-radar systems use optical materials PF p73 July 20
 Electronics in A-bomb detection, design for peace EDN p38 July 20
 Infrared traffic control, five states testing EDN p18 July 20
 Infrared transmission materials would be unaffected by radiation in space ART p74 Oct 26
 Oceanography, opportunities in systems design EDN p34 July 6
 Radar interference with microwave communications DIG p160 July 20
 Radars, new moving target indicator adapted to EDN p34 Aug 17

HUMAN FACTORS

Are you conscious or unconscious when you choose an engineering job? DYF p222 Oct 12
 How to design scales that humans can read ART p82 Sept 14
 Maintainable designs, products for ART p64 Oct 26
 Maintainable Equipment, checklist of 241 design features ART p50 Oct 26
 Maintainability in action ART p42 Oct 26
 Maintainability keys computer design EDN p8 Sept 28
 Maintainability specifications, no time-base is needed in Signal Corps ART p58 Oct 26
 Maintainability, techniques in designing for ART p36 Oct 26
 Maintainability, where it came from; where it's going ART p30 Oct 26
 Make your point by friendly persuasion DYF p186 Sept 28
 What job should you seek? Test yourself and find out DYF p166 July 20

INDUSTRY

General
 Classified ASW sessions featured at WESCON EDN p12 Oct 26
 Computer will count election ballots EDN p30 Aug 17
 Cutting lead time in design ART p36 Dec 7
 Electronic industry "shakeout" predicted by Fortune magazine article EDN p25 Aug 31
 Electronics learns from biology EDN Staff p38 Sept 14
 Flat-screen TV, concentrated efforts on EDN p16 July 6
 Hi Fi, highlights of recent shows ART p36 Dec 21
 IDEP data exchange plan minimizes lab duplication EDN p32 Nov 23
 Japanese electronic exports to U.S. continue to rise EDN p49 Nov 23
 Latin America still good market for U.S. tubes and semiconductors EDN p12 Aug 17
 NASA and Grumman in talks for orbiting space conservatory EDN p25 Nov 9
 Oceanography—opportunities in systems designs EDN p34 July 6

Pay-TV system being readied for field test EDN p36 Sept 14
 RF plasma torch reaches heat near that of sun EDN p34 Nov 23
 Russia seen No. 2 computer-maker by '65 EDN p12 Oct 12
 Russian reader uses defocused optics EDN p12 July 6
 Shipments of U.S. components reach another all-time high EDN p44 Nov 23
 Signal Corps orders radios to replace three current models EDN p19 Aug 31
 Six manufacturers kick off traveling show on Long Island EDN p43 Nov 9
 Sixth Communication Symposium is largest ever .. EDN p20 Oct 12
 Space meeting stresses electronics EDN p12 Sept 14
 Strobed, rotating number drum cuts cost of digital voltmeter DD p200 Aug 3
 U.K. electronic exports to U.S. down \$2 million from last year EDN p25 Oct 12
 Ultrasonic cleaners keynote simplicity EDN p28 Aug 17
 Wealth of information featured at NEC sessions EDN p20 Oct 26
 WESCON exhibits draw 40,076 EDN p14 Sept 14
 WESCON opens in Los Angeles with parade of products EDN p4 Aug 31
 WESCON, outstanding electronic designs at EDN p14 Aug 17
 What the two candidates say about science EDN p4 Oct 26
 Widespread research progress, reliability stressed at NEREM EDN, p4 Dec 7

Government-Military

Anti-sub advisory group adds two committees EDN p28 July 20
 Army may use factorial test design EDN p26 Nov 23
 Army new Hipar radar aids Nike effectiveness EDN p28 Sept 28
 Army systems research to use advanced components EDN p17 Dec 7
 CW, non-doppler ranging system for Samos EDN p8 July 20
 Commercial use of space bringing new problems EDN p26 Sept 14
 DOD sets up RFI compatibility plan EDN p4 July 6
 Disposable equipment modules give economical operation DIG p156 Aug 17
 Echo balloon satellite put to work by engineers EDN p12 Aug 31
 Experimental satellite TV relay planned EDN p4 Nov 9
 Guiding moon vehicle, optical tracker designed for EDN p60 Aug 3
 Indicator, moving target, adapted to most radars EDN p34 Aug 17
 Keystone of ASROC system is shipboard digital computer EDN p20 July 20
 MIL-STD-704 helps designers achieve more performance, reliability in airborne equipment S&S p194 Sept 14
 Military approved transistor specs .. ART p52 July 6
 Military-contract 'top off' predicted in EIA report .. EDN p18 Sept 28
 Military meeting stresses systems needs EDN p4 July 20
 Minuteman, firms seek ultrareliability for EDN p4 Sept 14
 Month marked by significant firings .. EDN p7 July 6
 Most frequently used transistors in Signal Corps R&D ART p50 July 6
 Navy Bureau of Weapons seeks new design ideas ... EDN p16 July 20
 Navy subs, new thermoelectric devices sought for ... EDN p64 Aug 3
 NERV capsule launched by NASA traveled to 1,200-mile height EDN p38 Nov 9
 Shipboard success speeds transit project EDN p12 Aug 3
 Tiro II launched at Cape Canaveral EDN p12 Dec 7
 Titan, Polaris programs spark rise in welded modules EDN p4 Sept 28

INDUSTRIAL ELECTRONICS

British IEA show keynotes simplification with flexibility EDN p17 July 6
 British show design ideas at New York exhibition ... EDN p25 July 6

Electronics in process control stressed at ISA meeting EDN p4 Oct 12
 Industry growth continuing Navy survey shows EDN p26 July 20
 Machines monitored for continuous operation by new German device EDN p42 Nov 9
 Post office installing electronic handlers EDN p46 Aug 3
 Russians seen catching up in automation EDN p4 Sept 28
 Transistor preferred lists, airline industry completes ART p54 July 6
 WESCON—Big shows take on a new look EDN p26 Aug 3
 WESCON—Electronics in the West: the 1960 look ... EDN p36 Aug 3
 WESCON features pre-planned workshop sessions ... EDN p15 July 20
 WESCON—Most products to be displayed for first time EDN p104 Aug 3

MATERIALS

Copper-laminate board ideal for RF bread-boarding ... IFD p148 July 20
 Infrared transmission materials would be unaffected by radiation in space ART p74 Oct 26
 Laminations, U-shaped, help cut transformer's size, weight PF p72 July 20
 Magnetics conference keyed by microwave gains EDN p8 Dec 7
 Metals, metallic compounds grown in large, single crystals PF p110 July 6
 Optical materials for dual infrared-radar systems ... PF p73 July 20
 Plastic clay fabrication speeds microwave matching ... IFD p158 Sept 28
 Plastic models facilitate equipment design DD p182 Oct 12
 Preformed capacitor cases give greater environmental immunity DD p142 Sept 28
 Reliable hookups, more to it than soldering ART p 32 Dec 7
 Special potting method provides waterproof seal around Teflon wire IFD p148 July 6
 Transitions, superconductives, revealed by new technique EDN p52 Aug 3
 Woods metal good for plugging plumbing IFD p165 Sept 14

MEASUREMENTS, INSTRUMENTATION, TEST EQUIPMENT

Antenna patterns recorded using off-the-shelf test equipment ART p78 Aug 3
 Audio frequency precision measurement GA p158 July 20
 Bolometer, high sensitive, in works EDN p34 July 20
 Capacitance bridge measures waveguide dimensions ... GA p170 Sept 28
 Counter, solid-state gated, rated at 100 mc PF p58 Oct 12
 Decade-counting circuit RT p156 July 20
 Electronic wrist watch offers greater accuracy EDN p18 Oct 26
 Four-resistor decade improved upon IFD p200 Oct 12
 Generator, impulse—an RFI measurement tool ART p68 July 20
 Heat sensitive diode calibrates rms meter for noise voltage readings IFD p151 July 6
 "Homemade" electronic tester may save hundreds of man hours EDN p31 Nov 23
 Indicator, servo-operated, gives analog and digital readout DD p128 Aug 17
 Instrument measures rotary movements as small as 1/3 sec of an arc PF p66 Sept 28
 Load sharing for high-voltage bridge insured by four extra diodes IFD p138 Oct 26
 Measure average value over a selected time interval with device that integrates input PF p68 Nov 23
 Measuring intermodulation distortion with a standard method ART p42 Oct 12
 Meters—input signal squared and averaged in rms reading dvm DD p180 Oct 12
 NBS accuracy standards called inadequate EDN p12 July 20
 NBS technique compares results of similar tests performed at different laboratories EDN p16 Sept 28
 Oscilloscope, If, converts for hf use with sampling accessory GA p154 Aug 17



WHAT
 THIS UNUSUAL
 AC-DC "PLUG-IN"
 TRANSISTORIZED
 POWER SUPPLY
 DESIGN
 GIVES YOU...



One piece finned aluminum extrusion, achieving high heat dissipation. Most units need no external heat sink to 55° C ambient. All units have adjustable output. Platform mounted standardized subassemblies and components enable quick delivery of a wide range of voltages and currents.



Specifications:

Input: 105 to 125V AC, 45 to 420 cps, single phase
 Regulation: 0.1% (line or load)
 Stability: Better than 0.25% for 8 hours
 Ripple: 0.02% rms
 Response time: less than 100 microseconds
 Low dynamic impedance



Designed primarily as a component power supply, units are widely used in computers, electronic instrumentation, production test equipment, and quality control check out systems. Best of all, the unique design makes these units available at the lowest possible cost to you.

(Unit pictured above: Model #1R 90-1; 85-95 V; 0-100 ma; Price \$145.00) Prices on other units range from \$100 to \$200.

All solid state — zener diode reference transistor amplifiers and regulator
 Output Voltages: from 2.0 to 300V DC
 Output Power to 30 Watts
 Reliable short circuit protection
 All components readily accessible

CONSOLIDATED AVIONICS CORPORATION

A SUBSIDIARY OF CONSOLIDATED DIESEL ELECTRIC CORPORATION

800 Shames Drive • Westbury, L. I. • EDgewood 4-8400

CIRCLE 143 ON READER-SERVICE CARD



Wire leads are cemented to resistor by Du Pont thermosetting silver composition.

Du Pont CONDUCTIVE CEMENTS are easy to apply... eliminate soldering

Du Pont offers high-quality thermosetting gold and silver cements, especially formulated for application on silicon, germanium, carbon and other bases. These Du Pont conductive cements are easily applied by dip, brush or squeegee... eliminate soldering:

- Thermosetting gold compositions #5780 and #7728 are suitable for dip, brush or squeegee application.
- Thermosetting silver composition #5504-A is suitable for application by squeegee—composition #5815 for application by dip or brush.

After proper curing and drying, these compositions exhibit good adherence, electrical conductivity and abrasion resistance.

Du Pont conductive cements find wide application for lead attachments in diodes, transistors, resistors and similar components. Gold cements are particularly suitable for applications where

resistance to strong etching acids is required.

Silver Preparations: Du Pont also offers a full line of silver preparations—conductive coatings used in the electronic industry. Du Pont silver preparations are solderable... easy to handle... have excellent electrical properties.

For more detailed information, write for bulletins on high-quality Du Pont Conductive Cements or silver preparations. Mention the application you have in mind so that appropriate literature can be supplied. Du Pont, Electrochemicals Department, Ceramic Products Division, Wilmington 98, Del



Better Things for Better Living... through Chemistry

CIRCLE 144 ON READER-SERVICE CARD

INDEX OF ARTICLES

Oscilloscope tracer developed, photoelectric EDN p8 Aug 3
 Oscilloscope, transistorized, weighs less than 2 lb ... PF p86 Sept 14
 Oscilloscopes and oscillographs test equipment—Part 2: types and characteristics ... ART p56 Nov 9
 Point plotter using numerical control techniques and digital position encoders provides 0.0015-in. accuracy PF p108 July 6
 Probe design for capacitive level measurements ART p82 Aug 3
 Pulsar uses 50-v trigger to short four 200-v diodes ... DD p128 Oct 26
 RFI test equipment ART p74 Sept 14
 Recorder claims two-thirds cost slice EDN p36 Nov 9
 Recorder, magnetic tape, monitors 65 different variables in flight EDN p26 July 20
 Recorder, pen, drives slotted line for accurate vswr plots DD p142 July 6
 Recorder, direct-writing, operates over a 100 per cent wider bandwidth PF p84 Sept 14
 Recorder, tape, design for minimum size, weight, and power ART p62 Nov 23
 Recorder, wideband, performance boosted DD p138 July 20
 Recovering low-frequency data from magnetic tape—a simple technique ART p40 Oct 12
 Reflection table speeds transmission line computations ED p131 Aug 17
 Russian electronic test equipment ... ART p70 Aug 17
 Russian test equipment and ours ... ART p50 Aug 17
 Sensitive pulsing circuit measures 10^{-15} amp IFD p199 Nov 23
 Simulator, PCM signal, claims unmatched flexibility PF p64 Oct 12
 Standard method of measuring intermodulation distortion ART p42 Oct 12
 Sweep-frequency techniques for measuring high frequency impedances ART p64 July 20

Tape system, low-cost analog, records or plays back dc to 400 cps PF p78 Oct 26
 Test equipment, types and characteristics—part I: analog meters ART p46 Oct 12
 Test equipment—part 2—types and characteristics: oscilloscopes and oscillographs ... ART p56 Nov 9
 Test equipment: types and characteristics—Part 3—frequency meters ART p56 Nov 23
 Tester, direct-reading switching-time, samples nanosecond waveforms PF p96 Aug 3
 True-rms vtvm gives high accuracy with clean or distorted waveshapes PF p100 Nov 9
 Universal ratio set suitable for voltage comparisons ... IFD p142 Aug 17
 Universal test station handles many components, provides savings PF p64 Oct 12

MICROWAVE COMPONENTS, TECHNIQUES

Antenna, di-optic, cuts cross-section by 50, replaces horn PF p76 Oct 26
 Bitermitron provides two-terminal M-type BWO ... PF p60 Oct 12
 Directional coupler, 3 db, with 20-db isolation produced by stripline techniques ... ART p52 Aug 31
 Errors in low-noise system calculations caused by approximate radar range equation ED p183 Oct 12
 Low pass filters, designing from lossy helical coaxial line ART p28 Dec 7
 Maser, optical, announced by Bell Labs EDN p4 Oct 12
 Microwave gains key magnetics conference EDN p8 Dec 7
 Microwave matching speeded by fabrication from plastic clay IFD p158 Sept 28
 Microwave noise source GA p180 Sept 14
 Microwave power, airborne, converter progress speeded EDN p12 Nov 9
 Microwave power tubes, their future ART p114 Dec 21

YOURS TODAY—

A frequency standard so accurate
that it measures time with a rate of change
of less than one second in sixty years!

5×10^{-10} /DAY



Total Dimensions, Standard and Power Supply: 7½" W x 6" H x 12½" D. Shown mounted in 7" x 19" rack panel.

THE JK-SULZER FS-1100T FREQUENCY STANDARD is a standard of frequency and time... born of and for the age of space. It is fully transistorized. A double proportional control oven houses a 1 mc precision quartz crystal having a Q exceeding 2 million. Each unit is built, aged, and calibrated at Washington, D.C., against groundwave signals of WWV. Simultaneous outputs of 1.0 mc and 100 kc. A companion power supply permits operation from 115 volt AC plus automatic 12 hours minimum of emergency or portable operation from batteries. Today, you can order this 5×10^{-10} /Day stability, for early delivery, for a wide range of research and test applications. Write for technical literature.

The James Knights Company, Sandwich, Illinois

SPECIALISTS IN FREQUENCY MANAGEMENT for space exploration programming, high speed navigation, and spectrum conservation in the growing communications field.

CIRCLE 145 ON READER-SERVICE CARD

ELECTRONIC DESIGN • December 21, 1960

Microwave progress speeded by test equipment developments ART p182 Nov 23
 Microwave rectifier tube designed at Raytheon EDN p58 Aug 3
 Microwave spectrum squeeze spotlights advanced components ART p176 Nov 23
 Microwave systems, new tube for agile, reliable, power systems ART p172 Nov 23
 Microwaves, breakout in antenna designs ART p166 Nov 23
 Microwaves invade new commercial fields ART p161 Nov 23
 Microwaves, trends ART p161 Nov 23
 Multiresonator directional filter uses strip transmission line ART p110 Dec 21
 Nomogram, characteristic impedance for concentric transmission lines ED p147 Sept 28
 Plugging plumbing with woods metal IFD p165 Sept 14
 Radar interference with microwave communications DIG p160 July 20
 Radio refractometer, airborne, tracks missiles EDN p8 Oct 12
 Recorder, pen, drives slotted line for accurate vswr plots DD p142 July 6
 Solid state microwave signal sources PF p66 Nov 23
 Surface-wave antenna radiates from waveguide bends RT p206 Nov 23
 TWT's have come a long way toward environmental insensitivity ART p54 Oct 12
 Waveguide dimensions measured by capacitance bridge GA p170 Sept 28

NAVIGATION AND GUIDANCE TECHNIQUES

ASR-4 radar, made by Texas Instruments, slated for 34 air terminals EDN p62 Sept 14
 CW, non-doppler ranging system for Samos EDN p8 July 20
 Inertial guidance key is the stable platform DIG p182 Sept 14
 Infrared traffic control, five states testing EDN p18 July 20

Navigation, automatic, designed to project aircraft position on map screen for pilot EDN p32 July 6
 Optical tracker designed for guiding moon vehicle EDN p60 Aug 3
 Trajectory system planned with high accuracy EDN p4 Aug 3
 Transit project, shipboard success speeds EDN p12 Aug 3

NUCLEAR SCIENCE

A-bomb blasts, underground, to be monitored near Fort Sill EDN p10 Dec 7
 Design for peace; electronics in A-bomb detection EDN p38 July 20
 Generator uses reactor core heat EDN p30 July 20
 Guidelines in designing for a nuclear environment ART p68 Sept 14

PACKAGING TECHNIQUES, ELECTRO-MECHANICAL-THERMAL DESIGN, PRODUCTION PROCESSES AND EQUIPMENT

Compartment separators in wall slot improve isolation in RF equipment DD p181 Nov 9
 Cutting lead time in design ART p36 Dec 7
 Equipment design facilitated with plastic models DD p182 Oct 12
 Electronic packaging and gracious living EDN p60 Sept 14
 Estimation of external surface case temperature rise for closed electronic equipment ED p131 Oct 26
 Fabrication from plastic clay speeds microwave matching IFD p158 Sept 28
 Heat flow problems solved by simple analog circuit ART p60 July 20
 Interconnections lag device developments ART p84 Nov 9
 Micromin plans, services spelling out EDN p42 Aug 3
 Micromin poses business threat EDN p18 Nov 9
 Microminiature designs—guidelines ART p61 Nov 9
 Microminiaturization, comparing key characteristics of major approaches ART p94 Nov 9

AMPEX CHOOSES

JAMES CHOPPERS FOR NEW ANALOGUE FR-600 EQUIPMENT

THE "MINUTEMAN" PROGRAM RELIES ON THE FR-600 FOR RECORDING

Ampex and James engineers together developed a unique new economical chopper from the basic JAMES low level DPDT instrument mechanism for this critical application. The resulting component with its precision reliability and accuracy controls the FM record and reproduce amplifiers. The FR-600 with double the bandwidth of previous recorders, provides Direct-recording response to 250 Kc or FM-Carrier recording from DC to 20 Kc within 1/2 db.

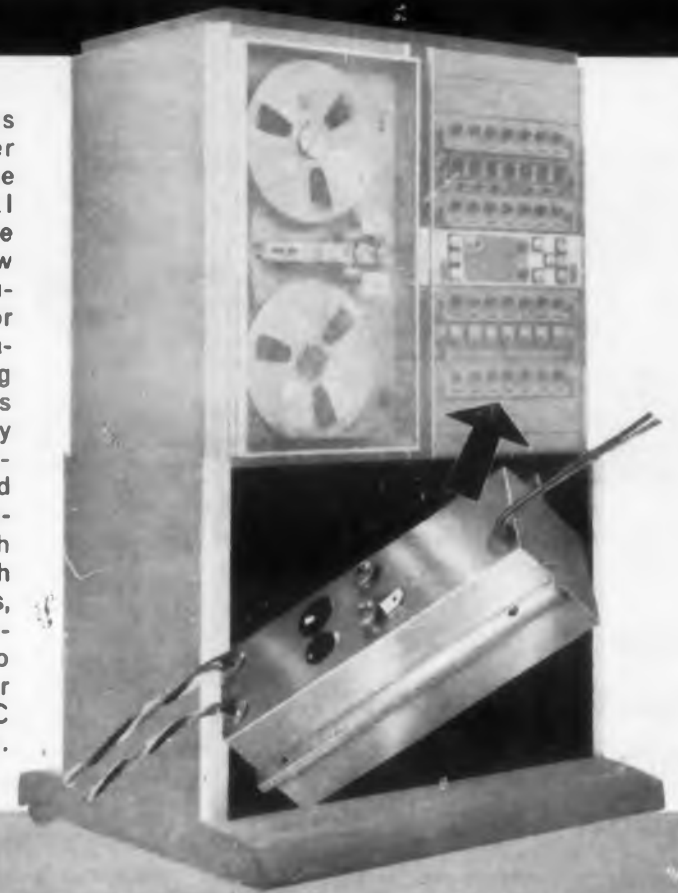

The JAMES instrument chopper, now the standard in low level instrument design, provides unique characteristics for analogue DC amplifiers and recording equipment.

- DPDT and SPDT in a variety of packages for low noise and 1 to 500 cps operation.
- Low residual noise permitting microvolt performance at all carrier frequencies.
- Low Thermal emfs means equipment stability over wide temperature ranges and from all types of transducers.
- Reliability and long life by thousands of components in all phases of industrial and military instrumentation.

Consult JAMES engineers with your low level modulator, demodulator and input transformer requirements. Matched components insure optimum performance and lowest cost.

CHOPPERS • INSTRUMENT TRANSFORMERS • MINIATURE TRANSFORMERS

JAMES ELECTRONICS INC.
 4050 N. Rockwell St., Chicago 18, Illinois
 CO 7-6333

ELECTRONIC • PRINTED CIRCUIT • GRAPHIC SYMBOLS MADE TO ORDER

Repetitive symbols . . . in fact any drafting, blueprint or specification detail items . . . can be applied in seconds, rather than drawn in hours. If your engineers or draftsmen haven't yet discovered the speed and economy of STANPAT, they are wasting valuable hours . . . and valuable money.

STANPAT tri-acetate sheets are quickly and easily adhered to your tracings without special equipment. Reproductions are crisp and clean . . . Won't dry out, come off or wrinkle. Mail the coupon today and see for yourself.



pre-printed • tri-acetate
STANPAT
 sheets
 Used by more than 30 Industries

STANPAT CO., Whitestone 57, N. Y.
 Phone: Flushing 9-1693-1611 Dept. 50

- Please quote on enclosed samples
 Kindly send literature and samples

Name _____
 Title _____
 Company _____
 Address _____
 City _____ State _____

CIRCLE 146 ON READER-SERVICE CARD

CIRCLE 147 ON READER-SERVICE CARD

DRAFTING TRENDS



In a typical application of the POST Diazo Materials Selector Chart, a draftsman, supervisor and reproduction specialist solve a special print-making problem in short order.

Solve unusual reproduction problems with new Diazo Selector Chart

Keeping up with rapid developments in graphic reproduction and communication techniques is a difficult job these days, even for the experts.

From the engineer's and draftsman's point of view, it's largely a matter of sorting out the specific information which helps him do a better job.

The new Post Diazo Materials Selector Chart does just that—provides a condensed, tabular reference piece that helps you anticipate the ideal diazotype prints for various needs before they occur. This convenient chart gives brief information on sensitized papers, intermediates and specialties in terse "what, when, why and where" style.

If you're concerned, for instance, with print distribution to different departments, units or groups, then prints on a variety of colored stocks might be the answer.

Increasing print production from diazo equipment with a lower-power light source . . . making legible prints from worn old tracings . . . even making copies from an opaque print . . . all can be handled by use of new Post 206M-14, a fast, extra-sensitive whiteprint paper.

Suppose a design conference calls for a poster, actual size, made from a large engineering drawing, rigid enough for display, tough enough for extreme handling and on-the-spot sketches? Post diazo-sensitized cardstock in 32 or 50 lb. weight can turn the trick on standard reproduction equipment, ammonia process or semi-moist. For many more helpful solutions to similar situations, ask for your personal file-size copy, of the Post Selector Chart, available from your Post dealer or Frederick Post Company, 3644 North Avondale Avenue, Chicago 18, Illinois.



SENSITIZED PAPERS & CLOTHS • TRACING & DRAWING MEDIUMS • DRAWING INSTRUMENTS & SLIDE RULES
ENGINEERING EQUIPMENT & DRAFTING SUPPLIES • FIELD EQUIPMENT & DRAFTING FURNITURE

CIRCLE 148 ON READER-SERVICE CARD

INDEX OF ARTICLES

Microminiaturization—five major approaches pursued . . . ART p62 Nov 9
Microminiaturization in perspective . . . ART p96 Nov 9
Potting method provides waterproof seal around Teflon wire . . . IFD p148 July 6
Reliable hook-ups, more to it than soldering . . . ART p32 Dec 7
Simplify potting process by encapsulating with plastic shells . . . ART p58 Nov 23
Thermoelectric junction cools transistors for temperature testing . . . IFD p194 Nov 9
Transistor mount saves space, cuts production cost . . . DD p130 Aug 17
Welded modules, Titan & Polaris programs spark rise in . . . EDN p4 Sept 28

POWER SOURCES

Converting heat to electricity . . . ART p32 Sept 28
DC motor drive regulation improved by reactor . . . IFD p196 Nov 23
Power supply, all-transistor, features ultra-high regulation . . . PF p102 Aug 3
Power supplies, new line protected against overload by power-sensing circuit . . . PF p56 Aug 31
Temperature conversion chart for thermoelectric data . . . ED p145 Sept 28
Thermoelectric devices sought for Navy subs . . . EDN p64 Aug 3

RADIO FREQUENCY INTERFERENCE

Interference key to space frequency controversy . . . EDN p4 Aug 3
RFI compatibility plan set up by DOD . . . EDN p4 July 6
RFI measurement tool—the impulse generator . . . ART p68 July 20
RFI—natural interference in space systems . . . ART p90 Aug 3
RFI test equipment . . . ART p74 Sept 14

Radar interference with microwave communications . . . DIG p 160 July 20

RELIABILITY

Cost, failure time dictate unit size in reliability test . . . DIG p190 Sept 14
Disposable equipment modules give economical operation . . . DIG p156 Aug 17
MIL-STD-704 helps designers achieve more performance, reliability in airborne equipment . . . S&S p194 Sept 14
Reliability enhanced by assuming majority of computers is right . . . DD p182 Oct 12
Reliability quiz . . . ART p74 Aug 3
Reliability, widespread research progress stressed at NEREM . . . EDN p4 Dec 7
Ultrareliability for Minuteman sought by firms . . . EDN p4 Sept 14

SYSTEMS

Chicago traffic plotter puts traffic data onto tube . . . EDN p18 Aug 31
Computer makes weather map for Navy . . . EDN p12 Sept 28
Computer will count election ballots . . . EDN p30 Aug 17
Design for peace—new field opens up for electronics system design in A-bomb detection . . . EDN p38 July 20
Natural interference in space systems . . . ART p90 Aug 3
Oceanography—opportunities in systems design . . . EDN p34 July 6
Pulse code modulation terminal and repeater methods . . . ART p98 July 6
Reader scans 10,000 envelopes an hour . . . EDN p14 Oct 12
Supersystems, planning for new monitoring . . . EDN p26 Nov 9
System alerts drivers nearing edge of road . . . EDN p30 Nov 9

PRECISE SHAFT POSITIONING EASY



WITH GURLEY RESOLVER TEST STAND

The new Gurley Resolver Test Stand solves the long-standing need for a reliable instrument in production tests of resolvers, synchros, potentiometers and other such equipment.

The Gurley Model 7530 test stand is a precision shaft-positioning device, consisting of an optical coincidence reading system with ± 2 second accuracy, a rack and gear for precise shaft positioning, and an adaptor plate and coupling.

For an illustrated bulletin, write on your letterhead to Industrial Division, W. & L. E. Gurley, 525 Fulton Street, Troy, N. Y.

W. & L. E. GURLEY
TROY, N. Y.

System applications of ferrite devices
 BOOK p168 Sept 14
 Systems needs stressed in military meeting
 EDN p4 July 20

TUBES, SEMICONDUCTORS

Backward diode, GaAs tunnel diodes made available ..
 PF p78 Aug 17
 Blocking diodes stabilize multi-frequency against 1-
 IFD p158 Sept 28
 Diode cartridge, replaceable, used by feedback stab-
 ilized probe DD p202 Aug 3
 Diode, cut-off, triggers fast output pulses
 IFD p212 Aug 3
 Diode forward voltage drop clamps outputs to zero ..
 IFD p156 Sept 28
 Diode, heat sensitive, calibrates rms meter for noise
 voltage readings IFD p151 July 6
 Diode, silicon, stands 10 times power overload, toler-
 ates red hot operation PF p98 Aug 3
 Diodes and transistors: how they're numbered; what
 military specs and standards are applicable
 S&S p200 Dec 7
 Electronics in process control stressed at ISA meeting
 EDN p4 Oct 12
 Emission of primary screen grid measured
 IFD p164 Sept 14
 Epitaxial proceeds to take leading role
 EDN p38 Nov 23
 Four extra diodes insure load sharing in high voltage
 bridge IFD p138 Oct 26
 Image-tube development aids astronomers
 EDN p15 Aug 31
 Multi-function compactron tubes planned by GE
 EDN p14 July 6
 Multivibrators, designing hard tube delay
 ART p52 July 20
 Rectifier, silicon controlled, automatically sets initial
 multivibrator state ART p104 July 6
 Silicon tetrode suitable for switching and memory ...
 PF p100 Aug 3
 Silicon transistor circuits: how to stabilize them with
 silicon resistors ART p28 Dec 21

Solid state relay varies operational amplifier gain ...
 IFD p210 Aug 3
 Thermal resistance determines power safety dissipated
 at a collector junction ART p52 Oct 12
 Traffic data put onto tube by Chicago traffic plotter ..
 EDN p18 Aug 31
 Transistor, centrifugally switched, controls motor
 speed DD p203 Aug 3
 Transistor circuits, designing low-noise
 ART p86 Aug 3
 Transistor data chart, eighth annual ART p67 July 6
 Transistor multivibrator, design of a long time con-
 stant asymmetrical ART p70 Aug 3
 Transistor, diode selection for logic applications
 ART p46 July 6
 Transistor, microminiature, silicon, mesa, increases
 power output by 50 per cent ... PF p74 Aug 17
 Transistor specs approved by military
 ART p52 July 6
 Transistors, mesa, used in wideband video amplifier
 design ART p46 Aug 17
 Transistor most frequently used in Signal Corps R&D
 ART p50 July 6
 Transistors: prepared list completed by airline in-
 dustry ART p54 July 6
 Transistors, series connected, increase voltage switched
 to load RT p218 Aug 3
 Transistors, silicone, mesa, used in designing 175-mc
 amplifier DIG p218 Oct 12
 Tube, gated beam, has novel multivibrator applica-
 tions IFD p140 Aug 17
 Tubes available for entertainment, twelve-pin, multi-
 function, industrial devices PF p74 July 20
 Tunnel diode is sensitive level detector
 IFD p148 July 20
 Tunneltron may be new basic component
 EDN p4 Dec 7
 U.S. tubes, semiconductors still have good market in
 Latin America EDN p12 Aug 17
 Uni-tunnel diode claims high efficiency at low voltages
 PF p78 Aug 17
 Vapor phase devices made by Bell, IBM
 EDN p4 July 6

DEEP THOUGHTS FROM DEEP DOMES / NO. 6 OF A SERIES



Ticklefinger on economics

Augustus van den Ticklefinger (1776-1840), professor of advanced folk-dancing at Schuylkill Tech, asked the cogent question that still has economists in a dither: "Who paid the rent for Mrs. Rip van Winkle, when old man Winkle was away?" Just the kind of fearless-stating-of-unpopular-questions which has made us at HOOVER ELECTRONICS a growing influence in our field!

For example, we asked: how can we design a new and better power converter for mobile, marine, and airborne use in the 100-150 watts class, to be sold at a moderate cost? Echo, the fickle jade, came back with no answer, so we had to do some work on the problem. Depressing thought. But it produced an interesting result, as you can see below, and we're proud of our contribution to basic economics, too.

.....
 This new power converter, pint-sized but potent, is not only moderately priced. Its reliability is improved over that of converters previously available, and the improvements have actually contributed to the lower cost. Layer-wound transformers and a very low external base emitter impedance, with precise control of voltage "spikes" are some of the reasons. Ask us for a spec sheet on the others.



THE HOOVER COMPANY
 ELECTRONICS DIVISION

110 WEST TIMONIUM ROAD • TIMONIUM, MARYLAND
 Field Liaison Engineers / Los Angeles, California

NOW—Complete Line

dekatron®

Electronic Counting Tubes
 (up to 20,000 counts/sec.)

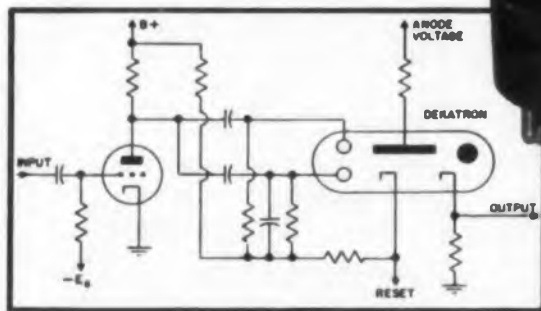

Typical Drive Circuit

Now available—only complete "Hand Book of Counting Tubes" in print. Tube specifications, applications, sample circuits, design criteria are included. Available at \$1.00 a copy through Dekatron Tube Section, Baird-Atomic, Inc.

No C. O. D. or purchase orders, please! Cash, check or money order accepted.

Baird-Atomic, Inc.

33 UNIVERSITY RD., CAMBRIDGE 38, MASS



Instrumentation for Better Analysis

CIRCLE 150 ON READER-SERVICE CARD

ELECTRONIC DESIGN • December 21, 1960

CIRCLE 151 ON READER-SERVICE CARD

149

How Do You Meet a Challenge?



Delco Radio is doing it
with TALENT and RESOURCES

We feel the challenge of new concepts in electronics and Solid State Physics can only be met by an intelligent application of outstanding abilities and resources.

To meet this challenge, Delco—over the years—has built up over one million square feet of modern manufacturing, laboratory and office facilities. Newest in the Delco complex is a 125,000 sq. ft. engineering and research facility now under construction in Kokomo, Ind., and scheduled for completion in 1961. In addition, Delco has available the extensive services of the General Motors Technical Center and field test facilities.

But physical resources are only half the answer. It took bold, imaginative talent to lead Delco to its present respected position in the electronics industry. Likewise, the challenge of the future requires a constant infusion of new ideas and new talent.

To maintain and further expand leadership in these areas, we are conducting aggressive programs in semiconductor device development and new materials research. This activity has created unusual opportunities for those who qualify. Specifically, we are vitally interested in ambitious men with experience and TALENT in the following areas:

ELECTRONIC ENGINEERS

Experienced in: transistor, communication and radio circuitry, servo systems and antennas; also, machine controls (relay and/or static) to assist in the development and application of static transistorized controls.

TRANSISTOR PROCESS ENGINEERS

EEs, MEs, and IEs to develop and create new processes for manufacturing germanium and silicon semiconductor devices. Experience preferred.

COMPUTER ENGINEERS

For development of control type, special, or general purpose units. Experience in digital to analog and analog to digital converter design. Or magnetic core or drum type memory. Mechanical engineers for package design. Electronic engineers for test design, servo-analysis, and circuit design.

PHYSICISTS, CHEMISTS AND METALLURGISTS

For semiconductor device development. With experience in: semiconductor materials (to lead a program on metallurgical research of new semiconductor materials), semiconductor device encapsulation, alloying and diffusion, chemistry of semiconductor devices.

We're eager to find experienced personnel with a desire for a stimulating challenge and the abilities to fulfill this challenge. Responsible positions are available for those who qualify.

If you're interested in becoming a member of our Delco—GM team of outstanding scientists and engineers, send your resume today to the attention of Mr. Carl Longshore, Supervisor Salaried Employment.

Division of General Motors • Kokomo, Indiana

CIRCLE 901 ON CAREER INQUIRY FORM

DELCO
DEPENDABILITY
RADIO
RELIABILITY

YOUR CAREER

ENGINEER-IMPROVEMENT COURSES AND SEMINARS

Below are courses and seminars intended to provide the engineer with a better knowledge of various specialties. Our grouping includes several different types of meetings: National Courses—those held on consecutive days and intended to draw attendees from all geographical areas; One-Day Seminars—one-day intensive seminars which move from city to city; and Regional Lectures—regional symposia or lecture series which generally run one night a week for several weeks.

National Courses

CBS's Transistor Home-Study Course

The new 1960 edition of the CBS transistor home-study course is revised and expanded to include the latest information on transistor devices and applications. This new version of CBS Electronics' course offers ten lessons covering simplified basic semiconductor theory with practical experiments and severe techniques for amplifiers, oscillators, rectifiers and deflection circuits. For further information write to: "Transistor Course," CBS Electronics, 100 Endicott St., Danvers, Mass.

Lavoie Inaugurates Robotester Training Program

A monthly schedule of classes in the operation of the Lavoie Robotester for users and potential users of the instrument has been announced by Lavoie Laboratories, Morganville, N.J. The Robotester is a tape-programmed testing device that performs rapid checkouts of complicated electronics circuits. It is employed widely in missile manufacturing and at electronic installations because it permits quick correction of equipment faults. Technicians become proficient in operating the Robotester after a short, intensive training period.

Quotas for initial Robotester classes, which are conducted on four consecutive days, have been filled. Interested Robotester users are requested to apply for participation in the classes at least 30 days in advance. For further information write: Lavoie Laboratories, Morganville, N.J.

One-Day Seminars

Industrial Education Institute Sponsors Seminar on Industrial Experimentation

Controlling and Reducing Costs of Industrial Experimentation is a two-day seminar sponsored

After completing, mail career form to *ELECTRONIC DESIGN*, 830 Third Avenue, New York, N. Y. Our Reader Service Department will forward copies to the companies you select below.

(Please print with a soft pencil or type.)

Name _____ Telephone _____

Home Address _____ City _____ Zone _____ State _____

Date of Birth _____ Place of Birth _____ Citizenship _____

Position Desired _____

Educational History				
College	Dates	Degree	Major	Honors

Recent Special Training _____

Employment History				
Company	City and State	Dates	Title	Engineering Specialty

Outstanding Engineering and Administrative Experience _____

Professional Societies _____

Published Articles _____

Minimum Salary Requirements (Optional) _____

Use section below instead of Reader Service Card. Do not write personal data below this line. This section will be detached before processing.

Circle Career Inquiry numbers of companies that interest you

900 901 902 903 904 905 906 907 908 909 910 911 912 913 914 915 916 917 918 919 920 921 922 923 924
925 926 927 928 929 930 931 932 933 934 935 936 937 938 939 940 941 942 943 944 945 946 947 948 949

Advancement Your Goal? Use CONFIDENTIAL Action Form

ELECTRONIC DESIGN's Confidential Career Inquiry Service helps engineers "sell" themselves to employers—as confidentially and discreetly as they would do in person. The service is fast. It is the first of its kind in the electronics field and is receiving high praise from personnel managers.

To present your job qualifications immediately to companies, simply fill in the attached resume.

Study the employment opportunity ads in this section. Then circle the numbers at the bottom of the form that correspond to the numbers of the ads that interest you.

ELECTRONIC DESIGN will act as your secretary, type neat duplicates of your application and send them to all companies you select—the same day the resume is received.

The standardized form permits personnel managers to inspect your qualifications rapidly. If they are interested, they will get in touch with you.

Painstaking procedures have been set up to ensure that your application receives complete, confidential protection. We take the following precautions:

- All forms are delivered unopened to one reliable specialist at *ELECTRONIC DESIGN*.
- Your form is kept confidential and is processed only by this specialist.
- The "circle number" portion of the form is detached before the application is sent to an employer, so that no company will know how many numbers you have circled.
- All original applications are placed in confidential files at *ELECTRONIC DESIGN*, and after a reasonable lapse of time, they are destroyed.

If you are seeking a new job, act now!

Electronic Engineers

for assignments
on APL's
satellite program



Research • Development Systems Engineering

You will find association with APL particularly rewarding if you appreciate an atmosphere conducive to original thinking, and if you are capable of making contributions to advance the state-of-the-art.

Satellite Development Group

The group is concerned with research and development of satellite-borne equipment, which will be capable of performing highly complex functions. The instruments have to operate in a space environment on exceedingly low power sources, and they have to work for five to ten years without malfunction.

Emphasis is on conceptual design rather than hardware fabrication. Engineers will work without close supervision, will enjoy freedom to create and investigate, and do not have to spend much time writing proposals. BS or more in physics or electronic engineering required. Two or more years of experience in transistor switching circuits and familiarity with utilization of memory and/or logical devices desired.

Satellite Ground Systems Group

This group is responsible for the design of data handling systems for use in shipboard and airborne navigational equipment, and for ground tracking equipment. Assignments involve development of novel and highly sophisticated data processing systems, systems coordination, and technical supervision of contractors.

BS or more in physics or electronic engineering plus four to five years of experience in data processing systems required.

For details about these career
opportunities, address your inquiry to:
Professional Staff Appointments

The Applied Physics Laboratory
The Johns Hopkins University

8649 Georgia Avenue, Silver Spring, Md.
(Suburb of Washington, D. C.)

CIRCLE 902 ON READER-SERVICE CARD

"Thanks To Cadillac

A Salary Increase of \$2,800.00
with a Company that's going places"

R.D.M. Electronic Engineer

This thank-you is typical of the hundreds of letters received from men placed in the electronics field through Cadillac Associates—the nation's largest electronics executive placement service.

For the man who wants challenging work and earnings reflecting his capabilities we are retained by the top 479 electronic firms (both "giants" and "comers"). Cadillac can therefore offer the greatest number of positions available at any given moment.

Our service is COMPLETELY CONFIDENTIAL and available to you ABSOLUTELY FREE OF CHARGE.

FREE—Monthly Opportunities Bulletin

If you wish to receive a monthly bulletin of the finest available electronic opportunities, simply send us your name and home address (and if you wish, a review of your qualifications)—Our services are without cost to you through our Chicago office and our Los Angeles subsidiary, Lon Barton Associates.



JACK L. HIGGINS Vice President

Cadillac Associates, Inc.

29 East Madison Bldg., Chicago 2, Illinois, Financial 6-9400

"Where More Electronic Executives Find Their Positions
Than Anywhere Else in The World"

CIRCLE 890 ON READER-SERVICE CARD

FIGHT HEART DISEASE

HELP YOUR HEART FUND—HELP YOUR HEART

ELECTRONIC DESIGN • December 21, 1960

CAREER COURSES

by the Industrial Education Institute. The seminar, first held in Boston on Dec. 5, is scheduled for Philadelphia on Jan. 9 and Jan. 10, 1961 at Hotel Sheraton Towers, and will end in Cleveland on Feb. 23 and Feb. 24 at Hotel Sheraton Cleveland.

Registration fee is \$100 per man less 10% discount for three or more men.

For further information and reservations write to: Industrial Education Institute, 221 Columbus Ave., Boston 16, Mass.

Controlling and Reducing Indirect Costs of Manufacturing Sponsored by IEI

The Industrial Education Institute is sponsoring a one-day seminar on Controlling and Reducing Indirect Costs of Manufacturing. The seminar started in Philadelphia on Nov. 9, 1960, and will be held in Baltimore Jan. 3, 1961 at Hotel Sheraton-Belvedere and in New York Jan. 11, 1961 at Hotel Park-Sheraton.

Registration fee is \$50 per man less 10% Team Discount for three or more men.

For further information and reservations write to: Industrial Education Institute, 221 Columbus Ave., Boston 16, Mass.

PAPER DEADLINES

Convention Program Chairmen have issued the following deadlines to authors wishing to have their papers considered for presentation.

Dec. 30: Deadline for papers on environmental investigations of space systems, missile and aircraft systems, together with supporting equipment. The National Meeting of the Institute of Environmental Sciences is to be held April 7, 1961 at the Sheraton-Park Hotel in Washington, D.C. Send papers to: *David Askin and John Sexton, Program Chairmen, Institute of Environmental Sciences, P.O. Box 191, Mount Prospect, Ill.*

Jan. 2: Deadline for abstracts for the Electrochemical Society Symposium to be held April 30 to May 4, 1961, at the Claypool Hotel in Indianapolis, Ind. Subjects include: electric insulation, electronics, electrothermics and metallurgy, industrial electrolytics and theoretical electrochemistry. Submit manuscripts in triplicate, underlining the name of the author who will present the paper, to: *Managing Editor of the Journal, The Electrochemical Society, 1860 Broadway, New York 23, N.Y.*

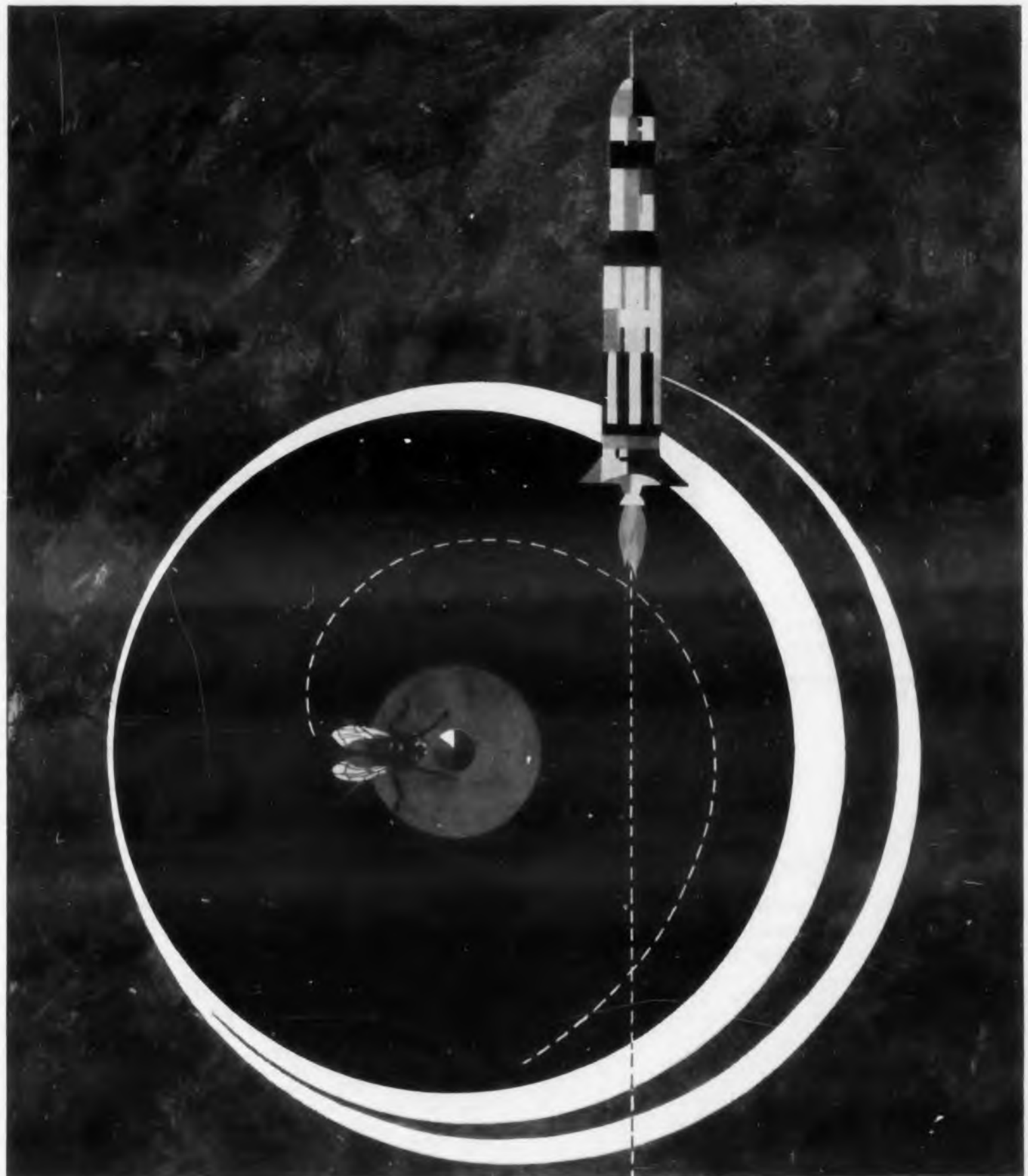

THANKS, MONSIEUR CORIOLIS, BUT WE PLAY IT STRAIGHT!

Your theory is a little complicated for us. Rather than work in rotating coordinates and compensate for your famous acceleration, we avoid the problem. Our guidance system platforms are stabilized in inertial space instead of rotating Earth space. The result is simpler guidance system computations for missiles like Titan. If you are challenged by reducing classic theory to practical hardware, and have a BS, MS or PhD in Physics, ME, EE, or Math, please contact Mr. C. G. Allen, Director of Scientific and Professional Employment, 7929 S. Howell, Milwaukee 1, Wisconsin.

AC SPARK PLUG ⚡ THE ELECTRONICS DIVISION OF GENERAL MOTORS



CIRCLE 903 ON READER-SERVICE CARD

looking for a product?



Diodes

See also Rectifiers, Tubes
CRYSTAL: all-glass diodes designed for military and commercial electronic applications; Sylvania Electric Products, Inc. ED 6:70 Write In 906.

1 - 1:7:59	4 - 2:18:59	7 - 4:1:59
2 - 1:21:59	5 - 3:4:59	8 - 4:15:59
3 - 2:4:59	6 - 3:18:59	9 - 4:29:59



reach for EDC'S PRODUCT LOCATOR

It's easy to use the "Product Locator" (Section I of EDC). Here's how it works:

1. *Products are described alphabetically* by major product category from **Abrasives** to **Yokes**. Each category is further sub-divided from **A** to **Z** by type. For example: sub-listings for **Diodes** range from "CO-AXIAL" to "ZENER."
2. *Check the code numbers* that follow each listing. "More data in catalog section" means that you can find more catalog data about this product in Section II of EDC. Look for it *alphabetically by manufacturer's name*.

In the example shown at left, "DIODES, CRYSTAL," code numbers follow which read:

"ED 6:70—Write In 906"

The "ED 6:70" means this product was reviewed in the 6th issue of *Electronic Design* on page 70.*

The "Write In 906," is the number to fill in on EDC's Reader Inquiry Card if you want the manufacturer to mail you more information on this product.

EDC is designed to be of service to you. The more you use EDC, the more information manufacturers will place in EDC. EDC will welcome your constructive comments and suggestions.

*You can find the exact date of issue by referring to the key which is repeated on the bottom of each page of the locator. In this case, March 18, 1959.

*the industry's basic information
and reference source*

ADVERTISERS' INDEX

December 21, 1960

Advertiser	Page
AMP, Incorporated	126
Aerospace Corporation	155
Airpax Electronics, Inc.	142
Allegheny Ludlum Steel Corporation	51, 124
*Allied Control Company, Inc.	92
*Alpha Wire Corp.	137
American Bosch Arma Corp.	88
American Time Products, Inc.	46
*Amperex Electronic Corporation	75
*Arnold Engineering Company, The	35
*Baird-Atomic, Inc.	149
Becco Chemical Div., Food Machinery & Chemical Corp.	70
*Behlman Engineering Co.	27
Bendix Aviation Corporation, Eclipse Pioneer Components Div.	50
Biley Electric Co.	132
Boehme, Inc., H. O.	140
Borg Equipment Div., Amphenol-Borg Electronics Corp.	56
*Bourns, Inc.	39, 47, 55
Bowmar Instrument Corp.	138
Bristol Co., The	23
Britton Electronics Corp.	141
Bulova Electronics Div.	7
Burnell & Co., Inc.	34
Burroughs Corp.	42, 43
Cadillac Associates, Inc.	152
California Technical Industries	144
Canoga Electronics Corp.	3
Capitron Div. of AMP, Incorporated	117
Carborundum Co., The	85
Centralab, The Electronics Div. of Globe-Union, Inc.	54
*Clarostat Mfg. Co., Inc.	15
*Clevite Transistor, A Div. of Clevite Corp.	132 A-B
*Clifton Precision Products Co., Inc.	Cover II
Consolidated Avionics Corp.	145
Continental Diamond Fibre	78
Cornell-Dubilier Electric Div.	52, 53
Corning Glass Works	96
*Curtiss-Wright Corp.	58
Delco Radio, Div. of General Motors Corp.	103, 150
Dimco-Gray Co.	141
*Dow Corning Corp.	68, 69
*Du Mont Laboratories, Allen B.	17
DuPont, de Nemours & Co., E. I., Ceramic Products Div.	146
DuPont de Nemours & Co., E. I., Photo Products Dept.	129
*Dynamics Instrumentation Co.	136
*ESC Electronics Corporation	45
Eastman Kodak Co.	137
Eitel-McCullough, Inc.	119
Elastic Stop Nut Corp. of America	128
Elco Corporation	125
Electrical Industries	83
Electronic Designers' Catalog	154
Engineered Electronics Co.	12
Epsco Instruments	123
*Fairchild Semiconductor Corp.	13
Fansteel Metallurgical Corp.	76, 77
*Fluke Mfg. Co., Inc., John	6
G-C Electronics Co.	140
Gamewell Co., The	93
General Ceramics	104
General Electric Company, Magnetic Metal Section	66

*Manufacturers' catalog, appears in 1960-1961 ELECTRONIC DESIGNERS' CATALOG