

ELECTRONIC DESIGN

OCTOBER 1968

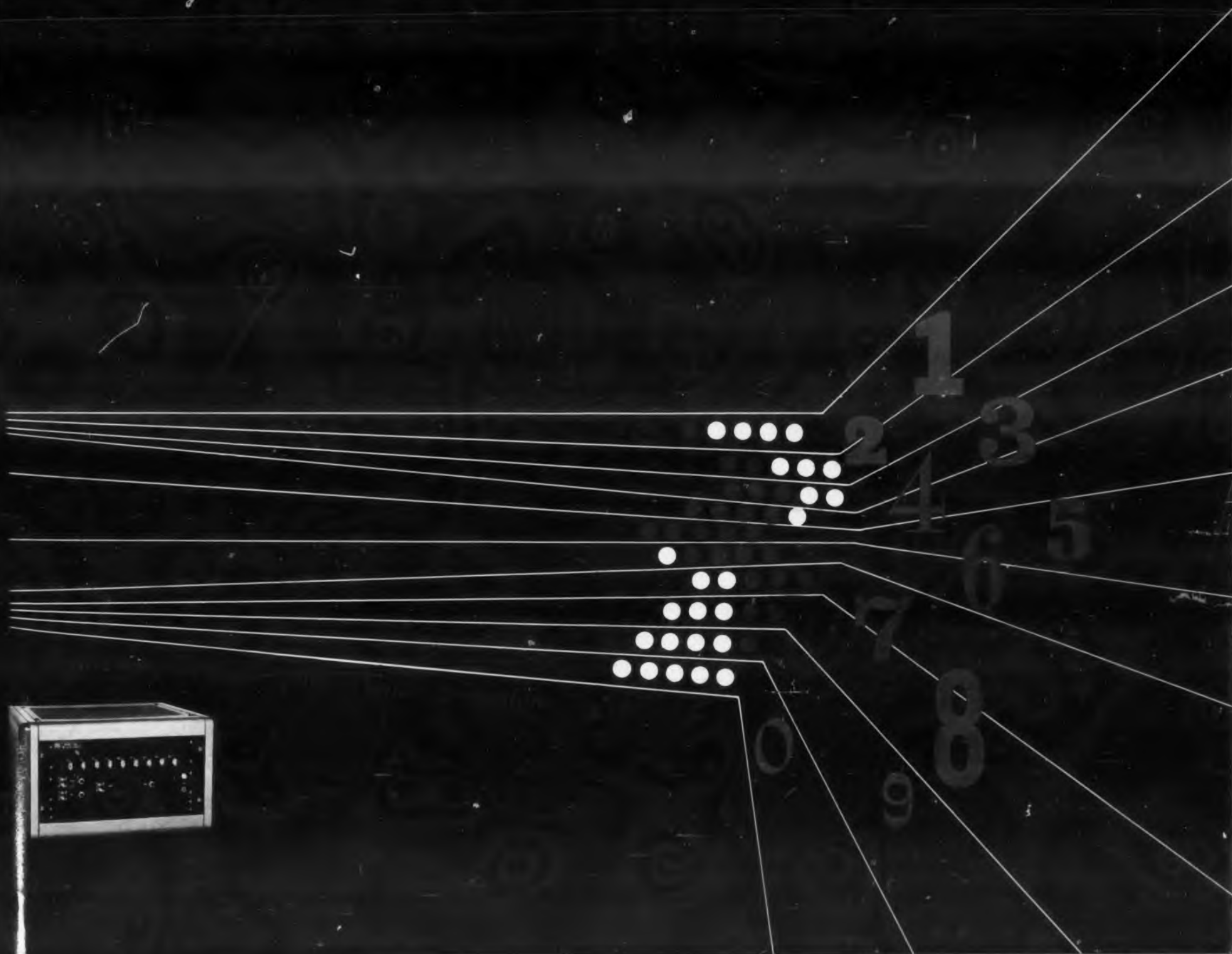

GIVE YOUR PRODUCTS MORE RELIABILITY AND BETTER PERFORMANCE WITH

FREED QUALITY

Ruggedized, MIL STANDARD POWER & FILAMENT TRANSFORMERS

Primary 105/115/125 V 50-60~

| Cat. No. | Appl. | MIL Std. | MIL Type |
|----------|--------------|----------|--------------|
| MGP 1 | Plate & Fil. | 90026 | TF4RX03HA001 |
| MGP 2 | Plate & Fil. | 90027 | TF4RX03JB002 |
| MGP 3 | Plate & Fil. | 90028 | TF4RX03KB006 |
| MGP 4 | Plate & Fil. | 90029 | TF4RX03LB003 |
| MGP 5 | Plate & Fil. | 90030 | TF4RX03MB004 |
| MGP 6 | Plate | 90031 | TF4RX02KB001 |
| MGP 7 | Plate | 90032 | TF4RX02LB002 |
| MGP 8 | Plate | 90036 | TF4RX02NB003 |
| MGF 1 | Filament | 90016 | TF4RX01EB002 |
| MGF 2 | Filament | 90017 | TF4RX01GB003 |
| MGF 3 | Filament | 90018 | TF4RX01FB004 |
| MGF 4 | Filament | 90019 | TF4RX01HB005 |
| MGF 5 | Filament | 90020 | TF4RX01FB006 |
| MGF 6 | Filament | 90021 | TF4RX01GB007 |
| MGF 7 | Filament | 90022 | TF4RX01JB008 |
| MGF 8 | Filament | 90023 | TF4RX01KB009 |
| MGF 9 | Filament | 90024 | TF4RX01JB012 |
| MGF 10 | Filament | 90025 | TF4RX01KB013 |

MAGNETIC AMPLIFIERS

- Hermetically Sealed To MIL Specifications
- No Tubes
- Direct Operation from Line Voltage
- Fast Response
- Long Life Trouble Free Operation
- Phase Reversible Output

Power Gain 2 x 10⁴



Transistor Preamp. MAT-1 Wt. 10 oz.
Mag. Amp. MAF-5 Wt. 18 oz.
Motor

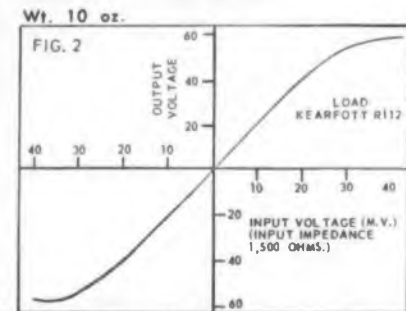

TOROIDAL INDUCTORS

- MIL Grade 4 — Metal Case
- MIL Grade 5 — Molded
- Uncased Units
- Highest Q
- Highest self-resonant freq.
- Low temperature coefficient
- No hum pickup-astatic construction
- Can be supplied with center taps



FREQUENCY RANGE: 500CP TO 15KC

| Type | Max Q | Inductance Range |
|-------|-------|------------------|
| TI-11 | 290 | 1MH to 50Hy |
| TI-12 | 255 | 1MH to 30Hy |
| TI-1A | 250 | 1MH to 30Hy |
| TI-1 | 210 | 5MH to 20Hy |
| TI-4 | 195 | 5MH to 5Hy |
| TI-5 | 130 | 5MH to 2Hy |
| TI-16 | 72 | 1MH to 2Hy |

FREQUENCY RANGE: 10KC TO 50KC

| Type | Max Q | Inductance Range |
|-------|-------|------------------|
| TI-13 | 303 | 1MH to 500MH |
| TI-2 | 285 | 1MH to 500MH |
| TI-6 | 279 | 1MH to 400MH |
| TI-7 | 200 | .500MH to 200MH |
| TI-17 | 110 | .100MH to 100MH |

FREQUENCY RANGE: 30KC TO 200KC

| Type | Max Q | Inductance Range |
|-------|-------|------------------|
| TI-18 | 115 | .1MH to 100MH |
| TI-8 | 140 | .1MH to 100MH |
| TI-10 | 185 | 1MH to 200MH |
| TI-9 | 175 | 1MH to 500MH |
| TI-19 | 100 | .1MH to 5MH |
| TI-3 | 260 | .1MH to 10MH |
| TI-3A | 310 | 10MH to 100MH |

HIGH FREQUENCY TOROIDAL INDUCTORS

FREQUENCY RANGE: 20KC TO 10MC

| Type | Max Q | Inductance Range |
|-------|-------|------------------|
| TI-21 | 205 | .010MH to .150MH |
| TI-22 | 250 | .010MH to .700MH |
| TI-23 | 210 | .010MH to .500MH |
| TI-20 | 305 | .050MH to 5MH |

FREED QUALITY INSTRUMENTS FOR PRECISION LABORATORY TESTING



- Inductance: 1 Millihenry to 1000 Henry
- Maximum Direct Current: 1 Ampere



- Variable DC test voltage: 50 to 1000 volts
- Resistance range: .1 megohm to 4,000,000 megohms

- Maximum power efficiency and optimum pulse performance.
- For use in blocking oscillator, interstage coupling and low level output circuits.
- Ruggedized construction — Grade 4.
- Series or parallel connection of windings for optimum turns ratio.



| Cat. No. | MIL Type | Pulse Voltage Kivolts | Char. Imp. Ohms |
|----------|-----------|-----------------------|-----------------|
| MPT-1 | TF4RX35YY | 0.25/0.25/0.25 | 250 |
| MPT-2 | TF4RX35YY | 0.25/0.25 | 250 |
| MPT-3 | TF4RX35YY | 0.5/0.5/0.5 | 250 |
| MPT-4 | TF4RX35YY | 0.5/0.5 | 250 |
| MPT-5 | TF4RX35YY | 0.5/0.5/0.5 | 500 |
| MPT-6 | TF4RX35YY | 0.5/0.5 | 500 |
| MPT-7 | TF4RX35YY | 0.7/0.7/0.7 | 200 |
| MPT-8 | TF4RX35YY | 0.7/0.7 | 200 |
| MPT-9 | TF4RX35YY | 1.0/1.0/1.0 | 200 |
| MPT-10 | TF4RX35YY | 1.0/1.0 | 200 |
| MPT-11 | TF4RX35YY | 1.0/1.0/1.0 | 500 |
| MPT-12 | TF4RX35YY | 0.15/0.15/0.3/0.3 | 700 |

NEW HERMETICALLY SEALED CONSTANT VOLTAGE TRANSFORMERS.

- Meets Military Specifications
- No Tubes
- No Moving Parts
- Accurate Regulations
- Fast Response
- Fully Automatic



Here at last is a hermetically sealed magnetic voltage regulator that will provide constant output voltage regardless of line and/or load changes.

| SUPPLIED EITHER MIL. OR COMMERCIAL | | | | |
|------------------------------------|-------------|------------|--------------|------------|
| CAT. # | INPUT VOLT. | LINE FREQ. | OUTPUT VOLT. | OUTPUT VA. |
| MCV-620L | 95-130 v | 60 cps. | 115 | 20 |
| MCV-670L | 95-130 v | 60 cps. | 115 | 70 |
| MCV-6130L | 95-130 v | 60 cps. | 115 | 130 |
| MCV-670F | 95-130 v | 60 cps. | 6.4 | 70 |
| MCV-6130F | 95-130 v | 60 cps. | 6.4 | 130 |
| MCV-420F | 95-130 v | 400 cps. | 6.4 | 20 |

Send for NEW TRANSFORMER AND INSTRUMENT CATALOGS

FREED TRANSFORMER CO., INC.

1727 Weirfield Street Brooklyn (Ridgewood) 27, New York

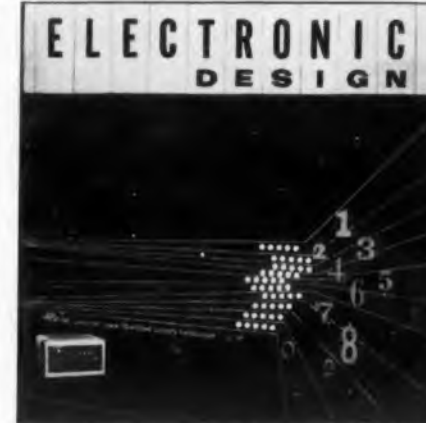

COVER: In a conventional four-binary decimal counting unit, the input binary must operate at the maximum frequency of the instrument. But the new 100-mc counter shown on the cover requires no binary to operate at more than one-fifth the maximum frequency of the unit. This is permitted by the device's novel binary circuitry, which employs a gating technique based on five binaries rather than four. The cover drawing symbolizes the digital values assigned by the five binaries. For the story on the counter, turn to p 58.

Selected Topics In This Issue

Circuit Techniques

- Simple Device for Recovering Low-Frequency Data from Magnetic Tape 40
- A Suggestion for a Standard Method of Measuring Intermodulation Distortion 42
- Summing-Core Logic Yields Digital-Circuit Flexibility 46

Microwaves

- TWT's Have Come a Long Way Toward Environmental Insensitivity 54
- Bitermitron Provides Two-Terminal M-Type BWO 60

Test Equipment

- Test Equipment: Types and Characteristics
- Part 1: Analog Meters 46
- 100-Mc Solid-State Gated Counter 58
- Unmatched Flexibility Claimed for PCM Signal Simulator 64

Sidelights of the Issue

Men in Motion

October means rustling leaves and backyards filled with smoke. It also means rustling papers and hospitality suites filled with smoke. By rough count, the month will see some 34 electronics meetings, and at a considerable number of these, *ELECTRONIC DESIGN* engineers will be in attendance.

These meetings, which range from Anaheim to Cambridge and cover everything from hi-fi to high flight, are grist for our mill. Our editors fan out from New York and Los Angeles to cover them and the results can largely be seen in our News Department. At some, of course, they don't find stories, but they usually manage to find leads for stories.

In the month of August, which is generally a time of vacations, we covered six major meetings, including fielding a squad of seven editors for the big doings at WESCON. In addition to this, our editors managed to get in 37 visits to electronics plants, bringing the total number of plants visited to 247 since the beginning of the year.

These plant visits are just as important to *ELECTRONIC DESIGN* as are the meetings. From them come ideas for by-line pieces by engineers and ideas for News and other special features.

By sending our editors out into the field to talk to the men who are doing the work, we best serve the industry.

Job Insecurity

The other day, an engineer not without experience in job-hunting, put the whole recruiting business in a nutshell. "In a job interview," he said, "you sit around and tell lies about all your experience; the interviewer tells lies about how wonderful the job is—and then you sit and argue salary."

A bit less cynical and considerably more helpful is Richard Haitch's article in this issue's "Designing Your Future" section. Entitled "Are You Conscious or Unconscious When You Choose an Engineering Job?" the article shows that engineers are too often both, and offers some hints on how best to sell your experience and also how best to find out some necessary details about your prospective employer.

hp 456A AC CURRENT PROBE

Converts ac current to
ac voltage directly
(1 amp = 1 volt)
for reading on your
scope or voltmeter



Just clamp around
and read:



Tube circuits view current on your scope or measure it with a VTVM

Transistor circuits measure small signals dynamically, without clipping leads or circuit loading; study diodes at breakdown

Logic circuits measure ac current in presence of dc current

Impedance measuring . . . with a dual-channel scope, measure current, voltage magnitude; phase angle

Power measuring with dual-channel scope read current, voltage directly, calculate power

Frequency counting use 456A with counter for clip-on frequency access

And, how about these? . . . phase comparisons of ac carrier waveforms; instrument fuse current ratings; cable identification, response of magnetic cores; magnetic field sensing; silicon rectifier peak currents

SPECIFICATIONS

Sensitivity: 1 mv/ma $\pm 1\%$ at 1 KC
Frequency Response: $\pm 2\%$, 100 cps to 3 MC
 $\pm 5\%$, 60 cps to 4 MC
— 3 db at 25 cps and above 20 MC
Maximum Input: 1 amp rms; 1.5 amp peak.
100 ma rms above 5 MC
Maximum dc current: Dc up to 0.5 amp has no appreciable effect
Input Impedance: Probe adds to test circuit only approx. 0.05 ohms in series with 0.05 μ h
Equivalent Input Noise: Less than 50 μ a rms (100 μ a ac powered)
Power: 10 radio mercury cells; approx. 400 hours service normally supplied. Ac supply available
Size: 5" wide, 1 1/2" high, 6" deep, weight 3 lbs.
Price: \$190.00; for ac operation \$210.00.
hp 456-95A ac supply for field installation \$32.00
Data subject to change without notice
Prices F.O.B. Factory

Just clamp the Φ 456A probe around a wire under test and view or read ac current directly on an indicating device. Model 456A's 1 mv to 1 ma unity conversion permits direct readings up to 1 ampere rms. The instrument's wide bandwidth permits use with oscilloscopes to view complex current waveforms with rise times to 0.017 μ sec. No direct circuit connection is required; there is no loading, no appreciable impedance change in the circuit under test, and the impedance of the test circuit is immaterial.

HEWLETT-PACKARD COMPANY

1028K Page Mill Road, Palo Alto, California, U. S. A.
Cable "HEWPACK" • Davenport 5-4451



HEWLETT-PACKARD S. A.

Rue du Vieux Billard No. 1, Geneva, Switzerland
Cable "HEWPACKSA" • Tel. No. (022) 28. 43. 36



offers almost 400 precision test instruments



photo courtesy Sippican Corp.

Take the big step to reliability through the miracle of electronic welding. Your component packaging can benefit from these five proven advantages:

- SIZE AND WEIGHT REDUCTION
- INCREASED RELIABILITY
- GREATER STRENGTH
- EXACT REPEATABILITY
- LOWER PRODUCTION COSTS



Solder Joint



Weldmatic Joint

The reason is revealed in the joint. Compare these tinned copper-wire resistor leads, welded and soldered, each magnified 50 times. In the solder joint, resistance is created through plating on the surface and through the addition of solder. Note the poor connection. In the Weldmatic welded joint, you can see complete fusion of the parent metals. This welded joint is stronger than the parent metals, has excellent conductivity, and can be produced without operator skill.

Ask Weldmatic for a free sample weld evaluation... you'll receive the best in current technical knowledge.

WELDMATIC DIVISION

UNITEK

950 Royal Oaks Dr., Monrovia, Calif.

CIRCLE 3 ON READER-SERVICE CARD

| | |
|---|-----|
| Let's Look at the Assumptions | 35 |
| An Editorial | |
| All-Pass Networks—Part 1: The Anatomy of Networks | 36 |
| Analyzing non-attenuating, phase-shift networks. First article in a series on their application to improving transient response of other networks—Y. J. Lubkin | |
| A Simple Technique for Recovering Low-Frequency Data from Magnetic Tape | 40 |
| Superimposing dc pulses on the tape permits standard playback heads to extract data recorded with dc or low frequencies—J. L. Janning | |
| A Suggestion for a Standard Method of Measuring Intermodulation Distortion | 42 |
| A simple substitution technique compares distortion voltage to equivalent voltage at specified frequencies—H. F. Spierer, D. E. MacLaughlin | |
| Test Equipment: Types and Characteristics—Part 1: Analog Meters | 46 |
| A survey and tabulation of the various meters and how they respond to signals—A. J. Reynolds | |
| Summing-Core Logic Yields Digital-Circuit Flexibility | 48 |
| A technique which imbues conventional cores with unusual circuit flexibility—R. Wasserman | |
| Thermal Resistance Determines Power Safely Dissipated at a Collector Junction | 52 |
| If thermal resistance between collector junction and ambient medium is too high, rated power will not be dissipated without excessive heating—C. Weber | |
| TWT's Have Come a Long Way Toward Environmental Insensitivity | 54 |
| Magnetic compensation and other solid design schemes have reduced adverse effects on TWT's of changes in ambient conditions—J. Posner | |
| 100-Mc Solid-State Gated Counter | 58 |
| This counter-timer uses a new decimal counting logic | |
| Bitermitron Provides Two-Terminal M-Type BWO | 60 |
| This device extends usefulness of M-type, backward-wave oscillator by providing 2-terminal access | |
| Unmatched Flexibility Claimed For PCM Signal Simulator | 64 |
| This unit simulates the digital output of an airborne or ground multiplexer and digitizer for calibration and checkout use | |
| Universal Test Station Handles Many Components, Provides Savings .. | 64 |
| By means of a specially prepared tape, it even tests itself | |
| Are You Conscious or Unconscious When You Choose an Engineering Job? | 222 |
| A psychological study suggests you are both. Here are concrete suggestions that more than a subconscious opinion dictates your choice of a new employer and a new job—R. Haitch | |
| ELECTRONIC DESIGN Engineering Data | 183 |
| Approximate Radar Range Equation Causes Errors in Low-Noise System Calculations—L. D. Smith | |

| | | |
|-----|--|-----|
| 35 | ELECTRONIC DESIGN News | 4 |
| | ISA Meeting Stresses Electronics in Process Control | 4 |
| | Bell Labs Announces Optical Maser | 4 |
| 36 | Airborne Radio Refractometer Tracks Missiles | 8 |
| | Russia Seen No. 2 Computer-Maker by '65 | 12 |
| | Reader Scans 10,000 Envelopes an Hour | 14 |
| | Sixth Communications Symposium Is Largest Ever | 20 |
| | U. K. Electronic Exports to U. S. Down \$2 Million From Last Year | 25 |
| | Airborne IR Seeker-Tracker Nears Completion | 26 |
| 40 | New GlobCom System To Use Orbital Scatter | 30 |
| | Design Decisions | 180 |
| | Input Signal Squared and Averaged in RMS Reading DVM | 180 |
| | Plastic Models Facilitate Equipment Design | 182 |
| 42 | Reliability Enhanced by Assuming Majority of Computers Is Right | 182 |
| | Ideas For Design | 200 |
| | Four-Resistor Decade Was Improved Upon | 200 |
| 46 | Low-Impedance Transistor Circuit Drives Coaxial Line | 201 |
| | Russian Translations | 208 |
| | Designing Electronic Relays | 208 |
| 48 | German Abstracts | 214 |
| | Twin Tee Filters | 214 |
| | ELECTRONIC DESIGN Digests | 216 |
| 52 | Electrostatic and Magnetic-Drum Storage Combined in 2,000-Channel Analyzer | 216 |
| | Designing 175-Mc Amplifier Using Silicone Mesa Transistors | 218 |
| 54 | Washington Report | 22 |
| | New Products | 62 |
| 58 | Production Products | 176 |
| 60 | Services For Designers | 178 |
| 64 | New Literature | 185 |
| | Patents | 202 |
| | Books | 206 |
| 64 | Report Briefs | 220 |
| | Careers | 222 |
| 222 | Advertiser's Index | 228 |



ELECTRONIC DESIGN is published bi-weekly by Hayden Publishing Company, Inc., 830 Third Avenue, New York 22, N. Y., Richard Gascoigne, Chairman of the Board; James S. Mulholland, Jr., President; Robert E. Ahrensdorf, Publisher. Printed at Hildreth Press, Bristol, Conn. Accepted as controlled circulation at Bristol, Conn. Additional entry, New York, N. Y. Copyright © Hayden Publishing Company, Inc., 1960, 37,100 copies this issue.

SPECIAL OR STOCK SPECIFY

MICROTRAN[®]

miniature TRANSFORMERS
...with confidence

from stock!

TRANSISTOR DRIVER
Designed specifically for transistor, servo and audio
Frequency response 70-20K
Size AF null through AH hermetically sealed to MIL-T-27A

LOW LEVEL CHOPPER
Efficiently transfers 30 to 500 cps. Transducer or thermocouple signals to instrument amplifiers. Signal level range from 5V to 5 millivolts. Resin impregnated to minimize mechanical vibrations noise signal. Low hum pickup assured by 3 mu metal and 2 copper shields.

DC-DC CONVERTER
All items designed for 110V except 8034 which is for 28V input
TYPICAL DC-DC CONVERTER CIRCUIT

SILICON RECTIFIER Power Supply
Circuitry Primary 105/115/125 Volts**
Hermetic, sealed to MIL-T-27A
See Catalog for additional information.

MINIATURE TRANSISTOR
Available in 8 case types.
Hermetic 10 1/2" x 1 1/2" x 1 1/2" WT 1 1/2 oz
Model 10 1/2" x 1 1/2" x 1 1/2" WT 1 1/2 oz
Open Frame 7 1/2" x 1 1/2" x 1 1/2" WT 1 oz

| Part Number | Application | Pr. Imp. | Sec. Imp. |
|-------------|-------------|----------|-----------|
| 100 | 100 | 100 | 100 |

VERI-MINIATURE TRANSISTOR
Open 1/2" x 1/2" x 1/2" or size 1/2" x 1/2" x 1/2"
Frame 1/2" x 1/2" x 1/2" or size 1/2" x 1/2" x 1/2"
Model 1/2" x 1/2" x 1/2" or size 1/2" x 1/2" x 1/2"
4 color coded leads, resin impregnated

| Part Number | Application | Primary Impedance (DC) | Secondary Impedance (DC) |
|-------------|-------------|------------------------|--------------------------|
| 100 | 100 | 100 | 100 |

Write for NEW 1961 Catalog NOW available.

MICROTRAN Co., Inc.
145 E. Mineola Ave.
Valley Stream, N. Y.

*no waiting
no delays
no hedging on delivery*

CIRCLE 4 ON READER-SERVICE CARD

Bell Optical Maser Transmits Light 25 Miles

*Unmodulated Signal Transmitted at 20 W Lights 200-Ft Circle;
High Coherence and Monochromaticity Are Also Reported*

AN OPTICAL maser has been successfully used in long-distance communication experiments by the Bell Telephone Laboratories with pulses of coherent light transmitted over a 25-mi line-of-sight path between laboratories at Holmdel and Murray Hill, N.J. Red light generated by a "brute force" ruby maser at Holmdel was visible to the naked eye at Murray Hill and was detected electrically by photomultiplier tubes. The beam angle of 0.1 deg illuminated a circle of only 200 ft diam at Murray Hill. According to BTL scientists, a searchlight of equal directivity would require a 500-ft mirror.

Experiments have also been conducted in which the maser beam was transmitted through a quarter mile of 2 in. diam helical, wire-wound waveguide. The interior of the waveguide was not optically reflective and the transmission was again over a line of sight path. However, transmission along a curved path should be possible with a highly polished circular waveguide, a BTL researcher told ELECTRONIC DESIGN.

The maser employed in these tests is similar

to the type recently disclosed by the Hughes Research Laboratories. Chromium ions in a ruby cylinder are raised to a higher energy level by intense optical pumping (the so-called "brute force" approach). Their return to the base energy level generates light of a lower frequency than that of the pumping light. Although this process resembles the natural fluorescent action in ruby, maser output is ideally highly monochromatic, coherent, and directional. These properties would make the optical maser extremely attractive as a communications device and a number of companies are actively pursuing maser development with an eye on optical radar and space communication uses (*ED*, Aug. 3, p 14).

Development Surpasses Expectations

Although this optical maser essentially confirms the work of Dr. Theodore H. Maiman at Hughes, the BTL research group headed by Dr. Arthur L. Schawlow has reached some encouraging conclusions not heretofore apparent. At

the time of the Hughes disclosure, many scientists doubted that a ruby maser could achieve the coherence and monochromaticity theoretically possible. In the Bell and Hughes masers a ruby cylinder, silver-plated at both ends, acts as a Fabry-Perot interferometer to reinforce the light output along the axis of the cylinder. It was anticipated, however, that internal reflections from the cylinder walls would also be reinforced and reduce the coherence of the output. A number of schemes to reduce internal reflections were accordingly proposed.

The experiments at Bell indicate that internal reflections are actually less intense than expected. Dr. Schawlow attributes this to the fact that the side-wall propagation modes have a much lower Q than the desired axial mode.

The coherence of the Bell maser was confirmed by a classic, double-slit diffraction experiment. Light emitted from two fine, parallel slits in the silver coating at one end of the ruby formed interference patterns indicative of a coherent source. The light output centering on

ISA Stresses Electronics in Process Control

*Papers Cover Field from Strain Gages to Adaptive Systems;
New Companies Provide Some Surprises at New York Meeting*

THE GROWING importance of electronics in process control was strongly emphasized by exhibits and technical sessions at the Instrument Society of America's Instrument-Automation Conference held recently in New York. Displays at the Coliseum ranged from digital computers for process control to ultraviolet-sensitive flame detectors. At the technical sessions, the role of electronics in instrumentation was also evident with papers covering the field from strain gages and pyrometers to nuclear reactor controls and adaptive systems.

Although the exhibits included the usual assortment of valves, pumps, compressors, and other mechanical hardware, this year's show set

a record for the variety and quantity of electronic devices on display. Flowmeters, sensors, controllers, analyzers, and recorders—all using electronic circuitry either directly or indirectly—were among the many devices offered by the more than 300 exhibitors at the show.

New Companies Bring New Products

Old-line instrumentation manufacturers were seen continuing their move to electronic systems, but much of what was new and interesting came from new companies or from manufacturers beginning to diversify into this field.

New devices shown this year include:

- Ultraviolet-sensitive flame detectors—Min-

neapolis-Honeywell and Thomas A. Edison, Inc. (The M-H unit is being promoted under the unlikely name of "Purple Peeper.")

- Gyroscopic mass flowmeters—Decker Corp. and General Electric.

- Analog converter-recorder — Mmemotron Corp.

- Tuning fork-controlled synchronous motor—Hathaway Instruments.

Process-control computers, both analog and digital, were shown by more than 20 manufacturers, among them Librascope's Libratrol 1000 solid-state digital computer.

The increasingly common practice of tie-ins

(continued on p 6)



Monochromaticity of ruby maser was determined in this diffraction experiment. Dr. Arthur L. Schawlow (left) watches as C. G. B. Garrett inserts ruby cylinder into flash lamp. Camera at right photographs interference patterns.

6943 Å is 60 times narrower than the natural fluorescent line of ruby. This is said to be an improvement over the results obtained by Hughes, though a further reduction by a factor of 10 is needed to reach the theoretical limit of coherence.

Another unusual effect observed in the Bell maser is the pulsed nature of the output. Because of the flash lamp used for optical pumping, maser action is sustained for only 1 msec at a time. Within this interval, however, the output is emitted in short, intense bursts on the order of one microsecond each. The pulses occur at 5- to 10- μ sec intervals with the rate generally shortening as the pumping intensity is increased. This effect is thought to be analogous to the operation of a conventional blocking oscillator. Average output of the maser is approximately 20 w.

Signals Not Modulated

The signals transmitted in the communication experiments were not modulated in any way. While it is possible to transmit information by means of simple pulses, practical application of the optical maser requires a continuously operating device and a means of modulating the signal. Traveling wave-type masers have been proposed and are reportedly in development by several organizations, including Bell Labs.

The group working with Dr. Schawlow includes R. J. Collins, D. F. Nelson, W. L. Bond, C. G. B. Garrett and W. K. Kaiser. A separate team at Bell Labs is currently working on gas optical masers while the Schawlow group is concentrating on ruby and other solids including lanthanum chloride doped with samarium or europium and other unspecified rare earth chlorides. W. S. Boyle was in charge of the communication experiments reported here. ■ ■

CIRCLE 5 ON READER-SERVICE CARD ▶

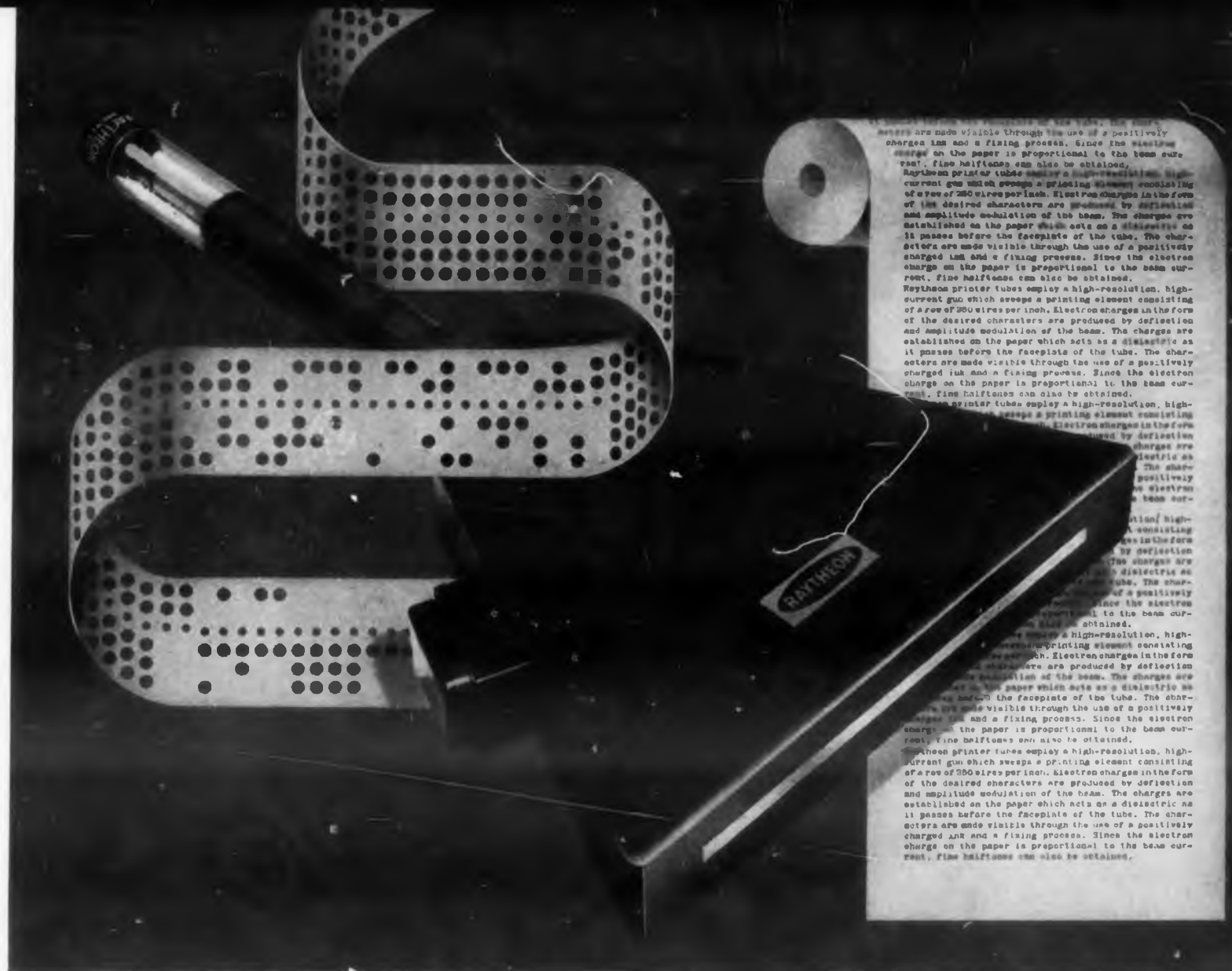

New Raytheon Cathode Ray Printer Tubes Print as Fast as Computers Think!

Raytheon cathode ray printer tubes now make possible the design of extremely high speed electronic printing equipment capable of printing 20,000 characters per second — or over 10,000 lines of computer information per minute — fast enough to keep pace with the output of modern computers.

These new tubes bring into focus a host of amazing new applications. Instant coast-to-coast transmission of mail — continuous photographic recording of freight traffic movement — incredibly fast printing of labels, or facsimile data — these are just a few examples.

Four developmental Raytheon printer tubes, the CK 1366 and CK 1368 with single row printing elements and the forty row CK 1367 and CK 1369, are available for producing writing widths of approximately 2¾ and 8½ inches. For complete technical data and design assistance, please write to: Raytheon, Industrial Components Division, 55 Chapel St., Newton 58, Mass.

RAYTHEON COMPANY

INDUSTRIAL COMPONENTS DIVISION

HOW IT WORKS. Raytheon printer tubes employ a high-resolution, high-current gun which sweeps a printing element consisting of a row of 250 wires per inch. Electron charges in the form of the desired characters are produced by deflection and amplitude modulation of the beam. The charges are established on the paper which acts as a dielectric as it passes before the faceplate of the tube. The characters are made visible through the use of a positively charged ink and a fixing process. Since the electron charge on the paper is proportional to the beam current, fine halftones can also be obtained.

RAYTHEON

10 Mc COUNTER

does everything without plug-ins



MODEL 7570

8 3/4"

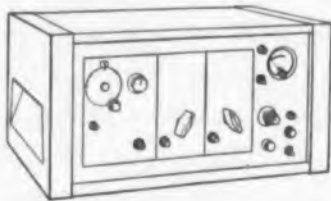
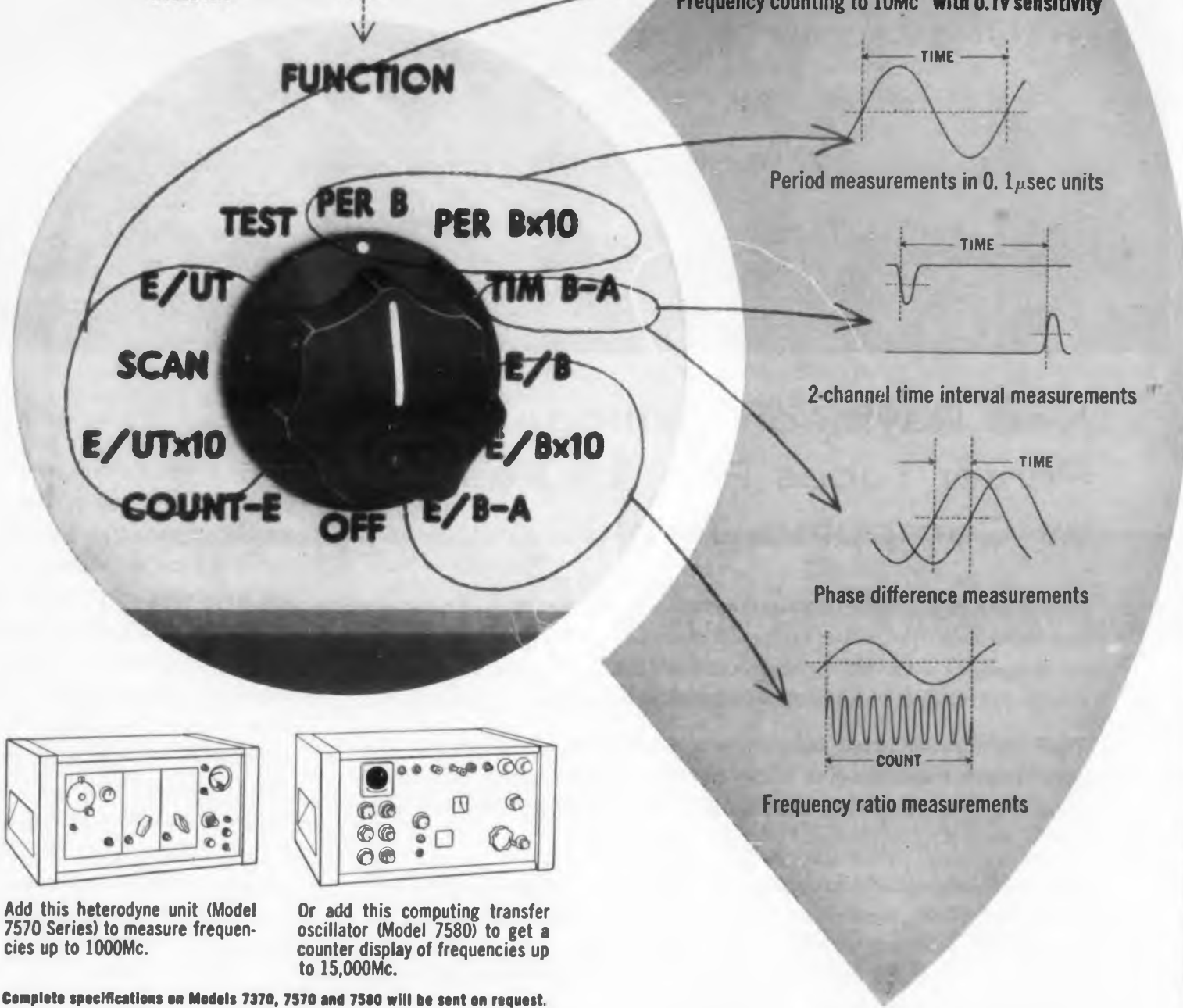

Add this heterodyne unit (Model 7570 Series) to measure frequencies up to 1000Mc.

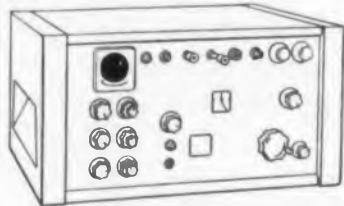

Or add this computing transfer oscillator (Model 7580) to get a counter display of frequencies up to 15,000Mc.

Complete specifications on Models 7370, 7570 and 7580 will be sent on request.



Beckman

Berkeley Division
2200 Wright Avenue, Richmond 3, California
a division of Beckman Instruments, Inc.

CIRCLE 6 ON READER-SERVICE CARD

NEWS

(continued from p 4)

between computer and instrument manufacturers (such as RCA-Foxboro and Philco-Leeds & Northrup, came in for some criticism by those attending the show. One top ISA officer told ELECTRONIC DESIGN that the systems provided by such working arrangements were not altogether satisfactory to the larger users of automated process control equipment. These larger buyers generally have their own applications engineering staffs and prefer to keep system design work in-house rather than purchase "ready-to-wear" automation. On the other hand, it was agreed that smaller customers, unable to design their own equipment, would continue to benefit from the availability of integrated systems resulting from these working arrangements.

Auerbach Predicts Simplified Controls

In his keynote speech at ISA's data handling workshop, I. L. Auerbach, president of Auerbach Electronics Corp., predicted a significant breakthrough in practical control and decision-making equipment using hydraulic elements exclusively. Potential low cost and high reliability were cited as favoring their application. Such systems could operate pneumatic and hydraulic actuators without the need for intervening electronic equipment. The resultant simplicity would also favor the use of hydraulic computers, as would their potential for operation where control is exercised in adverse environments such as hot-gas servos. Mr. Auerbach warned, however, that many serious design problems remain to be overcome before the potential of hydraulic and pneumatic logic systems can be fully realized. "Economics, not novelty, will be the determining factor in their application," Mr. Auerbach said.

Coincidentally, operating hydraulic and pneumatic computing elements were displayed at the show by the Diamond Ordnance Fuze Laboratories. These were simple demonstration models of oscillators, amplifiers, and flip-flops which showed quite clearly the operating principles of hydraulic and pneumatic logic devices.

Government Has Many Exhibits

An unusual feature of this year's ISA show was the large number of exhibits representing the Department of Defense and other government agencies. Some 20 R&D branches of the armed services as well as NASA, the National Bureau of Standards, and the Office of Civil and Defense Mobilization exhibited at the show. Booth space for these displays was contributed by ISA which had also extended invitations to other non-profit agencies, research foundations, etc. Military aspects of instrumentation were al-

most entirely non-existent either at the government exhibits, industrial exhibits, or technical sessions.

Government exhibits of interest to designers included an automatic type-placement system developed by the Army Map Service, a miniaturized telemetering system for physiological data developed by the Naval Medical Research Institute and a full-sized mock-up of the Project Mercury capsule shown by NASA.

Spokesmen for the Department of Defense said those attending the show were showing considerable interest in these displays and that the resulting exchange of information between exhibitors and visitors should prove valuable all around.

'Progress Through Instrumentation'

ISA technical sessions, centered on the theme "Progress Through Instrumentation," provided extensive coverage of oceanography, meteorology, strain gages, and computers. The oceanography sessions were, in particular, the most extensive ever conducted by a group not directly involved in the field. The various aspects of undersea electronics were treated in 24 pages at six sessions during the conference.

New instruments described at the sessions included the following:

- Telemetering current meter—James Snodgrass, Scripps Institution of Oceanography.
- Salinity measuring device—Jerome Williams, Chesapeake Bay Institute.
- Turbulence meter—Calvin Congwer and Earl Finkle, Aerojet-General.

Complex instrumentation systems such as used aboard the bathyscope "Trieste" and on a Texas Tower erected by the Naval Electronics Laboratory were also described.

The volume of oceanographic papers came as something of a surprise to ISA officials. "We thought of running a session or two on the subject and sent out a call for papers," said Bert Green of the Vortex Foundation, who developed the program for ISA, "But the response floored us; the papers were too good to be rejected so here we are with six sessions attended by a 'Who's Who' of oceanography."

At the end of the conference, ISA officers were strongly considering the establishment of an underwater electronics section within the framework of the organization.

Strain-gage instrumentation was the subject of four separate sessions. Special emphasis was placed on semiconductor strain gages with three separate papers on developments in this area. Silicon-whisker strain gages said to be 50 to 60 times more sensitive than conventional units were reported by Dr. William V. Wright of Electro-Optical Systems, Inc. ■ ■

Typical response curves indicating the various shape factors available in standardized Burnell Crystal Filters

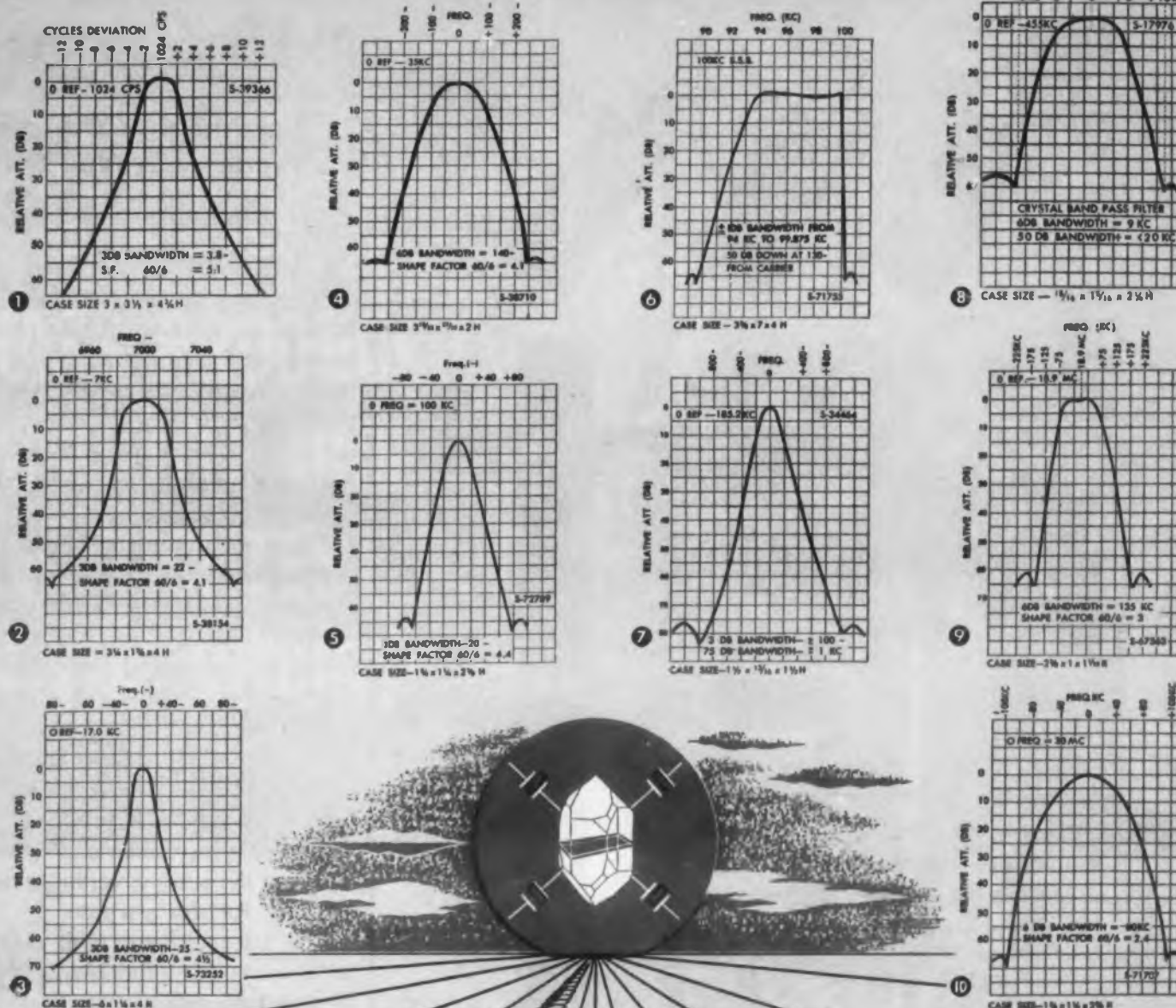

Running the gamut in crystal filters

BURNELL CRYSTAL FILTERS NOW COVER FULLEST RANGE YET POSSIBLE
1 kc to 30 mcs

To its notable achievements in advancing the electronic arts, Burnell & Co. now adds another—the development of moderately priced high attenuation crystal filters covering the extraordinary range of 1 kc. to 30 mc. This represents a range many times broader than previously thought practicable. In addition, the Burnell Crystal Filter line now includes several types heretofore considered impossible.

More than 15 years research, development and experience are represented in the designs illustrated in the response curves shown. Burnell & Co. has taken crystal filters out of the luxury class in applying its experience to their design and manufacturing without incurring developmental and engineering costs.

Whether your crystal filter needs are for standard units or those engineered to center frequency, band width, selectivity and impedance level, call on our Crystal Filter Division for quick delivery. Send now for Crystal Filter Catalog, XT455.

Burnell & Co., Inc.

PIONEERS IN MICROMINIATURIZATION OF TOROIDS, FILTERS & RELATED NETWORKS

EASTERN DIVISION
DEPT. D-37
10 PELHAM PARKWAY
PELHAM, N. Y.
PELHAM 8-5000
TELETYPE PELHAM 3633



PACIFIC DIVISION
DEPT. D-37
720 MISSION ST.
SOUTH PASADENA, CALIF.
MURRAY 2-2841
TELETYPE PASACAL 7578

Mfd. in Canada by Edo (Canada) Ltd., Cornwall, Ont. • WELLINGTON 2-6774

CIRCLE 7 ON READER-SERVICE CARD



KEEP WIRED IN...

with Electron Products' new encapsulated epoxy-tube capacitors. They help solve capacitor problems because they're smaller, lighter and cost less than hermetically sealed units ... yet match them in performance and environmental capability.

Applicable sections of MIL-STD-202(106A) and MIL-C-25 are met or exceeded ... humidity, temperature, immersion cycling, shock, vibration. Certified test data are available on request.

Available for immediate delivery with metallized Mylar*, Mylar foil or metallized paper dielectrics: up to 600 VDCW rating in a host of values from 0.001 mfd. Standard tolerance $\pm 20\%$... tighter tolerances available from stock. Special capacitors built to meet your specifications.

Wire yourself into the latest capacitor engineering news ... write, telephone or telegraph for Data File ED-2.

ELECTRON PRODUCTS
division of Marshall Industries
430 North Halstead Street
Pasadena, California



*Trademark of DuPont

60110 © 1960 MARSHALL INDUSTRIES

CIRCLE 8 ON READER-SERVICE CARD

NEWS

Airborne Refractometers Track Missiles

*They Measure Air Index of Refraction;
Developed by NBS Boulder Laboratories*

AIRBORNE radio refractometers developed by the National Bureau of Standards, Boulder, Colo., will figure prominently in improving the accuracy of missile tracking systems. A major electronic concern is reportedly planning to use these units to refine the accuracy of measurements at its Cape Canaveral tracking installation.

These measurements, made by radio ranging techniques, are dependent upon a precise knowledge of air index of refraction, and hence of propagation, along the measured path. Airborne refractometers flown in the vicinity of the paths could provide constant monitoring of this rapidly changing factor.

The Colorado Research Corp., Broomfield, Colo., which is preparing to manufacture the instruments in quantity, has received inquiries concerning delivery of six units for this purpose.

The refractometers will also be used in a variety of other experiments. The National Bureau of Standards will soon

perform atmospheric turbulence studies at its Haswell, Colo., site with an array of 15 instruments arranged along three orthogonal axes. One of the axes will consist of a 500-ft tower. The University of Hamburg, Germany, is using a prototype instrument on loan from NBS for propagation studies and is due to receive a production unit from CRC this month. NBS will, in addition, follow up its turbulence studies with a wide range of meteorological and propagation experiments using the refractometer.

Two Designs Available

Two separate refractometer designs have been developed at NBS by Maurice J. Vetter. Both designs employ a sampling cavity open to the air, a sealed reference cavity and a klystron oscillator to drive the cavities. The refractometers differ primarily in their methods of comparison between the sampling and reference cavities. The two designs offer a choice between long-term stability and fast response.

In one unit, designated by CRC as model 3A, the emphasis is on fast response obtained through phase comparison circuitry. Klystron frequency is

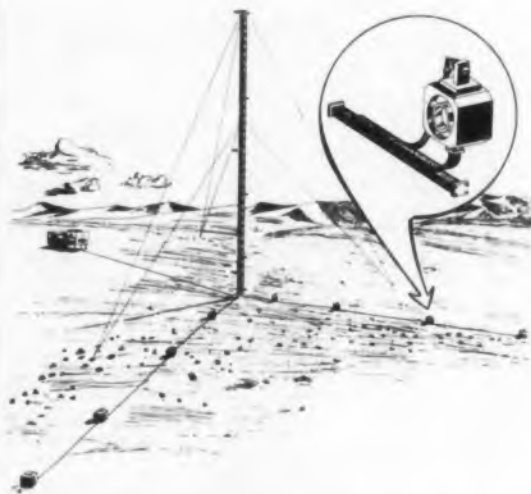

Atmospheric turbulence will be studied by the National Bureau of Standards at Haswell, Colo. with an array of 15 refractometer cavities. Sketch shows 500-ft tower and arrangement of units along three orthogonal axes at the tower. Inset shows how cavities are connected to feed line by unidirectional couplers. Return path to multichannel recording system in trailer is via coaxial cable. A single reference cavity and klystron serve the entire array.

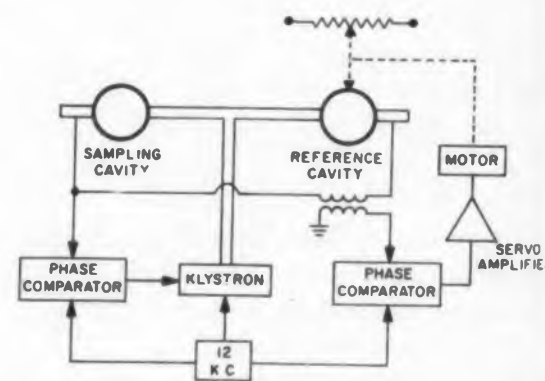

"Absolute" refractometer uses tunable klystron and tunable reference cavity for increased long-term stability. Phase comparator at left provides error signal that tunes klystron to the resonant frequency of the sampling cavity. Phase comparator at right and servo system tune reference cavity to the same frequency.

PHILCO ANNOUNCES

**NEW HIGH-SPEED
SWITCHING TRANSISTOR
IN TO-18 CASE...**

**MASS PRODUCED with
ABSOLUTE UNIFORMITY
to the TIGHTEST SPECS
IN THE INDUSTRY**



swept ± 10 mc from 9400 kmc by applying a 5-kc sawtooth voltage to the klystron repeller. Resonance of the sampling and reference cavities occur at different times. Each event switches a flip-flop so as to produce a square wave whose width is the time interval between the two resonant points. This time is then converted to N (index of refraction) units.

Changes in N at rates up to 50 cps are said to be measurable by this method. The design also permits the simultaneous use of several sampling cavities with a single reference cavity and klystron. This is convenient for multiple unit arrays such as will be used in the NBS atmospheric turbulence studies.

Klystron Drift Limits Accuracy

Long-term accuracy of the time comparison method is limited, however, by klystron drift. Errors are compensated to some extent by modifying the sawtooth voltage to the repeller so that the ascending portion of the wave is "S"-shaped rather than linear. Long-term accuracies of two to five N units are said to be attainable with the model 3A refractometer.

A more sophisticated comparison method based on mechanical tuning of the reference cavity by a servo-driven probe is used in the second instrument. This unit has been designated as the "Absolute" refractometer and is said to have less than 1/10th the long term drift of the model 3A.

In the "Absolute" refractometer, klystron center frequency is tuned to the resonant frequency of the sampling cavity. The klystron is swept about a 9.4-kmc center frequency by a 12-kc sine wave applied to the repeller. Frequency tracking is performed by phase comparing reference cavity output and the 12-kc sine wave. Comparator output is then fed back.

Servo Tunes Reference Cavity

A second-phase comparator yields an output related to the frequency difference between the reference and sampling cavities.

(continued on p. 10)

This new Philco Germanium MADT is specifically designed for high-speed switching applications and is the ideal NOR logic transistor. The MADT Precision-Etch* process makes it possible to manufacture the 2N779 with the tightest control of parameters of any transistor in the entire industry. This extreme uniformity greatly simplifies the design of high performance, low cost switching circuits. For complete data and information, write Dept. ED101260.

*Trademark Philco Corp.

Immediately available
from your Philco
Industrial Semiconductor
Distributor.

| MADT ^o 2N779 ABSOLUTE MAXIMUM RATINGS | | | | | |
|--|-----------------|------|------|------|--------------|
| Storage Temperature | -65°C to +100°C | | | | |
| Collector Voltage, V_{CE} | -15 volts | | | | |
| Total Device Dissipation at 25°C | 60 mw | | | | |
| ELECTRICAL CHARACTERISTICS (T=25°C) | | | | | |
| Static Characteristics | | Min. | Typ. | Max. | |
| Collector Cutoff Current, I_{CBO} ($V_{CB} = -5v$) | | | 1.0 | 3 | μA |
| DC Current Amplification Factor, h_{FE} ($V_{CE} = -0.5v$, $I_C = -10$ ma) | 50 | 90 | 200 | | |
| Base Voltage, V_{BE} ($I_C = -10$ ma, $I_B = -0.5$ ma) | 0.29 | 0.33 | 0.36 | | volt |
| Collector Saturation Voltage, $V_{CE(SAT)}$ ($I_C = -10$ ma, $I_B = -0.5$ ma) | .09 | 0.12 | 0.16 | | volt |
| High Frequency Characteristics | | | | | |
| Output Capacitance, C_{ob} ($V_{CB} = -3v$, $I_E = 0$, $f = 4$ mc) | | 1.9 | 2.5 | | $\mu\mu f$ |
| Input Capacitance, C_{ib} ($V_{EB} = -1v$, $I_C = 0$, $f = 4$ mc) | | 6.0 | 10 | | $\mu\mu f$ |
| Gain Bandwidth Product, f_T ($V_{CE} = -5v$, $I_E = 7$ ma) | 320 | 450 | | | mc |
| Switching Characteristics | | | | | |
| Rise Time, t_r ($\beta_{DC} = 10$) | | 13 | 18 | | $\mu\mu sec$ |
| None Storage Factor, K' | | 39 | 50 | | $\mu\mu sec$ |
| Fall Time, t_f ($\beta_{DC} = 10$) | | 10 | 18 | | $\mu\mu sec$ |

PHILCO
Famous for Quality the World Over

LANSDALE DIVISION • LANSDALE, PENNSYLVANIA



When it
comes
to printed
circuit
prototypes
Proto-Circuits
people
always have
a
WIGGLE
on



RUSH — is the middle name of those highly trained and experienced personnel in Photocircuits' prototype and short run division.

In 1959 alone Proto-Circuits people handled over one thousand separate printed circuit projects representing tens of thousands of circuit boards — many delivered in 48 hours or less.

Proto-Circuits offers the absolute maximum in service with no limitations on sophistication. From schematic to fully assembled and tested boards your prototypes and short runs are made with production methods and materials.

Test your equipment as soon as it comes off the drafting board. Contact your local Photocircuits Application Engineer or call us collect for further information. ORiole 6-8000

Photocircuits
C O R P O R A T I O N
Glen Cove, New York

NEWS

The comparator output signal drives a servo which tunes the reference cavity to the resonant frequency of the sampling cavity. A potentiometer and shaft-position digitizer coupled to the system indicate servo position which is then converted to index of refraction units.

This comparison system is not affected by klystron drift as the operating point of the klystron is insignificant. Tracking error between the klystron and the sampling cavity is likewise immaterial. Though frequency response is presently limited to several cps by the use of a mechanical system, the greater long-term stability of the "Absolute" unit may prove more desirable in certain applications. Units to be used in connection with missile tracking measurements would probably be of the "Absolute" type. At the same time, work is in progress to improve frequency response to the order of 50 cps.

Circuitry of the "Absolute" refractometer is transistorized; the model 3A employs vacuum tubes. CRC states that both units will meet military specifications for airborne equipment.

Improved Cavities Sought

Further development of the refractometers with emphasis on improved cavities is in progress both at NBS and CRC. The present units employ Invar cavities with stainless steel temperature-compensating inserts. Various ceramics and metals having a lower temperature coefficient than Invar are being considered. Cavity designs less prone to temperature hysteresis and simpler to fabricate are also sought. ■ ■



Maurice J. Vetter, designer of the "Absolute" refractometer, adjusts reference cavity of the instrument at the National Bureau of Standards, Boulder, Colo. Newest model of the refractometer is at the right. Openings in sampling cavity at rear of unit admit air.

Navy Aims at Reduced Crews Through Study of Automation

The Navy is studying the installation of shipboard automated machinery to reduce crews. The study, called Project SURIC (Surface Ship Integrated Control), is expected to be completed within a year.

According to the Navy, the program will "simplify and centralize shipboard operations in such a way that vessels will continue to operate efficiently, but with fewer people."

To date, the study has concentrated on optimum use of current communication techniques. It has been found, for example, that relaying information by voice communication on radio-telephone often produces a time-lag—and, even, confusion. These could be eliminated, it is felt, if voice communication were superseded by a data-processing system.

Data Correlation Gets Under Way On Recent EIA Stereo FM Radio Tests

The data gathered from completed stereophonic fm radio tests are being correlated and will be presented for review by the coordination committee of the National Stereophonic Radio Committee. Finished two weeks ahead of schedule, the test results will then be submitted to EIA for filing with the Federal Communications Committee.

The test conducted by EIA at the request of FCC, measured transmission and stereophonic reception of six stereo fm systems. They also evaluated the compatibility of monophonic receivers to the broadcasts. This was done at three signal levels—1,000, 2,000, and 50 μ v input to receiver baluns.

For subjective evaluation, a specially prepared program of musical selections was pre-recorded on a test tape which was broadcast on the experimental station KG2XIU, using the facilities of station KDKA in Pittsburgh.

Stereo transmission systems tested were: Electronics Music Industries, Ltd.; Crosby-Teletronics Corp.; General Electric Co.; Zenith Radio Corp.; Multiplex Development Corp.; and Calbest Electronics Co.

Accuracy Is Our Policy . . .

In the issue of June 22, p 24, the location of the Electronic Tube Div. of Westinghouse Electric Corp. was incorrectly given as Youngwood, Pa. The correct location is Elmira, N.Y.

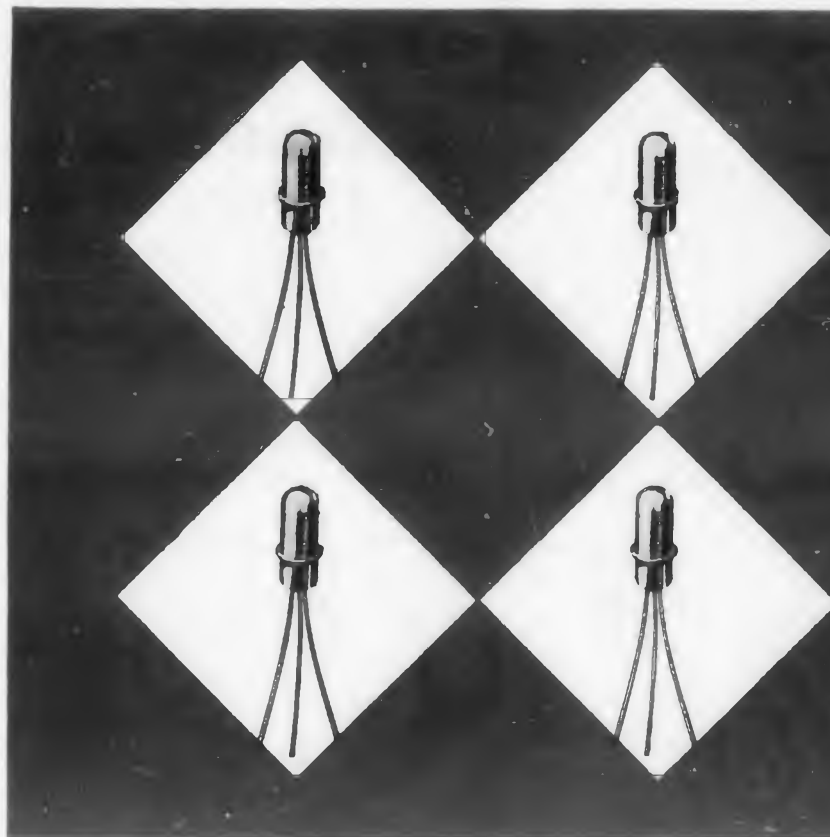

AVAILABLE NOW IN MASS PRODUCTION

- the highest r-f operating frequency
- the fastest switching time
- cadmium junctions for cooler operation, greater reliability
- storage temperatures up to 100 C

YOU CAN GET SPRAGUE* MADT® TRANSISTORS AT SENSIBLE PRICES

Sprague Germanium Micro-Alloy Diffused-Base Transistors, well-known for their rugged vhf performance, are now *priced below other transistors* with comparable electrical characteristics. In many areas, this permits designers to improve circuit techniques without necessarily increasing costs. Expanded production facilities enable us to *ship quantity orders on short notice*. Add to this their *ultra-fast switching time*, and you have three good reasons why Sprague MADT® Transistors have achieved their high level of acceptance.

With Sprague Transistors, circuits in vhf amplifiers and oscillators can now operate with collector currents as high as 50 ma . . . with power dissipation up to 50 mw . . . with collector to base voltages to 15 v. They have been application tested through the entire military electronics vhf spectrum.

The application table may well suggest the use of one or more Micro-Alloy Diffused-Base Transistor types in your latest circuit designs.

For complete engineering data on the types in which

• • •

**Sprague micro-alloy, micro-alloy diffused-base, and surface barrier transistors are fully licensed under Philco patents. All Sprague and Philco transistors having the same type numbers are manufactured to the same specifications and are fully interchangeable.*

MICRO-ALLOY DIFFUSED-BASE TRANSISTOR APPLICATIONS

| Type | Application |
|--------|---|
| 2N499 | Amplifier, to 100 mcs |
| 2N501 | Ultra High Speed Switch (Storage Temperature, 85 C) |
| 2N501A | Ultra High Speed Switch (Storage Temperature, 100 C) |
| 2N504 | High Gain IF Amplifier |
| 2N588 | Oscillator, Amplifier, to 50 mcs |

you are interested, write Technical Literature Section, Sprague Electric Co., 347 Marshall St., North Adams, Massachusetts.

You can get off-the-shelf delivery at factory prices on pilot quantities up to 999 pieces from your local Sprague Industrial Distributor.

SPRAGUE

THE MARK OF RELIABILITY

SPRAGUE COMPONENTS:

CAPACITORS • RESISTORS • MAGNETIC COMPONENTS • TRANSISTORS • INTERFERENCE FILTERS • PULSE NETWORKS
HIGH TEMPERATURE MAGNET WIRE • CERAMIC-BASE PRINTED NETWORKS • PACKAGED COMPONENT ASSEMBLIES

CIRCLE 11 ON READER-SERVICE CARD

BREAKTHROUGH IN THE SCIENCE OF PRESSURE CONTROL



*digital-servo
reliability
crystal-determined
accuracy*

WIANCKO'S Q3700 SERIES DIGITAL PRESSURE GENERATOR

This system, employing unique digital-servo concepts, provides instant selection of a pneumatic pressure accurate to ± 0.05 PERCENT.

Pressure in a reservoir is measured and converted to a precision frequency. This frequency is compared with a selected reference frequency. If the frequency from the pressure sensor is high with respect to the reference frequency, the comparator produces a difference frequency in the form of pulses. These pulses then drive momentary exhaust valves until the pressure drops to the pre-selected value. When the frequency is low, error signals are produced which operate momentary pressurizing valves. The Q3700 is the best answer yet to pressure control and calibration problems.

Ideal for:

- Programming precision pressure/time functions
- Automatic end-to-end calibration of data and telemetering systems
- Rapid calibration of pressure devices
- Ground checkout of instrument and control systems

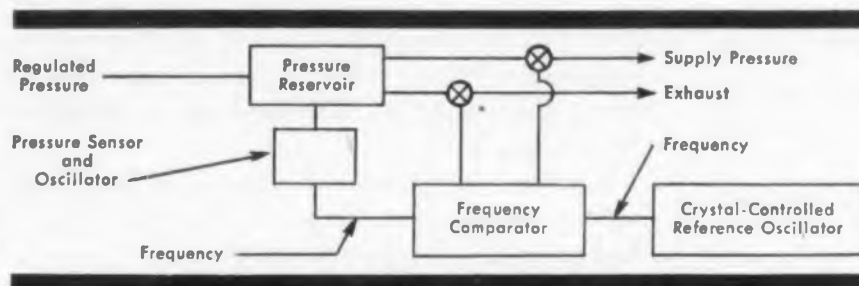

For complete information please request Product Bulletin 111

WIANCKO
ENGINEERING COMPANY



Precision with lasting reliability

255 North Halstead Avenue • Pasadena, California

CIRCLE 12 ON READER-SERVICE CARD

NEWS

USSR Seen as No. 2 Computer-Maker by '65

*Auerbach Makes Prediction After European Tour;
Says U.S. Leads Continent by a 'Couple of Years'*

ALTHOUGH the U.S. "without question" enjoys a lead in information-handling technology, within five years the Soviet Union will be hard on its heels, according to Isaac L. Auerbach of Auerbach Electronics, Philadelphia, just returned after a seven-week tour of European computer factories and laboratories.

He said the U.S. lead of "a couple of years" over Europeans was due to two factors:

- The U.S. started earlier.
- It is spending more money on computer development.

At the moment, Mr. Auerbach said, the United Kingdom, France, and West Germany are the ranking three countries in the field. But Russian strides in the field will permit that country to overhaul them and rank behind the U.S.

within five years.

Auerbach said it also had been reported to him that Communist China was making "astounding" advances in computer technology. He repeated a report which said that the Soviet had recently given the Chinese a computer which the Chinese duplicated within a year with "frightening" improvements.

He paid tribute to European computer theory and said that the Bull computer, for example, was "brilliant" in concept and the Ferranti Atlas—which he compared to the U.S. Stretch—is based on a most unusual concept.

In general, however, he called U.S. hardware "leagues ahead" of the European developments.

Reviewing the industry and the state of the art in Europe before a seminar sponsored by the Office of Naval Re-

'Van Allen-Proof' Solar Cells Described

*ARS Meeting Hears New Signal Corps Development
Is 'At Least 10, Perhaps 50 Times' More Resistant*

SOLAR cells "at least 10 times if not 50 times more resistant to radiation," were announced last week at the American Rocket Society Space Power Systems Conference in Santa Monica, Calif., according to Dr. Nathan W. Snyder of the Research Engineering Support Group for Defense Analysis. The new solar cells, developed at the Signal Corp's R&D in Fort Monmouth, N.J., will stand up from 10 to 50 times better in the high-energy ionizing radiation of the Van Allen belts.

By diffusing phosphorous into the surface of a P-type silicon crystal, SCL scientists William Cheery and Joseph Madelkorn fabricated N-on-P-type solar cells instead of the conventional P-on-N boron-diffused types.

The new units are produced at lower

temperatures than present types, the Army announced, less damage is caused to the crystal structure of the silicon. For this reason, said the Army, the new cells may be produced at lower cost.

The exact mechanism that gives these cells their unique properties has yet to be isolated. ELECTRONIC DESIGN learned from Dr. Snyder that for whatever reason N-type silicon is inherently more resistant to electron-proton radiation.

Using the synchrocyclotron at the University of California, Dr. Joseph Denny of Space Technology Labs has found that the new cells are approximately four times more resistant to 740 mev protons than convention types. Other tests have shown that the new cells are 40 times more resistant to an energy flux of 0.6 mev protons than

search, Mr. Auerbach found, in general, that the amount of money and manpower devoted to automatic data processing is far smaller there. The U.S., he said later, will stay ahead "just as long as our government continues to sponsor a major portion of our research."

He noted that thin-film accomplishments are "in the very, very basic technique stage," comparable to that of transistors some years ago. He said that International Computers and Tabulators Co., an English firm, has developed a new and secret "Gyra" film alloy which has solved the reproducibility problem and has licked the noise problem. It is not yet in a computer, however.

He noted that the majority of Continental computer makers use ALGOL-60 language for translators, but that a number of English firms do not.

The most impressive hydraulic-logic work is being done by IBM in Zurich. This can be used "very handsomely" for industrial control. The Russians, he has heard, have already built a pneumatic computer. (For more on Mr. Auerbach's views on hydraulic logic, see p 6.) ■ ■

P-on-N types. Because of this, the Army says radiation-resistant transistors and other semiconductors may be on the way.

Dr. Snyder told ELECTRONIC DESIGN that the Soviet Union produced the first N-on-P solar cells for space research. He added, however, that Soviet scientists have discontinued using the new cells in favor of the P-on-N types.

During a panel discussion at the ARS meeting on results of solar-cell-storage-battery systems development for the U.S. space vehicles, Dr. Snyder, who was chairman of the discussion, stated that he is "discouraged" over the development of Ni-Cad batteries, which have comprised about half the weight of the payloads orbited to date.

Roughly half the Ni-Cad Batteries now employed leak when in the vacuum of space, according to Walter Scott of Applied Physics Labs. Harmon A. Goyette of STL revealed that Pioneer V malfunctioned because of the failure of the Ni-Cad batteries. "We would be happy with their present size and weight if the batteries performed at optimum efficiency," Goyette added. ■ ■

NEWEST ADVANCEMENT IN SILICON DIODES / FAIRCHILD

FD 300

WHAT

These silicon diodes combine parameters never before available together:

High conductance — 200mA min. @ 1.0 volt

Lowest leakage — 1.0 m μ A max. @ -125V, 25° C.

Low capacitance — 6 μ f max. @ 0 volts

WHY

Minimum values of voltage drop, capacitance and leakage current give the designer more flexibility on circuits

which require large numbers of diodes. Reliability, too, is inherently greater. The FD-300 is the ideal diode for all applications where speed is not of prime importance. (Where speed is critical, the Fairchild FD-100 and FD-200 are recommended.)

HOW

By means of surface passivation and planar structure — technological advances exclusive to Fairchild —

these outstanding characteristics have been combined in one totally new silicon diode.

DIODE DIVISION
4300 REDWOOD PARKWAY
SAN RAFAEL, CALIFORNIA
GLENWOOD 6-1130



A WHOLLY OWNED SUBSIDIARY OF FAIRCHILD CAMERA & INSTRUMENT CORPORATION

CIRCLE 13 ON READER-SERVICE CARD

Reader Will Scan 10,000 Envelopes Per Hour

Post Office Field Tests to Start Early Next Year in Washington; Fully Transistorized Unit Can Handle Wide Variety of Type Fonts

AN AUTOMATIC address reader designed to sort typewritten envelopes to 40 destinations at a rate of 10,000 per hr will begin field tests on live mail early next year at the Post Office Laboratory in Washington, D. C. The all-transistorized prototype being assembled by the Intelligent Machines Research Corp. of Alexandria, Va. will be capable of reading a wide variety of typewritten, business machine, and printed fonts. Cities, states, and common abbreviations for states will be recognizable by the machine.

The unit will only read addresses consisting of upper- and lower-case letters (such as Brooklyn, New York). However, additional logic circuits enabling it to read all-upper-case addresses

(such as CHICAGO, ILL.), imprinted by addressograph plates, are being designed and are to be incorporated into the machine by the end of next August. Prototype development and manufacture, including the all-upper-case logic, are being conducted under a \$250,000 contract from the Post Office Dept.

Accuracy requirements for the address reader are still indefinite. Performance of earlier models, however, indicates that the device will at least match the accuracy of manual sorting. The reject rate, on the other hand, may be rather high as the machine's logic is designed to reject an envelope rather than "guess" its destination.

The scanning and logic techniques of the address reader generally parallel those of IMR's

commercial alphanumeric readers (*ED*, May 11, p 26). However, the alphanumeric readers are designed to read only one particular type font, while the address reader must cope with a variety of type faces.

Characters Recognized By Special Classes

Thus, in general, the address reader does not recognize individual letters as such. In order to do the job with a machine of reasonable size, its designers have chosen to concentrate on the recognition of special *classes* of characters. The arrangement of these special letters within a word is sufficient to identify the address. The special classes of characters are:

- Characters with ascenders (b, d, f, h, i, k, l, t)

Scanning and optics system of IMR's address reader include two separate reading stations. Pre-read station locates bottom line of address; main reading station, of higher resolution, scans the bottom line. Scanning in each instance is by slotted disk and fixed slits. Mirror at the main reading station is servo-positioned to read bottom line as determined by the pre-read station.

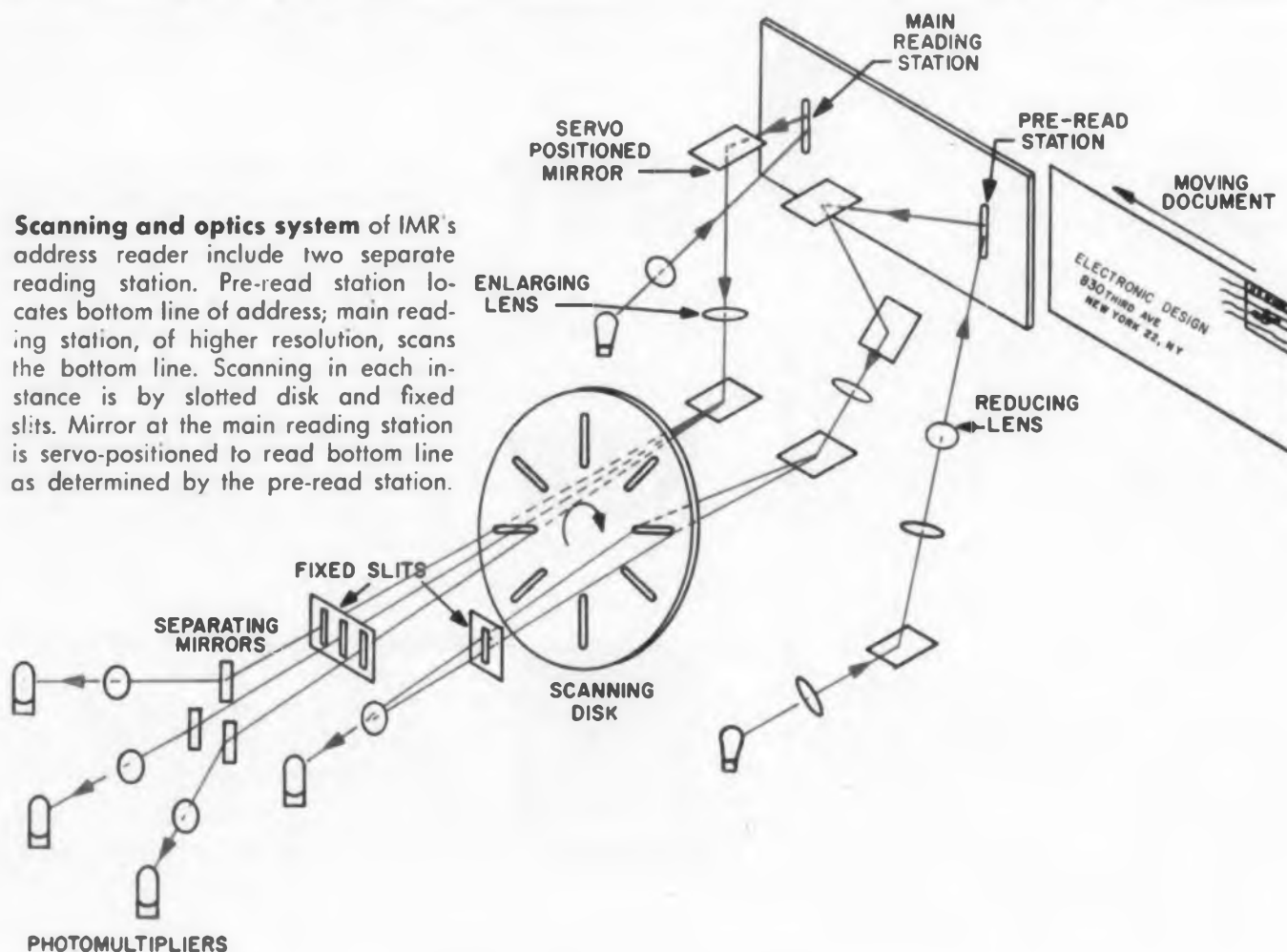

All-Electronic Reader

Keeping in step with recent design trends in character-recognition equipment, the Post Office Department has awarded Philco's Research Division a two-year, \$346,000 contract for development of an all-electronic address reader. Performance of experimental hardware designed for use with a forthcoming computer reportedly clinched the job for Philco over several other major bidders.

Unlike IMR's reader, the Philco unit is to read addresses by separate recognition of all 26 alphabetic and 10 numeric characters. A high-resolution flying spot crt employing advanced electron optics evolved from the "Apple" color TV tube will be used.

The problem imposed by different type fonts is to be attacked by a double scan. Data from the first scan will be analyzed by area correlation methods to identify the type style. Machine logic will be reprogrammed accordingly and a second scan, properly adjusted in height and width, will then read the characters. A processing rate of up to 1,000 characters per sec is expected.

The contract calls for delivery of a prototype reader having a 75-address capacity. Post Office Department engineers emphasize that design of the Philco reader is still in its initial stages and may be modified considerably during the term of the contract.

Connecticut

Arizona

North Carolina

Chicago

Letters shown in color are those identifiable by the address reader and used to determine the address. Some upper case letters are uniquely recognized; other letters are identified as belonging to special classes. Number and position of these special letters are sufficient to identify address.

- Characters with descenders (j, p, q, y)
- Three-crossing characters (a, e, s, z) which are crossed three times by a vertical scan.

- Lower case "g"

Except for "g", these letters are identified as belonging to a particular class rather than as discrete letters.

Some upper case characters are uniquely identifiable, but others can as yet only be recognized by groups. Such groups include the letters KMNHW, UV, IC, and EBF. The differences between each letter in a group are readily apparent here in print, and IMR's commercial readers can distinguish between them. But recognizing these letters in a variety of type fonts turns out to be much more difficult.

How To Recognize "Chicago"

Letters can be sorted either by city, by state, or both. "Chicago" for example, could be defined by the following criteria:

- Upper case "C"
- Immediately followed by two successive ascending letters (h, i).
- Later followed by a three-crossing character (a).
- Immediately followed by a "g" not at the end of the word.

Not all these criteria may be necessary to identify "Chicago" from among all other possible addresses—particularly if "Illinois" or "Ill." are included in the definition. Thus, the definition of "Chicago" can be simplified, for the word contains many identifiable characteristics. The upper case "C", which cannot always be positively



**NO
VITREOUS
ENAMEL
POWER
RESISTOR EVER
OFFERED
GREATER
DEPENDABILITY!**

Test after test by independent evaluation laboratories have proved the outstanding dependability of Clarostat Greenohm "V" vitreous enamel resistors. Be sure to always specify this proved dependability.

Available in all popular wattages, ohmage, adjustable or fixed. Write for complete information.

Greenohm V

Write for complete details



CLAROSTAT MFG. CO., INC.

DOVER, NEW HAMPSHIRE

In Canada: CANADIAN MARCONI CO., LTD., Toronto 17, Ont.



*direct
line
service*

**IMMEDIATE
DELIVERY!**

Your local Clarostat Distributor stocks Greenohm "V" resistors in depth—call him for fast delivery...

CIRCLE 14 ON READER-SERVICE CARD

Design Engineers:

KEEP AHEAD WITH HAVEG

HAVELEX™

(formerly G. E. Mycalex)

Haveg's Precision Molded Rigid Inorganic Insulating Material offering these unique advantages

- Dimensional Stability
- 1000° F. Continuous Temperature Resistance

- Dielectric Strength
- Mechanical Strength
- Low Loss Factor

- Low Power Factor
- Arc Resistance
- No Moisture Absorption

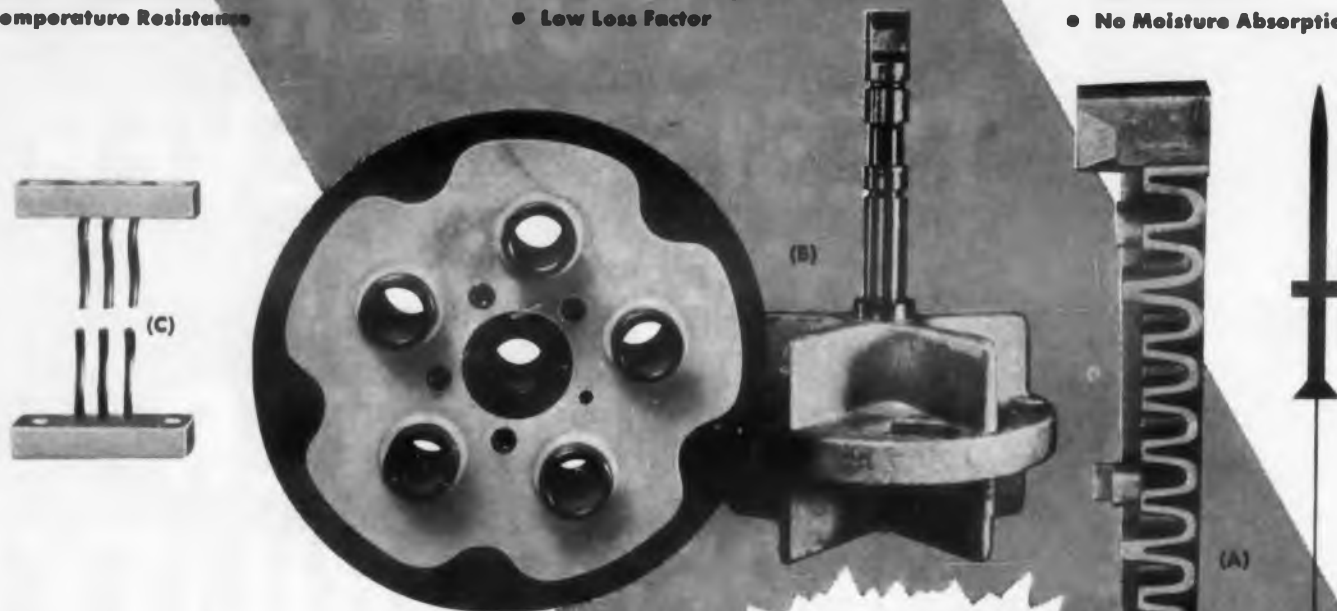

JUST ANNOUNCED

Haveg Industries has achieved a significant milestone in its Research and Development Laboratory with a new Havelex molding.

Five metal inserts (three terminals, a mounting post, and the outer ring) are hermetically sealed with the Havelex body. Engineers may now consider hitherto unexplored design concepts wherein intricate part designs and close tolerances offered by Havelex are enhanced with hermetically sealed metal inserts.

Recent noteworthy applications of Havelex pictured here are:

(A) Ionizer Components — air filter unit for home heating system.

(B) Disconnect Assembly nearly 5 inches in diameter with massive inserts — Havelex provides the electrical insulating "heart" of this disconnect device used in "on the ground" service to military jet aircraft. If for any reason the power disconnection is made while the aircraft is drawing its electrical power from the airport installation, an instantaneous disconnection is insured by this device; hence, protection against personnel injury or equipment damage.

(C) Transistor Test Socket — three stainless steel tubes (.010" wall) integrally molded into Havelex body. A key component in reliability testing of transistors in high ambient temperatures.

Havelex is composed of special glass reinforced with mica. Grey to white in color, this dense stone-like material provides an ideal insulator for wide ranges of ambient operating conditions and electrical stresses. The unusual combination of properties in Havelex plus Haveg's ability to provide precision molded tolerances and intricate shapes permit unlimited design possibilities. Complex metal inserts can be permanently molded in position, facilitating component assembly and assuring end product reliability.

Our forty years experience in custom molding Havelex to stringent specifications, include an extremely wide range of applications... such as Lightning Arrestors, Circuit Breakers, Potentiometers, Vacuum Tubes, Switchgear, Terminal Strips, Arc Barriers, Actuators, Armatures, and Transistor Test Sockets.

Haveg engineers welcome the opportunity to work with customers to assure the most efficient and economical component designs. For technical data on Havelex send for your copy of our new informative brochure.

Keep Ahead with

HAVEG

FIRST IN *Engineered* PLASTICS

TAUNTON DIVISION

HAVEG INDUSTRIES, INC.

336 Weir Street • Taunton, Massachusetts

Other Operating Divisions: Blow Molding Division — Bridgeport, Connecticut • Chemical Materials Division — Wilmington, Delaware • Haveg Corporation — Wilmington, Delaware
Reinhold Engineering & Plastics Co., Inc. — Norwalk, California • American Super-Temperature Wires, Inc. — Burlington, Vermont • Hemisphere Products Corporation — Rio Piedras, Puerto Rico

CIRCLE 15 ON READER-SERVICE CARD

NEWS

identified, might be removed from the definition. The address reader operates with a total of 22 criteria based on special character classes and 15 criteria based on upper case letter groups.

Abbreviations A Problem

Identification of complete state names by these criteria is fairly straightforward as there are only 50 possibilities. State abbreviations present a much greater problem in that each abbreviation contains relatively little useful information. "Ala." and "Ark." are easily distinguished from each other by the number and relative position of the three-crossing and ascending characters. Hower, "Penn." and "Tenn." are quite difficult to separate, as are "Tex." and "Tenn." Possible methods of solution include refinement of upper case identification and recognition of character widths.

The scanning system of the address reader is quite similar to the type used in IMR's commercial machines. The principal modifications embodied in the new machine accommodate for the non-uniformity of address positions among envelopes. "Random noise" in the form of advertising matter printed on envelopes was also considered in the logical design of the machine.

Each envelope passes two separate stations as it travels through the reader. The first or

Optical Unit Reads Card Numbers



Another optical character reader—this one from IBM and scheduled for 1962 manufacture—will read numbers directly into IBM's 1401 computer after optically scanning at rates up to 480 characters a second from up to 400 card-size documents a minute.

pre-read station, locates the bottom line of the address and positions a mirror at the main reading station to bring the bottom line into the field of the main scanning system. The pre-read station has relatively low resolution but covers a field ranging from 0.3 to 2.0 in. from the bottom of the envelope. The station senses advertising matter at the left of the address and positions the mirror accordingly. However, since envelopes are scanned from left to right, the address is the final determinant of mirror position.

Horizontal scanning is due to the motion of the envelope itself through the reader. Envelopes travel on a continuously moving belt at a speed of 45 in. per sec, first passing the pre-read station and then the main reading station.

Vertical scanning is by a slotted disk spinning behind a fixed, slotted plate. A 7-in. disk with

Progress Being Made

Development of electronic systems to speed the mails is being pushed forward on a number of fronts with results likely to become increasingly apparent in coming months.

- This month will see the opening of Project Turnkey, a highly automated post office at Providence, R. I.

- Early next month ITT will demonstrate an experimental facsimile mail system between New York and Washington, D. C.

- Tests of the IMR address reader will begin next February, with the Philco reader due in 1962.

In addition, the Post Office Department is supporting development of a magnetic address coding system by Radinow Engineering, Washington, D. C.

The man directing these projects is Harold Lieske, head of R&D at the Post Office Department, and hard-headed realist about the problems of postal automation. On the subject of design requirements for address reader, Mr. Lieske has this to say:

"We're willing to accept a high reject rate if it means greater accuracy. Even if a machine rejected half its input, it would still be an enormous benefit, but we can't afford very many misroutings. With hand sorting there are perhaps 10 people down the line who can spot a mistake; with the automatic loading and bundling system now coming into use the changes are that a misrouted letter will go right on through."

Research and development projects are selected with an eye toward reasonably short-term results. Work on handwriting readers, for example, has been shelved temporarily.

While the department is always on the lookout for new ideas, it discourages premature announcement of its work. Every time the magazines do a story on us," said one post office engineer, "We're besieged by people who claim to have the answer to all our problems—we have neither the time, money or personnel to cope with them." It was suggested that designers think through and test their ideas very carefully before trying to land a Post Office contract.

Data-Pak #1. Germanium Computer & Switching Transistors. 26 TYPES

Data-Pak #2. Germanium General Purpose Audio Transistors. 12 TYPES

Data-Pak #3. Germanium General Purpose RF Transistors. 8 TYPES

Data-Pak #4. Germanium Entertainment Transistors. 16 TYPES

Data-Pak #5. Silicon High Temp. Small Signal Transistors. 17 TYPES

Data-Pak #6. Silicon High Temp. Switching Transistors. 12 TYPES

Data-Pak #7. Silicon High Temp. High Frequency General Purpose Transistors. 7 TYPES

Data-Pak #8. Silicon High Reliability Junction Diodes. 32 TYPES

Data-Pak #9. Germanium Diodes Point Contact. 32 TYPES

Data-Pak #10. Germanium Diodes Schottky. 9 TYPES

Data-Pak #11. Rectifiers Silicon Diffused Junction. 36 TYPES

Data-Pak #12. Rectifiers High Current. 11 TYPES

Data-Pak #13. Rectifiers High Power. 34 TYPES

Data-Pak #14. Silicon High Power Transistors. 7 TYPES

SIMPLIFIED SEMICONDUCTOR SELECTION

Bring your files up to date on these fast-growing families of widely used semiconductors with latest Raytheon Data-Paks

Here's transistor, diode, and rectifier information organized with *your* projects in mind! Technical information and performance characteristics on many related Raytheon types are grouped into

handy Data-Paks for ready reference. By putting all the facts at your fingertips, they'll help you specify the right units for your needs from the big (and fast growing) line of reliable Raytheon semiconductors.

Look over the selection above . . . then write on your company letterhead for the Data-Paks you can use. They'll help you put this broad semiconductor line to best use in solving your circuit problems.

RAYTHEON COMPANY



SEMICONDUCTOR DIVISION

SILICON AND GERMANIUM DIODES AND TRANSISTORS • SILICON RECTIFIERS • CIRCUIT-PAKS

ENGLEWOOD CLIFFS, N. J., Lowell 7-4911 (Manhattan, Wisconsin 7-6400) • BOSTON, MASS., Hillcrest 4-6700 • CHICAGO, ILL., National 5-4000 • LOS ANGELES, CAL., Plymouth 7-8181
 ORLANDO, FLA., Garden 3-0518 • SYRACUSE, N. Y., Howard 3-9141 • BALTIMORE, MD., Southfield 1-0450 • CLEVELAND, OHIO, Winton 1-7716 • DETROIT, MICH., Trinity 1-1710
 SAN FRANCISCO, CAL., (Redwood City), Emerson 9-8568 • CANADA: Waterloo, Ont., Sherwood 5-6831 • GOVERNMENT RELATIONS: Washington, D. C., Metropolitan 8-6235

CIRCLE 16 ON READER-SERVICE CARD



AEROTAN[®]

SOLID TANTALUM CAPACITORS

Whenever your spec calls for miniature size, light weight and long-life performance over a wide range of severe environmental conditions there can only be one answer...Aerovox AEROTAN Solid Tantalum capacitors.

Aerovox offers you a complete line of solid electrolyte units manufactured in the industry's newest and most advanced production facility. These subminiature units are housed in hermetically sealed metal cases and feature a semiconductor electrolyte to assure a completely dry assembly with absolute freedom from corrosion or leakage.

You'll find Aerotan capacitors most applicable in DC blocking, AC coupling and bypass and filtering applications as well as in integration, storage phasing and timing applications. Manufactured in un-insulated case styles (ST12) and insulated cases (ST13) they are designed for continuous operation over the temperature range of -80°C to $+125^{\circ}\text{C}$ in voltage ratings of 6, 10, 15, 20, and 35 VDCW for 85°C operation; in 4, 7, 10, 13, and 23 VDCW for 125°C operation.

Get all the facts on these superior solid tantalum capacitors by writing to...

AEROVOX CORPORATION

NEW BEDFORD, MASSACHUSETTS

CIRCLE 17 ON READER-SERVICE CARD

NEWS

44 radial slots and spinning at 17,000 rpm is used.

The pre-read scan is through a single fixed slit at one side of the disk. At the other side of the disk, diametrically opposed to the single slit, there are three additional fixed slits for the main scan. Four 931A photomultipliers, one serving each fixed slit, detect the variations in light intensity as the address is scanned.

The main reading station employs a high resolution optical system which examines a 0.3-in. vertical zone on the envelope. As the document moves across the main reading station, elements of the bottom line are scanned in turn by each of the three fixed slits. The first slit drives a circuit to indicate the bottom of the element being scanned, while the second indicates the top of the element. Signals from the third slit, together with the information generated by the first two slits are used by analog decision circuits which recognize individual stroke characteristics. These decisions are based on pulse position, pulse width and the repetition of such signals during a certain number of scans through the character.

Digital and Logic Circuits Employed

Next in line are digital circuits that combine the detected stroke characteristics to determine the presence of letters or classes of letters.

Logic circuits then establish the class, number, and sequence of these special characters and determine the address. These logical functions will be programed on a removable plugboard on which the 40 sub-routines defining the various state and city-state addresses can be conveniently organized or modified. Plugboard output is then converted into a seven-level binary code that



Postmaster General Arthur Summerfield (left) and S. Lang Makrauer of Farrington, IMR's parent company, inspect printed circuit board for the IMR address reader. Unit itself is in background. Device at right transfers envelopes from input bin to the address reader.

controls an electro-mechanical mail sorter. Envelopes come off the address reader and into the mail sorter where they are routed into bins corresponding to their address.

Modular Construction Planned

The prototype unit will consist of modular blocks and will include sufficient space for the additional circuitry required for the all-upper case program. The modules include scanner, signal shaping, format, interpreter and output units. The shaping unit prepares photomultiplier signals for use in the interpreter, where the various special character classes and upper case letters are recognized. The format module controls the bottom line locator.

An indication of the address reader's logical capacity is given by the approximately 3,000 transistors and 4,000 diodes used in the circuitry. Transistors are generally wired in complementary symmetry pairs to provide push-pull outputs from single-ended inputs.

Present test plans call for the sorting of raw mail, with the result that the reader would reject handwritten and all-upper case addresses. To achieve more efficient utilization of the reader, IMR has designed a pre-sorter that could be used ahead of the reader to remove handwritten mail. According to Abraham Tersoff, IMR's chief of character-recognition engineering, the logic for the pre-sorter is "minuscule" compared to that of the address reader. The device operates by recognizing the wide variation in character heights and wide swings between characters typical in handwritten matter. Mr. Tersoff claims that the pre-sorter would be 98 per cent reliable on live mail. ■ ■

Titan ICBM Re-Entry Vehicle Will Use Ablating Materials

The new Titan re-entry vehicle, called the Mark 6, will use ablating materials for protection from the terrific heats of re-entry. These materials dissipate the heat by burning and vaporizing into the atmosphere.

This re-entry vehicle for the advanced Titan II ICBM will be the third major Air Force missile re-entry vehicle to be developed by General Electric Missile and Space Vehicle Dept. of Philadelphia, Pa.

GE is also developing an operational-type re-entry vehicle (Mark 3) for the Air Force Atlas ICBM; and it has recently completed work on the Mark 2 re-entry vehicles which are now operational on the Thor intermediate-range ballistic missile and on the Atlas.



Miniature Soldiers. Army ants carry out intricate maneuvers of wheeling, flanking, and envelopment with faultless precision. Their columns are led by "majors", preceded by "scouts". Raids are conducted by "skirmishers". Between campaigns, they form "bivouacs". Army ants are nature's tiny troopers.

Miniature Ball Resolver, approximately $3\frac{3}{8}$ " x $2\frac{1}{2}$ " O.D. continuously calculates position of aircraft and missiles traveling at supersonic speeds. MPB bearings at critical points keep torque low, and help make possible an accuracy of 0.33 of 1%. This is another man-made miracle in miniaturization.

Man with Miracle. This is Dick Anderson, one of MPB's Sales Engineers, whose cooperation with customers includes expert aid in the application of miniature and instrument bearings. MPB's technical staff, most experienced in its field, can assist you with your own miracles in miniaturization.

Miracles in Miniaturization

Actual Size of MPB Bearings
in Ball Resolver Shown Above



Every day man's advances, both on this planet and beyond, are opening new and challenging areas of application for miniature components and mechanisms. And at each step forward, MPB is ready to help with research, engineering and manufacturing facilities unsurpassed in the miniature bearing industry. MPB makes more than 500 types and sizes of bearings ranging from $\frac{3}{8}$ " O.D. down, meeting requirements of the most exacting nature. Specials developed on request. For a confab on design problems or our latest catalog write **Miniature Precision Bearings, Inc.**, 110 Precision Park, Keene, N. H.

MPB Helps you perform
miracles in miniaturization

CIRCLE 18 ON READER-SERVICE CARD

ONE INTEGRATED SOURCE for Ceramic-to-Metal Seals



Standard types of Alite high voltage bushings are available in various sizes and configurations.

In *all* phases of planning for ceramic-to-metal seals—from design to finished assembly—you can rely on ALITE for the know-how and "do-how" required to produce highest quality ceramic-metal components for critical applications.

High alumina Alite is the ideal material for making rugged, high performance hermetic seals and bushings. It has superior mechanical strength, high temperature and thermal shock resistance, plus reliable electrical characteristics. Our complete high temperature metalizing and bonding facilities assure delivery of the finest seals available—mass-spectrometer tested for vacuum-tightness.

Please contact us for valuable performance data and information regarding ceramic-to-metal applications . . . no obligation.

INSIDE LOOK AT ALITE—



Fact-packed, illustrated Bulletin A-40 gives vital technical data and product information. Write today.

ALITE DIVISION

U. S. STONEWARE

New York Office
60 East 42nd St.

12F-1

CIRCLE 19 ON READER-SERVICE CARD

NEWS

Communications Meeting

Symposium Is Dominated by Efforts To Meet Demand at Reasonable Cost

THERE is now appearing a new hierarchy of systems, surpassing in scope the availability of analytical technique and engineers of adequate breadth. The systems are being designed by a mixture of science and black magic. Optimization of such systems is merely a concept to which one can give little more than rhetorical dignity." So said J. W. Halina, International Telephone and Telegraph Communications Systems, Inc., in describing the new design problems arising through the appearance of super-systems like SAGE, statewide banking systems, and satellite surveillance systems.

Mr. Halina, who told the largest audience ever to attend the National Communication Symposium that the electronics industry lacks suitable supersystems engineers, supporting techniques, and programs to attack the problems posed by today's and tomorrow's systems. He was one of the many speakers at the sixth annual symposium in Utica, N.Y., to point out that communications technology was barely keeping up with advancing requirements.

Another speaker, Roman Krzyczkowski, General Electric Co., examined the same problem from the viewpoint of economics in a paper on communications economics. "Products of our ingenuity, skill, and knowledge," he said, "have become so complex that few of us can even claim to know about it, let alone understand, every problem in the large systems we help to create. Since such systems are very expensive, advanced economic analysis becomes essential for the appropriate selection if the engineer is to realize even a penny's value for a penny expended."

Trends away from the 'Conventional'?

Mr. Krzyczkowski noted "the trend in complete systems away from 'conventional' communications equipment and toward other techniques. In work on space communications systems, we are often more concerned with launching pads, boosters, guidance, and other satellite problems than with communications dilemmas, which, in comparison, appear almost easy. This is true even on the ground; while outlining a large, complete, ground-to-ground communications system, I have found that 'conventional' communications equipment accounted for only

etinfaces the Facts of Life

fforts
Cost
rchy of
lability
of ade-
signed
Optimi-
cept to
etorical
ational
ns Sys-
prob-
super-
stems.

one fifth of the total cost. The other four fifths was at the rear end of my transmitters and receivers in various forms of data-processing equipment." He suggested that designers and economists work together.

In making his presentation, Mr. Krzyckowski quoted a Rand Corp. survey, in which, for the first time, many general cost figures on communications equipment were published as state-of-the-art equations. The figures are based on current AN equipment used by the three services and are reportedly valid within about 15 per cent.

Cost in dollars of portable equipment is 160 times the square root of equipment's weight or 500 times the square root of equipment's power plus 150. Cost of airborne equipment is \$50 per lb, or 500 times the square root of the power doubled. Cost of vehicular equipment is \$17 per lb, or 1,000 times the fourth root of the power. Cost of fixed transportable equipment is \$90 per lb, or 6,250 times the cube root of the power.

Trends to Narrow-Band Systems?

dience
a Sym-
s suit-
tech-
blems
s. He
annual
t com-
ng up

K. A. Pullen Jr., Ballistic Research Laboratories, Aberdeen Proving Grounds, told a symposium audience that there is much interest today in narrow-band systems as a solution to the problems of extra-long range communications which are being faced.

Other symposium highlights:

Gen-
blem
per on
ur in-
"have
claim
every
reate.
anced
e ap-
realize
."

■ A variable data-rate technique was described by J. E. Palmer, Radio Corp. of America. The technique calls for designing systems, not for the worst channel conditions expected, but for adaptability to the varying conditions of the channel. This results in use of variable data rates.

com-
com-
tech-
tems.
ching
ellite
mas.
This
ng a
nical
onal
only

■ The possible use of propagation characteristics of "outer space" near the earth to communicate on the earth was discussed in a paper prepared by H. Hodara, Hallicrafters Co.; G. I. Cohn, Illinois Institute of Technology; and H. R. Raemer, Sylvania Electric Products, Inc. Keyed to use of outer space is a radiation window in the vlf range in which waves are guided by lines of earth's magnetic field.

960

■ Keynote speaker Maj. Gen. C. H. Mitchel, commander of the Air Force's Electronic Systems Center, reported on the Air Force's drive to have equipment and systems for command and control designed for survival, with particular emphasis on surveillance and warning systems. ■ ■



NEW!



ADVANCED DESIGN POWER TRANSISTORS FROM CLEVITE

Three new lines of germanium power transistors by Clevite feature new advances in controlled gain spread, fully specified collector-to-emitter voltage characteristics and low current leakage — even at maximum voltages and high temperatures.

The new 8 ampere switching series can be used to replace the older, more costly ring-emitter types in 3 to 8 ampere service.

The new 25 ampere switching type offers exceptionally low saturation voltage and is available with either pin terminal or solder lugs.

The new Spacesaver design not only affords important savings in space and weight, but its significantly improved frequency response means higher audio fidelity, faster switching and better performance in regulated

power supply applications. Its low base resistance gives lower input impedance for equal power gain and lower saturation resistance, resulting in lower "switched-on" voltage drop. Lower cut off current results in better temperature stability in direct coupled circuits and a higher "switched-off" impedance.

CLEVITE NOW OFFERS THESE COMPLETE LINES

| Switching Types | Amplifier Types |
|---------------------|-------------------|
| 5 ampere | 2 watt |
| 8 ampere | 4 watt |
| 15 ampere | |
| 25 ampere | 2 watt Spacesaver |
| 3 ampere Spacesaver | |

All Clevite germanium power transistors are designed for low thermal resistance, low base input voltage, low saturation voltage and superior current gain.

For latest data and prices or application assistance, write for Bulletin 60 . . .



Reliability in volume . . .

CLEVITE TRANSISTOR

254 Crescent Street Waltham 54, Mass. Tel: TWinbrook 4-9330

CIRCLE 20 ON READER-SERVICE CARD



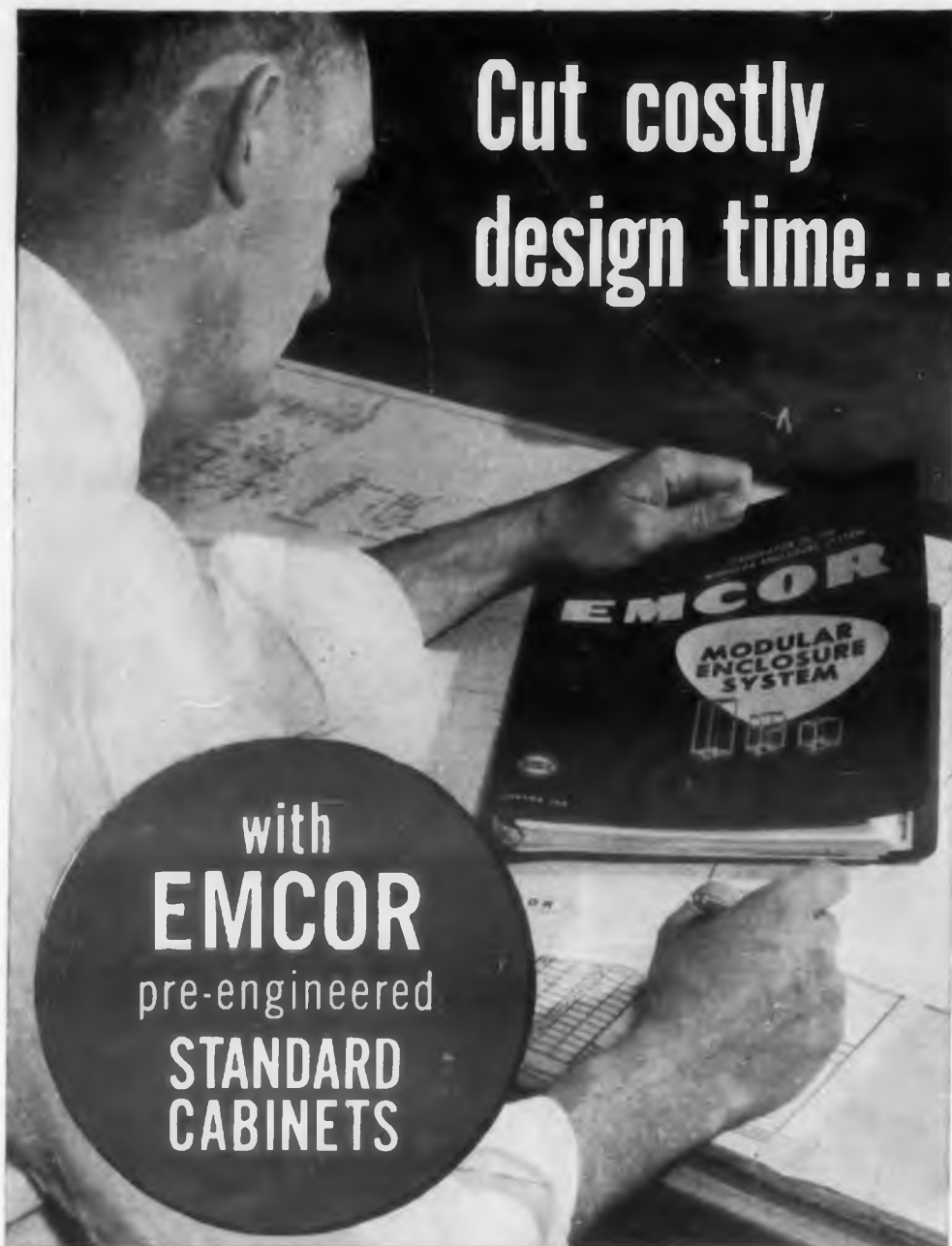

Cut costly
design time...

with
EMCOR
pre-engineered
**STANDARD
CABINETS**

Costly design time and modification of custom type enclosures are a thing of the past. EMCOR meets your enclosure requirements with over 600 standard basic frames and thousands of component parts and associated equipment. Only EMCOR, the originator of the Modular Enclosure System provides the ultimate in design, flexibility, compatibility, rugged structural capabilities, beauty and quality controlled craftsmanship in the fabrication of metal enclosures. Let EMCOR "Know-How" serve and save for you. Write for Condensed Version of Catalog 106 Today!

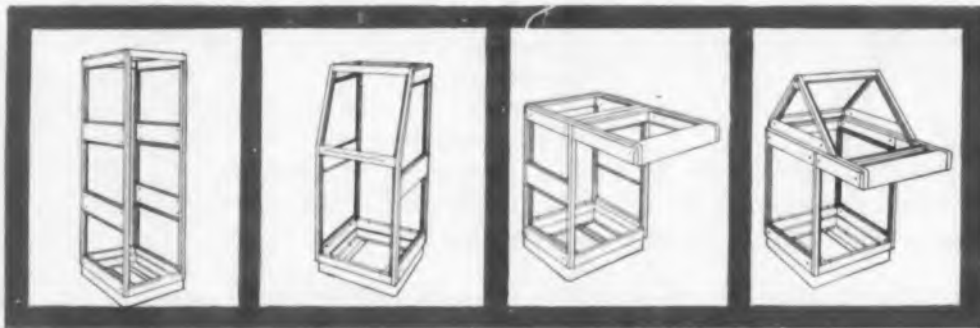

Originators of the Modular Enclosure System
Ingersoll PRODUCTS DIVISION
BORG-WARNER CORPORATION
630 Congdon Avenue Dept. 1221 Elgin, Illinois
CIRCLE 21 ON READER-SERVICE CARD

WASHINGTON REPORT



Ephraim Kahn

UPGRADING OF B-70 PROGRAM implies some increased spending for military electronics over the next five years. Instead of being a research program, the B-70 supersonic bomber now may be operational by 1966, according to Lt. Gen. Roscoe C. Wilson, chief of development for the Air Force. Congress appropriated an extra \$290 million for the B-70 in the current fiscal year, and the Defense Department is making about \$105 million available for use. But additional funds for the Mach 3 aircraft program may not come as easily. Indications are that readjustments in existing programs will be demanded so that "savings" can be shown which will make commitment of additional money less of a new budgetary drain.

VIRTUALLY PERFECT RELIABILITY is expected of the Ballistic Missile Early Warning System, says the Deputy Director of Communications and Electronics for the Air Force, Brig. Gen. John B. Bestic. When the system goes into operation it will be self-testing. The reliability of the data provided by the checkout system "can be accepted without question," he noted, since prior provision has been made to avoid disruption of the system because of failure of a computer. The BMEWS computers, he revealed, not only track targets but compare their trajectories "with those of observer satellites and with auroral and meteor trail characteristics."

UNDERESTIMATE OF SPACE COSTS in figures hitherto presented has been implied by NASA chief Dr. T. Keith Glennan. The agency has \$915 million for the current fiscal year, and more will be needed "if we are to continue pressing forward." By the mid-'60s or earlier, "it is more than likely that the annual cost of our civilian space programs will have passed the \$1.5 billion mark and be approaching an even higher figure approximating \$2 billion," he says. Earlier this year, NASA told Congress that about \$12 billion to \$15 billion would be needed to finance its space technology program for the current decade.

CONTRACTOR FINANCING POLICY of the Defense Department—the so-called 80-20 system—may be changed by the end of the year. In response to persistent military and Congressional pressures, abetted by sharp criticism from the General Accounting Office, serious thought is being given to abolition of the practice of denying advance payments for the last 20 per cent of Contractors' costs. A compromise, proposed by the Defense Department Comptroller would have sought to quell Congressional criticism

by cutting back on fee and profit allowances to contractors. The Army and the Navy appear to favor abandonment of the 80-20 policy. The Air Force is not opposed to its retention. Since the system can be used to postpone cash outlays—useful to the military at times of budgetary stringency—the odds are that it will not be dropped entirely but be made more flexible.

MORE RESEARCH IN BIONICS—patterning of systems after living organisms—is to be performed by the Air Research and Development Command. "Significant contributions to miniaturization" may be made by living models and "radical design and development" may stem from applying to circuitry the sensory principles of living organisms, asserts Lt. Gen. Bernard E. Schriever, ARDC commander. Intensive research will be done by ARDC itself so as to make sure that the Air Force has "technical management competence in problem analysis, and in the formulation of methods to solve them."

SPECIFICATION REVISION for ground support equipment probably will not be ready until February 1961. At that time, the technical data requirements spelled out in MIL-D-9412C should be ready for application. This specification, designed to assure "operational integrity" of all support systems, is basic to Air Force attainment of centralized management of this type of equipment. Objective of the program is to hold to a minimum the variety of electronic and other test equipment used on the ground to check the functioning and readiness of weapons systems. To the maximum extent possible, such equipment will be bought commercially, according to R. L. Gilbert of the Air Force Directorate of Maintenance Engineering.

NO CONFLICT IN ION-ENGINE PROJECTS of the Air Force and of NASA exists: it is a "complementary" relationship, according to Russell D. Shelton of the space agency's Marshall Space Flight Center. The details of the projects are "quite different" he states, so that there is no unnecessary duplication of effort.

PATENT-POLICY MODIFICATION, sought by the electronics industry particularly for the National Aeronautics and Space Administration, may run into some new problems. NASA and the Defense Department have set up a joint board to coordinate space and air activities. Though the board has not stated that it will be involved in patent policy, its mere existence means, to some Congressional experts, that the two agencies can already act together to solve a number of the problems which were supposed to be taken care of in the last session's proposed Space Act modifications. If much of the Space Act, which passed the House but not the Senate, is thus shown to be unnecessary, a change in the restrictive patent provisions of the basic NASA law might have to be handled separately. This would be more difficult to push through Congress, particularly since Senate opposition to such a move would be stiff. Most recent Congressional action on patents—passage of the Coal Research and Helium Acts—incorporated patent provisions similar to the NASA rules.

CIRCLE 22 ON READER-SERVICE CARD >

At Macarr Inc. . . .

where dependability comes first



RED/LINE timing relays "Pay Off"!

After trying several other time delay devices in their automatic control equipment for carbon arc lamps, design engineers at Macarr Inc. turned to G-V Red/Line Timing Relays. By holding in a current limiting resistor in the circuit until the arc had struck, the Red/Line Relay provides complete continuity of operation and lengthens the life of the DC power supply feeding the carbon arc. As an added advantage, it also facilitates smooth, soft starting of the carbon arc. So, at Macarr, the high quality of G-V Red/Line Timing Relays is "paying off".



More and more companies are finding the reliable performance of G-V Red/Line Timing Relays makes them best for their products. G-V Red/Line Relays will "pay off" in your product, too. Your customers appreciate the importance of high quality, reliable components. G-V Red/Line Timing Relays are specially designed for industrial applications. They have the precision, reliability and long life needed to "pay off" in industrial use.

Your G-V distributor has them in stock now. Call him or write for Bulletin 131 today.



G-V CONTROLS INC.
Livingston, New Jersey

for clear display of:

Single-shot nuclear events • Fast diode turn-on • Avalanche transistor waveforms • Tunnel diode waveforms
Recovery time of fast diodes • High-speed circuit response • Transistor switching waveforms • Radio frequency waveform



Switching and storage times in fast transistors and diodes can be measured using the outstanding characteristics of the Type 519. In this typical diode-recovery-time waveform, the upper trace is +45 ma reference, the middle trace shows the diode turn-off, and the lower trace shows the diode shorted.

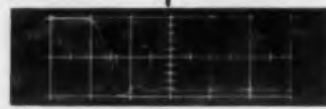

The Type 519 Oscilloscope is an invaluable tool for testing active or passive wideband circuits. In this wideband amplifier waveform little or no correction is necessary for the inherent risetime of the oscilloscope.

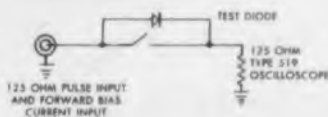

The NEW TEKTRONIX KMC OSCILLOSCOPE

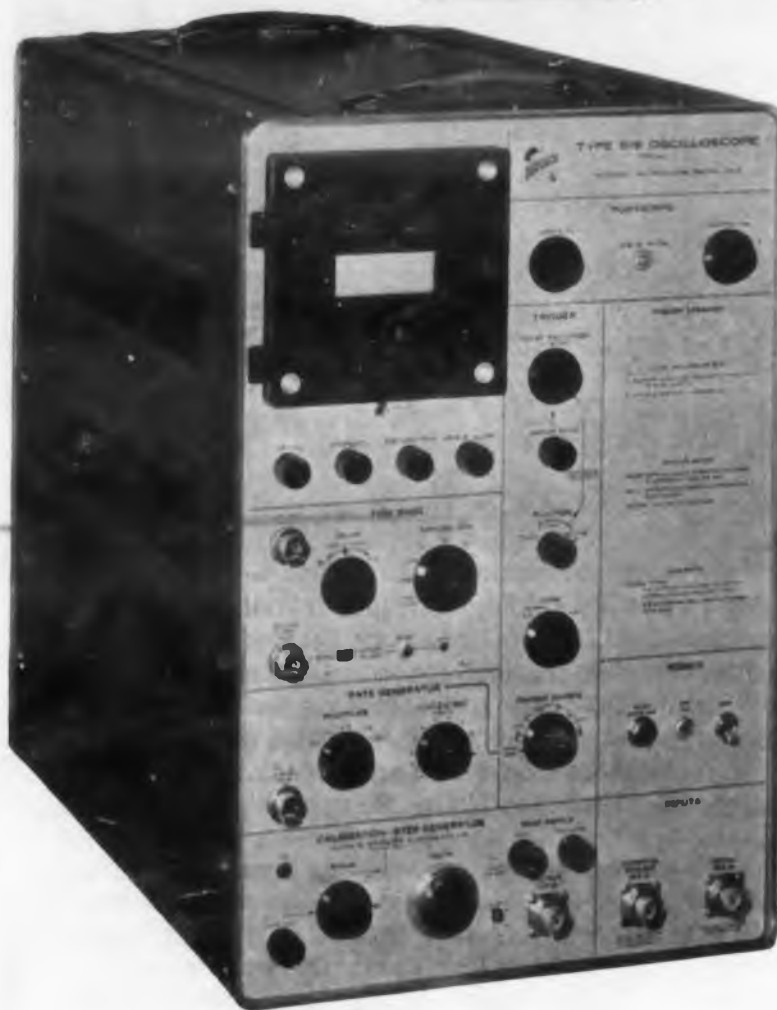

CAREER OPPORTUNITIES now exist at Tektronix in the following fields: Instrument design, Circuit design and engineering, Cathode ray tubes, Electron physics, Solid state and semi-conductor devices. For information write to Irving Smith, Professional Placement.

Tektronix, Inc.

P. O. Box 500 • Beaverton, Oregon
Phone Mitchell 4-0161 • TWX—BEAV 311 • Cable: TEKTRONIX

TEKTRONIX FIELD OFFICES: Albuquerque, N. Mex. • Atlanta, Ga. • Baltimore (Towson, Md.) • Boston (Lexington, Mass.) • Buffalo, N.Y. • Chicago (Park Ridge, Ill.) • Cleveland, Ohio • Dallas, Texas • Dayton, Ohio • Denver, Colo. • Detroit (Lathrup Village, Mich.) • Endicott (Endwell, N.Y.) • Greensboro, N.C. • Houston, Texas • Indianapolis, Ind. • Kansas City (Mission, Kan.) • Los Angeles, Calif. Area (East L.A. • Encino • West L.A.) • Minneapolis, Minn. • New York City Area (Albany, N.Y. • Stamford, Conn. • Union, N.J. • Orlando, Fla. • Philadelphia, Pa. • Phoenix (Scottsdale, Ariz.) • Poughkeepsie, N.Y. • San Diego, Calif. • San Francisco (Palo Alto, Calif.) • St. Petersburg, Fla. • Syracuse, N.Y. • Toronto (Willowdale, Ont.) • Canada • Washington, D.C. (Annandale, Va.)

TEKTRONIX ENGINEERING REPRESENTATIVES: Hawthorne Electronics, Portland, Oregon • Seattle, Washington. Tektronix is represented in twenty overseas countries by qualified engineering organizations. In Europe please write Tektronix Inc., Victoria Ave., St. Sampsons, Guernsey C.I., for the address of the Tektronix Representative in your country.

CIRCLE 23 ON READER-SERVICE CARD

Type 519

DC to over 1000 Megacycles
24-kv Accelerating Potential



The new Tektronix Type 519 Oscilloscope is a calibrated high-speed laboratory instrument designed for observation, measurement, and photographic recording of fractional nanosecond risetimes. A 2 x 6 cm viewing area coupled with 24-kv accelerating potential affords bright displays with excellent definition.

Performance features include: passband from dc to beyond 1000 mc, risetime less than 0.35 nsec, sensitivity of 10 v/cm, linear sweeps to 2 nsec/cm, sweep delay to 35 nsec, and a sensitive wideband triggering system. All features are fully compatible with the signal bandwidth capabilities of the instrument. The single unit houses a fixed signal delay line, a convenient sweep-delay control, a pulse-rate generator, a standard amplitude and waveform generator, and electronically-regulated power and high voltage supplies. Only two connections are necessary for normal operation—signal input and power cord.

Combining simple operation with laboratory precision and reliability, the Tektronix Type 519 Oscilloscope is ideally suited to single-shot or random nuclear events. In addition, the extreme bandwidth of the Type 519 permits application to general measurements where oscilloscope risetime must be much faster than signal risetime.

PRICE, Type 519 \$3800
f.o.b. factory

Please call your Tektronix Field Engineer for complete specifications and a demonstration of the Type 519 in your own applications.

NEWS

Improved Missiles and Components Needed for Communications System

Better communications satellites to form a synchronous 24-hr world communications system await the development of more advanced missile technology and more reliable components, according to speakers at the Space Electronics and Telemetry Conference in Washington, D.C.

Several areas for further study were outlined in papers by Clifford D. May Jr., of the Army's Chief Signal Officer's Office and by S. G. Lutz, senior scientist at Hughes Research Laboratories. These areas included:

- Higher-output satellite power sources.
- Reliable satellite-stabilization systems.
- Improved methods for keeping satellites on station.
- Systems to make satellites less susceptible to interference.

Interference control was called crucial in Mr. Lutz's paper, if satellites are to be used on a frequency-sharing basis. If earth terminals are to work through surface frequencies without mutual interference, high-gain antennas with effective suppression of sidelobes are necessary, he said.

Accuracy Is Our Policy . . .

In the story, "Firms Seek Ultrareliability for Minuteman" (*ED*, Sept. 14, p 4), we made an error which was based on erroneous information given to us by the Autonetics Div. of North American Aviation. The table on contributions showed Sprague Electric Co., North Adams, Mass., to have a contract for \$1,260,000 for solid and foil tantalum capacitors. This round figure actually represented only the solid tantalum capacitors. Sprague's contract calls for \$1,263,356 for solid tantalum and \$1,700,596 for foil tantalum capacitors, a total of \$2,963,962.

CHANGES IN PRICE AND AVAILABILITY

NON-CAPACITOR GRADE TANTALUM SHEET has been reduced 10 per cent in price by Kaweck Chemical Co. of Boyertown, Pa. The new price is the same as that formerly charged for standard tantalum sheets.

U.K. Electronic Exports to U.S. Down \$2 Million over Last Year

British exports of electronic products to the U.S. in the first quarter of this year totaled \$4,298,000, down 8 per cent from the same period of 1959, reports the Electronics Div. of the Business and Defense Services Administration, Dept. of Commerce.

United Kingdom shipments of electronic equipment and parts to the U.S. during January-March of this year were at an annual rate of \$20 million, compared with \$22 million for 1959.

Shipments of electronic phonographs achieved the highest percentage increase for the first quarter of 1960 compared with the same period in 1959, up 157 per cent to \$100,000, followed by the basket class "Other electronic products," up 127 per cent to \$465,000. Phonograph parts and accessories dropped by 60 per cent to \$203,000 in the first quarter of 1960 as compared to the first quarter of 1959. Electron-tube shipments fell 38 per cent to \$391,000, and radio receivers fell 19 per cent to \$51,000.

British exports of communications, navigation, and radar equipment to the U.S. rose from \$441,000 to \$638,000, a 45 per cent increase.

Details of British exports of electronic products to the U.S. in the first quarter of 1960 and annual shipments for the years 1958 and 1959 are shown in the table.

U.K. Exports of Electronic Products to the U.S.

January 1958-March 1960

| Product | Value in thousands of dollars (1) | | |
|--|-----------------------------------|--------------|-----------------|
| | 1958 Year | 1959 Year | 1960 Jan-Mar |
| TOTAL | 17,184 | 21,974 | 4,298 |
| Radio Receivers | 135 | 292 | 51 |
| Radio Phonographs .. | 304 | 232 | 83 |
| Speakers & Microphones | 479 | 532 | 147 |
| Phonographs, electronic | 149 | 147 | 100 |
| Phonograph parts and accessories | 904 | 1,207 | 203 |
| Record playing mechanisms | 9,198 | 12,362 | 1,850 |
| With record changer | 8,678 | 11,739 | 1,797 |
| Less record changer | 520 | 623 | 53 |
| Electron tubes | 2,303 | 2,381 | 391 |
| Components and parts | 1,221 | 1,243 | 370 |
| Communications, navigation, and radar equipment .. | 1,388 | 2,178 | 638 |
| Other electronic products | 1,103 | 1,400 | 465 |

(1) Converted to U.S. dollar equivalents at the rate of £ = U.S. \$2.80.

Sources: Data compiled by the British Radio Equipment Manufacturers' Association from statistics of H.M. Customs and Excise.

← CIRCLE 249 ON READER-SERVICE CARD

ELECTRONIC DESIGN • October 12, 1960

Magnetic tapes of "Mylar"[®] insure reliability of recording and playback

Much information recorded on magnetic tapes can never be replaced because of the tremendous cost of duplicating test conditions. You can protect your investment in such valuable data with tapes of "Mylar"^{*} polyester film. Their small additional cost is negligible compared to the cost of the data they contain. Here's why they provide higher reliability than any other tapes:

CHART NO. 1

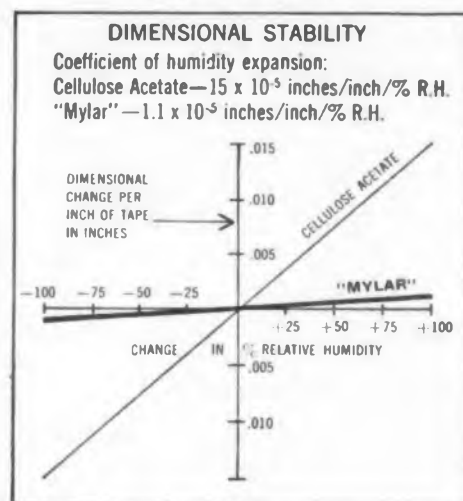

Less signal dropout.

Chart 1 shows that dimensional change in "Mylar" with humidity change is negligible compared to acetate. This exceptional stability prevents tape shrinking, swelling or cupping that could result in shifting of

tracks or loss of contact with the recording or playback head. Possibility of signal dropout or garbled or weak signals are minimized and reliability of recorded data is assured.

CHART NO. 2

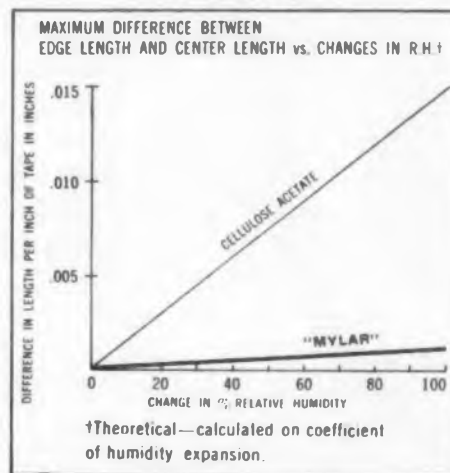

Fewer garbled signals.

If magnetic tape picks up or loses moisture unequally across the tape width there will be a difference in length between the edges and center. Chart 2 compares this effect for "Mylar" and cellulose acetate tapes. Because "Mylar" is virtually non-hygroscopic there is no dimensional difference between edges and center to cause poor registration of timing across adjacent tracks on the tape.

Less tape breakage.

Since most breaks start as edge nicks,

the high initial tear strength of "Mylar" reduces chance of breakage and subsequent failure to record critical information. Chart 3 compares initial tear strength of "Mylar" and acetate. In addition, "Mylar" has the highest tensile strength of any instrumentation tape base. And "Mylar" does not lose its toughness with age, repeated playbacks or storage because it has no plasticizer to dry out.

CHART NO. 3

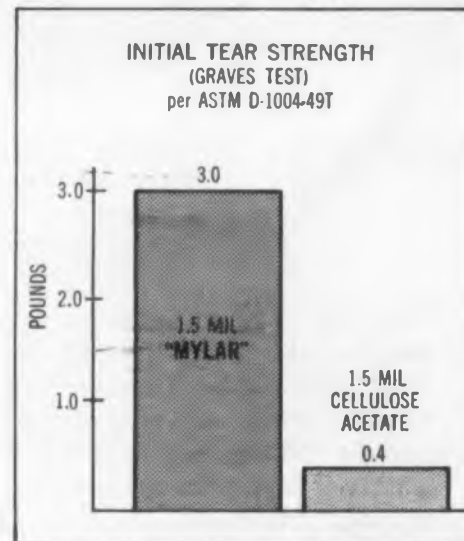

The superiority of "Mylar" can make an important contribution to reliability of your magnetic tape system. Ask your magnetic tape supplier to recommend the specific tape of "Mylar" for your needs.



Better Things for Better Living . . . through Chemistry

DU PONT
MYLAR[®]
POLYESTER FILM

^{*}Du Pont's registered trademark for its polyester film

E. I. du Pont de Nemours & Co. (Inc.)

Film Department, Room ED-10, Wilmington 98, Delaware

Please send free, 12-page booklet of comparative test data to help me evaluate magnetic tape reliability.

Name _____ Position _____

Company _____

Address _____

City _____ Zone _____ State _____

CIRCLE 24 ON READER-SERVICE CARD

ALLIED CONTROL'S
NEW
Polarized
Magnetic
LATCHING
Relay



Allied Type JP Relay
Weight: 0.6 ounces
Actual Size

The inherent vibration and shock resistance and high sensitivity of Allied's Type JP *Permanent Magnet Polarized Latching Relay*, combined with its ability to operate from a short pulse and remain operated without holding power, make it suitable for all phases of Aerospace applications.

Because of its latching feature and availability with single or double coils, it is also suitable as a logic or memory switching element in computers and data processing applications.

OPERATING CONDITIONS:

Vibration: 5 to 55 cps at 0.195 inch double amplitude • 55 to 2000 cps at a constant 30g

Shock: 100g operational

Sensitivity: JP (single coil) 115 milliwatt maximum transfer power • JPA-JPB (double coil) 230 milliwatt maximum transfer power

Contact Rating: Non-inductive—2 amperes at 29 volts d-c or 1 ampere at 115 volts a-c
Low level contacts are available on request

ALLIED CONTROL
ALLIED CONTROL COMPANY, INC.
2 EAST END AVENUE, NEW YORK 21, N. Y.
CIRCLE 25 ON READER-SERVICE CARD

NEWS

Airborne IR Seeker-Tracker Nears Completion

Uses Array of 14 Gold-Doped Germanium Detectors, But Cadmium May Be Used as Future Doping Agent

A UNIQUE infrared seeker-tracker designed for anti-missile, anti-submarine warfare, and airborne reconnaissance systems is in advanced development at the Martin Co., Baltimore. Assembly of a prototype airborne unit for ICBM warning and decoy discrimination will be completed this month with flight testing due soon thereafter. According to Irving Distelhorst, in charge of the project, the seeker-tracker, flown at 50,000 ft, will detect ICBM exhaust plumes more than 1,000 nautical miles away and can discriminate between reentry bodies up to 100 miles away.

The entire detection system—including mirrors, detectors, amplifiers, and coolant—rotates as unit. Absence of relative motion between detectors and mirrors is said to eliminate the mirror blindness effects inherent in chopper-type systems. In addition, the spinning elements serve as the rotor in a gimbal-mounted, three-degree-of-freedom gyro. Scanning, tracking and stabilization are accomplished by energizing torquers to precess the gyro. Slew rates of up to 20 deg per sec without overshoot and a wide variety of scan patterns are possible by this precession-mode technique.

Fourteen Detectors Arrayed Radially

An array of 14 detectors is used. These are gold-doped germanium units sensitive from 1 to 8.5 microns. Four of the detectors serve for tracking; input to the remaining units is individually restricted by interference-type filters to

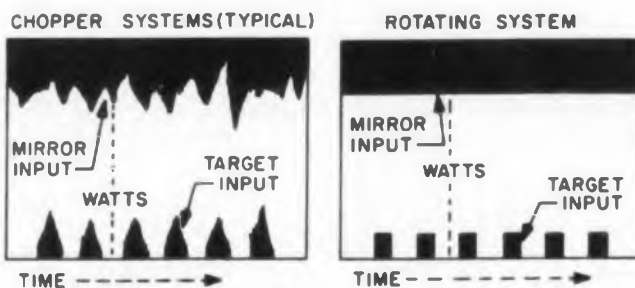

Mirror blindness in optical chopping systems resulting from relative motion between mirrors and detectors is shown in diagram at left. By synchronizing rotation of mirror and detector, non-uniformities of mirror temperature are always seen by the same detector. As shown in diagram at right, target signals are thus readily identifiable as small increases in detector output.

provide 10 separate channels for target temperature discrimination. The detectors are arranged radially about the center of the image plane and are wedge shaped—widening out from 1 mm at their inner edges to 2 mm at the outside. Each detector is 1 cm long and 1 cm thick. The taper compensates for defocusing of the image at progressively greater distances from the center and permits complete interception of the target image by the detector. The 1-cm thickness allows maximum possible absorption of the infrared.

This particular detector configuration can be readily modified for other applications. An earlier prototype used 24 zinc-doped germanium units arranged along a diameter of the target plate. Martin is also experimenting with microminiature arrays and has produced detectors as small as 50 microns square by a photo-etch process. Thus, densely populated arrays, using a mixed variety of detectors and configurations could be incorporated into the seeker-tracker as necessary.

Hushed Transistor Amplifiers Boost Output

Detector output is boosted by specially designed hushed transistor amplifiers sensitive to microvolt-level signals. Circuit details are proprietary, but the design includes two preamp and three amplifier stages.

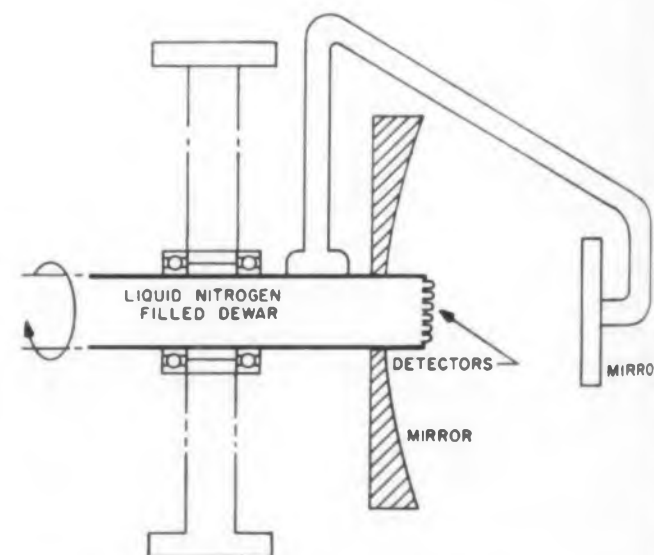

Detectors and mirrors rotate in unison to eliminate mirror blindness effect in the seeker scanner. Rotating parts also act as a gyro for stabilization, tracking and scanning.



Rotating seeker-scanner for far infrared sees down to 40 microns. Unit shown is earlier version using Zinc-doped germanium. New model being assembled for airborne use will have temperature-discriminating capability in the 1 to 8.5 micron range. Mirror is 12 in. across. Total weight of the device including electronics is about 75 lb.

The detectors operate at liquid nitrogen temperatures. A Dewar flask stores sufficient coolant for 12 to 18 hours of airborne operation. Closed-cycle cooling systems to permit satellite-borne operation of the seeker-tracker await development of suitable power sources. Martin is experimenting with cryostats for use with the system but has not been able to reach efficiencies greater than 200 of power per watt of cooling.

The cassegrain optical system includes a 12-in. primary mirror and has an aperture of $f/1$. The mirrors are fabricated of honeycomb pyroceram. Maximum theoretical coverage is nearly 4π steradians. However, this is sharply reduced in airborne applications by window size limitations. Infrared transmitting domes of the size required for full coverage do not appear feasible at this time.

Rotation from 100 to 1,000 Rpm

Rotation can be varied from 100 to 1,000 rpm as desired. Spinning parts are supported by double preloaded ball bearings; outputs are picked off by silver slip rings and beryllium brushes.

Martin is also developing several new detector materials for possible use in advanced versions of the seeker-tracker. The most promising of these is cadmium-doped germanium (about 10 parts per million) which, according to Jack Leonard, research engineer at Martin, appears to be



... \$575 to \$1100 less with the new NLS 484 digital voltmeter



Here is the only 4-digit voltmeter to provide printer connection and automatic print control for only \$2150 . . . the only digital voltmeter at this price to provide heavy duty *plug-in stepping switches*, snap-out readout, and simple single-package design. With plug-in NLS accessories it forms a host of automatic data logging systems. Performance? The 484 retains the basic design and quality construction of the NLS 481, the world's most popular 4-digit voltmeter. Contact NLS for complete information on the 484 if you require $\pm 0.01\%$ accuracy and printout at low cost.

BRIEF SPECIFICATIONS: Accuracy $\pm 0.01\%$ of full scale on each range . . . ranges: $\pm 9.999/99.99/999.9$ volts DC, $\pm 99.99/999.9$ millivolts DC using NLS 140 Preamplifier, $9.999/99.99/999.9$ volts AC using NLS 125B AC/DC Converter . . . input impedance: 10 megohms at balance, 1000 megohms on lowest range by modification . . . automatic range and polarity selection . . . balancing time: 1 sec., average . . . internal standard cell for verification of calibration . . . simple conversion to ratiometer.



Originator of the Digital Voltmeter

non-linear systems, inc. DEL MAR (SAN DIEGO), CALIFORNIA

CIRCLE 26 ON READER-SERVICE CARD



The move to Oak Stock Switches wins Design Time

One of our 124 different stock switches may be just what you need to put your prototype on the production line. The model you choose is available for 48-hour delivery, in quantities up to 249. What's more . . . most types and sizes are available from OAK only—fully assembled or as sub-assemblies.

And remember—if you can't find an OAK

Stock Switch to suit your needs, OAK's creative engineering staff will quickly modify an existing unit or develop a new one to meet your exact specifications.

Learn how OAK Stock Switches will save you time. Contact your nearest OAK representative or send for Catalog 399 showing complete stock line and prices.



OAK MANUFACTURING CO.

1260 CLYBOURN AVENUE, CHICAGO 10, ILLINOIS
phone MOhawk 4-2222

Switches • Rotary solenoids • Choppers • Vibrators • Tuners • Subassemblies

CIRCLE 27 ON READER-SERVICE CARD

Creative engineering • Quality components

NEWS

as sensitive at liquid nitrogen temperatures as conventional detectors are at liquid helium temperatures. The material is sensitive from 8 to 25 microns with a peak at 20 microns. Response time is 1 msec or less.

The detector could be operated at liquid nitrogen temperatures if desired, but Mr. Lennard plans to use it under reduced aperture to cut background noise and to compensate for the reduction in target signal by operating at liquid helium temperatures.

Detectors Are Epitaxially Doped

The cadmium-doped material is being manufactured by an epitaxial-growth process, but Martin has not disclosed the type to vapor used to carry the dopant.

Other members of Mr. Lennard's 12-man research group are investigating compensated, double-doped germanium detectors. Arsenic and antimony secondary dopants are being used with a zinc primary doping agent. Response down to 40 microns has been achieved with zinc-doped detectors.

Miniature detector arrays for improved resolution with individual units 25 microns square are also being considered. Photoengraving and precision sandblasting techniques are among the fabrication schemes in development.

The seeker-tracker and detector programs are company-funded. However, Martin is preparing application proposals in such areas as reconnaissance satellites, space navigation, anti-missile systems and ASW. Through use of the seeker-tracker and improved detectors Martin expects to achieve performance equivalent to detection of a human being at 50 miles. ■ ■

University of Wisconsin Buys Control Data 1604 Computer

A giant Control Data 1604 computer will soon be aiding researchers at the University of Wisconsin. The university has accepted a \$500,000 grant from the Wisconsin Alumni Research Foundation and an additional \$400,000 grant from the National Science Foundation towards purchase of the computer. Further support from the U.S. Army Mathematics Research Center on campus has completed the financing for the computing system which will cost more than \$1,000,000.

The 1604 will be the largest university-owned computer in the U.S.

Voice from the Ionosphere Undergoes Testing at Eglin AFB

A new emergency communications system broadcasting from a radio transmitter rocketed 300 miles into the ionosphere in a successful test at Eglin AFB, Fla.

The project, named "Tattle Tale," was being conducted by Air Research and Development Command's Wright Air Development Div. to determine the feasibility of using rockets to communicate—by voice or code signal—over distances of several thousand miles in event enemy action destroys ground networks.

Although the system was developed for the Air Force by Hughes Aircraft Co. of Culver City, Calif., it is expected to have broad applications in the vast field of satellite communications.

"In the event of total war," said R. E. Wendahl, Hughes vice president, "it can be considered probable that many of the permanent ground communications installations may be destroyed or disrupted. 'Tattle Tale' is the solution we have developed for that problem."

Special electronic equipment was integrated into an Aerobee-300 sounding rocket and fired over the Eglin Gulf Test Range. Receiving stations were installed at Eglin; WADD, Dayton, Ohio; and the National Bureau of Standards, Boulder, Colo. In addition to ground receiving sites a WADD aircraft received a signal while flying over 40,000-ft at San Antonio, Tex.

Digital Flight Simulator Completed



Digital simulation of jet aircraft flights are provided by a card-programmed Universal Digital Operational Flight Trainer, Tool, UDFFT, delivered to the Naval Training Device Center, Port Washington, N. Y., by Sylvania Electric Products Inc. The flight simulator, developed under a joint Navy-Air Force \$2 million contract, is now capable of simulating F-100A and F9F-2 operation and is being considered for use in more advanced systems, such as the Dyna-Soar re-entry vehicle.

imagine!... 7,500,000*

Think of it—the highest magnetic power ever achieved, in virtually any size and shape—through the use of commercially produced ALNICUS 75®... an entirely new and exclusive development of U.S. MAGNET & ALLOY CORPORATION.

This revolutionary advance in the development of a high energy level permanent magnet material is in marked contrast to the time when we were boys experimenting with the magic of magnetism—an era when industry knew little of the many possible uses of the magnet.

Today—an age of space and automation—the permanent magnet has become a vital component used in one form or another in all industries. ALNICUS 75®, with its nominal energy product of 7,500,000 gauss-oersteds, broadens the scope of magnet use. For example—with commercially produced ALNICUS 75® it is now possible to have increased magnetic energy with no increase in unit size or weight... or, retain the same magnetic energy with less magnet weight. More important... ALNICUS 75® can be cast into virtually any size or shape... because it maintains its high magnetic power in all configurations!

ALNICUS 75® is of signal importance to the design and development groups in the fields devoted to the manufacture of ■ Loudspeakers ■ Generators ■ Motors ■ Magnetrons ■ Galvanometers ■ Magnetos ■ Tachometers ■ Relays ■ Separators ■ Magnetic Chucks ■ Oil Filters ■ Holding Magnets ■ Recorders ■ Radar Equipment ■ Meters ■ Computers ■ Electronic Equipment

For complete information about ALNICUS 75® and its advantages for the Design and Development group in your firm, write for Brochure 10-D. Please address general inquiries to Dept. 10-D. *gauss-oersteds



MAGNETIC MATERIALS DIVISION

U.S. MAGNET & ALLOY CORP., 266 Glenwood Avenue, Bloomfield, N.J.



CIRCLE 28 ON READER-SERVICE CARD

Synthane makes and fabricates laminated plastics

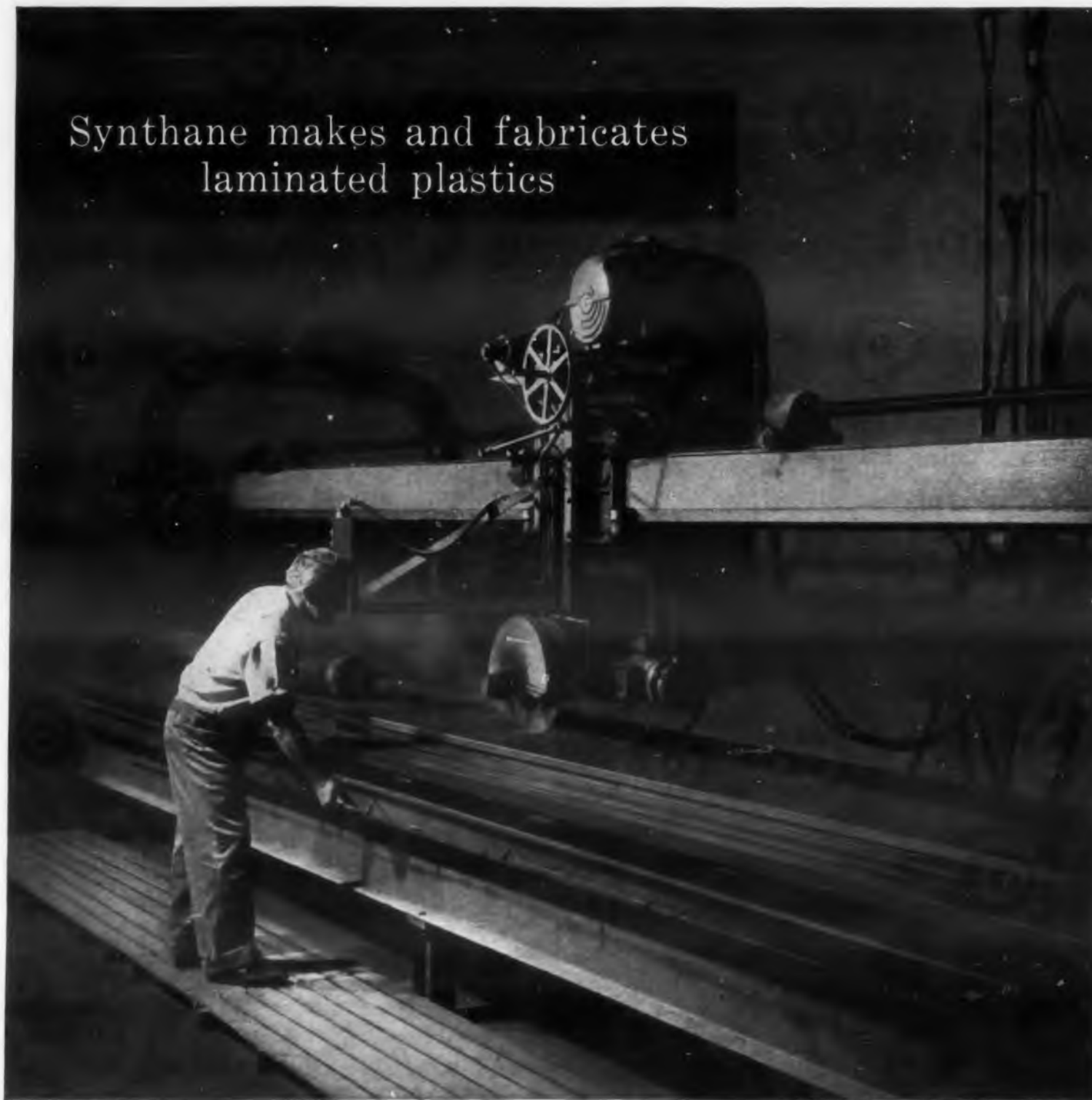

Why "do-it-yourself" fabrication seldom pays

This is a "long length" saw, especially built to cut sheets of Synthane laminated plastics of over 25 feet in length.

It is extremely improbable that you would ever have sufficient work to make the purchase of such a machine profitable. Yet the long length saw is only one of hundreds of unusual machines necessary for

fast, accurate, economical fabrication of laminates.

Without the advantage of special machines and tools, and faced with the possibility of errors, waste, delays, mistakes in tolerances or dimensions—at your expense—you may come to the same conclusion as have nearly all of our customers—buy your lam-

inated plastics from us and have us fabricate them for you. Call any of our representatives—located in all principal cities—for a quotation or write to Synthane Corporation, 42 River Road, Oaks, Pa.

SYNTHANE
CORPORATION **S** OAKS, PENNA.
Sheets • Rods • Tubes • Fabricated Parts
Molded-laminated • Molded-macerated

You furnish the print—we'll furnish the part

CIRCLE 29 ON READER-SERVICE CARD

NEWS

New GlobCom System

Complements Iono-Troposcatter According to MIT Scientist's Paper

A NEW method of reliable global communications by using orbital scatter for teletype, voice, and TV was described in a paper presented by W. E. Morrow, Jr., of Massachusetts Institute of Technology, at a meeting of the International Scientific Radio Union in London.

The new technique uses the reflective properties of a belt of tiny metallic fibers, or dipoles, about 1/2 in. long and one-third the diameter of a human hair, placed in orbit several thousands of miles above the earth. Radio waves transmitted to the belt will be scattered back to earth where they can be picked up by radio receivers. Transmitting and receiving antennas will be trained on the same spot in the belt. The reflective principle will be similar to that employed in ionospheric and tropospheric radio communications.

Promises High System Reliability

With two such belts, one east-west over the Equator and one north-south over the Poles, communications can be established between any



Two orbital scatter belts (one east-west over the equator and one north-south over the Poles) will relay radio messages over very long distances in communication system being developed by MIT Lincoln Laboratory. The tiny metallic fiber (dipoles) in the belts will be hundreds of feet apart.

Use Orbital Scatter

two points on earth, and can link widely separated points. This technique offers promise of very high system reliability, since all of the active radio equipment is located on the ground and easily accessible for maintenance.

It is estimated that within one to two months the dipoles will spread to form a continuous belt around the earth. In a completed belt, using the example described in the technical paper, it is calculated that the small fibers will be separated on the average by about 1,000 ft.

Orbital scatter appears to offer a number of advantages in long-distance radio communications. With two orbits, only two rockets will be required to provide practically world-wide coverage. The electronic and physical characteristics of the dipole belt will afford a very large number of communications circuits. Since the dipole belt will be relatively stationary in space, transmitting and receiving antennas on the ground can be trained continuously on the same spot in the belt with a movement of only a few degrees per day. This slow motion eliminates the need for high-speed tracking equipment. The lifetime of the belt can be varied from a matter of months to years, depending on the altitude and inclination of the orbit together with the dipole design. As the belt nears the end of its useful life, the dipoles will be dissipated harmlessly in the atmosphere. Belts with a relatively short lifetime are proposed for an initial experiment.

Little Undesirable Change Seen

Theoretical studies have indicated that known phenomena such as solar radiation pressure, atmospheric friction, sun and moon gravitation, micrometeorites, magnetic-field effects, and the influence of high-energy particles will not produce excessive undesirable changes in the belt.

Computations, prepared on the hypothetical example discussed in the technical paper, have convinced MIT scientists that the dipoles in orbit will have negligible adverse effects both on the use of space, and on the various types of astronomical observations—optical, radio, and radar. Discussions with other scientists and scientific groups, including an Ad Hoc Committee of the Space Science Board of the National Academy of Sciences have reportedly confirmed this opinion. ■ ■

OHMITE PRECISION RESISTORS

5 TYPES ... TOLERANCES TO 0.1%



This large family of precision resistors offers you flexibility for varied applications and traditional Ohmite quality for the most exacting requirements. Many of these styles are stocked in a wide range of values by the factory and Electronics Distributors throughout the country.

1 METAL FILM (SERIES 77) Units consist of metal film on glass substrate, hermetically sealed in high temperature resin. They possess long load and shelf life, low noise level, excellent high-frequency characteristics, and exceed military specifications. Rated at 125°C and 150°C. Resistances from 25 ohms to 2.5 megohms. Wattages from 1/4 to 2 watts. Cylindrical, semicylindrical, or flat-sided shapes with radial or axial leads. Tolerances are 0.1%, 0.25%, 0.5%, and 1%. *Bulletin 155.*

2 MOLDED WIRE-WOUND (SERIES 88, Power Type) These resistors utilize a single-layer winding on a ceramic core, welded connections throughout, and a molded silicone ceramic jacket. Uniform physical size in each rating. Supplied in 1, 3, 5, 7, and 10-watt sizes; resistances to approximately 50,000 ohms. Units meet MIL-R-26C specifications. Tolerances are

0.1%, 0.25%, 0.5%, 1.0%, and 3.0% (at 25°C). *Bulletin 153.*

3 ENCAPSULATED (SERIES 85 AND 86) Resistance wire, pie-wound on a steatite bobbin, is enveloped in an epoxy type resin. Welded connections throughout. Units meet and surpass military specifications. Series 85 has axial leads; Series 86, lug-type terminals. Designed to meet the requirements of MIL-R-93B. Resistance values to 3.1 megohms. Tolerances are 0.1%, 0.25%, 0.5%, and 1%.

4 VARNISH IMPREGNATED (SERIES 83, 84) Enameled wire is pie-wound or non-hygroscopic ceramic bobbin, and entire unit is vacuum impregnated. Radial wire lead, or radial lug terminals. Made to order only. Resistances from 0.1 ohm to approximately 5 megohms; 1/2 and 1-watt sizes. Tolerances are 0.1%, 0.25%, 0.5%, and 1%.

5 VITREOUS ENAMELED (POWER TYPE) Most Ohmite power resistors can be provided to close tolerances when precision as well as high wattage is desired. Depending on the requirements, the units are generally derated (often to 10% of free air watts) to minimize the effect of TC and maintain the best stability.

CIRCLE 30 ON READER-SERVICE CARD

OHMITE

MANUFACTURING COMPANY

3643 Howard Street
Skokie, Illinois

RHEOSTATS • RELAYS • POWER RESISTORS
PRECISION RESISTORS • MICROMODULES
TAP SWITCHES • GERMANIUM DIODES
TANTALUM CAPACITORS • R. F. CHOKES
VARIABLE TRANSFORMERS



Working from 18,000 to 90,000 mc?

**Don't
settle
for
less
than
narda
precision
Impedance
Meters!**



**MILLIMETER
IMPEDANCE METERS**

| Model: | Price: |
|--------|---------|
| K218 | \$ 500. |
| V217 | 600. |
| Q217 | 1100. |
| M217 | 995. |
| E217 | 1650. |

Just because you're working in millimeter bands is no reason to "make do" with lesser specs than you get from L to KU Bands. It's true that it's more difficult to maintain top specs at 90,000 mc than at X Band, for example, but in most cases Narda does it! And especially, in our slotted lines!

Precision instruments in every way, Narda millimeter Impedance Meters give you these important benefits: Smooth, stable carriage travel, absolutely parallel to the transmission line axis, with complete freedom from backlash. Imperceptible slope (0.01 max.), thanks to precision milling of tellurium copper

main transmission line, followed by a silver plate of molecular thickness and a rhodium flash.

Residual VSWR is under 1.01 for K and V Bands; 1.02 for Q, M and E. Position of the built-in probe is measured with a precision dial indicator having a least count of 0.001". And as an added advantage, the probe is usable with any waveguide detector.

All in all, an exceptionally fine instrument — and yet, typical of all Narda millimeter products. For complete information on the entire line, write for a free catalog. Address: Dept. ED-6.

Rely on narda for these other precision millimeter products:

Direct Reading VARIABLE ATTENUATORS
HARMONIC GENERATORS
High-Directivity DIRECTIONAL COUPLERS
FREQUENCY METERS

SLIDING TERMINATIONS
FIXED TERMINATIONS
TUNABLE SHORTS
CRYSTAL DETECTORS

STANDARD GAIN HORNS



the **narda** microwave corporation

118-160 HERRICKS ROAD, MINEOLA, L. I., N. Y. • PIONEER 6-4650

CIRCLE 31 ON READER-SERVICE CARD

NEWS

**Universal Sensor Display System
Used in Unmanned Jet Aircraft**

A universal sensor data-display system under development will provide instantaneous processing and display of surveillance information transmitted from unmanned jet planes to forward command posts. The system, developed by CBS Laboratories, Stamford, Conn., is part of the Army's new surveillance drone system.

Designated the AN/USD-5, the long-endurance, airborne electronic combat-surveillance system is a new version of the electronic ground receiving equipment originally developed by CBS Laboratories as part of the Photoscan system for aerial surveillance and reconnaissance.

The AN/USD-5 drone has completed two successful test flights and is the first high-speed unmanned jet drone to be used as the aerial element in a military surveillance system, according to the Department of Defense.

Present sensors to be carried by the drone include photographic, infrared, and radar. TV, electromagnetic, and nuclear sensory sub-systems are being considered for future integration into the system.

The drone system includes two air-transportable huts, the jet-powered delta-wing drone, and associated mobile launch and recovery equipment. The CBS-developed data-display system located in one of the huts acquires and processes the information sent back by the drone. Other electronic equipment pre-programs and monitors the drone's flight.

The drone uses inertial guidance and will not depend upon radio commands or other ground control. It can follow the contour of the terrain to avoid detection or can be sent to high altitudes if required.

**Electronics Used to Train Pilots
In Simulated Convair Jet Cockpit**

An electronic "airplane" is helping Delta Air Lines pilots learn to fly the Convair 880 jet airliner without ever leaving the ground.

A carbon copy of the CV-880 cockpit area, this simulator, manufactured by Link Aviation, Inc. of Binghamton, N.Y., is reportedly a realistic duplicate of all flying conditions from take-off to touchdown, including instrument simulation, cockpit motion, and sound simulation.

Included on the simulator flight deck are 120 instruments used by the three-man Convair 880

crew. The instruments, linked to a series of analog computers, indicate the engine and flight conditions of the simulated flights undertaken by students. Instruments react to the pilot's use of the controls as well as to external conditions—such as weather and radio signals—introduced by an instructor seated at the monitoring console. A realistic loading system assures that control "feel" will correspond to what it would be under similar conditions in actual flight.

During a simulated flight the instructor locates and generates the ground radio signals used as navigation aids, and also serves as control-tower operator.

Graphic automatic flight recorders, which plot the simulated aircraft's progress on a map of the earth, are used in the instructor's area. Approach recorders are also provided for evaluating pilot accuracy during critical approach and landing operations.

The instrument realism provided by the simulator results from the computers which are actuated by either the pilot's or instructor's use of the controls. These computers solve the necessary equations to react to simulated conditions just as they would in actual flight.

For training in radio and navigation the student pilot may receive up to six radio stations, including any combination of VOR, ILS, GCA, non-directional beacon, low-frequency radio range, and broadcast.

It costs approximately \$1,000 an hour to train in a Convair 880, including depreciation, maintenance, and flying operations costs. Simulator costs are approximately \$180 per hr.

Simplified Optical Reader Developed; Makes Decisions in Reading Head

A simplified optical reading machine, which makes decisions in the reading head rather than with complex circuits, is claimed by Briggs Associates, Inc., Norristown, Pa.

The technique is adaptable to any type face with minor modifications of the machine, according to a Briggs spokesman. The device should permit reading speeds of 1,000 characters a second, he added, although this speed has not yet been achieved.

The new reading technique is expected to permit low-cost readers to be produced without extremely precise tolerances on production. The company is preparing a line of reading equipment to produce punched paper tape, punched cards, or magnetic tape from source documents having printed numerical digits.

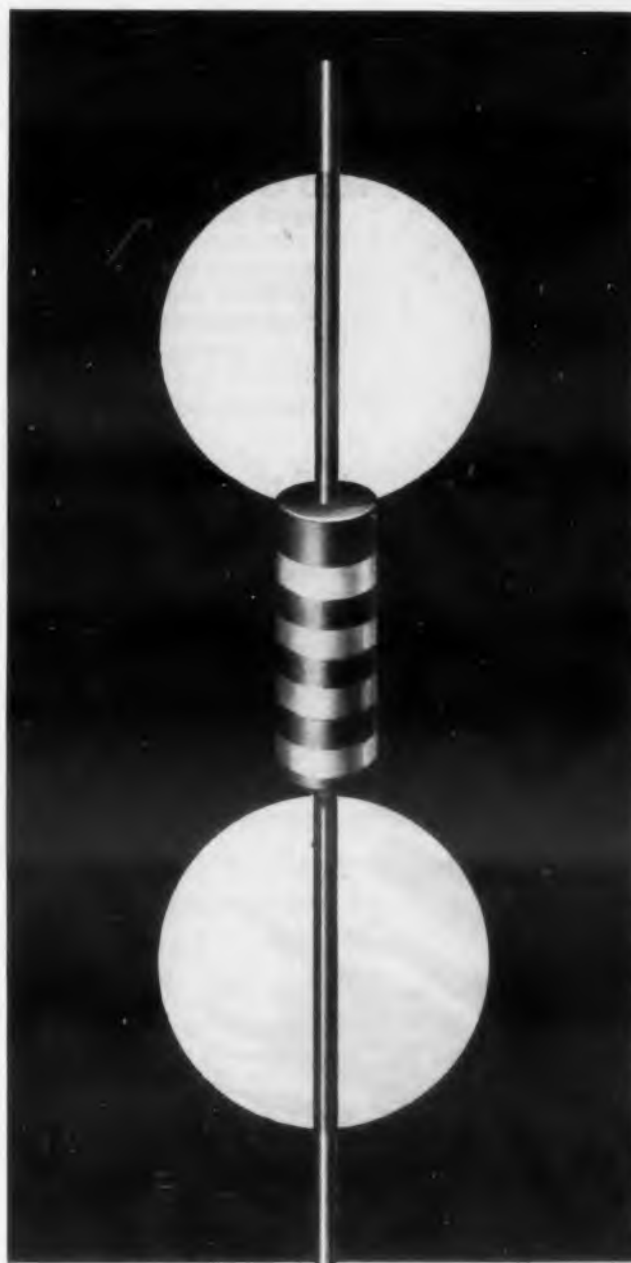

Coldite 70+ Resistors Save You Money on Assembly Work!

Stackpole Coldite 70+ resistors solder easier and stay soldered more surely. Thanks to an extra solder coating applied AFTER the usual tin-lead coating, they solder perfectly by ANY method—dip or iron. Moreover, resistance variations from normal soldering heat are negligible.

Get a head-start on production with "solder-coated" resistors

You can pretty well take for granted that any one of several leading resistor brands will meet or exceed your performance requirements. But there's another factor to be considered too—ease of handling on your assembly lines. Mainly that means ease of soldering—and here Stackpole Coldite 70+ "solder-coated" fixed composition resistors stand head and shoulders above the field. Not only do these famous cold-molded resistors meet today's critical specifications, but they provide unmatched "solderability" on any hand or automatic, open wiring or printed circuit operation. That makes not only for a real saving in assembly work, but also stands to reduce subsequent service costs resulting from poor soldered connections.

ELECTRONIC COMPONENTS DIVISION
STACKPOLE CARBON COMPANY, ST. MARYS, PA.

STACKPOLE
Coldite 70+

FIXED COMPOSITION RESISTORS

CERAMAG® FERROMAGNETIC CORES • SLIDE AND SNAP SWITCHES • VARIABLE COMPOSITION RESISTORS • CERAMAGNET® CERAMIC MAGNETS • FIXED COMPOSITION CAPACITORS • ELECTRICAL CONTACTS • BRUSHES FOR ALL ROTATING ELECTRICAL EQUIPMENT • HUNDREDS OF RELATED CARBON, GRAPHITE, AND METAL POWDER PRODUCTS

CIRCLE 32 ON READER-SERVICE CARD

Miniature rectangular HYFEN is available in 14, 20, 26, 34, 42, 50, 75, and 104 contact sizes. All contacts are size 20 (.040" dia. pin) and a range accommodates wire sizes #18 thru #26. Individual contacts snap-lock in and out of connectors.



Crimped connections comply with requirements of MIL-T-7928. ALSO AVAILABLE: Center jack screw connector accommodating both miniature HYFEN coax contacts and standard contacts. Completely interchangeable, HYFEN can mate with existing solder types.

miniature rectangular **HYFEN**[®] provides high density connections



104
CRIMP-TYPE
SNAP-LOCKED
CONTACTS

For further details write OMATON DIVISION

BURNDY 60-11

NORWALK, CONNECT. • BICC-BURNDY Ltd., Lancs., Prescot, England • In Continental Europe: Antwerp, Belgium • TORONTO, CANADA

NEW PRODUCT

Versatile High Speed Crimping Tool



The Omaton Division of the Burndy Corporation has available for the electronic industry its extremely versatile, semi-automatic, portable pneumatic crimping tool, type YD, which provides for controlled crimping in volume production work.

This magazine-fed tool automatically prepositions, feeds, and crimps contacts such as those used with BURNDY's MODULOK[®] and CRABLOK[®], STAPIN[®] and HYFEN[®] lines of connectors. This simplifies contact installations, permitting highly reliable connections to be made at a high production rate.

The YD HYPRESS[®] crimps up to 1000 contacts per hour by advancing and positioning the contacts automatically. The YD accommodates up to 70 contacts per load.

Contacts to be installed with the YD are furnished pre-loaded in color coded plastic expendable carry strips carrying fourteen contacts per strip and packaged five strips to a magazine load. The plastic strips are automatically ejected from the tool after the contacts have been used.

The power unit of the YD HYPRESS is an air cylinder which is controlled pneumatically (no mechanical ratchets) to provide full cycling control which assures that each contact is properly crimped. The tool is factory set to operate at 80-100 psi line pressure and develops 2500 lbs. force when operated at 90 psi.

Burndy Corporation, Norwalk, Connect.

CIRCLE 33 ON READER-SERVICE CARD

◀ CIRCLE 34 ON READER-SERVICE CARD

EDITORIAL

Let's Look at the Assumptions

"Let's look at the facts" is a common cry in the midst of an election campaign. But where the politician wants the voter to look at his facts alone, the engineer must get all of the facts.

And if we are to look at all of the facts, we must re-examine those minor facts all too frequently glossed over.

FACTS + ASSUMPTIONS + LOGICAL DEDUCTIONS = SOLUTIONS.

The excellence or soundness of the Engineering Solution will depend largely upon the second term of this equation. Assumptions encompass a vast area including the known and the unknown. Apparently engineers pride themselves in working with facts. The unknown can't be tolerated but it is too often assumed that the unknown is a negligible factor that can be ignored.

Let's examine some of these assumptions. One is environment is constant. The designer perfects a device which works well under controlled laboratory conditions but he doesn't allow for temperature, shock, and vibration extremes found outside the lab. Assumption number two that is unfounded: the operator can make minor calibration and trimming adjustments. Not many operators are as deft with a screwdriver as the engineer. A related assumption is that the human operator is a hydra-headed, multi-armed superman who can read simultaneously panel meters that are 6-ft apart and 0.5-in. in diameter while tuning to a third harmonic.

Another assumption: a trained technician will always be on the spot to diagnose and repair the trouble. This latter assumption implies another: that electronic equipment will fail; that it is not expected to last. Fortunately our uncritical acceptance of this assumption is being challenged by the military which is insisting on a guaranteed number of trouble-free hours of operation.

We must re-examine our assumptions, not only regarding reliability of a product, but also looking at cost, accuracy, and ease of operation, to name just a few.

It is an old principle of law that when a man performs an act, he assumes the natural and logical consequences of that act. Let that apply to design. Let us, as design engineers, no longer assume that A will never happen or that X is too small a factor to be important. Let's look at our assumptions.

James G. Kipp

new!

Universal
**IMPEDANCE
 MEASURING
 SYSTEM...**

model

291-A



An improved, Ultra-High Performance Model of the 291 Laboratory Favorite

NEW HIGHER ACCURACY

Resistance, 0.05% — capacitance and inductance, 0.1%.

NEW GREATER RESOLUTION

Four-dial Dekadial® decade dial provides 120,005 divisions of resolution.

NEW IMPROVED RESISTORS

Extremely low temperature coefficient and high stability assure measurements of maximum accuracy.

NEW NO ZERO CAPACITANCE

Requires no correction for zero capacitance inside the bridge. Simplifies making three-terminal capacitance measurements.

Includes both ac and dc generators and detectors which have been specifically designed for use with the bridge, thus assuring adequate sensitivity for attaining specified accuracy throughout the measurement range.

Price: \$1095, f.o.b., Portland, Oregon. Delivery 30 days.



formerly ELECTRO-MEASUREMENTS, INC.

SEND FOR DESCRIPTIVE LITERATURE

VISIT OUR DISPLAY

1960 ISA SHOW

BOOTH 531

Electro Scientific Industries

7524 S.W. MACADAM • PORTLAND 19, OREGON

CHerry 6-3331

CIRCLE 35 ON READER-SERVICE CARD

All-Pass Networks—Part 1

The Anatomy of Networks

An all-pass, or phase-shift, network permits the shaping of another network's transient response without paying the price of additional attenuation. In this first of a series of articles on all-pass networks, Yale Jay Lubkin, describes them and shows how their responses may be calculated in the time domain. Succeeding articles will deal with the application of these networks to improving transient response.



Y. J. Lubkin

Loral Electronics Corp.
The Bronx, N.Y.

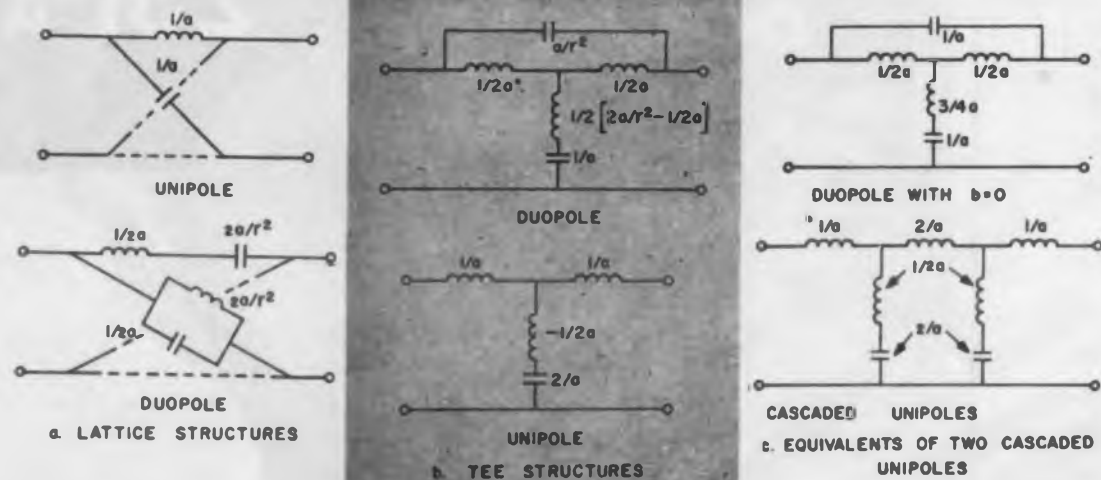

Fig. 1. Forms in which all-pass networks may be realized physically.

WHEN PHASE characteristics and transient response are important, the all-pass, or phase-shift, network is a valuable tool to the designer.

Some of the advantages of these networks are:

- 1) They permit phase control over a narrow or wide band anywhere in the spectrum.
- 2) They produce no attenuation (ideally).
- 3) They are easily realizable in either balanced or unbalanced form.
- 4) They can be cascaded indefinitely without interaction.

5) Any all-pass characteristic can be expressed as a cascade of simple forms (that is, sections), and the network written down by inspection.

6) For some application, such as delay networks, they permit the greatest theoretical component economy.

7) An arbitrary amplitude characteristic can be combined with an arbitrary phase characteristic and a time delay. Conventional filters and networks are generally of the minimum phase-shift type (phase and amplitude characteristics are interdependent, and specification of one completely determines the other).

8) By using single sections as successive approximations to the difference between the actual phase shift and the desired phase shift, design effort can be broken into a sequence of simple steps.

Advantages Can Be Disadvantages

There are certain restrictions on the use of phase-shift networks. The disadvantages are similar to the advantages, but are viewed from a different angle. For instance:

- 1) Because all-pass networks have no attenuation, other networks must be used in order to produce a non-flat amplitude characteristic.
- 2) A great number of sections may have to be used for elaborate shaping.

Response of Unipole and Duopole to Common Input Waveshapes.

| Waveshape | Time Response | | Comments |
|--|--|---|---|
| | Unipole | Duopole | |
| Impulse | Impulse | Impulse | Impulse output may be inverted. |
| Step | $h_1 = 1 - 2e^{-at}$ | $h_2 = 1 - \frac{4a}{b} e^{-at} \sin bt$ when $b \neq 0$ $h_2 = 1 - 4ate^{-at}$ when $b = 0$ | 1) Critical damping for duopole is when $b = 0$. 2) When $b = 0$, duopole is equivalent to two, identical, cascaded unipoles. |
| Exponential $g(t) = e^{-ct}$ | $h_1 = \frac{1}{1 - \frac{c}{a}}$ $\left[2e^{-at} - \left(1 + \frac{c}{a}\right) e^{-ct} \right]$ when $c \neq a$ $h_1 = (1 - 2t) e^{-at}$ when $c = a$ | $h_2 = \frac{4ace^{-at}}{(a-c)^2 + b^2}$ $+ e^{-ct} \left\{ \left[1 - \frac{4ac}{(a-c)^2 + b^2} \right] \cos bt - 4 \frac{a}{b} \left[\frac{a(a-c) + b^2}{(a-c)^2 + b^2} \right] \sin bt \right\}$ | 1) For small c , response is essentially step response times exponential waveshape. 2) For large C , response is just impulse response (i.e. unity) times input exponential. |
| Rectangular Pulse of unity amplitude for $0 \leq t \leq t_0$ | $h_1 = 1 - 2e^{-at}$ when $0 \leq t \leq t_0$ $h_1 = 2e^{-at} (e^{at_0} - 1)$ when $t > t_0$ | $h_2 = 1 - 4 \frac{a}{b} e^{-at} \sin bt$ when $0 \leq t \leq t_0$ $h_2 = 4 \frac{a}{b} e^{-at}$ $[e^{-at_0} \sin b(t-t_0) - \sin bt]$ when $t > t_0$ | 1) Unipole responds to input transients as does R-C or R-L hi-pass filter. 2) For duration of the input pulse, response is same as for step input. |

3) Except for extremely high frequencies, there is a finite delay through any all-pass network, (in fact, through any network containing inductors and capacitors). This delay generally increases with the complexity of the network, and may be objectionable in some applications. (In many applications, delay is desirable.) These networks will be developed in two forms suggested by two simple transfer functions that produce phase shift without attenuation.

Properties of Transfer Functions

Any lumped parameter network has a transfer function that is a quotient of two polynomials. For no attenuation at any frequency, the absolute value of this quotient must be unity for real frequencies and the transfer function must be of the form:

$$F(s) = \frac{P(-s)}{P(+s)} \quad (1)$$

where P is a polynomial.

Because all poles of a passive network must lie in the left half plane, all the zeros of the all-pass network must lie in the right half plane. In fact the zeros are the reflections of the poles about the imaginary axis. (The poles are the

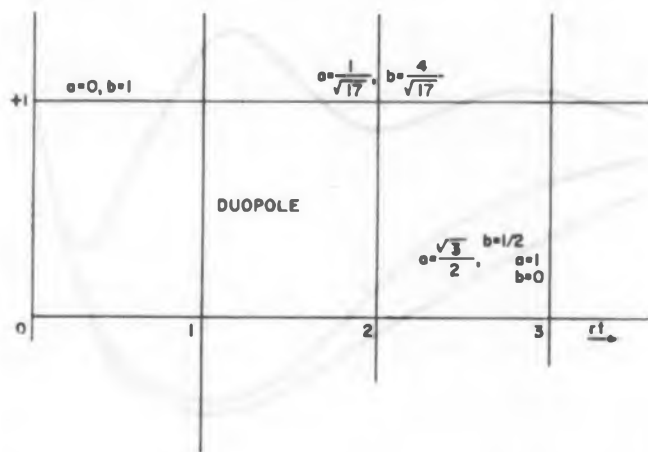
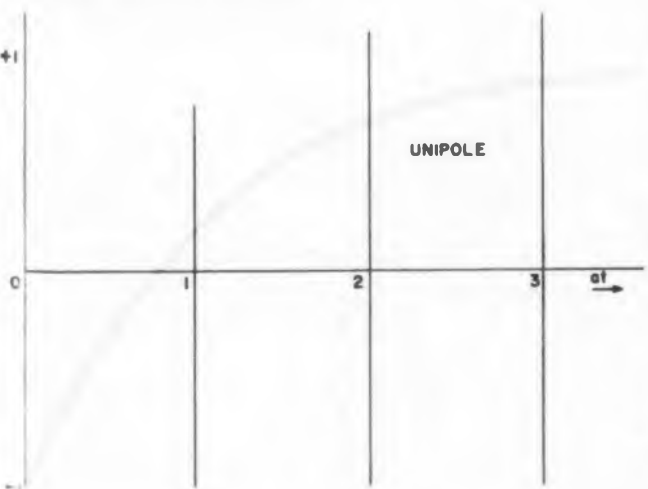

Fig. 2. Graph illustrates the response of unipoles and duopoles to step functions.



roots of $P(+s)$, the zeros are the roots of $P(-s)$.)

The reflection coefficient of an all-pass network is zero, by definition, so that any number may be cascaded without interaction, provided they have the same characteristic impedance.

The characteristic impedance for all frequencies is constant and resistive, which is quite different from the behavior of networks having attenuation. (The usual figure given for the characteristic impedance of filters and networks is the limit as the center of the passband is approached.)

This permits the development of any all-pass network as a cascade of two simple forms, one representing a real pole and associated zero and the other two poles and two zeros symmetrical to the poles.

The simplest all-pass network has a transfer function:

$$F(s) = \frac{a-s}{a+s} \quad a > 0 \quad (2)$$

Unipole Gives 0-180 Deg Phase Shift

Eq. 2 shows that the zero frequency phase shift is zero, and the infinite frequency phase shift is 180 deg. The phase shift can always be shifted by 180 deg by reversing the output terminals.

The response to an arbitrary input waveshape can be calculated by either of the following equations:

$$h(t) = -g(t) + 2ae^{-at} \int_0^t g(\tau) e^{a\tau} d\tau \quad (3a)$$

$$h(t) = g(t) - 2g(0^+)e^{-at} - 2e^{-at} \int_0^t g'(\tau)e^{a\tau} d\tau \quad (3b)$$

where τ is a dummy time variable.

In Eq. 3, $h(t)$ is the output wave shape, $g(t)$ is the input waveshape, and $g(\tau)$ is the derivative of $g(\tau)$. Eq. 3b shows that the response to a

step ($g'(\tau) = 0, g(\tau) = 1$) at the input is an exponential rise of twice the amplitude of the input, with a time constant of $1/a$.

The other elementary phase-shift network has a transfer function:

$$F(s) = \frac{(s-a)^2 + b^2}{(s+a)^2 + b^2} \quad a, b > 0 \quad (4)$$

For this network there is no phase inversion with either at zero or at infinity. Corresponding to Eq. 3, we have

$$\begin{aligned} h(t) &= g(t) - 4ae^{-at} \int_0^t g(\tau) e^{a\tau} \\ &\quad \left[\cos b(t-\tau) - \frac{g}{b} \sin b(t-\tau) \right] dt \quad (5) \\ &= g(t) - \frac{4ab}{r} e^{-at} \int_0^t g(\tau) e^{a\tau} \\ &\quad \sin(bt - b\tau - \theta + 180) d\tau \end{aligned}$$

where $r^2 = a^2 + b^2$ and $\tan \theta = a/b$

Sharp Transients Not Delayed

From the response equations we see that any abrupt change of voltage at the input produces an immediate change of the output by the same amount, so that sharp transients are not delayed. (At $t = 0$, all of the integrals are zero, and the output is equal to the input).

If it is essential that transients be suppressed, as for delay line use, it would be necessary to add a low-pass filter or to provide for interference suppression, (as used, for example, in the Ferranti lumped parameter delay lines.)

In the single-pole all-pass network, the parameter, a , is the frequency for which the phase shift is exactly 90 deg.

In the duopole, the two-pole network, $\omega = r = \sqrt{a^2 + b^2}$ is the angular frequency for which the phase shift is exactly 180 deg and a is equal to half the bandwidth between points

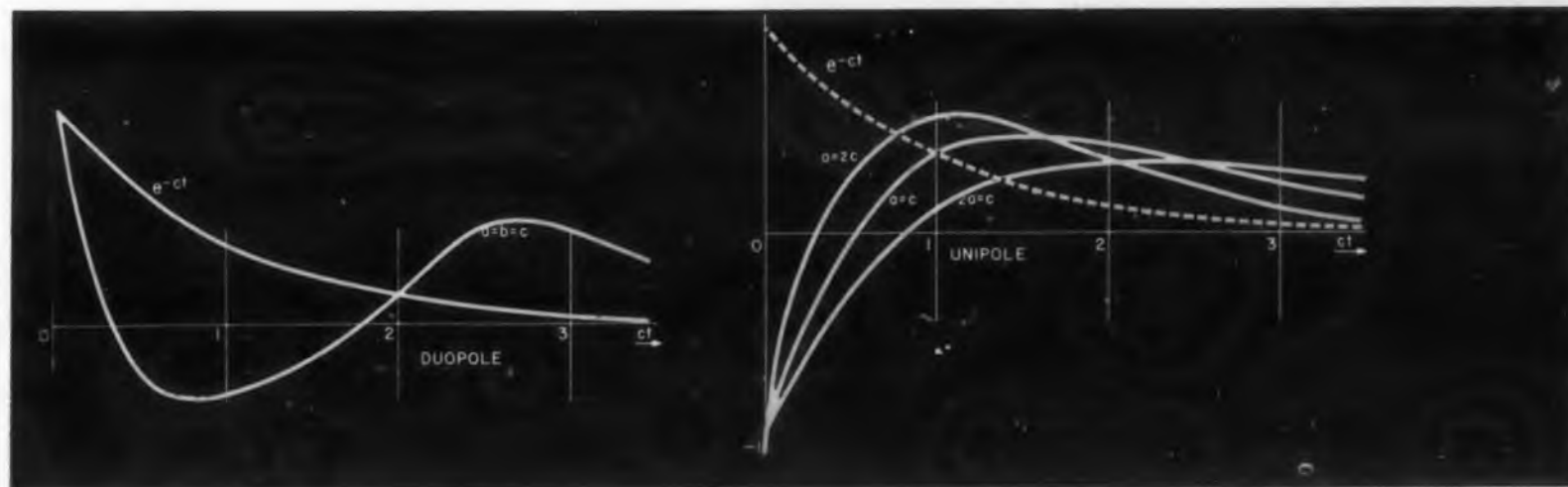

Fig. 3. Response of unipoles and duopoles to exponential functions.

of 90 deg phase-shift and 270 deg phase-shift. (Note that this bandwidth is not centered on

$$\omega = \sqrt{a^2 + b^2}$$

but is centered on

$$\omega = \sqrt{2a^2 + b^2}.$$

Networks Realized in Three Forms

The two basic phase shift networks can be realized in either a balanced lattice, a tee or a pi, as shown in Fig. 1.

The pi network can be realized only by the use of a negative capacitance. The tee networks require negative inductances, which are readily obtained with mutual inductances.

The tee form of the unipole is especially convenient, because the inductors may be combined when cascading a number of sections, thus physically simplifying the construction. A simplification of structure is possible by using a degenerate duopole ($b = 0$) in place of two identical cascaded unipoles.

Response to Common Waveshapes

The response of the unipole and the duopole to various common waveforms is indicated in the Table and Figs. 2 to 4.

By using the pulse response or the step response, time-function computation can be done rapidly, simply and fairly accurately by graphical means. The input time waveform is broken into a superposition of rectangular pulses or steps and the response to them added, a procedure very similar to graphical integration.

The techniques are identical to those used in simple pulsed data systems, where an input is impulse modulated, passed through a clamper and then through a smoothing filter. For a sufficiently high-modulation frequency, the result is

an accurate, but delayed, representation of the input.

Effect of Cascading Unipoles

The result of passing a unit step through a cascade of n identical unipoles is:

$$h_n = (-1)^{n+1} + (-1)^n e^{-at} P_{n-1}(at)$$

where P_{n-1} is a polynomial in (at) of $(n-1)$ th degree. The coefficient of $(at)^{n-1}$ is $2^n/(n-1)!$, which goes to zero as n increases. The constant term in P_{n-1} is 2 for odd n and 0 for even n .

All responses feature an initial spike followed by a sequence of oscillations, with $n-1$ extremes separated by an increasing time, as shown in Fig. 5.

This suggests that inclusion of a low-pass network (before or after the unipoles) would have little effect on the response beyond a certain time, t , depending on a and on the cut-off frequency of the low-pass characteristic.

This also suggests a study of the effects of restricting inputs to low-frequency signals. (A major purpose of the low pass filter is the elimination of the initial spike generated by fast rising inputs.) This study will lead to a convenient approximation to the network's time domain response to practical waveshapes.

Band Limited Inputs Practical

An all-pass network has a transmission characteristic that can be expressed as $e^{-j\phi(\omega)}$, $\phi(\omega)$ being the phase shift. If the input to this network were band-limited, with limit ω_0 (which may be arbitrarily large as long as it is finite), then the output would be:

$$h(t) = \int_{-\omega_0}^{\omega_0} G(j\omega) e^{-j\phi(\omega)} e^{j\omega t} d\omega \quad (10)$$

$G(j\omega)$ is the Fourier transform of the input.

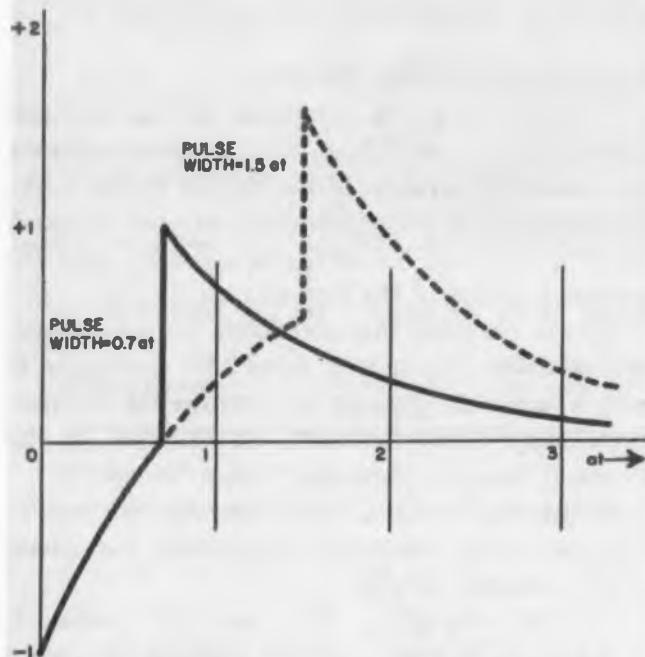

Fig. 4. (Top) Response of a unipole to a pulse. (Bottom) response of a duopole to a pulse when $a b = \sqrt{3}$. Response to leading edge is like response to step function.

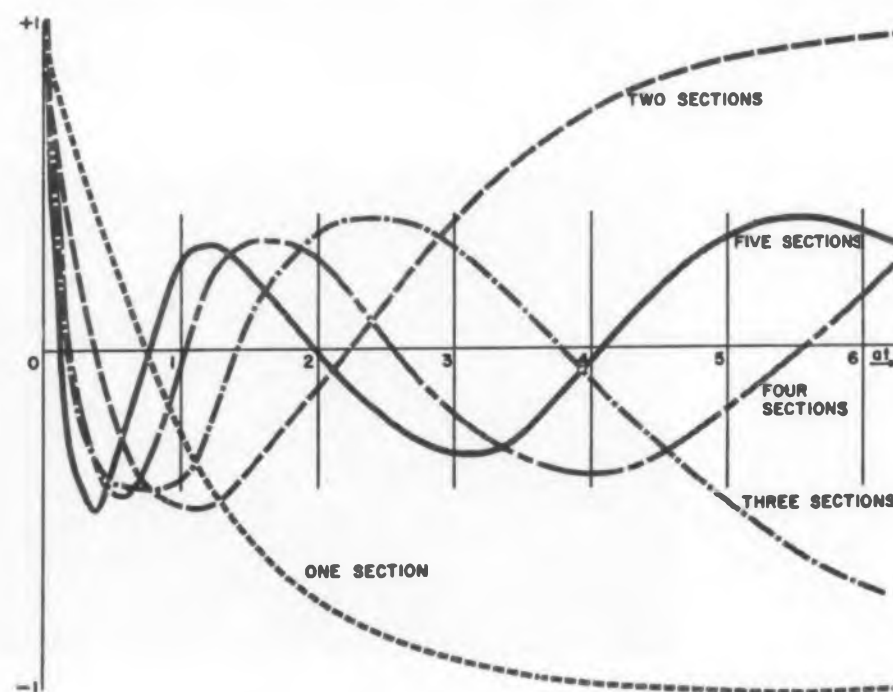
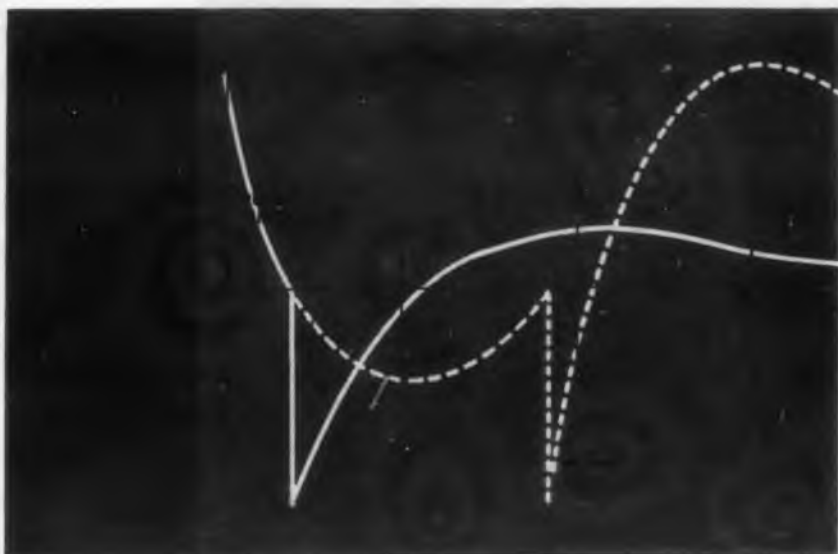

Fig. 5. Response of cascaded unipoles to step function.

Terms and Symbols

- A. All time-dependent functions are designated by small letters, such as $g(t)$, $h(t)$.
- B. All frequency-dependent functions are designated by capital letters, such as $G(w)$, $H(w)$.
- C. All time-dependent functions are assumed to be zero for $t < 0$.
- D. Network inputs are $g(t)$ and $G(w)$.
- E. Network outputs are $h(t)$ and $H(w)$.
- F. Network response to a unit impulse is designated by $f(t)$ and $F(w)$.
- G. If the output of a network has infinite amplitude when the input waveform is $ke^{-\alpha} \sin wt$ (k is any number) then the network has a pole at $s = \alpha + jw$, and conversely. For all networks under discussion, α is negative.
- H. If the output of a network has zero amplitude when the input waveform is $ke^{-\alpha} \sin wt$ (k is any number) then the network has a zero at

$s = \alpha + jw$, and conversely. For zeros, α may be any real number.

- I. A section is a four terminal network which cannot be divided into a cascade of two simpler four terminal networks.
- J. A network transfer function is a frequency-dependent function whose value at frequency, s , is the ratio of output to input voltage when the input is of frequency s .
- K. An all-pass (or phase shift) network is a four terminal network whose transfer function has an absolute value of unity. There is, therefore, no attenuation of a sine wave through such a network.
- L. A unipole is an all-pass section with one pole and one zero.
- M. A duopole is an all-pass section with two poles and two zeros.

It is not necessary to know $G(jw)$. Because ϕ is an odd function of frequency, it can be expanded around the origin into a power series with only odd terms. For the unipole and duopole, the series take the form

$$\phi_1 = 2 \arctan \frac{\omega}{a} \quad (11)$$

$$= 2 \left[\frac{\omega}{a} - \frac{1}{3} \frac{\omega^3}{a^3} + \frac{1}{5} \frac{\omega^5}{a^5} - \dots \right]$$

$$\phi_2 = 2 \arctan \frac{2a\omega}{r^2 - \omega^2} \quad (12)$$

$$= 2 \arctan \left[\frac{a}{r} \tan \left(2 \arctan \frac{\omega}{r} \right) \right]$$

$$= \frac{4a}{r} \left[\frac{\omega}{r} + \frac{\omega^3}{r^3} \left(1 - \frac{4}{3} \frac{a^2}{r^2} \right) \right.$$

$$\left. + \frac{\omega^5}{r^5} \left(1 - 4 \frac{a^2}{r^2} + \frac{16}{5} \frac{a^4}{r^4} \right) \right.$$

$$\left. + \frac{\omega^7}{r^7} \left(1 - \frac{8a^2}{r^2} + \frac{16a^4}{r^4} - \frac{64}{7} \frac{a^6}{r^6} \right) + \dots \right]$$

where $r^2 = a^2 + b^2$

Both expansions converge very rapidly for small ω/a , and for many purposes no more than four terms need be taken.

By using the series expansions for ϕ , we can express the output in a somewhat different form: one that makes it fairly suitable for graphical calculation. Because:

$$\phi = \alpha\omega + \beta\omega^3 + \gamma\omega^5 + \dots \quad (13)$$

we can substitute it into Eq. 10

$$h(t) = \int_{-\omega_0}^{\omega_0} G(j\omega) e^{j\omega(t-\alpha)} e^{-j(\beta\omega^3 + \gamma\omega^5 + \dots)} d\omega \quad (14)$$

and make use of the rapidly converging expan-

sion for e^z

$$h(t) = \int_{-\omega_0}^{\omega_0} G(j\omega) e^{j\omega(t-\alpha)} \left[1 - j\beta\omega^3 - j\gamma\omega^5 - \frac{\beta^2}{2} \omega^6 - j\delta\omega^7 \dots \right] d\omega \quad (15)$$

$$= \int_{-\omega_0}^{\omega_0} G(j\omega) e^{j\omega(t-\alpha)} d\omega - j\beta \int_{-\omega_0}^{\omega_0} \omega^3 G(j\omega) e^{j\omega(t-\alpha)} d\omega + \dots$$

Eq. 15 has a simple interpretation: The first integral is just $g(t - \alpha)$, the input delayed by α seconds. (This is the response of an ideal delay line.) The second integral is the third derivative of $\beta g(t - \alpha)$, and so forth.

Because we have restricted the bandwidth of the input, this series of derivatives converges rapidly, and not too many terms are needed.

For the unipole $\alpha = 2/a$, $\beta = -2/3a^3$ and $\gamma = 2/5a^5$, so that:

$$h_1(t) = g(t - 2/a) + \frac{2}{3a^3} g^{(3)}(t - 2/a) - \frac{2}{5a^5} g^{(5)}(t - 2/a) \quad (16a)$$

and for the duopole,

$$h_2(t) = g(t - 4a/r^2) + \frac{4a}{r^4} (1 - 4a^2/3r^2) g^{(3)}(t - 4a/r^2) - \dots \quad (16b)$$

Where

$$g^{(n)} = \frac{d^n g}{dt^n}$$

Therefore, for an input waveshape to a phase-shift network, the output waveform may be determined exactly, but at great pain, using Eqs. 3 and 5, or approximately, and more conveniently, with Eq. 16. (The approximation may be made arbitrarily precise by taking more and more terms.) ■ ■

What's YOUR Portable Power Problem?

BURGESS has more than 5000 battery types to choose from:

ZINC-CARBON

NICKEL-CADMIUM MERCURY
WATER-ACTIVATED

each with the highest measure of uniform dependability! This is why 2 of 3 electronic engineers specify

BURGESS BATTERIES



BURGESS
IS THE MOST COMPLETE ONE-SOURCE
LINE OF *Portable Power!*



EXCLUSIVE WAFER CELL CONSTRUCTION

... offers compactness, long shelf life, exceptional service life. A 30% increase in battery life at no increase in size.

TRANSISTOR ACTIVATORS

Burgess Activator Batteries for transistor circuits are smaller and more compact in size! Yet they deliver 30% more power because of the patented "Wafar-Cell" construction! Burgess Activators give you compact power, uniform performance, longer shelf life... all combined with modern packaging.



RESERVE BATTERIES

High energy output in a compact power source. Can be stored dry for years! Activated only when immersed in water. No handling of dangerous electrolyte, no spilling or leaking! Wide range of efficient operating temperatures. Designed for your specific applications.



MERCURY ACTIVATORS

Burgess constructional features provide uniform quality and dependable service! Burgess exclusive patents offer sealed-in-steel protection, wide temperature range efficiency, controlled venting, patented inner cell connector, and flat discharge curve.



SEALED NICKEL-CADMIUM BATTERIES

A secondary rechargeable battery system which delivers high energy output from a small package! Hermetically sealed-in-steel cells eliminate annoying maintenance and addition of liquids. Can be recharged many times, by trickle or quick charge, for long lasting economical power!



Check with your Burgess Distributor for complete local stocks of fresh BURGESS BATTERIES! Or your distributor can order from Burgess the special battery needed for your specific application!

FREE DESIGN SERVICE

For special applications, skilled Burgess Engineers offer you a FREE battery design service. Burgess will manufacture the exact battery to fit your needs, regardless of quantity required.

NEW ENGINEERING MANUAL

New 100-page dry battery handbook now available! Engineers engaged in the design of battery-powered equipment are invited to write to Burgess Battery Company, Dept. ED, Freeport, Ill., to secure a copy. Others may buy the manual for \$1.00.



BURGESS BATTERY COMPANY
DIVISION OF SERVEL, INC.
FREEPORT, ILLINOIS

CIRCLE 36 ON READER-SERVICE CARD

A Simple Technique for Recovering Low-Frequency Data From Magnetic Tape



John L. Janning, works in the Advanced Projects Department of the National Cash Register Co., Dayton, Ohio. He didn't like the idea of using special playback heads and techniques to recover low-frequency data from magnetic tape, so he developed his own technique for use with conventional playback heads.

John L. Janning
National Cash Register Corp.
Dayton, Ohio

A SIMPLE method permits recovery of dc and low-frequency data from magnetic tape using standard playback heads. Normally, special heads or techniques—such as fm recording—are required.

The method is to sample the signals on the tape by recording a pulsating dc—like the output of an unfiltered half-wave rectifier—over the signal. The effect is to amplitude modulate the pulses with the waveform of the low-frequency signal.

The information now can be extracted from the tape because the flux is varying at a rate sufficient to activate the standard playback head.

The extracted waveform need only be detected to yield the original data.

If data are recorded at high and low frequencies, the tape must be played back twice to recover all the data stored. The first playback recovers all high frequency components. Then, the tape is “developed” by recording the pulsating dc. The second playback, after “developing,” yields the low-frequency components.

The Developing Procedure

Fig. 1 shows a typical recording curve. For linear recording, the dc bias, on the basis of this curve, should be 1.2 ma, and the recording current should not exceed 0.8 ma peak-to-peak. This keeps the recorded signal on the linear part of the curve.

The developing pulses must be in the same di-

rection as the dc bias was when recording. However, during the developing process, no bias is used. The amplitude of the pulses should almost equal that required to reach saturation on the curve.

The circuit used to generate the pulses and apply them to the tape is shown in Fig. 2.

The optimum developing frequency gives maximum output with a particular head. However, the higher the developing frequency the higher the frequency that can be extracted from the tape by the process.

The reason is that at least six points are required to plot one cycle of a sine wave, and each developing pulse touches the recorded waveform at one point. Hence, the highest frequency that can be recovered is about 1/6 the developing frequency.

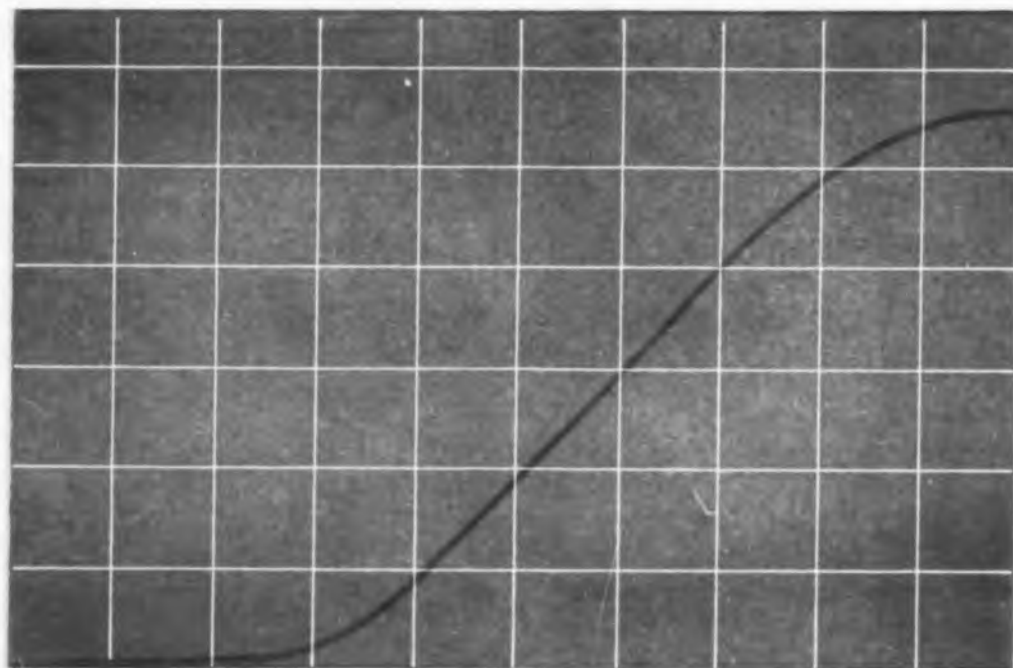

Fig. 1. A typical recording curve. Recording currents normally are restricted to those on the linear part of the curve.

Experimental Results

Signals from dc to 10 kc were recorded with a bias of 1.2 ma and a peak-to-peak current variation about 10 per cent less than the permissible 0.8 ma.

The frequency of the developing pulses was chosen as 3 kc and the highest recorded frequency that could be extracted by developing was 500 cps.

It was found that frequencies between 50 and 500 cps could be extracted from the tape by conventional playback or the developing process. The conventional playback extracted frequencies from 50 cps to 10 kc, and the developing process extracted signals from dc to 500 cps.

Fig. 3, top, shows a 1/2-cps square wave after the developing process and playback but before detection. It is superimposed on the 3-kc developing signal. A 4.5-cps square wave is shown at bottom. A 20-cps sine wave is shown in Fig. 4. undetected, at top, and detected at bottom. ■ ■

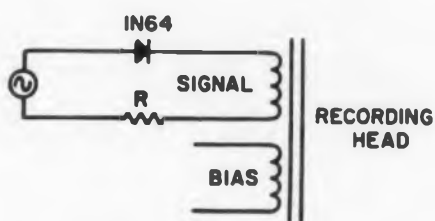

Fig. 2. The circuit used to generate dc pulses and apply them to recording head.

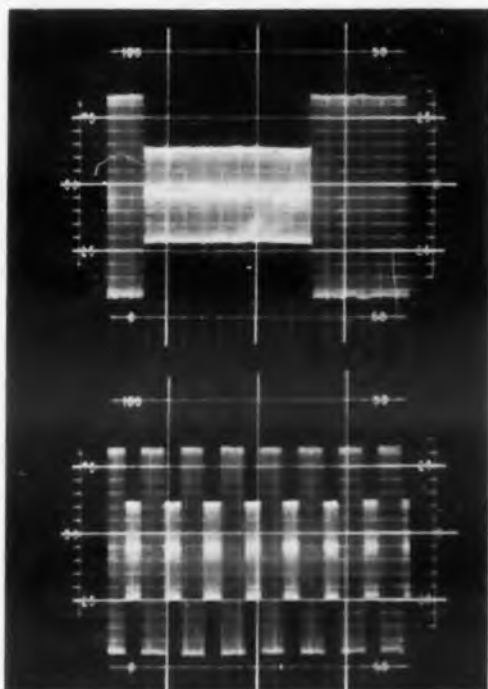

Fig. 3. (Top) A 1/2-cps square wave (the recorded data) superimposed on the pulses used to "develop" the tape. (Bottom) A similarly treated 4.5-cps square wave.

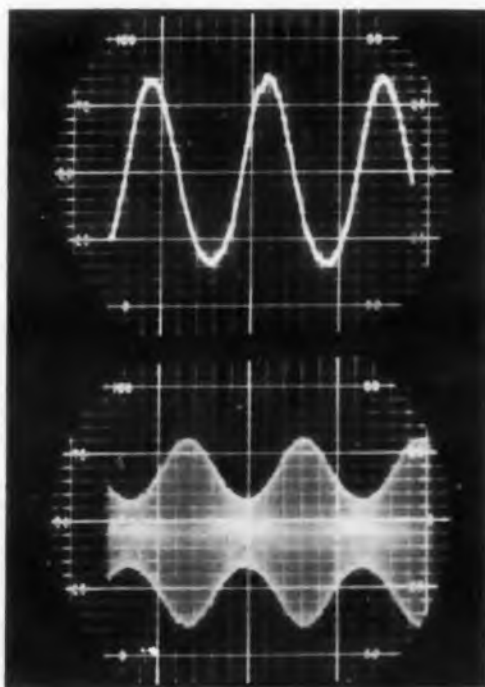

Fig. 4. (Top) A 20-cps sine wave (the recorded data) superimposed on the pulses used to "develop" the tape. (Bottom) The 20-cps wave after detection.

DO YOU KNOW THE SIMPLEST WAY TO STABILIZE MICROWAVE FREQUENCIES?

Short-term frequency stability as high as one part in 10^9 , plus substantial noise reduction, can be achieved by a VARIAN STALO which is a combination of klystron local oscillator and stabilizing cavity. The stalo cavity is a hollow shell—highly refined.

By means of passive stabilization, this cavity in many applications accomplishes the same ends as either active AFC stabilization systems or crystal-plus-electronic-multiplier circuits. But the stalo cavity, because it is passive, has extreme reliability and an infinite life. Most of them require no troubleshooting or maintenance effort—ever—once they have been properly designed and installed in a microwave circuit.

Varian offers stalo cavities to match every klystron oscillator in its present catalog, providing stabilization at any desired frequency in C-band, X-band or K-band. Application Engineering Bulletins 14 and 15, on passive stabilization and on phase locking respectively, fully explain the stalo principle of operation and application to microwave circuits. May we send you copies?



VA-1299 Stalo Cavity shown with VA-201B Klystron

GENERAL CHARACTERISTICS OF VARIAN STALOS

(Exact specifications on individual models available in catalog and data sheets)

| | |
|--------------------------------------|---|
| Short-term frequency stability . . . | As high as 1 part in 10^9 |
| Long-term frequency stability . . . | As high as 1 part in 10^8 |
| Stabilization factor . . . | As high as 120 |
| Noise reduction | Typically by a factor of 20 as compared to the klystron without stalo cavity |
| Unloaded Q | As high as 110,000 |
| Temperature compensation | As close as one part in 10^8 per degree Centigrade |
| Tunability | Fixed frequency or tunable types covering as high as 10% of frequency |
| Environmental tolerance | Suitable for extreme airborne service |
| Cavity size and weight | Comparable to or less than active stabilization circuits of similar effectiveness |

Representatives thruout the world



VARIAN associates
PALO ALTO 21, CALIFORNIA

KLYSTRONS, WAVE TUBES, GAS SWITCHING TUBES, MAGNETRONS, HIGH VACUUM EQUIPMENT, LINEAR ACCELERATORS, MICROWAVE SYSTEM COMPONENTS, NMR & EPR SPECTROMETERS, MAGNETS, MAGNETOMETERS, STALOS, POWER AMPLIFIERS, GRAPHIC RECORDERS, RESEARCH AND DEVELOPMENT SERVICES

CIRCLE 37 ON READER-SERVICE CARD

A Suggestion for a Standard Method of Measuring Intermodulation DISTORTION



Intermodulation distortion is always good for an argument when considering measurements. So far, there is no standard method of measuring this distortion, and different methods can give different results—none of them necessarily wrong. Herbert F. Spirer and Douglas E. MacLaughlin offer a simple, substitution technique that they hope might be considered for adoption as a standard method of measuring intermodulation distortion. The method is to compare distortion voltage to an equivalent voltage at specified frequencies.

Herbert F. Spirer, Douglas E. MacLaughlin
Spirer Associates
Stamford, Conn.

A SIMPLE substitution technique can be applied to the measurement of intermodulation distortion in the range 2-32 mc. The technique avoids many common sources of error and gives the measurement a high repeatability.

The precision—or repeatability—of the measurement is about $\pm 1/2$ db. A specification of accuracy is a little more complicated. The reason is that the measurement of intermodulation distortion is not standardized. A test may use different frequencies or a different principle than that suggested here.

However, a safe statement on accuracy is: for the two fundamental frequencies used here, the accuracy is as good as that of the instruments used.

The simplicity of the suggested test procedure makes it convenient to set up and maintain, and, conceivably, to adopt as a standard measurement. The method is based on the definition of this type of distortion.

Intermodulation distortion is the most commonly specified type that results from a device's nonlinearity. When two signals of frequencies f_1 and f_2 appear in a nonlinear circuit, product frequencies of the form $f_p = \pm mf_1 \pm nf_2$ are formed for all combinations of integral m and n . The order of a given product is defined as $m + n$.

For equipment evaluation purposes, it is customary to consider only second and third order products. There are two second order products, $f_1 + f_2$ and $f_1 - f_2$, and three or four third order products depending on the relative frequencies.

One practice is to specify the maximum output amplitude of a distortion product of a given order, referred to the output amplitude of the fundamental signal. The amplitude of the input signal also is specified, and it is convenient, but certainly not necessary, to give measurement frequencies.

Two Generators Give Test Signals

The principle of the recommended test procedure is illustrated by the simplified block diagram of Fig. 1. Signal generators SG1 and SG2 give the two input signals. They are connected at

FL1, a filter that attenuates frequency products in the generator output. The resultant signal is fed to the unit under test.

The test-unit output passes through FL2, which attenuates the fundamental frequencies, and is detected by a receiver tuned to the appropriate product frequency.

Meter M1 can be switched to determine the level of either the input or output signals. Meter M2 reads the receiver if signal.

The distortion product voltage is measured in the following manner.

Generator Signal Substituted

The gain of the receiver is adjusted so M2 indicates a convenient value. The input to FL2 is switched from the test unit to that of signal generator, SG3. The output of SG3 is then adjusted so M2 indicates the same value obtained with the test unit in the circuit.

This reading is the desired product voltage. Its ratio to the fundamental output voltage, expressed in decibels, is then an indication of the nonlinearity of the test unit.

Two auxiliary checks may be made to confirm the validity of the test just described.

First, the variable attenuator VAI may be used to reduce the input to the test unit by known amounts. If, for instance, the input is reduced by 1 db, the receiver output should drop by 2 db when a second order product is being investigated, or by 3 db in the case where a third order product is being investigated.

Receiver's Tuning is Checked

The success of this test assures that the receiver is correctly tuned (that is, that the product signal

under observation is not of improper order—produced by a combination of signals from different orders that happen to fall at the same frequency, or produced by some part of the test setup other than the test unit itself).

The second is known as the “residual” test. The test unit is removed from the circuit and replaced by VA2, a variable attenuator with the same apparent gain as the test unit.

(If the test unit is an amplifier it is preceded and followed by pads, so a low gain amplifier will have an overall gain of less than unity. A high-gain amplifier simply is replaced by a short circuit.

This provides a check on the linearity of the system excluding the test unit. If the test setup is operating correctly, the distortion product as read by M2, should drop by 20 db or more.

Preliminary Tests Increase Accuracy

These two tests, performed for every measurement, greatly reduce the probability of an incorrect reading. If the apparatus passes the tests, one can be reasonably sure that the setup is operating properly.

A complete block diagram of the setup is shown in Fig. 2, and a list of equipment in Table 1. The impedance of the system is either 50 or 75 ohms, depending on the test unit impedance.

Because the output impedance of all three signal generators is nominally 50 ohms, impedance-matching pads will be required for the signal generators if the test unit impedance is 75 ohms. All pads, coaxial cables, etc., should be chosen to make the vswr as low as possible.

H1 is a “hybrid” transformer providing isolation between SG1 and SG2, with minimum attenuation of the transmitted signal. Resistive isolation also may be used, although it is not always sufficient.

Test Switch Has Four Positions

All switching is performed with the “switch box,” whose circuit diagram is shown in Fig. 3. There are four switch positions: position 1 is for measurement of the input level to the test unit; position 2 for the distortion measurement; position 3 for the residual test; and position 4 for the calibration of M2 by SG3.

Three pairs of input frequencies are used: 9 and 12 mc, 21 and 30 mc, and 6.2 and 8.4 mc. The second order product frequencies are 21 mc, 9 mc, and 2.2 mc, respectively. The third order product frequencies are 30 mc, 12 mc, and 4 mc, respectively.

This choice of frequencies covers the band and minimizes the number of filters required for FL1 and FL2 (the 15-mc low-pass and 17-mc high-pass filters are interchanged for the 9-12 and

Fig. 1. Simplified block diagram of test set-up. SG stands for signal generator, FL for filter, M for meter, and VA for variable attenuator.

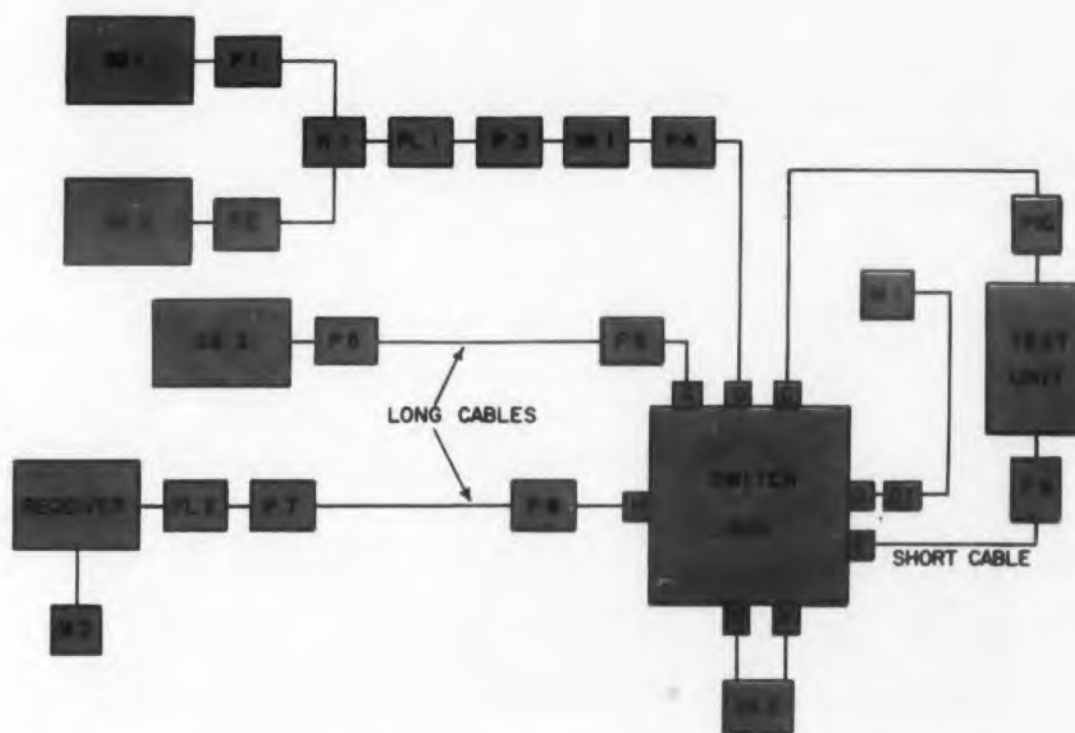
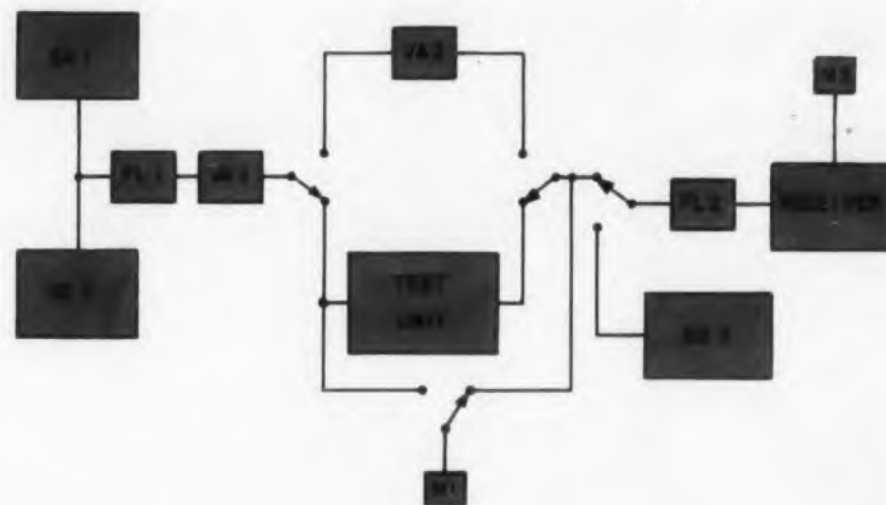

Fig. 2. Complete block diagram of test set-up. Equipment is specified in table.

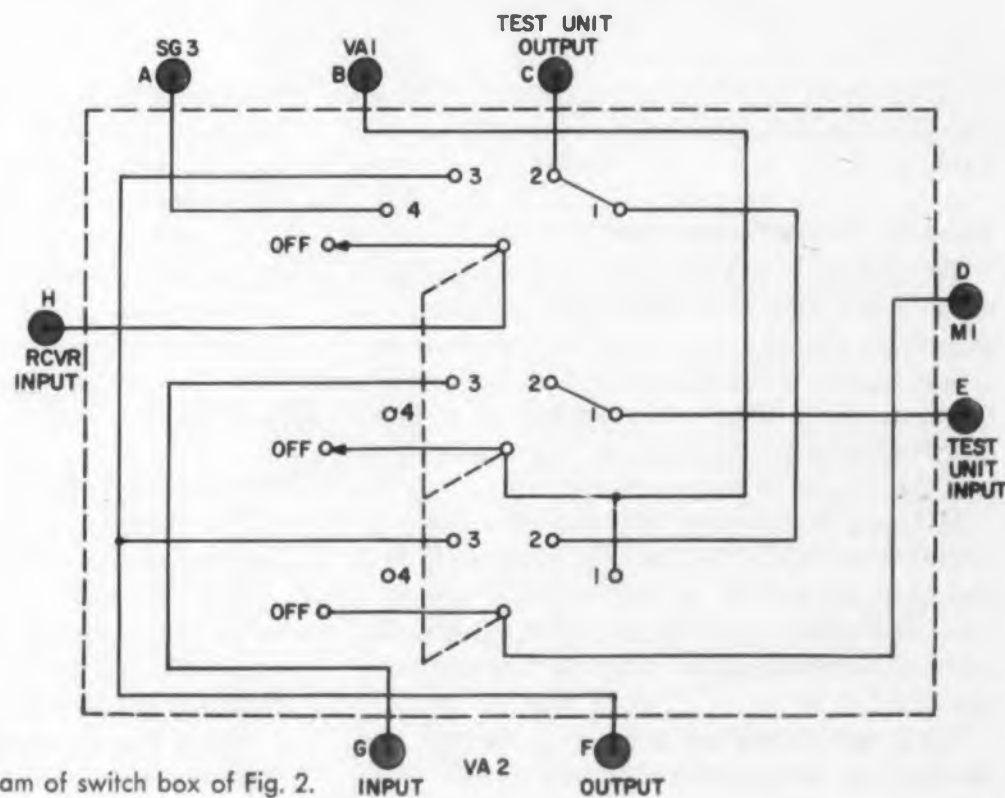

Fig. 3. Schematic diagram of switch box of Fig. 2.

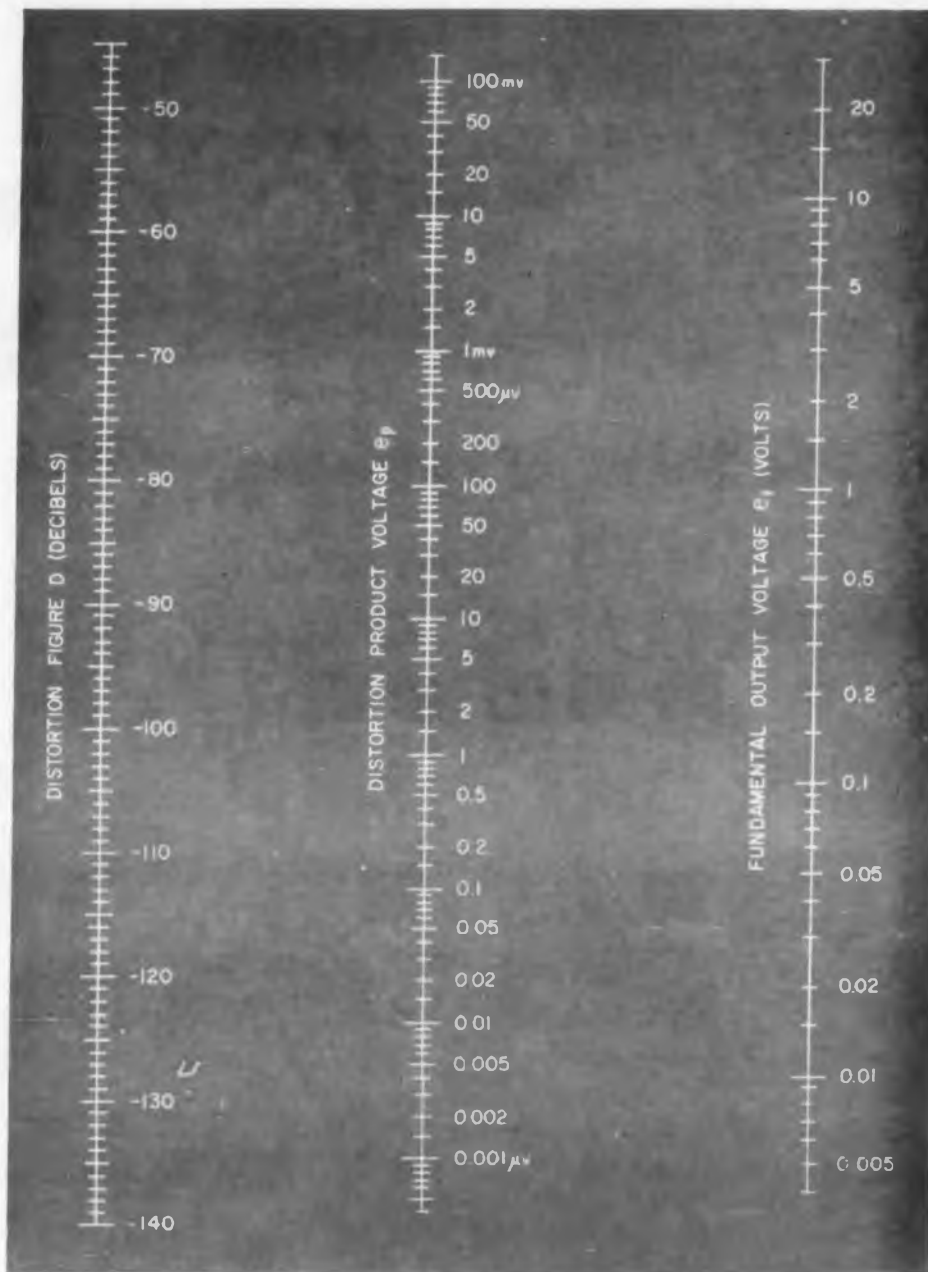

Fig. 4. Nomogram for calculating distortion figure. Pass a straight line through the measured values of fundamental voltage (e_f) and product voltage (e_p). Read distortion figure (D).

21-30 mc fundamental frequency pairs). The filters used for each measurement are indicated in Table 2.

Same Test for all Frequencies

The following test procedure has been found to be rapid and convenient. The procedure is essentially the same for each of the three frequency pairs (after inserting the appropriate frequency and filter combinations). It will be described only for the 9-12 mc fundamental pair and the second order product 21 mc.

SG1 and SG2 are set to 9 and 12 mc respectively. With the switch box in position 1, SG1 and SG2 are turned on and adjusted one at a time. The gain of each is set so the input to the test unit is the desired value—in the neighborhood of 1/4 v.

Then, the switch box is set to position 2, and the test unit output voltage is read on M1. (This

voltage is measured after a pad, but, because the pad is linear and the product voltage is measured at the same point, a true indication of the distortion is obtained.)

The receiver is tuned to 21 mc, the product signal located, and the receiver gain set at a convenient value, about 20 db as measured on M2. VAI then is adjusted so the input is reduced by 1 db. This should reduce by 2 db the signal measured by M2.

Generator Set to Product Frequency

The switch box then is set to position 3. The reading of M2 should drop by at least 20 db. Finally, the switch box is set to position 4. SG3 is set to 21 mc, and its output adjusted so M2 reads 20 db. The product voltage then is read from the appropriate dial of SG3.

Fig. 4 is a nomogram that gives the distortion figure once the output fundamental and product

Table 1. List of Test Equipment

| No. of pieces | Ckt. designation | Description | Manufacturer and Mod. No. |
|---------------|------------------------------------|---------------------------------------|--|
| 2 | SG 1, SG 2 | Signal generator | Measurements Corp. Mod. 65-B |
| 1 | SG 3 | Signal generator | Measurements Corp. Mod. 80 or 65-B. |
| 1 | H1 | Hybrid transformer | Trak Electronics Co., Wilton, Conn. |
| 1 | | 15 mc low-pass filter | |
| 1 | (see Table 2) | 17 mc high-pass filter | |
| 1 | | 6 mc high-pass filter | |
| 1 | | 4 mc low-pass filter | |
| 7 | P 3, P 4, P 6, P 7, P 8, P 9, P 10 | 50 or 75 ohm, 6 db attenuator | Applied Research, Inc. HFA-50 or HFA-75 |
| 3 | P 1, P 2, P 5 | 50 or 50-75 ohm 6 db attenuator | Measurement Corp. |
| 1 | SWITCH BOX | Switch box | (see Fig. 3) |
| 1 | RECEIVER | Distortion product detection receiver | Any receiver covering 2-32 mc such as National NC-125, Hammarlund SP-600, etc. |
| 1 | M 1 | VTVM | Boonton Electronics 91C or 91CA. |
| 1 | D 1 | High-impedance diode probe | Boonton Electronics |
| 1 | M 2 | VTVM | Ballantine 361 or equiv. |
| 2 | VA 1, VA 2 | 50 or 75 ohm variable attenuator | Daven 651-50 or 651-75 |

Various lengths of 50 or 75 ohm coaxial cable, connectors, etc.

voltages are known. The equation upon which this nomogram is based is:

$$D = 20 \log_{10} (e_p/e_f) - A,$$

where D is the distortion figure in decibels, e_p is the fundamental voltage.

Table 2. Measurement Frequency and Filter Data

| Fundamental pair (Mc.) | 2 nd order product | 3 rd order product | Filters | |
|------------------------|-------------------------------|-------------------------------|---------------|---------------|
| | | | FL 1 | FL 2 |
| 9 and 12 | 21 | 30 | 15 mc lo-pass | 17 mc hi-pass |
| 21 and 30 | 9 | 12 | 17 mc hi-pass | 15 mc lo-pass |
| 6.2 and 8.4 | 2.2 | 4 | 6 mc hi-pass | 4 mc lo-pass |

The term *A* is inserted to account for attenuation between SG3 and the point where input and output voltages nominally are measured. *A* is the amount of this attenuation (measured by P 6) in decibels. (There is provision on the output dial of the model 80 signal generator for taking account of the 6-db pad.)

There are several possible sources of error. These are not inherent in the test itself, but rather in the operator, who needs a little experience to ascertain what particular misconnection, omission, etc., is producing an erroneous result.

Possible Errors Cited

If there were insufficient input, it could be that the 15 and 17 mc filters had been reversed. If there were too much input when calibrating SG1 or SG2 individually, or if the signal were not varying with the gain control of either SG1 or SG2, it could be that both generators were turned on inadvertently.

On the other hand, if only one generator were on during the distortion test it could be impossible to find a product. If the "input reduction" test does not give the correct result, the receiver could be tuned to the wrong signal, or it even could be tuned to a signal produced outside the apparatus.

In general, it is a good idea to check the setting of the switch at every step, and also to make sure the receiver is peaked, etc., because the equipment may drift during the test.

The coaxial cable leads should be as short as possible, especially at the point marked on Fig. 2. For a reasonable arrangement of equipment on the test bench, relatively long leads are permissible at the points marked in Fig. 2.

The vswr in the system should be minimal. This can be checked by standard methods. All meters should be calibrated and checked for frequency response, etc. For convenience and higher repeatability, the gain control on the receiver should be as smooth as possible and as stable as possible. ■ ■



VK[®] Micro-miniature CERAMIC CAPACITORS

Meets MIL-C-11015/18 and 19 (USAF)



- 47-10,000 mmf
- -55°C to 150°C
- 200 vdc rating
- Small case size:
 .2 x .2 x .1 through 1000 mmf
 .3 x .3 x .1 through 10,000 mmf
- Also available uncased for complete assembly encapsulation.



..... Rugged pre-molded flame-resistant outer case assures standard wall thickness, guaranteeing environmental immunity and absolute product uniformity. Square modular shape affords highest capacity per usable volume.

..... Epoxy potting solidly anchors, hermetically seals capacitor within case; increases mechanical strength and eliminates humidity leaks around leads.

..... Resilient, moisture-proof plastic sheathing protects unit during assembly and absorbs thermal shock at extremes of temperature cycling.

..... Uniformly exact dielectric margins around electrodes eliminate short circuiting and breakdown across edges under surge voltages through 400% of rating. Single standard 0.2" lead dimension for all values simplifies circuit design.

VITRAMON[®]

INCORPORATED
 Box 544, Bridgeport 1, Conn.

CIRCLE 38 ON READER-SERVICE CARD



Test Equipment: Types and Characteristics



A. J. Reynolds, general manager of Technical Information Corp., has been associated with instruments and their manufacturers for 19 years. At TIC, he is in charge of compiling a voluminous Directory of Technical Specifications. In this first of a series of articles for ELECTRONIC DESIGN, Mr. Reynolds describes what makes meters run. The next article will deal with oscilloscopes and oscillographs. Part 3 of the series will describe frequency meters. Subsequent articles will deal with phase meters, wattmeters, signal generators, etc.

A. J. Reynolds
Technical Information Corp.
New York, N. Y.

METERS come in enough sizes, shapes and sufficiently overlapping characteristics to make a choice among them difficult.

They are among the oldest types of measuring instruments and, like many apparently simple devices, can be used incorrectly if their operation is not understood.

Meters often are regarded as the electrical equivalent of the 6-in. rule. That is, the assumption is made that their accuracy is that of the mechanical division of the scale. Nothing could be further from the truth. The lowly panel meter has a tolerance on accuracy and most manufacturers take all of it.

Meter accuracy usually is quoted as $\pm P$ per cent, meaning per cent of full scale. The performance of a practical movement is more nearly described by the type of specification used by the British Standards Association.

A typical B. S. Spec. for meter movements reads: accuracy ± 1 per cent of the reading from full scale to half scale, ± 4 per cent of full scale from half scale to one-tenth scale, no specification limit below one-tenth scale. The British method of specification is not necessarily advocated, but is offered as an example to illustrate the behavior of meters.

The moral is, of course, always choose a range

where deflection above half scale can be achieved, unless, as the doctors say, it is contradicted by such considerations as current drain or a resulting need to make measurements on two ranges.

In most pointer meters the long-term accuracy and physical ruggedness is a function of spring strength. When the manufacturer has made the best magnet he knows how, and wound the coil with the maximum practical number of turns of the finest wire available, the only way he can improve sensitivity is to weaken the springs.

In the case of standards, that extra low milli-ampere range, specified but not really needed, can cost dear in terms of permanence of calibration. Generally, when considering high-grade instruments of the laboratory standard type, the more power they consume the better the permanence of their calibration.

Most ac meters, including vtvm's, are calibrated in terms of rms, but only moving iron, dynamometer, thermal and electrostatic instruments contain an e^2 term in their equation, and, hence, respond to this quantity.

Instruments containing rectifiers will respond to half-wave average, full-wave average or peak unless the rectifier circuit has been tailored to give an rms response. With these instruments, unless the input is a sine wave, a waveform error will result that may be a large percentage error. A peak-reading instrument, to choose just one example, will display the same deflection—apparent rms value—for a sine, sawtooth, and

pulse if their peak amplitudes are the same.

The important characteristic of a vtvm is its high input impedance, not, as is often thought, its wide frequency response. At least three other types of voltmeter—the thermocouple, electrostatic and diode—have a comparable frequency response and as good or better accuracy.

The thermocouple and diode types are inherently low-impedance devices, while the electrostatic rapidly becomes so as frequency rises, particularly in the most sensitive ranges. The high impedance of the vtvm is often bought at a price that includes inaccuracy, bad waveform error and drift at both ends of the scale.

Thermocouple meters have many desirable qualities. They are inherently sensitive, have wide frequency range and are square law or true rms reading. However, being square law in response, they also burn out as the square of the current. Because a sensitive thermoelectric junction in a vacuum has extremely low thermal inertia, it dies quickly and with no fuss, even upon a transient overload; not even a bent pointer remains as evidence of the crime.

Another class of thermal instrument is the hot-wire movement; this is not listed on the chart because it is virtually obsolete.

Although not covered here, a separate class of voltage-measuring devices is represented by potentiometers. They are by far the most accurate means of measuring voltage, but generally are suitable only for calibration because they are inconvenient to operate. ■ ■

The Characteristics Of Analog Meters*

The bars indicating frequency range are divided into three sections. Solid lines indicate commercially available frequency range; broken lines indicate frequency coverage available on special order; dotted lines indicate that covering these frequencies would be too expensive and difficult for a practical instrument of the designated type.

| Type and Dynamic Range | Class | Scale Shape | Waveform Response | Frequency Range | | | | | | | | Weight Range | Size Range | Remarks |
|---|----------|--------------------------|--|-----------------|-----|------|---|-----|------|-------|------|------------------|--|--|
| | | | | 100cps | 1kc | 10kv | 100kc | 1mc | 10mc | 100mc | 1kmc | | | |
| PIVOTED MOVING COIL 5 μ a to 100's of ma | DC | linear | — | | | | Accuracy 1% Commercial 0.01% max | | | | | oz to 10's of lb | 1 in ³ -1 ft ³ | Fairly rugged. Best attainable accuracy as laboratory standard. |
| SUSPENDED MOVING COIL 1 μ a to 10's of ma | DC | linear | — | | | | Accuracy 0.5% Commercial 0.25% max | | | | | lb to 10's of lb | few in ³ to 1 ft ³ | Exceptionally rugged. High accuracy; great overload capacity. |
| MOVING IRON 10's ma to amps | AC DC | square law | true rms | | | | Accuracy 2 to 5% Commercial 0.1% max | | | | | oz to 10's of lb | few in ³ to 1 ft ³ | Rugged but consumes considerable power. Waveform error if harmonics exceed frequency limit. |
| DYNAMOMETER ma to 10's of ma | AC DC | square law | true rms | | | | Accuracy 0.5% Commercial 0.1% max | | | | | lb to 10's of lb | 0.5 to 1.5 ft ³ | Rugged. Best ac standard available. Consumes considerable power. |
| THERMOCOUPLE 100's of μ a to 10's of amps | AC DC | square law | true rms | | | | Accuracy 0.5 to 5% Commercial 0.1% max | | | | | oz to lb | 1 in ³ to 0.5 ft ³ | Upper freq depends on stray reactance. Easily damaged by overload. Impedance: ohms to low K. |
| ELECTROSTATIC 10's v to 100's of kv | AC DC | square law | true rms | | | | Accuracy 3% Commercial 0.5% max | | | | | oz to 10's of lb | few in ³ to ft ³ | Very high impedance. Aperiodic, upper freq response varies with capacity which varies inversely with fs volts. |
| CRYSTAL mv to volts | AC DC | linear or square law | yes & no true rms in mv range linear above | | | | Accuracy 3% Commercial 0.5% max | | | | | oz to lb | 1 in ³ to few in ³ | Low impedance in the order of ohms. Easily damaged by overload. |
| VTVM (Amplifier type) μ v to 100's of v | AC & DC | linear log or square law | usually responds to average | | | | Accuracy 3 to 5% Commercial 0.1% max | | | | | lb to 10's of lb | 0.5 to 1 ft ³ | A prolific class. Input impedance can be 10's of meg. Can respond to peak or rms. |
| MOVING COIL WITH RECTIFIER mv to volts | AC | quasi-linear | responds to average | | | | Accuracy 2% Commercial 0.5% max | | | | | oz to lb | 1 in ³ to 0.5 ft ³ | Fairly rugged. Unsuitable as standard because of waveform error. |
| VTVM (Diode Rect Type) below 1v to 100's of v | AC | linear above 1v | responds to peak | | | | Accuracy 3% Commercial 1% max | | | | | lb to 10's of lb | few in ³ to 1 ft ³ | High impedance; megohms at vhf. Input capacity can be as low as 1pf. |

*Technical Information Corp.

Summing-Core Logic Yields Digital-Circuit Flexibility

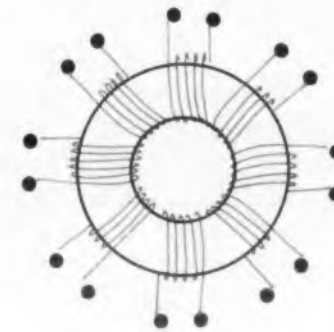

The magnetic core, says Reuben Wasserman, is the most natural computer-logic element. Used with the technique of flux summation, the core provides an extremely versatile component.

Mr. Wasserman is associate head of the Digital Systems Div. of Hermes Electronics Company in Cambridge, Mass.

Reuben Wasserman
Cambridge, Mass.
Hermes Electronics Co.

SUMMING-CORE logic, using multiple-input windings on conventional cores, offers a high degree of flexibility in digital circuitry. The summing-core technique is unusual in that it offers increased flexibility at negligible cost since it takes advantage of physical properties of magnetic cores.

Core Threshold Level Determines Logic Function

With summing logic, logical decision depends on whether or not the sum of the input levels exceeds a preselected threshold. Varying the threshold level permits changes in the logical function.

Magnetic fields produced by input current pulses are summed within a core. When the net field exceeds a certain value for a sufficient time, the core changes its remanent state.

The typical square hysteresis loop of Fig. 1 shows a threshold level of coercive force H_c established at the value $+1/2$. Any single unit pulse, with a value of $+1$ will exceed this thresh-

old. Here, the core functions as an OR gate.

This threshold level can be varied by a bias flux weighted with a value of ± 1 , ± 2 , or with another desired value. With a bias weight of -1 , the core becomes a 2-input AND gate or, more precisely, it gives a 2-out-of- x function where x is the number of inputs to the core.

In general, the core changes state if the net weight of the inputs is equal to or greater than $+1$. The number of logical functions that can be obtained using a single core increases rapidly

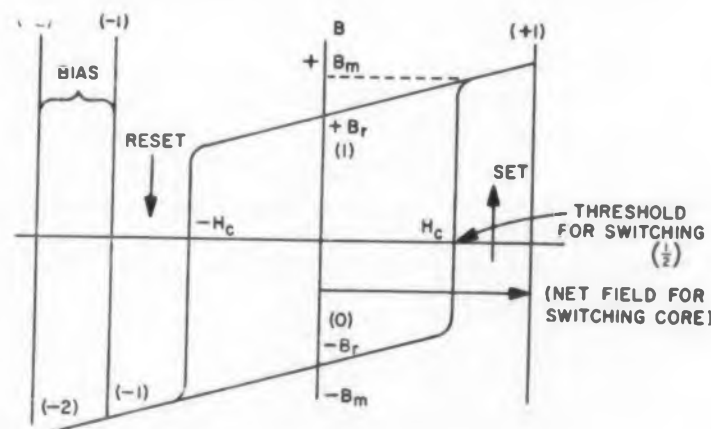

Fig. 1. Typical square hysteresis loop shows how core can be biased to establish different logic functions.

with the number of inputs that can be wound on a core.

In designing a summing core, several basic decisions must be made before a design can be started. It is necessary to determine:

- The required logical flexibility—the ease in changing logic.
- The required power gain of each summing core—the number of other elements to be driven.
- The pulse-repetition rate.
- The phase-clocking or time restandardization

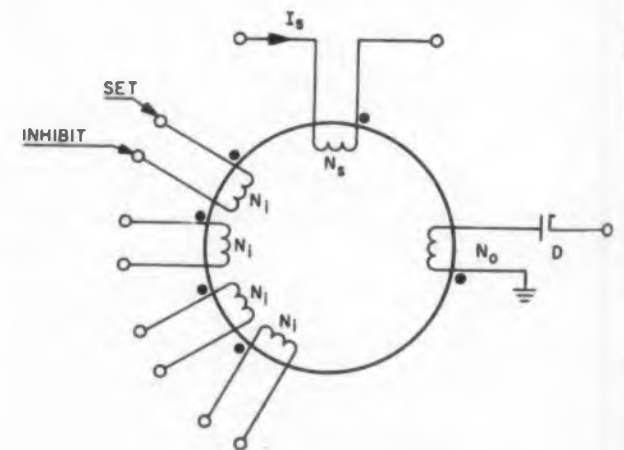

Fig. 2. A basic, summing-core logic element.

CIRCLE 39 ON READER-SERVICE CARD

necessary after each logic action.

In one specific computer application, the flexibility requirement called for a minimum of three variables with a possibility of as many as five. This degree of flexibility should serve most digital computer applications.

If the summing core can drive at least six other cores and a maximum of about 12, it should have adequate power gain for most applications.

Pulse-repetition rate is basically limited by the type of core material. For ferrite, the range is from 100 to 200 kc.

"Best Compromise" Determines Core Selection

To minimize power consumption, the smallest practical core should be selected. Core power consumption is proportional to the coercive force H_c , so one should select a low- H_c material. However, variations in H_c affect the core's switching rate, so one should use a material with low switching coefficient to yield a high repetition rate at low power consumption.

Square-loop ferrite cores are available which provide the following advantages.

- Low material cost.
- Uniform characteristics.
- Low H_c .
- Small size.
- High squareness ratio.

To determine the best core material for the job, two families of curves may be plotted. The first set should be a plot of applied field vs inverse switching time for the different core materials. A second set should present applied field vs output flux change.

This latter set of measurements, commonly known as the S-curve test, gives a picture of the front part of the hysteresis loop of a core under pulsed conditions. The S curve gives the incremental permeability, the core squareness, and the coercive force. The two sets of curves will yield a best-compromise core.

For example, the S curve for RCA's 222M2 core shows an open-loop coercive-force requirement of 270-ma turns. To allow for core-tolerance variations, leakage inductance and closed-loop external loading, the designer would usually design for a threshold of about 450-ma turns. The plot of applied field vs inverse-switching time would give a 3- μ sec switching time for an applied field of 450-ma turns.

Summing Core Operates in Two Phases

Fig. 2 shows the basic core logic element with N_i representing the input windings, N_o the output winding, and N_s the shift or power-transfer

← CIRCLE 39 ON READER-SERVICE CARD

ELECTRONIC DESIGN • October 12, 1960

An "off-beat" project in precision for Fafnir bearing engineers!

Instrument bearing problems? Fafnir has ball bearing engineers who specialize in solving them. But a leading instrument maker recently asked for help of a different order — production of complete gyro spin motors for the inertial guidance systems of Convair B-58 Hustler bombers. By manufacturing the complete "package", Fafnir was able to produce motors that measured up to the precision standards the customer had been seeking.

An unusual assignment for a ball bearing manufacturer. But one that shows the engineering resources Fafnir has at its command. Worth bearing in mind when you have instrument or miniature ball bearing problems! The Fafnir Bearing Company, New Britain, Connecticut.



Gyro spin motor produced by Fafnir for the B-58 Hustler bomber. Fafnir super-precision ball bearings have inner races ground on the shaft, and outer races in the motor housing.



CONVAIR B-58 HUSTLER. WORLD'S FIRST SUPERSONIC BOMBER



FAFNIR
BALL BEARINGS

CIRCLE 40 ON READER-SERVICE CARD

NOW!

A SINGLE INSTRUMENT TO

SIMULATE INPUTS
MEASURE OUTPUT ANGLES
RECORD DRIFT OF

SERVO SYSTEMS



OFF-THE-SHELF-DELIVERY
SYSTEM ERROR BRIDGE
TESTS

- Inertial Platforms
- Master Transmitters
- Servos
- Autopilots
- Vertical Gyros
- Aircraft Indicators
- Navigational Computers
- Antenna Pedestals

Write today for detailed technical bulletin.

GET EXACT SHAFT ROTATION

of
Synchros • Resolvers • Pots
Digital Encoders • Rotary Transducers

THETA'S
PRECISION
ANGULAR
DIVIDER

OFF-THE-SHELF
DELIVERY



Certified accuracy of less than 20 sec.-of-arc composite error at the point of contact with your shaft.
Ready to use — no fixturing required.
Approved and used throughout the world.

Write today for detailed technical bulletin.

MANUFACTURER OF PRECISE
TEST EQUIPMENT FOR SERVO
SYSTEMS.

Theta

INSTRUMENT CORPORATION

520 Victor Street • Saddle Brook, New Jersey
Hubbard 7-3508 • TWX: HKK 952-U

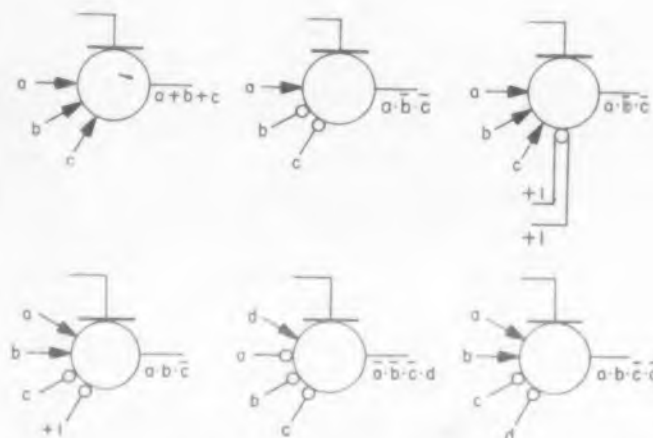
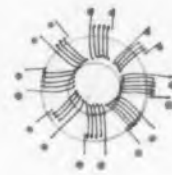

Fig. 3. Symbolic representation of AND and OR logic. Signals with arrowheads enter the core windings in the forward-current direction. Signals terminated in circles enter the windings in the reverse-current direction. Overrules indicate negation, so \bar{a} is read as not a .

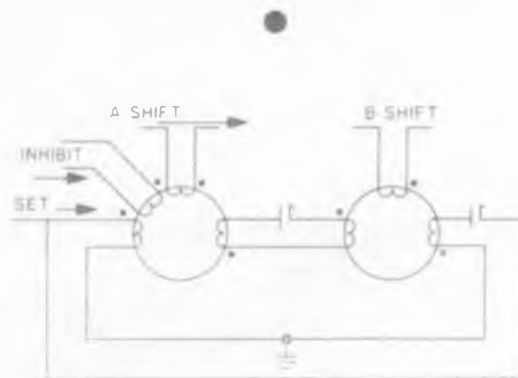

Fig. 4. The dynamic flip-flop requires two cores.

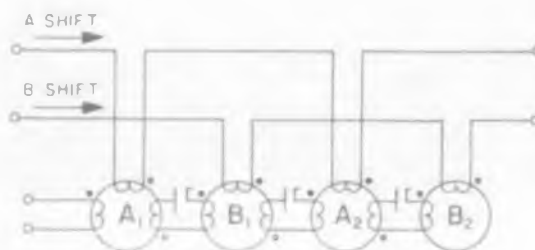

Fig. 5. Shift register advances information one stage after each sequence of A and B shift pulses.

winding. The core element operates in two phases: First, the core performs logic to determine whether it is to be set to 1 or remain in the 0 state. This depends on whether or not the total flux summation exceeds the switching threshold.

In the second phase, a pulse applied through the shift winding resets the core to 0 if a 1 has been previously set. This, in turn, transfers the pulse energy to succeeding core-logic elements. The core element resembles a two-core-per-bit shift register in operation.

Input Signals Can Vary Switching Threshold

The switching threshold is defined as the minimum applied field required for setting the core to the binary 1 state. Each input winding receiving a current pulse of a certain magnitude should set up a field equal to or greater than this threshold.

Each input winding is given a weighting factor of +1. This exceeds the threshold value of +1/2. Hence, as it stands, the core is a natural OR gate; any of the four inputs will set it to 1.

If one of the input windings is given a negative unit weight (reverse current into winding), its switching threshold is increased by a unit weight. Then, setting the core to the 1 state will require that at least two other input windings be energized simultaneously to +1. This provides what can be called a 2-input AND gate. Any input winding can be used to vary the threshold, thus varying the logical function of the element.

Core Needs Power Gain To Drive Other Cores

The core element must have power gain so its output pulse can set a number of other cores simultaneously. The output current pulse must therefore come from a high impedance, constant-current source and must drive input impedances which are several magnitudes smaller.

The output impedance should normally be from 100 to 200 times the value of the sum of the input impedance of a load and the forward impedance of the load-isolating diode. The diode should isolate the driven core from other driven cores without disturbing the coupling to the driving core.

In the design of the shift winding, the important consideration is the number of core stages that can be driven from a given-size driver. To reduce the voltage drop per shift-winding stage, the number of turns must be decreased and the current drive increased. This also requires compromise as leakage inductance provides a low-end limit on the number of turns. If leakage inductance is too high, not enough energy will be transferred to the output cores for satisfactory operation.

The number of turns for a shift winding is a compromise of maximum current drive, minimum leakage inductance, and practical core-window area.

Summing Core Applications Highlight Logical Flexibility

The logical flexibility of summing cores allows them to be used in a wide variety of applications. In most cases, the logic technique is conventional; in some cases the technique differs somewhat from conventional techniques. A few applications follow:

AND and OR Gates. The most obvious use of summing cores is in AND or OR gates. Several examples of these are illustrated in Fig. 3. In such applications, all inputs are given unit weight $+1$. The threshold level is established by H_c at $+1/2$, so any single unit pulse will exceed the threshold by a factor of two, making the core function as an OR gate. This threshold can be varied by a bias flux through any input winding. Current amplitudes and pulse widths must be controlled within close tolerances to insure adequate summations or cancellations.

Dynamic Flip-Flop. The dynamic flip-flop (Fig. 4) is actually a one-stage shift register in a closed loop. It can take either of two dynamic states. If, for example, core A is initially at 1, shift pulse A will switch the core to 0 and the current pulse will be delayed through core B.

Core B's output pulse will reset A to the 1 state. The state of the flip-flop can be changed to 0 by applying a signal to the inhibit winding at the same time that the output of core B is trying to reset core A, thereby preventing the resetting of A. With A in the 0 state, the next shift pulse applied to it will have no effect and the flip-flop will remain at 0 till A is reset to 1 by an external insert pulse.

Shift Register. In the shift register (Fig. 5), shift-pulse A will reverse the state of all stages storing 1's. Shift-pulse B will delay the output-current pulses of all the B cores. This delay insures that all the A cores transfer their information before receiving new information from previous A cores. Information is thus advanced one stage after each sequence of A and B shift pulses.

Bit Comparator. A comparator compares the magnitude of two numbers to determine whether equality or inequality exists. Fig. 6 shows a simple bit comparator which provides an output on inequality and no output on equality.

To detect the inequality of two words, each consisting of several bit pulses, the comparator tests the digits of the two words sequentially and uses a dynamic flip-flop as memory. If two compared bits are equal, it does not set the flip-

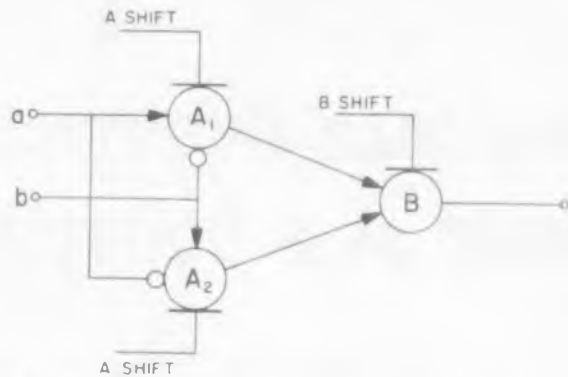

Fig. 6. This simple bit comparator gives an output if a does not equal b .

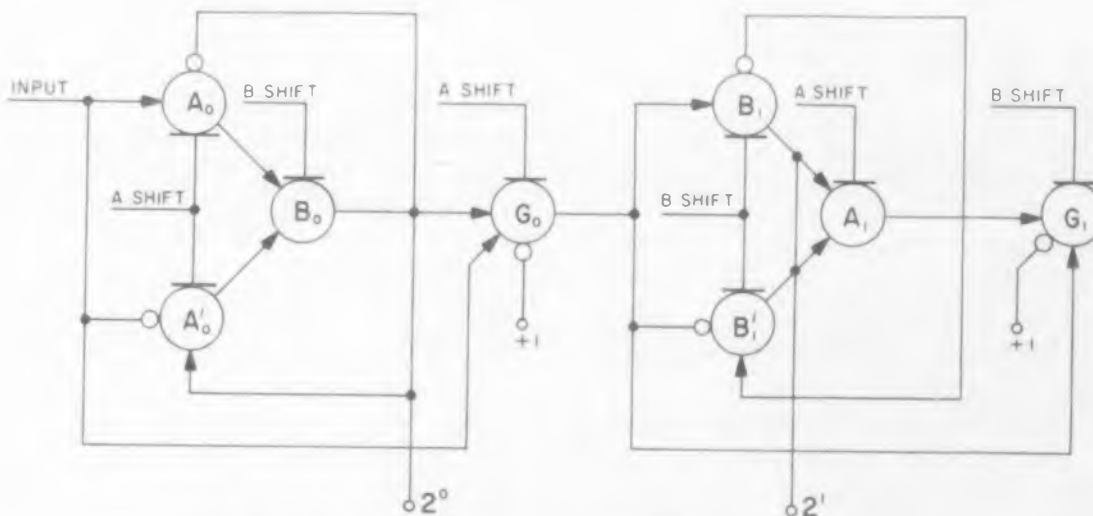

Fig. 8. A binary counter using identical flip-flop counter stages.

flop. If they are unequal, the comparator sets a flip-flop which generates a series of 1's till the flip-flop is reset by a clear pulse.

The comparator of Fig. 7 is basically a dynamic flip-flop which is set by an input to core A3 before the comparison starts. An inequality at inputs A and B resets the flip-flop by stopping the recirculation of a stored 1.

Binary Counter. The summing-core logic element has a basic limitation in that the element cannot shift other core elements. This offers some difficulty in using the elements in straightforward binary counters. Fig. 8 shows one technique, somewhat different from the conventional, which serves many of the needs of standard binary counters.

It uses identical flip-flop counter stages which can be extended to as many stages as desired.

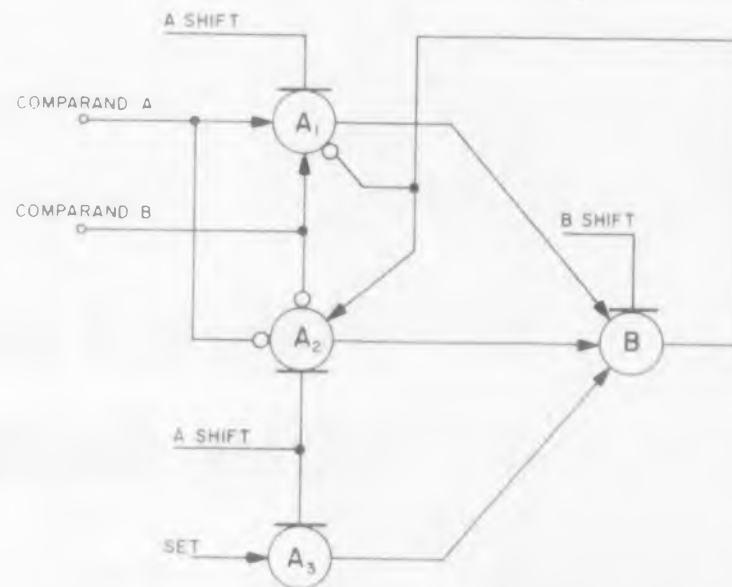

Fig. 7. This comparator uses a flip-flop which is set by an input to A3 before comparison starts.

An input pulse is sent to the next stage through gate G_0 each time the binary counter stage is reset from 1 to 0.

The count stored in the counter is indicated by the condition of flip-flops 2^0 and 2^1 in the various stages. Particular counts can be sensed by using AND gates. For example, the count of 3 would be sensed by feeding the outputs of 2^0 and 2^1 into an AND gate. ■ ■

Acknowledgment

The material in this paper has been made possible through funds provided by the Office of Naval Research under Contract NONR-2133(00) for the development of a majority gate for improving digital system reliability. We also acknowledge the contribution of Mr. William Nutting and Mr. Gerry Buzzell in the development and application of magnetic core logic elements.

Thermal Resistance Determines Power Safely Dissipated at a Collector Junction

Charles Webber raises the question: When is a 50-w transistor a 50-w transistor? and answers that it depends on the thermal resistance between the collector junction and the ambient medium. If thermal resistance is too high, the rated power cannot safely be dissipated.

Charles Webber
Litton Industries
Woodland Hills, Calif.

A 50-w transistor is not always a 50-w transistor. Whether or not the device can safely dissipate its advertised rating depends on the thermal resistance between the collector junction and the ambient medium.

Thermal resistance is analogous to electrical resistance. The amount of heat flowing from places of high temperature to places of low temperature depends on the temperature differential. Temperature difference is analogous to voltage difference, and heat to current. Thermal resistance is expressed as degrees C per watt.

Any temperature control problem can be analyzed by establishing the maximum thermal resistance that can be tolerated. Closer examination reveals where improvement is possible, and how much improvement would make a significant contribution to the problem.

Many germanium power transistors are advertised as capable of dissipating 50 w at the collector junction—the heat source. A conservative limit of 90 C for the thermal potential of this heat source is generally accepted.

Air Generally is the Heat Sink

In most applications, the heat goes to the air surrounding the junction. A common working value for the thermal potential of the air is 25 C.

If the transistor is to dissipate its full rating of 50 w, and if the collector-junction temperature is not to exceed 90 C, the total thermal resist-

ance between the junction and the ambient air must not exceed:

$$R_{total} = \frac{90 \text{ C} - 25 \text{ C}}{50 \text{ w}} = 1.3 \text{ C/w}$$

Examination of the transistor and its package indicates this total thermal resistance is a heat-flow circuit consisting of three definable thermal resistances in series.

The first is the path from the transistor junction to the transistor's mounting surface. A low, advertised claim for this thermal resistance is 0.5 C/w. Accordingly, the remaining series resistance cannot total more than 0.8 C/w.

Interface Loss is Significant

The second resistance is called the interface loss. The discontinuity resulting from the pressure mating of two metallic bodies might seem insignificant, but, expressed as thermal resistance, interface temperature loss is important.

At best, with a material such as silicone grease, interface resistance for typical transistors is at least 0.3 C/w. A few tenths greater can be expected if the joint is dry, and several times greater if an insulating washer made of a material like mica is used. Any washer implies two interfaces, plus the additional resistance of the insulating material.

The internal resistance of the transistor cannot be controlled by the application engineer, although he can calculate what his needs are. The interface resistance can be minimized by using air-displacing materials, and by obviating insulating washers at the interface.

The third resistance in the series is that between the transistor's mounting surface and the ambient air. The responsibility for minimizing this resistance belongs to the packaging engineer, and it is within his domain to anticipate and provide for problems that might arise.

Commercial Heat Sinks Available

He has the choice of designing his own heat transfer system or purchasing commercial devices that can be very effective if used properly.

If the third resistance were to take the form of a carefully finned and ducted heat exchanger, utilizing forced ambient air, a resistance as low as 0.5 C would be feasible.

A still-air device depending on natural convection will approach several times this value under optimum conditions, although localized turbulence can be quite helpful.

Power data that cannot be translated into thermal resistance values, are obviously meaningless. An ethical manufacturer will also include in his specification the interface resistance experienced in his laboratories.

In many cases when a manufacturer's product has a thermal resistance greater than unity, he will publish its reciprocal, thus giving a misleadingly low value.

Realistic Specs Cited

A transfer manufacturer's claim of 50 w is realistic for a carefully qualified situation such as the following:

Allowable collector junction
temperature 90 C

Thermal Comparison of Common Materials

| | Thermal Resistance of a strap 10-in. long by 1-in. wide, by 0.062-in. thick | Requirements Compared to Aluminum | |
|---|---|-----------------------------------|--------|
| | | Cross Section | Weight |
| Silver | 14 C/w | 48% | 186% |
| Copper (pure) | 16 C/w | 52% | 170% |
| (Beryllium) | 35 C/w | 110% | 330% |
| Aluminum | 31 C/w | 100% | 100% |
| Magnesium | 41 C/w | 130% | 85% |
| Iron | 100 C/w | 325% | 925% |
| Lead | 180 C/w | 600% | 2500% |
| <hr style="border-top: 1px dashed black;"/> | | | |
| Granite | | 5,000% | |
| Ice | | 9,000% | |
| Water | | 36,000% | |
| Asbestos | | 135,000% | |
| Air (stagnant) | | 850,000% | |

The perfect heat conductor does not exist. The slightest length of metallic path introduces significant thermal resistance. Introduction of a thin film of insulating material (listed below dotted line) causes thermal resistance to soar. The chart also indicates an equivalent cross-section and weight of aluminum needed to give same thermal resistance obtained with material considered.

Internal thermal resistance0.5 C/w

Resistance from transistor "stud" to

heat exchanger input air0.8 C/w

Unfortunately, power transistors, without exception, have a general purpose configuration. These configurations are fairly well suited to mounting on a sheet-metal chassis, which, in turn, prevents high power operation.

Vastly superior designs could be marketed at a lower cost than that incurred with general purpose designs. Over-all thermal resistance from the junction to the input air could approach 0.5 C/w. This would double the power ratings of existing units, with a reduction of weight and volume.

Low power transistors have thermal resistances of the order of 1000 C/w from the junction to the case. Their design violates all the rules of low thermal resistance, and there is no reason why revolutionary improvements cannot be made. It is expected that the undeniable needs of space vehicles will be stronger than the influence of conventional engineering. ■ ■

hp Audio, telemetry and low frequency oscillators

Pictured here are six of the most widely used oscillators in electronics. All employ the highly stable, dependable, accurate resistance-capacity circuit. They require no zero setting. Output is constant, distortion is low and frequency range is wide. Scales are logarithmic for easy reading; all are compact, rugged and broadly useful basic instruments. Brief specifications are given below; call your  rep for demonstration or write direct for complete data on any instrument.

| Model | Frequency Range | Calibration Accuracy | Output to 600 ohms | Recommended Load | Maximum Distortion | Max. Hum & Noise † | Input Power | Price |
|-------|-----------------------------|----------------------|--------------------|------------------|--|--------------------|-------------|----------|
| 200AB | 20 cps to 40KC (4 bands) | ±2% | 1 watt (24.5 v) | 600 ohms | 1% 20 cps to 20 KC 2% 20 KC to 40 KC | 0.05% | 70 watts | \$150.00 |
| 200CD | 5 cps to 600 KC (5 bands) | ±2% | 160 mw 10 volts | 600 ohms* | 0.5% below 500 KC 1% 500 KC and above | 0.1% | 75 watts | \$170.00 |
| 200J | 6 cps to 6 KC (6 bands) | ±1% † | 160 mw 10 volts | 600 ohms* | 0.5% | 0.1% | 110 watts | \$300.00 |
| 200T | 250 cps to 100 KC (5 bands) | ±1% † | 160 mw 10 volts | 600 ohms* | 0.5% | 0.03% | 160 watts | \$450.00 |
| 201C | 20 cps to 20 KC (3 bands) | ±1% † | 3 watts (42.5 v) | 600 ohms** | 0.5% ‡ | 0.03% | 75 watts | \$225.00 |
| 202C | 1 cps to 100 KC (5 bands) | ±2% | 160 mw 10 volts | 600 ohms* | 0.5% § | 0.1% | 75 watts | \$300.00 |

*Internal impedance is 600 ohms. Frequency and distortion unaffected by load resistance. Balanced output with amplitude control at 100. Use line matching transformer for other control settings. **Internal impedance approximately 600 ohms with output attenuator at 10 db or more. †Approximately 75 ohms below 5000 cps with attenuator at zero. ‡Internal, non-operating controls permit precise calibration of each band. §0.5%, 10 cps to 20 KC at 1 watt output. 1.0% over full range at 3 watts output. §0.5%, 10 cps to 100 KC. 1.0%, 5 to 10 cps. 2.0% at 2 cps. 3.0% at 1 cps. ¶Measured with respect to full rated output.

HEWLETT-PACKARD COMPANY

1015K Page Mill Road • Palo Alto, California, U.S.A.
Cable "HEWPACK" • DAVenport 6-7000
Hewlett-Packard S.A., Rue du Vieux Billard No. 1, Geneva, Switzerland
Cable "HEWPACKSA" • Tel. No. (022) 26. 43. 36
Field representatives in all principal areas

6036



 200AB
Audio Oscillator



 200CD
Wide Range
Oscillator



 200J
Interpolation
Oscillator



 200T
Telemetry
Oscillator



 201C
Audio
Oscillator



 202C
Low Frequency
Oscillator



pioneered the world-famous resistance-capacity oscillator circuit

CIRCLE 42 ON READER-SERVICE CARD

TWT's Have Come a Long Way Toward Environmental Insensitivity



A few years ago TWT's took a giant step out of the laboratory with the introduction of periodic-permanent magnet-focusing. However, the sizable weight-reduction achieved was paid for at the cost of environmental sensitivity. Jason Posner describes here how these blocks to general use of TWT's are being removed by solid designs.

James S. Posner
Radio Corp. of America
Harrison, N. J.

THE TRAVELING wave tube is becoming increasingly useful to microwave engineers because it has been made more insensitive to vibration, impact and temperature changes.

The last factor is the severest environmental factor limiting the performance of tubes that use a periodic-permanent-magnet stack to focus the electron stream.

Such a stack, whose construction features are indicated in Fig. 1, is responsible, in large measure, for the sizable reduction of tube bulk, weight and power consumption for a given application. An early tube, for example, that delivered medium power at 3,000 mc used a 50-lb, 400-w solenoid as the focusing device. Use of the periodic-permanent-magnet stack cut the weight to 7 lb, and obviated the power supply.

Temperature Increases Reduce Field Strength

However, temperature changes cause drastic fluctuations—both reversible and irreversible—in the stack's magnetic field.

The reversible changes can be corrected or compensated for by a thermo-magnetic shunt; the irreversible changes can be accounted for by proper stabilization procedures. Without compensation, the usable temperature range of traveling-wave tube would be limited to about 25 to 50 C.

A temperature cycle irreversibly affects the operating point of the magnets, which are made of barium-ferrite material. After stabilization or

precooling, for example, losses up to 10 per cent of the saturated value of the ferrite magnet have been observed; at values less than saturation, the percentage loss decreases.

Reversible Changes are Most Important

However, this irreversible loss occurs only in the first few temperature cycles. Once this loss has been compensated for by magnetizing and precooling the magnet below the lowest environmental temperature, only reversible magnetic changes are important.

Fig. 2 shows that the axial field strength of a typical magnet assembly changes by 30 per cent over a 200 C temperature range. The degree to which a traveling-wave tube can tolerate this variation, and still perform properly, depends on other design considerations, such as optimum beam-diameter, power level, gain flatness, and,

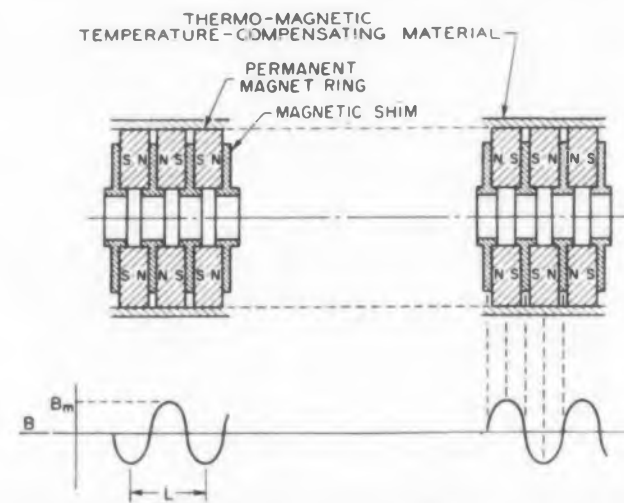

Fig. 1. Cross-section of periodic-permanent-magnet focusing structure and the resultant periodic fluctuation of axial magnetic field strength.

of course, permissible variation of performance characteristics.

For example, if the beam diameter increases because of decreasing field strength, the gain generally increases. The reason is that the beam interacts more with the signal carried by the slow-wave structure.

Helix-Interception Current Must Be Limited

However, beam interception also increases. In power tubes, a maximum of about 5 per cent of the beam current can be safely dissipated along the helix. In low-noise tubes, beam alignment is more critical because helix interception current tends to increase the noise figure. The beam alignment in the slow-wave structure must be such that the helix-interception current at high temperature is, generally, less than one per cent of the beam current.

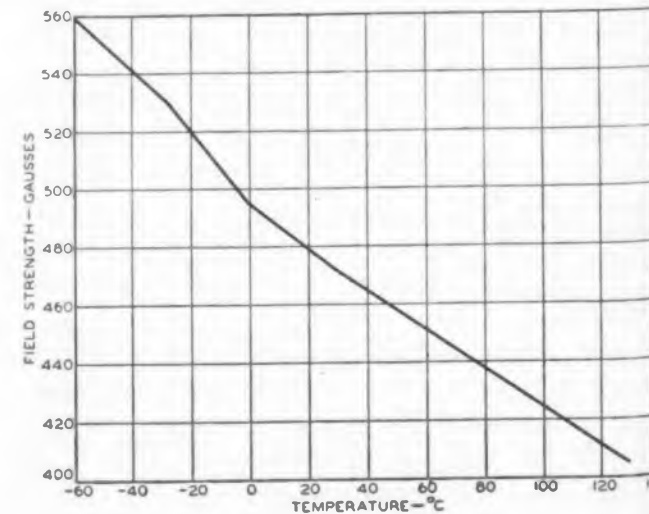

Fig. 2. Variation of axial field strength of a typical focusing structure with changes in temperature.

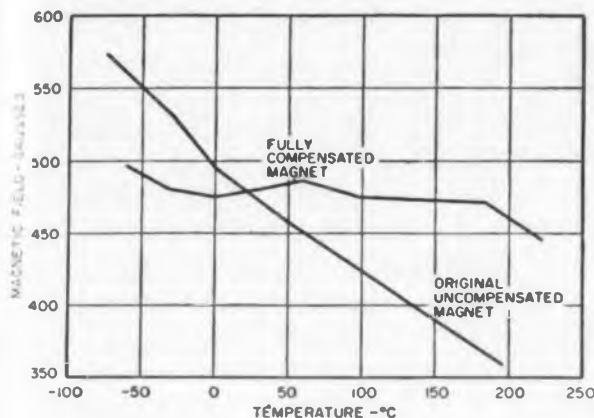

Fig. 3. Magnetic compensation of focusing structure reduces field-strength fluctuations with temperature changes.

Conversely, as the temperature drops, the magnetic field increases, constricts the beam, and, thus depresses gain and power output.

Thermo-magnetic shunts, for controlling reversible field changes, are made of temperature-compensating, iron-nickel alloys. Fig. 3 compares variation in axial field strength for uncompensated and compensated stacks and Fig. 4 (a) and (b) shows the result of temperature compensation on power output. This particular compensation technique is common in instruments that must perform with a high degree of accuracy in fluctuating ambient temperatures.

Magnetic Shunt Gives Insensitivity To Temperature

The field strength of the ceramic-barium-ferite magnet changes proportionally to the temperature change (slightly less than 2 gauss per 100 gauss per 100 C). By adding a magnetic shunt whose permeability is also temperature dependent, the fluctuating field strength of the magnet and the fluctuating permeability of the shunt can be made to cancel, thus yielding a temperature-stable focusing stack.

The iron-nickel alloys in a thermo-magnetic shunt contain between 29 and 33 per cent nickel. This group of alloys is unique in that Curie points are close to room temperature.

If the nickel content were below 29 per cent, the compensator alloy would behave like ordinary steels. (Steels exhibit critical points when heated and cooled.) A gap between critical points on heating and cooling cycles exists. Because of this gap or temperature hysteresis, the magnetic properties of these alloys are changed irreversibly by temperature cycling.

Nickel Content of Shunt is Critical

When the nickel content is above 29 per cent, these alloys have stable crystallographic structures. For this reason, changes in their thermo-magnetic properties due to temperature cycling are reversible.

(continued on page 56)

ROAST IT!

DALOHM
Ω
TYPE RH RESISTORS

INHERENT STABILITY Assured in a DALOHM RH Resistor

Even searing heat from a glowing bed of coals causes no deviation from the inherent stability that is standard in Dalohm resistors.

Stored on the shelf for months... or placed under continuous load... operating in severe environmental, shock, vibration and humidity

conditions... Dalohm precision resistors retain their stability because it has been "firmly fixed" by Dalohm design and methods of manufacture.

For all applications demanding resistors that meet or surpass MIL specifications, you can depend on Dalohm.

HIGH POWER • WIRE WOUND • MINIATURE DALOHM TYPE RH RESISTORS

Designed for specific application of high power requirements, coupled with precision tolerance. Mount on chassis for maximum heat dissipation.

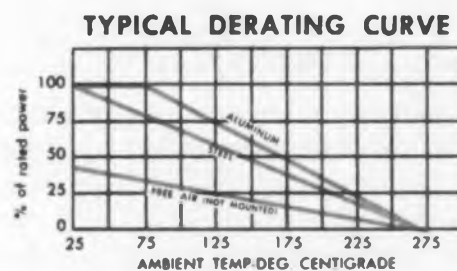

Write for Bulletin R-21, with handy cross-reference file card.

- Rated at 5, 10, 25, 50, 100 and 250 watts
- Resistance range from 0.1 ohm to 175K ohms, depending on type
- Tolerances $\pm 0.05\%$, $\pm 0.1\%$, $\pm 0.25\%$, $\pm 0.5\%$, $\pm 1\%$, $\pm 3\%$
- Temperature coefficient 20 P.P.M.
- Operating temperature range from -55°C . to $+275^\circ\text{C}$.
- Welded construction from terminal to terminal.
- Ruggedly housed; sealed in silicone and inserted in radiator finned aluminum housing.
- Smallest in size, ranging from $\frac{1}{8}'' \times \frac{1}{8}''$ to $3'' \times 4\frac{1}{2}''$
- Surpass applicable paragraphs of MIL-R-18546B (Ships).

SPECIAL PROBLEMS?

You can depend on Dalohm, too, for help in solving any special problem in the realm of development, engineering, design and production. Chances are you can find the answer in our standard line of precision resistors (wire wound, metal film and deposited carbon); trimmer potentiometers; resistor networks; collet-fitting knobs; and hysteresis motors. If not, just outline your specific situation.

DALE ELECTRONICS, Inc.
FORMERLY DALE PRODUCTS, INC.
1328 28th Ave., Columbus, Nebr.
A DIVISION OF
Hathaway
INSTRUMENTS, INC.

CIRCLE 43 ON READER-SERVICE CARD

The Curie points of the alloys rise rapidly with slight increases in the percentage of nickel content. At 33 per cent nickel content, the Curie point is approximately 240 C.

The ability of the shunt to conduct magnetic flux also is temperature-dependent. As the temperature drops, the magnetic field of the permanent magnet increases and the permeability, and consequently the shunting action, of the thermo-magnetic alloy become proportionally greater.

The magnetic shunt functions up to its Curie point; at higher temperatures, the alloy is non-magnetic and, therefore, does not provide shunting action. As the temperature drops below the Curie point, the rate of change of permeability is relatively constant (until it reaches 100 C.) Below this point, the rate of change of permeability decreases so that compensation becomes less effective.

Two-Shunt Materials in Parallel Increase Temperature Range

It is possible to use two or more materials, with staggered Curie points, in parallel to increase the temperature-compensated range. Parallel shunting can limit axial field fluctuations to slightly more than 5 per cent of the stack strength at room temperature over a temperature range -65 to +190 C.

The dimensions of the magnetic shims between sections of the focusing magnet will, in part, determine the effectiveness of the shunt. The main function of the shim is to provide a highly permeable path that channels flux to the beam region, and to insure the axial field's uniformity or symmetry.

In Fig. 1, it is seen that the outer diameter of the shim is smaller than that of the magnetic ring. This shim dimension is a compromise to achieve lightest weight and highest axial field strength. However, the most effective shunting action occurs when the contact area between the shim and shunt is as large as possible.

Shunt Location is Variable

The location of the thermo-magnetic shunt on the periodic-permanent-magnet structure can be varied in several ways. The shunt material may be placed internally along the inner diameter of the ring magnets; it may be placed in cored holes through the magnets; or it may be placed peripherally around the outer diameter.

This last method, shown in Fig. 1, is most frequently used because it simplifies fabrication. Minor adjustments may be made with a minimum of effort, and fringing fields, which may be detrimental to other system components, are minimized.

The symmetry of the axial magnetic field that

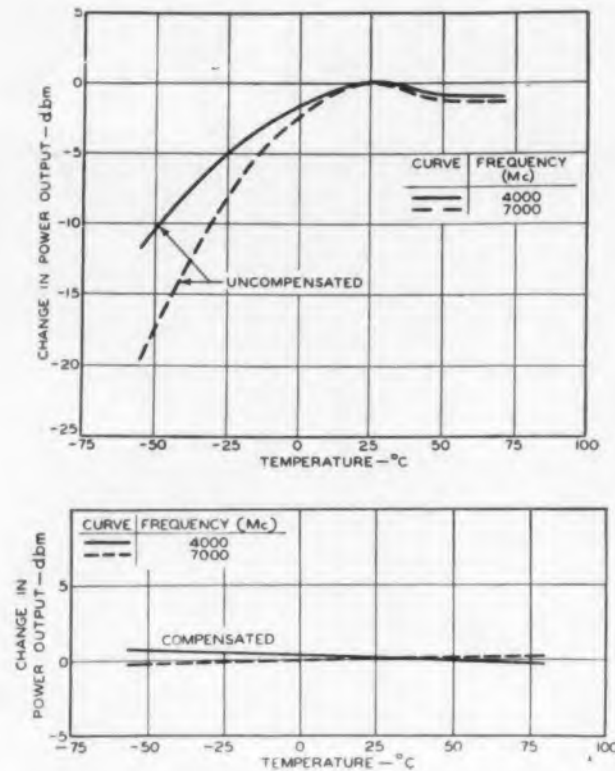

Fig. 4. (a) Changes in TWT power output with temperature changes when magnetic focusing stack is uncompensated (b). Compensation reduces power-change fluctuations.

keeps the beam properly aligned is critical. The introduction of fringing fields, which have transverse components, tends to misalign the beam or to locally defocus the beam. Such misalignment or defocusing increases helix interception with the attendant possibilities of gas evolution and helix burn-out.

Transverse Fields Must be Minimized

Hence careful consideration must be given to the design and processing of the permanent-magnet stack to minimize the possibility of introducing stray or transverse magnetic fields.

Transverse fields that originate from non-uniformities in the magnet may best be prevented by proper inspection procedures. Transverse fields that originate from magnet misalignment can be eliminated by proper design, such as a center aligning tubulation, or by use of precision-ground magnets.

A proper annealing schedule of the shim material reduces undesirable high magnetic remanence and further reduces the possibility of transverse fields.

Thermal Expansion of Parts a Factor

As the traveling-wave tube is temperature-cycled, the physical dimensions of the tube and capsule change unequally. A typical 12-in. long traveling-wave tube (basically a glass envelope in an aluminum capsule) operating in an ambient temperature range -60 to +100 C, has been found to experience eventually a differential ex-

pansion of approximately 30 mils at the temperature extremes.

If the envelope were "fixed" without regard for differential expansion, several detrimental effects could occur.

If the tube envelope were fixed both at the collector and gun ends, without room for expansion and construction, the tube could be destroyed during temperature cycling. If the collector end were fixed and the gun end left free to move with respect to the magnetic stack, beam launching conditions would be less than optimum because of relative motion.

In extreme cases, the tube may become defocused. This phenomenon often is confused with magnetic fluctuation. The possibility of defocusing can be eliminated, however, if the gun end is fixed, and the collector is seated in the radiator with a sliding fit.

Vibration Minimized by Solid Construction

Tubes must be designed to withstand shock and vibration and to exhibit little or no amplitude modulation. This objective is best accomplished by considering the tube first as an assembly of separate parts, and then as a functional unit.

Resonances of parts and relative motion then can be noted and casual structural deficiencies eliminated. The most sensitive areas, from the point of view of over-all tube ruggedness are the helix, the gun, and the support holding the tube envelope in its package.

The support of the slow-wave, or helical transmission circuit, is critical. This component basically is a long, thin, non-rigid structure and, as such, readily distorts when exposed to shock and vibration.

Uniform electrical performance, however, depends on the dimensional accuracy of the slow-wave structure and its ability to remain free of distortions. Therefore, it is necessary to "lock" the helix both with respect to the beam and with respect to each of its turns.

Two Methods Used to Support Helix

Two principal methods are commonly used to support the helix. The first, or so-called "shrink," method consists of actually imbedding the helix in precision-fluted glass tubing. The second is to support the helix on ceramic rods, running the length of the tube.

Both methods of helix support exceed present vibration specifications without hitting resonant points or distorting. These structures have found application in tubes required to operate under 6 g over 2000 cps with less than 0.5 db of amplitude variation, and after impact shock loads of 30 g for 11 msec without permanent impairment of performance.

Electron Gun Must be Rugged

The physical stability and alignment of the aperture of the electron gun with respect to the slow-wave structure is important. If the cathode, or any of the focusing grids, or the whole aperture structure were to resonate, either with respect to itself or to the helix, it would produce increased levels of amplitude modulation.

A basic gun design used is the glass-rod supported type, in which a cylindrical, heat-softened glass rod is forced into smaller partially opened slots in the grids. This gun can amply meet present and foreseeable shock and vibration specifications.

However, glass-supported guns, in their current state of development, have certain disadvantages that could limit design of future traveling-wave tubes—particularly those that must operate at high ambient temperatures.

Several alternate gun designs have been developed for high-temperature operation. One approach is to use a molybdenum-sapphire material instead of glass. A second approach is a stacked ceramic construction. Essentially, this gun consists of a series of ceramic cylinders sandwiched between appropriate grid elements. When this structure is brazed, the result is a highly rigid structure.

Glass Tube not Always Best

In addition of the use of glass envelopes, metal-and-ceramic structures have been designed and developed. The choice of structure depends on the requirements which the tubes are designed to meet.

For example, ceramic-metal construction is a logical choice for operation at high temperatures, where glass would soften. Also, the development of higher-power tubes will mean proportionally larger tube dimensions. Large dimensions make the expansion mismatch between hot metal and relatively cold glass more pronounced.

The demonstrable advantages of ceramic construction should always be compared with certain inherent advantages of glass before a decision is made on construction of a tube.

Glass is extremely resilient, and, when properly supported, has never been known to fall under conditions of shock and vibration. As a vacuum envelope, glass, because it has fewer discontinuities in the form of joints, and by the nature of the material itself, is less prone to the passage of gas. Freedom from gas leakage increases shelf and operational life.

These considerations are not exhaustive, but rather, they indicate major factors influencing traveling-wave-tube design that are compatible both with electro-mechanical and environmental requirements. ■ ■

"WE PLATE MISSILE CONTACTS WITH SEL-REX BRIGHT GOLD* —AN EXTRA MEASURE OF RELIABILITY"

—Elco Corporation, Philadelphia, Pa.

The failure of a single component can put even the mighty Atlas Missile out of commission. That's why an electroplate of SEL-REX BRIGHT GOLD is specified to give an extra measure of reliability to Elco's patented VARICON Contacts used in missiles, rockets, computers and similar critical applications.

The VARICON Contact, with its fork-like design and 4 coined mating surfaces, offers exceptional resistance to numerous punishing insertions and withdrawals—meeting or surpassing the most exacting specifications. Patented SEL-REX BRIGHT GOLD, which produces a fine grained, dense electroplate—twice as hard as conventional 24K Gold plate—is a major reason for the reputation of quality and reliability enjoyed by VARICON throughout all industry.

SEL-REX makes the world's largest selection of processes and systems which take the guesswork out of plating with precious metals. Baths are simply maintained with scientific precision by additions of pre-measured salts or solutions. Your assurance of consistent quality results from one batch to the next.

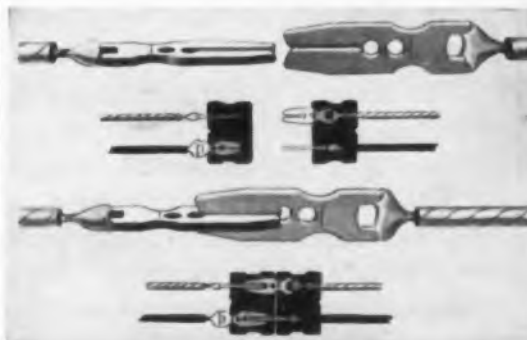

Photo shows Elco's patented Varicon Connectors and unique fork-like contact plated with Sel-Rex Bright Gold.



An internationally based network of sales and service technicians is at your beck and call to make sure you get the optimum results built into every SEL-REX PROCESS.

Complete technical literature free on request. Specify precious metal(s) and your application.

*Patented

Patented processes for plating with Gold, Rhodium, Platinum, Palladium, Silver, and to produce "custom alloys" for your particular requirements.

SEL-REX CORPORATION

NUTLEY 10, NEW JERSEY

The World's Largest Selling Precious Metal Plating Processes

CIRCLE 44 ON READER-SERVICE CARD

A NEW APPROACH TO MACHINE PROCESS CONTROL Step Sequencing

the new
**Eagle
Step
Switch**

use any type of
time or sensing
device to advance
the **Eagle
Step Switch**

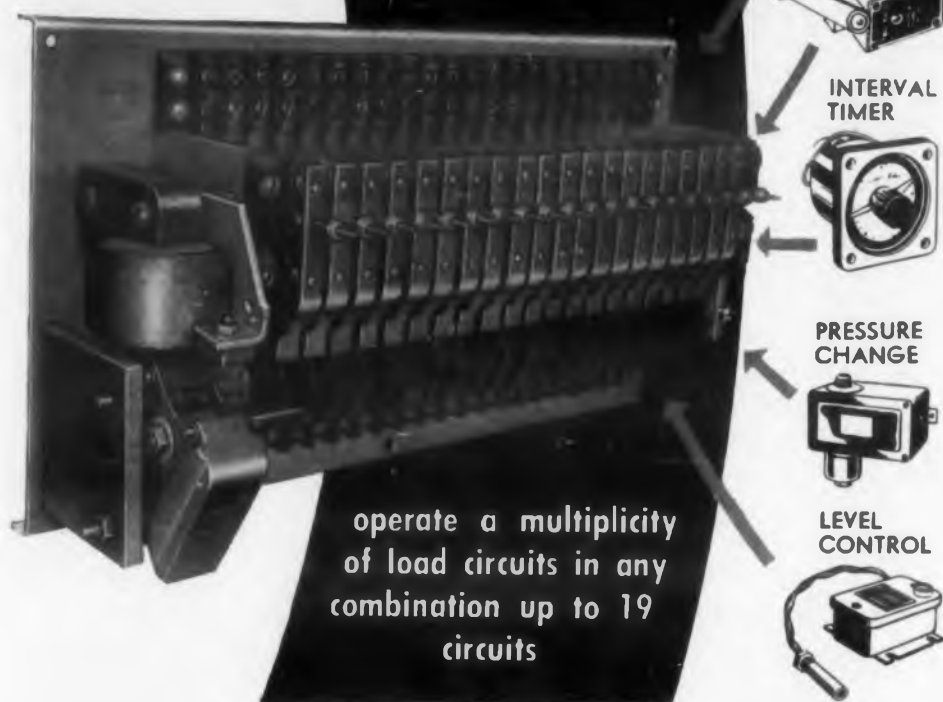

This new Eagle Step Switch also provides:

- | | |
|--|---|
| <p>1 SEQUENCING INTERLOCK when used with multiple indexing circuits.</p> <p>2 10 AMP SWITCH CONTACTS control load switches direct — no need for load relays.</p> | <p>3 MECHANICAL CIRCUIT INTERLOCK by cam action — eliminates interlocking relays.</p> <p>4 115 VOLT COIL operates direct on AC with heavy duty ratchet mechanism — insures long life.</p> |
|--|---|

Write us regarding your count problem, or see your local phone directory or Thomas Register under the heading, "Timers, Electric" for your nearest Eagle Signal representative.

OTHER POPULAR HIGH QUALITY EAGLE TIME-COUNT CONTROLS

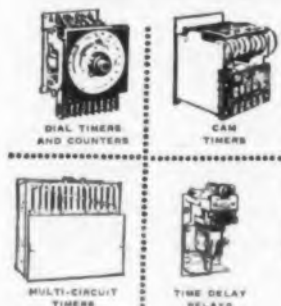

BLISS
EAGLE SIGNAL COMPANY • Moline, Illinois
A DIVISION OF THE GANWELL COMPANY,
AN E. W. BLISS COMPANY SUBSIDIARY

MANUFACTURERS OF A COMPLETE LINE OF INDUSTRIAL TIME-COUNT CONTROLS

CIRCLE 45 ON READER-SERVICE CARD

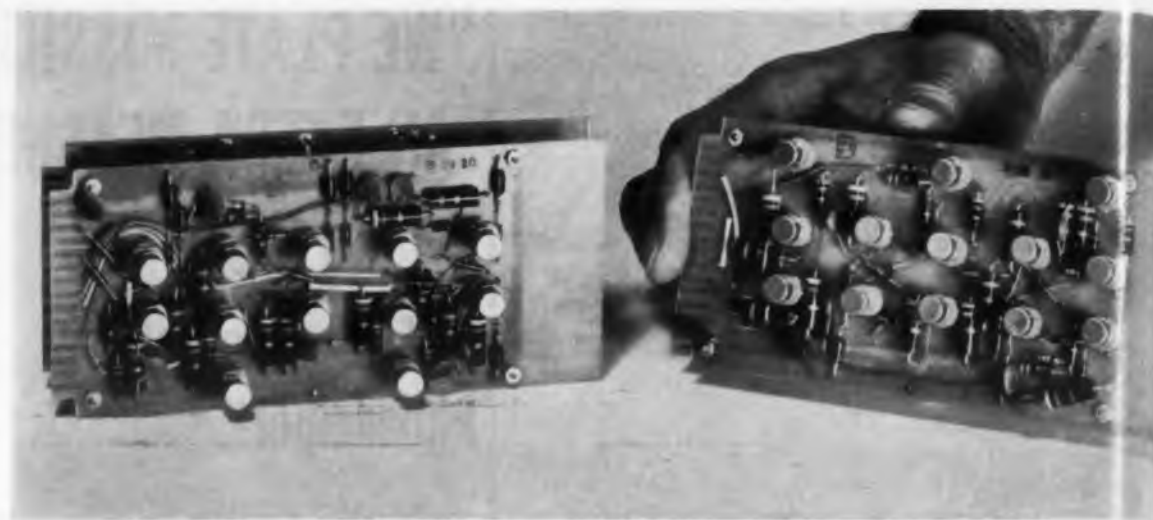

Eldorado's 100-mc decimal counting unit

100-Mc Solid-State Gated Counter

USING a new decimal counting logic, Eldorado's model 1050 100-mc gated counter achieves its high counting rate using standard components. It is a triple-purpose instrument which can be used to count random events or to measure frequency up to and including 100 mc. Or it can be used as a time-interval meter to measure duration to within 10 nsec.

As a counter, the model 1050 offers nine digits of storage with in-line Nixie display, 10-nsec double pulse resolution, and 100-mc continuous counting rate. It may be started and stopped locally or remotely. When used as a time-interval meter, an external oscillator is required as a time reference source.

Binary Requirements Reduced

In a conventional four-binary decimal counting unit, the input binary must operate at the maximum frequency of the instrument. However, with the reduced requirements of this technique, no binary need operate at more than one-fifth the maximum frequency of the instrument according to the designer, Mr. Zoltan Tarczy-Hornoch, Technical Director of Eldorado Electronics, 2821 Tenth St., Berkeley, California.

A block diagram of the logic used is presented in Fig. 1. In the reset condition as shown, all the binaries are off and side A conducts. The "AND" gates

are arranged so they will pass the input pulse only if the input is connected to the "O" side of the binary. If the signal gets through the gate it will turn that side of the binary on from "0" to "1". If it is already on, no switching will occur. With the first pulse applied, gates 1B, 2A, 3A, 4A and 5A pass the input pulse but the last four gates are feeding into the "1" side of the binary and therefore only gate 1B is able to act. With the first binary turned on, gates 1B, 2B, 3A, 4A and 5A are open for the second pulse. Continuing, the second binary will be switched by the second pulse, the third binary by the third pulse and this will continue until all the binaries are on. This condition is the exact opposite of the reset state since in all stages side B is conducting instead of side A. Every stage will now switch in the same sequence but to the opposite side.



Model 1050, 100-mc solid-state gated counter

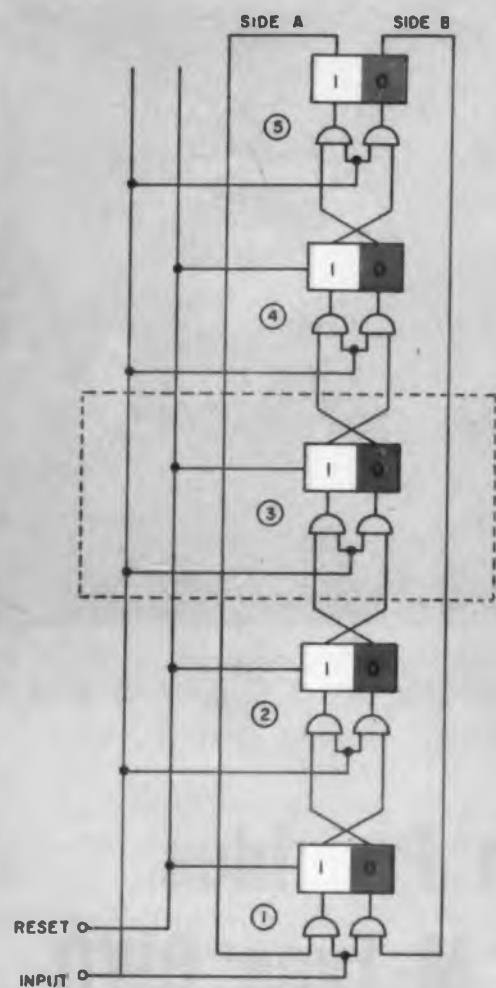

In the reset condition as shown, all the binaries are off, with side A conducting

The sixth pulse will turn off the first binary and after the tenth pulse all the binaries will be off again. The circuit details of an actual binary-gate combination will be described in a future issue of ELECTRONIC DESIGN.

Specifications for the unit as a counter are: storage, 10^9 counts; readout, in-line Nixie; maximum counting rate, 100 mc; double-pulse resolution, 10 nsec; input pulse amplitude requirements, +4 v; pulse width, 7 nsec; rise time, 3 nsec; fall time, 3 nsec; input impedance, 50 ohms.

Specifications for the unit as a time interval meter are: maximum stored time, $10^9 \times$ time base; resolution 10 nsec with 100-mc time base; start-stop amplitude requirements, -5 v; pulse width, 10 nsec; rise time, 5 nsec; minimum time interval, 50 nsec; input impedance, 50 ohms.

The 100-mc solid-state gate counter is presently in production.

For further information turn to the Reader-Service Card and circle 251.

Certi-Crimp* • A-MP-O-LECTRIC • Plasti-Grip • SOLISTRAND • Plasti-Bond • AMP-O-MATIC • Amplifilm • AM

TION • COPALUM • Ampli-Bond • DYNA-CRIMP • TERMALUM • FASTON • AMPLIMAR • CERTI-SEAL • PING • A

MPOWER • DIAMOND GRIP • AMPORAPOWER • AMP EDGE • Certi-Crimp • A-MP-O-LECTRIC • Plasti-Grip •

SOLISTRAND • Plasti-Bond • Ampli-Bond • DYNA-CRIMP • TERMALUM • FASTON • AMPLIMAR • CERTI-SEAL • PING • A

RIMP • SEAL • PORTAP



INDUSTRY LEADERS

BECAUSE IT'S THE CRIMP THAT COUNTS!

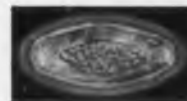

All connectors may look alike but when faced with the test of performance . . . contact crimp reliability makes them all different. The big difference between other connectors and the AMPin-cert connector is the snap-in design contact attached to the wire by AMP's precision-controlled, compression-crimp technique. Twenty years of intensified research, development and production stand behind the industry-accepted compression technique which produced Solistrand®, Diamond Grip®, Pre-Insulated Diamond Grip®, Plasti-Grip®, Certi-Crimp® and the

more than 15,000 different AMP circuit termination products. This is the common denominator which spells out unquestioned reliability in all our products including the AMPin-cert connector line. ANOTHER AMP FIRST! Now AMP offers tape-fed, automated application of AMPin-cert contacts. Production levels of up to 1,500 terminations per hour can be achieved with standard A-MP-O-LECTRIC® machines. Also, the AMPORAMATIC crimping tool is available for tape-fed terminations in hard-to-reach locations.

Visit us at the A.E.S. Show, San Diego; Oct. 20-21, 1960, Booths 29 to 31 and in Los Angeles; Oct. 26, 27 and 28, 1960, Booths 313 to 315.

AMP INCORPORATED

GENERAL OFFICES: HARRISBURG, PENNSYLVANIA

AMP products and engineering assistance are available through subsidiary companies in: Australia • Canada • England • France • Holland • Italy • Japan • Mexico • West Germany

CIRCLE 46 ON READER-SERVICE CARD

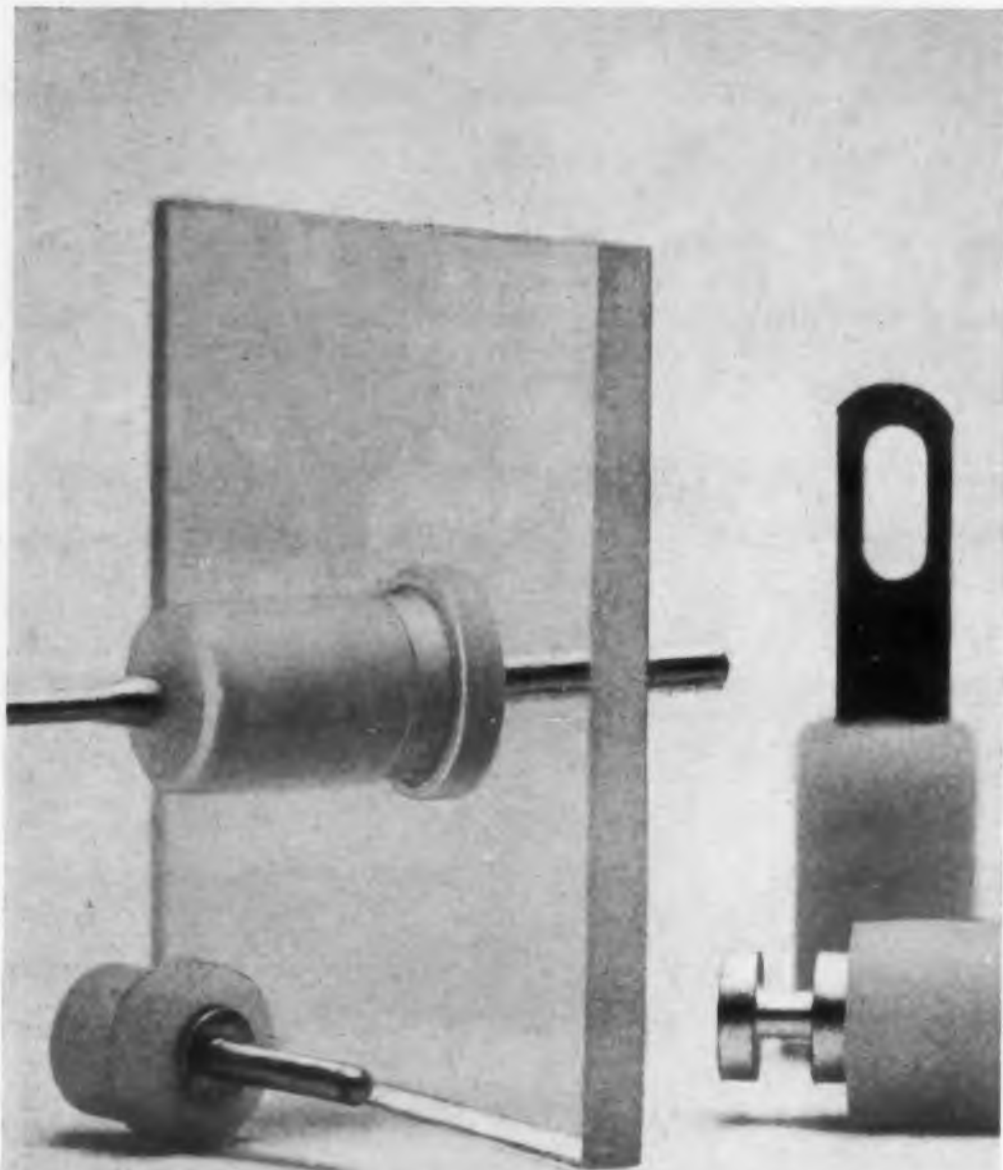

CANNON KWIK-TERM TERMINALS

**PERMANENT VIBRATION-PROOF
INSTALLATION IN SECONDS!**

Cannon's complete range of subminiature terminals gives you simplified electrical connections for circuitry in communication equipment, radar, scientific instrumentation, and many other applications where space is a criteria. "Kwik-Term" terminals are quickly installed by pressing through pre-drilled mounting holes...special resilient insulation provides permanent, vibration-proof connections. Wide variety of colors, bushing and pin diameters, and lengths. Available through Cannon Sales/Engineering Offices and authorized Distributors throughout the world. Write for Catalog KT-2 to:

**CANNON
PLUGS**

CANNON ELECTRIC COMPANY, 3208 Humboldt St., Los Angeles 31, Calif.

CIRCLE 47 ON READER-SERVICE CARD



S-band Bitermitron coupled to a conventional cross-field backward wave oscillator, showing the similarity between the structure of the two tubes. In this configuration the two-terminal Bitermitron is used as an amplifier.

Bitermitron Provides Two-Terminal M-Type BWO

ACCCESS to either end of the slow-wave structure of an M-type backward-wave oscillator is provided by a new two-terminal microwave-tube.

The tube, called a Bitermitron, can be used as a voltage-tunable crossed-field backward-wave amplifier with beam currents below the start oscillation level. Initial application for the device is in classified ECM equipment along with a conventional internally-terminated M-type BWO, with the Bitermitron acting as a power booster. The Bitermitron was developed by Raytheon Co., Waltham, Mass.

When operated at beam currents comparable to those used in the conventional tube, however, the Bitermitron can function as a locked oscillator as well as an amplifier when connected in series with the M-type BWO. Because of the similar structure the pair of tubes have essentially the same electrical characteristics so that for most purposes they can be treated as a single voltage-tunable backward-wave locked oscillator. The small signal driving requirement and high efficiency of this combination make it attractive for this application.

When used in this frequency tracking

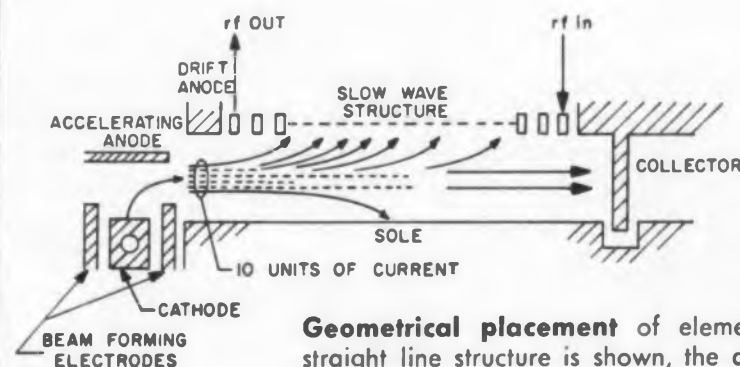

Geometrical placement of elements in a Bitermitron. Although a straight line structure is shown, the actual tube is circular with the sole acting as the inner element of the coaxial structure formed. Arrows indicate proportions of the beam current collected by the sole, the collector, and the circuit in an amplifying Bitermitron.



W100 series pushbutton switches are built to MIL-S-6743 specifications, drawing MS-25089. Resist over 50G shock and 20G vibration. Silicone rubber sleeve seals out dust & moisture. Anodized aluminum housing, with silvered terminals molded in phenolic. At 28 VDC: 10 amp res., 5 amp ind. Other buttons and adapters available.



T2150 toggle switches have a positive cam-roller snap action that can not be "teased" off contact. Miniature cylindrical shape saves vital space in modern instruments, control systems, appliances. Anodized aluminum case, integral silver overlaid terminals and contacts. On-Off action. 1 amp res. at 28 VDC and 115 VAC.



L20,046 indicator light photo above is really actual size. Stainless steel case with 7/32" diam. lens and moisture-proof sealing to case. 5 volt lamp pulls .060 amps with rated life of 60,000 hours. Stranded insulated leads. Weighs .002 lb. Lens colors: red, white, green, blue, yellow, amber.



T3 snap-action switch has exceptionally high current capacity in tiny case, yet is UL listed at 7.5 amps, 125/250 VAC. Also rated at 7.5 amps, 28 VDC res.: 2.5 amps, 28 VDC ind. Mounts singly or side-by-side, four to the inch. Excellent shock and vibration characteristics. Solder terminals. Rated to 250° F. Also roller leaf actuator.

... all actions, all sizes, all operating characteristics are available in rugged, reliable switches and lights from Control Switch Division. Shown above are only four of the range of miniature units. For more information on our complete line, write for a free copy of our new CONDENSED CATALOG #100.

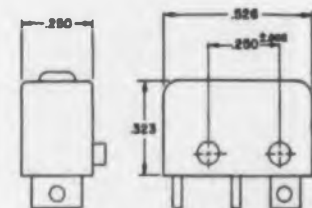
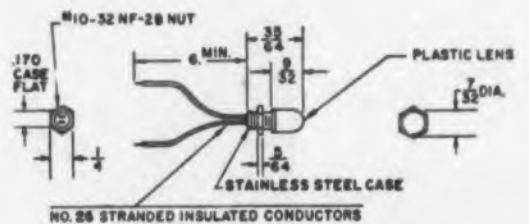
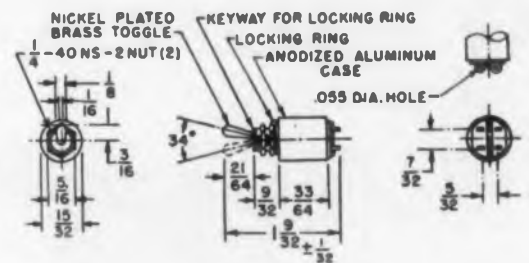
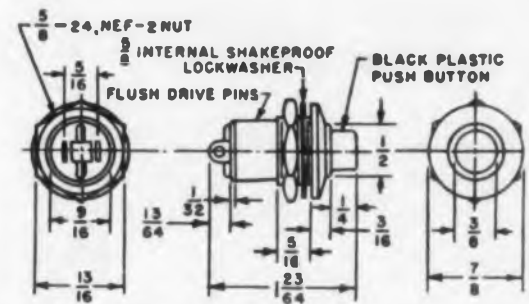

ELECTROSNAP • HETHERINGTON

CONTROL SWITCH DIVISION

CONTROLS COMPANY OF AMERICA
1420 Delmar Drive • Folcroft, Pennsylvania
TELEPHONE LUdlow 2-2100 • TWX 5HRN-H-602

CIRCLE 48 ON READER-SERVICE CARD

mode, the output of the Bitermitron can be locked by a small input-signal, as much as 20 db down from its output level.

Another potential application of the combination is in a frequency diversity pulse-type system, in which frequency is shifted either randomly or as required between pulses. Frequency modulation could also be applied to the Bitermitron-BWO combination.

With the shift of telemetry frequencies to the 1435-1535-mc and 2200-2300-mc bands, the Bitermitron may also be found useful in new microwave telemetry systems.

In analyzing the Bitermitron and M-type BWO driver circuit, with the assumptions of no delay line loss and equal efficiencies for the two tubes, the Bitermitron gain would be 3 db. Since there is some delay line attenuation, and the Bitermitron's efficiency is greater than that of the driver, two opposing effects act to change this gain figure. At S-band where line losses are small a typical gain figure of 4 to 5 db has been attained, but moving up to X-band where line losses become more severe a figure of 3 to 4 db gain is typical.

The original Bitermitron, designated QK540, was designed to operate with Raytheon's QK625, a 180-w, M-type BWO operating between 2500 and 3300 mc. The cw system output of the two-tube combination was specified at 450 w minimum. Each tube weighs about 25 lb.

For further information on the Bitermitron turn to the Reader-Service Card and circle 252.

NEW PRODUCTS

Covering all new products generally specified by engineers designing electronic original equipment. Use the Reader's Service Card for more information on any product. Merely circle number corresponding to that appearing at the top of each description.



Generator Produces 713 Alpha-Numeric Characters

The DOTitron generation and display system generates and displays alpha-numeric characters or any arbitrary patterns on the face of a conventional cathode-ray tube, either electrostatic or electromagnetic, or projection tube equipment. The display is in the form of closely adjacent luminous dots positioned to generate the required patterns. The character selection and position order are in the form of parallel digital codes. This system is flexible in that new characters or symbols can be added by providing the corresponding resistor networks using simple scaling or interpolation. No analyses of wave shapes are necessary.

General Precision, Inc., Link Div., Dept. ED, Binghamton, N. Y.

Price: Basic character generator unit is priced from \$8,000 to \$12,000.

Availability: 30 to 120 days after order received.



Dc Amplifier Has 716 Dual Application

This four-terminal, true differential dc amplifier has both its input terminals isolated from both output terminals and all four terminals isolated from ground. By a quick disconnect, it can function simultaneously as a dc to 20 kc isolation transformer and floating 3-terminal, wideband dc amplifier. The unit amplifies low-level signal sources from dc to 20 kc at all gain settings; gain is continuously adjustable from 10 to 1,000, with zero and "OP" positions. Input impedance is 100,000 ohms over entire bandwidth. The unit rejects common mode signals up to 200 v from signal source and long input lines.

Computer Engineering Associates, Inc., Dept. ED, 350 N. Halstead, Pasadena, Calif.



Power Rectifiers Rated 714 At 15 Amp From 50 to 400 V

Types MR312 through MR316 silicon power rectifiers are rated for 15 amp operation and designed for 50, 100, 200, 300, and 400-v applications. Claimed to be priced at about 50% of comparable units now on the market, the diffused-junction devices are housed in an all-welded, hermetically sealed 11/16-in. hex stud-mounted package for heat sink or direct chassis mounting. They are rated for operation at temperatures up to 175 C.

Motorola Semiconductor Products Inc., Dept. ED, 5005 E. McDowell Road, Phoenix, Ariz.

Price: Ranges from \$1.95 for 50-v units to \$3.50 for the 400-v devices in 100 and up quantities.



Power Supplies Have Temperature Coefficient Of 0.003% Per Deg C 712

This series of transistorized, dc, plug-in power supplies have a temperature coefficient of 0.003% per deg C. They are rated in voltages up to 36 v and currents up to 500 ma. Developed for computer applications requiring high stability, the units have an input of 105 to 125 v ac. Line regulation is $\pm 0.02\%$ and load regulation is 0.05%. The stability is less than 15 mv total drift for 8 hr. Measuring 3.5 x 3.75 x 6.5 in., the units weigh 3 lb, 6 oz, and operate in an ambient temperature of -10 to $+60$ C.

Valor Instruments, Inc., Dept. ED, 13214 Crenshaw Blvd., Gardena, Calif.

Price: Fixed output, \$155; variable output, \$185. Availability: 2 to 4 wk.



Tube Senses Fire's Ultraviolet Radiation 711

This electronic tube detects fire by sensing its ultraviolet radiation. Designated the U-V Detector, the unit is insensitive to direct sunlight, normal illumination enclosed in glass, cosmic and nuclear radiation. Having many industrial applications, the tube is operative within an ambient temperature range of -75 to $+400$ F. It measures 1-1/8 in. in diameter and 1-1/4 in. long, including mounting pins which fit an ordinary radio tube socket. Ultraviolet radiation from flames, containing wave lengths of between 1900 and 2900 Å release electrons from the negative electrode in the tube.

Thomas A. Edison Industries, McGraw-Edison Co., Dept. ED, West Orange, N.J.
Price: About \$10 each.

(POWER SUPPLY-WISE) KEPCO'S "SM GROUP" sets a new transistor- ized design standard

In Performance >

These 15 new transistorized voltage regulated power supplies reconcile ruggedness and wide power capability (without mag-amps) with excellent ripple reduction, regulation, and negligible transient response characteristics.

In Reliability >

Unique "fail-proof" design inherently protects series "pass" transistors from damaging overloads (dissipation requirements of pass elements actually reduced under high load demand or short circuit).

Size-Wise >

New sophisticated circuit simplicity permits greater reduction in size (without "shoehorn" techniques). Five wide voltage ranges, in three panel height groups scaled to popular power requirements. All models standard rack width 19", depth 13".

| MODEL | DC OUTPUT VOLTS | DC OUTPUT AMPS. | PANEL HEIGHT |
|------------|-----------------|-----------------|--------------|
| SM 14-30 | 0-14 | 0-30 | 8 3/4" |
| SM 36-15 | 0-36 | 0-15 | |
| SM 75-8 | 0-75 | 0-8 | |
| SM 160-4 | 0-160 | 0-4 | |
| SM 325-2 | 0-325 | 0-2 | |
| SM 14-15 | 0-14 | 0-15 | 5 1/4" |
| SM 36-10 | 0-36 | 0-10 | |
| SM 75-5 | 0-75 | 0-5 | |
| SM 160-2 | 0-160 | 0-2 | |
| SM 325-1 | 0-325 | 0-1 | |
| SM 14-7 | 0-14 | 0-7 | 3 1/2" |
| SM 36-5 | 0-36 | 0-5 | |
| SM 75-2 | 0-75 | 0-2 | |
| SM 160-1 | 0-160 | 0-1 | |
| SM 325-0.5 | 0-325 | 0-0.5 | |

REGULATION:
0.1%*

(RIPPLE:
1 Mv. rms.)



Model SM75-8M



Model SM325-1M



Model SM36-5M

INPUT REQUIREMENTS FOR ALL MODELS: 105-125 VAC, 60 \pm 1/2 cps.
METERS OPTIONAL: Model Nos. listed in table are for unmetere units.
To specify metered units, add "M" to Model No. (e.g. SM 14-30M)

*0.01% REGULATION MODELS AVAILABLE ON SPECIAL ORDER.

FOR DETAILED SPECIFICATIONS ON MORE THAN 150 STANDARD MODEL POWER SUPPLIES SEND FOR KEPCO CATALOG B-601

kepco
Inc.

131-36 SANFORD AVENUE • FLUSHING 52, N. Y. • IN 1-7000 • TWX # NY 4-5196

CIRCLE 49 ON READER-SERVICE CARD

measure

I **AC and DC**
10⁹ to 10 amps ±2% DC, ±3% AC

R 10 ohms to 10 megohms
±5% center scale

E **AC** 1 mv to 1 kv ±3%
20 cps to 1 mc
DC 1 mv to 1 kv ±2%



Model 810 IRE Meter • Price: \$445.00

with the **New**
Smith-Florence
Multi-Function **IRE Meter**

This versatile new instrument combines all the desirable functions of a multimeter, vacuum tube voltmeter, and exceptionally wide range AC and DC ammeter in one space saving, easy-to-use package. Truly the design engineer's answer to bench clutter, the Smith-Florence Model 810 takes the measurements you make most for only 1/3 the cost of comparable instrumentation.

And These Features, Too—Individually illuminated ranges controlled by the positioning of the function switch. Two calibrating output voltages: 1 vdc and 1 vac rms square wave controlled by a zener reference circuit to an accuracy of .1%. Scope and recorder output. 1 mc dbm scale for audio work. Measures two functions simultaneously. Rack mounting at no extra cost.

OTHER INPUT IMPEDANCE, 10 megohms • POWER REQUIREMENTS, 117 vac
SPECIFICATIONS ±10%, 50-60 cps • DIMENSIONS, 13" W x 7 1/2" H x 13" D (cabinet) —
19" W x 7" H x 13" D (rack) • WEIGHT, 18 lbs.

For complete technical information, contact your nearby Smith-Florence engineering representative, or write the factory.



SMITH-FLORENCE, INC.
4228-36 23RD WEST • SEATTLE 99, WASHINGTON • ATWATER 4-0170
Another New Instrument For The Sixties From Smith-Florence
CIRCLE 50 ON READER-SERVICE CARD

1



Occupying 5-1/4 in. on a standard 19-in. relay rack, this digital signal simulator is designed for PCM systems in the field or in the development laboratory.

Unmatched Flexibility Claimed for PCM Signal Simulator

THE FRONT panel of the new ESS-500 signal simulator, designed for PCM systems in the field or the development laboratory, provides controls for selecting word length, frame rate and length, operating frequency, and frame position for master sync and fixed-word

data. Claimed to have "unmatched" flexibility, the unit simulates the digital output of an airborne or ground multiplexer and digitizer for both calibration and checkout, presenting serial data.

Made by Telemetry, Inc., the signal simulator is designed to accept inter-

Universal Test Station Handles Many Components, Provides Savings



By means of a specially prepared tape, the test station can even test itself.

Designed to automatically test a wide variety of electronic components, a new universal test station is reported to provide significant savings to electronic manufacturers, particularly those who make many types of units in small quantities.

The unit, made by Consolidated Avionics Corp., 800 Shames Drive, Westbury, N. Y., is described by the firm as "a self-contained mobile unit for automatically stimulating, measuring, evaluating and recording the response of electronic or electrical devices within the specified performance limits."

changeable coding modules, which plug in flush with the front panel. They enable the unit to generate any type of code, including binary, bcd, excess 3, biquinary, hexadecimal, and 1224.

Solid-state electronics of the unit are also built on a modular basis and are readily accessible for easy maintenance. Chassis space is allowed for expansion of the circuitry to meet any special customer requirement.

Word-length selection is from 6 to 15 bits per word. In one frame, three separate and distinct words can be generated: master sync code, fixed data word, and 11 special data codes. Bit rate of seven separate bit-rate oscillators is from 100 to a half-million bits per second. Frame size is variable from one to 500 words per frame.

NRZ and RZ output signals are provided at +20 v and -10 v for full scale, with zero volt for zero scale. The completely transistorized unit occupies only 5-1/4 in. on a standard 19-in. relay rack.

For more information on this unit—the manufacturer's address is 12927 S. Budlong Ave., Gardena, Calif.—turn to the Reader-Service Card and circle number 253.

Test sequences are fed into the unit from programed punched tape along with predetermined tolerance limits. Changing the test program for one type unit to that for another consists of inserting a new tape and plugging the new type unit into a prefabricated cable.

The system is capable of measuring ac and dc voltage or current amplitudes, ratios, frequency, impedance and events-per-unit-time. An oscilloscope is provided for visual monitoring of wave shapes.

Savings, the company claims, result from (1) savings in time normally required to set up and knock down special test equipment for each different type unit to be tested, (2) savings in time required to run tests, (3) lower skills needed to make tests, (4) the elimination of test reports and (5) the elimination of manual data recording. The unit is self-checking to eliminate internal errors.

For more information on this automatic test unit, turn to the Reader-Service Card and circle number 255.

Electronic Products **NEWS**

by **CARBORUNDUM®**

Need High-Power Packaged Loads? Here's an example: Custom engineered PULSE AND RF LOADS

Designed to individual customer requirements, completely assembled pulse and RF loads are offered by Carborundum's Global Plant. They utilize GLOBAR® high power, non-inductive resistors mounted so as

to present the lowest possible inductance.

A typical modulator load is pictured here. Peak pulse voltage is 12 KV and the average power rating is 10 KW. The load is cooled by forced air at 300 CFM. A viewing resistor is provided so that 1/1000 of the pulse voltage is available at a BNC jack. Similar loads can be designed using cooling.

Loads utilizing the non-linear characteristics of GLOBAR varistors are also supplied for simulating the characteristics of magnetrons and other microwave tubes. For information, write Global Plant, Refractories Division, Dept. EDL-90, The Carborundum Co., Niagara Falls, N. Y.

CIRCLE 804 ON READER-SERVICE CARD

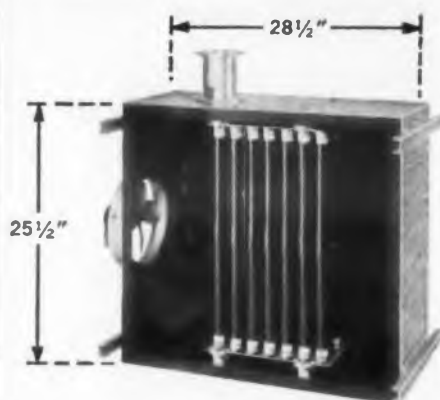

BORON NITRIDE...new Carborundum material offers wide possibilities for MACHINED INSULATING SHAPES

Boron nitride is a comparatively new insulating material having high electrical resistivity, high dielectric strength, and good mechanical properties even at elevated temperatures. It differs from the usual ceramic materials in that parts can be easily

machined using standard machining techniques. No subsequent firing is involved. Close tolerances, high surface finishes and intricate shapes are readily produced. Advantages for many electronic applications will be apparent.

Production of machined shapes to customer specifications is a specialty of Carborundum's Latrobe Plant. Tooling provides for long or short runs on the most economical basis. Savings in time due to simplicity of production are often considerable.

The photo shows the machining of a semi-conductor jig produced in volume for a leading electronics manufacturer. A technical bulletin giving the properties of boron nitride is available. Write Latrobe Plant, Refractories Div., Dept. EDB-90, Carborundum Co., Latrobe, Pa.

CIRCLE 805 ON READER-SERVICE-CARD



CIRCLE 804, 805, 806, 807 ON READER-SERVICE CARD



Close tolerances possible in ALUMINA SHAPES

Ceramics made of high purity alumina withstand most voltages, frequencies and temperatures encountered in electronic applications. Both simple and highly complex shapes are produced in volume by Carborundum. Machining and grinding operations both before and after firing make it possible to manufacture intricate O.D. and I.D. designs to extremely close tolerances.

The photo shows examples of parts designed for a radome application. Similar shapes are produced for missiles, rockets and aircraft. Three types of alumina are available from Latrobe:

1. 1510 (100% alumina) special purpose porous body for vacuum devices. Can be degassed easily.
2. 1542 (96% alumina) developed primarily for vacuum tube envelopes. Exceptional strength, refractoriness and wear resistance.
3. 1550 (85% alumina) vitreous body with high mechanical strength.

For information, write Latrobe Plant, Refractories Div., Dept. EDA-90, Carborundum Co., Latrobe, Pa.

CIRCLE 806 ON READER-SERVICE CARD

LATEST INFORMATION ON KOVAR® ALLOY

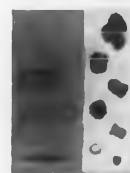

Kovar is the standard matched-expansion alloy for critical glass-to-metal sealing problems. Bulletin gives data on composition, properties and applications. Write Latrobe Plant, Refractories Div., Dept. EDK-90, Carborundum Co., Latrobe, Pa.

CIRCLE 807 ON READER-SERVICE CARD

RCA SEMICONDUCTOR AND MATERIALS DIVISION

Announces

World's Fastest Tunnel Diodes

NOW COMMERCIALY AVAILABLE FOR SWITCHING APPLICATIONS

New RCA Gallium Arsenide Type 1N3138 and

Germanium Types 1N3128, 1N3129, 1N3130, specifically designed

for ultra high-speed computers, attain switching speeds to 0.1 nanosecond.

From RCA's semiconductor research and engineering resources comes another major advance in Tunnel-Diode Development that opens the way to remarkable new increases in computer-speed capability. Three new RCA Germanium Tunnel Diodes with switching speeds to 1/10 of a millimicrosecond and peak-to-valley ratios to 15:1, and a new RCA gallium-arsenide tunnel diode with a switching speed up to 1/5 millimicrosecond and a peak-to-valley ratio to 40:1 are now commercially available. Already, these new types are being incorporated in plans for data-processing equipment designed to operate at a clock rate of 1 KMc.

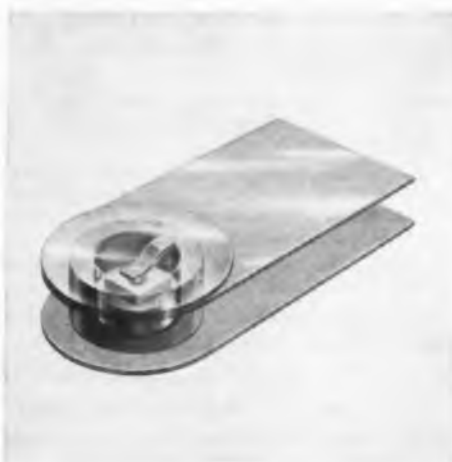

New RCA Tunnel Diodes are encased in the exclusive, RCA developed, low-inductance ceramic-to-metal package. Now can be hand-soldered or dip-soldered—withstanding 275°C for 10 seconds.

Wide Operating Temperature Range—In addition to high-speed capability, RCA Tunnel Diodes have a broad operating temperature range—from -65°C to +150°C. Maximum storage temperature is 175°C.

High Peak Current Ratings—RCA Tunnel Diodes have high peak current (I_p) covering the range to 50 ma. as the chart indicates. Minimum peak-to-valley ratios (I_p/I_v) are 8:1 and 20:1.

Tight Tolerances—High peak current ratings are held to a tolerance within $\pm 5\%$.

Exclusive Low-Inductance Case—New RCA Tunnel Diodes are encased in RCA's unique low inductance (0.4 millimicrohenry) ceramic-to-metal package which minimizes the possibility of parasitic oscillations and permits full utilization of their outstanding high-frequency characteristics.

Design Benefits—Each of the new RCA Tunnel Diodes has these additional design features:

Mesa Construction—for high reliability, stability, and unit-to-unit uniformity. **Low Noise**—lower than most other electronically active devices. **Resistance to Radiation**—greater than conventional semiconductor devices.

| NEW RCA TUNNEL DIODES | | | | | |
|-----------------------|--------------|-----------------------|-----------------------|-------|------------------|
| Type | I_p (Ma) | I_p/I_v Ratio (min) | Capacitance (C) (typ) | (max) | Material |
| 1N3128 | 5 $\pm 5\%$ | 8:1 | 7 | 15 | Ge |
| 1N3129 | 20 $\pm 5\%$ | 8:1 | 10 | 20 | Ge |
| 1N3130 | 50 $\pm 5\%$ | 8:1 | 12 | 25 | Ge |
| 1N3138 | 50 $\pm 5\%$ | 20:1 | 10 | 30 | Gallium Arsenide |

For additional information on high-performance, low-price RCA Tunnel Diodes, call your RCA representative. For further technical data write RCA Semiconductor & Materials Division, Commercial Engineering, Section J-18-MN-1, Somerville, N. J.

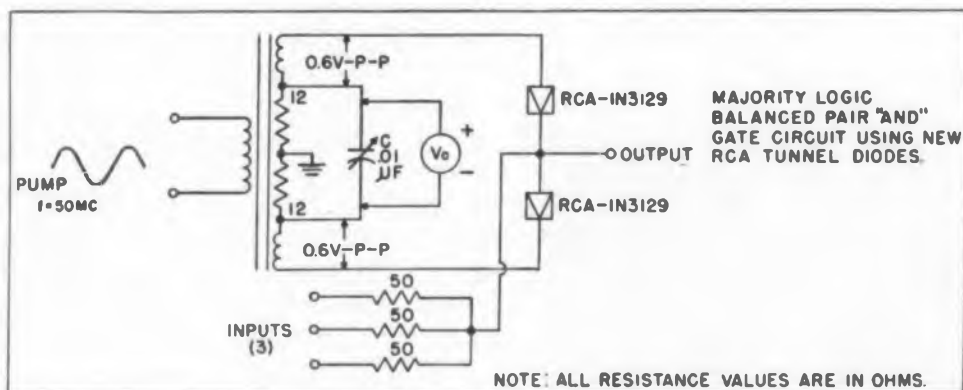

RCA SEMICONDUCTOR & MATERIALS DIVISION FIELD OFFICES

EAST: 744 Broad Street, Newark, N. J., HUmboldt 5-3900. NORTHEAST: 64 "A" Street, Needham Heights 94, Mass., Hillcrest 4-7200. EAST CENTRAL: 714 New Center Bldg., Detroit 2, Mich., TRinity 5-5600. CENTRAL: Suite 1154, Merchandise Mart Plaza, Chicago, Ill., WHitehall 4-2900. WEST: 6355 E. Washington Blvd., Los Angeles, Calif., RAymond 3-8361 • 1838 El Camino Real, Burlingame, Calif., OXford 7-1620. SOUTHWEST: 7905 Empire Freeway, Dallas 7, Texas, FLEetwood 7-8167. GOVT: 224 N. Wilkinson St., Dayton, Ohio, BAldwin 6-2366 • 1725 "K" Street, N.W., Washington, D. C., FEderal 7-8500.

Available Through Your RCA Distributor



The Most Trusted Name in Electronics
RADIO CORPORATION OF AMERICA

NEW PRODUCTS

Frequency-Sensitive Relay

659

For 9,000-cps systems



Model FR7004 is designed for application to a 9,000-cps system. Relay contacts, rated at 2 amp at 28 v dc or 115 v ac, are closed above 9,000 cps and open below 9,000 cps. Operating frequencies in the range of 50 cps to 20 kc are available on special order. The unit resists shock and vibration, and maintains an accuracy of $\pm 1\%$ from -55 to +85 C.

Natel Engineering Co., Dept. ED, Van Nuys, Calif.

Price: \$125 to \$250.

Availability: Three weeks.

S-Band Filters

660

Are tunable from 2,700 to 2,900 mc



These preselector filters blank interference from infringing radars. They attenuate 60 mc frequencies from the preselected operating frequency by more than 50 db. Frequencies of 100 mc from the preselected operating frequency are attenuated more than 60 db. They provide a 3-db passband about 10 mc wide at center frequency. Ripple is less than 0.5 db and insertion loss is 0.75 db.

Texas Instruments, Inc., Dept. ED, 6000 Lemon Ave., Dallas 9, Tex.

Availability: Small quantities, from stock.

Angular Displacement Transducer

375

Range is 3,600 deg



This 10-turn, angular displacement transducer, type 200, is designed for use as a high-output angular position feedback element for measurement of angular position where total rotation may be as high as 3,600 deg. Linearity is within 0.5%. Sensitivity is 1.5 v per revolution with an input of 12 v, 400 cps. Inputs up to 115 v and 6,000 cps are suitable. Temperature range is -65 to +220 F. The device weighs 4-1/2 oz and measures 1 in. in diameter, 3/8 in. long.

Dynamic Measurements Co., Dept. ED, 301 Old York Road, Jenkintown, Pa.

Price & Availability: \$95; available from stock in small quantities.

Modular Logic Elements

642

Twenty-one units available

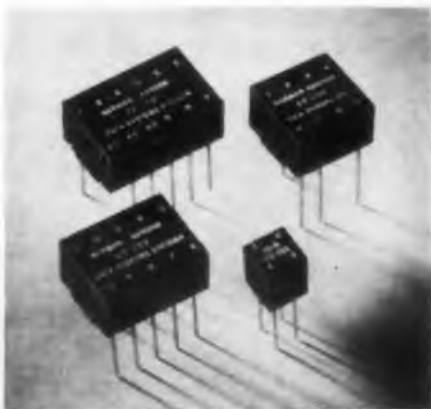

This series of modular logic elements consists of 21 units including delay-triggers, inverter-shifters, flip-flops, gates, followers, inverters, multivibrators and amplifiers. The devices use 0 and -10 v logic levels and ± 12 v power supplies. They operate from 0 to 200 kc and over a -65 to +85 C temperature range. Typical units weigh less than 6 gm; devices occupy from 0.08 to 0.48 cu in.

Harman Kardon, Inc., Data Systems Div., Dept. ED, 520 Main St., Westbury, L.I., N.Y.

Price: \$11 to \$36.

Availability: From stock.

NEW

... FROM ESC



MINIATURE MODULAR COMPUTER DELAY LINES

... designed for printed board mounting

| Module No. | Delay | Size |
|------------|---------------------|---|
| 15-89 | 100 msec. | $\frac{3}{8}$ " x $\frac{1}{2}$ " x $3\frac{5}{8}$ " |
| 15-90 | 75 msec. | $\frac{3}{8}$ " x $\frac{1}{2}$ " x $3\frac{5}{8}$ " |
| 15-91 | 20, 10, 10, 5 msec. | $\frac{3}{8}$ " x $\frac{1}{2}$ " x $3\frac{5}{8}$ " |
| 15-92 | 50 msec. | $\frac{3}{8}$ " x $\frac{1}{2}$ " x $2\frac{1}{16}$ " |
| 15-93 | 20, 20 msec. | $\frac{3}{8}$ " x $\frac{1}{2}$ " x $2\frac{1}{16}$ " |
| 15-94 | 10, 5 msec. | $\frac{3}{8}$ " x $\frac{1}{2}$ " x $2\frac{1}{16}$ " |

As a group these miniature, modular, lumped constant delay lines constitute an adjustable delay line. They offer great flexibility in design by providing adjustable delays ranging from 5 msec. to 335 msec. or greater, if additional units are employed.

Impedance — 93 ohms with a maximum pulse attenuation of .5 db and pulse rise time of 30 msec. (max.) for any module.

Modules with variations of rise time, delay or impedance can be supplied upon request.



ESC

WRITE TODAY FOR COMPLETE TECHNICAL DATA.

exceptional employment opportunities for engineers experienced in computer components... excellent profit-sharing plan.

ELECTRONICS CORP. 534 Bergen Boulevard, Palisades Park, New Jersey

Distributed constant delay lines • Lumped constant delay lines • Variable delay networks • Continuously variable delay lines • Step variable delay lines • Shift registers • Video transformers • Filters of all types • Pulse-forming networks • Miniature plug-in encapsulated circuit assemblies

CIRCLE 53 ON READER-SERVICE CARD

NEW PRODUCTS

Synchronous Motor

658

For use in hazardous areas



Type X250 synchronous motor is designed for use in areas where a small arc or spark could cause an explosion. It can be started, stopped or reversed instantly with a single-pole, three-position switch. Specifications are: input, 120 v at 40 to 70 cps, single phase, 0.6 amp; output speed, 72 rpm; and torque, 250 oz-in.

The Superior Electric Co., Dept. ED, Bristol, Conn.

Price: \$90.

Availability: From stock.

Pressure Switch

644

For missile launching



This unit, weighing 0.25 oz, operates at pressures up to 500 psi. It indicates full charge of primary missile batteries. The contacts open and close within 15 psi from the set point. A 3-oz switch monitors manifold fill pressure in jet engines and actuates a solenoid valve to regulate fuel flow. It operates at 50 psi at temperatures up to 400 F and has a proof pressure of 1,500 lb. The firm's line of switches includes

NEW SYLVANIA FLEXI-CORE TRANSFORMER

creates new freedom for designers!

Radically new in concept! Radically different in construction! Radically smaller and lighter! That's the dramatic news in the Sylvania Flexi-core transformer. And for the design engineer, Flexi-core opens up whole new design possibilities.

Thanks to this new core construction, Sylvania can now make transformers up to 30% smaller and lighter than types now in use! Odd size and special shape transformers can be made without the usual penalties in cost and delivery. **RESULT:** the design engineer can make the sweeping changes he desires and still stay within budget restrictions.

The heart of the new transformer is a formed core consisting of nests of laminations of fabricated steel strips.

These transformers have identical electrical characteristics.

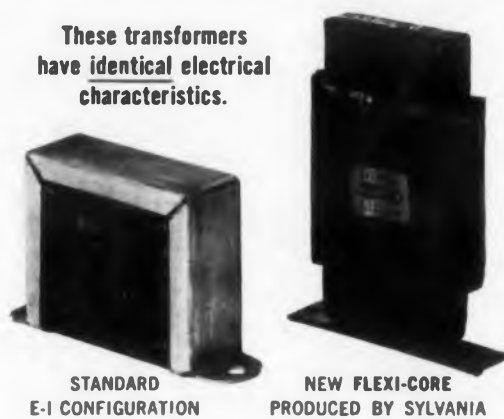

The nests are fitted together providing 100% interleaving, thus minimizing magnetizing current. And since virtually any size core can be produced from the steel strips—no tools or dies are needed. **RESULT:** the design engineer now for the first time can dictate the physical configuration of a transformer, depending upon the electrical characteristics required.

Consult your Sylvania Special Products representative. Or write: Sylvania Electric Products Inc., Ipswich, Mass.

units that can be used in applications having temperatures up to 1,000 F, pressures up to 5,000 psi, and vibration to 2,000 cps.

B. F. Goodrich Co., Dept. ED, Akron, Ohio.
Price: Varies with complexity of design.
Availability: Prototypes, 60 days.

Power Rheostat

710

Has 25 w-rating



The RE-25 power rheostat has a rating of 25 w in free air. Standard resistance range is from 25 to 500 ohms at $\pm 10\%$ tolerance. Three-terminal construction permits use as potentiometer.

Tru-Ohm Products, Dept. ED, 2800 N. Milwaukee Ave., Chicago 18, Ill.

Price: On request.

Availability: 10 days to 2 weeks.

Transistorized Power Amplifier 643

For military applications



Model 265 dual-channel power amplifier delivers better than 60 v peak-to-peak or 20 v rms. Some specifications are: input, 100 to 130 v ac; input signal, 0.3 to 10 v ac; input frequency, 40 cps to 20 kc; input impedance, greater than 5 K; output impedance, less than 100 ohms; frequency response, ± 1 db.

E. D. P. Corporation, Dept. ED, 3501 S. Orange Blossom Trail, Orlando, Fla.

Price: \$900 to \$1,200.

Availability: 3 to 4 weeks.

SYLVANIA

Subsidiary of **GENERAL TELEPHONE & ELECTRONICS**



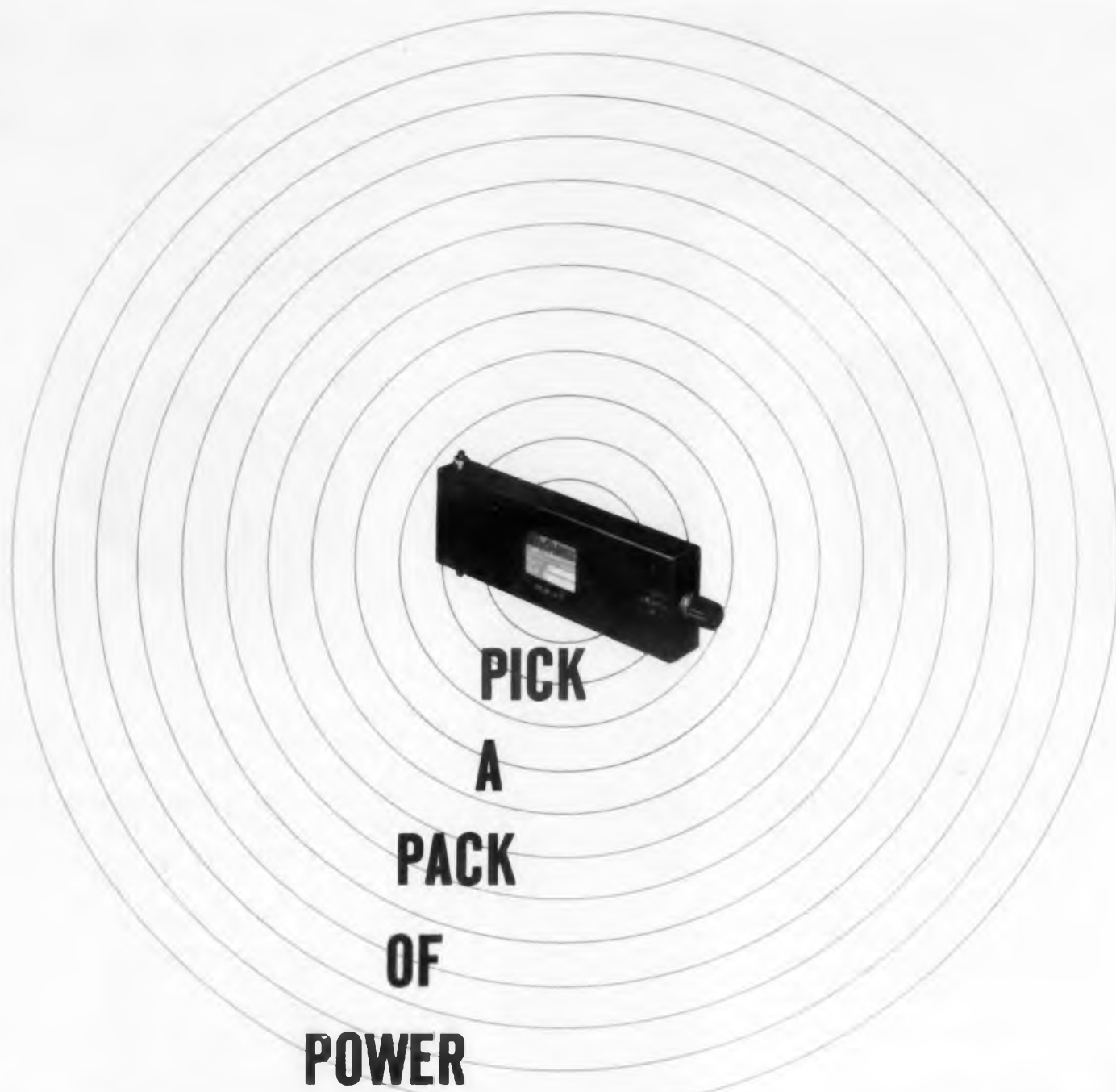

When it comes to High Voltage power packages—boosting power or shrinking size or both together—AMP's Capatron Division is completely equipped to tackle your toughest design and production problem. It has skilled personnel and research facilities—has the exclusive AMPLI-FILM dielectric for tremendous power in smaller packages—has, too, extensive production facilities to give you High Volume and complete quality control.

And, for off-the-shelf power packages, Capatron has developed keep-alive, indicator and modulator power supply packages that set new standards for high output and small cube. Whether your requirement concerns low ripple voltage, close regulation, minimum size or rugged construction, see Capatron first. Engineering facilities are also available for designing AC/DC input transistorized supplies for missile or other applications. For more information, write today.

CAPITRON DIVISION AMP INCORPORATED

Elizabethtown, Pennsylvania

Capatron products and engineering assistance are available in Canada through Aircraft-Marine Products of Canada, Ltd., Toronto, Canada

CIRCLE 54 ON READER-SERVICE CARD



HA/HV LEADS

For 12,000, 25,000 and 28,000 volts at 5 amps, these new—and much smaller—high altitude, high voltage, high temperature leads offer corona free operation to 23 KV peak pulse and meet radio noise specifications.

NEW PRODUCTS

Radar Test Sets

382

Operate from 2,700 to 10,500 Mc



These radar test sets, operating in a frequency range between 2,700 and 10,500 mc, are combinations of power meter, frequency meter, spectrum analyzer, signal generator and synchroscope. Model CTS-24 test set covers the range of 2,700 to 3,550 mc, and model CTS-810 test set operates in the 8,500 to 10,500 mc range. Units are portable, compact and of rugged construction. Military specifications are met.

Polarad Electronics Corp., Dept. ED, 43-20 34th St., Long Island City 1, N.Y.

Price & Availability: CTS-24, \$6,500; CTS-810, \$5,905; *delivery is about 6 mos.*

Microwave Oscillator

422

Frequency range is 200 to 2,500 mc



Designed for measurement, testing and calibration, this high-level signal source provides 40 w at 200 to 400 mc, 25 w at 400 to 1,050 mc, and 10 w at 950 to 2,500 mc. Designated model 1141, the unit is furnished in two separate transit type cabinets; one contains the cavity oscillator, the other contains the power supply and modulator. Uses include antenna radiation pattern measurements, noise and interference measurements, and rf production testing.

W. L. Maxson Corp., Dept. ED, 475 Tenth Ave., New York 18, N.Y.

CIC**PRECISION FILM POTS****AVAILABLE
FROM STOCK!**

You can have any of these precision film pots on their way to you within hours. No need to wait for "custom" pots.

LINEAR SINGLE TURN FILM POTENTIOMETERS

| Diameter | Resistance | Linearity |
|----------|------------|-----------|
| 1/2" | 1K..... | ± .5% |
| | 10K..... | ± .5% |
| | 50K..... | ± .5% |
| 7/8" | 1K..... | ± .5% |
| | 10K..... | ± .5% |
| | 50K..... | ± .5% |
| 1-3/32" | 1K..... | ± .5% |
| | 10K..... | ± .5% |
| | 50K..... | ± .5% |
| 2" | 1K..... | ± .25% |
| | 10K..... | ± .25% |
| | 50K..... | ± .25% |
| 3" | 1K..... | ± .1% |
| | 10K..... | ± .1% |
| | 50K..... | ± .1% |

SINE-COSINE SINGLE TURN FILM POTENTIOMETERS

| Diameter | Resistance | Conformity |
|----------|------------|------------|
| 1-3/32" | 10K..... | ± .75% |
| | 20K..... | ± .75% |
| 2" | 10K..... | ± .25% |
| | 20K..... | ± .25% |
| 3" | 10K..... | ± .15% |
| | 20K..... | ± .15% |

LINEAR MOTION FILM POTENTIOMETERS

| Size | Resistance | Stroke | Linearity |
|--------|------------|-----------|-----------|
| 1" Sq. | 10K... | 1" Stroke | ± .5% |
| | 20K... | 1" Stroke | ± .5% |
| | 10K... | 2" Stroke | ± .25% |
| | 20K... | 2" Stroke | ± .25% |
| | 10K... | 3" Stroke | ± .1% |
| | 20K... | 3" Stroke | ± .1% |

Write or call in your order! Potentiometers will be in your plant within 24 hours.

CIC
COMPUTER INSTRUMENTS CORPORATION

90 MADISON AVE., HEMPSTEAD, L. I., N. Y.

CIRCLE 55 ON R.A.D.-SERVICE CARD

HERE'S ONE WAY TO GET WORK DONE WHEN WIRE-WOUND POT FAILURES OCCUR...

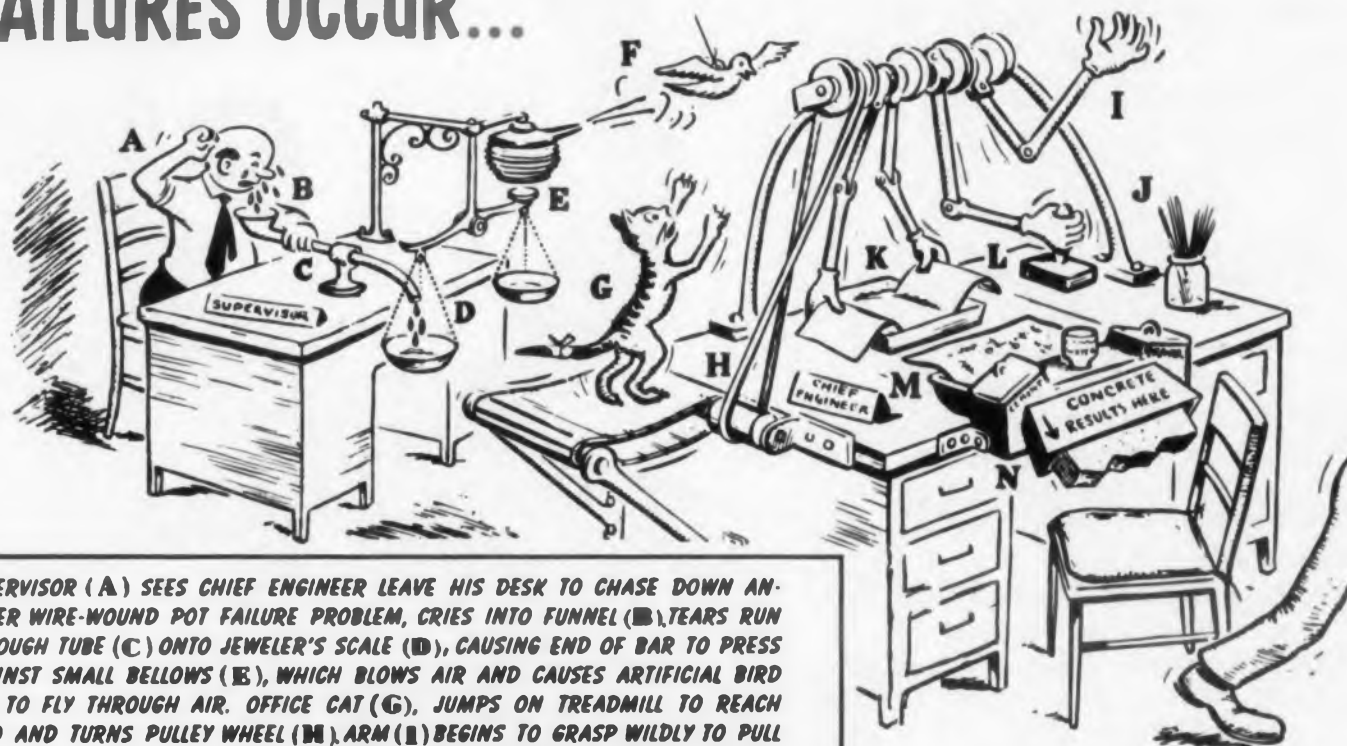

SUPERVISOR (A) SEES CHIEF ENGINEER LEAVE HIS DESK TO CHASE DOWN ANOTHER WIRE-WOUND POT FAILURE PROBLEM, CRIES INTO FUNNEL (B), TEARS RUN THROUGH TUBE (C) ONTO JEWELER'S SCALE (D), CAUSING END OF BAR TO PRESS AGAINST SMALL BELLOWS (E), WHICH BLOWS AIR AND CAUSES ARTIFICIAL BIRD (F) TO FLY THROUGH AIR. OFFICE CAT (G), JUMPS ON TREADMILL TO REACH BIRD AND TURNS PULLEY WHEEL (M), ARM (J) BEGINS TO GRASP WILDLY TO PULL IDEAS OUT OF THIN AIR [IN EMERGENCIES, ARM GRASPS AT STRAWS PROVIDED (J)]. ORIGINAL IDEAS DEVELOP FURTHER IN TRAY (K), DESIGN RECEIVES SUPERVISOR'S APPROVAL STAMP (L), PASSES INTO HOPPER (N), MIXES WITH CEMENT, WATER AND GRAVEL, AND EMERGES IN CONCRETE FORM (N). NOTE: MACHINE REACHES EFFICIENCY OF 87.326% IF OFFICE CAT IS KEPT HUNGRY.

Send for full scale reproduction of this unique "circuit machine" drawing.

BUT THE BEST WAY YET...

USE INHERENTLY RELIABLE* C.I.C. FILM POTS—THEY DON'T FAIL!

**GAIN THE TIME TO DEVELOP YOUR OWN CIRCUITS**

*The single, solid broad-band resistance element, along with the multiple finger wiper design, insure continuous high-reliability operation of this unique precision potentiometer, and guarantee that the element cannot "open" even under the worst environmental conditions. Send for our free package of "POT RELIABILITY FACTS."



1/2" to 5" Diameters.

- INHERENT RELIABILITY
- INFINITE RESOLUTION
- PRECISION LINEARITY
- LOW OPERATIONAL NOISE
- MULTI-MILLION CYCLE LIFE
- VIDEO FREQUENCY OPERATION

FIRST IN FILM POTS

CIC**COMPUTER INSTRUMENTS CORPORATION**

92 MADISON AVENUE • HEMPSTEAD, L. I., NEW YORK

CIRCLE 56 ON READER-SERVICE CARD

NEW PRODUCTS

Transistorized Crystal Oscillator 433

Standard output of 5 kc to 100 kc

Model S-50002-PA plug-in transistorized crystal oscillators have standard output frequencies of 5 kc, 10 kc, 20 kc, 100 kc, with other frequencies available on special order. The units have a sine-wave output with an amplitude of approximately 7 v peak to peak when used with an impedance load of 1.5 K or higher. Two mounting styles permit these circuits to be individually or multiple mounted.

Plug-In Instruments Inc., Dept ED, 1416 Lebanon Road, Nashville, Tenn.

Price & Availability: The approximate price is \$50 per unit with delivery two weeks after order is received.

Sweep Signal Generator 390

Center frequency is 15 to 400 mc

Model SG-132 sweep signal generator has a center frequency range of 15 to 400 mc. It has trace stabilization, and wide and narrow bandwidth at any frequency setting. Sweep width is 40% of the center frequency with an average of $\pm 0.5\%$ at fundamental frequencies. Output is cw, am and fm and is calibrated from 0.1 to 150,000 μv throughout the frequency range. It includes an oscilloscope.

Van Norman Industries, Electronics Div., Dept. ED, 186 Granite St., Manchester, N.H.

Price & Availability: \$2,440 per unit with delivery 45 days after order received.

Zener Reference Diodes 565

Rated at 400 mw

Rated at 400 mw, types 1N821 and 1N822 Zener reference diodes are diffused-junction, low-temperature-coefficient units. The sub-miniature units meet the require-

NOW...call your
CLARE
DISTRIBUTOR...

CLARE

CLARE

CLARE

C.P. CLARE CO.
FIRST IN THE
INDUSTRIAL FIELD

1 Puget Electro Products
5028 First Avenue
Seattle 1, Washington

2 Bell Electronic Corporation
306 E. Alondra
Gardena, California

2 Bell Electronic Corporation
1070 O'Brien Drive
Menlo Park, California

3 Radio Specialties Co., Inc.
6323 Acoma Road, S. E.
Albuquerque, New Mexico

4 Engineering Supply Company
6000 Denton Drive
Dallas 35, Texas

5 Harrison Equipment Co., Inc.
1422 San Jacinto St.
Houston 1, Texas

6 Busacker Electronic Equipment
Co., Inc.
1216 West Clay St., Houston 19, Texas

7 Relay Sales
P. O. Box 186
West Chicago, Illinois

8 Srepc, Inc.
314 Leo Street, Dayton 4, Ohio

9 Pioneer Electronic Supply
Company
2115 Prospect Avenue, Cleveland 15, Ohio

10 Relay Supply, Inc.
1492 Highland Avenue
Needham 92, Massachusetts

11 Avnet Electronics Corporation
70 State Street
Westbury, L. I., New York

12 Electronic Supply
1301 Hibiscus Boulevard
P. O. Drawer 1655, Melbourne, Florida



Type F relay—small, sealed, postage-stamp sized relay with unusual flexibility for long-life operation.



CLAREED sealed contact reed relay—A high reliability switching device available in a variety of packages.

for immediate delivery at factory prices



Type J relay—a compact telephone-type relay of unequalled long life and superior performance.

Mercury-wetted contact relay capable of billions of extremely fast operations with no maintenance.



Stepping switches—a full line with capacities from 10 to 52 points and capable of millions of steps without readjustment.

Here's what this new CLARE service means to you:

Top quality—the same fine design and long life you get in CLARE custom-built relays and switches

Fast service—overnight delivery on many items

Easy purchasing—because you can order CLARE devices along with other components

Able engineering assistance—available through CLARE field engineers, working in close cooperation with CLARE distributors.

When *standard* CLARE relays or switches meet your needs, distributor service saves you time, costs no more. When your special needs require custom design and production, *CLARE custom-built devices* give you exactly what you require.

C. P. Clare & Co., 3101 Pratt Blvd., Chicago 45, Illinois. In Canada: C. P. Clare Canada Ltd., P.O. Box 134, Downsview, Ontario. Cable Address: CLARELAY

*Relays and
Related Control Components*

CLARE

ments of MIL-E-1/1134. Voltage range is 5.9 to 6.5 v at 7.5 ma and 25 C. Maximum dynamic impedance is 15 ohms at 25 C and 7.5 amp. Maximum operating temperature is 150 C.

Hoffman Electronics Corp., Dept. ED, 3761 S. Hill St., Los Angeles, Calif.

Price & Availability: Type IN821, \$8.50 in quantities of 1 to 99 and \$7.15 in quantities of 100 to 999; type IN822, \$13.50 and \$10.50. Delivery is from stock.

Precision Potentiometers 356

Resistances are 100 to 100,000 ohms

These 1-5/8-in. precision potentiometers stand 100-g vibration, operate at 150 C for 2,000 hr, and come in resistance values from 100 to 100,000 ohms.

The units are manufactured with 2-ppm resistance wire. Resistance tolerance is $\pm 5\%$ standard to $\pm 1\%$ on special order. Types 136F with bronze bearings and 136H with ball bearings are stock items. The drum design used in all types permits conformities to 0.1% for all resistance values.

Carter Manufacturing Corp., Dept. ED, 23 Washington St., Hudson, Mass.

Planar Tube Oscillator 502

Frequency range is 920 to 1,400 mc

This L-band Planar tube oscillator is tunable from 920 to 1,400 mc. For cw or pulse operation, the unit has an output of up to 50 w. Power dissipation is 5 w max and plate driving capacity is 70 pf max. All leads are filtered for rf leakage. The oscillator is suitable for low-power transformers, signal generators, local oscillators, receivers, and test fixtures.

General Communication Co., Dept. ED, 677 Beacon St., Boston, Mass.

Price & Availability: \$300 to \$400; 60-day delivery.

Which cable has the Beldfoil*?



Both shielded cables have the same number of twisted pairs with identical AWG. But . . . the cable with exclusive Belden BELDFOIL is smaller in diameter.

What does this mean to you? It means that when you specify BELDFOIL, you are really buying extra space—extra conduit space, extra raceway space, extra console and rack space.

A new development by Belden—BELDFOIL shielding is 100% effective. It is a major development in quiet cables. BELDFOIL eliminates crosstalk and is superior for stationary or limited flexing at both audio and radio frequencies.

BELDFOIL shielding is a lamination of aluminum foil with Mylar which provides a high dielectric strength insulation that is lighter in weight, requires less space, and is usually lower in cost. For multiple-paired cables, with each pair separately shielded, the Mylar is applied *outside* with an *inward* folded edge.** This gives 100% isolation between shields and adjacent pairs.

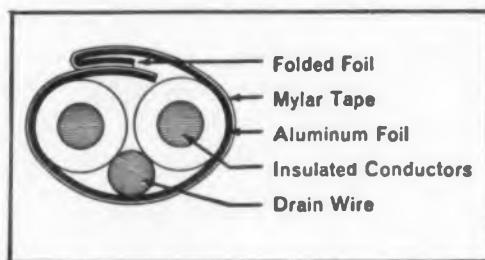

For complete specifications, ask your Belden electronics jobber.

Belden
 WIREMAKER FOR INDUSTRY
 SINCE 1902
 CHICAGO

*Belden Trademark
 Reg. U. S. Pat. Off.
 **Patent applied for

power supply cords • cord sets and portable cordage • electrical household cords • magnet wire • lead wire • automotive wire and cable • aircraft wires • welding cable



NEW PRODUCTS

Digital Readout

381

For on-the-spot wiring



Series 8000P digital readout permits on-the-spot servicing without disturbing the internal wiring of the system in which the readout is used. It is suitable for field use. Applications include computers, ground support equipment, visual training aids, control panels, and test equipment. The unit has one-plane presentation. The digit 0 through 9 and + or - signs are rear-projected on the front-viewing screen. The digit is 3.75 in. high; over-all dimensions of the readout are 3.25 x 5.25 x 13 in.

Industrial Electronic Engineer, Inc., Dept. ED, 5528 Vineland Ave., North Hollywood, Calif.
 Price: \$47 ea.

Single Line Tape Reader

601

Reads 60 lines per sec



Model No. 220 tape reader can operate either single line or continuous run from an external trigger source. It will accommodate 5 to 8 hole, 1-in. tape and can read 60 lines or characters per sec, self-stepping, or 50 lines per sec, impulse stepping. The contact head is pivoted into accurate alignment and permits the tape to be changed easily. The reader measures 6 x 6 x 6 in. and weighs 7 lb. It can be supplied rack-mounted in panels.

California Technical Industries Div., Textron, Inc., Dept. ED, 1421 Old County Road, Belmont, Calif.

Price: \$235, *job Belmont, Calif.* Panels for rack mounting are \$5.00 each.

BOURNS
TRIMPOT®

Schweber

FOR
IMMEDIATE
LARGE
QUANTITY
DELIVERY
AT
FACTORY
PRICES

Yes! Schweber can sell
any model of BOURNS TRIMPOT®
at factory prices.

Sizeable quantities are
available for immediate
shipment from stock from
Schweber's warehouse.

 Schweber
ELECTRONICS

60 HERRICKS ROAD, MINEOLA, L. I., N. Y.

PIONEER 6-6520, TWX G-CY-NY-580U
CIRCLE 58 ON READER-SERVICE CARD

At Last—High Reliability in Carbon-Film Potentiometers!

Bourns Trimpot® carbon-film potentiometers now offer you twice the stability of any carbon unit heretofore available... at temperatures as high as 150°C. Now, for the first time, you can incorporate high-resistance, infinite-resolution potentiometers in your circuit without sacrificing reliability. The reason: Resiston®, a remarkable new carbon element that virtually eliminates the problems normally caused by extremes of temperature and humidity.

Thanks to this exclusive Bourns development, Trimpot carbon units can operate at temperatures

up to 150°C—with resistance shift only half that of ordinary carbon elements. In addition, they far exceed the requirements of Mil-Specs for humidity and MIL-R-94B.

Trimpot Resiston units are available from factory and distributor stocks with three terminal types... three mounting styles... and standard resistances ranging from 20K to 1 Meg. Resiston elements are available in most Bourns configurations. Write for the new Trimpot summary brochure and list of stocking distributors and representatives.

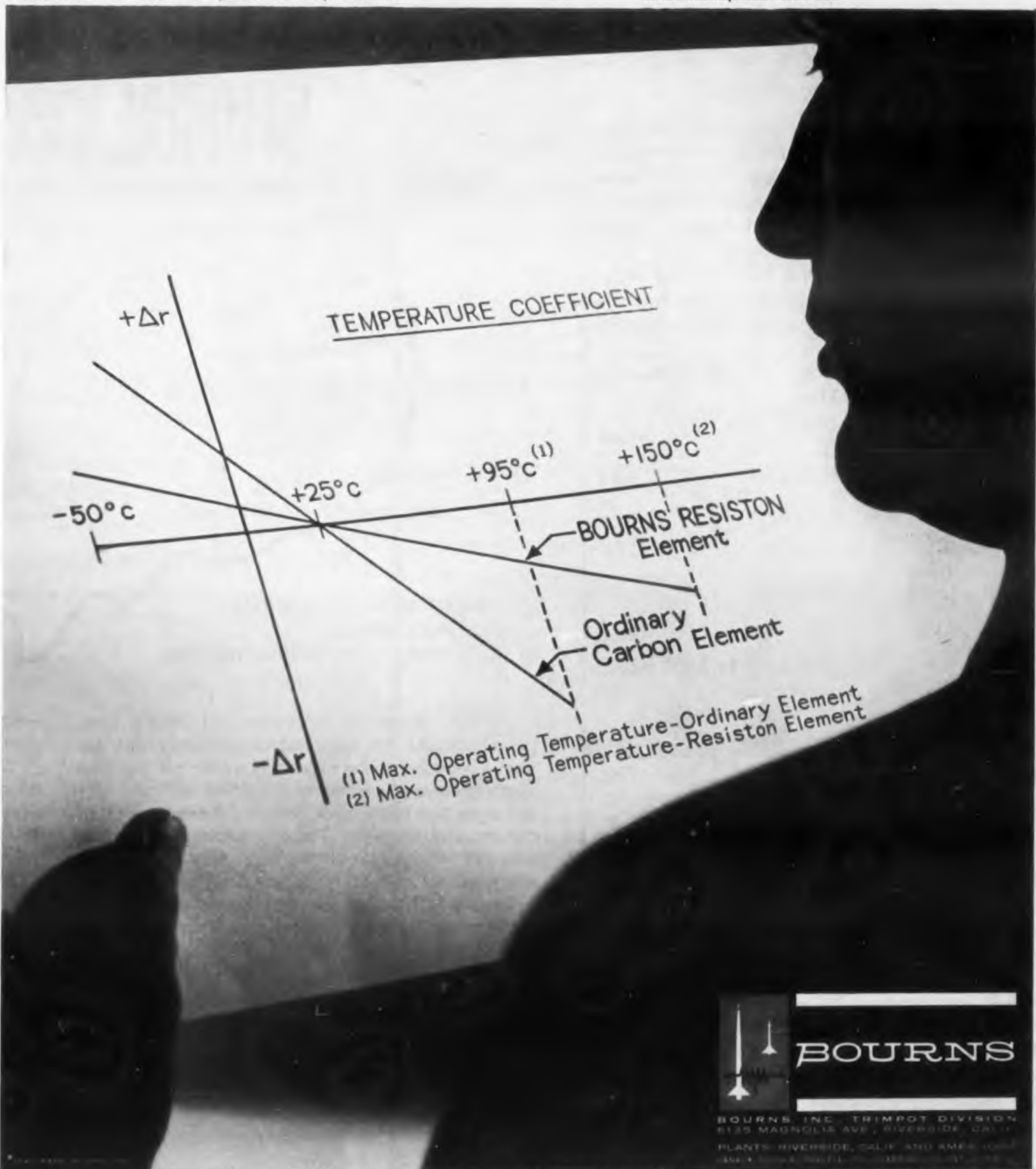

Exclusive manufacturers of Trimpot®, Trimit® and E-Z-Trim®. Pioneers in transducers for position, pressure and acceleration.

CIRCLE 59 ON READER-SERVICE CARD

 BOURNS
BOURNS INC. TRIMPOT DIVISION
6155 MAGNOLIA AVE., RIVERSIDE, CALIF.
PLANTS: RIVERSIDE, CALIF. AND AMES, IOWA

NEW PRODUCTS

Transistor Tester

526

Uses a pulse-drive technique



Model NC-1 transistor tester uses a pulse-drive technique to make direct measurements of dc parameters at power levels equal to the maximum dissipation of the transistor. Both the ammeter and voltmeter peak-detect current pulses, produce a measure value equal to a steady direct current. Both medium and high-power transistors can be tested under variable duty-cycle conditions. Readings are registered on 3-in. meters.

Baird-Atomic, Inc., Dept. ED, 33 University Road, Cambridge 38, Mass.

Price & Availability: \$2,995; from stock.

Microwave Amplifiers

439



For 1,700 to 2,400 mc

These microwave amplifiers deliver 1 kw outputs and operate in the range of 1,700 to 2,400 mc. Type 240F-2A is for transportable scatter communication, measures 24 x 24 x 51 in., and requires 208 v ac, three-phase, at 380 to 420 cps. Type 240F-2B measures 24 x 24 x 64 in., weighs 580 lb, and requires 208 v, three-phase, at 47 to 63 cps. In both units, a permanent-magnet klystron provides a minimum power gain of 55 db, synchronously tuned, and 40 db when tuned for maximum efficiency. Bandwidth is 2.5 mc with synchronous tuning, or 12 mc.

Collins Radio Co., Dept. ED, 1930 Hi-Line Drive, Dallas 7, Tex.

General Instrument and General Transistor have merged!

Here is the most outstanding customer service available to the semiconductor industry!

GENERAL INSTRUMENT GENERAL TRANSISTOR

TRANSISTORS, DIODES, RECTIFIERS

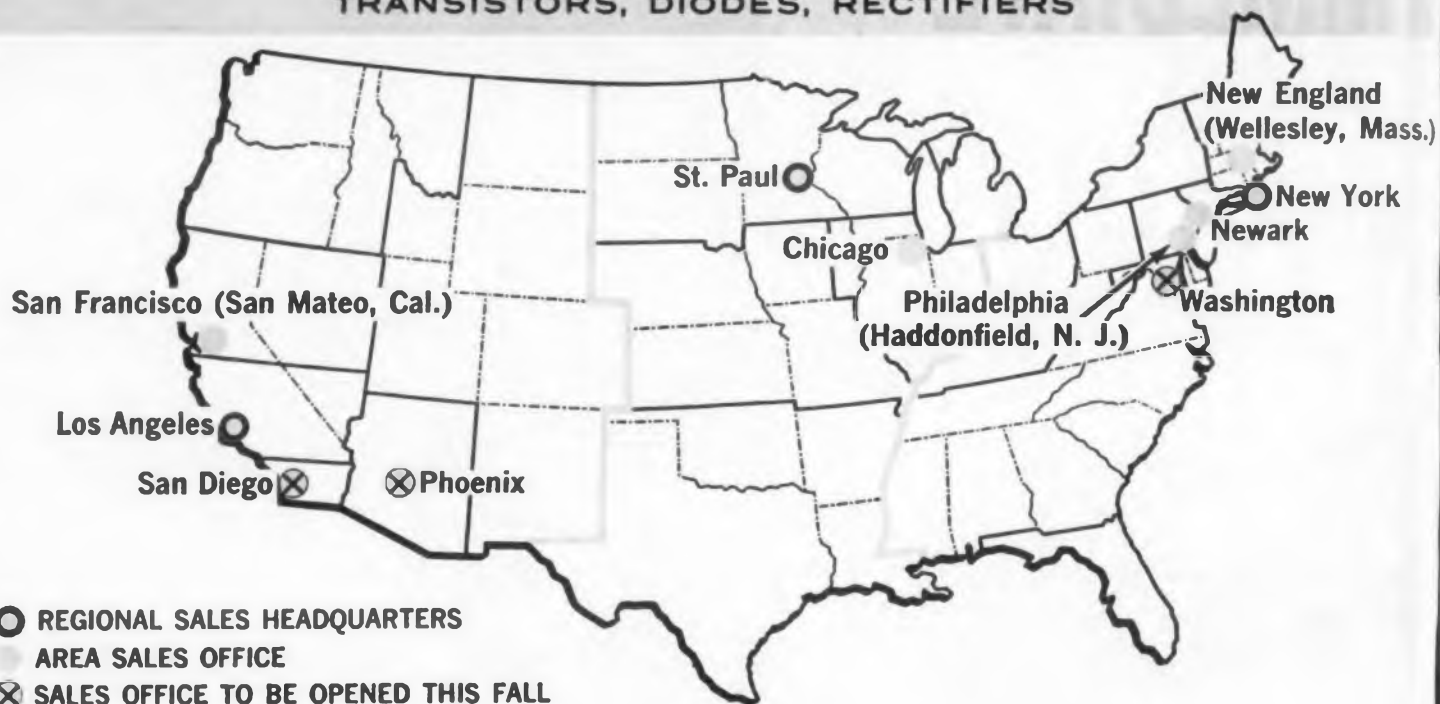

The merger of General Instrument and General Transistor outpaces the semiconductor industry with the most unique marketing organization ever put together! Ready to serve you within minutes! Here assembled for you is the pick of the most capable sales engineer staff our Industry has seen. These semiconductor experts will work with you on all transistor, diode or rectifier problems.

General Instrument proudly presents an integrated customer service organization of creative engineers in a

national marketing network unparalleled in the semiconductor industry.

Today you can dial one number for the most experienced application assistance! Dial one number for immediate product availability of the industry's most complete line. Dial one number for proven design data you can rely on.

Phone today—right now—and let us show you why GI is your best supplier of transistors, diodes and rectifiers.

GI SEMICONDUCTOR
DIVISION OF GENERAL INSTRUMENT CORPORATION
65 Gouverneur Street, Newark 4, New Jersey



CIRCLE 60 ON READER-SERVICE CARD

ELECTRONIC DESIGN • October 12, 1960



G FACTORY SALES OFFICES

WESTERN REGIONAL HEADQUARTERS

 11982 Wilshire Boulevard
Los Angeles, California
Granite 8-4750

SAN FRANCISCO AREA OFFICE

 60 West 41 Street
San Mateo, California
Fireside 1-7407

MIDWESTERN REGIONAL HEADQUARTERS

 Griggs Midway Building
1821 University Avenue
St. Paul 4, Minnesota
Midway 4-3721

CHICAGO AREA OFFICE

 5232 W. Diversy Avenue
Chicago, Illinois
Avenue 2-6700

EASTERN REGIONAL HEADQUARTERS

 87-11 130 Street
Jamaica, New York
Hickory 1-1000

NEW ENGLAND AREA OFFICE

 204 Worcester Street
Wellesley, Massachusetts
Cedar 5-4406

NORTHERN NEW JERSEY AREA OFFICE

 65 Gouverneur Street
Newark 4, New Jersey
Humbolt 5-2100

PHILADELPHIA AREA OFFICE

 36 Tanner Street
Haddonfield, New Jersey
Hazel 8-1250

DISTRIBUTOR NEAR YOU:

For the name of your local authorized G distributor, contact — Distributor Division Headquarters, General Instrument Corporation, 65 Gouverneur Street, Newark 4, New Jersey — HUmbolt 5-2100.

SEMICONDUCTOR
DIVISION OF GENERAL INSTRUMENT CORPORATION
65 Gouverneur Street, Newark 4, New Jersey

CIRCLE 61 ON READER-SERVICE CARD

ELECTRONIC DESIGN • October 12, 1960

Flywheel 636

This reinforced, lead-alloy flywheel slips over the knurled shafts of tuner knobs and holds with a press fit. It can be used on the knob control of communications tuners.

The Staver Co., Inc., Dept. ED, 47 N. Saxon Ave., Bay Shore, L. I., N.Y.

Cabinet 637

The Transit cabinet, having Bond-Alply construction, is designed to be portable and to protect electronic components which can be mounted in each drawer. Volume is 24 cu ft and weight is 360 lb.

White Div., Inc., Zero Manufacturing Co., Dept. ED, Palmer, Mass.

Panel Bushing Assembly 650

Designed to accommodate 1/8 in. diam, this No. 1818 assembly includes: hex-ended bushing, standard hex nut, and internal tooth lock washer.

Cambridge Thermionic Corp., Dept. ED, 445 Concord Ave., Cambridge 38, Mass.

Insulating Tape 389

This 1-mil tape in skived Teflon is for use on thermocouple wire and in other applications where cable size and weight must be minimized. Widths are 3/8 to 12 in. with a tolerance of ± 0.0002 in. Dielectric strength is 3800 to 4200 v, tensile strength is 3000 psi, and elongation is 250% min.

Dixon Corp., The Plastics Div., Dept. ED, Bristol, R.I.

Microfilming Machine 387

For high-speed microfilming of engineering drawings, this machine handles sheets to 22 x 34 in. and roll drawings to 42 in. wide. It processes up to 1200 drawings per hr.

The de Florez Co., Inc., Dept. ED, Englewood Cliffs, N.J.

O-Ring Seals 388

Viton O-rings are now offered in all ARP sizes. Processing methods provide finer dimensional control than previously possible.

Parker Seal Co., Dept. ED, Culver City, Calif.
Availability: The product is stocked with distributors for immediate delivery.

Output Transformer 469

Type VO-109, vertical-deflection output transformer covers 54 different turns ratios for two-winding, isolation type connections. An equal number of turns ratios are available for connecting the unit as an autotransformer. It measures 2 x 3.25 x 2 in.

Chicago Standard Transformer Corp., Dept. ED, 3501 Addison, Chicago 18, Ill.

Price & Availability: Immediately available; fixed list price of \$9.20 per unit.

ADVANCED DESIGN COMPONENTS



New ULTRASONIC DELAY LINES

Low cost — Small size

Development engineers can now employ new concepts in existing and proposed applications. These Curtiss-Wright delay lines are extremely small, hermetically sealed and vibration proof. They are ideally suited for use in computers, coders and decoders, telemetering and navigational systems.

SPECIFICATIONS

Delay range 5 to 6000 microseconds
Tolerance ± 0.1 microsecond
Signal to noise ratio . . . Greater than 10:1

Input & output impedance . . . 50-2000 ohms
Carrier frequency 100 kc-1 mc
Delay to pulse rise time Up to 800:1

DIGITAL MOTORS For high reliability applications



These stepping motors meet the requirements of assured reliability and long life for aircraft, missile and automation systems.

FEATURES

Dynamically balanced
Bi-directional • Positive lock
Simplicity of design
High pulsing rate

TIME DELAY RELAYS For high vibration applications



"H" Series thermal time delay relays are designed to meet the high shock and vibration conditions of today's military applications.

FEATURES

Time delays from 3 to 180 seconds
Temperature compensated
Hermetically sealed • Miniature
Meets rigid environmental specifications

WRITE FOR COMPLETE COMPONENTS CATALOG 260
ELECTRONICS DIVISION

CURTISS  WRIGHT

CORPORATION • EAST PATERSON, N.J.

CIRCLE 62 ON READER-SERVICE CARD

**ENGINEERED
COMPONENTS**
for the Electronic
Industry



Garlock electronic components are skillfully engineered for high temperature, high voltage, high frequency service.

GARLOCK

ELECTRONIC PRODUCTS

Garlock maintains complete electrical, chemical, and physical laboratories staffed by top-flight research and development engineers.

Find out more about what Garlock offers. Contact the Garlock Electronic Products representative near you. Call him, or write for Catalog AD-169, Garlock Electronic Products, Garlock Inc., Camden 1, New Jersey.

*Registered Trademark **DuPont Trademark
†Trademark, Minnesota Mining & Manufacturing

WHERE RELIABILITY IS CRITICAL

1. Chemelec* Stand-Off and Feed-Thru Insulators are easy to install, resistant to heat and breakage, and—above all—reliable under severest conditions . . . ideal for critical electronic circuits such as missile guidance, fire control, tracking, radar systems. Teflon**—due to its excellent dielectric, mechanical and thermal properties—is used as the insulator body. And, Chemelec Compression-Mounted Stand-Off and Feed Thru Insulators are designed for easy installation. You simply press them into pre-drilled holes; they become self-fastening, requiring no additional hardware or adjustment. Available in compression-mounted, metal-base, miniature and sub-miniature types . . . standard R.M.A. colors, a wide range of sizes and terminal designs.

2. Chemelec Sub-miniature Tube and Transistor Sockets have body insulating material of Teflon; contact material of brass, silver-plated and gold flashed. Capacitance pin to pin .6 MMF—pin to $\frac{1}{16}$ " Chassis .7MMF. Chassis retention 50 lbs min. in $\frac{1}{16}$ " panel. Contact retention 4 oz. per pin.

3. Chemelec Connectors are Teflon-insulated for outstanding high frequency service. Once installed, they require no further adjustment or hardware. .040, .050, .064 pin size, female also in .080 size.

4. Plastic Stock Shapes and Intricate Parts, inserts, thin sections, threaded parts to precision tolerances are available. Excellent facilities and experience in compression and injection molding, extruding, machining of Teflon, Nylon, Delrin**, Kel-F† or other industrial plastics.

Garlock facilities and personnel are at your disposal for design and development of new electronic products.

NEW PRODUCTS

Time-Delay Relay

Tolerance is $\pm 0.2\%$ or ± 1 msec



Model 50-129 time-delay relay provides sequential time-delay switching within a tolerance of $\pm 0.2\%$ or ± 1 msec. The relay energizes at 100, 250, and 450 msec. It operates from 28 v dc, switches up to 1 amp dc, and is similar to a three-pole, single throw relay. Dimensions are 3 x 3 x 6 in. Operating life is 1000 hr.

Hydro-Aire Co., Dept. ED, 3000 Winona Ave., Burbank, Calif.

Pushbutton Switch

Fits 19-in. rack

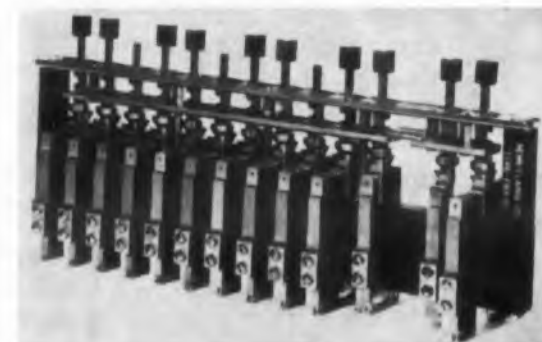

Type PBS-10 pushbutton switch, measuring 15 in. long and 7.5 in. deep, fits a standard 19-in. rack. The switch serves as a patching field for a 10-wire control bus from the unit to the device being controlled. The buttons are arranged in a straight horizontal or vertical line.

Nems-Clark Co., Dept. ED, 919 Jesup-Blair Drive, Silver Spring, Md.

Price: \$95 ea; discounts for quantity orders.

Plunger Switch

Over-travel is 0.06 in. min

Type B-2PD miniature switch has an over-travel plunger for cam action in rotary applications. The unit has electrical and environmental characteristics which meet MS-25085. Dimensions are $25/32$ x $1/4$ x 0.871 in. Over-travel is 0.06 in. min, pre-travel is 0.015 max, and operating force is 10 oz max. The return force is 1 oz min

402

405

648

and the movement differential is 0.001 in. The unit can be furnished with drilled single or double turret terminals.

402 P. R. Mallory & Co., Inc., Dept. ED, Indianapolis 6, Ind.

Availability: From stock.

Miniature Ratio Drives

377

In-line and concentric



These permanent lubricated units provide rotary control between input and output shafts which are directly in line. Models with concentric shafts are useful in meeting critical space problems. Units are available in a range of driving ratios from 2.66:1 up to 19.65:1.

405 Jan Hardware Manufacturing Co. Inc., Dept. ED, 38-01 Queens Blvd., Long Island City 1, N. Y.

Ignitron

626



For welding control

The type 7585 ignitron is designed for single-phase welding control and similar applications. It is interchangeable with existing C-size tubes, and its electrical characteristics are identical with the type 5552A. The tube has a spiral cooling coil arranged to concentrate cooling action around the discharge chamber to promote condensation at the bottom of the tube and reduce arc-back.

Amperex Electronic Corp., Industrial Tube Div. Dept. ED, 230 Duffy Ave., Hicksville, L.I., N.Y.

Price & Availability: The units are available immediately. Price is \$99.

Centralab CERAMIC CAPACITORS FOR SEMI-CONDUCTOR CIRCUITS

**COST
UP TO
40%
LESS
THAN PAPERS OR
ELECTROLYTICS**



These are Ultra-Kaps*—ultra-miniature ceramic capacitors for any low voltage use requiring extremely high capacities, low power factor and small size.

Ultra-Kaps have excellent stability from -55°C to $+85^{\circ}\text{C}$... and there has never been a case of electrical failure among the millions of them now in the field.

SPECIFICATIONS

10 VDCW Ultra-Kaps

Capacitance Range..... .05 to .47 mfd.
Sizes..... .290" to .840" diam.
Thickness..... .156"
Power Factor at 1 KC..... 10%

3 VDCW Ultra-Kaps

Capacitance Range..... .02 to 2.2 mfd.
Sizes..... .125" to .840" diam.
Thickness..... .156"
Power Factor at 1 KC..... 3%

For complete technical data and price, write us or see your CENTRALAB Sales representative. Ultra-Kaps* are also available in industrial quantities for immediate delivery at factory prices through your local CENTRALAB distributor.

Centralab

The Electronics Div. of Globe-Union Inc.
960K E. Keefe Ave. • Milwaukee 1, Wis.
In Canada: P. O. Box 400, Ajax, Ontario

*Trademark

D-6015

CIRCLE 64 ON READER-SERVICE CARD



Polarity Of Aluminum Electrolytic Capacitors

Many electrolytic capacitors have plus and minus terminals, like flashlight batteries, which makes them quite different from other types of capacitors. Polarity becomes necessary because of special construction that provides maximum capacitance for a given volume, weight, and cost.

Aluminum electrolytic capacitors are built around one of the best overall dielectric materials available. Aluminum oxide formed on a high-purity aluminum foil has a dielectric constant of from 7 to 10 and an extremely high dielectric strength of 2.5 million volts per 0.1 inch of thickness.

These unique dielectric characteristics of aluminum oxide can be utilized fully by controlling thickness of the oxide dielectric from a film only a few molecules thick to any depth required for conventional voltage ratings of electrolytic capacitors. Furthermore, aluminum foil can be etched to increase its surface area as much as ten times, increasing capacitance proportionally.

This extremely thin dielectric film offers very high resistance to passage of electrical current as long as the anode is positive with respect to the cathode. If the capacitor is connected with polarity reversed, the oxide film offers very little resistance to current flow and the resulting high currents will cause the capacitor to overheat.

 This is the reason why polar electrolytic capacitors must be properly connected in a d-c circuit. Most electrolytic capacitors for filter, by-pass, and energy storage applications are polar capacitors. That is, they are constructed with the anode covered with dielectric oxide to a thickness capable of withstanding both rated and surge voltage of the capacitors. The negative plate normally has no dielectric oxide other than a thin film formed when aluminum is exposed to air.

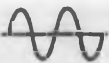
 It is possible to adapt the electrolytic principle for a non-polar capacitor to a-c applications. Two anodes are used, each plate having an aluminum-oxide dielectric formed on its surface to a thickness capable of withstanding normal and surge-voltage rating in either direction. When connected to an a-c source, one foil acts as an anode for one-half the cycle while the other functions as an anode on the other half of the cycle. Thus, there is no need to observe polarity with a non-polar capacitor. Because a non-polar capacitor is really two capacitors in series, it will have approximately one-half the capacitance of a polar capacitor of the same voltage rating when read on a bridge. Or, to put it another way,

it will have twice the volume of a polar capacitor for the same capacity and voltage rating.

Non-polar electrolytic capacitors can operate on a-c provided service is intermittent or if reactive currents are low enough to prevent overheating. They cannot operate continuously at a-c potentials higher than 40 volts rms because of their high power factor and small surface area for dissipation of heat.



Type DCM, Polar Energy Storage Type MJ, Non-Polar Motor Starting Type TR, Polar High Reliability Type MT, Polar General Purpose

Motor-starter capacitors are non-polar. They are also used where voltage may reverse on occasion or where a-c current must be passed continuously during the starting period.

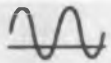
 There is another large family of electrolytic capacitors which, for lack of a better name, are called semi-non-polar. As the name implies, oxide is purposely formed on the negative plate, but of a thickness less than that formed on the anode. Most semi-non-polar capacitors are especially designed for particular applications.

Where a-c ripple voltage across semi-non-polar capacitors is high in filter applications, it is desirable to have oxide formed on the cathode capable of withstanding peak-to-peak voltage of the ripple wave — otherwise, oxide will accumulate on the cathode which will reduce capacitance and increase impedance.

Since non-polar and semi-non-polar electrolytic capacitors have more foil area to absorb heat, more parallel paths for current, and larger case sizes with greater area to dissipate heat, they are used where high a-c ripple currents and/or low impedance requirements make polar capacitors impractical.

Sangamo has a complete line of polar and non-polar capacitors for filtering, energy storage, motor starting, by-pass, coupling, and non-critical timing circuit applications. Where semi-non-polar capacitors are required, Sangamo engineers are well qualified to supply the most economical design that will give good service and long life.

SC60-6

SANGAMO ELECTRIC COMPANY, Springfield, Illinois

— designing toward the promise of tomorrow

CIRCLE 65 ON READER-SERVICE CARD

NEW PRODUCTS

Thermistors

358

Have high negative temperature coefficient

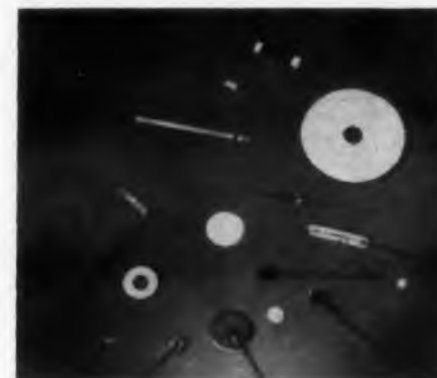

These thermistors use three new materials to achieve high negative temperature coefficient. They are available in special configurations as well as conventional disc and rod types, and subminiature beads measuring 1 mm. A power thermistor will handle 1,500 w.

Nucleonic Products Co., Inc., Dept. ED, 1601 Grande Vista Ave., Los Angeles 23, Calif.
Availability: Delivery is 30 to 45 days.

Toggle Switch

616

Has 8pdt contacts



This toggle switch, Model No. 53574, designed for an aircraft navigational system, consists of four pairs of Series 5300 snap-action switches with electrical ratings of 5 amp, 30 v dc, and 3 amp, 115 v ac. From the center position, one can actuate dpdt circuitry in each of the four momentary positions spaced 90-deg apart. The 0.11-lb unit is 2-3/32 in. high and 1-29/64 in. long. Operating force is 0.5 lb.

Haydon Switch, Inc., Dept. ED, Waterbury 20, Conn.

Price: \$31.50 each in quantities of 1 to 25.

Slide Switch

649

Has 4 pdt circuit

Model SW-742 slide switch has a 4 pdt circuit and is suited for applications related to audio systems, measuring devices, and industrial controls. The switch is not a ganged modification, but

is integral in one frame with one actuating knob. The volume under the mounting surface is slightly over 0.5 cu in. All terminals and contacts are silver-plated.

Continental-Wirt Electronics Corp., Dept. ED, 5221 Greene St., Philadelphia 44, Pa.

S-Band Variable Attenuator

603

For airborne applications



The miniature coaxial attenuator, designed for airborne applications, has an insertion loss of less than 0.5 db. The vswr for bandwidths of 15% or less is 1.3 max on the input end. Total attenuation is 20 db min at about 3 kmc, achieved in less than 180 deg of revolution. Type N male connectors are used. Average power capacity is 10 w, with a peak of 5 kw. The unit is 3 in. in diameter, 1-1/8 in. high and weighs about 14 oz.

Antenna and Radome Research Associates, Dept. ED, 27 Bond St., Westbury, N.Y.

Availability: Delivery is about four weeks.

Noise Source

610



Uniform from 30 cps to 300 kc

Output frequencies of this noise source are uniform to ± 2 db from 30 cps to 300 kc with proper amplifier circuits. Output voltage is 0 to 10 mv rms into a 1,000-ohm load. Transistorized, the unit requires 12 v dc, 12 ma. Shielded in a metal case and encapsulated, the unit measures 1-1/2 x 3 in. It is primarily intended to be a component in laboratory noise generators.

Raytheon Co., Industrial Components Div., Dept. ED, 55 Chapel St., Newton, Mass.

Price: The unit is priced at \$88.00.

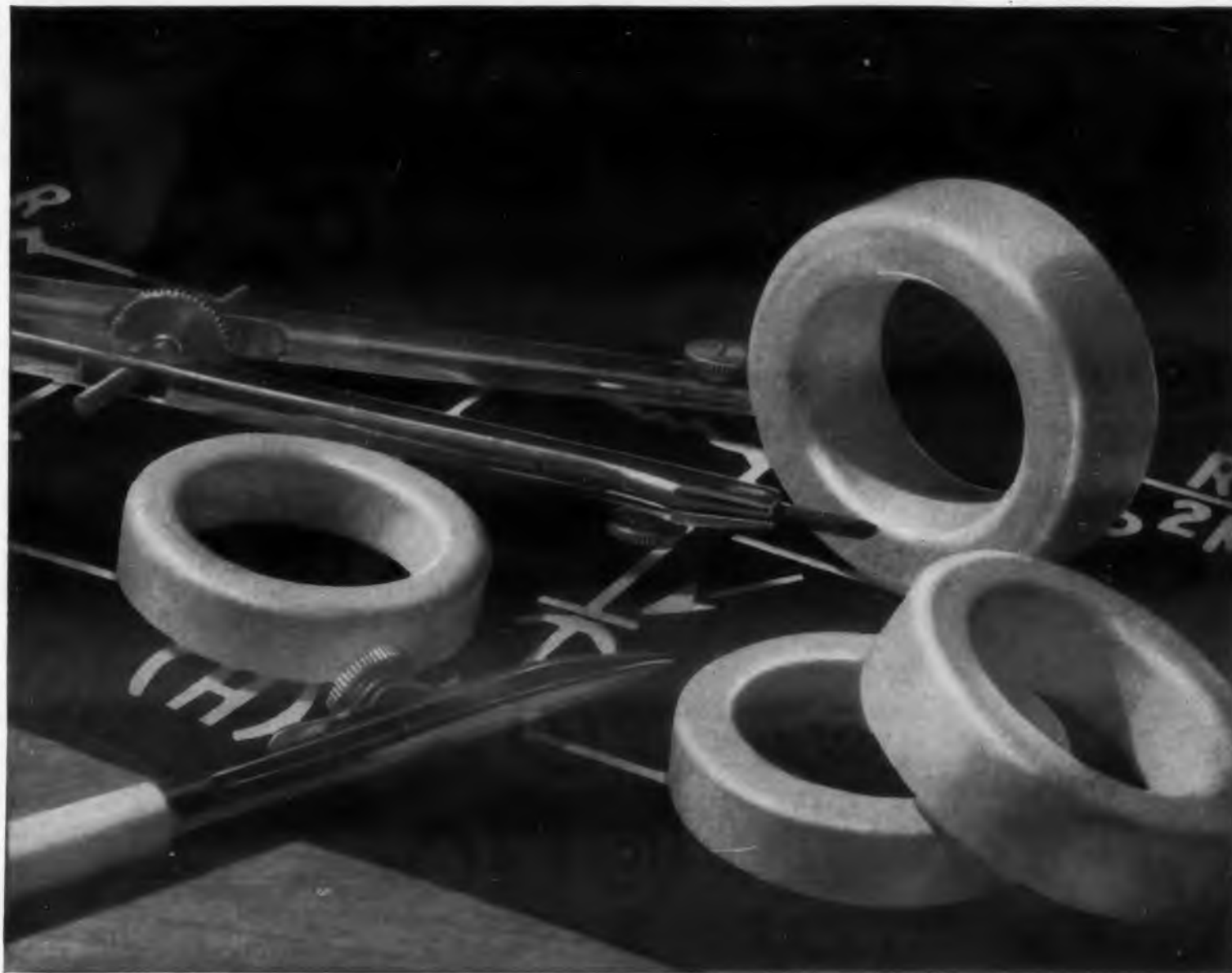

You get an extra measure of design freedom with ... POWDERED PERMALLOY FILTOROID® CORES*

The high permeability and low core loss of powdered permalloy Filtoroid cores can remove design roadblocks for you. You can build extra frequency stability into filter networks with these cores. Their permeability *remains* stable with changes in time and flux levels. Distortion factors are held to a bare minimum. Temperature coefficient of inductance is tightly controlled.

There's extra design flexibility for you, too, in

the broad range of Filtoroid cores available. They're made in three standard permeabilities—150, 125 and 60—in sizes up to 1.570" O.D., all carried in stock for immediate shipment.

Our engineers are ready right now to help you select the proper Filtoroid core for your filter circuits. Write or call for a discussion of your needs, or send for Bulletin G-1.

*MADE UNDER A LICENSE AGREEMENT WITH WESTERN ELECTRIC COMPANY

MAGNETIC METALS

transformer laminations • motor laminations • tape-wound cores
powdered molybdenum permalloy cores • electromagnetic shields

MAGNETIC METALS COMPANY • Hayes Avenue at 21st Street, Camden 1, N. J.

CIRCLE 66 ON READER-SERVICE CARD

Experience—the added alloy in A-L Electrical Steels



Greater permeability for Allegheny Ludlum's AL-4750...and it's guaranteed

promises more consistency, higher predictability for magnetic cores

AL-4750 nickel-iron strip now has higher *guaranteed* permeability values than ever before. For example, at 40 induction gaussses AL-4750 now has 57% higher permeability than in the past, using the standard flux density test.

This greater permeability means better consistency and predictability for magnetic core users . . . and allows careful, high performance design.

This improvement in AL-4750 is the result of Allegheny Ludlum's continuing research on electrical alloys and

nickel-bearing steels. Moly Permalloy has been similarly improved in permeability. A-L constantly researches silicon steels, including A-L's well-known grain-oriented silicon, Silectron, and other magnetic alloys.

Complete facilities for the fabrication and heat treatment of laminations are available at Allegheny Ludlum. And A-L's technical know-how guarantees you close gage tolerance, uniformity of gage throughout the coil and minimum spread of gage across the coil-width.

If you have a problem on electrical steels, laminations or magnetic material, call A-L for prompt technical assistance. Write for blue sheet EM-16 for complete data on AL-4750. *Allegheny Ludlum Steel Corporation, Oliver Building, Pittsburgh 22, Pa. Address Dept. ED-10.*

ALLEGHENY LUDLUM
STEELMAKERS TO THE ELECTRICAL INDUSTRY

Export distribution, Electrical Materials: AIRCO INTERNATIONAL INC., NYC 17

Export distribution, Laminations: AD. AURIEMA, NYC 4

CIRCLE 67 ON READER-SERVICE CARD



NEW PRODUCTS

Counting System

Is complete in one unit



Type N-250 counting system contains a scaler, ratemeter, and power supply in one compact unit that is suitable for rack mounting. Sensitivity of the scaler is -0.25 to -5 v, adjustable. Display is from five 1-in. glow transfer tubes. The ratemeter provides time constants of 0.5, 2, 10, and 40 sec at an accuracy of $\pm 2\%$. It has six count ranges extending to 100,000 counts per min. Power requirement is 115 v, 60 cps, 20 w.

Hamner Electronics Co., Inc., Dept. ED, P. O. Box 531, Princeton, N.J.

Availability: Immediate.

Variable-Speed Drives

Cover 1/3 to 3/4 hp



Model SC-41 variable-speed drives cover the range of 1/3 to 3/4 hp and can be furnished with a variety of speeds. They are electrical drives, having no tubes. They have wide speed ranges with stepless adjustment from zero to full speed.

Applied Technology Corp., Dept. ED, 475 Fifth Ave., New York 17, N.Y.

Phenolic Molding Powders

Fast curing

These fast-curing phenolic molding powders are designed for both cold-powder automatic molding and pre-heat compression and transfer applications. The powders, manufactured in standard industry flows and to a 14-mesh grind, are

447 available in a pre-heat black, a cold powder black and a two-way brown. Electrical blocks and contact covers, lamp sockets, switch covers and electrical receptacles are among the applications.

General Electric Co., Chemical Materials Dept., Dept. ED, Pittsfield, Mass.

Analog Programmer

446

Generates voltage directly from graph



Model 750 analog programmer, an arbitrary function generator, permits any single valued function drawn on graph paper with conductive ink to be converted to a proportional voltage as a function of time. The unit has an accuracy of $\pm 0.5\%$ and a response time of less than 10 μsec to full scale. It consists of a chart-supporting drum, a resistive roller or potentiometer, and two contact rollers.

American Measurement & Control, Inc., Dept. ED, 240 Calvary St., Waltham 54, Mass.

Fluxmeter

442

Range is 1 to 52 kilogauss



Model F-8 fluxmeter provides precise measurement and control of uniform magnetic fields in laboratory and industrial-magnet applications. Instrument range is 1 to 52 kilogauss. The unit functions without a local oscillator near the magnetic field, thus eliminating air-gap clutter. It uses a probe that is completely buffered from frequency-determining circuitry. Standard probe cable is 6 ft long; the addition of an extension cable permits operation at 50 ft.

Varian Associates, Instrument Div., Dept. ED, 611 Hansen Way, Palo Alto, Calif.



**SOLID STATE
ULTRA RELIABLE
HIGH PERFORMANCE
MILITARY QUALITY**

ONE OF MANY EXAMPLES
OF EXCELLENCE IN THE DATA
HANDLING FIELD

Cook Electric Company's

New

DIGITAL TAPE TRANSPORT



The Data-Stor Model 59 Digital Tape Transport is ideally suited for use in computer, instrumentation and control applications. It incorporates the highly reliable features of military tape transports developed by Cook Electric Company during the past 12 years, and has been proven in the Atlas, Titan, Polaris and other missile programs.

These features include exclusive use of modern ultra reliable solid state circuitry, eliminating gas or vac-

uum tubes. Precise tape handling is insured by proportional reel drive servo systems that have no jerky step servos. Tension error sensing is accomplished by synchro transmitters with no unreliable potentiometers or contact pile-ups. Field adjustments are eliminated by building tolerances into a single rugged tape deck casting. Endurance and quality are assured by strict adherence to the exacting design and workmanship requirements of MIL-E-4158.

TAPE SPEEDS TO 150 IPS • LESS THAN 3 MS STOP/START • REWIND SPEEDS TO 400 IPS • NO PROGRAMMING RESTRICTIONS • PACKING DENSITIES TO 600 NRZ BPI • OPERATES FROM 5 VOLT CONTROL PULSES OR LEVELS OF EITHER POLARITY • FRONT PANEL ACCESS • CHOICE OF NARTB, IBM, OR SPECIAL REELS • ANY TAPE TO 1" • CONDUCTIVE LEADER, LIGHT TRANSMISSIVE, OR LIGHT REFLECTIVE END OF TAPE SENSORS • SOLID STATE READ/WRITE AMPLIFIERS • METAL FACED READ/WRITE MAGNETIC HEADS • AVAILABLE AS HIGH SPEED PHOTOELECTRIC READER.

Experienced recording systems engineers are invited to apply for existing employment opportunities.

Data-stor
A DIVISION OF
Cook Electric Company

Designers and makers of ground and airborne magnetic recording systems, photoelectric readers and computer peripheral equipments.

ADDRESS YOUR INQUIRIES TO
8100 MONTICELLO AVENUE
CIRCLE 68 ON READER-SERVICE CARD
SKOKIE, ILLINOIS

the industry's *ONLY*

miniaturized CAPACITOR STANDARDS

KIT #SS-32

32 standards, including every integral value from .0001 to 0.5 mfd.



Dimensions:
12 $\frac{3}{4}$ "w x 11 $\frac{1}{2}$ "h x 4 $\frac{7}{8}$ "d

- $\pm 0.1\%$ TOLERANCE
- 50% reduction in size
- 5 to 10 times the accuracy of the best decade boxes
- Reduces reading errors to almost zero
- Lower in cost
- Every integral value available

Approved and now being used by the Air Force and Army in their calibration centers and laboratories. All units 100% calibrated directly against National Bureau of Standards certified primary standards.

SPECIFICATIONS

| | |
|-------------------------|---|
| ACCURACY | $\pm 0.1\%$ ± 0.5 mmf. of nominal printed on capacitor at 1000 cycles frequency and 23°C. |
| LONG TERM STABILITY | $\pm 0.05\%$ ± 0.1 mmf. |
| INSULATION RESISTANCE | 5000 megohm-microfarads or 50,000 megohms, whichever is the lesser. |
| DISSIPATION FACTOR | .0001 to .0004 mfd. - 0.15% .0005 to .001 mfd. - 0.1% .002 to 0.5 mfd. - 0.05% |
| TEMPERATURE COEFFICIENT | .0001 to .1 mfd. $+40 \pm 15$ ppm/°C; 0.2 to 0.5 mfd. -120 ± 15 ppm/°C. |
| MAXIMUM VOLTAGE | .0001 to 0.04 mfd. 500 volts peak; 0.5 to 0.5 mfd. 300 volts peak |

Individual standards also available

Write for price, delivery or additional information.



Manufactured by:

ARCO electronics inc.

64 White St., New York 13, N. Y. • Branches: Dallas 7, Los Angeles 35

CIRCLE 69 ON READER-SERVICE CARD

MANUFACTURERS OF:

Polystyrene capacitors, both hermetically sealed and in plastic jackets . . . multiple composition temperature controlled capacitors . . . energy storage reference units . . . precision RC networks . . . and special capacitor products.

PFC
DIVISION | precision
film
capacitors

NEW PRODUCTS

Pulse and Waveform Generator 543

Pulse lengths from 100 μ sec to 10 sec



Model P-1 generates pulses and square, triangular and sine waves. Pulse length is continuously variable from 100 μ sec to 10 sec. The unit supplies sufficient power to drive power transistors and relays, electro-hydraulic valves and other elements directly from the output terminals. Duty cycle is variable from 10% to 90%.

Parabam, Inc., Dept. ED, 13000 Yukon Ave., Hawthorne, Calif.

Impulse Generator 611

Operates 60 kc to 10 kmc



Output of Model 91263-1 impulse generator is adjustable in 0.25-db steps from 10 db to the maximum output, which is above 1 μ v per mc max. Repetition rate is 50 to 60 pps, each pulse having a 0.0005 μ sec duration. Spectral intensity is flat within ± 0.5 db from 60 kc to 1000 mc; the useful output is through 10 kmc. The unit, 10 x 9-1/2 x 7-3/8 in., weighs 9-1/2 lb.

Stoddart Aircraft Radio Co., Inc., Dept. ED, 6644 Santa Monica Blvd., Hollywood 38, Calif.
Price & Availability: \$275, delivery from stock.

Miniature Photoelectric Reader 651

For automatic control systems

Model 100 photoelectric reader is designed for automatic control systems based on intensity of reflected light. A 6-v lamp, a polished glass cylindrical lens, and a photocell are combined into one unit measuring 1-1/4 x 7/8 x 1/2 in. Light from the lamp is focused onto a rectangular target area, about 1/2 x 1/32 in., located 1/4 to 3/8 in.



ACTUAL
SIZE



SIDE VIEW



TOP VIEW

.2630 mfd. $\pm 0.1\%$

By quick and easy insertion of ARCO standard capacitors into the adapter jig, a capacitance value of four significant figures with an accuracy of $\pm 0.1\%$ is obtained.

543 from the aperture. Reflected light is refocused onto a variable-resistance photocell that requires a nominal input voltage of 20 v dc, 300 v max. The package design can be adapted for phototransistors or photovoltaic cells.

Melpar, Inc., Special Products Dept., Dept. ED, 3000 Arlington Blvd., Falls Church, Va.

Price & Availability: The units, priced at \$29, will be available from stock by August 1.

Expanded Scale Voltmeter 548

Has accuracy of 0.1%



611 These voltmeters are for ac or dc applications and have an accuracy of 0.1%, which is made possible by the combination of a taut band meter movement and a precise expansion network. The meter maintains its accuracy in any position and can be used with a magnetic or non-magnetic panel.

Voltron Products, Inc., Dept. ED, 1020 S. Arroyo Parkway, Pasadena, Calif.

Price & Availability: The dc model is \$200, the ac model is \$230; availability is 30 days.

Computer 523

Has calibration-curve information



651 The DOC computer is for applications where there is repetitious use of a calibration curve. Any electrical instrument producing an output that must be converted by referring to the instrument's calibration curve, can be connected. The computer can be used, for example, with temperature-reading devices that use a thermistor.

Custom Engineering and Development Co., Dept. ED, 2647-49 Locust St., St. Louis 3, Mo.
Price & Availability: \$900; 30 days.

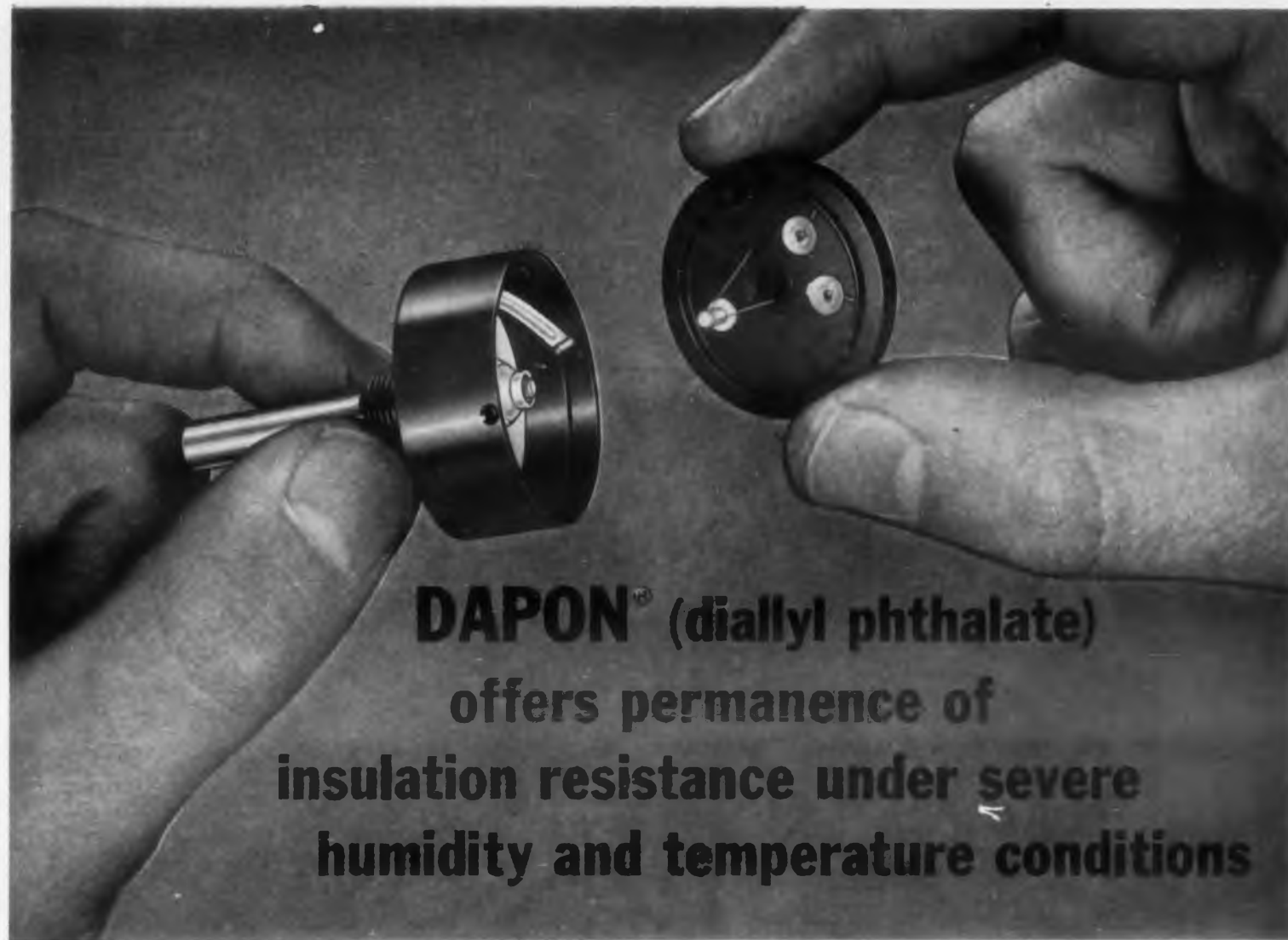

DAPON® (diallyl phthalate)
offers permanence of
insulation resistance under severe
humidity and temperature conditions

This plastic is ideal for applications where changes in humidity can affect electrical values. DAPON can prevent costly "in service" failures in electrical and electronic components.

A new molded plastic potentiometer produced by New England Instrument Company features exceptional resistance to humidity, high reliability and low noise. A raised conductive plastic ring is used in place of resistance wire in these miniature units. The new potentiometers are ideal for servo and instrumentation applications where long life and extreme accuracy are important factors.

The solid resistance element, insulating base and silver terminal leads are molded in one operation with DAPON (diallyl phthalate) Resin. Result: a single, almost indestructible precision unit.

New England Instrument chose DAPON because of its superior electrical and physical properties, and its low moisture absorption. DAPON also molds easily around metal inserts without cracking, and withstands extremes of temperature, vibration and shock.

Specify DAPON (diallyl phthalate) Resin when you need:

- Low dielectric loss
- High dielectric strength
- Superior dimensional stability
- Excellent arc resistance
- High volume and surface resistance after high humidity-high temperature conditioning

Write for FMC's data sheet containing technical information about DAPON, suggested uses for this resin, and the names of DAPON compounders.

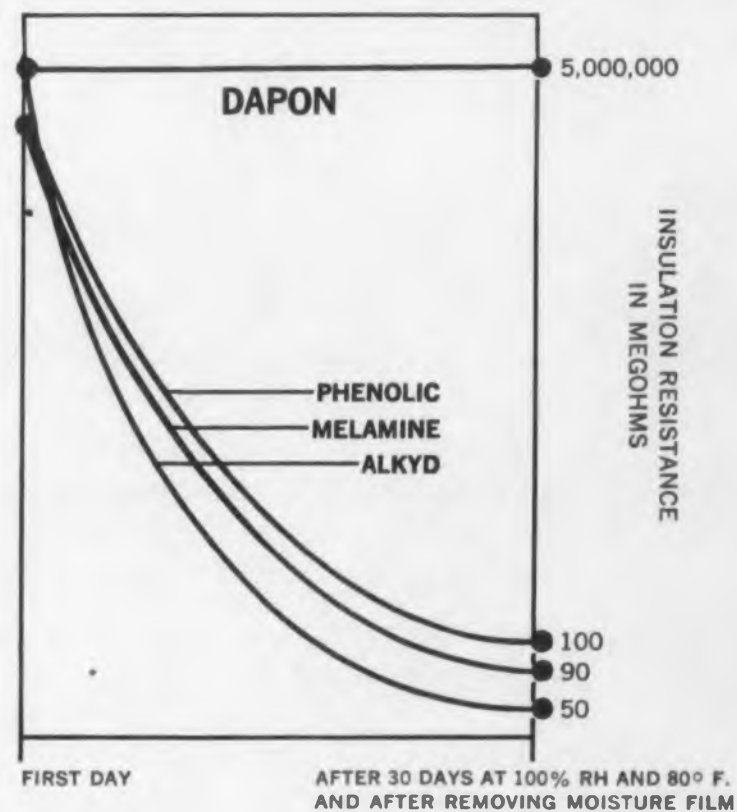

FOOD MACHINERY AND CHEMICAL CORPORATION
Dapon Department
161 East 42nd Street, New York 17, New York

CIRCLE 70 ON READER-SERVICE CARD



*If safety factors are a
MUST in your application...*

Specify SRC!

An outstanding illustration of SRC quality, reliability and safety is found in its 35 ampere silicon power rectifiers. For example, these hermetically sealed diodes are so conservatively rated that they will withstand **1200 ampere** surges!*

These silicon rectifiers are nominally rated at 35 amperes and are available in a range of 50 to 600 volts. Readily interchangeable with standard existing 35 ampere units, this entire premium rectifier series is now available for immediate delivery at no premium in price!

For further detailed information and technical data send today for your free copy of the new SRC Silicon Rectifier Handbook and Catalog covering the full line up through 400 ampere units.

*As substantiated by United Testing Laboratories



STANDARD OF QUALITY

STANDARD RECTIFIER CORP.

620 East Dyer Road, Santa Ana, California • Klumberly 5-8241

NEW PRODUCTS

Silver-Zinc Batteries 593

For missile use

Type SC-04 silver-zinc battery is designed for portable communications, instrumentation, and control systems for airborne, underwater, and special industrial applications. The cells may be interconnected. Nominal capacity is 0.5 amp-hr with a maximum current output of 10 amp. The cell maintains a terminal voltage of 1.4 v under a 2-amp load. No-load voltage is 1.86 v. The unit measures 1.52 x 1.08 x 0.54 in. and weighs 0.5 lb.

Cook Batteries, Dept. ED, 3850 Olive St., Denver 7, Colo.

Seam Welder 594

Is self tuning

This self-tuning ultrasonic seam welder is applicable to foil manufacture and production of foil-wound capacitors and transformers. It can be used in a system with one generator serving several welding heads. Thickness of the material can be from 0.00017 to 0.006 in. Dissimilar materials can be joined. The self-tuning feature automatically adjusts the welding frequency to optimum value despite fluctuations in acoustical conditions at the welding tip or other factors.

International Ultrasonics, Inc., Dept. ED, 1697 Elizabeth Ave., Rahway, N.J.

Variable Resistor 595

Has a 11/16-in. diam

Model 3W 1.5-w wirewound variable resistor measures 11/16 in. in diameter, 5/16 in. deep, and 1/8 in. in shaft diameter. Resistance range is 4 ohms to 30 K. It meets MIL-R-19 and recommended for use up to 125 C. Terminals are of gold-plated stainless steel.

Centralab, Div. of Globe Union, Inc., Dept. ED, 900 E. Keefe Ave., Milwaukee 1, Wis.

Magnetic Amplifier 492

Power gain is 4×10^6

This magnetic amplifier consists of a single-ended, single-stage circuit with self-contained fixed bias. It is suited for a variety of applications requiring dc control. The output depends upon a dc signal derived from an external thermistor bridge. Power gain is 4×10^6 . Excitation output is 12.5 ma dc for a 100-ohm thermistor bridge at 25 C. The unit is designated A5150-01.

Kearfott Div., General Precision, Inc., Dept. ED, 1150 McBride Ave., Little Falls, N.J.

Ionization Gage Control 493

Is completely automatic

Type IGC-58 ionization gage control with a strip chart recorder operates automatically. It produces a single logarithmic chart from 10^{-3} to 10^{-9} mm Hg. It has less than 2% drift in 24 hr. Sensitivity is 100 μ a per micron. Output is 0 to -2 v.

F. J. Cooke, Inc., Vacuum Products Div., Dept. ED, 145 Water St., S. Norwalk, Conn.

Price & Availability: \$595; from stock.

Pressure Transducer 495

Comes in sizes of 0 to 5 psi to 0 to 500 psi

This pressure transducer changes electrical resistance over thousands of ohms in a deflection of less than 0.0001 in. Called the Micro-Ducer, it contains a bourdon tube having a 3/32-in. diam. Sizes range from 0 to 5 psi up to 0 to 500 psi. Each unit is equipped with a pre-load adjustment so that pressures to 1,000 lb can be sensed. A typical unit measures 1 in. in diameter and 1.5 in. long, weighing 75 g.

Clark Electronic Laboratories, Dept. ED, Box 165, Palm Springs, Calif.

Price & Availability: \$85; from stock.

STEMCO THERMOSTATS

RANK FIRST
IN
PRECISION TEMPERATURE CONTROL

In today's military and commercial projects, you can't afford to overlook any one of these important areas: Reliability, Size, Availability, Economy.

And because Stevens is in production now on the largest number of different types and styles of bimetal thermostats, all these advantages are yours automatically when you specify Stemco thermostats.

1st in Reliability. Proven designs, latest production techniques, most stringent inspection procedures.

1st in Size. Stemco thermostats score in compactness and lightness without sacrificing performance.

1st in Availability. Tooling for most types is in existence. Flexibility of design cuts lead time on other types.

1st in Economy. Mass production of many standard Stemco types with hundreds of terminal arrangements and mounting brackets cuts your costs.

*Refer to Guide 400EO for U.I. and C.S.A. approved ratings.
A-891A

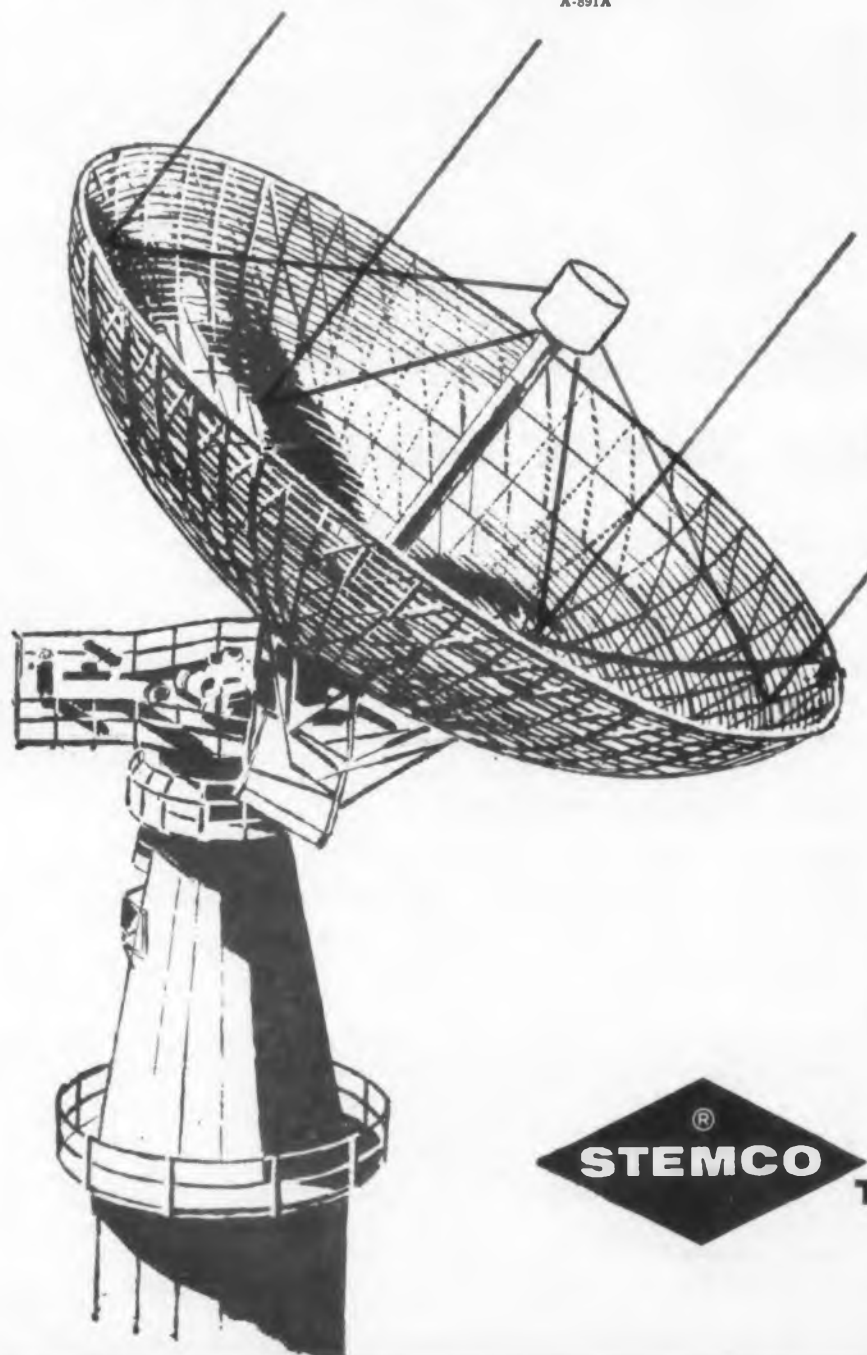

TYPE A* semi-enclosed. Bimetal disc type snap action thermostats; give fast response to temperature changes. Can be made to open on rise or close on rise. Single-throw with double make and break contacts. Operation from -20 to 300°F. Lower or higher temperatures on special order. Average non-inductive rating 13.3 amps, 120 VAC; 4 amps, 230 VAC and 28 VDC. Various mountings and terminals available. Bulletin 3000.

TYPE A hermetically sealed. Electrically similar to semi-enclosed Type A. Various mountings, including brackets, available. Bulletin 3000.

TYPE MX hermetically sealed. Snap acting bimetal disc type units to open on temperature rise. 2 to 6°F differentials as standard. 1 to 4°F differentials available on special order. Depending on duty cycle, normal rating 3 amps, 115 VAC and 28 VDC for 250,000 cycles. Various terminals, mountings and brackets available. Bulletin 6100.

TYPE MX semi-enclosed. Construction and rating similar to MX hermetically sealed type. Bulletin 6100.

TYPE M hermetically sealed. Bimetal disc type, snap acting thermostats. Also available in semi-enclosed. Operation from -20 to 300°F. Lower and higher temperatures available on special order. Depending on application, rated non-inductive 10 amps, 120 VAC; 3 amps, 28 VDC. Various terminals, wire leads and brackets available. Bulletin 6000.

TYPE C hermetically sealed. Also semi-enclosed styles. Small, positive acting with electrically independent bimetal strip for operation from -10 to 300°F. Rated at approximately 3 amps, depending on application. Hermetically sealed type can be furnished as double thermostat "alarm" type. Various terminals and mountings. Bulletin 5000.



THERMOSTATS

STEVENS manufacturing company, inc.
P.O. Box 1007, Mansfield, Ohio



New Cubic 3-in-1 d-c amplifier has built-in strain-gauge power supply

Important savings in cost, space, and setup time are now possible for users of strain gauges with the Cubic Model 1100 d-c wideband amplifier. This newest addition to the Cubic line of instrumentation amplifiers is really three units in one. It is (1) a differential-input, wideband d-c amplifier, (2) a bridge balance circuit, and (3) a well regulated strain-gauge power supply

For applications not requiring the self-contained power supply, modules which contain two d-c amplifiers can be supplied. You can mount 8 of these modules abreast (16 amplifiers) in a single standard rack.

Model 1100 amplifiers with built-in power supplies eliminate the hookup problems formerly encountered in multiple-strain-gauge operations. Even more important, they permit saving \$200-400 per channel since separate power supplies and bridge balance circuits are no longer needed

ALSO THE 1000-SERIES

The Cubic line of d-c wideband amplifiers also includes the

Model 1000 series. These highly sophisticated solid-state instruments incorporate all the design improvements of 1960's state-of-the-art. Key to their versatility is the *Cubi-plug*, a module that plugs into the 1000-series amplifier chassis to provide any required gain, fixed or variable, and single-ended or differential input.

SPECIFICATIONS AVAILABLE

Write for complete specifications and ordering information on Cubic's complete line of instrumentation amplifiers. Dept. ED-1, Industrial Division, Cubic Corporation, San Diego 11, California.

cubic

CIRCLE 73 ON READER-SERVICE CARD

NEW PRODUCTS

Reversible Timing Motors

604

Provide automatic braking and clutching

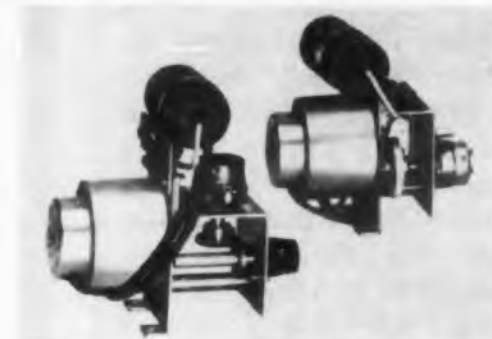

An axial shift of Series RP-100 motors upon energizing and de-energizing of the coils causes an automatic braking and clutching action. The motors are suitable for remote adjustment of potentiometers, condensers and other control devices. The motors can be modified to provide a free shaft when de-energized.

Bristol Motors, Div. Vocaline Co. of America, Dept. ED, Old Saybrook, Conn.

Availability: The motors can be delivered in 4 to 6 weeks.

Peak Following Amplifier

662



Produces proportional dc level

Model V63 peak following amplifier amplifies signals from crystal-type accelerometers. It produces a proportional dc level for each peak of acceleration. At its output, it provides up to 100 ma. Input impedance is in excess of 1,000 meg. Bandwidth is from 5 cps to 5 kc. The output is dc coupled, at an impedance of less than 1 ohm from dc to 5 kc.

Video Instruments Co., Inc., Dept. ED, 3002 Pennsylvania Ave., Santa Monica, Calif.

Price & Availability: Price is \$685 ea. Can be delivered 30 days after order received.

FROM INDUSTRY'S BROADEST LINE OF SEMICONDUCTORS

1N914 and 1N916
DIFFUSED MESA
DIODE
RECOVERY TIME

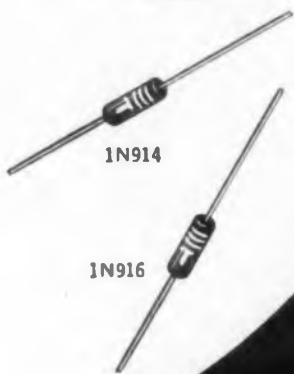
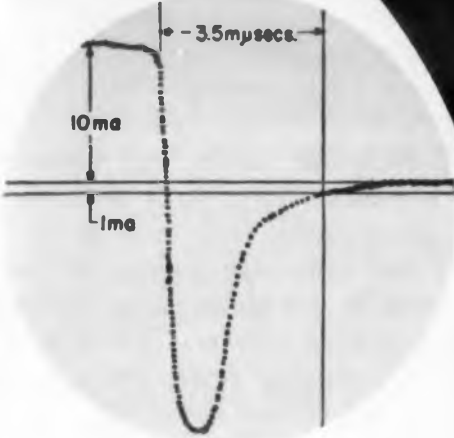

DIFFUSED SILICON MESA DIODES

IN NEW RUGGEDIZED PACKAGE
with .004 μ sec recovery,
low capacitance

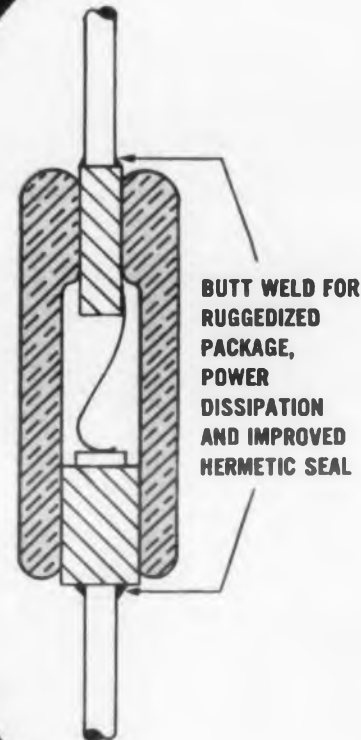

BUTT WELD FOR
RUGGEDIZED
PACKAGE,
POWER
DISSIPATION
AND IMPROVED
HERMETIC SEAL

SPECIFICATIONS

| Conditions | 1N914 | 1N916 |
|--|-------|----------------|
| Max. Reverse Recovery Time (from 10mA I_F to 6 volts V_R) | .004 | .004 μ sec |
| Max. Capacity (at 0 volts bias) | 4 | 2 μ f |
| Min. Forward Current (at 1 V) | 10 | 10 mAdc |
| Min. Saturation Voltage (at 100 μ A) | 100 | 100 volts |
| Max. Reverse Current (at -20V) | .025 | .025 μ Adc |

MAXIMUM RATINGS

| Conditions | 1N914 and 1N916 |
|----------------------------------|-----------------|
| Reverse Voltage (-65° to +150°C) | 75 Volts |
| Average Rectified Current (25°C) | 75 mA |
| Operating Temperature Range | -65° to +150°C |
| Storage Temperature Range | -65° to +200°C |

Transitron's new 1N914 and 1N916 diffused silicon mesa diodes have fast recovery times and low capacitance ideal for computer circuits. And their "Hour-Glass" construction provides rugged, shock-resistant characteristics meeting environmental requirements of MIL-S-19500B.

NEW METAL PLUG PACKAGE . . . engineered for strain relief at *both ends* — prevents cracking of glass-to-metal seals for 4 times greater strength in pull test, greatly increased bend resistance . . . gives added power handling ability.

Write for Bulletin No. TE-1350G

Transitron



electronic corporation
wakefield, melrose, boston, mass.

SALES OFFICES IN PRINCIPAL CITIES THROUGHOUT THE U. S. A. AND EUROPE • CABLE ADDRESS: TRELCO



Leadership in
Semiconductors

NOW

OFF-THE-SHELF DELIVERY FROM THESE
FULLY-STOCKED TRANSITRON
INDUSTRIAL DISTRIBUTORS IN QUANTITIES
FROM 1-999

ARIZONA, Phoenix
Kimball Distributing Co.
1029 N. First St.
ALPine 4-2539

CALIFORNIA, Gardena
Bell Electronic Corp.
306 East Alondra Blvd.
FAcully 1-5802

CALIFORNIA, Inglewood 1
Liberty Electronics Corp.
9817 Inglewood Ave.
ORegon 8-7163

CALIFORNIA, Long Beach 6
Dean's Electronics
2310 Long Beach Blvd.
NEvada 6-0266

CALIFORNIA, Menlo Park
Bell Electronic Corp.
1070 O'Brien Drive
DAvenport 3-9431

CALIFORNIA, Palo Alto
Liberty Electronics Corp.
2443 Ash St.
DAvenport 1-1965

CALIFORNIA, San Diego
Western Radio & T.V. Supply
1415 India St.
BEImont 9-0361

CALIFORNIA, San Francisco
Fortune Electronics Corp.
1321 Mission St.
UNderhill 1-2434

CANADA, Montreal
Atlas Wholesale Radio, Inc.
4965 Buchan St.
REgent 3-7135

CANADA, Toronto, Ontario
Alpha Arcon Radio Co., Ltd.
555 Wilson Ave.
DOWnview Post Office
MEIrose 5-6181

COLORADO, Denver 2
Kimball Distributing Co.
621 17th St.
AComa 2-6208

D.C., Washington
Siberne Industrial Sales Corp.
3400 Georgia Ave., N.W.
TUCKerman 2-5000

FLORIDA, Cocoa
Thuraw Electronics, Inc.
540 St. Johns St.
NE 6-6331

FLORIDA, Miami
Thuraw Electronics, Inc.
1800 N.W. 23rd St.
NE 5-0651

FLORIDA, Orlando
Thuraw Electronics, Inc.
625 W. Central Ave.
CHerry 1-3695

FLORIDA, Tampa
Thuraw Electronics, Inc.
121 So. Water St.
TAMpa 2-1885

GEORGIA, Atlanta
Specialty Distributing Co., Inc.
763 Juniper St.
TRinity 3-2521

HAWAII, Honolulu
Industrial Electronics, Inc.
832 S. Queen St., P.O. Box 135
Tel. 506-095

ILLINOIS, Chicago 44
Radio Distributing Co., Inc.
5144 West Madison St.
EStebrook 9-2121

INDIANA, South Bend 24
Radio Distributing Co., Inc.
1212 High St.
ATLantic 8-4664

IOWA, Cedar Rapids
Iowa Radio Supply Co.
719 Center Point Rd., N.E.
EMpre 4-6154

KANSAS, Wichita
Radio Supply Co.
115 Laura St.
AMherst 7-5218

MARYLAND, Baltimore 11
Kann-Ellert Electronics, Inc.
2050 Rockrose Ave.
TUusado 9-4242

MASSACHUSETTS, Boston
DeMambo Radio Supply Co. Inc.
1095 Commonwealth Ave.
ALgonquin 4-9000

MASSACHUSETTS, Worcester
DeMambo Radio Supply Co., Inc.
222 Summer St.
PLessant 7-5628

MICHIGAN, Detroit 27
Radio Specialties Co., Inc.
12775 Lyndon St.
BRoadway 2-4200

MINNESOTA, St. Paul 1
Gopher Electronics Co.
370 Minnesota St.
CApitol 4-9666

MISSOURI, Kansas City
Burstin-Applebee Co.
1012-1014 McGee St.
BALtimore 1-1155

MISSOURI, St. Louis 16
Interstate Supply Co.
4445 Gustine St.
FLanders 1-7585

NEW HAMPSHIRE, Manchester
DeMambo Radio Supply Co., Inc.
1308 Elm St.
NAIonal 4-4006

NEW MEXICO, Albuquerque-
Kimball Distributing Co.
1307 San Mateo, N.E.
AMherst 5-0644

NEW YORK, Binghamton
Federal Electronics, Inc.
Vestal Parkway, East
Plioneer 8-8211

NEW YORK, Buffalo 3
Radio Equipment Corp.
147 E. Genesee St.
MOhawk 1415

NEW YORK, Long Island City 6
H. L. Dalis, Inc.
35-35 24th St.
EMpire 1-1100

NEW YORK, New York 7
Harrison Radio Corp.
225 Greenwich St.
BARclay 7-7777

NEW YORK, New York 13
Milo Electronics Corp.
530 Canal St.
BEekman 3-2980

N. CAROLINA, Winston-Salem
Electronic Distributors
823 S. Marshall
PARk 4-0541

OHIO, Cincinnati
Hughes-Peters, Inc.
1128 Sycamore St.
DUunbar 1-7625

OHIO, Cleveland 15
Radio & Electronic Parts Corp.
3235 Prospect Ave.
UTah 1-6060

OHIO, Dayton 2
The Stotts-Friedman Co.
108-112 N. Jefferson St.
BAldwin 4-1111

OKLAHOMA, Tulsa
Radio, Inc.
1000 S. Main St.
GIBson 7-9124

PENNSYLVANIA, Philadelphia
Radio Electric Service Co.
of Pa., Inc.
701 Arch St.
WAlnut 5-5840

RHODE ISLAND, Providence
DeMambo Radio Supply Co., Inc.
90 Broadway
JAckson 1-5600

TEXAS, Dallas 7
Contact Electronics, Inc.
P.O. Box 10393
2403 Farrington St.
RIverside 7-9831

TEXAS, Houston 19
Busacher Electronic
Equipment Co.
P.O. Box 13204
1216 W. Clay
JAckson 6-4661

UTAH, Salt Lake City
Kimball Distributing Co.
350 Pierpont Ave.
EMpre 3-5813

WASHINGTON, Seattle
C & G Electronic Co.
2221 3rd Ave.
MAAm 4-4355

WASHINGTON, Tacoma
C & G Electronic Co.
2502 Jefferson Ave.
BRoadway 2-3181

Transitron

electronic corporation 
wakefield, Massachusetts

SALES OFFICES IN PRINCIPAL CITIES THROUGHOUT THE U.S.A.
AND EUROPE • CABLE ADDRESS: TRELCO

CIRCLE 74 ON READER-SERVICE CARD

◀ CIRCLE 75 ON READER SERVICE CARD

why did **PACKARD BELL COMPUTER**
select **ELCO VARICONS** for its
new **PB250** model?



because...the reliability which Packard Bell required for its amazingly small, medium-scale, low cost model (capable of competing with large-scale, high cost models) was "... further increased by the use of Varicon Connectors." This is another example of another world famous manufacturer relying upon the reliability of the Varicon contact, with its unique forklike design and 4 coined mating surfaces. Packard Bell specified our Series 7001, 35 contact subminiature printed circuit Varicons. They are also available to you along with countless others for a limitless variety of applications. In each, you will find the same unchallenged reliability; plus the versatility challenged only by your own imagination!

SO why not request your copy of Varicon Catalog V4 immediately!

IF IT'S NEW... IF IT'S NEWS... IT'S FROM



"M" Street below Erie Avenue, Philadelphia 24, Pa., CU 9-5500
Elco Pacific: 2200 Centinela, W. Los Angeles 64, Cal., GR 8-0671

CIRCLE 76 ON READER-SERVICE CARD

NEW PRODUCTS

Log Voltmeter and Converter 617
Has 70 db range



The Model HLV-150, 70-db, log voltmeter and converter is accurate to 0.2 db or 2% throughout its 14 in., three-decade scale with ac or dc. A mirror scale and knife-edge pointer eliminate parallax. A manually adjustable scale provides for any arbitrary zero db reference. The rf inputs are handled with a separate probe. An input attenuator extends the voltage range from 1 mv to over 320 v. Input impedance is 5 meg min. Response is flat to 0.25 db from 20 cps to 50 kc. The voltmeter is peak reading with an rf probe above 50 kc.

Houston Instrument Corp., Dept. ED, P. O. Box 22234, Houston 27, Texas.

Price & Availability: Price is \$1250, delivery is 60 to 90 days.

Reliability Tester 527
For life testing components



This reliability tester is designed for development laboratories; it subjects electronic equipment, in days, to conditions that normally take months or years to realize. The unit performs these operations: automatically switch equipment on and off; switch half or no load to full load; provide minimum and maximum operating voltages. It will also age diodes, capacitors, relays, and other devices. Model RT-5 has a range of 0.5 sec to 15 min; model RT-10, 0.3 sec to 5 min. Operations are recorded on a 6-digit counter.

Eagle-Tron Co., Dept. ED, 2137 Canyon Drive, Los Angeles 28, Calif.

Price & Availability: Model RT-10, \$220; model RT-5, \$470. Delivery is in two weeks.

Plotting Instrument

468

The Coordinatograph is for such uses as plotting printed circuit layout with optional comparators. Working area is 47-1/4 x 47-1/4 in. Maximum operating speed is 3 in. per sec; slowest speed is 0.003 in. per sec. Accuracy is 0.0015 in. It accepts tape or card input.

Aero Service Corp., Dept. ED, 210 E. Courtland St., Philadelphia 20, Pa.

Transistor Checker

370

Model 1003, having an accuracy of $\pm 3\%$ on all scales, checks all important transistor dc parameters, including those in the inverted connection. A remote connector permits checking while a transistor is in an environmental chamber.

Dynatron Laboratories, Dept. ED, 71 Glenn Drive, Camarillo, Calif.

Price: \$37 fob Camarillo.

Self-Locking Wing Nuts

683

Available in thread sizes 8, 10, 1/4, 5/16, and 3/8 in both coarse and fine threads, these nuts have nylon locking collars to prevent loosening under impact, vibration, or stress reversal whether fully seated or positioned anywhere on a bolt or stud.

Elastic Stop Nut Corp. of America, Dept. ED, 2330 Vauxhall Road, Union, N.J.

Plug-In Circuit Boards

378

For assembly of experimental and prototype circuits, these blank circuit boards have holes for inserting the firm's eyelets or terminals. The boards permit components to be mounted, connected with jumper wires, and soldered.

Plug-In Instruments, Inc., Dept. ED, 1416 Lebanon Road, Nashville 10, Tenn.

Availability: From stock.

Power Supply

379

Model S-94002-PD provides outputs of 10 to 35 v dc with a continuous current of 0 to 0.5 amp. Line and load regulation is better than $\pm 0.75\%$. Ripple is less than 1.5 mv rms. Seventeen of these plug-in units can be mounted in a 19-in. panel.

Plug-In Instruments, Inc., Dept. ED, 1416 Lebanon Road, Nashville 10, Tenn.

Availability: 10 to 14 days.

Running-Time Meter

380

This time utilization meters panel can be connected to ten different machines or operations to be monitored at distance to 5,000 ft. It uses 26 v. The readout can be to the nearest hour and tenth, hour tenth and hundredth, or minutes and tenths. It has testing, research, and development applications.

Correll & Correll, Dept. ED, 336 Old Hook Road, Westwood, N.J.

Price & Availability: \$249; from stock.

V-BAND MAGNETRONS



Life — over 700 hours reported

Peak power available — more than 10 kw.

(More power than you can get from any other device at this frequency)

Duty cycle — up to 0.001. (For the BL-221, it is 0.00055)

Vibration — will survive 10 g's

Shock — 50 g's at 4 millisecc

Lightweight — 7.25 lbs

Mounting — mates to modified standard flange

Ruggedized — Ceramic and metal construction

Fixed tuned

| Model | Tube Type | Frequency Range (MHz) | Minimum Peak Power (KW) | Power Output (KW) |
|--------|-----------|-----------------------|-------------------------|-------------------|
| BL-225 | | 31,000-54,000 | 10 | 10000/10 |
| BL-236 | | 54,000-57,000 | 30 | 10000/10 |
| BL-237 | | 57,000-60,000 | 30 | 10000/10 |
| BL-221 | | 69,000-70,500 | 30 | 10000/10 |

BOMAC laboratories, inc.
SALEM ROAD - BEVERLY, MASSACHUSETTS

Circle 77 on Reader-Service Card

**NOT
FOR
SALE....**



UNTIL all Saratoga Semiconductors have qualified under a battery of gruelling, fully controlled tests totalling thousands of hours.

The rigid 20% salt atmosphere test (pictured above) verifies resistance to salt corrosion, permanence of markings and strength of the hermetic seal.

Altitude, humidity, temperature, impact shock, vibration and 20,000 "G" radial acceleration tests are among those that must be passed.

These tests are reasons why the Saratoga can be called the "Thoroughbred of Semiconductors."

Send for our new catalogue SS-2001 outlining details, specifications, and applications of Saratoga silicon zener regulators* and silicon power rectifiers.*

SARATOGA SEMICONDUCTOR DIVISION, Saratoga Springs, N.Y.

ESPEY MFG. & ELECTRONICS CORP.

NEW PRODUCTS

Telemetry Signal Generator 458

Simulates PAM and PDM pulse trains

Model 145B telemetry signal generator simulates PAM and PDM pulse trains for checkout, calibration, and evaluation of telemetry demodulation equipment. It also generates non-standard signals and simulates data-transmission faults such as missing channels, commutator speed variations, and duty-cycle variations. The unit has front-panel controls. Relative channel-to-channel accuracy over an 8-hr period, referred to a constant reference, is better than $\pm 0.5\%$ of full scale.

Electro-Mechanical Research, Inc., Dept. ED, Sarasota, Fla.
Price & Availability: \$7,500; 100-day delivery.

Wirewound Resistors 580

Rated to 10 w

These miniature axial-lead power wirewound resistors are available in 2, 3, 5, 7 and 10-w ratings at 125 C ambient, with deratings to 350 C. Commercial units have 1% and 3% tolerances, and 0.05% tolerance on special order. Units with tolerances of 5% meet G and V requirements of MIL-R-26-C. Devices are of welded construction and are silicone-coated.

International Resistance Co., Dept. ED, 401 N. Broad St., Philadelphia 8, Pa.
Availability: Three weeks.

Audio Amplifiers 506

With outputs from 150 mw to 3 w

Audiotran amplifiers are hermetically sealed, audio amplifiers constructed to fit 7 or 8-pin sockets. They are tubeless and require no matching input or output transformers. Components are partially encapsulated. Six models are available. Type AA-1 has a power output of 150 mw, an input resistance of 150 ohms, an output resistance

◀ CIRCLE 78 ON READER-SERVICE CARD



* Meet all requirements of MIL S-19500B

of 6 ohms and a power gain of 60 db. Type AA-6 has a power output of 3 w, an input resistance of 600 ohms, an output resistance of 3.2 ohms, and a power gain of 42 db.

Ferrotran Electronics Co., Dept. ED, 693 Broadway, New York 12, N.Y.

Price: \$55 to \$95.

Test Instruments 497

For non-magnetic rods, tubes and wires

Series FW-400 instruments are for quick response, eddy current testing of non-magnetic rods, tubes and wires, in sizes from 1/16 to 5-1/2 in. in diameter. The units detect laps, seams, inclusions, voids, concentrated porosity, and other defects. Readout can be by means of a variety of methods, including scope, pen recorder, and flashing light.

Borg-Warner Corp., Emcor Ingersoll Products Div., Dept. ED, 630 Congdon Ave., Elgin, Ill.

High-Temperature Laminated Plastics 419

Thermosetting

These laminated plastics are high-temperature thermosetting materials available in sheet, strip or tubular form. Grade ARF-HT laminate has an asbestos mat reinforcement with a modified phenolic resin binder. Grade G3-HT laminate has a glass fabric reinforcement and a modified phenolic resin holder and is suited for applications requiring high mechanical strength. Both materials are designed for use at 500 F. In addition, Grades FR-1 and FR-2 laminates are paper-based with flame-retardant phenolic binders. Grade FR-3 laminate is an alpha paper-base laminate with an epoxy resin binder and self-extinguishing properties. Grades FR-2 and FR-3 laminates are suitable for printed-circuit applications, while the FR-1 laminate is designed for electrical applications.

Synthane Corp., Dept. ED, Oaks, Pa.

NEW...
from
Cinch

SUB-MINIATURE SOCKETS for NUVISTORS



for Mechanical Mounting

The 133-65-10-001 tube socket is fastened to the chassis by these two tabs rolled against the underneath side of the chassis.

- Impossible to Insert Tube Incorrectly or Damage the Contacts . . . The socket provides two slots of different widths. These mate with the two corresponding legs depending from the metal envelope of the tube to index the tube and socket contacts.

- Sub-Miniature Size Requires Minimum Space.

- Socket Body is Low Loss; Type MFE, Phenolic Insulation.

Saddle is of cold rolled steel, cadmium plated. Contacts are of copper alloy with cadmium plating.



or Solder Mounting

The tube 133-65-10-002 socket is furnished with solder washer which solders directly to the chassis at 430°F. Resists minimum pressure of 20 lbs.

Dimensions of Chassis Aperture

Here is shown the size of the Chassis hole for the sockets, either solder or mechanically fastened.

The thickness of the chassis may vary between .032 and .082 inches. The tube socket will resist a minimum pressure of 20 lbs. before dislodging.



Available Now! Complete engineering data and detailed specifications on both of these Nuviator sockets are yours for the asking. Phone NE. 2-2000 today or write/wire



Cinch
ELECTRONIC
COMPONENTS

CINCH MANUFACTURING CORPORATION

1026 SOUTH HOMAN AVENUE, CHICAGO 24, ILLINOIS

Division of United Carr Fastener Corporation, Boston, Massachusetts

Centrally located plants at Chicago, Illinois; Shelbyville, Indiana; City of Industry, California, and St. Louis, Missouri



CIRCLE 79 ON READER-SERVICE CARD >

HOLTZER-CABOT

offers these

CUSTOM FEATURES

in a new stock motor

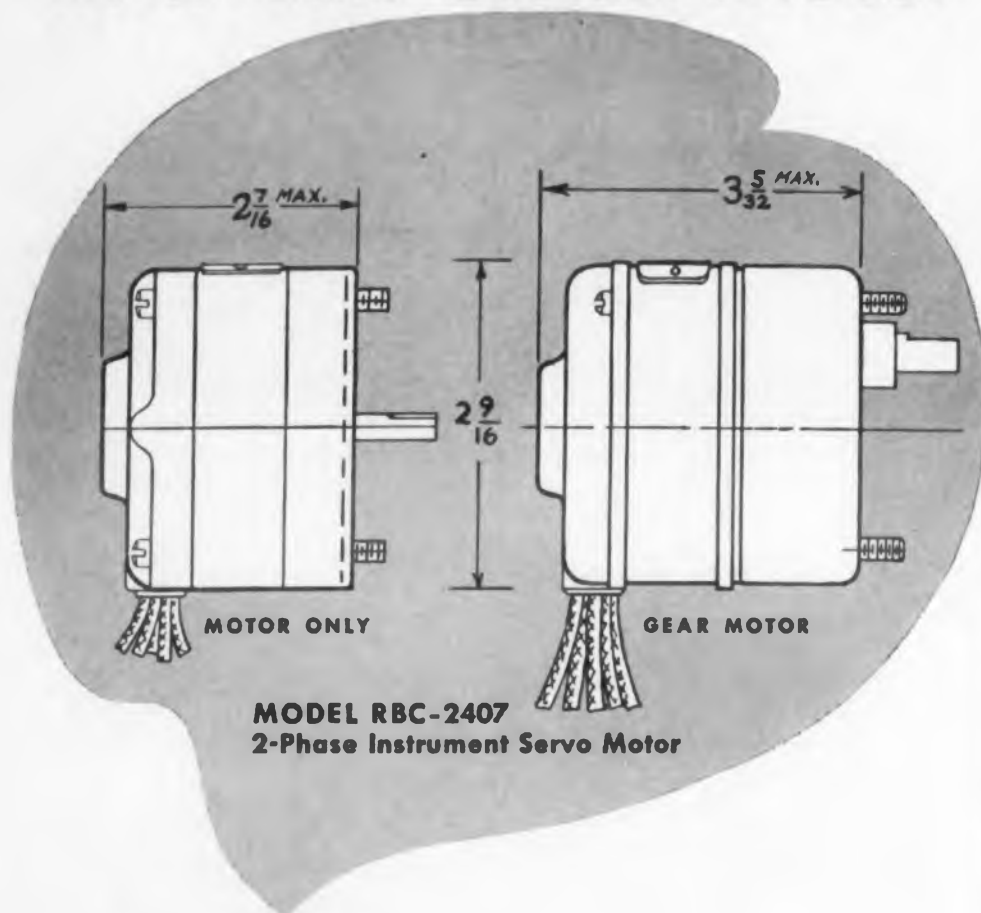

MODEL RBC-2407
2-Phase Instrument Servo Motor

- High torque-to-inertia ratio
- Torque to meet your needs
- Several output speeds to choose from
- Control winding impedance of 5400 ohms locked rotor
- New motor end cap design for easier mounting, better heat dissipation

The RBC-2407 is available as a basic motor or with four stock gear ratios to meet your application requirements. All gear motors are electrically and mechanically interchangeable. Send coupon for free bulletin covering complete details, including physical dimensions and electrical specifications of this Model RBC-2407 instrument motor.

HOLTZER-CABOT MOTOR DIVISION • NATIONAL PNEUMATIC CO., INC.

Sales-Service Representatives in Principal Cities throughout the World

Designers and manufacturers of **NP** electric and electronic mechanical, pneumatic, hydraulic, equipment and systems

HOLTZER-CABOT MOTOR DIVISION, Department ED
National Pneumatic Co., Inc., 125 Amory St., Boston, Mass.

Please send: Complete details of Model RBC-2407 Servo Motors
 Information on other H-C Instrumentation Motors

NAME _____ TITLE _____

COMPANY _____

ADDRESS _____

CIRCLE 80 ON READER-SERVICE CARD

NEW PRODUCTS

UHF Meter

529

Range is 400 to 800 mc



Model 707 uhf meter has a range of 400 to 800 mc and a sensitivity of 5 μ w. The instrument requires no cables, no external power supply, and no electrical connection to the circuit under test. Its accuracy is within 0.5%. Applications include: measurement of uhf tuned circuits, calibrating output signals, and determining resonant frequencies.

Electronic Ventures, Dept. ED, 472 Kuehnis Drive, Campbell, Calif.

Price: \$96.80.

Dynamic Balancing Machine

545

For precision balancing



Model K balancer determines unbalance vibrations as small as 1/4 of 1 millionth of an inch. The apparatus consists of two units, a balancing stand and an amplifier. It can accommodate rotors of diameters up to 2-1/2 in. and weighing up to 16 oz. Balancing speeds from 8,000 to 60,000 rpm are available. It can be used with gyros and other electro-mechanical devices.

Micro Balancing, Inc., Dept. ED, Herricks Road, Garden City Park, N. Y.

Paper Tape Converter

353

For magnetic tape computers

The Model 7765 converts paper tape to magnetic tape at 150 characters per sec. Components are a paper-tape reader with photoelectric reading mechanism and a magnetic-tape writing unit. The machine will convert most paper tape in use today, including five-track telegraphic code and IBM eight-track (858) code. The output tape is the seven-track, 200-character-per-in. Mylar magnetic tape used on the IBM 727, 729 I, 729 II and 729 IV tape units. The solid-state machine needs

CRYSTAL BANDPASS FILTERS

1 MC THRU 21 MC



The Keystone KCF Series of crystal filters is available in 3 standard case styles covering the frequency range from 1 MC through 21 MC. Higher frequencies and special case sizes are also available to conform to individual custom requirements. Compact, ruggedized packaging meets all applicable Mil specs. The KCF series has particular applications in Doppler Radar, Receiver IF, Comb Filter sets or wherever filters of high stability factors and narrow bandwidths are required.

Write for complete technical data.

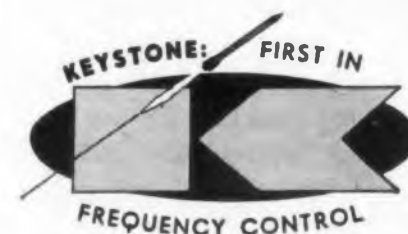

THE KEYSTONE ELECTRONICS CO.

65 SEVENTH AVE., NEWARK 4, N. J.

Subminiature component ovens • crystal ovens • crystal filters and discriminators • quartz crystals—100 KC thru 150 megacycles or higher upon request.

CIRCLE 81 ON READER-SERVICE CARD

ELECTRONIC DESIGN • October 12, 1960

no special air conditioning, and needs only a 115-v power connection.

International Business Machines Corp., Data Processing Div., Dept. ED, 112 E. Post Road, White Plains, N. Y.

Price: The machine rents for \$1,475 per month. Purchase price is \$69,500.

Slip Clutch

733

Over-all length is 0.8 in.



The Dynaco slip clutch eliminates galling and maintains a uniform slipping torque. Over-all length of the unit is 0.8 in. It can be installed in complex gear trains as a safety device. Set to a predetermined torque value, the clutch maintains this value even after extended periods of slipping. Diametrical pitch is 48, 64, 72, 80, 96, and 120. Pitch diameters are 0.75 through 2 in. with a 14.5- or 20-deg pressure angle.

Dynamic Gear Co., Inc., Dept. ED, Dixon Ave., Amityville, L.I., N.Y.

Price & Availability: \$32 ea; from stock.

Crystal Clock

550

Completely transistorized



Type CAQ portable clock, completely transistorized, is designed for controlling the aging rate of crystals by comparison with the time signals of WWV. The only accessory required is a suitable receiver. The clock is self-starting and unaffected by line failures. It will run for 12 hr on its battery. A built-in crystal oscillator has a frequency of 100 kc and an accuracy of 1×10^{-8} per day.

Rohde and Schwarz, Dept. ED, 111 Lexington Ave., Passaic, N. J.

Price & Availability: \$2,700 ea, fob Passaic; delivery is 30 to 60 days after order received.



From concept to countdown

Pesco creative engineering
meets the challenges
of space!

Imaginative concepts are translated into reality at Pesco . . . where engineering ingenuity combines with production proficiency to create specialized components for the aerospace industry. And Pesco extends its total engineering capabilities through a close working relationship with the Borg-Warner Research Center! Advanced design principles to meet tomorrow's needs are embodied in many Pesco products now specified for an impressive list of operational air vehicles. Current projects include electronic and hydraulic power packages, environmental cooling systems, cryogenic pumps . . . plus research programs in electrical control actuation, thermo-electric infra-red sensor cooling and thermo-electric power generation. Write today for information about Pesco's integrated design-and-build capabilities.

PESCO PRODUCTS DIVISION

BORG-WARNER CORPORATION

24700 North Miles Road • Bedford, Ohio

EXPORT SALES: Borg-Warner International Corp.
36 South Wabash Avenue • Chicago 3, Illinois

CIRCLE 82 ON READER-SERVICE CARD



THE 7 HATS OF BORG-WARNER
(top) national defense; oil, steel and chemicals; (middle) agriculture; industrial machinery; aviation; (bottom) automotive industry; home equipment.



NOW... from the pioneering R & D experience and skilled manufacturing hands of the developers of the Industrial RPM (Regulated Power Module)...

16 NEW R/P/MS
FOR MILITARY APPLICATIONS
Designed to meet MIL-E-16400B

...fills
the void

with higher reliability... higher environmental immunity to shock, vibration and humidity... 5 year life expectancy in continuous use... 0.05% REGULATION NL to FL... RIPPLE less than 1 mV RMS on all models... extended operating temperatures -20°C to +65°C, wide choice of D.C. Voltages from 145 to 325 Volts at Currents from 50 to 400 MA. Request new ACDC Technical Bulletin #500 containing complete specifications on both the Military and Industrial RPMs.

Sales offices in
principal
cities



ACDC ELECTRONICS, INC.
2979 North Ontario Street
Burbank California

Manufacturers of regulated power supplies, inductive devices from power to radio frequencies, pulse circuitry components and magnetic amplifiers

CIRCLE 83 ON READER-SERVICE CARD

NEW PRODUCTS

Microwave Modulator

540

Pulse width is 200 to 4,000 pps



Model 10003 microwave modulator is designed for operation with beacon-type magnetrons. Measuring 8.5 x 18 x 12 in., it contains a generator that provides a pulse width of 200 to 4,000 pps, pulse voltage from 0 to 5 kv, and a pulse current of 2 amp max. Pulse repetition rate is continuously variable from 0.4 to 2.2 μ sec.

Narda Microwave Corp., Dept. ED, 118-160 Herricks Road, Mineola, N. Y.
Price & Availability: \$2,450; from stock.

Tuning-Fork Resonator

530

Weighs 0.8 oz.



Weighing 0.8 oz and measuring 3/8 in. in diameter and 2-3/8 in. long, type 056 tuning-fork resonator mounts on circuit boards. It can be used alone or in combination with oscillators, dividers, or multipliers; it may also be incorporated into low-power oscillators for missile applications. Frequency range is 350 to 1,800 cps; accuracy is $\pm 0.01\%$ over a moderate frequency range.

Gyrex Corp., Dept. ED, 3003 Pennsylvania Ave., Santa Monica, Calif.
Availability: Prototype units; 30 days; production quantities, 60 days.

Hook-Up Wire

655

Teflon insulated

The U/L approved Type E Teflon wire is rated at 80 and 105 C, with voltage ratings dependent upon application. It meets standard MIL-W-16878. Available in sizes 20 through 26 AWG, the insulation has a 10-mil wall thickness, high tem-

50% SAVINGS
with

BEAD CHAIN
Multi-Swage Parts

CONTACT PINS

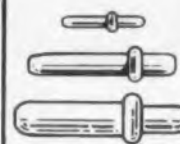

TERMINALS

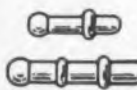

JACKS

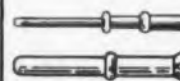

FRICION CONTACTS

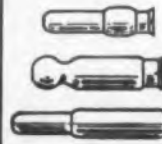

also PRINTED CIRCUIT
MINIATURE PARTS

Contact pins, terminals, jacks or any small tubular parts. Maximum 1/4" diameter x 1 1/4" length.

Send sketch for quotations.

BEAD CHAIN DRIVES

Low-speed positive drives or motion transfer
... at far less cost!

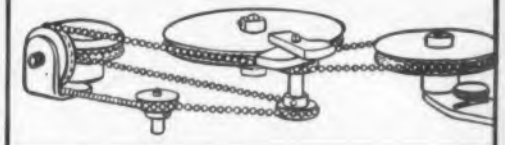

Send for Multi-Swage or
Bead Chain Drive Catalog!

THE BEAD CHAIN MFG. CO.

205 Mountain Grove St., Bridgeport 5, Conn.
CIRCLE 84 ON READER-SERVICE CARD

NEW!



SPRING & FUSE CLIPS,
LOCK WASHER TERMINALS

Order from Zierick stocks for quick delivery. New terminals with #4, 6, 8 holes, spring and fuse clips made from .018 brass or phosphor bronze, hot tinned. Special parts quoted from sketches or blueprints. Production on our upright presses or multi-slide machines. Over 500 stampings and wire forms to choose from.

STANDARD
ELECTRICAL
PARTS delivered
FAST!

Lugs • Clips • Terminals
Wire Forms from Stock

Send for your copy of the new
Zierick catalog No. 22 TODAY!

ZIERICK MANUFACTURING CORP

96 Beechwood Ave., New Rochelle, N.Y. • NEW Rochelle 6-8520

CIRCLE 85 ON READER-SERVICE CARD

CIRCLE 86 ON READER-SERVICE CARD

For Electronic Applications



RELIABLE General Electric Inductrol[®] Induction Voltage Regulators

General Electric's complete line of 50-, 60-, and 400-cycle Inductrol regulators gives you extra values in *reliability* and *compactness*. In ratings up to 600 volts, 750 load kva—single phase, and up to 2000 load kva—three phase, you get these special features:

- **SIMPLE, NO-BRUSH DESIGN**—fewer maintenance problems.
- **HIGH SHORT-CIRCUIT STRENGTH**—will withstand up to 25 times normal current, for 2 seconds.
- **HIGH OVERLOAD CAPACITY**—will withstand up to 100% overloads for one hour.
- **HIGH EFFICIENCY**—97% to over 99% at full load.
- **NO HARMFUL WAVEFORM DISTORTION.**
- **ECONOMICAL, COMPACT DESIGN**—requires less floor space.
- **DRIFT-FREE CONTROLS**—voltage automatically held to $\pm 1\%$ bandwidth.

FOR MORE INFORMATION about General Electric's complete line of Inductrol regulators, contact the voltage regulator representative at your nearby General Electric Apparatus Sales Office. Or, write to General Electric Company, Section 457-03, Schenectady 5, New York.

*Registered trade-mark of General Electric Company.

VOLTAGE REGULATOR PRODUCT SECTION

GENERAL ELECTRIC

PITTSFIELD, MASS.

CIRCLE 87 ON READER-SERVICE CARD

perature protection, soldering protection and chemical resistance.

Times Wire & Cable Co., Dept. ED, Wallingford, Conn.

Availability: Wire can be delivered 10 days after receipt of order.

Test Fixture

542

For cable-connected equipment



The Cable-Connek test fixtures are for checking cable-connected electronic equipment. These flat, 0.5-in. panels contain an array of junction cells connected to a cable receptacle on the front of the panel. The panels are wired at the factory. Standard, miniature, or subminiature connectors having up to 50 contacts may be specified. The panels are suitable for use where multi-contact connectors are to be used as test points in checking out black-box equipment.

Plastic Associates, Dept. ED, 2900 S. Coast Blvd., Laguna Beach, Calif.

Price & Availability: \$20 to \$35; two-week delivery.

Vacuum Oven

533

Provides temperatures to 500 F

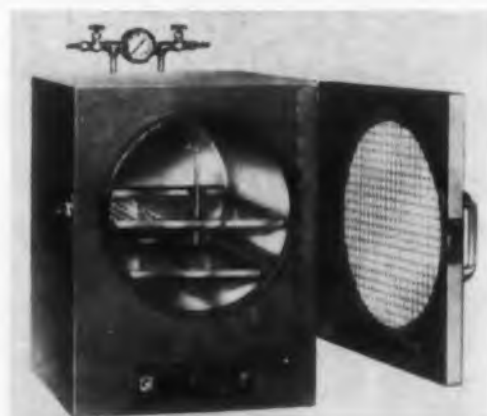

The Super-Temp Duo-Vac oven heats to temperatures of 500 F in 1 hr. Temperature uniformity is ± 1 F. The chamber measures 11 in. in diameter and 12 in. deep. Outside dimensions are 18 x 17 x 18 in.

Labline, Inc., Dept. ED, 3070-82 W. Grand Ave., Chicago 22, Ill.

Price: \$395.



High and Medium Temperature MULTI-CONDUCTOR CABLE For Critical Applications

TIMES' experience in designing and manufacturing R.F. coaxial cable, data transmission cable, and low frequency control cable adds up to multi-conductor versatility to solve *your* problems.

As a "one source" manufacturer of all multi-conductor cable components, TIMES can produce round and ribbon cables utilizing almost infinite combinations of coaxial cable, Teflon[®], PVC and polyethylene hook-up wire, and low capacitance cable.

Choose from TIMES *standard* engineered multi-conductor cables, or let our Engineering Service assist you in designing cables and *cable assemblies* to meet your specific requirements.

®DuPont

TIMES WIRE & CABLE DIVISION
The International Silver Company
WALLINGFORD, CONNECTICUT, U.S.A.

Clip This Coupon To Your Calling Card or Letterhead

Please rush FREE literature on:

- Coaxial Cables
- Data Transmission Cables
- Multi-Conductors & Hook-up Wire
- Fo: Info Only Have Rep. Call



CIRCLE 88 ON READER-SERVICE CARD

CIRCLE 86 ON READER-SERVICE CARD

TRANSCO K-BAND DELAY LINE

*non-loaded wave guide
now in use with missile system*

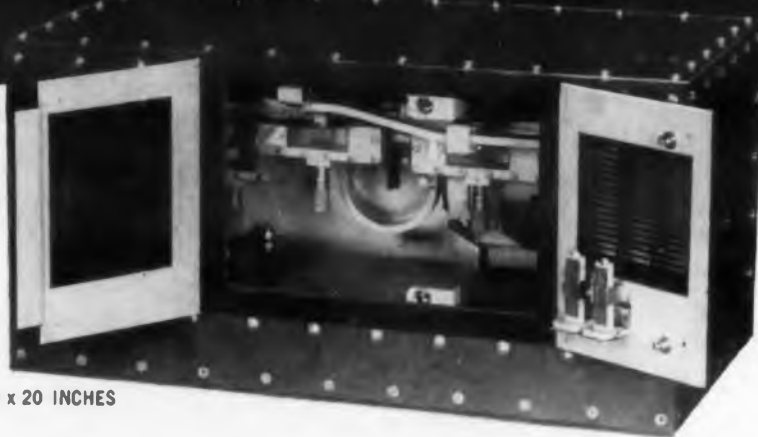

10 x 10 x 20 INCHES

Designed for ground check-out of a missile radar system, this new Transco 47,000 K-Band Delay Line is currently in use with one of the newest missile systems. The unit features two delays that may be remotely selected. Other features include three precision attenuators, two wave guide transfer switches, and a ferrite modulator. Also provided is a variable attenuation bleed line with a directional coupler and monitor crystal.

Using these same proved techniques, Transco can supply delay lines for other applications with delays from .01 to 5.0 microseconds at K-Band or other frequencies. Where size reduction is needed, use of the reflective principle or loaded guides can be provided.

Transco specializes in designing, testing and manufacturing microwave components and systems. Write for delay line data sheet.

TYPICAL COMPONENTS MANUFACTURED BY TRANSCO FOR THEIR K-BAND DELAY LINE



Precision attenuator, 47150 - 0-70 db range, .3 db repeatability.

Waveguide switch, 47100 - 2 pole transfer, 18-26 KMC, 1.05 VSWR, .07 insertion loss, 80 db crosstalk.



18, 20, 40 db directional couplers, E-plane and H-plane mitre joints, high and low power loads.

TRANSCO

PRODUCTS, INC.
12210 Nebraska Avenue
Los Angeles 25, Calif.

COAXIAL SWITCHES
WAVEGUIDE SWITCHES
ANTENNAS
MICROWAVE COMPONENTS
VALVES
ACTUATORS

CIRCLE 89 ON READER-SERVICE CARD

NEW PRODUCTS

Vacuum Gage

539

Indicates down to 10-14 mm Hg



The Redhead Magnetron Gage, a high-vacuum, cold-cathode ionization gage and gage control, indicates pressures down to the 10^{-14} mm Hg range. Applications include solid-state research. The design eliminates the need for a special means of outgassing the gage elements. Four operating controls are provided.

NRC Equipment Corp., Dept. ED, 160 Charlemont St., Newton 61, Mass.

Price & Availability: Model 552 gage, \$245; model 752 control, \$850. Delivery is from stock.

Absorption-Type Wave-Meter 524

For use as marker cavity

Model 24-1 absorption-type wavemeter is designed for use as a marker cavity with broadband sweep generators. The device, which uses coaxial resonators and coaxial rf transmission line connections, is tuned by a precision micrometer head with 100 large thimble divisions for each revolution. Readability and resetability is 0.025%. Range is 2 to 4 kmc; accuracy, 0.05%; loaded Q, 1000.

Frequency Standards, Dept. ED, Asbury Park, N.J.

Stepping Motor

546

Uni-directional



This uni-directional stepping motor is jam-proof and completely enclosed; it has a magnetic anti-overcoast and is permanently lubricated.

BRAND-REX CABLEMANSHIP

The Big Difference
In MIL-C-13777B
Neoprene
Jacketed Cables!

Missile men, especially, know the advantages of Neoprene jacketed cables . . . low temperature flexibility, abrasion resistance and resiliency. And missile men who are also cablemen know it pays at the count down to count on Brand-Rex Cablemanship! And you should too.

There's more to the absolute reliability of Brand-Rex cables than just rigid adherence to specifications. Brand-Rex Cablemanship combines technology, skill, broad cable engineering services, production capability of three coast-to-coast plants and technical field service . . . all delivered by a tightly-knit organization backed by the vast resources of the American Enka Corporation.

Whatever your requirements for wire or cable, regardless of the rigidity of your specifications for conductors, layup patterns, insulation materials, shielding or armoring, you can count on the Cablemanship of Brand-Rex.



Write for samples and information today!

BRAND
REX

WILLIAM BRAND-REX
DIVISION

American ENKA Corporation
SUDBURY ROAD, CONCORD, MASS.

CIRCLE 90 ON READER-SERVICE CARD

ELECTRONIC DESIGN • October 12, 1960

Stepping rate is 15 to 25 steps per sec. Environmental specifications are: vibration, 10 g, 2,000 cps; shock 100 g, 6 msec; operating temperature, -55 to +120 C.

Ledex Inc., Dept. ED, 123 Webster St., Dayton 2, Ohio.

Price & Availability: Prices range from \$11.30 to \$14.70 in quantities of one to nine. Available from stock.

Time-Delay Relay

534

Range is 100 msec to 60 sec

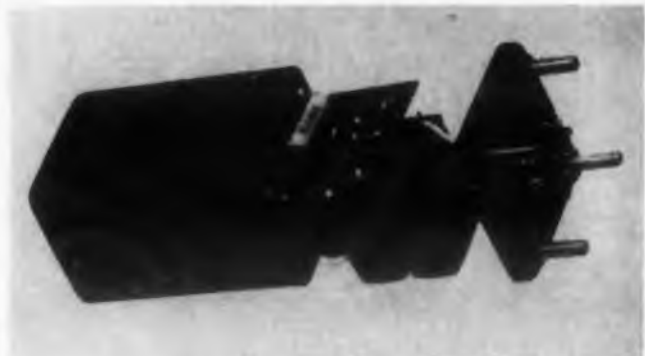

Suitable for airborne applications, this time-delay relay has a timing range of 100 msec to 60 sec. It stands 15 g of vibration of 2,000 cps and 50 g of shock. The unit offers fast recycle, reverse polarity protection, voltage compensation, and is protected against transient voltages of 70 v for 50 msec.

Leach Corp., Controls Div., Dept. ED, 5915 Avalon Blvd., Los Angeles 3, Calif.

Availability: Three weeks.

Ferrite Tee Circulator

535

Handles peaks of 20 kw



This compact K_a-band ferrite tee circulator handles 20 kw, peak, and 20 w, avg. Isolation between channels is 20 db min; maximum insertion loss is 0.5 db. Frequency range is 34.5 to 35.1 kmc; bandwidth, 0.6 kmc. Maximum vswr is 1.2. Designed for use with an RG 96/U waveguide, the device occupies 1-1/8 cu in.

Litton Industries, Airtron Div., Dept. ED, 200 E. Hanover Ave., Morris Plains, N. J.

BRAND-REX CABLEMANSHIP

the big difference in Teflon®
Insulated Wire and Cable!

From the smallest single conductor hook-up wires to the most complex Teflon primary insulated and jacketed multiconductor cables, Brand-Rex Cablemanship makes the difference.

And what is Brand-Rex cablemanship? Of course it involves technology and skill. But more than that, it's a tightly-knit organization of broadly experienced cablemen backed by the vast resources of the American Enka Corporation. It's progressive cable design engineering. It's the production capability of three modern quality-controlled production plants, strategically located from coast to coast, operating around the clock with the most advanced high-speed equipment. Combine these with technical field service in depth and that's Brand-Rex Cablemanship!

In terms of your requirements for Teflon TFE or FEP insulated wire or cable, Brand-Rex cablemanship will pay big dividends to you... regardless of how varied, complex or rigid your requirements may be for conductors, lay-up patterns, shields, armors or jackets. For complete information and samples, write today!

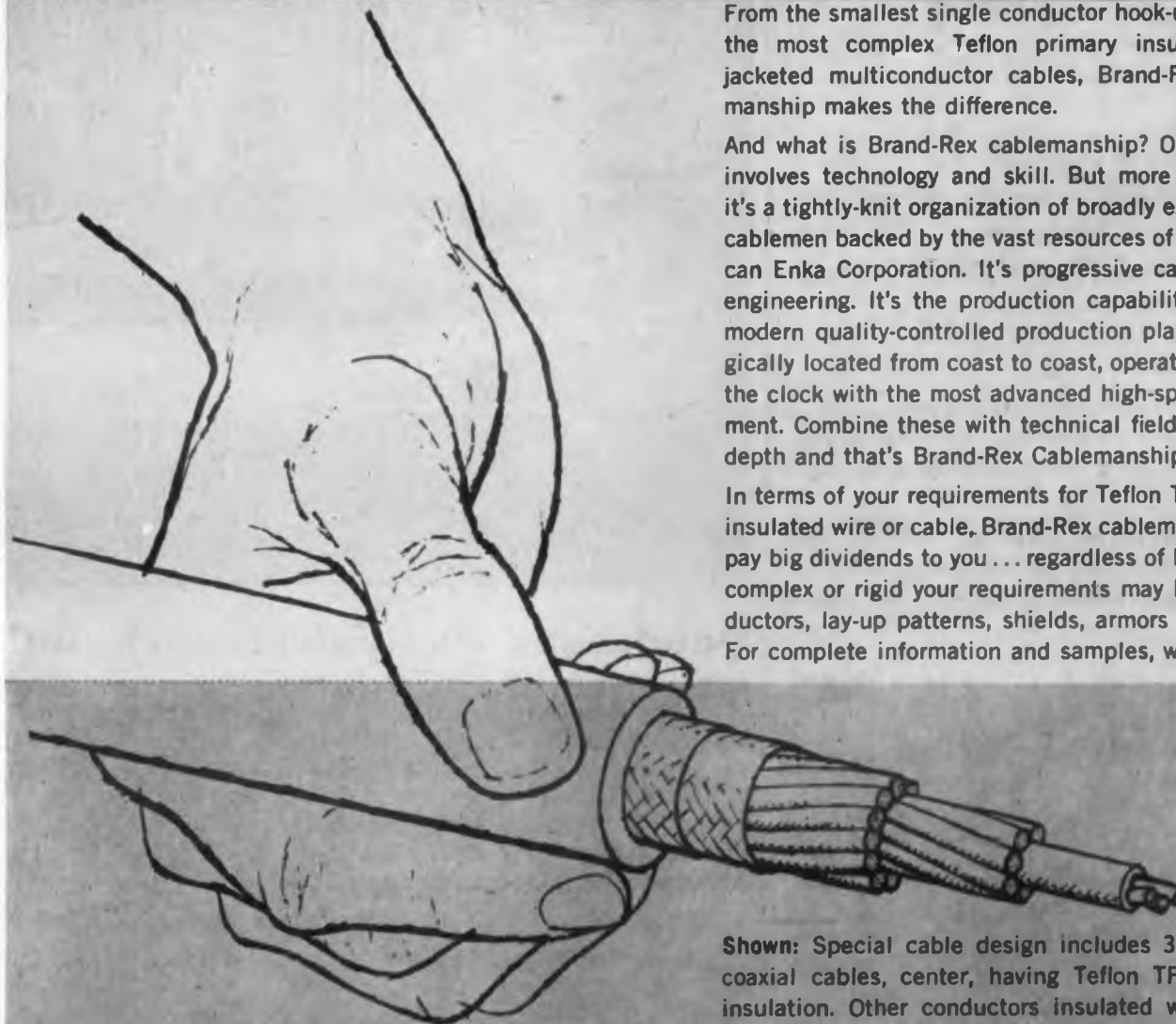

Shown: Special cable design includes 3 miniature coaxial cables, center, having Teflon TFE primary insulation. Other conductors insulated with Teflon FEP. Braids Dacron. Jacket Neoprene.



Left: Cables can be furnished with individual coaxials, pairs, triples or other components positioned within the cable exactly to specs. Center: Brand-Rex coaxial cables use Teflon dielectrics and meets all government and commercial requirements. Right: Brand-Rex quality-control procedures cover every step of manufacture.

©Registered Trademark of DuPont



WILLIAM BRAND-REX DIVISION

American ENKA Corporation

DEPT. W, 39 SUDBURY ROAD, CONCORD, MASSACHUSETTS

Telephone: EMerson 9-9630

Vinyl, Teflon, Polyethylene, Nylon and Silicone Rubber Wires and Cables
Electrical Tubing and Sleeving — UHF Cast Plastics — Plastic Extrusions

CIRCLE 91 ON READER-SERVICE CARD

NEW PRODUCTS

Decade Ring Counter

536

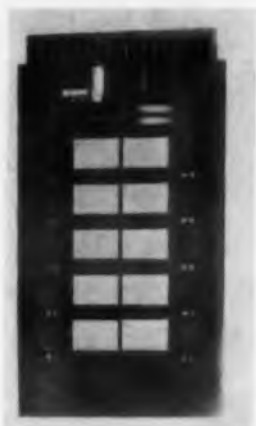

Solid state, magnetic

Model PRC solid-state, magnetic decade ring counter is reversible. Counting rates as high as 100 kc are possible. Clear and preset time is 10 μ sec; time to reverse is 10 μ sec. A ± 12 -v, unregulated power supply is required. Applications include industrial control, telemetry, rate measurement, code generation, frequency division, and digital-data processing. Measuring 4.5 x 8.5 in., it mounts on a plug-in, printed-circuit card.

Magnetics Research Co., Dept. ED, 255 Grove St., White Plains, N. Y.

Price & Availability: \$175 per decade; 60 days.

Relay Drivers

681

Transistorized

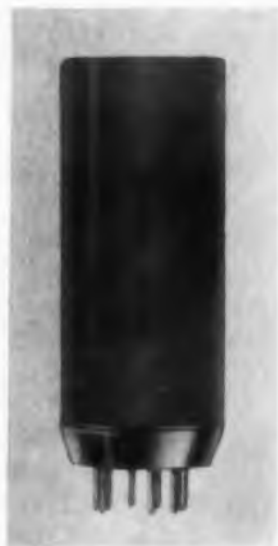

Types T-134 and T-135 relay drivers provide the power to operate sensitive relays, indicator elements or resistive loads. These dual units switch a resistive load at frequencies to 50 kc at currents ranging to 50 ma max and voltage to 28 v max. The T-134 requires a turn-on signal of -11 v and a turn-off signal of -3 v; the T-135 requires -3 and -11 v. Both units require ± 12 v dc.

Engineered Electronics Co., Dept. ED, 1441 E. Chestnut Ave., Santa Ana, Calif.

SILICONE NEWS from Dow Corning

How To Combat Heat.

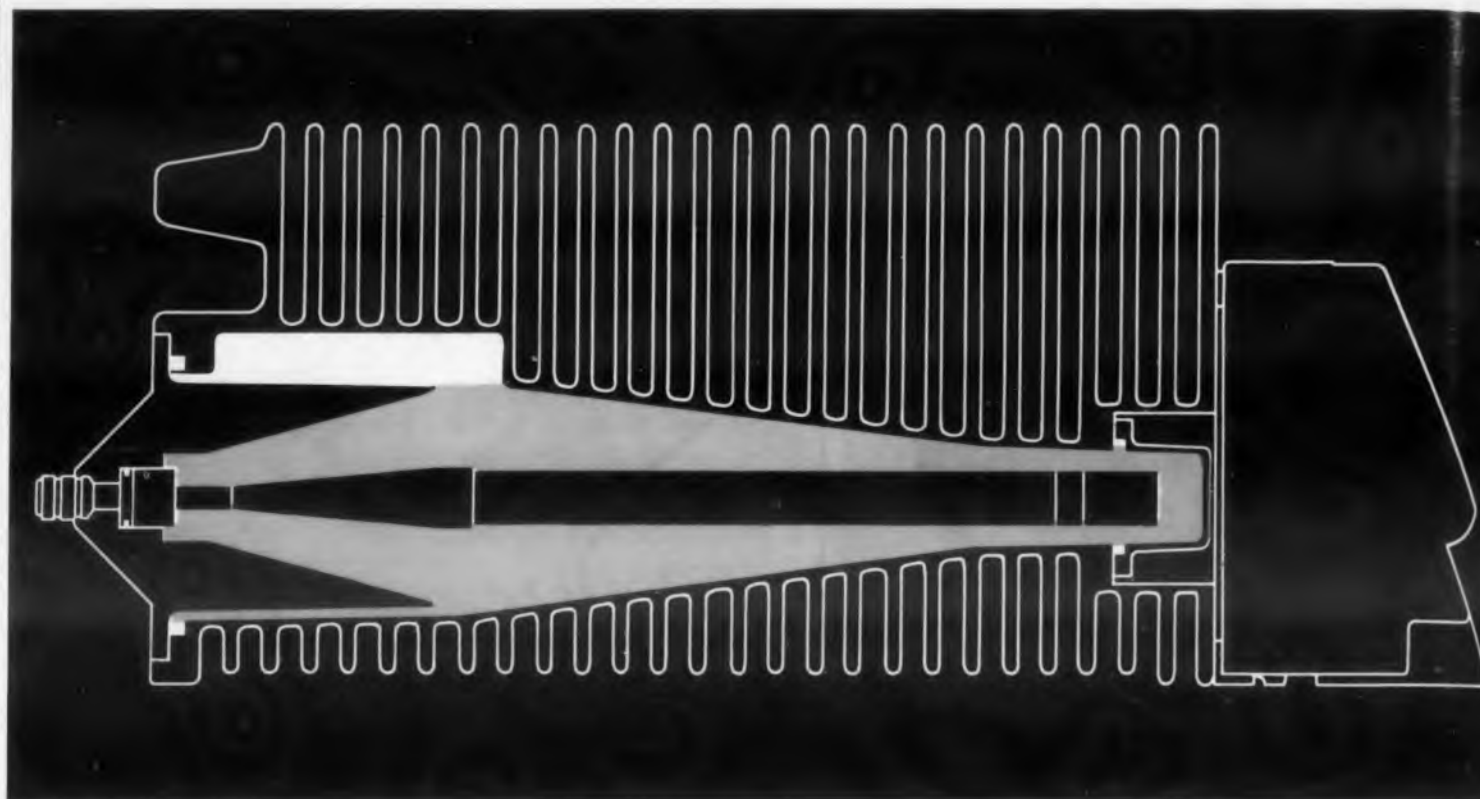

Good heat dissipation with dielectric strength are unique silicone properties

An example: Dow Corning silicone fluids are used as dielectric coolants for rapid dissipation of heat because of their thermal stability and relatively flat viscosity-temperature curves. (See chart below.) They can be pumped at high speeds without breakdown due to shear; maintain consistency from -65 to 250 C; and they will not oxidize or act as corrosives to metals even at high temperatures.

Low vapor pressure is an additional reason why Sierra Electronic Corporation, Menlo Park, California, specifies Dow Corning 200 Fluid as the heat transfer medium in their 100 and 500 watt, 50 ohm coaxial RF loads. Heat losses are dissipated through the dielectric coolant to fins on the cast housing, providing integral liquid cooling without loss of dielectric strength.

These terminations have excellent stability. Prolonged operation within their rating produces no measurable change of characteristics, even with an ambient temperature of 104 F (40 C).

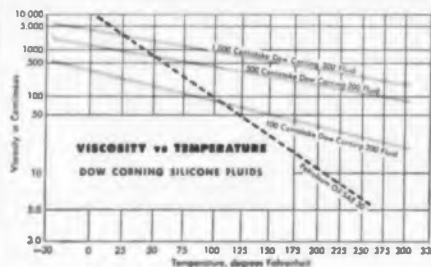

From direct current to 3 kmc these coaxial line loads have a low VSWR ratio of less than 1.2 . . . are compact and light in weight. And Dow Corning 200 Fluid helped Sierra engineers lick the heat problem by providing a dielectric with good heat conduction.



CIRCLE 800 ON READER SERVICE CARD

For "Silicones for the Electronic Engineer", Write Dept. 3310.



Dow Corning

at... Specify Silicones

Elastic Jacket for Heat or Cold

Exposed to environmental extremes of blistering heat and bitter cold, the molded jacket of this flexible wave guide is made from Silastic®, the Dow Corning silicone rubber. According to Co-Operative Industries engineers, the Silastic jacket provides a smooth exterior over the corrugated brass of the wave guide, gives added resistance to dents, corrosion and abrasion. It also helps control flexing characteristics. Rubbery parts made of Silastic retain their physical and dielectric properties over the wide temperature span of -90 to 250 C . . . resist ozone, corona and fatigue stress. Initial properties remain unchanged despite rapid thermal cycling or long term storage.



CIRCLE 801 ON READER SERVICE CARD

Silicone Team "Beats" Heat

This solenoid, manufactured by Cannon Electric Company, Los Angeles, California, is subjected to high temperatures and other environmental extremes. One typical use: in pneumatic starters for aircraft turbine engines. To beat the heat, Cannon engineers specify a silicone insulation system consisting of: Dow Corning impregnating varnish; silicone-glass tape; silicone rubber impregnated glass sleeving; silicone fiber glass insulators; silicone compound for plating terminals; and, Silastic caulking paste. Completed solenoids must withstand environmental tests including salt spray, humidity, high and low temperatures and vibration. Cannon Electric chose the *silicone team* "for its superior characteristics in resisting heat, moisture and abrasion; and, its outstanding dielectric properties."



CIRCLE 802 ON READER SERVICE CARD

Heat-Stable Vacuum Pump Fluid

Dow Corning silicone diffusion pump fluids offer a combination of properties that add up to high production rates and long runs without maintenance. These properties provide heat stability, low vapor pressure, high vacuum, rapid recovery, quick pump down, inertness to air and metals and resistance to gamma radiation. Silicone diffusion pump fluid is non-toxic and chemically inert . . . pump vacuum can be released without first cooling the boiler . . . decomposition does not occur when hot fluids are exposed to air. To improve the performance of your diffusion pump, specify a Dow Corning diffusion pump fluid . . . They produce vacua in the range of 10^{-5} to 10^{-7} mm of Hg.



CIRCLE 803 ON READER SERVICE CARD

Shipping Container

393

Having contour-cut K-foam urethane, these containers are offered in five sizes to house parts ranging from 1/8 to 3 in. thick. They are suitable for shipping electronic tubes and instruments.

Henry B. Katz Industries, Inc., New Industrial Products Corp., 45-47 Hollywood Plaza, East Orange, N.J.

Price: Starts at \$25 for 100 cases.

Microwave Ferrite Switch

394

The R-107H enables two antennas to be time-shared by a common transmitter and receiver. It operates over a band of 2% between 15.7 and 16.9 kmc, with loss of 0.5 db, vswr of 1.2 max, and isolation between parts of greater than 20 db.

Ferrotec, Inc., Dept. ED, 217 California St., Newton, Mass.

Epoxy Dipping Compounds

395

Types 103 and 104 are offered in a variety of viscosities and degrees of thixotropy. Dielectric constant is 4 for type 103 and 4.4 for type 104.

Isochen Resins Co., Dept. ED, 221 Oak St., Providence, R.I.

Instrument Enclosures

396

These enclosures can have heights in any multiple of 1-3/4 in. Front-to-rear dimension is 0 to 26 in 1-in. increments. The dolly is mounted on casters 3 in. in diameter.

Electro-Rack, Inc., Dept. ED, 11505 Jefferson Blvd., Culver City, Calif.

Price & Availability: \$65 up; 2-week delivery.

Thermal Analog Tubes

397

Thermions are furnished in all miniature size classes of electron tubes. Subminiature types can also be supplied. Cooling requirements are precisely determined under simulated operating conditions.

Research Council Inc., Dept. ED, 151 Bear Hill Road, Route 128, Waltham, Mass.

Zener Diodes

398

The firm has extended its line to include ratings of 750 mw. The units have a larger heat-sink area. These diodes are designated B configuration.

Pacific Semiconductors, Inc., Dept. ED, 12955 Chadron Ave., Hawthorne, Calif.

Price: Same as for the firm's standard 500-mw units.

Centrifuge Slip Ring

399

Series 1156 provides rotating electrical connections for instrumenting and monitoring components under test. It has 60 circuits, 51 rated at 10 amp and 9 rated at 33 amp.

Slip Ring Co. of America, Dept. ED, 3612 W. Jefferson Blvd., Los Angeles 16, Calif.

ng CORPORATION MIDLAND, MICHIGAN

branches: ATLANTA BOSTON CHICAGO CLEVELAND DALLAS LOS ANGELES NEW YORK WASHINGTON, D.C.
CIRCLE 800, 801, 802, 803 ON READER-SERVICE CARD

WEIGHT of your system can be cut if you specify components capable of outstanding performance. Example: high output lets *one* Sperry traveling wave tube replace *two* ordinary tubes in Nike-Zeus. If weight reduction is a knotty problem for you, call Gainesville, Florida, FRanklin 2-0411 collect, for full information about Sperry capabilities.

SPERRY

**ELECTRONIC
TUBE
DIVISION**

Gainesville, Florida • A Division of Sperry Rand Corporation



SPERRY'S FAMILY OF TRAVELING WAVE TUBES covers P through X Bands with unusually high output and light weight. These characteristics, combined with the inherent ruggedness of metal-ceramic construction, conduction cooling and wide-range thermal compensation, make Sperry traveling wave tubes particularly suitable for airborne applications.

**SPECIFY RAPIDLY
AND ACCURATELY
WITH SPERRY'S
SPECI-FILE**



Now you can have Sperry's complete family of klystron and traveling wave tubes right at your fingertips for faster, more accurate tube selection. Attractively packaged and comprehensively indexed, the Sperry's Spec-File gives you complete electronic and physical characteristics of every tube in the Sperry line.

TO GET YOUR FREE

Speci-File, use this coupon:

Section D-103
SPERRY
ELECTRONIC TUBE DIVISION
Gainesville, Fla.

Please send me a **FREE** Sperry Spec-File:

Name _____

Title _____

Company _____

Address _____

City _____

State _____

Circle 791 on Reader-Service Card



GAINESVILLE, FLORIDA
A Division of Sperry Rand Corporation

← Circle 792 on Reader-Service Card

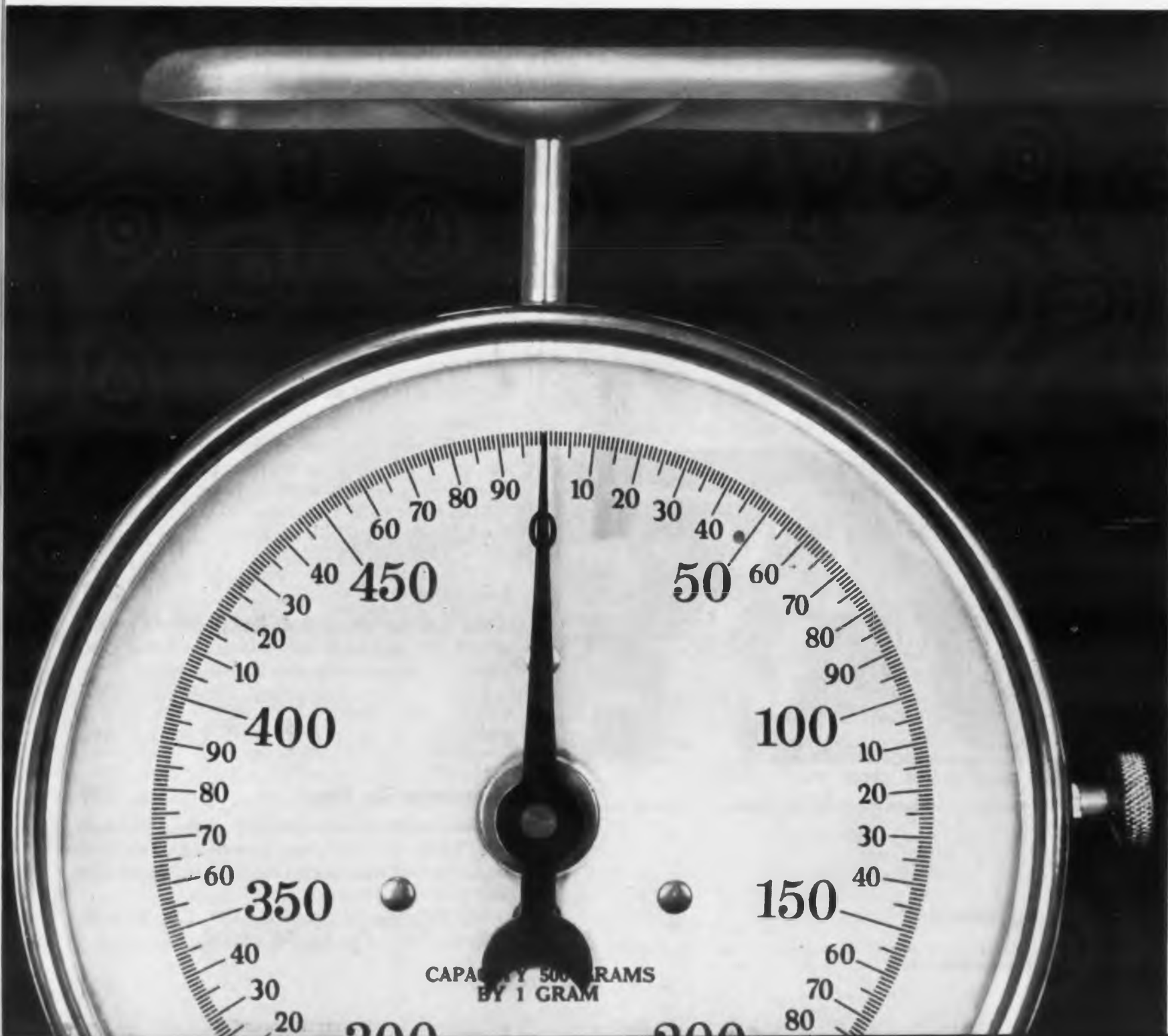

NEW PRODUCTS

Silicon Rectifiers

531

Plug-in type

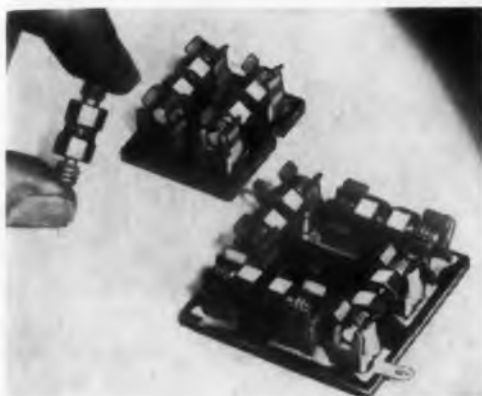

Rated at 500 ma, these silicon, plug-in rectifiers have a reverse current at 200 μ a at rated piv, and average surge rating of 50 amp for one cycle, and a forward drop of 0.92 v. The piv range is 200 to 600 v. They can be used in motor control, audio-amplifier, industrial power supply, and other circuits using clip-type rectifier holders. Designated types X5M2, X5M4, X5M5, and X5M6, the units operate from -20 to $+130$ C.

International Rectifier Corp., Dept. ED, 1521 E. Grand Ave., El Segundo, Calif.

Price: \$1 to \$1.70 in quantities of 1 to 99.

Pressure-to-Frequency Converter

677

For missile and airborne use



The Osciducer, a miniature pressure-to-frequency transducer is for missile and airborne applications and can also be used in industrial telemetering. It consists of a silicon-transistor oscillator and a variable-inductance pressure transducer. Frequency deviation is nominally $\pm 7.5\%$ of center frequency. Diaphragm and flush-type transducers are available with from 5 to 5,000 psi differential, absolute or gage. Units can be supplied for all IRIG channels.

Solid State Electronics Co., Dept. ED, 15321 Rayon St., Sepulveda, Calif.

Price & Availability: Made on order with a six-week delivery, units are priced at \$625 to \$695.



Approximately actual size

This 3 lbs. of transistorized new AC amplifier gives you 20 or 40 db gain, increases scope or VTVM sensitivity 10 or 100!

This new 466A AC Amplifier is just 4" high, 6" wide and 6" deep. Yet it can become one of the most helpful instruments on your bench, or in the field. It is ac or battery powered; battery operation gives you hum-free performance and easy portability. Response is flat within approximately $\frac{1}{2}$ db over the broad range of 10 cps to 1 MC, distortion is

less than 1%, and gain is stabilized by substantial negative feedback to virtually eliminate effects of transistor characteristics and environment.

For a demonstration on your laboratory or field application, call your representative or write direct.

Specifications

| | | | |
|---------------------|---|-------------|--|
| Gain: | 20 and 40 db, ± 0.2 db at 1000 cps. | Distortion: | Less than 1%, 10 to 100,000 cps. |
| Frequency Response: | ± 0.5 db, 10 cps to 1 MC; ± 3 db, 5 cps to 2 MC. | Power: | Ac line power normally supplied, but battery operation available. (12 radio type mercury cells, battery life about 160 hours.) Specify battery operation if desired. |
| Output Voltage: | 1.5 v rms across 1500 ohms. | Dimensions: | 6 $\frac{1}{4}$ " wide, 4" high, 6 $\frac{1}{4}$ " deep. Weight: approx. 3 lbs. |
| Noise: | 75 μ v rms referred to input, 100,000 ohm source. | Price: | \$150.00 f.o.b. factory. (Either ac or battery operation.) |
| Input Impedance: | 1 megohm shunted by 25 μ f. | | |
| Output Impedance: | Approximately 50 ohms. | | |

Data subject to change without notice.

HEWLETT-PACKARD COMPANY

1015K Page Mill Road, Palo Alto, California, U.S.A.
Cable "HEWPACK" • Davenport 5-4451



HEWLETT-PACKARD S.A.

Rue du Vieux Billard No. 1, Geneva, Switzerland
Cable "HEWPACKSA" • Tel. No. (022) 26. 43. 36

Field Representatives in all principal areas

CIRCLE 93 ON READER-SERVICE CARD



now a low storage silicon mesa
with the high reliability...

high uniformity of the
Motorola germanium mesa

ANNOUNCING MOTOROLA'S 2N706B SILICON MESA

The new Motorola 2N706B high-speed switching transistor has all the advantages of 2N706 and 2N706A... with improved high-frequency performance, lower base resistance (r'_b) and lower saturation voltage ($V_{CE(SAT)}$).

NOW ALL THREE 2N706B - 2N706A - 2N706 FROM MOTOROLA ELECTRICAL CHARACTERISTICS at 25°C

| PARAMETER | SYMBOL | 2N706B | 2N706A | 2N706 | UNIT |
|---|---------------|---------|---------|--------|-------|
| Collector-Base Voltage | V_{CB0} | 25 | 25 | 25 | volts |
| Collector-Emitter Voltage | V_{CER} | 20 | 20 | 20 | volts |
| Emitter-Base Voltage | V_{EBO} | 5 | 5 | 3 | volts |
| Power Dissipation @ 25°C case temperature | P_D | 1.0 | 1.0 | 1.0 | watts |
| Power Dissipation @ 25°C ambient temperature | P_D | 0.3 | 0.3 | 0.3 | watts |
| Forward Current Transfer Ratio | h_{FE} | 20-60 | 20-60 | 20 min | — |
| Base-Emitter Saturation Voltage | $V_{BE(SAT)}$ | 0.7-0.9 | 0.7-0.9 | 0.9 | volts |
| Collector Saturation Voltage | $V_{CE(SAT)}$ | 0.4 | 0.6 | 0.6 | volts |
| Base Resistance | r'_b | 50 | — | — | ohms |
| Storage Time | t_s | 25 | 25 | 60 | nsec |
| Turn On Time | t_{on} | 40 | 40 | — | nsec |
| Turn Off Time | t_{off} | 75 | 75 | — | nsec |



Actual
Size

The new 2N706B Motorola silicon mesa transistor is available now for your critical aircraft, missile, industrial and computer circuitry. In addition, Motorola is also supplying the 2N706A and 2N706. These Motorola silicon devices utilize a new, exclusive "E structure" mesa configuration which provides the same high uniformity and extreme reliability that has made Motorola the world's largest producer of high-quality germanium mesas.



MOTOROLA
Semiconductor Products Inc.

A SUBSIDIARY OF MOTOROLA, INC.

FOR COMPLETE TECHNICAL INFORMATION and quantity price information, contact your Motorola Semiconductor district office:

BOSTON 385 Concord Ave., Belmont 78, Mass. IVanhook 4-5070
CHICAGO 39, 5234 West Diversey Avenue AVenue 2-4300
DALLAS 19, 3915 Lemman Avenue LAkeside 4-8931
DAYTON 3120 Far Hills Avenue, Dayton, Ohio AMinster 3-4164
DETROIT 27, 13131 Lyndon Avenue BRoadway 3-7171
LOS ANGELES 1741 Ivar Avenue, Hollywood 28, Calif. HOlywood 2-0821
MINNEAPOLIS 27, 7731 6th Avenue North Liberty 5-2198
NEW YORK 1051 Bloomingfield Ave., Clifton, N.J. GRegory 2-5300
from New York Wisconsin 7-2980
ORLANDO Knowel Building, Winter Park, Fla. Midway 7-2507
PHILADELPHIA 130 South Eastern Rd., Glenside, Pa. TURner 7-7020
SAN FRANCISCO 1299 Bayshore Highway, Burlingame, Calif. DIamond 2-3228
SYRACUSE 101 South Saline GRANite 4-3321
WASHINGTON 8405 Cameron St., Silver Spring, Md. JUNiper 5-4483

CIRCLE 94 ON READER-SERVICE CARD

NEW PRODUCTS

DC Amplifier

Bandwidth is dc to 40 kc



Model 233 wideband dc amplifier is designed to amplify signals from strain gages, thermocouples, and other low-level signal sources. It has a bandwidth of dc to 40 kc which is unaffected by gain setting or load resistance. Maximum noise level is less than 12 μ v to 50 kc. A minimum input impedance of 100,000 ohms is maintained over the entire bandwidth. Output capability is \pm 50 V at \pm 50 ma. It drives direct recorders, analog-to-digital converters, and tele-metering and voltage-controlled oscillators.

Computer Engineering Associates, Inc., Dept. ED, 350 N. Halstead, Pasadena, Calif.

Indicator Lamp

Has a transistorized switch



The Minisig R-342 filament lamp indicator operates directly from digital, plug-in circuit modules. The unit includes a self-contained transistorized switch designed to turn the lamp at -3 v and off at -11 v. Power drain is 0.65 ma at -2 v and 42 ma at +12 v. It is suitable for balancing power-supply currents.

Engineered Electronics Co., Dept. ED, 1411 E. Chestnut Ave., Santa Ana, Calif.

Price & Availability: \$13.85 in lots of 1 to 9; from stock.

Immersion Salts

400

The Wes-X 500 immersion tin process imparts a white color to copper and copper-base alloys to prevent oxidation of copper during soldering. It is particularly applicable to soldering printed circuits and electronic components.

Westinghouse Electric Corp., Dept. ED, P.O. Box 2099, Pittsburgh 30, Pa.

Insulating Cloth and Tape

401

This self-adhering material is fully cured to raise its dielectric strength. Both cloth and tape are available and suited for Class H applications. It consists of a silicone-rubber coating on one or both sides of a continuous-filament glass fabric.

Westinghouse Electric Corp., Micarta Div., Dept. ED, Trafford, Pa.

Multi-Pole Sensitive Relay

366

Type 5D2C, dpdt, and 5D3C, 3 pdt, plug-in relays have self-wiping contacts with operating power as low as 25 mw per pole for dc operation. Contact rating is 5 amp, 28 v dc or 115 v ac; coil resistances range to 20,000 ohms.

Kurman Electric Co., Dept. ED, 191 Newel St., Brooklyn, N.Y.

Price & Availability: \$6.30 to \$8.20 in quantities of 10. Delivery is from stock.

RF Amplifier

367

Model UH-2(A)SPC provides moderately wide-band amplification and is designed for outdoor applications. Frequency range may be at any center frequency from 30 to 300 mc, bandwidths are up to 10% of center frequency, and gains are greater than 20 db.

Applied Research Inc., Dept. ED, 76 S. Bayles Ave., Port Washington, N.Y.

Availability: 45-day delivery.

Punched Tape Reader

373

This tape reader, able to read 5-, 6-, 7-, and 8-hole punched paper tape, has variable speeds up to 1000 characters per sec. Solid-state photoelectric elements are used.

Genesys, Dept. ED, 10131 National Blvd., Los Angeles 34, Calif.

Price: \$2,350.

Thermocouple Extension Cable

360

Multi-lead T/C thermocouple extension cables come in lengths up to 1,000 ft and have from 4 to 8 pair of thermocouple extension wires. Wire pairs are cabled with aluminum-backed Mylar tape and sheathed with PVC, a steel armor, or a combination steel armor-PVC over-all sheath.

Pyrometer Co. of America, Inc., Dept. ED, Pennington, N.J.

Availability: Two to three weeks.

Special Works Memo

TO Production Engineering and Process Control Depts.

FROM Chief Engineer, Special Projects Division.

Tests have been carried out on two new Armstrong Whitworth Equipment products. Results have been excellent and these items might well be the answer to several of our problems. Preliminary details are:-

(1) Avro High Temperature Strain Gauges

Strain or minute structural variation measurable accurately at temperatures up to 1,000°C. Transverse resistance cross sensitivity negligible due to rectangular grid section design and stray thermo-electric effects nil. Ceramic cement impregnated non-removable fibrecloth backing bends around small radii. Fixing is by proven adhesives. Illustration shows typical hot point use for gauges. Note that temperature compensating thermo couples may be supplied built into each gauge!

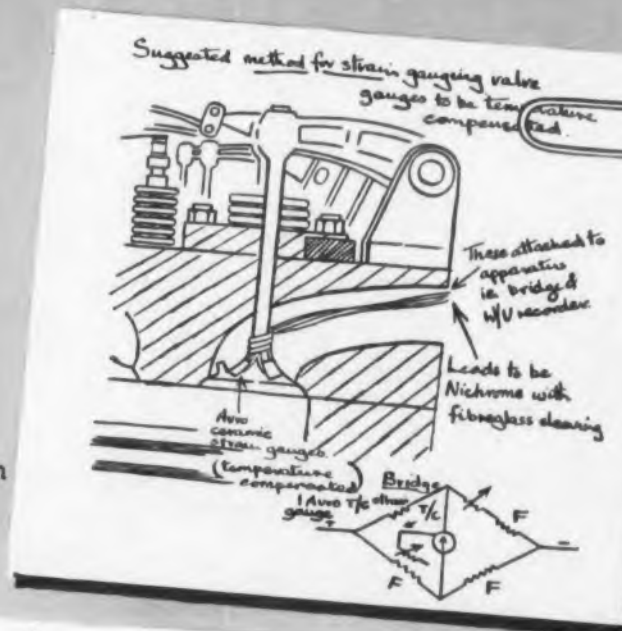

(2) Limited Angle Tacho-Generator

Operates on a 30° angle about a mid position. Size 1" rotor (2" nominal dia. case 3.75" long). There is also a 3" diameter rotor generator for special order. Sensitivity 5 volts/radian/sec. ±15% Load 27 kil-ohms Frequency response 3 db down at 37 cycles/sec. Winding resistance 1,680 ohms ±5% Operating torque 500 gm. cm. Direct lever drive eliminates gear back lash discrepancies. Illustration shows use for velocity feed-back measurement on swash-plate pump driving large machine tool.



ARMSTRONG WHITWORTH EQUIPMENT, Hucclecote, Gloucester. Telephone: Gloucester 66781
SIR W. G. ARMSTRONG WHITWORTH AIRCRAFT LTD., MEMBER OF HAWKER SIDDELEY AVIATION
CIRCLE 95 ON READER-SERVICE CARD



Seven full waveguide bandwidths are each covered by a separate meter in this 532 series of nine reaction-coupled frequency meters, extending over the complete range from 3.95 to 40.0 kmc/s.

These frequency meters consist of a TE₁₁₁ mode cavity resonator tuned by a non-contacting plunger. Ruggedness for long trouble-free life is assured by the all-metal housing. Maximum readability, resolution and accuracy to ±0.08% are the result of an optimized design distinguished by a drum type spiral scale more than 8 feet long.

| Type No. | Frequency Range (kmc/sec) | Waveguide (Size in Inches) | Flange | Accuracy (%) | Price |
|----------|---------------------------|----------------------------|----------|--------------|-------|
| 532 | 3.95 to 5.85 | 2 x 1 | UG-149/U | ±.08 | \$380 |
| 533 | 5.85 to 8.2 | 1½ x ¾ | UG-344/U | ±.08 | \$295 |
| 534 | 7.0 to 10.0 | 1¼ x ¾ | UG-51/U | ±.08 | \$290 |
| 535 | 8.2 to 12.4 | 1 x ½ | UG-39/U | ±.08 | \$175 |
| 536 | 12.4 to 18.0 | .702 x .391 | UG-419/U | ±.1 | \$285 |
| 537 | 18.0 to 26.5 | .500 x .250 | UG-425/U | ±.1 | \$290 |
| 537-F1 | 18.0 to 26.5 | .500 x .250 | UG-595/U | ±.1 | \$290 |
| 538 | 26.5 to 40.0 | .360 x .220 | UG-381/U | ±.2 | \$300 |
| 538-F1 | 26.5 to 40.0 | .360 x .220 | UG-599/U | ±.2 | \$300 |

BROADBAND DIRECT READING FREQUENCY METERS

Most Complete Line...

For Every Purpose, Every Budget

High Precision, Direct Reading Meters (0.015%)

Series 555 to 579 consists of 30 different types covering from 0.925 to 39.0 kmc/s. Representing highest state of the art, these frequency meters fully qualify as transfer or secondary standards for exacting laboratory or production service. Features include: hermetically sealed invar cavity, temperature-compensation, high Q, optimum cavity geometry, high conductivity plating. Price range: \$1200.-\$1500.

Precision Heterodyne Frequency Meter (0.002%)

PRD 504, for 100 to 10,000 mc/s with accuracy of 0.002% at crystal check points every 5 mc/s and 0.03% or better between check points. Automatic interpolation by unique patented spiral-scale dial. Beat indication by both external earphones and built-in CRT. Meter is self-contained and portable. Price: \$695.

Inexpensive, Direct Reading Meters (0.08%)

Series 585-A to 590-A affords excellent accuracy at lowest cost from 5.1 to 10.0 kmc/s. Ideally suited for panel mounting and systems use. Price range: \$150.-\$350.

Direct Reading UHF Meter (±0.2%)

PRD 587-A, covers range 250 to 1000 mc/s. Spiral drum scale 60 inches long enables precision direct reading. May also be used as a tunable narrow band filter. Price: \$275.

PRD ELECTRONICS, INC.

A Subsidiary of Harris-Inter-type Corporation

Formerly Polytechnic Research & Development Co., Inc.

202 Tillary Street, Brooklyn 1, New York, ULster 2-6800
1608, Centinela Ave., Inglewood, Calif., ORgon 8-6922

NEW PRODUCTS

Elapsed-Time Indicators

Minimum indication is 1/10 hr



Series 5700 elapsed-time indicators have a range of 99,999.9 hr and a minimum time indication of 1/10 hr. Black numerals on white nylon are used. Ratings are: 115 v, 60 cps; 230 v, 50 cps; 230 v, 60 cps, and 24 v, 60 cps. These indicators provide rigid control because they cannot be reset and operate only when the motor is energized. They occupy 2-3/16 x 2-13/64 x 3-7/8 in. Uses are with computers, recording instruments, battery chargers, induction heaters and other devices.

Automatic Timing & Control, Inc., Dept. ED, King of Prussia, Pa.

Doppler Simulator

Range is from 10 cps to 1 mc

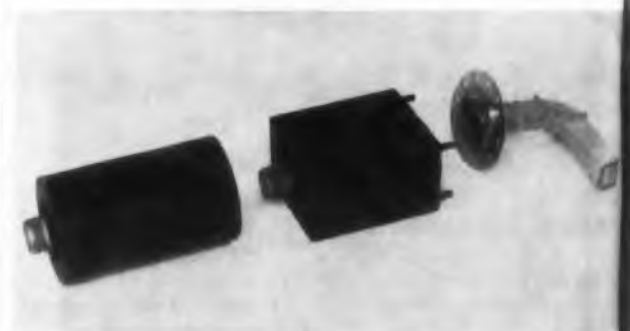

This radar augments and Doppler simulator increases radar detection range and probability of detection of objects with small radar cross sectional areas. Equipment simulates a 30 m target at X-band with 45 x 20 deg coverage in pulse operation and 100 m² with OMNI coverage for cw operation. The simulated Doppler output ranges from 10 cps to over 1 mc. The augments functions as a phase coherent repeater and a precise frequency translator with 35-dB gain for 1-μsec pulses and over 60-db gain for cw signals.

The Emerson Electric Manufacturing Company, Electronics and Avionics Div., Dept. ED, St. Louis 36, Mo.

CIRCLE 96 ON READER-SERVICE CARD



REMEMBER!

For immediate information
on "SCOTCH" BRAND
Instrumentation Tapes, contact
your nearest 3M branch office:

ATLANTA, GA.—732 Ashby Street, N.W.
Telephone: TRinity 6-4401

BEDFORD PARK, ILL. (Chicago Office)—
6850 South Harlem Avenue, Argo Post Office,
Telephone: GLobe 8-2200 (Chicago—LUdlow
5-7800)

BUFFALO, N.Y.—330 Greene Street (P. O.
Box 2012, Zone 5), Telephone: BAiley 5214

CINCINNATI, OHIO—4835 Para Drive, Tele-
phone: ELmhurst 1-2313

CLEVELAND, OHIO—12200 Brookpark Road,
Telephone: CLearwater 2-4300

DALLAS, TEXAS—2121 Santa Anna Avenue
(P. O. Box 28158), Telephone DAvis 7-7311

DETROIT, MICH.—411 Piquette Avenue, Tele-
phone: TRinity 5-7111

HIGH POINT, N. C.—2401 Brevard Street
(P. O. Box 151), Telephone: 3496

HONOLULU, HAWAII—1410 Kapiolani
Boulevard. Telephone: 996-483

LOS ANGELES, CALIFORNIA—6023 South
Garfield Avenue. Telephone: RAymond 3-6641

NEWTON CENTER, MASS. (Boston)—1330
Centre Street, Telephone: DEcatur 2-9810

PHILADELPHIA, PENN.—5698 Rising Sun
Avenue, Telephone: PILgrim 2-0200

RIDGEFIELD, NEW JERSEY (New York)—
700 Grand Avenue, Telephone: WHitney 3-
6700 (N.Y.—OXford 5-5520)

ST. LOUIS, MISSOURI—10725 Baur Boule-
vard, Telephone: WYdown 1-1320

ST. PAUL, MINNESOTA—367 Grove Street,
Telephone: PRospect 6-8511

SEATTLE, WASHINGTON—3663 First Avenue
South, Telephone: MUtual 2-5550

SOUTH SAN FRANCISCO, CALIFORNIA—
320 Shaw Road, Telephone: PLaza 6-0800

MINNESOTA MINING AND MANUFACTURING COMPANY
... WHERE RESEARCH IS THE KEY TO TOMORROW 

CIRCLE 97 ON READER-SERVICE CARD

A GOOD RESOLUTION ON TAPE—

Tape high frequencies, whip the dropout problem
with "SCOTCH" BRAND High Resolution Tapes



RIGHT HANDS UP, GENTLEMEN? Then repeat this phrase: "We resolve to get the tape that gets all the high frequencies — 'SCOTCH' BRAND High Resolution Tape."

All levity aside, there's no need to settle for second-best. With "SCOTCH" BRAND Tapes 158 and 159 you get sharp resolution in high frequencies, good low frequency response—plus the consistent performance of a uniform tape.

Since "SCOTCH" BRAND high potency oxides are more efficient than ordinary oxides, a thinner coating can be applied to the polyester backing, and the sensitivity at short (1 mil) wave lengths is still about 3½ db greater than that of ordinary oxides. This thinner coating means a more flexible tape, permitting the intimate tape-to-head contact so necessary to sharp resolution in the higher frequencies. Thanks to "SCOTCH" BRAND silicone-lubricated binder system, backing and oxide are locked together as a system. Tape passes over heads friction-free, with even motion, minimizing phase and frequency shift distortion.

You can pack more pulses per inch, and get either standard or extra playing time with "SCOTCH" BRAND High Resolution Tapes. Your dropout count is lower because uniformity is higher. Only "SCOTCH" BRAND can draw on 3M's more than 50 years of experience in precision coating techniques. The result is a consistent tape with a uniform coating you can depend on for reliable performance.

"SCOTCH" BRAND High Resolution Tapes meet your need for top high-frequency response even in pulse code modulation (PCM) and pre-detection (video) applications; so switch now from tapes that may well be made obsolete by new instruments.

Whatever your application—data acquisition, reduction, or control programming—experienced "SCOTCH" BRAND technology has a dependable tape for the job. Sandwich Tapes 188 and 189 cut head-wear, eliminate oxide rub-off, last 10 times longer than ordinary tapes. New Heavy Duty Tapes 198 and 199 give long wear, minimize static charge build-up. High Output Tape 128 gives top output in low frequencies, even at temperature extremes. And "SCOTCH" BRAND Standard Tapes 108 and 109 remain the standard for instrumentation.

Your nearby 3M Representative serves as a convenient source in all major cities. For details consult him or write Magnetic Products Div., 3M Company, Dept. MBQ-100, St. Paul 6, Minn.

© 1960 3M Co.
"SCOTCH" is a registered trademark of 3M Company, St. Paul 6, Minnesota.
Export: 99 Park Avenue, New York, N.Y. In Canada: London, Ontario.

SCOTCH BRAND MAGNETIC TAPE
FOR INSTRUMENTATION



MINNESOTA MINING AND MANUFACTURING COMPANY
... WHERE RESEARCH IS THE KEY TO TOMORROW 

CIRCLE 98 ON READER-SERVICE CARD

Analog Computer 491

Solves algebraic problems

The ESIAC analog-type computer calculates and plots values of algebraic functions of a complex variable; thus it computes and plots root locus and Bode diagrams and evaluates residues. Areas in which the instrument can be used include modern network synthesis, transient analysis, and feedback control system design.

Electro Scientific Industries, Inc., Dept. ED, 7524 S. W. Macadam Ave., Portland 19, Ore.

Price & Availability: \$9,800, including installation; 30-day delivery.

Infrared Tracker 391

For high-speed airborne targets

Model 21-110 high-resolution infrared tracker is a passive system designed to track high-speed airborne targets. It can operate in total darkness. The tracker receives infrared radiation emitted by the target and generates error signals for transmission to tracking servos. The unit has a 4 x 4 deg acquisition field and a 7.5 x 7.5 mil tracking field. It is quickly centered on the target and tracking continues at an accuracy of 0.25 angular miles or better, with less than 400- μ sec delay between the time of a tracking error and a proportional correcting signal.

Barnes Engineering Co., Dept. ED, 30 Commerce Road, Samford, Conn.

Rate Gyro 494

Inverter-demodulator type

This dc rate sensor regulates, inverts, and feeds a 28-v dc input to an ac gyro motor and pick-off. Output of the microsyn-type pick-off is then demodulated, balanced, gain adjusted, and filtered, providing up to 12 v dc. Resolution is below 0.05%. The unit is insensitive to 100 g of shock, and temperatures

RELAX! Just select the power output, bandwidth, everything else you need: and radiation tolerance...

Telephone today! New York, WI 7-4065.... Boston, DE 2-7122.... Washington, EX 3-3600.... Chicago, SP 7-1600.... Dallas, RI 7-4296.... Los Ar

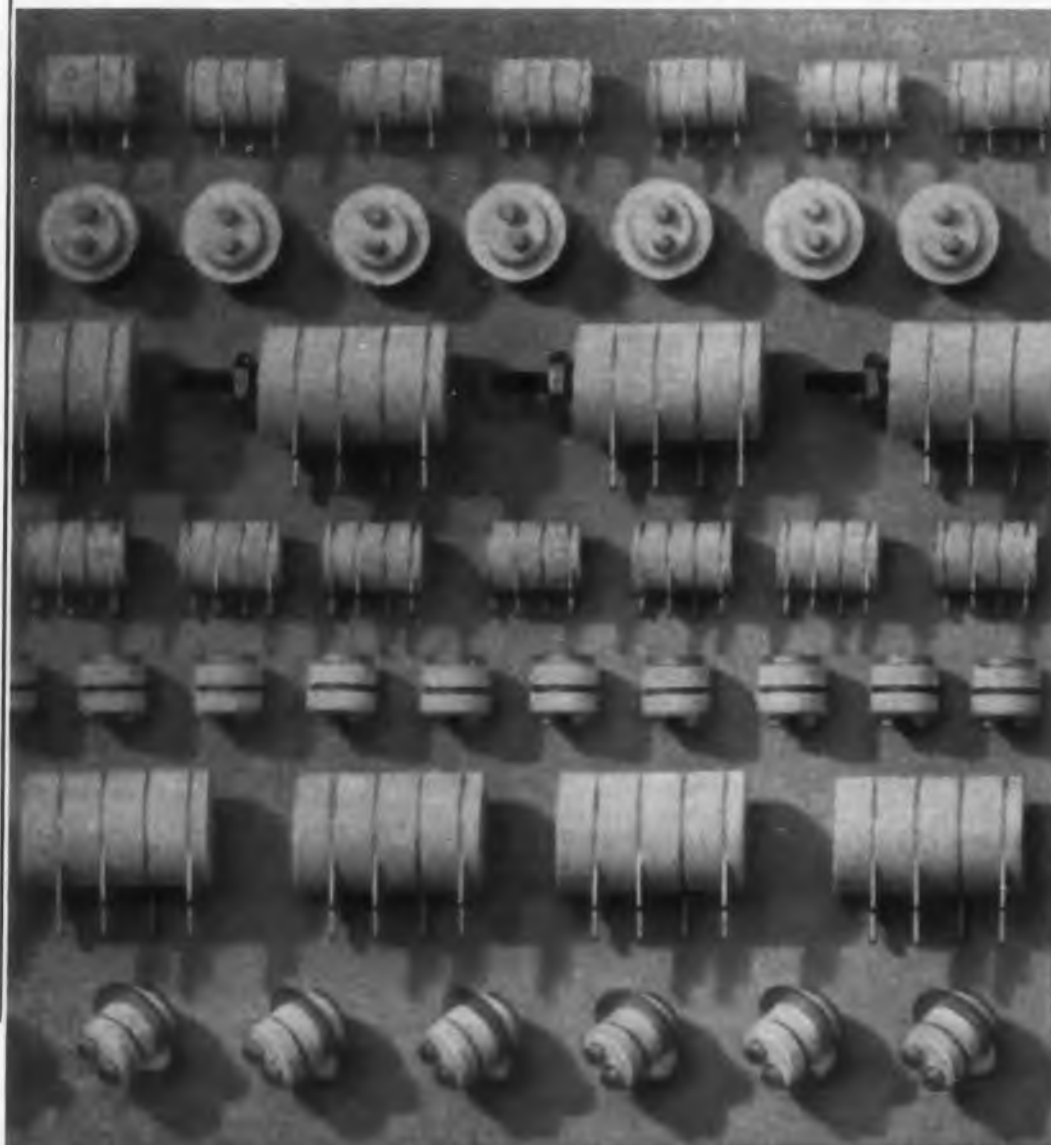

(ACTUAL SIZE)

7462

RF-amplifier triode

7486

RF oscillator-mixer triode

7296

VHF-UHF low-power triode,
shown with mounting bolt

7625

High voltage-gain triode

7266

VHF-UHF detector diode

Developmental, broadband,
40,000-G_m triode

7077

RF-amplifier triode

eright frequency, function,
 h. G-E Ceramic Tubes have
 d: ruggedness...temperature
 ...high gain...low noise.

7-4296... Los Angeles, GR 9-7765, BR 2-8566... San Francisco, DI 2-7201... Or call your General Electric Industrial Tube distributor.

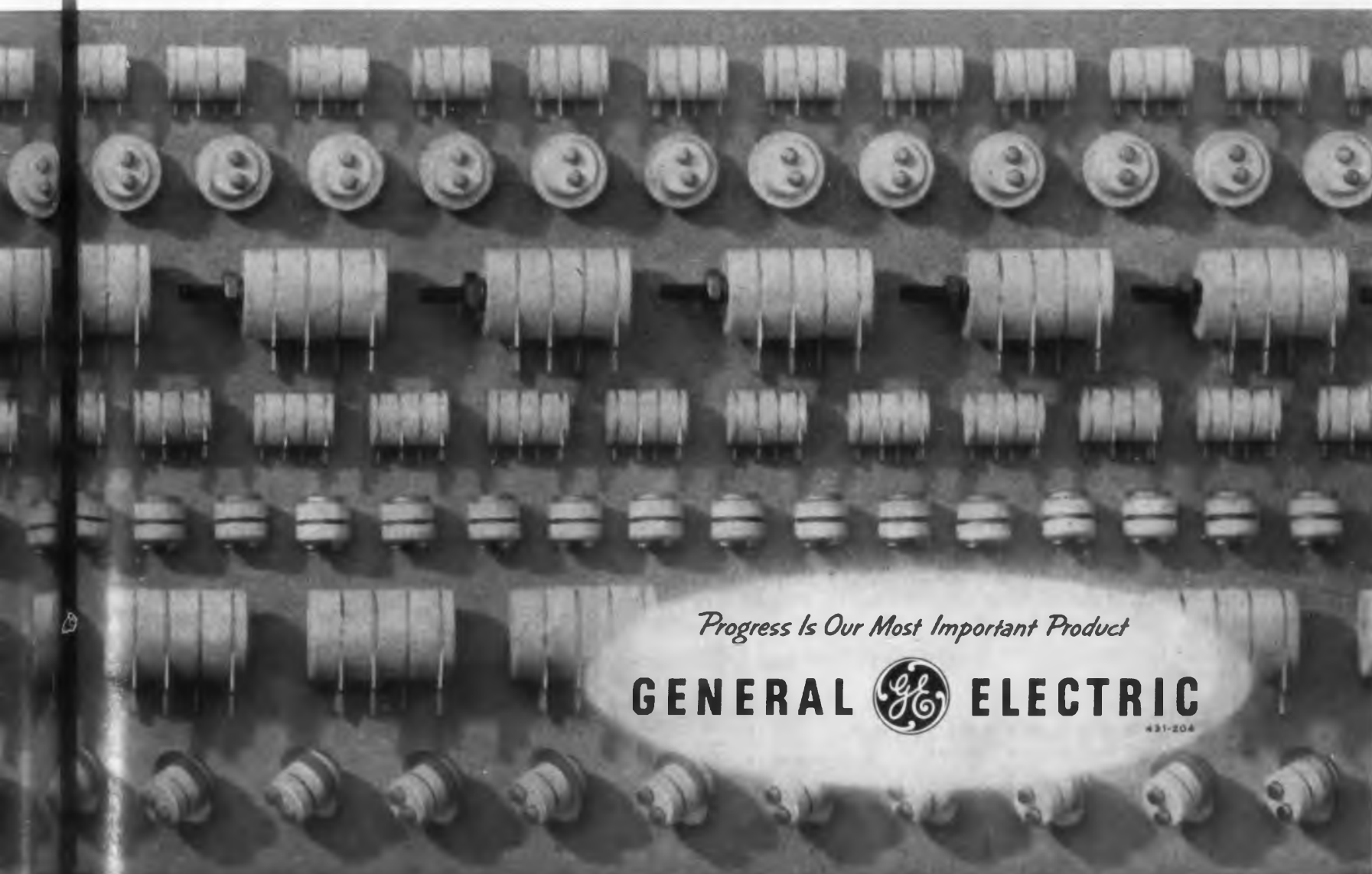

from 0 to 185 F. Damping coefficient is within $\pm 0.15\%$ of nominal, linearity is 1% of maximum rate, and zero calibration is 0.01% to 0.02% of maximum rate.

R. C. Allen Aircraft Instrument Div., Dept. ED, 333 Commerce S. W., Grand Rapids, Mich.

Availability: The unit is made to customer specs.

Silicon Rectifiers 504

Are hermetically sealed

This new series of hermetically sealed silicon rectifiers is designed for solder mounting. PIV ranges of 50 to 400 are available in each of four series rated at 10, 15, 25 and 35 amp dc at 150 C. All units are available in standard or reverse polarity types. They are for applications where conventional construction is not required and a threaded stud is unnecessary. Case height is 7/16 in. and base diameter is 5/8 in.

Syntron Co., Semiconductor Div., Dept. ED, Homer City, Pa.
Price & Availability: \$0.85 for 10-amp, 50-piv units to \$4.50 for 35-amp, 400-piv units in lots of 500. Delivery is three to four weeks.

Acceleration-Sensitive Switch 505

Range is 0.2 to 1,000 g

Model AS-4 acceleration-sensitive switch responds to acceleration in one direction along a single axis. Resetting is by means of high acceleration in the opposite direction or manual reset. Range is 0.2 to 1,000 g, accuracy is 0.2 g, response time is 50 msec, and natural frequency is 115 cps, undamped. The unit is suited for commercial, industrial and military use. Weighing 3 oz, it measures 3/4 x 3/4 x 1-1/2 in.

Eastern Technical Associates, Inc., Dept. ED, Main St., North Acton, Mass.

Price & Availability: \$38.50; two to six weeks.

◀ CIRCLE 99 ON READER-SERVICE CARD

"KEMET" CAPACITORS HELP CONTRIBUTE TO THE PERFORMANCE AND RELIABILITY OF THE BOEING 707 ELECTRICAL CONTROL SYSTEM



Boeing 707 commercial jet transport.

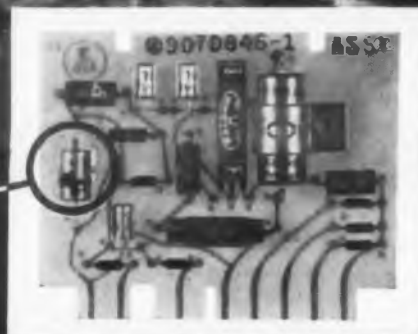

A transistorized panel showing position of a "Kemet" solid tantalum capacitor.

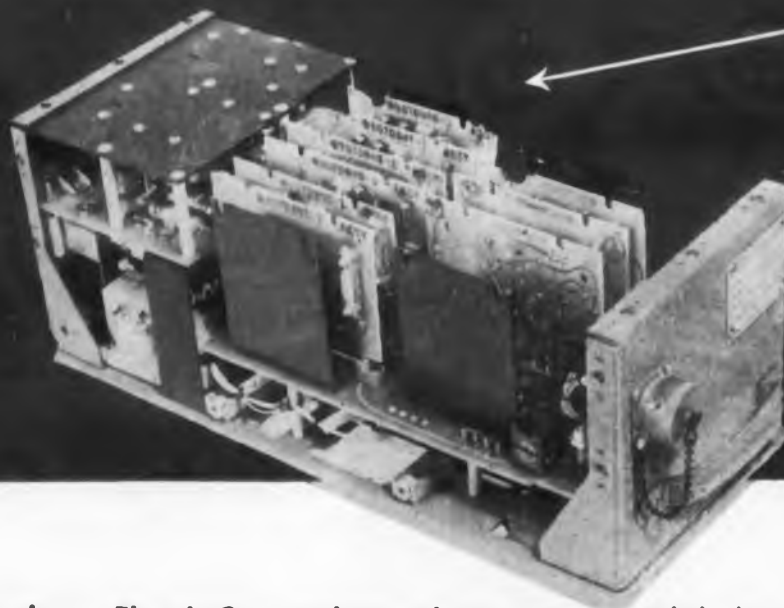

Uncovered control panel with transistorized panels in position.

Westinghouse Electric Corporation engineers are using "Kemet" capacitors in the control for the electric power system used on the Boeing 707. This most modern a-c electrical power system — each system comprised of a generator, control panel, voltage regulator and current transformer—provides optimum performance . . . simplified control . . . and automatic protection so essential in jet transport operation.

Transistorized control panels utilize static components in place of conventional relay circuits to provide reliability equal to that of the equipment being protected. "Kemet" solid tantalum capacitors were specified to help achieve this purpose. These extremely rugged capacitors insure the reliability required to

minimize maintenance and alterations . . . the small physical size needed to reduce power plant bulk . . . and the stability of operation demanded by the power supply to insure maximum efficiency and dependability from the associated equipment. These "Kemet" capacitors, along with the other components of this electrical system, help provide precise instrumentation data to the crew and offer increased safety and comfort to the passengers.

You can apply the proved reliability and performance of "Kemet" capacitors to your equipment. For details, write Kemet Company, Division of Union Carbide Corporation, 11901 Madison Avenue, Cleveland 1, Ohio.

"Kemet" and "Union Carbide" are registered trade-marks for products of

KEMET COMPANY

CIRCLE 100 ON READER-SERVICE CARD

NEW PRODUCTS

Connectors

592

Accommodates from 5 to 75 wires

Series 5040 subminiature rack and panel connectors accommodate 5, 7, 11, 14, 20, 26, 29, 34, 42, 50 and 75 wires. Locked-in floating contacts are individually self-aligning. Positive polarization is insured by pairs of opposed guide pins and guide sockets.

Precision Connectors Inc., Dept. ED, P.O. Box 96, Mineola, Long Island, N.Y.

Semiconductor Tester

609

Has current-limited source



Model TTS-100 semiconductor tester, with scope calibration voltages of 5 v vertical and 80 v horizontal, has a current-limited source to prevent damage to the semiconductor under test. Characteristics of transistors, Zener diodes, rectifiers and tunnel diodes can be determined for current values up to 1 amp and potentials up to 80 v. The unit is housed in a carrying case for bench-top operation and is 7 x 14 x 11 in.

PRL Corp., Dept. ED, P.O. Box 215, East Brunswick, N.J.

Price & Availability: \$295 fob East Brunswick. Delivery is from stock.

Circuit Breaker

563

Has hydraulic-magnetic tripping element

Using a hydraulic-magnetic tripping element, this line of circuit breakers is designed for aircraft, missile and ground-support applications. Called Hynetic breakers, they are supplied in 360 standard current ratings from 0.02 to 50 amp, or any fractional rating within these limits. They have three trip ranges: standard, fast, and instantaneous. The four voltage ratings are: 32 or 50 v dc, and 125 or 250 v at 60 cps. Interrupting capacity ranges from 1,000 to 3,000 amp.

Westinghouse Electric Corp., Dept. ED, P.O. Box 2099, Pittsburgh 22, Pa.

Price & Availability: Delivered 28 days after order received; price is \$12.60 for ratings from 1 to 50 amp, \$15.55, 0.02 to 1 amp.

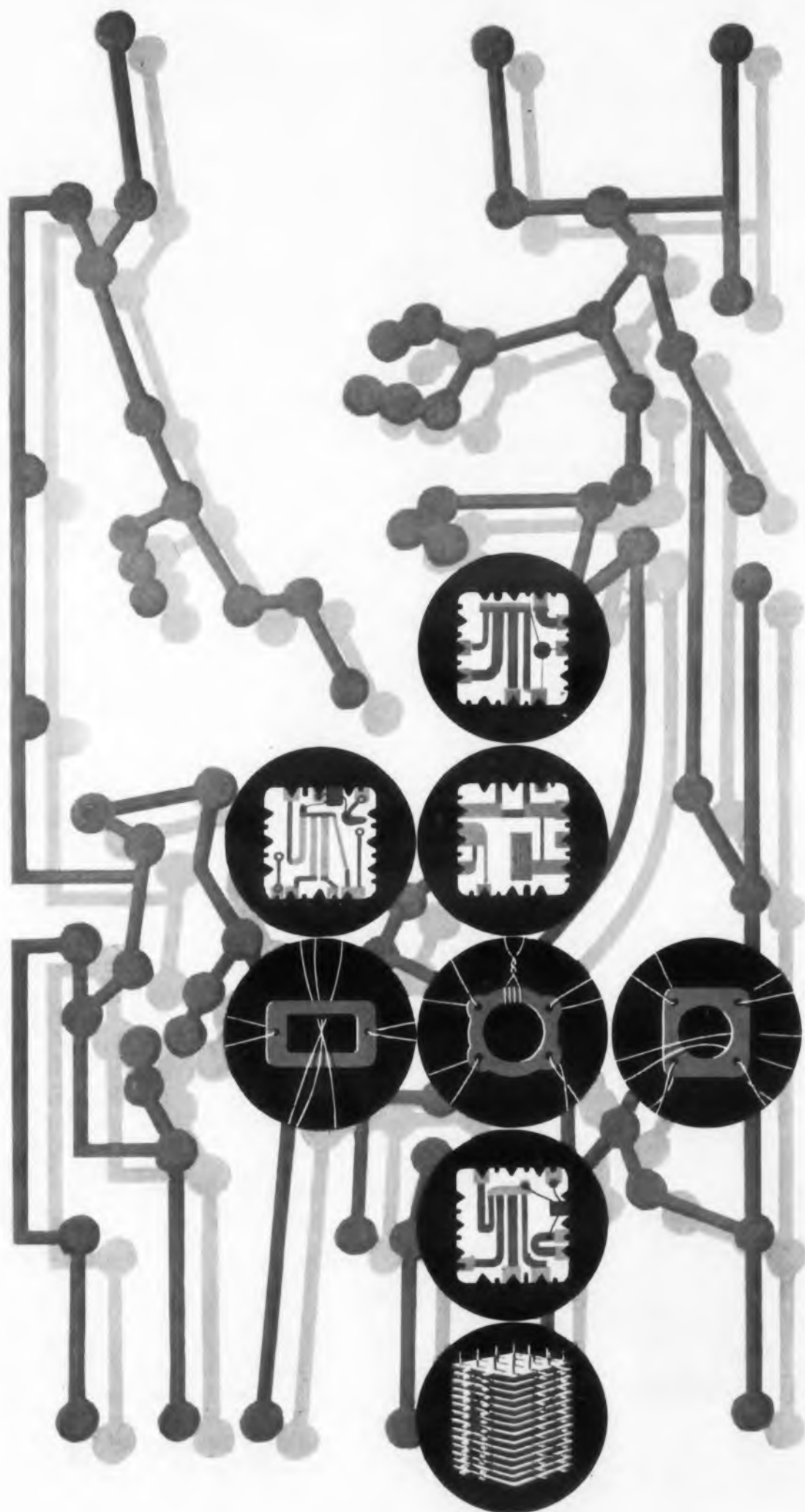

ADVANCED COMPUTER RESEARCH AT LOCKHEED

Challenging new concepts in the computer field are being investigated at Lockheed's Missiles and Space Division research laboratories in Palo Alto, California. Important progress is being made in pure and applied research as well as in the development of new and unusual design concepts.

Advanced research programs are being carried on in such areas as:

Switching theory • Modular codes • Logical design • Mechanical language translation • Digital system theory • Ferrite-wire logic circuits • Tunnel diode circuits • Microwave digital techniques • Magnetic thin films • Micro circuitry

Engineers and Scientists who are able to make contributions in these areas are invited to write to: Research and Development Staff, Dept. J-21, 962 West El Camino Real, Sunnyvale, California. U.S. citizenship or existing Department of Defense industrial security clearance required.

Lockheed

MISSILES AND SPACE DIVISION

*Systems Manager for the Navy POLARIS FBM;
The Air Force AGENA Satellite in the
DISCOVERER, MIDAS and SAMOS Programs*

SUNNYVALE, PALO ALTO, VAN NUYS,
SANTA CRUZ, SANTA MARIA, CALIFORNIA
CAPE CANAVERAL, FLORIDA • HAWAII



Heinemann's new Series VP circuit breaker can give you elbow room to work with in engineering compact equipment. Just $2\frac{1}{2}$ " x $\frac{5}{8}$ " x $2\frac{1}{4}$ " overall, it tips the scales at a piddling $1\frac{1}{2}$ ounces, and requires only a half-inch of panel space (without the ON-OFF plate). Yet, small as it is, it can double in brass. The standard series-trip model, for example, can serve you as a toggle switch as well as overload protector. Other models with special internal circuit constructions (shunt-trip, relay-trip, calibrating-tap, auxiliary contacts) can do even more to simplify a schematic, eliminate components. □ Like all Heinemann circuit breakers, the VP breaker is magnetically actuated, has a hydraulically controlled, inverse time delay. Completely non-thermal, it doesn't have to be de-rated for high ambient temperatures. □ You can have this breaker in any integral or fractional current rating from 0.050 to 15 amps, for 110 V, 60 or 400 cycles AC, or 50 V DC. Our new Bulletin VP will give you more information. Drop us a line, and a copy's yours.

HEINEMANN ELECTRIC COMPANY  **156 BRUNSWICK PIKE, TRENTON 2, N. J.**

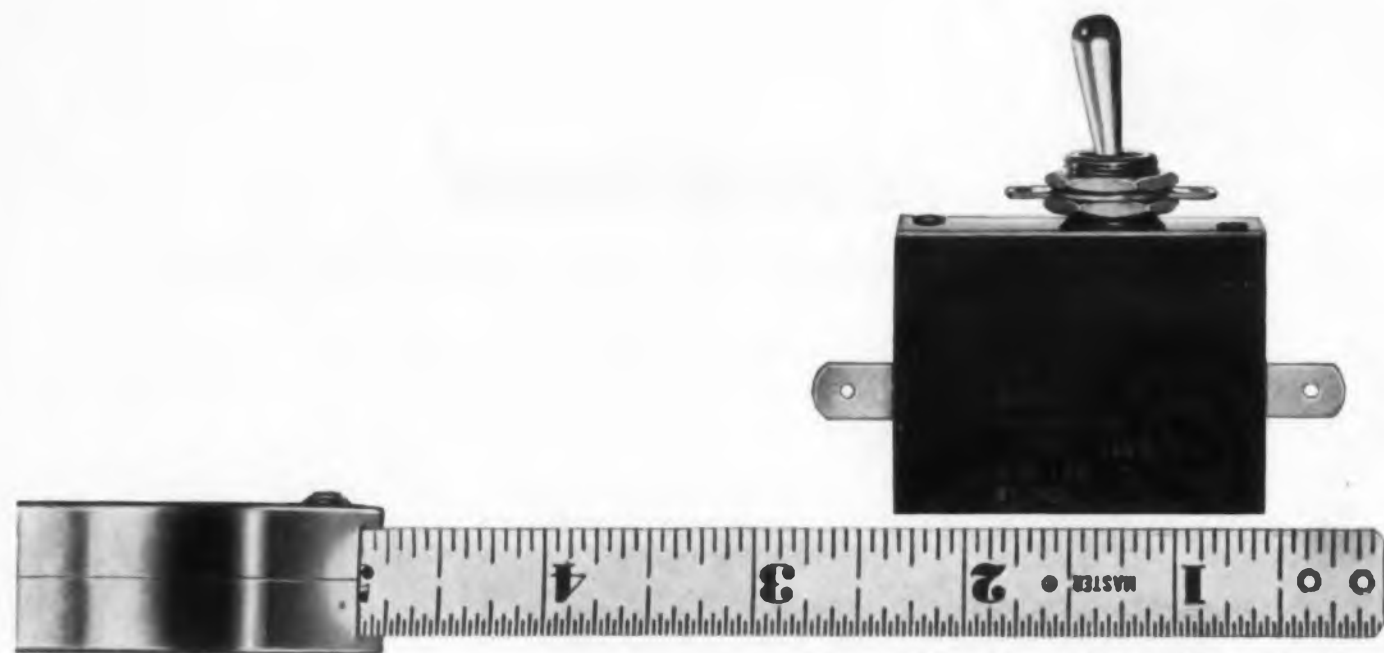

Try this breaker for size

CIRCLE 101 ON READER-SERVICE CARD

NEW PRODUCTS

Flat-Bed Recorders

573

Plot log, linear and root functions

These recorders, models 1813, 1815 and 1817, plot a fixed audio frequency input signal from 500 to 2500 cps with respect to angular position in cartesian coordinates. Functional responses include logarithmic, linear and square root, or combinations. Pen speed is 25 in. per sec, max; chart-plotting speed is 5 in. per sec, max, with a static positional accuracy within 0.02 in.

Antlab, Inc., Dept. ED, 6330 Proprietors Road, Worthington, Ohio.

Price: Prices from \$4990 to \$5950, depending on plotting function.

Rate Gyro

661



Has a quadrilever spring

Type M-100 6-oz rate gyro, having a quadrilever spring, provides constant damping without heaters. It measures $2\frac{5}{8}$ in. long and operates over the temperature range of -65 to $+250$ F. Damping is accomplished by the positive-displacement technique. The unit is suited for military aircraft and guided missile application, as well as for autopilot damping, radar antenna stabilization, and control installations.

Minneapolis-Honeywell Regulator Co., Dept. ED, 40 Life St., Boston, Mass.

Spiral Cable Wrapping

517

Available in nylon and polyethylene

Spiral cable wrapping is available in nylon (Type N), clear polyethylene (Type F) and white flame-resistant polyethylene (Type R). It will wrap cables from $\frac{1}{16}$ to 4-in. in diam. The wrapping is flexible, and is suitable for door hinge cables or isolated runs. It is removable and reusable. It is applied with a simple wiring tool supplied with the wrapping. Lengths of 100 and 1,000 ft are available.

Panduit Corp., Dept. ED, 14461 Waverly Ave., Midlothian, Ill.



**FOR
YOUR COPY
OF THE
MOTOROLA
POWER
TRANSISTOR
HANDBOOK**

**Contact These
DISTRIBUTORS**

| | |
|--|---|
| BIRMINGHAM Ack Semiconductors, Inc. 3101 Fourth Ave., So. FAirfax 2-0588 | LOS ANGELES Kieruff Electronics 820 W. Olympic Blvd. Richmond 8-2444 |
| BOSTON Cramer Electronics, Inc. 811 Boylston St. COpley 7-4700 | MELBOURNE, FLA. Electronic Supply 1301 Hibiscus Blvd. Parkway 3-1441 |
| Lafayette Radio 110 Federal St. HUBbard 2-7850 | NEWARK, N. J. Lafayette Radio 24 Central Ave. Market 2-1661 |
| CAMDEN General Radio Supply Co. 600 Penn St. WOODlawn 4-8560 | NEW YORK Lafayette Radio 100 6th Ave. WOrth 6-5300 |
| CEDAR RAPIDS Deeco Inc. 618 First St., N. W. EMpire 4-2493 | Milgray Electronics 136 Liberty St. REctor 2-4400 |
| CHICAGO Allied Radio Corp. 100 N. Western Ave. HAYmarket 1-6800 | OAKLAND Elmar Electronics 140 11th St. TEmplebar 4-3311 |
| Newark Electronics Corp. 223 W. Madison St. STate 2-2944 | PHOENIX Radio Specialties 917 N. 7th St. ALPine 8-6121 |
| Semiconductor Specialists, Inc. 5706 W. North Ave. NAtional 2-8860 | SAN DIEGO San Delco 3831 Park Blvd. CYpress 8-6181 |
| DENVER Inter-State Radio & Supply 1200 Stout Street TA 5-8257 | SEATTLE Elmar Electronics 3466 E. Marginal Way MAIn 3-6456 |
| DETROIT Radio Specialties Co. 12775 Lyndon BRoadway 2-4200 | WASHINGTON, D. C. Electronic Industrial Sales 2345 Sherman Ave., N. W. Hudson 3-5200 |
| HOUSTON Lenert Co. 1420 Hutchins CApitol 4-2663 | CANADA Canadian Motorola Electronics Ltd. 105 Bartley Drive Toronto 16, Ontario PL 9-2222 |
| JAMAICA, N. Y. Lafayette Radio 165-06 Liberty Ave. AXtel 1-7000 | |



CIRCLE 102 ON READER-SERVICE CARD

ELECTRONIC DESIGN • October 12, 1960

a valuable *new*
reference
book for circuit
engineers . . .

MOTOROLA'S

**power
transistor
handbook**

PRICE \$2

FOR YOUR COPY OF THE NEW POWER TRANSISTOR HANDBOOK
CONTACT THESE DISTRIBUTORS or write Motorola Semiconductor

Products Inc., Dept. PTH, 5005 East McDowell, Phoenix, Arizona
Birmingham, Ack Radio Supply Co. / Boston, Cramer Electronics, Inc.,
Lafayette Radio / Camden, General Radio Supply Co. / Cedar Rapids, Bunn
Inc. / Chicago, Allied Radio Corp., Newark Electronics Corp., Semiconductor
Specialists, Inc. / Denver, Inter-State Radio & Supply / Detroit, Radio
Specialties Co. / Houston, Lenert Co. / Jamaica, N. Y., Lafayette Radio /
Los Angeles, Kieruff Electronics / Melbourne, Fla., Electronic Supply /
Newark, N. J., Lafayette Radio / New York, Lafayette Radio, Milgray
Electronics / Oakland, Elmar Electronics / Phoenix, Radio Specialties /
San Diego, San Delco / Seattle, Elmar Electronics / Washington, D. C.,
Electronic Industrial Sales

Here's the first book of its kind — a 200 page manual dealing exclusively with power transistor theory, design considerations and applications. It has over 200 illustrations and circuit diagrams. You'll find it a valuable addition to your reference bookshelf. And, it's available for only \$2 from your Motorola Semiconductor distributor listed below.



9 CHAPTERS COVER . . .

(1) Semiconductor Electronics, (2) Transistor Characteristics (Mechanical — Electrical — Thermal — Characteristic Curves — Maximum Ratings), (3) Power Amplifiers, (4) Power Transistor Switching Applications, (5) Electronic Ignition Systems, (6) Special Transistor Circuits, (7) Power Supplies and Power Rectification, (8) Transistor Testing, (9) Transistor Specifications

LOOK TO MOTOROLA FOR ALL
YOUR POWER TRANSISTOR NEEDS

- Both Diamond (TO-3) and Doorknob (TO-36) packages
- 3, 5, 10, 15 and 25 amp series ● Up to 120 volts
- Special "Meg-A-Life" types offering military quality devices for industrial applications
- Only Motorola power transistors offer 90 watts dissipation (150 watts in TO-36), 0.8°C/W maximum thermal resistance (0.5°C/W in TO-36) and 100°C junction operating temperature.

IMMEDIATELY AVAILABLE
from the authorized
distributors
listed below.



MOTOROLA
Semiconductor Products Inc.

A SUBSIDIARY OF MOTOROLA, INC.

District Offices: Boston, Chicago, Detroit, Los Angeles, Minneapolis, New York, Philadelphia, Orlando, San Francisco, Syracuse and Washington, D.C.

CIRCLE 103 ON READER-SERVICE CARD



Westinghouse

**SILICON POWER
RECTIFIERS
AND
TRANSISTORS**

NOW IN STOCK

**YOU CAN OBTAIN
UP TO 1000 PIECES
OF MOST TYPES
AT
FACTORY PRICES
FROM**

Schweber

ELECTRONICS

60 HERRICKS ROAD.

MINEOLA, L. I., N. Y.

PIONEER 6-6520.

TWX G-CY-NY-580U

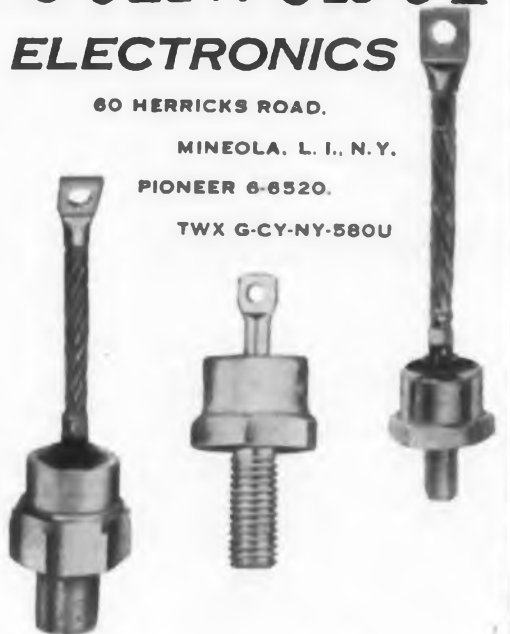

CIRCLE 104 ON READER-SERVICE CARD

**new
low
prices**

**ON WESTINGHOUSE
SILICON POWER
TRANSISTORS**

**PRICES
REDUCED
UP TO 40%!**

AVAILABLE NOW IN ANY QUANTITY! Now you can have the proven quality and reliability of Westinghouse Silicon Power Transistors at the lowest cost yet. Types 2N1015 and 2N1016 are available in 30, 60, 100, 150 and 200 volt ratings in production quantities to meet your requirements at all times. Because these transistors have **True Voltage Ratings**, they can be operated continuously at full published voltage ratings without risk of failure.

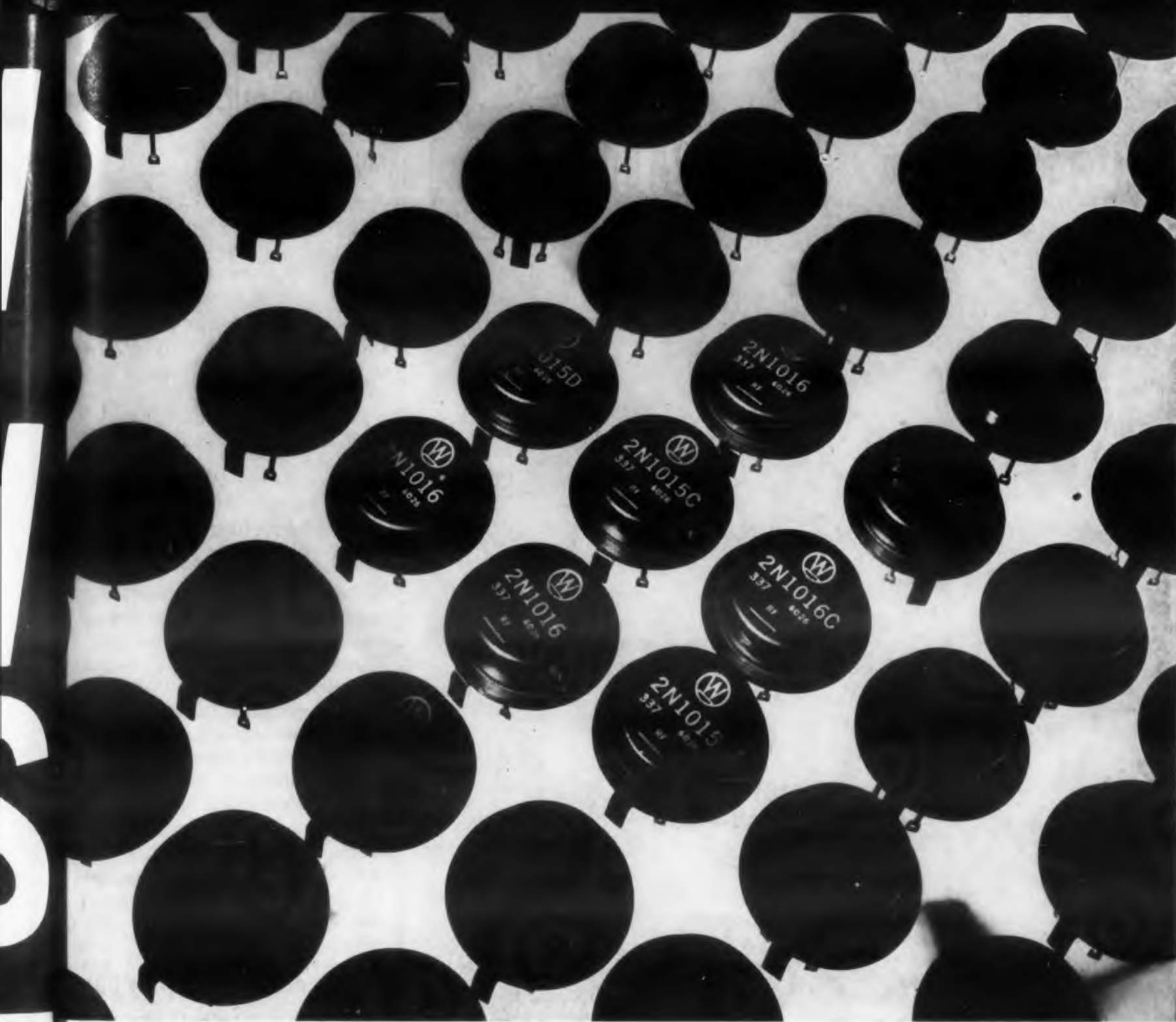

Westinghouse

SILICON POWER
RECTIFIERS
AND
TRANSISTORS

NOW IN STOCK

YOU CAN OBTAIN
UP TO 1000 PIECES
OF MOST TYPES
AT
FACTORY PRICES
FROM

Schweber

ELECTRONICS

60 HERRICKS ROAD,
MINEOLA, L. I., N. Y.
PIONEER 6-6520.
TWX G-CY-NY-580U



CIRCLE 105 ON READER-SERVICE CARD
← CIRCLE 106 ON READER-SERVICE CARD

Other Westinghouse Transistor advantages include:

- High Power . . . up to 150 watts
- Collector current to 7.5 amperes
- Junction temperature to 150° C
- Designed to meet or exceed MIL specifications
- Extremely low saturation resistance

Present industrial and military applications include: Inverters • Regulators • Amplifiers • High Power Switching • Telemetry • Guidance • Power supplies.

For additional information, and quotation of new low prices, call your nearest Westinghouse representative or semiconductor distributor. Or write: Westinghouse Electric Corporation, Semiconductor Department, Youngwood, Penna. You can be sure if it's



Each Westinghouse Silicon Power Transistor is guaranteed by 100% power testing before shipment.



True Voltage Ratings—you can operate Westinghouse Silicon Power Transistors at full rating without risking transistor failure.

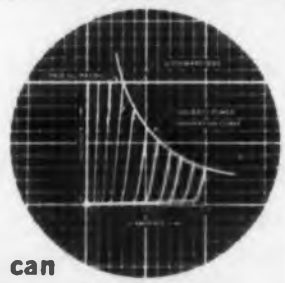

For immediate "off-the-shelf" delivery, order from these Westinghouse distributors:

| EASTERN | | MIDWESTERN | |
|--------------------------------|------------------------------|--|-------------------------------|
| CAMERADIO | Pittsburgh, Pa./EX 1-4000 | ELECTRONIC COMPONENTS FOR INDUSTRY CO. | St. Louis, Mo./WO 2-9917 |
| CRAMER ELECTRONICS, INC. | Boston, Mass./CO 7-4700 | INTER-STATE RADIO & SUPPLY CO. | Denver 4, Colo./TA 5-8257 |
| ELECTRONIC SUPPLY | Melbourne, Florida/PA 3-1441 | LENERT CO. | Houston, Texas/CA 4-2663 |
| GENERAL RADIO SUPPLY CO., INC. | Camden, N.J./WO 4-8560 | RADIO DISTRIBUTING CO. | Indianapolis, Ind./ME 7-5571 |
| KANN-ELLERT ELECTRONICS, INC. | Baltimore, Md./TU 9-4242 | SEMICONDUCTOR SPECIALISTS, INC. | Chicago, Ill./NA 2-8860 |
| MILGRAY ELECTRONICS | New York, N.Y./RE 2-4400 | UNITED RADIO, INC. | Cincinnati, Ohio/MA 1-6530 |
| RADIO & ELECTRONIC PARTS CORP. | Cleveland, Ohio/UT 1-6060 | WHOLESALE ELECTRONICS SUPPLY | Dallas, Texas/TA 4-3001 |
| SCHWEBER ELECTRONICS | Long Island, N.Y./PI 6-6520 | WESTERN | |
| | | ELMAR ELECTRONICS | Oakland, Calif./TE 4-3311 |
| | | HAMILTON ELECTRO SALES | Los Angeles, Calif./BR 2-8453 |
| | | NEWARK ELECTRONICS CO. | Inglewood, Calif./OR 4-8440 |

SC-1001

General Electric Offers . . .

2 New Compact, Lightweight VTM's



NEW HIGH-POWER (50 W MIN.) VOLTAGE-TUNABLE MAGNETRON

Type Z-5424

2900 to 3200 mc. Specially designed for airborne ECM, remote telemetry, data link systems and rapidly tuned radar. Compact and lightweight . . . a 42.5 cu. inch package, weighing only 4.5 lbs. Gives approximately 60 percent conversion efficiency.



NEW COMPACT VOLTAGE-TUNABLE MAGNETRON—ONLY 24 oz.

Type Z-5337

2900 to 3100 mc. 4 watts (min.) output. Bowl-magnet design reduces size (only 15 cu. inches) as well as weight. Also offers increased reliability. One of several similar designs ranging from 1625 to 4400 mc., with outputs in the order of 2 watts. Now available for applications in missiles and aircraft.

General Electric VTM line offers you these outstanding features...

LINEAR TUNING permits design of simpler circuits. **HIGH EFFICIENCY** eliminates need for forced air-cooling. Reduced battery load increases battery life. **UNIFORM POWER SPECTRUM** assures driving traveling-wave tubes at optimum conditions. **SMALL SIZE** aids in design of compact, lightweight equipments.

SELECT, THEN SPECIFY General Electric VTM's. For application engineering assistance in simplifying new or retrofit circuits . . . for sample price and availability, contact nearest G-E Power Tube Sales Office. Bulletins PT-1 and PT-39 available. *Power Tube Department, Section 8481-30, General Electric Company, Schenectady 5, New York.*

265-02

POWER TUBE DEPARTMENT

GENERAL  ELECTRIC

G-E Power Tube Department FIRST with the finest in:

- Ignitrons
- Thyratrons
- Magnetrons
- Metal-ceramic tetrodes
- Camera pick-up tubes
- Traveling-wave tubes
- Parallel-plane microwave tubes
- High-power duplexers
- High-power waveguide filters
- Klystrons

NEW PRODUCTS

Silicon Rectifiers 498

Have ratings to 1.5 amp

The BC20 series silicon-rectifier assemblies are rated up to 1.5 amp at 100 C. The piv ratings range to 6,000 v with derating of forward current to zero at 190 C. Various circuits can be supplied with up to six hermetically sealed diodes and six terminals.

Bradley Semiconductor Corp., Dept. ED, 275 Wolton St., Hamden, Conn.

Sensitive Relay 499

For airborne and missile use

Series 10,000 close-differential sensitive relay meets the airborne and missile requirements of MIL-R-6106C and MIL-R-5757C. Relays are offered in spdt and dpdt configurations with 2-amp contacts. The operate and release voltages range from 5 to 150 v dc with accuracy maintained from -65 to +200 C. Units stand 20-g vibration from 10 to 2,000 cps and 50-g shock.

Electro-Mechanical Specialties Co., Inc., Dept. ED, 528 W. Lambert Road, Whittier, Calif.

Germanium Transistor 501

For high-speed switching

An npn germanium-alloy high-speed switching transistor, type 2N1605, is similar electrically and mechanically to its pnp counterpart, type 2N404. The device has a collector-to-base voltage of 25 v max, a collector current of 200 ma max, a power dissipation of 150 mw at 25 C, and a maximum junction temperature of 100 C. The devices have a TO-5 JEDEC package.

Sylvania Electric Products, Inc., Dept. ED, 100 Sylvan Road, Woburn, Mass.

Price & Availability: Type 2N1605, \$1.45 in lots of 1 to 99, \$0.98 in lots of 100 to 999; type 2N404, \$1.50 and \$1. Delivery is from stock.

Potentiometer 500

Linearity is $\pm 0.5\%$

Model 7216 has standard resistances of 10 to 125,000 ohms and $\pm 0.5\%$ standard linearity. Diameter is $7/8$ in., shaft diameter is $1/4$ in. and bushing mount is size $3/8-32$. The 10-turn unit is rated at 2 w at 25 C, derating to zero at 85 C. Minimum operating temperature is -55 C.

Beckman Instruments, Inc., Helipot Div., Dept. ED, 2500 Fullerton Road, Fullerton, Calif.

Tape Recorder-Reproducers 420

For telemetry and video applications

Model C-100 instrumentation recorder-reproducer is suitable for telemetry applications. The transistorized system has modular construction, dynamic braking, instantaneous selection of six speeds, and dc operation. Bandwidth is 50 cps to 120 kc. The Model CM-100 unit is a multi-speed video band recorder-reproducer capable of both analog and pulse recording. At 120 ips, this device has a frequency range of 400 cps to 1 mc on each of seven video tracks.

Minnesota Mining and Manufacturing Co., Mincom Div., Dept. ED, 2049 S. Barrington Ave., Los Angeles 25, Calif.

Tape Reader 496

Bi-directional

This bi-directional, high-speed perforated tape reader, designated model B3500, operates on loops or strips of tape. A spooler is available at speeds to 300 characters per sec with 8-in. reels. The standard unit is complete with power supply, gating and shaping circuits, and amplifiers. The unit is designed for rack mounting.

Digitronics Corp., Dykor Tape Reader Div., Dept. ED, Digitronics Corp., Albertson, L.I., N.Y.

Price & Availability: \$2,830 ea in quantities of one to four; 30- to 45-day delivery.

Eight channels on a 7" high single chassis, provide economical, general purpose recording . . . choice of two amplifier types — low gain (0.01 to 500 volts); high gain 10 uv to 100mv.

8-channel direct writing "350" style recorder in a single 17½" high package . . . immediately visible inkless traces made by heated stylus on rectangular coordinate charts, at any of 9 electrically controlled chart speeds.

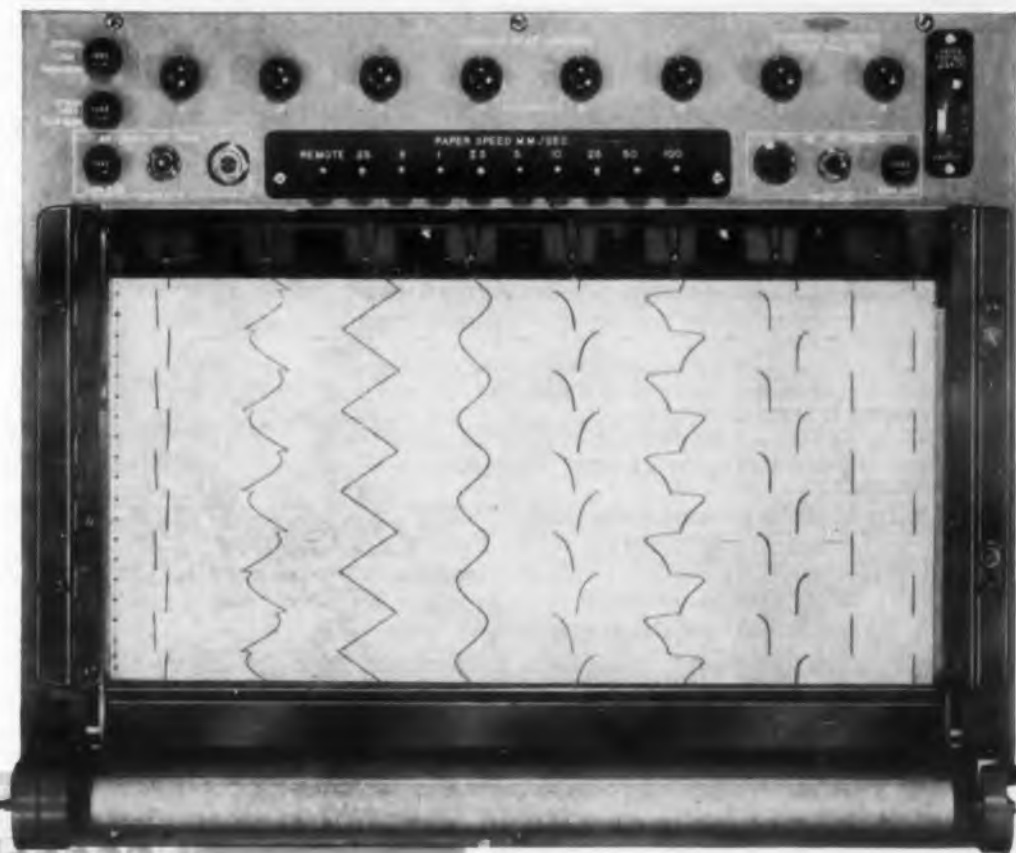

PRACTICAL ECONOMY and WIDE USEFULNESS in a NEW SANBORN DIRECT WRITER

FOR MANY channels of accurate and economical microvolt to volt general purpose recording, investigate the performance and price of this new Sanborn "950" system. Choice of transistorized high or low gain amplifiers for stability, instantaneous operation and low power consumption.

With Model 958-1000 High Gain Amplifier

With Model 958-2900 Low Gain Amplifier (also 958-2900A without zero suppression)

| Input Range | Input Impedance | Common Mode Voltage | Common Mode Rejection | Frequency Response | Zero Suppression |
|------------------------------------|--|---|--|--|--|
| 10 uv to 2mv/div. | 10000 ohms all ranges. Floating and grounded | ± 200 volts max. | 140 db min. DC 120 db min. at 50 cps with no unbalance 100 db min. at 60 cps with 5000 ohm unbalance | 0-100 cps within 3 db at 10 div peak-to-peak | None |
| 10 to 500 mv/div and 1 to 10 v/div | 3 megohms each side balanced to ground | ± 2.5 v max. in most sensitive range; increasing to ± 500 v on others | 34 db on most sensitive range; 28 db on all other ranges | 0-150 cps within 3 db at 10 div peak-to-peak | For Model 958-2900 ± 32 input, single-ended or balanced inputs |

(Specifications and prices subject to change without notice)

Get complete "950" information from any Sanborn Sales-Engineering Representative, located in principal cities throughout the United States, Canada and foreign countries.

SANBORN COMPANY INDUSTRIAL DIVISION 173 Wyman Street, Waltham 54, Mass.

New Gertsch Freq Meter

MEASURES AND GENERATES: 20 mc to 1000 mc

ACCURACY: 0.0001%, exceeding FCC requirements 5 times

MODULATION: AM, 30% at 1000 cps; FM, 1 kc at 30 mc
5 kc at 150 mc, or 15 kc at 450 mc max.

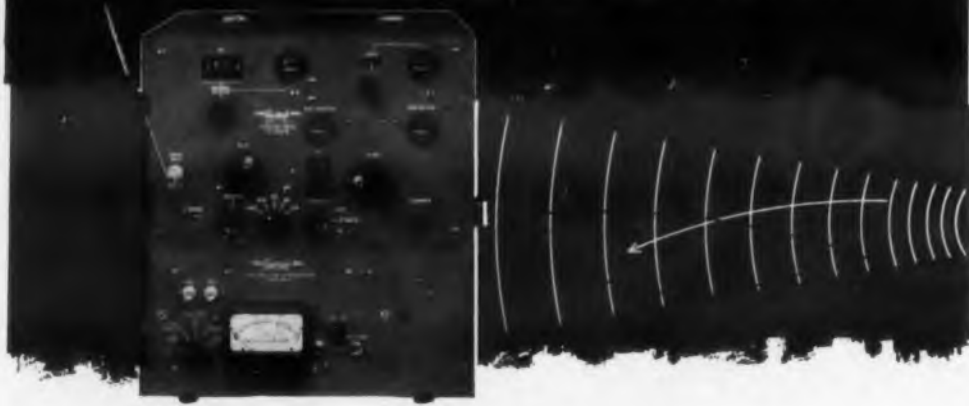

This portable instrument in one complete package enables you to measure both frequency and frequency deviations in the maintenance of mobile communications systems.

As optional equipment the FM-7 Frequency Meter can be combined with the new DM-3 Deviation Meter as illustrated. The DM-3 is a dual-range deviation meter with 15 kc and 7.5 kc full scales.

By combining the FM-7 and the DM-3 you get a single instrument capable of measuring and generating carrier frequencies plus reading peak modulation deviation.

Write for complete literature.

Gertsch

GERTSCH PRODUCTS, Inc.

3211 South La Cienega Boulevard, Los Angeles 16, California • UPlon O-2761 - VErmont 9-2201

CIRCLE 109 ON READER-SERVICE CARD

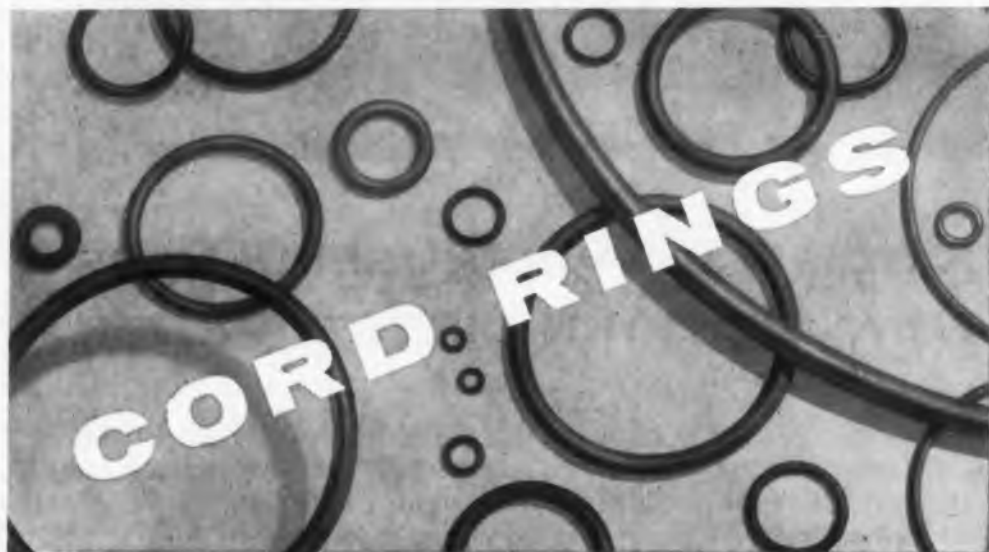

...by WESTERN are better!

Because now, at no extra cost, the principle hazard found in ordinary seal rings has been removed by Western's *No Splice* method of one-piece construction. In addition, dimensional requirements are maintained at less cost and service is vastly improved.

Don't use a spliced ring for technical seal applications, but profit from our more than 50 years experience—specify *Cord Rings* by Western.

Write or phone for information or a visit by our sales engineer in your area.



WESTERN RUBBER CO.

GOSHEN 7, INDIANA

MOLDED AND LATHE-CUT RUBBER PARTS FOR ALL INDUSTRIES

CIRCLE 110 ON READER-SERVICE CARD

NEW PRODUCTS

Printed Circuit Laminate 591

For the hot stamping method

Laminate 200XP, developed for the hot stamping method of printed circuitry, has a prepared surface for adherence to copper and the capability of absorbing deformation from stamping. It can be punched easily and cleanly and it has X-grade dielectric characteristics. The material is a paper-base grade and is available in several sizes up to 36 x 72 in.

Reiss Associates, Inc., Dept. ED, Reiss Ave., Lowell, Mass.

Power Dividers 670

For microwave systems



These variable power dividers are intended to be used in the design of microwave components where a variable power source is needed for test purposes. Four models, ranging in frequency from 2.6 to 17 kmc, are offered. The units can also function as duplexers, devices used to mix two signals of different frequencies while maintaining considerable isolation between them. An isolation of 25 db or more between transmitter and receiver is possible.

Bomac Laboratories, Inc., Dept. ED, Salem Rd., Beverly, Mass.

Pushbutton Switch 575

Weighs 3.5 gm

This 3pst subminiature pushbutton is designed for rugged applications in survival kits, missiles and ground-support equipment. Contact rating is 2-amp, resistive, and 1-amp, inductive, at 29 v dc or 115 v ac. Type PM-7 is normally open, and type PM-8 normally closed. Electrical life is rated at 10,000 on-off cycles at 100 cpm. The switch meets MIL specs for environmental conditions.

Allied Control Co., Inc., Dept. ED, 2 East End Ave., New York 21, N. Y.

Price & Availability: Available from stock; priced at \$2.71 in quantities less than 25.

300% FASTER ULTRASONIC CLEANING*



WITH THE NEW SELF TUNING AUTOSONIC BY POWERTRON

Powertron Autosonics are the only cleaners that continuously tune themselves electronically to give you peak cleaning efficiency. Regardless of load changes, liquid level, liquid temperature, or operator inattention, you get top cleaning performance hour after hour with no controls other than a single switch.

The Powertron self tuning feature is available in a complete line of Autosonic tank units, consoles, cabinet models, immersible transducers, and vapor degreasers that...

ELIMINATE OPERATOR TRAINING AND MONITORING
IMPROVE QUALITY
REDUCE REJECTS
CUT LABOR AND SOLVENT COSTS

*Case histories on file show up to 900% faster cleaning consistently and savings as high as \$3,000 a month in labor costs under ideal conditions.



Send for Powertron's free booklet 60-1, "How to Clean Ultrasonically with Self Tuning."

POWERTRON ULTRASONICS CORPORATION

DEPT. ED-10 • PATTERSON PL., ROOSEVELT FIELD
GARDEN CITY, L.I., N.Y. • Pioneer 1-3220

CIRCLE 111 ON READER-SERVICE CARD

Impulse Counters 702

Come in two types

Types TCe7E and TCe8E 7- and 8-digit electric impulse counters can be furnished with counting speeds of 25 or 10 impulses per sec. The units occupy 1.653 x 1.22 x 4.37 in. and are suitable for flush mountings. For the 10-impulse unit, the power requirement is 1.6 w at 24 v dc.

Landis & Gyr, Inc., Dept. ED, 45 W. 45th St., New York 36, N.Y.

Diode Tester 703

Measures recovery time

This diode tester measures recovery time in accordance with JAN 256. It operates on a go/no-go basis; no oscilloscope presentation is necessary. Reverse voltage is adjustable from 0.1 to 100 v; forward current bias is continuously adjustable from 1 ma to 1 amp, and recovery current is continuously variable from 5 to 1,000 μ a in two ranges. Internal switch time is 1 nsec. Adjustable discrete time intervals at which the recovery current is measured in four settings are 0.1, 0.2, 0.3 and 0.4 μ sec.

Contronics, Inc., Dept. ED, 37 Leon St., Boston, Mass.

Price: \$2,700.

Switching Transistors 686

For military and commercial use

These three types of high-speed switching transistors are for military and commercial data processing systems. Type 2N706 silicon npn transistor has a storage time of 60 μ sec at an I_c of 10 ma, a minimum beta of 20, and a dissipation of 1 w at 25 C. Type 2N706-A, also an npn, silicon unit, has a storage time of 25 μ sec at an I_c of 10 ma. Type 2N1683 has a typical beta of 85 at an I_c of -40 ma and a dissipation of 150 mw at 25 C; its stored charge is low. Units meet Mil specs.

Radio Corp. of America, Semiconductor & Materials Div., Dept. ED, Somerville, N.J.

a new look in counters

AND NEW RELIABILITY, TOO

CMC was first to introduce the all-transistor 10 megacycle counter. Now CMC scores another important first with its complete new line of vacuum tube counting, timing and frequency measuring equipment. Note the clean, functional lines of these tastefully styled instruments... user engineered to eliminate costly "cockpit trouble". These instruments are the most reliable vacuum tube counters ever built. In the counter-timer below, for example, nine tubes have been eliminated. New modular circuitry simplifies maintenance and reduces weight. Unitized construction is exceptionally rugged. And to further simplify matters, all models have three key components in common—input amplifiers, power supplies, and shaping circuits. In short, these instruments will give you long, trouble-free operation.

BUT SEEING IS BELIEVING—Your nearby CMC engineering representative will be happy to arrange a demonstration and provide complete technical data. Or you can write us direct. Dept. 36.

CMC's Model 226B Universal Counter-Timer (1 mc) leads a complete new line which includes a 220 kc universal counter-timer, a time interval meter and a frequency-period meter.



PRICES:
Model 226B, \$1175; Model 226BN, illustrated, \$1445 with Nixies;
Model 225C, \$900; Model 203B, \$995; Model 251B, \$915. Rack mount \$10 extra. F.O.B. Sylmar, California.

CMC

32

Computer Measurements Co.

A Division of Pacific Industries

12970 Bradley Avenue, Sylmar, California
Phone: EMpire 7-2161



It's Bonded

Every one of these hermetic connectors has the Deutsch Seal... a glass-to-metal bond that guarantees you leakproof performance. The unique compression glass insert is molded as one solid piece, with steel contacts fused in and numbers imbedded in the glass for quick identification. Every year is a vintage year at Deutsch because each hermetic receptacle is manufactured under quality control procedures that have set new standards in the industry. For more information on the connector with bonded performance, contact your local Deutschman or write for Data File C-10.

DEUTSCHI
Electronic Components Division
Municipal Airport • Banning, Calif.

ADVANCED SPECIFICATION MINIATURE ELECTRICAL CONNECTORS
CIRCLE 113 ON READER-SERVICE CARD

NEW PRODUCTS

Transistorized Digital Translators

588

Ten decimal digit capacity

The TR-100 Series of transistorized digital translators is designed to convert binary-coded input signals to decimal and/or binary-coded decimal outputs. Storage acquisition time is 20 μsec, translation time is 20 μsec per decimal digit. Each translator has a maximum capacity of 26 standard Datex CM-100 Series Circuit Modules.

Datex Corporation, Dept. ED, 1307 S. Myrtle Ave., Monrovia, Calif.

Cable Supports

621

Molded nylon

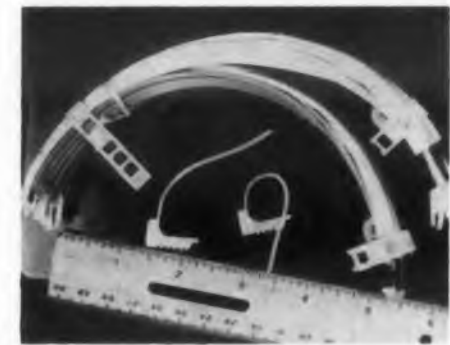

Anviloc molded Nylon supports for wire bundles and harnesses are adjustable for 3/8 to 3/4 in. bundles. No tools are required for bundle-installation, and wires can be added or removed without changing the support. The supports have been tested up to 20 g at 2,000 cps, and at 120 g shock. Temperature range is -75 to +175 F.

Roberts Engineering Group, Dept. ED, P.O. Box 305, Los Alamitos, Calif.

Price & Availability: Supports are priced at \$9.75 per 100 in quantities to 2,500, \$8.29 per 100 in quantities to 5,000. Delivery is immediate.

Binary Bits Transceiver

589

Transmits 2400 bits per second

Model S-C 301 transceiver, which uses solid-state circuitry exclusively, makes direct transmission between high speed data equipments possible over regular commercial telephone lines at a rate of 2,400 bits per second. The input signal may be polar or impulse type binary information. An automatic frequency control system eliminates the need for synchronizing signals.

Stromberg-Carlson, Dept. ED, Rochester 3, N.Y.

Availability: Delivered immediately in sample quantities, in 180 days in production quantities.

Magnetic Detector 693

For use near recording media

Model 700M magnetic detector can measure the magnetic field intensity near the surface of recording media such as magnetic tapes and memory disks and drums. Comprised of a high-gain, low-noise, narrow-bandwidth amplifier and an indium-antimonide Hall effect probe, the unit can resolve 5 millionths of 1 sq in. Its applications include use by magnetic tape manufacturers for quality control where magnetic field of tape samples can be measured in a stationary state.

Halex, Inc., Dept. ED, 310 E. Imperial Highway, El Segundo, Calif.

Price & Availability: \$4,600; 60 to 90 days.

Microwave Components 404

Are interchangeable

Model Z116A universal carriage assembly and series 115 slotted sections have been added to the firm's line of interchangeable microwave components. The slotted sections are obtainable in frequency ranges from 3.95 to 18 kmc. Their insertion length is 10-3/8 in. and slot width is 0.1 in. The carriage is equipped with a vernier scale which can be read to 0.1 mm.

FXR, Inc., Dept. ED, 25-26 50th St., Woodside 77, N. Y.

Telemetry System 704

Measures phenomena at 30,000 miles

Radiation and other phenomena at altitudes to 30,000 miles are measured and telemetered by this 2-lb instrument. The system designated Digilock, has been designed for the Air Force Journeyman sounding rocket. It has 250-mw transmitting power and will operate for 15 hr from a 1-1/8 lb battery. Data rate can be either 64 or 256 bits per second.

Space Electronics Corp., Dept. ED, Glendale, Calif.

CIRCLE 117 ON READER-SERVICE CARD ➤



How to get accurate data on a small recorder

Ampex's new CP-100 nicely balances four desirable qualities

Compact. Definitely, and a great advantage in trailers, in airplanes, in submarines, or even in regular laboratory use. There's complete front access to everything. All-transistor amplifiers and power supplies cut power needs and keep down the heat — an advantage in tight equipment layouts.

Portable. We'll frankly admit it takes two men to carry it — not just one and a half. But by calling in an occasional fractional man (or by using an accessory dolly) you gain exactly the needed performance that portables have lacked until now. In laboratory use, the CP-100 is "bench-top equipment."

Precise. Let the numbers talk. Though compact, the CP-100 is a full-fledged, uncompromised laboratory recorder: 200 kc response at 60 ips tape speed (and proportional at others); flutter well within telemetered-data requirements; intermodulation distortion so low it never adds spurious data of its own.

Universal. Yes, in numerous ways. The CP-100 isn't fussy about power; takes 115 or 230-volt AC at 50, 60 or 400 cycles or 28-volt DC from batteries or generator. Kinds of data: direct or FM-carrier, by interchangeable plug-in amplifiers. And it records and plays back as well.

The essential data

Model: CP-100 Compact Recorder/Reproducer. Reel size and tape width: 10 1/2-inch reels with 1/2- or 1-inch tape (as specified). Types of recording: direct or FM carrier by plug-in interchangeable amplifiers. Tape speeds: 60, 30, 15, 7 1/2, 3 3/4 and 1 1/2 ips. Frequency response: direct, 300 to 200,000 cps ± 3 db at 60 ips; FM carrier, 0 to 20,000 cps at 60 ips; response at other speeds proportionate. Tape compatibility: yes, with Ampex FR-600, AR-200 or interchangeable with FR-100, FR-1100, 300 and 800 series.

May we tell you more? Please write



AMPEX DATA PRODUCTS COMPANY
Box 5000 • Redwood City, California • EMerson 9-7111

NEW PRODUCTS

Water-Cooled Rectifiers 685

Cover 50 to 200 piv

The ZB series of 1,000-amp, water-cooled rectifiers covers the piv range of 50 to 200 v. Approximate rectifier voltage drop is 1 v. Maximum peak current is 6,000 amp. Total volume required for each device is less than 60 cu in.

Sarkes Tarzian Inc., Semiconductor Div., Dept. ED, 415 N. College Ave., Bloomington, Ind.

AC Power Supply 688

Outputs are 0 to 500 va

The Varivolt ac power supply handles loads ranging from 0 to 500 va. Operating from a 115-v, 60-cps, single-phase input, the unit provides a regulated 60-cps output voltage adjustable from 0 to 260 v. Magnetic voltage regulation holds the output voltage within $\pm 0.5\%$ of maximum for line input variations from 95 to 130 v ac. Typical load regulation is less than 5% for a load change of 50%. Response time is 2 cps and harmonic distortion does not exceed 3%.

Raytheon Co., Sorensen & Co., Dept. ED, Richards Ave., S. Norwalk, Conn.

Power Transformers 697

For missile and aircraft use

Series 1-19 power transformers, for missile and aircraft use, are rated from 0.5 to 175 va with output voltages up to 3,000 v. They meet MIL-T-27A and MIL-STD-202 requirements for shock, vibration, and humidity. Units have integrally cast mounting holes for attachment to chassis or printed-circuit board. Straight pins, hooked pins, and flexible Teflon leads can be furnished.

Arnold Magnetics Corp., Dept. ED, 6050 W. Jefferson Blvd., Los Angeles 16, Calif.

Availability: Prototypes can be supplied on short delivery.

No, it's not a transistor..



... it's the new Spectrol ultraminiature trimmer ... the smallest trimming potentiometer on the market! Measuring 1/3" in diameter, weighing only 1 gram, and designed specifically for transistor circuits, the Spectrol Model 80 is a remarkable breakthrough in component technology.

Design engineers can now shrink printed circuit packages in all three dimensions. The single turn adjustment is from the top, rather than the side. It is ideal for printed circuit applications. Sealed construction allows complete package encapsulation.

THE MODEL 80 is approximately one-quarter the size of ordinary trimmers, yet it offers greater resolution and resettability because the resistance element is nearly twice as long. These trimmers meet all applicable military and commercial specifications including the most severe humidity cycling and immersion tests.

AND TWO NEW MINIATURE POTENTIOMETERS, TOO!

Sturdy construction provides reliable operation at a modest price. Only one-half inch in diameter, the new bantam weight Models 140 and 150 rotary potentiometers are well suited to trimming, control and servo applications where space and environmental conditions are critical. Standard linearity is $\pm 1.0\%$ with $\pm 0.5\%$ available on special order. Servo mount ball bearing type units have standard linearity of $\pm 0.5\%$. Slotted shafts are standard on all models.



SPECIFICATIONS

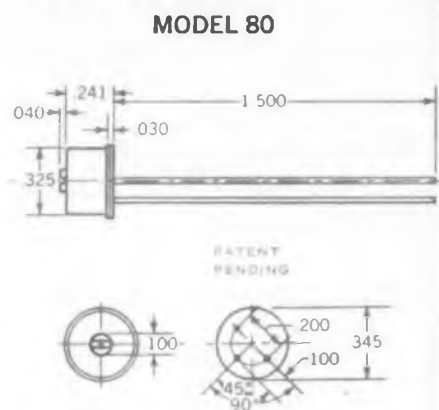

DIAMETER: 0.345"
STANDARD RESISTANCES (ohms): 50, 100, 200, 500, 1K, 2K, 5K, 10K
RESISTANCE TOLERANCE: $\pm 5\%$
NO. TURNS: ONE
POWER RATING: 1 watt at 70°C
LINEARITY: $\pm 1.0\%$
NOISE: 100 Ω ENR per NAS-710
SHOCK: 50 G
VIBRATION: 30 G to 2,000 CPS
HUMIDITY: MIL-E-5272C, Proced. I (10 days, cycling) and MIL-STD-202A, Method 104, Condition A (immersion in hot water)
SALT SPRAY: MIL-STD-202A, Method 101A, Condition A (96 hours)
LOAD LIFE: 1000 hours
WEIGHT: 1 Gram
PRICE (1-9 units): \$6.00 each

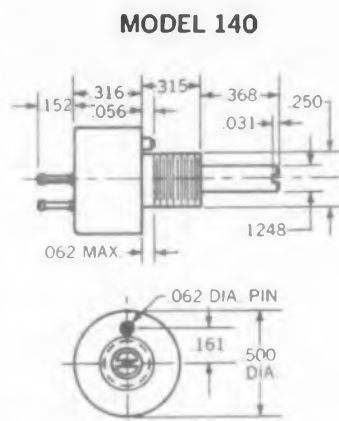

DIAMETER: 0.500"
STANDARD RESISTANCES (ohms): 50, 100, 200, 500, 1K, 2K, 5K, 10K
RESISTANCE TOLERANCE: $\pm 5\%$
NO. TURNS: ONE
POWER RATING: 2 watts at 70°C
LINEARITY: $\pm 1.0\%$ standard, $\pm 0.5\%$ special ($\pm 0.5\%$ standard on servo mount)
NOISE: 100 Ω ENR per NAS-710
SHOCK: 50 G
VIBRATION: 30 G to 2,000 CPS
HUMIDITY: MIL-E-5272C, Proced. I (10 days, cycling)
SALT SPRAY: MIL-STD-202A, Method 101A, Condition A (96 hours)
LOAD LIFE: 1000 hours
WEIGHT: 0.1 oz.
PRICE (1-9 units): \$10.00 each

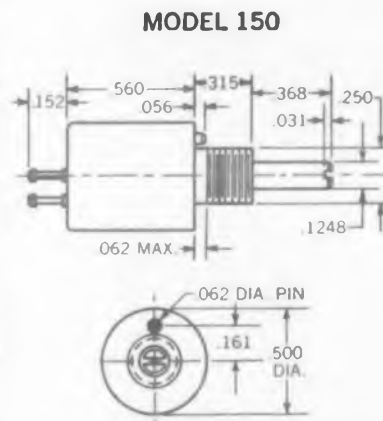

DIAMETER: 0.500"
STANDARD RESISTANCES (ohms): 20K, 50K, 70K (50 ohms to 20K also available)
RESISTANCE TOLERANCE: $\pm 5\%$
NO. TURNS: ONE
POWER RATING: 2 watts at 70°C
LINEARITY: $\pm 1.0\%$ standard, $\pm 0.5\%$ special ($\pm 0.5\%$ standard on servo mount)
NOISE: 100 Ω ENR per NAS-710
SHOCK: 50 G
VIBRATION: 30 G to 2,000 CPS
HUMIDITY: MIL-E-5272C, Proced. I (10 days, cycling)
SALT SPRAY: MIL-STD-202A, Method 101A, Condition A (96 hours)
LOAD LIFE: 1000 hours
WEIGHT: 0.15 oz.
PRICE (1-9 units): \$12.00 each

The Spectrol name, your assurance of quality. New Spectrol trimmers and miniature potentiometers are produced to the same exacting standards of quality and reliability engineered into the entire Spectrol potentiometer line... the largest selection in the industry.

Available now for immediate delivery. Standard models of Spectrol trimmers and miniature potentiometers, as well as other standard precision potentiometers, are available from your nearby Spectrol distributor. For complete technical information, contact your Spectrol engineering representative or write directly to the factory. Please address Dept. 36.



ELECTRONICS CORPORATION

1704 South Del Mar Avenue • San Gabriel, California
 Phone: ATLantic 7-9761

Manufacturers of precision and miniature wirewound potentiometers, trimmers, solid state power supplies, servo mechanisms and other precision electronic components.

CIRCLE 118 ON READER-SERVICE CARD

ELECTRONIC DESIGN • October 12, 1960

Transmitter Tube 689

For use with 2,500 mc

Designed for use as an oscillator, frequency multiplier or amplifier, type ML-7211 radio transmitter tube operates at frequencies to 2,500 mc. It is a high-mu, planar triode of ceramic and metal construction. The anode is air-cooled and the cathode is an indirectly-heated, oxide-coated disk. Heater voltage is 6.3 v at 1.3 amp.

Raytheon Co., Machlett Laboratories, Inc., Dept. ED, Springdale, Conn.

Ultrasonic Cleaner 692

Has magnetostrictive transducer

The Sonex ultrasonic cleaning system employs a magnetostrictive transducer comparable to transducers used in military applications. The system withstands tank operating temperatures up to 300 F. 350 w of power are needed to activate a 5-gal tank. The system operates at 22 kc. Tank dimensions are 15-3/4 x 10-3/4 x 14-1/2 in. and inside tank area is 14 x 9 x 9-1/2 in. The generator, a separate unit, measures 19-1/2 x 15-1/2 x 12-1/2 in.

General Instruments, Harris Transducer Corp., Dept. ED, Woodbury, Conn.

Availability: From stock.

Magnetic Loop Tracer 694

For all types of materials

The Magnetotracer is a basic lab tool for measuring the magnetic properties of thin films of magnetic materials. It measures the magnetic properties of virtually all types of magnetic materials. Magnetizing force is continuously adjustable from 0 to 1,000 oersteds. The instrument can be connected to the X and Y terminals of an oscilloscope.

Halex, Inc., Dept. ED, 310 E. Imperial Highway, El Segundo, Calif.

Price & Availability: \$6,250; 60 to 90 days.

FANSTEEL S·T·A SOLID TANTALUM CAPACITORS

Series 5 Series 6 Series 7 Series 8

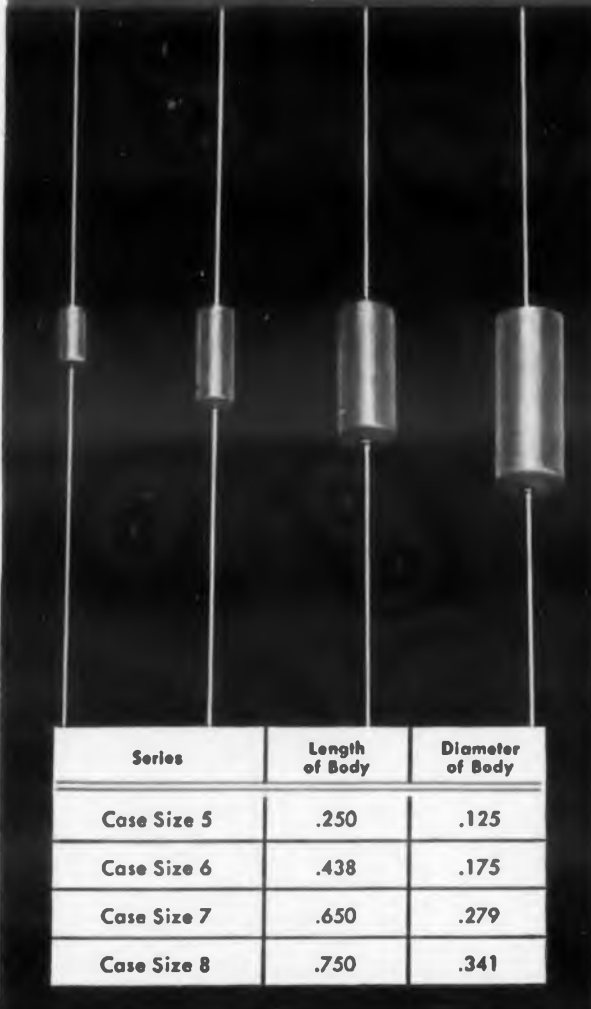

| Series | Length of Body | Diameter of Body |
|-------------|----------------|------------------|
| Case Size 5 | .250 | .125 |
| Case Size 6 | .438 | .175 |
| Case Size 7 | .650 | .279 |
| Case Size 8 | .750 | .341 |

Now
IN STOCK
In
4
Standard
Military
Case
Sizes

Adequate distributors' stocks insure overnight delivery to anywhere in the U. S. A.

Fansteel S-T-A Solid Tantalum Capacitors are available in capacity ranges of 0.033 to 330 mfd, from 6 to 35 wvdc. Construction and characteristics are perfectly suited for transistor circuitry—military or commercial.

For complete technical data, including specifications, typical curves and ordering references, write for Bulletin 6.112-5. Fansteel Metallurgical Corporation, North Chicago, Ill., U.S.A.

FANSTEEL
where reliability dictates standards

CM7A

CIRCLE 119 ON READER-SERVICE CARD

NEW PRODUCTS

L-Band Oscillator 559

For pulse and cw service



The type 9127 L-Band oscillator is end-tuned over the range of ± 25 mc at 1,090 mc. Designed for pulse and cw service, the device will provide 250-w power output at 1-kv pulse voltages or 20-mw cw output with a 60-v plate voltage. The oscillator is stable within ± 250 kc from 20 to 100 C. The unit measures 1-1/8 in. in diameter and 6 in. long, and weighs 8 oz.

Trak Electronics Co., Microwave Components Dept., Dept. ED, 48 Danbury Road, Wilton, Conn.
Availability: Immediate shipment in small lots.

Data-Transmission System 690

Transmits 62,000 characters per sec

This data-transmission multiplex system is capable of transmitting 62,000 characters per sec over a microwave relay system. It can be used to transfer data between computer centers or from gathering points to the computer location. Working from a magnetic-tape input, the equipment converts data from parallel to serial form. A single wide-band subcarrier channel is used.

Motorola Inc., Communications and Industrial Electronics Div., Dept. ED, 4501 W. Augusta Blvd., Chicago 51, Ill.

Availability: Made on order.

Memory Devices 691

Full line offered

A full line of rotating magnetic memories for commercial, industrial, and military applications is offered. The units can be furnished as computer components, laboratory test models, or console models with companion electronic circuits. A typical unit, model UMM-3A, incorporates an 8-in. disk, has a speed of 1,800 rpm, and provides a capacity of 400,000 bits. It has a write current of 30 to 60 ma, peak-to-peak; read voltage of 75 mv, peak-to-peak; less than 15% modulation pattern, and a life of over 5,000 hr.

Genesys, Dept. ED, 10131 National Blvd., Los Angeles 34, Calif.
Price & Availability: \$4,850 for model VMM-3; 30-day delivery.

Tape Recorder 567

For recording data during missile flight



This magnetic tape recorder is designed to record more than 30 sec of analog data during the flight of a surface-to-surface missile. It is able to withstand 500-g impact deceleration and 1,500-g shock without loss of recorded data. Fourteen tracks of 1-in. tape are used. The unit is mounted in a hermetically sealed cylindrical case measuring 3 in. high and 4 in. in diameter. It weighs less than 4 lb.

Litton Industries, Westrex Div., Dept. ED, 6601 Romaine St., Hollywood 38, Calif.

Availability: 60- to 90-day delivery.

Ferrite Switch

687

Rise time is 175 μ sec

This ferrite switch is for operation over the frequency range of 7.75 to 8.35 kmc. Rise time is 175 μ sec. Other specifications are: isolation, 25 db; insertion loss, 0.3 db; vswr for all ports, 1.3 max; switching rate, 1 to 1,000 cps; and power handling capacity, 50 w, avg, and 5 kw, peak.

Rantec Corp., Dept. ED, Calabasas, Calif.

Transistor Transformers

698

Come in 47 standard values

Built in accordance with MIL-T-27A, Grade 5, for use at altitudes to 50,000 ft, type TT transistor transformers can be furnished in 47 standard values. The units have excellent response to load distortion, and high power capabilities. They are compact.

Arco Electronics Inc., Dept. ED, 64 White St., New York 13, N.Y.

Availability: From stock.

Silicon Controlled Rectifiers

554

Weigh 1 oz



Able to replace mechanical relays where load currents of 1 amp are required, types XIRC2 through XIRC20 silicon controlled rectifiers weigh as little as 1/10 oz. Units

have piv ratings of 20, 30, 50, 70, 100, 150 and 200 v. They are hermetically sealed and are of all-welded construction. Uses are in computer circuitry, temperature control, and servomechanisms.

International Rectifier Corp., Dept. ED, 1521 E. Grand Ave., El Segundo, Calif.

Price: \$4.50 to \$15.

Data Acquisition System

701

Prepares data for computer energy

Model 10000 differential data acquisition system produces data suitable for entry in most computers. The system consists of a high-speed scanner in 10-channel multiples, an analog-to-digital converter, and an output format control. The scanning and conversion equipment accept low-level signals. Inputs from such devices as thermocouples, strain gages, and transducers can be accepted directly. The format control receives information from the analog-to-digital converter or from external channels. Digital information from clocks or counters is also acceptable. Scanning speed is 600 channels per sec.

Electro Instruments, Inc., Dept. ED, 3540 Aero Court, San Diego 11, Calif.

Price & Availability: \$50,000 to \$75,000; 60 to 90 days.

Logarithmic Amplifier

696

Full dynamic range is 70 db

Model LA-° logarithmic amplifier makes 70-db dynamic sweep frequency filter measurements possible with standard oscilloscopes or X-Y recorders. The unit is suitable for aligning crystal and other types of high-attenuation filters. Units with single-octave frequency ranges from 2 to 100 mc and with an over-all gain of about 100 db can also be furnished.

Jerrold Electronics Corp., Dept. ED, 15th and Lehigh Ave., Philadelphia 32, Pa.

Price: \$500.

MORE NEW FANSTEEL SILICON POWER RECTIFIERS

1N Series

5 Amp.

Type 9A

12 Amp.

Type 7B

20 Amp. 35 Amp.

Type 6B

Type 4B

50 Amp. 70 Amp.

Type 10A

Type 8B

Fansteel's silicon power rectifiers are produced in a new Fansteel semiconductor plant that is considered one of the most spotless, dust-free buildings to be found anywhere in the world. Pictured below is its "white room", where the units are assembled and where cleanliness is most critical. Because it takes only one lint speck to destroy a rectifier's reliability, this environment is kept as sterile as possible through such means as triple air filtering, strict personnel controls and special wall and work surfaces. Result: consistent reliable performance from Fansteel silicon power rectifiers.

Write for latest technical data on Fansteel Silicon Power Rectifiers.

Advertising Department
FANSTEEL METALLURGICAL CORPORATION
North Chicago, Illinois, U.S.A.



CIRCLE 120 ON READER-SERVICE CARD



appearances are not deceiving

THIS P & B 10-AMP RELAY IS AS RELIABLE AS IT LOOKS

Our AB relay looks rugged . . . and it is. You can specify it for 10 amp switching and confidently expect 100,000 cycles. Yet it is compact, easily mounted, and does not require special handling. Installation is simple, using your preference of screw terminals (adapters), quick connects, or dip soldering.



ABC Series—AB series can be supplied enclosed in sturdy metal dust cover, 1¹/₄" x 2¹/₂" x 2¹/₂".

Designers specify the AB for air conditioners and other products where dependable, continual service is paramount.

These standard AB and ABC relays are listed by Underwriters' Laboratories and Canadian Standards Association:

| Type | Arrangements | Type | Arrangements |
|--------|--------------|---------|--------------|
| AB7AY | DPST-NO | ABC7AY | DPST-NO |
| ABBAY | DPST-NC | ABC8AY | DPST-NC |
| AB11AY | DPDT | ABC11AY | DPDT |

Coil voltages: 6, 12, 24, 115 and 230 volts AC, 50/60 cycle.
Contact rating 10 amps, 115 volts AC or 5 amps, 230 volts AC noninductive.

U/L File E-29244

CSA No. 15734

Write for complete data or contact your nearest P & B sales engineer.

AB AND ABC RELAYS ENGINEERING DATA

GENERAL:
Insulation Resistance: 100 megohms minimum.
Life: 3 million cycles (mechanical).
Breakdown Voltage: 1500 volts rms between all elements and ground.
Temperature Range: DC: -55 to +45°C.
AC: -55 to +45°C.

Weight: AB—5 ozs. ABC—7 ozs.
Terminals: Fit 1/4" quick-connect terminals, or may be applied to printed circuits using dip soldering. Screw adapters furnished on request.
Enclosure: ABC: Heavy duty dust cover.
Dimensions: 1¹/₄" x 2¹/₂" x 2¹/₂".

CONTACTS:
Arrangements: DPDT
Material: 1/4" dia. silver. Other materials available.
Load: 5 amps at 230 volts AC or 10 amps at 115 volts AC noninductive.
10 amps at 28 volts DC.

COIL:
Voltage: DC: 6 to 110 volts.
AC: 6 to 230 volts.

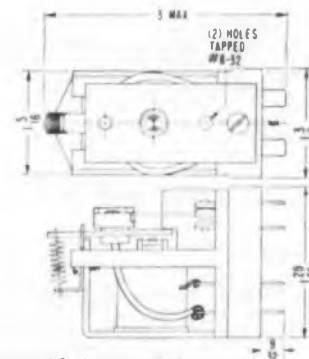

Power: DC: 2 watts nominal.
AC: 6.4 volt-amps.
Resistance: 35,000 ohms max.
Duty: Continuous: DC coils will withstand 6 watts at +25°C.

MOUNTINGS:
AB: Two 8-32 tapped holes on 1/4" centers.
ABC: One 8-32 stud 1/4" long and locating tab.

P & B STANDARD RELAYS
ARE AVAILABLE AT YOUR LOCAL
ELECTRONIC PARTS DISTRIBUTOR

NEW PRODUCTS

Mica Capacitor 700

Tolerance is $\pm 1/2\%$

Type DM-10 silvered mica capacitor, measuring 5/16 x 1/4 x 1/8 in., has a tolerance of $\pm 1/2\%$ and a temperature range of -55 to +150 C. At 500 wvdc, the capacity range is from 1 to 250 pf; at 300 wvdc, to 300 pf, and at 100 wvdc, 360 pf. The unit meets requirements of MIL-C-5B and EIA spec RS-153.

Arco Electronics, Inc., Dept. ED, 64 White St., New York 13, N.Y.
Availability: Immediate.

Size 11 Synchro 717

Operation stable from -55 to +85 C

The use of a special potting compound makes operational stability from -55 to +85 C possible for these size 11 synchros. All metallic parts have the same coefficient of expansion. The stator is potted in the housing, giving greater resistance to shock, vibration and moisture. Units are available with accuracy to 3 min of arc. Higher temperature models, from -55 to +200 C, are available on special request.

United Aircraft Corp., Norden Div., Dept. ED, Jericho Turnpike, Commack, L.I., N.Y.

Closed Entry Test Jack 720

Provides stud terminal

The type SKT-35 Press-Fit test jack provides closed entry and a stud terminal. The device is designed for use with a probe 0.032 in. in diameter and 0.2 in. long. It has a Teflon body and beryllium-copper contacts. Test jack body is 0.148 in. in diameter for through-chassis installation, and has a 0.172 in. diam above the chassis.

Sealectro Corp., 610 Fayette Ave., Dept. ED, Mamaroneck, N.Y.
Availability: Device is made to order; can be delivered in 30 days.

◀ CIRCLE 121 ON READER-SERVICE CARD



POTTER & BRUMFIELD

DIVISION OF AMERICAN MACHINE & FOUNDRY COMPANY, PRINCETON, INDIANA

IN CANADA: POTTER & BRUMFIELD CANADA LTD., GUELPH, ONTARIO



Research Manufacturing Divisions

SPECIFIES TI CONTROLLED RECTIFIERS FOR RELIABLE TURBINE OVERSPEED MONITOR

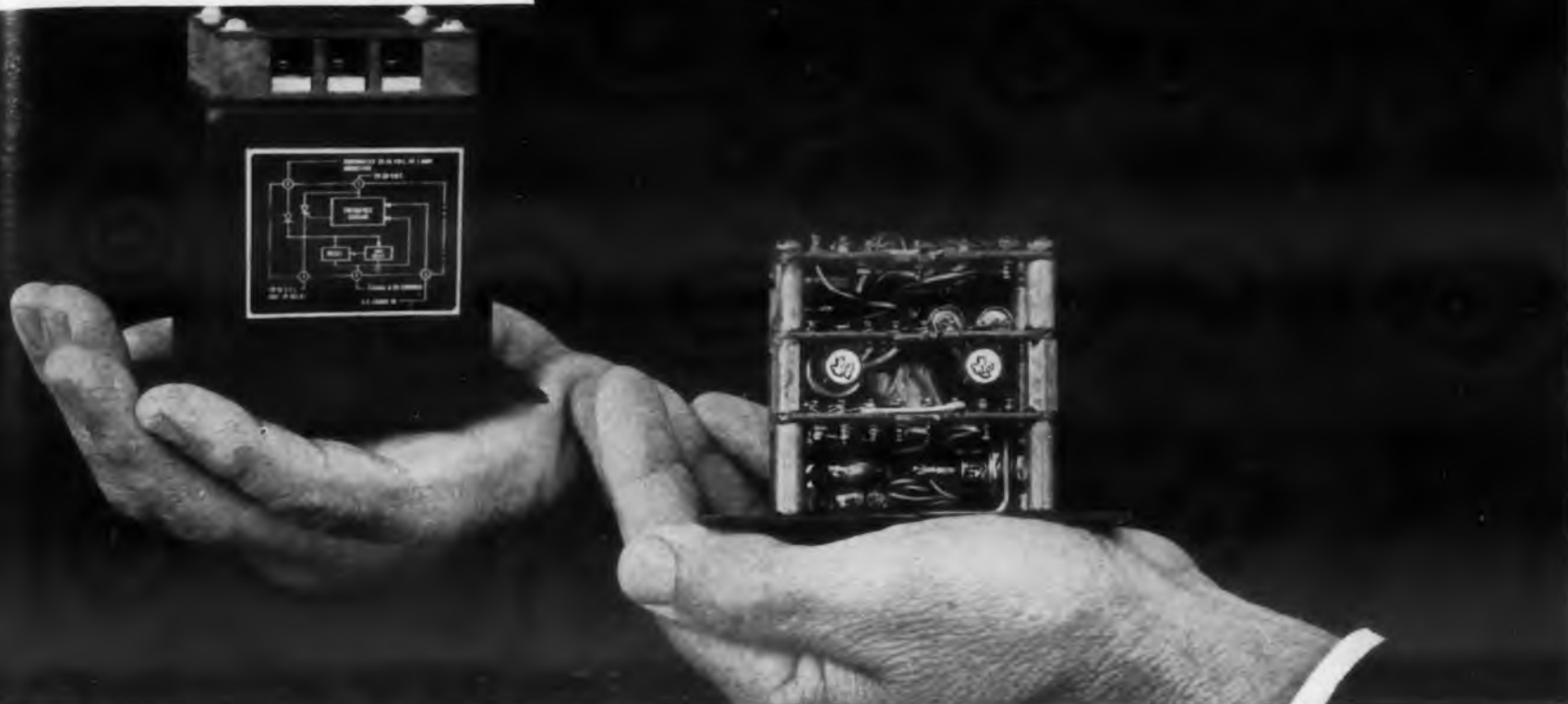

All-diffused TI 2N1595 in TO-5 case provides superior static control

Engineers at the Los Angeles AiResearch Manufacturing Division of the Garrett Corporation designed the Turbine Overspeed Monitor for use in missiles and aircraft. This 12-ounce unit utilizes electromagnetic sensing at 5000 cps for firing TI silicon controlled rectifiers to provide 1 amp of corrective current at 24 volts dc.

To obtain top missile reliability, AiResearch specified TI 2N1595 silicon controlled rectifiers. These all-diffused highly reliable devices provide unique device characteristics, size and weight savings . . . in the more economically priced TO-5 case. TI provided AiResearch

with controlled rectifiers featuring guaranteed specifications, tighter leakage tolerances, and consistent stability.

In addition to controlled rectifiers, AiResearch engineers have designed other TI components into such equipment as temperature controls, frequency converters, and frequency monitors . . . applications where maximum reliability is of paramount importance.

Contact your nearest TI sales office for price, delivery, and technical information concerning all reliable TI components.

Remember . . . you can *rely* on TI!

SILICON CONTROLLED RECTIFIERS

| Type | At 80°C Case Temp | | Non-Recurrent Surge Current 1 Cycle at 60 cps Amps | Min Fwd Off Voltage* V | PIV | Min Breakdown Voltage V | Max Case Temp °C | Max Fwd Gate Current ma | Gate to Cathode PIV V | max Fwd Voltage Drop @ Avg Rect Fwd Current @ 25°C Stud Temp V @ A | Gate Current Req to Fire ma | |
|--------|-----------------------------|--------------------------------|--|---------------------------|-----|----------------------------|------------------|----------------------------|--------------------------|---|--------------------------------|-----|
| | Av Rect Fwd Current Amps | Recurrent Peak Current Amps | | | | | | | | | Typ | Max |
| 2N1600 | 3 | 10 | 25 | 50 | 50 | 60 | 150 | 100 | 5 | 2 @ 3 amps | 1 | 10 |
| 2N1601 | 3 | 10 | 25 | 100 | 100 | 120 | 150 | 100 | 5 | 2 @ 3 amps | 1 | 10 |
| 2N1602 | 3 | 10 | 25 | 200 | 200 | 240 | 150 | 100 | 5 | 2 @ 3 amps | 1 | 10 |
| 2N1603 | 3 | 10 | 25 | 300 | 300 | 360 | 150 | 100 | 5 | 2 @ 3 amps | 1 | 10 |
| 2N1604 | 3 | 10 | 25 | 400 | 400 | 480 | 150 | 100 | 5 | 2 @ 3 amps | 1 | 10 |
| 2N1595 | 1 | 3 | 15 | 50 | 50 | 60 | 150 | 100 | 5 | 2 @ 1 amp | 1 | 10 |
| 2N1596 | 1 | 3 | 15 | 100 | 100 | 120 | 150 | 100 | 5 | 2 @ 1 amp | 1 | 10 |
| 2N1597 | 1 | 3 | 15 | 200 | 200 | 240 | 150 | 100 | 5 | 2 @ 1 amp | 1 | 10 |
| 2N1598 | 1 | 3 | 15 | 300 | 300 | 360 | 150 | 100 | 5 | 2 @ 1 amp | 1 | 10 |
| 2N1599 | 1 | 3 | 15 | 400 | 400 | 480 | 150 | 100 | 5 | 2 @ 1 amp | 1 | 10 |
| TI-010 | 1 | 3 | 15 | 50 | 50 | 60 | 150 | 100 | 5 | 2 @ 1 amp | 1 | 10 |
| TI-025 | 1 | 3 | 15 | 50 | 50 | 60 | 150 | 100 | 5 | 2 @ 1 amp | 1 | 10 |
| TI-050 | 1 | 3 | 15 | 50 | 50 | 60 | 150 | 100 | 5 | 2 @ 1 amp | 1 | 10 |

*Measured with 1K ohm resistor gate to cathode

See data sheet for switching information

ANOTHER DIODE/RECTIFIER PRODUCT FROM TI

MOLOY/G DIODES (mesa computer, general purpose, reference)
 • gallium arsenide microwave varactor diodes and tunnel diodes
 • high-voltage diode stacks • controlled rectifiers • high-current/
 high-voltage rectifiers • epoxy economy rectifiers • special
 encapsulated circuit functions • resistors and capacitors

SEMICONDUCTOR-COMPONENTS DIVISION

TEXAS INSTRUMENTS
 LIMITED INCORPORATED
 9700 LAS ROAD • BEDFORD, ENGLAND 13600 NORTH CENTRAL EXPRESSWAY • DALLAS, TEXAS

NOW!
 ALL TEXAS INSTRUMENTS
 SEMICONDUCTORS ARE
 IMMEDIATELY AVAILABLE
 OFF-THE-SHELF
 FROM

**ESCO
 IN
 DALLAS**

YOUR AUTHORIZED
 TI DISTRIBUTOR

A corporate division of
Texas Instruments Incorporated



Engineering Supply Company—a corporate division of Texas Instruments Incorporated—offers you dependable delivery direct from Dallas on all TI semiconductors and components* through carefully controlled inventories that assure local off-the-shelf availability . . . always.

Design now with use-proved, guaranteed TI units and know that ESCO can deliver immediately from fully stocked shelves . . . at factory prices.

For complete specifications on any TI semiconductor or component, write ESCO today.

*TI silicon and germanium transistors, silicon diodes and rectifiers, precision carbon film resistors, *gensistor*® silicon resistors, *tan-TI-cap*® tantalum capacitors.

Your Authorized  TI Distributor

ESCO ENGINEERING SUPPLY COMPANY

A CORPORATE DIVISION OF
 TEXAS INSTRUMENTS INCORPORATED
 DALLAS: 6000 DENTON DRIVE, FL 7-6121
 FORT WORTH: ED 2-9361
 TULSA: 1124 EAST FOURTH ST., LU 3-8121
 CIRCLE 122 ON READER-SERVICE CARD

◀ CIRCLE 123 ON READER-SERVICE CARD

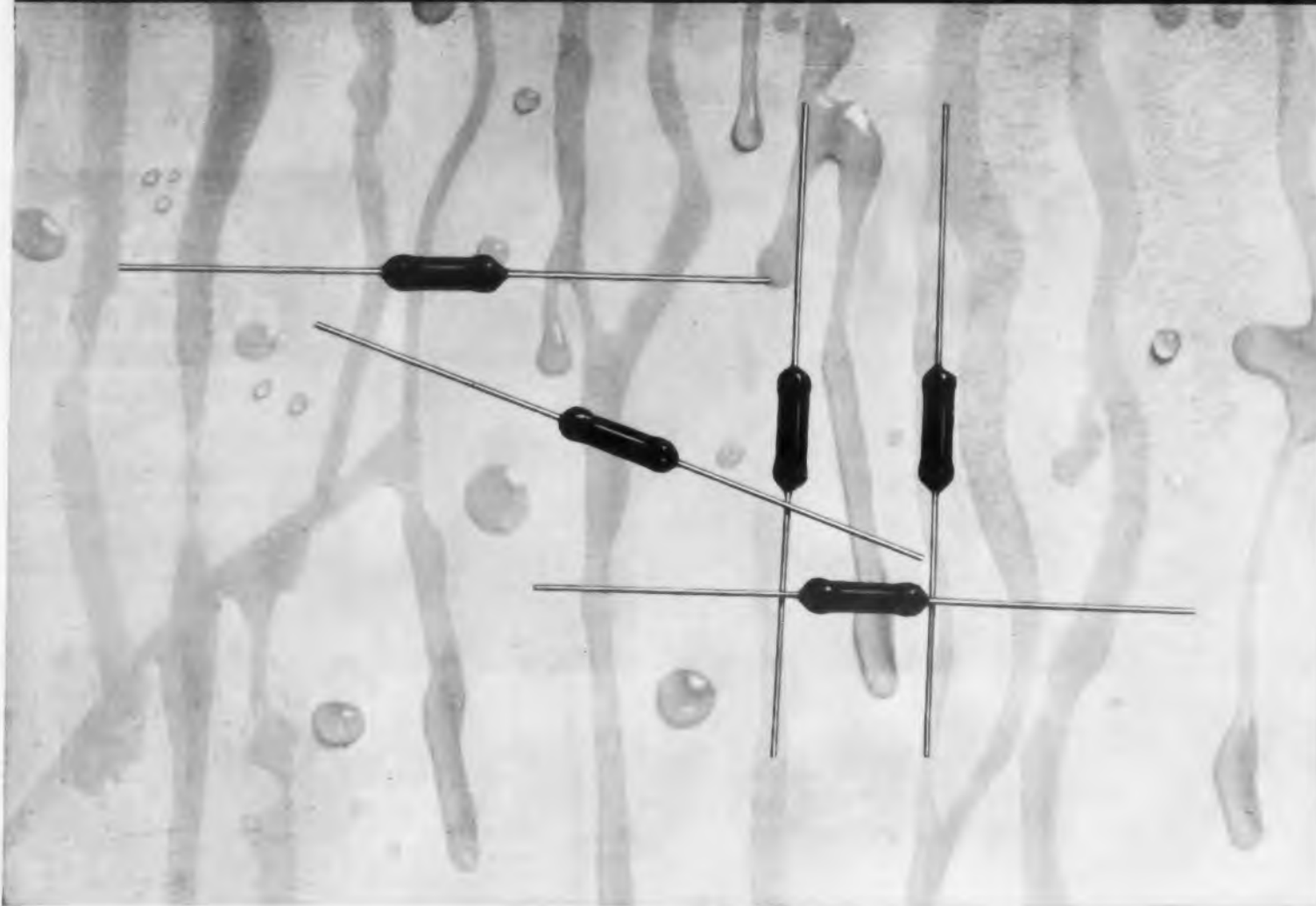

New M^{*}COAT for resistors takes 30 cycles of MIL moisture

Moisture Resistant—Resistors with M Coat withstand 30 cycles of moisture, 300% of the MIL-R-10509C Characteristic B requirement, tested in accordance with MIL Standard 202. No other RN20X style film resistor on the market matches this performance.

Damage Resistant—M Coat adds greater protection for the resistance element, eliminates handling and assembly damage.

Superior Insulation—over 100 megohms after 30 cycles of moisture.

M Coat is currently available in the $\frac{1}{2}$ watt size of IRC Precision Film Deposited Carbon Resistors, a type already noted for superior temperature characteristics, close tolerances, accuracy, and stability at high frequencies.

Rating: $\frac{1}{2}$ watt at 70°C Ambient

Standard tolerance: $\pm 1\%$

Range: 10 ohms to 2.49 megohms

Max. continuous working voltage: 350

Recommended Applications: Computer, amplifier, metering, and voltage divider circuits.

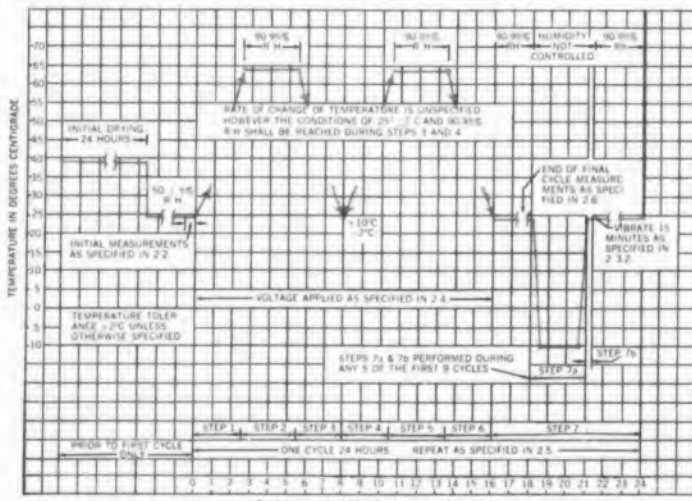

Write for Bulletin AE-15, International Resistance Co., 401 N. Broad St., Philadelphia 8, Pa.



*Trademark Exclusive IRC Moisture-proof Coating

Leading supplier to manufacturers of electronic equipment

CIRCLE 124 ON READER-SERVICE CARD

NEW PRODUCTS

Analog-To-Digital Converters 586
Transistorized

These ac-dc multimeter-ratiometer analog-to-digital converters meet all the requirements of Mil-P-2664-A and are transistorized. They will convert to binary coded decimal output the following: ac and dc voltages; resistance; in-phase and quadrature components of ac voltages; ratios of ac or dc signals. One system has a resolution of one part in a thousand with an accuracy of 0.1% and a speed of 10,000 conversions per sec. The second system has a resolution of one part in 10,000 with an accuracy of 0.02% and a speed of 2,000 conversions per sec.

Epsco, Inc., Dept. ED, 275 Massachusetts Ave., Cambridge 39, Mass.

AC Reference Standard 676

Accuracy is within 0.05%



Accurate to within 0.05%, model 102 ac reference standard is designed for use where Bureau of Standards level of instrumentation is required. It provides outputs from 0.5 v to 500 v rms at 400 cps with a load reading of 0 to 2 mils. Other units for 60 to 1,000 cps and for power applications can be furnished.

Remanco, Inc., Dept. ED, 1805 Colorado Ave., Santa Monica, Calif.

Digital Module Circuits 577

For missile and aircraft computers

These modules serve as building blocks for computer circuitry. There are 10 basic types and 15 variations of the modules. Each is vacuum-encapsulated with epoxy resin and contains up to 35 components per cu in. The modules are 0.8 in. high and 1 in. long, with width varying from 0.4 to 1 in. Pins for dip soldering to printed-circuit boards or for resistance welding to wiring are provided. Power requirement is 6 v. MIL specs are met.

General Motors Corp., Delco Radio Div., Dept. ED, Kokomo, Ind.

Footswitch 421

The Jupiter Duet footswitch is available in 10 switch ratings from 7 to 15 amp, weighs approximately 2 lb, and measures 6-1/4 in. long, 3-1/2 in. wide, and 1-1/2 in. high. It has a skid-proof basepad.

Vemaline Products Co., Dept. ED, Franklin Lake, N.J.

Price and Availability: Delivery is 3 wk; approximately \$6 to \$10 ea.

Static Inverter 369

This inverter is rated at 150 to 4000 VA with 65% to 90% efficiency. Phase angle control is accurate to 0.5 deg. Phase amplitude control is $\pm 1\%$; 2% total harmonic distortion is typical.

Delco Radio Div., General Motors Corp., Dept. ED, Kokomo, Ind.

Punched Card Reader 372

The Elliott card reader, for direct application to data systems as a card transport, handles standard cards with rectangular or round holes, 80 or 45 columns. Capacity of the unit is 600 cards; maximum feed rate is 400 cards per min.

Genesys, Dept. ED, 10131 National Blvd., Los Angeles 34, Calif.

Price & Availability: \$3,950; from stock.

Calibrated Drawing Ruler 392

This plastic, 12-in., combination triangle, T-square and parallel ruler is for drawing vertical, horizontal and angular parallel lines in automatically measured distances. Circles and arcs can be scribed up to a diameter of 22 in.

Rol-Ruler Co., Dept. ED, P.O. Box 164, Riegelsville, Pa.

Price & Availability: \$3.95 ea. available from stock.

Transformers 376

These 400-cps power and isolation transformers are epoxy molded, miniature units built to MIL-T-27A. Type UM34-M, a typical unit, measures 1/2 in. in diameter and 1/2 in. high. It has a power level of 500 mw.

Microtran Co., Inc., Dept ED, 145 E. Mineola Ave., Valley Stream, N.Y.

Price: Type UM34-M, about \$4.

Permanent Magnet Alloy 354

Cunife, a ductile copper-nickel-iron permanent magnet alloy, is suited for applications requiring close tolerance parts with strong directional magnetic properties. The alloy is available as finished magnets fabricated to specific requirements or as wire and strip.

Hoskins Manufacturing Co., Dept. ED, 4445 Lantton Ave., Detroit 8, Mich.

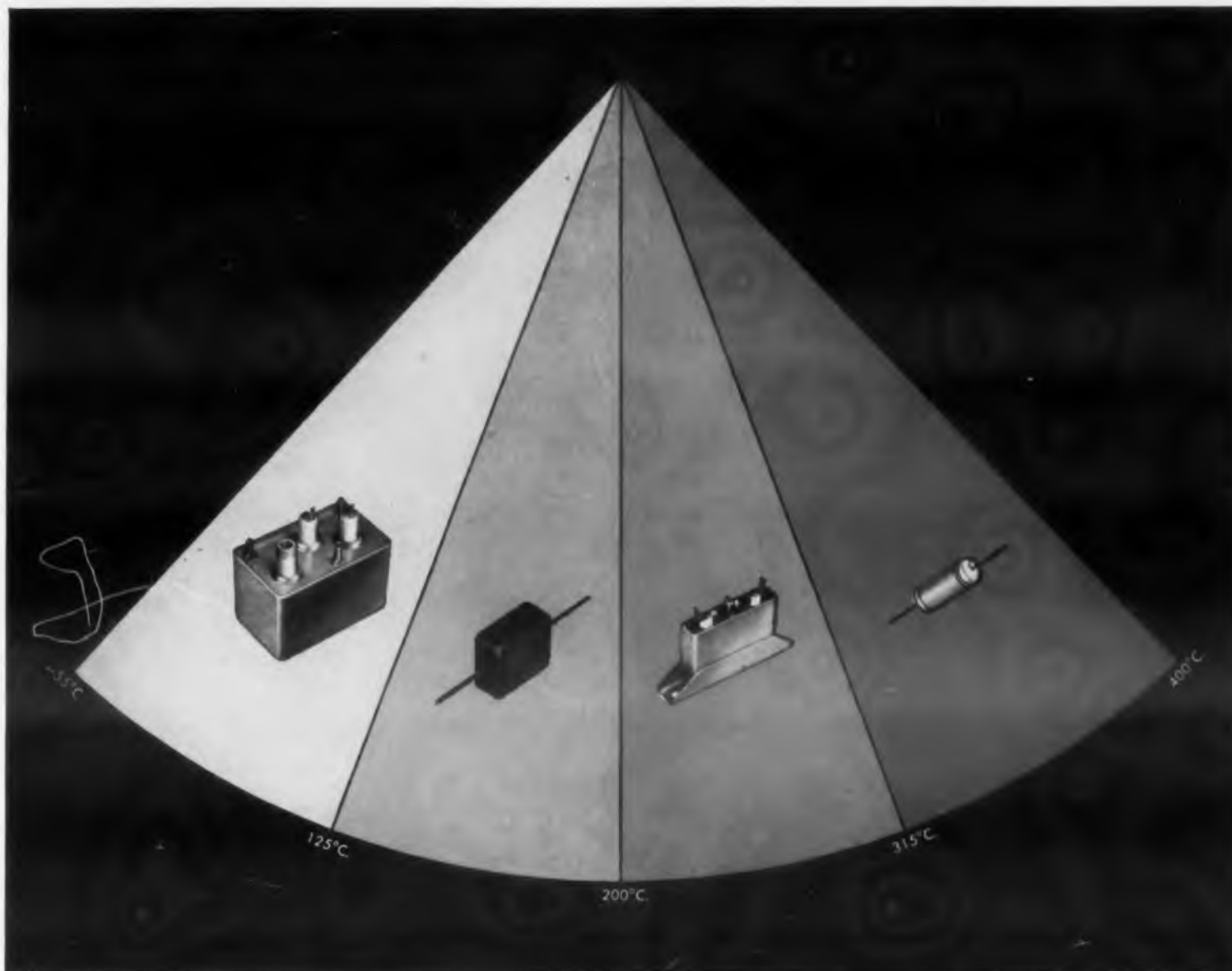
**BENDIX CAPACITORS COVER A FULL TEMPERATURE SPECTRUM**

ALL FEATURE THESE IMPORTANT ADVANTAGES:

Environmental resistance
No voltage derating

Wide voltage range
Solid impregnants

High I. R.
Wound mica papers

Radiation resistant
Exceptional stability

Under 125°C.—Specials

• Size and weight reductions at high voltages • Drift—0.25% capacitance change typical from -55°C. to +125°C. • High I. R.—1500 megohm X microfarads typical at 125°C. • Solid impregnants—no liquid leakage.

125°C. to 200°C.—Available soon

• .001 to 6.0 mfd., 200 V to 3 KV, specials to 10 KV. • Molded and metal housed; tubular and rectangular

• Size and weight reduction—over plastic film and stacked mica types, particularly at high voltages • Drift—1% capacitance change typical from -55°C. to +200°C. • High I. R.—50 megohm X microfarads typical at 200°C. • Proved in 4 years' usage.

200°C. to 315°C.—In production

• .05 to 4.0 uf, 600 V and up • Drift—3% capacitance change typical from

-55°C. to +315°C. • High I. R.—10 megohm X microfarads typical at 315°C. • Nothing smaller at 315°C.

315°C. to 400°C.—In development

• .001 to 6.0 uf, 150 V and 600 V • Drift—5% capacitance change typical from -55°C. to +426°C. • High I. R.—1 megohm X microfarad typical at 400°C. • Prototype availability • Only inorganic materials used.

For full details, write:

Scintilla Division

Sidney, New York



CIRCLE 125 ON READER-SERVICE CARD

New LAMBDA

Regulated Power Supplies

5 and 10 AMP 0-34 VDC



- Convection cooled—no internal blowers to wear out
- Guaranteed for a full 5 years
- Ambient temperature 50°C
- Excess ambient thermal protection
- Special, high purity foil, hermetically sealed long-life electrolytic capacitors
- Hermetically sealed transformer designed to MIL-T-27A
- Remote sensing and DC vernier

New LAMBDA LA Series Condensed Data

DC OUTPUT:

(Regulated for line and load)

| MODEL | VOLTAGE RANGE ¹ | CURRENT RANGE ² | PRICE |
|------------|----------------------------|----------------------------|-------|
| LA50-03A | 0-34 VDC | 0- 5A | \$395 |
| LA50-03AM | 0-34 VDC | 0- 5A | \$425 |
| LA100-03A | 0-34 VDC | 0-10A | \$510 |
| LA100-03AM | 0-34 VDC | 0-10A | \$540 |

¹ The output voltage for each model is completely covered in four steps by selector switches plus vernier control and is obtained by summation of voltage steps and continuously variable DC vernier as follows:

| MODEL | VOLTAGE STEPS |
|-----------------------|-----------------------------------|
| LA 50-03A, LA 50-03AM | —2, 4, 8, 16 and 0.4 volt vernier |
| LA100-03A, LA100-03AM | —2, 4, 8, 16 and 0.4 volt vernier |

² Current rating applies over entire output voltage range

Regulation: Line: Better than 0.15 per cent or 20 millivolts (whichever is greater).
Load: Better than 0.15 per cent or 20 millivolts (whichever is greater).

Transient Response: Line or Load: Output voltage is constant within regulation specifications for step function line voltage change from 100-130 VAC or 130-100 VAC or for step-function load change from 0 to full load or full load to 0 within 50 microseconds after application.

Ripple and Noise:

Less than 1 millivolt rms with either terminal grounded.

AC INPUT:

100-130 VAC, 60 ± 0.3 cycle. This frequency band amply covers standard commercial power lines in the United States and Canada.

OVERLOAD PROTECTION:

Electrical: Magnetic circuit breaker front panel mounted. Special transistor circuitry provides independent protection against transistor complement overload. Fuses provide internal failure protection. Unit cannot be injured by short circuit or overload.

REMOTE SENSING:

Provision is made for remote sensing to minimize effect of power output leads on DC regulation, output impedance and transient response.

PHYSICAL DATA:

Size: LA 50-03A... 3 1/2" H x 19" W x 14 3/8" D
LA100-03A... 7" H x 19" W x 14 3/8" D

Panel Finish: Black ripple enamel (standard). Special finishes available to customers specifications at moderate surcharge. Quotation upon request.

Send today for complete data

 **LAMBDA** ELECTRONICS CORP.
11-11 131 STREET • DEPT. 2 • COLLEGE POINT 56, N. Y. • INDEPENDENCE 1-8500

NEW PRODUCTS

Dummy Load 695

For L-band radar

Model 890374 dummy load can be used in the frequency range of 1,120 to 1,700 mc. It dissipates 8 kw avg and 2,200 kw peak without liquid cooling. Size of the unit is 32-7/8 x 8-7/8 x 11-7/16 in. and weight is 80 lb. It is compatible with the RG-103/U waveguide.

Litton Industries, Airtron-Pacific Inc., Dept. ED, 5873 Rodeo Road, Los Angeles 16, Calif.

Availability: From stock.

Balanced Crystal Mixers 564

Frequency range is 1,000 to 5,600 mc



Designed for the frequency range of 1,000 to 5,600 mc, model BCM balanced crystal mixers provide an rf input vswr of less than 1.5:1 at 50 ohms over a 15% frequency band. Units provide more than 20-db mutual isolation between the local isolator and the rf inputs. Rejection of noise and modulation is better than 20 db. Units have these ranges: 1,000 to 1,200 mc, 1,200 to 1,700 mc, 1,700 to 2,600 mc, 2,600 to 4,000 mc, and 4,000 to 5,600 mc.

Empire Devices Products Corp., Dept. ED, Amsterdam, N.Y.

Availability: Two weeks.

Wirewound Potentiometer 723

Has infinite resolution

This infinite resolution, multi-turn, wire-wound potentiometer

◀ CIRCLE 126 ON READER-SERVICE CARD

has a precious metal brush which follows the exact helical path of the resistance wire to eliminate sliding and helical errors between contact and wire. This gives a stepless output, low electrical noise, and an independent linearity of 0.01%. The units are available in 1 to 10 turns with a resistance range from 1 to 3,000 ohms.

Vogue Instrument Corp., Electronics Div., Dept. ED, 381 Empire Blvd., Brooklyn, N.Y.

Phase Sequence Indicator 719

Voltage range is 104 to 480 v

The model VA2 phase sequence indicator is designed for direct connection, without switching, to poly-phase circuits with voltages between 104 and 480 v. The frequency range of the instrument is 30 to 1,000 cps. Connections are made with three 36-in. oil-resistant test leads. The device measures 6-1/4 x 3-3/4 x 3-1/4 in., and weighs 24 oz. Panel connections are oil-tight.

Opad Electric Co., Dept. ED, 43 Walker St., New York 13, N.Y.

Price & Availability: \$27.50; from stock.

Coaxial Low-Pass Filters 718

Cut-off frequencies range from 100 to 10,000 mc

These miniaturized coaxial low-pass filters, model F-30, are available with cut-off frequencies of 100 to 10,000 mc. In the pass band, vswr is 1.2 and insertion loss is 0.2 db. Stop band rejection is 60 db from 1.35 to 5 times the cutoff frequency. Power rating is 100 w. Units can be supplied with N, C, or TNC connectors. Length, depending on frequency, is from 4-3/4 to 12-1/4 in.

RLC Electronics, Inc., Dept. ED, 805 Mamaroneck Ave., Mamaroneck, N.Y.

Price & Availability: \$30 to \$55; stock to two weeks delivery.

CIRCLE 127 ON READER-SERVICE CARD >

new white-light

STROBOTAC



stops motion with 7 million candlepower light flash

- * One Microsecond Flash Duration
- * 110 to 25,000 RPM Direct Reading, Useful to at least 250,000 RPM

Electronic Equipment Tests

Machine Design

Appliance Design

Vibration Studies — and Environmental Testing

Investigation of Mechanical Properties of Materials

Aeronautical and Military Work

Electromechanical Development

Write For Complete Information

GENERAL RADIO COMPANY

WEST CONCORD, MASSACHUSETTS

NEW YORK, WOrth 4-2722
NEW JERSEY, Ridgefield, WHiney 3-3140

CHICAGO
Oak Park
Village 8-9400

PHILADELPHIA
Abington
HAncock 4-7419

WASHINGTON, D.C.
Silver Spring
JUniper 5-1088

SAN FRANCISCO
Los Altos
WHitecliff 8-8233

LOS ANGELES
Los Angeles
HOLlywood 9-6201

IN CANADA
Toronto
CHerry 6-2171

Measures **1mv**
to **1000v**
from
10 cps
to
250 kc

BALLANTINE ELECTRONIC VOLTMETER

Model 300-D
Price \$255.



Note these outstanding features:

- ★ **Top Accuracy:**
better than 2% throughout voltage and frequency ranges and at all points on the meter scale.
- ★ **High Input Impedance:**
2 megohms shunted by 15 pf, except 25 pf on lowest range.
- ★ **Excellent Stability:**
less than 1/2% change with power supply voltage from 105 to 125 volts.
- ★ **Long Life:**
several thousands of hours of operation without servicing or recalibration.
- ★ **Five Inch, Mirror-Backed, Easy-to-Read Meter:**
logarithmic voltage scale reading from 1 to 10 with 10% overlap at both ends; auxiliary linear scale in decibels from 0 to 20.

Also available in 9 1/2 and 19 inch relay rack models

This instrument is an improved version of Ballantine's original Model 300, famous for its accuracy, sensitivity, and reliability for more than 20 years.

Write for brochure giving many more details

— Since 1932 —



BALLANTINE LABORATORIES INC.

Boonton, New Jersey

CHECK WITH BALLANTINE FIRST FOR LABORATORY AC VACUUM TUBE VOLTMETERS, REGARDLESS OF YOUR REQUIREMENTS FOR AMPLITUDE, FREQUENCY, OR WAVEFORM. WE HAVE A LARGE LINE, WITH ADDITIONS EACH YEAR. ALSO AC/DC AND DC/AC INVERTERS, CALIBRATORS, CALIBRATED WIDE BAND AMPLIFIER, DIRECT-READING CAPACITANCE METER, OTHER ACCESSORIES.

CIRCLE 128 ON READER-SERVICE CARD

NEW PRODUCTS

Teflon Insulated Wire 547

For high temperature operation

This extruded teflon insulated nickel-plated wire is designed for continuous operation at 260 C. It meets all requirements of MIL-W-27300 (USAF) and MIL-W-16878C (Types E and EE). Designed for use with high-temperature grommet-seal connectors, the smooth extruded insulation allows proper moisture sealing. Wire sizes from 26 through 12 AWG are available.

Suprenant Mfg. Co., Dept. ED, 172 Sterling St., Clinton, Mass.

DC Power Supply 516

For aircraft ground support



Model M-1216-1 dc power supply has an output of 22 to 33 v at 50 amp and is designed for aircraft ground support equipment. Efficiency is 70% at 28 v, from 25 to 50 amp. All static and reactor-controlled, the unit maintains its dc output at from 22 to 33 v, no load to full load, on an input of 220 or 440 v nominal +10%, -15%, three phase, 60 cps ±5%. Ripple is less than 5% rms.

Perkin Engineering Corp., Dept. ED, El Segundo, Calif.

Ceramic Sheet 514

Available in fixed dielectric constants

Eccoceram Hi K series ceramic sheet is a low loss material available in fixed dielectric constants from 5 to 90. Dissipation factor at vhf, uhf and microwave frequencies is below 0.001. The material is designed for high-temperature applications up to 1500 F. It is hard and requires diamond tools for machining. It is available in disks about 5-in. in diameter and 1/2 or 1-in. thick.

Emerson & Cuming, Inc., Dept. ED, 869 Washington St., Canton, Mass.

Price & Availability: The material is \$5.00 per lb and is available from stock.

RUGGED

BUT PRECISE



CINEMA

INSTRUMENT SWITCHES

- ★ Long Life
- ★ Rugged Construction
- ★ Low Circuit Resistance
- ★ Meet Military Specifications

Cinema Engineering offers a complete range of instrument switches to meet practically every application and all the requirements of critical circuitry and precision performance.

Switches feature contacts of one homogenous material to provide minimum EMF and to insure positive metal-to-metal wiping contact and continuous low electrical resistance for long-life operation. Advanced engineering and construction techniques provide permanent precision alignment and elimination of field failures. Available in 1 to 8 deck styles for operation up to 100KC and for all DC circuits. 2 to 16 decks are available on a single shaft through the use of a unique Cinema precision gear drive.

Choice of Contact Arrangement—shorting (make-before-break) or non-shorting (break-before-make); Contact Material—solid nickel silver or Coin Silver for lower switch circuit resistance; Deck Material—fine linen base phenolic or glass epoxy for extremely high insulation resistance.

Write for your free copy of our all-new Precision Switch Catalog.



CINEMA ENGINEERING

DIVISION AEROVOX CORPORATION
1100 Chestnut, Burbank, California

CIRCLE 129 ON READER-SERVICE CARD

ELECTRONIC DESIGN • October 12, 1960



a **spot** is a **spot**
is a high
resolution **spot**
with
CELCO YOKES

● **Celco YOKES**
keep spots **smallest**

● **Celco YOKES**
keep spots **roundest**

● **Celco YOKES**
keep spots **sharpest**

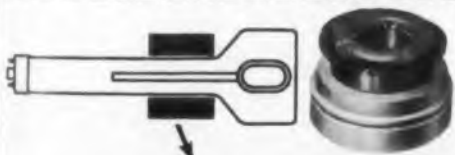

Use a **CELCO DEFLECTION YOKE** for
your high resolution applications.

In a **DISPLAY SPOT?** call **Celco!**

Celco
*Constantine Engineering
Laboratories Co.*

Main Plant: MAHWAN, N. J. DAVIS 7-1123

● Pacific Division - Cucamonga, Calif. - YUkon 2-2688

Sound Analyzer

386

Type 100 sound analyzer is a combination sound-level meter and analyzer that provides for octave analysis of sound. The unit provides overall db sound measurements and octave band analysis and has a built-in acoustic and electrical calibrator.

Rudmose Instruments Co., Dept. ED, P.O. Box 476, Richardson, Tex.

Stabilized Platform

351

Type T-28 stabilized platform provides automatic roll and pitch stabilization through a remote azimuth control box. The platform is vertically oriented, with reference to a type ARX-3 vertical gyro, to a probable error of 25 mir. It is designed to stabilize heavy equipment such as infrared detectors, antennas and television cameras in airborne, shipboard and land-based vehicles.

The Aeroflex Corp., Aeroflex Laboratories Div., Dept. ED, 34-07 Skillman Ave., Long Island City 1, N. Y.

Price & Availability: Delivery is 60 to 90 days; price is \$8,500 ea.

Analog To Digital Converter

423

This analog-to-digital converter provides 128 counts per revolution and true binary read-out. Non-ambiguity is obtained through the use of V-scan brushes. It is available in a synchro mount case with an OD of 2 in. and with sine-cosine, Gray code, BCD and special readouts.

Airflyte Electronics Co., Dept. ED, 535 Ave. A, Bayonne, N.J.

Sheffer Stroke Modules

424

The HS Series modules provide Sheffer Stroke gates for mechanizing digital systems. Complete digital switching networks, including flip-flops, can be built from these gates. Available gates have from two to six inputs. When Stroke gates are used with the firm's clocked flip-flops, two-level logic can be operated with a single phase clock at 3 mc.

Abacus, Inc., Dept. ED, 3040 Overland Ave., Los Angeles 34, Calif.

Antenna Mount and Control System

357

Model 3514-3S antenna mount supports a load of 1500 lb. It delivers an elevation torque of 500 ft-lb and an azimuthal torque of 600 ft-lb. Elevation speed is 90 deg in 7.5 sec, max, and azimuth speed is 2 rpm, max. Table size is 32 sq in. Model 7514-S servo control system provides for either manual speed control or remote servo operation. It has simultaneous dual-action variable speed control in either direction.

Antlab, Inc., Dept. ED, 6339 Proprietors Road, Worthington, Ohio.

Price: Antenna mount is \$5250; servo control system is \$2380.

EXTEND THE M.F.P.* WITH PRESSURES TO 1×10^{-9} mm Hg

Here is equipment that opens up entirely new fields for research—attaining Vacuum below 1×10^{-9} and making that Vacuum available for practical tests and studies with realistic pump down periods. Under favorable conditions Vacuum in the order of 1×10^{-10} mm Hg has been attained with this

Kinney[®]

ULTRA HIGH VACUUM SYSTEM

Illustrated is the KINNEY UH-9E Ultra High Vacuum System which employs the principle of differential pumping and features Ultevac[®] Ionic Pumps together with a Sorption Pump and Molecular Sieve for the ultimate in clean, dry Vacuum, free from all traces of hydrocarbon contamination. Write for descriptive literature today.

* Mean Free Path



KINNEY VACUUM DIVISION
THE NEW YORK AIR BRAKE COMPANY 

3561K WASHINGTON STREET · BOSTON 30 · MASS.

Please send me Bulletins on KINNEY Ultra High Vacuum Systems by return mail.

Name

Company

Address

City Zone State

CIRCLE 131 ON READER-SERVICE CARD

Write

Get full information on UH-9E and UH-9 Ultra High Vacuum Systems

count them...



...9 basic types

temperature-compensated motor-tachometers

Only at Daystrom's Transicoil Division can you find such a splendid array of temperature compensated high-accuracy motor-tachometers.

Here's the lineup:

4- and 6-pole in Sizes 8 and 11; 4- and 8-pole in Sizes 15 and 18; and a special high-torque 4-pole model in Size 18. But this is only the beginning—it doesn't include all the variations in motor windings and shaft configurations that we can conjure up to meet unusual requirements.

And what about performance? Let us merely assure you that these are the most temperature stable servo components of their kind we've ever had the opportunity to test.

Deviation of Output Voltage vs. Ambient Temperature

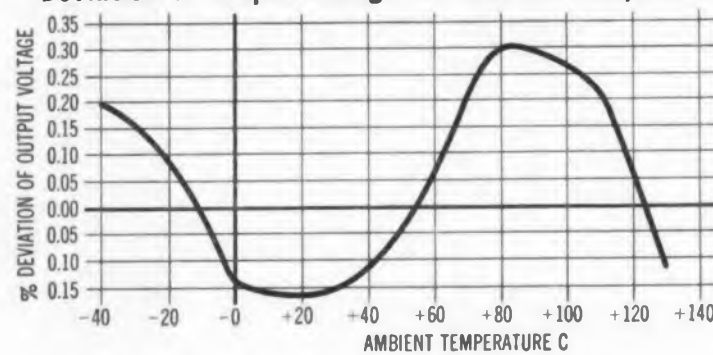

Ask to see our specification sheets and then discuss your needs with Daystrom's Transicoil Division.

Foreign: Daystrom International Div., 100 Empire St., Newark 12, New Jersey. In Canada: Daystrom, Ltd., 840 Caledonia Rd., Toronto 19, Ontario.

DAYSTROM, INCORPORATED
TRANSICOIL DIVISION

WORCESTER • MONTGOMERY COUNTY • PENNSYLVANIA

NEW PRODUCTS

Potentiometer 722

Has plastic case

This 3/4-in. potentiometer has a plastic case and meets MIL-R-19A and MIL-R-19/1A specifications. It has an "O" ring shaft seal and complete internal sealing to provide the same protection as encapsulation in less space. Resistance range is 1 to 20,000 ohms $\pm 5\%$, torque is 0.3 to 6 oz-in., and weight is 0.02 lb. It dissipates 1.5 w at 40 C.

Waters Manufacturing, Inc., Dept. ED, Wayland, Mass.

Dummy Load 568

Dissipates 4.5 kw avg



No. 890375 dummy load, for use with S-band radar, dissipates 4.5 kw of average power and 3,200 kw of peak power without liquid cooling. Weighing 11 lb, it measures 14 x 4-7/8 x 6-3/8 in. It is compatible with the RG-75U waveguide. The absorptive element is inert, high-temperature silicon carbide.

Litton Industries, Airtron, Inc., Dept. ED, 5873 Rodeo Road, Los Angeles 16, Calif.
Availability: From stock.

Panel-Mounted Fan 721

Pressurizes cabinet with filtered air

This panel-mounted fan, model 1PB65W, is designed for installation on the outside of electronic

← CIRCLE 132 ON READER-SERVICE CARD

ELECTRONIC DESIGN • October 12, 1960

722
has a
R-10A
tions.
and
pron-
cap-
tance
 $\pm 5\%$,
weight
w at

racks. It pressurizes the cabinet with air filtered through a permanent, washable filter. The unit moves 295 cfm. The lubricant meets MIL-G-3278 specifications and has a temperature range of -62 to $+93$ C.

McLean Engineering Laboratories, Dept. ED, P. O. Box 228, Princeton, N.J.

Availability: From stock.

High-Power Hydrogen 518 Thyatron

For radar modulator service

Inc.,
568

Type Z-5101 hydrogen thyatron, suited for radar modulator and other pulsing service, has a peak power of 48 megawatts, a peak anode voltage of 40 kv and a peak current of 2,400 amp. An average power of 80 kw at an average current of 4 amp can be attained. The tube is water-cooled at 1 gal per min. Its anode dissipation factor of 45×10^6 and ceramic-metal construction render the thyatron useful in mobile radar systems. Overall length is 16 in.; diameter is 6 in.; weight is 10 lb.

General Electric Co., Power Tube Dept., Dept. ED, Schenectady 5, N.Y.

Price & Availability: Available in sample quantities at \$2,800.

For use
res 4.5
200 kw
d cool-
asures
s com-
wave-
ment is
on car-

Subminiature Toggle 519 Switches

Take 300-amp overload

These subminiature spdt, dpdt and center-off toggle switches come with either "on" or "momentary" switch action. They are rated at 25,000 operations at 5 amp, 29 v dc or 115 v ac. They will withstand 300-amp short-circuit overload without damage. Contact pressure of 100 g assures low contact resistance. Switches meet MIL specs.

Allied Control Co., Inc., Dept. ED, 2 East End Ave., New York 21, N.Y.

Price & Availability: Prices from \$2 to \$5 ea; available in 4 to 6 weeks after order received.



Tung-Sol transistors handle four major jobs in

Beckman/Berkeley peak accuracy frequency counter

The Beckman/Berkeley Model 5310 EPUT Meter makes frequency measurements from 10 cps to 200 kc with an accuracy of up to 1 part in 10^6 . In military applications, such as missile check-out, where operating time is brief but success "a must", the EPUT Meter "gets in and gets out" quickly with fire-away data. Where long-term service with minimum downtime is a critical requirement, as in industrial monitoring processes, the equipment is also ideally suited.

Naturally, this exacting combination of highest accuracy and greatest dependability demands the most reliable component performance. And that's precisely why Beckman/Berkeley chose Tung-Sol transistors to assume four of the unit's primary operations. Tung-Sol's 2N414 high speed computer logic germanium transistors handle time division and fre-

quency counting. The tasks of conversion and current amplification for digital read-out are assigned to Tung-Sol's 2N383 medium power germanium transistors.

Why don't you get the benefit of Tung-Sol's component know-how too? Whether it's tubes or semiconductors — and there's a premium Tung-Sol unit for virtually every military and industrial need — you'll be designing only the best components into your circuit. You'll be getting quality units that have made the name of Tung-Sol synonymous with the finest componentry. Tung-Sol Electric Inc., Newark 4, N. J. TWX: NK193.

For prompt and competent technical consultation on Tung-Sol components call the Tung-Sol Commercial Engineering office nearest you. Atlanta, Ga.; Columbus, Ohio; Culver City, Calif.; Dallas, Texas; Denver, Colo.; Detroit, Mich.; Irvington, N. J.; Melrose Park, Ill.; Newark, N. J.; Philadelphia, Pa.; Seattle, Wash. Canada: Montreal, P. Q.

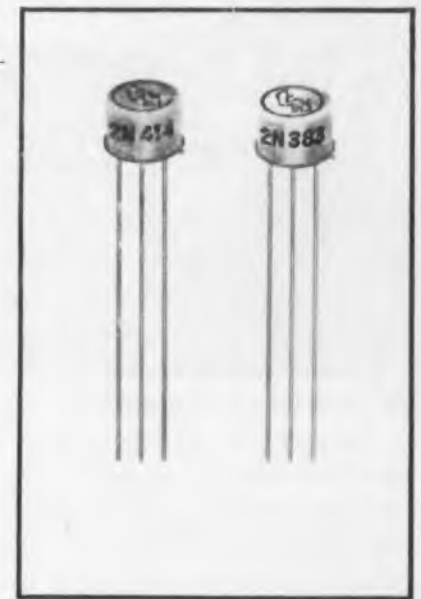

TUNG-SOL®

CIRCLE 133 ON READER-SERVICE CARD >



FOTOCERAM circuit board blanks are made using the micro-accuracy of photography. All holes and shapes are produced by simple exposure to light, heat, and an etching operation.

No bending, bowing or delaminating with a FOTOCERAM printed circuit board

Made of one solid piece of Fotoceram material, these printed circuit boards can't delaminate, because there are no laminations—the problem of bending, twisting and warping are eliminated, even under high ambient temperatures.

Dimensional stability is so great you'll want to use them for environmental stress tests.

Through-hole plating presents no problems, either. We plate through the hole uniformly with the same conductor material. Thermal conductivity, as well as electrical conductivity, is exceptionally good. You can even make a solder bridge over a hole with no gap and without a wire.

Resolderability is excellent—we've removed and resol-

dered components over fifty times on a Fotoceram board without damage to runs or holes.

In addition, Fotoceram boards provide good adhesion, exceptional pull strength, zero water absorption. They are non-flammable, never blister.

We are now equipped to produce Fotoceram printed circuit boards in quantity on a mass production basis and at a practical cost.

For more information, write for our data sheet to **Corning Glass Works**, 540 High Street, Bradford, Pa. Or contact our sales offices in New York, Chicago or Los Angeles.



CORNING ELECTRONIC COMPONENTS

CIRCLE 134 ON READER-SERVICE CARD

NEW PRODUCTS

Voltmeters

509

Portable and panel mounting

These multi-purpose voltmeters are designed as portable instruments that can be converted for panel or switchboard mountings. The instrument line includes dc voltmeters and milliammeters and an ac rectifier-type voltmeter. No special adapters are necessary for conversion to panel or switchboard mounting. Ratings range from 0 to 1000 v at 20,000 ohms per v dc and 5000 ohms per v ac, and from 0 to 100 ma. Accuracy is within 1% in 0 to 100 v ranges and 2% in 300 to 1000 v ranges.

Daystrom, Inc., Weston Instruments Div., Dept. ED, 614 Frelinghuysen Ave., Newark 12, N.J.

Coaxial Terminations

674

For high voltage use



Designed for cable-to-air or cable-to-oil operation, these terminations for RG coaxial cable have insulation bodies of vacuum-cast epoxy and have internal electrical stress control. The unit shown is rated at 75 kv and for minimum corona level with a flash-over voltage of 127 kv peak. Other units with ratings beyond 300 kv can be furnished.

Components for Research, Inc., Dept. ED, 979 Commercial St., Palo Alto, Calif.

Tapered-Pin Connector

582

For printed-circuit boards

These phosphor-bronze and beryllium-copper contacts for printed-circuit boards withstand over 1000 insertions. They mate with 3-1/2 deg taper pins and have a minimum capacity of 5 amp and 2150 v ac. Polarization pins are available. The body material of the connector is Alkyd-mag 422, meeting MIL-M-14E. Connectors come in six sizes from 12 to 14 contacts per unit.

Astral Electronics, Inc., Dept. ED, 14620 Arminta St., Van Nuys, Calif.

Price & Availability: Priced from \$1.56 to \$4.98 ea; most models immediately available.

CBS MADT* HIGH-SPEED SWITCHING TRANSISTORS OFFER YOU... MORE

SPEED
EFFICIENCY
ECONOMY
UNIFORMITY
RELIABILITY

FROM THESE COMBINED ADVANTAGES... CHECK THEM

Diffused Base

Low base resistance and collector capacitance minimizes delay, rise and fall times. Storage time is radically reduced by built-in field.

Electrochemical Etching

Storage time is shortened and circuit simplified by optimal collector positioning. Low collector saturation voltage reduces power supply costs, increases efficiency.

Microalloy Cadmium Junctions

High-injection emitter achieves greater efficiency; more accurate device geometry provides greater uniformity.

Automated Mass Production

Exceptional reliability is assured by uniform, in-line mass production permitting 100% quality control of each transistor and resulting in minimized costs.

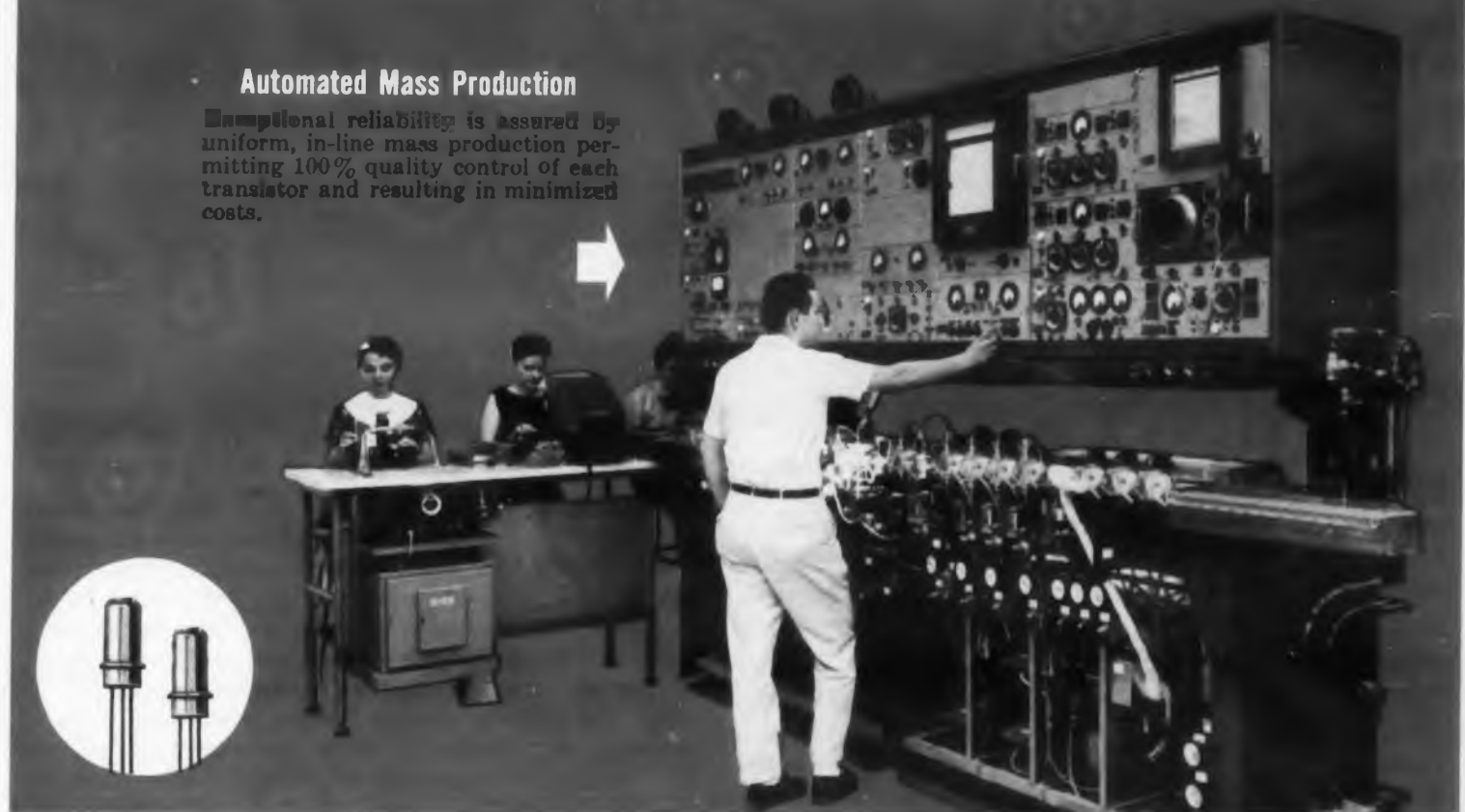

*Micro Alloy Diffused-base Transistor, trade-mark Philco Corp.

YOUR LOGICAL CHOICE... for high-speed switching is CBS MADT* transistors. You get more speed, more efficiency, more economy, more uniformity, and more reliability. Order the CBS 2N501 and 2N501A... ask for engineering data... today from your local sales office or Manufacturers' Warehousing Distributor.

CBS **semiconductors**

CBS ELECTRONICS, Semiconductor Operations, Lowell, Mass. • A Division of Columbia Broadcasting System, Inc.

Sales Offices: Lowell, Mass., 900 Chelmsford St., GLenview 2-8961 • Newark, N. J., 231 Johnson Ave., TAlbot 4-2450 • Melrose Park, Ill., 1990 N. Mannheim Rd., EStebrook 9-2100 • Los Angeles, Calif., 2120 S. Garfield Ave., RAymond 3-9081 • Atlanta, Ga., Cary Chapman & Co., 600 Trusco Way, S. W., PLaza 8-4506 • Minneapolis, Minn., The Heimann Co., 1711 Hawthorne Ave., FEderal 2-5457 • Toronto, Ont., Canadian General Electric Co., Ltd., LENnox 4-6311

CIRCLE 135 ON READER-SERVICE CARD

Temperature Indicators 549

Temp-Plates, adhesive-backed temperature indicating labels, for temperature detection and indication through 1100 F, are calibrated to an accuracy of $\pm 1\%$. Uses are in nose cones, heat exchangers, and in other devices.

Pyrodyne, Inc., Dept. ED, 11973 San Vicente Blvd., Los Angeles 49, Calif.

Photosensitive Glass 487

"Fotoform B" is a photosensitive glass that can be precision patterned by chemical machining. The material is non-porous, dimensionally stable and heat-resistant. Applications include printed-circuit boards, fine mesh screens and dielectric spaces.

Corning Glass Works, Dept. ED, Corning, N. Y.

Stainless Steel Tubing 374

This stainless steel tubing shields and jackets cables and wires that are subject to extreme punishment. Called Zippertubing, it will offer protection from shrapnel and abrasive forces that would otherwise cut the wires. The tubing, in sheet or strip form, is made into tubing on the job without special dies, guides or other equipment. It is installed by one operator in a single operation.

The Zippertubing Co., Dept. ED, 752 S. San Pedro St., Los Angeles, Calif.

Availability: Immediate delivery.

Force Gages 587

These mechanical force gages are for measuring tension in a permanent test set-up. The DT series includes capacities of 20, 50, 75, 100, 150, 200, and 500 lb. They hold the maximum dial reading after the load has been removed.

Hunter Spring Co., Dept. ED, 1 Spring Ave., Lansdale, Pa.

Soldering Fluxes 590

The Lonco Organo-Fluxes are non-resinous, water-based and have instantly soluble, non-charring residues. Applications are in transistors, diodes, connectors, terminal boards, and in other electronic uses.

London Chemical Co., Inc., Dept. ED, 1535 N. 31st Ave., Melrose Park, Ill.

Lamination Shapes 639

Designed for filter choke and transformer uses, Types F-14 and F-187 laminations are 6 and 16 mils thick. The F-14 has a 0.434 in. top leg, a diagonally cut center leg, and a 0.047-in square window area. The top leg of the F-187 is 0.531 in. long, the center leg is 0.3125 x 0.1875 in., and the window area is 0.082 in. square. Both are 0.75-in. high.

Magnetics Inc., Dept. ED, Butler, Pa.

Availability: From stock.

NEWEST way to write performance . . .

servo/riter*

SELF-BALANCING POTENTIOMETRIC RECORDER

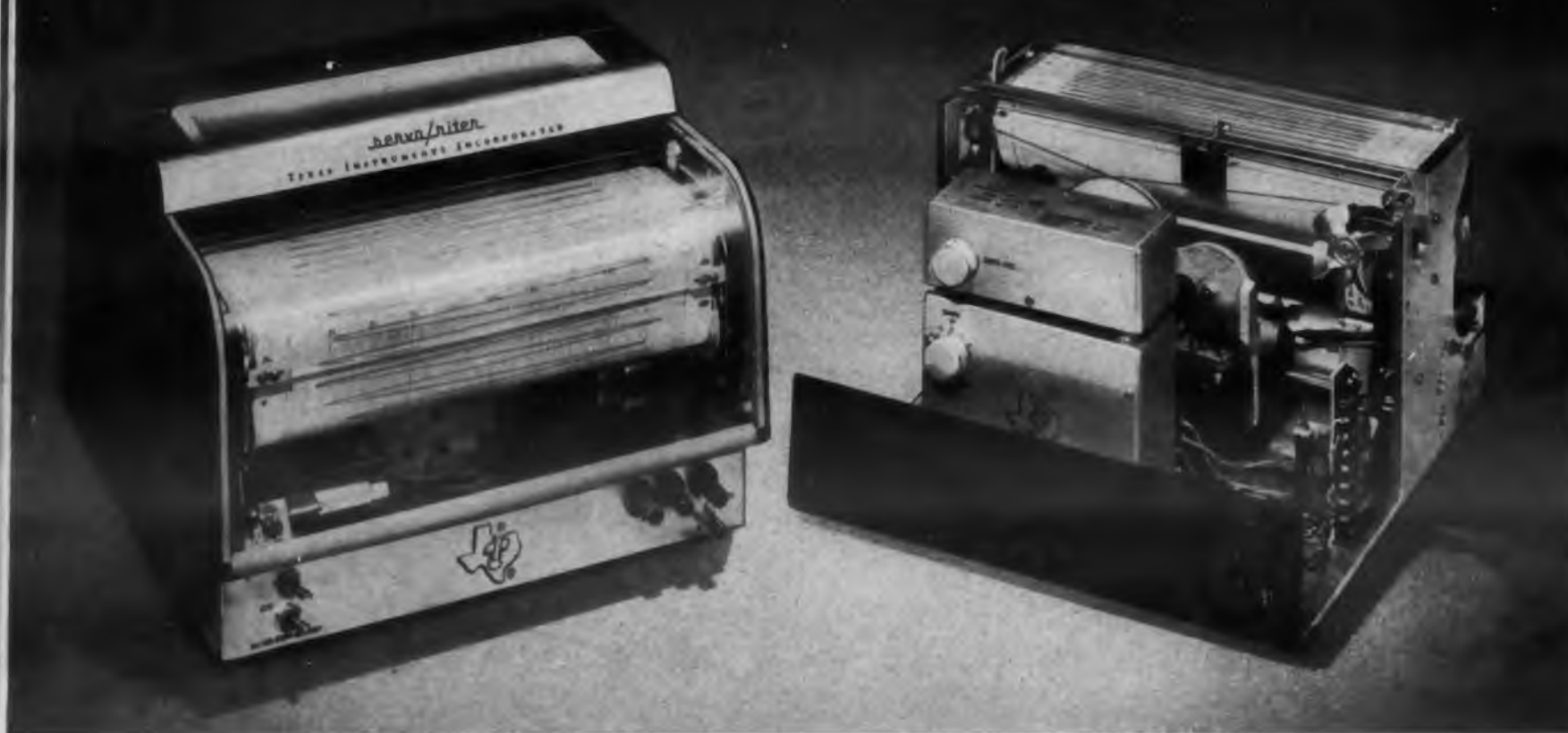

OFFERS YOU MORE HIGH PERFORMANCE FEATURES THAN ANY OTHER RECORDER...at any price!

The old cliché, "You can pay more but you can't buy better" was never more applicable than in the new "servo/riter" recorder. Texas Instruments has developed a self-balancing potentiometric recorder that incorporates *premium* engineering refinements, sensitivity, reliability and quality construction as *standard* equipment.

High-Sensitivity — Standard electrical span of 2.5 millivolt d-c with off-balance input resistance of 4 megohms gives a power sensitivity of better than 10^{-17} watts.

Fast Pen Speed — Span step response is less than 0.5 second.

High Interference Rejection — Good filtering provides high orders of rejection to common-mode d-c and all types of 60 cps interference. Guard shields permit making full-accuracy measurements at hundreds of volts above ground.

Long-Term Reliability — Tube life is prolonged by

heat-dissipating shields. Amplifier gain is stabilized by partial negative feedback. Non-lash, non-wearing, toothed belt drive gives long consistent performance.

Superior Operating Conveniences — Recorder function is easily changed by plug-in input units. Presently standard are 2.5, 5, or 10 millivolt d-c electrical spans . . . special applications and ranges are easily accommodated. "Micrometer" control for zero adjustment and main amplifier gain control are readily accessible as are all other adjustments, connections, and controls. The popular 10-speed chart gears and the high-capacity, easy-prime ink handling system proved on the "recti/riter"[®] recorder are standard equipment on the "servo/riter" recorder.

There are four "servo/riter" recorder models to choose from . . . *Single Channel, Narrow Grid; Single Channel, Wide Grid; Dual Channel, Narrow Grids; and Dual Channel (overlapping pens), Wide Grid.* Write for technical literature and TI engineering assistance in your specific end or OEM use.



TEXAS INSTRUMENTS
INCORPORATED

GEOSCIENCES & INSTRUMENTATION DIVISION
3609 BUFFALO SPEEDWAY • HOUSTON 6, TEXAS • CABLE: TEXINS

The new "servo/riter" recorder is a companion to the proved "recti/riter" recorder.

*"servo/riter" is a trademark of Texas Instruments

NEW PRODUCTS

Shaft-Position Encoder 715

Provides 360 counts per revolution

This shaft-position encoder provides 360 discrete counts per rotation of the input shaft. It presents a numerical indication of shaft position in degrees in 8-4-2-1 binary-coded-decimal code. Used for applications on machine tools and navigation devices, it is packaged in a size 33 standard BuOrd synchro mount.

United Aircraft Corp., Norden Div., Dept. ED, Wiley St., Milford, Conn.

Infrared Detector Measurement Console 520

Complete instrumentation package

Type ISL 302 infrared detector measurement console is a complete instrumentation package that measures photoconductive, photovoltaic, photoelectromagnetic and pyroelectric detector characteristics. Thermistor bolometer and ac thermocouple characteristics can also be measured. Measurements of black-body sensitivity from 350 to 1,000 K and spectral response from 1 to 5.5 microns in 0.5-micron steps are obtained as functions of frequency, noise bandwidth at a given frequency, and bias voltage.

Infrared Industries, Inc., Dept. ED, P. O. Box 42, Waltham 54, Mass.

Variable Phase Controller 521

For silicon controlled rectifiers

Designated Silcotrig, this variable phase controller provides the phase gating signal necessary for silicon controlled rectifiers. Specifications are: input, 108 to 132 v, 47 to 63 cps; output, 12 v at 50 amp; regulation, $\pm 5\%$ full load to no load; ripple, 50 mv, peak-to-peak.

Bergen Laboratories Inc., Dept. ED, 60 Spruce St., Paterson 1, N.J.

237

◀ CIRCLE 136 ON READER-SERVICE CARD

Silicon Power Rectifier

522

PIV from 100 to 400 v

The Style 51 silicon power rectifier is a double-diffused, hermetically sealed unit. PIV is from 100 to 400 v in 100-v steps. It is rated at 80 amp avg at 20 C ambient on a 7 x 7 x 1/8 in. copper heat sink. Peak forward voltage is 1.25 v, max, at 200 amp; peak surge current is 1500 amp for 1/2 cycle of a 60-cps sine wave. Peak inverse current is 50 ma at rated piv.

Syntroon Co., Dept. ED, 283 Lexington Ave., Homer City, Penn.

Price & Availability: Delivery is 14 days after order received; prices range from \$10.44 to \$59.20 ea, depending on quantity and piv.

Microminiature Relay 528

Withstands 50-g shock

Type BC dc relay, hermetically sealed and can withstand 20 g to 2000 cps and 50-g shock. Operating from -65 to +125 C, the unit requires 40 mw at pull-in at 25 C. Contacts are rated at 2 amp at 32 v dc and for 100,000 operations. Unit measures 0.4 x 0.8 x 1.275 in.

Hi-G, Inc., Dept. ED, Bradley Field, Windsor Locks, Conn.

Availability: Made to order, the units can be delivered four weeks after order received.

Miniature Delay Relay 538

Hermetically sealed in metal can

This miniature delay relay, Model 900G, is a standard, nine-pin socket unit hermetically sealed in a metal can. The time delay ranges from 2 to 180 sec. Voltage range is 6.3 to 115 v ac or dc. The unit is intended for both military and commercial use.

Thermal Controls, Inc., Dept. ED 41 River Road, North Arlington, N.J.

Price & Availability: From stock, \$1.75 to \$3.30 ea, depending on quantities.

CIRCLE 137 ON READER-SERVICE CARD ▶

New Daven video distribution equipment

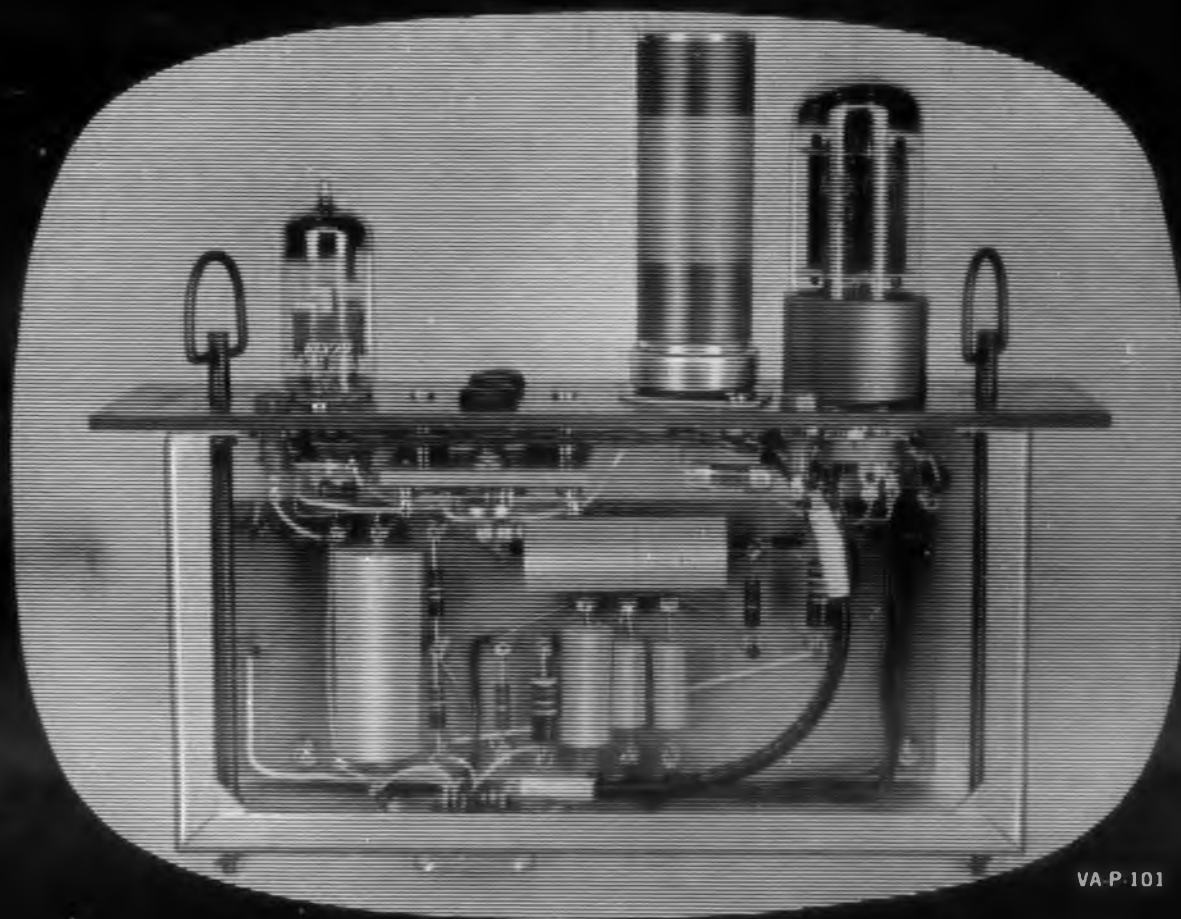

VA-P-101

Greatest versatility for color or black-and-white!

- More outputs in less rack space
- Greatest selection to meet specific needs
- More flexibility for every possible application

Greatest versatility, combined with very low differential phase and gain, plus extremely wide band width, offers the optimum solution to all of your video distribution problems.

Plug-in Video Amplifier Specifications

| Type | Description | Nominal Gain | Nominal Input Level | No. of Outputs | Bandwidth | Diff. Gain At 1V. Out | Diff. Phase At 1V. Out | Approx. B+ Drain |
|------------|---|--------------|---------------------|----------------|----------------------------------|-----------------------|------------------------|------------------|
| VA-P-101 | 1 in/1 out Video Dist. Amp. | Unity | 1 Volt | 1 | Flat $\pm 2\%$ to at least 8.0mc | 0.7% max | 0.35° max | 50 ma |
| VA-P-102 | Sync Adder for VA-P-101 or VA-P-103 Amps. | — | 4 Volts | 1 to 7 | — | — | — | 30 ma |
| VA-P-103 | 1 in/1 out Video Dist. Amp. | +3db | 0.7 Volt | 1 | Flat $\pm 2\%$ to at least 8.0mc | 0.7% max | 0.35° max | 60 ma |
| VA-P-201-0 | 1 in/3 out Video Dist. Amp. | Unity | 1 Volt | 3 | Flat $\pm 2\%$ to at least 8.0mc | 0.7% max | 0.35° max | 125 ma |
| VA-P-201-3 | 1 in/3 out Video Dist. Amp. | +3db | 0.7 Volt | 3 | Flat $\pm 2\%$ to at least 8.0mc | 0.7% max | 0.35° max | 125 ma |
| VA-P-201-6 | 1 in/3 out Video Dist. Amp. | +6db | 0.5 Volt | 3 | Flat $\pm 2\%$ to at least 8.0mc | 0.7% max | 0.35° max | 125 ma |
| VA-P-202 | Sync Adder for VA-P-201 Amps. | — | 4 Volts | 1 to 3 | — | — | — | 30 ma |
| VA-S-101 | Mounting Shelf, to accommodate VA-P-101, VA-P-102 and VA-P-103 amplifiers. Requires 8¾ inches of rack height. | | | | | | | |
| VA-S-201 | Mounting Shelf, to accommodate VA-P-201 and VA-P-202 amplifiers. Requires 8¾ inches of rack height. | | | | | | | |

*Most units are also available as "bathtub" rack mounted chassis.

Write today for new 4-page technical bulletin on Daven video equipment for color and black-and-white.

THE **DAVEN** CO.



LIVINGSTON
NEW JERSEY

TODAY, MORE THAN EVER, THE DAVEN © STANDS FOR DEPENDABILITY

Specify

SAGE

TYPE "M" Miniature Precision Wire-wound Resistors

MIL-R-18546B
STYLES



RH25

M10W



M25W



RH50

M50W

TYPE "CS" CLIPPER



CS3W



CSR5W



CSS7W



CSR7W



CS10W

SAGE

ELECTRONICS CORPORATION
COUNTRY CLUB ROAD
EAST ROCHESTER, N. Y.

CIRCLE 138 ON READER-SERVICE CARD

NEW PRODUCTS

UHF Signal Generator

532

Has 20 w output

Type SLRD uhf signal generator operates from 275 to 2750 mc with an output of 20 w max; it has high frequency and amplitude stability. The generator is direct reading and provides two frequency ranges without changing cavities. An 80-db attenuator is available for low output. The device permits determination of radiation characteristics of antennas and measurements on high-attenuation filters and four-terminal networks, wattmeters and directional couplers.

Rohde & Schwarz, Dept. ED, 111 Lexington Ave., Passaic, N.J.

Transistorized Counter

673

Uses digital logic techniques



The CT-100 transistorized counter uses digital logic techniques to register every input signal at rates to 100 kc. Units are available with preset count features and can be arranged to count up or down to a predetermined number. The cumulative count may be binary-decimal or natural binary code. Output signals are in the form of voltage levels. A visual indication of the count can be supplied.

Datex Corp., Dept. ED, 1307 S. Myrtle Ave., Monrovia, Calif.

Ground Speed and Drift Angle Indicator

657

For helicopters and airships

The hermetically sealed, Model T8605-11N servoed indicator has a variable gain preamplifier and operates in conjunction with the firm's A4708-01 power supply and servo amplifier. The unit, with luminescent pointers and figures, is designed to meet MIL-E-5422 and -5272C specs. The unit requires 115 v, 400 cps, and 27-v dc power. With a scale factor of 0.1 v per knot, a 0.015-v change causes a discernible pointer movement.

Kearfott Div., General Precision Inc., Dept. ED, 1150 McBride Ave., Little Falls, N.J.

**ALLEN
AVIONICS**

new!



DELAY LINES



new
bulletin

New Allen Avionics Bulletin "DL" describes lumped constant, phase and frequency compensated Delay Lines, utilizing sub-miniature inductors and temperature compensating capacitors.

Write for your copy today!

ALLEN AVIONICS, INC.

PRECISION COILS, CAPACITORS, DELAY LINES, FILTERS, TRANSFORMERS

255 EAST SECOND STREET • MINEOLA, NEW YORK
Phone: Pioneer 7-5450

CIRCLE 139 ON READER-SERVICE CARD

PHAZOR
PAT. PEND.

**NULL
METER**

**A PHASE
SENSITIVE
NULL METER
WHEREIN NOISE
AND HARMONIC
VOLTAGES ARE
EFFECTIVELY
ELIMINATED**



MODEL 100A

- Allows separate balance of in-phase or quadrature in null circuits.
- Eliminates the necessity for filters.
- High sensitivity.
- Direction of null clearly shown on zero centered meter.
- Synchro zeroing without recourse to coarse and fine switching.

PRICE
\$29900
F.O.B.
NEW YORK

For further information contact your nearest representative or write for brochure

ITECO

INDUSTRIAL TEST EQUIPMENT CO
55 E. 11th ST. • NEW YORK 3 • GR. 3-4684

VISIT BOOTH 403, NEC, Chicago, Oct. 10, 11, 12, 1960
CIRCLE 140 ON READER-SERVICE CARD

ELECTRONIC DESIGN • October 12, 1960

**SPECIFICALLY ENGINEERED
FOR STABILITY
UNDER HIGHER HEATS**

**HEMINWAY
& BARTLETT**

DACRON LACING TAPES

with "G.E." Finish

Here's a Dacron lacing tape with a fungus-proof, non-slip finish that has great stability under higher heats! It ties faster, easier and tighter... knots won't slip...assemblies stay tight and firm!

Write today for full information and samples.



THE HEMINWAY & BARTLETT MFG. CO.
Electronics Division: 500 Fifth Avenue, New York 36
Distributor—Alpha Wire, New York

CIRCLE 141 ON READER-SERVICE CARD

free send for the
ALLIED
1961 ELECTRONIC
SUPPLY CATALOG

572 PAGES • MOST COMPLETE

BUY AT FACTORY PRICES

WORLD'S LARGEST STOCKS...SPECIALIZING IN:

- Semiconductors
- Connectors
- Relays
- Transformers
- Knight-Kit® Instruments in Low-Cost Kit Form
- Electronic Parts for Every Industrial Need
- Special-Purpose Tubes
- Test Equipment, Meters
- Resistors, Controls
- Switches, Timers

ONE ORDER TO ALLIED FILLS THE WHOLE BILL

Have the world's largest stocks of electronic equipment at your command. No need to deal with hundreds of separate factories—one order to us fills the whole bill. You get same day shipment. You buy at factory prices. Write today for the FREE 1961 ALLIED Catalog—your one-source electronic supply guide.

ALLIED RADIO

100 N. Western Ave., Dept. 69-K
Chicago 80, Ill.

your dependable source for everything in electronic supply

send for
FREE
CATALOG

CIRCLE 142 ON READER-SERVICE CARD

ELECTRONIC DESIGN • October 12, 1960

Mechanical Differentials

605

The mechanical differentials are useful for adding and subtracting shaft movements, reversing shaft rotation, as variable speed changers and as a clutch or brake. Other applications include instruments and tuning devices.

Gries Reproducer Corp., Dept. ED, 400 Beechwood Ave., New Rochelle, N.Y.

Price: Price is less than \$0.10 ea.

SSB Receiver

606

Model RSSB-59-1A sss receiver is available for am broadcast use. It is designed for relaying radio broadcast signals, program monitoring in difficult reception areas and various Conelrad applications. It operates on 110 v ac or an emergency battery.

Kahn Research Laboratories, Inc., Dept. ED, 81 S. Bergen Place, Freeport, N.Y.

Container Latch

368

Designed for rugged service, Type 37L latch has an ultimate tension and shear strength of 4500 lb; 5-1/4 and 3-7/8 in. lengths are available. The unit is fused for pin-shearing on overload.

Camloc Fastener Corp., Dept. ED, 22 Spring Valley Road, Paramus, N. J.

Silicon Rectifiers

385

These units are for medium-power use at up to 6 amp. They are offered in eight piv ratings from 50 to 600 v and in 1/2-in. hex ceramic insulated or 7/16-in. hex styles.

Cornell-Dubilier Electronic Corp., Dept. ED, Norwood, Mass.

Work Holder

462

For use in light production such as assembly of electronic and aircraft components, this work holder can be bolted to a work table or bench. It facilitates run changes by the operator and may be put together in any shape by means of a screw driver.

Wilton Tool Manufacturing Co., Inc., Dept. ED, Schiller Park, Ill.

Video Amplifier

635

This one-chassis video-amplifier weighs 22 lb and measures 19 x 7 x 9.5 in. Internal switching permits use as a distribution amplifier, a line amplifier, or a combination of the two.

Television Utilities Corp., Dept. ED, 300 Denton Ave., New Hyde Park, L. I. N.Y.

Resistance Thermometer

578

This platinum resistance thermometer measures liquid hydrogen with a repeatability of 0.05 F. Resistance at -435 F is 19.8 ohms. The transducer has a resistance change of 27.6 ohms.

Trans-Sonics, Inc., Dept. ED, Burlington, Mass.

Specify

SAGE
TYPE "S" Miniature Precision Wire-wound Resistors

MIL-R-26C STYLES

RW59 → SA1W

→ SB1W

RW59 → SA2W

→ SB2W

→ S2W

→ S3W

→ SS5W

RW57 → SR5W

→ SS7W

RW55 → SR7W

RW58 → SS10W

RW56 → S10W

SAGE
ELECTRONICS CORPORATION
COUNTRY CLUB ROAD
EAST ROCHESTER, N. Y.

CIRCLE 143 ON READER-SERVICE CARD

Only \$285
per pound
(prox!)
—and
They're real
space
savers, too.



The Series BH100

MILLI-V-METER™

The Instrument with the TAPE-SLIDEWIRE



**for PETROLEUM, CHEMICAL, STEEL,
ALUMINUM and other processing plants...**
to accurately indicate
**TEMPERATURE, FREQUENCY, FLOW,
LEVEL, PRESSURE, R.P.M., WEIGHT, etc.**

Every function of the producing plant may be measured *and controlled* with high accuracy. Ideally small and designed for uniform panel installation, the MILLI-V-METER is completely self-contained...including power supply, servo unit, slidewire and amplifier. Every measurement exhibited on the counter is a precisely (electronically) calibrated value.

1/10 the size
10 times the
accuracy
of standard instruments

QUALITIES

- 1) Accuracy 1 part in 1000. Laboratory precision for industry or the military.
- 2) Compatibility with any transducer—AC or DC.
- 3) For strain gage, linear differential transformer, thermocouple, thermistor, resistance thermometer, pulse or variable frequency circuits or systems.
- 4) Operates directly from 60- or 400-cycle power as specified.

SPECIAL FEATURES

For Recording... a re-transmitting slidewire may be provided within the case.
For Controlling... switch contacts may be provided to operate control units, remote indicators, or printers.
For Computers or Telemetering... counters with decimal outputs may be added.

*Produced by
the makers of JETCAL®
jet engine Analyzer
...in worldwide military
and airline use!*

*Full information
is available for the asking!*

*Sales-Engineering Offices:
ATLANTA, GA.; COMPTON, CAL.
DAYTON, OHIO; WICHITA, KAN.
VALLEY STREAM, L. I., N. Y.
TORONTO, ONT. (George Kelk Ltd.)
MITCHAM, SURREY, ENGLAND
(Bryans Aeroquipment Ltd.)*



HOWELL INSTRUMENTS, INC.

FORMERLY E&H INSTRUMENT CO., INC.

3479 WEST VICKERY BLVD. • FORT WORTH 7, TEXAS

CIRCLE 144 ON READER-SERVICE CARD

NEW PRODUCTS

Digital Indicator 585

For changeable-message boards

This digital indicator has been designed for application in changeable-message public information boards, digital clocks, computer readouts, and other visual message systems. A new design principle eliminates all message belt slippage and position adjustment problems. Motors are available in 6 to 220 v, 50 to 60 cps ratings. The standard single-light-showing indicator has a 2 x 4-1/2 in. visual character and cases are 2-5/8 x 6 x 9-3/4 in. Other units are available with message visual areas up to 40 x 4 in.

The Electric Indicator Co., Inc., Dept. ED, Springdale, Conn.

Trimmer Potentiometers 365

Single-turn unit



A single-turn, top-adjusting miniature potentiometer, the Wee Round model 530 trimmer has a 1/2-in. diameter, is 1/5 in. thick and weighs less than 2 g. Units are available in standard resistance values from 10 to 50,000 ohms. Wiper rotation is continuous; temperature range is -55 to +150 C. MIL-E-5272A specifications are met.

Handley, Inc., Dept. ED, 12960 Panama St., Los Angeles 66, Calif.

Synchronous Motor 579

Has 150 oz-in. torque

Type SS150M militarized Slo-Syn synchronous motor has a torque of 150 oz.-in. and a speed of 72 rpm. It has instant stop, stop and reverse characteristics, and is suitable as a dc stepping or inching motor. Input power is 120 v, 40 to 70 cps; maximum current is 0.4 amp at 60 cps. The unit weighs 6-1/2 lb. Planetary gear assemblies, providing speeds of 16.6, 3.3, 0.67, 0.133 or 0.027 rpm, are available.

The Superior Electric Co., Dept. ED, Bristol, Conn.

Price: Price is \$64.00 without planetary gears.

Specify

SPERRY

for

**2N327A
2N328A
2N329A
2N330A**

**SILICON
PNP TRANSISTORS**



*New low levels of I_{co};
baked at 200° C for
200 hours for
utmost stability.*

*Specify Sperry through
AVNET
exclusive Sperry
Distributor East of the
Rockies.
Factory Prices, for
quantities 1-999*

**Call your
Avnet
Applications
Engineer**

For dependable service



and immediate delivery

AVNET

AVNET • 70 State St., Westbury, N. Y. - ED 3-5800
AVNET • 45 Winn St., Burlington, Mass. - BR 2-3060
AVNET • 4180 Kettering Blvd., Dayton 39, Ohio - AX 8-1458
AVNET • 2728 N. Mannheim Rd., Melrose Park, Ill. - GL 5-8160

CIRCLE 145 ON READER-SERVICE CARD

High-Voltage Test Set 435

Provides ac potentials to 150 kv

This high-voltage test set, mounted in a console type cabinet, provides ac potentials to 150 kv for breakdown and insulation leakage tests. Models are available with maximum outputs of 30, 50, and 75 kv, with ratings of 1, 2 and 5 kva, as well as up to 150 kv.

Associated Research Incorporated, Dept. ED, 3777 W. Belmont Ave., Chicago 18, Ill.

Price & Availability: Bench types start at \$895, deluxe console models at \$1,900. Delivery from 4 to 6 wk after order received.

Infrared Calibration 436 System

Range is 50 to 600 C

This secondary standard calibration system provides a versatile means of calibrating test sources of infrared energy. It provides a simultaneous comparison of IR sources with a secondary source whose radiation characteristics are accurately known. Calibration over the temperature range 50 to 600 C is possible. The unit can be used to calibrate sources up to 12 in. in diameter and 50 lb in weight. It is designed to test sources having aperture sizes from 0.0087 to 0.50 in. in diameter.

Perkin-Elmer Corp., Dept. ED, Norwalk, Conn.

High-Mu Triode 437

For TV and fm tuners

Type RCA-6CW4 high-mu triode, a Nuvistor tube, is designed for use in TV and fm tuners. The rf amplifier tube has a reported noise factor 2 to 4 db better than tuner tubes now in use. Operation data: heater voltage, 6.13 v $\pm 10\%$; current at 6.3 v, 0.13 amp; plate voltage, 70 v; grid supply voltage, 0 v; amplification factor, 68; transconductance, 12,500 μmhos ; plate current, 8 ma.

Radio Corp. of America, Electron Tube Div., Dept. ED, Harrison, N.J.

RCA Thyristors
Commercially available...
NEW RCA BILION POWER TRANSISTORS
6 NEW RCA INTERMEDIATE POWER TRANSISTORS
RCA Announces... 7 new low-cost DIFFUSED-JUNCTION SILICON RECTIFIERS for Industrial and Consumer Products
NOW NINE-NINETY-NINE AT YOUR NEAREST RCA SEMICONDUCTOR DISTRIBUTOR

RCA's entire line of Silicon and Germanium Transistors and Silicon Rectifiers is now as close as your telephone and can be obtained at factory low prices in quantities up to 999. The new "Drift Field" types... Thyristors, exciting new bi-stable switching transistors... the High Power, Intermediate Power and Medium Power Silicon Transistors featuring exceptionally low-saturation resistance... are just a few examples of the rapidly expanding line of RCA Semiconductor Products you can now quickly and conveniently order from your nearby RCA Semiconductor Distributor. And don't forget these extra benefits a call to your RCA SEMICONDUCTOR DISTRIBUTOR will bring to you:

- Prompt delivery of the latest RCA types for your evaluation
- Valuable technical assistance when you need it
- Orders filled from factory-fresh stock
- "One-stop" service on your orders
- Up-to-date, practical product information
- Specialists who understand your problems and your electronic needs

Semiconductor Products
Distributor Sales
Harrison, N. J.



The Most Trusted Name in Electronics
RADIO CORPORATION OF AMERICA



NEW \$3,500,000 FACILITY ANNOUNCED BY VOUGHT ELECTRONICS

On July 21, Vought Electronics broke ground for a new \$3.5 million facility in the Great Southwest Industrial District, midway between Dallas and Fort Worth. Completion date for the ultramodern 80,000 square foot building is January 1961, with expansion to 175,000 square feet projected within the next few years.

Complete Electronics Facility The completely self-contained facility will house engineering, assembly and manufacture, quality control, marketing, finance and administrative areas. Also included will be five laboratories—inertial guidance, servomechanism, fluids, microwave and environmental—all with advanced equipment.

Diversified Products Recent major Vought Electronics contracts include: production of actuators for the *Minuteman* ICBM, factory check-out equipment for the inertial guidance system of the *Titan* ICBM, guidance systems and autopilots for the new *Crusader* F8U-2N fighter.



B. H. Ciscel, general manager of Vought Electronics (left) and A. G. Wynne, Jr., president of Great Southwest Corporation, check details of new facility.

Among other new products are an aircraft navigational system, space vehicle guidance units, ASW devices, advanced antennas, a commercial fingerprint identification system.

FOR COMPLETE INFORMATION ON HOW THE NEW VOUGHT ELECTRONICS FACILITY CAN SERVE YOU, write:

CHANCE VOUGHT  **ELECTRONICS DIVISION** DALLAS, TEXAS

ANTENNAS • AUTOMATIC CONTROLS • NAVIGATIONAL ELECTRONICS • GROUND SUPPORT ELECTRONICS
CIRCLE 147 ON READER-SERVICE CARD

NEW PRODUCTS

Variable Delay Line

362

Printed circuit applications

Suited for printed circuit applications, this delay line provides a high ratio of delay to rise time in minimum space. The variable tap may be locked in any position. The unit has a -55 to $+125$ C temperature range, a 0.1-in. grid spacing for printed-circuit mounting, about 1 db per μ sec attenuation, an extremely low temperature coefficient, and positive end stops.

JFD Electronics Corp., Dept. ED, 6101 16th Ave., Brooklyn, N. Y.

Price & Availability: The units will be priced at about \$70.00 and will be available from stock in August, 1960.

Servo Repeater

672

Has digital indication



Model SR-113 servo repeater, suitable for use with a synchro-transmitting unit, indicates the angular position of a remote shaft in digital form. The coded output can be fed to printers, tape punches, card punches, and light banks. The digital code output is 00000 to 35999. The unit contains a resolver, servo motor, servo amplifier, transformer, shaft-position encoder, and gear trains. Maximum input shaft speed is 250 rpm. Absolute accuracy is ± 1.5 counts.

Datex Corp., Dept. ED, 1307 S. Myrtle Ave., Monrovia, Calif.

Insulation Materials

576

Bonded laminated plastics

These bonded, combination materials combine the advantages of laminated plastics and vulcanized fibres with those of other materials. Rubber-phenolite combinations have resilience, shock-absorption and metal-sealing characteristics; rubber-fibre combinations are suitable for condenser sealing washers and shock absorbing applications; phenolite-fiber combinations provide arc resistance and mechanical strength.

CIRCLE 148 ON READER-SERVICE CARD

ELECTRONIC DESIGN • October 12, 1960

metal-phenolite combinations are suitable for printed circuits. Also available are metal-fibre, asbestos-fibre and vulcanized fibre-Mylar.

National Vulcanized Fibre Co., Dept. ED, 1060 Beech St., Wilmington 99, Del.

High-Potential Test Sets

For non-destructive testing



The series 650 high-potential test sets and megohm meters for non-destructive testing have special circuitry for protection of components under tests. They offer tests of dielectric strength from 0 to 5,000 v, dielectric leakage from 20 μ a to 3 ma, insulation resistance from 0.5 to 10 million meg and from 10 to 500 v dc, surface resistance and capacitor leakage. A standard resistance for calibration is built in. Accuracies are from 2% to 10%.

General Hermetic Sealing Corp., Dept. ED, 99 E. Hawthorne Ave., Valley Stream, L. I., N. Y.

Stub Tuners

Cover 200 to 12,000 mc



This line of coaxial stub tuners includes a complete selection of single, double, and triple-stub units. They cover the frequency range of 200 to 12,000 mc in three overlapping bands and are provided with one male and one female connector in either N, BNC, TNC, C, or HN series.

Microlab, Dept. ED, 570 W. Mount Pleasant Ave., Livingston, N. J.

Price & Availability: Single-stub units, \$40 to \$60, double, \$90 to \$140; and triple, \$140 to \$180. **Delivery is immediate.**

◀ CIRCLE 148 ON READER-SERVICE CARD

ELECTRONIC DESIGN • October 12, 1960

Now for the first time — a single source of supply for CONTOUR* cable, connectors and custom engineered inter-connection and harness systems

Hughes offers a complete line of continuous and etched CONTOUR cable and connector components — off-the-shelf and custom engineered. They are designed to meet the most rigid performance requirements. Their use offers marked advantages over conventional methods in fabricating all types of wiring harnesses, interconnecting cables, moving joint connectors, and relay rack drawer connections. For technical assistance in the application of these components to your interconnecting and wiring problems; for literature, price or delivery information, write, teletype (TWX INGL 4117) or call collect: HUGHES Industrial Systems Division, P.O. Box 90904, International Airport Station, Los Angeles 45, California. For export information, write: HUGHES International, Culver City, California.

*Trademark of Hughes Aircraft Company

CREATING A NEW WORLD WITH ELECTRONICS

HUGHES

INDUSTRIAL SYSTEMS DIVISION

HUGHES AIRCRAFT COMPANY

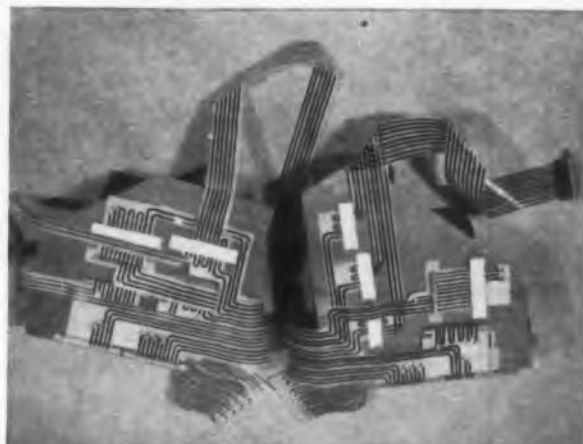

CONTOUR CABLE WIRING HARNESS

DOUBLE CONTACT ETCHED CIRCUIT
CONTOUR CABLE CONNECTION



CONTOUR CABLE STRIPPER



CONTOUR CABLE



ROTARY JOINT CONNECTION



HYDROSTATIC CABLE TO CABLE
ENVIRONMENTAL CONNECTOR

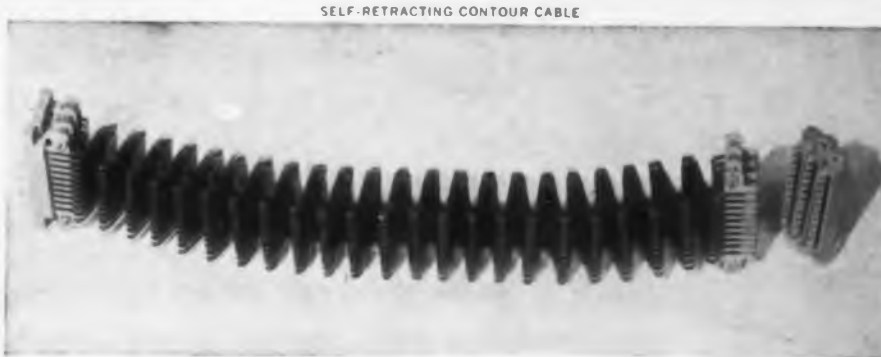

SELF-RETRACTING CONTOUR CABLE

◀ CIRCLE 149 ON READER-SERVICE CARD



still waiting for your pots?

Are your pot delivery schedules figured in weeks instead of days? If you're a member of the Pot Waiter's Club, read on:

At ACE, we fully inventory all parts for our complete standard line! And when a pot has to be made from scratch — we cut time there, too. All raw materials are warehoused, and a complete machine shop, including Swiss screw machines, is maintained. Our special prototyping department lops the time off special requirements.

Prepared engineering releases and part prints for standard pots await your incoming order. That's why, within hours after receipt, your order for standards is into manufacturing! So specify from Ace's comprehensive line of standards, in full resistance ranges, sizes, configurations and functions. Your "special spec" is probably among our standard line — and that means time and money saved for you!



This 1-1/16" ACEPOT® typifying the entire standard line, is available on prompt delivery!

ACE ELECTRONICS ASSOCIATES, INC.
99 Dover Street, Somerville 44, Mass.
SOMerset 6-5130 TXM SMVL 181 West, Union WUX

Acepot® Acetrim* Acetel® Aceohm® *Reg. Appl. for

CIRCLE 150 ON READER-SERVICE CARD

NEW PRODUCTS

Inertial Component Test Table 613

Two-axis servo-driven

Model 6001 test table can statically and dynamically evaluate gyros and systems weighing up to 150 lb. Constant rates between 0.15 deg per hr and 1,200 deg per sec are available. The unit can also be used as a harmonic motion table. Slip-ring and brush block assemblies, with 24 circuits, can be provided for each axis. Units with pancake resolvers or synchros yield standard accuracies. Accuracies to 3 sec are available with inductive precision angular pickoffs.

Power-Tronic Systems, Inc., Dept. ED, 10 Pine Court, New Rochelle, N.Y.

Power Supply 558

Output is 0 to 32 v



Model 3210 transistorized, laboratory power supply provides an output of 0 to 32 v at a rated load of 1 amp. Maximum output current, selected by front-panel control, can be 1.25, 0.7, 0.35, and 0.1 amp. Ripple is less than 1 mv and voltage regulation is better than 0.1%. Input is 105 to 125 v at 60 to 400 cps.

Power Instruments Corp., Dept. ED, 235 Oregon St., El Segundo, Calif.

Price & Availability: \$295; from stock.

Placard Lights 361

Lamps easily replaced

These twin-lamp lights illuminate legends on 1-3/16 x 9/32 in. translucent plastic strips. Type T-1-3/4 midget incandescent lamps are used and can be replaced without special tools. Types available are: VM281 (2-terminal), VM282 (3-terminal "press-to-test"), SW284 (3-terminal normally closed "press-to-switch") and SW287 (4-terminal normally open "press-to-switch").

Dialight Corp., Dept. ED, 60 Stewart Ave., Brooklyn 37, N. Y.

Availability: Lights are available from stock. For free samples, engineers write on company letterhead to above address.

WHITSO STANDOFF TERMINALS ...Largest Line Available

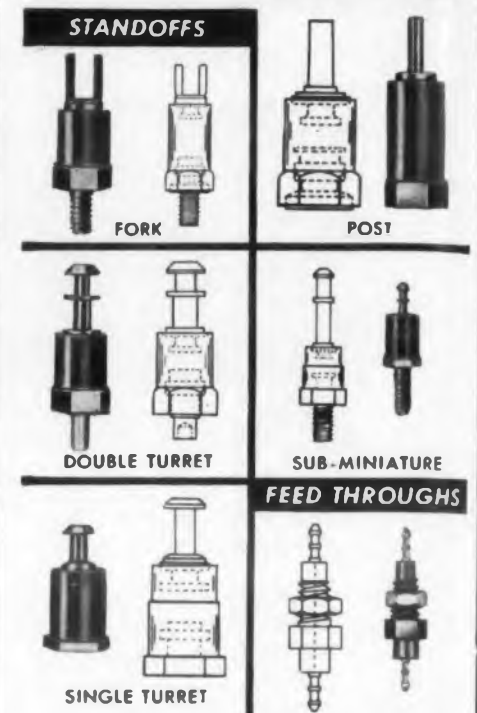

DIALYL PHTHALATE AND MELAMINE BODY MATERIALS TO MEET MILITARY STANDARDS

Get the exact standoff or feed through terminal you want from a full range of types, sizes, body materials and plating combinations. Specials can be supplied to specification. The Whitso line is complete to the fullest extent of every industrial, military and commercial requirement.

Standoff terminals include fork, single and double turret, post, standard, miniature and sub-miniature body types—male, female or rivet mountings—molded or metal base. Feed through terminals are furnished standard or to specification.

Plating Combinations: Many terminal and mounting combinations furnished as standard.

Specials: Body materials and plating combinations, also dimensions, can be supplied to specifications.

PROMPT DELIVERY IN ECONOMICAL QUANTITY RUNS

Get facts on the most complete, most dependable source for terminals and custom molded parts. Request catalog.



WHITSO, INC.
9326 Byron Street, Schiller Park, Illinois
(Chicago Suburb)

CIRCLE 151 ON READER-SERVICE CARD



tubular capacitors

ultra-high precision
with a

**NEW DEGREE
of
RELIABILITY**



SOUTHERN ELECTRONICS CORP. has long been a leader in the design and manufacture of high-precision tubular capacitors, and has pioneered in supplying them for critical applications in computers, missiles, communications and other high-grade military and commercial equipment. They are made to the same standards as our high precision polystyrene capacitors so widely accepted for military applications.

SEC tubular capacitors are manufactured under unusually critical quality control standards, resulting in tolerances as low as 0.5% in most values, and hermetic sealing guarantees accuracy over wide environmental changes.

SEC tubulars are available in a wide range of tolerances to meet your needs, from 100 mmfd. to any higher value, in polystyrene, mylar, metallized mylar, teflon and dual-dielectrics.

All SEC tubular capacitors meet or exceed the most rigid MIL-SPECS.

In addition, we manufacture a complete line of tubular capacitors for commercial applications. Let us know your requirements.

Write today for detailed technical data and general catalog.



Fast delivery schedules—Phone or write for complete information

**SOUTHERN
ELECTRONICS
Corporation**

150 WEST CYPRESS AVENUE
BURBANK, CALIFORNIA

CIRCLE 152 ON READER-SERVICE CARD

Transistor Choppers 490

Available in matched pairs

Available in matched pairs, these transistor choppers have applications in multiplex and analog switching circuits. Specifications include: low off-set voltage, low off-set current, high frequency, and high temperature resistance.

Philco Corp., Lansdale Div., Dept. ED, Church Road, Lansdale, Pa.

Pressure Transducer 515

Withstands 35-g acceleration



Type 4-383 potentiometer pressure transducer withstands 35 g of acceleration at 2,000 cps. It is designed for use in space missiles and supersonic aircraft. Maximum deviation due to linearity, hysteresis, repeatability, and friction is less than $\pm 1\%$. Gage and absolute models measure from 600 to 3,500 psi; other ranges can be ordered. Effective operating temperatures are -65 to $+200$ F.

Consolidated Electrodynamics Corp., Dept. ED, 360 Sierra Madre Villa, Pasadena, Calif.

Price & Availability: From \$415 in lots of 1 to 9 to \$325 in lots of 100 and up; delivery time is 45 days.

Flame-Retardant Laminate 352

For printed circuits

This epoxy glass laminate, No. 6097 Lamicoid, known as CuClad, has high moisture resistance, surface resistance of 500,000 meg, and extinguishes itself 2 sec after flame removal in a standard flame retardancy test. The laminate, available with 1- or 2-oz copper foil bonded to either or both sides, is readily fabricated by conventional techniques; and the high-peel-strength copper bond is unaffected by standard plating and etching solutions. Connections may be made by dip or float soldering. The laminate exceeds MIL-P-18177B type GEB specifications.

Mica Insulator, Div. Minnesota Mining and Manufacturing Co., Dept. ED, Schenectady 1, N. Y.

Price & Availability: The laminate is available in 36 x 42 in. sheets, 1/64 to 2 in. thick. It is priced at \$3.48 per lb in thicknesses of 0.05 in. and over.

HELIPOT® ...

POTS : MOTORS : METERS

POTENTIOMETERS: The most complete lines of multi-turn and single-turn precision pots...linear and non-linear. Also dials; delay lines; and a complete line of precision trimming pots. Write for data file P712.

SERVOMOTORS: Motor-generators, motors, velocity damps and inertia damps...Sizes 8-11-15 & 18. Beckman® Servomotors feature the most rapid response in the industry...models are available for both 26-volt and 115-volt operation, or anything in between. Write for data file P713.

METERS: Panel meters and expanded scale meters...either commercial or ruggedized and sealed. A full range of sizes in voltmeters, ammeters, milliammeters, microammeters and frequency meters. Write for data file P714.



Beckman/Helipot®

POTS : MOTORS : METERS

Helipot Division of
Beckman Instruments, Inc.
Fullerton, California



© 1960 B.I. 61001

CIRCLE 153 ON READER-SERVICE CARD



**"From transistor radios to computers—
one of National's 116 materials and grades will
give you optimum performance in your design."**

Why go on a wild goose chase from supplier to supplier for the special plastic material you need for your design? A time- and trouble-saving check with National gives you unbiased help and a material best suited to your property requirements.

National offers the broadest line of basic engineering materials in the industry . . . over 115 materials and grades. You can select the *one best material* to fit your design electrically . . . mechanically . . . chemically. For example:

If you are looking for a new printed circuit material with self-extinguishing properties against fire, National offers XXXP-475. It is made without costlier resins—can be punched at warm temperatures (130° F.—150° F.).

Vulcanized Fibre, extruded thermoplastics and PHENOLITE® laminated plastics offer a wide range of property combina-

tions, such as high electrical-mechanical values plus excellent water absorption and dimensional stability characteristics. Or, electrical properties plus rigidity and heat resistance. Or, electrical properties plus chemical resistance and dimensional stability under load.

You will also find three other important "properties" at National: an understanding of your needs; a willingness to work *with* you; and a facility to fill your requirements fast and efficiently.

You can obtain National materials in standard forms—sheet, tube, rod—in precision fabricated parts to your design, or special-molded polyester shapes. For objective assistance, contact your nearby National Sales Engineer today. Or write us direct, Dept. E-10, Wilmington, Delaware.

CIRCLE 154 ON READER-SERVICE CARD

NEW PRODUCTS

Microwave Crystals

489

For rf power switching

These X-band crystals are for rf power switching. Specifications include: isolation, 18 db min; insertion loss, 2 db max; power level 100 mw; and switching speed, 1 nsec.

Philco Corp., Lansdale Div., Dept. ED, Church Road, Lansdale, Pa.

Microwave Switch

730

Frequency range is 8.2 to 12.4 kmc



Designed for laboratory testing applications, model WXS-120 microwave switch is an spdt, manually-operated unit with a frequency range of 8.2 to 12.4 kmc. It can be used for switching from a slotted line to a reflectometer and ready switching from one signal source to an alternate source for gain measurement. Size is 1-5/8 in. high and 3-1/2 in. deep. Minimum mechanical life is 100,000 cycles.

Waveguide, Inc., Dept. ED, Costa Mesa, Calif.
Price: \$275 *job* Costa Mesa.

Tunnel Diodes

583

Made from germanium dendrites

Type WX822 tunnel diodes are made of germanium grown by the dendritic crystal process. Ratings of the devices include: peak-to-valley ratio (I_P/I_V), 8 to 1; forward current, 25 ma; reverse current, 25 ma; dissipation, 50 mw; junction temperature, 100 C. They operate at high frequencies and are suited for applications in logic, switching and computer circuitry where faster switching times than those possible with transistors are required.

Westinghouse Electric Corp., Dept. ED, Box 2278, Pittsburgh, Pa.

Price: Prices range from \$4.00 to \$5.50 *ea* in quantities up to 24; from \$3.20 to \$4.00 on orders of 25 or more.



CHOOSE FROM THESE MATERIALS...

Vulcanized Fibre: 10 standard grades; many special grades.

PHENOLITE® Laminated Plastic: over 80 standard and modified grades; paper, cotton fabric, nylon, asbestos, glass fabric, cotton and glass mat bases; phenolic, melamine, polyester, epoxy, teflon or silicone resins.

PEERLESS Electrical Insulation: coil, strip, corrugated.

Extruded Nylon, "Delrin", "Penton": rod, strip, tubing, special shapes.

Polyester Glass Mat: 4 standard sheet grades; custom molded shapes.

PHENOLITE Copper-Clad Laminates: 10 standard grades.

Combination Materials: Rubber-PHENOLITE; Rubber-Fibre; Wood-Fibre; Metal-Fibre; Asbestos-Fibre; PEERLESS-PHENOLITE.

BACKED BY THESE SERVICES...

Field Application Assistance
Complete Fabricated Parts Service
Stock Program for Immediate Shipment

BY CALLING THESE OFFICES...

Baltimore VAlley 3-0393
Boston TWinbrook 4-3500
Chicago AUstin 7-1935
Cincinnati GARfield 1-0632
Cleveland ERview 1-0240
Dallas DAVis 4-4386
Denver MAIn 3-2077
Detroit UNiversity 3-3632
Griffin, Ga. 8-1308
Indianapolis WAINut 3-6381
Los Angeles RAYmond 3-0291
Milwaukee BRoadway 6-6995
New Haven LOCust 2-3594
Newark MITchell 2-6090
New York COrtlandt 7-3895
Philadelphia SHerwood 8-0760
Pittsburgh FAirfax 1-3939
Rochester HILLside 5-0900
St. Louis PARkview 5-9577
St. Petersburg 5-5505
San Francisco DAVenport 6-4667
Seattle MELrose 2-7298
Wilmington OLympia 5-6371

IN CANADA:
National Fibre Co. of Canada, Ltd.
Toronto LENnox 2-3303
Montreal AVenue 8-7536

NATIONAL
VULCANIZED FIBRE CO.

WILMINGTON 99, DELAWARE

In Canada:
NATIONAL FIBRE COMPANY OF CANADA, LTD., Toronto 3, Ontario

CIRCLE 155 ON READER-SERVICE CARD

Ultrasonic Material Tester 663

Model CM100 tester provides for the following kind of inspection: flaw detection, surface or internal; thickness measurement from one side; and determination of physical and structural properties. Designed for in-plant use, the unit is portable.

Circo Ultrasonic Corp., Dept. ED, 51 Terminal Ave., Clark, N.J.

Wire Straights 638

For hermetic sealing, wire straights with square-cut ends and with no surface markings come in standard sizes of Rodar and No. 52 alloy. Non-standard wire diameters and alloys can also be furnished.

Art Wire and Stamping Co., Dept. ED, 227 High St., Newark 2, N.J.

Availability: Immediate delivery on stock items.

Solderless Terminals 434

Multiple V-notches in the barrel of these solderless terminals insure positive contact and good holding power. The terminals are made of pure soft copper, electro-tin plated for corrosion resistance. Wire ranges are clearly stamped on each terminal.

Malco Manufacturing Co., Dept. ED, 4025 W. Lake St., Chicago 24, Ill.

Lead Extractors 608

Called Little Joe lead extractors, these tools are used to eject insulated leads through the shields of braided wire. Five models are available; they accommodate most wires from 32 to 14 AWG.

MacDonold & Co., Dept. ED, 1325 Ethel St., Glendale 7, Calif.

Price: Price is \$4.25 ea.; for 10 or more, \$4.00.

Expendable Elapsed Time Indicator 406

The Chronistor elapsed time indicator is a sub-miniature, expendable timer which operates on the electroplating principle. Current required is 1 ma at any voltage greater than 6 v dc. Full scale hours from 100 to 10,000 are available. It fits any standard 3AG cartridge fuse clip.

Bergen Laboratories Inc., Dept. ED, 60 Spruce St., Paterson 1, N.J.

Metal-Filled Silicone Rubber 407

Designated Cohrlastic HG, this material combines a high percentage of heavy metal particles finely divided and uniformly dispersed in silicone rubber. It has a temperature range of -85 to $+500$ F; good resistance to weather, ozone and ultraviolet light; uniform shielding against high energy radiation. Electrical resistance is 10^{17} ohm-cm. Uses include radiation shielding and acoustic damping.

The Connecticut Hard Rubber Co., Dept. ED, 407 East St., New Haven, Conn.

READ .0002 $\mu\mu f$



PRECISION 3-TERMINAL (INSENSITIVE TO GROUNDED CAPACITANCE) CAPACITANCE BRIDGES

MODEL 74C

- 100 KC Test Frequency
- 0.0002-11,000 $\mu\mu f$
Generally 0.25%
- 1000 ohms to 1000 megohms
Shunt Resistance
- 0.001 to 1000 μmhos
Conductance

Price \$935

MODEL 75A

- 1 Mc Test Frequency
MIL SPEC. TESTING
- 0.0002 to 1000 $\mu\mu f$
Generally 0.25%
- 1000 ohms to 100 megohms
Shunt Resistance
- 0.01 to 1000 μmhos
Conductance

Price \$990

MODEL 74C-88 (Shown)

- With -5 to $+100$ V DC Bias
for Diode Testing

Price \$995

MODEL 75A-88

- With -5 to $+100$ VDC Bias
for Diode Testing

Price \$1050



Boonton ELECTRONICS Corp.

MORRIS PLAINS, N. J. • Phone JEFFERSON 9-4210

CIRCLE 156 ON READER-SERVICE CARD

work in Southern California on the

EAGLE



ADVANCED OPPORTUNITIES FOR SENIOR ENGINEERS

Bendix-Pacific Division, North Hollywood, California, as a member of the Bendix Corporation "EAGLE" Development Team, is a major contributor to the Navy's newest air-to-air Missile "EAGLE." This weapon system is a second generation air-to-air Fleet Defense System and offers challenging design opportunities to the creative engineer.

ADVANCED POSITIONS ARE OPEN TO MEN WITH BACHELOR, MASTER AND DOCTOR DEGREES IN ELECTRICAL AND MECHANICAL ENGINEERING WITH EXPERIENCE IN ELECTRONIC CIRCUIT DESIGN AND MECHANICAL PACKAGING. OTHER HIGH-LEVEL ELECTRONIC ENGINEERING POSITIONS AVAILABLE

Please send resume to
W. C. WALKER,
ENGINEERING EMPLOYMENT MANAGER

Bendix-Pacific Division
11604 SHERMAN WAY
NORTH HOLLYWOOD, CALIFORNIA



CIRCLE 906 ON CAREER INQUIRY FORM, PAGE 223

VOLTAGE ($\pm 1\%$ fs)
 $\pm 100 \mu\text{v}$ to $\pm 1000\text{v}$

D-C MICROMULTIMETER

totally isolated from power line

ALL-TRANSISTOR CIRCUIT
NICKEL-CADIUM BATTERY
WITH AUTOMATIC RECHARGE

CURRENT

($\pm 1\%$ fs)
 $\pm 100 \text{ m}\mu\text{a}$
to $\pm 1.0\text{a}$



Model 4182

Price \$785.00

RESISTANCE

10 ohms (fs)
to 100M (fs)

WHEATSTONE BRIDGE
CURRENT THROUGH UNKNOWN
ALWAYS LESS THAN 1mA
3 DIGIT ACCURACY

D-C MICROVOLTMETERS AND
D-C MICROVOLT/AMMETERS ARE
ALSO AVAILABLE, IN BOTH RACK
AND PORTABLE MODELS, FOR THOSE
WHO DO NOT REQUIRE THE RESISTANCE BRIDGE.

COMPLETE SPECIFICATIONS ARE AVAILABLE ON REQUEST.

DYNAMICS
INSTRUMENTATION COMPANY

583 MONTEREY PASS ROAD, MONTEREY PARK, CALIF.

CIRCLE 159 ON READER-SERVICE CARD

NEW PRODUCTS

Backward Diodes

488

For computer use

Available in both germanium and gallium arsenide types, these backward diodes may be used as a unilateral coupling element in tunnel-diode logic circuits. Peak current is controlled to within $\pm 2.5\%$. Capacity, inductance and series resistance are low.

Philco Corp., Lansdale Div., Dept. ED, Church Road, Lansdale, Pa.

Crystal Oven

675

Is stable to 0.005 C



This crystal oven is stable to within ± 0.005 C with a constant ambient temperature and within 0.001 C per deg C from -20 to $+65$ C. Power consumption is 8 w max. Input voltage is 115 v ac. Outside dimensions are 4 x 2 in. round. The oven has a thermostatic, mercury control with transistor switching.

Monitor Products Co., Dept. ED, 815 Fremont, South Pasadena, Calif.

Signalling equipment

363

Uses frequency-shift tone

This signalling system uses a frequency shift in tone rather than the usual on-off method, resulting in greater independence of propagation characteristics, reduced susceptibility to interference and fail-safe operation. Three frequencies can be carried on each channel. The rack-mounted equipment is transistorized and modularized.

Hammarlund Manufacturing Co., Inc., Dept. ED, 460 W. 34th St., New York 1, N. Y.

Price & Availability: The transmitter is priced at \$100, the receiver at \$220. They can be delivered within four to six weeks.

Magnetic Shielding Cans 486

These Netic and Co-Netic magnetic shielding cans are designed for choppers, miniature tubes, transformers and other nominally sized components. Heat treatment after fabrication assures uniform magnetic properties.

Magnetic Shield Div., Perfection Mica Co., Dept. ED, 1322 N. Elston Ave. Chicago 22, Ill.

Insulation Analyzer 602

The D-K analyzer, a direct reading instrument that measures dielectric constant and dissipation factor of insulating materials, is now furnished with probes for non-destructive examination of parts made of glass reinforced plastics and other materials.

Delsen Corp., Dept. ED, 719 W. Broadway, Glendale 4, Calif.

Paper Packaging Protects Copper 640

Daubrite is a chemically treated paper using volatile corrosion inhibitors to prevent tarnish and oxidation of copper and its alloys. It is suitable for packaging copper electronic components and printed circuits.

Daubert Chemical Co., Dept. ED, 4700 S. Central Ave., Chicago 38, Ill.

Phase Loss Detector 641

This Solid-state detector indicates open circuits in three-phase, 400-cps motor systems and is suitable for 115-v, line-to-neutral, four-wire power systems. Main component is precision-wound toroidal magnetic core.

Hydro-Aire Co., Electronics Dept., Dept. ED, 3000 Winona Ave., Burbank, Calif.

Vibration Calculator

The Dialor is designed for determining the relationship between displacement, velocity, and acceleration according to the sinusoidal motion theory.

Ling-Altec Electronics, Inc., Dept. ED, 1515 S. Manchester, Anaheim, Calif.

Availability: Will be furnished without charge upon receipt of company letterhead request.

Turntable 507

The T-898 air-bearing rate turntable is for use in high and low infinitely rate ranges. Bench mounted or portable, the machine needs 115 v of 60-cps power and 80 psi of shop air.

Sterling Precision Corp., Instrument Div., Dept. ED 17 Matinecock Ave., Port Washington, L.I., N.Y.

Tapping Screw 508

Called Tapits, this hole-drilling tapping screw eliminates hole punching or drilling of light-gage sheet metal. It is used with a 1/4-in. power screw driver.

Parker-Kalon, Dept. ED, Clifton, N.J.



Model PS4232M
115-325 volts DC out
at 1.5 amp maximum

30 DAY DELIVERY

on all
models



Model PS4315M 0-36 volts DC out at 15 amp maximum

NEW

TRANSISTOR - REGULATED

- *Five-Year Warranty*
- *Transient-Free Output*
- *Exclusive Regulator Circuit*

Two new lines of power supplies — one high and one low voltage line — are available now from POWER SOURCES, INC. Both lines feature the exclusive POWER SOURCES regulator circuit that provides full protection for the transistors *without* DC fuses. Both lines are warranted for *five full years*. Warranty includes all semi-conductor components. Cooling systems of advanced design insure long life and trouble-free operation.

For prices and complete specifications on POWER SOURCES high and low voltage solid state power supplies, write, wire or phone today.



Specify POWER SOURCES BY

POWER SOURCES, INC.

 Burlington, Massachusetts

POWER SUPPLIES

High Voltage Supply Specifications

| | PS4222 | PS4230 | PS4232 |
|--------------------|--|----------------------------|-----------------------------|
| DC Output Range | 35-215 volts 0-1.5 amps | 90-300 volts 0-1.5 amps | 115-325 volts 0-1.5 amps |
| AC Input | 105-125 volts, 50-60 cps*, all models | | |
| Regulation (line) | Better than 0.1% or 0.2 volts over entire input range (whichever is greater) | | |
| Regulation (load) | Better than 0.1% or 0.2 volts for no-load to full load (whichever is greater) | | |
| Transient Response | Output remains within regulation limits for step-function change of -10 volts in 105-125 volt input range Output remains within regulation limits for changes from no-load to full-load or full-load to no-load | | |

Low Voltage Supply Specifications

| | PS4305 | PS4315 | PS4330 |
|--------------------|---|-------------------------|-------------------------|
| DC Output Range | 0-36 volts 0-5 amps | 0-36 volts 0-15 amps | 0-36 volts 0-30 amps |
| AC Input | 105-125 volts, 50-60 cps*, all models | | |
| Regulation (line) | Better than 0.025% or 3 mv over input range (whichever is greater) | | |
| Regulation (load) | Better than 0.05% or 5 mv, no-load to full-load variation (whichever is greater) | | |
| Transient Response | Output remains within regulation limits for line voltage steps of -10 volts within input range Output recovers in 100 usec for no-load to full-load or full-load to 50% load step changes. | | |

*400 cps available on order

S.S. White

FLEXIBLE SHAFT HANDBOOK

NEW 4TH EDITION NOW AVAILABLE!

Your free copy of the new 4th Edition of the S. S. White Flexible Shaft Handbook is now ready for you. All it takes is your request.

Here is a complete selection and application guide to designing better products with flexible shafts. For years the authority in its field, the S. S. White handbook has been completely revised and brought up to date to include...

- a new system for easy selection of flexible shafting: *Standard... Pre-engineered... Custom-designed flexible shafts.*
- complete data on new, improved Series 7 (remote control) and Series 9 (power drive) flexible shafts.
- information on other new improvements, such as *integral formed square drives.*
- handy reference charts and tables.

WRITE FOR YOUR FREE COPY!

1147

S. S. WHITE INDUSTRIAL DIVISION,
Dept. 25, 10 East 40th Street, New York 16, N.Y.

S.S. White

FIRST NAME

IN FLEXIBLE SHAFTS

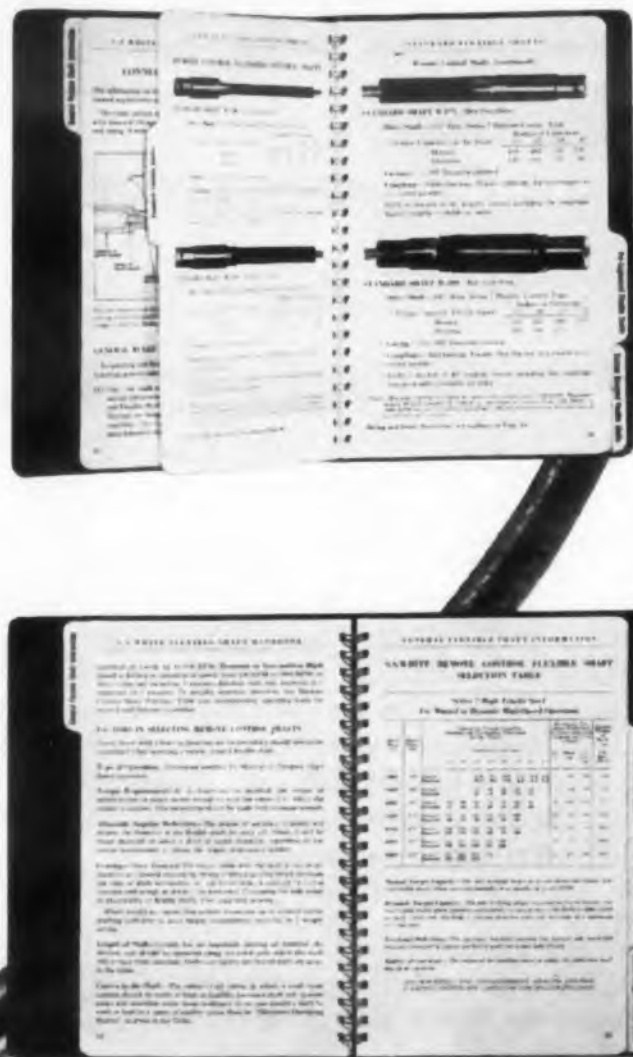

NEW PRODUCTS

Switching Transistors

483

Switching rates are to 300 mc

The 2N769 switching transistors, designed with a micro-alloy diffused base, are for use in saturated switching circuits at rates to 300 mc. Gain bandwidth product is 800 mc. Units have low hole storage factor, and low emitter and collector diode capacities.

Philco Corp., Lansdale Div., Dept. ED, Church Road, Lansdale, Pa.

Price & Availability: \$7.45 in quantities of 1,000 up; immediate delivery.

Converters

555

Supply from 10 to 150 v dc



The Transidyne converters are static power sources designed to replace motor-generator and vibrator-type devices for the conversion of dc inputs to dc outputs of different voltage levels. The 763 series covers 15 models, varying in output from 10 to 150 v dc with a nominal 28 v dc input. Maximum output power is 75 w, maximum output current is 4 amp, ripple is 20 mv rms max, and regulation is 0.1%.

Spectrol Electronics Corp., Dept. ED, 1704 S. Del Mar Ave., San Gabriel, Calif.

Price: About \$300.

Circuit Modules

481

Weigh from 1.8 to 2.2 oz

Weighing from 1.8 to 2.2 oz and occupying 1 cu in., these circuit modules include several types. Available are: general-purpose amplifiers with 40-db gain; high-impedance input amplifiers with 20 db gain; power supplies with a 20-v dc, 10-ma output at 400 cps; and rectifier-filters with separate full wave and rectifying filter circuits rated at 30 v each.

Rosemount Engineering Co., Dept. ED, 4900 W. 78th St., Minneapolis 24, Minn.

Price & Availability: \$65 to \$115; immediate.

Low-Capacitance Bridge

478

For measuring to 0.002 pf

Model 1342 capacity bridge measures capacitance from 0.002 to 1,111 pf and resistance from 1 to 1,000 meg at an accuracy of 0.2%. Uses of the instrument includes measuring temperature coefficient of small components or printed circuits; tube capacities and circuit strays can also be measured.

Marconi Instruments, Dept. ED, 111 Cedar Lane, Englewood, N.J.

Price & Availability: \$450; from stock.

Direct-Writing Recorder

572

For analog and event data



Mark II model 2522 direct-writing recorder permits unattended recording of analog and event data over prolonged periods even under conditions of environmental extremes. Two channels of analog data and two channels of coded event or time data can be recorded on a common time base. Chart speeds are 0.4, 2, 10 and 50 mm per sec. Full scale deflection from center is ± 200 mv.

Clevite Corp., Brush Instruments, Dept. ED, 37th and Perkins, Cleveland 14, Ohio.

Price & Availability: \$1,450; immediate.

Universal Bridge

477

Direct-reading

This direct-reading universal bridge measures inductance from 1 μ h to 100 h, capacitance from 1 pf to 100 μ f, and resistance from 0.1 ohm to 100 meg. Inductance or capacitance measurements can be made at 1 or 10 kc, resistance at dc. Identified as model 868B, the system is contained in a single unit. Only one dial is used. Accuracy is 1%.

Marconi Instruments, Dept. ED, 111 Cedar Lane, Englewood, N.J.

Price & Availability: \$440; immediate.



Titles

alone are not a true measure of an engineer's strength

Big wheel? Little wheel?

A sign on a desk or an office door can't tell you. In industry many of the most valuable engineers don't have impressive titles. Yet, they're heavyweight engineers — thinking, planning, carrying out, developing, designing, analyzing. Their value lies, not in governing, but in doing. Other engineers, equally as capable, serve best by stimulating and leading engineers. Both kinds are vitally necessary because without them you fail to accomplish your goals and you fail to grow.

Fortunately, we have the best of both at RCA West Coast. And we're looking for more good ones:

Advanced Systems Engineers, Development and Design Engineers, and Project Engineers with experience in these areas: Electronic Countermeasures, Data Processing and Computer Systems, and Missile Ground Support Systems.

So, whether you have an impressive title or not, a very bright future can be yours at RCA West Coast. How bright depends on you. Check our very illuminating box at right.

RCA
WEST COAST

Call collect or write:
Mr. O. S. Knox
EMpire 4-6485
8500 Balboa Blvd.
Dept. 360-J
Van Nuys, California



RADIO CORPORATION OF AMERICA

WEST COAST MISSILE AND SURFACE RADAR DIVISION

The name you know is the place to grow!



CIRCLE 907 ON CAREER INQUIRY FORM, PAGE 223

FIRST Tiros Weather Satellite

Uses

HERMES CRYSTAL FILTERS

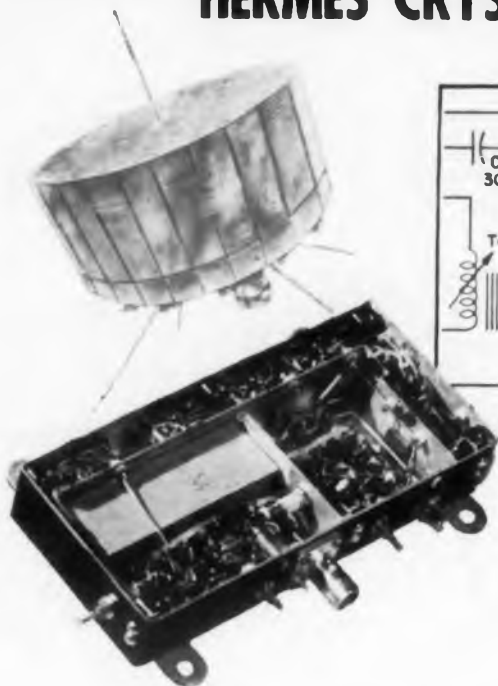

One of the two Command Receivers in TIROS

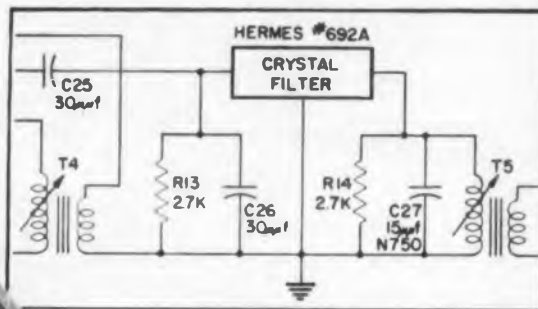

A portion of the schematic diagram for the Command Receiver in TIROS showing Hermes 20 Mc Crystal Filter at first mixer.



Hermes Crystal Filter, Model 692A, shown half size, occupies only 1.5 cu. ins.

The TIROS satellite, carrying the nation's most advanced space-borne television "eye" to study the world's weather, comprises perhaps the most elaborate electronics package yet sent into orbit.

The information-gathering element in a complex satellite-and-ground system developed for the National Aeronautics and Space Administration by RCA, TIROS contains miniature TV cameras, video tape recorders, transmitters, solar cell and re-chargeable battery power supplies, and an array of control and communications equipment. One Hermes Crystal Filter, Model 692A, is used in each of two Command Receivers which pick up coded signals transmitted from the ground to establish the time during orbit when cameras, tape recorders, and playback equipment will operate. Launched April 1, 1960, TIROS relayed meteorological data for 78 days.

Hermes Crystal Filters were selected because of their unusual ability to meet the severe environmental conditions encountered in space, while providing extremely high selectivity to receive command signals reliably. Characteristics of Hermes Crystal Filter, Model 692A, include: *Center Frequency: 20 mc \pm 1 kc; 6db Bandwidth: 40 kc min; Passband Response Variation: \pm 1/2 db; 60 db Bandwidth: 100 kc max; Impedance: 1K nominal; Midband Insertion Loss: 3 db max; Size: 1.5 cu. ins; Environment: Shock: 100 G's; Vibration: 20 G's - 2000 cps; Center Frequency Variation: \pm 2 kc over the Temperature Range: - 55° C. to + 85° C.*

If you have a filtering problem, call on Hermes engineering specialists to assist you in the design of your circuitry and in the selection of filter characteristics best suited to your needs. Write for Crystal Filter Bulletin to Hermes Electronics Co., Dept F, 75 Cambridge Parkway, Cambridge 42, Mass.

A limited number of opportunities are available to experienced circuit designers. Send Résumé to Dr. D. I. Kosowsky.

Hermes



75 CAMBRIDGE PARKWAY, CAMBRIDGE 42, MASS.

A DIVISION OF Itek

CIRCLE 163 ON READER-SERVICE CARD

NEW PRODUCTS

Microwave Loads

485

Cover to 4,000 mc

These microwave coaxial terminations cover the frequency range from dc to 4,000 mc. Type ML-2000 has a vswr of 1.03 max from 1,000 to 2,000 mc and can be used to dc with a vswr of 1.05 max. Type ML-4000 has a vswr of 1.03 max from 2,000 to 4,000 mc and can be used to 1,000 mc with a vswr of 1.05 max. Both types have a nominal impedance of 50 ohms, handle 1 w, and can be supplied with type N or C connectors.

Maury & Associates, Dept. ED, 10373 Mills Ave., Montclair, Calif.

Price: \$35 to \$47.50.

Harmonic Mixers

461

For frequency measurements to 18 kmc



Type P932A fixed-tuned, harmonic mixer, operating in the P-band of 12.4 to 18 kmc, mounts directly in a waveguide system and operates with the firm's 540A or 540B transfer oscillator. Maximum input power is 100 mw; minimum video output is 0.1 rms with 0 dbm input. Also offered, model 934A operates from 1 to 12.4.

Hewlett-Packard Co., Dept. ED, 1501 Page Mill Road, Palo Alto, Calif.

Price & Availability: Model P932A, \$250; model 934A, \$150. Delivery is from stock.

Optical Index Head

612

Direct reading to 1 min

Model THM-102 optical index head provides calibration and error determination of digital code disks, calibrated dials, rotary switches, precision gears and rotary optical gratings. It features direct reading of 1-min of angle. The index wheel is mounted in a vertical plane, permitting the operator to work in a seated position. The initial setting and subsequent readings are accurate to 6 sec. The operator can quickly swing to any part of the dial for rapid indexing before re-engaging the micrometer-drive dial-lock.

Millitest Corp., Dept. ED, 88 Madison Ave., Hempstead, L.I., N.Y.

QUALITY WITHOUT COMPROMISE
Performance
Flexibility
Reliability



PACKAGED LEAK TEST STATIONS

VEECO's MS-9 leak test consoles are packaged stations with guaranteed constant sensitivity. The helium mass spectrometer permits hermetically sealed units to be certified leak proof at a sensitivity of 10⁻¹⁰ std. cc/sec.

VEECO manufactures a complete line of high vacuum equipment... Components, Leak Detectors, Evaporators, Systems... accepted as the quality line for over a decade.

For MS-9 Brochure
or Complete Catalog
write Dept. G834

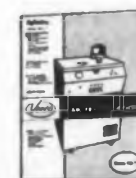

VACUUM-ELECTRONICS CORP.
Terminal Drive • Plainview, L. I. N. Y.

HIGH VACUUM & LEAK DETECTION EQUIPMENT

CIRCLE 164 ON READER-SERVICE CARD

ELECTRONIC DESIGN • October 12, 1960



To beat the heat in electronic cabinets is quite a feat. Overheated components give poor service. To keep them cool, there's just one rule. What I mean is . . . use the old bean and install McLean. Man, they're the coolest!



McLEAN MODEL 2E408

The industry's standard . . . over 15,000 in use all over the world. High velocity, fast cooling. (7" x 19", 300 cfm).

Extend the life of sensitive tubes, transistors and other components with McLean packaged cooling units. Prevent system failure . . . maintain calibration and accuracy. Find out how in McLean's 1960 catalog . . . 44 pages of helpful information on cooling electronic equipment. McLean's rack-mounted fans and blowers are smart, compact, easy-to-install and have a multitude of mounting possibilities. Over 100 models in various panel heights and CFM's. Mil. Spec. equipment for packaged cooling also available.



WRITE TODAY
44 Page Packaged Cooling Catalog

See us at the I.R.E. Show, Booth #1624

McLEAN ENGINEERING LABORATORIES

World Leader in Packaged Cooling

Princeton, N. J. • WALnut 4-4440

TWX Princeton, New Jersey 636

CIRCLE 165 ON READER-SERVICE CARD

ELECTRONIC DESIGN • October 12, 1960

Telemetering Preamplifier 652

The TP-1P low-noise unit is complete with power supply and is for rack mounting in mobile field equipment. Noise figure is 3.2 db, gain is 38 db, and pass band is 32 mc min, centered at 231 mc.

Lel, Inc., Dept. ED, 380 Oak St., Copiague N.Y.

Epoxy Resin 653

Maraglas epoxy resin used with No. 555 hardener can be cured at 180 F and with a Rockwell hardness between M 50 and M 100. It can be used for bonding glass to glass, electronic encapsulation, and making prototypes and models.

Marblette Corp., Dept. ED, 37-31 Thirtieth St., Long Island 1, N.Y.

Price & Availability: A sample kit of resin, hardener, and accessories is available for \$6.

Revolution Counter 654

The SP-MF electrically operated, predetermined counter is designed for mounting on a stator winder to measure the progress of the winding and shut off the machine when the exact number of turns have been made.

Durant Manufacturing Co., Dept. ED, 1923 N. Buffum St., Milwaukee 1, Wis.

Surface Thermometer 383

RdF Strapons are designed to operate at temperatures from -100 to +500 F and intermittently from -300 to +575 F. They consist of a 100-ohm CP nickel element completely encapsulated in silicone rubber and stainless steel. The stainless steel is just 0.002 in. thick to provide maximum flexibility. They can be mounted on electronic subassemblies to monitor temperature.

Arthur C. Ruge Associates, Inc., Dept. ED, Hudson, N.H.

Phaselock Receiver 384

This 960-mc Phaselock loop receiver, for tracking long range missiles and satellites, has aural-visual lock indication, modular construction, and is ruggedly designed for long life.

Resdel Engineering Corp., Dept. ED, 330 S. Fair Oaks Ave., Pasadena, Calif.

Price: About \$25,000.

Glass Epoxy Material 415

Spauldite G11-820, a glass epoxy laminate, maintains over 50% of its flexural strength at 150 C without any loss of its high electrical and mechanical properties. Designed for computer, missile and aircraft components, it is available in 40 x 48 in. sheets, copper-clad or unclad strips, blocks, or in fabricated parts to customer specifications. Thicknesses range from 1/32 to 1/2 in.

Spaulding Fibre Co., Dept. ED, 310 Wheeler St., Tonawanda, N.Y.

Price and Availability: Made on order only, prices vary with thickness, size, etc.

REC's.....

Precision Temperature Probes.....at off the shelf prices!

Want low cost temperature probes on short notice – without sacrifice in quality? Rosemount Engineering Company now offers high-performance platinum resistance temperature sensors from stock.

MODEL 179A

Sensing element fully supported, mounted in ceramic insulation. Stainless steel guard tube with additional support at the element tip gives maximum protection from flow.



MODEL 179A



MODEL 152T

MODEL 152T

Sensing element supported by a light cage and exposed to working fluid to give extremely fast response in fluids which are not electrical conductors. Element protected by stainless steel guard tube with additional support at the element tip.

Fourteen stem lengths and 6 different fittings of each model available. These immersion probes have wide application in research, development and industrial process controls. Recommended for use in most hydrocarbons, gaseous or liquid air, oxygen, nitrogen, hydrogen or helium. Sensing elements, of precision platinum, are calibrated at liquid helium point and the ice point. General specifications:

- Temperature Range – from -435° F to 500° F
- Stability – Stable within 0.20° F at 32° F
- Pressure – 6,000 psi maximum
- Element Length – from 1 1/8" to 2 3/4", in 1/8" increments
- Time Constant – 152T – 0.2 seconds } Dow Corning No. 200
179A – 0.5 seconds } 1.5 CTSK Oil
- Resistance at 32° F – 152T – 200 ohms
179A – 500 ohms

For additional information write for advance bulletin number 5603.

Plus Circuit Modules

Rosemount also offers a series of preassembled circuit components, featuring small size and durability. Built to meet environmental requirements of MIL-E-5272 and MIL-E-8189.

- General purpose amplifier, Model 510A, 40 db voltage gain minimum, 10 cps to 100,000 cps, -55° C to 125° C.
- High impedance input amplifier, Model 511A, 20 db power gain, input impedance greater than 1 x 10⁶ ohms, 10 cps to 50,000 cps, -55° C to 125° C.
- Power supply, Model 531A, 117 volts, 400 cps; 20 volt DC regulated, 10 milliamperes, 0.1 percent ripple, -55° C to 125° C.
- Rectifier-filter, Model 532A, diodes and RC filter for two full wave DC supplies. Rated 30 volts DC each at 0.1 percent ripple, -55° C to 125° C.

For additional information write for advance bulletin 46028.

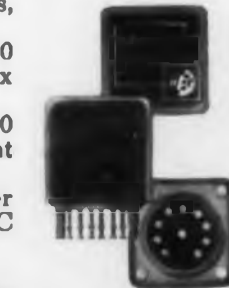

(Size 1 x 1 x 1 Inch)



ROSEMOUNT ENGINEERING COMPANY

4900 West 78th Street, Minneapolis 24, Minn.

CIRCLE 166 ON READER-SERVICE CARD

YOUR GUARANTEE OF PRODUCT RELIABILITY

ACKNOWLEDGMENT
CORNISH WIRE COMPANY
INCORPORATED
50 CHURCH ST. - NEW YORK 7

DATE: SEPTEMBER 15, 1960
OUR ORDER #: 90-524

SOLD TO: A. B. O. ELECTRONICS MANUFACTURING COMPANY
1515 DEANWOOD AVENUE
FOREST HILLS, N. J.

SHIP TO: []

QUANTITY: 3276
DATE: 9/12/60
SPECIAL BILLING INSTRUCTIONS

| QUANTITY | DESCRIPTION | SHIPPED | PRICE |
|------------|--|---------|----------|
| | | DATE | QUANTITY |
| 27,000 FT. | 12/2 CABLE IN ACCORDANCE WITH MIL-C-5756B | | |
| 22,000 FT. | 00-00 MCF (3/18) S30 U375 IN ACCORDANCE WITH MIL-C-3432A | | |
| 100,000 | 006-2 (12) IS ACCORDANCE WITH MIL-C-3884 | | |

MATERIAL TO BE SOURCE INSPECTED IN ACCORDANCE WITH APPLICABLE SPECIFICATIONS

CONTRACT #18120-PP-60-C1-C2

THIS ORDER IS ACCEPTED SUBJECT TO CONDITIONS PRINTED ON REVERSE SIDE HEREOF.

SHIPPING SCHEDULE

WE WILL SHIP FROM WILLIAMSTOWN, MASSACHUSETTS

ITEMS 1 AND 2 - OCTOBER 15, 1960

ITEM 3 - NOVEMBER 1, 1960

By: _____

41 years of design, engineering and manufacturing experience goes into every Cornish cord set, wire and cable assembly. Manufactured to rigid military specifications, Cornish products have proven their high standard of reliability in a wide variety of electronic applications. Design problems, requiring custom components, are a specialty with Cornish engineers. We welcome the opportunity to discuss the requirements of your specific problems with you.

Cornish produces a wide range of products to meet military specifications some of which are: MIL-C-5756B / MIL-C-7974 / MIL-C-12064A(CE) / J-C-90A / MIL-C-3432A / MIL-C-3884 /

CORNISH WIRE COMPANY, 50 CHURCH STREET, NEW YORK 7, NEW YORK



NEW PRODUCTS

Traveling-Wave Tube

47

For C-band use

Type Z-3028 C-band traveling wave tube designed primarily for use as a preamplifier for radar receivers, but can be used in other applications including microwave relay systems and automatic gain control. It covers the frequency range of 4,000 to 8,000 mc. Noise figure is 10 db max; average integrated noise figure is about 8 db. Minimum small signal gain is 25 db and power output is 5 mw. The unit measures 9.25 x 4.5 x 2.9 in. and weighs 12 lb.

General Electric Co., Power Tube Dept., Dept. ED, Schenectady 5, N.Y.

Price & Availability: \$2,850; 30 to 60 days.

Control Relay

55

Handles up to 20 poles



The Multistak control relay handles up to 20 poles. Individual four-pole contact blocks can be added as needed to the basic frame. The blocks are rated at 10 amp, 60 v resistive; coil voltages include 110, 220, and 440 v. Of molded phenolic construction, the blocks measure 2 x 1-1/2 x 1-1/2 in.

Lake Shore Electric Corp., Dept. ED, 205 Wilkies St., Bedford, Ohio.

Price & Availability: \$7 to \$44; from stock.

Swept Signal Generators

48

For frequencies from 1 to 18 kmc

These swept signal generators are available in five models, covering the L, S, C, X, and K bands, from 1 to 18 kmc. A common power supply and sweep supply can be used with any of the units. Model SGS-2, a typical unit, is for S-band use and has a power output that is constant to within 1 db. The frequency-time characteristic is linear within $\pm 4\%$ during sweeping. All or any sector of the band of 2 to 4 kmc can be swept at rates from 0.3 to 30 cps.

Melabs, Inc., Dept. ED, 3300 Hillview Ave., Palo Alto, Calif.

Price: \$2,300 for S-band unit to \$4,500 for K-band unit.

Thermocouple Wire Insulators 413

These thermocouple wire insulators can be made of cordierite, steatite or mullite. Cordierite stands 2,300 F and has low thermal expansion; steatite stands 2,300 F; mullite stands temperatures in excess of 3,200 F.

Du-Co Ceramics Co., Dept. ED, Saxonburg, Pa.

Servo Mounting Clamps 414

These clamps are available in 200 different sizes and shapes. They are made of stainless steel and aluminum.

Vemaline Products Company, Dept. ED, 511 Commerce St., P.O. Box 1, Franklin Lakes, N. J.

Price & Availability: Available from stock at \$0.38 ea in small quantities.

Mobile Microphone 596

Model 405, weighs 8 oz and resists shattering, breaking, cracking due to vibration. It comes in controlled magnetic, carbon, and transistor-amplifier models and is electrically identical to the 505.

Shure Brothers, Inc., Dept. ED, 222 Hartrey Ave., Evanston, Ill.

Remote Control System 597

This radio transmitter-receiver combination operates in the 27-mc citizens band for remote control of objects or devices. Keying the transmitter actuates an spdt relay at the receiver. Control may be on-off or pulsed. Range is 1 mile.

Alpha Tech Products, Dept. ED, Appleton, Wis.

Test Probes 598

The Kleps series test probes hold on to wires, solder joints, terminals, small projections, nuts, and screws. They stand 5,000 v. No soldering is necessary.

The Rye Sound Corp., Dept. ED, 145 Elm St., Mamaroneck, N.Y.

Caps 599

Designed to replace drawn metal caps, Beaucaps are made of linear polyethylene, have high resistance to physical damage, and provide good dielectric characteristics. Cable openings of 5/16 and 7/16 in. are standard.

Beauchaine and Sons, Inc., Dept. ED, Lakeport, N.H.

Availability: From stock.

High-Thrust Bearing 600

A bearing capable of standing 5 lb of thrust is offered as an alternate on the firm's timing motors. For optimum life, maximum thrust is 3 lb. The bearing uses a 1/4-in., threaded output bearing.

Bristol Motors, Dept. ED, Old Saybrook, Conn.

Some Ideas

When it comes to lettering—plain or fancy—professionals the world over turn to LEROY® Equipment by K&E. In drafting rooms, art departments—not to mention schools, business offices, churches, clubs, hospitals—LEROY has become almost as necessary as pencil and paper.

Truly, there's no magic about LEROY—



just a beautifully simple idea, translated into products which reflect the highest manufacturing skill and imagination. Not easy, we grant you... but not magic.

However, to keep the LEROY line constantly up to the changing requirements of the times—that does require a wizard. Fortunately, we have just such a gentleman firmly settled on the K&E payroll. And he begs that we report several of the more recent minor miracles of LEROY right here and now. So, in the famed standard, sans-serif lettering template, let's make with a little...

abracadabra

Templates

Every year sees new additions made to the already long list of LEROY templates. Case in point: the new electronic tube symbol templates for use in one of the most modern, fastest changing industries of them all. Also, there are foreign language templates (such as Russian and Greek), music templates, special designs, and a variety of handsome type faces (Caslon, Cartographic, Bernhard Modern to name some newer additions).

The best advice we can give for keeping current on LEROY templates is to have the LEROY catalog on hand. (It just so happens that we recently put out a brand new edition of the catalog, and it's yours for the asking. See coupon at right.) Finally, of course, we should add that if you don't see what you need in our catalog, don't despair. We'll produce it,

K+E

for your file of practical information on
drafting and reproduction... from
----- **KEUFFEL & ESSER CO.** -----

custom-made, to your design—as we have done for thousands of others.

A "Bullit-In" Pencil Point

The business of stopping work to put a sharp point on a lettering pencil is now largely over and done with, thanks to another new LEROY item. The point of the new LEROY "020" pencil never blunts or

uniform, and of exactly the same density (a careful balance, chosen to give good wear without sacrificing print-making quality). You never saw pencil work look so good.



The Pen With A "Bullit-In" Inkwell

Here's your ticket to faster ink work with far fewer refills—K&E's new LEROY Reservoir Pen. You'll be amazed at the mileage you can get between refills with this newly perfected pen. Its refillable cartridge holds enough ink for many hours of smooth, uninterrupted lettering, thus eliminating the need for daily cleaning. The pen's cartridge is airtight—made of a non-porous, unbreakable, translucent material. The level of ink is always visible, and any non-solvent, waterproof India drawing ink can be used (for best results and quicker, easier filling we recommend the LEROY Lettering Ink-Cartridge #2950).

A tiny weighted needle inside the pen's feed tube assures a clear passage of ink from reservoir to point. Light vertical shaking of the pen activates this needle, removing any particles which may have settled in the tube when the pen was set aside. The needle also provides efficient cleansing action when you wash out the pen.

LEROY Reservoir Pens are furnished in seven sizes, from 00 to 5, for use with all LEROY scribers. Ideal for lettering work, the points glide easily over paper, cloth or film based surfaces, producing sharp, uniform lines that reproduce crisply.

Order Your LEROY Catalog Now

Other new additions and improvements—too numerous to go into here—are described in the new LEROY catalog. The coupon below brings your copy, free.



shaft. No need to remove it from the scriber, by the way. This new pencil fits all LEROY scribers, and guarantees faster, smoother work. As to appearance—all lines drawn with the "020" are perfectly

KEUFFEL & ESSER CO., Dept. ED-10, Hoboken, N. J.

Please send me the latest catalog on LEROY Lettering Equipment by K&E.

Name & Title _____

Company & Address _____

CIRCLE 168 ON READER-SERVICE CARD

THE AWHAYDON COMPANY

MIRROR IMAGE ON BOTH COASTS
EAST ELECTRICAL TIMING DEVICES
WATERBURY, CONNECTICUT

ELECTRONIC TIMING DEVICES **WEST**
CULVER CITY, CALIFORNIA

Have it your way: electronic or electro-mechanical timing devices and test equipment. ■ The A. W. Haydon Company will design and manufacture either type...or both...to your rigid specifications. And with the same precision, compactness and high reliability as always. ■ For electro-mechanical devices call on our timing specialists at Waterbury, Conn. If your requirements are electronic, our Culver City, Calif. plant can meet your needs. ■ On either coast...on both coasts...there's only one A. W. Haydon.

THE AWHAYDON COMPANY

CIRCLE 169 ON READER-SERVICE CARD

NEW PRODUCTS

Micro Energy Switch 482 For fast switching

Type 2N768 micro energy switch is designed to provide fast switching rates at 1/20 the power level of conventional high-speed switching devices. Maximum temperature is 100 C; collector and emitter capacitance is low.

Philco Corp., Lansdale Div., Dept. ED, Church Road, Lansdale, Pa.

Speed Changer 552 With self-contained magnetic clutch



This electromagnetic speed changer with a self-contained magnetic clutch provides an input shaft concentric to 0.0015 in. with the output shaft. By energizing or de-energizing the clutch, speed ratios of 1:1 and 9:1 are available. At 1:1 the unit transmits 70-oz-in. torque at the output shaft; at 9:1, 30 oz-in. In either position, maximum torque is 85 oz in. Input required is 115 v dc at 5 w.

Orbit Instrument Corp., Dept. ED, 131 Eileen Way, Syosset, L.I., N.Y.

Availability: 45 days delivery.

Electrostatic Vidicon 614 Diameter is 1-1/8 in.

Type GEC-7522 electrostatic vidicon is 6-1/4 in. long and 1-1/8 in. in diameter. Its scanned area is 1/2 x 3/8 in. Typical signal output current is 0.14 to 0.12 μ a, with signal electrode voltage from 10 to 100 v, depending upon illumination. Typical characteristics include: grid No. 2 voltage, 300 v; grid No. 4 voltage, 200 v; focusing electrode voltage 0 to +50 v; grid No. 1 voltage, -45 to -100 v; minimum peak blanking voltage, 30 v on first grid or 10 v on cathode; deflection voltage, 180 v.

General Electrodynamics Corp., Dept. ED, 4430 Forest Lane, Garland, Tex.

Price & Availability: Delivered 14 days after order received; priced at \$1,000.



64-IN-1 ELECTROMETER

You can measure dc voltage, current, and resistance over 64 ranges with the Keithley 610A Electrometer. Some examples of its extreme versatility are voltage measurements of piezo-electric crystals and charged capacitors; currents in ion chambers, photocells, and semi-conductors; and resistance measurements of insulation.

The input resistance of the 610A can be selected from one ohm to over 10^{14} ohms; it checks its own resistance standards and is a stable dc preamplifier. Brief specifications are:

- **9 voltage ranges** from 0.01 to 100 v full scale, 2% accuracy all ranges.
- **current ranges** from 3 amperes to 1×10^{-12} ampere full scale with 2 ranges per decade.
- **resistance ranges** from 10 ohms to 10^{14} ohms full scale on linear scales.
- **gains to 1000** as a preamplifier, dc to 500 cps bandwidth, 10 volts and one milliamper outputs.
- **accessory probes** and test shield facilitate measurements and extend upper voltage range to 30 kv.
- **price**, \$480.00.

Write for complete details



**KEITHLEY
INSTRUMENTS**

12415 EUCLID AVENUE
CLEVELAND 6, OHIO

CIRCLE 170 ON READER-SERVICE CARD

ELECTRONIC DESIGN • October 12, 1960



We Can Make Precision Ceramic-to-Metal Assemblies for Your Stock or Special Requirements

On your right is a specialized ceramic-to-metal assembly that we make in small quantity.

On your left are some of our stock terminal insulators. They are made in large runs for economical, off-the-shelf delivery.

Coors furnishes either metalized ceramic parts ready for brazing by the customer, or complete ceramic-to-metal assemblies in sizes up to 10" OD by 12" length.

If you need ceramic-to-metal assemblies, in quantity or prototype, get in touch with us here in Golden, contact the Coors regional sales manager nearest you, or write for new bulletin.

REGIONAL SALES MANAGERS

West Coast.....William S. Smith, Jr.
EM 6-8129—Redwood City, Calif.
Midwest.....John E. Marozek
FR 2-7100—Chicago, Ill.
Central.....Donald Dobbins
GL 4-9638—Canton, Ohio
East Coast.....John J. McManus
MA 7-3996—Manhasset, N.Y.
New England.....Warren G. McDonald
FR 4-0663—Schenectady, N. Y.
Southwest.....Kenneth R. Lundy
DA 7-5716—Dallas, Texas
Southwest.....William H. Ramsey
UN 4-6369—Houston, Texas

Coors

Alumina Ceramics

COORS PORCELAIN COMPANY
600 NINTH ST., GOLDEN, COLORADO

Wire-Wound Potentiometer 408

Specifications on the series F-888 potentiometer are: resistance, 1/2 to 25 K; power rating, 2 w; linearity, 3%; resistance tolerance, $\pm 10\%$. It measures 1.125 in. in diameter by 0.560 in. deep. Rotors are insulated with a one-piece molded element.

Continental-Wirt Electronics Corp., Dept. ED 26 Queen Lane, Philadelphia 44, Pa.

Low Pass Filter 409

Model LF-197 low-pass filter operates with a cut-off frequency of 3,000 cps. The unit measures 1-5/8 x 1-5/8 x 2-3/8 in. Attenuation is 3 db at 3,000 cps and 40 db at 4,000 cps and above.

Control Electronics Co., Inc., Dept. ED, 10 Stepar Place Huntington Sta., L. I., N.Y.

Time Indicator 410

Type 620 time totalizer is a time indicator designed for reliable performance under severe operating conditions. It registers up to 9,999.9 hr total operating or non-operating time for any type of electrically controlled equipment. The unit weighs 4 oz and is hermetically sealed.

Cramer Controls Corp., Dept. ED, Centerbrook, Conn.

Worm Gear Reducer 411

This small-size worm gear reducer is available in 12 sizes with center distances from 1-1/8 to 8 in., input capacities from 0.01 to 68 hp, and output torque up to 46,000 lb-in. Speed ratios are available from 5:1 to 70:1.

Foote Bros. Gear and Machine Corp., Dept. ED, 4545 S. Western Blvd., Chicago 9, Ill.

Constant Voltage Transformer 412

This 60-cps, 500-va constant voltage transformer has an output of 115 v ac with an input of 95 to 130 v ac. The unit has a line regulation of $\pm 1-1/2\%$. It can be hermetically sealed for military applications.

Freed Transformer Co., Inc., Dept. ED, 1718 Weirfield St., Brooklyn 27, N.Y.

Miniature Electrical Actuator 449

The Hammer-Blow actuator operates on 20 v, 1.5 amp and delivers a force of 70 lb. It is suitable for emergency operation of switches, valves, fire protection apparatus.

Electro-Seal Corp., Dept. ED, 946 A North Ave., Des Plaines, Ill.

Gold Alloy Preforms 445

These gold alloy preforms are available in discs, washers and spheres. Diameters from 0.01 to 1/2 in. and thickness down to 0.0005 in. are available.

Accurate Specialties Co., Inc., Dept. ED, 37-11 57th St., Woodside 77, N.Y.

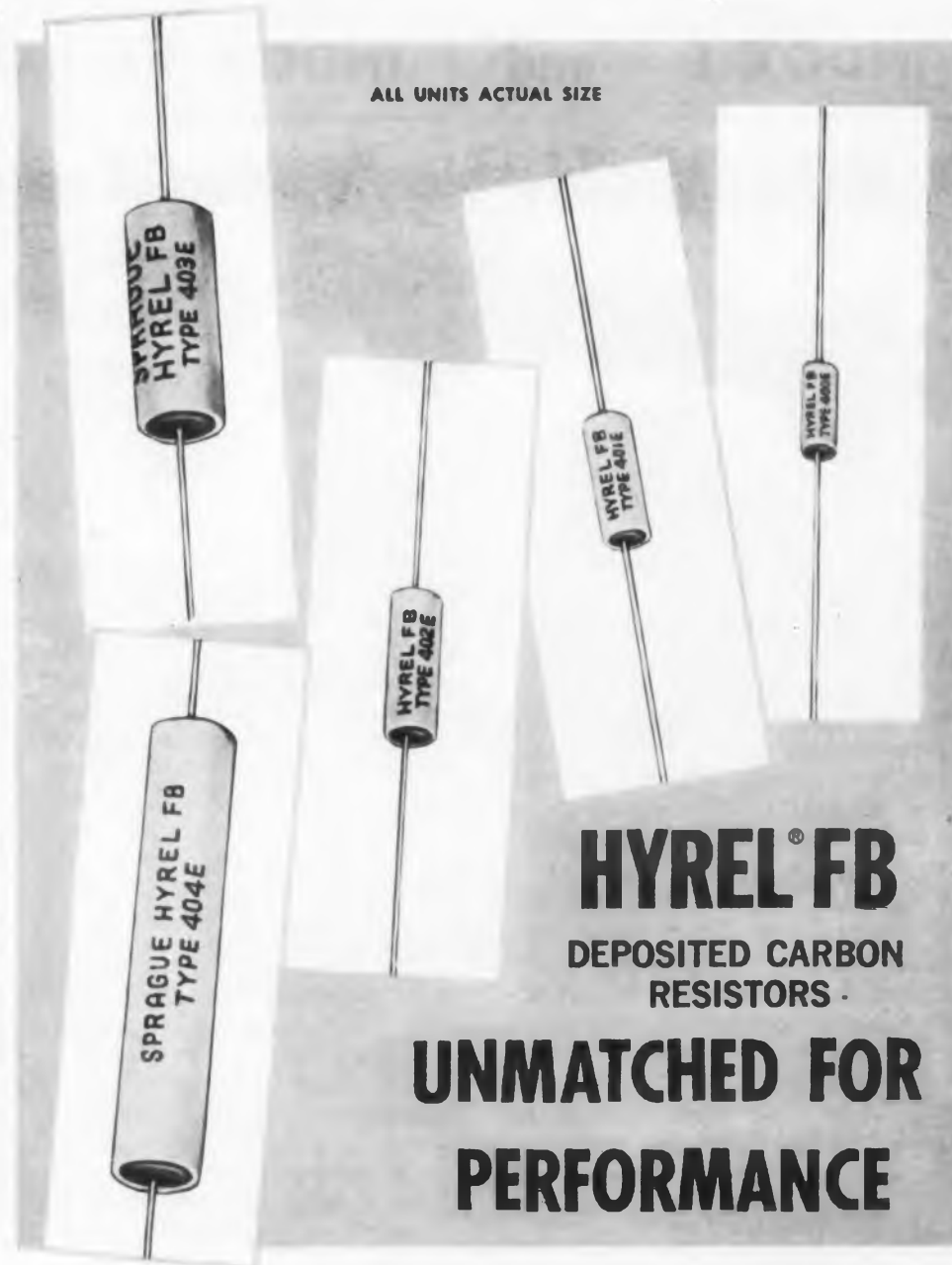

... hermetically sealed in ceramic jackets against moisture and vapor ... safely protected against mechanical abuse. The Hyrel FB series is intended for applications in military, commercial and telephone electronic equipment where long life under high humidity, small size, stability of electrical characteristics are important.

WRITE FOR
ENGINEERING BULLETIN 7010B

SPRAGUE ELECTRIC COMPANY
34 Marshall Street, North Adams, Mass.

Made to far exceed
MIL-R-10509C Specifications

SPRAGUE®

THE MARK OF RELIABILITY

SPRAGUE COMPONENTS:
CAPACITORS • RESISTORS • MAGNETIC COMPONENTS • TRANSISTORS
INTERFERENCE FILTERS • PULSE NETWORKS
CERAMIC-BASE PRINTED NETWORKS • HIGH TEMPERATURE MAGNET WIRE
PACKAGED COMPONENT ASSEMBLIES

INDOX I

and

INDOX VI

Permanent Magnets

Make Possible Simple, More Compact TWT Design



If your line of microwave equipment includes traveling wave tubes, you will be interested in Indiana Steel's amazing ceramic permanent magnets called INDOX.

Unlike heavy Alnico materials, INDOX offers designers of microwave equipment a new, light, inexpensive and easy-to-assemble permanent magnet in the sizes, shapes and strengths necessary for today's critical applications.

For example, in periodic focusing traveling wave tubes, INDOX can supply a much higher flux density due to its higher intrinsic coercive force. And INDOX pieces may also be magnetized prior to assembly without appreciable loss of flux density.

Not only does INDOX open new doors of design, but Indiana Steel now offers two grades of INDOX to meet special microwave design problems—INDOX I and INDOX VI.

INDOX I

In addition to having a higher intrinsic coercive force than Alnico, INDOX I is an inexpensive material manufactured to design specifications at moderate die cost. Irreversible flux density losses do not occur until very low operating temperatures are reached. And INDOX I produces a greater flux density than many other materials when operating low on the demagnetization curve. (See curve below.)

INDOX VI

Through extensive research in Indiana's R&D laboratories, a new, more powerful INDOX material has now been released for use in microwave equipment, particularly the TWT's. Having a greater energy product, INDOX VI can be used when a greater flux density is required or when a smaller magnet must be used.

AVAILABLE FROM STOCK NOW!

Many unground sizes of INDOX I and VI magnets are now in stock. If required, magnets may be ground to closer tolerance prior to assembly. Magnets may be magnetized before or after shipment, as desired.

DESIGN ENGINEERING NOTE:

Indiana manufactures the widest selection of permanent magnet materials, available in thousands of sizes and shapes. Therefore, you can depend upon Indiana to give unbiased advice in choosing the correct magnet material for your application.

What are your permanent magnet requirements in the broad-band microwave field? It's likely an experienced Indiana application engineer can help you, so write for full information. Request Bulletin 18M10 (INDOX I and V) and Bulletin 353M10 (INDOX VI).

NEW! Recently published data on predicting effect of low temperature on INDOX V and VI, compiled by Indiana scientists. For your copy, write for *Applied Magnetics, Fourth Quarter, 1959.*

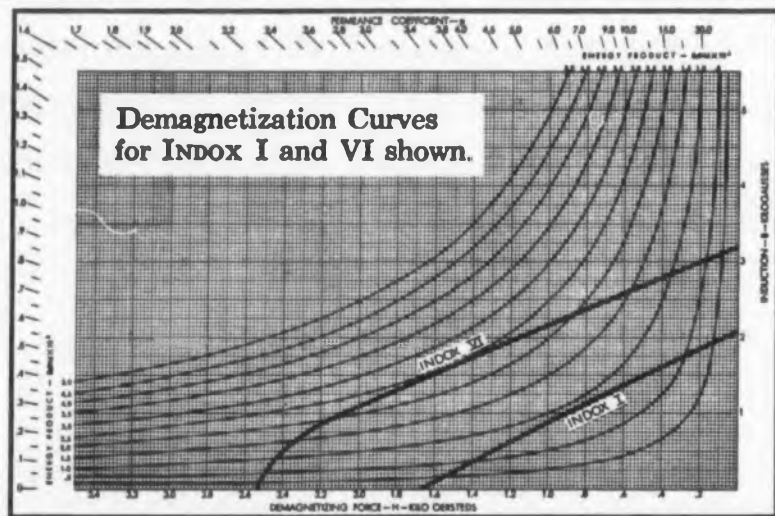

TYPICAL CHARACTERISTICS

| | INDOX I | INDOX VI |
|--|-----------------------|------------------------------------|
| Coercive Force (H _c) oersteds - | 1,825 | 2,550 |
| Residual Induction (B _r) gauss - | 2,200 | 3,200 |
| Peak Energy Product (B _r H _d) - | 1.0 x 10 ⁶ | 2.4 x 10 ⁶ |
| Reversible Permeability - | 1.2 | 1.06 |
| Temperature Coefficient - | -0.19%/°C | -0.19%/°C |
| Magnetization Field for Saturation, oersteds - | 10,000 | 10,000 |
| Chemical Composition - BaFe ₁₂ O ₁₉ | | BaFe ₁₂ O ₁₉ |
| Specific Gravity - | 4.7 or 0.17 lb/cu in | 4.5 or 0.162 lb/cu in |

INDIANA STEEL PRODUCTS

Division of Indiana General Corporation
Valparaiso, Indiana

In Canada: The Indiana Steel Products Company of Canada Limited,
Kitchener, Ontario

INDIANA PERMANENT MAGNETS

CIRCLE 173 ON READER-SERVICE CARD

NEW PRODUCTS

Wavemeter

615

For coaxial transmission lines

Model 12-1 wavemeter is intended for use as a marker cavity with a broad-sweep generator. The search-type unit uses coaxial resonators and transmission line connections. Specifications are: range, 1 to 2 kmc; accuracy, 0.5%; loaded Q (nominal), 1000; connectors, female N; absorption dip, 10% min. Resettability and readability is 0.025%.

Frequency Standards, Dept. ED, P. O. Box 504, Asbury Park, N.J.

DC Amplifier

551

Gain is 10 to 80 db



Providing a gain of 10 to 80 db, model VS-67A dc amplifier drives slow ink recorders. It is shown with a recorder having a maximum recording sensitivity of about 150 mv full scale. Frequency response is 0 to 3 cps; linearity is 0.5% at 0 to 100 μv, 1.5% at 0 to 250 μv. Maximum output is ±2.5 v at ±1 ma. Noise voltage is 1 μv rms max, referred to the shorted input.

Millivac Instruments, Div. of Cohu Electronics, Inc., Dept. ED, Box 997, Schenectady, N.Y.
Price & Availability: \$480; from stock.

Magnetic Amplifier

476

Meets missile requirements

Model 1211 bistable magnetic relay amplifier, weighing less than 1 lb, is designed to meet the requirements of missile use. It has as its input a photo-resistor with a resistance of 2 to 5 meg. It functions at low levels of current and is capable of reacting to 10 or 25-μa signals. Output is about 10 v at 10 mils.

Lumen, Inc., Dept. ED, P. O. Box 905, Moen Ave., Joliet, Ill.

Price & Availability: \$282 in small quantities; four or five-week delivery.

Vibration Calibrator

440

The Vibracal decals for spot-checking the calibration of vibration measuring systems during environmental vibration tests, provide an optical indication of motion of 0.085 in., double amplitude. They can be affixed to a shake table or test specimen near the vibration pickup. Several optical patterns can be furnished. Accuracy is $\pm 5\%$.

Wrisley Engineering, Inc., Dept. ED, P. O. Box 56, Winchester, Mass.

Price: \$1.75 for five.

Synchro Holding Fixture

441

This fixture holds synchros for transformation ratio, phase shift impedance, primary power and current tests as specified in MIL-S-20708A. It fits sizes 5 to 19. Quick mounting and disconnect clamps are used.

Angler Industries, Dept. ED, 3 Lexington Drive, Metuchen, N.J.

Price & Availability: \$32 job Metuchen; one-week delivery.

Armoured Plug Provides Ground Connection

444

This armored plug has a polarized chisel-edge grounding blade which automatically makes contact with the faceplate of a 2-hole receptacle or the grounding hole of a 3-hole receptacle. Rating is 125 v at 15 amp. Mil specs are met.

A. P. M. Corp., Dept. ED, 252 Hawthorne Ave., Yonkers, N.Y.

Test Jack

429

The SKT-34 test jack is designed to receive a 0.032 in. diameter probe to a depth of 0.2 in. max. Its closed entry construction assures alignment of the probe in test operations. Contacts are beryllium copper. A double-turret stud on the reverse side of the chassis is provided for circuitry termination.

Selectro Corp., Dept. ED, 139 Hoyt St., Mamaroneck, N.Y.

Temperature Control Element

430

The D-140 temperature control element has a length of 1-1/2 in., an OD of 1/4 in. and weighs 1/4 oz. The setting standard tolerance is approximately 5% depending on the balance of the electrical circuit involved.

Scaico Controls, Inc., Dept. ED, 210 Taylor St., Riverside, N.J.

Vibration And Shock Control Mounting

431

This all-metal vibration and shock control mounting system, model 2678-1, is a center-of-gravity type which meets the requirements of Mil-E-5272A. Its natural frequency is 16 cps with a vertical transmissibility of 4.

Robinson Technical Products, Inc., Dept. ED, Teerboro, N.J.

Metallurgical Memo from General Electric

G-E thermistor in the wall control eliminates fluctuations in room temperature



A thermistor is a small, inexpensive and trouble-free resistor that is extremely sensitive to temperature. Mounted in the wall control, this element signals any temperature variation from the dial setting, even as small as 1/10 degree. These signals are transmitted by low voltage wiring through a tube-type or transistorized amplifier to a fuel control valve which automatically regulates the burner flame. Room heat loss is immediately replaced. Thus the thermistor supplants bi-metals, false-starting mercury capsules, and other undesirable moving parts.

Other applications for thermistors in the industrial and home heating fields include time delays of fuel oil valve operation and heat pump cycling. Use G-E thermistors in your heat control design!

If you have a temperature compensation or current inrush suppression problem, it may be solved by a thermistor, too. Send for literature and one of our sample kits, then write for assistance of a G-E engineer for your specific application—*Magnetic Materials Section, General Electric Company, 7820 N. Neff Ave., Edmore, Michigan.*



TRY-IT-YOURSELF APPRAISAL KITS!

Send for Kit B. Contains 2 each of 6 high resistance thermistors for laboratory study and evaluation. Price \$12.50.

MAGNETIC MATERIALS SECTION

GENERAL  ELECTRIC

CARBOLOY® CEMENTED CARBIDES • MAN-MADE DIAMONDS • MAGNETIC MATERIALS • THERMISTORS • THYRITE® • VACUUM-MELTED ALLOYS
CIRCLE 174 ON READER-SERVICE CARD

... Where only a Precision Wirewound
is **Precise** Enough!

Shallcross

"P" type RESISTORS

Exclusive tapered lugs for wrap-around or feed-thru connection

Lug flexing will not destroy hermetic seal

Mineral-filled epoxy resin bobbins & encapsulating coating

Windings of pre-tested wire to meet specific operating needs

Unique contour provides long leakage paths

RADIAL LUG, AXIAL LEAD, and PRINTED CIRCUIT RESISTORS

PRECISION RESISTOR NETWORKS using specially stabilized resistors which may be matched to an accuracy of 0.005% with a tracking temperature coefficient of 5 ppm per °C—for use where voltage or current must be precisely controlled.



As specialists in precision wirewound resistors and resistor assemblies for over 30 years, Shallcross offers unmatched experience in meeting the most exacting matched resistor requirements. Encapsulated "P" Types illustrated are available in over 25 basic types—many to critical MIL-R-93A, MIL-R-93B, and MIL-R-9444 Specifications. Detailed performance comparisons to applicable MIL specs are available for all types.

SHALLCROSS MANUFACTURING CO., 4 Preston St., Selma, N. C.
CIRCLE 175 ON READER-SERVICE CARD

NEW PRODUCTS

Digital Printer 607

Has solid-state, all-electronic matrix

This digital printer, Model 14-27A, features a solid state, all-electronic matrix, an aluminum cabinet and easy accessibility for servicing. Specs are: power input, 115 v ac, 100 va; print rate, 1.5 lines per sec; 1-2-2-4 binary code, capacity, 8 digit; dimensions, 17 x 17 x 7 in.

Northeastern Engineering Inc., Dept. ED, 25 S. Bedford St., Manchester, N.H.

Price & Availability: Delivery is 60 days after order received; from stock after 1 Sept, 1960. \$875 ea.

Voltage Reference 561

Output voltage is 6.2 v dc



These miniature voltage references are available for circuit-board, tube-socket, and chassis mountings. Output is 6.2 v dc nominal with a load of 1 ma. Output voltage deviation is less than 0.005% for a $\pm 20\%$ input variation. Temperature stability is better than $\pm 0.001\%$ per deg C. Printed-circuit and 9-pin tube-socket types require 1 va at 28 v dc $\pm 20\%$.

Dynage, Inc., Dept. ED, 75 Laurel St., Hartford, Conn.

Availability: Three to four weeks delivery.

Solar Energy Converters 480

Modular

Called Solar Modules, these solar-energy converters are self-contained power generating units that mount five shingled, plastic-encased, silicon solar shells. They can be used separately or arranged in series, parallel, or series-parallel combinations. Each module measures 1 x 2.5 in. and weighs about 1/6 oz. A typical unit, model H5B provides 32 ma at 2 v.

Hoffman Electronics Corp., Dept. ED, 3761 Hill St., Los Angeles, Calif.

Price & Availability: Type H5B is priced at \$16 ea. Units are immediately available in production quantities.

Now 2 to 3
week delivery
on popular
BUORD items...



and in production quantities!

Mark 7 Mod 0 Size 15 Servo Motor
Mark 7 Mod 1 Size 15 Servo Motor
Mark 12 Mod 0 Size 15 Motor Generator
Mark 12 Mod 1 Size 15 Motor Generator
Mark 16 Mod 1 Size 18 Motor Generator
Mark 16 Mod 3 Size 18 Motor Generator
(For transistor circuits)

The addition of our second factory means delivery in six to twelve weeks on many other G-M Servo Motors and Motor Generators as well; sizes 8 to 18, including other BuOrd items.

*Now Bureau of Naval Weapons



Ask also for full information; G-M Recommended Specification No. 665 and Catalog.

G-M Servo Motors
Manufactured by the Components Division of
G-M LABORATORIES INC.
4284 N. Knox Avenue • Chicago 41

now available in
a wide range of
STANDARD SIZES



beryllium copper CONTACT STRIPS AND RINGS

BTI now offers a complete line of standard strips and rings used for grounding—shielding and contacts in high frequency equipment. Commonly known as "finger stock," these parts can be supplied without tooling charges in a large variety of widths, shapes and contours.

All parts are made under **BTI's** high precision quality control, which insures uniformity. Special heat treatment process guarantees flatness and close tolerances for critical applications.

Save engineering time by specifying **BTI** strips and rings. Your catalog is available by writing today for **Bulletin No. E 106** describing this line.



BTI also offers custom fabrication to your specifications on special slotting, punching, etc., on standard parts.

BRAUN TOOL & INSTRUMENT COMPANY, INC.

138 Fifth Ave., Hawthorne, N.J.



CIRCLE 177 ON READER-SERVICE CARD

ELECTRONIC DESIGN • October 12, 1960

Wirewound Resistors **627**

Series 50 is provided with ribbon leads for welding in microminiature circuits. The leads are 2-in. long. The 0.1-w units measure 0.125 x 0.375 in. and the 0.3-w units measure 0.25 x 0.75 in.

Kelvin Electric Co., Dept. ED, 5907 Noble Ave., Van Nuys, Calif.

Self-Locking Nut **628**

J-Lok nuts can be used either side up in automatic assemblies and can be made for high-temperature applications. The internal locking ring can be Delrin or Polypropylene.

Jacobson Nut Manufacturing Corp., Dept. ED, Box 177, Kenilworth, N.J.

Availability: Standard sizes now available.

Digital Clocks **629**

Models 570A and 571B fit into the firm's 560A and 561B digital recorders. They indicate time to 23 hr, 50 min, 50 sec. Display is by long-life, in-line indicator tubes and all time digits are available for printing.

Hewlett-Packard Co., Dept. ED, 275 Page Mill Road, Palo Alto, Calif.

Power Relays **630**

The contact rating of the PR series relays has been increased from 13 amp to 25 amp at 115 to 230 v ac, non-inductive. The 25-amp rating is also for 1 hp, 115 to 230 v, non-inductive, single phase.

Potter & Brumfield, Dept. ED, Princeton, Ind.

Bonding Compound **634**

Bondaid is for preparing Teflon, TFE, FEP, and KEL-F surfaces for bonding to other materials. It makes fluorocarbons bondable to metals, other plastics, glass ceramics, textiles, and woods.

W. S. Shamban & Co., Polytex Div., Dept. ED, Box 1037, Culver City, Calif.

Availability: The product is furnished directly from the factories.

Adjustable Speed Drives **371**

ECI-Drives, easily controlled and programmed, insure 1% to 2% regulation without tachometer feedback to automatically drive machine tools and special purpose machinery. Ratings from 1/40 to 3 hp are available.

ECI Manufacturing Div., Electronic Controls Inc., Dept. ED, 85 Magee Ave., Stamford, Conn.

RF Beam Power Pentode **633**

Type WL-7371 is for communication transmitters and is adaptable for single-sideband linear-amplifier service. Input power rating is 300 w; plate dissipation is 75 w. Signal power dissipation is 125 w max.

Westinghouse Electric Corp., Electronic Tube Div., Dept. ED, P. O. Box 284, Elmira, N.Y.

MINIATURE "C" BAND TRIODE OSCILLATOR

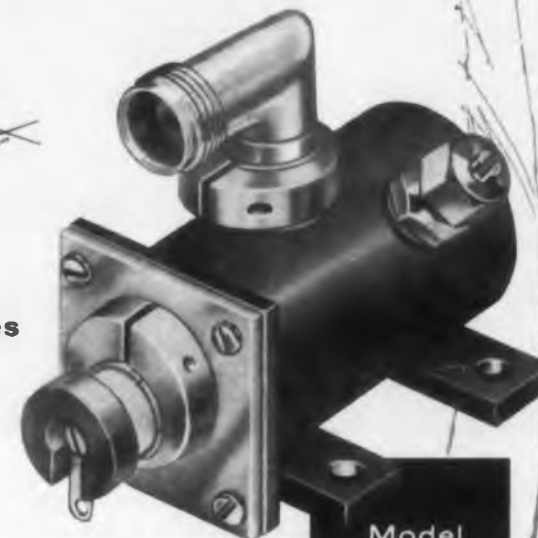

Model
151C

4½ ounces

60 Milliwatts at 4800 MC

20 Milliwatts at 6000 MC

±10 KC per degree C

±1 MC FM at 20 G's 20-2000 cps

Only 200V plate voltage

The John Gombos Co., Inc. Model 151C has applications as a local oscillator, CW signal source and driver for harmonic generators.

JOHN
GOMBOS

CO., INC.

WEBRO ROAD, CLIFTON, N. J.

We are a recognized, quality manufacturer of a complete line of Triode Oscillators, Amplifiers and Multipliers from "L" Band through "C" Band. We also produce a complete line of Tunable Band Pass Filters from "L" through "Ku" Band.

WRITE TODAY for Data Sheet C-2.

CIRCLE 178 ON READER-SERVICE CARD

integrated protection

for avionic systems

communications/navigation/fire control/countermeasure/flight control

Get exactly what you need in an integrated mounting system by utilizing the special skills of Lord, the leader in vibration/shock/noise control. This move will assure all the benefits offered by consolidating your aerospace electronic system on one structural base.

The marriage of "black boxes" and protective structures is a highly developed Lord capability. This gives you the most system for your money—one that is lighter, smaller, more reliable, longer lasting.

Lord offers custom design and qualification testing plus construction of complete, integrated mounting systems. To meet your most rigid specifications, Lord has available such exclusive materials as:

BTR® Elastomeric Mountings—excellent all-attitude control of high-frequency vibration from -65° to $+300^{\circ}$ F.

Dyna-damp Structural Laminates—built-in damping provides a new approach to control of acoustic fatigue and structural response.

Why not take a few minutes and check with Lord now? Your inquiry will be welcomed at the nearest Field Engineering Office or the Home Office, Erie, Pa.

FIELD ENGINEERING OFFICES

ATLANTA, GEORGIA · CEder 7-9247
BOSTON, MASS. · HAncock 6-9135
CHICAGO, ILL. · MICHigan 2-6010
DALLAS, TEXAS · RIVERSide 1-3392
DAYTON, OHIO · BAldwin 4-0351
DETROIT, MICH. · DIamond 1-4340
KANSAS CITY, MO. · WEstport 1-0138

LOS ANGELES, CAL. · HOllywood 4-7593
NEW YORK, N. Y. (Paramus, N. J.)
New York City · BRyant 9-8042
Paramus, N. J. · DIamond 3-5333
PHILADELPHIA, PA. · PEnnypacker 9-3559
SAN FRANCISCO, CAL. · EXbrook 7-6280
WINTER PARK, FLA. · MIdway 7-5501

"In Canada—Railway & Power Engineering Corporation Limited"

LORD MANUFACTURING COMPANY • ERIE, PA.

CIRCLE 179 ON READER-SERVICE CARD

BL-1909-1-1



TYPICAL INTEGRATED MOUNTING SYSTEM

Performance Characteristics:

Application: navigational system for jet aircraft — four ¼ ATR units, two ⅜ ATR units, computer, blower. Weight: equipment — 51.7 lbs., base — 11 lbs. Shock/vibration protection: all-attitude — meets MIL-E-5272C plus sustained accelerations. System natural frequency: 25 cps vertical. Isolators: eight BTR Mountings, 10 lb. rating. Operating temperature range: -65° to $+300^{\circ}$ F. Cooling: provided for four units. Special hardware: tie-down clamps, locating pins, plenum chamber, seals, throttling orifices, provisions for electrical connectors.



NEW PRODUCTS

Low Impedance Adaptor 475

For use with an rf bridge

Type Z-601 low-impedance adaptor extends the measurement range of the firm's rf bridge type B-601 to 10 ohms. A T-network circuit is used. The device enables measurements of 5% accuracy to be made on such components as small inductors, large-value capacitors, and semi-conductors.

Wayne Kerr Corp., Dept. ED, 1633 Race St., Philadelphia 3, Pa.

Price & Availability: \$28; four weeks.

Photomultiplier Tube 562

Has 10 stages



This 5-in., 10-stage photomultiplier tube, designated type 1015, withstands 40 g of shock of 11-msec duration and 10 g vibration of 0 to 2,000 cps in each of three planes. The faceplate is plano-concave with S-11 photocathode deposited on a curved surface to provide uniformity of response. Linear output current ranges to 200 ma for 100-nsec pulses.

CBS Laboratories, Electron Tube Dept., Dept. ED, High Ridge Road, Stamford, Conn.

Price & Availability: \$150; from stock.

Axial Flow Fan 511

Noise level less than 65 db

This fan operates with a noise level of less than 65 db and was designed for shipboard and airborne applications. It delivers 140 cfm at a pressure rise of 2 in. of water. The motor operates on 400 cps, 3 phase, 115 v. The fan housing is 4.25 in. in diameter, 4.5 in. long; it weighs 3.5 lb. The fan housing and impeller are made of aluminum.

The Cosmodyne Corp., Dept. ED, 12833 Simms Ave., Hawthorne, Calif.

Availability: Delivery is 3 to 5 weeks, depending on quantity.

Spray Cleaner

632

Elektrokleen instant spray solvent permits components to be cleaned without removing them. The aerosol container uses a nozzle that releases the solvent in a narrow-cone, long-range drenching spray. It leaves no film or residue.

Montgomery Chemical Co., Dept. ED, Jenkintown, Pa.

Price & Availability: The 16-oz can is priced at \$1.95 ea. Cases of 12 cans are available at a discount. Trial cans can be furnished at the special price of \$1.30 ea.

VU Meter

416

This VU meter, Model VU-100, is designed to eliminate guesswork as far as level control is concerned and to prevent overmodulation. Specs are: 4.5-in. VU meter; two-color scale; modulation calibrations, 0 to 100%; VU calibrations, -20 to +3; dual impedance input sensitivity, 200 μ a; shunts for 1.2 or 12 v; mounts in 2-3/4 in. hole; depth, 1.5 in.

Robins Industries Inc., Dept. ED, Flushing, N.Y.
Price: List price is \$22.

Subminiature Test Jack

417

This subminiature, press-type, Teflon-insulated test jack accepts a 0.061 in. probe. Nine test jacks may be installed in a space measuring 9/16 x 15/16 in.

Hiram Jones Electronics, Dept. ED, 2313 W. Olive St., Burbank, Calif.

Price and Availability: Available from stock; prices start from \$0.065 ea in quantity lots.

Cable Sheath Slitter

418

This cable sheath stripper, model N-62267, is designed for heavy-duty cable sheathings and handles large and small diameter cable equally well. It allows cable cutting at any point without previous notching.

P. K. Neuses, Inc., Dept. ED, 511 N. Dwyer St., Arlington Heights, Ill.

Price: With two blades cost is \$4.20.

Full-Wave Bridge Rectifier

668

This three-phase, full-wave bridge rectifier has an oil-immersed plate and filament transformer. Various sizes are available up to 150 kw dc.

The Light Electric Corp., Dept. ED, 212 Lackawanna Ave., Newark 4, N. J.

Double-Pole Toggle Switch

669

This switch is a double-pole toggle switch with a 20-amp rating. Terminals come in spade, screw and solder type, housing dimensions are: 1.237 in. from front to end of spade, 1.2 in. long and 0.762 in. wide. Electrical ratings are: 20 amp, 125 v, ac 1-1/2 hp; 250 v, ac non-inductive, 0 amp; 250 v, ac 2 hp.

McGill Manufacturing Co., Inc., Dept. ED, Valparaiso, Ind.

FIRST* DC Standards Laboratory

PRIMARY-STANDARD DC VOLTAGE DIVIDER

0.0001 %
ABSOLUTE

PRIMARY-STANDARD ABSOLUTE DC VOLTAGE REFERENCE

0.0001 %
ABSOLUTE

PRIMARY-STANDARD DC VOLTAGE-CURRENT POTENTIOMETER

VOLTAGE
0.0015 % ABS.
CURRENT
0.003 % ABS.

ULTRA-PRECISE DC VOLTAGE GENERATOR-CALIBRATOR

0.0015 %
ABSOLUTE

ULTRA-PRECISE DC CURRENT GENERATOR-CALIBRATOR

0.003 %
ABSOLUTE

ULTRA-SENSITIVE DC AMPLIFIER-NULL DETECTOR

2 μ V
THRESHOLD



This instrument complex is unique.

It provides complete facilities for the performance of every type of DC Calibration and Standardization — at absolute accuracies an order of magnitude better than conventional laboratory potentiometers and references.

Over the past five years, a growing number of standards and calibration laboratories have purchased it to replace less accurate, less versatile, less dependable equipment.

NBS certifications and test reports over five years consistently verify the validity of our absolute accuracy and stability ratings.

May we send you a complete description?

Model PVC-504, \$6,400. Available with NBS certification and test data at additional cost.

*and only commercially-available instrumentation
— providing complete DC measurement facilities.
— based entirely on self-contained Primary Standards.



INSTRUMENT NETWORKS, INC. MANUFACTURING SUBSIDIARY OF
JULIE RESEARCH LABORATORIES, INC.

556 W. 168th Street, New York 32, N. Y. LOrraine 8-8700

CIRCLE 180 ON READER-SERVICE CARD

Dr. Lucius Cuppington introduces . . .



VERNITEL, heart of HOOVER's new FM/FM telemetering system that prolongs the life of FM/FM systems now in use, improving their accuracy by a whole order of magnitude:



Count Vladimir Butts Binswinger shows . . .



HOOVER's new Mixer Amplifier, the palm-sized part of the Vernitel system that helps FM/FM telemetering systems live beyond their income, by prolonging their lives amazingly:



Personalities

at

HOOVER
ELECTRONICS COMPANY

Sir Joshua Wormwood Scrubbs offers . . .



HOOVER's new Millivolt Transistorized Oscillator that eliminates DC amplification from telemetering, allowing fewer and smaller packages and an end to one source of error:



Dr. Herpes Zoster introduces . . .



HOOVER's new Transistorized Subcarrier Oscillator, for FM/FM telemetering circuits, offering a linearity within 0.3% of band-width and a frequency stability within 1.5%.



HOOVER
ELECTRONICS COMPANY

SUBSIDIARY OF THE HOOVER COMPANY

110 WEST TIMONIUM ROAD • TIMONIUM, MARYLAND

Field Liaison Engineers
Los Angeles, California

NEW PRODUCTS

Ceramic Capacitors 474

For operation at 95% humidity

Able to operate during 95% humidity tests, these ceramic capacitors are offered in two types: type RH05 measuring 0.2 x 0.2 x 0.1 in. and type RH06 measuring 0.3 x 0.3 x 0.1 in. They are made to stand shock and vibration.

San Fernando Electric Manufacturing Co., Dept. ED, 1509 First St., San Fernando, Calif.

Frequency Converter 566

Ranges are 50 to 4,000 cps



Model 4025A frequency converter delivers 250 va and provides a selection of frequencies from 50 to 4,000 cps with fixed-frequency accuracies to 0.001%. It handles resistive or reactive loads, has a harmonic distortion of 1% nominal, and has zero output impedance. It is for use with guided-missile checkout systems, servo systems, and aircraft-instrumentation testing.

Tel-Instrument Electronics Corp., Dept. ED, 728 Garden St., Carlstadt, N.J.

Price & Availability: \$840; from stock.

Hot Wire Anemometer 584

Completely transistorized

Model 54A1 hot wire anemometer uses a transistorized circuit to maintain the constant resistance ratio of a hot and a cold filament through a feedback amplifier. It provides a continuous measurement of the mass velocity of air and other gases. Velocity is read directly on a meter and an external output is provided for chart recorder or oscilloscope. Standard range is 0 to 4,000 fpm on three scales, higher velocities up to 18,000 fpm are available. Frequency response is dc to 1,000 cps with an accuracy of 5% of the reading.

Flow Corp., Dept. ED, 85 Mystic St., Arlington, Mass.

MAGNETRON CONNECTORS

by *jettron*

Specify JETTRON for all types of magnetron connectors for vital military or commercial equipment. Complete facilities for the design and production of "specials" and other precision components including sockets and cable assemblies.

Magnetron Input Connector Cat. 9000-C

Fits 4J52A and similar Magnetrons. Features floating heater contact, eight prong heater-cathode contact of silver plated, heat treated beryllium copper. Molded silicone encloses metal body.



Magnetron Input Connector Cat. 9005-C

Fits 4J52A and similar Magnetrons. Features identical to Cat. 9000-C. In addition has 75 mil thick silicone insulated cables for higher potential applications. Made with 4700 µaf built-in capacitor.



Magnetron Input Connector Cat. 9040

One of the many "Specials" Jettron has made Basic Input Connector with floating heater contact. Supplied with or without bypass capacitor. Normally potted to magnetron input end.



Magnetron Input Connector Cat. 9050

Fits Miniature Magnetrons such as L-3028B. Beryllium copper heater and cathode contacts assure dependable contact. Silicone cup fits snugly over magnetron input end. Leads insulated with silicone.



Magnetron Input Connector Cat. 9060

Fits Miniature Magnetrons such as L-3028B. Features similar to Cat. 9050 but supplied less silicone enclosure. Leads extend axially from body of connector. Normally potted to magnetron input end.



Call or write for bulletins on special sockets, magnetron and other connectors

JETTRON
PRODUCTS • INC

56 Route 10, Hanover, New Jersey
Telephones: TUcker 7-0571-0572

Sales Engineers in Principal Cities

CIRCLE 182 ON READER-SERVICE CARD

ELECTRONIC DESIGN • October 12, 1960

CIRCLE 181 ON READER-SERVICE CARD

**For 100%
Reliability Effort**



ARE YOU MEASURING...

- Actual life span of your equipment?
- Consumption of rated life of critical equipment or components?
- Mean-time-to failure?

You can reduce the odds against failure by constant monitoring and timely replacement of equipment approaching the end of assured performance . . . by thoughtful application of the . . .

WALTHAM SUB-MINIATURE ELAPSED TIME INDICATOR



MODEL
WT-1
Actual
Size

1 1/16" O.D. x 1 1/16" 3 OZ.

10,000 Hour Total Readout
(Easily Read to Closest Hour)
400 CPS

Whether it's for reliability and life testing, design or system analysis, utilization studies . . . or to continuously monitor and log critical equipment or components . . . when you incorporate the Waltham WT-1 in your plans, you add that "measure of reliability" so important for military acceptance.

The WT-1 meets MIL-E-5272A and is available "FROM STOCK"
Write Now for Bulletin 5001!

WALTHAM

PRECISION INSTRUMENT
COMPANY

Waltham 54, Massachusetts
CIRCLE 183 ON READER-SERVICE CARD

ELECTRONIC DESIGN • October 12, 1960

Storage Unit

467

Has 25 relays

Model 218 storage unit has 25 relays with two spdt contacts; Form C contacts are available for 50 additional combinations. The unit is to be used with the firm's Supertester programmed systems. In actual testing, the storage unit is programmed by the tape and performs automatic gating junctions.

California Technical Industries, Dept. ED,
1421 Old County Road, Belmont, Calif.
Availability: Immediate.

Gear Motor

560

Weights 1.25 lb



Measuring 1-3/8 x 2-1/4 x 4-3/8 in. and weighing 1.25 lb, this gear motor delivers output power approaching 1/10 hp, continuous duty, or 1/4 hp, intermittent duty. It has toroidal field windings. The unit shown has a 3:1 gear reduction and delivers about 22 oz-in. of torque at 3.5 amp, 27 v dc.

The Bendix Corp., Bendix-Pacific Div., Dept. ED, 11600 Sherman Way, North Hollywood, Calif.

Availability: 90 to 120 days after order received.

Tone Generator

472

For missile environments

A subminiature device designed for missile environments, model G-137 tone generator consists of ten high-stability tone oscillators, operating within 30 to 400 cps, and a mixing amplifier. It uses silicon solid-state components. The unit indicates remote functions such as failures of missile components or the separation of missile stages. Other uses include the transmission of binary data where binary information is converted into various tone frequencies and transmitted through a single transmission link.

Alto Scientific Co., Inc., Dept. ED, 855 Commercial St., Palo Alto, Calif.

Price & Availability: \$2,500; 60-day delivery.

PRECISION ALIGNMENT FOR MISSILE SYSTEMS



KAY Rada-Sweep® Sr. CATALOG NO. 385-A SWEEPING OSCILLATOR

- Fixed Center Frequencies Set to Your Specifications — 1 mc to 260 mc.
- Narrow Sweep Widths Available.
- 24 Pulse-Type, Crystal-Controlled Markers Set to Your Specifications.
- Provides Fundamental Frequency Sweeps Over 6 Switched Bands — No Spurious Output.
- Missile System Receivers and Transmitters, Communications Front Ends, IF Strips, Doppler Radar.

SPECIFICATIONS

SWEEP WIDTH: 70% of center frequencies selected — 1 and 100 mc; 60 to 70 mc for frequencies — 100 and 260 mc.

SWEEP RATE: Variable around 60 cps; locks to line frequency.

RF OUTPUT: 0.5 volt rms into nominal 70 or 50 ohms. Higher for lower frequency units. Output held constant to within ± 0.5 db over widest sweep by AGC circuit.

ZERO REFERENCE: A true zero base line produced on oscilloscope during retrace time.

ATTENUATORS: Switched 20 db, 20 db, 10 db, 6 db, 3 db plus continuously variable 6 db.

MARKERS: Accurate to $\pm 0.05\%$. Markers are placed four to a swept band; no individual switches on markers.

MARKER AMPLITUDE: Continuously variable from zero to approximately 10 volts peak.

SWEEP OUTPUT: Regular sawtooth synchronized with sweeping oscillator. Amplitude approximately 7.0 volts peak.

POWER SUPPLY: Input approx. 150 watts 117-V ($\pm 10\%$) 50-60 cps. 8+ electronically regulated.

DIMENSIONS: 8 3/4" x 19" rack panel, 13" deep. Suitable for rack mount — supplied also with cabinet.

WEIGHT: 34 lbs.

PRICE: \$725.00 including cabinet, f.o.b. factory. Crystal Marks \$17.00 each, extra.

KAY Rada-Sweep® 300

CATALOG NO. 386-A
SPECIALIZED SWEEPING OSCILLATOR SIMILAR
IN SPECIFICATION TO RADA-SWEEP SR.
1 mc TO 350 mc.

- Any 12 Fixed Center Frequencies Set to Your Specifications.
- Up to 30 Pulse-Type, Crystal-Controlled Markers Set to Your Specifications.

Price: \$925.00, f.o.b. factory, plus markers at \$17.00 each.

KAY Rada-Sweep®

CATALOG NO. 380-A
Standard Center Frequencies — 30 mc - 60 mc.
Sweep Widths — 2 Switched Bands; Wide,
20 mc; Narrow, 3 mc, (Variable over Center
50% of Each Band.)

- Up to 9 Pulse-Type, Crystal-Positioned Markers — Four Standard, 25, 35, 55 & 65 mc (others at your specifications).

Price: \$450.00, f.o.b. factory, with 4 Crystal Markers.

Write for New Kay Catalog

KAY ELECTRIC COMPANY

ED-10

Maple Ave., Pine Brook, N. J.

CApital 8-4000

CIRCLE 184 ON READER-SERVICE CARD

ECC83
12AX7

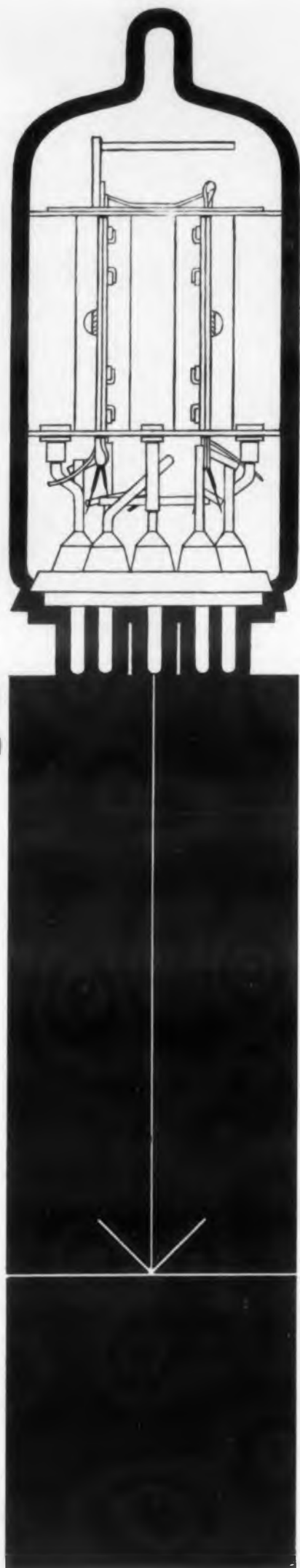

high gain
double
triode

Double Triode having separate cathodes, primarily intended for use as a resistance-coupled amplifier or phase inverter.

characteristics (each section)

| | | |
|-------|------|-----------------|
| V_a | 100 | 250 V |
| I_a | 0.5 | 1.2 mA |
| V_g | -1.0 | -2.0 V |
| g_m | 1.25 | 1.6 mA/V |
| μ | 100 | 100 |
| r_a | 80 | 62.5 k Ω |



Mullard is the trademark of Mullard Ltd.

Mullard
ELECTRONIC TUBES

BRITAIN'S FIRST CHOICE
FOR FIRST EQUIPMENTS

SUPPLIES AVAILABLE FROM
IN THE U.S.A.
International Electronics Corporation
81 Spring Street, New York 12, N.Y.
Worth 6-0790

IN CANADA
Rogers Electronic
Tubes & Components
116 Vanderhoof Avenue,
Toronto 17, Ontario.
Hudson 5-8621

MULLARD OVERSEAS LTD., MULLARD HOUSE,
TORRINGTON PLACE, LONDON, ENGLAND

CIRCLE 185 ON READER-SERVICE CARD

NEW PRODUCTS

Thermoelectric Probe 466

For type testing

Model TE-1 thermoelectric probe is for type testing of semiconductors and metals, detection of p-n junctions in semiconductors and measurement of relative thermoelectric power. It consists of a sensitive galvanometer, a cold base, a hot point and a variable dc attenuator. Sensitivity is adjustable; limits can be set for production testing of materials or for comparison of various thermoelectric materials.

Electro Impulse Laboratory, Inc., Dept. ED,
208 River St., Red Bank, N. J.

Price: \$250.

Electronic Integrator 569

Operates from a millivolt signal



Called the Lectrocount, this electronic integrator operates from a millivolt signal. It provides up to 10,000 output counts per min in the form of pulses and monitors the input without using a recorder. Output speed is furnished to meet customer requirements.

Royson Engineering Co., Dept. ED, Hathoro,
Pa.

Price & Availability: \$845; 60 days.

5-Kw Transmitter 355

Single sideband

Model 96 SSB transmitter, rated at 5 kw, will reach 6.8 kw peak-envelope power at any frequency from 2 to 32 mc. It operates on am, cw, mcw and fsk. The unit is 12-5/16 in. wide, 72 in. high and 27-3/4 in. deep. Components are mounted on a drawer-type slide to ease servicing. A modernization kit to convert the conventional Model 96 am transmitter to single sideband is also available.

Wilcox Electric Co., Dept. ED, 14th and
Chestnut, Kansas City 27, Mo.

Availability: Delivery 120 days after receipt of order.

CIRCLE 186 ON READER-SERVICE CARD

MEV 103

ELECTRONIC DESIGN • October 12, 1960

High-Voltage Power Supplies

664

High-voltage power supplies models 40-6 and 40-7 are based on the ORNL Q-2057 design and make use of 85A2 gas reference tubes for coarse control. For fine control the 40-6 uses Zener diodes. All switch positions are calibrated directly in volts.

Radiation Instrument Development Laboratory, Inc., Dept. ED, 61 E. North Ave., Northlake, Ill.

Temperature Indicating Controller

665

This temperature indicating controller is an electronic, on-off controller and pyrometric temperature indicator, designed for use on processes requiring continuous control. It is available in 11 ranges from 0 to 400 F to 0 to 3,000 F and an environmental test chamber range of -100 to +300 F.

Illinois Testing Laboratories, Inc., Allnor Instrument Co. Div., Dept. ED, 420 N LaSalle St., Chicago 10, Ill.

Copper-Aluminum Laminate

666

This laminate, known as Cladplate, consists of a layer of aluminum on which a layer of electrolytic copper is clad on one or both sides. The metals are bonded under heat and high pressure. It is available in most thicknesses of aluminum and copper in full sheet sizes up to 48 x 144 in. with commercial finishes as well as high polish finish.

Kenmore Sales Co., Dept. ED, Reiss Ave., Lowell, Mass.

Panel Enclosures

667

Panel enclosures Nema Type 12 are designed to house electrical controls and for use as terminal boxes and instrument enclosures. Handle assemblies accommodate padlocks, provision is made for installation of single strip fluorescent lamps, all seams are welded and a neoprene gasket is cemented inside the door for a liquid-tight seal. Sizes range from 16 x 12 x 6 in. to 72 x 60 x 12 in.

Keystone Manufacturing Co., Dept. ED, 23328 Sherwood Road, Warren, Mich.

Precision Welding Head

684

Type M is for automated production of sub-miniature devices such as diodes and transistors. It is designed for installation in a standard dry box. Welding action can be initiated by automatic programming or adapted to dial feed for high-production rate.

Raytheon Co., Commercial Apparatus and Systems Div., Dept. ED, 415 Providence Turnpike, Norwood, Mass.

DC Power Supplies

646

Voltage range of the model RS40B is 0 to 125 v; regulation is within 6 v over a 2 to 20 amp current range. Rack and cabinet mounts are available.

Ogad Electric Co., Dept. ED, 43 Walker St., New York 13, N. Y.

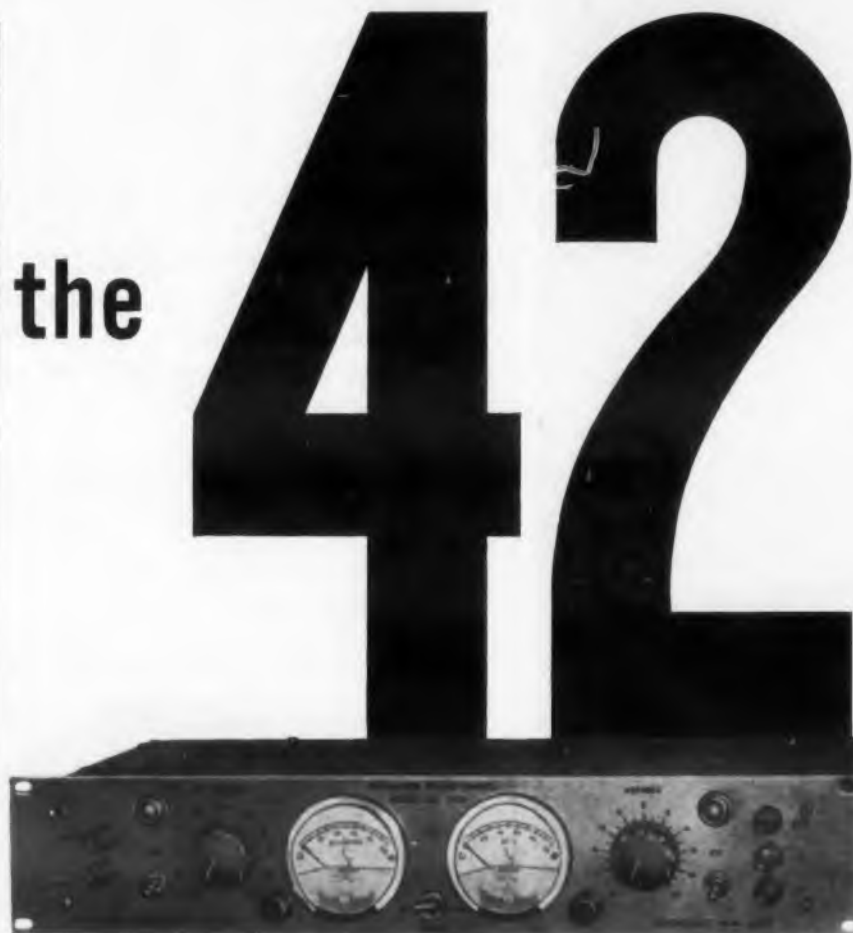

MODEL 212A \$129 WITHOUT METERS

| 0.1% REGULATION MODELS | DC OUTPUT | | 0.01% REGULATION MODELS |
|------------------------------|-----------|---------|-------------------------------|
| | VOLTS | MA | |
| 220A | 0-50 | 0-500 | 220AK |
| 213A | 0-50 | 0-1000 | 213AK |
| 215A | 0-50 | 0-3000 | 215AK |
| 225A | 0-75 | 0-2000 | 225AK |
| 212A ¹ | 0-100 | 0-100 | 212AK ¹ |
| 2-212A ^{1, 3} | 0-100X2 | 0-100X2 | 2-212AK ^{1, 3} |
| 224A ¹ | 0-100 | 0-200 | 224AK ¹ |
| 221A | 0-100 | 0-500 | 221AK |
| 214A | 0-100 | 0-1000 | 214AK |
| 226A | 0-100 | 0-2000 | 226AK |
| 218A | 0-100 | 0-3000 | 218AK |
| 229A | 0-150 | 0-300 | 229AK |
| 228A | 0-150 | 0-1000 | 228AK |
| 230A | 0-200 | 0-1000 | 230AK |
| 231A ² | 0-300 | 0-100 | 231AK ² |
| 232A ² | 0-300 | 0-200 | 232AK ² |
| 233A ² | 0-300 | 0-300 | 233AK ² |
| 234A | 0-300 | 0-500 | 234AK |
| 237A | 0-300 | 0-1000 | 237AK |
| 236A ² | 0-600 | 0-200 | 236AK ² |
| 235A | 0-600 | 0-500 | 235AK |

¹ Has modulation input.

² Has additional 0-150 V DC output and 6.3 V AC CT output.

³ Equivalent to two Model 212A's.

the 42[®] most popular REGATRON POWER SUPPLIES are programmable

Why programmable? Because Regatron Programmable Power Supplies give the design engineer an extra margin of versatility. For example, in automatic test work, the programmable feature reduces control circuitry. In critical laboratory application, the programmable feature permits near-perfect reproducibility of test voltages.

There are other advantages too. The programmable feature provides for remote sensing. This provision eliminates the effect of voltage drops in power leads . . . places the point of regulation at the load terminals. And there's more.

For complete descriptions and specifications ask for Specification Sheets 3010B and 3023B.

[®] Registered U.S. Pat. Off. Patents Issued and Pending.

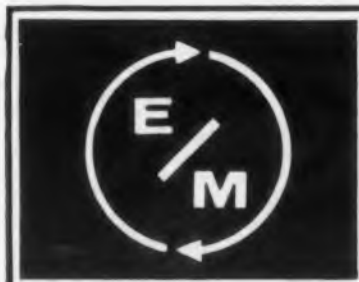

ELECTRONIC
MEASUREMENTS
COMPANY, INCORPORATED
EATONTOWN • NEW JERSEY

CIRCLE 188 ON READER-SERVICE CARD



because only the 330-M is continuously variable from 0.2 cps to 20 kc!

Now you can cover the complete frequency range from sub-audio through audio with one convenient variable electronic filter! Its bandwidth covers the most widely used frequencies in circuitry design, testing, measurement and research. The 330-M can replace — in a 17" x 8" x 12" size — banks of fixed filters, and massive inductors and capacitors.

More than this most frequently used bandwidth, the 330-M band-pass filter offers rapid attenuation beyond the cut-offs. Unwanted signals are attenuated up to 80 db, and maximum attenuation is maintained at all frequencies beyond cut-off. Low cut-off, high cut-off and center frequency are all continuously variable. Cut-off frequency dials are single log-scale, direct reading. Band switches give frequency ranges in five decades. Attenuation is 24 db per octave outside the pass-band, reaching 70 db in less than three octaves. Signal-to-noise ratio is greater than 80 db.

Write for full information on this wide-band, light-weight band-pass filter. Its convenient coverage of low frequencies through audio, and direct reading, continuously variable cut-offs give you real workload flexibility. Other Krohn-Hite band-pass filters include Models 330-A (0.02 to 2,000 cps), 310-AB (20 to 200,000 cps); and rejection filters as well. Also, Krohn-Hite Oscillators, Amplifiers and Power Supplies.



KROHN-HITE CORPORATION

580 Massachusetts Avenue • Cambridge 39, Mass.

Pioneering in Quality Electronic Instruments

CIRCLE 189 ON READER-SERVICE CARD

NEW PRODUCTS

Synchro and Resolver Tester 463

Console type

This semi-automatic tester performs tests on 400-cps resolvers, synchro transmitters, differentials, and control transformers. The unit consists of a phase-sensitive voltmeter, a filter vacuum tube voltmeter, relay module, signal module, transformation-ratio module, and power-supply module. Over-all size of the unit is 50-9/16 x 21-9/16 x 22 in.

Kearfott Div., General Precision, Inc., Dept. ED, 1150 McBride Ave., Little Falls, N. J.

Thyratron 570

For high-current control use



This 10-amp, 1,500-v piv and forward voltage thyratron is for control applications requiring high currents. Designated the 770L, the tube has a filament voltage of 2.5 v, a filament current of 25 amp, a peak anode current of 120 amp, and condensed mercury limits of -40 to +90 C.

National Electronics, Inc., Dept. ED, Geneva, Ill.

Availability: From stock.

Solenoid Actuator 620

Push and pull linkages available

Model L13 electromagnetic dc actuator is available with both push and pull linkages. It magnifies the original air-gap movement in an 8:1 ratio and has a life of 100 million operations. The unit may be set for either push or pull by reversing the position of an arm. It has a maximum stroke of 0.125 in., exerting a pull of 100 to 550 g and is capable of a 7-msec operating time at normal voltages. Operating voltages for standard units is 6, 12, 24, and 48 v.

James Cunningham, Son & Co., Inc., Dept. ED, Rochester 8, N.Y.

Price & Availability: Prices range from \$3.40 to \$4.90 ea; delivery is 10 days after order received.

NEW 2½-POUND COMMAND RECEIVER

SCREENS OUT NOISE ...PULLS IN SIGNAL

for targets, drones & missiles



MODEL R-400A UHF RECEIVER
260 MC—400 MC
6.8" L. x 3.5" W. x 3.1" H.

Operating under conditions of highly congested air space and a crowded radio spectrum, this tough, 44-ounce UHF remote receiver maintains excellent selectivity...eliminates spurious short time noise signals through an integrating time delay system. A crystal-controlled receiver, the R-400A operates on a very narrow channel with a stability greater than ±.01% of the input frequency over a temperature range of -65°F to +160°F. It offers unlimited application in remote control of targets, drones and missiles where single channel remote control is desired. Selectivity (RF-IF) is: 6 db down, 60 kc ± 10 kc; 60 db down, 170 kc ± 20 kc. Sensitivity is better than 2 microvolts. Meets requirements of MIL-T-9790A.

For complete information, write for Data File ED-1257-2



INTERNATIONAL AIRPORT
LOS ANGELES 45, CALIF.

CIRCLE 190 ON READER-SERVICE CARD

ELECTRONIC DESIGN • October 12, 1960

STRAITS TIN REPORT

News of developments
in the production
and uses of tin



Alpha-titanium, containing 2.5% tin, is the structural material used for the X-15 manned spaceship. Addition of tin provides greater creep resistance. This alloy is widely used in aircraft applications. It has the characteristics of high-grade steel, but only half the weight.

Tin alloys may be used as hot-dipped or electrodeposited coatings on other metals or they may be cast as the base metal. Use of tin will result in one or more of these characteristics being added to finished products:

- malleability • nontoxicity
- lubricity • corrosion resistance
- solderability • wear resistance
- excellent bearing qualities
- ductility • attractive finish

Tin is commonly alloyed with copper, lead, antimony, bismuth, aluminum or iron; less commonly with nickel, cadmium, magnesium, zinc, mercury, silver, manganese, tellurium.

Electronic components use tin in many applications. Transistor leads and caps are tinned. Tin-indium solder joins glass to metal, glass to glass. Printed circuits use 60-40 tin-lead solder. Potentiometer brush arms and springs are made of tin-containing spring-temper phosphor bronze. A tin chemical, bismuth-stannate, stabilizes capacitors against temperature change.



Write today for more data on these items or for a free subscription to TIN NEWS—a monthly bulletin on tin supply, prices and new uses.

The Malaysian Tin Bureau
Dept. 12K, 2000 K Street, N.W., Washington 6, D.C.

CIRCLE 191 ON READER-SERVICE CARD

Industrial TV Camera Tube 623

Needs no alignment correction

Model ML-7038A is an industrial television camera tube which requires no alignment correction. Gun design eliminates correcting coils and magnets. The tube has a mesh-assembly support fused into glass tubing and an evaporated electrode. The screen is of 750 lines-per-inch mesh. The tube has a photoconductor surface of uniform thickness, permitting constant voltage gradient, uniform dark current and uniform sensitivity across the entire scanned area.

Raytheon Co., Machlett Laboratories, Inc., Dept. ED, Springdale, Conn.

Coaxial Filters 571

For operation from 3.5 to 4 kmc



Designed for operation from 3.5 to 4 kmc, type 90116 two-section coaxial filter is individually tuned by a micrometer drive to provide a 3-db bandwidth of 14 mc, nominal. It has an input vswr of 1.25 max and an insertion loss of 1.3 db max. The rejection at a nominal operating frequency ± 30 mc is 22 db min. The unit is intended for laboratory use with the micrometer drive providing an accurate correlation to frequency.

Waveline, Inc., Dept. ED, Caldwell, N.J.
Availability: Made on order.

DC Power Supply 624

Completely transistorized

Model QR36-15A is a completely transistorized dc power supply which furnishes a regulated, completely adjustable output voltage from 0 to 36 v dc at 15 amp. Designed for powering critical transistor circuits, the unit includes filtering and rapid recovery from line or load transients, providing spike-free output. It may be operated with positive or negative ground, or with ungrounded output.

Raytheon Co., Dept. ED, Waltham 54, Mass.



power alone
is not enough...

it's the ultra low distortion — .005%
in this audio amplifier
that makes the big difference!

Here's a fifty-watt power amplifier with harmonic and intermodulation distortion of less than .005%. Distortion so low — you'd need special equipment to measure it!

That's why the UF-101A is a natural as a reference source, with a suitable oscillator, for low distortion measurement of power components, as well as a highly linear amplifier within the audio band.

The other characteristics of the UF-101A are equally outstanding. Phase distortion is negligible — $\pm 2^\circ$ maximum deviation from linear phase shift. Total hum and noise level less than 10 microvolts input equivalent. Frequency range is from 20 cps to 20 kc. For convenience, the UF-101A has taps for matched load impedances from 1 to 225 ohms.

Some of the applications of this ultra-low distortion amplifier are: checking the residual distortion of distortion-measuring equipment, reproducing non-sinusoidal wave forms faithfully, and as an ultra-low distortion, high power source to supply test benches. Write for full information on the UF-101A.

Other Krohn-Hite amplifiers include the direct-coupled, wide band DCA-10 (10 watts), and DCA-50 (50 watts). Also, *Krohn-Hite Oscillators, Filters and Power Supplies.*



KROHN-HITE CORPORATION

580 Massachusetts Avenue • Cambridge 39, Mass.

Pioneering in Quality Electronic Instruments

CIRCLE 192 ON READER-SERVICE CARD

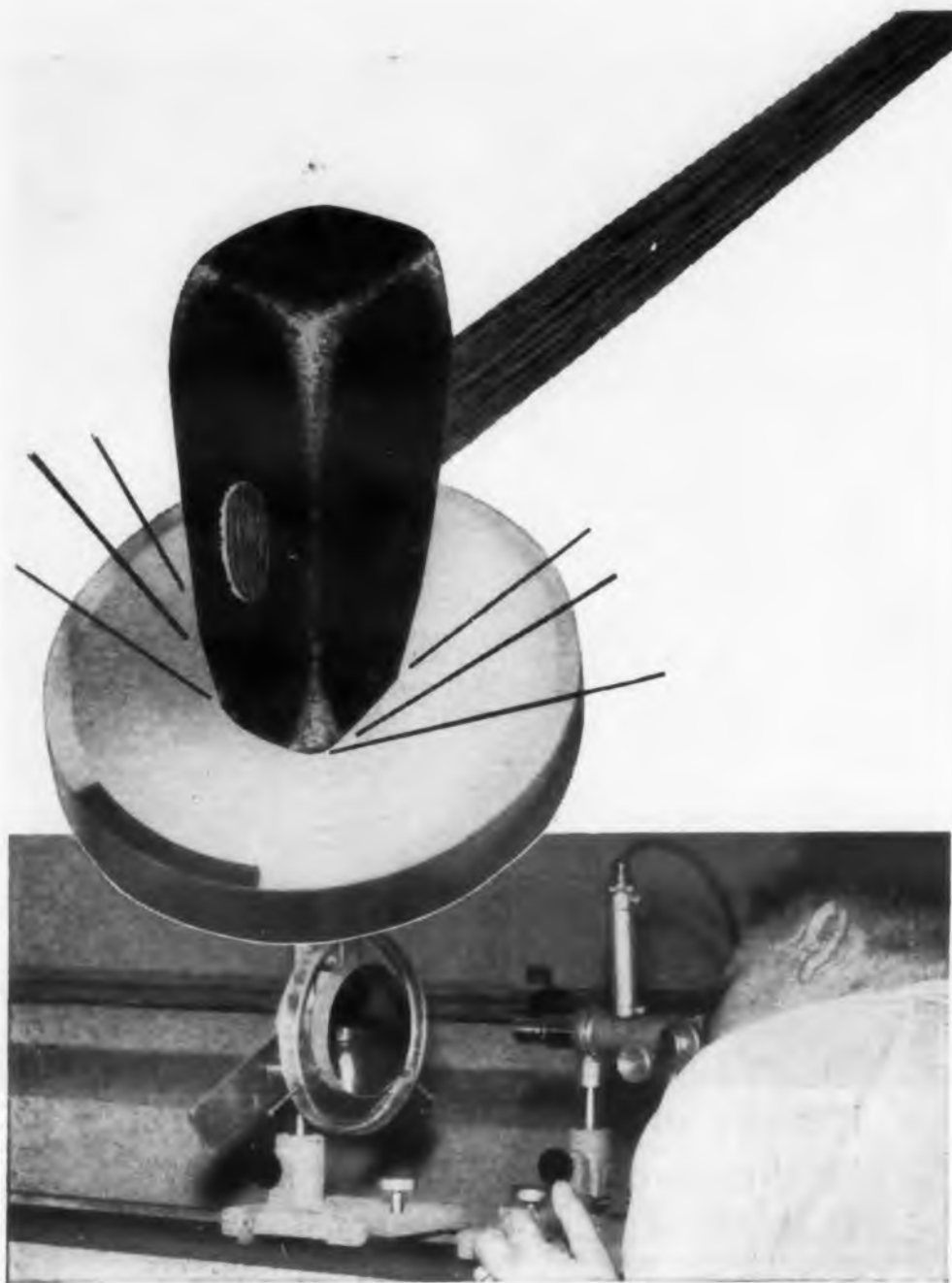

22,000 g's shock have been successfully applied to this plastic replica mirror at Singer-Bridgeport. Here an engineering physicist in the optics lab inspects test sample. These Singer plastic mirrors, called Repli-Kote, are an important contribution to the state of the optics art, providing a fast, economical method of duplicating ground glass mirrors from epoxy resins. Currently work is going forward in replica optics under Frankford Arsenal research and development contract.

Today Singer-Bridgeport's skills in precision machining and exacting assembly work are at the service of the Military. Anti-submarine devices, bomb rack assemblies are now in production.

Industry, too, depends on Singer-Bridgeport as a partner, not just a vendor, in engineering and producing electronic and electro-mechanical systems and components.

Singer-Bridgeport's comprehensive capabilities are detailed in a new illustrated brochure, yours for the asking.



SINGER-BRIDGEPORT

A DIVISION OF THE SINGER MANUFACTURING COMPANY
915 Pembroke Street Bridgeport 8, Conn.



*A Trademark of THE SINGER MANUFACTURING COMPANY

CIRCLE 193 ON READER-SERVICE CARD

NEW PRODUCTS

Amplifier Demodulator 622

Converts 400 cps to dc

Model M3102-02 amplifier-demodulator converts a 400-cps signal to dc. This transistorized unit provides isolation, moderate power gain, high input impedance and stable, linear operation over the temperature range from -55 to $+71$ C. Typical characteristics are: power input, 27 v dc, 20 ma max, 115 v ac 400 cps; input signal, 400 cps $\pm 5\%$, 1 v rms max; input impedance, 50-K; output, 1.3 ma dc per volt rms ac into 500 ohm load; power gain, 16 db.

General Precision Inc., Kearfott Div., Dept. ED, 1150 McBride Ave., Little Falls, N.J.

Digital Clock 574

Performs three basic functions



Model 224A digital clock provides three basic clock functions: digital-time display, digital time in 1-2-2-4 coded output form, and elapsed-time measurement with digital-time display and coded output. Real time or time measurement is display in hours, minutes and seconds. The internal 1-cps clock pulses are generated by synchronization with the 60-cps power line or by external sources such as a crystal-controlled time generator. Nixie readout is optional.

Computer-Measurements Co., Dept. ED, 12970 Bradley Ave., Sylmar, Calif.
Price: \$695.

Analog-to-Digital Converter 625

High speed capability

This electronic converter is capable of supplying two and one-half million samples of information per second, with an accuracy of 1/2% of full scale. It is less than a cubic foot in size and converts analog or continuous signal information into digital form for processing by a digital computer.

Raytheon Co., Dept. ED, Waltham 54, Mass.

STROMBERG-CARLSON TELEPHONE HANDSETS

MODELS FOR MANY INDUSTRIAL APPLICATIONS



No. 26: short, lightweight, sturdy. Comes with capsule-type receiver and transmitter.

No. 27: high-gain version of No. 26 handset.



No. 28: "push-to-talk" handset. Rocker bar switch; various spring combinations.

No. 29: high-gain version of No. 28 handset.

Typical applications: mobile radio • intercom systems • carrier and microwave • aircraft and railroad.

Modern handset cradle for mobile or panel use fits any Stromberg-Carlson handset.
Write to Telecommunication Industrial Sales, 116 Carlson Road, Rochester 3, New York. Or in Atlanta call TRinity 5-7467; Chicago: STate 2-4235; Kansas City: HARRison 1-6618; Rochester: HUBbard 2-2200; San Francisco: OXFord 7-3630.

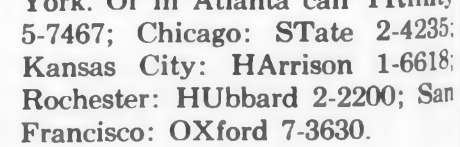

STROMBERG-CARLSON
A DIVISION OF
GENERAL DYNAMICS

CIRCLE 194 ON READER-SERVICE CARD

ELECTRONIC DESIGN • October 12, 1960

Reactance Sliderule

448

This reactance sliderule is used for simple calculations of resonant frequencies, and capacitive and inductive reactances. It also solves coil Q and dissipation factor problems that cover a frequency range from 5 cps to 10,000 μ c.

Shure Brothers, Inc., Dept. ED, 222 Hartrey Ave., Evanston, Ill.

Price: Price is \$1.

Nylon Cleaners

631

Nylo-Fast fasteners eliminate the need for insulating bushings, washers, and couplings. They provide low dielectric constant, high dielectric strength, and resist heat, shock, and vibration.

Anti-Corrosive Metal Products Co., Inc., Plastics Div., Dept. ED, Castleton-on-Hudson, N.Y.

Price & Availability: Delivery is immediate. A free sampling kit can be furnished.

Wire And Cable Strapping

647

This wire tying system, called Insuloid Strapping, consists of a PVC plastic belt with spaced, mounting holes and stud-like inserts. It can secure all types of unsupported wire and cable. It is available in 75-ft coils and two widths, 5/16 in. and 1/2 in.

Electrovert Inc., Dept. ED, 124 E. 40 St., New York 16, N. Y.

Price & Availability: The 5/16 in. width is \$2.25 per coil, the 1/2 in. width is \$3.75 per coil. Studs are \$5 per thousand. From stock.

Metalized Transformer Terminals

458

These metalized ceramic transformer terminals include feed-through and stand-off types, both in steatite and alumina ceramics, glazed and unglazed. Two types of hardware are available, solder lug and threaded bushing. The Transformer terminals cover a voltage range up to 22,500 v.

Metalizing Industries, Inc., Dept. ED, 338 Hudson St., Hackensack, N.J.

Diamond Spatula

459

This diamond spatula is used to clean contact points on relays and other electric and electronic devices. The original metal shaft has been replaced by a nylon shaft for greater flexibility and insulation.

Jonard International Corp., Dept. ED, 624 Madison Ave., New York, N.Y.

Price: Prices range up to \$4.95 ea.

Subminiature Metalized Housing

432

This metalized housing has an OD of 0.03 in., an ID of 0.012-in. Metalized with molybdenum manganese and nickel plated on both flat surfaces, it can be hermetically sealed by brazing or soft solder. The 0.008-in. device may be used with diodes.

Mitronics, Inc., Dept. ED, 1290 Central Ave., Hillside, N.J.

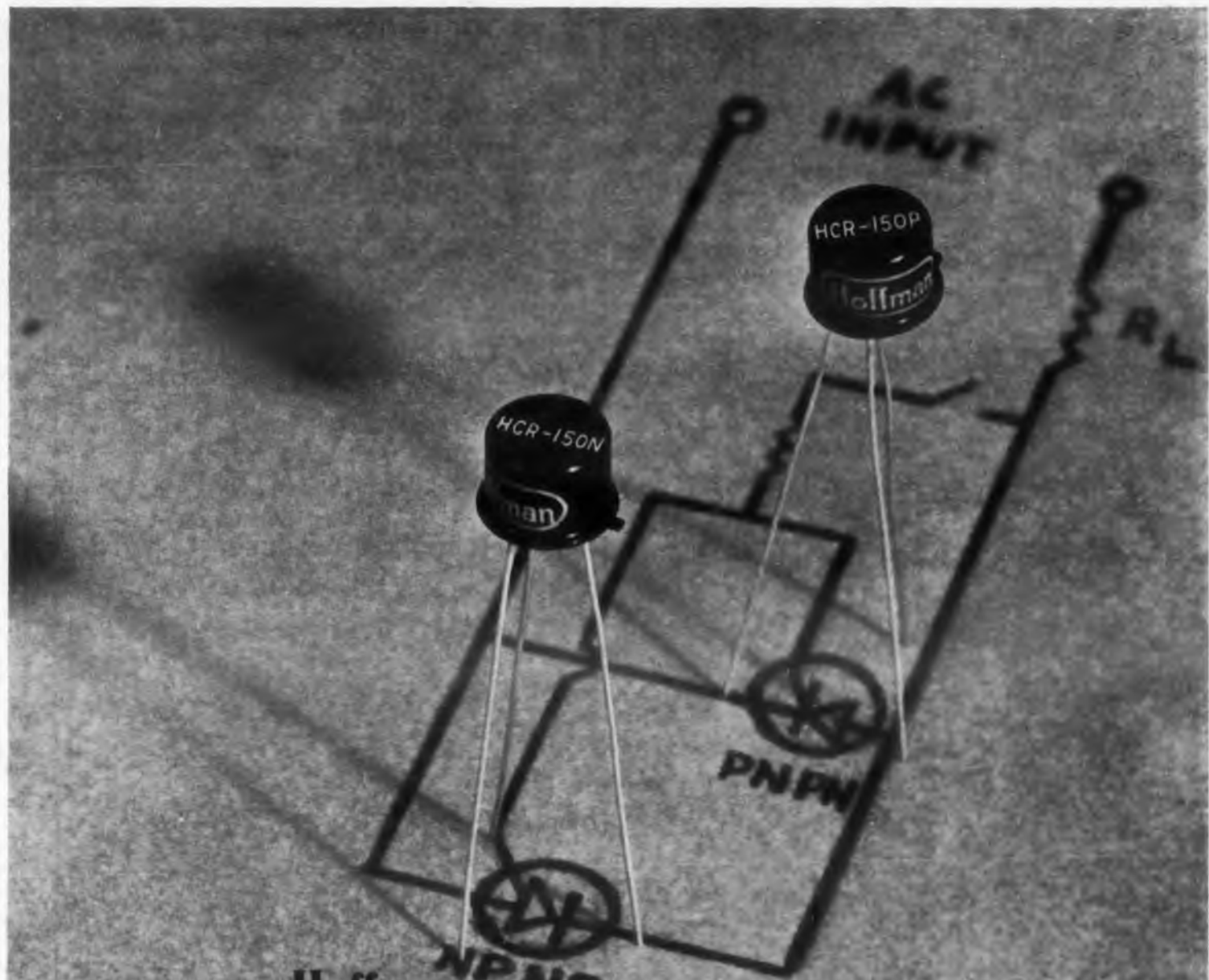

Another First From Hoffman

COMPLEMENTARY SILICON CONTROLLED RECTIFIERS

- RATED 1 AMP AT 80°C
- IN TRANSISTOR TO-5 PACKAGE
- FROM A SINGLE SOURCE

Designed and built to improve the reliability of your system

- by simplifying circuitry
- by saving weight and space
- by increasing design flexibility

TYPICAL APPLICATIONS

Missile and aircraft control systems, industrial control systems, static switching, conversion and regulation, relay drive circuits, and related applications.

| Hoffman Type No. 1 | IEDEC Equivalent | SPECIFICATIONS* (-65°C to +125°C) | | MAXIMUM RATINGS (-65°C to +125°C) | |
|--------------------------------|---------------------|-----------------------------------|---|--|-----------------------|
| | | AV and BV _{RM} (volts) | Max. V _F @ 1A [†] (volts) | V _{RRM} and V _{RM} (volts) | I _{FM} (amp) |
| PNPN—1 AMP @ 80°C [‡] | | | | | |
| HCR-30P | — | 30 | 2 | 30 | 1.4 |
| HCR-50P | 2N150B | 60 | 2 | 50 | 1.4 |
| HCR-100P | 2N150B | 120 | 2 | 100 | 1.4 |
| HCR-150P | — | 150 | 2 | 150 | 1.4 |
| HCR-200P | 2N1507 | 240 | 2 | 200 | 1.4 |
| HCR-300P | 2N1508 | 300 | 2 | 300 | 1.4 |
| HCR-400P | 2N1508 | 400 | 2 | 400 | 1.4 |
| NPNF—1 AMP @ 80°C [‡] | | | | | |
| HCR-30N | — | 30 | 2 | 30 | 1.4 |
| HCR-50N | 2N150A [§] | 60 | 2 | 50 | 1.4 |
| HCR-100N | 2N150A [§] | 120 | 2 | 100 | 1.4 |
| HCR-150N | — | 150 | 2 | 150 | 1.4 |
| HCR-200N | 2N1507 [§] | 240 | 2 | 200 | 1.4 |

NOTES: (1) Average rectified forward current. (2) Suffix "P" denotes positive gate polarity referred to cathode (standard device). Suffix "N" denotes negative gate polarity referred to anode (complementary device). (3) Derate 20 mA/°C above 80°C. (4) JEDEC complement.

Hoffman

ELECTRONICS CORPORATION
Semiconductor Division

1001 Arden Drive, El Monte, California

TWX: El Monte 9735

Plants: El Monte, California and Evanston, Illinois

CIRCLE 195 ON READER-SERVICE CARD

move
power
to you



Central XD-2

Central's 7132/XD-2* hard tube diode was especially designed for rectifier, charging and shunt diode service. As a rectifier the XD-2 will withstand 40 Kv (P.I.V.) at a 3 ampere average—150 amperes (peak) as a clipper. This tried and proven tube features a special Thorium-tungsten filament capable of high peak currents and long life, and has a very efficient external anode which can dissipate 5 Kw continuously.

* air cooled version—7131/XD-2

If power is your problem—see Central first!



**NUCLEAR
CORPORATION
OF AMERICA**

Central ELECTRONIC MANUFACTURERS

A Division of Nuclear Corporation of America
DENVILLE, NEW JERSEY
Export Department: 333 East 48th St., New York 17, N. Y.

CIRCLE 196 ON READER-SERVICE CARD

NEW PRODUCTS

Buffer Storage Units 465

Capacities are 36 to 4,032 characters

These digital storage systems have storage capacities of 36 to 4,032 characters. Character loading and unloading time is 5 μ sec; repeat at loading or unloading rate is 100,000 characters per bit. Magnetic logic techniques are used. Commercial and military types can be furnished.

Di/An Controls, Inc., Dept. ED, 40 Leon St., Boston 15, Mass.

Price & Availability: \$0.65 per bit in 4,032-character size; \$10 per bit in 36-character size. Delivery time is 6 weeks to 8 months.

Accelerometer Transducer 678

Weighs less than 3 oz



Weighing less than 3 oz model 4-202 temperature-compensated, strain-gage accelerometer is designed to measure acceleration perpendicular to the mounting surface. It occupies 1 cu in. Linearity and hysteresis characteristics are rated at less than $\pm 0.75\%$ of full range output. Standard ranges are between ± 5 g and ± 500 g. Over-acceleration up to 20 times the rated range is permitted by mechanical stops. Input voltage is 5 v with a full-range output of ± 20 mv.

Consolidated Electrodynamics Corp., Dept. ED, 360 Sierra Madre Villa, Pasadena, Calif.

Power Supply 359

Output is 0 to 50 v

This bench-type power supply provides a continuously adjustable output of 0 to 50 v dc at 0 to 500 ma. The input is 95 to 125 v ac, rms, 60 cps, single phase. Ripple is 3.5 mv at maximum voltage and full load. Stability after warm-up is 0.01%; long term thermal drift from start to stable temperature is 50 mv. Output impedance is less than 0.1 ohm. Size of the unit is 5 1/4 x 4 1/4 x 5 in.

Autotronics Inc., Dept. ED, Box 208, Florissant, Mo.



TERAGLAS[®]

**A NEW CLASS B INSULATION
WITH RESILIENT WEAVE AND HIGH
DIELECTRIC STRENGTH UNDER STRETCH**

Natvar Teraglas is a new flexible insulating material comprising a base fabric, woven from polyester (polyethylene terephthalate, or "Dacron") warp yarns and continuous filament glass filler yarns, coated with an improved varnish, possessing exceptional dielectric strength under elongation. It will withstand Class B (130°C) operating temperatures.

In view of the higher dielectric strength of Natvar Teraglas compared to bias varnished cambric, thinner sections or fewer layers may be used to provide the voltage breakdown protection desired. Consequently, at comparable tape prices, a significant saving may be realized in production costs, while permitting up-grading to Class B (130°C) temperatures.

Natvar Teraglas will prove advantageous in many applications—for insulating motors, generators, transformers, cables, switch gear, bushings, and other apparatus and equipment where resiliency and high dielectric strength are desirable.

Natvar Teraglas is available in four thicknesses, .008, .010, .012 and .015"—in tapes, in full width rolls (36"), or in sheets. Ask for Data Sheet and Samples.

NATVAR CORPORATION

FORMERLY THE NATIONAL VARNISHED PRODUCTS CORPORATION
Telephone: FULTON 8-8800 Cable Address: NATVAR: RAHWAY, N.J.

TWX: Rahway, N. J., RAH 1134

241 RANDOLPH AVENUE • WOODBRIDGE, NEW JERSEY

CIRCLE 197 ON READER-SERVICE CARD

Complete range of HIGH PERFORMANCE XENON FLASH TUBES



Complete line includes tiny FX-6A illustrated (14,000 cp output, one billion flashes at 0.01 WS, repetition rate as high as 1,000 pps) ... FX-1 which can be made to provide up to 50° arc ... FX-12 with 10-million cp/sq cm. peak brightness ... and other special-purpose tubes for microscopy, underwater work, etc.

Stroboscope — A complete electronic control unit easily adaptable to any high speed shutter system. Min. flash duration 1.2 micro-seconds at rates up to 6,000 cps.

Double-flash Light Source — Precision without complexity. A complete portable system for double exposure photography at accurately timed intervals. Readily adaptable for single-flash use.

Mark VI Sensometer — Ensures uniformity of repeated exposures to within 5%. Flatness of light 2%. Light source closely approximates daylight. Minimal loss when corrected for tungsten.



**EDGERTON, GERMESHAUSEN &
GRIER, INC.** 161 BROOKLINE AVE., BOSTON 15, MASS.

CIRCLE 198 ON READER-SERVICE CARD

ELECTRONIC DESIGN • October 12, 1960

INVO MASTER SPUR GEARS ULTRA-HIGH PRECISION



Immediate delivery from stock

- .0002 Maximum Composite Error
- 20 Pitch and Finer
- 14½° and 20° Pressure Angles
- Hardened and Ground Tool Steel

INVO SPLINE, INC.

P. O. BOX 25 HAZEL PARK, MICH.
PHONE Slocum 7-8840 SEND FOR STOCK LIST

CIRCLE 199 ON READER-SERVICE CARD

molded
Black Nylon
screws
and nuts

Insulate and Fasten
without bushings,
washers, etc. In Stock
2-56, 4-40, 6-32, 8-32,
10-32 and ¼-20.



Black Nylon
"NyGrip"
cable
clips

Light-weight non-
conducting support
for wiring, tubing, etc.
In Stock ¼" to
1½" Dia.



Free samples • write **WECKESSER CO.**

5703-05 Northwest Highway, Chicago 46, Illinois

CIRCLE 200 ON READER-SERVICE CARD

ELECTRONIC DESIGN • October 12, 1960

Waveguide Meters 452

These waveguide meters provide vswr measurements on larger waveguides including the WR2300 and WR2100. The instruments have adjustable mounts and ball-bearing carriages. Construction is rugged.

Schutter Microwave Corp., Dept. ED, 80 E. Montauk Highway, Lindenhurst, N.Y.
Availability: Immediate.

Rotary Index Head 457

The index wheel of the type THM 101 rotary index head is calibrated with both clockwise and counter-clockwise angular markings. Settings may be made in 30-sec increments to an accuracy of 3 sec of arc.

Millitest Corporation, Dept. ED, 88 Madison Ave., Hempstead, Long Island, N.Y.

Acceleration Indicator 453

Model AT-1 direct-indicating acceleration sensor records acceleration and shock up to 150 g. Accuracy is ±5% of full scale. The unit is tubular, less than 3 in. long, weighs 0.3 oz, and mounts in a cable clamp or fuse clip. It is suitable for shock-testing of equipment.

Eastern Technical Associates., Inc., Dept ED, Main St., North Acton, Mass.
Price & Availability: Prices from \$5 to \$3, depending on quantity; delivery from stock.

Constant-Temperature Cabinets 454

These constant-temperature cabinets are for storage and protection of heat-sensitive missile components such as gyroscopes and velocity meters on both sea and shore. Built to Navy specs, the cabinets provide safety alarm circuits and special loading systems as well as close temperature control. A number of sizes are offered. The cabinet can be adapted to meet various requirements for temperature, control, and loading.

Precision Scientific Co., Dept. ED, 3737 W. Cortland St., Chicago 47, Ill.

Temperature Control 455

This on-off temperature control enables a mercury tube to switch loads up to 10 amp at 28 v dc with no moving parts.

Vapor Heating Corp., Vap-Air Div., 6240 W. Howard St., Chicago 48, Ill.

Radio Command Receiver 456

Radio command receiver, model RR-575, is used in flight control of target and aircraft drones. The receiver operates in the range of 406 to 550 mc with a frequency stability of ±0.01%. It has a 60-db image and spurious frequency rejection.

Electronic Specialty Co., Dept. ED, 5121 San Fernando Road, Los Angeles 39, Calif.



**MORE
POWER
TO YOU!**

**Central
XD-45**

Today's radars demand more pulse power in less space. Central's answer is the 7545/XD-45, specifically designed for switch tube service. Though compact in size, this proprietary tube will switch 3.4 megawatts at 25 Kv hold-off anode voltage with pulses up to 25 µ seconds, 200 amperes peak. The XD-45 is air cooled—6 Kw anode dissipation, and is available from stock.

*When your design calls for pulse power—
see Central first!*

NUCOR
NUCLEAR
CORPORATION
OF AMERICA

**Central
ELECTRONIC MANUFACTURERS**

A Division of Nuclear Corporation of America

DENVILLE, NEW JERSEY

Export Department: 333 East 46th St., New York 17, N. Y.

CIRCLE 201 ON READER-SERVICE CARD

LEC LOCKHEED ELECTRONICS
AVIONICS AND INDUSTRIAL PRODUCTS DIVISION COMPANY

Quality components mass produced

Advanced engineering and manufacturing techniques are your assurance of the highest reliability in these mass-produced Lockheed Electronics components.

Lockheed offers its customers years of experience as both a major buyer and supplier of components as well as the complete resources of the Lockheed complex. This experience is coupled with the most up-to-date facilities for the manufacture of a variety of quality electronic components. Our design engineering staff is available to assist you with special component problems.

For information on Lockheed Electronics, write: Marketing Branch - Lockheed Electronics Co. Avionics & Industrial Products Division, 6201 East Randolph Street, Los Angeles 22, California
Or phone: OV 5-7070

PRODUCTION PRODUCTS

Shock Test Machine

260

Produces up to 3,000 g

Model SM-005 pneumatic shock-test machine produces up to 3,000 g. It handles loads of up to 30 lb and produces all shock pulses required for testing electronic components with an impact shock velocity of up to 192 in. per sec. The machine has an over-all height of 46 in.

Avco Research and Advanced Development Div., Dept. ED, 201 Lowell St., Wilmington, Mass.

Price & Availability: \$2,195; 10-day delivery.

Semiconductor Test Station

261



Automatic, Go, No-Go testing

This automatic semiconductor test station features Go, No-Go testing of transistor or diode performance. Up to 700 units per hr may be tested with 100% measurement reliability. Up to 25 individual tests may be included in any sequence. Ratings are from 0 to 100 v and up to 3 amp. Test accuracy is 1%.

Optimized Devices, Inc., Dept. ED, 864 Franklin Ave., Thornwood, N.Y.

Price & Availability: Price is approximately \$10,000, depending upon selection of modules; delivery is 3 mo.

Component Cleaner

262

Uses high-speed spray

Model RT-R-13-5 parts cleaner cleans crystal case relays and other precision components at a rate of 900 per hr. Components to be cleaned are mounted on a rotary turntable and automatically subjected to high-velocity spray-clean operations. Oil, grease, silicone lubricants, rosin flux, fingerprints, lapping compounds, and other soluble and insoluble contaminants are rapidly removed. Solvent is non-flammable and leaves no residue on evaporation.

Cobehn, Inc., Dept. ED, Passaic Ave., Caldwell, N.J.

CIRCLE 202 ON READER-SERVICE CARD

Impregnation Equipment 263

Comes in heated and unheated models

This impregnation equipment comes in heated models for waxes and asphalts, and unheated models for varnishes and resins. It uses a two-step cycle of high vacuum and high pressure for removal of air and moisture from parts and penetration and coverage of the impregnant. In the heated model, the dual 9-ft capacity tanks are insulated and have thermostatic control from 0 to 500 F.

Metallizing Company of America, Inc., Dept. ED, 3520 W. Carroll Ave., Chicago 24, Ill.

Tape Welder 264

Operates at production-line speed

Made to operate at production-line speeds, Model W-2 tape welder joins resistance alloy wires measuring 0.025 to 0.0007 in. in diameter. The weld is stronger than the parent wire and accurate to one turn. The unit welds without pressure and causes no heat damage to adjacent parts. It completes a weld in 12 sec. Maximum power consumption is 30 w.

Hanjohn Co., Inc., Dept. ED, 2711 E. Foothill Blvd., Pasadena, Calif.

Price & Availability: \$375; one week.

Dip Soldering Equipment 265

For printed and etched boards

Model 13-DSM-16D dip soldering machine is designed for the soldering of printed and etched boards. It has a capacity of 60 boards per hour with the dwell time set at 6 sec. Dwell time can be controlled from 0 to 14-1/4 sec in 0.3-sec steps and is regulated within 0.1 sec of the selected time. Dross accumulation is automatically removed prior to each cycle.

Jefferson Electronic Products, Dept. ED, 109 De la Guerra St., Santa Barbara, Calif.

Availability: Immediate delivery.

Mixing Unit 266

For rapid setting compounds

The Meter-Mix unit meters, mixes and delivers a homogenous air-free mixture of rapid setting, two component sealants and epoxy resins on a continuous or intermittent basis at any rate up to 10 gal per hr. The unit may be cleaned for shut-down in 60 sec. The base material and the accelerator are metered and pumped by a separate positive displacement pumps which can be metered 0 to 100%.

Murphy and Miller, Inc., Dept. ED, 600 W. Taylor St., Chicago, Ill.

High-vacuum measurement—all types —one source



VTP 6578 IONIZATION GAUGE TUBE Especially designed for high ultimate vacuum applications. 3 filaments for long life. Reliable, positive calibration. Flanged for use in metal vacuum systems.



VTP 7169 IONIZATION GAUGE TUBE All glass. Designed for use in glass vacuum systems. Electrically identical to VTP 6578. Both may be outgassed easily by passing heater current through grid structure.



VTP 6343 THERMOCOUPLE GAUGE TUBE Fast response: less than 0.1 second! Pressure range: 0.1 to 1000 microns. Ruggedized all-metal construction. Useable for leak detection on vacuum systems as well as absolute pressure measurement.



VTP TC-43 THERMOCOUPLE GAUGE CONTROL Dual meter control. Indicating meters for heater current and system pressure. Rotary switch permits selective measurement of pressure at any one of four separate measuring points.



VTP PGC-7 PHILIPS GAUGE CONTROL Simple, inexpensive Philips gauge (cold cathode) control measures pressures down to 10⁻⁹ mm Hg. Rugged construction assures dependable operation under difficult operating conditions.



VTP PG-7 PHILIPS GAUGE Small, compact, stainless steel gauge. Measures to 10⁻⁹ mm Hg. Withstands 425° bakeout temperatures. Easily cleaned. Leak-free. Adaptable to any vacuum system. Sputter shield for long service life.



VP-6 ION PUMP Small, highly efficient ultra-high vacuum pump. Designed to stay clean for long, trouble-free operating life. Maintains 10⁻⁴ to 10⁻⁹ mm Hg in closed vacuum systems—either metal or glass. Gauges as it pumps.



VPC-6 ION PUMP CONTROL Completely self-contained unit with circuitry and controls for vacuum pumping to 10⁻⁹ mm Hg. Accurate pressures readable while pumping. Special feature prevents meter burnout from accidental shorts or pressure changes.

For your laboratory and production use, the world's most complete line of vacuum measurement devices is available from Hughes Vacuum Tube Products Division.

Backed by over 13 years of research, development and production experience in the high-vacuum field, these precision instruments offer you the maximum in accuracy and reliability—plus long operating life!

Precise, dependable Hughes' vacuum gauge tubes are especially designed to give you extra-long life plus interchangeability in existing systems.

For detailed information on Hughes' complete line of vacuum gauge tubes and controls—or sound solutions to your particular vacuum measurement problems, write:

HUGHES
Vacuum Tube Products Division
2020 Short Street
Oceanside, California

For export information, write:
Hughes International
Culver City, California

Creating a new world with ELECTRONICS

HUGHES

VACUUM TUBE PRODUCTS DIVISION
HUGHES AIRCRAFT COMPANY

CIRCLE 203 ON READER-SERVICE CARD

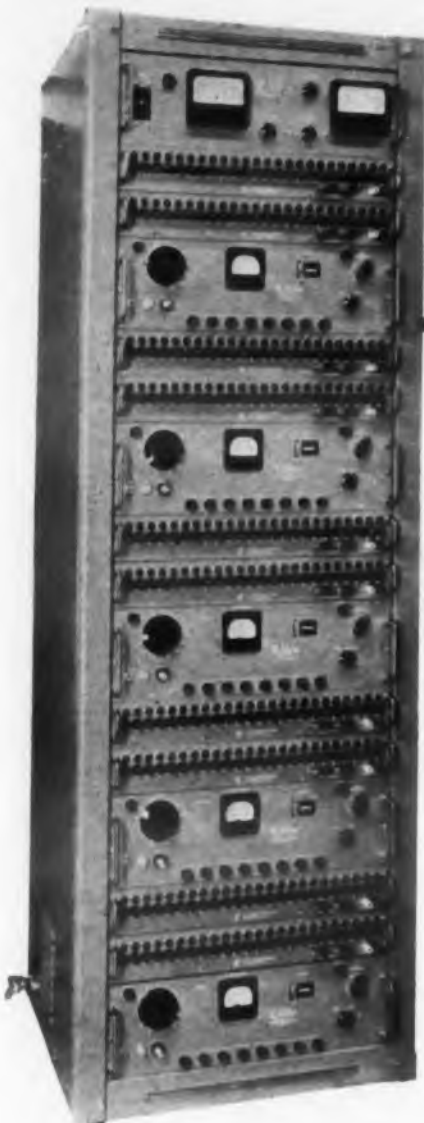

Modular Life Tester

The Wallson Model 154 Power Supply is used as a basic power supply in life testing semiconductor rectifiers. It incorporates the principles of simulator circuits, as opposed to brute force testing, i.e., a low voltage, high current transformer is used to supply forward current, and a high voltage, low current transformer is used to supply the reverse voltage.

- Operating Costs Reduced By a Factor of 50. The Model 154 will supply 32 amperes average rectified DC with inverse voltage from zero to 1000 volts peak. When operated at full capacity, over the course of a 1000 hour life test, the Model 154 can effect a savings of as much as \$242.24 at .01/Kw. hr. in operating cost.
- Forward current and reverse voltage may be adjusted independently.
- 100 Ma to 10 amp. forward current. Power can be brought out to the rectifiers under test through a variety of distribution panels which are designed to meet the user's requirements for metering and indication of failure.

Write Today For Free Descriptive Literature



WALLSON
ASSOCIATES, INC.
912-914 Westfield Ave., Elizabeth, N. J.
Flanders 1-0700

CIRCLE 204 ON READER-SERVICE CARD

SERVICES FOR DESIGNERS

Teflon Shapes Built To Individual Requirements 267

The Teflon engineering service provided by Timely Technical Products, Inc. includes die design and the compounding of special additives needed by individual customer requirements. Shapes of all types are extruded with a T-6 powder compound. The service is available nationally through the firm's representatives.

Timely Technical Products, Inc., S. Jefferson Road, Whippany, N.J.

Reinforced Plastics Service Is Described in New Brochure 268

The services offered by the Reinforced Plastics Division of Atkins & Merrill Inc. are described in a new brochure. The firm's facilities cover a wide range of plastics molding and fabricating techniques. Examples are contact-laminating, vacuum-bag molding, pressure-bag molding, and matched-metal die molding. The applications engineering service helps in selecting the right materials and the right manufacturing technique for each application.

The brochure includes a chart showing typical physical properties of polyester and epoxy resins used in combination with reinforcement materials.

Reinforced Plastics Div. of Atkins & Merrill, Inc., Dept. ED, Bartlett St., Marlboro, Mass.

Metal and Carbon Resistors 269

Having complete facilities for the production of metal and carbon film resistors, Film Resistors, Inc. provides complete cooperation on design and engineering problems. Specializing in microwave and precision miniature types, the firm produces rod, disk, film card, and wafer shape resistors on glass, ceramic, and mica substrates. Deliveries are timed to the customer's production-line requirements.

Film Resistors, Inc., Dept. ED, P. O. Box 49, 242 Ridgedale Ave., Morristown, N.J.

Instrument Bearing Assemblies 270

The Rotassembly Div. of New Hampshire Ball Bearings, Inc. manufactures instrument bearing assemblies to customer specifications. Evaluation and costs of customer-originated designs are done by experienced engineers. Test and assembly equipment used is the same as that employed in producing bearings to ABEC 7 tolerances.

New Hampshire Ball Bearings, Inc., Rotassembly Div., Dept. ED, Peterborough, N.H.

General Electric RTV* LIQUID SILICONE RUBBER



*Cures at room temperature,
useful from -70°F to +600°F*

General Electric RTV silicone rubber compounds provide the dielectric properties of silicone insulation in a form well suited for potting, encapsulating, sealing and impregnating. Available in a wide range of viscosities from 120 to 15,000 poises, they do not shrink or form voids. RTV resists temperature extremes, moisture, ozone, weathering, aging and aircraft fuels. Applications include:

Potting and Encapsulating

RTV is used to pot whole electronic assemblies, while RTV encapsulation protects components from moisture, ozone, physical shock and high-altitude arc-over and corona. Also used as a conformal coating on printed circuits.

Transformer Impregnation

Impregnation with RTV assures top performance for aircraft transformers up to 250°C. Other materials failed due to poor high-temperature resistance or failure to penetrate tightly wound coils.

Cable Connection Potting

Connectors and junctions of high-temperature cable, such as missile wiring harnesses or industrial power and control cables in severe environment, are potted with RTV because of its ability to stand for long periods and then perform reliably when needed.

Longer Life for Motors

Electric motors last longer when stator windings are encapsulated with RTV. RTV's outstanding moisture resistance enables dripproof motors to meet certain applications which formerly required totally enclosed units.

*Room Temperature Vulcanizing.

For more information and a free test sample, write (briefly describing your application) to General Electric Company, Silicone Products Department, Section L1030, Waterford, New York.

GENERAL ELECTRIC

CIRCLE 205 ON READER-SERVICE CARD

ELECTRONIC DESIGN • October 12, 1960

TRIPLE PURPOSE TRIPLE SERVICE



L&N's Stabilized 9835-B Microvolt Amplifier

Designed for low-level d-c measurements of thermocouples, strain gages, etc., in research and production testing, this amplifier combines the functions of three instruments in one:

1. A Direct Reading Indicator that has a sensitivity of 0.25 μV ;
2. A Recorder Preamplifier that extends the range of any Speedomax[®] (type G or H) 0-to-10 MV Recorder;
3. A Null Detector that provides a short period of only two to three seconds.

Ranges — -25 to +25, -50 to +50, -100 to +100, -250 to +250, -500 to +500 and -1000 to +1000 microvolts.

Accuracy — As recorder preamplifier, $\pm(0.4\%$ of range $+0.5 \mu\text{V}$). As direct reading indicator, $\pm(1.4\%$ of range $+0.5 \mu\text{V}$).

Source Resistance — 10,000 ohm, max.

Response Time — Within 1% of balance:
(1) 2 sec. for 2,000 Ω max. source resistance; (2) 3 sec. for source resistance from 2000 to 10,000 Ω .

Switches — (1) Six-position range switch; (2) Three-position selector switch: non-linear meter response, linear meter response, recorder-output to recorder connector; (3) On-off line power switch.

Amplifier Output at Recorder Connection — with extremes of meter scale: (1) ± 5 mv across 500 Ω for null recorder; (2) ± 0.5 volt for external indicator having resistances of 20,000 Ω or higher.

Case — 10 3/4" (h) x 19 3/8" (w) x 8 3/8" (d). Weight is approximately 34 lbs.

Power Input — 115 volts, 60 or 50 cycles.

Price — \$640.00 F.O.B. Phila. or North Wales, Pa. (subject to change without notice). Specify List No. 9835-B when ordering from L&N, 4908 Stenton Ave., Phila. 44, Pa. or nearest L&N Office.

LEEDS NORTHROP
Instruments Automatic Controls • Furnaces

CIRCLE 206 ON READER-SERVICE CARD

ELECTRONIC DESIGN • October 12, 1960

Service Provides Abstracts of Russian Technical Literature 271

A subscriber to the Teklit search service can request English abstracts of any relevant Soviet articles in electronics and physics. Articles from the Russian journals are indexed and retrieved by a professional staff, using the Uniterm system of crossfiling. Descriptive terms are compiled in a cumulative index, which a subscriber uses in specifying a search. The abstracts are sent to the subscriber within five business days after request.

Teklit, Inc., Dept. ED, Box 400, New York 27, N.Y.

Switches Custom Built 272

A source for custom-built switches and similar equipment for electronic, missile, and communication applications, this company offers design, engineering, and manufacturing services.

Essar Engineering Co., Dept. ED, 612 W. Monroe St., Chicago, Ill.

Meter Conversion Facility Handles Small Quantities 273

This meter conversion facility converts standard meters to special purpose types. Small quantities can be handled. The firm is equipped for servicing all makes of meters and has a complete stock of repair parts.

Ram Meter, Inc., Dept. ED, 1100 Hilton Road, Ferndale 20, Mich.

Module Building Service Saves Space Using Standard Components 274

The Wire Wrap service offers possibilities for compact construction in circuit modules using standard parts. Provided by the same firm, the Pin Wrap service for building modules permits building up and down as well as horizontally.

Stratocon Corp., Dept. ED, Morristown Airport, P.O. Box 10, Morristown, N.J.

Computing Center Facilitates Design and Testing 275

This computing center furnishes computing time on a service-bureau basis to scientific organizations. The principal computer is the Control Data 1604 digital unit with 32,768 48-bit words of high-speed, magnetic-core storage. Also provided are the model 160 intermediate-capacity computers which operate with the 1604 plus a complete battery of peripheral equipment.

Control Data Corp., Computer Div., Dept. ED, 501 Park Ave., Minneapolis 15, Minn.



doing something
useful with
light beam interruptions

Our affiliate, The Fisher-Pierce Co., is in the photoelectric control business and began fooling around with CdS photocells as a replacement for phototubes some 6 or 7 years ago. We in turn are pretty well into the electromagnetic relay business, and have been tweaking springs and whiffing magnets for about 20 years. It shouldn't surprise a soul then to learn that we have a new line of photorelays, consisting very simply of the respective products living inside a little can. This is a new "line", which gives you a choice in the type of cell, relay contact arrangement, packaging and operation under on-off, slowly changing or high ambient light conditions. The 8RCO1A, for example, has a CdS cell, responds to "light-no light" conditions, switches 3 amp. 120 VAC resistive loads with SPDT contacts, and has an aluminum dust cover with plug-in base. If your machinery or control circuit is already built, you might be more interested in the complete "package deal" consisting of both photorelay receiver and light source, whose application requires bolting the units onto something and plugging in the line cord.

There are all sorts of things these photorelays can do for you, coupled with a small amount of ingenuity and 120 volts. They can act as the brains to prevent a

process or machine from grinding on if the feed is empty or the operator's hands are in the way; look at the level in a bin or column, or "measure" the level between set points; turn on inside lights in response to a night watchman's flashlight; switch display or sign lighting on at dusk, off at midnight, on again from 6 A. M. to dawn, in conjunction with a time switch (this is the sort of thing in which Fisher-Pierce shines); and all the familiar counting, door-opening and 60-second hand-drying applications.

If you're interested in more exotic uses and have any hot nonincandescent bodies lying around, we can build you a special model with a cadmium selenide cell responsive to infrared rays (sources of infrared we cannot supply at the moment). Other non-standard possibilities include hermetically sealed units, special contact materials and units with low or high foot-candle turn-on points.

Be not faint of heart if your application lies beyond the commonplace. One man of vision found success and happiness by using a Sigma Photorelay in his Chinese fortune cookie machine... with a little luck, you might be able to open a new frontier in light-beam-actuated swiss cheese manufacture. Bulletin with guiding specs on request.



SIGMA

SIGMA INSTRUMENTS, INC.
91 Pearl Street, So. Braintree 85, Mass.

AN AFFILIATE OF THE FISHER-PIERCE CO. (Since 1930)

CIRCLE 207 ON READER-SERVICE CARD

179

LERMER PLASTIC CONTAINERS



Exceptional printing makes the difference...

Helps make the sale!

- Printed or decorated up to 4 colors on crystal clear, transparent or opaque colors
- Largest line of **[RIGID]** plastic containers
- 1/5 the weight of glass—greatly reducing ever-increasing shipping and handling costs
- Lightweight and shatterproof—with rigid wall protection
- Economical—with customer re-use value
- Also made of new high density polyethylene—Poly-Opal*. Are chemically inert, stain resistant and have lower permeability to moisture and gases than conventional polyethylene.

*T. M.

Write for full-color catalog, samples and prices.

LERMER PLASTICS, INC.



572 South Avenue
Garwood, New Jersey

PIONEERS AND SPECIALISTS IN
PLASTIC CONTAINERS SINCE 1919

CIRCLE 208 ON READER-SERVICE CARD

DESIGN DECISIONS

Featuring the clever and unusual in packaging appearance design and circuitry in electronic equipment.



Input Signal Squared and Averaged In RMS-Reading DVM

A NORMALLY unstable thermocouple was obviated in an rms-reading digital voltmeter by circuits that squared and averaged an electrical signal.

A block diagram of the instrument, manufactured by Electro Instruments, Inc., San Diego, is shown below. The device responds not directly to an input, but to the difference between an input and a reference.

It was desirable to eliminate the thermocouple, which responds directly to the rms of signals, because the devices have long-term drifts of several

tenths of a per cent and are easily overloaded and damaged.

The input signal is full-wave rectified (after amplification) so that subsequent circuits see only its magnitude and not its polarity.

The rectified voltage is squared and then averaged by the integrator over a reasonable number of cycles. The output of the integrator approximates the mean square value of the input to better than 0.1 per cent accuracy.

This output is converted into a pulse train that operates the digital readout circuits. This initial

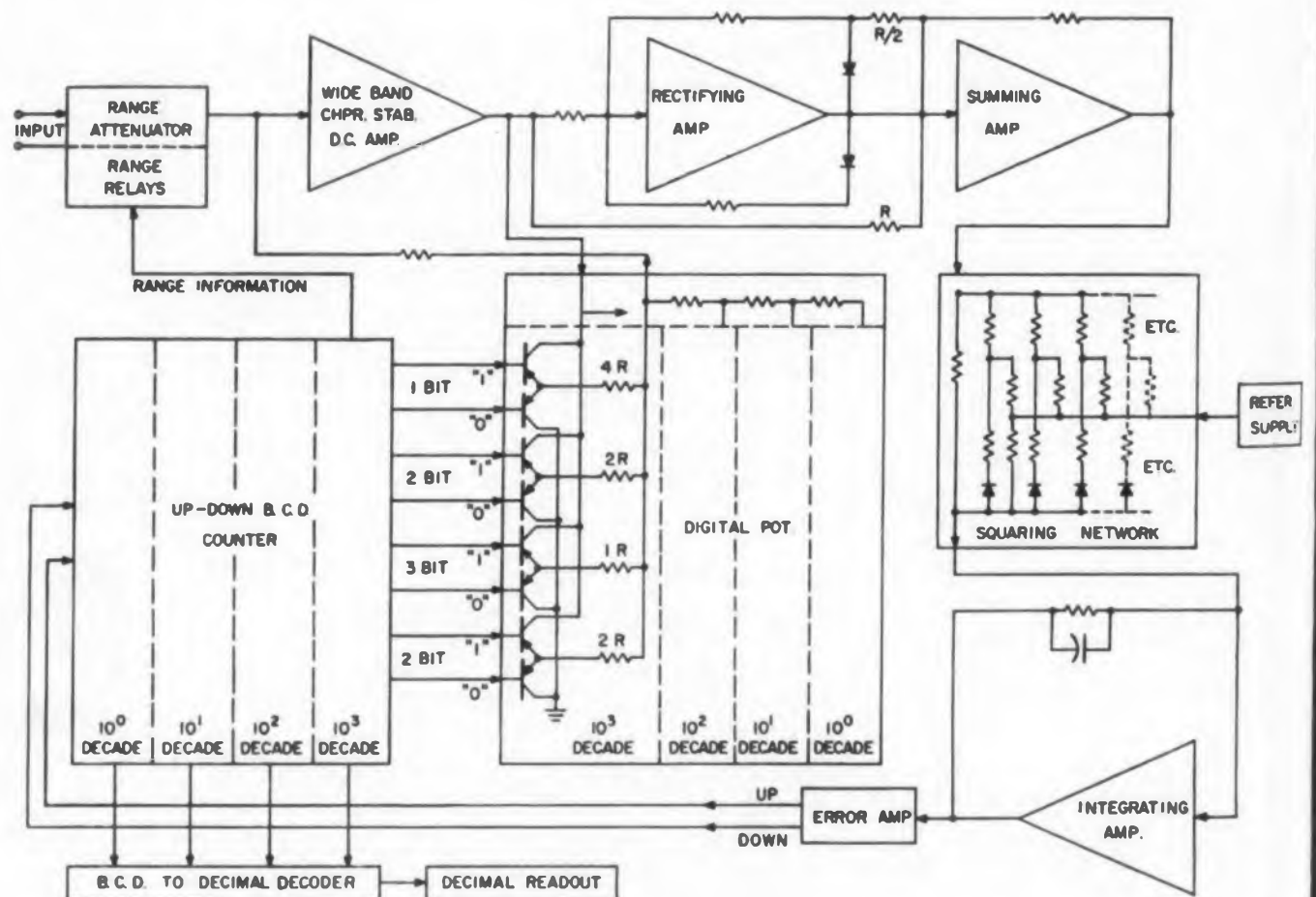

Block diagram of digital voltmeter. Output from binary counter regulates resistance of digital pot, which, in turn, determines gain of loop including the pot and the dc amplifier. Binary counter output also is "read-out."

signal, however, does not give the correct answer, which is obtained by means of the feedback loop from the integrator output to a variable resistance connecting the input and output of the dc amplifier.

The magnitude of this variable resistance—denoted in the diagram as a digital pot—depends on the integrator output. The reason is that this digital pot essentially is a decade box whose switching is done by transistors instead of manually. The integrator output is the switching signal.

The gain of the dc amplifier is sufficiently high so the gain of the loop that includes the dc amplifier and the digital pot depends almost exclusively on the value of the digital pot.

The feedback mechanism works as follows:

The output of the squaring network is proportional to the input squared minus a constant (the reference supply). Hence, the output is zero for only one particular value of input—the square root of the reference supply divided by the proportionality constant.

The integrator output, by means of the transistor switches and the digital pot, changes the gain of the dc amplifier until the output of the squaring network is zero.

Hence, the output of the integrating amplifier is zero, and the output of the error amplifier is zero. The digital readout stops.

The digital circuits effectively read the change in dc-amplifier gain that was necessary to produce a zero error signal. Because this gain depends upon the input, it is also an effective measure of the input.

Ideally, the squaring network has a parabolic transfer function. In practice, this is approximated to within 0.2 per cent accuracy by a piece-wise linear transfer function.

The first leg of the circuit is a potentiometer, so the output is proportional to the input. At a given voltage, a diode breaks down and transfers the signal to another potentiometer. The output is again proportional to the input, but this time, by a different proportionality constant. Thus, each potentiometer-diode circuit gives a linear approximation to a different portion of the ideal parabola.

The stability of the squaring network depends upon the stability of the diodes' back-voltage characteristics. This is obtained by keeping the diodes in a constant-temperature oven.

The squaring-network reference supply is a conventional Zener configuration. The dc amplifier is a wide-band, chopper, stabilized type.

The resistors in the digital pot are of the metal-film variety, rather than wirewound. This eliminates inductive effects, and helps insure the accuracy of the pot, upon which the accuracy of the whole system pivots. ■ ■

STATIC INVERTERS

for every missile system

STANDARD LINE . . . DC AC INVERTERS 28 VDC input -55 C to +71 C MIL specs

| MODEL | POWER RATING | OUTPUT VOLTAGE | OUTPUT FREQUENCY | SPECIAL FEATURES |
|--|------------------------------------|---|-------------------------------------|--|
| SIS 40311 series SIS 40511 series | 30 VA 1 ϕ 50 VA 1 ϕ | 115 VAC adjustable 10% | 400 cps 01 to 05% | Precision frequency, excellent waveform, voltage regulated $\pm 1\%$ for line, $\pm 2\%$ to load |
| SIS 408042 series | 80 VA 1 ϕ | 115 VAC 5 V | 400 cps $\pm 1\%$ | Wide range stabilization, input 18-30 VDC, Voltage regulated $\pm 1\frac{1}{2}\%$ no load to full load |
| SIS 410042 series SIS 425041 series | 100 VA 1 ϕ 250 VA 1 ϕ | 115 VAC 5% | 400 cps 1% LC osc. tune ing fork | Magnetic Amplifier voltage regulated Rapid on-off switching no transients high efficiency |
| SIS 3 425042 series SIS 3 450022 series | 250 VA 3 ϕ 500 VA 3 ϕ | 115 VAC 2% | 400 cps 2% 1% | Regulates to $\pm 2\%$ with simultaneous variation of zero to full load, and line 25 volts to 29 volts |
| SIS 3 47512 series | 750 VA 3 ϕ | 208 115 V or 115 66.5 volts Adj. $\pm 5\%$ | 400 cps 002% | Extreme frequency accuracy Phase lock circuitry Magnetic voltage regulator |
| SIS 3 40613 series | 60 VA 3 ϕ | 26 VAC Adj. $\pm 5\%$ | 400 cps 01% | Short circuit protected, reverse voltage protection, high temp. 100 C. Voltage regulated |

DESIGN NOTE: any of the special features described may be combined in a single unit to meet your special requirements.



THE SIEGLER CORPORATION

Engineering conferences at your or our facilities. Write-call-or wire (TWX 2931)

MAGNETIC AMPLIFIERS DIVISION

632 TINTON AVE., NEW YORK 55, N. Y.

CYPRESS 2-6610



30 & 50VA Precision Frequency

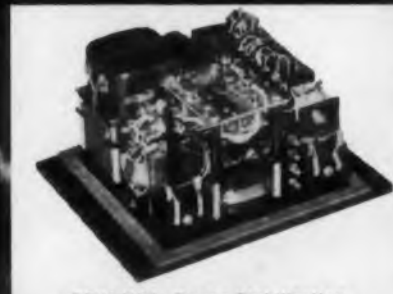

80VA Wide Range Stabilization



250 & 500VA 1 ϕ Short Circuit Protected



750 & 1KVA 3 ϕ Phase Locked Circuitry



60VA 3 ϕ High Temperature, Reverse Voltage Protected

CIRCLE 209 ON READER-SERVICE CARD

New key to better electronic design...from 3M... where research is the key to tomorrow



**NEW...the thinnest
pressure-sensitive
electrical grade
Polyester Film Tape
ever...only 1 mil
thick overall.**

**A new product of
3M Research!**

"SCOTCH" Brand Electrical Tape No. X-1113
is specifically designed for insulating all
fine-wire components. Non-corrosive; high
electric strength; very good mechanical
strength; highly conformable with minimum
build-up. Write for complete information:
3M Co., 900 Bush Ave., St. Paul 6,
Minn., Dept. EAC-100.

"SCOTCH" IS A REGISTERED TRADEMARK OF 3M CO., ST. PAUL 6, MINN. EXPORT: 99 PARK AVE., NEW YORK 16, CANADA: LONDON, ONTARIO

Electrical Products Division | **MINNESOTA MINING AND MANUFACTURING COMPANY**

... WHERE RESEARCH IS THE KEY TO TOMORROW



CIRCLE 210 ON READER-SERVICE CARD

DESIGN DECISIONS

Plastic Models Facilitate Equipment Design

Design of equipment can be facilitated by first building a plastic model of the apparatus.

The "model" technique is not new, but the use of plastics can improve it. The reason is that plastics are more dimensionally stable than conventional materials used in model-construction.

In addition, plastics are easy to cement, are strong in thin sections, and are relatively light in weight. The plastics that presently find considerable application in models are vinyls, acrylics, acetates and fluorocarbons (Teflon, Kel-F, etc).



Plastic dish is model of 140-ft diam parabolic antenna for radio telescope to be erected in West Virginia. Model, of acrylic, was made by Electric Boat Division of General Dynamics Corp., Groton, Conn.

Reliability Enhanced by Assuming Majority of Computers Is Right

The assumption that the majority of computers in parallel is always right, improved the reliability of a production control line.

For continuous monitoring of the quality of the product—coils of tinplate—at least two computers had to be used in case one malfunctioned. In this case, however, which computer was giving the wrong answer? The solution was to add a third computer. When one output failed to agree with that from the other two, the answer was taken as the output from the two in agreement.

This technique was used in an automatic quality-control system developed by Airborne Instruments Laboratory, Deer Park, L. I., N. Y.

this Howard
fractional H. P.
gear motor can
be used for



BOTH
universal and
induction
applications

POWERED BY
HOWARD

Divisions: Electric Motor Corp., Cyclohm Motor Corp., Racine Electric Prods., Lloyd Scruggs Co

CIRCLE 161 ON READER-SERVICE CARD

RATIOS FROM 10:1 to 60:1

MODEL 2900: 2 Pole—4 Pole Induction with A26 Gear Unit
DIAMETER: $3\frac{3}{16}$ "
LENGTH: $7\frac{3}{4}$ " to $8\frac{1}{4}$ "
HORSE POWER: 1/70 to 1/15 depending on length of stacking.
TORQUE OUTPUT: Up to 60 in. lbs. depending on ratio.
BEARINGS: Permanently lubricated and sealed ball bearings.

Check your specifications with Howard. Write for complete details and prices on these and other Howard gear motors and reduction units.

MODEL 29-500: Universal AC/DC or Shunt with A26 Gear Unit
DIAMETER: $3\frac{3}{16}$ "
LENGTH: $7\frac{13}{16}$ " to $7\frac{3}{4}$ "
HORSE POWER: 1/70 to $\frac{1}{4}$ depending on length of stacking.
TORQUE OUTPUT: Up to 60 in. lbs. depending on ratio.
BEARINGS: Permanently lubricated and sealed ball bearings.

HOWARD INDUSTRIES, INC.
1725 State St., Racine, Wisconsin

✓ PRECISION ✓ PRICE ✓ PERFORMANCE

FOR SMALL PRODUCTION RUNS
of all types of motors Heinz Mueller
is your most dependable source

For limited quantities of special motors, Heinz Mueller offers unexcelled facilities. Whether you need comprehensive, original engineering or devoted attention to your own design, Heinz Mueller production guarantees you craftsmanship and quality at modest cost.

Take advantage of the engineering skill and experience for which Heinz Mueller has become famous. It is at your service to help you solve your specific problems. Write — today — for your copy of the HM catalog describing the range of HM production.



DC Motors Cool running, quiet operating motors in especially compact designs where space requirements are rigid.

Capacitor Type Motors For 24 to 220 Volts. Can be supplied with terminal studs or leads, as specified. Ball bearing or sleeve bearing, commercial or military applications.



DC Dynamotor Especially designed for high altitude aircraft operation where service is critical.



AC/DC Series Motors Especially low-priced power units for appliances, office machines, etc. Has wide range of practical applications.



HEINZ MUELLER

Engineering
Co., Inc.

4727 W. Iowa, Chicago 51, Illinois

CIRCLE 160 ON READER-SERVICE CARD

ELECTRONIC DESIGN • October 12, 1960

DESIGN

Approximate Radar Range Equation Causes Errors in Low-Noise System Calculations

Noise figure measurements, based on a standard temperature of 290 K, have come in for considerable discussion recently in light of advances made in low-noise receivers. Old definitions seem inadequate. Miscalculation occurring in noise measurements carry over to estimates of radar range improvements possible with new, low-noise technique. Author Larry Smith shows how large miscalculations can be avoided by using a different form of the radar range equation.

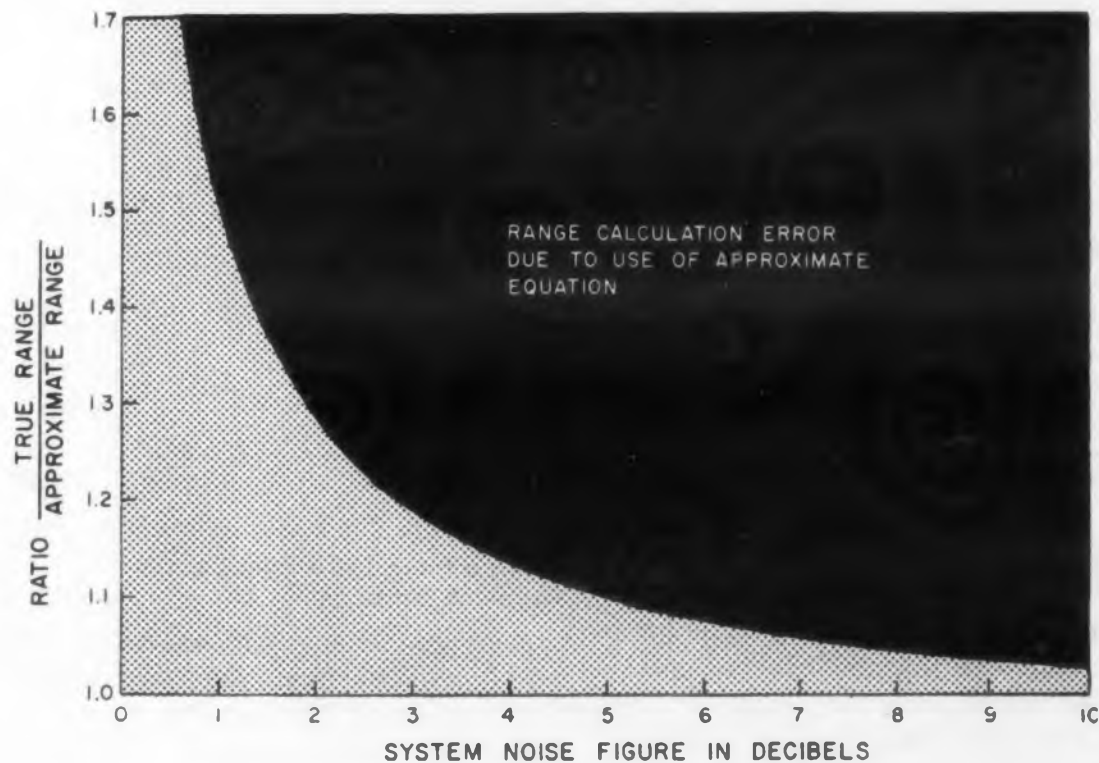

Breakdown of the approximate form of the radar range equation is shown by this plot.

Larry D. Smith

Electronics Engineer,
Heavy Military Electronics Dept.,
General Electric Co.,
Syracuse, N.Y.

MICROWAVE radars are now being designed and built with systems-noise figures considerably less than 8 db. This is the point at which

the almost universally used approximate range equation begins to break down. Large errors can result in systems calculations for low-noise receivers if the approximate form of the radar range equation is used.

In making a comparison between alternate methods of solving a system problem, use of the approximate form could lead to the wrong alternative. The conclusion could be reached that the

(continued on p. 184)

ENGINEERING DATA

apparently small improvement due to a sophisticated low-noise receiver is not worth the resultant cost and complexity. According to the approximate equation, a 1-db improvement in noise figure always give 1/4-db improvement in range; exact calculations may show improvement of many times this figure.

The approximate radar range equation is expressed as:

$$R = \sqrt[4]{\frac{P_t G^2 \lambda^2 A}{(4\pi)^3 k T B F V}} \quad (1)$$

where

- P_t = Transmitter power
 G = Antenna gain
 λ = Wavelength
 A = Target area
 k = Boltzman's constant
 T = 290 K
 B = Over-all receiver bandwidth
 F = System noise figure
 V = Visibility factor

The widely used form of the range equation can be intuitively judged for low-noise figures merely by examining the limiting condition of a noiseless receiver and a noise-free atmosphere. Under these conditions, the system noise figure, F , would be 1 and the range according to the equation would be finite. Intuitively one feels that the range under such conditions should approach the infinite.

Tracing Approximate Equation's Origin Spotlights the Source of Error

The radar range equation is obtained by determining the minimum discernible signal (MDS) power for the system under receiving conditions and equating it to the transmitter power reflected by a target. It is in the expression for the MDS signal that the misleading approximation is to be found. If this is corrected, the radar range equation can still be used for comparing the relative merits of different systems.

Notice that the noise figure referred to is the system noise figure. It must contain the effects of the receiver self-noise, losses between the antenna and receiver and the noise due to atmospheric sources. Thus the system noise figure is the effective noise figure measured at the antenna, and system as used here includes the atmosphere.

In fact, if atmospheric absorption is appreciable and the noise figure of the receiver alone is low enough, the system noise figure should be referred to the range at which the target is located. The effective system noise figure will actually change with the location of the target. Such refinements, however, will not be directly considered here.

At the antenna input, the signal reflected from a target must compete with the effective noise power described by the system noise figure. The MDS power or P_{min} as it is sometimes referred to is usually taken to be equal to the noise power described by the equation

$$P_{min} = k T_e B \quad (2)$$

where

- k = Boltzman's constant
 T_e = the effective noise temperature referred to the antenna, and includes the effect of atmospheric noise
 B = the over-all receiver bandwidth

Both k and B are self-evident. T is easily obtained from the system noise figure by means of the IRE standard definition of noise figure.

$$F = \frac{T + T_e}{T}$$

or $T_e = (F - 1) T \quad (3)$

where

$$T = 290 \text{ K}$$

Using a More Exact Equation Removes the Error

From the above equations, the approximation of the most used form of the radar range equation can be seen. The equation $T_e = (F - 1) T$ has been approximated by $T_e = FT$. Little error results as long as F is large enough. However, as F becomes ever smaller due to low-noise receiver techniques, the approximation breaks down. The more exact form of the radar range equation is then given by

$$R = \sqrt[4]{\frac{P_t G^2 \lambda^2 A}{(4\pi)^3 k t B (F - 1) V}} \quad (4)$$

The figure shows the range error resulting from use of the approximate equation. This error is avoided using Eq. (4) for low-noise cases. ■ ■

25 years of progress in tiny parts

- Reduce costs
- Simplify assembly
- Improve appearance with

GRC DIE CAST ZINC ALLOY & MOLDED NYLON FASTENERS

**NOW!
NYLON SCREWS
AND NUTS**
also available
in Delrin



MACHINE SCREWS from miniature #0 thru 1/4" in wide range of lengths and head types. Also SET SCREWS, NUTS from #2 thru 5/16".

GRC's wide selection of molded fasteners available from stock. Samples sent immediately.

- High in quality
- Uniformly accurate
- Low in cost
- Wide range of stock styles, types, sizes and threads

Die cast or molded in one high speed automatic operation, GRC's exclusive methods assure uniformity, smooth, rust-proof & corrosion resistant surfaces and the lowest possible cost. New kinds of fasteners never before available... modifications in stock fasteners for specialized use... infinite variety in styles, types and sizes, have been made possible by GRC's special automatic die casting and molding machines.

Write, wire, phone RIGHT NOW for samples, prices,

your copy of GRC's NEW DETAILED FASTENER CATALOG

GRIES

GRIES REPRODUCER CORP.
World's foremost Producer of Small Die Castings
40 Second St., New Rochelle, N.Y. NEW Rochelle 3-8600
Be sure to see us at the METALS SHOW—Booth 1211

CIRCLE 157 ON READER-SERVICE CARD

DIE CAST ZINC ALLOY



ONLY ONE MOVING PART IN New Pressure-to-Voltage System

- stiff metal diaphragm moves only .003"
- 0-5 volt, DC output, full scale
- operating range from -85F to 212F
- operates from standard 28-volt DC supply
- any range: 0-.1 PSI; 0-3500 PSI
- send for complete specifications



ULTRADYNE
INCORPORATED
P.O. BOX 3308 ALBUQUERQUE, NEW MEXICO

A Member
of The Condec Group

CIRCLE 158 ON READER-SERVICE CARD
ELECTRONIC DESIGN • October 12, 1960

NEW LITERATURE

Miniature Strain Gages 276

A line of subminiature, free-filament wire strain gages, Type HT, designed for strain measurement on any test surface or material, is discussed in this four-page data sheet, No. 4330. Line drawings, graphs and tables supplying data and specifications are included. Baldwin-Lima-Hamilton Corp., Electronics & Instrumentation Div., 42 Fourth Ave., Waltham 54, Mass.

High Voltage Pentode 277

The Type 7234 pentode, designed for operation at plate voltages of 10 kv, is described in this four-page data sheet, Form 2156-9. Electrical and mechanical specifications and ratings, typical application ratings and circuits, and curves of transfer, screen and plate characteristics are included. Victoreen Instrument Co., 5806 Hough Ave., Cleveland 3, Ohio.

Potentiometers, Generators 278

In 10 pages this catalog describes the Vernistat Series of precision ac potentiometers, adjustable function generators, and related special components. Theory of design, operation and application are discussed, and electrical and mechanical specifications of the units are included. Perkin-Elmer Corp., Norwalk, Conn.

Aluminum DC Capacitors 279

The firm's line of Compulytic aluminum electrolytic capacitors are listed with detailed specifications in this 12-page bulletin, No. 3441B. Tabulated data, impedance curves and performance characteristics are included for Series 32D capacitors. Sprague Electric Co., North Adams, Mass.

Sampling Transformers 280

Bulletin No. PT-260, a single-page data sheet, describes a line of current-sampling transformers which develop synchronizing, low-voltage pulses from high-current pulses. Application, specification and price information is included. Valor Instruments, Inc., 13214 Gresham Blvd., Gardena, Calif.

Microwave Equipment 281

Catalog No. 60 provides 32 pages of information on microwave receiver front ends including data on a number of waveguide and coaxial mixer-preamplifier assemblies. Other products described include solid-state, miniature and sub-miniature if amplifiers, twt amplifiers, octave rf amplifiers, beacons and afc units. LEL, Inc., 380 Oak St., Copiague, L.I., N.Y.

Miniature Limit Switches 282

Data Sheet No. 171, two pages, covers the Series 400EN miniature, sealed, limit switches. Physical, electrical and dimensional data are given, and pricing information is included. The devices have a diameter of 11/16 in., and have missile and aircraft applications. Micro Switch, Freeport, Ill.

Liquid Silicone Rubber 283

This 12-page booklet outlines applications of room temperature vulcanizing (RTV) liquid silicon rubber. Uses as a sealing, coating, impregnating and bonding compound in electrical and electronic assemblies, as a flexible mold, and as a sealant in missiles and aircraft are described and illustrated. General Electric Co., Silicone Products Div., Waterford, N. Y.

Epoxy Molding Compounds 284

This chart for compression and transfer molders compares the mechanical, electrical and thermal properties of general-purpose thermosetting materials. The relative abilities of different epoxy molding compounds in flexural and impact strength, heat distortion and dielectric strength tests are described. Fiberite Corp., Winona, Minn.

Adhesives 285

Adhesives for bonding metals, rubbers, plastics, fabrics, leather, glass and wood materials are described in this four-page bulletin. Applications include electrical insulation, and moisture and air sealing. Bostik Adhesives, B. B. Chemical Co., 784 Memorial Drive, Cambridge, Mass.

Hermes Solid State BINARY TO DECIMAL CONVERTER

for converting any 4 bit code
to decimal illuminated display

Performs better



... Costs less

Binary to Decimal
Converter, Model 260,
shown approx. 1/2 size

\$95

(Nixie Bulb
not included)

Discounts for
quantity purchases

NO FALSE READOUTS
Relays and tubes eliminated

MAXIMUM RELIABILITY
100% solid state circuitry

LONG USEFUL LIFE
No preventive maintenance required

OPERATIONAL FLEXIBILITY
Variety of four bit codes can be converted

LATCHING CIRCUITS
Provide memory for binary information

Write for Technical Bulletin 260

Hermes



ELECTRONICS CO.

75 CAMBRIDGE PARKWAY, CAMBRIDGE 42, MASSACHUSETTS

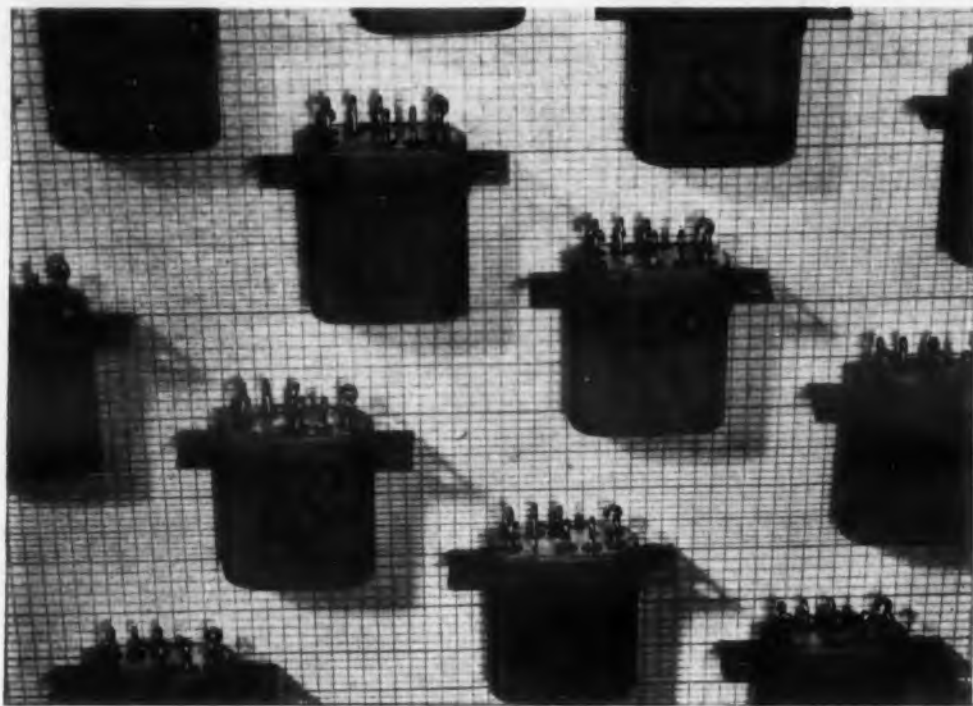

This is the new Union Crystal Case Relay

The UNION 2-PDT General Purpose Crystal Case Relay is designed to consistently meet the requirements of MS 24250, Mil-R-25018, Mil-R-5757C. Use it where minimum size and *optimum reliability* are essential—in control systems, computers, airborne and guided missile electronic equipment.

To provide vibration immunity, we have incorporated a unique feature in this relay's armature suspension system. A torsion wire is anchored to the armature and backstrap. It acts as a biasing spring; supports the armature and eliminates end play. The relay uses the rotary principle of operation, found in the entire line of extremely reliable Union Switch & Signal miniature relays.

The 2-pole, double throw, bifurcated contact structure increases reliability and efficiency in dry circuit applications. UNION Crystal Case Relays are designed for continuous operations in the -65°C to $+125^{\circ}\text{C}$ range.

Union Switch & Signal's manufacturing capabilities and experience make it possible to provide these quality relays in quantity. Manufacturing techniques make it possible to provide the ultimate in reliability.

The new UNION Crystal Case Relay is available with the 0.2" grid-spaced header or "S" type header, with solder lugs, plug-in terminals, or 3-inch leads, and for various operating voltages.

Contact Union Switch & Signal for additional information about this new Crystal Case Relay. Write for bulletin 1064.

Vibration: 20 G—2,000 cps

Shock: 50 G

Temperature Rating: -65°C to $+125^{\circ}\text{C}$

Contact Rating: Dry circuit to 2 amp., 28-volt DC resistive load.

"Pioneers in Push-Button Science"



UNION SWITCH & SIGNAL

DIVISION OF WESTINGHOUSE AIR BRAKE COMPANY —

PITTSBURGH 18, PENNSYLVANIA

CIRCLE 214 ON READER-SERVICE CARD

NEW LITERATURE

Precision Meters 286

This two-page data sheet describes the firm's series of "frictionless" precision meters. An explanation of the bifilar suspension principle and electrical ratings of the meters are included. Greibach Instruments Corp., 315 North Ave., New Rochelle, N.Y.

Silicon Controlled Rectifier Manual

This manual is intended as a guide in the application of silicon controlled rectifiers in electronic and electrical equipment. The manual has 255 pages divided into 13 chapters. It contains information on voltage transients in SCR circuits, test circuits, turn-off characteristics of the device and methods, firing characteristics and firing circuits, and series and parallel operation of SCR's. Included are 224 circuit diagrams, charts, nomographs and oscilloscope traces. Send \$1.00 to General Electric Co., Dept. SCR, Charles Bldg., Liverpool, N. Y.

Silicones 287

Applications of silicones in various physical forms for coating, impregnating and molding of electrical and electronic parts and systems is covered in this 12-page engineering guide. Tabulated data is supplied for the firm's line of silicones. Processing information and engineering data are given for each particular application. Dow Corning Corp., Midland, Mich.

Industrial Box Kilns 288

These bulletins give the range and specifications of box kilns in graphic and tabular form. No. LB-160 bulletin describes 10 units with 5.8 to 16.7 cu ft capacities for operation to 2,750 F. The other bulletin, No. SB-160, describes eight smaller kilns offering from 0.75 to 3.3 cu ft with the same temperature range. Heating and cooling curves, dimensions, weight and capacities are included. Harper Electric Furnace Corp., 110 Pearl St., Buffalo 2, N. Y.



You can simplify those external connections to printed-wiring boards, no matter how jammed up. Kulka Type 520 miniature terminal blocks mount on board, with terminal pins slipping into standard connector mounting holes for dip soldering. Screw connections for external leads. Readily connected or disconnected. Available in 2 to 24 terminals. Entire printed-circuit board with terminal blocks and lead wires, can be encapsulated if desired.

WRITE FOR LITERATURE . . .

Descriptive bulletin on request. If you do not already have the big Kulka Terminal Block Catalog in your reference file, ask for it.

KULKA ELECTRIC CORP.

633-643 So. Fulton Avenue
Mount Vernon, N. Y.

KULKA

CIRCLE 215 ON READER-SERVICE CARD

Copper Alloy 289

The firm's copper-sulfur alloy, Amsulf, is described in this six-page brochure. Abilities of the alloy for machining and drawing are presented in graphic form. Mechanical and physical properties are tabulated. Advantages of the metal in various applications are presented. American Metal Climax, Inc., Amco Div., 1270 Avenue of the Americas, New York 20, N.Y.

Multiplex Carrier 290

The firm's series TCS-600 transistorized multiplex carrier equipment is described in four-page bulletin No. ECM-122. The equipment transmits from 1 to 600 full duplex toll-quality voice channels over a single radio beam. General Electric Communication Products Dept., P.O. Box 4197, Lynchburg, Va.

Plastics 291

This 15-page brochure, No. AD-171, catalogs a line of Teflon, nylon, CTFE, and other thermoplastics made in sheet,

rod, tubing and related forms. Sizes and physical properties are tabulated. Both mechanical and electrical characteristics of the different plastics are compared on a two-page chart. The firm's facilities for molding, extruding and research are described. Garlock, Inc., 447 Main St., Palmyra, N.Y.

Fibreglas Components 292

Designated the "Specification Handbook," this booklet gives technical limits, terminology, production characteristics and specification outlines for tubular laminated Fibreglas components. Pacific Laminates Inc., R and D Div., 1919 Placentia Ave., Costa Mesa, Calif.

Data Translator 293

This two-page data sheet describes the operation of the firm's model ZA-26965 paper-to-magnetic tape data translator. The output format of the instrument is suitable for the IBM 704/705 data-processing machine. Electronic Engineering Co., 1601 E. Chestnut Ave., Santa Ana, Calif.



These accurate, sensitive instruments detect currents as small as 1×10^{-17} amperes; charges to 6×10^{-16} coulombs, voltages as low as 20 microvolts. Cary Electrometers provide proven unequalled performance and versatility for measuring charging phenomena, hysteresis and photo effects of semi-conductors and insulating materials. Applications include air ionization studies, measurement of ion currents in mass spectrophotometry, radioactivity measurements of solids, liquids, gases, and Hall effect studies.

APPLIED PHYSICS CORPORATION • 2724 South Peck Road, Monrovia, Calif.

CIRCLE 216 ON READER-SERVICE CARD

For information on
Cary electrometers
and accessories,
write for data file A17-100



Look at the specs on this brand new UNION 4-PDT-10 amp. relay

4-pole 10 amp. rating
Rotary-type armature
Shock: 50 G
Vibration: 30 G—2000 cps
Temperature: -65°C to $+125^{\circ}\text{C}$
Contact Rating: 10 amp. 28-Volt DC resistive load

The new 4-pole, 10 amp. UNION miniature relay is designed to meet the requirements of Mil-R-6106. It has exceptionally sturdy terminals and a very rugged, welded metal armature with glass-coated metal actuators. It has been designed to withstand the toughest environment.

For example:

- ... The balanced, rotary-type armature gives maximum resistance to severe shock and vibration.
- ... The glass-coated cylindrical actuators provide full width contact drive to assure square mating of contact surfaces.
- ... It has an all-glass header.

The unique combination of design features in this new UNION 4-pole, 10 amp. relay makes it possible to have a power relay that is extremely rugged, yet takes no more space than the UNION 6-PDT, 2-amp. relay. It is the smallest 4-pole, 10 amp. rotary-type relay now available.

Union Switch & Signal has the manufacturing facilities to immediately handle large quantity orders for this addition to the fine family of UNION Reliable Relays. Call or write today.

"Pioneers in Push-Button Science"



UNION SWITCH & SIGNAL

DIVISION OF WESTINGHOUSE AIR BRAKE COMPANY —

PITTSBURGH 18, PENNSYLVANIA

CIRCLE 217 ON READER SERVICE CARD

IMPULSE

A DIGEST OF NEW DEVELOPMENTS
IN ELECTRONICS AND AUTOMATION

PUBLISHED BY ROME CABLE DIV. OF ALCOA, ROME, N. Y.
PIONEERS IN INSTRUMENTATION CABLE ENGINEERING

ICE CREAM, not beans, from Boston steps into the limelight, at least from an electronic point of view. A dairy in that New England city reports a production increase of 70 per cent (with no increase in plant space) since the installation of electronic computers and rate-of-flow meters. Faster output starts with an analog computer that recalculates on a daily basis the mix formula, a task made necessary by the unpredictable daily fluctuation in butterfat content. Each new formula is translated into digital form (it takes only 50 milliseconds!) and recorded on a punch card. This card then goes to the programming control panel where it master-minds the electronic equipment that handles the flow of raw materials from storage to blending tanks. The punch cards also can be used for inventory and accounting purposes.

DOWN BUT NOT OUT. That's the latest on the Navy's radar-seeking missile projects. Though the *Corvus* program has been cancelled, work is still being done on the *Cobra*, another air-launched missile. Both the Air Force and Navy continue with anti-radar missile studies, and *Corvus* birds are available for possible research and development work.

ELECTRONIC DRIP-DRY? The strategists in charge of making optimum use of the *Minuteman* ICBM are asking electronic engineers to help with a number of tough problems. One of the most pressing arises from the fact that the missile men would like to locate these missiles at fixed offshore sites, under 100 to 150 feet of water. The problem comes from the fact that, though these sites would be hard to destroy, there's a good chance that ocean currents might throw the *Minuteman* off course. So what's wanted is an electronic way to correct for the currents, rather than the compressed air system used by the Navy with its *Polaris*. Other needs include a remote control check system, a guidance system that will hold up in storage for at least three years, and systems that won't go out of kilter if the missile gets shaken up when transported over rough terrain. Answers, anyone?

TWICE THE SIZE of the radio telescope at Jodrell Bank, England, is the one now being completed near Danville, Illinois. Measuring 600 feet long, by 400 feet wide, by 62½ feet deep, the scope will be the world's largest. Its reflector was scooped out of the earth by grading the surface of a small valley into the shape of a parabolic cylinder. So that it will retain its shape, the "dish" is covered with prefab asphalt and topped with mesh for reflectivity. The British scope at Jodrell Bank set a record for communication when it kept contact with America's *Pioneer V* for the first 22,500,000 miles of its trip around the sun. The U.S. has another big radio telescope under construction at Sugar Grove, Va. First project for the Illinois facility will be a 611-mc map of the sky.

CABLEMAN'S CORNER. The old adage "Don't put the cart before the horse" was never so true as it is in these days of automation and instrumentation. With all the intricate pieces of equipment being designed these days, it is important that careful consideration be given to the wire and cable that may be employed in any system. Often forgotten is the unromantic aspect of the connecting links of the system. Cables are the arteries through which must flow the power and informational pulses necessary for reliable performance.

Don't take a chance on being able to obtain a cable that will fit into what is left. Many times, important characteristics such as conductor size, insulating walls, protective sheaths, flexibility and flex-life have to be sacrificed. Don't sacrifice reliability in your cables for an existing space or connector fittings.

For 100% reliability in multi-conductor cables, call on a cable specialist—and call on him as soon as possible. Phone Rome 3000, or write: Rome Cable Division of Alcoa, Dept. 11-100, Rome, New York.

These news items represent a digest of information found in many of the publications and periodicals of the electronics industry or related industries. They appear in brief here for easy and concentrated reading. Further information on each can be found in the original source material. Sources will be forwarded on request.

CIRCLE 218 ON READER-SERVICE CARD

NEW LITERATURE

Glass Fiber Cushioning 294

Applications of glass fiber in package cushioning, vibration isolation and molded pads are discussed in this four-page bulletin. Physical properties of the material are described and graphed. Material meets Mil specs. Fibrous Glass Products, Inc., Alpa Plaza, Hicksville, L.I., N.Y.

Subminiature Switches 295

"Thinking Small" is a 16-page booklet describing the development of subminiature switches from the design to the application stage. Operating principles of snap action switches, various testing procedures, variations in characteristics and actuators are described and illustrated. Micro Switch, Freeport, Ill.

Powdered Magnetic Cores 296

This 12-page bulletin, No. G1, on powdered Permalloy Filtoroid cores gives extensive information on core loss, Q

calculation data, and inductance variation with temperature and dc current. Tables and curves giving physical and electrical characteristics are included. Magnetic Metals Co., Hayes Ave. at 21st St., Camden, N.J.

Immersible Transducers 297

Data sheet No. 3 gives descriptions and specifications of the series T-400 and T-500 immersible transducers. These units can be used to add ultrasonic cleaning stages to existing cleaning tanks or vapor degreasers. National Ultrasonic Corp., 111 Montgomery Ave., Irvington, N.J.

Test Equipment, Panel Meters 298

The firm's line of electronic test equipment and panel meters for industrial maintenance and communications are cataloged in this 10-page booklet, No. 28/Industrial. Multimeters, vtvm's, tube and transistor testers, oscilloscopes, sig-

miniature solenoids...

do big jobs in small space.

- Completely tested
- Proven reliable
- Mounting furnished to meet your requirements.
- Hundreds of other designs for both AC and DC application.
- Push or pull units to 200 lbs. force.
- Send your specifications today.

ALL SOLENOIDS SHOWN HALF SIZE

The trademark on millions of solenoids since 1927

WEST COAST ELECTRICAL MFG. CORP.

233 W. 116TH PLACE • DIVISION 110 • LOS ANGELES 61, CALIFORNIA • PLYMOUTH 5-1138
CIRCLE 219 ON READER-SERVICE CARD

nal generators, decade boxes, and panel meters are included. General descriptions, specifications, dimensions and illustrations are provided. Precision Apparatus Co., Inc., 70-31 84th St., Glendale 27, L.I., N.Y.

Frequency Counters 299

A line of frequency counters and associated equipment including converters, plug-in units, Nixie readouts, digital printers, and data-recording systems, is covered in this four-page Catalog, No. 605. Ratings and illustrations of the instruments are provided. Northeastern Engineering, Inc., Manchester, N.H.

Timing Devices and Controls 300

This six-page bulletin, No. 5907, describes typical electronic timing devices and controls produced by the firm. Suggested applications are given. Operation is briefly described and diagrammed. Services offered by the firm are also outlined. Tempo Instruments Inc., P.O. Box 338, Hicksville, N.Y.

Format Control Buffer 301

This four-page data sheet on the firm's model ZA-751 format control buffer describes the operation of the unit in producing digital magnetic tapes for inputs to IBM 650, 704, 705, and 709 data-processing machines. Technical specifications of the buffer are included. Electronic Engineering Co., 1601 E. Chestnut Ave., Santa Ana, Calif.

Pure Gold 302

Gold, 99.999% pure, is described on the single-page data sheet, Bulletin No. HP-101. Applications in semiconductor fields are described. Physical constants are tabulated. High Purity Metals, Inc., 340 Hudson St., Hackensack, N.J.

Die-Cast, Nylon Fasteners 303

Die-cast zinc-alloy wing and cap nuts, and molded nylon nuts and screws are described in this two-page data sheet. Illustrations and tabulated specifications are included. Gries Reproducer Corp., 400 Beechwood Ave., New Rochelle, N.Y.

FOR MAXIMUM RELIABILITY

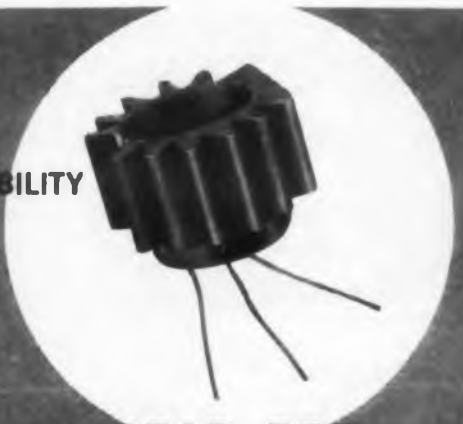

**INCREASE TRANSISTOR EFFICIENCY
25% - 27% and prevent thermal runaway**

THERE'S A BIRTCHER RADIATOR FOR MOST TRANSISTORS!

Birtcher transistor radiators for most sizes of transistors permit you to get up to 25% to 27% better output efficiency. You can now either increase your input wattage up to 27%, or eliminate up to 27% of the heat with Birtcher radiators.

and thermal runaway is prevented!

To assure circuitry reliability... specify Birtcher radiators. Birtcher qualification tests conducted under MIL standards prove these performance results.

FOR CATALOG and TEST REPORTS write:

THE BIRTCHER CORPORATION industrial division

745 S. Monterey Pass Rd.
Monterey Park, Calif.
ANGelus 8-8584

Sales engineering
representatives in
principal cities.



CIRCLE 220 ON READER-SERVICE CARD

BUILD ON...

Eastern

CONTROL EXPERIENCE: SERVO SYSTEMS



Typical assignment: design and develop a missile elevon control servo with a single hydraulic power supply and three actuators. Weight and space considerations critical.

Solution: a system designed and built around the Eastern E/HIS 5 type 100A hydraulic power supply, using a 400-cycle motor. Minus motor, but including pump, reservoir, expansion chamber, pressure regulating valve and filter, the supply weighs only 2.6 lbs.

Eastern achieved a 20% saving in hydraulic power supply capacity by the use of one of its own *pulse length modulated* single-stage servo valves, manifolded to each actuator. Zero first stage leakage, zero hysteresis, plus the high response and efficiency which characterize this valve contributed to the successful meeting of the demanding requirements.

Specifications:
force level: 300 lbs.
total stroke: 1/2 in.
max. velocity: 1.5 in./sec.
time constant: 0.1 sec.
max. actuator width: 1.25 in.

For genuine contributions to the solution of your servo problems, call in the Eastern engineer.



servo-valves • fuel controls • actuators

**EASTERN
INDUSTRIES
INCORPORATED**
100 SKIFF STREET
HAMDEN 14, CONN.



CIRCLE 221 ON READER-SERVICE CARD

Teflon-Insulated Wire 309

This four-page bulletin describes and illustrates series 100 and 120 Teflon-insulated hook-up wire, which meets Mil specs. Two tables give dimensions and specifications for wire sizes 8 through 32. Business machine wire and multi-conductor cable also are briefly described. Philadelphia Insulated Wire Co., Moorestown, N.J.

Microwave Equipment 310

This catalog gives specifications of over 600 microwave tubes and components. Components include TR and ATR tubes, shutters, reference cavities, crystal protectors, diodes, magnetrons, klystrons, duplexers, noise source tubes, and triode oscillators. Bomac Laboratories, Inc., Salem Road, Beverly, Mass.

Resistance Alloy 311

Bulletin No. 110, eight-pages, describes Chromel-AA 80-20 nickel-chromium resistance alloy, developed for use as a heating element in controlled-atmos-

phere furnaces. A table of physical properties, typical-life and temperature-resistance curves, and resistance test data are given. Tables listing resistivity and density values, and furnace conversion data are included. Hoskins Manufacturing Co., 4445 Lawton Ave., Detroit 8, Mich.

Regulated Power Modules 312

Bulletin No. 500 describes a series of regulated power modules which meet Mil specs. Output is rated from 145 to 325 v dc at current levels from 50 to 400 ma. Specification data for 36 standard catalog models are included. ACDC Electronics, Inc., 2979 N. Ontario St., Burbank, Calif.

Toggle Switches 313

The firm's series 0111 toggle switches are described in this one-page bulletin. Electrical ratings, circuitry, dimensional diagrams, and operating characteristics are given. McGill Manufacturing Co., Inc., Electrical Div., Valparaiso, Ind.

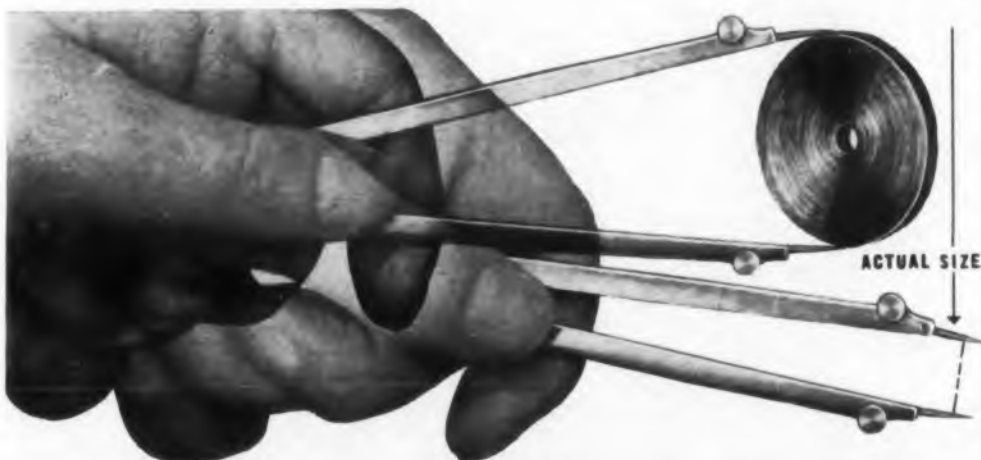

MINIATURE COILS EXACTLY AS YOU SPECIFY

... manufactured
on a
production
basis

MINIATURE PRODUCTS DIVISION

Deluxe COILS, INC.
WABASH, INDIANA

CIRCLE 224 ON READER-SERVICE CARD

ELECTRONIC DESIGN • October 12, 1960

FROM RIVERSIDE-ALLOY



"Put ups" by the ALLOYIST* pay off in Production

There's a right *kind* of wire or strip "put up" for your production equipment . . . there's a right *size* for long runs and short runs. But, are you getting the kind and size of "put up" you need, *when* you need it?

The ALLOYIST has them all . . . spools, reels and Pay-Off-Paks for wire in overlapping weights 25 to 1000 pounds . . . strip by coil weight to 2000 pounds or exact lengths . . . rod in exact lengths or randoms. Start the job right. Order your alloys from the ALLOYIST for a pay-off in smoother production.

*Riverside-Alloy is the ALLOYIST to the electrical/electronic industry . . . a single, reliable source of strip, rod and wire in Nickel, Nickel silver, Cupro nickel, Stainless steels (ISOLOY), Phosphor bronze, Monel and Inconel . . . a supplier whose manufacturing processes insure your product superiority.

Riverside-Alloy Metal Division, H. K. Porter Company, Inc., Riverside, New Jersey.

RIVERSIDE-ALLOY

PORTER

METAL DIVISION

H.K. PORTER COMPANY, INC.

PORTER SERVES INDUSTRY with steel, rubber and friction products, asbestos textiles, high voltage electrical equipment, electrical wire and cable, wiring systems, motors, fans, blowers, specialty alloys, paints, refractories, tools, forgings and pipe fittings, roll formings and stampings, wire rope and strand.

CIRCLE 225 ON READER-SERVICE CARD

The Accuracy, Performance AND the Models You Want!

1½ - INCH PANEL METERS

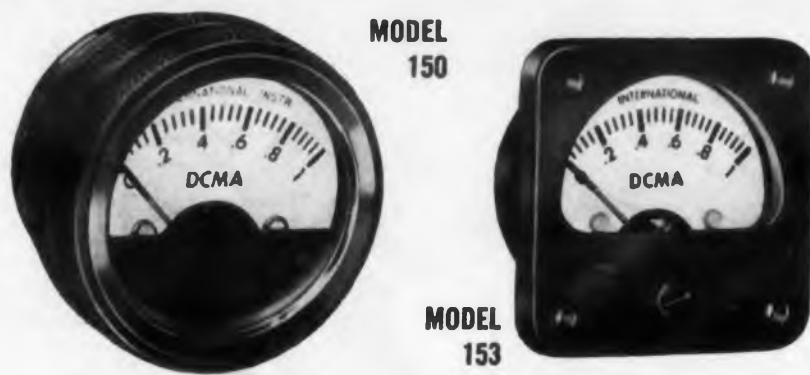

- ROUND OR SQUARE • COMMERCIAL, MILITARY AND RUGGEDIZED MODELS • VU, AND Db METERS

Combine small size and light weight with an initial accuracy held to $\pm 3\%$ of full scale for d-c meters and $\pm 5\%$ for a-c meters. Ideal for portable, marine, airborne and a variety of other applications requiring maximum precision and dependability in minimum space. Available in a wide variety of standard and non-standard ranges, starting at 0-100 microamps.

1-INCH PANEL METERS



MODELS 100, 104 and 106, ACTUAL SIZE

- COMMERCIAL, WATERTIGHT AND MILITARY MODELS • VU, Db
- AN UNUSUALLY WIDE RANGE OF CASE DESIGNS FOR SPECIAL APPLICATIONS

Ideal for geophysical and military communication, testing and control equipment, and other applications demanding smallest possible size plus high sensitivity and dependability. Accuracy is $\pm 3\%$ of full scale for d-c, $\pm 5\%$ for a-c. Scale is 0.760", providing excellent readability. Available in a very wide choice of standard ranges — with special scales, ranges, sensitivities, resistances, cases and other modifications supplied on order.

See Your Distributor... or Write for Engineering Data Sheets

HEADQUARTERS FOR MINIATURE COMPONENTS



**international
instruments inc.**

P. O. BOX 2954, NEW HAVEN 15, CONN. • CABLE: "INTERINST"

CIRCLE 226 ON READER-SERVICE CARD

NEW LITERATURE

Silver-Zinc Batteries 314

This 10-page brochure describes the firm's silver-zinc batteries. A general description of construction, operation, and application of the units is provided. Discharge and temperature-effect curves, operating characteristics, and assembly information are included. Electrical and physical characteristics of over 40 units are tabulated. Yardney Electric Corp., 40-50 Leonard St., New York, N.Y.

Phase Meters 315

A line of phase meters and delay lines are covered on 25 data sheets bound into this catalog. General descriptions, tabulated specifications, and suggested applications of the instruments are included. A transfer function analyzer, a capacitor tester, and a miniature battery-operated preamplifier are included among the instruments. Ad-Yu Electronics Lab., Inc., 249 Terhune Ave., Passaic, N.J.

Analog Computer 316

This 15-page booklet entitled "Mathematical Applications of the Dynamic Storage Analog Computer" describes application of Dystac computers in mathematical problems. Included are discussions of dynamic memory, sequential calculations, the definite integral, multiple integration, and continuous memory. Circuit diagrams accompany the text. Computer Systems, Inc., Culver Road, Monmouth Junction, N.J.

Vacuum Impregnation 317

The process of vacuum impregnation is described in this 16-page brochure, No. 652. Applications improving the dielectric efficiency of electronic components are described. A line of impregnating systems is cataloged with tabulated specifications and illustrations of the equipment. F. J. Stokes Corp., 5500 Tabor Road, Philadelphia 20, Pa.



IDEAL FOR
COMPUTER
PATCHWORK
PANELS

Take your pick from the large selections of CAMBION miniature jacks and plugs. Varying widely in types, these top quality, precision made units are ideal for quick, tight, space-saving patchwork on panel boards.

The jacks make perfect electrical connections, thanks to their special beryllium copper compression springs, floating D keys and solid fronts. Jacks are available in shank lengths for varying panel thicknesses, pin diameters of the plugs are .080", .062" and .045".

Write Cambridge Thermionic Corporation, 457 Concord Avenue, Cambridge 38, Mass. for full details on these and other products in the wide line of

CAMBION®

The guaranteed electronic components

CIRCLE 227 ON READER-SERVICE CARD

CIRCLE 233 ON READER SERVICE CARD

ELECTRONIC DESIGN • October 12, 1960

Multi-Track Voice Monitor 318

A voice monitor capable of recording 19 voice tracks and one time track for 24 hr on one reel of tape is described in this 12-page catalog, No. DB-7100. Construction, operation, and several suggested applications of the instrument are included. Physical and electrical specifications are given. Minneapolis-Honeywell, Industrial Systems Div., 10721 Hanna St., Beltsville, Md.

Circuit Breakers 319

Bulletin No. AM 513, four pages, tabulates and illustrates standard current ratings, release coil impedances, typical time-delay curves, and mounting and outline dimensions of a line of circuit breakers. A glossary of terms is included. Airpax Electronics Inc., Cambridge Div., Cambridge, Md.

Dynamic Digital Logic 320

The proceedings of the first users' conference on dynamic digital logic appear in this 72-page booklet. Papers

cover applications of digital techniques in a meteor-burst communication system, a T-Pac wiring program and logic simulation techniques for the IBM 709 computer, a BIDEC converter, and six other applications of dynamic logic. The uses of serial techniques in an incremental computer and digital systems are also covered. Computer Control Co., Inc., 983 Concord St., Framingham, Mass.

Heat Exchanger 321

This brochure describes the firm's Rotary-X-Changer air-to-air heat exchanger designed to recover heat from contaminated exhaust air or to cool fresh air coming into refrigerated spaces. Heat Recovery Corp., 671 Mt. Prospect Ave., Newark 4, N.J.

Fluorocarbon Resins 322

Properties and applications of Teflon TFE and Teflon 100 FEP fluorocarbon resins are given in this four-page bulletin. Industrial Plastics and Equipment Co., Inc., 477-24 Main St., Orange, N.J.

WHY YOU SHOULD PROGRAM YOUR TESTING THIS BETTER WAY

WITH EECo's UNIQUE 80-BIT BI-DIRECTIONAL PUNCHED TAPE PROGRAMMER

For automatic programming of test equipment, the EECo TP-201A offers these decisive advantages over stepping switches or single-line 8-bit programmers:

(a) Far more elaborate programs can be automated...up to 240,000 bits per reel, presented at 80 bits per step. (b) Random or sequential access to any of the 3000 frames on each 250-foot tape. (c) Provision for visual selection of program step. (Printed information on tape correlates with punched information). (d) Reduced training time and skill requirements for tape punch personnel. (e) Programs can be stored and re-used. (f) Small size panel is 6"x11 $\frac{3}{4}$ ", depth below panel 5 $\frac{3}{4}$ ".

Tough Mylar tape contributes to improved reliability. No special punch needed. Bi-directional electrical drive system. Positive detent action for accurate positioning of tape.

Other models available for automatic programming, process control, and precision time base programming. Write for data sheet.



TWO SWITCHES IN ONE

Grayhill Miniature Concentric Shaft Switch offers new flexibility in a rotary tap switch.

- 2 shafts (2 switches)
- 2 to 6 decks -up to 3 decks controlled by each shaft
- 2 to 10 positions per deck
- Shorting or Non-Shorting contacts
- Break 1 amp. 115 V. AC resistive, carries 5 amps.
- Available in over 6500 combinations of decks and positions!

Write for Catalog

Grayhill
Series 6
Miniature
Concentric
Shaft Switch



Grayhill
INC

Phone: Fleetwood 4-1040
565 Hillgrove Avenue,
LaGrange, Illinois

PIONEERS IN MINIATURIZATION
CIRCLE 228 ON READER-SERVICE CARD

CIRCLE 233 ON READER SERVICE CARD

ELECTRONIC DESIGN • October 12, 1960



Anaheim Electronics Division

Electronic Engineering Company of California

1601 East Chestnut Ave. • Santa Ana, Calif. • KImberly 7-5501 • TWX: S ANA 5263

MISSILE & AIRCRAFT RANGE INSTRUMENTATION • DIGITAL DATA PROCESSING SYSTEMS
COMPUTER LANGUAGE TRANSLATORS • SPECIAL ELECTRONIC EQUIPMENT

CIRCLE 229 ON READER-SERVICE CARD

MASSA RECORDERS

ONLY SOURCE FOR

HIGH SPEED RECTILINEAR INK WRITING

NOW IN 4 CHANNEL — 40 MM



Convenient, instant chart paper reloading from front of recorder.



Easy threading of chart paper to internal take-up roll for data storage.



Alternately, chart paper may feed out from front as shown.

All of the exclusive features incorporated in previous Massa Recorders, including the *New Controlled Linearity Oscillographs*, are incorporated in the NEW 4 CHANNEL RECORDING SYSTEM. The all new front design greatly simplifies chart paper loading and permits full instant view of pen action and recorded signals on 7 x 10" writing table. Improved tracking, instant loading, accurate performance, are some of the novel features included in the new design.

Other features: 40 mm (full scale) Oscillographs, DC to 120 cps • Ink or electric rectilinear writing • 18 chart speeds, from 0.5 cm/hr to 20 mm/sec • Event Marker • Automatic warning light for low chart indicator.

The new 4 channel recorder is now available in complete recording systems including individual transistorized driver amplifiers and power supplies for each channel, and a choice of interchangeable plug-in preamplifiers including DC, AC, Carrier and Chopper.

MASSA

A DIVISION OF

COHU

ELECTRONICS, INC.

7 FOTTLER ROAD

HINGHAM, MASSACHUSETTS

OTHER MASSA PRODUCTS

COMPLETE LINE OF
MULTICHANNEL AND PORTABLE RECORDING SYSTEMS

ACCELEROMETERS
HYDROPHONES

MICROPHONES
AMPLIFIERS

SONAR TRANSDUCERS

MORE DATA

PER DOLLAR

NEW LITERATURE

DC Power Supplies 323

The firm's series 20 modular regulated dc power supplies, rated from 5 to 50 v, are described in this illustrated one-page data sheet. Specifications of the units are given. Dressen-Barnes Corp., 250 N. Vinedo Ave., Pasadena, Calif.

Variable Delay Lines 324

Six miniature variable delay lines, with total delays ranging from 0.5 to 10 μ sec, are covered in this one-page illustrated bulletin, No. DL 560. Application information and specifications are given. Valor Instruments, Inc., 13214 Crenshaw Blvd., Gardena, Calif.

UHF Power Oscillator 325

The firm's model 1141 uhf wideband power oscillator is described in this bulletin. Specifications, performance data and application notes are included. W. L. Maxson Corp., Instruments Div., 475 10th Ave., New York 18, N.Y.

Adhesives Properties Chart 326

This four-page adhesives-properties foldout chart gives applications, cure times, and physical properties of over 20 types of epoxy adhesives. The reverse side gives test methods, application suggestions, and availability. Furane Plastics, Inc., 4516 Brazil St., Los Angeles 39, Calif.

Soldering Iron 327

This two-page data sheet describes the Ersa-Mintype soldering iron. Included are illustrations, a graph, and a chart. Caig Laboratories, 46 Stanwood Road, New Hyde Park, L.I., N.Y.

Low-Impedance Bus Duct 328

Application data for a low-impedance bus duct is given in 20-page booklet No. 30-662. Drawings, dimensions, specifications, engineering and test data are included. Westinghouse Electric Corp., P.O. Box 2099, Pittsburgh 30, Pa.

TADANAC BRAND

Special Research Grade

INDIUM

The purity of this specially refined indium is such that no individual impurity exceeds 0.1 ppm. It was developed primarily for use in the production of intermetallic compounds.

Other TADANAC Brand high purity metals or compounds include: Special Research Grade antimony and tin, High Purity Grade bismuth, cadmium, indium, lead, silver, tin, zinc and indium antimonide. Send for our brochure on TADANAC Brand High Purity Metals.

COMINCO

THE CONSOLIDATED MINING AND SMELTING COMPANY OF CANADA LIMITED
215 ST. JAMES ST. W., MONTREAL 1, QUEBEC, CANADA • PHONE AVI 8-3103

0160

CIRCLE 231 ON READER-SERVICE CARD

ELECTRONIC DESIGN • October 12, 1960

Strain Indicator 329

This two-page bulletin, No. 360, describes the firm's model HW-1 portable strain indicator. Applications, construction information, and specifications are given. Photos are included. Polyphase Instrument Co., Strainsert Co. Div., Bridgeport, Pa.

Interchangeable Tubes 330

This eight-page handbook lists 900 interchangeable industrial tubes. Included are power supply, radiation counter, transmitting, microwave, amplifier, photo-sensitive, storage, ignitron, industrial cathode ray, and other special purpose tubes. Raytheon Co., Distributor Products Div., Waltham 54, Mass.

Planar Diodes 331

Eight-page, two-color Brochure No. SL-201/1 describes more than 200 Planar diodes. Included are electrical specifications, performance graphs, and outline drawings. Fairchild Semiconductor Corp., 4300 Redwood Highway, San Rafael, Calif.

Balancing Machines 332

This eight-page bulletin, "Tinius Talks," Vol. 12, No. 1, describes the firm's Olsen-Rava line of electro-dynamic balancing machines. Applications of the machines are included. Tinius Olsen Testing Machine Co., 428 Easton Road, Willow Grove, Pa.

Surge Test Adapter 333

This two-page data sheet No. 107, describes a 75-amp-surge test adapter. Included is an illustration and electrical specifications. Wallson Associates, Inc., 912-914 Westfield Ave., Elizabeth, N.J.

Trimmer Potentiometers 334

Four-page Brochure No. 5 describes the firm's Trimpot and Trimit leadscrew-actuated potentiometers. Information summarized on 16 standard models includes resistance, terminal types, power ratings, operating temperatures, and dimensions. Cut-away drawings and prices are included. Bourns, Inc., 6135 Magnolia Ave., Riverside, Calif.



NOW! NEW LOWER PRICED COIL FORMS

Interchangeable with industry standards

Thermosetting epoxy cement permanently positions collars and lugs to withstand severe shock under high temperature (250°C). Available in any lug configuration. Completely rustproof and moisture resistant. Ceramic conforms to Grade L5 JAN-1-10 silicone impregnated. Lightweight aluminum bushing. Silicone fibre glass washers. Unique built-in dependable tension device guarantees vibration-proof, smooth tuning. Nickel-plated parts conform to MIL-P-5879 QQ-N-190. Diameters: .205, .260, .375, .500. Frequencies: .1-1.5 mc, .5-10 mc, 10-30 mc, 30-50 mc, 30-150 mc, 50-200 mc, and brass slugs. Write for quotes and bulletin CF-860.



ALSO AVAILABLE IN EXCLUSIVE RIBBED DESIGN
CIRCLE 232 ON READER-SERVICE CARD

The future . . . from your point of view



A good day's growth for a hard day's work.

A position to suit your talents, experience and ambition.

Opportunity to exercise full initiative in Research, Radar, Doppler Navigational Systems, Magnetic Memory Systems, Microwave and Computers.

PLUS

Management awareness encouraging exploration beyond the range of present knowledge.

APPOINTMENTS NOW AVAILABLE:

DESIGN ENGINEER

Radar Circuitry

Experience and state-of-the-art knowledge in one or more of these: oscillators, cw or pulse modulators, video, IF or microwave amplifiers, differentiators, integrators, power supplies, pulse coders and decoders, phase detectors, MTI cancellers. Projects include: R&D of advanced techniques; ground, airborne, space equipment.

PHYSICIST

Applied Research

Advanced degree in physics or engineering physics, plus an appreciation of theory. To design a series of experiments in plasma physics, taking responsibility for equipment specification and installation plus all other experimental considerations.

For confidential discussion, please write:

Eugene Rust
Laboratory for Electronics
75 Pitts Street, Boston 14, Massachusetts



Laboratory for Electronics

CIRCLE 908 ON CAREER INQUIRY FORM, PAGE 223



CHARLES E. MCGINNIS, B.E.E., M.S.E.E., CHIEF COMMUNICATIONS ENGINEER

●● Why did I move to Martin-Orlando? Opportunity for professional growth...doing as big a job as I could handle. More money and better position, too. Any company that's growing as fast as Martin presents many opportunities. You don't outrun the company. You grow with it. If you have a worthwhile idea that will benefit the company, and you can demonstrate that it will, you get everything you need to put that idea into action. Martin isn't ponderous... it lets you move fast and get things done. ☪ I head up a group of people responsible for getting Martin further into the field of communications, both related and non-related to missiles. We're working on tropospheric scatter systems, random access discreet address communication systems, air traffic control communications, very long range communications systems, applied research on speech bandwidth compression systems... things like that. ☪ My wife and I really like living in Florida. Never housebound in winter, no snow suit to put on my little girl every time she goes out. A great place to raise a family. The school system is good too. ●● Write: C. H. Lang, Director of Employment, The Martin Company, Orlando 10, Florida. FOR CAREER OPPORTUNITIES, SEE PAGES 197 AND 199

WORK IN THE CLIMATE OF ACHIEVEMENT

MARTIN
ORLANDO

NEW LITERATURE

Electrical Resins 335

This 28-page, illustrated booklet catalogs the Scotchcast line of electrical resins. It discusses over 20 flexible, semi-flexible, rigid and special resins, with examples of their applications. Preparation, curing, handling and storage of the resins are considered. Properties of the resins are included in tabular form. Minnesota Mining & Manufacturing Co., 900 Bush Ave., St. Paul 6, Minn.

Laminated Plastics 336

Two copper-clad, flame-restardant laminated plastics called Fireban 321-R and Fireban 321-E are described in Technical Data Bulletin No. 3.1.25.1. Properties listed in this two-page data sheet include thickness of copper foil, bond strength, dissipation factor, insulation resistance, surface resistivity and heat resistance. Taylor Fibre Co., Norristown, Pa.

Varistor, Thermistor Catalog 337

Specifications and technical data on the firm's line of bead, rod, disk and washer thermistors, and disk and washer varistors are given in this eight-page technical catalog. Technical descriptions of related special items and a discussion of associated theory and terminology are included. Victory Engineering Corp., 519 Springfield Road, Union, N. J.

Diode Testing System 338

"New Diode Evaluation System" is a four-page catalog on the firm's diode testing system. The catalog describes the Model DE-48 module and the Type TM-1 visual diode evaluation monitor. Technical data on testing units are included. Flite-Tronics, Inc., 3312 Burton Ave., Burbank, Calif.

Transistorized Power Supplies 339

The company's series ST power supplies are described in this four-page bulletin. Specifications, mounting dimensions, special features and prices are given for 19 off-the-shelf units. Mid-Eastern Electronics, Inc., 32 Commerce St., Springfield, N.J.

Teflon Enameled Wire 340

Magnet wire and thin-wall instrument wire, Teflon insulated, is described in this 8-page, illustrated catalog. Physical, thermal and electrical properties are tabulated. Mechtron Div., Tensolite Insulated Wire Co., Inc., 1000 N. Division St., Peekskill, N.Y.

BEEDE ELECTRICAL INDICATING INSTRUMENTS



MODEL 16 - BAKELITE - FLUSH
4²¹/₃₂" x 4³/₁₆"



MODEL 230 - STYRENE - FLUSH
4⁵/₈" x 3⁵/₈"

MODEL 310
BAKELITE
FLUSH
3¹/₂" DIA.



MODEL 23
STYRENE
FLUSH
4²¹/₃₂" x 4³/₁₆"

**FOR EVERY SPOT
WHERE A DEPENDABLE
ACCURATE MEASUREMENT
IS A MUST**

LONG LASTING — EASY TO READ

Catalog on request



**BEEDE ELECTRICAL
INSTRUMENT
CO., INC.**
PENACOOK
NEW HAMPSHIRE

CIRCLE 234 ON READER-SERVICE CARD

ELECTRONIC DESIGN • October 12, 1960

new flux discovery!

ALPHA activated liquid rosin flux sets new printed circuit standards!

Even metal surfaces normally resistant to fluxing action can now be soldered quickly and safely with ALPHA's new printed circuit flux; tests prove it.

Subjected to a grueling 42-day, high-temperature, high-humidity trial, this new flux revealed no evidence of corrosion or breakdown. ALPHA fluxes meet government specifications! Write for details and samples.

When dependability counts!

In Los Angeles, Calif.:
2343 Saybrook Ave.

In Chicago, Ill.:
ALPHALOY Corp.,
2250 S. Lumber St.

alpha INC.
metals
58B Water St., Jersey City 4, N. J.

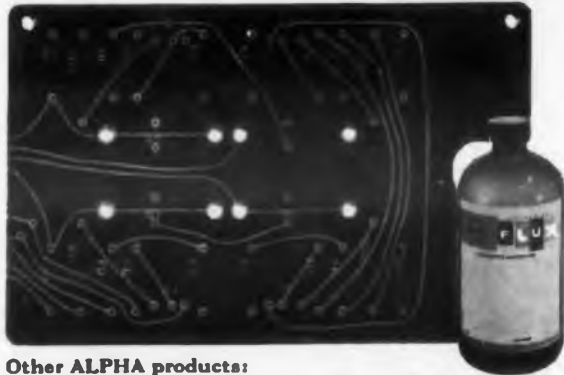

Other ALPHA products:
Core and Solid Wire Solders • Preforms • High Purity Metals

CIRCLE 235 ON READER-SERVICE CARD

Electrolytic Capacitors 341

Four-page bulletin No. EL-5 describes sub-miniature electrolytic capacitors designed for high-quality transistor equipment or similar applications. The bulletin contains test specifications and operating characteristics, a table of capacitor dimensions, graphs of typical performance characteristics, and a dimensional diagram of capacitor construction. Pyramid Electric Co., Darlington, S.C.

Transformers 342

Stancor catalog S-105 carries detailed listings of over 700 units for radio, television, industrial and communications applications. Chicago catalog CT9-59 lists nearly 500 units for military, 400-cycle high-fidelity, communications, industrial control and power circuit applications. Both include specifications for about fifty units for transistor applications. Chicago-Standard, 1 N. LaSalle, Chicago 2, Ill.

Relay Magnetic Amplifiers 343

This six-page Bulletin, No. 70, contains detailed information on four of the firm's relay magnetic amplifiers. Theory of operation and application, typical methods of application and operating characteristics are described. Specifications include electrical, environmental and mechanical characteristics and curves of output voltage vs input current. Acromag, Inc., 22519 Telegraph Road, Southfield, Mich.

Polycarbonate Resins 344

Two technical information bulletins describe production methods for processing Merlon polycarbonate resins. Bulletin No. 44-M2 describes the procedure for producing plastic parts by injection molding; bulletin No. 47-M3 covers the extrusion process. The publications supplement an earlier bulletin, No. 41-M1, which provides a general description of the thermoplastic. Mobay Products Co., Penn-Lincoln Parkway West, Pittsburgh 5, Pa.

Electro-Mechanical Control Systems 345

Electro-mechanical control systems and components for use on a wide variety of production machinery are described in a six-page catalog. No. EE-1008. Information on point-to-point control systems, speed control systems and fractional and integral horsepower servo systems is included. Applications of control systems are suggested with illustrations and graphs. Seneca Falls Machine Co., Electronics Div., 12 Fyfe Bldg., Seneca Falls, N.Y.



CHARLES E. MCGINNIS
CHIEF COMMUNICATIONS ENGINEER

Did I mention that Orlando's average February temperature is 62 degrees—August average is 82 degrees? CAREER OPPORTUNITIES IN FLORIDA. Participate in creative assignments on Army, Navy and Air Force prime contracts—including Pershing, Bullpup, GAM-83 and Lacrosse missiles, Missile Master and other electronic systems. Current openings in design, development, fundamental and applied research, reliability, quality, systems test, manufacturing and associated engineering areas. Write C. H. Lang, Director of Employment, The Martin Company, Orlando 11, Florida. SEE PAGE 196

WORK IN THE CLIMATE OF ACHIEVEMENT

MARTIN
ORLANDO

this **free** engineering specification manual shows you how...

total 2
gives you the Superior Solution to your Retaining Ring Problems

This Free Manual shows you the advantages of BOTH Modern Types of Retaining Rings—and ONLY Ramsey can give you BOTH!

FREE TECHNICAL BULLETIN SERVICE shows you how other leading companies are solving their toughest problems with Spirolox and Circolox Rings.

Mail this coupon today!

RAMSEY CORPORATION
Box 513, Dept. P, St. Louis 66, Missouri
Send my FREE Engineering Specification Manual and put my name on the list to receive Free Technical Bulletin Service.

Name.....
Address.....
City..... Zone..... State.....

CIRCLE 237 ON READER-SERVICE CARD

KESTER

SOLDERFORMS®

BIG STEP in PRODUCTION COST-CUTTING!

Preformed solder, all shapes and sizes engineered to your needs; rings, washers, discs, coils, pellets, others. Flux filled or solid types, all alloys including rare metals.

Write for free sample assortment and engineering detail.

KESTER SOLDER COMPANY
4266 Wrightwood Avenue
Chicago 39, Illinois

Newark 5, New Jersey
Anaheim, California
Brantford, Ontario, Canada

OVER 61 YEARS' EXPERIENCE

CIRCLE 236 ON READER-SERVICE CARD

There's a
New
DIAL
HEAD
AGASTAT



for every time/delay/relay application

Here's what you get with every Agastat time/delay/relay

- Easy adjustment
- Repeatable accuracy
- Instantaneous recycling
- Unaffected by voltage variations
- Low power consumption

GET THE WHOLE STORY—write today for Bulletin No. SR-10 and find out how Agastat can help you to solve your time delay problems. Write to Dept. A35-1024



AGASTAT TIMING INSTRUMENTS

ELASTIC STOP NUT CORPORATION OF AMERICA
1027 NEWARK AVENUE, ELIZABETH 3, NEW JERSEY
CIRCLE 238 ON READER-SERVICE CARD

...eliminate costly errors
save time, speed shipments
...prevent warehouse
and stockroom confusion

COLOR
your
CODE inventory
with
AVERY

pressure-sensitive labels

For faster coding and price marking, for inventory control, for bin and shelf marking, for instant dating and identification of contents—by quality, type, size or quantity—wherever there's need for a label—AVERY pressure-sensitive LABELS do it best! They stick to all types of surfaces—glass, plastic, metal, wood, film, and paper. There's no moistening, no mess, no fuss. Two types of labels—AVERY Kum Kleen LABELS can be easily removed, if need be... AVERY Perma-Grip are on securely and PERMANENTLY!



Avery's manual or automatic dispensers will help you obtain fast, clean and economical labeling. Write for details.



Please send me free samples and details on AVERY color coding.

Tell me more about Avery Label Dispensers.

AVERY LABEL COMPANY Div. 135
117 Liberty St., New York 6
608 S. Dearborn St., Chicago 5
1616 S. California Ave., Monrovia, Calif.

Name _____
Company _____
Street _____
City _____ Zone _____ State _____

* Have you seen Avery's new pressure-sensitive Metallics for decorative trim, panels and identification plates?

CIRCLE 239 ON READER-SERVICE CARD

NEW LITERATURE

Time Delays 346

Adjustable transistorized time delays from 0.1 to 300 sec are featured in this four-page brochure. Illustrated with dimensional diagrams, curves, and photos, the brochure provides a general description of the units, the principle of operation, features, and specifications. G-V Controls, Inc., 101 Okner Parkway, Livingston, N.J.

Instrument Cases 347

"Standard Cases for Custom Equipment" is a 12-page booklet that covers features, sizes, colors, and standard hardware that may be obtained when ordering these pre-designed cases. Photos of the various units, a dimensional diagram, and a postage-paid ordering card are included. TA Manufacturing Corp., 4607 Alger St., Los Angeles 39, Calif.

Thermistors 348

What thermistors are, what they do, and how they are used are covered in 24-page brochure EMC-3. This brochure also tells how to solve thermistor problems, lists the firm's line of thermistors, and includes resistance-temperature tables. Fenwal Electronics, Inc., 51 Mellen St., Framingham, Mass.

Trimmer Potentiometer 349

Series 140, 1/4-w carbon trimmer potentiometer is described in this one-page data sheet. Dimensional drawings, electrical and mechanical specifications and MIL test data summary tabulations are included. CTS Corporation, Elkhart, Ind.

Voltage Digitizers 350

The two-page bulletin, "What Adage Voldicons Are Doing," suggests applications of the firm's line of voltage digitizers. Intended functions of the instruments are listed, and examples of actual applications are described. Adage Inc., 292 Main St., Cambridge 42, Mass.

Servo Gearhead and Speed Reducer 740

The firm's line of 400-cycle servomotor gearheads and speed reducers, Series 11, are described on this two-page data sheet. Electrical and mechanical specifications, dimensional drawings, performance curves and general descriptions are included. Guidance Controls Corp., 110 Duffy Ave., Hicksville, N.Y.

Environmental Chambers

AND LOW TEMPERATURE FREEZERS

FOR CONTROLLED ATMOSPHERIC CONDITIONS
Temperature • Altitude • Humidity

Free!

28-Page Brochure on
Environmental Chambers



It's one of the most helpful brochures ever published for users of environmental chambers and low temperature freezers.

WRITE FOR YOUR COPY TODAY!

A FEW APPLICATIONS

- Aging of Steel
- Aluminum Storage
- Metal Hardening
- Nuclear Radiation Testing
- Research and Production
- Shrink-fitting of Parts
- Rivet Storage
- Stabilization of Steels
- Simulated Atmospheric Conditions
- Thermal Shock Tests
- Tool Steel Treatment

RANGES

- Temperature: -225° F. to +1000° F.
(Any temperature desired in this range)
- Altitude: 0 to 500,000 ft.
- Humidity: 20% to 95%
- Capacity: Any size for any application

WEBBER MANUFACTURING CO., INC.

P.O. Box 217V • Indianapolis 6, Ind. • Phone: MEIrose 2-1378
CIRCLE 240 ON READER-SERVICE CARD

an infinite variety STANDARD PLASTIC PARTS

knobs, handles, feet, pulls,
pointers etc. in a thousand
and one variations... all available
without tooling costs.



FREE
CATALOG
samples on request

HARRY DAVIES MOLDING COMPANY
1428 N. Wells St., Chicago 10, Ill.

CIRCLE 241 ON READER-SERVICE CARD
ELECTRONIC DESIGN • October 12, 1960

Feeds, stakes and fuses Eyelets In PRINTED CIRCUIT Boards

**WITH 100%
RELIABILITY**



**EDWARD SEGAL
MODEL NR-ESSM
automatic eyelet
attaching machine**

In every environmental test!

This revolutionary machine, supplied as a complete installation, is obsoleting manual eyelet attaching and soldering. Leading manufacturers, in many cases using batteries of them, find Segal's new Model NR-ESSM is a completely dependable automatic method of making continuous electrical circuits of the printed elements on opposite sides of a board — or a single side if desired. Stakes and fuses 30 eyelets or more a minute, top and bottom, with never a reject.

There are other models for cold staking flat and funnel type eyelets, and for feeding and staking tube pins and turret terminals with equal reliability. All are highly economical. Segal can improve your eyelet attaching production. Write section ED-10.



Manufacturers of eyeleting machinery,
special hoppers and feeding devices
132 LAFAYETTE STREET, NEW YORK 13, N. Y.

CIRCLE 242 ON READER-SERVICE CARD

*For instruments, timing devices, control apparatus
and other continuous duty applications . . .*



**use Bodine
"Instrument"
SPEED
REDUCER
MOTORS**

- For the design engineer who is looking for a sturdy, reliable, compact, low speed, fhp motor
- Small—only 2 1/4" high and wide
- Helical or spur gear reduction
- Synchronous or nonsynchronous
- Speeds 300 to .7 rpm; torque 1.3 to 120 inch-ounces

FREE Ask for Bulletin 1023C

BODINE

fractional horsepower

MOTORS

Bodine Electric Co., 2528 West Bradley Place, Chicago 18, Ill.

CIRCLE 243 ON READER-SERVICE CARD

ELECTRONIC DESIGN • October 12, 1960

Digital Control System 741

A punched-card programed digital control system is described in this two-page bulletin, No. 350-2. A general description, including operation and application, of the system and its components is included. Datex Corp., 1307 S. Myrtle Ave., Monrovia, Calif.

Plastic Tubing 742

Engineering data, including dielectric strength, temperature rating and flammability, in tabular form, are available on the Alphlex line of tubing in this eight-page catalog. Included are descriptions of insulating tubing, sleeving, and zipper tubing. Alpha Wire Corp., 200 Varick St., New York 14, N.Y.

Blowers 743

A description of panel mounting blowers with their specifications appears in this catalog. Among the blowers included are the universal blower, base recessed blowers, and intake and exhaust fans, which are specifically designed for cooling electronic equipment enclosures. Blower accessories that simplify many cooling problems are also covered. Amco Engineering Co., 7333 W. Ainslie St., Chicago, Ill.

Choppers And Transformers 744

The model C-1800 chopper and the associated series A-1500 input-output transformers are described and illustrated in this data sheet. Characteristics of the choppers are tabularly compared with those of transistors and magnetic amplifiers. Specifications of all units are given. James Electronics, Inc., 4050 N. Rockwell St., Chicago 18, Ill.

Variable Capacitors 745

The firm's line of variable capacitors is listed in this 15-page catalog, No. 60. Complete electrical and mechanical specifications are provided for each type listed, including tuning and trimming models. Hammarlund Manufacturing Co., Inc., 430 W. 34th St., New York 1, N.Y.

Power Supplies 746

Featured in this eight-page bulletin are high-voltage power supplies. Photos of main components in the broad range of single and dual units for operation up to 5,000 v accompany descriptions, applications, and specification data. The Victoreen Instrument Co., 5806 Hough Ave., Cleveland 3, Ohio.



**CHARLES E. MCGINNIS
CHIEF COMMUNICATIONS ENGINEER**

**Did you know that there
are 53 lakes within the
city limits of Orlando?**

**CAREER OPPORTUNITIES IN
FLORIDA.** Participate in creative assignments on Army, Navy and Air Force prime contracts — including Pershing, Bullpup, GAM-83 and Lacrosse missiles, Missile Master and other electronic systems. Current openings in design, development, fundamental and applied research, reliability, manufacturing and associated engineering areas. Write C. H. Lang, Director of Employment, The Martin Company, Orlando 12, Florida.

SEE PAGE 196

WORK IN THE CLIMATE OF ACHIEVEMENT

**MARTIN
ORLANDO**

**Just
published
by KODAK**



If you are working with infrared-actuated devices, you need this new Kodak folder, *Kodak Ektron Detectors*. It tells what you need to know about types and availabilities of these photosensitive resistors.

There are curves for the six different depositions available in Ektron Detectors that give specific responsivity and detectivity (signal-to-noise ratio) against wave length. Also description of physical forms available and a quick summary of basic effects.

To get your free copy, write to Special Products Sales,

**EASTMAN KODAK COMPANY
Rochester 4, N.Y.**

**Kodak
TRADE MARK**

CIRCLE 244 ON READER-SERVICE CARD



There's really not much
to custom-designing
rotary switches...

It's a matter of routine . . . when you have talented engineers with lots of experience . . . first quality materials . . . and advanced manufacturing techniques.

Fortunately, The Gamewell Company has all three. When customers' specifications come in, our engineers get busy. The precious metal ring, heart of a Gamewell Rotary Switch, is designed with as many segments as required. Brushes are provided which assure smooth, trouble-free action with either MAKE-BEFORE-BREAK or BREAK-BEFORE-MAKE contacts. Then a highly versatile arrangement of terminals connecting to ring segments is devised for the periphery of the switch housing. And so on, depending on requirements.

The end result is a highly versatile, reliable switching component. Cased in special plastic, it's inherently fungus resistant and stable at high temperatures. It can be used with confidence over a wide range of environmental conditions.

Gamewell is well qualified to design rotary switches for circuit sampling, programming, digital generators and various electronic data processing systems. *Your* specs will receive prompt attention.

Write to THE GAMEWELL COMPANY, 1395 Chestnut Street, Newton Upper Falls 64, Massachusetts. A Subsidiary of E.W. Bliss Company.



The Gamewell SG-270 Switch is available with diameters of $\frac{3}{8}$ ", $1\frac{1}{4}$ ", $1\frac{3}{8}$ ", 2", 3" and 5" in various mounting styles.

BLISS
Gamewell
PRECISION POTENTIOMETERS
"INTEGRALS OF
HIGH PERFORMANCE"

CIRCLE 245 ON READER-SERVICE CARD

IDEAS FOR DESIGN

Get \$10.00 plus a by-line for the time it takes you to jot down your clever design idea. Payment is made when the idea is accepted for publication.

Four-Resistor Decade Was Improved Upon

Referring to the "Four-Resistor Decade," submitted by Ralph U. Moody (*ED*, July 20, 1960, p 149), I would like to present my version, Fig. 1, designed in 1956.

As you will note this circuit does not require shorting out any of the resistors although it uses the same type two-section, two-pole, 11 position rotary switch.

I would also like to submit my version of a "Four-Capacitor Decade" with the same type

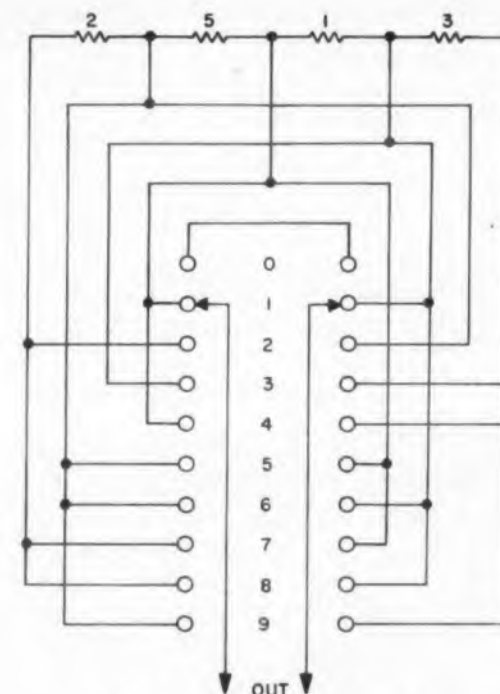

Fig. 1. Four-resistor decade.

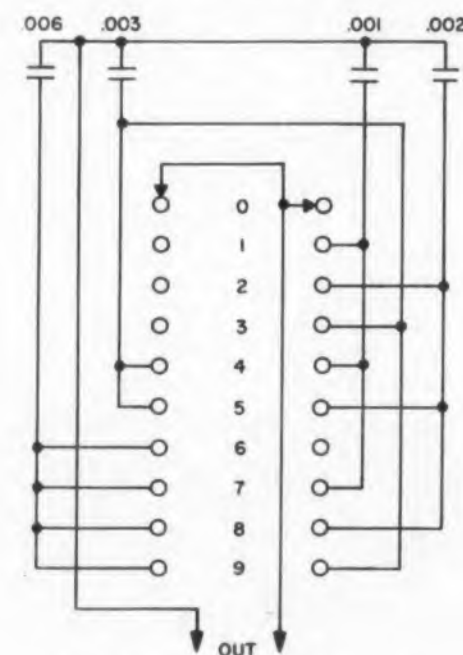

Fig. 2. Four-capacitor decade.

switch, which parallels the capacitors in numerical sequence.

Warren T. Abbott, Design Engineer, Convair Astronautics, San Diego, Calif.

Low Impedance Transistor Circuit Drives Coaxial Line

To preserve the shape of short, fast rise-time pulses transmitted along coaxial line, the impedance of the driver should match the characteristic impedance of the line. The coax driver circuit shown in Fig. 1, a combination of a saturated inverter and an emitter follower, provides an excellent low impedance drive.

With zero volts input, R_1 and R_2 act as a voltage divider to bias T_1 off. With T_1 in the non-conducting state, the current in R_3 causes emitter follower T_2 to conduct, and the output is negative. The output impedance at this time depends on the current gain and the emitter-to-base voltage drop of T_2 .

When the input is negative, transistor T_1 conducts and pulls the base of T_2 up to 0.1 v. Transistor T_2 is cut off. Diode D_1 conducts and pulls the output up to near ground. The output impedance in this state is the impedance of the saturated transistor T_1 and the forward biased diode D_1 .

The effect of the drive circuit working into a 30-ft section of Microdot cable is shown in Fig. 2. There is a 22-nsec delay in the inverter, a 4-nsec delay in the emitter follower and 50-nsec delay in the coaxial cable length.

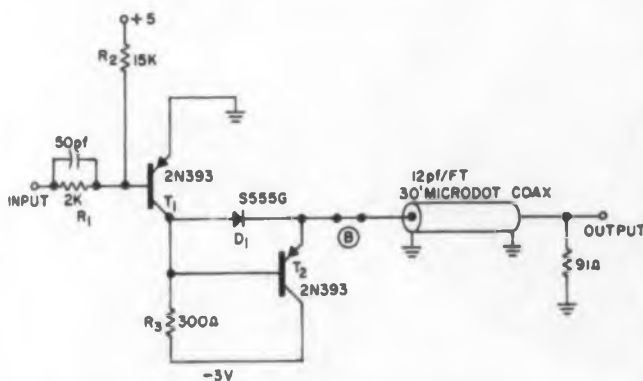

Fig. 1. Driver circuit provides low impedance match to characteristic impedance of coaxial cable.

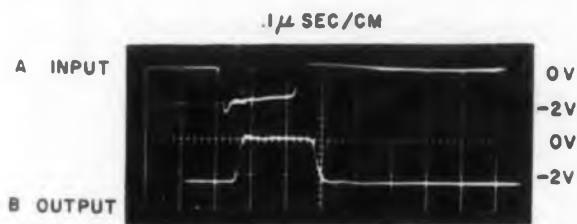

Fig. 2. Inverted output waveshape (b) is slightly delayed but still fast and sharp.

Forrest O. Salter, Applied Mathematics Div., Argonne National Laboratory, Argonne, Ill.



EIMAC OFFERS RF POWER FOR ALL AIR-SPACE SYSTEMS

From miniature microwave devices to the highest power klystron, Eimac offers rf power for every type of air-space system. With tubes designed for airborne communication. For warning systems. For tracking and guidance. You can look to Eimac as the one source of all your rf power needs. ■ For still further progress, new tube types to meet new needs, Eimac continues to forge ahead with the most advanced research facilities available today for power tube development. And its manufacturing program is unmatched in ability to turn blueprint ideas into quantity production. No wonder Eimac tubes power nearly every major air-space system the world over: telemetry, troposcatter, navigational radar, high-power radar—including the recent BMEWS program. Eitel-McCullough, Inc., San Carlos, Calif.



CIRCLE 246 ON READER-SERVICE CARD

PURITY as high as
99.9975%
 with **LINDE RARE GASES**

MONATOMIC
 DIATOMIC
 RADIOACTIVE
 SPECIAL MIXTURES
 COMBINATIONS

All LINDE atmospheric gases are produced under continuous Mass Spectrometer Control—insuring highest possible purity.

Huge production facilities and a widespread distribution system make it possible for LINDE to supply large quantities of these gases and mixtures throughout the country—in bulbs or in cylinders of various sizes. These unique capabilities are the result of 50 years of pioneering research and development work in rare gases and their behavior.

LINDE gases serve the electronics industry in a wide range of uses, such as electron tubes including thyatrons, Geiger-Muller, and high-voltage regulator tubes; x-ray fluorescence analyzers, electric displays, and insulation for high-voltage terminals; standard and miniature incandescent lamps and high-speed photographic lamps. Many new uses are constantly being developed.

For complete data on gases, write for a copy of F-1002C, "Linde High Purity Gases." Address Dept. ED102, Linde Company, Division of Union Carbide Corporation, 270 Park Avenue, New York 17, N. Y. In Canada: Linde Company, Division of Union Carbide Canada Limited, Toronto 7.

LINDE **UNION**
COMPANY **CARBIDE**

Linde and Union Carbide are registered trademarks.

CIRCLE 765 ON READER-SERVICE CARD

PATENTS

Benjamin Bernstein

Time Base Circuits

Patent No. 2,938,140, F. W. Cook. (Assigned to A.T. & E, Ltd.)

An rf pulse may be examined in detail by simultaneously displaying the pulse on two or more cathode ray tubes. The time bases of the tubes are synchronized by appropriately delayed impulses.

The circuit typical for two CRO's is given in block form. Main time base am-

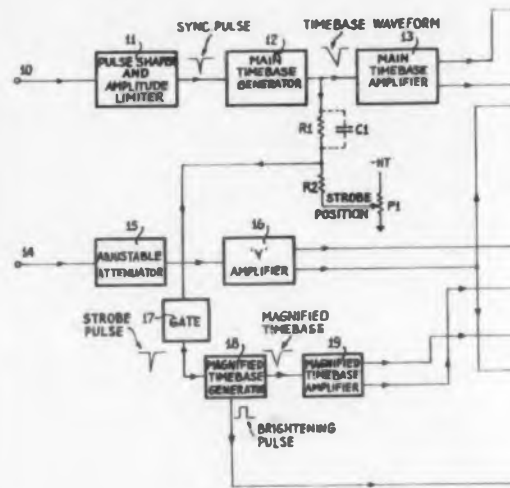

plifier 13 is triggered by the main pulse applied at terminal 10. The main linear sweep couples to comparator 17 which is gated by an adjustable dc pedestal voltage set by a voltage divider. Thus, the gate passes a trigger, properly delayed with respect to the main trigger pulse, so that the second CRO displays the rf pulse, or a part of it, on a second horizontal sweep. It is possible to set up any number of CRO's to display other aspects of the pulse.

High Frequency Oscillators

Patent No. 2,943,235, R. Dunsmuir. (Assigned to British Thompson-Houston Co. Ltd.)

The oscillator is a toroidal shaped magnetron having an odd number of resonator segments around its circumference. A rotating electron stream, in conjunction with the resonators, generates waves that travel around the magnetron in only one direction.

GUDELACE
TAKES THE
SLIPS
OUT OF
LACING

Try this simple test. Tie a piece of Gudelace around a pencil in a half hitch and pull one end. Gudelace's flat, nonskid surface grips the pencil—no need for an extra finger to hold Gudelace in place while the knot is tied!

Gudelace makes lacing easier and faster, with no cut insulation, or fingers—no slips or rejects—and that's *real* economy. Gudelace is the original flat lacing tape. It's engineered to *stay* flat, distributing stress evenly over a wide area. The unique nonskid surface eliminates the too-tight pull that causes strangulation and cold flow. Gudelace is made of sturdy nylon mesh, combined with special microcrystalline wax, for outstanding strength, toughness, and stability.

Write for a free sample and test it yourself. See how Gudelace takes the slips—and the problems—out of lacing.

GUDEBROD

BROS. SILK CO., INC.

Electronic Division
 225 West 34th Street
 New York 1, N.Y.

Executive Offices
 12 South 12th Street
 Philadelphia 7, Pa.

CIRCLE 751 ON READER-SERVICE CARD

Parallel Transistor Amplifiers

Patent No. 2,941,154, S. C. Rogers. (Assigned to Bell Telephone Labs)

The inequality of the ac parameters of two transistors operated in parallel is compensated for by cross-coupling the emitters with a unity-ratio transformer. Each transistor is forced to conduct the same current.

Transistors 10 and 11 in parallel drive load 12. The emitter of each transistor connects to the winding of transformer 16. With equal emitter currents, no change in flux is produced in the transformer. An unbalance in the emitter currents causes the transformer to generate voltages which respectively oppose the base drive on one transistor and aid the base drive on the other. This forces the transistor currents to become equal.

Circuit performance was demonstrated

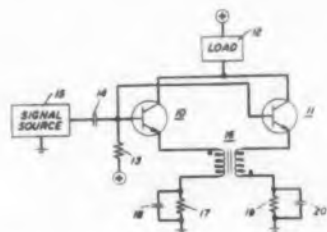

by arbitrarily selecting a grown transistor and an alloy transistor. Without compensation, the currents were 2:1 unbalanced. By contrast, the transformer cross-coupling caused the unbalance to be less than 5 per cent.

Broad-Band Low Capacity Microwave Balanced Mixer

Patent No. 2,943,192, F. T. Liss. (Assigned to United States.)

Two microwave signals are connected by passing them individually through separate waveguides and crystal diodes. The diode outputs are connected at the mixer output point.

Pulse Distribution Indicator

Patent No. 2,943,149, E. A. Irland and A. E. Ruppel. (Assigned to Bell Telephone Laboratories, Inc.)

The indicator measures the statistical distribution of random pulses with respect to cyclic pulses. The unit uses binary counter stages to compare the incidence of random pulses with the incidence of cyclic pulses.

THESE BLOWERS ACTUALLY HAVE the MOTIVATION ENERGY NECESSARY

...they SUPPLY ACTUAL RATED OUTPUT

Ratings are based on tests outlined in 1955 NEMA publication FM1-7.02

Assurance of actual delivery of rated CFM is generated by two Western Devices features: Ample Power (standard: NEMA 1/4 HP ball bearing motor—1/3 HP for higher outputs); Superb Engineering (double width tight scroll blower assembly with dual rotor).

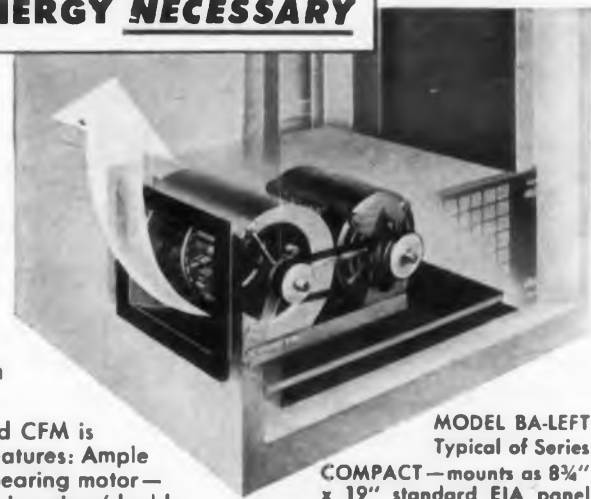

MODEL BA-LEFT
Typical of Series

COMPACT—mounts as 8 3/4" x 19" standard EIA panel (7" and 5 1/4" models also available)

OTHER FEATURES:

- Large cooling capacity—to 1200 CFM
- MIL quality construction and finish (special finish available)
- Interference-free—meet MIL-1-16910A radio interference specs
- Quiet operation—cushion mounted—noise level only 51 db in 300-600 cps range, only 54 db in 4800 cps-infinity range (52 db isolated)

- Side, top, rear discharge areas; 8 standard models (plus variations, Twin Blowers, others 'to order')
- Easy maintenance without removing
- Cleanable filter—disposable available
- Motor—115 vac, 60 cps with thermal overload protection (MIL spec single- or 3-phase or 400-cycle also available)
- Sealed ball bearings support dual rotor's stainless steel shaft

Write or phone for complete data on BA Series above
... and our 6,000 and 12,000 BTU Refrigerated Blowers

ONE SOURCE...

for VENTILATED RELAY RACK CABINETS,
CONTROL CONSOLES, BLOWERS, CHASSIS,
CHASSIS-TRAK®, RELATED COMPONENTS

WESTERN DEVICES, Inc.

600 W. FLORENCE AVE., INGLEWOOD 1, CALIF.

ORegion 8-7827

CIRCLE 752 ON READER-SERVICE CARD

HIGHLY RELIABLE

SHAFT POSITION-TO-DIGITAL CONVERTERS



Kearfott's rugged shaft position-to-digital converters are resistant to high shock and vibration and high and low temperature environments. Ideally suited for missile applications, these converters are available for many uses, including latitude, longitude, azimuth or conventional angular shaft displacement conversion and decimal count conversion. Exclusive drum design provides large conversion capacity (typical unit 2¹⁵) in smallest available size. Combination counter converter assemblies for both visual and electrical readout also available.

KEARFOTT DIVISION
Little Falls, New Jersey



GENERAL PRECISION, INC.
Other Divisions: GPL, Librascope, Link

CIRCLE 753 ON READER-SERVICE CARD

ELGIN ADVANCE RELAYS

POWER TYPE RELAYS FROM STOCK

| POWER CONTROL TYPES | | | |
|--------------------------------------|------------|---------------------|------|
| TYPE | CONTACTS* | COIL VOLTAGE (VAC) | |
| PC/1C | SPDT 15A | 6, 12, 24, 115, 220 | |
| PC/2C | DPDT 15A | 6, 12, 24, 115, 220 | |
| PC/3C | 3PDT 15A | 6, 24, 115, 220 | |
| PC/4C | 4PDT 15A | 6, 24, 115, 220 | |
| COIL VOLTAGE (VDC) | | | |
| PC/1C | SPDT 15A | 6, 12, 24, 110 | |
| PC/2C | DPDT 15A | 6, 12, 24, 110 | |
| PC/3C | 3PDT 15A | 6, 12, 24, 110 | |
| PC/4C | 4PDT 15A | 6, 12, 24, 110 | |
| COIL VOLTAGE VDC COIL RES. DC (OHMS) | | | |
| PG/2C/6VA | DPDT 15A | 6 VAC | 1.4 |
| PG/2C/24VA | DPDT 15A | 24 VAC | 25 |
| PG/2C/115VA | DPDT 15A | 115 VAC | 400 |
| PG/2C/220VA | DPDT 15A | 220 VAC | 1600 |
| PG/2C/6VD | DPDT 15A | 6 VDC | 16 |
| PG/2C/12VD | DPDT 15A | 12 VDC | 63 |
| PG/2C/24VD | DPDT 15A | 24 VDC | 250 |
| PG/12/6VD | SPDT 30A | 6 VDC | 16 |
| PG/12/115VA | SPDT 30A | 115 VAC | 400 |
| POWER TRANSFER TYPES | | | |
| PH/1A/6VD | SPSTNO 20A | 6 VDC | 16 |
| PH/1A/115VA | SPSTNO 20A | 115 VAC | 400 |
| PH/1C/6VD | SPDT 20A | 6 VDC | 16 |
| PH/1C/115VA | SPDT 20A | 115 VAC | 400 |
| PV/1A/6VD | SPSTNO 30A | 6 VDC | 16 |
| PV/1A/115VA | SPSTNO 30A | 115 VAC | 450 |
| PV/1C/6VD | SPDT 30A | 6 VDC | 16 |
| PV/1C/115VA | SPDT 30A | 115 VAC | 450 |

*Resistive rating

ELGIN ADVANCE RELAYS

ELGIN-ADVANCE RELAYS ELGIN-NATIONAL WATCH CO.
2435 N. NAOMI ST. / BURBANK / CALIFORNIA

CIRCLE 754 ON READER-SERVICE CARD

3-IN-ONE AMCO ENCLOSURE SYSTEM

**Provides Cooling, Mounting and Lighting
for Electronic Instruments in Any Installation**

No one type of enclosure meets all environmental and physical demands. AMCO has developed 3 complete systems integrated into 1 system with interchangeable accessories, applicable for both commercial and military use.



CUSTOM . . . *When space and appearance are critical* . . . 16 ga. double-channel steel frames, based on increments of 19 $\frac{1}{8}$ " widths, supports in excess of 3000 lbs. Multi-width panels and cowlings give single-unit appearance with series mounted racks. Meets EIA Standards.

Aluminum



SEMI-CUSTOM . . . *Heavy-duty, more internal clearance* . . . 14 ga. box-channel steel frames, 12 ga. gusseting provides exceptional rigidity both front-to-back and side-to-side. Frames based on 22 $\frac{1}{8}$ " increments provides clearance for recessing 19" wide panels. Meets EIA Standards.

Semi-Custom

ALUMINUM . . . *Unique! Meets any size* . . . almost any configuration from 6 basic parts . . . 3 castings and 3 extrusions. Any size from 6" to 20 ft.; any slope from 0° to 90° is standard. Mil Specs strength and material (6061-T6 extrusions and 356-T6 castings).

In addition, Amco manufactures all necessary blowers, chassis slides, doors and drawers, writing surfaces, cowlings lights and other accessories. *Check the extra savings you get thru Amco's combined-discount system of racks and accessories, PLUS FREE ASSEMBLY.*

Amco is your one complete source of Modular Instrument Enclosure Systems and Accessories. Write today for catalog of complete specifications.



REALISTIC 3 WEEK DELIVERY

Factory trained representatives in principal cities of U.S. and in Canada.

Custom



AMCO ENGINEERING CO.

7333 West Ainslie Street, Chicago 31, Illinois

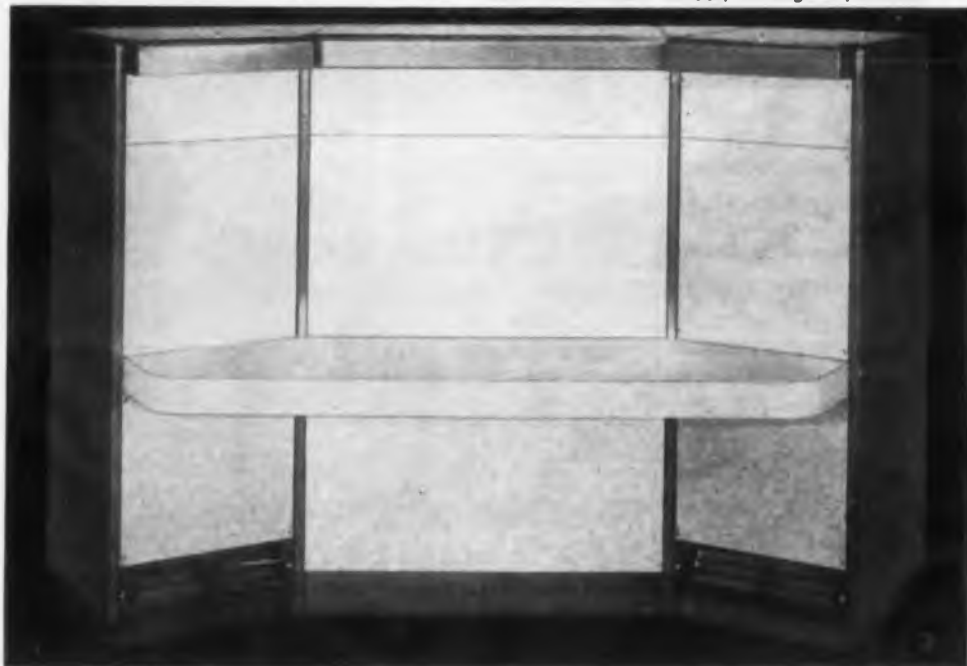

CIRCLE 755 ON READER-SERVICE CARD

PATENTS

Transistor Switching

Patent No. 2,933,692, S. T. Meyers. (Assigned to Bell Telephone Labs)

A signal pulse is amplified regeneratively by simultaneously switching transistors of opposite conductivity type; the power drain from the battery is kept minimum.

Quiescent, pnp transistor 1 is biased to conduct through the high impedance

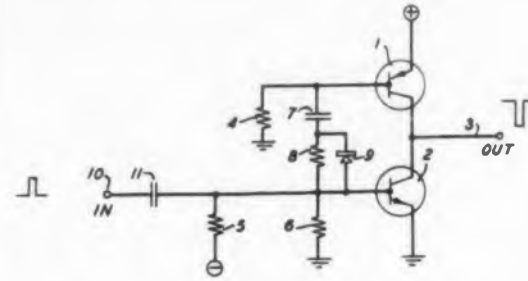

presented by npn transistor 2 which is separately biased by means of the voltage across resistor 6. A positive going pulse drives transistor 1 to cut off and transistor 2 conducts hard to couple an amplified pulse to output terminal 3.

Measuring the Amplitude of Low Frequency Oscillations

Patent No. 2,941,148, R. Catherall. (Assigned to The Solartron Electric Group Ltd.)

The amplitude of a very low frequency oscillator (100 sec or more per cycle) is obtained by connecting two thermocouples in series through a dc meter.

Oscillator 10 drives the thermocouple heater 11 to produce an output proportional to the square of the generator output. After a 90-deg phase shift, the signal source drives thermocouple heater 14

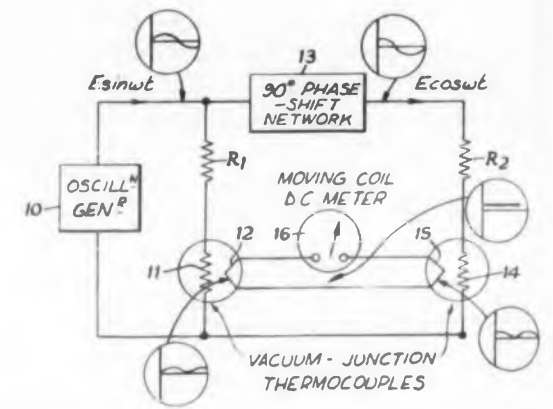

PROVEN PROCESSES

At Buckbee Mears, photomechanical techniques have been refined and applied to products in the electronic field.

Results are:

- Shadow masks for Color T.V. tubes
- Electroformed mesh for storage display tubes
- Micro Mesh Sieves for particle sizing
- Etched reticles in glass or metal
- Etched metal parts to rigid specifications
- Etched circuits, rigid board or flexible

All of these and many more products are possible through the application of proven processes at Buckbee Mears.

*For assistance with your problem,
call or write*

BUCKBEE MEARS CO.

ST. PAUL 1, MINNESOTA

CIRCLE 756 ON READER-SERVICE CARD

ELECTRONIC DESIGN • October 12, 1960

which also produces an output proportional to the square of the generator amplitude. The thermocouple outputs are in series-aiding so that the meter registers the amplitude of the signal.

Cathode Ray Tube

Patent No. 2,935,643, K. Slesinger. (Assigned to Motorola)

In a flat display tube, deflection defocusing is reduced by tapering the spac-

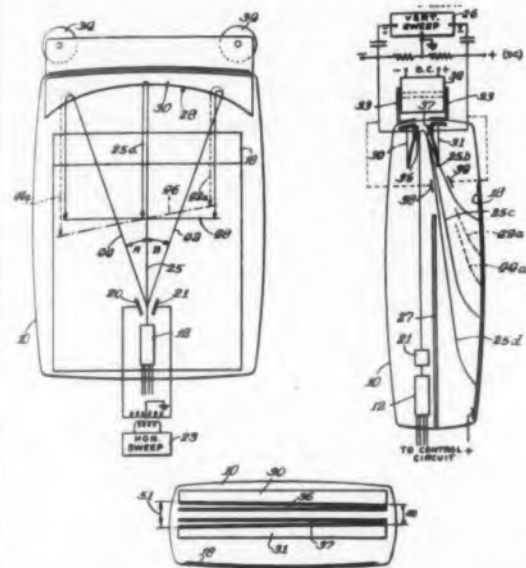

ing of the pole pieces of the electron mirror.

A crt is shown with horizontal deflection plates 38 and 39 and an electron mirror comprising parabolic pole pieces 30 and 31. However, the transit time for an electron along path 42 is longer than along path 44. This is compensated for by increasing the spacing on one side to reduce the mirror strength.

Additional decrease of deflection defocusing is obtained by tilting screen 18 until the trace is properly focused.

Multi-Electrode Tube Circuit

Patent No. 2,943,237, N. W. Bell. (Assigned to Bell and Howell Co.)

The circuit constrains the tube elements to conduct one at a time. The elements are connected to a common output through different transfer functions, thus providing different output voltages. When the output voltage comes closest to an established reference, the element that provided that voltage remains conducting, and the conduction state is not passed on to the next element.

Analab Type 1100-R Rack-Mounted Oscilloscope

NEW!

Only 7 inches high!
Accommodates all Analab
7-inch high Plug-ins and
all Analab Type 3000 Series
Oscilloscope Recording Cameras.

Type 1100-R, operating as a basic indicator or X-Y plotter, features:

- Identical X & Y amplifiers D-C to 500 kc; 40 mv/cm.
- Beam finder for trace location.
- Exceptional long-term d-c level and gain stability.
- New, high light output, high resolution, precision CRT, Type 5AQP-B
- Off-ground operation

PRICES

Type 1100-R Rack Scope \$385.00
(portable model Type 1100, same price)
Type 700 Dual-Channel,
Null-Readout Plug-in 310.00
Type 100 X-Y Plotter Plug-In 37.50
Delivery: Oscilloscopes, 30 days.
Cameras, one week.

Write for bulletins on Analab scopes and the new Type 3000 Series Oscilloscope Recording Cameras.

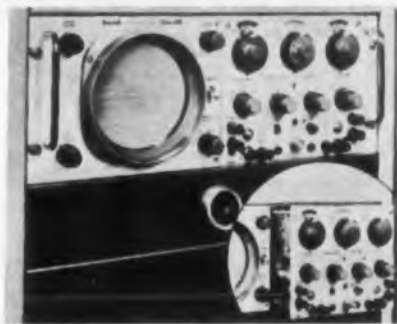

The New Analab Type 1100-R with Type 700 Plug-In. Type 1100-R accommodates all Analab 7-inch high Plug-Ins.



The New Analab Type 1100/700 Portable Oscilloscope with Type 3000 Oscilloscope Camera.

Analab
INSTRUMENT CORPORATION

30 CANFIELD ROAD, ESSEX COUNTY,
CEDAR GROVE, N. J., U. S. A.
Center 9-6500

ANALYtical LABORatory Instruments

CIRCLE 757 ON READER-SERVICE CARD



NO SPRINGS IN KEARFOTT'S RELIABLE SERVO VALVE

Kearfott's unique approach to electrohydraulic feedback amplification design has resulted in a high-performance miniature servo valve with just two moving parts. Ideally suited to missile, aircraft and industrial applications, these anti-clogging, 2-stage, 4-way selector valves provide high frequency response and proved reliability even with highly contaminated fluids and under conditions of extreme temperature. Titanium construction provides high strength-to-weight ratio.

KEARFOTT DIVISION
Little Falls, New Jersey



GENERAL PRECISION, INC.
Other Divisions GPL Librascope Link

CIRCLE 758 ON READER-SERVICE CARD



HOPKINS MINIATURE FEED-THRU CAPACITORS

- choice of 5 dielectrics
- immediate delivery on all types

You can choose Mylar* & Foil, Metallized Mylar, Polystyrene, Metallized Paper, or Hy-Therm. Pick the type best suited for your application. **Hermetically sealed** in non-magnetic tubular cases, units are unaffected by extremes of temperature, humidity and other environmental conditions. **Excellent attenuation characteristics**—reactance closely matches the curve of a perfect capacitor through all frequencies up to 1000 megacycles. **Immediate delivery**—Hopkins is tooled up to provide quick service on the dielectric you specify, in any quantity.

*DuPont
trade name

HOPKINS Engineering COMPANY

12900 Foothill Blvd., San Fernando, Calif. • Tel. EMpire 1-8691
CIRCLE 759 ON READER-SERVICE CARD



actual size

BRISTOL
chopper
helps put

... Every component in the U. S. Navy's TARTAR, newest supersonic surface-to-air guided missile must meet the highest standards for statistical reliability.

No exception is the Bristol Syncroverter* chopper used in the TARTAR's guidance system. The TARTAR, produced for the Bureau of Naval Weapons by Convair (Pomona) Division of General Dynamics Corporation, is slated to form the primary antiaircraft weapon aboard destroyers and secondary antiaircraft batteries aboard cruisers.

The Bristol Syncroverter chopper has a long history as a component in U. S. guided missiles. It's the ideal miniature electromechanical chopper for use in d-c analog computers or wherever utmost reliability is required.

BILLIONS OF OPERATIONS have been completed without a failure on Bristol's continuing life tests—aimed at improving the Syncroverter's already superlative characteristics. Just one sample: A group of five choppers, with 400 cps drive and 12v, 1 ma resistive contact load have been going for more than 26,000 hours without failure. That's more than 2.96 years continuous operation or more than 37 billion complete cycles!

No matter what your chopper requirements, we're sure you can find the model you need among the wide selection of Syncroverter choppers and high-speed relays available... including low-noise, external coil types. For complete data, write: The Bristol Company, Aircraft Equipment Division, 150 Bristol Road, Waterbury 20, Conn.

O. 13

*T.M. Reg. U. S. Pat. Off.

BRISTOL FINE PRECISION
INSTRUMENTS FOR OVER SEVENTY YEARS

Navy
TARTAR on
target



See us in Booth 508 at the National Electronics Conference

CIRCLE 760 ON READER-SERVICE CARD



BOOKS

International Directory of Radioisotopes, Vols. I and II

The International Atomic Energy Agency, Karnter Ring, Vienna I, Austria, Vol. I, 264 pp, Vol II, 213 pp. (Distributed by International Publications, Inc., 801 Third Ave., New York 22, N.Y.)

Compiled by the International Atomic Energy Agency, this directory is a suitable reference for the specialist in the fields of radioisotopes and radiation. The information provided includes specific gravity of the various compounds, sources of supply and prices, (when available). Volume I contains data on unprocessed and processed radioisotopes and solid radiation sources for specific applications, Volume II deals with the compounds carbon 14, hydrogen 3,

iodine 131, phosphorus 32 and sulphur 35. The first volume contains a glossary of terms, regulations for handling radioactive materials and procedures for obtaining radioisotopes.

The data are presented in tabular form with the radioisotopes listed in alphabetical order.

The Engineering Index

Engineering Index, Inc., 29 W. 39th St., New York 18, N.Y., 1,633 pp, \$70.

The Engineering Index, covering all phases of engineering activity, has annotations on over 3,000 articles in the present volume. The annotated reference items provide a comprehensive digest of information, published last year

**SAVE TIME
SAVE DOLLARS
SOLVE PROBLEMS**

Write today for

**STAR'S
STAINLESS HINGE**

**FACT
SHEET**



RIGHT OFF-THE-SHELF® . . .

- More than 30 different sizes and types including continuous or piano type hinges, butt hinges in blank, fixed-pin and loose-pin types, etc.
 - Wide range of variations for special applications.
- HELP YOURSELF from Star's new catalog of stainless steel hinges and other stainless steel fastenings.

Write, wire,
phone for your
copy **RIGHT NOW**



STAR STAINLESS SCREW CO.

**CORROSION
RESISTANT**

663 Union Blvd., Paterson 2, New Jersey
Telephone: CLifford 6-2300 • TWX-LTSFJ-1382
Direct New York phone: WIsconsin 7-6310
Direct Philadelphia phone: WAInut 5-3660

CIRCLE 761 ON READER-SERVICE CARD

ELECTRONIC DESIGN • October 12, 1960

in engineering magazines, special bulletins and government reports. A complete list of these publications is included.

Basic Carrier Telephony

David Talley, John F. Rider Publisher, Inc., 116 W. 14th St., New York 11, N.Y., 170 pp, \$5.75 (cloth binding), \$4.25 (soft cover).

This book is directed to the reader who is not a specialist in communications and must rapidly obtain information on carrier telephone systems and multiple signaling over single wires. Early chapters provide definitions and theory. The author goes on to discuss types of equipment and carrier system operations. Illustrations and diagrams are used; mathematics is kept at a minimum.

Electronic Business Machines

J. H. Leveson, Editor, Philosophical Library, New York, N.Y. 267 pp, \$15.

Intended as an introduction to industrial and commercial applications of

computers, this book might be used by the specialist seeking a broad coverage of this field. The topics covered include programming, sorting and flow charting, managerial problems involved in the choice of a computer, and accessory equipment. The material is taken from courses given at the Dundee Technical College in Scotland during June and July, 1958.

Directory of Nuclear Reactors, Volume II

The International Atomic Energy Agency, Karntner Ring, Vienna I, Austria. Distributed by National Agency for International Publications, Inc., 801 Third Ave., New York 22, N.Y. 346 pp, \$3.50.

Following Volume I on power reactors, this directory is concerned with research, test and experimental reactors now in operation or under construction. It provides details on reactor physics and data on core and fuel elements, heat transfer, control dimensions, shielding and cost for 88 reactors in 21 countries. Most of the information is provided in tabular form.

Next time, try the Alden "Plug-in" System!

Would you like to put prototypes together more quickly and efficiently?

Alden can help free you from the mechanical chores of your job so that you can spend more time doing what you're paid to do — design.

Write today for complete information on Alden plug-in components for electronic systems. Discover how Alden modular components can offer every design engineer an easier, faster and proven way to lay out and package systems from off-the-shelf components.



ALDEN

PRODUCTS COMPANY
10139 Main Street,
Brockton 64, Mass.

Design and production engineers who write on their company letterhead will receive Alden's big 250-page handbook, "Ideas, Techniques, and Designs".

CIRCLE 762 ON READER-SERVICE CARD



MINIATURE, HIGH PERFORMANCE MAGNETIC BRAKE CLUTCHES

Typical applications involving these Size 11 magnetic clutches, brake clutches, and brakes include service as output controls in mechanical differential computers, as motor brakes, and as speed changers and uncouplers. Kearfott can also provide magnetic clutches, brake clutches and brakes in various other sizes to suit desired applications. Unit illustrated features clutch torque of 4 in. oz. and brake torque of 6 in. oz.

KEARFOTT DIVISION
Little Falls, New Jersey

GENERAL PRECISION, INC.
Other Divisions: GPL, Librascope, Link

CIRCLE 763 ON READER-SERVICE CARD

DIMCO-GRAY SNAPSLIDE FASTENERS

PROVIDE VIBRATION-PROOF HOLDING
AND QUICK, FOOL-PROOF RELEASE!

APPROVED UNDER ARMY-NAVY STANDARDS

Here's a simple, easy means of securely fastening assemblies to withstand shock or vibration, and yet allow quick removal for inspection or repair. Instant snap action engages or releases fastener . . . no tools are required! After installation, fasteners never need adjustment . . . even with repeated use.

Three sizes available for different load requirements. Large and medium sizes are made of corrosion-resistant stainless steel. Small size is made of nickel-plated brass. Stock parts fit various thicknesses of flanges and mounting plates . . . special parts can also be supplied.

WRITE FOR YOUR FREE CATALOG



201 E. Sixth Street Dayton, Ohio
CIRCLE 764 ON READER-SERVICE CARD

To Help Solve Your Design Problems



The circled numbers on a Reader Service card get special attention from ELECTRONIC DESIGN. We know that you're interested in certain products—that you want more information to help you evaluate them. And we know that you want this information in a hurry.

When your card comes in, ELECTRONIC DESIGN's trained Reader Service staff types your name and address on special labels and sends them to the manufacturers you've designated. This is done within *One Day* of receipt. Inquiries going west are sent via air mail. The manufacturers affix the labels to envelopes. They enclose the information you need, and send it on its way to you.

So, when seeking more information about products you've seen in advertisements or in our New Products Section, simply circle the Reader Service numbers. It's the fast way. The easy way.

RUSSIAN TRANSLATIONS

J. George Adashko

Designing Electronic Relays

IN CALCULATING the parameters of electronic relays, such as shown in Fig. 1, it is usually assumed that the resistance of the plate load R_a is considerably less than the resistance of the coupling divider $R_{ag} + R_g$. This assumption simplifies the computation, since a change in $R_{ag} + R_g$, for a chosen R_a , does not greatly influence the operating conditions of the relay. In high-speed relays, however, it is necessary to make the coupling divider resistance small, since they help determine the slope of the pulse front. When the plate load and divider resistances are of the same order of magnitude, the latter also influence the relay operating conditions and the input pulse amplitude. The problem then becomes much more complicated and calls for obtaining approximate solutions of systems of higher-order equations.

We present here a relatively simple method for calculating the relay parameters for the case of approximately equal resistances in the plate and grid networks.

Plate Resistance Determines Relay Speed

For given values of network capacitances, the transient characteristic determining the speed of the relay depends on the equivalent resistances

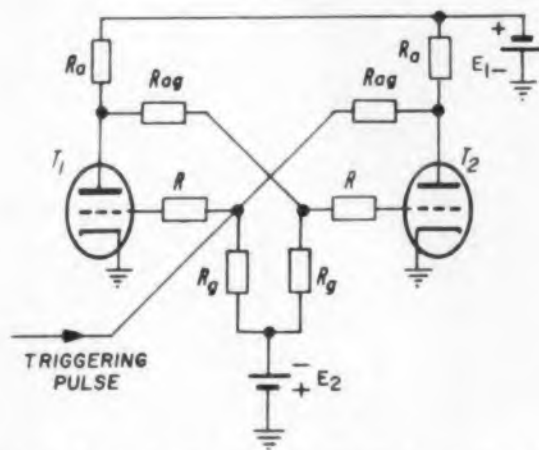

Fig. 1. Schematic of an electronic relay with voltage divider resistances R_{ag} and R_g .

of the plate circuit $R_{as} = R_a R_{i0} / (R_a + R_{i0})$ and of the grid circuit $R_{gs} = R_{ag} R_g / (R_{ag} + R_g)$, where R_{i0} is the dc resistance of the tube.

The quantities R_{as} and R_{gs} depend on the required rise time of the output network

$$\tau_f = \frac{R_a R_{i0}}{R_a + R_{i0}} C' \quad (1)$$

and on the time between two control pulses

$$T = 2.3C'' \frac{R_{ag} R_g}{R_{ag} + R_g} \quad (2)$$

In these equations, C' consists of the output capacitance of the tube, the wiring capacitance, and the capacitance of the load connected to the output circuit of the relay. C'' consists of the input capacitance of the tube, the wiring capacitance, the capacitance of the source of control pulses connected to the input of the relay, and the coupling capacitance connected in parallel with R_{ag} .

For a specified value of the voltage drop across the plate load, U_a , and for a known source voltage E_1 and tube type, we determine the network parameters R_a , R_{ag} , R_g and E_2 when $R_a \approx R_{ag} + R_g$.

Fig. 2a shows the equivalent circuit for the cut-off tube, while Fig. 2b shows the circuit when the tube conducts in one arm of the relay. The following symbols are used in the equivalent circuits: I and $U_g^{(+)}$ are the current flowing

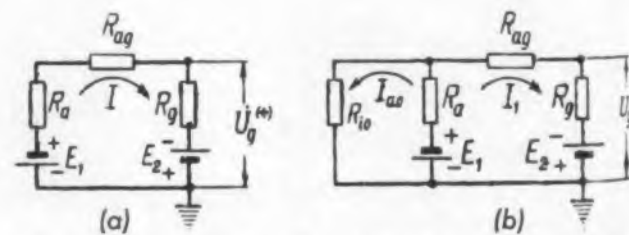



Fig. 2. (a) Equivalent circuit when one tube is cut off (b) Equivalent circuit when one tube is conducting.

FLEXLEAD**SILICONE
RUBBER****LEAD
WIRE**

When your project requires a high temperature lead wire with excellent electricals, corona resistance, flexibility, oil and weather resistance, and rated for continuous use at 200°C, try Markel FLEXLEAD Silicone Rubber Insulated Lead Wire. Silicone Rubber is precision-extruded over stranded conductors of silver-plated copper wire to make FLEXLEAD SR, newest product in the *Line of Excellence*. Ask for prices and data.

L. FRANK **MARKEL** & SONS

1 SOURCE for EXCELLENCE in
Insulating Tubings, Sleeveings, and Lead Wire

NORRISTOWN, PENNSYLVANIA
CIRCLE 767 ON READER-SERVICE CARD

ELECTRONIC DESIGN • October 12, 1960

through the coupling divider and the voltage across the divider output with the tube cut-off; I_{a0} is the current flowing through the tube with zero potential on the grid; I_1 and $U_g^{(-)}$ are the current flowing through the coupling divider and the voltage at the divider output with the tube conducting.

The resistance of the plate load is determined from Eq. 1

$$R_a = \frac{\tau_f R_{i0}}{R_{i0} C' - \tau_f} \quad (3)$$

The voltage at the coupling divider output is, with the tube cut-off

$$U_g^{(+)} = IR_g - E_2 = \frac{R_g (E_1 + E_2)}{R_a + R_{a0} + R_g} - E_2; \quad (4)$$

and with the tube conducting

$$U_g^{(-)} = E_2 - I_1 R_g = E_2 - \frac{E_1 R_{i0} + E_2 (R_a + R_{i0})}{(R_{a0} + R_g) (R_a + R_{i0}) + R_a R_{i0}} R_g \quad (5)$$

From the operating principle of the relay it follows that for stable operation, the voltage $|U_g^{(+)}|$ at the output of the divider with the tube cut-off should be greater than or equal to zero; and the voltage $|U_g^{(-)}|$ with the tube conducting should be greater than U_c , where U_c is the tube cut-off voltage.

For $U_g^{(+)}$ to be equal to zero, the voltage drop across R_g must be numerically equal to the voltage of the source E_2 , that is

$$\frac{R_g (E_1 + E_2)}{R_a + R_{a0} + R_g} = E_2. \quad (6)$$

Consequently

$$R_g = \frac{E_2 (R_a + R_{a0} + R_g)}{E_1 + E_2} \quad (7)$$

For $U_g^{(-)}$ to be equal to U_c , the voltage drop across R_g should be less than the source voltage E_2 by an amount equal to U_c .

Substituting in Eq. 5, U_c instead of $U_g^{(-)}$, inserting R_g from Eq. 7, and making some transformations, we obtain

$$R_{a0} + R_a = \frac{U_c R_a R_{i0} (E_1 + E_2) + E_2^2 R_a^2}{E_1 E_2 R_a - U_c (E_1 + E_2) (R_a + R_{i0})} \quad (8)$$

We shall find it convenient later to determine the limiting value of E_2 , below which the resistance of the coupling divider $R_{a0} + R_a$ grows to infinity. From Eq. 8 it follows that this occurs when the source voltage E_2 is

$$E_2 = \frac{U_c E_1 (R_a + R_{i0})}{E_1 R_a - U_c (R_a + R_{i0})} \quad (9)$$

The voltage drop U_a across the plate load is given by the difference between the voltage drop $(I_{a0} + I_{a1})R_a$ with the tube conducting, and the



N-83
ACTUAL
SIZE

NEW G-E GLOW LAMP (NE-83) EFFECTIVELY HANDLES CURRENTS UP TO 10 m.a.

Here's a General Electric Glow Lamp that operates at currents many times higher than most glow lamps. At 10 milliamperes, the NE-83 will hold its breakdown and maintaining voltage within five volts of initial for an average life of 500 hours. Life will be correspondingly higher at lower currents.

Although this product is too new for us to establish voltage regulation specifications, it shows considerable promise for this application in the 1 to 10 milliamperere range.

Leads of the NE-83 are plated for easier soldering. It contains a mild radioactive additive to reduce breakdown voltage in darkness.

DIRECT CURRENT SPECIFICATIONS

| | |
|---|--------------------|
| Breakdown Voltage | 60-100 volts d-c |
| Maintaining Voltage at 10.0 m.a. | avg. 65 volts d-c* |
| Design Current | 10.0 m.a. d-c |
| Life (at 10 m.a. d-c for an average change of 5 volts in breakdown and maintaining voltage) | 500 hours |
| *Average after 100 hours burning at rated current. Individual lots may vary from average. | |

There's a General Electric Glow Lamp to suit every circuitry need. For the latest information on Glow Lamps as Circuit Components and Indicators, write for 4-page Bulletin #3-0193. General Electric Co., Miniature Lamp Dept. M-038 Nela Park, Cleveland 12, Ohio.

Progress Is Our Most Important Product

GENERAL  ELECTRIC

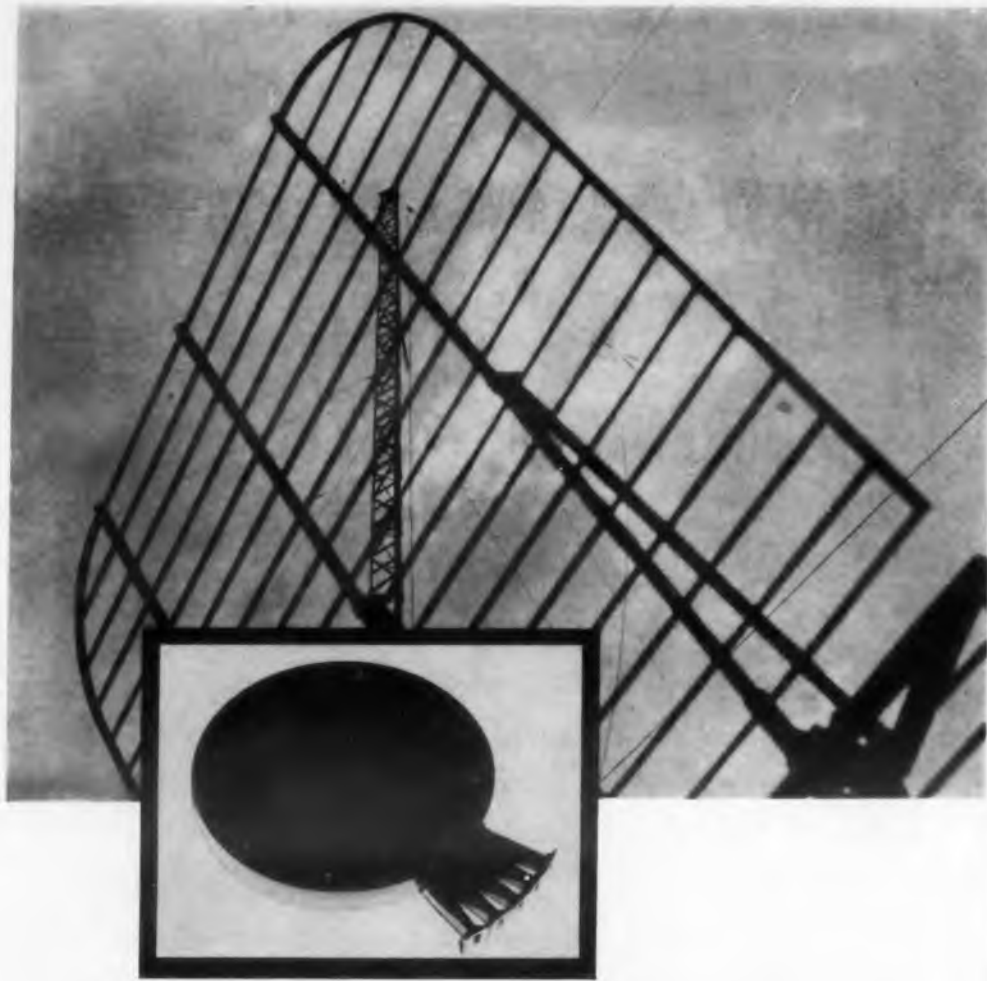

First Luneberg Lens Antenna with FIVE separate outputs...

another design problem solved by HRB-SINGER

In this instance—the application is classified—the problem was to design five separate outputs on the X-band Luneberg Lens Antenna. Through the facilities of HRB's antenna research laboratories, this new feed system was developed with excellent results. The high isolation (in excess of 20 db) and low sidelobe characteristics attained make the antenna ideal for application where it is desirable to receive signals from the same area simultaneously on more than one receiver. Due to its high isolation, each feed can be used as a separate antenna or in various combinations to meet specific customer applications.

This multiple-feed achievement is only one of many remarkable developments taking place at HRB. Years of experience in the development of highly complex and versatile antenna designs provide a diversified capability to solve your specific antenna problem. Investigate by writing Dept. E-10. A series of comprehensive data sheets describing the HRB-SINGER antenna capability is yours for the asking.

ELECTRONIC RESEARCH AND DEVELOPMENT in the areas of:
 Communications • Countermeasures • Reconnaissance • Intelligence • Human Factors • Weapons Systems Studies and Analysis • Nuclear Physics • Antenna Systems • Astrophysics • Operations Research.

HRB A SUBSIDIARY OF THE SINGER MANUFACTURING COMPANY
 Science Park, State College, Pa.



CIRCLE 769 ON READER-SERVICE CARD

RUSSIAN TRANSLATIONS

voltage IR_a with the tube cut-off

$$U_a = (I_{a0} + I_1 - I) R_a$$

or

$$U_a = \left(\frac{E_1 - I_1 R_a}{R_a + R_{i0}} + \frac{E_1 R_{i0} + E_2 (R_a + R_{i0})}{(R_{a0} + R_g) (R_a + R_{i0}) + R_a R_{i0}} - \frac{E_1 + E_2}{R_a + R_{a0} + R_g} \right) R_a.$$

After transformations, we obtain

$$U_a = \frac{E_1 R_a (R_{a0} + R_g)^2 - E_2 R_a^2 (R_{a0} + R_g)}{(R_a + R_{i0}) (R_{a0} + R_g)^2 + R_a (R_a + 2R_{i0}) (R_{a0} + R_g) + R_a^2 R_{i0}}; \quad (10)$$

Hence

$$R_{a0} + R_g = \frac{B + \sqrt{B^2 + 4U_a R_a R_{i0} A}}{2A} \quad (11)$$

where

$$A = E_1 - U_a \frac{R_a + R_{i0}}{R_a}$$

and

$$B = E_2 R_a + U_a (R_a + 2R_{i0})$$

It follows from Eq. 11 that the resistance $R_{a0} + R_g$ will tend to infinity when the source voltage E_1 is

$$E_1 = \frac{U_a (R_a + R_{i0})}{R_a}. \quad (12)$$

Eqs. 8 and 11 make it possible to determine the source E_2 and the divider resistance $R_{a0} + R_g$ that yield the required values of $U_g^{(-)}$ and U_a .

Divider Resistance Solved for Graphically

Because it is difficult to solve Eqs. 8 and 11 algebraically, it is advisable to use graphic solutions. When Eqs. 9 and 11 are plotted with $R_{a0} + R_g$ and E_2 as coordinates, the intersection of the curves, that is, their simultaneous solution, yields the values of $R_{a0} + R_g$ and the source voltage E_2 . Then, using Eqs. 7 and 2, it is possible to determine R_g and R_{a0} separately. R_g is determined next. If it is found that its value exceeds the one specified, other relay elements are chosen and the calculation must be repeated. In particular, a tube with large transconductance and smaller internal resistance must be selected, or, if possible, the voltage E_1 must be increased.

In calculating the relay parameters it is necessary to take account of the spread in tube parameters, and also of the variation of E_1 and E_2 if unstabilized supply sources are used. Let us denote the increase in voltage by E'_1 and E'_2 , and a decrease in voltage by $-E''_1$ and E''_2 .

From an analysis of the foregoing equations, it follows that the choice of the relay parameters depends on the way in which the supply-voltage



**Choice of
189
standard capacitors**

iei

originator of miniature aluminum foil electrolytic capacitors, offers these polar units in subminiature sizes. Capacities from 2 to 2000 microfarads, voltage range from 3 to 50 WVDC.

APD series, axial lead capacitors, in 13 case sizes offering 91 standard units.

APS series, single end units, in 14 case sizes covering 98 standard choices, a total selection of one hundred eighty-nine (189) choices.

Many other types of aluminum foil capacitors are available as Specials . . . including intermediate voltages, closer capacity tolerances, non-polar, and multiple section capacitors.

FOR: Computers • Transistor Radios • Audio Crossover Networks • Hi-Fi Tuners and Amplifiers • Tape Recorders • Mobile Communications and every application where space and weight saving, combined with reliable performance and long life, are of prime importance. Write for Bulletin 2641.

International Electronics Industries, Inc.
 Box 9036-V, Nashville, Tenn.

iei

AN **sps** COMPANY

where reliability replaces probability

CIRCLE 770 ON READER-SERVICE CARD

ELECTRONIC DESIGN • October 12, 1960

EXACTING CONSTANT TEMPERATURE TASKS

such as

- ✓ Semiconductor Testing
- ✓ Critical Incubations
- ✓ Guidance Components Testing
- ✓ Plastics Conditioning

REQUIRE A

Treas

CONSTANT TEMPERATURE CABINET WITH

guaranteed temperature uniformity as close as $\pm 0.90^\circ\text{C}$... Long lasting stainless steel interiors ... Electronic control.



You can choose from 60 models...all sizes...all temperature ranges...all guaranteed for 5 years and backed by 56 years of proved performance...

Write for Bulletin 302

Treas

Built By

SINCE 1920
PRECISION SCIENTIFIC CO. **PS**

3751 West Cortland St., Chicago 47, Ill.

Local Offices In
Chicago • Cleveland • Houston
New York • Philadelphia • San Francisco

CIRCLE 771 ON READER-SERVICE CARD
ELECTRONIC DESIGN • October 12, 1960

sources E_1 and E_2 vary. The variations of these sources fall into three groups:

- a) The voltages E_1 and E_2 change proportionally in the same direction.
- b) The voltages E_1 and E_2 change in the same direction, but E_1 changes more rapidly than E_2 .
- c) The voltages E_1 and E_2 change in the same direction, but E_1 changes more slowly than E_2 .

In the first and second cases, the relay parameters are calculated for reduced supply-source voltages. However, when calculating the relay conditions for the second case, account must be taken of the change in R_{i0} , due to the tube current. As a result of redistribution of the voltages, this current will appear when the source voltages rise.

Fig. 3 shows the equivalent network of one arm of the relay in the presence of grid current in the tube. In this circuit, the voltage between the grid and the cathode of the tube is

$$U_{gk} = \frac{r_{gk} [E_1 R_g - E_2 (R_a + R_{ag})]}{(R + r_{gk}) (R_a + R_{ag} + R_g) + R_g (R_a + R_{ag})} \quad (13)$$

where r_{gk} is the resistance of the grid-cathode circuit and R is the resistance connected to match the relay input with the output of the control-pulse source, ($R \ll R_{g0}$).

In the third case, the relay will be stable in operation if $U_g^{(+)} = 0$ and the specified value of U_a is obtained at the maximum voltages E_1 and E_2 , while $U_g^{(-)} = U_0$ is obtained at minimum source voltages E_1 and E_2 . It should be recognized that here the resistance R_g (Eq. 7) is determined at a maximum E_1 and E_2 , while $U_g^{(-)}$ is determined at the minimum values of these voltages. Consequently, for this case Eq. 8 cannot be used and must be replaced by the following equation

$$U_0 (E_1' + E_2') + E_2' \frac{(E_1'' + E_2'' \frac{R_a}{R_{i0}}) - E_1' E_2''}{(E_1' E_2'' + E_2' U_0 - E_1' U_0) \frac{R_a + R_{i0}}{R_a R_{i0}} - \frac{E_2' E_1''}{R_a}} \quad (14)$$

(Continued on page 212)

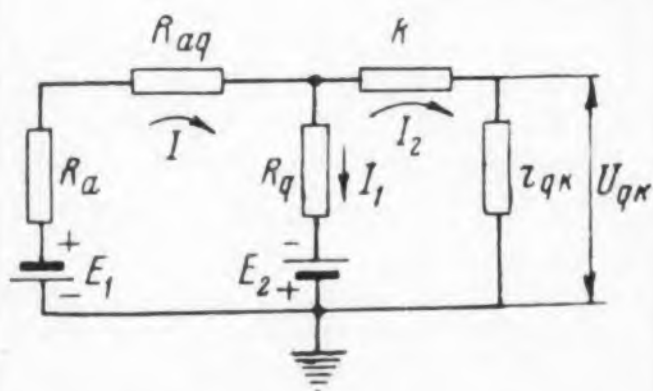
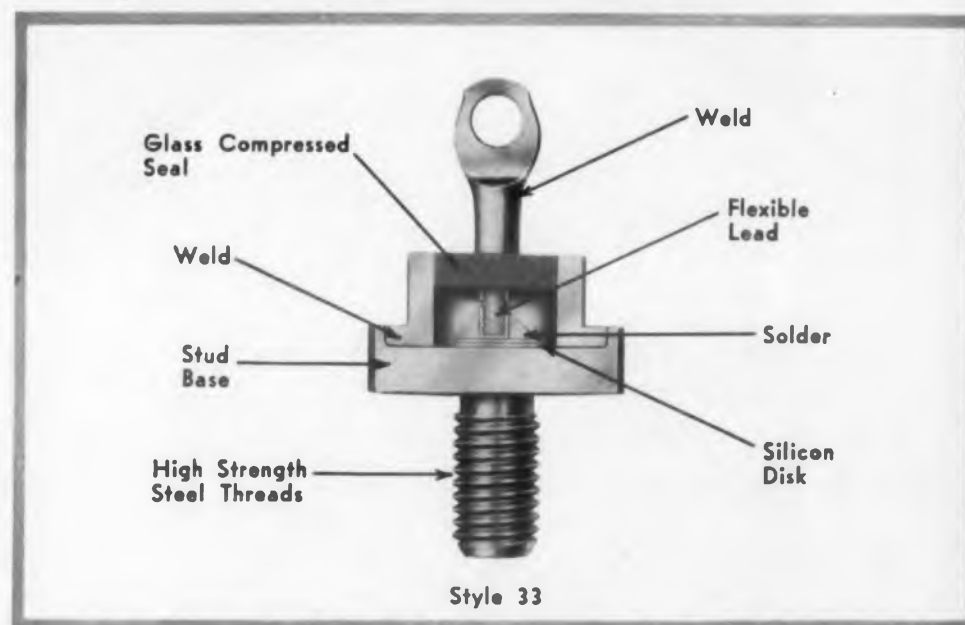

Fig. 3. Equivalent circuit for one relay arm with grid current flow present.

Specify reliable all STEEL construction Silicon Rectifiers

by
SYNTRON



SYNTRON'S exclusive all STEEL

assembly—high
tensile strength
100% welded
construction

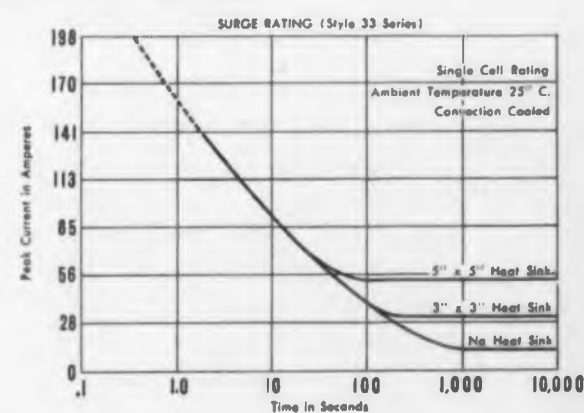

100 inch pound mounting torque for maximum heat transfer—less corrosion—greater reliability—better contact. Mechanically and electrically superior.

Write for information and specifications

SYNTRON RECTIFIER DIVISION

SUBSIDIARY OF LINK BELT COMPANY

283 Lexington Ave.

Homer City, Penna.

Sales Engineers in: New York, Chicago, Los Angeles and Canada
Canadian Manufacturing Plant: Syntron (Canada) Ltd., Stone Creek, Ontario
Export Representative: Dage Corporation, 219 E. 44th Street, New York, N. Y.
Sales and Engineering Representatives: Robert O. Whitesell and Associates, 6620 East Washington Street, Indianapolis 15, Indiana, Offices in Cleveland, Dayton and Cincinnati

CIRCLE 772 ON READER-SERVICE CARD

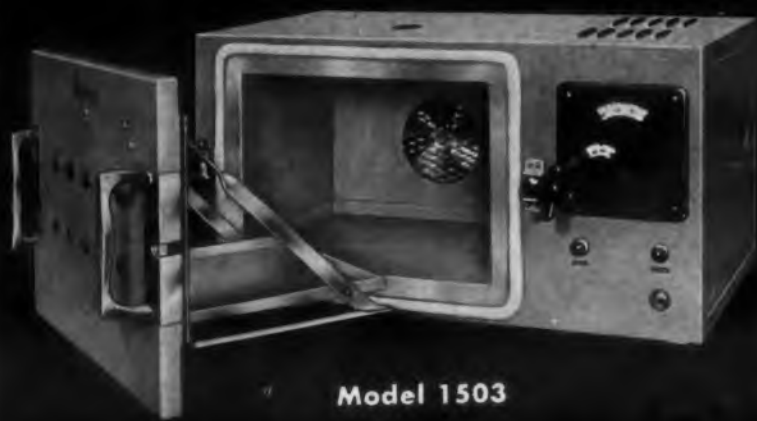

Model 1503

HIGH-LOW TEST CHAMBER... an ECONOMICAL SPACE SAVER!

New Hotpack table top test chamber delivers temperature range from -100°F to 400°F within $\pm 1^{\circ}\text{F}$

This light, compact Hi-Lo test chamber has been specially engineered by Hotpack for rapid cycling of electronic components undergoing quick pull-down thermal shock tests and other environmental conditioning. Convenient, portable model 1503 offers a complete stainless steel chamber and pullout drawer. A time-saving program-controller — releasing valuable man hours for other jobs — is optional. Liquid CO_2 refrigerant is rapidly dispersed by a high velocity blower... brings chamber temperature down to -100°F in minutes! Above or below ambient you're in complete control of Hotpack's Hi-Lo chamber. Independent adjustable thermostat sets high or low control points and automatic Limitstat breaks heater circuit should temperature exceed setting. Maximum heat retention is assured by double-wall, glass wool insulation. And heating time is reduced by a double-bank of nickel chromium wire heaters (which also provides uniform thermal distribution!). Hotpack's Hi-Lo chamber offers the ultimate in economy, dependability and space-saving, measures 28" wide, 24" deep and 15" high. Other models up to 61" x 50" x 53".

For Hi-Lo bulletin write to:



5065 COTTMAN AVENUE • PHILADELPHIA 35, PA.

CIRCLE 779 ON READER-SERVICE CARD

RUSSIAN TRANSLATIONS

Here R_{10} is determined in the presence of a grid current, which appears for the same reason as before, but at reduced source voltages.

Example

By way of an example, we determine the parameters of a relay using a 6N8 tube which has to meet the following specifications:

- 1) Duration of the transient characteristic front of the output network $\tau_f = 0.16 \mu\text{sec}$;
- 2) The relay should operate in the interval between the control pulses at the relay input equal to $T = 0.36 \mu\text{sec}$, and
- 3) The voltage drop across the plate load should be $U_a = 40 \text{ v}$ at a source voltage $E_1 = 200 \text{ v}$.

Furthermore, the relay will be designed for fluctuations in E_1 and E_2 for the three previously considered cases. Thus, for first case (a) E_1 and E_2 both change by ± 5 per cent; in the second case (b) the changes are ± 10 per cent for E_1 and ± 5 per cent for E_2 ; in the third case (c) the changes are ± 5 per cent for E_1 and ± 10 per cent for E_2 .

Using Eq. 1, we first determine the resistance of the plate load. Capacitance C' equals $40 \mu\text{f}$ and the mean value of R_{10} is 8,000 ohms.

Then

$$R_a = \frac{\tau_f R_{10}}{R_{10} C' - \tau_f} = 8 \text{ K}$$

From Eq. 2, we determine R_{gs} . If we assume $C'' = 35 \mu\text{f}$, then

$$R_{gs} = \frac{T}{2.3 C''} = 4.35 \text{ K}$$

Case a. We determine the limiting value of E_2 , using Eq. 9. For values less than this, Eqs. 8 and 11 cannot be solved for. We assume that for the 6N8 tube at $E_1 = 200 \text{ v}$, $U_2 = 12 \text{ v} \pm 28$ per cent $= 15 \text{ v}$. From Eq. 9, we obtain $E_2 = 35 \text{ v}$.

Specifying values of E_2'' in Eqs. 8 and 11 of 50, 60 and 65 v, and $E_1' = 190 \text{ v}$, we obtain three points each for the curves (from Eq. 8). That is, $R_{ag} + R_g$ equals 21.2, 15, 13.6 K and from Eq. 11, $R_{ag} + R_g$ equals 14, 14.7 and 15 K.

Plotting these points as in Fig. 4 we obtain

$$R_{ag} + R_g = 15 \text{ K and } E_2'' = 60 \text{ v}$$

Using Eq. 7 we find that $R_g = 5.5 \text{ K}$, $R_{ag} = 9.5 \text{ K}$, and $R_{gs} = 3.48 \text{ K}$. We see that R_{gs} is less than specified by the conditions of the computation (4.35 K), which means that the relay will operate at a higher speed than expected.

Let us next verify the operating conditions of

Malco IS YOUR BEST SOURCE FOR SOLDERING LUGS TERMINALS PRINTED CIRCUIT HARDWARE



HERE'S WHY:

- Specialized high production techniques afford lowest possible unit cost.

- Precision tooling, rigid quality control assure tolerances to critical specifications.

- Ample stocks of over 1000 different parts permit prompt delivery.

- Malco specializes in a complete line of small stampings for Radio-TV, electrical/electronic and automotive industries.

- Our line includes terminals and printed circuit hardware in loose or in chain form for automatic insertion.

Let Malco show you how you can save on production time and costs. Contact us today.

REQUEST
BULLETIN
592



Malco MANUFACTURING COMPANY

4027 W. LAKE ST. • CHICAGO 24, ILL.
CIRCLE 780 ON READER-SERVICE CARD

be SMART

be sure you have the latest data on one of the industry's most complete lines...



LABORATORY FOR ELECTRONICS
COMPUTER PRODUCTS DIVISION
1079 COMMONWEALTH AVE.,
BOSTON, MASS., Dept. 1012-E

Please send me a copy of the new
Ultrasonic Delay Line catalog

Name _____

Title _____

Company _____

Division _____

Address _____

CIRCLE 781 ON READER-SERVICE CARD

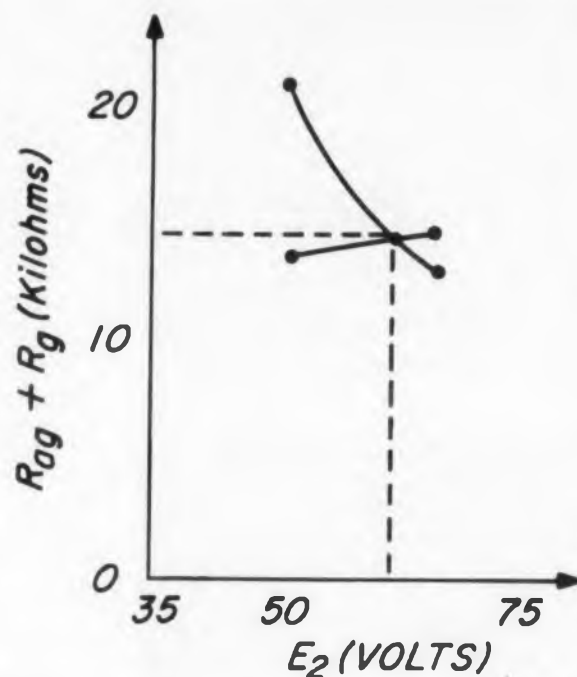

Fig. 4. Graphical solution for value of $(R_{ag} + R_g)$.

the relay (Eqs. 4, 5, and 10). We obtain

$$\begin{aligned} U_g^{(+)} &= 0 \\ 15 < U_g^{(-)} < 16.6 \text{ v} \\ 41.5 < U_a < 45.3 \text{ v} \end{aligned}$$

Case b. After analogous calculations, we obtain $R_{ag} + R_g = 16 \text{ K}$, $R_g = 6 \text{ K}$, and $R_{ag} = 10 \text{ K}$, and $R_{gs} = 3.75 \text{ K}$. Using Eq. 13 for $R = 0.1 \text{ K}$ and $R_{gK} = 1.5 \text{ K}$, we determine the voltage U_{gK} produced when the voltages E_1 and E_2 have their maximum values. That is:

$$U_{gK} \approx 15 \text{ v}$$

From the plate-grid characteristics of the 6N8 tube we find that $R_{i0} = 6 \text{ K}$. Again verifying the operation of the relay (Eqs. 4, 5, and 10), we obtain

$$\begin{aligned} 0 < U_g^{(+)} < 1.5 \text{ v} \\ 15 < U_g^{(-)} < 17 \text{ v} \\ 40.2 < U_a < 41.5 \text{ v} \end{aligned}$$

Case c. Using Eq. 14, we find that $R_{ag} + R_g = 17 \text{ K}$.

We then obtain

$$R_g = \frac{E_2' (R_a + R_{ag} + R_g)}{E_1' + E_2'} = 6 \text{ K} \quad (14f)$$

This yields $R_{ag} = 11 \text{ K}$ and $R_{gs} = 3.9 \text{ K}$. A check on the operation of the relay shows that

$$\begin{aligned} 0 < U_g^{(+)} < 0.6 \text{ v} \\ -15 < U_g^{(-)} < 19.5 \text{ v} \\ 52.6 < U_a < 49 \text{ v} \end{aligned}$$

Translated from an article "Design of Electronic Relays" by V. I. Shpakov, *Elektrosvyaz*, No. 6, 1960, pp 18-23.

NEW

DC driven CHOPPERS



What... No AC?

In transistorized d-c amplifiers, the use of a d-c driven Chopper instead of the usual a-c drive, removes an additional source of stray a-c signals from the critical chassis wiring. The 94 cycle chopping rate also eliminates the null off-sets resulting from the use of a 60 cycle chopping rate.

In portable d-c amplifiers, the advantages of low level operation plus a 94 cycle chopping rate are now available, using a 12, or 24 volt battery as the chopper drive source.

Write for Catalog 554.



STEVENS INCORPORATED ARNOLD

QUALITY SINCE 1943

7 ELKINS ST., SOUTH BOSTON 27, MASS.

S/A-20-1/2

CIRCLE 782 ON READER-SERVICE CARD



TOROIDS AND FILTERS ... TAILOR MADE ... DELIVERED IN DAYS

Need quick delivery on *special* toroidal components?

We can usually design and deliver samples of toroidal coils and filters to your exact specifications on short notice.

We are equipped to produce toroids and toroidal filters with outstanding temperature stability to either commercial or military requirements.

Whether your application is communications, missiles or data reduction systems, our facilities backed by a quarter of a century of service to industry assure you of a solution ... fast. Many engineers find our folder "Toroids and Filters" helpful in developing specifications. A copy is yours for the asking.



Barker & Williamson, Inc.

Canal St., Bristol, Pa.

Specialists in designing and building equipment to operating specifications

A few other B&W products: I. P. TRANSFORMERS • COMMUNICATIONS EQUIPMENT • AUDIO PHASE SHIFT NETWORKS • TEST EQUIPMENT • and many types of standard and special electronic components and equipment.

CIRCLE 773 ON READER-SERVICE CARD

GERMAN ABSTRACTS

E. Brenner

Twin Tee Filters

THE TWIN Tee, Fig. 1, is a convenient RC filter, particularly for low frequency application where inductances must generally be avoided.

Denoting the frequency where the transmission is zero by f_0 and assuming that r_1 and r_2 are chosen from impedance level criteria given below, one chooses

$$r_3 = r_1 r_2 / (r_1 + r_2) \quad (1)$$

The value of each capacitor is calculated from

$$C_n = 1 / (2\pi f_0 r_n); \quad n = 1, 2, 3 \quad (2)$$

The complex open circuit voltage transfer function is then

$$\frac{V_2}{V_1} \frac{1 - u^2}{1 - u^2 + j2u/a} \quad (3)$$

where $u = f/f_0$ and a is the symmetry factor

$$a = r_2 / (r_1 + r_2) \quad (4)$$

When $a = 0.5$, the transmission curve has log-

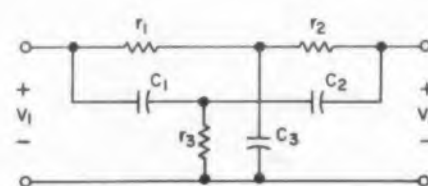

Fig. 1. Twin Tee filter.

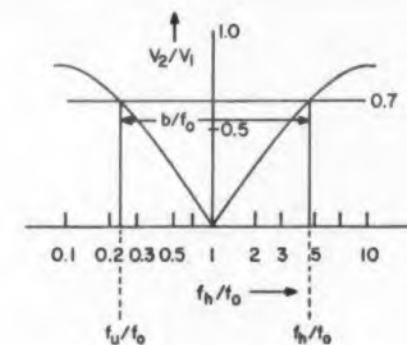

Fig. 2. Voltage transfer function of symmetrical twin Tee.

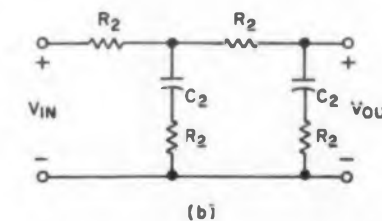
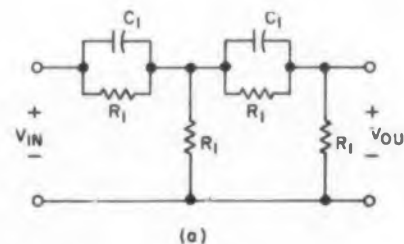

Fig. 3. Cascaded network used for narrowing bandwidth. (a) Double lead network, (b) double lag network.

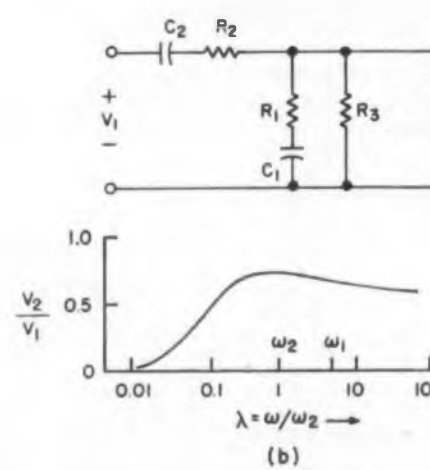
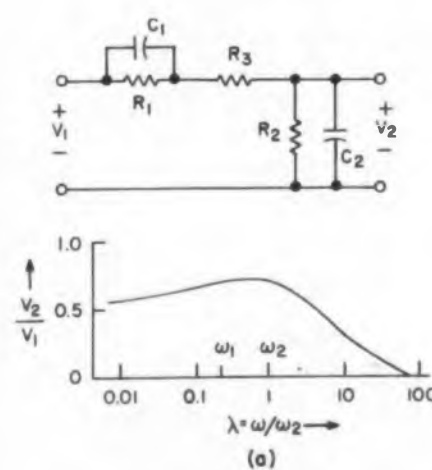

Fig. 4. Network used in cascade to convert twin Tee to (a) low-pass filter, (b) high-pass filter.

arithmetic symmetry about f_0 , Fig. 2. The bandwidth b , as well as the upper and lower band limits f_h, f_L , defined in Fig. 2, are given by

$$b = \frac{f_0}{a} [2(1 + a^2)^{1/2}] \quad (5)$$

$$f_{h,L} = \frac{f_0}{a} [\pm 1 + (1 + a^2)^{1/2}] \quad (6)$$

For tuning, r_3 is generally adjustable. One may deviate from Eq. 1 to obtain finite transmission at f_0 . In addition, either C_3 or r_1/r_2 with $(r_1 + r_2)$ equal to a constant, is adjustable.

When the filter is terminated in $R_T \gg r_1 + r_2$, the input impedance is

$$Z = \frac{1}{2}(r_1 + r_2)(1 - a)(1 - j) \text{ at } f = f_0 \quad (7)$$

$$Z_i \approx \frac{1}{2}(r_1 + r_2)(a - a^2) \text{ for } f \gg f_0 \quad (8)$$

$$Z_i \approx r_1 + r_2 + R_T \text{ for } f \ll f_0 \quad (9)$$

When the filter is supplied by a source whose output resistance is R_s , the filter output impedance Z_o is

$$Z_o = \frac{1}{2}(r_1 + r_2)a(1 - j) \text{ at } f = f_0 \quad (10)$$

$$\frac{1}{Z_o} \approx \frac{2}{r_1} + \frac{2}{r_2} + \frac{1}{R_s} \text{ for } f \gg f_0 \quad (11)$$

$$Z_o \approx r_1 + r_2 + R_s \text{ for } f \ll f_0 \quad (12)$$

While the transmission property, Eq. 3, is based on a filter supplied by a zero impedance source and terminated in an open circuit, the following inequalities are sufficient for practical purposes

$$6R_s \leq (r_1 + r_2)(a - a^2) \quad (13)$$

$$R_T \geq 3(r_1 + r_2) \quad (14)$$

If R_s and R_T are given, one chooses

$$(r_1 + r_2)^2 = 2R_s R_T / (a - a^2) \quad (15)$$

In any event, it is necessary that

$$\frac{R_T}{R_s} \geq \frac{20}{a - a^2} \quad (16)$$

The sharpness of resonance can be improved by using a double lead network, Fig. 3a, and/or a double lag network, Fig. 3b, in cascade with buffer stages between networks.

To obtain high or low pass filters, RC sections shown in Figs. 4a and b respectively are cascaded (with buffer stages).

For Fig. 4a

$$2R_2 = 3R_1; \omega_1 = 1/R_1 C_1; \omega_2 = 1/R_2 C_2 \quad (17)$$

$$4R_3 = R_1; \omega_2 = 5\omega_1; \omega/\omega_2 = \lambda$$

For Fig. 4b

$$3R_2 = 2R_1; \omega_1 = 1/R_1 C_1; \omega_2 = 1/R_2 C_2 \quad (18)$$

$$R_3 = 4R_1; 5\omega_2 = \omega_1; \omega/\omega_2 = \lambda$$

The original paper also discusses active filters, that is, frequency selective amplifiers using RC filters.

From an article by H. G. Jungmeister and H. Y. König, Archiv der Elektrischen Übertragung, Vol. 14, No. 7, July 1960, pp 317-324.

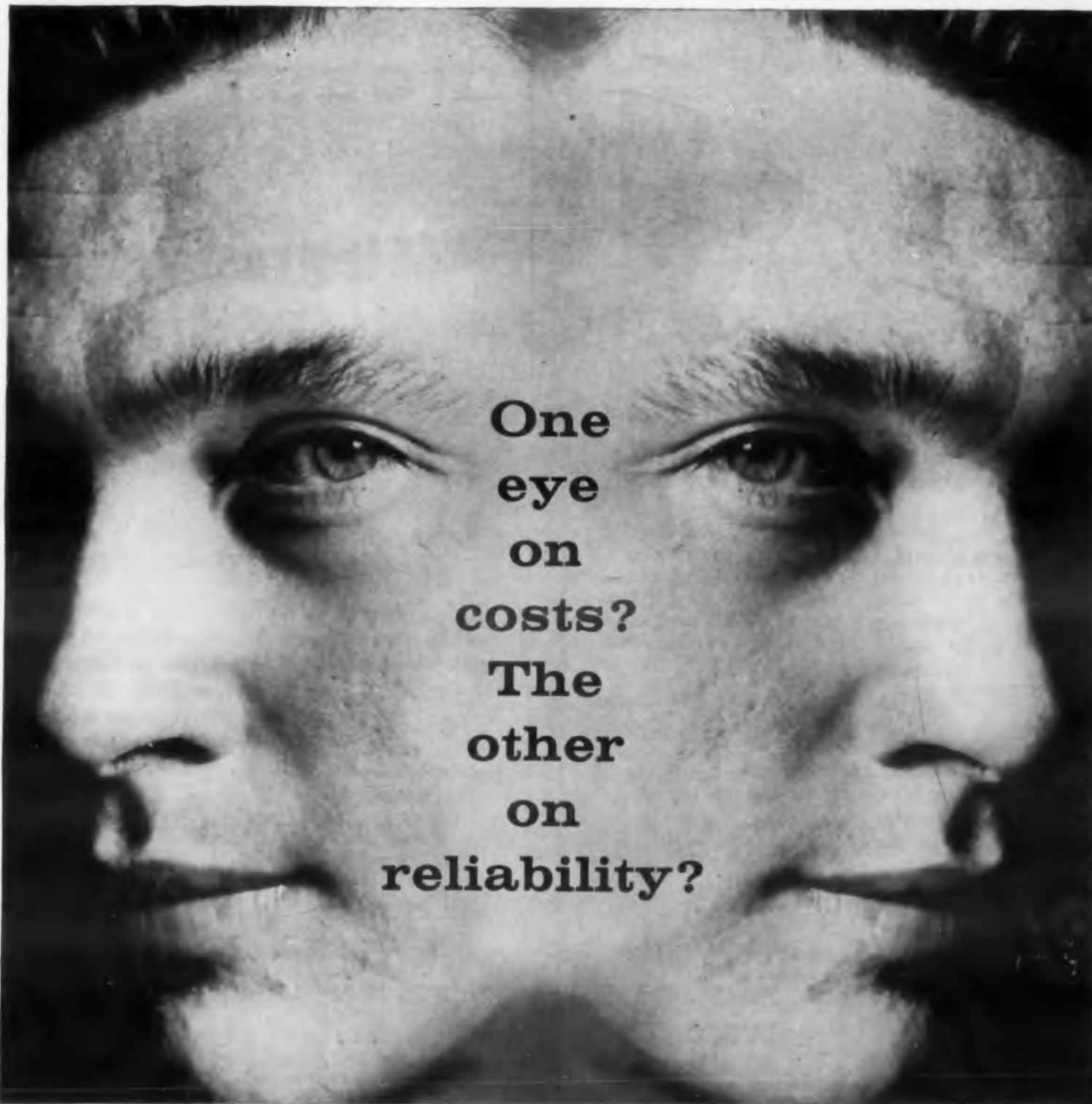

**One
eye
on
costs?
The
other
on
reliability?**

Now! A sealed pot at a regular commercial pot price!



Model PT 3/4

Dust! Corrosion! Moisture! Fumes! All are foes of commercial and industrial equipment, yet ordinarily costly to keep out. Now, however, Waters introduces a new $\frac{3}{4}$ " plastic case pot — the PT $\frac{3}{4}$ — with sealed pot reliability at a price no higher than many regular commercial pots! Even meets tough military specs (MIL-R-19A, MIL-R-19/1A)! "O" ring shaft seal and complete internal sealing virtually eliminate environmental problems. Provides the same protection as encapsulation in less space. Resistance range (ohms), $\pm 5\%$, 1 to 20,000. Electrical and functional rotation, 355° without stops; 300° with stops. Dissipates 1.5W at 40°C. Torque, .3 to 6 oz./in. Weight, .02 lbs. Available with split or plain bushings, $\frac{1}{4}$ " or $\frac{3}{8}$ " in diameter. Write for Bulletin PT 760.



WATERS MANUFACTURING, INC. • WAYLAND • MASS.

POTENTIOMETERS • COIL FORMS • POT HOODS • PANEL MOUNTS • TORQUE WATCH GAUGES • C'TROL METER/CONTROLLER • INSTRUMENTS
CIRCLE 774 ON READER-SERVICE CARD

**THIS
CAN'T
HAPPEN**

when you use

**BUD
Chassis Slides**



This man obviously doesn't have Bud Chassis Slides in his rack. Besides losing his temper he is certainly damaging the delicate components because his slides don't operate smoothly. If you want slides that perform properly under all conditions, be sure to specify BUD Chassis Slides.

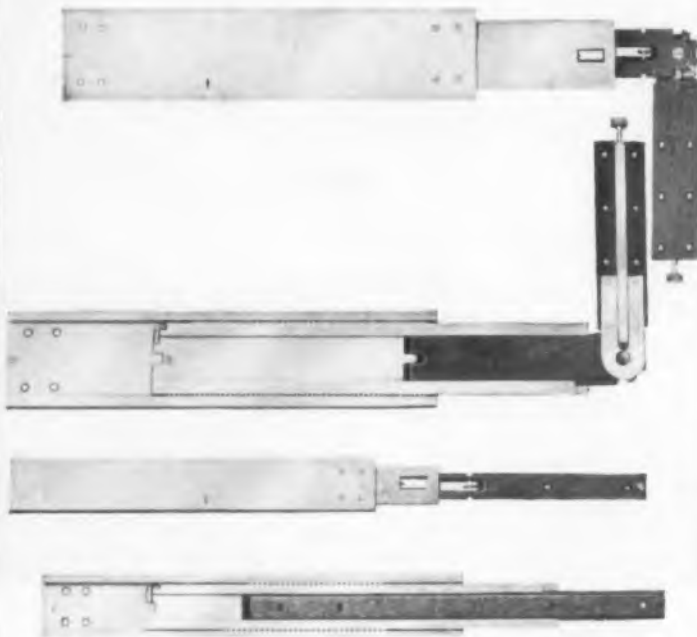

There are two types of Bud Slides. The "SI" line is for industrial or military purposes where exceptional use requirements or adherence to MIL specifications are necessary. And the "SC" line designed for commercial applications. Each is available in three types and three sizes to fit standard relay rack. All are of exceptional quality and workmanship with features that make them exceptionally versatile.

See the BUD Chassis Slides at your authorized Bud Distributor or write for Bulletin S-6060.



BUD RADIO, INC.
Cleveland 3, Ohio
Dept. ECD

CIRCLE 775 ON READER-SERVICE CARD

ELECTRONIC DESIGN
DIGEST
of recent papers and literature

Electrostatic and Magnetic-Drum Storage Combined in 2,000-Channel Analyzer

A 2,000-channel analyzer, for neutron spectroscopy combines electrostatic and magnetic-drum storage to obtain a high-speed, large-capacity memory device.

The analyzer, used with Columbia University's synchrocyclotron, has a channel width of 0.1 μ sec and a dead time of 0.8 μ sec. This is provided by the electrostatic storage system. Data are transferred to the magnetic drum system during the 14,667 μ sec of waiting time between data-collection periods.

The simplified block diagram of the analyzer

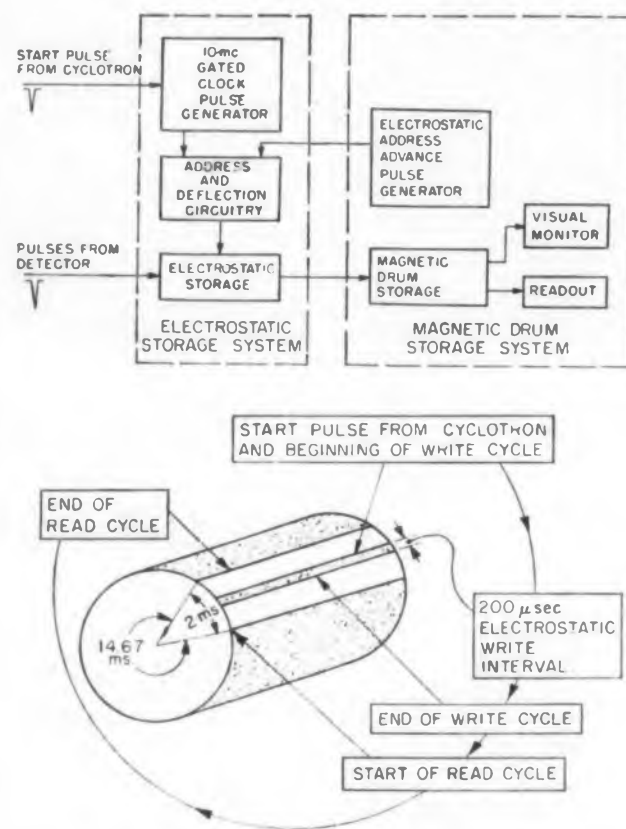

Fig. 1. (Top) Simplified blok diagram of 2,000-channel analyzer; (Bottom) Sequence of data handling. Data recorded by electrostatic system during the "write" period is transferred to magnetic drum system during "read" period.

and the sequence of data handling with respect to drum position are shown in Figs. 1a and 1b.

The initial cyclotron pulse initiates a train of 10-mc pulses. These cause the "address" generator and storage-tube circuits to step sequentially through the 2,000 addresses—or points on the electrostatic tube face where data are stored.

When the "writing cycle" is completed, and the drum in the proper position, the drum sends the first of 2,000 address advance pulses to the address and deflection circuits, and the 2,000 addresses are "interrogated."

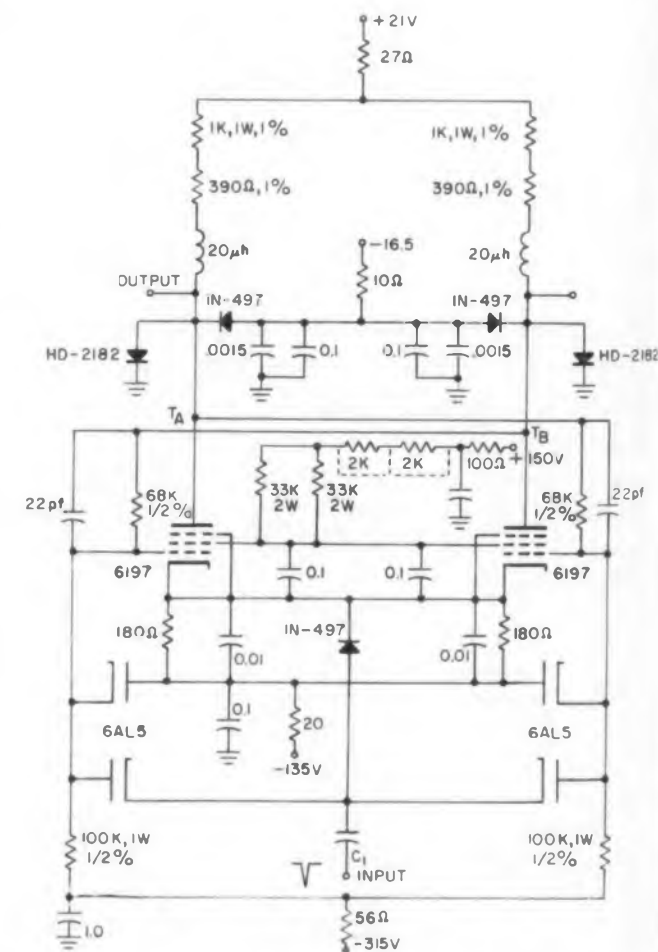

Fig. 2. Basic 10-mc flip-flop circuit used in 2,000-channel analyzer.

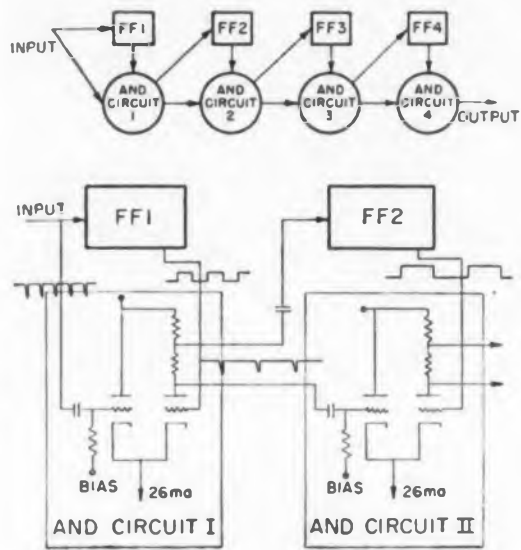

Fig. 3. (Top) Triggering flip-flop chain through AND circuits reduces carry time, and hence delay. (Bottom) Simplified schematic of two stages of flip-flops triggered through AND circuits.

The pattern of 2,000 addresses on the tube face is in a rectangular array of 64 by 32 dots, or 2,048 in total, of which only 2,000 are used to store data.

The deflection voltage is a staircase waveform. During the write cycle, the address pattern is traced out in 200 μ sec (assuming 0.1 μ sec channels). Each step is triggered by a pulse from a 10-mc gated oscillator.

During the "read cycle" the same 2,000 dots are traversed again. This time, each step corresponds to an address advance pulse from the drum. The rate during read is 7 or 8 μ sec per channel, which is consistent with the drum's ability to accept data. During the read cycle, each spot is interrogated, and if a "1" was stored during the write cycle, an appropriate signal is returned to the drum and the "1" erased.

The basic circuit used in the scaling and counting stages was the 10-mc flip-flop shown in Fig. 2. This circuit also was used whenever a steep gating waveform was required.

Conventionally a flip-flop chain is triggered by differentiating the signal from one plate to the flip-flop and applying this signal to the succeeding flip-flop. However, when steep waveforms are used, this can introduce a delay per stage of about one-half the rise time of the driving signal.

This difficulty was overcome by using "AND" circuits to detect the state of the flip-flop before the trigger occurred. As shown in Fig. 3a, the trigger propagated down the line of "AND" circuits that were coupled to the flip-flops.

Digested from "A 2,000-Channel Analyzer for Neutron Spectroscopy," by J. Hahn and W. W. Havens, Jr., of Columbia University. Their paper appeared in "The Review of Scientific Instruments," May, 1960.

Important facts to know about Laminated Plastics

LAMINATED PLASTICS *What they are, where they can be used*

Taylor laminated plastics, also known as reinforced plastics, are thermosetting-type materials formed by impregnating paper, cotton cloth, asbestos, glass cloth, nylon or other base materials with synthetic resins and fusing them into sheets, rods, tubes and special shapes under heat and pressure. These materials exhibit a valuable combination of characteristics, including high electrical insulation resistance, structural strength, strength-to-weight ratio, and resistance to chemical reaction; also adaptability to fabricating operations.

Types of laminated plastics made by Taylor
There are four basic types of Taylor laminated plastics commonly specified and used throughout industry today. They are as follows:



Phenolic Laminates. Paper, cotton fabric or mat, asbestos, glass cloth or nylon bases impregnated with phenol formaldehyde resins. These provide strength and rigidity, dimensional stability, resistance to heat, chemical resistance, and good dielectric characteristics. Some Taylor grades are excellent basic materials for gears, cams, pinions, bearings and other mechanical applications. Others are widely used in terminal boards, switchgear, circuit breakers, switches, electrical appliances and motors. Also in radios, television equipment and other electronic devices; and in missiles as nose cones, exhaust nozzles, and combustion chamber liners.



Melamine Laminates. Glass cloth or cotton fabric impregnated with melamine formaldehyde resin. Taylor melamine laminates have superior mechanical strength and are especially desirable for their arc-resistant qualities. Good flame and heat resistance, good resistance to the corrosive effects of alkalis and most other common solvents, besides other favorable characteristics. Typical applications include arc barriers, switchboard panels, and circuit-breaker parts in electrical installations.



Silicone Laminates. Continuous-filament woven glass fabric impregnated with a silicone resin. These laminates combine high heat resistance (up to 500°F. continuous) with excellent electrical and mechanical properties. They are primarily used in high-temperature electrical applications and high-frequency radio equipment.

Epoxy Laminates. Continuous-filament woven glass fabric or paper impregnated with epoxy resin. Glass-fabric grades are designed for use in applications requiring high humidity-resistance, good chemical resistance,

CIRCLE 776 ON READER-SERVICE CARD



and strength retention at elevated temperatures. Paper grades are used under high-humidity conditions where resistance to acids and alkalis is required. Both grades are characterized by good dielectric strength, low dielectric losses, and high insulation resistance even following severe humidity conditions.

Recent technical advances in the bonding of various metallic and nonmetallic materials to laminated plastics have opened up new design opportunities. It is now possible to bond virtually any compatible material with a laminated plastic to form a composite which combines the advantages of both. One of the first composite materials was a copper-clad laminate used for printed circuits. More recent composite laminates, usually manufactured to customer specification, include the following: Taylorite[®] vulcanized fibre-clad, rubber-clad, asbestos-clad, aluminum-clad, beryllium-copper-clad, stainless-steel-clad, magnesium-clad, and silver-and-gold-clad. Any one of these materials can be sandwiched between sheets of laminates, too, and can be molded to fit specific requirements.

Send for complete information about any or all of these Taylor laminates. And remember Taylor's new selection guide will simplify your problems in choosing the right laminate for your specific application. Taylor Fibre Co., Norristown 48, Pa.

Taylor
LAMINATED PLASTICS VULCANIZED FIBRE

FIRM FOOTING

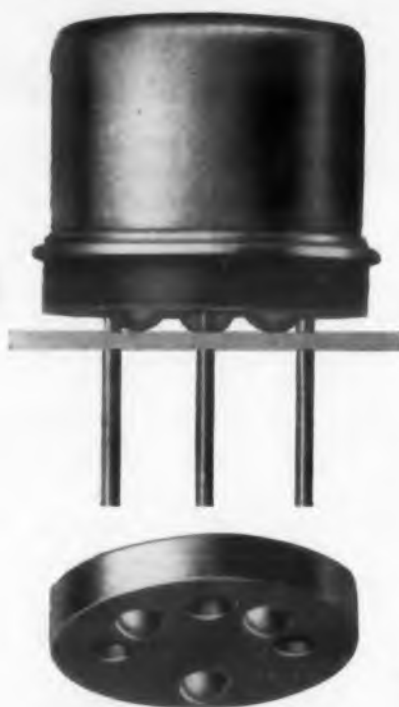

FOR TRANSISTORS

Transipads put a little

extra security into printed-circuit assemblies. For a cost you count in pennies. A Transipad mounting is rock solid. It eliminates strain on delicate leads, provides vibration-proof separation between them. It isolates the transistor case from contact with printed conductors. And, perhaps most important, it provides a built-in air space to dissipate the heat of soldering (how many transistors have you lost lately through heat shock?). Transipads come in sizes and styles to fit most transistor types; some will convert lead arrangements from in-line to pin-circle, or vice-versa; others will widen lead spacing. Samples and drawings are yours for the asking. A note or a phone call will bring them.



THE MILTON ROSS COMPANY

236 Jacksonville Road, Hatboro, Pa. Phone: OSborne 2-0551

CIRCLE 777 ON READER-SERVICE CARD

DIGEST

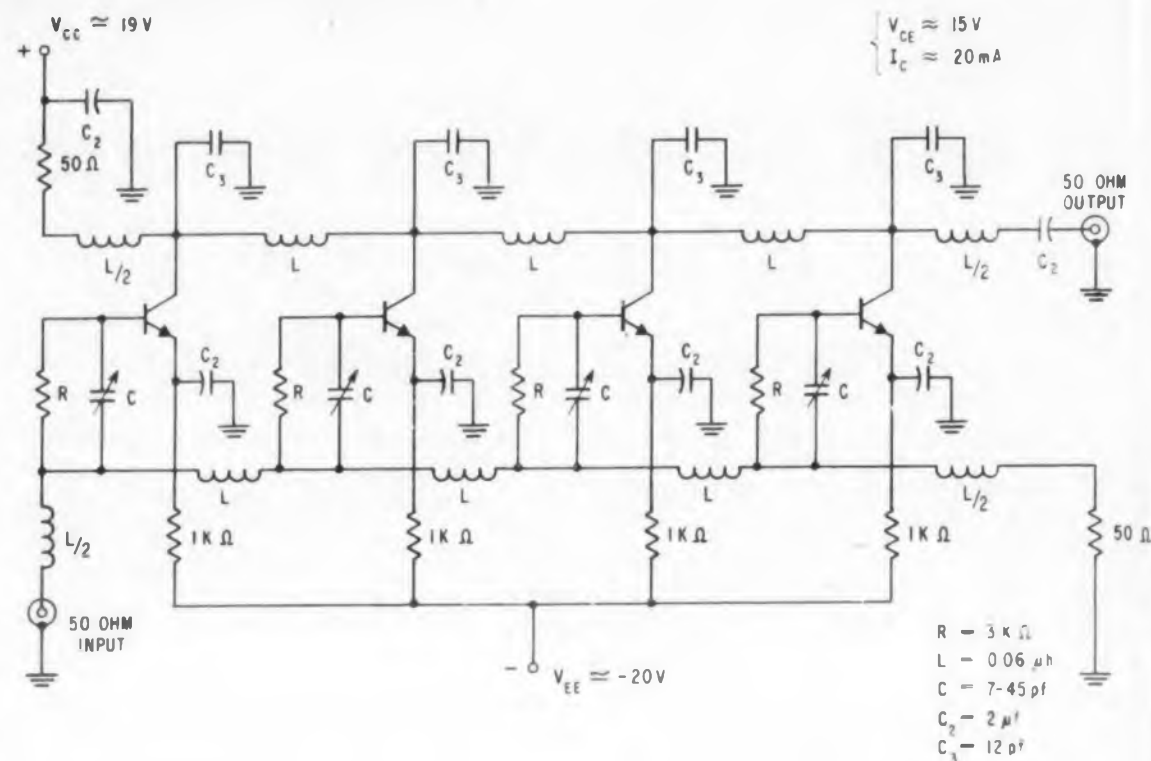

Designing 175-Mc Amplifier Using Silicon Mesa Transistors

TRANSISTORS can be used effectively as wideband distributed amplifiers. However, one difficulty with many silicon mesa transistors is that the hybrid- π equivalent circuit is not valid through a wide frequency range. This complicates the design of delay lines.

The following scheme was found useful with the 2N706, which has an alpha cut-off frequency greater than 500 mc. The scheme consists of compensating the 6-db-per-octave drop in current gain at higher frequencies by a 6-db-per-octave increase in base current.

The amplifier shown was designed so the impedance of the input and output lines was 50 ohms. Each stage has a base and a collector delay line made up of a T section with series inductance $L/2$ and shunt capacitance.

The amplifier gave a rise time of 3 nsec, and an output of about 4 v peak-to-peak with no distortion.

The design procedure is as follows:

1) Select Z_0 , the characteristic impedance of the T section, and f_c , the corner frequency (about

Four-stage,
wideband distributed amplifier
compensates for 6 db per octave
drop in current
gain by 6 db per octave
increase in base current.



LEADS THE INDUSTRY IN ULTRA-HIGH-POWER DUPLEXING

with both **GAS DISCHARGE**
and **FERRITE DUPLEXERS**

Selecting a duplexer for high-power applications involves consideration of peak power, average power, transmit loss, receive loss, expected life, and versatility of operation.

All Microwave Associates high power gas duplexers utilize special window structures for optimum switching efficiency without sacrifice in low-level loss characteristics. These windows insure reliable, long-life performance. Both our gas and ferrite duplexers may be operated over very broad bandwidths at the common microwave frequencies.

Exceptionally complete ultra-high-power design and test equipment is utilized by our Research and Production Departments. Each duplexer is fully tested at maximum rated power before shipment.

We have extensive experience in designing and manufacturing high-power duplexer devices and are interested in working on newest ultra-high-power applications. We are now developing ultra-high-power duplexers for more efficient switching at UHF, L, C, and S bands.

Our Applications Engineers would like to discuss the future of high power duplexing with you.

| Frequency Band | Duplexer Type | Peak Power | Average Power | Transmit Loss (max.) | Receive Loss (max.) | Bandwidth |
|----------------|---------------|------------|---------------|----------------------|---------------------|--|
| UHF | Gas | 5 Mw | 300 Kw | 0.1 db | 0.4 db | Tunable 10% Nominal 4% Nominal |
| | Gas | 25 Mw | 75 Kw | 0.1 db | 0.4 db | |
| L | Gas | 25 Mw | 50 Kw | 0.1 db | 0.5 db | |
| S | Gas | 6 Mw | 30 Kw | 0.1 db | 0.7 db | |
| | Ferrite | 3 Mw | 15 Kw | 0.5 db | 0.9 db | |
| C | Gas | 5 Mw | 5 Kw | 0.1 db | 0.7 db | |
| | Ferrite | 5 Mw | 7.5 Kw | 0.3 db | 0.8 db | |
| X | Gas | 500 Kw | 500 W | 0.2 db | 1.0 db | |
| | Ferrite | 1 Mw | 1 Kw | 0.3 db | 0.9 db | |
| Ku | Gas | 150 Kw | 150 W | 0.2 db | 1.0 db | |
| | Ferrite | 150 Kw | 150 W | 0.3 db | 0.9 db | |
| Ka | Ferrite | 75 Kw | 75 W | 0.3 db | 1.1 db | 4% Nominal |

All Microwave Associates duplexers incorporate low-loss, long-life, receiver protectors which guarantee crystal protection over wide temperature ranges and under extreme environmental conditions.

*The duplexer receiver loss includes the loss due to receiver protector TR tubes.

At each frequency band of the microwave spectrum, Microwave Associates has devices for efficient switching of high power.



MICROWAVE ASSOCIATES, INC.

BURLINGTON, MASSACHUSETTS

Western Union FAX-TWX: Burlington, Mass., 942 • BRowing 2-3000

CIRCLE 778 ON READER-SERVICE CARD

1.5 times the upper frequency of interest).

2) Calculate L and C from

$$L = Z_0 / \pi f_c$$

and

$$C = 1 / \pi f_c Z_0$$

3) Select R to give the proper corner frequency from

$$1/2\pi RC = f_t / \beta_o$$

where f_t = frequency at which $h_{fe} = 1$, and β_o = low-frequency current gain.

The low-frequency gain per stage of the amplifier is given by:

$$e_o/e_g = n\beta_o R_L / 2R$$

where n = number of transistors per stage.

In practice, C is usually a trimmer, and adjustment is made with the help of a sweep generator. The collector capacitance need not be a trimmer, but C_{ob} and stray wiring capacitance (about 5 pf) should be considered.

Digested from "A 175 MC Distributed Amplifier Using Silicon Mesa Transistors," by Paul J. Beneteau and Larry Blaser, Fairchild Semiconductor Corp., Mountain View, Calif.

ELECTRONIC DESIGN

Printed

—PRECISELY

for Design Engineers

Just as you take measures to achieve precision in your work, ELECTRONIC DESIGN also works to bring you accuracy. The magazine maintains a policy which demands truth in every word printed in its pages. The result is editorial data that you can rely on, and factual advertising to help you select products. ELECTRONIC DESIGN's Accuracy Policy is contained in every issue.

Strongly supporting its policy, ELECTRONIC DESIGN takes exacting care to verify all editorial material. Articles are checked repeatedly before they go to press. If an error does appear, steps are taken to correct it in the very next issue. Concerning advertising, the manufacturer must prove any product claim questioned by a reader. If the claim is not proved, the magazine reserves the right to reject the advertising from future issues.

ELECTRONIC DESIGN assumes full responsibility for accuracy. But you can help, too, by reporting any misstatement you find. You're encouraged to do so. It is through such a dual guardianship—readers and editors—that ELECTRONIC DESIGN can guarantee you highest reliability . . . from cover to cover.

REPORT BRIEFS

Printed Circuits

Two independent methods for producing printed circuits and components were developed. Both utilized the idea of placing layers of conductive and resistive materials on ceramic substrates and of selectively etching these layers to produce the components. In one method, the conductive, resistive, and dielectric layers were deposited by vacuum evaporation techniques; in the other, a combination of chemical deposition techniques, such as hot spraying and electroplating, were employed. Conductive lines, connectors, and resistors formed by these methods were capable of prolonged operation, without hermetic sealing, at 500 C. *Performing Research on New Approaches to Printed Circuitry*, Haloid Co., Rochester, N.Y., Nov. 1957, 85 pp, Microfilm \$4.80, Photocopy \$13.80. Order PB 137520 from Library of Congress, Washington 25, D.C.

Magnetic Computing System

Early results are presented of the study of some of the major technical areas concerned with computer logic in all-magnetic circuits. A logical development of the circuit approach as presently conceived and the circuitry of a two-input, three-output module are given. A system design using approximately 750 such modules is briefly outlined. This system has the capability of five-decimal-digit addition, subtraction, and multiplication under keyboard control. *Research on the Realizability of an All Magnetic Computing System*, H. D. Crane, Stamford Research Institute, Menlo Park, Calif., Oct. 1959, 48 pp, Microfilm \$3.30, Photocopy \$7.80. Order PB 145285 from Library of Congress, Washington 25, D.C.

Microwave Low-Noise Amplifiers

Preliminary experimental results are presented on the operation of a microwave third-harmonic generator. In the experimental model, the input signal frequency is about 1,000 mc, and the impedances presented to the fundamental, second, and third harmonic currents are independently variable. The inability to obtain the large predicted values of gain-bandwidth products at higher operating frequencies is tentatively attributed to diode lead inductance. *Application of Semiconductor Diodes to Microwave Low-Noise Amplifiers and Harmonic Generators*, J. C. Greene, E. Kraemer, et al., Airborne Instruments Laboratory, Melville, N.Y., April 1959, 23 pp, Microfilm \$2.70, Photocopy \$4.80. Order PB 145807 from Library of Congress, Washington 25, D.C.

Parametric Amplifiers

In an effort to improve the reception of low level radio frequency signals encountered in satellite and space vehicle tracking, work has been carried out on the investigation and development of a number of specialized forms of parametric amplifiers. Units described in this report together with preliminary design and performance characteristics include a strip circuit adaptation of the resonant quarter-wave form of amplifier and an antenna-amplifier in which the resonant elements are integrated within a half-wave dipole antenna. *Parametric Amplification Techniques for Use in Satellite Tracking Systems, Albert D. Frost and Donald W. Melvin, Antenna Systems Laboratory, University of New Hampshire, Durham, N.H., Nov. 1959, 21 pp, Microfilm \$2.70, Photocopy \$4.80. Order PB 145284 from Library of Congress, Washington 25, D.C.*

Microminiaturization

Major programs in electronic microminiaturization currently being pursued by education, Governmental, and industrial laboratories are described. The techniques reviewed include: (1) welding of miniature commercial parts, (2) soldering of miniature commercial parts to miniature etched-wiring boards, (3) riser-wire connection of wafer microelements, (4) printing of multicomponent circuits on single ceramic substrates and (5) forming of both integrated and functional solid circuits. An extensive bibliography is also included. *Status of Electronic Microminiaturization: Feb. 1960, Norman J. Doctor, Diamond Ordnance Fuze Labs., Washington, D.C., March, 1960, 29 pp, \$0.75. Order PB 161674 from OTS, Washington 25, D.C.*

Antenna Patterns

The general problem of transmission between antennas is solved in terms of field theory formulas for self and mutual impedance. Simple formulas for the radiation patterns of antennas on spheres, cylinders, and cones are derived in terms of the solution for a plane wave incident on a sphere. Various uniqueness theorems are obtained together with practical applications. A general eigen-function expansion for the reaction is derived and used to give the transmission between antennas in a waveguide or near a sphere. *Antenna Analysis in General with Specific Reference to Frequency Independent Antennas, V. H. Rumsey, Electronics Research Laboratory, University of Calif., Berkeley, Calif., Feb. 1959, 31 pp, Microfilm \$3.00, Photocopy \$6.30. Order PB 145497 from Library of Congress, Washington 25, D.C.*



Information on Vernistat a.c. potentiometers for design engineers

A FISTFUL OF CONTROL



To call the Vernistat a precision a.c. potentiometer is correct . . . to say that it has high linearity, high resolution, and low phase shift is also correct . . . but none of this goes far enough. This servo design component can also be defined as: A precision circuit element that multiplies input voltage by some function of shaft position . . . (this gladdens the hearts of computer people). An essentially nondissipative voltage divider that stays cool. A pot with its own built-in transformer . . .

Even the circuit diagram (shown below) leaves a lot unsaid. As you see, it fails to show the Vernistat's continuous rotation (up to 30 turns!) that stretches the voltage scale for super-accuracy. It ignores the fact that Vernistat has continuous rotation, that is, it goes forward instead of backward to its initial position.

This unique component deserves a long, searching look from every designer of accurate electronic equipment. You can use it to achieve phase inversion, step up voltage, generate mathematical functions. It eliminates isolation amplifiers in analog equipment . . . can be used as a low-impedance source, attenuator, feedback control. Find out how the Vernistat can help make your electronic systems more simple, compact, accurate and reliable by writing to the address below.

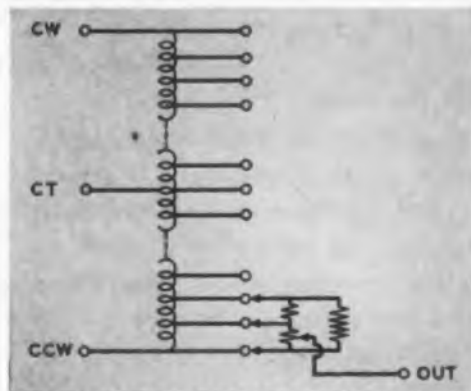

Get on the mailing list for Vernistat Design Reports. Packed with ideas. Ask us.

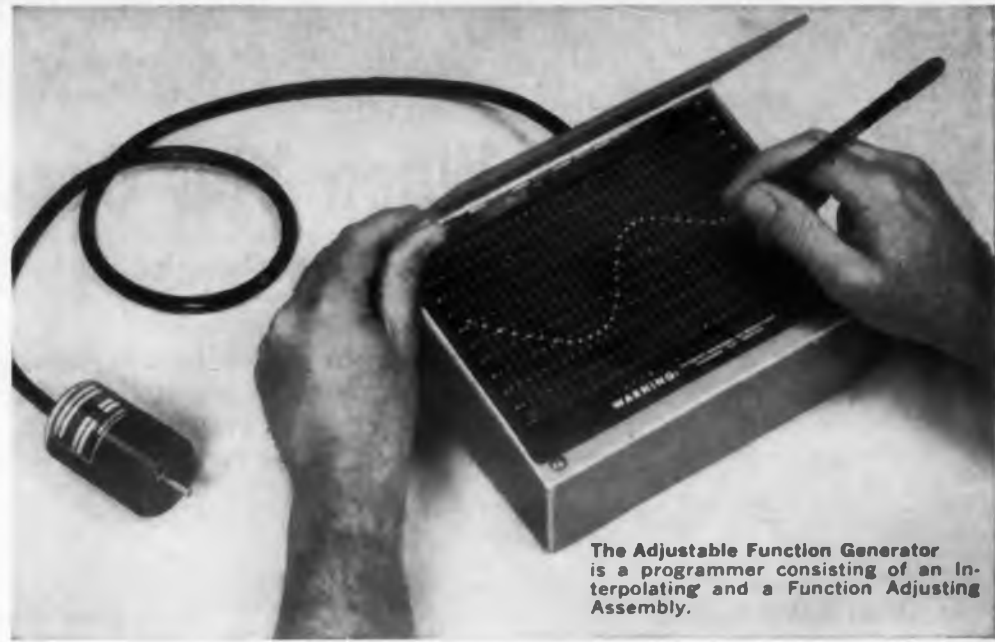

The Adjustable Function Generator is a programmer consisting of an Interpolating and a Function Adjusting Assembly.

FOR A NON-LINEAR SIGNAL OUTPUT—THE VERNISTAT ADJUSTABLE FUNCTION GENERATOR

See that curve on the panel? You adjust it by hand . . . any shape, real quick! You draw your own $Y = f(X)$ curve and pull out a repeating, nonlinear voltage to control the process you require.

Almost any process that can be controlled by a varying voltage can be controlled by the signal from a Vernistat Adjustable Function Generator.

Here's the story:

In the Vernistat, the autotransformer uses equally spaced taps, giving a highly linear output. These taps can be crowded or spread apart, in which case you get a permanent, nonlinear output related to their spacing. In the Function Generator, the autotransformer has 101 equally spaced taps which you can select to form the nonlinear function you desire. Using 34 sliders, you set your voltage up and down the Y-axis, graphing the Y-values against X. The X-axis represents angular position of the shaft over a range of 10 shaft turns.

Actually, the entire Function Adjustable Assembly is nothing more than a switch for pulling the proper curve out of the Vernistat. Once the curve is set an Interpolating Vernistat provides for

a smooth voltage output between taps. The steel case of the Assembly is 3 x 7 x 8 inches, which shows you how compact the mechanism is.

APPLICATIONS

You can use the Function Generator both as a lab instrument and a system component. Some important uses are:

1. **Rapid Empirical Determination of Functions:** Eliminates time-consuming mathematical calculations and the production and wiring of a large number of special padding resistors. Once a curve is determined, a nonlinear Vernistat can easily be constructed to provide a simplified, permanent, function-generating unit.
2. **Linearization:** The Function Generator can be used to compensate for nonlinearities in electronic systems. It can be placed in series with the signal to be corrected or used as a nonlinear feedback element in a servo loop.
3. **Input to Analog Computer:** It converts nonlinear data to an electrical input.
4. **Control and Programming:** Used in chemical, petrochemical and other continuous processes to control a variety of functions. If the shaft is rotated at constant speed, control will be a function of time.

Several series of Vernistats are available for use with the Function Generator. For a complete description drop us a line.

vernistat[®] division

PERKIN-ELMER CORPORATION • 765 Main Avenue, Norwalk, Connecticut

CIRCLE 784 ON READER-SERVICE CARD



Are You Conscious or Unconscious When You Choose An Engineering Job?

A Psychological Study Suggests You Are Both

Here is evidence that before engineer job seekers even get in touch with companies personally, they have definite opinions about them as employers—opinions they have formed subconsciously. Here, too, are concrete suggestions to help insure that more than a subconscious opinion dictates your choice of a new employer and a new job.

Richard Haitch

E. N. GINEER, electronic design engineer extraordinary, left the R&D director's office and strode purposefully to his cluttered desk. For a minute, but no longer, he let the director's parting message filter through his tidy brain:

"... and the circuit must be redesigned better than any we have ever built. It's your baby now. This is a crash program, and the company's reputation depends on it."

A tall order, Gineer thought. But he approached the design problem in characteristic fashion. The first thing he did was recall all the rumors he had heard about the best materials to use in such a circuit; he immediately narrowed his choice to these. Next he remembered the advice of colleagues who had built not necessarily the same type of circuit but somewhat similar ones; he followed their advice to a tee. He had read more than one technical article about circuits like this in the last year, but he did not bother to check either the articles or the data in them; he could trust his infallible memory and intuition. Gineer had a few ideas of his own, of course, but he didn't press them too strongly—just enough to strengthen his conviction that the information he now had secondhand and by hearsay was good enough. He ordered his components at once without checking them out.

When he had finished the circuit, Gineer knew that it was the best he (and probably anyone) had ever created.

Fantastic? Of course. Sheer fiction? Naturally.

It goes without saying that no sane engineer would design a circuit that way. Would it surprise you then to hear that when it comes to choosing a job, the odds are heavy that you may react in comparable fashion?

That job-hunting engineers do so react has been established by psychological study. Secondhand information, rumor, innuendo, hearsay—all figure importantly in steering engineers to certain companies. Nor is it abnormal for an engineer to rely on such wispy intelligence. Strange as it may seem, he is not even aware that he reacts in this way when he chooses a job. And even if he were aware, he could not decree events otherwise.

The study that uncovered this has alerted the engineer to the wisdom of conducting a full, personal investigation before accepting employment with a company. There are specific questions every engineer should ask a prospective employer, specific job conditions that should be explored, of which more presently.

The Engineer and the Image

The psychological study of engineer job seekers originated with an assumption put forth at Deutsch & Shea, Inc., technical manpower consultants, that engineers set up within themselves images of engineering companies; that these images are formed unwittingly over a period of time; that long before an engineer changes jobs, he has selected certain of these images as likely employers and eliminated others.

When Deutsch & Shea set out to test its assumption, it knew, as psychologists long have

known, that some human actions are undertaken largely without conscious thought. These subconscious actions are conditioned by previous influences. The conditioning factor may be something a person has experienced, something he has seen or heard that has left a marked impression. Filed in the human mind, such influences are ready to trigger behavior all but automatically at an opportune time.

To what extent, if any, engineers are so influenced when they choose an employer was the subject of a pilot investigation by specialists in human behavior. Depth interviews, using clinical psychologists as interviewers, were used to uncover the findings in the Deutsch & Shea study. The depth-interview technique was selected because it offered two advantages over a routine questionnaire: by exploring the subconscious, it could yield a truer picture of motivations than the "accepted" replies people usually give to standard questionnaires; and because it penetrated the human facade, a smaller-than-average sample of subjects was needed.

Twelve engineering companies of various size and structure were studied. The psychologists interviewed 50 engineers—20 electrical, 20 mechanical and 10 aeronautical. Of these, 45 per cent were 30 to 40 years old; 20 per cent, 20 to 30 years; 12 per cent, 50 to 60, and 10 per cent, more than 60. They worked for 44 different companies. All but two were college graduates, and these two held advanced engineering positions. Roughly half of the subjects were members of a professional engineering society.

(Continued on page 224)

ELECTRONIC DESIGN **CAREER INQUIRY SERVICE**

USE BEFORE NOV. 23, 1960

After completing, mail career form to *ELECTRONIC DESIGN*, 830 Third Avenue, New York, N. Y. Our Reader Service Department will forward copies to the companies you select below.

21

(Please print with a soft pencil or type.)

Name _____ Telephone _____

Home Address _____ City _____ Zone _____ State _____

Date of Birth _____ Place of Birth _____ Citizenship _____

Position Desired _____

Educational History

| College | Dates | Degree | Major | Honors |
|---------|-------|--------|-------|--------|
| | | | | |
| | | | | |
| | | | | |
| | | | | |

Recent Special Training _____

Employment History

| Company | City and State | Dates | Title | Engineering Specialty |
|---------|----------------|-------|-------|-----------------------|
| | | | | |
| | | | | |
| | | | | |
| | | | | |
| | | | | |

Outstanding Engineering and Administrative Experience _____

Professional Societies _____

Published Articles _____

Minimum Salary Requirements (Optional) _____

Use section below instead of Reader Service Card. Do not write personal data below this line. This section will be detached before processing.

Circle Career Inquiry numbers of companies that interest you

900 901 902 903 904 905 906 907 908 909 910 911 912 913 914 915 916 917 918 919 920 921 922 923 924
 925 926 927 928 929 930 931 932 933 934 935 936 937 938 939 940 941 942 943 944 945 946 947 948 949

**Advancement
Your Goal?
Use
CONFIDENTIAL
Action Form**

ELECTRONIC DESIGN's Confidential Career Inquiry Service helps engineers "sell" themselves to employers—as confidentially and discreetly as they would do in person. The service is fast. It is the first of its kind in the electronics field and is receiving high praise from personnel managers.

To present your job qualifications immediately to companies, simply fill in the attached resume.

Study the employment opportunity ads in this section. Then circle the numbers at the bottom of the form that correspond to the numbers of the ads that interest you.

ELECTRONIC DESIGN will act as your secretary, type neat duplicates of your application and send them to all companies you select—the same day the resume is received.

The standardized form permits personnel managers to inspect your qualifications rapidly. If they are interested, they will get in touch with you.

Painstaking procedures have been set up to ensure that your application receives complete, confidential protection. We take the following precautions:

- All forms are delivered unopened to one reliable specialist at *ELECTRONIC DESIGN*.
- Your form is kept confidential and is processed only by this specialist.
- The "circle number" portion of the form is detached before the application is sent to an employer, so that no company will know how many numbers you have circled.
- All original applications are placed in confidential files at *ELECTRONIC DESIGN*, and after a reasonable lapse of time, they are destroyed.

If you are seeking a new job, act now!

S MAKE A S
S MILLION S
S In Electronic Engineering? S

Not likely. Only a few have done it. However, most electronics engineers realize that above average earnings can be theirs in the electronics market. For the man who wants challenging work & earnings reflecting his capabilities, we are retained by 479 top electronics firms (both "giants" and "comers")

FREE — MONTHLY OPPORTUNITIES BULLETIN

If you wish to receive a monthly bulletin of the finest available electronic opportunities, simply send us your name and home address (and if you wish, a review of your qualifications)—Our services are without cost to you through our Chicago office and our Los Angeles subsidiary, Len Barton Associates.



Jack L. Higgins
Vice President
**Cadillac
Associates, Inc.**

29 E. Madison Bldg. Chicago 2, Ill.
Financial 6-9400

CIRCLE 877 ON READER-SERVICE CARD

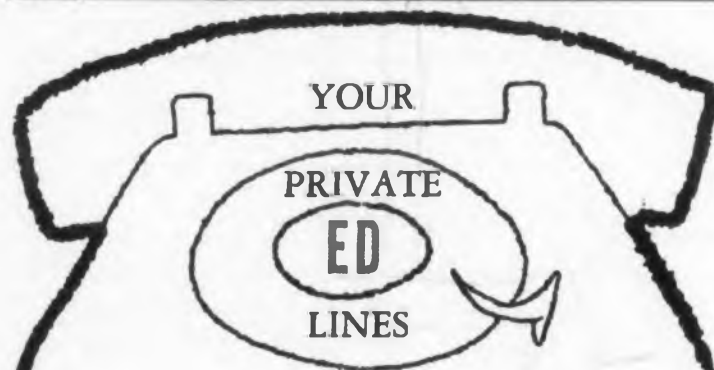

When employment information is obtained through *ELECTRONIC DESIGN*, it's sent direct to your home, so that only you and one prospective employer at a time know about it. You can conduct your employment campaign privately—as it should be conducted.

This is why every Reader Service Card reserves a line for your home address, and why circled numbers are detached from Career Inquiry Service Forms sent to companies.

You can apply for many jobs simultaneously . . . only you will know how many.

Use the Career Inquiry Service Form, and the Reader Service Card when job hunting. They're your *private lines* to employment opportunities . . . another service for you from *ELECTRONIC DESIGN*.

DESIGNING YOUR FUTURE

Interviews were conducted in the engineers' homes to promote a relaxed atmosphere. The engineers were encouraged to talk about all of their associations, images, feelings or impressions about the companies under study.

Preconceptions Without Personal Contact

Here is what Deutsch & Shea found, among other things:

Engineers have definite preconceptions about companies as places for work, even though they may not have had personal contact with them, and these preconceptions color their evaluations of the companies as potential employers.

The preconceptions are not based on salary or location of a plant.

While personal contacts appear to exert the strongest influence on opinions about companies as employers, other factors can and do play a part. Twenty-four per cent of the engineers, for example, credited "experience with company's products" as having influenced their job choice.

Like the consumer who responds to both the real and imagined attributes of a particular brand when he makes a purchase, engineers entering the job market tend to respond favorably to the recruitment advertising of some companies and to ignore or disbelieve similar advertising by other organizations.

"There is, however," the psychologists concluded, "this difference: while consumers generally are familiar with the attributes of the prominent brands of most consumer products, very few engineers have had personal contact with more than a portion of the companies about which they hold opinions. Their company images, which often are very strongly held, are typically based only in small part on personal experience. The reputation of a particular company has its roots in reports by colleagues, in advertising and promotional materials, in rumors about administrative and employee practices, and other similar elements."

Advantage Can Be Yours

Now there is nothing eccentric about subconscious behavior. To paraphrase a line, each of us could well say, "Some of my best actions are subconscious." How would you like, for example, to be forced to stop and deliberate about the task every time you tied your shoelaces, or whenever you flicked the wheel of your car while driving? We do such things habitually without thinking—and what are habits but subconscious manifestations.

Most engineering companies, Deutsch & Shea found, are not even aware that they foster a subconscious reaction in job applicants. The employment image an engineer builds of an engineering company can, in some respects, be compared with the image a typical bridegroom-to-be forms of his prospective bride. The bridegroom's vision is romantically colored, and while most of the traits he attributes to the woman on the pedestal are unquestionably present in varying degrees (at least he hopes they are), other aspects of character—the very ones that may later prove disruptive to the marriage—remain obscured to his view. For this he is partly to blame, psychologists tell us, because, under the immutable spell of romance, he does not search for them, and even were they pointed out to him, he would be inclined to reject them; romantically, he prefers ignorance.

In reality the engineer cannot stop building images of companies, or even obliterate the images once they are formed. He cannot order his subconscious processes to quit functioning. Realistically, though, he can channel them to his advantage. He can use an image he has formed of a company as the impetus for a thorough investigation of the company's traits and qualifications. By doing so he will insure, insofar as is sensibly possible, logical selection of the best job; he will avoid later disappointment and dissension with the company.

Get Specific Facts About Employers

What constitutes a thorough investigation of a company's potential? Personal contact to obtain *specific* information, as opposed to the generalizations contained in most preconceptions about companies. With the general image you may already have of a company, with the general idea you should have of its financial strength and prestige before requesting an interview, here are some penetrating questions to ask a job interviewer, as suggested by Deutsch & Shea. Many will be familiar. Use them as a check list.

At the preliminary interview, ask:

Will you please give me statistics on sales for the last five years?

(You can get a fuller picture of a company's present stability and where it is headed by comparing its growth.)

What has the staff totaled for the last five years? Is any expansion planned for the rest of this year? For 1961?

(Consider whether the staff is growing steadily or is subject to wide fluctuations.)

What projects is the plant working on at present and how long does it expect to be working on them?

(Aside from classified information, most com-



panies will give you enough details to gage whether there is sufficient technical challenge for you, whether the projects are long-term and whether they are of sufficient size and diversity.)

How is the management organized with respect to lines of authority? Who makes the decisions in the company?

(Some engineers have strong prejudices against large companies, others against small ones, but the important thing is not necessarily the size but the corporate structure. Some large companies, for example, have decentralized management. Who makes the decisions and at what level they are made are vital.)

What is the starting salary for this engineering position and what is its upper limit? How do these figures compare with salaries for administrative positions of comparable experience?

(The initial salary is a governing factor in your decision obviously, but don't neglect the potential. And if you aim to be a technical specialist, you will want to know whether administrative specialists have an edge on pay day.)

Are there regular salary increases?

(It's sometimes nice to count on sure money when planning your own budget.)

Aside from salary, does the company have a benefits program?

(Some concerns offer paid life insurance, accident and health policies, stock-bonus plans, profit sharing and the like.)

Visit the Company Plant

At the plant interview, ask:

What will my first job assignment be? Please give me details.

(Countless engineers sour on their positions because they expected them to be infinitely more challenging and interesting than they turned out to be. Brochures of plant programs can sometimes stir unrealistic flights of enthusiasm in a job hunter. Sometimes there is not enough diversity in assignments to match an engineer's interests. Try to guard against these pitfalls by getting details of your first assignment and a description of the normal work day in the group you may join.)

Is there opportunity to broaden my technical

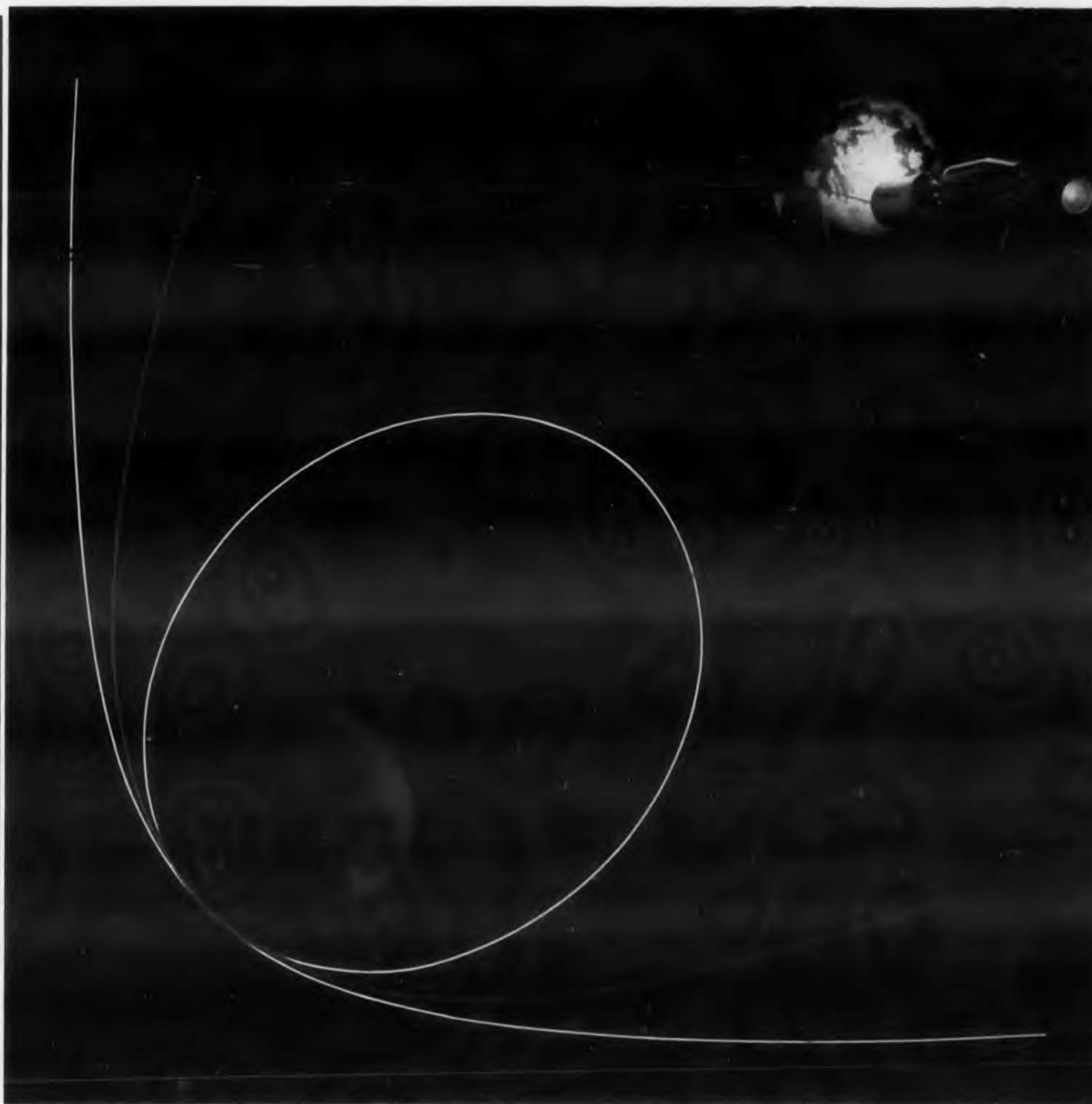

Orbits through space

The space-flight paths diagrammed above represent a closed elliptical orbit, a parabolic orbit, and, on the outside, an open, hyperbolic orbit characteristic of the start of an interplanetary flight.

Orbital flight mechanics is one of the many areas of advanced investigation at Boeing. The staff of the Boeing Scientific Research Laboratories, for example, carries out basic research in such fields as energy conversion, hypersonics, magneto-hydrodynamics and plasma physics.

Other Boeing scientists and engineers are working toward the advancement of supersonic flight, propulsion systems, gas turbine engines, commercial and military aircraft, vertical and short take-off and landing aircraft.

Professional-Level Openings

The wide scope of Boeing programs in all areas of manned and unmanned flight, from theoretical research to advanced precision fabrication, offers careers of unusual interest to professional specialists in engineering and scientific fields, as well as in other-than-engineering areas. Drop a note, mentioning degrees and major, to Mr. John C. Sanders, Boeing Airplane Company, P. O. Box 3822 - ESD, Seattle 24, Washington.

BOEING

Divisions: Aero-Space • Transport • Wichita • Industrial Products • Vertol • Also: Boeing Scientific Research Laboratories • Allied Research Associates, Inc. — a Boeing subsidiary

CIRCLE 902 ON CAREER INQUIRY FORM

ENGINEERS • SCIENTISTS

Large-scale system engineering requires the anticipation of the need for design and integration of new equipments and sub-systems to maintain a continually effective command and control structure.

The elements of these systems — communication networks, computers, detection systems and weapons — must be continually evaluated, upgraded and integrated to assure total system compatibility. Effectiveness can only be maintained by the "open end" concept.

MITRE, a nonprofit system engineering organization, is engaged in the design, development and evaluation of electronic command and control systems.

Appointments to MITRE's Technical Staff are available to engineers and scientists with advanced degrees and interest in combining large-scale system engineering with electronic system development.

COMMAND AND CONTROL SYSTEMS... EXPANDABLE TO 1970 AND BEYOND

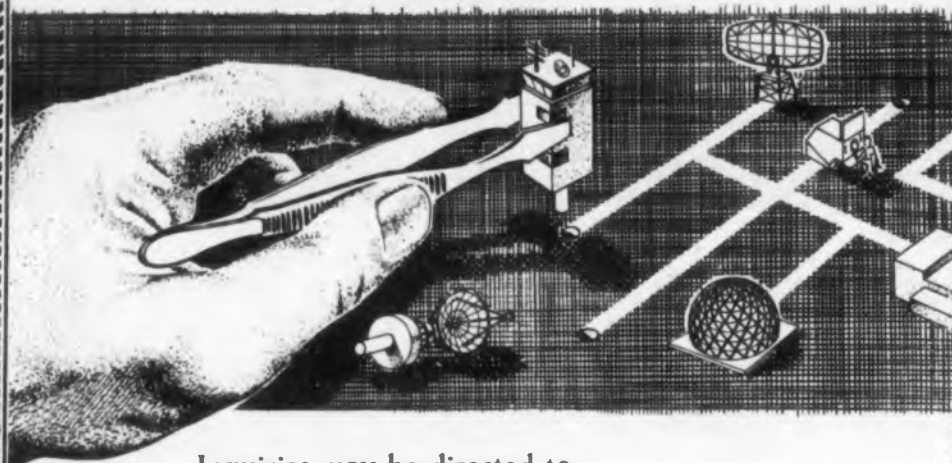

Inquiries may be directed to:

VICE PRESIDENT — TECHNICAL OPERATIONS

THE
MITRE
CORPORATION

Post Office Box 208 — 15AB — Bedford, Massachusetts

CIRCLE 903 ON CAREER INQUIRY FORM

DESIGNING YOUR FUTURE

standing? Is company training or other aid available to help me grow professionally?

(Your growth as an engineer depends mainly on your initiative and the facilities available for study. Some companies offer courses at the plant, a technical library, or even financial aid for graduate study. If company aids are not offered, a nearby college or technical facility may be able to fill the gap. Explore all possibilities.)

How large is the group I will be working with? May I please see the table of organization?

(Try to estimate whether one or two engineers—or a dozen—will have to advance before your own chance for promotion comes.)

With regard to promotions, how much importance is attached to merit? To seniority?

(Nearly every company will say merit is key to promotion, but ask for tangible evidence of this: ask for illustrations of how men in the organization have forged ahead strictly on merit and whether this is the general practice or the exception to the rule.)

How much responsibility will I have in a project as a development or design engineer?

(A satisfactory reply depends on your personal needs. Some engineers are happy only if they can carry their ideas through the hardware stage; some are content to leave the final design and production details to others while they concentrate on successive R or D problems. In any case, you will want to know if the company will have enough confidence in you to let you work without excessive restraint on your initiative.)

How many non-engineers—such as technicians, laboratory assistants, draftsmen, clerical workers—does the plant employ, as compared with engineers?

(A high ratio of non-engineer to engineers may indicate high professional status for engineers, with little of their time dissipated on non-professional work.)

Tell me how communications are organized at the plant. Will I be informed regularly about all the important company operations and policies? How would I go about obtaining assistance from another department if I needed it? Are there regular arrangements for technical conferences?

(A chronic complaint among engineers is that no one tells them what is going on outside of their immediate work area. This can be a handicap in fulfilling your engineering mission. Another thing you will need is ready cooperation from lateral engineering groups, with a minimum of managerial red tape.)

FOR TIMELY DESIGN INFORMATION



In *Electronic Design*, engineers find not only more new products, but all the new products normally encountered in the design of electronic original equipment. 26-time publishing frequency brings this information quickly to the engineer's attention, timed to a fast-moving industry. *Electronic Design* is more up-to-the-minute, more complete, more helpful, and easier to read than any other electronic publication. No wonder more and more engineers read *Electronic Design* first!

ELECTRONIC DESIGN

a HAYDEN publication
830 THIRD AVENUE, NEW YORK 22, N. Y.



Does the company reward outstanding individual achievement?

(Some concerns have cash-bonus incentives or other rewards for performance above that ordinarily attained. Periodic review of salaries, with merit increases to the worthy are also important to any job seeker.)

Is there a job-rotation program?

(Maybe you weary, as some engineers do, of the same microcosmic view of the project. Shifting assignments can be a refreshing way to combat job boredom.)

Don't Neglect the Fringe Areas

There will be other questions you will want to ask, observations you will be making on your visit to the company plant. Some of these will arise spontaneously as the interview proceeds; others will relate to your individual needs.

Observe, for example, the technical equipment available to engineers. Ask about specific equipment that you consider essential in your specialty. Note the working conditions: Quiet or noisy? Privacy and ample room for every engineer or communal, cramped quarters?

Does the company and do conditions at the plant encourage creativity? Be on your toes for the indirect clues. Talk with non-supervisory engineers as well as supervisors at the plant and get their views. How many patents are granted to the company's engineers in a year? How many papers do the engineers have published? You can get a good idea of the climate for creativity by combining clues such as these.

What of the plant's location? Is it accessible to a decent residential area? See if the area has such features as adequate transportation, shopping that will meet with your wife's approval, good schools (not overcrowded) where your children can study without distraction, and cultural and recreational facilities, such as theatres, sports, libraries.

Stick with the investigation to the end. Let the evidence, not your preconditioned opinions, be the final test. You will be infinitely more satisfied for having done so. And so will the company—for having gained a contented employee. ■ ■

Deutsch & Shea, founded in 1939, has offices at 230 W. 41st St., New York, N.Y.

(F101, AIR FORCE PHOTO)



National has had many years' experience making significant contributions to the defense effort, including airborne components.

COMPARE THIS OPPORTUNITY WITH WHAT YOU ARE NOW DOING!

HERE'S WHAT *National's* NEW MILITARY RESEARCH AND DEVELOPMENT PROGRAM OFFERS.

This operation will interest any engineer or scientist possessing enough self-confidence—ability and experience—to develop projects initially and carry them through to completion.

WHO WE'RE LOOKING FOR

National is looking for military-oriented scientists and engineers who hold a B.S. degree or advanced degrees. You should be working in electronic, electro-mechanical, mechanical, physics, optics, mathematics, or other related areas. Preference will be given to those who have had several years' experience dealing with prime contractors and government agencies.

As a member of National's New Military Development Team—you will be working initially with our Military Proposal Group. As proposals become specific projects, your responsibility will continue through the contractual stage for technical liaison, fulfillment of contractual obligations including hardware development, meanwhile retaining sufficient flexibility to continue your proposal efforts.

WHY YOU SHOULD INVESTIGATE

National's new Military Research and Development Program offers you unusual latitude in responsibility. It offers you the chance to participate in military projects

from start to finish. Furthermore, you now have the opportunity to join an operation still in its formative stage—yet backed by one of the world's most successful . . . most reputable corporations.

COMPLETE INFORMATION is yours by sending your résumé to Mr. T. F. Wade, Technical Placement Section F3-1, The National Cash Register Company, Dayton 9, Ohio. All correspondence will be kept strictly confidential.

THE NATIONAL CASH REGISTER COMPANY, DAYTON 9, OHIO

ONE OF THE WORLD'S MOST SUCCESSFUL CORPORATIONS

76 YEARS OF HELPING BUSINESS SAVE MONEY

CIRCLE 904 ON CAREER INQUIRY FORM



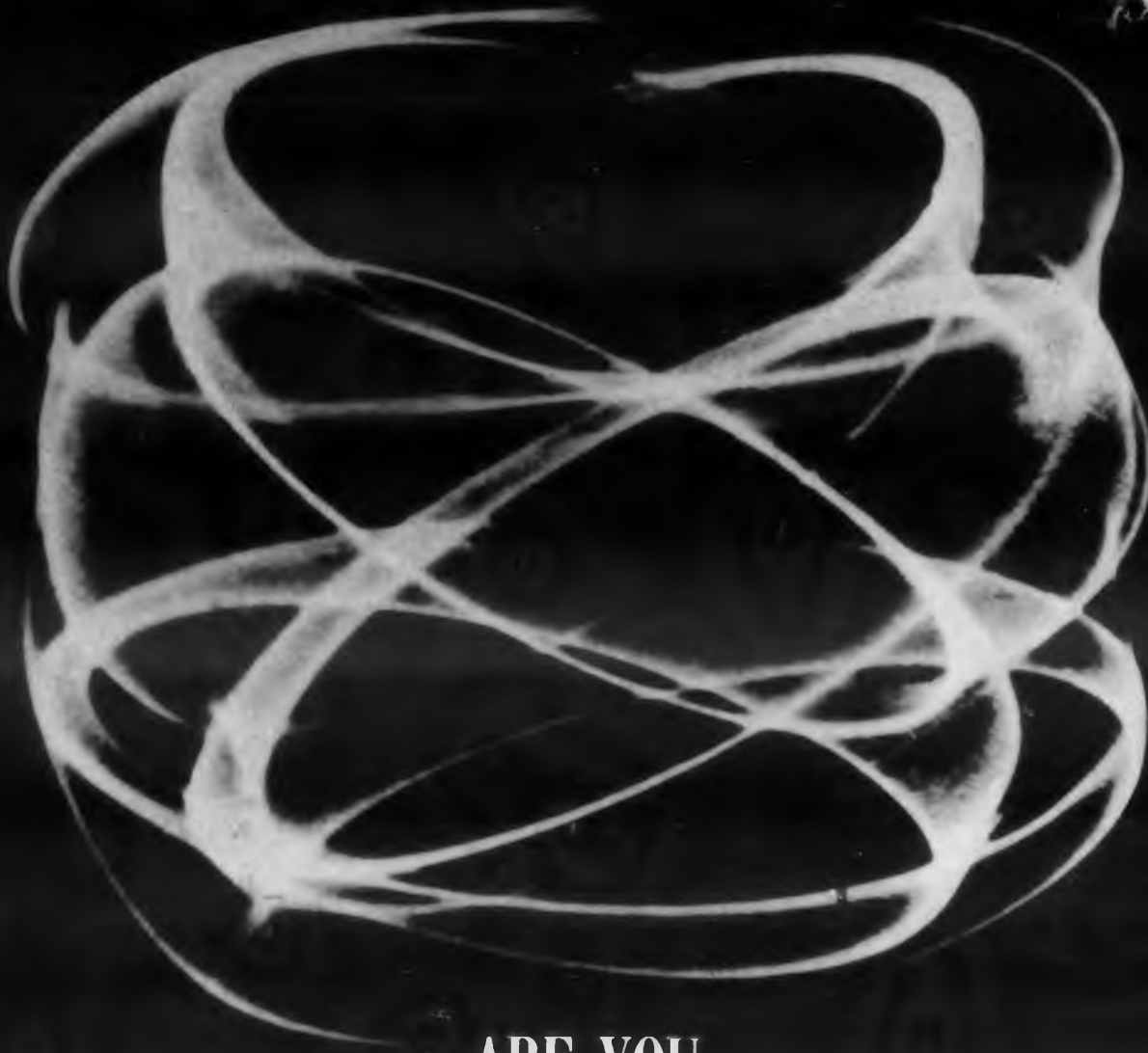

ARE YOU THE MAN TO HELP COLLINS BRING

NEW IDEAS INTO FOCUS?

Collins needs Electrical and Mechanical Engineers who find adventure in engineering and enjoy probing for solutions to challenging electronics problems.

There is much to recommend Collins as the foundation for your professional future.

Collins is one of the nation's leading electronics growth companies, producing for both government and business. Commercial fields include airline and business aircraft, communication and navigation

CEDAR RAPIDS — Mr. L. R. Nuss
Manager of Professional Employment
Collins Radio Company, Cedar Rapids, Iowa

DALLAS — Mr. B. E. Jeffries
Manager, Employment, Collins Radio Company
1930 Hi-Line Drive, Dallas 7, Texas

BURBANK — Mr. Al Peachey
Collins Radio Company
2700 West Olive Avenue, Burbank, California



COLLINS RADIO COMPANY • CEDAR RAPIDS, IOWA • DALLAS, TEXAS • BURBANK, CALIFORNIA

CIRCLE 905 ON CAREER INQUIRY FORM

equipment, amateur radio, broadcast and ground communication equipment.

Collins is a company of engineers . . . 20% of its 13,000 workers are actively employed in engineering. Collins' business, basically, is selling the products of imaginative engineering . . . the sort that inspires the best in a man.

If you feel that you are the man to help Collins sharpen the image on new ideas, send your resume to the location of your choice:

ADVERTISERS' INDEX

October 12, 1960

| Advertiser | Page |
|---|----------|
| ACDC Electronics, Inc. | 96 |
| AGA Div. of Elastic Stop Nut Corp. of Amer. | 198 |
| Ace Electronics Associates | 146 |
| Acromag, Inc. | 190 |
| Aerovox Corp. | 18 |
| Alden Products Co. | 207 |
| Allegheny Ludlum Steel Corp. | 82 |
| Allen-Bradley Co. | 144A-B |
| Allen Avionics | 140 |
| Allied Control Co., Inc. | 26 |
| Allied Radio Corp. | 141 |
| Alpha Metals, Inc. | 197 |
| Amco Engineering | 204 |
| AMP, Inc. | 59 |
| Ampex Data Products Co. | 121 |
| Analab Instrument Corp. | 205 |
| Applied Physics Corp. | 187 |
| Arco Electronics, Inc. | 84 |
| Avery Label Co. | 198 |
| Avnet Electronics Corp. | 142 |
| Ballantine Laboratories, Inc. | 132 |
| Barker & Williamson, Inc. | 214 |
| Bead Chain Mfg. Co. | 96 |
| Beckman, Berkeley Div. | 6 |
| Beede Electrical Instrument Co. Inc. | 196 |
| Belden | 74 |
| Bendix Corp., The, Eclipse Pioneer Div. | 150 |
| Bendix Corp., The, Scintilla Div. | 129 |
| Birtcher Corporation, The | 189 |
| Bodine Electric Co. | 199 |
| Boeing Airplane Co. | 225 |
| Bomac Laboratories, Inc. | 91 |
| Boonton Electronics Corp. | 149 |
| Bourns, Inc. | 75 |
| Brand Rex Div., William | 98, 99 |
| Braun Tool & Instrument Co., Inc. | 163 |
| Bristol Co., The | 206 |
| Buckbee Mears Co. | 204 |
| Bud Radio, Inc. | 216 |
| Burgess Battery Co. | 39 |
| Burndy Corporation | 34 |
| Burnell & Co., Inc. | 7 |
| CBS Electronics | 137 |
| Cadillac Associates, Inc. | 224 |
| Cambridge Thermionic Corp. | 192 |
| Cannon Electric Co. | 60 |
| Capitron Div. of AMP, Inc. | 70 |
| Carborundum Co. | 65 |
| Celco Constantine Engineering Labs, Co. | 133 |
| Centralab, The, Div. of Globe-Union, Inc. | 79 |
| Central Electronic Manufacturers | 174, 175 |
| Chance Vought Electronics Div. | 144 |
| Cinch Mfg. Corp. | 93 |
| Cinema Engineering | 132 |
| Clare & Co., C. P. | 72, 73 |
| Clare, C. P., Transistor Corp. | 48A-B |
| Clarostat Mfg. Co., Inc. | 15 |
| Clevite Transistor, a Div. of Clevite Corp. | 21 |

| | |
|---|-------|
| Colins Radio Co. | 228 |
| Computer Instruments Corp. | 71 |
| Computer-Measurements Co. | 119 |
| Consolidated Mining & Smelting Co. of Canada, Ltd., The | 194 |
| Continental Connectors Corp. | 120-C |
| Control Switch Div. | 61 |
| Cook Electric Co. | 83 |
| Cools Porcelain Co. | 159 |
| Corning Glass Works | 136 |
| Cornish Wire Company | 156 |
| Cubic Corp. | 88 |
| Curtiss-Wright Corp. | 77 |

| | |
|--|----------|
| Dale Products, Inc. | 55 |
| Davies Molding Co., Harry | 198 |
| Daven Co., The | 139 |
| Daysstrom Inc., Transicoil Div. | 134 |
| Del Mar Engineering Labs. | 170 |
| DeLuxe Coils, Inc. | 191 |
| Deutsch Electronic Components Div. | 120 |
| Dimco-Gray Company | 207 |
| Domier Scientific Company | 230 |
| Dow Corning Corp. | 100, 101 |
| Du Pont, E. I. de Nemours & Co., Freon Pds. Div. | 120-A |
| Du Pont, E. I. de Nemours & Co., Mylar Div. | 25 |
| Du Pont, E. I. de Nemours & Co., Plastics Div (Teflon) | 96A-B |
| Dynamics Instrumentation Corp. | 150 |

| | |
|---|----------|
| ESC Electronics Corporation | 67 |
| ESI/Electro Scientific Industries | 35 |
| Eagle Signal Co. | 58 |
| Eastern Industries, Inc. | 189 |
| Eastman Kodak Company | 199 |
| Edgerton, Gernsmaier & Grier, Inc. | 174 |
| Eitel-McCullough, Inc. | 201 |
| Elco Corp. | 90 |
| Electric Hotpack Company | 212 |
| Electro-Measurements Co., Inc. | 169 |
| Electronic Design | 208, 220 |
| Electronic Engineering Co. of Calif. | 193 |
| Elgin-Advance Relays | 203 |
| Emcor, Ingersoll Products Div. | 22 |
| Endevco Corp. | 231 |
| Engineering Supply Co. | 127 |
| Espey Mfg. & Electronics Corp. | 92 |

| | |
|---------------------------------------|----------|
| Fairchild Semiconductor Corp. | 13 |
| Fansteel Metallurgical Corp. | 124, 125 |
| Food Machinery and Control Corp. | 85 |
| Freed Transformer Co., Inc. | Cover II |

| | |
|--|----------|
| G-M Laboratories, Inc. | 162 |
| G-V Controls, Inc. | 23 |
| Gamewell Company, The | 200 |
| Garlock Electronic Products | 78 |
| General Cable | 156 |
| General Electric Co., Ceramic Tubes .. | 108, 109 |
| General Electric Co., Metallurgical Products Dept. | 161 |
| General Electric Co., Miniature Lamp Dept. | 209 |
| General Electric Co., Silicone Products Dept. | 178 |
| General Electric Co., Power Tube Dept. ... | 116 |
| General Electric Co., Voltage Regulator Products Section | 97 |
| General Instrument Corp. | 76, 77 |
| General Radio Co. | 131 |
| Gertsch Products, Inc. | 118 |
| Gombos Co., Inc., John | 163 |
| Grayhill, Inc. | 193 |
| Gries Reproducer Corp. | 184 |
| Gudmund Brothers Silk Co., Inc. | 202 |

Opportunities in Systems Development

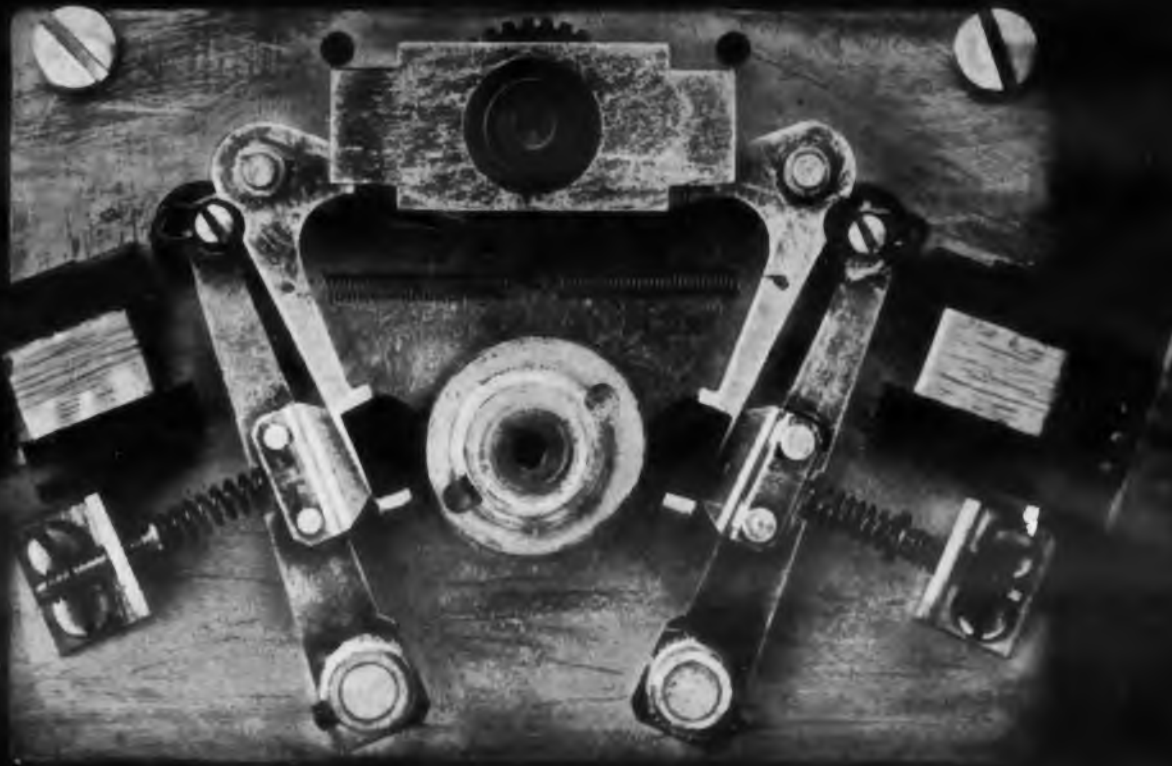

Harnessing a new principle of incremental drive

Here is a new way to convert high-speed shaft motion into precise increments, stepping forward, backward or oscillating alternately. It was developed from scratch by IBM engineers.

This truly clutchable incremental stepper provides precise control of acceleration, runs at high speed, and has great accuracy.

The Method of Attack

IBM engineers tackled the problem of high-speed, start-and-stop motion on a theoretical basis. They analyzed the loads and accelerations involved, and decided

what masses and forces would be practicable. The stepper they developed is not only more versatile and efficient than alternate methods but also gives greater life expectancy, requires no elaborate oil bath, and is easier to package into a machine assembly.

Whether it's a problem in mechanics, electronics or physical science, IBM engineers are encouraged to attack problems from fresh viewpoints. Depending on your field, you might be interested in the advances IBM people are making in magnetics, microwaves, semiconductors and inertial

guidance. In every area of research and development, you will find IBM receptive to the individual who wants to make significant contributions.

How to Start an IBM Career

Right now, there are several key openings in IBM's expanding research and development staff. If you have a degree in engineering, mathematics or one of the sciences—plus experience in your field, write, briefly describing your qualifications, to:

Manager of Technical Employment
IBM Corporation, Dept. 555W2
590 Madison Avenue, New York 22, N. Y.

IBM

INTERNATIONAL BUSINESS MACHINES CORPORATION

DONNER Desktop Computers



The small analog computer you see here accurately predicts system performance with extraordinary speed and simplicity.

To illustrate, consider the problem of stabilizing the inverted pendulum below. Solving this problem requires a rigorous study of the stability of solutions to the Mathieu-Hill equation:

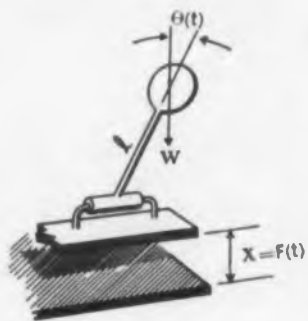

$$\frac{d^2 \theta}{dt^2} = \frac{g}{l} - A F(t)$$

In just 30 minutes, the computer solved the equations and established definite parameters. An expert mathematician who tackled the same problem at the same time was still working on his second page of calculations! After half a day's work, he had proved only that stability could be achieved—not that it was feasible for this particular pendulum.

The basic computer used in this problem, including two multipliers, costs less than \$4,000. It can be readily expanded, initially or as your needs grow. Other Donner computers are available for your particular requirements.

By selecting the proper pivot excitation, $A=F(t)$, the pendulum can be stabilized. The graph shows the time variations in displacement, $\theta(t)$ as a function of pivot displacement $F(t)=A \sin \omega t$.

For a closer look at methods of studying non-linear systems with the analog computer, including a clear step-by-step analysis of the inverted pendulum, write for Donner Tech Note #2. We'll also send you a brochure on the Model 3400 computer. Please address Dept. 36.

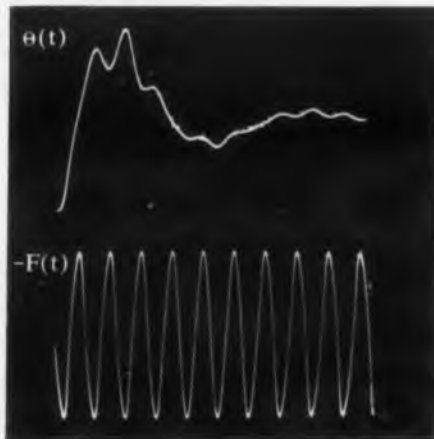

DONNER SCIENTIFIC COMPANY

CONCORD, CALIFORNIA
Phone MUIberry 2-6161 • Cable 'Donner'

CIRCLE 785 ON READER-SERVICE CARD

Call your Donner rep now for a demonstration

Your nearby Donner engineering representative will be happy to provide you with more information on Donner computers. Let him arrange a demonstration in your plant at no obligation of course. His name and phone number are listed below.

ALBUQUERQUE, New Mexico
Paul Wright (Hyde Electronics)
AM. 8-1111

ATLANTA 5, Georgia
E. G. Holmes & Associates
BL. 5-6660

CHICAGO 31, Illinois
Robert L. Lang & Associates
SP. 4-3610

CLEVELAND, Ohio
Tiby Company
ER. 1-5335

DAYTON, Ohio
Laurence D. Bruno
AX. 3-8703

DETROIT, Michigan
Tiby Company
UN. 4-9298

FORT WORTH, Texas
Mitchell Spears Company
WA. 6-4444

KANSAS CITY (Shawnee), Kansas
Design & Sales Engineering Company
HE. 2-2528

LOS ANGELES 5, California
Charles W. Fowler Company
DU. 4-7203

NEW YORK CITY (Mt. Vernon), New York
Burlingame Associates
MtV. 4-7530

ORLANDO, Florida
E. G. Holmes & Associates
CH. 1-2128

PHILADELPHIA (Upper Darby), Pennsylvania
Burlingame Associates
SH. 7-9080

SAN FRANCISCO (Menlo Park), California
Ault Associates
DA. 6-1760

SCARBOROUGH, Ontario, Canada
Instronics, Ltd.
AX. 3-7806

SEATTLE 4, Washington
Comptronics
MA. 4-5135

ST. LOUIS 5, Missouri
Design & Sales Engineering Company
PA. 1-6403

STITTSVILLE, Ontario, Canada
Instronics, Ltd.
TA. 8-1253

SYRACUSE, New York
Burlingame Associates
GR. 4-7409

WASHINGTON, D.C.
Burlingame Associates
OL. 4-6400

WALTHAM, Massachusetts
Burlingame Associates
TW. 4-1955

17C

Advertiser

Page

| | |
|---|-----------------|
| HRB Singer, Inc. | 210 |
| Haveg Industries, Inc. | 16 |
| Haydon, A. W., Co. | 158 |
| Heinemann Electric Company | 112 |
| Heinz Mueller Engineering Co. | 183 |
| Helipot, Div. of Beckman Instruments, Inc. | 147 |
| Heminway & Bartlett Mfg. Co. | 141 |
| Hermes Electronics Co. | 154, 185 |
| Hewlett-Packard Company | 1, 53, 103 |
| Hi-Temp Wires, Inc. | 232 |
| Hoffman Electronics Corp. | 173 |
| Holtzer-Cabot Motor Div. | 94 |
| Hoover Electronics Co. | 166 |
| Hopkins Engineering Co. | 205 |
| Howard Industries, Inc. | 183 |
| Howell Instruments, Inc. | 142 |
| Hughes Aircraft Co. | 24A-B, 145, 177 |

| | |
|--|-----|
| Indiana Steel Products | 160 |
| Industrial Test Equipment Co. | 140 |
| International Business Machines Corp. | 229 |
| International Electronics Industries Inc. | 210 |
| International Instruments, Inc. | 192 |
| International Resistance Co. | 128 |
| Invo Splinc, Inc. | 175 |

| | |
|--|-----|
| Jettron Products, Inc. | 166 |
| Julie Research Laboratories, Inc. | 165 |

| | |
|---|---------------|
| Kay Electric Co. | 167 |
| Kearfott, Div. General Precision, Inc. | 205, 207, 209 |
| Keithley Instruments | 158 |
| Kemet Co. | 110 |
| Kepeco, Inc. | 63 |
| Kester Solder Co. | 197 |
| Keuffel & Esser Co. | 157 |
| Keystone Electronics Co. | 94 |
| Kinney Vacuum Div. | 133 |
| Krohn-Hite Corp. | 170, 171 |
| Kulka Electric Corp. | 186 |

| | |
|---------------------------------------|----------|
| Laboratory for Electronics, Inc. | 195, 213 |
| Lambda Electronics Corp. | 130 |
| Leeds & Northrup | 179 |
| Lerner Plastics, Inc. | 180 |
| Linde Co. | 202 |
| Lockheed Electronics Co. | 176 |
| Lockheed Missiles & Space Div. | 111 |
| Lord Mfg. Co. | 164 |

| | |
|--|---------------|
| McLean Engineering Laboratories | 155 |
| Magnetic Amplifiers, Inc. | 181 |
| Magnetic Metals Co. | 81 |
| Malco Mfg. Co. | 212 |
| Markel, L. Frank & Sons | 209 |
| Marshall Industries | 8 |
| Martin Orlando | 196, 197, 199 |
| Massa, a Div. of Cohu Electronics, Inc. | 194 |
| Malayan Tin Bureau, The | 171 |
| Microtran Co., Inc. | 3 |
| Microwave Assocs., Inc. | 219 |
| Mincom Div. Minnesota Mining & Mfg. Co. | 168-B |
| Miniature Precision Bearings, Inc. | 19 |
| Minnesota Mining & Mfg. Co., Magnetic Pds. Div. | 107 |
| Minnesota Mining & Mfg. Co., Electrical Pds. Div. | 182 |
| Mitre Corp. | 226 |
| Motorola Semiconductor Products, Inc. | 104, 113 |
| Mullard Ltd. | 168 |

| | |
|-------------------------------|----------|
| Narda Microwave Corp. | 32 |
| National Cash Register Co. | 227 |
| National Vulcanized Fibre Co. | 148, 149 |
| Natvar Corp. | 174 |
| Non-Linear Systems, Inc. | 27 |

| | |
|-----------------|----|
| Oak Mfg. Co. | 28 |
| Ohmite Mfg. Co. | 31 |

| | |
|----------------------------------|--------|
| PRD Electronics, Inc. | 106 |
| Pesco Products Div. | 95 |
| Phelps Dodge Copper Products Co. | 120B-C |
| Philco, Lansdale Div. | 9 |
| Photocircuits Corp. | 10 |
| Porter Co., Inc., H. K. | 191 |
| Potter & Brumfield | 126 |
| Power Sources, Inc. | 151 |
| Powertron Ultrasonic Corp. | 118 |
| Precision Scientific Co. | 211 |

| | |
|--|--------------|
| Radio Corp. of America, Electron Tube Div. | 143 |
| Radio Corp. of America, Semiconductor & Materials Div. | 66, Cover IV |
| Radio Corp. of America, West Coast Missiles & Surface Radar Div. | 153 |
| Ramsey Corp. | 197 |
| Raytheon Co., Industrial Components | 5 |
| Raytheon Co., Semiconductor Div. | 17 |
| Rome Cable, a Div. of Alcoa | 188 |
| Rosemount Engineering Co. | 155 |
| Ross Co., The Milton | 218 |

| | |
|---|--------------|
| Sage Electronics Corp. | 140, 141 |
| Sanborn Co. | 117 |
| Sangamo Electric Co. | 80 |
| Sarkes Tarzian, Inc. | 190 |
| Schweber Electronics | 75, 114, 115 |
| Segal, Edward | 199 |
| Sel-Rex Corp. | 57 |
| Shallcross Mfg. Co. | 162 |
| Sigma Instruments, Inc. | 179 |
| Singer-Bridgeport | 172 |
| Smith-Florence, Inc. | 64 |
| Southern Electronics Corp. | 147 |
| Spectral Electronic Corp. | 122, 123 |
| Sperry Electron Tube Div. | 102 |
| Sprague Electric Co. | 11, 159 |
| Stackpole Carbon Co. | 33 |
| Staedtler, J. S., Inc. | 168A |
| Standard Press Steel | 210 |
| Standard Rectifier Corp. | 86 |
| Star Stainless Screw Co. | 206 |
| Stevens-Arnold, Inc. | 213 |
| Stevens Mfg. Co., Inc. | 87 |
| Stromberg-Carlson Co., Div. of General Dynamics | 172 |
| Sylvania Electric Products, Inc. | 68, 69 |
| Synthane Corp. | 30 |
| Syntron Rectifier Div. | 211 |

| | |
|-----------------------------|----------|
| Taylor Fibre Co. | 217 |
| Tektronix, Inc. | 24 |
| Texas Instruments, Inc. | 127, 134 |
| Theta Instrument Corp. | 50 |
| Times Wire & Cable Div. | 97 |
| Tranco Products, Inc. | 98 |
| Transitron Electronic Corp. | 89 |
| Tung-Sol Electric, Inc. | 135 |



NEW ACCELEROMETERS—After comprehensive design-proof testing Endevco introduced the 2220 series accelerometers in 1959. The unique physical design of this series is now further enhanced by Piezite® Element Type VI, a product of Endevco electroceramic research. This new crystal makes possible the unequalled combination of complete case isolation, high natural frequency (to 70 KC) and sensitivity (to 15 mv/g) in a versatile configuration of small size and light weight. Now Endevco announces, at no increase in price

UNIQUE NEW "C" MODEL - GENERAL PURPOSE - 350°F ACCELEROMETERS

HIGH NATURAL FREQUENCY — LARGE SENSITIVITY—The 2220 Series retain these essential characteristics of all Endevco Accelerometers. The natural frequency of the mounted accelerometer is determined by actual frequency response and phase shift plots. Large sensitivity insures high signal to noise ratios over a wide dynamic range.

CASE ISOLATION—Complete case isolation prevents errors due to structural bending and high acoustic noise fields. **LOW CROSS AXIS SENSITIVITY**—The annular design reduces cross axis sensitivity. Nominally 2-3% in the maximum axis and 0% in the minimum axis. A maximum of 1% in any axis can be supplied on special order.

OPERATING TEMPERATURE OF +350°F—PIEZITE® Element Type VI makes possible a general purpose accelerometer with sensitivity vs. temperature linearity of $\pm 10\%$ from -65°F to $+350^\circ\text{F}$ without external swamping capacity. A maximum of $\pm 5\%$ variation of sensitivity vs. temperature can easily be obtained with the addition of external capacity.

NBS TRACEABILITY—Every Endevco Accelerometer is provided with complete calibration data. Frequency response from 20 cps to 4 kc, cross axis sensitivity, capacity, voltage and charge sensitivity. Basic calibrations are traceable to the National Bureau of Standards as required by Mil. Quality Control procedures. Special calibrations of frequency, temperature and transient characteristics are available on request.

1. MODEL 2221C—The unique ring configuration permits ease of mounting in corners with long cables attached in limited space. Integral electrical ground isolation makes the Model 2221C ideal for either bolt or cement installation. Nominal sensitivity 15 pk-mv/pk-g—Capacity 750 $\mu\mu\text{fd}$ —Weight 9 grams.

2. MODEL 2223C—Accurate triaxial vibration measurements can be made with minimum space (1" x 1" x 5/8") and weight (1.4 ounces). Integral electrical ground isolation is provided. Nominal sensitivity 10 pk-mv/pk-g — Capacity 750 $\mu\mu\text{fd}$ —Meets Mil-E-5272B.

3. MODEL 2224C—Small size — top connector — 10-32 or 1/4-28 insulated mounting stud available for ground isolation. Nominal sensitivity 10 pk-mv/pk-g — Capacity 750 $\mu\mu\text{fd}$ — Meets Mil-E-5272B.

4. MODEL 2225C—NEW Shock Accelerometer. Natural Frequency above 70 kc — Nominal sensitivity 1.0 pk-mv/pk-g — Capacity 750 $\mu\mu\text{fd}$ — Size 9/16 hex. by 0.52" high

WRITE DIRECT TO DEPARTMENT S FOR LITERATURE **ENDEVCO CORPORATION** 161 EAST CALIFORNIA BOULEVARD PASADENA, CALIFORNIA. TWX: 7764 CABLE: ENDEVCO SYCAMORE 5-0271

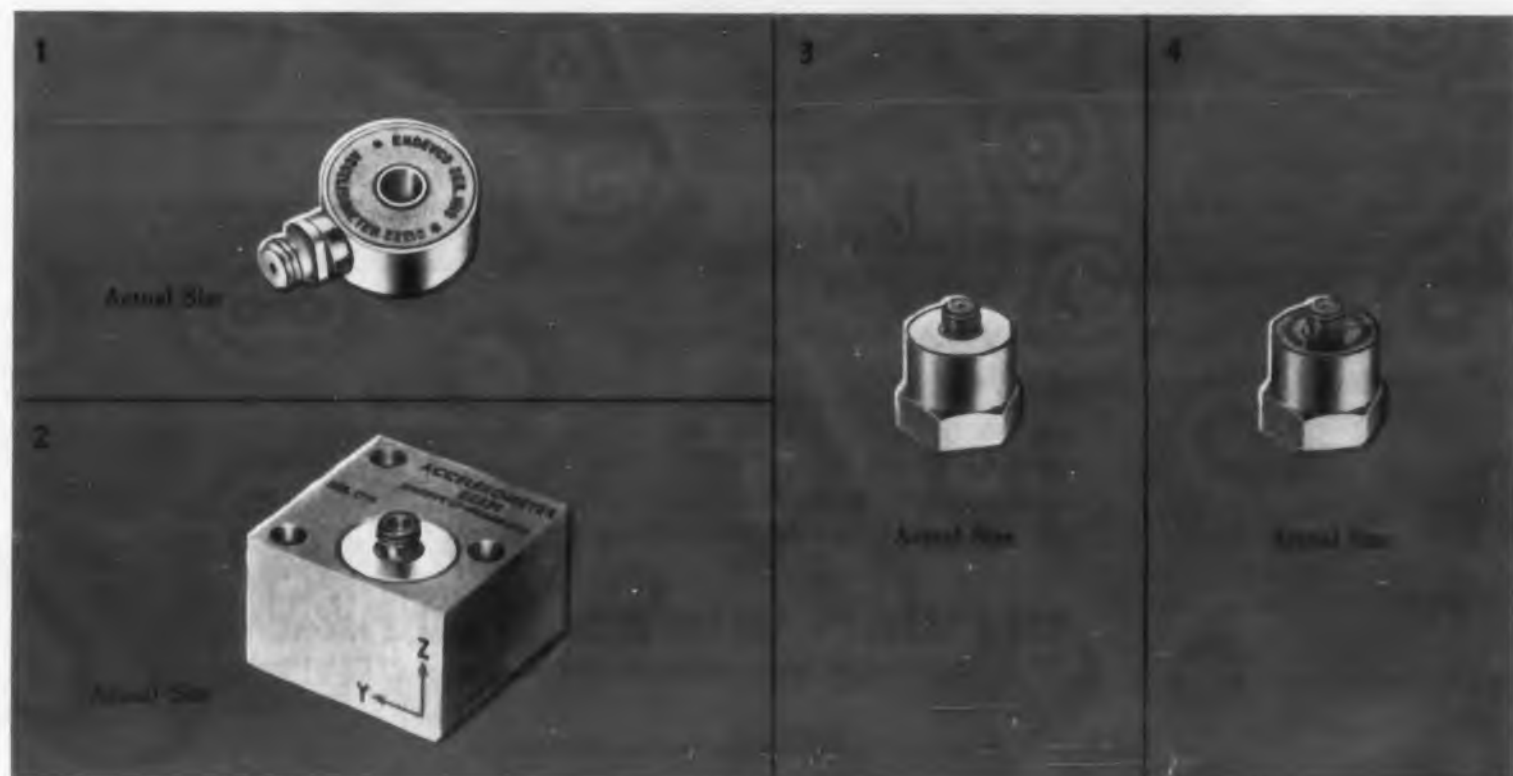

CIRCLE 786 ON READER-SERVICE CARD



**FIRST
IN
CLASS**

MCDONNELL VOODOO

Above 1200 mph, it isn't enough to put just mechanical "muscle" at the pilot's command; he needs an assist with "mental" aerobatics, too.

Teaming-up with McDonnell engineers, the specialists of the Aeronautical Division at Minneapolis-Honeywell Regulator Company turned out a mechanical co-pilot specifically for the F-101B. For nerves and sinews in this M-H Autopilot, they specified Hitemp Teflon* coated wire and cable.

As the leading specialist in high temperature insulated wires and cables, Hitemp Wires, Inc. is proud to stand among those devoted to safeguarding our country.

HITEMP WIRES, INC.

1200 SHAMES DRIVE, WESTBURY, NEW YORK

*Registered trademark for Du Pont fluorocarbon resins.

CIRCLE 787 ON READER-SERVICE CARD

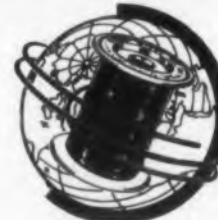

| Advertiser | Page |
|--|-----------|
| Ultradyn, Inc. | 184 |
| Union Switch & Signal Div., Westinghouse Air Brake Co. | 186, 187 |
| U.S. Magnet & Alloy Corp. | 29 |
| U.S. Stoneware | 20 |
| United Transformer Corp. | Cover III |
| Unitek | 2 |

| | |
|---|-----|
| Varian Associates | 41 |
| Veeco Electronics Corp. | 154 |
| Vernistat Div., Perkin-Elmer Corp. | 221 |
| Vitramon, Inc. | 45 |

| | |
|---|----------|
| Wallson Associates, Inc. | 178 |
| Waltham Precision Instrument Co. | 167 |
| Waters Manufacturing, Inc. | 195, 215 |
| Webber Mfg. Co., Inc. | 198 |
| Weckesser Co. | 175 |
| Weldmatic Div., Unitek | 2 |
| West Coast Electrical Mfg. Co. | 188 |
| Western Devices, Inc. | 203 |
| Western Rubber Co. | 118 |
| Westinghouse Electric Corp., Semi- Conductors | 114, 115 |
| White Industrial Div., SS | 152 |
| Whitworth Aircraft, Ltd., Sir W. G. | 105 |
| Whitso, Inc. | 146 |
| Wiancko Engineering Co. | 12 |

| | |
|-------------------------|----|
| Zierick Mfg. Corp. | 96 |
|-------------------------|----|

Advertising Representatives

Adv. Sales Manager: Bryce Gray, Jr.

New York: Robert W. Gascoigne,
Richard Parker, Blair McClenachan,
James P. Quinn, Ralph Richardson,
Donald J. Liska, Charles J. Stillman, Jr.,
830 Third Avenue, Plaza 1-5530

Chicago: Thomas P. Kavooras, Berry
Conner, Jr., Fred T. Bruce, 664 N.
Michigan Avenue, Superior 7-8064

Los Angeles: John V. Quillman,
Wayne Stoops, 3275 Wilshire Blvd.,
Dunkirk 2-7337

San Francisco: Stanley I. Ehrenclou,
292 Walter Hays Drive, Palo Alto,
Davenport 1-7646

Southeastern: Pirnie & Brown, Morgan
Pirnie, Harol V. Brown, G. H. Krimisier,
1722 Rhodes-Haverty Bldg., Atlanta,
Ga., Jackson 2-8113

London EC4: Brad Nichols, 151 Fleet
Street

**PAGES
MISSING
ARE NOT
AVAILABLE**