

# ELECTRONIC DESIGN

OCTOBER 16, 1957

B 676198

OCT 22 1957 THE LIBRARY OF  
CONGRESS  
SERIALS ACQUISITION

NOV 4

Copy



*Cooling  
Electronic  
Equipment*

A FRESH APPROACH TO CLOSE TOLERANCE NEEDS



## FEATURES

• Now available in 5 wattage ratings • Metallic resistive film accurately controlled and applied to special high quality ceramic cores • Designed to surpass characteristic A of specification MIL-R-10509B • Low noise level independent of range • Voltage coefficient can be disregarded

Here are molded metal film resistors that set new standards of performance—units that will withstand full load at 125° C. ambient to zero at 175° C. In addition to high initial accuracy, these new MIL type units combine a stability on load and a low, controlled temperature coefficient never before available in film resistors. They also provide low inductance and shunt capacitance plus excellent high frequency characteristics.

Small in size and weight, IRC precision metal film resistors can replace precision wire wound resistors in many applications. They are available in five temperature coefficient spans for maintaining or controlling resistance over wide temperature ranges. They can be used where high stability must be obtained under difficult load and humidity conditions. You'll also want to investigate them for high frequency applications. Send for complete details.

Insulated Composition Resistors • Deposited and Boron Carbon Precistors • Power Resistors • Voltmeter Multipliers • Ultra HF and Hi-Voltage Resistors

*Whenever the Circuit Says*

Low Wattage Wire Wounds • Resistance Strips and Discs • Selenium Rectifiers and Diodes • Hermetic Sealing Terminals • Insulated Chokes • Precision Wire Wounds • Potentiometers



SEND TODAY FOR IRC CATALOG B-3a

INTERNATIONAL RESISTANCE CO. Dept. 264, 401 N. Broad St., Philadelphia 8, Pa.; In Canada: International Resistance Co., Ltd., Toronto, Licensee  
CIRCLE 1 ON READER-SERVICE CARD FOR MORE INFORMATION

## Staff

<b>Editor</b>	Edward E. Gro
<b>Managing Editor</b>	J. A. Lipke
<b>Sr. Associate Editor</b>	E. T. Ebersol, Jr.
<b>Associate Editor</b>	G. H. Rosiky
<b>Assistant Editors</b>	S. Dresner P. J. Lohey T. E. Mount D. S. Viebig E. T. Blake T. E. Melville M. M. Robinson
<b>Contributing Editors</b>	S. H. Hubelban J. M. Montstrea J. G. Adashko E. Brenner
<b>Editorial Assistants</b>	F. Muehleck M. S. Buckley D. Zuckerman
<b>Art Director</b>	S. Sussman
<b>Asst. Art Director</b>	R. A. Schulze
<b>Art Assistant</b>	S. F. Richter
<b>Production Manager</b>	T. V. Sedita
<b>Asst. Production Manager</b>	M. W. Baron
<b>Production Assistant</b>	J. Siegel
<b>Business Manager</b>	P. L. Canfield
<b>Circulation Manager</b>	S. Buffinton
<b>Reader Service</b>	E. Hession

## Co-Publishers

T. Richard Gascoigne  
James S. Mulholland, Jr.

## Advertising Sales Manager

Bryce Gray, Jr.

## Advertising Representatives

**New York:** Owen A. Kean  
19 E. 62nd St.  
Robert W. Gascoigne  
Templeton 8-1940  
Harley F. Macomber  
Blair McClenahan  
Richard Parker

**Chicago:** Berry Conner Jr.  
664 N. Michigan Ave.  
Fred T. Bruce  
Superior 7-8054

**Los Angeles:** Robert E. Ahrensford  
5720 Wilshire Blvd.  
John Quillman  
WEbster 8-3881  
David W. Morgan

**San Francisco:** Donald E. Kerwin  
260 Kearny St.  
EXbrook 7-0690

## Subscription Policy

ELECTRONIC DESIGN is circulated only to qualified electronic design engineers of U. S. manufacturing companies, industrial consultants, and government agencies.

If design for manufacturing is your responsibility, you qualify for subscription without charge provided you send us the following information on your company's letter head: Your name and engineering title, your company's main products, and description of your design duties. The letter must be signed by you personally. Any address changes for old subscribers necessitates a restatement of these qualifications.

Subscription rate for non-qualified subscribers—\$12.00 for 1 year only.

Hayden Publishing Company, Inc.  
19 East 62nd Street  
New York 21, New York

# ELECTRONIC DESIGN

## Contents

Vol. 5, No. 20

October 15, 1957

<b>Cooling Electronic Equipment (Cover)</b> . . . . .	following p.	90	
<b>Editorial</b> . . . . .		4	
<b>Engineering Review</b> . . . . .		5	
Washington Report . . . . .		18	
<b>Features</b>			
Thermal Design—I, H. M. Passman . . . . .		26	
Portable Plenum Test Chamber, G. H. Siegel . . . . .		30	
Flying Spot Programmer . . . . .		34	
Principles of Filtering—II, L. S. Schwartz . . . . .		36	
Microvolt Instrument Transformer . . . . .		40	
A New Evaporative Cooling Technique, R. Berner . . . . .		42	
New Vibration System . . . . .		46	
<b>Cooling Electronic Equipment</b>			
Why Thermal Design? . . . . .		ii	
Designing Cooling Systems for Airborne Electronic Equipment, C. A. Hathaway . . . . .		iv	
Weight Flow Nomograms For High Altitude Air Cooling, J. C. Van Rijn . . . . .		xii	
Motor Design for Fans and Blowers, O. W. Giesecke . . . . .		xviii	
Manufacturers of Cooling Equipment for the Electronic Industries . . . . .		xxi	
<b>Ideas for Design</b>			
Antenna Ice Alarm . . . . .		146	
Results from Ultrasonic Soldering . . . . .		148	
Self-Biased Blocking Oscillator . . . . .		149	
Low Cost Constant-Voltage Source . . . . .		150	
Hum Reduction . . . . .		151	
"Zippertubing" Saves Time . . . . .		151	
<b>Russian Translations</b>			
What The Russians Are Writing . . . . .		162	
<b>Abstracts</b>			
Electronic Differentiation and Integration . . . . .		166	
Heat-Storage Cooling . . . . .		168	
RF Voltmeter Calibration . . . . .		170	
<b>Departments</b>			
Letters . . . . .	20	New Literature . . . . .	131
Meetings . . . . .	22	Report Briefs . . . . .	152
New Products . . . . .	48	Patents . . . . .	156
Production Products . . . . .	118	Books . . . . .	160
New Materials . . . . .	122	Standards & Specs . . . . .	172
Services for Designers . . . . .	128	Careers . . . . .	176
Advertisers' Index . . . . .			177

ELECTRONIC DESIGN is published semi-monthly by Hayden Publishing Company, Inc., 19 E. 62nd Street, New York 21, N. Y., T. Richard Gascoigne, President; James S. Mulholland Jr., Vice-President & Treasurer and David B. Landis, Secretary. Printed at Hildreth Press, Bristol, Conn. Acceptance under section 34.64 P. L. & R. authorized. Copyrighted 1957 Hayden Publishing Company, Inc. 30,000 Copies this issue.



*but only when components are reliable*

Modern fire control and gun direction equipment must depend completely on the reliability of hundreds of components. The products of G-V Controls Inc. have been adopted by the major manufacturers of this vital equipment and have proven themselves by a long record of dependable performance.

#### **G-V Hot Wire Time Delay Relays**

*1/10 to 5 seconds with fast recovery*

#### **G-V Thermal Time Delay Relays**

*Adjustable delays of 2 to 300 seconds*

#### **G-V Voltage & Current Sensing Relays**

*For circuit protection*

#### **G-V Electrical Thermostats**

*Hermetically sealed, still adjustable*

A well-qualified G-V Representative is ready to serve you. Write for data.



## **G-V CONTROLS INC.**

18 Hollywood Plaza, East Orange, N. J.



CIRCLE 2 ON READER SERVICE CARD FOR MORE INFORMATION

Approved and Accepted in TOUGH Applications



# CK6832 RELIABLE SUBMINIATURE TWIN TRIODE for D.C. AMPLIFIER and COMPUTER SERVICE

with *all* the reliability specified, including *heater cycling life test; 100 hour survival rate life test; 500 hour intermittent high temperature life test*; — and with the desirable performance characteristics of its prototype, the miniature CK5755.



CK6832

#	26
Gm	1050 $\mu$ mhos
Ib	0.8 mAdc

Developed for Bell Telephone Laboratories  
under Army Ordnance Contract.

### Featuring:

UNIQUE ELECTRICAL STABILITY... 12 mVdc, max.

The grid to grid unbalance voltage resulting from a reduction of heater voltage from 6.3 to 5.9 volts

UNIQUE MECHANICAL STABILITY... 20 mVac, max.

The grid to grid unbalance voltage resulting from six repeated shocks having an acceleration of several hundred G

CLOSE BALANCE  
BETWEEN SECTIONS... 24 mVdc, max.

The grid to grid unbalance voltage resulting from six operating cycles of fifteen minutes "on" and five minutes "off"

LOW GRID CURRENT...  $3 \times 10^{-9}$  A, max.

Each section

LOW MICROPHONICS... 10 mVac, max.

Output of each section resulting from vibration at 40 cps, 15 G

## SPECIAL TUBE DIVISION

RELIABLE MINIATURE AND SUBMINIATURE TUBES • VOLTAGE REFERENCE TUBES  
VOLTAGE REGULATOR TUBES • PENCIL TUBES • NUCLEONIC TUBES



NEWTON, MASS.: 55 Chapel St. • Btgelow 4-7500  
NEW YORK: 589 Fifth Ave. • PLaza 9-3900  
CHICAGO: 9501 Grand Ave., Franklin Park • TUXedo 9-5400  
LOS ANGELES: 5236 Santa Monica Blvd. • NOrmandy 5-4221

CIRCLE 3 ON READER SERVICE CARD FOR MORE INFORMATION

## Editorial

### A Problem Is Ventilated

The staggering cost of electronic repairs in the field emphasizes the vital importance of reliability in original equipment design. More often than not, troubles are traced to overheating. This has accentuated the need for better thermal design.

Authorities in the field of thermal design are in complete agreement on one score. "The electronic design engineer is woefully inattentive to thermal aspects of his design." The usual practice, it seems, is to complete a design, complete the chassis layout, then, observing an unoccupied corner of the chassis, comment: "I guess we can put a fan there."

This situation, exaggerated perhaps, is nevertheless representative. The literature abounds in theoretical approaches to thermal problems. The electronic design engineer has little enough time, and sometimes inadequate background, to permit himself the luxury of an intensive study of thermal design.

In answer to the need for basic, practical design information, this issue of ELECTRONIC DESIGN is devoted principally to the problems of cooling electronic equipment. We have assembled a variety of articles to present a many-sided picture of the cooling problem, and approaches to its solution.

In *A New Evaporative Cooling Technique*, Mr. Berner discusses a method employing two old techniques to form a new approach. The evaporative technique is, in itself, not new. It is well known that equipment can reject a great deal of heat in boiling water. Normally, components are immersed directly in the water. This, unfortunately, raises problems of corrosion, insulation and dielectric losses. The use of good, thermal conductive paths from heat source to sink is also not new. The combination of the two techniques in this application is rather novel and appears to operate admirably.

Mr. Giesecke, in *Motor Design for Fans and Blowers*, airs out an aspect of the cooling problem too often left to the end of a system layout.

In a comprehensive analysis, Mr. Hathaway discusses four basic design approaches employing air as a cooling medium. His *Designing Cooling Systems for Airborne Electronic Equipment* is directed toward a situation where overcooling is almost as serious a problem as undercooling, involving, as it does, enormous penalties for excess weight.

In addition to these and other cooling stories, ELECTRONIC DESIGN is presenting a special section in this issue, devoted exclusively to cooling electronic equipment. You may obtain a free reprint of the entire section if you circle 491 on the Reader Service Card.—GR

# Engineering Review

For more information on developments described in "Engineering Review," write directly to the address given in the individual item.

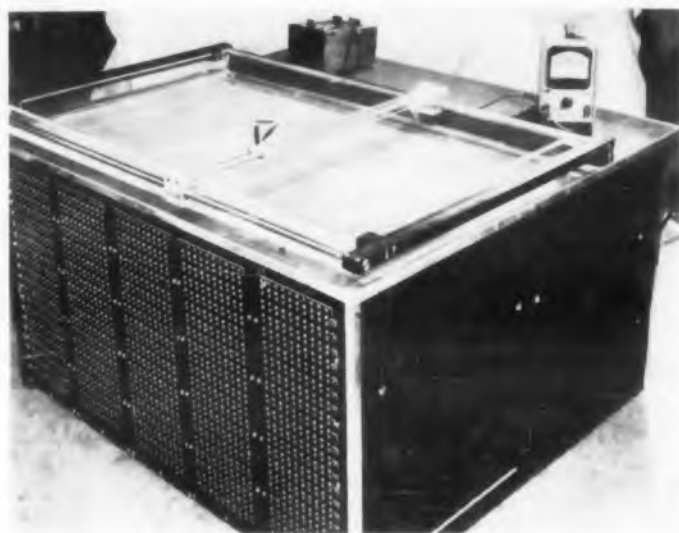

This electrolyte tank when connected to a computer, yields information on the operation of nuclear reactors.

## Electrolytic Analog Computer

Measurement of electric currents and voltages in a tank of electrolytic liquid provides information on the internal conditions of experimental nuclear devices at the Pratt and Whitney Aircraft Division of the United Aircraft Corp., Dayton, Ohio.

This electrolytic analog computer designed by the Nuclear Development Corp. of America, White Plains, N.Y., solves the formidable problems by setting up an analogous situation, in which the measurement of electric current and voltage in an electrolyte are comparable to the conditions of heat flow and temperature in corresponding locations of a nuclear reactor.

The plexiglass tank containing the electrolyte is three by five feet by three inches deep. Readings are taken by means of 1500 electrodes inserted into the solution.

## Varicap, Variable Capacitor

This tiny electronic component, the size of a tear-drop, has special characteristics necessary for effective operation as a voltage variable capacitor. Varicap, produced by Pacific Semiconductors Inc., Culver City, California, has no filament to heat, and has no moving parts, as does the reactance tube and the variable capacitor which this device is capable of replacing.

The unit weighs less than a gram, is a highly rugged device, and operates reliably from  $-65$  to  $+150$  C. For FM transmission and reception, the miniaturization factor is extremely important, as it allows the production of light weight devices of greater adaptability and reliability. In television manufacture, it is possible through the use of this capacitor, to eliminate the fine tuning control. In color television, the incorporation of this device into the circuitry, will permit automatic observation and maintenance of color fidelity.

ELECTRONIC DESIGN will carry a complete technical article on this device in the next issue.



The tiny Varicap unit shown on the right has replaced the tuning capacitor in an experimental standard broadcast receiver. It has also replaced an afc vacuum tube circuit in an fm tuner.

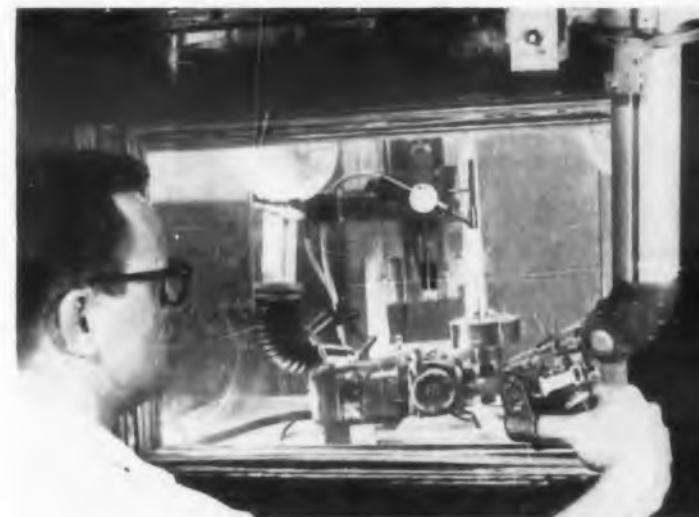

## Remote Welding of Radioisotope Capsules

A new welding unit for sealing highly radioactive materials in stainless steel capsules was recently placed in operation at Oak Ridge National Laboratory, Oak Ridge, Tennessee. The unit is remotely operated and uses an inert gas shielded arc welding torch.

Radioactive materials such as cesium-137, iridium-192, and cobalt-60, in multi-curie quantities, have been prepared in capsule form by the Radioisotope Department at the Laboratory for some time, using such sealing methods as soldering and gasketing. However, numerous requests for radioactive sources to be used in high-temperature operations or in corrosive solutions necessitated the use of welded stainless steel jackets which would tolerate these conditions.

The welding equipment manufactured by Union Carbide Nuclear Co., 30 East 42nd St., New York, N.Y. consists of two portable units, a power supply unit, and a remotely-operated assembly. The welding unit is of conventional design and includes a welding machine, control panel, and motorized amperage control.

# Broad Temperature Range elastomers for **LORD** bonded rubber mountings

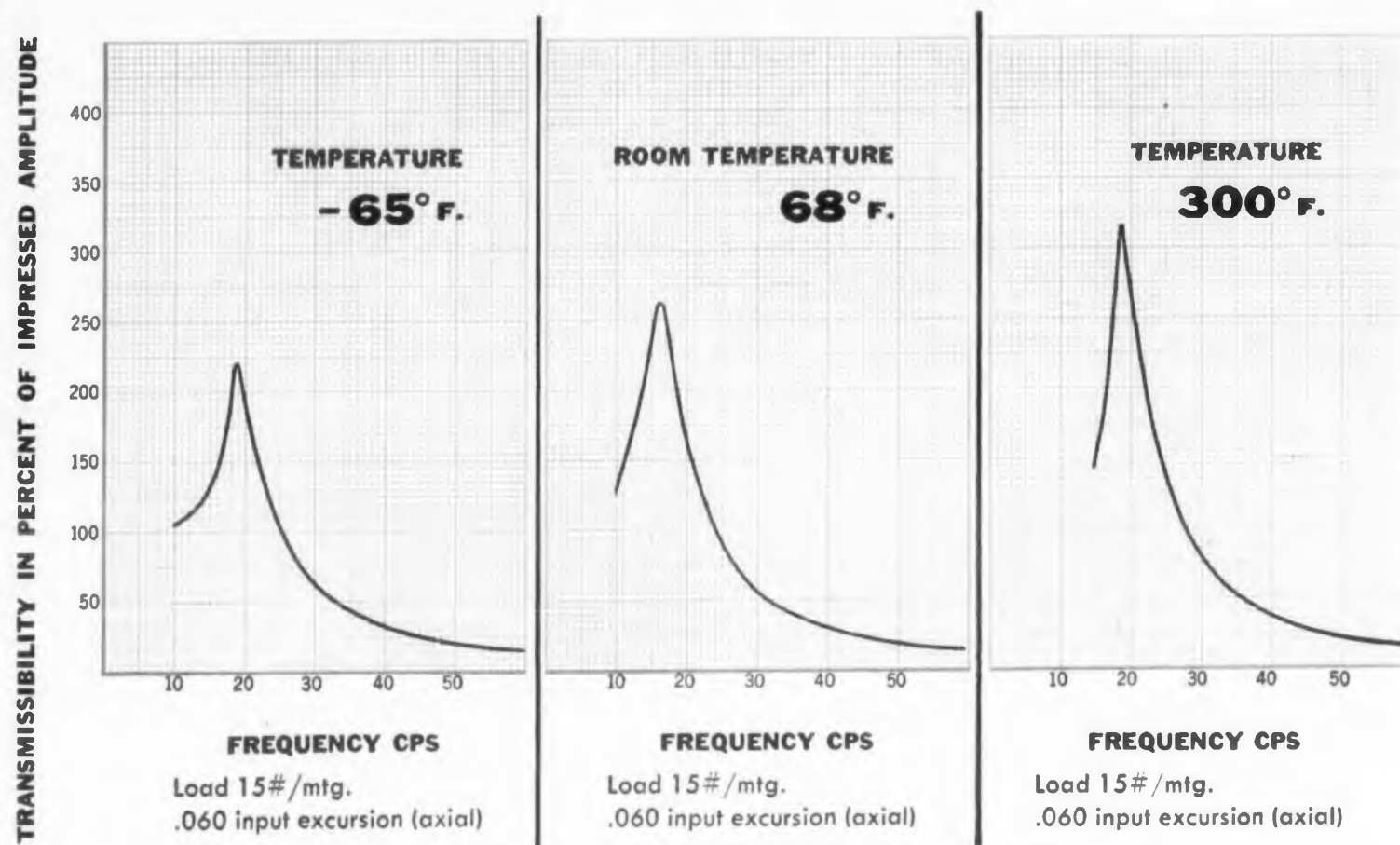

**BROAD TEMPERATURE RANGE** — Transmissibility curves for LORD Mounting with new type BTR elastomer indicate that temperature extremes produce minimum change in physical properties. Transmissibility at resonance is three or less at 68°F. or lower temperatures, and 3.5 or less at 300°F.

■ A new type Broad Temperature Range elastomer with resistance to temperature extremes is now available from LORD Manufacturing Co.

This new material is used in performance-proved LORD mounting designs to assure superior vibration isolation under severe environmental conditions. It is resistant to oil and ozone, and functions efficiently in temperature ranges from -65°F. to 300°F. Its proven mechanical

properties include high tensile strength, high tear resistance, and good flex life. The hysteresis characteristic of the material eliminates the need for auxiliary dampers, which generate harmonics destructive to mounted equipment.

For further information on this new elastomer, contact your nearest LORD field engineer or the Home Office, Erie, Pa.

ATLANTA, GEORGIA - Cedar 7-1123  
BOSTON, MASS. - HAncock 6-9135  
CHICAGO, ILL. - Michigan 2-6010  
CLEVELAND, OHIO - SHadyside 9-3175  
DALLAS, TEXAS - RiVerside 1-3392

DAYTON, OHIO - Michigan 8871  
DETROIT, MICH. - TRinity 4-2060  
KANSAS CITY, MO. - WEstport 1-0138  
LOS ANGELES, CAL. - HOLlywood 4-7593  
NEW YORK, N. Y. - Circle 7-3326

PHILADELPHIA, PA. - LOcust 4-0147

"In Canada—Railway & Power Engineering Corporation Limited"

**LORD MANUFACTURING COMPANY • ERIE, PA.**



designers  
and producers  
of bonded  
rubber  
products  
since 1924

CIRCLE 4 ON READER-SERVICE CARD FOR MORE INFORMATION

## Engineering Review

### Machine Tells If Heart Is Still Beating

Vital information on the condition of the heart of an unconscious, pulseless person is made immediately available by an electrical monitoring device, presented before the fall general meeting of the AIEE in Chicago.

The device was described as a cardiac monitor and is portable, battery-operated, inexpensive, explosion proof, and uses transistors. This monitor is used in aiding in the detection of stoppage of the heart, fibrillation or quivering of the heart, and collapse of that organ.

Diagnosing of the condition of an unconscious, pulseless patient, resulting from disease, accident or drugs, is difficult. Serious brain damage or death will result if the heart does not resume normal beating within four minutes, and death is almost certain over 12 minutes. Attempts to restart the heart by making incision in the chest and massaging the vessel, or using defibrillators or pacemakers, may be futile unless there is a correct diagnosis of the heart condition.

The cardiac monitor will give a continuous, instantaneous, visual monitoring of the rate and rhythm of the heart, indicating its condition and serving as a guide to attending physicians.

### Designing for Maintainability

A comparison of British and American maintenance procedures indicates that the British "probably" give more attention to maintainability in their designs of electronic equipment than do American designers.

In a paper concerning "British and American Maintenance Techniques" by Milton V. Ratynski, delivered at the Military Electronics Convention in Washington, it was contended that "any survey of American equipment design will reveal many more 'trick' and 'marginal' type circuits than British designers would dare to use. American designers seem to delight in using only the latest . . . in components and circuitry, often at the cost of stability, reliability, or maintainability."

Since equipment design has a great influence on test equipment used and needed in field maintenance, often sufficient test equipment is not available in the field for proper maintenance. "Almost every time a new electronic equipment arrives, it also needs a new or different set to maintain it properly . . . literally dozens of different test sets differ only slightly in characteristics but are not generally interchangeable."

CIRCLE 5 ON READER-SERVICE CARD



# MICROWAVE SIGNAL GENERATION

**Complete Coverage  
650 to 11,500 mc.**

Each Polarad Microwave Signal Generator is equipped with the unusually simple UNI-DIAL control that tracks reflector voltages automatically while tuning continuously. Frequency, accurate to  $\pm 1\%$ , is read directly on the single frequency dial. These rugged instruments include internal modulation, pulse and FM; internal square wave modulation; synchronization outputs, delayed and undelayed; provision for multi pulse modulation input; provision for external modulation and synchronization, variable attenuator calibrated directly in dbm, engineered ventilation to insure specification performance over long operating periods.



These Polarad Microwave Signal Sources are direct reading and continuously tuned with Polarad's UNI-DIAL control that automatically tracks the reflector voltage as the klystron cavity is being tuned. Maximum power output is assured throughout the entire range of each instrument by means of a power set control.

For improved stability, a klystron tube is in an external precision cavity. All Polarad Signal Sources can be externally modulated with either square wave or FM signals.

\*Model SSX-E 7,850-11,500 available on special order.

ur of  
no di-  
evice,  
f the  
onitor  
e, ex-  
tor is  
of the  
d col-  
ious,  
ent or  
death  
beat-  
ertain  
urt by  
e ves-  
ay be  
heart  
is, in-  
e and  
n and  
ainte-  
"prob-  
lity in  
an de  
merican  
tynski  
tion in  
vey of  
y more  
ish de-  
s seem  
compe-  
lity, re  
nce ad  
mainte-  
t avail-  
"Almos-  
ives,  
tain  
est set-  
are no  
CARD  
195

# MICROWAVE SIGNAL GENERATION

**Complete Coverage  
12,400 to 50,000 mc**

EHF Microwave Signal Generators

- A completely integrated self-contained signal generator covers 12,400 to 17,500.
- 7 plug-in r-f tuning units and a basic unit cover the frequency range from 18,000 to 39,700 mc.
- Direct-reading calibrated output attenuator, accuracy  $\pm 2$  db.
- Frequency calibration accomplished by a  $\pm 0.1\%$  direct-reading wavemeter.
- Internal 1000 cps square-wave modulation.
- Capable of external modulation, both pulse and FM.
- Equipped with integral electronically regulated power supplies.

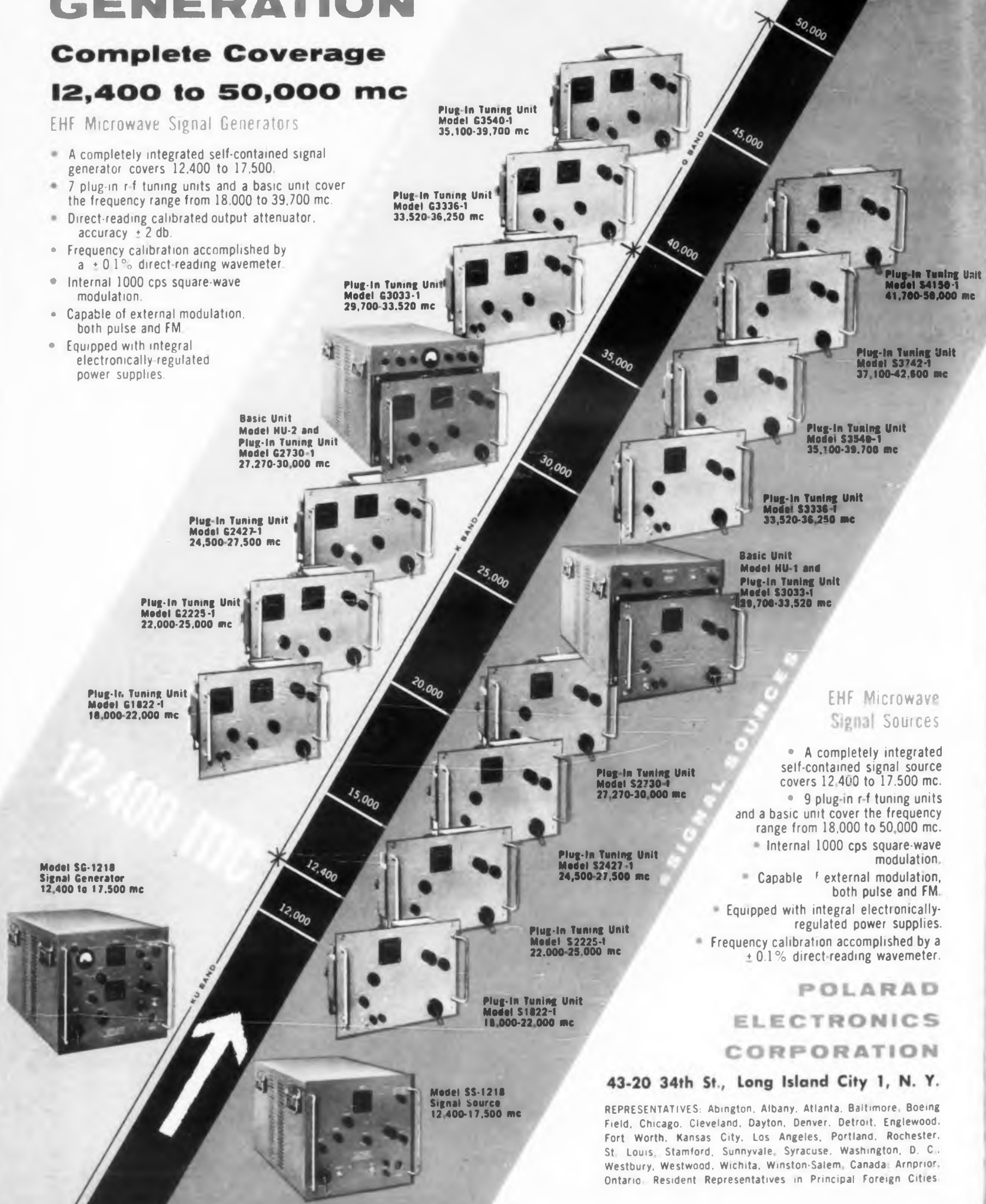

## EHF Microwave Signal Sources

- A completely integrated self-contained signal source covers 12,400 to 17,500 mc.
- 9 plug-in r-f tuning units and a basic unit cover the frequency range from 18,000 to 50,000 mc.
- Internal 1000 cps square-wave modulation.
- Capable of external modulation, both pulse and FM.
- Equipped with integral electronically-regulated power supplies.
- Frequency calibration accomplished by a  $\pm 0.1\%$  direct-reading wavemeter.

**POLARAD  
ELECTRONICS  
CORPORATION**

43-20 34th St., Long Island City 1, N. Y.

REPRESENTATIVES: Abington, Albany, Atlanta, Baltimore, Boeing Field, Chicago, Cleveland, Dayton, Denver, Englewood, Fort Worth, Kansas City, Los Angeles, Portland, Rochester, St. Louis, Stamford, Sunnyvale, Syracuse, Washington, D. C., Westbury, Westwood, Wichita, Winston-Salem, Canada: Arnprior, Ontario. Resident Representatives in Principal Foreign Cities.

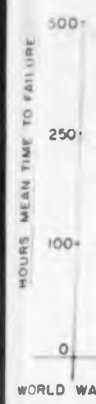

Relation of past

One stability controllances to nal level ardzed

When point, th liability equipm maintain stance. In of comp Prediction sary to s

In ad Chief of Develop the perfor mary dra dures. E

actions I out rega ment. Of same tes s operat which a Sampling such as

Eight Mr. Raty built-in t rics and

checking liately sh ma or cor way equ me it mod

engineering to by he tec feel nician

CIRCLE 5 ELECTRO



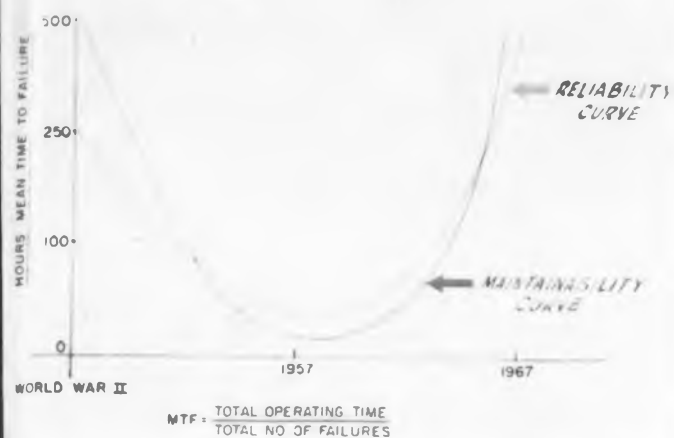

Relationship between reliability and maintainability of past, present and future electronic equipment.

One suggestion to increase equipment maintainability is to establish rigid standards for readily controlled design factors including input impedances to chassis or sub-chassis and voltage and signal level at test points, perhaps by utilizing standardized equipment modules.

When designing from a maintainability viewpoint, the inherent conflict between this and the reliability approach is a major consideration. If equipment could be made 100 per cent reliable, maintainability would naturally be of no importance. If this is not attainable, however, prediction of component function would be the next best thing. Prediction is still not possible so that it is still necessary to strive for a compromise in design.

In addition to poor design, Mr. Ratynski, who is Chief of the General Engineering Lab. at Rome Air Development Center in N. Y., cited wasted effort in the performance of unnecessary functions as a primary drawback in present field maintenance procedures. Existing procedures require that specific actions be performed at predetermined times without regard to the condition of the electronic equipment. Often the testing apparatus does not give the same test as does the circuit in which the equipment is operated, resulting in the rejection of materials which are actually better than the new ones. Sampling tests of discarded tubes have shown as much as thirty-five per cent to be functional.

Eight design techniques were recommended by Mr. Ratynski to increase maintainability, including: built-in test equipment; overall self-checking devices and systems to offset present point-by-point checking procedures; built-in indicators to immediately show whether a circuit or sub-circuit or even one or components are operating; the use of throwaway equipment; standard circuits; standard equipment modules; failure prediction; and human engineering to permit the equipment to be maintained by the technician who is in the field rather than the technician who is supposed to be in the field.

CIRCLE 5 ON READER-SERVICE CARD

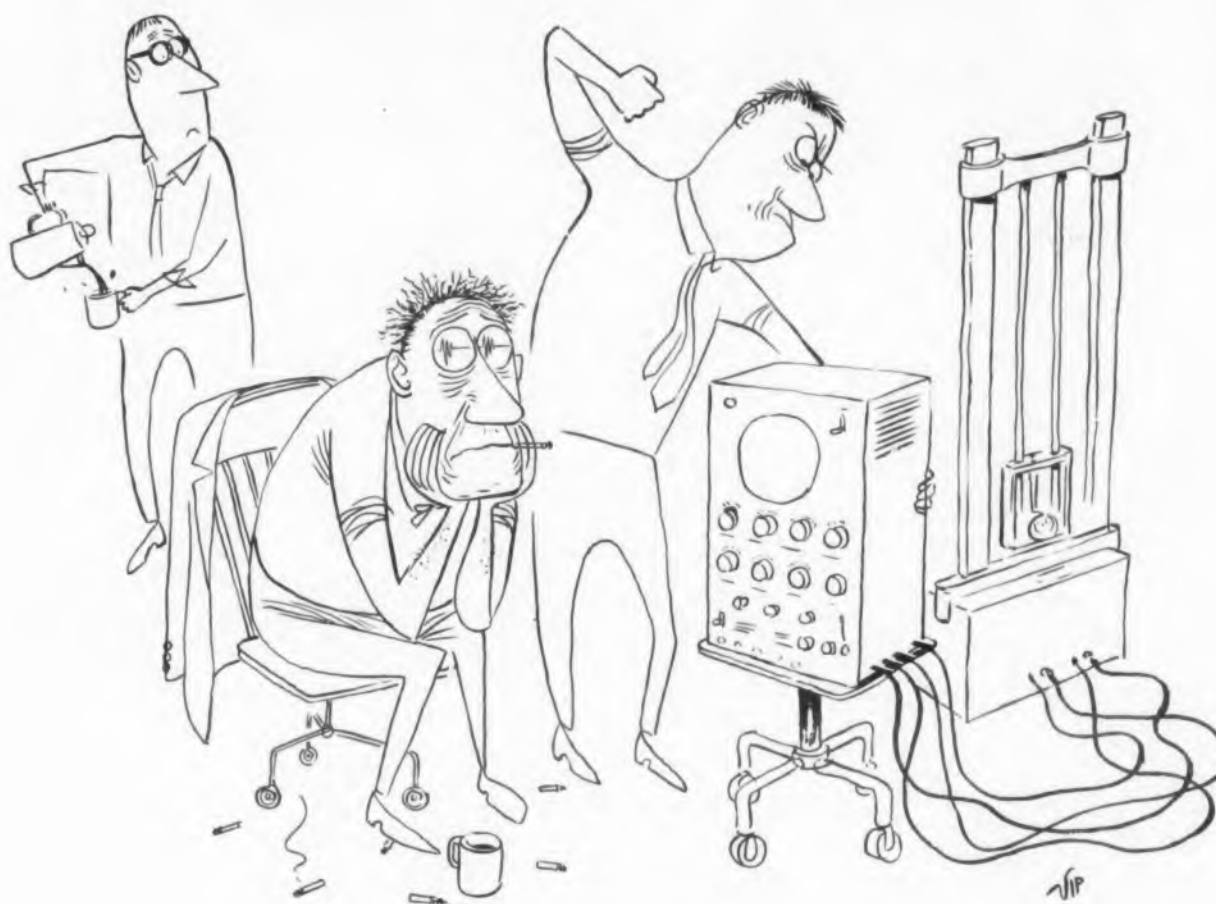

**PROBLEM:** Transients—Capture and Study



Ask to see the MEMO-SCOPE Oscilloscope in action. A Hughes representative will arrange an on-the-job demonstration — at your convenience. Make your request to:

**HUGHES PRODUCTS**, MEMO-SCOPE Oscilloscope  
International Airport Station, Los Angeles 45, California

If you're engaged in watching transients, the profit-watchers may be watching you. Because transient study on conventional scopes can waste time, effort and research dollars. Inability to "capture" traces need never happen to you.

**SOLUTION:** The happy answer is the new Hughes MEMO-SCOPE® Storage Type Oscilloscope. A transient recorder with a *memory*, it can capture and retain single or successive writings for an *infinite length of time* or until intentionally erased. Any number of elusive wave forms may be instantly "frozen" in brilliant display for study or photography *at leisure*. The savings to you are self-evident.

**HUGHES MEMO-SCOPE OSCILLOSCOPE**

**STORAGE TUBE**

5-inch diameter Memotron® Direct Display Cathode Ray Storage Tube. Writing speed for storage: 125,000 inches per second. The optional Speed Enhancement Feature multiplies writing speed approximately four times.

**MAIN VERTICAL DEFLECTION AMPLIFIER**

Frequency Response: DC to 700 KC down 3 db at 700 KC.

**MAIN HORIZONTAL DEFLECTION AMPLIFIER**

Frequency Response: DC to 250 KC down 3 db within that range.

Sensitivity: 0.5 volts to 50 volts per division continuously adjustable.

Input Impedance: 1 megohm shunted by 50  $\mu$ f.

Creating a new world with **ELECTRONICS**

**HUGHES PRODUCTS**

® Trademark Hughes Aircraft Company

CIRCLE 6 ON READER-SERVICE CARD FOR MORE INFORMATION



# DESIGNER'S



ROUND MODEL



SQUARE MODEL



PORTABLE MODEL



PROTECTIVE CONDUIT CASE

## New General Electric time meters provide easier reading, cost less

OLD  
(Life Size)



99940.9

NEW  
(Life Size)

Now, at a new low cost, you can build-in a far more readable measurement of operating time of your electronic equipment with new General Electric Time Meters. New, easy-to-read dials are 2½ times larger than dials on ordinary time metering equipment. This reduces the chances of errors in readings, speeds up routine checking.

More precise, wider-range measurement is provided, too. Each of the meters in this new and complete line has an extra 1/10 digit to permit finer measuring . . . from 0 to 99999.9 minutes or hours.

Operating temperature range—now from -67 F to 150 F—has been widened to increase possible uses, lengthen meter life.

On all but sealed models, a conveniently located reset knob is available optionally. Extended terminals on all models simplify hookup, and totally enclosed construction provides dustproof protection.

A special model is also available to meet military specifications MIL-M-6A, paragraphs 4.6.1, 4.5.16, and 4.6.18A.

**Round and Square models**, with or without reset, for mounting on panels or test equipment, are made in 2½ and 3½ inch sizes. **Portable stand meter** is for laboratory use or where a permanent mounting is not desirable. **Protective conduit case** is easily installed, helps protect against moisture. For details, see Bulletin GEA-6710.

## Now—G-E silicon cells with either polarity simplify equipment design

New high-power silicon rectifiers made by General Electric are now available with either positive or negative base, to simplify your design of power supply equipment. You can now use the negative and/or positive busbar for a combination heat sink, current conductor, and mechanical support for the cells. Construction of stacked assemblies is also simplified.

Large flexible take-off leads are used to increase the effectiveness of heat transfer from the cell. Axial or radial flexible leads are provided according to the particular application.

Hermetically sealed General Electric silicon component rectifiers are available in all voltage ratings up to 350 PIV. Low forward-voltage drop and efficient thermal package permit current ratings up to 140 amperes. For more information, check Bulletin GEC-1470.



**HERMETICALLY SEALED** silicon cell shown above is mounted on a standard ½-20 stud for mounting on a plate-type heat sink. Cell can also be furnished on a ¼-in. pipe thread stud for other types of heat sinks, including liquid-cooled busbars.

**ACTUAL-SIZE VIEW** of G-E silicon rectifier cell shows the hermetically sealed silicon wafer. This construction has been performance-tested for 4 years in G-E high-power germanium rectifier equipment totalling over 55,000 kw.

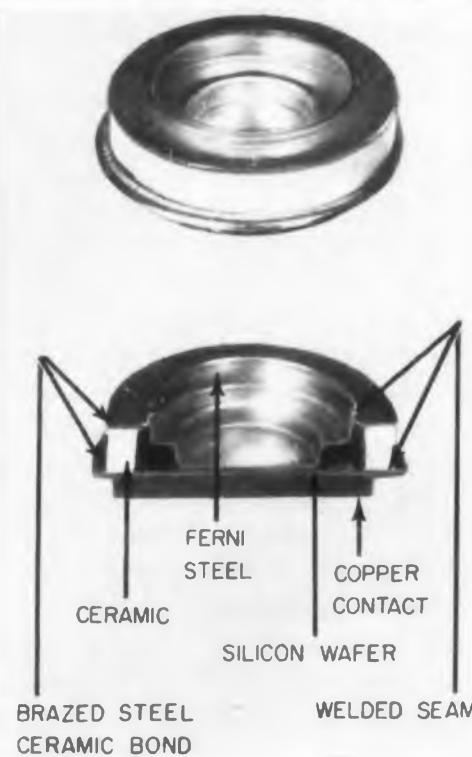

# GENERAL ELECTRIC

### At half the cost of metal-clad tubular capacitors— Subminiature molded PVZ\* capacitors operate from -55C to +125C

Critical space and temperature problems in electronic design can be solved with less effort and at far less cost with the help of General Electric's molded PVZ paper tubular capacitors. Now immediately available, these capacitors are priced at less than half the cost of comparable metal-clad tubulars. Subminiature units are designed for a minimum of one year's life at rated voltage and 125C operation.

#### MEETING EXACTING CIRCUIT NEEDS

These molded PVZ capacitors meet the performance requirements of Characteristic "E" for MIL-C-91A, and at the present time are being widely used in computers, missiles, and other high-grade military and commercial electronic equipment. PVZ paper tubular capacitors are impregnated with a high-temperature organic resin and feature extended foil construction throughout. The solid capacitor rolls are contained

\*Trade-mark of General Electric Company.

in a mineral-filled phenolic plastic case. Completely solid after molding, the unit offers high lead strength and excellent resistance to shock, vibration and moisture because of the high-grade case material and controlled molding techniques.

#### RATINGS COVER WIDE RANGE

General Electric PVZ capacitors are supplied in 100, 200, 300, and 400 volt ratings. Microfarad values range from .00047 to .15 uf at 100 volts; .00047 to .1 uf at 200 volts; .00047 to .068 uf at 300 volts; and .00047 to .022 uf at 400 volts. Units are available with  $\pm 20\%$ ,  $\pm 10\%$  and  $\pm 5\%$  tolerances. Nine different sizes are offered, ranging from .175 inch diameter by .625 inch long to .375 inch diameter by 1.0625 inches long. Microfarads, volts, and capacitances are indicated by a convenient color code. See Bulletin GEC-1452, listed below.

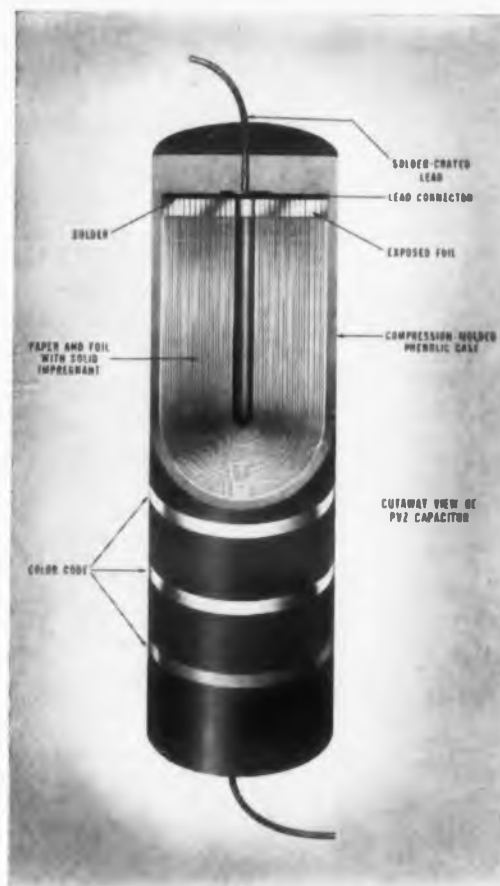

CUTAWAY VIEW OF PVZ capacitor shows its insulated body and solid impregnant. These features provide resistance to shock, moisture.



SPACE-SAVING, subminiature PVZ capacitors range in size from .175 inch diameter by .625 inch long to .375 inch diameter by 1.0625 inches long.

## High power, extra-fast response are combined in space-saving d-c motor-tachometer unit

Small size, great power and fast response are the outstanding features of this General Electric d-c motor-tachometer unit. It is readily applicable to practically any servo system. An example of its use is the driving

of a ground radar antenna in a missile guidance system.

Model shown is less than 15 inches long and only 5.16 inches in diameter—yet it packs 2.2 hp at 5500 rpm, 200 volts d-c,

with Class B insulation. Motor reaches 63 per cent of rated speed in only .014 seconds from standstill. When blower-cooled by the customer, it delivers 2.65 lb-ft of torque over the entire speed range from standstill

to 4500 rpm. Stall torque is 10 lb-ft.

Motor is made in two frame sizes, operates at any angle, and uses any d-c control power supply. For more information, check your nearest Apparatus Sales Office.

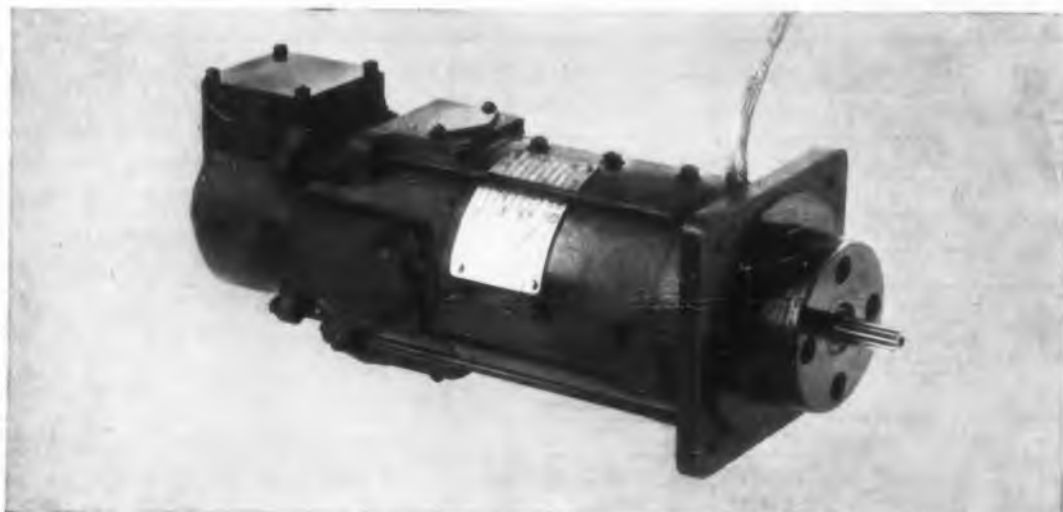

CIRCLE 7 ON READER SERVICE CARD FOR MORE INFORMATION

GENERAL ELECTRIC COMPANY, APPARATUS SALES DIVISION, SECTION A667-38,  
SCHENECTADY 5, NEW YORK

Please send me the following:

for reference only

for planning an immediate project

GEA-6710 Time meters

GEC-1452 Molded tubular capacitors

GEC-1470 High-current silicon rectifiers

For more information on other products, contact your nearest G-E Apparatus Sales Office.

NAME \_\_\_\_\_

COMPANY \_\_\_\_\_

CITY \_\_\_\_\_

STATE \_\_\_\_\_

## Engineering Review

### Machine Takes Own Orders

An automatic assembly machine which takes orders from itself has been developed for use in automatically fastening components onto printed circuit panels before they are inserted into computers and other electronic equipment. When a change in the layout and componentry of a panel is called for, the machine gets instructions from punched cards and then automatically resets itself for the new assignment. Assembly speed is reportedly over ten times faster than is possible by manual methods and a more uniform product can be obtained.

The system was built by IBM and is being used at the Poughkeepsie facility. It is capable of inserting one component every second and one-half. A proposed market version of the system is a one-a-second machine. Key to successful design and operation was the decision to standardize many characteristics of printed panels as well as dimensions of electronic components. Now, for example, all components are packaged in one of two ranges of size regardless of their individual characteristics.

Components are grouped according to their electrical values, mounted on masking tape belts, and wound on cut-off reels, much in the same way that machine gun bullets are loaded in drums. Several thousand components are stored on each reel. The system has a capacity of twenty reels, although it can be expanded to accommodate many times that number if necessary. The reels are set in place on the selection rack and the lead-taped components are fed into cut-off stations.

In order to attach a component on a printed panel, three instructions must be provided simultaneously by the system's card reader. Two columns of a punched card contain the three instructions needed to insert any one component. The first tells the device which one of twenty different stored components to select, cut-off from its reel, and deliver to the insertion system. The second and third instructions position the panel so that the selected holes are accurately aligned under the insertion mechanism. When all three instructions have been obeyed, the insertion system automatically inserts the selected component and staples it to the panel. This process continues repeatedly until all instructions have been followed and the printed panel is completely assembled.

The system will accommodate any size panel up to 10 in. sq and will operate to accuracies of better than 0.002 in. A two-directional servo system, which performs the positioning operation, can locate the panel to receive a component at any intersect of a 0.05 in. grid.

# NOW: available on as

For engineering evaluation of thermistor and varistor characteristics, you can now obtain any of 37 individual test kits, each containing six pieces. The minimum quantity per order is three kits. Shipment will be made postpaid to any destination in the United States and Canada.

## Global THERMISTORS

To evaluate thermistor circuit applications for:

1. Temperature compensation.
2. Time delay.
3. Temperature sensing and control.

Test Kit No.	Type	Body Size		R at 25° C ± 20%	Nom. Temp. Coeff. "B" Constant	Max. Watt Loading at 40° C	Price
		Length	Dia.				
T-1	997F	1 <sup>9</sup> / <sub>64</sub> "	7 <sup>3</sup> / <sub>64</sub> "	40 ohms	1500	0.25	\$3.95
T-2	997F	1 <sup>9</sup> / <sub>64</sub> "	7 <sup>3</sup> / <sub>64</sub> "	220 ohms	1750	0.25	3.95
T-3	997F	1 <sup>9</sup> / <sub>64</sub> "	7 <sup>3</sup> / <sub>64</sub> "	10000 ohms	1950	0.25	3.95
T-4	763F	5 <sup>8</sup> / <sub>8</sub> "	7 <sup>3</sup> / <sub>32</sub> "	5 ohms	1200	0.5	3.70
T-5	763F	5 <sup>8</sup> / <sub>8</sub> "	7 <sup>3</sup> / <sub>32</sub> "	10 ohms	1400	0.5	3.70
T-6	763F	5 <sup>8</sup> / <sub>8</sub> "	7 <sup>3</sup> / <sub>32</sub> "	15 ohms	1500	0.5	3.70
T-7	763F	5 <sup>8</sup> / <sub>8</sub> "	7 <sup>3</sup> / <sub>32</sub> "	20 ohms	1500	0.5	3.70
T-8	763F	5 <sup>8</sup> / <sub>8</sub> "	7 <sup>3</sup> / <sub>32</sub> "	120 ohms	1700	0.5	3.70
T-9	763F	5 <sup>8</sup> / <sub>8</sub> "	7 <sup>3</sup> / <sub>32</sub> "	1000 ohms	1800	0.5	3.70
T-10	763F	5 <sup>8</sup> / <sub>8</sub> "	7 <sup>3</sup> / <sub>32</sub> "	10000 ohms	2100	0.5	3.70
T-11	763F	5 <sup>8</sup> / <sub>8</sub> "	7 <sup>3</sup> / <sub>32</sub> "	120000 ohms	2150	0.5	3.70
T-12	763F	5 <sup>8</sup> / <sub>8</sub> "	7 <sup>3</sup> / <sub>32</sub> "	330000 ohms	2150	0.5	3.70
T-13	416H	1 <sup>1</sup> / <sub>16</sub> "	5 <sup>1</sup> / <sub>16</sub> "	1200 ohms	3800	0.5	3.95
T-14	479H	1 <sup>1</sup> / <sub>8</sub> "	1 <sup>1</sup> / <sub>2</sub> "	1000 ohms	3800	1.5	3.95
T-15	373H Metallized Faces Only	1 <sup>1</sup> / <sub>8</sub> "	3 <sup>3</sup> / <sub>4</sub> " o.d. 1 <sup>1</sup> / <sub>4</sub> " i.d.	10 ohms	2700	3.5	4.55
T-16	373H Metallized Faces Only	1 <sup>1</sup> / <sub>8</sub> "	3 <sup>3</sup> / <sub>4</sub> " o.d. 1 <sup>1</sup> / <sub>4</sub> " i.d.	40 ohms	2700	3.5	4.55
T-17	343H	1 <sup>1</sup> / <sub>8</sub> "	3 <sup>3</sup> / <sub>4</sub> " o.d. 1 <sup>1</sup> / <sub>4</sub> " i.d.	5.5 ohms	2700	3.5	4.85
T-18	343H	1 <sup>1</sup> / <sub>8</sub> "	3 <sup>3</sup> / <sub>4</sub> " o.d. 1 <sup>1</sup> / <sub>4</sub> " i.d.	20 ohms	2700	3.5	4.85
T-19	549H	3 <sup>3</sup> / <sub>4</sub> "	7 <sup>3</sup> / <sub>64</sub> "	5000 ohms	3200	0.75	3.95
T-20	588H	1"	7 <sup>3</sup> / <sub>64</sub> "	11000 ohms	3200	1.	4.25
T-21	763H	5 <sup>8</sup> / <sub>8</sub> "	7 <sup>3</sup> / <sub>32</sub> "	500000 ohms	4600	0.5	3.95

## Global THERMISTORS

For evaluation of surge current suppression in series filament and pilot light circuits in radio and television receivers.

Test Kit No.	Type	Body Size		R at 25° C ± 30%	Nominal R at 45° C and Rated Current	Price
		Length	Dia.			
T-22	763F	5 <sup>8</sup> / <sub>8</sub> "	7 <sup>3</sup> / <sub>32</sub> "	145 ohms	40 ohms at 150 m.a.	\$3.70
T-23	759F	3 <sup>3</sup> / <sub>4</sub> "	1 <sup>1</sup> / <sub>4</sub> "	500 ohms	85 ohms at 135 m.a.	3.95
T-24	441F	1 <sup>1</sup> / <sub>8</sub> "	3 <sup>3</sup> / <sub>8</sub> "	880 ohms	100 ohms at 150 m.a.	4.25
T-25	341F	3 <sup>3</sup> / <sub>4</sub> "	5 <sup>8</sup> / <sub>8</sub> "	375 ohms	40 ohms at 300 m.a.	4.55
T-26	525F	1 <sup>1</sup> / <sub>8</sub> "	1 <sup>1</sup> / <sub>2</sub> "	250 ohms	20 ohms at 600 m.a.	4.55
T-27	327F	3 <sup>3</sup> / <sub>8</sub> "	1 <sup>1</sup> / <sub>2</sub> "	460 ohms	35 ohms at 600 m.a.	4.85
T-28	421F	3 <sup>3</sup> / <sub>8</sub> "	1" x 1 <sup>1</sup> / <sub>8</sub> " Wafer Type	125 ohms	43 ohms at 600 m.a.	5.15
T-14	479H	1 <sup>1</sup> / <sub>8</sub> "	1 <sup>1</sup> / <sub>2</sub> "	1000 ohms	50 ohms at 150 m.a.	3.95
T-17	343H	1 <sup>1</sup> / <sub>8</sub> "	3 <sup>3</sup> / <sub>4</sub> " o.d. 1 <sup>1</sup> / <sub>4</sub> " i.d.	5.5 ohms	.31 ohms at 3.0 amps.	4.85

# selective basis...

## THERMISTOR AND VARISTOR

# Globar<sup>®</sup> TEST KITS

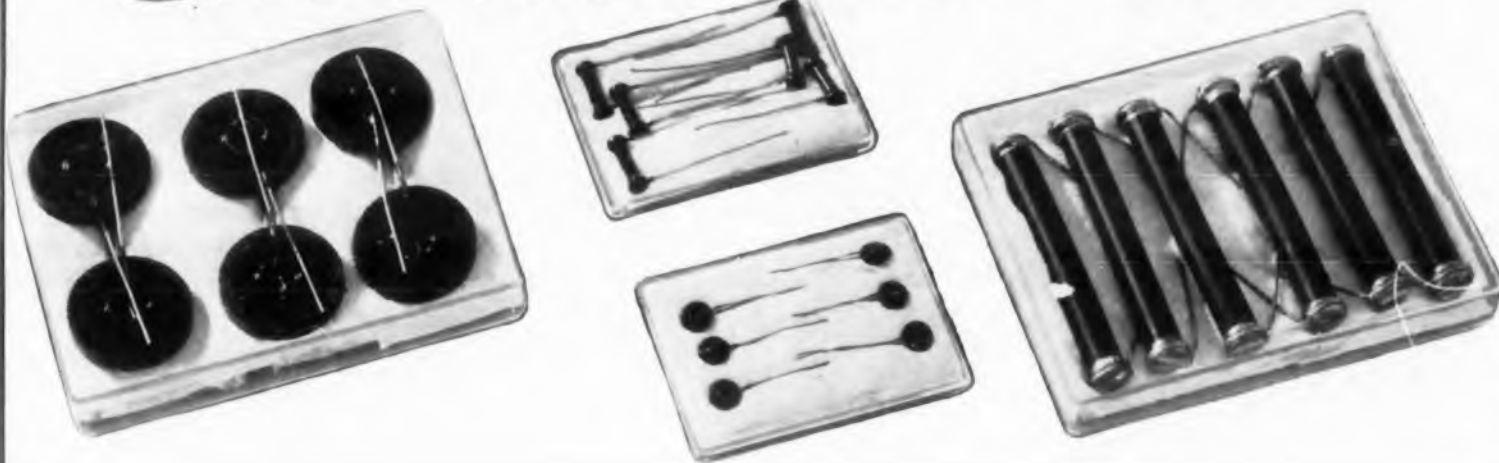

To evaluate varistor circuit applications for:

1. Reduction of surge voltage peaks.
2. Reduction of relay contact arcing.
3. Voltage stabilization.
4. Generation of harmonics.

## Globar VARISTORS Type BNR

Test Kit No.	Type	Body Size		R ± 20% at D.C. Calibration Voltage	Max. Watt Loading at 40° C	Price
		Length	Dia.			
V-1	432BNR	1/8"	1/2"	1000 ohms at 10.5V	0.25	\$3.70
V-2	432BNR	1/8"	1/2"	25000 ohms at 10V	0.25	3.70
V-3	432BNR	1/8"	1/2"	100000 ohms at 10V	0.25	3.70
V-4	432BNR	1/8"	1/2"	1 megohm at 10V	0.25	3.70
V-5	479BNR	1/8"	1/2"	100000 ohms at 100V	0.3	3.75
V-6	328BNR	1/8"	3/4"	10000 ohms at 40V	0.5	3.85
V-7	463BNR	1/8"	1"	24000 ohms at 40V	1.	3.95
V-8	524BNR	3/8"	1 1/4"	24000 ohms at 100V	1.5	4.25
V-9	430BNR	1/4"	1 1/2"	17500 ohms at 175V	2.7	4.55

**ORDER YOUR KITS NOW! Use this handy coupon**

THE CARBORUNDUM COMPANY, GLOBAR DIVISION, Dept. ED-87-72,  
Niagara Falls, New York

Please ship the following test kits (Min. quantity per order—3 kits).

THERMISTORS:  
TEST KIT  
Numbers \_\_\_\_\_

VARISTORS:  
TEST KIT  
Numbers \_\_\_\_\_

NAME \_\_\_\_\_

TITLE \_\_\_\_\_

COMPANY \_\_\_\_\_

ADDRESS \_\_\_\_\_

CITY \_\_\_\_\_

ZONE STATE \_\_\_\_\_

Check enclosed

Please invoice us

CIRCLE 8 ON READER-SERVICE CARD FOR MORE INFORMATION

### Transistors Measure Levels

A transistorized electronic system for measuring the level of liquid in any of 100 remotely located storage tanks, with accuracy of performance, reliability and self-checking features has been introduced by Texas Instrument Inc., Dallas 9, Texas. Called the Data-Gage, the system was designed and developed especially for the oil and chemical industries to control inventories, quickly and accurately, in large installations such as tank farms. It can be used, however, wherever liquid materials are stored in large tanks.

Major components of system are a receiver console, field selector unit, and liquid level gauge embodying a special float. The entire system may be installed at the tank site, or the receiver console may be located in a remote office at any distance from the tanks. Direct wire, telephone, carrier or microwave transmission may be employed to carry the information to the console. Up to 100 tanks or stations may be monitored on a single system, with liquid depth up to 64 feet in each tank measured with an accuracy of one-sixteenth inch.

The operator dials the particular tank to be monitored and is connected immediately through the field selector unit to the liquid level gage on that specific tank. A dynamic mechanical surface finder is activated and when the bottom of the float breaks the surface tension of the liquid in the tank, the data is telemetered to the receiver console where it appears in lighted numerals.



**Hydrogen Atmosphere Furnace:** This box molybdenum furnace is used by the Gordon McKay Laboratory of Applied Science at Harvard University for developmental work on microwave tubes. Built by the General Electric Company's Industrial Heating Department, Schenectady, N. Y., the furnace has a maximum temperature of 3100 F and includes a cooling chamber. Microwave tube parts are soldered and brazed in the furnace in a hydrogen atmosphere, to prevent oxidation which might occur if the parts were exposed to air.

# Globar<sup>®</sup>

Over 30 years' experience  
in the field of ceramic special  
resistance devices.



# E-I has everything in glass-to-metal seals\*

- STANDARD TERMINALS
- CUSTOM TERMINALS
- CUSTOM SEALING
- ON-THE-SPOT  
ENGINEERING ASSISTANCE
- NEW PLANT TO SPEED PRODUCTION
- ENGINEER-DESIGNER  
HANDBOOK AND CATALOG



**Almost two decades of progressive engineering  
are your assurance E-I can serve you better**

Hermetic sealing problems of the most difficult kind are nothing new at E-I... for we have been solving them constantly for almost 20 years. Today, the complete E-I line offers designers a choice of over 500 standard preferred types, each available with optional features and modifications. If required, custom types can be produced to specifications, or E-I will seal components of your manufacture. Standard terminals and typical custom seals are included in latest E-I catalog-handbook available on request. Call or write for your copy, today!

\*Canadian Pat. 523,390; British Pat. 734,583; U. S. Patent Pending - All Rights Reserved

**E-I ELECTRICAL  
INDUSTRIES**

A Division of Philips Electronics, Inc. - MURRAY HILL, NEW JERSEY

## Engineering Review

### Electrical Engineering Instructors Meet

Professors of Electrical Engineering from a hundred American colleges recently met at MIT to discuss problems and to plan for educating the next generation of Electrical Engineers. The Curriculum Workshop in Electrical Engineering Education received financial support from the National Science Foundation. Visiting faculty people were given a set of unpublished textbooks prepared at MIT. They observed laboratory and classroom presentations and practices. And since many of them had been working on the same problem, they offered suggestions and criticisms on how engineering education can best meet the challenges of tomorrow's technology.

### Accelerator for Propulsion:

This three-million-v Van de Graaff positive ion accelerator, the largest such device in use within the aircraft industry, has recently been installed at the Lockheed Nuclear laboratory in Palo Alto, Calif., to pursue investigation of the use of nuclear power for missile propulsion. Investigations will cover the fields of nuclear reactor design, radiation shielding design, and material damage.

Three-ft-thick concrete walls contain the radiation within the 2500-sq-ft accelerator room, and a large pit under the target prevents neutrons from being reflected from the floor in such a way as to interfere with measurements. The accelerator is operated from an adjoining 500-sq-ft control room, which is also shielded from the nuclear device by three-ft-thick concrete walls. An electrically-operated door into the accelerator room automatically locks before radiation reaches a level which could be dangerous to personnel. The nuclear laboratory also contains a radiation-proof work cell with three-ft-thick walls and a thirty-in.-thick glass viewing window, located near the accelerator room. In this cell natural or artificial sources of radiation may, by remote control, be removed from their lead storage containers to expose various materials.

◀ CIRCLE 9 ON READER-SERVICE CARD

## Adapt Wide Screen Pictures to Home TV

A new method of compressing Cinemascope and Vista-Vision films so they can be shown on standard-size home television screens without noticeable cropping or distortion of the picture has been developed. The project was successfully initiated at Bartlesville, Oklahoma by General Precision Laboratory Inc., Pleasantville, N.Y.

The successful adaptation of these film techniques to the aspect ratio of TV screens has been accomplished without lens changes or the use of an anamorphic lens. Rather, the sweep of the camera is altered electronically and is controlled by a series of push-buttons on the monitor console.

The film projectors are the Simplex 35mm XL theatre type specially modified for television with a 3-2 shutter intermittent movement to synchronize the standard film projection speed of 24 frames per second with the TV transmission rate of 30 frames. The projectors are also equipped with a separate shutter motor which remains in synchronism with the drive motor and allows still frame operation. The machines can be controlled at both their own and the console-monitor positions.

## Now Back to ICBM

What this country needs is not a good 5 cent cigar, but rather an eraser key on the typewriter. This is the opinion of the man who has just given up trying to invent it. George Alton, national administrator of Sales for Clary Corp., manufacturer of business machines, says modern science has solved practically everything except the costliest mistake in American business, the time lost in erasing mistakes on the typewriter. Alton's almost perfect eraser key, the one he has just given up trying to finish, contained a special chemical that erased mistakes perfectly but had this one defect: By the time the letter reached the addressee, the acid left on the paper had eaten a million small holes in the correspondence.

# MISSILES to MACHINERY

## Century MODEL 420 ELECTROGRAPH

covers the oscillograph recording field



### TELEMETRY APPLICATIONS

- QUICK-LOOK monitoring in the telemetry ground station permits continuous observation of missile in-flight programing results.
- ON-THE-SPOT monitoring permits making in-flight function corrections in controlled missiles or piloted aircraft.
- A NATURAL for mobile telemetry vans . . . compact, rugged, low power consumption, record is PERMANENT, no fading or fogging when exposed to direct sunlight.

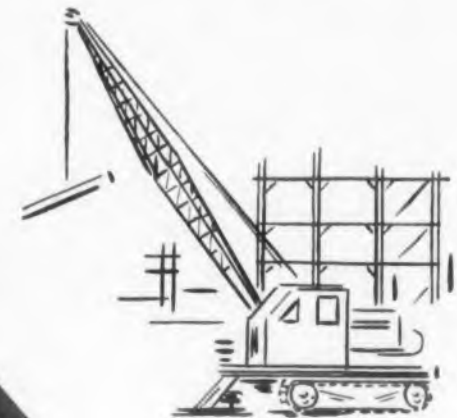

### INDUSTRIAL APPLICATIONS

- STRESS-STRAIN RECORDING with "first-hand" read-out during test.
- PERMANENT record obtained at test site may be stored indefinitely for purpose of future data reduction.
- PORTABLE — extremely useful for field test applications where a "multiplicity" of data must be collected with the least amount of instrumentation.
- No amplifiers required for many applications.

USES a variety of tubular mirror galvanometers pioneered by Century

## ENGINEERS . . .

Check your requirements against these FEATURES!

- Permanent continuous record produced within recorder.
- Developed record may be viewed an INSTANT after exposure.
- HIGH CONTRAST photographic qualities . . . black intelligence traces are recorded on light colored background.
- As many as 24 intelligence channels may be recorded on the 8-inch x 200-foot record roll.
- Record is REPRODUCIBLE without loss of contrast by Ozalid, Bruning, etc., processes . . . NO deterioration due to ultra-violet exposure.
- Eliminates need for costly darkroom facilities.

**COSTS NO MORE THAN OLD-FASHIONED METHODS**



## Century Electronics & Instruments, Inc.

1333 NO. UTICA, TULSA, OKLAHOMA

For further information, call on our nearest representative:  
EXPORT OFFICE: 149 BROADWAY, NEW YORK CITY — TEL.: BARCLAY 7-0562

PHILADELPHIA, PA.  
TEST EQUIPMENT SALES CO.  
4347 N. BODINE ST.  
TEL.: MICHIGAN 4-1822

DALLAS, TEXAS  
ARNOLD BARNES CO.  
5126 DYER ST.  
TEL.: EMERSON 1-6716

REDWOOD CITY, CALIF.  
G. S. MARSHALL CO.  
2015 EL CAMINO REAL  
TEL.: EMERSON 8-8214

SAN DIEGO, CALIF.  
G. S. MARSHALL CO.  
3525 5TH AVENUE  
TEL.: CYPRESS 8-8234

ATLANTA, GEORGIA  
E. G. HOLMES & ASSOCIATES  
209 PHARR ROAD, N. E.  
TEL.: CEDAR 7-7901

DAYTON, OHIO  
ELECTRO SALES ASSOCIATES  
517 ORANGEWOOD DRIVE  
TEL.: WALNUT 5426

CHICAGO, ILL.  
CARLSON SALES CO.  
5877 NO. NORTHWEST HIGHWAY  
TEL.: NEWCASTLE 1-8848

AGINCOURT, ONTARIO, CANADA  
ELECTROMECHANICAL PRODUCTS  
MARHAM ROAD  
TEL.: ADMINISTER 3-7011

LONG ISLAND CITY, N. Y.  
TEST EQUIPMENT SALES CO.  
29-45 NORTHERN BLVD.  
TEL.: STILLWELL 4-7120

TUCSON, ARIZONA  
G. S. MARSHALL CO.  
3086 BAKER PLACE  
TEL.: EAST 7-1201

SAN MARINO, CALIF.  
G. S. MARSHALL CO.  
2045 HUNTINGTON DRIVE  
TEL.: RYAN 1-6781

DENVER, COLORADO  
RAPHNELL ASSOCIATES  
6120 WEST 62ND AVE  
TEL.: HARRISON 4-7733

CLEVELAND, OHIO  
ELECTRO SALES ASSOCIATES  
281 E. 218TH ST.  
TEL.: REDWOOD 2-7844

ORLANDO, FLORIDA  
E. G. HOLMES & ASSOCIATES  
56 W. COLUMBIA ST.  
TEL.: 3-9524

SEATTLE, WASH.  
TESTCO  
RM. 105 BOEING FIELD  
TEL.: LANDER 8000

EXPORT  
NEW YORK CITY  
149 BROADWAY  
TEL.: BARCLAY 7-0562

CIRCLE 10 ON READER-SERVICE CARD ➤

## WHERE DEPENDABILITY IS VITAL

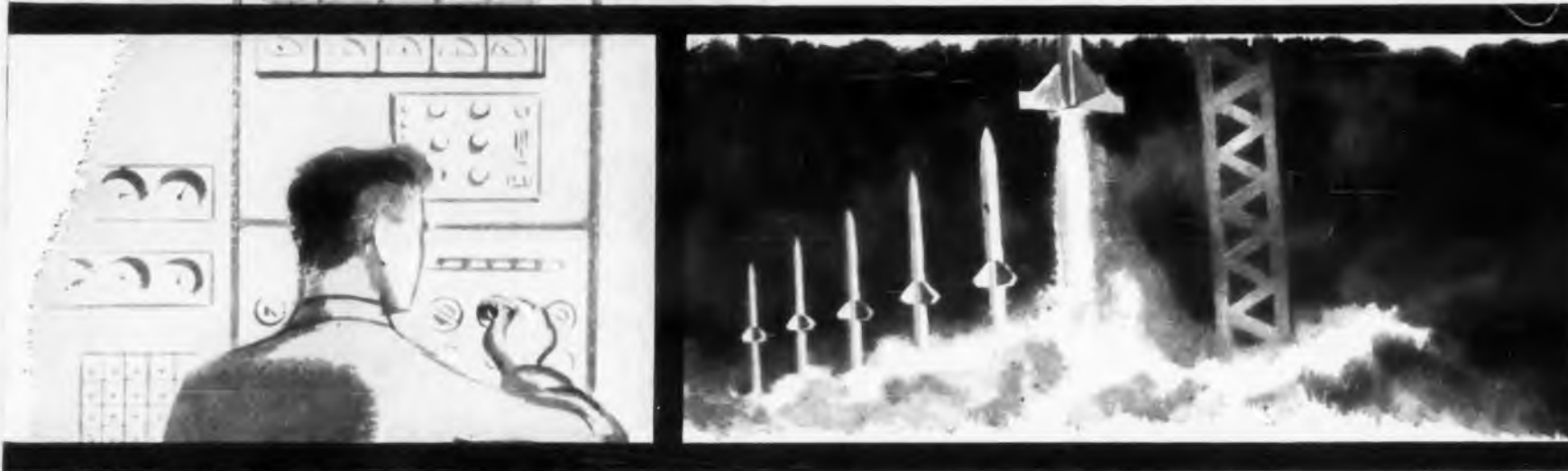

### DAVEN

### ROTARY SWITCHES

### ARE SPECIFIED

**Here's why:** Positive solutions to critical rotary switch requirements can be found within the thousands of combinations of poles, positions and decks available from DAVEN's complete line of precision rotary switches.

- *Patented knee-action rotor*—ensures low and uniform contact resistance. It also provides tamper-proof and trouble-free operation over the life of the switch.
- *One-piece combination contact and solder lug*—solid-silver alloy contacts, gold plated to resist corrosion.
- *Turret-type solder lugs* for excellent mechanical and electrical connections.
- *Roller-type detent* gives positive indexing action.
- As many as *Eight poles* available on each deck—where minimum space is a factor.

Write for complete data, catalog and engineering information.



THE **DAVEN** CO.

Livingston, New Jersey

TODAY, MORE THAN EVER, THE DAVEN Ⓢ  
STANDS FOR DEPENDABILITY!

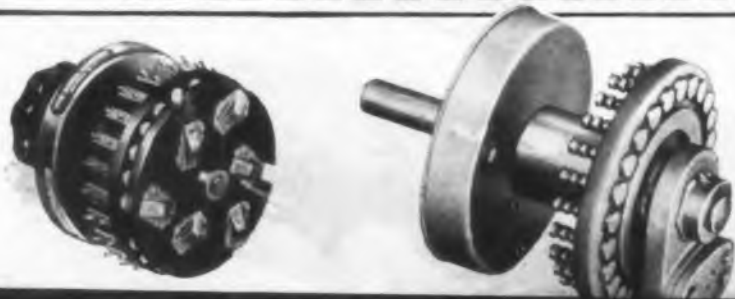

## Engineering Review

### Low-Cost Technique For Infrared Systems

A low-cost infrared detection method, adaptable to a wide range of specific applications, was demonstrated by Hoffman Laboratories, Inc., Los Angeles, Calif. This lightweight, portable, fully-transistorized infrared radiometer promises to open new areas to IR applications. These include a large number of both military and industrial uses. The radiometer was designed for automatic infrared measurements of a 360 deg radiation pattern of jet aircraft in "inflight" operation. The low power drain of its all-transistorized circuitry permits its operation from self-contained batteries. This feature, coupled with its small size and light weight, provides for easy-portability. A further development envisioned for the radiometer is to power it by solar energy converters which would charge the batteries for continuous operation in remote areas. Included among the areas of possible military application of IR techniques are: missile guidance, target detection, mapping, navigation, communication, and other fields where radar has previously held a virtually monopoly. In addition, IR offers some distinct advantages over radar in that it is a passive system—therefore cheaper and less complex. It is also less vulnerable to countermeasures and in some cases offer better identification. In industry, IR techniques have already been suggested for such applications as detection of a hot-box on railroad cars, detection of forest fires, and a host of uses in manufacturing control, such as the measurement and control of fast-moving, continuous-process products, high-speed rotating members, heat-cured items, and hot spots in furnaces. In its demonstration, Hoffman used a model electric train to show how an infrared detector could be used to detect a hot-box in rolling stock. In this application, the radiometer can detect abnormally overheated bearings and flash a warning before any damage can be done.

◀ CIRCLE 11 ON READER-SERVICE CARD



### Synthetic Glue for Copper Coils

Epoxy, a synthetic glue, will hold some light metals together under a force of 8000 lb per sq in. when cooled to a temperature as low as -150 F. This report was made recently at the Boulder Labs of the National Bureau of Standards. The research was started when design of a liquid hydrogen cooled electromagnet being developed at Los Alamos required that copper coils be stuck together with a resin. These coils are subjected to sudden and extreme decreases in temperature. A resin was needed that would contract at the same ratio as the copper parts it was bonding. If the resin contracted more rapidly or more slowly than the copper, the bond might not hold. Epoxy will not become brittle at very low temperatures, will increase in strength.

### Amateurs to Track Satellite

Known as project Moonbeam, organization and technical assistance will be provided to amateur radio groups for the operation of simplified satellite tracking systems during the International Geophysical Year. These systems will enable volunteers to locate the IGY satellite in its flight and to receive scientific data transmitted from it. The Naval Research Laboratory, with the assistance of the Jet Propulsion Laboratory of the California Institute of Technology, has been named to head the project. The American Radio Relay League will give active support to the program.

The Moonbeam program will materially assist the primary satellite tracking system Minitrack, which uses radio signals transmitted from the satellite both for precision tracking, and for the recording of scientific data. The cost of the simplified tracking system developed for use in Moonbeam is expected to be within the reach of interested amateurs. Of particular importance will be the role of Moonbeam volunteers in detecting small deviations in the satellite's orbit due to local irregularities in gravity and in recording scientific data which might be telemetered from the satellite coincident with a solar flare.

CIRCLE 12 ON READER-SERVICE CARD ➤

**DUPONT**  
REG. U.S. PAT. OFF.

Better Things for Better Living  
... through Chemistry

## ELECTRONIC DESIGN

LATEST PROPERTY AND APPLICATION DATA ON

**TEFLON**®

tetrafluoroethylene  
resins

# NEWS

## Impedance-matching weather protection of Du Pont **TEFLON**® tetrafluoroethylene resins featured in new variable-polarization K-band antenna

Du Pont **TEFLON** tetrafluoroethylene resins are uniquely qualified as materials for making the matching devices and radome used in the feed system of the new Diamond K-band antenna. The 16,000 mc radar signal passes through an impedance-matching and weatherizing system based on components of a **TEFLON** resin, and is reflected from the accurate parabolic dish. The .027" wall of the radome matches the horn to space.

No other material could compare with **TEFLON** resins for this highly critical electronic application. They are unaffected by outdoor weathering and have so little moisture absorption that their dielectric constant remains unchanged under all humidity conditions. The very low dielectric constant of **TEFLON** resins gives the material its excellent matching characteristics. They are rated at 2.1 from 60 cycles through the super-high frequency range and have a power factor of under 0.0003 from 60 cycles to over 10,000 mc, so that the loss figure in transmission is very low. Dirt has no tendency to stick to the naturally "slick" surface. **TEFLON** is unaffected by heating to 260° C.

With this system, the plane of polarization can be varied a full 90° by Faraday rotation. Use of a **TEFLON** resin overcomes the impedance-matching problem. Moreover, no orienting effects are produced by radomes of this resin. VSWR of the antenna is less than 1.2:1 over the required  $\pm 1\%$  frequency band.

For your own designs, you are invited to take a closer look at the many outstanding advantages of Du Pont **TEFLON** tetrafluoroethylene resins in electronic applications. The coupon will bring you details.

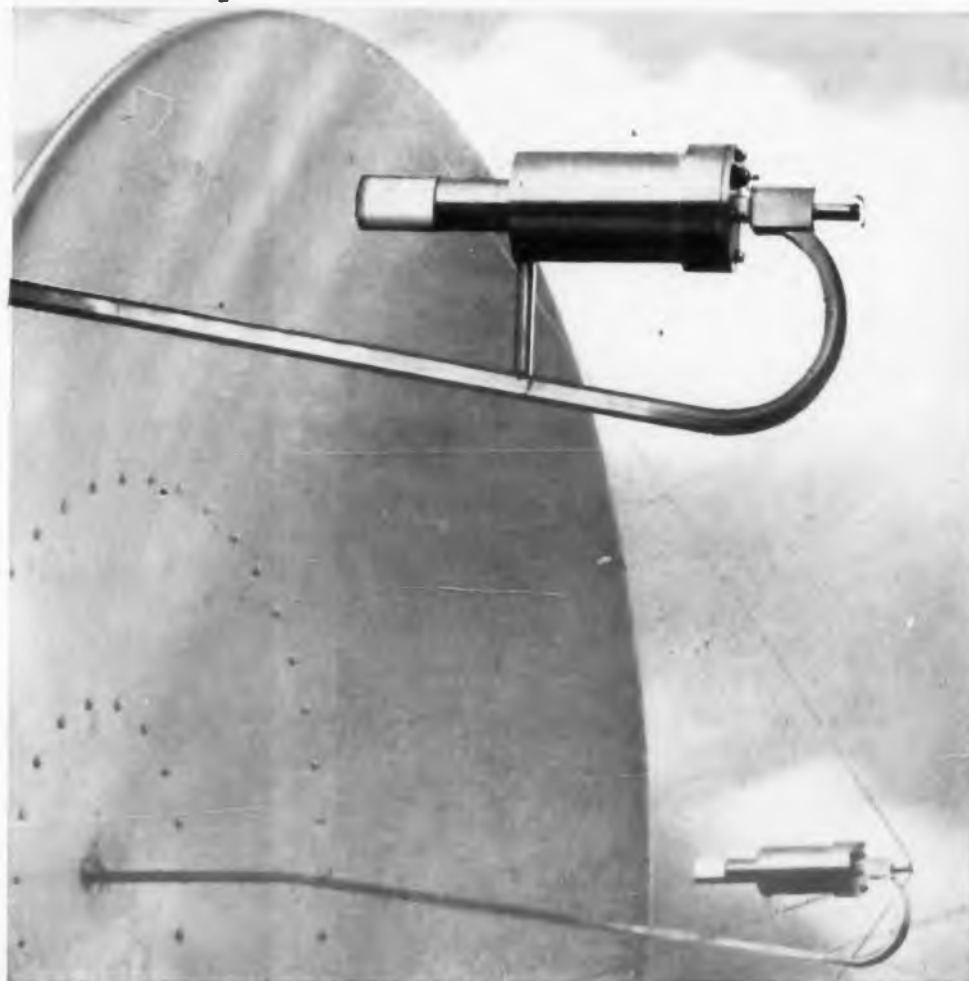

**RADOME** of a **TEFLON** resin matches impedance of feed horn to space and provides protection against weather. Wave-guide impedances at input and output of ferromagnetic

rotator in the feed are matched with minimum insertion loss by internal cones of a **TEFLON** resin. (Made by Diamond Antenna and Microwave Corp., Wakefield, Mass.)

### Tapes made of **TEFLON**® tetrafluoroethylene resins provide high dielectric strength

Tapes made of **TEFLON** resins are strong, smooth and easy to handle. They have a dielectric strength of 500 to 4,000 volts, depending on thickness. Arc resistance is high, too; no carbonized path is formed by a surface arc. Tapes of

**TEFLON** resins make high-grade electrical insulation which "snugs down" easily, conforms to sharp corners and odd shapes, and becomes tighter as temperature rises.

**TEFLON**®

is a registered trademark...

**TEFLON** is the registered trademark of the Du Pont Company. It should not be used as an adjective to describe a product of another concern, nor may this registered trademark be used in whole, or in part, as a trademark for any product.

### SEND FOR INFORMATION

For additional property and application data on Du Pont **TEFLON** tetrafluoroethylene resins, mail this coupon.

F. I. du Pont de Nemours & Co. (Inc.) Polychemicals Dept.  
Room 181015 Du Pont Building, Wilmington 93, Delaware  
Please send me more information on Du Pont **TEFLON** tetrafluoroethylene resin. I am interested in evaluating this material for \_\_\_\_\_  
Name \_\_\_\_\_  
Company \_\_\_\_\_ Position \_\_\_\_\_  
Street \_\_\_\_\_  
City \_\_\_\_\_ State \_\_\_\_\_  
Type of Business \_\_\_\_\_

## Engineering Review

### UHF Commercial Scatter Link

The successful operation of a complete "forward scatter" communications link in frequencies above 2,000 mc has been established by the Research and Development Div. of Allen B. Du Mont Laboratories, Inc. According to Du Mont engineers, the path length of the new Du Mont link is 124 miles, and transmission and reception are at 2180 mc. The transmitter is located at Cedar Grove, N. J. and the receiver is at Somers, Conn. near the Massachusetts state line. The increased problems of



Transmitting antenna and feed horn of communications link.

the crowded radio spectrum make communications in these low microwave frequencies of particular importance in both military and commercial communications. More information can be transmitted in these higher frequencies within a relatively smaller segment of the spectrum, and at these higher frequencies it is possible to produce more effective radiated power from a particular sized dish. The transmitter dish of the Du Mont system has an 18 ft diameter and is mounted on a 24 ft tower. It is connected by wave guides to a 1 kw transmitter utilizing an air-cooled Eimac klystron

# AMP-lok

## The new concept in

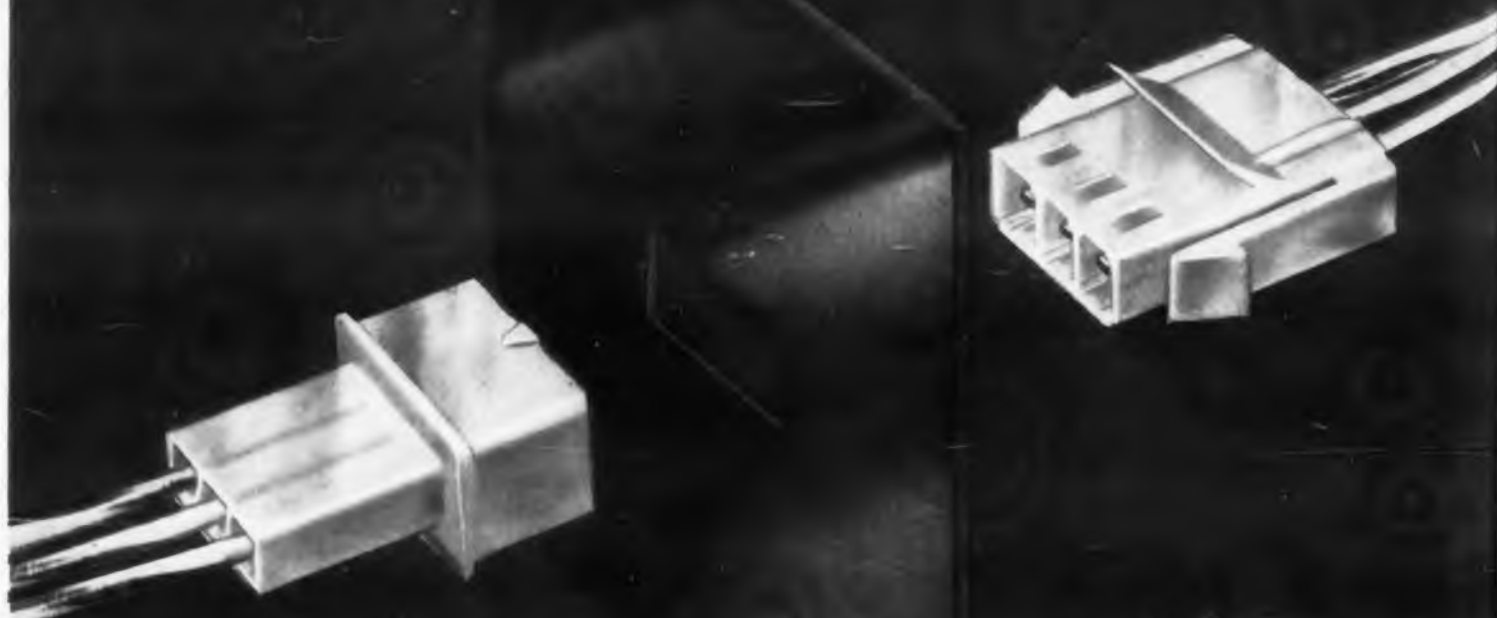

AMP-lok eliminates the necessity for supplementary mounting devices in through panel multiple connector applications.

## n multiple connector design

*... IT'S SELF-ANCHORING*

AMP-lok obsoletes all it replaces because of the following design features:

- contacts are identical . . . self-cleaning . . . recessed for safety
- finger grip engagement and disengagement
- polarized to eliminate circuit error
- wide panel thickness accommodation — one simple mounting hole required
- color-coding available

AMP-lok can be used as a safe, free-hanging multiple connector, also.

Additional literature and samples available on request.

## AMP INCORPORATED

GENERAL OFFICES:

**3539 Eisenhower Blvd., Harrisburg, Pa.**

Wholly Owned Subsidiaries: Aircraft-Marine Products of Canada, Ltd., Toronto, Canada • Aircraft-Marine Products (Great Britain) Ltd., London, England • Societe AMP de France, Le Pre St. Gervais, Seine, France • AMP — Holland N. V. 's-Hertogenbosch, Holland  
Distributor in Japan: Oriental Terminal Products Co., Ltd., Tokyo, Japan



CIRCLE 13 ON READER-SERVICE CARD FOR MORE INFORMATION

tube. The transmitter is capable of 72 voice channels with a band-width of 2.5 mc. Use of the 1 KW Klystron provides a reasonably priced, high power commercial package, according to Du Mont spokesmen. A unique feature of the transmitter is a magnetic amplifier regulated power supply for the klystron, which requires no tubes. An interesting problem in choosing the transmission path was presented by the Palisades on the west side of the Hudson River. By directing the signals through a gap at Sparkill, N.Y., the horizon for the signals was extended 10 additional miles. Reception at Somers, Conn., utilizes two 10 ft dishes on 25 ft towers. The specially designed, highly sensitive 52 tube dual diversity receiver operates reliably on a signal strength of 8  $\mu$ v.



**High Altitude Sun Photographs:** This specially constructed telescope, designed to provide optical performance at the theoretical limit, was carried aloft in a giant unmanned skyhook balloon to an altitude of 80,000 ft recently to photograph the sun's surface. The primary element of the telescope is a 12 in. aperture f/8 quartz mirror. A Newtonian secondary quartz mirror is mounted on a swinging arm so that it will remain in the sun's image only long enough to obtain a photographic exposure. The mirror will rotate once per second and actually will be cooling about 98 per cent of the time. The primary image will be transferred from the secondary mirror to the film plane by a relay lens working at a magnification of 25. The net effective focal length of the system is 200 ft. Since the solar energy may change the focal length of the primary optics, this relay lens is designed to move continuously so that it searches over a region of space for the correct focus. During a cycle of 20 consecutive secs, the relay lens will be in 20 different positions. The camera will record all 20, but at the most only one will be in perfect focus with perhaps two near the best focus. The telescope was designed and built by Perkin-Elmer Corp., Norwalk, Conn.

## FROM THE TRANSMITTER-RECEIVER TO THE ANTENNA



**Airtron** inc.

## supplies the vital links in microwave transmission

Airtron, Inc. supplies a complete line of microwave relay waveguide components for system manufacturers and installations throughout the free world.

Many of Airtron, Inc.'s special designs have become so widely used that today they are considered standard units — proof of Airtron, Inc.'s practical design experience which can meet the most stringent engineering requirements of the ever-growing microwave relay field.

Recognition and acceptance of Airtron, Inc.'s microwave components are predicated on the many advances that Airtron, Inc. is daily contributing; and on its having one of the most extensive microwave manufacturing facilities in the world. As proof, a new series of **high conductivity copper waveguides** (100% conductivity) recently introduced by Airtron, Inc. has opened up a new era of high efficiency performance in long line microwave relay transmission. Unique con-

figurations in **flexible waveguide**, transmission lines, **broad band ferrite isolators**, mechanical and ferrite switches, and antenna feed horns have already become standard in their field.

Airtron, Inc. has kept pace with these developments. Since its inception over a decade ago, the company has expanded into five separate divisions, each concerning itself with a separate phase of microwave production, yet each flexible enough to be able to draw on the know-how of all the other divisions. All of Airtron, Inc.'s manufacturing plants combine the best in engineering, production and quality control.

Airtron, Inc. offers designers and manufacturers a triple service . . . the creative design engineering born of a decade of microwave specialization; practical production abilities and equipment; six, separate manufacturing plants to produce reliable and precise microwave components.

**Airtron** inc.  
LINDEN, NEW JERSEY

FOREIGN AFFILIATES  
AIRTRON CANADA LTD. TORONTO CANADA | W. H. SANDERS (ELECTRONICS) LTD. STEVENAGE HERTS, ENGLAND | SIVERS LAB., HAGERSTEN, SWEDEN

MICROWAVE AND ELECTRONIC ENGINEERS — OUTSTANDING OPPORTUNITIES WITH AIRTRON, INC.

CIRCLE 14 ON READER-SERVICE CARD FOR MORE INFORMATION

## Washington Report

Herbert H. Rosen

### FCC Moves on Pay-TV and into Hot Water

The Federal Communications Commission finally decided what to do about Pay-TV. They are going to experiment. But in making this announcement, the Commission brought down the wrath of Congressman Celler (D-NY), the NARTB, and the networks. Even the five proponents of toll TV weren't satisfied entirely with the decision.

The Commission has decided to accept applications from individuals who wish to inaugurate Pay-TV services. The applicants must make their own choice of system from the five proposed: Zenith, Skiatron, International Telemeter, Teleglobe, and Blonder-Tongue. Those approved may be part of a three-year experiment. After which the FCC will decide which, if any, system will be adopted. Further, the applicants must submit detailed plans as to how they will conduct the experiment. However, no action on any application will be taken by the FCC until March 1, 1958.

This decision and lofty approach were taken by the FCC after a scathing denunciation by the Senate Interstate Commerce Committee. The committee averred that the Commission had jurisdiction over this problem and should do something about it. Several months ago the Commissioners agreed that they did have an interest in toll TV and that controlled experiments should be conducted. Their latest move seems to be their interpretation of experimentation.

Almost immediately after the announcement was made, Rep. Emanuel Celler released a condemnation of the whole scheme. He concluded that the FCC was toying with public property and effectively turning it over for private exploitation. He insisted that the issue can be resolved only by the express approval of Congress. He inferred that the House Interstate Commerce Committee—of which he is a member—should hold hearings on the subject as soon as possible.

Shortly thereafter, Harold Fellows, President of the National Association of Radio and Television Broadcasters, issued his broadside. He contended that the FCC "does not have the authority to authorize the introduction of Pay Television into the broadcast band. We believe that Congress intended that the American people should receive broadcast programs without charge after the purchase of sets."

He duly noted that the FCC decision to withhold action until March 1, 1958 falls during the

CIRCLE 16 ON READER-SERVICE CARD

next congressional session. "I am quite sure that the Congress, directly representing the people of this country, will have something to say about this proposition, which would add millions and millions for programming similar to that which they have been receiving free."

And so the FCC has disturbed another hornets' nest. One side of Congress is prodding the Commission, the other is condemning it. The industry, too, is divided along similar lines, networks being the loudest opponents to toll TV. With so much controversy, it would not be surprising to find the FCC pulling back its decision for "further study."

#### AMB a Reality

By professional political standards, the crew of men that wrote, presented, and pushed through the Air Modernization Act of 1957 are amateurs. And the feat of getting passage for this sweeping bill borders on the phenomenal. The Act calls for the establishment of an Air Modernization Board, to chart the nation's course in the Jet Air Age.

Within 15 minutes of his signing the Act into public law, President Eisenhower sent the name of General E. R. "Pete" Quesada to the Senate for confirmation as the AMB's first Chairman.

As the new Chairman of the AMB, Quesada will be wearing two hats. He is still the Presidential Airways Advisor. In addition to Quesada, the Board members include the Secretary of Defense and the Secretary of Commerce. The AMB is expected to take over the Air Navigation Development Board. Thick, stock, and barrel. However, the enactment of the law happened so quickly, the officials haven't had time to make definite plans as to the details of the absorption. This will be gradual. It must be, because one of the more important jobs of the AMB is the planning of its own demise. The Act states that the Board must be replaced within three years by a Federal Airways Agency.

Meanwhile, the Board will have to settle the issue arising out of the need for a new Washington Airport. Also, the Airlines Pilots and Owners Association has accused the Air Coordinating Committee of forcing acceptance of the new VORTAC air control system. APOA claims the airlines no longer are in favor of TACAN, the military-inspired control system. The Association further asserts that it would cost the taxpayer more than half a billion dollars for the airlines to convert to VORTAC, the marriage between VOR and TACAN.

But these are only the minor problems facing the AMB in the Jet Age. Much of the electronic equipment the modernization plan depends upon is still either on the drawing boards or in the minds of the design engineers. However, design and study contracts should be coming out shortly.

CIRCLE 16 ON READER-SERVICE CARD

1957 ELECTRONIC DESIGN • October 15, 1957

## Type 663-UW



**Good-ALL**  
capacitors

## A really SUB-MINIATURE Tubular capacitor with space saving "SKIN-TIGHT" case

This thin, tough Mylar\* case provides excellent moisture and abrasion resistance—yet adds less than 1/64" to the body diameter.

Miniature size is gained through the use of space-saving mylar dielectric. High insulation resistance and real stability with life are key electrical characteristics.



Type  
**663UW**

#### APPLICATIONS:

- Instrumentation • Filter Networks
- Transistor Circuitry • Amplifiers
- Test Equipment • Computers

A dense thermo-setting plastic that bonds securely to the lead and case. The completed assembly is rugged and durable.

#### SPECIFICATIONS

**INSULATION RESISTANCE:** See curve reproduced below for typical performance

**LEAD PULL TEST:** Steady force of 10 lbs. applied axially for 60 seconds.

**LIFE TEST:** 250 hours at 85°C and 125% of rated voltage

**DIELECTRIC STRENGTH:** 2 times rated voltage

**HUMIDITY RESISTANCE:** Far exceeds requirements of RETMA Spec. REC-118-A

**TEMPERATURE RANGE:** Operation at rated voltage from -60°C to +85°C and to +125°C with 50% derating.

\*DuPont's trademark for polyester film.

#### TYPICAL SIZES, TYPE 663 UW

Capacity	100 Volts	200 Volts	400 Volts
.001	.156 x 1/2	.156 x 1/2	.156 x 3/8
.0047	.156 x 1/2	.156 x 1/2	.186 x 3/8
.01	.156 x 1/2	.171 x 3/8	.250 x 3/8
.047	.234 x 3/4	.296 x 3/4	.343 x 7/8
.1	.281 x 7/8	.375 x 7/8	.421 x 1
.47	.468 x 1 1/4	.546 x 1 1/4	.671 x 1 1/2

Insulation Resistance vs. Temperature

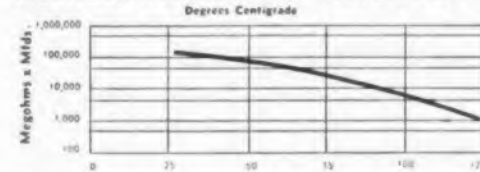

Capacitance Change vs. Temperature

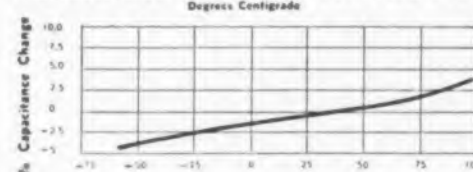

Soon in stock at your local distributor.

CIRCLE 15 ON READER-SERVICE CARD FOR MORE INFORMATION

now...

# Clevite announces a new diode

# GERMANIUM

# ALLOYED WITH

# SILICON!

New Clevite Germanium-Silicon Alloy Gold Bonded Glass Diodes, now available for immediate delivery.

**Better high temperature performance than germanium.**

**Higher forward conductance at lower voltages than silicon.**

All germanium RETMA specifications can now be met at higher temperatures with these new Germanium-Silicon alloy diodes... plus increased reliability at all temperatures.

For complete information write or phone for Engineering Bulletin B-215.



Brush Electronics Co.



Cleveland Graphite Bronze Co.



Clevite Harris Products Inc.



Clevite Ltd.



Clevite Research Center

CLEVITE

# CLEVITE

TRANSISTOR PRODUCTS  
241 Crescent St., Waltham 54, Mass. TWInbrook 4-9330



A Division of Clevite Corporation

CIRCLE 17 ON READER-SERVICE CARD FOR MORE INFORMATION



### Wrong Reference

Dear Sir:

The credit line following the abstract which appears on pages 102 and 103 of the 15 March issue of *ELECTRONIC DESIGN* indicates the source of the tone ringer article as Bell Laboratories' Record, June, 1956, page 201.

Investigation reveals that pages 201-206 of the June 1956 Record are occupied by Felker's article on mechanized-memory, so your citation is clearly in error. As I cannot recall ever having seen the Crutchfield and Power article on the tone ringer, I would appreciate receiving correct source information.

James R. Wylie  
Circuit Development  
Leich Electric Co.  
Genoa, Ill.

► We apologize for the referenced error. The tone ringer article appeared on page 48 of the February 1957, Bell Laboratories Record.

### Errata—

Dear Sir:

We want to commend you on the 15th July issue of *ELECTRONIC DESIGN*. It is a good and useful job.

However, we were quite concerned with the data listed for our Model 126H and 126R curve tracers, on page xviii. Inquiries from the field have already indicated cause for concern.

The corrections involved are as follows: Model 126H: Max. Base Current: 120 ma; Model 126R: Max. collector current: 25 a, Delivery: 4 weeks.

R. M. Goodman  
American Electronic Labs Inc.  
121 N. 7th Street  
Philadelphia 6, Pa.

## Letters to the Editor

### Call for Help

Dear Sir:

We would appreciate your assistance in supplying us with the names of manufacturers who are in a position to offer the following products:

1. DC amplifiers to operate from low voltage, low impedance signal sources (thermocouples, strain gauges, etc.). These units should be in the ultrastable classification generally associated with the latest advances in circuitry for dc low level amplifiers. Approximately 60 units are currently required.

2. A special computer is needed to provide the time rate of change of a variable. The input signal will be a low level, low impedance source (thermocouples, strain gauges, etc.); and the output of a unit will be a null balance potentiometer. The range of time constants will be between 0.1 and 20 sec.

3. A special computer is needed to provide the ratio of two pressure input signals. These signals originate in Statham transducers. The range of ratio is 0.5 to 1.1.

We invite inquiries from interested manufacturers on the above products.

Louis K. Pollen  
Project Engineer  
Systems Division  
Panellit Service Corp.  
7401 No. Hamlin Ave.  
Skokie, Ill.

► We are glad to pass on Mr. Pollen's problems to our readers. All information on available equipment to fill his needs should be sent direct to Mr. Pollen.

**Correction:** The rectangular 3-in. cathode ray tube, appearing on page 39 of the September 1 issue, lacked complete identification. The tube belongs to the 3AHP Series currently under production by Waterman Products Co., Inc., 2445 Emerald St., Philadelphia 25, Pa.

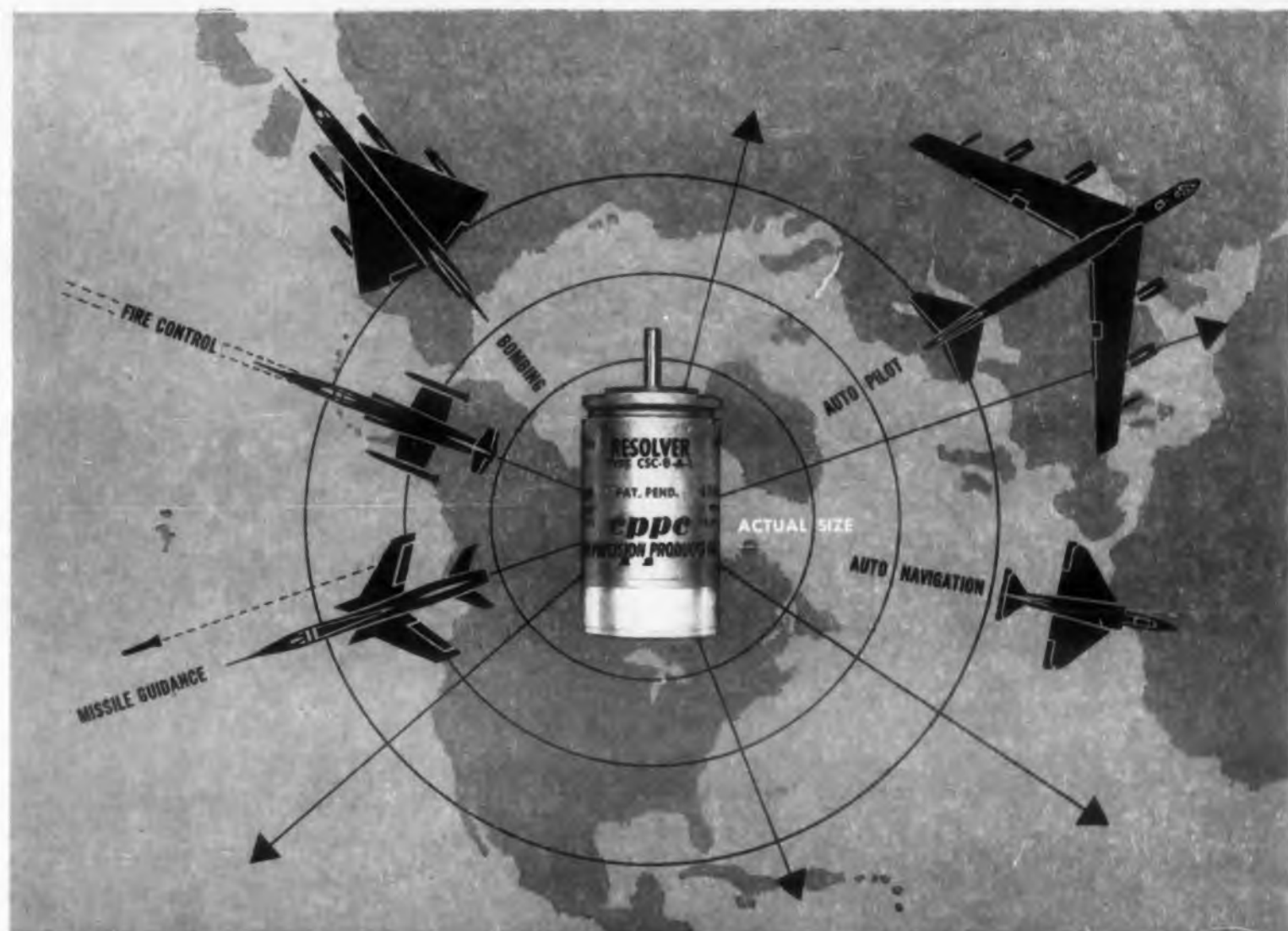

## IN AVIONIC EQUIPMENT, WHY LOAD ON EXTRA WEIGHT?

use Clifton Precision Size 8 Synchros

## WEIGHT 32 GRAMS

SYNCHRO FUNCTION	CPPC TYPE	ROTOR AS PRIMARY						STATOR AS PRIMARY						D. C. RESISTANCE		IMPEDANCE					
		Input Voltage (400~)	Input Current (Amps)	Input Power (Watts)	Output Voltage (Volts)	Sensitivity (MV/deg)	Phase Shift (deg load)	Input Voltage (400~)	Input Current (Amps)	Input Power (Watts)	Output Voltage (Volts)	Sensitivity (MV/deg)	Phase Shift (deg load)	Rotor (Ohms)	Stator (Ohms)	Z <sub>ro</sub> (Ohms)	Z <sub>so</sub> (Ohms)	Z <sub>ss</sub> (Ohms)	Max. Voltage Error (MV)	Max. Error (Mils)	
Torque Transmitter	CGC 8 A 7	26	100	5	11.8	206	8	—	—	—	—	—	—	—	37	12	54 · j260	12 · j45	80 · j20	30	7
Control Transmitter	CTC 8 A 1	—	—	—	—	—	—	11.8	0.90	2	23.5	410	9	150	24	212 · j684	22 · j115	246 · j60	30	7	
Control Transformer	CTC 8 A 4	—	—	—	—	—	—	11.8	0.29	0.8	22.5	390	8	389	64	560 · j1860	90 · j340	640 · j190	30	7	
Torque Receiver	CRC 8 A 1	26	100	5	11.8	206	8	—	—	—	—	—	—	—	—	54 · j260	12 · j45	80 · j20	30	30 sp.	
Electrical Resolver	CSC 8 A 1	26	0.38	42	10.8	190	20	11.8	0.78	26	23.2	400	11	230	27	286 · j620	45 · j148	350 · j75	30	7	
Electrical Resolver	CSC 8 A 4	26	0.38	42	26	4.4	20	26	0.30	23	21.5	375	12	230	170	286 · j620	250 · j830	350 · j75	30	7	
Control Differential	CDC 8 A 1	—	—	—	—	—	—	11.8	0.85	21	11.8	206	9	36	25	38 · j122	27 · j120	48 · j14	30	7	
Vector Resolver	CVC 8 A 1	26	0.57	34	11.8	206	10.2	—	—	—	—	—	—	—	—	103 · j440	8 · j30	—	30	7	

LOOK TO CPPC FOR SYNCHRO PROGRESS **eppc**  
CLIFTON PRECISION PRODUCTS CO. INC. Clifton Heights, Pa.

CIRCLE 18 ON READER-SERVICE CARD FOR MORE INFORMATION

# WESTON

## 250° SCALE PANEL METERS

*—sizes,  
sensitivities,  
accuracy,  
damping,  
to meet your  
special needs!*



This comprehensive group of Weston d-c and rectifier type a-c panel meters provides not only increased scale readability, but higher accuracies and improved sensitivities and ballistic characteristics as well. Available in 2½"–3½"–4½" and 5½" sizes, in standard flanged and aircraft cases for a wide range of voltage and current indications, as well as for tachometry and temperature applications. All movements embody Weston spring-backed jewels, and are magnetically self-shielded permitting their use interchangeably on magnetic or non-magnetic panels. For the complete story, consult your nearest Weston representative, or write for literature. Weston Electrical Instrument Corporation, Newark 12, New Jersey.



CIRCLE 19 ON READER-SERVICE CARD FOR MORE INFORMATION

## Meetings

### Oct. 24-25: Fourth Annual Computer Applications Symposium

Morrison Hotel, Chicago, Ill. Sponsored by the Armour Research Foundation of Illinois Institute of Technology. Advances in automatic coding and new computers and applications will be stressed. Both management and engineering applications will be considered. More information may be obtained by writing the Secretary, Computer Applications Symposium, Armour Research Foundation, 10 W. 35th St., Chicago 16, Ill.

### Oct. 24-25: General Assembly of the Engineers' Council for Professional Development and the Engineers Joint Council

Statler Hotel, New York City. Subjects to be discussed are military service and professional development, the community college and technological education, the place of the engineer in industrial management, and new dimensions in post-graduate education for the young engineer. Further details may be obtained from either the Engineer's Council for Professional Development or the Engineers Joint Council, 29 W. 39th St., New York 18, N.Y.

### Oct. 28-30: Fourth Annual Atomic Industry Conference

Plaza and Waldorf-Astoria Hotels and Coliseum, New York City. Sponsored by the Atomic Industrial Forum. For information write to AtomForum, 3 E. 54th St., New York 22, N.Y.

### Oct. 28-30: Fourth Annual East Coast Conference on Aeronautical and Navigational Electronics

Fifth Regiment Armory and the Lord Baltimore Hotel, Baltimore, Md. Sponsored by the Baltimore Section of the IRE and the Professional Group on Aeronautical and Navigational Electronics. Sessions and papers are listed below.

#### Mon. pm, Oct. 28 Navigation Systems

1. The Navigational Computer Versus the Polar Regions.
2. The Effects of Terrain Bias Error on Doppler Navigator Accuracies.
3. Air Route Surveillance Radar Facilities.
4. Transonde System.



- Frontier Airline's Airways System.
- Performance Analysis of Doppler Navigation Systems.

#### Equipment Analysis

- 1. An Analytical Approach to the Vibration Design of Airborne Electronic Equipment.
- 2. New Electronic and Metallurgical Ideas, Materials, and Techniques.
- 3. A Ram Air Cooling Study.
- 4. A Research Flight Simulator.
- 5. Procedures for Preliminary Analysis of Infra-Red Detection systems.
- 6. Factors Affecting Tracking Performance When Using the Moving Aircraft Display.

Tues. am, Oct. 29

#### Military Navigation Techniques

- 1. Sidelobe Suppression for ATC Beacon.
- 2. A Hypothesis on the Use of Time.
- 3. A Proposal for an Automatic Position Correction of a Dead Reckoning Navigational Computer Using Astro-Tracker Derived Celestial Data.
- 4. Automatic Thrust Control for Turbojet Aircraft.
- 5. Radar Ground Mapping Resolution.
- 6. Air/Ground Communication Problems.

#### Equipment Design

- 1. Liaison Engineering.
- 2. Automatology.
- 3. Prediction of Temperatures in Forced Convection Cooled Equipment.
- 4. A Forced Air Cooling System in Present Aircraft.
- 5. Progress in Transistorized Audio Systems for Modern Airliners.
- 6. An Electronic System for Protecting Aircraft Fuel Tanks from Fire and Explosion.

Tues. pm, Oct. 29

#### Civil Navigation Techniques

- 1. An Automatic Guidance Computer Using Magnetic Amplifiers.
- 2. Radio Compass Testing with Small Shielded Enclosures.
- 3. A New Navigation Package for the VHF Omni-Range System of Aircraft Navigation.
- 4. New Design Philosophies for Lightweight Civil Airborne Weather Radars.
- 5. Interference Blanker Development.

Wed. am, Oct. 30

#### Microwave Components

- 1. Multiplex Ferrite-Type Antenna Switch.
- 2. Ferrite Antenna Systems.
- 3. Status in Systems Application of Available 8-9-

*ESC* corporation, first in custom-built delay lines,

*announces the opening of its new . . .*

*electronic components division*

**ESC**®

*pulse transformers*

*medium and low-power transformers*

*filters of all types*

*pulse-forming networks*

*miniature plug-in encapsulated circuit assemblies*

*exceptional employment opportunities  
for engineers experienced in pulse techniques*



ESC CORPORATION • 534 BERGEN BOULEVARD • PALISADES PARK, NEW JERSEY

CIRCLE 20 ON READER-SERVICE CARD FOR MORE INFORMATION

**± SIX MICROVOLT INPUT DRIFT  
OVER AN EIGHT HOUR PERIOD**



**THE RHEEM REL-120 dc AMPLIFIER**

represents the latest in the "state of the art" in instrumentation amplifiers. / Complete solid state circuitry / Transistorized / Low space requirement / Unique closed loop drift control

For further information contact Rheem Electronics Marketing Department

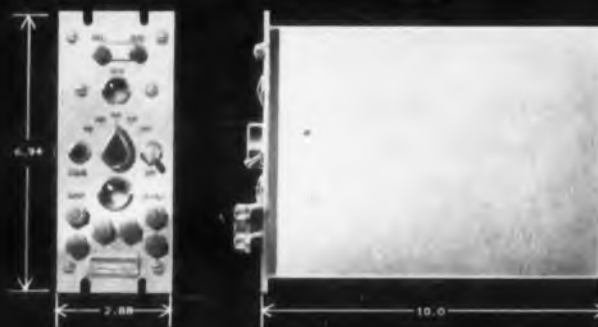

**ELECTRONICS DIVISION / RHEEM MANUFACTURING COMPANY**

Phone number: RAymond 3-8971 ... 7777 Industry Ave., Rivera, California

electronics  
division

Millimeter Wave Length Components—Magnetrons—TR and ATR Tubes—Crystal Mixers and Detectors.

4. A Novel Antenna Feed which Provides for Any Remotely Selectable Polarization; Vertical, Horizontal, Right or Left Hand, Circular Polarization Without Moving Parts.

5. A Packaged Medium-Power Traveling-Wave Amplifier Tube for Airborne Service.

6. High-Power, Wide Tuning-Range, X-Band Magnetrons Extremely Stable at Rates of Rise Above 200 KV/Usec.

**Electronic Components**

1. Ceramic Stacked-Mount Receiving Tubes.

2. A Transistorized Pulse Generator.

3. Applications of Direct-View Storage Tubes to Air Traffic Control and Navigation.

4. Improvement in Radar Presentation.

5. Operating Time Indicator.

6. Floated Rate-Integrating Gyro Performance—Criteria Optimization.

Address correspondence to C. J. Knight, Jr., Mail No. J-376, The Martin Co., Baltimore 3, Md.

**Oct. 31-Nov. 1: Third Annual Technical Meeting of the IRE Professional Group on Electron Devices**

Shoreham Hotel, Washington, D.C. The conference program will include technical sessions covering advances in electron tubes, semiconductor devices, and photoconductive and storage devices. For additional information write R. K. Kilbon, RCA Labs., Princeton, N.J.

**Nov. 4-6: Ninth Annual AIEE Machine Tool Conference**

Hotel Schroeder, Milwaukee, Wis. Sponsored by the Machine Tool Sub-Committee of the AIEE. Concentration will be given to extended use of static systems of control. For further details write to the AIEE, 33 W. 39th St., New York, N.Y.

**Nov. 6-8: SAMA Laboratory Apparatus and Optical Sections Midyear Meeting**

Edgewater Beach Hotel, Chicago, Ill. Details may be obtained from Jim Irving, Director of Public Information, Scientific Apparatus Makers Assoc., 20 N. Wacker Dr., Chicago 6, Ill.

**Nov. 11: Regional Technical Conference on Plastics for Airborne Electronics**

The Ambassador Hotel, Los Angeles, Calif. Sponsored by the Southern California Section of the Society of Plastics Engineers. Among the topics to be discussed are the electrical, chemical, and mechanical properties of various plastics. Silicones,

encapsulations, and polyurethanes in electronic systems will also be covered. Address inquiries to Jack G. Fuller, Hercules Powder Co., 3460 Wilshire Blvd., Los Angeles 5, Calif.

#### Nov. 11-13: Radio Fall Meeting

King Edward Hotel, Toronto, Canada, Sponsored by the Electronic Industries Association (formerly RETMA). There will be sessions on international standardization, reliability in receivers, all aspects of radio and television, and the design, development, and application of electronic devices such as transistors, vacuum tubes, and cathode ray tubes. For more information write to J. A. Caffiaux, EIA, 11 W. 42nd St., New York 36, N.Y.

#### Nov. 13-15: First Annual Industrial Audio-Visual Exhibition

Trade Show Building, New York City. The exhibit will feature current audio-visual equipment and techniques for conducting training sessions, sales meetings, visual presentations, and advertising promotions. For information write Exhibitions, Inc., 17 E. 45th St., New York 17, N.Y.

#### Nov. 19-21: Symposium on Electromagnetic Interference

Fort Monmouth, N.J. Sponsored by the U. S. Army Signal Engineering Labs. The purpose of the symposium is to smoke out those technical factors, theoretical and practical, which limit the efficient use of the electromagnetic spectrum and to invite discussion of means to attain more efficient usage of the spectrum to satisfy future electronic density needs. Both classified and unclassified papers will be read. Principal subject areas to be covered are systems approach, electromagnetic wave propagation, antennas, transmitters, and receivers. Address requests for information to Commanding General, U. S. Army Signal Engineering Labs., Ft. Monmouth, N.J., Attn: SIGFM/EL-DPS (Symposium).

#### Paper Deadlines

Nov. 1: Deadline for papers to be presented at the 1958 IRE National Convention. The convention will be held March 24-27 at the Waldorf-Astoria and the New York Coliseum, New York, N.Y. Prospective authors should submit a 100-word abstract and a 500-word summary. Both must be in triplicate with the title of the paper and the name and address of the author. The technical field in which the paper falls must also be indicated. Only papers not published or presented prior to the convention will be considered. Military or company clearance must be obtained before submittal. Address all material to Dr. George L. Haller, Chairman, 1958 Technical Program Committee, IRE, 1 E. 79th St., New York 21, N.Y.

These Little

**E - FORM**

Trade Mark

Pellets Will

# REVOLUTIONIZE



## YOUR ENCAPSULATION PROCEDURES

The prescribed technique for encapsulating components, using "E-CASES" and "E-FORMS":

#### UNTIL TODAY...

The trouble of tedious mixing and measuring of hardener and resin, the danger of toxicity, the waste of material due to the instability of the compound... all of these factors combined, make epoxy encapsulation an extremely inefficient operation.

#### NOW...

A dry, stable, non-toxic pellet of preformed, premixed Epoxy compounds, tailored to your exact requirements, can make encapsulation one of the simplest operations in your manufacturing process.

Developed by Epoxy Products' experienced staff of plasticists, these pellets, though designed primarily for use in conjunction with Epoxy "E-CASE" Shells, are being widely used wherever epoxy resins are required for bonding, sealing or encapsulation.

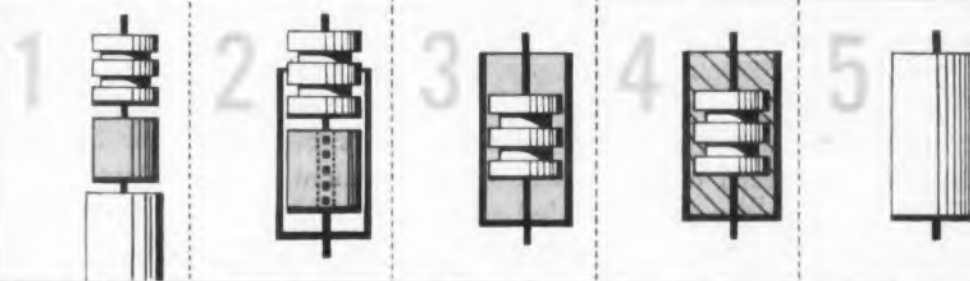

The "E-FORM" pellet and electronic component are inserted into the "E-CASE", in that order. The assembly is then subjected to heat, with a gentle pressure exerted on the component. The heat causes the pellet to liquefy and flow around the component. Further heating gels and then cures the epoxy. The result is a completely epoxy-encased unit, resistant to humidity, temperature variations and corrosive influences.

#### E-FORMS eliminate:

- Wasteful mixing of hardener and resin
- Dermatitis problems (completely non-toxic)
- Dixie cups and liquid metering machines
- The need for a trained chemist to supervise operation

"E-CASES" plus "E-FORM" pellets make mass production and automation techniques feasible since these combinations can be automatically fed, positioned and assembled with the use of standard available machinery.

Pat. Appl. For

Write for complete information.

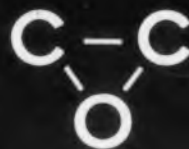

epoxy products, inc.

A DIVISION OF  
JOSEPH WALDMAN & SONS  
137 Coit Street, Irvington, New Jersey • Essex 5-6000

CIRCLE 22 ON READER-SERVICE CARD FOR MORE INFORMATION

**Editor's Note:** This is Part I of a two-part article. The first part deals with test techniques necessary for thermal evaluation of commercial airborne electronic equipment. Part II will deal with design improvements. Though the author limits the scope of his article to airborne electronic equipment, it should prove valuable to engineers endeavoring to save space.

# Thermal Design – I

Harry M. Passman

Collins Radio Co.  
Cedar Rapids, Iowa

**T**ECHNIQUES for thermal evaluation of commercial airborne electronic equipment are described here. Special emphasis is placed on how to instrument equipments for temperature and air flow measurement, including instrumentation of vacuum tubes. Design improvements are described. They include:

- Use of improved tube shields;
- Proper general grouping of components—zones of desirability concept;
- Proper individual location of components;
- Dust cover ventilation design including covers for optional ARINC cooling.

## Introduction

Anyone who attempts to explain all aspects of good thermal design for all types of electronic equipment is either unfamiliar with the subject or is about to write a very long paper. In an effort to land somewhere between these two extremes, this paper deals only with some thermal aspects of typical commercial airborne electronic equipment of the type used by the scheduled airlines. Typical airline equipment is packaged in unpressurized cases conforming to the ATR case sizes as specified in Aeronautical Radio, Inc. (ARINC), Specification 404. These sizes are similar to the cases called out in specification MIL-C-172B.

This type of equipment uses miniature tubes rather than subminiature tubes and is normally operated in shelf type radio racks in a pressurized, air-conditioned location in the aircraft cabin.

Long life, dependable operation, and ease of maintenance are extremely important in this type of equipment. Radios may be operated an average of 10 hours a day for 15 years.

This paper describes equipments which, although they have no forced air cooling of their own, can utilize the new ARINC integral cooling system as an optional cooling means. In this system, cooling air can be supplied to an entire rack of equipment from a single blower in the aircraft. Although the equipment will operate satisfactorily without forced cooling, longer life results when such cooling is used.

In a representative system air is drawn into

an equipment through inlet holes which may be located anywhere in the dust cover. This air passes through the equipment and exits through a specified area in the bottom of the case. Each equipment shelf contains a plenum duct with a suitable rubber seal for each equipment, which contacts the bottom of the case. Air is drawn into this plenum duct and then dumped overboard.

## Thermal Test Techniques

Proper thermal test equipment and techniques are as essential to thermal design work as good electrical test equipment and proper technique are to circuit design.

Fig. 1 shows typical test equipment used to check an airline radio. A recording type multipoint logger will provide a printed record of several dozen thermocouple temperatures in a minute or two and is therefore more convenient than a thermocouple bridge when many temperatures must be taken. A flowrator in series with a variable air supply is a convenient way to provide a controlled amount of air. Static pressure is measured by means of a static pressure tube and a micromanometer.

## Thermocouple Technique for Tubes

The finest thermocouple bridge will not give an accurate indication of a miniature tube bulb temperature unless the tube has been properly instrumented. Accurate bulb temperature measurement requires considerable effort, but unless care is taken, erroneous results may be obtained.

It is recommended that thermocouples be embedded in the glass for three reasons:

- Unless thermocouples are embedded, a low reading will result.
- Many tube shields have metal fingers or liners which come in contact with the tube. These contacting parts tend to scrape the thermocouples off unless they happen to be embedded below the surface of the bulb.
- Thermocouple wires cemented above the glass surface will raise fingers or liners of conducting type shields so that they do not contact the glass.

The thermocouples should be located at the tube hotspot, which is normally opposite the plate structure in approximately the middle of the tube. Tube shields with fingers or corrugated liners which con-



Fig. 1. Typical test equipment used for temperature and air flow measurements

act the tube will give a low thermocouple reading if the thermocouple is in contact with the metal liner or finger. Locate the thermocouple junction half way between the areas where two fingers or corrugations contact the tube.

Use number 40 (0.003 in.) copper constantan thermocouple wires which have been resistance-welded to form a tiny junction bead. Small wire is used to minimize conduction of heat from the junction to the lead-in wire. Strip the two wires and twist them together for a distance of about 1/8 in. Connect a potentiometer in series with a 28 v dc supply; one side is connected to a carbon rod, the other side to the thermocouple wires, as shown in Fig. 2. The twisted wires are briefly touched to the carbon rod until a welded junction is formed. Next, untwist the wires so that the only point at which they touch is the welded junction. The potentiometer must be adjusted by trial and error until a good weld is obtained.

Referring to Fig. 3, two parallel grooves are etched from the spot to be measured to the base of the tube. Tubes are etched by coating them with paraffin, then cutting through the paraffin in the areas to be etched, and etching with hydrofluoric acid. These grooves are approximately 0.020 in. wide by 0.008 in. deep.

The thermocouple (#40 wire) is secured in the groove with narrow pieces of tape, then glued in place with epoxy cement. The thermocouple is embedded below the surface. Excess adhesive is removed with a file so that the contour of the tube is a normal one.

#### Thermocouple Technique for Resistors, Capacitors, Transistors, etc.

The technique used on resistors, capacitors and transistors, is similar to that for miniature tubes except that number 30 copper constantan is used

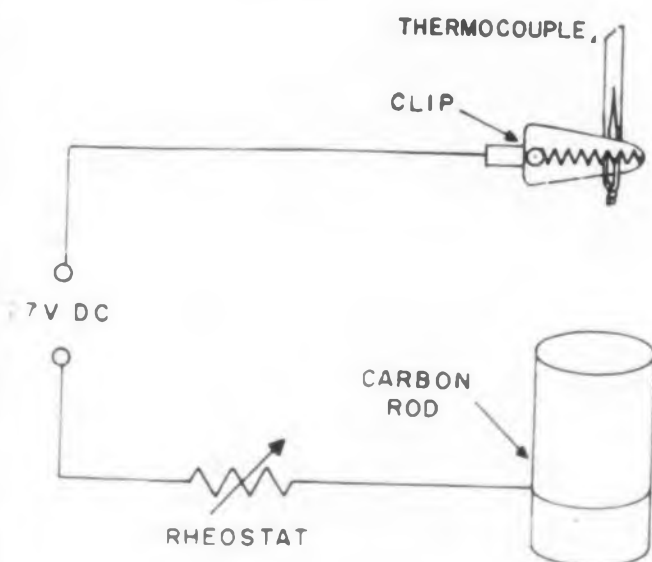
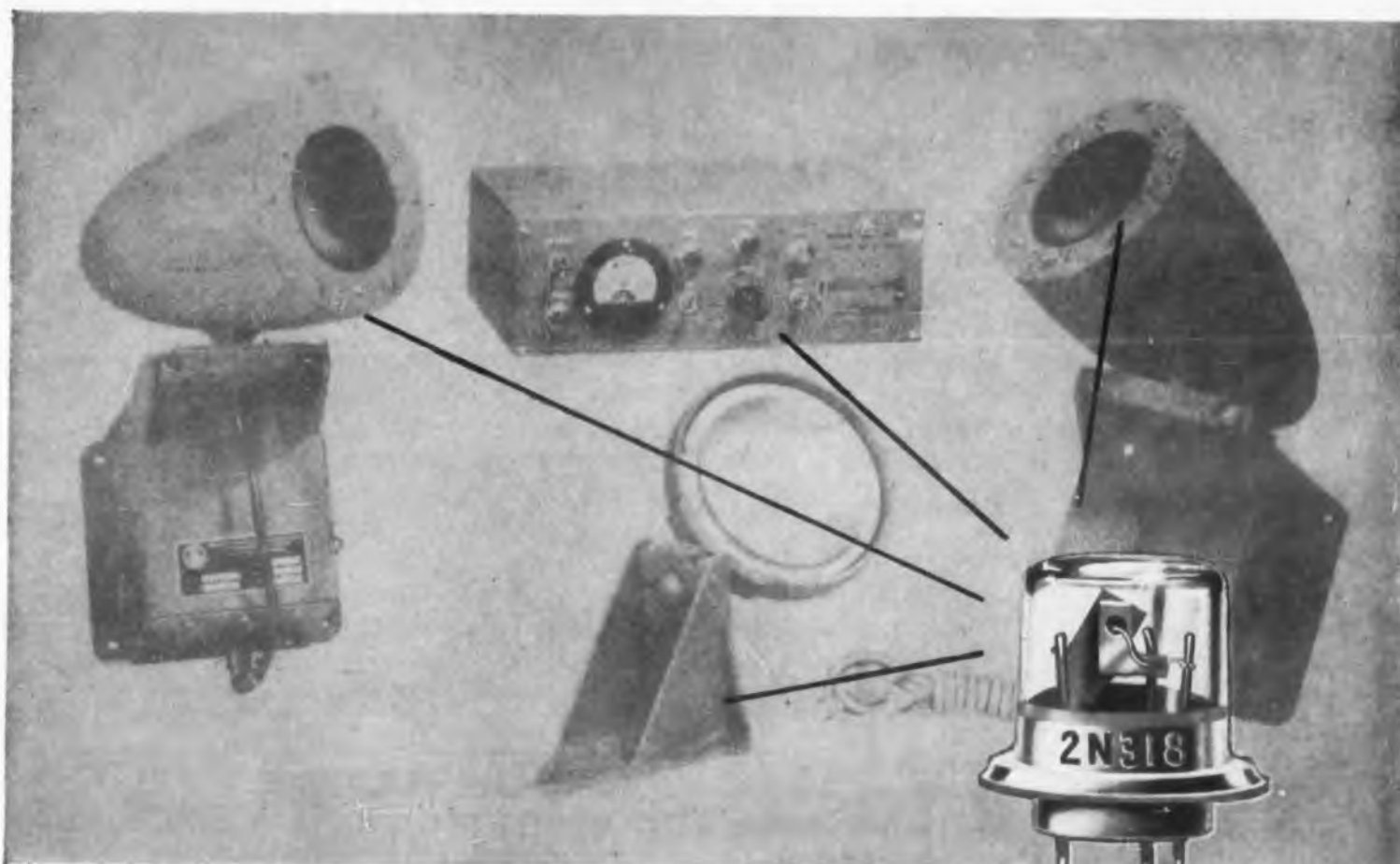

Fig. 2. Thermocouple welder schematic

# GENERAL TRANSISTOR

SELECTED FOR RELIABILITY BY

**Walter Kidde & Company**



## TRANSISTORIZED PHOTO-ELECTRIC ALARM

### Features.. ELECTRONICALLY MODULATED BEAM

Walter Kidde engineers had the problem of designing a circuit that would be completely reliable even under severe operating conditions. Reduced size at a realistic cost was also of extreme importance. Kidde engineering designed a transistorized unit which completely eliminated vacuum tubes and the replacement and service problems which accompany them. This Model, #1100, is unaffected by line voltage variations from 95 to 130 volts and is easily serviced.

Walter Kidde made a thorough investigation of the market and, after extensive testing, selected the one transistor that was able to meet all physical, electrical and reliability specifications . . . General Transistor's Photo-Transistor 2N318/GT-66.

This is just one more example why General Transistor is the fastest growing name in transistors.

Write today for complete technical information — Specification Sheet 2N318.



## GENERAL TRANSISTOR

C O R P O R A T I O N

91-27 138TH PLACE JAMAICA 35, NEW YORK

CIRCLE 23 ON READER-SERVICE CARD FOR MORE INFORMATION

FOR IMMEDIATE DELIVERY FROM STOCK, CONTACT YOUR NEAREST AUTHORIZED GENERAL TRANSISTOR DISTRIBUTOR OR GENERAL TRANSISTOR DISTRIBUTING CORP., 95-27 SUTPHIN BLVD., JAMAICA 35, NEW YORK

FOR EXPORT: GENERAL TRANSISTOR INTERNATIONAL CORP., 91-27 138TH PLACE JAMAICA 35, NEW YORK

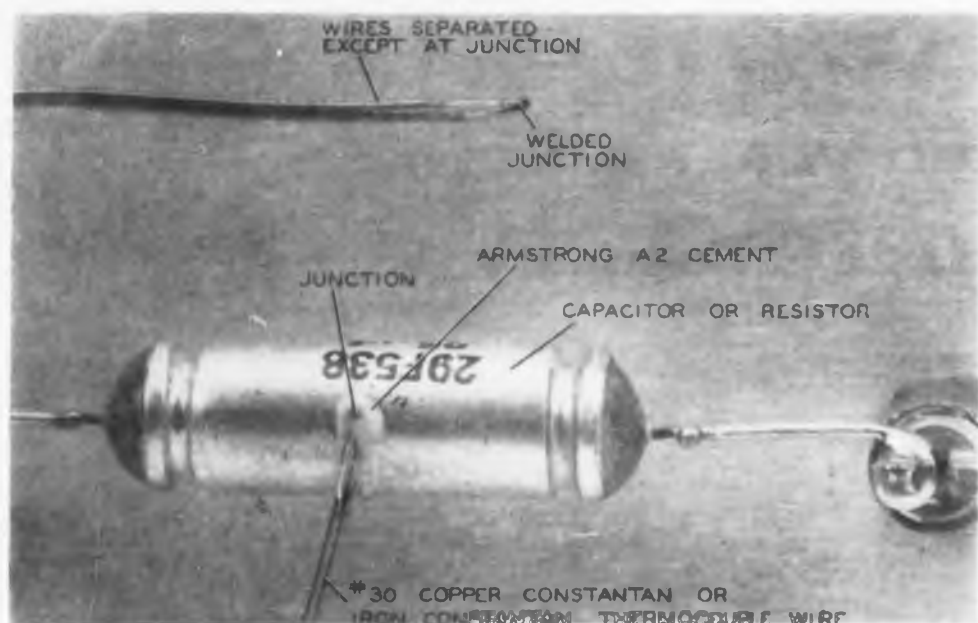

Fig. 3. Steps in putting thermocouples on miniature tubes

and the thermocouple is cemented directly to the component outer surface with epoxy cement. Fig. 4 shows a capacitor which has been instrumented. The thermocouple is normally located in the center of resistors and axial lead capacitors.

#### Importance of Thermal Testing

Airline electronic equipment must meet the thermal requirements of RTCA paper 100-54/DO-60 (April 13, 1954), in order to be type-certificated. This calls for operation of the equipment on an individual shockmount for one hour in an ambient of 55 C (131 F), and for 30 minutes in an ambient of 70 C (158 F). The 55 C ambient test represents the worst environment the equipment will be placed in as a steady diet. The 70 C ambient for 30 minutes simulates emergency conditions which would exist for a short time only.

These tests show up catastrophic type failures. The fact that an equipment operates for this short length of time does not, however, guarantee a reliable design. Most components can be operated above their rating for a short time without failure, but their life may be greatly reduced under such operating conditions.

In order to insure reliable operation, the equipment designer must:

- Establish his own standard test conditions.
- Measure component temperatures under these standard conditions.

Because in many airline installations, the equipment "sees" an ambient which is approaching 55 C, this manufacturer has established a standard test condition at a 55 C ambient. Equipment is tested both on an individual shockmount and on a shelf with dummy cases on either side at the same spacing used in typical installations (3/8 in. between equipments).

For convenience, the equipment is tested at room ambient to establish the temperature rise above ambient. This temperature rise above ambient can

then be added to 55 C to give component temperature at that condition, or to any ambient condition of interest. The temperature rise would actually be slightly less at 55 C than at 25 C because of the increased heat transfer by radiation at 55 C. This difference is normally slight and may be neglected since the answer used is on the conservative side.

Now that the designer is finding out how high components will run under a situation which represents the worst actual service conditions, his next step is to attempt to keep all components below their maximum rated temperature at this condition.

## PERFORMANCE

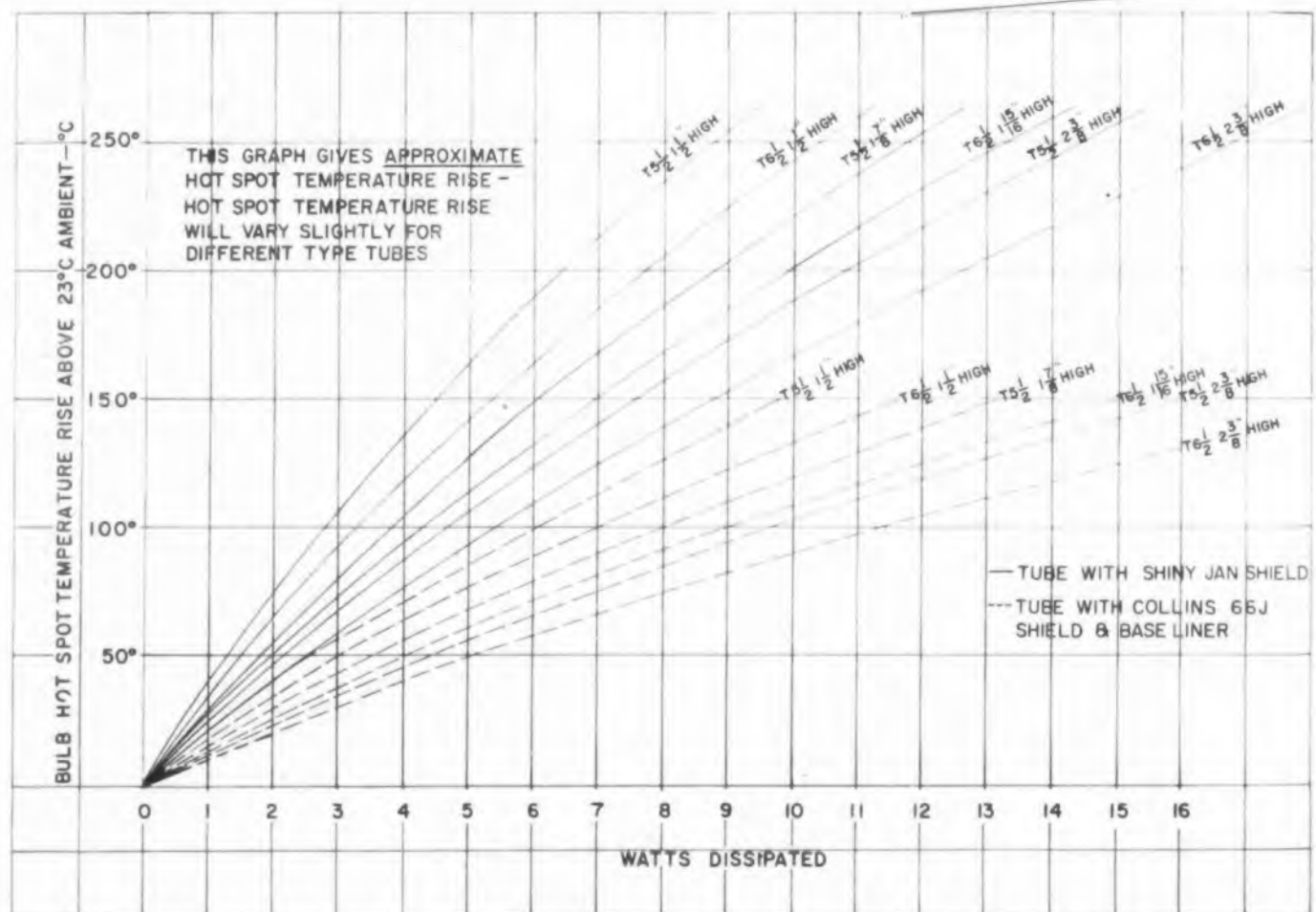

Fig. 5. Hot spot temperature rise vs watts dissipated for six sizes of miniature tubes in free, still air at 23 C

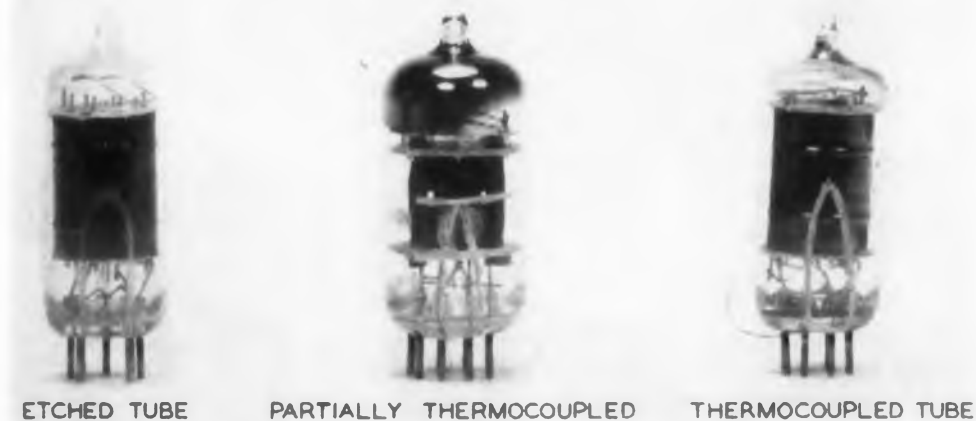

Fig. 4. Thermocouple attached to capacitor

This is much easier said than done.

A further refinement is the establishment of a new temperature level below the maximum allowable—a temperature level for maximum reliability, based on life test data.

Example: Soft glass miniature tubes normally have a maximum allowable hot spot temperature of 165 C. Recent life tests have shown that, in applications where extremely long life is of paramount importance, these tubes should be operated at bulb temperatures as low as 100 C.

We are currently attempting to operate miniature

tubes below 100 C. This is very difficult since it allows only 45 C rise above 55 C ambient. However, as we approach this new level of temperature, we will have much more reliable equipment.

The importance of accurately measuring component temperatures can not be overstressed—it is much easier to make improvements when you know what you are trying to improve upon, and how many degrees you improve something with a particular change.

#### Selection of Components to be Measured

Ideally, you would measure the temperature of all components in an equipment when thermally evaluating it. Fortunately for everybody, this is not necessary since it is possible to predict which components will be the hottest.

#### Tubes

Knowing the number of watts dissipated in a tube and the type of tube shield used, you can roughly predict temperature rise. Fig. 5 gives approximate temperature rise for tubes with shiny JAN shields and Collins 66J heat reducing shield. A medium height 9-pin tube (T 6-1/2-1-15/16 high) dissipating five watts will have a rise of 112 C with a shiny JAN shield and 62 C with a 66J shields. The hot spot temperature, which should not exceed 100 C for maximum reliability, is the sum of the ambient temperature and the hot spot temperature rise.

Normally it is not necessary to instrument tubes with a predicted rise below 35 or 40 C unless some unusual situation is involved.

#### Composition Resistors

Graphs are available which give temperature rise of composition resistors versus power dissipated. These graphs should be used with care since temperature rise of a resistor is very dependent on the conduction path of the lead terminations as well as on proximity of other heat sources such as other resistors. Experience will allow prediction of those areas that cause trouble.

Generally speaking, 1/2 watt or smaller resistors, which are operating at less than 1/2 their wattage rating and are not connected to or near other heat sources, will not require checking.

#### Capacitors

Capacitors will normally operate close to chassis temperature unless heat is conducted through their leads from hot components to which they are soldered or unless hot components are located close by. Electrolytic and tantalum capacitors with their low thermal rating should be checked.

#### General

Design personnel will be able to predict accurately which components should be checked after testing a few equipments.



Engineered by Tinnerman...

## On the assembly line...and in the field plug-in **SPEED CLIPS**<sup>®</sup> simplify rectifier installation

At General Electric, two variations on a single SPEED NUT<sup>®</sup> principle are being used to make things easier for production-line assemblers and for electronics servicemen.

The basic idea of the Tinnerman front-mounting SPEED CLIP is incorporated into the sockets of GE germanium rectifiers made by GE's Semiconductor Products Department, Syracuse, for industrial electronics applications.

On the TV production line, the Tinnerman SPEED CLIP permits rapid, tight, and simple installation of rectifiers. In the field, merely by unplugging the original equipment rectifier and plugging in its germanium replacement, the serviceman can quickly get a unit back in service.

Working together, General Electric and Tinnerman engineers developed the two types of SPEED NUT parts that are fabricated right into the rectifier shells.

Unusual applications of the SPEED NUT principles to scores of different products are developed every day at Tinnerman. That's why over 9,000 different forms of SPEED NUT Brand Fasteners

have been designed for all leading manufacturers.

Your fastener problem can probably be solved quickly by a call to your Tinnerman sales representative. If his name isn't in your telephone directory, write to:

**TINNERMAN PRODUCTS, INC.**  
Dept. 12 • P. O. Box 6688 • Cleveland 1, Ohio



CANADA: Dominion Fasteners Ltd., Hamilton, Ontario. GREAT BRITAIN: Simmonds Aeroaccessories Ltd., Troforest, Wales. FRANCE: Simmonds S.A., 3 rue Salomon de Rothschild, Suresnes (Seine). GERMANY: Mecano-Dandy GmbH, Heidelberg.  
CIRCLE 24 ON READER-SERVICE CARD FOR MORE INFORMATION

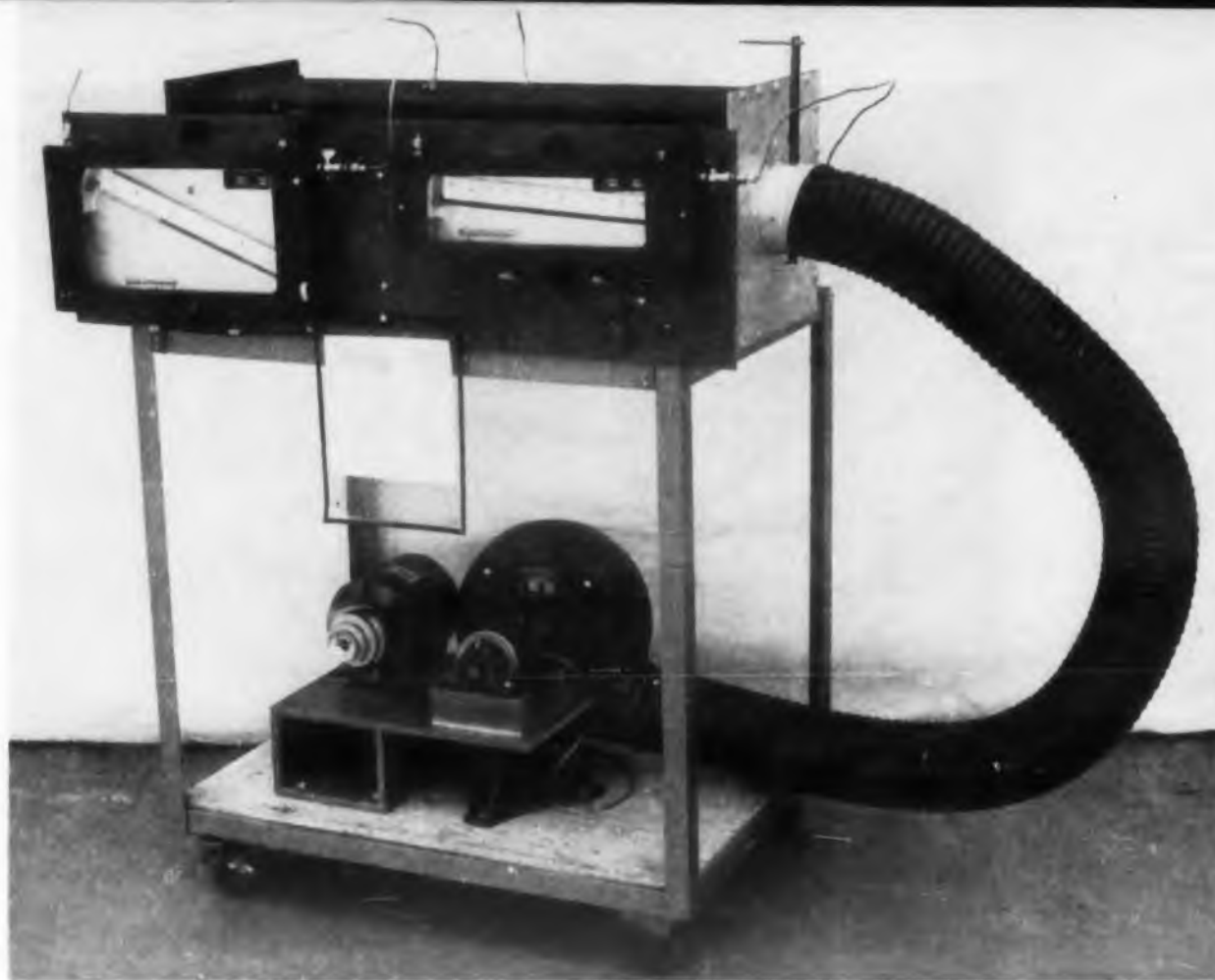

## Portable Plenum Test Chamber

George H. Siegel  
General Electric Co.  
Utica, New York

**S**ATISFACTORY performance of electronic equipment depends upon operation at reasonable ambient temperatures. Specifying necessary cooling equipment can often be a bothersome problem for the electronic engineer. Sharp corners, irregular surfaces and other air-flow obstructions which add to the complexity of the problem are common in electronic equipment. Design and fabrication of a portable plenum\* test chamber to measure air flow accurately are described in this article. The chamber is light weight, movable and extremely flexible. It can be placed in a climate chamber and operated at both low or high ambient temperatures, or at simulated altitudes, employing proper instrumentation.

In a plenum chamber, the pressure is made greater or less than that of the outside atmosphere. To make this chamber useful for test purposes, a blower is placed at the outlet, illustrated in Fig. 1. Air passing through the tested equipment comes

from the plenum through the nozzle. The pressure difference across the nozzle is a measure of the flow, and the gage pressure at the intake of the tested equipment indicates the corresponding pressure drop across that equipment.

### Design

The chamber is designed to measure flow rates to 150 cfm, at heads to 1 in. of water. A heavy-duty blower with a capacity of 300 cfm at 4 in. of water is used. Following the blower manufacturer's recommendations, a one-half horsepower motor is used to drive the blower. An air valve and a four-step cone pulley on the motor are used to regulate air flow.

Since the plenum is to be used both for "blowing" (positive pressure) and "exhausting" (negative pressure), a blower with identical inlet and outlet configurations—in this case a five-inch diameter pipe—is chosen. By employing a length of flexible tubing, either end of the plenum may be connected to either side of the blower. In Fig. 2 is shown the two arrangements described.

Flow through a nozzle (or orifice) is determined by measuring the difference in static pressure across it. This pressure difference is directly related to the rate of flow. The area of the large plenum, or settling chamber, upstream of the nozzle is made greater than ten times the nozzle throat area, and distributes the air so that uniform flow approaches the nozzles.

The nozzle is much preferred over the orifice as a measuring device, since it is far less sensitive to non-uniformities in the velocity distribution of the approach stream.

A great deal of data is available on the ASME Long Radius Nozzle, making it an obvious choice. One nozzle does not allow accurate exploration of the low flow rates; an excessive number results in cumbersome changing procedures. For economic reasons a number of identical nozzles are preferred to a selection of nozzles. Nine nozzles provide a convenient number and a symmetrical arrangement. A .7 in. throat can be readily spun, and can handle flows to 20 cfm with a 4 in. differential head.

It is desirable to limit the flow velocity through the nozzle to about 7000 fpm. For a .7 in. diameter

\*"Plenum" is the Latin word for space, or a condition in which the pressure of the air in an enclosed space is greater than that of the outside atmosphere.



nozzle with a maximum flow of 20 cfm, the highest velocity is 7200 cfm. The maximum flow capacity is therefore  $20 \times 9 = 180$  cfm.

Unused nozzles can be blocked off by adhering squares of tape to the faces of the nozzles. The tape is easily applied, easily removed, and does not damage the nozzle, or distort the flow.

### Chamber Cross-sectional Size

After selecting the nozzles, the chamber cross-sectional size must be determined. It has been recommended<sup>1</sup> that the center-to-center distance of nozzles be greater than three times the nozzle diameter, and the distance from the center of any nozzle to the walls of the chamber be at least 1-1/2 times the nozzle diameter. This will prevent the nozzle intake from disturbing the entrance area flow. These dimensions, are 4 and 2 in., respectively, considerably in excess of the minima. This makes the chamber size 12 x 12 in. Fig. 3 shows the principal dimensions of the chamber.

The length of the chamber upstream of the nozzles is set at 18 in., to allow space for mixing screens and for a nozzle access port. The downstream chamber is also made 18 in. long. As noted previously, it is necessary for the flow to approach the metering nozzles with a rather uniform velocity distribution. Since air is supplied through a 5 in. diameter tube in a 12 x 12 in. wall, the concentrated air stream must be broken up into small jets, and reformed as a uniform flow. Four expanded-metal screens are placed in series upstream of the metering nozzles for this purpose. The spacing between screens (1.5 in.) is approximately four times the opening (1/4 in.). Adjacent metal screens are alternated, with one directing the air stream upward, the next down, and so on.

A pair of static pressure taps, mounted flush with the top of the plenum wall upstream and downstream of the nozzles, measure the pressure differential. If greater precision is necessary, one tap may be placed in each of the four walls, in the same plane, and the four taps connected together to average the pressure reading. Measurements made with probes in all four sides of the chamber have indicated a difference of only a few per cent between the two methods. Because of this, one tap is installed on each side of the nozzle plate.

An inclined 4 in. differential manometer, or draft gage, measures the drop across the nozzle. This instrument requires only balancing to retain its accuracy, once it has been calibrated.

A second gage, of 1 in. capacity, is used to measure the head against which the tested fan or equipment is working. One end of the gage is connected to a proper measuring point on the equipment and the other end of the gage is left open to the atmosphere. Placement of the pressure tap at the "proper measuring point" is largely a matter of dis-

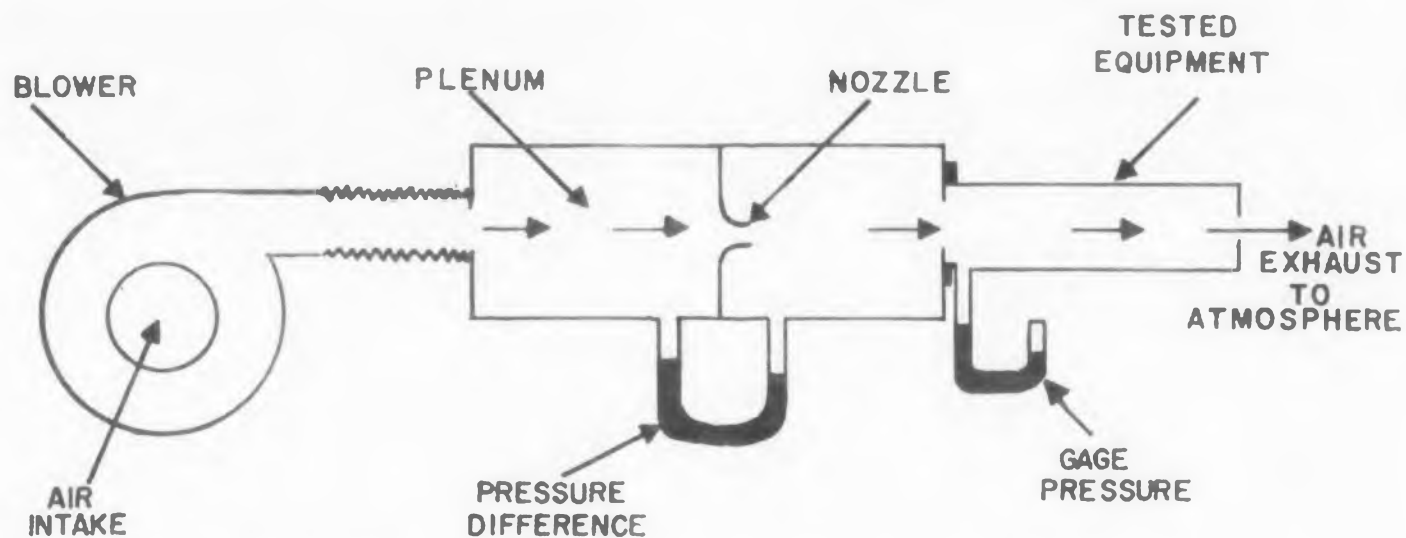

Fig. 1. Flow diagram showing essential requirements for Plenum test chamber.

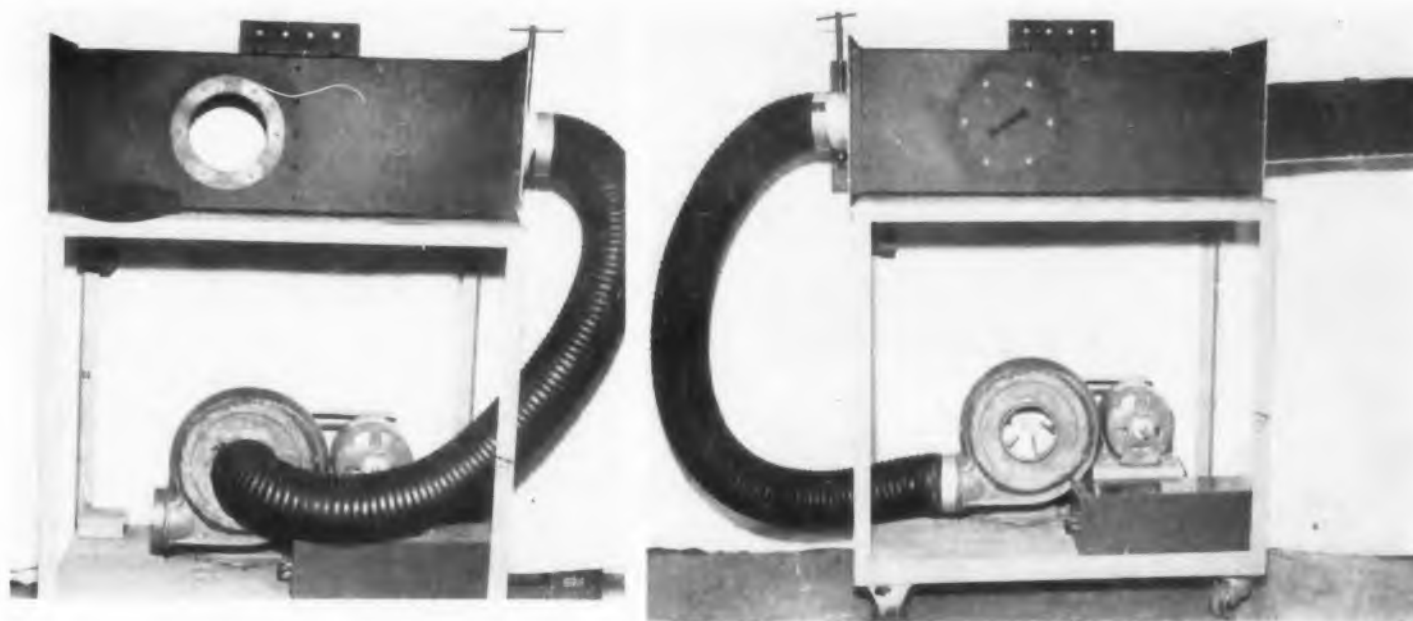

Fig. 2. Plenum chamber connected for exhausting (left) and blowing (right).

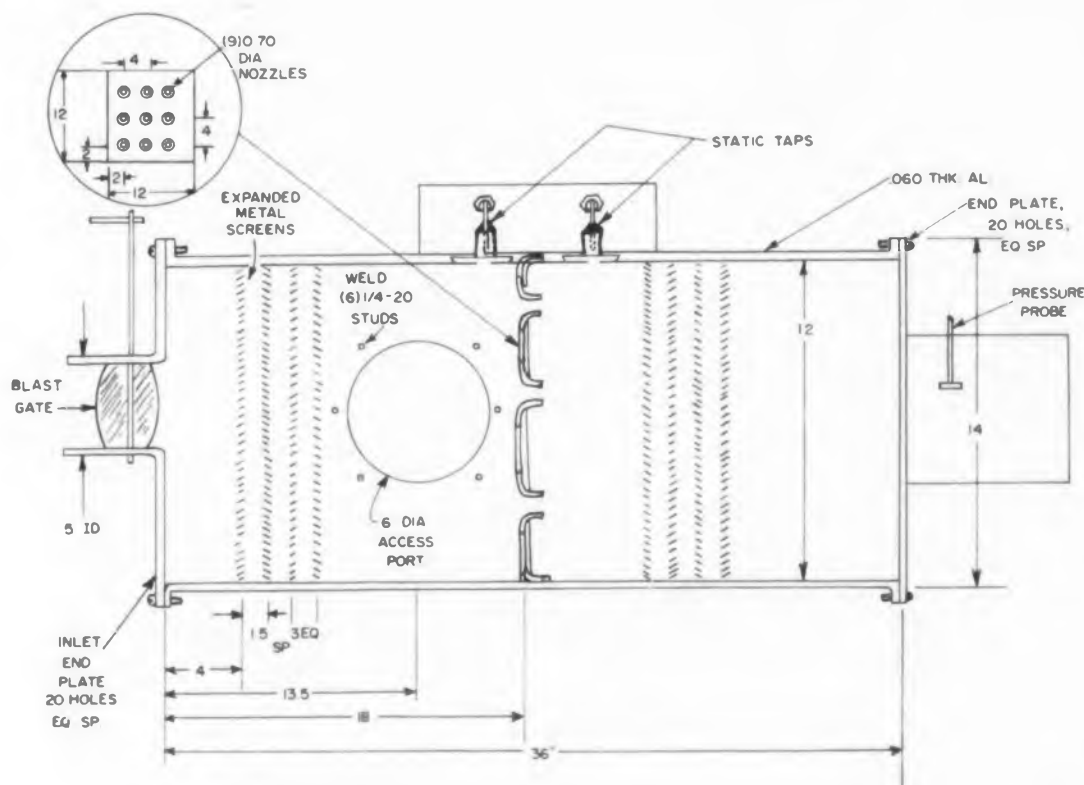

Fig. 3. Principal dimensions of test chamber. Metal screens brake concentrated air stream from jets into uniform flow.

## RAYTHEON PANEL COMPONENTS



# Color!

For fast visual control identification or for blending with color-styled equipment, Raytheon control knobs are available in standard or special colors. Can be furnished in solid color, or with contrasting colored cap. A complete selection of Braille color cap knobs also available. *Color helps it sell!*



**GET FREE DATA**  
on Raytheon control knobs  
by writing to the address  
below, Dept. 6120-A



*Excellence in Electronics*

**RAYTHEON MANUFACTURING COMPANY**  
Waltham 54, Massachusetts  
CIRCLE 25 ON READER-SERVICE CARD FOR MORE INFORMATION

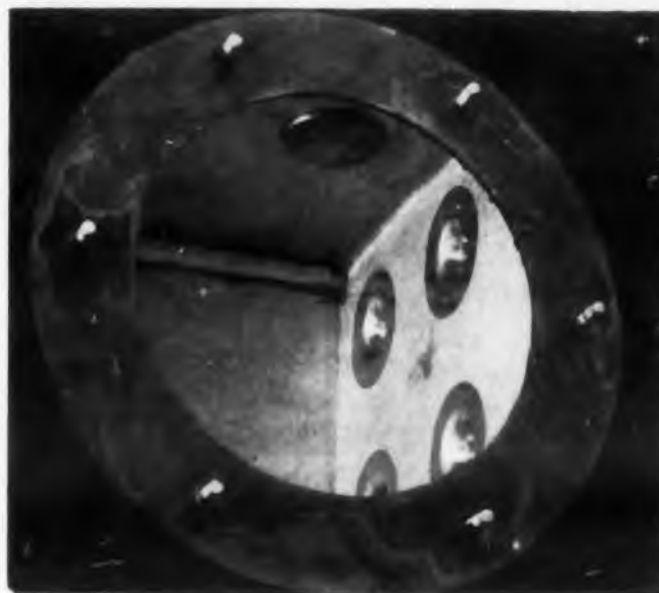

**Fig. 4.** Interior view showing pressure taps and nozzles. An epoxy resin is used to seal the nozzles in the plate.

cretion. On small blower-cooled equipment, a kiel probe or similar tap, mounted just outside the normal blower outlet, serves as a proper measuring point. Since the equipment normally exhausts to the atmosphere, the other end of the draft gage is unconnected.

The plenum chamber normally rests on the top shelf of a portable truck. To isolate vibrations the motor and blower are mounted on the plywood base of this truck.

*It is important to ground the chamber proper to prevent the buildup of an electrostatic charge due to the passage of high-velocity air.*

## Fabrication

An aluminum box, 12 x 12 x 36 in. long is formed and welded. Six studs welded about the access port provide an anchor for the cover plate. Nozzles chosen for the plenum are built according to the ASME Code (PTC 19.5 4-1949). The nozzle outline is laid out on paper several times its actual size, and then photographically reduced. The negative can then be used as a template for fabricating a nozzle-spinning tool. After spinning, the aluminum nozzles are checked by go, no-go plug gages, and the contour template, and the nine nozzles selected for use. No variation in the nozzle throat greater than .001 inch should be permitted among the nine nozzles selected.

The nozzle plate consists of 1/16 in. aluminum, with the edges formed into a box, and with nine 1.50 in. holes for the nozzles' base. A flat plate is punched with nine 2.50 in. holes to clear the nozzle OD, and the plate is spot-welded to the box.

Mounting of the nozzles required considerable care. An epoxy resin is used to cement and seal the nozzles in the plate (see Fig. 4). The nozzle assembly is then mounted in the chamber, and all spaces between the nozzle plate and the chamber walls are sealed with epoxy. When the resin hardens, holes are drilled in the chamber top for the pressure taps, and the taps installed (see Fig. 5). The metal screens are slipped into position and retained by wooden spacers cemented to the chamber corners.

The pressure taps in Fig. 5 are fabricated by brazing a bulkhead fastener to a flat brass plate, and drilling and reaming a 1/16-in. hole through the center of the plate. A short length of copper

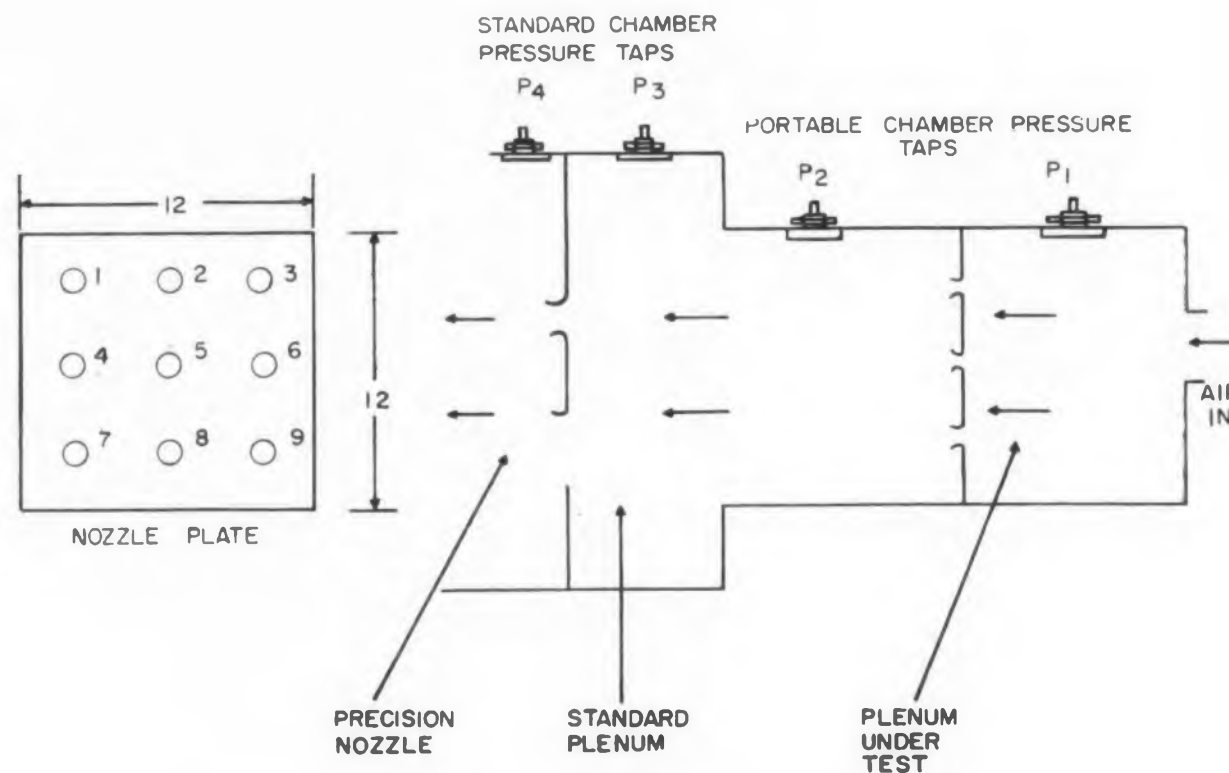

**Fig. 6.** Flow diagram for nozzle calibration test.

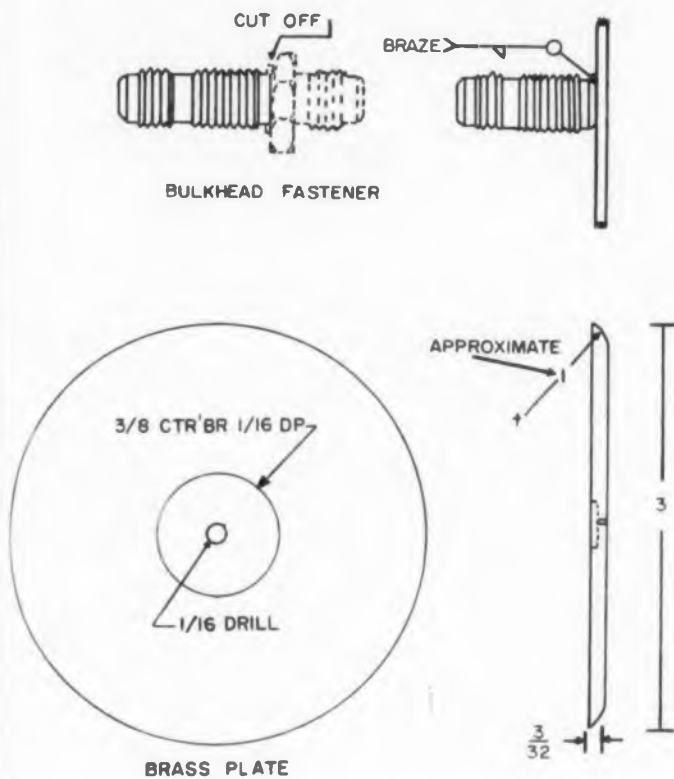

Fig. 5. Static pressure taps.

tubing leads from the pressure taps to a small top bracket. Neoprene gaskets are cemented to each end flange, and around the access port. The cover is fastened, and the plenum chamber is complete. Air connections to the instruments mounted on the truck are made with clear plastic tubing.

An end plate is required to connect the blower tubing to the chamber. A five-inch ID pipe is welded to the center of a 14 x 14 inch plate, and a butterfly-valve blast gate is installed (see Fig. 3).

Openings cut into additional end plates serve to mount blowers, ducts, equipments, etc. No specific guiding principles can be laid down, but any opening which simulates normal operation of the tested equipment will serve.

#### Calibration

Nozzle characteristics and chamber leakage must be determined. The theoretical relation between nozzle flow and pressure is derived from the Bernoulli equation (appendix 1).

A calibration test of the chamber, using a large plenum chamber as a standard, is illustrated in Fig. 6. The "standard" chamber employs precision .8 inch and 2.5 inch nozzles.

Flow-pressure characteristics are determined for several of the nozzles used singly and in various combinations.

A calibration curve plotted for a typical nozzle, can be used for all tests. Where several nozzles are opened in parallel, the flow readings are simply multiplied by the number of open nozzles. All results must be corrected to standard conditions if absolute values are required.

The constant demand for use of the plenum chamber by the various engineering units of our organization, and also by the test section, demonstrates the utility of this instrument, and the confidence our engineers place in its performance. Cost of this portable plenum chamber is \$500-\$600, which is relatively low when compared with its utility. The parts can be fabricated by a good model shop in a few weeks, and almost no maintenance is ever required on the operating chamber.

#### APPENDIX NOZZLE FLOW EQUATION

$$\frac{V_1^2}{2g} + H_1 + Z_1 = \frac{V_2^2}{2g} + H_2 + Z_2 + \text{Losses}$$

For properly constructed chamber and nozzles.

$$Z_1 = Z_2; \text{ losses } \cong 0$$

$$V_2 > V_1; V_2^2 \gg V_1^2;$$

Therefore neglecting  $V_1^2$ :

$$\frac{V_2^2}{2g} = H_1 - H_2 = \Delta H;$$

$$V_2 = \sqrt{2g \Delta H}$$

$$Q = AV_2 = \frac{\pi D^2}{4} \sqrt{2g \Delta H}$$

This reduces to:

$$Q = 5.98 C_n D^2 \sqrt{\frac{\Delta H}{W_a}}$$

Where:  $Q$  = Flow in cubic ft. per min.

$D$  = Nozzle diameter in inches

$\Delta H$  = Head in inches of water

$W_a$  = Fluid density in pounds per cubic ft.

For  $D = .70$ ;  $C_n \cong .955$ ;  $W_a = .075$

For Standard Air:

$$Q = 10.22 \sqrt{\Delta H}$$

$C_n$  is an area coefficient, a function of Reynold's No. For a .7 inch nozzle,  $C_n$  varies from .951 to .960 as  $\Delta H$  varies from .25 to 2.

The density of "Standard" Air at 68°F, 29.92" Hg, 50% Rel. Hum. is .075 lb. per cubic ft. To correct volume at any condition to Standard Air,

$$\text{use } Q \text{ std.} = Q \sqrt{\frac{.075}{\rho}}$$

#### Credits

The writer wishes to acknowledge the work at G. E.'s Light Military Electronic Equipment Department of H. Lazar, for devoting his energies to this project, and L. Fried, for his recommendations. At the General Engineering Laboratories, we are obligated to N. J. Lipstein for his advice and for calibrating our nozzles. Also, credit is due Mr. L. Tomlinson, upon whose pressure tap design ours is based.

#### Reference

<sup>1</sup>D. D. Wile, ASRE Journal, June 1947, p. 516

## RAYTHEON TEST JACKS

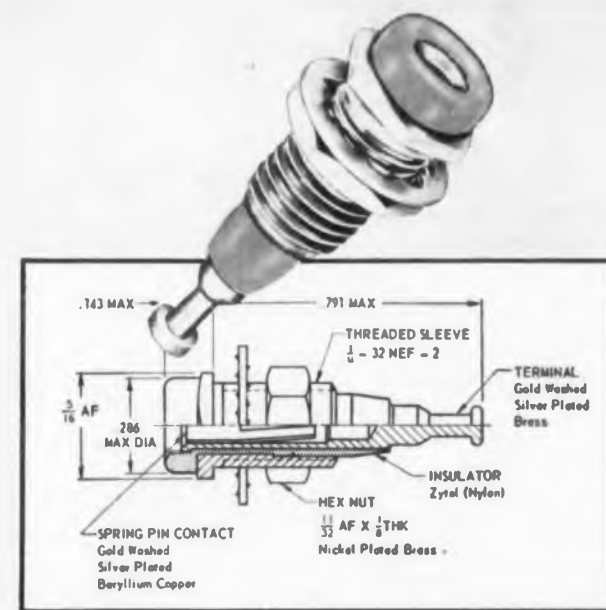

# Contact!

Raytheon's sure-contact test jacks—standard, printed-circuit, and subminiature types—are ruggedly built, have passed gruelling tests. Exclusive beryllium-copper spring-pin contacts insure smooth prod insertion, low contact resistance throughout long life. Nylon insulators available in 9 colors.



Send for **FREE Booklet** on Raytheon's line of advanced-design test jacks. Please write to Dept. 6120-C at address below.



Excellence in Electronics

**RAYTHEON MANUFACTURING COMPANY**

Waltham 54, Massachusetts

CIRCLE 26 ON READER-SERVICE CARD FOR MORE INFORMATION

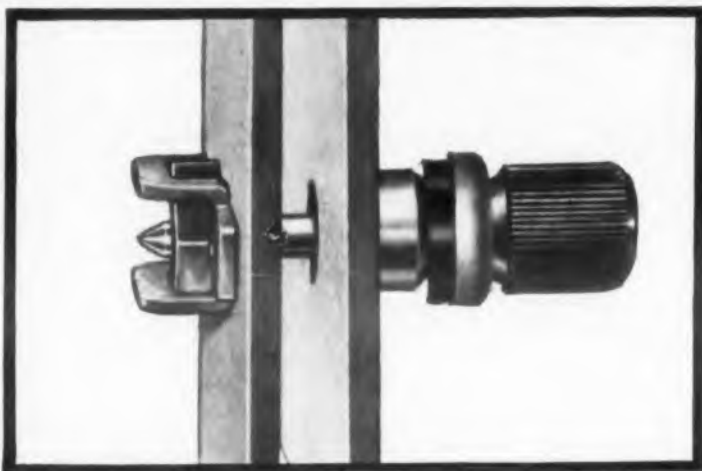
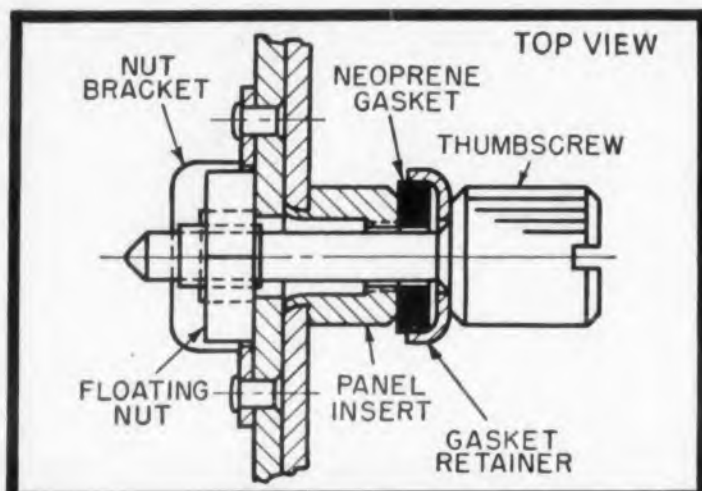

# Closure!

Fast, easy access — simple, firm closure... assured by this unique captive closure hardware.

No fumbling with loose nuts, screws or bolts. Convenient panel thumb screw lines up automatically with captive nut on rack or cabinet. Neoprene gasket seals against dirt and moisture. A variety of standard sizes available from stock. Designed in accordance with government specifications.



**COMPLETE DATA** on captive hardware and other Raytheon mechanical components. Please write to Dept. 6120-F at the address below.



*Excellence in Electronics*

**RAYTHEON MANUFACTURING COMPANY**  
Waltham 54, Massachusetts

CIRCLE 27 ON READER-SERVICE CARD FOR MORE INFORMATION

## Flying Spot Programmer

**D**ESIGNED to convert a curve drawn on graph paper into a voltage to be used for control or programming, this program scanner uses a "flying spot" crt in combination with a photomultiplier to extract information from the curve. A number of program scanners, each with its own program, may be operated synchronously; or several programs may be tape recorded on multichannel tape from one scanner. The output from the scanner is fed directly to an amplifier which is used in the control function.

Developed by Spar Engineering and Development, Inc., Paxson and South Avenues, Wyncote, Pa., the Model 6275 Program Scanner operates by placing a photographic transparency of the time-function curve in front of the "flying spot" tube, and sweeping it by a vertical line which is moved horizontally across the face of the tube. The upper part of the curve is opaqued; consequently the photomultiplier, acting as a switch, sees the time the spot is below the curve, and fires on and off a Schmidt trigger. The output of the Schmidt is

clamped to a glow-tube reference to produce a constant amplitude square wave. The resulting variable width pulses may be recorded on a channel of tape for future use or injected directly into a control amplifier as a program reference. Fig. 1 shows this operation.

A block diagram of the Program Scanner circuit is presented in Fig. 2. The sine wave output of the master oscillator is shaped and differentiated. A clamp drives the saw-tooth generator, which drives an amplifier loaded with the yoke. The pre-amplifier following the multiplier adds a differentiated signal ( $T = 50 \mu\text{sec}$ ) to aid in sharpening the rise time of the pulses. The output of the preamplifier is shaped, clamped, and its average value is used as the scanner's output.

Spar amplifiers and accessories are shown, but other amplifiers may be used simply by converting the output of the scanner or tape recorder to a dc or 60 cycle ac signal.

For more information on this product, turn to the Reader's Service Card and circle 29.

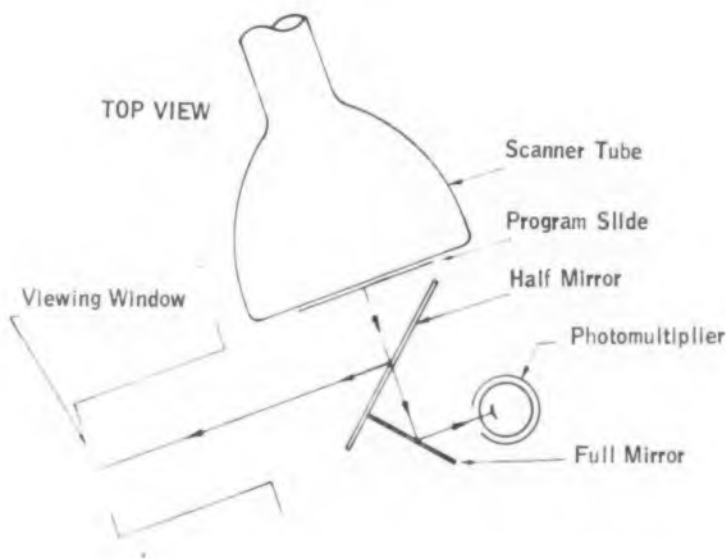

**Fig. 1.** Operation of programmer. Time during which flying spot shows under curve is read by the photomultiplier tube, which activates a Schmidt trigger.

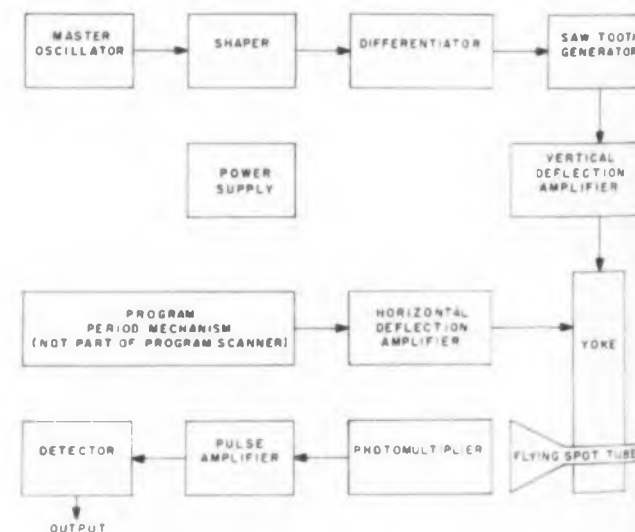

**Fig. 2.** Block diagram of the Program Scanner circuit.



This Program Scanner reads a curve drawn on graph paper and converts it into a signal for control or programming. This service uses a "flying spot" cathode ray tube to read the curve, a photomultiplier as a transducer. Shown in the photograph is a transparency with a curve that consists of a pulse and a linear rise wave form.

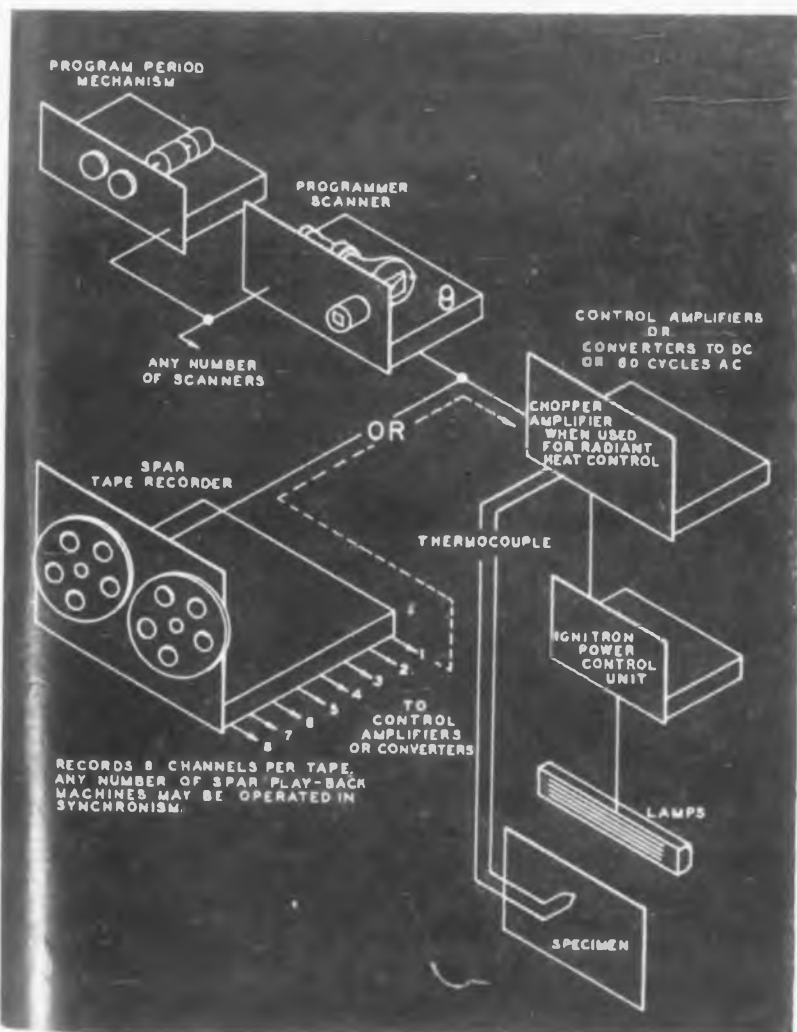

Fig. 3. Program Scanner as it would be set up for programming temperature changes. Any number of scanners may be run simultaneously.

## RAYTHEON VOLTAGE REGULATORS



# Steady!

The life and operation of your equipment need not be affected by ups and downs in line voltage. Whether your line is 95 or 130 volts, the Raytheon voltage regulator will supply rated output within  $\pm 1/2\%$ . Response is within 1/20 second. Standard units from 15 to 2,000 watts; specials from 5 to 10,000 watts.



**FREE LITERATURE**  
giving ratings and physical dimensions. Please write Dept. 6120G, address below.



*Excellence in Electronics*

**RAYTHEON MANUFACTURING COMPANY**  
Waltham 54, Massachusetts  
CIRCLE 28 ON READER-SERVICE CARD FOR MORE INFORMATION

## RAYTHEON MAGNETIC COMPONENTS

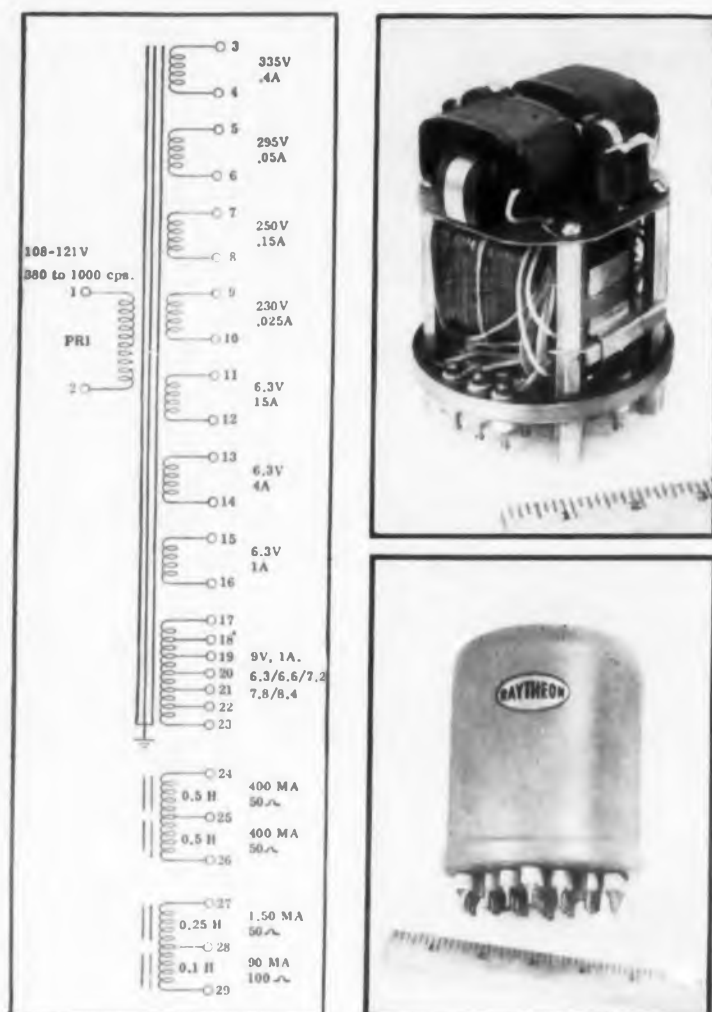

# Size!

4 filter reactors and a 350-VA power transformer—all in 60 cubic inches! A ticklish design problem. The \$64,000 question: how to get rid of the heat? Raytheon engineers did it with new "evaporative cooling" techniques, using a high-dielectric liquid fluorochemical. Raytheon pioneering can pay off for you, too. Write us about your magnetic component problem. Our engineers will study it and suggest a possible solution.



**FREE DATA** on this and other Raytheon magnetic components. Please write to Dept. 6120-E, address below.



Excellence in Electronics

**RAYTHEON MANUFACTURING COMPANY**  
Waltham 54, Massachusetts

CIRCLE 30 ON READER-SERVICE CARD FOR MORE INFORMATION

Second of two parts. The first part discussed the criterion and inverse probability methods of receiver design and evaluated envelope detection. Matched filtering as a technique for improving the signal-to-noise ratio at the receiver was described. In this part other techniques designed to improve the signal-to-noise ratio are presented and the relationship they bear to each other considered. Applications for linear filtering techniques are given, such as in synchronous detection, autocorrelation radar and doppler radar.

## Principles of Filtering – II

L. S. Schwartz  
New York University

**T**HE comb filter integrates over more than one pulse. Comb-filter operation is tantamount to insertion of band-pass filters of infinitesimal width at the spectral lines of a repetitive signal. Thus, the essential frequency components of the signal are admitted by the filter whereas the noise which fills the region between spectral lines is rejected. If the band-pass filters are infinitely narrow, the filter, in effect, operates on an infinite pulse train, and the filtering is perfect.

In practical applications perfect operation is not possible, and comb filtering must be limited to a finite number of pulses. In view of this, it is necessary to consider the shape of the spectrum of a finite group of pulses as distinct from the spectrum of a succession of repetitive pulses of infinite extent.

The frequency spectrum of a signal consisting of a train of  $N$  rectangular pulses of constant width and amplitude and period  $T$  is

$$S(\omega) = \sum_{k=-\infty}^{\infty} F \left( \frac{2\pi k}{T} \right) \left[ \frac{\sin NT(\omega - 2k/T)}{NT(\omega - 2\pi k/T)/2} \right] \quad (1)$$

where  $k=n/N$  is restricted to integral values.<sup>1</sup> Thus, the frequency spectrum of a finite pulse train consists of curves of the form  $\sin x/x$  centered about the spectral lines in the spectrum of an infinite pulse train; the maximum height of the individual  $\sin x/x$  is equivalent to the height of the corresponding spectral lines, so that the envelope of the entire spectrum is also of the form  $\sin x/x$ . As  $N$ , the number of pulses in the train, increases, the individual  $\sin x/x$  curves

about the spectral lines become increasingly spiked, and the spectrum approximates the line spectrum of an infinite train of pulses. The improvement obtainable with a comb filter increases with the number of pulses on which the comb filter operates, because, as just observed, the spread of the  $\sin x/x$  function about the spectral lines decreases as  $N$  increases, admitting less noise to the output of the filter.

Since the transfer characteristic of an ideal (linear) integrator consists of a series of spikes at the spectral lines, the transfer characteristic of a comb filter approximates that of an ideal integrator as  $N$  increases. Because of the functional similarities between the comb filter and the linear integrator and because of the technical difficulties involved in achieving the necessary frequency stability for satisfactory operation of the comb filter its use is not recommended.

### Linear Integration

Integration and correlation have been widely described in the literature and have been employed to aid in the detection of periodic signals obscured by noise. The advantage of integration or correlation consists in the fact that signals reinforce upon successive additions in time, whereas noise both reinforces and cancels. It is evident that the best result is obtained when the noise has minimum correlation with itself, i.e., when it has the statistical structure of thermal noise.

Integration may be achieved by introducing the signal wave form into a number of storage elements

The resultant rms noise voltage on the other hand will be proportional to

$$\left( \sum_0^{\infty} a_n^2 \right)^{1/2}$$

since the noise is uncorrelated between successive repetition periods. The improvement in signal-to-noise power ratio is therefore

$$R_1 = \left( \sum_0^{\infty} a_n \right)^2 / \left( \sum_0^{\infty} a_n^2 \right). \quad (3)$$

It is clear that the signals are summed with a weighting function which, in the case of the linear integrator for radar pulses, has peaks in the repetition frequency and its harmonics. The frequency characteristic of the integrator is therefore of the comb-filter type, passing the Fourier components of the pulse train and attenuating noise at other frequencies.

#### Correlation

The subject of correlation is concerned with relations which exist between parts of the same signal, or between parts of one signal and parts of another. The former is defined by the *autocorrelation function* whose symbolic expression is

$$\Psi_{11}(\tau) = \lim_{T \rightarrow \infty} 1/2 T \int_{-T}^T f_1(t) f_1(t+\tau) dt \quad (4)$$

Physically, the autocorrelation function is simply the average product obtained by comparing the given signal with itself.

If the signal is completely random, different parts of the same signal will be independent of each other and, consequently, the value of the autocorrelation will be zero except for  $\tau = 0$  meaning that the signal is correlated with itself only. An example of a completely uncorrelated signal is thermal noise, the autocorrelation function of which is a spike at  $\tau = 0$ . For more correlated time functions, the autocorrelation function decays to zero for increasing  $\tau$ .

The *crosscorrelation function* differs from the autocorrelation function in that it represents the average product relationship which exists between two different time functions and is thus a measure of the amount of correlation which exists between the functions at different intervals of time. Cross-correlation is applied when *a priori* information concerning the frequency of the signal is known. If there is no *a priori* information, no advantage is obtained over autocorrelation.

If a sinusoidal function is crosscorrelated with a periodic signal possessing more than one frequency, one of which is a frequency equal to that of the sinusoidal function, the output of the correlator is a sinusoidal function of the same frequency as the correlating sinusoid. This is the same result as would be obtained if the periodic signal were



with given delays and then summing the delayed signals. Ideally, an infinite number of pulses would be summed to obtain an infinite improvement in signal-to-noise ratio. A far from ideal example of a linear integrator is a low-pass filter which integrates by eliminating high-frequency components in the noise. Signal frequencies, however, may also be eliminated if the bandwidth of the filter is reduced beyond the point at which the signal spectrum has significant energy.

For pulsed signals, as in radar, the signal spectrum has little energy at frequencies greater than  $1/\delta$ , where  $\delta$  is the pulse width. Hence, frequencies beyond  $1/\delta$  can be eliminated without materially affecting the signal.

To integrate and yet retain range information, the bandwidth must be reduced in a way that does not destroy the pulse nature of the signal. The method depends upon the possibility of storing radar signals for indefinite periods without distortion. Each repetition period is treated as a unit, and its signals are sorted in such a way that they can be recovered in their correct time sequence.

The combined signal, with pulses from fixed target correctly superimposed, is given by

$$S(t) = \sum_{n=0}^{\infty} a_n s_n(t-nT), 0 < t < T. \quad (2)$$

The change in signal-to-noise ratio may be calculated by considering a particular instant. If this instant lies within a signal pulse, the signal amplitude will add to a sum proportional to  $\sum_0^{\infty} a_n$ .

## RAYTHEON TRANSFORMERS



# Shape!

This unique spherical pulse transformer (designed for blocking oscillator) measures just  $3/4$  inch in diameter. It was developed to meet a customer's special space requirements without sacrificing electrical performance. Special configurations and sizes are no obstacle to Raytheon transformer design engineers. Let them tackle your problem.



#### FREE DATA SHEETS:

Please write to Dept. 6120-D, address below stating requirements.

# RAYTHEON

Excellence in Electronics

**RAYTHEON MANUFACTURING COMPANY**  
Waltham 54, Massachusetts

CIRCLE 31 ON READER-SERVICE CARD FOR MORE INFORMATION

having your ups  
and downs?



... if they involve POTENTIOMETERS

# DALOHM

has the answer!

All Dalohm components are carefully designed and skillfully made to assure you of supreme quality and dependability, plus the widest versatility of application. These recent additions to the Dalohm line already have met with wide acceptance and enthusiasm:



You  
can  
depend  
on



A10-W

## TRIMMER POTENTIOMETER

Wire Wound, High Temperature, Humidity-Proof, Ruggedized

This Dalohm Trimmer is designed to meet the ever-increasing requirements of such specifications as MIL-E-5272A and MIL-R-12934. It provides precision adjustments in critical electronic circuits under extreme environmental conditions. It has an extended winding surface and assures high precision resolution without sacrificing sub-miniature design. Size is .220 x .310 x 1.250; weight is 2.25 grams.

- Resistance values 10 ohms to 100,000 ohms; standard tolerance 5%; power rating 0.8 watt; temperature coefficient of wire 0.00002/Deg. C. Other resistances, tolerances, leads available on special order.
- Completely sealed; housing of thermosetting, glass filled material with heat resistance of 200° C continuous. Precious metal plating on all terminals; air evacuated and filled with silicone grease.
- Unique new type sliding contact; unique safety clutch.
- Unit holds set resistance values.
- Mounting flexibility provided for either stacked or multiple arrangements.

Write for Bulletin R-32B

## Mil-E-Trized DP-12 POTENTIOMETER

Built to Surpass JAN-R-19

- Hermetically Sealed
- Moisture-Proof • Ruggedized

Write for Bulletin R-31



JUST ASK US!

Write for the complete Dalohm catalog of potentiometers and precision resistors and knobs.

If none of our standard line fills your need, our staff of able engineers and skilled craftsmen, equipped with the most modern facilities, is ready to help you solve your problem in the realm of development, engineering, design and production.

Just outline your specific situation.

• Export Dept. Pan Mar Corp.

1270 Broadway New York 1, N.Y.

DALE  
PRODUCTS, INC.  
1328 28th Avenue  
Columbus, Nebraska, U.S.A.

CIRCLE 32 ON READER-SERVICE CARD FOR MORE INFORMATION

passed through an infinitely narrow filter centered on the frequency of the correlating sinusoid.

Since this discussion is limited to theoretically ideal correlators for which the time of integration is infinite, the correlator can be regarded as the equivalent of an infinitely narrow filter in the frequency domain. It is noted that the latter filter would have an infinite build-up time.

Although correlation has its frequency domain analog, such that the time and frequency domain viewpoints are operationally equivalent, it may be easier to build a highly stable oscillator than a correspondingly narrow bandwidth filter. If a periodic signal with harmonic components is correlated with another periodic signal possessing an infinite set of harmonic components of equal amplitude, the output of the correlator will consist of discrete frequency components representing the original signal. Thus, the ideal correlator behaves like a comb filter.

In summary, the three linear techniques discussed in the foregoing and the matched filter discussed in Part 1—also a linear technique—are equivalent for signals in Gaussian noise. They all maximize signal-to-noise ratio by linear integration; minimize the probability of error associated with decision making.

Because of the importance of linear filtering techniques and because all linear techniques may be considered a form of correlation, it is worthwhile to look at some well-known applications to see if their noise-reducing properties can be attributed to correlation.

### Synchronous Detection

Conventional envelope detection utilizes only amplitude information and discards phase information, thus according to information theory, throwing away the equivalent of 3 db in signal-to-noise

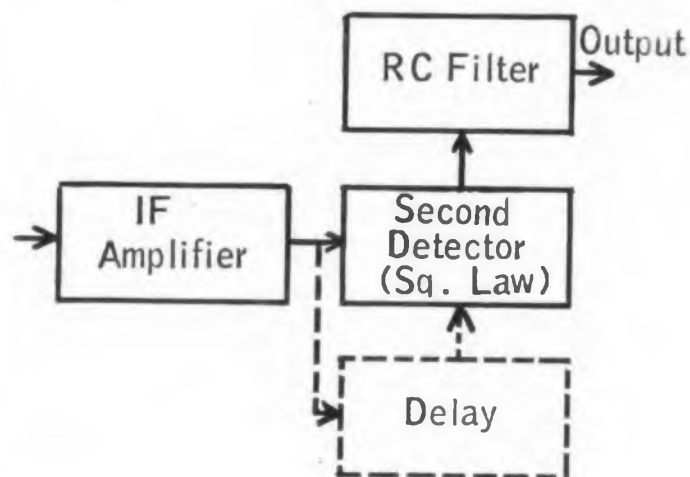

Fig. 1. Block diagram of conventional radar.

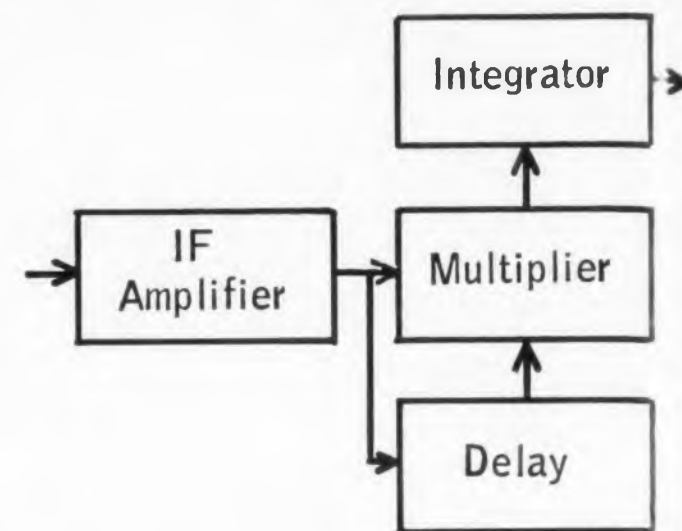

Fig. 2. Block diagram of auto-correlation radar.

ratio. Much more serious, however, is the fact that envelope detection is a nonlinear operation which suppresses the signal if the noise exceeds the signal in amplitude.

Thus, if the signal is 10 db below the noise at the input to the second detector, it will be 20 db below the noise at the output.<sup>2</sup> Also, because of the alteration in the statistical properties of the noise in the second detector, averaging filters are not as effective at video frequencies as they are at intermediate frequencies. From a practical standpoint, this proves to be unfortunate because the technical problems in filtering at intermediate frequencies are much more difficult than at video frequencies. Therefore, it is highly desirable to find an alternative to envelope detection.

Synchronous detection seems to be a promising alternative. Its properties are as follows. Transmitter and receiver frequencies are coherent so that the system uses phase information. Hence, it provides a 3-db signal-to-noise improvement over simple envelope detection. Secondly, the detection process is linear so that no suppression of the signal by the noise occurs for signals smaller than noise, since filtering operations can be conducted with equal efficiency before and after detection, practical difficulties in filtering at intermediate frequencies can be avoided.

The operation of synchronous detection is as follows. The message function  $f_m(t)$  is modulated into a cosine or sine carrier at the transmitter to give

$$f_s(t) = f_m(t) \cos \omega_0 t \quad (5)$$

At the receiver the incoming signal is multiplied by a cosine or sine reference voltage of the same frequency as the carrier, the resultant voltage being

$$f_s(t) \cos \omega_0 t = f_m(t) (1 + \cos 2\omega_0 t)/2 \quad (6)$$



The signal is then passed through a low-pass filter which eliminates the carrier frequency term. The output is  $f_m(t)/2$ .

Synchronous detection is thus seen to be a linear means for removing fine structure from a received signal. To the extent that it employs multiplication with a known frequency and averaging, it resembles cross correlation, but it is not complete cross correlation because a low-pass filter is used which permits all essential harmonic components to be passed. A true correlator would permit the carrier frequency term only to be passed and thus would function as an infinitely narrow band filter.

#### Correlation and Radar

A pulse-amplitude-modulated radar with a square-law second detector bears a striking resemblance to the autocorrelation system shown in Fig. 1, since it is really the conventional system in Fig. 2 with a delay network added. If the input signal to the circuit of Fig. 1 is a rectangularly shaped pulse, the output is a triangularly shaped pulse. If the input to the second detector in Fig. 2 is

$$f_1(t) + f_1(t+\tau), \quad (7)$$

the detector output is

$$[f_1(t)]^2 + 2f_1(t)f_1(t+\tau) + [f_1(t+\tau)]^2. \quad (8)$$

The RC filter is a low-pass filter which functions approximately as integrating device. Hence, the output of the detector is integrated and this results in

$$2\phi_{11}(0) + 2\phi_{11}(\tau), \quad (9)$$

two autocorrelation functions. Because  $\phi_{11}(0)$  is constant for a stationary process, the first term can be eliminated by calibration. For rectangular input pulses,  $\phi_{11}(\tau)$  is a triangular function of time and thus it is seen that, with a slight modification, the pulse radar receiver can be modified to perform as an autocorrelation detector.

*Continuous-wave doppler and frequency-modulated radars are fundamentally correlation systems since they heterodyne, i.e., multiply the received signal and a locally generated time function in the mixer. Passage of the doppler beat frequency or frequencies through a low-pass filter is approximately integration. The systems preserve phase information which they depend upon for their reading. Thus, the detection process is approximately cross correlation.*

#### References

1. Comb Filters for Pulsed Radar Use, S. F. George, A. S. Zamanakos, Proceedings, Institute of Radio Engineers, New York N.Y., vol. 42, July 1951, p. 1159.
2. Appendices to Comparison of Modulation Methods, S. F. George, National Convention Record, Ibid., pt. 8, Information Theory, March 1953, pp. 21-25.

For a reprint of this article, turn to the Reader's Service Card and circle 33.

## SMALLEST...lightest in its class!

*NEW*  
**OAK**  
SERIES M  
DC-AC low level inverter



\*Depending on packaging



**designed for 30G vibrations  
from 0-500 CPS**

While the rugged Series M is probably the smallest, lightest, polarized relay ever built, electronic designers will find that it has other characteristics equally exciting. For example, tests indicate that variations of the standard unit produce the *lowest* noise level ever achieved in this class of chopper.

Another valuable feature is the unusually wide selection of custom-built packages available to designers. These include: side, vertical, and flange mounts; coil leads at top or bottom; straight plug-in; flexible pigtailed; solder mounts; dual unit package; and double sealing with shock mounting between the two cans.

Investigate the Series M now. Contact your Oak representative, or write for complete data.

**OAK** MFG. CO.   
1260 Clybourn Ave., Dept. D, Chicago 10, Ill.  
Phone: MOhawk 4-2222

**UNIQUE DESIGN ELIMINATES  
PARTS FOR UNUSUAL SIMPLICITY**

The Series M chopper gains its extreme simplicity from a new design approach based on the advantages of an oriented ceramic magnet. In addition, the switch unit contains no organic insulation, is mounted independently of the drive coil, and has its own hermetic seal.

**Operating Frequency**—0-1000 cps; special units to 1800 cps.  
**Coil**—6.3 volts  $\pm 20\%$  at 60 to 500 cps; 60 ma max at 400 cps; 85 ohms (DC).  
**Phase Angle, Lag**— $55^\circ \pm 10^\circ$  at 400 cps;  $20^\circ \pm 2^\circ$  at 60 cps.  
**Dwell Time**—165 min.  
**Dissymmetry**—15% max.  
**Mounting**—Any position.  
**Temperature**—From  $-55^\circ\text{C}$  to  $+100^\circ\text{C}$ ; special to  $+125^\circ\text{C}$ .  
**Weight**—Less than  $\frac{3}{4}$  oz. for the plug-in unit.



**SWITCHES • ROTARY SOLENOIDS • CHOPPERS • VIBRATORS • SPECIAL ASSEMBLIES**  
CIRCLE 34 ON READER-SERVICE CARD FOR MORE INFORMATION

# 1 W



## Panel Chanel® does any wiring job with one-third the work

PANEL CHANEL is the new way to wire panels. It eliminates costly, time-consuming bundling and lacing methods . . . actually makes any wiring job easier. It has helped boost production and simplify user maintenance for many leading electrical and electronic equipment manufacturers.

PANEL CHANEL requires no special tools or hardware. Made of a strong, lightweight material, it will not warp under high temperatures normally encountered in control panel service.

PANEL CHANEL is available in a wide variety of standard sizes and styles . . . can be produced in special designs to reduce work on your wiring jobs.



HOW-TO-DO-IT Booklet . . . gives full details on this new wiring method. It is profusely illustrated, graphic and complete. Send for your copy of Bulletin S-301.

## Panel Chanel®

STAHLIN BROTHERS, Inc., 102 Maple Street, Belding, Michigan  
CIRCLE 35 ON READER-SERVICE CARD FOR MORE INFORMATION



Operates with signal levels from 0.1  $\mu$ v to 0.5 v.

## Microvolt Instrument Transformer

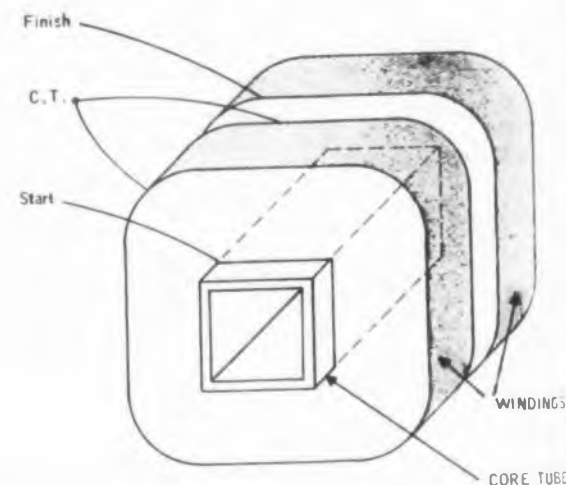

Fig. 1. Simultaneously winding two separate primaries—one from each end of the core—gives 75 percent less distributed capacity than conventional layer wound primary with center tap.

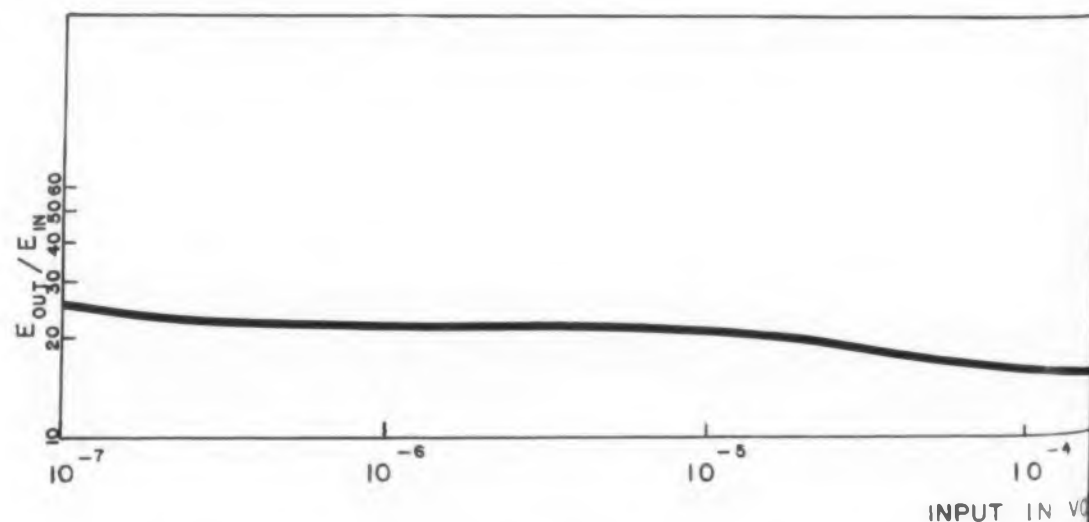

Fig. 3. Transformer characteristics applicable to chopper operation.

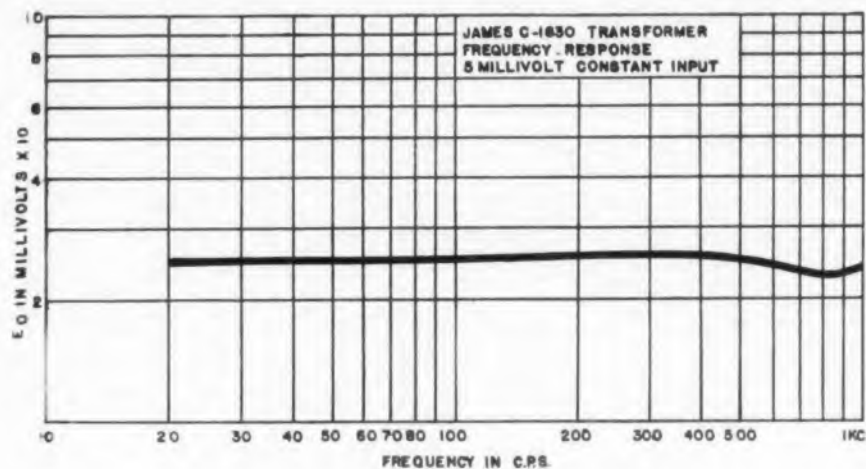

Fig. 2. Transformer has a flat frequency response for transducer generated from 20 cps to over 500 cps.

simultaneously gives a seventy-five per cent reduction in distributed capacity over a conventional layer wound primary. It also provides uniform magnetic coupling and extremely accurate center tapping. Equal dc resistance in each arm is insured by maintaining uniform wire tension on both primary halves during winding. The frequency response curve for the transformer is shown in Fig. 2.

#### Electrostatic Shielding

Electrostatic shielding between the primary and secondary windings is accomplished with a sheet of copper foil wound into the transformer. Foil shielding reduces inter-winding capacity by a factor of ten-to-one over the more common coil-type electrostatic shield.

Foil-type shielding allows satisfactory operation with input circuits having very instrument amplifiers, adequate electro-high common mode noise. Since this type

of noise will be capacitively coupled to the static shielding is essential.

Transformer magnetic shielding is provided to prevent spurious outputs from stray flux. Either one or two high permeability shields give 45 db and 70 db shielding, respectively.

One-half primary resistance is 216 ohms and one-half primary leakage inductance 9 mh. With 980 one-half primary turns 60 cps primary impedance is 7.2 K. The secondary winding can be proportioned to give the desired voltage and impedance transformation. Core material is Carpenter Hy Mu 80.

Typical applications for the transformer include operational amplifiers in analog computers and dc transducer generated information, such as thermocouples and strain gages.

For further information on this instrument transformer turn to the Reader's Service Card and circle 36.

JAMES C-1830 TRANSFORMER  
INPUT vs OUTPUT/INPUT  
400 C.P.S. CHOPPER MODULATED  
D.C. INPUT



## UPB...

### the capacitor...with immortality

Well, not quite. But for the critical applications where extended long capacitor life and highest dependability are imperative, the C-D UPB Electrolytic takes over where the normally long-life electrolytic succumbs.

Many intricate communication systems, telephone networks, laboratory test and control instruments, computing equipment, military and aircraft devices, and the like, require capacitors having this extra high degree of dependability and long service life.

Such a capacitor is the C-D TYPE UPB ELECTROLYTIC.

Materials ordinarily quite acceptable for commercial capacitors are discarded—only super-pure materials are used in the UPB. Every processing step is meticulously supervised under controlled atmospheric humidity and temperature conditions. All of the engineering and manufacturing skill of C-D's 46 years of experience is built into this UPB.

The result is an electrolytic capacitor with "Immortality"—service life far beyond that of the conventional high-grade commercial electrolytic capacitor.

Engineering data and ratings gladly furnished. Address Manufacturer's Division, Cornell-Dubilier Electric Corporation, South Plainfield, New Jersey.

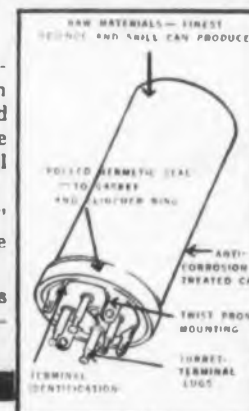

## CORNELL-DUBILIER CAPACITORS

CONSISTENT HI-DEPENDABILITY  
SOUTH PLAINFIELD, N. J.; NEW BEDFORD, WORCESTER & CAMBRIDGE, MASS.; PROVIDENCE & HOPE VALLEY, R. I.; INDIANAPOLIS, IND.; SANFORD, FUGUAY SPRINGS & VARINA, N. C.; VENICE, CALIF.; & SUBSIDIARIES, THE RADIART CORPORATION, CLEVELAND, OHIO, CORNELL-DUBILIER ELECTRIC INTERNATIONAL, N. Y.

CIRCLE 37 ON READER-SERVICE CARD FOR MORE INFORMATION

# A New Evaporative Cooling Technique

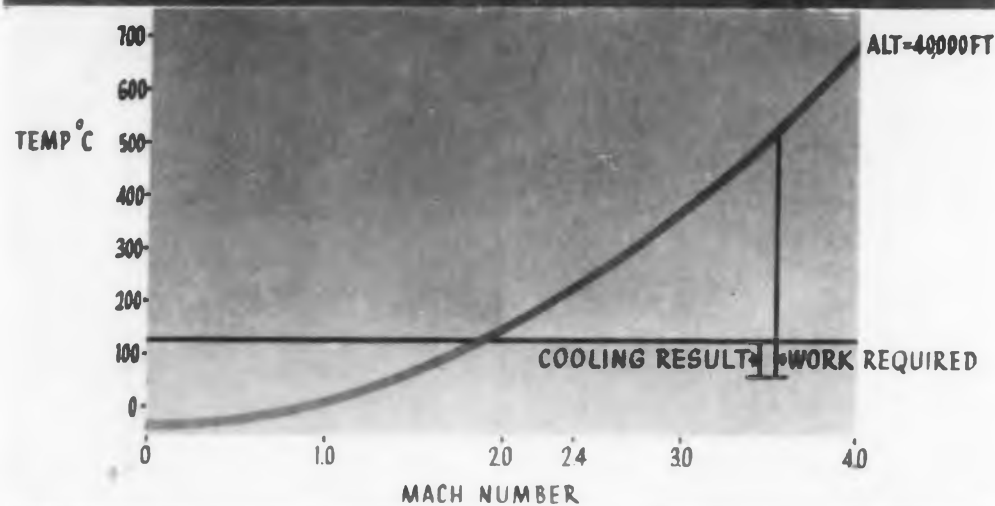

Fig. 1. Ram Temperature Rise.

LATENT HEAT BTU/LB

LATENT HEAT BTU/FT<sup>3</sup>

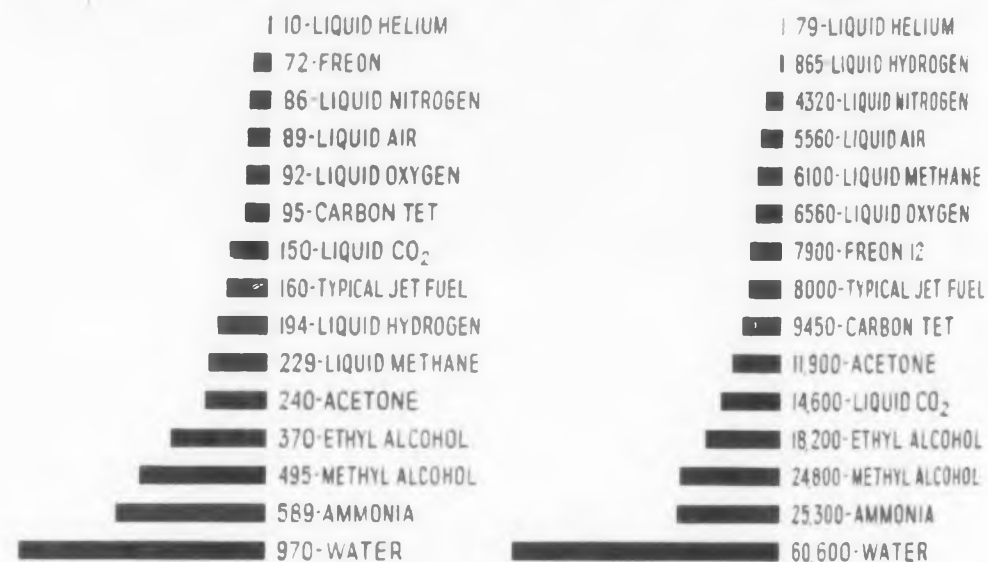

Fig. 2. Comparison of latent heats of vaporization for various coolants.

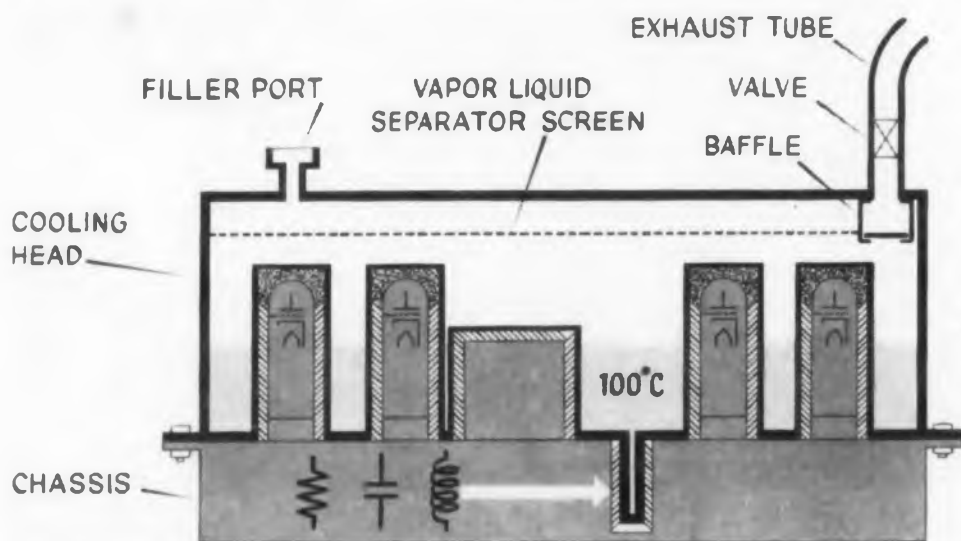

Fig. 3. Sketch of application of new evaporation cooling technique.

THE DAMAGING effect of heat on electronic component parts during high speed flight is a familiar problem. There are two broad approaches. To overcome the difficulty, equipment must be designed so that it will be able to live with high temperature or, if this is not feasible, cooling must be provided.

Considerable effort has gone into the first course—the development of high temperature electronic component parts. Even so, only a few parts are available today that can withstand temperatures above 125 C. This article discusses cooling principles in general and describes a new evaporative method of cooling.

## The Cooling Problem

For high performance aircraft like the F104 and the F8U there is no alternative to extensive cooling. The cooling element is usually ram air or refrigerated air. On Fig. 1 the dark line indicates a hypothetical component part temperature. At lower speeds the ram air is still cooler than the part. To the right, however, the slope of the curve increases rapidly, and the temperature of the ram air far exceeds the allowable temperature of the electronic components involved.

The work required to bring this ram air down to the point where it will provide cooling is much greater than the amount of cooling that can be obtained, and this situation gets rapidly worse at higher speeds. The range of ram air systems can be extended only through the use of higher temperature components.

In a typical air cycle configuration hot air is drawn from the jet engine and passes through an intercooled rejecting its heat to ram air. Then it passes through an air expansion turbine and is routed to the electronic equipment.

The first limitation of air cycling is that it rejects heat to ram air, and Fig. 1 shows how hot ram air

### Robert Berner

Thermal Engineer  
The Martin Company  
Baltimore, Md.



gets at higher speeds. Also, the present ratios of pressure into the turbine to pressure out of the turbine limit the temperature drop. It is felt that very little can be done in turbine development. Air cycles consequently become ineffective as Mach 2 is approached.

Adding a water boiler in the circuit can extend the range. The heated air is passed through the water boiler; the water is dumped overboard as steam. This extends the range of the air cycle system to the Mach 2.5 region.

But at these speeds, the water boiler is doing the majority of work. Also, the jet engine may not be in operation at these speeds, and, therefore, there would be no ram air supply.

These problems have led to a general trend toward a cooling method which might be termed the insulate and isolate technique. Designers insulate the airframe or the component and prevent high temperature air from coming in. Internal heat is removed by a heat sink, such as jet fuel. Unfortunately, the amount of heat that can be transferred to fuel is too small. The so-called high energy fuels are no better and possibly worse. Thus the designer must select a new type of heat sink.

One solution is to recirculate some fluid, either air or liquid, through the electronic components, and then through a heat sink such as water. If the temperature is still too high, a vapor cycle system must be added. The water boiler becomes a condenser for the vapor cycle system, but a compressor, expansion valve, and evaporator are added. These systems require power. In addition, as the number of elements are multiplied—each of which is less than 100 per cent efficient—inefficiencies are compounded. It would be much more efficient if possible, to place this water right at the heat source—in the electronic equipment.

Fig. 2 compares water with some of the other liquids which might be used as vaporizing refriger-

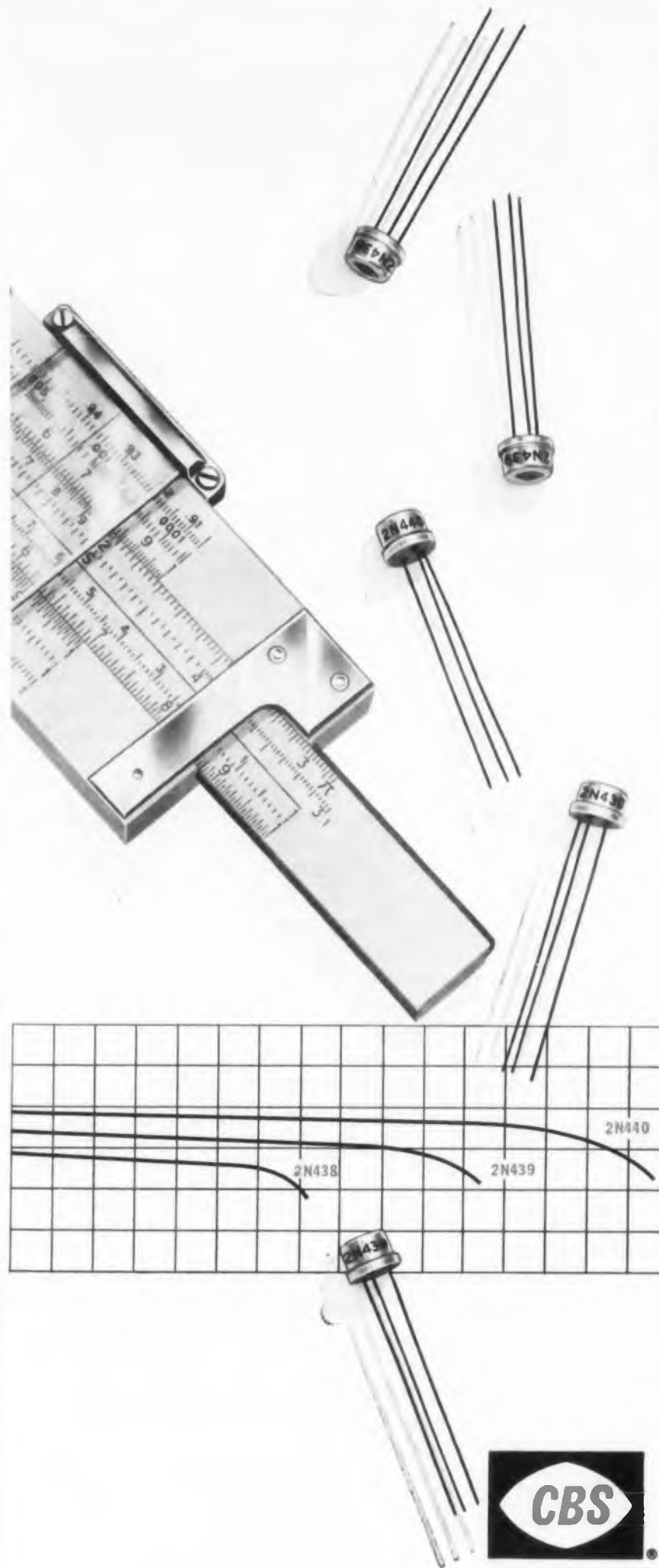

## For high-speed switching

CBS  
HIGH-FREQUENCY  
TRANSISTORS

2N438

2N439

2N440

These transistors are designed for high-speed switching, control, analog and digital computer applications. All three are available in symmetrical versions, and they feature:

1. *JETEC Case* . . . employs a standard metal case (with .200 inch pin spacing) welded to achieve reliability never before approached with NPN transistors.
  2. *Alloy-Junction* . . . for greater uniformity, higher voltage and current, flatter gain, and lower saturation resistance.
- Note the many desirable features. Write for Bulletin E-268 giving complete data and helpful application notes.

#### CHECK THESE FEATURES

1. High frequency response:  
2N438 . . . . . 2.5 to 5 mc.  
2N439 . . . . . 5 to 10 mc.  
2N440 . . . . . 10 to 20 mc.
2. High operating voltage . . . up to 30 volts.
3. High switching speed . . . below 0.2  $\mu$ sec.
4. High current amp. factor . . . up to 100.
5. High dissipation rating . . . up to 100 mw.
6. Low leakage current . . . . . 3  $\mu$ amps av.
7. Low base resistance . . . . . 150 ohms av.
8. Low collector capacitance . . . . . 10  $\mu$ f.

Reliable products  
through Advanced-Engineering.



## semiconductors

**CBS-HYTRON**

Semiconductor Operations, Lowell, Mass.

A DIVISION OF COLUMBIA BROADCASTING SYSTEM, INC.

CIRCLE 38 ON READER-SERVICE CARD FOR MORE INFORMATION

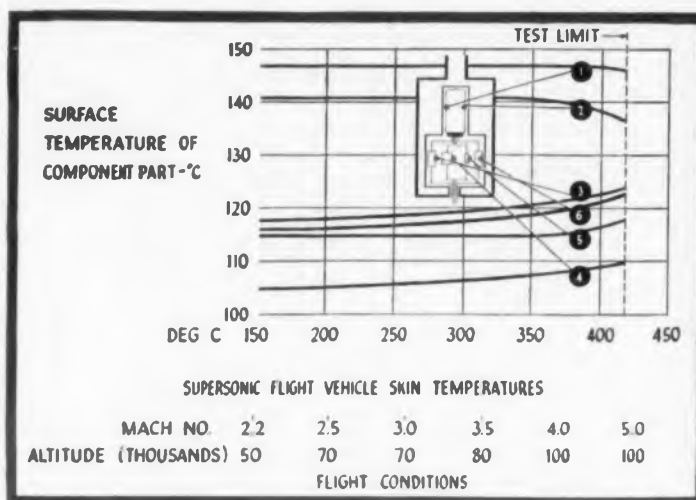

Fig. 4. Test results on single tube amplifier test vehicle.

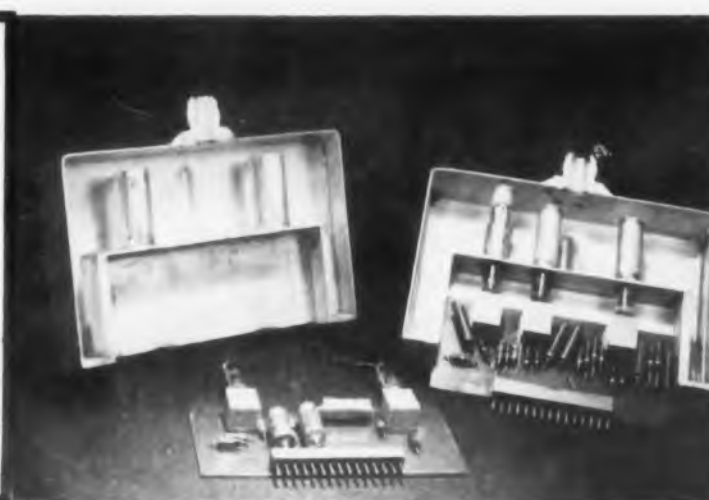

Fig. 5. Cutaway view of three tube amplifier and two tubes multivibrator employing new cooling techniques.

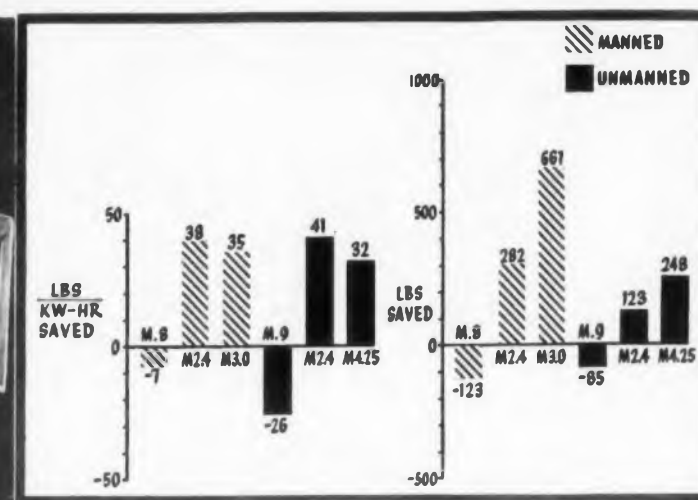

Fig. 6. Weight saving as a function of Mach number.

ants. In both btu per pound and btu per cubic foot, water is well out in front of the rest.

Professor Robinson of Ohio State, who has done considerable work in the electronics cooling area, mentioned in a recent paper: "The great superiority of water in respect to the evaporant weight and space requirements is evident. Therefore it is worthwhile to employ the best available heat transfer techniques in order to minimize the over-all temperature difference required between the evaporant and the electronic components so as to make the high boiling point of water acceptable, perhaps even under ground level pre-launch operating conditions."

Following is a description of a technique which will provide high heat transfer.

#### The New Evaporative Method

Fig. 3 shows the new evaporative cooling system. There is a conventional electronics chassis with tubes or transformers projecting from the surface and components of various other types in the lower portion of the chassis. Mating with this chassis mechanically is a container carrying water which is used as the evaporant fluid. Around each of the tubes is a recess.

High heat transfer is obtained by direct contact between the surface of the tube and the fluid. First, the heat passes through a finger type material which is wrapped around the tube to give metallic contact between the surface and the inside of the shell. Then it goes through the shell to the boiling water on the outside of the shell with a high heat transfer coefficient.

The design provides a filler port and a vent through which the steam escapes. A check valve in the vent functions during inverted flight or negative gravity conditions to prevent loss of water; the same valve controls the boiling pressure. A baffle prevents loss of water during violent boiling.

#### Test Program

This system has been tested for more than a year. Initial models proved conclusively that electronics equipment would provide sufficient heat to boil water, and that the technique is feasible for components mounted in the base of the chassis. Additional work would be required for rejecting heat at very high temperatures.

A single tube amplifier circuit test vehicle (Fig. 4) contained in an aluminum capsule was designed for the system. Surrounding the capsule is a container providing a space for the water. The amplifier tube and components were instrumented to indicate surface temperatures at the hot spots. The amplifier in its capsule was mounted inside a small cylindrical fuselage and this fuselage in turn was mounted inside an oven.

Oven temperature ranged from 150 to about 400 C. The heat was held down to 400 C because the oven temperatures approached 1000 F, which was too much for the insulation on the instrumentation wiring. The cooling technique, however, was not tested to its limit.

Significant conclusions can be drawn. Component temperatures remain essentially constant as the oven temperature travels from 150 to more than 400 C. No curve rises more than 10 C. The water used for this test amounted to 4 ounces.

What this means in terms of flight mission profiles is shown on the lower scale. A range from a little more than Mach 2 to approximately Mach 5 was covered. Components remained at essentially the same temperature.

This system takes care of both internal heat and the external aerodynamic heating. At the high temperature range approximately 95 per cent of the heat was coming into the case from the outside, thus simulating aerodynamic heating. Only 5 per cent was developed by the internal one tube amplifier circuit.

No attempt was made to insulate the exterior of

the assembly. The use of insulation to reduce aerodynamic heating would depend on the mission profile—whether it is better to carry the weight in insulation or in additional water.

Proceeding from this single tube test specimen, a multiple specimen, using a three tube audio amplifier and two tube multivibrator relay circuit, assembled by the printed wiring technique was made. These were mounted in the container shown in Fig. 5. A separate container protects the sixth or normally unprotected side. Because of time limitations this particular assembly was then tested at a temperature level of only 315 C. The temperature range of the tubes varies from about 137 to 150 C. All other components operated cooler.

#### Reliability

If a part is rated in 85 C temperature and it is under the full power output, it develops a surface temperature rise of 40 C. The surface temperature of that part is actually 125 C. If by these techniques one can hold that part at this temperature, operation takes place at its rated point. If the surface temperature level can be lowered, the life can be increased. At a 200 C surface temperature, a decrease in the surface temperature of 10 C, will increase the life from approximately 900 hrs to a little better than 1000 hrs, or about a 10 per cent improvement.

#### Packaging

In a packaging survey of some 50 different pieces of electronics equipment for such applications as range, communication, navigation and information, radio and audio frequency amplifiers, and power supplies, the evaporative technique would result in a 10 per cent weight increase in the packaging of the unit, not including the weight of the water. The volume increase would be minor.

The technique allows simplification of the compensation in the electronic circuitry considerably.

The actual manufacture calls for ordinary production techniques such as dip-brazing. No new techniques need to be learned. Bench testing varies little from what has been the practice in the past.

As for the installation, since the cooling system is self contained, it opens up the possibility of remotely locating the equipment. In other words, the black box can be put out on the wing tip adjacent to the antenna instead of in the fuselage near the cooling system.

#### Effect on Performance

Both manned and unmanned aircraft over the speed range of Mach 0.9 to Mach 4.25—going into electronic, thermal, propulsion, weight, and aerodynamics considerations have been studied. Total cooling load, the drain on the propulsion system resulting from either bleed air or power extraction, and other factors like the drag resulting from bringing ram air onto the aircraft, and the additional fuel required have been considered. Comparisons have been made between the most effective conventional cooling system for each vehicle and the new evaporative system.

Fig. 6 shows weight saved on the various flight vehicles as a function of speed range. It is plotted as both total weight saving and weight saving per kilowatt. In low speed ranges ram air is still most satisfactory for cooling.

At higher speeds, though, the increasing complexity and weight of conventional systems steps up the weight savings for this evaporative system. On a total weight saving basis, the saving is greater for manned vehicles since these tend to carry a larger total kw load. At the higher speed ranges this evaporative system was compared with evaporative systems employing a liquid cold plate evaporation system.

Volume saving in manned aircraft is about 64 cu ft. For missiles it is much smaller—about 1-1/2 to 3 cu ft. The biggest volume saving comes from eliminating storage tanks and the pressure feed source required to force evaporant through a liquid cold plate evaporative system.

#### Conclusion

The problem of high temperature effects on electronics components parts is a serious one. Much work has been done toward development of high temperature electronics components parts. Even so, air is the principal medium for cooling. However, diminishing returns with air cooled systems are rapidly being reached.

The new evaporative cooling technique is efficient. Efficiency is bound to show up in terms of improved weapon system performance. It is adaptable to any means of design currently in use, to any mission profile, to any type of propulsion. It appears that it can handle any temperature level or heat density.

# POCO TIEMPO IS SPECIAL!



**Special group!** With its own coil-winding, machining and assembly facilities.

Its own sales, engineering, purchasing, inspection and shipping activities. Its own everything

but red tape. **Special orders!** Potentiometers, in prototype quantities, with these special modifications: resistance values, tolerances, linearities, taps, shafts, lids, bushings, ganged

assemblies, torque, bearings and rotation. Take your pick. **Special Delivery!** In 10 days

or less. **Special price?** No! Not one cent extra! *For your non-standard prototype pots,*

*go fast, go first-class, go Poco Tiempo! Ask for it by name.*

Beckman  
Helipot

Helipot Corporation, Newport Beach, California  
a division of Beckman Instruments, Inc.  
Engineering representatives in principal cities

CIRCLE 39 ON READER-SERVICE CARD FOR MORE INFORMATION

# Four Bulletins on FANSTEEL TANTALUM CAPACITORS

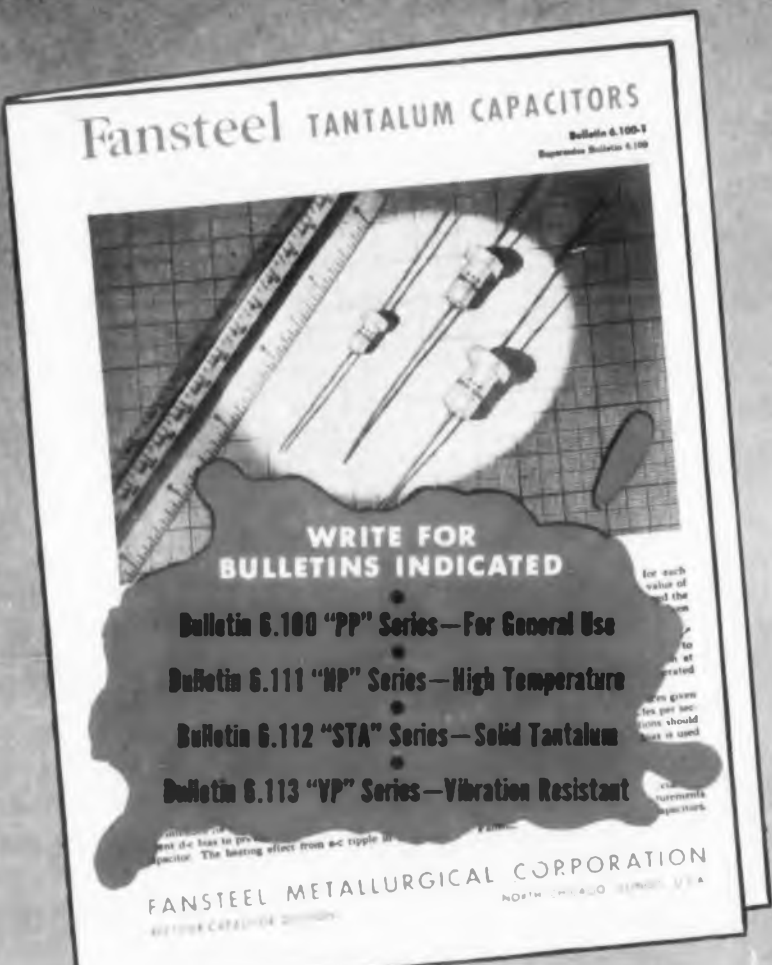

**Fansteel TANTALUM CAPACITORS**  
Bulletin 6.100-1  
Replaces Bulletin 6.100

**WRITE FOR BULLETINS INDICATED**

- Bulletin 6.100 "PP" Series—For General Use
- Bulletin 6.111 "WP" Series—High Temperature
- Bulletin 6.112 "STA" Series—Solid Tantalum
- Bulletin 6.113 "VP" Series—Vibration Resistant

FANSTEEL METALLURGICAL CORPORATION  
NORTH CHICAGO, ILLINOIS, U.S.A.



C577A

**FANSTEEL METALLURGICAL CORPORATION**  
North Chicago, Illinois, U. S. A.

CIRCLE 40 ON READER-SERVICE CARD FOR MORE INFORMATION

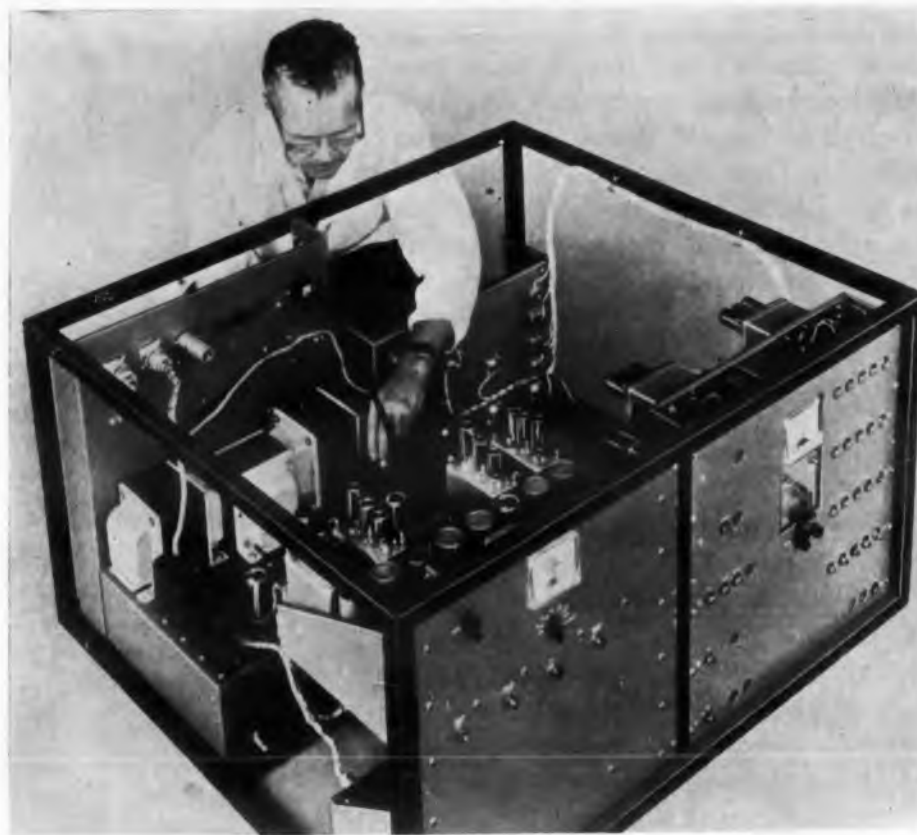

All electronic supplies, operational and servo amplifiers and servo networks are mounted in this rack.

## New Vibration System

UTILIZING a new principle of electronically controlled hydraulic power, this new vibration excitation system can provide previously unattainable combinations of force, acceleration and frequency.

Originally developed by Northrop Aircraft, Inc., the system, known as the "Hydrashaker," was refined and is manufactured by Wyle Manufacturing Corp., 124 Maryland St., El Segundo, California.

With its moving assembly weighing only 16 lb, it has a force capacity, effectively many times greater than electrodynamic equipment types with moving assemblies weighing over 275 lb. This is due to the fact that in any vibration system the sum of the moving assembly weight and speci-

men weight, times the magnitude of acceleration equals the required force.

At 45 g, for example, only 720 lb of the new system's total available force is absorbed by the moving assembly, permitting the test of a 350 lb specimen at this acceleration level. Equipment with a force rating of 12,500 lb is normally required to accelerate a 275 lb moving assembly at 45 g.

The basic system comprises three major integrated assemblies—an exciter, control console, and power supply.

The exciter is a matched unit consisting of an output cylinder and a two-stage servo valve actuated by an electrodynamic transducer. Linear variable differential transformers dynamically sense the position of



each servo valve stage and the output piston to provide the feedback necessary to close the servo loops around each stage.

Flow of the hydraulic fluid through the units provides the driving force as well as lubrication and temperature control. A dynamic fluid cushion supports all moving parts, eliminating metal-to-metal contact. The exciter occupies the space of an 18 in. cube and weighs only 75 lb.

The control console enables a single operator to control all operations of the system by five controls. It includes all electronic equipment, including built-in sequences and safety devices. Rack mounting in the console, employing plug-in units and modular design allow convenient servicing and maintenance.

The hydraulic power supply includes all the equipment for the conversion of electrical power to hydraulic power. Motors, pumps, relief and check valves, a filter, a heat exchanger, and an accumulator are mounted on a 150 gal reservoir.

The system features insensitivity of the small exciter to various environments; achievement of pure vibration through elimination of magnetic fields near test specimens; an automatic centering of the output piston, permitting heavy specimens to be attached directly to the exciter.

For further information about this vibration system, turn to the Reader's Service Card and circle 41.

Three basic units comprise the vibration excitation system. At upper left is the control console which integrates all electronic equipment and controls. At upper right is the power supply for conversion of electrical power to hydraulic power. In the foreground, resting on a block is the small exciter.



## New Bulletin



# FANSTEEL SILICON RECTIFIERS

- Write today for your FREE Copy

FANSTEEL METALLURGICAL CORPORATION  
North Chicago, Illinois, U. S. A.



CIRCLE 42 ON READER-SERVICE CARD FOR MORE INFORMATION

# New Products

## High Voltage Relay Ceramic Envelope



The RL-C30 ceramic high voltage relay for use where extreme mechanical shock and vibration are encountered is designed for use in pulse-forming networks, antenna systems and switching in explosive atmospheres. The unit is constructed for partial oil immersion and will stand off 30 kv dc at a 500 a pulse current. It will also withstand a temperature excursion from  $-70\text{ C}$  to  $+300\text{ C}$ .

Resistron Laboratories, Inc., Dept. ED, 2908 Nebraska, Santa Monica, Calif.

CIRCLE 43 ON READER-SERVICE CARD FOR MORE INFORMATION

## 400 CPS Phase Meter Eliminates Need of Scope



A panel-mounting phase null meter has been designed to eliminate the complexities of an oscilloscope in making phase measurements. Designated the Model 122-236, the instrument consists of a phase-sensitive VTVM and a calibrated phase shifter. Accuracy is  $\pm 1$  deg over a selected range.

Trio Labs., Inc., Dept. ED, 4025 Merrick Rd., Seaford, N.Y.

CIRCLE 44 ON READER-SERVICE CARD FOR MORE INFORMATION

## Transistor Blocking Oscillators For Miniature Pulse Transformer



A number of new specially designed pulse transformers have been developed for use in transistor blocking oscillating circuits. Using a flat-bed ferrite core with very high permeability, ( $2400\ \mu$ ), these new units achieve very low leakage inductance and present an excellent impedance match to the transistor. This characteristic plus their extremely low core loss permits the operation of these Stat-Tran's at repetition rates to 500 kc. In a typical evaluation circuit, a high impedance trigger of 0.4 v will produce low impedance output pulses essentially equal to the supply voltage. These pulses can be varied from 0.2 to 40  $\mu$ sec and are relatively free from effects of trigger amplitude, rise time and width. Dimensions of these miniature pulse transformers are  $7/16 \times 3/4$  in.

Pulse Engineering, Dept. ED, 2657 Spring St., Redwood City, Calif.

CIRCLE 45 ON READER-SERVICE CARD FOR MORE INFORMATION

## Ultra-Sensitive Relay Operates on 25 $\mu$ w



Called Tnymag, this relay combines a sensitive magnetic amplifier and a relay in a single 2 cu in. package. The relay will operate positively on a

25  $\mu$ w input signal, eliminating the need for pre-amplifiers. The relay can accept unfiltered dc signals directly from a thermocouple, resistance bridge, photocell, synchro, or even the detector of a radio receiver. The relay is completely absent of contact chatter as pick-up and drop-out are approached. This allows the unit to operate at full sensitivity in a 40 g shock, 20 g vibration environment with high reliability. Excitation required for the relay unit is 26 v at 400 cps, with other voltages and frequencies available. Power consumption is a few mw. Contacts are rated at 2 a resistive per contact. Input signal impedance is a nominal 2500 ohms, although higher and lower impedances can be designated. Operating temperature range is from  $-55$  to  $+100\text{ C}$ .

Torwico Electronics, Inc., Dept. ED, 1090 Morris Ave., Union, N.J.

CIRCLE 46 ON READER-SERVICE CARD FOR MORE INFORMATION

## 90 Db Transistor Amplifier 1 Per Cent Closed-Loop Stability



Model 198 features a 1 per cent closed-loop gain stability from  $-60$  to  $+125\text{ C}$ . It is a high-gain, low-power plug-in amplifier designed for servo and audio applications. It has an open-loop gain of 90 db and a closed-loop gain variable from X2 to X1000. It will operate at 40 g at 60 cps without significant increase in background noise. The unit weighs less than 2 oz and has a bandwidth of 5 cps to 50 kc.

Taber Instrument Corp., Dept. ED, 111 Goundry St., N. Tonawanda, N.Y.

CIRCLE 47 ON READER-SERVICE CARD FOR MORE INFORMATION

### Crystal Filter

#### Single Side Band Application



Bandwidth of the Type OE 6 crystal filter to the 2 db point is 5 kc, with 600 cps cross over from 2 to 60 db. The filter has been designed into a compact 3 x 1.5 x 2 in. can, with a weight of less than 5 oz.

Bulova Watch Co., Electronics Div., Dept. ED, Woodside 77, N.Y.

CIRCLE 48 ON READER-SERVICE CARD

### Power Supply

#### Low Panel Height



With the introduction of this new space-saving com-pak series, all power supply needs through 1.5 a are covered. The 200 and 400 ma models need only 5-1/4 in. of panel height; 800 ma models require only 7 in.; 1.5 a models, 8-3/4 in. All com-pak models are available in three voltage ranges: 0 to 200, 125 to 325, 325 to 525 v dc. Units with the addition of meters for output voltage and output current, are available in a 24 model series. The 400 ma, 800 ma and 1.5 a units include high efficiency, long life, hermetically sealed semiconductor rectifiers. All models in the series are constructed with hermetically sealed transformers, chokes and capacitors. The rear panel swings open for quick access to tubes and controls; simplifies and speeds in-rack servicing.

Lambda Electronics Corp., Dept. ET 11-11 131st St., College Point, N.Y.

CIRCLE 49 ON READER-SERVICE CARD

CIRCLE 50 ON READER-SERVICE CARD

Raytheon — World's Largest Manufacturer of Magnetrons and Klystrons



**NOW AVAILABLE—  
WITHOUT CHARGE**

**New Consolidated  
Data Booklet for  
Raytheon  
Magnetrons,  
Klystrons and  
Special Tubes**



#### TECHNICAL DATA SERVICE

The most complete data service available for magnetrons, klystrons, special tubes and semiconductor products. Available on a continuing basis at a modest charge. Use coupon to get full details.

Regional Sales Offices: 9501 W. Grand Avenue, Franklin Park, Illinois • 5236 Santa Monica Blvd., Los Angeles 29, California

Raytheon makes: Magnetrons and Klystrons, Backward Wave Oscillators, Traveling Wave Tubes, Storage Tubes, Power Tubes, Miniature and Sub-Miniature Tubes, Semiconductor Products, Ceramics and Ceramic Assemblies

Comprehensive presentation of maximum ratings, typical operating values, frequency ranges, and power levels for most of the principal unclassified types manufactured. An essential reference-guide for microwave engineers and purchasing departments.

Raytheon is the world's largest producer of CW and pulse magnetrons, available in either fixed or tunable designs.

Raytheon klystrons, which can be tuned mechanically or thermally, fit the widest range of requirements from 550 to 60,000 Mc. The special tubes include backward wave oscillators, square law tubes, storage tubes and others.

Use coupon below to reserve your copy of the new Raytheon Consolidated Data Booklet. There is no cost or obligation, of course.

#### MAIL THIS COUPON

#### RAYTHEON MANUFACTURING CO.

Microwave and  
Power Tube Operations  
Section PT-24,  
Waltham 54, Mass.



Please send me, without cost or obligation:

- Free Consolidated Data Booklet.  
 Complete details on Raytheon's Technical Data Service for Microwave and Power Tubes.

Name \_\_\_\_\_ Title \_\_\_\_\_

Company \_\_\_\_\_

Street \_\_\_\_\_

## New Products

### Germanium Transistor

#### 100 V Collector Diode Rating

The DT-100 has a collector diode rating of 100 v with a current handling capacity equal to other of the company's power transistors. Quantity prices on these transistors fall into the price range recently announced by the company. The three other transistors have been designated 2N441, 2N442, and 2N443. They are high power, 12 a, 55 w transistors offering narrow gain limits and with 40, 50, and 60 v collector diode ratings respectively.

General Motors Corp., Delco Radio Div., Dept. ED, Kokomo, Ind.

CIRCLE 51 ON READER-SERVICE CARD

### Metal Film Resistors

#### Low Noise Level



Unlike ordinary film resistors, the Series 850 film resistors give no more noise than on precision wire-wounds. This low noise level is inherent in the thick metallic film which is an alloy of precious metals. No semiconductor effect is present in the resistors.

The Daven Co., Dept. ED, Livingston, N.J.

CIRCLE 52 ON READER-SERVICE CARD

### Variable Inductors

#### Low Frequency Application

Type AF-87 and AF-88 inductors are designed for low frequency applications or where proportionately high inductance values are required. The units peak at 400 and 800 cps respectively. Variable inductors are available in all inductance values to 80 hys.

Burnell & Co., Dept. ED, 10 Pelham Parkway, Yonkers, N.Y.

CIRCLE 53 ON READER-SERVICE CARD



OFFICIAL U. S. ARMY PHOTOGRAPH

**ARMY'S HAWK MISSILE**, recently revealed, destroys attackers flying at even the lowest altitudes and in the blind zone of conventional radars. Raytheon is prime contractor with complete systems responsibility for HAWK—and for the Navy's new air-to-air Sparrow III.

To the one man in three who will qualify as a Raytheon engineer:  
our small, versatile project groups are staffed with extremely capable engineers. This policy pays off exceedingly well for energetic, imaginative men who are looking for individual recognition with the challenge of responsibility and ready opportunity for advancement.

**Which of these interesting  
Situations with a Future  
is right for you?**

As one of the world's fastest growing electronics companies with a record for history-making achievements, Raytheon is continually expanding. Interesting, rewarding openings for all types of engineers now exist in:

**COMMUNICATIONS** (Commercial and Military) —scatter, microwave relay, multiplex, mobile transistorized equipment.

**COUNTERMEASURES** —radar countermeasures equipment, advanced study projects.

**RADAR** (Pulse and CW Systems) — search, fire control, bombing, navigation, air traffic control, weather and commercial marine.

**MARINE EQUIPMENT** —submarine, ship, and airborne sonar, depth sounders, direction finders.

**GUIDED MISSILES** —prime contracts: Navy Sparrow III (air-to-air), Army Hawk (ground-to-air).

**MICROWAVE TUBES** —amplitrons, magnetrons, klystrons, traveling wave tubes, storage tubes.

**ELECTRON TUBES, SEMICONDUCTOR DEVICES, MAGNETIC COMPONENTS • MICROWAVE COOKING OVENS, ELECTRONIC INDUSTRIAL EQUIPMENT, ELECTRONIC MEDICAL EQUIPMENT**

Raytheon plants are ideally situated for delightful suburban living in New England, California and Tennessee.

*For the details you want*, please write to Leonard B. Landall, Raytheon Manufacturing Company, Waltham 54, Mass. There's no obligation and your inquiry is completely confidential.

**RAYTHEON MANUFACTURING COMPANY  
WALTHAM 54, MASSACHUSETTS**

Are you the  
ONE MAN IN THREE?

Excellence  
in Electronics



**Raytheon Engineering Opportunities**



**MICROWAVE & POWER TUBE** engineers check operation of Raytheon microwave tubes in Air Force jet.



**WAYLAND LABORATORY** engineers developed this 40-foot L-band antenna to extend the range of radar.



**MAYNARD LABORATORY** engineers design and flight test airborne navigational and guidance systems.



**MISSILE SYSTEMS DIVISION** facilities include observation tower with radar tracking equipment.

**Thermostat Metal**

**Nonmagnetic**

Truflex S125 will not be influenced by, and will not cause disturbances in magnetic fields. In addition to responding to temperature changes, other thermostat metals are detrimentally influenced by magnetic fields which exist in the instrument. These disturbances by magnetic fields are eliminated. Magnetic forces to 250 oersteds fail to move the material.

Metals & Controls Corp., General Plate Div., Dept. ED, Attleboro, Mass.

CIRCLE 55 ON READER-SERVICE CARD

**Electroverter**

**Converts AC to Proportional DC**



The Electroverter converts ac voltages, currents, or power to a dc voltage directly proportional to the true root square value of the alternating current being converted. It is superior to instrument rectifiers in that it gives accurate answers to different types of wave forms. It is compensated both for temperature and rate of change of temperature and is suitable for use from the lowest audio frequencies up into the microwave region. The Electroverter is a hermetically-sealed, rugged element that requires very little power. The unit consists of three or more fine thermocouples of noble metals arranged such that the ac current flow directly heats two or more thermocouples from which a dc output voltage is generated. These units do not contain vacuum thermocouples whose calibration change with small changes in the degree of vacuum.

Hastings-Raydist, Inc., Dept. ED, Hampton, Va.

CIRCLE 56 ON READER-SERVICE CARD

# AUTOMATIC

## silicon power rectifiers

now  
up to  
20  
amperes!



ACTUAL SIZE

**AUTOMATIC**  
MANUFACTURING

The same high quality and complete reliability that has made the name of Automatic famous in rectifiers is now offered in a new silicon power rectifier—available in 5, 10 and 20 amperes. The prompt service and competitive prices that you are accustomed to from Automatic are applicable for this new unit.

Write today for complete technical information.

MASS PRODUCERS OF ELECTRONIC COMPONENTS

AUTOMATIC MANUFACTURING  
DIVISION OF GENERAL INSTRUMENT CORPORATION  
65 GOUVERNEUR ST.  
NEWARK 4, N. J.

ABSOLUTE MAXIMUM RATINGS (For 135°C. Case Temperature)		AM 0505	AM 1005	AM 1505	AM 2005	AM 2505	AM 3005	AM 3505
Peak Reverse Voltage	Vdc	50	100	150	200	250	300	350
RMS Voltage	Volts	35	70	105	140	175	210	245
Average DC Output Current	Amps	5	5	5	5	5	5	5
Peak recurrent forward current	Amps	25	25	25	25	25	25	25
Surge Current (5 seconds)	Amps	15	15	15	15	15	15	15
Forward Voltage drop at 15 amp (Measured at 25°C.)	Volts	1.25	1.25	1.25	1.25	1.25	1.25	1.25
DC Reverse Current at rated PIV	Ma	5	5	5	5	5	5	5

ABSOLUTE MAXIMUM RATINGS (For 135°C. Case Temperature)		AM 0510	AM 1010	AM 1510	AM 2010	AM 2510	AM 3010	AM 3510
Peak Reverse Voltage	Vdc	50	100	150	200	250	300	350
RMS Voltage	Volts	35	70	105	140	175	210	245
Average DC Output Current	Amps	10	10	10	10	10	10	10
Peak recurrent forward current	Amps	45	45	45	45	45	45	45
Surge Current (5 seconds)	Amps	25	25	25	25	25	25	25
Forward Voltage drop at 25 amp (Measured at 25°C.)	Volts	1.25	1.25	1.25	1.25	1.25	1.25	1.25
DC Reverse Current at rated PIV	Ma	5	5	5	5	5	5	5

ABSOLUTE MAXIMUM RATINGS (For 135°C. Case Temperature)		AM 0520	AM 1020	AM 1520	AM 2020	AM 2520	AM 3020	AM 3520
Peak Reverse Voltage	Vdc	50	100	150	200	250	300	350
RMS Voltage	Volts	35	70	105	140	175	210	245
Average DC Output Current	Amps	20	20	20	20	20	20	20
Peak recurrent forward current	Amps	90	90	90	90	90	90	90
Surge Current (5 seconds)	Amps	50	50	50	50	50	50	50
Forward Voltage drop at 50 amp (Measured at 25°C.)	Volts	1.25	1.25	1.25	1.25	1.25	1.25	1.25
DC Reverse Current at rated PIV	Ma	5	5	5	5	5	5	5

## New Products

### Televideo System

#### Missile Tracking and Testing

Employing a 37-in. telescope lens system for its camera tube, this 60-line high resolution Televideo System is patterned after the TV Boresight-Camera System designed for the Navy. Applications include missile engine testing, missile tracking, and aircraft testing. The unit provides critical focus and iris control regulated by a light-sensitive circuit. Remote control focussing offers full flexibility. The system permits exceptionally detailed kinephoto film recording and video tape recording.

Canoga Corp., Dept. ED, 5955 Sepulveda Blvd., Van Nuys, Calif.

CIRCLE 58 ON READER-SERVICE CARD

### Motor Kit

#### For Systems Development



This Motor Kit makes it possible to determine the proper servo, torque or synchronous motor required for instrumentation and automation applications. The kit contains all the necessary motors, motor components, and gear reduction units to assemble thirty-two different servo, torque or synchronous motors, with or without integral gear reduction units. A simplified manual is included which contains assembling instructions and complete motor performance data including speed-torque curves.

National Pneumatic Co., Inc., Holtzer-Cabot Motor Div., Dept. ED, 125 Amory St., Boston 19, Mass.

CIRCLE 59 ON READER-SERVICE CARD

← CIRCLE 57 ON READER-SERVICE CARD

## Polyester Coated Magnet Wire

### Highly Heat-Resistant

Anatherm is reportedly the first polyester film-coated magnet wire to be offered under the Class F (155 C) rating established by the AIEE. The magnet wire was designed to give greater thermal and chemical stability, abrasion resistance and dielectric strength, and it complies with UL requirements for magnet wire to be used in Class B motors and transformers. Anatherm is available in single and heavy film thickness in AWG sizes from 15 through 25.

Anaconda Wire & Cable Co., Dept. ED, Muskegon, Mich.

CIRCLE 60 ON READER-SERVICE CARD

## CRT Deflection Components

### For Color TV

Development of two color television deflection components for operation in TV receivers using the new round all-glass color picture tube Type 21CYP22 has been announced. They consist of a horizontal output and high voltage color transformer which utilize a small ferrite core for high efficiency and a color TV deflection yoke which is designed for mounting directly on the neck of the picture tube. The transformer, XD-3207, can supply up to 22.5 kv with a power of approximately 25 w to the ultor of the kinescope and up to 5.4 kv to the focusing electrode. Such a circuit is capable of maintaining regulation within  $\pm 5$  per cent from full-load to no-load. The XD-3199 deflection yoke has been developed to operate efficiently with the XD-3207 transformer to provide good convergence and minimum astigmatism. The XD-3199 yoke incorporates such design features as including the insertion of a thermistor in the vertical winding to improve stability of dynamic convergence with warmup and a bridge network and low impedance vertical winding to minimize ringing.

Radio Corporation of America, Dept. ED, Camden, N.J.

CIRCLE 472 ON READER-SERVICE CARD

CIRCLE 61 ON READER-SERVICE CARD

# Transitron Silicon Transistors



ACTUAL  
SIZE

## Features ...

- Low  $I_{co}$ , typically under .02  $\mu$ a
- Operation to 175°C
- 200 mw Power Rating
- High Frequency Operation
- High Temperature Tested
- Excellent Stability
- Welded Hermetic Seal

... for high  
temperature  
operation

Transitron's NPN silicon transistors are designed for a wide range of small signal applications in the power range up to 200 mw. They will provide dependable operation up to 175°C in circuits such as RF and IF amplifiers, video and audio amplifiers, servo control, switching, and many others.

Manufactured by diffusion in the liquid phase during crystal growth, these transistors are essentially free of parameter drift and instability common in conventional grown junction transistors. Through close process control, these units have exceptionally low  $I_{co}$  up to their maximum voltage and temperature ratings. As a result, performance reliability can be achieved even at higher voltage levels.

For environmental stability, extensive temperature cycling and storage as well as mechanical and hermetic seal tests are included as a regular part of the manufacturing process.

Type	Minimum Common Emitter Current Gain, B	Maximum Collector Voltage V <sub>re</sub> Peak (volts)	Typical Cut-off Frequency (mc)	Maximum Collector Cut-Off Current at 25°C at V <sub>c</sub> Max. ( $\mu$ a)
ST42	40	45	11	.5
ST32	40	30	11	.5
ST12	40	15	11	.5
ST33	30	30	17	.5
ST13	30	15	17	.5
ST41	20	45	10	.5
ST31	20	30	10	.5
ST11	20	15	10	.5
2N332	9	45	7	50
2N333	18	45	9	50
2N334	18	45	11	50
2N335	37	45	10	50

Send for  
Bulletin TE-1353

# Transitron

electronic corporation • wakefield, massachusetts

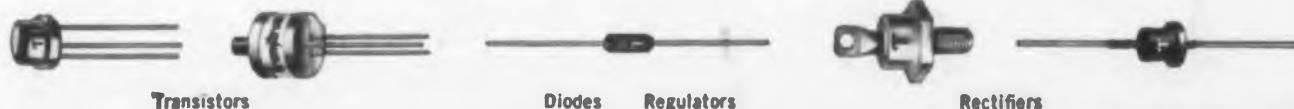

T

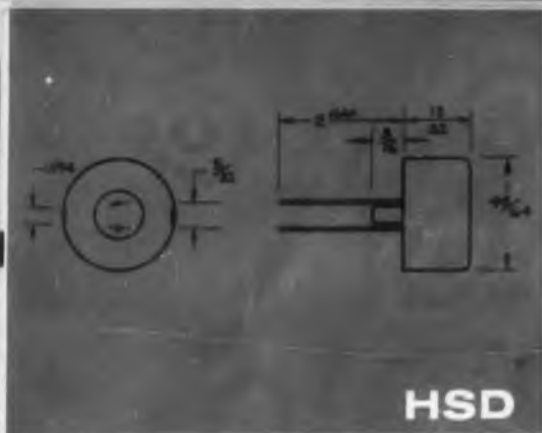

HSD

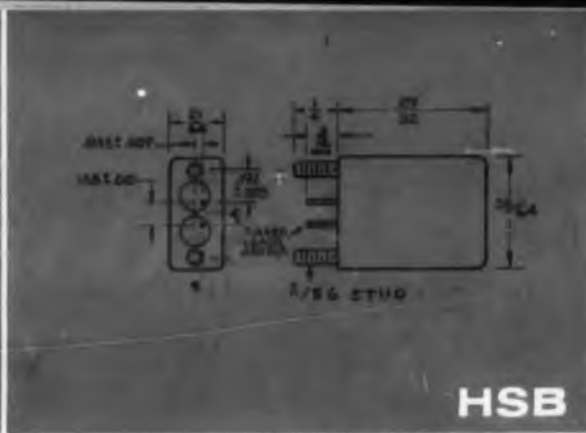

HSB

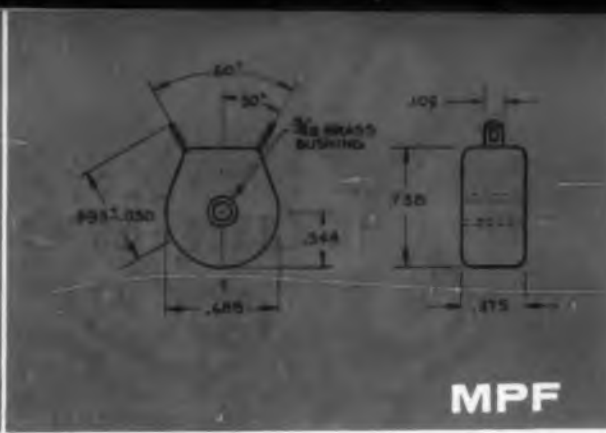

MPF

THREE STANDARD PACKAGES AVAILABLE IN THREE CORE TYPES

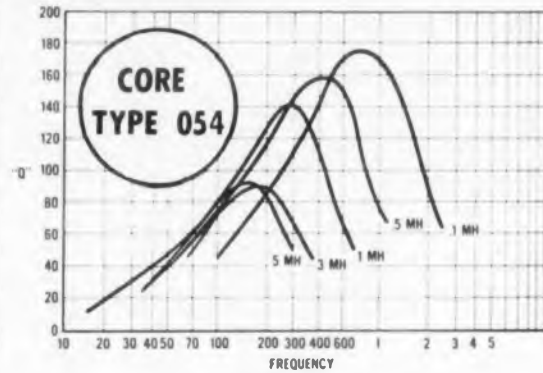
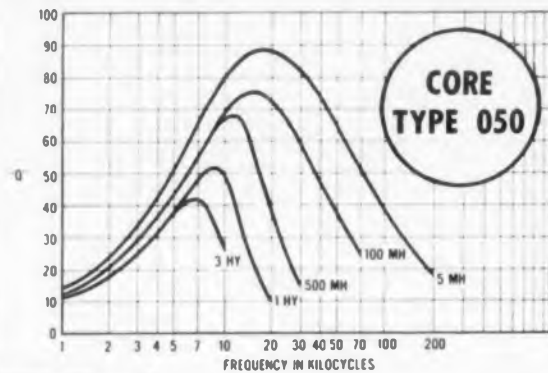
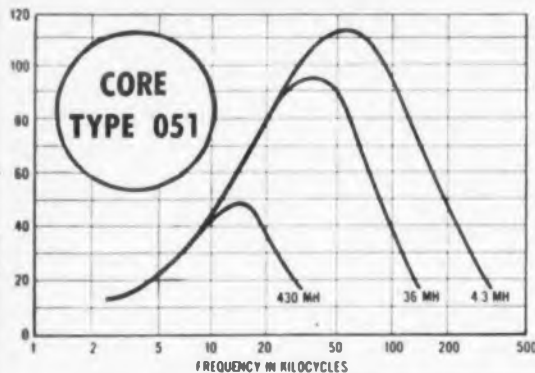

**MOLDED and CASED TOROIDS**

**STANDARD INDUCTANCE VALUES:**

Dash No.	050	051	054
-1	5.0 MH	1.0 MH	.05 MH
-2	6.0	1.2	.06
-3	7.2	1.5	.072
-4	8.6	1.75	.086
-5	10.0	2.0	.100
-6	12.0	2.4	.120
-7	15.0	3.0	.150
-8	17.5	3.6	.175
-9	20.0	4.3	.200
-10	24.0	5.0	.240
-11	30.	6.0	.300
-12	36	7.2	.360
-13	43	8.6	.430
-14	50	10.0	.500
-15	60	12.0	.600
-16	72	15.0	.720
-17	86	17.5	.860
-18	100	20.0	1.0
-19	120	24.0	1.2
-20	150	30.0	1.5
-21	175	36.0	1.75
-22	200	43.0	2.0
-23	240	50.0	2.4
-24	300	60.0	3.0
-25	360	72.0	3.6
-26	430	86.0	4.3
-27	500	100	5.0
-28	600	120	6.0
-29	720	150	7.20
-30	860	175	8.6
-31	1.0 HY	200	10.0
-32	1.2	240	
-33	1.5	300	
-34	1.75	360	
-35	2.0	430	
-36	2.4	500	
-37	3.0		

IN ORDERING: Please designate type, core, dash number, and inductance value. For example: "MPF 050 -10 24 MH."

**SUBMINIATURE TOROIDS**

*unlimited!*

HSD-HSB and MPF SERIES NOW STOCKED FOR SAME DAY SHIPMENT

The country's largest facilities for the production of toroidal components now makes possible the maintaining of warehouse stocks and immediate delivery of CAC's popular subminiature toroids—in a wide range of inductances.

This is CAC's answer to heavy industry-wide demand. Elaborate testing and inspection procedures assure both quality and required performance.

Our "Heart of America" location minimizes transit time to all parts of the U. S.



World's Largest Exclusive Producer of Toroidal Windings

**COMMUNICATION ACCESSORIES COMPANY**

Lee's Summit, Missouri • Phone Kansas City BRoadway 1-1700

A Subsidiary of Collins Radio Company



AUTOTUNES  
FERRITE CORES  
HEAT DISSIPATING TUBE SHIELDS  
MAGNETIC AMPLIFIERS  
MISSILE POWER TRANSFORMERS  
MECHANICAL FILTERS

UNCASED TOROIDS  
PLASTIC CASED TOROIDS  
HERMETICALLY SEALED CASED TOROIDS  
SUBMINIATURE TOROIDS  
PERMEABILITY-TUNED VFO'S

SEALED MISSILE POWER SUPPLIES  
LAMINATED TRANSFORMERS AND INDUCTORS  
PRECISION RATIO COMPUTER TRANSFORMERS  
L.C. FILTERS

**New Products**



**Morse-To-Teleprinter Converter**

Decodes 300 WPM

The CMP-16 accepts Morse code as tone or keyed dc at rates up to a maximum average speed of 300 wpm and operates a page printer, high-speed punch and a recorder. The conversion matrix is removable without tools by releasing four fasteners and a cable plug. It may be replaced by another matrix for different conversions.

CGS Labs., Dept. ED, 391 Ludlow St., Stamford, Conn.

CIRCLE 66 ON READER-SERVICE CARD

**Insulated Metal Screws**

Permit Easy Assembly of Relays

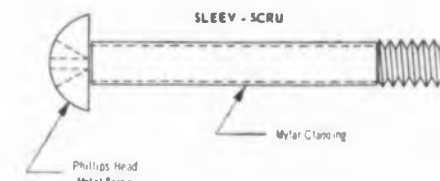

Named the Sleeve-screw, this fastener consists of a metal screw whose shank is insulated with an integral cladding of Mylar polyester film which provides electrical insulation between the fastener and the parts assembled with it. It was developed to replace inconvenient screw and insulating tube assemblies, especially in relay or contact blade stacks. A smaller overall assembly and lower cost blades and spacers are additional benefits. These are possible since the diameter of the insulated shank is the same as the outside diameter of the threaded section of the screw.

Pylon Co., Inc., Dept. ED, Attleboro, Mass.

CIRCLE 67 ON READER-SERVICE CARD

CIRCLE 65 ON READER-SERVICE CARD



**Portable Nibbler  
Cuts Titanium**



Design features of the HN portable nibbler make it suitable for cutting titanium, stainless, and all types of non-ferrous metals, without distortion on either side of the cut, leaving the edge ready for fabricating. The tool cuts up to 55 in. per min and can handle a small radius turn. Weighing 13 lbs, and measuring 13 in. in length, the nibbler operates on ac or dc, 115 v, 60 cycles, with 220 v optional.

Fenway Machine Co., Dept. ED, Willow Grove, Pa.

CIRCLE 68 ON READER-SERVICE CARD

**Miniature Tube Sockets  
Feature Ejector**



Maintenance problems encountered in restricted chassis areas can be solved by this type 584 and type 592 Kool Klamps for tubes with T 5-1/2 and T 6-1/2 envelopes. An ejector pin, incorporated into a self-aligning floating socket which is locked into the Kool Klamp, makes tube changing simple and feasible where cramped quarters limit access. Retaining the heat-transfer and retention qualities of the standard Beryllium and Silver alloy Kool Klamps, the new types retain most popularly used 5- and 7-pin miniature tubes under extremes of shock and vibration.

Birtcher Corp., Dept. ED, 4371 Valley Blvd., Los Angeles 32, Calif.

CIRCLE 69 ON READER-SERVICE CARD

CIRCLE 70 ON READER-SERVICE CARD >

**2  
NEW  
LEAD  
TYPES**



150ma TYPE  
(400ma at 25°C)

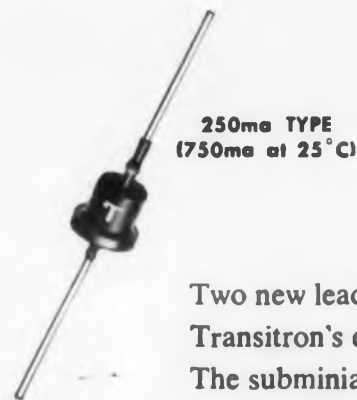

250ma TYPE  
(750ma at 25°C)

RATINGS TO 600V. PIV IN BOTH TYPES

**Features . . .**

- Operation to 175°C
- High power handling ability
- Convenient mounting
- Small size
- Hermetically sealed

**Transitron  
Silicon  
Rectifiers**

Two new lead types have now been included in Transitron's expanding family of silicon rectifiers. The subminiature glass units combine high current-voltage ratings with the smallest possible size to provide greater design versatility. For applications requiring ratings in the region of 250 ma per cell, the new standard series is recommended.

The same high degree of reliability which has been characteristic of Transitron's silicon diodes and stud type rectifiers has been "built into" these new lead types. Extensive environmental testing insures dependability under the most severe operating conditions.

Type	Peak Recurrent Inverse Operating Voltage (volts)	Maximum Average Forward Current @ 150°C (ma)	Maximum Average Forward Current @ 25°C (ma)	Maximum Inverse Current @ 150°C Full Load (ma)
<b>SUBMINIATURE TYPES</b>				
TG62	600	150	400	.2
TG42	400	150	400	.2
TG22	200	150	400	.2
<b>STANDARD TYPES</b>				
1N547	600	250	750	.3
1N540	400	250	750	.3
1N538	200	250	750	.3
1N537	100	250	750	.4

Send for  
Bulletin TE-1351

**Transitron**

electronic corporation • wakefield, massachusetts

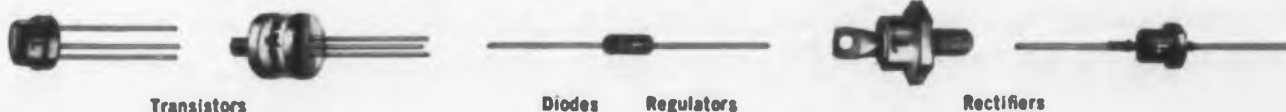

Transistors

Diodes Regulators

Rectifiers



## Amperex®

6960 and 6961

**HEAVY-DUTY RF AMPLIFIER  
AND OSCILLATOR TRIODES  
6 kw plate dissipation**

Developed specifically for use in industrial RF generators, as well as communications transmitters. Exclusive Amperex "K" grid reduces primary and secondary grid emission, permits exceptionally high grid dissipation ratings and results in higher plate power output with intermittent industrial loads in Class C operation. Maximum ratings apply up to 30 Mc. Type 6960 is water-cooled; Type 6961 is forced-air cooled.



**whether you require high power reserve**

*for heavy-duty industrial RF generators*

## Amperex® 7004

**COMPACT COAXIAL UHF  
TRANSMITTING TRIODE**

**300 watts maximum plate dissipation**

Developed for UHF oscillator, amplifier and frequency multiplier service. Unique, space-saving design; external anode; forced-air cooling; integral radiator. Maximum ratings apply up to 900 Mc. Available in glass or ceramic versions.



**or outstanding HF performance**

*up to 900 megacycles for compact communications transmitters*



*ask Amperex  
about tubes, data and applications engineering assistance.*

address all correspondence to:

Communications and Industrial Tube Division, Amperex Electronic Corp., 230 Duffy Avenue, Hicksville, L. I., N. Y.

In Canada: Rogers Electronic Tubes & Components, 11-19 Brentcliffe Road, Leaside Toronto 17.

## New Products

### Portable Wide Band Oscilloscope

**Sensitivity of 50 Mv per In.**

Having a performance comparable to many larger scopes, an oscilloscope has been made available which weighs 8-1/2 lbs. The vertical amplifier has a frequency response within 3 db from 10 cps to 4 mc. Vertical sensitivity is 50 mv per in. A peak to peak voltage calibration circuit will accurately measure voltages from 10 mv to 100 v.

Allen Mfg. Co., Dept. ED, 87 Rosewood Drive, Menlo Park, Calif.

CIRCLE 74 ON READER-SERVICE CARD

### Precision Potentiometer

**Linear and Non-Linear**



Resistance values from 1/2 ohm to 500,000 ohms with standard linearity of 0.5 per cent are available in the Model WP1-5/8 precision potentiometer. Featuring accuracies heretofore available only in 2 in. or larger diameters, these potentiometers save needed space in designs requiring precision control. The Model WP1-5/8 Waters linear or non-linear precision potentiometer is contained in an anodized aluminum case 1-5/8 in. in diameter and 1-1/32 in. deep behind the panel. Turret-type terminals mounted on a fungus-proof insulating strip of high-impact Epon-Glass Laminate are provided for circuit connection. Servo or 3-hole mountings are standard; bushing mount is also available, in a case of 25/32 in. deep.

Waters Manufacturing, Inc., Dept. ED, Boston Post Rd., Wayland, Mass.

CIRCLE 75 ON READER-SERVICE CARD

◀ CIRCLE 73 ON READER-SERVICE CARD

## Digital Selector

### Responds to Pulse Codes

The Secode Type 49 selector is an electro-mechanical switch responsive to direct current pulses, which is designed to close its contacts only upon receipt of a specific sequence of pulses, rejecting all others. The digital selector is designed to respond to pulses with a minimum duration of 0.05 sec, spaced 0.03 to 0.1 sec and occurring at a rate of 4 to 20 pps. Maximum duration of pulses is not critical. Power requirement during pulsing is 5 w. The combination of pulses which will cause the selector to close its contacts may be changed in less than one min without the use of tools. Over 100,000 code combinations are possible.

Electrical Communications, Inc., Dept. ED, 765 Clementina St., San Francisco 3, Calif.

CIRCLE 76 ON READER-SERVICE CARD

## Miniature Relay

### Operable to 250 C



By means of a controlled process, the coil assembly of the Type 47 Relay is hermetically isolated from the contact assembly. The relay, now in production, will provide continuous duty to 200 C and intermittent duty to 250 C. Achieving a high level of reliability for the sub-miniature field, the unit is built to withstand extremes of shock and vibration. Its weight is 0.5 oz.

Reltron Corp., Dept. ED, 282 Centre St., Newton 58, Mass.

CIRCLE 77 ON READER-SERVICE CARD

CIRCLE 78 ON READER-SERVICE CARD >



## MINIATURIZED SEALED RELAYS



# COLD...but still in control!

Chances are you've never seen a sealed relay frozen in an ice-cube tray. But, this illustration does dramatize the ability of General Electric miniaturized sealed relays to operate in similar low-temperature regions. G-E sealed relays can function normally in solid ice!

The fact is, the best of laboratory equipment is used to check the continuous operation of all G-E hermetically sealed relays at ambient temperatures of *minus 65 C*—about 65 degrees colder than the ice cubes in this tray! Inherent temperature-resistant characteristics qual-

ify *all* General Electric sealed relays for use on any job where cold is a serious environmental problem.

Extreme low-temperature operation is just one of the many "plus" features—such as high-shock resistance, high-vibration resistance, high-temperature operation, and rugged construction—you get with *all* Miniature, Sub-miniature, and Micro-miniature G-E sealed relays. Today, General Electric relays are proving their reliability on a variety of military and industrial electronics jobs.

What's more, you get all of General

Electric's complete line of standard-listed relays on only *3-week shipment from receipt of order*—plus—immediate service on samples and prototypes.

For further information, contact your G-E Apparatus Sales Office—or—write to General Electric Co., Sect. 792-8, Schenectady 5, N. Y., for complete relay data. *Specialty Control Dept., Waynesboro, Virginia.*

*Progress Is Our Most Important Product*

**GENERAL  ELECTRIC**

## DESIGN ACHIEVEMENTS WITH SUPRAMICA\* CERAMOPLASTICS

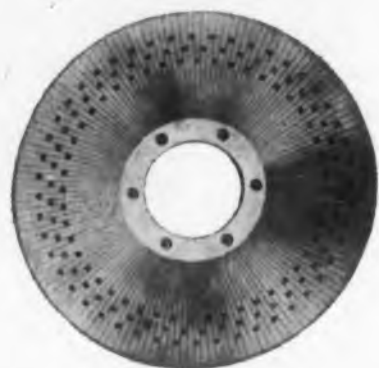

OPTICALLY FLAT CAPACITY COMMUTATOR  
PLATE | SUPRAMICA 500



HIGH-TEMPERATURE AIRCRAFT TERMINAL  
BLOCK | SUPRAMICA 560



HIGH-TEMPERATURE A-N CONNECTOR  
| SUPRAMICA 560



RADIATION RESISTANT AIRCRAFT ENGINE  
CONNECTOR | SUPRAMICA 555



HIGH TEMPERATURE FIREWALL  
THERMOCOUPLE | SUPRAMICA 555



ORGANIC VAPOR FREE HIGH TEMPERATURE  
SEALED RELAY | SUPRAMICA 555

## HIGH TEMPERATURE ceramoplastic INSULATION

### SUPRAMICA ceramoplastics provide broader design scope for product engineers

Increased thermal endurance . . . total, permanent dimensional stability . . . better electrical properties . . . lower density and improved machineability of SUPRAMICA ceramoplastics bridge the design gap between organic plastics and conventional ceramics. The world's most nearly perfect insulation, SUPRAMICA ceramoplastics allow product engineers to meet the requirements of today's thermal problems.

There is no possibility of shrinkage, growth or age polymerization since the materials are completely inorganic, made with SYNTHAMICA\* synthetic mica. Metal inserts molded in SUPRAMICA ceramoplastics cannot loosen during thermal cycling because coefficients of expansion are

closely matched. Other desirable properties are high dielectric strength, radiation and arc resistance, low electrical loss, resistance to moisture, oil and organic solvents. In thousands of military and critical industrial applications, SUPRAMICA ceramoplastics are contributing to better, safer, more reliable operation of electrical and electronic equipment.

Write for complete technical information.

SUPRAMICA\* 560 — for temperatures over 500°C (932°F)

SUPRAMICA\* 555 — for temperatures up to 650°F

SUPRAMICA\* 500 — sheet and rod material for machining

\*SUPRAMICA is a registered trademark of Mycalex Corporation of America. 560 and 555 and 500 are trademarks of Mycalex Corporation of America.

SYNTHAMICA is a trademark of Synthetic Mica Corporation, a subsidiary of Mycalex Corporation of America.

**MYCALEX**  
CORPORATION OF AMERICA

EXECUTIVE OFFICES:  
30 ROCKEFELLER PLAZA  
NEW YORK 20, NEW YORK

GENERAL OFFICES AND PLANT:  
CLIFTON, NEW JERSEY

SALES OFFICES:  
CHICAGO - LOS ANGELES - DAYTON  
WASHINGTON - MIAMI



WORLD'S LARGEST MANUFACTURER OF GLASS-BONDED MICA AND CERAMOPLASTIC PRODUCTS.

CIRCLE 81 ON READER-SERVICE CARD FOR MORE INFORMATION

## New Products

### Voltage Regulator For 400 Cps Aircraft Systems



A typical unit in the new line of magnetic ac line voltage regulators for 400 cps aircraft and missile systems is a filament regulator. The regulator has three outputs, one delivering 115 v at 0.3 a, and the other two supplying 6.3 v, 2.5 a each. Used with windings in parallel, the latter two outputs will furnish a total of 6.3 v at 5 a. Used in series, they will provide a total output of 12.6 v at 2.5 a. The unit has an 8-pin glass header. Rated at 30 va, the regulator performs with 80 per cent efficiency at full load. It provides 1 per cent regulation against line change and 0.5 per cent regulation against 20 per cent load change. It operates on a 102-124v input at 300 to 1000 cps. Additional ratings are also available. The unit measures 1-3/4 x 5 x 2-1/2 in.

Magnetic Research Corp., Dept. ED, 3160 West El Segundo Blvd., Hawthorne, Calif.

CIRCLE 82 ON READER-SERVICE CARD FOR MORE INFORMATION



### Quick Release Fastener Holds Components Securely

This component clamp eliminates the tedious and time consuming manual manipulations required on presently available types. The clamp is a powdered metal casting of stainless steel with a core of partially threaded plastic. The captive sub assembly is screwed into a mounting hole until it bottoms, and then backed off until the flat is opposite the diameter of the component. After installing the clamp, the component is mounted with the clamps open. The clamp is then turned with a screwdriver until it is in a locked position, holding the component in position.

Timber Top Inc., Dept. ED, P.O. Box 14, Freeport, N.Y.

CIRCLE 83 ON READER-SERVICE CARD FOR MORE INFORMATION

## Transparent Relay

### Permits Visual Inspection

Visual inspection of enclosed relays is made practical by a series of enclosed plug-in relays with plastic observation windows. The enclosures are dust tight of conventional metallic construction with a heavy plastic insert in the end of the container for visibility.

Currently available for ac and dc operation with contact combinations to 6 pdt. Can be supplied with contacts ranging from bifurcated contacts for switching low voltage and low current to power contacts rated 10 a at 115 v ac, non-inductive load.

Magnecraft Electric Co., Dept. ED, 3350D W. Grand Ave., Chicago 51, Ill.

CIRCLE 84 ON READER-SERVICE CARD FOR MORE INFORMATION



## Mass Blower

Constant Mass  
of Air

This mass blower makes use of an induction motor and a magnetic coupling. At sea level the speed of the fan is approximately 1/3 of the motor speed. As the density of the air decreases, reducing air resistance to the blades, the speed of the fan increases, approaching the relatively constant speed of the motor, thus delivering a higher volume and maintaining a constant mass flow. The coupling consists of a permanent magnet with a series of poles protruding axially. These poles face a washer-shaped follower, with an air gap between, which is attached to the fan blade. Rotation of the magnet induces rotation in the follower and fan blade. As the drag on the fan blade is reduced, due to the decreasing air density, the speed increases. The power input to the motor is also essentially constant since the torque is controlled by the magnetic coupling, while the speed of fan rotation is controlled by air density. This allows the design criteria for heat exchanger surfaces to be reduced, since it no longer is necessary to design these surfaces for the minimum air density encountered.

Eastern Industries, Inc., Dept. ED, 100 Skiff St., Hamden 14, Conn.

CIRCLE 85 ON READER-SERVICE CARD FOR MORE INFORMATION

## TYPICAL CAPACITANCE vs TEMPERATURE CHARACTERISTICS at 1000~

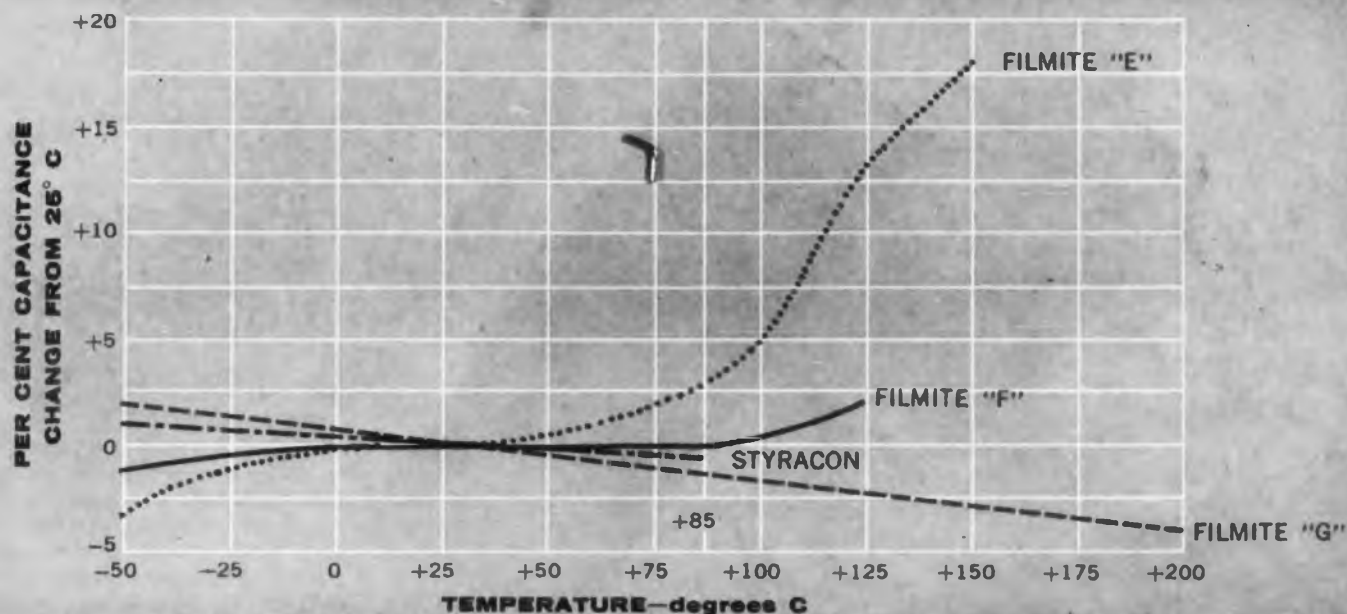

	STYRACON (85°C)	FILMITE "E" (150°C)	FILMITE "F" (125°C)	FILMITE "G" (200°C)
RATINGS	.001 to 1.00 $\mu$ F 50 to 600 WVDC	.001 to 1.00 $\mu$ F 200 to 2500 WVDC	.001 to 1.00 $\mu$ F 200 to 600 WVDC	.001 to 1.00 $\mu$ F 200 to 600 WVDC
STYLES	tubular metal cases screw-neck cases drawn metal cases	tubular metal cases screw-neck cases	tubular metal cases screw-neck cases "bathtub" cases	tubular metal cases screw-neck cases drawn oval cases
WRITE FOR TECHNICAL DATA	Engineering Bulletin No. 2510	Engineering Bulletin No. 2410	Engineering Bulletin No. 2560	Engineering Bulletin No. 2610

## 4 kinds of film dielectric capacitors for specialized applications

Here are four plastic-film dielectric capacitors now in regular production at Sprague:

**STYRACON CAPACITORS** find wide application in laboratory equipment and in industrial controls where their low dielectric hysteresis (low "soak"), high insulation resistance, high "Q", low and linear temperature coefficient of capacitance are of great value.

**FILMITE "E" CAPACITORS** are general-purpose capacitors for use up to 150°C where capacitance stability with temperature is of secondary importance. They are also used at lower temperatures where very high insulation resistance is a prime requirement.

**FILMITE "F" CAPACITORS** are intended for use in circuits where

the absolute minimum in capacitance change with temperature is a must and relatively large capacitance values are used. These capacitors typically will be within .05% of their 25°C value from -10°C to +85°C. They may be used up to 125°C where greater capacitance excursion is tolerable.

**FILMITE "G" CAPACITORS** have the highest temperature rating of any organic dielectric. They may be used up to 200°C! All units are nickel-plated to withstand high temperature corrosion. They also have the highest insulation resistance, the lowest dielectric hysteresis, and the lowest dissipation factor of any capacitor made so that they are often used at lower temperatures which are above the 85°C limit of the lower-cost Styracon Capacitors.

**CAPACITANCE VS. TEMPERATURE CHARACTERISTICS** of all four types of film capacitors are compared in the chart above for the benefit of the circuit designer.

**ALL SPRAGUE FILM CAPACITORS** are designed to have positive electrical contact between leads and electrodes, even at low operating voltages.

**WRITE FOR ENGINEERING BULLETINS** on the Sprague plastic-film capacitors in which you're interested. Address your letter to Sprague Electric Co., Technical Literature Section, 347 Marshall Street, North Adams, Mass.

**SPRAGUE**  
the mark of reliability

### SPRAGUE COMPONENTS:

CAPACITORS • RESISTORS • MAGNETIC COMPONENTS • TRANSISTORS • INTERFERENCE FILTERS • PULSE NETWORKS • HIGH TEMPERATURE MAGNET WIRE • PRINTED CIRCUITS

CIRCLE 86 ON READER-SERVICE CARD FOR MORE INFORMATION



# yardsticks

You choose the measure . . . whether Editorial? Circulation? Frequency?  
Format? Readership? . . . then let us demonstrate to your satisfaction the  
best, and most logical, media buy in the industry.

ELECTRONIC DESIGN • New York • Chicago • Los Angeles

## New Products

### Magnetic Brake

#### 25 Oz-In. Torque

A magnetically released spring-set brake, Model 25C, has been designed for computers, radar antennas, and other control systems. Torque rating is 25 oz-in., and it consumes 4.9 w. Approximate physical dimensions are 1-3/8 in. in diam by 2 in. long, and it weighs a little over 8-1/2 oz. The brakes have been wound for 28 v dc.

Stearns Electric Corp., Dept. ED,  
120 N. Broadway, Milwaukee 2, Wis.

CIRCLE 88 ON READER-SERVICE CARD

### Toroid Coils

#### 2 to 20 Mh



A new series of extremely stabilized toroid coils for high frequency application have been introduced. Temperature stabilization covers the range from -40 to +85 C. This MQD series consists of six different types ranging from 2 millihenry to 20 millihenry inductance. The Q is 170 at 50 kc, ranging down to approximately 80 at 12 kc and 130 kc (slightly lower for higher inductances). These MQD units are hermetically sealed to MIL-T-27A specifications. Their dimensions are 11/16 x 1-9/32 x 1-23/32 in. with a weight of 4 oz.

Shappe-Wilkes, Inc., Dept. ED, 215  
Fourth Ave., New York 3, N.Y.

CIRCLE 89 ON READER-SERVICE CARD



**Portable Power  
Supply  
Variable Regulated  
Output**

Combining ruggedness and compactness in a precision instrument, this power supply is offered as a general purpose instrument for laboratory, field or industrial use. Features include a continuously variable output, high voltage vernier adjustment, and a regulation of 0.1 per cent for a 20 v line variation or a change of output from no to full load. AC input is 105 to 125 v, 50 to 60 cps. DC output is 120 to 300 v, 0 to 100 ma for Model PR-100, and 0 to 200 ma for Model PR-200. Ac output is 6.3 v. Internal impedance is less than 2 ohms, and ripple is less than 10 mv. Meters show output voltage and output current.

Nutron Mfg. Co., Inc., Dept. ED, 67 Monroe Ave., Staten Island 1, N.Y.

CIRCLE 90 ON READER-SERVICE CARD FOR MORE INFORMATION

**Punched Card Reader**

**Simplifies Circuit Switching**

This Punched Card Reader is a simplified circuit switching device having great versatility, which provides a substitute for patch cord panel systems used in the changing of circuit connections at random intervals. It features a molded block with 400 floating contacts passing from one face to the other. This block is sandwiched between two printed wire boards having strip conductors in various grill-like formations. The contacts make connections between groups of conductors on one of these printed wire boards to other groups on the other, except where a card interposes an insulation. Perforations in the card permit connections to be made where desired, and to be changed by substituting a new card.

Ordinary 3 x 5 in. cards are used, containing the 400 hole positions, in a 20 by 20 array. Facilities for perforating the cards as required are to be made available. The contact blocks can be mounted in multiples for complicated switching problems, augmented by larger printed wire boards. Due to the wide variety of configurations possible with the printed wiring boards, this Reader will find applications in the most complicated circuit switching.

Cinch Mfg. Co., Dept. ED, 1026 S. Homan Ave., Chicago 24, Ill.

CIRCLE 91 ON READER-SERVICE CARD FOR MORE INFORMATION

**NEW! Mincom's  
Magnetic Tape System**

**112,000 DATA BITS  
PER INCH ON 1/2 INCH  
MAGNETIC TAPE**



Mincom's laboratories have developed multi-channel (as many as 7 channels on half-inch tape) magnetic systems, in which each channel is capable of directly recording the full frequency response of radar video, t-v video, high speed data signals, or other similar types of data information.

Mincom's ten years of research have resulted in greater head definition, higher signal-to-noise ratios, uniform phase and frequency response—especially for organizations desiring an up-to-date system suitable for problems of the future.

Mincom's direct frequency recording is utilized for response from 200 cycles to 2.5 megacycles, and in addition, FM techniques can be used on each channel for extension of frequency response down to DC. Many special techniques have been developed to provide practically an error-free recording system, i.e., wow and flutter compensation, drop-out reduction devices, high accuracy speed control, etc. Equipment has been developed for both airborne and ground-base use which meets military requirements for ruggedness. A number of systems are in use and have proved to excel in performance and reliability.

Complete systems have been delivered to: Westinghouse Electric and Manufacturing Company • United States Army Signal Corps • United States Air Force • Temco Aircraft Corporation.



*\*"This reel contains 13 billion data bits of stored information."*

Write for complete specifications



**Mincom**

**MINNESOTA MINING &  
MANUFACTURING COMPANY**

**DIVISION**  
2049 South Barrington Avenue, Los Angeles 25, California

Formerly Electronics Division, Bing Crosby Enterprises, Inc.

CIRCLE 92 ON READER-SERVICE CARD FOR MORE INFORMATION

available  
soon...

# HYFEN

a big step  
toward  
automation  
of wiring  
harnesses

**Crimped  
pins and  
sockets  
snap-locked  
in plug  
or receptacle.  
Individual circuit  
removal or  
gang disconnect.**

Hyfen ends the need for time consuming solder operations — and the high rejection rate inherent with solder. Pins and sockets are speedily crimped on wire ends by automatic installation tooling — or where more convenient, by bench or hand tools. Dies control and provide a uniform depth of indent which can be inspected by depth micrometer assuring absolute unvarying reliability. Crimping may be done before or after harness is in place.

Hyfen meets or exceeds MIL specifications for voltage drop, dielectric strength, contact engaging force, and contact retention force. It provides high corrosion resistance since there are no fluxes or dissimilar metals involved. Floating contacts in both plug and receptacle make for uniform mating and disconnecting force by the alignment flexibility provided.

Hyfen principle is not limited as to size, shape of plug and receptacle nor to number or size of connections. Wire for bulletin.

Burndy, Norwalk, Connect.—Scarboro, Canada



# BURNDY

CIRCLE 93 ON READER-SERVICE CARD FOR MORE INFORMATION

## New Products

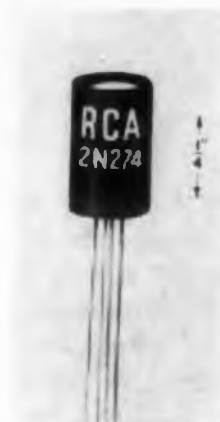

**2N274 Drift  
Transistor**  
For RF Amplifier Service

The 2N274 is a small, hermetically sealed drift transistor of the germanium pnp type designed primarily for rf amplifier service in compact military, mobile, and communications equipment and in entertainment-type receivers operating at frequencies covering the a-m broadcast band and up into the short-wave bands. It is also suitable for use as an i-f amplifier or as a mixer-oscillator.

The 2N274 utilizes shielding to minimize interlead capacitance between the collector lead and the base lead and to minimize coupling to adjacent circuit components.

The 2N274 features low collector transition capacitance allowing satisfactory gains in the a-m broadcast band without the use of a neutralizing network, a collector dissipation of 35 mw maximum, and a power gain as high as 45 db at 1.5 Mc.

Radio Corporation of America, Semiconductor Div., Dept. ED, Somerville, New Jersey.

CIRCLE 473 ON READER-SERVICE CARD FOR MORE INFORMATION

## Voltage Rate-of-Change Meter

Measures  $Mv/sec^2$



This deltameter has an output signal representing mv per sec per sec visually shown on a calibrated meter or fed into a recorder or a controlled system. A voltage change in the order of a few parts per ten thousand is within normal sensitivity.

Miljan, Inc., Dept. ED, P.O. Box 396, Paramount, Calif.

CIRCLE 95 ON READER-SERVICE CARD FOR MORE INFORMATION





### Linearity Testers

For Precision  
Potentiometers

The Linearity Tester eliminates time-consuming and costly manual testing of precision linear potentiometer in electronic instruments and data handling systems which require frequent checks for linear accuracy. Test time is greatly reduced and accuracy improved.

Technical Products Co., Dept. ED, 6670 Lexington Ave., Los Angeles 38, Calif.

CIRCLE 96 ON READER-SERVICE CARD FOR MORE INFORMATION

### High-Voltage Jack and Plug

5000 V RMS



Type SKT-15 Press-Fit jack or female member has a Teflon body 0.387 in. long or 0.732 in. overall including lug, with 0.220 in. diam for bushing and 0.250 in. diam face. Contact members are of machined beryllium-copper, with gold flash, over silver plate. Simple, fast, positive Press-Fit installation is done with a simple insertion tool available from Sealectro, held in drillpress or arbor type equipment. The companion plug or male member, Type PR-15, also measures 0.220 in. for bushing diam and 0.250 in. for face with the 0.050 in. pin mounted on a smaller diameter extension that fits into the jack for a longer leakage path. Rated at 5000 v rms at sea level, or actual flashover of 11,000 v and 1400 v at 50,000 ft for the two units in combination. Teflon body provides ideal insulation, over a temperature range of  $-65$  to  $+200$  C. Jack and plug may be mounted directly on metal chassis or casing for high-voltage breakaway connections. These items come in a choice of eight RETMA code colors.

Sealectro Corp., Dept. ED, 610 Fayette Ave., Mamaroneck, N.Y.

CIRCLE 97 ON READER-SERVICE CARD FOR MORE INFORMATION



Further technical data, prices and delivery information — on the 5490/5495 Console Recording Systems and two- to eight-channel 5475/5480 Systems are available on request from your Sanborn Sales-Engineering Representative or the Industrial Division in Waltham.



## SANBORN COMPANY

INDUSTRIAL DIVISION

175 Wyman Street, Waltham 54, Massachusetts

CIRCLE 98 ON READER-SERVICE CARD FOR MORE INFORMATION

for  
analog computer  
readout:

modern, compact, mobile

## SANBORN CONSOLE RECORDING SYSTEMS

Up to eight problem variables can be recorded in inkless, permanent, rectangular-coordinate tracings — with Sanborn's improved six- and eight-channel 156-, 158-5490 Console Systems. Less than four feet high and about two feet in width and depth, these Systems are completely mobile and designed for maximum operating convenience. Controls and indicators on the sloping top panel include individual-channel attenuation, position, balance, sensitivity and stylus heat adjustments; switch for turning off B+ of output amplifiers; chart drive motor switch (can also be remotely controlled); code marker and or one-second interval timer stylus switch. The Recorder unit, either six or eight channels, features paper loading from the top, and nine precisely controlled speeds from 0.25 to 100 mm/sec. Four dual-channel DC Driver Amplifiers of current feedback design are housed below the Recorder, and are mounted on a chassis which may be withdrawn for inspection.

Electrical specifications of the Console Recording Systems include a basic sensitivity of either .01 volt/chart division (5490 types) or 0.1 volt chart division (5495 types); linearity of 1%; drift less than 1/2 chart division/hour (5490), less than 1/20 chart division hour (5495); flat frequency response to 20 cps, down 3 db at 60 cps for all amplitudes to 5 cm peak; either single-ended or push-pull input signals of 5 meg. impedance (each input lead to ground).

A useful companion instrument is the new Sanborn Model 183 Programmer, designed to provide a connecting link between an analog computer and the Console Recording System. Shown mounted at the top rear of the Console, the Programmer operates the Console in the following automatic sequence: turns recorder drive on — feeds calibration signals to all channels — reads initial DC levels of computer — closes contacts to start computer problem — records computer output for a preset chart length — turns off recorder drive and resets itself for another cycle.

# NEW RATE GYRO FOR SEVERE AMBIENT CONDITIONS

New Products

## DESCRIPTIVE DATA

- EXCELLENT LINEARITY: 0.25 % of full scale.
- LOW HYSTERESIS: Less than 0.1 % of full scale.
- LOW THRESHOLD: Less than 0.01 degree/second.
- MICROSYN PICKOFF: Variable reluctance type providing infinite resolution and high signal-to-noise ratio.
- FULL SCALE RATE: Up to 1000 degree/second.
- FULL SCALE OUTPUT: Up to 12 volts.
- RUGGED: Withstands 100 G shock.
- VIBRATION: Withstands 15 G to 2000 cps.
- SIZE: 2 7/8" diameter 4 1/8" long.
- WEIGHT: 2 lbs.



Honeywell Rate Gyro  
Type JRT  
Shown actual size.



## Now! Constant Damping Over Entire Operating Temperature Range

This new HONEYWELL RATE GYRO, Type JRT, is a precision instrument for measurement of absolute rates of rotation in inertial space. Fluid viscosity is electromechanically controlled to maintain a constant damping ratio over the entire operating temperature range of  $-65^{\circ}\text{F.}$  to  $+175^{\circ}\text{F.}$

The Type JRT is designed expressly for flight control of long range missiles and flight instrumentation in missiles and aircraft where ambient temperatures are not controlled . . . and at the same time where low threshold, minimum hysteresis, excellent linearity, high natural frequency and ruggedness are essential. Honeywell inertial components and engineering experience are available to assist in the solution of your Gyro system problems. Write for Bulletin JRT . . . Minneapolis-Honeywell, Boston Division, Dept. 10, 1400 Soldiers Field Road, Boston 35, Mass.

MINNEAPOLIS  
**Honeywell** H

BOSTON DIVISION

CIRCLE 99 ON READER-SERVICE CARD FOR MORE INFORMATION

## Rack and Panel Connectors Designed for Potting



Environmentally sealed rack and panel connectors designed for potting are available with 57 electrical contacts and 2 coaxial connectors or 75 electrical contacts with 3 coaxial connectors. Electrically rated at 7-1/2 a per contact at 600 v dc. Coaxial connectors have captivated contacts, accommodate RG-58/U or RG-141/U and have a nominal impedance of 50 ohms. Temperature range:  $-65$  to  $+125$  C with appropriate potting compound. Features include: spring-loading of female connector, no air voids, and hooded female contacts.

Amphenol Electronics Corp., Dept. ED, 1030 S. 54 St., Chicago 50, Ill.

CIRCLE 100 ON READER-SERVICE CARD FOR MORE INFORMATION

## Wet Cell Battery Minimum Weight and Volume



Monobloc construction eliminates the case and one wall thickness in this battery. A special intercell connector saves 2/3 of terminal height and eliminates threaded terminals and connectors. These reductions provide a higher output of power per unit of weight and volume. The basic unit consists of a 10 cell unit. Molds are possible in any size or shape for production quantities.

Yardney Electric Corp., Dept. ED, 40-50 Leonard St., New York 13, N.Y.

CIRCLE 101 ON READER-SERVICE CARD FOR MORE INFORMATION

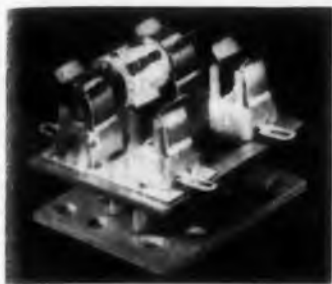

### Silicon Rectifier Holder

Used on Printed Circuits

This holder assures the same surface contact between a silicon rectifier and the clip. Specifically made for the Sarkes Tarzian rectifier the holder provides foolproof positive polarization. The clip can also be inserted in pairs directly into a printed circuit board by the user.

Illinois Tool Works, Fastex Div., Dept. ED, 195 Algonquin Rd., Des Plaines, Ill.

CIRCLE 102 ON READER-SERVICE CARD FOR MORE INFORMATION

### Rectangular-Wave Generator Modular Design



The Model RWG-8A rectangular-wave generator is the first of a line of modular instruments with self-contained power supplies for operation directly from 117 v 60 cps ac. Featuring output rise and fall times of 0.25  $\mu$ sec, this instrument converts a sine wave or any other periodic waveform into a rectangular wave of the same frequency. Alternatively upon the flick of a front-panel switch, a rectangular wave at the power-line frequency is generated. Two Model A195-15A isoplys are employed in a unique direct-coupled discriminator circuit that provides an 8 v zero-based negative-going output signal at low impedance. Optional features include an amplitude control and variable output bias. Case dimensions are 1-3/4 x 8 x 8-1/8 in., with a 1-3/4 x 9-1/2 in. front panel for mounting in a standard half-width relay rack. Other modular units with the same size and general appearance as the unit shown include a wide-band decade dc amplifier, flip-flop, binary scaler, gated oscillator, and pulse generator. The self-contained power supply feature provides a maximum of convenience and a minimum of interaction when various modular units are interconnected to make a complete system. The complete instrument weighs only 3 lb and 2 oz.

Fluor, Inc., Dept. ED, P.O. Box 354, McLean, Va.  
CIRCLE 103 ON READER-SERVICE CARD FOR MORE INFORMATION

# New! Mallory STNT

... a subminiature tantalum capacitor  
for transistorized circuits—  
another Mallory first

4 to 40 mfd.  
3 to 50 volts working  
.145" in diameter  
.250" in length  
tantalum construction  
-55 to +85° C ratings  
metal cased  
axial leads

Write—or ask your Mallory representative for complete information and specifications on these new STNT subminiature tantalum capacitors, or an application engineering consultation, on the entire Mallory tantalum line.

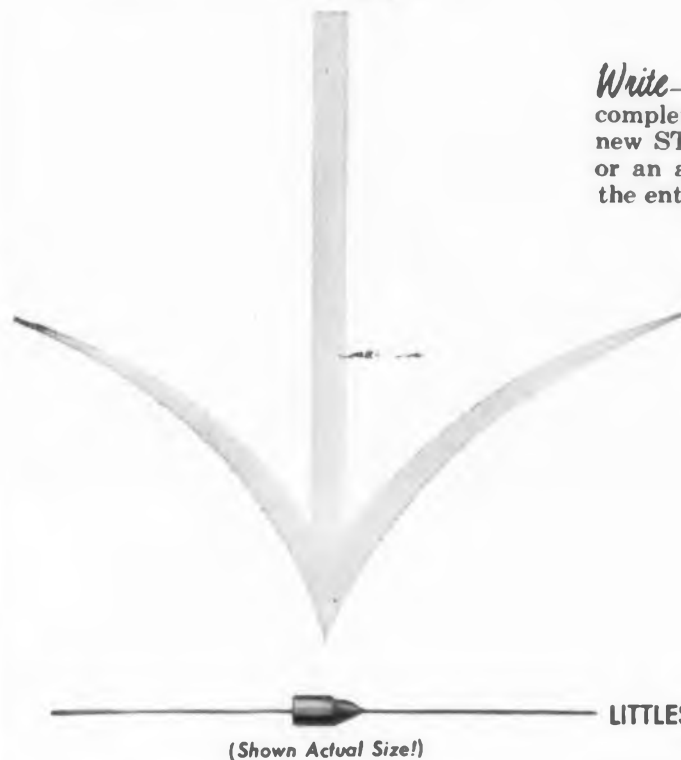

LITTEST BIG CAPACITORS EVER MADE!

(Shown Actual Size!)

Expect more... get more from



Serving Industry with These Products:

Electromechanical—Resistors • Switches • Tuning Devices • Vibrators  
Electrochemical—Capacitors • Mercury and Zinc-Carbon Batteries  
Metallurgical—Contacts • Special Metals • Welding Materials

CIRCLE 104 ON READER-SERVICE CARD FOR MORE INFORMATION

# PYLE *star-line* CONNECTORS

Assure long-lasting protection of vital connections under a wide range of extreme environmental conditions

Currently establishing itself as a performance leader in the missile systems field, Pyle-Star-Line connectors offer engineers an entirely new line of electrical connectors for universal military and industrial use.

With characteristics of construction and performance never before combined in compact, rugged, lightweight standardized connectors, they exceed NEC requirements and classes A, B, C and E of military specifications MIL C-5015C.

## FEATURES

**Tough, lightweight shell:** Strength comparable to mild steel, yet weighs only 1/3 as much.

**Anodic coating:** Gives shell toughness of case-hardened steel. Takes up to 1800 volts to penetrate coating.

**"Sandwich" insulation:** Silicone laminate floats between two rigid discs. Silicone disc absorbs shock, lets contacts align themselves freely; rigid discs impart just the right amount of restraint. Gives all advantages of both flexible and rigid mountings.

**Chamber sealing:** Silicone insulation disc positively and completely prevents water, gas, moisture or dust from passing into shell.

**Wide range of pin and socket configurations:** Configurations from 2 to 100 poles available. Within each form size all inserts are interchangeable and reversible.

Environmental Limits of Pyle-Star-Line connectors	
Temperature	-80 F. to 225 F.
Pressure	300 PSI External, 200 PSI Internal
Chemical Resistance	Most acids, most alkalis, oil
Corrosion Resistance	Salt Spray: 300 days without failure
Dust Resistance	Exceed requirements of MIL C-5015C
Shock Resistance	50G Minimum
Vibration	Exceed 20G to Method II of Mil C-5015C
Humidity & Moisture Resistance	Exceed Class E. Spec. of Mil C-5015C
Air Leakage	Meet Class E Spec. of Mil C-5015C

Write today for complete specifications.

the PYLE-NATIONAL company



Where Quality is Traditional

1331 North Kostner Avenue, Chicago 51, Illinois

District Offices and Representatives in Principal Cities of the United States  
CONDUIT FITTINGS • CIRCUIT CONTROLS • LIGHTING EQUIPMENT

CIRCLE 105 ON READER-SERVICE CARD FOR MORE INFORMATION

## New Products

### Variable Timer With Manual Trigger



Model PM-47 variable timer provides for a settable time delay between 0.3 and 10 sec with an accuracy of  $\pm 5$  per cent, and provides an output energy in excess of 35,000 ergs. Temperature ambients from  $-70$  to  $+165$  F and accelerations up to 100 g have no effect on its operation. The electric timer is suitable for use in missile systems and airborne applications, pilot escape systems, sled timers, programming devices and explosive element initiation. The time delay is initiated by the release of a pull wire which allows a spring driven plunger to complete the necessary switching action.

Universal Winding Co., Patterson, Moos Div., Dept. ED, P.O. Box 1605, Providence, R.I.

CIRCLE 106 ON READER-SERVICE CARD FOR MORE INFORMATION



### Weighing System For Strain Gage Load Cells

The electronic weighing unit is designed for strain gage load cells of any bridge resistance. Manual balance is accomplished with digital read-out of 4 significant figures. In using the unit for control operations, relay closure occurs within 15 msec after the applied load reaches the dial setting. For certain applications when used with strain gage pressure transducers, the unit becomes a rapid and highly accurate pressure switch.

The control unit weighs 22 lb and is 16 x 8 x 9-1/2 in. Ranges of 1 to 10 mv/v full scale, corresponding to full scale loads of 50 to 500,000 lb with currently available load cells. Resolution is  $0.4 \mu\text{v/v}$ .

Hoover Electronics Co., Dept. ED, Instrumentation Div., 1122-C San Mateo Blvd., SE, Albuquerque, N. Mex.

CIRCLE 107 ON READER-SERVICE CARD FOR MORE INFORMATION

ELECTRONIC DESIGN • October 15, 1957

### PC Tab Terminal

Automatic or Manual Insertion



This narrow tab terminal packaged electronic circuit has been developed for use with printed or etched board circuitry. Originally designed for automatic insertion, it can also be manually inserted. The new narrow tab terminals are designed for easy plug-in to 0.055 holes with perfect alignment of terminals on 0.172 in. centers, approved RETMA standard spacing. This tab is now available on request on all the company's basic plate sizes.

Centralab, Div. of Globe Union Inc., Dept. ED, 900 E. Keefe Ave., Milwaukee 1, Wis.

CIRCLE 108 ON READER-SERVICE CARD FOR MORE INFORMATION

### Analog Multiplier

High Accuracy and Speed



This analog computer multiplier, Model 251, generates a voltage proportional to the instantaneous product of two arbitrary input voltages from dc to 5 kc, with less than 5  $\mu$ sec delay. Multiplication is accurate and dependable over long periods of time since operation does not depend upon the non-linear characteristics of vacuum tubes or diodes. With no moving parts in the small unit, multiplication is accomplished at high speeds. Accuracy is  $\pm 0.1$  per cent of full scale over most of the band. After a short warm-up, no adjustments are required for at least eight hrs if accuracies of  $\pm 0.25$  per cent are adequate. Built-in metering system facilitates calibration and performance testing while unit is in use. The instrument operates with a 450KC carrier, which is phase-modulated and amplitude modulated by the two inputs to produce an output proportional to the product of these two modulating voltages. Modulation and demodulation are performed in diode-ring balanced modulators of special design to yield the required linearity, stability, and trouble-free operation.

Chadwick-Helmuth Co., Dept. ED, 472 E. Duarte Rd., Monrovia, Calif.

CIRCLE 109 ON READER-SERVICE CARD FOR MORE INFORMATION

any eye can understand...



these automatic electrical measurements

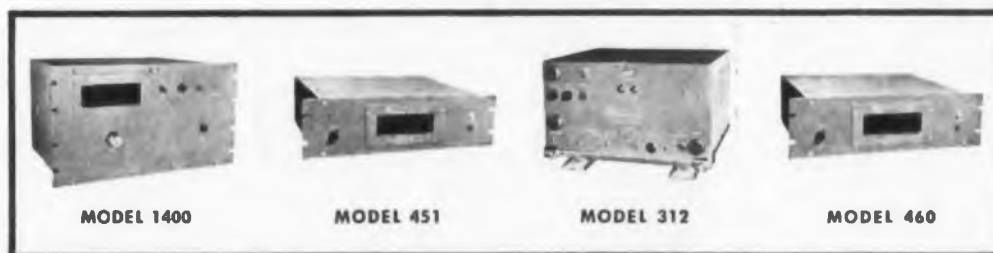

It's as simple as 1, 2, 3, for even untrained personnel to clearly and accurately make electrical measurements with NLS digital meters. Inch-high numerals are legible from 30 feet away. NLS originated the automatic digital voltmeter and now manufactures a broad range of these and other precise, related instruments for both laboratory and industry. Accuracy, ruggedness, and dependability are proven features of these digital meters for measuring resistance or voltage. Automatic data recording on Clary printer, electric typewriter, card, or paper punching equipment is available. Whatever your need for high speed, completely reliable electric measurement instruments, you'll find your answer in the NLS complete line. Write on your letterhead for the name and address of your nearest NLS representative, who will be glad to discuss your needs, or mail the coupon for full information on these high precision instruments.



Originators of the Digital Voltmeter

non-linear systems, inc.

San Diego County Airport, Del Mar, California  
Sales Engineering Offices in Los Angeles, San Francisco,  
Phoenix, Cleveland and Orlando, Fla.

Digital Ohmmeters • AC-DC Converters • Data Reduction Systems • Digital Readouts  
Peak Reader Systems • Binary Decimal Converters • Digital Recording Systems

CIRCLE 110 ON READER-SERVICE CARD FOR MORE INFORMATION

**MODEL 1400** Wide Range Voltmeter—Utilizes mercury wetted relays for maximum life and reliability.

**MODEL 451** General Purpose Voltmeter—For display or recording of  $\pm 0.001$  to  $\pm 999.9$  volts DC.

**MODEL 312** High-Speed Voltmeter—For airborne analog-to-digital conversion.

**MODEL 460** High Sensitivity Voltmeter—For thermocouple and strain gage systems.

One of the many EXCLUSIVE FEATURES pioneered by NLS... Oil immersed stepping switches that insure trouble-free life and dependable operation.

NON-LINEAR SYSTEMS, INC.  
Dept. K-1067, Del Mar Airport, Del Mar, Calif.

Please send technical information on:

AC or DC voltmeters  ohmmeters  
 analog-to-digital converters  automatic testing systems

NAME \_\_\_\_\_  
COMPANY \_\_\_\_\_  
ADDRESS \_\_\_\_\_  
CITY \_\_\_\_\_ ZONE \_\_\_\_\_ STATE \_\_\_\_\_

## New Products

### Coincidence Relay Monitors Three Circuits



The Coincidence Relay, Model CR-1, provides fail-safe continuous monitoring of three external normally closed signal or alarm circuits. The opening of any two of the three monitored circuits de-energizes the relay. The relay resets only when all three circuits are normal or in the closed position. The relay is plug mounted, and is enclosed in a dust resistant, plated, metal housing. A mating, eleven pin, octal style socket is furnished with each relay. Contacts are dpdt and rated at 10 a, 115 v ac. The dimensions are 1-7/8 x 2 x 3-1/8 in. and the unit weighs 15 oz.

Certi-Fact Engineering, Inc., Dept. ED, P.O. Box 774, Sherman Oaks, Calif.

CIRCLE 111 ON READER-SERVICE CARD FOR MORE INFORMATION



### Adjustable Diameter Linear Bearing No Shaft Play

A ball bearing for linear motion known as adjustable diameter ball bushings, are split longitudinally as illustrated and are designed to easily provide line-to-line or slight preload fits when mounted in an adjustable diameter housing. The objective of free-running no-play linear motion is a practical and simple matter as these bearings allow adjustable tolerance on both the shaft diameter and bearing bore. This principle provides for compensation for wear that might eventually develop in severe applications. These bearings are frequently used in a housing that is merely split and provided with an adjusting screw. Adjustable diameter ball bushings are available in standard sizes for shaft diameters ranging from 1 to 4 in.

Thomson Industries, Inc., Dept. ED, Manhasset, New York.

CIRCLE 112 ON READER-SERVICE CARD FOR MORE INFORMATION

CIRCLE 113 ON READER-SERVICE CARD >

## New components made from technical ceramics cut costs

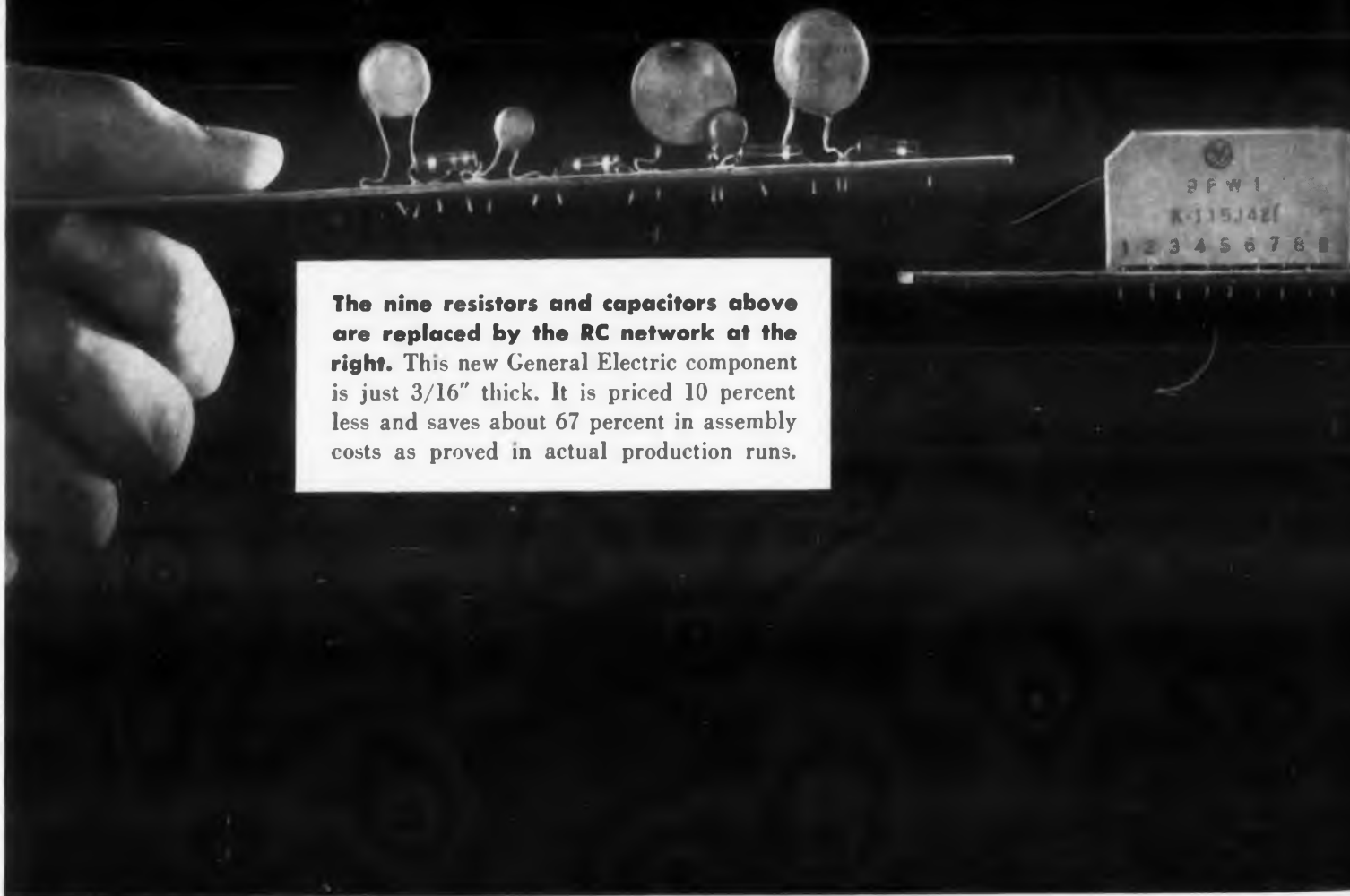

The nine resistors and capacitors above are replaced by the RC network at the right. This new General Electric component is just 3/16" thick. It is priced 10 percent less and saves about 67 percent in assembly costs as proved in actual production runs.



### Lead Metaniobate

A piezoelectric material recently developed by General Electric, Lead Metaniobate remains remarkably stable over the temperature range from  $-54^{\circ}\text{C}$  to  $265^{\circ}\text{C}$ , an important fact in high-temperature instrumentation devices. It displays superior aging characteristics compared with other ceramic piezoelectric bodies. The high Curie temperature ( $570^{\circ}\text{C}$ ) allows repeated heat cycling with no effect on electrical output.



### Thru-Con print wire board

Now you can design a compact wiring pattern on both sides of the board *without* the cost of further processing to connect them. The "Thru-Con®" board additive technique plates *through* the holes at the same time it plates the wiring pattern. This permits high-speed dip soldering remarkably free from rejects. No special eyelets or pre-cleaning are required. Assembly weight is reduced, and inventory is simplified.

# of electronic assemblies

## Basic Improvements in RC Networks and Capacitors Developed by General Electric Research

**Technical ceramics** have remarkable electrical and mechanical properties that lead to the utmost simplification in component parts—as superior to present components as the auto was to the horse.

The new RC network shown at the left replaces a host of individual resistors and capacitors. The price saving can be ten percent or better. The assembly saving in print wire boards—inserting one unit instead of five or ten—averages about 67 percent. Furthermore, this small RC network results in a smaller overall assembly, at proportionate savings in board costs. Yet you are not restricted to the usual limitations due to environmental temperatures, for the new network operates at 95°C, ten degrees over the normal requirement.

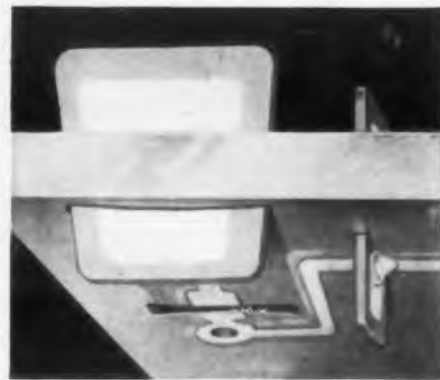

Wejcap capacitors also show that four of them can be inserted in the time it takes to put in three ordinary capacitors. If only three Wejcap capacitors are applied in your volume-production chassis, you can expect to cut as much as 20 percent from your capacitor costs.

Both Wejcap capacitors and RC networks are available in a range that makers of medium and high volume assemblies can capitalize on. For further information fill out the coupon.

**Wejcap** capacitors are small, flat capacitors that have no leads at all. They are merely wedged into print wire boards. Leads are an encumbrance. They get bent and broken. They are tough to align. They have to be crimped. Wejcap capacitors eliminate these problems and cost 25 percent less. Tests on



**Strain Gage Module**  
For Missiles and Aircraft

The P-500 plug-in module contains complete circuitry for strain gage balance, and is the first of a series of expendable units available for aircraft and missile electronic systems. The strain gage balance module achieves precise calibration and adjustment through use of micro-miniature resistors and a miniature pot. Circuit packaging permits shrinking both standard and special circuitry for other applications, incorporation of miniature amplifiers, cathode followers, pulse circuits and others employing transistors or sub-miniature vacuum tubes. Equipped with male or female miniature connectors in one or both ends, they can be inserted directly in the line or used in tandem in appropriate combinations. The modules are designed for operation at ambient temperatures up to 125 C and altitudes up to 60,000 ft.

North Atlantic Industries, Inc., Dept. ED, Westbury, N.Y.

CIRCLE 114 ON READER-SERVICE CARD FOR MORE INFORMATION

**Pressure Pickup**  
Measures to 5000 PSIG



Unbonded strain-gage windings connected in a four-arm bridge comprise the sensing elements of this variable-resistance-type transducer. It permits accurate measurements of pressures up to 5000 psig under unfavorable environmental conditions. The Type 4-317, available in nine gage pressure ranges of 100 to 5000 psi, can be operated continuously at 5 v maximum input over a temperature range of -350 to +600 F with allowable transients up to +750 F. Linearity and hysteresis deviations combined are less than ±1.5 per cent of full-range output, as measured from a straight line drawn through the full-scale end points. Allowable acceleration is 100 g in any axis.

Consolidated Electrodynamics Corp., Dept. ED, 300 N. Sierra Madre Villa, Pasadena, Calif.

CIRCLE 115 ON READER-SERVICE CARD FOR MORE INFORMATION

◀ CIRCLE 113 ON READER-SERVICE CARD

Manager of Sales, Specialty Electronic Components Department,  
General Electric Company, Auburn, New York

Please send me complete technical information on

<input type="checkbox"/>	RC Networks	<input type="checkbox"/>	Lead Metaniobate
<input type="checkbox"/>	Ferrites	<input type="checkbox"/>	Wejcap capacitors
<input type="checkbox"/>	Thru-Con® Print Wire Boards		

Name \_\_\_\_\_ Position \_\_\_\_\_

Company \_\_\_\_\_

Address \_\_\_\_\_

City \_\_\_\_\_ Zone \_\_\_\_\_ State \_\_\_\_\_

Progress Is Our Most Important Product  
**GENERAL ELECTRIC**

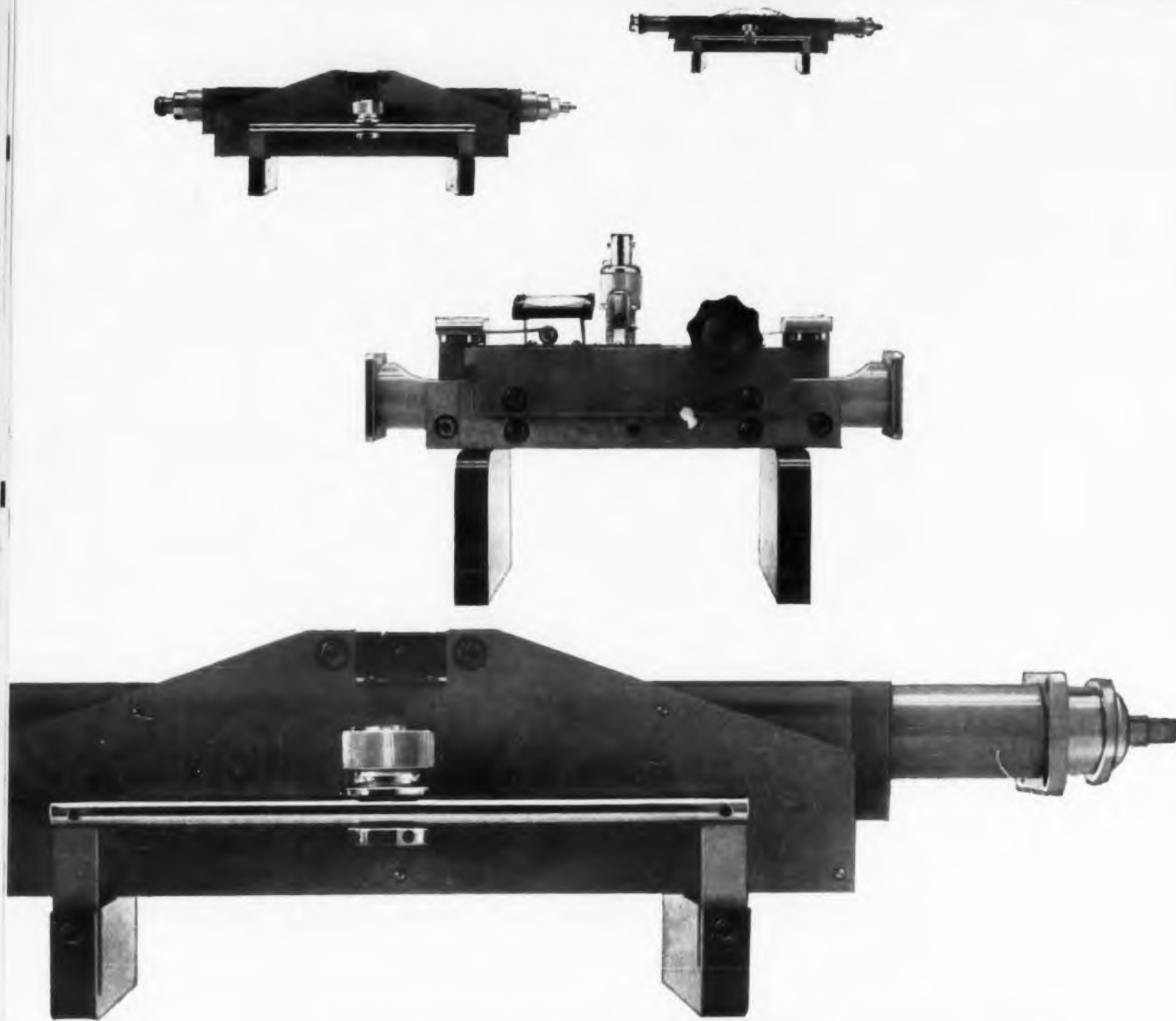

## FINEST, MOST COMPLETE LINE of Precision Slotted Sections

### TYPICAL SPECIFICATIONS

Model	Line Size	Equivalent Wave Guide Type	Frequency Range kmc/sec	Insertion Length
200-C	7/8"		1.0 to 4.0	17"
215-A	3/8"		1.0 to 4.0	14 3/8"
203-E		RG-52 U	8.20 to 12.4	7 1/8"
210-A		RG-91 U	12.4 to 18.0	8 1/8"

For full technical details on the complete line of PRD Slotted Sections, or for consultation on the particular model best suited to your needs, call your local PRD Engineering Representative; or write to Applications Engineering Group 1.

### Ready for IMMEDIATE Delivery!

Whether you are working up VSWR or impedance data in the design or testing of new transmission line components, or are designing an impedance matching device for monitoring antenna and transmission line VSWR in communications systems . . . PRD Slotted Sections provide the superlative answer for precise and accurate information with simplicity and dependability of use.

They have no equal in providing precise standing wave and impedance measurements. PRD Slotted Sections are built of precision-machined "micro-finished" transmission line.

The probe is secured to a ball-bearing carriage that travels in precision-ground, hardened grooved runways. Thus the probe travels in a path exactly parallel to the axis of the transmission line. A marked advantage of PRD Slotted Sections is their permanent adjustment, at the factory, to zero slope—there is no need for adjustment to correct for changing slope characteristics. PRD Slotted Sections are designed to mate with standard MIL type connectors and flanges. Low reflection adaptors are available where additional types of connectors are used.

The ultimate in precision measurements is achieved when PRD accessory items such as Type 250-A Broadband Probe and Type 218-K Accessory Kit are used.

## POLYTECHNIC RESEARCH & DEVELOPMENT CO., Inc.

202 Tillary Street, Brooklyn 1, N. Y.

## New Products

### Traveling Wave Tube Amplifier Permanent Magnet Focused

A broadband traveling wave amplifier, the HA-20, operates from 8.2 to 12.4 kmc without the necessity of any electrical or mechanical adjustments. Elimination of the solenoid and its associated supply results in a weight reduction by a factor of 10 in this amplifier package. Focusing is accomplished by arranging high-coersive-force ceramic magnets in a periodic structure. Specifications include: small signal gain of 20 db min (8.2 to 12.4 kmc); small signal gain of 30 db min (8.2 to 11 kmc); power output of 7.5 to 10 dbm min; capsule length of 14 in.; capsule diam of 2 in.; net weight, 3.75 lb.

Huggins Labs., Inc., Dept. ED, 711 Hamilton Ave., Menlo Park, Calif.

CIRCLE 117 ON READER-SERVICE CARD



RF Co-axial  
Connector

Push-  
button-  
disconnect

These connectors offer the advantage of quick disconnect without the necessity of removal of cable from the assembly. The hermetically sealed lightweight constant 50 ohm rf connectors feature exceptionally good rf characteristics and mechanical construction. The push-button connectors are available with type N or HN hermetically sealed co-axial receptacles. The units can be used where the quality of screw-in type connectors is required along with the advantage of the push-button-disconnect feature. In the "off" position, the isolation exceeds 60 db down from 500 to 5000 mc, and 50 db down from 5000 to 10,000 mc.

Don-Lan Electronics Co., Dept. ED, 1101 Olympic Blvd., Santa Monica, Calif.

CIRCLE 118 ON READER-SERVICE CARD

◀ CIRCLE 116 ON READER-SERVICE CARD



## Miniature Photodiode

High Lumen Intensity



The 1N77B junction photodiode is designed for rapid, highly sensitive scanning and reading applications, such as in computer tape or punched-card readout. Other applications include infrared detection and heat-seeking devices since it is sensitive to light wave lengths extending from near ultraviolet into infrared.

Other applications for the 1N77B, which replaces the 1N77A, include liquid level control, headlight and street light dimmers, intensity controls, photoelectric controls and motion picture sound pickup. With superior power dissipation and higher temperature capabilities than previous types, the unit has a higher lumen intensity and a high output impedance of particular value when the device is coupled into tubes or grounded collector transistor circuits.

Sylvania Electric Products, Inc., Dept. ED, 1740 Broadway, New York 19, N.Y.

CIRCLE 119 ON READER-SERVICE CARD

## Servo-Controlled Tilt Table

For Functional Checking of Gyros

A tilt table for functional checking of a missile's internal guidance gyros has been developed. It generates angular position and velocity inputs to the gyro. The table proper is a two-gimbled support structure capable of carrying a 125-lb guidance package. The gimbles are driven through precision gearing by two 2-phased 400 cps servo motors (one on each gimble). Gimble position is measured to 30 sec of arc. Angular velocities are measured to 0.025 deg per sec. Velocity range is from 0.1 to 35 deg per sec.

Thompson Products, Inc., Dept. ED Electronics Div., 2196 Clarkwood Rd., Cleveland 3, Ohio.

CIRCLE 120 ON READER-SERVICE CARD

CIRCLE 121 ON READER-SERVICE CARD >



# This AC Regulator?

## Get In Line!

Sorensen AC Line Regulators Handle 150 VA to 15 KVA;  
Accurate within  $\pm 0.1\%$  against Line or Load. Highly  
Dependable with Clean Wave Form and Frequency Insensitivity.



It's a sure thing you can depend on a sustained steady voltage level, in circuit or hook-up, when there's a Sorensen AC Line Voltage Regulator cut into your power source.

On applications such as communications equipment, appliance testing, instrument calibration, and color photography—and for general laboratory use, the refined Sorensen regulating circuit gives unequalled accuracy and dependability.

An exclusive factor, unique and effective, is the safety diode which produces a voltage drop, in place of a surge, when there's a filament break in any tube. Over-voltage circuit breakers are also included in units of more than one KVA rating.

The unusual reliability and acceptance of these voltage regulators is established overwhelmingly by the thousands of installations using them throughout the world, with great numbers of these Sorensen units in continuous service for ten years and more.

Check your local Sorensen representative on what these line voltage regulators can do in your operations. Or, for technical data, write directly to **SORENSEN & COMPANY, Inc.**, Richards Avenue, South Norwalk, Conn.

### SPECIFICATIONS Model 1000 S\* (illustrated)

Output voltage	115 VAC, single phase, adjustable 110-120 volts	Power factor range	From unity to 0.7% lagging
Input Voltage	95-130 VAC, single phase, 50/60 cycles, $\pm 10\%$	Load range	0 to full
Regulation accuracy	$\pm 0.1\%$ , against line; $\pm 0.1\%$ , against load	Width	17 $\frac{1}{4}$ "
Distortion produced	3% Max.	Height	8 $\frac{1}{4}$ "
Time constant	0.1 second	Depth	11"
		Rack mount height	8 $\frac{1}{4}$ "
		Net weight	75 lbs.
		Shipping weight	87 lbs.

\*Ask for data on other models and capacities.



controlled power for research and industry

## New Products



**Series Servo  
Dampers**  
Solves Stability  
Problems

This viscous-coupled inertia dampers solve servo stability problems without requiring tachometers or networks. The servo dampers mount directly on Diehl FPE-25 5 w servomotors. Dampers for other motors also available. Time constants are adjusted at factory to meet customer's specification.

Feedback Controls, Inc., Dept. ED, 899 Main St., Waltham 54, Mass.

CIRCLE 124 ON READER-SERVICE CARD FOR MORE INFORMATION

### AC VTVM

2 Per Cent Accurate to 71 C



The new 121 series single-range ac vtvm's not only withstand exposure to temperatures as high as 85 C, but maintain their  $\pm 2$  per cent accuracy to temperatures as high as 71 C. Embodying the company's panel-mounting design, the instruments are ideal for military applications—where space and weight are at a premium, and where rugged reliability is a must. The device, designed for operation in equipment meeting MIL-E-5400 and MIL-T-945A, uses a meter movement which itself meets MIL-M-10304A, weighs little more than a pound and takes no more panel space than a standard 3-1/2 in. meter.

This ac vtvm has an input impedance of 1 megohm, frequency range of 20 to 50,000 cps and is available in any range from 30 mv to 300 v ac. Power required is 6.3 v and 125 to 200 v dc.

Trio Labs., Inc., Dept. ED, 4025 Merrick Rd., Seaford, N.Y.

CIRCLE 125 ON READER-SERVICE CARD FOR MORE INFORMATION



**10 YEARS AGO MARTIN  
TOOK A CALCULATED LOOK  
AT THE SKY**

This company's strategic position as a prime contractor to our military security, and to our scientific future in the sky, is the result of ten years of planning toward the finest available manpower and facilities in the frontier field of guided missiles.

Some 20,000 hours ago, as the missile flies, America's first operational tactical missile - the TM-61 MATADOR - was nearing the field test stage, and the Martin VIKING research rocket program was already under way.

A new age was being born. And having participated in the delivery, at that time we made a positive decision:

The effective development and growth of tomorrow's missiles and rockets would depend heavily, we said, upon our own ability to engineer and deliver the *total* missile system, complete with launching, guidance and operational facilities, integrally engineered for reliability in the *customer's* hands.

The decision we made was important. For today, 20,000 hours later, Martin's new missile facilities are the most modern in the industry ... the performance record of our products among the finest *in the sky*, where missiles and rockets write the true score.

**MARTIN**  
BALTIMORE · DENVER · ORLANDO

**Deposited Carbon Resistors  
High Stability**



A line of deposited carbon high stability resistors called Hi-Stab is available in molded, non-insulated, and hermetically sealed ceramic encased types. They are extremely stable under severe environmental conditions and are designed to exceed MIL-R-10509B specifications. Hi-Stab resistors have been tested by exposure to a humid underground atmosphere for three years, during which, the average resistance change was only 0.3 per cent. In another test these same resistors were immersed in tap water for 4500 hr with negligible average resistance change.

The company states that Hi-Stab resistors are more economical than wire-wound resistors and are ideally suited for low noise applications and installations in which high stability with low inductance is essential. It suggests their use for military radar and guided missiles and for commercial computer circuits, communications, instrumentation, quality radio, TV, and hi-fi sets.

Erie Resistor Corp., Dept. ED, 644 W. 12 St., Erie, Pa.

CIRCLE 127 ON READER-SERVICE CARD FOR MORE INFORMATION

**Transistor Power Supplies  
6 to 50 V DC**

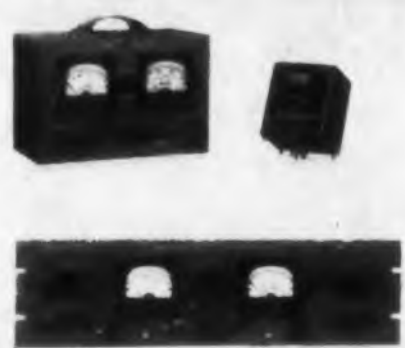

A complete line of transistorized power supplies, are available with nominal voltages ranging from 6 to 50 v dc, with full load ratings from 50 to 500 ma. Designed for either 60 or 400 cycle operation, ripple and regulation are better than 0.5 per cent. The units will stand temperature excursions from -30 to +65 C, and have passed shock and vibration tests.

Electronic Assembly Co. Inc., Dept. ED, 5 Prescott St., Boston 19, Mass.

CIRCLE 128 ON READER-SERVICE CARD FOR MORE INFORMATION

**NEW!**

**DC to DC and DC to AC  
solid-state power converters  
voltage regulated, frequency  
controlled, for missiles,  
telemetry, gyros, servos**



Interelectronics Inverter solid-state thyristor-like elements and magnetic components convert DC to any number of voltage regulated or controlled frequency AC or filtered DC outputs from 1 to 1800 watts. Light weight, compact, 90% or better conversion efficiency.

Ultra-reliable in operation, no moving parts, unharmed by shorting output or reversing input polarity. Complies with MIL specs for shock, acceleration, vibration, temperature, RF noise.

Now in use in major missiles, powering telemetry transmitters, radar beacons, electronic equipment. Single and polyphase AC output units now power airborne and marine missile gyros, synchros, servos, magnetic amplifiers.

Interelectronics - first and most experienced in the DC input solid-state power supply field, produces its own solid-state gating elements, all magnetic components, has the most complete facilities and know-how—has designed and delivered more working KVA than any other firm!

For complete engineering data write Interelectronics today, or call LUDLOW 4-6200 in N. Y.

**INTERELECTRONICS  
CORPORATION**

2432 GR. CONCOURSE, N. Y. 58, N. Y.

CIRCLE 129 ON READER-SERVICE CARD



## "I'M CHECKING RELIABILITY!"

Getting inside is one way son, but it's not practical. However, with increasingly complex circuitry, and with no electronic equipment better than its weakest component, it is important to know how that transformer will perform.

How do you determine its reliability? Quality of materials, workmanship, design . . . all are hermetically sealed from view. You can test it, of course, but the good and the poor can test alike at first.

The answer is that in the beginning, it's impossible to know the dependability of this transformer except by the mark of its maker.

ADC is grateful for the extent to which the industries it serves have come to know and trust the mark of this maker.



CIRCLE 130 ON READER-SERVICE CARD FOR MORE INFORMATION

## New Products

### Constant Delay Line

5  $\mu$ Sec Rise Time



A 246  $\mu$ sec delay with a rise time of 5  $\mu$ sec is made possible by this hermetically-sealed miniaturized unit. Designed to close tolerances and having an attenuation of 3 db, the delay unit can be supplied with octal plugs for standard tube sockets. The unit has a low coefficient of delay with an operating temperature range of  $-55$  to  $+105$  C.

PCA Electronics Inc., Dept. ED, 16799 Schoenborn St., Sepulveda, Calif.

CIRCLE 131 ON READER-SERVICE CARD FOR MORE INFORMATION



### Thyatron Grid Drive With Magnetic Amplifier

This half wave model pre-engineered all-magnetic thyatron grid drive provides positive, reliable firing of all types of thyatron tubes. The basic unit consists of a fast response magnetic amplifier, which generates a continuously phase-variable pulse. It features a rise time of less than 500  $\mu$ sec, and a pulse amplitude which varies with the firing angle to a maximum of 140 v.

Three different input windings are available for maximum control circuit flexibility. Ac or dc input signals, variable resistance control, or vacuum tube or preamplifiers can be used. A high impedance input requires 200  $\mu$ a to reset and will match the plate of a 12AX7 tube with 1.5 v on the grid for full control. The medium impedance input requires 2 ma and will match the cathode of a 12AT7 tube with 18 v on the grid for full control. The low impedance winding is especially chosen to match a transistor. This is a high current (8 ma) low voltage winding to minimize temperature problems.

Fairfield Engineering Corp., Dept. ED, 934 Hope St., Springdale, Conn.

CIRCLE 132 ON READER-SERVICE CARD FOR MORE INFORMATION

## Do you think of pressure transducers?

### The Martin Company does...

and uses Statham Model PA183  
pressure transducers in  
the SeaMaster program.



The Navy's P6M Martin SeaMaster is a 600-mile-per-hour pioneer aircraft of tomorrow's mobile sea-plane striking forces.

The Model PA183 pressure transducer is available in ranges from 0-5 to 0-1,000 psi absolute with characteristics ideally suited to flight test.

The transducing element is the rugged Statham unbonded strain gage. A feature of the design is that the case permits stacking one instrument upon another.

**WHEN THE NEED  
IS TO KNOW...FOR SURE  
SPECIFY STATHAM**

Please request Bulletin No. PA183TC

*Statham*

LABORATORIES  
LOS ANGELES 64, CALIFORNIA

CIRCLE 133 ON READER-SERVICE CARD

**Transistorized Current Stabilizer**  
Handles 30 A



The CG 12 current governor is a two terminal current stabilizer, modulator and electronic load. Completely transistorized, it permits selection of current levels in 50 ma steps from 0.5 to 30 a. Applications include diode testing, transistor testing and magnetic core investigation.

North Hills Electric Co., Inc., Dept. ED, 402 Sagamore Ave., Mineola, N.Y.

CIRCLE 134 ON READER-SERVICE CARD

**Binary Time Code Generator**  
Produces 128 Coded Time Signals



The Model DC-103 binary time code generator is functionally designed to produce a serial output of one synchronizing pulse followed by eight bits of binary coded dc timing signals per sec. The total number of unique binary coded time signals produced is 128. The binary pulses identify each second of time, using pure binary notation while the synchronizing pulses identify the beginning of each second. The reference pulse is readily identifiable since it is three times the width of the coded pulses (minimum code pulse width is 30 msec). The pulse voltage levels are not critical since a pulse signifies an on-off condition rather than an absolute value. The DC-103 contains a provision to allow checking the accuracy of each second of time by a pulse interval method.

C. M. Giannini & Co., Inc., Dept. ED, 918 East Green St., Pasadena 1, Calif.

CIRCLE 135 ON READER-SERVICE CARD

CIRCLE 136 ON READER-SERVICE CARD >



*Not much taller than a pack of cigarettes...*

## See how much space you save with New Lambda COM-PAK® Power Supplies

**THREE VOLTAGE RANGES:**  
0-200, 125-325, 325-525 VDC



Economically priced. 400 MA Lambda Com-Pak model (illustrated) needs only 5 1/4" of panel height, from \$244.50 Other models include 200 MA (5 1/4") priced from \$159.50, 800 MA (7") from \$315, and 1.5 amperes (8 3/4") from \$550.

**FAST IN-RACK SERVICING**

Wiring, tubes, and other components readily accessible. You can reach them easily, service them fast.



Quick rear access to tubes and controls.

Rear panel swings open for servicing.



C-200 series - 200 MA - need only 5 1/4" of panel height  
C-400 series - 400 MA - need only 5 1/4" of panel height  
C-800 series - 800 MA - need only 7" of panel height  
C-1500 series - 1500 MA - need only 8 3/4" of panel height

*Space-saving models available for all power supply needs up to 1.5 amperes*

You get king-size performance as well as real space economy with Lambda's new Com-Pak regulated DC supplies. Completely new electrical and mechanical design. More functional - easier to combine with other components - designed for faster, handier maintenance and servicing.

400 MA and higher current range models have high-efficiency, long-life hermetically-sealed semi-conductor rectifiers. All Com-Pak models include hermetically-sealed transformers, chokes and capacitors.

LAMBDA Electronics Corp., Dept. ED-1057  
11-11 131st Street, College Point 56, New York

Send me literature listing complete specifications for all Lambda Power Supplies.

Name \_\_\_\_\_ Title \_\_\_\_\_

Company \_\_\_\_\_

Address \_\_\_\_\_

City \_\_\_\_\_ Zone \_\_\_\_\_ State \_\_\_\_\_



**LAMBDA Electronics Corp.**  
11-11 131 STREET • COLLEGE POINT 56, NEW YORK  
INDEPENDENCE 1-8500 Cable Address: Lambdatron, New York

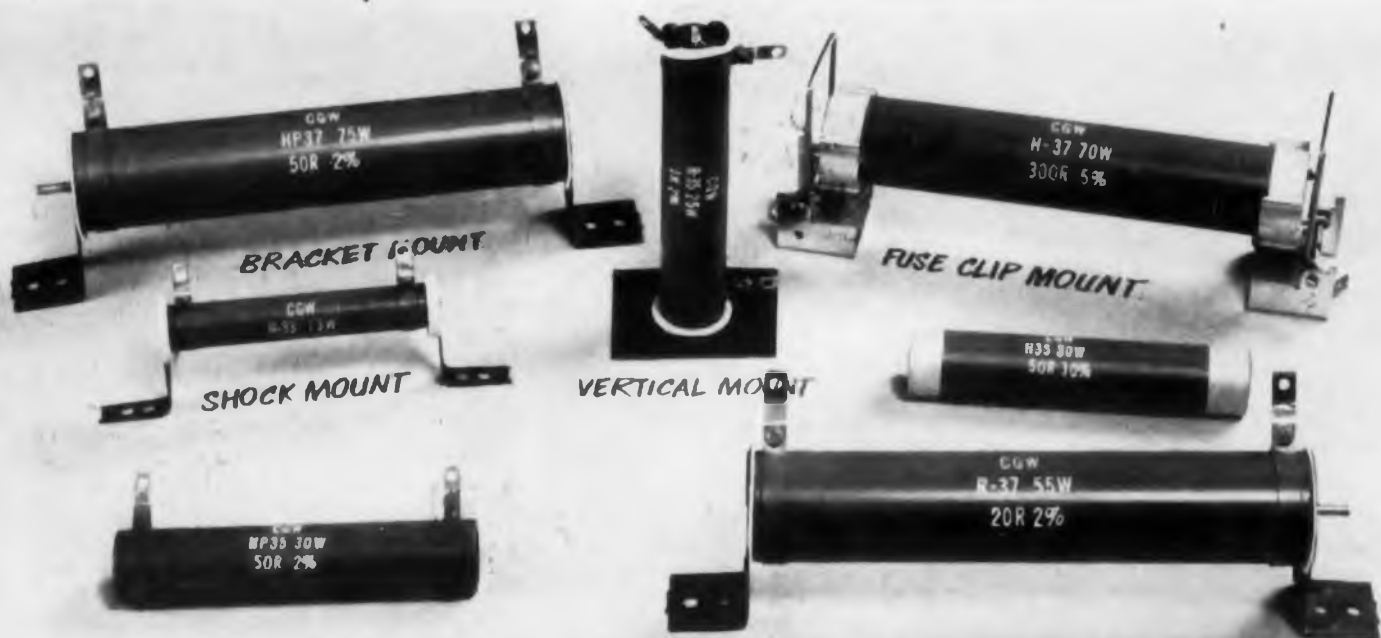

TYPE	RES. RANGE		POWER RATING		LENGTH
	MIN.	MAX.			
R	10 $\Omega$	1,000 K	7-115 W	DC	1 1/2" to 12"
H	10 $\Omega$	1,000 K	7-140 W	AC	1 1/2" to 12"
HP	10 $\Omega$	500 K	17-150 W	DC	3" to 12"

## Why Corning High-Power, High-Frequency Resistors meet your most exacting circuit requirements

You'll find Corning High-Power and High-Frequency Resistors designed for stable, long-life service—even under the most difficult operating conditions.

With Corning Resistors you get the highest resistance range for a given physical size compared to wire-wound resistors.

Their thin-film construction makes them inherently non-inductive. The noise level of these resistors is so low it's difficult to measure. The resistive film is a metallic oxide, fused to the PYREX® glass core at red heat to form a permanent bond. This special glass insures highest core resistivity even at elevated temperatures, great resistance to chemical attack and to mechanical and thermal shock.

These Corning Resistors are remarkably stable regardless of mois-

ture and humidity.

*They meet all characteristics of MIL-R11804B.*

The chart in the next column gives you a quick idea of their exceptional frequency characteristics.

The ranges and ratings shown in the illustration are for our standard lines, but we can design and build resistors to match your own requirements for all usable frequencies. We have made specials with ratings up to 150 kw. and we can go higher.

Within the standard range of these resistors, we can give you wide variations in mounting hardware. You can get hardware for vertical or horizontal mountings and mountings to absorb mechanical shock and severe vibration. Ferrule-type terminals are available for use with standard fuse clips.

For more complete details, write for catalog sheets.

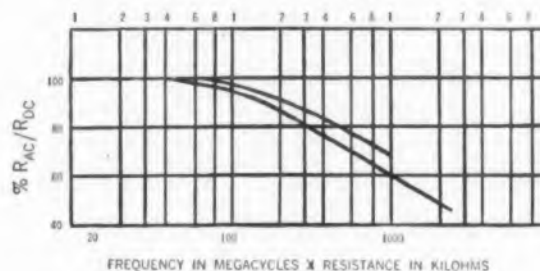

*Keep your file up-to-date with data on these other electronic components made by Corning in addition to the Types R\*, H, and HP Resistors: Low Power, Types N, S\*, and WC-5; Capacitors: Fixed Glass\*, Transmitting, Canned High-Capacitance, Subminiature Tab-Lead, Special Combination. Direct Traverse\* and Midget-Rotary\* Trimmers. Metallized: Glass Inductances; Attenuator Plates; Fotoform Glass; Electrolytic Level Switches.*

\*Distributed by Erie Resistor Corporation

Corning means research in Glass



**CORNING GLASS WORKS, 97-10 Crystal Street, Corning, N. Y.**

Electronic Components Sales Department

CIRCLE 138 ON READER-SERVICE CARD FOR MORE INFORMATION

## New Products

### Miniature Rotary Switch

Fits in 1-1/8 In. Circle



A tiny rotary switch that will fit in a 1-1/8 in. circle, requiring less than one sq in. of panel area, is supplied in 8, 10, and 12-position wafers, with the latter providing up to 18 insulated contacts. Standard shaft diameter for the new Series A is 1/4 in., but 5/32 and 1/8 in. shafts are also available. Clips are a miniature version of a double-wiping design. They are formed from either solid spring-silver alloy or silver-plated spring brass. Solid rivets fasten clips to the switch sections. Silicone fiber glass, meeting specification MIL-997 Type GSC, is used for the switch stator. The rotor is punched from KEL-F.

Oak Mfg. Co., Dept. ED, 1260 Clybourn Ave., Chicago 10, Ill.

CIRCLE 139 ON READER-SERVICE CARD FOR MORE INFORMATION

### Plug-In Amplifier

5 Mv Per Cm, for 10 Mc Scope



The Model 151A, a high sensitivity plug-in vertical amplifier for the Model 150A 10 mc oscilloscope has an input sensitivity of 5 mv per cm from dc to 10 mc and features low drift. After 1/2 hr warmup trace drift is less than 1 cm per hr. Input sensitivity is selected by a single selector switch from 5 mv to 20 v per cm. A vernier control extends the sensitivity to approximately 50 v per cm. Etched circuitry is used for performance and accessibility, and to simplify servicing and tube replacement.

Hewlett-Packard Co., Dept. ED, 275 Page Mill Rd., Palo Alto, Calif.

CIRCLE 140 ON READER-SERVICE CARD FOR MORE INFORMATION



### Crash-Resistant Magazine Protects Oscillograph Recordings

Designed for the protection of oscillograph recordings in flight-test work, the 5-032 record magazine will withstand 400-g shock and 2,000 F fire. It is explosion-proof in accordance with military standards. Particularly made to fit the company's Type 5-119 oscillograph, the magazine consists of a ductile-iron casting, surrounded by a stainless-steel shell. The space between the casting and shell is filled with foamed silicone resin to provide heat insulation. In addition, the outer shell is painted with a fire-resistant paint. This paint foams at about 300 F and forms a thick insulating layer. The magazine is 8 in. wide, 12-1/2 in. high, and 17 in. long. With a full roll of paper it weighs 80 lb.

Consolidated Electrodynamics Corp., Dept. ED, 300 North Sierra Madre Villa, Pasadena, Calif.

CIRCLE 141 ON READER-SERVICE CARD FOR MORE INFORMATION

### Radiation-Monitoring System Completely Self-Contained



This self-contained radiation monitoring system, Model GA-3B, has been engineered to provide accuracy, stability, and reliability. The unit is battery-operated and assures continuous operation for a period of 4 months or over. The system consists of a control unit with meter relay, manual reset, 3 or 6 decade log scale, calibration controls, electronic calibration test adjustments and 10 mv recorder output. The system incorporates calibration methods allowing complete electronic check and adjustments at both ends of the scale independent of radiation. The unit will measure, display, record and control alarms for gamma radiation from background 0.025 mr/hr to 100 kr/hr or higher in the range from 80 kv to 1.3 mev. The detecting units or chambers are of the pressurized ionization type stainless steel 0.02 wall and are equipped with removable amplifiers. Entire chamber unit is housed in a waterproof aluminum 3-1/2 x 9 in. container.

Higgs Nucleonics Co., Dept. ED, 2390 Olive Ave., Altadena, Calif.

CIRCLE 142 ON READER-SERVICE CARD FOR MORE INFORMATION

ELECTRONIC DESIGN • October 15, 1957



**JUNIOR VoltOhmyst® WV-77C**—Biggest value in vacuum-tube volt-ohmmeters! Factory tested and calibrated to lab standards. Measures dc from 100 millivolts to 1200 volts; ac from 100 millivolts to 1200 volts rms; resistance from 0.2 ohm to 1,000 megohms. User Price **\$59.50\***



**SENIOR VoltOhmyst® WV-98A**—Improved circuit provides greater accuracy, 3% on BOTH ac and dc measurements. Measures directly the peak-to-peak values of complex wave forms and rms values of sine waves. **LARGE** full-vision meter, with less than 1% tracking error, provides one of the easiest reading VTVM scales. User Price **\$79.50\***



**MASTER VoltOhmyst® WV-87B**—Ideal for TV, radar and other types of pulse work. Has accuracy and stability necessary for laboratory applications. Features  $\pm 1\%$  multiplier and shunt resistors; a  $\pm 2\%$  meter movement; DC polarity reversing switch; zero-center scale adjustment for discriminator alignment;  $\pm 3\%$  accuracy on AC and DC voltages, many other features. User Price **\$137.50\***

## FOR YOUR LAB OR LINE



**ELECTRON-TUBE MicroMhoMeter WT-100A**—Accuracy suited for electronic equipment manufacturers, research and development, maintenance groups. Precision tube testing under actual circuit conditions. Built-in "shorts" test; burnout protected meter; regulated power supplies for dc voltages; measures gm up to 100,000 micromhos in 6 ranges. User Price **\$785.00\***



**ULTRA-SENSITIVE DC MICROAMMETER WV-84B**—Popular choice in industrial, chemical, general lab applications. Designed to measure extremely "feeble" currents, extremely high resistances. Self-contained batteries permit use almost anywhere. Low-drain tubes extend battery life, meter protected from accidental overloads. User Price **\$110.00\*** (less batteries)



**5" OSCILLOSCOPE WO-66A**—An all-purpose scope for general lab use, production-line alignment and testing. Built-in voltage calibrating facilities permit simultaneous waveshape display and peak-to-peak voltage measurements. Sync polarity instantly reversible with front panel switch. Directly coupled, push-pull amplifiers in vertical circuit provide flat response down to dc. User Price **\$179.50\***

## CHOOSE AN RCA DESIGN!



**5" OSCILLOSCOPE WO-91A**—Dual Band 4.5 Mc scope, for waveshape observation and measurement, signal tracing and alignment of chrominance circuits and wide-band amplifiers—voltage-calibrated input step-attenuators and calibrated graph screen make possible direct voltage readings as easily as with a VTVM. User Price **\$239.50\***

\*User Price (Optional)



**7" OSCILLOSCOPE WO-56A**—For phase measurements or vector display—7-inch screen plus trace expansion of 3 times screen diameter provide unusually large waveshape display for distant or close examination of minute portions of waveshapes. Frequency-compensated voltage-calibrated attenuators in both "V" and "H" amplifiers. User Price **\$289.50\***



**5" OSCILLOSCOPE WO-78B**—Famous "engineer's choice" dual-band scope for use when extra sensitivity and extended frequency response are required. Uses flat-faced cathode-ray tube with post-ultra potential of 3000 volts; automatic sync limiting; push-button for calibration checking; excellent phase characteristics; full screen deflection over entire rated frequency range. User Price **\$475.00\***

For fast delivery of the best in test instruments for lab, line or shop... call your RCA Distributor!



# RADIO CORPORATION of AMERICA

COMPONENTS DIVISION

CAMDEN, N. J.

CIRCLE 471 ON READER-SERVICE CARD FOR MORE INFORMATION

## Another Application for FERRAMICS®

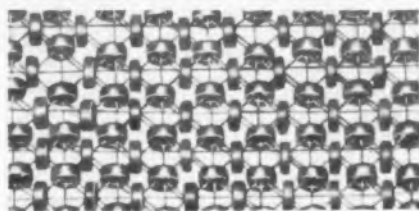

Section of typical memory plane enlarged approximately 3 times.

### Ferramic® Cores help IBM Sage Computer Perform Amazing Feats of Memory

General Ceramics Magnetic Memory Cores play an important role in the reliable functioning of the Sage Computer. G-C engineers developed rectangular hysteresis loop ferrites and worked closely with Lincoln Laboratories at MIT and IBM to perfect toroids with the required magnetic properties for this vital defense system.

These dependable components provide increased speed and accuracy for computers and automatic controls. General Ceramics cores and completely assembled memory planes are available for automation systems. For complete information write today to General Ceramics Corporation, Keasbey, New Jersey—Dept. ED.

## GENERAL CERAMICS

Industrial Ceramics for Industrial Progress... Since 1906



FERRAMIC CORES



MAGNETIC MEMORY CORES AND PLANES



PRECISION STEATITES



"ADVAC" HIGH TEMPERATURE SEALS



SOLDERSEAL TERMINALS

CIRCLE 143 ON READER-SERVICE CARD FOR MORE INFORMATION

## New Products

### Subminiature Capacitors

1/10 In. Diam



Known as the STNT line, these tantalum capacitors measure 1/4 in. in length by a little over 1/10 in. in diam. They are available in five ratings from 40 mfd at 3 v to 4 mfd at 50 v. Of tantalum construction, the capacitors are designed for operation over a temperature range from  $-55$  to  $+85$  C. They feature metal cases, true hermetic seals, axial leads, and an exceptionally high resistance to mechanical shock.

P. R. Mallory & Co., Inc., Dept. ED, 3029 E. Washington St., Indianapolis, Ind.

CIRCLE 144 ON READER-SERVICE CARD FOR MORE INFORMATION

### Paralleling Reactors

Equalize Current



With this PR 1600 paralleling reactor, equalization of current distribution to selenium stacks, germanium and silicon rectifiers operated in parallel, variable transformers, adjustable reactors and rheostats, is possible. This unit is rated at 1600 a rms for a 50 C temperature rise, with normal convection cooling. When forced air cooled, 1000 lfm, their rating can be increased to 2200 a rms. The PR 1600 functions in the same way as a current transformer with a one-to-one ratio, forcing equality of current in its windings, even if connected to two junctions of different forward voltage drop.

International Rectifier Corp., Dept. ED, 1521 E. Grand Ave., El Segundo, Calif.

CIRCLE 145 ON READER-SERVICE CARD FOR MORE INFORMATION



## Constant Speed Drive

High Stability by Mechanical Means



Designed to maintain 400 cps ac generator speed constant in aircraft installations regardless of variation in input speed or electrical load, this initial unit is a 20 kva size, and is smaller and lighter than comparable units. The drive eliminates the requirement for a large number of precision parts through a simple mechanical approach, proven by continuous endurance stand operation at high loads and with oil in temperatures up to 302 F. Stability of  $\pm 0.25$  per cent is provided.

Avco Manufacturing Corp., Lycoming Div., Dept. ED, 550 S. Main St., Stratford, Conn.

CIRCLE 146 ON READER-SERVICE CARD FOR MORE INFORMATION



**Rack Handle**  
Locks and Seals

A triple purpose latch designed for heavy duty use, provides a vibration-proof seal on electronic chassis. Composed of two working parts for each assembly, latch and adjustable fork, this unit, identified as 27L, acts as lock, pull, and handle. Its size, 2 x 4.75 in. and 0.625 in. in diam, and its weight, permit easier handling of heavy equipment. Fork and latch are interchangeable with those of earlier series 21L.

Another development is the adjustable feature of the fork to meet mounting tolerance specifications and allow use of higher friction forces. Latch sizes accommodate a minimum panel size of 5 in. A 6 lb maximum load disengages the handle lock; maximum horizontal working load is 400 lb, ultimate load, 600 lb.

Cumloc Fastener Corp., Dept. ED, 22 Spring Valley Rd., Paramus, N.J.

CIRCLE 147 ON READER-SERVICE CARD FOR MORE INFORMATION

ELECTRONIC DESIGN • October 15, 1957

# HETHERINGTON

SWITCHES • INDICATOR LIGHTS • SPECIAL ASSEMBLIES

## ENGINEERING NEWS #7

### ILLUMINATING ANSWERS FOR COMPUTER PROBLEMS

A newcomer to the Hetherington indicator light line is this low-cost series for analog and digital read-out devices, computers, and a host of precision instruments. Dubbed the "Digicator" series, these subminiature lights provide an attractive, easily-mounted display of numerals, letters or symbols in minimum space.

Figures engraved on black plastic lenses are boldly illuminated by midsize flange-base AN3140-type incandescent or neon lamps. Serrated spring metal fingers snap lenses and lamps into positive contact—yet allow lenses to be freely rotated to position the figures. A slight pull removes both lens and lamp in one operation for quick, front-of-panel lamp replacement.

Digicator light sockets are available individually, in strips, or as special assemblies to meet individual requirements. To allow lights to be grouped

closely together, the usual mounting nut and lock-washer have been replaced with an integral collar which is flared to the mounting surface—like an eyelet—using an inexpensive flaring tool and anvil.

Special patch cord plugs are available to convert any group of Hetherington Digicator sockets into a complete, low-cost program board. Simply by substituting patch cords for desired lens and lamp assemblies in a read-out panel, for instance, electrical signals can by-pass the visual stage and feed other equipment directly.

Full details on the entire Digicator line are shown in Hetherington's new four-page Data Bulletin L-4—available upon request.

CIRCLE 148 ON READER-SERVICE CARD



### Push-On, Push-Off Switching

FOR SAFETY AND CONVENIENCE



Hetherington "Push-Push" Switches have long been familiar to airline passengers as reading light switches. Now, they're also finding important new industrial uses where their maintained contact pushbutton action offers added convenience and sales appeal, as well as eliminating the hazards of protruding toggles.

Both types have sturdy escapement-type mechanisms that provide positive snap action with moderate operating pressures. The large J100 Series carries a husky 15 amps (inductive) at 28v dc. The considerably newer, and smaller J4000 Series measures only 1 1/2" overall, yet carries a full 3 amps (inductive) at 28 volts.

Dimensions and full specifications on Hetherington "Push-Push" switches will gladly be sent on request.

CIRCLE 150 ON READER-SERVICE CARD



HETHERINGTON INC. DELMAR DRIVE, FOLCROFT, PA. • 139 Illinois St., El Segundo, Calif.

NOW IN LARGER FACILITIES TO SERVE YOU BETTER

### MOISTUREPROOF SWITCHES

Discipline 10 "Airborne Amps"

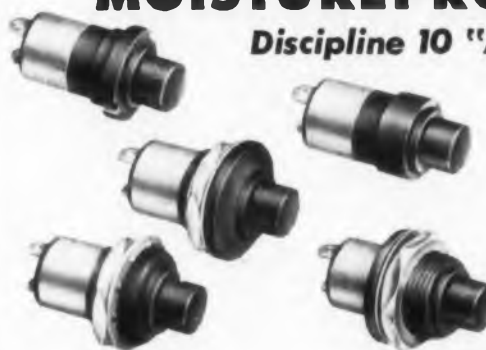

Ordinary "earth-loving amps" are fairly well behaved and reasonably predictable. Put them on a plane, however, and it's a different story. Combinations of altitude, humidity, and cramped quarters make them a bit tipsy and rambunctious—often setting off heated battles with nearby components.

For years now, Hetherington W100 Series pushbutton switches have successfully chaperoned these charges on thousands of military and commercial flights. Specially trained by MIL-S-6743 in the care and handling of amps, these tiny snap-action switches resist salt spray, corrosion, shock, vibration and most other temptations. Each can keep 10 amps (@ 28v dc, resistive) in tow for more than 25,000 operations before its equanimity becomes disturbed.

The entire Hetherington W100 Series includes six different contact arrangements and three button styles. There's also a choice of eight plain- or color-anodized aluminum mounting adapters—including MS25089 types A thru E. Dimensions and full specifications are shown in Bulletin S-2.

CIRCLE 149 ON READER-SERVICE CARD

reliability...for the nerve centers of these mighty



over 7000  
Westmold  
transformers  
helping the air force  
stay in the air

Operating through a wide range of temperatures and altitudes, electrical systems of the giant Boeing KC-135 tankers serving the Boeing B-47 and B-52 demand the utmost reliability from their components. Over 7000 Westinghouse Westmold transformers in MAGAMP\* voltage regulators for electrical systems of these and other Air Force planes are proving that they have this dependability—under all operating conditions. The low-voltage type Westmold transformers are molded of a flame-resistant plastic material which maintains its flexibility at extreme temperatures. Westmold transformers pass the type "C" thermal shock test of MIL-C-16923 — heating to 130°C, then plunging into a -55°C alcohol-dry-ice bath.

Exclusive dimensional fidelity is assured — the shape of the transformer is fixed by the mold into which it is poured. In addition, the thicker coating of resin afforded by molding, plus completely filled, void-free coils, increases the transformer's ability to withstand high humidity.

For further information, contact your Westinghouse representative, or write Westinghouse Electric Corporation, Specialty Transformer Department, P. O. Box 231, Greenville, Pennsylvania.

\*Trade Mark.

J-70823

YOU CAN BE SURE...IF IT'S

Westinghouse



CIRCLE 151 ON READER-SERVICE CARD FOR MORE INFORMATION

## New Products

### Composite Metal Strip For High Temperature and Frequency

This metal is silver-clad-on-copper, and is precision-rolled in all thicknesses down to foil gages, to thickness tolerances as close as  $\pm 0.0001$  in. Applications include miniaturized high-temperature coils, high-frequency conductors, connectors, tabs on step switches, and radar cable braiding.

The silver is metallurgically bonded to the copper base under extreme heat and pressure. The result is a metal with the characteristics of both silver and copper, but occupying the space of a single metal. Oxidation-resistance at high temperatures, excellent resistance to atmospheric corrosion, and exceptional electrical conductivity are some of the important characteristics.

American Silver Co., Dept. ED, 36-07 Prince St., Flushing 54, N.Y.

CIRCLE 152 ON READER-SERVICE CARD FOR MORE INFORMATION

### Transistorized Power Supply Regulated DC



A complete line of ac to dc regulated power supplies utilizing power transistors in the regulator stages has been developed using no magnetic amplifiers or vacuum tubes in the circuitry. This all solid state power supply provides voltage regulation of better than  $\pm 0.25$  per cent for load changes of 0 to 5 amp, and for variations of 105-125 v ac. The ripple is less than 3 mv peak to peak at rated load and the response time from no load to full load is 5 msec or faster. The transient peaks are held to less than one volt overshoot for load changes from full load to no load or no load to full load. There is virtually no transient from power off to power on.

The MIP series of regulated power supplies is available with nominal output voltages of 28 VDC, with a voltage adjustment range of 10-30 VDC. The input is 115 v  $\pm 10$  per cent, either 60 cycle or 400 cycle. The Model MIP-150-1R is rated at 28 VDC output, 0 to 5 a, this unit weighs approximately 30-35 lbs. Available with a standard 5-1/4 in. high relay rack panel or in a cabinet with meters.

Modern Industries, Inc., Dept. ED, 2601 Colorado Ave., Santa Monica, Calif.

CIRCLE 153 ON READER-SERVICE CARD FOR MORE INFORMATION

### Transistor Power Supply Regulated Voltage and Current



Designed specifically for transistor engineering, this supply will avoid damage to transistors due to overvoltage. Model CV-10-10 delivers regulated voltage or current in 4 ranges up to 100 v or ma.

Oregon Electronics, Dept. ED, 2105 S. E. Sixth Ave., Portland, Oreg.

CIRCLE 154 ON READER-SERVICE CARD FOR MORE INFORMATION

### New DPDT Switch One-Way Action



This die-cast switch provides simultaneous, one-way action on two poles. Exclusive one-way action results in an electrical impulse on the inward stroke and does not operate the switch on the return to its normal position. The snap-action of the four circuit switch mechanism is totally independent of the speed of the plunger movement. The dpdt basic switch is housed in an aluminum die-cast case with a splash proof neoprene boot to protect its switching mechanism. The ES4-DM3 is designed to eliminate complicated one way dogs, extra switches, and costly relays. It is claimed to be excellent for pulsing electrical control on both pneumatic and hydraulic valves and other similar installations requiring momentary one-way electrical impulses. The simultaneous break of two poles permits great flexibility in wiring variations.

Electro Snap Switch & Mfg. Co., Dept. ED, 4218 West Lake St., Chicago 24, Ill.

CIRCLE 155 ON READER-SERVICE CARD FOR MORE INFORMATION

# B.F. Goodrich



## New low reflective absorber makes free space tests more reliable

Ten times *lower* reflection is now available with all B. F. Goodrich Microwave Absorbers. This 0.1% material gives reliability to measurements previously unattainable for testing of guided missiles in a free space chamber.

You can now be sure, by selecting the proper B. F. Goodrich material, that you will get this 0.1% performance at any point on the microwave frequency spectrum.

In addition to this outstanding quality, the B. F. Goodrich absorber is light-weight, fire-retardant, easy to install. It will not deteriorate in performance when walked upon and has excellent water and weather resistant properties. For darkroom use, a special

white compound can be applied to the surface of the pads to increase light reflectance.

When you're investing thousands, start right—specify B. F. Goodrich—the company with the longest experience and record for *consistently* high quality microwave material. For new booklet on these absorbers write B. F. Goodrich Sponge Products, a division of the B. F. Goodrich Company, 394 Derby Place, Shelton, Connecticut.

List of B. F. Goodrich Broadband Absorbers

Designation	Lowest Frequency*	Thickness	Maximum Reflection
12 CM	2500 mc	1½"-2"	2%
12 CM - 1%	2500 mc	1½"-2"	1%
12 CM - 30db	2500 mc	1½"-2"	0.1% at X-band. 2% elsewhere.
6 CM	5000 mc	1"	2%
30 CM	1000 mc	3½"-4"	2%
30 CM - 1%	1000 mc	3½"-4"	1%
60 CM	500 mc	7"-8"	2%
60 CM - 1%	500 mc	7"-8"	1%
100 CM	300 mc	10"-11"	2%
200 CM	150 mc	26"	2%
600 CM	50 mc	69"	2%
8 CM-glass fiber	3600 mc	1"-1½"	2%
4 CM-glass fiber	7500 mc	¾"	2%

Most of the above absorbers can be furnished with 0.1% maximum reflection at selected points in the frequency band.

\*All perform up to 30,000 mc

CIRCLE 156 ON READER-SERVICE CARD FOR MORE INFORMATION

**B.F. Goodrich**

SPONGE PRODUCTS

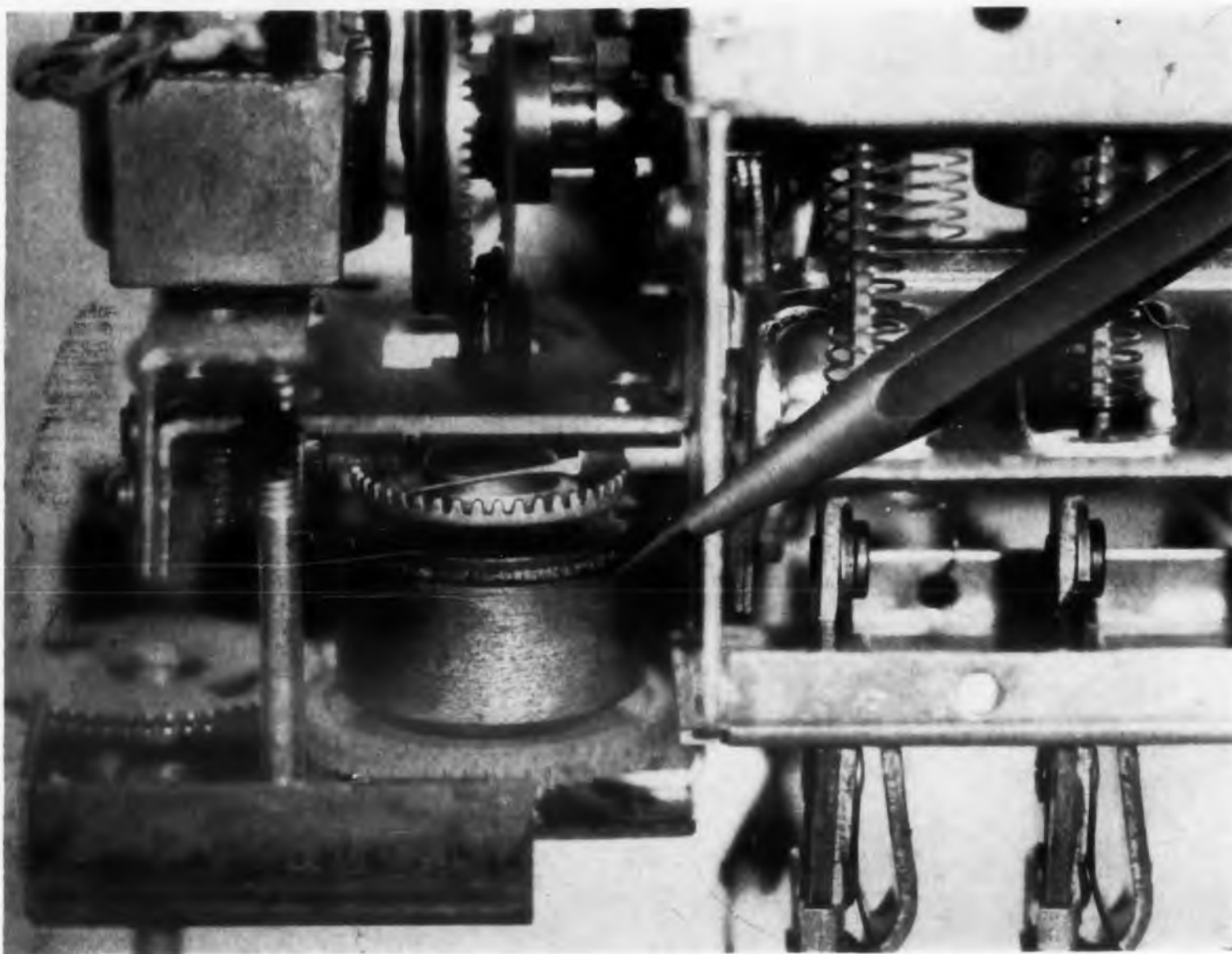

## New low cost magnetic clutches from



Now you can get the same magnetic clutches used in today's finest signal seeking radio tuners. Originally designed by R/C for the rigid price-performance requirements of the automotive industry, they are finding new applications throughout electrical manufacturing. Designers are using them to replace cumbersome, complex assemblies . . . to save space and eliminate costly production steps. They show further promise in accomplishing jobs now being wastefully done with heavy duty and servo types at fifty to one hundred times the cost.

Two types of R/C magnetic clutch are in high volume production now. Designed for operation at from 11 to 16.2VDC, they are also available for 32V operation . . . and can be further modified to meet your special requirements.

We'll be happy to send you complete information on the two types shown, or if you wish, we'll have an R/C engineer at your desk ready to work with you to better fit R/C clutches to your needs.



CIRCLE 157 ON READER-SERVICE CARD FOR MORE INFORMATION

## RADIO CONDENSER CO.

Davis & Copewood Streets • Camden 3, New Jersey  
 EXPORT: Radio Condenser Co., International Div., 15 Moore St., N.Y. 4, N.Y.  
 CABLE: MINTHORNE  
 CANADA: Radio Condenser Co. Ltd. 6 Bermondsey Road, Toronto, Ontario

Operating Characteristics Of New R/C Magnetic Clutches	
Voltage	11 to 16.2V 32V also available
Torque	8 in.-oz. minimum
Residual Torque	0.3 in.-oz. maximum
Operating Temperature	130F to -20F
Relative Humidity	tested to 95%
Life	successfully completed 120,000 operations with no sign of failure

## New Products

### 2-Pin Pilot Light Indicator For Mass Production



A low-cost 2-pin lamp socket and holder designed for mass production applications in TV and radio sets, ranges and other appliances using small indicator lights, designated the Model 1K, is designed for use with the GE No. 10, 12 and 15 two-pin indicator lamps. Made of high-impact melamine, with terminals of cadmium-plated beryllium copper.

Two types of mounting fasteners are available for the holder. One, a steel clip with a black oxide finish, clamps the holder firmly on three sides, and may be riveted or screwed to a flat surface. The other type is a lower-cost push-on fastener, made of cadmium plated steel, which is mounted without rivets or other materials. Available in production quantities with or without bulbs or clips.

Eldema Corp., Dept. ED, 9844 Remer St., El Monte, Calif.

CIRCLE 158 ON READER-SERVICE CARD FOR MORE INFORMATION



### Differential Pressure Transducer

1 Per Cent Accurate

The Model P3D is a magnetic reluctance pressure transducer for the measurement of differential pressure in ranges from 0-0.1 to 0-500 psid, at line pressures up to 5000 psi. A magnetic diaphragm pressure sensing element controls the inductance ratio between two pickoff coils embedded in the case on either side, and the effect is utilized in an ac bridge circuit to give a voltage output proportional to applied differential pressure.

Pace Engineering Co., Dept. ED, 6914 Beck Ave., North Hollywood, Calif.

CIRCLE 159 ON READER-SERVICE CARD FOR MORE INFORMATION

### Miniature Solenoid

For Missile Control Use

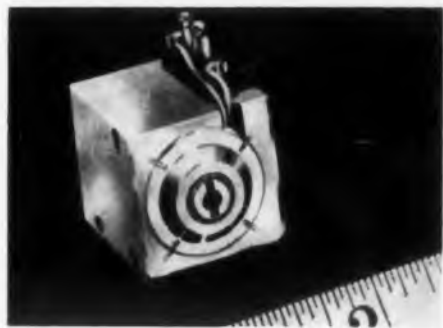

This linear-stroke solenoid measures about 0.6 in. cube and is designed for instrumentation and missile control. Weighing less than an ounce, the solenoid is made of CR steel finished in cadmium plate. Operating on 28 v, the splunger stroke bridges a gap of 0.008 in. at 24 v and exerts a minimum pull of 6 oz.

J. A. Maurer, Inc., Dept. ED, 37-01 31st St., Long Island City, N.Y.

CIRCLE 160 ON READER-SERVICE CARD FOR MORE INFORMATION

### Electrical Insulation Testers

2100 V AC to 2500 V DC



The 16 lb Model 122 quickly checks insulation of products for resistance, power factor, and breakdown strength. Useful in the engineering lab, in field testing, and in maintenance service, this tester features a sensitive voltmeter, a dual-range leakage microammeter, compensator for cancelling capacity effects, continuously variable testing voltage, high sensitivity arc detector, and limited current output for safety. Requires no warm-up period, and is permanently calibrated.

Standard stock Model 122 has a test voltage range to 2100 v ac with a microamp leakage meter providing an overall useful range to more than 200 meg ac insulation resistance. Arc detector sensitivity is better than 20  $\mu$ a. Companion stock Model 125 tester is a dc unit having a test voltage range to 2500 v dc with a microamp leakage meter providing an effective range to more than 500 meg dc insulation resistance. Both the Model 122 ac tester and the Model 125 dc tester are available in other ranges to 10,000 v.

Saughter Co., Dept. ED, Piqua, Ohio.

CIRCLE 161 ON READER-SERVICE CARD FOR MORE INFORMATION

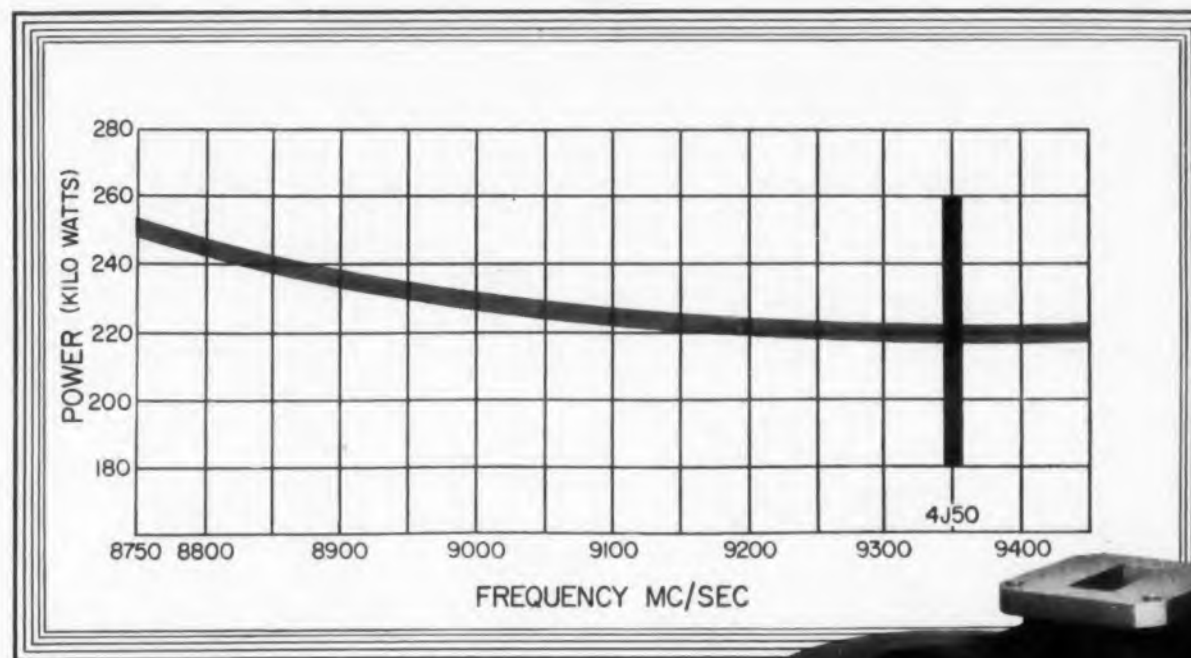

Sylvania duplicates the power and package of the 4J50 in a...

# Tunable Magnetron

Type 6874

Adds flexibility to existing equipment as well as to new designs

Sylvania sets the pace in magnetrons with its newest, high-powered tunable unit, type 6874, that covers the frequency range between 8800 and 9400 Mc. The tunable 6874 directly replaces the fixed frequency 4J50 magnetron. It provides rapid and inexpensive conversion of fixed frequency systems to meet latest military requirements.

Designed for airborne radar and missile applications, the 6874 is mechanically ruggedized for severe shock and vibration requirements. Thus a very compact tunable package is provided even for very severe environmental conditions.

#### Typical Characteristics:

Heater Voltage (Preheat)	13.75 Volts
Heater Current	3.00—3.75 Amps
Peak Anode Current	27.5 Amps
Peak Power Output	200 KW nominal
Peak Anode Voltage	21 KV
Pulse Duration	1.0 $\mu$ sec (3.34 sec max)
Duty Cycle	.001

#### Sylvania moves ahead in Magnetrons

With tripled magnetron production facilities now in operation at its Williamsport, Pa., plant, Sylvania meets expanding military and commercial needs. Call your Sylvania representative for full information on the complete Sylvania magnetron line.



Sylvania's Williamsport, Pa., plant houses expanded magnetron production facilities

# SYLVANIA

SYLVANIA ELECTRIC PRODUCTS INC.  
1740 Broadway, New York 19, N. Y.  
In Canada: Sylvania Electric (Canada) Ltd.  
Shell Tower Bldg., Montreal

LIGHTING

RADIO

TELEVISION

ELECTRONICS

CIRCLE 162 ON READER-SERVICE CARD FOR MORE INFORMATION

**new and unique!**



**Eliminate  
Breadboard Layout!  
SPEED DESIGN OF TRANSISTOR CIRCUITS  
With the SPRAGUE TRANSIMULATOR**

Bring transistor circuits to life in a matter of minutes with the Sprague LF-1 Transimulator. This new instrument lets you simulate any amplifier stage, a-c or direct-coupled, short of high power audio output; also multivibrator, switching, phasing, push-pull, Class A and B, and many others using cross-coupled Transimulators . . . whether the circuit is common or grounded emitter, base, or collector . . . whether the transistors are PNP, NPN, or Surface Barrier. You can simulate circuits stage-by-stage for cascade operation . . . or use a separate Transimulator for each stage to get simultaneous multi-stage operation.

**Bring Circuit Diagrams To Life In Minutes**

Everything you need for RC amplifier circuits is built right into the LF-1, including coupling capacitors . . . bias and load resistors . . . battery voltage supplies . . . Base Collector—Voltage Divider stabilization circuits . . . 5-way binding posts for transformer coupling and metering.

Whether you're designing audio circuits or switching circuits, you'll get a true picture of operating parameters minutes after you've drawn the circuit diagram . . . without wasting valuable time with breadboard and soldering gun.

**Pays For Itself In A Matter Of Weeks**

An ideal laboratory instrument, Transimulators are inexpensive enough to justify several on every bench. You can even use the LF-1 to test transistors *in the circuit* . . . the only real proof of design parameters. And a complete step-by-step instruction manual makes operation fast, simple, and easy.

**FEATURES OF THE LF-1 TRANSIMULATOR**

- TRANSISTORS—PNP and NPN Junction, and Surface Barrier.
- CIRCUITS—Common or Grounded Emitter, Base, Collector.
- RANGE—Audio, up to 100 kc.
- TRANSISTOR POWER—Through medium power audio output.
- BATTERY SUPPLY—Separate bias and load, 1.5, 3, 4.5, 6 volts d-c. Polarity Reversing Switch.
- COUPLING—2  $\mu$ f and 20  $\mu$ f Direct, and Ext. C. posts, on both Input and Output.
- BIAS RESISTANCE—Up to 555,000 ohms continuously variable.
- LOAD RESISTANCE—Up to 277,500 ohms continuously variable.
- EMITTER RESISTANCE—Up to 2,500 ohms variable. Series resistor and bypass capacitor can be added.
- BASE COLLECTOR STABILITY—Up to 250,000 ohms variable. Series resistor and bypass capacitor can be added.
- VOLTAGE DIVIDER STABILITY—Up to 50,000 ohms variable.
- 5-WAY BINDING POSTS—For meters, transformer coupling, external supply voltage, degeneration, bypass, coupling, signal input and output, almost any connection required.

**only \$79.50  
NET**

**SPRAGUE®**

SPRAGUE PRODUCTS COMPANY, NORTH ADAMS, MASSACHUSETTS

CIRCLE 163 ON READER-SERVICE CARD FOR MORE INFORMATION

**New Products**



**Three Speed  
Hysteresis Motor  
For Tape Recorders**

This three speed hysteresis motor provides tape speeds of 3-3/4, 7-1/2, and 15 in. per sec with a direct drive. Precision ground capstans are held to close concentric and diametral tolerances and designed as an integral part of the rotor shaft to insure accurate velocities with minimum of flutter. Quiet in operation, these motors are ideal as a precise drive for recording and reproducing equipment such as tape recorders, computer storage drums, turntables, and other devices.

Technical Electronics Corp., Dept. ED, 4060 Ince Blvd., Culver City, Calif.

CIRCLE 164 ON READER-SERVICE CARD FOR MORE INFORMATION

**Micro-Microammeter**

Measures Ion Chamber Currents



Extremely sensitive, the Model 565A Electrometer can detect differences of current as small as  $5 \times 10^{-15}$  a. Accuracy of the system is better than 1 per cent of full scale; stability after the first hour of operation exceeds 1 per cent per 24 hr. Linearity is  $\pm 1$  per cent of full scale. With minimum capacity in the circuit, the RC time-constant is approximately 10 sec. Each additional micro-microfarad of capacity increases the time-constant by 1 sec.

The unit incorporates five ranges of from  $2.5 \times 10^{-9}$  to  $2.5 \times 10^{-13}$  a. Maximum full-scale current sensitivity is  $2.5 \times 10^{-13}$  a; maximum full-scale voltage sensitivity is 0.25 v. The Electrometer operates on 115 v, 60 cycles and draws 35 w. Panel dimensions are 8 x 16 in. and shipping weight is 35 lb.

The Victoreen Instrument Co., Dept. ED, 5806 Hough Ave., Cleveland 3, Ohio.

CIRCLE 165 ON READER-SERVICE CARD FOR MORE INFORMATION



### Tunable Thermistor Mount

34 to 36 Kmc with  
1.5 VSWR

The tunable thermistor mount, with thermistor, is designed for sensitive measurement of rf power in RG-96/U waveguide transmission systems. Frequency coverage is 34 to 36 kmc with maximum vswr of 1.5. The unit may be used over the complete waveguide range (26.5 to 40 kmc) if a higher input vswr is not a consideration. Nominal operating resistance is 200 ohms. Power handling capability is 10 mw max. The insertion loss is determined at 34.86 kmc, and the value is marked with an accuracy of  $\pm 1/4$  db. The critical element is a thermistor bead which is machined from brass and is silver plated. External surfaces are painted with a blue-gray lacquer.

Microwave Associates, Inc., Dept. ED, Burlington, Mass.

CIRCLE 166 ON READER-SERVICE CARD FOR MORE INFORMATION

### Symbol Diagrammer

For MIL-STD-15A and ASA Y32.2

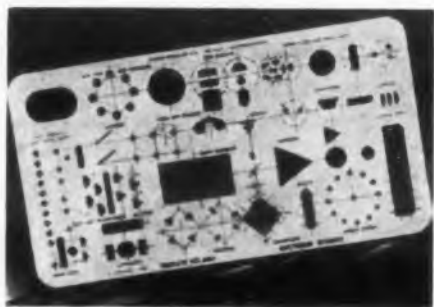

A broad range schematic diagrammer for electronic circuitry work covering the newly revised MIL-STD-15A and American Standards ASA-Y32.2 specifications is expected to be of value in reducing designing and detailing time—as well as making possible a high degree of technical uniformity. Among the sharply engraved symbols it offers are pnp and npn transistors, diodes, electronic tubes, power plugs, pilot lamps, relays, phone jacks, connectors, rotary switches, resistors, capacitors, inductors, transformers, amplifiers and blocks. A user survey showed these symbols to be among the most useful and necessary in TV and radio, electric control work, power layouts, Hi Fi, electrical appliance design, communications, military and commercial instrumentation and medical electronics.

Lawrence Karp, Dept. ED, 16 Putnam Pk., Greenwich, Conn.

CIRCLE 167 ON READER-SERVICE CARD FOR MORE INFORMATION

ELECTRONIC DESIGN • October 15, 1957

## how to make 8000

equal

# INFINITY!

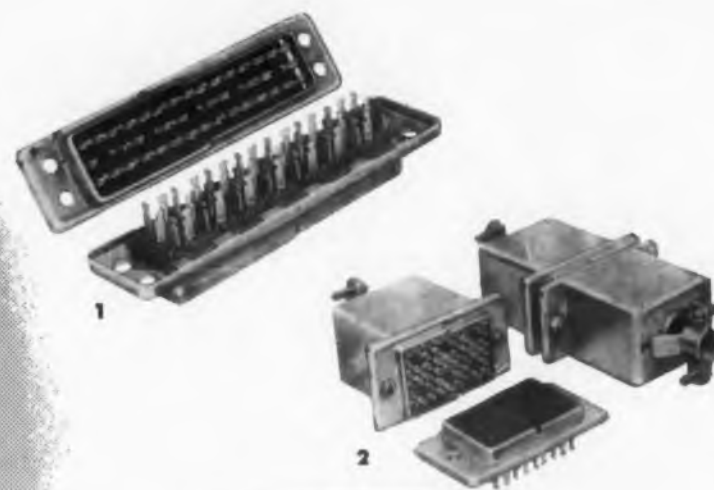

1—40-Contact Rack-and-Panel Single Tier Connector.

2—(Left) 48-Contact Double Tier Cable-to-Panel Connector. (Right) 48-Contact Double-Tier Cable-to-Cable Connector.

3—48-Contact Double-Tier Connector Showing Wire Connections to Contacts; and Honeycomb Insulator.

### ...with 8 to 80 contacts!

Use Elco's new 8000 Series Subminiature Varicon Connectors in an infinite number of applications. Yes, where space is your problem, Elco's 8000 Series is your solution because it offers a maximum number of contacts in minimum space. In addition, it offers Elco's justly famous Varicon mating principle—reliably proven and of proven reliability.

More: it offers the reply to your quest for subminiaturization with assurance of safe, dependable operation of equipment. And, as with all Elco products, it is interesting and important to note that it is competitively priced; in fact, under-priced for such design, operating and quality characteristics. Complete Specifications are yours upon request on your company letterhead. Write today.

IF IT'S NEW...IF IT'S NEWS

...IT'S FROM **ELCO** CORPORATION

1100 MARKET STREET, PHILADELPHIA 24, PA., CU 9-5500

CIRCLE 168 ON READER-SERVICE CARD FOR MORE INFORMATION



Elongation test of sample heelpiece metal typifies quality control measures that leave nothing to chance at Automatic Electric.

STANDARDS THAT DETERMINE RELAY QUALITY /

## a distortion-proof heelpiece

### 53 dimensional checks assure perfect alignment

The heelpiece of a relay is the platform on which all other parts rest. To maintain accurate contact spacing and pressure, the heelpiece must never shift, never twist, never bend.

We insure flatness and dimensional stability on both Class A and Class B relays, by planishing the heelpiece to relieve strains. In addition, we exercise unusual accuracy in the positioning, drilling and tapping of the

holes, in forming the 90° angle bend, and in the contour of the armature end of the heelpiece.

On this single part, fifty-three specified dimensions are maintained and checked—many of which must be accurate to less than 0.002". Rigid tests and inspections safeguard the quality of the raw material itself—a very special sort of magnetic iron.

Care like this in the manufacture of each component makes it clear why Automatic Electric relays are the most reliable that money can buy.

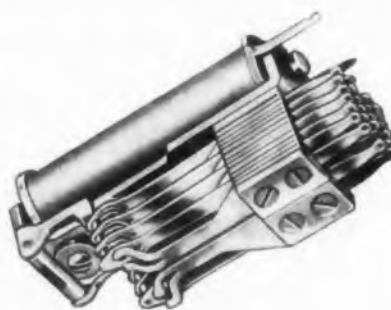

Class "B" Relay, for outstanding endurance and dependability. Write today for Bulletin 537. Address: Automatic Electric Sales Corporation, Northlake, Ill. In Canada: Automatic Electric Sales (Canada) Ltd., Toronto. Offices in principal cities.

**AUTOMATIC ELECTRIC**  
A member of the General Telephone System -  
One of America's great communications systems



CIRCLE 169 ON READER-SERVICE CARD FOR MORE INFORMATION

## New Products

### Regulated Power Supply Uses Transistor Magnetic Amplifier



This precision type transistor-magnetic amplifier regulated 0-60 v at 5 a power supply, contains neither vacuum tubes, moving parts, nor vibrating contacts. With an ac input of 95 to 135 v, single phase at 60 cps its dc output voltage range is 0-60 v at 5 a dc with 1 mv rms maximum ripple. This concept in power supplies is well suited for precision laboratory testing, instrumentation work, transistor circuit testing, production testing of precision type circuits, and in cases where the use of a precisely regulated power supply is necessary.

Perkin Engineering Corp., Dept. ED, 345 Kansas St., El Segundo, Calif.

CIRCLE 170 ON READER-SERVICE CARD FOR MORE INFORMATION



### Accelerometer ±0.5 g to ±150 g

The model 7-31 accelerometer offers temperature controlled damping without use of a heater. Temperature range is -55 to +200 F with less than 1 per cent calibration shift. Acceleration ranges are ± 0.5 g through ± 150 g (or any included non-symmetrical range) with maximum resolution of 0.25 per cent. A mass suspension reduces transverse vibration sensitivity and permits greater side loads without damage or change of calibration. Case dimensions are 1-7/8 in. diam x 2.22 in. ht.

Edcliff Instruments, Dept. ED, PO Box 307, 1711 S. Mountain Ave., Monrovia, Calif.

CIRCLE 171 ON READER-SERVICE CARD FOR MORE INFORMATION

ELECTRONIC DESIGN • October 15, 1957



### Rotary Switch Environment-Free

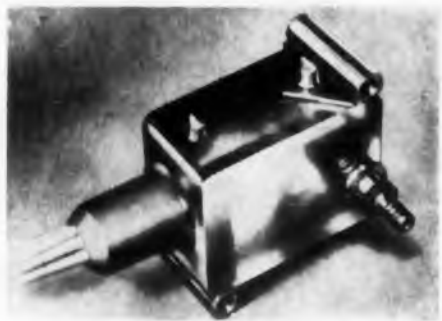

An assembly of two hermetically sealed MS24456-Type basic switches comprises the design for a new line of rotary switches. Completely environment-free, the rotary switch is designed for aircraft landing gear and engine controls, missile launchers, and radar and industrial equipment. It has a current capacity of 10 a, resistive, 30 v dc, 115 v ac. In the C9178 model, shown, the actuator shaft can continuously rotate 360 deg in either direction. Other models have limited-rotation shafts or are spring-returned. Connectors, potted leads and choice of actuators are optional on this line of switches. Engineering samples are now available.

Metals and Controls Corp., Dept. ED, Spencer Thermostat Div., Attleboro, Mass.

CIRCLE 172 ON READER-SERVICE CARD FOR MORE INFORMATION

### Non-Inductive Video Dummy Load

Handles 100 Mw Peak



This non-inductive Model 32A video dummy load is capable of handling up to 100 Mw of peak power and 50 kw of average power and has been tested in operation with 400-kv, 250 a-pulses. It consists of a water load tube, a sump tank containing water whose salinity and conductivity can be varied over wide ranges, a pump to circulate the fluid in the load, the tube-type heat exchanger which can use tap water as the coolant for the dummy-load fluid. Resistance can be varied from the order of a hundred ohms to several thousand ohms suiting it for testing of modulators designed for the pulsing of beam-type tubes and magnetron-type devices.

Levinthal Electronic Products, Inc., Dept. ED, Stanford Industrial Park, Palo Alto, Calif.

CIRCLE 173 ON READER-SERVICE CARD FOR MORE INFORMATION

## glass-base laminates?

## C-D-F DILECTO® is the answer!

Teflon\*, silicone, epoxy, melamine, and phenolic glass-fabric laminates. Polyester glass-mat laminates.

You can improve design, speed production, and save money by specifying one of the many C-D-F Dilecto grades. Whatever your application for these laminates — with fine- or medium-weave glass-cloth base — you'll find a better answer to your problem at C-D-F. (Melamine can also be made with glass-mat base.) And C-D-F offers modern machining and fabrication facilities to deliver production quantities of finished Dilecto parts to your specifications.

See our catalog in Sweet's Product Design File, where the phone number of your nearby C-D-F sales engineer is listed. For free trial samples of glass-base Dilecto, or of any other C-D-F plastics, mica, or fibre product, send us your print or your problem! Write for your free copy of C-D-F Technical Bulletin 64.

\*DUPONT TRADEMARK FOR TETRAFLUOROETHYLENE RESIN

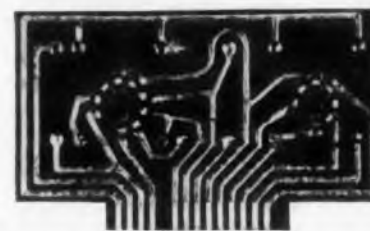

SPEED AUTOMATIC PRODUCTION of printed circuits with warp-resistant C-D-F metal-clad Teflon\* and epoxy laminates. Other advantages: high bond strength of copper to laminate, superior blister-resistance in solder immersion.

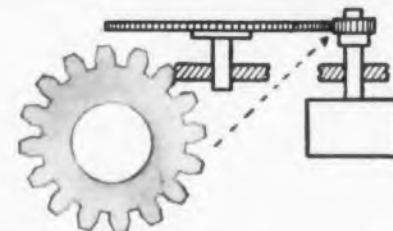

HIGH-VOLTAGE (1800v.) RF ISOLATION is achieved by miniature C-D-F Dilecto gears in an aircraft receiver-transmitter switch. They also had to exhibit dimensional stability through a wide temperature range, resistance to fungus growth and thermal shock.



PRECISE MACHINING AND FABRICATION are standard benefits of Dilecto laminated plastics. These silicone glass-base parts (coil mountings, aircraft terminal board) were sawed, drilled, punched, and milled in production quantities by C-D-F and customer.

### PROPERTIES OF SOME TYPICAL C-D-F DILECTO GLASS-BASE GRADES

Grade	Equivalent NEMA or ASTM grade	Flexural Strength Lengthwise (PSI)	Dissipation Factor at 10 <sup>6</sup> Hz Cond. A	Dielectric Strength Parallel Step x step	Insulation Resistance Cond. C96/35/90	Arc Resistance (seconds)	Maximum Operating Temp. (°C.)
GB-112T (Teflon*)	None	14,000	0.0015	65	100,000	180+	250
GB-12S (Silicone)	G-7	28,000	0.002	60	100,000	180+	200
GB-28E (Epoxy)	G-10	70,000	0.019	65	75,000	130	150
GB-28EFR (Flame-Retardant Epoxy)	G-10	68,000	0.010	65	100,000	180	150
GB-28M (Melamine)	G-5	50,000	0.014	50	100	185	135
GB-261D (Phenolic)	G-1 and G-2	22,000	0.020	55	10,000	5	150
GM-PE (Polyester)	GPO-1	35,000	0.020	70	200	130	150

These are typical grades for typical applications. To meet special requirements, C-D-F makes many other Dilecto grades, one of which may serve your purpose better than any of these listed here. Consult the C-D-F Technical Department for expert assistance with your design problem involving laminated plastics products.



## CONTINENTAL-DIAMOND FIBRE

A SUBSIDIARY OF THE *Budd* COMPANY • NEWARK 107, DELAWARE

CIRCLE 174 ON READER-SERVICE CARD FOR MORE INFORMATION

# More power for its size than any other transistor

## Honeywell Weld-Seal Transistors

More rugged, more compact, more flexible—specifically designed for the following applications:

- *D. C. Power Converters*—(shown at right)
- *Amplifier for Servo Motors*—for control motors or indicator motors
- *Voltage Regulation*

WHERE miniaturization is vital, yet high power is still required, Honeywell's complete line of Weld-Seal Transistors is your best answer.

Honeywell Weld-Seal Transistors combine smaller size per power output with greatest flexibility and interchangeability.

They offer a narrow span of characteristics—along with superior electrical performance and high uniform power gain over a wide range of collector current values.

Honeywell Weld-Seal Transistors are hermetically sealed by *welding*—so you can build new ruggedness and durability into your equipment. You get long life along with outstanding performance.

For complete information on the Honeywell transistor line, write or phone your nearest Honeywell representative:

UNION, N. J.  
MURdock 8-9000  
P.O. Box 161

CHICAGO  
IRving 8-9266  
7350 N. Lincoln Ave.

BOSTON  
ALgonquin 4-8730  
1230 Soldier Field Rd.

MINNEAPOLIS  
FEderal 2-5225  
2749 4th Ave. So.

LOS ANGELES  
RAmond 3-6611 or  
PArkview 8-7311  
6620 Telegraph Rd.



Honeywell Weld-Seal H6 Transistors make this 48-watt, 14 ounce D. C. Power Converter more compact than any other.

Note these new specifications—developed with  
the design engineer in mind

	H5	H6	H7
Input Resistance	24—48 ohms	27— 54 ohms	30— 60 ohms
Power Conductance	17.5—52 mhos	35—105 mhos	71—213 mhos
Current Gain, Median	30	40	60

(At a collector current of 2 amps.)

The H6 and H7 Transistors are available for immediate delivery.

## Honeywell

 *First in Controls*

CIRCLE 175 ON READER-SERVICE CARD FOR MORE INFORMATION

## New Products

### Sine Switch 10 A Capacity at 275 F



This miniature switch, designed to operate continuously at temperatures as high as 375 F and designated KX5, is a high capacity type capable of withstanding severe environmental conditions. Sealing is accomplished with the aid of glass and fused ceramic headers. The switching element is the Sine Blade. Auxiliary leaf, roller, and push button actuators providing additional over-travel are available. The unit has a current capacity of 10 a at 275 F. It is unaffected under rapid cycling from -65 to +375 F within 5 min. Life expectancy is 25,000 cps, minimum under rated load. The switch weighs approximately 1 oz.

Metals & Controls Corp., Dept. ED, Spencer Thermostat Div., Attleboro, Mass.

CIRCLE 176 ON READER-SERVICE CARD FOR MORE INFORMATION

### Transformer Eliminates Servo Saturation



These new servo system components, Models QR-400 and QR-60 Quadrature Rejectors, eliminate the troublesome problem of quadrature in ac servos. Iron saturation in high gain amplifiers is no longer a problem. Interstage unit (transistor or tube) passes signal with 6 db maximum attenuation while rejecting quadrature 40 db minimum. Temperature range -55 to +100 C. Size 1-1/2 in. cube. Available for 400 and 60 cps applications.

Feedback Controls, Inc., Dept. ED, 899 Main St., Waltham 54, Mass.

CIRCLE 177 ON READER-SERVICE CARD FOR MORE INFORMATION

ELECTRONIC DESIGN • October 15, 1957

**Resistor-Capacitors**  
Space Saving Units



Requiring only the space of a tubular capacitor, the Tube-R-Cap incorporates a capacitor and a resistor in parallel on the same body. New sizes have been included to increase the range of applications. The units are described as useful in many design applications, and are particularly suitable for antenna lines. The standard capacity range of the 500 v Type CC20 is 400 to 2150  $\mu\text{f}$ , the resistance tolerance being  $\pm 20$  per cent below 1 meg. The CC25 has a range of 970 to 5000  $\mu\text{f}$ .

Centralab, Div. of Globe-Union Inc., Dept. ED, 900 E. Keefe Ave., Milwaukee 1, Wis.

CIRCLE 178 ON READER-SERVICE CARD FOR MORE INFORMATION

**Multiple Slide Rule**

Solves Electrical Heating Problems

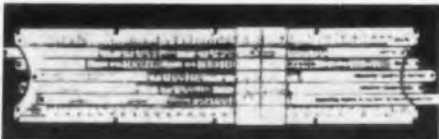

Greatly reducing computation time in the design of wire type electrical heating elements, the Multiple Slide Rule presents a new approach to the determination and selection of various factors vital in the production of helix, flat sinuated, or return-bund ribbon wire type heating elements. With seven easy-to-read slides representing volts, watts, ohms, resistor length, specific resistance, sinuated width or mean diam and wire size, the rule shows the relationship of various factors in any given electrical heating problem at a glance. It permits adjustment of any one factor and gives instantly the effect of the change on all the related factors. The rule gives complete electrical heating answers with one setting.

The application of the multiple slide rule principle lends itself to development of rules for the solution of other design engineering problems. Quotations on slide rules for individual problems will be submitted upon receipt of complete details.

Calorel Co., Dept. ED, 375 S. Main St., Homer City, Pa.

CIRCLE 79 ON READER-SERVICE CARD FOR MORE INFORMATION

**NEW!**  
**1/4-WATT**  
**insulated**  
**hot molded**  
**composition**  
**resistor**  
**only 1/4" long!**

Here's a new 1/4-watt, solid insulated composition resistor in a truly small size . . . ONLY ONE QUARTER OF AN INCH LONG . . . that provides the same superlative performance, reliability, and uniformity which have made the Allen-Bradley hot molded resistor preferred the world over.

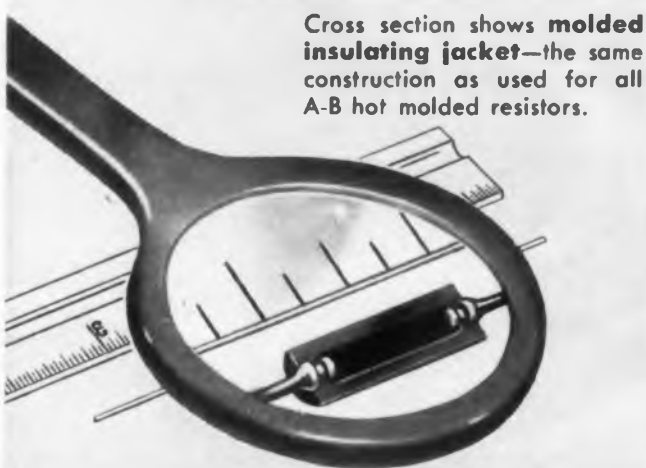

Cross section shows molded insulating jacket—the same construction as used for all A-B hot molded resistors.

Although exceptionally small, Allen-Bradley Type CB hot molded resistors are rated for "continuous operation" at 70°C ambient temperatures. The hot molded construction of this Type CB resistor makes impregnation unnecessary . . . it also provides the most reliable protection against extended periods of high humidity, as encountered in practical applications. Available in all RETMA resistance values from 10 ohms to 22 megohms. Tolerances: 5%, 10%, and 20%.

Where space is at a premium . . . and where failures would be disastrous . . . you owe it to yourself to investigate this new addition to the Allen-Bradley quality line. Please write today for complete specifications. Samples available for your tests.

Allen-Bradley Co.  
1315 S. First St., Milwaukee 4, Wis.  
In Canada—Allen-Bradley Canada Ltd., Galt, Ont.



**OTHER HOT MOLDED RESISTORS IN THE A-B FAMILY**

Allen-Bradley fixed, molded resistors rated at 70°C ambient are available in standard RETMA values from 2.7 ohms to 22 megohms in 1/2 and 1-watt sizes . . . and from 10 ohms in the 2-watt size. In 5%, 10%, and 20% tolerances.

Allen-Bradley solid-molded resistors are packaged for either automatic or manual assembly. A B carton packaging prevents bent or tangled leads. Pressure sensitive tape used to hold resistors in place on reels—for most economical assembly.

**ALLEN-BRADLEY**  
**HOT-MOLDED COMPOSITION RESISTORS**  
QUALITY

CIRCLE 180 ON READER-SERVICE CARD FOR MORE INFORMATION

## New Products

### Terminal Board Teflon Terminals

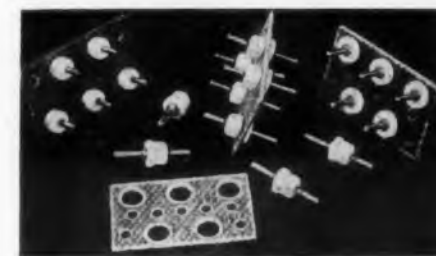

Glass-reinforced plastic sheet and Teflon are used in applications involving vhf and uhf currents, temperature cycling of from  $-65$  to  $-250$  F and shock loads in excess of 10 g. A thickness of less than  $1/64$  in. provides stability and performance superior to heavier boards made of other materials. The plastic board is readily punched to receive Teflon-insulated terminals which are corked into closely-spaced openings. Assembly eliminates costly machining operations common with other board types, provides rapid and permanent terminal installation without staking or use of hardware.

Tri-Point Plastics, Inc., Dept. ED, 175-177 I. U. Willets Rd., Albertson, L.I., N.Y.

CIRCLE 182 ON READER-SERVICE CARD FOR MORE INFORMATION



### Miniature Relay High Vibration Resistance

This miniature relay is designed for continuous duty, general purpose dc use in aircraft, missiles, communications and other circuit control applications. The series 5400, superceding series 5500, resists 15 g vibration through 500 cps. It withstands 5 to 70 cps at 0.6 in. double excursion and 15 g from 70 to 500 cps without chatter or transfer. The relay is available in arrangements up to 6 Form A or 4 Form C (total of 12 springs). The standard contact material is palladium, rated at 3 a 26.5 v dc or 115 v ac resistive. It can be supplied in ratings up to 10 a per contact. The maximum coil resistance is 10,000 ohms, and it is normally supplied with a coil resistance of 280 ohms, plus or minus 10 per cent for operation on 26.5 v dc. The unit weighs 1.7 oz.

Price Electric Corp., Dept. ED, Frederick, Md.

CIRCLE 183 ON READER-SERVICE CARD FOR MORE INFORMATION



## McLEAN *Cabinet Cooling* FANS and BLOWERS are LIFE SAVERS for Sensitive Components



RACK MOUNTED FOR EASY ASSEMBLY • FIT STANDARD 19" RACKS

STANDARD MODULAR PANEL HEIGHTS COVER WIDE RANGE OF AIR DELIVERIES

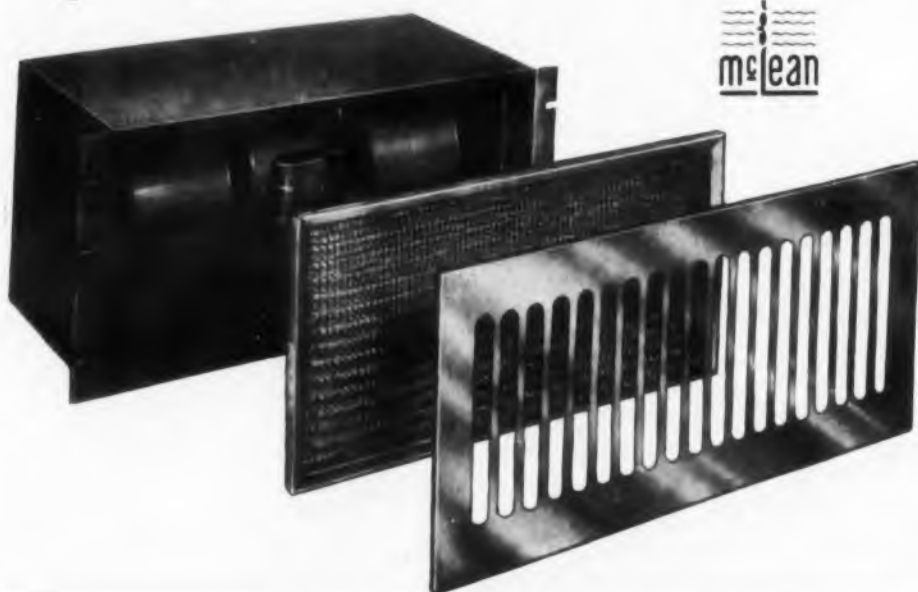

mclean

Install McLean Fans and Blowers in computers, control units, data processors, etc., to extend the life of expensive, sensitive components. McLean's small packaged units pressurize the cabinet with cool filtered air, keeping dust out. They are complete in one unit and ready for use. Standard RETMA notching allows mounting on rack . . . no cutting or fitting is necessary. All units contain an easily replaceable filter. Smart stainless steel grilles add beauty and eliminate the necessity of matching cabinet finishes.

### BASIC SPECIFICATIONS

Over 15 models of McLean Fans and Blowers are available in panel heights of  $3\frac{1}{2}$ " to  $10\frac{1}{2}$ " in increments of  $1\frac{3}{4}$ " . . . and with a range of 80 to 800 CFM. Models available for other width racks and for DC and 400 cycle operation.

## McLean Engineering Laboratories

Princeton, New Jersey • Princeton 1-4440

Agents in Principal Electronic Manufacturing Areas

Send for one or all of the following . . . no obligation

1. Sixteen page catalog.
2. Individual Specification Sheets.
3. "Cooling Packaged Electronic Equipment," a helpful 12 page article containing valuable engineering information.

CIRCLE 181 ON READER-SERVICE CARD FOR MORE INFORMATION

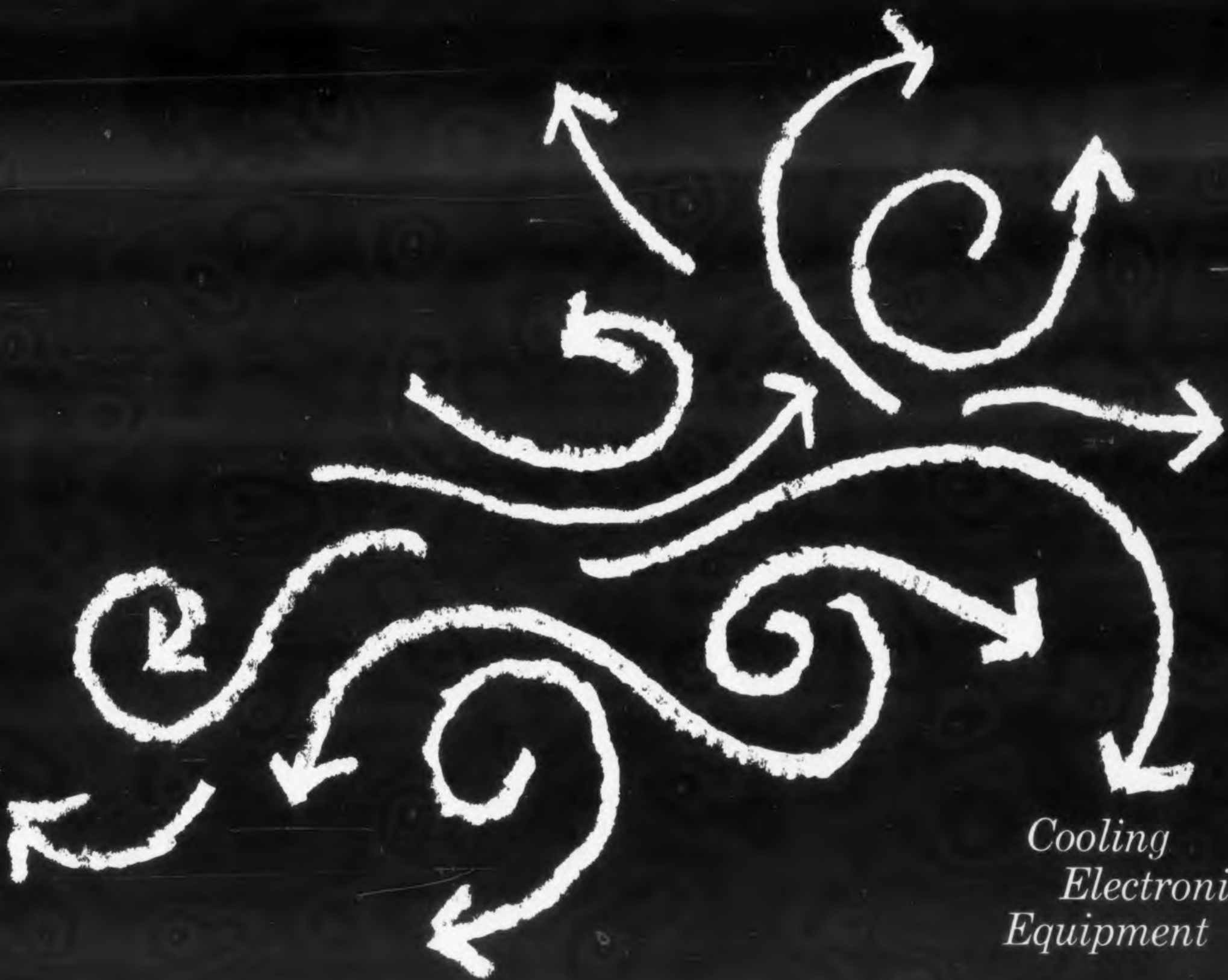

*Cooling  
Electronic  
Equipment*

are  
nts,  
and  
ess  
nce  
als,  
ive  
nto  
tly  
ard  
in-  
U.  
ON

us  
as  
a-  
e-  
is  
m  
y  
4  
st  
v  
8  
C  
s

# Cooling Electronic Equipment



## Why Thermal Design?

**T**HE LAST decade has seen an enormous growth in the complexity of electronic equipment. Together with this, increased miniaturization has led to an increased concentration of thermal energy in electronic packages.

The investigation of these thermal problems has lagged far behind the feverish growth of complexity and miniaturization of equipment.

Today's efforts towards improved reliability have forced us to assign positions of primary importance to thermal design considerations along with considerations of electronic and mechanical design. Poor reliability is always associated with inadequate heat removal.

A decrease in operating temperature can almost always prolong equipment life. The deleterious effects of excessive temperatures are only too well known. Vacuum tubes are decimated by loss of emission, release of gas and electrolysis of glass envelopes at the base. Resistors become unstable; a 1 per cent resistor can be forced out of tolerance by a 25 C change in ambient temperature. Capacitors decompose and suffer dielectric failure; the insulation resistance of paper capacitors may be halved for each 10 C increase in working temperature.

There would be no thermal design problem for us if it were not for this frailty of electronic components. One might say, with tongue in cheek perhaps, that once we have developed diodes, transistors, tubes, resistors, capacitors and insulators to tolerate 500 C, we will no longer have thermal design problems.

But the problems are with us today—and with a



vengeance. In response to these problems some of the more progressive companies have recently added heat transfer specialists to their engineering staffs, unfortunately, more often than not, placing them at a disadvantage by consulting them only after thermal difficulties are encountered rather than during the basic design phase.

Costly 'cut-and-try' techniques have taught us that satisfactory thermal design should start on the drafting board simultaneously with electronic and mechanical design activities.

**ELECTRONIC DESIGN**, recognizing the need for convenient, down-to-earth, basic thermal design information, has gathered material by some of the leading authorities in the field of cooling electronic equipment. We've made no attempt to present an exhaustive treatment of all phases of thermal design, nor do we hope to say the last word on the subject in these pages.

The articles presented, deal for the most part, with the use of forced air cooling, since this is by far the most popular system in use. This is not to imply that forced air cooling is, under all circumstances, the best.

Each electronic system has its own peculiar thermal problem. There are no hard and fast rules to dictate the best cooling technique for a given situation. Other considerations often dictate a choice. In the Convair B-58 for example, refrigerated air is employed to great advantage. Jet engine compressed bleed air is processed by two air cycle refrigeration units to provide cooling air for the cabin and for electronic equipment. Considerations

of weight, volume, reliability, access to equipment, effect of cooling medium on circuit performance, and cost may all contribute to our choice.

In general, one can suggest that the type of cooling system to be employed depends on the heat concentration (power density).

Natural cooling is recommended for most miniaturized electronic subassemblies with power densities to about 0.15 w per cu in. Metallic conduction may be used effectively to about 2 w per cu in. Where spacing between parts is adequate for air flow, forced air cooling may be best suited to concentrations to 7 w per cu in. It should be noted here that the power required to force air over objects and through ducts can sometimes be prohibitive.

Direct liquid cooling is useful to 10 w per cu in. However, it may be used only where the circuitry can tolerate the increased stray capacitance and electrical losses due to the high dielectric constant and power factor of the coolant liquids. The coolant must be compatible with the electronic parts. Maintenance difficulties may be increased, and leaks may render the unit inoperative. Indirect liquid cooling systems, using continuously circulated fresh water, have found wide application in cooling large transmitting tubes and in cooling shipboard electronic equipment.

Vaporization cooling, the most effective method known, is useful to 20 w per cu in. This method, employing the latent heat of vaporization, absorbs very large quantities of heat to convert a liquid to its vapor state.

In both vaporization and liquid cooling methods,

<b>CONTENTS</b>	
<b>Why Thermal Design? . . . . .</b>	<b>2</b>
<b>Designing Cooling Systems for Airborne Electronic Equipment, C. A. Hathaway . . . . .</b>	<b>4</b>
<b>Weight Flow Nomograms for High Altitude Air Cooling, J. C. Van Rijn . . . . .</b>	<b>12</b>
<b>Motor Design for Fans and Blowers, O. W. Giesecke . . . . .</b>	<b>18</b>
<b>Manufacturers of Cooling Equipment for the Electronic Industries . . . . .</b>	<b>22</b>

For a free reprint of this section,  
Circle 491

the expendable systems are simple, but require removing the vapor and replacing the coolant. The continuous flow systems are complex and expensive, requiring heat exchangers and often, pumping systems.

Radiation cooling is rarely recommended as a preferred system since it requires very large temperature differences for appreciable heat transfer and entails problems in controlling the cooling path.

The design engineer who wishes more information is referred to three excellent sources which, though somewhat dated (the latest one appeared in March 1955), contain excellent basic design information. These reports were prepared by the Cornell Aeronautical Laboratory, Inc. under contract with the Bureau of Ships. They contain comprehensive bibliographies and are available from the Superintendent of Documents, U. S. Government Printing Office, Washington 25, D.C. The titles are: *Heat Transfer in Miniaturized Electronic Equipment* (NAVSHIPS 900,189), *Manual of Standard Temperature Measuring Techniques, Units, and Terminology for Miniaturized Electronic Equipment* (NAVSHIPS 900,187), and *Guide Manual of Cooling Methods for Electronic Equipment* (NAVSHIPS 900,190).

In future issues of **ELECTRONIC DESIGN**, we plan to present more detailed information on these less common heat transfer techniques, their advantages, and the problems which are associated with them.

For a free reprint of this entire section, please turn to the Reader's Service Card and Circle 491.

# Designing Cooling Systems for Airborne Electronic Equipment

**Charles A. Hathaway**, Chief Engineer  
Air Impeller Div.  
The Torrington Manufacturing Co.  
Torrington, Conn.



**D**ESIGN of blower systems for cooling airborne electronic equipment has become a more frequent and difficult problem for the electronic design engineer as operating altitudes have become increasingly higher, and space for the apparatus more and more cramped. The performance of the equipment, the operating life of its components, and its overall size and weight are all affected by the action and design of the cooling apparatus. Too often, however, cooling is an afterthought—a matter of guesswork and cut-and-try—where it should be considered early in development while the chassis is being designed and the electronic elements located. After discussing the four concepts of cooling which affect the arrangement of elements, this article will describe methods for calculating the required static pressure and flow rate at the highest altitude on the basis of known sea-level requirements, and methods for determining the type and size of blower. An example will then be given for a particular set of environmental conditions.

Guesswork in designing a cooling system can be wasteful in two ways. First, additional engineering time and operating difficulties are involved in correcting an undercooled condition. Secondly, excessive cooling can mean burdening the aircraft with the extra weight and bulk of unnecessarily large blowers and blower motors. While undercooling is wasteful, it is usually observed right away and corrected through cut-and-try testing. Overcooling, on the other hand, is much more serious because it is often undetected and simply adds to the cost of the aircraft. Miniaturization of electronic components and chassis, as part of the effort to reduce



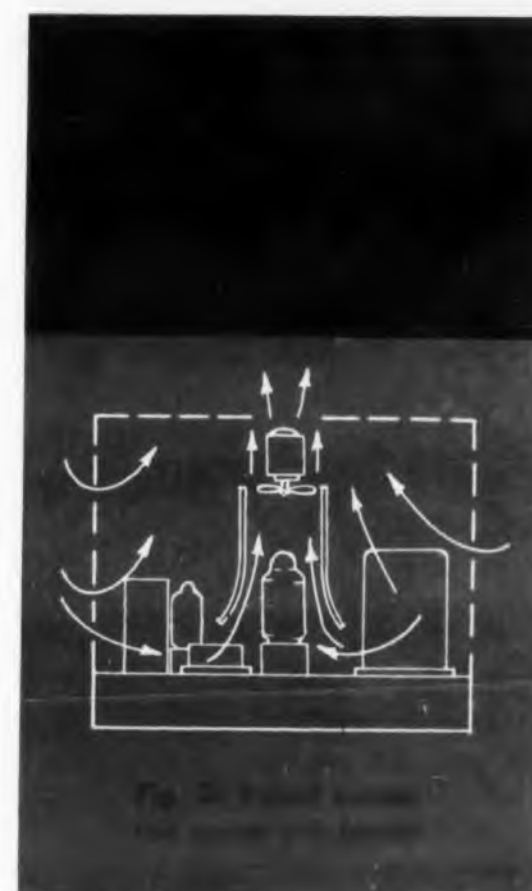
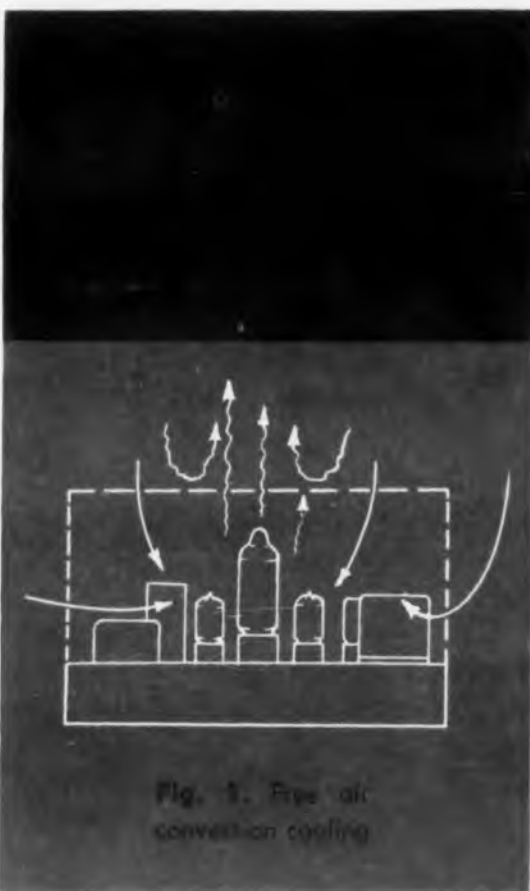

space and size, itself makes it tougher to design the cooling system. The penalty of poor design of cooling systems can be tremendous—with the large number of separate blower systems often required to cool the many electronic units.

### Three Steps in Design

There are three basic steps in designing a cooling system:

- Arrange the elements of the system for most efficient cooling.

- Calculate the specific blower characteristics needed to obtain the required cooling capacity under the most severe cooling conditions.

- Determine the actual blower type and size.

The system elements—including blower, deflectors, orifices, and diffusers—can be arranged for minimum blower size, weight, cost and power input independently of ambient conditions. The particular cooling arrangement that is most efficient at any given temperature and pressure will also be best at all other ambients.

With the most efficient arrangement of elements, the maximum flow rate demanded of the blower—which occurs usually at the highest operating altitude—will be no greater than is absolutely necessary, and the size of the motor will be optimum. A blower and motor selected on this basis may provide overcooling at lower altitudes (which can be at least partly avoided) but will never undercool under even the most severe conditions.

The type of blower—either a centrifugal air impeller (wheel) or axial impeller (fan)—and its approximate size can be calculated on the basis of

theoretical relationships. The actual blower is then selected from performance characteristics published by impeller manufacturers.

### Arranging The Cooling Elements

**Four Design Approaches.** The four approaches in cooling electronic equipment are 1. free convection, 2. semi-free convection, 3. forced convection, and 4. a combination of the first three. Radiation effects will not be considered here as they need not bear directly on this treatment of cooling design.

**Free convection,** as shown in Fig. 1, consists of electronic elements arranged with ample space and with properly arranged open areas through (and outside) the cabinet to allow natural circulation. No blower is necessary. It is evident that the space occupied and weight of the assembly are large and therefore normally undesirable for airborne installation. Commercial radio and television chassis are typical of this design.

In **semi-free convection** (Fig. 2), the cabinet is ventilated and a blower or fan is provided for general air circulation to keep the ambient temperature within the cabinet down. Artificial air circulation does allow somewhat less space between electronic elements in the chassis and more latitude in locating the chassis itself.

In a **forced-convection** system (Fig. 3), minimum size and weight of the equipment is permitted. The air paths through the elements (in the simplified example of Fig. 3, a single power tube) have been designed to provide high-velocity air scrubbing of the surfaces to improve the heat transfer coefficient.

The hypothetical electronic chassis in Fig. 4 illus-

trates the combination of cooling effects which are met under actual conditions. Forced convection by fans or blowers is concentrated on the critical cooling points—or “hot spots”—in the air flow system through the equipment, while other electronic elements of varying size and spacing (and varying heat dissipation problems) are cooled by semi-free convection. The designer's attention is then concentrated on forced convection at the hot spots, and the requirements of the remaining elements are taken care of as part of the air flow system.

### Forced Convection Cooling

The heat dissipated from a single element ( $W$ ) by forced convection cooling is given by

$$W = h_c A (t_e - t) \text{ watts} \quad (1)$$

where  $h_c$  = forced convection heat-transfer coefficient in Btu/hr-ft<sup>2</sup>-°F,  $A$  = cross sectional area through which heat flows in sq ft,  $t_e$  = surface temperature of the hot element in deg F, and  $t$  = mean circulating air temperature at the hot spot in deg F. The surface temperature of the hot element ( $t_e$ ) may also be considered the control temperature, the maximum allowable surface temperature for proper operation of the element. Surface area ( $A$ ) and control temperature ( $t_e$ ) are constant for a given element. The mean circulating air temperature ( $t$ ) is fixed by ambient conditions. Thus, the only variable in equation (1) that can be controlled is the heat transfer coefficient ( $h_c$ ).

The heat transfer coefficient itself is given\* by

\*W. H. McAdams, “Heat Transmission” (McGraw-Hill, 1942).



## Airborne Cooling Systems

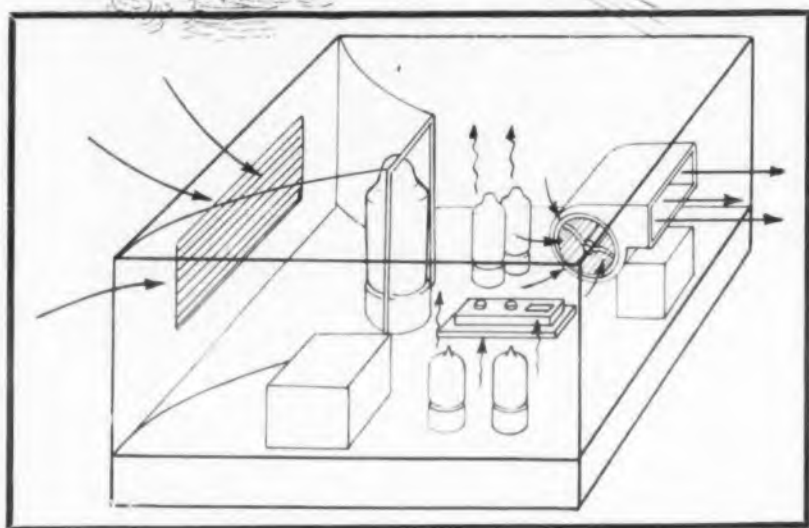

Fig. 4. Example of free, semi-free and forced convection cooling in one chassis.

$$h_c = \alpha \left( \frac{K}{D} \right) \left[ \frac{c\mu}{K} \right]^n \left[ \frac{DV\rho}{\mu} \right]^p \text{ Btu/hr-ft}^2\text{-}^\circ\text{F} \quad (2)$$

where  $\alpha$  = a dimensionless constant of proportionality,  $K$  = thermal conductivity of fluid in Btu/hr-ft- $^\circ\text{F}$ ,  $D$  = a length parameter of the system in feet,  $c\mu/k$  = the dimensionless Prandtl number, and  $DV\rho/\mu$  = Reynold's number, also dimensionless. The Prandtl number for air is relatively insensitive to a wide range of ambient temperatures and pressures;  $K$ ,  $\rho$  and  $\mu$  are physical properties fixed by the ambient air conditions; and  $D$  is a dimensional characteristic of the element being cooled. Therefore, equation (2) can be simplified to

$$h_c \sim (V)^p \text{ Btu/hr-ft}^2\text{-}^\circ\text{F} \quad (3)$$

where  $V$  = air velocity in ft/min and  $p$  is an exponent which varies with the type and orientation of the heat transfer surfaces. For the most accurate results, a value of  $p$  is selected which best describes the nature of the heat transfer<sup>10</sup>. In this article, the exponent  $p$  will be assumed to be 0.6, a reasonable value for gases flowing across tubes or wires.

It is evident then in equation (3) that the heat dissipation from an element as expressed in equation (1) can be raised by increasing the air velocity.

**Increasing Hot-Spot Velocity.** There are two methods for increasing the localized air velocity at

<sup>10</sup> Ibid

hot spots. First, the rate of air flow ( $Q$  in cubic feet per minute) can be increased without changing the flow area ( $A$ ), so that flow velocity ( $V = Q/A$ ) is proportionately increased. However, the increase in the brake horsepower on the blower would be substantial, since horsepower is proportional to the cube of flow rate. Thus, air velocity at all other points has been needlessly increased in order to obtain the higher value at the hot spot. The larger blower motor required would be uneconomical in cost, weight, and size.

The second and more satisfactory method for increasing hot-spot velocity is to converge the flow stream at the hot spot in a manner similar to those suggested by the sketches in Fig. 5. The reduction of flow area ( $A$ ) as the given volume of air ( $Q$ ) converges on the hot spot then results in increased air velocity ( $V$ ), while on the other side of the hot element the velocity of the diverging air stream (in a converging-diverging baffle like that in Fig. 5b) drops to approximately its previous value. In converging the air stream, static pressure is converted to velocity pressure at that hot spot and, if a diffusing baffle is used, velocity pressure is reconverted to static pressure in the diverging stream at the outlet (static pressure will always be lower than its original value because of conversion losses). A baffle which allows air to by-pass the hot spot (such as a cross baffle which does not extend from

side to side like that in Fig. 5a) will not provide enough air flow around the hot element. Actually, the high flow resistance of the baffle and hot element will probably reduce the air velocity at the element. As shown in Figs. 4 and 5, all air flow must be directed to the hot spot.

Any system, like those in Fig. 5 for localizing air velocity, will increase the static-pressure drop in the cooling system to the degree that it interrupts free air flow. As discussed further, it may then be necessary to select another type of cooling impeller.

### Calculating Blower Characteristics

**Altitude Needs Based on Sea-Level Tests.** Cooling requirements of airborne electronic equipment at sea level can be conveniently determined in the laboratory by studying operation of the equipment in air flow tests. The more difficult design problem, however, is that the output demand on the cooling impeller (which may be either a blower wheel or fan) changes radically as ambient temperatures and pressures decrease with increasing altitude. While this problem might simply be solved by testing in environmental chambers, many electronic manufacturers cannot justify the high cost of a chamber, and others are using their chambers to full capacity and cannot spare the test time.

It is more convenient and certainly less expensive to perform air flow tests under sea level conditions in the laboratory, and by calculation determine cooling requirements for operation at various altitudes during flight. In view of the extreme premium on size and weight, the engineer's approach in determining the optimum type and size of cooling blower is based on providing a known constant cooling capacity at all altitudes with minimum horsepower input. This procedure is primarily concerned with finding the blower characteristics required to give the same cooling capacity at the highest expected operating altitude as tests have shown is needed at sea level.

**Air Flow Testing At Sea Level.** Standard air flow test procedures and equipment are used to determine cooling requirements at sea level. The electronic chassis is placed in a conventional air flow test chamber or duct arrangement, in which flow rate and pressure across the equipment can conveniently be measured. The chassis is operated during the test, and the surface temperatures of hot-spot elements are monitored. The air flow across the chassis can be changed and the effect on the control temperature at the hot spots observed. Various methods for converging the air stream at hot spots can be evaluated during this test procedure. The results of such a laboratory test give the air flow rate ( $Q_{SL}$ ) and static pressure ( $P_{SSL}$ ) required at sea level. The heat to be dissipated (given by the component manufacturer) and the control temperature (usually specified) are normally constant and independent of altitude.

**Altitude Cooling Requirements.** In order to obtain basic equations useful in determining altitude cooling requirements, equation (2) for the forced convection heat transfer coefficient is better expressed in terms of weight flow of air ( $G$ ) in lbs./min. The quantity,  $DV_0$ , is proportional to weight flow of air through a given piece of equipment, and all the remaining quantities in equation (2) can be grouped in a new parameter,  $\beta$ , which includes all design characteristics of the heat transfer path. The parameter,  $\beta$ , is characteristically different for each particular system under consideration but is independent of atmospheric conditions. Assuming a value  $p = 0.6$  in equation (2), the heat transfer coefficient is given as

$$h_c = \beta (G)^{0.6} \text{ Btu/hr-ft}^2\text{-}^\circ\text{F} \quad (4)$$

Equations (1) and (4) may now be combined to give the following equation for heat dissipation:

$$W = \beta (G)^{0.6} A (t_c - t) \text{ watts} \quad (5)$$

Neither  $\beta$  nor the area,  $A$ , can be precisely evaluated. The constant,  $\beta$ , is a design variable which will remain constant if one considers the overall system but will have a new value if only part of the system is of interest. The area,  $A$ , is usually a complex surface which is impossible to calculate accurately. However, the relationship in equation (5) includes all the fundamental variables and enables the engineer to predict altitude cooling requirements in terms of those known at sea level.

Since  $W$  and  $t_c$  are usually independent of altitude, only weight flow of air ( $G$ ) and mean ambient temperature ( $t$ ) in equation (5) change with altitude. Therefore, the weight flow of air at any given altitude ( $G_A$ ) can be given in terms of the known weight flow of air at sea level ( $G_{SL}$ )

$$G_A = G_{SL} \left[ \frac{t_c - t_{SL}}{t_c - t_A} \right]^{1.67} \text{ lb/min} \quad (6)$$

in which  $\beta$  and  $A$  have been eliminated and  $t_{SL}$  and  $t_A$  are the average ambient temperatures at sea level and altitude, respectively. Since  $Q = G/\rho$ , equation (6) may be converted to give air flow at altitude ( $Q_A$ ) as

$$Q_A = Q_{SL} \left( \frac{\rho_{SL}}{\rho_A} \right) \left( \frac{G_A}{G_{SL}} \right) \text{ cfm} \quad (7)$$

where  $\rho_{SL}$  and  $\rho_A$  are air densities in lb/cu ft at sea level and altitude, respectively.

Weight flow of air is shown in equation (6) to be independent of altitude only when the temperature conditions are invariable. However, it is quite unlikely that any equipment mounted in the non-pressurized portion of the plane will be subjected to constant ambient temperatures. Equipment within the pressurized areas, on the other hand, does not present a particularly difficult problem when selecting an appropriate cooling blower.

Equation (6) may not be used directly to predict

air volume requirements at altitude. Temperatures  $t_{SL}$  and  $t_A$  are mean ambient values that lie somewhere between the inlet ( $t_i$ ) and outlet ( $t_o$ ) air temperatures. The precise relationship between the ambient temperatures,  $t_{SL}$  and  $t_A$ , and the inlet and outlet temperatures,  $t_i$  and  $t_o$ , will vary with the design. However, a good estimate of  $t_{SL}$  and  $t_A$  can be obtained if the mean air temperature is used, particularly where air temperature rises are small. Thus, it may be assumed that

$$t_{SL} \text{ or } t_A = \frac{t_i + t_o}{2} \text{ deg F} \quad (8)$$

in which  $t_i$  and  $t_o$  are temperatures at either sea level (for  $t_{SL}$ ) or altitude (for  $t_A$ ).

The inlet temperature ( $t_i$ ) is normally the standard atmospheric air temperature at the given altitude (NACA standard atmospheres). Outlet air temperature ( $t_o$ ), of course, is initially unknown and may be determined in the following calculation procedure. Inlet and outlet temperatures and weight flow of air are related to the heat dissipated in the air stream heat balance equation

$$W = 4.22 G (t_o - t_i) \text{ watts} \quad (9)$$

which includes the specific heat of air as 0.24 Btu/lb- $^\circ$ F.

**Calculation Procedure.** With the known values of air flow and pressure at sea level, the flow rate required at altitude may be determined in equa-

tions (6), (8) and (9) in the following manner, there being no convenient unique solution. Knowing  $t_i$  at the maximum altitude and  $W$  as required, weight flow of air ( $G$ ) in terms of various values of  $t_o$  can be obtained in equation (9). Since  $G_{SL}$  is known,  $t_{SL}$  and  $t_o$  at sea level can be determined in equations (8) and (9). By inserting the known values of  $G_{SL}$ ,  $t_c$  and  $t_{SL}$  in equation (6), an expression is obtained for weight flow of air at altitude ( $G_A$ ) in terms of mean ambient temperature at altitude ( $t_A$ ). Weight flow of air ( $G_A$ ) is then calculated for several values of  $t_A$  in equation (6).

In addition, these assumed values of  $t_A$  and the known value of inlet temperature ( $t_i$ ) at altitude will establish definite value for  $t_o$  in equation (8). For each of these values of  $t_o$ , the value of  $G_A$  is determined in equation (9). The actual weight flow of air will be obtained when the values of  $G_A$  calculated in equations (6) and (9) are equal. Since it is unlikely that one of the assumed values of  $t_A$  occurs at this point of equality, the incremental error between the two values of  $G_A$  may be plotted against  $t_A$  and the value of  $t_A$  at zero error observed. The actual values of  $G_A$  and  $t_o$  can then be determined from  $t_A$  at altitude. The required air flow rate ( $Q_A$ ) at the maximum altitude can then be determined from  $G_A$  by dividing by the known air density at that altitude ( $\rho_A$ ).

The drop in static pressure ( $\Delta P_{s,A}$ ) in the cooling

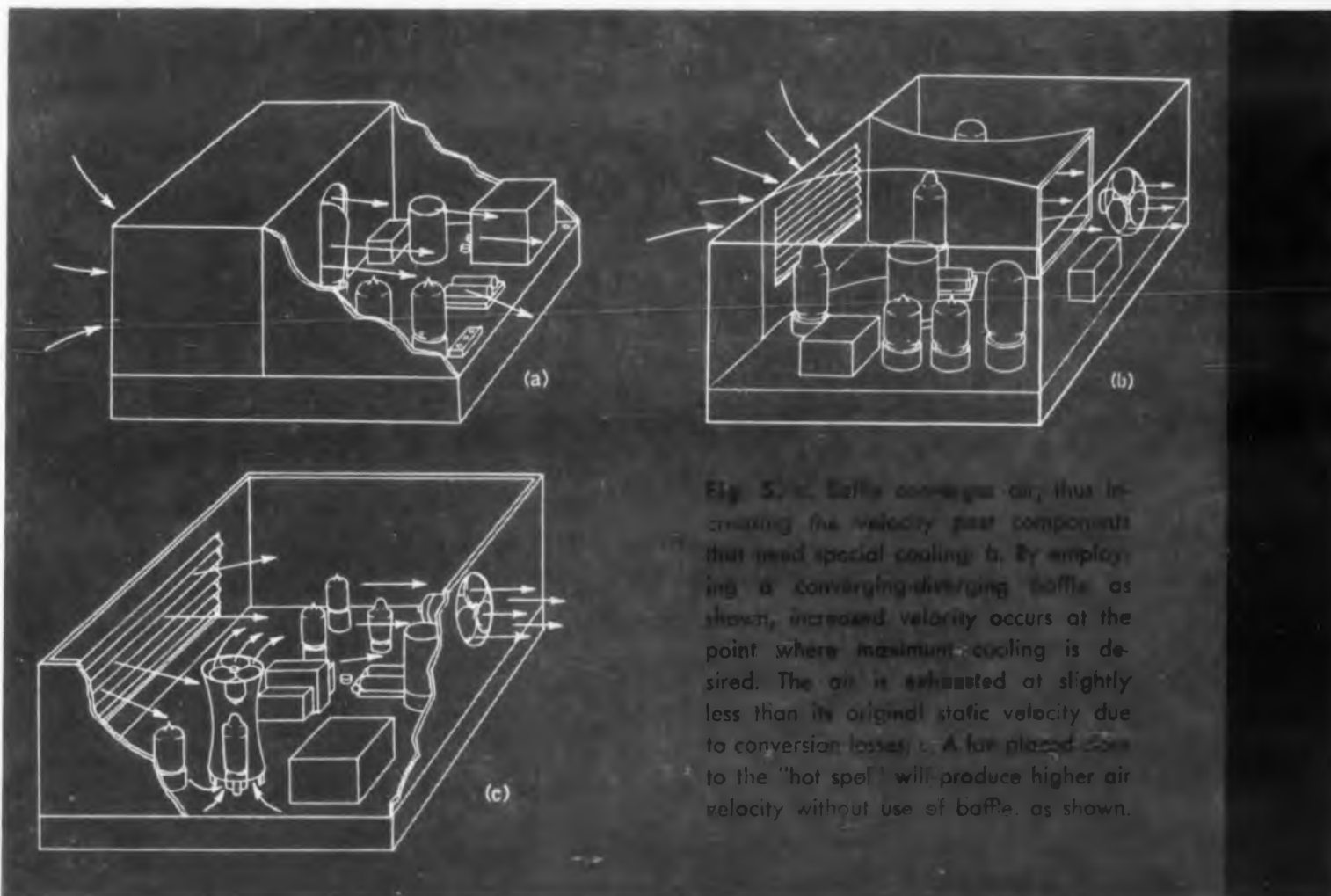

Fig. 5. (a) Baffle converges air, thus increasing the velocity past components that need special cooling. (b) By employing a converging-diverging baffle as shown, increased velocity occurs at the point where maximum cooling is desired. The air is exhausted at slightly less than its original static velocity due to conversion losses. (c) A fan placed close to the "hot spot" will produce higher air velocity without use of baffle, as shown.



## Airborne Cooling Systems

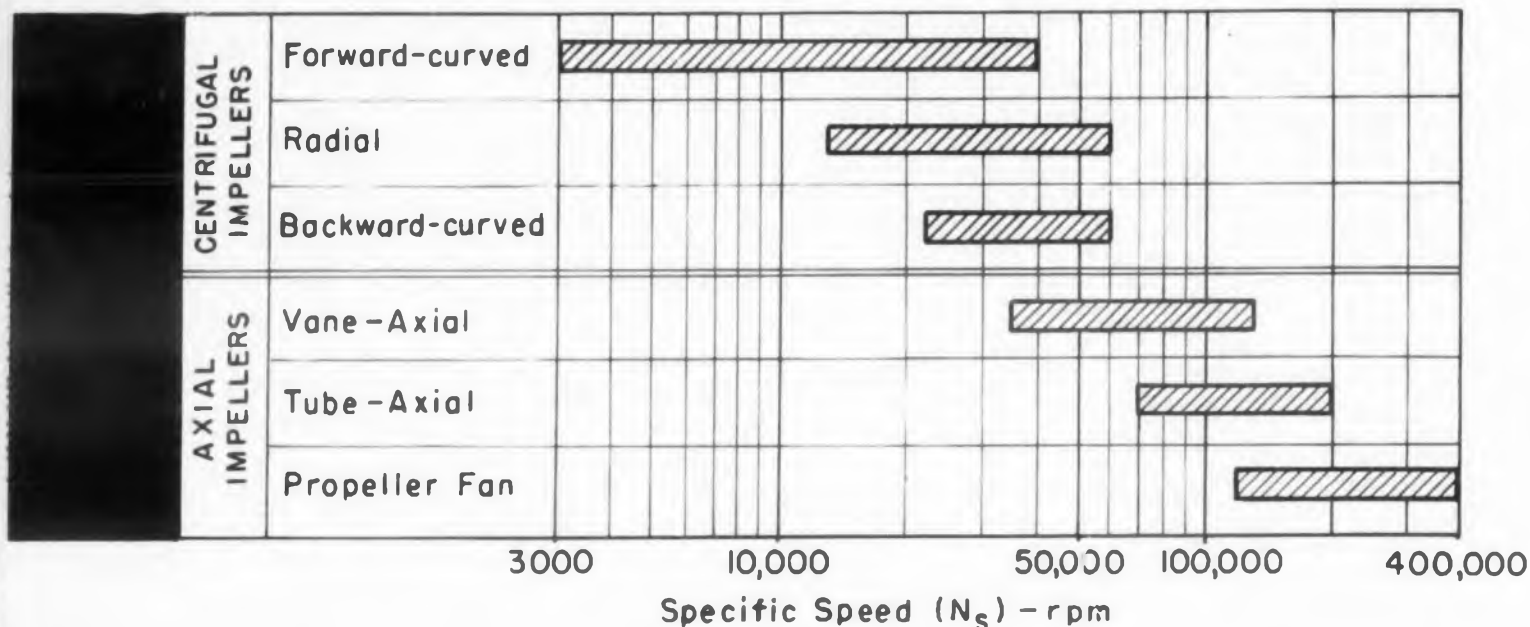

Fig. 6. Ranges of working speeds for basic types of impellers.

system at altitude may then be determined in the formula

$$\Delta P_{sA} = \Delta P_{sSL} \left( \frac{\rho_A}{\rho_{SL}} \right) \left( \frac{Q_A}{Q_{SL}} \right)^2 \text{ inches of water (10)}$$

where  $\Delta P_{sSL}$  is the original static pressure drop corresponding to  $Q_{SL}$  in sea-level tests. Assuming motor speed is constant and with a constant flow rate independent of air density (a blower selected to deliver the required  $Q_A$  at altitude will also deliver that quantity at sea level at the same speed), the static pressure at sea level corresponding to  $Q_A$  becomes

$$\Delta P_{sSL}(\text{alt}) = \left( \frac{Q_A}{Q_{SL}} \right)^2 (\Delta P_{sSL}) \text{ inches of water (11)}$$

which usually exceeds  $\Delta P_{sSL}$  originally tested as required at sea level. The brake horsepower required to produce  $Q_A$  and  $\Delta P_{sSL}$  is given in manufacturers' catalogs, in which these performance characteristics are uniformly given for standard conditions.

### Determining Blower Type and Size

Once the air flow rate and total pressure under standard conditions at sea level has been determined on the basis of altitude cooling requirements, selection of a specific blower or fan type and size depends on the motor speed ( $N$ ) selected. In selecting the blower, the motor speed will be assumed constant at all altitudes, although there will then be overcooling at sea level (due to the difference between  $\Delta P_{sSL}(\text{alt})$  and  $\Delta P_{sSL}$ ). Possible remedies for overcooling are discussed below.

Again in order to minimize the size and weight of the blower motor (usually a 400-cps induction type), extremely high operating speeds are specified. In reviewing different impeller makes and designs of the required type, it is important that the operating speed not exceed the performance limit set by the manufacturer.

**Type of Blower.** The most appropriate type of blower for cooling particular electronic apparatus may most easily be determined in terms of the specific speed ( $N_s$ ) required by the cooling system at

sea level. Specific speed is calculated from the motor speed ( $N$ ) selected in the equation

$$N_s = \frac{N \cdot \sqrt{Q_{SL}}}{[\Delta P_{sSL}(\text{alt})]^{3/4}} \text{ rpm (12)}$$

where  $N$  = blower operating speed in rpm, and  $\Delta P_{sSL}(\text{alt})$  and  $Q_A$  are the magnitudes of pressure and flow at sea level corresponding to required altitude performance with a constant-speed motor. The table in Fig. 6 shows the ranges of specific speed for the six basic types of air impellers, with centrifugal impellers predominating below 50,000 rpm and axial types above that specific speed.

A particular type of impeller selected on the basis of its specific speed calculated at sea level will also be the best type for all other ambient conditions at any altitude, assuming that motor speed is constant. Thus, specific speed must be determined in equation (12) only for sea level conditions. Because of the effect of the decreasing air density at altitude, the same specific-speed equation cannot be used for conditions at altitude.

**Size of Blower.** With the known values of  $Q_A$ ,  $\Delta P_{sSL}(\text{alt})$ , and  $N$ , the following formulas can be used to determine the approximate diameter ( $D$ ) and width ( $W$ ) of forward-curved centrifugal impellers (blower wheels) commonly used in airborne cooling

$$D = \frac{1.25 \times 10^4 \sqrt{\Delta P_{sSL}(\text{alt})}}{N} \text{ inches (13)}$$

$$\frac{W}{D} = 765 \left( \frac{Q_A}{D^3 N} \right) \text{ (14)}$$

where  $W/D$  should be in the range, 0.20 to 0.75. The quantities  $D$  and  $W/D$  may instead be determined in the nomographs in Figs. 7 and 8, respectively, which represent equations (13) and (14). The approximate blade-tip diameter of propeller fans may be determined in the following equation

$$D = \frac{K_D}{N} \sqrt{\Delta P_{sSL}(\text{alt}) \cdot N_s} \text{ inches (15)}$$

where  $N_s$  is specific speed determined in equation (12) above and  $K_D$  is a diameter factor determined in Fig. 9 for the known  $N_s$ .

Manufacturers' performance data for commercial impeller units of the type and in the size range determined should then be reviewed in order to make the final selection. These data will also provide the magnitude of brake horsepower required by the blower in order to establish the motor size. The manufacturer's engineers should be consulted if a standard impeller does not seem suitable for the performance requirements.

### Problem Example

Assume that the following air cooling requirements at sea level have been determined in tests on a particular piece of electronic apparatus:

$$\begin{aligned} Q_{SL} &= 200 \text{ cfm} \\ \Delta P_{SL} &= 2 \text{ inches of water} \\ t_i &= 68 \text{ F} \\ W &= 1000 \text{ w} \\ N &= 7200 \text{ rpm} \end{aligned}$$

The maximum operated altitude is 50,000 ft, where  $\rho_A = 0.0114 \text{ lb/cu ft}$  and  $t_i = -67 \text{ F}$ . Inlet temperature ( $t_i$ ) is 68 F at sea level.

The weight flow of air at sea level is  $G_{SL} = \rho_{SL} \cdot$

$Q_{BL} = 0.075 \cdot 200 = 15 \text{ lb/min}$ . The outlet air temperature ( $t_o$ ) at sea level is first calculated in equation (9)

$$t_o = t_i + \frac{W}{4.22 G_{SL}} = 68 + \frac{1000}{4.22 \cdot 15} = 83.8 \text{ F}$$

and the mean ambient temperature ( $t_{SL}$ ) in the system at sea level is determined in equation (8)

$$t_{SL} = \frac{68 + 83.8}{2} = 75.9 \text{ F}$$

Substituting the known values of  $t_{SL}$ ,  $t_o$  and  $G_{SL}$  in equation (8), weight flow of air ( $G_A$ ) at the maxi-

imum altitude of 50,000 ft is given as a function of mean air temperature ( $t_A$ ) at altitude in

$$G_A = 15 \left[ \frac{200 - 75.9}{200 - t_A} \right]^{1.67} = 15 \left[ \frac{124.1}{200 - t_A} \right]^{1.67} \text{ lb/min}$$

The second column of the Calculation Table shows four values of  $G_A$  calculated in the above formula for assumed values of  $t_A$  of  $-30 \text{ F}$ ,  $-40 \text{ F}$ ,  $-50 \text{ F}$ , and  $-60 \text{ F}$ , all temperatures at regular intervals just above the known inlet temperature at 50,000 sq ft of  $-67 \text{ F}$ . For the assumed mean air temperatures ( $t_A$ ) and the known inlet temperature ( $t_i$ ) at altitude, equation (8) may be used to determine cor-

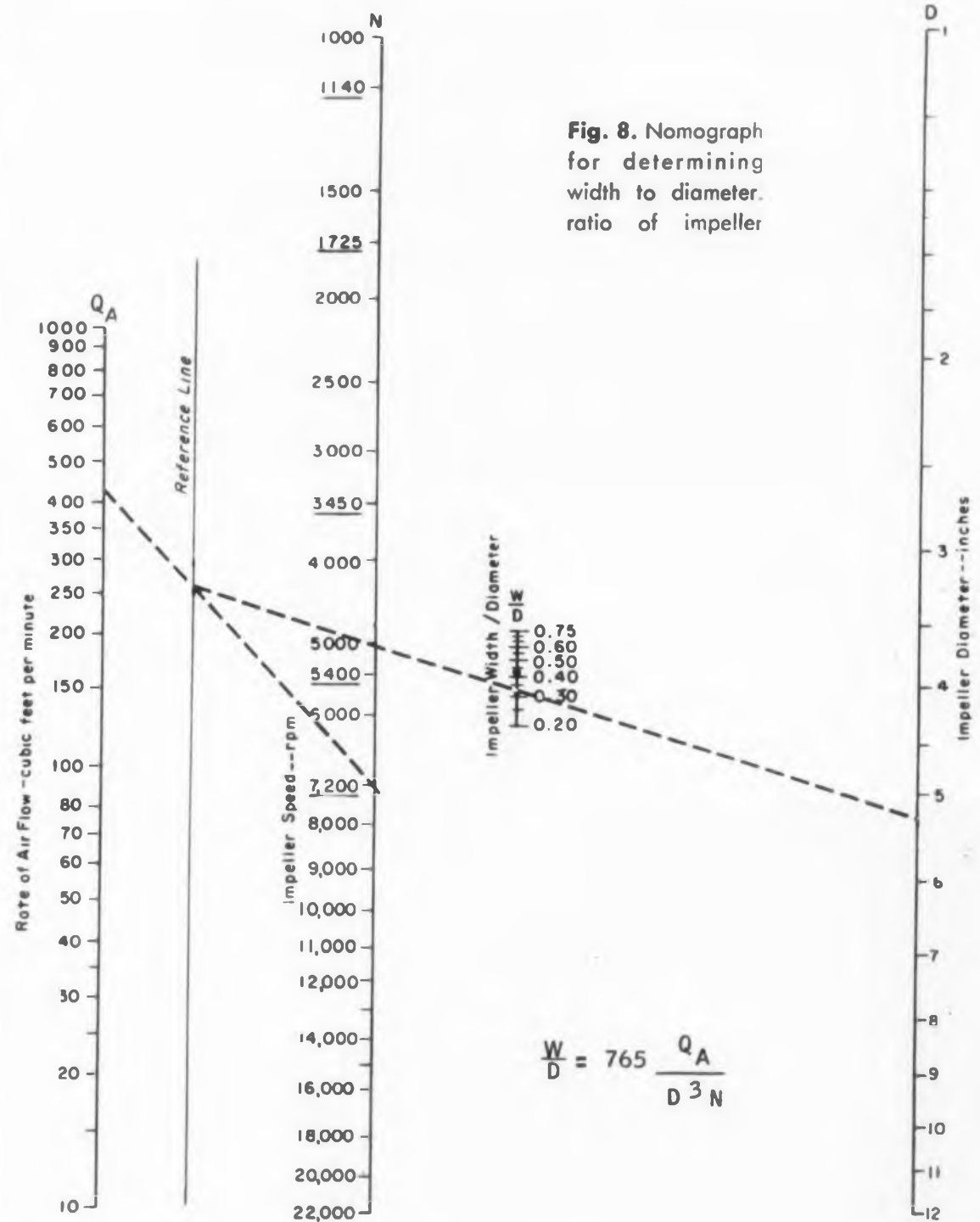
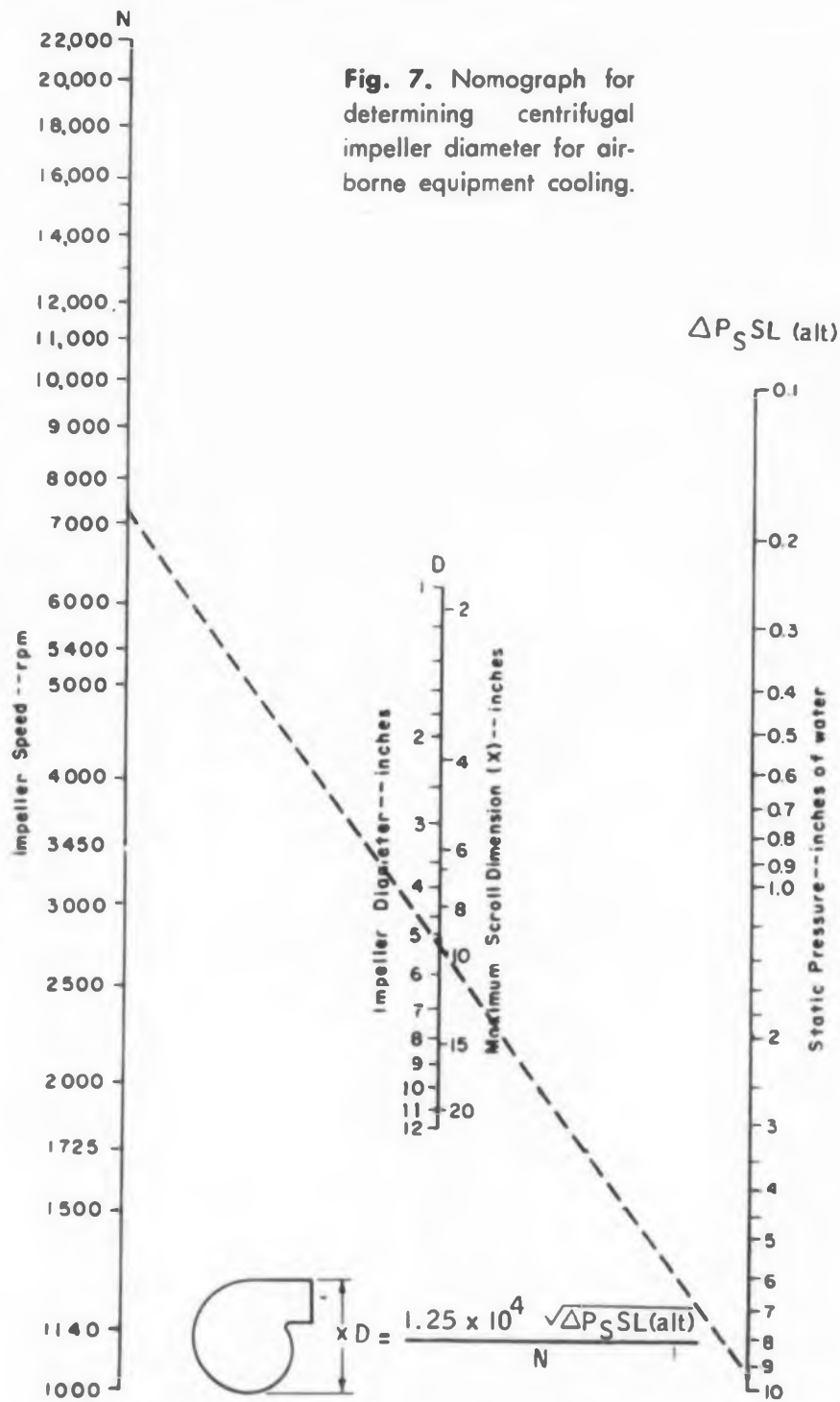

## From sea level to 70,000 ft.

**R**otron 400 CPS

ALTIVAR fans

are 500% lighter

draw 95% less power

are 50% quieter

... compared with any

conventional

constant speed counterpart

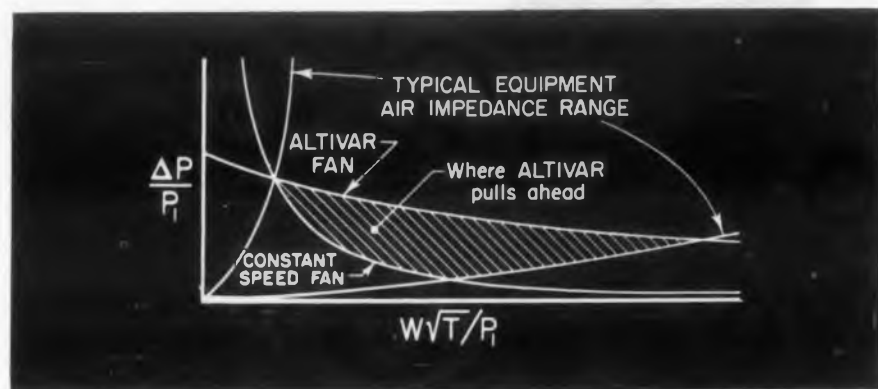

Altivar induction motor fans

increase speed 3 to 5 times

from sea level to 70,000 ft.

Send for Catalog Sheet 30101-3



**ROTRON** mfg. co., inc.

WOODSTOCK • NEW YORK

CIRCLE 462 ON READER-SERVICE CARD FOR MORE INFORMATION



## Airborne Cooling Systems

Calculation Table

Assumed $T_A$	$G_A$ (Eq. 6)	$t_o$ (Eq. 8)	$t_o - t_i$	$G_A$ (Eq. 9)	$\Delta G_A$
-30	5.37	7	74	3.2	2.17
-40	4.98	-13	54	4.39	0.59
-50	4.65	-33	34	7.0	-2.35
-60	4.38	-53	14	16.9	-12.5
-42.5 (check)	4.86	-18	49	4.86	0

responding values of outlet temperature ( $t_o$ ), as recorded in the table. The weight flow of air at altitude ( $G_A$ ) is then determined in equation (9) for each of the four values of  $t_o - t_i$  and recorded in the fifth column of the table.

The last column in the table gives the difference in the values of weight flow of air calculated in equations (6) and (9). By plotting the incremental error in weight flow of air given in the last column against the assumed values of  $t_A$ , it is found that the values of weight flow of air calculated for the two equations are equal at  $t_A = -42.5$  F. Calculation in equations (6)

and (8) show that  $G_A = 4.91$  lb/min and  $t_o = -18$  F for  $t_A = -42.5$  F at 50,000 ft.

The air flow rate at 50,000 ft would then be  $Q_A = G_A/\rho_A = 4.91/.0114 = 431$  cfm. The drop in total pressure through the system at 50,000 sq ft may then be calculated in equation (10) as follows

$$\Delta P_{T,A} = 2 \left( \frac{.0114}{.075} \right) \left( \frac{431}{200} \right)^2 = 1.41 \text{ inches of water}$$

If a constant-speed motor is used, the blower will have to deliver 431 cfm at sea level as well as at 50,000 ft. The static pressure drop at sea level given in equation (11) would then be

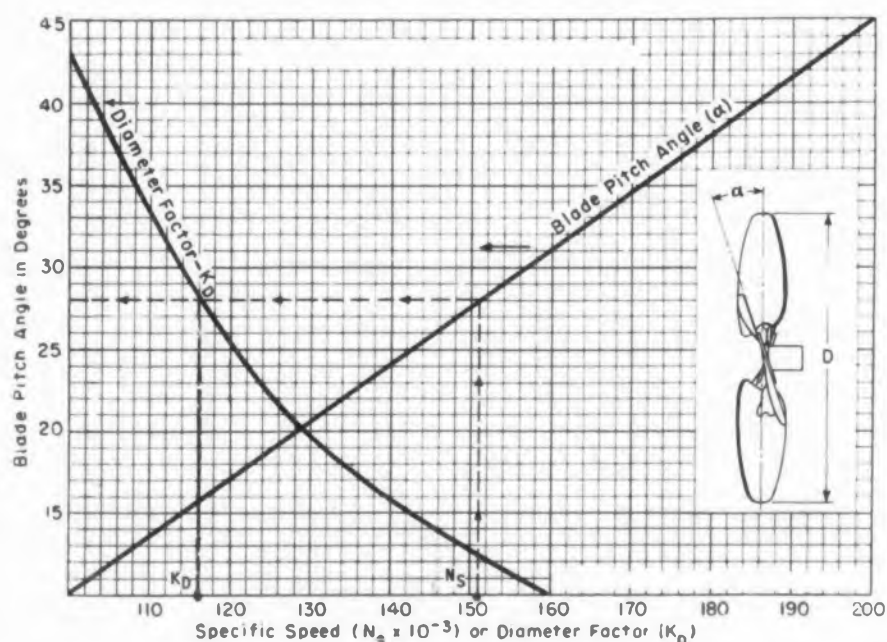

Fig. 9. Nomograph for determining blade tip diameter of propeller fans.

$$\Delta P_{sL} (\text{alt}) = \left(\frac{431}{200}\right)^2 (2) = 9.3 \text{ inches of water}$$

Sufficient information has now been obtained to determine the optimum type of blower in equation (12) and Fig. 6. In equation (12),

$$N_s = \frac{7200 \cdot \sqrt{431}}{(9.3)^{3/4}} = 29,200 \text{ rpm}$$

and the table in Fig. 6 indicates that a forward-curved centrifugal blower would be suitable. Using all the quantities known for standard conditions at sea level, the nomographs in Figs. 7 and 8 show the approximate blower diameter ( $D$ ) and width ( $W$ ) to be 5.2 in. and 1.7 in., respectively. The maximum dimension of the blower housing with a normal scroll is shown in Fig. 7 to be about 9-1/2 in. for a 5.2-in. blower. It would probably be necessary to ask for an impeller manufacturer's recommendations in this case, since catalog data does not usually cover performance at such high speeds.

**Overcooling and Power Consumption.** The blower or fan size required to maintain the desired cooling capacity at maximum altitude may be overcooling substantially—both air flow and total pressure will be unnecessarily high—when operating at the same speed at sea level. Overcooling, of course, is itself not so much a problem as the excessive power consumption at sea level, since the power consumed in cooling increases directly with air density while the volume flow rate remains constant.

Sea-level power can be reduced somewhat with a centrifugal blower by throttling down to the lower flow rate (original sea-level test value) required for the same cooling capacity at sea level. On the other hand, throttling will not work with axial impellers because these impellers do not unload as they are throttled. The most satisfactory approach in reducing sea level power for any type of cooling impeller is to reduce operating speed through external means.

Since flow rate of a blower in a fixed system is directly proportional to operating speed, the optimum speed reduction at sea level can easily be determined. Various methods of motor speed control involving pressure switches have been used, not always with success. Multi-pole motors with several synchronous speeds have been found effective in some cases.

Whatever the method of motor speed control, cooling specifications based on the method described above will state a required air volume and total pressure at the highest expected altitude, expecting that unnecessary but acceptable overcooling may occur at all lower altitudes. Limitations can also be imposed on power consumption at lower altitudes in order to conserve power, as long as the limitations are consistent with the type of motor and controls being used.

# Performance through Precision

## fans • motors • blowers

# Adaptability through Variety

		
<b>C 2364-1</b> Voltage 115 V Frequency 400 cps Phase Single Air Delivery 12 CFM @ 0" S.P.	<b>C 15G-1</b> Voltage 115 V Frequency 400 cps Phase Single Output 50" oz. at 21 RPM	<b>A 15BD-11</b> Voltage 115 V Frequency 60 cps Phase Single Air Delivery 70 CFM @ 0" S.P.
		
<b>B 1324-1</b> Voltage 115 V Frequency 60 cps Phase Single Air Delivery 125 CFM @ 0" S.P.	<b>M 06C-1</b> Voltage 115 V Frequency 400 cps Phase Single Speed 11,000 RPM	<b>B 10CF-3</b> Voltage 208 V Frequency 400 cps Phase Three Speed 5600 RPM
		
<b>B 1221-7</b> Voltage 115 V Frequency 60 cps Phase Single Speed 3400 RPM Air Delivery 495 CFM at 0" S.P. 305 CFM at .4" S.P.	<b>F 1343-1</b> Voltage 208 V Frequency 60 cps Phase Three Air Delivery 720 CFM at 0" S.P.	<b>C-2241-2</b> Voltage 115 V Frequency 400 cps Phase Single Air Delivery 140 CFM @ 0" S.P. NAFM 48 CFM @ .6" S.P. NAFM

years-ahead  
engineering...

Air Marine Motors equipment features stainless steel thru-bolts... die-cast aluminum housings... riveted stators... positive bearing alignment... uniform air gap... ball bearings... shock and vibration resistance... humidity and fungus resistance... omni-position mountings... temperature lubrication.

AIR MARINE MOTORS equipment will meet virtually all your sub-fractional power requirements and AN specifications.

Write for specific information and brochure about any of these units, or for the complete catalog... and use the Air Marine advisory services without obligation.



## air-marine motors, inc.

369 Bayview Avenue, Amityville, L. I., N. Y. • AMityville 4-3700  
West Coast Factory: 2055 Pontius Avenue, Los Angeles 25, Calif.

CIRCLE 463 ON READER-SERVICE CARD FOR MORE INFORMATION



# Weight Flow Nomograms for High Altitude Air Cooling

**J. Constant Van Rijn**  
Rotron Manufacturing Company, Inc.  
Woodstock, New York

WHEN cooling electronic gear with ambient air, the cooling efficiency changes radically with altitude. This is due to the gradual reduction in density of the ambient air, with increasing altitude.

The equipment (black box) to be cooled may be considered as a heat exchanger and the heat transfer process is subject to the changes in temperature as well as the changes in mass flow of the air which occur at varying altitudes. Over and above these two changes, however, the efficiency of the heat transfer process is also governed by changes in heat capacity and thermal conductivity of the air and particularly by the mode of the airflow, that is, its turbulence and the subsequent effects on boundary layers. Calculation of the change in cooling efficiency as resulting from all of the above factors is an involved and lengthy process. Such calculation is seldom justified and moreover rarely practical because electronic black boxes are not normally of a sufficiently straightforward geometric nature to allow application of heat transfer formulae.

## Two Practical Formulae

Although one would therefore conclude that the only practicable approach is a series of heat transfer measurements on completed prototypes, under controlled conditions of density and temperature, two simplified formulae are hereby given which may be used by the design engineer in the early stages of his work and which will give him considerable practical guidance at those crucial moments when type, size, and power of cooling fans have to be forecast. Once equipment has been dimensioned by the use of these formulae, the design should be verified by laboratory measurements made on prototypes under conditions of actual heat transfer and under simulated altitude conditions.

The following data are based on the realization that the conditions for heat transfer efficiency can be broken down into *two* categories, whereby the required altitude-to-sea level air weight flow ratios required for constant cooling rate become a simple expression, viz.:

$$\begin{array}{l} \text{Turbulent Flow} \\ \frac{W_{ALT.}}{W_{SEA L.}} = \frac{\Delta T_{T SEA L.}}{\Delta T_{T ALT.}} \end{array} \quad \begin{array}{l} \text{Laminar Flow} \\ \frac{W_{ALT.}}{W_{SEA L.}} = \left( \frac{\Delta T_{T SEA L.}}{\Delta T_{T ALT.}} \right)^2 \end{array} \quad (1) \quad (2)$$

with the following notations applying:

$T_I$  = inlet temperature of cooling air entering the equipment being cooled.

$T_O$  = outlet temperature of cooling air leaving the equipment being cooled.

$T_B$  = body temperature of component being cooled

$W$  = air mass flow

$U$  = air volume flow

$Q$  = heat transferred

$\Delta T_A = T_O - T_I$  = temperature rise between incoming and outgoing cooling air



$\Delta T_T = T_B - T_I =$  available temperature gradient between incoming cooling air and body temperature

UTILIZATION:  $\frac{T_o - T_I}{T_B - T_I} = \frac{\Delta T_A}{\Delta T_T}$

Whether one or the other condition pertains to any given black box or part of a black box is for the designer to determine. A first approximation may be obtained on the basis of the expected heat transfer efficiency or thermal "utilization," which is essentially constant with altitude and can be measured on a sample layout under laboratory sea level conditions. Fig. 1 gives a graphical representation of the "utilization" formula:

#### Available Temperature Gradient

As seen from formulae (1) and (2), the required weight flow of cooling air at any altitude depends exclusively on the "available temperature gradient"  $\Delta T_T$ , which is the difference in temperature between the cooling air and the surface of the body being cooled and which temperature difference therefore constitutes the driving force in the heat transfer process. The temperature  $T_I$  of the incoming cooling air may be the ambient temperature outside the airframe or some other higher temperature prevailing inside the airframe. Fig. 2 gives a quick review of variations in temperature of the air (outside the airframe) with altitude per various government specifications, as well as two curves of variation in temperature inside the airframe per MIL-E-5400. The  $\Delta T_T$  figure required for the use of formula (1) for turbulent flow or formula (2) for laminar flow is simply arrived at by subtracting the applicable ambient temperature at any particular altitude from the highest permissible body temperature of the most temperature-critical component in the black box. The temperature of the applicable cooling air for any particular component in the black box may of course be dependent upon previous temperature rises of this cooling air on its way through the box as well as of stagnation temperature figures applying to airframes at high speed, and many other factors which make the cooling of modern airborne electronic equipment a subject requiring a high degree of engineering skill and experience.

#### Nomogram For Laminar Flow

When formula (2) is used for making a weight flow calculation under conditions of laminar flow, Fig. 3 will facilitate determination of the required change in weight flow. A ruler is laid from the required mass flow  $W$  to the available temperature gradient  $\Delta T_T$  pertaining to any known condition, for example, at sea level. By retaining the intersection point with the index line, the ruler is then simply rotated to cover the new  $\Delta T_T$  pertaining to any other altitude and the weight flow read on the

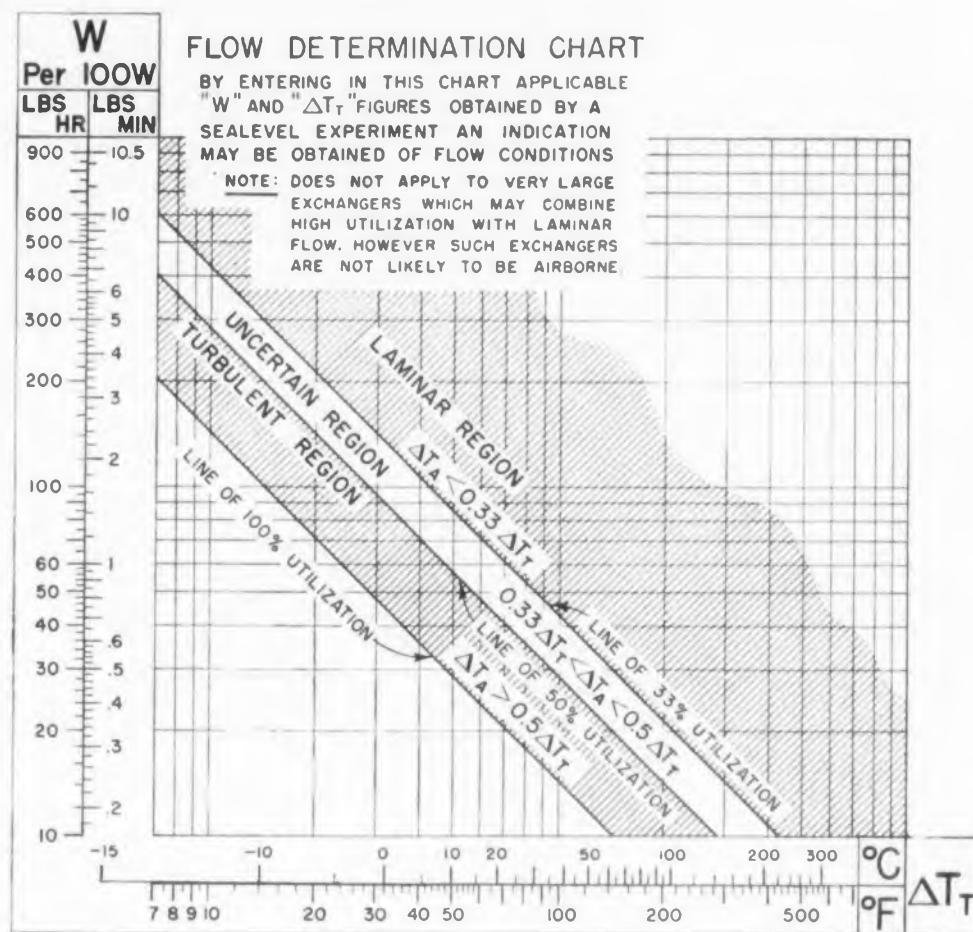

Fig. 1. Flow determination chart.

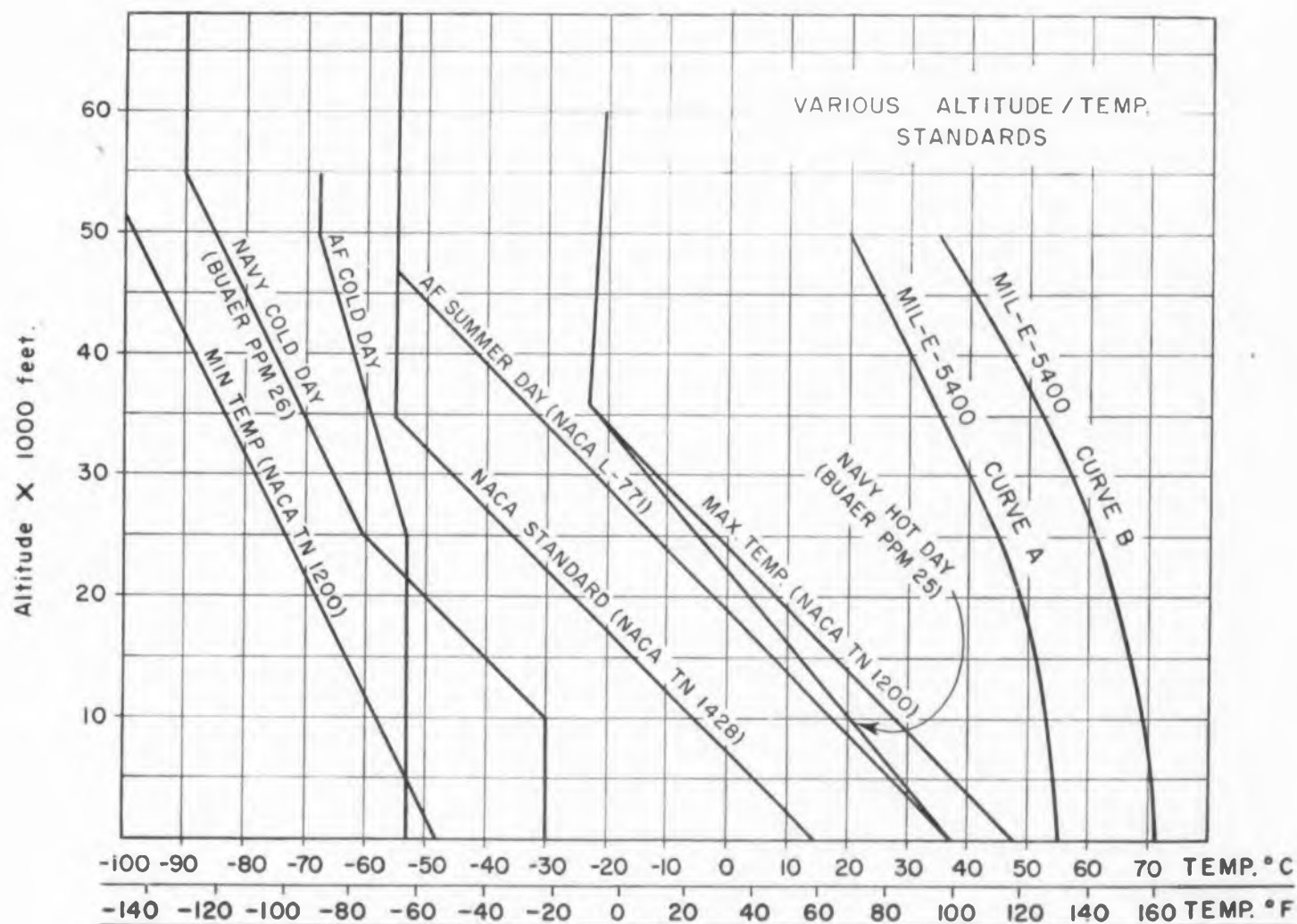
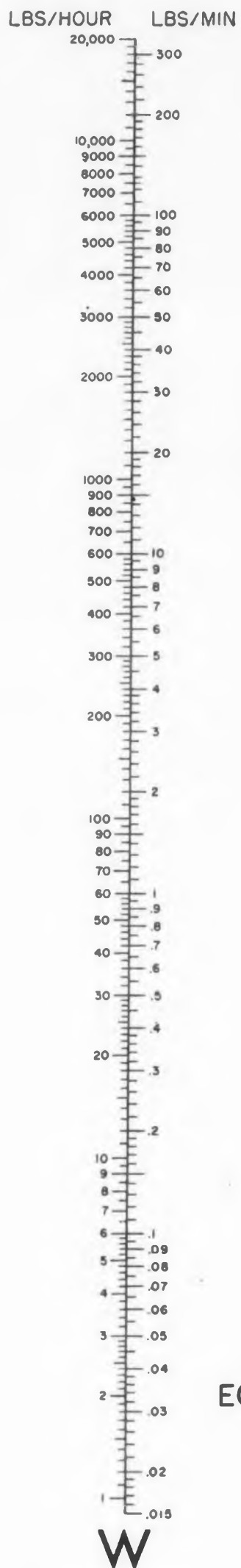

Fig. 2. Altitude vs temperature standards.

# Weight Flow Nomograms



AIR MASS FLOW

# LAMINAR FLOW

DETERMINATION OF MASS FLOW W AT ANY ALTITUDE AS A FUNCTION OF CHANGE IN AVAILABLE TEMPERATURE DIFFERENCE  $\Delta T_T$

$$\text{EQUATION: } W_{\text{ALT.}} = W_{\text{SEAL.}} \left( \frac{\Delta T_T \text{ SEAL.}}{\Delta T_T \text{ ALT.}} \right)^3$$

INDEX  
LINE

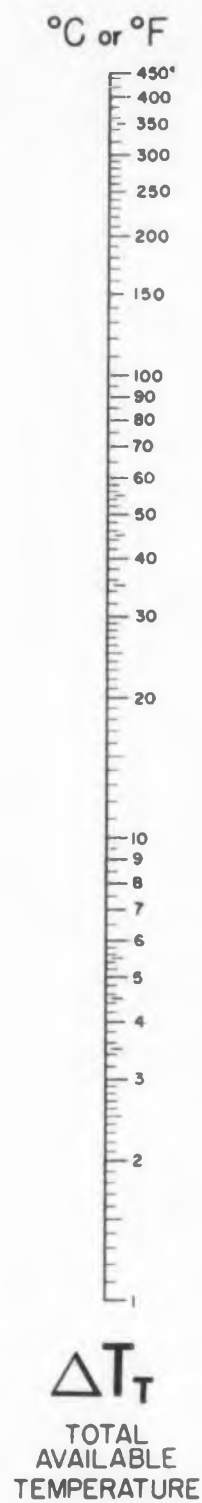

Fig. 3. Laminar flow nomogram.

left  
flow  
this

In  
is th  
volum  
use  
weig  
quire  
and  
fixed  
exist  
ship  
suriz  
with  
agree  
tures  
black  
the c  
air. T  
perat  
To m  
volum  
A  
altitu  
densi  
the f  
*only*  
agree  
social  
set o  
press

WI  
The  
watta  
weigl  
ship  
simpl  
rema

Exam

Ass  
being  
ture-v  
maxim  
exper  
coolin  
amou  
ferenc  
air. F  
794 II  
was 2  
that t  
8 per  
we m  
vails

ELEC

left hand scale. For the equivalent case of turbulent flow per formula (1) no nomogram is given since this represents a simple proportional relationship.

#### Weight Flow To Volume Flow Conversion

In heat transfer calculations weight or mass flow is the basically significant parameter rather than volume flow, and the above formulae consequently use weight flow designations. For the conversion of weight flow to volume flow and vice versa, we require the knowledge of *two* variables, viz. *pressure* and *temperature*. The pressure at any altitude is a fixed quantity about which universal agreement exists. Fig. 4 shows this altitude-pressure relationship which consequently applies to any non-pressurized black box in the airframe. Unfortunately, with regard to temperature, there has been less agreement, as Fig. 2 shows dramatically. Temperatures inside the airframe and at the air-entrance of black boxes may vary considerably and with them the density as well as the cooling capacity of the air. To obtain density of air from pressure and temperature, use the three righthand scales of Fig. 5. To make conversions from air mass flow  $W$  to air volume flow  $U$ , use the three lefthand scales.

A warning should be given with respect to the altitude-equivalent figures associated with the density figures on the center scale of Fig. 5. From the foregoing it is already clear that density can *only* be associated with altitude *if* temperature is agreed upon; consequently the altitude figures associated with this density scale are for one typical set of altitude-temperature conditions only, as expressly indicated on the nomogram scale.

#### Heat Capacity Of Air

When air absorbs heat, it rises in temperature. The rise in degrees is exactly proportional to the wattage absorbed if the flow of air is expressed in weight per unit of time. Fig. 1 shows this relationship graphically. The present context justifies the simplified assumption that the specific heat of air remains constant.

#### Example 1. Laminar Flow

Assume an enclosure in which 1 kw of power is being dissipated and in which the most temperature-vulnerable element is a tube seal with a maximum allowable temperature of 150 C. In an experimental set-up at sea level we find that proper cooling of this seal is obtained with an unknown amount of air corresponding to a temperature difference of 10 C between incoming and outgoing air. From Fig. 6 we see that this corresponds to 794 lbs per hr of "standard" air. If the ambient air was 20 C during this experiment, we further note that the thermal utilization  $(T_o - T_i)/(T_B - T_i) = 8$  per cent, which is less than 30 per cent, so that we may assume that a laminar mode of flow prevails and formula (2) applies. Assume that the

altitude-temperature conditions of specification MIL-E-5400, Curve A apply (see Fig. 2). Then we find for  $T_B = 150$  C, an available temperature difference  $\Delta T_T$  of 95 C at sea level, 105 C at 25,000 ft and 130 C at 50,000 ft. Turning to Fig. 3, we draw a line through the 2 points:  $\Delta T_T = 95$  and  $W = 794$  lbs per hr and note its intersection with the index line. For 25,000 ft altitude conditions we may now draw a line through this intersection and the new  $\Delta T_T$  figure of 105 C, as found above and see that we shall require 580 lbs per hr of air. Similarly for 50,000 ft, we find 300 lbs per hr. Turning to Fig. 5, we see that the above three altitude conditions require a volume of cooling air of respectively 200 cfm, 370 cfm, and 570 cfm.

For a fixed "piping system," the volume output of a fan or blower is directly proportional to its

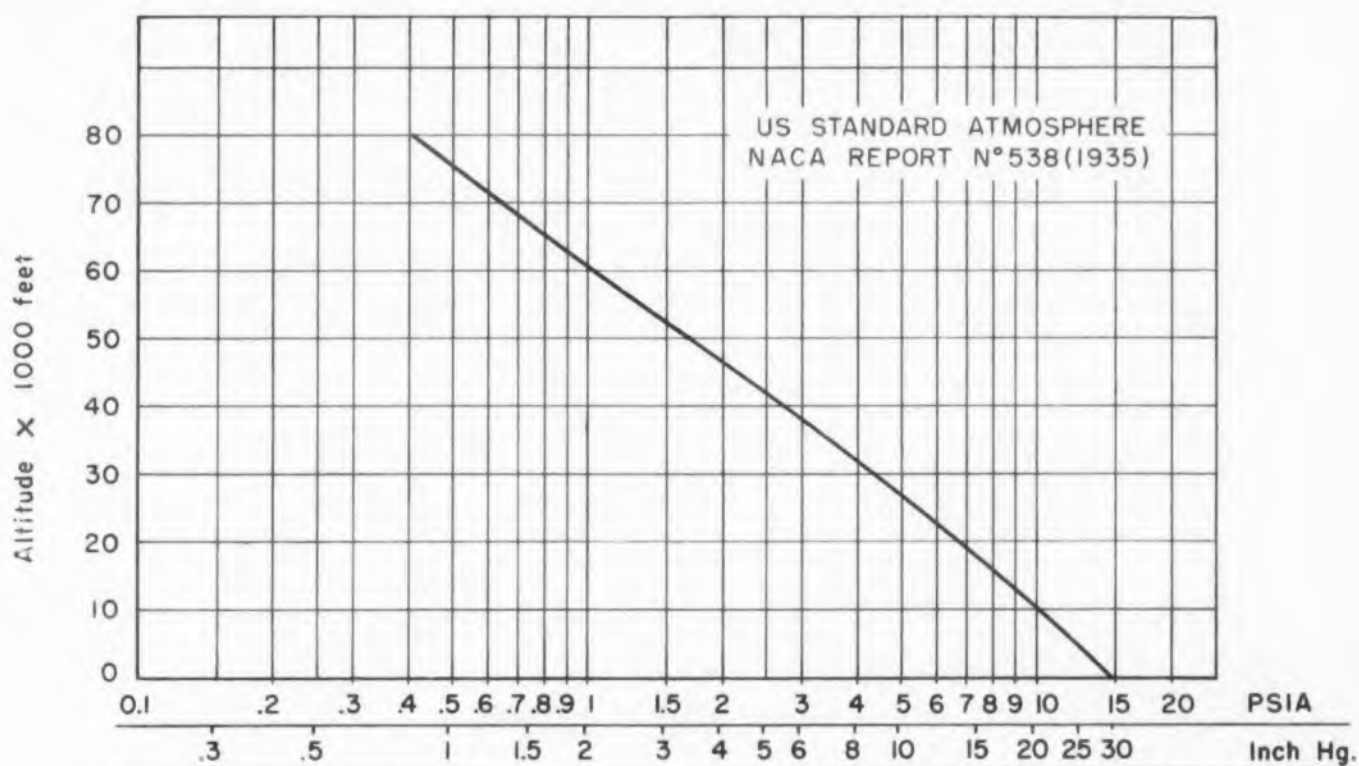

Fig. 4. Altitude-pressure chart.

shaft speed (regardless of density). Therefore in order to maintain adequate cooling at altitude, we shall have to increase the shaft speed of our fan or blower by a factor  $370/200 = 1.9$  at 25,000 ft and  $570/200 = 2.9$  at 50,000 ft, assuming, of course, that the fan or blower was running at sea level at such speed as to move 794 lbs per hr or 180 cfm and no more through this "piping system." Such variable speed operation may be obtained by the use of a suitable motor, which varies its speed automatically with changing load (air density). It should be further noted that adequate cooling at all altitudes may be obtained by the same fan or blower running at a fixed speed equal to the *highest* speed required at any altitude, although this may require a driving motor of prohibitively high horsepower.

# Weight Flow Nomograms

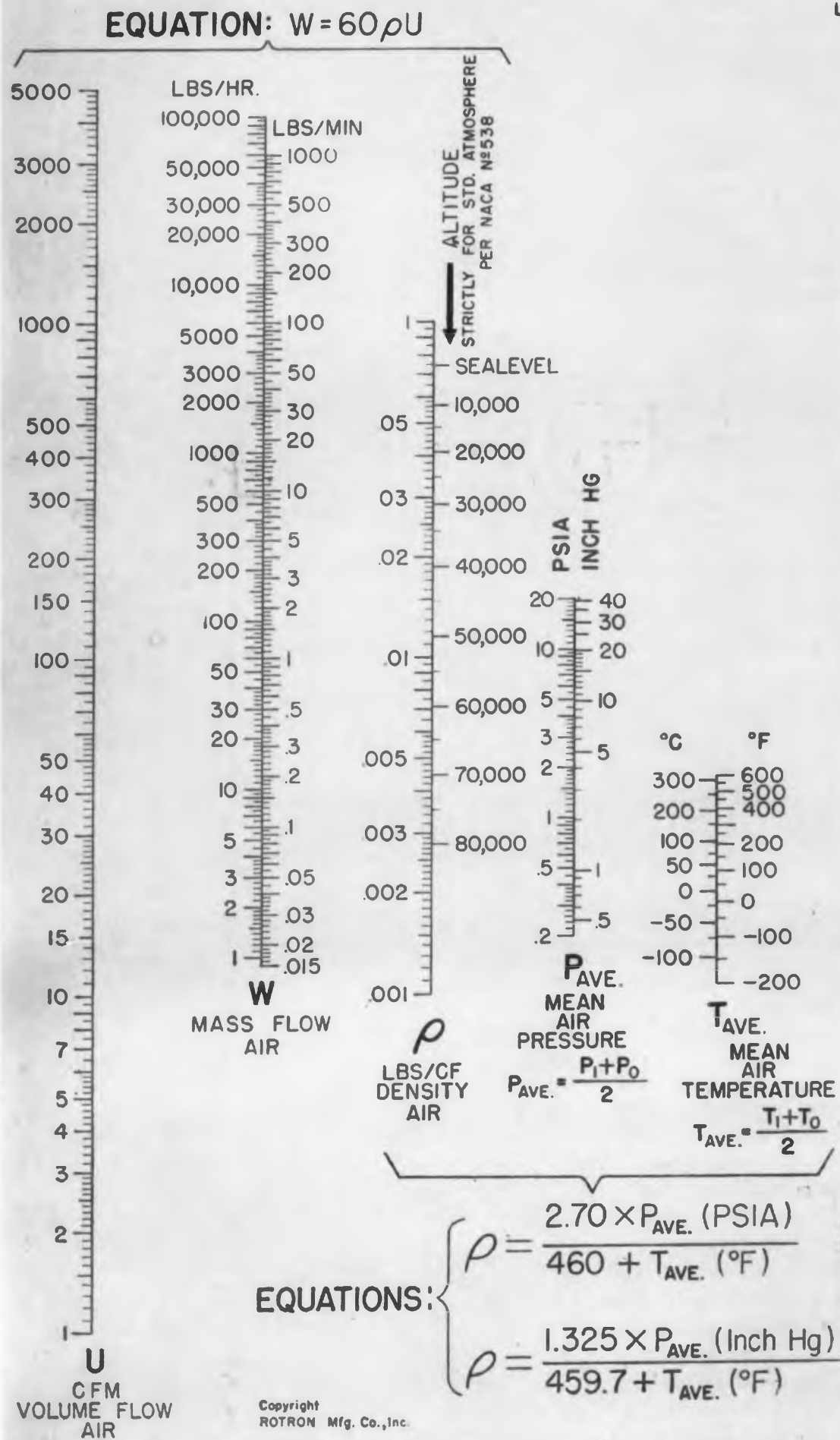

Fig. 5. Flow, density, pressure and temperature conversion nomogram.

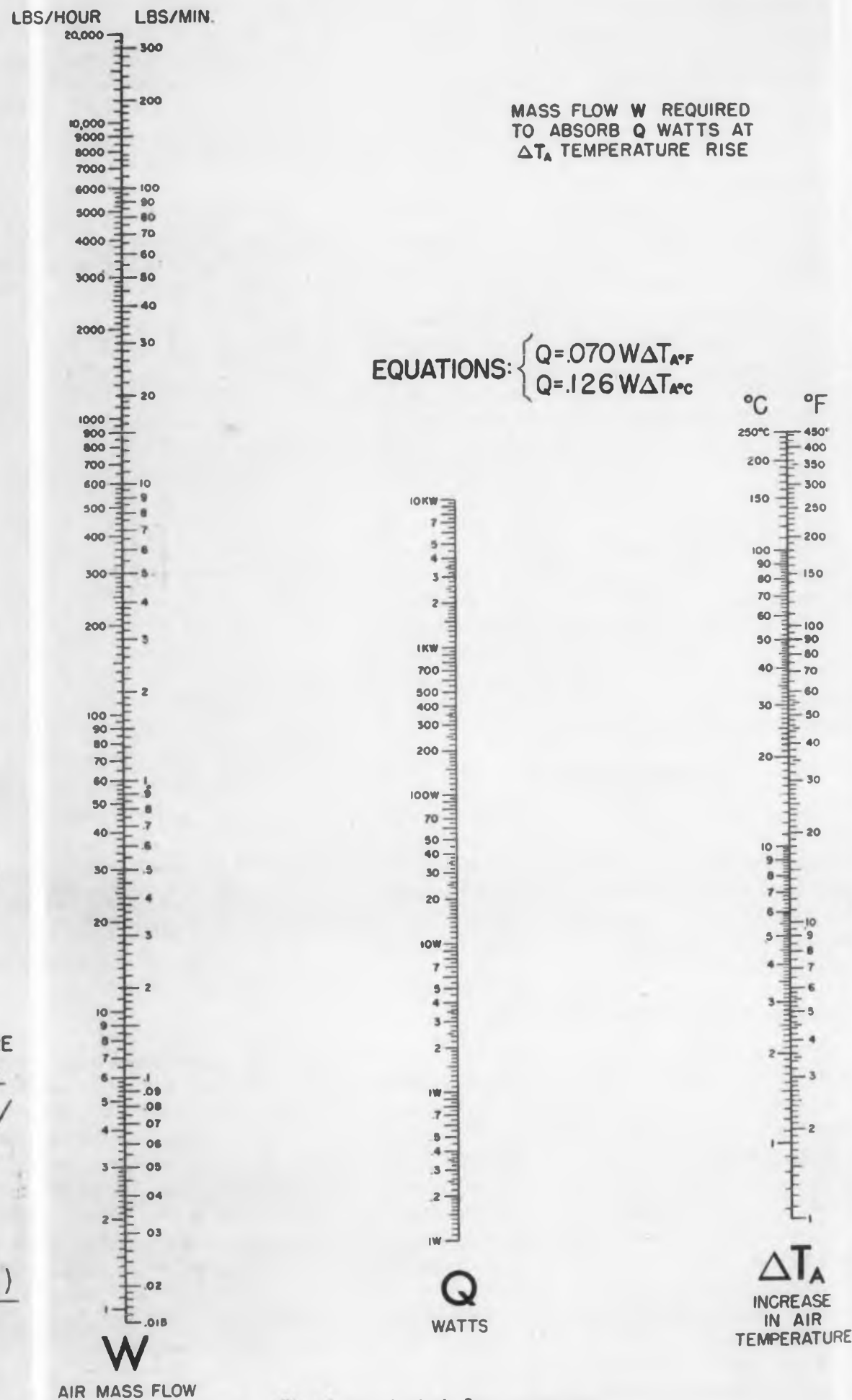

Fig. 6. Required air flow nomogram.

### Example 2. Turbulent Flow

Assume that the inside wall of a circular duct is being cooled by passing turbulent air through the duct. Let the temperature of the duct at the air inlet side  $T_B$  be 80 C and assume that we have to dissipate 150 w. If the ambient air inlet condition again is per MIL-E-5400, Curve A (55 C at sea level), then our available temperature difference  $\Delta T_T$  at sea level is 80 C less 55 C, or 25 C. From Fig. 6 we find that 0.8 lbs per min of cooling air is required to absorb the required 150 w. From the utilization graph, (Fig. 1), we see that the air in our duct is well in the turbulent region and that we should therefore use weight flow ratios per formula (1). For typical conditions at 25,000 ft and 50,000 ft we obtain from Fig. 2,  $\Delta T_T$  figures of respectively 35 C and 60 C and applying formula (1), we find that air weight flow requirements at those two altitudes become respectively 25/35th and 25/60th of those at sea level or 0.57 and 0.33 lbs per min respectively. The prevailing air densities at those altitudes depend on the temperatures and pressures encountered and by use of Figs. 2, 4, and 5 are found to be 0.0260 and 0.00775 lbs per cu ft. Per Fig. 5 lefthand scales this corresponds to 22 and 43 cfm, as against 12 cfm at sea level. If our fan or blower is a constant speed device, we shall have to move the full 43 cfm at all altitudes. If this leads to a too large and too powerful fan or blower, we shall have to revert to a variable speed fan or blower and the volume figures of 12, 22, and 43 will give us the required minimum speed ratios for such variable speed device.

### Example 3. Unknown Flow Conditions

Assume that sea level experiment indicates that the fins of a magnetron dissipating 500 w can be kept at the required temperature of 100 C by an air stream of 35 cfm. Further assume that ambient conditions per MIL-E-5400, Curve A, apply and  $T_1$  is therefore 55 C at sea level. From Fig. 5 we find that 35 cfm at 55 C and 29.9 in. Hg corresponds to a mass flow of 130 lbs per hr of air. Fig. 6 shows a  $\Delta T_A$  of 30 C for these conditions. The air outlet temperature  $T_0$  will be  $30 + 55 = 85$  C and the Available Temperature Difference  $\Delta T_T$  will be  $100 - 55 = 45$  C. Using the utilization formula we find that  $\Delta T_A/\Delta T_T = 30/45$  or 67 per cent and this indicates that turbulent conditions prevail and formula (1) is applicable. To find required weights and volumes of cooling air at other altitudes than sea level, we can now simply proceed as in the previous examples, by using formula (1) to obtain the weight flow at any altitude and subsequently the nomograms to obtain the corresponding densities and from these the corresponding volume flow.

For a free reprint of this and a useful nomogram reading ruler, Circle 492 on the Reader's Service Card.



## A NEW

## ENVIRONMENTAL COOLING SYSTEM FOR ELECTRONIC EQUIPMENT



U-518078  
Wt. 6.75 lbs.  
(9 x 5.9 x 4.375 in.)

**PERFORMANCE:** 275 Watts Heat Rejection: OS-45 Coolant; 2 lb/min/40 psi discharge pressure; air-in temperature range 160° F/sea level to 36.5° F/70,000 ft altitude; coolant inlet temperature will not exceed 204° F from sea level to 70,000 ft altitude. These temperatures are dependent on the variations of air density and compartment temperature. **POWER SOURCE:** 400 cycle; 3-phase; 208 V AC with 28 V DC interlock safety provision.

### AIRPLANES • MISSILES • GROUND • SHIPBOARD

UAP has been able to design and deliver cooling packages and systems for electronic installations that consistently reduce allowable figures for weight and envelope size. If you would like to get some suggestions regarding the dissipation of the heat generated by YOUR electronic installation please call the nearest UAP Regional Office. UAP Contractual Engineers are qualified to recommend heat exchanging packages for air cycle, vapor cycle and evaporation systems. A heat exchanging system which is tailored to your requirements is bound to have more efficiency, less weight and smaller envelope than any package that is produced for "across-the-board" use.

### UAP CONTRACTUAL ENGINEERING OFFICES

CALIFORNIA • 1101 Chestnut Street • Burbank, California.....Victoria 94236  
NEW YORK • 50 East 42nd Street • New York 17, N.Y.....Murryhill 7-1283  
DAYTON • 1116 Bolander Avenue • Dayton, Ohio.....Michigan 3841  
CANADA • United Aircraft Products, Ltd., 5257 Queen Mary Road • Montreal, Canada...Elmwood 4131

*a famous family of aircraft essentials since 1929*



Heat Exchangers



Diverter Segregator Valves



Cold Weather System Hoppers



Oil Tanks



Fuel Control Valves

## UNITED AIRCRAFT PRODUCTS, INC.

1116 BOLANDER AVENUE, DAYTON, OHIO  
CIRCLE 466 ON READER-SERVICE CARD FOR MORE INFORMATION



# Motor Design for Fans and Blowers

**O. W. Giesecke**  
Air-Marine Motors, Inc.  
369 Bayview Ave.  
Amityville, N. Y.

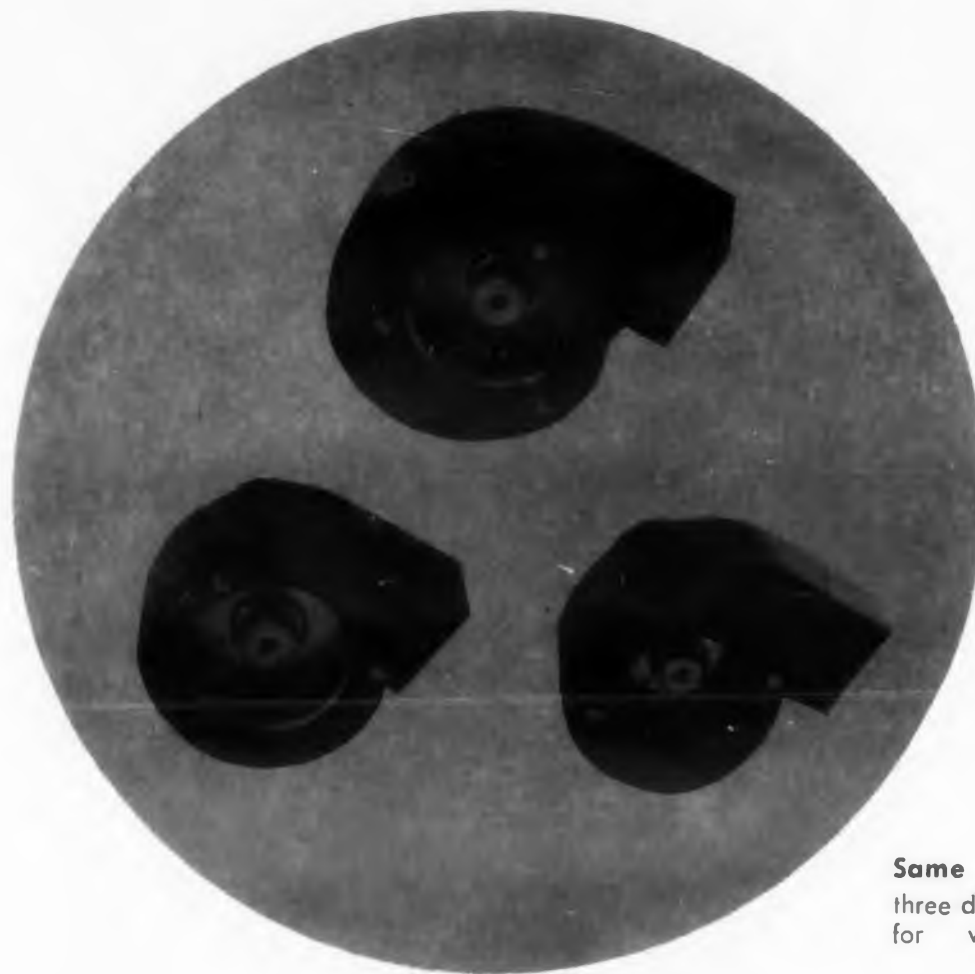

Same motor with  
three different wheels  
for varied CFM.

**T**HE ELECTRONIC design engineer must consider many alternatives before selecting a blower for cooling his equipment. To obtain a reliable unit for a minimum weight and size, the motor should be chosen so as to match the blower used. After the equipment is packaged for optimum cooling, static pressure determined, and the required cfm known, the type of blower must be selected. The motor characteristics should be considered at this point. Since brush type motors often cause problems as to radiation and brush life, induction motors are commonly used for cooling electronic equipment.

The efficiency of an induction motor varies with slip. Generally, the best efficiency of an induction motor used for blowers is at a speed between 85 and 90 per cent of synchronous speed. The efficiency of the motor determines its size and weight. With small units, where the power used is not significant, obtaining a desired slip will be the governing factor in determining motor size.

The general conditions to be considered before selecting a motor are the following:

- Frequency available
- Altitude conditions
- Reliability

#### Frequency Considerations

First let us consider a blower to operate on 400 cps with no appreciable change in air density to

be encountered. Synchronous speed on an induction motor is equal to  $\text{rpm} = 120f/P$  where  $f$  is frequency in cycles per second and  $P$  is number of poles. The ideal speeds for an induction motor at 400 cps are, 21,600-20,200 for a 2-pole unit; 10,800-10,000 for a 4-pole unit; and 7,200-6,800 for a 6-pole unit. The limitations of a blower wheel or fan blades, noise, and life considerations will limit the possible speeds to probably one or two variations in number of poles to be used. With this settled, we are ready to select the type of blower to be used.

With a given static pressure and cfm requirement, we may fall within one definite category—centrifugal blower or axial fan—or we may have a choice between two general types, such as centrifugal blower or axial vane. If there is a choice, then we should pick the type that falls into the optimum motor speed. If, however, the category is well defined, we still have a number of variations which do not require expensive tooling. In the case of a centrifugal blower, the combination of wheel and housing may be altered. In case of an axial fan, configuration of the outlet ring or venturi ring may be changed to alter the cfm vs. static pressure characteristics. We might also select a pressure blade as against a standard axial fan blade. Let us compare cfm vs. static pressure curves of a blower using the same size housing and the same motor when we change wheel size. (See Figs. 1 and 2.)

The curves of Fig. 2 are for the larger wheel. Since we use the identical motor in both blowers, the speed has dropped in Fig. 2. The motor temperature would be higher unless the blower operates above 3 in. SP. If our requirement is 40 cfm at 1.5 in. SP, Fig. 1 should be used. If we require 40 cfm at 2 in. SP, we must use Fig. 2 and design the motor accordingly. We would have almost the same physical size unit with about 20 per cent increase in weight but would, at 2 in. SP, get 44 cfm instead of 32 cfm. If we require 2.3 in. SP, the difference would then be two to one.

It is quite an elaborate process to make up recommendations for a wide variety of applications. We are, in these examples, merely trying to point out types of solutions possible and the importance of knowing various possible solutions if the design engineer is required to hold size, weight, and cost at a minimum. In the past, most static pressure curves were taken with a duct and pitot tube. These measurements are difficult and result in errors. With the most modern plenum chambers available today, taking blower curves has become a simple and accurate process and, therefore, the safety factor used by design engineers can be reduced.

There are still many prints in circulation where air delivery at 0 in. SP is given even though the static pressure of the system to be cooled is appreciable. Even though, for the purposes of stand-

ardization, a blower is used on several equipments, it is preferable that the range of static pressures vs. cfm to be met are stated. Figs. 1 and 2 were made with units having all outside dimensions identical. If the full curves were not known, the user could be in difficulty if the blower in Fig. 2 were used and the equipment required over 2 in. SP. A manufacturer might meet specifications at 0 in. S.P. but the performance would be inadequate.

If we cannot come up with a good design in the optimum motor speed range then the motor manufacturer can, without tooling, or with minimum tooling, alter the motor design to be optimum for other speeds. However, the efficiency of the motor will decrease. We must bear in mind that an induction motor must run at some slip and will have zero output near synchronous speed. Therefore, most leeway is achieved by increasing slip or reducing speed. This is a desired condition for altitude applications which we will discuss later and it is unavoidable when using a variable frequency source of power.

Since it is not possible to hold motor speed constant over a wide frequency range, the design engineer must be sure that the maximum speed over the range does not go higher than the recommended speed of the blower wheel or fan and that life and temperature rise and noise do not become excessive. Typical rpm vs. frequency curves are shown in Figs. 4 and 5. We see here that performance will

peak at some frequency. In some cases, dips occur so that the whole curve must be known or there will be some undercooling at some frequencies.

Sometimes it is economically advantageous to use one blower for several applications. In this case it may be preferable to sacrifice performance to some extent and choose a motor with more than optimum slip which speeds up with back pressure and is thus more versatile. In case of large air density differences to be encountered, it is usually desirable to use a high slip motor such as shown in Fig. 3 and frequently a motor with considerably more slip.

#### High Altitude Blowers

We have found that it is desirable to operate a blower at a definite low slip in ground or pressurized equipment in most cases. As soon as we add an altitude spec, the opposite is true. Then, we should strive for high slip and the low slip unit is the exception. This means a decrease in motor efficiency. If a 3 phase, 400 cps current is available, it should be used since the speed-torque curve of the motor is ideal and can be adjusted by simple motor design variations to match the applications. The first consideration is the change in ambient temperature, if any, at sea level and at various altitudes. The selection of the type of blower is the same as for sea level applications. The determination of housing configuration or fan outlet ring is again established by static pressure vs. cfm require-

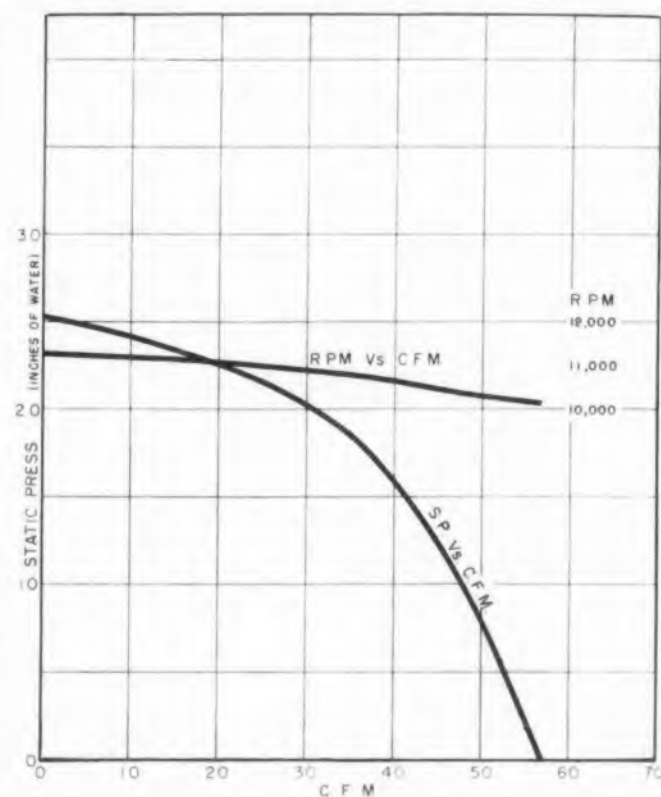

Fig. 1.

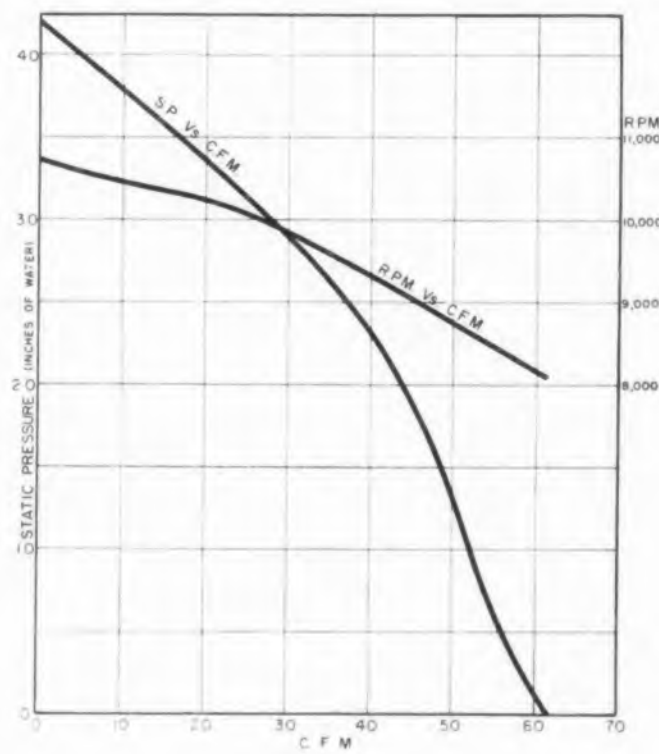

Fig. 2.

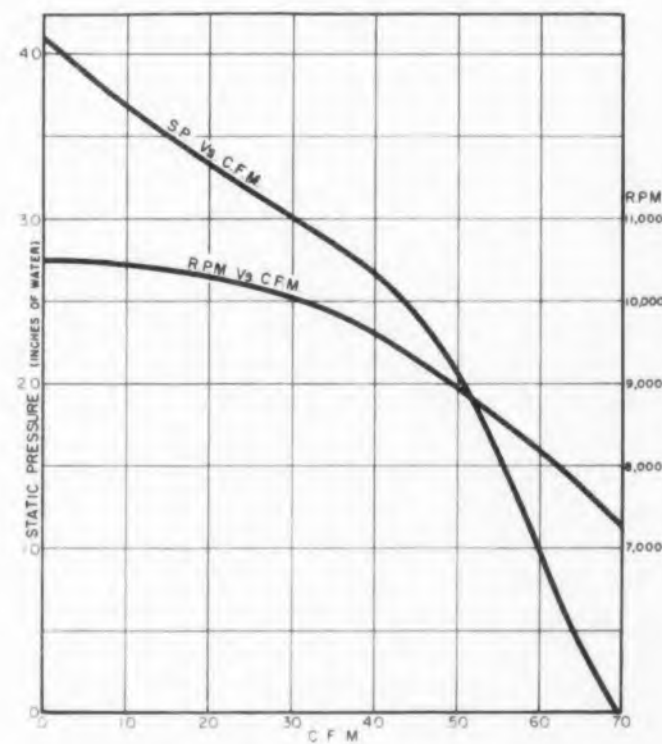

Fig. 3.

Figs. 1, 2, and 3. These curves are for different blower units employing the same motor. Figs. 1 and

2 use different wheels in the same housing. Figs. 2 and 3 use the same wheel in different housings.



## Motor Design

ments. We must in addition determine the cfm required at sea level as well as at various altitudes.

To use the smallest blower which will cool the equipment properly, we should hold the box temperature constant between sea level and maximum altitude specified. There are many equipments in which there is one vital component which requires most cooling in which case the component manufacturer tells us the cfm required at various altitudes and this determines our specification. When a piece of equipment has to be limited to a certain temperature rise, we first study the ambient temperature

density. If the ratio becomes much higher than this, we must consider overcooling at sea level. A reliable blower manufacturer acquainted with altitude problems should be consulted before the physical size becomes established or serious problems may be encountered later. Determining, with the blower manufacturer, what the cooling requirements are is well worthwhile when you consider the fact that the power required to drive a blower varies with the cube of the speed of the blower. If very little cooling is required usually a more or less constant speed blower is adequate, but with a blower requiring five times the cooling at altitude than at sea level, we need a motor with 125 times the power actually needed.

Let us take a specific example: The requirement in this example is for a blower to deliver three times the air at 50,000 feet than at sea level with the cooling air in the box 25 F lower at 50,000 feet. Since air density at the same temperature would be 11-1/2 per cent and since density increases roughly 1 per cent per 5 deg F decrease in cabinet air, we know

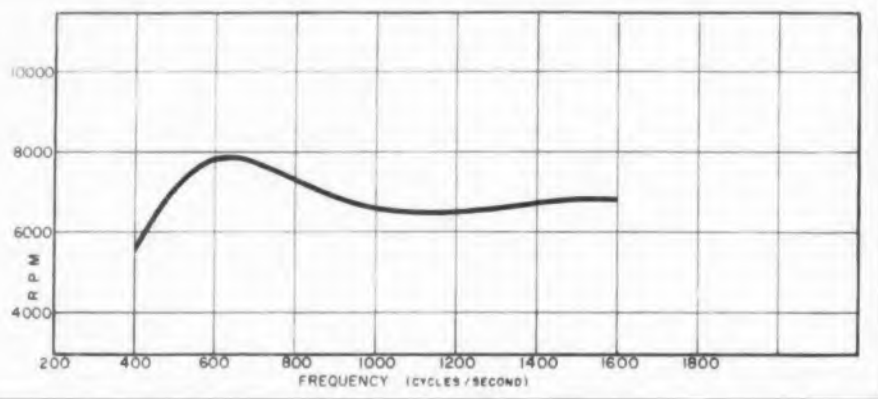

Fig. 4. (left) Speed-frequency curve for a single phase variable frequency motor in the 400 to 1600 cps range.

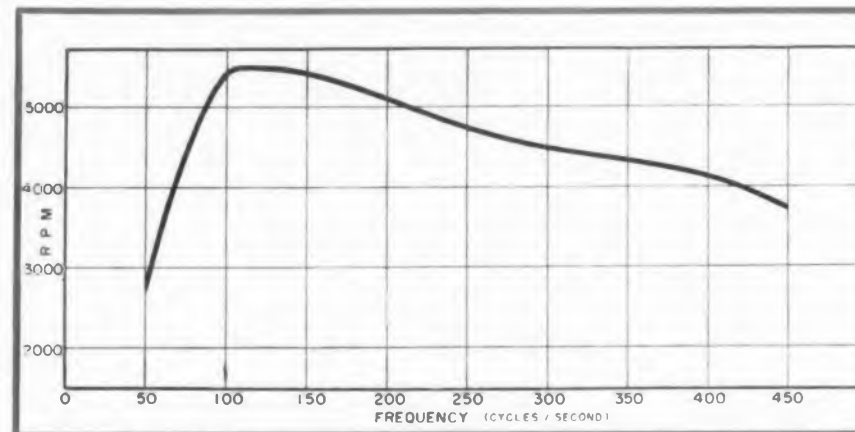

Fig. 5. (right) Speed-frequency curve for a single phase motor in the 50 to 450 cps range.

variations. The cfm needed for cooling must increase in proportion to the decrease in air density.

After establishing the cfm requirements, we must determine the static pressure of the system, bearing in mind that static pressure decreases directly with air density and increases with the square of the blower speed. Therefore, the static pressure may be more or less at say 50,000 ft. But from the static pressure vs. cfm curve, we know that this has a very appreciable effect on air delivery. Fortunately, we do not need to take these curves at various altitudes. Our sea level curve will suffice. We simply read the sea level cfm at the static pressure required at altitude and use this as our base to calculate blower speed required at altitude.

The next consideration is the maximum speed of available blower wheels, fans, and impellers. We know that the induction motor will lose efficiency with less than 10 per cent slip. Assume our maximum speed is established at 20,000 rpm. If we require four times the cfm at maximum altitude, the blower should operate at 5000 rpm at sea level and then increase speed directly with decrease in air

that we will be working at a slightly higher static pressure at altitude than at sea level if speed is to change 3 to 1. The specific requirement here is 45 cfm at 0.5 in. SP at sea level and 135 cfm at 50,000 ft. We select the blower of Fig. 2 and see that we get 56 cfm at 0.5 in. SP. We can, therefore, decrease the blower speed at sea level or raise the altitude speed by a factor of 2.3, which brings altitude speed to 19,300 rpm.

Since static pressure goes up with the square of speed, it would appear that static pressure is less than 0.5 in. at altitude. However, if we use the blower of Fig. 2, we will be operating at more than 0.5 in. SP at sea level, close to 0.6 and the unit will deliver 135 cfm at 0.55 SP. If we used a constant-speed motor in this application, we would have to increase the blower size to give us 135 cfm at a lower speed, or bring up the blower speed to 19,300 rpm at sea level. To bring up the speed at sea level would require fourteen times the power. The efficiency of the motor would be approximately four times better but the unit would still have to be three and a half times larger.

smaller blower or fan to operate the unit at the same speed as it would operate at altitude.

From the specifications and environmental conditions, the motor manufacturer must choose a bearing size and type, the material of the bearing, shaft, and housing of the bearing, as well as the type and fill factor of grease, the radial play of the bearings, and the limits of unbalance allowable in the rotor. These factors contribute to the price of the motor and, to be competitive, the manufacturer must make a choice. Therefore, the specification for a blower should be so written that all critical conditions are tied down.

A variable frequency blower may have several thousand hours life at 60 cps and last but a few hours at 1000 cps if the temperature limit of the grease used is exceeded at this point. Some greases are excellent at low speeds of say 3000 rpm but deteriorate rapidly at 20,000 rpm. Therefore, a maximum speed compatible with the bearing and lubrication used should be specified. If all the facts are known to the blower manufacturer, he can then design the unit to minimize failures.

## Reliability

Operating a high slip blower over altitude conditions or over a wide range of frequencies increases the difficulty of writing a specification which assures reliable performance in the field. The most difficult problem for the motor manufacturer is often bearing life. Temperature ranges and speed variations add two variables which affect life of the bearings tremendously. It is necessary to test life at the worst conditions.

From speed-torque curves and power input curves, we can find the point of highest watts lost in heat and use this condition for life testing, and in the written specification, limit the maximum watts input at that frequency or speed. When long life is expected at altitude, most companies will have difficulty tying up an altitude chamber several weeks or months. We can get a reliable test at sea level by adjusting voltage input so that our watts input to the motor is equivalent to the watts input at altitude and then load the motor with a



# COOL YOUR INSTRUMENTS

EXACTLY WHERE NEEDED

## PANEL MOUNTING BLOWERS

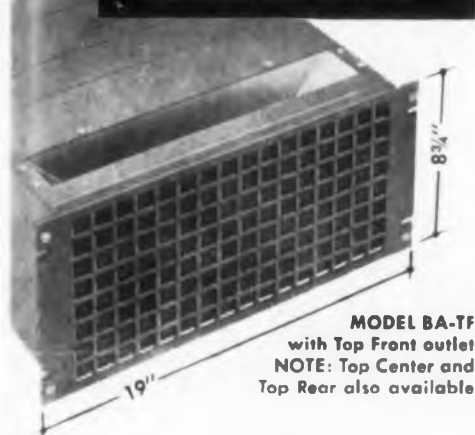

- **MIL SPEC QUALITY**  
Meet radio interference requirements of MIL-I-16910A
- **LARGE COOLING CAPACITY**  
600-1200 CFM output
- **COMPACT SIZE**  
Mount as standard 8 3/4" RETMA panel—15" front-to-back
- **CLEANABLE FILTER**
- **AIR DISCHARGE AREAS TO SUIT NUMEROUS APPLICATIONS:**  
Vertical Printed Circuit Cards, Horizontal-mount Chassis, Vertical-mount Chassis, etc.

YOUR CHOICE OF  
8 DIFFERENT  
STANDARD MODELS  
(others 'TO ORDER')

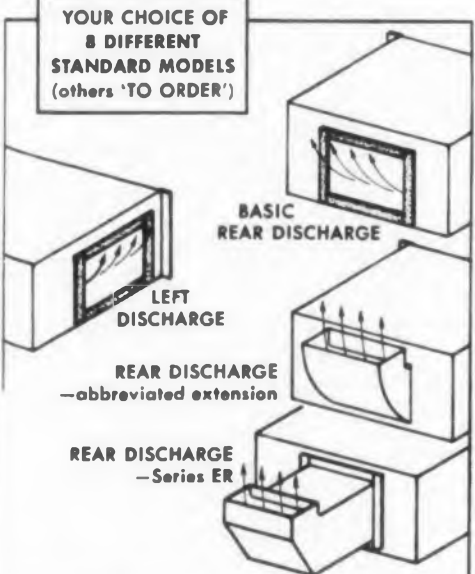

### ONE SOURCE...

for VENTILATED RELAY RACK  
CABINETS, CONTROL CONSOLES,  
BLOWERS, CHASSIS, 'CHASSIS-  
TRAK', RELATED COMPONENTS

ORchard 4-3510

**WESTERN DEVICES, INC.**

603 W. FLORENCE AVE., INGLEWOOD, CAL.

\*For Inquiries on 'Chassis-Trak', East of Rockies:  
Chassis-Trak Corp., Indianapolis

CIRCLE 464 ON READER-SERVICE CARD

# Manufacturers of Cooling Equipment for the Electronic Industries

THE PROBLEMS of cooling electronic equipment, if they have not given rise to a new industry, have certainly provided a powerful impetus for the growth and expansion of segments of other industries devoted to cooling electronic equipment.

For the convenience of our readers, we are providing, a tabulation of representative manufacturers, together with their addresses. These manufacturers are involved in many different phases of the cooling problem. They range from the design and manufacture of fans and blowers to the production of temperature sensitive devices which may be used for measurement of thermal conditions, or for warning or alarm service in a completed unit.

For simplicity, the table is presented with company names only, along with their principal products of interest in thermal design. Complete names and addresses are presented separately.

In the thermal design of electronic equipment, most applications call for the use of properly designed fans or blowers, strategically placed to achieve optimum cooling of an entire chassis or group of chassis. Applications often arise, however, which demand unusual approaches.

For example, *Sanders Associates, Inc.* has developed a subminiature blower and motor, combined in a compact, one inch cube package, which weighs only one ounce. It can be mounted directly on equipment or on a small bracket.

Other examples are *Amco Engineering Co.* and *Rotating Components, Inc.* who provide plug-in blower assemblies for mounting in standard rack type cabinets. The *Aircraft Division of The Hussman Refrigerator Company* manufactures trailer mounted air conditioning units for use in cooling the electronic bays of jet aircraft or guided missiles on the ramp or launching facility. *United Aircraft Products* provides cold plates and heat exchangers.

As a further example, *Eastern Industries* specializes in cooling electronic equipment using a liquid medium.

The accompanying table includes only those manufacturers who carry

MANUFACTURERS	Air Filters	Airflow Switches	Blowers (Complete)	Blower Wheels	Blower Housings	Ductwork	Fans (Complete)	Fan Blades	Fan Housings	Heat Exchangers	Motors	Temp. Sensing Devices	Vacuum Tube Coolers
Aero Research												x	
Aerovent			x				x	x	x				
Air-Marine Motors			x		x		x		x		x		x
Amco Engineering			x										
American Air Filter	x		x	x	x		x	x	x				
American Electronics			x		x		x		x		x		x
Arrow Tools	x												
Barber-Colman			x				x	x			x	x	
Beach Precision										x			
Bendix-Friez												x	
Buffalo Forge			x				x	x	x	x			x
Burling Inst.												x	
Carey Electronic Eng.	x											x	
Century Controls						x						x	
Control Products												x	
Craig			x				x				x		
Curtis Dev. & Mfg.		x										x	
Dean & Benson			x	x	x	x	x	x	x				
Dresser Ind.			x							x			
Dunham-Bush										x			
Eastern Air Devices			x		x		x		x		x		
Eastern Industries			x							x			x
T. A. Edison												x	
Farr	x												
Fenwall												x	
Garrett			x	x	x	x	x	x	x	x	x	x	x
Globe Ind.			x		x		x				x		
G-V Controls												x	
Hankison	x												
Howard Ind.			x								x		

# Manufacturers

MANUFACTURERS	Air Filters	Airflow Switches	Blowers (Complete)	Blower Wheels	Blower Housings	Ductwork	Fans (Complete)	Fan Blades	Fan Housings	Heat Exchangers	Motors	Temp. Sensing Devices	Vacuum Tube Coolers
Hupp Electronics			x	x			x				x		
Ilg Electric Vent.			x				x						
Induction Motors			x	x	x		x	x	x		x		
Industrial Development												x	
Joy							x	x	x				
Kearfott											x		
Lamson			x	x	x								
Master Appliance	x		x	x	x						x		x
McGraw-Edison			x				x				x		
McLean Engineering Labs.	x		x		x	x	x		x				
Mercoid		x										x	
Mine Safety Appliances	x												
John Oster			x				x				x		
Peerless Electric			x	x	x		x	x	x		x		
Penn Controls												x	
Poroloy Eqpt.	x												
Propulsion Research			x	x	x		x	x					
Quick Charge			x		x	x			x		x		
Research Products	x												
Robbins & Myers			x				x	x	x		x		
Rotating Components			x				x				x		x
Rotron	x	x	x	x	x		x	x	x	x	x		x
Arthur C. Ruge												x	
Sanders			x										x
Servo-Tek											x		
Simpson Electric												x	
Small Motors			x				x				x		
Stevens												x	
Thermo Electric												x	
Thompson Res. & Mfg.												x	
Torrington			x	x	x		x	x	x				x
Trane										x			x
Trans-Sonics												x	
Turbo Research			x		x		x			x			
George Ulanet												x	
United Aircraft Products													x
United Control		x										x	
United Electric Controls												x	
Valverde												x	
Victory Engineering												x	
West Inst.												x	
Western Devices		x	x		x	x			x		x		
Western Gear			x				x						
Westinghouse Electric	x		x	x	x		x	x	x				

stock items useful in thermal design. Most of these companies also provide custom design, research, and testing facilities. Some companies and individuals, not listed here, carry no stock items in this category, but provide consulting and custom design facilities on contract only. The list is compiled from verified responses to our editorial inquiry.

**Aero Research Instrument Co., Inc.**  
315 N. Aberdeen St.  
Chicago 7, Ill.

**Aerovent Fan Co., Inc.**  
Piqua, Ohio

**Air-Marine Motors, Inc.**  
369 Bayview Ave.  
Amityville, N.Y.

**Amco Engineering Co.**  
7333 W. Ainslie St.  
Chicago 31, Ill.

**American Air Filter Co., Inc.**  
215 Central Ave.  
Louisville 8, Ky.

**American Electronics, Inc.**  
655 W. Washington Blvd.  
Los Angeles 15, Calif.

**Arrow Tools, Inc.**  
1900 S. Kostner Ave.  
Chicago 23, Ill.

**Barber-Colman Co.**  
P. O. Drawer 99  
Rockford, Ill.

**Beach Precision Parts Co.**  
120 Mechanic St.  
Boonton, N.J.

**Bendix Aviation Corp.**  
Friez Instrument Div.  
1400 Taylor Ave.  
Baltimore 4, Md.

**Buffalo Forge Co.**  
Buffalo 5, N.Y.

**Burling Instrument Co.**  
16 River Rd.  
Chatham, N.J.

**Carey Electronic Engineering Co.**  
Metal Wool Div.  
Springfield, Ohio

**Century Controls Corp.**  
Allen Blvd.  
Farmingdale, N.Y.

**Control Products, Inc.**  
300 Sussex St.  
Harrison, N.J.

**Craig Corp.**  
50 Eastern Ave.  
Boston 9, Mass.

**Curtis Development & Mfg. Co.**  
3266 N. 33rd St.  
Milwaukee 16, Wis.

**Dean & Benson Research, Inc.**  
16 Richmond St.  
Clifton, N.J.

**Dresser Industries, Inc.**  
Roots-Connersville Blower Div.  
900 W. Mount St.  
Connersville, Ind.

**Dunham-Bush, Inc.**  
West Hartford 10, Conn.

**Eastern Air Devices, Inc.**  
385 Central Ave.  
Dover, N.H.

**Eastern Industries, Inc.**  
100 Skiff St.  
Hamden 14, Conn.

**Thomas A. Edison Inc.**  
Instrument Div.  
West Orange, N.J.

**Ellis & Watts Products, Inc.**  
Monroe at Spencer  
Cincinnati 36, Ohio

**Farr Co.**  
2301 E. Rosecrans  
El Segundo, Calif.

**Fenwal Inc.**  
Ashland, Mass.

**The Garrett Corp.**  
AIResearch Manufacturing Div.  
9851 Sepulveda Blvd.  
Los Angeles 45, Calif.

**Globe Industries, Inc.**  
1784 Stanley Ave.  
Dayton 4, Ohio

**G-V Controls Inc.**  
28 Hollywood Plaza  
East Orange, N.J.

**Hankison Corp.**  
951 Banksville Rd.  
Pittsburgh 16, Pa.

**Howard Industries, Inc.**  
1760 State St.  
Racine, Wis.

**Hupp Electronics Co.**  
743 Circle Ave.  
Forest Park, Ill.

**Hussman Refrigerator Co.**  
Aircraft Div.  
819 E. Taylor St.  
St. Louis 15, Mo.

**Ilg Electric Ventilating Co.**  
2850 N. Pulaski Rd.  
Chicago, Ill.

**Induction Motors Corp.**  
570 Main St.  
Westbury, N.Y.

**Industrial Development Labs., Inc.**  
17 Pollock Ave.  
Jersey City 5, N.J.

**Joy Manufacturing Co.**  
Oliver Building  
Pittsburgh 22, Pa.

**Kearfott Co., Inc.**  
Little Falls, N.J.

**Lamson Corp.**  
Syracuse 1, N.Y.

**Master Appliance Mfg. Co.**  
4th & Ontario  
Racine, Wis.

**McGraw-Edison Co.**  
Power Tool Div.  
110 Main St.  
Burlington, Vt.

**McLean Engineering Labs.**  
70 Washington Rd.  
Princeton, N.J.

**The Mercoid Corp.**  
4201 Belmont Ave.  
Chicago 41, Ill.

**Mine Safety Appliances Co.**  
201 N. Braddock Ave.  
Pittsburgh 8, Pa.

**John Oster Manufacturing Co.**  
Avionic Div.  
1 Main St.  
Racine, Wis.

**The Peerless Electric Co.**  
1401 W. Market St.  
Warren, Ohio

**Penn Controls, Inc.**  
Goshen, Ind.

**Poroloy Equipment, Inc.**  
14943 Califa St.  
Van Nuys, Calif.

**Propulsion Research Corp.**  
1860 Franklin St.  
Santa Monica, Calif.

Quick Charge, Inc.  
10th & Missouri Sts.  
Oklahoma City 17, Okla.

Research Products Corp.  
1015 E. Washington Ave.  
Madison 10, Wis.

Robbins & Myers, Inc.  
Propellair Div.  
Springfield, Ohio

Rotating Components, Inc.  
267 Green St.  
Brooklyn 22, N.Y.

Rotron Manufacturing Co., Inc.  
Schoonmaker Lane  
Woodstock, N.Y.

Arthur C. Ruge Associates, Inc.  
733 Concord Ave.  
Cambridge 38, Mass.

Sanders Associates, Inc.  
Nashua, N.H.

Servo-Tek Products Co., Inc.  
1086 Goffle Rd.  
Hawthorne, N.J.

Simpson Electric Co.  
5200 W. Kinzie St.  
Chicago 44, Ill.

Small Motors, Inc.  
2076 Elston Ave.  
Chicago 14, Ill.

Stevens Manufacturing Co., Inc.  
69 S. Walnut St.  
Mansfield, Ohio

Thermo Electric Co., Inc.  
Saddle Brook, N.J.

Thompson Research & Manufacturing Co.  
Box 116  
Davenport, Fla.

Torrington Manufacturing Co.  
Air Impeller Div.  
Franklin Pl.  
Torrington, Conn.

The Trane Co.  
La Crosse, Wis.

Trans-Sonics, Inc.  
Burlington, Mass.

Turbo Research Corp.  
1630 Euclid St.  
Santa Monica, Calif.

Twigg Industries  
Brazil, Ind.

George Ulanet Co.  
413 Market St.  
Newark 5, N.J.

United Aircraft Products, Inc.  
1116 Bolander Ave.  
Dayton, Ohio

United Control Corp.  
4540 Union Bay Pl.  
Seattle 5, Wash.

United Electric Controls Co.  
85 School St.  
Watertown 72, Mass.

Valverde Labs.  
252 Lafayette St.  
New York 12, N.Y.

Victory Engineering Corp.  
Springfield Rd.  
Union, N.J.

West Instrument Corp.  
4363 W. Montrose Ave.  
Chicago, Ill.

Western Devices, Inc.  
600 W. Florence Blvd.  
Inglewood, Calif.

Western Gear Corp.  
Electro Products Div.  
132 W. Colorado St.  
Pasadena 1, Calif.

Westinghouse Electric Corp.  
Sturtevant Div.  
Hyde Park  
Boston 36, Mass.

CIRCLE 465 ON READER-SERVICE CARD ➤

# cooling avionic systems

During World War II, Eastern Industries pioneered cooling systems for aircraft electronic systems. Now, thousands of installations later, and as the leader in this challenging field, Eastern is still pioneering.

Experience has been a springboard to new developments . . . compactness, simplification, refrigeration cycles. Research and development continue to play their vital parts in perfecting systems to overcome the new problems as expanded aircraft performance produces fantastic rises in temperatures.

If you have a challenging problem, come to the leader in the field for complete and creative engineering help.

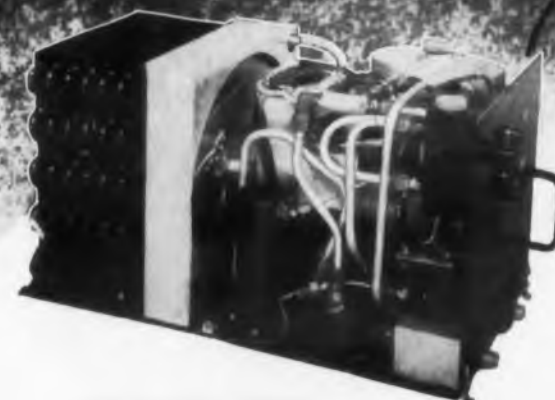

COOLING UNIT



REFRIGERATION-TYPE

## ELECTRONIC TUBE COOLING UNITS

Custom-made units, with or without refrigeration cycles, provide a method of maintaining safe operating temperature limits in electronic equipment. Standard sub-assemblies and components normally are used to create a custom-made design to fit your exact needs. Costs are minimized for these completely self-contained units by combining heat exchangers, fans or blowers, liquid pumps, reservoirs, flow switch, thermostat, and other common components.

Write for Eastern AVIONICS BULLETIN 340

## PIONEER OF THE THERMAL FRONTIER

EASTERN  
AVIATION PRODUCTS

**Eastern**

**INDUSTRIES, INC.**

100 Skiff St., Hamden 14, Conn.

West Coast Office: 1608 Centinela Avenue • Inglewood 3, California

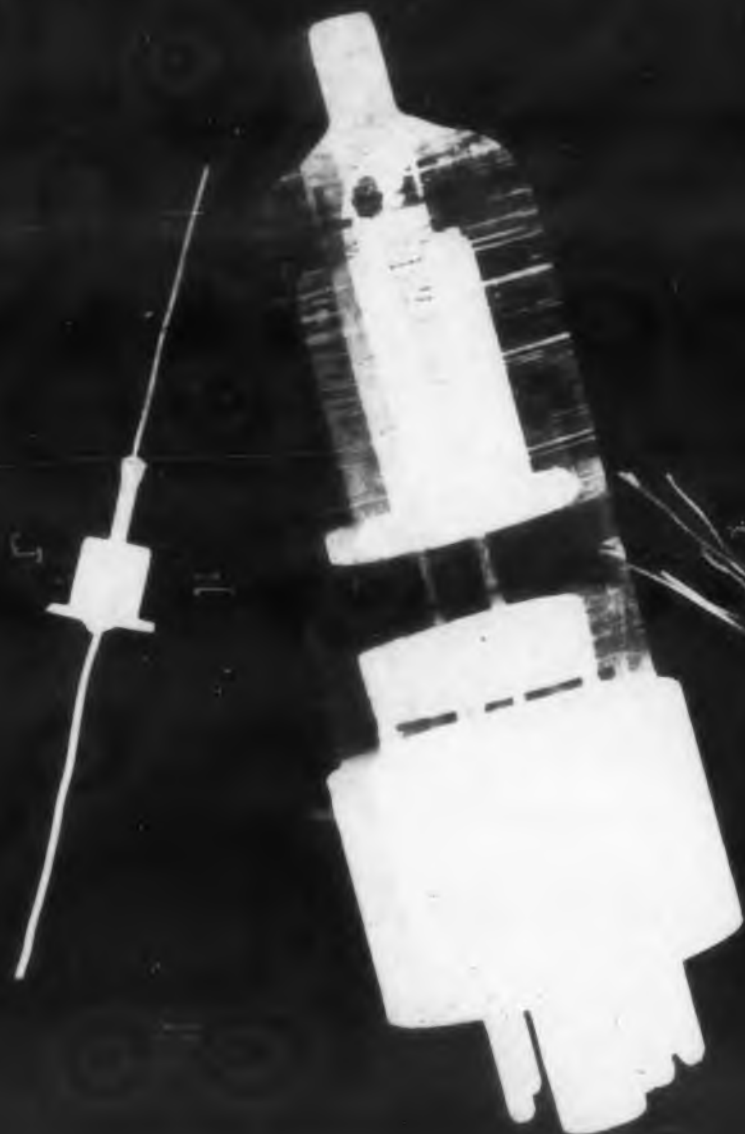

Pro  
outp  
cryst  
ment  
semb  
and a  
in. st  
The  
viron  
tional  
ature  
temp  
ture-s  
oven  
The  
cyclin  
Ma  
Ave.,  
CIRCLE

Have  
to cab  
three  
shortin  
of the  
a matt  
ments.  
tion of  
brushe  
The  
motor  
filter. A  
synchr  
Sampli  
switch  
depth.  
block f  
the sw  
Gene  
Princet

CIRCLE 1

ELECTR

### High Stability Oscillator

Drifts 1 Part in  $10^8$  Per Day



Precision temperature control provides excellent output frequency stability for this low-cost 1-mc crystal oscillator. Called the RD-140, the instrument consists of a one-tube (6AH6) oscillator assembly, a thermo-oven, which houses the crystal, and an oven control amplifier, mounted on a 3-1/2 in. standard 19 in. relay-rack panel.

The instrument is virtually unaffected by environmental temperature changes, since the proportional control system never allows the oven temperature to vary more than 1/1000 of the ambient temperature change. A single element, a temperature-sensitive resistance bridge, is used both for oven heating and for sensing temperature change. The system completely eliminates temperature-cycling and oven power-surfing.

Manson Labs., Inc., Dept. ED, 207 Greenwich Ave., Stamford, Conn.

CIRCLE 184 ON READER-SERVICE CARD FOR MORE INFORMATION



### Sampling Switches

Replaceable Brushes

Having miniature multipin connectors attached to cables of convenient length, this switch has up to three poles with 60 shorting channels or 30 non-shortening channels per pole. The special construction of the switch affords replacement of all brushes in a matter of minutes without force, or phase adjustments. The cover plate is easily removed for inspection of the brushes and contacts. The rotor and all brushes may be replaced as a unit.

The switch is normally supplied with a 28 v dc motor having a governor and a separate shielded filter. A 115 v, single phase, 400 cps ac hysteresis synchronous motor can be supplied upon request. Sampling rates are available from 0.5 to 10 rps. The switch is approximately 3-1/2 in. in diam by 2 in. in depth. Tapped holes are provided in the motor block for vertical mounting and also in the face of the switch for horizontal mounting.

General Devices, Inc., Dept. ED, P.O. Box 253, Princeton, N.J.

CIRCLE 185 ON READER-SERVICE CARD FOR MORE INFORMATION

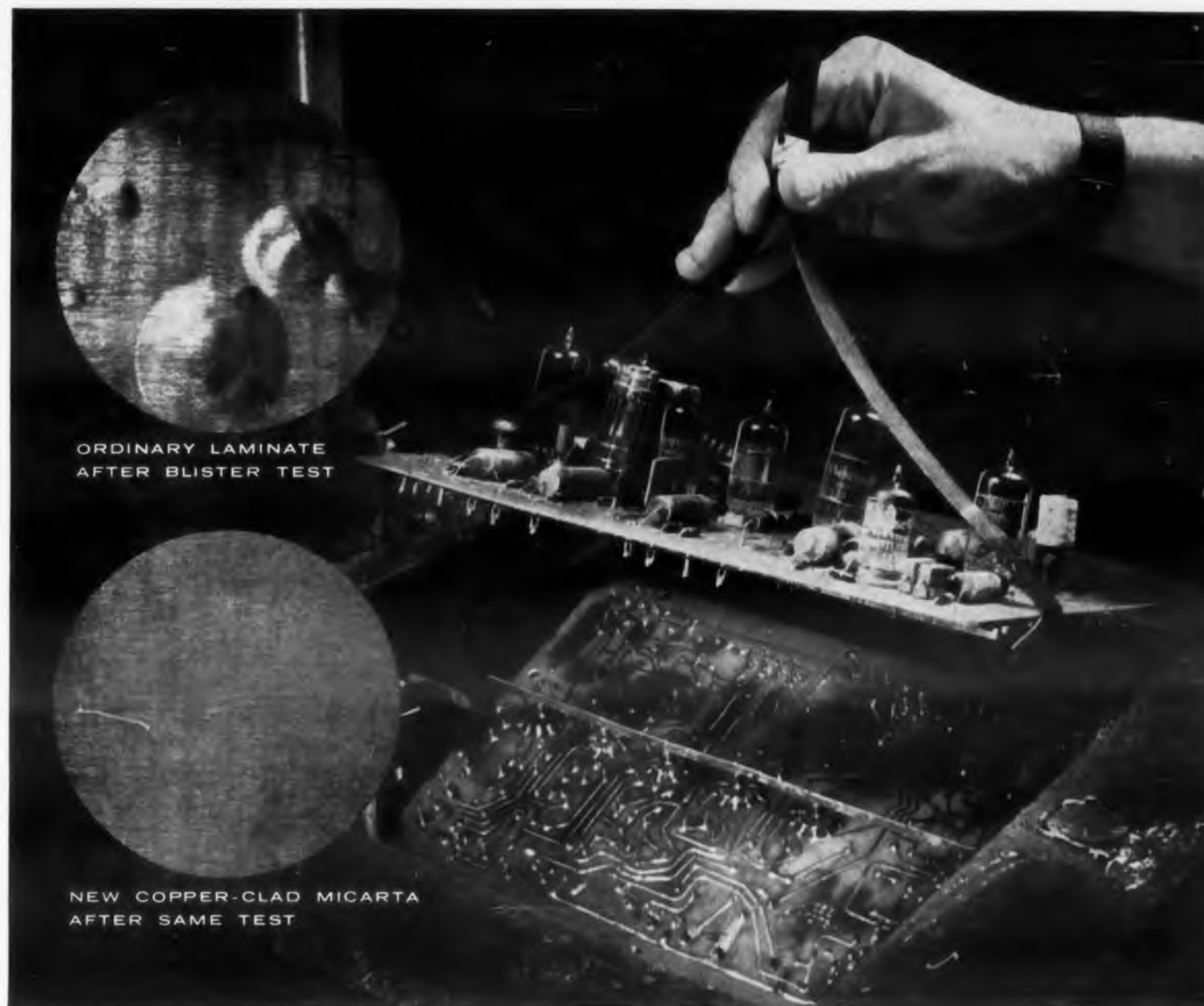

ORDINARY LAMINATE  
AFTER BLISTER TEST

NEW COPPER-CLAD MICARTA  
AFTER SAME TEST

## New copper-clad MICARTA® takes dip solder bath without blistering!

New H-3032 copper-clad MICARTA® cuts costs and production time of printed circuits. Copper-clad MICARTA speeds up soldering, without the normal accompaniment of an increase in rejects and missed connections. It can be cold punched without cracking or chipping.

The laminate won't blister even when dip soldered for 10 seconds at 500°F! Examine the two close-up photographs. One shows an ordinary laminate after a laboratory test. Note the blistering, then look at the MICARTA dip soldered for the same length of time—and there is no blistering!

A special adhesive is used which has the same

high electrical properties, solvent resistance and low moisture absorption as the MICARTA laminate itself. Actually, adhesive strength is increased during soldering.

Because of a new adhesive process, copper-clad MICARTA keeps its high bond strength—from 10 to 13 pounds versus an industry standard of six pounds—even after heating and cooling is repeated many times. This is especially valuable for electronic circuits.

Copper-clad MICARTA may be the answer to your circuit assembly problem. Write for further information and technical data to Westinghouse Electric Corp., MICARTA Div., Hampton, S. C.,

J-06624-X

**YOU CAN BE SURE...IF IT'S  
Westinghouse**

CIRCLE 186 ON READER-SERVICE CARD FOR MORE INFORMATION



How would  
you like  
your **SHIFT REGISTERS?**

Whatever your requirements relating to buffer storage, pulse distribution or other pulse, digital and logic functions, we would like to talk to you about them. Epsco designs a wide variety of transistorized, transistor-driven and tube-driven shift registers and magnetic logic elements, featuring high reliability, low-power consumption and compactness . . . and manufactures them in volume right to the letter of each individual specification.

Custom engineering-production of electronic components (shift registers, magnetic logic elements, delay lines, special pulse transformers, etc.) is our specialty. You can count on the cooperation of Epsco's engineering staff and field representatives for effective, economical fulfillment of your performance requirements and for conscientious service right down the line. Your inquiry will receive prompt action. Write for Shift Register technical bulletin.

Epsco, Incorporated, Dept. E-107, 108 Cummington St., Boston 15, Mass.

START-TO-FINISH cooperation  
... an Epsco guarantee

**Epsco**   
**COMPONENTS**

**SALIENT FEATURES OF EPSCO SHIFT REGISTERS**

- Standard packaging—9-pin miniature base, dip-solder terminals for printed circuits, and solder-lug panel with mounting ears; standard epoxy and hermetically sealed cases, or custom packaging to your specifications.
- Minimum size—below  $\frac{1}{4}$  cu. in. per binary digit.
- Surpass applicable MIL specification.
- Extremely low power consumption—less than 0.25 watt peak power for 3kc rate; 0.6 watt peak power for 100 kc rate.
- Wide operating tolerances; dependable field performance.

CIRCLE 187 ON READER-SERVICE CARD FOR MORE INFORMATION

## New Products

### Counting Unit Remote Preset

The Model 101AR Remote Preset Decade Counting Unit is controlled through the use of a five-wire cable brought out the back of the decade terminating in a small five-pin plug. The cable may be extended to any reasonable distance and a simple switch at the extremity is then used to select any digit from 0 to 9. The actuating voltage



can be from 6 to 24 v dc. The small size of the switch lends itself to installation in a simple housing.

The direct reading Model 101AR is designed to provide an output pulse at a selected number of rates in excess of 40,000 counts per sec. If reset is not required, they are capable of counting at a 100,000 cps rate. These units are readily connected in cascade in order to emit a pulse at any desired count. Among the typical applications are batching, sorting, packaging, automatic counting and controlling, frequency division, and generation of precise delays. The Model 101AR is of the coincident type with an 11 pin base, pulse output at 0 reset. The companion Model 101BR unit offers a 9 reset. Companion Model 101CR is also coincident type with 11 pin base plus 4 pin plug, 4 line 1-2-2-4 coded output, 0 reset for operation of digital printers and others.

Computer Measurements Corp., Dept. ED, 5525 Vineland Ave., N. Hollywood, Calif.

CIRCLE 188 ON READER-SERVICE CARD FOR MORE INFORMATION

ELECTRONIC DESIGN • October 15, 1957

**Automatic Programmer**  
24 Separate Circuits



This power programmer controls 24 separate circuits and is designed for direct actuation of power devices. The unit eliminates the need for relays and cumbersome interlocking circuits. Switching capacity is high enough to carry loads normally carried by relays. All contacts make and break simultaneously. Unaffected by intense vibration or shock, the unit is for use in programming missile firing control, missile guidance control, and industrial electronic equipment. It measures 3 in. in diam and 9 in. in length and weighs 4 lb.

Mason Electric Corp., Dept. ED, 3839 Verdugo Rd., Los Angeles, Calif.

CIRCLE 189 ON READER-SERVICE CARD FOR MORE INFORMATION

**Dual Speed Positioner**  
Readable to 0.1 Deg

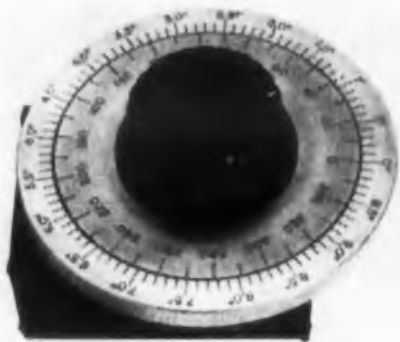

Precise shaft positioning of potentiometers, revolvers, or tuning capacitors is possible with this manually operated speed reducer. The mechanism is offered in two basic forms: the spur-gear type for low to moderately high velocity ratios, and planetary type for extremely high velocity ratios. Both types feature large concentric input dials, in-line input and output shafts, high positional accuracy, and freedom from backlash within the rated torque output range. With a 36 to 1 ratio a direct readability of 0.1 deg may be obtained and 0.05 deg can be easily estimated when the outer dial has 100 divisions.

Acton Laboratories, Inc., Dept. ED, Acton, Massachusetts.

CIRCLE 190 ON READER-SERVICE CARD FOR MORE INFORMATION

# DELCO HIGH POWER TRANSISTORS

*Now available . . .*  
***FOUR*** new types!  
*New LOWER prices!*



**Typical Characteristics**  
at 25° C

	DT100	2N441	2N442	2N443
Maximum Collector Current	13	13	13	13 amps
Collector Voltage, Emitter Open	100	40	50	60 volts
Saturation Voltage (12 amps)	0.7	0.7	0.7	0.7 volts
Power Dissipation	55	55	55	55 watts
Thermal Gradient from Junction to Mounting Base	1.2°	1.2°	1.2°	1.2° °C/watt
Nominal Base Current $I_B$ ( $V_{EC} = -2$ volts, $I_C = -1.2$ amp.)	-19	-26	-26	-26 ma
Distortion (Class A <sub>1</sub> , 10 watts)	5%	5%	5%	5%

Delco Radio offers four new alloy junction germanium PNP transistors to meet an even wider range of applications. Like all of Delco Radio's High Power transistors, these are characterized by high output power, high gain and low distortion. All, too, are normalized to retain their fine performance characteristics regardless of age. Furthermore—these new types are all in volume production. Other types are available at new, lower prices. Data and application sheets and price lists are available upon request.

## DELCO RADIO

Division of General Motors  
Kokomo, Indiana

CIRCLE 191 ON READER-SERVICE CARD FOR MORE INFORMATION

## New Products

### Elapsed Time Meter

#### Features Readability

Use of automobile odometer design is a major factor in improved readability of a line of time meters. Larger digits, placed closer to the front of the meter, make the type KT models easier to read than the former design. The odometer contains six digits, compared with five in the old meter design, and will measure down to one-tenth of an hour or minute.

General Electric Corp., Instrument Div., Dept. ED, Schenectady 5, N. Y.

CIRCLE 193 ON READER-SERVICE CARD FOR MORE INFORMATION

### Linear Accelerometer

#### Negligible Hysteresis



A high output voltage, fluid damped, linear accelerometer exhibiting good performance characteristics as regards hysteresis, linearity, repeatability, temperature range and vibration is available on a production basis. Internal design reduces hysteresis to a negligible factor of 0.5 per cent max in models 12001 and 12002. Both 12001 and 12002 have a linearity of  $\pm 1.5$  per cent with repeatability of 0.5 per cent, max, temperature range from  $-54$  to  $+200$  C with a temperature effect less than 0.75 per cent. Vibration performance is respectively, 25 g to 2000 cps and 15 g to 2000 cps along any axis but the sensitive axis. In addition to these characteristics, this instrument has a resolution of 0.002 for all ranges.

Physical Measurements Corp., Dept. ED, Santa Monica, Calif.

CIRCLE 194 ON READER-SERVICE CARD FOR MORE INFORMATION

ELECTRONIC DESIGN • October 15, 1957



## Want a standard power reactor from 50 to 2000 watts? Put your finger on CONTROL

No need to put up with extra costs for special design of saturable reactors. No reason for waiting for special units to be designed to meet your individual requirements. CONTROL offers two complete lines of power reactors. You pick them from our catalog. We take sub-assemblies from our shelves, add control windings to your specifications, and deliver complete units—fast.

CONTROL reactors are ready in eleven sizes in both 120 and 240 volt ranges. Our unique catalog R-10 gives you complete physical and operating characteristics. It tells you, for instance, that six ampere-turns control nearly 2,000 watts in the largest size, and that only two ampere-turns are needed for the 50-watt smallest size, illustrating the extremely high gain of these units.

Want to know about cut-off ratios? CONTROL reactors run at least 40 to 1. Want to know about construction? Cutaway shows you the tough, rugged design that insures "forever" operation with no servicing or maintenance, if operation is normal.

Yes, there's a real improvement here for harassed engineering departments. Standardization means reliability and quality at a competitive price. Write for Catalog R-10 today and read all about it. CONTROL, Dept. ED-42, Butler, Pennsylvania.

Reliability begins with **CONTROL**



A DIVISION OF MAGNETICS, INC

CIRCLE 192 ON READER-SERVICE CARD FOR MORE INFORMATION



## Integrators

### For Strip Chart Recorders

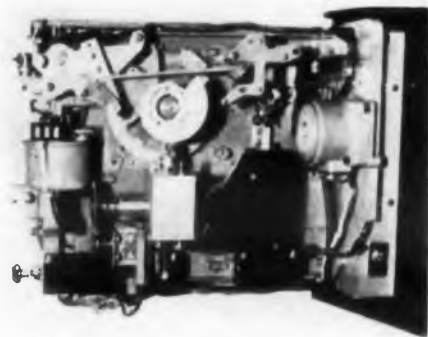

A greater number of readout methods on strip chart recorders has been made possible with the adaptation of ball and disc integrators to recorders. For integrating against time, a synchronous motor is provided, and to integrate against inches the chart drive itself is used. A few of the readout methods that can be employed include: use of a visual counter operated from electrical pulses obtained from output contacts, with the manual reset mounted in any number of convenient positions; use of a model RI-4 Identichart, printing in digital form on the chart of the same recorder; and conversion of electrical pulses into pips along the edge of a chart.

Royson Engineering Co., Dept. ED, 100 N. Penn St., Hatboro, Pa.

CIRCLE 195 ON READER-SERVICE CARD FOR MORE INFORMATION

## Pulse Generator

### Variety of Outputs

Model 138 produces pulses over the range of 1 μsec to 1 sec—singly, recurrently, single pairs, recurrent pairs, single trains and recurrent trains. The output is reversible and supplies 35 v into 50 ohms. Repetition frequencies from less than 1 cps to 250 kc are available internally. The instrument will follow external sync anywhere in this range aperiodically or periodically.

American Electronic Labs., Inc., Dept. ED, 121 N. 7th St., Philadelphia, Pa.

CIRCLE 196 ON READER-SERVICE CARD FOR MORE INFORMATION

*Howard W. Sams*

specialized services help you  
in the preparation of your technical manuals

Over 80 leading manufacturers and government agencies (list on request) avail themselves of our services regularly.

We apply our own specially developed techniques (with resulting economies) to all phases of manual preparation and production: Engineering analysis, technical illustration, layout, copy preparation—right down to final printed production, if you wish. Our experience as the world's largest electronics data publishing firm—producers of the famous PHOTOFAC Service Data—qualifies us to produce the most competent publications relating to the theory, operation, maintenance or repair of electronic devices.

Any one or all of our services can help solve your technical publication problems efficiently, speedily, economically. Let us show you how our unique facilities can be of service to your company.

## which of these services can you use?

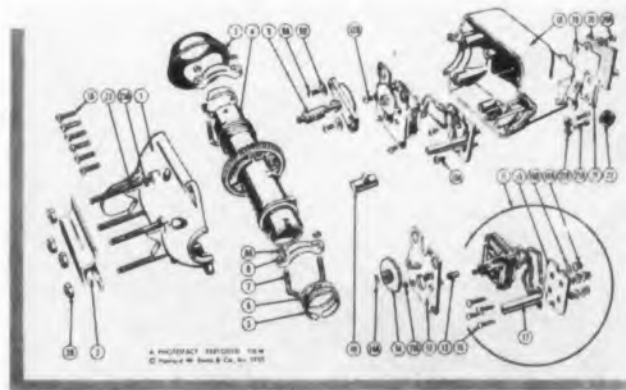

**EXPLODED VIEWS:** Our skilled drawings in proper perspective simplify replacement parts ordering—make reassembly and maintenance easier and more positive.

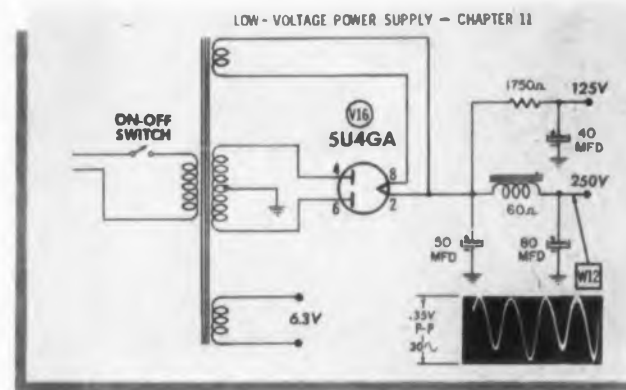

**SCHEMATICS:** Our famous Standard Notation Schematics are the industry's standard for legibility, easy use and clear understanding.

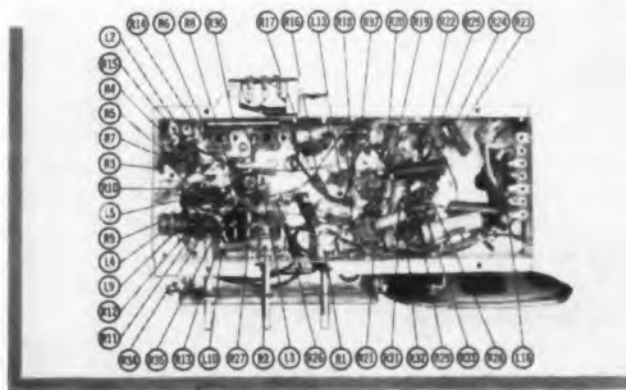

**KEYED PHOTOS:** There's no confusion when your parts lists, schematics and copy are "keyed" to an actual photo of your product (one of our specialties).

## HOWARD W. SAMS & CO., INC.

Industrial Service Division, Dept. 3A  
2201 East 46th Street, Indianapolis 5, Indiana  
Phone: CLifford 1-4531



Write or phone for this 24-page brochure showing the services we perform for the Electronic industry

Please send informative brochure to:

Name \_\_\_\_\_

Company \_\_\_\_\_

Address \_\_\_\_\_

City \_\_\_\_\_ Zone \_\_\_\_\_ State \_\_\_\_\_

CIRCLE 197 ON READER-SERVICE CARD FOR MORE INFORMATION

for  
**HEARING  
AIDS**



or  
**RECORDING  
HEADS**



or **ANY MAGNETIC MATERIALS JOB ...**

Write for  
your Copy

"MAGNETIC  
MATERIALS"



This 32-page book contains valuable data on all Allegheny Ludlum magnetic materials, silicon steels and special electrical alloys. Illustrated in full color, includes essential information on properties, characteristics, applications, etc. Your copy gladly sent free.

ADDRESS DEPT. ED-94

You can rely on core materials like the Allegheny 4750 components illustrated above, in your receivers, recording heads or microphone assemblies.

In fact, whether your equipment is small or large, the extra-broad line of A-L magnetic materials will solve your magnetic core problems. It includes all grades of silicon steel sheets or coil strip, as well as Allegheny Silectron (grain-oriented silicon steel), and a wide selection of high-permea-

bility alloys such as 4750, Mumetal, Permendur, etc.

Our service on these materials also includes complete facilities for the fabrication and heat treatment of laminations. (For users of electrical sheets and strip, our lamination know-how is a real bonus value!) Either way, we'll welcome the chance to serve you. *Allegheny Ludlum Steel Corporation, Oliver Building, Pittsburgh 22, Pa.*

**STEELMAKERS to the Electrical Industry**

**Allegheny Ludlum**

W80 8338



CIRCLE 198 ON READER-SERVICE CARD FOR MORE INFORMATION

## New Products

### Telemeter Oscillator Transistorized



A new line of transistorized subcarrier oscillators is available for fm/fm telemetering systems. Two are voltage controlled for both high and low temperature ranges, and will operate at any subcarrier frequencies in a choice of input ranges. Stability, linearity, and resistance to severe environmental conditions are improved. A third type is a silicon transistor resistance bridge subcarrier oscillator used for the measurement of stresses where strain gages are used.

Bendix Aviation Corp., Pacific Div., Dept. ED, 11600 Sherman Way, North Hollywood, Calif.

CIRCLE 199 ON READER-SERVICE CARD FOR MORE INFORMATION

### Crystal Ovens Variation of $\pm 0.2$ C



Series A of the ET series of crystal ovens have an ambient temperature range of  $-25$  C to  $5$  C below specified operating temperature. Nominal operating temperature is  $75$  C, unless otherwise specified. Temperature variation after warmup is  $\pm 0.2$  C, with a power consumption of  $15$  w max., heater voltage is  $115$  v ac although other voltages are available. Warmup time is  $7$  min.

Monitor Products Co., Dept. ED, South Pasadena, Calif.

CIRCLE 200 ON READER-SERVICE CARD FOR MORE INFORMATION

ELECTRONIC DESIGN • October 15, 1957

## Liquid Nitrogen Refrigerator

Chills at -320 F



This portable liquid nitrogen refrigerator, LNR-25B, consists of a double-walled jacket of Heliarc welded stainless steel insulated by a special vacuum-powder combination. The inner container is filled with liquid nitrogen having a temperature of -320 F, in which baskets filled with material for freezing are lowered into the liquid nitrogen. The LNR-25B will then hold material at a constant temperature of -320 F as long as liquid nitrogen, in any quantity, is present.

Linde Co., Div. of Union Carbide Corp., Dept. ED, 30 E. 42nd St., New York 17, N.Y.

CIRCLE 201 ON READER-SERVICE CARD FOR MORE INFORMATION

## A/D Translation

In-Line Readout



Completely transistorized, the Dadit analog-digital integrating translator operates faster than previous models and features an in-line read out. It is designed for industrial instrumentation and process control to provide almost total availability. Although volumetrically equal to the vacuum tube version, the Dadit lends itself to compact construction, as in aircraft use in gun fire control and navigational systems.

Daystrom, Inc., Dept. ED, Murray Hill, N.J.

CIRCLE 202 ON READER-SERVICE CARD FOR MORE INFORMATION

3M Chemicals opening new worlds of use for epoxies



## Low-viscosity epoxy flexibilizer can help you mold more complex shapes more cheaply

Pour Cardolite® NC-513! You can see its low viscosity!

Extreme fluidity like this means this 3M epoxy resin flexibilizer brings you two major advantages:

1) With NC-513 you can flow flexibilized epoxies around the most complex shapes, without weakening your resin systems by addition of solvents.

2) With NC-513 you can cut costs by adding more filler to your resin systems.

What's more, epoxies containing NC-513 keep their flexibility for extended times at both extremely low and ex-

tremely high temperatures. And because NC-513 sets up with the same reacting agent as the epoxy, you don't weaken the cured resin. Electrical properties, chemical- and age-resistance are excellent.

The result, NC-513 by 3M is opening new uses for epoxy resins daily . . . in electrical potting, encapsulation, tooling resins, adhesives and countless applications where flexibility is essential.

Major epoxy producers recommend Irvington Chemical Division's NC-513. Investigate this 3M chemical. Send for a free sample and literature

by writing: Chemical Products Group, 3M Company, Dept. WD-107, St. Paul 6, Minnesota.

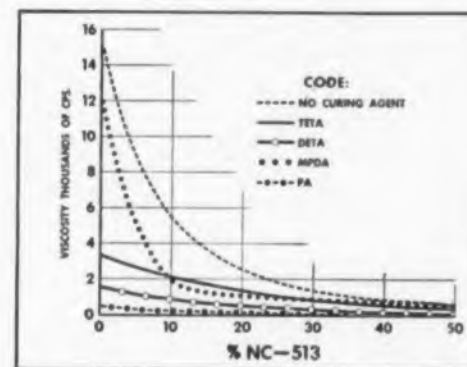

Viscosity of typical NC-513 epoxy system.

IRVINGTON CHEMICAL DIVISION • CHEMICAL PRODUCTS GROUP

MINNESOTA MINING AND MANUFACTURING COMPANY

... where Research is the key to tomorrow

CIRCLE 203 ON READER-SERVICE CARD FOR MORE INFORMATION





## Six sound investments...



### EF86

6267

Exceptionally low hum, low microphony and low noise tube. Specially designed for input stages of high sensitivity in high quality equipment.

The Mullard range of audio tubes has won universal acclaim among high fidelity sound experts: and it is easy to understand why. Every single tube in this range has been specially developed to meet the exacting needs of sound reproduction.

Read the specifications here: see for yourself what makes each tube such a sound investment.



### ECC83

12AX7

Double triode with especially good microphony performance and high gain. Used in equipments where utmost versatility is required.



### EL84

6BQ5

Economical, high sensitivity output pentode. Of miniature all-glass construction on the noval base. Two tubes in push-pull can provide 17W output for only 20V drive (grid-to-grid).



### EL34

6CA7

High sensitivity 25W pentode. Two tubes in ultralinear push-pull provide up to 40W output. For public address work, two tubes in push-pull can supply up to 100W of audio power.



### EZ81

6CA4

Compact full-wave rectifier of miniature all-glass construction on noval base. Provides up to about 350V output at 150mA with good regulation.



### GZ34

5AR4

Modern full-wave rectifier supplying up to 600V at 160mA, or 450V at 250mA with good regulation. Recommended for the larger type of Hi-Fi equipment.

Supplies available from:

in the U.S.A.

International Electronics Corporation,  
Dept. ED10, 81 Spring St., N.Y. 12,  
New York, U.S.A.

in Canada

Rogers Majestic Electronics Limited,  
Dept. JJ, 11-19 Brentcliffe Road,  
Toronto 17,  
Ontario, Canada.

# Mullard

## ELECTRONIC TUBES

used throughout the world



MULLARD OVERSEAS LTD., MULLARD HOUSE, TORRINGTON PLACE, LONDON, ENGLAND

Mullard is the Trade Mark of Mullard Limited and is registered in most of the principal countries of the world.

MEV 52

CIRCLE 204 ON READER-SERVICE CARD FOR MORE INFORMATION

## New Products

### Push Button Switch

Life of 100,000 Operations



Model No. 35-1 is a silent-action, momentary contact, dpdt switch, rated at 1/2 a, 115 v ac, resistive load. It is claimed to have a life expectancy of over 100,000 operations. Housing and button are of electrical grade molded phenolic. Equipped with 15/32-32 threaded mounting bushing with a hex nut and solder terminals.

Grayhill, Inc., Dept. ED, 561 Hillgrove Av., LaGrange, Ill.

CIRCLE 205 ON READER-SERVICE CARD FOR MORE INFORMATION

### Vernier Potentiometer

Accurate Resolution



Model 85A vernier potentiometer is a precision voltage divider consisting of two switch controlled decades of high accuracy fixed resistors, together with a precision wire wound pot for continuous interpolation between decade steps. This combination provides linearity accuracy to better than one part in 10,000, and resolution of more than 0.002 per cent. Control is provided through three coplanar dials mounted on coaxial shafts, enabling the unit to be mounted in a single 7/16 in. diam hole. Less than three turns of the calibrated dial cover the full range of the resistance decades, which provide range and resolution equal to a conventional 100 turn helical pot.

Research Instrument Corp., Dept. ED, 7962 S.E. Powell Blvd., Portland 6, Ore.

CIRCLE 206 ON READER-SERVICE CARD FOR MORE INFORMATION

ELECTRONIC DESIGN • October 15, 1957

### Elapsed Time Meter

#### Miniature 400 Cps Model



This elapsed time counter indicator is designed for use where it is necessary to keep an accurate record of actual on time. Typical applications include radar sets, computers and navigation systems. Principal design features include a new type of low speed synchronous motor and a gear train arrangement which provides a 14,400:1 ratio while utilizing only 4 gears, thus contributing to increased simplicity and maximum reliability. The indicator measures 1-1/4 x 1-1/4 x 2-1/4 in. and weighs 4 oz. Time range is 9999.9 hrs which is indicated on five counter wheels.

Magnetic Instrument Manufacturing Corp., Dept. ED, 546 Commerce St., Thornwood, N.Y.

CIRCLE 207 ON READER-SERVICE CARD FOR MORE INFORMATION

### Self-Locking Insert

#### For Soft Materials

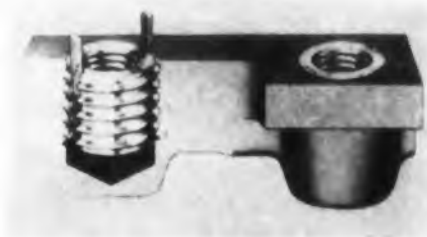

Called Keensert, this easily installed, self-locking threaded insert is designed to provide a strong internal thread for bolt attachment in relatively soft materials, such as aluminum and magnesium alloys and plastics. It may also be installed in the harder metals to provide a self-locking internal thread in a blind hole. Keenserts are supplied as one-piece, all-metal units. They may be screwed by hand into tapped holes prepared with standard drills and taps. The inserts are externally threaded along their entire length to provide maximum pull-out resistance. The prevailing torque is extremely consistent and well within the range established in MIL-N-25027, Table III.

Newton Insert Co., Dept. ED, 6500 Avalon Blvd., Los Angeles 3, Calif.

CIRCLE 208 ON READER-SERVICE CARD FOR MORE INFORMATION



For better transistors at low cost . . .

## TRY BENDIX HIGH GAIN POWER TRANSISTORS

If you are in design, project, or research and development, Bendix Transistors can mean much to you and your job. The enthusiastic endorsements of other engineers show that Bendix Transistors help in these six ways: (1) High power and current gain; (2) Low leakage; (3) Life stability; (4) High breakdown voltage; (5) Low thermal resistance; (6) Linear temperature variation.

The extra quality at no extra cost stems from our transistor program. Here, the simplified design *increases dependability* and also *cuts costs*. The component parts and materials—all exceeding specification requirements by a sizeable margin—*provide extra performance capability*. Our close quality control uses Bendix-developed methods and instruments to assure uniformly dependable quality. And improved manufacturing techniques at high-volume level make for *better transistors at low cost*.

Write us now for complete details or for help with your circuitry problems. SEMICONDUCTOR PRODUCTS, BENDIX AVIATION CORPORATION, LONG BRANCH, NEW JERSEY.

#### LARGE SELECTION OF POWER TRANSISTORS FOR MANY DIFFERENT APPLICATIONS

Type Number	Primary Application	Max. Collector Voltage Vdc	Max. Collector Current Adc	Thermal Resistance °C/W	Collector Dissipation W <sup>a</sup> at °C <sup>b</sup>	Current Gain B at Ic	Power Gain at Max. Power Out db	Max. Undistorted Power Out W
2N234 2N234A	Audio Amp.	30 Vce	3	1.5	7.5 75	25 0.5	30	2
2N235 2N235A	Audio Amp.	40 Vce	3	1.5	7.5 75	50 0.5	36	2
2N236 2N236A	Audio Amp.	40 Vce	3	1.5	10 80	40 0.75	35	4
2N285 2N285A	Audio Amp.	40 Vce	3	1.5	5 85	150 0.5	39	2
2N399 <sup>d</sup>	Push Pull Amp.	40 Vce	3	1.5	7.5 75	40 0.75	33	8 <sup>c</sup>
2N400	Audio Amp.	40 Vce	3	1.5	18 60	80 1.3	35	6
2N401 <sup>d</sup>	Push Pull Amp.	40 Vce	3	1.5	7.5 75	40 0.5	30	5 <sup>c</sup>
2N420 2N421 <sup>e</sup>	High Current Switch	40 Vce	5	1.5	10 80	50 4.0	—	—

<sup>a</sup>—Each transistor

<sup>b</sup>—Mounting-base temperature

<sup>c</sup>—Output power using two transistors in push-pull

<sup>d</sup>—Supplied in matched pairs

<sup>e</sup>—Missile transistor with collector solder lug

VOLUME PRODUCTION ASSURES IMMEDIATE DELIVERY

Red Bank Division



CIRCLE 209 ON READER-SERVICE CARD FOR MORE INFORMATION

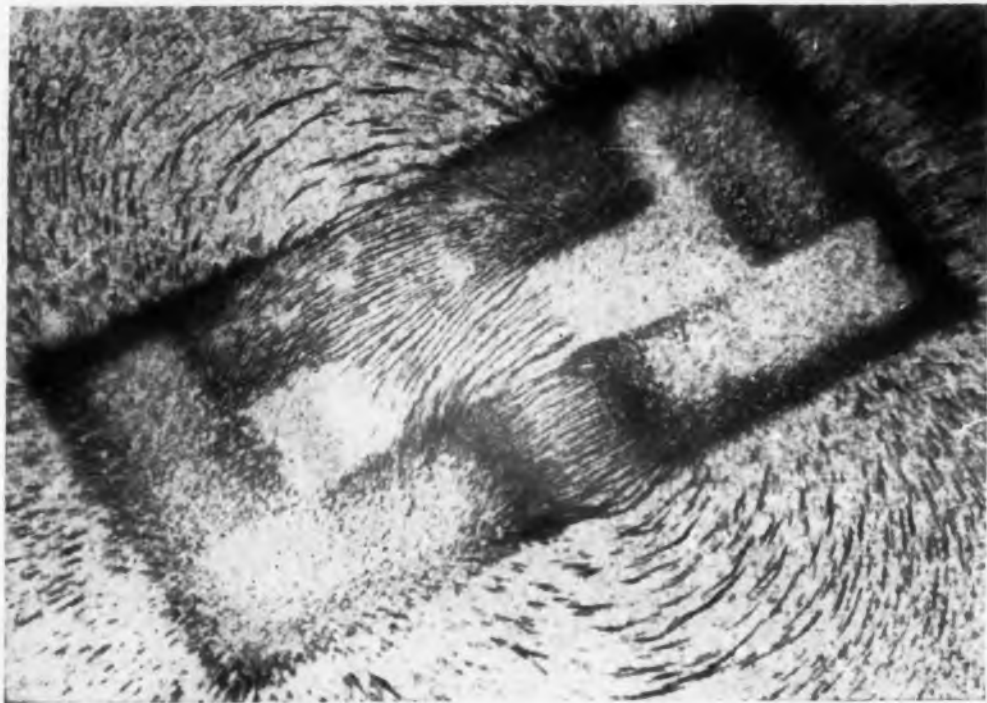

Flux pattern of experimental magnetic circuits

## How location of magnets affects magnetic circuits

Adapted from an article by Charles A. Maynard, vice president, Research and Engineering, The Indiana Steel Products Company

The LOCATION of permanent magnets in a magnetic circuit is a definite factor in design. To determine the extent to which this is true, involved calculations are necessary.

A comparatively simple experiment, however, which shows the nature of the changes that take place when permanent magnets are placed in different positions in a magnetic circuit, was devised by Mr. Maynard. The material on which the following questions and answers are based was taken from a report, "An Experiment in Magnet Location," published in Vol. 3, No. 5, of Applied Magnetism. A copy of this issue is available on request to The Indiana Steel Products Co., Dept. M-10, Valparaiso, Ind.

**Question:** What effect does the location of permanent magnets have on a magnetic circuit?

**Answer:** It has a marked influence on the flux density in the various portions of the magnetic circuit.

**Question:** Is there a preferred location for magnets?

**Answer:** Yes, it is important to place the magnets as close to the air gap as possible.

**Question:** What is the benefit of their location?

**Answer:** The leakage flux is reduced, and the useful flux in the air gap is increased.

**Question:** How is this an important factor in design?

**Answer:** It minimizes the amount of magnet material required to produce a given flux in the air gap.

**Question:** Does this mean lower magnet costs?

**Answer:** Generally, this is true. However, structural considerations may prevent the placement of permanent magnets at preferred positions.

**Question:** Are there available quantitative data which indicate the degree to which magnet position influences the efficiency of a circuit?

**Answer:** A brief experiment was conducted on the nature and magnitude of the changes that occur when magnets are placed in various positions in a simple magnetic circuit. The results are discussed in *Applied Magnetism*, Vol. 3, No. 5.

### World's largest permanent magnet separates electron particles

The largest and most powerful permanent magnet ever designed is an important part of a new Mass Spectrometer to be used for high molecular weight hydrocarbon



Indiana's C. A. Maynard inspects air gap of giant Alnico V magnet assembly

analysis at the Whiting, Indiana, research and development laboratories of a large Midwestern oil company. Function of the spectrometer is to establish a strong magnetic field that separates electron particles.

The Alnico V permanent magnet used in the assembly has a maximum field strength of 6,000 gauss . . . equal to 10 tons of magnetic holding force . . . and weighs 1,300 pounds. The complete assembly, which weighs approximately 4,700 pounds, was designed and fabricated by The Indiana Steel Products Company, Valparaiso, Indiana.

THE INDIANA STEEL PRODUCTS COMPANY  
VALPARAISO, INDIANA

THE WORLD'S LARGEST MANUFACTURER  
OF PERMANENT MAGNETS

INDIANA  
PERMANENT  
MAGNETS

In Canada . . . The Indiana Steel Products Company of Canada, Limited, Kitchener, Ontario

CIRCLE 210 ON READER-SERVICE CARD FOR MORE INFORMATION

## New Products

### Chopper

#### Zero Phase Shift



Model 333058 all-electronic chopper is used primarily as a dc to ac voltage converter sensitive to the phase of the reference voltage. It may also be used to convert ac into a dc voltage. Primary features of this chopper include: zero phase shift, 180 deg dwell time, frequency range from 60 cps to 20 kc, meets or exceeds the requirements of MIL-E-5272A, and has standard 7 pin miniature socket plug-in base.

Kearfott Co., Inc., Dept. ED, Little Falls, N.J.  
CIRCLE 211 ON READER-SERVICE CARD FOR MORE INFORMATION

### Motor-Generator

#### Brushless Inductor Type



Illustrated is a 2000 w 400 cps motor generator set. The alternator is of the inductor type with 115 v, single phase output. The capacity-start 4 hp drive motor maintains speed of 3428 rpm. The unit measures 25 x 13 in. These motor generators in sizes of 500, 1000, 1500, and 2000 w sizes can be supplied with radio filtration, indication and control panels as well as vibration dampers.

Kato Engineering Co., Dept. ED, 1415 First Av., Mankato, Minn.

CIRCLE 212 ON READER-SERVICE CARD FOR MORE INFORMATION

ELECTRONIC DESIGN • October 15, 1957

## Instant Reset Thermal Delay

### Permits Immediate Restarting

Type BR Thermal Time Delay resets instantly when its energizing circuit is interrupted, either during the timing cycle or after its completion. This time delay relay combines thermal and magnetic elements in a single case, short heating period followed by a much longer cooling period, after which the output contacts operate. Repeated energizing pulses, no matter how close together cannot operate the contacts so long as no pulse is longer than the minimum operate time.

The unit operates on 28 v dc and draws an average of 6 w during the timing cycle. Tolerance on the time delay is  $\pm 10$  per cent. The output contacts are spst, either normally open or normally closed. Contact rating is 2 a at 230 v ac, resistive, 1 a 32 v dc, resistive. All components are hermetically sealed. It operates over a temperature range of  $-65$  C to  $125$  C and withstands 30 g shock, 10 g vibration at 5 to 500 cps.

G-V Controls, Inc., Dept. ED, Hollywood Plaza, East Orange, N.J.

CIRCLE 213 ON READER-SERVICE CARD FOR MORE INFORMATION

## Precision Switch

### Roller-Lever Actuated

This switch, designated BZ-RW922-A2, has many of the advantages of a pin plunger switch, such as low pretravel, close repeatability and stability, and also has exceptionally high overtravel. Because of its high overtravel, the switch can be used with fast-moving cams. It is well adapted for use on control mechanisms such as radar units, precision machine tools and other uses needing constant precision actuation.

A 0.25 in. bronze roller is located on top of a double lever arm. As the lever is depressed, both levers moved downward until the switch is actuated. The upper lever then proceeds on downward, providing additional high overtravel. The electrical rating for this switch is 125, 250, or 460 volts ac, at 10 a. Contact arrangement is spdt.

Minneapolis-Honeywell Regulator Co., Micro Switch Div., Dept. ED, Freeport, Ill.

CIRCLE 214 ON READER-SERVICE CARD FOR MORE INFORMATION

ELECTRONIC DESIGN • October 15, 1957

**NOW, PRECISION AT A  
PRICE YOU CAN AFFORD!**

# 2 New Ultra-Stable frequency sources

- Stabilities of better than 1 part in  $10^8$  per day
- Priced at a fraction of comparable instruments

### MANSON MODULAR HIGH STABILITY OSCILLATOR

An exceptionally compact, stable and low-cost crystal-controlled oscillator suitable as a one-megacycle reference source or as a master oscillator in frequency control systems. Its panel-mounted sub-assembly construction meets MIL specifications for construction and environmental temperature range.

#### SPECIFICATIONS

**FREQ. STABILITY:** Better than 1 part in  $10^8$  per day.  
**FREQUENCY:** 1 megacycle, adjustable 10 cycles to compensate for crystal aging and to allow periodic resetting of frequency.  
**OUTPUT:** Sine wave, 1 volt RMS across 50 ohms.  
**MOUNTING:** Standard 19" relay-rack panel, 3½" high, with handles.

Available, less oscillator assembly, as Manson Model RD-130 PROPORTIONALLY-CONTROLLED OVEN SYSTEM for temperature controlling crystals, oscillator circuits, thermocouples and other temperature-sensitive components. This non-cycling system holds oven temperature to within 1/1000 of ambient changes. Oven can be set at any point from  $10^{\circ}$ C to  $100^{\circ}$ C above ambient, with vernier adjustments available.

#### MODEL RD-140

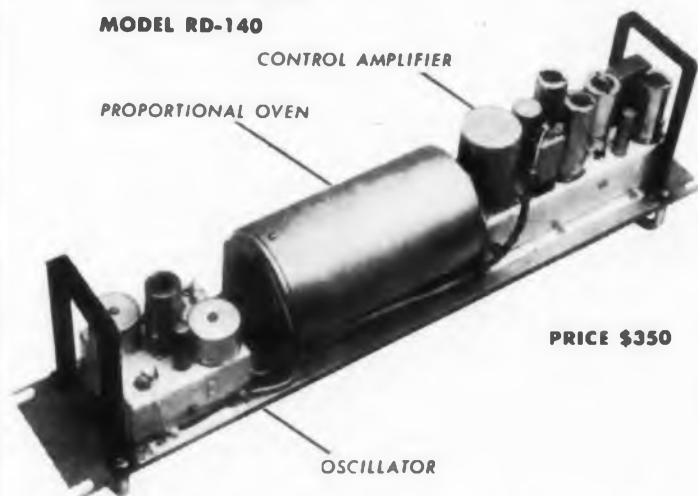

PRICE \$350

Write today for full information

### 1-MC. HARMONIC REFERENCE OSCILLATOR a laboratory-level frequency standard

plus  
a jitter-free milli-microsecond pulse source  
for harmonic measurements

A complete, self-contained system for frequency measurement or monitoring. Built-in balanced mixer enables the direct determination of unknown frequencies up to 1000 mc. Unique circuit provides extra wide-range tunability. Non-microphonic design and proportionally-controlled thermo-oven insure exceptional insensitivity to both vibration and temperature. Regulated power supply incorporated.

#### SPECIFICATIONS

**FREQ. STABILITY:** Better than 1 part in  $10^8$  per day.  
**FREQUENCY:** 1 megacycle tunable  $\pm 25$  cycles.  
**TUNING ACCURACY:** To 0.1 cps with ultra-linear dial. Direct readout frequency counter assures substantially zero-error readability and resettability.  
**OUTPUTS:** Pulse: Jitter-free, balanced, 40 volts peak across 250 ohms; rise time better than 20 milli-microseconds.  
Sine wave: 3 volts RMS across 50 ohms.  
**HARMONICS:** Usable harmonics extend to the kilomegacycle region.  
**SIZE:** 5¼" H x 19" W x 11¼" D for rack or bench.

#### MODEL RD-110



### 100-KC HARMONIC REFERENCE GENERATOR

Model RD-120 available as accessory, providing additional fundamental frequency with jitter-free pulse and sine-wave outputs. Incorporates own mixer and beat-frequency amplifier. Also usable as an independent 100-kc oscillator.

**MANSON LABORATORIES**  
207 Greenwich Avenue  
Stamford, Connecticut



Manson offers to engineers and technicians a rewarding present and attractive future in suburban Connecticut.

CIRCLE 215 ON READER-SERVICE CARD FOR MORE INFORMATION

# Can <sup>specialized</sup> business publication advertising actually sell?

By reputation, salesmen are reluctant to credit anything but their own selling efforts for getting names on the dotted line.

Actually, it's quite a different story. The most successful salesmen will tell you two important things about selling. 1. That the selling process is largely a matter of communicating ideas. 2. And that specialized business publication advertising can help importantly to register information with prospects.

Of course each salesman will express this in his own way... but they all agree that selling would be far more difficult without the advertising that appears in the industrial, trade, and professional publications that serve the specialized markets to which they sell.

Here, for instance, is what a salesman has to say about this kind of advertising:

William W. Cox  
AMP, Incorporated  
sells to industry



## Says Mr. Cox:

"The quickest way we can introduce a product is by introducing it through advertising in business papers. That way we get it around faster than we can by word of mouth alone. On occasion my home office has inquiries out to me before I can get to the customer or prospect to introduce a new product. They've already seen it in a trade magazine.

"It's interesting to note that within the last two weeks I received a survey which shows about 80% of the new customers we get on our books come through our trade publication advertising. Of course, our company is only 15 years old and we have grown from what you might say, *nothing*, to the biggest in our business. Certainly a lot of that has come from our advertising campaigns. Our name is known throughout the world right now, purely because of our advertising program. When I go to a prospect now, they know my company, they know my product... it makes

my job easier, and opens doors when I have to make cold calls."

**Ask your own salesmen** what your company's business publication advertising does for them. If their answers are generally favorable you can be sure that your business publication advertising is really helping them sell. If too many answers are negative it could well pay you to review your advertising objectives—and to make sure the publications that carry your advertising are read by the men who must be sold.

### How salesmen use their companies' advertising to get more business

Here's a useful and effective package of ideas for the sales manager, advertising manager or agency man who would like to get more horsepower out of his advertising. Send for a free copy of the pocket size booklet entitled, "How Salesmen Use Advertising in Their Selling," which reports the successful methods employed by eleven salesmen who tell how they get more value out of their companies' advertising.



You'll find represented many interesting variations in how they do this. Some are very ingenious; all are effective. You can be sure that more of your salesmen will use your advertising after they read how others get business through these simple methods.

The coupon is for your convenience in sending for your free copy. Then, if you decide you want to provide your salesmen with additional copies, they are available from NBP Headquarters in Washington, at twenty-five cents each. Or if you choose you can reprint

the material yourself and distribute it as widely as you please. But first, send for your free copy.

NATIONAL BUSINESS PUBLICATIONS, INC.  
Department 4D  
1413 K Street, N. W.  
Washington 5, D. C. STerling 3-7533

Please send me a free copy of the NBP booklet  
"How Salesmen Use Advertising in Their Selling."

Name \_\_\_\_\_  
Title \_\_\_\_\_  
Company \_\_\_\_\_  
Street Address \_\_\_\_\_  
City \_\_\_\_\_ Zone \_\_\_\_\_ State \_\_\_\_\_

## National Business Publications, Inc.



... each of which serves a specialized market in a specific industry, trade or profession.

## New Products



### Digital Data System Samples 100 Inputs

Capable of sampling inputs of up to 100 Vibrotron digital transducers at rates of up to 100 per sec, the S-100 delivers directly-digital information either sequentially or upon demand. Pressure variations are measured by Vibrotron pressure transducers. Temperature data and inputs from other measurement instrumentation are also accepted by the system. Measurement data received are transferred to the storage register until demanded by a data-recording system. Information from the buffer storage register may be programmed by the system operator and routed to the appropriate output equipment. Includes a variety of output media.

Borg-Warner Corp., BJ Electronics, Dept. ED, 3300 Newport Blvd., Santa Ana, Calif.

CIRCLE 216 ON READER-SERVICE CARD FOR MORE INFORMATION

### Variable Speed Pulley Economical and Light



Molded of impregnated nylon Fiber-glass, this variable speed pulley is self-lubricating, has extreme chemical resistance, and long-wearing qualities. The VP-1 unit measures 1-7/8 in. OD with a maximum 1-5/8 in. pitch diam. It has a range of 2-1/4 times and a spring-loaded tension, with shaft bores of 1/4, 5/16 and 3/8 in. Weight is less than 3 oz. Typical uses include drive mechanisms for instruments and servo systems, business machines, aircraft devices and similar applications. The molded plastic design overcomes many problems of sticking parts, corrosion and high replacement rates.

Rampe Mfg. Co., Dept. ED, 14915 Woodworth Ave., Cleveland 10, Ohio.

CIRCLE 217 ON READER-SERVICE CARD FOR MORE INFORMATION

ELECTRONIC DESIGN • October 15, 1957





**Miniature Servo Amplifier**  
6 W Maximum

This servo amplifier can deliver a maximum power of 6 w. A plug-in type component, this amplifier is potted in a compound having high strength, high stability, and lightweight characteristics. Gain of the amplifier may be established at various values between 100 and 1000 by inserting one external resistor to achieve the gain desired. Should it be necessary to interchange one unit for another, gain tolerance between interchanged units will not exceed  $\pm 10$  per cent.

Kearfott Co., Inc., Dept. ED, 1378 Main Ave., Clifton, N.J.

CIRCLE 218 ON READER-SERVICE CARD FOR MORE INFORMATION



**Sweeping Oscillator**  
No Band-switching

A range of 20 cycles to 20 kc in a single dial sweep is a feature of this new Model 207A Audio Sweep Oscillator. The instrument employs a new variation of the time tested rc oscillator circuit and achieves its extreme frequency range without bandswitching and with greater stability than other audio sweeping types. The accuracy of the Model 207A is  $\pm 4$  per cent including warmup drift and aging of tubes and components. The oscillator has been designed for motor drive, to speed the testing of audio circuits and devices of many kinds.

Hewlett-Packard Co., Dept. ED, 275 Page Mill Rd., Palo Alto, Calif.

CIRCLE 219 ON READER-SERVICE CARD FOR MORE INFORMATION

ELECTRONIC DESIGN • October 15, 1957

# New!

## Honeywell Motors



for chart drives, servos,  
balancing circuits, remote positioners

Now from Honeywell come these newly-designed synchronous and two-phase motors of highest quality. New, sectioned die cast housing . . . new wicking to prevent oil leakage . . . ball bearings to reduce friction . . . printed circuits . . . are some of their many maintenance-saving features. What's more, you can replace any part in two minutes, usually without disconnecting the leads from your installation.

Order these motors in small quantities for prototype development, or by the thousands for production runs. Models charted at right are available for fast, dependable delivery.

MINNEAPOLIS-HONEYWELL REGULATOR Co., *Industrial Division*, Wayne and Windrim Aves., Philadelphia 44, Pa.

### TWO-PHASE INDUCTION

Nominal No-Load RPM*	Gear Ratio	Intermittent Rated Load (oz.-in.)	Max. Starting Torque (oz.-in.)	Power (watts)† Loaded	Current (amps.) Loaded	Temp. Rise Deg. F
330	44:1	4	10	7.6	.11	70
148	10:1	5	20	7.0	.11	70
44	30:1	15	50	7.6	.11	70
22	60:1	30	120	7.6	.11	70

†6.0 watts in field winding, balance in amplifier winding.

### SYNCHRONOUS

RPM*	Gear Ratio	Pull-In Torque, Min. (oz.-in.)	Continuous Torque (oz.-in.)	Power (watts) Loaded	Current (amps.) Loaded	Temp. Rise Deg. F
180	10:1	12	12	19	.21	100
180	10:1	3.5	4	13	.11	65
90	20:1	14	12	11	.095	55
60	30:1	13.5	12	13	.11	65
30	60:1	27.5	12	13	.11	65

\*1/6 less at 50 cycles. Some speeds available at 25 cycles.

Weight: 29 oz. Write for Specification 5900-3.

# Honeywell



*First in Controls*



*In the channel fog*  
**HER  
 ENGINE  
 FALTERED**



A few minutes out of Dover, fog wrapped the flimsy Bleriot monoplane like a shroud.

The pretty young woman in the smart flying costume (she'd designed it herself—"bloomers, blouse, and hood of mauve satin") glanced at her compass. It was the first time she'd ever used one. She thought of instructor Hamel's parting words:

"Be sure to keep on course, Miss Quimby, for if you get five miles out of the way, you'll be over the North Sea, and you know what that means."

She climbed to 6,000 feet. Freezing cold and still fog. She pointed her nose down. The comforting clatter of the Gnome engine changed to a coughing splutter. It was conking out! She leveled off, figuring how she'd ditch.

To her relief, the engine suddenly took hold. Harriet re-checked her compass.

Some time later, breaking into clear sky, she saw a stretch of beach below. She put down at Hardelot; and on April 16, 1912, Harriet Quimby, first American woman to earn a pilot's license, became the first woman in the world to fly the English Channel.

As charming as she was brave, Harriet Quimby combined the thorough femininity and the self-confident ability which make American women like no others on earth. And help make this country so strong in character

that investing in America is the wisest thing any American can do!

Today more than 40,000,000 of us have more than \$11,000,000,000 securely invested in our country—through U. S. Savings Bonds. Bonds in which *America* guarantees the safety of our savings and the return we receive. There's no greater security! Buy Bonds regularly—where you bank or through the Payroll Savings Plan.

**Now Savings Bonds are better than ever!** Every Series E Bond purchased since February 1, 1957, pays 3 1/4% interest when held to maturity. It earns higher interest in the early years than ever before, and matures in only 8 years and 11 months. Hold your *old* E Bonds, too. They earn more as they get older. And they're safe as America!

**PART OF EVERY AMERICAN'S SAVINGS BELONGS IN U. S. SAVINGS BONDS**

The U. S. Government does not pay for this advertisement. It is donated by this publication in cooperation with the Advertising Council and the Magazine Publishers of America.



## New Products

### Silicon Diodes

Replace 1N91 Germanium Type



The SD-91, SD-92, and SD-93 are comparable in cost and electrical ratings to the 1N91, 1N92 and 1N93 germanium diodes. Temperature capabilities to 85 C, and lower leakage values, are among the advantages these units hold over the germanium diodes they supplant. The diodes are of all-welded construction, hermetically sealed, and feature a piv range from 100 to 300 v. Maximum rectified dc current ranges from 100 to 150 ma at 85 C ambient.

International Rectifier Corp., Dept. ED, 1521 E. Grand Ave., El Segundo, Calif.

**CIRCLE 222 ON READER-SERVICE CARD FOR MORE INFORMATION**

### Magnetic Clutch

No Collector Rings



Clutches are manufactured in sizes ranging from 1-3/8 in. diam up to 5 in., with torque ranges from 25 oz. in up to 170 in. lb. All clutches are wound for dc, with max ratings from 28 v on smaller clutches to 90 v on larger sizes. Featured in these units are a stationary magnet eliminating collector rings, high quality friction linings for high torque values, simple design, for ease in adaptation to machine tools, computers, motion picture cameras.

Stearns Electric Corp., Dept. ED, 120 North Broadway, Milwaukee 2, Wisc.

**CIRCLE 223 ON READER-SERVICE CARD FOR MORE INFORMATION**

**ELECTRONIC DESIGN • October 15, 1957**

TY  
 0.1  
 300  
 100  
 mult  
 cura  
 ±3  
 quer  
 supp  
 Ac  
 CIRCLE

A P  
 witho  
 tests  
 exceed  
 of the  
 sides  
 insula  
 It con  
 tough  
 makin  
 windin  
 For th  
 high f  
 Othe  
 It can  
 and fi  
 many  
 ity, co  
 is requ  
 Beld  
 St. Ch  
 CIRCLE 2  
 ELECT

### Multi-Purpose VTVM

Several Ranges



Type 815-A has 9 dc full-scale voltage ranges, 0.1 to 1000 v; 8 ac full-scale voltage ranges, 0.1 to 300 v; 9 dc full-scale current ranges, 0.001  $\mu$ a to 100 ma; and 9 resistance ranges, 0.2 to 500 with multipliers X0.1 to X10 meg. The dc voltage accuracy is approximately  $\pm 2$  per cent and the ac is  $\pm 3$  per cent, both for 1 v range and higher. Frequency response is from 15 cps to 100 mc. Power supplied by line.

Acton Labs., Dept. ED, Main St., Acton, Mass.

CIRCLE 224 ON READER-SERVICE CARD FOR MORE INFORMATION

### Film Coated Wire

Solders Without Stripping



A polyurethane magnet wire solders consistently without stripping at 700 to 750 F. Comparative tests have shown that Beldsol's thermal stability exceeds that of previously available magnet wires of the oleoresinous and the vinyl acetal types. Besides its solderable feature, Beldsol has excellent insulation resistance in the presence of moisture. It combines low temperature solderability and a toughness of film coating comparable to Formvar, making a wire that is desirable for almost any winding where Formvar now is used satisfactorily. For these reasons, it is especially well suited for high frequency coils where high Q is required.

Other uses of Beldsol are practically unlimited. It can be wound into transformers, motor armature and field coils, radio and TV universal coils, and many other random wound coils where solderability, coupled with excellent film abrasion resistance is required. It is available in sizes 14 through 40.

Belden Mfg. Co., Dept. ED, 4647 W. Van Buren St., Chicago 44, Ill.

CIRCLE 225 ON READER-SERVICE CARD FOR MORE INFORMATION

ELECTRONIC DESIGN • October 15, 1957

## Electronic

## Cooling

## Package...by AiResearch



#### SPECIFICATIONS OF TYPICAL AIRESEARCH COOLING PACKAGE

Air Flow	60 CFM
Fan Air Inlet Pressure	18 PSIA
Fan Pressure Rise	1.2 inches water
Heat Exchanger Pressure Drop	1.0 inches water
Liquid	Water
	Methanol
	(70% Methanol)
Liquid Flow	0.4 GPM
Heat Rejection*	300 Watts
Fan Power	30 Watts, 110 V., single phase, 400 cycle
Package envelope dimensions	7 x 6 x 3 inches
Package wet weight	2.5 lbs.

\*Assumes Class A (85°C.) electronic components,  
liquid inlet temperature to heat exchanger, 55°C.  
Includes heat from fan motor.

This high performance AiResearch package cools sealed and pressurized electronic equipment. The fan circulates air through the liquid cooled heat exchanger and over electronic components in a hermetically sealed module. Air cooled units are also available. Fan and heat exchanger are designed, built and packaged by AiResearch for matched performance. Package size is tailored to your individual cooling requirements.

The Garrett Corporation, through its AiResearch Manufacturing divisions, is an industry leader in components and cooling systems for aircraft, missiles and nuclear applications. This wide experience is now being offered to the electronics industry to provide a cooling package to meet any cooling requirement. Send us details of your problem or contact the nearest Airsupply or Aero Engineering office for further information.

**THE GARRETT CORPORATION**



**AiResearch Manufacturing Divisions**

Los Angeles 45, California • Phoenix, Arizona

#### AERO ENGINEERING OFFICES:

MINEOLA • ATLANTA • BALTIMORE • BOSTON • CHICAGO • CINCINNATI • COLUMBUS  
DETROIT • INDIANAPOLIS • PHILADELPHIA • ST. LOUIS • SYRACUSE • WINTER PARK

#### AIRSUPPLY OFFICES:

BEVERLY HILLS • DENVER • FT. WORTH • KANSAS CITY • SAN DIEGO • SAN FRANCISCO  
SEATTLE • TULSA • WICHITA

CIRCLE 226 ON READER-SERVICE CARD FOR MORE INFORMATION

ACEPOT\*  
ACETRIM\*

# Sub-Miniature Potentiometers and Trimmers

1/2" size, precision wire-wound,  
up to 250K,  $\pm 3\%$  linearity

setting new standards  
for dependability  
in sub-miniaturization

Let the facts speak for themselves! ACE Sub-Miniature Precision Wire-Wound Potentiometers and Potentiometer Trimmers are the result of 4 years development and over a year of successful use by leading electronic equipment manufacturers. Users have conclusively proved that ACEPOTS and ACETRIMS meet requirements for space and weight saving compactness, while at the same time meeting MIL specs' most stringent qualifications for performance and dependability. Why invite trouble with untested components when you can protect your reputation with ACEPOT and ACETRIM . . . the subminiature potentiometers and trimmers proved in actual use.

## Condensed Engineering Data

	ACEPOT (potentiometer)	ACETRIM (trimmer)
Resistance Range	10 $\sim$ to 250K $\pm 2\%$	10 $\sim$ to 150K $\pm 3\%$
Linearity	$\pm 3\%$	$\pm 3\%$
Resolution	extremely high	excellent
Ambient Temperature	-55° C to 125° C*	-55° C to 125° C
Torque	low or high	low or high

The above specifications are standard — other values on special order.

Available in threaded bushing, servo, flush tapped hole or flange mounting, and ganged units. All units sealed, moistureproofed, and anti-fungus treated. Meet applicable portions of JAN specs and MIL-E-5272A standards.

\*New X-500 ACEPOT operates to a new high of 150° C.

Expedited delivery on prototypes; prompt servicing of production orders.  
Send for Fact File and application data sheets.

\*trademarks applied for

ACEPOT\*  
ACETRIM\*

**ACE ELECTRONICS ASSOCIATES**

Dept. ED, 101 Dover St. • Somerville 44, Massachusetts

CIRCLE 227 ON READER-SERVICE CARD FOR MORE INFORMATION

## New Products

### Line Voltage Regulator Servo Actuated



Model 601 is designed for industrial or laboratory use in the control of power line voltage variations. It is independent of power factor thus making its application unrestricted. It is particularly useful in areas where line voltage is subject to wide fluctuations. Model 601 provides RMS voltage regulation, operating over a 50-70 cps frequency range. The output voltage is continuously adjustable by means of a front panel control over a range of  $\pm 10$  per cent of 115 v. The output will be regulated if the input voltage remains within  $\pm 10$  per cent of the output. This range can be extended to  $\pm 20$  per cent by simply changing one connection. At the above ranges the unit has a capacity of 3.6 k va.

Tel-Instrument Electronics Corp., Dept. ED, 728 Garden St., Carlstadt, N.J.

CIRCLE 228 ON READER-SERVICE CARD FOR MORE INFORMATION

### Binary Transformer Tape Wound



This tape wound binary transformer is shock mounted to withstand 10 g at 2000 cps. The toroid coil is supported top and bottom with special silicone rubber which does not change in environmental conditions. This type of support prevents shock and pressure upon the core from changing the hysteresis characteristics. Each has been hipped at 110 v for 100 hr while being cycled between -65 and 80 C. Binary transformers of this type are now available for general application to specific customer ratings.

Laboratory for Electronics Inc., Dept. ED, 75 Pitts St., Boston 14, Mass.

CIRCLE 229 ON READER-SERVICE CARD FOR MORE INFORMATION

need higher  
Dielectric  
in  
potted  
components  
with  
guaranteed  
uniformity?



Only high-vacuum potting insures complete elimination of air and moisture—provides thorough penetration for dense, homogeneous, non-porous castings, free of voids.

Only the new Hull Vacuum Potting Units are specifically engineered to guarantee these results, every time, day in and day out in routine production . . . with maximum accuracy, efficiency, economy and cleanliness . . . because the entire mechanized cycle (evacuating, degassing, mixing, filling molds and curing) is performed without interruption under high-vacuum.

If you are having trouble meeting dielectric specs. in potted components, write for details.

**HULL Corporation**

Phone: OSborne 5-5000 / HATBORO, PENNA.  
Export Division: 1505 Race St., Phila. 2, Pa., U.S.A.

Also for new economies in Automatic Plastics Molding—write Hull-Standard Corporation.

CIRCLE 230 ON READER-SERVICE CARD



## ultra-sensitive relays

### HELPFUL DATA FOR YOUR CIRCUITRY IDEA FILE...

(No. 3 in a series by Barber-Colman Company)

The circuit drawing below indicates just one of the hundreds of ways many manufacturers are utilizing Barber-Colman Micropositioner ultra-sensitive relays to solve complex control problems. Could this be the answer to some of yours, too?

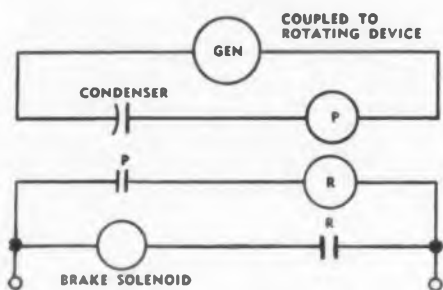

#### ACCELERATION CONTROL

The circuit shown above provides an acceleration control to prevent skidding of aircraft, truck, or bus wheels when brakes are applied. Similar Micropositioner circuits can also be designed for many applications where limited acceleration or deceleration is important.

In these circuits a Barber-Colman Micropositioner is connected in series with a condenser across the output of a Barber-Colman permanent magnet d-c generator coupled to the rotating wheel. When the generator velocity is constant (acceleration zero), no voltage appears across the Micropositioner coil. A change in velocity produces a coil input proportional to the acceleration. Polarity of input depends on whether the velocity is increasing or decreasing. When the input is large enough to close the Micropositioner contacts, P, a secondary relay, R, operates the solenoid in the braking circuit.

If your projects involve control of acceleration, why not make a test with a Micropositioner engineered for circuits similar to that shown above? Write for technical bulletins F-7279 and F-3961-6.

#### BARBER-COLMAN MICROPOSITIONER POLARIZED DC RELAYS



Various types...plug-in, solder-lug, screw terminal, hermetically sealed. Operate on input powers of 50 to 1,000 microwatts for use in photoelectric circuits, resistance bridge circuits, and electronic plate circuits. Send for data.

BARBER-COLMAN COMPANY  
Dept. V, 1883 Rock Street, Rockford, Illinois

CIRCLE 231 ON READER-SERVICE CARD

### High-vacuum Gages Use Thermopile Circuitry



Operating on the principle of a thermopile, these vacuum gages measure very low absolute pressure. They incorporate a circuit, in which an array of noble metal elements are securely butt-welded into continuous wires. The hot junctions of the thermopile are heated by ac while the cold junctions are kept at ambient temperature by heavy copper mounting studs, thus generating a dc voltage. Direct heating of the couples insures fast and complete response. As pressure is reduced in the vacuum system, and in the sensing tube connecting the gage to it, the changing thermal conductivity of the gas surrounding the heated junctions is measured. Three models cover pressure ranges from 1 to 100 microns; 1 to 1000 microns; and 1 to 20,000 microns.

F. J. Stokes Corp., Vacuum Equipment Div., Dept. ED, 5500 Tabor Rd., Philadelphia, Pa.

CIRCLE 232 ON READER-SERVICE CARD FOR MORE INFORMATION



#### DC Power Supply

10 Kv, 1 A with Low Ripple

The Model PC-58 power supply produces 0 to 10 kv at 0 to 1 a dc with 1 per cent rms ripple. Either positive or negative polarity can be obtained with the opposite side grounded. It utilizes a three-phase full-wave bridge circuit with metering for both voltage and current. The unit is completely monitored and protected and capable of being interlocked with other equipment. Equipment requires about 15 kva of power from a 230 v three-phase 60 cps source.

Levinthal Electronic Products, Inc., Dept. ED, Stanford Industrial Park, Palo Alto, Calif.

CIRCLE 233 ON READER-SERVICE CARD FOR MORE INFORMATION

# 2 CAREERS in 1...

When you  
build a career  
at *FTL*

...you build a  
career with the  
**ITT** System!

"TWO Careers in ONE" exemplifies one of the many reasons why Federal Telecommunication Laboratories is such a distinctive place to work and grow.

Achievement at FTL not only brings professional recognition, but simultaneously enhances your stature as a member of International Telephone and Telegraph Corporation's distinguished engineering team!

FTL's "small-company" project system provides unlimited opportunities for advancement. Assignments in FTL's eight laboratories are of the highest calibre and national importance... facilities are the finest. Stability is assured by FTL's long-range, diversified program and extensive expansion on the East and West Coasts. All popular medical-surgical, pension and insurance benefits are available. Typical assignments at our East Coast Laboratory include:

Radio Communication Systems • Traveling Wave Tubes  
Electronic Countermeasures • Air Navigation Systems  
Antennas • Missile Guidance • Computers  
Transistors and other Semiconductor Devices  
Telephone and Wire Transmission Systems



FTL's East Coast Laboratory, Nutley, N. J.—  
only 28 minutes by bus from New York City

#### If you prefer CALIFORNIA

Opportunities for relaxed living and career-building also at FTL's West Coast Laboratories: San Fernando, Cal., 15151 Bledsoe St.—openings in Digital Computers, Inertial Navigation Systems and Infra Red Systems. Palo Alto, Cal., 937 Commercial Street—openings in Carrier Systems.

#### MAIL THIS COUPON TODAY ED-10

Federal Telecommunication Laboratories  
500 Washington Avenue, Nutley, N. J.  
Please send literature describing opportunities and benefits at FTL, in Nutley, New Jersey.

Name \_\_\_\_\_

Address \_\_\_\_\_

City \_\_\_\_\_ Zone \_\_\_\_\_ State \_\_\_\_\_

# FTL



*Federal Telecommunication Laboratories*  
A Division of INTERNATIONAL TELEPHONE  
AND TELEGRAPH CORPORATION

CIRCLE 553 ON READER-SERVICE CARD FOR MORE INFORMATION

**always  
the leader  
— all ways**

**Engineered Economy\* Iron Cores  
originated by  
Radio Cores, Inc.**



\*trademark

★ the leader in quality

★ the leader in price

★ the leader in engineering

★ the leader in volume

★ the leader in design

Just a few short years ago, Iron Cores cost over 100% more than at the present time. This has been achieved by the creation of our line of ENGINEERED ECONOMY\* IRON CORES which enables us to reduce the amount of your minimum inventory through guaranteed immediate delivery service . . . this has been achieved by the new use of automation which enables us to cut costs and pass these savings on to you . . . this has been achieved by more efficient production methods, which reduce processing and material costs which again means savings to you.

Now, you can select from over 19 types of ENGINEERED ECONOMY\* IRON CORES which do the job of over 100 types custom made cores at stock prices. We invite your inquiry.

Also, custom iron cores to your specifications.

**Radio Cores, Inc.**

9540 Tulley Avenue Oak Lawn, Illinois

Copyright 1956  
Radio Cores, Inc.



CIRCLE 234 ON READER-SERVICE CARD FOR MORE INFORMATION

## New Products



### Packaged Relays

Low Voltage, High Amperage

Packaged relays for low voltage, low and high current (10 a) switching, are designed for two-hole mounting on walls or shelves in the radio compartment where provision is made for holes protected by grommets for access by the connecting leads. The K-15 Relay is a spst assembly normally used in aircraft for switching up to 10 a at 30 v. An spdt arrangement is provided in the K-16 Relay. Contacts are rated 1/2 a, 115 v. The K-17 Relay is a dpdt with contacts rated the same as in the K-16.

Aircraft Radio Corp., Dept. ED, Boonton, N.J.

CIRCLE 235 ON READER-SERVICE CARD FOR MORE INFORMATION

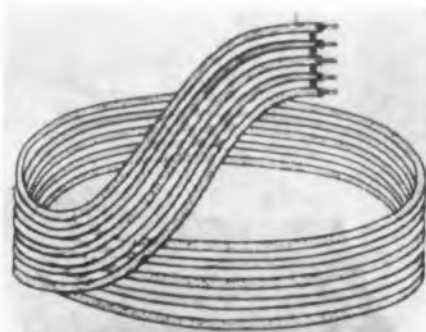

### Flat Cable

Low Capacitance

An application of the strip technique to the making of spaced cable is called Very Low Capacitance Cable (VLC), and is produced in all gages, colors, and numbers of conductors. The spacing is accomplished by the insertion of plastic tubing between the wires of the cable, resulting in the production of a flat, flexible band. It has effectively replaced shielded and coaxial leads in certain applications, and is expected to be used in the computer field.

Uniformity between assemblies is close enough, that the inter-wire capacitance can be used, in many cases, as part of the circuit. Temperature build-up in the cable is at the minimum, and its flat form makes it a space saver.

Organic Development Corp., Dept. ED, 10052 Larson Ave., Garden Grove, Calif.

CIRCLE 236 ON READER-SERVICE CARD FOR MORE INFORMATION

% STILL  
OPERATING

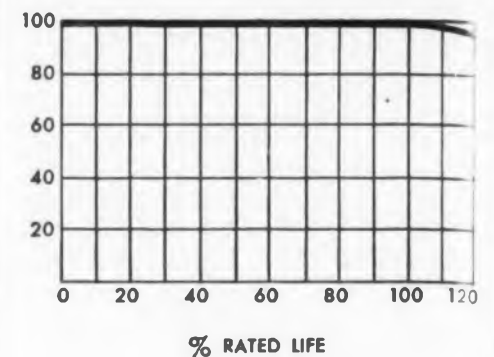

**If you want  
reliable transformers**

*..don't overlook this old solution*

Right now, you demand more from transformers than ever before. You must have high reliability, even at extreme altitudes, and you need smaller lighter units.

Used, and *proved*, for decades, oil-encased transformers should not be forgotten in a search for new methods.

Everyone knows the advantages: effective convection of heat, excellent insulating properties, complete insurance against hidden leaks. Oil-sealed types (with a nitrogen bubble) are good, light, high-altitude transformers. Gas-free oil-filled types (with a bellows to allow for heat expansion) withstand very high voltage stresses. Except in the smallest sizes, they save space, too.

You can place several high voltage units close together in a single oil-filled case, and save case weight. Those connections moved inside the case no longer need large insulators. Even the units themselves can be smaller. This all adds up—particularly in high altitude service—to interesting savings in space and weight.

We make all sorts of transformers and special assemblies for the communication industry: encapsulated, cast in epoxy or foam, and just potted in pitch. But oil transformers still have an important place.

Whatever type you need, we'll be glad to hear from you. Our facilities in design, production, and quality control are at your service. Our experience, too.

**CALEDONIA**

ELECTRONICS AND TRANSFORMER CORPORATION

Dept. ED-10, Caledonia, N. Y.

In Canada: Hackbusch Electronics, Ltd.  
23 Primrose Ave., Toronto 4, Ontario

CIRCLE 237 ON READER-SERVICE CARD

# HOLTZER -CABOT

## Instrument Control Motors



R-24 MOTOR

The R-24 4-pole induction motor, with reversible rotation, is adaptable to a wide variety of applications. Typical uses are in servo mechanisms; as a balancing motor in recording instruments, and as a control motor for voltage regulators. When operated 2 phase, it can be controlled electronically; it can also be run single phase as a permanent split capacitor motor.

Specifically engineered to operate effectively with other engineering apparatus. Also available with gear-train. Send coupon below for additional information.



### Index Stands With 5 Deg Precision Bridge

These Index Stands are equipped with either a synchro or resolver bridge built as an integral part of the unit. The bridge is mechanically connected to the stand so that correct angular relationship is maintained for all positions of the indexing wheel. This feature reduces operator fatigue and possible error. Test time is also reduced, thereby making this stand useful for high volume testing. Either stand can be used with an external bridge for testing alternate components. Each specific index stand holds only one of the following size synchros: 8, 11, 15, 18, 23, and 25.

Kearfott Co., Inc., Dept. ED, 1378 Main Ave., Clifton, N.J.

CIRCLE 239 ON READER-SERVICE CARD FOR MORE INFORMATION

### Gyro-Stabilized Compass System

Low Cost, Light Weight

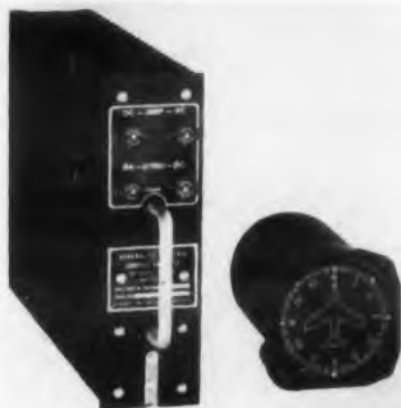

Low initial cost and reduced size and weight make this compass system suitable for use in any size aircraft down through the smallest business type. The system consists of a panel-mounted, electrically driven gyroscope which is slaved electrically to a remotely located compass transmitter. This provides a gyro-stabilized magnetic heading reference of great accuracy and dependability. The output synchro is capable of operating up to three RMI repeaters and may also be used to provide initial signal to a compass servo adapter for additional outputs if required.

Designed to operate on 115 v ac and 14 or 28 v dc, the system has a power consumption of from 17 to 24 w. Overall weight is approximately 10.5 lb installed. The system is CAA type-certified for use on scheduled airline aircraft.

Wilcox Electric Co., Dept. ED, 1400 Chestnut, Kansas City, Mo.

CIRCLE 240 ON READER-SERVICE CARD FOR MORE INFORMATION

*Yours for  
the asking!*



...a complete data file  
for electronic designers  
concerned with -

## RF SUPPRESSION!

Here's a new METEX data file that's just bulging with important information for designers. This folder contains individual data sheets plus a big, illustrated, 16-page, two-color bulletin on the suppression of radio interference.

Get your free copy of this valuable, informative, fact-filled folder today. Just fill in and mail the coupon below for complete data.



*Mail  
coupon  
today!*

7-239

### METAL TEXTILE CORPORATION

Electronics Division

Roselle, N. J.

Gentlemen:

Please send me your fact-filled METEX data file today.

Name \_\_\_\_\_

Address \_\_\_\_\_

City \_\_\_\_\_ Zone \_\_\_\_\_ State \_\_\_\_\_

**NP** HOLTZER-CABOT MOTOR DIVISION  
NATIONAL PNEUMATIC CO., INC.  
125 Amory Street, Boston 19, Mass.

GENTLEMEN:  Please send me data sheets on the Holtzer-Cabot R-24 Motors.  
 Please have representative call on..... (date)

Name.....  
Company.....  
Street.....  
City..... Zone..... State.....

CIRCLE 238 ON READER-SERVICE CARD

CIRCLE 241 ON READER-SERVICE CARD FOR MORE INFORMATION

**LOW  
OUTPUT  
IMPEDANCE...  
WIDE  
FREQUENCY  
RESPONSE...**

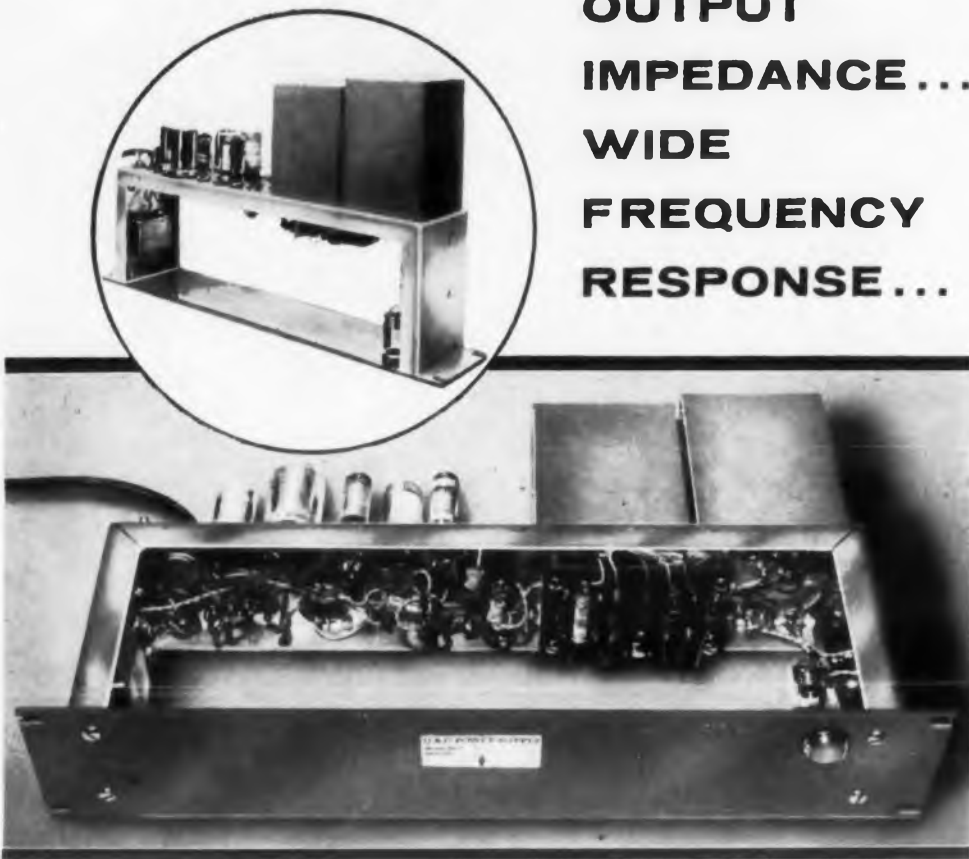

## UAC Transistorized Computer Power Supplies

- for Airborne Applications
- for Portable Instruments
- for Line Operation

UAC Multiple Computer power supplies are reliable, compact, versatile units with 115v 400cps input for airborne applications, 24 VDC for portable instruments, and 115v 60cps for line operation.

These units provide exceptional performance under intermittent variable and pulse loads. They have low output impedance (DC to 100Kc) and regulation is available to 0.1%.

They operate efficiently over the temperature range  $-55^{\circ}$  to  $\pm 55^{\circ}$ C. Operation to  $85^{\circ}$ C is available.

Typical output voltages and currents follow. Units with all 7 outputs are available from any of the inputs listed above.

+30	volts DC @ 2 Amps—Regulation 1%
+10	volts DC @ 6 Amps—Regulation 1%
+ 1.5	volts DC @ 1 Amp—Regulation 1%
- 1.5	volts DC @ 1 Amp—Regulation 1%
-10	volts DC @ 5 Amps—Regulation 1%
-11	volts DC @ 3 Amps—Regulation 1%
-30	volts DC @ 5 Amps—Regulation 1%

Line operated unit fits a standard 19" x 8 $\frac{3}{4}$ " relay rack and weighs approximately 22 lbs.

Tell us your specific requirements.



**UAC** Electronics  
A DIVISION OF

Universal Transistor Products Corp.

Dept. ED107 • 36 Sylvester St. Westbury, L. I., N. Y. • Edgewood 3-3304 • Cable Address: UNIVATOMS

CIRCLE 242 ON READER-SERVICE CARD FOR MORE INFORMATION

## New Products

### 20-W Transistorized Amplifier 5 x 5 x 2 In. Package



A 20-w transistorized plug-in amplifier for public address systems replaces units more than eight times its size. The unit occupies only 50 cu in. It has built-in equalization, a signal to noise ratio greater than 30 db, and less than 3 per cent harmonic distortion at the low frequency end. Input impedance is matched to tape recorder magnetic playback head. Frequency spectrum from 50 to 20,000 cps available. The amplifier includes peak clipping and gain control, and meets military environmental specifications.

Universal Transistor Products Corp., Dept. ED, 143 E. 49th St., New York 17, N.Y.

CIRCLE 243 ON READER-SERVICE CARD FOR MORE INFORMATION



### Survey Meter Measures Alpha Contamination

The survey meter, portable and battery-operated, incorporates a thin window ionization chamber to measure alpha contamination on flat surfaces. The instrument is factory calibrated directly in disintegrations per min for uranium alpha particles. It may also be used to detect low level beta and gamma radiation, and can be calibrated by the user for this purpose. The meter will detect alpha particles with energies as low as 1 mev or beta radiations with energies as low as 15 kev.

Technical Associates, Dept. ED, Burbank, Calif.

CIRCLE 244 ON READER-SERVICE CARD FOR MORE INFORMATION

## Malco IS YOUR BEST SOURCE FOR SOLDERING LUGS TERMINALS PRINTED CIRCUIT HARDWARE



### HERE'S WHY:

- Specialized high production techniques afford lowest possible unit cost.
- Precision tooling, rigid quality control assure tolerances to critical specifications.
- Ample stocks of over 1000 different parts permit prompt delivery.
- Malco specializes in a complete line of small stampings for Radio-TV, electrical/electronic and automotive industries.
- Our line includes terminals and printed circuit hardware in loose or in chain form for automatic insertion.

Let Malco show you how you can save on production time and costs. Contact us today.



Request handy reference catalog containing specifications on standard and custom-made lugs, terminals, corona rings, pins, contacts and similar stampings.

**Malco** TOOL and MANUFACTURING CO.  
4027 W. Lake St., Chicago 24, Ill.  
CIRCLE 245 ON READER-SERVICE CARD



# STRAITS TIN REPORT

New developments in the production, marketing and uses of tin



A tin "doughnut" is now being used to reduce water evaporation from reservoirs—an important conservation measure in our chronic, and growing, shortage of water. It dispenses flakes of hexadecanol, which lab studies indicate reduces evaporation losses up to 65%. This "doughnut" is a tub-shaped device without top or bottom, and 6 feet in perimeter. The outside surface is brass screen and the inside surface sheet tin. It is supported by means of inflated plastic bags.

By using modern printed circuit soldering techniques, British scientists have now developed a radar receiver so compact it occupies no more than 170 cubic inches, a small fraction of a cubic foot.

Development of a new tin field near Kampar, Perak, in the Federation of Malaya, may be undertaken shortly. The field is reported to contain millions of dollars' worth of tin ore.

Add one more "product" to the growing list now supplied in tin cans. This time it's fresh Florida air, packed as a souvenir by a novelty company in the Sunshine State.

The International Tin Council recently estimated that the surplus of tin from world production this year will be between 5000-7000 long tons. Thanks in large part to the International Tin Agreement, prices have fluctuated only between 1% and 2% since the beginning of 1957. This new price stability, in the opinion of many, makes tin an even more useful material in any plans for the future.



Ask us to send you TIN NEWS, a monthly letter. It will keep you posted on tin supply, prices, new uses and applications.

**The Malayan Tin Bureau**

Dept. 12K, 1028 Connecticut Ave., Washington 6, D.C.

CIRCLE 246 ON READER-SERVICE CARD

ELECTRONIC DESIGN • October 15, 1957

## Full-Wave Rectifier

100 Ma Output

A 9-pin (T6-1/2) miniature cathode type full-wave rectifier tube features a center tapped heater, separate cathode connections and high output current capabilities. Designated Type 12DF5, the new tube has particular appeal to manufacturers of test equipment, phonographs and mobile radios. Its construction, basing and performance characteristics lend themselves to extreme flexibility in all types of rectifier applications.

With an output current rating of 100 ma, the 12DF5 can be used in a wider variety of applications than presently available miniature rectifiers. Separate pin connections for each cathode enable the 12DF5 to operate as a voltage doubler or provide negative voltage from the same transformer.

Capable of developing either positive or negative voltage, the 12DF5 has a maximum 450 v rating of heater negative with respect to cathode and an ac heater-cathode rating up to 225 v (rms) ac maximum. The tube is capable of performing the same task as power supply making use of two half-wave rectifiers. The center tapped heater of the 12DF5 permits operation from either a 6 or 12 v supply, a versatility valuable in mobile radio units.

Sylvania Electric Products, Inc., Dept. ED, 1740 Broadway, New York 19, N.Y.

CIRCLE 247 ON READER-SERVICE CARD FOR MORE INFORMATION

## Electronic Timer

Small, Lightweight



An electronic timer for industrial control, life test cycling, interval photography, and other applications is small, lightweight, and accurate. The timing cycle is adjustable from 45 sec to 15 min, with other time ranges available on special order. The timer may be reset at any time during the cycle, and repeat cycle accuracy is 3 per cent. Operation may be either manual or automatic. Contacts are rated at 5 a, 115 v, and can be furnished either single pole normally open or single pole normally closed. Overall dimensions are 6-1/2 x 4-5/8 x 3-7/8 in.

Radex Corp., Dept. ED, 2076 Elston Ave., Chicago 14, Ill.

CIRCLE 248 ON READER-SERVICE CARD FOR MORE INFORMATION

# BIG-POT PERFORMANCE in Miniature-pot size

## Waters PRECISION MINIATURE POTENTIOMETERS

are built, tested, and certified\* to such rigid specifications as AIA, RETMA, JAN-R-19, MIL-E-5272A, and other applicable military specifications. This new line of single-turn pots packs Waters traditional performance into tight spots.

\*Complete test data on request.

NOW! A complete single-turn-pot line from Waters

CHECK THESE SPECIFICATIONS

Model	Resistance Range (ohms)	Standard Linearity†	Case Dia. (inches)	Standard Shaft Dia. (inches)
WP 1/2	1/2 to 250K	1.0%	1/2	1/8
WP 7/8	1/2 to 250K	0.5%	7/8	1/8 or 1/4
WP 1 1/16	1/2 to 350K	0.5%	1 1/16	1/8
WP 1 1/4	1/2 to 350K	0.5%	1 1/4	1/4
WP 1 5/8	1/2 to 500K	0.5%	1 5/8	1/4

† For best possible linearity submit detailed specifications. Servo mount standard, three hole and bushing mounting available.

A micro-miniature potentiometer that meets the requirements of today and tomorrow for high performance, while retaining the rugged dependability of the approved Waters design.

TYPE  
WP 1/2

Proved reliable in thousands of military and commercial installations. Available in dual unit with Waters new concentric shaft construction.

TYPE  
WP 7/8

Offers Waters reliability in the AIA nominal one-inch diameter. Available as servo or bushing-mounted unit, it gives high precision in a miniature size.

TYPE  
WP 1-1/16

Provides higher resistance values with better resolution and linearity, yet is a miniature unit in every sense. Available as dual unit with concentric shafts.

TYPE  
WP 1-1/8

Reliability and precision equal to many 2-inch or larger potentiometers results from Waters proved miniature design and assembly techniques.

TYPE  
WP 1-5/8

Write for catalog of the Waters complete single-turn-pot line: precision, trimmer, low torque, miniature.

**Waters**  
MANUFACTURING, inc.

APPLICATION ENGINEERING OFFICES  
IN PRINCIPAL CITIES

Wayland, Massachusetts



CIRCLE 249 ON READER-SERVICE CARD FOR MORE INFORMATION

# MICRO-BEARING ABSTRACTS

by A. N. DANIELS, President  
New Hampshire Ball Bearings, Inc.

## MEASUREMENT OF RADIAL RUNOUT

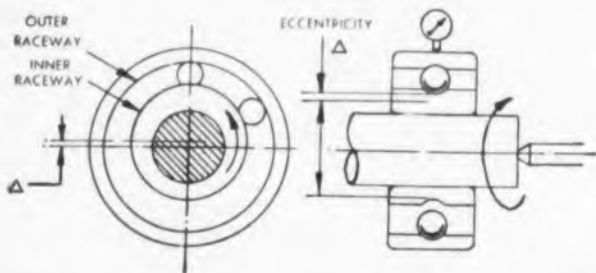

Fig. 1 — Measuring eccentricity of bore with respect to inner raceway.

Occasionally questions are raised about the methods of measuring "radial runout" and "out-of-round". In order to define "radial runout" properly, a discussion of "eccentricity" and "out-of-round" is necessary.

The amount of out-of-round, or lack of roundness of a given part (inner or outer ring or ball) is the difference between the maximum and the minimum diameter of the part in question.

Eccentricity refers to the distance between the centers of two circles. Concentricity refers to the exact coincidence of the centers of two or more circles. In high grade instrument bearings there is a very small tolerance on the permissible eccentricity between the bore and the inner ring raceway, and likewise between the outside diameter and the outer ring raceway.

Inner raceway out-of-round is measured by forcing the ring between the rounded edges of two discs, one of which is fixed and the other of which is mounted on the indicating mechanism. The difference between the maximum and minimum readings reveals the amount of out-of-round. Out-of-round of the outer ring raceway is measured by placing the ring over two rounded points which engage the raceway. One point is fixed and the other actuates an indicating mechanism. As the ring is rotated, the difference between the maximum and minimum readings indicates the degree of out-of-round.

The true amount of eccentricity between the bore and the inner ring raceway can be measured, providing these circles are not out-of-round, by mounting the assembled bearing on a slightly tapered arbor, applying a calibrated indicator on the center of the stationary outer ring, and then slowly rotating the arbor. The eccentricity is the difference between the minimum and maximum gage reading as the arbor is



Fig. 2 — Inner raceway is out-of-round, although concentric with bore.

rotated through one revolution. Similarly, the eccentricity of the outer ring is measured by the difference in the dial readings with the arbor and inner ring held stationary while the outer ring is rotated one revolution. Fig. 1 shows the set-up with an inner raceway which is eccentric with respect to the bore.

In the case above it has been stipulated that the bore and inner raceway must not be out-of-round, for only under these conditions is the true eccentricity measured.

If the raceway is out-of-round, while being either eccentric or concentric with respect to the bore, the out-of-round will be transmitted to the indicator, thereby influencing the reading. A condition in which the inner raceway is out-of-round although concentric is shown in Fig. 2.

In view of the fact that the majority of bearing rings will unavoidably be somewhat out-of-round and eccentric, however slightly, it is obvious that the measurement described above indicates neither true eccentricity nor true out-of-round but a summation of the two quantities. Hence, the measurement is more correctly termed radial runout.

### DESIGN HANDBOOK OFFERED FREE

If you work with miniature bearings, you'll find this new, 70-page authoritative publication contains a further discussion of radial runout and is a great help in solving problems in designing instruments or small electro-mechanical assemblies.

It will be sent free to engineers, draftsmen and purchasing agents. Write to: New Hampshire Ball Bearings, Inc., Peterborough 1, N.H.



**NEW HAMPSHIRE BALL BEARINGS, INC., PETERBOROUGH 1, NEW HAMPSHIRE**

CIRCLE 250 ON READER-SERVICE CARD FOR MORE INFORMATION

## New Products



110 Deg  
TV Tube  
Length 15-7/8 In.

This rectangular glass TV tube, Type 24AHP4, has a 24-in. diagonal envelope, an overall length of 15-7/8 in., and a 110-deg deflection angle. A small neck diameter of 1-1/8 in. makes possible the use of a deflecting yoke having high deflection sensitivity and also permits using minimum power to deflect the beam. The tube's electron gun is of the straight type designed to minimize deflection distortion and to eliminate an ion-trap magnet.

The 24AHP4 is of the low-voltage electrostatic-focus and magnetic-deflection type. It has a spherical Filterglass faceplate, an aluminized screen measuring 21-7/16 x 16-7/8 in. with slightly curved sides and rounded corners, and a minimum projected screen area of 332 sq in.

Radio Corporation of America, Dept. ED, Harrison, N.J.

CIRCLE 251 ON READER-SERVICE CARD FOR MORE INFORMATION



### Microwave Power Attenuator

Range: DC to 4 Kmc

Designed for a wide range of frequencies, this broad band power attenuator, Model AT-70 may be used for: isolating power sources up to 50 w continuous power, from low-power measuring devices, i.e., bolometers; decreasing power output of transmitters (for reduced radiation); or as a dummy transmitter load to permit simultaneous monitoring of transmitter output.

The attenuators are T-networks of concentric line construction and use carbon precision resistors. Series elements are rod resistors, shunt elements are discs. For maximum power dissipation, the AT-70 is oil filled and equipped with cooling fins. Accuracy is within  $\pm 1/2$  db and vswr better than 1.3 to 1 over the entire frequency range.

Empire Devices Products Corp., Dept. ED, Amsterdam, N.Y.

CIRCLE 252 ON READER-SERVICE CARD FOR MORE INFORMATION

## HIGH RESISTANCE MEG OHMMETER



- ★ Up to 50,000,000 megohms!
- ★ Test voltage variable 100-600 vdc!
- ★ Uncrowded 4 1/2" meter scale!
- ★ Automatic capacitor discharge!
- ★ Safe test terminals!
- ★ Only \$365!

Here's the only high resistance megohmmeter selling at \$365 with features not found on instruments selling for twice as much. Measuring range up to 50,000,000 megohms to meet the requirements of recent advances in insulating materials. The L-7 Megohmmeter is housed in a hardwood case with recessed vertical panel and convenient carrying handle.

Industrial Instruments has a wide selection of megohmmeters for both laboratory and high-speed production testing. Choose the model that best suits your needs from this table of specifications.

Model	TEST Voltage	RANGE		POWER Consumption	PRICE
		Low	High		
L-2A	200 fixed	1 meg.	100,000 meg.	40 watts	\$200
L-4A	200 and 500 fixed	1 meg.	100,000 meg.	52 watts	\$230
L-6B	100 to 600*	1 meg.	100,000 meg.	82 watts	\$295
L-7	100 to 600*	1 meg.	5x10 <sup>11</sup> ohms	75 watts	\$365

\*Continuously variable, built-in voltmeter for accurate setting.

Write today for complete catalog of  
Electrical Test Equipment manufactured by...



**Industrial  
Instruments Inc.**

89 Commerce Road, Cedar Grove, Essex County, N.J.

CIRCLE 253 ON READER-SERVICE CARD

# 3 ways you can get better

Forty-four years' experience in handling industry's toughest plating and electroforming problems are "on call" to serve you through Bart—one of the most extensive engineering and research organizations in the field.

## IF YOU DO PLATING YOURSELF

Bart offers complete facilities for testing existing methods, and for developing new plating techniques. Bart can revise your plant layout for higher efficiency, design new machines and equipment, supervise installation and initial operation.

## OR IF YOU'RE PLANNING TO

Bart will design and supervise the building of your plating department or plant — and even run it for you. Among many successful plants Bart has engineered is the AEC plating plant, one of the largest in the world, where 100,000 gallons of solution are in daily operation.

## IF YOU FARM OUT YOUR PLATING

Bart contract plating services may save you money, produce a better job. Or perhaps your own plant, engineered by Bart, may be the answer. Because Bart works both ways, the Bart approach is impartial.

All Bart services cover the full range of industrial plating — iron, copper, heavy nickel, precision chrome, etc. and the plating on unusual metals such as titanium, magnesium, aluminum, molybdenum.

Bart will gladly set up an informational session with your key personnel to discuss any plating problem, large or small.

# BART LABORATORIES & DESIGN, INC.

231 Main St., Belleville 9, New Jersey

CIRCLE 254 ON READER-SERVICE CARD

## Wiring Raceway Self Extinguishing



A wiring channel made of tough reinforced phenolic, will under no circumstances support combustion. If subjected to direct flame, it is immediately self-extinguishing without after-glow when the flame is removed. This new composition is lightweight, durable, and does not warp or sag even under high temperatures normally encountered in panelboards.

Stahlin Brothers, Inc., Dept. ED, 344 Maple St., Belding, Mich.

CIRCLE 255 ON READER-SERVICE CARD FOR MORE INFORMATION



## Portable Force Calibrator

Direct Reading,  
Automatic  
Balance

This portable force calibrator, Model 170, for calibrating existing weight, force and thrust measuring systems is a direct reading, automatic balance, digital servo indicator. According to the manufacturer, it provides an extremely fast and simple method of force calibration and has direct digital readout, requiring no interpolation of reading and, in most ranges, no application of correction constants. System accuracy is 0.1 per cent of reading or 0.1 per cent of lowest range, whichever is greater. NBS calibration can be supplied. Complete case measures 6-9/16 x 13-1/2 x 16 in.

Gilmore Industries, Inc., Dept. ED, 5713 Euclid Ave., Cleveland 3, Ohio.

CIRCLE 256 ON READER-SERVICE CARD FOR MORE INFORMATION

## Smallest, most versatile, multiple-circuit rotary switch

### Centralab Series 100

An ultra-small switch that measures less than 1" in diameter — weighs less than an ounce — yet has the electrical rating of larger, heavier switches.

Available up to 12 positions. Make and break, resistance load, .5 ampere at 6 volts d.c.; 100 milliamperes at 110 volts, a.c.; current-carrying capacity, 5 amperes.

Ideal for band switching in subminiature electronic equipment, transistor circuits, aircraft instruments, and guided missiles.

Features not found in  
phenolic-type switches

Maximum voltage flashover  
High Q — Low loss  
Minimum inter-circuit capacity  
Maximum circuit flexibility

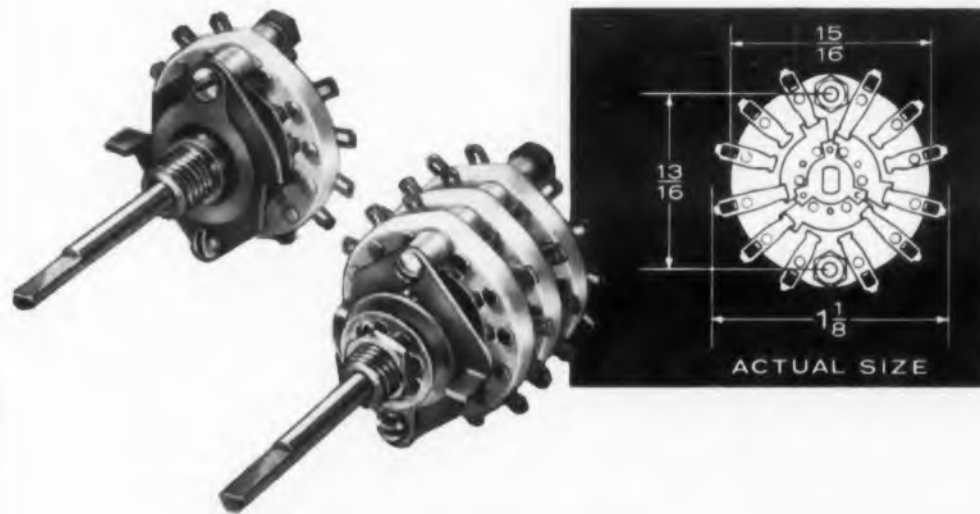

## Centralab

A DIVISION OF  
GLOBE-UNION INC.

960J E. Keefe Ave.  
Milwaukee 1, Wis.

In Canada:  
804 Mt. Pleasant Road  
Toronto, Ontario



### New 36-page Switch Catalog

Provides specifications on the complete line of CRL switches capable of handling power from a kilowatt to a microwatt. Write for this catalog today.

CIRCLE 257 ON READER-SERVICE CARD FOR MORE INFORMATION

# Pin Point Navigation Requires Precision Components



## Engineering Data:

**Servo Motor** 28 volts D. C. split field type, 6000 RPM no load, 40 oz. in. locked rotor torque.

**Tachometer Generator** Induction type, excitation 26 volts, 400 cycles, output 0.33 volts/1000 RPM, adjustment for null voltage.

**Dimensions** Approximately 2.5" diameter x 6" long

**Rotor Inertia** 0.7 oz. in.<sup>2</sup>

- ★ This Servo Motor Tachometer Generator for operating control surfaces in latest automatic pilots illustrates Wright's exceptional capacity for production of special small precision components and assemblies.

Consult Wright on your next requirements for . . .

**A. C. and D. C. Motor  
Servo Tach Units  
Synchros In All Categories  
Gyro Motors  
Tachometer Generators  
And Related Components and Assemblies**



CIRCLE 258 ON READER-SERVICE CARD FOR MORE INFORMATION

## New Products

### Stainless Steel Clip For Miniature Components



Measuring about 1/4 in. at its base, this clip meets military requirements for retention of transistors and other rounded components used on printed circuit boards and conventional chasses. The stainless steel clip can be fastened in place by rivet, solder or dip-solder methods and may be used to secure components such as diodes, relays, miniature capacitors and resistors within its size limits, under extreme vibration or shock.

Textron Inc., General Cement Mfg. Co., Div., Dept. ED, 400 S. Wyman St., Rockford, Ill.

CIRCLE 259 ON READER-SERVICE CARD

### Packaged Electronic Speed Control

For Fractional H.P. Motors



Designed for operation of any shunt or compound dc motor to 1/4 hp from a standard 117 vac power supply, the Model SC-1/4 electronic motor control provides variable speed from 0 to full motor speed at essentially constant torque, forward or reverse. It will maintain desired speed uniformly, regardless of line voltage variations as high as 20 per cent. An adjustable dynamic brake is incorporated in the unit to provide any desired degree of braking. Control system is suitable for remote or automatic operation in use.

B & B Co., Dept. ED, 3124 E. 14th St., Oakland, Calif.

CIRCLE 260 ON READER-SERVICE CARD

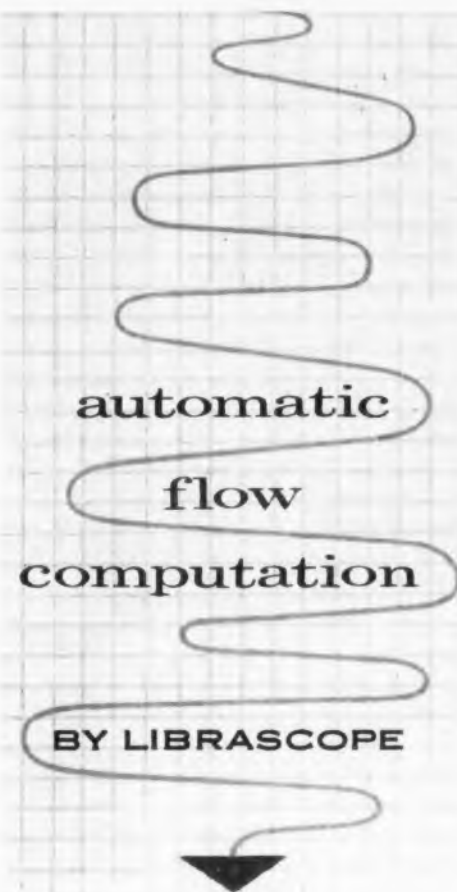

MODEL 25

### Computing Linear Integrator

... is designed for temperature recording, averaging and area computation in gas analysis procedures. Providing a fast, accurate and a continuously integrated total of data as it is being recorded, the Librascope Model 25 can be installed on any device having shaft rotation or displacement as an output.

Write for New Bulletin

Representatives in principal cities



A SUBSIDIARY OF GENERAL PRECISION EQUIPMENT CORPORATION

133 E. SANTA ANITA AVE., BURBANK, CALIF.  
CIRCLE 261 ON READER-SERVICE CARD

YOU CAN ALWAYS

**RELY ON  
WHITSO**  
FOR  
INSULATED  
TERMINALS  
AND OTHER  
ELECTRONIC  
COMPONENTS



**HERE'S  
WHY:**

We are specially equipped to furnish standoff and feed through terminals in a full range of materials and sizes . . . in economical quantity runs . . . from either our standard line or custom fabricated to your specifications . . . and deliver them promptly.

**Whitso Standoff Terminals** are available in over 100 varieties . . . fork, single and double turret, post and miniature types . . . male, female or rivet mountings . . . molded or metal base. They are molded from melamine thermosetting materials for best electrical properties.

**Whitso Feed Through Terminals** can be furnished as standard or to your individual specifications.



**Whitso Melamine Jacks** are electrically and mechanically designed for long, reliable service. A wide range of colors are available for color coding. Special colors can be supplied.



**Whitso Pointer Knobs**, widely popular in military use, are readily suited to countless communications and industrial applications. They are supplied in attractive black phenolic with satin finish.



**Whitso Custom Molded Parts** for electro-mechanical use include general purpose, mica filled and high impact phenolics, ureas, melamines, alkyds, glass reinforced alkyds and nylons.

Get full facts on Whitso terminals and other electronic components. Ask for our new catalog.



**WHITSO, INC.**

326 Byron Street, Schiller Park, Illinois  
(Chicago Suburb)

CIRCLE 262 ON READER-SERVICE CARD

**Lateral Action Connectors**  
Allows Compact Equipment Design



Oblong connectors with 15 butt-type contacts represent a new concept of lateral action mating in which inter-connecting equipment is fastened via a sliding action. Lateral action concept allows for more compact equipment design and increased reliability through more secure electrical and mechanical contact. Connectors are rated at approximately 500 v at 10 amps per contact. Mated pair measure 3-1/2 x 1-1/3 x 1-1/3 in.

Amphenol Electronics Corp., Dept. ED, Chicago 50, Ill.

CIRCLE 263 ON READER-SERVICE CARD

**Portable Electroplater**  
For Electrical Components

A portable, completely automatic electroplating unit, designed specifically for electrical and other precision components, requires only approximately 18 x 38 in. of floor space, in the 10, 20 and 30 gallon capacities.

The Jet Plater consists of a Sel-Rex Selenium Rectifier with automatic timer; stainless steel tank (which may serve as the anode) fitted with a water jacket for temperature control; a movable work rack which accommodates a portable plating barrel; a centralized control panel equipped with ammeter and powerstat control; a filter; and drip-proof pump with motor. Larger than standard capacity units can be made easily, to individual order. Jet Platers of 200 gallon capacities and over have already been installed. Agitation is accomplished through a pump and a perforated stainless steel tube at the bottom of the plating tank. The resultant constant motion of the solution assures even deposits, and high quality plating.

Sel-Rex Corp., Dept. ED, 155 Manchester Place, Newark 4, N.J.

CIRCLE 264 ON READER-SERVICE CARD

**Kinney**<sup>®</sup>  
**VACUUM**  
PRESCRIBED FOR YOUR PROJECT

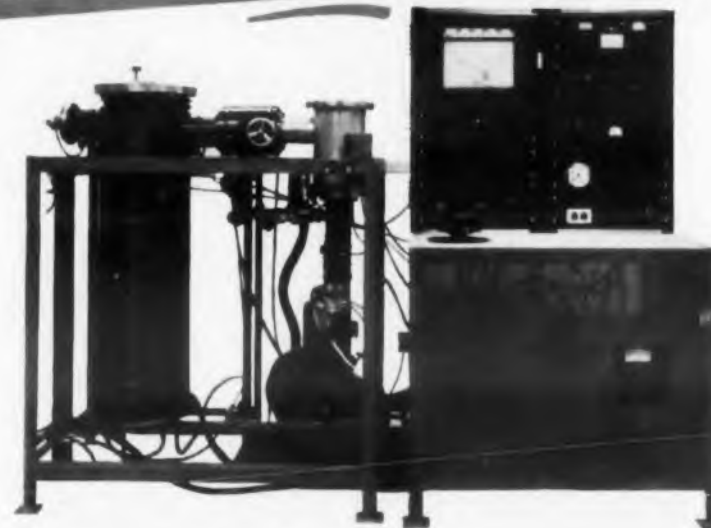

A new tool for the researcher as well as manufacturers of transistors and semi-conductors of all types . . . the standard KINNEY Crystal Growing Furnace.

Advances in High Vacuum equipment and technology are significant in many industries . . . but none more than in Electronics. And, KINNEY High Vacuum Pumps, Complete Systems and Component Parts, play a particularly important role in these advances . . . important to you from the standpoint of: *Product Improvement, Increased Production and Sound Economy.*

The KINNEY Mechanical Booster Pump delivers ultimate pressures to less than 0.1 micron.

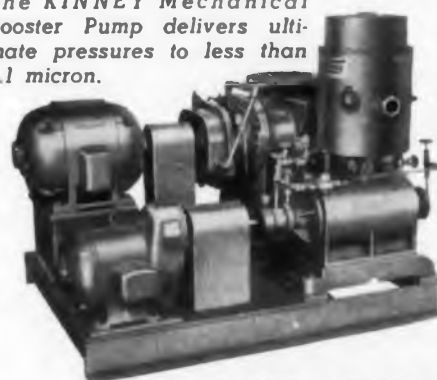

Today, the KINNEY line represents the broadest selection of High Vacuum Pumps in the world. In performance, KINNEY Pumps deliver ultimate pressures to 0.10 micron. Thus, with KINNEY you can provide a *Prescription Answer to Your Vacuum Problem.*

What is true of Pumps is also true of new developments in complete High Vacuum Systems for research, pilot plant or full production.

**KINNEY MFG. DIVISION**  
**THE NEW YORK AIR BRAKE COMPANY**

3561K WASHINGTON STREET - BOSTON 30 - MASS.

Kindly send me full information on new developments in

- KINNEY High Vacuum Pumps
- KINNEY High Vacuum Components
- KINNEY High Vacuum Systems for Electronics

Name \_\_\_\_\_

Company \_\_\_\_\_

Address \_\_\_\_\_

City \_\_\_\_\_ Zone \_\_\_\_\_ State \_\_\_\_\_

**WRITE:**

get the facts on  
**KINNEY High  
Vacuum Pumps,  
Complete Sys-  
tems, Valves,  
Gauges, etc.**

CIRCLE 265 ON READER-SERVICE CARD FOR MORE INFORMATION

For **VOLTAGE CONTROL**  
in Aircraft,  
Missiles, Land Vehicles,  
and Other Equipment

**Hoffman**

**10 WATT**  
**SILICON DIFFUSED JUNCTION**  
**zener power**  
**VOLTAGE REGULATORS**



**HZPR Series**

- ★ Extremely low dynamic resistance in zener region provides stable DC source regardless of severe line voltage changes.
- ★ Broad choice of low voltage values makes them especially suitable for transistorized circuitry.
- ★ Excellent long-time stability.

**Characteristics:** Available with tolerances of 10% and 5% at zener voltages between 10 volts and 100 volts; maximum dissipation 10 watts for 25°C case temperature; typical dynamic resistance — 1 ohm for unit with 20 zener volts at 500mA.

Please write for our Technical Information Bulletin which gives limits of Zener Impedance for all voltage ranges as well as information on temperature coefficient of voltage.

**Hoffman Semiconductor Division**

HOFFMAN ELECTRONICS CORPORATION

930 Pitner Avenue, Evanston, Illinois

formerly  
National  
Semiconductor  
Products

MANUFACTURERS OF: silicon junction diodes - zener reference elements - medium and high power rectifiers - silicon solar cells

CIRCLE 266 ON READER-SERVICE CARD FOR MORE INFORMATION

**New Products**

**Ultrasonic Solid Delay**  
Stable-Miniature



Utilizing ultrasonic propagation in fused quartz, the unit gives stable delays from 0.5 to 10  $\mu$ sec. A single input pulse results in multiple output pulses accurately calibrated in microseconds or yards. Cases housing these devices are hermetically sealed and shock and vibration proof. Maximum length is 1-1/2 in. and diameter is 3/8 in. Mounting is through a BNC type flange.

Microsonics, Inc., Dept. ED, Hingham Industrial Center, Hingham, Mass.

CIRCLE 267 ON READER-SERVICE CARD

**Pre-TR Tube**  
For High Power Application



The BL-612, an L-band pre-TR tube designed with ceramic windows for use in high power applications, operates at 6 megawatts (peak) and 12 kw average. The bandpass is from 1250 to 1350 mc. Two gaskets are supplied with the BL-612 to allow mounting in a standard 10-hole L-band mounting seat. The tube weighs approximately 5-1/2 lb and is 8-11/16 in. long, 5-7/16 in. wide and 3.6 in. (max) in height.

Bomac Labs., Dept. ED, Beverly, Mass.

CIRCLE 268 ON READER-SERVICE CARD

**Production Time Recorder  
Measures Production Time Only**



This production time recorder measures a machine's production time only, in hundredths of hours. Control-arm is connected by a cable to a recording unit. By converting vibrations into signals which actuate the recording units, only actual production time is recorded. Non-production time is erased automatically. The entire system is mounted in a carrying case 22 x 10 x 7 in. and weighs 21 lb. A 20 ft long cable with provision for extension to 120 ft is provided.

Moses Electronics Co., Dept. ED, 330 Locust St., P.O. Box 58, Hartford, Conn.

CIRCLE 269 ON READER-SERVICE CARD

**Single-Scale Megohmmeter  
Speeds Production Testing**



The Model 510 megohmmeter measures six decades of resistance on a single six-in. mirror scale and has 5 to 10 times faster response than conventional ohmmeters. Typical uses are: rapid checking of insulation resistance of motor windings, capacitors, transformers, cables and many appliances; and measurements of surface and volume resistivity in insulating compounds. Having 5, 50 and 500 v test potentials, it provides safe measuring of all test samples and checking of voltage coefficients.

Keithley Instruments, Inc., Dept. ED, 12415 Euclid Ave., Cleveland 6, Ohio.

CIRCLE 270 ON READER-SERVICE CARD

# THE ELIN DK-102 PRECISION POWER OSCILLATOR!



© Reg. U.S. Pat. Off. Pat. Pending.

For top precision performance in the oscillator field it's ēlin oscillators that can speed your results, save dollars! Ideal for pre-flight missile system checkouts, power source for all "bridge type" transducers, precision 400 cycle gyro testing, special power sources, time correlations, etc.—*wherever* you need "tuning fork" Frequency Stability, Absolute Voltage values, extremely low Output Impedance, Ultra-low Distortion and High Power Capacity!

The ēlin Precision Power Oscillator gives you all this through an exclusive High-Q LC tuned circuit and special voltage-sensitive bridge combined in a circuit employing a large amount of negative feedback. Standard model—2 watts power output (6 watt model, DK-106) at fixed audio frequencies between 250 to 15,000 cps. Special models available in higher power capacities and at other frequencies or to customer specifications. Write for literature TODAY!

**SPECIFICATIONS:**



**FREQUENCY**  
250 CPS. to 15,000 CPS.

**POWER**  
2 Watts (DK-102, DK-102R).  
6 Watts (DK-106, DK-106R).

**VOLTAGE**  
10, 30 & 100 volts RMS.  
All with floating, center tapped output.

**DISTORTION**  
0.1% maximum harmonic content  
0.05% maximum AC hum  
0.01% maximum noise

**FREQUENCY STABILITY**  
±0.5% maximum, under usual  
lab ambient conditions.  
±0.02% maximum, per ±10 volts  
variation in line voltage.  
±0.05% maximum, zero to full load.

**AMPLITUDE STABILITY**  
±0.1% maximum, under usual  
ambient conditions.  
±0.02% maximum, per ±10 volts  
variation in line voltage.  
±0.2% maximum, zero to full load.

PRICE: from \$295.00

ELIN LEADS A "DOUBLE LIFE" of quick-change versatility providing fast modification from a DK-102 (cabinet model) to a DK-102R for rack mounting! All models are smartly styled, compact (5¾"H x 9"D x 16¾"W) and built to give reliable, trouble-free service. 115V AC plug-in power is made to either lugs or AN adapter at rear of chassis!

**ēlin. / ELECTRONICS INTERNATIONAL CO.**

145 West Magnolia Boulevard, Burbank, California

Special Products Division of International Electronic Research Corporation, Burbank, California

CIRCLE 271 ON READER-SERVICE CARD FOR MORE INFORMATION

**REVERE**

# Thermocouple Wires



bought **FIRST**  
because they  
**LAST**

Day in, day out . . . in aircraft, refinery vessels, fire protection systems, furnaces, molding presses . . . under extremes of heat and cold, moisture, chemicals and abrasion, Revere thermocouple wires stand up because they're tailor-made for each application.

Solid or stranded chromel-alumel, iron-constantan and copper-constantan conductors available in various gauge sizes. Wrapped, carded or extruded insulations include polyethylene, vinyl, nylon, Revcothene\*, Teflon†, fiber glass, asbestos and pure silica glass fiber. Outer braids treated with flame and abrasion resistant saturants. Metallic braids for severe service. L & N, SAMA or NBS calibration. Wires constructed to Military Specifications MIL-W-5845, MIL-W-5846 and MIL-W-5908.

Whether your application requires extreme flexibility, chemical inertness or resistance to temperature, flame, abrasion, moisture, acids or solvents, a standard or special Revere thermocouple wire will meet your specific need.

\*Revere trade name

†E. I. DuPont trademark

Send for Engineering Bulletin No. 1701 describing Revere Thermocouple Wires and Extension Leads.

21

**REVERE CORPORATION OF AMERICA**

Wallingford, Connecticut

A SUBSIDIARY OF NEPTUNE METER COMPANY

CIRCLE 272 ON READER-SERVICE CARD FOR MORE INFORMATION

**neptune**

## Production Products

### Convection Oven Low Temperature Gradient



These ovens are designed for accurate heating, tempering, normalizing and drawing of both ferrous and non-ferrous metals, drying of ceramics, mold drying, chemical processing, curing of rubber, heat processing of plastics, paint baking and other uses. The Turbo-Convection feature yields close heating chamber gradients of plus-minus 3 F. This low gradient is made possible through a combination of full muffle directed forced convection and recirculation.

The various voltages in ac, dc and also the various phases are available as well as extra power for heavy loads and fast heat-up. Stands and extra heavy shelves are also available as well as various temperature controllers and timers. An exhaust adaptor is also available for venting exhaust to standard stovepipe. There are six standard models, ranging from 225 to 1000 F, and in heating chamber size from 4.75 to 27 cu. ft.

L and L Mfg. Co., Dept. ED, 136 Eighth St., Upland, Delaware County, Pa.

CIRCLE 273 ON READER-SERVICE CARD FOR MORE INFORMATION

### Pneumatic Base Filling Machine

#### For Lining Tubes

This pneumatic base filling machine for lining the bases of tubes, incandescent lamps and similar products with basing cement, produces up to 2,000 pieces per hr. Machine No. 1416, a typical model,

## An Engineer Speaks Out...

### Exciting Thriller Breaks Model Shop Mystery



This saga of the intrepid investigator veers off on a taut and timely theme — the engineering enigma of that inexplicable time lag in getting new servosystem designs into prototype form. Scene of the crime, written in a tempo of gore and gusto, is cued by the title — MURDER IN THE MODEL SHOP.

There's a switch in the pitch of this turbulent tale . . . no one seems to care who done it! The question is, what can be done about it. And this crime has its solution too, but agreement with the publisher precludes revealing the denouement here.

A possible clue to the answer is suggested by the sleuth's bringing in his trusty SERVOBOARD®, that life-saving instrumentality for assembling models or prototypes of systems in jig time. The SERVOBOARD is armed with a rigid aluminum base plate perforated with tapped holes, and a comprehensive range of gear sets, dial assemblies, hangers, clamps, and other hardware for summary execution of any and all servo designs.

And if there's any question whether the varmint is a true mechanism or a machination, the SERVOSCOPE® beats out any lie detector ever concocted — gets the facts, ma'am, on gain, and phase lead or lag, digs the figures for plotting Nyquist diagrams, sings out with the square wave for transient functions.

With the latest edition now coming off the press, MURDER IN THE MODEL SHOP contains fifty pulse-packed pages — printed on genuine pulp. You've never had such an adventure in lurid lingo, even at many times the price which is exactly nothing . . . to engineering and design people.

**SERVO CORPORATION OF AMERICA**

20-20 Jericho Turnpike, New Hyde Park, L. I., N. Y.

Write, wire, or call for your free copy of MURDER IN THE MODEL SHOP, published by SERVO CORPORATION of America.

The publisher also produces SERVOBOARD, SERVOSCOPE Servosystem Analyzer, etc.

CIRCLE 274 ON READER-SERVICE CARD



I. D.  
 ©. D.  
 and  
 P. D. Q.

Short description of our unique "custom tailored" seamless tubing service.

**SIZES:** O.D. from .010" (finer than human hair), to .625". Wall thickness down to .001". Tolerances are commercial or precision—down to .0003", if required. Every order is "made to order"—to exact specifications and with fine finish.

**METALS:** Almost any analysis—brass, copper, beryllium copper, phosphor bronze, aluminum, duraluminum, low carbon and stainless steels, Monel, nickel, Inconel, Nickel silver, precious metals and many other alloys. Specified temper is maintained uniformly, throughout.

**DELIVERY:** Three to four weeks, normal schedule. On occasions we have produced customers' emergency requirements, such as on projects involving a time penalty clause, in three or four days—making round the clock deliveries to local air terminals. A phone call starts us working for you.

**TUBING, plus:** Uniform Tubes' "know-how", gained through 20 years of experience, and their specialized facilities are not limited to the production of tubing, alone. A complete fabrication service for tubular components, in large or small production quantities, is offered—permitting you to cut sub-contracting costs, concentrate responsibility, save scrap losses, reduce paper work and get better delivery of finished components.

Write for literature or send us your drawings or specifications for quotations.

**UNIFORM TUBES, INC.** 1200 Level Rd., Collegeville 2, Pa. HUxley 9-7276



Chicago 11, Illinois, DElaware 7-7644  
 Pasadena, Calif., RYan 1-9534  
 St. Paul 4, Minn., Mldway 5-4637  
 Wellesley, Mass., WEllesley 5-1874  
 Buffalo 25, N.Y., SPring 8481

is equipped with quick-change adaptors to handle all types of bases. Completely air operated controls with an automatic timing device insure precision and uniformity in all models. The base-filling machine is easily maintained and cleaned.

Kable Engineering Co., Dept. ED, 1307 Seventh St., North Bergen, N.J.

CIRCLE 276 ON READER-SERVICE CARD FOR MORE INFORMATION

**Helium Leak Detector**  
 Has Fast Response



A newly-improved electronic leak detector can detect one part of helium in two million parts of air. The re-designed mass spectrometer leak detector features extreme sensitivity, fast reponse, and high resolution. The new M-2 leak detector finds and locates leaks in vacuum or pressure systems, readily detects a leak rate of  $1 \times 10^{-10}$  standard cubic centimeters of air per second.

The device has a response as low as two seconds and a high resolution which helps eliminate the possibility of response to elements other than the tracer gas (hydrogen or helium) introduced into a system for leak detection. The use of plug-in components in the electronic circuitry has simplified maintenance and operation. The mass spectrometer tube can be removed and replaced without shutting down the vacuum system.

General Electric Co., Dept. ED, Schenectady 5, N.Y.

CIRCLE 277 ON READER-SERVICE CARD FOR MORE INFORMATION

now! 7-day  
 delivery

on any 3 standard data printers

Now from Clary! Data printers delivered to you in a fraction of the usual time! Only Clary offers you 3 standard data-printing models with your choice of special dials and punctuation. Years of experience in this field have shown that these 3 standard models can be used in 85% of all data-printing applications... and at tremendous time and cost savings. Special built models are also available, if needed.

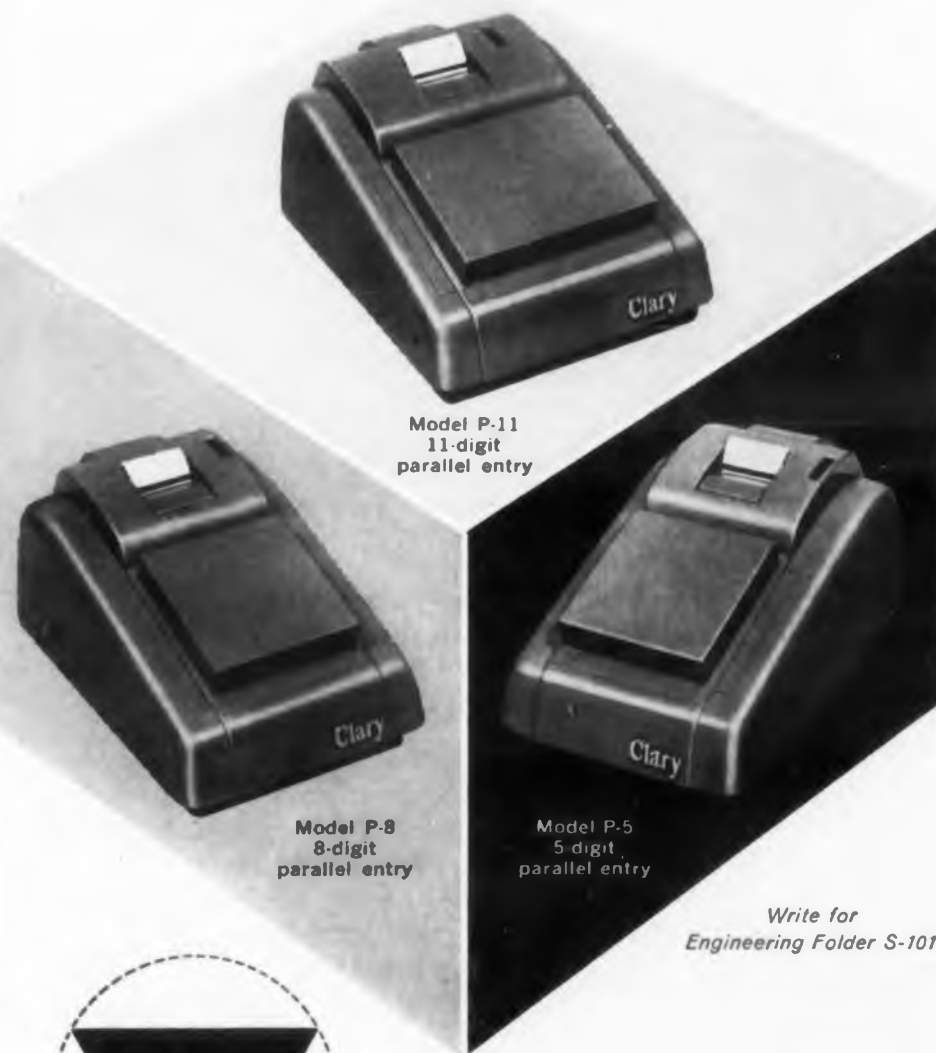

Model P-11  
 11-digit  
 parallel entry

Model P-8  
 8-digit  
 parallel entry

Model P-5  
 5 digit  
 parallel entry

Write for  
 Engineering Folder S-101



Manufacturer of Industry's most versatile data printers

**ELECTRONICS DIVISION**

Clary Corporation, San Gabriel, California

Manufacturer of business machines, electronic data-handling equipment, aircraft and missile components.

CIRCLE 278 ON READER-SERVICE CARD FOR MORE INFORMATION

CIRCLE 275 ON READER-SERVICE CARD

It's just part of the Victoreen story . . .

## HIGH STABILITY RESISTORS

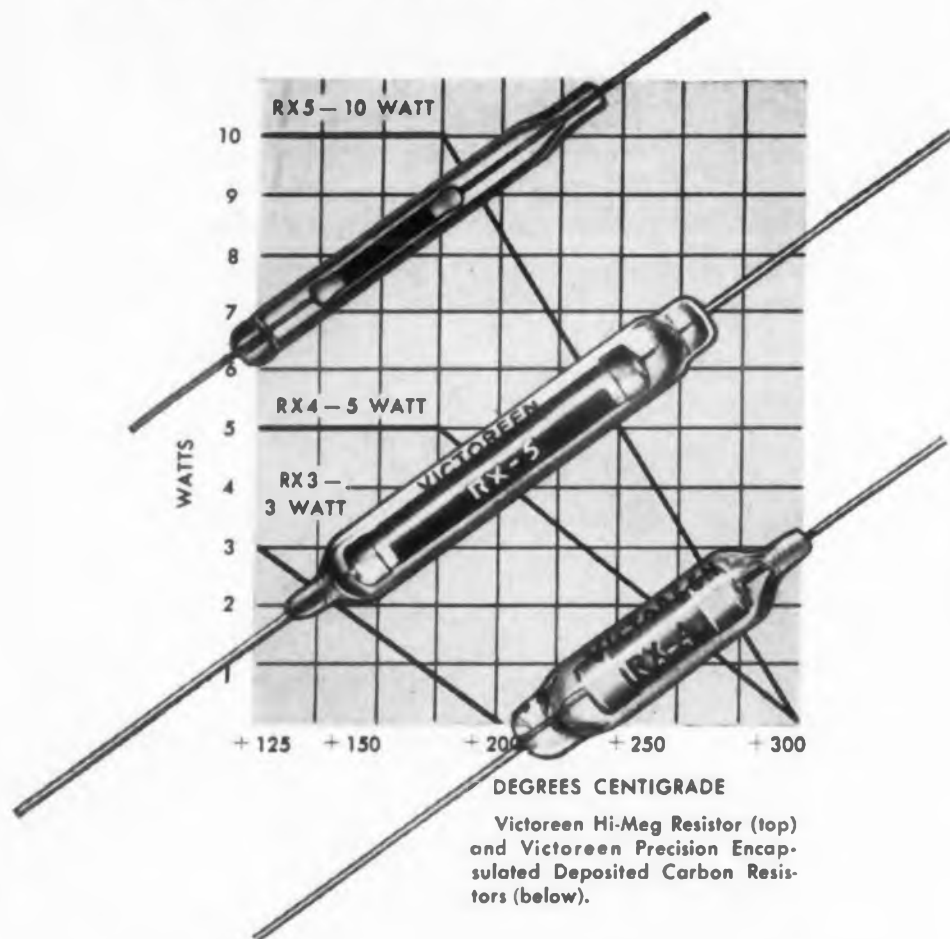

High stability, exceptional accuracy and performance that easily exceeds the normal electrical specifications of MIL 10509C—even in high ambients to 300°C where more than normal life expectancy is required. That's the story, in brief, of Victoreen deposited carbon resistors.

Hi-Meg resistors have a carbon-coated glass rod element, the ends of which are banded with silver for best electrical contact.

Hi-Meg resistors are vacuum-sealed in a glass envelope treated with special silicone varnish to keep envelope moisture-free.

For the ultimate in accuracy, stability and long-time performance, specify *Victoreen precision resistors*.

For the full story on Victoreen deposited carbon or Hi-Meg resistors, write for your free copy of Form 3025A.

ATTENDING WESCON? Be sure to see Victoreen's engineers. They'll be waiting for you at Booth 407.

The **Victoreen Instrument Company**  
Components Division  
5806 Hough Avenue, Cleveland 3, Ohio

CIRCLE 279 ON READER-SERVICE CARD FOR MORE INFORMATION

## Production Products

### High Speed Press Electromagnetic Unit

Designed for punching, jolting, drawing, bending, riveting, cutting, or stamping, this electro magnetic high speed press weighs 140 lbs. Stroke adjustment permits a choice of single stroke operation or of multiple stroke operation over a range of 10 to 200 strokes per minute. Force of impact can be adjusted from 600 lbs to 3-1/2 tons.

The power unit is an electro-magnet. A movable iron core traveling within the magnet acts as a ram.



This type of construction eliminates the use of moving parts subject to mechanical wear and fatigue stresses. The compact size of the press makes it equally adaptable to production line operation, shop utility operation or the repair bench.

McCauley Industrial Corp., Dept. ED, 1840 Howell Ave., Dayton 7, Ohio.

CIRCLE 280 ON READER-SERVICE CARD FOR MORE INFORMATION

Mr. Auburn says:

If it's  
INSULATION COMPONENTS  
you need.. I'M YOUR MAN!



Washers  
Shims  
Insulators  
Grommets  
"O" Rings  
Gaskets

BY

## AUBURN

For a quick and definitive solution to design and production problems, call on Auburn's 85 years of specialized experience in engineering materials to specific sealing and packing applications. Send us your prints and specifications — you'll get our recommendations and quotations promptly!

Our extremely wide range of materials includes:

Fibre • Phenolics • Plastics • Teflon  
Kel-F • Fibreglas • Silicone Rubber •  
Neoprene Rubber • Leather • Asbestos  
• Cork • Compositions • Cloth • Paper  
• Cardboard • Brass • Steel • Copper  
• Aluminum • Other Special Materials.



THE  
**AUBURN**  
MANUFACTURING COMPANY

306G Stack Street, Middletown, Conn.  
Representatives: Atlanta, Ga. • Detroit Mich. • St. Louis, Mo. • Los Angeles, Cal. • Minneapolis, Minn. • Washington, D.C. • New York, N.Y. • Cincinnati, O. • Rochester, N. Y. • Pittsburgh, Pa. • Fort Worth Tex.

CIRCLE 281 ON READER-SERVICE CARD

# MINIATURE THERMAL RELAYS

with  
99.99% Plus  
Reliability

SERVICE-FITTED  
SERVICE-TESTED  
SERVICE-APPROVED

Our complete  
environmental  
testing laboratory  
samples and certifies  
daily production.

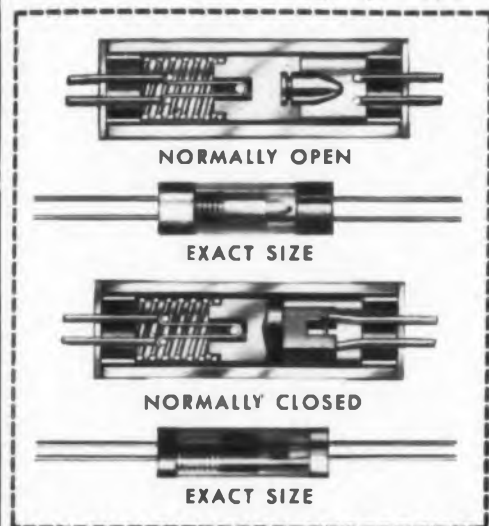

New NORMALLY CLOSED RELAYS NOW AVAILABLE. They both meet or exceed requirements for guided missiles and complex electronic gear.

They are hermetically sealed by bonding metal headers to high thermal, shock resistant glass housings.

They open or close a circuit positively in 0.1 second or other delay times.

They can also be safely used as a "squib" or timing mechanism.

#### Typical Characteristics

Temperature: -100°F. to +450°F.  
Vibration: 20-3000 CPS at 40 G's  
Shock: 250 G's

Brochure containing complete characteristics and specifications available upon request.

## NETWORKS ELECTRONIC CORPORATION

14806 OXNARD ST., VAN NUYS, CALIF.

Original designs for highest reliability in glass based miniature Relays and Resistors for all purposes

CIRCLE 282 ON READER-SERVICE CARD

## Production Products

### High Vacuum Pump Uses Titanium Layer

The Evapor-ion pump is a new electronic method for producing high vacuum without the use of organic pump fluids, and creates a "dry" vacuum in the pressure range from  $10^{-4}$  to  $10^{-8}$  mm Hg. It has high pumping speeds (1900 liters per second for nitrogen; 3000 liters per second for hydrogen), low ultimate pressure, and does not require mechanical pump forepressure for continuous opera-



tion. By eliminating organic vapors, refrigerated traps and baffles are not required to produce low ultimate pressures and full advantage can be taken of the maximum pumping speed.

Titanium wire is fed onto a post heated by electron bombardment from the filament. The titanium evaporates and, upon striking the cooled pump wall, condenses as a thin layer. Gas molecules wander into the pump from the vacuum chamber, move aimlessly about, and eventually strike the titanium layer. Molecules of the active gases, comprising over 99 per cent of the air, combine chemically with the titanium as stable compounds. As each layer of titanium becomes chemically saturated, a fresh layer of metal is then deposited.

Consolidated Electrodynamics Corp., Dept. ED, Rochester, N.Y.

CIRCLE 283 ON READER-SERVICE CARD FOR MORE INFORMATION

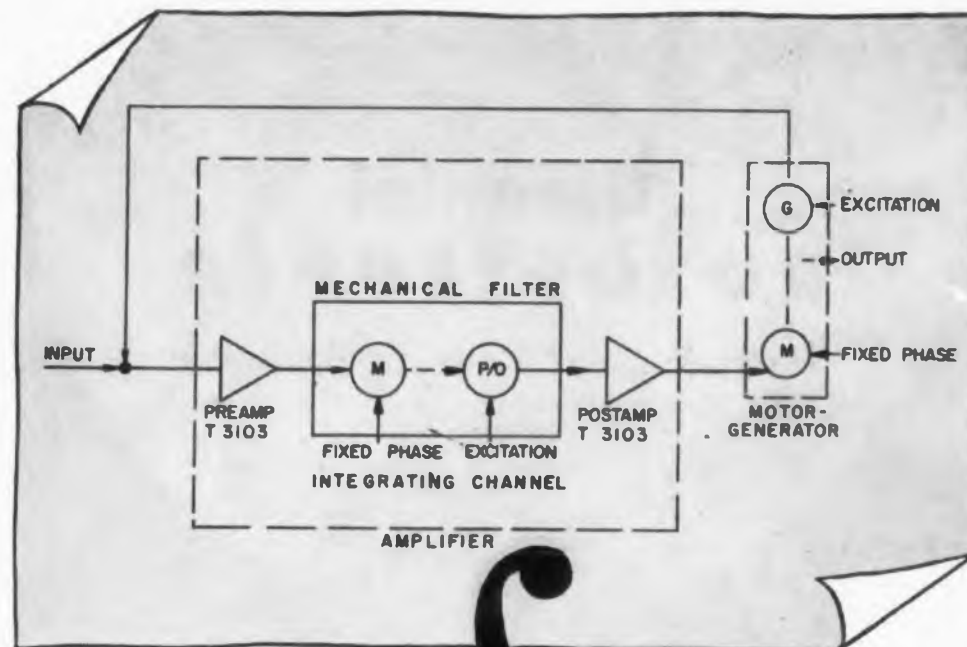

This diagram illustrates an optimum configuration of a precise integrating servo system. The essential components are shown below.

# S(f) dt



#### SERVO MOTOR GENERATOR

This size 15 unit represents the latest in design for precise integrating tachometers. Temperature stabilized to within 1° C; linearity, 0-3600 R.P.M., .03% of 3600 R.P.M., 0-4800 R.P.M., .05% of 3600 R.P.M.



#### MECHANICAL FILTER

This size 11 filter, used in conjunction with amplifiers shown, provides an integral-plus-proportional circuit. Eliminates quadrature and noise in the error signal and the need for high gain, critical amplifiers.



#### TRANSISTORIZED AMPLIFIERS

This T3103 amplifier provides a 40 v., 6 w. output. Meets the requirements of MIL-E-5400. Dimensions 1 5/8" x 1 5/8" x 1 1/8" high, weight 4.7 oz.

The above units are available as components for your specific applications or as packaged sub-assemblies.

#### KEARFOTT COMPONENTS INCLUDE:

Gyros, Servo Motors, Synchros, Servo and Magnetic Amplifiers, Tachometer Generators, Hermetic Rotary Seals, Indicators and other Electrical and Mechanical Components

#### KEARFOTT SYSTEMS INCLUDE:

Directional Gyro Compass Systems, Three Gyro Stable Platform Systems and Inertial Navigational Systems.

# Kearfott

A SUBSIDIARY OF  
GENERAL PRECISION EQUIPMENT CORPORATION

## KEARFOTT COMPANY, INC., LITTLE FALLS, N. J.

Sales and Engineering Offices: 1378 Main Avenue, Clifton, N. J.  
Midwest Office: 23 W. Calendar Ave., La Grange, Ill. South Central Office: 6211 Denton Drive, Dallas, Texas  
West Coast Office: 253 N. Vinado Avenue, Pasadena, Calif.

CIRCLE 284 ON READER-SERVICE CARD FOR MORE INFORMATION

# Giannini ROTOSTEPPER

*Pulse-to-shaft Position Converter*



**Powerful, rapid, absolutely controllable shaft rotation in precise 2° increments... for DC pulse-to-analog shaft positioning in computers, sequence switching, algebraic counting, remote shaft positioning.**

Pulsed DC from hand operated switches, choppers, or any similar manual or automatic pulsing devices controls the Giannini Rotostepper in precise 2° angles of rotation.... unlimited in either direction, at the rate of one step per pulse.

Optional control mechanisms available on the versatile Rotostepper provide homing to a fixed reference angle, automatic continuous stepping with a steady DC voltage, and/or potentiometric divided voltage functional to shaft position.

#### SPECIFICATIONS:

- TORQUE:** Up to 14 oz-in
- SPEED:** Up to 60 steps per second
- ROTATION:** Unlimited CW or CCW in 2° increments
- LOCK:** Spring detent locks shaft in a position accurate to  $\pm 6'$
- INPUT:** 28 volts DC, 10 milliseconds minimum duration per step

## Giannini

PRECISION INSTRUMENTS & CONTROLS

*For further information write for Rotostepper Bulletin 8915*

G. M. GIANNINI & CO., INC., 918 E. GREEN ST., PASADENA, CALIF.

CIRCLE 287 ON READER-SERVICE CARD FOR MORE INFORMATION

## New Materials

### Brazing Alloy For Complex Joints

Braze-Clad type N is supplied as a predetermined thickness of silver brazing alloy on one or both sides of a pure nickel base. The new material is particularly useful for high temperature applications, such as stainless steel honeycombs, tubes, and other structures. The alloy is used either as a brazing shim where close control of the flow of brazing alloy is mandatory in order that joints be perfect and free of voids; or where the entire surface is stamped and formed from the Braze-Clad metal, so that the entire surface of the metal will be completely covered with silver brazing alloy. In this way, the brazing alloy will be automatically preplaced so that blind joints of large area can be easily accomplished.

Because the prebonded brazing alloy is anchored to the nickel base, and does not relax its grip during the heating cycle, no matter how shaped, an even distribution of the brazing alloy throughout the joint area results, with intimate contact at every point with metals to be joined. Dependence on capillary creep is eliminated. There are no voids or oxide islands formed.

American Silver Co., Inc., Dept. ED, 36-07 Prince St., Flushing 54, N.Y.

CIRCLE 288 ON READER-SERVICE CARD FOR MORE INFORMATION

### Flexible Magnetic Shielding Foil Can be Cut or Wrapped

The same metal alloys used in Netic and Co-Netic magnetic shielding have been newly developed into lightweight flexible foils which shield both low and high frequencies at low intensities. The foils have high tensile strength and are difficult to tear, yet are cut as easily as paper with ordinary scissors to any required size or shape. The material bends easily and remains indefinitely in the desired bent shape. It wraps tightly like tape and does not spring back into original form because annealing leaves it dead soft. Attenuation results attained by a single layer of Co-Netic AA are: 10:1 for low level 60 cps, 14:1 for 1000 cps, 20:1 for 10 meg, 1000:1 for 250 meg. Netic S3-6 gives 8:1, 10:1, 80:1, and 1200:1 attenuation for the same frequencies.

Perfection Mica Co., Dept. ED, Magnetic Shield Div., 1322 N. Elston Ave., Chicago 22, Ill.

CIRCLE 289 ON READER-SERVICE CARD FOR MORE INFORMATION

## TUBING STRAIGHT... PREFORMED OR COAXITUBE

FROM .010" TO 1.000"  
TO YOUR SPECIFICATIONS

Whatever you need in tubing to any size, shape or alloy... Precision can supply it with precision accuracy, extra quality and at no extra cost.

Oxygen free copper and copper alloy tubing, nickel and nickel alloys, aluminum alloys, stainless steel—tubing for all electronic applications. Formed to exact specifications, single or double flared ends, complete with Standard A N Fittings.

Precision Coaxitube—A semi-rigid coaxial pair of conductors, sub-miniature sizes—low as .050" diameter, polyethylene or teflon dielectrics. Excellent mechanical properties, efficient shielding, low noise level for communication networks and missile guidance systems—protected from false signals.

Let Precision's engineers help you improve your product and reduce manufacturing costs with preformed tubing, assemblies and Coaxitube. Write for folder and full details to Precision Tube Company, Inc., Dept. 4, North Wales, Pa.



## PRECISION TUBE COMPANY

CIRCLE 290 ON READER-SERVICE CARD

# Quality



that protects  
your company's name...

There is no substitute for quality whether you are interested in the components, the workmanship or the end product you manufacture.

One of the basic components of almost every industry is fasteners. Successful operations that cash in on every opportunity for faster assembly utilizing maximum worker output with minimum loss of materials—find that quality fasteners such as Southern Screws form a dependable foundation for profitable production.

Although Southern has earned for itself an enviable reputation for fast service, and its stock of over One Billion fasteners—Quality is the benchmark of Southern products . . . constant quality that has become synonymous only with U. S. A.-made fasteners produced by U. S. A. workers.

If yours is a quality product, protect your company's name with Southern fasteners. Southern makes every screw it sells.

Write on company letterhead for samples, Stock List and Regional Stock Guide, Box 1360-ED, Statesville, N. C.



Wood Screws • Machine Screws & Nuts • A,BC,&F  
Capping Screws • Stove Bolts • Roll Thread  
Wing Bolts • Dowel Screws • Hanger Bolts  
Wood & Type U Drive Screws

Warehouses: NEW YORK • CHICAGO  
DALLAS • LOS ANGELES

CIRCLE 291 ON READER-SERVICE CARD

## Transparent Plastic High Abrasion Resistance



This clear plastic, CR-39, is designed for instrument glazing, particularly where internal or edge lighting is used to illuminate precision scale markings. Having thirty times the resistance to abrasion of methacrylate and unaffected by any known solvent, the plastic will also withstand constant temperatures up to 200 F. It can be sawed, drilled, bored and machined without difficulty, and has superior weathering characteristics as it does not crack, craze or discolor on exposure to sunlight and the elements. It has a persistent memory for its original shape, high impact strength, and is not brittle at low temperatures.

The Homalite Corp., Dept. ED, 15 Brookside Dr., Wilmington 4, Del.

CIRCLE 292 ON READER-SERVICE CARD FOR MORE INFORMATION

## Plastic Finishing Compound Eliminates Static Problem

This scratch-free buffing compound for cutting and coloring all types of plastics contains a special anti-static ingredient that dissipates static electricity from the finished part. The compound, called PC-52, was specifically formulated for such thermoplastic materials as acetate, styrene and the acrylics, since these softer plastics present a greater static problem. However, it has also provided good buffing results on thermosetting phenolics in initial field installations.

The composition includes: a soft abrasive that provides scratch-free cutting and coloring action in one operation; a built-in lubricant to minimize roll-over or burning problems, particularly when finishing softer plastics; and an anti-static agent.

The anti-static properties imparted to a part by PC-52 will be retained through an extensive series of subsequent handling operations. The compound provides a clear unclouded finish. PC-52 is available in all standard bar sizes for both manual and automatic application.

Hanson-Van Winkle-Munning Co., Dept. ED, Grand Rapids, Mich.

CIRCLE 293 ON READER-SERVICE CARD FOR MORE INFORMATION

## the new science of cable-tronics

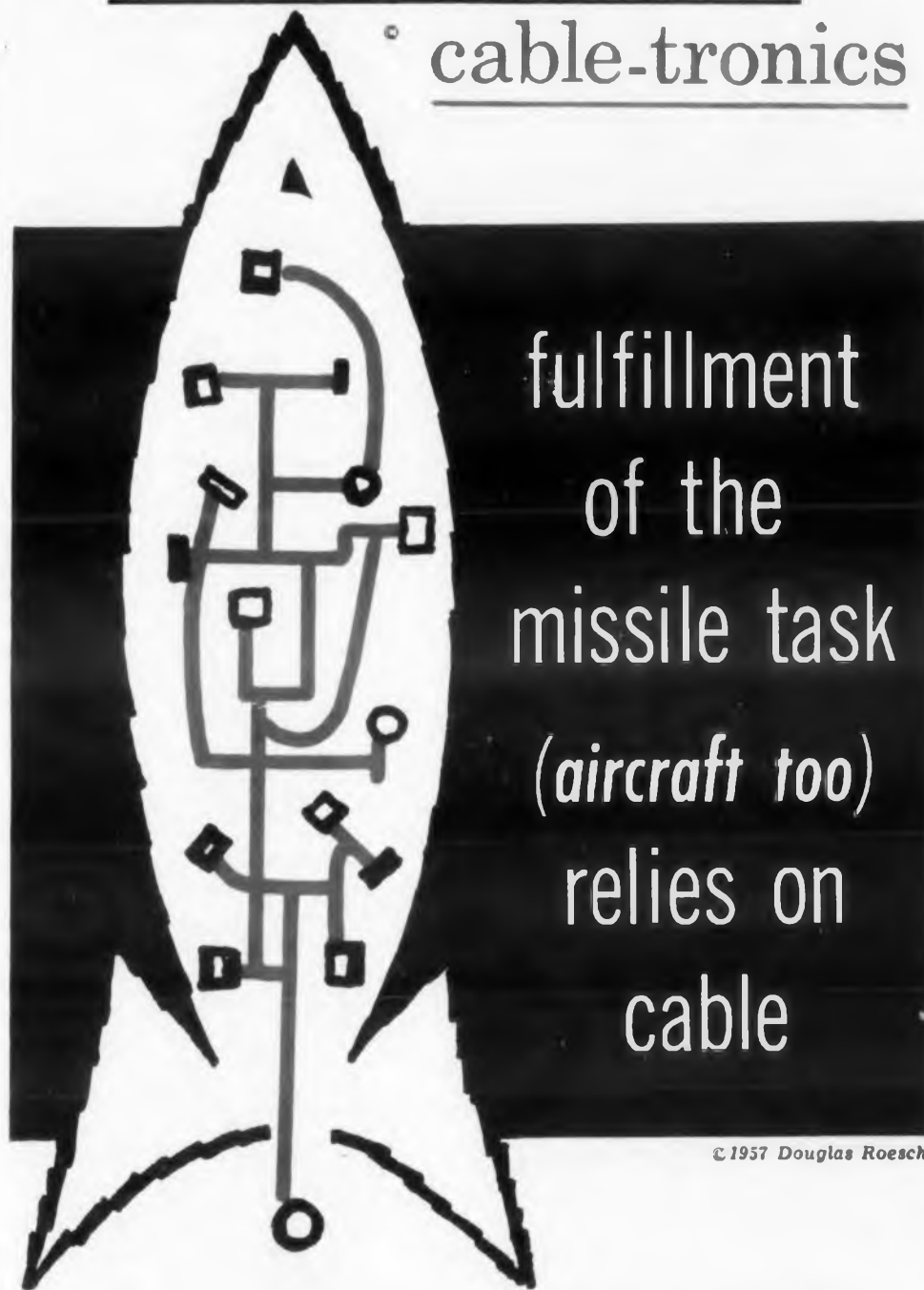

fulfillment  
of the  
missile task  
(aircraft too)  
relies on  
cable

© 1957 Douglas Roesch

For a missile to realize its inherent reliability factor every system component must "be in tune." The burden of sensitive and complex electronic functions multiplies the problems. The inadequacy of conventional electric cabling, using standard jacketing concepts, is now recognized. Hence there has arisen the demand for "cable-tronics"—the new systems design concept of true electronic cable structures to meet specific requirements.

D.R., "cable-tronic" pioneers, are equipped to custom fabricate complete systems from cable spinning through connectors... molded breakouts... metal work... fasteners... testing and assembly to your specifications or research and design systems to meet your requirements.

Write for complete facilities brochure.  
Rep inquiries invited.

Douglas  
Roesch

CABLE DIVISION OF  
Hall-Scott

Incorporated.

2950 NO. ONTARIO ST., BURBANK, CALIFORNIA

Cable-Tronics • Electronics • Heavy Duty Engines • Industrial Products  
CIRCLE 294 ON READER-SERVICE CARD FOR MORE INFORMATION

# NOW...

## ONE CALL FOR ALL

# CANNON

### PLUGS AND CONNECTORS

Standard, miniature and panel plugs and receptacles for all military and commercial applications.

No need to wait for deliveries of AN Connectors, UG Coaxial Connectors and RG Coaxial Cables. PROGRESS carries the largest inventory in the industry and all orders are shipped on the same day received. Call PROGRESS . . . your one stop source for Cannon Electric, Diamond Division of Cannon, Amphenol Electronics, Industrial Products Co., Kings Electronics, Dage Electric and Federal Telephone & Radio products. Write for comprehensive free catalog.

*Get it today...  
Get it from  
Progress!*



CALL WORTH 2-8041  
or wire/write . . .

**PROGRESS**  
ELECTRONICS CO.  
296 BROADWAY, NEW YORK, N. Y.

CIRCLE 295 ON READER-SERVICE CARD FOR MORE INFORMATION

## New Materials

### Glass Epoxy Laminate Flame Retardant

Combining flame retardant properties with high strength, this insulating laminate can be used at temperatures up to 300 F. Above this temperature it can be used intermittently. It is available in plain form for power applications and metal clad form for printed circuitry. Applications for this new grade of laminate include: switchgear components such as circuit breaker arms, flash-guards and insulating barriers; panels, terminal boards and other related power equipment, and radio and television relays, printed circuit panels and other electronic components requiring self-extinguishing characteristics.

Continental-Diamond Fibre Corp., Dept. ED, Newark, Del.

CIRCLE 296 ON READER-SERVICE CARD FOR MORE INFORMATION

### Teflon Spaghetti Tubing Flexible Thin Wall Design

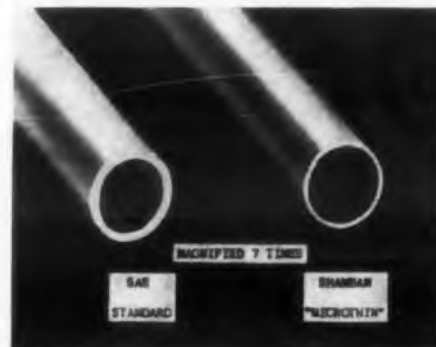

Called Microthin, this tubing is extremely flexible and thin, but retains all the strength and properties of the standard heavy wall type. Requiring less material to manufacture, the tubing is price-competitive with vinyl tubing, yet is claimed to be superior in every respect. Having Teflon properties, a temperature range of  $-450$  to  $+550$  F and ease of handling, it is highly advantageous in the assembly of compact electrical and electronic components requiring sharp tubing bends in restricted corners. Heat resistance allows high-speed soldering techniques. Produced in the standard color coding range, the tubing is available in wall thicknesses from 0.005 to 0.01 in., AWG sizes No. 30 through No. 10.

W. S. Shamban & Co., Dept. ED, 11617 W. Jefferson Blvd., Culver City, Calif.

CIRCLE 297 ON READER-SERVICE CARD FOR MORE INFORMATION

NEWEST OF 5

## MICRO-MICROAMMETERS

412 Log Model indicates from  $10^{-13}$  to  $10^{-7}$  ampere on a single six-decade scale

**STABILITY**, economy, and fast response are all combined in this versatile logarithmic instrument. Typical uses of the new Keithley 412 include reactor control, radiation monitoring, materials testing, and measurement of other widely varying micro-currents from sources of one volt or more.



KEITHLEY MODEL 412  
LOG MICRO-MICROAMMETER

**FEATURES** include a single range of six decades from  $10^{-13}$  to  $10^{-7}$  ampere, accuracy of 0.2 decade, zero drift within 0.5 decade in eight hours, and response time of less than 2 seconds to 90% of currents larger than  $10^{-12}$  ampere with 5000 mmf across the input.

**IT'S SIMPLE** to set up and use. The sole operating control is the on-off switch. It has only three calibration potentiometers, and reads out on a six-inch illuminated meter.

**CONNECTORS** furnished include a 216-volt tap for polarizing ion chambers and a single-ended 6-volt output that drives both 50-millivolt and 5-milliamperere recorders. The instrument is furnished for bench or rack mounting.

**NEW CATALOG B** contains detailed data on the 412 and all other Keithley Instruments. A request on your company letterhead will bring your copy promptly.

**KEITHLEY**  
INSTRUMENTS, INC.  
12415 Euclid Ave., Cleveland 6, Ohio

CIRCLE 298 ON READER-SERVICE CARD

An Engineer  
Speaks Out...

...to Introduce  
the **NEW Servotherm®**  
Industrial Pyrometers

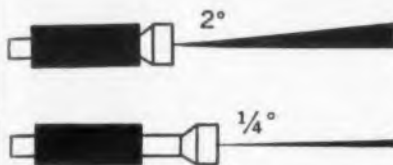

Two of the series of interchangeable lenses for distant objects available for Servotherm Industrial Pyrometers.

Our Servotherm Industrial Pyrometer Systems have taken on a new look. The amplifier and power units have been combined into one convenient, compact cabinet to give the system greater mobility. We've also included a selection of interchangeable accessory lenses as well as aperture plates to meet the growing diversity of applications throughout industry.

These changes have been made to enable our standard Servotherm Industrial Pyrometer System to provide better automatic temperature measurement and control of industrial processes where direct contact is not possible. Servotherm Systems detect and control temperature remotely, with a response time of just .250 milliseconds. They are critically accurate - temperature is measured within  $\pm 1\%$  and variations as small as 1.0°F are detected and controlled.

Today, our Servotherm Industrial Pyrometer Systems are solving many critical processing problems for the following industries:

- Ceramic & Glass Products
- Primary Metal Industries
- Fabricated Metal Products
- Textile Mill Products
- Paper & Allied Industries
- Chemical & Plastics
- Rubber Products

Our Applications Engineering Department is ready to help you with any remote temperature measurement and control problem you may have.

*J. N. Howell*

Chief Engineer, Infrared Div.

**SERVO**  
CORPORATION  
OF AMERICA

20 Jericho Turnpike, New Hyde Park, L. I., N. Y.

The engineering specifications on our Servotherm Systems are fully covered in this 4-page technical data brochure. Address your request to Dept. SH-9.



CIRCLE 299 ON READER-SERVICE CARD

ELECTRONIC DESIGN • October 15, 1957

**Thin Metal Parts  
Made Without Dies**

An economical method for producing thin metal parts without dies or presses is one of the services being offered by this company. The process, known as Photo-Etching, requires an inked drawing of the desired part. This drawing is photographed onto sheets of sensitized metal and is etched free of the un-wanted surrounding metal.

Shapes too intricate for stamping are easily made to tolerances of  $\pm 0.002$  in. No burr is left by the process. Modifications in design can be made by reworking the original inked drawing and rephotographing. The time required is short and the expense nominal.

Randolph Co., Dept. ED, 1018 Rosine, Houston, Tex.

CIRCLE 300 ON READER-SERVICE CARD FOR MORE INFORMATION

**Copper-Clad Teflon  
For Printed Circuits**

For printed circuit and cable strip applications, this copper-clad material assures under duress a uniform dielectric constant which is a significant advantage over Teflon-impregnated glass cloth. No delamination of insulating material is possible. Other properties in this material are a low dielectric constant (2.05), dissipation factor (0.002 max at 1 mc under condition D/48/50), and water absorption (0.02 per cent per MIL-E-5272-A). In addition, this material has a bond strength of greater than 7 lb per in. peel back and is unaffected by 500 F solder.

United States Gasket Co., Fluorocarbon Products Div., Dept. ED, Camden 1, N.J.

CIRCLE 301 ON READER-SERVICE CARD FOR MORE INFORMATION

**Silicone Rubber Compound  
150 C Wire Insulation**

Offering a good combination of electrical and physical properties plus low water absorption, SE-975 wire insulation may be used in long service at 150 C and for many applications at 200 C.

Physical properties after a cure of one hour at 300 F include 1150 psi tensile strength, 425 per cent elongation, and 125 pi tear strength. SE-975 is furnished as a white compound and may be tinted to obtain a wide range of colors. Processing characteristics of SE-975 have been reported as especially suited for thin wall extrusions by wire fabricators working with the compound.

General Electric Co., Dept. ED, Silicone Prod. Dept., Waterford, N.Y.

CIRCLE 302 ON READER-SERVICE CARD FOR MORE INFORMATION

**NEW PHAOSTRON  
EXPANDED SCALE  
AC Voltmeter**

Available now from distributors in 90V to 130V Range, AC Rectifier Type in all custom styles and sizes.

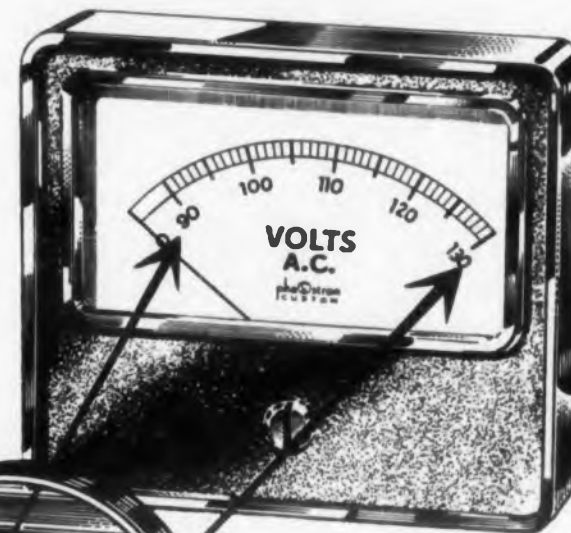

3 1/2" or 4 1/2" rectangular meter

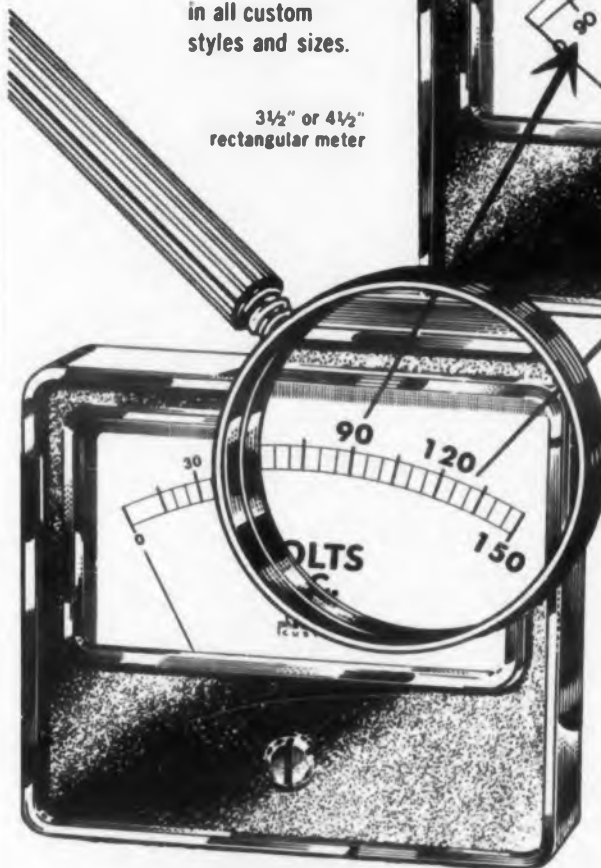

NOW!... all the time-tested proven Phaotron features PLUS UP TO TEN TIMES GREATER READABILITY for greatly increased accuracy!

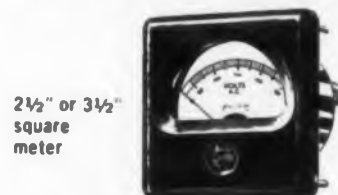

2 1/2" or 3 1/2" square meter



6" rectangular meter



2 1/2" or 3 1/2" round meter

All meters available with illuminated dial on special order

Phaotron has squeezed down that under 90V portion of the scale, where you don't need it, and expanded the section where you need it most—between 90 and 130V. Precisely calibrated 1 volt scale increments provide greater reading accuracy. Wide frequency range—linearity—true rms reading and Phaotron craftsman construction.

Phaotron Custom Panel Meters, with expanded scale, 90V to 130V AC rms, are available in nine types at your Parts Distributor. For special requirements for AC or DC expanded scale meters, write to Product Development Dept. for practical recommendations.

**PHAOSTRON**

PHAOSTRON INSTRUMENT & ELECTRONIC CO., 151 PASADENA AVE., SOUTH PASADENA, CALIF.  
CIRCLE 303 ON READER-SERVICE CARD FOR MORE INFORMATION

# ONE OF THESE 4 PACIFIC Accelerometers

**CAN PROVIDE RELIABLE ACCELERATION  
MEASUREMENT FOR YOUR OWN NEEDS!**

Four basic Pacific Accelerometer types — already designed and developed — can be used to meet practically any acceleration measurement requirement! Send for complete data sheets!

## HIGH ACCURACY POT

Single or dual potentiometer pick-off and/or switches... automatic caging mechanism. A unique torsion-bar suspension and restraining system provides very low hysteresis with exceptionally rugged, long life. Available in a wide variety of G ranges.

SERIES 4202



## LIGHTWEIGHT, MINIATURE

accelerometer combines a wide flexibility of design and performance characteristics with a proven, high production instrument. Potentiometer pick-off... wide selection of G ranges with an operating range of 0-±1 G to 0-±50 G.

SERIES 4201



## HIGH ACCURACY AC OUTPUT

linear accelerometer designed for high response systems requiring AC signal. This unit provides an accurate, large output AC signal while maintaining a high natural frequency and low cross talk. Temperature compensated fluid damping provides exceptional dynamic characteristics without heater.

SERIES 4204



## NO CROSS TALK

due to uni-directional design this instrument measures acceleration in one direction only, and cannot produce any output signal from cross accelerations. Pot pick-off... available in a choice of many G ranges.

SERIES 4203



**PACIFIC SCIENTIFIC CO.**  
P.O. BOX 22019 LOS ANGELES • LUDLOW 3-1121  
LOS ANGELES • SAN FRANCISCO • SAN  
DIEGO • SEATTLE • ARLINGTON, TEXAS  
**REPRESENTATIVES:**  
Eastern U.S.  
AERO ENGINEERING CO  
Canada  
GARRETT MFG. CORP.

CIRCLE 304 ON READER-SERVICE CARD FOR MORE INFORMATION

## New Materials

### Magnet Wire Insulation Dacron Provides Improved Qualities

The addition of dacron to glass results in an insulation which greatly improves the flexibility, adherence, and abrasion resistance of square and rectangular magnet wire. Both the glass and the dacron-glass are available with either standard varnish (Class B-130 C) or Silicone varnish (Class H-180 C). The glass or the dacron-glass insulation can be applied to square magnet wire in sizes 1/0 through 14, to rectangular magnet wire in sizes 106000 through 6500 CMA, and to round magnet wire in sizes 1/0 through 10.

Belden Mfg. Co., Dept. ED, 4647 W. Van Buren, Chicago 80, Ill.

CIRCLE 305 ON READER-SERVICE CARD FOR MORE INFORMATION

### Low Exotherm Packaging Compound Molds in Less than 10 Min

Developed to package electronic or mechanical components, EP-300 Series encapsulating compounds enable the user to mold assemblies in less than 10 min at room temperature. Exotherm reaction can be controlled to lower than 100 C and shrinkage during the curing cycle is considerably less than 0.5 per cent. When cured, EP-300 Series compounds will withstand -35 to +85 C and have good electrical properties.

Electronic Plastics Corp., Dept. ED, 675 Barbey St., Brooklyn 7, N.Y.

CIRCLE 306 ON READER-SERVICE CARD FOR MORE INFORMATION

### High-purity Alumina For Microwave Applications

A high-purity, aluminum oxide ceramic is being offered for use in radomes, wave guide components, vacuum tube envelopes and other applications where high resistance to radiation is required. The alumina has notable dielectric properties in the microwave region. At 50 kmc its loss factor is 0.000093; X-band and Ku-band loss factors vary from 0.0017 at room temperature to 0.00017 at 1000 F. In particular, its dielectric constant of  $9.38 \pm 1$  per cent remains stable over the entire temperature range up to 1000 F. A high mechanical strength and dimensional stability at high temperatures together with chemical and erosion resistance recommend the use of this material in microwave insulators and windows. The material can be fabricated in a wide range of shapes to close tolerances.

Kearfott Co., Inc., Dept. ED, 1378 Main Ave., Clifton, N.J.

CIRCLE 307 ON READER-SERVICE CARD FOR MORE INFORMATION

## Protect Your Printed Circuits against corrosion BEFORE SOLDERING DURING SOLDERING AFTER SOLDERING

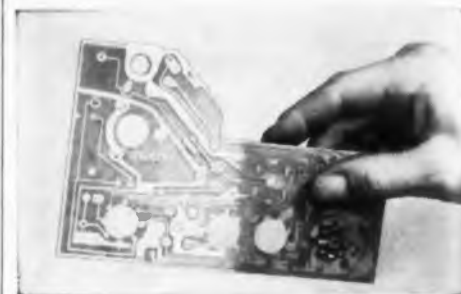

## FLUXCOTE 21-XR

The liquid soldering flux with protective coating characteristics...

*plus:*

- Smooth, fast action
- High insulation resistance
- Light, tack-free, varnish-like protective film after soldering

Whatever your printed circuit production, dip... spot... or area soldering you get full three-way protection against corrosion with Lonco Fluxcote 21-XR.



← REQUEST FREE  
TECHNICAL BULLETIN  
"The Soldering of  
Printed Circuits"

Also request free samples and data on other Lonco Products used in printed circuit manufacture: INSULATING ROSIN FLUXES

SEALORITE COATINGS • SOLDER RESIST • FLUX REMOVERS  
FLUX THINNERS • OXIDE REMOVERS



**LONDON CHEMICAL  
COMPANY, Inc.**

1531 North 31st Avenue  
Melrose Park, Illinois

CIRCLE 308 ON READER-SERVICE CARD

ELECTRONIC DESIGN • October 15, 1957



# PRECISION CAMS

from FORD INSTRUMENT



FLAT CAMS      3D CAMS      BARREL CAMS

- offered in a variety of types
- with tolerances to  $\pm 0.0005''$
- for wide range of computing and motion applications

Whatever your computing or motion application, Ford Instrument can make the cam to meet your exacting needs... 3-D Cams, grooved flat cams, external flat cams, grooved cylindrical cams. The Company's unique cam-production facility — and many years of experience — guarantee unmatched performance in this field.

**FREE** — Fully illustrated data bulletin gives specifications and performance information. Please address Dept. ED



## FORD INSTRUMENT COMPANY

Division of Sperry Rand Corporation  
31-10 Thomson Ave.  
Long Island City 1, N. Y.

Ford Instrument's standard components

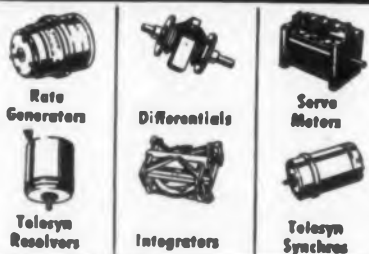

CIRCLE 309 ON READER-SERVICE CARD

## Anodic Insulation For Aluminum Wire and Strip

A new process for anodizing aluminum makes possible an effective insulation with a minimum ac breakdown of 450 v across two wires twisted together to provide turn to turn resistance. The anodized wire is very flexible, and can be bent to a radius three times its own diameter without crazing or fracturing the film.

The coating is essentially electro-chemical oxides formed over the aluminum. The aluminum oxide formed has a melting point of about 3650 F which is higher than any organic insulation, while the base aluminum metal melts at 1220 F. The use of aluminum in place of copper reduces weight by 50 per cent and eliminates bulky organic insulation. Film thickness is about 0.00015 in., and being heat resistant, obviates the necessity for cooling units needed in many transformers. Because of its flexibility, all kinds of coils can be wound.

Permaluster Inc., Dept. ED, 2012 Burbank Blvd., Burbank, Calif.

CIRCLE 310 ON READER-SERVICE CARD FOR MORE INFORMATION

## Gold Plating Solution Dipping Provides 24-Carat Surface

Called Atomex, this process requires no current or special equipment—objects to be coated are immersed in a bath and plating takes place within a few minutes. Other than ornamental applications include printed circuits, metallized plastics, and electrical connectors. The coating obtained is denser than that from electroplating, so that the same appearance can be achieved with 35 per cent less gold. Since there is no electrical shielding effect, there are no low- or high-density areas—all parts of the object, including the inside of tubing, receive a uniform deposit. The gold interlocks with the base metal, providing a much firmer bond.

Copper-clad printed circuits which have been plated by the process retain their solderability for 12 to 18 months when protected with a few millionths of gold. In some applications, the gold coat itself can be used as a solder between such metals as tungsten and nickel.

The process has been tested successfully on copper and copper-base alloys, cadmium, zinc, nickel, iron, Woods metal, nickel-silver, steel, die-cast alloys, soft solder, pewter, Alumel, cobalt, and bismuth alloys. Coatings up to 10 millionths thick can be applied to most metals.

Baker & Co., Inc., Dept. ED, 113 Astor St., Newark 2, N.J.

CIRCLE 311 ON READER-SERVICE CARD FOR MORE INFORMATION

# WHY

## TIC TRIMMERS?

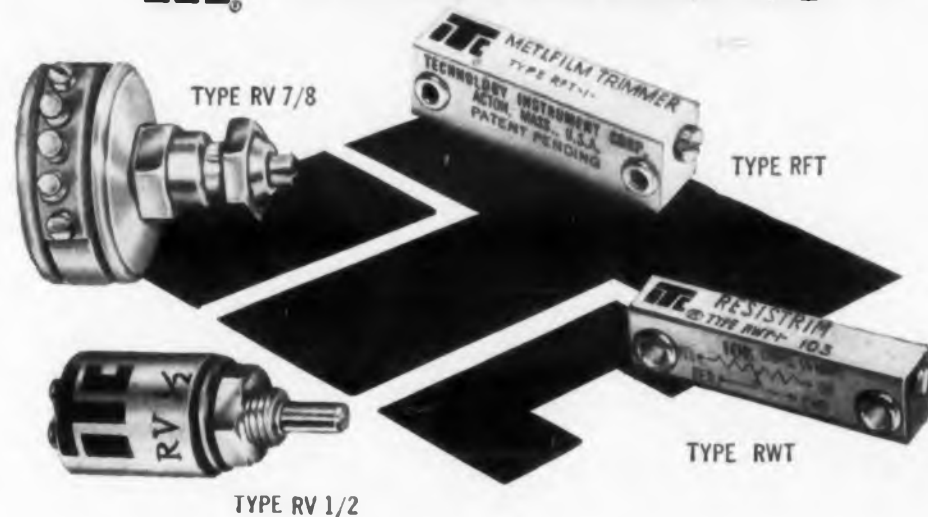

TIC, originator of trimmer pots, combines advanced design techniques and craftsmanship in its miniature and subminiature precision trimmer potentiometers. Pot size ranges from  $\frac{1}{8}$  inch to  $\frac{3}{8}$  inch... power ranges up to 4 watts.

TIC pots provide the ultimate in:

- Long Term Reliability by use of precious metal contacts, low temperature coefficient of resistance
- Sealing Design Techniques provide protection against moisture and salt spray
- Rugged Construction for resistance to shock and vibration
- Flexibility of Design Applications, a variety of shapes for optimum space use
- High Resolution

TYPE	TURNS	RESIST. RANGE	TEMP. RANGE
RFT*	25	50 — 25K ohms	-55° to +125°C
RWT	1	50 — 15K ohms	-55° to +95°C
RV 1/2	1	50 — 100K ohms	-55° to +145°C
RV 7/8	1	100 — 100K ohms	-55° to +145°C

\*Optimum spacing — as many as 7 in area of 1 sq. in.

All designed for the most stringent aircraft and rocket applications.

All units are available from stock

in production quantities.

Complete information on request.

These advanced design features provide for wide applications:

- Threshold voltage adjustment
- Fixed gain adjustment
- Parameter compensation
- Critical magnetic and electric bias
- Establishing circuit values
- Padding
- Balancing adjustments
- Adjusting scale factors

# TIC TECHNOLOGY INSTRUMENT CORP.

555 Main Street, Acton, Mass. COlonial 3-7711

CIRCLE 312 ON READER-SERVICE CARD FOR MORE INFORMATION

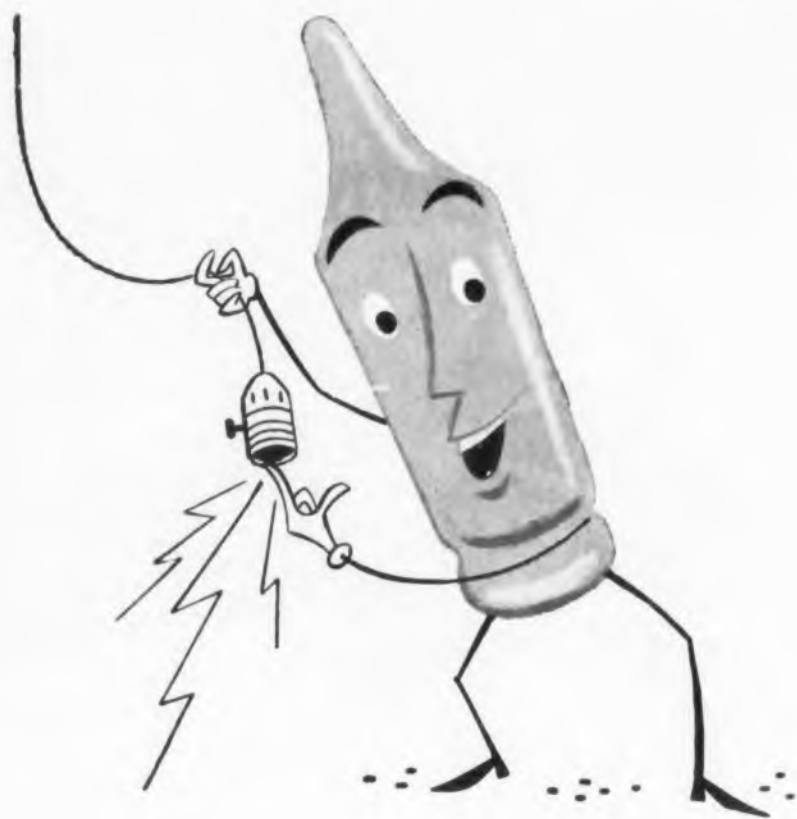

## G-E GLOW LAMPS OBEY THE IMPULSE ... TO SERVE AS INDICATORS

Every live circuit should have an indicator—and with radio-type resistors, G-E Glow Lamps become simple indicators that give long, uninterrupted service. Only glow lamps offer small size, low wattage, long life, wide voltage tolerance, and rugged construction—for as little as 3½¢ each! They don't fail suddenly, so there's almost no chance of false indications. All these features help make General Electric Glow Lamps the ideal choice for hundreds of applications as indicators in the electrical and electronics industries.



If you'd like more information on the amazing G-E Glow Lamps, send today for your free copy of the folder, "G-E Glow Lamps for Pilot and Indicator Use". Write: General Electric Co., Miniature Lamp Dept. ED-107 Nela Park, Cleveland 12, Ohio.

**A Single G-E Glow Lamp May Serve As A:  
RELAXATION OSCILLATOR • LEAKAGE INDICATOR  
SWITCH • VOLTAGE REGULATOR • VOLTAGE INDICATOR**

*Progress Is Our Most Important Product*

**GENERAL  ELECTRIC**

## Services for Designers

### Bonding and Potting Service

A bonding and potting service, directed toward gyroscope and other precision instrument manufacturers, has been added to the rubber molding service of Bacon Industries, Inc., Watertown, Mass. The materials used are carefully selected to meet the stringent requirements of the manufacturer. Potting can be done using standard vacuum potting techniques or latest vacuum-pressure techniques.

### High Reliability Etched Circuits

Etched circuits meeting high reliability and precision requirements are available from the Industrial Division of the Bureau of Engraving, Inc., Minneapolis, Minn.

Complete etched circuit services include drafting, photoetching, tool design, fabrication, flushing, silk screening, post forming, custom laminating, through-hole plating, electroplating of solder,

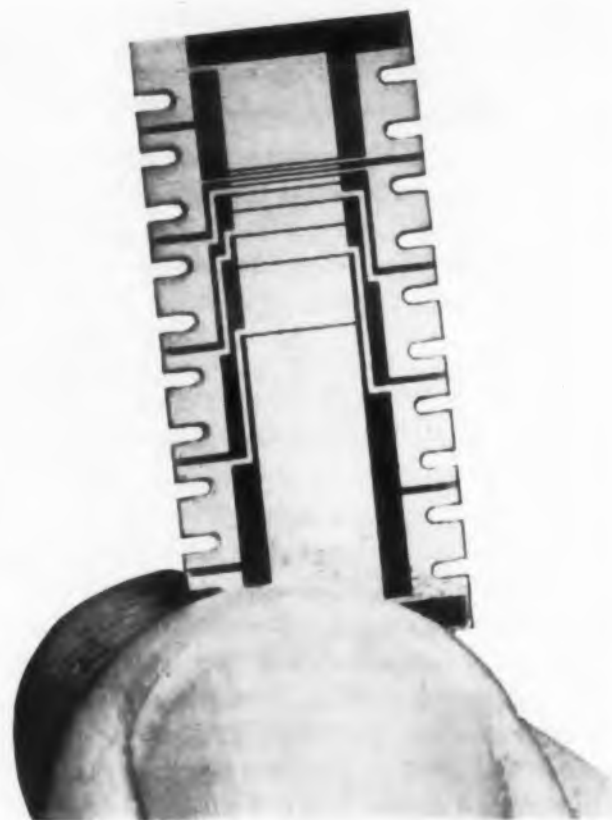

nickel, rhodium, gold, silver, and completed sub-assemblies. This work has computer, missile, aircraft and marine applications.

Typical of precision production by the Bureau is the tiny nickel and rhodium plated board of epoxy glass for a micro timing switch. This board is etched to a minimum path width of 0.0035 in. Minimum distance between paths is 0.0025 in.

**CRITICAL  
POT SPECS\*  
are met at CIC**



Equipment designers who demand more than "shelf item" specifications, rely on CIC for dependable delivery of ultra-precise potentiometers.

The result of CIC research, carbon film potentiometers are setting new standards of accuracy, life at higher speeds and performance reliability.

CIC has assisted many firms in a wide variety of industrial instrumentation, military fire control and flight guidance equipment.

Why not discuss your specific requirements with us?

\*New carbon film techniques assure virtually infinite resolution; linearity to .01%, sine-cosine to .025%; compact ganging; precision ball bearing servo construction.

**"For Precision Performance...specify CIC"**

Detailed Technical Data Sheets available on request.

**cic** **COMPUTER INSTRUMENTS CORPORATION**

92 Madison Ave. • Hempstead, Long Island, N. Y.

CIRCLE 314 ON READER-SERVICE CARD

## Using Thermistors

Edited by  
FENWAL ELECTRONICS

Here's more news on thermistors — the tiny, highly temperature-sensitive, semi-conductors that are being used in more and more applications in all types of industry.

Let's look at just three ways thermistors are now being used . . . Time Delay, Remote Control and Switching.

A thermistor placed in series with a variable resistor in series with a battery and a relay (Fig. 1) makes an excellent time delay relay. The high resistance of the thermistor limits the current flow when the switch is closed. The delay time may be increased or decreased by increasing or decreasing the series resistance.

By selecting a thermistor with the same constant as the tube filament it will be in series with, you can keep the current constant during the initial warm-up and prevent an initial current surge.

Bead thermistors are available with attached heaters and mounted in a vacuum bulb. (Fig. 2) The thermistors' resistance is reduced when power is applied to the heater. When placed in the input of a vacuum tube amplifier these thermistors make smooth, noiseless remote gain controls, because there are no moving parts or controls in the grid circuit.

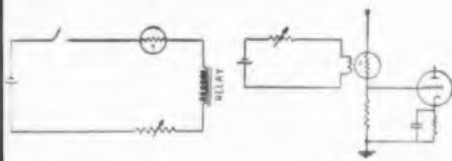

FIG. 1

FIG. 2

When several low voltage light bulbs are connected in series with a suitable thermistor connected in parallel with each unit, (Fig. 3) very little current will pass through the thermistors. Thermistors are not appreciably heated by the small voltage drop across the bulb. If one bulb burns out, the other bulbs remain lighted — the thermistor continues to carry the load of the extinguished bulb. When the bulb is replaced it takes the current from the thermistor. The thermistor then cools off and returns to its idle condition of high resistance and low current.

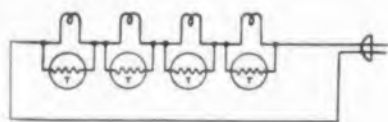

FIG. 3

Engineers: these and other thermistor applications are discussed in 12-page catalog EMC-1. Write for your copy to FENWAL ELECTRONICS, INC., 12 Mellen St., Framingham, Massachusetts.



Makers of Precision Thermistors  
CIRCLE 315 ON READER-SERVICE CARD

## 3-D Plastic Reproduction

Three dimensional reproduction of parts and models in polyester and epoxy plastics without expensive molds or tools is made available by a new casting technique. Working directly from a model or sample (or making a sample from drawings or sketches), parts can be reproduced with the exact finish of the sample in various solid materials including wood, metal, plastic and plaster.



The parts can be furnished by DuVal Industries, Camel Hollow Road, Huntington, New York, in any color, clear or with any compatible filler, and in many cases with undercuts and skew surfaces not possible by normal molding processes.

The embedment of electrical coils and electronic assemblies with provision for plastic case with intricate external detail, nameplates or embossing, offers a service to the manufacturer of commercial or military equipment for simultaneously weather-proofing and stylizing his products.

## Ultrasonic Equipment Rental

Ultrasonic systems and equipment are now available to industry on a rental basis. The equipment is available from Gulton Industries, Inc., Metuchen, N.J. There will be no exploitation of the company's patent position as the purchaser has the option of renting or buying the equipment outright.

The three-phased program includes the outright purchase of equipment with standard RETMA guarantees, the purchase of equipment along with a Gulton Industries service and maintenance contract, and monthly rental of equipment. Simultaneous with the rental plan, authorized service centers will be established in major United States districts.

An example of rental equipment is the Glennite industrial small parts cleaner, console model. Outright purchase of the cleaner would cost \$3000. On the rental plan, the console model will be available for \$250 monthly including maintenance, parts repair, lifetime guarantee and a service contract.



SNAPS BACK

Reclaiming spring forces grip down. Holds it firmly in place against surface.



NO PINCHING

Handle back plate design permits grip to lift to 90° position. Keeps fingers free.



EXTRA STURDY

Easily attached, each handle is strong enough to lift 200 lbs. with ample safety factor.

## BEST HANDLE YET FOR INDUSTRIAL CONTAINERS, CARRYING CASES OR ELECTRONIC EQUIPMENT!

Meets Military Specifications  
C-4150A and T-945A

There's nothing fragile about this handle! It's strong, rugged, rattle proof, rust and corrosion resistant. Made of tough stainless steel and heavy-gauge anodized aluminum, it will lift 200 lbs. with a big safety factor in reserve.

This Bendix handle has proven its superiority on military and industrial carrying cases, shipping containers and

on electronic equipment. The special grip sleeve will not crack, chip, become sticky or tacky in temperatures from -65° to +160°F. Our patented design eliminates pinching, holds grip firmly against surface when not in use. Attaches easily with nuts and bolts, welding, etc.

Write today for complete specifications and quantity discounts. Bendix-Friez, 1404 Taylor Ave., Baltimore 4, Maryland.

Friez Instrument  
Division



CIRCLE 316 ON READER-SERVICE CARD FOR MORE INFORMATION



Edward E. Grazda, E.E.  
Editor



James A. Lippke, B.F.E.  
Managing Editor



E. T. Ebersol, Jr. B.S. in E.E.,  
M.A. Associate Editor



George H. Rotsky, B.E.F.  
Associate Editor



Simon Dresner, B.A.  
Assistant Editor



Patrick J. Lahey, B.S.E.  
Assistant Editor



Thomas E. Mount  
Assistant Editor



Edwin T. Blake, B.A.  
Assistant Editor



D. S. Viebig, B.A.  
Assistant Editor



S. H. Hubelbank, B.A.  
Contributing Editor



J. G. Adashko, E.E., M.S.  
Contributing Editor

## progress is often practical

One of the marks of a scientist is the desire to publish the news of research or discovery.

But what about the progress in dealing with, or in applying, these discoveries?

This practical, day-to-day, down-to-earth task of communicating ideas, applications, methods, product improvements, techniques, etc. is of prime importance to the industry and its growth.

There is no better way to communicate your ideas than through *Electronic Design*. Your audience, now numbering more than 25,000, is a select group who will recognize the value of what you have to say.

**ELECTRONIC  
DESIGN**

a HAYDEN publication

New York

Chicago

Los Angeles

# New Literature

## Shock Tester 317

The brochure now available points out that this dynamic instrument provides for accurate simulation of shock experience by equipment in actual use. The tester is capable of producing thrusts up to 12000 lbs instantaneously and exactly with precision waveform control. Widely varying accelerating and decelerating forces can be applied for controlled time periods. It is essentially a piston in a cylinder, subjected to differential pressures on its two faces. Built of modular components, it is available in a variety of forms to meet any application. Consolidated Electrodynamics Corp., Rochester Div., 1775 Mt. Read Blvd., Rochester 3, N.Y.

## Fractional Horsepower Motors 318

Design advantages of GE fractional horsepower motors are described in Bulletin 6424 now released. The 16-page full-color bulletin shows components in an integrated insulation system of general purpose fractional horsepower motors used in the equipment manufacturing field on such applications as power tools, heating and ventilating equipment, compressors, fans, water pumps, and machine tools. The publication includes a cutaway drawing of Form G motor and describes production facilities, quality-control tests, application-engineering assistance, and small motor service station plan available for general purpose fractional horsepower motors. General Electric Co., Schenectady 5, N.Y.

## Temperature Monitoring Systems 319

Temperature monitoring systems are described in Bulletin No. 72 just released. It gives in detail (1) various standard sub-assemblies, (2) the arrangement of these sub-assemblies to form one completely integrated temperature monitoring system for capacities up to several hundred points. Individual components are illustrated in the bulletin by photos and cut-aways while a diagram shows how they are adapted to meet individual needs. In addition, this comprehensive bulletin provides complete information on operational details, specifications, applications, optional equipment, temperature ranges for thermocouples and resistance bulbs, and the various types of signalling devices used. Thermo Electric Co., Inc., Saddle Brook, N.J.



### MODEL 372 SLIDING COAXIAL TERMINATIONS

This equipment, available only from Narda, provides the most convenient means for evaluating the residual VSWR of coaxial slotted lines. VSWR of the element is 1.05 or less; covers range from 2000 to 12,400 mc.

N Connector, male or female \$110 C Connector, male or female \$116



### MODEL 371 FIXED COAXIAL TERMINATION

This Narda coaxial termination is the first and only to cover the entire frequency range from S to X band. Same range and element VSWR as above.

N Connector, male or female \$55 C Connector, male or female \$58

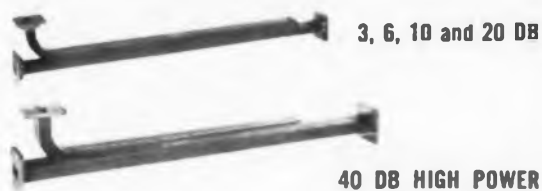

3, 6, 10 and 20 DB

40 DB HIGH POWER

### HIGH DIRECTIVITY COUPLERS

The 40 db High Power Coupler is another exclusive Narda product. Similar to standard types, except that coupling irises are in the narrow wall, it may be used at full rated power of the waveguide size. Nominal coupling value is 40 db; directivity 40 db. Directivity for 3, 6, 10 and 20 db couplers is also 40 db. Standard cover flanges on primary line; low VSWR termination and standard cover flange on secondary. All bands covering frequencies from 2600 to 18,000 mc.



### STANDARD REFLECTIONS

Narda offers five values of reflections for each of six different waveguide sizes—the most complete choice we know of! Provides calibrated reflections or VSWR's for use in standardizing reflectometers or calibrating slotted line impedance meters.

#### SPECIFICATIONS

Reflection Coefficient	0.00	0.05	0.10	0.15	0.20
Accuracy	0.002	0.0025	0.0035	0.0045	0.007
VSWR Equivalent	1.00	1.105	1.222	1.353	1.50

Models for 2.60 to 18.0 kmc, from \$125 to \$300

## Microwave engineers—

# Where can you use these exclusive features offered by narda?



## Waveguide and Coaxial IMPEDANCE METERS

Exclusively in Narda Waveguide and Coaxial Impedance Meters, the carriage mounting and drive mechanism are integral with the precisely machined transmission line casting. This insures permanent accuracy and freedom from slope errors—no more tedious adjustment or possibility of misalignment.

Other features include angle-mounted scale and vernier for optimum visibility; readily removable supporting pedestal; and smooth carriage travel action. Waveguide models, accurate for VSWR's of 1.01, are available for complete coverage from 2600 to 18,000 mc; N or C Connector coaxial models, from 1500 to 12,400 mc.

#### WAVEGUIDE IMPEDANCE METERS

Frequency (kmc)	Narda Model	Residual VSWR	Price
2.6 — 3.95	224	1.01	\$425
3.95 — 5.85	223		350
5.3 — 8.2	222		325
7.05 — 10.0	221		270
8.2 — 12.4	220		250
12.4 — 18.0	219		270

#### COAXIAL IMPEDANCE METERS

Frequency (kmc)	Connectors (One Male, One Female)	Narda Model	Price
1.5 to 12.4	Series N	231	\$360
1.5 to 12.4	Series C	232	390

### Complete Coaxial and Waveguide Instrumentation for Microwaves and UHF—including:

DIRECTIONAL COUPLERS	TUNERS	ATTENUATORS
TERMINATIONS	ECHO BOXES	STANDARD REFLECTIONS
FREQUENCY METERS	SLOTTED LINES	BOLOMETERS
HORNS	BENDS	THERMISTORS

### MAIL COUPON TODAY FOR FREE CATALOG AND NAME OF NEAREST REPRESENTATIVE

The Narda Microwave Corporation  
160 Herricks Road  
Mineola, N. Y.  
Dept. ED-1

NAME \_\_\_\_\_

COMPANY \_\_\_\_\_

ADDRESS \_\_\_\_\_

CITY \_\_\_\_\_ ZONE \_\_\_\_\_ STATE \_\_\_\_\_



the narda  
microwave corporation

160 HERRICKS ROAD, MINEOLA, N. Y. • PIONEER 6-4650

CIRCLE 320 ON READER-SERVICE CARD FOR MORE INFORMATION



DO  
YOU  
WANT  
TO...



GENERATE PULSES



DELAY PULSES



WIDEN PULSES



REGISTER PULSES



COUNT PULSES



SUM PULSES



DO BINARY LOGIC



DRIVE TRANSISTOR CIRCUITS

You can do all of these functions with the new integrated line of NAVCOR transistorized pulse programming equipment . . . available in miniaturized building blocks.

Send for free data file!



NAVIGATION COMPUTER CORP.

1621 SNYDER AVE., PHILADELPHIA 45, PENNA. / HOward 5-7700

CIRCLE 321 ON READER-SERVICE CARD FOR MORE INFORMATION

## New Literature

### Laboratory Power Supplies 322

A brochure illustrating and describing three power supplies in the laboratory instrument line has been released.

The units discussed in the four page brochure Types 9001, 9102 and 9202 provide up to eight standard voltage outputs both positive and negative from +100 v dc to -400 v dc and cover a range of current capacities from 2 ma to 6 amp. Regulation on each of the supplies is maintained at better than  $\pm 5$  per cent for all output voltages, and ripple voltage is kept to a minimum of less than 0.5 per cent rms. Burroughs Corp., Electronic Instruments Div., 1209 Vine St., Philadelphia 7, Pa.

### Automatic Wave Analysis 323

How automatic wave analyzers can speed reduction of analog data and increase statistical reliability is the subject matter for Bulletin 9001. The booklet explains the operation of automatic wave analyzers with typical examples. It shows how analog data reduction eliminates manual fairing, measuring, sampling, or analog-digital conversions. The bulletin concludes with a rundown of the general specifications of two analyzers that automatically perform all reductions from the original recorded data to a permanent printed plot of amplitude vs frequency or power vs frequency. Minneapolis-Honeywell Regulator Co., Davies Labs. Div., 10721 Hanna St., Beltsville, Md.

### Seal-Release 324

A material, known as Sonite Seal-Release, is described in Technical Bulletin No. 19 recently released. This release agent can be rubbed to an imperceptible film for easy parting of epoxy resin castings from plaster molds, or from metal, wood, or epoxy masters. The technical bulletin includes prices of various quantities of the material.

It describes methods of applying Seal-Release, by rubbing, brushing or spraying. Use with materials such as plaster or gypsum for making of case molds, and plaster or formed styrene sheets for making vacuum molds is covered. Smooth-On Mfg. Co., 572 Communipaw Ave., Jersey City 4, N.J.

### Noise Control 325

An 8-page illustrated brochure entitled "Noise Control" has been released. It illustrates with charts and photographs the applications of the pneumatic mufflers for the elimination of exhaust noises of air

## Now! Elastic Stop® Nut Miniatures to NAS 696-7-8, NAS 1067-8



These new miniature self-locking nut series added to the full lines of counterbored, low height NAS 679-695 parts previously announced, offer avionic engineers a wide variety of 550°F. fasteners to meet the severest application problems imposed by the space limitations of new missile and electronic designs. All of these new Elastic Stop nuts use ESNA's AN-approved offset locking closure which exerts locking torque radially and elastically for vibration-proof tightness and extended re-usability. Write Dept. S4-1057 for specification sheets on the new LHTA51 and LHTA51M series.



ELASTIC STOP NUT CORPORATION  
OF AMERICA

2330 Vauxhall Road, Union, New Jersey

CIRCLE 326 ON READER-SERVICE CARD FOR MORE INFORMATION

## Electronic TIME DELAY RELAY Transistorized

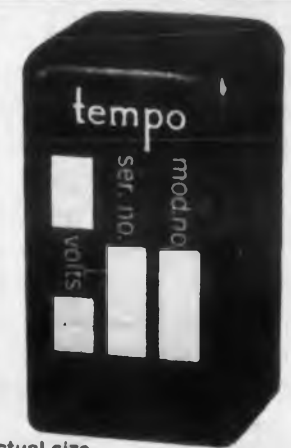

- Time delay..... .01 to 60 sec.
- Accuracy.....  $\pm 10\%$
- Recycling..... Instantaneous
- Temperature... -55° to +125°C
- Vibration..... 20 g, 2000 cps
- Input..... 18 to 31 VDC
- Contacts..... DPDT, 2 amp
- Life..... 100,000 cycles min.
- Weight..... 2 ounces

AND — 30 day delivery of limited quantities



TEMPO INSTRUMENT INCORPORATED  
240 Old Country Rd., Hicksville, N. Y.

Creating New Concepts in Advanced Electronics

CIRCLE 327 ON READER-SERVICE CARD FOR MORE INFORMATION

Partners... YOU AND YOUR  
**NO. 50 POCKET PAL**



\$1.00 AT YOUR LOCAL DEALER  
CATALOGUE NO. 49 AVAILABLE UPON REQUEST

.030 MATTE FINISH MATHEMATICAL QUALITY DOUBLE-CURED PLASTIC.  
ALL HOLES SMOOTH-MILLED TO ENGRAVING MACHINE ACCURACY.  
ONE OF MORE THAN 30 RAPIDESIGN TIME-SAVER TEMPLATES— ALL  
OF WHICH ARE BETTER MADE, MORE USEFUL AND LESSER PRICED.

**RAPIDESIGN** INC.  
P. O. BOX 592 GLENDALE, CALIF.

CIRCLE 328 ON READER-SERVICE CARD FOR MORE INFORMATION

## WIRE HARNESS CLAMPS

With **TEFLON\*** and Other  
Cushioning Materials

TA 710 clamp has a special V-shaped wedge which forms escape-proof grommet. Eliminates need for taping for assembly. Permits easy replacement of single strands. Saves time. Fully protects wires against pinching, the cause of 40% of short circuits.

Recommended for installations where extra margin of safety is desired, such as proximity to fuel, gas, inflammables, explosives, etc. Available in aluminum, steel, stainless steel. Sizes from 1/8" to 4" dia. Choice of cushioning materials, AMS 3209, TA-74 High Temp. Cushion, Silicate Rubber Cushion and in the popular new **TEFLON\***. Send for 201G Engineering Manual.

\*A Du Pont Company Trademark.



**TA mfg. corp.**

(Formerly Thomas Associates)

4019 Alger Street, Los Angeles 39, California

CIRCLE 329 ON READER-SERVICE CARD FOR MORE INFORMATION



operated equipment. The charts illustrate the performance data of the mufflers in frequency and attenuation levels in decibels, loudness and attenuation levels in sones, air flow CFM, noise levels and attenuation levels at various airline pressures.

Three inserts accompany the brochure. One shows muffler construction by model and its dimensions and configurations, the second an air graph, and the third a price list. Allied Witan Co., 12500 Bellaire Rd., Cleveland, Ohio.

### Fiberglass Reinforced Plastics 330

First complete catalog and price list of materials for fiberglass reinforced plastics is now available. Included in the 14-page catalog are complete ranges of fiberglass fabrics and fibers, polyester and epoxy resins and catalysts, and other necessary supplies. The catalog lists fiberglass cloths, tapes, chopped strand mats, surface and overlay mats, rovings, chopped strands and milled fibers.

Available sizes, grades and prices are shown under each material, along with thumbnail descriptions of properties and recommended applications. Two pages of property tables of polyester resins and fiberglass cloths are included. Cadillac Plastic & Chemical Co., 15111 Second Ave., Detroit 3, Mich.

### Blower 331

Model L Multistage Blower described in catalog sheets 40302-1, 2 is now available. The blower as indicated in the catalog sheets delivers 25 to 300 cfm at static pressure of 10 to 55 in. water column (2 psi) on suction or pressure, and incorporates 3 to 9 cascaded pressure stages.

There are no wearing parts. The blower is directly coupled to a 1/4 to 2 horsepower motor which is an integral part of the unit. Since the shaft speed is only 3400 rpm the noise level is low. The illustrated sheets show the entire assembly runs on 2 ball bearings. Dimensions, electrical characteristics and performance curves, are also fully given in the catalog. Rotron Mfg. Co., Woodstock, N.Y.

### Hex Head Cap Screws 332

The four pages of a recently-released bulletin describe self-locking and self-sealing hexagon head cap screws. Supplying features, specifications, and recommended practices of installation, this bulletin also explains how cap screws are made self-locking and vibration proof by a patented nylon pellet inserted in the threaded portion of the screws. A table shows the diameter and location of pellets for hex head cap screws available from stock in sizes 1/4 through 1 in. diameters, fine and coarse threads. Photographs and diagrams aid in the discussion. The Cleveland Cap Screw Co., Box 202, Cleveland 28, Ohio.

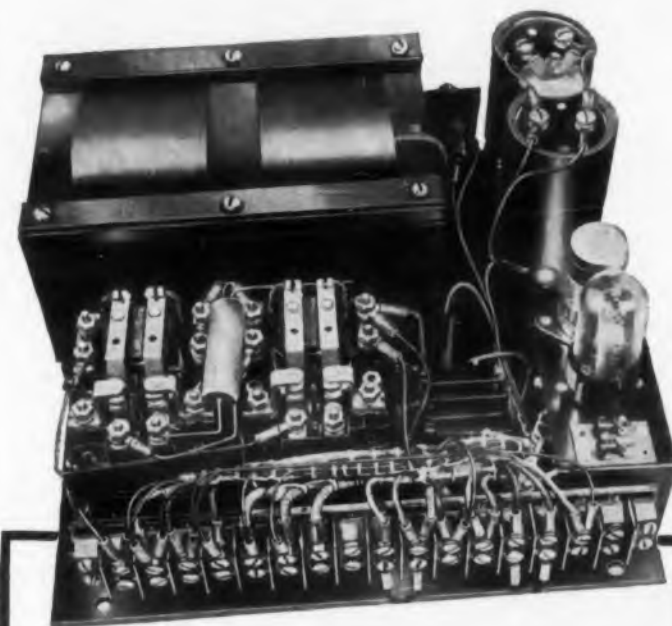

## D. C. REGULATED Power Supplies

by Acme  Electric



Our experience in manufacturing dependable DC power supplies may be the "know how" to improving the performance of your product. We have the engineering personnel and the facilities to furnish regulated power supplies of the saturable reactor,



series tube, stabilizer or transistor types and unregulated power supplies for either 60 cycle or 400 cycle service.

The specifications you submit will be thoroughly studied, suggested improvements (if any) submitted and quotation made on the highest quality units that can be produced, anywhere.

For further information write

**ACME ELECTRIC CORPORATION**  
9010 WATER ST. CUBA, NEW YORK

**Acme  Electric**  
TRANSFORMERS

CIRCLE 333 ON READER-SERVICE CARD FOR MORE INFORMATION

GENUINE

*Koiled Kords*

THE ORIGINAL  
RETRACTILE CORDS

are the result of  
seventeen years of  
research, design and  
service in industry  
and communications.

The experience of  
**KOILED KORDS, INC.**

is your assurance  
of a high quality  
product built  
to give long  
uninterrupted  
service.

© 1957  
*Koiled Kords*  
INCORPORATED

BOX K  
NEW HAVEN 14, CONN.

Koiled Kords is a trade mark of KOILED KORDS, INC.

CIRCLE 334 ON READER-SERVICE CARD FOR MORE INFORMATION

## New Literature

### The Proper Twist

335

Thread-gaging booklet, now available, explains how it makes a big difference whether you twist the screw into the gage or the gage into the screw. You can force oversize screws through a ring gage if you turn the larger-diameter gage onto the screw or even if you turn the screw into the gage with a large handle key or wrench. Too much torque or twist is developed—better to hold the screw between two fingers and turn firmly into the gage.

The booklet points out that failure to observe these and other basic gaging techniques is causing industry to accept misfit fasteners with resulting troubles in the assembled product or on production line. Standard Pressed Steel Co., Box 202, Jenkintown, Pa.

### Servosystems Lab. Manual

336

Designed to aid industries and schools in furthering engineering education, the 32-page "Servosystems Laboratory Manual" furnishes the framework for an introductory laboratory course in servomechanisms, feedback control systems, and other related fields. Seven integrated, class-tested experiments are included, each of them building upon what the student has learned in previous experiments.

Intended for use in conjunction with standard texts in the field, the manual stresses practical applications of principles and minimizes theoretical material. Containing numerous diagrams and photographs, it is available at \$2.00. Servo Corp. of America, 2020 Jericho Turnpike, New Hyde Park, N.Y.

### Lubricants

337

"Breaking Lubrication Barriers"—a 16-page brochure in four colors covers the history and development of molybdenum disulfide lubricants.

A textbook on the technical aspects of molybdenum disulfide as an extreme pressure lubricant, the bulletin covers the physical and chemical properties of the compound as well as providing charts which prove its superior lubricity.

## PRODUCTION TEST



Photo courtesy of Fenwal, Inc., Ashland, Mass.

INSULATION  
RESISTANCE  
with  
**VIBROTEST**

Insulation resistance testing of electrical products with Vibrotest instruments—from the tiny "Thermoswitches" shown above to appliances, cable harness and large motors—is the fast, low-cost way to make sure of insulation safety. Vibrotest operation is simple, quick and accurate . . . instrument design and construction make it ideal for continuous production line and portable use. Get details on Vibrotest today!

Write for Vibrotest Bulletin 2C

- CUT REJECTS
- INSURE SAFETY
- SPEED QUALITY CONTROL

**ASSOCIATED RESEARCH,**

"Electrical Testing Instruments Since 1936"

*Incorporated*

3709 West Belmont Avenue

Chicago 18, Illinois

Field Representatives in Principal Cities

Export Dept., 549 W. Washington Blvd., Chicago 6, Illinois

CIRCLE 338 ON READER-SERVICE CARD FOR MORE INFORMATION

specify  
standard



**FLEXLOC SELF-LOCKING NUTS**

#### FLEXLOC DESIGN FEATURES

one-piece, all-metal  
construction

resilient locking  
section

controlled locking  
torques

lock and stop nut in one  
every thread carries its  
full share of load

DO YOU KNOW? FLEXLOCS do not have to be seated to lock. They lock anywhere on a bolt as soon as the locking threads are fully engaged. And FLEXLOCS are stocked by authorized industrial distributors in a full range of sizes from #0 to 2". Write for Bulletin 866. STANDARD PRESSED STEEL CO., Jenkintown 12, Pa.

STANDARD PRESSED STEEL CO.

FLEXLOC LOCKNUT DIVISION

**SPS**

JENKINTOWN PENNSYLVANIA

CIRCLE 339 ON READER-SERVICE CARD FOR MORE INFORMATION

ELECTRONIC DESIGN • October 15, 1957



Featured in the book are (a) a catalog-type selection table; (b) four full pages of photographs showing a variety of uses; and (c) a section on bonded solid film lubricating coatings. The Alpha Molykote Corp., 65 Harvard Ave., Stamford, Conn.

### Long Life Capacitors

340

Long life capacitors get attention in Catalog 1165. Twelve pages of text point out their advantages and characteristics, suggest applications, and list some standard types with capacities, working voltages and dimensions. Mountings to match are catalogued too. The booklet covers round bakelite cased capacitors and twist-lock capacitors for dc operation, and midget polarized and nonpolarized capacitors for dc and low-voltage ac operation. A number of graphs show shelf characteristics, time constants, and voltage and temperature effects on current leakage and insulation resistance. Photographs and dimensional drawings supplement descriptions. Industrial Condenser Corp., 3243-65 N. California Ave., Chicago 18, Ill.

### Technical Journal

341

The first issue of a quarterly technical journal may be had for the asking. Entitled "Berkeley Engineering," the publication is edited by Robert Schweitzer. Its goal will be to contribute to the general interchange of ideas and information essential to the growth of the electronic industries. Drawing from staff technical knowledge, each issue will contain a feature article and announcements of new products, applications literature, and service notes. The first issue offers an article by Mark Harris, "Servomultiplier Performance." Beckman Instruments, Berkeley Div., 2200 Wright Ave., Richmond 3, Calif.

### Automatic Control Equipment

342

Components, devices and systems comprising an entire range of automatic control equipment are described in a recent booklet. Details are furnished on standard control switching units, process control units, subminiature and standard size light beam projectors, and photoelectric detectors. Sensor units including temperature thermistor, proximity detector, and special transducers for pressure, acceleration, displacement and temperature are also discussed. A special data section covers the Neuron high-speed electromechanical digital counter. Au ron Engineering, Inc., 1254 W. 6th St., Los Angeles 17, Calif.

## New Bendix SM-E Connector

(smaller, lighter than AN-E but equally dependable)



Here is the newest in the ever growing family of Bendix\* environment resistant connectors. The new SM-E Series (Short "E") will provide the same performance as the standard AN-E connectors, but is shorter, lighter and more easily serviced. Not only does this connector conform to the vibration resistant requirements of the "E" connector in the MIL-C-5015C government specification, but it also provides effective moisture barriers both at the solder well ends and mating surfaces using the full range of wire sizes. Of particular interest to production and maintenance people is the back nut design, which provides a jacking action on the grommet during disassembly, thereby lifting it free of the solder wells. This feature when combined with the new Bendix "slippery rubber" grommets makes easy work of wire threading and grommet travel over the wire bundles.

Available in all standard AN shell sizes and tooled for most of the popular AN configurations.

Write for complete descriptive folder.

\*TRADEMARK



Comparison based on size 40 mated assemblies. Space savings for smaller sizes are proportional.



SCINTILLA DIVISION of  
SIDNEY, NEW YORK



Export Sales and Service: Bendix International Division, 205 East 42nd St., New York 17, N. Y.

FACTORY BRANCH OFFICES:

117 E. Providencia Ave., Burbank, Calif. • Paterson Building, 18038 Mack Ave., Detroit 24, Mich. • 545 Cedar Lane, Teaneck, N. J. • 5906 North Port Washington Rd., Milwaukee 17, Wisc. • Hulman Building, 120 W. Second St., Dayton 2, Ohio • 2608 Inwood Road, Dallas 19, Texas • 8425 First Ave., South. Seattle 8, Washington • 1701 "K" Street, N.W., Washington 6, D. C.

CIRCLE 343 ON READER-SERVICE CARD FOR MORE INFORMATION



# RESISTORS

PRECISION WIRE WOUND • HIGH VOLTAGE • HIGH MEGOHM • HIGH FREQUENCY

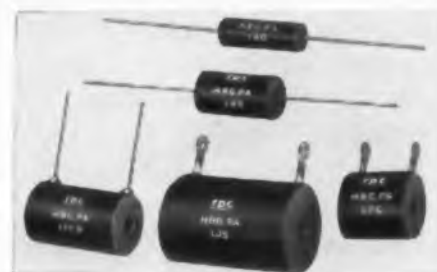

Encapsulated Precision Wire Wound Resistors

RPC Type L Encapsulated Resistors will withstand temperature and humidity cycling, salt water immersion and extremes of altitude, humidity, corrosion and shock without electrical or mechanical deterioration. Type L resistors are available in many sizes and styles ranging from sub-miniature to standard with lug terminals, axial or radial wire leads. Available for operation at 105° C. or 125° C. ambient temperatures. These resistors will meet all applicable requirements of MIL-R-93A, Amdt. 3. Type L can be furnished with all resistance alloys and resistance tolerances from 1% to .02%.

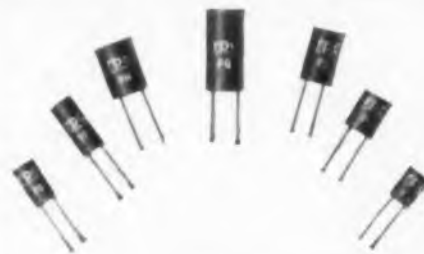

Printed Circuit Precision Resistors

To meet the requirements for printed circuitry, RPC has developed Type P Encapsulated Wire Wound Precision Resistors. Miniature, single ended units designed for easy rapid mounting on printed circuit panels with no support other than the wire leads. Many newly developed techniques are employed in the manufacture of Type P Resistors. These units can be operated in ambient temperatures up to 125°C. and will withstand all applicable tests of MIL-R-93A, Amdt. 3. Available in 6 sizes, rated from 1/10 watt to .4 watt. 3/16" diameter by 3/16" long to 3/16" diameter by 3/16" long. Resistance values to 3 megohms. Tolerances from 1% to 0.05%.



High Frequency Resistors

Used where requirements call for very low inductance and skin effect in circuits involving pulses and steep wave fronts. Depending on size and resistance value, these resistors are usable at frequencies to over 400 mc. Resistance values range from 20 ohms to 100 megohms with tolerance of 20% to 5%. 2 types available. TYPE F resistors (shown) in 8 sizes from 9/16" long x 0.10" diameter to 6 1/2" long x 9/16" diameter, with lugs or wire leads. Power ratings 1/4 to 10 watts. TYPE G resistors (not shown), in 6 sizes up to 18 1/2" long. Power ratings 10 to 100 watts.

## RESISTANCE PRODUCTS COMPANY

914 SOUTH 13TH STREET,

HARRISBURG, PENNA.

SPECIALIZING IN  
THE MANUFACTURE  
OF QUALITY RESISTORS  
IN ANY AMOUNT

CIRCLE 344 ON READER-SERVICE CARD FOR MORE INFORMATION



## EVERYTHING UNDER CONTROL *with* GUARDIAN STEPPERS

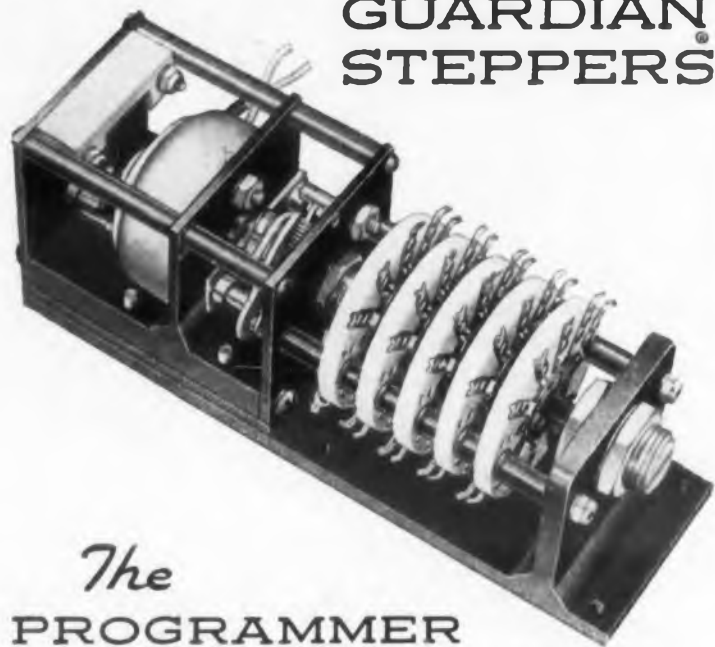

### The PROGRAMMER

• reliable • rugged • long-life

● Guardian offers this new, compact, rugged, long-life, highly reliable Programming Stepper which meets and exceeds MIL-S 25259 (Proposed). Approved and used for control of guided missile and in-flight equipment, it is available now for a wide variety of control engineering projects including automated production systems, machine tools and industrial products. Use it singly, or in combination with Guardian relay matrixes, control banks and in complete control assemblies as the "heart" of your unit. Open or sealed, it operates under extreme temperatures, high altitude and severe vibration or shock. Carries 8-12-18 or 24 points sealed or unsealed; up to 16 wafers and unlimited switching arrangements.

MORE POWER is efficiently distributed by the unique design of the ratchet mechanism.

LESS SPACE required to make your product more compact, more efficient, more saleable.

Thousands of Variations  
in Guardian's Complete Stepper Line



P.E.R.  
ELECTRICAL RESET  
STEPPER



P.C.  
CONTINUOUS ROTATION  
STEPPER



R.A.S.  
ADD AND SUBTRACT  
STEPPER

write for details on Guardian's Programmer  
and for Stepper Bulletin P-84

**GUARDIAN**  **ELECTRIC**  
1622-L W. WALNUT STREET CHICAGO 12, ILLINOIS  
CIRCLE 345 ON READER-SERVICE CARD FOR MORE INFORMATION

## New Literature

### Thinplate Adhesives

346

A detailed description of the characteristics and recommended uses of Thinplate adhesive backings are the subjects of a four-page fact folder called "Thinplate Adhesives Fact Folder" just released.

In chart form, this fact folder gives adhesive recommendations for the application of Thinplates to surfaces of various textures, materials and finishes. It shows how nearly every nameplate and trim mounting problem can be solved without the use of screws or rivets.

Thinplates are used for decorative trim, identification and information purposes by manufacturers of electronics equipment, and many other industrial and consumer products. Park Nameplate Co., Inc., 34-10 Linden Pl., Flushing 54, N.Y.

### Conversion Tables

Scientists, engineers, designers, production men, exporters, and students, are frequently required to convert from the U.S. system of units to the Metric system or vice versa. To do this is not difficult, however, it is a tedious manipulation. More often than not, the appropriate conversion factors are not on hand. These conversion tables are a practical, simple aid for every person faced with this problem. To convert units of length, weight, and volume from one system into the other no calculation is required, the appropriate answer is obtained by reading it directly from the proper table. The use of this booklet will save time, aggravation, and it will eliminate errors. Copies of these tables can be obtained by sending \$1.00 to M. Stand, 527 Lexington Ave., New York 17, N.Y.

### Acceleration Test Equipment

348

Four g-accelerator or centrifuge models used to subject aircraft and guided missile components to simulated operational g-loadings are presented in an illustrated catalog. Special design and operational features are provided along with detailed specifications and engineering data for each model. The range of the types described varies from 0.02 to 1000 g with payload capacity up to 500 lb. Various types of speed-indicating equipment are listed, including special tachometers, strobe systems, a Microflex timer and Veeder-Root counter, a magnetic pickoff and electronic counters. Optional equipment such as integral air systems, optical systems, special slip-ring configurations and a closed-circuit television system are also listed. Genisco, Inc., 2233 Federal Ave., Los Angeles 64, Calif.

## Gurley Standard Binary Code Discs Now Available in Four Versions

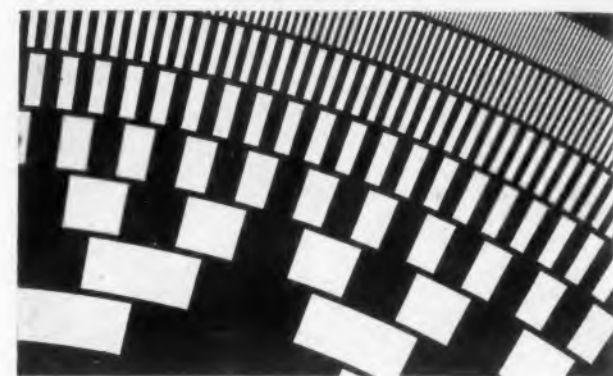

Gurley, manufacturer of the standard binary code disc for the electronics industries, is now able to supply four versions for use in either photo-electric, magnetic or contact types of pickups.

Containing concentric zones of information in the gray (reflected) code, the Gurley discs contain alternate clear and opaque sectors. Thin annular rings separating adjacent zones are opaque. Varying patterns record up to 8192 bits of information (65,536 on special designs!).

Four coatings are available: "Type T"—photoengraver's glue with colloidal (black) silver, essentially grainless; "Type R" with etched metal coating, for reflectivity and transmission contrast; "Type M" with chemically deposited ferrous alloy possessing both magnetic and optical transmission contrast; and "Type C"—metal bonded on glass for electrical contact use as well as in contrast of optical transmission. WRITE FOR BULLETIN 7000.

W. & L. E. GURLEY • 525 Fulton Street, Troy, N. Y.

**GURLEY** since 1845

CIRCLE 349 ON READER-SERVICE CARD FOR MORE INFORMATION

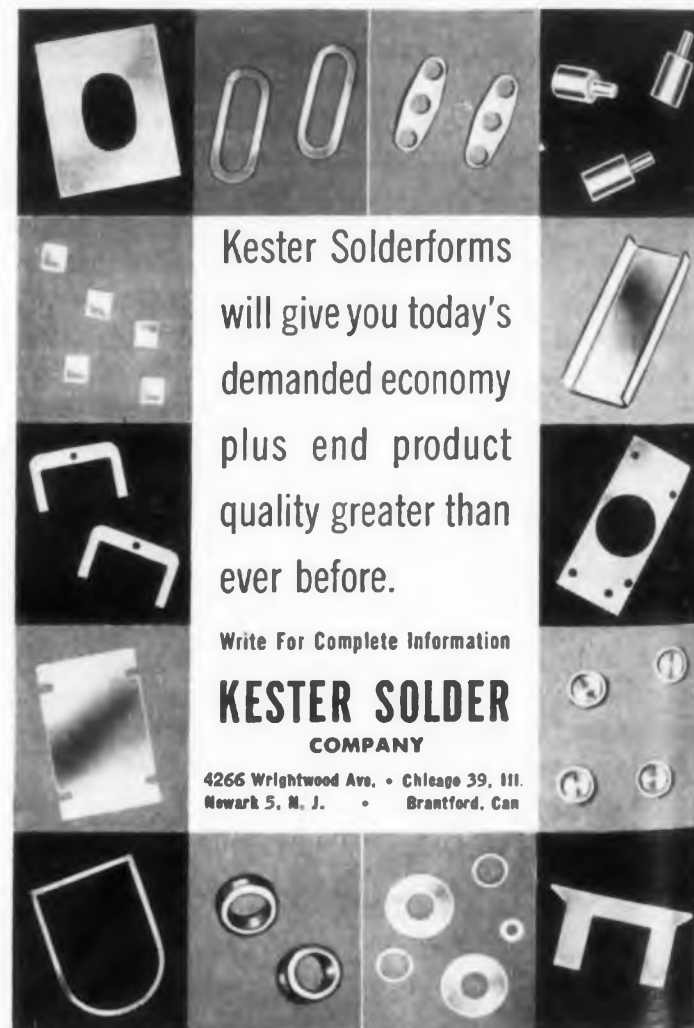

Kester Solderforms  
will give you today's  
demanded economy  
plus end product  
quality greater than  
ever before.

Write For Complete Information

**KESTER SOLDER  
COMPANY**

4266 Wrightwood Ave. • Chicago 39, Ill.  
Newark 5, N. J. • Brantford, Can.

CIRCLE 350 ON READER-SERVICE CARD FOR MORE INFORMATION

ELECTRONIC DESIGN • October 15, 1957

## CORNING GLASS ELECTRONIC COMPONENTS



DIRECT TRAVERSE  
TRIMMER

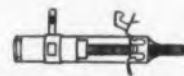

ROTARY TRIMMER



LOW POWER  
PRECISION RESISTORS



FIXED CAPACITORS

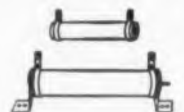

HIGH POWER  
PRECISION RESISTORS

are available  
through these authorized  
**ERIE Distributors**

**MARYLAND:** Kann-Ellert Electronics, Inc.  
Baltimore, Maryland  
Wholesale Radio Parts Co., Inc.  
Baltimore, Maryland

**MASSACHUSETTS:** Cramer Electronics, Inc.  
Boston, Mass.  
Radio Shack Corp.  
Boston, Mass.

**NEW JERSEY:** Federated Purchaser, Inc.  
Mountainside, New Jersey  
General Radio Supply Co.  
Camden, New Jersey

**NEW YORK:** Federal Electronics, Inc.  
Binghamton, N. Y.  
Milgray Electronics, Inc.  
New York, N. Y.  
Milo Electronics, Inc.  
New York, N. Y.  
Davis Electronics Corp.  
Hempstead, N. Y.  
Rochester Radio Supply Co., Inc.  
Rochester, N. Y.

Arrow Electronics, Inc.  
Mineola, L. I., N. Y.  
Electronics Center, Inc.  
New York, N. Y.  
Hudson Radio & TV Corp.  
New York, N. Y.  
Interstate Electronics, Inc.  
New York, N. Y.

**PENNSYLVANIA:** Herbach & Rademan, Inc.  
Philadelphia, Pa.



CIRCLE 351 ON READER-SERVICE CARD FOR MORE INFORMATION



## NEW DEVELOPMENT PROTECTS ELECTRONIC EQUIPMENT

General Electric Company has perfected miniature, hermetically sealed breakdown gaps that protect costly condensers, transformers, tubes, and other components from over-voltage conditions. These units are ideal for applications where, due to weight and size restrictions, normal operation is at maximum ratings.

The gaps are completely unaffected by altitude, humidity, temperature or foreign particles because they are hermetically sealed. Stainless steel electrodes are supplied for normal applications—tungsten electrodes for heavier duty. Choice of voltage ratings up to 6000v. available.

For further information, write ACCESSORY EQUIPMENT DEPARTMENT, General Electric Company, Bridgeport 2, Connecticut.

*Progress Is Our Most Important Product*

**GENERAL ELECTRIC**

CIRCLE 352 ON READER-SERVICE CARD FOR MORE INFORMATION

ELECTRONIC DESIGN • October 15, 1957

## Insulating Materials

353

Booklet B-7206 supplies eight pages of information on insulating materials. With illustrations, it outlines types, characteristics, and applications for class A shellac- and varnish-coated papers, varnished fabrics, slot cell insulation and organic varnished glass. The organic varnished glass is also described for class B insulation. Class H insulations covered are silicone varnished glass, silicone rubber-coated glass cloth, and semicured silicone-treated glass cloth. Insulating varnishes, enamels, primers, finishes and compounds are discussed by type, characteristics and applications. Westinghouse Electric Corp., P.O. Box 2099, Pittsburgh 30, Pa.

## Technical Wire Bulletin

354

Fine resistance wire, bright and enameled is described in 12 page Technical Bulletin No. 157 now available. It gives complete data on the electrical and physical properties of their principal resistance alloys, Karma, Nichrome, Nichrome V, and Advance. Karma enamel-coated resistance wire is now in commercial production in diameters as small as 0.00045 in., with resistance of 3951 ohms per foot at 20 C.

Complete with charts and tables, the bulletin shows the user how to determine exactly which alloy will prove economical and effective for his specific purpose. Driver Harris Co., Harrison, N.J.

## Stainless Steel Data

355

The 16-page bulletin—No. 22 includes a good deal of information on stainless steels that has not previously been readily available. Characteristics of the three major types of stainless steels are outlined, together with their advantages in various kinds of applications. In a compact reference table, characteristics of these stainless steels at elevated temperatures are detailed as to strength and toughness, scale resistance, grain growth and structural changes, and corrosion resistance. A section is devoted to special metal finishes and treatments available. The Allen Mfg. Co., Hartford 2, Conn.

## Testing Aircraft Electric Systems

356

Aircraft electric systems laboratory to help speed development and qualification of complete electric systems is described in 4-page Bulletin 3339 now available. The bulletin illustrates how the lab assists its customers in determination of component compatibility, development and evaluation of new systems, qualification testing and reporting on complete systems, and co-ordination and assistance in developing components related to electric systems with customer personnel. General Electric Co., Schenectady 5, N.Y.



And if you're the  
man whose product  
needs this  
Tung-Sol Relay,  
then it's you I'm  
fishing for.

Tung-Sol makes an extensive line of relays in the general operating range typified by the No. 609. Simplicity of construction provides utmost reliability under extreme service conditions.

Snap-action principle of operating permits almost instantaneous response to current conditions. Cycling is extremely uniform. Compact and lightweight, Tung-Sol Relays are ideal for instrument, equipment and missile applications.

### NOMINAL DESIGN CONSIDERATIONS

Contact capacity.....1 amp 30 volt resistive  
Contact arrangement.....SPST (NC) or SPDT  
Operating power.....As low as 1/2 watt  
Time delays.....Up to 5 seconds  
Operate on current differential as small as .05 amps  
Operate on voltage differential as small as .3 volts

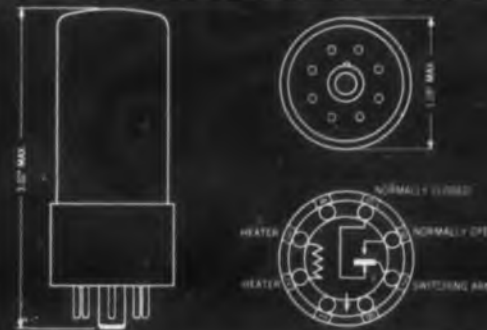

### NOMINAL CHARACTERISTICS OF 609

Operating voltage.....6.4 volts  
Operating time.....1. plus or minus .5 seconds  
Release time.....1. plus or minus .5 seconds  
Contact capacity.....1 amp at 30 volts  
Contact arrangement.....SPDT

For additional data write:

Electroswitch Division, Tung-Sol Electric Inc., Newark 4, N. J.  
Sales Offices: Atlanta, Ga.; Columbus, Ohio; Culver City, Calif.; Dallas, Tex.; Denver, Colo.; Detroit, Mich.; Irvington, N. J.; Melrose Park, Ill.; Newark, N. J.; Philadelphia, Pa.; Seattle, Wash. Canada: Montreal, P. Q.

**TUNG-SOL THERMAL RELAYS**

CIRCLE 357 ON READER-SERVICE CARD FOR MORE INFORMATION

HIGH

ALTITUDE

# BALLOON

CONTROL INSTRUMENTS

require MAXIMUM Performance

MINIMUM Size - Weight - Power Drain

BRAILSFORD  
AGS TIMERS  
ARE UNMATCHED  
IN THESE BASIC  
REQUIREMENTS

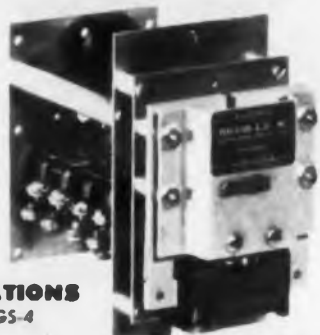

IF YOU HAVE A  
TIMING PROBLEM  
WHERE SIZE,  
MASS AND POWER  
DRAIN ARE CRITICAL  
READ THESE



## SPECIFICATIONS

Model AGS-4

NUMBER OF CIRCUITS—4 SPDT

WEIGHT—6.1 OZ.

SPEED REGULATION  $\pm 1.0\%$  @  $\pm 50.0\%$  VOLTAGE SHIFT

SIZE—3 IN. X 2 1/4 IN. X 1 1/4 IN.

POWER INPUT—.008 AMP. @ 6 V.D.C.

ALSO AVAILABLE 1—2 OR 3 CIRCUITS

WRITE FOR LITERATURE

## BRAILSFORD & CO. INC.

670 MILTON ROAD

RYE, N.Y.

ENGINEERING

DEVELOPMENT

BRAILSFORD

MANUFACTURING

SUB FRACTIONAL WATT D.C. MOTORS

SIGNALLING SYSTEM COMPONENTS

CIRCLE 358 ON READER-SERVICE CARD FOR MORE INFORMATION



MODEL 212A . . . 0 to 100 V dc,  
100 ma. Regulation 0.1% or 0.02  
volt over entire range of load and  
input voltage. Weight 14 lbs.  
3 1/2" H x 19" W x 9 1/4" D. Price  
\$129.00 unmetred.

FOR THE BEST IN  
STRAIN GAUGE  
PERFORMANCE

## POWER WITH REGATRON<sup>®</sup>

REGATRON Power Packs  
are ideally suited for excita-  
tion of resistance-type strain  
gauges.

The REGATRON circuit is  
such that even with the out-  
put control set at a fraction  
of a volt there is no loss  
of specified regulation, out-  
put current capabilities or  
stability.

Available in voltage ranges  
up to 100 and currents up to  
3 amperes. All models have  
a continuously variable main  
voltage control and a vernier  
control for fine adjustments  
. . . and only REGATRON  
Power Packs are remotely  
programmable for process  
control and automation. Write  
for bulletin.

® Registered U.S. Patent Office.  
Patents Pending.



CIRCLE 359 ON READER-SERVICE CARD FOR MORE INFORMATION

## New Literature

### Press-Fitted Terminals 360

Almost everything known and applied in Teflon "press-fit" terminals is found in the "Press-Fit" manual now available. Hundreds of different types and sizes of stand-offs and feed-thrus are listed in quick-reference tables showing dimensions and characteristics at a glance. Also test-point jacks, companion plugs, breakaway connections, taper-pin-receptacle terminals and other items. Sealectro Corp., 610 Fayette Ave., Mamaroneck, N.Y.

### Small Electronic Instruments 361

Small-size self-balancing electronic potentiometers and bridges are described in bulletin just released. The four-page, two-color bulletin, P1271, indicates the instruments are available in three basic circuit types: ac bridge, dc potentiometer, and differential transformer balance types. Bristol Co., Waterbury 20, Conn.

### New Catalog 362

A complete listing of electronic parts and equipment for all phases of the electronic industry, is described in catalog now released. Detailed information on ham, high fidelity, industrial, public address and service products is shown in this catalog. Freck Radio & Supply Co., Inc., 38-40 Biltmore Ave., Asheville, N.C.

### Tantalum Wire Capacitors 363

Bulletin 148B describes two miniature Series TW tantalum wire electrolytic capacitors claimed to be the smallest units of their type. The release also reviews an expanded line of units, gives the maximum capacities and voltages for each of the six case sizes, and lists the stock values immediately available. Technical information and data concerning Mylar-sleeve insulated capacitors is added. Ohmite Mfg. Co., 3634 W. Howard St., Skokie, Ill.

## TRUE DIFFUSED JUNCTION SILICON DIODES FOR HEAVY-DUTY POWER RECTIFICATION

THERMOSEN TYPE NO.	MAX. FWD. D.C. CURRENT*	PEAK INVERSE VOLTS	LEAKAGE MA.
P2505	25 AMPS	50	< 5
P2510	25 AMPS	100	< 5
P2520	25 AMPS	200	< 5
P2540	25 AMPS	400	< 5

\*6" x 6" heat sink



ACTUAL SIZE

**THERMOSEN** offers for the first time the superior uniformity and reliability of true diffused junction silicon power diodes. These small, rugged, efficient devices are the best answer yet to your heavy-duty power rectification problems. Conservatively rated, hermetically sealed (guaranteed to 175°C), with an ambient temperature range of -65°C to +150°C, these diodes are reliable long-life components for new or replacement designs.

Thermosen has the experienced staff and complete facilities to develop and manufacture special electronic or semi-conductor diodes to your most exacting specifications.

Booths A1, A2, A3, Atlanta IRE Conference, Nov. 11-13.

### THERMOSEN, INC. 375 FAIRFIELD AVE. • STAMFORD, CONN.

CIRCLE 364 ON READER-SERVICE CARD FOR MORE INFORMATION

## Crystal Filter

365

New crystal filter technical information is now available. "Reduction of Interference in the Hf Range through Use of Band-pass Crystal Filter" is the title of a recent Rome Air Development Center Technical Memorandum. Of particular interest is the improvement in sensitivity from 100  $\mu\text{v}$  to 7  $\mu\text{v}$  by the insertion of a Crystal Filter between the antenna and first rf amplifier. Hycon Eastern, Inc., 75 Cambridge Parkway, Cambridge 42, Mass.

## Torque-Tension Data

366

The first of its kind, an 8-page technical guide is now available with torque-tension data on the tightening torque required to produce a desired screw tension for all standard sizes of the company's socket head cap screws. Screw design considerations are emphasized, and torque-tension terms are explained in detail. Diagram and graph-illustrated, the guide covers physical characteristics, specifications, dimensions, and thread lengths of standard stocked sizes. Strong, Carlisle and Hammond, Mac-it Screw Div., 1392 W. Third St., Cleveland 13, Ohio.

## Copper-Clad Laminates

367

Several design suggestions for printed circuits with copper-clad laminates, covering the areas of circuit design, provisions for solder fillets, insertion of eyelets and lugs, and assembly of components, are featured in Catalog No. 20. This folder includes a table listing properties of copper-clad laminates after etching, such as water absorption, power factors, dielectric constants, and loss factors. Suggestions for punching copper-clad laminates are given, and punching temperature ranges recommended. The Richardson Co., 2777 Lake St., Melrose Park, Ill.

## Storage Batteries

368

Characteristics, construction, and discharge curves of sintered plate nickel cadmium batteries are shown in outline form in Bulletin 501A. The two illustrated pages include a brief summary of background and applications of pocket plate and sintered plate nickel cadmium batteries. Nickel Cadmium Battery Corp., Easthampton, Mass.



# WELWYN

## High Stability Carbon Resistors



Uniformity and reliability are essential criteria in the selection of critical components. Availability is another. And these relate directly to the experience and facilities of the manufacturer.

Four full-time Welwyn Plants in Britain and in Canada are today supplying a steady flow of precision resistors to meet an ever-growing American demand. With sales engineering and service facilities operating out of Ohio, these Welwyn users in the U.S. are enjoying prompt, efficient and reliable handling of all their quality resistor requirements.

The Welwyn organization has been devoted to the study and development of carbon film techniques for nearly a quarter of a century. The value of this experience is being constantly demonstrated in the superior performance and dependability of Welwyn Carbon Resistors in critical applications.

For complete information, write to:

**WELWYN INTERNATIONAL INC.**

3355 Edgecliff Terrace, Cleveland 11, Ohio, or phone WInton 1-1333

CIRCLE 369 ON READER-SERVICE CARD FOR MORE INFORMATION

# PROTOTYPE PROBLEMS?

Magnetic Metals Company can make sample tape wound cores to specification... with one week delivery!

THIS CALLS FOR SPECIAL CORE PARTS-AND DEADLINE FOR OUR TEST MODEL ONLY 2 WEEKS AWAY!

EASY MAN! YOU CAN HAVE THE GREATEST IN 1 WEEK-GET Centricores!

NO CAUSE FOR CONCERN, MEN! I'VE ALREADY CALLED THE MAGNETIC METALS MAN FOR CONSULTATION!

HE'S REAL-GONE FOR CENTRICORES!

GIVE US THE SPECS FOR ANY SPECIAL CORE APPLICATION-WE'LL DELIVER MATCHED CENTRICORES TO ORDER-FAST!

SO-ON SCHEDULE

GLAD YOU GOT THE IDEA TO CALL ON MAGNETIC METALS TO SOLVE OUR CORE PROBLEM, BUDDIE! WELL, OFF TO THE MOON!

ARRIVIDERCI...

Specify Centricores having uniform magnetic properties.

Wide variety of standard sizes available for quick delivery in either metallic or phenolic cases!

USE 'EM IN FLYING SAUCERS OR ANY TYPE PROTO...

"Buddie" was thinking ahead when he called for Centricores; when the prototype is approved and production gets underway, Centricores can be depended on for uniform characteristics. Magnetic Metals Company through closely controlled production methods can assure uniformity—to the most exacting physical and electrical specifications. You may have complete dimensional and test data; write for bulletin C4.

# MAGNETIC METALS COMPANY

ELECTROMAGNETIC CORES and SHIELDS

HAYES AVENUE AT 21st STREET • CAMDEN 1, N. J.

CIRCLE 370 ON READER-SERVICE CARD FOR MORE INFORMATION

# LEACH

## SOLVES RELAY ENVIRONMENTAL PROBLEMS

Unique Balanced-Armature Relays meet all requirements of the most exacting operating environments — shock, acceleration, vibration and high temperatures.

In the Leach Balanced-Armature Relay, shock and vibration forces cannot move the relay armature. This eliminates faulty operation of contacts during extreme vibration and acceleration.

These Leach Relays meet or exceed requirements of MIL-R-5757, MIL-R-6106, MIL-E-5272. Typical ratings include: vibration, 20 G's to 500 cps (higher ratings available); shock and acceleration, more than 50 G's; temperature, -50° to +125°C; life, 50,000 continuous operations minimum at rated load; available 28 vac, 115 vac, 400 cps operation. At right is Leach 9226, 1.49x1.49x1.68 inches.

Leach has gained a unique reputation for creating reliable relays, *custom-tailored* to solve specific circuitry problems. Write for your copy of the Leach Balanced-Armature Relay Catalog.



**LEACH** CORPORATION  
LEACH RELAY DIVISION

5915 Avalon Blvd., Los Angeles 3, California

District Offices and Representatives in Principal Cities of U. S. and Canada

CIRCLE 371 ON READER-SERVICE CARD FOR MORE INFORMATION

## New Literature

### Printed Circuitry

372

"Superior Printed Circuitry" was prepared for electronics manufacturers who are interested in complete control of quality, delivery schedules and unit cost of their printed circuits. It gives the research and development engineers a fast, proven method with which to carry out work identical to that which will later be done on a production basis. Edward M. Power Co., Inc., Bessemer Blvd., Pittsburgh 22, Pa.

### Frequency Measurements

373

Data File 111, describing many ways frequency meters can be used, is now available. The 17-page booklet covers such items as measurement of low to uhf frequencies, rotational velocity, flow, pressure, temperature and strain. It has many graphs and charts. Beckman/Berkeley, 2200 Wrights Ave., Richmond 3, Calif.

### Optical Toolings

374

The basic principles of optical tooling are described in 56 page manual now available. Photographs and drawings illustrate the major instruments and accessories used in optical tooling. Drawings show the optical principles used in applying the equipment. Keuffel & Esser Co., Hoboken, N.J.

### Magnetic Tape

375

The effects of heat, humidity, and tension on magnetic tape are discussed in "Sound Talk," Bulletin No. 35 which is now available. The bulletin is illustrated with three graphs showing stress characteristics of the different types of magnetic tape. It also points out where magnetic tape is used under abnormal or extreme conditions. Minnesota Mining & Manufacturing Co., 900 Bush St., St. Paul 6, Minn.

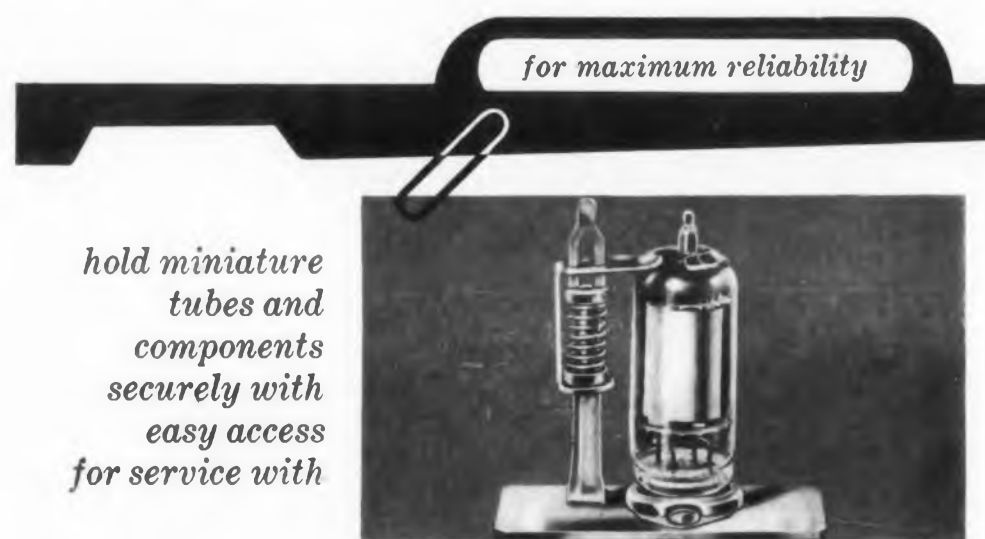

*hold miniature  
tubes and  
components  
securely with  
easy access  
for service with*

## BIRTCHER TYPE 2 TUBE CLAMPS

**MATERIAL**  
Type 302  
stainless steel

**SIZES**  
12 modifications in  
height and design  
available for  
retention of all  
miniature tubes and  
plug-in components.

Designed for the positive retention of all miniature electronic tubes and plug-in components, Birtcher TYPE 2 TUBE CLAMPS offer ready access for service or tube replacement. The spring-loaded cap slides up the post and swings completely out of the way for service in tight quarters. More than one-million of these clamps are in use in civilian and military equipment.

### THE BIRTCHER CORPORATION

INDUSTRIAL  
DIVISION

4371 Valley Blvd.,  
Los Angeles 32, Calif.

Write for catalog

CIRCLE 376 ON READER-SERVICE CARD FOR MORE INFORMATION

**DC to AC Converters****377**

A complete line of dc to ac converters is presented in Converter Catalog 557 recently issued. It presents illustrated listings of the new Mark II superconverters, including special models engineered for railroad, marine and industrial service. The catalog includes complete list of performance charts, dimension diagrams, converter selector chart for tape recorder applications, installation instructions, and a brief description of factory. Carter Motor Co., 2711 W. George St., Chicago, Ill.

**Electrolytic Capacitors****378**

For computer circuits requiring high reliability, the Type CQM electrolytic capacitors are available; for information on these capacitors, a 4-page bulletin has been released. Containing photos, tables, and graphs, this bulletin indicates that CQM capacitors may be ordered in various capacitance and voltage combinations ranging from 45,000  $\mu$ f at 5 v to 850  $\mu$ f at 400 v. Container diameters are 1-3/8, 2, 2-1/2, and 3 in., while the height of all units is 4-1/8 in. Pyramid Electric Co., 1445 Hudson Blvd., North Bergen, N.J.

**Precision Electronic Equipment****379**

Phase meters, null meters, impedance comparators and precision power oscillators are some of the electronic instruments discussed in a 2-page catalog now available. In concise form, this illustrated brochure contains descriptions, specifications and applications for the various precision devices. Industrial Test Equipment Co., 55 E. 11th St., New York 3, N.Y.

**Linear Transducers****380**

With the aim of providing data for design engineers who wish to apply linear magnetic transducers in replacing precision potentiometers and synchros and also develop new low impedance automatic circuitry of high precision, a 32-page handbook has been published. The text treats the theory and most advanced application of differential transformers; characteristics of various differential transformers are explained, tabulated, and charted. This diagram-illustrated handbook shows and describes 22 basic circuits, and is available for \$2.00. Automatic Timing & Controls, Inc., King of Prussia, Pa.

**miniature solenoids...**

do big jobs  
in small space

- Completely tested
- Proven reliable
- Mounting furnished to meet your requirements.
- Hundreds of other designs for both AC and DC application.
- Push or pull units to 200 lbs. force.
- Send your specifications today.



The trademark on millions of solenoids since 1927

**WEST COAST ELECTRICAL MFG. CORP.**

233 W. 116TH PLACE • DIVISION 110 • LOS ANGELES 61, CALIFORNIA • PLymouth 5-1138  
CIRCLE 381 ON READER-SERVICE CARD FOR MORE INFORMATION

**470 Mc****FM 470-10 Mc****AS  
SUPPLIED****TO:—****MARCONI  
SIGNAL GENERATOR**

**STILL**  
*Unique*



Exceptional stability, wide frequency range and the precisely calibrated carrier shift control make Model 1066/1 a joy to use.

First produced in 1955, it is now the accepted test instrument for narrow or wide band applications. It is still the only FM generator with such complete range.

Recent improvements have made microphony and attenuator reaction negligible and have increased tube life. The oscillator chassis is now gold plated.

**SPECIFICATION**

**Frequency Range** 10-470 Mc in 5 ranges. Contactless turret is capacity coupled.  
**Frequency Stability** .0025% per 10 minutes after warm-up.  
**Carrier Shift Controls** Calibrated 1-200 kc continuously variable. Also stepped increments  $\pm 5$ ,  $\pm 10$ ,  $\pm 15$  kc.  
**Frequency Modulation** 0-20 and 0-100 kc continuously variable.  
**Amplitude Modulation** 0-80%.  
**Output** .01  $\mu$ V to 100mV, 52  $\Omega$ . Piston attenuator.  
**Tubes** 6AK5, 6C4, 12AT7, DET22, 6L6, 5651, XB1, OB2, 5Z4G

Price \$1495

FM Deviation Monitor Model 791C is a companion instrument. Range 4-540 Mc. Accuracy  $\pm 3\%$ .

**GOV'T. AGENCIES**

A E C  
Kelley A F B  
Navy Electronic Lab.  
New York Ordnance  
U. S. Forest Service  
U. S. Signal Corps  
White Sands P. C.  
Wright Patterson A F B  
etc.



**MARCONI instruments**  
44 NEW STREET • NEW YORK 4, N. Y.

CIRCLE 382 ON READER-SERVICE CARD FOR MORE INFORMATION

# IMC MOTORS

*precision with a purpose*



**2900 Frame Motor**  
**INPUT:** 400 cycles, 1 phase capacitor type 225 watts (motor can be wound 3 phase AC or DC)  
**OUTPUT:** 200 cfm @ 2.50" H<sub>2</sub>O sp at standard conditions and 8000 rpm  
**WEIGHT:** 5½ lbs

Bulletin 29F1



**2000 Frame DC Motor**  
**INPUT:** 6-115 volts DC  
**OUTPUT POWER:** 1/75 to 1/10 hp depending on speed, duty cycle and cooling  
**LIFE:** 1000 hr brush life; 250 hrs at high altitude  
 Available with gear speed reducer and/or speed governor, shunt, series, or compound wound.

Bulletin 20F2



**3000 Frame Dynamotor**  
**INPUT:** 6-115 volts as specified  
**OUTPUT VOLTAGE:** 6-450 volts as specified  
**OUTPUT POWER:** Up to 100 watts, depending on duty cycle and cooling  
**WEIGHT:** 5¼ lbs

Bulletin 30F3



**900 Frame AC Motor**  
**FREQUENCY:** 320-1000 cps  
**AIR DELIVERY:** 10 cfm @ 0" sp; 8 cfm @ 0.2" sp  
**RPM:** 7000 @ 400 cps  
**WEIGHT OZ.:** 7  
**WEIGHT OF MOTOR OZ.:** 4½  
 \*Also available in 1" blower size.

Bulletin 9F4



**1500 Frame Dynamotor**  
**SIZE:** 1½ x 1½ x 3 in.  
**WEIGHT:** 1 lb  
**LIFE:** 100 hrs brush life at 50,000 ft altitude, 500 hrs at sea level

Bulletin 15F5



**3800 Frame AC Motor**  
**INPUT:** 26-230 volts AC; 1, 2 and 3 phase  
**INPUT FREQUENCY:** 25-400 cycles  
**NUMBER OF POLES:** 2, 4, 6, 8 and 12 poles  
**OUTPUT POWER:** Induction motors—to 1 hp  
 Torque motors—10 to 200 oz. in. stall torque  
 Hysteresis synchronous motors—1/200 to ¼ hp  
 (Can be wound for single, dual or three speed.)  
**BEARINGS:** Ball or sleeve  
**WEIGHT:** 8-11 lbs

Bulletin 38F6

These units, as are others in the complete IMC line of dynamotors, servo, gear, blower and actuator motors, are constructed to meet MIL specifications for environment and performance. For further information, write



**Induction Motors Corp.**

570 Main St., Westbury, L. I., N. Y. Phone: EDgewood 4-7070  
 CIRCLE 383 ON READER-SERVICE CARD FOR MORE INFORMATION

## New Literature

### Epoxy Encapsulation 384

Engineering, development and production service information for all types of electronic components, assemblies, and circuitry is offered in bulletin just released. Units are designed to meet the most exacting requirements of the design engineer for his specific applications. Low-cost molding techniques for short-run requirements are included. Rue Products, 1628 Venice Blvd., Venice, Calif.

### Pnp and Npn Transistors 385

A line of pnp and npn transistors for radio, rf, and i-f applications is the subject of Bulletin G-120. Information on 4-, 6-, and 7-transistor radio kits is provided, in addition to accompanying circuit diagrams. General Transistor Corp., 91-27 138th Pl., Jamaica 35, N.Y.

### Transistor Manual

The second edition of the "Transistor Manual" is now available, contains basic information on transistors and their use in electronic circuits. The booklet is designed to assist electronic design engineers, service technicians, and hobbyists in working with transistors. Included in the manual is information on basic semiconductor theory, construction techniques used to make the various types of transistors now on the market, explanations of transistor specification symbols now in common use and specifications with outline drawings of all transistors registered with the Electronic Industries Association (formerly RETMA). Copies of the second edition may be obtained by sending \$5.50 to Section PRR, Semiconductor Products Dept., General Electric Co., Syracuse, N.Y.

## A. R. C. CERAMIC INSULATED CONNECTORS



**Minimize Leakage, Save Space**

We developed this ceramic-insulated connector to obtain performance features we needed in our airborne communications and test equipment. Doubly silicone coated, it is virtually impervious to extremes of moisture, and mechanically stable under heat. Eight contact points per pin make for

low contact resistance. Being of small overall dimensions, these connectors are space savers. 2, 3, 4, 6, 8, 12 and 19 contact connectors each are available in three-key keyway combinations to prevent incorrect insertion. Design them into your equipment for extra dependability. Write for details.

Dependable Airborne Electronic Equipment Since 1928

**AIRCRAFT RADIO CORPORATION**  
 BOONTON, NEW JERSEY



CIRCLE 387 ON READER-SERVICE CARD FOR MORE INFORMATION

Wire  
 A  
 cerns  
 offers  
 polyt  
 lated  
 sleeve  
 cable  
 Amer  
 W. C  
  
 Test  
  
 Tw  
 and i  
 ments  
 ment.  
 perfor  
 diagra  
 merou  
 applic  
 throug  
 and l  
 access  
 meter  
 meter  
 Keith  
 Ave.,



## Wire and Cable Catalog

388

A 30-page catalog recently released concerns Teflon insulated wires and cables. It offers complete specifications and prices for polytetrafluoroethylene and silicone insulated magnet wires, lead wires, lacing cords, sleeving, tubing, shielded and miniature cables. Application data is also provided. American Super-Temperature Wires, Inc., W. Canal St., Winooski, Vt.

## Test Instruments Catalog

389

Twenty-four page Catalog B describes and illustrates the entire line of test instruments for electronic control and measurement. Included are detailed design and performance specifications, 22 schematic diagrams, typical application circuits, numerous constructional photos and a useful application summary. Profusely pictured throughout, the catalog covers industrial and laboratory instruments with related accessories and includes micromicroammeters, electrometers, vacuum tube voltmeters, amplifiers and similar products. Keithley Instruments, Inc., 12415 Euclid Ave., Cleveland 6, Ohio.

## Magnetic Shielding Can

390

For convenience in specifying, Data sheet 126 has a cutaway view of the developed 3-layer economical rotary drawn magnetic shielding cans and a time-saving checklist to indicate size, number of layers, construction and extent of magnetic shielding required. Included in sheet is a page illustrating a variety of typical shapes, sizes and constructions. The rotary drawn process eliminates substantial tool charges formerly necessary and makes it possible to encase components containing moving or stationary permanent magnets without distorting their magnetic field or otherwise reducing their sensitivity. Perfection Mica Co., Magnetic Shield Div., 1322 N. Elson Ave., Chicago 22, Ill.

## Thyratron-Rectifier Data

391

Thyratrons and rectifier tubes are featured in a 12-page catalog recently issued. Included are charts, wiring schematics, cross-reference replacement data and descriptive matter. Continental Electric Co.-Taylor Tubes, Inc., 6 N. Michigan Ave., Chicago 2, Ill.

## the DYNAMIC DIODE TESTER by TECHNITROL



This moderate-price instrument provides an invaluable means for the rapid, accurate checking of semiconductor diodes for instability and irregularities. The dynamic curve, far more revealing than static testing, is quickly apparent on a scope screen, and is readily adapted to volume testing. In addition, the easy portability of this 16-pound instrument makes

it ideal for field work as well as bench or rack installation.

Designed for use with a D.C.-coupled oscilloscope, the Technitrol Diode Tester provides for a variety of back and forward voltages, as well as independently-controlled ranges for back and forward currents.

### CALIBRATED RANGES:

- Forward voltage ..... 0-5 v.
- Back voltage ..... 0-100 v.
- Forward current ..... 0-50 ma.
- Reverse current ..... 0-1 ma.



Write today to:

CIRCLE 392 ON READER-SERVICE CARD FOR MORE INFORMATION



You don't need  
a light touch  
to keep from  
stripping threads

...use **HELI-COIL**  
Screw-Thread  
Inserts

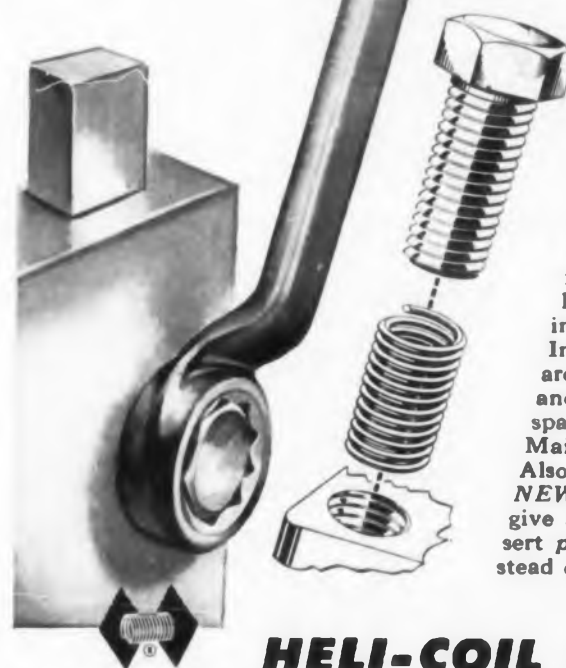

Precision-Formed  
Stainless Steel Wire Inserts  
Produce Permanent Threads  
in Tapped Holes.

No need to worry about too much load on tapped threads when you use Heli-Coil Inserts. They withstand excessive torque and, even in soft metals, bolt will shear off before female threads strip. Thread life is increased . . . corrosion, seizing and galling eliminated. Heli-Coil Inserts allow designers to use standard bosses, lighter materials, shorter and fewer fasteners—save time, space, weight and assembly costs. Mail coupon for complete data. Also ask for information on the NEW Screw-Lock Inserts which give all benefits of the regular insert plus an internal lock. Use instead of lock nuts, lock wiring, etc.

\*Reg. U.S. Pat. Off.

## HELI-COIL CORPORATION

A Division of Topp Industries, Inc.

### HELI-COIL CORPORATION

410 Shelter Rock Lane, Danbury, Conn.

- Send me design manual on Heli-Coil Screw-Thread Inserts
- Send me design manual on Heli-Coil Screw-Lock Inserts
- Send me address of nearest Heli-Coil Applications Engineer

NAME \_\_\_\_\_ TITLE \_\_\_\_\_

FIRM \_\_\_\_\_

ADDRESS \_\_\_\_\_

CITY \_\_\_\_\_ ZONE \_\_\_\_\_ STATE \_\_\_\_\_

IN CANADA: W. R. WATKINS CO., LTD., 41 Kipling Ave. S., Toronto 18, Ont.

CIRCLE 393 ON READER-SERVICE CARD FOR MORE INFORMATION

10,000  
now in use  
throughout  
the world



MV-17C  
DC-VTVM

Still  
\$295

100 microvolts to 1 KV-DC.

For Sensitivity And  
Ultimate Reliability Choose  
the Millivac MV-17 C DC-VTVM

Millivac established its leadership in the field of sensitive DC VTVM's in 1948 when we introduced the world's first high impedance millivoltmeter for DC, the MV-17 A, forerunner of the present MV-17 C. It had a lowest range of 0-1 mV, at 6 megohms input impedance. Since then we have steadily improved our DC meters. Our latest model, the MV-27 C, is 4 times more sensitive than the original instrument (0-250 uV, 6 meg).

These instruments are available in portable or rack-mounted form, also with or without circuitry to drive recorders, with or without insulated dummy ground as well as for regular 60 cps line operation or for odd line frequencies (50 cps-500 cps, 117V).

Over 10,000 of these meters are now in general use throughout the world. If you are not yet familiar with the MV-17 C or MV-27 C, write for complete literature.

Tomorrow is our yesterday

MILLIVAC INSTRUMENT CORP.  
BOX 997, SCHENECTADY, N. Y.



CIRCLE 394 ON READER-SERVICE CARD FOR MORE INFORMATION

## New Literature

### Micro-Bearing Selection

395

The importance of ball rolling speed as a factor in the correct selection of miniature ball bearings is stressed in 4-page Engineering Bulletin No. 19. The first 18 bulletins in this series were included in Technical Design Catalog, publisher in 1956.

The bulletin rejects the theory that bearing life, running noise and lubrication requirements are a direct function of shaft rpm. It establishes the fact that the real determining factor is the linear speed with which the balls roll along the raceways.

The bulletin explains how to find the ball rolling speed, using either the inner and outer raceway diameters or the pitch diameter and ball size. Formulae are provided to determine ball rolling distance per bearing revolution. New Hampshire Ball Bearings, Inc., Peterborough, N.H.

### Electronic Cooling Article

396

A two-part article entitled "Cooling Packaged Electronic Equipment" is now available in reprint form as it appeared in the May 15 and June 1, 1957 issues of ELECTRONIC DESIGN.

In Part I, the author, A. Donald Hay, presents "Basic Design Principles" of cooling and describes methods of air convection and metallic conduction. The second part of the article discusses in detail various methods of cooling, in addition to design data which aids in selecting the right method for a particular design application. Eight pages and illustrated, this reprint contains engineering tables and charts on comparative methods of cooling, impeller performance, range of application, with supplementary information on new products designed for the cooling of electronic equipment. McLean Engineering Labs., P.O. Box 228, Princeton, N.J.

### Daily Reminder

397

A "KW Daily Reminder" calendar listing 144 important meetings, conventions, and educational seminars of interest to people in the electrical industry has been released. It covers the period from September 1, 1957, through August 31, 1958. The durable folder, which fits easily into a brief case, also includes a page for personal notes and a complete twelve-month calendar giving national and local holidays, with extra space for jotting down daily reminders. Kaiser Aluminum & Chemical Sales, Inc., 919 Michigan Ave., Chicago 11, Ill.

**GLASS** for  
**HERMETIC SEALING**

- EPOXY PREFORMS
- PRESSED CERAMICS

PERAMCO CERAMICS CO.  
THORNTON HEATH  
SURREY, ENGLAND

CIRCLE 398 ON READER-SERVICE CARD FOR MORE INFORMATION

when designing  
a product

**Don't worry  
about the relays**

We'll take care  
of that for you.

Simplify your job—save time  
and money. Let our engineers  
figure out the right relay for  
your requirements. Just send  
specifications, we'll submit  
suggestions promptly. No cost  
or obligation.

**Comar** ELECTRIC COMPANY  
3349 ADDISON ST. CHICAGO 18, ILLINOIS

RELAYS • SOLENOIDS • COILS • SWITCHES • HERMETIC SEALING

CIRCLE 399 ON READER-SERVICE CARD FOR MORE INFORMATION

## standard knobs



## widest choice



## fastest delivery



Variety and versatility in a complete standard line of thermosetting plastic knobs. Combinations, variations in types, sizes and colors delivered promptly. Send for catalog.

## kurz-kasch

Kurz-Kasch, Inc., 1415 S. Broadway, Dayton 1, Ohio

CIRCLE 400 ON READER-SERVICE CARD FOR MORE INFORMATION

## GUARANTEED



to meet all military  
environmental specs

G-M specializes in the design and manufacture of servo motors for military uses. Readily available both in standard sizes and as special units. Precision built to meet *all* military specifications: altitude, high and low temperatures, vibration and shock, humidity and salt spray.

## FREE! 16 data filled pages

- Dimensional Drawings • Characteristics Charts
- Performance Data • Complete Specifications

Write today!

Your copy sent  
postpaid.  
No obligation.



## G-M Servo Motors

manufactured by the Components Division of  
G-M LABORATORIES INC.  
4284 N. Knox Avenue • Chicago 41

CIRCLE 401 ON READER-SERVICE CARD FOR MORE INFORMATION

## Testing Services 402

A 12 p brochure contains a complete illustrated description of plant and equipment facilities as well as details of the various services offered to manufacturers of military and commercial equipment. Also included in the booklet are listings of the many tests performed and the types of avionic, electronic, mechanical, pneumatic, and hydraulic equipment that are tested. Aerotest Labs. Inc., 129-11 18th Ave., College Pt. 56, N.Y.

## Silicone Rubber 403

Silicone rubber, and how it is being used to advantage in a wide variety of mechanical parts, is described in Brochure 9-106 now available. Resistance to heat, cold weathering, ozone, moisture, oils and chemicals are discussed, each illustrated with graphs, tables, and actual on-the-job examples. The six-page, two-color pamphlet includes the applications range from jet engines to steam irons, from automotive transmissions to domestic oven doors. Dow Corning Corp., Midland, Mich.

## Precision Delay Generator 404

Designed as a piece of laboratory type test equipment for applications requiring accurate, variable, time interval pulses, the precision delay generator, Type 6010, is discussed in a 4-page brochure now available. The brochure divides this device into its three operating units, the trigger generator, the delay generator, and the regulated power supply; operation, features, and applications of these are described. Included are illustrations of all output waveforms from the delay generator, in addition to particular specifications for each waveform such as rise time, pulse width, and amplitude. Burroughs Corp., 1209 Vine St., Philadelphia 7, Pa.

## Synchro and Resolver Bridges 405

The SB-11 synchro bridge and the RB-11 resolver bridge are discussed in catalogs of six and seven pages respectively. The bridges are used to measure the angular error of synchro components or systems. In both catalogs detailed attention is given to operation theory applications. Covered are such topics as the composition of the bridge output, performance under loading, frequency, and voltage. Also detailed are the various testing procedures authorized by the Bureau of Ordnance. The catalogs list specifications, connector designations and ordering information. Several related products are described in brief. Diagrams illustrate the text. Theta Instrument Corp., 204 Market St., East Paterson, N.J.

high gain, low noise

## UHF CONVERTER

the ultimate in sensitivity & performance

- Communications • Radar
- Telemetry • Monitoring systems



Model UHC-R Converter for Rack Mounting

Model UHC-R Converters were developed by Applied Research Inc. to provide the highest level of converter performance for experimental and developmental fixed frequency operations in laboratory and field.

The UHC-R Converter consists of a Model UH-2(A) RF Amplifier and a Model UH-C(A) Converter. The units may be obtained separately and operated remotely, advantageous under many conditions.

Model UH-2(A)

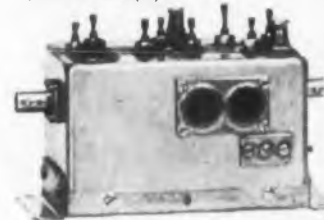

Radio Frequency Amplifier



Model UH-C(A) Converter

## Specifications

Model:	UHC-R-4.5	UHC-R-6	UHC-R-7	UHC-R-8.2
Input frequency:	400-525 mcs	525-650 mcs	650-775 mcs	775-900 mcs
(Input freq. is factory preset to customer specifications)				
Input impedance:	Factory preset to 50 or 75 ohms			
RF bandwidth:	10 mcs	10 mcs	10 mcs	10 mcs
Noise figure:	5.5 db	6.5 db	7.5 db	8.5 db
Output frequency:	Factory preset to 30 or 60 mcs			
Output bandwidth:	5 mcs	5 mcs	5 mcs	5 mcs
Output impedance:	Factory preset to 50 or 75 ohms			
Converter gain:	50 db (minimum) overall			
Power requirements:	6.3VAC at 2.0 A, +200VDC at 80 Ma (regulated)			
Size (L.W.H.):	19" x 7" x 7"			
Mounting dimensions:	Standard 19" relay rack			
Tube complement:	UH-2(A) Amplifier—2 G.E. Type GL-6299; UH-C(A) Converter—G.E. Type GL-6299, 6AM4, 6AF4, 6BK7A			

Model UHC-R Converters are also available at other frequencies, at RF bandwidths of up to 50 mcs, and to customer specifications. Write for further information.

## Applied Research inc.

76 South Bayles Avenue, Port Washington, N. Y.

CIRCLE 406 ON READER-SERVICE CARD FOR MORE INFORMATION

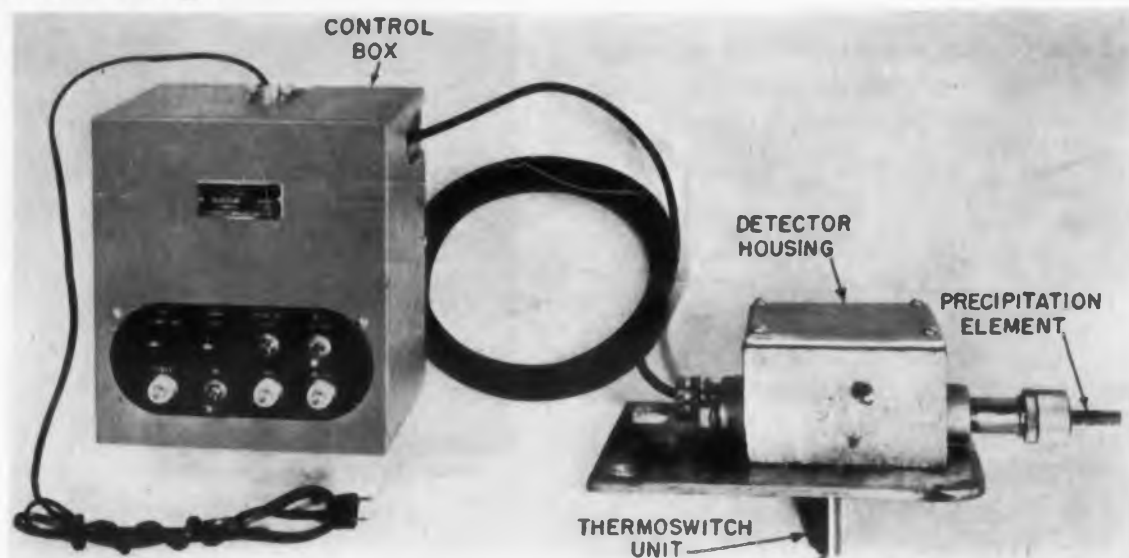

Fig. 1. Ice alarm system.

**T**HIS sleet-and-ice alarm system is designed to detect incipient icing conditions for protecting antenna towers. Icing is a problem on antenna towers, not only because it deposits a heavy and sometimes hazardous weight on the structure, but also because it distorts the beam pattern and increases power leakage.

Developed by American Instrument Co., Inc., of Silver Spring, Md., the system differs from existing ice alarm systems, such as the venturi-type or strain-gage type, in that it responds when atmospheric conditions favor ice formation—before the ice actually forms.

The American Instrument system, Fig. 1, consists of two parts: 1. the detection unit, which is installed

on the antenna or other outdoor location; and 2. the control box and associated alarm devices, which are installed indoors. This system can anticipate icing because it is actuated by two types of sensing elements which respond to the two ice-forming conditions; that is, low temperature and precipitation. The two sensing elements are connected in series so that the alarm system will remain inoperative unless both conditions exist concurrently. When the alarm circuit actuates, a spdt relay switches off the "no ice" indicator light on the control box, energizes the "ice" indicator light, and sounds an alarm bell. The alarm circuit will also turn on the antenna heaters, if desired. As soon as the icing conditions pass, the system clears itself automatically.

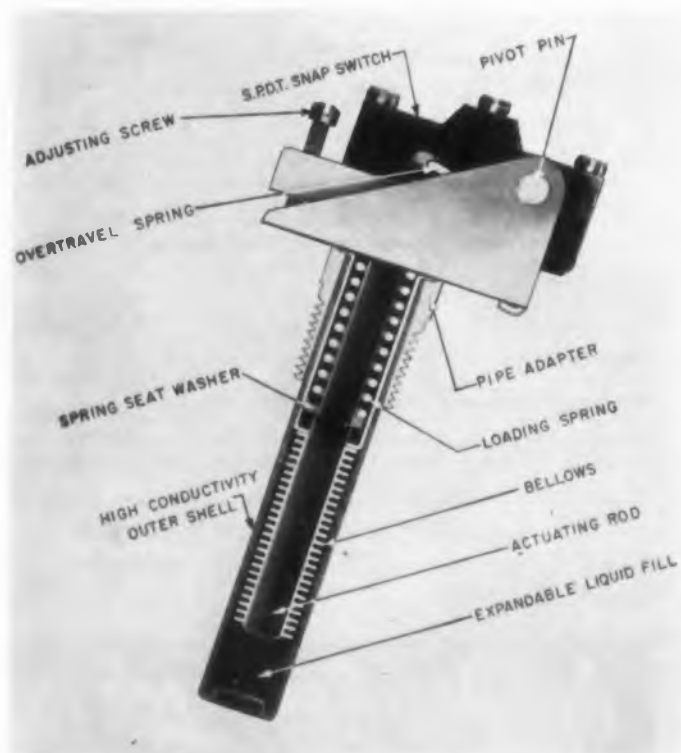

Fig. 2. Cut-away of snap-action Thermoswitch (Fenwal) unit which provides the temperature-sensing part of the detection unit.

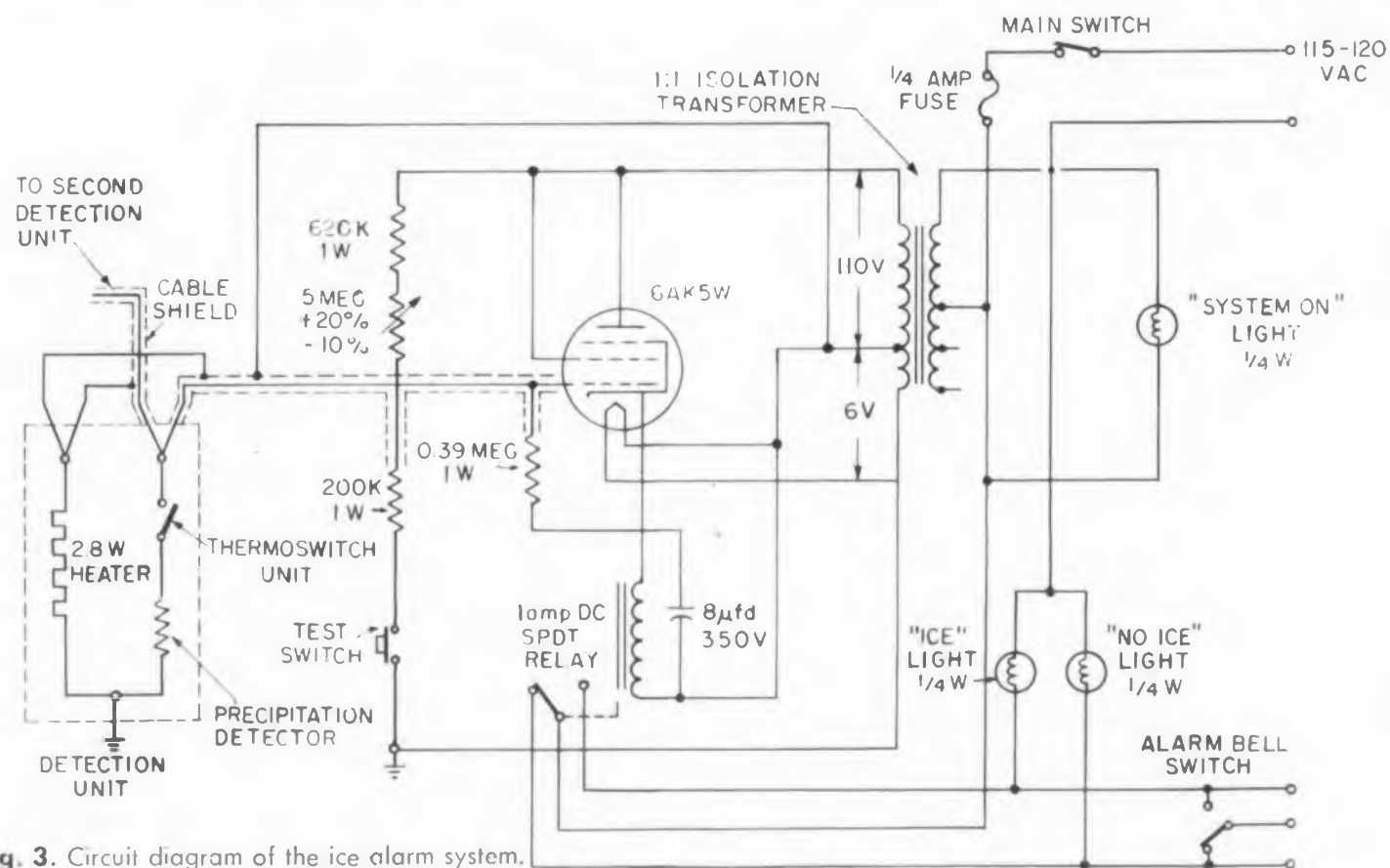

Fig. 3. Circuit diagram of the ice alarm system.

## Antenna Ice Alarm

### Detection Unit

The two sensing elements in the detection unit consist of a specially-developed element to monitor for precipitation, and a Fenwal snap-action thermoswitch unit to sense air temperature. This particular type of thermostat, Fig. 2, was selected for several reasons. First, it can be exposed indefinitely to  $-100$  F and to well above  $125$  F and still operate precisely at its setpoint temperature. Second, there is a direct and constant relationship between angular rotation of the temperature setting screw and the amount of adjustment in setpoint temperature (1 full turn =  $23$  F). This made it possible to equip the thermostat with a direct-reading temperature dial and pointer so that the unit can be set in the

field v  
the co  
stalle  
detect  
limite  
ing ra  
plicat  
and th  
is set  
occur  
cause

The  
coils o  
side o  
detect  
the w  
(prov  
are clo  
tains a  
tinuou  
serves  
falling  
will be  
tion; s  
celerat  
itself o

The  
supply  
an ass  
and de  
lation  
from t  
cable s  
contact  
elemen  
and g  
change  
resistor  
circuit  
variabl  
thresh  
resistan  
winding  
switch  
alarm o

Each  
detection  
may be  
box usi  
RG-62/  
tion un  
alumin  
to ver.  
moistur  
gasketi  
and p  
housing

field without reference to a calibration table. Third, the compact head of the unit permitted it to be installed, even with the added dial and pointer, in the detection-unit housing where clearance is severely limited. The thermostich used has a total operating range of  $-75$  to  $+125$  F. However, in this application, only the range of  $+30$  to  $+50$  is used, and the dial is so calibrated. The thermostat usually is set to actuate at  $35$  F dry bulb, since icing can occur outdoors a few degrees above freezing because of evaporative cooling.

The precipitation detector consists of two parallel coils of fine nichrome wire wound around the outside of a plastic coil form. A drop of water on the detector provides sufficient conductivity to short out the windings and complete the circuit to ground (provided the contacts of interlocking thermostat are closed). The inside of the tubular coil form contains a potted  $2.8$  w,  $6$  v heater which operates continuously while the system is in use. This heater serves two purposes: It changes any snow or sleet falling on the detector to water so that the element will be equally responsive to all types of precipitation; second, by keeping the detector warm, it accelerates drying which enables the system to clear itself quickly when the precipitation stops.

#### Control Unit and Circuitry

The control unit, which operates on a  $125$  v ac supply, contains a cathode-follower amplifier and an associated alarm circuit, Fig. 3. The amplifier and detection units are powered through a  $1:1$  isolation transformer, the  $2.8$  w heater being supplied from the  $6$  v tap of the transformer through the cable shield. The combination of closed thermostat contacts and shorted windings of the precipitation element develops a small voltage between the grid and ground. This produces a sufficient current change through the cathode follower and its biasing resistor to actuate the  $1$  a dc relay of the alarm circuit. The amplifier circuit contains a  $5$  megohm variable resistor to enable the operator to adjust the threshold sensitivity of the unit to compensate for resistance changes on the precipitation element windings from the accumulation of dirt. A test switch is also provided to test the amplifier and alarm circuits.

#### Equipment Layout

Each control box may be connected to one or two detection units wired in parallel. The detection units may be placed up to  $1000$  ft away from the control box using RG-69/U cable, and  $2000$  ft away using RG-62/U cable. Ground connections for the detection unit are usually made by mounting the cast aluminum housing directly on the metal antenna tower. The housing of the detection unit is fully moisture-proofed by a gasket in the cover and by gasketing in the bushings where the thermostich and precipitating units are threaded into the housing.

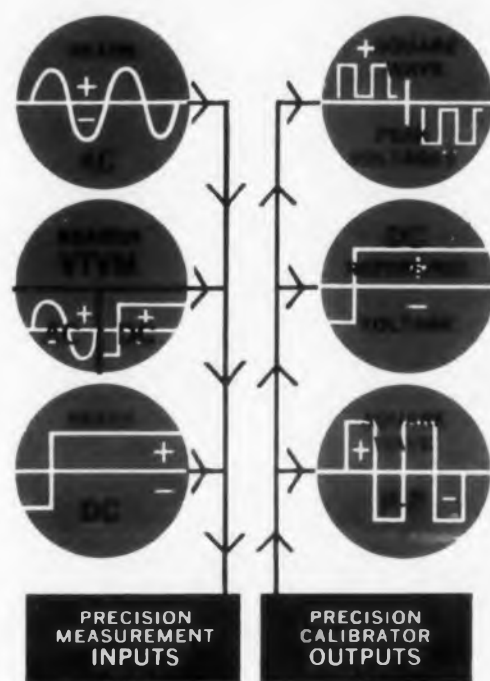

# 1=4/VOCA model 101

IN ONE INSTRUMENT!

DEMOLAB introduces the VOCA, a precision differential null type potentiometric voltmeter and search VTVM for AC and DC, including a precision calibrator delivering square wave and DC output reference voltages. Plus accessories.

.1V to 500 Volts in a 5 digit readout.  
4 Digits .01V to .1V—3 Digits .001V to .01V. 2 Digits .001V to .01V—Usable readouts down to 50 uv.

to .05% from 0 to 500 Volts DC  
to .1% from .5 to 50 Volts RMS AC

1 part in 10,000 at low end of each range.  
1 part in 100,000 at high end of each range.

Amplitude referenced against a Standard Cell. Super regulated power supply for stability.

BUILT-IN FEATURES

RANGE

ACCURACY

READOUT RESOLUTION



**ACCESSORY FEATURES:**  
A family of input probes, shunts, and output units extending the AC range and the basic accurate reference standards of the instrument to an infinite variety of functional uses is available.

**DEMOLAB CORPORATION**  
Instrument Division

1550 North Highland Avenue  
Hollywood, California  
Representatives in all major areas

ACCESSORIES

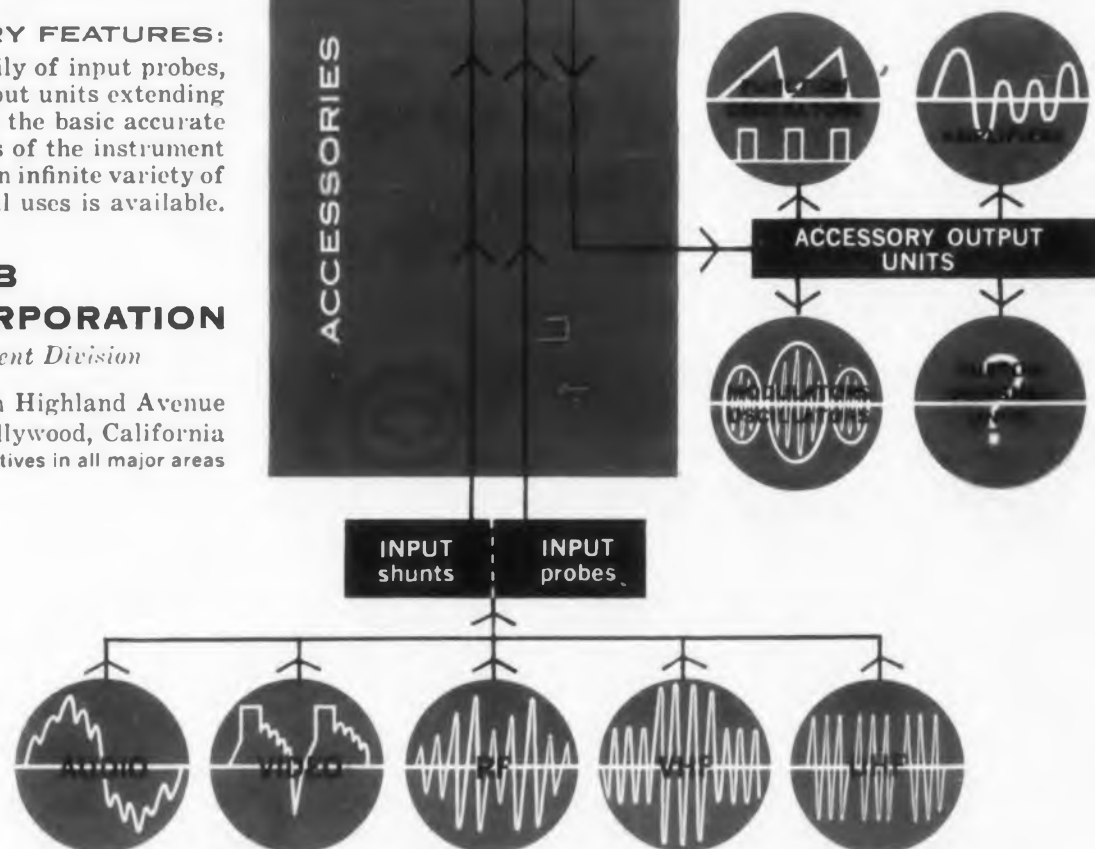

CIRCLE 407 ON READER-SERVICE CARD FOR MORE INFORMATION

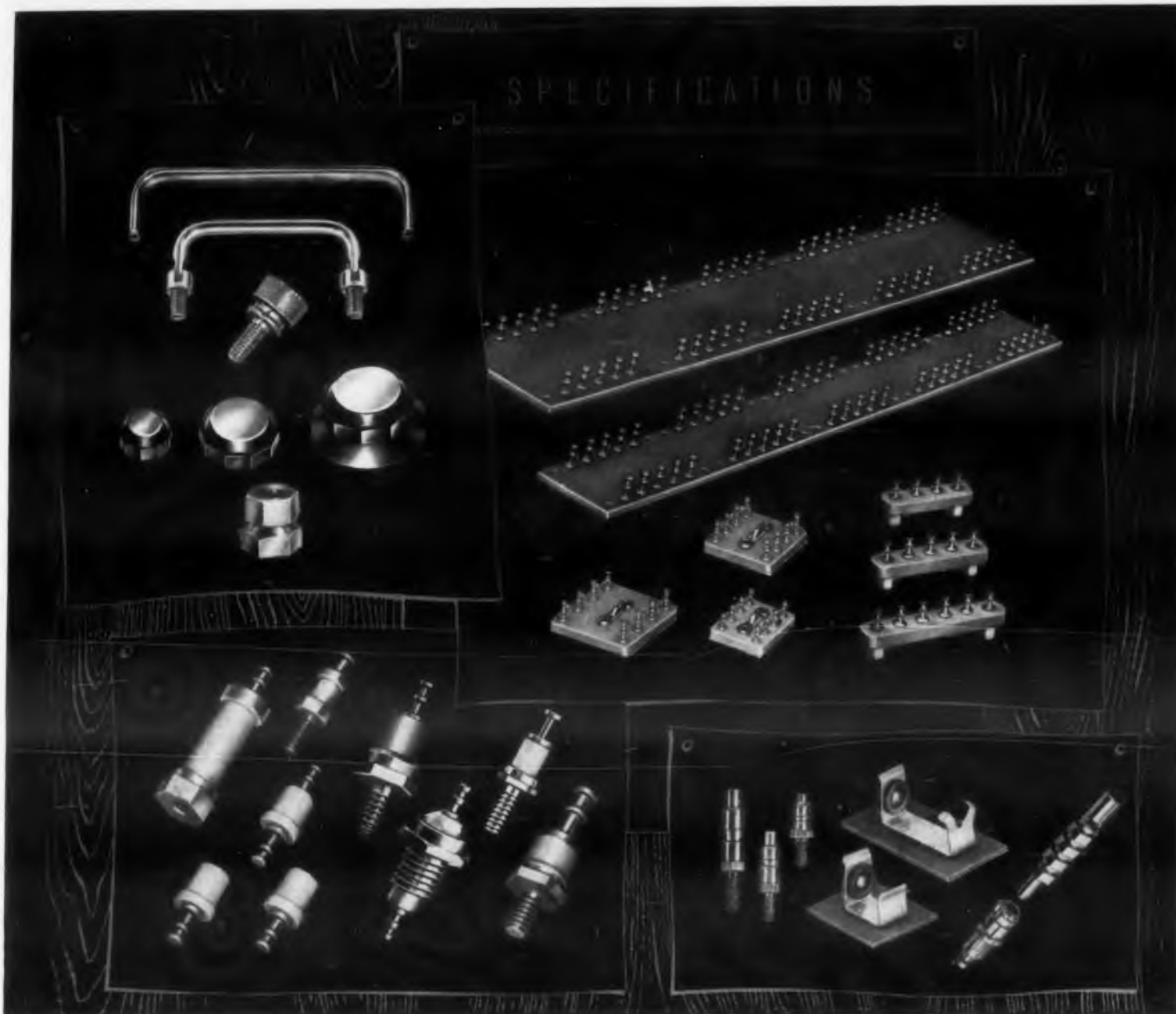

Photo shows wide variety of CTC components. Upper left, hardware, knobs, panel screws. Upper right, standard terminal boards, phenolic and ceramic. Bottom row, insulated terminals in ceramic and teflon, diode clips, battery clips, plugs and jacks. Common denominator — CTC reliability.

## If specifications call for durability specify CTC hardware

Durability is not just a term at CTC — it's practically a manufacturing process! Take the above line of CTC hardware for example. CTC guarantees it and every one of its components unconditionally — in any quantity! That's high quality control — quality control that meets or betters all applicable military and government specifications. CTC quality controls the raw material, each step of production and the finished product — the result — *exceptional durability*.

Best of all you get this durability economically. In fact — you couldn't make such hardware items

cheaper yourself! Our large selection of standard panel and chassis hardware fills most needs. If you require custom design, contact us direct.

Send for CTC's Catalog 600 — it has all the details of CTC's complete hardware line. Write to Sales Engi-

neering Dept., Cambridge Thermionic Corporation, 457 Concord Ave., Cambridge 38, Mass. On the West Coast contact E. V. Roberts and Associates, Inc., 5068 West Washington Blvd., Los Angeles 16, and 1560 Laurel St., San Carlos, Calif.

**CAMBRIDGE THERMIONIC CORPORATION**

*makers of guaranteed electronic components  
custom or standard*



CIRCLE 408 ON READER-SERVICE CARD FOR MORE INFORMATION

## Ideas for Design



Using an ultrasonic soldering iron to fill a blow hole in an aluminum casting. Ultrasonic power is applied to the surface of the metal through molten solder. The cavitation effects produced in the solder completely remove the oxide film on the metal, and tinning takes place. Oxide dross appearing on the surface of the solder is easily removed by wiping. No flux required.

### Results from Ultrasonic Soldering

Here's how to obtain the best results with an ultrasonic soldering iron:

1. Make certain that the area to be worked is absolutely clean. Grease is particularly detrimental.
2. Flux must not be used.
3. Do not trap oil or grease, or anything which will give off a vapor within the work.
4. Make sure that there is sufficient molten solder on the bit—it is this which carries the ultrasonic energy to the metal being worked.
5. Use pre-heating on large jobs, or for speed on small ones—gas jet, hot plate or both. Remember aluminum carries heat away faster than tin plate.
6. Move the iron slowly over the area to be tinned; Before joining, wipe off the dross which will float to the surface with a steel scraper or glass wool.
7. Try to heat sheet metal evenly—aluminum may be permanently deformed by localized heating.
8. Do not use butt joints on sheet metal unless supplementary mechanical strength is provided.
9. Cover all soldered areas likely to be exposed to tropical or other adverse weather conditions with a suitable protective lacquer.
10. Use pure solder consisting of 90 per cent tin and 10 per cent zinc. Do not file the bit. Its length is important, and if cleanliness has been observed, filing should not be necessary.
11. Ultrasonic soldering is applicable to the following metals: pure and commercial-pure aluminum; aluminum light alloys and anti-corrodal alloys up to

10 per cent magnesium; also for the fluxless soldering of copper, brass, and zinc; joining dissimilar metals together, e.g. brass or steel to aluminum; and zinc base alloys when not subjected to humidity.

Ralph Reynolds, Technical Director, Acoustica Associates, Inc.

## Self-Biased Blocking Oscillator

### The Problem

A design for a block oscillator to develop a 60 v pulse across a 75 ohm load proved to be unreliable because there was not sufficient signal to trigger the circuit for adverse variations within tolerances of voltages, tube and resistors in the fixed bias voltage divider. Since it was not feasible to increase the triggering signal, the development of a more stable and more sensitive blocking oscillator circuit was indicated.

### The Solution

Stable operation and adequate triggering sensitivity were secured without a pre-set control by using self bias rather than fixed bias for the blocking oscillator. The final circuit is shown. Quiescent plate current develops a voltage across the 6800 ohm cathode resistor sufficient to bias the tube just past the point at which self-sustained oscillations occur. Operation of the tube near, rather than beyond, plate current cut-off results in a satisfactory measure of self-adjustment to variations in tube characteristics. The several means for triggering a blocking oscillator and for delivering an output pulse are not necessarily altered by the self-biasing arrangement exemplified by the figure.

Harvey G. Talmadge, Jr., Electronic Scientist, U.S. Naval Research Lab., Washington, D.C.

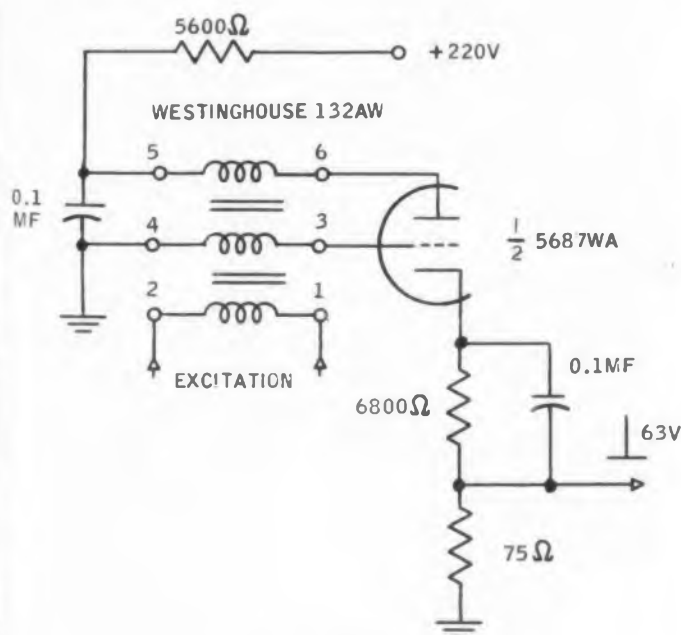

Self-Biased Blocking Oscillator.

# RADIO FREQUENCY AND VIDEO SLIP RING ASSEMBLIES

NO. 3

of a Series of  
Data Sheets

Slip Ring Assemblies for radio frequencies have been used primarily in the i.f. circuits of radar receivers whose i.f. frequencies are in the order of 30 mc or 60 mc.

Some radar systems have the local oscillator and preamplifier located in the rotating structure and the second detector located in the fixed structure. For the transmission of more than

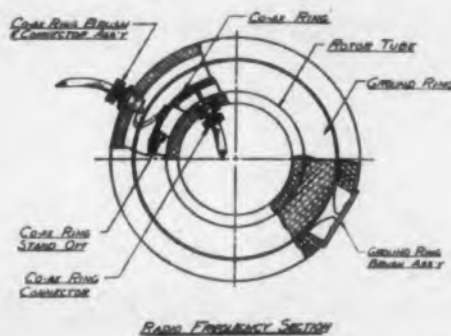

one i.f. signal, or should the axis of rotation of the structure be occupied by an air line or a coolant line, it then becomes mandatory to use a slip ring for transmission.

Radio frequency slip rings are not limited to i.f. signal transmission. They may be used for any radio frequency up to an approximate practical frequency of about 100 mc and for very low level signals such as received from a television transmitter to high voltage and high current signals.

Radio frequency slip rings are designed to have a very wide frequency range with essentially flat frequency characteristics.

The radio frequency slip ring at the higher frequencies is part of the terminating circuit of a transmission line. If the slip ring assembly is inserted in a matched circuit, whatever standing wave is present is due to the

slip ring assembly in the circuit. If the impedance the line "sees" is the characteristic impedance, then the slip ring assembly's impedance is the characteristic impedance of the line and there is no standing wave. It is therefore necessary to make the characteristic impedance of the slip ring assembly as close as possible to the characteristic impedance of the line.

For purposes of calculation of the slip ring assembly parameters, the slip ring may be considered a lumped circuit. This assumption seems to hold to 60 mc and the standing wave to be expected for any design can be calculated quite accurately. Indications are that the slip ring tends to become a distributed circuit if the dimensions of the ring circuit exceed much over .05 wave length.

The terminating impedance of the transmission line is a T-network having inductive and capacitance elements and with the characteristic impedance as a load. By calculating the terminating impedance, knowing the characteristic impedance of the line, the reflection coefficient and the voltage standing wave can be calculated.

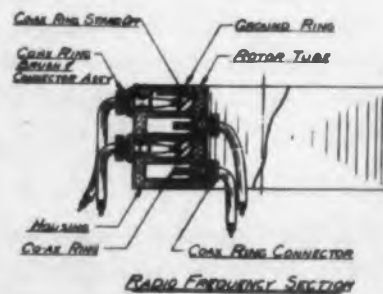

For a particular slip ring tested the calculated value of voltage standing wave was 1.05 at 30 mc and the measured standing wave ran from 1.05 to 1.1 for the seven rings of the assembly. The calculated standing wave was 1.94 at 60 mc and the measured value was 2.0.

With the use of low loss materials in the circuit, insertion loss is usually very low, not more than 0.1 db excluding cables.

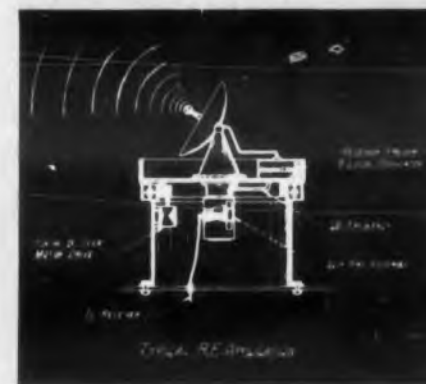

Cross talk between rings is dependent on several factors and the major one is the space between the fixed shield section and the rotating shield section. This space is kept to a minimum width and the length of the space is made as large as practical. A gap length to width ratio of approximately 6 to 1 is usual. The shield ring is grounded to the housing by brushes at several places to insure the ring shield is kept at ground level.

By proper design it is possible to obtain 80 db at 150 KC, 70 db at 30 mc and 50 db at 60 mc cross talk between adjacent rings.

## Makepeace SLIP RINGS

D. E. MAKEPEACE COMPANY Attleboro, Mass.

ENGELHARD INDUSTRIES

CIRCLE 409 ON READER-SERVICE CARD FOR MORE INFORMATION

# Designing for Low Cost Production

Components  
Standardization

Designing Metal and  
Plastic Parts

Selecting Hardware

Prototype-Production  
Compatibility

Automatic vs  
Hand Assembly

The Designer's  
Responsibility

What Makes Designs  
Unproducible?

Design Differences for  
Large and Short Runs

Design Hints for  
Low Cost Producibility

**SPECIAL  
REPORT ON  
PRODUCTION.  
CLOSING DATE  
OCT. 20th**



Designing for low cost production is the theme of *Electronic Design's* 1st annual production issue, November 15th. If your equipment, components, or services can help the designer with producibility problems, or reduce the limitations imposed on the designer, this will be an issue you will not want to ignore. Packaging for production, production short-cuts, drafting techniques, automatic controls, and associated equipment will be heavily advertised. Plan now to be included in the PRODUCTION ISSUE . . . Closing October 20th.

*Your electronics advertising will be read in  
Electronic Design*

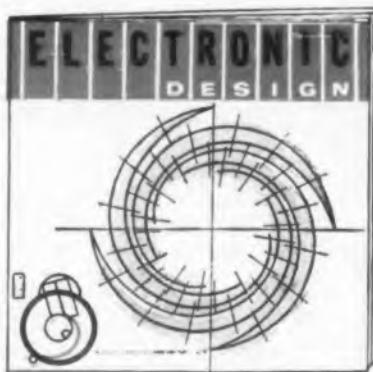

a HAYDEN publication

New York

Chicago

Los Angeles

## Ideas for Design

### Low Cost Constant-Voltage Source

A constant voltage was necessary to operate a transistorized circuit. The normal method of doing this would be the use of a zener silicon diode, but the simplicity of the circuit precluded the possibility of using an item as expensive as a zener diode. The circuit shown has been designed at a much reduced cost to deliver 4.5-5.5 v dc to a 680 ohm load, with a variation of input voltage from 5.5 to 14 v dc.

The No. 47 pilot bulbs in series with a standard 65 ma selenium rectifier is placed across the input,

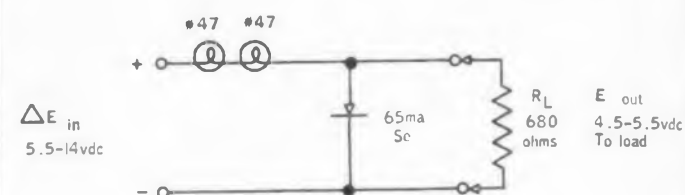

and the load to be regulated is placed across the selenium rectifier. Further experiments indicate that other bulbs and rectifiers may be used where other loads are used, and with other input voltages and expected variations. Use of this circuit to replace a zener diode effects a savings of 400 per cent at the manufacturers price level.

*J. Frank Brumbaugh, Marine Project Engineer,  
Heath Company, Benton Harbor, Michigan.*

### Hum Reduction

The circuit shown was designed to reduce excessive hum or ripple in low level stages, particularly where the cathode resistor is unbypassed—hum which can be traced to the heater circuits.

This circuit will provide a small amount of dc power, enough for one or two stages, with very low cost and small size. The ripple is quite low and has been found adequate for all audio applications

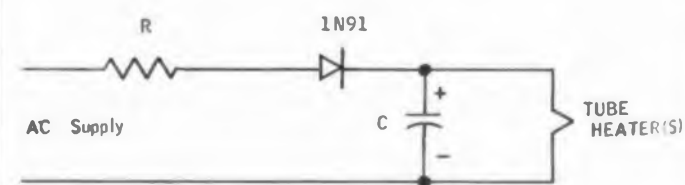

C = 1000 uf ohms  
R = 2.7 to 22 ohms  
(SEE TEXT)



and most instrument uses. The value of resistor  $R$  must be adjusted to provide the proper voltage at the tubes heater(s). Since peak rectification is used, the rms value of the voltage can be maintained as long as the capacitor  $C$  is sufficiently large. The value shown has proven adequate. In some cases, the current rating of the rectifier will be exceeded; however, with the low peak inverse voltages involved, there is no great amount of heating due to reverse current, and higher forward currents are permissible.

Thomas P. Prouty, Engineering Section Chief, Hallamore Electronics Co., Anaheim, Calif.



### "Zippertubing" Saves Time

Prior to using Zippertubing, the cabling used in the Telecomputing Corp. Point O'Sale Recorder shown was pulled through conventional vinyl tubing by hand. By this method the tubing was secured to the end of an air pipe, and 125 lb of air pressure was forced through the vinyl tubing to expand it and eliminate friction. The cabling was then pulled through the tubing by means of a hand-operated winch. This operation required fifty minutes hard work by two men to pull ten feet of cabling through the vinyl tube. This same operation is now accomplished in ten to fifteen minutes by two women using Zippertubing as shown in the insert.

designed  
with...

**beryllium**

**copper**

## FUSE CLIPS HAVE GREATER GRIP STRENGTH--WITHSTAND HIGH CURRENTS WITHOUT ANNEALING

Because of the high tensile strength of the beryllium copper alloy, "BERYLCO" 165, clips of this material grasp the fuse cap up to 1000% tighter than clips made of other copper alloys.

In comparison, the alloy provides lower contact resistance and much higher conductivity than other possible clip materials, such as phosphor bronze.

Beryllium copper fuse clips greatly reduce contact point heating. They will not buckle or anneal at high temperatures. Clips of this alloy are immune to mechanical fatigue from rough and severe usage arising from the continuous insertion and extraction of fuses in the fuse clip.

THE BERYLLIUM CORPORATION  
READING / PENNSYLVANIA

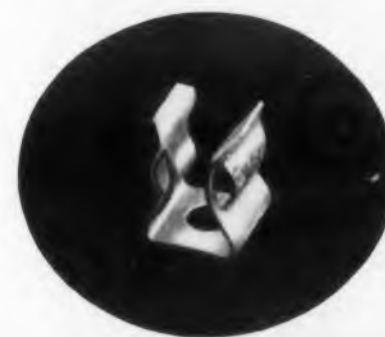

#### TECHNICAL BULLETIN NO. 38

describing the design advantages of "BERYLCO" beryllium copper in fuse clips manufactured by Littelfuse, Inc., Des Plaines, Ill., is available upon request. Write for your free copy now.

#### PHYSICAL PROPERTIES OF "BERYLCO" 165 STRIP

Specific Gravity	8.26
Density, lb. per cu in	0.298
Melting range, °F	1600-1800
Thermal expansion coefficient, per °C, 20° to 200°	0.0000170
Thermal expansion coefficient, per °F, 68° to 392°	0.0000094
Thermal conductivity, btu/sq ft/in/hr/°F at 68°F	750-900*
cal/sq cm/cm/sec/°C at 20°C	0.26-0.31*
Electrical conductivity, IACS % at 20°C	22-30*
Electrical resistivity, microhm cm at 20°C	7.8-5.7*
*Heat treated	

#### BERYLLIUM COPPER ALLOYS HAVE RESISTANCE TO:

WEAR

FATIGUE

CORROSION

MAGNETISM

SPARKING

CIRCLE 410 ON READER-SERVICE CARD FOR MORE INFORMATION

# B-A

## COMPLETE, ACCURATE TRANSISTOR TESTING EQUIPMENT

Baird-Atomic Transistor Test Equipment has been specifically designed and developed to provide highly accurate transistor characteristics and classification data. The units illustrated below are part of our complete line of transistor testing instruments.



TRANSISTOR  
TEST SET  
Model GP4

The transistor tester that is rapidly becoming the standard of the industry . . . for  $h$  parameters and equivalent T coefficients . . . NPN and PNP junction and surface-barrier transistors . . . grounded-base or emitter circuits . . . alpha and beta cut-off . . .  $I_{co}$  . . . and  $C_c$ . Test frequency from 100 cps to 1 mc.

MEDIUM POWER  
TRANSISTOR  
TESTER  
Model KP1



Measures all  $h$  parameters . . . provisions for measuring transistor reverse characteristics and external measurement of  $I_{co}$ . Wide range of test conditions —  $I_c$  and  $I_e$ , variable from 0.5 to 300 ma;  $V_c$ , 0 to 100 volts; frequency 200 cps to 200 KC.



BETA,  $h_{11} - I_{co}$   
TESTER  
Model KT1

Light . . . portable — completely self-contained . . . utilizes transistorized, printed-circuit construction. Contains 1 KC oscillator and long-life mercury-cell power supply. Provision for collector waveform observation . . . meter overload protection.

Complete technical data available on these and other B-A Transistor Test Equipment. Engineering representatives throughout the United States and abroad.



**Baird-Atomic, Inc.**

33 UNIVERSITY RD., CAMBRIDGE 38, MASS.  
CIRCLE 412 ON READER-SERVICE CARD FOR MORE INFORMATION

## Report Briefs

### RF Shielded Room Design

Fundamental shielding theory for cylindrical and spherical shields is considered and reconciled with design parameters and performance characteristics of the plane-surface shields of shielded enclosures. Formulas, correction factors, and tables are included for calculating shielding effectiveness of sheet metal enclosures and screen rooms. Shielding effectiveness tests are described for various fields and frequencies. The NADC AEEL Take-down Cell Type Screen Room is described and evaluated. *Theory, Design and Engineering Evaluation of Radio-Frequency Shielded Rooms*, C. S. Vasaka, U.S. NADC-Johnsville, Pa., PB 121927, Aug. 1956, 120 pp, \$3.00. Order from OTS, U.S. Dept. of Commerce, Washington 25, D.C.

### HF Transistor Equivalent

This report is concerned principally with the characterization of junction transistor triodes at high frequencies by means of small-signal equivalent circuits and associated four-pole parameters. *Some New High Frequency Equivalent Circuits for Junction Transistors*, R. M. Scarlett, Stanford Univ., Electronics Research Lab., Stanford, Calif., PB 125569, Mar. 1956, 94 pp, microfilm \$5.40, photocopy \$15.30. Order from Library of Congress, Washington 25, D.C.

### Synthesis of Chebyshev Filters

Work of R. M. Fano on the theoretical limitations of broadband impedance matching it utilized to give a straight-forward procedure for synthesis of optimum, lossless, Chebyshev, wideband impedance-matching networks for various classes of loads. Procedures are described and examples are presented for low-pass, high-pass, and band-pass matching network design for use with specified loads so as to meet prescribed band-width and reflection coefficient magnitude specifications. The design procedure is greatly simplified by the use of tableted reflection coefficient polynomials each of which is a function of frequency  $p$  and design parameter. The application of this procedure to Chebyshev filter and vacuum-tube amplifier interstage design is also discussed. *Synthesis of Chebyshev Impedance Matching Networks, Filters, and Interstages*, George L. Mattaei, Calif. Univ., PB 124870, June 1955, 64 pp, microfilm \$3.90, photocopy \$10.80. Order from Library of Congress, Washington 25, D.C.

every day,  
designers are  
discovering  
new ways to  
make products  
better, more  
efficient...with

PRECISION  
**ACE NYLON BALLS**

ACE PLASTIC COMPANY Extrusion Molders  
and Fabricators  
71 38 Van Wyck Expressway, Jamaica 35, N. Y. • JAMAICA 3-5500  
CIRCLE 413 ON READER-SERVICE CARD FOR MORE INFORMATION

## MINIATURIZED EQUIPMENT GROWS SMALLER STILL

with

**DAGE** DM series  
RF Cable Connectors

half the size of standard BNC's



- Tiny but rugged, can withstand a cable pull of over 50 lbs.
- Twelve polarity groups—two and three lug
- Vibration-proof bayonet locking (MIL-C-5015)
- Teflon insulators permit use over wide temperature-range with low electric loss
- .002" silver plate and gold flash affords excellent corrosion resistance

Dage Catalog 201-B gives full details with specifications on sub-miniature DMs. Write for your free copy.

**DAGE ELECTRIC CO., INC.** 67 No. Second St.  
Beech Grove, Ind.

CIRCLE 414 ON READER-SERVICE CARD FOR MORE INFORMATION

Precision manufactured from DuPont Nylon 6/6 to close tolerance of  $\pm .001$  on diameters and  $\pm .0005$  on sphericity. Ace Nylon Balls have design flexibility and production economy. Light in weight . . . tough at low temperatures . . . stable at high temperatures . . . resistant to corrosive chemicals such as sulphuric acid, etc. . . almost abrasion-proof . . . these mass-produced balls have hundreds of industrial applications. Come in 14 standard sizes from  $\frac{1}{16}$ " to  $\frac{1}{2}$ ". Complete facilities for fabrication of plastic parts for all industries. Estimates submitted promptly on receipt of blueprints or specifications.

Write TODAY for samples, bulletin, price list

## Printed Wiring CAPACITY



10 Tube  
Television  
Circuit  
Panel

The newest and largest plant facility devoted to printed circuit manufacture combined with Methode's seasoned tooling, fabricating and processing know-how provides reliable deliveries on quantity circuit board requirements.

Since acceptance of auto-assembly techniques, Methode has established superior quality and service ratings for electronics' largest users. Experienced personnel, the industry's most mechanized equipment and continuous high production momentum assure superior performance.

Further, the SPECIAL CIRCUIT DIVISION, a separate entity within the organization, has its only interest in the rapid service of sample orders, short run and military requirements.

"Printed Circuit Handbook" a primer of design information on request

Address:  
Manager,  
Special  
Circuit Dept.

**M** **METHODE Mfg. Corp.**  
7447 W. Wilson Ave., Chicago 31, Ill.

CIRCLE 415 ON READER-SERVICE CARD FOR MORE INFORMATION

## Only Fenwal's Precision Instrument Offers This 3-in-1 Temperature Control

Fenwal's new Series 560 Temperature Indicating Control uses the hermetically glass-sealed, steel en-

closed thermistor element. It offers sturdy, simplified operation and extra sensitivity in a wide variety of industrial and laboratory applications. It is the only instrument that has such 3-way control . . . on-off, proportional, adjustable differential . . . all at the flip of a switch. It is assured accurate to within 1% of 1% of full scale, using inexpensive standard wiring up to 100 ft. The thermistor's great resistance change allows use of a simple null balance bridge circuit for sure stability in temperatures from 200°F to 600°F, with resulting lower initial cost and minimized maintenance. Send for detailed Series 560 data to Fenwal Incorporated, 1710 Pleasant Street, Ashland, Mass.

**Fenwal** Controls Temperature  
... Precisely

CIRCLE 416 ON READER-SERVICE CARD FOR MORE INFORMATION

## Frequency Translation

For the purposes of this work a transit-time device is defined as a device in which each cycle of the carrier initiates a disturbance that propagates from the input terminal to the output terminal with a transit time  $\tau$ . The transit time of a particular disturbance is determined by conditions which exist at the input terminal at the time the disturbance is initiated. The klystron and the traveling-wave tube are microwave electronic examples of such a transit-time device. A general spectrum analysis for combined transit-time modulation (TTM) and amplitude modulation (AM) is given. A corresponding analysis for combined phase modulation (PM) and amplitude modulation (AM) is presented, and the similarities and differences in the results of the two analyses are pointed out. *Frequency Translation by Modulation of Transit-Time Devices*, Raymond C. Cumming, Stanford Univ., PB 122990, Aug. 1955, 133 pp, microfilm \$6.90, photocopy \$21.30. Order from Library of Congress, Washington 25, D.C.

## Crystal Handbook

The report covers material considered useful in the design of crystal oscillators for electronic equipment. It is a comprehensive manual of piezoelectric control of radio frequencies, containing background material, circuit theory, and components data. Appendices contain a bibliography, a list of manufacturers, specifications and standards, and conversion charts. *Handbook of Piezoelectric Crystals for Radio Equipment Designers*, John P. Buchanan, Philco Corp., PB 111586r, Oct. 1956, 702 pp, \$7.00. Order from OTS, U.S. Dept. of Commerce, Washington 25, D.C.

## Oscillations in Data Control

Oscillations between sampling instants in the response of sampled-data control systems imposed certain limitations on the z-transform method and other methods available for synthesis of such systems. It is shown that these oscillations appear in the response because of certain forms of the open loop transfer function  $G(s)$ . Theorems relating to initial and final values of the response in the form of modified z-transforms have been presented. Two examples have been discussed in which such oscillations occur and the modified z-transform method has been applied in their analysis. *Hidden Oscillations in Sampled-Data Control Systems*, E. I. Jury, California Univ., Electronics Research Lab., Berkeley, Calif., PB 122230, Dec. 1955, 20 pp, microfilm \$2.40, photocopy \$3.30. Order from Library of Congress, Washington 25, D.C.

## MR. ENGINEER!... BURGESS

### EXCLUSIVE WAFER CELL CONSTRUCTION

GIVES GREATEST SELECTION

IN DRY BATTERIES



Whatever You Need in...

CAPACITY	VOLTAGE	SERVICE
 A correct cell size for any capacity.	 Wafer Cell construction produces from 1½ volts on up.	 Burgess will make batteries to fit any application.

## BURGESS

Has The Widest  
Choice of Dry  
Batteries Ever  
Manufactured . . .

The revolutionary Wafer Cell offers a 30% increase in battery life at no increase in size. This exclusive Burgess construction consists of a sandwich of manganese dioxide mix between two flat electrodes of zinc and carbon with spots of hot silver wax applied to each exposed pole of the cell, allowing perfect electrical contacts throughout and almost complete absence of vibration. Cells are wrapped in Mylar film and packed in such modern materials as aluminum for compactness, long shelf life, exceptional service life, outstanding dependability.

Burgess design specialists will work out the exact battery to fit your needs. Send your requirements to Dept. E57.

**BURGESS BATTERY COMPANY**  
FREEPORT, ILLINOIS

CIRCLE 417 ON READER-SERVICE CARD FOR MORE INFORMATION

### SIZES AND SHAPES



Wafer Cell construction can meet any space, size and weight requirements.

### RESERVE BATTERIES

Can be stored dry for years. Activated only when immersed in water. No handling of dangerous electrolyte, no spilling or leaking. Wider range of efficient operating temperatures than any other type of battery.

**"SHIMNUT"**

SPACER PLATE NUTS

SINGLE UNIT SHIM NUT

**SAVE Time Material Weight**

Eliminates use of NAS 463 shims. Permits use of single length screws at tapered joints. Available for bolt sizes from 10-32 to 3/8-24, spacer heights from 1/16 to 7/16.

Nuts are cadmium plated steel with nylon insert (ESNA 52Y) or all metal (SPS-F1309). Spacer is 7075-T6 Aluminum Alloy. Holder is Anodized in various colors to indicate height of spacer.

Write for Our Latest Catalog

**WM. H. SNOW CO.**  
1413 E. Franklin Ave.  
El Segundo, California

CIRCLE 418 ON READER-SERVICE CARD FOR MORE INFORMATION

## for Amplitude-Frequency Tests on Audio Equipment



### Here's the BEST Beat Frequency Generator

- FREQUENCY RANGE** 20 c to 40 kc (20 c to 20 kc audio range covered in a single sweep of dial)
- OUTPUT VOLTAGE** essentially constant — output meter calibrated in open circuit volts and in dbm
- FREQUENCY SCALE** logarithmic, 12 inches long
- OUTPUT VOLTAGE** continuously variable from less than 5 millivolts to 50 volts
- HARMONIC DISTORTION** less than 0.25% from 100 c to 10 kc
- OUTPUT POWER** 1 watt max. into 600 ohms
- DIAL CAN BE MOTOR DRIVEN** for sweep applications
- Type 1304-B Beat-Frequency Audio Generator: \$595** (available both in bench and relay rack models)

## GENERAL RADIO Company

275 Massachusetts Avenue, Cambridge 39, Massachusetts, U.S.A.

Broad Avenue at Linden, Ridgely, N. J. **NEW YORK AREA** 920 S. Michigan Ave. **CHICAGO 5**  
4055 13th St., Silver Spring, Md. **WASHINGTON, D. C.** 1150 York Road, Abington, Pa. **PHILADELPHIA**  
1000 N. Seward St. **LOS ANGELES 38** 1182 Los Altos Ave., Los Altos, Calif. **SAN FRANCISCO**

CIRCLE 419 ON READER-SERVICE CARD FOR MORE INFORMATION

## Report Briefs

### Radiation on Components

The usual causes and effects of reactor radiation on electronic components and systems are briefly reviewed. It was observed that damage resulting from nuclear radiation is a function of type and energy of the radiation, as well as other environmental factors, such as temperature, humidity, stress, and rate of irradiation. *AIEE Transaction Paper on the Effects of Nuclear Radiation on Electronic Components and Systems*, J. Robert Milliron, Wright Air Development Center, Electronic Components Lab., Dayton, Ohio, PB 131051, Mar. 1957, 9 pp, \$0.50. Order from OTS, U.S. Dept. of Commerce, Washington 25, D.C.

### High Power Beam Tubes

Projects assigned to this contract fall into two groups. Relatively speaking, the first group is of a more applied nature, and the second of a more basic nature. Projects in the applied group involve developmental work on new microwave tube devices and will be carried to the point of constructing experimental models suitable for evaluation by equipment groups. The first three projects in this report are in this group. Projects in the basic group will provide better understanding of fundamental electron-bunching phenomena and will furnish important design data for microwave tubes. The last two projects in this report are in this group. *Research In High-Power Beam Tubes*, Stanford University, PB 125154, June 1956, 27 pp, Microfilm \$2.70, Photocopy \$4.80. Order from Library of Congress, Washington 25, D.C.

### Components at High Temperatures

Electronic materials for use above 200 C, based on requirements for electronic component materials and devices of current Air Force contracts, are discussed. Magnetic, ferroelectric, dielectric and insulating, conductor, semiconductor and miscellaneous categories are covered. Marginal improvements have proved insufficient and major breakthroughs in research are essential to assure future supremacy in the application of electronic materials at elevated temperatures. *Electronic Material at Elevated Temperatures*, James W. Ballard, U.S. Air Force, ARDC, WADC, PB 131157, May 1957, 10 pp, \$0.50. Order from OTS, U.S. Dept. of Commerce, Washington 25, D.C.

## Avoid circuit failures with KPR\*

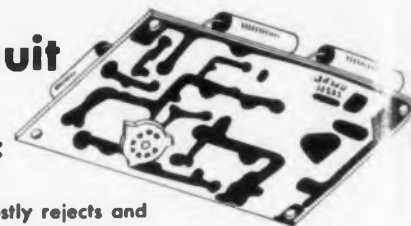

KPR helps you avoid costly rejects and make-overs. It saves you time and money because it is simple to use. Your operators can make etched electrical-electronic circuits with a minimum of training and experience. Here's why.

There are just six basic steps in using KPR:

- (1) Cleaning the metal is fast and sure with a power brush.
- (2) With a quick acid rinse, you're sure of good adhesion of the KPR coating.
- (3) Choose the coating method that suits you best—spraying, whirling, dipping. You can coat safely months in advance (during slack periods, for example), then store KPR coated plates till you need them. KPR is stable, does not change.
- (4) Exposure times are short with high-intensity arc or ultraviolet light. Exposure time never varies with atmospheric changes. Heat, humidity, and long storage do not affect KPR coated plates.
- (5) Developing is fastest in a vapor-spray degreaser on large runs. Small runs can be developed in trays or tanks.
- (6) KPR protects the circuit image during assembly of components. "Skate" the coated circuit board on solder bath, when assembly is completed, and KPR disappears leaving strong, clean solder joints.

No statement or suggestion in this advertisement is to be considered a recommendation or inducement of any use, manufacture, or sale that may infringe any patents now or hereafter in existence.

**EASTMAN KODAK COMPANY**  
Rochester 4, N. Y.

**Kodak**  
TRADEMARK

CIRCLE 420 ON READER-SERVICE CARD FOR MORE INFORMATION

# NOW!

SAVE WEIGHT, SPACE and COST

in computing and control systems

## GAMEWELL Sinusoidal Precision Potentiometers

A specially designed oblong resistance element rotating under 4 wipers generates precision sine and cosine voltages, proportional to the sine or cosine of the shaft rotation angle. Functions produced to an inherent accuracy and smoothness unobtainable by other resistive methods. Can replace eccentric gears, cams and complicated mechanisms in computing, analyzing, navigational and control systems.

Send for technical data! Functional detail, dimensions and specifications will help you apply.

THE GAMEWELL COMPANY  
Newton Upper Falls 64, Mass.

**GAMEWELL**

PRECISION POTENTIOMETER DIVISION

CIRCLE 421 ON READER-SERVICE CARD FOR MORE INFORMATION

ELECTRONIC DESIGN • October 15, 1957

# EXCEPTIONALLY POWERFUL

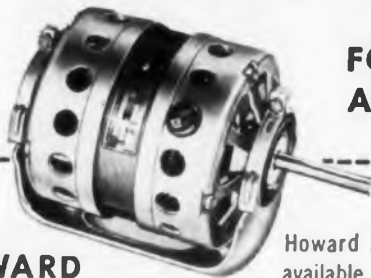

**FOR ITS SIZE  
AND WEIGHT**

## HOWARD MODEL 3700 INDUCTION MOTOR

for 1/25 to 1/8 h.p.

Howard Model 3700 motors are available in Hysteresis, Synchronous and Normal Induction motor types in 2 pole versions, both single phase and polyphase.

As a Normal Induction motor, Model 3700 is used for laboratory equipment, vending machine and general service requiring h.p. ratings up to 1/4 h.p.

As a Hysteresis Motor, 3700 series are used widely in recording and facsimile equipment. These motors are the ultimate in quiet operation. Resilient mounting base is normally supplied. For complete performance data, write today to Howard.

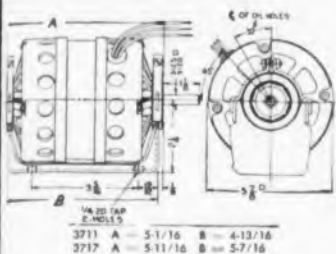

**HOWARD  
MOTORS**

DEPT. ED-11 HOWARD INDUSTRIES, INC. • RACINE, WIS.  
DIVISIONS: ELECTRIC MOTOR CORP. • CYCLOHM MOTOR CORP. • RACINE ELECTRIC PRODUCTS  
1725 State St., Racine, Wisc.

CIRCLE 422 ON READER-SERVICE CARD FOR MORE INFORMATION

## 0 cps to 1 mc!

**DIRECT READING**  
Computer-Measurements

### NEW! Model 226A UNIVERSAL COUNTER- TIMER

**OUTSTANDING FEATURES:**

- ★ Three independent, adjustable trigger level controls permitting full rated sensitivity at any voltage level between -300 and +300 volts.
- ★ Small voltage increments ordinarily masked by attenuators are easily selected.
- ★ Simplified color-coded controls and direct read-out in kc, mc, sec, or millise. with automatic decimal point indication.
- ★ Oscilloscope marker signals facilitate start and stop trigger level adjustment for time interval measurement of complex waveforms.

A brand new, multi-purpose instrument provides precision measurement of frequency, frequency ratio, period (1 frequency) and time interval. Pressure, velocity, acceleration, displacement, flow, RPS, RPM, etc., may also be measured with suitable transducers. The 226A may be used as a secondary frequency standard. Price: \$1,100.00  
100 kc Model 225A \$840.00

Data Subject to Change Without Notice - Prices F.O.B. Factory

Complete catalog data available  
**Computer-Measurements Corp.**  
5528 Vineland Ave., N. Hollywood, Calif., Dept. 76-K

CIRCLE 423 ON READER-SERVICE CARD FOR MORE INFORMATION

## Twelve Guides to Reliable Design

This report is based primarily on an extensive literature survey. Reliability topics discussed include the effects of increased equipment failure, techniques of reliable design, and selection of components. Vacuum tubes, resistors, and capacitors are the only components discussed at any length. Resistors and capacitors are considered from the viewpoint of comparative specifications rather than experimentally determined reliability. Tube-reliability factors briefly covered are: filament current surges, cathode-interface formation, tube envelope temperatures, new cathode designs, and the use of special tubes. Also given is a bibliography of 89 of the better articles reviewed. *Twelve Guides to Reliable Electronic Design*, Gordon G. Johnson, U.S. Naval Ordnance Test Station—China Lake, Calif, PB 121123, April 1955, 57 pp, \$1.50. Order from OTS, U.S. Dept. of Commerce, Washington 25, D.C.

## Design of Magnetic Amplifiers

A design manual for magnetic amplifiers describing various design methods for the standard magnetic amplifier circuits. The step-by-step procedures are especially intended for the *inexperienced designer* in the magnetic amplifier art. The basic full-wave circuits of the centertap, doubler, and bridge connections are considered, in addition to some of the more recent half-wave circuits. The first portion of the manual is concerned with the theory of operation of each of the various circuits, describing the function of the core and rectifier components and the effects of their properties upon amplifier response. Also included in this section are discussions of the problems of stability resulting from a variance of environmental factors, amplifiers, in cascade, and various types of loads together with some of the techniques of compensation. The second part contains the design procedures for the different circuits including examples. Designs with core configuration of toroids, U laminations, and C cores are described. Materials of construction for magnetic amplifiers form the last part of the manual. Magnetic cores, rectifiers, wires, insulations, and encapsulation and potting materials are discussed. Testing procedures, matching techniques, and some of the characteristics of these materials are also included. The appendices contain the theoretical analyses that form the basis for the design relationships contained in the manual. *Design Methods for Magnetic Amplifiers and Saturable Reactors*, James R. Walker and Max Frank, Wayne University, Engineering Research Institute, PB 121765, July 1956, 628 pp, \$9.50. Order from OTS, U.S. Dept. of Commerce, Washington 25, D.C.

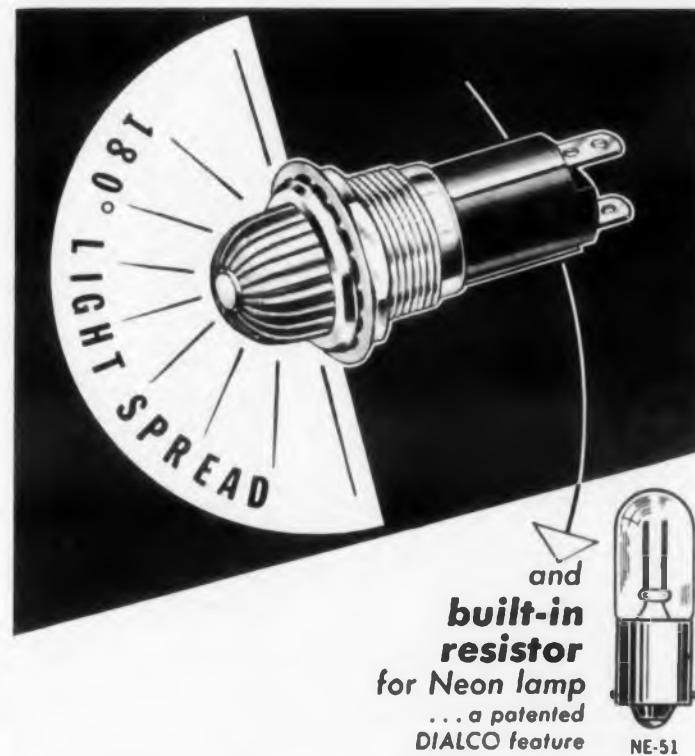

and  
**built-in  
resistor**  
for Neon lamp  
... a patented  
DIALCO feature

... two of many special features obtainable in

## DIALCO PILOT LIGHTS

The DIALCO series of Pilot Lights, exemplified by the unit shown above, is designed to house the *NE-51 Neon Glow Lamp*, and for direct use on 125 volt to 250 volt circuits. Since Neon lamps require a current limiting (ballast) resistor, the necessary resistor is "built-in"—an integral part of the lamp socket.

The resistor itself is completely insulated in moulded bakelite and sealed in metal (U.S. Pat. No. 2,421,321) ... Small space is required—units are available for mounting in 9/16" or 11/16" clearance holes.

A wide choice of optional features includes metal finishes, terminal types, lens shapes and colors, etc. Meet Military (*MIL Spec*) and Civilian (*UL* and *CSA*) requirements.

All Assemblies Are Available Complete with Lamp.

### SUB-MINIATURE | OIL-TIGHT

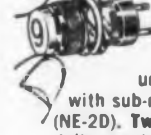

#### Pilot Lights

For use with tiny incandescent bulbs (T-1 3/4 ... Many units available for use with sub-miniature Neon bulbs (NE-2D). Two-Terminal units are fully insulated. Single-Terminal units are for use on grounded circuits. Also Dimming and Non-Dimming sub-miniatures. Meet all applicable Military Specifications.

#### Indicator Lights

For heavy-duty industrial applications. Impervious to oil, water, and dust. Rugged— withstands shock and vibration. Complete series for 11/16", 1", and 1-3/16" mounting. Use incandescent lamps and — with patented built-in resistor—Neon lamps.



SAMPLES ON REQUEST — AT ONCE — NO CHARGE

Foremost Manufacturer of Pilot Lights

# DIALIGHT

CORPORATION

46 STEWART AVE., BROOKLYN 37, N. Y. • HYacinth 7-7600

DIALIGHT CORP., 46 Stewart Ave., Brooklyn 37, N. Y.

Send brochures  for NE-51 Neon lamp  Sub-Miniatures  Oil-Tight on Pilot Lights

Name ..... Position .....

Company .....

Address .....

CIRCLE 460 ON READER-SERVICE CARD FOR MORE INFORMATION



### SPECIFICATIONS

**CAPACITANCE RANGE:**  
0 to 120 microfarads in 7 ranges, resolution 0.01 micromicrofarads per dial division. Accuracy  $\pm 0.2\%$  (accuracy to better than 0.1% at 1kc can be maintained with occasional calibration against a known standard).

**Dissipation Factor Range at 1kc:**  
0 to 1.05 in 3 ranges, 0.0001 per dial division. Accuracy  $\pm 0.0005$  plus 2% of reading.

For complete information contact your nearest ESI engineering representative or

**ELECTRO-MEASUREMENTS, INC.**

7524 S. W. MACADAM AVENUE  
PORTLAND 1, OREGON

CIRCLE 426 ON READER-SERVICE CARD FOR MORE INFORMATION

**esi**

*Key way*  
to accuracy in  
**CAPACITANCE  
MEASUREMENT**

## MODEL 270 CAPACITANCE BRIDGE

A precision laboratory bridge designed to measure a wide range of capacitance at audio frequencies. Extreme simplicity of operation with direct-reading dials and multipliers, plus dual range null indicator. Excellent shielding; no zero capacitance correction needed with suitable test leads. Unique carrying handle converts to adjustable bench stand.



## GOES DIELECTRIC STRENGTH

(Up to 2,500 VRMS\* as required by MIL Specs—even up to 3,000 VRMS\*)

## GOES INTERNAL TEMP. RISE

(25% cooler internal hot spot)

50 WATT  
0.3 to 60,000 ohms



25 WATT  
0.1 to 16,000 ohms



Tolerances  
from 3%  
to .05%

Meet all requirements of applicable military specifications in existence or in prospect.

\*GUARANTEED (AT SLIGHT PREMIUMS)

## NEW SAGE Type "M" (Metal-clad) "Silicohm" Resistors Give You BOTH!

If you have been stumped because miniature, chassis-mounted resistors in the past offered only 1,000 VRMS dielectric, then here's good news. Thanks to a superior, new type of filling material and new production techniques, SAGE now offers this new, improved, precision wire-wound resistor with a standard rating of 1,500 VRMS dielectric strength—and up to 3,000 VRMS on special order. And the cooler hot-spot means longer life, improved stability and greater all-around reliability.

Complete data available on request

**SAGE**

**ELECTRONICS CORPORATION**

302 North Goodman St., Rochester 7, N.Y.

CIRCLE 427 ON READER-SERVICE CARD FOR MORE INFORMATION

## Patents

### Single Stage Amplifier-Detector-Amplifier

Patent No. 2,785,299. J. G. Spracklen. (Assigned to Zenith Radio Corporation)

The amplifier combines in a one tube stage a circuit which amplifies the input signal, demodulates the signal and amplifies the demodulation components of the input signal. The amplifier is suitable for frequencies of about 1 megacycle or higher. Accomplishing these various functions in one tube results in a reduction in the cost of making a receiver using the amplifier.

In the complete circuit of the figure, the input signal is amplified, converted to an intermediate-frequency and the intermediate-frequency is amplified in a conventional manner. The amplified and converted input signal is coupled through the capacitor 41 to the input grid 32 of the tube 30. An accelerating electrode or grid 33 is provided between the input or first control grid and a second control grid 34. This arrangement provides a virtual cathode at the second control grid. By selection of a proper inductive load circuit for the second control grid which is greater than the reciprocal of the effective trans-

conductance between the grids 32 and 34 at the intermediate frequency, amplification of the intermediate frequency signal is secured across the load circuit 44. This amplification ratio may be ten or more.

The second control grid has an accelerating grid 36 between this control grid and plate. The second control grid to cathode circuit also includes a rectifier 49 and a passive network consisting of the resistor 50, capacitor 47 and the interelectrode capacitance 46. The time constant of the rectifier load network is short with relation to the highest video frequency component which is to be detected in the circuit. The detected signal which appears across the resistor 50 and capacitor 47 is applied to the second control grid through the coil 45. The electron flow to the plate 35 is therefore modulated and further amplified. The audio intercarrier signal is taken off at the transformer 59 in the plate circuit of the tube and the video signal is applied to the cathode ray tube through a video amplifier 15. The synchronizing signals are also taken from the circuit at a point between the transformer and inductor 56.

The patent describes various other forms

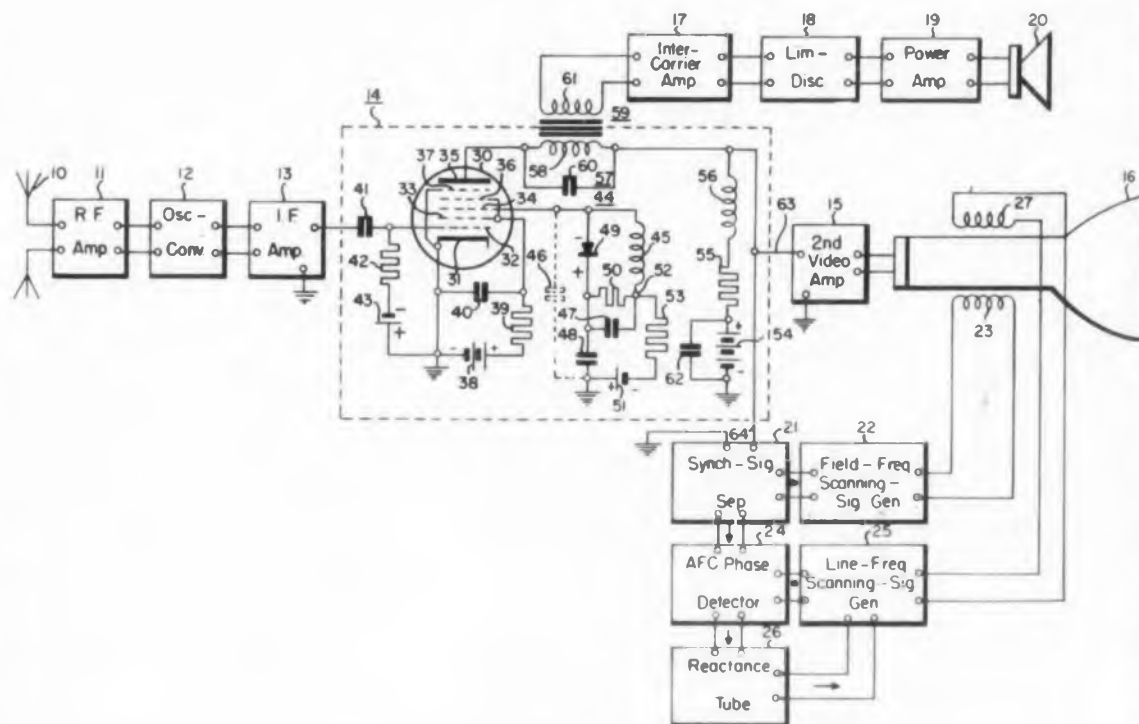

the circuit which accomplishes the functions enumerated in a single stage. It also describes a circuit in which the amplifier may be used in a circuit in which the audio and the video portion of the signal for a television receiver are separately detected.

#### Reactance Tube Circuitry

Patent No. 2,790,147. A. C. Armstrong et al. (Assigned to Vitro Corporation of America)

Numerous circuits require the frequency of an oscillator to be shifted above and below a natural or center frequency. Usually, the frequency shift is dependent upon a

This circuit is designed to prevent the amplitude modulation which occurs in prior circuits and its operation is clear from the diagram. Elements 12 and 13 are adjusted so that their impedance is the same at the central frequency of the oscillator. As the frequency varies from the central frequency, the impedance of the series connection 12-13 varies and this injects a component of voltage, which is in phase, or in opposite phase, with respect to the potential across the terminals 4-5, and hence across the tank circuit 7-8. The effect is the injection of an apparent resistive component which is either positive or negative, depending on the phase relation.

Various L, C, R, components may be substituted in the circuit between 4 and 5 and 14 and 15.

This patent also describes various forms of circuits of the push-pull type using two reactance tubes coupled to the tank circuit, improving operation of oscillator.

#### Square Wave Phase Shifter

Patent No. 2,798,970. William G. Hall and Robert I. Van Nice. (Assigned to Westinghouse Electric Corporation)

The circuit simplified includes a square wave generator providing an output of two separate square wave signals. One square wave signal is applied to the primary winding of a transformer. An impedance element is in series with the secondary winding. The opposite ends of the series combination of the secondary winding and the impedance elements are connected with a first rectifier and a first inductor as well as with a second rectifier and a second inductor. Suitable means are provided for selectively saturating the first and second inductors. The circuitry adds at least a portion of the voltage across the impedance element with one of the square wave signals from the generator to produce a resultant square wave signal.

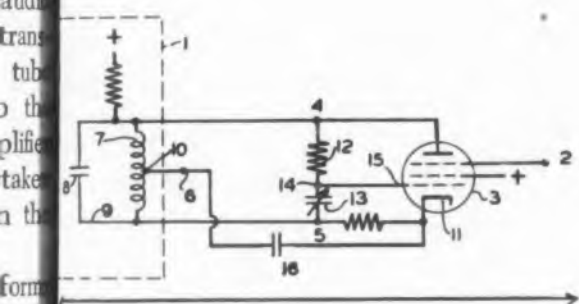

modulating signal applied to the oscillator. As shifting of the central frequency has been accomplished by varying the reactance of the tank circuit for the oscillator, by injecting a variable current into the tank circuit. The injection method does not physically change the circuit, however the apparent reactance values are changed, so that the resonant frequency of the tank circuit has also changed. Reactance tubes have been used for securing current for injection into the tank circuit, but have not previously provided a completely satisfactory solution. These circuits introduce voltage components which have the apparent effect of producing additional resistance into the tank circuit, changing the Q of the tank circuit, causing amplitude modulation of the frequency modulated output signal from the oscillator.

# A Radical New Approach!

TO DIFFICULT SWITCHING REQUIREMENTS

## CERAMIC VACUUM RELAYS

by *Jennings*

### Vacuum Enclosure

Insures Clean Contacts that stay clean at dry circuit levels.

Reduces Contact Arcing and Pitting at high currents.

### Stacked Ceramic Construction

Permits Small, Compact Design that insures reliable performance under extremes of vibration, temperature, and shock.

### Three Sets of Parallel Contacts

Increase Reliability because three relays in parallel are more reliable than one.

Decrease Bounce Time to less than 100  $\mu$ sec.

Increase Make Current to 100 amperes inrush because contacts are not bouncing and arcing.

Increase Contact Life when interrupting currents up to 15 amperes at 28 vdc or 2 amp at 300 vdc.

(Heavy duty contacts will interrupt up to 60 amps at 28 vdc)

This revolutionary new vacuum relay has been fully tested and is available in production quantities.

Send for catalog literature on SPDT and 4PDT Type RA relays.

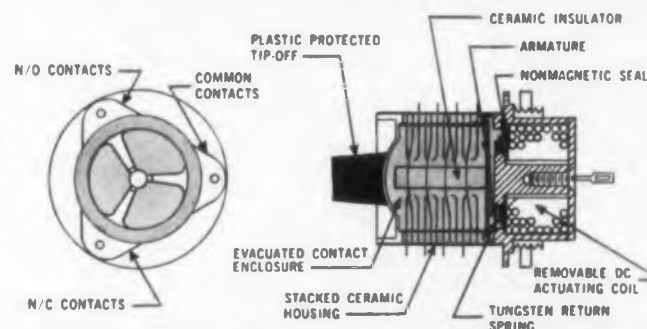

JENNINGS RADIO MANUFACTURING CORPORATION • 970 McLAUGHLIN AVE. P.O. BOX 1278 • SAN JOSE 8, CALIFORNIA

CIRCLE 428 ON READER-SERVICE CARD FOR MORE INFORMATION

# INTRODUCING



## A NEW SERIES OF SIX PLUG-IN BLOCKING OSCILLATOR CIRCUITS

Designed for the engineer who needs a triggered blocking oscillator for research or prototype development. Ready-to-operate unit (less 12AU7 tube) plugs into standard octal socket. Available in six different pulse widths: 0.1, 0.2, 0.5, 1.0, 2.0, and 5.0 microseconds. Two outputs: one positive and one reversible positive or negative.

Immediate delivery on pre-production or sample quantities. No obligation for engineering pulse transformers or complete blocking oscillator circuits to meet individual requirements.



Engineering kits containing various assortments of sub-miniature and miniature pulse transformers available. Kit KA4, pictured above, contains five different hermetically-sealed subminiature pulse transformers conforming to MIL-T-27A specifications.



Blocking Oscillator Bulletin BO.  
Pulse Transformer Bulletin KA.



C.B.C. ELECTRONICS CO., INC.  
2601 NORTH HOWARD ST.  
PHILADELPHIA 33, PENNA.

CIRCLE 429 ON READER-SERVICE CARD FOR MORE INFORMATION



Fairchild Pressure transducers are built to the same high standards of reliability and accuracy that are characteristic of Fairchild precision potentiometer components. The TP-200, illustrated, is a compact unit approximately two inches in diameter. It measures absolute, differential or gauge pressures in the range of 0-5 to 0-100 psi.

## MINIATURE PRESSURE TRANSDUCERS

These components are available in 2" and 3" diameter sizes in single or dual types. Resistance range is from 500 ohms to 50K ohms in either linear or non-linear, single or dual potentiometer outputs. Other types of D.C. and A.C. pick-ups also can be supplied. They are designed to meet applicable military environmental specifications. Total overall accuracy of the units is better than 2%. The temperature-compensated capsular diaphragm in standard units restricts temperature error to within 1% of the full scale pressure up to 100°C. For complete information write Fairchild Controls Corp., Components Division, Dept. 140-86N.

EAST COAST  
225 Park Avenue  
Hicksville, L. I., N. Y.

WEST COAST  
6111 E. Washington Blvd.  
Los Angeles, Calif.

**FAIRCHILD**  
PRECISION POTENTIOMETERS  
and COMPONENTS

CIRCLE 430 ON READER-SERVICE CARD FOR MORE INFORMATION

## Patents

### Sync Separator

Patent No. 2,797,258. B. E. Denton. (Assigned to Radio Corporation of America)

The circuit has for its purpose an improvement in the operation of the synchronizing pulse separator in the presence of noise. A signal source, having one output terminal, provides synchronizing pulses of positive sense. An automatic gain control unit is coupled to the signal source and provides a control potential of an amplitude dependent upon the signal strength. This automatic gain control unit has a relatively slow time constant response characteristic. The sync separator circuit has an amplifier tube with its grid input circuit coupled to the output terminal of the signal source. A grid leak biasing circuit, which has a relatively fast time constant, is coupled in the grid input circuit and is operable upon grid current flow at the peaks of the synchronizing pulses. This establishes a bias in such direction as to provide a variable threshold for the synchronizing pulses. A circuit connects the automatic gain control unit to the grid leak biasing circuit in such polarity as to aid the variable threshold action. With the circuit, noise immunity is secured in the presence of weak signals and improved synchronizing pulse separation can be attained over a wide range of variation in the signal strength.

### Steep Wave Front Voltage Generating System

Patent No. 2,798,985. Alfred J. Hansen. (Assigned to Allis-Chalmers Manufacturing Co.)

The system uses a tube having an input circuit which impresses a relatively steep front voltage wave upon the control grid. The input circuit includes a saturable core reactor having an inductive winding and a control winding. Current is supplied to the control winding to presaturate the reactor to a predetermined value. The inductive

winding constitutes a part of a series circuit including a source of alternating voltage, a capacitor, and a parallel circuit of a resistor and a diode. The parallel circuit is connected between the grid and cathode of the tube with the positive pole of the diode at the control grid.

### Control Apparatus

Patent No. 2,798,157. Warren W. Gruber. (Assigned to Minneapolis-Honeywell Regulator Company)

The control apparatus includes a controlled circuit having a single adjustable impedance element adjusted to various values. The circuit is actuatable into one or another of its conditions depending upon the relationship between the adjusted value to which the impedance element is adjusted and a control point value. A first means operates the element to shift the value of the element and hence the control point value between two predetermined values alternately during periods which alternate at a predetermined frequency. A first and second responsive portions are responsive to the condition of the control circuit. A second means is operated by the responsive portions to cause one of the portions to respond to the condition of the circuit during the periods in which the control point has one of two predetermined values and to cause the other of responsive portions to respond to the condition solely during the alternate periods in which the control point has the other of the two values.

### Active Transducer

Patent No. 2,788,496. J. G. Linvill. (Assigned to Bell Telephone Laboratories, Inc.)

A wave filter for transmission particularly at very low frequencies often requires the use of large and expensive conductors. A wave filter using only resistors and ca-



capacitors generally has high losses in the transmission band and requires many additional elements as compared to one using inductors and capacitors. An earlier patent by Dietzold, 2,549,065, is referred to, in which the limitations of transmission networks are overcome by using an active

transducer to provide a gain. The networks can be designed to eliminate one type of reactor and the number of reactors will compare with prior transmission networks without restriction in the transmission characteristic of the circuit. The passive networks may be made including inductors and capacitors or may be made up of reactors of the same type. Because resistors and reactors are more desirable from the standpoint of cost and size, they are more commonly used than inductors. The passive network portions may be of the various known types.

Illustrated is one of the transmission networks having passive networks 1 and 2 between which is a negative impedance converter serving as the active transducer. The converter may take several forms and may be of the vacuum tube or transistor type. Two or more converters may be used isolated from each other by one or more amplifiers. The patent describes in detail the network theory and the formulas which may be used in designing a circuit to meet required transmission characteristics. The circuit may be designed for low pass, high pass or band pass filters.

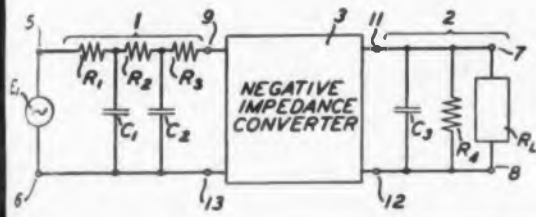

transducer between passive networks. The active transducer described in the Dietzold patent uses a stabilized feedback amplifier. This new patent describes and illustrates a variety of transmission networks consisting of two passive networks with an active transducer between the networks in which the transducer is a negative impedance converter. This circuit enables a simplified design procedure to be used, and the circuit may be designed to reduce the loss in the transmission band, or the circuit may be de-

## POSITIVELY SEAL OUT ALL... *Dirt-Dust-Fumes-Moisture*

with

# APM

**HIGH PRESSURE  
SWITCH and SHAFT SEALS,  
SELF-SEALING SCREWS**



HEXSEALS\*

APM HEXSEALS for Switches and Shafts consist of a grooved nut to which is molded a rubber boot. High pressure sealing is maintained by a gasket rib — an integral part of the boot — which seats firmly against any panel surface regardless of finish.

APM SEELSKREWS — Pre-assembled, vibration resistant fasteners, designed for panels and motor housings. A rubber O-ring is pressed into a groove underneath the head of the screw. They will seal in excess of 500 psi, internal and external pressure.

**HEXSEALS and SEELSKREWS**

**Meet Military Specs:**

MIL-B-005423A (ASG)

MIL-B-19257 (Ships)

SCL-6303 (Sig. Corps)



SEELSKREWS\*

Send for complete  
Military Catalog M-3,  
or Commercial Catalog C-3.



**AUTOMATIC and PRECISION MANUFACTURING CO.**  
252 Hawthorne Ave., Yonkers, N. Y.

CIRCLE 432 ON READER-SERVICE CARD FOR MORE INFORMATION

Drive coil leads out the top (as shown) or through base pins

1 7/16"

3/4"

Fits 7-pin miniature socket

### Miniature 60-CPS Servo Chopper

Here is a highly reliable mechanical modulator for use in servo systems and operational amplifiers — whenever rectified. It withstands all normally encountered environments; remains within specifications for 2,000 hours.

- \*Nominal drive is 6.3 volts at 60 CPS, operates 30-90 CPS.
- \*Hard alloy contacts are rated for 0-2 ma at 0-100 volts.
- \*Phase angle is 20 degrees; dwell time is 167 degrees.
- \*Noise is only 50 microvolts average.

**AIRPAX**  
PRODUCTS  
COMPANY

CAMBRIDGE DIVISION  
JACKTOWN ROAD  
CAMBRIDGE  
MARYLAND

CIRCLE 433 ON READER-SERVICE CARD FOR MORE INFORMATION

another  
wonderful  
**GRC idea**  
for designers

## GRC's UNIQUE AUTOMATIC METHODS INSERT THREADED PIECES, WIRES, even CONTINUOUS ELEMENTS, RIGHT IN THE MOLDING OR CASTING CYCLE

Fast . . . economical, GRC's exclusive automatic machines insert elements in zinc alloy die castings . . . in thermoplastic moldings, assure uniformity, eliminate assembly . . . make possible entirely new designs . . . cut labor and costs.

Write for bulletins, send prints for quotation.

No size is too small! Maximums: Zinc Alloy 1 1/2", 1/2 oz.  
Plastic 1 1/4", .03 oz.

Be sure to see GRC at the Metal Show Booth 1343

**GRIES REPRODUCER CORP.**

World's Foremost Producer of Small Die Castings

40 Second St., New Rochelle, N. Y. • New Rochelle 3-8600

CIRCLE 431 ON READER-SERVICE CARD FOR MORE INFORMATION

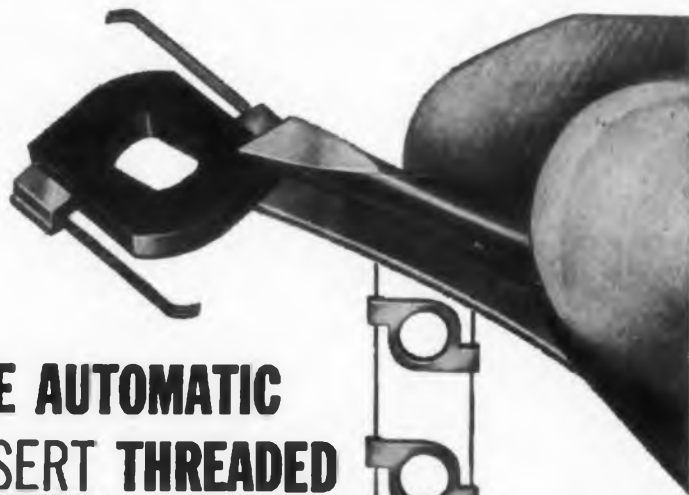

A DOUBLE  
INSERT Part, auto-  
matically produced

For this IBM Brush  
Assembly, the core is  
die cast automatically  
and continuously  
onto 6 strands of  
music wire on  
each side.

In the second cycle  
the nylon insulating  
jacket is molded  
automatically and  
continuously . . .  
right onto the die  
cast core and  
wire inserts.

**GRIES**



## LOW BUDGET

CUSTOM MOLDED  
COIL FORMS



With presses and equipment of our own design we are able to produce custom designed coil forms from almost any moldable material, (including nylon Kel F and the so-called high heat materials used in "class C" bobbins).

Our fast delivery, low tool cost and high quality have made Booker & Wallestad, Inc. one of the country's largest producers of custom molded, ready to use, coil forms.

Don't improvise by using "stock" bobbins without getting our quotation.

Custom Molders of Plastics for Industry

**Booker & Wallestad, Inc.**

3336 CORHAM AVE. • MINNEAPOLIS 26, MINN.

CIRCLE 434 ON READER-SERVICE CARD FOR MORE INFORMATION

## The A. W. HAYDON COMPANY'S ELAPSED TIME INDICATORS

measure a  of time . . . for

**INDUSTRIAL,  
AIRCRAFT  
and  
MILITARY  
applications**

Preferred  
Where  
Performance  
is  
Paramount



7500 Series Reset Type Elapsed Time Indicator. Send for Bulletins: AWH ETG01. Reset Type Elapsed Time Indicators 7500, 12500, 24200 Series.



7500 Series DC Elapsed Time Indicator. Send for Bulletins: AWH ET600. Basic Elapsed Time Indicators 7500, 12500, 24200 Series.

Now the Company offers a complete line of timing motors and devices to record the operating time of any electrical or electronic equipment. Compact, minimum weight, each unit has five digits. They can be used to provide daily running time plus a total running record, eliminating estimating or manual totalizing. In both AC and DC, continuous or manual reset for 50 or 60 up to 400 cycle line frequency. Will measure hours or on down to 10ths of seconds. All models can be supplied with Radio Interference Filtering, to meet MIL-1-6181B.

**A. W. HAYDON Company**

22 NORTH ELM STREET, WATERBURY 20, CONNECTICUT  
Design and Manufacture of Electro-Mechanical Timing Devices

Shown at the left is the new A. W. Haydon Co. catalog describing the complete line of timing motors and devices; if you haven't received your copy write for it on your company letterhead.

CIRCLE 435 ON READER-SERVICE CARD FOR MORE INFORMATION



## Books

### Receiving Tube Instruction Guide Book, Third Supplement

H. A. Middleton, John F. Rider Publisher, Inc., 116 West 14th St., New York 11, N.Y., 72 pages, \$1.35.

Most of the substitutions contained herein are for use in television receivers. Due to the heavy influx of British and other European electronic equipment a European-American and American-European tube substitution guide has been introduced. This supplement does not attempt to instruct the reader in how to improve radios, television receivers and other electronic equipment but rather advises the use of tubes which are available. A short descriptive passage concerning proper replacement of picture tubes has been included, however. Also included is a cumulative index indicating the volume and page in this and previous issues where the tube which requires substitution may be located.

### Fundamentals of Mechanical Design

Richard M. Phelan, McGraw-Hill Book Co., Inc., 330 West 42nd Street, New York 36, N.Y., 526 pages, \$8.75.

Written primarily as a textbook, this work broadly integrates the most important concepts normally covered in the design sequence for mechanical engineers, e.g., kinematics, mechanism, dynamics of machinery, and design of machine elements. Major emphasis is placed on what can be done, what principles are involved and where one can find the additional information that may be required in actual design or selection of mechanical elements or a machine. A large number of illustrations of actual parts and machines is included and handbook information has been kept to a minimum. Text coverage is extended by sample problems of wide scope.

### Transistor Circuit Engineering

Richard F. Shea, Editor, John Wiley and Sons, Inc., 440 4th Ave., New York 16, N.Y., 468 pages, \$12.00.

Guest Reviewer—Joseph P. Harper, Ph.D.

In the few years since transistors came into being there has been a steady evolution in the manner of their treatment and in the development of circuits particularly suited to their inherent characteristics. It was soon evident that with the proper types of transistors and associated circuits all of the operations heretofore performed by vacuum tubes could be accomplished equally well with transistors. In addition it was also found that transistors were more readily adaptable for certain applications than vacuum tubes, as for example, in switching circuits. With the mounting drive for miniaturization of complex electronic systems, for which transistors have an obvious appeal, there has been increasing activity in the development of special purpose transistors and more suitable circuits by which to utilize their characteristics most effectively. Such advancement has encouraged the publication of new texts on the subject, of which *Transistor Circuit Engineering* is an excellent example.

This book was written with the aim of keeping the reader abreast of the rapidly expanding field of transistor utilization and to bring him up-to-date on the advancements in the knowledge of transistor characteristics and performance. It was written by a group in the GE Electronics Laboratory in Syracuse and edited by Richard F. Shea of the GE KAPL, who edited an earlier transistor text, *Principles of Transistor Circuits* (1953).

The first few chapters deal with transistor parameters and equivalent circuits, and with the standard applications of transistors in radio and TV. Many forms of audio power, intermediate and rf amplifiers are

well as oscillators, modulator and detector circuits, are illustrated and analyzed. Matrix equations are employed in setting up the relationships between transistor parameters and external currents and voltages. Additional useful notes on matrix algebra are included in the Appendix. One chapter is allotted to the rather troublesome problems of bias stabilization and temperature equalization.

Perhaps the most significant part of the book to those already modestly familiar with transistors and their circuits will be the last three chapters which deal with pulse circuits, systems and special circuits. Of particular interest to the budding computer engineer is a comprehensive treatment of the many pulse circuits which find wide applications in digital computers such as gates, logic circuits, flip-flops, scalars, registers, multivibrators and magnetic-core driver circuits. Another notable feature is the consideration given to active filters, dc converters, inverters and voltage regulator circuits under the chapter heading of Special Circuits.

A set of problems and pertinent bibliographic material is included at the end of each chapter. The book might well serve

as an advanced undergraduate text for an engineering course in transistor circuits or as a reference book for the engineer already active in the transistor field.

*Dr. Harper is Staff Consultant, Daystrom Instrument, Archbald, Pa. and Head of the Dept. of Physics, Univ. of Scranton.*

#### Spheroidal Wave Functions

*Carson Flammer, Stanford University Press, Stanford, Calif., 220 pages, \$8.50.*

A detailed and unified account of the properties of spheroidal wave functions as they are known to date, with 166 useful tables facilitate the use and calculations of these functions. The present work treats in addition to the electromagnetic problems of the prolate spheroidal monopole antenna, and the scattering of electromagnetic waves by a perfectly conducting circular disk, the prolate and oblate spheroidal wave functions. In view of its express purpose the nomograph is directed to the applied mathematician, the mathematical physicist, and the mathematical engineer, and not to the pure mathematician. The existence of solutions and the completeness of sets of functions are presumed and not shown.

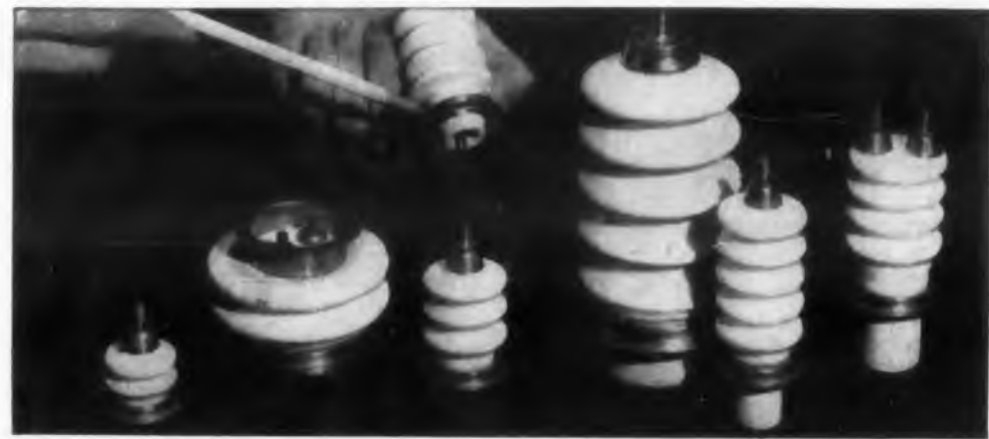

*For exacting, high-temperature applications...*

## CERAMASEAL LEAK-TIGHT TERMINALS

Assuring you savings in installation and operation, these Ceramaseal high-temperature terminals are 100% leak-tested and guaranteed leak-tight when shipped.

**High-alumina ceramic** and metal parts of Ceramaseal terminals are joined by an exclusive process to form a high-strength, long-life molecular seal.

**Brazing, welding or soldering** techniques can be used for installation, without resulting damage to the seal, thus eliminating costly rework or replacement.

**For brochure** and spec sheets, or complete information on special high-temperature terminals, write: Ceramaseal, Inc., Box 25, New Lebanon Center, New York.

*Supplying High-temperature, Quality Terminals for Five Years*

# CERAMASEAL, Inc.

CIRCLE 436 ON READER-SERVICE CARD FOR MORE INFORMATION

- Accurate
- Compact
- Light Weight
- Portable

Designed for the field... Exacting enough for laboratory use

THIS  
ELECTRONICS  
TESTING  
EQUIPMENT  
IS  
PRECISION IN  
MINIATURE



\$150

For balanced output, two MATCHING TRANSFORMER models are available. These are in cases which attach permanently to the bottom of the 510B.

	T10	T11
Output level	+8dbm	+10dbm
Impedance	150/600	135/600
Range	20-50,000cps	20-200,000cps
Price	\$40.	\$90.



333 Sixth Avenue, New York 14  
Watkins 9-2795

Write for full catalog  
DELIVERY FROM STOCK



CIRCLE 437 ON READER-SERVICE CARD FOR MORE INFORMATION



## NEW GLASSCAPS

Glasscaps TYPE of capacitors are manufactured with improved characteristics.

**TEMPERATURE RANGE** with full NEW rated voltage  $-55^{\circ}\text{C}$  to  $85^{\circ}\text{C}$ .

**NEW LOW POWER FACTOR** at 60 cycles less than 0.9% over temperature range  $-40^{\circ}\text{C}$  to  $-20^{\circ}\text{C}$  less than 0.4% from  $-40^{\circ}\text{C}$  to  $100^{\circ}\text{C}$ .

**NEW LOW TEMPERATURE COEFFICIENT** less than 4% change from room temperature to  $-55^{\circ}\text{C}$  or  $100^{\circ}\text{C}$ .

**NEW HIGH RESISTANCE** at high temperature—greater than 100 megohms x mfg. at  $100^{\circ}\text{C}$  with FULL RATED VOLTAGE applied.

Write for FREE Glasscaps Information



# Plastic Capacitors, Inc.

2620 N. CLYBOURN AVE., CHICAGO 14, ILL.

CIRCLE 438 ON READER-SERVICE CARD FOR MORE INFORMATION

Pulse Distortion Produced by Noise in Phase-Modulated Tonal-Telegraphy Channel. A. M. Zingenko, (10 pp, 7 figs, 1 table).

Detailed theoretical analysis of the pulse-duration time distortion produced in a phase-modulated channel by sinusoidal, fluctuating, and pulsed noise. It is shown that phase-modulated tonal-telegraphy channels have twice the noise rejection of AM channels, but are not as good as FM channels.

# What the Russians Are Writing

J. George Adashko

## ELECTRICAL COMMUNICATIONS

(Contents of *Elektrosviaz'* No. 2, 1957)

### CIRCUIT THEORY

**Technical Calculation of Attenuation Errors, D. D. Voieikov (5 pp, 2 figs, 3 tables).**

A method for calculating the errors occurring in attenuators operating at a fixed input voltage is described. The results are summarized in the accompanying table, which lists various types of attenuators (Column 1), their transfer functions (Col. 2), the relationships between their elements (Col. 3), the total ( $\xi$ ) and probable ( $\sigma$ ) relative errors in the transfer function in term of the tolerances ( $b_A, b_B$ , etc.) of the individual attenuator elements (A, B, etc.) (Col. 4), simplified values of the errors for the case when the tolerances of all the elements are equal ( $b_A = b_B = \dots = b$ ) (Col. 5), and the maximum errors (Col. 6). Equations are also derived for the transfer-factor errors of more complicated attenuator circuits.

**Problems in the Design of Bridged-T Filter Circuits, I. I. Petrov, (4 pp, 7 figs).**

The author shows that bridged-T filters are variants of M-derived filters and can be calculated with the same M factor. All arguments pertaining to the location of the attenuation peak apply to the bridged-T filter as to the M-derived filter.

Type of attenuator circuit	Equation for transfer factor $T = \frac{u_1}{u_2}$	Ratios between elements for $R=r$
	$1 + \frac{B}{r} + \frac{B}{C}$	$A = C = r \operatorname{ctg} \frac{\theta}{2} = r \frac{T+1}{T-1}$ $B = r \operatorname{sh} \theta = r \frac{T^2-1}{2T}$
	$\frac{AB + A(r+C) + C(B+r)}{Cr}$	$A = B = r \operatorname{tg} \frac{\theta}{2} = r \frac{T-1}{T+1}$ $C = r \frac{1}{\operatorname{sh} \theta} = r \frac{2T}{T^2-1}$
	$1 + \frac{A(BC + BD + Br + CD)}{r(AD + BC + BD + CD)}$	$B = C = r$ $A = r(T-1)$ $D = r \frac{1}{T-1}$
	$\frac{ABC + ABD + ACD + ACr + ADr + BCD + BCr + BDr}{r(AC - BD)}$	$B = D = r \operatorname{tg} \frac{\theta}{2} = r \frac{T-1}{T+1}$ $A = C = r \operatorname{cth} \frac{\theta}{2} = r \frac{T+1}{T-1}$
	$1 + (B+D) \left( \frac{1}{r} + \frac{1}{C} \right)$	$A = C = r \operatorname{cth} \frac{\theta}{2} = r \frac{T+1}{T-1}$ $B = D = \frac{1}{2} r \operatorname{sh} \theta = r \frac{T^2-1}{4T}$
	$\frac{(A+C+D)(B+C+E+r)}{Cr} - \frac{C}{r}$	$A = B = D = E = \frac{1}{2} r \operatorname{tg} \frac{\theta}{2} = \frac{1}{2} r \frac{T-1}{T+1}$ $C = r \frac{1}{\operatorname{sh} \theta} = r \frac{2T}{T^2-1}$

## INFORMATION THEORY

Concerning One Scheme for Signal Reception, A. A. Khar'kevich (5 pp, 6 figs, 1 table).

Discussion of one possible method by which a binary signal is received "as a whole." Such schemes, in which the received signal is compared with the set of transmitted signals and is identified with the code symbol from which it differs least, are the basis of most error-detecting and error correcting systems. A brief theoretical discussion of the

system is followed by a block diagram and description of a possible receiver circuit suitable for this purpose, using a cathode-ray screen as the receiver.

## CONDUCTORS

Calculation of Active Resistance of Tubular Conductors, G. P. Delektorski (5 pp, 1 table).

The author determines at what frequencies it becomes advisable to substitute tubular for solid conductors, and derives the optimum tube wall.

## ACOUSTIC MEASUREMENTS

Improved Methods for Measuring Nonlinear Distortion, N. L. Bezladnov, (10 pp, 5 figs, 1 table).

Analysis of methods for obtaining the best agreement between measurements and the degree of subjective perception of nonlinear distortion of sound reproduction. Since the subjective perception is most sensitive to the loudness of the distortion, to its masking by the transmitted signals, and to the background noise, these factors must be taken into

## TABULATION OF ATTENUATION ERRORS

Equations for errors	Simplified Equations for errors	Maximum errors
$\xi = \frac{(T-1)^2}{2T^2} \left[ \sigma_C + \frac{2T}{T-1} \sigma_B + \frac{T+1}{T-1} \sigma_r \right]$ $\sigma = \frac{(T-1)^2}{2T^2} \sqrt{\sigma_C^2 + \frac{4T^2}{(T-1)^2} \sigma_B^2 + \frac{(T+1)^2}{(T-1)^2} \sigma_r^2}$	$\xi = 2\sigma \left( 1 - \frac{1}{T} \right);$ $\sigma = \sigma \left( 1 - \frac{1}{T} \right) \sqrt{1.5 + \frac{1}{2T^2}};$	$\xi_{\text{max}} = 2\sigma$ $\sigma_{\text{max}} = 1.22\sigma$
$\xi = \frac{T-1}{2T^2(T+1)} [2T^2\sigma_A + (T^2+1)\sigma_B + 2T(T-1)\sigma_C + (T+1)^2\sigma_r],$ $\sigma = \frac{T-1}{2T^2(T+1)} \sqrt{4T^4\sigma_A^2 + (T^2+1)^2\sigma_B^2 + 4T^2(T-1)^2\sigma_C^2 + (T+1)^4\sigma_r^2}$	$\xi = \sigma \left( 1 - \frac{2}{T+1} \right) \left( 3 + \frac{1}{T^2} \right);$ $\sigma = \sigma \left( 1 - \frac{2}{T+1} \right) \sqrt{2.5 - \frac{1}{T} + 3\frac{1}{T^2} + \frac{1}{T^3} + \frac{1}{T^4}};$	$\xi_{\text{max}} = 3\sigma$ $\sigma_{\text{max}} = 1.58\sigma$
$\xi = \frac{1}{2T^2} [(T^2-1)\sigma_A + (T-1)\sigma_B + (T-1)^2\sigma_D + (T^2-1)\sigma_r]$ $\sigma = \frac{1}{2T^2} \sqrt{(T^2-1)^2\sigma_A^2 + (T-1)^4\sigma_B^2 + (T-1)^4\sigma_D^2 + (T^2-1)^2\sigma_r^2}$	$\xi = 2\sigma \left( 1 - \frac{1}{T} \right);$ $\sigma = \sigma \left( 1 - \frac{1}{T} \right) \sqrt{1 + \frac{1}{T^2}};$	$\xi_{\text{max}} = 2\sigma$ $\sigma_{\text{max}} = \sigma$
$\xi = \frac{T^2-1}{8T^2} [(T+1)\sigma_A + (T-1)\sigma_B + (T+1)\sigma_C + (T-1)\sigma_D + 4\sigma_r]$ $\sigma = \frac{T^2-1}{8T^2} \sqrt{(T+1)^2\sigma_A^2 + (T-1)^2\sigma_B^2 + (T+1)^2\sigma_C^2 + (T-1)^2\sigma_D^2 + 16\sigma_r^2}$	$\xi = \frac{1}{2} \sigma \left( 1 - \frac{1}{T^2} \right) (T+1);$ $\sigma = \sigma \frac{T}{4} \left( 1 - \frac{1}{T} \right) \sqrt{1 + \frac{5}{T^2}};$	$\xi \rightarrow \infty$ $\sigma \rightarrow \infty$
$\xi = \frac{T-1}{2T^2} [T\sigma_B + T\sigma_D + (T-1)\sigma_C + (T+1)\sigma_r]$ $\sigma = \frac{T-1}{2T^2} \sqrt{T^2\sigma_B^2 + T^2\sigma_D^2 + (T-1)^2\sigma_C^2 + (T+1)^2\sigma_r^2}$	$\xi = 2\sigma \left( 1 - \frac{1}{T} \right);$ $\sigma = \sigma \left( 1 - \frac{1}{T} \right) \sqrt{1 + 0.5 \frac{1}{T^2}};$	$\xi_{\text{max}} = 2\sigma$ $\sigma_{\text{max}} = \sigma$
$\xi = \frac{T-1}{4T^2(T+1)} [2T^2(\sigma_A + \sigma_D) + (T^2+1)(\sigma_B + \sigma_E) + 4T(T-1)\sigma_C + 2(T+1)^2\sigma_r]$ $\sigma = \frac{T-1}{4T^2(T+1)} \times$ $\times \sqrt{4T^4\sigma_A^2 + 4T^4\sigma_D^2 + (T^2+1)^2(\sigma_B^2 + \sigma_E^2) + 16T^2(T-1)^2\sigma_C^2 + 4(T+1)^4\sigma_r^2}$	$\xi = \sigma \left( 1 - \frac{2}{T+1} \right) \left( 3 + \frac{1}{T^2} \right);$ $\sigma = \sigma \left( 1 - \frac{2}{T+1} \right) \sqrt{1.87 + \frac{1}{T} + 2.75 \frac{1}{T^2} + \frac{1}{T^3} + 0.375 \frac{1}{T^4}}$	$\xi_{\text{max}} = 3\sigma$ $\sigma_{\text{max}} = 1.36\sigma$

For Ultra High Frequency Insulation

## REXOLITE 1422

In cast rods of diameters to 6" and plates up to 36" x 36", from .031" to 1 1/2" thickness.



### REXOLITE 1422 CHARACTERISTICS

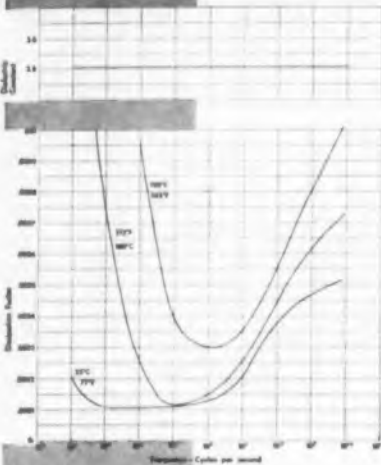

- Withstands high temperatures — to 400° F.
- Does not exhibit cold flow.
- Has low dielectric constant and power factor.
- Specific gravity of 1.045-1.050.
- Is strong and rigid with good tensile and impact strengths.
- Unusual chemical inertness permits its use where others fail.
- Readily machinable to close tolerances.

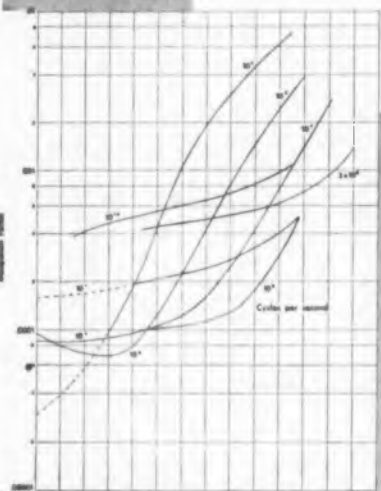

### WHERE PERFORMANCE PLUS PRICE IS A FACTOR REXOLITE 2200

UHF insulation in thermosetting sheets 36" x 36", .031"-.125" thick

- Has good punching properties.
- High impact strength.
- Good machinability.
- Dielectric constant 10-10,000mc, 2.77.

Send for complete technical data and samples

**The REX CORPORATION**  
Electronics Division

210 Hayward Rd.

West Acton, Mass.

CIRCLE 439 ON READER-SERVICE CARD FOR MORE INFORMATION

## Russian Translations cont.

account in any measurement procedure. Block diagrams for both static and dynamic measurement setups are given. Refers to "Factors Governing the Intelligibility of Speech Sounds" by French and Steinberg (Journal Acoust. Soc. Am., vol. 19, No. 6, 1947) and "A Table of Intermodulation Products" by A. A. Wass (Jl. Inst. EE, Vol. 95, part III, No. 33, 1948).

### OTHER ARTICLES IN THIS ISSUE

"Heinrich Hertz, On his 100th Birthday," G. A. Levin (2 pp). "Use of Contactless Elements in Control Circuits of Automatic Telephone Stations," V. N. Roginski, (10 pp, 11 figs). "Equalizer Circuits for Central-Battery Telephone Sets with Transistor Amplifiers," A. S. Sadovski, (10 pp, 6 figs, 1 table). "Status of Color TV Abroad," A. K. Kustarev (8 pp). Covers USA, France, England, and Holland.

### RADIO ENGINEERING AND ELECTRONICS

(Contents of Radiotekhnika i Elektronika No. 3, 1957)

The March 1956 "Radiotekhnika i Elektronika" continues the publication of papers delivered at the Eighth All-Union Conference on Semiconductors, held in Leningrad on November 14-20, 1955. The

first report was published in the August 1956 issue of Radiotekhnika i Elektronika (ED May 15, 1957). Although most of these articles deal with topics usually not treated in this periodical, the editors decided to publish all the papers delivered at this conference for the sake of completeness. We list by title and author only the entire contents of this issue except for the following three articles, which should be of interest to our readers.

### TRANSISTORS

**Investigation of Transistors with a Cathode-Ray Curve Tracer, A. M. Bonch-Bruevich, U. S. Soltamov (6 pp, 5 figs).**

Description of a laboratory model of oscillographic cathode-ray curve tracer that displays on the oscillograph screen all four families of static transistor characteristics (collector and emitter voltages vs. collector and emitter currents). Fig. 1 shows a block diagram of the instrument.

### GERMANIUM DETECTORS

**Investigation of Input Impedances and Experimental Check on the Equivalent Circuits of Germanium Detectors in the 1000-10,000 Mc Range, N. E. Skvortseva, (15 pp, 14 figs, 2 tables).**

The input impedance of germanium detectors with welded contacts was investigated over the range from 1,000 to 10,000 mc, and a proposed equivalent circuit of such detectors was experimentally verified in this range.

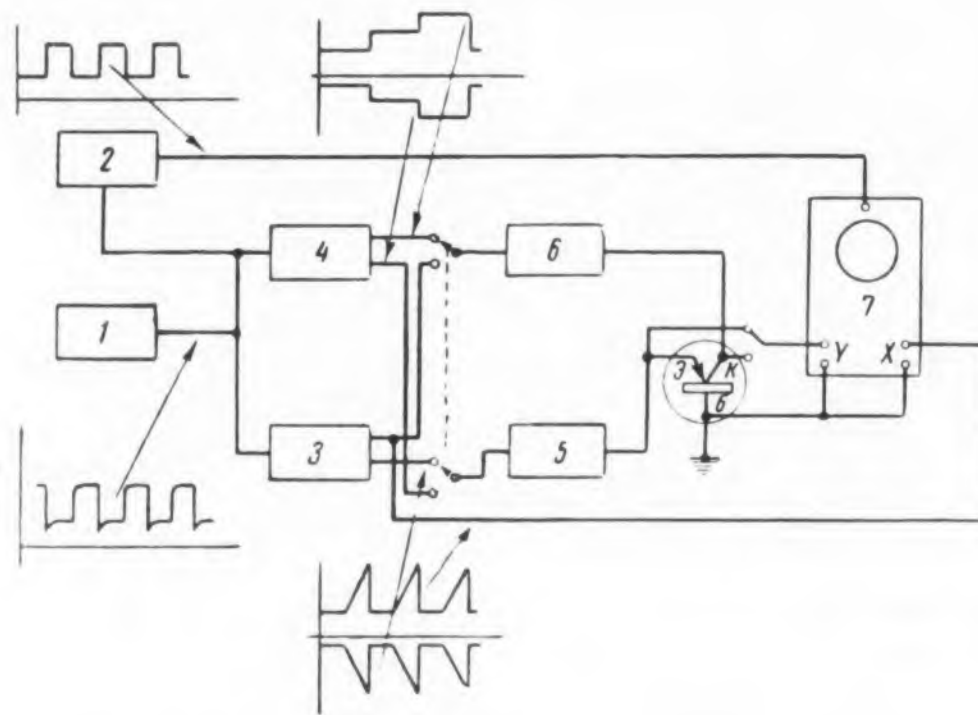

Fig. 1. Block Diagram of Cathode Ray Curve Tracer for Transistors. 1—multivibrator; 2—illumination pulse generator; 3—saw-tooth voltage generator; 4—staircase-voltage generator; 5—emitter-circuit supply; 6—collector-circuit supply; 7—oscillograph.

The input impedances were found to be functions of the detector construction, of the semiconductor properties, of the welding current, and of the fixed positive bias current.

It is shown that the proposed detector equivalent circuit is useful for the analysis of the frequency behavior of detectors, and for the design of detectors to meet specific requirements.

#### SEMICONDUCTOR BOLOMETERS

**Certain Problems Involved in the Application of Semiconductor Bolometers, A. M. Bonch-Bruevich, Ia. A. Imas (6 pp, 2 figs).**

The use of semiconductor bolometers for the investigation of high-speed processes is limited by the slow response time of bolometers. However, introducing an RC compensating network reduces the overall time constant of the measuring circuit to less than the time constant of the bolometer itself. The authors analyze also the change in threshold sensitivity caused by the compensation network and show that in some cases the compensation method reduces the threshold sensitivity less than an increase in the bolometer heat transfer (to reduce its response time).

#### Other Articles in This Issue

Effect of External Voltage and of other Factors on the Capacitive Photo Response of Semiconductors, V. E. Kozhenin, V. E. Lashkarev.

Effect of Adsorption of Molecules and of External Electric Field on Photoconductivity of Semiconductors, V. I. Liashenko, O. V. Snitko.

Photoelectric and Optical Properties of  $HgI_2$ , D. V. Chepur.

Production of Photo-EMF in Layers of Lead Sulphide, D. Ia. Berlaga, M. A. Rumsh, L. P. Strakhov.

Color Centers in KCl Crystals and in KCl Mixed with Ag, N. G. Politov.

New Modification of the Capacitor Method of Measuring the Contact Potential Difference and its Use in the Investigation of Contact Potentials of Semiconductors, V. F. Bogoliubov.

Vacuum X-Ray Spectrograph with Geiger Counter for the Investigation of Energy Levels in Solids, A. P. Likurski.

Theory of Spontaneous Magnetization of Ferrites, E. I. Kondorski, A. S. Pakhomov, T. Shiklosh.

Temperature Dependence of Spontaneous Magnetization in Co-Zn Ferrites at Low Temperatures, N. M. Reinov, M. F. Stel'makh.

Thermoelectric Properties of Ferrites Near the Curie Point, S. A. Verchenia, Ia. G. Dorfman.

Experimental Investigation of Field Emission from Lanthanum Hexaboride, M. I. Elinson, G. F. Vasil'ev.

Time Lag of Internal Photoeffect in Silver Chloride, K. K. Demidov.

## NEWS ABOUT SILICON DEVICES



SILICON RECTIFIERS are finding increasing use at elevated temperatures in aircraft and missile applications by providing more power per pound.

## Now...design improvements made possible with components of Du Pont Hyperpure Silicon

Today silicon rectifiers make possible a vast improvement in jet-age aircraft generators—the use of engine oil as a coolant instead of less-efficient ram air. Silicon rectifiers take the place of oil-sensitive brushes, commutator and slip rings... are completely unaffected by 150°C. engine oil. Result: a brushless generator of less weight and size than ordinary generators.

Silicon devices can similarly help you miniaturize—improve design and performance. Silicon rectifiers have excellent stability... can operate continuously at -65 to 200°C. They're up to 99% efficient—reverse leakages are only a fraction of those of other semiconductors. Both transistors and rectifiers of silicon can pack more capacity into less of your equipment space.

**Note to device manufacturers:** You can produce high-quality silicon transistors and rectifiers with Du Pont Hyperpure Silicon now available in three grades for maximum efficiency and ease of use... purity range of 3 to 11 atoms of boron per billion... available in 3 forms, needles, densified, cut-rod. Technical information is available on crystal growing from Du Pont... pioneer producer of semiconductor-grade silicon.



#### NEW BOOKLET ON DU PONT HYPERPURE SILICON

You'll find our new, illustrated booklet about Hyperpure Silicon helpful and interesting—it describes the manufacture, properties and uses of Du Pont Hyperpure Silicon. Just drop us a card for your copy. E. I. du Pont de Nemours & Co. (Inc.), Silicon N-2496-ED-10, Wilmington 98, Delaware.

#### PIGMENTS DEPARTMENT



BETTER THINGS FOR BETTER LIVING  
...THROUGH CHEMISTRY

CIRCLE 440 ON READER-SERVICE CARD FOR MORE INFORMATION



**ELGIN**  
announces the

**NEW ADVANCE**



**GH**  
SERIES

*Low Cost*

# Midget Relays

... open or plastic enclosed

Elgin's new GH series combines the high efficiency required of general purpose relays with low cost. Their midget size suits them for installations where space is a problem (see specifications below). Open relays in 5 and 10 ampere ratings and clear plastic dust-tight enclosed 5 ampere relays are immediately available from stock. Specify dependable ELGIN performance... specify GH from your electronic parts distributor!

## SPECIFICATIONS

**NOMINAL POWER REQ.**—DC relays, 1 to 2 watts; AC relays, 2 to 3 volt amperes.  
**NOMINAL VOLTAGE**—DC relays, 6 to 120 volts; AC relays, 6 to 220 volts. (On specification, DC voltage coil up to 220 volts or AC voltage coil up to 440 volts can be supplied.)

**RESISTANCE**—DC relays, 25 to 8,000 ohms; AC relays, 4 to 5,000 ohms.

**PULL-IN CURRENT VALUES**—7.2 Milliamps max. at 2,500 ohms; 5.0 milliamps max. at 5,000 ohms.

**DUTY CYCLE**—continuous.

**TEMPERATURE RANGE**— $-55^{\circ}$  to  $+85^{\circ}$  C when specified.

**INSULATION RESISTANCE**—100 megohms min.

**DIELECTRIC STRENGTH**—standard: 500 volts RMS. (When specified, 1,000 volts RMS can be met.)

**MAXIMUM WEIGHT**—2 ounces.

**GHA SERIES, 5 amp. open relay**

Contact rating, 5 amps. resistive, 2 amps. inductive at 115 volts AC or 26.5 volts DC. Contact material is fine silver, 1C, 2C, 3C arrangements only. Relay is 1.1" high, 1.732" long and .937" wide. Contact terminals can be used as solder lugs or for printed circuitry.

(Also available: GHB series, 10 amp. open relay.)

**GHP SERIES, 5 amp. clear plastic enclosed relay.**

Dust-tight plug-in. Contact rating, 5 amps. resistive, 2 amps. inductive at 115 volts AC or 26.5 volts DC. Contact material is fine silver, available in 1C or 2C arrangements only. Enclosure is  $2\frac{1}{16}$ " x  $1\frac{13}{32}$ " overall.  $2\frac{1}{8}$ " overall length above chassis.



**ELECTRONICS DIVISION**

ELGIN NATIONAL WATCH COMPANY

2435 N. Naomi Street, Burbank, California

CIRCLE 441 ON READER-SERVICE CARD FOR MORE INFORMATION

## Electronic Differentiation and Integration

E. Brenner

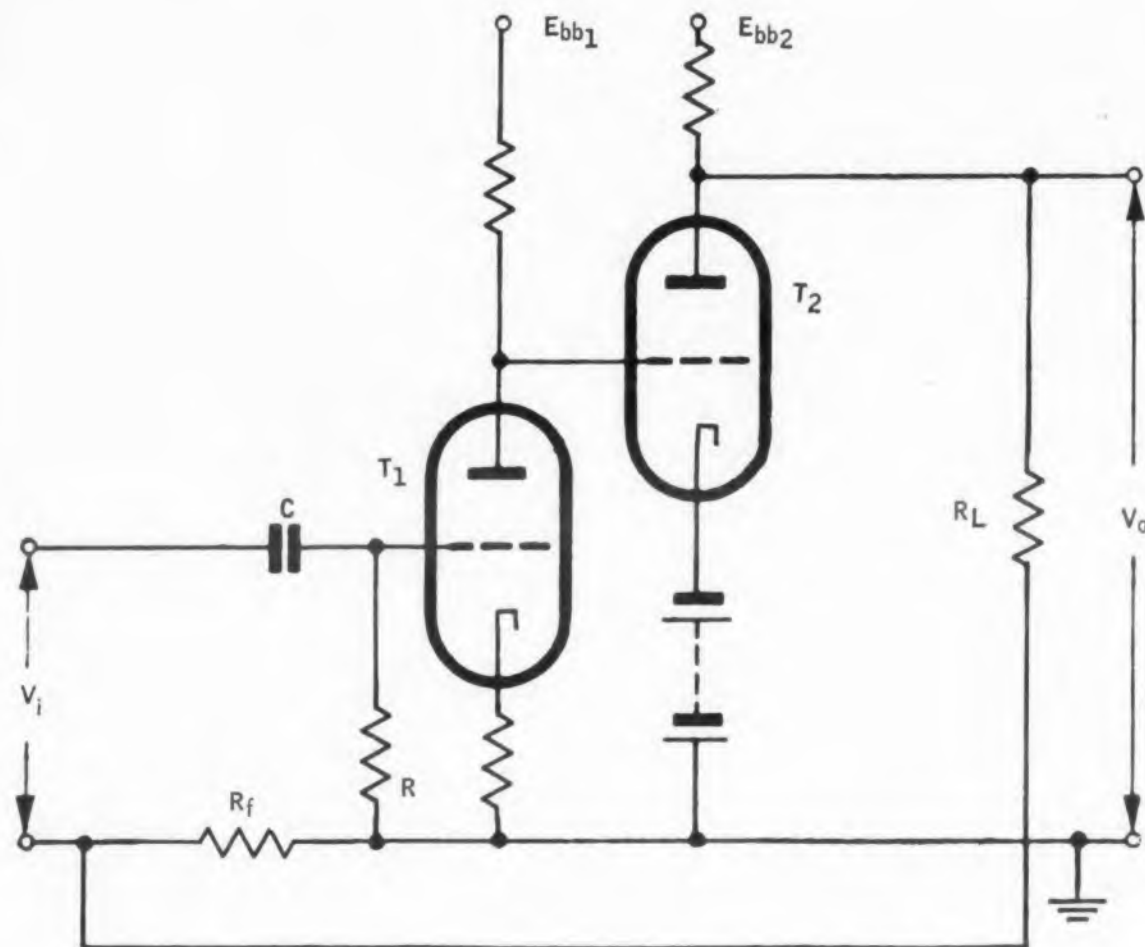

Fig. 1. Circuit for electronic differentiation. For integration R and C are interchanged.

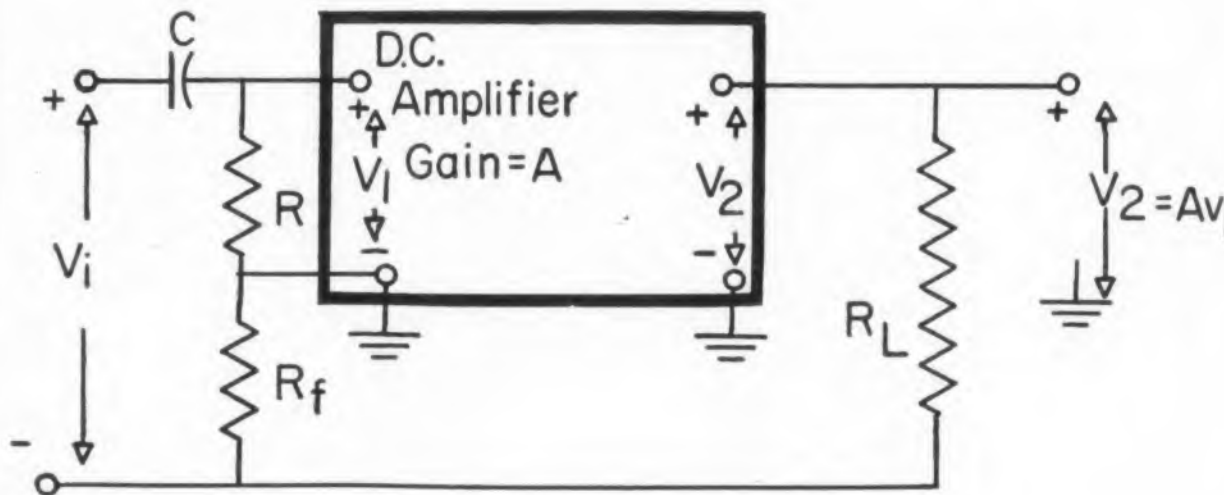

Fig. 2. Block diagram for analysis of Fig. 1. For integration R and C are interchanged.



## THE NATIONAL SCENE

THE FEEDBACK amplifier network shown in Fig. 1 is, if precisely adjusted, capable of integrating or differentiating the signal  $v_i(t)$ . Referring to the block diagram of Fig. 2, (neglecting the output impedance of the amplifier or including it in  $R_L$ ) the application of Kirchhoff's voltage law to the input mesh reads

$$\frac{1}{RC} \int v_i dt + \left[ \frac{R + R_f}{R} - \frac{AR_f}{R_L + R_f} \right] v_i = v_i \quad (1)$$

so that if

$$(R + R_f)(R_L + R_f) = ARR_f \quad (2)$$

the output voltage is proportional to the derivative of the input voltage, i.e.:

$$v_2 = A \cdot RC \frac{dv_i}{dt} \quad (3)$$

If  $R$  and  $C$  in Fig. 2 are interchanged then we have

$$(R_f + R)C \frac{dv_i}{dt} + \left[ 1 - \frac{AR_f}{R_L + R_f} \right] v_i = v_i \quad (4)$$

so that if

$$\frac{AR_f}{R_L + R_f} = 1 \quad (5)$$

the output voltage is proportional to the integral of the input voltage, i.e.:

$$v_2 = Av_1 = \frac{A}{(R_f + R)C} \int v_i dt \quad (6)$$

The order of magnitude of the gain required for satisfying condition (2) is 6400 (if  $R_f$  is small, e.g. 300 ohms) while a typical gain value required for condition (5) is 2500. (Abstracted from two articles by H. Wittke, *Electronische Rundschau*, Vol. 11, No. 1, January 1957, p7 and Vol 11, No. 3, March 1957, p73.)

**Abstracters Note:** In comparing the "operational amplifiers" proposed in the above abstract with the "conventional" circuits used in d.c. analog computers the following comments appear appropriate. In the new circuit the input is not grounded; this may be a serious defect. Moreover the exact operational property depends on satisfying exactly the conditions (2) and (5). Amplifier drift, component variations etc. not only change the scale in the new circuit but also impair the operation to as yet an uncertain extent. In the conventional, high gain operational amplifiers it is necessary to maintain exceedingly large gain but gain changes do not influence the operation, provided only that the gain remain above some minimum value. E.B.



"YOU FRAMED ME, NICK. AND I TOLD YOU I'D GET SQUARE. NOW . . ." And then the film broke! Film breakage—cause of movie audience irritation in the "old days"—is a minor problem today. Tomorrow

it will be a rarity. *Reasons:* Newly developed, polyester base motion picture film of unusual strength and durability (duPont "Cronar," for example) and better film splicers like that shown here.



**NATIONAL HELPS NEW SPLICER BOND FILM INSTANTLY**—without disturbing original molecular orientation. Non-acetate film cannot be spliced satisfactorily by conventional methods. So the new device, developed by Shepard Laboratories, Inc., Summit, N. J. uses intense high-frequency heat to fuse the film instantly—without "burning" or affecting grain, high strength or durability. Side result: a superior splicer for all types of film.



**IMPROVES PERFORMANCE—KEEPS COSTS DOWN.** PHENOLITE®, used in electrode supporting blocks, offers complete resistance to carbonizing. Copper-clad PHENOLITE for printed circuits cuts costs and improves circuitry. Shepard tells us: "PHENOLITE passed our tests . . . Reasonable price holds our costs down."

### NATIONAL CAN HELP YOU

reduce unit product cost or improve product performance at no added cost. Here's why: You can select the "one best material" from over 100 grades of PHENOLITE®, Vulcanized Fibre and National Nylon—without compromise in properties or cost. You can simplify production and purchasing with the timed delivery of 100% usable parts—from a single, reliable source. You gain competitively with National's new materials and grades—the direct results of programmed materials research. You benefit by calling National first. Check Sweet's PD File 2b/Na, the Telephone Directory Yellow Pages, or write Wilmington 99, Delaware, Dept. E-10.

**NATIONAL**  
**VULCANIZED FIBRE CO.**

WILMINGTON 99, DELAWARE

In Canada: NATIONAL FIBRE CO. OF CANADA, LTD., Toronto 3, Ont.

CIRCLE 442 ON READER-SERVICE CARD FOR MORE INFORMATION

# IDEAS FOR DESIGN—ENTRY BLANK

To the *Ideas-For-Design* Editor of ELECTRONIC DESIGN —  
19 E. 62nd St., New York 21, N. Y. • TEmpleton 8-1940

Here is my design idea for possible publications in your *Ideas For Design* department. I can expect \$10 for this idea if accepted for publication.

(Ideas suitable include: 1. new circuits or circuit modifications, 2. new design techniques, 3. designs for new production methods, 4. clever use of new materials or new components in design, 5. design or drafting aids, 6. new methods of packaging, 7. design short cuts, or 8. cost saving tips)

## STATEMENT OF THE PROBLEM—

MY SOLUTION. AND WHY— (Please be explicit. Included sketches or photos that will help get the idea across)

Signed \_\_\_\_\_

Title \_\_\_\_\_

Company \_\_\_\_\_

Address \_\_\_\_\_

(Place illustrations on separate sheet if necessary)



## Heat-Storage Cooling

A STUDY was made to find out whether cooling of components using heat storage materials as heat sinks was practicable. The study had particular reference to electronic equipment in high speed aircraft and missiles. Representative temperatures were simulated and a variety of chemicals examined for the proper characteristics.

The chemical literature was examined for materials undergoing a reversible solid-to-liquid phase transformation. Some 600 compounds were found; more careful examination reduced this number to 30, and finally two—paraffin and beeswax—were chosen for extensive testing.

The test program consisted of subjecting beeswax and paraffin, in two types of apparatus, either to step increases or step decreases in ambient temperatures—from 50 to 400 F, or from 200 to 50 F. The general result of these tests is that these two materials *do not have* sufficiently favorable properties. They would not yield a practical design of a heat-storage device for protection of a representative piece of electronic equipment, if this were subjected to a step increase in ambient temperature from 50 to 400 F. This conclusion is noted for design of either an external heat exchanger or for the design of individual component protection employing heat-storage materials.

Consider first the use of an *external heat exchanger*, containing heat-storage material, for protection of an electronic package with a representative maximum value of the air temperature of 200 F. From the test data for paraffin and beeswax, it is concluded that the heat flow during 20 min is very small for a heat exchanger of

pract  
begin  
This  
cause  
ity of  
resist  
large  
chang  
creas  
all th  
that s

Com  
in a d  
data s  
the h  
appar  
small  
ture i  
ing t  
were  
paraff  
protec  
data c  
solidi  
long 1

Cor  
for p  
nents,  
for an  
it was  
put of  
order  
solid  
ducin  
to 100  
Hence  
at all  
mostly  
the tr  
other  
could  
does n

The  
expen  
sinks f  
tions.  
clusio  
wax a  
electro  
there  
basica  
ter pro  
the lat  
storag

Abst  
Coolin  
R. M.  
MIT f

ELECT

practical geometry. The latent heat does not begin to be utilized until a time of 200 min later. This low value of the rate of heat transfer is caused by the low values of thermal conductivity of paraffin and of beeswax. Since the thermal resistance of this heat-storage material would be large and fairly constant in an external heat exchanger, although the air flow could be increased somewhat in order to decrease the overall thermal resistance, it is the authors' opinion that such a design is impractical.

Consider next the use of paraffin or beeswax in a design based on a *plane latent-wall*. The test data show that the amount of heat transferred to the heat-storage material in the plane latent-wall apparatus, during the first twenty minutes is too small to be significant, even if the air temperature is raised to 400 F. If the permissible operating temperature of the electronic equipment were raised to 400 F, the heat exchanger using paraffin or beeswax would not offer adequate protection. Another conclusion reached from data on cooling tests is that the time required for solidification of liquid paraffin or beeswax is too long for practical purposes.

Consider finally the use of paraffin or beeswax for protection of individual electronic components, in an *annular latent-wall* type of apparatus, for an ambient of 400 F. For an ambient of 50 F, it was necessary to reduce the heater power input of one w per linear in. of heater surface, in order to keep the heat-storage material in the solid phase. But the heat flux of most heat-producing electronic components will be from 100 to 1000 times as large as used in these tests. Hence beeswax and paraffin could not be used at all in the solid state, since they would be mostly in the liquid phase at the beginning of the transient heating process. It is possible that other compounds with higher melting points could be found, but such a protection device does not appear practical at the present time.

The study was limited to the use of non-expendable heat-storage materials as latent heat-sinks for short periods of abnormal flight conditions. All the facets of the study lead to the conclusion that heat-storage materials such as beeswax and paraffin would not adequately protect electronic equipment. In the authors' opinion, there exist today cooling methods which are basically far more adequate and offer much better protection, for the same weight penalty, than the latent heat sink using non-expendable heat-storage materials.

*Abstracted from Final Report on Heat-Storage Cooling of Electronic Equipment, by J. Kaye, R. M. Fand, W. G. Nance, and R. J. Nickerson, MIT for WADC, PB 121980, Feb. 1957.*

# New Westinghouse WL-6249A tunable x-band Magnetron

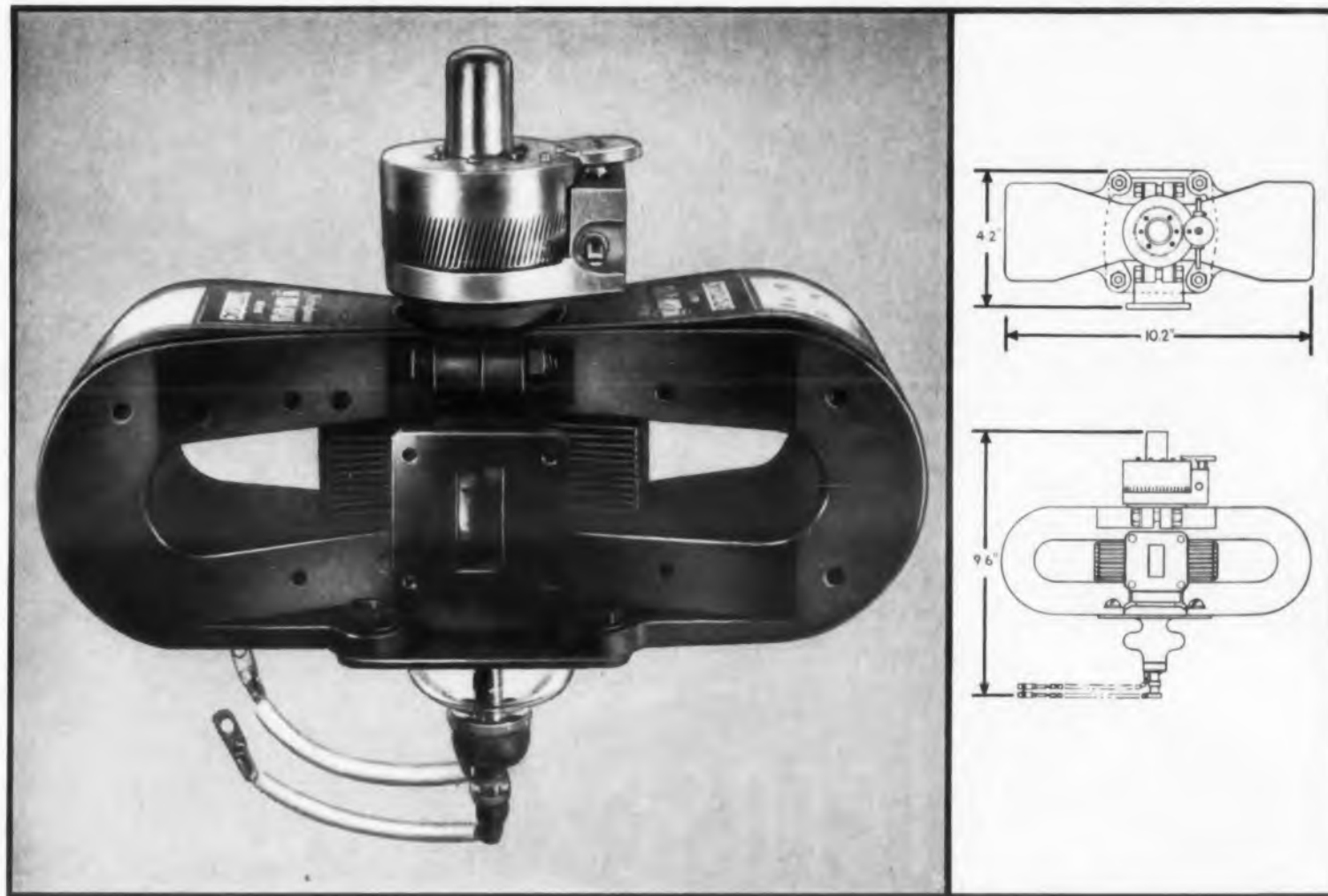

## Highest power tunable x-band Magnetron commercially available.

Now Westinghouse brings you a new high-powered mechanically tunable x-band Magnetron designed to operate over a wide frequency range. The tube meets U. S. Air Force Specification MIL-T-8128A, and is designed for airborne radar and missile applications.

An air cooled pulsed type Magnetron with integral magnet and unipotential cathode, the WL-6249A has excellent stability during warm up and operation.

**Electrical characteristics: Frequency: 8500-9600 Mc.  
Minimum Power Output: 200 watts average. Duty: .001**

Write for detailed data sheet today. The WL-6249A can fit into your present or future design needs.

**YOU CAN BE SURE... IF IT'S**

# Westinghouse

Electronic Tube Division Elmira, N. Y.

**HIGHER PEAK POWER VERSION UNDER DEVELOPMENT!** A modification of the WL-6249A now undergoing experimental work by Westinghouse may be the answer to your need for a more powerful tunable x-band Magnetron. Westinghouse engineers will be happy to work with you on new higher power applications. Submit requirements to Westinghouse, P. O. Box 284, Elmira, N. Y. c/o Industrial Tube Sales Manager.

CLIP AND MAIL COUPON

**Commercial Eng. Dept., Electronic Tube Div.  
Westinghouse Electric Corp., Elmira, N. Y.**

Please send me complete information on your new WL-6249A tunable x-band Magnetron.

NAME \_\_\_\_\_

TITLE \_\_\_\_\_

COMPANY \_\_\_\_\_

ADDRESS \_\_\_\_\_

CIRCLE 444 ON READER-SERVICE CARD FOR MORE INFORMATION

## DECADE RESISTANCES

... with precision wirewound resistors mounted on steatite-insulated switches. *TEN* resistors per decade ... giving better than 0.1% accuracy above 10 ohms.



DECADE BOX

Type	Dials	Ohm Steps	Total Resistance—Ohms	Price
817	3	0.01	11.1	\$60.00
818	3	0.1	111	51.00
820	3	1	1,110	56.00
821	3	10	11,100	60.00
822	3	100	111,000	63.00
823	3	1,000	1,110,000	77.00
824	3	10,000	11,100,000	120.00
817-A	4	0.01	111.1	75.00
819	4	0.1	1,111	71.00
825	4	1	11,110	77.00
826	4	10	111,100	79.00
827	4	100	1,111,000	92.00
828	4	1,000	11,110,000	139.00
8285	5	0.1	11,111	94.00
829	5	1	111,110	101.00
830	5	10	1,111,100	113.00
831	5	100	11,111,000	155.00
817-C	6	0.01	11,111.1	105.00
8315	6	0.1	111,111	109.00
832	6	1	1,111,110	121.00
833	6	10	11,111,100	169.00



UNMOUNTED DECADE

Type*	Dials	Ohm Steps	Total Resistance—Ohms	Price
435	1	0.1	1	\$12.00
436	1	1	10	13.25
437	1	10	100	13.25
438	1	100	1,000	15.00
439	1	1,000	10,000	16.00
440	1	10,000	100,000	18.50
441	1	100,000	1,000,000	32.50
442	1	1,000,000	10,000,000	60.00

\* Knob (#M-25594) not included. Available at additional cost.

# Shallcross



## DECADE VOLTAGE DIVIDERS

... same quality construction as in Decade Resistances. Choice of Kelvin-Varley or conventional potentiometer circuits.

### KELVIN-VARLEY CIRCUIT

Type	Dials	Input Resistance (Accuracy $\pm 0.05\%$ )	Price
8350	4	10,000	\$140.00
8349	4	50,000	145.00
8348	4	100,000	150.00

\* RESOLUTION—Any ratio between 0.0000 and 1.0000 in steps of 0.0001.

### POTENTIOMETER CIRCUIT

Type	Dials	Ohm Steps	Total Resistance (Accuracy $\pm 0.1\%$ )	Price
837	4	0.1	1,000	\$126.00
835	4	1.0	10,000	139.00
836	4	10.0	100,000	146.00
849	5	0.1	10,000	165.00
848	5	1.0	100,000	176.00

SHALLCROSS MANUFACTURING COMPANY, 526 Pusey Avenue, Collingdale, Pa.  
CIRCLE 445 ON READER-SERVICE CARD FOR MORE INFORMATION

## Abstract

## Rf Voltmeter

**W**ITH consoles developed at NBS' Radio Standards Lab very accurate rf voltmeter calibrations can be performed quickly in a fraction of the time heretofore required. Rf voltmeters can be calibrated for any practical voltage level starting with 0.2 v at discrete frequencies of 30, 100, 300, 400, 500 and 700 mc. The major components comprising a complete calibrating system at each frequency consist of rf sources, reference voltage standards, rejection filters, impedance matching networks, automatic level controls, manual level control, protective and indicating circuits.

### Operation

Seven fixed-type AT voltmeters, calibrated for levels of 0.2 to several hundred volts, are mounted on the underside of a special metallic ground plate that permits rapid connection of an "unknown" voltmeter on the top side of this plate. The input planes of the unknown and of the AT



RF calibration consoles of the type used in the calibration of voltmeters.

## Calibration

voltmeter are located very close together across the terminals of a coaxial cable imbedded in the plate. The cable furnishes rf voltages to the two voltmeters thus connected in parallel with essentially no connecting leads. This eliminates errors normally introduced by standing waves.

The rf voltages originate in constant temperature crystal-controlled oscillators. These voltages are amplified, filtered to reduce all harmonics at least 60 db below the fundamental, and fed via proper matching networks to the voltmeters. Overload circuits and relays protect the thermoelements of the AT voltmeters from being accidentally overloaded. An automatic amplitude stabilizing circuit keeps the rf voltage, applied to the voltmeters, constant to 0.1 per cent over a period of one hour or longer. Errors caused by voltage drifts during observations are thus made negligibly small. The rf voltage levels are indicated on a common panel indicator and are translated into voltage values by the use of line charts obtained when the AT voltmeters are calibrated in terms of NBS primary standards.

Three of the AT voltmeters covering values to 20 v each have a nominal 50-ohm input impedance. These are calibrated and used at two discrete frequencies. Two additional higher-input-impedance AT voltmeters are added for each of the two frequencies at high voltage levels. The total of seven AT voltmeters furnish facilities for the complete voltage range at two frequencies. The apparatus for the two frequencies is assembled into two cabinets and is combined with another similar apparatus for two other frequencies to form a four-frequency console as in photo. Three consoles will cover the entire frequency and voltage range indicated above. The combinations and number of consoles were chosen to allow simultaneous calibration work on three to six voltmeters.

*Abstracted from RF Voltmeter Calibration Consoles, National Bureau of Standards, U.S. Dept. of Commerce, Washington 25, D.C.*

## Ge and Si from Sylvania . . . . . . now cut to size to cut growing pains —and costs

Crucible-size pieces of Sylvania germanium or silicon cut waste and handling time.

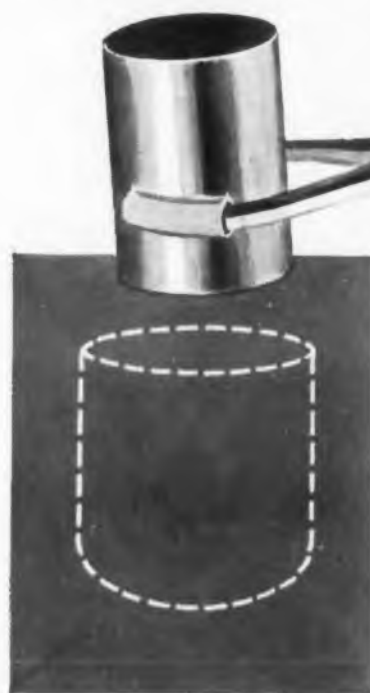

**Here's Another Contribution** to efficiency in your single-crystal growing operation from Sylvania, your dependable source of *both* germanium and silicon:

When you order either semiconductor material in charge size, you eliminate the delays and waste that go with further cutting and etching. Pieces are ready for your crucible as they are delivered.

In addition to this important service, Sylvania can meet your semiconductor requirements in practically any form you specify.

**Sylvania n-type germanium**—with a resistivity greater than 40 ohm cm—is available as either undoped single crystals or polycrystalline as-reduced or purified ingots. Sylvania can supply special cut pieces for practically every size and shape of crucible for vertical or horizontal crystal growth. Transistor and diode manufacturers report unusually high uniformity and yield from these Sylvania materials.

**Sylvania silicon** can be supplied as polycrystalline stalagmatic rod in three standard grades based on resistivity—from solar grade to over 100 ohm cm p-type, or 40 ohm cm n-type. Standard diameter is 1½ inches. All grades are available in cut pieces to your specification.

Write today for information on Sylvania's semiconductor materials—for specifications on crucible-sized pieces.

TUNGSTEN • MOLYBDENUM • CHEMICALS • PHOSPHORS • SEMICONDUCTORS

 **SYLVANIA**

LIGHTING • RADIO • ELECTRONICS • TELEVISION • METALS & CHEMICALS

CIRCLE 446 ON READER-SERVICE CARD FOR MORE INFORMATION



**ANNOUNCING**  
the newest  
**HUPP Powermaster**  
**Photocell CDS-10**

This Photocell will control relays without amplification.  
It has far greater sensitivity than the usual phototube.  
Good stability under temperature changes.  
Long service life.

**Specifications:**

15 to 30 MA at 50 foot-candles and 22.5 Volts  
Dark resistance over 1 megohm  
Power dissipation 1/2 watt  
Operating temperature: 0-175°F. and to 212°F. at reduced power

Write factory for Bulletin 198A  
Photocells available soon through distributors.

DIVISION OF  
**HUPP**  
Corporation

**HUPP ELECTRONICS CO.**

755 Circle Avenue • Forest Park, Illinois

CIRCLE 447 ON READER-SERVICE CARD FOR MORE INFORMATION

**WRITE TODAY FOR**

**New Technical Data on  
MICROWAVE FERRITE  
MATERIALS & DEVICES**



GET FULL DETAILS on Raytheon's completely new line of microwave ferrite materials and devices including the exclusive high-power L-band load isolator, miniaturized X, K<sub>v</sub>, and K<sub>u</sub> band isolators and others for C and S bands.

Write to W. C. Plouffe at the address below.

**RAYTHEON MANUFACTURING COMPANY**  
Special Microwave Device Group  
Seyon St., Waltham 54, Mass.

CIRCLE 448 ON READER-SERVICE CARD FOR MORE INFORMATION

**Standards and Specs**

Sherman H. Hubelbank

**Packaging**

MIL-C-12000C, CABLE, CORD, AND WIRE, ELECTRIC, PACKAGING AND PACKING OF, 26 DECEMBER 1956

This spec covers packaging and packing for domestic and overseas shipment and storage of electric cable, cord, and wire. Cord and wire, except magnet and bare wire, having an outside diameter of less than 0.50 inch, and having lengths not exceeding 500 feet are wound on coils or spools. If the outside diameter is greater than 0.50 inch, the cord and wire may be wound on either coils, spools, or reels. If the length is greater than 500 feet, reels must be used. Magnet wire must be wound on spools or reels. Bare copper wire will be furnished in one-pound spools or in five and ten pound spools, as specified in the contract or order. Unless otherwise specified, cable will be furnished in either coils or reels.

MIL-P-1755D(SHIPS), PREPARATION FOR DELIVERY OF ELECTRONIC EQUIPMENT; MISCELLANEOUS ELECTRICAL EQUIPMENT, (EXCEPT ROTATING ELECTRICAL EQUIPMENT) AND ASSOCIATED REPAIR PARTS, 15 FEBRUARY 1957

This spec covers the cleaning, preservation, packaging, packing, and marking requirements for electronic equipment, accessories, auxiliary equipment furnished as part of a complete electronic system, miscellaneous electrical equipment (except rotating electrical equipment) and associated repair parts. Complete tables are included which give the type of preservation and packaging required for electronic equipment and electrical, electronic and electro-mechanical items.

**Encoder Adjustment**

EIA RS-189, ENCODED COLOR BAR SIGNALS, JULY 1957

This standard is intended as a test signal for adjustment of encoders or colorplexers, for rapid checks of color television transmission systems, and for the adjustment of color monitors or monitor receivers. It includes a description of the standard signal and provides complete specifications for the signal. Copies of this standard are available from the Electronic Industries Association (formerly RETMA), 11 West 42nd Street, New York 36, N.Y. for 30 cents per copy.



**NEVER BEFORE!** A SWITCH SO SMALL  
**SO LIGHT (6 1/2 oz.) • SO LOW PRICED**  
**AS LINEMASTER COMPACT**  
**FOOT SWITCH**

Write for folder and prices NOW.

Our brand new Linemaster "COMPACT" combines unbelievable low price with the finest, most efficient design now available. It's small and light for maximum adaptability. The absolutely foolproof actuating mechanism has amazing sensitivity which permits versatile operation by foot, finger, knee or elbow. Ruggedly constructed of long lasting heavy gauge steel, featuring a handsome black crackle finish and non-skid base, "COMPACT" switch has thousands of potential profit-making industrial applications.

Let us quote on your special switch requirements.

**LINEMASTER SWITCH CORP.**  
130 Putnam Road • Woodstock, Conn.

CIRCLE 449 ON READER-SERVICE CARD FOR MORE INFORMATION

**New! Improved J.I.C. Wiring Boxes!**

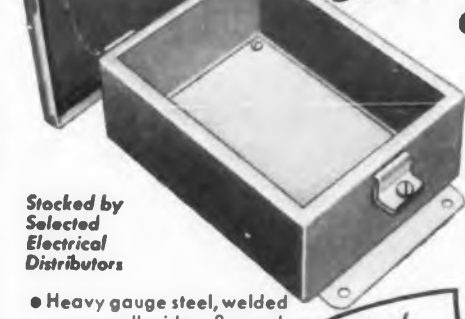

**OIL-PROOF  
DUST-PROOF**

Stocked by Selected Electrical Distributors

- Heavy gauge steel, welded seams, all sides flanged.
- Neoprene gasketed cover. No oil, water or dust can enter.
- Cover clamps on box, has no screw holes to leak oil or water.
- Cover chained to box, cannot be lost or mislaid.

Look what you get!

- Easy to open! Just loosen clamp screws a few turns!
- Clamp screws captivated, cannot be lost or mislaid.
- External mounting feet of heavy 12 gauge steel, welded, cannot come loose.
- Available with or without removable panel.
- Panel mounting spacers are integral with box—no holes—no leaks.
- JIC and Underwriters Laboratories approved.
- Attractive grey hammer-tone baked enamel finish.
- Special sizes, finish and special construction if you desire.

**SPECIFICATIONS**

Write us today!

BOX SIZE	PANEL SIZE	DEPTH COVER TO PANEL	GAUGE STEEL
4 x 4 x 3	No Panel	No Panel	16
6 x 4 x 3	4 1/8 x 2 3/8	2 3/8	16
6 x 6 x 4	4 1/8 x 4 1/8	3 3/8	14
8 x 6 x 3 1/2	6 1/8 x 4 1/8	2 3/8	14
10 x 8 x 4	8 1/8 x 6 1/8	3 3/8	14
12 x 10 x 5	10 1/8 x 8 1/8	4 3/8	14
14 x 12 x 6	12 1/8 x 10 1/8	5 3/8	14
16 x 14 x 6	14 1/8 x 12 1/8	5 3/8	14

**Hoffman** ENGINEERING CORPORATION

Dept. ED-52, Anoka, Minnesota

CIRCLE 450 ON READER-SERVICE CARD FOR MORE INFORMATION

### Transistor Specs

MIL-T-19500A; GENERAL SPECIFICATION FOR TRANSISTORS, AMENDMENT 1, 3 APRIL 1957

This amendment lists the effective supersession of specs MIL-T-12679 (SigC) and MIL-T-25380 (USAF) as being November 1957.

### Microwave Relay Antennas And Reflectors

EIA RS-195, MECHANICAL CHARACTERISTICS FOR MICROWAVE RELAY SYSTEM ANTENNAS AND PASSIVE REFLECTORS, JULY 1957

The mechanical characteristics of antenna and passive reflector assemblies for microwave relay systems applications are established by this standard. Copies of this standard may be obtained from the Electronic Industries Association (formerly RETMA), 11 West 42nd Street, New York 36, N.Y. for 50 cents per copy.

### Quartz Crystals

EIA RS-192, DEFINITIONS AND DIMENSIONAL CHARACTERISTICS OF QUARTZ CRYSTAL UNITS, JULY 1957

Definitions of quartz crystals are given. Dimensional characteristics are given for various crystal units. This standard is a revision of TR-112-A and includes additional crystal holders and provides more realistic dimensions and tolerances for crystal holders already listed. Copies of this standard are available from the Electronic Industries Association (formerly RETMA), 11 West 42nd Street, New York 36, N.Y., at the rate of 50 cents per copy.

### Markings

MIL-STD-129B, MARKING FOR SHIPMENT AND STORAGE, 10 APRIL 1957

Uniform marking of military supplies and equipment for shipment as well as storage is provided for by this standard.

## NEW FROM PYRAMID

### DRY ELECTROLYTIC CAPACITOR FOR EXTREME TEMPERATURE RANGE REQUIREMENTS TYPE TR

For applications previously reserved for Tantalum capacitors, Pyramid announces a new high reliability, dry electrolytic to be designated as Type TR. These are extended life capacitors using high purity aluminum foil, and can be supplied for any capacity requirements desired. Units are available in both polarized and non-polarized construction.

**4 OPERATING TEMPERATURE RANGES:** Type 20-85 TR  $-20^{\circ}\text{C}$  to  $+85^{\circ}\text{C}$ , Type 20-100 TR  $-20^{\circ}\text{C}$  to  $+100^{\circ}\text{C}$ , Type 40 TR  $-40^{\circ}\text{C}$  to  $+85^{\circ}\text{C}$ , Type 55 TR  $-55^{\circ}\text{C}$  to  $+85^{\circ}\text{C}$ .

**CAPACITANCE TOLERANCES:** Pyramid type TR units are made with commercial capacitance tolerances.

**POWER FACTOR:** TR units rated less than 15 working volts have a maximum power factor of 25% at  $25^{\circ}\text{C}$  and 120 cps. Type TR units rated 15 working volts and over have a maximum power factor of 15% at  $25^{\circ}\text{C}$  and 120 cps.

**D.C. LEAKAGE:** Leakage current limits for Pyramid type TR capacitors measured after the working voltage has been applied for 5 minutes may be determined from the following formulas: At  $25^{\circ}\text{C}$ ;  $I = 0.04CV$ , At  $85^{\circ}\text{C}$ ;  $I = 0.35CV$ , At  $100^{\circ}\text{C}$ ;  $I = 0.63CV$ . Where:  $I$  = leakage current in microamperes,  $C$  = capacitance in microfarads,  $V$  = rated working voltage.

**WORKING VOLTAGE:** Pyramid type 20-85 TR can be supplied up to 450 working volts. Pyramid types 20-100 TR, 40 TR and 55 TR can be supplied up to 150 working volts.

**SURGE VOLTAGE:** The surge voltage rating of Pyramid type TR capacitors at  $85^{\circ}\text{C}$  and  $100^{\circ}\text{C}$  is 115% of the rated working voltage.

**LIFE TEST:** After 1000 hours at  $85^{\circ}\text{C}$  or  $100^{\circ}\text{C}$ , and working voltage applied, Pyramid type TR capacitors meet the following specifications at  $25^{\circ}\text{C}$  and 120 cps. The capacitance is within  $\pm 40\%$  of the capacitance measured before life test. The power factor is less than 150% of the power factor measured before the life test. The leakage current is within the limits specified above.

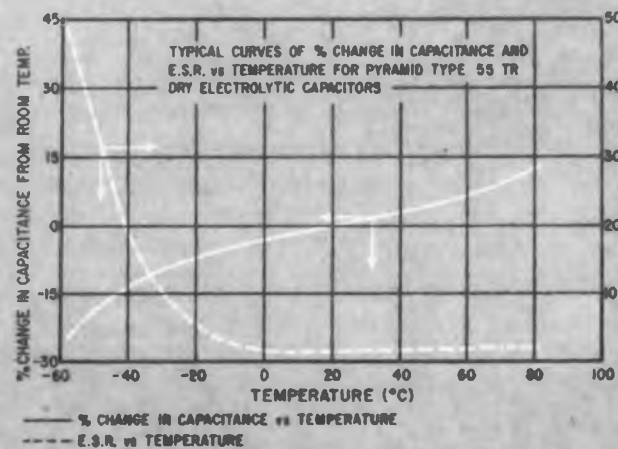

For circuit application information and a copy of TR Engineering Bulletin write to Industrial Division:

**PYRAMID**  
ELECTRIC COMPANY  
1445 HUDSON BOULEVARD  
NORTH BERGEN, NEW JERSEY

## VOLUME-PRODUCED TO TIGHT TOLERANCES

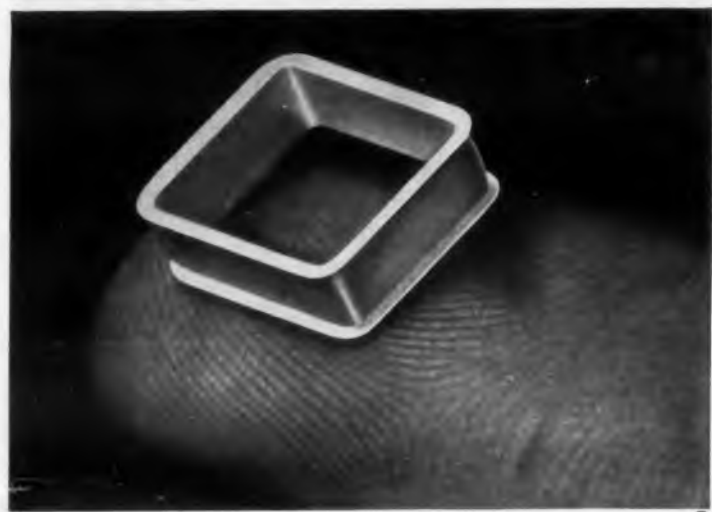

H&H close tolerance part—mowing coil form, volume-produced for d'Arsonval galvanometers. Width .362 ± .002 • Length .4219 ± .001 • Depth .160 ± .001 • Wall thickness .008 ± .0005

### SPECIALIZED TUBULAR METAL PARTS

Want specialized metal tubular parts in extremely close tolerances? At lowest possible cost? H&H Machine Company volume produces an almost endless variety—to your specifications, in all commercial alloys, in sizes from .01 in. to 3/8 in. diameter. No production difficulties—we do the complete job from tooling up to rigid inspection. No design problems—we make our own tools and dies to meet specified tolerances precisely.

Write for literature, or send blueprint with quantities desired.



**H & H MACHINE COMPANY, INC.**  
Noble & Jackson Sts. Norristown, Pa.  
Phone BRoadway 2-6453 BRoadway 9-2327

CIRCLE 454 ON READER-SERVICE CARD FOR MORE INFORMATION

## SNAP-ACTION SWITCHES

CHERRY offers methods for...

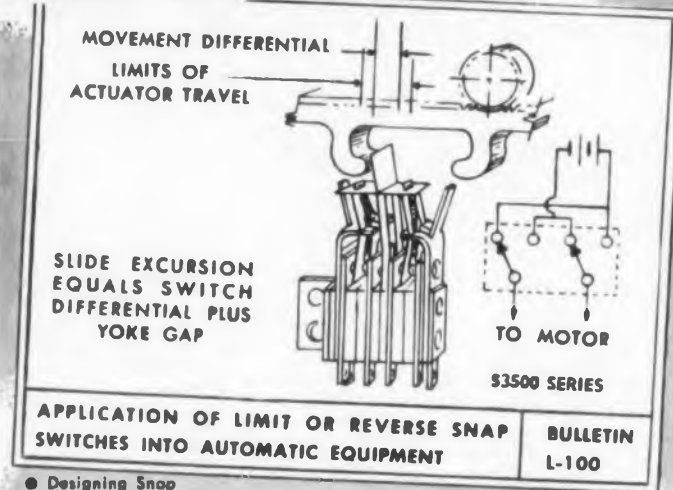

- Designing Snap Action Switches into a cam operated switch system—Bull. C-200
- Application of Snap Switches for interlock function—Bull. I-300

**CHERRY ELECTRICAL PRODUCTS CORPORATION**  
1646 Deerfield Road • Highland Park, Illinois

Please send Bulletin

C-200  L-100  I-300  On complete CHERRY line

Name \_\_\_\_\_

Position \_\_\_\_\_

Company \_\_\_\_\_

Street \_\_\_\_\_

City \_\_\_\_\_

Zone \_\_\_\_\_ State \_\_\_\_\_

CIRCLE 423 ON READER-SERVICE CARD FOR MORE INFORMATION

## Standards and Specs

### Reference Standards

NBS CIRCULAR 552, STANDARD SAMPLES AND REFERENCE STANDARDS

This circular contains an up-to-date descriptive listing of the various standard samples issued by the National Bureau of Standards. A schedule of weights and fees, as well as directions for ordering, is included. Summarized tables of analyses are included to indicate the type of standards of composition presently available. Over 500 different standard samples of chemicals, ores, ceramics, and metals are prepared, certified, and distributed by NBS. This 24-page booklet is available from the Superintendent of Documents, Government Printing Office, Washington 25, D.C. for 25 cents.

### Connectors

MIL-C-3767, CONNECTORS (ELECTRICAL, POWER, BLADED TYPE), AMENDMENT 2, 28 JUNE 1957

Qualification inspection has been deleted and pre-production inspection has been substituted.

CIRCLE 455 ON READER-SERVICE CARD FOR MORE INFORMATION

CIRCLE 424 ON READER-SERVICE CARD FOR MORE INFORMATION

CIRCLE 425 ON READER-SERVICE CARD FOR MORE INFORMATION



## Meters

MIL-M-6B, METERS, ELECTRICAL INDICATING, PANEL TYPE, (24 INCH AND 3-1/2 INCH), 10 MAY 1957

An additional color scheme designator "Y" (black markings and pointer with buff dial background) has been added. The meter types formerly covered in the body of the basic spec as individual spec paragraphs are now covered by twelve detailed specs. An appendix covering Qualification Inspection procedures has been added. This revision with the detailed specs supersedes spec MIL-M-6A and Amendment 2.

## Relays

MIL-R-19648 (SHIPS), GENERAL SPECIFICATION FOR HERMETICALLY SEALED THERMAL TIME DELAY RELAYS, 6 JUNE 1957

The general requirements for hermetically sealed thermal time delay relays with contacts up to 6 amps are established by this spec. Three classes of relays have been established based on the ambient temperature range for continuous operation. Three grades of relays have been established based on the operating vibration range. A typical type designation of a relay conforming to this spec is RYA-WIA/1.

## Spare Parts

MIL-M-17993B (MC), PROVISIONING PROCEDURES TECHNICAL DATA, AND REPAIR PARTS LIST REQUIREMENTS FOR U.S. MARINE CORPS EQUIPMENT, AMENDMENT 1, 3 JUNE 1957

The requirement specifying the Navy Department General Spec for Inspection of Material has been deleted. In the event source inspection is not a contract requirement, the two press-proof copies of the Repair Parts List shall be submitted to IMPAC direct. Each secret and top secret drawing shall be marked in accordance with the current security regulations.

## Parts Provisioning

MIL-B-5005A, BREAKDOWN; PROVISIONING PARTS AND ILLUSTRATED PARTS FOR AERONAUTICAL ARTICLES, AMENDMENT 2, 14 MARCH 1957

An example of a typical numerical index for provisioning parts breakdown has been included for the Army and the Air Force and a separate one for the Bureau of Aeronautics. Individual requirements for the Army, the Air Force, and the Bureau of Aeronautics have been itemized. An index is required for all provisioning parts breakdowns having an excess of 200 items. The construction of the description of items listed in a PPB has been completely changed. The listing of applicable standards and specs has been revised.

CIRCLE 456 ON READER-SERVICE CARD ►

# How magnetic tape converts blueprints to parts

## From numbers to metal without templates or models



Photo Courtesy of Lockheed Aircraft Corporation

This part was made with "production tooling" that cost less than conventional machining on a single sample. The "tooling" was a reel of magnetic tape programmed from blueprints by computer and electronic director. In a kind of machine-shop black magic, the part sprang into being on a Giddings and Lewis Numerically Controlled Milling Machine. Much larger parts are also similarly made on this same mill.

## NOW AT WORK IN ACTUAL PRODUCTION

This is not just a futuristic experiment. A commercial version has been delivered to a number of manufacturers. The first, at Lockheed Aircraft Corporation, produced 96 different complex parts in its second month of operation. Lockheed is using the tape-controlled mill to improve tolerances, eliminate human error and cut machining costs — often by over 50% (\$21.32 versus \$89.50 per part on one item). It is used for cams, templates and other intricate tooling — also for production parts on Lockheed's supersonic F-104 "Starfighter."

From initial experience at Lockheed, tape-controlled machining shows promise of reducing lead time from drawing board to production of parts by 60 to 70 percent. Since the "complete sets of tooling" are reels of tape, they can be stored as neatly as a row of books. Additional production runs can be made with a minimum of setup.

Earlier, at the Giddings and Lewis factory, tape-controlled milling was used to make one-of-

a-kind cams and templates for tracer-controlled machines. Cost on a competitive bid basis was less than 50% of that for same work by conventional means. Ironically, this intricate tooling is what numerical control will eliminate wherever it supplants tracer-controlled machines.

## A SIMPLE WAY TO HANDLE A MILLION COMMANDS

For the numerically controlled mill, magnetic tape provides 200 commands per second, each defining exact tool positions in three linear coordinates (angular coordinates too, on some). A minimum signal commands

only 0.000125 inch of tool motion. One reel of tape programs up to 1½ hours of machine time.

These closely spaced commands are ideal for a self-correcting system of servo controls. Also they eliminate need for expensive computing and interpolating equipment at the individual machine. Centralized programming can make tapes for many machines and is not tied to the time-consuming repetitions of actual production.

With its fourteen tracks, a one-inch magnetic tape has ample reserve for extra functions. Six are used for tool-position coordinates. The others control start, stop, coolant, and even voice instructions for impending tool change. Tracks can even be shared by several functions, allowing still further expansion.



Control tape on an Ampex FR-100 can hold over 1 million commands for each axis of tool movement

We will be glad to furnish more facts on magnetic tape recording and its use in machine tool control. Write Dept. ZZ-8.

MAGNETIC  
TAPE  
APPLICATION  
BY AMPEX

ONE OF A SERIES



Series FR-100



Series 800 Mobile  
and Airborne



Model FR-200  
Digital



Series PL-100  
Loop Recorders



Series FR-1100

INSTRUMENTATION  
DIVISION

AMPEX  
CORPORATION

FIRST IN MAGNETIC TAPE INSTRUMENTATION

934 CHARTER STREET · REDWOOD CITY, CALIFORNIA

District offices serving all areas of the United States and Canada; Foreign Representatives in countries around the world.

## New UNIVERSAL PHOTOMETER

For Low Level Light Measurements



- WITH LINE MODEL PH 200
- \* Luminous Sensitivity:  $> 10^{10}$  Lumens
  - \* Amplifier Stability: Better than 0.1% Full Scale after warmup
  - \* Reliability: Signal circuitry involves only one vacuum tube
  - \* Range: Density — 0 to 6  
Transmittance —  $10^{-6}$  to 1.0

The Model PH 200 Photomultiplier Photometer uses the latest circuit techniques to provide the most reliable and flexible photometer commercially available. The instrument is designed to operate with all types of photomultiplier or phototubes and includes an adjustable high voltage supply. An output jack is provided on the rear chassis for driving an oscilloscope or recorder.

Price: \$495.00 including detector and photomultiplier tube type 931A.

Write for complete technical information.  
Address Dept. E 10 3

### Eldorado Electronics

1401 MIDDLE HARBOR ROAD • OAKLAND, CALIF.

CIRCLE 457 ON READER-SERVICE CARD FOR MORE INFORMATION

## Standards and Specs

### Null Balancing Recorders

ASA C39.4-1956, AUTOMATIC NULL-BALANCING ELECTRICAL MEASURING INSTRUMENTS

Strip-chart and circular-chart null balancing recorders are covered in this spec. It provides definitions and test procedures for step response, frequency response, ramp response, and for determining conformance with performance ratings. Also given are rated operating conditions covering temperature, humidity, line voltage and frequency and pick-up. Performance ratings throughout the range of rated operating conditions are given. The standard analyzes extreme operating conditions denoting limits of conditions within which operation is permissible. New terms are also introduced in order to avoid ambiguity. The standard also outlines test conditions and detailed test procedures. Copies of this standard are available from ASA for \$1.25 per copy.

### Transistors

AIEE No. 425, TEST CODE FOR TRANSISTORS, AUGUST 1957

This standard includes transistor definitions and letter symbols for electrical quantities and electrical parameters. In addition methods of test are given for small signal, direct-current characteristics, small signal applications, and large signal applications for point contact transistors. Environmental test and noise measurements are also included. A list of 32 references is also given. Copies of this publication are available from the American Institute of Electrical Engineers, 33 West 39th Street, New York 18, N.Y.

### Electrical Insulation

AIEE No. 803, PROPOSED TEST CODE FOR AIRCRAFT EQUIPMENT ELECTRICAL INSULATION, JULY 1957

Acceptable methods of testing electrical insulation in aircraft electrical equipment are defined in this spec. This code is limited to the consideration of test procedure applicable to insulation in aircraft equipment or to manufactured components or sub-assemblies of such equipment. The code also recommends test procedures for use in inspection of insulation in aircraft electric equipment to determine its airworthiness after service, repair, and/or periods of storage. This test code is intended only as a guide to acceptable procedure. It is not intended to be used as a test spec for any specific equipment. Copies of this publication are available from the American Institute of Electrical Engineers, 33 West 39th Street, New York 18, N.Y.



Now...  
shake-test  
to 5000 cps  
with  
1750 lbs force!

WITH highest operating frequency in its force range, the Model C10 VB exciter exhibits no table diaphragming or disturbing resonances under 5000 cps. It delivers up to 1750 lbs force output for continuous sinusoidal testing . . . and extends the range of random motion testing to 5000 cps.

This exciter can be used with the MB Model T666 amplifier and TEMC control cabinet to subject specimens such as relays, electronic and control components through a wide range of vibratory frequencies to as high as 58 "g". Also, by the addition of the MB Model T88 complex motion console, it can be used for complex motion testing where specimens are subjected to the actual "noise" spectrum of the environment. Send for Bulletin 420-C.



manufacturing company

A DIVISION OF TEXTRON INC.

1058 State Street, New Haven 11, Conn.

CIRCLE 459 ON READER-SERVICE CARD FOR MORE INFORMATION



what...

7-minute delivery  
of etched, anodized  
metal nameplates?

Sounds impossible, BUT...

with Miller Dial's revolutionary new Fotofoil Kit, short run problems for nameplates, dials, panels, schematics and templates, are solved in just 7 minutes...and it's all done in your own plant! Fotofoil Kit requires no darkroom, skilled technicians or photographic equipment. This self-contained kit includes all necessary chemicals, equipment and Fotofoil to produce top quality product identification . . . in just a few easy steps! Fotofoil is supplied in all standard anodized colors and thicknesses from .003. Designed for "crash" programs, research and development departments, prototype models.

Territories open for Industrial Suppliers



MILLER DIAL &  
NAME PLATE CO.

4400 N. TEMPLE CITY BLVD., EL MONTE, CALIF.

Offices in principal cities

CIRCLE 461 ON READER-SERVICE CARD FOR MORE INFORMATION

ELECTRONIC DESIGN • October 15, 1957

**Hassall**  
**DECIMAL EQUIVALENT  
WALL CHART**

Send for  
Your **FREE**  
Copy...

• Color Coded  
• Uniform Number Size  
• 4-Place Carry  
• Extremely Legible  
• Large 16" x 23" Wall Size  
Ideal for Designers and Engineers.  
Write for your FREE copy today!

John Hassall, Inc., P. O. Box 2202  
Westbury, Long Island, N. Y.

MANUFACTURERS  
SINCE 1850

**Hassall**

SPECIAL MAIL RIVETS SERVICE  
SPECIAL MAIL RIVETS SERVICE

CIRCLE 458 ON READER-SERVICE CARD FOR MORE INFORMATION

# ELECTRONIC ENGINEER

A POSITION TAILORED TO FIT THE CREATIVE MAN

*Is this your idea of a creative assignment?*

Solving complex circuit design problems in these fields: frequency division techniques, memory circuits, digital and analog devices, synchronous communications.

An engineer with the necessary intellectual curiosity and an inventive mind to carry such problems to a successful conclusion can go far at the G-E Light Military Electronic Equipment Department.

Fill out the coupon below for further information.

Mr. Richard C. Kimm, Light Military Electronic Equipment Dept.  
General Electric Company, French Road, Utica, N. Y.

Name \_\_\_\_\_ Degree \_\_\_\_\_

Address \_\_\_\_\_

Area of Specialization \_\_\_\_\_



LIGHT MILITARY ELECTRONIC EQUIPMENT DEPARTMENT

**GENERAL ELECTRIC**

964  
B

CIRCLE 555 ON READER-SERVICE CARD FOR MORE INFORMATION

## HOW TO USE THE HOME REPLY FORM

If you wish to inquire about any of the employment opportunities listed in the "Career Section" simply circle the appropriate Reader Service number in the grey (shaded) area of your Reader Service card. Be sure to include your home (or non-business) address in the space provided at the bottom of the card. In this way, the privacy of your inquiry will be protected while still providing the speed and efficiency of ELECTRONIC DESIGN's Reader Service card system.

Last year ELECTRONIC DESIGN processed more than 60,000 individual reader cards. Now ELECTRONIC DESIGN is first to add a confidential inquiry form—one more step to its speeding communications between reader and advertiser.

### MOUNTAIN VIEW, CALIFORNIA

- ▶ **Reconnaissance Systems Laboratory**  
Newest of Sylvania's Mountain View facilities offers opportunities for research, development and fabrication of military electronic reconnaissance systems for detection and surveillance of electromagnetic radiation in and around the earth.
- ▶ **Electronic Defense Laboratory**  
Research, development and fabrication of electronic countermeasures systems and equipment.
- ▶ **Microwave Physics Laboratory**  
Research and advanced development in guided microwave control devices utilizing ferrites, gaseous electronics, ferroelectrics and paramagnetic resonance.
- ▶ **Microwave Tube Laboratory**  
Research, design, development and production of Klystron, Traveling Wave tubes and Backward Wave oscillators.

Openings in the following fields:

- Operations Research
- Guided Microwave Devices Research & advanced development
- Systems Analysis
- Systems Development
- Design & Development Transmitters, receivers, components, antennas
- Data Handling
- Electronic Packaging
- Field Engineering
- Mechanical Engineering
- Microwave Tubes Research, design & development

For further information on these West Coast opportunities, send your resume to

J. C. Richards  
P.O. Box 1296  
Mountain View, Calif.

### ENGINEERS and SCIENTISTS

Sylvania  
Now  
Selecting  
Men  
for Advanced  
Electronic  
Research and  
Development  
in East  
and West  
Coast  
Locations

East or West, Sylvania Laboratories are in the forefront of advanced electronic research and development, offering positions to men capable of important scientific contributions...and interested in the rewards this growing company offers for creative work.

Salaries are entirely commensurate with background and ability. Benefits are broad, and include ample provision for graduate study. Opportunities for growth are genuine.



**SYLVANIA**

SYLVANIA ELECTRIC PRODUCTS INC.

### WALTHAM, MASSACHUSETTS

#### ▶ Missile Systems Laboratory

Openings for senior men in weapons systems analyses, design, development & management.

- High Power Radars
- Electrically Scanned Antennas
- Missiles & Guidance
- Operations Research
- Information Theory
- Data Processing
- Electronic Physics

#### ▶ Avionics Laboratory

- Electronic Systems Design & Development
- Microwave & Antenna Research & Development
- Electronic Packaging & Test Design
- Computer Systems Engineering & Logical Design
- Technical Coordination & Liaison

#### ▶ Applied Research Laboratory

- Operations Research
- Communications Theory
- Automatic Controls
- Airborne Interceptor Radar
- Radar Simulators
- Missile Electronics

For further information on these East Coast opportunities, send your resume to

Graydon A. Thayer  
100 First Ave.,  
Waltham, Mass.

CIRCLE 554 ON READER-SERVICE CARD FOR MORE INFORMATION



# temperature limited **DIODE** type 1236C

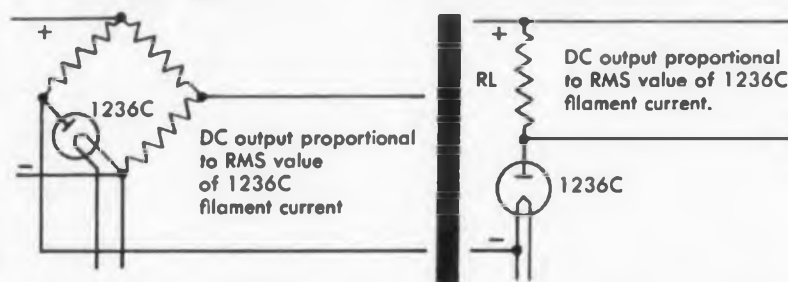

Temperature limited DIODE type 1236C is designed for service as an RMS detector for a-c voltage and current stabilizers . . . as a detector for d-c voltage and current stabilizers . . . as an RMS detector for differential voltmeters and in other similar applications.

Rigid test conditions and rugged construction assure long dependable tube life under all conditions.

## characteristics

### ELECTRICAL

	AVERAGE	MAXIMUM
<b>CATHODE</b> (Tungsten)		
VOLTAGE	1.9 Volts A-C or D-C	2.3 Volts A-C or D-C
CURRENT	440 MA	520 MA
<b>PLATE</b>		
VOLTAGE	600 Volts D-C	700 Volts D-C
CURRENT	0.7 MA D-C	1.0 MA D-C

### MECHANICAL

MOUNTING POSITION	Any
MAXIMUM OVER-ALL LENGTH	3 3/8 inches
SEATED LENGTH	2 13/16 inches ± 1/8 inch
MAXIMUM DIAMETER	1 17/64 inches
WEIGHT (APPROXIMATE)	1 ounce
BULB	T9 with bakelite base
BASE	Locking-in type DB-1, 8 pin

Ask for DIODE type 1236C at your local distributor or write for complete technical data.

Be sure to see  
**SUPERIOR ELECTRIC'S**  
Mobile Display  
when it is in your area

Offices: Los Angeles, California • San Francisco, California • Miami, Florida  
Chicago, Illinois • Baltimore, Maryland  
Detroit, Michigan • New York, New York  
Cleveland, Ohio • Dallas, Texas  
Seattle, Washington



a precision product of  
**THE SUPERIOR ELECTRIC COMPANY**  
1710 BRADLEY AVENUE, BRISTOL, CONNECTICUT

Please send data sheet on DIODE type 1236C.  
Have your representative call.

Name.....  
Company.....  
Street.....  
City..... Zone..... State.....

CIRCLE 451 ON READER-SERVICE CARD FOR MORE INFORMATION

## ADVERTISING INDEX October 15, 1957

Advertiser	Page
AMP, Inc.	16, 17
Ace Electronics Associates	106
Ace Plastic Co.	152
Acme Electric Corp.	133
Air Marine Motors, Inc.	Insert XI
Aircraft Radio Corp.	142
Airpax Products Co.	159
Airtron, Inc.	18
Allegheny Ludlum Steel Corp.	96
Allen-Bradley Co.	89
Allied Radio Corp.	174
Amperex Electronics Corp.	56
Ampex Corp.	178
Applied Research, Inc.	115
Associated Research, Inc.	111
Auburn Mfg. Co.	120
Audio Development Co.	74
Automatic & Precision Mfg. Co.	151
Automatic Electric Co.	86
Automatic Mfg. Co.	52
Baird-Atomic, Inc.	159
Barber-Coleman Co.	101
Bart Laboratories	113
Bendix Aviation Corp., Freiz Inst. Div.	129
Bendix Aviation Corp., Red Bank Div.	99
Bendix Aviation Corp., Scintilla Div.	135
Beryllium Corp.	151
Bircher Corp.	140
Booker & Wallestad, Inc.	160
Brailsford & Co., Inc.	138
Burgess Battery Co.	153
Burdy Corp.	62
CBC Electronics Co., Inc.	158
CBS-Hytron	43
Caledonia Electronics & Transformer Corp.	108
Cambridge Thermionic Corp.	148
Carborundum Co., The	10, 11
Centralab Div. of Globe Union, Inc.	113
Century Electronics & Instruments, Inc.	13
Ceramaseal Co., The	161
Cherry Electrical Products Corp.	174
Clary Corp.	119
Clevite Transistor Products	26
Clifton Precision Products Co., Inc.	2
Comar Electric Co.	144
Communication Accessories Co.	54
Computer Instruments Corp.	128
Computer-Measurements Corp.	155
Continental Diamond Fibre Co.	87
Cornell-Dubilier Electric Corp.	41
Corning Glass Works	76
Dage Electric Co.	152
Dale Products, Inc.	38
Daven Co., The	14
Delco Radio Div., General Motors Corp.	93
Demolab Corp.	147
Dialight Corp.	155
Du Pont, E. I. de Nemours & Co., Plastics Div.	15
Du Pont, E. I. de Nemours & Co., Pigment Div.	165
ESC Corp.	23
Eastern Industries, Inc.	Insert XXIII
Eastman Kodak Co.	154
Elastic Stop Nut Corp.	132
Elco Corp.	85
Eldorado Electronics Co.	176
Electrical Industries	12
Electro-Measurements, Inc.	156
Electronic Measurements Co.	138
Electronics International Co.	117
Elgin National Watch Co.	166
Epoxy Products Div.	25
Epsco, Inc.	92
Erie Resistor Corp.	137
Fairchild Controls Corp.	158
Fansteel Metallurgical Corp.	46, 47
Farr Co.	174
Fastex Div. Illinois Tool Works	174
Federal Telecommunication Labs.	107
Fenwal Electronics, Inc.	129
Fenwal, Inc.	153
Ford Instrument Co., Inc.	121
G-M Laboratories, Inc.	141
G-V Controls, Inc.	151
Gamewell Co.	151
Garrett Corp.	105
General Ceramics Corp.	78
General Electric Co., Accessory Equipment Div.	137
General Electric Co., Designers Digest	8, 9
General Electric Co., Industrial Equipment	5
General Electric Co., Electronic Equipment Sales	18, 19
General Electric Co., Electronic Components	68, 69
General Electric Co., Lamp Div.	124
General Electric Co., Light Military Div.	179
General Radio Co.	151
General Transistor Corp.	27
Giannini & Co., G. M.	122
Good-All Electric Mfg. Co.	19
Goodrich, B. F., Sponge Products	81
Gries Reproducer Corp.	159
Guardian Electric	136
Gurley, W. & L. E.	166
H & H Machine Co.	174
Hassall, John, Inc.	176
Haydon, A. W. Co., Inc.	160
Heli-Coil Corp.	143
Helipot Corp., Div. Beckman Instruments, Inc.	45
Hetherington, Inc.	79
Hewlett-Packard Co.	179
Hoffman Engineering Corp.	172
Hoffman Semi-Conductor Div.	116
Holtzer-Cabot Div. National Pneumatic Co.	109
Howard Industries, Inc.	155
Hughes Aircraft Co.	7
Hull Standard Corp.	106
Hupp Electronics Co.	172

Advertiser	Page
Indiana Steel Products Co.	100
Induction Motors Corp.	142
Industrial Instruments, Inc.	112
Interelectronics Corp.	73
International Resistance Co.	2
Jennings Radio Mfg. Corp.	157
Kearfott Co., Inc., Little Falls Div.	121
Keithley Instrument Co.	124
Kester Solder Co.	136
Kinney Mfg. Div. New York Air Brake Co.	115
Koiled Kords, Inc.	134
Kurz-Kasch, Inc.	145
Lambda Electronics Corp.	75
Leach Corp.	140
Librascope, Inc.	114
Linemaster Switch Corp.	172
London Chemical Co.	126
Lord Mfg. Co.	6
M B Mfg. Co.	176
McLean Engineering Laboratories	90
Magnetic Metals Co.	139
Magnetics, Inc.	94
Makepeace, D. E. Co.	149
Malayan Tin Bureau, The	111
Malco Tool & Mfg. Co.	110
Mallory, P. R. & Co.	65
Mansol Ceramics	144
Manson Laboratories	101
Marconi Instrument Co.	141
Martin, Glenn L. Co.	72, 73
Metal Textile Corp.	109
Methode Mfg. Co.	153
Miller Dial & Name Plate	177
Millivac Instrument Corp.	144
Mincom Div. Minnesota M & M Co.	61
Minneapolis-Honeywell Regulator Co., Boston Div.	64
Minneapolis-Honeywell Regulator Co., Industrial Div.	103
Minneapolis-Honeywell Regulator Co., Transistor Div.	88
Minnesota Mining & Mfg. Co., Chemical Products Div.	97
Mullard Ltd.	98
Mycalex Corp. of America	58
Narda Corp., The	131
National Vulcanized Fibre Co.	167
Navigation Computer Corp.	132
Networks Electronic Corp.	121
New Hampshire Ball Bearings, Inc.	112
New York Air Brake Co., Kinney Div.	115
Non-Linear Systems, Inc.	67
Oak Mfg. Co.	39
Pacific Scientific Co.	126
Phaotron Co.	125
Plastic Capacitors Co.	161
Polorad Electronic Corp.	6, 7
Polytechnic Research & Development Co.	70
Precision Tube Co.	122
Progress Electronics	124
Pyle-National Co., The	66
Pyramid Electric Co.	173
Radio Condenser Co.	82
Radio Corp. of America	180
RCA Commercial Electronic Products	77
Radio Cores	108
RapidDesign	133
Raytheon Mfg. Co., Commercial Equipment Div.	32, 33, 34, 35, 36, 37
Raytheon Mfg. Co., Microwave & Power Tubes Div.	49, 172
Raytheon Mfg. Co., Personnel Div.	50, 51
Raytheon Mfg. Co., Semi-Conductor Div.	4
Resistance Products Co.	135
Revere Corp. of America	118
Rex Corp., The	164
Rheem Mfg. Co.	24
Roesch, Douglas, Inc.	123
Rotron Mfg. Co.	Insert XI
Sage Electronics Corp.	156
Sams & Co., Howard W.	95
Sanborn Co.	63
Servo Corp. of America	118, 125
Shallcross Mfg. Co.	170
Snow, W. H. Co.	154
Sorensen & Co., Inc.	71
Southern Screw Co.	123
Sprague Electric Co.	59, 84
Stahlin Bros., Inc.	40
Standard Pressed Steel Co.	134
Statham Laboratories, Inc.	74
Superior Electric Co.	178
Sylvania Electric Products, Special Components Div.	83
Sylvania Electric Products, Tungsten & Chemical Div.	171
Sylvania Electric Products, Waltham Div.	177
Technitrol Engineering Co.	143
Technology Instruments Corp.	127
Tempo Instruments, Inc.	132
Thermosen, Inc.	138
Thomas Associates	133
Tinnerman Products, Inc.	29
Transitron Electronic Corp.	53, 55
Tung-Sol Electric Co.	137
Uniform Tubes, Inc.	119
United Aircraft Products	Insert XVII
Universal Transistor Products Corp.	110
Victoreen Instrument Co.	120
Waters Mfg. Co.	111
Waveforms, Inc.	161
Welwyn International, Inc.	139
West Coast Electrical Mfg. Co.	141
Western Devices	Insert XXI
Westinghouse Electric Corp., Industrial Tubes Div.	169
Westinghouse Electric Corp., Industrial Micarta Div.	91
Westinghouse Electric Corp., Specialty Div.	80
Veston Electrical Instrument Co.	22
Whitso, Inc.	114
Wright Machinery Co.	115

New simplicity,  
counter accuracy!

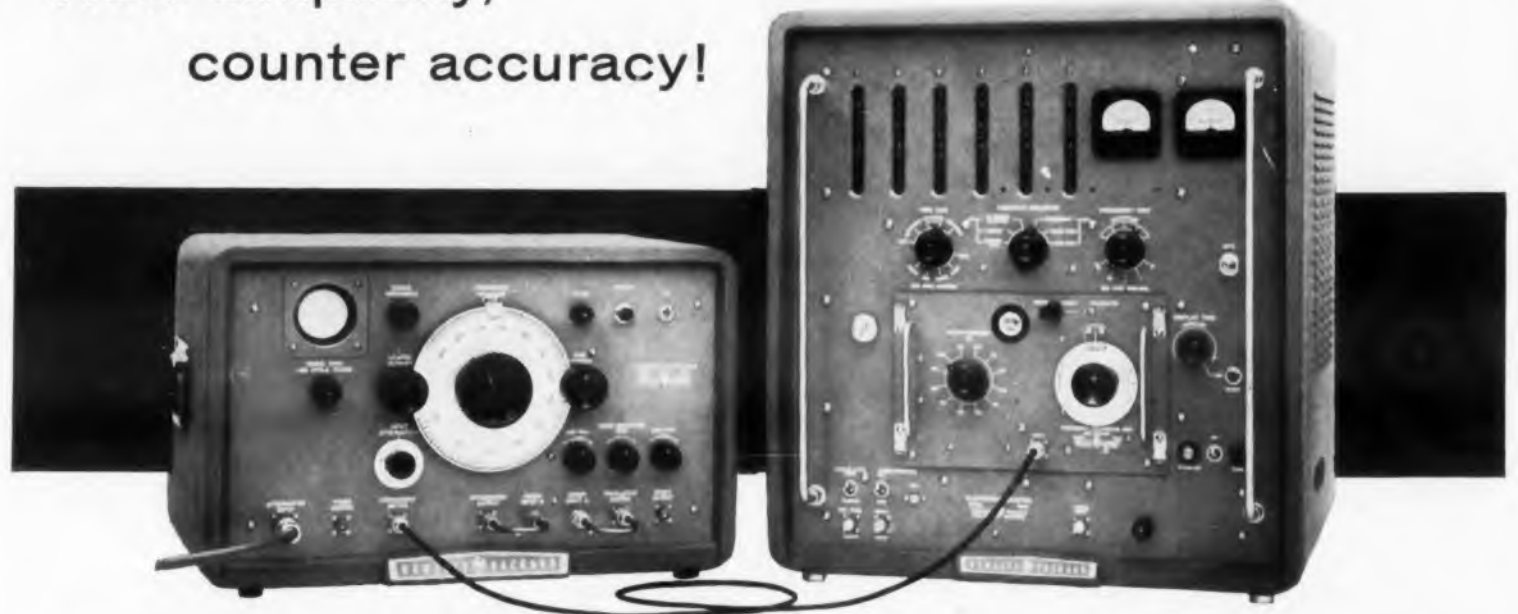

-hp- 540A Transfer Oscillator

-hp- 524B Electronic Counter

Measure frequency to 12 KMC on  
pulsed, AM, FM, CW and noisy circuits

Fast, convenient, simple set up

Just two -hp- instruments—Model 540A Transfer Oscillator and Model 524B Electronic Counter (with plug-ins) permit you to measure unknown frequency to 12 KMC with speed and accuracy.

Complex instrument arrangements and tedious trial-and-error work are eliminated. When approximate signal frequency is known, the 540A oscillator is merely tuned until one of its harmonics zero beats with the unknown. The multiplying factor is noted, and the 540A frequency measured precisely on the 524B Counter. The 524B reading, times the multiplying factor, is the unknown.

When the signal frequency is totally unknown, a simple calculation employing two or more harmonics determines the proper multiplying factor; the measurement is then made as before.

On clean CW signals accuracy is about 1/1,000,000; overall accuracy is better than 10 times that of the best microwave wavemeters.

For complete discussion and information, see your -hp- representative or write -hp- for Technical Data sheets and -hp- Journal, Volume 6, Number 12.



#### Many different uses

The unique 540A/524B combination is particularly useful for swift CW and AM frequency determination, measuring center frequency or deviation range on FM signals, measuring frequency on high noise circuits and making high-accuracy measurements on pulsed signals.

#### Features—Model 540A Transfer Oscillator

Oscillator Fundamental Frequency Range 100 to 220 MC. Harmonic Frequency Range to 12 KMC. Stability better than 0.002% change per minute after warmup. Output 2 v into 50 ohms. Attenuator range 20 to 80 db, into 50 ohms, low SWR. Amplifier 40 db variable gain, 1 v output. Self-contained oscilloscope 100 cps to 200 KC, vertical deflection sensitivity 5 mv rms/inch at mixer output. Prices: -hp- 540A Transfer Oscillator, \$615.00; -hp- 524B Electronic Counter, \$2,150.00; -hp- 525B Frequency Converter Unit, \$250.00.

Data subject to change without notice. Prices f.o.b. factory.

#### HEWLETT-PACKARD COMPANY

4192K PAGE MILL ROAD, PALO ALTO, CALIFORNIA, U.S.A.  
CABLE "HEWPACK" • DAVENPORT 5-4451

Field representatives in all principal areas



Complete instrumentation for frequency measurement

CIRCLE 452 ON READER-SERVICE CARD FOR MORE INFORMATION

HAYDEN PUBLISHING COMPANY, INC.  
19 East 62nd Street, New York 21, N. Y.

A new  
measure of  
performance



miniature RCA-6973...for your compact high-fidelity designs

To help you endow your popular-priced high-fidelity amplifier designs with a noteworthy measure of concert-hall presence, RCA proudly presents its latest audio-tube development—the RCA-6973. Featuring linear operation over a wide range of power, a pair of these beam-power, 9-pin miniatures can deliver 20 watts of audio power with only 1.5% distortion. Here, too, is a tube that offers the advantages of low heater wattage (6.3v at only 450 ma)!

And, for a new measure of performance in medium-priced high-fidelity FM receivers, RCA presents two new tubes—the 6DT8 and the 12DT8. These new RF amplifier and mixer-oscillator tube types can make valuable contributions to your FM-tuner designs. Both types have inter-unit shielding enabling you to achieve substantial reductions in antenna radiation.

For data sheets on any of these new types, or for information on other well-known RCA "audio" tubes, such as the 12AX7 and 6L6-GB, write to RCA Commercial Engineering,

Section J-18-Q-2, Harrison, N.J.

Your RCA representative is ready to discuss your high-fidelity tube requirements. Why not call him today at the field office nearest you?



## TUBES for HIGH FIDELITY

RADIO CORPORATION OF AMERICA  
Electron Tube Division      Harrison, N.J.

### RCA District Offices:

#### East:

744 Broad Street, Newark, N. J.  
HUMboldt 5-3900

#### Midwest:

Suite 1181, Merchandise Mart Plaza  
Chicago, Ill.  
WHitehall 4-2900

#### West:

6355 E. Washington Blvd.  
Los Angeles, Calif.  
RAYmond 3-8361

◀ CIRCLE 470 ON READER-SERVICE CARD