

ELECTRONIC DESIGN

SEPTEMBER 1955

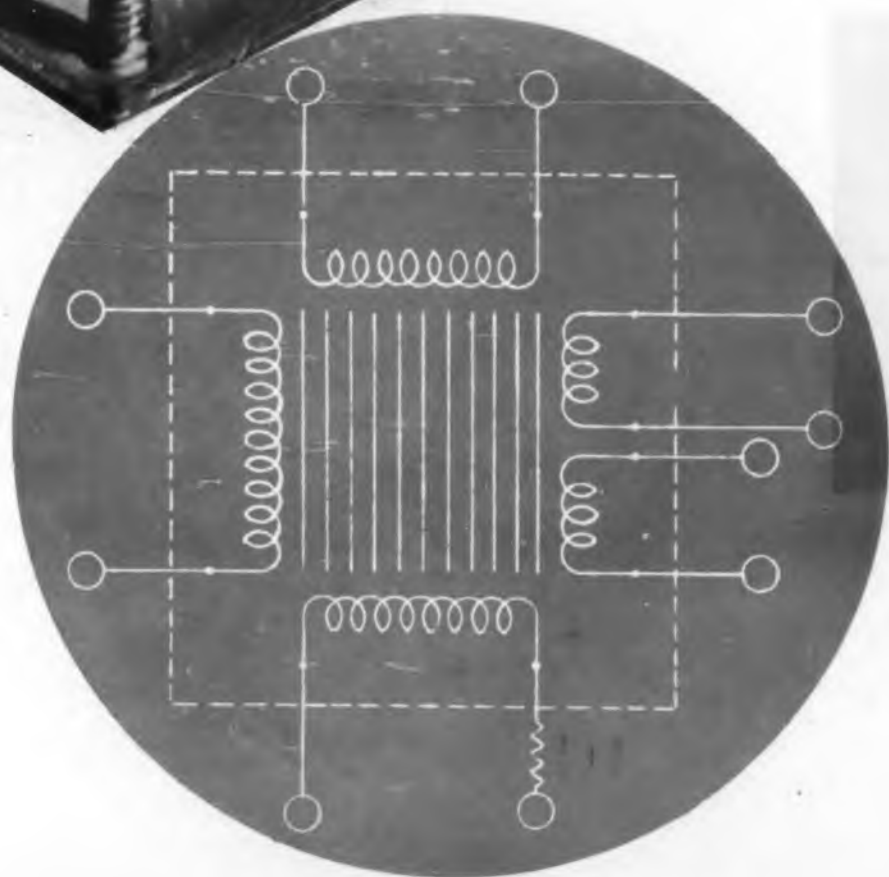

W. 359
 Call 9/19
 9/20
 SWS
 9/20
 9/20
 CM 4
 9-26
 9/27/55
 9/27/55
 9/27/55

This magnetic modulator is stable, yet sensitive, and has unlimited life.

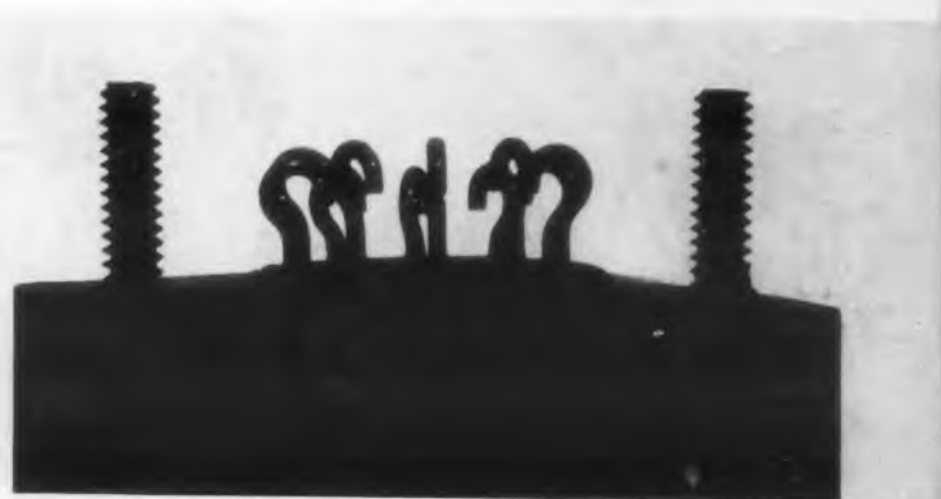

For Quality, Accuracy & Dependability

USE THESE FREED TELEMETERING COMPONENTS

TELEMETERING BAND PASS FILTERS

Covers the frequency band from 400 cps to 70 kc. 3 DB Band width $\pm 9\frac{1}{4}\%$ of center frequency. Features octal "plug in" header. Size $2\frac{1}{4}'' \times 3\frac{1}{2}'' \times 4\frac{1}{2}''$.

FREED #	CENTER FREQUENCY	3 DB BAND WIDTH
FBP-34	400 cps	$\pm 9\frac{1}{4}\%$ CF
FBP-35	560 cps	$\pm 9\frac{1}{4}\%$ CF
FBP-36	730 cps	$\pm 9\frac{1}{4}\%$ CF
FBP-37	960 cps	$\pm 9\frac{1}{4}\%$ CF
FBP-38	1300 cps	$\pm 9\frac{1}{4}\%$ CF
FBP-39	1700 cps	$\pm 9\frac{1}{4}\%$ CF
FBP-40	2300 cps	$\pm 9\frac{1}{4}\%$ CF
FBP-41	3000 cps	$\pm 9\frac{1}{4}\%$ CF
FBP-42	3900 cps	$\pm 9\frac{1}{4}\%$ CF
FBP-43	5400 cps	$\pm 9\frac{1}{4}\%$ CF
FBP-44	7350 cps	$\pm 9\frac{1}{4}\%$ CF
FBP-45	10500 cps	$\pm 9\frac{1}{4}\%$ CF
FBP-46	12300 cps	$\pm 9\frac{1}{4}\%$ CF
FBP-47	14500 cps	$\pm 9\frac{1}{4}\%$ CF
FBP-48	22 KC	$\pm 19\frac{1}{2}\%$ CF
FBP-49	30 KC	$\pm 19\frac{1}{2}\%$ CF
FBP-50	40 KC	$\pm 19\frac{1}{2}\%$ CF
FBP-51	40 KC	$\pm 9\frac{1}{4}\%$ CF
FBP-52	40 KC	$\pm 19\frac{1}{2}\%$ CF
FBP-53	52.5 KC	$\pm 9\frac{1}{4}\%$ CF
FBP-54	52.5 KC	$\pm 19\frac{1}{2}\%$ CF
FBP-55	70 KC	$\pm 9\frac{1}{4}\%$ CF
FBP-56	70 KC	$\pm 19\frac{1}{2}\%$ CF
FBP-57	70 KC	$\pm 19\frac{1}{2}\%$ CF

CHARACTERISTIC IMPEDANCE 2500 OHMS

Band pass filters FBP-10 through FBP-33 feature the same attenuation characteristics as the above listing and are supplied with solder lug terminals.

DISCRIMINATOR INPUT LOW PASS FILTERS

Covers the frequency band of 400 cps to 70 kc. Less than .05 DB attenuation at $\pm 9\frac{1}{4}\%$ of center frequency, 30 and 50 DB attenuation at the third and fifth harmonic of the pass band frequencies. Size $1\frac{1}{2}'' \times 1\frac{1}{2}'' \times 4\frac{1}{2}''$.

CHARACTERISTIC IMPEDANCE 30,000 OHMS

LPI -	Fo
10	400 CPS
11	560 CPS
12	730 CPS
13	960 CPS
14	1300 CPS
15	1700 CPS
16	2300 CPS
17	3000 CPS
18	3900 CPS
19	5400 CPS
20	7350 CPS
21	10.5 KC
22	12.3 KC
23	14.5 KC

CHARACTERISTIC IMPEDANCE 5100 OHMS

LPI -	Fo
24	22. KC
25	30. KC
26	40. KC
27	52.5 KC
28	70. KC

SLUG TUNED DISCRIMINATORS

Covers the frequency band of 3 kc to 70 kc. Frequency deviation $\pm 8\frac{1}{2}\%$ of center frequency. $\frac{1}{2}\%$ linearity. Features slug tuned adjustment. Size $1\frac{1}{2}'' \times 2\frac{1}{4}'' \times 4\frac{1}{2}''$.

FREED #	DST	Fo	DEVIATION	LINEARITY	DC OUTPUT
17	3	KC	$\pm 8\frac{1}{2}\%$ Fo	WITHIN .5%	32.5V
18	3.9	KC	$\pm 8\frac{1}{2}\%$ Fo	WITHIN .5%	32.5V
19	5.4	KC	$\pm 8\frac{1}{2}\%$ Fo	WITHIN .5%	32.5V
20	7.35	KC	$\pm 8\frac{1}{2}\%$ Fo	WITHIN .5%	32.5V
21	10.5	KC	$\pm 8\frac{1}{2}\%$ Fo	WITHIN .5%	32.5V
22	12.3	KC	$\pm 8\frac{1}{2}\%$ Fo	WITHIN .5%	32.5V
23	14.5	KC	$\pm 8\frac{1}{2}\%$ Fo	WITHIN .5%	32.5V
24	22	KC	$\pm 8\frac{1}{2}\%$ Fo	WITHIN .5%	32.5V
25	30	KC	$\pm 8\frac{1}{2}\%$ Fo	WITHIN .5%	32.5V
26	40	KC	$\pm 8\frac{1}{2}\%$ Fo	WITHIN .5%	26V
27	52.5	KC	$\pm 7\frac{1}{2}\%$ Fo	WITHIN 1%	26V
28	70	KC	$\pm 15\%$ Fo	WITHIN 1%	26V
29	22	KC	$\pm 15\%$ Fo	WITHIN 1%	26V
30	30	KC	$\pm 15\%$ Fo	WITHIN 1%	26V
31	40	KC	$\pm 15\%$ Fo	WITHIN 1%	26V
32	52.5	KC	$\pm 15\%$ Fo	WITHIN 1%	26V
33	70	KC	$\pm 15\%$ Fo	WITHIN 1%	26V
FIXED DISCRIMINATORS					
10		400 cps	$\pm 8\frac{1}{2}\%$ Fo	WITHIN .5%	32.5V
11		560 cps	$\pm 8\frac{1}{2}\%$ Fo	WITHIN .5%	32.5V
12		730 cps	$\pm 8\frac{1}{2}\%$ Fo	WITHIN .5%	32.5V
13		960 cps	$\pm 8\frac{1}{2}\%$ Fo	WITHIN .5%	32.5V
14		1300 cps	$\pm 8\frac{1}{2}\%$ Fo	WITHIN .5%	32.5V
15		1700 cps	$\pm 8\frac{1}{2}\%$ Fo	WITHIN .5%	32.5V
16		2300 cps	$\pm 8\frac{1}{2}\%$ Fo	WITHIN .5%	32.5V

DISCRIMINATOR OUTPUT LOW PASS FILTERS

Covers the frequency range from 6 cycles to 10,000 cycles. Features octal "plug in" header. Size $4'' \times 6'' \times 4\frac{1}{2}''$.

CHARACTERISTIC IMPEDANCE 330 OHMS

ATTENUATION: LESS THAN .2DB UP TO .5 TIMES Fo
LESS THAN .7DB FROM .5 Fo TO 1. Fo
MORE THAN 20DB AT 2 TIMES Fo
MORE THAN 30 DB FROM 3 TIMES Fo TO 100 KC

LPO -	Fo
10	6 CPS
11	8 CPS
12	11 CPS
13	14 CPS
14	20 CPS
15	25 CPS
16	35 CPS
17	45 CPS
18	60 CPS
19	81 CPS
20	110 CPS
21	160 CPS
22	185 CPS
23	220 CPS
24	330 CPS
25	450 CPS
26	600 CPS
27	790 CPS
28	900 CPS
29	1050 CPS
30	1200 CPS
31	1600 CPS
32	2100 CPS
33	2100 CPS
34	7200 CPS
35	10000 CPS

IN STOCK FOR IMMEDIATE DELIVERY

Send for further information and catalog
FREED TRANSFORMER CO., INC.
 1727 Weirfield Street Brooklyn (Ridgewood) 27, New York

Edward E. Grazda..... Editor
 M. Mandell..... Associate Editor
 J. A. Lippke..... Associate Editor
 D. S. Viebig..... Assistant Editor
 R. Graham..... Contributing Editor
 S. H. Hubelbank..... Contributing Editor
 J. M. Montstream..... Contributing Editor
 G. F. Zuckert..... Editorial Assistant
 M. L. Bradley..... Editorial Assistant
 S. Lynch..... Art Director
 E. Dadinos..... Production Manager
 P. L. Canfield..... Business Manager
 J. B. Gilchrist..... Circulation Manager
 E. M. Shaffer..... Reader Service

Co-Publishers

T. Richard Gascoigne
 James S. Mulholland, Jr.

Advertising Representatives

New York: Blair McClenachan
 B. Wesley Olson
 Owen A. Kean
 A. E. Russell
 19 East 62nd St.
 New York 21, N. Y.
 Templeton 8-1940

Chicago: Thomas P. Kavooras
 664 No. Michigan Ave.
 Chicago 11, Ill.
 Superior 7-8054

Los Angeles: Robert E. Ahrensford
 1140 Wilshire Blvd.
 Los Angeles 17, Calif.
 MADison 9-2681

Subscription Policy

ELECTRONIC DESIGN is circulated only to qualified electronic design engineers of U. S. manufacturing companies, industrial consultants, and government agencies.

If design for manufacturing is your responsibility, you qualify for subscription without charge provided you send us the following information on your company's letterhead: your name and title; your company's name, address, and main product. Electronic, research, development project, electrical, and chief engineers are typical qualifying titles.

If you have a design responsibility not indicated by your title, add a description of those responsibilities. Any job change requires requalification.

Hayden Publishing Company, Inc.
 19 East 62nd Street
 New York 21, New York

ELECTRONIC DESIGN is the fastest growing of all business publications.

Advertising increased 545 pages during first nine months of 1955 over the same period of 1954.

◀ CIRCLE 1 ON READER-SERVICE CARD

ELECTRONIC DESIGN

Vol. 3, No. 9
September 1955

Contents

Cover	36
Editorial	4
Engineering Review	5
Features	
Conductance Curve Design of Relaxation Circuits, K. A. Pullen, Jr.	24
Analog Field Plotter	28
Touch Control Switch	32
Electrostatic Speakers	34
Magnetic Modulator	36
Transistor Servo Amplifier	40
Design Procedures for Power Transistors—2, H. T. Mooers	42
Perspective-Sketch Template	46
Lab-Built Standard Source	48
Tape Potentiometer	50
Digital Meter with Recorder	52
Thumb Size Servo	56
Miniature Circuit Breakers	58
Background for Designers	
Dielectric Breakdown Properties of Thermo-setting Laminates, N. A. Skow	60
The Effect of Heater Coating Thickness on Warm-Up Time, R. L. Pear, A. Szilasi	64
Design Forum	
Compact Oscilloscope	38
Easily Operated Preamplifier	54
Ideas for Design	
Epoxy Resins in H-F Inductor Design, D. Lichtman	30
Departments	
New Products	66
New Literature	142
Patents	152
Meetings	172
Books	160
Abstracts	162
Standards and Specs	170
	172



ELECTRONIC DESIGN is published monthly by Hayden Publishing Company, Inc. at 19 E. 62nd Street, New York 21, N. Y., T. Richard Gascoigne, President; James S. Mulholland, Jr., Vice-President & Treasurer, and Ralph E. Marson, Secretary.



Printed at Publishers Printing Company, New York, N. Y., ELECTRONIC DESIGN is circulated monthly without charge to men in the electronic industries who are responsible for the design and specification of manufactured devices, including development and design men of consulting laboratories and government agencies. Acceptance under section 34.64 P. L. & R. authorized. Copyright 1955 Hayden Publishing Company, Inc. 24,000 copies this issue.

836.0

864.9

483.6

167.93

999.9

291.83



faster! more channels!
more versatile!

THE NEW POTTER DIGITAL MAGNETIC-TAPE HANDLER

0 to 60 inches/sec. in 5 msec! 2, 6 or 8 channels

High-speed magnetic tape recorders with low start-stop times bring a new dimension to data handling by absorbing and dispensing digital information when and where it's needed! Any phenomenon can be recorded as it occurs, continuously or intermittently, fast or slow. It can later be fed into computers, punch cards, printers, etc.

Speeds of 60 inches per second with 5-millisecond start-stop times permit digital techniques with jobs previously requiring more expensive, less reliable methods. Typical applications include business problems, high-speed industrial control processes, missile study, and telemetering.

In addition, Potter Magnetic Tape Handlers offer wider tape widths for more channels with lower tape tension controlled by photoelectric servos. Yet, the price is a fraction of much less versatile recorders. Other data handling components and complete systems are available for special problems.

DETAILED SPECIFICATIONS

Model	902AJ	902BJ	902BK	902CJ	902CK
Number of Channels	2	6	6	8	8
Tape Width (Inches)	¼	½	½	¾	¾
Tape Speed (in./sec.)	15/30	15/30	15/60	15/30	15/60
Reel Size (dia. in inches)	10½	10½	8	10½	8
Reel Capacity (feet)	2,400	2,400	1,200	2,400	1,200
Start Time	5 Milliseconds				
Stop Time	5 Milliseconds				

For complete information, write to Department 10-F.



POTTER INSTRUMENT CO., INC.
115 Cutter Mill Road, Great Neck, N. Y.

Editorial

Designers and the Atom

Practically all scientific, industrial, and commercial activities make use of electronics in some form. The latest field to call upon the talents of electronic design engineers is atomic energy and its by-products.

It can truly be said that without electronic techniques, the advances made in both military and peaceful atomic energy development would have been impossible. The recent international conference on "Peaceful Uses of Atomic Energy" therefore has special significance for electronic design engineers. Each of the advances reported at this meeting, and many yet to be revealed, is tied to some advance in electronic techniques.

The importance of electronic technology to the atomic energy development program is indicated by the many electronic patents being released to industry by the Atomic Energy Commission on a royalty-free basis. The rapidly growing nuclear instrument industry also indicates the close tie between the two sciences.

This is a two-way relationship. The needs of the atomic scientist stimulate new and fresh design thinking among electronic design engineers to create new electronic devices. These in turn give the atomic scientist new tools with which to explore new frontiers which again create a need for more sensitive devices, and so on.

To stimulate this process, an exchange of information is needed. The electronic design engineer must know the needs of the atomic specialist. The government's plan to release more information on the atomic energy program is a great step in the right direction. It is however, only one step. What is really needed is a regular program of continually challenging the electronic industries to come up with needed devices. This challenge should be explicit, direct, and widely circulated among electronic engineers.

ELECTRONIC DESIGN will continue to do its part to stimulate electronic design engineers along these lines by bringing to their attention the needs of the growing atomic industry.

◀ CIRCLE 3 ON READER-SERVICE CARD

Eno
The
will
cost
aliz
over
visio
circ
orig
stra
retu
nati
proj
agen
cont
agai
T
tell
and
tome
the
plim

W
recei
are
live
room
"Tel
an e
imag
wher
tape.
long-
of P
by a
for p
take
pend
radio
tape
Th
are r
from
in ai
All
ELEC

Time and time again we hear that 10, 15, 20 . . . yes, even 25 years continuous use can be expected from **Daven** attenuators under normal conditions. A number of our customers expect 22-year life. This expectation is based on their experience with **Daven** attenuators still in operation which were purchased 25 years ago.

This kind of durability in electronic equipment isn't an accidental by-product at **Daven**. Skilled engineering at every step of design and production assures that **Daven** attenuators consistently outperform original equipment specifications. Check these exclusive **Daven** features that add up to leadership in the attenuator field:

"Knee-Action" Rotor

- Tamper proof
- Uniform contact pressure and low contact resistance over the life of every unit.
- Each rotor blade individually supported to give positive contact in operation under all types of conditions.

Low-Loss Molded Terminal Board

- For high resistance to leakage.

Rigidly Self-Supported Resistor Strips

- With air insulation.

Brass Case of 2-Piece Construction

- Greatly reduces clearance space required for removal of cover in rear of unit.

"Lock-Tite" Dust Cover

- Held by positive, bayonet-type lock which prevents cover from becoming detached under stress of vibration.

Enclosed Roller-Type Detent Mechanism

- For extra long life and positive indexing.
- Addition of detent does not increase depth of unit.

Write for catalog.

D

THE **DAVEN** CO.

191 Central Avenue, Newark 4, New Jersey

World's Largest Manufacturer of Attenuators

Engineering Review

For more information on developments described in "Engineering Review", write directly to the address given in the individual item.

Enormous Electronic Installation in New Mart . . .

The world's largest building, the Palace of Progress, will incorporate revolutionary new electronic facilities costing millions of dollars. If present plans materialize, the huge merchandising mart will be constructed over Pennsylvania Station in New York City. Television programs, for both broadcasting and closed-circuit transmission to all parts of the nation, will originate in its extensive studios and by means of strategically placed cameras all over the building. In return, cameras in industrial plants all over the nation will feed images of heavy machinery to huge projection screens for the benefit of purchasing agents. Elaborate electronic computing facilities will control traffic, air conditioning, heating, and guard against fire.

To aid visitors, electronic travel directories will tell them how to reach a particular exhibit of goods and also inform the exhibitor that prospective customers are on their way. A bank of TV monitors in the entrance halls will give visitors a generous sampling of activities and exhibits in the building.

Long-Range TV Transmission

World-wide news will both originate from and be received in the building. Extensive press facilities are planned, while TV news programs originating live all over the World would be displayed in main rooms by projection. This latter feature is called "Teleprint" transmission. A cameraman will shoot an event by means of a portable TV camera. The image will be transmitted to a nearby central station, where the transmission would be recorded on magnetic tape. This tape is fed into a radio transmitter for long-range transmission to New York. At the Palace of Progress an identical magnetic tape is produced by a receiver. This tape is then placed in a kinescope for projection in main rooms. The projection could take place within minutes after the event occurs, depending on handling time and the bandwidth of the radio signal. The wider the bandwidth, the faster the tape can be fed into the transmitter.

The elaborate electronic building control facilities are necessary because large groups of people moving from one space to another require rapid adjustments in air conditioning, elevator operation, and policing. All of these electronic control facilities would be

supervised by a master computer. At night when the building is empty, this computer could be used to solve business problems for the various tenants.

Twenty-four completely equipped TV studios are planned. The TV facilities call for the design and development of some unusual camera-mounting arrangements known as the "mobilescope" and the "remotemobile". The mobilescope is a remotely directed unit containing a camera and equipped with octopus-like arms supporting microphones and lights. A number of mobilescopes would run on monorails about the main exhibition halls. They would be directed by technicians in a large control booth suspended from the ceiling. A considerable number of servomechanisms are needed in the mobile scopes.

Remotemobile

The remotemobile (illustrated on another page) is a self-contained vehicle with two mobilescopes attached to it. It would be manned by two technicians, who would drive it about the building providing

spot news coverage and supporting the regular camera facilities. It will be quite a feat to design a small vehicle containing a power source, drive motor, TV monitors, and remote controls for the mobilescopes. In order to transmit the pictures photographed by the remotemobile, it will most likely have to be plugged into a nearby outlet by cable, thereby restricting its mobility. An enormous number of outlets and miles of co-ax cable would have to be built into the walls of the building.

The building would be constructed by Webb & Knapp, Inc., of New York City. The unusual TV facilities were conceived by Pereira & Luckman, 8 E. 54th St., New York 22, N. Y., in association with many leading electronic manufacturers.

All the features of this building are hardly likely to be duplicated anywhere else, but many of them may be applied in other ways to serve other purposes. A wider market for the electronic industry, new employment opportunities for engineers and technicians, and another chance for the electronic art to help raise our standard of living if this remarkable building is ever constructed as planned.



News events taking place thousands of miles away will be projected on huge screens in the main rooms of the Palace of Progress within minutes by means of the yet-to-be-developed "Teleprint" TV system.

Bomac

125 MW

REFLEX KLYSTRON

BL-800/6780 FOR X-BAND APPLICATIONS

A new and important addition to Bomac's line of microwave products is the BL-800/6780 Reflex Klystron.

Rugged and reliable the BL-800/6780 klystron offers improved local oscillator performance and dependability for X-band radar systems.

Unexcelled high altitude operation, without pressurization and ease of installation without disrupting associated components or plumbing is now possible.

Controlled manufacturing procedures and rigid testing standards assure the user electrical uniformity and mechanical stability.

FEATURES

1. Light-weight, rugged construction
2. Low microphonics
3. Rapid warm up
4. Lock-nut tuning
5. Viking connector for convenient installation

Frequency Range	8.5 to 10.0 kmc
Heater Voltage	6.3 v
Heater Current	1.2 amps

Resonator Voltage	350 v
Resonator Current	42 ma
Reflector Voltage	0 to -1000 v

Output Connection	Bolts to UG-39/U flange or UG-40A/U choke for 1 x 1/2 x 0.050 inch waveguide
Base	Molded flexible leads, 7 inch leads terminated in Viking Connector (VP5 2AA1 plug — VS7/23C1 hood)
Cooling	Convection
Tuner	Lock-nut

We invite your inquiries regarding

- ENGINEERING
- DEVELOPMENT
- PRODUCTION

Bomac Laboratories, Inc.

BEVERLY, MASSACHUSETTS

GAS SWITCHING TUBES - TR, ATR and PR-TR - DUAL TR and ATR TUBES - SILICON DIODES - WAVEGUIDE SWITCHES
REFERENCE CAVITIES - MAGNETRONS - PRESSURIZING WINDOWS - SHUTTER TUBES - HYDROGEN THYRATRONS
REFLEX KLYSTRONS - TRAVELING WAVE AMPLIFIER TUBES - SYSTEMS

Catalog on request.
Write (on your company letterhead) Dept. ED-9
BOMAC Laboratories,
Inc. Beverly, Mass., or
phone Beverly 6000.

Cooperative Reactor . . . Eight industrial organizations have joined together to provide funds to construct a cooperative nuclear facility for industrial and medical research. The reactor, to be located near New York City, will be operated by a leading university as the Industrial Research Laboratories.

The participating firms are AMF Atomics, Inc., which will also build the "swimming pool" reactor, American Tobacco Co., Continental Can Co., Corning Glass Works, International Nickel Co., Chas. Pfizer & Co., Inc., Socony Mobil Oil Co. Inc., and United States Rubber Co. Other companies are expected to join in the venture.

Part of the operating time of the reactor will be devoted to medical research. The reactor should be in operation in the fall of 1956.

In addition to its participation in the cooperative nuclear research facility, the Socony Mobil Oil Co., Inc., 26 Broadway, New York 4, N. Y., is establishing its own Nuclear Research Center. The center will operate a Van de Graff accelerator and various other radiation sources including secondary types utilizing antimony-124, cobalt-60, and iron-59.

Radio Show Back at Armory . . . Despite earlier assurances (*ED, June, 1955, p 6*) that the Coliseum in New York City would be completed in time for the next Radio-Engineering Show, it will not be ready before April, 1956. As a result the show will be held at the Kingsbridge Armory, the Bronx, for the third successive year, according to William C. Copp, exhibits manager. The show will run from March 19 to 22, 1956.

Over 750 exhibits are planned, compared to a record 705 last year. More than 250 concerns are on the waiting list for booths. According to Mr. Copp, there isn't a structure in the entire United States that could house all the exhibitors who want to participate in the 1956 Radio-Engineering Show.

Explosion Proofing . . . Design of electrical flight test instrumentation so that it cannot cause an explosion in flight is not too difficult, according to a paper read at the AIEE Pacific Meeting in August. B. F. Hager, Boeing Airplane Co., Seattle, Wash., pointed out that measuring and recording gear used in flight testing was designed primarily for non-hazardous locations such as laboratories. This equipment might ignite fuel vapors that are sometimes present in aircraft.

Hager suggested that certain design steps be taken to make this equipment explosion proof. These include hermetic sealing, proper venting, and holding heat-producing parts to a safe temperature—below 450°F. He stated that these design steps can best be taken by the original manufacturer.

CIRCLE 4 ON READER-SERVICE CARD FOR MORE INFORMATION

Tetrode Transistor Works at 1000Mc . . . An experimental tetrode junction transistor that oscillates at 1000Mc has been developed. The improved frequency characteristic results from the addition of the fourth electrode and greatly reducing the width of the central p-layer to less than 2/1000". The unit was produced at Bell Telephone Laboratories, Inc., 463 West St., New York 14, N. Y.

Blueprint Maintenance Mechanized . . . The finding, copying, and filing of engineering drawings, a very costly operation for most design laboratories and manufacturing plants, has been mechanized by new techniques. Prompted by exhaustive studies by various branches of the Government, a system involving the mounting of microfilm copies of the drawings in punched cards has been developed. One of the cards is illustrated below.

The punched cards are marked for identification and handled by conventional punched-card equipment. A special device known as the "Filmsort Surveyor" will project the drawing on a 24" x 36" screen from the mounted microfilm. The device is a product of Filmsort Div., Dexter Folder Co., Pearl River, N. Y. Microfilm now available is of a fine enough grain to permit projection of fine-line drawings on such a large screen.

The apertures can be made in the card and the film mounted in the hole both manually or mechanically with various devices. Laboratories can set up their own mechanized blueprint department or hire various service organizations to perform the task.

A microfilm copy of an engineering drawing mounted in a punched card and equipment used to project the drawing on a large screen.

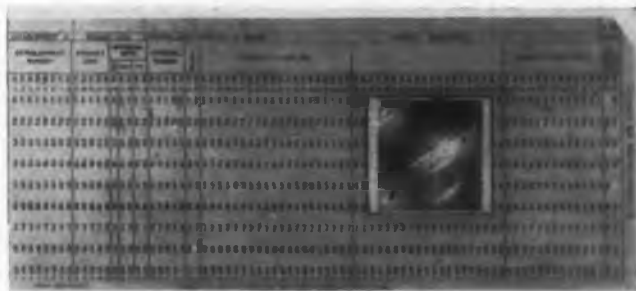

PERKIN TUBELESS!!

MAGNETIC AMPLIFIER REGULATED

DC POWER SUPPLY

Immediate Delivery!

28 Volts @ 30 Amperes
± 1/2% REGULATION

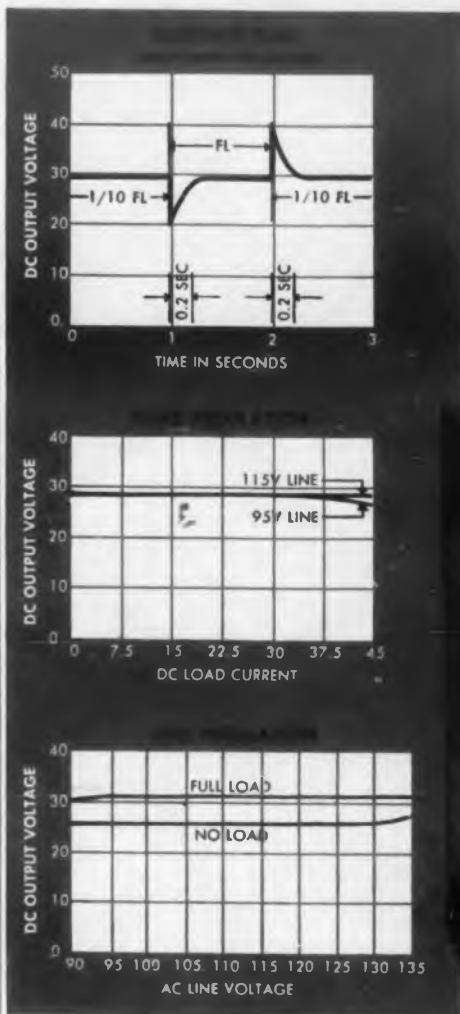

Model
28-30 WXMC

28 Volts
±10%
adjustable
@ 30 amperes
(continuous)

For **PROMPT REPLY**, wire the factory collect or phone our nearest sales office.

New York City:	HUNter 2-7784
Philadelphia:	NORristown 5-2600
Chicago:	DIVERsey 8-6885
St. Louis:	DEImar 7701
Kansas City, Mo.:	JEfferson 7221
Dallas:	FORrest 8-8306
Denver:	MAIn 3-0343
San Francisco:	ULmar 1-7129
Syracuse:	2-1167
Pittsburgh:	WALnut 1-2959
Minneapolis:	MIDway 2-7884
Seattle:	MOhawk 4895
Albuquerque:	5-9632



SPECIFICATIONS:

Regulation Accuracy: ± 1/2% for line changes from 95 to 130 volts AC or load changes from 3 to 30 amperes DC

Ripple: 1% RMS

Response: 0.2 sec. max.

Meters: 4 1/2" Ammeter and Voltmeter

Type cooling: Convection cooled

AC Input amps: 20 amps

Ambient Temperature Range: Up to 45°C

Dimensions: 22" Wide x 15" deep x 23" high

Mounting: Cabinet with handle or (19" Rack Panel - 19" wide x 15" deep x 21" high)

Finish: Baked Grey Enamel

Weight: 175 lbs.

PERKIN ENGINEERING CORP.

345 KANSAS ST. • EL SEGUNDO, CALIF. • PHONE: OREGON 8-7215

CIRCLE 5 ON READER-SERVICE CARD FOR MORE INFORMATION

*Save assembly time . . .
with quality-controlled ceramics*

made of

ALSiMAG[®]

Your line workers will appreciate the ease and speed with which they can assemble ALSiMag ceramics. Your production planning staff will be well pleased with the excellent quality as well as the rapid delivery of these parts.

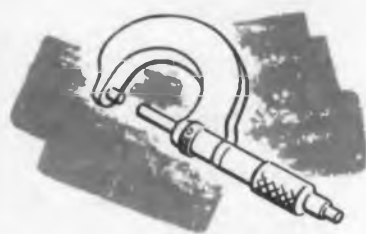

Physical dimensions and tolerances are checked at every key stage of manufac-

ture by thoroughly trained Quality Control inspectors to insure shipment of a superior product.

Four large, completely equipped plants assure you of hundreds—or hundreds of thousands—of ALSiMag precision made parts when you want them.

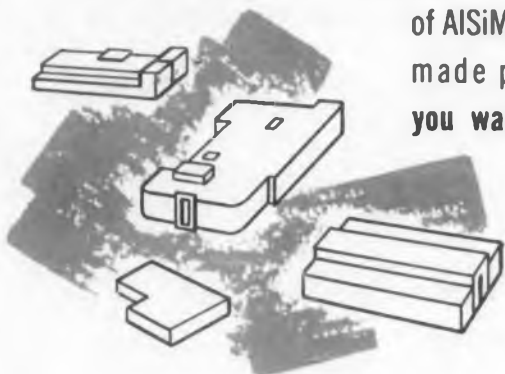

You can confidently specify ALSiMag ceramics—backed by over fifty years of specialized experience in the technical ceramics field.



54TH YEAR OF CERAMIC LEADERSHIP
AMERICAN LAVA CORPORATION
A SUBSIDIARY OF MINNESOTA MINING AND MANUFACTURING COMPANY
CHATTANOOGA 5, TENNESSEE
Branch offices in these cities (see your local telephone directory): Cambridge, Mass. • Los Angeles, Calif. • Cleveland, Ohio • Dallas-Houston, Texas • Indianapolis, Ind. • St. Louis, Mo. • Newark, N. J. • Philadelphia-Pittsburgh, Pa. • Tulsa, Okla. Canada: Irvington Varnish & Insulator Div., Minnesota Mining & Mfg. of Canada, Ltd., P. O. Box 757, London, Ontario. All other export: Minnesota Mining & Mfg. Co., International Division, 99 Park Avenue, New York, N. Y.

Transistors in Telephony . . . A telephone repeater utilizing transistors has been developed. The unit is used to raise transmission levels, thereby eliminating the need for expensive heavier cables.

The repeater was developed by Automatic Electric Co., 1033 West Van Buren St., Chicago 7, Ill. When located near the electrical midpoint of the line, it provides a gain of up to about 10db.

ASTM Committee on Electronic Materials . . . A new committee on electronic materials has been organized by the American Society for Testing Materials, 1916 Race St., Philadelphia, Pa., to cover the field of materials for electron tubes and semiconductor devices.

The committee, designated F-1 on Materials for Electron Tubes and Semiconductor Devices, will be concerned with materials for electron tubes such as grid wires, cathodes, mica stampings, glass-to-metal seals, and luminescent materials used in cathode-ray tubes and in fluorescent lighting.

TV Sets Kept Longer . . . People are holding on to their TV sets longer than heretofore, according to a report by the American Research Bureau, National Press Bldg., Washington 4, D. C. The average age of sets replaced has risen from 30 to 36 months. As a result sets should be designed to last for a longer period.

Production Speeded Electronically . . . By handling, inspecting, and testing speaker magnets by means of electronically controlled devices, production has been tripled at one plant. In addition, the new production line takes about 1/3 as much space as the old hand-labor line. Only two operators are required. The improvement was made at the Edmore, Mich., plant of the Carboly Dept., General Electric Co.

◀ CIRCLE 6 ON READER-SERVICE CARD



PROPERTY AND APPLICATION DATA ON THESE
VERSATILE ENGINEERING MATERIALS: "ZYTEL,"
"ALATHON," "TEFLON," "LUCITE."

NEWS

NO. 4

1955

American Color TV Shown Abroad

... American color TV broadcasting and testing equipment was exhibited at the recent International Trade Fair in Hanover, Germany. The closed-circuit demonstration, stimulated by an invitation from the U. S. Dept. of Commerce, was put on by Telechrome Inc., 88 Merrick Rd., Amityville, N. Y. The exhibit attracted a great deal of attention from technical people and businessmen.

1000-Ampere Rectifier ... A germanium rectifier with a capacity of 1000amp has been developed. Designed for plating operations, the rectifier is made by General Electric Co., Schenectady, N. Y. Down-draft air cooling is utilized to minimize the amount of dust and dirt taken into the unit.

Tuition Refunds ... More than 1500 employees of the Radio Corp. of America are taking courses at colleges and universities outside working hours under the company's Tuition Loan and Refund Plan. During 1954, the corporation spent \$141,000 to reimburse employees for the completion of their studies made possible by the plan.

In appreciation for the cooperation of over 60 colleges and universities where employees studied during the 1954-55 academic year, the corporation is making grants of up to \$2500 to each institution.

Trans-Atlantic TV ... At a recent press conference held in Paris, France, Henry Cassirer, head of the United Nations Education, Scientific, and Cultural Organization, predicted that television may span the Atlantic within the next five years, enabling an exchange of live shows originating in Europe and the United States. Submarine cables or relay links would be utilized in the predicted system. Present obstacles are high cost and the time differential, but the latter will always be present.

CIRCLE 7 ON READER-SERVICE CARD ➤

Miniaturized Components Utilize Unique Insulating Properties of TEFLON®



The paper clip indicates the small size of these coils. The insulation of "Teflon" is one important reason why they can be miniaturized.

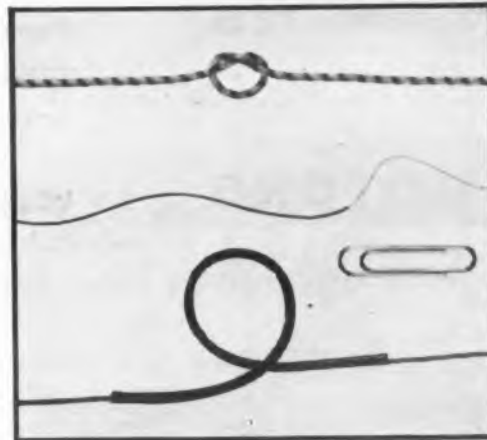

Here are shown (top) a striped, wrapped lead wire and (bottom) two samples of miniaturized flexible sleeves—all insulated with "Teflon."

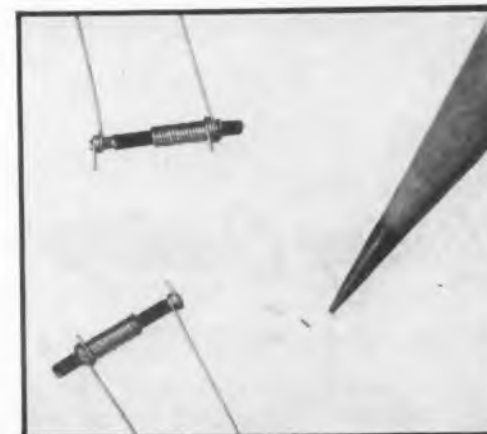

These small capacitors use "Teflon" as the dielectric. Their degree of miniaturization is shown by comparison with end of lead pencil.

Working temperature range of Du Pont "Teflon": -450°F. to +500°F.

Miniaturization of electronic components is possible with a unique engineering material: Du Pont "Teflon" tetrafluoroethylene resin.

"Teflon" has a low loss factor, low dielectric constant, and high volume resistivity. It is nonflammable, and unaffected by moisture. "Teflon" is the only insulating material available today that is inert to every commercially used solvent and chemical, excepting only molten alkali metals and fluorine at high temperatures and pressures.

Use of "Teflon" helps cut production costs, too. In soldering operations, the iron will not burn or melt insulation of "Teflon." This important fact can save time, labor, and materials.

The three photographs on this page show some current uses for insulation of "Teflon." The wire is manufactured by Hitemp Wires, Inc., Mineola, New York. Other typical applications by Hitemp which utilize Du Pont "Teflon" are listed below.

The six products listed, insulated with "Teflon" and used in a wide variety of applications, illustrate the application of this material in current electronic designs:

MAGNET WIRE. Such wire, coated with "Teflon," is widely used on high-temperature components for aircraft and guided missiles: transformers, relays and various types of motors.

HOOKUP WIRE AND LEAD WIRE. Insulation of "Teflon" on hookup and lead wire proves advantageous on transformers, motors, and harness assemblies for high-temperature applications. The chemical resistance of "Teflon" is particularly valuable in gyros and other hermetically sealed components.

COAXIAL CABLE. Used as the dielectric medium of coaxial cable, "Teflon" permits the design of miniature constructions which are the equivalent of coaxial cables using much thicker insulation of other materials.

TUBING. Insulation of "Teflon" provides excellent protection for tubing used as bus wire and jumpers.

RESISTANCE WIRE. Insulation of "Teflon" on small resistance wire facilitates miniaturization of heating equipment.

FIBER-GLASS PRODUCTS. Insulation of "Teflon" is being applied currently to such fiber-glass products as lacing, tape and sewing thread. "Teflon" provides excellent temperature resistance, and withstands cutting action of glass fibers.

NEED MORE INFORMATION?

CLIP THE COUPON . . .

If you would like further information about the properties and uses of "Teflon" as an electronic design material, fill out and mail the coupon.

E. I. du Pont de Nemours & Co. (Inc.), Polychemicals Department
Room 419, Du Pont Building, Wilmington 98, Delaware
In Canada: Du Pont Company of Canada Limited,
P. O. Box 560, Montreal, Quebec

Please send me more information on the Du Pont engineering materials checked: "Teflon"® tetrafluoroethylene resin; "Alathon"® polyethylene resin; "Zytel"® nylon resin; "Lucite"® acrylic resin. I am interested in evaluating these

materials for _____

NAME _____

POSITION _____

COMPANY _____

STREET _____

CITY _____ STATE _____

TYPE OF BUSINESS _____

* "Teflon," "Alathon," "Zytel" and "Lucite" are registered trademarks of E. I. du Pont de Nemours & Co. (Inc.)

Printed Circuit Machinery . . . Another ingenious device has been added to the growing list of machinery for automatically assembling printed circuits. The machine will insert up to 40 self-retaining terminals in a printed circuit board in 3sec.

Known as the Automatic Pin and Contact Inserting Machine, it is made by Malco Tool and Manufacturing Co., Dept. EDN, 4025 West Lake St., Chicago 24, Ill. The device will insert the terminals in any symmetrical or non-symmetrical pattern. Components are then mounted in the terminals by some other means in the next production step.

TV Tube Sales Gain . . . Manufacturers' sales of receiving and cathode-ray tubes during the first six months of 1955 were considerably above the comparable period of 1954, the Radio-Electronics-Television Manufacturers Association, 777 14th St., Washington 5, D. C., reported. For the first half of this year RETMA reported sales of 4,914,024 picture tubes valued at \$94,893,559 compared with 3,957,238 tubes worth \$82,985,981 sold in the same 1954 period. From January through June manufacturers sold 226,502,544 receiving tubes with a value of \$168,675,903 compared with 165,709,060 tubes worth \$120,720,391 sold in the first half of 1954.

Forms Sorted Electronically . . . One of the most tiresome tasks in a business office—sorting forms of various types—has been placed on a mechanized basis. The operator glances at the form, depresses the proper key on a standard typewriter keyboard, and the form is placed in the proper bin automatically. The operation is about six times as fast as manual sorting.

The device, known as the "Rapid-Sort", was developed by Universal Business Machines, Inc., Columbia, S. C. It is being marketed by Underwood Corp., 1 Park Ave., New York 16, N. Y. It can handle various forms such as sales slips, bank checks and job tickets.

TV Sets in College Colors . . . Considering the success of the Bell Telephone System in installing phones done in college colors in dormitory rooms, TV manufacturers might develop a new market by offering portable receivers in college colors. According to the August 4 edition of *The Wall Street Journal* (p 1), the phones were very popular in a test installation at Georgia Tech.

These successful uses of
PHELPS DODGE BONDEZE
 magnet wire . . .



HOOP-SHAPED COIL

Suggest

UNLIMITED NEW

COILS

Random-wound, Layer or Paper-section for potentiometers, telephones, brakes and clutches, clocks and timers, hearing aids, instruments, speakers, relays, television, radio and other applications.

TRANSFORMERS

Paper-section, Random-wound, Oil-filled, Air-cooled and High Voltage for distribution, current, X-ray, television, radio and other applications.

MOTORS

Windings for shaded pole, series fields, instruments, induction and others.



First for Lasting Quality—from Mine to Market!

CIRCLE 8 ON READER-SERVICE CARD FOR MORE INFORMATION

ELECTRONIC DESIGN • September 1955



FLY-BACK COIL

PANCAKE COIL

TV YOKE COIL

APPLICATIONS!



Redesigning? BONDEZE may provide one answer to your overall cost reduction program!

BONDEZE is Phelps Dodge magnet wire with a special thermo-plastic film applied over the insulation. It offers a quick, economical means of bonding wires together, turn to turn, through single application of heat or solvents.

BONDEZE offers unusual opportunities for redesign of windings and in many cases influences finished product design with overall savings to the user.

Any time magnet wire is your problem, consult Phelps Dodge for the quickest, easiest answer.

***BONDEZE** is a Phelps Dodge Trademark



PHELPS DODGE COPPER PRODUCTS CORPORATION

INCA MANUFACTURING DIVISION
FORT WAYNE, INDIANA

CIRCLE 8 ON READER-SERVICE CARD FOR MORE INFORMATION

Accurate Microwave Measurements . . . An apparatus that measure frequencies from 2400 to 40,000Mc to an accuracy of 0.001% has been placed on the market. This Microwave Frequency Standard consists of a temperature stabilized crystal oscillator followed by a multiplier-amplifier chain with outputs at 100, 500, and 1500Mc.

The instrument was developed by Narda Corp., Mineola, L. I., N. Y. It is supplied complete with sweep circuits for use with reflex klystron local oscillators to obtain beats with harmonics of the standard output.

Wireless F-M Microphone . . . An f-m wireless microphone for TV studio use has been developed. With its battery compartment, it can easily be concealed in the clothing of performers. It eliminates the need for booms and their cables.

The microphone and battery cases are each 4-1/2" x 2-1/2" x 1" in dimension. Output is 75mw in the band from 26.110 to 26.470Mc. The unit was developed by Budelman Radio Corp., 375 Fairfield Ave., Stamford, Conn. A companion receiver is also available. An eight-transistor wireless microphone (*ELECTRONIC DESIGN, November, 1954, p 14*) has been available for some time, but it broadcasts a-m signals at 530kc.

Chemicals Examined Electronically . . . Carbide and Carbon Chemicals Co. has purchased an electron microscope to speed quality control tests of chemicals. The unit, with a magnification power of 30,000, will examine the particle size and structure of vinyl resins.

The microscope has been installed at the firm's S. Charleston, W. Va., plant where it will also be used in materials research. It was made by Radio Corp. of America, Camden, N. J. It would be interesting if the chemicals examined by the device were eventually used in electronic equipment or their manufacture.

Automation Equipment for TV . . . Automation of TV station film and slide programming equipment has been demonstrated by the General Electric Co. Once the system, now in the experimental stage, is set into operation, supervision of the equipment is not necessary. All station breaks, commercials, and programs are handled automatically by the automation system. Key to this system are inaudible tone signals recorded on magnetic tape.

The system is being used to demonstrate new color film and slide equipment for TV stations. It could be used to control a TV station's complete programming schedule.

DEVELOPED FOR
APPLICATIONS ...

... beyond today's horizons

New HEIGHTS
OF PERFORMANCE
Achieved by
advance-design
**ASTRON CAPACITORS
AND R.F. FILTERS**

Today's design requirements foreshadow tomorrow's revolutionary applications ... imposing critical new areas of performance on electronic components.

The vexing problem of efficient capacitor and R. F. filter operation under these ultra-severe conditions of extreme heat, cold, moisture and vibration challenges the imagination of the component manufacturer ... truly he must create "something completely new under the sun"!

A foremost pioneer in the exacting development of advance-design components, to cope with these requirements, is Astron ... leader in miniaturization, manufacturer of industry's widest variety of types, whose experience, ability and creative far-reaching point of view produces the significant, highly-engineered designs pictured here ... proof of a dedication to progress.

The types and styles illustrated are but a few of the many available ... for complete technical and application information on all Astron products, please request catalog AC-4.



Blue • Point® Molded Plastic Paper Capacitors



Meteor® High Temperature Miniaturized Capacitors



Series "X"® Mylar † - Plus Capacitors



Comet® Molded Plastic Metallized Paper Capacitors

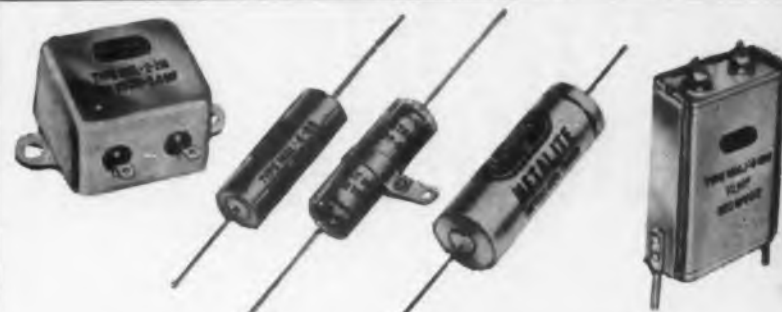

Metalite® and Hy-Met® Sub-Miniature Metallized Paper Capacitors



Safety Margin "SM"® Miniature Electrolytic Capacitors



Safety Margin "SM"® Twist-Prong and Cardboard Cased Electrolytic Capacitors



MIL-Type Hermetically Sealed Paper Capacitors

R. F. Noise Suppression Filters. Complete noise suppression "Packaged" service—Definition of requirements • Engineering analysis • Efficient solutions. Advance-type components • Quality production.

Attention West Coast Buyers
Astron now maintains a complete West Coast Stock of all standard items ... see your local Astron distributor.



ASTRON
CORPORATION

255 SOUTH AVENUE EAST NEWARK, N. J.

Ultrasonic Pickling ... Ultrasonic vibrations are being used in the pickling and descaling of metals in acids and caustics and in electroplating and electroless plating.

Developed by the General Ultrasonics Co., Hartford, Conn., the "Soni-strip" process accelerates the pickling and cleanup effects of acid or caustic solutions by radiating ultrasonic vibrations at 19,800cy. In the electroplating process, ultrasonic vibrations are introduced into the plating bath, increasing plating current density and throwing power, and eliminating anode polarization and edge build-up.

Computer Donated to Stevens ... The Underwood Corp., Long Island City, N. Y., has donated one of its ERECOM 100 digital computers to Stevens Institute of Technology, Hoboken, N. J. The instrument will be employed in the graduate and research programs at the school.

TV Production Predictions ... Radio and TV set manufacturers estimate that monochrome TV production be about 7 million sets in 1955 and somewhat less in 1956. According to the same unofficial poll conducted by the Radio-Electronics-Television Manufacturers Association, 777 14th St., N. W., Washington 5, D. C., radio set production should be about 13 million sets in 1955, including 4.5 to 5 million automobile radios.

Manufacturers were in less agreement about color TV set production but the average predictions were 35,000 receivers for 1955 and between 250,000 and 300,000 in 1956.

TV Sales Up ... The number of TV receivers shipped to dealers during the first five months of this year was up nearly 13% above the same period in 1954. According to the Radio-Electronics-Television Manufacturers Association, 777 14th St., N. W., Washington 5, D. C., 2,677,630 sets were shipped during January to May, 1955 compared to 2,370,098 units shipped during the same months in 1954.

◀ CIRCLE 9 ON READER-SERVICE CARD

Home Computer . . . A simplified computer to perform household chores was mentioned as an electronic possibility in a recent speech. Dr. W. R. G. Baker, general manager, Electronics Div., General Electric Co., Syracuse, N. Y., discussed the computer in a speech on the effects of electronic research on American life. Among the duties of such a computer would be starting of the stove, turning on the radio or TV set, adjusting the thermostat, and closing the garage door.

Nuclear Energy Libraries . . . Technical libraries of non-classified data on nuclear energy and its applications have been shipped to 23 nations by the Atomic Energy Commission, Washington 25, D. C. Each library consists of approximately 6500 AEC research and development reports; 34 volumes of scientific and technical texts on nuclear theory; and 11 volumes of abstracts of some 50,000 reports and articles published in this country and abroad.

Engineers Largest Profession . . .

There are some 700,000 persons in the United States who may be classified as engineers and physical scientists. The ministry, medicine, and law account for only 200,000 each, the engineers and scientists outnumbering the other three traditional professions combined, M. D. Hooven, AIEE president, said at a recent meeting. The demand for engineers is said to be 30,000 to 40,000 new graduates annually. This annual demand is three times the requirements of the other three professions put together.

Nuclear Society Officers . . .

Dr. W. H. Zinn, director of the Atomic Energy Commission's Argonne National Laboratory, Lemont, Ill., has been elected the first president of the American Nuclear Society. Other officers are Philip Sporn, American Gas Electric Co., vice-president; Dr. Karl Cohen, Walter Kidde Nuclear Laboratories, Inc., treasurer; and Dr. G. Beckerly, Schlumberger Well Surveying Corp., editor.

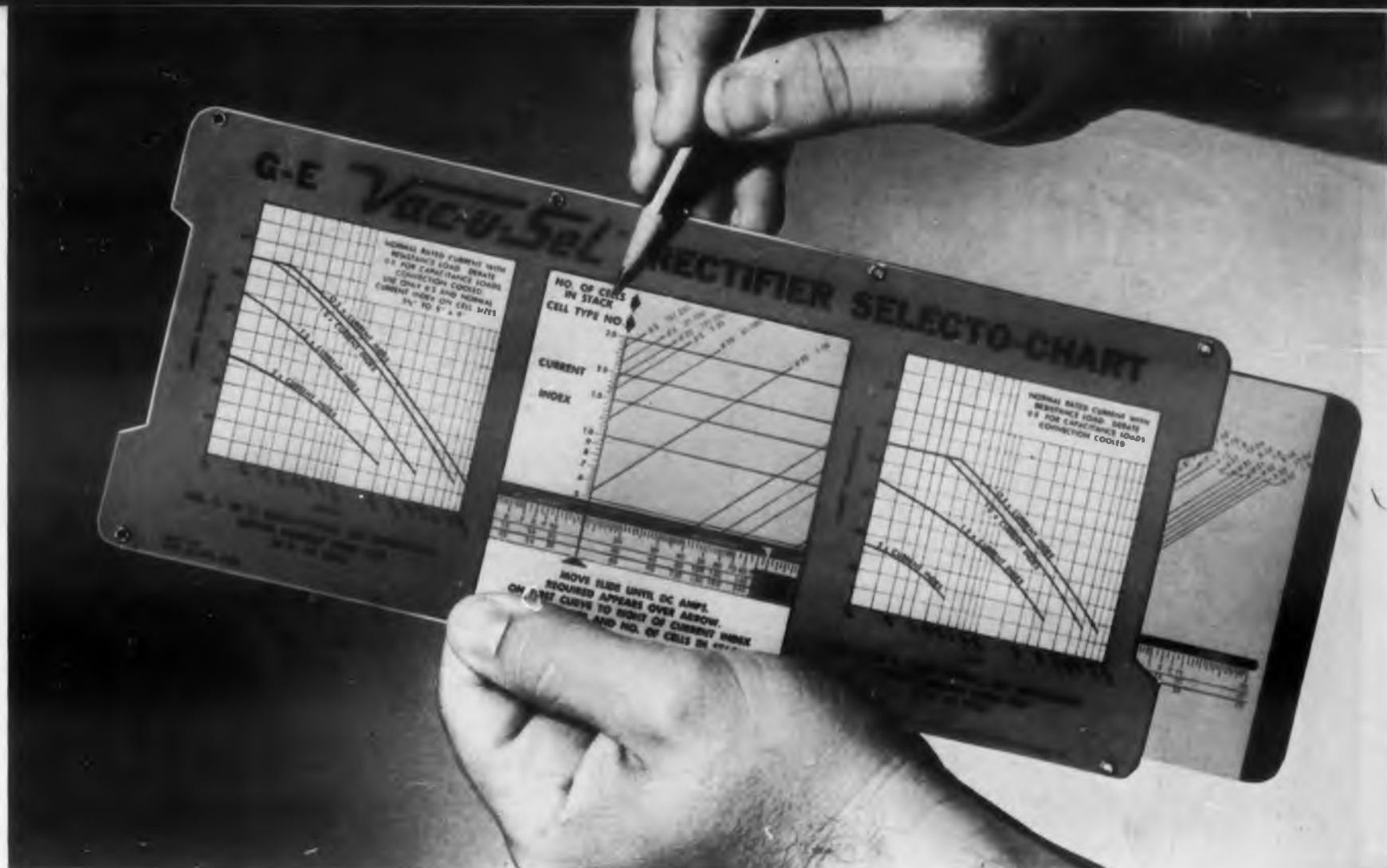

THIS G-E DESIGNED SELECTO-CHART, KEY TO THE NEW APPLICATION APPROACH, COMPUTES EXACT VAC-U-SEL RECTIFIER STACK YOU NEED.

NEW G-E APPLICATION APPROACH CUTS DESIGN TIME . . .

The Exact *Vac-u-Sel** Rectifier You Need Can Now Be Chosen in Minutes . . . On-the-spot

This new application approach, recently developed by General Electric, assures you of getting the correct Vac-u-Sel rectifier to meet your exact requirements. Now you are assured of getting the full advantage from the long life and outstanding technical characteristics inherent in all the many sizes and types of Vac-u-Sel rectifiers. In addition, in practically all cases, the sales engineer can give you the exact identification and price of your stack on the spot, without the inconvenient delay involved in getting data from the factory.

THIS NEW APPLICATION APPROACH brings top quality to your products by permitting complete and efficient utilization of the outstanding electrical characteristics, dependability, and predictable operation found in the many sizes, housings, finishes, and ratings of Vac-u-Sel component rectifiers.

FOR MORE INFORMATION on this new application approach, or the outstanding Vac-u-Sel line of rectifiers, contact your nearest G-E Apparatus Sales Office, or write Section 461-38, General Electric Co., Schenectady 5, N. Y.



G-E SALES ENGINEERS are able to determine, on the spot, the exact Vac-u-Sel stack to suit your particular application.

*Reg. Trade-mark of General Electric Co.

GENERAL  ELECTRIC

CIRCLE 10 ON READER-SERVICE CARD >

help yourself to more dollars worth of quiet
specify the new, small

RAYTHEON

Type 2N133
Important Characteristics—Grounded Emitter (30°C)
Current Amplification Factor (Ave.).....50
Power Gain* (Ave.).....38db
Noise Factor† (Ave.).....6.5db
Noise Factor† (Max.).....10db
*Source: 1000 ohms; Load: 20,000 ohms
†In a one-cycle band at 1000 cycles
Above characteristics obtained with $V_c = 1.5$ volts;
Ic 0.5 mA

First of a new series of Raytheon hermetically sealed transistors, the 2N133 is the smallest yet — $\frac{1}{3}$ to $\frac{1}{4}$ the size of the CK727 it replaces — and as low in noise as they come.

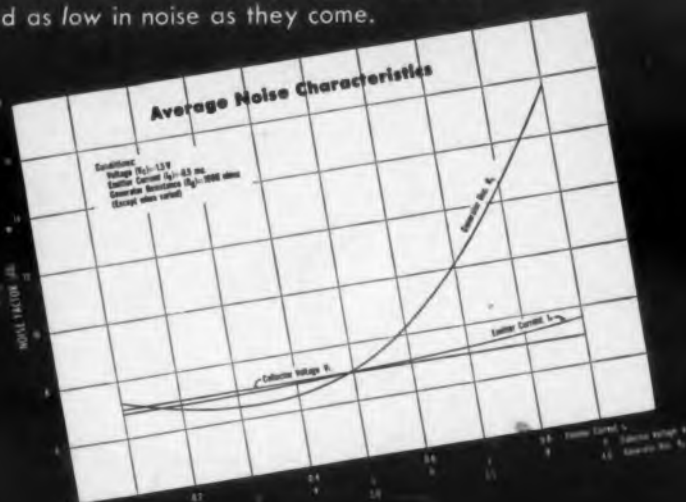
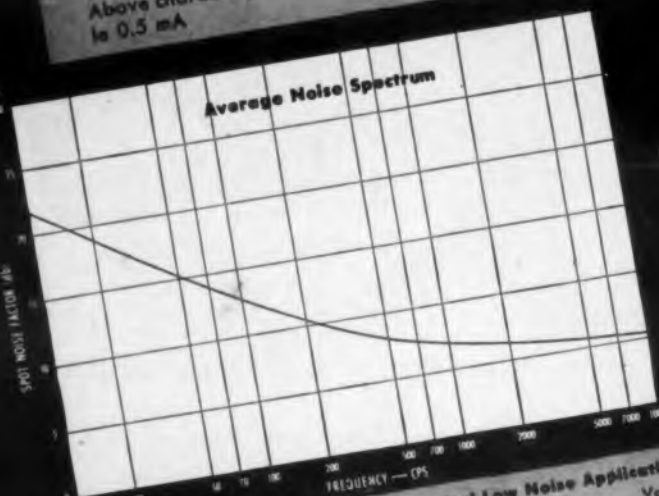

Typical Low Noise Application PHONO PRE-AMPLIFIER

No. of Stages	2	Transistor	2
Type of Response	RIAA	8AA	44db
Gain (IKC)	32db	1: 2N133	
Tube	1: 6SC7	1: 2N132	
Transistors	0.4v	1.6v	
Signal Output	100µv*	200µv	
Noise Output	72db	78db	
S/N			
*110 millivolt signal from reluctance cartridge *exclusive of hum which may average 500 µv or higher with typical tubes			

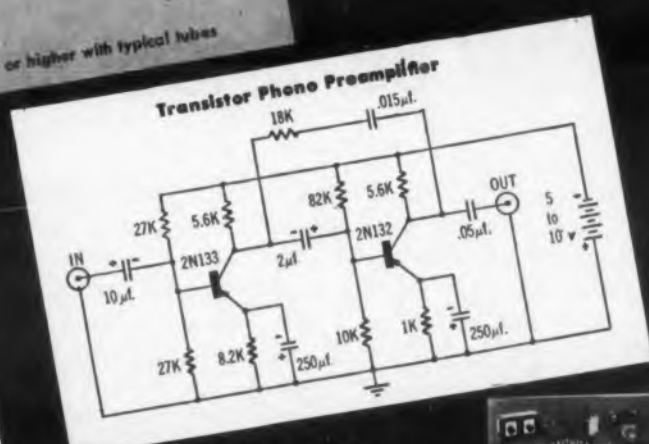
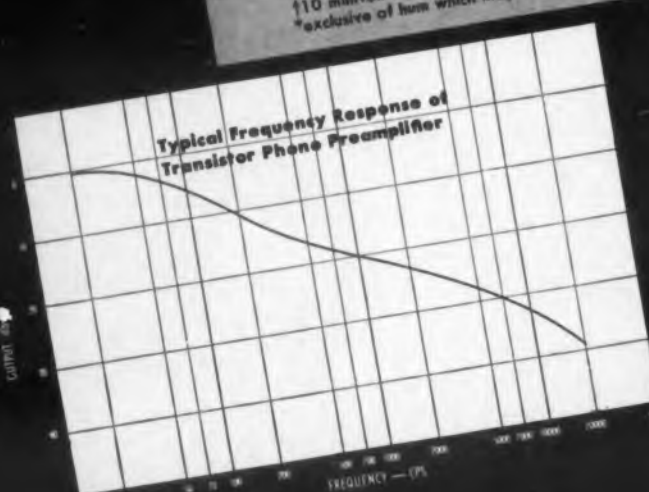

Get This RAYTHEON TRANSISTOR APPLICATION BOOK!
116 pages — over 50 practical circuits including timers, receivers, oscillators, etc. all using low cost Raytheon Transistors. For your copy send 50¢ to Dept. P12, Raytheon Mfg. Co., Newton 56, Mass.



RAYTHEON TRANSISTORS

more in use than all other makes combined

CIRCLE 11 ON READER-SERVICE CARD FOR MORE INFORMATION

Electronics in Oil Industry . . . The oil industry is continuing to spend many dollars on electronic devices. An automatic control system for a pipe line, a two-ton electronic mass spectrometer, a tank-gaging system, and new microwave communication facilities are among the new installations.

The Minneapolis-Honeywell Regulator Co., Minneapolis, Minn., is providing electronic flow controls for a key section of the Interprovincial Pipe Line. The line stretches from Alberta to Ontario, Canada. Built into the control system are a variety of protective devices that can instantaneously shut down the station when required, or can signal abnormalities in pressures or pumping engine operation.

Consolidated Engineering Corp., Pasadena, Calif., has constructed a new mass spectrometer for the Houston, Texas, Refinery Research Laboratory of the Shell Oil Co. This instrument will identify two to three times as many chemical compounds in petroleum as the conventional mass spectrometer. The mass spectrometer breaks up, identifies, and counts the elements of complex gas and liquid mixtures by bombarding the substance with an intense electron beam. The unit weighs two tons.

Gilbert and Barker Mfg. Co., West Springfield, Mass., is supplying an electronic tank gage to the oil industry. The gage measures the depth of oil in large tanks to accuracy of $\pm 1/64$ ". It also sounds an alarm when the level is too high.

Collins Radio Co., Cedar Rapids, Iowa, is going to build a large microwave communications facility for the Continental and Sinclair pipe line companies. To stretch from northern Oklahoma to Houston, Texas, near the Gulf of Mexico, the system is designed to carry 120 conversations simultaneously. There will be 25 relay stations between the terminals.

More Transistor Radios . . . Four more transistor radios have been placed on the market. Radio Corp. of America, New York, N. Y., has produced two types, a six-transistor type and a seven-transistor model. The former will fit in a case 5-1/2" x 3-1/4" x 1-1/2" in dimension. Both will sell for about \$80.

Crosley Div., Avco Manufacturing Corp., Cincinnati, Ohio, will market a hybrid portable. Like the previously announced Emerson portable (*ED, July, 1955, pp 48 and 49*), it will have two transistors and three subminiature tubes. It will be mounted in an enclosure 7" x 4-5/16" x 2" in dimension.

A four-transistor plus one diode portable has been developed by Mitchell Manufacturing Co., Chicago, Ill. It has the same semiconductor complement as the previously announced Regency portable and also costs about \$50. It operates on a 22.5v battery. Several other manufacturers are expected to market all or part transistor radios in the near future. It will be of interest to see if the all-transistor or hybrid radio gains the greatest consumer acceptance.

Fiber Glass Antenna Reflectors . . . Fiber-glass reinforced plastics are being used to make large lightweight, inexpensive reflectors for radar antennas. The reflector is being employed in a K-band radar that observes aircraft taxiing about crowded airports.

This method of constructing plastic reflectors was developed by Emerson & Cuming, Inc., 869 Washington St., Canton, Mass. A wooden form, like the one illustrated below, is first assembled. Metal templates are set in the surface at 2" intervals. Then sheets of aluminum foil, which will form the reflecting surface, are stretched over the form. Fiber glass saturated with epoxide resin is then laid over the foil. A core material, either aluminum honeycomb, fiber glass honeycomb, or plastic foam, is applied on the cloth. A backing layer of fiber glass reinforced plastic is then placed over the honeycomb. Pads are embedded in this layer for attaching the supporting framework. The entire mass is cured to a rigid structure.

Instead of the aluminum foil, a metal could be sprayed on the laminate to form the reflecting surface. This reflector is used in a taxi radar developed by Airborne Instruments Laboratory, Inc., Mineola, N. Y. The antenna is made by ITE Circuit Breaker Co., Philadelphia, Pa.

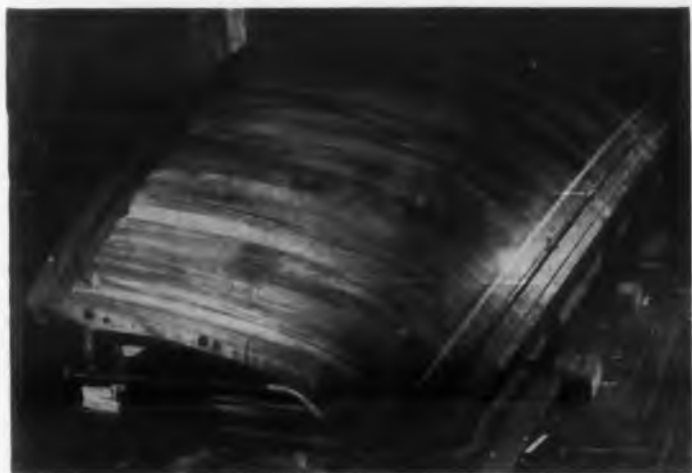

The surface of this peruvian wood form for making antenna reflectors is accurate to ± 0.007 ".



Aluminum reflecting surface of the fiber-glass reinforced antenna reflector for a taxi radar.

ELECTRONIC DESIGN • September 1955



TWO NEW TICKETS TO

OPERATING

for all military and commercial portable, battery operated electronic equipment

— developed under U. S. Signal Corps contract

— backed by Raytheon's unequalled technical skill and engineering experience in the design and production of filamentary subminiature tubes

CK6611

a new IF amplifier, for 20 mc or more that requires 50 to 60% less filament power — 30% less plate voltage than present types 1AH4 and CK5678

CK6612

a new RF amplifier good for 100 mc or more, with filament power down 20%, mutual conductance up 50% compared to present type 1AD4

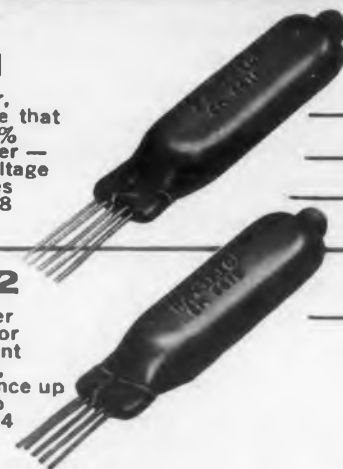

Type	Filament Current at 1.25V mA	Plate and Screen Volts	Mut. Cond. μmhos	Plate mA	Grid Plate Capacity $\mu\mu\text{f}$ (max.)
CK6611	20	30	1000	1	0.007
1AH4	40	45	750	0.75	0.01
CK5678	50	45	820	0.8	0.01
CK6612	80	30	3000	3	0.01
1AD4	100	45	2000	3	0.01

Both these new tubes offer the following advantages:

- long life expectancy
- low filament and plate power permit smaller and lighter batteries
- mechanical ruggedness
- oxide coated tungsten filaments — a feature of all Raytheon filamentary subminiatures
- metallic shield coating over entire bulb
- better performance with less operating power
- Raytheon's flat press seal — The Seal of Reliability



CIRCLE 12 ON READER-SERVICE CARD FOR MORE INFORMATION

CONTROLLED QUALITY PRODUCTION



HiperCore

ELECTRONIC CORES

**PERMIT SUPERIOR PERFORMANCE
IN MANY ELECTRONIC PRODUCTS**

The superior performance of Moloney HiperCore Electronic Cores is immediately discernable when incorporated in various electronic products. This is the result of rigid quality control during manufacture.

To begin with...every mill shipment of cold-rolled, oriented grain, high permeability steel for HiperCore Cores must pass rigid Epstein Tests. Then, during manufacture...*care and precision* in the winding on Moloney's patented winding mandrels... absolute control of tension... exact overall dimensions. *Care*... in annealing to relieve stresses by maintaining accurate temperature and atmospheric control. *Care*... in cutting, to obtain a minimum gap followed by an etching process to insure inter-laminar insulation.

Production, in quantity, is available to you if you need superior performance, smaller size, less weight in your electronic cores.

Moloney also manufactures a complete line of high voltage, large capacity transformers and reactors for all electronic applications... Rectifier Transformers—Filament Transformers—Filter Reactors—Pulse Transformers—Charging Reactors—Modulation Transformers—Modulation Reactors—in the following types—Air, Askarel, Oil, Compound, Group 2 (Class B) and Group 3 (Class H).

WRITE FOR DESCRIPTIVE LITERATURE

ME55-38

M O L O N E Y E L E C T R I C C O M P A N Y

Power Transformers • Distribution Transformers • Load Tap Changing Transformers • Regulating Transformers • Step Voltage Regulators • Primary Unit Substations • Secondary Unit Substation Transformers • Network Transformers • Series Street Lighting Transformers • Subway Transformers • Industrial Dry Type Transformers • Capacitors • Magnetic Components for Electronics

**SALES OFFICES IN ALL PRINCIPAL CITIES • FACTORIES AT ST. LOUIS 20, MO. AND TORONTO, ONT., CANADA
CIRCLE 16 ON READER-SERVICE CARD FOR MORE INFORMATION**

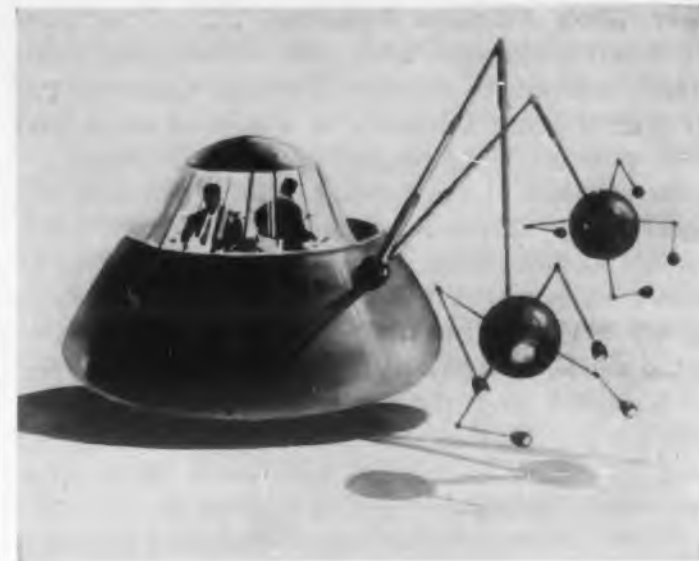

Mobile TV Studio

One of the electronic features of the "Palace of Progress" (see p 5) will be this self-propelled, self-contained "Remotemobile". The round objects contain TV cameras and servo equipment that controls the movements of the microphones and lights extending from the camera housing. The vehicle would move about providing spot news coverage.

Atomic Power Plant . . . An atomic-electric power plant of at least 150,000kw using the homogeneous-type reactor is planned for 1962. It is expected that such a plant will be commercially competitive with generating stations using conventional fuels. The reactor and plant will be developed by Westinghouse Electric Corp., and Pennsylvania Power and Light Co.

The fuel in a homogeneous reactor is in liquid form. This liquid, in addition to containing the radioactive fuel, also includes coolant and moderator to control the fission process. The liquid circulates freely throughout the nuclear power plant's system and carries heat to steam generators. The use of the liquid fuel system will permit the reactor to operate continuously as new liquid fuel can be added while the reactor is running.

Airlines Handle Reservations Electronically . . .

Two airlines have joined the various transportation organizations that are now handling reservations by electronic data-processing equipment. United and National Airlines have purchased such electronic devices from Teleregister Corp., Stamford, Conn. This firm has recently sold similar equipment to the New York Central and New Haven Railroads.

The installations should result in considerable savings in handling reservations, quicker service, and fewer errors. The installation purchased by United Airlines, 5959 S. Cicero Ave., Chicago 38, Ill., is more extensive. It will be tied in with IBM automatic ticket printers. Eighty cities along United's routes will be

linked together. The equipment purchased by National Airlines, 80 E. 42nd St., New York, N. Y., will handle 3600 inquiries per hour.

The nation's large intercity bus systems are the only other possible means of transportation that have not as yet purchased automatic reservations devices. The ship lines are not likely to require such equipment.

40,000 Amperes . . . A capacitor recently developed for nuclear research purposes has an allowable peak r-f current of 40,000amp. The special capacitor is employed to provide a large amount of power in a very short time.

The unit was developed by Tobe Deutschmann Corp., Norwood, Mass. In order to accomplish the rapid discharge required, the internal inductance and resistance of the capacitor must be held to a minimum. This unit, encased in a cylinder 3' diam x 2' high, has an inductance of 0.08uh and an internal resistance corresponding to a Q in excess of 1000. The electrical rating is 0.12 μ fd at 50kv. Such capacitors are also used in high-power r-f generators.

Disappearing Antenna . . . The highest priced line of Crosley TV receivers for 1956 includes a disappearing indoor antenna. The directional antenna telescopes into a hole in the top of the cabinet.

Another line of receivers manufactured by the Cincinnati firm features an indoor antenna that plugs into the top of the cabinet. When not in use, this plug-in antenna can be stored in a rack on the back of the cabinet. All of this firm's receivers have their controls on the side of the cabinet.

Cyrano-Like Nose

The nose of this Learstar executive plane has been stretched to accommodate a Bendix X-band weather radar. The dotted line indicates the shape of the nose before the radome was installed. The speed of the craft, made by Lear Inc., Santa Monica, Calif., will actually be improved by the addition of the aerodynamically designed fiberglass radome to the aircraft.

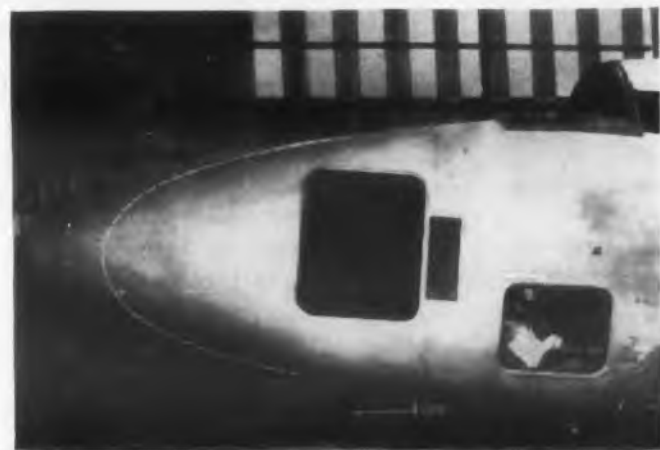

leadership in semi-conductors

from

Transitron

SILICON

GERMANIUM

Transitron

SILICON POWER RECTIFIERS

Send for Bulletin TE-1321

Transitron

SUBMINIATURE GLASS GERMANIUM DIODES

Send for Bulletin TE-1319

Transitron

MEDIUM POWER SILICON RECTIFIERS

Send for Bulletin TE-1321 D

Transitron

GOLD BONDED GERMANIUM DIODES

Send for Bulletin TE-1300

Transitron

HIGH POWER SILICON RECTIFIERS

Send for Bulletin TE-1321 C

Transitron

MATCHED QUADS

Send for Bulletin TE-1310

Transitron

SILICON BONDED DIODES

Send for Bulletin TE-1308

Transitron

AUDIO TRANSISTORS

Send for Bulletin TE-1320

Transitron

SILICON JUNCTION DIODES

Send for Bulletin TE-1322

Transitron

POWER TRANSISTORS

Send for Bulletin TE-1320 C

All Transitron semi-conductors are produced to the most rigid military and commercial specifications to assure long life and complete reliability. They provide the trouble-free, dependable performance that is so essential in modern complex electronic equipment.

Whether your requirements are for Germanium or Silicon, the solution can be found in Transitron's diversified line of semi-conductors. A wide variety of standard types, along with over 300 special types, are available. Your inquiries are invited.

Transitron

electronic corporation
melrose 76, massachusetts



CIRCLE 13 ON READER-SERVICE CARD FOR MORE INFORMATION

NEW HIGH STANDARDS OF CAMERA-TUBE PRODUCTION

Tube Simulates Typesetting . . . An electron-image tube translates coded signals from tape, keyboard, or radio into clearly defined letters and figures at speeds up to 100,000 words per minute for high-speed photographic recording. Further development is expected to fit the tube for wider application in general printing as an electronic means of typesetting.

In operation, the tube simulates typesetting in selecting letters and figures from a font and placing them in luminous form on the 5" circular tube face either in lines or in any pattern desired. The source of the coded information can be perforated paper tape, magnetic tape, wire or radio signals, keyboard selection, or an electronic storage unit.

Since the image on the tube face is to be recorded on photographic film, the tube can produce letters with clear definition and high level of brightness. In laboratory tests 2,000 characters per second have been recorded from the tube face on standard 35mm film. The tube was developed at the David Sarnoff Research Center, Radio Corp. of America, Princeton, N. J.

Nuclear Waste for Atomic Batteries

. . . At the recent international "Atoms - for - Peace" Conference in Geneva an American scientist suggested that radioactive waste from nuclear reactors could be used in making atomic batteries. Dr. E. G. Linder, Radio Corp. of America, New York, N. Y., made the suggestion in pointing out the large amounts of energy latent in the waste.

New AEC Division . . . A Division of Civilian Application has been established in the Atomic Energy Commission. The new Division takes the place and assumes the responsibilities of the Division of Licensing and carries out other civilian use activities.

The Division is responsible for developing AEC regulations and other instructions dealing with licenses and authorizations; authorizing the distribution of source, special nuclear, by-product, and other materials; administering the program of access to restricted data for civilian use; and



Extreme delicacy in processing parts for G-E camera tubes is shown as this glass technician fabricates an image-orthicon target. The glass bubble she holds is only 1/10,000 inch thick. After cutting out a small section, she seals this carefully to a metal ring. Any slip or other false movement would completely ruin the fragile target.



Without aid from magnification, the human eye cannot see the openings (250,000 to a square inch) in this copper mesh for a G-E image orthicon—shown here being welded to its ring. Note the rubber finger cots used by the General Electric worker, to avoid contaminating the silk-fine mesh!



Target and mesh are assembled, then riveted together with a spacing of 1/500 inch, to form a link between optical image and electrical signal. A single dust particle could mar tube performance; so before work starts, these G-E specialists sit quietly for ten minutes, to permit any dust to settle that may remain in the air after filtering and conditioning.



18-inch offset screwdrivers are used to tighten the set-screws holding target and mesh assembly in place in the camera tube. Skill, care, and time are needed to complete the delicate operation. Again, dust and lint are barred. An important step toward cleanliness, is the lint-free Nylon garments worn by all persons in the G-E camera-tube area.

CIRCLE 15 ON READER-SERVICE CARD ➤

PRECISION CRAFTSMANSHIP FEATURE BY GENERAL ELECTRIC!

To include image orthicons, vidicons, other commercial and military types.

G.E.'s entry into camera-tube manufacture is a project of major proportions. Extensive facilities and advanced equipment have been acquired; impressive engineering and technical skills have been assembled; workers have been exhaustively trained.

The purpose is high-quality, long-life camera tubes of all types—from TV image orthicons, now in full G-E production, to vidicons and other "seeing" tubes for commercial and military uses.

How improved performance is built into G-E camera tubes, these pictures show in part. Every operation described is rivalled by numerous others that call for the same or greater precision.

You are invited to familiarize yourself with G-E camera-tube manufacture, by written request for information. Problems involving camera tubes to meet your special design needs, will be welcomed. Tube Dept., General Electric Co., Schenectady 5, N. Y.

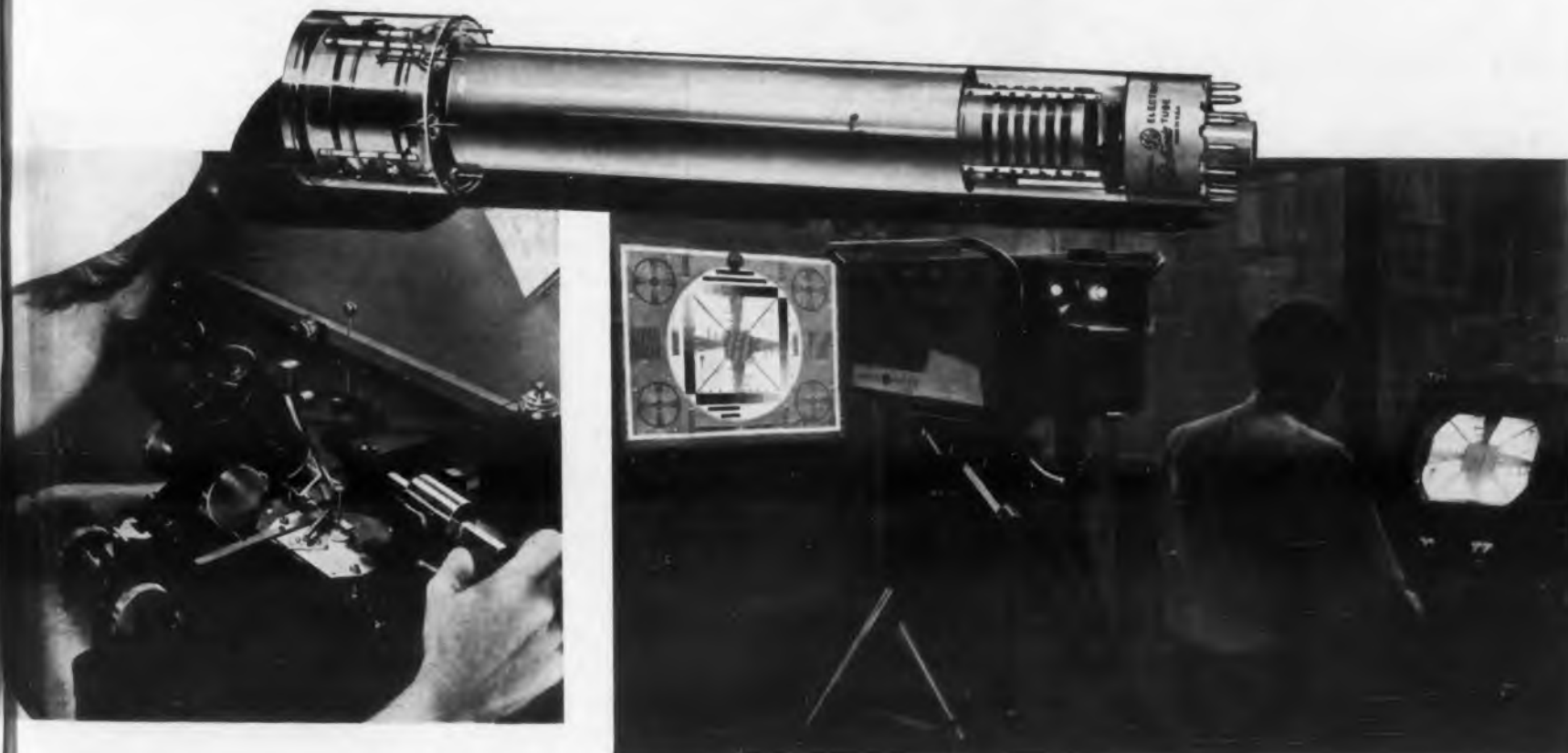

Powerful lenses aid trained hands. In building G-E camera tubes, numerous precision operations call for the aid of microscopes. Here a micro-drill operator drills a 1/500-inch hole—less than the diameter of a hair—for the beam-limiting aperture in the first dynode of a G-E image orthicon tube.

Final testing of a G-E image orthicon uses actual performance as the yardstick. Instrumentation supplements the verdict of the inspector's critical eyes. Life tests, under the most unfavorable conditions, also are regularly conducted by General Electric, to increase the service life and improve the performance of all G-E camera tubes . . . Above: a G-E image orthicon—Type GL-5820—ready for the TV camera.

Progress Is Our Most Important Product

GENERAL  ELECTRIC

162-184

handling authorizations to export equipment and materials or to engage in atomic energy activities outside the United States.

More Homes With TV . . . More than six times as many households had TV sets in June 1955 than in April 1950, according to the results of a survey of the United States recently conducted by the Bureau of the Census. About 32 million, or 67% of the households enumerated in June had one or more TV sets, whereas in 1950, the first time that a question on TV was included in a census of housing, there were about 5 million households with TV sets or 12% of the total.

This finding agrees with a report made by RETMA that the number of TV sets shipped to dealers in the first half of 1955 was considerably above that of a comparable period last year. During the first six months of this year, 3,084,717 TV sets were shipped compared with 2,667,603 receivers shipped during the same 1954 period.

Accelerator to Middle East . . . A 3 million volt Van de Graaff positive ion accelerator has been sold to the Weizmann Institute of Science, Rehovoth, Israel. The machine, manufactured by High Voltage Engineering Corp., Cambridge, Mass., will be the first accelerator in the Middle East. It will be installed in the new nuclear physics department building.

The accelerator will be used in the study of nuclear reactions produced by bombardment of nuclei with high energy protons. It is expected that the machine will contribute substantially to Israel's atomic research program.

Electronic Firewatchers . . . TV cameras in forest lookout towers now are being used to relay TV pictures of surrounding areas back to forest headquarters, it was reported in the August issue of *Industrial Research Newsletter*, Armor Research Foundation, Chicago, Ill. The system of TV monitors and rotating, remote controlled cameras was demonstrated by Raytheon Manufacturing Co. to the Forestry Conservation Communications Association.

◀ CIRCLE 15 ON READER-SERVICE CARD

If your manufacturing operations include potting, sealing, impregnating, laminating, bonding or tooling . . .

Easy to use

EPON[®] RESIN

can give improved mechanical and electrical properties . . . plus faster processing

Because of their excellent mechanical and dielectric properties, Epon resins are important materials in electrical and electronic manufacture. Epon resins combine high strength with low shrinkage on curing and extreme dimensional stability.

For potting, sealing and impregnating, Epon resins permit safe enclosure of delicate components, maintain high insulation resistance under extremes of temperature and humidity, and are resistant to chemicals.

Epon resins laid up with inert fibrous fillers produce laminates that have excellent dielectric properties and can be sheared, punched, drilled and bath soldered.

Solvent-free Epon resin adhesives, curing with contact pressure alone at room temperature, form powerful bonds between glass, metal, wood or plastic.

Because of dimensional stability and impact resistance, Epon resins play the key part in making plastic tools such as forming dies, jigs, patterns, templates and fixtures.

Write for "Epon Resins For Structural Uses." Your letterhead request will bring you a sample for evaluation.

(Epon resins are the epoxy polymers manufactured exclusively by Shell Chemical Corporation.)

SHELL CHEMICAL CORPORATION
CHEMICAL PARTNER OF INDUSTRY AND AGRICULTURE
380 Madison Avenue, New York 17, New York

Atlanta • Boston • Chicago • Cleveland • Detroit • Houston • Los Angeles • Newark • New York • San Francisco • St. Louis
 IN CANADA: Chemical Division, Shell Oil Company of Canada, Limited • Montreal • Toronto • Vancouver



Miniature electronic components potted in Epon resin by Freed Transformer Company, Brooklyn, New York.



Section of magnetic amplifier coils embedded in Epon resin by Westinghouse Electric Corporation, Pittsburgh, Pennsylvania.



Potting transformer with Epon resin at PCA Electronics, Inc., Santa Monica, California.



Underwater TV

An RCA closed-circuit TV camera is enclosed in this diving bell. The U. S. Fish and Wildlife Service is employing it to study experimental fishery methods at the ocean's bottom. Images obtained with natural light were clear enough for photography. The bell turns 360° and up and down.

New Computer Uses . . . Computers are now being used by various companies in solving machining problems, research for the utility gas industry, inventory control, aircraft manufacturing, refinery monitoring, and weather forecasting.

An electronic analog unit developed by the Carbony Dept., General Electric Co., Detroit, Mich., will solve machining problems for tool engineers. The unit will determine whether the correct set of conditions for machining a job are being used; arrive at a proper set of conditions for setting up a new machining operation; or indicate the relative advantages of changing some of the present job conditions to obtain greater production.

Research in the utility gas industry will be facilitated by the use of a computer, ALWAC III. The computer will be used in computing composition of gas mixtures, pressure drops and flows, flame temperatures, thermodynamic properties of gases, and other research problems. The machine was built by Logistics Research Inc., Redondo Beach, Calif., and is installed at the Institute of Gas Technology, Illinois Institute of Technology, Chicago, Ill.

Nuclear Development Associates, Inc., White Plains, N. Y., is building a computer to watch over 35,000 different inventory items in the stock rooms of the Otis Elevator Co. The computing system will keep a continuous up-to-date record of quantity of each item on hand and on order; warn the company when and in what quantities to reorder items, provide

a daily report for expeditors on all items that are going on shortage and all contracts affected by these shortages, and provide information for scheduling production to meet contract dates.

An analog computer that predicts the increasingly high temperatures that aircraft brakes must absorb without failure is at work in the B. F. Goodrich Co. airplane wheel and brake plant, Troy, Ohio. The machine supplies facts concerning heat flow characteristics of metals. Use of the computer makes it possible to discover immediately whether or not a new design or material has promise as an airplane brake part and if it warrants further research and engineering effort.

Three electronic data processing systems will be installed at the U. S. Air Force's Arnold Engineering Development Center, Tullahoma, Tenn. One will be for a fully automatic wind tunnel system that will measure pressures on jet engines and air-foil sections during wind tunnel tests. The second system will measure force and moments (lift, pitch, drag, yaw, side force, roll, etc.) on aerodynamic and propulsion models. Another data-processing system will speed up testing of turbojet, ramjet, and turboprop engines under simulated flight speeds, altitude, and flight conditions.

Decimal digital differential analyzers are used to solve differential equations employed in describing the dynamics of aircraft and missiles by Convair Div., General Dynamics Corp., San Diego, Calif.

An industrial data reduction system for the Canadian and Petrofina Ltd. refinery, Montreal, Canada, is scheduled to go into operation in November. The "Automatic Logger" will automatically monitor, analyze, and record a total of 480 variables for the nine production units at the refinery.

The effects of violent surges of lightning on electrical apparatus can be studied in more detail through the use of an analog computer. One of the primary uses of the computer will be calculating voltages and stresses so that transformers can be designed and built to prevent damages inside transformers when lightning strikes the equipment. It has been installed at the Westinghouse Electric Corp., Transformer Div., Sharon, Pa.

Experimental weather forecasting has been carried on for some time using the International Business Machine's 701 digital computer. The computer is in use at the U. S. Weather Bureau, Suitland, Md.

Exporting Know-How . . . A private "Point Four" program has been set up by an American firm. The Minneapolis-Honeywell Regulator Co. has announced that it will establish a technical training school in England to train technical personnel in the use of American automatic control equipment. At first classes will comprise only members of the firm stationed in Europe, but later students from customer firms will be included in the instruction program.

DO YOU HAVE A

SEALING

PROBLEM, too?



When it comes to *static* sealing you can depend upon the specialized experience and know-how of the Franklin C. Wolfe Company.

Nearly every leading industrial producer in America uses at least one Wolfe sealing design.

In fact, many companies have found that it pays to take advantage of our free sealing design consultation service. This service saves many hours of design-engineering time and effort by helping to "seal the entire assembly at the design stage." If your designs require sealing

why not use this free service yourself?

For full particulars just drop us a line on company letterhead.



LOCK-O-SEAL



RIV-O-SEAL



GASK-O-SEAL

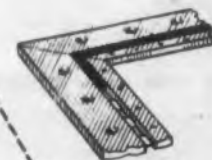

STRIP-O-SEAL



STAT-O-SEAL



BOLT-O-SEAL

To seal fasteners, flanges, or fittings one of the "O-seal" family is your assurance of safe, sure, zero-leakage sealing.

"It pays to cry WOLFE for sealing!"



FRANKLIN C. WOLFE CO., INC.

3644 Eastham Dr.

Culver City, Calif.

"Sealing design specialists"

CIRCLE 17 ON READER-SERVICE CARD FOR MORE INFORMATION

ALLEN-BRADLEY QUALITY COMPONENTS for PRINTED CIRCUITS

FIXED MOLDED RESISTORS

Stable characteristics, uniform size, accurate lead wire dimensions, special uniform solder coating of leads, and mechanical strength are essential requirements for components used for printed circuit applications. It is on these features that the Quality reputation of Allen-Bradley molded resistors was established. Made in 1/10, 1/2, 1, and 2 watt sizes, meeting all applicable RETMA and MIL-R-11A specifications, and rated at 70C ambient temperature, these resistors do not require the derating usually necessary on plastic board assemblies.

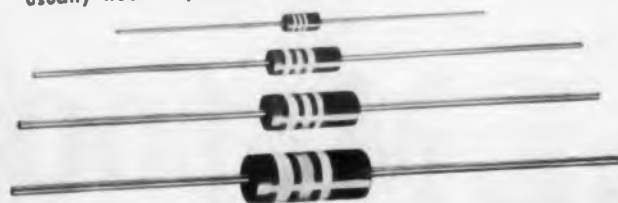

SMALL POTENTIOMETERS

Allen-Bradley Type GP and Type T adjustable molded resistors are designed for printed circuits where quality—not price—is the important requirement.

They are available in resistance values from 100 ohms to 5 meg-ohms in standard tapers.

Both are rated at 1/2 watt.

The Type GP potentiometer is 1/2 inch in diameter and is supplied with gold-plated lugs.

The Type T potentiometer is 1 inch in diameter and has round, solder-coated leads.



Type GP



Type T

CERAMIC CAPACITORS

Type CE and Type DS ceramic capacitors are available for printed circuit assemblies in all commercial characteristics. These units were developed for operation at above normal ambient temperatures and are impervious to moisture.

Type DS resin-enclosed capacitors have a new lug adapted for insertion in a round hole. The lug is so designed as to properly space the capacitor above the printed board.



Type DS



Type CE

OTHER MINIATURE COMPONENTS

Type FT feed-thru and Type SO stand-off discoidal capacitors incorporate the maximum performance characteristics together with extreme ruggedness and small size. They are available in standard nominal values from 5 to 1,000 mmf.

Allen-Bradley Type FC Ferri-Cap feed-thru filter is a new, unique device consisting of a discoidal feed-thru capacitor combined with ferrite material to provide internal impedances in series with both ends of the feed-thru electrode.

Investigate these truly superior miniature components.



Type FT



Type FC



Type SO

COMPONENT PACKAGING

To keep step with the automatic trends of industry, small components, such as the molded fixed resistors and the ceramic capacitors, are now offered by Allen-Bradley in reel packages wherein the components are attached to a pressure-sensitive tape, ideally adapted for automatic assembly or preassembly operations.



Carton packaging (Standard)



Reel packaging (Special)

Allen-Bradley Co.
1344 S. Second St.
Milwaukee 4, Wis.

ALLEN-BRADLEY
RADIO & TELEVISION COMPONENTS

QUALITY

CIRCLE 18 ON READER-SERVICE CARD FOR MORE INFORMATION

In Canada
Allen-Bradley Canada, Ltd.
Galt, Ont.



Helmet Transceiver

The range of the hybrid f-m transceiver mounted on the soldier's helmet is a quarter-mile. Operating in the 45 to 50Mc range, unusually high for transistors, the experimental device weighs only 15 oz. The 10-transistor superhet receiver can be detached for separate use. The transmitter uses two transistors and one tube. Developed by RCA, the unit is now being evaluated by the Signal Corps.

Pleasing the Public . . . RETMA has taken two steps to insure better understanding between the public and the television manufacturing and servicing industry. An "accreditation" program for television servicemen has been proposed, and another edition of a booklet telling how to buy a TV receiver has been published.

If the accreditation plan goes into effect, local committees would sponsor servicing courses for servicing personnel. All men passing the course would receive a certificate from RETMA suitable for hanging in their shops. The public would benefit from their improved proficiency.

The booklet is entitled "Things You Should Know About the Purchase and Servicing of Television Sets". Better Business Bureaus and local TV dealers will distribute the booklet.

Engineers Following Plants Inland? . . . The Air Force's emphasis on dispersal of aircraft manufacturing plants inland may force many electronic engineers to move. The major aircraft companies are building new factories in the Southwest, Middle West, and South rather than on the coasts. At present only a very small percentage of the nation's electronic engineers are employed in the Southwest and South.

ELECTRONIC DESIGN • September 1955

TV in Trailers . . . The growing number of trailers purchased in the United States represents a potentially valuable market for TV receivers. Although some trailers among the close to 100,000 being sold each year are equipped with TV, no manufacturer has brought out a set specifically designed for this market.

A small screen (14 or 17") set with some shock-mounting and ruggedization is required. It must be able to operate in fringe areas. Some means of securing it to the wall of the trailer or to a shelf should be incorporated. For high sales, the set would have to be sold as original equipment, just as most auto radios are sold today.

Literature Searches Simplified . . . The National Bureau of Standards has devised a punched-card system for speeding searches by Government researchers into previously published literature on instrumentation. Searches in this field are particularly time-consuming because the material is not as well organized and because the same information may be required by researchers in widely divergent fields.

Referred to as the "multidimensional approach", the system was designed and constructed by Joshua Stern of the Bureau's Office of Basic Instrumentation. Only inexpensive hand-operated indexing equipment is required for use with the system.

Rear Warning Radar . . . Among the electronic devices demonstrated at the recent air show at Le Bourget airport, Paris, France, was a rear warning radar. According to the August, 1955, issue of *Wireless World* (p 375), the device was installed on a French "Ouragan" jet fighter. It would be especially valuable in warning of approaching interceptors.

A radio compass in which the indicator is a small cathode-ray tube was also demonstrated. A product of the French firm S.I.N.T.R.A., it avoids the use of moving parts. It also has the advantage of indicating immediately if the equipment stops working.

High Research Total in '65 . . . National research and development expenditures will be at the annual rate of between six and seven billion dollars by 1965. This prediction was recently made by Dr. W. R. G. Baker, general manager, Electronics Div., General Electric Co., Syracuse, N. Y.

In order to spend such a huge amount on research, the number of students studying the sciences and technologies will have to be increased. At the present time the number of students entering scientific training institutions is dropping alarmingly.

If you need to locate a special component, send a brief statement of your specifications addressed to Bulletin Board, Electronic Design, 19 E. 62nd St., New York 21, N. Y. Include your complete address.



Look closely at this little black box ...IT'S LOADED!

NO MATTER WHO YOU ARE or what you do, the chances are good that this little black box will have a far-reaching effect on your way of life within the very near future.

For this is "TRANSAC"*—the smallest, lightest, and fastest "electronic brain" yet announced—and its development by Philco scientists finally unlocks the door to mass production and widespread use of electronic computer and control systems in industry, science, business, and the Armed Forces.

And a well-locked door it was—

Because the demand for the benefits of automatic computation mushrooming out of World War II has, until now, put a breaking strain on computer design. As they have grown more complex they have grown more cumbersome and harder to produce.

Their thousands of vacuum tubes have generated not only heat and the need for bulky air-conditioning, but also problems of power consumption

and maintenance. And their size and weight have barred their use in many urgent military applications.

To this dead-end situation Philco engineers brought a fresh outlook and combined it with their experience from pioneering the "Surface Barrier" Transistor.

By utilizing the unique high frequency properties of the Philco "Surface Barrier" Transistor, they evolved an entirely new concept in computer design—the Philco *Direct Coupled* Transistor Circuits.

This "direct coupling" of transistors is the key that unlocks the door.

By one basic stroke, it cuts sharply the number of elements in a circuit, pares down the bulk and weight, slashes cost and production time . . . and speeds up computation!

"TRANSAC", for example, is one-third smaller and lighter, and 10 times faster than any transistorized computer announced to date. It operates on one

small battery, with less than 1/1000th of the power needed by a comparable vacuum tube computer, and generates less heat than a Christmas tree bulb.

Yet it performs all computer functions—multiplies, divides, compares, and "carries" for 19 binary digits and algebraic sign, and also performs 416,000 complete additions or subtractions per second!

The civilian applications for this system are limitless. And the military uses—with the emphasis on lightweight portability, low power consumption, and high accuracy—are only to be hinted at.

Thus "TRANSAC" becomes one more example of the teamwork of Research, Engineering, and Application that has made "Philco" synonymous with "leadership" in Electronics.



*"TRANSAC"—Trademark of Philco Corporation for Transistor Automatic Computer
For further information, write Philco, 4700 Wissahickon Avenue, Phila. 44, Penna.

ANOTHER FIRST FROM THE PHILCO LABORATORIES

CIRCLE 19 ON READER-SERVICE CARD FOR MORE INFORMATION

Conductance Curve Design of Relaxation Circuits

Keats A. Pullen, Jr., Ballistic Research Labs
Aberdeen Proving Ground, Maryland

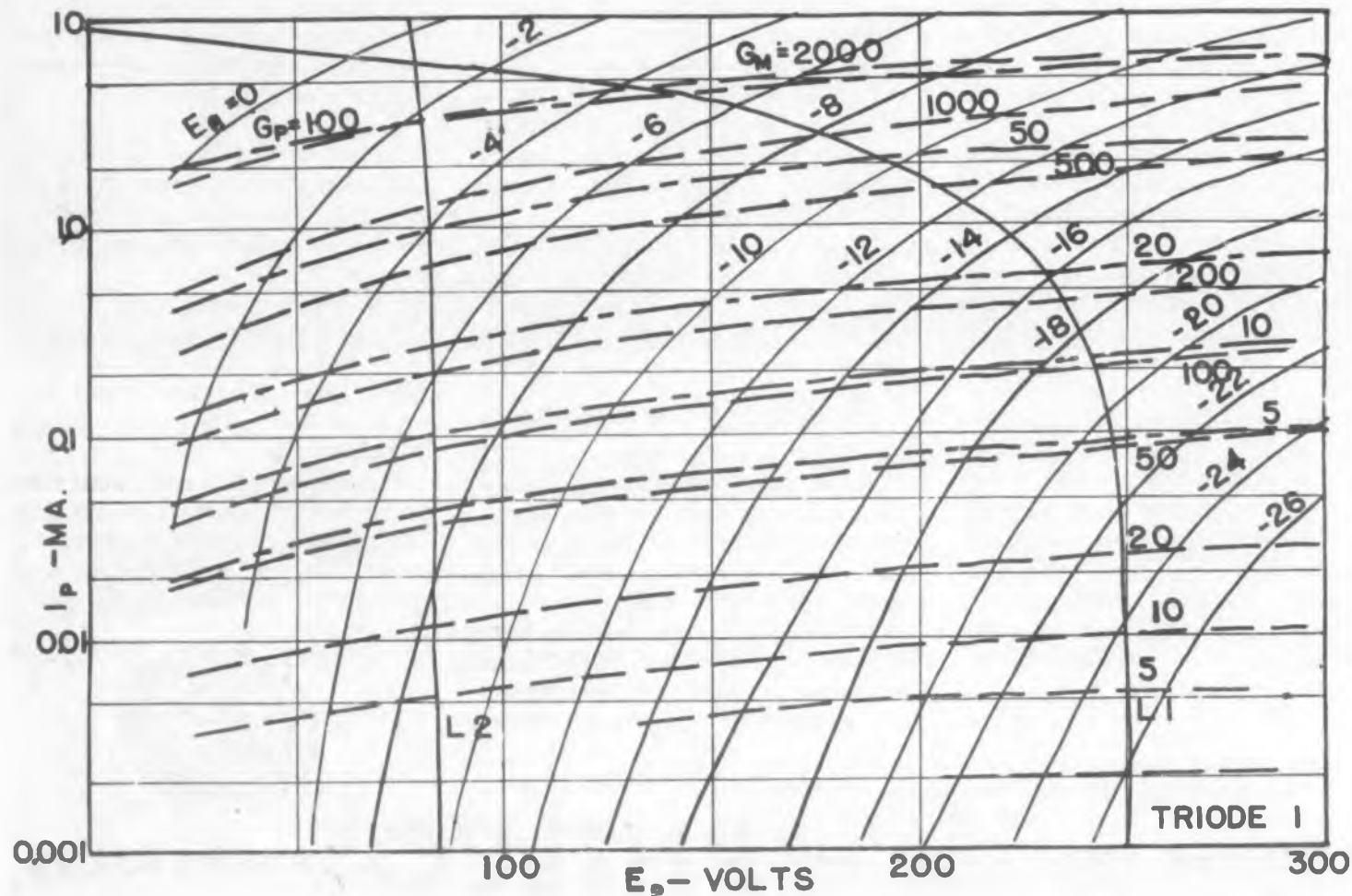

Fig. 1. Logarithmic plate current scale for plate conductance characteristic curve of 6SN7 tube.

Small signal amplification and distortion as well as preferred component sizes can be determined directly from conductance type data sheets. Conductance curves are contours of given constant values of transconductance, g_m , and plate conductance, g_p , plotted on I_p vs E_g graphs.

Values of g_m and g_p are read at the bias contour-load line intersections of interest. The pairs of values are then inserted in the amplification and distortion equations.

$$VA = -g_m R_L / (1 + g_p R_L)$$

The approximate second harmonic distortion is found by substituting VA for the limit values of grid bias in the distortion equation

$$\% \text{ Distortion} = 25(VA_1 - VA_2) / (VA_1 + VA_2)$$

For a more complete discussion of electron tube circuit design using conductance curves, see reference at the end of this article.

PLATE conductance data for dynamic conditions as determined from conductance curves can aid in the analysis and design of relaxation circuits. General equations which can be used in conjunction with conductance curve data are presented to help determine exact initiation time.

Analysis and design of relaxation circuits may be divided into two phases. The first phase might be called the passive phase. The second phase is the active phase. The techniques for calculating passive circuit performance are well understood. However, the correction for plate conductance on the decay characteristic in multivibrators has been handicapped by the lack of adequate plate conductance data. Lack of adequate data on dynamic parameters of the active elements has hampered the determination of the initiation point and active transition characteristics.

The problem of presentation of dynamic data for aiding the design of comparatively linear tube circuits has been described (see references). However, where a wide degree of variation for the range of the tube parameters is required, previously described forms of curves may not prove adequate.

The use of a logarithmic plate current scale on the standard plate or screen conductance type characteristics curves provides the required range of data on at least the static parameters. Choice of suitably scaled contour values for the conductance contours could then provide the dynamic data.

A set of logarithmic curves on the 6SN7 (6J5) triode tube has been prepared on one triode section. Fig. 1. As can be noted, the plate current range is from $1\mu\text{amp}$ to 10ma . The grid bias range is from 0 to -26v . The transconductance and plate conductance contours plotted are those having 1, 2, 5, 10, 20, 50, etc. μmhos up to the maximum value provided

in the tube at zero bias. The comparison with conventional curves is indicated by Fig. 2.

Although the requirement of a curved load line would initially appear to lower the usefulness of the semi-logarithmic plot of Fig. 1, as compared to Fig. 2, the operation of plotting the curved load line is not difficult. Whenever a wide range of data must be provided, the usefulness of the spreading of the data in the low transconductance area more than offsets the inconvenience.

During the initiation of transition in the multivibrator, dynamic characteristics on both active elements must be known. Transition initiation in a free-running multivibrator occurs as a result of the slow drift of the bias of the tube which has been switched off back toward the conducting condition. Transition may be expected to start immediately upon establishment of an open circuit loop amplification of approximately unity. The drift of bias, neglecting the effect of loop amplification, would be comparatively uniform. The effect of the rise of loop amplification is to speed up the transition by introduction of a voltage in series with the discharging capacitor which acts in such a direction as to change the bias more rapidly. If, for example, the amplification of triode 1 is minus A_1 and triode 2 is minus A_2 , the voltage change in triode 2 from a change in voltage E_0 in the grid of triode 1 is $E_0 A_1 A_2$. Consequently, the apparent voltage applied at the grid of tube 1 now becomes $E_0 (1 + A_1 A_2)$. Expanding this equation with successive cycles of feedback, gives a product series.

The voltage rise due to amplification, of course, does not occur instantaneously. The rate of rise depends on the stray circuit capacitances as well as the amplifications of the two amplifier tubes. Strictly, at least two build up functions will interact to control the time delay around the loop. The amplification then may be written as

$$VA = \frac{\pi}{j} [1 + A_{1j} A_{2j} \sigma_{1j} \sigma_{2j} \Delta b_j^2] \quad (1)$$

The function σ is related to G 's and C 's, which are variable, and must be calculated from the circuit parameters by the use of equations 2 and 3.

$$\begin{aligned} G_{1j} &= 1/R_{t1} + G_{p1} + 1/R_{c2} \\ G_{2j} &= 1/R_{t2} + G_{p2} + 1/R_{c1} \end{aligned} \quad (2)$$

$$\begin{aligned} C_{1j} &= C_{pk} + C_{pc1} + C_{ck2} + (1 + A_{2j}) C_{cp2} + C_d \\ C_{2j} &= C_{pk2} + C_{pc2} + C_{ck1} + (1 + A_{1j}) C_{cp1} + C_d \end{aligned}$$

$$\sigma_{1j} = G_{1j}/C_{1j}; \quad \sigma_{2j} = G_{2j}/C_{2j} \quad (3)$$

The physical significance of equation 1 is rather interesting. The effect of amplification in the multivibrator is to cause a multiplication of voltage change on successive loops around the feedback circuit. Consequently, relatively small rates of change of bias can be converted into extremely high rates of change at the steepest point in the transition. This steepness may be great enough to render the steepest part

of the transition difficult to observe on even the highest speed oscilloscopes.

Practical use of equation 1 does not require its reduction to an integral equation. Choosing a value of Δt_j to satisfy the relation $A_{1j} A_{2j} \delta_{1j} \delta_{2j} \Delta t_j^2 = c \leq 0.1$ on an iterative basis enables one to determine the time required per incremental ratio of amplification change. This relation does not indicate the rate of change of bias with time. Conversion of the rate of change of amplification to rate of change of voltage requires division of Δt_j by $(1 + c)^j$, since the initiating voltage for each pass around the loop should be reduced by $1/(1 + c)$ of the final output voltage of the previous passage around the loop.

A table giving on a point by point basis the values of A_{1j} , A_{2j} , δ_{1j} , δ_{2j} , Δt_j , and $1/(1 + c)^j$ may be formulated for a given multivibrator. The values of C_{1j} , C_{2j} , G_{1j} , and G_{2j} must be determined in order that the deltas, equation 3, may be used in the determination of both the amplification values and the net bias values. The correct value of j must be determined on the basis of the chosen value of c , and the amount of the total bias change. If the basic increment ΔE_0 is taken as 10^{-3} v, for example, $E_{c1} - E_{c0} = (1 + c)^j \Delta E_0$ volts or $(1 + c)^j 10^{-3}$ v.

Completing the solution in the indicated manner, produces several interesting results. The first is that the rate of transition in a multivibrator may reach 1000v per μ sec. Secondly, the second tube apparently is cut off before the first tube reaches zero bias.

Examination, however, of the plate voltage change in the second tube required to carry the first tube to grid conduction shows that a nominal bias change on the second tube of the order of between one and five volts is sufficient to provide full transition. Integration of $A_{1j} A_{2j}$ as a function of input bias shows the bias change at tube 1 required for the active portion of the transition. When the integral of $A_{1j} A_{2j}$ with respect to the bias on the first tube numerically equals the initial negative bias on tube 1, transition should be nominally completed.

The input capacitance of the second tube prevents the nominal voltage changes read from the tube characteristics contours from being realized. The input capacitance of the first tube has a similar effect. If $\delta_{1j} = \delta_{2j}$, the loss of voltage change due to time constant would be the same, percentagewise, on each tube. Where δ_{1j} and δ_{2j} are not equal, however, the time delays must be distributed between both tubes.

Effect of Plate Conductance

The decay circuit which controls triggering in the conventional multivibrator is a resistance-capacitance combination which holds a decaying negative potential on a tube grid. Three resistors are included in the decay path for the capacitance. The first of these is the conducting-tube load resistance, the second the conducting-tube plate conductance, and the

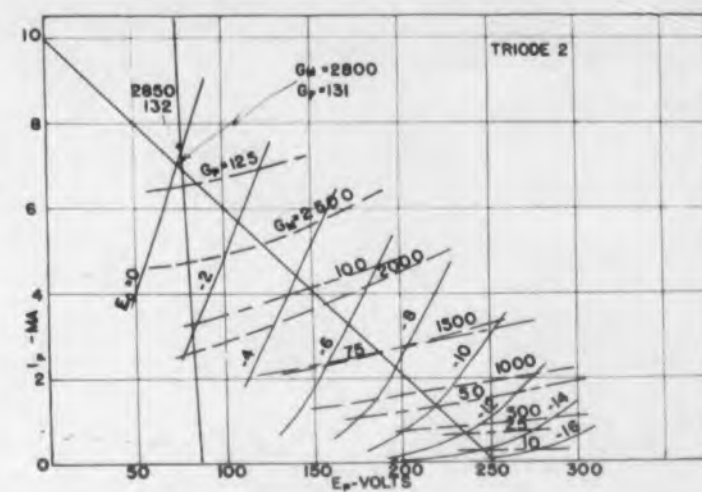

Fig. 2. Conventional plate conductance curves for 6SN7.

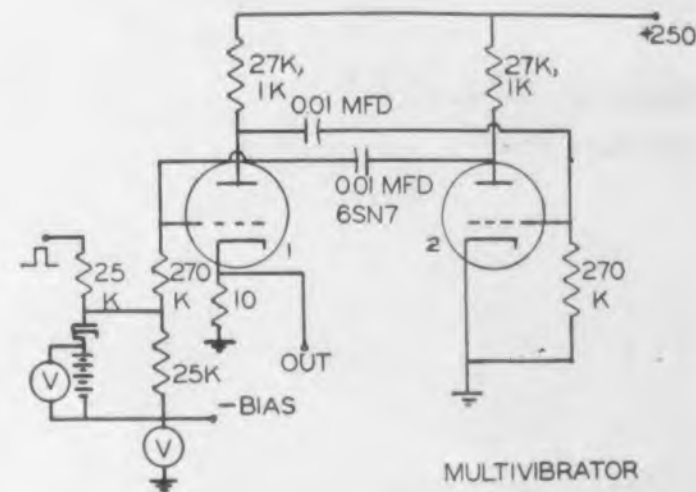

Fig. 3. Circuit to test the triggering of multivibrators.

	$E_b = 250v$	$E_b = 85v$
Load Impedance	27000 ohms	1000 ohms
Initiation Bias	-25.5 volts	-5.4 volts
Uncorrected Initiation Gain	1.21	1.26
Corrected Gain*	0.88	1.003

* Taking time constant into account.

Initiation conditions for different plate loads and voltages.

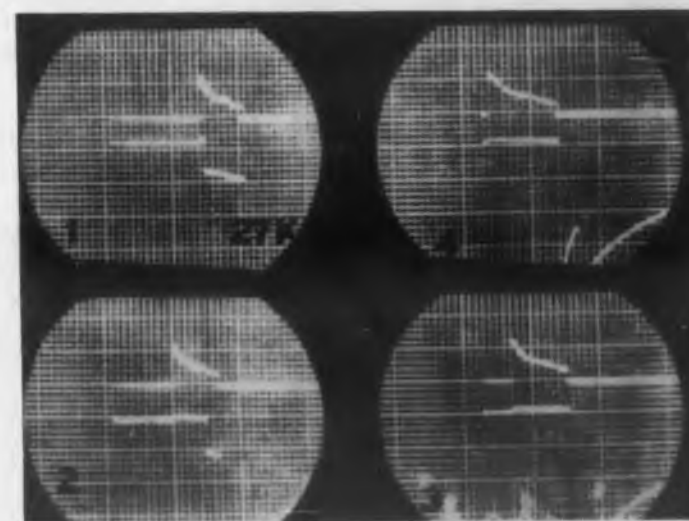

Fig. 4. Smooth output change for different bias values.

**CUT CORES
TOROIDAL
SQUARE,
RECTANGULAR**



Anything You May Need in **TAPE-WOUND CORES**

RANGE OF MATERIALS

Depending upon the specific properties required by the application, Arnold Tape-Wound Cores are available made of DELTAMAX . . . 4-79 MO-PERMALLOY . . . SUPERMALLOY . . . MUMETAL . . . 4750 ELECTRICAL METAL . . . and SILECTRON.

RANGE OF SIZES

Practically any size Tape-Wound Core can be supplied, from a fraction of a gram to several hundred pounds in weight. Toroidal cores are made in twenty-seven standard sizes with protective nylon cases. Special sizes of toroidal cores—and all cut cores, square or rectangular cores—are manufactured to meet your individual requirements.

RANGE OF TYPES

In most of the magnetic materials named, Arnold Tape-Wound Cores are produced in the following standard tape thicknesses: .012", .004", .002", .001", .0005", or .00025", as required.

For complete details, write for Bulletins TC-101A and SC-107.

Applications

Let us help with your core problems for Pulse and Power Transformers, 3-Phase Transformers, Magnetic Amplifiers, Current Transformers, Wide-Band Transformers, Non-Linear Retard Coils, Reactors, etc.

ADDRESS DEPT. ED-59

W&D 5465

THE ARNOLD ENGINEERING COMPANY

SUBSIDIARY OF ALLEGHENY LUDLUM STEEL CORPORATION

General Office & Plant: Marengo, Illinois

DISTRICT SALES OFFICES . . . New York: 350 Fifth Ave.

Los Angeles: 3450 Wilshire Blvd.

Boston: 200 Berkeley St.

CIRCLE 20 ON READER-SERVICE CARD FOR MORE INFORMATION

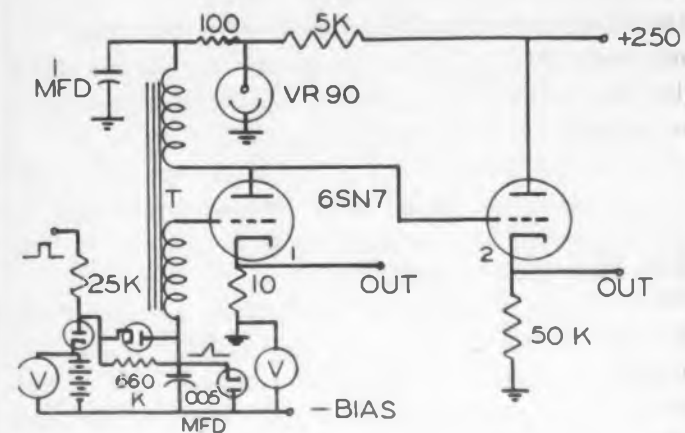

Fig. 5. Circuit for testing initiation of blocking oscillator.

third the grid resistance in the grid of the non-conducting tube. If the coupling circuit is reduced to its simplest form, the plate load resistor and the plate conductance in parallel are effectively connected in series with the grid resistor. The rate of decay is determined by this combination. The plate conductance may be read from the plate characteristics curve as in Fig. 1 or Fig. 2. The decay action may be assumed to continue until the unity loop amplification is reached.

Experimental tests on the multivibrator were made first, to examine the predictability of the initiation point and secondly, to attempt to learn something about the triggering of multivibrators. The tests were made with the circuit shown in Fig. 3. One set of tests was performed with 27,000-ohm tube load resistors and a 250v supply, the second with 1000-ohm load resistors and an 85v supply. The former required a bias near cut-off at the initiation point, and the latter design required very small bias at the initiation point. Initiation conditions for the four tests made are given in the table on the preceding page. In the initial tests giving loop amplifications of 1.21 and 1.26, the initiation point could be moved back and forth smoothly across the initiating pulse by shifting the applied bias. Fig. 4 shows a series of oscillograms of this test with different values of bias. The smoothness of the change indicated that a time constant effect was being observed. The time constant involved proved to be that of the 0.01 μ f capacitor and the 270,000-ohm resistor connected to the grid of tube 1 in Fig. 3. The circuit behaved as if the capacitor were returned to ground potential instead of appearing to have zero signal potential across the capacitor which would be expected statically at unity loop again. (Reduction of the coupling capacitor size to 0.001 μ f proved the correctness of the analysis.)

The requirement of slightly less than unity amplification for initiation with the 27,000-ohm load resistors at first appears curious. The possibility of existence of this condition with a large-gain margin had been postulated on the basis that with loop amplifications very close to unity, the system might not

reach stability before the unity amplification point had been reached. This condition apparently can occur. The initiation points, corrected for time constant, were calculated from the time constant of the pulse buildup and were also checked by experiment. Over-all results are believed to be within about 5%.

The Blocking Oscillator

The blocking oscillator uses a tube and a transformer to initiate and form a pulse through uncontrolled regeneration, Fig. 5. Initiation, as in the multivibrator, results from slow decay of the charge stored in the capacitor. The capacitor in this case is in the grid return lead.

The presence of the transformer provides several interesting characteristics to the blocking oscillator. For very slow rates of change of bias, the transformer will behave as if it were without appreciable resistance, reactance, or magnetic coupling. When the grid voltage leaks off to a point that the effect of the grid voltage change on the transconductance produces sufficient change of plate current, the transformer behaves as a unity coupled transformer-phase inverter. Its load is then the grid leak resistor until zero bias is reached, then the grid conductance and grid leak resistor is in parallel. After cycle reversals the loading exists in reverse order.

Answers to two questions were desired in the tests performed on the blocking oscillator. The first of these was: Does the blocking oscillator initiation point vary with the slope of the applied triggering pulse? A corollary question was: If so, does it vary in such a way that $L g_m (dE_c/dt)$ is approximately constant? The second question was: What is the appearance of the blocking oscillator load line?

The significance of the first question is that $L g_m (dE_c/dt)$ will be constant if a loop gain, with the transformer behaving purely as an inductance, of a fixed value is required for initiation of the blocking oscillator. The measurements made indicate that the triggering of the blocking oscillator tested does appear to depend on the slope of the triggering pulse. In fact, to at least a rough approximation, the function $L g_m (dE_c/dt)$ does appear to be a constant at the initiation point.

The circuit of Fig. 5 was designed to provide access to both the cathode current and the plate voltage to permit oscillograph recordings to be made of the load line. Two typical load lines obtained: the first of these was made without the two clamper diodes (high vacuum) across the sawtooth generator circuit. The load line rises as expected but then drops vertically and follows the zero current axis. This condition apparently is a result of the load line shift with accumulation of rectification bias. With clamping diodes to discharge this bias, the load line takes a more conventional appearance.

See K. A. Pullen, "Conductance Curves Speed Triode Amplifier Design", *Tele-Tech*, May 1953 for further references.

Where can you use these dependable Sylvania products...to improve quality; cut costs?

TUNGSTEN:

Wire, plated wire, rod, powder, formed parts, coils.

MOLYBDENUM:

Wire, plated wire, rod, sheet, powder, formed parts.

GERMANIUM:

High purity powder and metal.

SILICON:

High purity powder.

50/50 TUNGSTEN MOLYBDENUM:

Wire, plated wire, formed parts.

PHOSPHORS:

For black-and-white or color picture tubes, CR tubes. All types and colors available in bulk to eliminate color matching problems.

CHEMICALS:

Sodium tungstate, tungstic acid, tungstic oxide, high-purity potassium silicate, emission carbonates.

Write for complete information to:
Sylvania Electric Products Inc.
1740 Broadway, New York 19, N. Y.
In Canada:
Sylvania Electric (Canada) Ltd.
University Tower Bldg., Montreal

Sylvania's highly developed production facilities and exacting quality control add up to dependability—in both quality and supply. Sylvania's metal and chemical products are used in the world's finest vacuum, TV and CR tubes... and are available to you in the same high quality, at reasonable cost.

SYLVANIA

Lighting • Radio • Electronics • Television • Atomic Energy

Analog Field Plotter

Examples of analogies between problems in five different types of fields.

Type of field and	Typical example	Showing identical flux or flow line patterns	Showing identical equipotential line patterns	Showing identical Combined orthogonal field pattern [(3)+(4)]
Electrostatic Section of oppositely charged plane and slot Potential diff.		(Flux function) Flow lines	(Potential function)	
Magnetostatic Section of air gap of alternator M.M.F. diff.				
Current Section of copper bus bar having an enlarged center section Voltage diff.				
Heat Flow Section of thermal conductor having an enlarged center section Temperature diff.		Flow lines		
Fluid Flow (Gas or liquid) Section of long enclosed channel with an enlarged center section Pressure diff.				

Method for getting equipotential lines. Current flow lines can be plotted by cutting out initial electrodes and painting new lines as electrodes as shown in boxed sketch at top of illustration.

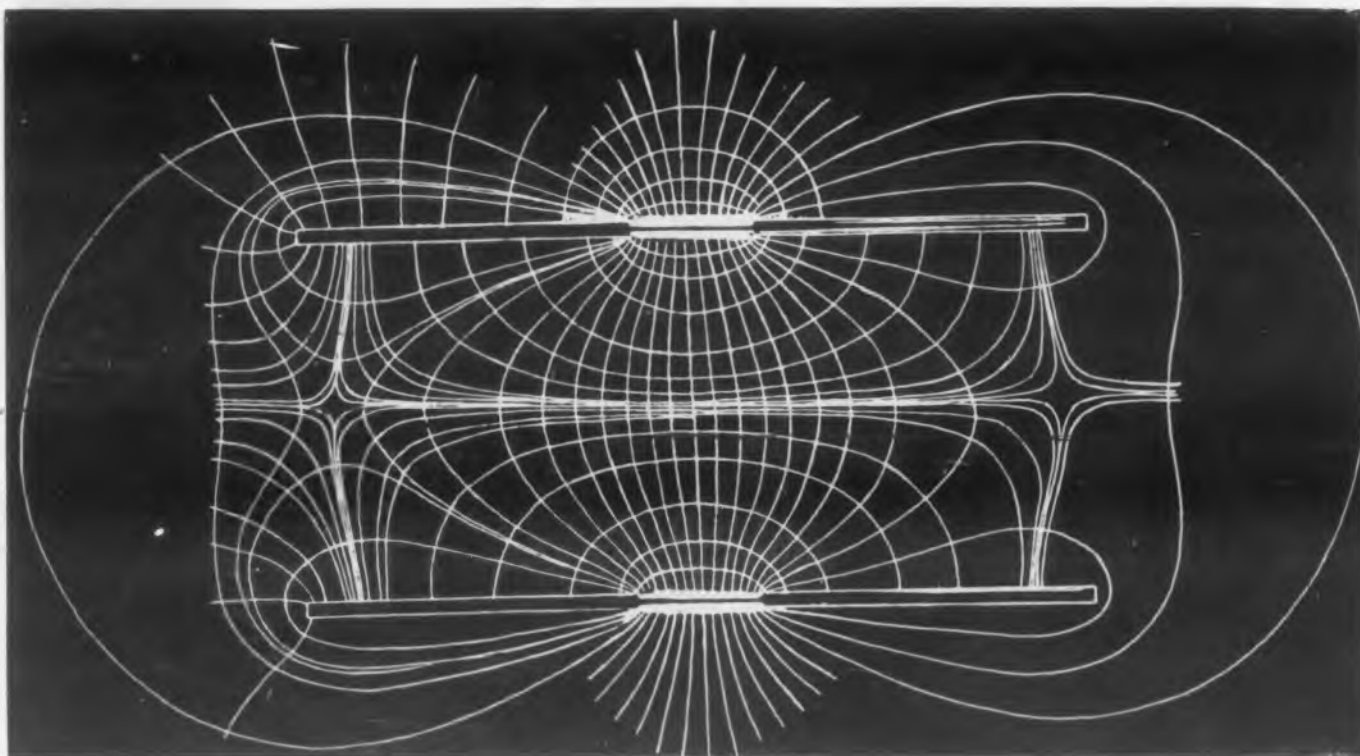
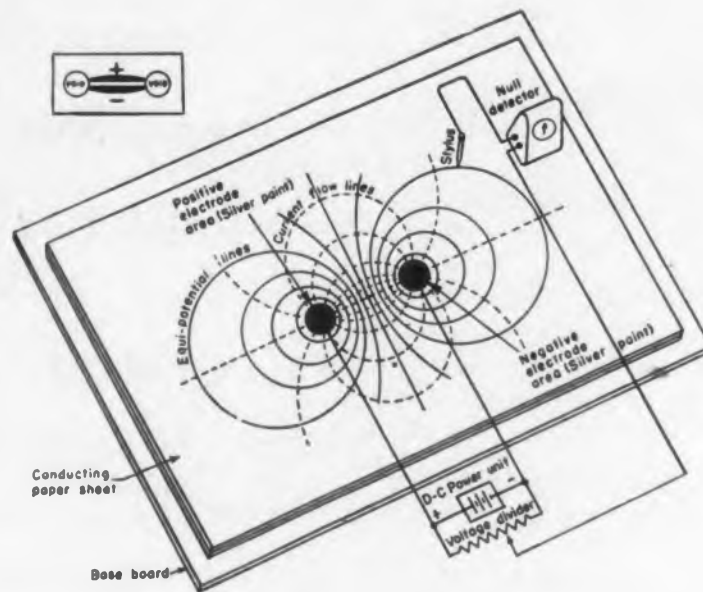

Field plot of experimental electron lens system showing 2-stage combined plot of dielectric flux and equipotential lines.

ELECTRIC current flowing in a sheet of thin conducting paper set up on this device creates a potential pattern which is analogous to electrostatic and electromagnetic fields, and current, thermal, fluid-, or air-flow. By probing and detecting the potential drop between appropriately shaped electrodes, a visual permanent record is plotted. The plotter is a valuable tool in studies of electrostatic patterns around wires, insulators, and shields; magnetic flux distribution and intensity in magnetic circuits and pole-piece arrangements; current flow and temperature distribution in conductors; electrode shapes; and field patterns in waveguides and electron lenses. It is also useful for studies of air flow in wing and propeller design, fluid flow patterns and velocity gradients in steam and gas-turbine blade design, and, orifice and piping design.

The analog field plotter, manufactured by Sunshine Scientific Instrument, 1810 Grant Ave., Philadelphia 15, Pa., consists of a plotting board, graphite impregnated paper, a 6v d-c power supply and high-accuracy voltage divider (potentiometer), a sensitive microammeter null detector, and exploratory stylus. Silver paint, and rolls of bare copper and nickel wire are also furnished for construction of electrodes. A comprehensive instruction manual is included showing the basic approach to a variety of technical problems.

The conducting paper, which is 0.004" facsimile paper, can be cut with a scissors in the desired pattern. The opposing plates, or electrodes, can be made of silver conducting paint or copper bars or wire tacked to the paper. In operation, equipoten-



Analog Field Plotter set up to study flow around turbine blade.

tial lines are located with the exploring stylus. If it is desired to plot, for example, the 10% equipotential line, the potentiometer is set to 10%. The exploring stylus is moved in contact over the conducting paper until the null detector indicates zero. The point of the stylus is pressed to indent the paper. The stylus is moved in this manner until enough points are selected to form the desired 10% equipotential line. The potentiometer is changed to another reading and the procedure is repeated. In the illustrations showing two oppositely charged parallel conductors, plots of both dielectric equipotential lines and dielectric flux lines can be made in two stages. Equipotential lines, resulting from current flow lines, can be probed directly after painting on the electrode area. Since the flux lines are the reverse, the second stage requires that the original electrode be physically cut out and two new electrode strips painted on as shown in the sketch with "void" circles. The direct interchangeability of various "flux" and "potential" components of different types of field systems is shown graphically in the accompanying table.

The experimental determination of a field pattern is accomplished very simply with this current-sheet type of field plotter, and the considerable effort that might be required to build scale models is saved. The process for determining the electron lens pattern is far simpler with the plotter than it would be to actually construct the lens elements and then take and record hundreds of potential values. For more information on this field plotter, turn to the Reader's Service Card and circle 22.

ELECTRONIC DESIGN • September 1955

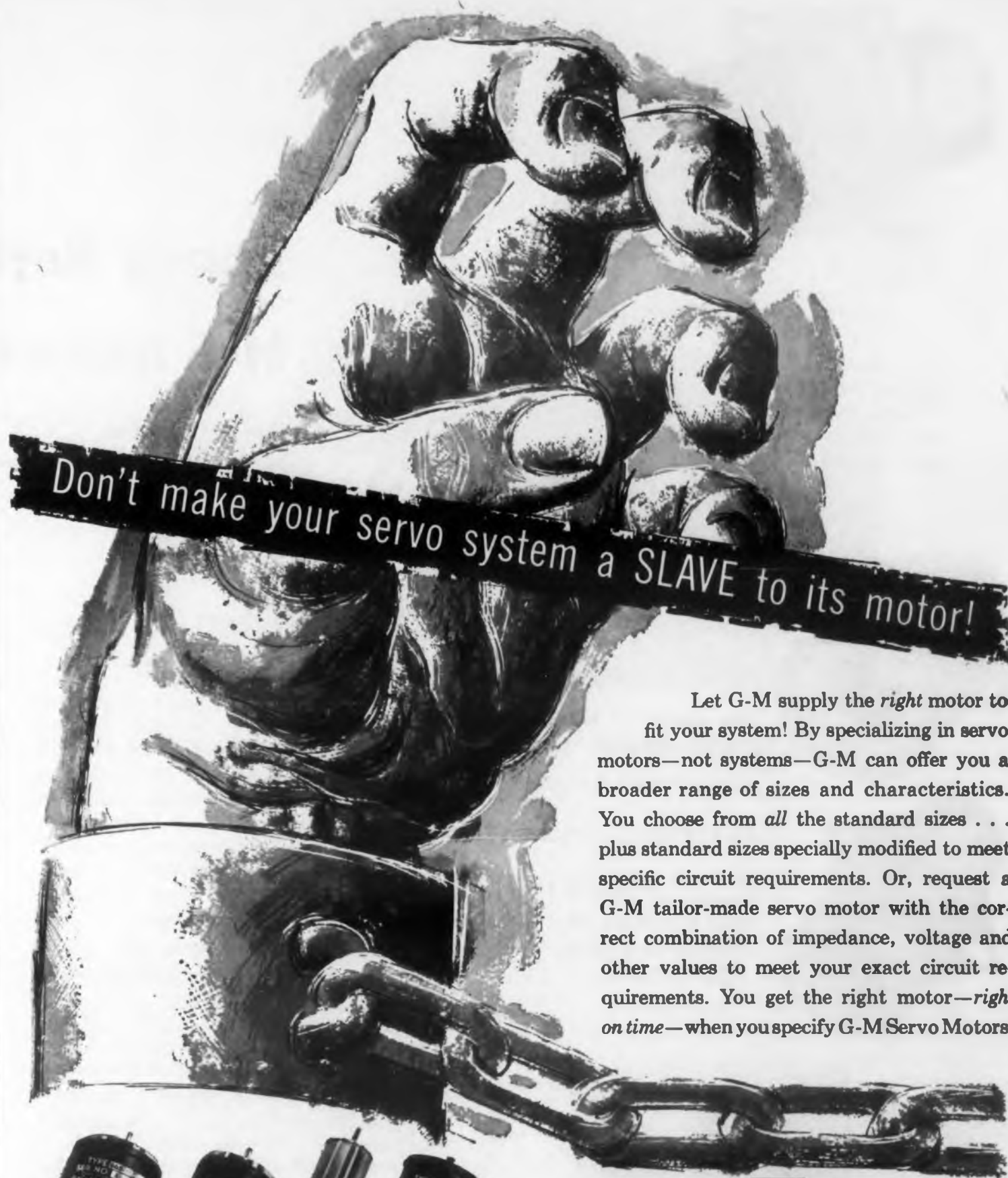

Don't make your servo system a SLAVE to its motor!

Let G-M supply the *right* motor to fit your system! By specializing in servo motors—not systems—G-M can offer you a broader range of sizes and characteristics. You choose from *all* the standard sizes . . . plus standard sizes specially modified to meet specific circuit requirements. Or, request a G-M tailor-made servo motor with the correct combination of impedance, voltage and other values to meet your exact circuit requirements. You get the right motor—*right on time*—when you specify G-M Servo Motors!



• SERVO MOTORS • MOTOR GENERATORS • SYNCHRONOUS-HYSTERESIS MOTORS

Write for literature and information! Use G-M charts and specifications to select the best values for the control phase of your servo motor. Whether you are designing a new system, or seeking better performance in an existing system, let G-M help.



CIRCLE 23 ON READER-SERVICE CARD FOR MORE INFORMATION



Two views (top and right) of the first step in making these inductors—cutting the helix groove in the tube.

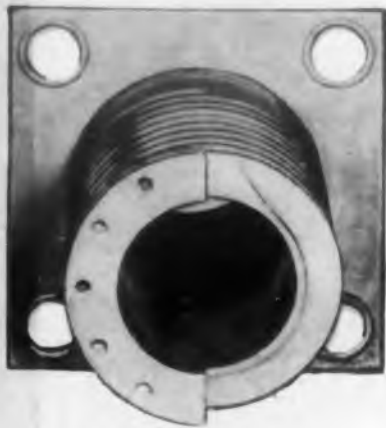

The groove has been covered with resin.



All the excess metal has been cut out of the interior to form the coil. The excess resin has also been removed.



The tuning slug shorts out turns of the inductor.

Epoxy Resins in H-F Inductor Design

David Lichtman

Airborne Instruments Laboratory,
Mineola, N. Y.

VARIOUS properties of epoxy resins were essential to the making of the high-power, high-frequency variable inductor whose design is discussed here. The plastic's exceptional adherence to metal, excellent machineability, and very low shrinkage were necessary to the mechanical design of the inductor, while the ease with which it is formulated and cast and its resistance to plating solutions simplified the manufacture of the unit. These inductors can be employed to 400Mc and dissipating 40w and more.

Starting with a thick-walled brass tube, the desired helical shape of the inductor is machined on the outside. The part is then cleaned and silver plated. The inductor is then placed in a simple aluminum mold, which has been well greased with No. 7 Mold Release, made by Dow Corning Corp., Midland, Mich. In some cases, a Teflon mold was used. The resin used in this application was Araldite 502, manufactured by Plastics Div., Ciba Co., New York, N. Y. The proper amount of hardener is added to the base resin and stirred carefully to keep the mixture bubble-free. It is then poured into the mold by tilting the mold and pouring down the side (as is done with beer to prevent foaming). It was found that pouring in this manner prevented the inclusion of any air bubbles in the helical turns. The mold was then placed in an upright position in a drying oven and baked for several hours at 40 to 50°C. By increasing the temperature slightly, the viscosity of the resin is reduced appreciably, thereby enabling air bubbles to rise to the surface. This low-temperature bake-out

was usually sufficient to remove any small air bubbles that may have remained in the resin mixture.

After the resin has cured completely, the inductor is removed from the mold. The unit is then placed in a lathe, and the inside metal is machined away until the inner metallic wall is just removed, leaving the plastic-supported helix. The inductor can then be silver-plated and a rhodium flash put on the inside exposed surfaces. The epoxy resin has the additional advantage of not being attacked by any of the plating solutions. We now have the desired inductor held in a precise shape, mechanically supported and electrically insulated. In actual use, the inductor is mounted by the base plate. The tuning slug rides inside the inductor. This tuning slug has spring fingers that make contact with the exposed surfaces, and its forward motion is calibrated to provide the desired tuning operation.

Design Procedure

In designing an inductor of this type, one can determine an approximate set of parameters using the standard inductance formula for a single-layer solenoid. From the circuit involved, one can calculate the maximum inductance required. We must then make several assumptions based on the necessary mechanical configuration. In order to facilitate the designing of the tuning slug assembly, a reasonable coil inner diameter must be selected. Let us choose one inch. This diameter should allow ample space for the tuning slug and should result in an inductor



The spring fingers of the tuning slug contact the helix.

that is capable of handling the specified power. To make the helix easy to cast and bore out, the length should not be too long. Let us choose 1-1/2".

The formula for the approximate inductance of a single-layer solenoid is:

$$L = FN^2 D$$

where L is the inductance in microhenries, F is the form factor, N is the number of turns, and D is the diameter of the coil in inches. From the values of the diameter of the coil and its length, one can find the form factor F^* . In this case, the ratio of diameter to length is 0.67, which yields a form factor of .013.

Putting these values into the formula, the turns are found to be approximately 9 for the application discussed on these pages. One can then make a coil with these parameters and test it in the equipment. These tests should indicate if any small changes have to be made in the design.

Using the above procedure, inductors up to 6" long x 3" in diameter have been constructed. For large inductors of this type, it may be necessary to add a powdered quartz filler to the epoxy resin to bring its temperature coefficient of expansion closer to that of brass. If necessary, polyamide can be added to the epoxy to give greater resiliency.

* From the form factor table on p. 75, *Reference Data for Radio Engineers Handbook*, New Third Edition, Federal Telephone and Radio Corp., 67 Broad St., New York, N. Y., 1955.

Now! 37
STACKPOLE
MOLDED COIL FORM TYPES

... with the easiest-to-solder leads on the market
(even for printed wiring techniques)

... stocked for prompt delivery

... at rock-bottom cost

PHENOLIC TYPES...

Molded of dense, low-loss Bakelite. Stocked for immediate delivery in over 15 standard sizes with securely-anchored axial or hairpin leads.

IRON TYPES...

Molded of high-resistance powdered iron in standard grades G1F and Z25. Ready for immediate delivery in 20 standard sizes. Other types on special order.

PHENOLIC-with-IRON INSERT TYPES...

Combines the high-Q of iron types with the high resistance of phenolic. Stocked with 2, 3, and 4 hairpin leads in grades G1F and Z25.

37 standardized Stackpole Molded Coil Form types cover practically the entire range of today's requirements for r-f coils, chokes, and other low-loss inductors. They pave the way to real economies in smaller assemblies, point-to-point wiring and an absolute minimum of soldered connections. And, speaking of soldering, Stackpole forms solder firmly and surely at the touch of an iron... because all leads are hot tin-dipped right up to the body of the form.

FREE PLASTIC REFERENCE CHART

... gives dimensions, grades and specifications in handy form. Write for your copy today.



Electronic Components Division **STACKPOLE CARBON COMPANY**, St. Marys, Pa.

In Canada: Canadian Stackpole Ltd., 550 Evans Ave., Etobicoke, Toronto 14, Ontario

CIRCLE 24 ON READER-SERVICE CARD FOR MORE INFORMATION



IBM selects DU MONT TYPE 329* as test oscillograph for their new type 702 computer



When IBM Corporation, world's largest manufacturer of computer equipment, produced their new Model 702, an essential phase of the project involved selection of a cathode-ray oscillograph to go into the field with each computer as standard test equipment. Requirements were strict.

IBM's approach to the problem was to conduct side-by-side evaluation with other competitive instruments. On the basis of actual performance, they selected the Du Mont Type 329 as their test oscillograph.

What are some of the primary reasons why IBM decided on the Du Mont Type 329? Excellent sensitivity—either d.c. or a.c. coupled. Precisely calibrated sweeps with movable notch magnification—ideal for making accurate measurements. Brightness—adequate for display of very fast pulses. Synchronization simplicity—

the Type 329 "locks in" on almost any type of signal. Stability—the trace remains steady as a rock despite power line fluctuations, etc. Reliability in service—calibration adjustment requires no extra test gear and is a simple one-step process. And virtually any tube may be replaced without special selection.

Another factor contributing to the selection of the Type 329 was the well known Du Mont Field Service Organization, which assures that regardless of where in the United States the equipment is used, swift, competent service facilities are in the immediate vicinity.

If you have instrumentation requirements, Du Mont facilities are always available for discussion and recommendations. Write us today for complete information on the Type 329, or on any problem you may have relating to cathode-ray instrumentation.

**Modified slightly for IBM's application.*

DU MONT

ALLEN B. DU MONT LABORATORIES, INC. • TECHNICAL SALES DEPARTMENT

760 Bloomfield Avenue, Clifton, New Jersey

CIRCLE 25 ON READER-SERVICE CARD FOR MORE INFORMATION

Touch-Control Switch

TOUCHING two metal areas simultaneously with the hand is all that is required to operate the illustrated switch. This "Touchtron" switch could be utilized in many electronic devices for the consumer market such as TV receivers, radios, and sound-reproduction equipment. It could also be used in various automatic controls for machinery as a safety device. The switch is particularly useful for paralyzed or similarly handicapped people.

The initial form in which the switch is made is the illustrated disc, which is about 4-3/4" diam x 1-1/8" thick. This form is used in lamp bases. However, the components can be rearranged to fit any suitable shape having a minimum volume of about nine cubic inches. Capable of controlling a-c loads of up to 5amp or more, depending on the type of load, the circuit has been designed for complete stability throughout the voltage range of 100 to 125v a-c. It is not dependent on the polarity of the a-c power plug, nor are any ground planes required. The switch is normally activated continuously, but only negligible standby power is consumed. The unit is manufactured by Accessory Equipment Dept., General Electric Co., Bridgeport, Conn.

As shown in the circuit diagram, the incoming a-c power is rectified for circuit control by a half-wave rectifier. The rectified d-c voltage, while dependent on the magnitude of the a-c input, never reaches the voltage required to break down the control tube. The latching relay operates whenever the control tube fires, discharging the electrolytic capacitor. The control tube fires whenever a hand is placed across the two metal areas, thus connecting the firing electrode of the tube to the anode side of the a-c line. For more information, turn to the Reader's Service Card and circle 26.

ELECTRONIC DESIGN • September 1955



The initial form of the switch. It can be packaged in a variety of shapes.

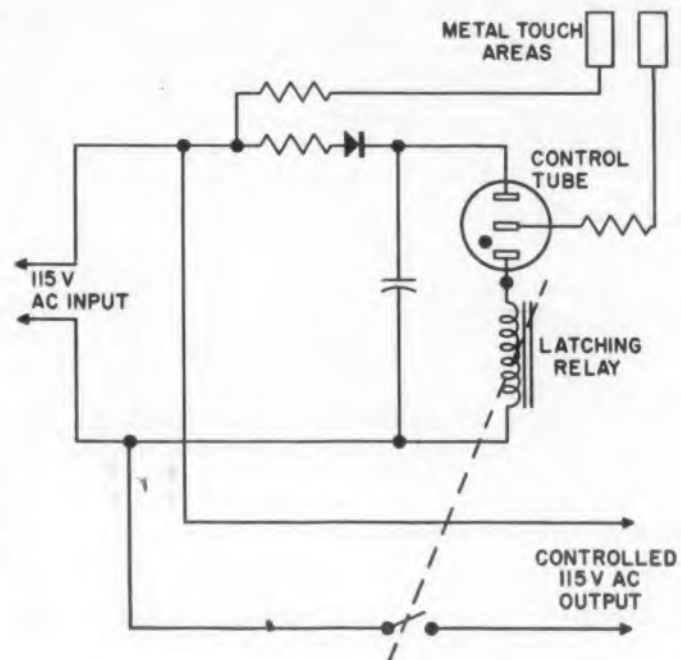

Circuit of the "Touchtron" switch.



RAYTHEON TRANSFORMERS designed for your specialized applications

CUSTOM DESIGN

To meet your need for specialized electronic signal and power range transformers, Raytheon offers exceptional standard transformers and custom design facilities. An unusually large and widely experienced engineering staff is at your service to design and develop transformers that best fit your particular applications.

PERSONAL SUPERVISION

Available to you are the resources of Raytheon's entire transformer engineering staff. Yet in order to best satisfy your needs, design, development and production of your transformers are turned over to an individual Raytheon engineer who sees your job through from start to finish.

PRODUCTION AND TESTING

All types of winding, core processing, impregnation and baking equipment are available for model making or full production runs. Raytheon also offers complete facilities for testing.

25 YEARS' EXPERIENCE

Raytheon has successfully custom engineered over 30,000 transformer designs and millions have been produced. Proof of Raytheon quality is this fact: *in 25 years less than 1/4 of one percent of all Raytheon transformers have been returned from the field for any reason.*

For full information write Department 6120. Request catalog 4-100

RAYTHEON MANUFACTURING COMPANY

Equipment Marketing Division

Dept. 6120, Waltham 54, Mass.

CIRCLE 27 ON READER-SERVICE CARD FOR MORE INFORMATION



Excellence in Electronics

WesCo announces

3 new solenoid designs to make your job easier!

completely tested...
proven reliable

MODEL A-4 (actual size)

PARTIAL
SPECIFICATIONS

Temperature to 500° F.
Class H insulation.
Plunger opening sealed to
withstand 200 P.S.I.
3 lbs. pull @ $\frac{3}{16}$ " stroke.
Continuous duty.

HOT SOLENOID



2 new miniatures

MODEL A-205 Shown PARTIAL SPECIFICATIONS

PUSH OR PULL

9 oz. @ $\frac{1}{16}$ " stroke
7½ oz. @ $\frac{1}{8}$ " stroke
6 oz. @ $\frac{3}{10}$ " stroke
5 oz. @ $\frac{1}{4}$ " stroke

MODEL A-1 Shown PARTIAL SPECIFICATIONS

PUSH OR PULL

5 lbs. @ $\frac{1}{4}$ " stroke
3½ lbs. @ $\frac{1}{8}$ " stroke
2½ lbs. @ $\frac{3}{32}$ " stroke
1½ lbs. @ $\frac{1}{8}$ " stroke



*Many other solenoid models
available. Mounting furnished
to meet your requirements.*

The
Trademark
of over
6,000,000
solenoids
since 1927

WesCo

NOTICE

WesCo DC solenoids are used
throughout the world—are famed
for reliable service. The complete
line is shown in WesCo's DC
catalog. Write for it today—on
your company letterhead, please.

Catalogs also available on
WesCo's quality AC solenoids.
25 to 400 cycle.

WEST COAST ELECTRICAL MFG. CORP.

233 WEST 116TH PLACE • DE BAY, LOS ANGELES 61, CALIFORNIA • PLANNED 5-1128

CIRCLE 28 ON READER-SERVICE CARD FOR MORE INFORMATION



Electrostatic Speakers

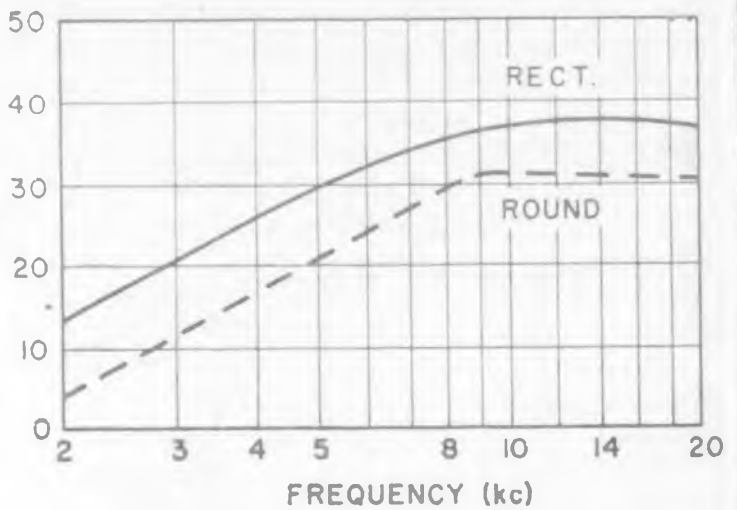
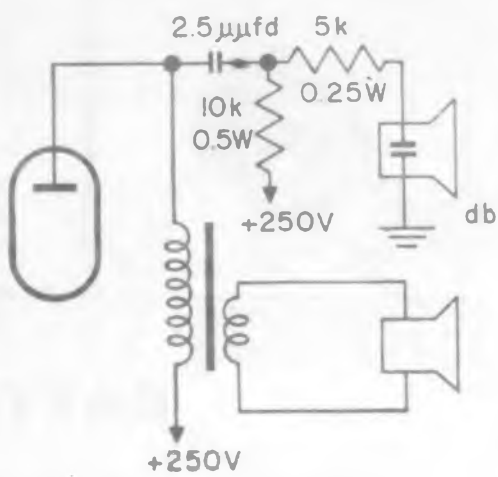

An r-c coupled circuit utilizing an electrostatic speaker and the frequency response of both the round and rectangular types in this circuit.

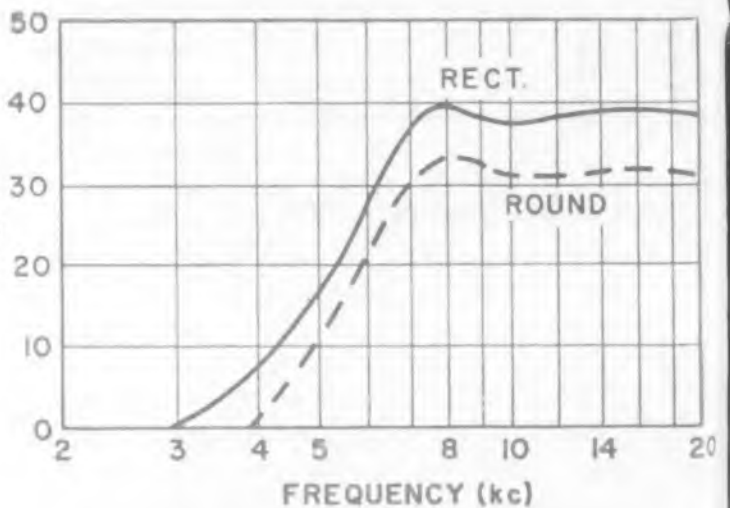
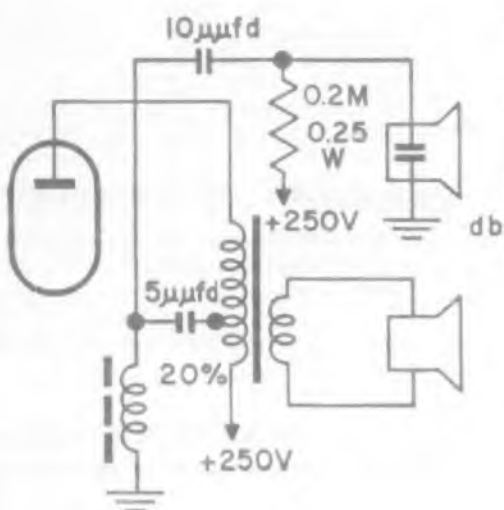

The frequency response of the rectangular speaker is better in this l-c coupled circuit.

The round speaker is shown actual size. The rectangular speaker is actually 7" long.

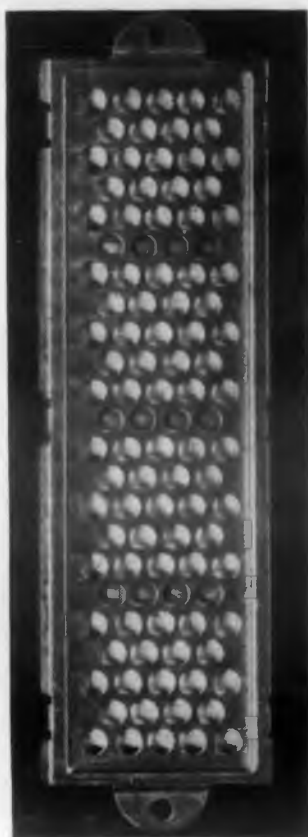

HIGH-FREQUENCY response of phonographs, TV receivers, and radios can be greatly improved at low cost by utilizing these electrostatic speakers. Since the units are very compact, they can be easily added to a line of equipment already in prototype form or even in production.

These "Isophon" speakers are made in two models: round (Type StHIB7) and rectangular (Type StH5/16). The moving element is a gold-metallized synthetic plastic foil. Two circuits in which the speakers are used in conjunction with conventional dynamic speakers with low-frequency response are illustrated. In the 1-c coupled circuit, the by-pass inductance has values of 72mh and 180 ohm, and 42mh and 180 ohm for the round and rectangular types, respectively. These speakers are made by E. Fritz & Co., Berlin, Germany. They are available here from Arnhold Ceramics, Inc., 1 E. 57th St., New York 22, N. Y.

Although these speakers can carry an a-c potential of 180v, the recommended maximum is 60v. The d-c voltage must be at least 50% greater than the a-c signal, but should not exceed 350v. The membrane of the larger rectangular type, because of its large size, acts like a number of small single speakers. The round speaker has baffles across its face which diffuse the sound. Both types should be mounted in the vertical position. The long side of the rectangular type should be perpendicular to the floor. The units are mounted in bakelite cases. For more information, turn to the Reader's Service Card and circle 29.

Designers and Production Engineers agree—



Sylvania's
H-V ANTI-CORONA
OCTAL SOCKET
 —pays for itself
 in performance

As a designer, you'll find Sylvania's all-molded H-V anti-corona socket increases the efficiency of high-voltage circuit design—your product gives better, longer, trouble-free performance in the field.

Production engineers will say it cuts down production snags and expensive after-assembly "tailoring" to eliminate corona problems.

Whatever the nature of your electronic equipment, if high voltage circuits tend to exhibit corona problems, this is the socket for you. It's doing the job where other anti-corona measures prove inadequate.

Despite its extremely high efficiency you'll be surprised by the relatively low cost of Sylvania's H-V anti-corona socket. Write for data, address Dept. J-22S.

SYLVANIA[®]

SYLVANIA ELECTRIC PRODUCTS INC.
 1740 Broadway, New York 19, N. Y.
 In Canada: Sylvania Electric (Canada) Ltd.
 University Tower Building, Montreal

LIGHTING • RADIO • ELECTRONICS • TELEVISION • ATOMIC ENERGY
 CIRCLE 30 ON READER-SERVICE CARD FOR MORE INFORMATION

**Which one of these
Genisco centrifuges meets
your requirements for testing
components under simulated
operational G-loadings?**

...as required by Mil 5272A, procedure II

Genisco G-Accelerators provide a quick, precise means of testing components in an acceleration environment similar to that encountered in actual operation.

They are extremely accurate machines, easy to operate and built to withstand years of hard use.

These features particularly suit them for large volume testing programs, as well as for precise laboratory prototype development.

More than 100 Genisco G-Accelerators of various capacities are now in use throughout the world.

Complete technical information on all models and accessories is available. Please direct your inquiry to: Contracts Manager, Genisco, Inc., 2233 Federal Avenue, Los Angeles 64, California.

MODEL C159 The larger capacity of this machine permits whole system components and complete packages to be tested. Two objects, each weighing 100 pounds and 24" x 24" x 18" in size, can be accommodated simultaneously. G-range of the machine is 0.024 G to 75 G's. Maximum centrifugal capacity is 2000 G-pounds. Nominal radius of gyration 48".



MODEL B78 Used primarily for testing relays, switches, tubes, motors, valves, and other small components, and to calibrate and evaluate accelerometers. Accommodates objects weighing up to 25 lbs.; has G-range of 0.017 G to 120 G's. Maximum centrifugal capacity is 1200 G-pounds. Nominal radius of gyration 24".

MODEL D104 A high-speed machine, designed to test accelerometers and other instruments under acceleration forces from 1 to 850 G's. Full centrifugal capacity is 1000 G-pounds. Nominal radius of gyration 12".



MODEL E185 This newest and largest Genisco centrifuge was recently built for the U.S. Air Force. Two mechanical or electronic packages, each weighing up to 300 pounds, can be subjected to an acceleration environment of up to 65 G's simultaneously. Nominal radius of gyration of the machine is six feet. An automatic dynamic balancing system automatically compensates for any excessive unbalance in the machine during test runs.



ACCESSORIES ADD TO OPERATING EASE A number of accessories including a strobe system, air system, optical system, tub cover, access doorway, and slip ring systems, designed to give greater operating convenience, are available for Genisco G-Accelerators, Models B78 and C159.

Modifications in any basic machine or accessories to meet your particular requirements will be carefully considered.

Genisco
INCORPORATED

RELIABILITY FIRST

CIRCLE 31 ON READER-SERVICE CARD FOR MORE INFORMATION

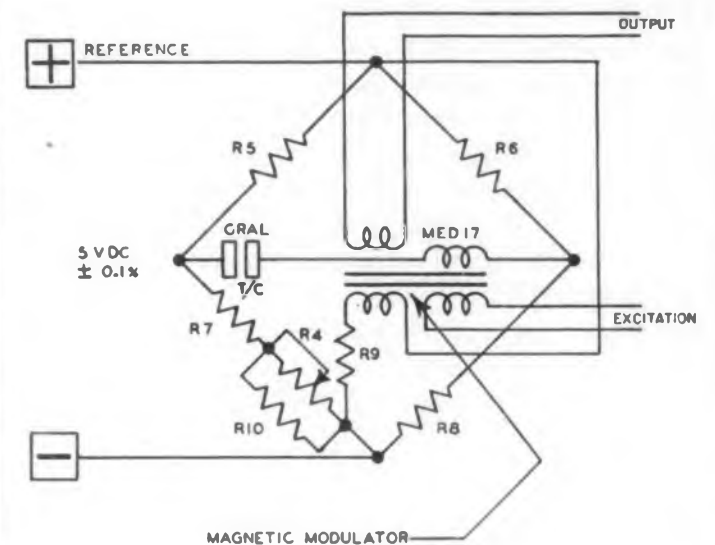

This temperature control circuit, used by Manning, Maxwell & Moore, Inc., is a typical application for the magnetic modulator. A reference voltage is compared with the error signal originating in the thermocouple and the d-c result is converted to a-c.

Magnetic Modulator

UNLIMITED life and good stability coupled with high sensitivity are features of this magnetic converter which answers the demand for modulators with no moving parts. Weak bipolar d-c can be converted to 400cy sinusoidal a-c voltages of corresponding amplitude and phase sense for control of servomotors or other automatic regulating devices. The complete schematic diagram of the unit is illustrated on the front cover.

The null amplitude of the "1000" model illustrated, manufactured by General Magnetics, Inc., 135 Bloomfield Ave., Bloomfield, N. J., can be established for 20-30mv rms or lower. Average units may have a null or noise level rating of 10mv (which can be made as low as 1mv). The amplitude response curve for the "1000" units shows an output of 5.5v rms for 100 μ a d-c control current (the signal range is 0 to 200 μ a). The input impedance is 1000ohms. Null stability under adverse environmental conditions is good; 10⁻⁹w is average. Excitation for the unit pictured is 5v rms, 300-500cy. Magnetic modulators can be designed for excitation frequencies ranging from 10cy to 10kc and up. A d-c bias signal is necessary, 1.7ma is typical. A separate bias winding is used.

The speed of response is about 1/100sec—or within a half cycle. Hysteresis is extremely low. The output phase is 0 or 180° ±10%. Operating range extends from -70° to +200°C. The size is 1" by 11/16" by 1-3/4" high. It weighs but 3 oz. The unit has high shock and vibration resistance; it meets all requirements of MIL-T-27. For more information about this unit's specs and other models, turn to the Reader's Service Card and circle 32.



Why "Dutch Boy" activated rosin core solders give perfect joints nearly every time

"Practically no poor joints..."
 "50-60% more joints per pound..."
 "Twice as many chassis wired in a day"

This is what users of "Dutch Boy" activated Rosin-core Solders are saying, today. For National Lead Research has come up with new answers to many old soldering problems.

Take "skips"... the trouble-making breaks in flux core continuity that lead to poor joints, interrupt production, raise reject percentages. Previously these breaks just couldn't be detected prior to use.

Not so, now! National Lead's new mercury bath test shows up "skips" like a sore thumb. In this inspection technique, 18" samples from each batch of cored wire are laid in a mercury bath. Presto! Solder dissolves, leaving entire core afloat, intact, visible. Even a tiny defect is reason enough for National Lead to withdraw the batch from shipment. You never see it.



New "Dutch Boy" mercury bath inspection does away with trouble-making "skips" in core continuity of rosin core solders.

*Sold under trade term "95-B"
 **Sold under trade names "Evan" and "Nuan"

Other new solder, flux developments

To speed solder flow and increase coverage... new "Dutch Boy" Activated Rosin Flux*. To prevent "bridge-over" in printed circuits... a highly refined "Dutch Boy" solder, of low melting point and high surface tension. To speed capillary rise and flow... a specially designed "Dutch Boy" non-corrosive solder-flux combination.**

You may want to look into these developments. Or perhaps you need some special solder alloy or flux. National Lead solder specialists will be glad to help. Just write or call National Lead Company, 111 Broadway, New York 6, N. Y.

Dutch Boy®
 SOLDER AND FLUXES



CIRCLE 33 ON READER-SERVICE CARD FOR MORE INFORMATION

Compact Oscilloscope

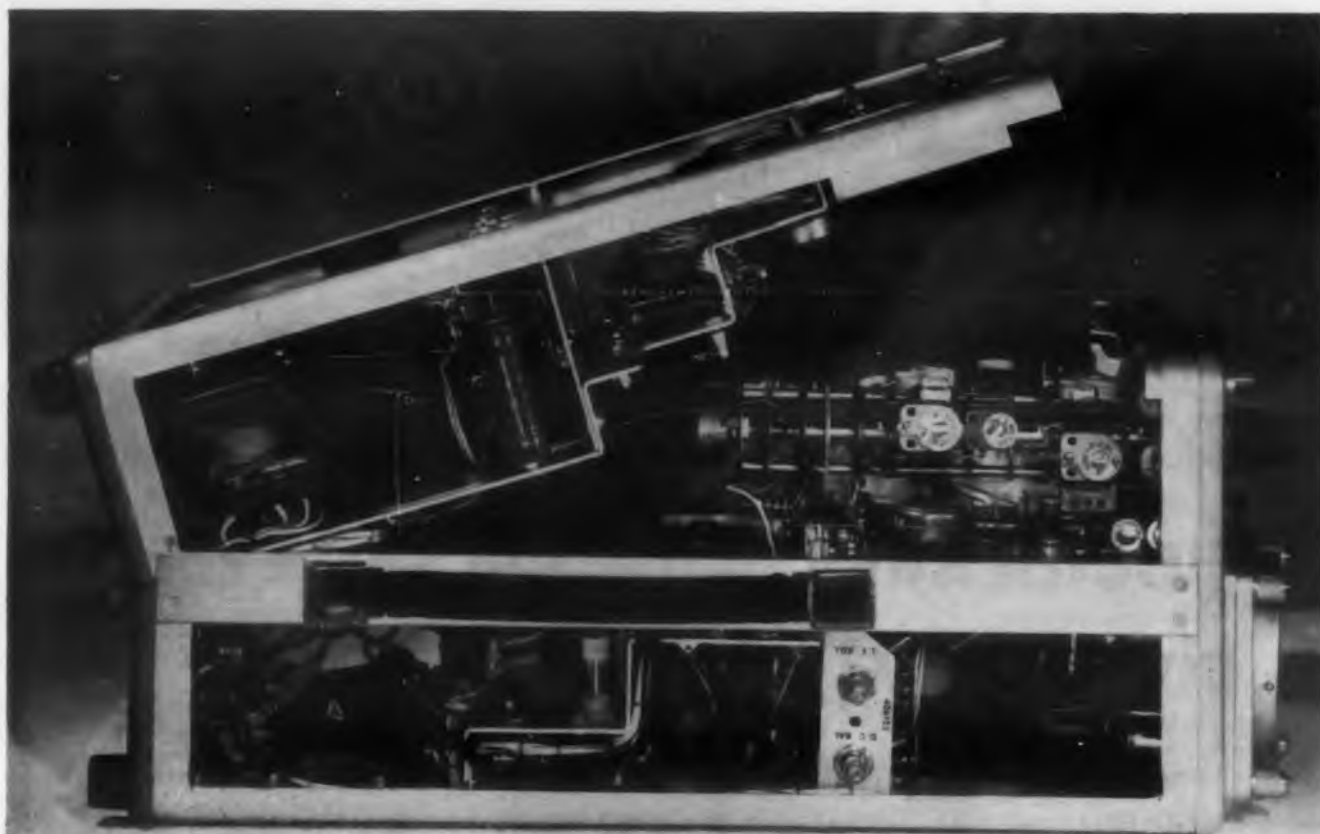

SPECIFICATIONS for the oscilloscope shown on these pages called for an instrument weighing about 20 lb and occupying about 3/4 cubic foot. Planned for field use, it must have performance comparable to that of laboratory oscilloscopes. By first constructing a dummy to determine heat rise and then utilizing an unusual hinged and stepped chassis, the designers of this instrument have produced a rugged equipment that can be used in crowded planes where the temperature inside the unit nears 80°C.

Known as the Type 310 oscilloscope, it is made by Tektronix, Inc., Portland, Ore. A preliminary survey of the requirements (For technical specifications and characteristics of this unit, see p. 74, July, 1955, issue of *ELECTRONIC DESIGN*, or turn to the Reader's Service Card and circle 59.) showed that it would

be necessary to have at least 30 to 35 tubes, 5 or 6 selenium rectifier assemblies, a bulky power transformer, and several filter capacitors in addition to numerous other components. In order to meet the sweep speed and bandwidth requirements, power requirements were 200w. Since a cooling fan was not practical because it would have to operate on 60 to 800cy supplies, a study was made of a proposed instrument with dimensions of 6-1/2" x 9-1/4" x 14" to see if it could dissipate 200w. (The final dimensions are 6-3/4" x 10" x 17").

In order not to exceed the ratings on the capacitors and other components, a dummy instrument was constructed of the proposed size. Resistors were placed throughout the dummy to simulate the tubes and the dummy was operated with 200w dissipated in the



The 310 oscilloscope can be operated when hinged apart.

The two hinged and stepped chassis parts are not equal in size.

resistors. Thermocouples placed throughout the dummy checked on the temperature rise. By using a packaging material made of perforated metal with at least 40% opening and placing the heat producing elements near the outside of the case, the dummy instrument dissipated 200w safely. The heat-producing elements were arranged in natural chimneys.

To place all the heat-producing elements as arranged in the dummy, the stepped and hinged chassis shown in the photographs was developed for the completed oscilloscope. The "fold-apart" line was to some extent dictated by some of the major parts such as the power transformer and the cathode-ray tube.

In the initial case design, the front and back panels were in single sections, and the instrument was split diagonally down the center. In the final design,

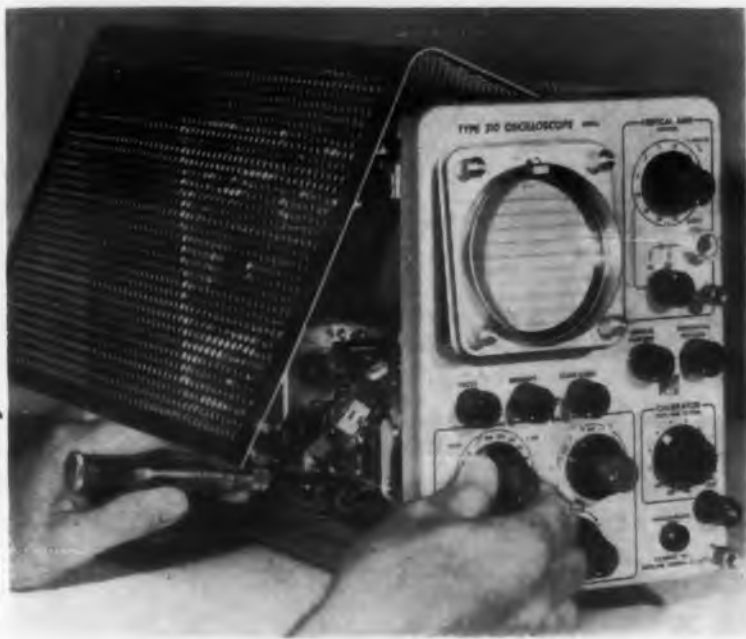

The perforated sides raise for quick servicing.

the back panel is split down the center and the unit is divided into two unequal parts. The final case is composed of three pieces: a bottom section that snaps on and two identical side panels which fold up and are removable for ease of servicing. All three pieces are made of perforated aluminum. The side pieces are attached with coin-operated fasteners.

As planes fly faster and higher, it is becoming more and more difficult to simulate test conditions on the ground that can equal the actual environment to which electronic and other equipment will be subjected. Test instruments must be taken aloft. The designers of this oscilloscope are to be congratulated for developing a fine instrument that can be used in the air and under demanding field conditions as well as in the design and development laboratory.

Announcing **A-MP**

MINIATURE *TAPER PINS*

FOR MINIATURIZED COMPONENTS!

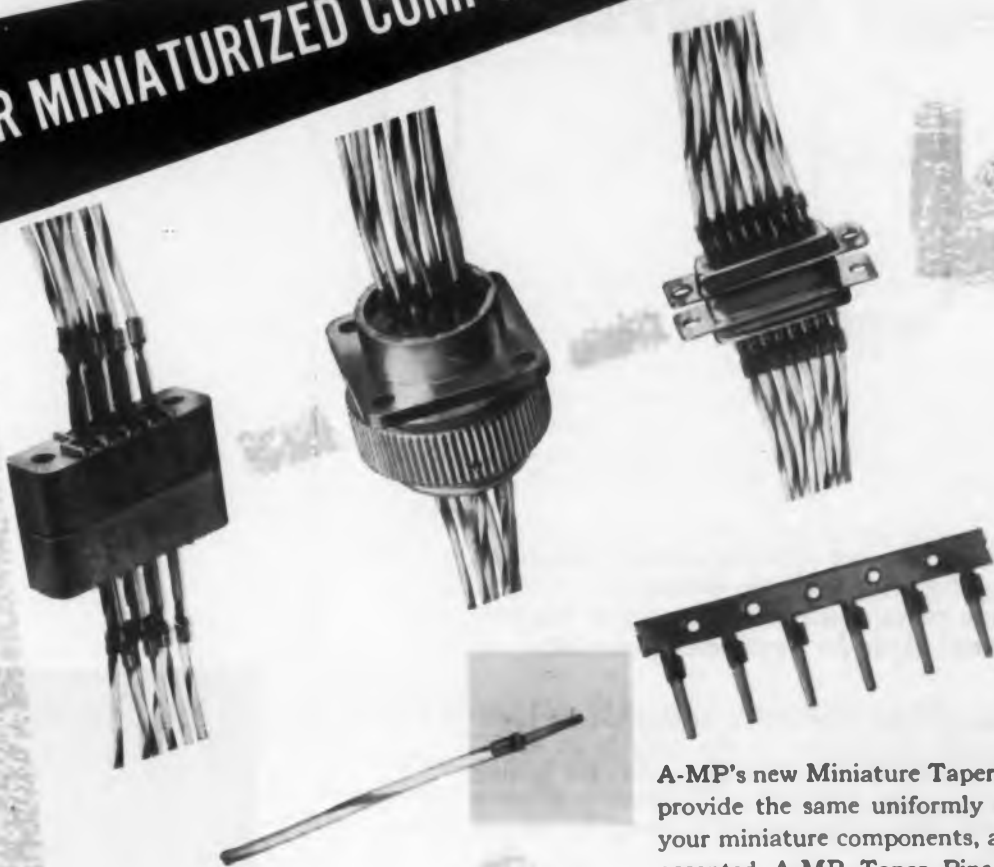

A-MP's new Miniature Taper Pins, shown here actual size, provide the same uniformly reliable wire connections for your miniature components, as the larger, widely used and accepted A-MP Taper Pins. Miniature Taper Pins are applied to wire with A-MP Automatic Machines at speeds up to 4000 per hour. They are then inserted into components quickly and easily with A-MP CERTI-LOK Insertion Tools. Miniature Taper Pins are available for wire sizes #26 to #20.

A-MP

GA-MP



Send today for your copy of "A-MP's Creative Approach to Better Wiring"

AIRCRAFT-MARINE PRODUCTS, INC., 2100 Paxton Street, Harrisburg, Pa.
In Canada: AIRCRAFT-MARINE PRODUCTS OF CANADA, LTD., 1764 Avenue Road, Toronto 12, Ontario, Canada

CIRCLE 34 ON READER-SERVICE CARD FOR MORE INFORMATION

Electronic
engineers
designing
vacuum
tubes,
read
this
important . . .



How to get it news

from

Metal Hydrides

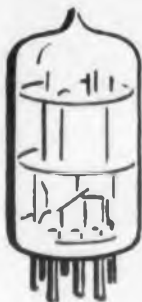
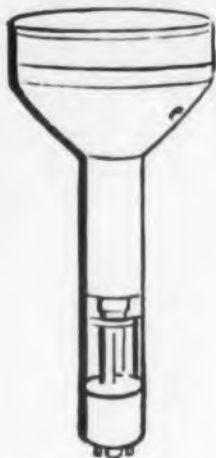

Prompt delivery in any quantity, quality-controlled adherence to rigid standards of composition and uniformity, plus nineteen years of pioneering in metal for electronics make Metal Hydrides your best source for:

TITANIUM HYDRIDE POWDER

For hydrogen sources and gettering in electronic tube applications. Appreciable dissociation of the hydride at 450°C and up. Increases wettability of brazing powders for joining ceramics to metal, graphite to ceramics, or ceramic to graphite to metal. Wets many metals that cannot be joined by conventional techniques.

TITANIUM-COPPER, ZIRCONIUM-COPPER

Lump form, master alloys for improving the quality of contact materials.

ZIRCONIUM POWDER

For flash bulb applications. Two grades available.

ZIRCONIUM HYDRIDE POWDER

For hydrogen source and gettering in electronic tubes.

Metal Hydrides' sales engineers will gladly give you specific information. Your call, wire, or letter will receive immediate attention.



Metal Hydrides

INCORPORATED

16 CONGRESS STREET, BEVERLY, MASSACHUSETTS

CIRCLE 35 ON READER-SERVICE CARD FOR MORE INFORMATION



Transistor Servo Amplifiers

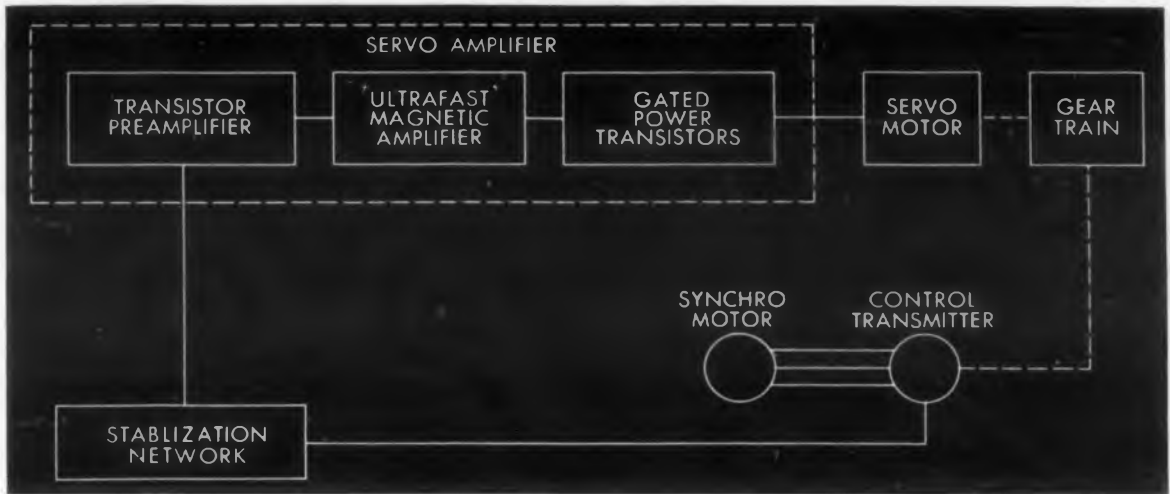

Block diagram of unique combination mag-amp and transistor servo amplifier which converts amplitude modulated signals to pulse time modulated voltages.

Demon
left, o
amplif
a l m o

C
fi
ampli
taine
unit
The
a ser
fied s

Th
factu
Glenn
ampl
lation

occu
feedi
the h
the t
one-h
respo
of 40
stand
of tr
power
5000

an a
The
by s

TH
dian
It w
on t
turn

Demonstration model, left, of this new servo amplifier is shown almost full size.



COMBINING the advantages of magnetic amplifiers and transistors, these highly-efficient servo amplifiers are housed in small, plug-in type containers. Two types are available: a standard 60cy unit and a magnetically-gated converter unit. The 60cy version is capable of delivering 10w to a servo motor, such as Kearfott Type R160, modified slightly for transistor operation.

The "Ultra-Fast" type magnetic amplifier, manufactured by Librascope Inc., 808 Western Ave., Glendale 1, Calif., is used as a converter to change amplitude modulated signals into pulse time modulation. The signal sent to the power transistors occurs before a half cycle of line frequency power feeding the magnetic amplifier elapses. Because of the high speed of response of the magnetic amplifier, the time lag of the complete amplifier is less than one-half cycle of line frequency. The frequency response is flat within $\pm 3\text{db}$ to 30cy either side of 400cy. It then drops off 12db per octave. In the standard 60cy, 10w servo amplifier, a single stage of transistor preamplification is used. The overall power gain is 100,000 with an input impedance of 5000 ohms. Full output power can be delivered over an ambient temperature range of -55 to $+55^\circ\text{C}$. The temperature range can be extended to $+85^\circ\text{C}$ by substituting silicon diodes for germanium.

The amplifier package is cylindrical, with a diameter of 1-1/2" and an overall length of 5-3/4". It weighs less than 20 oz. For more information on these radically new transistor servo amplifiers, turn to the Reader's Service Card and circle 36.

new

Oster

1 1/4" P.M. MOTOR

smaller · more efficient
minimum radio noise
MEETS MIL-M-8609 SPECS

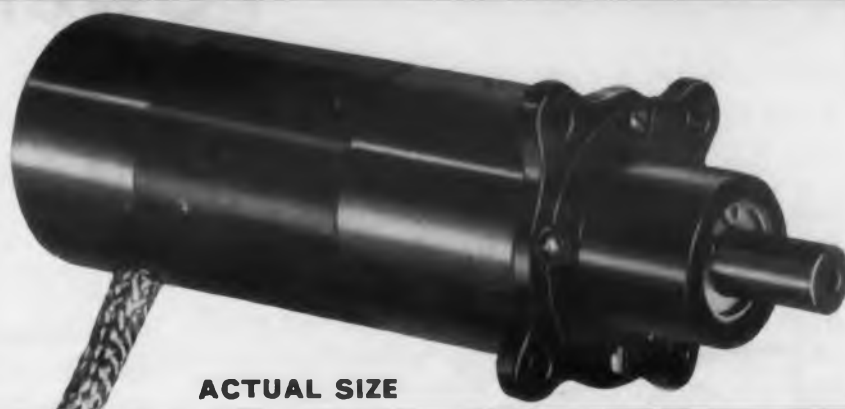

a complete new line of 1 1/4" P.M. Motors

- **Smaller:** 5 oz. weight, 2.14" L, 1.25" OD. (A typical example—Type AM-210).
- **Exceptionally High Torque** due to unique, simpler magnet design.
- **Radio Noise Minimized.**
- -55°C to $+71^\circ\text{C}$ temperature range.
- 6000 to 20,000 RPM motor speed range. Speeds controllable to $\pm 1\%$ over a voltage range from 24V to 29V by using a governor.
- Altitude-Treated Brushes have exceptionally long life.
- Specially Designed Metal Brush Holders avoid sticking in environmental tests and do not protrude into outside housing, permitting full design freedom.
- Available with gear train, governor, brake or any combination thereof. For gear train ratios, see chart.
- Applications: radio, radar, actuators, drive mechanisms, antenna tilt-motors, tuning devices, blowers, cameras and many others. Write for further details today.

PERMANENT MAGNET MOTOR GEAR TRAIN DATA

Motor can be designed for speeds from 6000 RPM to 20,000 RPM. Length of motor will vary according to power. Length of gear train will vary according to gear ratio required—

1000:1 to 33,000:1	6 stages
300:1 to 5,900:1	5 stages
100:1 to 1,000:1	4 stages
40:1 to 183:1	3 stages
15:1 to 32:1	2 stages

Other products include Actuators, AC Drive Motors, DC Motors, Fast Response Resolvers, Servo Torque Units, Servo Motors, Synchros, Reference Generators, Tachometer Generators and Motor Driven Blower and Fan Assemblies.

BURTON BROWNE ADVERTISING

TORQUE AT OUTPUT SHAFT OZ. IN.	GEAR RATIO OF GEAR TRAIN
25	15:1 to 33,000:1
100	15:1 to 33,000:1
300	15:1 to 33,000:1
400	15:1 to 5,500:1
600	15:1 to 5,500:1

John Oster

MANUFACTURING CO.

Your Rotating Equipment Specialist

avionic division
RACINE, WISCONSIN

CIRCLE 37 ON READER-SERVICE CARD FOR MORE INFORMATION

Design Procedures for Power Transistors — II

Howard T. Mooers, Transistor Engineering
 Minneapolis-Honeywell Regulator Co.,
 Minneapolis, Minn.

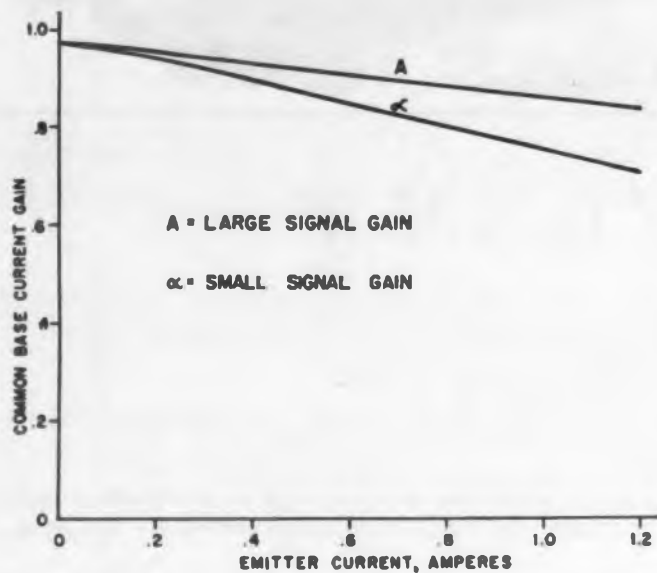

Fig. 1. Variation of common base current gain with emitter current with base at 70°F and $V_c = 2v$.

PARAMETERS of power transistors are not constant and may vary depending on values of bias current, temperature, voltage, etc. This Part II discusses external behavior of the transistor as it affects circuit design and indicates what may be expected in parameter variation. Previously in Part I (*ED*, July 1955, p. 58), it was illustrated that neither voltage, current, or power limits of transistors can be exceeded even momentarily without danger of immediate failure. Maximum power output is the designer's goal; but this criteria is not the same as maximum power gain as will be pointed out.

Alpha is not constant. It drops with increasing current at extreme current densities. In the region near current cutoff, the value of α may decrease with decreasing currents. It does not change greatly with changes in collector voltage. The change of α with emitter current is shown in Fig. 1. The curve is essentially a linear function of the emitter current except for the region near zero emitter current where its value falls off.

The value and variation of α are certainly useful quantities, but since α is not constant, its value does

not indicate the collector current to expect for an emitter current of say 600ma. The first 100ma will increase the collector current more than the last 100ma. Consequently, the change in collector current due to 600ma emitter current is equal to the integral of α times the emitter current. The total collector current will include a small value of leakage current which is dependent principally on the collector junction quality, voltage, and temperature. By including the collector junction leakage current, I_{co} , the total collector current can be specified as

$$I_c = \int_0^{I_e} \alpha dI_e + I_{co} \quad (1)$$

or, to have a parameter which expresses the d-c collector current in terms of the d-c emitter current, the symbol A has been selected to represent this large signal or d-c value of α and $I_c = AI_e + I_{co}$.

The values of A are plotted on Fig. 1, also. It can be seen that for any emitter current, the value of A is the average value of α from zero to the value of emitter current in question.

The value A can also be defined as $A = I_c - I_{co}/I_e$. The leakage current of the collector junction, I_{co} , is given for one or more collector voltages with the emitter open. The variation of the leakage current with voltage is shown for a typical unit in Fig. 2.

The curve for the total leakage current seems to be composed of three parts. The first component is the theoretical leakage current which is labeled a . In a theoretical junction, this would be the only leakage current. With power transistors, it accounts for almost all the leakage current up to about 2v. The second component of this leakage current is shown as the curve b . It is ohmic in character, and is assumed to be various high-resistance leakage paths around the junction. The sum of a and b account for almost all of the leakage current up to about 40v. Here the actual curve again departs from the predicted values. For lack of a name, this is called "excess leakage current." This excess leakage current increases very fast with the voltage beyond a certain point.

The total leakage current is very temperature sensitive. It increases rapidly with increases of temperature. The theoretical leakage current is predicted to increase exponentially with temperature. The variation of leakage current at a collector voltage of two volts is shown in Fig. 3. It can be seen that the increase is exponential at the rate of about $4\frac{1}{2}\%$ per degree Fahrenheit.

The ohmic component and the excess leakage current also increase with temperature, but not nearly so fast. Consequently the leakage current at a higher voltage

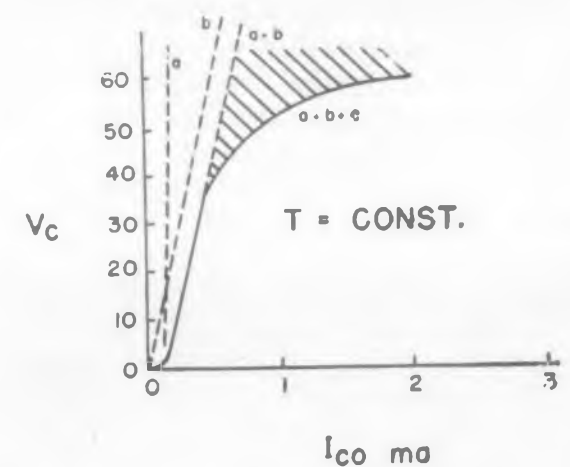

Figs. 2&3. Variation of I_{co} with V_c and temp.

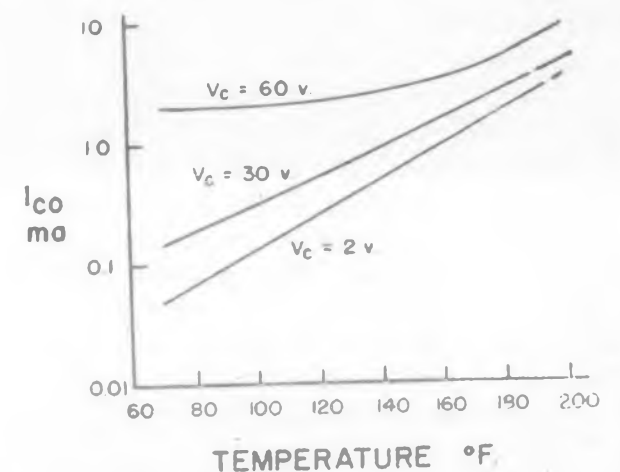

will increase at a rate dependent on the proportions of the various components.

The values of B and β are also functions of the operating point and, if plotted against the base current, the same type relationship can be established between B and β as exists between A and α . Since power output stages are usually designed from output to input it is convenient to plot B and β against collector current as shown in Fig. 4; $B = I_c - I_{co}'/I_b$ where I_{co}' is the common emitter leakage current with the base circuit open. The value of B at any base current is seen to be

the average value of β up to that point.

The common emitter leakage current with open circuit base has been specified many times as a parameter for the transistor. However, it is not an independent parameter. Solving I_e for the condition of zero base current gives $I_e = (1/1-A)I_{co}$. Since now $I_e = I_c$ because $I_b = 0$, $I_c = (1/1-A)I_{co}$.

Thus, the common emitter leakage is a parameter derived from the current gain of the unit and its basic collector junction leakage. Higher gain units will consequently have greater common emitter leakages than lower gain units for equal collector junction leakages.

Examination of the latter equations in the extreme right-hand column shows that with zero base current, the collector current is identical to that shown above. There is a belief that this leakage current represents the limit to which this device can be cut off in the common emitter configuration. This is not true. Suppose that the base current were reversed and made equal to $-I_{co}$. The next to the last equation in the extreme right-hand column would then be

$$\begin{aligned} I_c &= (A/1-A)(-I_{co}) + (1/1-A)I_{co} \\ &= (1-A/1-A)I_{co} = I_{co} \end{aligned} \quad (2)$$

Thus, if the collector junction leakage current can be supplied by the base lead, the leakage current in the collector circuit can be reduced to the fundamental collector junction leakage current.

Thermal Instability

The basic voltage limit for all junction transistors is set by the thermal runaway characteristic arising from the increased power dissipation caused by the normal increase of leakage current with junction temperature. The resulting increase in dissipation leads to still higher junction temperatures, and so on.* The condition for thermal stability for junction transistors (namely, that the increase in dissipation due to temperature increase

* John S. Saby, "Transistors for High Power Application," Convention Record of the I. R. E., 1954 National Convention, Part 3, pp 89-83.

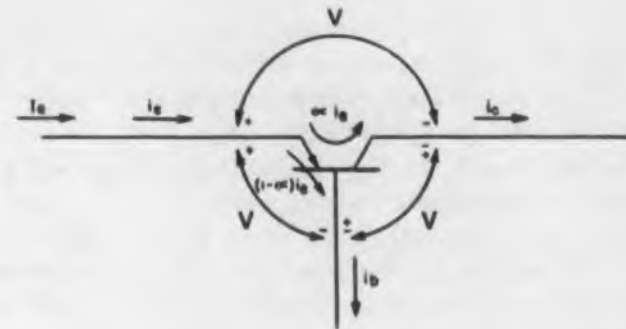

In normal transistor operation, current flows into the emitter junction at a low impedance level, and most of this current flows out the collector junction at a high impedance level. The difference of these currents flows out the base of the transistor. This is true both for d-c current signals (I) and for a-c current signals (i) which are superimposed upon a suitable d-c quiescent bias. If the collector circuit must drive a relatively high impedance, the a-c collector current will be reduced somewhat and the a-c base current will increase by this amount. The ratio (α) between the a-c collector current and the a-c emitter current is usually specified for an a-c short circuit termination of the collector.

$$\begin{aligned} i_c &\cong \alpha i_e \\ i_b &\cong (1 - \alpha)i_e \end{aligned}$$

Describing the d-c operation of transistors, emitter current flows into the transistor and most of it comes out through the collector junction. The remainder flows out the base. The d-c value of α is A . Superimposed upon this is the leakage current of the collector junction which flows into the base and out the collector circuit.

$$\begin{aligned} I_c &= AI_e + I_{co} \\ I_b &= (1 - A)I_e - I_{co} \end{aligned}$$

Here, the input current is given for the common base configuration, and these parameters are mostly used with the common base circuit. Solving for i_e and i_c in terms of i_b ,

$$\text{If } \beta = \alpha/(1 - \alpha)$$

$$\begin{aligned} i_c &= \beta i_b \\ i_e &= (\beta + 1)i_b \end{aligned}$$

Likewise,

$$\text{If } B = A/1 - A$$

$$\begin{aligned} I_c &= BI_b + (B + 1)I_{co} \\ I_e &= (B + 1)I_b + (B + 1)I_{co} \end{aligned}$$

The above equations are useful in the common emitter and common collector circuits since i_b is the input current.

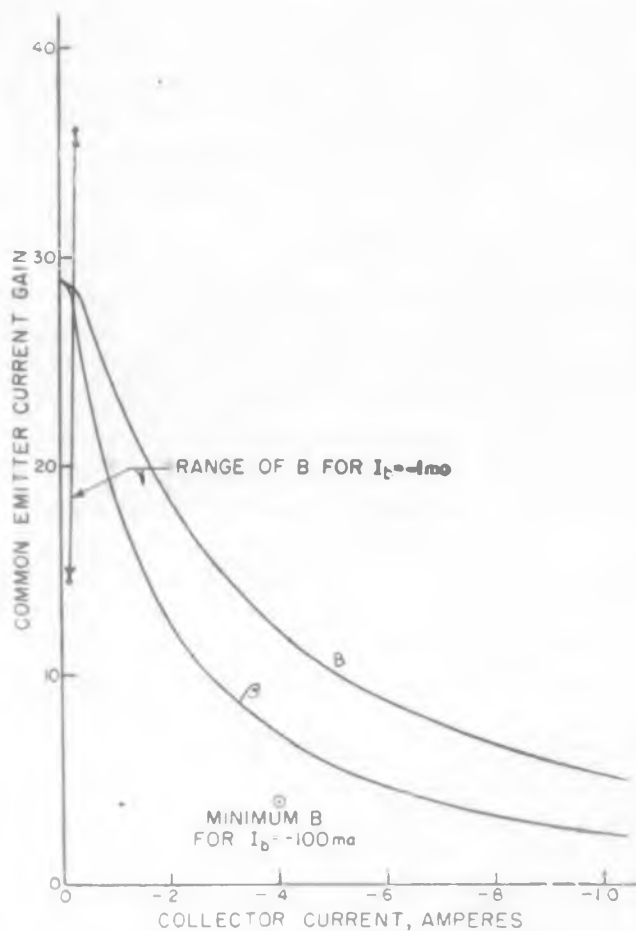
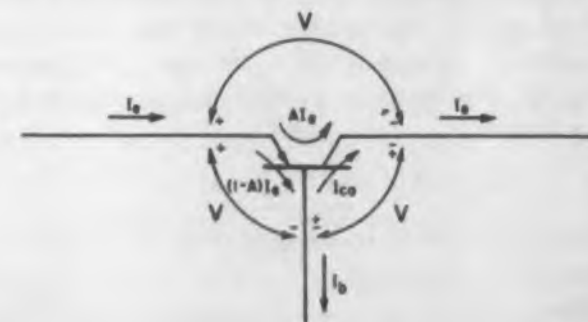

Fig. 4. Variation of common emitter current gain vs collector current at 70°F and V_c of $-2v$.

must be less than the corresponding increase in heat flow from the junction) can be written $dP_d/dT_j < 1/\theta$ where P_d is the total power dissipation of the transistor, T_j is the junction temperature, and θ is the total thermal resistance, i.e., the rise per watt dissipation of the junction temperature above ambient.

For a thorough evaluation of all of the operating points, an analysis of the input bias dissipation must be included to arrive at the total power dissipation as a function of temperature. In most cases the greatest share of the power dissipation is at the collector junction. An exception to this occurs when the transistor is driven into saturation, as in switching service.

The thermal stability of the leakage current is easier to evaluate because there is no input power dissipation. If the collector voltage is constant the circuit stability equation can be written $V_c (dI_c/dT_j) < 1/\theta$ where V_c is the collector voltage, and I_c is the collector leakage current (I_c being used in the general case).

If the rate of increase of junction leakage current with temperature is assumed to be approximately $4\frac{1}{2}\%$ per degree Fahrenheit (8% per degree Centigrade), as actually occurs at low collector voltages, the stability condition for cut-off conditions with a low impedance collector circuit can be derived.

In the common base circuit when the emitter current is zero the collector current is composed only of the leakage current which varies with temperature and voltage.

Assuming

$$I_c = I_{co} (1.045)^{\Delta T_j} \quad (3)$$

where T_j is measured in degrees F,

$$P_d = V_c I_c = V_c I_{co} (1.045)^{\Delta T_j} \quad (4)$$

$$\begin{aligned} dP_d/dT_j &= V_c I_{co} \ln(1.045) (1.045)^{\Delta T_j} \\ &= V_c I_{co} (0.044) (1.045)^{\Delta T_j} \end{aligned} \quad (5)$$

Evaluated at $\Delta T = 0$

$$dP_d/dT_j = V_c I_{co} (0.044) < 1/\theta \quad (6)$$

$$\text{or } V_c < 23 I_{co} \theta \quad (7)$$

$$\text{or } I_{co} < 23/V_c \theta \quad (8)$$

This means that with variations in collector voltage, total thermal resistance, and junction temperature, the common base circuit will have a theoretical limit of stability at the point where its common base leakage current I_{co} approaches the limit value given by equation 8 above.

For the most ideal condition where a 2N57 transistor is attached to an infinite heat dissipator the total thermal resistance will be $7\frac{1}{2}^\circ\text{F}/\text{watt}$ ($6\frac{1}{2}^\circ/\text{watt}$ internal, $1^\circ/\text{watt}$ interface resistance with the best contact from mounting base to heat dissipator using silicone oil, and $0^\circ/\text{watt}$ for the infinite heat dissipator). At a collector voltage of 60v, the unit will become unstable as the leakage current I_{co} approaches its stability limit.

$$I_{co} < 23/60 \times 7.5 = 51 \text{ ma} \quad (9)$$

Assuming the total leakage current I_{co} varies exponentially with temperature

$$I_{co} (\text{at } T_1) = I_{co} (\text{at } T_0) [1.045^{T_1 - T_0}] \quad (10)$$

The leakage currents can be measured at 60v and 70°F to predict stable operation at various elevated junction temperatures with a low impedance collector supply sources.

Highest Junction Temperature Expected	Predicted Safe Value of Maximum Junction Leakage Current 70°F and 60v.
200° F.	.17 ma
150° F.	1.51 ma
100° F.	13.6 ma

The table shows leakage limits extrapolated back to 70°F for a 2N57 transistor to predict the high temperature thermal stability. The above values are conservative because the total leakage current at 60v does not increase exponentially as was assumed in the derivation. The theoretical junction leakage current is the only component that increases at the above exponential rate. The other components also increase with a temperature increase, but not as fast. Thus, since the bulk of the leakage current is something other than the theoretical leakage current at 60v, the leakage current at this voltage will not increase as fast as predicted for changes in temperature. Consequently stability can be achieved with units which have 60v leakages somewhat higher than shown.

As the temperature increases, more and more of the total leakage current is due to the theoretical leakage and consequently the temperature coefficient will approach the theoretical increase at higher temperatures. The leakage current as calculated from equation (8) should be regarded as the leakage current limit for stable operation at any temperature.

This same limit of 51ma can be applied equally well to the common-emitter leakage current at 60v. The temperature coefficient of this leakage will be the same if the current gain at these low levels is constant with respect to the changes in leakage current and temperature. Since the gain falls off with both increased current and elevated temperatures, the above determined limit is somewhat more conservative for the common emitter configuration.

Current Stability

The common base circuit is relatively stable with respect to changes in temperature. The common emitter circuit, on the other hand, amplifies the leakage current when the base lead is open. This often causes high enough values of temperature sensitive collector current to make runaway possible.

The total common emitter leakage current can be reduced considerably by allowing or even encouraging the leakage current to flow through the base lead to the collector.

The various leakage current characteristics are shown in Fig. 5. Curve 1 shows the leakage current for the common base configuration when the emitter is open. If a resistor were connected between the emitter and base leads, the leakage current would increase. The smaller the value of the resistor, the higher will be

the leakage until the resistance is zero and the leakage is given by Curve 2. When the emitter and base are shorted, the common base and common emitter circuits are indistinguishable. In the common emitter circuit, the leakage is highest when the base is open. As the resistance between the base and emitter is decreased, the leakage current decreases, until with a short circuit base to emitter, the leakage will again be given by Curve 2 of Fig. 5.

Fig. 6a shows the circuit used to measure the common emitter leakage current. In actual use, this circuit is generally impractical. There will usually be a d-c resistance path from base to emitter which reduces the zero signal leakage of this circuit. A circuit using a capacitor input with no bleed resistor will duplicate this circuit and have the highest leakage current. Any appreciable drive will cause blocking due to the capacitor charging during the conducting cycle. Thus Curve 3 on Fig. 5 represents the high limit for leakage current.

Fig. 6b shows the circuit used to measure Curve 2 of Fig. 5. This leakage can be approximated in an actual circuit by resistors in the emitter and base leads so that the voltage from the emitter to the base is zero.

Fig. 6c provides a circuit which is basically a common emitter circuit, but the leakage characteristic is that of the common base circuit as shown in Curve 1 of Fig. 5. In this case, the leakage current is supplied by the base biasing configuration, and the emitter current becomes zero.

The curves for $I_b = -I_{co}$ and $I_b = 0$ are related to one another by the gain of the transistor. Specifically, the open base current is $B + 1$ times the collector junction leakage current. The curve for $V_b = 0$ is similar to the I_{co} curve, but at a somewhat higher current. The manner in which these two curves are related is dependent upon the internal resistance of base and emitter sections of the transistor. If the emitter junction is biased in the reverse direction, the leakage current will be below the normal I_{co} curve until some elevated voltage, at which time the curve will cross the I_{co} curve and the leakage will start to increase rapidly.

Within the boundaries shown in Fig. 5, we can establish whatever leakage current we desire by means of circuitry. Fig. 6d represents a general case of a source

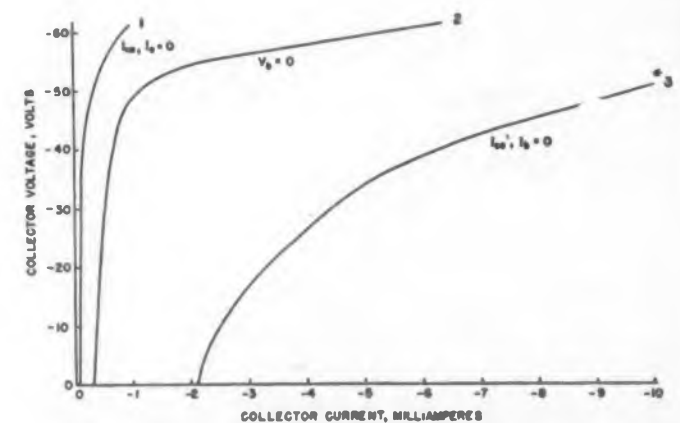
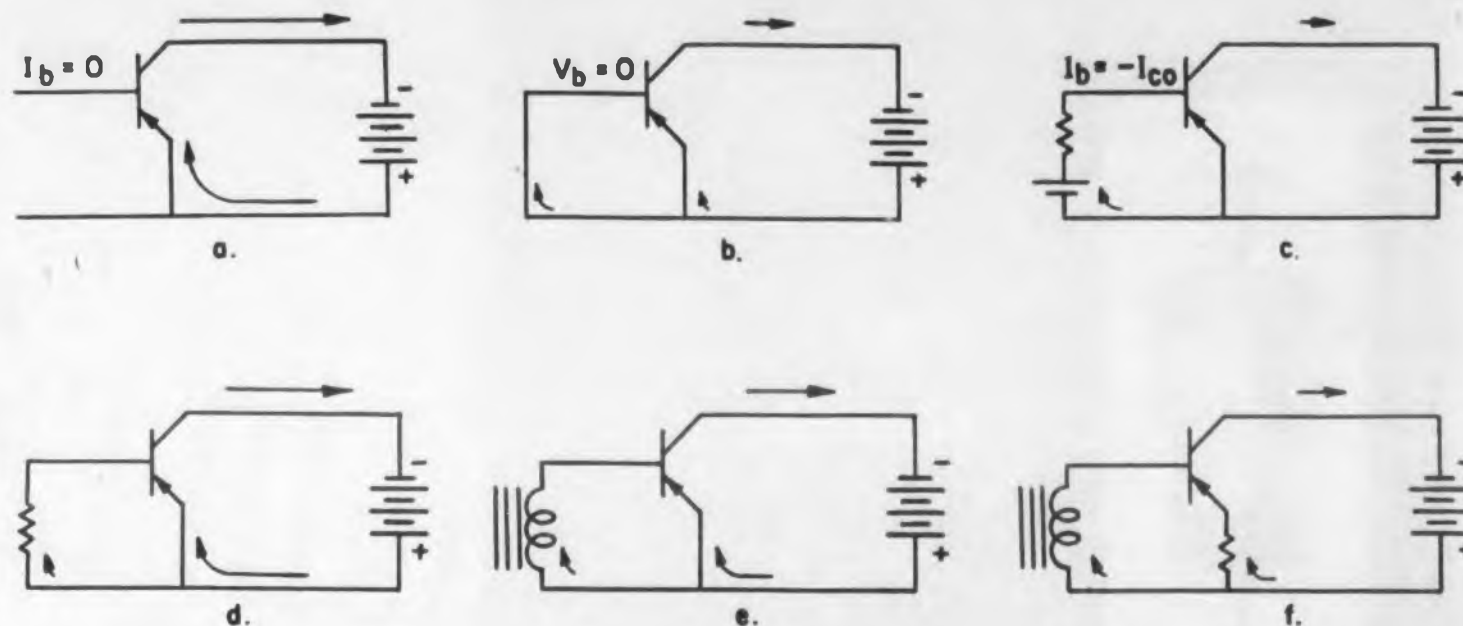

Fig. 5. Leakage current characteristics for emitter open 1, short circuit 2, and with test circuit 3.

Fig. 6. Circuit to measure common emitter leakage a; with emitter shorted b; leakage supplied by base biasing c; resistance for leakage control d; scheme for eliminating signal shunting e; and most effective method of leakage control f.



resistance in the base lead without an external resistance in the emitter lead. If this resistance is terminated on the emitter circuit, the leakage will be reduced. A high resistance will yield only a small reduction in leakage current from the $I_b = 0$ curve. Lower and lower resistances reduce the leakage further, until the leakage characteristic $V_b = 0$ is approached. Low resistance in this part of the circuit causes difficulty in driving the transistor due to signal shunting.

One solution is shown in Fig. 6e. A transformer has low d-c resistance and can do an excellent job of driving a transistor because of its impedance matching ability. The d-c resistance of the secondary winding will determine its excellence in reducing the leakage current.

Fig. 6f shows one of the most effective ways of controlling the leakage current. The portion of the leakage current not supplied by the base of the transistor is amplified and flows through the emitter resistor, causing a voltage drop that helps the base provide more of the leakage current. This is a self-bias device, and its operation depends upon some amplified leakage flowing through the emitter resistor. Consequently, it is impossible for this circuit to reduce the leakage current to the value of I_{co} . The amount of reduction will often be determined by the degree of degeneration or negative feedback that can be tolerated in the amplifier stage. The resistor will also reduce the available power output by about the value of the ratio of the emitter resistance to the load resistance.

The stabilizing effect can be retained, and the a-c degeneration eliminated, by bypassing the resistor with a suitable capacitor. This capacitor, however, may have to be inconveniently large for many applications.

For example, suppose that the temperature requirements were such that Class B push-pull operation must be limited to an output of $7\frac{1}{2}$ w. Using a 28v supply, the load line would be about 50 ohms. If the stabilizing emitter resistor should be 5 ohms, this would reduce the output power by about 10%, and approximately double the required power input. To bypass this

resistor for a 60cy signal and keep the phase shift under 6° , the reactance of the capacitor should be less than $\frac{1}{2}$ ohm. This would require at least 5000mfd.

The required value of the emitter resistor will be dependent upon the resistance in the base circuit. If the d-c resistance of the transformer in Fig. 6f is high, a higher value of emitter resistance is necessary. If the d-c voltage drop across the emitter resistor equals the d-c voltage drop across the base resistance, the emitter to base potential will be zero and the leakage will be equal to the characteristic for $V_b = 0$. If the base is positive with respect to the emitter, the leakage will be lower than for $V_b = 0$; and, if the base is negative with respect to the emitter, the leakage current will be greater than for $V_b = 0$.

A configuration such as Fig. 6c is often useful to reduce the leakage current to a minimum. In this case the value of the voltage and series resistance must be such that it will supply the total leakage current to the base at the highest junction temperature expected. When the junction temperature is decreased, a restraining potential will be applied to the base because of the smaller leakage current. This has two undesirable effects. First, it increases the collector junction voltage, and second, it causes an input voltage threshold. Low level signals will not be amplified until their magnitude is high enough to overcome this threshold.

Both of the above effects can be reduced and still provide the base with the total leakage current by using a smaller voltage and smaller resistor. This procedure is limited by the signal losses when the resistor becomes too low. For switching circuits, the input threshold is usually unimportant, because the switching signal will have little trouble in overcoming the threshold.

Power Gain vs. Power Output

The maximum power gain from a transistor is attained by matching the load resistance to the output impedance

of the transistor. Very high power gains can be achieved this way, but the power output will usually be very small. If the output impedance of a power transistor were 8000 ohms, then the maximum power gain can be achieved with a load of 8000 ohms. Operating the transistor from zero to 60v, the rms voltage will be about 20v. Thus, the power output will be 50 mw. With this power output, it is debatable if a high performance power transistor is economically desirable. The same job could possibly be done at a lower cost by using a lower power device. To attain a higher power output the transistor must be *mismatched considerably*, and, as a result, the power gain goes down as the power output is increased.

For most applications the load resistance is such a mismatch to the transistor that it makes no significant difference whether the output impedance is infinite, 50,000 ohms, or 1000 ohms. In addition, the collector resistance (which is the principal part of the output resistance) changes with collector voltage, collector current, and temperature. Consequently, no value can be stated without specifying the conditions, and, even if stated, has no use in most design problems.

The choice of a load line has other aspects. Suppose that a 28v supply is available, and it is desired to have a 2.5w Class A output from a 2N57 transistor. The load resistor could be 35 ohms and would pass a peak current of 0.800 amp. The power output would be 2.5w with a 15db gain.

If an output transformer were used, the same power output could be derived from a 140 ohm load. The quiescent bias point would be at 28v and 0.200 amp with a peak current of 0.400 amp. With this circuit the power output would also be 2.5w, but the gain would be 23db.

Even though power transistors are capable of high currents, it is often desirable to use them at a high voltage and low current, rather than at low voltage and high current. [Next month, specific problems.]



That shoulder you see in the capacitor body does away with eyelets. With no eyelets to take up space, these units can be mounted much closer together, leaving more room available on the chassis.

fast mounting. These capacitors won't tilt when mounted because they're self-centering. And the shoulder holds each unit at the proper distance above ground, so that jiggling is unnecessary. Just drop the Step-Cap into the chassis, and it's ready for the solder oven.

quick soldering. Silver is bonded homogeneously to the ceramic to facilitate soldering directly into the chassis. And in lead-thru wiring, the cupped ends speed soldering by serving as solder retainers, thus keeping solder from bridging the insulating gaps.

available immediately in unlimited quantities —and priced low.

They are available in capacity ranges from 3 to 275 mmf @ $\pm 10\%$ and $\pm 20\%$ tolerances; from 276 to 1000 mmf @ GMV. Units are rated at 1000 VDCW. Mounting hole: .192". Can be furnished without center lead as a lead-thru type. Write for complete details on the Solar Step-Cap.

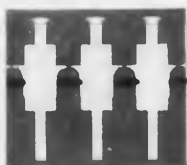

WIDELY SEPARATED
FLANGED CAPACITORS



"STEP-CAPS" MOUNT
CLOSE TOGETHER

"QUALITY ALWAYS"

SOLAR MANUFACTURING CORP.

New York, N. Y.



SALES OFFICES: *46th & Seville, Los Angeles 58, Calif.*
4000 W. North Ave., Chicago 39, Ill.

CERAMIC CAPACITORS • PRINTED NETWORKS • PIEZO CERAMICS

CIRCLE 38 ON READER-SERVICE CARD FOR MORE INFORMATION

Perspective-Sketch Template

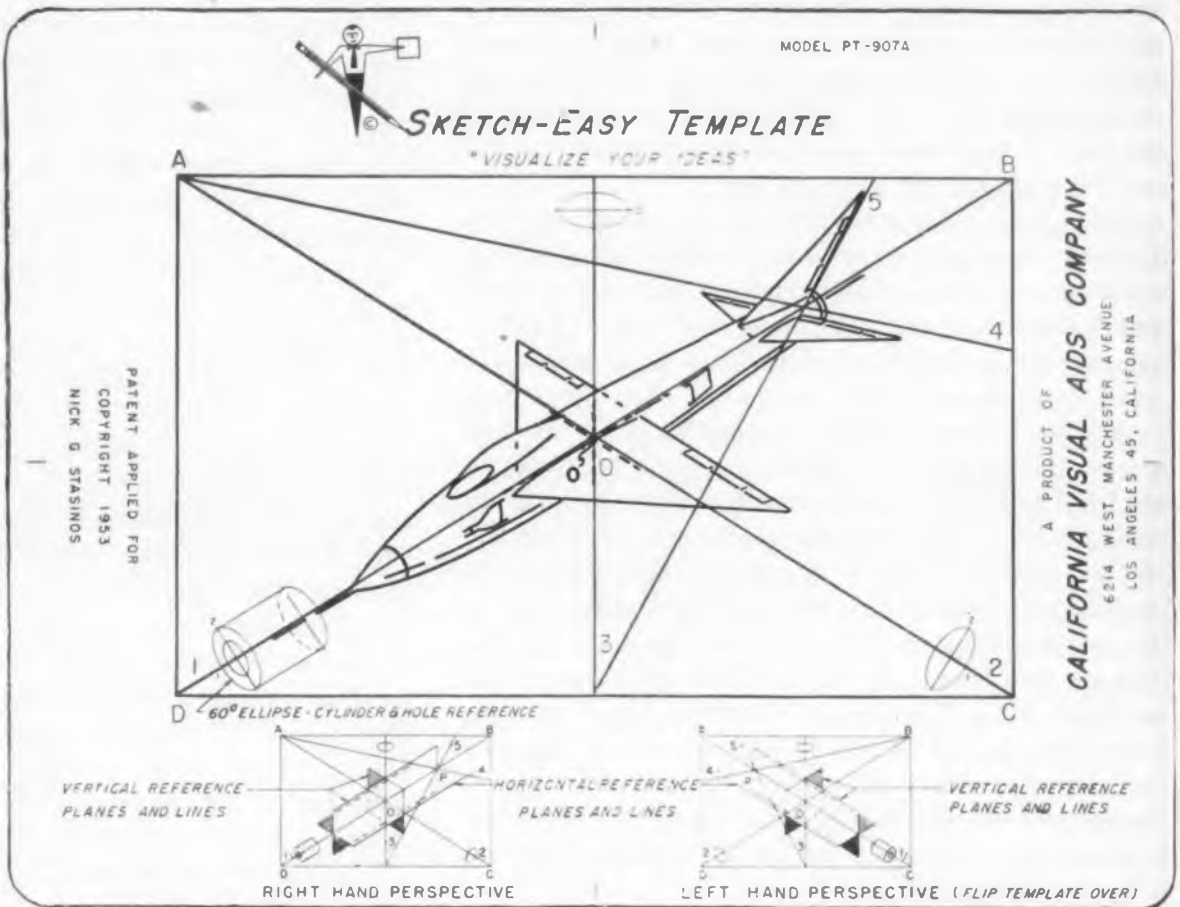

Template is in color. Complicated detail parts as well as products can be drawn easily in perspective.

A
D

O
you
pla
ima
as
ten
dra
sen
anc
qui
Dr
by
anc
sio
nee

sta
the
Vi
Te
Ins
Ca
tio
suf
tee
ou
Tr
off

pr
izo
lin
an
tio
ing
su
its
to

EL

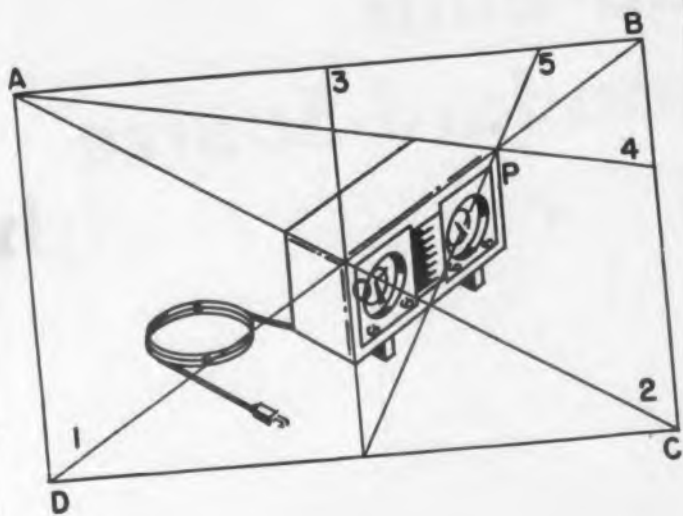

ORIGINAL technical ideas can be visualized and understood readily if you sketch them yourself with the aid of this Sketch-Easy Template. Since no one can visualize, describe, or imagine the potentialities of your original ideas as clearly as you can, this new visual aid is intended to help you express yourself. Engineers, draftsmen, shop personnel, liaison or sales representatives concerned with the need to originate and transmit technical information and ideas quickly and rapidly can use the device beneficially. Drawings can be made in about 1/3 the time taken by conventional methods. Mechanical assemblies and individual parts can be sketched and dimensioned in perspective and orthographic projections need never be made.

Artistic talent or training is not necessary to start making lucid pictorial-type drawings with the aid of the template, a product of the California Visual Aids Co., and available to industry from Technical Service, Div. of Northrop Aeronautical Institute, Inc., 250 South Prairie Ave., Hawthorne, Calif. Sketching examples in the 24-page instruction booklet which accompanies the template give sufficient background information to make any technical sketch desired. Once practise in laying out a job is achieved, the aid can be put aside. Training time involves but a few hours (a course offered by Technical Service runs 8 hrs).

The template aids the sketcher in four ways: it provides a common starting point, it provides horizontal and vertical reference planes and guide lines in perspective, it defines proper proportions and locates the major parts of the subject in relation to one another, it provides a means of sketching many different perspective views of the same subject. For more information about the template, its application, and training services available, turn to the Reader's Service Card and circle 39.

POTENT POWER + SMALL SIZE
 Up to 5100 mmf at 300 vDCw
 Up to 3900 mmf at 500 vDCw
 (size) Length 3/4"
 average Width 7/16"
 average Thickness 3/16"
 DM-20 shown actual size

El-Menco Dur-Mica DM-20

DIPPED MICA CAPACITOR WITH PARALLEL LEADS

PEAK PERFORMANCE
 ideal for new miniaturized designs and printed wiring circuits
 MEETS ALL HUMIDITY, TEMPERATURE AND ELECTRICAL REQUIREMENTS OF MIL-C-5 Specifications!

TEST IT AND COMPARE!

- El-Menco's Dur-Mica DM20 costs even less than our famous molded mica capacitors.
- Provides greater versatility — wider applications.
- Tougher phenolic casing assures longer-life and greater stability through wide ranges in temperature.
- Parallel leads simplify application in transistor and sub-miniature electronic equipment including printed circuits for military and civilian use.

For Extreme Miniaturization Use Our DM15

DM15 — Up to 510 mmf at 300 vDCw
 Up to 400 mmf at 500 vDCw

Available in 125°C operating temperature.
 Minimum capacity tolerance available $\pm 1/2\%$ or 0.5 mmf (whichever is greater).

El-Menco
 Capacitors

to meet modern miniature requirements

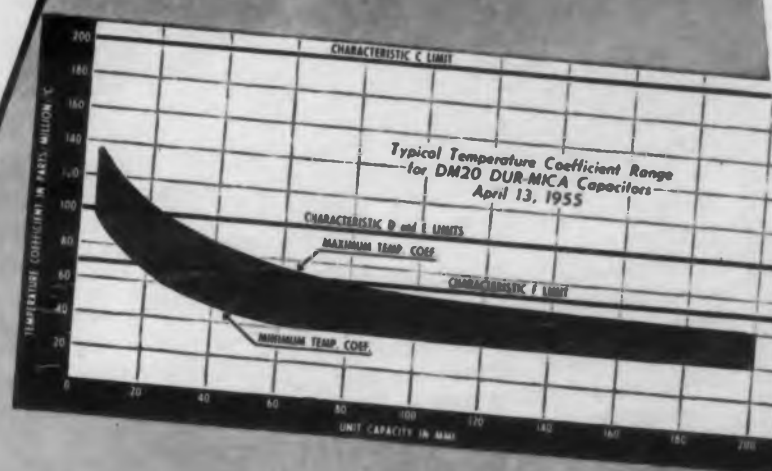
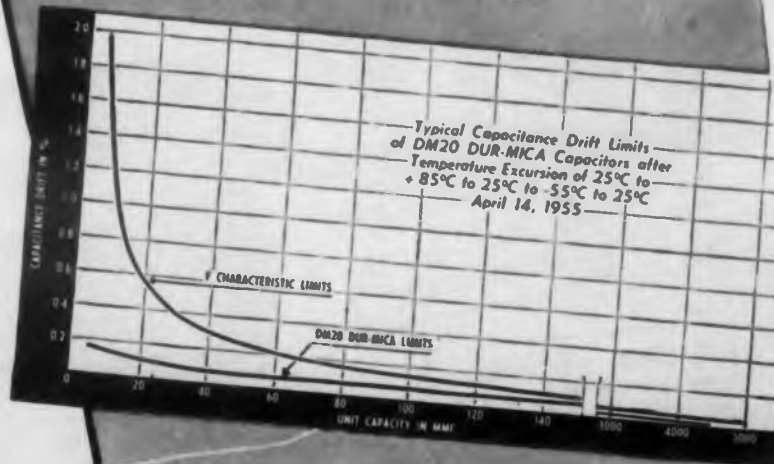

For your special requirements — we are pleased to offer information and assistance. Write for free samples and catalog on your firm's letterhead.

THE ELECTRO MOTIVE MFG. CO., INC.
 WILLIMANTIC CONNECTICUT
 • molded mica • mica trimmer
 • tubular paper • ceramic

Arco Electronics, Inc., 103 Lafayette St., New York, N. Y.
 Exclusive Supplier To Jobbers and Dealers in the U.S. and Canada

CIRCLE 40 ON READER-SERVICE CARD FOR MORE INFORMATION

REVERE

Revcothene*

INSULATED

WIRE

TOUGH

HEAT-RESISTANT

CHEMICALLY INERT

NON-VOLATILE



Because of its extreme toughness, high heat resistance, and chemical inertness, Revcothene insulated wire is widely recommended for hermetically sealed equipment . . . for devices operating with small gauge wire at high temperatures . . . and for conditions where corrosion is a problem.

Revcothene is silver-plated copper wire with an extruded coating of monochlorotrifluoroethylene. Even at 150° C. (302° F.) the insulation is inert . . . with no volatile lacquers or plasticizers to ruin contacts. Revcothene withstands abrasion and flexing, and resists such corrosives as ozone, acids, alkalis and petroleum products.

Available in eight standard sizes from 28 to 10 gauge . . . in 15 colors. Flexible strandings, copper or silver braid shielding, heavy wall insulation and jacketing can also be furnished. Multiple-conductor cables are also available.

Revcothene is only one of many insulated wire and thermocouple wire products made to exacting specifications by Revere Corporation of America. Technical design assistance gladly offered. Write today.

TYPICAL SPECIFICATIONS — 22-Gauge Revcothene Wire

Spark Test Voltage	7500
Insulation Resistance	1000 megohms/1000'
Operating Temperatures:	
Flexing Application	—40° C. to 135° C.
Non-Flexing Application	—65° C. to 150° C.
Flammability	Does not support combustion
Operating Voltage	1000 volts
Water Absorption	0.00
Effect of Acids & Alkalis	Generally unaffected
Cold Flow (Compressive Strength)	32,000 PSI
Abrasion Resistance (MIL-T-5438)	Passes 36"-400 grit aluminum oxide with 0.3 pound weight

* Revere's tradename for monochlorotrifluoroethylene

Revere CORPORATION OF AMERICA



WALLINGFORD, CONNECTICUT A subsidiary of Neptune Meter Company

CIRCLE 41 ON READER-SERVICE CARD FOR MORE INFORMATION

Lab-Built Standard Source

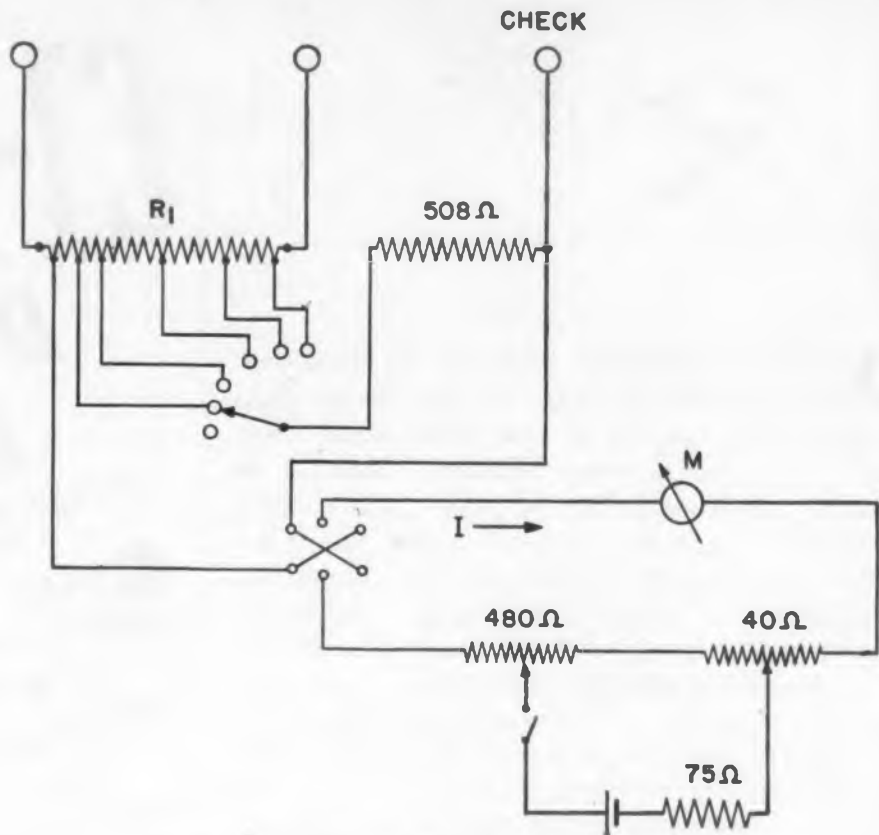

Wiring diagram for the voltage comparator.

CONSTRUCTION details and the wiring diagram given in this article should enable electronic design engineers to make their own standard voltage sources. This comparatively inexpensive standard is accurate to 0.002%. It was developed at the National Bureau of Standards, Washington 25, D. C., by A. W. Spinks and F. L. Hermach with the aid of H. F. Stimson.

The portable apparatus consists essentially of four saturated (containing an excess of cadmium sulphate) standard cells, a temperature-controlled air bath for the cells, and a thermofree potentiometer for intercomparing them. Saturated cells have a negative temperature coefficient of about $50\mu\text{V}/^\circ\text{C}$ at room temperature, so that some form of constant-temperature enclosure is necessary.

The standard cell container of the comparator is made of two cast aluminum boxes, one inside the other. A thermal insulating layer of balsa wood separates the

boxes, and another layer surrounds the outer box. Four standard cells are placed in the inner box which, in turn, is surrounded by electrical heating coils. Continuous power is required from a 60cy 120v line to maintain the cells at 34°C . The power is supplied through a stepdown transformer and is controlled by a thermoregulator of high sensitivity.

Failure of the power supply (i.e., loss of temperature control) is indicated by a loss in time as shown by a synchronous clock connected to the input power line in the regulator circuit. A mercury-in-glass thermometer, with its bulb in the outer box, indicates the operating temperature. The scale of the thermometer is read with a low-power microscope, as illustrated.

The built-in Lindeck potentiometer is used to compare the emf's of the cells. This potentiometer provides known voltage differences by utilizing the voltage drop produced in a special four-terminal shunt

by
curr
meta
divi
T
shu
stri
per
taps
a co
sisto
valu
the
1.0
T
star
of
ries
enc
the
of
oth
unl
ELE



One form in which the standard source was constructed.

by a measured current. This adjustable current is measured with a 2ma milliammeter shown as *M*. This meter has a 100-division face and an accuracy of $\pm 0.5\%$.

The special four-terminal multiple-range shunt consists of an annealed manganin strip to which are silver-soldered long copper leads to provide appropriate potential taps. The resistor is thermally shielded by a copper box which surrounds it. Each resistor section is adjusted to the desired value to better than 0.1%. The five taps on the shunt, R_1 , are at 0.05, 0.1, 0.25, 0.5 and 1.0 ohm, respectively.

To perform an intercomparison, the standard cell of known voltage and the cell of unknown voltage are connected in series, emf's opposing, and the small difference in their potentials is measured with the potentiometer. The negative terminals of the two cells are connected to each other, and the positive terminal of the unknown cell is connected to one post of

the potentiometer. The positive terminal of the known cell is connected through a galvanometer and a switch to a second post of the potentiometer. When the voltages are balanced, the difference in the emf's of the two cells is equal to the product of the milliammeter reading and the resistance value of the shunt for the taps used. A reversing switch indicates by its position which cell has the higher emf. By applying this difference to the value for the known cell, the emf of the unknown is found.

In order to insure the most reliable accuracy, it is essential that the standard cell comparator be maintained continuously at a constant temperature. The thermoregulator used in the illustrated comparator has an inherent sensitivity of $\pm 0.02^\circ\text{C}$. Tests have shown that the temperature of the cells does not vary by more than 0.01°C . Thus changes in emf arising from temperature variations of the cells in the comparator should be less than $0.5\mu\text{v}$.

KEARFOTT

ANNOUNCES

a new rotation-type

ferrite isolator*

FERRITE ISOLATOR
MODEL W152-1A

The new Ferrite Isolator is a useful device with applications such as oscillator isolation with the following advantages to system performance:

- Reduces long-line loading
- Prevents undesired frequency shift
- Insures uniform power output
- Improves transmitted pulse spectrum

The charts indicate the exceptional performance of this light-weight unit (less than 2 lbs.)

REVERSE ISOLATION

This shows very clearly the good unilateral decoupling effect between the antenna and transmitter.

INSERTION LOSS

This illustrates the exceptionally low loss from the transmitter to the antenna.

VOLTAGE STANDING WAVE RATIO

The VSWR introduced into the transmission line by the 'Isolator'

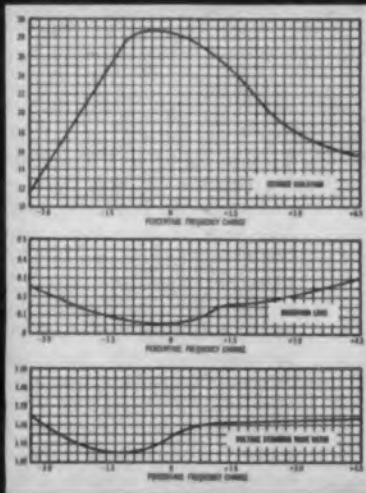

MODEL
W154-1A

Special units can be produced by Kearfott to meet your frequency requirements.

FERRITE RESONANCE ABSORPTION TRANSVERSE FIELD ISOLATOR for use where high power handling capacity is required. This new model operates over a 10% band width, with these electrical characteristics:

- Greater than 9 db isolation
- Less than 0.4 db insertion loss
- VSWR less than 1.03

Write or call today for complete detailed information on Kearfott components and their application to your Radar Systems.

Kearfott

COMPANY, INC.

LITTLE FALLS, NEW JERSEY
WESTERN MANUFACTURING DIVISION
14844 OXNARD ST. - VAN NUYS, CALIF.

SALES OFFICES

Eastern Office
1278 Main Ave.
Hartford, Conn.

Midwest Office
1000 N. Lincoln St.
Chicago, Ill.

South Central Office
6119 Duntin Drive
Dallas, Texas

Western Area Office
2511 Vermont Ave.
Pasadena, Calif.

CIRCLE 42 ON READER-SERVICE CARD FOR MORE INFORMATION

STABLE at 120°C

ACTUAL SIZE
(2 WATTS)



...new
**POLYOHM
1% RESISTOR**

—takes full power at ambient temperature three times that specified by MIL-R-10509A

—exceeds all other MIL-R-10509A specifications

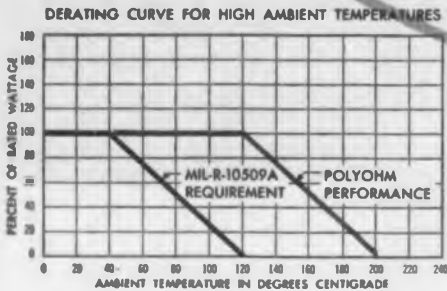

If you need a 1% resistor that is stable at high ambient temperature and humidity, we would like you to test free samples of our newly developed POLYOHMS. They exceed all MIL-R-10509A specifications as you can see from the comparison table below. Note, for example, that they take full power at ambient temperatures up to 120°C instead of only 40°C. Thus, they are ideal for use in aircraft and guided missiles. The same fact, of course, will result in much longer life when they are operated at lower temperatures.

POLYOHMS are well suited to replace bulky, expensive and highly inductive wire-wound resistors.

The resistor will remain well within its 1% tolerance even under the stringent moisture test which allows a 5% change. Its temperature coefficient is always lower than both the R and X characteristics.

POLYOHMS are manufactured in ½, 1, and 2 watt sizes with facilities controlled by the Signal Corps. They are presently available only for government end use. Please request samples on company letterhead.

TABLE OF TEST RESULTS

TEST	MIL-R-10509A Allowable change	POLYOHM Test Results (Median Value)
Temperature cycling	1%	.03%
Low temperature exposure	3%	.08%
Short time overload	.5%	.03%
Load life @ 40°C — 1000 hrs. @ 120°C — 1000 hrs.	1% —	.2% .5%
Temp. coeff. ppm/°C (char. X) (char. R)	± 500 ± 300	— 150 — 150
Moisture resistance test	5%	.3%

Polytechnic

RESEARCH

& DEVELOPMENT CO. INC

202 TILLARY ST.
BROOKLYN 1, N.Y.
Telephone
ULster 2-6800



Midwest Sales Office:
1 SO. NORTHWEST HWY., PARK RIDGE, ILL. — TAicot 3-3174

Western Sales Office:
737-41, SUITE 7, NO. SEWARD ST., HOLLYWOOD 38, CAL. • HO 5-5287

CIRCLE 43 ON READER-SERVICE CARD FOR MORE INFORMATION

Tape Potentiometer

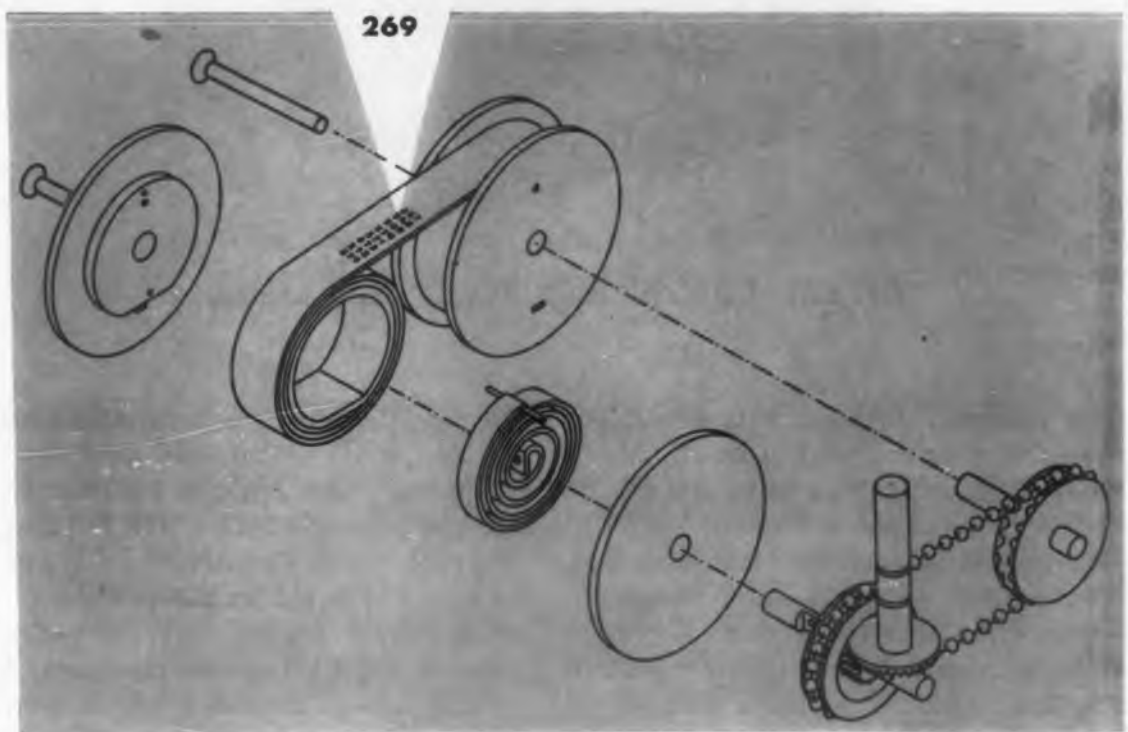

Exploded view shows constructional design of tape potentiometer. Spring keeps tape taut. Resistance-wire element is bonded to edge of the fibre tape. Embossed numerals on tape indicate resistance.

R
tent
direc
wire
can
linea
min
terp
L
ohm
spir
bond
1200
the
Nor
unit
non
cura
brat
it w
as C
spo
gag
dire
F
tur
tur
Cas
long
wha
tur
ELE



RESISTANCE wire bonded to the edge of numeral-embossed tape makes this clever potentiometer unique: one compact package features direct-reading calibration and laboratory slide-wire advantages. A straight slide wire, 144" long, can be directly calibrated in either linear or non-linear functions. Direct-reading of numerical digits minimizes the possibility of human error in interpreting scale readings.

Low-resistance straight wire elements up to 300 ohms for infinite resolution, or high-resistance spiral-wound elements up to 30,000 ohms can be bonded to the white vulcanized fibre tape. Up to 1200 calibration-number points can be added by the manufacturer, Howell Instrument Co., 1106 Norwood, Fort Worth 7, Tex., to a 144" roll. The units are calibrated after assembly, linearly or non-linearly, on a resistance increment basis accurate to $\pm 0.1\%$. The potentiometer can be calibrated in conjunction with the circuit with which it will be used. With this method, accuracy as high as 0.05% is obtainable. Temperature curves corresponding to different type thermocouples, strain-gage calibrations, resistance-bulb calibrations, or direct readings in resistance values are examples.

Power dissipation is 2w at 40°C. Wire temperature coefficient is ± 0.00002 . Approximately 12 turns of shaft rotation are necessary to cover 144". Case size is approximately 1-1/4" wide x 4-7/8" long x 2-1/2" high. Clearance dimensions are somewhat greater. For more information on this tape pot, turn to the Reader's Service Card and circle 44.

ELECTRONIC DESIGN • September 1955

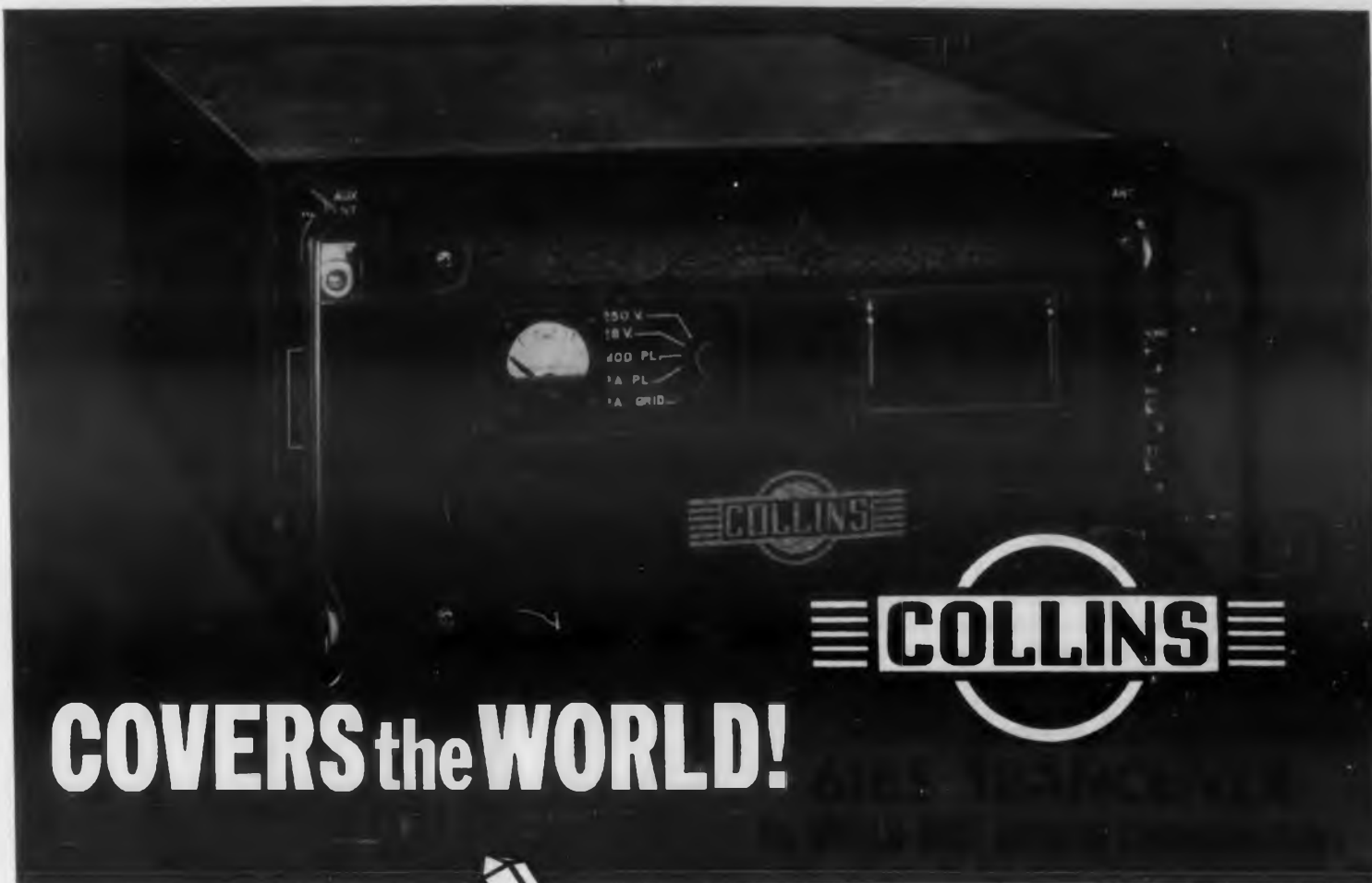

...and of course it uses

Midland CRYSTALS

100-WATT POWER ON 144 CHANNELS gives the Collins 618S Tranceiver truly world-wide operation. Collins airborne HF communications equipment is *first choice of most U. S. trans-oceanic airlines*, and of many foreign and domestic carriers, as well as private and military aviation.

Midland crystals do the key job of frequency control in the 618S Tranceiver as in all Collins aviation equipment. In this critical service, there can't be any question of stability, precision, and sure-fire performance under toughest conditions.

Midland Crystals measure up to Collins' strict standards because every one of the millions of these crystals in use today is a product of Midland Quality Control. This is the system that constantly checks every crystal at every step in processing.

Midland employs the finest technical skill and production facilities in the industry to make sure you'll get completely dependable crystal quality and performance.



A crystal for every kind of service, including the new Midland Miniatures

*Whatever your crystal need, conventional or specialized
When it has to be exactly right, contact*

Midland

MANUFACTURING COMPANY, INC.
3155 Fiberglas Road • Kansas City, Kansas

WORLD'S LARGEST PRODUCERS OF QUARTZ CRYSTALS

CIRCLE 45 ON READER-SERVICE CARD FOR MORE INFORMATION

Build SORENSEN REGULATION into your products with these new

MAGNETIC VOLTAGE REGULATORS

CAPACITIES — 15VA, 30VA, 60VA, 120VA, 250VA, 500VA.

TUBELESS — *trouble free*

COMPACT — *saves space in your equipment*

LIGHTER *than comparable regulators*

GOOD APPEARANCE — *enhances your product*

THERMALLY ISOLATED CASE — *simplifies your design problems*

ELECTRICAL SPECIFICATIONS

Input voltage range	95-130VAC, 1Ø, 60 cycles.
Output range	115VAC, RMS, 1Ø.
Regulation accuracy	±0.5% against line changes.
Load conditions	±0.5% against line at any given load from 0 to full.
Time constant	From 2 to 6 cycles for line changes.



MVR15



MVR60



MVR250



MVR30



MVR120



MVR500

GET MORE INFORMATION: Catalog MVR2 is yours for the asking; gives complete data on the new Magnetic Voltage Regulator line. Contact your local Sorensen representative, or write to General Sales Department, Sorensen & Co., Inc., 375 Fairfield Ave., Stamford, Conn.

CONTROLLED POWER FOR



RESEARCH AND INDUSTRY

SORENSEN

CIRCLE 46 ON READER-SERVICE CARD FOR MORE INFORMATION

Digital Meter with Recorder



The readings on this meter are recorded at the rate of one per second on the recorder at the right.

ANOTHER device—a vtvm with a recording attachment—to aid design and development engineers in these times of scarce technical assistance is illustrated on these pages. The Model 503 Multitester also features a digital display, which means that parallax errors are avoided. Designers testing some circuit parameter with this instrument can tend to other problems while voltage or resistance values are recorded continuously on standard adding-machine paper tape.

The meter and the Model 504 Digital Recorder are available separately. The vtvm measures positive and negative d-c voltages to 1000v, a-c voltage to 1000v rms from 50cy to 100ke, and resistance to 10megohm. Accuracy on d-c, a-c, and resistance reading is $\pm 0.15\%$, $\pm 1\%$, and $\pm 0.2\%$, respectively, of full scale. Over-all linearity is 1%, ex-

1 2 3 1 2 5 6
 1 1 5 6 3 6 6 9
 1 1 4 5 6 6 8 9
 1 4 4 8 6 6 3 9
 4 5 3 2 2 5 9 9
 4 5 3 6 8 8 9 9
 1 2 3 5 5 8 9 9
 1 4 5 3 0 0 0 0
 0 0 0 0 0 0 0 0
 0 0 0 0 0 0 0 0
 0 0 0 0 0 0 0 0
 0 0 0 0 0 0 0 0
 0 0 0 0 0 0 0 0
 3 1 4 8 5
 1 2 5 6 3
 2 2 5 6 6 3
 1 4 5 5 2 1
 2 4 5 3
 1 4 8 8 9
 1 4 7 3 2 4
 1 2 5 8 9 6
 3 2 1 5 9
 2 1 4 5 3 6
 1 2 4 5 8 3
 2 1 4 7 8
 0 0 0 0
 0 0 0 0
 2 2 4 8 8 9
 4 5 6 6 8 9 9
 2 2 4 7 8 9
 2 2 5 8 9
 2 2 3 6 6
 2 3

A typical parameter recording on paper tape.

cept for a-c measurements. The meter has a read-out of 20 times a second. The recorder can print once a second. A single probe is used for all measurements. The meter is not damaged by the application of excessive voltage when the selector switch is turned to resistance reading. Both of these devices are manufactured by Laboratory for Electronics, Inc., 75 Pitts St., Boston 14, Mass.

The recorder can be attached to other instruments made by this firm. The meter and recorder can also be used in production-line testing as well as in the laboratory. The meter weighs 35 lb and is 14-3/4" high x 9-1/4" wide and 12" deep. The recorder is 12-1/2" wide x 13" high x 15-1/2" deep and weighs 45 lb. For more information on the use of these two unusual laboratory instruments, turn to the Reader's Service Card and circle 47.

these famous names

**FASTEN IT
and FORGET IT**

with

Everlock

INDUSTRIAL FASTENERS

Vibration, twisting, Impact—when you fasten it with EVERLOCK lock washers you can *forget* all these enemies of your product. That's because EVERLOCK lock washers are different—have alternating *chisel edges* that bite into the face of both work and screw under powerful spring tension. *They just won't let go!*

EVERLOCK lock washers are available in standard types or to your own specifications. Ask us about them now—so that next time you order lock fasteners you'll be in a position to specify EVERLOCK. More and more quality manufacturers do.

THOMPSON-BREMER & CO.
 Dept. D, 520 Dearborn Street, Chicago 10, Ill.
 Subsidiary of AMERICAN MACHINE & FOUNDRY COMPANY, New York

GET PROMPT SERVICE FROM

YOUR LOCAL **Everlock** REPRESENTATIVE

Kenneth D. Delaney Dayton 3, Ohio	W. L. Barth, Jr. Chicago 34, Ill.	Richard C. Dudek Beverly Hills, Calif.
Oscar P. Martin Lakewood 7, Ohio	C. W. McNeil Houston, Texas	P. L. Robertson Milton, Ont. Can.
J. Ramsey Reese, Inc. New York 7, N.Y.	Leonard F. Berg St. Paul 14, Minn.	Sam T. Gleaves Louisville 5, Ky.
J. M. Murphy Manchester, Conn.	Thom Lundeen Moline, Illinois	J. J. McIntosh Atlanta 6, Ga.
Russell T. Brosius Philadelphia 3, Pa.	Forrest Moschner St. Louis, Missouri	Donald G. Teeling Indianapolis 44, Ind.
Sam T. Keller Detroit 1, Mich.	A. J. Murphy DeWitt, N.Y.	Oregon Indus. Factors Portland 1, Oregon



Lock Washers Sems Spin-down Lock Nuts Terminals

FREE CATALOG!

Comprehensive, complete. Your "bible" for the best in lock fasteners. Mail the coupon for your free copy.

THOMPSON-BREMER & CO.
 Dept. D, 520 N. Dearborn St., Chicago 10, Ill.

Send me your catalog of EVERLOCK Industrial Fasteners.

NAME _____
 COMPANY _____
 ADDRESS _____
 CITY _____ ZONE _____ STATE _____



CIRCLE 48 ON READER-SERVICE CARD FOR MORE INFORMATION

Ideas, Techniques, Designs

from the Alden Handbook of mechanical components to mount, house, fasten, connect and monitor electronic circuitry.

Now for the first time, using standard Alden Terminal Mounting Card components, you can mount all circuitry elements including vacuum tubes and other plug-in sockets directly on terminal cards with all their associated components . . . to have a construction that for all intents and purposes makes your terminal card the complete electronic chassis by itself.

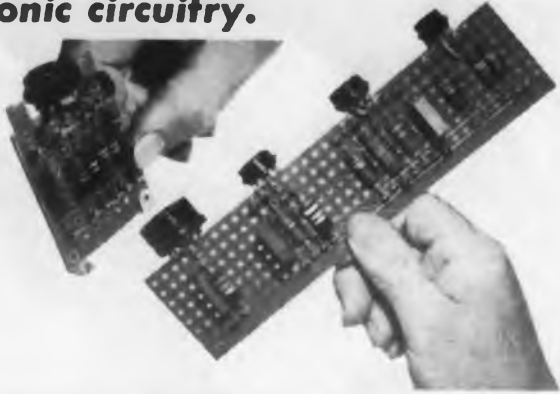

It's as simple as this — you start with these standard Alden Terminal Mounting Card Components in your lab:



1 You take the Alden Pre-punched Terminal Mounting Cards and plan your component locations on planning sheets.

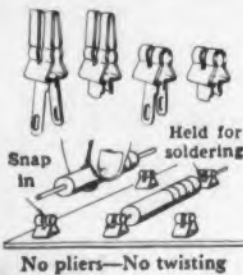

2 Choose the Alden Miniature Ratchet Terminals that fit your components, and stake them per pattern using lab staking tool.

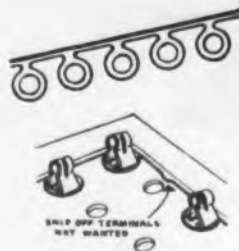

3 Use Jumper Strip staked under terminals to eliminate wiring to common circuit.

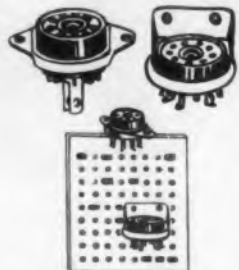

4 Bracket and turret mounting Tube Sockets eyelet directly to the card.

Simply and easily you end up with beautiful sub-assemblies of completed circuitry. If you wish, Alden will handle the volume staking production, delivering to you the cards with all terminals staked in position.

Once organized in single planes for volume requirements, it's a simple step to go to printed circuitry as the next step. Even in printed circuitry, Alden Ratchet Terminals are desirable where components are heat sensitive, or where you might want to remove certain components without disturbing the solder of printed circuitry.

By making the Terminal Card your chassis, you —



1) Eliminate point-to-point chassis wiring.



2) Make your circuitry simple unit sub-assemblies . . .



3) . . . that mount compactly in chassis as accessible rows of wiring.

By organizing all circuitry in single planes, packaging problems are tremendously simplified by permitting their mounting in close spaced rows in metal chassis. The metal chassis now returns to its proper function of being a protective housing, like a watch case — and your circuitry, though taking little space, is accessible for easy checking, removal or replacement — with spare circuit functions being small enough to airmail.

For those who would like to house their circuitry in plug-in units, the Alden Basic Chassis are available into which

the circuitry planes snap mount, organizing all in-out circuitry leads as accessible "point of check" connections, and providing the quick-acting locking and ejecting mechanisms to make each metal chassis a plug-in unit replaceable in 30 seconds.

Send for samples and the latest Alden Handbook specification sheets on the Alden Terminal Card Mounting System.

ALDEN PRODUCTS CO.
139 N. MAIN ST., BROCKTON 64, MASS.

CIRCLE 49 ON READER-SERVICE CARD FOR MORE INFORMATION

Easily Operated Preamplifier



The entire outer cabinet of this preamplifier is perforated for improved cooling.

The red ball below the bar tonal control is a listening level control.

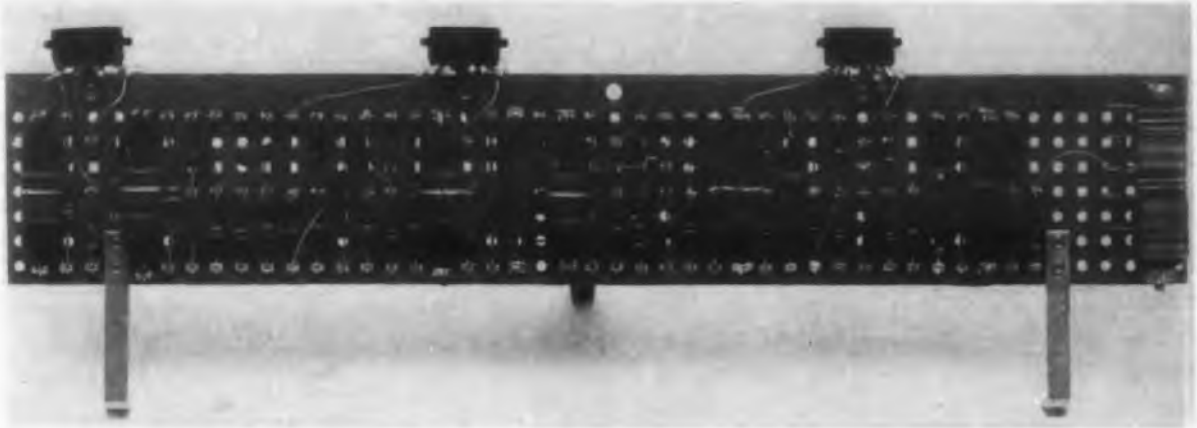

Circuit design and production were speeded by use of this terminal-board chassis.

S
hom
cha
tron
Fai
Sev
A
bas
on
Eac
elec
hor
con
ope
ing
res
the
res
vol
int
of
dev
Th
hav
nol
all
are
the
(A
suc
sav
be
dev
tw
On
car
im
me
EL

Design Forum

SIMPLIFIED controls are one of the outstanding features of this attractive high-performance home preamplifier. It also utilizes an unusual chassis construction technique of interest to electronic designers. The Model 240 is a product of Fairchild Recording Equipment Co., 154th St. and Seventh Ave., Whitestone 57, N. Y.

A control called the "Balanced-Bar" handles bass and treble response, as illustrated. The bars on either side of the main bar swing up and down. Each preamplifier is adjusted in the factory for electrically uniform response with the bars in the horizontal position. The setting can be adjusted for conditions in a particular room for "straight line" operation. In addition to this bar control, a listening level control just below it makes changing of response at different volumes very simple. When the red ball is thrown to the left for low level, bass response is increased. When the listener wants high volume, a more satisfying treble response change is introduced by throwing the ball to the right. Both of these controls can be read at a distance.

The chassis utilizes a construction technique developed by Alden Products Co., Brockton, Mass. The components are mounted in terminals that have been inserted in the illustrated strip of phenolic plastic. Since this board is mounted horizontally in the cabinet, the tubes are horizontal. They are removed through holes in the inner cabinet.

The terminals have a gripping action that holds the components in place until they are soldered. (All the solder points can be soldered in rapid succession at the same time for a considerable saving in labor costs.) This type of chassis can be used during the breadboard stage of circuit development, thereby eliminating design steps between the breadboard and the production model. Once the circuit is in production, design changes can easily be made. This last feature is particularly important these days when new, saleable improvements must be offered to the public every year.

"PIG-TAILORING"

... a revolutionary new mechanical process for higher production at lower costs. Fastest PREPARATION and ASSEMBLY of Resistors, Capacitors, Diodes and all other axial lead components for TERMINAL BOARDS, PRINTED CIRCUITS and MINIATURIZED ASSEMBLIES.

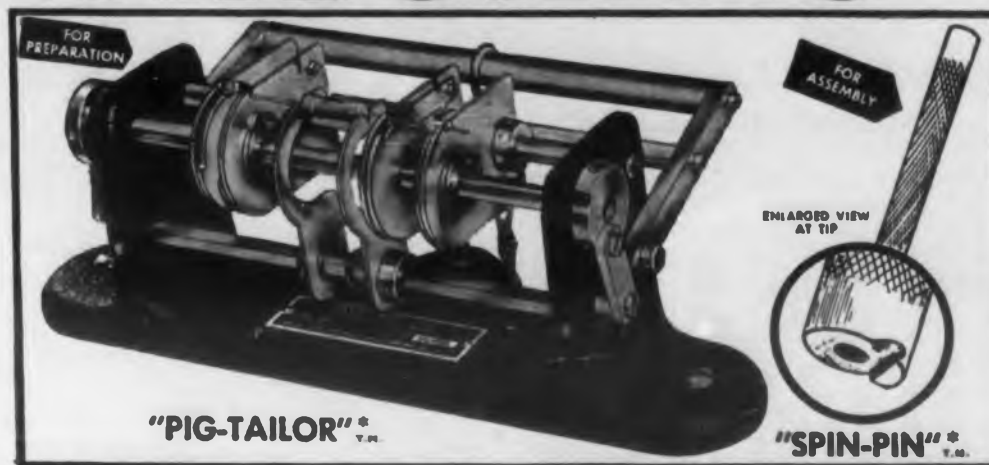

The "PIG-TAILOR" plus "SPIN-PIN" — Accurately Measures, Cuts, Bends, Ejects and Assembles both leads simultaneously to individual lengths and shapes — 3 minute set-up — No accessories — Foot operated — 1 hour training time.

PIG-TAILORING provides:

1. Uniform component position.
2. Uniform marking exposure.
3. Miniaturization spacing control.
4. "S" leads for terminals.
5. "U" leads for printed circuits
6. Individual cut and bend lengths.
7. Better time/rate analysis.
8. Closer cost control.
9. Invaluable labor saving.
10. Immediate cost recovery.

PIG-TAILORING eliminates:

1. Diagonal cutters.
2. Long-nose pliers.
3. Operator judgment.
4. 90% operator training time.
5. Broken components.
6. Broken leads.
7. Short circuits from clippings.
8. 65% chassis handling.
9. Excessive lead tautness.
10. Haphazard assembly methods.

* PATENT PENDING

Write for illustrated, descriptive text on "PIG-TAILORING" to Dept. ED 9-P

BRUNO-NEW YORK INDUSTRIES CORPORATION

DESIGNERS AND MANUFACTURERS OF ELECTRONIC EQUIPMENT

460 WEST 34th STREET

NEW YORK 1, N. Y.



Broadband RF Power Meters

THE CHOICE OF ALL ARMED SERVICES
FOR MICROWAVE POWER MEASUREMENTS

POWER: PULSE and CW — 5 μ W to 5W average

FREQUENCY: 20MC — 10,000MC

ACCURACY: \pm 5% Absolute at all ranges,
frequencies, temperatures

- **INDICATIONS:** Direct Reading
- **CALIBRATION:** Compensates for All Variables
- **R-F COMPONENTS:** 3, 6, 10 and 20db Attenuators,
Bolometer Mount and Elements, R-F Cable
- **BOLOMETER:** Broadband, High Overload Capacity
- **PLUMBING:** $\frac{3}{8}$ " and $\frac{7}{8}$ " 50-ohm Coaxial
- **POWER SOURCE:** 115VAC \pm 15%, 50-1000 cps
- **CONSTRUCTION:** Rugged, meets all JAN, MIL requirements

TYPICAL APPLICATIONS

Microwave Links ... Television ... Communications ...
Radar ... Telemetry ... Signal Generators ...
Laboratory Standards.

Write for descriptive literature to Department ED-9M

Bruno-New York Industries Corporation

DESIGNERS AND MANUFACTURERS OF ELECTRONIC EQUIPMENT

460 WEST 34th STREET

NEW YORK 1, N. Y.



CIRCLE 50 ON READER-SERVICE CARD FOR MORE INFORMATION

When you need a stable capacitor...

Specify RMC Type JL DISCAPS



Type JL

The ideal cost-saving replacement for paper or general purpose mica capacitors, Type JL DISCAPS, afford exceptional stability over an extended temperature range. Maximum capacity change between -60° and 110° C is only $\pm 7.5\%$ of capacity at 25° C. Standard working voltage is 1000 V.D.C. providing a high voltage safety factor. Type JL DISCAPS are manufactured in capacities between 220 MMF and 5000 MMF.

In addition to the advantages of longer life, dependability, and lower initial cost, their smaller size and greater mechanical strength provide additional economies in assembly line operations.



Wedg-loc

Type JL stable-capacity DISCAPS, as well as temperature compensating and by-pass types, are available with RMC "Wedg-loc" leads for printed circuit assemblies. The exclusive design of these leads lock securely in place on printed circuits... the capacitors cannot fall out and a uniform soldered connection is assured.

Manufactured in capacities between 2 MMF and 20,000 MMF, "Wedg-loc" DISCAPS have the same electrical specifications and tolerances as standard wire lead DISCAPS. Suggested hole size is a .062 square.



Plug-in

To simplify production line problems on printed circuits Type JL DISCAPS, temperature compensating and by-pass types, are available with plug in leads. These leads are No. 20 tinned copper (.032 diameter) and are available up to $1\frac{1}{2}$ " in length. Plug-in DISCAPS will provide worthwhile savings on printed circuit assemblies and include all of the electrical and mechanical features that have made standard DISCAPS a favorite with leading television and electronic manufacturers.

Write today on your company letterhead for expert engineering help on any capacitor problem.

DISCAP
CERAMIC
CAPACITORS

RMC

RADIO MATERIALS CORPORATION
GENERAL OFFICE: 3325 N. California Ave., Chicago 18, Ill.

FACTORIES AT CHICAGO, ILL. AND ATTICA, IND.
Two RMC Plants Devoted Exclusively to Ceramic Capacitors

CIRCLE 51 ON READER-SERVICE CARD FOR MORE INFORMATION

Thumb Size Servo



The stator of the tiny servo is shown beside it.

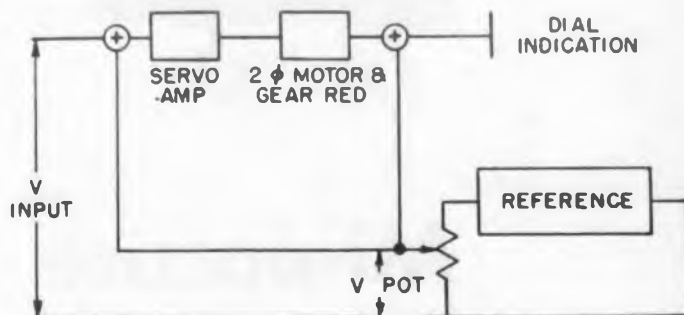

A dial-indication application of the 1.2 oz motor.

ONLY 5/8" in diameter and 1.2" long, this tiny two-phase servo motor can be utilized in many aircraft applications. It performs at altitudes up to 60,000'. Among its applications are null-method measurements and multiplication of two quantities.

The induction motor operates at a rated voltage of 26v, 400cy. It has a no-load speed of 21,000rpm and a stall torque of 0.11 in-oz. The moment of inertia is 0.0009 oz-in²/min. The motor was developed by the Instrument Div., General Electric Co., Lynn, Mass., for use with a gyro-compass.

In one application in which the 1.2-oz motor is used to initiate control, one phase is continuously excited from the 400cy line, while another is fed from the output of the servo amplifier. The necessary 90° phase shift between the input to the fixed phase and the variable phase may be introduced in the error signal circuit, in the amplifier, or in the fixed-phase circuit. In this way, the error signal from a synchro-control transformer may be amplified and used to initiate control through the servo motor.

If single-phase, 400cy power is supplied to the fixed phase of this servo, the output of the other phase will then be a single-phase voltage proportional to the velocity of the rotor. Such an arrangement permits the multiplication of two quantities, one of which is in the form of an a-c voltage, and the other in the form of a velocity. The motor may be used at ambient temperatures ranging from -55° to +90°C. For more data on these servos, turn to the Reader's Service Card and circle 52.

A TIME-RATE INDICATOR YOU CAN REALLY COUNT ON!

the LFE 501



facts

You Ought to Know
about The LFE 501

THE 501: Features built-in temperature compensated crystal controlled timing pulse generator with scaler determined time base. Measures frequency in megacycles up to 10 mc with accuracy up to 1 part in 10 million — and contains measurement. Measures periodic functions from 10 μ sec to 25,000 hours (period). Measures time interval in the range from 0.1 μ sec to 25,000 hours. Measures frequency ratio between two input frequencies. Counts up to 10 million pulses per second with a relative accuracy up to 1 ppm. Includes built-in wide band gain amplifier covering a bandwidth of 10 cps to 10 mc and with a sensitivity of 20 μ v.

accurate
reliable
lightning fast

What's your problem? Frequency measurements? Data recording? Process control?

Whether you're counting marbles or megohms — instrumentation or automation — LFE's 501 Time-Rate Indicator can do more for less money than any similar device on the market. This high speed electronic counter is much more reliable, because it uses a scaler-determined time base — a device of extraordinary accuracy found in no other indicator.



**LABORATORY FOR
ELECTRONICS, INC.**

75 PITTS ST., BOSTON 14, MASS.

Representatives in principal cities in U. S. and Canada.

Inquiries on export sales should be addressed to:

Andrew S. Szucs, Inc., 50 Broad Street, New York 4, N. Y.



Save Time in Circuit Design

Get advance information... in graphic form...
on vacuum-tube behavior in new circuitry —
with the **Type 570 Characteristic-Curve Tracer**



The Tektronix Type 570 Characteristic-Curve Tracer can save you many hours in circuit-development work by providing quick, accurate pictures of vacuum-tube characteristics. You have complete control of the operating-condition setup, permitting a realistic approach to actual circuit conditions, whatever they may be. You get curves that can be very important in a particular circuit problem; but are rarely, if ever, published in handbooks.

The Type 570 can also be used for rapid preselection of vacuum tubes, either by comparison with another vacuum tube, or with curves outlined on a crt mask.

Please call your Tektronix Field Engineer or Representative or write direct for new booklet, Type 570 Technical Description.

Displays Families of Curves on CRT Screen

Choice of four to twelve characteristic curves per family—with as many as 8 positive-bias curves per family.

Plots All Important Characteristics

Plate current against plate voltage.
Plate current against grid voltage.
Screen current against plate voltage.
Screen current against grid voltage.
Grid current against plate voltage.
Grid current against grid voltage.

Calibrated Controls

Accurate current and voltage readings directly from the crt screen.

Wide Display Range

11 current ranges from 0.02 ma/div to 50 ma/div.
9 voltage ranges from 0.1 v/div to 50 v/div.
11 series-load resistors from 300 ohms to 1 megohm.
7 grid-step values from 0.1 v/step to 10 v/step.

Price — \$925

f.a.b. Portland (Beaverton), Oregon

See and try the Type 570 at the National Electronic Conference in Chicago, Booths 133 and 134.

Tektronix, Inc.

P. O. Box 831, Portland 7, Oregon

CYpress 2-2611

Cable: TEKTRONIX

CIRCLE 54 ON READER-SERVICE CARD FOR MORE INFORMATION



Fig. 1 — Plate current plotted against plate voltage for one triode section of a 12AU7. Plate load is 5 k, peak plate-supply voltage is 500 v. Grid voltage is changed 5 v between curves, from -35 v to zero. Vertical sensitivity is 5 ma/div, horizontal sensitivity 50 v/div. Calibrated controls permit accurate current and voltage readings directly from the screen.



Fig. 2 — Same triode section of 12AU7 with only 20-v peak plate supply and sensitivities increased to 0.2 ma/div vertical and 2 v/div horizontal. Grid voltage is changed 2 v between curves, from -14 v to zero. This is essentially a 25-times magnification at the lower left portion of Fig. 1, showing the operating characteristics at low plate-supply voltage.



Fig. 3 — Screen current plotted against plate voltage with positive grid bias on a 6AQ5. Plate load is 300 ohms, peak plate voltage is 100 v, screen-grid voltage is 100 v, with grid voltage changing 2 v/step from +16 v to below zero. Vertical scale is 10 ma/div, horizontal scale 10 v/div.

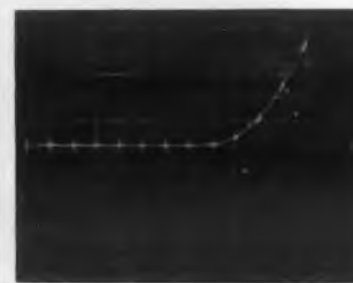
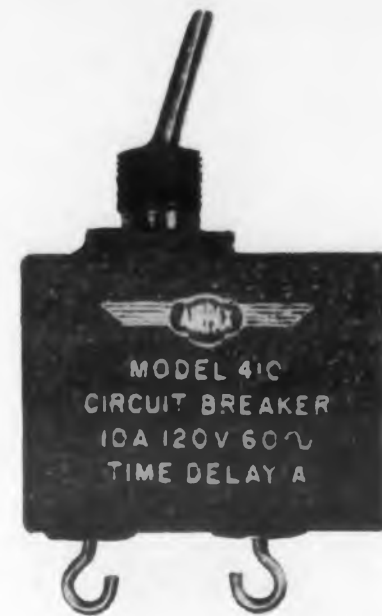

Fig. 4 — Typical Germanium Diode curve. Inherent flexibility of the Type 570 permits accurate evaluation of diode characteristics and detailed examination of any part of the curve. Calibrated scales above are 0.2 v/div horizontal, 0.5 ma/div vertical, with zero points at center of screen.



Miniature Circuit Breaker

POWER on-off control as well as circuit protection is provided with this miniature circuit breaker. Its operation is fully magnetic giving time-delay trip-free action. Its small size and light weight (less than 2oz) enables it to be used in any electronic equipment that normally contains an on-off switch. The bat handle has two positions: *on* and *off*. It moves to the *off* position when the breaker trips, yet the breaker cannot be prevented from tripping by holding the handle in its *on* position. Service is restored after a fault has been remedied by resetting the handle to *on*. A breaker having the maximum time delay of 30sec recovers its delay in about 20sec.

Being hermetically sealed, the breaker, manufactured by Airpax Products Co., Middle River, Baltimore, Md., is free from erratic effects of altitude. It operates reliably in any atmosphere withstanding 50g of shock and vibration of 0.03" amplitude at 10 to 55cy. The magnetic circuit can be made to have various time-overload responses. Two standard responses that meet most equipment needs for protection are illustrated. The trip coil can be wound to operate at any specified current from 50ma to 10a. The minimum trip level (lowest

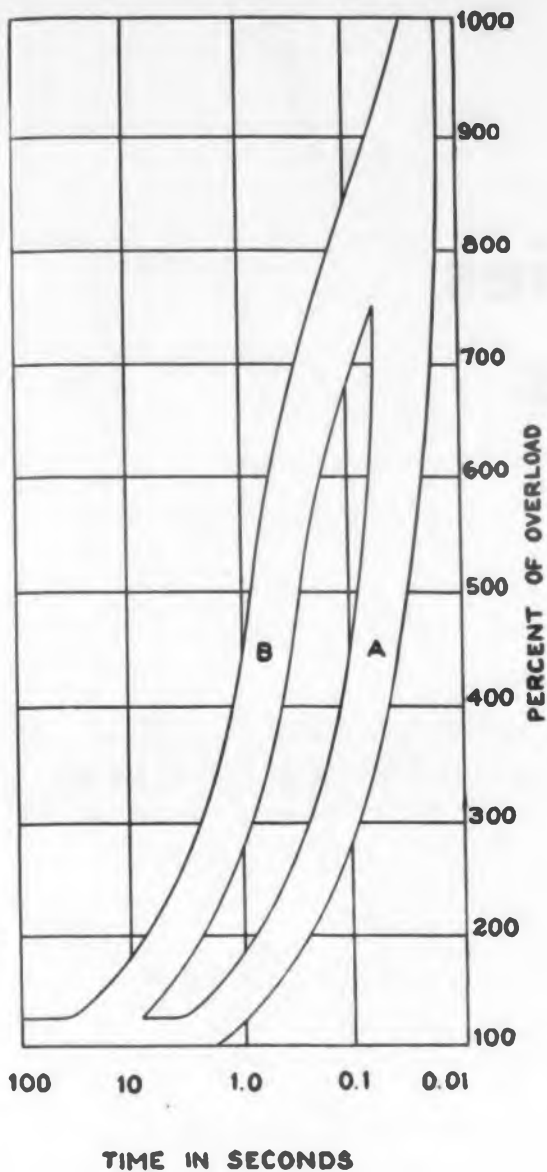

value of overload at which tripping is guaranteed) is 125% of continuous current rating; the unit can be produced with higher minimum trip points for special needs. In characteristic A, the 125% delay is centered about 3sec; in characteristic B, it is centered about 20sec. The instantaneous trip point is approximately 10 times the continuous current rating. The interrupting capacity is 500a at 30v d-c rating.

Typical electronic equipment utilizing inverse time delay circuit breaker protection includes blower motors and motor-operated auxiliary devices. Starting inrushes of about 800% of rated current can be handled for a fraction of a second. Response characteristic B is intended for this general circuit protection. Response A is suited to electronic equipment where extremely sensitive overload protection is desired.

The actual size is 5/8 by 1-1/2 by 1-1/2". Seven d-c ratings of 0.05a through 10a at 50v, and five a-c ratings of 1.0a through 10.0a at 120v, 60cy are available. Life is specified at 10,000 operations; tests have been run to 20,000. Temperature range is from -40 to +100°C. For more information, turn to the Reader's Service Card and circle 55.

KEPCO KR SERIES

7 NEW

VOLTAGE REGULATED POWER SUPPLIES
for powering electronic equipment

SAVE TIME AND MONEY
Build these compact Power Supplies
into your equipment!

Kepeco Voltage Regulated Power Supplies are conservatively rated and are designed for continuous duty at 50°C ambient. The regulation specified for each unit is available throughout its output voltage range for line voltage variations from 105-125 volts and load variations from 0 to full load.

FEATURES:

- Superior Regulation.
- Ultra-Stable 85A2, 063 Reference Tube.
- Low Ripple.
- Low Output Impedance.
- Fast Recovery Time, Suitable for Square Wave Pulsed Loading.
- Voltage Range continuously variable without Switching.
- Either Positive or Negative may be Grounded.
- Oil Filled Condensers.
- Wire Harness and Resistor Board Construction.
- Power Requirements 105-125 volts, 50-60 cycles. Units operate up to 400 cycles.
- Terminations and locking type voltage control on rear of unit.
- AC, DC Switches, Fuses, and Pilot Lights on Front Panel.
- Color Grey Hammertone.
- Guarantee One Year.

To include 3" Current and Voltage Meters, Add M to Model number (e.g. KR 1-M) and Add \$30.00 to the Price.
To include Dust Cover and Handles for Table Mounting, Add C to Model number (e.g. KR 1-C) and Add \$10.00 to the Price.
To include Meters, Dust Cover and Handles, Add M, to Model number (e.g. KR-1MC) and Add \$48.00 to the Price.
PRICES F.O.B. Flushing.



KEPCO LABORATORIES

131-38 SANFORD AVENUE • FLUSHING 55, N. Y.
INDEPENDENCE 1-7000



125 ma. KR SERIES

MODEL	OUTPUT	VOLTS	CURRENT	REGULATION		RIPPLE (RMS)	19" Rack Mount		
				line 105-125v	load 0-max		W	H	D
KR1 \$90.	1	100-200	0-125 ma.	0.3 volts	0.3 volts	3 mv.	19"	7"	7 1/2"
	2	6.3 AC	3 amp.	*	*				
KR2 \$90.	1	200-325	0-125 ma.	0.2 volts	0.2 volts	3 mv.	19"	7"	7 1/2"
	2	6.3 AC	3 amp.	*	*				

*AC Voltages unregulated.



300 ma. KR SERIES

MODEL	OUTPUT	VOLTS	CURRENT	REGULATION		RIPPLE (RMS)	19" Rack Mount		
				line 105-125v	load 0-max		W	H	D
KR3 \$100.	1	100-200	0-300 ma.	0.3 volts	0.3 volts	3 mv.	19"	7"	11"
	2	6.3 AC	5 amp.	*	*				
	3	6.3 AC	5 amp.	*	*				
KR4 \$100.	1	200-325	0-300 ma.	0.2 volts	0.2 volts	3 mv.	19"	7"	11"
	2	6.3 AC	5 amp.	*	*				
	3	6.3 AC	5 amp.	*	*				

*AC Voltages unregulated.



600 ma. KR SERIES

MODEL	OUTPUT	VOLTS	CURRENT	REGULATION		RIPPLE (RMS)	19" Rack Mount		
				line 105-125v	load 0-max		W	H	D
KR5 \$240.	1	100-200	0-600 ma.	0.3 volts	0.3 volts	5 mv.	19"	10 1/2"	13"
	2	6.3 AC	10 amp.	*	*				
	3	6.3 AC	10 amp.	*	*				
KR6 \$240.	1	195-305	0-600 ma.	0.2 volts	0.2 volts	5 mv.	19"	10 1/2"	13"
	2	6.3 AC	10 amp.	*	*				
	3	6.3 AC	10 amp.	*	*				
KR7 \$250.	1	295-405	0-600 ma.	0.2 volts	0.2 volts	5 mv.	19"	10 1/2"	13"
	2	6.3 AC	10 amp.	*	*				
	3	6.3 AC	10 amp.	*	*				

*AC Voltages unregulated.

CIRCLE 56 ON READER-SERVICE CARD FOR MORE INFORMATION

Dielectric Breakdown Properties of Thermosetting Laminates

Norman A. Skow

Director of Research
Synthane Corporation, Oaks, Pa.

PERPENDICULAR TO LAMINATIONS

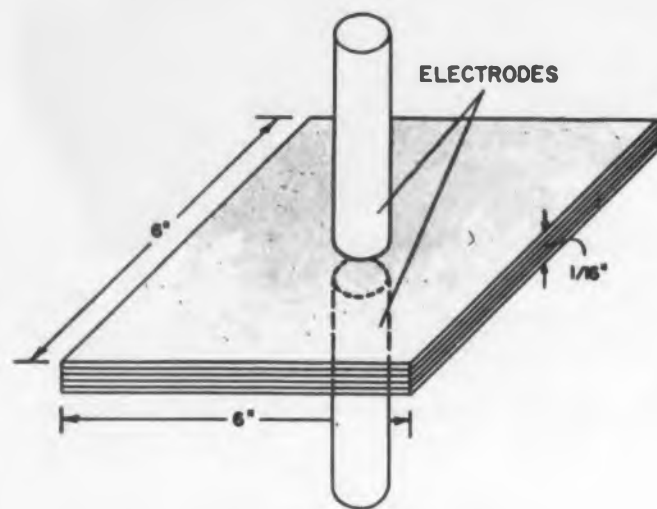
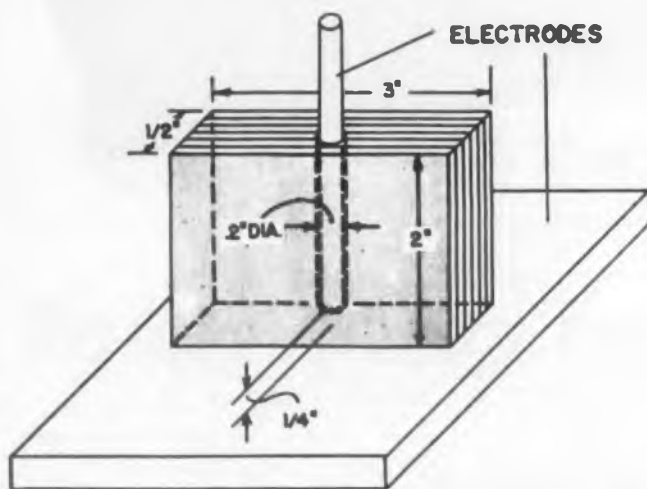

Fig. 1. Sample sizes and test arrangements for dielectric breakdown. For parallel tests, lower, thickness of laminates is 1/4". Thickness for perpendicular test, upper, is 1/16".

PARALLEL TO LAMINATIONS



WHEN selecting a laminate, aside from physical properties, the designer of electronic equipment is primarily concerned with insulation resistance, dielectric loss, and dielectric breakdown. The relative importance of these various properties depends on the application involved, but dielectric breakdown is almost always a major consideration.

Dielectric strength is the maximum potential gradient that a material can withstand without rupture. It is difficult to evaluate quantitatively because its magnitude varies with temperature, thickness of material, moisture content, and time exposed to stress.

Since long service without breakdown is a primary requirement of electrical insulating materials, determination of the endurance limit is most essential. This can be measured by stressing the laminate with voltages less than the short-time test value and recording the results at each voltage. The maximum voltage that can be applied for an indefinite time without breakdown establishes the endurance limit.

Differences between the dielectric breakdown properties of thermosetting laminates stressed *parallel* to laminations and those stressed *perpendicular* to laminations are sufficient to warrant investigation of behavior for each direction.

Seven typical NEMA grades of laminated thermosetting plastics were tested: Grades X, XX, XXP, LE, A, G-5, and N-1. Tests were made only upon laminates in sheet form, but the dielectric properties of tubes, rods and molded parts are quite similar.

Grades X, XX, and XXXP are paper-base laminates bonded with phenolic resin. Grade X is intended primarily for mechanical applications and is to be used with discretion under high-humidity conditions. Grade XX is made with a more absorbent paper and has a higher resin content. Grade XX is better electrically, although slightly weaker mechanically, than Grade X. Grade XXXP, which has a still higher resin content, is one of the best electrical laminates produced. Grade LE has a cotton-fabric

Table 1. Effect of sample thickness on short time dielectric strength of laminates at temperature rating of 73° F.

THICKNESS Inches	DIELECTRIC STRENGTH (SHORT TIME) Volts per Mil		
	PERPENDICULAR TO LAMINATIONS ¹	PARALLEL TO LAMINATIONS ²	
	Grade XX paper-base	Grade X paper-base	Grade XX paper-base
1/2	940	—	—
1/4	695	360	530
1/8	515	270	275
1/16	—	160	130
1/32	—	120	130
1/64	—	110	120

¹Average for five specimens, conditioned for 1 hr. at 220 F.
²Average for five specimens, conditioned for 8 hrs. at 220 F.

**Background
for
Designers**

Fig. 2. Effect of temperature on short time dielectric strength of laminates.

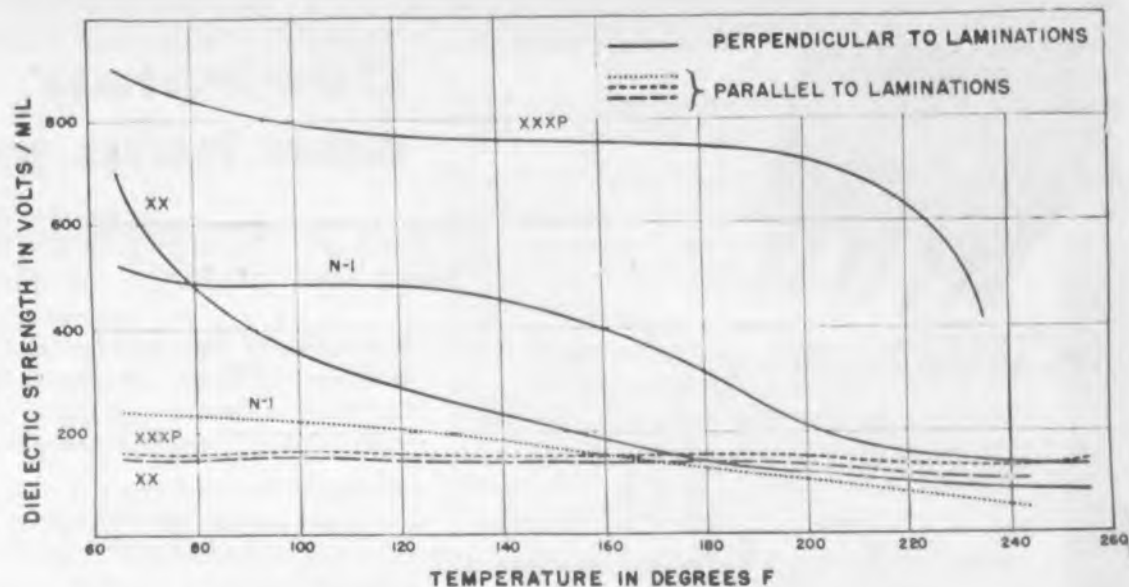

base and is bonded with phenolic resin. This grade is used on electrical applications requiring greater toughness than is provided by Grade XX.

Grade A is an asbestos paper-base laminate bonded with phenolic resin. It is more flame- and heat-resistant than the cellulosic grades. Bonded with melamine resin, Grade G-5 is a glass-base laminate with very high mechanical strength, excellent electrical properties under dry conditions and good heat, flame and arc resistance. Grade N-1, is a nylon-fabric-base laminate bonded with phenolic resin. It has excellent electrical and mechanical properties even under high humidity conditions.

The drawings in Fig. 1 indicate the sample size and test arrangements used. For testing perpendicular to laminations, samples were selected at random from standard production sheet 1/16" in thickness. For tests parallel to laminations, specimens were cut from standard sheets 1/2" thick. A small hole was drilled leaving a 1/4" thickness of laminate between the bottom of the hole and the edge of the sample.

Short-time dielectric strength measurements perpendicular to laminations were made with the specimens in oil. Samples were first dried in an oven at 220°F for 1 hour and then cooled in a desiccator for 16 hours at 73°F. Tests were made using five specimens for each grade. Measurements parallel to laminations were made in oil with a metal pin and plate as electrodes, Fig. 1. Because of the 1/4" thickness of the electrode gap, a longer conditioning period was necessary to insure uniform dryness.

Results of tests in both directions are plotted in Fig. 2 for Grades XX, XXXP, and N-1 at temperatures from 65 to 256°F. The breakdown strength for electrodes parallel to laminations is considerably less than that for the perpendicular arrangement.

Data from Fig. 2 indicates that for the parallel to laminations test, Grade N-1 (nylon-base laminate) has the most rapid decrease in dielectric strength (short-time) with temperature, while the breakdown

THICKNESS 1/16"-TESTED DRY AT 73°F

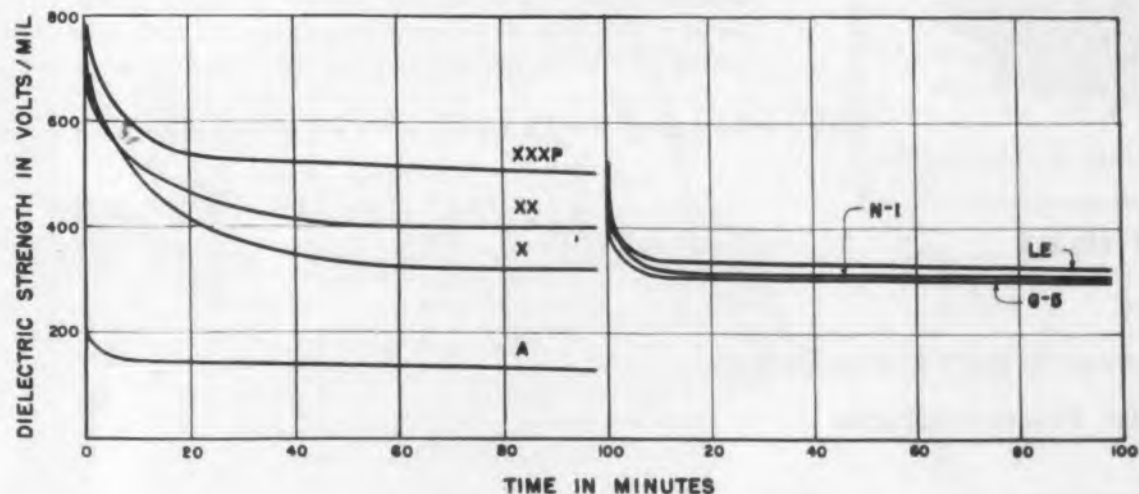

Fig. 3. Endurance limits of dielectric strength perpendicular to the laminations.

THICKNESS 1/4"-TESTED DRY AT 73°F

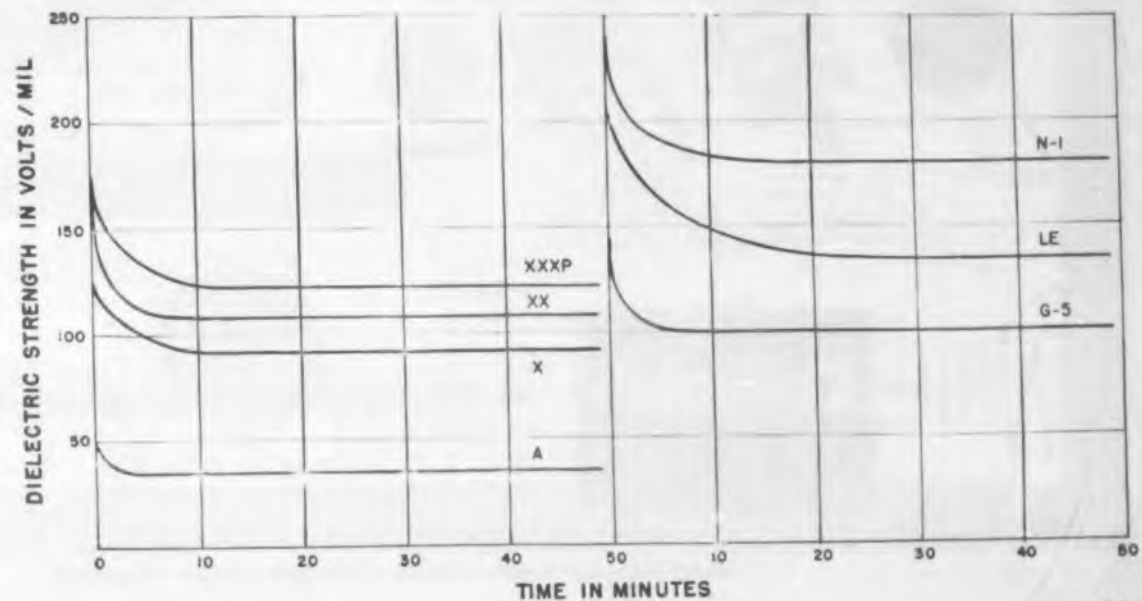
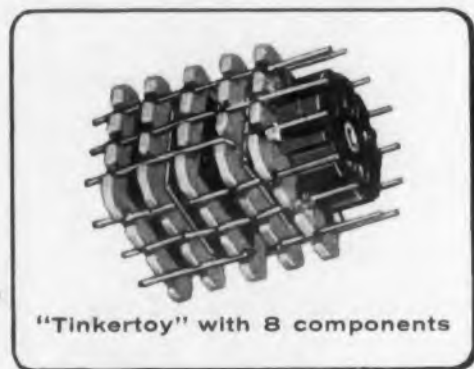
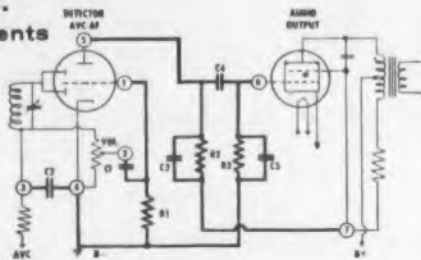

Fig. 4. Endurance limits of dielectric strength parallel to laminations.

Utilizing modular design for electronic circuitry?



Centralab P.E.C.
with 8 components



"Tinkertoy" with 8 components

**More proof that
if it's a job
for electronic components,
it's a job for Centralab**

Centralab's
advanced engineering
continues to create
the prototypes
of the components
industry



Volume Controls



Capacitors



Switches

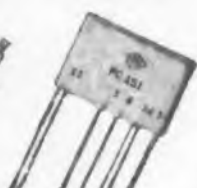

Packaged
Electronic
Circuits



Ceramics

Centralab can help you

— with packaged electronic circuits...
"tinkertoy" plates... authoritative counsel

Planning on "rolling your own" and assembling a circuit from scratch? That's one place Centralab can help you. For Centralab can supply "tinkertoy" plates the way you want them — bare or with components attached.

Or would you rather save design and assembly time, by buying performance, instead of parts? Centralab can help you there, also. Centralab "packages" electronic circuitry — physically reduces a complete circuit, with all wiring, resistors, capacitors, and small inductances, to a two-dimensional form. You save space and weight — and you get a complete, sub-assembly "package" that is tested and guaranteed for specific performance.

Which way should you go? Talking it over with Centralab engineering specialists can help you decide, just as it has helped others. But—and this is important—call in Centralab early in the planning stage, before you've "frozen" your design.

NEW THIS MONTH! Electroni-Kwiz No.7

1st Prize

Matched set of cowhide luggage
— including

1. Two-suiter
2. Brief bag

A combination you're proud to own. Like to try for it? Simply answer this question in 50 words, more or less:

If a young man — perhaps your son—wanted to pursue an engineering career in the field of electronics, how would you advise him to prepare for it?

A leading editor will pick the winner of this month's major prize.

Mail your entry to us before September 30.



†Nothing to buy. Employees of Centralab and their advertising agency not eligible. Duplicate prizes awarded in case of tie. Entries become the property of Centralab—none can be returned.

GRADE THICKNESS CONDITIONING	PERPENDICULAR TO LAMINATIONS		
	Short Time Diel. Str. Volts/Mil	Endurance Limits Volts/Mil	Endurance Limits Short Time Diel. Str. %
1/4" Thick Dry a	X	649	49.3
	XX	695	56.1
	XXXP	780	64.2
	LE	434	73.8
	A	155	83.8
	G-5 N-1	450 394	310 305
XX b	1/4", 96 hrs. at 90% RH 95F.	240	62.5
	1/4", 48 hrs. in H ₂ O at 122F	112	49.5
XXXP c	1/4", 96 hrs. at 90% RH 95F.	700	64.2
	1/4", 48 hrs. in H ₂ O at 122F	680	57.2

voltages of Grade XXXP, although it has a lower dielectric strength at lower temperatures, drop slightly between 65 and 256°F. The breakdown voltages of Grade XX appear between these two extremes throughout the temperature range.

Data in Table 1 indicates the effect of sample thickness on short-time dielectric strength measured in both directions. Here the decrease in dielectric strength may be compared to the law of diminishing returns in that each additional thickness of laminate provides a smaller increase in the total dielectric breakdown voltage of the sample.

The endurance limit of dielectric strength in both directions was determined by applying voltages at the rate of 10kv/sec until 85, 70, 60, 55, 50, and 45 per cent of the short-time breakdown value was reached. After rupture occurred, the voltage and time for failure were recorded. For all tests, the samples and testing procedure were made as uniform as possible to assure reliable results.

The endurance limits, perpendicular and parallel to laminations, for the seven grades of laminates tested are given in Figs. 3 and 4. The curves show that the breakdown voltage gradually approaches a magnitude that is independent of time. The endurance limit of the material is considered approximately equal to the maximum dielectric strength which will not rupture after a 100-minute exposure to stress. This assumption is based on tests on five samples which, after resisting breakdown for 100min, continued to withstand the applied stresses for 18 hrs.

Short-time dielectric strengths and endurance limit values are compared in tables above. In part a, where the seven grades of laminates are tested dry at 73°F, the ratios (per cent) of endurance limits to short-time dielectric strength are tabulated (data from curves in Figs. 3 and 4) to indicate the relative characteristics of the seven grades. Grade A (asbestos-base) plastic laminate has the lowest dielectric strength and endurance limit in either direction but is recommended in high-temperature applications be-

Centralab

A DIVISION OF GLOBE-UNION INC.

9601 E. Keefe Avenue • Milwaukee 1, Wisconsin
In Canada: 804 Mt. Pleasant Road, Toronto, Ontario

*Trademark

SINCE 1922, INDUSTRY'S GREATEST SOURCE OF STANDARD AND SPECIAL ELECTRONIC COMPONENTS

CIRCLE 57 ON READER-SERVICE CARD FOR MORE INFORMATION

GRADE THICKNESS CONDITIONING		PARALLEL TO LAMINATIONS		
		Short Time Diel. Str. Volts/Mil	Endurance Limits Volts/Mil	Endurance Limits Short Time Diel. Str. %
1/4" Thick Dry a	X	124	92	74.2
	XX	176	108	61.3
	XXXP	172	124	72.0
	LE	206	134	65.0
	A	48	36	75.0
	G-5	144	100	69.4
	N-1	240	180	75.0
XX b	1/4", 21 days at 90% RH, 50C.	100	80	80.0
	1/4", 21 days in water at 50C	38	18	47.4
XXXP c	1/4", 21 days at 90% RH, 50C.	112	96	85.7
	1/4", 21 days in water at 50C	56	28	50.0

cause of its superior heat resistance. The six remaining grades tested are suitable for high-voltage applications, Grade XXXP having the highest breakdown voltages perpendicular to laminations and Grade N-1 the highest parallel to laminations.

For dry specimens, the endurance limits (in either direction) of the seven standard grades of laminates tested vary from 49 per cent to 84 per cent of the corresponding short-time dielectric strength. Therefore the designer can consider a safety factor of three, based on the short-time test, to be sufficient. For Grades XX and XXXP exposed to high humidity and elevated temperatures (parts *b* and *c* of tables above), the percentage ratio of endurance limit to short-time dielectric strength ranges from 47 per cent to 86 per cent (including both directions). Again, a safety factor of three should be satisfactory. In actual practice, a designer may expect to use equipment under highly humid conditions, yet available data on the laminates may be limited to short-time dielectric strength under dry conditions. In these cases, the NEMA-recommended safety factor of six may be necessary.

Conclusions drawn from these tests would indicate that for selecting thermosetting plastic laminates to be used as a dielectric medium, it is important to know the temperature at which the equipment is to be operated, the atmospheric conditions to be encountered, the mechanical strain and the dielectric stress to be applied. If the equipment is used under dry conditions and the mechanical strength requirements are not severe, paper-base laminates are very satisfactory. If humid conditions are a factor it would be advisable to use the more water-resistant paper base grades such as Grade XXXP. Under dry conditions requiring high mechanical strength it may be necessary to use a fabric grade such as LE and under continuous humid conditions requiring high mechanical strength it may be necessary to use Grade N-1. If arc-resistance is an important requirement, Grade G-5 is indicated.



RHEEM ELECTRON TUBE ANALYZER



Measures operational qualities of electron tubes to MIL-E-1B specifications.

Use—fast automatic test processing and data storage provisions make it ideal for receiving, inspection, quality control and preventive maintenance of electronic installations.

Concept—modular packaging of isolated units programmed to perform a series of tests featuring automatic sequencing, and indicating each test result on a go-no-go basis, or if desired a digital readout can be provided.

Operation—completely automatic with provisional master manual controls.

Specifications—

1. Process over 1000 tubes per day
2. 30 seconds to reprogram for different tube type
3. 5% overall accuracy
4. Self-checking features
5. High quality components and workmanship

Tests—

Ip	Voltage Regulator
Isg	Ionization
Ig	Tube voltage
Gm	drop
Power output	Regulation
Rectifier	Thyratrons
HK Leakage	Anode
Insulation	Critical grid
Cutoff	voltage
*Intermittent short	Balance
	Noise

*The intermittent short test features continuously variable sensitivity over a range from 50 to 500,000 ohms. Sensitivity can be extended to 2 megohms if requested. A standard tube taper is included.

Each Analyzer is designed to perform approximately 10 of the basic tests listed. Since customer requirements vary, it is suggested, when asking for quotation, that a list of tests desired along with tube types to be tested be included with the request.

For complete information on this and other units or on specialized electronic design problems, contact:

**RHEEM
MANUFACTURING COMPANY**
Government Products Division
Research and Development Laboratories
9236 East Hall Road, Downey, California

YOU CAN RELY ON...



CIRCLE 58 ON READER-SERVICE CARD FOR MORE INFORMATION

The Effect of Heater Coating Thickness on Warm-Up Time

R. L. Pear and A. Szilasi

Westinghouse Electric Corp., Electronic Tube Div., Bath, N. Y.

SERIES-STRING tubes for radio and television receivers must have the same heater warm-up times. In the course of developing a group of 600ma series-string tubes, the following information and the illustrated graphs on the influence of heater coating thickness on heater warm-up time were compiled. An approximately linear function was established between heater warm-up time and coating volume.

The filaments to be compared were taken from the same spool of tungsten wire. This coating was applied by the drag coating process. After each section of coated wire, a piece of bare wire was cut out and the coating thickness was increased for the next section. Each section was held to as short a length as possible. The variations in wire size indicated by the pieces of bare wire were negligible. Consequently, the filaments had practically all the same tungsten core with different thicknesses of coating.

Each filament was cut to the same length and welded straight between two electrodes into the largest available bulb. The tube was evacuated, the filament degassed, and the getter flashed to guarantee a good vacuum in the enclosure.

Referring to Fig. 1, the filament voltage versus the filament current curves show that, for constant voltage, the current increases with coating thickness, that is, the hot resistance decreases. It is known that for tungsten wire the hot to cold resistance ratio determines the hot temperature. Assuming the same cold resistance for all experimental filaments (the variations were only slight due to inaccuracy of the welding process) it is evident that the applied coating decreases the average temperature of the core wire, apparently due to the bigger radiating surface.

The Emerson method, for determining warm-up time, uses a series resistor equal to three times the heater's hot resistance and a supply voltage equal to

four times the heater voltage. The heat-up time end point is the 80% point of the final heater voltage.

To compare different heaters with only one common property, the cold resistance, another common characteristic had to be chosen. The following possibilities could have been used:

1. same heater current.
2. same heater voltage.
3. same heater power.
4. same temperature or hot resistance.

Due to the fact that the heaters in receiving tubes are designed for a normal operating temperature of 1500°K, which corresponds to a ratio of hot-to-cold resistance of about seven, the comparisons of the different filaments were based on equal temperature, that is on equal hot resistance.

The necessary data for setting up the conditions of the warm-up time were furnished from Fig. 2. The ratio of hot-to-cold resistance of 6 and 7 times the cold resistance was selected. The average cold resistance was taken for all the filaments in order to simplify the test conditions.

The warm-up time measurements on filaments ranging from bare wire to about 11 mils coated diameter, based on a test point corresponding to a hot resistance of six and of seven times the cold resistance are shown in Fig. 3. A more linear function was achieved by plotting Fig. 4, the volume of coating versus warm-up time. It can be concluded that the warm-up time is better related to the volume of the body to be heated than to the diameter. Diameter readings were taken as an average of three readings because of the non-uniformity of the coating.

The warm-up time curves, for the ratios of six and seven times the cold resistance, show very little difference, the curve for six times the cold resistance requiring slightly longer warm-up times than for

seven. This difference of fractions of a second can be attributed to the greater influence of the end losses, when the filament is colder.

Comparison proves that the Emerson test method is fairly independent of the operating temperature of the heater to be tested, as long as conditions are adapted to varying hot resistance and heater voltage.

A third warm-up time curve versus coating thickness was based on a setting of constant power. The voltage-current characteristics of the different filaments served for the calculation of heater power versus heater voltage. A constant power of 4w was selected and the hot resistance and filament voltages read from Fig. 2 are shown in the table below.

	Filament OD (mils)	Filament Voltage	Hot Resistance (ohms)
Bare Wire	3.58	4.58	5.22
Coated	5	4.42	4.9
Coated	7	4.35	4.72
Coated	9	4.25	4.52
Coated	11	4.05	4.08

The above values were used in the warm-up test.

Fig. 4 shows less linearity than the curves for equal hot resistance, that is temperature. As the power settings correspond to different temperatures for the individual filaments, the curve for constant power crosses from the line of highest temperature over to lower temperatures.

The tests show a good linear relationship between coating volume and warm-up time. The values of warm-up time are in all cases smaller than those in regular tubes, although the filament used was very similar. Undoubtedly the addition of the cathode increases the mass to be heated. Calculations show that the presence of the cathode could easily double the warm-up time of the heater.

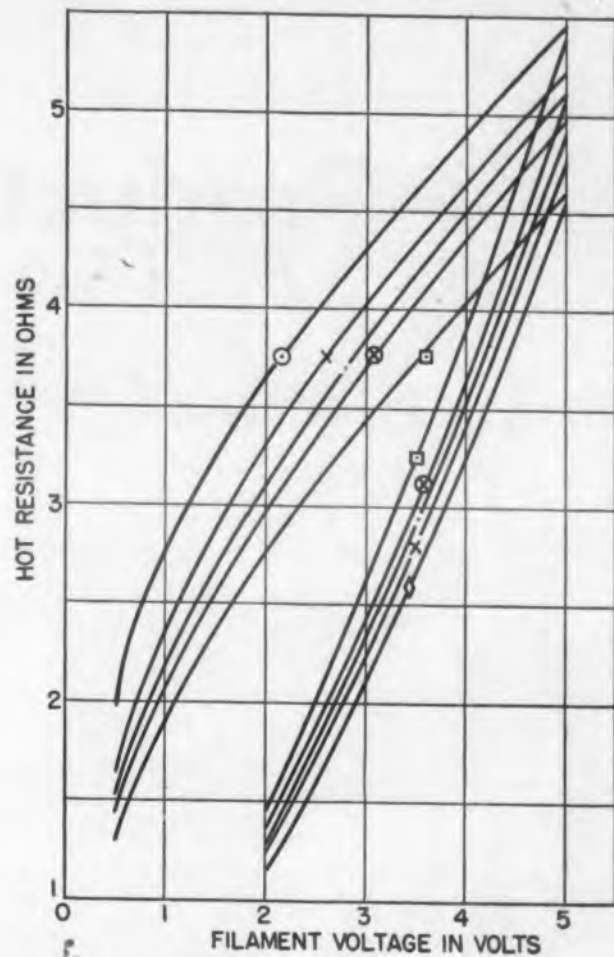
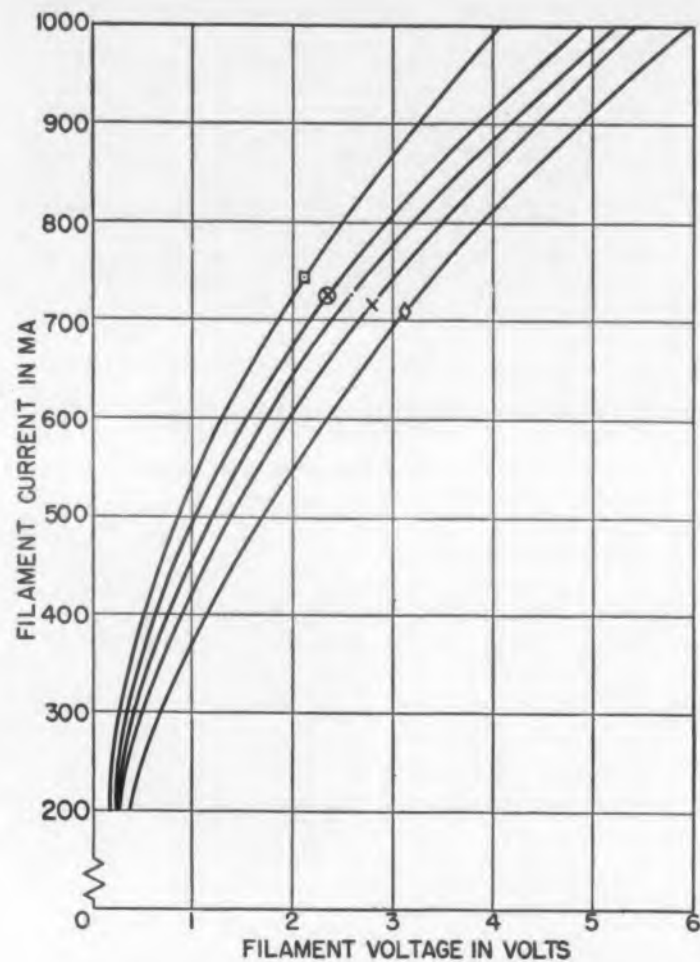

- ◇ Bare wire 3.58mil OD
- × Coated wire 5mil OD
- Coated wire 7mil OD
- ⊗ Coated wire 9mil OD
- Coated wire 11mil OD

The above key applies to Fig. 1 (left) and Fig. 2 (right).

- Hot resistance 6 times cold resistance
- ⊗ Hot resistance 7 times cold resistance
- Constant power on filament—four watts

The above key applies to the heating time characteristics shown in Fig. 3 (left) and Fig. 4 (right).

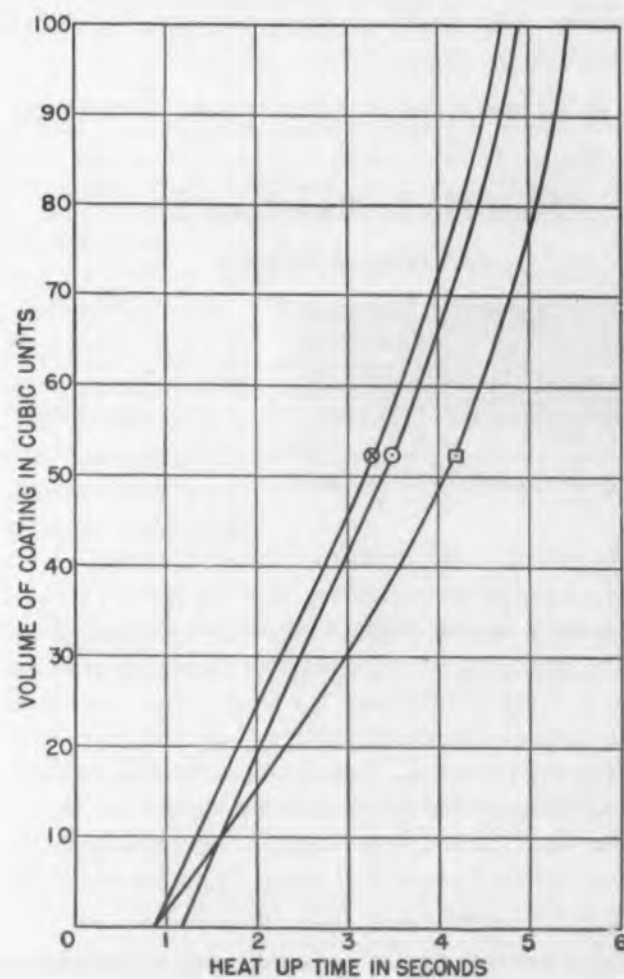
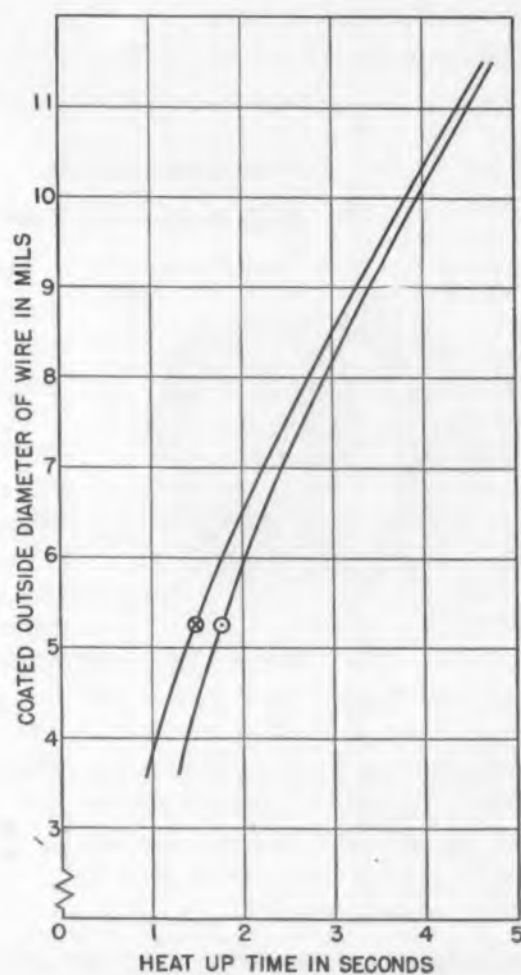

New Products

Microwave Oscillators Backward-wave Type



Known as backward-wave oscillators, these tubes sustain oscillation by energy interchange between an electron beam and a guided electromagnetic wave. Conventional applications

include local oscillators, sweep-frequency signal generators, high-speed AFC circuits, and laboratory microwave signal sources. With wide-range electronic tubing (a single type covers a 2000Mc range), they also have low pulling figure, freedom from hysteresis and long-line effects, and freedom from spurious modulation when modulated at high frequencies.

Tubes covering L-band through X-band are currently available. X-band through K-band types will be available soon. Raytheon Manufacturing Co., Dept. ED, Waltham 54, Mass.

CIRCLE 60 ON READER-SERVICE CARD FOR MORE INFORMATION

Multiple Carbon Controls For Printed Circuits



Strip-type carbon controls, with the resistance wafers mounted directly on a phenolic panel, are available from this firm for

printed circuit applications. The controls have straight, tinned terminals which project through punched slots in the printed sheet for dip soldering. They are mounted at right angles to the chassis by means of shouldered tabs. To save space, multiple sections can be mounted about 1/2" behind each other. The shafts of the rear section extend through holes factory-punched in the front strip.

Single, dual and triple sections are available, in resistance values from 250 ohms to 10 megohms. P. R. Mallory & Co., Inc., Dept. ED, Indianapolis, Ind.

CIRCLE 61 ON READER-SERVICE CARD FOR MORE INFORMATION

Feed-Thru Capacitor Mounted by Shoulder



"Step-Cap" ceramic feed-thru capacitors have a shoulder in the body for mounting, instead of an eyelet. By eliminating the eyelet, it is possible to mount the units in smaller areas, or mount them much closer together on the chassis. They will not tilt when mounted, because they are self centering. The only assembly operations needed are dropping the unit into place, and soldering. Silver is bonded homogeneously to the ceramic to facilitate soldering.

The units are supplied in capacity ranges from 3mmfd to 275-mmfd at $\pm 10\%$ and $\pm 20\%$ tolerances; from 276mmfd to 1000-mmfd at GMV. Units are rated at 1000v d-c (w). The mounting hole is 0.192". Solar Mfg. Corp., Dept. ED, 46th and Seville, Los Angeles 58, Calif.

CIRCLE 62 ON READER-SERVICE CARD FOR MORE INFORMATION

Potentiometers 2" High-Resolution Units

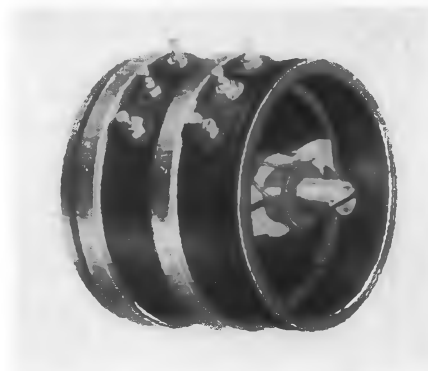

The Series K-200 High-Resolution Kohlräusch-wound Potentiometers are especially designed for low-torque, high-function-angle applications. These 2", ball-bearing potentiometers are completely enclosed

and can be used as single or multiple ganged units. Any practical number of sections can be ganged on a single shaft by one-piece stainless steel clamp rings. This arrangement permits precise independent phasing of each unit without disassembly of other units. DeJur-Amseco Corp., Dept. ED, 45-01 Northern Blvd., Long Island City 1, N. Y.

CIRCLE 63 ON READER-SERVICE CARD FOR MORE INFORMATION

Selenium Rectifiers For Printed Circuits

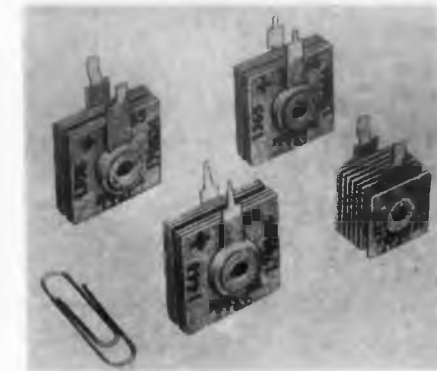

A line of selenium rectifiers for use with printed circuits has been announced by this firm. Employing three different types of terminals, they are designed for insertion into the printed circuit automatically or manually.

The three types of terminals available are: a square-tipped type for insertion into printed circuit boards up to 1/16" thick; a tapered type designed for maximum ease of insertion by automatic equipment in printed circuit boards up to 1/8" thick; and a snap-in type which holds the rectifier firmly in place even when the circuit board is subjected to vibration or inverted prior to soldering. Components Div., Federal Telephone and Radio Co., Dept. ED, 100 Kingsland Rd., Clifton, N. J.

CIRCLE 64 ON READER-SERVICE CARD FOR MORE INFORMATION

Relay For Printed-Circuit Use



The construction of the Series SQD Printed-Circuit Relay permits direct insertion of the relay terminals into the printed circuit board, ready for immediate soldering. The plug-in

terminals, instead of being brazed or welded together in sections, have been made integral parts of the coil terminals and contact springs to prevent internal loss in conductivity or continuity. The two contact arms of the relay permit two spring pile-ups of up to nine springs each. Automatic Electric Sales Corp., Dept. ED, 1033 W. Van Buren St., Chicago 7, Ill.

CIRCLE 65 ON READER-SERVICE CARD FOR MORE INFORMATION

I-F Amplifier

Measures Only 12" x 2" x 1"

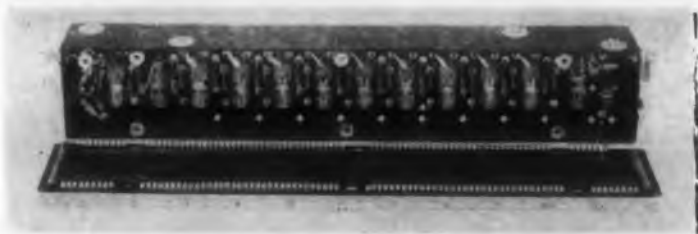

A series of subminiature i-f amplifiers for airborne radar systems and broadband receivers is available from this firm. Gains of over 100db are obtained simultaneously with bandwidths over 12Mc at center frequencies of 20Mc, 60Mc, or 90Mc. The construction provides complete shielding and absence of regeneration even with covers removed.

Tubes having a rated life of over 5000hr. Reduction of weight and size (12" x 2" x 1") is accomplished by use of subminiature components and novel assembly techniques.

Each model consists of a cascode amplifier followed by three flat staggered triples. The last triple feeds an infinite impedance detector and a cathode follower output stage. A bias adjustment is incorporated in each unit to control the gain over a range of at least 40db. Provisions are made to monitor crystal current. Maxson Instruments, Div. of W. L. Maxson Corp., Dept. ED, 47-37 Austell Pl., Long Island City 1, N. Y.

CIRCLE 66 ON READER-SERVICE CARD FOR MORE INFORMATION

Impulse Counter

Has Preselection Feature



The "Ti" Series of "Sodeco" electrical impulse counters features preselection. They are available with either manual pushbutton reset or electric reset. They are furnished either with a front plate for flush mounting, or one

for surface mounting. The counters are completely housed and sealed. Power requirements are low (0.8w to 3w), and speed is up to 12 impulses per sec.

The counters may be preset to any number up to 99,999 and then sealed to prevent tampering. As impulses come in, the upper (preset) register subtracts and the lower (counting) one adds. If desired, the counter will automatically reset to the original preselected figure at the end of each counting cycle. When the counting cycle is completed a built-in secondary contact can be actuated. Landis & Gyr, Inc., Dept. ED, 45 W. 45th St., New York 36, N. Y.

CIRCLE 67 ON READER-SERVICE CARD FOR MORE INFORMATION

ELECTRONIC DESIGN • September 1955

The
Greatest Names
in British
Electronics use

Mullard
TUBES

British equipment manufacturers are making a vital contribution to the development of electronics in all fields of application. Their products are being exported to every corner of the world, earning a universal reputation for advanced techniques and excellent performance.

The majority of these electronic equipment manufacturers consistently use Mullard tubes. This choice is decided upon because they prefer the greater assurance of efficiency and dependability, and because the vast manufacturing resources of the Mullard organisation guarantee ready availability of Mullard tubes wherever they are needed.

Write to the undermentioned distributors for full details of Mullard tubes:—

In the U.S.A. International Electronics Corporation,
Department E.D. 9
81, Spring Street, N. Y. 12, New York, U.S.A.

In Canada Rogers Majestic Electronics Limited,
Department J.A.
11-19 Brentcliffe Road, Toronto 17, Ontario, Canada.

Mullard
Electronic Tubes

used throughout the world

MULLARD OVERSEAS LTD., CENTURY HOUSE, SHAFTESBURY AVENUE, LONDON, ENGLAND

Mullard is the Trade Mark of
Mullard Ltd., and is registered in most of the principal countries of the world.



MEV 25

CIRCLE 68 ON READER-SERVICE CARD FOR MORE INFORMATION

Now! For AMP Taper Pin Connectors

E-I

COMPRESSION HEADERS



Type 90 GS/60W-AMP/S Compression Header, available with from 8 to 14 terminals, shown four times actual size.

...offering fast connect and disconnect, speedy assembly and positive connections without soldering!

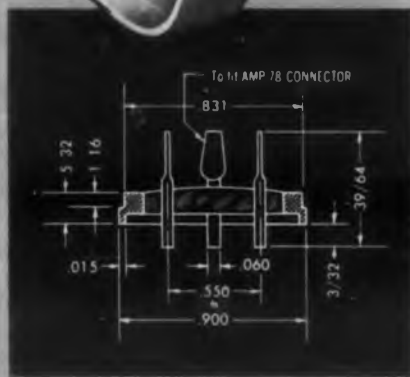

Available

IN COMPRESSION HEADERS AND PRACTICALLY ALL STANDARD E-I SINGLE TERMINAL EYELETS—

E-I offers single and multiple terminal type compression headers and practically every standard E-I single terminal compression eyelet for use with Type 78 AMP connectors*. For recommendations on specific sealed terminal applications, consult an E-I sales engineer, today!



PATENTS PENDING — ALL RIGHTS RESERVED

*Products of Aircraft-Marine Products, Inc. of Harrisburg, Pa.



Division of Amperax Electronic Corporation

ELECTRICAL INDUSTRIES

44 SUMMER AVENUE, NEWARK 4, NEW JERSEY

High Vacuum Pump Oil

No Traps Needed

Diffusion Pump Oil, known as Bevens 8, enables the attainment of high vacuum without resorting to traps involving liquid air or charcoal. It is chemically and thermally stable. Inspection samples of Bevens 8 oil are available at no cost, to qualified users stating potential application. A. Daigger & Co., Dept. ED, 159 W. Kinzie St., Chicago 10, Ill.

CIRCLE 69 ON READER-SERVICE CARD

Heat Resistant Decals

Wide Selection of Colors

These Heat Resistant Decals are particularly suited to jet aircraft fuel lines because of their ability to resist active solvents. Other applications are electronic equipment, transformers, and any other situation involving extreme heat. Meyerecord Co., Dept. ED, 5323 W. Lake St., Chicago 44, Ill.

CIRCLE 70 ON READER-SERVICE CARD

Miniature Screws

For Precision Instruments

Imported miniature screws in a complete range of sizes are available in the United States. Manufactured in Switzerland, the 0-80 and 1-72 screws range in size from 1/16 to 3/4", in length increments of 1/64". Heads and Threads, Inc., Dept. ED, 2816 Peterson Ave., Chicago 45, Ill.

CIRCLE 71 ON READER-SERVICE CARD

Characteristics Sheets

More Types Available

This firm is adding to the number of tube types for which it publishes large characteristics sheets. These 8-1/2" x 11" graphs aid in circuit design. The curves show plate characteristics, positive-grid characteristics, μ , g_m , and r_p . Some subminiature types are being added. Technical Publishing House, P. O. Box 61, Waltham 54, Mass.

CIRCLE 72 ON READER-SERVICE CARD

◀ CIRCLE 73 ON READER-SERVICE CARD

Taper Pin Terminal Board For Solderless Connections

This taper pin terminal board is highly versatile and applicable to experimental work. Using new taper pin terminals that permit solderless connections, the boards are available in 5 sections with either 25 or 50 terminals. The 5-section boards may be easily cut to single sections of 5 or 10 terminals each, or may be used in any multiple desired. Boards are available with either single-end or double-end taper pin terminals. Lerec Div., Lynn-Deatrick, Inc., Dept. ED, 501 S. Varney St., Burbank, Calif.

CIRCLE 74 ON READER-SERVICE CARD

Screen Process Ink Resist for Printed Circuits

P. C. Black is a free flowing screen process ink designed specifically to meet the requirements of printed electronic circuitry. Its opacity allows it to lay an unbroken resist line of hairline accuracy without blooming or breaking the circuit. Commonly used etching chemicals have no effect on this ink once it is applied to the printed blank. It reacts instantly to petroleum solvents and all traces of the resist vanish in seconds. Naz-Dar Co., Dept. ED, 461 Milwaukee Ave., Chicago 10, Ill.

CIRCLE 75 ON READER-SERVICE CARD

High Polymer Capacitors Various Temperature Coefficients

These new high polymer capacitors can be obtained in any temperature coefficient of capacitance from -125 ppm per degree C to $+60$ ppm per degree C within a temperature range of -60° to $+200^{\circ}$ C and a capacitance range of 0.001 mfd to 1 mfg 600 v d-c. This range of temperature coefficients is the result of combining various dielectric properties into one unit. Condenser Products Co., Div. of New Haven Clock and Watch Co., Dept. ED, 140 Hamilton St., New Haven, Conn.

CIRCLE 76 ON READER-SERVICE CARD

CIRCLE 90 ON READER-SERVICE CARD ➤

Electro-Snap Switches Can Be Adapted to Almost Any Job — Quickly, Easily, Economically

Just choose the Electro-Snap Basic Switch that meets your electrical requirements, add the proper actuator — and presto! — you have a tailor-made precision switch that exactly fits your application. Electro-Snap makes a wide variety of stock actuators to fit almost any requirement. And our engineering department is at your service if a standard combination "won't fill the bill."

For prompt action on your switching problems, send us a brief description and rough sketch of the switch you need.

Switching Problem?

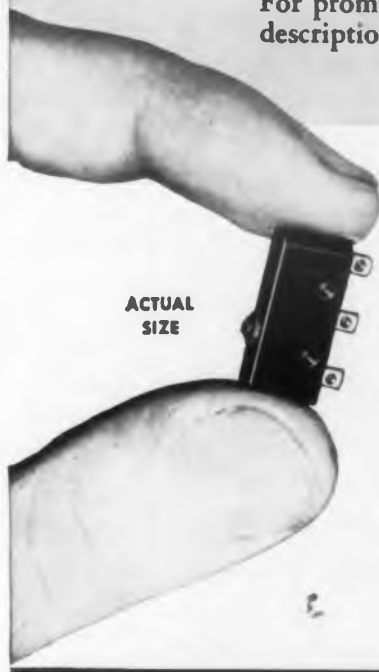

SUB-MINIATURE SWITCHES TYPE E-4

S.P.D.T., 1 circuit; 5 amps, 125/250 v. AC
Operating force 150 grams max.
Exceptionally vibration-resistant.
Special model E4-7 is stabilized for -65° to $+350^{\circ}$ F. operation.

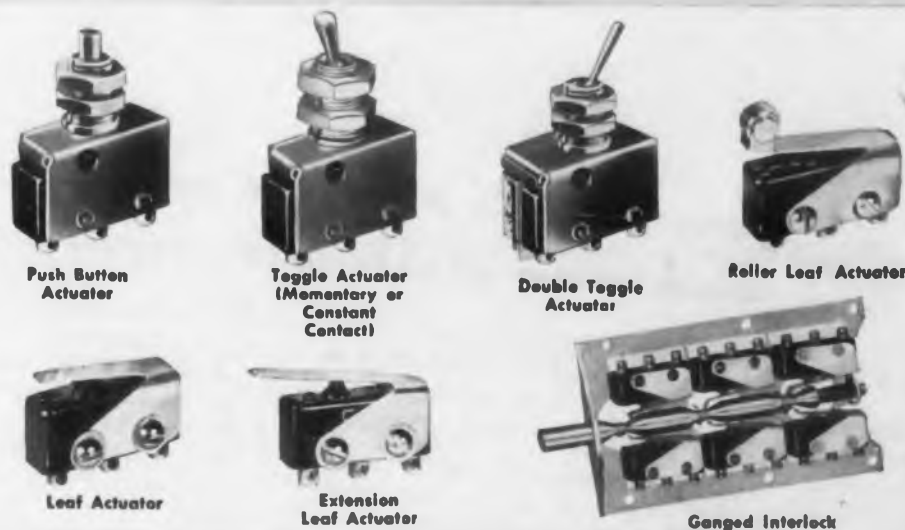

TYPE S SWITCHES Series S1



S.P.D.T., 2 circuit; 10 amps, 125/250 v. AC/ 30 v. DC. Ind. Screw or solder terminals on ends or one side of switch. Also available with reset button at bottom of switch or in Type S-100 Make-Before-Break Series where switch completes a new circuit before interrupting old one.



DOUBLE-POLE SIMULTANEOUS ACTION TYPE D-8

D.P.D.T., 4 Circuit
15 amps, 125/250 v. AC.
10 amps, 30 v. DC Ind.
Eight terminals and four separate circuits which operate simultaneously permit switch to reverse 3-phase motors, replace expensive relays, etc.



HERMETICALLY-SEALED DOUBLE-POLE SWITCH



D.P.D.T., 4 circuit 10 amps, 125/250 v. AC/30 v. DC.



ELECTRO-SNAP SWITCH & MFG. CO. 4220 West Lake Street, Chicago 24, Illinois
MANUFACTURERS OF A COMPLETE LINE OF PRECISION SWITCHES FOR INDUSTRY AND AVIATION

MICRO SWITCH Precision Switches

A PRINCIPLE OF GOOD DESIGN



MULTIPLE CIRCUIT
ROTARY SWITCH



ENVIRONMENT-PROOF
SWITCH

New MICRO SWITCH products meet exacting electronic requirements

Keeping pace with the ever-changing needs of the electronics industry has always been an important consideration of MICRO SWITCH engineering development.

New switches and new switch assemblies are always on the drawing boards and on test at MICRO SWITCH. Often designers find these switches fit, without change, the particular service at hand. At other times consultation with MICRO SWITCH engineering results in modification of an old design or development of one entirely new.

Whatever the task, MICRO SWITCH components either are or can be made available to give the utmost in reliable

service performance. Does your current problem involve any switches like these?

A Multiple Circuit Rotary Switch—Will handle up to 8 circuits at 20 amperes at 115 volts a-c.

New Environment-Proof Switch—Provided with split contact circuit arrangement.

Sealed Subminiature Switch—Completely environment-proof, has high electrical capacity and long life.

High Temperature Switch—Designed to operate perfectly in temperatures up to 1000° F.

MICRO SWITCH field engineers are conveniently located at 20 branch offices. Consultation with them involves no cost. It can save you much time and money.

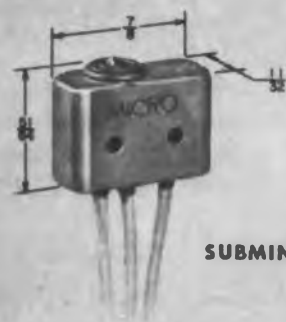

SEALED
SUBMINIATURE SWITCH

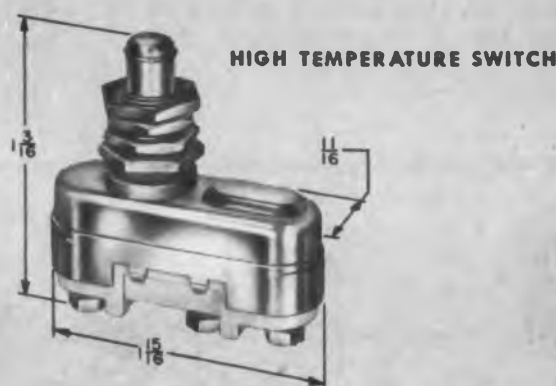

HIGH TEMPERATURE SWITCH



A complete line of snap-action and mercury switches

MICRO SWITCH provides a complete line of extremely reliable, small-size, high-capacity, snap-action precision switches and mercury switches. Available in a wide variety of sizes, shapes, weights, actuators and electrical characteristics. For all types of electrical controls.

MICRO SWITCH

A DIVISION OF MINNEAPOLIS-HONEYWELL REGULATOR COMPANY

In Canada, Leaside, Toronto 17, Ontario • FREEPORT, ILLINOIS



CIRCLE 77 ON READER-SERVICE CARD FOR MORE INFORMATION

Capacitors

Operate to 150° Without Derating



Series "X" Capacitors will operate from -65° to $+150^{\circ}\text{C}$ without derating and to $+200^{\circ}\text{C}$ with proper derating and adjustment. They use "Mylar" and other quality dielectric materials,

including a solid polyester impregnant.

The units are available in a wide selection of hermetically sealed tubular, "Squeeze Seam", and bathtub cases with glass-to-metal closures for positive environmental protection. They also feature high insulation resistance, good capacitance stability, excellent r-f and retrace characteristics, and immunity from vibration or shock damage.

For ease of application, these capacitors are manufactured in a selection of tolerances with standard non-inductive, extended foil, as well as inserted tab constructions. Astron Corp., Dept. ED, 225 Grant Ave., East Newark, N. J.

CIRCLE 78 ON READER-SERVICE CARD FOR MORE INFORMATION

RC and L Network

In Plug-In Units

These RC and L networks are hermetically sealed to withstand extreme environmental and vibration conditions. Built to customer specification and matched to as close as 0.01%, they save valuable chas-



sis space. Where needed, a built-in heater element and thermostat to control the operating temperature of the network is provided. The illustrated plug-in contains precision wire-wound resistors and polystyrene capacitors aged and matched to within 7 parts per million of each other. The built-in oven maintains a temperature of $75^{\circ} + 1^{\circ}\text{C}$.

Units from 1" x 1" with an octal base, to 12" x 18" with 48 standoff and mounting studs are being manufactured in a choice of identifying colors. Eastern Precision Resistor Corp., Dept. ED, Richmond Hill 18, New York.

CIRCLE 79 ON READER-SERVICE CARD FOR MORE INFORMATION

ELECTRONIC DESIGN • September 1955

Decade Counters

Extremely Compact Units

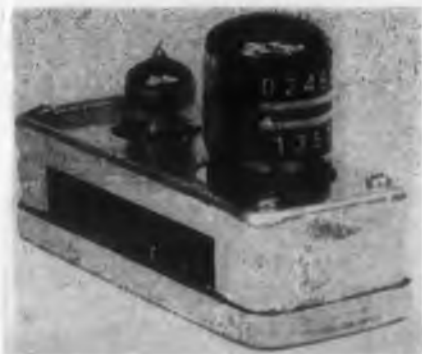

These electronic decade counters, employ the direct-reading EIT counter tube. Three types are available for immediate delivery, with ratings of 20kc, 100kc, and 250kc. The first two types weigh 7 oz

and employ two tubes each. The third weighs 8 oz and employs three tubes. All three types deliver 15v and require an input signal of 15v. Electric power at 6.3v a-c and 275v d-c is required for operation.

These plug-in units employ printed circuitry and are only 2-1/16" wide x 5-1/16" long, and, with tubes in place, are only 3-1/2" high. They can be arranged to provide a stairstep output voltage in ratio to count. Principal applications are in electronic and nucleonic measuring instruments, military and industrial electronic devices, and in automation as integral components of computers and counting devices. Ransom Research, Dept. ED, P. O. Box 382, San Pedro, Calif.

CIRCLE 80 ON READER-SERVICE CARD FOR MORE INFORMATION

Ratemeter

Counts at 100,000 per Second



This Ratemeter, Type 12112, combines two decade scalers and a tuning fork mounted in a fan-cooled cabinet. It can be operated as a ratemeter to measure frequency on a fixed time

basis; as a period meter for counts of 10,000, 100,000, or 1,000,000 on a fixed count basis; or as a ratio meter with two unknown signals. In the last case, the tuning fork is not used. The unit may also be used with diffractometers and spectrographs to obtain greater accuracy in rate measurement. Maximum counting rate is 100,000 per second. There is no minimum rate for fast waveforms and a minimum rate of 5cy for sine waves. Minimum resolving time is 10μsec.

The instrument will detect minimum signals of 2v peak, 1/2v rms sine waves. It requires a power input of 250w at 100-125v, 60cy. Research & Control Instruments Div., North American Philips Co., Inc., Dept. ED, 750 S. Fulton Ave., Mount Vernon, N. Y.

CIRCLE 81 ON READER-SERVICE CARD FOR MORE INFORMATION

ELECTRONIC DESIGN • September 1955

**DOW CORNING
CORPORATION**

Silicone Dielectrics

ELECTRICAL AND ELECTRONIC NEWS

No. 1

Silicone Resin Makes Wire-Wound Resistors More Moistureproof

The Tru-Ohm Division of the Model Engineering and Manufacturing Co., of Chicago, has improved its line of wire-wound resistors by using a silicone-based cement that is much more resistant to moisture than the silicate-type cements previously used. They make this cement by blending Dow Corning 996 silicone varnish with appropriate inorganic fillers. It is set by air drying for 3 hours and then baking for 3 hours at 450 F. Tru-Ohm produces the new resistors in 10, 15, 20 and 25 watt ratings for top-of-chassis mounting, and in 5, 7 and 10 watt ratings for axial leads.

No. 1

RF Transformers Impregnated with Silicone Fluid Exceed Humidity Specs



The RF Transformers in radio compasses made by LearCal Division of Lear, Incorporated, passed Ordinance tests for moisture resistance and extreme thermal shock. Lear felt, however, that for permanent protection, the transformers should be potted to come as close to forming a true hermetic seal as possible.

After potting with mica-filled epoxy resins, the transformers are, therefore, vacuum impregnated with Dow Corning 200 Fluid. Silicone treated transformers easily pass the humidity tests of SC-D-1594 and MIL-E-5400. They may be immersed in water for 30 minutes with no change in electrical properties.

No. 2

Silicone dielectrics most widely used are described in the 1955 Reference Guide to Dow Corning Silicone Products. The brief but comprehensive descriptions of each material include a review of properties and applications. With increasing demands for high temperature operation, such a guide to these remarkably stable dielectrics should be immediately available to every electrical engineer.

No. 3

ATLANTA CHICAGO CLEVELAND DALLAS DETROIT LOS ANGELES NEW YORK WASHINGTON, D.C.

KANAB: DOW CORNING SILICONES LTD., TORONTO GREAT BRITAIN: MIDLAND SILICONES LTD., LONDON FRANCE: ST. GOBAIN, PARIS



RTV SILASTIC PROTECTS AUTOPILOT IN BELL HSL-1 NAVY HELICOPTER

Electrical components in the autopilot system of the new HSL-1 tandem-rotor anti-submarine helicopter built by Bell Aircraft are encapsulated in Room Temperature Vulcanizing Silastic.*

Why was RTV specified? Here's what Bell engineers say:

"The decision to provide a protective coating was based on the stringent environmental and test conditions, including sand and dust, high humidity, salt spray and

wide temperature variations, to which the autopilot was subjected.

"Of the many coatings tested, only the silicone compounds provided adequate protection. They withstood extreme temperatures without embrittlement or softening. They exhibited low water absorption, and they have good thermal conductivity so that the heat transfer characteristics of coated components are not adversely affected."

"However, in most silicone rubbers, these optimum qualities are realized only after a controlled cure at elevated temperatures—temperatures higher than certain other autopilot components can withstand. This disadvantage was eliminated with the advent of Dow Corning RTV Silastic. RTV can be applied and cured under room temperature conditions or even in the field. Valuable time is saved and no extra equipment is needed either to apply initially or to repair this protective coating."

No. 5

* T M DOW CORNING CORPORATION

Silicone-Glass Laminates Offer Design Engineers New Freedom



Silicone and its chemical cousin glass combine here in lightweight structural parts for hot jobs. Dow Corning 2106 is used to bond glass cloth to form laminated tubes, ducts, plates and honeycomb structures. Light, strong and arc-resistant, these parts stand 500 F continuously and short time exposures as high as 700 F.

No. 4

Send Coupon for More Information

DOW CORNING CORPORATION - Dept. 4709

Midland, Michigan

Please send me 1 2 3 4 5

NAME _____

TITLE _____

COMPANY _____

STREET _____

CITY _____ ZONE _____ STATE _____

CIRCLE 82 ON READER-SERVICE CARD FOR MORE INFORMATION

COMPLETE POWER SUPPLY DEPENDABILITY \$57⁵⁰ FOR AS LITTLE AS



AMERICA'S MOST WIDELY USED POWER SUPPLIES,
MANUFACTURED AND GUARANTEED
BY LAMBDA

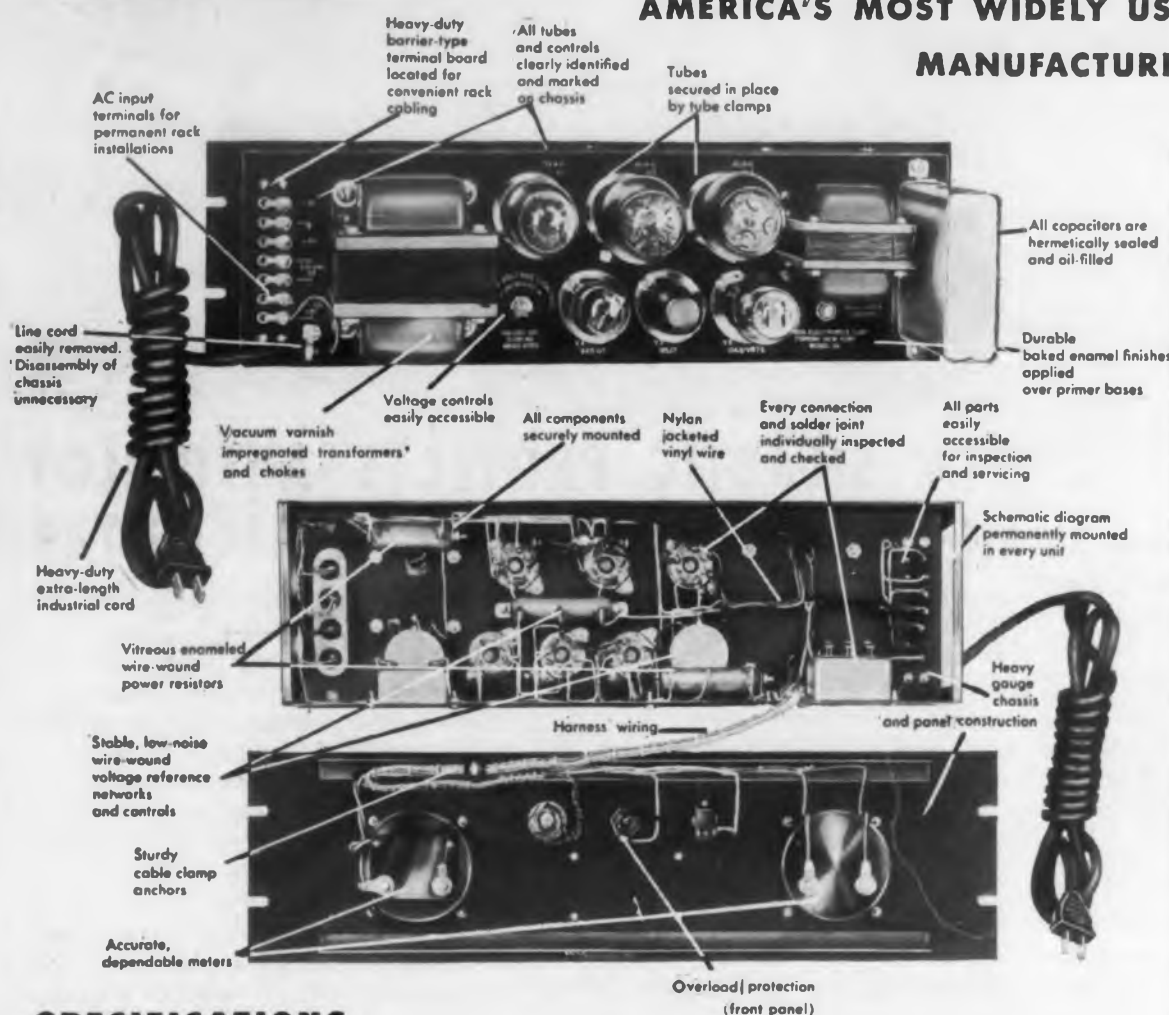

SPECIFICATIONS

DC OUTPUT (regulated for line and load):
Voltage and Current

Models	Voltage Range ¹	Current Range ²
28, 28M	200-325 VDC	0-100 MA
29, 29M	100-200 VDC	0-100 MA

¹Voltage is continuously variable over entire range.

²Current rating applies over entire voltage range.

Regulation (line) ... Better than 1%. For input variations from 105-125 VAC.

Regulation (load) ... Better than 1%. For load variations from 0 to 100 MA.

Internal Impedance ... Less than 10 ohms.

Ripple and Noise ... Less than 10 millivolts rms for Models 28, 28M. Less than 5 millivolts rms for Models 29, 29M.

Polarity ... Either positive or negative may be grounded.

AC OUTPUT (unregulated): 6.5 VAC at 3A (at 115 VAC input) ... Allows for voltage drop in connecting leads. Isolated and ungrounded.

AC INPUT ... 105-125 VAC, 50-60 CPS, 120 watts.³

³With all outputs loaded to full ratings and input at 125 VAC.

AMBIENT TEMPERATURE AND DUTY CYCLE ... Continuous duty at full load up to 50°C (122°F) ambient.

OVERLOAD PROTECTION:

External Overload Protection ... AC fuse, front panel.

INPUT AND OUTPUT CONNECTIONS: Heavy duty barrier terminal block, rear of chassis. 8 foot heavy duty rubber covered line cord with integral molded plug, also supplied.

METERS:

Output Voltage ... 3½" rectangular voltmeter on meter models.

Output Current ... 3½" rectangular milliammeter on meter models.

CONTROLS:

DC Output Control ... Screw driver adjusting control, rear of chassis.

AC Switch ... Front panel.

PHYSICAL DATA:

Mounting ... Standard 19" rack mounting.

Size ... 5¼" H x 19" W x 8" D.

Weight ... 19 lbs. net, 23 lbs. shipping weight.

Panel Finish ... Black ripple enamel (standard). Special finishes available to customer's specifications at moderate surcharge.

Model 28
200-325 VDC, 0-100 MA
\$57.50

Model 29
100-200 VDC, 0-100 MA
\$67.50

Model 28M (with meters)
200-325 VDC, 0-100 MA
\$87.50

Model 29M (with meters)
100-200 VDC, 0-100 MA
\$97.50

Rack models 28, 28M, 29 and 29M are long-lasting, dependable sources of power that deliver "workhorse" service ... yet cost as little as \$57.50 (for Model 28).

Intended primarily for fixed voltage use, these compact supplies are precision-built, as carefully engineered and quality-controlled as the most intricate models. They provide a convenient, low-cost power source for auxiliary equipment, also are well suited to production line applications.

Hydromagnet

Electric-Hydraulic Positioner

The AEG Hydromagnet is an imported electric-hydraulic positioner. Operation is as follows: a hydraulic pump is actuated by a "pumping" vibrator. The flow of hydraulic fluid from this vibrator is controlled by a "steering" vibrator into one or the other side of a power piston.

The product of output force and speed for this valve is a constant. The performance of the valve varies between full output stroke of 4" in 2sec for a 44 lb load and full output stroke of 4" in 8sec with a 172 lb load. By use of a lever connection, shorter strokes and bigger loads could be handled.

Speed of response is good because of the inherently low inertia of the device. Design simplicity also results in a maximum of reliability and minimum service requirements. Donald C. Seibert, Importer, Dept. ED, Box 281, Wilmington, Del.

CIRCLE 83 ON READER-SERVICE CARD

Conductive Lubricant For Hinge Switches

Conducto-Lube is a highly conductive top-grade lubricant designed for use in conducting hinge joint switches. The lubricant can be used on knife blade switches to prevent their "balling up" and "freezing". It is ideal for high-speed air blast breakers where a lubricant is essential. Its conductivity will reduce resistance and heating. Cool Amp Co., Dept. ED, 8603 S. W. 17th Ave., Portland, Ore.

CIRCLE 84 ON READER-SERVICE CARD

Iron Cores Low-Cost Units

Six new Economy Iron Cores have been added to expand this company's line to fourteen to cover most insert and threaded applications. Specification data is included in a booklet. Radio Cores, Inc., Dept. ED, 9540 Tulley Ave., Oak Lawn, Ill.

CIRCLE 85 ON READER-SERVICE CARD



LAMBDA Electronics Corp.

THE FIRST NAME IN POWER SUPPLIES

103-02 NORTHERN BLVD. • CORONA 68, NEW YORK

◀ CIRCLE 86 ON READER-SERVICE CARD

Photodized Plates

Photosensitive Aluminum Plates

A new type photosensitive aluminum plate known as Photodized plates are designed for producing engineering templates, comparator charts, etc. All processing can be done without special equipment other than a sun lamp, a tray for developing, and a hot plate for sealing.

They differ from other metalphoto plates in that they can be processed in subdued light. Exposure of plates can be made through photographed film negatives, glass charts, tracing vellum, etc., placed in contact with Photodized plate.

Developing time is one minute; and the plate is washed in running water. Where utmost in permanence of legend is desired, the plate is heat sealed by immersion in boiling water for 30 minutes. However, the plates can also be sealed by spraying or brushing on a clear lacquer. Metalphoto Corp., Dept. ED, 2903 E. 79th St., Cleveland 4, Ohio.

CIRCLE 87 ON READER-SERVICE CARD

Toggle Switch Seal

Seals Switch to Panel

Model 3268 Panel Seal for Toggle Switches exceeds the requirements of Specification MIL-B-5423 in sealing out water, dust, moisture, explosive, or combustible liquids, vapors, and gases, and in resisting ozone attack. The seal also acts as a lock-nut in securing the toggle switch to the panel, minimizing the danger of loosening under shock and vibration.

It uses a silicone-base membrane configuration to grip the toggle lever firmly, yet allow full movement. The metal insert is of stainless steel #303 (withstands more than 96hr salt spray test). It is sized and shaped to provide thorough bonding to the rubber and affords complete sealing to the panel without an additional O ring. Its hexagonal shape permits adjustment with standard tools. Panseal, Inc., Dept. ED, 10 Main St., Little Ferry, N. J.

CIRCLE 88 ON READER-SERVICE CARD

CIRCLE 89 ON READER-SERVICE CARD ➤



INFRA-RED LAMPS RAISE AMBIENT TEMPERATURE TO +125 C.

NEW G-E TANTALYTIC* CAPACITORS OPERATE AT +125°C AMBIENT

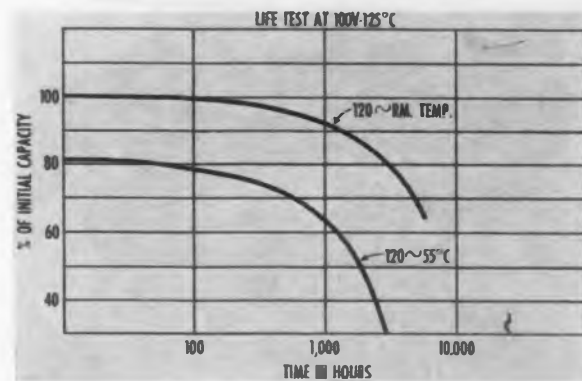

LONG LIFE of G-E high temperature Tantalitic capacitors is shown by this graph of life vs loss of capacitance for typical 100 volt d-c unit.

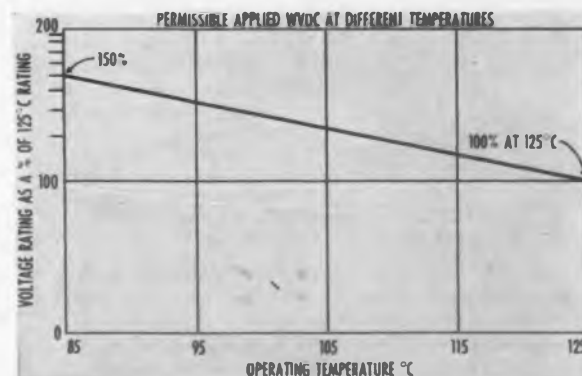

HIGHER VOLTAGES than 100 VDC can be applied . . . with no loss of life . . . at ambient temperatures below rated +125 C as shown above.

Available in ratings from 36 uf at 100 VDC to 180 uf at 30 VDC

Designed to operate at +125 C for 1000 hours with not more than 20% loss in initial +25 C capacitance, General Electric's new high-temperature Tantalitic capacitors meet the tough requirements of miniaturized military equipment.

FOIL CONSTRUCTION assures the same long life, high quality, and stable operating characteristics provided by +85 C Tantalitics. Unlike other types of Tantalitic capacitors, the foil construction also offers:

- Both polar and nonpolar construction.
- Chemically neutral electrolyte . . . minimizes corrosion danger.
- Excellent mechanical stability . . . freedom from electrical noise under shock and vibration.
- Excellent reliability at rated temperatures . . . extended life at temperatures below +125 C.

AVAILABILITY: G-E high-temperature Tantalitic capacitors can be obtained now in sample quantities for evaluation and prototype use. Production lots will be available by September in the following standard ratings:

Voltage	uf Case 1 3/4" x 3/4" x 1 1/8"	uf Case 2 3/4" x 3/4" x 3/8"	uf Case 3 3/4" x 3/4" x 1/2"
30	180	110	55
50	100	60	30
75	60	36	18
100	36	24	12

For more information, see your G-E Apparatus Sales Representative or write for Bulletin GEA-6258, General Electric Company, Section 442-27, Schenectady 5, New York.

*Reg. trade-mark of General Electric Co.

Progress Is Our Most Important Product

GENERAL  ELECTRIC

Wincharger dynamotors help power the nation's defense

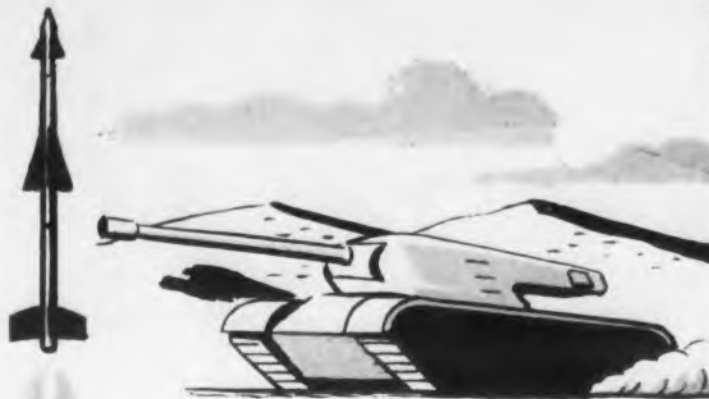

Vehicular HF Communication Transmitters



Airborne UHF and HF Communications Transceivers



VHF Omnidirectional Navigation Receivers



Guided Missile Development

WINCHARGER CORPORATION

Sioux City 2, Iowa

A wholly owned subsidiary of Zenith Radio Corporation

Engine Generators • Universal Motors • Dynamotors
Inverters • Wind Driven Generators

CIRCLE 91 ON READER-SERVICE CARD FOR MORE INFORMATION

Temperature Reference Junction For Thermocouple Circuits



This device permits the measurement of temperatures with a strip chart recorder, thus eliminating the necessity for using a separate pyrometer. Its basic principle involves the maintenance of a constant, predetermined temperature at the thermocouple circuit reference junction, regardless of variations in the ambient temperatures. Control is provided by a high-sensitivity thermostat operating a relay which meters electric power to a constant-temperature zone heater. This reference junction may be introduced at any point in the thermocouple circuit, regardless of the location of the measuring instruments or thermocouples.

The junction may be used in ambient temperatures from -65° to $+300^{\circ}\text{F}$. Any standard thermocouple materials may be specified for connectors. A small, lightweight version can be furnished for airborne uses. Thermo Electric Co., Inc., Dept. ED, Rochelle Park P. O., N. J.

CIRCLE 92 ON READER-SERVICE CARD FOR MORE INFORMATION

Power Rectifiers

In Variety of Germanium Types



These diffused junction germanium rectifiers are recommended for a-c to d-c power conversion where high power output, high efficiency, no aging, and

small unit size are required. Units can be supplied for voltage ranges from 10v to 100kv and from 10amp to 100,000amp by connecting junctions and assemblies in series or parallel.

Shown is a fan-cooled germanium unit, rated 750-amp at 40v output in a three-phase, half-wave circuit. Unlimited operating life can be expected over a temperature range of -55° to $+75^{\circ}\text{C}$ maximum when equipment is designed to operate within specified voltage, current, and temperature rise ratings. The rectifiers are available as natural convection, forced convection, and liquid cooled. International Rectifier Corp., Dept. ED, El Segundo, Calif.

CIRCLE 93 ON READER-SERVICE CARD FOR MORE INFORMATION

ELECTRONIC DESIGN • September 1955

Oscillator

Has Highly Stable Output



A constant-voltage precision oscillator, the DK-2 Series has low distortion and high stability under a wide range of working conditions. Properties of a 1000cy unit, typical of the DK-2 series, include a total harmonic content of less than 0.1% (60db down).

Frequency shift from application of full load is less than 1/10cy out of 1000cy; from line voltage variation of 10v, shift is less than 1/20cy out of 1000cy.

Amplitude shift due to application of full load is less than 0.2%; and due to 10v line variation, less than 0.05%. The oscillator has a center-tapped output circuit particularly suitable for vibration pickups and other applications requiring balanced input. The practically zero internal impedance is useful with pressure pickups, strain gages, and similar applications where interaction between loads must be avoided. Neucor, Inc., Dept. ED, 45 W. Union St., Pasadena, Calif.

CIRCLE 94 ON READER-SERVICE CARD FOR MORE INFORMATION

Beam Switching Tubes

In Two New Types



The basic Magnetron Beam Switching Tube, type MO-10, was recently made available in production quantities by this firm. New types now available are the DC-1R and the MO-10R, which incorporate external magnets similar to type MO-10. The basic MO-10 is a high-vacuum tube with 10

discrete positions, each capable of forming, clearing, or switching an electron beam. Any desired type of sequential, simultaneous, or random switching may be obtained, at a frequency range from static to greater than 1Mc.

Type DC-1R is designed primarily as a high-speed decade counter (static to above 5Mc) on a standard 9-pin stem.

The MO-10R differs from the MO-10 in that it has internally mounted-spade load vacuum resistors to permit operation at higher frequencies. The number of external stem leads is also reduced from 26 to 20 pins. Switching speed is static to above 5Mc. Haydu Brothers of New Jersey, Dept. ED, c/o Burroughs Research Center, Paoli, Pa.

CIRCLE 95 ON READER-SERVICE CARD FOR MORE INFORMATION

ELECTRONIC DESIGN • September 1955

low-cost "work horse" for heavy duty jobs



Automatic Electric Class "A" Relays are still "healthy" even after 100,000,000 operations!



Here's a relay built for hard work, and every critical point shows it!

Contact points are formed and life-welded to the spring in one operation. An exclusive armature back-stop design prevents armature freezing. A heavy-duty armature bearing is available for unusually heavy spring loads, or constant high-speed use.

Optional "long" or "short" lever armatures offer one lever-ratio for normal operating speeds... another for slow-to-release action, permitting a residual gap which holds the required release timing, even under heavy-duty conditions. When extreme conditions suggest added precaution, an armature damper spring may also be supplied to eliminate wear from induced vibration.

For complete details, write for Circular 1800. Automatic Electric Sales Corporation, 1033 West Van Buren Street, Chicago 7, Illinois. In Canada: Automatic Electric Sales (Canada) Ltd., Toronto. Offices in principal cities.

Dimensions

Overall length, 4"—Width, single pile-up 1 1/4"—double pile-up 1 7/8"—Height (depending upon the number of springs), Series AQA and ASO 1 5/8"; Series ASR and ASA 1 5/8"-2".

Four different types

Of Class "A" Relays are available to meet your needs: Series AQA—Quick-Acting, DC; Series ASO—Slow-Operating, DC; Series ASR—Slow-Releasing, DC; and Series ASA—Slow-Acting, DC.

Contacts

Normally single, but can be supplied with twin contacts. Load carrying capacity, 150 watts (maximum 3 amps., non-inductive).

Contact spring capacity

Can be supplied with single or double pile-ups. Series AQA and ASO, 13 springs per pile-up; Series ASR and ASA, 6 springs per pile-up. (More contacts can be accommodated at a sacrifice of operating speed and release time delay.)

CIRCLE 96 ON READER-SERVICE CARD FOR MORE INFORMATION

RELAYS

SWITCHES

PRODUCTS OF THE INDUSTRIAL DEPARTMENT OF
AUTOMATIC ELECTRIC

CHICAGO



G-E TOTALLY ENCLOSED MOTOR FOR GUIDED-MISSILE WARHEAD FUZES, rated .0024 hp, 4500 rpm, 24 volts d-c for intermittent duty is discussed by (l to r) Dr. W. W. Eaton, Industrial Consultant, Dr. C. A. Crowley, Director of Engineering and Development Division, Given Manufacturing Company, and E. Finkle, Given's Chief Project Engineer, Engineering and Development Division.

G.E. adapts motor for missile warhead fuzes, helps Given Company meet deadline, cut costs

"When our Company was selected by the Picatinny Arsenal for pilot production of fuzes for guided-missile warheads," says Dr. C. A. Crowley (center), Director of Engineering and Development, Given Manufacturing Company, "we were confronted with a design that called for a specially built motor to be used for the fuze gear train. Because of previous satisfaction, our first step was to consult General Electric.

"G-E engineers, working in co-operation with our own engineers, were successful in redesigning an existing G-E armament motor to our exact needs. This action not only helped us cut costs, but put us in production on schedule. We're sold on service like this," concludes Dr. Crowley.

As a component of these guided-missile warhead fuzes, the G-E motor is exposed to extremes of temperature from -65 to $+160^{\circ}\text{F}$, and must stand severe vibrations and high humidity. As a part of G.E.'s development work, these conditions were simulated by G-E testing facilities, and the motor passed all tests.

TO SERVE YOU, General Electric offers engineering experience like that provided the Given Engineering and Development Division—experience gained through years of helping solve hundreds of difficult aircraft and armament motor problems. Contact your local G-E Apparatus Sales Office early in your planning. Or write giving details to Section 704-55, General Electric Company, Schenectady 5, N. Y.

Progress Is Our Most Important Product

GENERAL  ELECTRIC

Clear Thermoplastic

Resists Cracking, Easily Worked

Opening new fields for use of clear plastics and providing improved performance for present applications, thermoplastic Dura-lite is now manufactured in sheets.

Dura-lite thermoplast is outstanding for its high abrasion resistance—five times that of ordinary methacrylate. It resists crazing and is immune to most corrosive chemicals. Completely formable and machinable, it also withstands severe weather conditions.

Its flexural strength is nearly twice that of methacrylate, and its tensile and impact strength has also been improved. Its improved abrasion resistance, for example, makes it more suitable for formed instrument panels and dials. Dura-lite is available in sheets. Homalite Corp., Dept. ED, 15 Brookside Drive, Wilmington 166, Del.

CIRCLE 97 ON READER-SERVICE CARD

Zinc-Base Metals

For Soldering Aluminum

These new zinc-base metals permit the soldering of aluminum without flux at reduced temperatures. They can also be operated in frictional applications without lubrication or appreciable heat buildup. Further they can be used to electrify liquids so they may be evaluated on d-c or a-c electrical instruments.

The ability to homogenize zinc and lead by the introduction of muriatic acid at high temperatures results in all these special properties. It penetrates aluminum surface oxides through capillary action without special treatment of flux for soldering. The powdered cuttings in liquid break water down into hydrogen gaseous bubbles. Such a solution becomes a bi-polar d-c battery having as many positive and negative distinct d-c voltages and currents as there are metal grains in the battery cell. Chemalloy Electronics Corp., Dept. ED, Gillespie Airport, Santee, Calif.

CIRCLE 98 ON READER-SERVICE CARD

◀ CIRCLE 99 ON READER-SERVICE CARD

Test Chamber For High and Low Range

Designed for high precision environmental testing of both individual components and entire systems, the Model D-102 high and low temperature test chamber operates over a range of -100°F to 300°F with $\pm 2^{\circ}\text{F}$ accuracy. An inner working volume of 12 cu ft permits installation of large assemblies, and a group of 3" access holes makes the attachment of instrumentation and power leads simple.

From room temperature, the test chamber can drop to -60°F in approximately 40 minutes or rise to 300°F in approximately 20 minutes. Mantec, Inc., Dept. ED, 130 Maryland St., El Segundo, Calif.

CIRCLE 100 ON READER-SERVICE CARD

Industrial Eraser Cleans Metal Surfaces

This anodized aluminum case, complete with heavy duty FybRglass cartridges is useful for removing oxide from silver contacts. During storage, the silver lugs and contacts of the switch wafer become oxidized. This film is removed safely and a clean matte surface free from scratches remains which is ideal for soldering.

It may be used to remove varnish insulation from resistance wire as well as undesired resist and plate through on etched printed circuit boards. The Eraser Co., Dept. ED, 1068 S. Clinton St., Syracuse 4, N. Y.

CIRCLE 1Q1 ON READER-SERVICE CARD

Anodized Metal Decal Is Fade Resistant

This new anodized, etched aluminum "Metal-Cal" is a combination matte and shiny surfaced plate. The matte finish may be marked and erased as many times as desired.

The plates are backed by pressure-sensitive adhesive, and require no fastening devices. C & H Supply Co., Dept. ED, 415 E. Beach Ave., Inglewood 3, Calif.

CIRCLE 102 ON READER-SERVICE CARD

CIRCLE 103 ON READER-SERVICE CARD >

PYRAMID SOLID DIELECTRIC GLASSEAL CAPACITORS FOR 6 POINT PREFERENCE

Burton Browne / New York



1
2
3
4
5
6

Especially sturdy capacitors capable of withstanding vibrational stresses of high acceleration and frequency, and severe shock conditions encountered in guided missiles and airborne equipment.

Utilize new, rugged compression-seal type, glass-to-metal solder-seal terminals. Terminals will not work loose or rotate under any operating conditions.

Functional operating range from -55°C to $+125^{\circ}\text{C}$.

Operates normally under severe humidity conditions.

Production tests for voltage breakdown, capacitance, power factor, insulation resistance and seal are performed on a 100% basis.

Capacitance range: .001 mfd. to 1.0 mfd.; voltage range: 100 to 600 V.D.C. operating; can be provided to standard tolerance of $\pm 20\%$ or to closer tolerances, if desired.

1. Hermetically sealed in metallic cases.

2. Power factor less than 1%.

3. Subminiature in size.

4. Available in both inserted tab and extended foil constructions.

For complete engineering information contact your local Pyramid representative or write to—



CAPACITOR DIVISION

PYRAMID ELECTRIC COMPANY

1445 Hudson Blvd. • North Bergen, N. J.

+ FACTORS



Non-Rigid Teflon Tubing

—90°C to +260°C

This "Temprene" non-rigid Teflon tubing features all of the outstanding combinations of properties offered by Teflon: noncombustible, inert to moisture and all known commercial solvents and chemicals; tensile strength of not less than 1500psi, minimum breakdown voltage of not less than 5000v rsm, plus complete flexibility to —90°C. Inside tubing diameter runs from a minimum of 0.014 to a maximum of 0.112, with wall thicknesses running from 0.008 to 0.012. It is 100% pin-hole checked for faults before shipment is made. Hitemp Wires, Inc., Dept. ED, 26 Windsor Ave., Mineola, N. Y.

CIRCLE 105 ON READER-SERVICE CARD

1 Mil Mylar Tape

With Adhesive

Constructed with a Polyester "Mylar" film, 1 mil thick backing and a rubber base adhesive which is free of corrosive agents and contains no sulfur, Tape P235 when cured is resistant to varnish and paint solvent. In addition it has a high tensile and tear strength, affording optimum performance in wire-holding applications. It also has a low moisture vapor permeability, making this tape a good moisture barrier when used in electrical component manufacture. P235 will withstand temperatures up to 150°C. Permacel Tape Corp., Dept. ED, New Brunswick, N. J.

CIRCLE 106 ON READER-SERVICE CARD

Transistor Kit

For Circuit Development

A kit of transistors which includes an assortment of seven of the most commonly used diffused p-n-p junction types is available for use in developing radio, hearing-aid, computer, Geiger-counter, and other instrument circuits. General Transistor Corp., Dept. ED, 95-18 Sutphin Blvd. Jamaica, N. Y.

CIRCLE 107 ON READER-SERVICE CARD

CIRCLE 108 ON READER-SERVICE CARD

NEW additions to ALLIED CONTROL'S MH LINE

THE ALLIED ORIGINAL MH SERIES



Allied Type MHJ • Performance Data

CONTACT RATINGS	Low level up to 2 amperes at 29v d-c or 115v a-c (non-inductive) Max. Contact Drop: 1 millivolt
CONTACT ARRANGEMENT	MHJ-12D: 4 PDT MHJ-18D: 6 PDT
COIL	MHJ-12D 26.5v d-c: 250 ohms resistance MHJ-18D 26.5v d-c: 200 ohms resistance (Other resistances are available.)
TEMPERATURE	Minus 65°C to plus 125°C
VIBRATION	10-55 cps at 0.125 inch double-amplitude 55-2000 cps at 20g
OPERATING SHOCK	100g
ALTITUDE	Sea level to 80,000 feet
WEIGHT	MHJ-12D: 3.0 ounces MHJ-18D: 4.2 ounces
OVERALL DIMENSIONS ...	MHJ-12D: 1-3/4 max. x 1-3/64 diameter MHJ-18D: 1-3/4 max. x 1-3/16 diameter
MILITARY SPECIFICATIONS	Meets tests conditions of MIL-R-5757B, MIL-R-6106A and MIL-R-25018

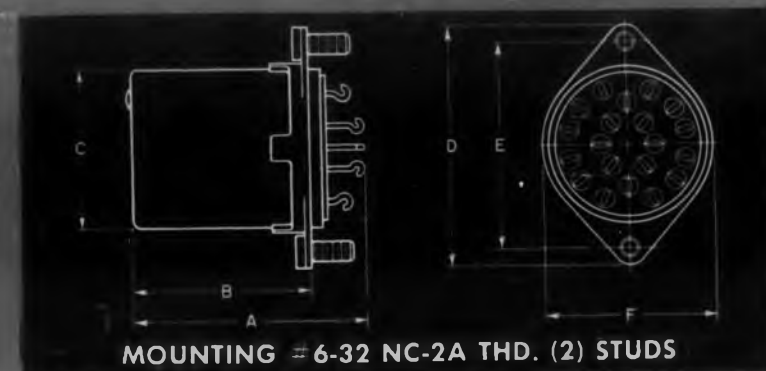

MOUNTING = 6-32 NC-2A THD. (2) STUDS

	A	B	C	D	E	F
MHJ-12D	1 3/4 max.	1 3/8	1 3/4	1 1/2	1.406	1 1/8
MHJ-18D	1 3/4 max.	1 3/8	1 3/8	1 1/8	1.562	1 1/4

Allied Type MHY • Performance Data

CONTACT RATINGS	10 amperes at 29v d-c or 115v a-c (non-inductive)
CONTACT ARRANGEMENT	MHY-6D: 2 PDT MHY-12D: 4 PDT
COIL	MHY-6D 26.5v d-c: 250 ohms resistance MHY-12D 26.5v d-c: 200 ohms resistance (Other resistances are available)
TEMPERATURE	Minus 65°C to plus 125°C
VIBRATION	10-55 cps at 0.125 inch double-amplitude 55-2000 cps at 20g
OPERATING SHOCK	100g
ALTITUDE	Sea level to 80,000 feet
WEIGHT	MHY-6D: 3.0 ounces MHY-12D: 4.2 ounces
OVERALL DIMENSIONS ...	MHY-6D: 1-25/32 max. x 1-3/64 diameter MHY-12D: 1-43/64 max. x 1-3/16 diameter
MILITARY SPECIFICATION	Meets tests conditions of MIL-R-5757B, MIL-R-6106A and MIL-R-25018

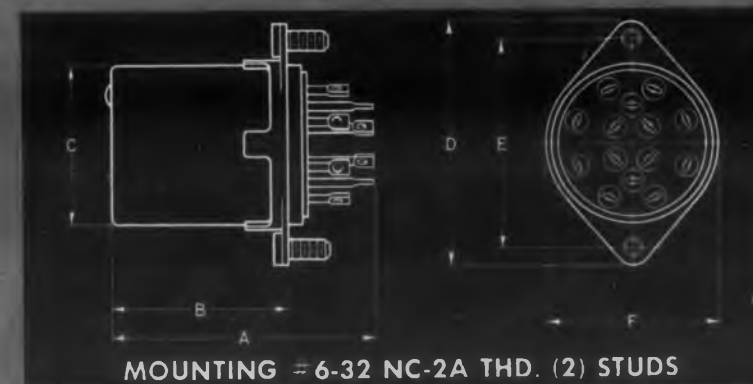

MOUNTING = 6-32 NC-2A THD. (2) STUDS

	A	B	C	D	E	F
MHY-6D	1 25/32 max.	1 3/8	1 3/4	1 1/2	1.406	1 1/8
MHY-12D	1 43/64 max.	1 3/8	1 3/8	1 1/8	1.562	1 1/4

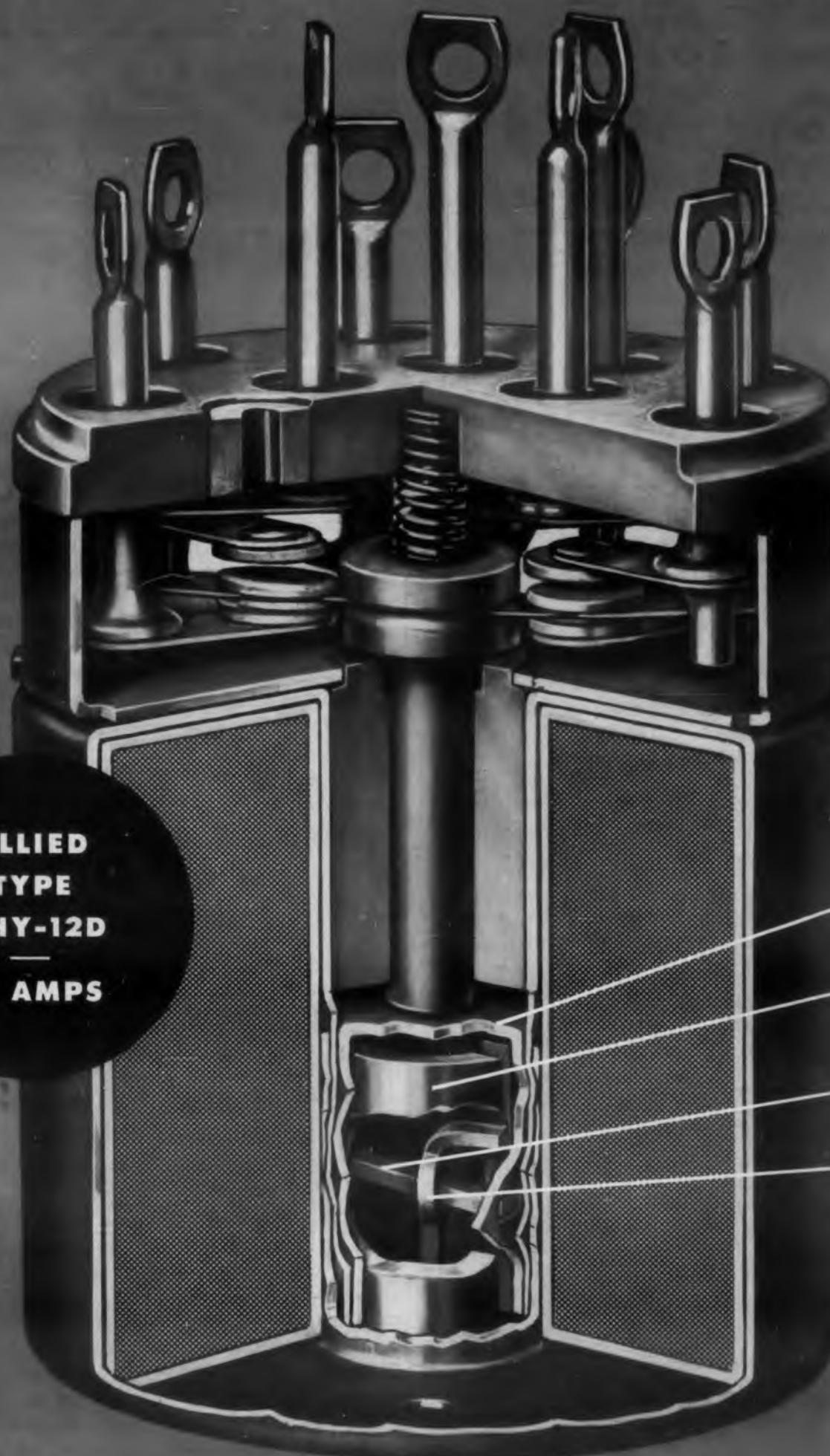

**ALLIED
TYPE
MHY-12D
—
10 AMPS**



ALLIED CONTROL

ALLIED CONTROL COMPANY, INC., 3 EAST END AVENUE, NEW YORK 21, N. Y.

Microwave Attenuator

Covers 4000 to 12,400Mc

This continuously variable, stub-tuned, mutual inductance attenuator is designed for external use in making microwave measurements with spectrum analyzers, signal sources, receivers, and for power measurements.

The Model SIJ attenuator (waveguide beyond cut-off type) will insure r-f circuit isolation and may be used to convert a signal source or laboratory oscillator to perform many of the functions of a signal generator. Frequency range of the device 4000 to 12,400Mc. Polarad Electronics Corp., Dept. ED, 43-20 34th St., Long Island City 1, N. Y.

CIRCLE 109 ON READER-SERVICE CARD

Vinyl Compounds

For Wire Coating

Three new vinyl compounds designated as Opalon 1038, 72254, and 72217, are all excellently suited to wire and cable insulation. It retains its flexibility over long periods. Opalon 1038 is a primary insulation compound for Type T and TW uses and exposure to oil at 60°C. Opalon 72254 is a general purpose, flame retardant jacketing compound, recommended for sheathing applications. Opalon 72217 is specifically for switchboard cable jacketing. Plastics Div., Monsanto Chemical Co., Dept. ED, Springfield, Mass.

CIRCLE 110 ON READER-SERVICE CARD

Variable Inductance Kit

Includes 8 Coils

This kit of 8 permeability tuned coils covers an inductance range of 1 to 1000 μ hys. A curve sheet shows inductance values per turn of ferrite core for each of 8 coils. Complete data on L_{min} , L_{max} , Q, self resonant frequency, R and C_o , for each coil is included. They are precision wound with universal or solenoid windings and Q max impregnated for maximum protection against moisture. United Technical Laboratories, Dept. ED, Morristown, N. J.

CIRCLE 111 ON READER-SERVICE CARD

ARMATURE

COUNTER-
BALANCE

LINK

PIVOT



◀ CIRCLE 108 ON READER-SERVICE CARD



Brown 2-phase reversible motors

give positive positioning,
high torque

... in servomechanisms,
computers, null circuits

This line of low inertia 2-phase motors provides high torque at low speeds. Ideal for numerous remote positioning applications, their performance has been proved by years of use as balancing motors in Brown *ElectroniK* instruments. They are self lubricating, and are totally enclosed . . . including the reduction gear train. They operate at ambients from 20 to 175 F.

A wide range of shaft speeds is available, including a new model with no-load speed of 1620 rpm. Rotor speed for all models is 1620 rpm. Power input is 115 volts, 60 cycles. 25 cycle models are also available. Line field takes 11 watts, amplifier field 2.5 watts. Motor load impedance averages 12,000 ohms. Dimensions are shown in the diagram.

For special applications, many variations in pinion, shaft, leads and materials can be supplied. Prompt delivery available on either standard or special models.

Order Now!

Prices from **\$40.50**

(even more favorable depending on quantity)

New

No-load speed—rpm	27	54	162	333	1620
Rated torque—in. oz.	30	15	5	4	5
Max torque—in. oz.	85	43	19	11	9
rpm for max power	15	31	92	190	900

MINNEAPOLIS-HONEYWELL REGULATOR Co., *Industrial Division*, 4591 Wayne Avenue, Philadelphia 44, Pa.

MINNEAPOLIS
Honeywell
BROWN INSTRUMENTS

First in Controls

CIRCLE 112 ON READER-SERVICE CARD FOR MORE INFORMATION

Printed Circuit Kit For Pototype Development



This kit contains the latest information, materials, and methods for adapting products to etched-wire printed circuits. Designed primarily as an aid in prototype development, it enables laboratories to

process their own etched-wire printed-circuit models.

By using the photographic method of resist application, projected savings can be determined from a pilot run made with the materials provided in this kit. Or, for development, the application of resist in the form of ink, or in the simple form of a special pressure-sensitive 1/16" wide tape, will permit frequent modifications to be made during prototype design. An assortment of sizes of XXXP copper-clad phenolic laminate is provided, including double-surfaced as well as single-surfaced boards. Special printed-circuit tube sockets of 10 different types allow engineers to experiment with numerous variations of model design. Special multi-contact printed circuit connectors are also provided. Printed Circuit Div., Techniques, Inc., Dept. ED, 135 Belmont St., Englewood, N. J.

CIRCLE 113 ON READER-SERVICE CARD FOR MORE INFORMATION

Ballistic Voltmeter Measures Peak Amplitude



The Model PT-M-7 Peak-Meter, with improved performance characteristics over earlier models, is a ballistic voltmeter for measuring crest amplitude of single voltage waveforms, handling pulses too fast for conventional voltmeters. It responds to peak regardless of waveform shape, and holds the reading until the reset button is depressed. Range is from 0.1v to 300v.

Response speed has been more than doubled to 2μsec, with accuracy improvement down to 2% of full scale. Although primarily intended for single pulses, the PTM-7 is more usable on repetitive signals than its predecessors. Control Devices, Inc., Dept. ED, 8299 E. 9 Mile Rd., Van Dyke, Mich.

Response speed has been more than doubled to 2μsec, with accuracy improvement down to 2% of full scale. Although primarily intended for single pulses, the PTM-7 is more usable on repetitive signals than its predecessors. Control Devices, Inc., Dept. ED, 8299 E. 9 Mile Rd., Van Dyke, Mich.

CIRCLE 114 ON READER-SERVICE CARD FOR MORE INFORMATION

ELECTRONIC DESIGN • September 1955

Brown fractional horsepower synchronous motors

Used for years as chart drive motors in *ElectroniK* recorders, these single-phase synchronous motors are ideal for many low-power continuous operations. External and mounting dimensions are the same as for the 2-phase balancing motors. Three different shaft speeds are available:

Nominal speed, rpm 30 60 180
Torque, in. oz. 20 10 4

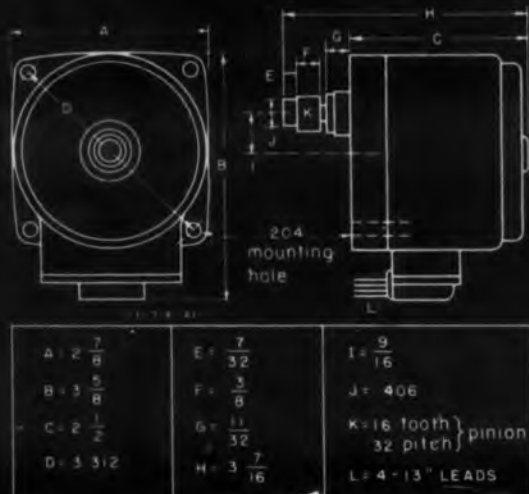

Transformer

Weights only 0.004 lb



This "Miniformer" miniature transformer is designed primarily to meet the smaller space requirements of hearing aid components, but has additional applica-

tions where space and weight factors are of prime importance, such as computers, pocket radios, F-M transceivers, telephone recorders, and airborne equipment. Size is only 1/4" x 5/16" x 3/8", and weight is 0.004 lb (242 transformers per lb).

The unit illustrated has the following impedances: a-c primary, 20,000 ohms, secondary, 1000 ohms; d-c resistance, primary, 1030 ohms, secondary, 167 ohms.

Power rating for primary inputs from 1 to 7v is 2.5mw. Other impedance matches are also available. Leads are color-coded and high-temperature-plastic insulated. Gramer-Halldorson Transformer Corp. Dept. ED, 2734 N. Pulaski Rd., Chicago 39, Ill.

CIRCLE 115 ON READER-SERVICE CARD FOR MORE INFORMATION

Motor-Alternator

A 2-Phase 30cy Unit



For use in the laboratory and in precision electronic equipment designs, the Model HA-2, features 2-phase, 30cy output at 18.5v. The rotor shaft is extended at both ends. Power output is equivalent to 2.7w from

the shaft and 1.37w of electrical power. Input is 115v, single-phase 60cy at 26w to 30w.

The unit features synchronous operation, dynamically balanced rotors on a common stainless-steel shaft, and two-bearing (Class 5 or better throughout) construction. It conforms to AN-E19 specifications. Weight is only 6 lb, and size 7" long x 3-1/2" diam.

Applications include synchronizing a driven shaft rotation with a precise 2-phase electrical signal; driving 2-phase alternators; serving as an accurate phase standard; and driving pulse generator wheels in synchronism with 2-phase pure sine-wave voltages. It can also drive small resolvers at the same time without sacrifice of its other functions. Synchronism pull-out torque is 2 in-oz. A second unit, Model HA-1, features 120cy input and 60cy output. Electric Motors and Specialties, Inc., Dept. ED, Garrett, Ind.

CIRCLE 116 ON READER-SERVICE CARD FOR MORE INFORMATION

ELECTRONIC DESIGN • September 1955

Save, save, save . . . time, trouble, money . . . when purchasing molybdenum permalloy* Powder Cores, for there can be no waste when you buy from Magnetics, Inc. Exclusively *Performance-Guaranteed*, these cores are also graded according to inductance, and color-coded so your assemblers know how many turns to put on without special testing. Write today for full details . . . Bulletin PC-103 and your Color-Coding Card . . . and remember . . .

PERFORMANCE - GUARANTEED

Permalloy Powder Cores

COST NO MORE-

WHY TAKE LESS?

MAGNETICS inc.

DEPT. 24-ED, BUTLER, PA.

*Manufactured under a license agreement with the Western Electric Co.

CIRCLE 117 ON READER-SERVICE CARD FOR MORE INFORMATION

Inductance Bridge

With Owen-Hay-Maxwell Circuits

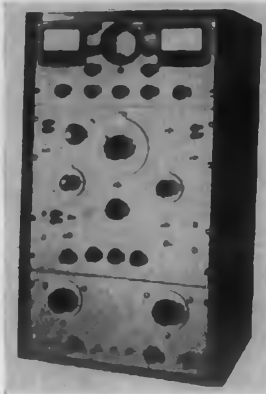

The Model 226 Incremental Inductance Bridge incorporates three different bridge circuits. A single rotary switch arranges branch arms according to Hay, Owen, or Maxwell. With the Hay arrangement, any inductance between 1mh and 2000h can be measured, provided the Q is larger than 5. With the Owen

arrangement, the same inductance range can be covered, but the Q must be comparatively low and can have a value as low as 0.06 at 60cy. The Maxwell arrangement is suitable for the measurement of low Q coils (below 5 at 60cy) without superimposed d-c and particularly for the measurement of leakage inductance. Both the Owen and the Hay circuits can be used with or without superimposed d-c. Measurements can be made up to 5000cy. Industrial Transformer Corp., Dept. ED, Gouldsboro, Pa.

CIRCLE 118 ON READER'S SERVICE CARD FOR MORE DATA

Pressure Transmitter

With Outputs to 40v



The Model 47155 Pressure Transducer is designed for industrial applications requiring an electrical output proportional to pressure. It is an improved, low-cost version of this company's Pressure

Transmitters that have been used in aircraft and missile applications.

Utilizing a pressure capsule that operates the wiper of a precision potentiometer in direct proportion to applied pressure, this instrument is available in ranges up to 100psi, for absolute, gage, and differential measurements. Outputs up to 40v can be obtained.

Standard resistance is 2000ohms, with a power rating of 0.5w. Accuracies to 0.8%, and sensitivity to 0.4% can be obtained. The instrument is approximately 2.75" square x 3" deep. Electromechanical Div., G. M. Giannini & Co., Inc., Dept. ED, 918 E. Green St., Pasadena 1, Calif.

CIRCLE 119 ON READER'S SERVICE CARD FOR MORE DATA

FIRST COMMERCIAL SILICON SOLAR BATTERY

Type S-400

Comprising Multiple S-1 Cell Assembly



SILICON SOLAR CELL

Type S-1

- ★ Hermetically sealed, weather-proof
- ★ Compact, approx. 1-3/8" O.D. by 3/16" thick
- ★ Designed for single cell or bank operation
- ★ Temperature stability
- ★ Available for prompt delivery

CIRCLE 120 ON READER-SERVICE CARD FOR MORE INFORMATION



NOW
AVAILABLE



FREE SOLAR POWER

NATIONAL ELECTRONIC PRODUCTS
MEMBER OF THE ELECTRONIC INDUSTRIES ASSOCIATION

Shaft Coupling Takes 1/16" Misalignments



The 104-1 all-metal 1/4" to 1/4" Shaft Coupling compensates for up to 1/16" axial and/or angular shaft misalignment. An inexpensive unit, it minimizes the possibility of shaft binding and galling. Less expensive and with a higher torque rating than conventional flexible-type shaft couplings of comparable size, the coupling features beryllium-copper spring material, overall nickel plating, and heavy-duty hubs with two 8-32 setscrews on each hub. E. F. Johnson Co., Dept. ED, Waseca, Minn.

CIRCLE 121 ON READER'S SERVICE CARD FOR MORE DATA

Pentode Gives Only 1.5 μ v Noise



The EF86 audio frequency pentode is a low-hum, low-noise, high-gain tube for pre-amplifier stages. Under recommended circuit conditions, the hum and noise voltage referred to the grid is only 1.5 μ v, and distortion is negligible with small inputs. It is a miniature all-glass type with a noval base. Mullard, Ltd., Dept. ED, Century House, Shaftesbury Ave., London, W. C. 2, England.

CIRCLE 122 ON READER'S SERVICE CARD FOR MORE DATA

Locking Screw Fastener Uses "Kel-F" Insert

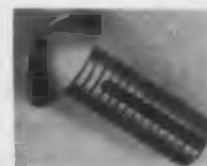

The "Long-Lok" is a self-locking, vibration-resistant screw fastener, furnished in a variety of sizes, head types, materials, and finishes in both aircraft and commercial qualities. Present sizes range from No. 4 upward. The locking element is a longitudinal "Kel-F" insert which remains serviceable and stable from -320° to +400°F. The length of the insert is only limited by the threaded length of the fastener, a feature which provides full engagement of the locking material. The insert also presents an effective seal against fluid leakage. T. L. McKay & Co., Dept. ED, 8404 Melrose Ave., Los Angeles 46, Calif.

CIRCLE 123 ON READER'S SERVICE CARD FOR MORE DATA

COTO-COIL
Finds the Answer
To Your
Coil Designing Problem

The answer lies in nearly 40 years of coil designing "know-how", plus the latest techniques and the most modern shop practices.

You get the *right* coil for the job, produced in volume with maximum economy.

Write for information to
Coto-Coil Company,
66 Pavilion Avenue, Providence 5, R. I.
New York Office: 10 East 43rd Street
New York 17, New York

Coto Coils
PRECISION WOUND

CIRCLE 125 ON READER-SERVICE CARD FOR MORE INFORMATION

Magnetic Amplifier Drives D-C Relays



Designed to drive d-c relays, this two-stage, 60cy magnetic amplifier features low drift, fast response, and high sensitivity. It replaces the usual thyatron amplifiers for relay actuation. The output swings from 7v to 30v across a 2500 ohm load for a differential input signal of $17\mu\text{amp}$. The

latter signal may be reduced to as low as $3\mu\text{amp}$ by the use of a positive feedback connection provided with the amplifier.

The differential control signal is derived from the signal source and an externally connected, variable bias supply. The amplifier is suitable for industrial control purposes, such as temperature control about a set point. A bias current of 10ma is required. Relay may be opened and closed 10 times per sec.

Insensitive to 10% tolerances on voltage or frequency, the amplifier requires a 2w, 115v rms, 60cy supply. Potted construction and plug-in connector are additional features. Dynamics Research Associates, Dept. ED, 414 Times Square Bldg., Seattle 1, Wash.

CIRCLE 126 ON READER-SERVICE CARD FOR MORE INFORMATION

Time Interval Meter

Measures from 1/10,000sec to 3sec



This direct-reading, electronic, time-interval meter accurately measures intervals from 1/10,000 to 3sec. It will measure the duration of an electric pulse, the time between

various combinations of positive and negative impulses, the time between two impulses with an impulse from a second source intervening, signals actuated from one or two sources, and the time various combinations of electric and light impulses. Accessories include a calibrator, which allows use of the instrument as an instantaneous frequency meter, a photoelectric receiver, and a light source. Sunshine Scientific Instrument, Dept. ED, 1810 Grant Ave., Philadelphia 15, Pa.

CIRCLE 127 ON READER-SERVICE CARD FOR MORE INFORMATION



KNOW-HOW

FOR RELIABLE
ASSISTANCE WITH SOLDER
AND FLUX PROBLEMS...

SEE THE **ALPHA** MEN

highly trained field SPECIALISTS
ALWAYS available in YOUR
TERRITORY to give you
QUALIFIED ASSISTANCE.

ALPHA METALS, INC.

69 Water St., Jersey City, N. J.



QUALITY CONTROLLED PRODUCTS
BY SPECIALISTS in Solders Fluxes, Tin
& Lead Products FOR OVER 50 YEARS

offers the facilities of a modern well equipped metallurgical laboratory, competent research staff and trained field specialists to help you solve

**PRINTED
CIRCUIT
FLUX or
SOLDER
PROBLEMS**

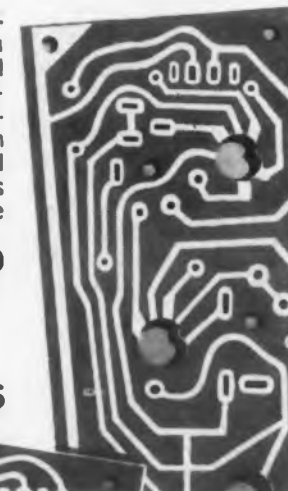

CIRCLE 128 ON READER-SERVICE CARD

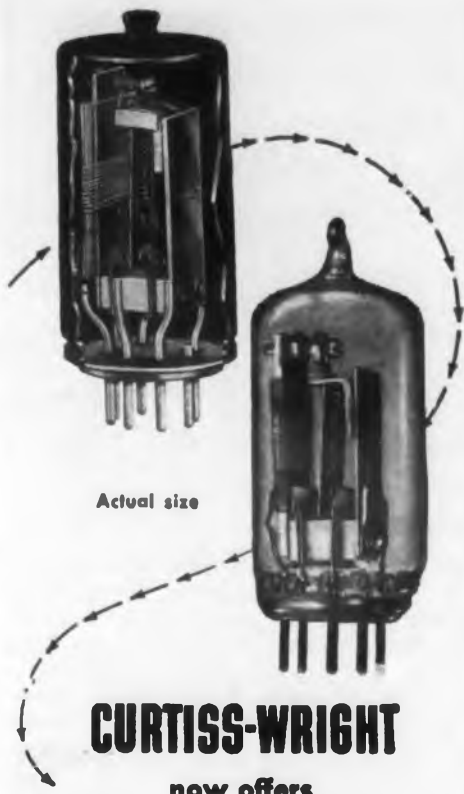

Actual size

CURTISS-WRIGHT

now offers

**THE "SNAPPER"
THERMAL TIME
DELAY RELAY**

Relied on for positive action and long life in scores of applications involving time delay in electrical circuits, the "SNAPPER," formerly produced by Elly Electronics Corp., is now a Curtiss-Wright product.

Single pole, double throw contact action eliminates chatter. These unique relays feature snap action, double throw, reliability, small size. They are adaptable to military and commercial applications. Time delay periods: preset from 3 seconds up. Envelope: metal, miniature (7 and 9 pin) or octal (8 pin). Glass, 9 pin only.

High-Low Differential Thermostat

The "SNAPPER" Thermostat is a single pole, double throw snap action temperature sensitive switch. Its snap action principle has been extended to provide a low differential thermostat with precision characteristics, at low cost.



Write for detailed data



CIRCLE 129 ON READER-SERVICE CARD

Chopper

Rated for 2000hr



A miniature 6.3v, 400cy mechanical modulator, the Type 300spdt chopper is rated for a life of 2000hr. Contacts are rated for a maximum of 1ma for signals from 0.1mv to 100v.

The chopper is constructed to operate in ambients from -65 to $+100^{\circ}\text{C}$, and it is hermetically sealed for use in humid atmospheres and at altitudes to 50,000'. It withstands mechanical shocks of 100g and vibrations of 0.06" total travel from 10 to 55cy.

Switching phase angle is $65 \pm 15^{\circ}$; dwell time on each pole is $145 \pm 20^{\circ}$; and balance between dwell times is $0 \pm 15^{\circ}$. Required driving frequency is $400 \pm 20\text{cy}$; required coil voltage is $6.3 \pm 0.6\text{v}$. Coil impedance is 230 ± 60 ohms at 400cy with 6.3v rms applied at 25°C . Airpax Products Co., Dept. ED, Middle River, Baltimore 20, Md.

CIRCLE 130 ON READER-SERVICE CARD FOR MORE INFORMATION

A-C Magnetic Bridge

Tests Permeability and Core-Loss



The Model 6400A A-C Magnetic Bridge rapidly and accurately measures permeability and core losses at inductions up to 16 kilogausses. Basically, the unit is a modified

Hay Bridge with extremely accurate resistor and capacitor decades, a complete switching network for ease of operation, and internal filters for 60cy, 400cy, and 1000cy measurements. A rugged, extremely accurate Epstein Frame is furnished with each instrument.

The bridge tests induction from less than 10 gausses to beyond 12 kilogausses on unoriented materials, and up to 15 gausses on oriented transformer-grade materials. Accuracy is equal to that of Epstein Methods, and all tests meet ASTM Standard 343-49. Through a unique arrangement of switching and binding posts, any component may be switched into any arm of the bridge in just a few seconds. Shallcross Manufacturing Co., Dept. ED, 10 Jackson Ave., Collingdale, Pa.

CIRCLE 131 ON READER-SERVICE CARD FOR MORE INFORMATION

Pacific rate gyros

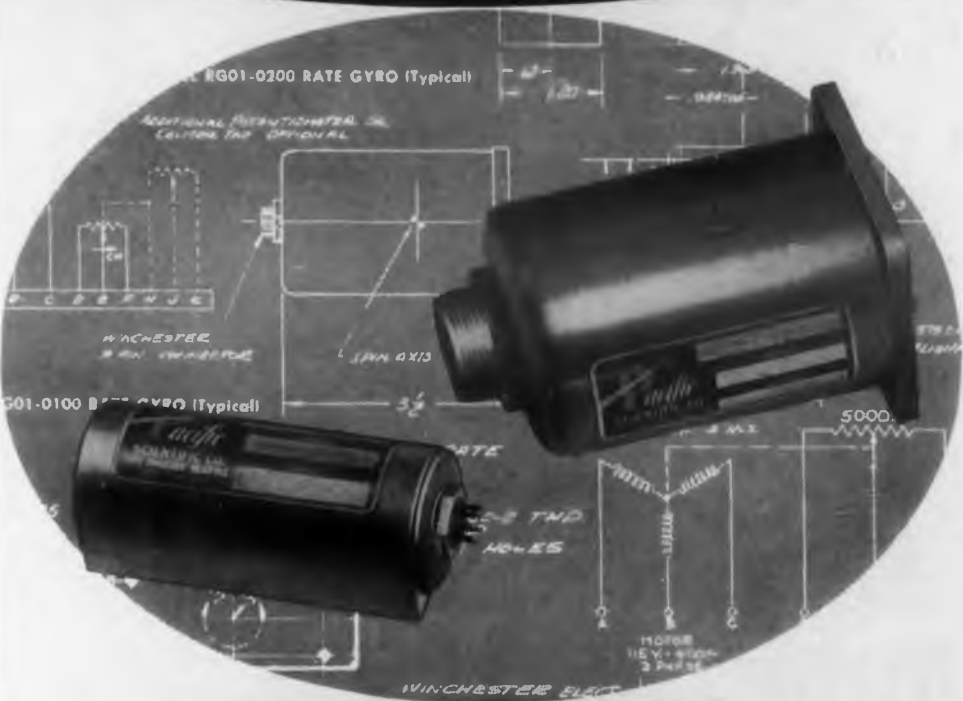

... advanced wheel design
gives **higher natural frequency**
over any rate range!

Now in production, an entirely new concept in wheel design provides Pacific Rate Gyros with unusually accurate and dependable performance. Combined with a special precision potentiometer, this advanced design Rate Gyro gives greater resolution and shock resistance...lower power consumption...light weight...and a higher natural frequency with any rate range!

A wide variety of Pacific Rate Gyros are built for any application. Production models from sub-miniature designs for use in stabilization or damper systems, to gyros for precision computer applications. Special models can be custom designed to your own specifications by Pacific's large staff of experienced gyro engineers.

For any Rate Gyro, Pacific's creative designs, complete manufacturing facilities and experience are backed by fully approved quality control. You're assured precision performance and rugged dependability in every unit.

**PACIFIC SCIENTIFIC—PIONEERS IN AIRCRAFT
INSTRUMENTATION AND ACCESSORIES SINCE 1919**

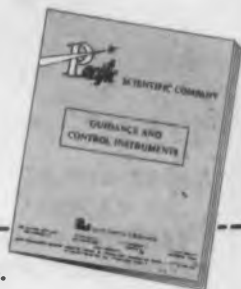

PACIFIC SCIENTIFIC CO.

1424 Granda Vista Ave.
Los Angeles 23, Calif.

Please send me your new catalog and specification sheets on:

- Rate Gyros Free & Vertical Gyros
 Accelerometers Potentiometers

name _____

company _____

address _____

city _____ state _____

• TRADE MARK

CIRCLE 132 ON READER-SERVICE CARD FOR MORE INFORMATION



Pacific SCIENTIFIC CO.
LOS ANGELES • SAN FRANCISCO • SEATTLE • ARLINGTON, TEXAS
REPRESENTATIVES:
Aero Engineering Co.
Atlanta, Ga. • Baltimore, Md.
Indianapolis, Ind. • Mineola, L.I., N.Y.
Columbus, Ohio • St. Louis, Mo.
GARRETT MFG. CORP., Toronto, Canada



Being hounded by a problem in sub-miniature design, weight and size reduction, power and component capsulation?

Send today for our new 24-page catalog, describing 450 types and sizes of

MPB's* such as these

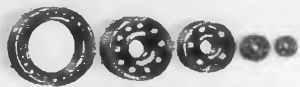

BALL BEARINGS ACTUAL SIZE

*MINIATURE PRECISION BEARINGS, INC.
7 Precision Park, Keene, N. H.

CIRCLE 316 ON READER-SERVICE CARD FOR MORE INFORMATION

New!!
"STANDCO"
PANEL MOUNTING
VIBRATING REED
FREQUENCY
METERS

THREE STYLES OF CASES:
BAKELITE • METAL
HERMETICALLY SEALED
3-1/2" FLUSH PANEL MOUNTING
STANDARD FREQUENCIES:
25, 50, 60 AND 400 CYCLES
OTHER FREQUENCIES:
15 TO 1500 CYCLES
Write for Bulletin 805

HERMAN H. STICHT CO., INC. 27 PARK PLACE, NEW YORK 7, N. Y.

CIRCLE 317 ON READER-SERVICE CARD FOR MORE INFORMATION

Standing Wave Detector For 100-1000Mc Range Measurements



The PRD 219 Standing Wave Detector was designed to supersede expensive and bulky slotted sections in the range of 100 to 1000Mc. It is a small-package, low-cost unit for making impedance measurements easily and accurately in this region. By connecting the output to a vswr indicator, such as the PRD Type 277, vswr may

be read directly on the indicator meter. No special detection equipment is required.

Reflection coefficient angle is easily determined by rotating the top drum dial to a minimum indication on the meter and reading the angle on the dial directly in electrical degrees. No calculations are required. The probe and crystal detector are self-contained. Usually it is more convenient to work with vswr and reflection coefficient angle directly; when other quantities are also of interest, they can easily be read from a conventional impedance chart. Polytechnic Research & Development Co., Inc., Dept. ED, 202 Tillary St., Brooklyn 1, N. Y.

CIRCLE 318 ON READER-SERVICE CARD FOR MORE INFORMATION

Servo-Tachometer Operates on 60cy



This combination servo motor and a-c tachometer generator operates on 60cy. Using a single-shaft mounting, it can be used to regulate the speed

of a motor or to stabilize closed-loop circuits. With this integral mounting, backlash is zero.

Available with five different gear reduction ratios, the unit is especially suitable as either a differentiating or integrating component of analog computers, or as a component of recording and controlling instruments. Adjustment may be made after installation, so that in-phase residual voltage of the tachometer is essentially zero. Stator windings are potted in an epoxy resin, which also forms the end covers of the motor. Outer housing is of aluminum.

Motor ratings are 1, 5, or 10w output. The same tachometer-generator component would be used with each of the three motors, and has an input of 115v 60cy, an output of 5.5v/1000rpm, and a linearity of 1%. Diehl Manufacturing Co., Dept. ED, 1129 Fin-derne Ave., Somerville, N. J.

CIRCLE 319 ON READER-SERVICE CARD FOR MORE INFORMATION

Curtis Terminal Blocks
Make Better Connections
Economically—Quickly.
A type for every purpose.

CURTIS
Types "M" & "MT"
Build-up
Terminal Block Kits

You Build Them to Your Needs

Both the "M" and "MT" Blocks built from these kits are identical to the factory assembled blocks of the same types. The only difference between the "M" and "MT" kits is the marking tag for circuit identification provided with the "MT" kit. They have been put in kit form to save you time on engineering, research, maintenance and repair work. They can be assembled in blocks of 2, 3, 4, 5, 6, 8, 10 and 12 terminals from the parts furnished. Rated 300 volts, 15 amperes.

Write for Bulletin DS-122. Also, ask about wide selection of other Curtis Blocks available.

CURTIS DEVELOPMENT & MFG. CO.
3236 North 33rd Street, Milwaukee 16, Wisconsin

CIRCLE 320 ON READER-SERVICE CARD FOR MORE INFORMATION

COMPRESSION TERMINALS and LINKS



All types, all sizes quickly, easily installed
with wide variety of matched tooling

All sizes of solderless lugs and links for all conductors and all applications in manufacturing and plant wiring can be rapidly, economically installed by means of Burndy tooling, coordinated with specific manufacturing methods and production requirements.

Burndy Hylugs and Hylinks are of one-piece, pure copper construction, so they can be indented on any side of the barrel and they can't split. There are no intermediate contact surfaces — current is carried by the entire cross-section. Plated to resist corrosion. Listed by Underwriters' for #22 through 2000 Mcm.

Intimate high-pressure contact between conductor and connector is assured by Burndy matched installation tools. Manual, hydraulic, and pneumatic tools are designed for portable, on-the-job use and for production bench operation.

For complete details and catalogs, write
Dept. ED, BURNDY, Norwalk, Connect.

CIRCLE 321 ON READER-SERVICE CARD FOR MORE INFORMATION

ELECTRONIC DESIGN • September 1955

Metron MINIATURE components
for **VARIABLE SPEED**
in **SMALL SPACE**



now in use

in countless precision devices where continuously variable speed is required... If small space and variable speed is your problem, investigate Metron Miniature Variable Speed Drives TODAY!

- ▶ Extremely small
- ▶ Up to .025 HP and 10,000 RPM
- ▶ Choice of 6 speed controls
- ▶ Complete, ready-to-go
- ▶ Compact, adaptable
- ▶ Quick delivery

Write for Bulletin 99 for details...



Metron INSTRUMENT COMPANY
450 Lincoln St., Denver 3, Colo.

CIRCLE 322 ON READER-SERVICE CARD FOR MORE INFORMATION

knots tie easier, faster
and do not slip!

fungus-proof

NYLON
FLAT BRAIDED TAPE,
ROUND LACING CORD

Heminway & Bartlett Nylon Lacing Cords and Tapes fit every lacing need. Their greater strength means minimum breakage - minimum rejects. Their special construction prevents knot slippage... makes knots tie tighter, faster and easier!

TAPES Meet Gov. Spec. FED-1613. In 3 finishes: wax free, wax and resin-coated finish

CORDS Comply with all construction and finish requirements of Gov. Spec. Jan-T-713 and Jan-T-152

HEMINWAY
& **BARTLETT**

WRITE FOR FREE SAMPLES AND PRICES

The Heminway & Bartlett Mfg. Co., ELECTRONICS DIVISION, 500 5th Ave., N. Y. 36
Sales Offices: Chicago, Philadelphia, Boston, St. Louis, Cincinnati, Dallas,
San Francisco, Los Angeles, Detroit, Charlotte, N. C., Gloversville, N. Y.,
Lynchburg, Va. Foreign Agent: Turner Halsey Co., Inc., 40 Worth St., N. Y.

CIRCLE 323 ON READER-SERVICE CARD FOR MORE INFORMATION
ELECTRONIC DESIGN • September 1955

Electrolytic Capacitors
For Low Ambient Temperatures



Two electrolytic capacitors, designed especially for service at low ambient temperatures, are offered by this firm. Both are made of etched aluminum foil in hermetically sealed metal cases. The positive terminal wire of one is connected through a rivet fastened to a vented rubber-Bakelite insulating washer which is spun-sealed into the case. The other unit's positive terminal is connected through a crimped stud which passes through the rubber-Bakelite insulating washer.

These capacitors have a temperature range from -55 to +65°C (and to +85°C for short operating periods) and are available at voltage ratings of 25, 50, and 150v d-c w. Case sizes range from 3/8 to 1" diam and 1-1/16 to 3" long. Cornell-Dubilier Electric Corp., Dept. ED, South Plainfield, N. J.

CIRCLE 324 ON READER-SERVICE CARD FOR MORE INFORMATION

Small Axial-Flow Blowers
In Capacities from 16-750cfm



A line of axial-flow blowers to provide highly efficient air delivery or exhaust is available for a wide variety of uses, including many industrial as well as aircraft applications. The blowers were developed and engineered by the English firm of Plannair, Ltd.; they are made under license in the United States by Pesco.

Standard sizes are at rated capacities from 16 to 750cfm. They are self-contained units incorporating a rotor coupled to an electric motor, either d-c or a-c. The smallest unit (illustrated) is a 1-3/8" diam blower which weighs 8 oz and delivers 16cfm at 0.75" pressure w.g. Other standard production units will vary up to 6" diam.

Intended for rugged duty, these blowers will withstand severe conditions of shock, temperature, pressure, altitude, humidity, and duty cycle. They are rated for continuous operation at high ambient temperatures. Pesco Products Div., Borg-Warner Corp., Dept. ED, 24700 N. Miles Rd., Bedford, Ohio.

CIRCLE 325 ON READER-SERVICE CARD FOR MORE INFORMATION

the greatest number of
IN-STOCK WIRE ITEMS for
the **ELECTRONICS INDUSTRY**

Write
for
NEW
FREE
catalog!



First in Quality Wire for over 34 years
ALPHA WIRE CORPORATION
430 BROADWAY, NEW YORK 13, N. Y.

CIRCLE 326 ON READER-SERVICE CARD FOR MORE INFORMATION



ARNOLD / TOROIDAL COIL WINDER

*sets up quickly... easy to operate...
takes wide range of wire sizes*

SPECIFICATIONS:

- Min. finished hole size: .18 in.
- Max. finished toroid O.D.: 4.0 in.
- Winding speed: 1500 turns/min.
- Wire range: AWG 44 to AWG 26
- Dual, self-checking turns counting system
- Loading (wire length) counter
- Core range: 1/4" I.D. to 4" O.D. to 1 1/2" high

LABORATORY USE

- Change wire and core size in 45 sec.

PRODUCTION USE

- 1500 turns per minute
- Insert core and load in 20 sec.

write for literature

ARNOLD MAGNETICS CO.
5962 SMILEY DRIVE, CULVER CITY, CALIFORNIA

CIRCLE 327 ON READER-SERVICE CARD FOR MORE INFORMATION

USE **VICTOREEN** **HI-MEG RESISTORS** WHERE ACCURACY AND STABILITY ARE ESSENTIAL

Unit illustrated actual size.
Capacity 18,600 Megohms.

Victoreen Hi-Meg resistors are not intended to replace conventional type resistors used in ordinary applications. But, if your resistor application, requires accuracy and stability beyond the resistance limits of other type resistors then test Victoreen Hi-Meg resistors. Carbon coated glass base with silver banded contact ends, vacuum sealed in a glass envelope, which is specially treated with silicone varnish to assure a moisture-proof, impervious seal. Power rating for any Hi-Meg resistor is equal to one divided by the resistance in Megohms. Voltage limit 1000 volts.

Write for bulletin 3025.

AVERAGE VOLTAGE COEFFICIENT OF HI-MEG
RESISTORS VERSUS RESISTANCE

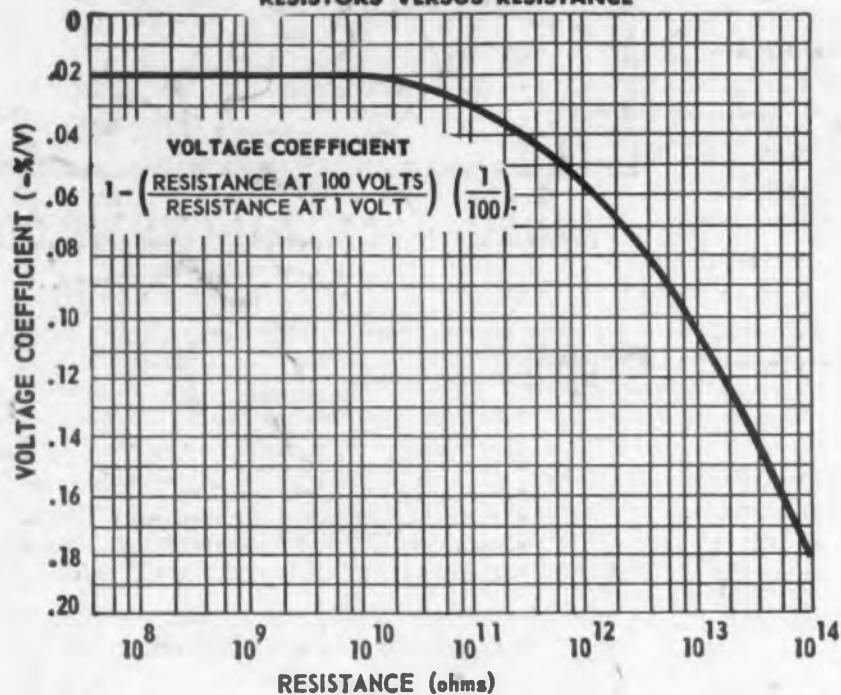

COMPONENTS DIVISION



The Victoreen Instrument Co.

3811 PERKINS AVE. • CLEVELAND 14, OHIO

CIRCLE 140 ON READER-SERVICE CARD FOR MORE INFORMATION

Integrators Ball-disk Units



This firm's 2-1/2" and 5" "DBR" integrators, originally developed for use in analog gunfire control computers, are now available commercially as the first standard units in an extensive group of integrators. Utilizing the "DBR" (disk, balls and roller) design, they employ two hardened steel balls in a carriage between the input disk and output roller to reduce friction to a minimum. A patented ball-roller-tilt device minimizes ball slip for all carriage positions, and is supplied as standard on both integrator sizes.

These integrators are high-precision units for an extremely wide variety of open and closed-loop applications. Maximum force to move carriage is 1/2 oz (approx), and maximum input torque at zero load is 1/2 oz-in (approx). Weights are 6.0 lb for the 2-1/2" unit, and 10.1 lb for the 5" unit. The 2-1/2" integrator is suitable for airborne systems. Ford Instrument Co., Div. of Sperry Rand Corp., Dept. ED, 31-10 Thomson Ave., Long Island City 1, N. Y.

CIRCLE 141 ON READER-SERVICE CARD FOR MORE INFORMATION

Size D Ignitron Designed to be Repairable



The NL-10533 is a size D ignitron of stainless steel construction. It includes a mounting plate for a thermostat to provide thermal protection. It is described as first repairable welding control ignitron, and it has an internal cooling coil. The increased cooling efficiency permits a greatly increased averaging time: 11sec at 500v, and 22sec at 250v.

Other ratings are the same as the conventional size D ignitron: 2400kva max demand, 355amp d-c maximum anode current per tube, at any voltage between 250 and 600v rms at 25 to 60cy. Cooling water required is 3gpm at a minimum inlet temperature of 0°C. National Electronics, Inc., Dept. ED, Geneva, Ill.

CIRCLE 142 ON READER-SERVICE CARD FOR MORE INFORMATION

convert SELF-BALANCING POTENTIOMETERS TO digital read-out

PRINTED TAPE • PUNCHED CARD
PUNCHED TAPE

Complete... Easy to Install... Reads from 0-1000; Accuracy ±0.1%. A complete system kit for obtaining digital information from standard self-balancing potentiometers. Easy to install, complete with all necessary hardware, this conversion does not affect the accuracy of the recording instrument, and no modification of the potentiometer is required. Readings can be taken while the recording pen is moving.

Non-linear calibrations available for use with thermocouple applications.



GIANNINI
ENCODER
KIT



CODED
COMMUTATOR:

Digitizes shaft position. Binary or Decimal Codes.

Giannini

SALES ENGINEERING OFFICES:
EMPIRE STATE BLDG., NEW YORK 1, N. Y. • CHICKERING 4-4700
PASADENA, CALIFORNIA • RYAN 1-7152
Laboratory Apparatus Division

G. M. GIANNINI & CO., INC.
PASADENA 1, CALIF.

CIRCLE 143 ON READER-SERVICE CARD

When a component
needs to be
tested:

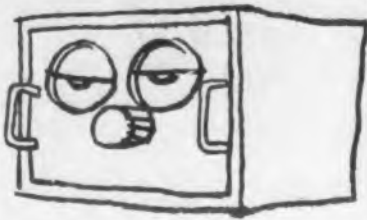

or replaced:



or repaired:



it takes less time
if it's mounted
on slides:



One second to
open... one second
to close.

We have a folder that will give
you an idea of the scope of
Grant Industrial Slides,
which we'd like to send
you. Write to Grant Pulley
and Hardware Corporation,
31-73 Whitestone Parkway,
Flushing, N. Y.

CIRCLE 144 ON READER-SERVICE CARD

Voltage Regulators

Plug-In D-C Units



The Models 211 and 212 D-C Voltage Regulators have been added to the "Red Line Uniplug" line. They require unregulated d-c source and a filament supply, and little more chassis area than a 6AS7G. Filtering action is better than a 10hy-30mfd combination.

Output voltage of the Model 211 is 150-225v d-c; for the Model 212, it is 205-305v d-c. Output current is 150ma maximum useable. Load regulation is adjustable to zero by means of the left potentiometer; without adjustment, the regulation will not exceed 1/4% for a 100ma load change. Line regulation is less than 1/2% for an input voltage change of 50% within the allowed limits. Filament supply is 6.3v a-c at 1.5amp. Output impedance is less than 15 ohms at all frequencies. Size is 3-1/8" x 3-3/8" chassis area; 5-1/4" high. C. J. Applegate & Co., Dept. ED, 1816 Grove St., Boulder, Colo.

CIRCLE 145 ON READER-SERVICE CARD FOR MORE INFORMATION

Self-Locking Bushing

Pulls AN Loads in Soft Materials

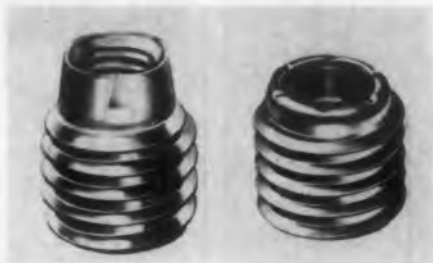

The Type 2424 is a self-locking, vibration - proof bushing for use in relatively soft castings, forgings, and extrusions, such as aluminum alloy, magnesium, mild steel, and some plastics. It is available in two designs, one a red nylon locking collar for temperatures up to 250°F, and the other with an all-metal locking device for temperatures between 250° and 550°F. Both elements provide complete locking torque protection and excellent re-use characteristics as required in AN-N-5b and AN-N-10a, respectively.

The bushings can be installed in any material whose hardness is less than Rc 25 by tapping the hole with a Class 2 controlled root tap. Installation of the bushing may be made by using a stepped bolt, or bolt and spacer, with any lubricating oil. The bushing may be readily removed by means of a standard screw extractor tool. Bushings are now available in 10-32, 1/4-28, 5/16-24, and 3/8-24 internal thread sizes. Elastic Stop Nut Corp. of America, Dept. ED, 2330 Vauxhall Rd., Union, N. J.

CIRCLE 146 ON READER-SERVICE CARD FOR MORE INFORMATION

PRESSURIZE ELECTRONIC EQUIPMENT

with
Eastern
UNITS

The extensive line of Eastern Pressurization Units for airborne electronic equipment accommodates a broad range of requirements, and meets appropriate government standards.

Units can be modified to meet your specific requirements. These modifications usually consist of: 1) Different compressors; 2) Motor change to meet your requirement; 3) Change in pressure switch settings; 4) Different mounting provisions. Eastern welcomes the opportunity to discuss and quote on your particular application problem.

MODEL E AP-100 TYPE 202

- Maintains a system pressure of 25 P.S.I.A. minimum.
- Motor is .03 H.P.—10,000 R.P.M., 208 V., 3 ph., 400 cy.
- Current draw is .7 amperes/phase maximum under normal operating conditions
- Unit operates continuously
- Weight is 4¾ lbs. maximum



MODEL E AP-150 TYPE 205

- Operating pressure switch maintains a system pressure of 17 P.S.I.A.
- Motor is 1/25 H.P. 7,500 R.P.M., 27 volts D.C. — T.E.B.S.
- Current draw is 2.0 amperes maximum under normal operating conditions
- Life is 500 operating hours
- Weight is 8 lbs. maximum



MODEL E AP-1500 TYPE 203

- Operating pressure switch maintains a system pressure of 30 P.S.I.A.
- Motor is 1/15 H.P. nominal 24-28 volts D.C., 5,000 R.P.M., continuous duty, shunt wound
- Current draw is 3.4 amperes maximum under normal operating conditions
- Life is 500 operating hours
- Weight is 12 lbs. maximum



MODEL E AP-2400 TYPE 201B

- Maintains system pressure of 31 P.S.I.A.
- Motor is 1/10 H.P., 24-28 volts D.C., 5,000 R.P.M. continuous duty
- Current draw is 5.5 amperes maximum
- Life is 500 operating hours
- Weight is 10-3/4 lbs. maximum



MODEL E AP-3600 TYPE 200

- Maintains system pressure of 31 P.S.I.A.
- Motor is 1/7 H.P., 10,000 R.P.M.

208 V., 400 cy., 3 ph.	continuous operation
24-28 V.D.C.	
- Current draw is { 1.3 amp./phase } amperes

7.1 on D.C.	
-------------	--

 maximum under normal operating conditions
- Life is 1,000 operating hours
- Weight is 8-1/2 lb. maximum



Eastern
INDUSTRIES, INC.



100 SKIFF STREET
HAMDEN 14, CONN.

COMPLETE
AVIATION
CATALOG #330-P
ON REQUEST.

AMERICA'S NO.

LINES

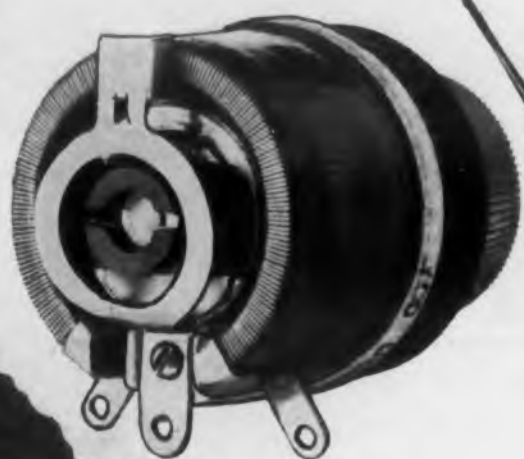

TRU-OHM

POWER RHEOSTATS

The finest power rheostats...
UL approved rheostats . . .
25 watt . . . 50 watt . . . 75 watt
. . . 100 watt . . . 150 watt.
We maintain a large stock for
ready shipment or can design
a rheostat with many special
features for your particular
need. Our rheostats are in-
terchangeable. Prompt engi-
neering service is available.

TRU-OHM PRODUCTS

TRU-OHM

VITREOUS ENAMELED RESISTORS

Because we are the world's
largest producers of wire-
wound resistors, we have
the production facilities to
GUARANTEE best delivery
and finest quality . . . from
stock or to your specifica-
tions.

CIRCLE 148 ON READER-SERVICE CARD FOR MORE INFORMATION

Q Meter

Accurate to 1%

The "Kilo-Q" covers a range of 20cy to 1Mc. For ease of operation, the unit combines a direct-reading dial over the entire range, accurate to as low as 1%.



Two positions are provided on the Q Range Control with full scale Q readings of 0 to 125 and 0 to 250 respectively. For reading Q values between 250 and 500, it is necessary to set the lever control to the X2 position on the dial and double the reading on the 250 scale. Kay Electric Co., Dept. ED, 14 Maple Ave., Pine Brook, N. J.

CIRCLE 149 ON READER-SERVICE CARD FOR MORE INFORMATION

Feldspathic Ceramic

A Rugged Dielectric



"Vitrolain", a feldspathic type ceramic, is offered as a superior dielectric with high mechanical strength. Its pore volume and moisture absorption are extremely low (less

than 0.25%). It is especially suited for parts used in the presence of moisture or chemical vapors.

This ceramic is available in white as well as a complete range of color glazes. Star Porcelain Co., Dept. ED, 151 Muirhead Ave., Trenton 9, N. J.

CIRCLE 150 ON READER-SERVICE CARD FOR MORE INFORMATION

Battery Motor

Uses Nylon Bearings



The BN Miniature Battery-Operated Motor is a quiet but inexpensive unit using nylon bearings to reduce motor noise and current drain. It draws as little as 40ma. Speed can be varied from 1300rpm to 12,000rpm, and voltage from 1v to 12v. Life is up to 1000 hours. Minitone.

Inc., Dept. ED, 55 W. 13th St., New York, N. Y.

CIRCLE 151 ON READER-SERVICE CARD FOR MORE INFORMATION

ELECTRONIC DESIGN • September 1955

1/10w Resistor

Highly Useful with Transistors



The Type TR is a molded resistor measuring 0.140" long x 0.015" diam with 1" leads and rated at 1/10w. It is a molded composition unit with an insulating coating. It is especially suitable for use with transistors, diodes, and other small components in miniaturized equipment. It may be used with or without encapsulating compounds or casting resins.

TR resistors are available in standard RETMA, JAN-R-11, and MIL-R-11 resistance values for standard tolerances of $\pm 5\%$, 10%, and 20%, from 10 ohms to 22 megohms. Voltage rating is (max continuous) 150v rms or d-c. They can be operated continuously with the insulation subjected to a maximum potential of 200v d-c.

Maximum continuous wattage at 70°C is 0.1w and 40°C is 0.2w. They derate linearly from 0.1w at 70°C to zero at 100°C. Allen-Bradley Co., Dept. ED, 1326 S. 2nd St., Milwaukee 4, Wis.

CIRCLE 152 ON READER-SERVICE CARD FOR MORE INFORMATION

Motor-Generator

Weights 6.2 oz

The type MG3013 is a subminiature motor-generator with an unusually high output in relation to its size. It measures only 1"OD x 2.625" long and weighs 6.2 oz. Output is 1.25v per 100rpm when operated into a load of 100,000 ohms. Speed is continuously



variable from 200rpm to 8700rpm. The output remains completely linear over the entire speed range. Harmonic distortion is under 5%. Magnetic detent stops the output shaft in any of four positions within five degrees accuracy.

The motor is a 115v, 400cy 2-phase drive motor with a stall torque of 0.15 oz-in. The unit has a stainless-steel housing with stainless-steel ball bearings and shaft and class "H" insulation for high-humidity and high-temperature applications. John Oster Manufacturing Co., Avionic Div., Dept. ED, 1 Main St., Racine, Wis.

CIRCLE 153 ON READER-SERVICE CARD FOR MORE INFORMATION

ELECTRONIC DESIGN • September 1955

The NEW GRAY AUDOGRAPH.



...GETS A VOICE

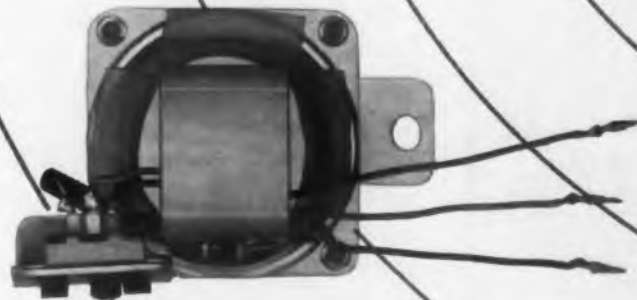

IN A HURRY...

HUBBELL *Interlock* Sub-Miniature Plugs

TRADE MARK

Eliminate Soldering For Fast Installation Of Speaker Kit!

Now, one model takes the place of three in the new Gray Audograph line. These famous dictation machines are designed with built-in eyelets to receive Type "C" Interlock Plugs. When speaker-equipped models are ordered, specially designed speaker kits, wired with the Sub-miniature Plugs, are quickly and easily plugged in. Hubbell Interlock's exclusive automatic lock-

ing-quick disconnect feature makes possible a solderless, low contact resistance connection from the speaker kit to the panel eyelets. The tiny Type "C" Plugs are also easily and quickly disconnected for maintenance or replacement of speaker if necessary. Our Development Laboratory will cooperate with your Engineers to adapt Interlock for your specific applications.



Sub-miniature Plugs: Cat. No. 601C31 • For Further Information, Write Dept. A

HARVEY HUBBELL, INC.



CIRCLE 124 ON READER-SERVICE CARD FOR MORE INFORMATION



All wound up in wound cores?

We can't blame you, when there are so many claims being made by manufacturers regarding merits of their cores.

Rather than add to this confusion of claims, here are just a few pertinent *facts* that you should know about Thomas & Skinner OrthoSil tape wound cores.

1. Made from OrthoSil, oriented silicon-iron.
2. The high permeability with low core losses results in high efficiency cores.
3. Made in 12 mil OrthoSil for 60-cycle applications.
4. In 4 mil OrthoSil for 400-cycle and higher applications.
5. All cores are magnetically inspected at three flux densities . . . 5,000, 10,000 and 15,000 gauss.
6. Testing is based on minimum areas, using a 90% stacking factor for 4 mil 400 cycle applications—and a 95% stacking factor for 12 mil 60-cycle usage.
7. Immediate delivery.
8. Complete engineering service available.

For further facts on OrthoSil tape wound cores write direct to Thomas & Skinner today.

SPECIALISTS IN MAGNETIC MATERIALS . . .

Permanent Magnets  Laminations  EI and Wound Cores 



Thomas & Skinner, Inc.

1157 E. 23rd STREET, INDIANAPOLIS 7, IND.

CIRCLE 154 ON READER-SERVICE CARD FOR MORE INFORMATION

Inverter

Weights 7 lb in 100va Size



This miniature inverter is a precision permanent-magnet motor generator which converts 28v d-c direct to 400cy. Equipped with governors for maintaining constant speed, it operates over an input

range of 18 to 30v d-c and an output of 90 to 150v a-c. The permanent-magnet construction makes the output voltage independent of the condition of the battery.

Available in 25, 100, and 250va ratings, units with standard winding put out 115v. However, the voltage can be varied to meet customer requirements. At a 0.9 power factor, the a-c voltage regulation is within $\pm 5\%$ and the frequency within $\pm 1\%$.

Designed for 1000 hours of trouble-free service through an ambient range of -55 to $+71^{\circ}\text{C}$, the units withstand 10g acceleration and meet military requirements for noise suppression. In the 100va size the inverter weighs 7 lb and occupies a space of 3.4" x 4.6" x 4.4". Arga Div., Beckman Instruments, Inc., Dept. ED, 220 Pasadena Ave., South Pasadena, Calif.

CIRCLE 155 ON READER-SERVICE CARD FOR MORE INFORMATION

Clutch Kit

For the Engineering Laboratory



An aid for designers and engineers in solving product design problems, the "Engineering Laboratory Kit" contains one complete clutch assembly, four clutch roller assemblies of various sizes, one ball-bearing mounted clutch, and one torque limiter.

The kit provides actual working samples that offer several possible answers to design problems involving infinitely adjustable ratchet feed, automatic cycling mechanisms, selective couplings, free wheeling of high inertia driven parts, dual or multiple drives, backstops or one-way brakes, and many other phenomena. The Miniclutch Co., Dept. ED, 375 Morse St., Hamden, Conn.

CIRCLE 156 ON READER-SERVICE CARD FOR MORE INFORMATION

New! SANDERS

"MINIVALVE"

MODEL SA-14



Compact

Lightweight

Non-Jamming

Low Input Power

Built-in Torque Motor

Wide Frequency Response

This miniature valve is an advanced design of a 2-stage hydraulic amplifier utilizing the "Bootstrap" principle to develop larger forces with low input power requirements. Its improved, self-clearing feature eliminates jamming.

SPECIFICATIONS:

Flow — 4 GPM for 1000 PSI drop across valve, System Pressure — 3000 PSI; Frequency Response — 100 cps. (Also available: "Minivalves" with flows up to 200 GPM.) Size — 1" x 1" x 3 $\frac{5}{8}$ "

For detailed specifications, write to Dept. ED-C



CIRCLE 157 ON READER-SERVICE CARD

DataReader

Model 546

A transport unit for high-speed searching, reading and recording of data on magnetic tape.



Vacuum column tape control

Vacuum method of sensing provides servo control of the reel drive motors, resulting in a highly sensitive tape feed control. Only a short length of tape need be accelerated to bring the tape to full speed. Exceptionally rapid acceleration and minimum tape strain are realized, since no mechanical system inertia need be overcome.

PERFORMANCE:

RAPID START—STOP—REVERSE—from stop to full speed in 6 milliseconds.

HIGH TAPE SPEED—optional single speed of 30, 40, 50, 60 or 75 in/sec.

TWO-DIRECTION SEARCH—either direction, automatically at full speed.

REMOTE OPERATION—forward, reverse, stop, rewind and selection of reading and writing.

END-OF-TAPE SENSING—stops automatically at either end of tape.

RAPID REWIND—2400 ft. of 1/2" or 3/4" tape in 3 minutes.

FOR FURTHER INFORMATION WRITE
ElectroData Corporation
Component Sales Division
460 No. Sierra Madre Villa
Pasadena 15, Calif.

ElectroData

An Affiliate of
CONSOLIDATED ENGINEERING CORPORATION
OF PASADENA, CALIFORNIA

ElectroData Corporation maintains a nationwide sales and service organization.

CIRCLE 158 ON READER-SERVICE CARD

Permanent-Magnet Motors

Gives Minimum Radio Noise



This line of efficient, 1-1/4" diam permanent-magnet motors is specially designed for minimum radio noise. Type AM-215 is a typical example. It is designed to meet MIL-M-8609 specifications. The motor alone weighs only 5 oz and measures 1.25"-OD x 2.14" long. An exceptionally high torque is made possible by a unique,

simple, magnet design. Radio noise is minimized by shielded leads. Altitude-treated bushes have exceptionally long life.

Temperature range is from -55 to +71°C. Motor speeds range from 6000 to 20,000rpm. Speeds are controllable to $\pm 1\%$ over a voltage range from 24 to 29v by using a governor. The motor is available with gear train, governor, brake, or any combination of these. When used with a gear train, gear ratios range from 6:1 to 4000:1. Avionic Div., John Oster Mfg. Co., Dept. ED, 1 Main St., Racine, Mich.

CIRCLE 159 ON READER-SERVICE CARD FOR MORE INFORMATION

Wollastonite Ceramic

For Ultra-High Frequency Uses



A wollastonite base ceramic is offered by this firm in dry pressed or extruded forms for a variety of electronic and electrical applications.

A very high grade ceramic, it was developed mostly through research by the Rutgers School of Ceramics under the sponsorship of the Army Signal Corp., the aim being to develop a low-loss ceramic insulating material.

This ceramic carries an L-6A rating per JAN-1-10 specs, and it has superior electrical properties (low loss factor, high dielectric strength, etc.), high mechanical strength, high resistance to thermal shock, and high impact strength. Suggested uses for the material are bushings, tube sockets, tubing, lead-in assemblies, washers, strain and spreader insulators, and pillar insulators.

Also available are steatite and standard electrical porcelain, for average and low-frequency uses, respectively. R. Guastavino Co., Dept. ED, 660 Main St., Woburn, Mass.

CIRCLE 160 ON READER-SERVICE CARD FOR MORE INFORMATION



RADAR TRANSFORMERS AND INDUCTORS



SKILLED ASSEMBLERS AND DESIGN ENGINEERS work hand in hand to produce the prototype oil-filled radar transformers and inductors for your system development projects.

SEPARATE DESIGN DEPT. AND MODEL SHOP ASSURE

Quick shipment of prototype radar transformers

Once you've told us what you want, work begins at once. We've pooled design engineers and a team of skilled assemblers in a separate section . . . organized to deliver prototype oil-filled units for your radar experimental or system de-

velopment projects *in a hurry*. Small orders are also filled in our high-speed model shop to avoid production-line delays. There's no waiting around for completion of larger projects. You're assured fast shipment on *all* orders.

Progress Is Our Most Important Product

GENERAL ELECTRIC

SEND ME YOUR NEW RADAR COMPONENT BULLETIN

General Electric Co., Section A434-2
Schenectady 5, New York

Name

Address

City

State



CIRCLE 161 ON READER-SERVICE CARD FOR MORE INFORMATION

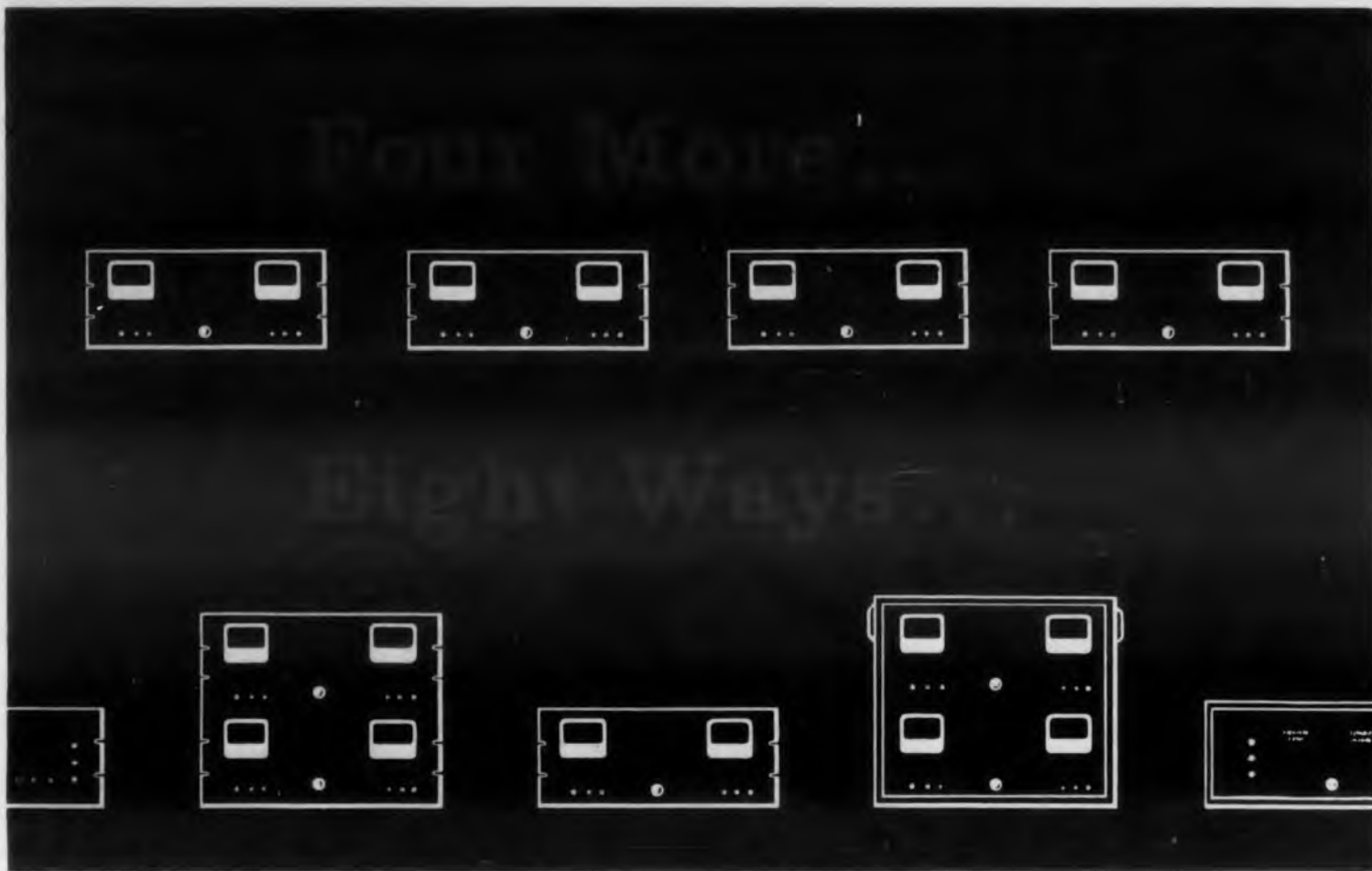

NJE has added four more basic ranges to the most complete power supply line in the industry.

Each one is the result of dozens of custom inquiries, indicating a need for such a stock model.

Each is available eight ways—as always—rack, rack-with-meters, cabinet, cabinet-with-meters, and similarly in our 4-way "duals", to double the range in parallel, series-aiding, series-opposing and isolated modes.

Each exemplifies the clean, conservative design and mass-production economy you have come to identify with NJE—the leader in the power supply field.

Model	Regulated Voltage Range Volts DC	Current Range MA DC	Line Regulation %	Load Regulation %	Unregulated Filament Supplies	Price (Rack - No meters)
S-150	200-325	0-200	0.3	0.3	Two - 6.35V @ 3A	\$ 96.00
S-250	100-200	0-200	0.5	0.5	Two - 6.35V @ 3A	\$104.00
S-350	200-325	0-300	0.3	0.3	Two - 6.35V @ 5A	\$137.00
S-900	0-600	0-300	0.3 or 0.5V	0.3 or 0.5V	Two - 6.35V @ 5A	\$225.00

Fixed or variable Bias supplies available. Meters, \$30.00 add'l. Cabinet, \$20.00 add'l.

Write for Catalog S-5

For our complete line of electronic power supplies See electronics Pp. 113-120 BUYERS' GUIDE



NJ E CORPORATION

Electronic Development and Manufacturing

COMPETENT ENGINEERING REPRESENTATION EVERYWHERE

343 Carnegie Avenue
Kenilworth, New Jersey

Rapid, complete, competitive custom quotes from 1000 Amperes (low voltage) to 250 KV (low current).

POWER SUPPLIES UNLIMITED

CIRCLE 162 ON READER-SERVICE CARD FOR MORE INFORMATION

Capacitors

For 125°C Operation



The Type 118P Subminiature "Metal-Clad" metallized paper capacitors are rated for operation at 125°C without

voltage derating. They withstand a dielectric test of twice rated voltage. Other features include self-healing dielectric, complete hermetic sealing with glass-to-metal solder-seal terminals, and corrosion-resistant cases. Both standard wire leads and solder tab terminals are available. The units meet environmental tests of MIL-C-25A. Sprague Electric Co., Dept. ED, 347 Marshall St., North Adams, Mass.

CIRCLE 163 ON READER-SERVICE CARD FOR MORE INFORMATION

Vacuum Gage

With 1-1000 Micron Range



This electronically regulated thermocouple vacuum gage, the TC-104, has a pressure range from 1 to 1000 microns, and maintains its accuracy over wide variations of line

voltage (95-125v). The entire instrument is only 5" x 9-1/2" x 3". It is regularly supplied with two rugged, calibrated, d-c heater thermocouple tubes with 1/8" IPS male thread. Electronic Research Laboratories, Dept. ED, 85 Surrey St., Brighton 35, Mass.

CIRCLE 164 ON READER-SERVICE CARD FOR MORE INFORMATION

Tube Retainer

Holds at 200cy, 20G



This tube retainer prevents parallel-mounted "flat press" or "button" base subminiature tubes from working loose from their sockets. It is mounted to the chassis by rivets.

It is silver-plated both to prevent corrosion and insure good electrical contact with metallic coated tubes. The spring base is made of beryllium copper. It has been successfully tested with vibrational frequencies up to 2000cy at 20G. P. R. Mallory & Co., Inc., Dept. ED, Indianapolis, Ind.

CIRCLE 165 ON READER-SERVICE CARD FOR MORE INFORMATION

ELECTRONIC DESIGN • September 1955

Clip-Type Rectifier

Requires No Assembly Tools



The "Qui-Klip" is a snap-in type rectifier featuring a clip arrangement which does not require tools for assembly. It is designed to speed assembly time and eliminate broken studs.

Developed by this firm in conjunction with the Tinnerman Products Corp., the unit does not require special sockets for mounting; it needs only two round holes to be snapped into place. In addition, solderless connectors are available for making electrical contact to the rectifier. Radio Receptor Co., Inc., Dept. ED, 240 Wythe Ave., Brooklyn, N. Y.

CIRCLE 166 ON READER-SERVICE CARD FOR MORE INFORMATION

Delay Line

Only 2" Long

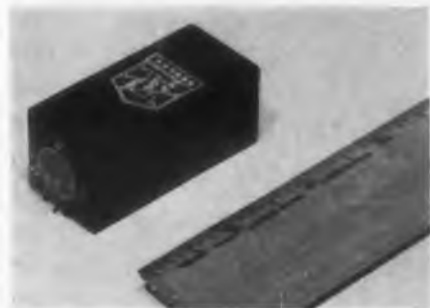

This highly compact delay line is only 2" long. In spite of its size, it provides a 3.0 μ sec delay with a 0.4- μ sec rise time at 2000 ohms impedance and 10% attenuation. Embedded in epoxy resin and hermetically sealed, it comes in a dust-proof case and meets all military specifications. E.S.C. Corp., Dept. ED, 534 Bergen Blvd., Palisades Park, N. J.

Embedded in epoxy resin and hermetically sealed, it comes in a dust-proof case and meets all military specifications. E.S.C. Corp., Dept. ED, 534 Bergen Blvd., Palisades Park, N. J.

CIRCLE 167 ON READER-SERVICE CARD FOR MORE INFORMATION

Power Supplies

Meet MIL-E-4158A Specs



Four power supplies are offered to meet MIL-E-4158A (USAF)—Electronic Equipment, Ground. They provide any fixed output voltage (adjustable $\pm 25v$) from 0-120v in three

standard current ranges: 300, 600, or 1200ma max. Regulation is held to 0.25% line or load, and standard ripple is 4mv rms. NJE Corp., Dept. ED, 345 Carnegie Ave., Kenilworth, N. J.

CIRCLE 168 ON READER-SERVICE CARD FOR MORE INFORMATION

ELECTRONIC DESIGN • September 1955

20% less reverse current!

with Federal germanium power rectifiers

The benefits of Federal's exacting standards of fabrication and testing are now within reach of every user of germanium rectifiers. Federal craftsmanship assures at least 20% lower reverse current than the RETMA specifications for every IN91, IN92, and IN93 rectifier.

FEDERAL, pioneer developer and manufacturer of semi-conductor products, has just completed a major expansion of its germanium rectifier production facilities . . . NOW, production quantities of diffused junction rectifiers are available for general industrial use.



types: IN91 • IN92 • IN93 • IN368

ELECTRICAL RATINGS

(based on 55° C ambient T., resistive loads, 60 cycle input)

CHARACTERISTIC	IN91	IN92	IN93
Peak Inverse Voltage, Max. (volts)	100	200	300
RMS Input Voltage (volts)	70	140	210
RMS Input Voltage (capacitive load) (volts)	35	70	105
DC Output Current, Max. (ma.)	150	100	75

*Leakage Current at Rated Peak Inverse Voltage (ma) (Retma Limits) *2.7 *1.9 *1.2

*Limits established by Federal assure at least 20% less leakage.

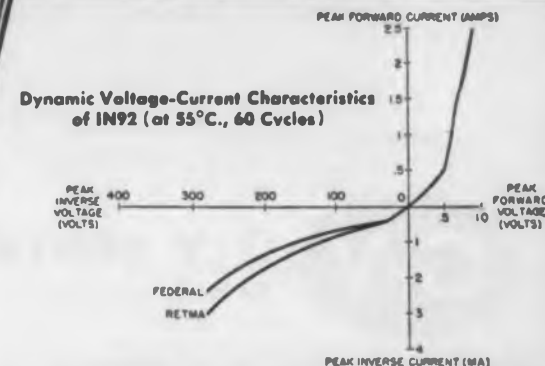

100% OF FEDERAL GERMANIUM RECTIFIER PRODUCTION IS 100% TESTED

For more information about Federal Germanium Diffused Junction Power Rectifiers call Nutley 2-3600, or write to Dept. F-735.

Federal



A DIVISION OF



IN368 Designed for magnetic amplifier and blocking applications where very high forward-to-reverse current ratios and high efficiencies are required. Meets all RETMA specifications!

IN368 ELECTRICAL RATINGS

Maximum Peak Inverse Voltage	200 volts
Maximum DC Output Current	100 ma
RMS Voltage	140 volts
Continuous Reverse Working Voltage	150 volts
Max. Leakage Current at 150 Volts Reverse DC	300 microamps DC



Federal Germanium Rectifier (actual size)

Federal Telephone and Radio Company

A Division of INTERNATIONAL TELEPHONE AND TELEGRAPH CORPORATION
COMPONENTS DIVISION • 100 KINGSLAND ROAD • CLIFTON, N. J.

In Canada: Standard Telephones and Cables Mfg. Co. (Canada) Ltd., Montreal, P. Q.
Export Distributors: International Standard Electric Corp., 67 Broad St., New York

CIRCLE 169 ON READER-SERVICE CARD FOR MORE INFORMATION

BIG NEWS...IN SEALED

THERMOSTATS!

G-V's Series C8 is Undamaged By 150 G Shock, Vibration up to 2000 Cycles, Exposure to -100°F. and +300°F.

This new series of electrical thermostats is specially designed to meet the difficult operating conditions of electronic and aircraft applications. Operating points, regardless of setting, are not changed by exposure to temperatures from -100°F. to +300°F. Shocks up to 150 G for 3 milliseconds, vibration of 25 G up to 1000 cps, and vibration of 10 G up to 2000 cps do not damage these thermostats or change their setting.

Hermetically Sealed But Rapid in Response

Sealed in a metal shell which is also its sensing element, the G-V Series C8 Thermostat responds as rapidly as a laboratory thermometer. Temperature settings may be made at the factory or by the user. Contacts are rated at 5 amps. 115 volts AC, or 3 amps. 28 volts DC, non-inductive load. Differential is about 1°F. Insulation test is 1250 v. between circuit and shell, and insulation resistance is over 100 megohms. These thermostats are suitable for direct control of heaters and for over-temperature and under-temperature indication, alarm, or cut-off.

**Available In Numerous
Convenient Mounting Forms**

WRITE...

for Bulletin with
complete technical and
application data.



G-V CONTROLS INC.

18 Hollywood Plaza • East Orange, N. J.



CIRCLE 170 ON READER-SERVICE CARD FOR MORE INFORMATION

Squaring Circuit

In a Plug-In Unit

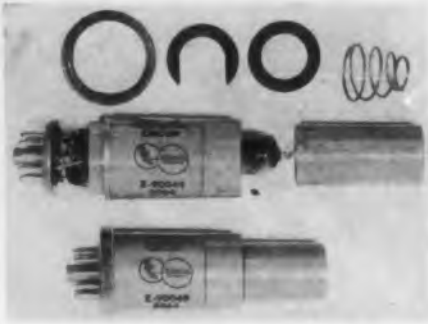

Squaring Circuit Z-90049 has been designed to operate from 0 to 1Mc. It is intended to square a sine or complex waveform input. It provides relatively fast rise and decay times,

and may also be used as a base and peak clipper.

The Z-90049 is packaged as a plug-in unit with an 11-pin base. It has a 1-1/2" overall diameter and a height of 4-5/32". The plug-in unit is designed to be taken apart or assembled without any tools. It weighs approximately 3.25 oz and is provided with a removable tube shield.

The unit requires a peak-to-peak input signal of 25v. Greater sensitivity may be obtained by using an external positive bias depending upon the source impedance and frequency. It requires +200v d-c at 12ma, -200v d-c at 1ma, and 6.3v at 300ma. The circuit provides a 110v peak-to-peak square or rectangular wave output up to 200kc and 85v at 1Mc. It has a negative going rise time of 0.4μsec or less and a positive going decay time of 0.8μsec or less. It has an output impedance of less than 10,000 ohms. EECO Production Co., Dept. ED, 827 S. Vermont, Los Angeles 5, Calif.

CIRCLE 171 ON READER-SERVICE CARD FOR MORE INFORMATION

Synchronous Gear Motor

With Two Speeds



This 2-speed, synchronous gear motor, in which speeds are changed electrically, provides outputs of 1800 and 300-rpm. Speed reduction below the normal 1800-

rpm is accomplished by electrically reversing the motor, and picking up a gear train through an internal over-riding clutch.

The basic motor is of the permanent split-capacitor type. It is designed for operation on 115v 60cy, and takes 10w at rated load. Designated Type RBC-2510, Model CS-4121, it is available with other speeds. Holtzer-Cabot Motor Div., National Pneumatic Co., Inc., Dept. ED, 125 Armory St., Boston 19, Mass.

CIRCLE 172 ON READER-SERVICE CARD FOR MORE INFORMATION

SERVO MOTORS

from FORD INSTRUMENT for
EXTREMELY LOW INERTIA AND
HIGH FREQUENCY RESPONSE



- STANDARD SERVO MOTORS
in nominal ratings of
10w, 5w, 2 1/2w,
1 1/2w and 1/2w
- SPECIALS to
customer requirements.

Ford Instrument's high precision servos are available in high and low voltage models, in 60cy and 400cy designs, for a multitude of applications. With Ford's smooth iron, low-inertia rotors, they offer these advantages:

- Linear torque-voltage characteristics
- Linear torque-speed characteristics
- Withstand continuous stalling
- High torque efficiency

FREE—Fully illustrated data bulletin gives specifications and performance information. Address Dept. ED.



48



**FORD INSTRUMENT
COMPANY**

Division of Sperry Rand Corporation
31-10 Thomson Ave.
Long Island City 1, N. Y.

Ford Instrument's standard components



CIRCLE 173 ON READER-SERVICE CARD

WANTED:

*Electronic and
Mechanical Engineers*
at
Bendix-Pacific

This is the new Engineering Center at Bendix-Pacific now nearing completion. With 100,000 square feet of area, it represents the latest and one of the most complete engineering facilities in the nation.

You are invited to consider becoming a member of this vital engineering group—with a forward looking company in Southern California.

Unusual engineering positions in electrical and mechanical design of radar, sonar and telemetering are available. These positions, which are directly associated with our long-range projects for industry and for defense, are available at all levels.

Please fill in the coupon or write us for complete information.



W. C. Walker, Engineering Employment Mgr.
Pacific Division, Bendix Aviation Corp.
11606 Sherman Way, North Hollywood, Calif.

Please send information.

I am a graduate engineer with _____ degree.

I am not a graduate engineer but have _____ years experience.

Name _____

Address _____

City _____ Zone _____ State _____

CIRCLE 174 ON READER-SERVICE CARD

Drafting Desk

Uses Endless Belt



The "Draft-A-Matic" is a drafting desk which makes possible the performance of all drafting operations in a seated position. The drafting platform is equipped with an endless, vinyl plastic belt. The belt is

48" wide and can accommodate a drawing 72" long. It provides a firm drawing surface. The belt moves over aluminum rollers at each end of the drafting platform. By merely turning the wheel at either end of the front roller, the draftsman moves the belt and the drawing affixed to it, so that any part of the drawing is brought well within visibility and reach. The General Fireproofing Co., Dept. ED, Youngstown, Ohio.

CIRCLE 175 ON READER-SERVICE CARD FOR MORE INFORMATION

Panel Boards

For Programming Computers



A series of precise-tolerance panel boards is being made by this firm for programming digital computers. In one application, the "Univac", a series of eight boards, each 8" x 10", containing 816 cavities, serve as a stationary terminal block for the equipment. A small spring jack is at-

tached to each cavity. Another series of eight boards serve as a terminal block for the electrical components which make up the problem analog.

These control panels are made of phenolic and are quantity molded to precise tolerances. Hole locations are held to ± 0.007 " from center to either end, and hole diameters are held to $+0.002$ ", -0.000 ". The dimensional accuracy required to mold boards complete with holes and slots is achieved by a special blend of phenolic compound, by a unique mold to promote uniform curing, and by controlled cooling. Auburn Button Works, Inc., Dept. ED, Auburn, N. Y.

CIRCLE 176 ON READER-SERVICE CARD FOR MORE INFORMATION

new...
precision

Continental Connectors

Series
'GA'



**40
Contacts ...
spring
loaded
for
quick release**

**Quick
Release**

PRESSURIZED CONNECTORS

for guided missile
and similar
applications

Here's the connector you can specify for pressurized equipment without fear of dangerous air leakage. The Series "GA" plug is molded from Orlon filled Diallyl Phthalate. When subjected to a pressure differential of 30 PSI at 25° C, leakage is less than 1 cubic inch of air per hour. This series is available with hood and cable clamp. Gold plated, nickel silver contacts take #16 AWG wire, and each is spring loaded for easy release. A spring action center screwlock permits quick, easy release or engagement without damage to the unit.

Write for complete technical data without obligation.

Note: Complete Continental Connector Catalog, covering sub-miniature, printed circuit, hermetic seal, pressurized, high voltage and power connectors, is available on request. Send us your name and title on your company letterhead.

Electronic Sales Division
DeJUR-Amsco Corporation,

45-01 Northern Boulevard, Long Island City 1, N. Y.

DeJUR

CIRCLE 177 ON READER-SERVICE CARD FOR MORE INFORMATION



FULL
SIZE
3" x 3" x 4"

Unsurpassed
IN PERFORMANCE
Unequaled
IN COMPACTNESS

CHARACTERISTICS

2 degrees of freedom
... 360° in roll, ±82° in pitch
Repeatability to established vertical
... 15 Minutes max. of ½ cone angle
Free drift rate
... 0.5°/Minute
Erection Time
... 3 minutes at start
Erection Rate
... 3°/minute-Normal 80°/minute-Fast
Synchro Output (each axis)
... 11.8 volts, 400 cycles

Only Kearfott can offer a *Miniature Vertical gyro* with big gyro *Performance*. Completely self contained, this gyro requires *No External Erection Amplifiers*. A gravity sensitive electrolytic device, within the gyro, directly associated with the torquer motors, provides the necessary vertical reference.

Hermetically Sealed, filled with a dry, inert gas. Satisfies the requirements of MIL-E-5272 as regards shock test (Procedure II) humidity, salt spray, fungus resistance, rain, sand, dust, immersion and explosion proof.

This gyro duplicates the performance of the Kearfott T2108 series in 1/8 the volume and weight.

KEARFOTT COMPONENTS INCLUDE:

Gyros, Servo Motors, Synchros, Servo and Magnetic Amplifiers, Tachometer Generators, Hermetic Rotary Seals, Aircraft Navigational Systems, and other high accuracy mechanical, electrical and electronic components.

Engineers: Many opportunities in the above fields are open. Please write for details today.

A SUBSIDIARY OF GENERAL PRECISION EQUIPMENT CORPORATION



KEARFOTT COMPANY, INC., LITTLE FALLS, N. J.

Sales and Engineering Offices: 1378 Main Avenue, Clifton, N. J.
Midwest Office: 188 W. Randolph Street, Chicago, Ill. South Central Office: 6115 Denton Drive, Dallas, Texas
West Coast Office: 253 N. Vinedo Avenue, Pasadena, Calif.

CIRCLE 178 ON READER-SERVICE CARD FOR MORE INFORMATION

Power Supply
Can Stacked for Varied Outputs



This compact, "stackable" power supply, the S-100-R, is designed to provide a variety of power at relatively low cost. Although the basic output range is 200-325v at 0-100ma, two, three, or four units can be stacked in parallel to furnish 0-200, 0-300, or 0-400ma.

In stacking, the junction between the pass-tube grids and the error-amplifier plate is brought to the rear terminal strip, permitting several units to be interconnected so that one error amplifier controls all the pass-tubes in use while the other error amplifiers remain inactive. In addition, this setup permits the use of one voltage control to set all the supplies to the desired output. Load division is uniform to 10%. The supply can be used in series (aiding or bucking), parallel, or isolated. New Jersey Electronics Corp., Dept. ED, 345 Carnegie Ave., Kenilworth, N. J.

CIRCLE 179 ON READER-SERVICE CARD FOR MORE INFORMATION

Rotary Latch
Operates with 1/4 Turn

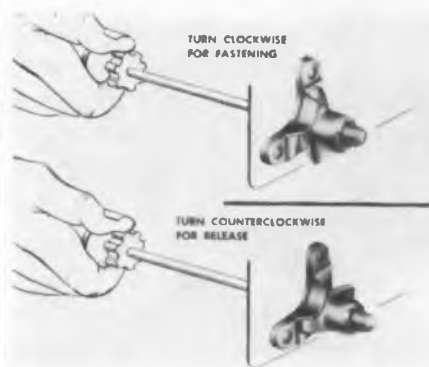

The "Paneloc" Rotary Latch is a strong and durable fastener for use on hinged or removable parts, such as inspection doors, access panels, covers, and electrical control panels. Made of cadmium-

plated steel, it consists of four parts: latch-screw, shim plate, anchor block, and latch-nut. The entire latch is assembled on the access panel only, which eliminates several of the operations required to install other types of fasteners.

Operating with a quarter turn, the latch cuts down on removal time of panels, doors, and covers. Three standard sizes are currently available, with more to be added. Scovill Manufacturing Co., Dept. ED, Waterbury 20, Conn.

CIRCLE 180 ON READER-SERVICE CARD FOR MORE INFORMATION

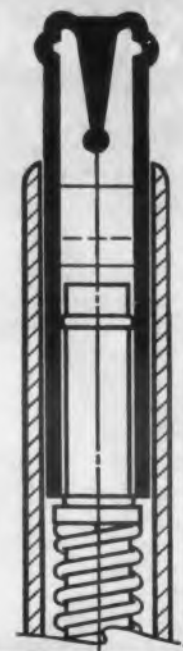

something
new on

MARS

Staedtler has been coming up with something new in pencils ever since the first Staedtler pencils were made three centuries ago.

Now it's the new, sturdy, solid brass lead sharpener built into the Technico Mars-Lumograph push-button lead holder. Saves you work, time, money.

Get the imported Mars Technico lead holder and leads today—they are the best, yet cost no more.

The 1001 Mars Technico clutch mechanism holds leads securely; light in weight, perfectly balanced; \$1.50 each, less in quantity.

1904 Mars-Lumograph leads are so opaque, inking-in is unnecessary; won't flake or smudge, give better reproduction. Perfectly graded in 18 degrees—EXB to 9H; \$1.20 doz., less in quantity.



J.S. STAEDTLER, INC.
HACKENSACK, NEW JERSEY

at all good engineering and drawing material suppliers

CIRCLE 181 ON READER-SERVICE CARD

NO SHOCK MOUNT EVER HAD IT SO TOUGH



PHOTO COURTESY THE MARTIN CO

That's why ALL-ANGL Barry mounts are used in MARTIN'S MATADOR

Under the cumulative shock of rocket-boosted zero-length take-off, jet-fighter flight maneuvering, and on-target dive that cracks the sound barrier, the nation's first operational pilotless bomber relies on ALL-ANGL Barrymount® isolators to protect critical electronic control gear.



Equally effective in every flight attitude, ALL-ANGL mounts permit bulkhead mounting that saves vital space in this deadly weapon. And their proved performance makes Barry mounts Martin's choice for the Matador.

Let us show you how Barry's new ALL-ANGL isolators can lick your tough mounting problems. Data sheet M-9 gives mechanical and dynamic specifications. For specific recommendations call your nearest Barry Sales Representative.

BARRY CONTROLS

INCORPORATED

775 PLEASANT ST., WATERTOWN 72, MASS.

SALES REPRESENTATIVES IN ALL
PRINCIPAL CITIES

CIRCLE 182 ON READER-SERVICE CARD

Blower

Weights Less than 2-3/4 oz



I-R No. 1, a self-contained motor-blower, uses a 1" diam impeller. It will efficiently move large volumes of air (36.8-cfm at 20,000rpm). Total weight of blower and motor is less than 2-3/4

oz. Designed to meet military specifications, it is available in clockwise or counter-clockwise rotation. Ripley Co., Inc., Dept. ED, Middletown, Conn.

CIRCLE 183 ON READER-SERVICE CARD FOR MORE INFORMATION

Gear-Box Adapters

Kit for Servo Motors

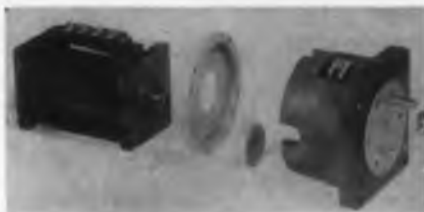

A series of adapter kits is available for coupling this firm's high-precision gear boxes to many of the most widely

used servo motors. Six kits for direct, in-line mounting to various type servo motors, and a special adapter kit for coupling the gear box to a flexible shaft are offered. Each kit contains an anodized aluminum adapter plate, coupling disk, and all necessary attaching parts. The gear boxes are available in speed ratios ranging from 10:1 to 3125:1. Link Aviation, Inc., Dept. ED, Binghamton, N. Y.

CIRCLE 184 ON READER-SERVICE CARD FOR MORE INFORMATION

Binding Post

Takes Five Connection Types

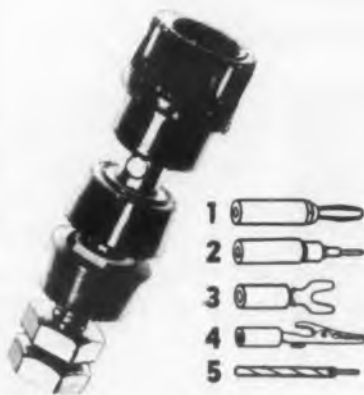

The Model No 260 is a 5-way all-molded binding post designed to accept standard phone tips, banana plugs, spade lugs, alligator clips, and most wire sizes. Mounting in a 5/16" hole, it locks securely in panels from 1/16" to 1/4" thick, and as-

sure complete insulation from all surfaces at 3000v a-c. Herman H. Smith, Inc., Dept. ED, 2326 Nostrand Ave., Brooklyn 1, N. Y.

CIRCLE 185 ON READER-SERVICE CARD FOR MORE INFORMATION

TO THE FINE ENGINEERING MIND
SEEKING THE CHALLENGING PROJECTS IN



TEST EQUIPMENT

TEST EQUIPMENT ENGINEERS (Senior Electronic Engineers and Electronic Engineers) are urgently needed for design and development of test equipment for aircraft and missile application at Convair. Unusual career opportunities are here now for engineers qualified in these fields: *telemeter equipment; auto pilot; rocket propulsion; system engineering; electronic packaging and cabling; electrical, hydraulic and pneumatic power distribution; data reduction systems, radar beacon, remote control systems, specification writers, test procedures, component test, inertial guidance.*

CONVAIR offers you an imaginative, explorative, energetic engineering department to challenge your mind, your skills, and your abilities in solving the complex problems of vital, new, immediate and long-range programs. You will find salaries, facilities, engineering policies, educational opportunities and personal advantages excellent.

Generous travel allowances to engineers who are accepted. Write at once enclosing full resume to:

H. T. Brooks, Engineering Personnel, Dept. 1009

CONVAIR

A Division of General Dynamics Corporation

3302 PACIFIC HIGHWAY

SAN DIEGO, CALIFORNIA

SMOG-FREE SAN DIEGO, lovely city on the coast of Southern California, offers you and your family a wonderful new way of life... a way of life judged by most as the Nation's finest for climate, natural beauty and easy (indoor-outdoor) living.

TUNG-SOL "Magic Mirror"

ALUMINIZED

PICTURE TUBE



**BRIGHTER-SHARPER
MORE DETAIL
MORE CONTRAST**

The "Magic Mirror" Aluminized Picture Tube creates the brightest, most realistic TV picture ever seen in the American home. The "Magic Mirror" Tube effectively utilizes *all* the light generated by the phosphor screen.

Tung-Sol has developed a unique method of backing the phosphor screen with a mirror-like aluminum reflector: Light is prevented from radiating uselessly back into the Tube. All of the intense detail of which the receiver is capable is brought out by the full light.

Tung-Sol's exacting standards of quality control, manufacture and testing further guarantee the high uniformity and maximum performance of the "Magic-Mirror" TV Picture Tube.

Let the superior qualities of "Magic-Mirror" Picture Tubes add selling advantages to your set.

TUNG-SOL ELECTRIC INC., Newark 4, N. J.

Sales Offices: Atlanta, Chicago, Columbus, Culver City (Los Angeles), Dallas, Denver, Detroit, Montreal (Canada), Newark, Seattle.

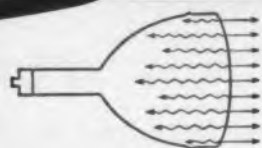

ORDINARY TUBE—Only *half* the light produced by the phosphor screen is utilized in the picture. Other half radiates wastefully back into tube.



RESULT—A light background within the tube which reduces picture contrast.

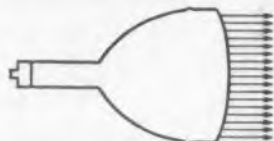

MAGIC-MIRROR ALUMINIZED TUBE—Aluminized reflector allows electron beam through. Blocks wasted light from backing up into tube. Reflects *all* the light into picture.



RESULT—Pronounced increase in contrast to make a bright, clear, more realistic picture.



CIRCLE 186 ON READER-SERVICE CARD FOR MORE INFORMATION

Microscope

For TV Tube Dot Alignment



The Color TV "Tuboscope" is a microscope to assist and simplify alignment of the dot pattern on picture tubes. A working distance of 4-1/4" is ample to view the periphery of the TV tube;

the safety glass shield need not be removed. Five different eyepieces are available and can be easily interchanged to give powers from 10X to 33X. The instrument is 7-1/4" long with OD of 1-1/2". Edmund Scientific Corp., Dept. ED, Barrington 3, N. J.

CIRCLE 187 ON READER-SERVICE CARD FOR MORE INFORMATION

Printed-Circuit Connectors

For Coaxial Cable

MINIATURE EC SERIES COAXIAL CONNECTOR



The "EC" Series miniature printed-circuit connectors consist of a coaxial plug assembly and a receptacle that can be mounted on a printed or etched card by five terminal

points using the solder dip method. The plug assembly is approximately 3/4" long x 9/32" diam. The receptacle has a mounting base 7/16" square.

Two receptacles can be mounted side-by-side without loss of printed or etched circuit lines. Terminals can be furnished for 1/16", 1/8" and 1/4" card thicknesses. H. H. Buggie, Inc., Dept. ED, 726 Stanton St., Toledo, Ohio.

CIRCLE 188 ON READER-SERVICE CARD FOR MORE INFORMATION

Delay Line

With 20 μ sec Period



This lumped parameter 20 μ sec delay line, XN-1, has a rise time of 1 μ sec. Impedance is 600 ohms. The unit is hermetically sealed in epoxy

resin, and operates through the temperature range from -70° to 135°C. Size is 10-1/4" (including terminal lugs) x 3-5/16" x 15/16". The Gudeman Co. of California, Inc., Dept. ED, 2661 S. Myrtle Ave., Monrovia, Calif.

CIRCLE 189 ON READER-SERVICE CARD FOR MORE INFORMATION

Got a
production or
design problem?

with

- GASKETS • PACKINGS
- WASHERS • SEALS • SHIMS
- BUSHINGS • "O" RINGS



85 YEARS OF

AUBURN "KNOW-HOW"

HAS THE ANSWERS!

Yes . . . over 85 years experience in engineering, designing, fabricating and production qualifies Auburn to help you find the ideal answer to your problem. Where gaskets, washers, and other sealing devices are concerned, Auburn engineers are tops in the field. Their know-how is yours—for the asking. We are tooled to fabricate in virtually any material:

- Leather • Asbestos • Teflon • Silicone Rubber
- Neoprene • Rubber • Cork • Fibre • Compositions
- Phenolics • Cloth • Felt • Paper • Cardboard
- Plastics • Brass • Steel • Copper • Aluminum
- Kel-F • Other Special Materials

Send us your specifications or blueprints.

You'll receive

quotations, recommendations without obligation.



AUBURN
MANUFACTURING COMPANY

306 Stack St., Middletown, Conn.

Representatives: Atlanta, Ga.; Detroit, Mich.; St. Louis, Mo.; Los Angeles, Cal.; Minneapolis, Minn.; Washington, D. C.; Cincinnati, O.; Rochester, N. Y.

CIRCLE 190 ON READER-SERVICE CARD

HIGH POWER FERRITE CIRCULATOR



The Canoga ferrite Circulator is a four port non-reciprocal hybrid junction, which, when used for stabilizing the operation of high power magnetrons, is connected as a Double Termination Load Isolator.

The Circulator may also be used as a combination isolator-duplexer. In this application, it replaces the dual T-R duplexer assembly commonly used in broadband systems. A simplified model uses a single termination, with decreased isolation.

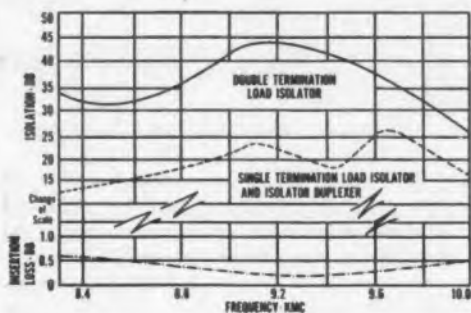

LOAD ISOLATOR SPECIFICATIONS

Frequency	8300-9800 mc
Isolation	30 db min.
Insertion Loss	Less than 0.6 db
Input VSWR, with 2:1 load VSWR	Less than 1.25:1 over the band
Power Handling Ability:	
Average Power	300 watts
Peak Power	250 KW
Cooling	None required
Length of Unit	8.5 inches
Weight	2 pounds
Magnetic Field Supply	Permanent magnet
Input & Output	
Flanges	UG-51/U, UG-52A/U or UG-39/U, UG-40A/U

Write For Complete Details and Applications

CANOCA CORPORATION

Radar Systems, Receivers, Test Equipment
Antennas, Waveguide Components

5953 SEPULVEDA BLVD.
VAN NUYS, CALIFORNIA

CIRCLE 191 ON READER-SERVICE CARD

ELECTRONIC DESIGN • September 1955

UHF Klystron

Delivers 2kw, 375-600Mc



The 3K3000LA delivers 2kw CW power output in 375-600Mc operation. Typical narrow band output is 2kw at 525Mc with 42% efficiency, obtained with a beam voltage of 8000v, 0.60amp, and a power gain of 1000X with 2w driving power.

The unit features resonant cavities completed outside the vacuum system, which is free of r-f circuitry, permitting wide-range tuning and easy input and output coupling adjustment. It is constructed entirely of metal and ceramic, has an oxide cathode, and is forced-air cooled. Eitel-McCullough, Inc., Dept. ED, San Bruno, Calif.

CIRCLE 192 ON READER-SERVICE CARD FOR MORE INFORMATION

Mercury Pulse Generator

With 10mv to 100v Range



For testing amplifiers and pulse height analyzers, and numerous other applications, the Model M-60 Mercury Pulse Generator provides a range of 10mv to 100v, negative or

positive pulses. Pulse shape is exponential rise to exponential decay. Rise time is better than 5×10^{-8} sec, variable over a range of 1000:1 in steps of ten. Decay time constant is 1, 10, or 100 μ sec on a selector switch. Radiation Instrument Development Laboratory, Dept. ED, 2337 W. 67th St., Chicago 36, Ill.

CIRCLE 193 ON READER-SERVICE CARD FOR MORE INFORMATION

Test Lead Kit

Has Universal Leads

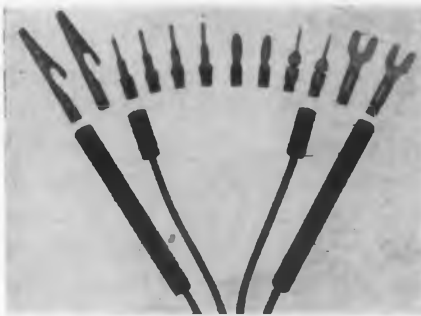

This kit contains completely interchangeable test leads. Tips, clips, plugs, and lugs with threaded inserts can be interchanged easily and quickly into one pair of leads at

both prod and meter ends. The one pair of test leads does the work of 50 different pairs. Herman H. Smith, Dept. ED, 2326 Nostrand Ave., Brooklyn, N. Y.

CIRCLE 194 ON READER-SERVICE CARD FOR MORE INFORMATION



NEW

DEVELOPMENTS

Broadband Sweep Generators

845 TO 1950 Mcs.

SIMULTANEOUS DISPLAY

As another step in the advancement in the field of Instrumentation, A.R.I. introduces its new Type HFS Broadband Sweep Generators.

From the Research Engineer to the Production Engineer, these NEW A.R.I. generators make instantly available a panoramic display of several hundreds megacycles. Now the advantages of RAPID . . . design, alignment and test of systems and components within the L Band frequency are realized.

Through the use of these NEW A.R.I. Sweep Generators the development and use of broadband multiple-tuned resonant circuits are made possible. Now the concept of lumped constant and distributed constant multiple-tuned circuits leave the realm of theory and become practical working units, and the typical Tschebycheff or Butterworth response curves are available at the discretion of the engineer.

The selectivities which can only be obtained from Quadruple, Sextuple and even Deca-tuple tuned circuits now becomes available. The response of a broadband antenna system is made visible instantly. The channeling of multiplexing systems becomes obvious, and the field of panoramic search of broadbands of frequency is realizable.



MODELS HFS — #1319 AND #813 SPECIFICATIONS

Frequency Range #1319	1350-1950 Mcs. (Min.)	Marker Frequency Range #1319	1200 to 2000 Mcs.
Frequency Range #813	845-1375 Mcs. (Min.)	Marker Frequency Range #813	750 to 1450 Mcs.
Power Output #1319	0.5 milliwatts (Min.)	Marker Accuracy	+ or - 1%
Power Output #813	1.0 milliwatts (Min.)	Sweep Frequency	60 Cycles
Source Impedance	50 ohms.	Sizes	14" h x 12" w x 8" d
Source Vswr #1319	1.5/1 (Max.)		
Source Vswr #813	1.3/1 (Max.)		
MAXIMUM TO MINIMUM OUTPUT AMPLITUDE RATIO		+ or - 1 db. (Max.)	

Applied Research



163-07 DEPOT ROAD, FLUSHING, N. Y.

WRITE TODAY for full information, and latest prices

MANUFACTURERS OF: BNC Attenuators and Coaxial Terminations
Bandpass and Bandreject Filters, Broadband Sweep Generators, Com-
munity TV Components, R. F. Amplifiers & Mixers (100-2000 Mcs.)

CIRCLE 195 ON READER-SERVICE CARD FOR MORE INFORMATION

Stupakoff

CERAMIC MATERIALS

At your fingertips...



NEW TECHNICAL DATA on *Stupakoff* CERAMIC MATERIALS

The very latest technical information on a wide range of ceramic materials is given in the new Stupakoff Technical Data Chart. Electrical and physical characteristics and the chemical composition of various grades of the following ceramic materials are included:

ALUMINA
ALUMINUM SILICATE
STEATITE

PORCELAIN
STUPALITH
CORDIERITE
MAGNESIA

ZIRCON
ZIRCITE
FORSTERITE

Valuable design and application suggestions included in the Stupakoff Data Chart help you engineer your ceramic parts for lowest cost and greatest satisfaction.

Send today for your free copy of the new Stupakoff Data Chart. Arranged for ready reference.



Stupakoff

Write Dept. ED.

Division of The **CARBORUNDUM** Company

LATROBE, PENNSYLVANIA

CIRCLE 196 ON READER-SERVICE CARD FOR MORE INFORMATION

VHF Balun

Operates Over 50-220Mc



The Model VB-1 UHF Balun was designed to operate in the frequency range of 50 to 220-Mc. It is actually a matching device that couples a signal from a 300-ohm balanced line to a

72-ohm unbalanced line, or vice versa. While it was primarily designed for 72-ohm coaxial cable, it can also be used for 52-ohm coaxial cable. American Electronics Co., Dept. ED, 1203 Bryant Ave., New York 59, N. Y.

CIRCLE 197 ON READER-SERVICE CARD FOR MORE INFORMATION

Anchor Nut

In No. 2 Size



A 2-56 thread size has been added to the "Kaylock line" of self-locking anchor nuts. It is of special value in electronics and guided missiles applications because its overall

envelope dimensions are so tiny.

Locking design utilizes a simple positive principle, wherein the upper threads are made elliptical and highly resilient, eliminating the necessity of an auxiliary locking device. It can be used in temperature ranges up to 550°F. The Kaynar Co., Kaylock Div., Dept. ED, 820 E. 16th St., Los Angeles, Calif.

CIRCLE 198 ON READER-SERVICE CARD FOR MORE INFORMATION

Signal Generator

With 10-500Mc Range



The Model TF-801B Signal Generator, with a frequency range of 10-500Mc, features long oscillator tube life, high output (2v down to 0.1- μ v), low f-m ensured by a tuned

amplifier, and a 50-ohm output from piston attenuation calibrated in volts, db, and dbm. Internal modulation is 0-90% metered, external modulation from d-c to 3Mc maximum. The unit has capacity-coupled, contactless coil turrets. Marconi Instruments, Dept. ED, 44 New St., New York, N. Y.

CIRCLE 199 ON READER-SERVICE CARD FOR MORE INFORMATION



NEW...the 400 cycle vernistat* a.c. Potentiometer you asked for!

The 400 cycle Vernistat is an a.c. potentiometer-type voltage divider that combines *high* linearity and *low* output impedance. It is essentially a non-dissipative element adaptable to high temperature operation. Size and mounting dimensions are designed to the BuOrd specification for a size 18 synchro.

Here are the details:

- **high linearity**, inherent in the design principle, is *maintained* over the life of the unit.
- **low output impedance** eliminates need for isolation amplifiers in many applications.
- **high output current capability.**
- **low phase shift** — less than 90 seconds depending on model.
- **can be coupled with synchros**, resolvers and other components — as well as ganged.
- **nonlinear functions can also be generated.**

Class 5 ball bearings, centerless ground shaft, and an aluminum housing machined to close tolerances combine to make the Vernistat a precision instrument. Shaft seals will be supplied where they are required by environmental conditions.

check these specifications:

Linearity Tolerance $\pm 0.05\%$

Minimum Output
Voltage Increment 0.01%

Output Impedance... less than 130 ohms

Input Voltage..... 130 v max.

Input Impedance... up to 75,000 ohms

*Trademark

vernistat

division

PERKIN-ELMER CORPORATION
Norwalk, Connecticut

CIRCLE 200 ON READER-SERVICE CARD



TECHNICRAFT

your primary source
for **WAVEGUIDE**

- SYSTEMS
- COMPONENTS
- TEST EQUIPMENT



Technicraft Laboratories specialize in research, development and manufacture of flexible and rigid waveguides, waveguide assemblies, and microwave test equipment. We will design and engineer to meet your needs and specifications, or re-engineer an existing design to improve mechanical and electrical characteristics or reduce manufacturing costs. For more details about our products and facilities, please write for your copy of "Progress in Microwave Transmission."



TECHNICRAFT LABORATORIES
INCORPORATED

1515 Thomaston Rd. • Thomaston, Conn.

Designers and Manufacturers of Rigid and Flexible Waveguide Assemblies, Microwave Test Plumbing and Components, Waveguide Systems.

CIRCLE 201 ON READER-SERVICE CARD

Gear Motor

With Parallel Output Shaft



To provide a universal gear motor with a parallel output shaft, this firm has developed the G-8 Gear Reducer, which can be adapted to its various motors. This unit is available in

any voltage up to 250v, and in speeds as low as 1rpm. It is designed to meet loads to 15 in-lb.

The motor can also be built with electric governor speed control. It can be rheostat controlled, dynamically or mechanically braked. The particular unit shown is the M-G-8. RAE Motor Corp., Dept. ED, P. O. Box 291, Racine, Wis.

CIRCLE 202 ON READER-SERVICE CARD FOR MORE INFORMATION

Wire-Wound Controls

Wiper-Arm Insulated



A wiper arm insulated from the shaft and mounting bushing is now available on the Series MII Controls. These units are low-cost conventional bushing mounted type insulated wire-wound controls

rated at 1w and available in resistance values from 2 ohms to 1000 ohms. Clarostat Mfg. Co., Inc., Dept. ED, Dover, N. H.

CIRCLE 203 ON READER-SERVICE CARD FOR MORE INFORMATION

Pulse Transformer

Has 0.02 μ sec Rise Time

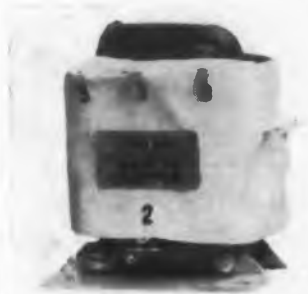

This magnetron pulse modulator transformer has a rise time of only 0.02 μ sec from 10% to 90%. Pulse width is 0.1- μ sec. Primary voltage is 1250v peak across 50 ohms. Secondary voltage is 5000v peak in the original application.

The transformer is encapsulated in epoxy resin and has a temperature range from -65° to $+150^{\circ}$ C. Size is 1-1/4" x 2" x 2-1/4". Weight is 6-3/4 oz. California Magnetic Control Corp., Dept. ED, 7245 Atoll Ave., North Hollywood, Calif.

CIRCLE 204 ON READER-SERVICE CARD FOR MORE INFORMATION

To Wind Coils of "INVISIBLE WIRE"

(or other minute
precision operations)



At the Hathaway Instrument Company, tiny galvanometer coils are wound with wire so fine that it is almost invisible to the unaided eye. Ingenious tooling and use of an AO Stereoscopic Microscope assure fast, precise workmanship.

These unique AO Microscopes provide two complete optical systems (one for each eye) to enhance the perception of depth and to provide three-dimensional reality plus an exceptionally wide field of view. Unlike ordinary microscopes, objects and movements are *not* inverted. Instead they appear in their natural directions. Because AO Stereoscopic Microscopes are unequalled for fabrication, assembly, inspection of minute precision parts, they are widely used in electronics, metal working, food and many other industries.

Let AO Stereoscopic Microscopes help you achieve high precision at low cost. Mail coupon below.

You NEED



Stereoscopic Microscopes

American Optical

 INSTRUMENT DIVISION
BUFFALO 15, NEW YORK

American Optical Company
Dept. U 219
Instrument Division
Buffalo 15, New York

Gentlemen:

Please send me further information on AO Stereoscopic Microscopes.

Signed

Organization

Address

City..... Zone..... State.....

CIRCLE 205 ON READER-SERVICE CARD FOR MORE INFORMATION

How BURROUGHS PULSE UNITS help engineers get more done



1. Save time getting started

Lose no time designing and building special pulse test equipment. To form the pulse system you need—simple or complex—simply connect together Burroughs Pulse Units. Units mount in a standard rack. Use standard cables. It only takes minutes.

2. Try new ideas

Burroughs Pulse Units are so easy to use you can try many new ideas you might otherwise never find time for. If you work with pulses, you need these new engineering tools.

3. Correct errors fast

Now if you discover an error in planning your pulse system, you lose none of your equipment investment. Simply reconnect the cables and correct the error. Burroughs units let you experiment with different arrangements.

4. Speed completion of engineering

Every day lost in engineering postpones product delivery. Save valuable engineering time. Equip your laboratory with Burroughs pre-engineered pulse units. Make it easier to meet your deadlines.

5. Use equipment over and over again

There's no waste with Burroughs Pulse Units. Usually you save on the first application. Then you can use them over and over again on different future projects—saving many times more over the life of the equipment.

CAN BURROUGHS HELP YOU ?

If you have an engineering problem involving pulses, write Burroughs. Without charge, we'll engineer your system for you, showing what Burroughs Pulse Units you need and how much they cost. Prove to your management how much you can save and how much more you can get done. Write today or send coupon.

ENGINEERS: The Electronic Instruments Division of the Burroughs Corporation now offers excellent opportunities to experienced electronic development engineers. Write Engineering Manager.

Burroughs CORPORATION

ELECTRONIC INSTRUMENTS DIVISION

Dept. 4-J, 1209 Vine St., Phila. 7, Pa.

Send me literature on Burroughs Pulse Units.

Name.....

Position.....

Company.....

Street.....

City.....Zone....State.....

CIRCLE 206 ON READER-SERVICE CARD FOR MORE INFORMATION

Crystal Microphone

Has Selective Base Boost



This crystal microphone, Model CR BB, acoustically amplifies frequencies between 40cy and 150cy up to 12db. The 60cy hum picked up in some equipment can be reduced considerably by adding 60cy base boost to the microphone and turning down the base tone control of the equipment. The frequency band to be amplified is selected by a control knob on the microphone.

The acoustically amplified bass can be set to compensate for deficiencies inherent in many recording and PA systems. It has a smooth bass response to below 60cy without the accompanying 60cy hum. It exceeds the boost of the expensive velocity (ribbon) microphones in the ability to bring out the low frequencies in the voice. With this microphone, it is not necessary to speak "close-in" as it is with the velocity type.

Although it can be set to amplify the lowest piano notes, when desired, its sharp-cut off characteristics below 40cy eliminate the pick-up of rumble and other similar extraneous sounds. Frequency response is 30-12,000cy, output is -52db. Dimensions are 1-1/2" x 6-1/2". Frank L. Capps & Co., Inc., Dept. ED, 20 Addison Pl., Valley Stream, N. Y.

CIRCLE 207 ON READER-SERVICE CARD FOR MORE INFORMATION

Ceramic Disk Capacitors

For Automation



These three ceramic disk capacitors are intended specifically for automation. Closest to the conventional disk ceramic is a pin-terminal type which has short, stiff terminals 3/16" long held at predetermined lead spacings. (upper right in photograph). This capacitor is furnished either in bulk or in "Tube-Paks" for direct magazine loading in component insertion machines.

The taper tab terminal unit (shown at lower right) is also intended for automatic insertion machines and is furnished in "Tub-Paks" if required, the flat terminals are designed to jam into chassis slots so the capacitors will be held firmly during subsequent operations prior to dip soldering. The diametral lead disk capacitor (shown at left) is intended for tape loading in magazines; tape-loaded capacitors then have their leads precut to size and are automatically inserted by machinery. Sprague Electric Co., Dept. ED, 347 Marshall St., North Adams, Mass.

CIRCLE 208 ON READER-SERVICE CARD FOR MORE INFORMATION



American Electric Model 313

COMBINATION DRIVE MOTOR AND BLOWER BUILT TO USAF SPECIFICATION 32590

This rugged, totally enclosed miniature combination drive motor and blower develops 1/2 hp at 7200 rpm, continuous duty. It operates on 3 phase, 400 cycle current at 200 volts. Teflon insulated for ambient temperature range from -65° C to 112° C. Weighs only 4.2 oz. Approx. overall length 5". Flange dia. 3 1/2".

Many Other Models Fully Developed

American Electric Miniatures are available for operation on 60, 400, 1600, or 2000 c.p.s. or on variable frequencies from 320 to 1200 c.p.s.

TWO TYPES:

INDUCTION—Output torque range from 1/2 in. oz. to 120 in. oz.

SYNCHRONOUS (Hysteresis or Reluctance Models) Output torque range from .01 in. oz. to 16 in. oz.

Ask for quotations on special requirements!



MODEL 162DA AXIAL FAN MOTOR—Totally enclosed, panel mount, screened intake, high temp. operation 20 CFM N.A.F.M. at free air. O.D. 1.45", 115 V., single phase, 400 cycle, or variable frequency models.



MODEL 430 AIRCRAFT DRIVE MOTOR—1/12 h.p. 11,000 r.p.m. Teflon insulation. -65° F. to +160° F. Completely qualified to MIL 7969 specs.



MODEL 323 ELEVON ACTUATOR—Develops 1/2 h.p. at 11,200 rpm. 200 V. line-to-line, 3 phase, 4 wire, 400 cycles. Teflon insulated for -65° F. to +160° F. operation. Meets MIL M 7969 specifications.



MODEL 201D HYSTERESIS SYNCHRONOUS MOTOR—For Reference Timing Applications 12,000 r.p.m., 5 to 25 gm. cm. torque. Plain or geared shaft extensions.

FIELD ENGINEERING OFFICES in all major industrial areas in the United States and Canada.

American Electric Motors, Inc.

Miniature Components Division of



4811 Telegraph Road, Los Angeles 22, California

CIRCLE 209 ON READER-SERVICE CARD

Custom Tailored FOR YOU!

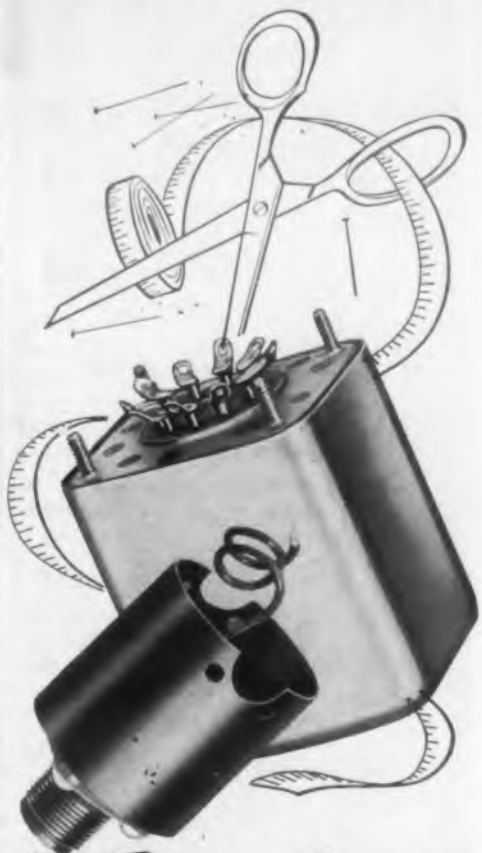

Electron FILTERS

Electron Products manufactures radio interference filters that are tailored to the exact application for which you need them. These filters are potted and impregnated in "Epicon"® which allows for the widest possible temperature ranges with low insertion loss. The units are resistant to extreme shock and vibration.

Because Electron filters are *built* to the highest quality standards and are *designed* to fit your specific requirements they will give the *best* possible service in the *smallest* amount of space.

We solicit your inquiries.

**Our own improved exclusive formula epoxy resin.*

ELECTRON PRODUCTS, INC.

SALES OFFICE: 1220 E. Green St., Pasadena 1, Calif.
FACTORY: 919 Riverside Drive, Los Angeles 31, Calif.

CIRCLE 210 ON READER-SERVICE CARD

ELECTRONIC DESIGN • September 1955

Lab Amplifier

With Bandwidth of 1cy to 10Mc



The "10Mc Laboratory Amplifier" is designed for application in color TV development, nuclear instrumentation, digital computer circuit development, and general

wideband circuit problems. It has built-in, front panel, controlled options of high or low output and input impedances, and continuous variable gain control. Provision is also made for external line terminations.

Bandwidth is from less than 1cy to 10Mc (3db), with overshoot less than 5% and compression maximum of 5% at maximum output. Tilt is less than 1% for 60cy square wave input. Maximum output is 150v peak-to-peak with gain of 40db. The unit is supplied complete with electronically regulated power supply and packaged suitable for rack or bench use. American Electronic Laboratories, Inc., Dept. ED, 641 Arch St., Philadelphia 6, Pa.

CIRCLE 211 ON READER-SERVICE CARD FOR MORE INFORMATION

Potentiometers

In Nine Single-Turn Models

The "S1" Series is a complete line of single-turn potentiometers, including nine models with a wide range of specifications, in diameters from 1/2 to 3". They are gangable continuous mechanical rotation units. The illustration shows five units coupled together. Mechanical stops are available on all models.



Specifications of the S1-5000 units include: housing diameter of 1"; housing length, 5/8"; mechanical rotation, 360°; electrical rotation, 352° ±5°; resistance range, 5 ohm to 50k; standard resistance tolerance, ±5%; linearity tolerance ±2%; wattage rating 1.5w; ambient temperature range, 55° to +85°C; weight per section, 1.3 oz; starting torque (max), 0.75 oz-in; and running torque (max), 0.7 oz-in. All housings are aluminum alloy, precision machined, black aluminized. General Scientific Corp., Dept. ED, 12027 Vose St., North Hollywood, Calif.

CIRCLE 212 ON READER-SERVICE CARD FOR MORE INFORMATION

SYSTEM TRACERS

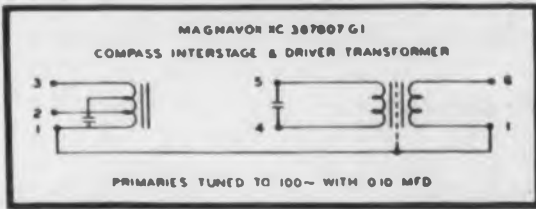

SPECIFICATION DATA

Cannon Electric dc Solenoid
CANNON ELECTRIC CO. - LOS ANGELES 31, CALIFORNIA

CATALOG NUMBER	
DRAWING NUMBER	
CONTINUOUS POWER MAX	Watts
TEMP. MAX	°F DUTY
VOLTAGE	V FORCE
RESISTANCE	ohms AT

WIRING DIAGRAM

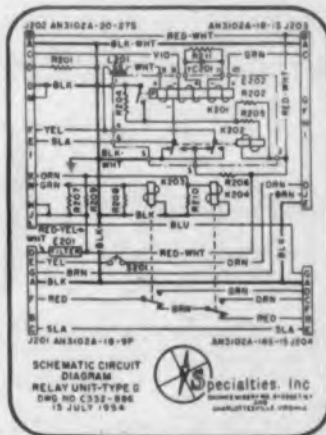

SERIAL NUMBERS

SIGNAL CORPS U.S. ARMY
RADIO RECEIVER TRANSMITTER
RT 125 / PRC 8
SERIAL NO. _____ ORDER NO. 16824-PH-51
EMERSON RADIO AND TELEGRAPH CORPORATION

FREQ. _____ MC.

PRODUCT IDENTIFICATION

<p>FISHER RADIO CORPORATION - N. Y.</p>	MODEL 50-C-3
	105-125 V - 50-60 CY
	15
	WATTS

What can
we make
for you
?



IS YOUR PROBLEM REALLY DIFFERENT?

Tell us what your identification problem is and let our engineers help you solve it. Write today for a free sample and find out why Metal-Cals are industry's most modern and economical method of identification.

Metal-Cal®

Patents Pending

METAL-CAL Manufactured by C & H Supply Co.
415 East Beach Avenue, Inglewood, California

I am interested in Metal-Cals.

Send literature and samples. Have a representative phone or call on me at (time desired) _____

Name _____

Company _____ Dept. _____

Street _____

City _____ Zone _____ State _____

CIRCLE 213 ON READER-SERVICE CARD FOR MORE INFORMATION

*a new lower cost precision camera
for economical single-frame
oscilloscope recording*

THE AREMAC RECORDOSCOPE 1414

utilizes the new small Polaroid
self-developing magazine, delivers
black-field prints in 60 seconds*

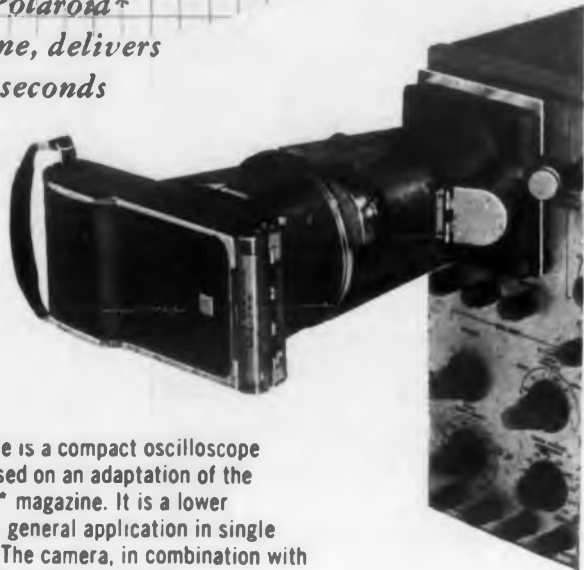

The new Aremac 1414 Recordoscope is a compact oscilloscope camera of special configuration based on an adaptation of the 60-second self-developing Polaroid* magazine. It is a lower cost model designed principally for general application in single frame oscilloscope data recording. The camera, in combination with a packaged accessory group, mounts easily and sturdily on any standard 3" or 5" scope.

A single camera is capable of servicing several scopes of different manufacture when used in conjunction with scope-mounted Aremac swing-away hoods. Overall versatility, plus fine technical performance at a new lower cost, makes the 1414 Recordoscope a standard engineering instrument requirement for electrical, electronic, industrial and basic r & d laboratories.

*POLAROID IS THE REGISTERED TRADE NAME OF THE POLAROID CORPORATION



1185-C MANUAL RECORDOSCOPE



1185-B AUTOMATIC RECORDOSCOPE

The 1185-B RECORDOSCOPE features automatic magazine-shifting operation. Camera pre-sets to record from 3-to-16 traces on each 3" x 4" print. Automatic movement is triggered by remote control, cable or manual shutter release. The 1185-C... a manually operated version for use where applications do not justify the automatic-magazine shifting feature.

*Write for complete technical literature on
Aremac's Oscilloscope Data Recording Cameras.*

Aremac ASSOCIATES

Manufacturers of Precision Mechanical and Optical Instruments
50 SOUTH SAN GABRIEL BLVD. • PASADENA 10, CALIF

AREMAC SALES REPRESENTATIVES IN PRINCIPLE U. S. CITIES

CIRCLE 214 ON READER-SERVICE CARD FOR MORE INFORMATION

Lettering Machine

For Prototypes; Short Runs



The Model 304 lettering machine is for marking chasses, panels, resistor sub-assemblies, and related items. It is designed for the manufacturer of prototype and other limited production models, and provides high

quality lettering and line art without the expense, time, and trouble involved with silk screen and rubber stamp methods.

Used with ordinary mechanical lettering pens and templets, only a few minutes' practice are necessary for its operation by unskilled personnel. Attachments are available for marking on a radius at any angle and for lettering below the templet plane. It is capable of marking chasses up to 20" square x 4" deep. Jansky & Bailey, Inc., Dept. ED, 1339 Wisconsin Ave., N. W., Washington 7, D. C.

CIRCLE 215 ON READER-SERVICE CARD FOR MORE INFORMATION

Ceramic Rotary Switch

In Miniature Size



Series M Ceramic Rotary Switch, a miniature unit, has numerous applications on guided missiles, airborne equipment, and portable and mobile ground equipment. It occupies

a panel area of less than 1-1/2 sq in and incorporates features that ensure long life and trouble-free operation. Coin silver contacts, rotors, and slip rings are provided for low contact resistance and excellent electrical characteristics.

Ceramic parts are silicone impregnated to withstand extreme humidity. Sturdy solder terminals are supplied for wiring.

The single-pole style has 18 shorting-type contact positions available in many combinations; several sections may be ganged by adding supplementary wafers. Two or three poles per deck may also be obtained. Flash-over voltage at 60cy is 1000v peak, and the current carrying capacity is 2amp. The Daven Co., Dept. SZ, 191 Central Ave., Newark, N. J.

CIRCLE 216 ON READER-SERVICE CARD FOR MORE INFORMATION

NEW

radically new
all metal
vibration mount

withstands repeated
15-G
shock loading
(meets all requirements
of MIL-C-172-B)

yet weighs less than
conventional mounts



Resonant frequency less than 10 cps... magnification factor less than 1/2 at resonance with no double peaks. "QPL", of course.

FINN

Pioneers in *lightweight shock and vibration controls*

T. R. FINN & CO., Inc.
200 Central Avenue
Hawthorne, New Jersey

Send for complete catalog

CIRCLE 217 ON READER-SERVICE CARD

As An Electronic Engineer

How's your GRASP?



You work with complex ideas. Do you "see" them quickly enough? You can with the new NORMA Pen and 3-Pencil Combination. It writes in 3 colors of pencil and as a pen . . . gives greater visual clarity . . . saves time! Guaranteed for mechanical perfection by NORMA, makers of quality Multicolor Pencils for over 25 years.

ACTUAL SIZE
Yellow or white leads also available

CLICK Black Pencil!
CLICK Blue Pencil!
CLICK Red Pencil!
CLICK IT'S A PEN!

The New

norma

pen and 3-pencil COMBINATION

#604—in Chrome \$5.95

INTRODUCTORY Offer: Extra ink refill FREE!

If not available at your dealer, order direct from:

NORMA PENCIL CORP., Norma Bldg., Dept. N
137 West 14th St., New York 11, N. Y.

Please send #604 NORMA PEN and 3-PENCIL COMBINATIONS at \$5.95 each. I desire them engraved at 50c each.

NAMES FOR ENGRAVING: (please print)

Send information on other models of NORMA —from \$5.00 up

I enclose Check Money Order Amt. \$ _____
(if in N.Y.C. add 3% tax)

NAME _____

ADDRESS _____

CITY _____ ZONE No. _____ STATE _____

CIRCLE 218 ON READER-SERVICE CARD

Torque Tester

For Instrument Bearings



This ball-bearing torque tester meets the requirements of Military Standard MIL-STD-206, as well as the recommendations of the American Ordnance Association. It will measure positive and negative

torques, with a sensitivity as low as 7mg-mm. Full scale ranges are adjustable from 700-0-700mg-mm to 50,000-0-50mg-mm. The tester will indicate torques ranging from those having low frequency due to errors in race geometry to those having high frequency due to race roughness.

With experience in analyzing records, an operator is able to distinguish such torques as caused by rough bearing races, geometrical errors in races, Brinell marks, and separator friction. The unit accommodates almost any instrument ball bearing size. The overall accuracy is within 5%, and readings are independent of line voltage variations. Sunshine Scientific Instrument, Dept. ED, 1810 Grant Ave., Philadelphia 15, Pa.

CIRCLE 219 ON READER-SERVICE CARD FOR MORE INFORMATION

Turns-Counting Dial

Weighs only 3 oz



The "Duodial" Series R turns-counting dial, with a diameter of only 2", provides 25 and 40-turn capacities for setting and indicating the revolutions of multi-turn components. Total weight is 3 oz.

Two coaxial dials form the unit: the inner dial counts hundredths of each turn; the outer dial counts the number of completed turns. The knob of the "Duodial" is part of the inner dial and connects directly to the shaft of the device, eliminating backlash.

The device is suitable for use with any multi-turn unit that has a 1/4" shaft. A built-in locking device to prevent rotation of the dials and driven unit is available at small extra cost. Helipot Corp., Dept. ED, 916 Meridian Ave., S. Pasadena, Calif.

CIRCLE 220 ON READER-SERVICE CARD FOR MORE INFORMATION

CIRCLE 221 ON READER-SERVICE CARD >

GENERAL ELECTRIC ANNOUNCES . . .

NEW, faster, smaller micro-miniature relay

LIGHT WEIGHT, SMALL SIZE: Weighs only .35 ounces and measures .34" x .781" x .84". This tiny relay utilizes balanced armature and simple design, giving you quality and more reliable operation at a consistently high level.

HIGH CONTACT RATING: For low contact resistance and long life, fine silver is used . . . contact rating is 2 amps resistive load at 30 V d-c or 115 V a-c . . . contact arrangement is 2PDT.

FAST OPERATION: With rated voltage on coil, operating time is 1.5 milliseconds. By adding series resistance in coil circuit or by applying high voltage pulse to coil . . . pickup time will be less than 1 millisecond!

LOW OPERATING POWER: 300 milliwatts for standard model . . . 150 milliwatts for current sensitive model.

HIGH SHOCK; VIBRATION RESISTANT: G.E.'s balanced armature and high tip forces withstand shock of over 50 g's and vibration of 10-55 cp's at .12" maximum excursion and 55-500 cp's at 20 g's acceleration.

HIGH TEMP OPERATION: This new micro-miniature relay gives you continuous and efficient operation at ambient temperatures of 125° C.

G.E.'s line of aircraft-type relays will help solve your space-weight problems. Contact your G-E Apparatus Sales office for more application information. General Electric Company, Schenectady 5, New York.

MAIL THIS COUPON FOR G-E RELAY DATA . . .

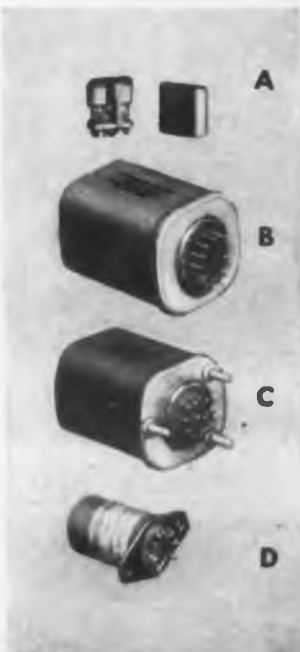

- A: Micro-miniature Relay—Bulletin GEA-6346
- B: High Speed Relay—Bulletin GEA-6212
- C: Miniature Relay—Bulletin GEA-6213
- D: Subminiature Relay—Bulletin GEA-6211
- E: Have Sales Engineer contact me.

Section E792-2, General Electric Company,
Schenectady 5, New York

NAME TITLE

COMPANY

ADDRESS

CITY STATE

GENERAL  ELECTRIC

OPPORTUNITY is knocking!

... for two eager, creative engineering editors to join the fastest growing publication in the electronic industries. ELECTRONIC DESIGN's expanding editorial services have created two openings on our editorial staff. Both men should have the following basic qualifications:

- *Electrical engineering graduate with training in electronics.*
- *Some practical design experience as he will be editing and writing for design engineers.*
- *Proven ability to write clearly, concisely, and logically.*
- *Pleasing personality and appearance as he will be visiting plants and meeting people as well as working with a closely knit staff.*
- *A real desire to make technical publishing a career.*

This is an opportunity for men who are seeking personal growth, job satisfaction and an outlet for creative editorial ideas. If you think you qualify, tell us why. Send us a resume of your background, experience, approximate salary requirements, as well as some evidence of your ability to write. Replies will be treated confidentially.

Edward E. Grazda, Editor
19 East 62nd Street
New York 21, New York

CIRCLE 222 ON READER-SERVICE CARD FOR MORE INFORMATION

Large Screen Oscilloscope With 40 Input Channels

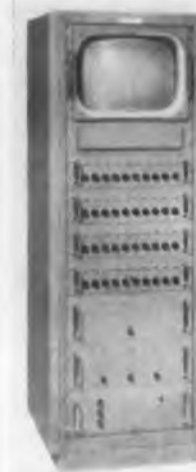

This large screen oscilloscope provides a vertical line graph 9" high x 12" wide on a 17" cylindrical-face cathode ray tube. Each vertical line terminates in a dot to permit rapid and accurate readability. The output of each of 40 amplifiers is scanned each 1/4sec. The vertical length of each line indicates the peak value of the maximum a-c input voltage which existed during the previous 1/4sec. A calibrated graticule is provided in front of the cathode ray tube for easy reading of voltage values

and channel identification.

The frequency response of each channel is within 2% from 10cy to 10ke and down no more than 3db at 50ke. Each channel input is high impedance, single ended with one side grounded. The maximum sensitivity for each channel is 45mv peak for full 9" vertical deflection. An attenuator and a "remote" switch is provided for each channel. Channel switching is accomplished with a motor-driven switch.

All equipment and power supplies are self contained, operate from 115v 60cy single phase, and are mounted in a sturdy relay rack 23-1/2" wide x 23" deep x 68" high. Net weight is 435 lbs. Electro-mec, Inc., Oscilloscope Dept. ED, 5121 San Fernando Rd., Los Angeles 39, Calif.

CIRCLE 223 ON READER-SERVICE CARD FOR MORE INFORMATION

Sealed Relay 6PDT Unit Withstands 60g Shock



The Type FC-6 6pdt Relay withstands 0 to 2000cy vibration to 30g, and withstands 60g shock without contact opening. It is designed to exceed MIL-R-5757B and to meet MIL-R-25018 and MS-24115 specifications. It is available for both 85°C and 125°C ambients. Nominal coil voltage is 26.5v d-c.

Features include: simplicity of moving parts; extreme rigidity; high contact pressures; low contact bounce; plenty of contact over-travel; and a complete absence of internal gaseous materials which might vaporize and cause contact unreliability. The construction, which permits lower price, incorporates varied safety factors. Struthers-Dunn, Inc., Dept. ED, Pitman, N. J.

CIRCLE 530 ON READER-SERVICE CARD FOR MORE INFORMATION

ELECTRONIC DESIGN • September 1955

Transmitting Tetrode

Dissipates 65w



The QY3-65 is a transmitting tetrode with a rated anode dissipation of 65w and a maximum operating frequency of 250Mc (150Mc full rating). The tube is of compact all-glass construction (seated height 4"). It has a quick-heating thoriated tungsten filament (6.3v, 3.5amp), which makes it suitable for aircraft and marine mobile applications where

conservation of power during standby periods is important.

The tube is suitable for use as an r-f drive, power amplifier, or power oscillator, or as an a-f power amplifier. It may also be used as a linear r-f amplifier for single sideband working. R-f power outputs up to 280w are obtainable under CW conditions, and power gain is high. Plate voltages ranging from 600v to 3000v may be employed. Mullard, Ltd., Dept. ED, Century House, Shaftesbury Ave., London, W.C.2, England.

CIRCLE 531 ON READER-SERVICE CARD FOR MORE INFORMATION

Field Intensity Meter

Covers 14-250kc Range

The NM-10A Radio Interference and Field Intensity Meter covers a 14-250kc frequency range. Designed for lab or field use, it is available with a complete selection of accessories. It measures field intensity of carrier current systems, and signal levels in such



equipment. It can be used to survey conducted or radiated interference. The supply permits operation from 105-125v or 210-250v, 50-1600cy. The NM-10A is identical to the Navy AN/URM-6B, a Class One Instrument. Stoddart Aircraft Radio Co., Inc., Dept. ED, 6644 Santa Monica Blvd., Hollywood 38, Calif.

CIRCLE 532 ON READER-SERVICE CARD FOR MORE INFORMATION

If you need a special component, send a brief statement of your specifications addressed to Bulletin Board, Electronic Design, 19 E. 62nd St., New York 21, N. Y. Include your complete address.

ELECTRONIC DESIGN • September 1955



Collins PRECISION VFO— Ready-to-Install ACCURACY and STABILITY

Accuracy and stability — the two most important features in Oscillator performance — can now easily be incorporated into your high-performance design, cutting engineering time to a minimum. Whether your project is a transmitter, receiver, test equipment, frequency standard or others, Collins offers a ready-to-install Variable Frequency Oscillator known for its linear calibration and stable output.

- Outstanding Stability
 - Average 24-hour stability under fixed-station conditions .003% or better.
 - Single-knob tuning with backlash of less than one cycle in 20 kc through use of mechanical loading and precision ballbearing construction.
 - Frequency modulation less than 100 cps under 5 G's acceleration at 60 cycles.
- Compact, ready-to-operate design.
- Linearity of calibration better than 1 kc throughout tuning range with multiple-turn tuning.
- Sealed against atmospheric changes.
- Available in fundamental ranges from 300 kc to 4 mc. Individual models achieve up to 2 to 1 tuning ratio.
- Uses standard power supply voltages.
- Each unit 100% tested under lab conditions to rigid specifications.
- Ease of installation.

Frequency Ranges Available

70E-1	1.0-1.5 mc
70E-10	600-800 kc
70E-12	1.955-2.955 mc
70E-15	2.0-3.0 mc
70E-20	1.65-2.05 mc
70E-21	300-400 kc
70E-25	2.0-4.0 mc
70H-2	2.455-3.455 mc
70H-3	1.5-3.0 mc

For requirements other than the above ranges or for detailed specifications write to the Collins office nearest you

COLLINS RADIO COMPANY CEDAR RAPIDS, IOWA

261 Madison Avenue, NEW YORK 16, NEW YORK
1200 18th Street N.W., WASHINGTON, D. C.
1930 Hi-Line Drive, DALLAS 2, TEXAS
2700 W. Olive Avenue, BURBANK, CALIFORNIA
COLLINS RADIO COMPANY OF CANADA, LTD.
77 Metcalfe Street, OTTAWA 4, ONTARIO



CIRCLE 533 ON READER-SERVICE CARD FOR MORE INFORMATION

Your
future
in

MICROWAVES

Positions
are
open
for
ENGINEERS
and
PHYSICISTS
qualified
in this
area.

THE MICROWAVE LABORATORY
at Hughes conducts fundamental research and long-range development in the field of microwave components and techniques. The antenna program is concerned with research on linear and two-dimensional arrays of slot radiators; transmission and radiation of surface-guided waves; very high resolution radar antennas; and the development and engineering of air-borne communication, navigation and fire control antennas.

INSTRUMENTATION
is developed for new measuring equipment to meet needs of the program. This has included development of automatic impedance and antenna pattern recorders, microwave power supplies stabilized in amplitude and frequency, microwave circuitry, and microwave applications of ferrite devices.

Scientific and
Engineering Staff

HUGHES

RESEARCH AND DEVELOPMENT
LABORATORIES

Culver City
Los Angeles County
California

CIRCLE 224 ON READER-SERVICE CARD FOR MORE INFORMATION

110

Gain-Standard Antennas Cover 100-50,000Mc Spectrum

Parabolas (as illustrated), horns, dipoles, and dipole arrays with precision gain calibration to 0.2db are offered by this firm as accurate laboratory tools to be used in the determination of propagation gain. The various types cover the frequency spectrum from 100Mc to 50,000Mc.



From 2600Mc to 50,000Mc, and for gains of 20db and more, parabolas are generally used. For lower gains in the same frequency region, horns are most widely useful, and can be supplied on short delivery in a series of nine sizes covering the commonly-used microwave frequencies.

For the frequency spectrum down to 100Mc, dipoles and dipole arrays are provided. Special requirements as to frequency, gain, and mechanical design can be met. Color Television, Inc., Dept. ED, 932 E. San Carlos Ave., San Carlos, Calif.

CIRCLE 225 ON READER-SERVICE CARD FOR MORE INFORMATION

Tone Units

For Remote Control and Metering



"Audio-Tone" Signaling Units are available in a completely new physical package of modular design. These units are used for transmitting and receiving signaling, dialing, telemetering, supervisory controls, and other information. Up to 48 on-off or raise-lower functions can be controlled over a single circuit—telephone line, microwave, or v-h-f radio—by the use of these devices, which operate in the range of 425 to 6025cy at intervals of 100 or 150cy.

The units are available in various combinations of transmitters and receivers. The frequency determining element of the tone generator is a separately mounted small unit, as is the filter for each receiver. Hammarlund Manufacturing Co., Inc., Dept. ED, 460 W. 34th St., New York 1, N. Y.

CIRCLE 226 ON READER-SERVICE CARD FOR MORE INFORMATION

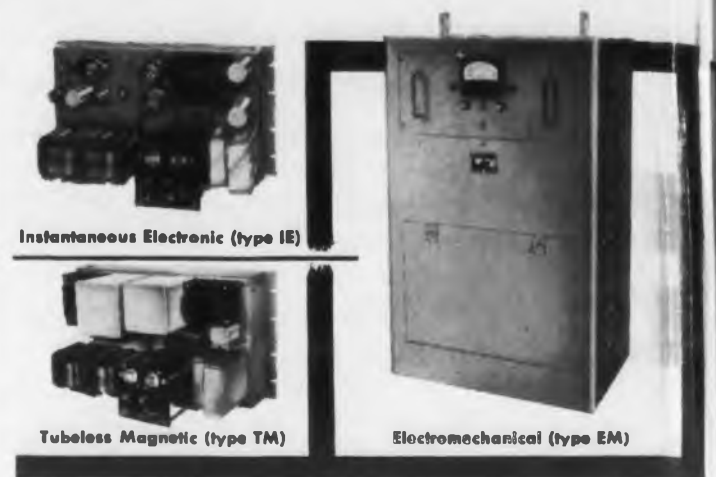

STABILINE AUTOMATIC VOLTAGE REGULATORS

*Designed to
Maintain
Root Mean Square
Voltage*

Here is a complete line of automatic voltage regulators designed with the application in mind . . . with operating characteristics that *always* equal or better the nameplate rating.

Of special importance is the fact that STABILINE maintains the root mean square voltage — the voltage rating for which all electrical equipment is designed. Before you purchase automatic voltage regulation equipment, make sure it is R.M.S. responsive.

We have detailed information about STABILINE automatic voltage regulators. Send the coupon for your copy of our Bulletin S351.



**THE
SUPERIOR ELECTRIC
COMPANY**
1709 Reynolds Avenue, Bristol, Conn.

CIRCLE 227 ON READER-SERVICE CARD FOR MORE INFORMATION

free send
for the
most widely used
electronic supply guide

ALLIED'S
COMPLETE 324-PAGE
1956 CATALOG



SEND FOR IT!

your buying guide to the world's largest stocks
of **ELECTRONIC SUPPLIES FOR INDUSTRY**

Here's how to simplify and speed *all* your purchasing of electronic supplies and equipment: send your orders to us for fast shipment from the world's largest stocks of electron tubes (all types and makes), transistors, test instruments, audio equipment, electronic parts (transformers, capacitors, controls, etc.). Our expert Industrial supply service saves you time, effort and money. Send today for your **FREE** 1956 ALLIED Catalog—the *complete* Buying Guide to the world's largest stocks of quality Electronic Supplies for Industrial use.

one complete
dependable source
for Everything
in Electronics

ALLIED RADIO

100 N. Western Ave., Dept. 69-J-5
Chicago 80, Illinois

Send for
**FREE
CATALOG**

CIRCLE 228 ON READER-SERVICE CARD FOR MORE INFORMATION

ELECTRONIC DESIGN • September 1955

Precision INSTRUMENT SWITCHES

STOCK MODELS FOR *YOUR* JOB

There's nothing like stock models of Shallcross Instrument Switches for cutting equipment cost and design problems. For over 20 years Shallcross has made scores of basic switch types with countless variations for practically every electric-electronic application. Many unique types—usually "Special items" with other manufacturers—can quickly be supplied by Shallcross from stock. For a fast solution to any problem involving rotary switches, drop a line to SHALLCROSS MANUFACTURING CO., 526 Pusey Ave., Collingdale, Pa.

Shallcross

CIRCLE 229 ON READER-SERVICE CARD FOR MORE INFORMATION

save with standard



UNBRAKO

BUTTON HEAD SOCKET SCREWS

BUTTON HEAD FEATURES
designed for applications where countersinking is not practicable
heat treated alloy steel for strength
low head height for streamlining designs
accurate hex sockets for nonslip drive and freedom from marred heads or mutilated work
fully formed threads—Class 3 fit

Save time and money by using standard UNBRAKO Button Head Socket Screws. Stocked in standard sizes—#8 through 5/8"—by your authorized UNBRAKO industrial distributor. Ask him for Bulletin 856. Or write STANDARD PRESSED STEEL Co., Jenkintown 12, Pa.

UNBRAKO SOCKET SCREW DIVISION

SPS

JENKINTOWN PENNSYLVANIA

CIRCLE 230 ON READER-SERVICE CARD FOR MORE INFORMATION

ELECTRONIC DESIGN • September 1955

Guided Missile Timer Spring-Wound Unit



This small timer is specifically suited for airborne equipment or missiles. It contains a spring-wound timer and an spdt switch which is thrown at the end of the set time.

The unit is available with three different types of starting actuators: pull wire, dimple (explosive) motor, or G weight actuators; a dimple unit is shown. The timer is suitable for mounting on a panel or plate in a manner similar to the way small potentiometers are mounted. Maximum time delays vary from 1sec to 6 minutes in the various models. The switch is rated at 5amp 250v non-inductive.

This timer will operate at 40g, -60 to +200°F, with an accuracy of ±10%. It measures 1-1/2" diam x 1-3/16" deep behind the panel. Finishes and materials conform to military specifications. Raymond Engineering Laboratory, Inc., Dept. ED, Smith St., Middletown, Conn.

CIRCLE 231 ON READER-SERVICE CARD FOR MORE INFORMATION

Thermal Time Delays Adjustable Hot-Wire Units



Time delay intervals from 1/10 up to 5sec are provided by the Series II Thermal Relays, using the hot-wire operating principle. Although the relays are completely hermetically sealed, their time delay intervals are adjustable by means of a screw accessible from the top. Recovery rate

is rapid, and the units are ready to time a new cycle after cooling only a few seconds. Standard energizing voltages range from 6.3 to 28v, and the relays may be energized interchangeably on d-c or a-c of any frequency.

Size is 3/4" diam x 2-3/8" high. Both flanged and 7-pin miniature plug-in forms are available. Weight is 1 oz. Contacts are spst, either normally open or normally closed. Contact rating is 3amp at 115v a-c. Relays are compensated for ambient temperatures from -70 to +100°C, and are designed to withstand the shock and vibration encountered in many military applications. G-V Controls Inc., Dept. ED, 28 Hollywood Plaza, East Orange, N. J.

CIRCLE 232 ON READER-SERVICE CARD FOR MORE INFORMATION



The most advanced developments in electronics are being made in the sphere of airborne radar and related ground control systems because of military emphasis. Further applications of electromechanical techniques in these fields are creating new openings in the Systems Division of Hughes Research and Development Laboratories.

Engineers who have demonstrated ingenuity and inventive ability will find interest in areas of work that call for devising reliable, maintainable, manufacturable designs for precision equipment developed at Hughes Research and Development Laboratories.

The design of this equipment, manufactured at Hughes, involves mechanical, electromechanical, electronic, microwave and computing problems. Design also requires the use of such advanced techniques as subminiaturization, unitized "plug-in" construction, with emphasis on design for volume production. Knowledge of electronic components, materials, finishes and military specifications is useful.

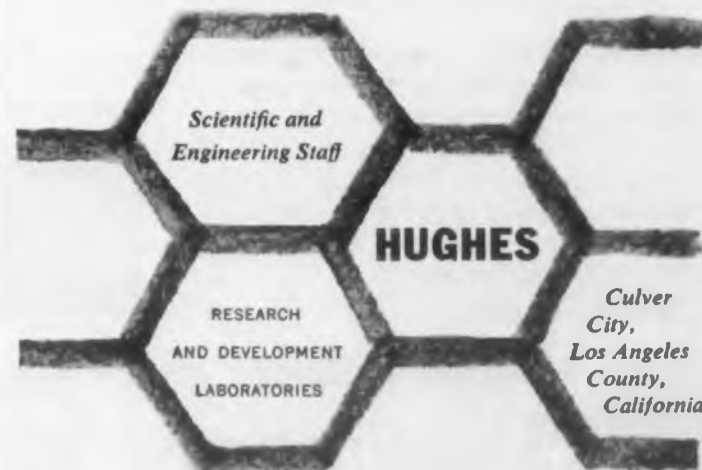

CIRCLE 233 ON READER-SERVICE CARD FOR MORE INFORMATION

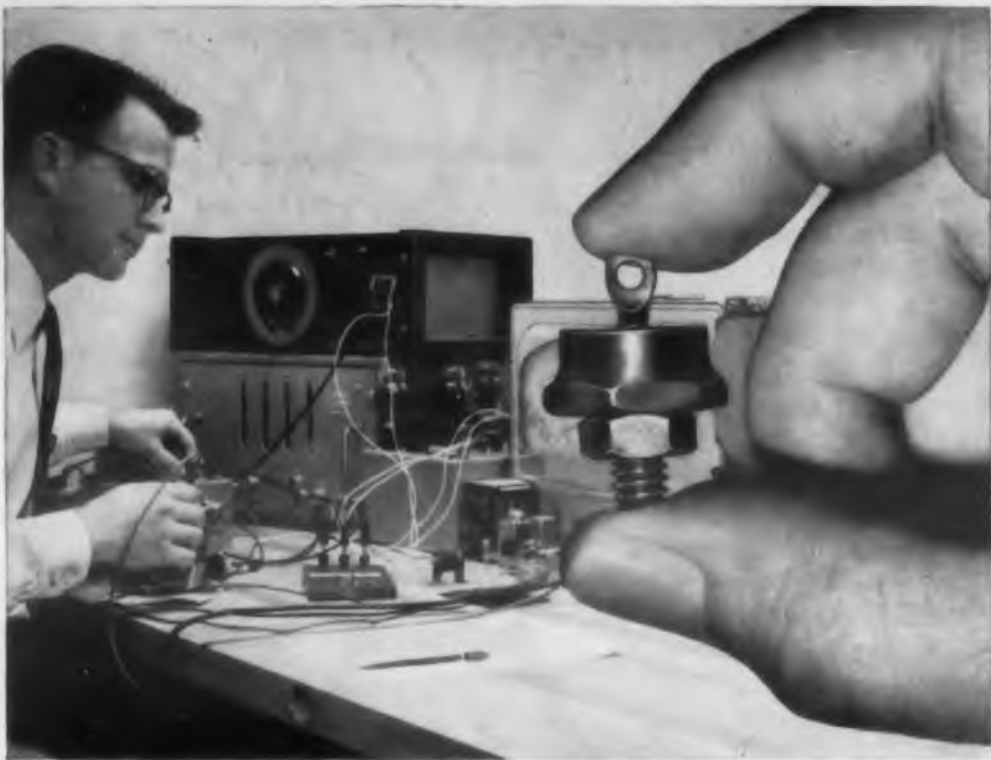

WESTINGHOUSE **NEW** SILICON POWER RECTIFIER puts you ahead...

High-temperature operation. Exhaustive tests have shown that these units are capable of operation up to 200°C with *no* detectable aging in their characteristics.

In rectifier efficiency. Forward voltage drop reaches only 0.85 volts at 40 amperes, 190°C junction temperature. Efficiency is over 99%. Ratings up to 200 volts maximum peak inverse are available in four classifications: 50, 100, 150 and 200 volts.

In compact design. Westinghouse silicon power rectifier (shown actual size above) takes only 1/50th the volume of the comparable selenium rectifier.

Write today for your free application *Facts Folder* describing the full range of silicon power rectifier characteristics. These rectifiers are available for immediate delivery. Call your local Westinghouse sales office, or write: Westinghouse Electric Corporation, 3 Gateway Center, P. O. Box 868, Pittsburgh 30, Pa. J-80002



YOU CAN BE **SURE**...IF IT'S
Westinghouse



CIRCLE 234 ON READER-SERVICE CARD FOR MORE INFORMATION

Electric Counters

For Base and Panel Mounting



The PIC-600 Series of medium-size electric counters is offered in basemount and panel mount models. Features include 50 million count life, 1000cpm rating, 7w power consumption, bal-

anced armatures for reliable operation on airborne equipment, and quiet operation with no a-c hum when energized. The units are made in 6-digit models. They are reset to zero by a single turn of the knob, and are available for practically any voltage up to 120v, a-c or d-c.

The basemount model measures 2-1/2" high x 3-1/2" x 1.668", less reset knob. The panel mount model has overall panel dimensions of 4-7/8" x 1-7/8"; overall depth behind panel is 2-23/32". Production Instrument Co., Dept. ED, 706-34 W. Jackson Blvd., Chicago 6, Ill.

CIRCLE 235 ON READER-SERVICE CARD FOR MORE INFORMATION

Jointed Rule

Also Serves as Protractor

This jointed stainless-steel 2' rule also serves as a protractor. It is a practical and useful aid for measuring longitudinal as well as angular dimensions, avoid-

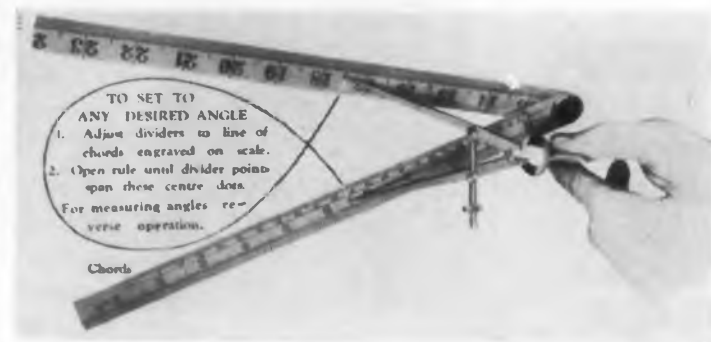

ing the difficulty of counting fine graduations.

The jointed rule has an accurate scale of chords engraved on one side from 0° to 120°, advancing by half degrees. It is also provided with two center dots, one on each blade, by which, when using a pair of ordinary dividers, the rule can be set to any desired angle; similarly, any angle can be determined. George Scherr Co., Inc., Dept. ED, 200 Lafayette St., New York 12, N. Y.

CIRCLE 236 ON READER-SERVICE CARD FOR MORE INFORMATION

If you need a special component, send a brief statement of your specifications addressed to Bulletin Board, Electronic Design, 19 E. 62nd St., New York 21, N. Y. Include your complete address.



Here are your
CANNON CONNECTORS

for **PRINTED CIRCUITS**

Available in 5 Sizes

1. DX-1052. Length 2-13/32". 10 contacts, spaced 5/32". For cards 0.057" to 0.067" thick.
2. DX-1852. Length 3-21/32". 18 contacts, spaced 5/32". For boards 0.060" to 0.071" thick.
3. DX-2252. Length 4-9/32". 22 contacts, spaced 5/32". For boards 0.060" to 0.071" thick.
4. DX-2842. Length 4-9/32". 28 contacts, spaced 1/8". For boards 0.060" to 0.071" thick.
5. DY-4453. Length 4-9/32". Double row, total of 44 contacts, spaced 5/32". For printed circuit boards 0.062" to 0.100" thick.



**Nylon plastic shells...
gold plated contacts**

DX contacts of phosphor bronze; DY the board, which enters to a depth of approximately 11/32". Each rated at 5-amp. Polarization studs provided. Flashovers 2000 and 2500 v. 60 cps ac rms.

Single-row types for boards printed on one side only, or both sides common. Double-row type for boards printed both sides having different circuits, not common.

Please refer to Dept. 143

**CANNON
PLUGS**



CANNON ELECTRIC CO., 3209 Humboldt St., Los Angeles 31, California. Representatives and distributors in all principal cities

CIRCLE 237 ON READER-SERVICE CARD

Northrup Engineers use

E-I DIGITAL IN-LINE READ-OUTS to visually display computer test positions



Small, compact decades save space; provide digital accuracy at a glance

The test console shown above is used by Northrup engineers to test missile-borne computer resistance values on a "go, no go" basis. Electrical positioning of the "go, no go" switching is displayed on two E-I Digital In-line Read-outs, to aid in locating any "no go" values which appear during the automatic cycling of the tester.

Two E-I decades, mounted in the center of the console, enable 99 positions to be displayed. Old style techniques would have required 99 pilot lights or 99 front panel switches. Important too, use of E-I In-line Read-outs assures unambiguous readings. Since test positions are displayed digitally, no interpretation is required, minimizing chance of reading error.

Adaptable to a Variety of Uses!

NO MOVING PARTS—Numbers engraved on lucite plates, arranged in depth. Only number or symbol which is edge-lighted appears in window.

GOOD READABILITY—Special techniques minimize incident lighting effects. 1-inch numerals are easily read at 30 feet.

FAST RESPONSE—Limited only by bulb response.

SMALL IN SIZE—1-inch and ½-inch models available.

NO MAINTENANCE—Other than occasional bulb replacement.

EASILY MOUNTED—Tapped holes provided for panel mounting.

1-, 2-, 3-, 4- & 5-decade models available. Write for complete information.

**ELECTRO
INSTRUMENTS
INCORPORATED**

3794 Rosecrans Street, San Diego 10, Calif.
Engineering representatives throughout
the United States and Canada

CIRCLE 238 ON READER-SERVICE CARD

Bridge Amplifier Meter Use Transistor Pre-Amplifier



The B A M - 1 Bridge Amplifier and Meter is handy for both dynamic and static work from d-c to 25,000cy with SR-4 strain gages, Statham pickups, and similar resistance-type transducers.

For static measurements, the meter on the unit is used. It is calibrated to read tension.

The scales are arbitrary with a simple system of calibration to make them read directly in terms of units being measured.

For dynamic measurements, a d-c cathode-ray oscilloscope is plugged directly into the front panel. The d-c stability is within 100mv per hour. Frequency response is flat within 5% from d-c up to 25,000cy and slowly drops off at high frequencies. Further, the instrument will drive up to 100μamp into external meters, strip chart recorders, automatic controllers, and strain galvanometers. Ellis Associates, Dept. ED, Box 77, Pelham, N. Y.

CIRCLE 239 ON READER-SERVICE CARD FOR MORE INFORMATION

Tape-Wound Core Box Made of Spun-Aluminum



A spun-aluminum core box is available for this firm's tape-wound cores, providing wall strength that assures that cores will be free from distortion and deflection after winding. The core box,

together with its silicone glass insert, is suitable for vacuum impregnating; no varnish can get into the core. These cores are unaffected by temperatures as high as 450°F.

The construction, with an inert cushioning material, makes the cores unusually shock and vibration proof. Available in 108 standard sizes, other sizes can be made to the customer specifications. They are available with Orthonol, Magnesil, Hy-Mu 80, and 48 Alloy, or other commercially available similar materials. Magnetics, Inc., Dept. ED, P. O. Box 230-E, Butler, Pa.

CIRCLE 240 ON READER-SERVICE CARD FOR MORE INFORMATION

CLIFTON - PRECISION OFFERS A SIZE 15 SYNCHRO TRANSMITTER

identical to BuOrd type 15CX4a

Except

ACCURACY SPREAD GUARANTEED 10' or LESS



The CG-15-MS-1 transmitter is interchangeable part for part with the U.S. Navy Bureau of Ordnance type 15CX4a synchro transmitter (Mark 22 Mod. 1) in every respect.

Because of quality workmanship in this unit we are able to guarantee accuracy spreads not to exceed 10'. From the chart it will be noted the majority of production units have error spreads between 5' and 8'—yet price remains exceedingly low.

Stainless steel bearings are provided for better environmental resistance.

FOR SALES INFORMATION, CONTACT:

New England: The Darbury Corp., 99 Elm St., W. Newton 65, Mass.

Southwest: Ammon & Woods Asso., 4163 Glenwick Lane, Dallas, Tex.

West Coast: Enright Engineering Co., 988 W. Kensington Rd., Los Angeles

Home Office: T. W. Shoop, Sales Mgr., Telephone (Phila.) MAAdison 6-210!

LOOK TO CPPC FOR SYNCHRO PROGRESS

CLIFTON PRECISION PRODUCTS CO. Inc.

CLIFTON HEIGHTS
PENNSYLVANIA



CIRCLE 241 ON READER-SERVICE CARD FOR MORE INFORMATION

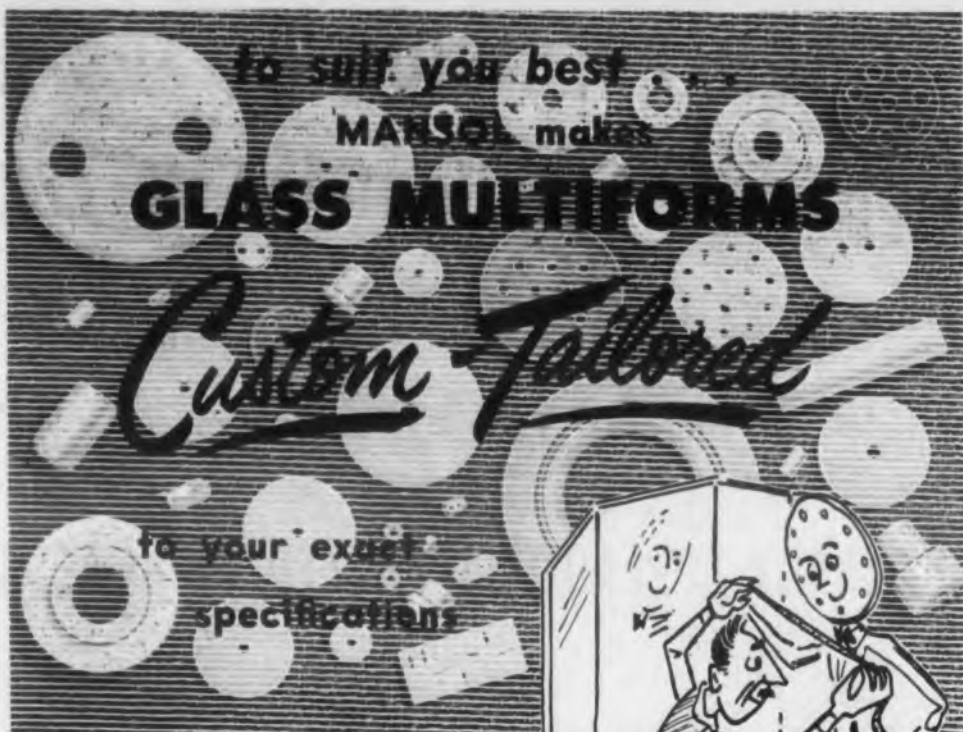

GLASS MULTIFORMS

Did you know that multiforms in glass have greater inherent elasticity to make them more shock resistant than glass tubing or pressed glass? Here are the ideal multiforms for *Iron Sealing* and *Kovar Sealing*, matching the expansion of these metals over their entire working range. They resist mercury attack, have ample mechanical strength and seal readily. Our laboratory is prepared to assist you in selecting the proper glass for any metal.

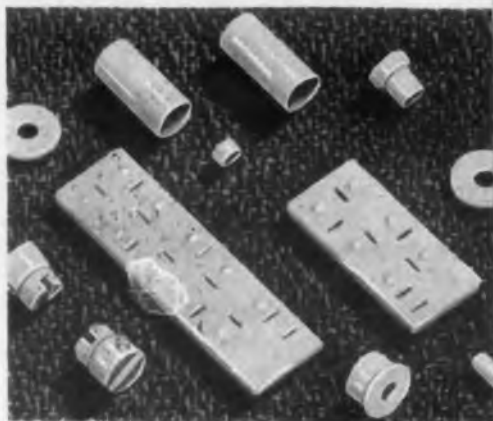

NOW USED IN MAKING OF:

Hermetic Seals, Gun Mounts, Thyatron Tubes, Diodes, transistors, Connectors, sealed-TERMINALS, Insulators and Dial Lights.

MANSOL can produce MULTIFORMS to seal to the following: Dumet, Kovar, Fernico, Rodar, Molybdenum, Mica, Platinum, #4 Alloy, Tungsten and Stainless Steel.

MANSOL also makes

MULTIFORMS of **STEATITE**

We specialize in small die-pressed ceramic parts held to the closest tolerances. All tools and dies are made in our shop to assure quick delivery.

● If you are still making your own multiforms, let Mansol help you with your multiform problems.

● Write to Dept. ED for the complete story about Multiforms, Steatite and our production facilities. No obligation, of course.



CIRCLE 242 ON READER-SERVICE CARD FOR MORE INFORMATION

Beam Power Tube

For Color TV

The 6CB5 is a high-perveance beam power tube of the glass-octal type designed especially for use as a horizontal-deflection amplifier tube in color TV receivers. It has a maximum plate-dissipation rating of 23w and a maximum grid-No. 2 input of 3.6w. These ratings, in addition to a peak positive-pulse plate-voltage rating of 6800v and a peak negative-pulse plate-voltage rating of 15v, enable a single 6CB5 to provide full deflection for the RCA-21AXP22 color picture tube.



Other electrical features are low- μ -factor, high plate current at low plate voltage, and a high operating ratio of plate current to grid-No. 2 current. Construction permits cool operation of both grids No. 1 and No. 2, with the result that emission from them is minimized. The structure also provides for maximum distribution of heat in order to prevent hot spots on the plate. Radio Corp., of America, Tube Div., Dept. ED, Harrison, N. J.

CIRCLE 243 ON READER-SERVICE CARD FOR MORE INFORMATION

30Mc Receiver

Measures Microwave Signals

The Type 110 Precision Test Receiver combines a high-gain, low-noise-figure, 30Mc receiver; a secondary standard of attenuation; and means for testing the i-f output of a wide variety of microwave mixers. When combined with a suitable local oscillator, it



becomes a sensitive detector of microwave energy. It may be used for accurate measurements of the differences in r-f and i-f power levels. Some of the applications are: noise-figure measurement, directional-coupler characteristics, SWR measurements, calibration of r-f attenuators, and selectivity characteristics of r-f filters, preselectors, etc. Airborne Instruments Laboratory, Dept. ED, 160 Old Country Rd., Mineola, N. Y.

CIRCLE 244 ON READER-SERVICE CARD FOR MORE INFORMATION

more lives
than a cat!



Quality Construction
—manufactured with
extreme care



Designed—with
fresh, new ideas
—manufactured
with the newest,
money-saving
production techniques



RELAYS

are standouts for
performance
... built to last!

One of today's most versatile relay lines, AEMCO relays are "first choice" for more than 100 of the top names in American industry. Design and construction is tops—for only the finest materials are used in AEMCO relays. Specify AEMCO and you're making your best relay buy. You'll profit by the newest production techniques that speed up delivery and save you money. You'll appreciate the prompt delivery on prototypes, the fast tool up for production. You'll find, too, that an AEMCO relay has more lives than a cat and is built to take it! Actually tested on the job, AEMCO relays are dependable and reliable . . . standouts for performance.

AEMCO relays are available in a wide variety of spring and coil combinations, operating potentials and contact ratings. Types include: Open, can, plug-in base, hermetically sealed, midgets, dual-purpose, delayed make or break, circuit control, current and potential relays. Should one of the hundreds of AEMCO relay types fail to meet your exact requirements, we will be happy to design and build a unit to meet or exceed your specifications.

WRITE TODAY

For more information on the standard AEMCO relay line, write for your free descriptive bulletin today!



AUTOMATIC ELECTRIC MFG. CO.
23 STATE ST. • MANKATO, MINNESOTA

CIRCLE 245 ON READER-SERVICE CARD

The Model TC-2 Temperature Test Chamber is a portable, self-contained, easy-to-operate unit ideal for laboratory and production line use. Write for literature.

Temperature Range: -65°F to $+350^{\circ}\text{F}$.
 Holding Accuracy: $\pm 2^{\circ}\text{F}$.
 Coolant: Dry ice, 15 lbs. capacity.
 Dry Ice Loading Port.
 Heater: Electric Strip Heater.
 Control: Thermostat, balancing heat against dry ice evaporation. Permanent thermometer.
 Test Load Access: Removable tray, with 15 through ports.
 Test Load Capacity: 600 cubic inches.
 Power Requirements: 115 volts, 5 amperes, 50-60 cycles, single phase.

STATHAM DEVELOPMENT CORPORATION
 12411 W. Olympic Blvd., Los Angeles 64, Calif.

PRICE \$550.00
 F.O.B. LOS ANGELES

MODEL
TC-2

FOR RAPID AMBIENT
 TEMPERATURE TESTS

**PORTABLE
 TEMPERATURE
 TEST CHAMBER**

CIRCLE 246 ON READER-SERVICE CARD

Power Supply

Offers Variable Frequency

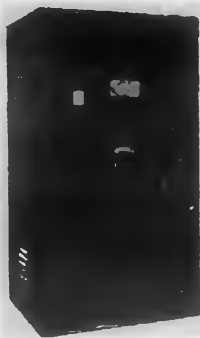

The Variable Frequency Power Supply, Model No. VP-400, is used for testing electrical and electronic equipment requiring line frequencies not available where the equipment is being tested. It has no moving parts and is not subject to mechanical wear and tear.

The frequency range is 47 to 6000cy, continuously variable in two ranges. A jack for external drive is provided. The power output (continuous operation) is 400w, into resistive load. The harmonic distortion is 5% maximum, total, into resistive load. Voltage regulation is 2% from no-load to full load.

Output ranges are from 75v to 150v and 150v to 300v. The primary power required is 115v, 60cy, (1300v-a). Dimensions are 42" x 22" x 18" deep. Empire Devices Products Corp., Dept. ED, 38-15 Bell Blvd., Bayside, N.Y.

CIRCLE 247 ON READER-SERVICE CARD FOR MORE INFORMATION

FM/AM Signal Generator

With 2-220 Mc Range



Signal Generator Model TF-.995A/1 provides continuous frequency coverage from 2 to 220Mc. Normal deviation is continuously variable for 0-25 and 0-75kc on all bands. High deviation of X2 normal is also available on the 2-13.5 and 27-54Mc bands; X4 normal on the 54-108Mc band; and X8 normal on the 108-220Mc band. The output may be continuous-wave, frequency-modulated, amplitude-modulated, or simultaneously both frequency and amplitude modulated.

Modulation distortion is less than 2%. Amplitude modulation, both internal or external, is variable up to 50%. The r-f level is variable from $0.1\mu\text{v}$ to 200mv, and the output impedances are 52 and 75 ohms. The generator enables measurements at i-f and carrier frequencies to be made with a single instrument. Marconi Instruments, Ltd., 23 Beaver St., New York 4, N. Y.

Modulation distortion is less than 2%. Amplitude modulation, both internal or external, is variable up to 50%. The r-f level is variable from $0.1\mu\text{v}$ to 200mv, and the output impedances are 52 and 75 ohms. The generator enables measurements at i-f and carrier frequencies to be made with a single instrument. Marconi Instruments, Ltd., 23 Beaver St., New York 4, N. Y.

CIRCLE 248 ON READER-SERVICE CARD FOR MORE INFORMATION

PANELOC announces

a new rotary latch

latch-nut



anchor block

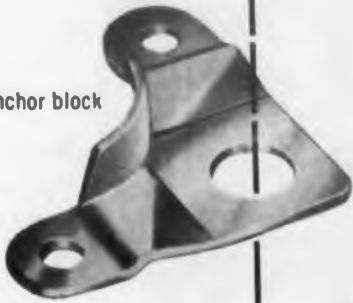

shim plate



latch-screw

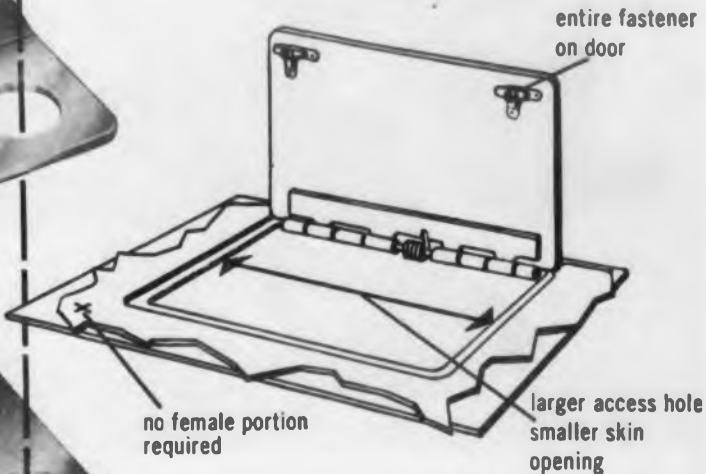

**Saves Cost • Saves Time
Saves Space • Saves Weight**

This new Paneloc Rotary Latch is a simple and economical, strong and durable fastener for access panels, electrical control panels, inspection doors, machinery doors, and other hinged or removable covers. It permits a larger access opening, operates quickly with a quarter-turn. Entire assembly on access panel itself, eliminating many installation steps; no special tools required. Only four simple parts; made of steel, cadmium plated. Three standard sizes now available, more to be added. Special sizes and finishes available on order. Cost very low, performance unsurpassed. Write for a catalog and price list for your file.

PANELOC... America's most versatile line of aircraft fasteners . . . Rotary Latches, Styles 1, 2, and 3 Panel Fasteners, High Performance Fasteners, Snap Fasteners.



PANELOC—A product of Scovill

Scovill Manufacturing Company, Aircraft Fastener Div.
99 Mill Street, Waterbury 20, Connecticut

Please send me fastener catalogs checked:

- () Rotary Latch () Style 3 (MIL-F-5591A)
() Styles 1 & 2 (MIL-F-5591A) () High Performance (NAS-547)
() Snap Fasteners (AN 227)

Send to:

Name _____ Title _____

Company _____

Address _____

CIRCLE 249 ON READER-SERVICE CARD FOR MORE INFORMATION

Do you have source spots?

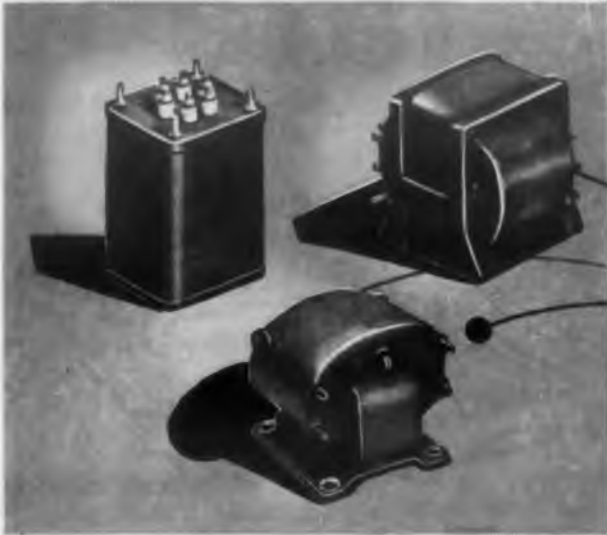

Every design engineer or production man we ever met makes mental notes of good places to get quick aid on needs out of the ordinary.

You might like to know, therefore, that a great deal of the work we do here at Wheeler on transformers, coils, harnesses, custom-built electronic assemblies, and communications components is just that kind of assignment.

We publish no catalog of the everyday standard items . . . they present no problem to anyone. We do serve an increasing group of engineering and production departments that require competent help . . . backed by ample manufacturing facilities . . . in producing components that are "a little (or a lot) different." Call or write us for an interesting story.

TRANSFORMERS • COILS • AMPLIFIERS
CUSTOM ELECTRONIC AND WIRING ASSEMBLIES
COMMUNICATIONS EQUIPMENT • MAGNET WIRE

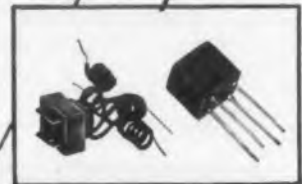

Wheeler is constantly adding to its staff of engineers. If you are available and qualify in this field, call us now.

THE WHEELER

INSULATED WIRE COMPANY, INC.

Division of Sperry Rand Corp.
1131 EAST AURORA STREET
WATERBURY 20, CONNECTICUT

BWH55

CIRCLE 250 ON READER-SERVICE CARD FOR MORE INFORMATION

Video Amplifiers

Bandwidth of 1cy to 10Mc

These low-cost video amplifying units are for use in distribution systems, color TV systems, computer development, nucleonic circuits, pulse control systems, etc. They have a bandwidth from less than 1cy



to 10Mc (3db). One unit has an output of 150v peak-to-peak into capacitive load of 25mmfd. The other's output is 10v peak-to-peak into 75 ohms. Overshoot is less than 5% on both units, and compression less than 3% on the former and less than 5% on the latter. Both units have a continuously variable gain control

Both units take up to 1.5v peak-to-peak input and are supplied with input impedances of 500k and 10mmf, 90 ohms, 75 ohms, or 50 ohms at option of user. Power requirements are 350v, 150ma and 6.3v, 2.5a. Size is 19" x 3-1/4" x 9". American Electronic Laboratories, Inc., Dept. ED, 641 Arch St., Philadelphia 6, Pa.

CIRCLE 251 ON READER-SERVICE CARD FOR MORE INFORMATION

Ratio Transformers

With Accuracy to 0.005%

Four ruggedized versions of this firm's Standard Ratio Transformers have been added to the "PT" Series, which now consists of nine models of both rack mounted and case types, specifically designed to



divide a-c voltage with accuracies as good as 0.005% and resolution as good as 0.00001%. Models are available to cover frequencies from 30 to 3000cy (to 10,000cy at reduced accuracy).

Uses include core material investigation, a-c meter calibration, transformer turns investigation, checking resolvers, servos, computers, synchros, selsyns, and a-c transducers, bridge ratio arm, a-c potentiometer checking, and ratio standard. Gertsch Products, Inc., Dept. ED, 11846 Mississippi Ave., Los Angeles 25, Calif.

CIRCLE 252 ON READER-SERVICE CARD FOR MORE INFORMATION

**fast,
f-l-e-x-i-b-l-e
breadboarding with
SPEED
CHASSIS**

Linkable chassis units,
pre-punched socket plates
offer endless lab setups!

SPEED THE JOB and cut chassis costs with Speed-Chassis, the versatile and inexpensive breadboard assembly with the interchangeable, pre-punched socket arrangements. Chassis is pre-assembled with control holes on both ends. Has four insulated tie-point strips and one grounded tie-point strip. Dust cover and panel available to make successful breadboard assemblies permanent. Units can be mounted on relay rack.



SIZE: 5" wide, 5/4" deep, 16 3/8" long.
Half-size (8 3/8" long). 20 styles of
plates stocked; 17 different, punched,
3 sizes of blanks.

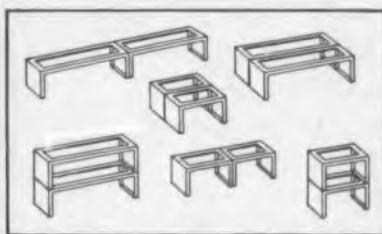

A few examples of the
many possible arrangements

Stocked by leading jobbers everywhere



14515 DICKENS STREET
SHERMAN OAKS 8, CALIF.

CIRCLE 253 ON READER-SERVICE CARD

Sweeping Oscillator

For HF and VHF Range

The Radaligner sweeping oscillator provides an instantaneous check of the entire bandpass of any equipment in the 10-169Mc range. Two or four bands are available. The unit offers a choice of four center frequencies for aligning radar i-f amplifiers. It also provides a variable marker and choice of 10 narrow, plus-type crystal-controlled markers.

The unit has extremely low amplitude modulation while sweeping—less than 0.05-db/Mc. The sweeping oscillators are completely electronic, with no mechanically driven elements. Kay Electric Company, Dept. ED, 14 Maple Ave., Pine Brook, N. J.

CIRCLE 597 ON READER'S SERVICE CARD

Printed Circuit Kit

Includes Etching Trays

Inclusion of items such as heating apparatus, thermometer, etching trays and the necessary handling equipment as well as the copper laminate, resist ink and conductive paint makes this a complete printed circuit kit.

Complete, easily followed step-by-step instructions and suggestions concerning printed circuit design are included. A description of each process as it is accomplished in automatic mass production is also furnished. Tele-Diagnosis Co., Dept. ED, 155 West 72nd Street, New York 23, N. Y.

CIRCLE 598 ON READER'S SERVICE CARD

Compression End Seals

Hermetically-Sealed Types

Additional types of compression end seals offer a broad range of dimensions in flared tube or pierced terminals with single or multiple lead terminations. These terminations are widely used for hermetically sealing capacitors, resistors and other tubular components.

In this exclusive compression construction, the glass remains under constant compression and is therefore extremely strong and difficult to put under stress. They possess extraordinary immunity to shock, vibration and pressure changes. Assembly is rapid as all metal parts are tin dipped for easy soldering. Electrical Industries, Dept. ED, Div. of Amperex Electronic Corp., 44 Summer Ave., Newark 4, N. J.

CIRCLE 599 ON READER'S SERVICE CARD

Phosphor for Radar Tubes

Bright, But Fades Rapidly

For short-range radar, tubes are needed which give a picture which persists brightly for two or three seconds and then fades rapidly before the next picture is painted. Further, the picture should be sharp and clear as possible. A single layer screen made of a special grade of magnesium fluoride has the required afterglow characteristics and at the same time gives the sharply defined picture necessary for short-range radar work.

The new phosphor has the advantage that the initial brightness is greater than that of double-layer screens. Electrostatically-focused radar tubes *AL22-10* and *AL31-10* which incorporate the new phosphor are available. Mullard Ltd., Dept. ED, Century House, Shaftesbury Ave., London, WC3.

CIRCLE 254 ON READER'S SERVICE CARD

Packaging Paper

Prevents Silver Tarnish

This new paper product, called Nox-Tarnish, is chemically treated to prevent silver from tarnishing. The chemicals impregnated in the paper neutralize the tarnishing sulfides thus preventing their action upon silver.

Nox-Tarnish can be used for the protection of bearings, and electronic components. Elimination of tarnish makes soldering easier. Protective Packaging Div., Dept. ED, Daubert Chemical Co., 333 N. Michigan Ave., Chicago 1, Ill.

CIRCLE 255 ON READER'S SERVICE CARD

Silicone Rubber

Is Flexible at 600° F

Designated Class 700, these new materials have been designed to extend the application range of silicone rubber to 600°F. The new materials are capable of remaining flexible for 150hr or longer during continuous peak-temperature exposure. Previously available types of silicone rubber became brittle in less than 24hr exposure to this heat.

The improvements have been obtained without sacrifice of other outstanding silicone rubber properties such as ozone, aging, and weathering resistance, low temperature flexibility and low moisture absorption. Silicone Products Dept., General Electric Co., Waterford, N. Y.

CIRCLE 256 ON READER'S SERVICE CARD

**IMMEDIATELY AVAILABLE
FROM STOCK ...**

magnetic servo amplifier series



MODELS
400 cps Series

MA-3-400
MA-6-400
MA-10-400
MA-15-400
MA-18-400
MA-40-400

Shown above Model MA-6-400

Actual size: 2-9/16" x 1-3/4" x 1-7/16". Wt. less than 12 oz.
Hermetically Sealed • 7-Pin Header

This complete series of precisely engineered Magnetic Servo Amplifiers is immediately available from stock, as standard components for servo systems application. Furnishes in compact form all the salient features of a high quality, hermetically sealed transformer.

OUTSTANDING PERFORMANCE CHARACTERISTICS ...

- Sinusoidal Phase Reversing Output
- Transistor or Tube Control ... AC or DC Input
- Ambient Temperature Range -55°C. to +100°C.
- Low Cost, Rugged, Compact, Efficient, Long Service Life
- Meets Military Specifications

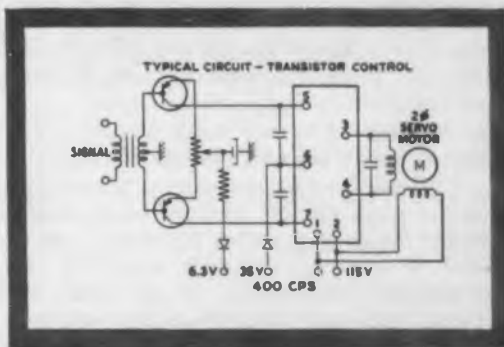

MAGNETIC SERVO AMPLIFIER SERIES

400 cps Models*

MA-3-400
MA-6-400
MA-10-400
MA-15-400
MA-18-400
MA-40-400

Applications

MK-14 (3-watt)
MK-7 (6-watt)
MK-8 (10-watt)
16-watt
18-watt
40-watt

* Equivalent 60 cps Series also available

If you are confronted with circuitry design or engineering problems involving magnetic components for servo system or other application, your inquiry directed to our engineering staff for information will receive prompt, courteous attention.

For complete technical data and performance curves ... request Engineering Bulletin on Magnetic Servo Amplifier Series.

MAGNETIC RESEARCH CORP.

200 CENTER STREET • EL SEGUNDO, CALIFORNIA

Mfrs. of Magnetic Amplifiers and Converters, Magnetically Regulated DC Power Supplies, Magnetic Pulse Generators.



CIRCLE 257 ON READER-SERVICE CARD FOR MORE INFORMATION

How Fafnir is prepared to meet MIL-STD-206 Standards of Torque Measurement for Instrument Ball Bearings.



NEW AUTOMATIC TORQUE TESTER FOR BALL BEARINGS

This Fafnir-developed torque testing equipment for instrument ball bearings automatically records in a matter of seconds a continuous series of starting torque peaks, from which maximum torque, average torque, and the frequency distribution of successive torque peaks are quickly determined. In addition, the trace distinctly reveals how torque is affected by dirt, race finish, race geometry, load, scratches, nicks, and retainer condition. By providing a multiplicity of readings in a very short span of time, inspection is simplified and chances of error minimized.

This continuous-rotation type torque tester is but one of many devices used for testing ball bearings in the Fafnir Instrument Division . . . all are operated to assure the highest standards of quality. Additional information on the manufacture of Fafnir Instrument Ball Bearings is contained in the newly-revised catalog. Write for a copy. The Fafnir Bearing Company, New Britain, Connecticut.

As a service to customers, Fafnir has been supplying the automatic torque tester. A manual giving complete detailed information on the torque tester is available upon request.



FAFNIR

BALL BEARINGS

MOST COMPLETE LINE IN AMERICA

CIRCLE 258 ON READER-SERVICE CARD FOR MORE INFORMATION

Vacuum Relays

Exceptionally High Ratings



These multiple-pole vacuum transfer relays are for switching antennas, pulse networks, and many d-c circuits. They are offered in dpdt and 4pdt models with removable 24v d-c actuating coils built into flanged bases. An efficient magnetic circuit penetrates the vacuum seal. Vacuum-enclosed contacts are rated at 12kv peak and are capable of continuously carrying 30Mc currents of 10amp rms.

Contact resistance is only 0.005 ohms, and it remains low even when broken under load, due to the complete absence of any contaminating materials within the vacuum enclosure. Switch capacitance between contacts is 0.33mmfd, and operate time is less than 30millisec. Size is 4-1/2" x 4" diam. The units withstand test voltages of 18kv between contact terminals and from the terminals to the base. Jennings Radio Mfg. Corp., Dept. ED, P. O. Box 1278, San Jose, Calif.

CIRCLE 259 ON READER-SERVICE CARD FOR MORE INFORMATION

TV Tuners

For V-H-F, U-H-F, or Both



These v-h-f, u-h-f, and all-channel combination v-h-f/u-h-f TV tuners are adaptable to virtually all makes of black and white receivers, and are smaller than this firm's previous models. All tuners include a special

radiation-suppression features meetings FCC limits.

The unit shown is a v-h-f switch-type tuner (Model 100) less than 4" long, 3" wide, and 3" high. It will be available in pentode or cascade amplifier designs, for sets using either parallel or series string tubes. It comes with 12 detent positions for straight v-h-f operations, or 13 positions for use with u-h-f tuners.

A small dual pre-selector u-h-f tuner (Model 202) is available for combination v-h-f/u-h-f sets. General Instrument Corp., Dept. ED, 829 Newark Ave., Elizabeth 3, N. J.

CIRCLE 260 ON READER-SERVICE CARD FOR MORE INFORMATION

Correction. Tone oscillators manufactured by Pacific Div. of Bendix Aviation Corp. (ED, July 1955 p 76) are available for frequency ranges from 500 to 600cy —not 600cy as reported earlier.

SAVE INSTALLATION TIME

with GRIEVE-HENDRY BATCH TYPE OVENS

Shipped completely "Set-Up"—Previously Tested and ready to operate



6 STANDARD MODELS

NO ENGINEERING CHARGES

It will pay you to check on the time and money saved by buying GRIEVE HENDRY Standard BATCH TYPE OVENS. 6 Standard Models—electric, oil or gas heated. Shipped promptly and at lower cost to you because they have been engineered to standards, thereby saving time and extra engineering charges. Design changes readily made to suit special requirements. These Ovens come to you—set-up—ready to work—just uncrate and make service connections to the outlets provided—no installation crew or tie-up necessary in your plant. . . . Latest convenience features and safety devices included. Write for bulletin No. 1-55

- Prompt quotations on ovens to your individual specifications.
- Standard models to 1200° F.—\$89.50 and up.
- Sales engineers in all principal cities and many foreign countries.



GRIEVE-HENDRY CO., INC.

CIRCLE 261 ON READER-SERVICE CARD FOR MORE INFORMATION

NOW!
over 15 million
Microdot coax
combinations

Microdot cuts design time by multiplying possibilities . . . with the world's smallest, lightest microminiature coax connectors and cables available at 50, 70 or 93 ohms to meet your rigorous environmental requirements. Write today for applications data.

1/3 BNC diameter
1/10 BNC weight!

MICRODOT
data
example
70 OHM

CABLES

Z₀
70 ohms
C
21 mmf/ft
• (400 mc)
.17 db/ft
V
70% (Teflon)
T
up to 400° F

CONNECTORS

"S"
Screw Series
"QC"
Quick Connect
"P"
Pressurized

Available:

Plugs, Jacks, Receptacles, BNC Adapters, Feed-throughs and special designs.



MICRODOT
1826 FREMONT AVENUE
SO. PASADENA • CALIF.

CIRCLE 262 ON READER-SERVICE CARD FOR MORE INFORMATION

ELECTRONIC DESIGN • September 1955



Electrical Indicating Panel Meters and Pyrometers

Model 261 shown,
Price \$11.50

White-face, Black-face, or Colored
Dials. Can be calibrated in any units:
(Amps, KV, FPM, Angstrom Units)

Pyrometers are medium resistance (4 ohms per millivolt). Accuracy 2%. Automatic, bimetal cold junction correction. Compensated for copper error. (Ranges from -400 to +3000°F.)

Large dial area—clearly visible. Less waste panel space. Easily lighted transparent plastic front and case. Anti-static treated. Tubing pointer normally supplied. Knife-edge and other types available. D'Arsonval movement in Alnico permanent magnet. Snap-fit construction, virtually dust-tight case. AC meters are rectifier type. Model 451 is 4½"; Model 351 is 3½"; Model 261 is 2½". Meters with Zero Right, Zero Center or up to two-thirds of range suppressed can be supplied.

AC and DC meters can be furnished in multiple ranges. Meter ranges: DC or AC 0/20 Microamps to 0/50 Amps. 0/5 Millivolts to 0/500 Volts. (Minimum AC Range 0/250 Millivolts). Panel meters and pyrometers

with black Bakelite cases also available. Model 301 shown. Write for Bulletin G-9, Assembly Products, Inc., Chesterland, Ohio. Phone: (Cleveland, O.) Hamilton 3-4436.

Booth A 150, Instrument Show, Sept. 12-16,
Los Angeles



Other products: meter-relays, VHS relays, Simplytrol Controls (temperature), and Versatrol Controls (for any variable which can be measured electrically.)

CIRCLE 263 ON READER-SERVICE CARD FOR MORE INFORMATION

Resistance Analyzer

With 0.1% Accuracy



This Resistance Analyzer, Model KED-15, is designed to check such characteristics as d-c resistance, temperature coefficient, and voltage coefficient of resistors according to JAN specifications. The

voltage coefficient of any resistor up to a capacity of 2w can be determined down to as low as 0.0002%/volt. Voltage across the measured resistance is continuously variable in three ranges from 0-500v by a self-contained regulated power supply. Resistors can be readily measured with good sensitivity with voltages as low as 0.5v. The unit is designed for 115v 60cy operation and measures 19-1/2" x 11" x 12".

The analyzer is capable of measuring the voltage coefficient of resistors over a range from 1000 ohms to 111 megohms to within 0.1%. Electronic Div., The Kuljian Corp., Dept. ED, 1200 N. Broad St., Philadelphia 21, Pa.

CIRCLE 265 ON READER-SERVICE CARD FOR MORE INFORMATION

If you need a special component, send a brief statement of your specifications addressed to Bulletin Board, Electronic Design, 19 East 62nd St., New York 21, N. Y. Include your complete address.

Selenium Rectifiers

In Aluminum Cans



These selenium rectifiers, manufactured by the Allgemeine Elek-tricitäets - Gesellschaft of Frankfurt/Main, are supplied in aluminum cans and are similar in appear-

ance to electrolytic capacitors. This type has been extremely popular in Germany and is available in units with octal sockets for the replacement of thermionic diodes. Only a very small area of the chassis is required for mounting.

The rectifiers are especially designed to furnish anode voltage in radio sets. Outstanding features are: long life, low losses, high direct voltage independent of load, high efficiency, no heating current required, and compact shock-proof construction. Donald C. Seibert, Importer, Dept. ED, Box 281, Wilmington, Del.

CIRCLE 266 ON READER-SERVICE CARD FOR MORE INFORMATION

TO ELABORATE....



This brush assembly conducts signal and power current through slip rings between stationary and rotating equipment.

a *Superior* Willingness
to **ELABORATE**

"Elaborate"? Yes, that's exactly what we mean. For, actually, "elaborate" means to *work something out*. Always, we at Superior are most willing to *work out* exactly what your application calls for... the right answer to perform a brand new operation most efficiently, to make your present equipment function more profitably, or to bring down the cost of manufacturing your product. *Please turn us loose on that next brush assembly problem.*

SUPERIOR CARBON PRODUCTS, INC.
9115 GEORGE AVENUE CLEVELAND 5, OHIO



CIRCLE 267 ON READER-SERVICE CARD FOR MORE INFORMATION

for

made-to-order
precision at mass-
production prices

Illustrated

Actual

Size

SEE

**GRC SMALL NYLON
COIL BOBBINS**

GRC Nylon Bobbins serve you better because they are made to your exact specifications. Yet they cost far less, thanks to Gries' mass-production methods. Bobbins are automatically produced, ready-for-use, in one swift, cost-saving operation. And Gries' unique single-cavity molding technique assures accuracy and uniformity—at prices that afford substantial savings. Send specification for Prompt Quotations on Production runs of 25,000 or more.

MAX. Weight .03 oz.
Length 1¼"

NO MINIMUM SIZE!

WRITE TODAY FOR FULL INFORMATION AND SAMPLES



GRIES REPRODUCER CORP.

World's Foremost Producer of Small Die Castings
40 Second St., New Rochelle, N.Y. • Phone NEw Rochelle 3-8600

CIRCLE 264 ON READER-SERVICE CARD FOR MORE INFORMATION

ELECTRONIC DESIGN • September 1955

THERMOSTATIC

DELAY RELAYS



Provide delays ranging from 2 to 150 seconds.

**MOST COMPACT
MOST ECONOMICAL
HERMETICALLY SEALED**

- Actuated by a heater, they operate on A.C., D.C., or Pulsating Current.
- *Hermetically sealed.* Not affected by altitude, moisture, or other climate changes. • Circuits: SPST

only—normally open or normally closed.

Amperite Thermostatic Delay Relays are compensated for ambient temperature changes from -55° to $+70^{\circ}$ C. Heaters consume approximately 2 W. and may be operated continuously. The units are most compact, rugged, explosion-proof, long-lived, and — very inexpensive!

TYPES: Standard Radio Octal, and 9-Pin Miniature.

PROBLEM? Send for Bulletin No. TR-81

Also — a new line of Amperite Differential Relays — may be used for automatic overload, over-voltage, under-voltage or under-current protection.



MINIATURE



BALLAST REGULATORS



T9 BULB

- Amperite Regulators are designed to keep the current in a circuit *automatically regulated* at a definite value (for example, 0.5 amp.).
- For currents of 60 ma. to 5 amps. Operates on A.C., D.C., or Pulsating Current.
- Hermetically sealed, light, compact; most inexpensive.

Amperite Regulators are the simplest, most effective method for obtaining *automatic regulation* of current or voltage. *Hermetically sealed*; not affected by changes in altitude, ambient temperature (-55° to $+90^{\circ}$ C), or humidity. Rugged; no moving parts; changed as easily as a radio tube.

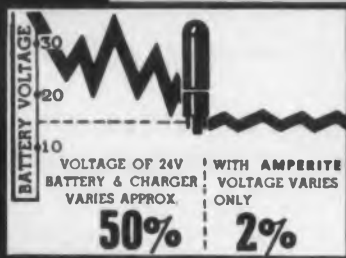

VOLTAGE OF 24V BATTERY & CHARGER VARIES APPROX. 50% WITH AMPERITE VOLTAGE VARIES ONLY 2%

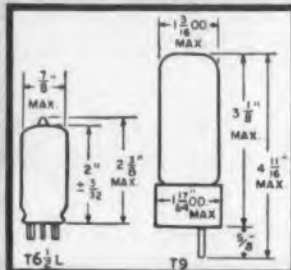

Write for 4-page Technical Bulletin No. AB-51

AMPERITE CO., Inc.

561 Broadway, New York 12, N. Y.

In Canada: Atlas Radio Corp., Ltd., 560 King St. W., Toronto 28

CIRCLE 268 ON READER-SERVICE CARD FOR MORE INFORMATION

Quartz Crystal Sealed in Vacuum

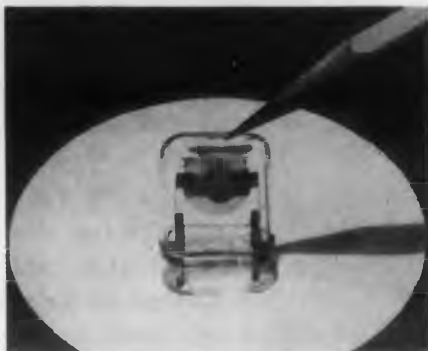

This all-glass, military-type quartz crystal will overcome electronic equipment failures due to crystal aging. Its production in commercial quantities is made possible through the development

of machinery which evacuates the glass envelope containing the quartz crystal and provides an air-tight glass seal between the envelope and glass base. The crystal is contained in a high vacuum where it maintains its activity and frequency stability under external operating conditions which cause frequent failure to crystals in metal type containers.

The crystal is interchangeable mechanically and electrically with the most commonly used types of military crystals. It has the same shape and dimension as the metal HC6/U holder which encloses types CR18/U, CR23/U, and CR27/U. Rogers Majestic Electronics, Ltd., Dept. ED, Leaside, Ontario.

CIRCLE 269 ON READER-SERVICE CARD FOR MORE INFORMATION

Galvanometer Element

Withstands Up to 25G Shock



A series of light-beam galvanometer elements of exceptional ruggedness and compactness is offered with sensitivities up to $0.0085 \mu\text{amp/mm}$ at 1 meter. They are designed for field work as well as for laboratory and industrial services. They may be installed as integral parts of instrumentation in the fields of colorimetry and densitometry, or for measurement of electrical potentials,

conductivity, light flux, or temperature (Wheatstone bridge or thermocouple).

When suitably housed with a light source and indicating scale, these movements comprise extremely sensitive instruments of minute currents and voltages.

Overall dimensions are only 3.36" x 1.75" x 1.32". They feature short period and high-speed response. Coil resistances of 20, 100, 500, and 1000 ohms are offered. A 14-k gold suspension is used. Howell Instrument Co., Dept. ED, 1106 Norwood, Fort Worth 7, Tex.

CIRCLE 270 ON READER-SERVICE CARD FOR MORE INFORMATION

NEW LOW FREQUENCY OSCILLATOR

0.35 to
52,000 cps.



Model 420-A

Krohn-Hite announces the new Low Frequency Oscillator Model 420-A which provides both sine and square wave voltages simultaneously at any frequency between 0.35 and 52,000 cps. Special circuitry is employed to minimize tuning and band switching transients. The unit features low distortion and hum at any setting of the calibrated output level control and excellent amplitude constancy over the entire frequency range. Other features include fast AVC action, vernier tuning control, and a single scale logarithmic dial. This exceptionally reliable oscillator is especially useful wherever an accurate source of low frequencies is needed. Price \$290.00 f.o.b. factory.

For Further Details Write

KROHN-HITE INSTRUMENT CO.

Dept. ED, 580 Massachusetts Ave., Cambridge 39, Mass.

CIRCLE 271 ON READER-SERVICE CARD FOR MORE INFORMATION

How to "borrow" ...ideas ...facilities ...experience from Thompson

FOR help in untangling knotty electronics problems, many manufacturers have learned to "count on Thompson".

Ideas? To Thompson electronics engineers, no research, development or production problem is "unsolvable". Given the opportunity, they'll come up with sound ideas to solve *your* electronics problems. "Borrow" those ideas!

Facilities? Complete development and testing laboratories... plus the most modern production equipment... are available to Thompson's electronics engineering staff. "Borrow" these facilities!

Experience? Thompson has had 53 years of successful problem-solving for the automotive, aircraft and general industries of America. The highly developed skills and combined experience of the entire Thompson organization are available to you for all your electronics problems. "Borrow" this experience!

One of the many Thompson Coaxial Switches



Electronics Division

Thompson Products, Inc.

2196 CLARKWOOD RD., CLEVELAND 3, OHIO

CIRCLE 272 ON READER-SERVICE CARD FOR MORE INFORMATION

ELECTRONIC DESIGN • September 1955

Special Purpose WIRE

**BERYLLIUM
COPPER**
Silvercote ®

titanium

phosphor bronze

ALUMINUM

● OTHER NON-FERROUS

Consider WIRE and the importance of its function in your product. Whether a highly engineered application or a simple stapling purpose, your choice of the proper alloy or composition, temper and type of wire could mean success or failure during crucial test.

round ● flat — square ■ half-round ▽

Precision gauges from 1/8 to .002. Close tolerances hold.

**SPRING WIRE — WIRE FOR INSTRUMENTS
ELECTRONICS — STRAND FOR WIRE ROPE AND
BRAIDED APPLICATIONS — MANDREL WIRE
WIRE FOR FORMS — RIVETS — STAPLING**

Send for descriptive folder.



**LITTLE FALLS ALLOYS
INCORPORATED**
195 Caldwell Avenue • Paterson 1, N. J.

CIRCLE 273 ON READER-SERVICE CARD FOR MORE INFORMATION

NOW AVAILABLE
from electronic distributors
TEFLON
Insulated ELECTRONIC COMPONENTS



Illustrated are ERIE TEFLON STAND-OFF INSULATORS. The Erie-Chemelec Teflon line also includes Feed-Thru Insulators; seven and nine pin Miniature Tube Sockets in Teflon and Kel-F; Crystal Sockets; nine, fifteen and eighteen pin connectors, and five sizes of spaghetti in three colors.

Write for catalog, price list and the name of your nearest stocking Erie-Chemelec Electronic Parts Distributor.

ERIE ELECTRONICS DISTRIBUTOR DIVISION
ERIE RESISTOR CORPORATION
Main Offices: ERIE, PA.
Factories: ERIE, PA. • LONDON, ENGLAND • TRENTON, ONTARIO

CIRCLE 274 ON READER-SERVICE CARD FOR MORE INFORMATION
ELECTRONIC DESIGN • September 1955

1% Resistor Takes Full Load at 120°C



The "Polyohm", a 1% resistor, offers performance exceeding all MIL-R-10509A specifications. Taking full power at ambient temperatures up to 120°C, it is valuable for use in aircraft, guided missiles, and other applications where high ambient temperatures rule out ordinary 1% resistors. At the

same time, operation at normal temperatures results in a much longer life than can usually be expected from resistors with lower temperature ratings.

The unit is also well suited for applications where wire-wound resistors are too expensive or bulky or the effect of their inductive and capacitive reactance cannot be tolerated.

The resistor will remain well within its 1% tolerance even under conditions of high humidity. Its temperature coefficient is only -150ppm/°C. The resistive element is an evaporated metal film.

The resistor is made in 1/2w, 1w, and 2w sizes, with facilities controlled by the Signal Corps. They are presently available only for government end use. Polytechnic Research & Development Co., Inc., Dept. ED, 202 Tillary St., Brooklyn 1, N. Y.

CIRCLE 275 ON READER-SERVICE CARD FOR MORE INFORMATION

Absolute Pressure Indicator With 0.1-20mm Hg Range



This Absolute Pressure Indicator, with a range from 0.1 to 20mm Hg, has an expanded scale in the 0.5-5mm range. A direct-reading instrument, it operates on 115v a-c and incorporates a heated thermopile principle. Noble-metal thermocouples are housed in nickel-plated gage tubes, affording freedom from out-gassing, system contamination, and corrosion. The tube is extremely rugged, has quick response, and is not damaged by release to atmospheric or positive pressures.

Dimensions of the gage tube are 1-1/2" long x 3/8"OD, with a 1/8" IPS male thread coupling. Internal volume of the tube is less than 0.05 cu in.

Any standard strip-chart millivolt recording instrument capable of operating from 10mv or less is suitable for recording pressure data from this instrument. The unit is practical for remote installation and may be calibrated for any length cable from the indicator to the gage tubes. Hastings Instrument Co., Inc., Dept. ED, Hampton, Va.

Write for catalog, price list and the name of your nearest stocking Erie-Chemelec Electronic Parts Distributor.

CIRCLE 276 ON READER-SERVICE CARD FOR MORE INFORMATION

Tomorrow's Ideas...

Today's
Designs

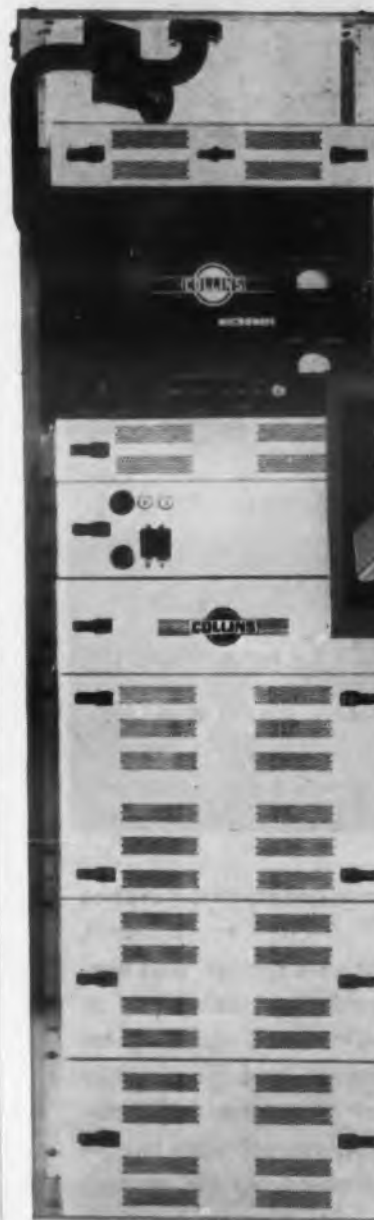

WITH
**HARTWELL
FLUSH
LATCHES**

Designing with the future in mind? Look what *Collins* has done with their modern radio equipment. Relay RF Racks are designed for fast, simple, economical accessibility with **HARTWELL** Flush Latches.

Do you see an opportunity in this application of Flush Latches? **HARTWELL** is serving and saving in thousands of applications all across the industry. You'll find them extensively used in all types and sizes of cabinets.

HARTWELL, "Flush Latch Headquarters" is ready today to help you design for tomorrow's competition. Fast, simple, positive-action... improved product appearance... lower production costs.



New Catalog illustrates and gives full details of complete line.

HARTWELL COMPANY
9035 Venke Blvd., Los Angeles 34, Calif.
Branch Offices: Wichita, Kansas; Fort Worth, Texas

Send illustrated new Catalog

Name _____
Company _____
Address _____
City _____ Zone _____ State _____

CIRCLE 277 ON READER-SERVICE CARD FOR MORE INFORMATION

FOR RELIABILITY AND LONG LIFE IN
ELECTRONIC COMPONENTS . . .



Use
**NICKEL and
NICKEL ALLOY**
Wire and Strip

Electron tubes, lamp leads, interference shielding, magnetostrictive components, thermostat parts, fine wire springs, and hundreds of other electronic applications rely on Nickel and Nickel Alloy Wire and Strip for dependable performance and long service life. Good electrical properties, high mechanical strength, excellent resistance to high temperatures and corrosion are the properties that make the Nickel group of metals a must in electronic design. We can supply you with wire and strip in Nickel, Monel, Inconel, Nickel Irons, Incoloy and special processed Gas-Free Nickel and Gas-Free Nickel-Iron Wire for your electronic applications.

Nickel-clad and Inconel-clad copper wire are also available for applications requiring high electrical conductivity plus outstanding resistance to high temperatures. Send today for free 40-page Nickel Handbook.



Ask about our
**High-Emissivity
Aluminum-clad Steel Strip.**

ALLOY METAL WIRE DIVISION



H. K. PORTER COMPANY, INC.
Prospect Park, Pennsylvania

CIRCLE 278 ON READER-SERVICE CARD FOR MORE INFORMATION

Tube Axial Blowers

Use 1" diam Motors

These light-weight miniature tube axial blower units are powered by a 1" diam motor. Designed for long life, they are for spot cooling of electronic equipment and for air changing in small, equipment-filled boxes.



These tube axial blowers have no brushes, and operate without arcing and without radio interference. At speeds of 11,000 and 20,000rpm, standard 400cy blowers produce 32 and 58cfm (at 0" of static pressure). Variable frequency 360 and 1600cy units produce a minimum of about 25cfm at 0" of static pressure. All blowers meet applicable MIL specs for aircraft use.

Typical blowers measure 2" diam x 3-3/8" overall length. Eastern Air Devices, Inc., Dept. ED, 391 Central Ave., Dover, N. H.

CIRCLE 279 ON READER-SERVICE CARD FOR MORE INFORMATION

Pulse Transformers

For Use in Printed Circuitry



This miniature pulse transformer, for use in printed circuitry, is carried in stock in pulse widths ranging from 0.1 to 16.0μsec, and in most popular 2, 3, and 4 winding turns ratios. Custom sizes can be built quickly to order. With low rise time and leakage inductances, the transformers are valuable for use in blocking oscillators; impedance matching; linear oscillators; as wide band input and output transformers; low voltage interstage coupling; triggering and counting circuits; d-c isolation; inversion pulse shaping; and pulse transmission circuits.

The transformers come with standard 7 and 9-pin pattern headers. Can sizes range from 13/32" height x 1/2"OD, to 5/8" height x 3/4"OD. All units are epoxy impregnated in hermetically sealed cans, and will withstand shock, temperature cycling, vibration, and humidity requirements of MIL-T-27, where applicable. PCA Electronics, Inc., Dept. ED, 2180 Colorado Ave., Santa Monica, Calif.

CIRCLE 280 ON READER-SERVICE CARD FOR MORE INFORMATION

Superior Tube's versatile CATHALOYS

Two new cathode alloys
simplify selection, prolong tube life



CATHALOY* P-50, is the only passive alloy, which is at present commercially available in both WELDRAWN* and Lockseam form for use as a disc cathode shank or cathode sleeve.

50% STRONGER. CATHALOY A-32 contains tungsten. Proved half again stronger than tungsten-free cathode alloys on this high temperature testing machine. Especially important in ruggedized tubes.

The unique versatility of these new CATHALOYS makes it possible for electron tube designers to choose the right alloy for most applications simply by selecting between them. A-32 is active. P-50 is passive. Both are free from interface impedance and offer extremely low sublimation effects. Write for complete catalog. Superior Tube Company, 2050 Germantown Ave., Norristown, Pa.

Superior Tube
The big name in small tubing

All analyses .010" to 1/4" OD. Certain analyses in light walls up to 2 1/2" OD.

*T.M. Superior Tube Co., Reg. U.S. Pat. Off. †Pat. applied for

CIRCLE 281 ON READER-SERVICE CARD FOR MORE INFORMATION

Hundreds of USES!
SMALL, DEPENDABLE
MICRO-METERS
by **DURANT**

- **READABLE** — Big, well-defined white numerals on black — no metallic glare.
- **COMPACT** — Round case, saves space. Can be positioned for user's convenience and accessibility.
- **ATTRACTIVE** — Highly polished die cast case — won't tarnish or rust.
- **VERSATILE** — Panel or Base mount in Rotary, Stroke or Ratchet-Rotary actions.

DURANT MANUFACTURING CO.
1993 N. Buffum St. Milwaukee 1, Wis. 193 S. Water St. Providence 3, R. I.
Representatives in Principal Cities

Send for Literature
PRODUCTIMETERS
SINCE 1879 *Count Everything*

CIRCLE 282 ON READER-SERVICE CARD FOR MORE INFORMATION

ELECTRONIC DESIGN • September 1955

specify
standard



FLEXLOC SELF-LOCKING NUTS

FLEXLOC	one-piece, all-metal construction	lock and stop nut in one
DESIGN	resilient locking segments	every thread carries its full share of load
FEATURES	controlled locking torques	

DO YOU KNOW? Because they are of one-piece, all-metal construction, FLEXLOCS can be used in temperatures to 550° F. Nuts lacking this design feature have more restricted temperature ranges and applications. And FLEXLOCS are stocked in a full range of sizes from #4 to 2" by authorized industrial distributors. Write for Bulletin 866. STANDARD PRESSED STEEL CO., Jenkintown 12, Pa.

FLEXLOC LOCKNUT DIVISION

SPS

JENKINTOWN PENNSYLVANIA

CIRCLE 283 ON READER-SERVICE CARD FOR MORE INFORMATION

NEW SWITCH CATALOG

ALL
NEW



ALL
NEW

24 PAGES

Saves time in
selecting
the right switch

GIVES COMPLETE
ENGINEERING DATA

- Photo of each switch type
- Detail drawing of each type
- Base and terminal data
- Operating characteristics
- Electrical ratings

Catalog gives detailed data on all these snap-acting switches: high-sensitivity, sub-miniature, low-cost, general-purpose, metal-cased, open-type, immersion-proof, and AN/JAN types.

Write today for your free copy.

UNIMAX

Division of the W. L. Maxson Corporation

460 WEST 34th STREET, NEW YORK 1, NEW YORK

CIRCLE 284 ON READER-SERVICE CARD FOR MORE INFORMATION

ELECTRONIC DESIGN • September 1955

Resistor

With $\pm 0.03\%$ /Year Stability

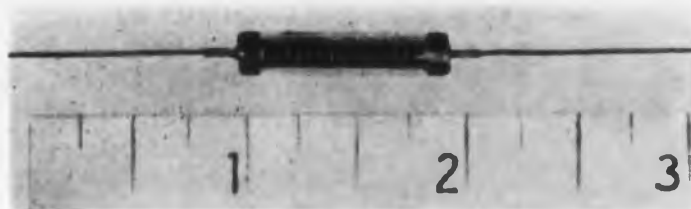

The PT1000 is a glass-sealed carbon film resistor which combines ruggedness and small size with high stability. Under low-power use, at any ambient temperature up to 125°C, these resistors are virtually unchanging for very long periods of time. Stability is better than $\pm 0.03\%$ per year at 0.5w rating and derating to zero power at 140°C. With a 1w rating, derating to 160°C, stability is better than $\pm 0.1\%$ in 1000 hours. Three months storage at 500°C has shown the seals to be completely vacuum tight.

Resistance values range from 1 ohm to 30 megohms. The units are available in sets with temperature coefficients matched to 1ppm/°C for higher precision use over wide temperature ranges. Mounting may be done on leads. Size is 3/16" diam x 15/16" body. Overall size, including weldable end studs, is 1-3/16" with 1-1/2" tinned leads. Other types available are in 0.5 and 2w ratings. Pyrofilm Resistor Co., Dept. ED, 8 Whippany St., Morristown, N. J.

CIRCLE 285 ON READER-SERVICE CARD FOR MORE INFORMATION

Size 11 Resolver

A Winding-Compensated Unit



This Size 11 winding - compensated resolver has a frame diameter of only 1.062". The smaller diameter reduces weight and makes instal-

lations more compact. The resolver can be supplied with Mark 4 Mod 0 electrical characteristics, possesses temperature stabilization, and is equipped with a closed loop path.

Stator winding excitation is 400cy, 60v. Input impedance is $200 \pm 10\% + j885 \pm 10\%$. Test voltage is 10v rms. When resonated, input impedance is 3.6k. Low corner frequency is 20cy. Peaking frequency is 150ke. Maximum perpendicularity of axes is ± 5 minutes. Maximum total null voltage is 1mv/v. Maximum functional error is $\pm 0.1\%$. Transformation ratio: rotor/stator 0.975 ± 0.020 , compensator/rotor 0.250 ± 0.010 . Time phase shift, rotor/stator $6.0^\circ \pm 1.5^\circ$. Inequality of rotor T.R.'s is 0.1%. American Electronic Mfg., Inc., Dept. ED, 9503 W. Jefferson Blvd., Culver City, Calif.

CIRCLE 286 ON READER-SERVICE CARD FOR MORE INFORMATION



You save money

ON SMALL PRECISION PARTS

With almost 90 years of precision metal-working experience, Torrington has developed many automatic machines and techniques to produce small precision parts in quantities, large or small, at real savings to you.

This experience and equipment enables us to give you temper, hardness, finish and tolerances exactly to your specifications—*faster, better and for less* than you could produce them yourself. Why not send a sample part or blueprint for our quotation. Ask for our Condensed Catalog which shows the many types of parts we can make economically.

THE TORRINGTON COMPANY
Specialties Division
37 Field Street, Torrington, Conn.



TORRINGTON SPECIAL METAL PARTS

Makers of
Torrington
Needle Bearings



CIRCLE 287 ON READER-SERVICE CARD FOR MORE INFORMATION



belongs
in your
fastening picture

Tubular Rivet

"THE TUBULAR WAY..."

... is more than rivets. It's a fast, strong, economical method of fastening things together. It includes rivets and automatic machines to set them — sometimes with spectacular savings of as much as 100%.

Designers know that rivets by *Tubular* belong in their design picture at the drawing board stage because they solve countless fastening and electrical contact problems in nearly all metals, plastics, woods, leathers, papers and fabrics. There's a *Tubular* rivet for every purpose. Send us your blueprint, sketch or sample assembly today. Competent, confidential engineering service available.

Purchasing Agents know that they can turn to *Tubular* now for immediate delivery on stock styles and lengths. "Specials" take a little longer.



Tubular Rivet
Studd Company

WOLLASTON (QUINCY) 70, MASS.
See your local classified directory for phone numbers.

BRANCH OFFICES: BUFFALO • CHICAGO
DALLAS • DETROIT • INDIANAPOLIS
LOS ANGELES • NASHVILLE • NEW YORK CITY
PHILADELPHIA • ST. LOUIS • SAN FRANCISCO

CIRCLE 288 ON READER-SERVICE CARD FOR MORE INFORMATION

Tape Transport

Uses No Clutches, Brakes

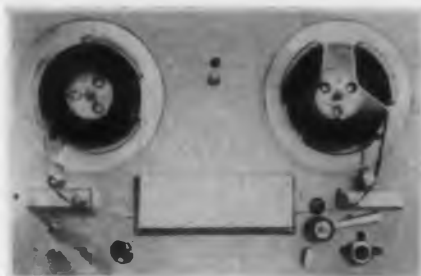

This tape transport uses the "Isimetric Drive", a magnetic differential drive, to operate the tape-handling mechanism without frictional clutches or brakes.

A single knob controls all reel motions. The drive is based on a multi-poled Alnico VI permanent magnet whirling freely between two drag cups and positioned axially by a sensitive feedback system. This arrangement automatically applies balanced relative torque to the reels for constant tape tension and continuously variable drive for editing and high-speed transport, as well as smooth, instant brake action.

The "Isimetric" drive maintains static and dynamic control of the magnetic fields to provide stable performance under all operating conditions. When either reel is empty or tension is released across the heads, motors are automatically turned off. The mechanism also slows down slightly at the end of each reel to avoid whipping the tape. International Scientific Instruments Corp., Dept. ED, 3101 E. 42nd St., Minneapolis 6, Minn.

CIRCLE 289 ON READER-SERVICE CARD FOR MORE INFORMATION

Machine Screws

Self-Sealing and Shake-Proof

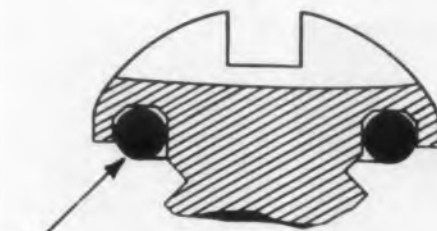

RUBBER OR PLASTIC
"O" RIB ASSEMBLED
AT FACTORY

This line of machine screws is designed for use on hermetically-sealed cabinetry or under conditions of severe vibration and are known as "Seel-screws".

The construction employs an "O-rib" made of silicone rubber, neoprene, or plastic, depending on the end use of the screw. The rib is held in a circular groove under the screw head. When the screw is tightened, the material is compressed under the head to form a positive hermetic seal. Wherever a "locking" or "shake-proof" screw is required, a plastic is used in place of the rubber.

The screws are made of brass or steel, plain or nickel-plated, in three sizes: 6-32, 8-32, and 10-32. Other sizes and materials may be obtained on special order. Automatic & Precision Manufacturing Co., Dept. ED, 252 Hawthorne Ave., Yonkers, 5, N. Y.

CIRCLE 290 ON READER-SERVICE CARD FOR MORE INFORMATION

marion
advancement
in instrument
design

NO DOUBT
ABOUT IT

... with the
versatile
**MULTI-RANGE
METER TESTER,**
Power Supply,
and
Limit Bridge

Precise, self-contained unit for laboratory and production use. For DC instrument calibration from 25 μ a full scale to 10 ma full scale, and 0-100 V DC; sensitivity and resistance measurement; DC current-voltage source; limit or Wheatstone bridge measurements from 0-5000 ohms. Regulated Power supply. Stepless vacuum tube voltage control. Accuracy exceeds 1/4% (current), 1/2 ohm or 1/2% (resistance). For 115 V, 60 cycle AC. Complete — needs no accessories.

marion electrical instrument co.
Grenier Field, Manchester, N.H., U.S.A.

Manufacturers of Ruggedized and "Regular"
Panel Instruments and Related Products.

copyright 1955 M.E.I. Co.

marion meters

CIRCLE 291 ON READER-SERVICE CARD FOR MORE INFORMATION

Write today for
your free copy of this
Technical Paper

ask for data file **906**

Criteria and Test
Procedures for Electromagnetic
Delay Lines

BY NORMAN GAW, JR.
Research Engineer
AND DAVID SILVERMAN
Eastern Plant Research Director
Helipot Corporation

Presented at the
1955 I.R.E. NATIONAL
CONVENTION

Helipot

first in precision potentiometers

Helipot Corporation
South Pasadena, California
a division of
Beckman Instruments, Inc.



BECKMAN

CIRCLE 292 ON READER-SERVICE CARD FOR MORE INFORMATION

ELECTRONIC DESIGN • September 1955

Versatile 'DIAMOND H' Relays

Handle Many Different Jobs

"Diamond H" Series R hermetically sealed aircraft type relays perform outstandingly over such a broad area that they are frequently used to do many different types of jobs in a given application. For example, they give excellent reliability in dry circuits yet will carry up to 10 amperes in power circuits . . . or even 20 amperes for reduced life requirements.

Savings inherent in uniform size and mounting arrangements for one relay family can be multiplied by the lower inventory of spare parts needed when a single model is used for two or more functions. Matching or surpassing requirements of USAF Spec. MIL-R-5757B as well as important provisions of MIL-R-25018, tens of thousands of Series R 4 PDT and DPDT relays are in use, engineered for:

Various brackets of vibration resistance from 10 to 2,000 cps, temperature ranges from -65° to $+200^{\circ}$ C, coil resistances from 1 to 50,000 ohms, operational shock resistance of 30, 40 or over 50 "G" and mechanical shock resistance to 1,000 "G", contact capacities from 350 V., D. C., 400 MA, to 10 A., at 30 V., D. C., as well as signal circuits.

For complete information, send for a copy of Bulletin R-250.

THE HART MANUFACTURING COMPANY
210 Bartholomew Avenue, Hartford, Conn.

CIRCLE 293 ON READER-SERVICE CARD FOR MORE INFORMATION

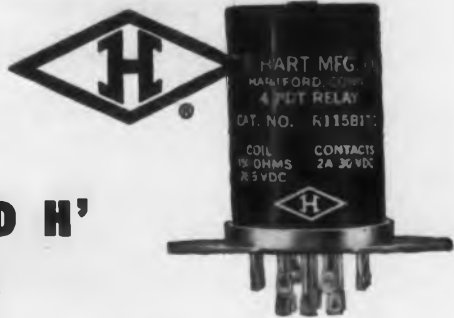

Shielding Material Uses Ferrite Powders



This new approach to shielding employs ferrite and ferrous powders coated on base materials by means of binders. The product can be obtained in coated and uncoated sheets and fabricated forms. In their coated state, the materials can be spun, bent, stamped, or drawn before being coated. Its non-sensi-

tivity to shock, its non-retentivity, and its durability, are outstanding features. Furthermore, the materials can support rough manhandling without suffering any deterioration in its shielding effectiveness. It has been useful in applications ranging from d-c to 300Mc.

Typical shielding applications are TV picture tubes, cathode-ray tubes, and photomultipliers. Transformer shielding made of this material cuts down hum effects. Shielded containers protect instruments from magnetic interference. Complete screen rooms can be built from the product. Magnetic Shield Div., Perfection Mica Co., 1322 N. Elston Ave., Chicago 22, Ill.

CIRCLE 295 ON READER-SERVICE CARD FOR MORE INFORMATION

Counter

Reads Events Per Unit Time



The Model 1005 Events-per-Unit-Time Meter is a five-digit unit which counts up to 100,000 in 1sec with an accuracy of ± 1 count. The instrument is intended for industrial, military, and laboratory applications for measuring the rate of occurrence of mechanical or electrical phenomenon during a 1sec period. It is especially suited to frequency

measurements as required in telephone carrier maintenance.

A crystal-controlled timing circuit, accurate to 0.001% at room temperature, gates the second counter for the 1sec interval. The count is directly displayed on the faces of direct-reading decade scaler tubes. When required, the instrument may be provided with an automatic reset circuit.

The instrument will operate at -20 dbm level from 60cy to 100kc. Input impedance is 100,000 ohms. It is designed for rack mounting. Ransom Research, Dept. ED, P. O. Box 382, San Pedro, Calif.

CIRCLE 296 ON READER-SERVICE CARD FOR MORE INFORMATION

*laminated plastic grade
selection now made easy and
dependable with the NEW*

FORMICA® COMPARATOR

GRADE →	Better Machining Grade CE		Moisture Resistant Grade C		Low P. T. 60C-Dim. Stab.		Good Mach.-Mech. Applications		Excellent for Machining		Application - Good Mach.		& Chemical Resistant		Acid Resistant	
	DNE	CHW	Z	L	L 42	LE	LN	LS	LI	LI	LI	LI	LI	LI	LI	LI
PROPERTY ↓																
WATER ABSORPTION	5	6	6	3	5	5	4									
DIMENSIONAL STABILITY (DUE TO MOISTURE)	3	5	8	1	5	3	5									
DIMENSIONAL STABILITY (DUE TO TEMPERATURE)	1	1	4	4	3	2										
INSULATION RESISTANCE	2	*	4	1	1											
PERP. TO LAMINATIONS	6	*	6	1												

53 grades compared qualitatively for 20 different electrical, chemical and mechanical properties.

Here's how you can use the Comparator Chart:

- 1 To select the Formica® grade with the most outstanding properties to fit your requirements.
- 2 To determine secondary properties that might be desirable in any given grade.
- 3 To compare quickly the properties of any grade in the entire Formica line, without checking every data sheet.

Send for your

**FREE FORMICA
COMPARATOR**

today

Start simplifying your job of
laminated plastic selection
and purchasing now.



The Formica Co., 4642 Spring Grove Ave., Cincinnati 32, Ohio

Gentlemen: Please send me at once a free copy of the new Formica Comparator (form 578).

NAME _____

COMPANY _____ TITLE _____

ADDRESS _____

CITY _____ ZONE _____ STATE _____

Formica, the most famous name in laminated plastics—
engineered for industry, Beauty Bonded for the home

CIRCLE 297 ON READER-SERVICE CARD FOR MORE INFORMATION

DATA SHEET

FAIRCHILD PRECISION POTENTIOMETERS

2.100" diameter

Type 747 — E
Linear
Potentiometer

Available with windings covering resistance range of 50 to 70,000 ohms; standard linearity tolerance of $\pm 0.15\%$. Clamp band provides unrestricted tapping area allowing up to 19 taps and simplifies phasing units in ganged assembly without disassembling units. Up to 6 units can be ganged on a single shaft. Cup width of .984 inches. Furnished with welded taps and end leads. Low starting torque only 1.0 oz-in per cup section. Low noise level and high resolution recommend units for computer assemblies, calibration controls, servo mechanisms, etc.

SAMPLES AVAILABLE ON ORDER

Fairchild's more complete line can help solve all your precision potentiometer problems. For more information write Fairchild Controls Corp., Potentiometer Division, 225 Park Avenue, Hicksville, L. I., N. Y., or 6111 E. Washington Blvd., Los Angeles, Cal., Dept. 140-68N.

CIRCLE 294 ON READER-SERVICE CARD FOR MORE INFORMATION



Electronic Design goes semi-monthly

What are the reasons behind this publishing move? What is the significance to advertiser as well as reader? These are some of the questions that



have been fired at both editor and publishers of *Electronic Design* since the decision to go semi-monthly was first announced in the June 17th issue of *Printers' Ink*.

"New product innovation", said Editor Edward E. Grazda, "is at its highest in the electronic industries. It is our policy to publish that type of material which is of *direct, immediate, and practical interest* to electronic design and development engineers. By coming out twice a month, the timeliness of our reporting will be more than doubled."

Although there will be additional editors and staff, the publication will remain the same—except there will be two issues instead of one each month. Each issue will offer top visibility for every advertiser.

Study reveals immediate readership

- When queried, the vast majority of *Electronic Design* subscribers say they read the magazine immediately on receipt—there is very little deferred readership



POINT OF DECISION. Reader survey (above) indicates an "immediate decision to read" . . . another proof of *Electronic Design's* time value and service to the reader.

No change in concept or philosophy contemplated

According to T. Richard Gascoigne and James S. Mulholland, Jr., co-publishers of three-year-old *Electronic Design*, the only modification in publishing philosophy will be to strengthen present editorial concepts. These will continue:

- To promote the progress of the electronic manufacturing industry by serving the key technical function—design.
- To make the electronic designers' task easier, more efficient and more productive.
- To provide a central source of electronic information pre-selected and concisely presented for convenient readership and use.
- To encourage two-way communication between electronic designer and manufacturer.

This is the publishing philosophy that has been responsible for *Electronic Design's* almost phenomenal rise . . . now leader in advertising page growth among all business publications.

Two issues will mean that the communication time between manufacturer and designer will be cut in half . . . new material can reach the design market faster and with greater frequency, and advertisers, already accustomed to the *immediate readership* offered by *Electronic Design*, will benefit from the increased visibility of a thinner book.

Here is the *basic medium* in a *basic market* which offers a *proven record* of immediate reader response. It is the only electronics publication in which you can accomplish both your short range and long range advertising objectives with equal effectiveness. *Electronic Design* is the only publication equipped to keep pace with the rapid expansion and constantly changing technology of the industry!

Advertising messages in *Electronic Design* receive immediate attention—according to surveys among readers. Two issues each month will continue to provide immediate readership because all material is of immediate usefulness!



85% of *Electronic Design's* inquiries are received within 15 days. Here is immediate readership—that will soon be available to advertisers twice each month . . . Hayden Publishing Co., Inc., 19 East 62nd St., New York 21, N.Y.

Capacitors High Stability Polystyrenes



Using polystyrene dielectric, the standard "ST" line consists of 200v, 400v, and 600v units in "bathtub" and rectangular metal cases with

capacities ranging from 0.05mfd to 25mfd. They can be had in tolerances of ± 5 , ± 2 , ± 1 , ± 0.5 , and $\pm 0.1\%$. Temperature operating range is -80° to $+75^{\circ}\text{C}$ with no voltage derating to 75°C . Temperature coefficient is -100 parts per million per $^{\circ}\text{C}$.

The insulation resistance with a 2-minute charge at 25°C is 1×10^6 megohms per mfd, and at 75°C is 5×10^4 megohms per mfd. The power factor at 1000cy at 25°C is 0.01-0.05%. Dielectric absorption is 0.01% maximum. Retrace is 0.1% (approx). Q at 1000cy at 25°C is 10,000. A variety of special units in the same series is available with special features such as glass tubular housings, extra low temperature coefficient, lower retrace, lower power factor, higher insulation resistance, silicone impregnation.

CIRCLE 299 ON READER-SERVICE CARD FOR MORE INFORMATION

If you need a special component, send a brief statement of your specifications addressed to Bulletin Board, *Electronic Design*, 19 East 62nd St., New York 21, N. Y. Include your complete address.

R-F Wattmeter

With $\pm 2\%$ Accuracy



The 641N is a calorimetric type wattmeter that measures r-f power with the precision of a primary standard. It can be used to check the accuracy of other types of r-f wattmeters, and to determine the actual output

of an r-f power source, the approximate magnitude of which is known. Frequency range is 0 to 3000Mc, and accuracy is better than $\pm 2\%$ of fullscale. It measures power in the 0-300w range. To establish an accuracy of better than 1%, it is calibrated by the user at d-c or 60cy with a $1/4\%$ wattmeter. VSWR is 1.1 to 1000Mc and 1.2 to 3000Mc. Time required for one reading is 2min. Recycling is 20min. The impedance is 52 ohms. M. C. Jones Electronics Co., Inc., Dept. ED, 185 N. Main St., Bristol, Conn.

CIRCLE 300 ON READER-SERVICE CARD FOR MORE INFORMATION

ELECTRONIC DESIGN • September 1955

Circuit Selector

For Remote Control Uses



This Ledex circuit selector, the "Experimenter I", can be used for circuit selecting, programming, homing, sequence operation, or remote selection. It is designed for remote control operation through a five wire master-slave circuit. The solenoid-operated slave switch will "home" to any one of twelve positions selected by the manual switch. The wafer-type circuit switch is a single-pole, twelve-position switch with shorting (make before break) type contacts. This switch may be used in an indicator circuit or to switch various types of loads. Additional wafer switches may be added, depending on the requirements of the application.

This unit is designed for a 110v 60cy single-phase input. The rectifier is a half-wave rectifier and acts as a filter so that the rectified a-c pulses the selector switch to the selected position. G. H. Leland, Inc., Dept. ED, 123 Webster St., Dayton 2, Ohio.

CIRCLE 301 ON READER-SERVICE CARD FOR MORE INFORMATION

Potentiometers

Low-Torque 2" Units



A high-precision series of ball-bearing 2" potentiometers, the Series BC-200, features lower starting and running torque, improved linearity due to reduced radial shaft play, and minimized backlash between

ganged sections for more accurate function repetition or solution of mathematical equations. Average starting torques do not exceed 0.5 oz-in per unit which is especially advantageous in multiple servo assemblies.

The extended terminal board design (illustrated) increases the area between tap terminals to provide space for mounting shunts and resistors directly to the potentiometer body itself without additional wiring or space.

A universal tap mounting ring permits up to 8 taps to be mounted on the same potentiometer unit. Completely enclosed ganged multiple assemblies also permit precise 360° external phasing and independent rotation of each section even after installation. DeJur-Amsco Corp., Dept. ED, 45-01 Northern Blvd., Long Island City 1, N. Y.

CIRCLE 302 ON READER-SERVICE CARD FOR MORE INFORMATION
ELECTRONIC DESIGN • September 1955

In Hycon's balance.... your future stability

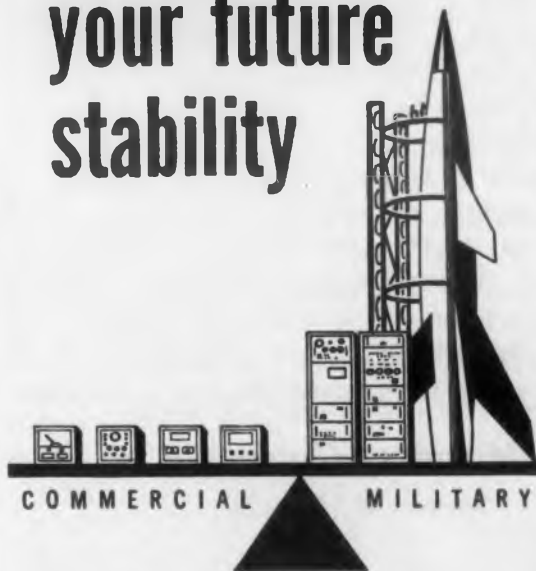

Hycon activities are part military, part commercial... a balanced blend of electronics, ordnance, photography. Qualified men with the following specialized electronic training or experience can find in this atmosphere long-term careers both satisfying and stimulating:

CIRCUIT DESIGN... D. C. and audio amplifiers, VTVM and CR 'scope deflection circuitry, military packaging and miniaturization.

MICROWAVE CIRCUIT AND COMPONENT DESIGN... in radar, microwave, traveling wave tubes, etc.

PULSE CIRCUITRY DESIGN... radar and allied applications, microwave circuitry.

SERVOMECHANISM AND ANALOG COMPUTER DESIGN... control systems, magnetic amplifiers, and similar fields.

ELECTRONICS SYSTEMS ENGINEERING... instrumentation, microwave, and control system design, particularly in guided missiles.

INTERVIEWS ARRANGED IN YOUR LOCALITY

If your professional background parallels our requirements, we'd like to hear from you. Send a resume to:

Hycon Mfg. Company

P.O. Box "N" Pasadena 15, California — "Where accuracy counts"

CIRCLE 303 ON READER-SERVICE CARD FOR MORE INFORMATION

A MIGHTY MITE FOR FREQUENCY MEASUREMENT...

MINIATURE, SEALED TYPE FRAHM[®]
RESONANT REED FREQUENCY METER



Hermetically sealed construction makes the Frahm Miniature Frequency Meter practically indestructible and foolproof in conditions of heavy moisture or fine dust. Design engineers who try Frahm Sealed Type Frequency Meters specify them

repeatedly for land, sea and airborne equipment because they withstand dirt, fungus attack, humidity and other destructive atmospheric conditions. The "miniature" is available in 2½" and 3½" sizes. WRITE FOR BULLETIN 32P2-ED.

ALSO AVAILABLE
IN STANDARD OR SPECIAL MODELS
FOR PANELBOARD OR PORTABLE USE

Frahm Resonant Reed Frequency Meters are available in a variety of standard shapes and sizes to indicate alternating current frequency from 15 up to 1500 cycles per second. They are applicable to pulsating or interrupted D-C as well as A-C supply circuits. If you have special design requirements for range, methods of activating, scale graduations, etc., we invite your correspondence. We are confident we can meet your specifications.

WRITE FOR BULLETIN 32-ED.

JAMES G. BIDDLE CO.

• ELECTRICAL TESTING INSTRUMENTS
• SPEED MEASURING INSTRUMENTS
• LABORATORY & SCIENTIFIC EQUIPMENT

1316 ARCH STREET
PHILADELPHIA 7, PA.



FRAHM RELAYS AND OSCILLATORS

Frahm Resonant Reed Relays and Oscillators open a new era to designers of electro-mechanisms. The transmission of a number of control signals over a single communication circuit of any type is simplified by the use of these components. WRITE FOR BULLETIN 33-DN (FRAHM RELAYS) AND BULLETIN 34-ED. (FRAHM OSCILLATORS).

James G. Biddle 9-116
1316 Arch St., Phila. 7, Pa. ED
Please mail following bulletins:
 32P2 32 33 34

NAME _____
JOB FUNCTION _____
COMPANY _____
ADDRESS _____
STATE _____

CIRCLE 304 ON READER-SERVICE CARD FOR MORE INFORMATION

Koiled Kords* permit EASY SERVICING of In-a-Door or Sliding Units . . .



A six inch section of KOILED KORDS retractile cord will extend to more than two feet when pulled and when released will retract immediately to its original neat, compact, spring-like shape. KOILED KORDS solve the problem of carrying current to movable units without having a long trailing cord to foul in the mechanism. They make it possible to retain electrical contact between units when they are pulled out for servicing, facilitating trouble location and correction.

KOILED KORDS extend as needed without looping, dangling or tangling.

KOILED KORDS are compact, neat, attractive, built to withstand continued flexing.

KOILED KORDS are available on special order to your specifications in multi-conductor types up to 37 conductors. Stocked types include 2, 3, 4 and 5 conductor #23 AWG communications cords and 2, 3 and 4 conductor Underwriters' Laboratories approved SO, SJO and SV-neoprene jacketed power cords. KOILED KORDS can be supplied in 48 inch mandrel lengths or prepared into cord sets for attachment to equipment.

WRITE FOR KOILED KORDS APPLICATION BULLETIN
SHOWING MANY USES.

Koiled Kords
Incorporated

Box K, New Haven 14, Conn.

*KOILED KORDS is the trademark of Koiled Kords, Inc.

CIRCLE 305 ON READER-SERVICE CARD FOR MORE INFORMATION

Centrifugal Blower For Airborne Equipment

This high-velocity, subminiature centrifugal blower for cooling airborne electronic equipment is only 2-7/8" long and weighs less than 6 oz. It meets all applicable MIL specifications.

It is available in either rotation and in single or double-ended models. Air delivery of the single-ended blower is 12cfm at 0" static pressure (20,000rpm) and 7cfm at 0" static pressure (11,000rpm). Velocity of the 20,000rpm model is 3000fpm. Eastern Air Devices, Inc., Dept. ED, 391 Central Ave., Dover, N. H.

CIRCLE 306 ON READER-SERVICE CARD FOR MORE INFORMATION



Miniature Clutches

Torque of 10 in-lb



These precision miniature clutches feature a positive displacement drive that will transmit up to 10 in-lb of

torque at speeds up to 1800rpm without external lubrication, and at higher speeds in an oil bath. The clutches are available in four basic types: single revolution, over-running, non-reversing, and indexing. Both sleeve mounts and through-shaft mounts are available in the four types. Length of the unit shown is 1-3/4". Precision Specialties, Dept. ED, 1342 E. 58th St., Kansas City, Mo.

CIRCLE 307 ON READER-SERVICE CARD FOR MORE INFORMATION

Power Supplies

Wide Series of 1.5amp Units

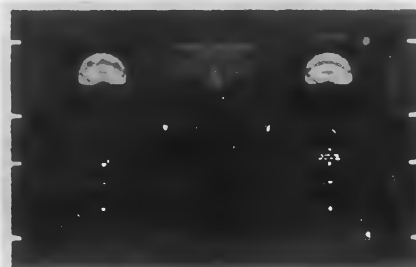

available in three ranges: wide (0-400v d-c), intermediate (125v band), and narrow (50v band, centered at 25v intervals from 25v to 375v d-c). In terms of d-c output voltage range, the series includes 28 basic models. Lambda Electronics Corp., Dept. ED, 103-02 Northern Blvd., Corona 68, N. Y.

CIRCLE 308 ON READER-SERVICE CARD FOR MORE INFORMATION

The "1500" line of 1.5amp regulated d-c heavy-duty power supplies is intended primarily for component use in original equipment. They are

Short Run STAMPINGS

May be Your Answer:



- For Cutting Costs
- For Expediting Experimental Work
- For Speeding Pilot Plant Operation
- For Making Quick Product Changes
- For Meeting Time and Cost Budgets
- For Replacement Parts on Obsolete Equipment
- For Small Orders

SHORT RUN STAMPING TIPS

FOR DESIGNERS, PURCHASING AGENTS, ENGINEERS, SUPERINTENDENTS AND MANAGERS.

Tells where and how you can save money using Short Run Stampings. Gives design tips that reduce stamping costs.

Write for your free copy of catalog 201 today

Federal TOOL AND MANUFACTURING CO.
3650 ALABAMA AVE. • MINNEAPOLIS 16, MINN.
QUALITY STAMPINGS IN SMALL QUANTITIES

CIRCLE 309 ON READER-SERVICE CARD FOR MORE INFORMATION

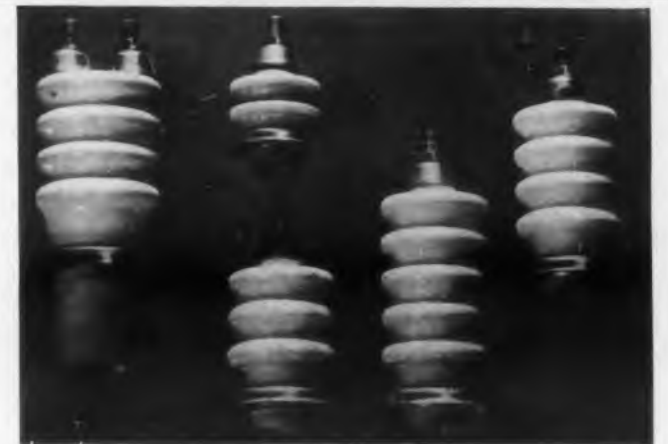

HIGH TEMPERATURE TERMINALS

100% leak tested, can be soldered, brazed, or welded

Now you can obtain electrical terminals made by a patented process utilizing a silver solder alloy to produce a molecular bond between metal and ceramic parts. They are hermetic, as proved by a mass spectrometer, and every terminal is leak tested before shipment. These high alumina-ceramic terminals operate at temperatures in excess of 350 deg. C. have unexcelled thermal and physical shock resistance, excellent electrical characteristics at high and low temperatures. Now used by leading electronic manufacturers in transformers, capacitors. Stocks on hand, 3/8" to 8" long, specials on request, engineering assistance provided for all your terminal needs. Call:

THE CERAMASEAL COMPANY
NEW LEBANON CENTER, N. Y.

CIRCLE 310 ON READER-SERVICE CARD FOR MORE INFORMATION

ELECTRONIC DESIGN • September 1955



**1000
contactors
in 1**

You're looking at the most versatile solenoid contactor ever developed for building electrical controls.

This Ward Leonard Size 2 contactor is available in *three* basic models, *six* major variations, *one thousand* combinations.

Your savings: reduced stock, minimum panel space, lower assembly costs, less layout and drafting time. Write for Bulletin 4450 to Ward Leonard Electric Co., 77 South St., Mount Vernon, N.Y. 4.15

WARD LEONARD ELECTRIC CO.

Result-Engineered Controls Since 1892

RESISTORS • RELAYS • MOTOR CONTROLS • CHROMASTER



CIRCLE 311 ON READER-SERVICE CARD FOR MORE INFORMATION

LOOK



**in this book...
over 7,000
STAINLESS STEEL
FASTENINGS
RIGHT-OFF-THE-SHELF
for immediate delivery**

STAINLESS STEEL

- Bolts & Cap Screws
- Socket, Set & Cap
- Nuts, Washers
- Machine Screws
- Sheet Metal Screws
- Wood Screws
- Pipe Fittings
- Dowel, Taper, Cotter Pins
- AN Drilled Fillisters
- Stud Bolts

● Avoid costly production and experimental delays! ● Brand new edition of Star Catalog now available.



Write, wire or phone for your copy today!

Stainless Stan says "Star's screws have clean, bright-and-shiny heads!"

STAR STAINLESS SCREW CO.

663 Union Blvd., Paterson 2, N. J.

Telephone: Little Falls 4-2300

Direct New York Tel. Wisconsin 7-9041.

CIRCLE 312 ON READER-SERVICE CARD FOR MORE INFORMATION

ELECTRONIC DESIGN • September 1955

Indicator A Universal Unit



The HCM 3/4 Universal Annunciator is a 1.3 oz, 3/4" diam D'Arsonval type indicator utilizing the Marion Coaxial Mechanism. This glass-to-metal hermetically sealed unit is available in

all typical panel instrument ranges, such as μ amp, ma, mv, volts, etc. It meets vibration requirements of MIL-E-5272A, Procedure I. Marion Electrical Instrument Co., Dept. ED, Manchester, N. H.

CIRCLE 313 ON READER-SERVICE CARD FOR MORE INFORMATION

Microwave Oscillator With Automatic Stabilization



Featuring an automatic stabilization indicator, this microwave oscillator, the Model 814, is a frequency generator in the X-band region which makes use of a discriminator and feedback loop

to secure short term stabilization in the order of five parts per hundred million. It also features simplified tuning. The tuning range is 8500Mc to 10,000Mc. Laboratory for Electronics, Inc., Dept. ED, 75 Pitts St., Boston 14, Mass.

CIRCLE 314 ON READER-SERVICE CARD FOR MORE INFORMATION

Spectrophotometer For Precise Measurements

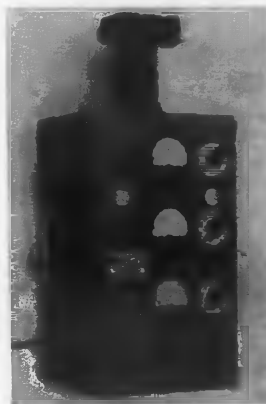

The Model 1602-A Tristimulus Spectrophotometer is for precise color measurements from various light sources. Small, light, and portable, this unit has sensitivity insured by the use of three built-in high-gain amplifiers having gains of over a million times. Light is split by means of semi-transparent mirrors and special filters into three

photomultiplier tubes producing taking characteristics which closely approximate the X, Y, Z distribution curves. Telechrome, Inc., Dept. ED, 632 Merrick Rd., Amityville, N. Y.

CIRCLE 315 ON READER-SERVICE CARD FOR MORE INFORMATION

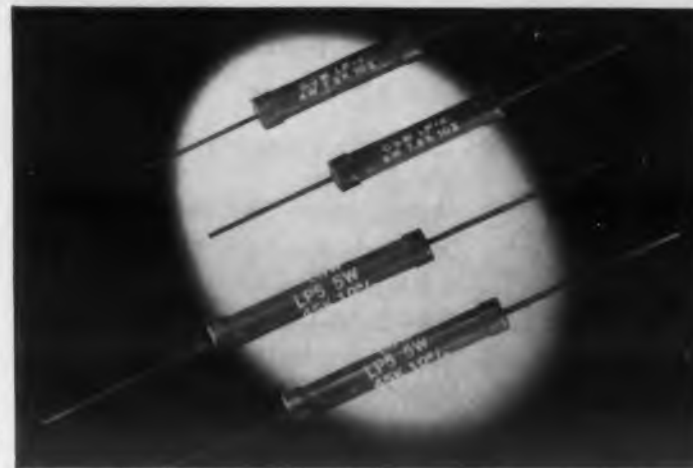

Types LP4-4 W. and LP5-5 W. shown. Also LP7-7 W. and LP10-10 W

Corning Low-Power Resistors for Radio and TV

You'll find that Corning Low-Power Resistors perform admirably under the most adverse radio and TV operating conditions. Their resistance range is the highest of any low-power resistor.

Small and compact, they save space. They are non-inductive and exceptionally stable.

The fired-in film of metallic oxides on glass forms is tough, abrasion-resistant, difficult to scratch. No need for special handling to prevent damage during installation.

The automatic resistance spiralling of these LP-type resistors is electronically controlled. Press-fitted caps with axial tinned leads ready to solder complete the assembly. This guarantees reliable uniformity of the following characteristics.

CHARACTERISTICS

Range—The LP4 resistors are available from 200 to 40,000 Ω ; LP5 from 200 to 45,000 Ω ; LP7 from 200 to 36,000 Ω ; LP10 from 200 to 50,000 Ω , with a $\pm 10\%$ tolerance.

Power Rating is based on 40° C. ambient temperature for the LP4 and LP5 resistors and 25° C. ambient for the LP7 and LP10 with an average hot spot of 275° C.

Derating—With suitable derating, resistors can be operated at ambient temperatures over 120° C.

Overload—Operated at 10 times the rated wattage for 5 seconds, resistance change is less than 2%.

Soldering—Permanent change in resistance due to normal soldering technique is less than 1/2%.

Moisture—Resistance change is less than 1% after 100 hours at an ambient temperature of 40° C. and 95% relative humidity.

At Radio Frequencies—The LP resistors are essentially non-inductive.

Mechanical Protection—A high temperature lacquer coating provides added protection during handling.

Availability—Immediately through Corning Glass Works or authorized distributors of Erie Resistor Corp. For new low prices and other information send the coupon, or write to Corning Glass Works, Corning, N. Y.



Corning means research in Glass

CORNING GLASS WORKS

39-9 CRYSTAL STREET, CORNING, NEW YORK

New Products Division

Please send me descriptive catalog sheet on Corning Low-Power Resistors.

Name Title

Company

Address

City Zone State

CIRCLE 534 ON READER-SERVICE CARD FOR MORE INFORMATION

Pulse Forming Network

Weights 47 Grams



The hermetically sealed "Pulse Expanding Network" GPEN-3K-5 will generate, in a simple circuit, a $5\mu\text{sec}$ pulse with input pulse widths from 0.05 to $2\mu\text{sec}$. Output amplitude may be made to follow input amplitude variations, or the output amplitude may be made to change in proportion

to the input pulse duration. Slight additional circuitry makes it possible to obtain constant output amplitude with varying input pulse width. Gudeman Co. of California, Inc., Dept. ED, 2661 S. Myrtle Ave., Monrovia, Calif.

CIRCLE 133 ON READER'S SERVICE CARD FOR MORE DATA

Line Filter

Cuts Down Radiation



The C-728 Filter is designed as a component for high frequency units such as diathermy and ultrasonic oscillators. Its use enables units of this type to meet FCC radiation re-

quirements of $15\mu\text{v}$ per meter at 100ft.

The filter meets requirements of 5ma current to ground, and is for 115-120v a-c operation. It is available for any current rating and in a wide variety of shapes and mounting arrangements. Potter Co., Dept. ED, 1950 Sheridan Rd., North Chicago, Ill.

CIRCLE 134 ON READER'S SERVICE CARD FOR MORE DATA

Dipped Mica Capacitor

Meets MIL-C-5 Specs



This miniature dipped mica capacitor with parallel leads, the "Dur-Mica" DM-20, meets all humidity, temperature, and electrical requirements of MIL-C-5. It is available in capacities up to 5100mmfd at 300v d-c(w) and up to 3900mmfd at 500v d-c(w) with operating temperatures up to 125°C .

Performance characteristics of the DM-20 in the lowest and highest capacities are better than the characteristic C limit throughout temperature ranges from -55° to 125°C . Electro-Motive Mfg. Co., Inc., Dept. ED, Willimantic, Conn.

CIRCLE 135 ON READER'S SERVICE CARD FOR MORE DATA

130

CABLES CONSTRUCTED with

BAKELITE POLYETHYLENE and VINYL PLASTICS

TRADE-MARK

feed the components of this IBM



Designed for business use, the IBM 702 Electronic Data Processing Machine has its component units housed in separate cabinets. This permits assembly of the most efficient system to fit user's needs. Essentials are the arithmetical and logical unit, the operator's control console, magnetic tape units, an input card reader, and an output printer and card punch. One or more magnetic drums are also often included.



Three input-output cables are shown leading into the central processing unit of the machine. They are separated here by a filament transformer.



This picture shows the tape control unit employing two harness cables through which its signals are transmitted. Two power cables are at left.

CIRCLE 136 ON READER-SERVICE CARD FOR MORE INFORMATION

electronic brain



The IBM 702 Electronic Data Processing Machine has a capacity of more than ten million operations an hour. Made up of half a dozen or more units, depending on the user's needs, the system can be assembled to assure utmost flexibility of operation.

To carry the signals between the units, the manufacturer uses input-output cable covered with BAKELITE Brand Vinyl Plastic. The cable contains 52 conductors insulated with BAKELITE Vinyl Plastic and 40 miniature coaxial cables insulated with BAKELITE Polyethylene.

These BAKELITE plastics offer a number of safeguards and advantages for cable construction. Polyethylene has an exceptionally low and stable dielectric constant and low power factor. Vinyl plastic is flexible, tough and abrasion resistant—an excellent protective material for complex cable assemblies.

Your own particular application for wire and cable may well benefit from the use of BAKELITE Polyethylene and Vinyl plastics, as insulation or jacketing. Write Dept. KM-56 for data and engineering assistance.

Here, two cables are interconnecting two processing machine units through a junction box. Wire mesh reinforcements are strain relievers which keep cable from being pulled out of lead-ins accidentally. Cable made by **Plastoid Corporation**, Hamburg, N. J.



BAKELITE COMPANY, A Division of Union Carbide and Carbon Corporation 30 East 42nd Street, New York 17, N. Y.
In Canada: Bakelite Company, Division of Union Carbide Canada Limited, Belleville, Ontario
The term BAKELITE and the Trefoil Symbol are registered trade-marks of UCC

CIRCLE 136 ON READER-SERVICE CARD FOR MORE INFORMATION

Vibration Indicator Meter

With High Sensitivity



The Vibration Indicator Meter Model 156, incorporates integrating amplifiers and reads amplitude in thousands of an inch. Small enough to allow four meters to be installed in a panel space of less than one foot square, each meter has a self-contained regulated power supply. Plug-in high pass frequency filters are available for any given application. Filters can be chosen to pass rotor-unbalance frequency and to eliminate lower frequency vibrations. Eastern Precision Resistor Corp., Dept. ED, 130-11 90 Ave., Richmond Hill 18, N. Y.

CIRCLE 137 ON READER'S SERVICE CARD FOR MORE DATA

Instrument Knobs

Lock on Shafts Without Damage



A line of collet-fitting instrument knobs produced by this firm permits positive locking on all standard shaft diameters with no damaging effect, even on soft metals. The knobs are available in three sizes: 1-3/4", 2-1/4" and 3". The collets are interchangeable among the different knob sizes and accommodate all shaft sizes from 1/8" through 3/8". Dale Products, Inc., Dept. ED, Columbus, Nebr.

CIRCLE 138 ON READER'S SERVICE CARD FOR MORE DATA

Mercury Plunger Relay

Withstands Rough Conditions



This mercury plunger relay has a protective fibre cylinder, combining the efficiency of glass with the ruggedness of metal. Heavy tungsten contacts are hermetically sealed within the tube, and mercury is used to make and break the coil circuit in inert gas. The relay takes 60 millisecc to close, 40 millisecc to open. It is available in a wide range of coil voltages, and its contacts handle motor loads up to 2hp. Size is 2-5/8" x 4-1/2" x 2-1/4". Mack Electric Devices, Inc., Dept. ED, 43 Glensick Ave., Wyncote, Pa.

CIRCLE 139 ON READER'S SERVICE CARD FOR MORE DATA

rounds



bars



rods



Sintered Alnico Magnets

..from stock

Yes, Indiana Sintered Permanent Magnets are available for your development work in dozens of standard sizes and shapes. Fast, 24-hour shipment on Sintered Alnico II Magnets can be made from stock. Also available in grades IV, V, and VI on special order.

Possibly Indiana Sintered Magnets can be applied successfully to your product. Additional detailed information available on request... write for 12-page Catalog No. 12-M9 on your company letterhead.



"U" shapes

INDIANA
PERMANENT
MAGNETS

The Indiana
Steel Products Company
VALPARAISO, INDIANA

World's Largest Manufacturer of Permanent Magnets

CIRCLE 328 ON READER-SERVICE CARD FOR MORE INFORMATION

news
notes

Berkeley

BECKMAN

FREE
DATA
FILE

"A Digital Method
for Precise Phase
Measurements"

by ROBERT S. MELSHEIMER

Complete data on techniques for precise phase measurements by digital means, as used for synchro and resolver calibration, servo system testing, low frequency response studies, etc. Also includes comprehensive discussion of digital measurement accuracies.

Write now for free copy; please request Data File No. 107, address Dept. D-9.

Berkeley

division

BECKMAN INSTRUMENTS INC.

2200 Wright Avenue • Richmond 3, Calif.

58

CIRCLE 329 ON READER-SERVICE CARD FOR MORE INFORMATION

132

Solenoid Actuator

In Push or Pull Types



The electromagnetic Solenoid Actuator, Model L22A, features a linkage system available in either a push or pull arrangement, which magnifies the original air gap movement in an 8:1 ratio. The actuator itself is extremely compact, displacing 1.4 cu in and weighing 50gr. It operates on 1.8w input, within 7millisec at normal

voltage. The linkage design permits even motion with minimum friction-induced loss of energy. The actuator remains cool in continuous operation.

The unit has a wide range of applications, including reciprocating motion, vibration generators, rotary step motion, model actuators, valve actuators, remote switches, release catch mechanisms, and operation of camera shutters. Coil specifications are 1260 ohms, 7400 turns, 48v d-c, 0.038amp, 1.8w; stroke 0.125"; pull 100 to 550gr. Other coils for 12 and 24v d-c, and special voltages up to 120v, are also offered. James Cunningham, Son & Co., Inc., Dept. ED, 13 Canal St., Rochester, N. Y.

CIRCLE 330 ON READER-SERVICE CARD FOR MORE INFORMATION

Thermistor Radiometer

Rapidly Measures Temperature



This wide-range thermistor radiometer is for direct measurement of surface temperatures and environmental radiant temperatures. It is available in the HL2 battery-powered d-c model for portable field use, and the HD2 a-c model for laboratory or clinical applications.

Contact with the surface being measured is not necessary, and temperature readings are made at a distance by merely directing the radiometer at the desired object.

The use of sensitive, rapid-response thermistors permits quick scanning of surfaces to measure temperature differences as small as 0.1°C. Radiometer metering circuits provide full-scale readings of 10, 30, and 100°C, which can be calibrated for either relative or absolute temperature readings. William-son Development Co., Dept. ED, 317 Main St., West Concord, Mass.

CIRCLE 331 ON READER-SERVICE CARD FOR MORE INFORMATION



Miniaturized
ROTARY SELECTOR
Switch

Only 3/4" d. x 13/16" l.
— overall — body and
terminals.

3/8" bushing. 1/4" shaft.

★ The remarkably compact Series BH Switch is available in single-pole (up to 12 positions), two-pole (6 positions), three-pole (4 positions), and four-pole (3 positions). Shorting or non-shorting, as required. Enclosed construction—constructed to military or commercial usages. ★ Engineering data on request. Let us quote!

Current ratings: 50 ma.
at 300 v. A.C. or D.C.;
500 ma. at 30 v.

U.S. Pat. No. 2,463,945.



CANADA:

CANADIAN MARCONI CO., LTD., TORONTO

CIRCLE 332 ON READER-SERVICE CARD FOR MORE INFORMATION

BRING US YOUR HEADER PROBLEMS!



SIMPLE OR COMPLEX — We make them all, ranging from 2- and 3-electrode crystal holder bases and standard octal headers, to 14- and 18-terminal headers for sealed Transformer and Relay applications — with a wide selection of styles and sizes in our series of basic designs.

SPECIAL DESIGNS — We also manufacture Sealed Headers and Terminals to meet special requirements, and will be glad to quote upon receiving your specifications.

COMPLETE ASSEMBLIES — We have facilities for handling the complete assembly of many units — including evacuating and pressure-filled enclosures.

NEW CATALOG — Just off the press, a new Hermaseal catalog, with descriptions and specifications of some of our standard Sealed Headers and Terminals. Write for your copy today!

Hermaseal

THE HERMASEAL CO., Inc.

Elkhart 45, Indiana

CIRCLE 333 ON READER-SERVICE CARD FOR MORE INFORMATION

ELECTRONIC DESIGN • September 1955

the **ONLY** instrument in the field that offers **ALL** these features at

**NO
EXTRA
COST!**



the new
DS-6100-T
FREQUENCY-PERIOD
electronic counter

A compact frequency-period counter designed for direct measurement of any mechanical, electrical or optical phenomena which can be converted to a varying voltage. Read-out in direct digital form. Ideal for use by skilled or unskilled personnel. Price \$700.00.

Write for complete catalog data **TODAY!**

- **FREQUENCY** Measurement
- **1 and 10 SECOND** Time Base
- **PERIOD** Measurement
- **1 and 10 CYCLE** Gate Time
- **PRECISION ACCURACY** Over 1-100,000 cps range
- **EASILY PORTABLE** Only 28 Pounds
- **SMALL SIZE** 14 1/4" W x 7 1/2" H x 13 1/2" D

NEW
*Improved
Sensitivity*



Representatives in all major areas.

COMPUTER-MEASUREMENT CORP.

5457 Cleon Avenue, Dept. 76-J
North Hollywood, California

CIRCLE 334 ON READER-SERVICE CARD FOR MORE INFORMATION

**midget
water
stills**

only
\$110⁰⁰



*Superior
Quality,
Automatic
and
Continuous
Operation*

What does it cost you to buy distilled water? * Precision Midget Water Stills can save you money and provide the convenience of...

Fresh pyrogen-free distilled water **WHEN** and **WHERE** you want it.

At a half gallon per hour rate—trouble-free operation.

Easy to install and maintain.

No plumbing connections required, compact, portable, automatic operation, easily cleaned.

Thousands of applications under varying conditions have proved their utility and performance.

- Smaller than a 5-gallon bottle
- Tinned copper parts in vital areas
- Gas-free water at all times
- Low current consumption
- Efficient preheating of raw water before entering evaporator.

*The Midget costs only 7 1/2¢ per gal. at 3¢ per kilowatt hour.

AVAILABLE FOR IMMEDIATE DELIVERY

Send for new bulletin No. 912

Precision Scientific Company

3759 West Cortland Street • Chicago 47

CIRCLE 335 ON READER-SERVICE CARD FOR MORE INFORMATION

ELECTRONIC DESIGN • September 1955

Digital Voltmeter
Reads Analog Outputs



The Model 450 Digital Voltmeter provides accurate and rapid digital readout for analog computers at low cost. Operating as a self-balancing digital potentiometer, its switching circuit utilizes oil-immersed stepping switches, life tested for 20 million readings. The measured voltages are displayed in a horizontal line of four luminous numerals 1" high, plus the decimal point and polarity sign.

Range is $\pm 00.01v$ to $\pm 99.99v$ d-c, accurate to $\pm 10mv$. Resolution is $00.01v$. Rate of operation is one reading per sec. External reference of $\pm 100v$ d-c is required. Input impedance is 1000 megohms. Printer control through a 50-pin connector is standard. No switching or adjusting is necessary during the process of making measurements.

Bench and rack mounting models are available. Weight is 25 lb. The power source is 115v 60cy. Non-Linear Systems, Inc., Dept. ED, Del Mar Airport, Del Mar, Calif.

CIRCLE 336 ON READER-SERVICE CARD FOR MORE INFORMATION

Midget Thermostats
Cover -50° to $+500^{\circ}F$



The midget "Thermoswitches" in this new line measure 1/4" diam x less than 2-1/2" long and weigh approximately 1 oz. They are designed for precise temperature control or heat detection applications in heated equipment, bearings, pumps, etc., wherever installation space is at a premium.

Thermostats may be set to actuate at any specified temperature between -50 to $+500^{\circ}F$. Contacts open when the temperature exceeds this set point; inverse action models are also available in which the contacts close above set point temperature. Units are available in a variety of head styles to meet various mounting requirements.

The thermostats are rated to handle an electrical load of 1amp, 115v a-c. Larger loads can be handled with a relay. Cartridge bodies and mounting accessories are of polished stainless steel; wiring leads are Teflon coated for long service life. Fenwal Inc., Dept. ED, 60 Pleasant St., Ashland, Mass.

CIRCLE 337 ON READER-SERVICE CARD FOR MORE INFORMATION

Standardized
CORD SETS
Ready for Your
APPLICATION



Cords manufactures a complete line of U.L. approved cord sets for any application. Through their extensive standardization, Cords Ltd. can reduce both your engineering and inventory costs . . . and at the same time furnish quality cord sets at a competitive price. Sales offices in principal cities.

Write Cords today for free catalog outlining complete specifications of standard cord sets . . . or for Bulletin C442 on new 3 conductor U.L. approved cord sets.

CORDS LIMITED

DIVISION ESSEX WIRE CORPORATION
121 DODGE STREET, DEKALB, ILLINOIS

CIRCLE 338 ON READER-SERVICE CARD FOR MORE INFORMATION

**No Fooling
with Tooling**

**Instrument and Control
Knobs—PRICED RIGHT**

High quality—
low cost stand-
ard parts

Hard finish ther-
mosetting plastic.
Available fast—
often from stock

Many more de-
signs than shown
—complete size
range in most

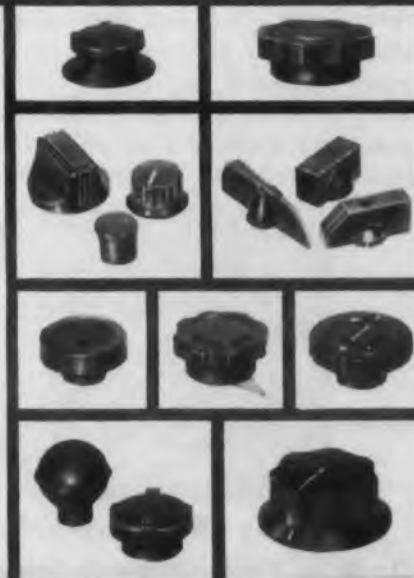

Send for complete catalog

KURZ-KASCH, INC.

Standard Parts Division
1422 S. Broadway, Dayton 1, Ohio

CIRCLE 339 ON READER-SERVICE CARD FOR MORE INFORMATION



High mechanical properties are obtained in these springs, diaphragms, wire. They're made of heat-treatable constant modulus alloy, Ni-Span-C, supplied by H. A. Wilson Company.

Designing precision instruments?

Look into Ni-Span C constant modulus alloy

Ni-Span-C* iron-nickel alloy has a constant modulus of elasticity between -50°F . and 150°F .

Heat-treatment produces excellent hardness, excellent mechanical properties . . . and a thermoelastic coefficient of zero or any desired value near zero.

This Ni-Span-C alloy does away with auxiliary temperature compensation in precision instruments. It assures constant frequencies, spring rates . . . above average corrosion resistance. Use this alloy in tuning forks, precision springs, diaphragms, bourdon tubes — wherever temperature change affects accuracy.

*Registered Trademark



Get this FREE fact-filled Booklet

The H. A. Wilson Company's 20-page booklet, "Wilco Ni-Span-C" gives you complete information about composition, properties, fabrication, and uses. Charts and data summaries, too. Circle the number below on the reply card of this magazine for your free copy of this booklet, or write to them in Union, N. J.

The INTERNATIONAL NICKEL COMPANY, Inc.
67 Wall Street New York 5, N. Y.



CIRCLE 340 ON READER-SERVICE CARD FOR MORE INFORMATION

Generator With 100-1700cy Range



The Model 1460, while intended primarily to cover the 360-440cy range, has an external oscillator which extends this range from 100cy to 1700cy. It is intended for

use as a bench testing source of power for 400cy devices which require observation of performance over $\pm 10\%$ of this frequency. It allows observation of the performance of individual pieces of equipment under test at any point within this range without disturbing test operations on the rest of the line.

Rated power output is 100va at 120v with a frequency stability of $1/4\%$ and total harmonic distortion of less than 2%. Voltage regulation is 1% from no-load to full load. Output voltage is adjustable over the range of 100-130v. Operation is from a 117v line $\pm 10\%$. Communication Measurements Laboratory, Inc., Dept. ED, 350 Leland Ave., Plainfield, N. J.

CIRCLE 341 ON READER-SERVICE CARD FOR MORE INFORMATION

Displacement Controller For Differential Pick-Ups



This unit provides automatic alarm or closed-loop control involving pressure, weight, stress, motion, or any other quantity measurable by differential transformer transducers. Features include regulated excitation voltage for the transducer, electrical zero and sensi-

tivity adjustments, a $4-1/2"$ contact-making meter with adjustable limit contact, and a spdt output relay for operation of external alarm or control devices.

In operation, the relay is energized whenever the measured quantity equals or exceeds the preset limit and opens when the quantity falls below the limit. A pilot light indicates the relay position at all times. Relay contacts are rated at 5amp 250v a-c. Maximum full scale sensitivity is $0-0.020"$ using a typical differential transformer, or 0-5 lb using Daytronic Series 140 Load Transducers. Daytronic Corp., Dept. ED, 216 S. Main St., Dayton 2, Ohio.

CIRCLE 342 ON READER-SERVICE CARD FOR MORE INFORMATION

FOR HIGH FREQUENCY-HIGH VOLTAGE SPACE SAVING APPLICATIONS GARDE Miniature & Sub-Miniature INSULATED STAND-OFFS, FEED THROUGH & SPACERS

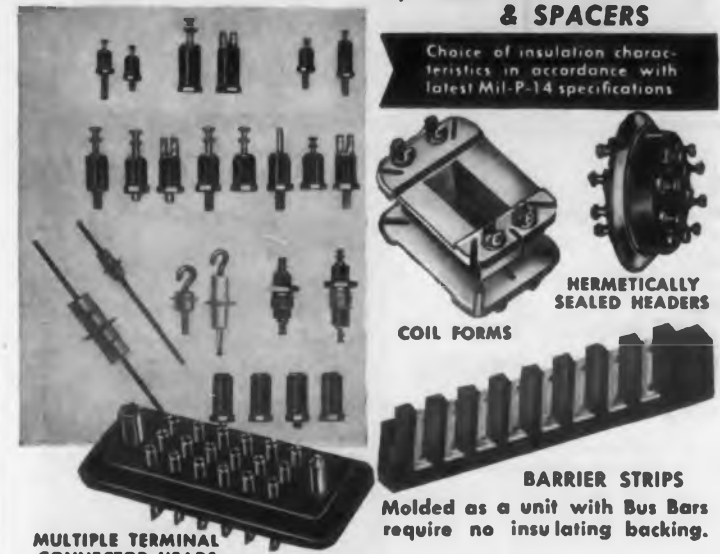

Choice of insulation characteristics in accordance with latest Mil-P-14 specifications

HERMETICALLY SEALED HEADERS

COIL FORMS

BARRIER STRIPS

Molded as a unit with Bus Bars require no insulating backing.

MULTIPLE TERMINAL CONNECTOR HEADS

For users to properly assess the outstanding features and advantages of Garde Components, samples will be sent on request. A detailed technical catalog is now available. Be sure your name is on our mailing list.

We have complete facilities to accommodate your special requirements, ranging from Engineering Consulting Service to Precision Design and Production.

GARDE MANUFACTURING COMPANY
MOLDERS OF THERMOPLASTIC AND THERMOSETTING MATERIALS
588 Eddy Street, Providence 3, Rhode Island
Sales Representatives in Principal Cities

CIRCLE 343 ON READER-SERVICE CARD FOR MORE INFORMATION

MICROWAVE 6334 DUAL TR TUBE DELIVERS LONG LIFE AT HIGH POWER



Now you can improve X-Band radar performance with a dual TR tube that features long life at high power levels . . . Microwave Associates' 6334 Dual TR Tube.

A new high has been scored in dependable tube performance with built-in Microwave features . . .

Heavy duty extra thick flanges hard soldered to the TR body insure mechanical rigidity and maintain electrical balance within slot hybrid duplexers.

Optimum balance for broadband response, maximum crystal protection and receiver isolation are insured by adjusting each tube in precision hybrids fed by a sweep oscillator. THE NEW LARGE X TO SMALL X TR TUBE TYPE MA-306 protects diodes at 300 KW and features long-life extra-duty performance. It is highly recommended for high power X-Band radar systems where weight and space considerations are paramount. The input and output flanges of the MA-306 mate with hybrid couplers in RG-51/U and RG-52/U waveguide respectively. No transformer is necessary.

The 6334 dual TR tube is normally supplied with thick flanges drilled with 4 holes. The older thin flange, 6 hole version is also available. For optimum TR-Tube performance, specify Microwave Associates.

ATR - TR - AND MAGNETRON TUBES
WAVEGUIDE COMPONENTS AND
TEST EQUIPMENT - SILICON DIODES



22 CUMMINGTON STREET
BOSTON 15, MASSACHUSETTS
COP 7-7577

CIRCLE 344 ON READER-SERVICE CARD FOR MORE INFORMATION



**MORE THAN
50,000,000 IMPULSES
COUNTED
WITHOUT A MISS**

We've been testing a SODECO Electric Impulse Counter out of a recent production run to find out how long it would last. The count has now reached the fifty million mark without the slightest indication of trouble. This is pretty good proof of rugged long-lasting quality built into all SODECO Counters.

Apart from long dependable service, you get many other plus values when you specify SODECO for your counting problems. For instance:

- **SPEED**—up to 25 impulses /sec.
- **COMPACTNESS**—The model illustrated measures only 1 3/8" x 2 3/8" x 4 3/8" and is suitable for flush mounting
- **ELECTRIC RESET**—Permitting simultaneous remote resetting of an entire bank.
- **LOW POWER REQUIREMENT**—These counters have been operated in electronic circuits.

A SODECO Counter may be the answer to your counting problem. Write for full information.

LANDIS & GYR, Inc.

45 WEST 45TH STREET, NEW YORK 36, N. Y.

CIRCLE 345 ON READER-SERVICE CARD FOR MORE INFORMATION

**DC-AC
CHOPPERS**

For 60 Cycle Use

Built to rigid commercial specifications.

Twenty-two types, both single and double pole.

Long life.

Low noise level.

Extreme reliability.

Write for Catalog 370.

**STEVENS
INCORPORATED
ARNOLD**

22 ELKINS STREET
SOUTH BOSTON 27, MASS.

S A-10

CIRCLE 346 ON READER-SERVICE CARD FOR MORE INFORMATION

ELECTRONIC DESIGN • September 1955

UHF Thermocouples
Ranging from 5ma Upward

A number of uhf type vacuo junctions (thermocouples) ranging from 5ma upwards have been added to this firm's line of standard types. Extremely small in size, they feature both minimum capacitance and inductance.



The thermocouples are electrically insulated from the heaters and tested to 100v d-c. Resistance tolerances for heater or thermocouple are $\pm 10\%$. Nominal output is 7mv. Over-all temperature coefficient does not exceed 0.2%. Dimensions do not exceed 5/8" approx. Current ratings can be exceeded by a 50% overload for long periods of time without damage to thermocouple. Heaters will withstand transient overloads of 100%. Special ranges and outputs can be made to user requirements. Beam Instruments Corp., Dept. ED, 350 5th Ave., New York 1, N. Y.

CIRCLE 347 ON READER-SERVICE CARD FOR MORE INFORMATION

Electric Counter

Built to be Tamper-Proof



The tamper-proof, tumbler-lock reset electric counter, Model 6-Y-1-2-MF, has been added to this firm's

line of electrically operated "Productimeters." Figures cannot be reset without a key.

The unit is designed for panel mounting, and comes equipped with mounting plate, the lock reset being at the right of the plate. The entire assembly can be placed into a panel directly from the front and securely fastened from the front. The counter is totally enclosed, affording protection against dust and moisture conditions.

Overall dimensions are 5-1/2" long x 2-1/16" deep x 2-1/8" high. Figures are 9/64" wide x 3/16" high, white on dark background. The number wheels are high in the window for maximum visibility.

Operating speed is up to 1000cpm. Standard voltage is 110v, 60cy. Voltage fluctuations on normal industrial circuits have no effect on accuracy. Durant Manufacturing Co., Dept. ED, 1993 N. Buffum St., Milwaukee 1, Wis.

CIRCLE 348 ON READER-SERVICE CARD FOR MORE INFORMATION

336,000
miles of
extrusions!

Our extruders have turned out enough plastic and rubber extrusions to reach to the moon and halfway back. In compiling this vast experience General Tire's Industrial Products Division has supplied thousands of original equipment manufacturers with just about every known type of extrusion. No job is too large, too small or too complicated for our design and production staff. Perhaps you can benefit from the fantastic extrusion mileage we've accumulated down through the years.

For literature or further information write to The General Tire & Rubber Company, Wabash, Indiana, Department I-2.

*"From Plans to Products
in Plastics and Rubber"*

**THE
GENERAL
TIRE** Industrial Products Division
WABASH INDIANA

CIRCLE 349 ON READER-SERVICE CARD FOR MORE INFORMATION

Where to get transformers for atomic submarines

Like General Dynamics' Stromberg-Carlson Division, you may at times need transformers that operate in a new circuit design under unusual and rugged conditions.

The shipboard announcing equipment Stromberg designed for the U.S.S. Nautilus, for example, must be 100% trouble-free because of the sub's ability to remain submerged indefinitely. It must also be able to withstand the terrific shock of depth bombs during battle.

Stromberg asked us to design and produce transformers that fit the system's advanced circuitry. The transformers we supplied them meet all the high standards of both Stromberg and the US Navy. They are now operating on the Nautilus and the second atomic sub, the U.S.S. Sea Wolf.

Just off the press! 16-page, illustrated brochure describing Caledonia's services and facilities for custom-designing and manufacturing transformers.

CALEDONIA

ELECTRONICS AND TRANSFORMER CORPORATION

Dept. ED-9, Caledonia, New York

CIRCLE 352 ON READER-SERVICE CARD FOR MORE INFORMATION

NEW AC RELAY

Cool-Running
Ideal for use where hermetic sealing and dust covers are required

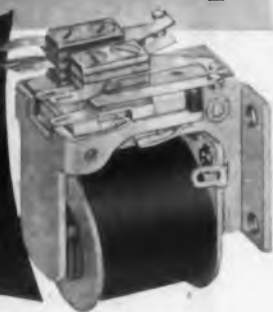

TYPE "R"

Withstands
Vibration
Up to 10G
at 5 to 55cps.

Shock
Resistance
20G, energized
15G, non-energized

COILS: For all standard voltages up to 220 volts, AC. Average coil consumption, 2.5 VA.

CONTACTS: 6PDT up to 5 amps. at average 7.5 VA; 4PDT up to 5 amps. at average 2.5 VA; DPDT up to 10 amps. at average 7.5 VA; fine silver. Other contact materials available.

SIZE: 1 1/2" x 1 1/4" x 2 1/4", depending on contact combinations.

Available hermetically sealed or with dust covers.

Send For Bulletin "R"



Comar ELECTRIC COMPANY
3349 ADDISON STREET, CHICAGO 18, ILLINOIS

RELAYS • SOLENOIDS • COILS • TRANSFORMERS • SWITCHES • HERMETIC SEALING
CIRCLE 353 ON READER-SERVICE CARD FOR MORE INFORMATION

Capacitors and Filters

Miniature Special Types



This firm has established a Miniature Components Division to design and manufacture special capacitors and radio noise filters. It builds foil and metallized paper capacitors to order in extremely small sizes and light weights. Typical is the 0.75-mfd miniature phase-

correction capacitor illustrated. Rated at 600v d-c w, it stands only 1-1/4" high, and operates successfully at 350°F. Glass-to-metal seals are provided, and the dielectric is epoxy resin.

In designing special radio noise filters, the division serves manufacturers who require miniature-sized units which carry heavier currents at higher temperatures than most units currently available. Electronic Specialty Co., Miniature Components Div., Dept. ED, 5121 San Fernando Rd., Los Angeles, Calif.

CIRCLE 354 ON READER-SERVICE CARD FOR MORE INFORMATION

See What's New in Electronics



FREE!

Send for NEWARK'S 1956 CATALOG

260 pages of the newest developments in test instruments, tubes, capacitors, transformers and everything you need in Electronics, Radio, TV, Amateur and High Fidelity.

NEWARK
ELECTRIC COMPANY
Dept. ED-9, 223 W. Madison, Chicago 6, Ill.

WEST COAST BRANCH
4736 W. Century Blvd., Inglewood, Calif.

CIRCLE 355 ON READER-SERVICE CARD FOR MORE INFORMATION

PRINTED CIRCUITS

can simplify your design . . .
speed output . . . cut costs

Eliminate wires! With Du Pont Conductive Coatings, you can print circuits for capacitors and couplings; for static shielding to replace foils and cans; for resistors and solder seals. Streamline your designs in television sets and radios, electronic equipment, meters and switchboards.

Coatings are easily applied by spray, brush, dip or stencil on metals or non-conductors. Fit right into high-speed assembly-line operation. Save you money. For up-to-date, descriptive bulletin write to: E. I. du Pont de Nemours & Co. (Inc.), Electrochemicals Department, Wilmington 98, Delaware.

DU PONT CONDUCTIVE COATINGS

—Best for printed circuits!



BETTER THINGS FOR BETTER LIVING
...THROUGH CHEMISTRY

CIRCLE 356 ON READER-SERVICE CARD FOR MORE INFORMATION

another miniature instrument

TO SAVE SPACE

IMPROVE PERFORMANCE AND CUT COSTS

MODEL 153
ACTUAL SIZE

1 1/2
INCH
miniature
meters



Model 153-W has successfully met the requirements of specification MIL-M-3823. For commercial applications order Model 153-C.

• RANGES: D.C. AMPS, 0-100 UA to 0-15 AA — D.C. VOLTS, 0-50 MV to 0-500 VV — A.C. VOLTS, 0-1 VV to 0-500 VV
• SPECIAL SCALES, RANGES AND OTHER CHARACTERISTICS TO MEET YOUR REQUIREMENTS

write FOR ENGINEERING DATA SHEETS ON:
1 1/2" Ruggedized Meters; 1" and 1 1/2" Panel Meters; 1 1/2" VU, DB and Illuminated Meters; Miniature Multitesters and Side Indicators.



international
instruments, inc.
P.O. BOX 2954, NEW HAVEN 15, CONN.

CIRCLE 357 ON READER-SERVICE CARD FOR MORE INFORMATION

ELECTRONIC DESIGN • September 1955

BOURNS NEW
CARBON TRIMPOT

Providing: INFINITE RESOLUTION
Resistances 20,000 to 1 Megohm • Power Rating 0.2 Watt

Bourns new carbon **TRIMPOT** is identical in sizes and configuration to the popular wirewound **TRIMPOT** which is approved as a standard component by engineers in aircraft, missile and electronic industries. Outstanding features are:

Compact size.....1/4" x 5/16" x 1-1/4"
Adjustment......25-turn, self-locking
Mounting...Single or stacked with #2-25 screws
Vibration.....10-20 G; 10-2,000 cps
Acceleration (steady state).....100 G
Optional features...Teflon leads, extended shaft

INSTRUMENTS SHOWN ACTUAL SIZE



Side Mounting Bracket No. 120-20-2 End Mounting Bracket No. 120-20-1

Bourns manufactures other precision potentiometers to measure Linear Motion, Gage, Absolute and Differential Pressure and Acceleration

BOURNS LABORATORIES
6135 MAGNOLIA AVE. • RIVERSIDE, CALIFORNIA

Technical Bulletin on Request, Dept. 172

© B.L.

CIRCLE 358 ON READER-SERVICE CARD FOR MORE INFORMATION

Partners... YOU AND YOUR
NO. 50 POCKET PAL

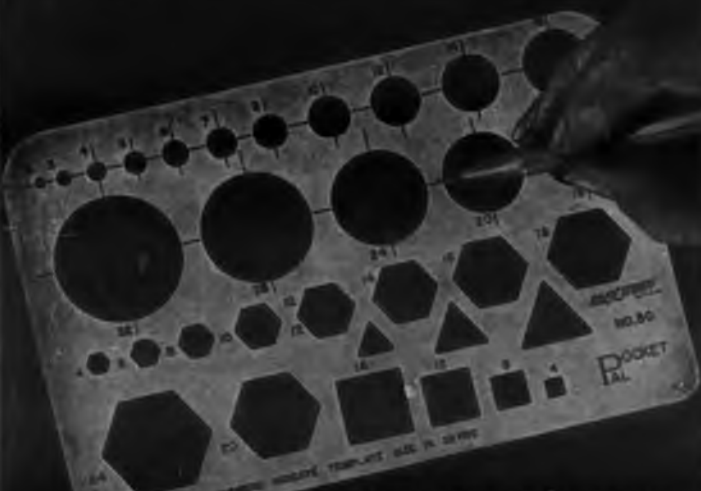

\$1.00 AT YOUR LOCAL DEALER
CATALOGUE NO. 49 AVAILABLE UPON REQUEST

.030 MATTE FINISH MATHEMATICAL QUALITY DOUBLE-CURED PLASTIC.
ALL HOLES SMOOTH-MILLED TO ENGRAVING MACHINE ACCURACY.
ONE OF MORE THAN 30 RAPIDESIGN TIME-SAVER TEMPLATES—ALL
OF WHICH ARE BETTER MADE, MORE USEFUL AND LESSER PRICED.

RAPIDESIGN INC.
P. O. BOX 592 GLENDALE, CALIF.

CIRCLE 359 ON READER-SERVICE CARD FOR MORE INFORMATION

ELECTRONIC DESIGN • September 1955

Magnetic Cartridge

Has 8-Poles



The "B&O Lo-Z" Magnetic Cartridge, made in Denmark, has a very small mass and negligible inertia, freedom from resonance over the whole audible range, high compliance, and low record wear. Frequency response is flat from 20 to 16,000cy ± 2 db, then gradually rising to over 20,000cy. Eight pole shoes surround the coil. A twisted armature turns around a vertical axis. The cartridge itself snaps into spring loaded mounting hardware made to American standards. Four models are available: single and dual styli, with sapphire or diamond micro tip for micro-groove or standard records. Fenton Co., Dept. ED, 15 Moore St., New York 4, N. Y.

CIRCLE 360 ON READER-SERVICE CARD FOR MORE INFORMATION

(Advertisement)

New Trio of Shielded Coil Forms

Ideal for IF Strips, RF Coils, Oscillator Coils, etc.



Shown 3/4 size

Now there are three CTC shielded coil forms available to you! New LS-10 and 11 have just joined CTC's LS-9 coil form to give you three size ranges from which to choose.

All three rugged coil forms are shock-resistant with mechanically enclosed, protected coils. Windings may be universal or layer wound to fit your application. Forms may be ordered disassembled, ready for winding, or CTC will wind to specification.

Electrical and mechanical shielding is complete, since the assemblies are comprised of brass shells enclosing powdered iron cup-cores, tuning slugs, phenolic coil forms and silicone fiberglass terminal boards. Three terminal board layouts are available: either two, three or four terminals with type X2089 silver plated solder terminals. For complete specifications and data on prices, write direct. Cambridge Thermionic Corporation, 457 Concord Ave., Cambridge 38, Mass.

CIRCLE 361 ON READER-SERVICE CARD FOR MORE INFORMATION

SQUARE AND SINE WAVES
20 Cycles to 500 kc



Type 1210-B... \$140.00

New GR Unit R-C Oscillator

★ Three outputs

Low Voltage: 0 to 7 v, 50 Ω ;
constant to ± 1 db to 200 kc

High Voltage: 0 to 45 v, 12.5
K Ω ; constant to ± 1 db from
200 c to 20 kc

Square Waves: 0 to 30 v,
peak-to-peak; 2500 Ω impedance
—less than 0.25 μ s rise time and
1% overshoot — hum at least
60 db down

★ Precision Slow-Motion Dial
can be motor driven (Type 908-P
Drive: \$27.50) for automatic
display

★ AVC System provides fast re-
sponse for constant output with
fluctuating line

★ Several Types of Unit Power
Supplies Available

GENERAL RADIO Company

275 Massachusetts Avenue, Cambridge 39, Massachusetts, U.S.A.

90 West Street NEW YORK 6 • 8055 13th St., Silver Spring, Md. WASHINGTON, D. C.

1150 York Road, Abington, Pa. PHILADELPHIA

920 S. Michigan Ave. CHICAGO 5 • 1000 N. Seward St. LOS ANGELES 28

CIRCLE 362 ON READER-SERVICE CARD FOR MORE INFORMATION

New Beryllium Copper ROLLPIN

Now... extend the proved advantages of Rollpin to a wide variety of applications where resistance to corrosion, good electrical properties and nonsparking or nonmagnetic characteristics are required.

Use it as you use carbon steel Rollpins—to replace taper pins, straight pins and set screws; to serve as a rivet, dowel, hinge pin or stop pin—to cut production costs by eliminating special machining, tapping, and the need for hole reaming or precision tolerances. Driven into a hole drilled to normal production standards, Rollpin locks securely in place, yet can be readily drifted out and reused whenever necessary. Beryllium Copper Rollpins are available from .062"-diameter to .250".

For all the information you need, write Elastic Stop Nut Corporation of America, 2330 Vauxhall Road, Union, New Jersey, Dept. R-36-957.

ROLLPIN
TRADEMARK



ELASTIC STOP NUT
CORPORATION OF AMERICA

CIRCLE 363 ON READER-SERVICE CARD FOR MORE INFORMATION



NEW NYLON INSULATED SOLDERLESS TIP PLUGS

- 1.** Tough, durable molded nylon sleeve—won't chip or crack.
- 2.** New, simplified solderless connection—up to 16 gauge wire held securely with positive electrical contact.
- 3.** No exposed metal surfaces—pin assembly is recessed, providing positive insulation.

Completely insulated, this rugged tip plug is the perfect "mate" to the Johnson nylon tip jack. Sleeve is molded of tough, durable nylon and will not chip or crack even when subjected to rapid or extreme temperature changes. Recessed construction prevents the exposure of metal surfaces when plug is engaged with any standard tip jack. These new Johnson nylon tip plugs are available in 11 bright colors to match the Johnson nylon tip jack series. Standard .081" diameter pin projects, 9/16"; sleeve length, 7/8"; sleeve diameter, 3/8".



NYLON INSULATED BANANA PLUGS

New nylon insulated banana plugs are also available. Made of high grade, nickel plated brass with nickel-silver springs and a rugged nylon insulating sleeve. Designed for solderless connection—accommodates up to 16 gauge stranded wire.

NYLON TIP JACK AND INSULATING SLEEVE

Complete assembly includes standard nylon tip jack with threaded nylon insulating sleeve. This assembly may be used for patch cords or sleeve may be used instead of a nut to mount tip jack on panels, providing insulation for the rear connection.

For complete information on these or other Johnson quality components write for your free copy of Components Catalog 976.



E. F. JOHNSON COMPANY

3423 Second Avenue Southwest • Waseca, Minnesota

CIRCLE 364 ON READER-SERVICE CARD FOR MORE INFORMATION

D-C Power Supply

Regulated, Low Noise



The Model R-10 power supply combines low noise level with "super voltage" regulation at low cost. Under most conditions of operation, the noise is less than $150\mu\text{v}$. Low internal impedance (0.05 ohms

over most of band for most operating conditions) eliminates the need for usual de-coupling circuits. Ripple and noise are so low that no additional filtering is needed when supplying most low level preamplifier stages.

D-c output is continuously variable from 200v to 325v at 100ma maximum load current; positive or negative ground. Regulation is better than 0.01% for line voltage variation of 105v to 125v. Voltage is constant to better than 0.07% from zero to full load. Laboratory of Electronic Engineering, Inc., Dept. ED, 413 L St., N. W., Washington, D.C.

CIRCLE 365 ON READER-SERVICE CARD FOR MORE INFORMATION

Signal Generator

For 7-70Mc Range



The Model 131 Signal Generator, is for testing i-f amplifiers and other circuits operating in the 7-70 Mc range. Capable of CW, pulse, or standard operation,

with a built-in 5000Mc crystal frequency standard, a completely electronic linear frequency sweep, and a continuously tunable frequency marker, the signal generator weighs 99 lb and is housed with an 11" x 16-3/8" x 18-1/4" cabinet.

Other features include: frequency deviation up to $\pm 30\%$; choice of two types of markers (spike or blanking); zero amplitude reference for sweep output; calibrated 0.5v rms output to 50 ohm impedance; a 0 to 101db step attenuator; choice of continuous-wave, pulse, or sweep operation; continuously tunable frequency marker; linear frequency sweep; built-in VTVM output calibration; fully shielded cabinet; r-f pulse characteristics identical to external pulse generator and independent use of the attenuator. Avion Instrument Corp., Dept. ED, 299 State Highway No. 17, Paramus, N. J.

CIRCLE 366 ON READER-SERVICE CARD FOR MORE INFORMATION

America's most complete line

Carter ROTARY POWER SUPPLIES

ROTARY POWER IS BEST

The "clap-clap" of "Old Bess" gave Grandma's buggy ride more vibration than the smooth Rotary Power of today's modern automobiles. **ROTARY POWER** is best for mobile radio, too . . . and for all DC to AC conversion . . . smoother . . . more dependable.



DC TO AC CONVERTERS



For operating tape recorders, dictating machines, amplifiers and other 110-volt radio-audio devices from DC or storage batteries. Used by broadcast studios, program producers, executives, salesmen and other "field workers".

DUO-VOLT GENEMOTORS

The preferred power supply for 2-way mobile radio installations. Operates from either 6 or 12-volt batteries. Carter Genemotors are standard equipment in leading makes of auto, aircraft, railroad, utility and marine communications.



CHANGE-A-VOLT DYNAMOTORS



Operates 6-volt mobile radio sets from 12-volt automobile batteries . . . also from 24, 32 and 64-volt battery power. One of many Carter Dynamotor models. Made by the world's largest, exclusive manufacturer of rotary power supplies.

BE SAFE . . . BE SURE . . . BE SATISFIED



AC can be produced by reversing the flow of DC, like throwing a switch 120 times a second. But **ROTARY** converters actually generate AC voltage from an alternator, same as utility stations. That is why **ROTARY** power is such clean AC, so dependable . . . essential for hash-free operation of recorders from DC power.

MAIL COUPON for illustrated bulletin with complete mechanical and electrical specifications and performance charts. Carter Motor Co., Chicago 47.

CARTER MOTOR CO.
2664 N. Mablewood Ave
Chicago 47, Illinois

Carter

Please send illustrated literature containing complete information on Carter "Custom" Converters and Dynamotor Power Supplies

NAME

Address

City

State

CIRCLE 367 ON READER-SERVICE CARD



**'dag' Colloidal Graphite
improves CRT performance**



Coat inside walls of CRTs with a dispersion of 'dag' Colloidal Graphite in de-ionized water to retard secondary emission and adsorb gases. The resulting film also acts as an electrical conductor and a ray-focusing material.

A 'dag' dispersion in lacquer, sprayed onto exterior tube surfaces, dries in one to two minutes and produces a smooth, black, adherent, conductive coating on any type of glass. Once thoroughly dried, the film is resistant to removal by water.

You'll find a surprising number of ways to use 'dag' dispersions described in our free booklet on 'dag' Colloidal Graphite for electronics and electrical applications. Write for Bulletin No. 433-R12.

Dispersions of molybdenum disulfide are available in various carriers. We are also equipped to do custom dispersing of solids in a wide variety of carriers.

ACHESON COLLOIDS COMPANY
 PORT HURON, MICHIGAN
 ... also ACHESON COLLOIDS LTD.
 LONDON, ENGLAND

CIRCLE 368 ON READER-SERVICE CARD

Diode Clip

Solderless and Widely Applicable



This solderless diode clip is designed to hold 90% of all standard diodes. Made with a beryllium-copper base, it is plated in 0.00002" gold,

0.0002" silver, or electro-tin and three styles are available: push-in, stake-in, and eyelet rivet. Size is 13/64" wide x 1" high (overall). Thickness is 0.0253" beryllium-copper. Diode mounting height is 1/2" above panel.

Designed to meet AN specifications, these clips may be used in printed circuits and other electronic components for missiles, computers, etc. The snap-in area places ferrules firmly in seating point, and prevents distortion of the clip. The diode ferrule held in place by this clip will remain tight after repeated uses. Metal Products Engineering, Inc., Dept. ED, 4000 Long Beach Ave., Los Angeles 58, Calif.

CIRCLE 369 ON READER-SERVICE CARD FOR MORE INFORMATION

If you need a special component, send a brief statement of your specifications addressed to Bulletin Board, Electronic Design, 19 East 62nd St., New York 21, N. Y. Include your complete address.

Pulse Instruments

Measure Time to $\pm 1/500 \mu\text{sec}$



The B4-100 Marker Generator (shown) and the B4-200 Oscillator, when used with this firm's B-2A Pulse Generator and the required power supply, provide accurate scope markers and pulse delays by means of which time intervals can be measured to $\pm 1/500 \mu\text{sec}$. The marker generator provides 0.1 and $1 \mu\text{sec}$ marker signals of either positive or negative polarity. Marker accuracy is 0.01%. These signals are designed for use as intensity markers on a scope. The oscillator consists of a free-running blocking oscillator which is phase locked to the $1 \mu\text{sec}$ marker pulses. The repetition rate can be varied from 1 to 10kc. These units, in conjunction with a pulse generator and a synchroscope, provide a system to measure delay line lengths to ± 2 millimicroseconds. Rutherford Electronics Co., Dept. ED, 3707 S. Robertson Blvd., Culver City, Calif.

CIRCLE 370 ON READER-SERVICE CARD FOR MORE INFORMATION



Model 2301 Servoscope with Cathode Ray Indicator

Engineers Call This the Ideal Test Instrument

Here's why.

Servoscope® is a multiple signal generator that provides a *direct* method for measuring gain and phase shifts of any component or system in the subsonic frequency ranges.

With just a few flicks of the phase dial, you get the values for plotting magnitude and phase curves. The dial actually shifts the Servoscope output signal an amount equal and opposite to the phase shift in the system under test. The phase lead or lag is then obtained by reading the big phase dial directly!

Servoscope replaces expensive and inefficient home rigs to save you time and costly errors in design and development and production testing. It is a well-designed, compact instrument that requires virtually no maintenance at all.

You'll find Servoscope now serving industry in the laboratory and on the production line in such diverse assignments as:

- automatic flight control design
- airborne weapons development
- autopilot and damper testing
- simulating rate gyro
- radar systems testing
- antenna servo analysis
- testing servo amplifiers
- solving frequency problems of servosystems
- phase angle measurement of servosystems
- testing computer response
- driving oscillating test table
- checking vibration
- checking frequency response of tachometer feedback loop
- providing unmodulated frequency signal
- testing frequency response of electro-hydraulic servosystem
- network response testing
- training

For further information, or to arrange for a demonstration of Servoscope in your laboratory or production line, clip coupon below and mail it today.

SERVO CORPORATION *of* AMERICA



New Hyde Park
Long Island, N. Y.

Please
Attach Coupon
to Your
Company
Letterhead

SERVO CORPORATION OF AMERICA
20-20 Jericho Turnpike, New Hyde Park, L. I., N. Y.

- Please send me further information on Servoscope.
 I would like to see a demonstration of Servoscope.

NAME.....
 TITLE.....
 COMPANY NAME.....
 ADDRESS.....
 CITY..... ZONE..... STATE..... ED-9

CIRCLE 371 ON READER-SERVICE CARD FOR MORE INFORMATION

**IT SAYS THAT
2 OUT OF 3
ELECTRONIC
ENGINEERS USE
BURGESS BATTERIES**



BURGESS DESIGN AND ENGINEERING SERVICES CAN SOLVE YOUR PROBLEM!
For more than forty years, Burgess has offered to Electronic Engineers design and engineering facilities to meet any dry battery need. Burgess popularity is based on uniform performance and consistent high quality that have earned and held the respect of Engineers everywhere.

FOR YOUR CONVENIENCE!
Burgess offers, at no charge, an engineering manual listing the complete line of Burgess Batteries, a handy check sheet for new battery specifications and the new Transistor catalog folder.

**BURGESS BATTERIES
BURGESS BATTERY COMPANY
FREEPORT, ILLINOIS**

CIRCLE 372 ON READER-SERVICE CARD FOR MORE INFORMATION



NEW!

New nylon Plasti-Grommets can reduce costs of nearly any assembly. It snaps into prepared hole, stays tight even under severe vibration, is non-corrosive, non-conductive, won't chip or craze, is available in any size, any color.

SHAKEPROOF®
PLASTI-GROMMET®
Blind screw receptacle locks tight, saves assembly time!

SHAKEPROOF®
"Fastening Headquarters"
DIVISION OF ILLINOIS TOOL WORKS
St. Charles Road, Elgin, Illinois
Offices in Principal Cities

CIRCLE 373 ON READER-SERVICE CARD FOR MORE INFORMATION



Computer Company of America, Division of Bruno-New York Industries Corp. also manufactures the IDA analog computers and accessories. Their usefulness in the field of dynamics has been proven over the years.

A complete line of standard computers, instruments and regulated power supplies is supplemented by the ability to design and manufacture specialized equipment for your particular applications. Your inquiries are invited.

HIGH RESOLUTION LABORATORY STANDARD DC VOLTMETERS

For most applications these rugged portable, self-contained nulling voltmeters replace a potentiometer, voltbox, galvanometer and standard cell combination. They are suitable for laboratory use, production line testing and field service.

Model LVM-5

Voltage Range: 0-100 Volts DC
Resolution: At least 50 microvolts between 0 and 1 volt
500 microvolts between 1 and 10 volts
5 millivolts between 10 and 100 volts
Absolute Accuracy: $\pm 0.1\%$ of reading
Input Impedance: Infinite at null

Model PVM-4

Voltage Range: 0-600 Volts DC
Resolution: At least 5 millivolts between 0 and 10 volts
50 millivolts between 10 and 600 volts
Absolute Accuracy: $\pm 0.1\%$ of reading
Input Impedance: Infinite at null

The Model LVM-5 may also be used as a deflection potentiometer, a sensitive null indicator and a precision millimicroammeter. Write for catalog PL which describes these instruments completely. Address Dept. ED 9-D.

Computer Company of America
DIVISION OF BRUNO NEW YORK INDUSTRIES CORP.
460 WEST 34TH STREET • NEW YORK 1, N. Y. **CCA**

CIRCLE 374 ON READER-SERVICE CARD FOR MORE INFORMATION

Power Cylinder Uses Controlled Explosives



These cylinders use a controlled explosives force to lift, and momentarily hold, various weights through a varied range of distances. The cylinders, with one type of cartridge, can lift and momentarily hold a 100 lb weight through a distance of 2-1/2" in an elapsed lifting time of 82millisec. Using another cartridge, a cylinder can lift and momentarily hold a 45 lb weight through a distance of 1/2" in 42millisec. Ordnance Material Div., Atlas Powder Co., Dept. ED, Wilmington 99, Del.

CIRCLE 375 ON READER-SERVICE CARD FOR MORE INFORMATION

Speed Reducers For Anti-Backlash Applications



The Series 107 Miniature Speed Reducers, with servo-mount ends, are available for anti-backlash applications in controls, computers, oscillographs, etc. They come in 448 different ratios from 1:1 to 531,441:1 Anti-backlash results from two

parallel gear trains that are spring loaded against each other; thus backlash is continuously taken up whether running or not. Metron Instrument Co., Dept. ED, 432 Lincoln St., Denver 3, Colo.

CIRCLE 376 ON READER-SERVICE CARD FOR MORE INFORMATION

Magnetic Clutch With Concentric Shafts



The torque characteristics and high-speed engagement and disengagement times of the Model T507-1 miniature magnetic clutch make it

valuable for application in guided missiles, computers, and miniature servo systems. It has the same case size as a MK 14 Mod O servo motor. Single-ended concentric input and output shafts are located at the mounting end of the unit, permitting all gearing to be located at this end. Sterling Precision Instrument Corp., Instrument Div., Dept. ED, 34-17 Lawrence St., Flushing 54, N. Y.

CIRCLE 377 ON READER-SERVICE CARD FOR MORE INFORMATION

ELECTRONIC DESIGN • September 1955



FIRST AGAIN—a high vibration, vertical mounting type hermetically sealed capacitor. Application and production proven characteristics for circuits designed with critical requirements in vibration and weight.

Eliminates a weakness common to capacitors of this style where the solder joint between the seal and the case makes the mechanical connection. Available and conforming to MIL-C-25A requirements.

WEST-CAP

LARGEST MANUFACTURER on the West Coast producing hermetically sealed, metal cased, MIL-C-25A and special application capacitors. Manufactured in both paper dielectric and plastic film dielectrics.

Visit our Booth 130 at National Electronics Conference, Chicago, Oct. 3, 4 & 5

SAN FERNANDO ELECTRIC MFG. CO.
1509 First Street
San Fernando, California

CIRCLE 378 ON READER-SERVICE CARD FOR MORE INFORMATION

Pulse Generator An All-Magnetic Unit



The MP-85 is an all-magnetic pulse generator for commercial radar and use as laboratory testing equipment. It uses saturable reactors instead of thyratrons as discharge devices. The

unit is basically a capacitor-type pulser in which electrical energy storage is achieved by means of a-c resonant charging. High pulse powers are obtained by rapid discharge of the condenser through saturable reactors. These reactors are in appearance and construction similar to transformers and act as static magnetic switches.

Typical specifications include: peak pulse power, 80-100kw; peak pulse voltage, 13.5-14.5kv, pulse width, fixed, 2μsec; repetition rate, fixed, 400pps; input, 230-300w 115v 400cy, 2.2-3amp; power factor, 0.85 to 1.0; peak output power (X-band), 45kw. Magnetic Research Corp., Dept. ED, 200-202 Center St., El Segundo, Calif.

CIRCLE 380 ON READER-SERVICE CARD FOR MORE INFORMATION

BEEDE^{NO} 23

THE MOST ACCURATE DEPENDABLE AND STURDY ELECTRIC INDICATING METER AVAILABLE



This modern CRYSTAL CLEAR PLASTIC case allows more space for informative copy on the dial.

It is clear and easy to read — 4⁵/₈" x 4³/₁₆" overall, of sturdy construction and like all BEEDE meters, model 23 is long lasting and accurate.

Write for a catalog

BEEDE ELECTRICAL INSTRUMENT CO., INC.
PENACOOK, N. H.

CIRCLE 382 ON READER-SERVICE CARD FOR MORE INFORMATION

RESINITE

...can increase efficiency of your iron core insertion production by 20%

EMBOSSED COIL FORMS



Special embossed construction eliminates torque control problems and stripping. Custom fabrication to your exact specification assures correct dimensions to within the most critical tolerances.

We will furnish — without charge — a pilot production run of custom-made embossed forms to fit your particular application.

Contact us now for full details about this special offer. Request technical bulletin, *Use of Threaded Tubes, Threaded Iron Cores VS. Torque Control.*

RESINITE CORPORATION

Sales Representatives in:

New England: Framingham, Massachusetts, Trinity 3-7091

Metropolitan New York, New Jersey:

Jersey City, New Jersey, Journal Square 4-3574

Upstate New York: Syracuse, New York, Syracuse 4-2141

Northern Ohio, Western Penn.: Cleveland, Ohio, Atlantic 1-1060

Indiana, Southern Ohio: Logansport, Indiana, Logansport 2555

California: Pasadena, California, Sycamore 8-3919

Canada: Montreal, Quebec, Canada, Walnut 0337

PRECISION PAPER TUBE COMPANY
2035C W. CHARLESTON ST. • CHICAGO 47, ILLINOIS

CIRCLE 379 ON READER-SERVICE CARD FOR MORE INFORMATION

ELECTRONIC DESIGN • September 1955

D-C Relay

Features Complete Wiping Action



Combining high sensitivity with thorough wiping action on each contact, the Relay 100-B is available hermetically sealed

or with dust cover. This unit has a wattage consumption of only 25mw, together with a genuine wiping action. Bounce and chatter are consequently eliminated by the built-in wiping action in the contact movement.

Designed for d-c applications, the relay has the advantage of an extremely long operating life. If desired, drop-out can be adjusted to about 65% of the pick-up. Capacity is to 1amp inductive and 3amp resistive load with coil resistance to a maximum of 30,000 ohms. The effect of residual magnetism and iron aging are eliminated by non-ferrous metals and hydrogen annealing of the magnetic components. The unit is available in spst up to dpdt contacts. Size is 1-1/4" diam x 3-5/8" above mounting line. Hedin Tele Technical Corp., Dept. ED, 640 W. Mt. Pleasant Ave., Livingston, N. J.

CIRCLE 381 ON READER-SERVICE CARD FOR MORE INFORMATION

NOW! FOR EVERY Electronics LABORATORY



UTL CALIBRATED VARIABLE INDUCTANCE KIT

HANDY SET OF 8 PERMEABILITY TUNED ADJUSTABLE COILS

SPECIAL FEATURES:

MR. ELECTRONICS ENGINEER

When you want a resistor or capacitor you can usually reach into your parts bin and come up with the desired value very quickly. But when you want a particular inductance it isn't so easy. Possibly you then "roll your own", with all the chart thumbing, slide rule slipping, winding and turn pruning that goes with the job.

The U. T. L. Variable Inductance Kit solves this problem for you. For inductance values between 1 and 1000 μhs. all you do is select one of the 8 permeability tuned coils, consult the numbered calibration curve and with a few twists of the wrist . . . there's almost exactly the inductance you want. Then too, the curve sheet gives values of Lmin, Lmax, Q, self resonant frequency, resistance and distributed capacity, which saves additional measuring time. Sounds like a MUST for your lab work, doesn't it?

- ★ WIDE INDUCTANCE RANGE—1 TO 1000 UNITS.
- ★ CURVE SHEET SHOWS INDUCTANCE VALUES PER TURN OF PERITE COILS FOR EACH OF 8 COILS.
- ★ COMPLETE DATA ON Lmin, Lmax, Q, SELF RESONANT FREQUENCY, R & C, FOR EACH COIL.
- ★ SELECTION CONVENIENCE OF CODED RESISTORS AND CAPACITORS NOW AVAILABLE IN INDUCTANCES.
- ★ PRECISION WOUND WITH UNIVERSAL OR SOLENOID WINDINGS.
- ★ G MAX IMPREGNATED FOR MAXIMUM PROTECTION AGAINST MOISTURE.
- ★ ALLOWS EXACT SETTING OF INDUCTANCE FOR NUMEROUS POINTS IN BLACK & WHITE OR COLOR TV CIRCUITS.
- ★ FOUR PAGE PAMPHLET GIVING HUNDREDS OF USES SENT WITH YOUR ORDER.

Special Offer!

1 IND. KIT \$4.50
3 " " @ 4.30 ... 12.90
6 " " @ 4.20 ... 25.20
12 " " @ 4.10 .. 49.20

IN LARGER QUANTITIES - \$3.95 EA.

UNITED TECHNICAL LABORATORIES
BOX 425 C • MORRISTOWN, N. J.

CIRCLE 383 ON READER-SERVICE CARD FOR MORE INFORMATION

"Up a Tree" with a Relay Tree? . . .

KELLOGG CROSSBAR

*solves complex
switching
problems
quickly, easily
and inexpensively*



The Kellogg *Crossbar Switch* illustrated below establishes the different types of electrical connections possible. Any cross point can be activated in less than 50 milliseconds by energizing one select magnet and one hold magnet. Standard contact material used in the Kellogg *Crossbar Switch* is palladium (gold can also be provided). Mounting brackets are available which provide drawer-like removal for easy inspection. Circuits can be maintained while the Kellogg *Crossbar Switch* is in the process of switching other circuits.

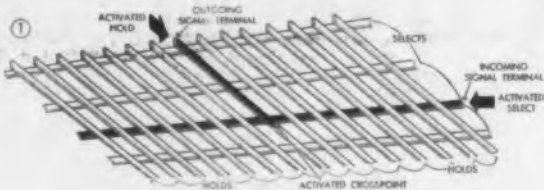

Drawing No. 1 illustrates the basic Crossbar principle which permits any of several incoming circuits to be connected to any of several output circuits. This type of switch can connect any of 60 circuits, 3 at a time, to any of 75.

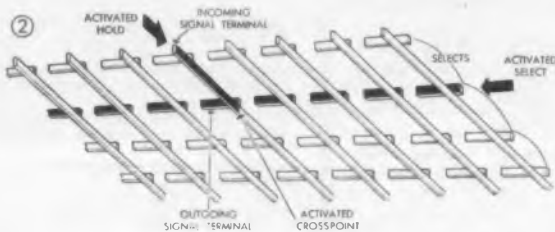

Drawing No. 2 shows a means of switching one incoming circuit to many possible outgoing circuits—accomplished by removing every other vertical. Thus, instead of having one cable terminal at one end of the switch, each remaining vertical has its own cable connection. This type of switch can easily be adapted to switch one circuit to any of 936.

Write for Technical Bulletin
Today! Dept. 68-1

A Famous Name
in Communications
Now Solving
Problems in the
Control Industry

KELLOGG DIVISION OF
IT&T

KELLOGG SWITCHBOARD AND SUPPLY COMPANY
A Division of International Telephone and Telegraph Corporation

CIRCLE 384 ON READER-SERVICE CARD FOR MORE INFORMATION

New Literature . . .

Rotary Machines

385

Bulletin No. 75-B catalogs this company's line of hand and power operated rotary machines, rolls, and accessories. An illustrated selection chart, showing various job operations, is included to simplify selection of machines and rolls. Niagara Machine and Tool Works, 683 Northland Ave., Buffalo 11, N. Y.

Adhesive Bonding

386

"Adhesive Bonding" is the title of an 8-page illustrated manual. The booklet features illustrations of such typical adhesive applications as aircraft aluminum honeycomb construction, fin tubing heat exchanger assemblies; new advances in printed circuitry. Rubber & Asbestos Corp., Dept. P, 225 Belleville Ave., Bloomfield, N. J.

Speed Sensitive Switches

387

This 8-page bulletin gives full information on this firm's line of speed sensitive switches and overspeed governors. The bulletin includes dimensional drawings of the overspeed, underspeed, one, two, and three switch governors with explanations of the various types of take-off and connectors. Synchro-Start Products, Inc., 8151 N. Ridgeway Ave., Skokie, Ill.

Carbide Blanks

388

Information concerning standard carbide blanks for mechanically held tools is included in an 8-page catalog. The publication (No. GT-292) covers carbide blanks for clamp-on style tools, solid carbide on-end inserts, round and square inserts, and triangular and square throw-away insert blanks. Carboloy Dept., General Electric Co., Detroit, Mich.

Radar Transformers

389

Oil-filled transformers and inductors for radar and other electronic applications are described in Bulletin No. GEA-5963. The bulletin cites the radar transformer model shop, where prototype units can be designed and built quickly. Design features of the regular production models are described. General Electric Co., 1 River Rd., Schenectady 5, N. Y.

Digital Converter

390

This 4-page bulletin has applications, specifications, characteristics, and an installation drawing of this company's ADC-1 digital converter. The ADC-1 has an unambiguous output of 13 binary digits and operates at high speed in clockwise or counterclockwise operation. Norden-Ketay Corp., 555 Broadway, New York 12, N. Y.

Silicone Rubber

391

A 4-page, 2-color bulletin on silicone rubber details properties and performance as affected by extreme temperatures, weathering, compression, chemicals, and dielectric service. It is illustrated with charts, tables, graphs, and actual application photographs. Dow Corning Corp., Midland, Mich.

Program Controls

392

Bulletin No. 1130, "Program Control of Process Variables", describes the methods and advantages of employing automatic, time-conditions control for many industrial processes and tests. A selection chart aids in choosing the right instruments for any program control application. Industrial Div., Minneapolis-Honeywell Regulator Co., Wayne & Windrim Aves., Philadelphia 44, Pa.

Magnified-Scale Voltmeters 394

Indicating and recording magnified-scale voltmeters are described in a new technical data sheet. Advantages and features of these instruments are discussed and a schematic diagram is included. Specifications and applications are given. Allgemeine Elektrizitaets-Gesellschaft, U. S. representative, Donald C. Seibert, Box 281, Wilmington, Del.

Lighting Equipment 395

Battery-powered emergency lighting equipment is described in an 8-page catalog. The catalog contains diagrams, charts, and specifications. Exide Industrial Div., Electric Storage Battery Co., Box 8109, Philadelphia 1, Pa.

Reproducers 396

This 4-page catalog describes new micro-groove heads made to plug in on tone arms, automatically providing correct record pressure for long-playing records. Radio Music Corp., 84 S. Water St., Port Chester, N. Y.

High Speed Typewriter 397

A high speed electronic typewriter which will type up to 15 lines per second is illustrated and described in a 4-page brochure. Applications, specifications, and dimensional drawings are given. Shepard Laboratories, 480 Morris Ave., Summit, N. J.

D-C Power Supply 398

A new bulletin describes a magnetic amplifier tubeless regulated d-c power supply. Advantages of the use of tubeless power supply units are outlined. Theory of operation, typical features, and components are described and illustrated. Complete characteristics are included. Perkin Engineering Corp., 345 Kansas St., El Segundo, Calif.

Electric Counters 399

A 4-page bulletin describes heavy duty electric counters designed for 200 million count life; tested at 1000cpm. The counters are made for 25, 40-50, 60cy and d-c service. Production Instrument Co., 706-34 W. Jackson Blvd., Chicago 6, Ill.

INDUSTRIAL DIVISION
LEACH & GARNER
COMPANY
ATTLEBORO, MASSACHUSETTS



Send for brochure
showing complete
facilities and products.
ASK FOR BROCHURE ED-1

Two Companies Under One
Roof Offer You a
Prime Source for . . .

PRECIOUS LAMINATED METALS and FABRICATED PARTS

Our aim is to give you fast, efficient PERSONAL SERVICE on all orders and inquiries. Write us, we'll show you we mean business when we talk SERVICE and QUALITY.

Leach & Garner produces solid and laminated precious metals in sheet, wire and tubing. General Findings & Supply Co. fabricates precision parts from these and many other materials to your specifications.

INDUSTRIAL DIVISION
**GENERAL FINDINGS
AND SUPPLY COMPANY**
ATTLEBORO, MASSACHUSETTS

CIRCLE 400 ON READER-SERVICE CARD FOR MORE INFORMATION

Thinking of
**SMALL
RELAYS?**

ADVANCE

*builds 'em
for heavy loads
and long
service!*

Cramped quarters don't cramp the style of ADVANCE midglets and miniatures. You can use them on loads up to 5 amperes continuously... and at three times their rating intermittently—with complete safety. They'll resist shock and vibration... stand up under temperature extremes. You'll find them readily adaptable to any mounting need... any type of duty.

Some examples:



**"Tiny Mite"
MM & MP SERIES**

This ultra-small dc relay occupies less than 1/2 cu. in. mounting space! It's stable under vibration and shock... plated to prevent corrosion. Operate time is 5 milli-seconds. Contact rating: .5 amp. or 1 amp.



**Miniature Telephone Type
TQ SERIES**

Only .94 cu. inches in size, yet this relay carries 5-amp. loads in any combination up to 4 PDT. Mechanically secured throughout, it's extremely efficient. Non-gassing insulation. Withstands 10G vibration. Temp. range: -55° to +125°C.



**General Purpose Midget
MG & MF SERIES**

Endless uses for this midget ADVANCE relay. It's engineered for high efficiency and low price. Operates in any position, with positive contact. Light vibration and shock resistance. Two-amp. or 5-amp. contacts.

Hermetic enclosures on these types are impervious to varying climatic conditions...are sealed and carefully checked against leakage.

*Write for literature on any of the above series,
or the complete ADVANCE line.*

ADVANCE ELECTRIC AND RELAY CO.
AN ELGIN NATIONAL WATCH COMPANY AFFILIATE
2435-M NORTH NAOMI STREET, BURBANK, CALIFORNIA

Sales Representatives in Principal Cities of U.S. and Canada



CIRCLE 401 ON READER-SERVICE CARD FOR MORE INFORMATION

When Timing Poses A Problem

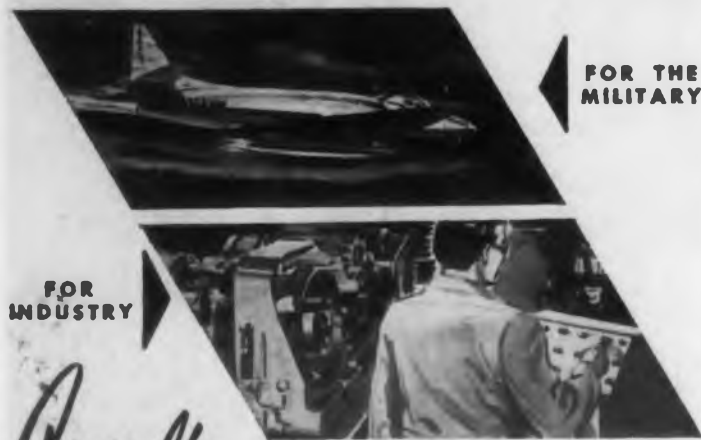

FOR THE
MILITARY

FOR
INDUSTRY

Consult the **A. W. HAYDON CO.**

Whether the problem involves a new Intervalometer for firing rockets from aircraft — a Time Delay Relay for controlling plate voltage to power tubes — a Timing Motor for use in Industry — or any precision Electro-Mechanical Timing Device — A. W. Haydon has compiled an unparalleled record of achievement. "Preferred Where Performance Is Paramount"! May we help you with your problem?



**A. W. HAYDON
COMPANY**

227 NORTH ELM STREET
WATERBURY 20, CONNECTICUT

Design and Manufacture of Electro-Mechanical Timing Devices

Write for catalog
or detailed
information.



CIRCLE 404 ON READER-SERVICE CARD FOR MORE INFORMATION

FIRST TRANSISTOR RADIO MADE POSSIBLE . . BY INSUROK® COPPER-CLAD PRINTED CIRCUITS!

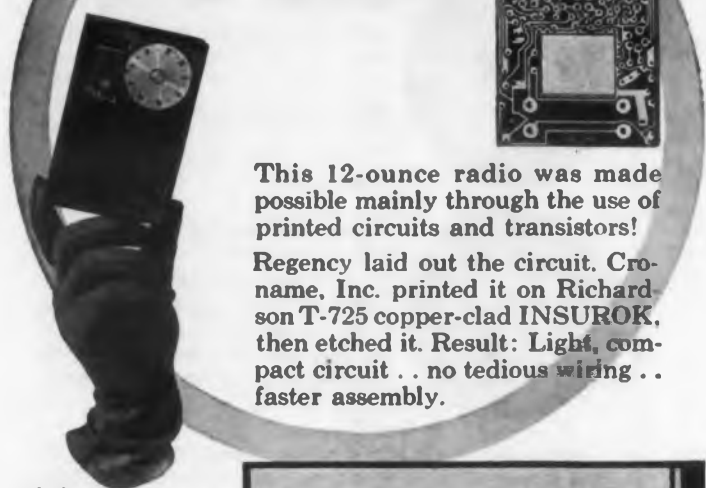

This 12-ounce radio was made possible mainly through the use of printed circuits and transistors! Regency laid out the circuit. Croname, Inc. printed it on Richardson T-725 copper-clad INSUROK, then etched it. Result: Light, compact circuit . . no tedious wiring . . faster assembly.

Ask for
bulletin, "INSUROK
T-725 Copper-Clad
Laminates"

**RICHARDSON Laminated
and Molded Plastics**

The RICHARDSON COMPANY

Founded 1858

2682 Lake Street, Melrose Park, Illinois (Chicago District)
SALES OFFICES IN PRINCIPAL CITIES

CIRCLE 405 ON READER-SERVICE CARD FOR MORE INFORMATION

144

Shaped Tubing 406

Shaped tubing is illustrated and described in Data Memorandum No. 17. The memorandum gives complete information on analyses available, tool charges, size range, commercial tolerances, lengths, and temper. Cross sections include squares, rectangles, hexagons, flat ovals, ellipticals, and partial rounds. Such shaped tubing is used for aircraft structural parts, radar screens and electrical equipment. Superior Tube Co., 1521 Germantown Ave., Norristown, Pa.

Arc-Cast Molybdenum 407

A compilation of all available technical and fabricating data on arc-cast molybdenum is presented in a 72-page booklet. Among the high temperature applications of molybdenum of special interest to electronic engineers are vacuum tube grids and high temperature thermocouples. Climax Molybdenum Co., 500 Fifth Ave., New York 36, N. Y.

Tables and Data 409

This 112-page book, "Selected Scientific and Engineering Tables and Data", contains selected chemical and physical, engineering plastics, bacteriological, leather, psychometric, and textile tables and charts. The book provides standard formulas, charts, and definitions in brief and concise form. United States Testing Co., Inc., 1415 Park Ave., Hoboken, N. J.



FOR MAGNETIC RECORDING

Brush heads

give perfect time-phase accuracy

This Brush multi-channel magnetic head (Model BK-1500 series) features precision gap alignment. When you use tape recorders incorporating these heads, you can record data on one machine, and play back on another—with all signals remaining in perfect time-phase relationship. As many as 14 tracks can be recorded on a single tape 1 3/4 inches wide.

Brush produces a complete line of magnetic recording heads, with models available for all existing applications. For complete information, write Brush Electronics Company, Dept. J-9, 3405 Perkins Avenue, Cleveland 14, Ohio.

BRUSH ELECTRONICS COMPANY

INDUSTRIAL AND RESEARCH INSTRUMENTS
PIEZOELECTRIC MATERIALS • ACOUSTIC DEVICES
MAGNETIC RECORDING EQUIPMENT AND COMPONENTS



Division of
Clevite Corporation

CIRCLE 408 ON READER-SERVICE CARD FOR MORE INFORMATION

NEWLY-
DEVELOPED
Sub Miniature
Type 10
H-SERIES

hermetically sealed resistors

The "H" Series Precision Resistors are encapsulated in a tough plastic compound. The result is a solid, homogeneous unit with unparalleled ruggedness, impervious to the effects of moisture, thermal shock and mechanical shock. The plastic is filled with heat conducting mineral which dissipates the heat and equalizes the "hot spots" in the resistor winding. The sealed-in terminal connections are welded.

SPECIFICATIONS:
MILITARY SPECIFICATIONS: Performance characteristics satisfy all requirements of MIL-R-93A & JAN-R-93.
TEMPERATURE COEFFICIENT: ±0.0022% per degree C.
OPERATING TEMPERATURE: -65°C. to +125°C.
RESISTANCE ACCURACY: Standard resistance tolerances are 1%, 0.5%, 0.25% and 0.1%.
TYPE 10 (illustrated): 1/4" dia. x 1/2" long.
Resistance range: 1.0 ohm - 0.35 meg.

Send for Bulletin H for complete description on other physical sizes and wattage ranges.
11423 VANOWEN ST., N. HOLLYWOOD 4, CALIF.
Subsidiary of International Resistance Company

HYCOR
Company, Inc.

CIRCLE 410 ON READER-SERVICE CARD FOR MORE INFORMATION

HEYCO NYLON STRAIN RELIEF BUSHINGS CUT PRODUCTION COSTS AND IMPROVE PRODUCT QUALITY



Approved

With Heycos it's no longer necessary to tie wire knots or use insulating grommets. Product life is increased and product appearance is greatly enhanced.

HEYMAN MANUFACTURING COMPANY
Kenilworth 16 New Jersey



Send wire sizes for free
samples and specifications.

CIRCLE 411 ON READER-SERVICE CARD FOR MORE INFORMATION

ELECTRONIC DESIGN • September 1955



CPC PLASTIC CLAMPS

20 SIZES
1/8" to 3"

ALL SIZES, SHAPES and MATERIAL

- FASTER
- SAFER
- TOUGH
- SIMPLER
- MORE SECURE
- ENDURING



For wires, cables, conduits, tubing, light hose. Name the use and Commercial has a clamp... or will design one. Pioneering "know-how" and advanced production methods of CPC offer unmatched quality... and at a saving, too! Send for sample clamps and prices.

2808 W. NORTH AVE. CHICAGO, ILL.
COMMERCIAL PLASTICS Co.

CIRCLE 414 ON READER-SERVICE CARD FOR MORE INFORMATION

Radiation Measuring Equipment 416

A 48-page catalog describes a complete line of radiation measuring equipment for medical, industrial, and research applications. Included are photographs and descriptions of individual instruments as well as suggested groupings of units for specific applications. Scalers, count rate meters, portable instruments, Geiger, proportional, and scintillation counters are described. Nuclear Instrument and Chemical Corp., 229 W. Erie St., Chicago 10, Ill.

Power Supplies 417

A 2-page catalog sheet describes this firm's line of low cost, general purpose d-c power supplies. In addition to listing the electrical ratings and their corresponding model numbers for the 22 models, the bulletin includes information on the minimum general specifications to which all units conform. Opad Electric Co., 69 Murray St., New York 7, N. Y.

Materials Handling Equipment 418

Lightweight vulcanized fibre materials handling containers that can be used for transport of radio and electronic components are described and illustrated in Catalog No. 54. These tote boxes, trays, and other receptacles can be supplied with removable compartments sized to fit all types of electrical parts and assemblies. National Vulcanized Fibre Co., 1055 Beech St., Wilmington 99, Del.

THE NEW WAY TO MARK EQUIPMENT...

with **GRAVO** flex

the first chip-proof, flexible engraving stock

on the
versatile
Engravo

shear it



bend it

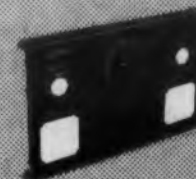

form it



punch it

So simple to engrave Gravoflex. Lettering will stand out permanently on contrasting background. No paint needed.

10,000 Engravographs in use for engraving on metals and plastics. Only the Engravograph has these patented features:

- Adjustable for 15 ratios.
- Self-centering holding vise.
- Automatic depth regulator.
- Adjustable copy holders.

Send for booklets
Engravograph Booklet M-88 • Gravoflex Booklet G-88

NEW HERMES ENGRAVING MACHINE CORP.
13-19 UNIVERSITY PLACE NEW YORK 3, N. Y.

CIRCLE 421 ON READER-SERVICE CARD FOR MORE INFORMATION



Baseball umpires need CONTROL...and so do electrical systems. For complete information, write:
ELECTRIC REGULATOR CORPORATION
140 Pearl Street, Norwalk, Conn.

REGOHM



CIRCLE 415 ON READER-SERVICE CARD FOR MORE INFORMATION
ELECTRONIC DESIGN • September 1955

DURABLE, ACCURATE Decade Resistance Boxes

36 types . . . 1 to 6 dials

ACCURACY:
10Ω & above ± 0.1% 0.1 Ω ± 1%
1.0 Ω ± 0.25% 0.01 Ω ± 5%

Closer tolerance on request.
TEMPERATURE COEFFICIENT: 0.002%/°C.
MAXIMUM LOAD: 1/2 watt per step
FREQUENCY LIMIT: Non-inductive to 20 Kc.

TYPE	DIALS	OHM STEPS	TOTAL RESISTANCE OHMS	PRICE
550	1	1,000,000	10,000,000	\$ 65.00
823	3	1,000	1,110,000	77.00
824	3	10,000	11,100,000	120.00
817-A	4	0.01	111.1	75.00
819	4	0.1	1,111	71.00
825	4	1	11,110	77.00
826	4	10	111,100	79.00
827	4	100	1,111,000	82.00
828	4	1,000	11,110,000	139.00
817-B	5	0.01	1,111.1	94.00
8285	5	0.1	11,111	94.00
829	5	1	111,110	101.00
830	5	10	1,111,100	113.00
832	6	1	1,111,110	121.00
833	6	10	11,111,100	169.00

Write for Bulletin L-17A for a complete listing of Shallcross Decade Resistance Boxes.

Shallcross MANUFACTURING COMPANY

526 PUSEY AVE., COLLINGDALE, PA.

CIRCLE 419 ON READER-SERVICE CARD FOR MORE INFORMATION

THE BUYER'S GUIDE TO BERYLLIUM



The "Product Directory," a 16 page booklet just published by The Beryllium Corporation, world's leading producer of beryllium copper and beryllium alloys, lists the most complete selection of materials and forms available in the industry:

- Beryllium copper and beryllium aluminum master alloys
 - Beryllium copper wrought products
 - Beryllium copper and beryllium nickel casting ingots
 - Beryllium copper safety tools, forgings and castings
- Send for your free copy today

THE BERYLLIUM CORPORATION,TM
Dept. 5-J, Reading 24, Pa.

Please send me at once a copy of the new "Product Directory."

Name _____ Occupation _____
Company _____
Street _____
City _____ Zone _____ State _____

CIRCLE 422 ON READER-SERVICE CARD FOR MORE INFORMATION

A NEW Low Voltage POWER SUPPLY

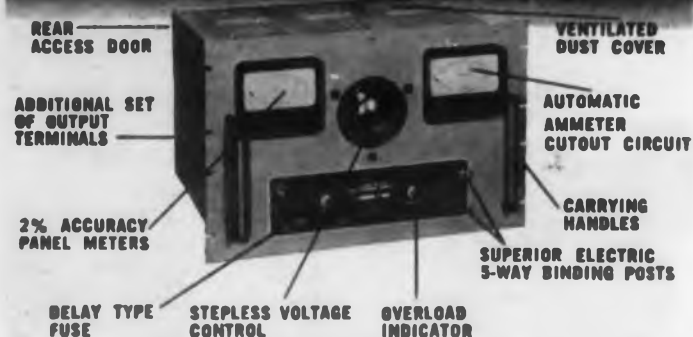

0-28 V.D.C. 20 Amps. 1% Ripple

REGULATION
D.C. Volts at Full Load: 28.5
D.C. Volts at 1/10 Load: 33.

**MODEL KM88
\$195**

OVERLOAD:
400% for 1/2 minute, 200% for 2 minutes.

INPUT:
115 V.A.C., 60 cycles, single phase.

**IMMEDIATE
DELIVERY**

WRITE FOR BULLETIN NO. 100



ELECTRIC COMPANY

69-16 MURRAY STREET • NEW YORK 7, N. Y.
Telephone: BEekman 3-7548

CIRCLE 424 ON READER-SERVICE CARD FOR MORE INFORMATION



Write directly to Dage Television Division of Thompson Products, Inc., Michigan City, Indiana. An experienced industrial TV engineer will be glad to help you . . . with no obligation on your part. For complete details on Dage installations write us for Booklet E.D.

As an efficient, modern "tool", Dage closed-circuit TV is saving time and money today for almost every type of business, industry and institution . . . keeping materials flowing . . . transmitting records accurately and swiftly . . . training personnel . . . safeguarding property . . . and doing literally hundreds of other vital jobs.



Its applications are endless — Let our engineers suggest an answer for your problems.

In Canada
Distributed by
Rogers Majestic
Electronics, Limited,
Toronto, Canada

DAGE

TELEVISION
Division of
Thompson Products, Inc.
Michigan City, Indiana



CIRCLE 425 ON READER-SERVICE CARD FOR MORE INFORMATION

146

Delay Lines 426

The passive, jitter-free, continuously variable Helidel delay line is the subject of this technical paper. Entitled, "A Precise, Wide-band, Continuously Variable Delay Line," the paper includes performance curves, graphs, and delay line configurations. Helipot Corp., 916 Meridian Ave., S. Pasadena, Calif.

Automatic Processing Protection 427

A 12-page brochure describes the technical aspects of the "Shur-flo" automatic interlock for processing plants. The interlock is a device to protect equipment when fluid flow is below the desired minimum or above a desired maximum. The brochure contains fluid flow charts wiring diagrams, and application information. Industrial Sales Div., Dept. No. 413, Hays Manufacturing Co., 818 W. 12th St., Erie, Pa.

Electrical Control System 428

A new electrical control system for predetermined repeat or non-repeat cycle on any machine with a mechanical tripping mechanism is described in Bulletin No. 55-1. A typical installation is illustrated and mounting dimensions are shown. Security Controls, Inc., 255 Franklin St., Buffalo 2, N. Y.

Space-Saving Aircraft Temperature Controls...

*Tiny Fenwal units ideal for many
other applications*

Fenwal Midget and Miniature THERMOSWITCH® controls are smaller, more compact than standard sized Fenwal temperature control and detection units. Yet they're equally resistant to vibration and shock, with the same positive action and instant sensitivity. That's why they're ideal for such applications as aircraft, guided missiles, antennas, electronic equipment, radar, motors, computers, wave guides, crystal ovens, etc.



MIDGET. Shell is 1/4" O.D. and is highly sensitive to changes over entire area. Single wire and two wire types; wide range from -50°F to 500°F; units which either make or break on temperature rise for control of gases, solids, liquids.

MINIATURE. Control within 2°F to 6°F is typical, even under 5G acceleration. Fully adjustable ranges of -20°F to 200°F or -20°F to 275°F. Hermetically sealed units -20°F to 200°F.

Get new, helpful facts on small-space temperature control and detection. Write for free bulletin MC-124, Aviation Products Division, Fenwal Incorporated, 99 Pleasant Street, Ashland, Massachusetts.

Fenwal

**Controls Temperature
... Precisely**

CIRCLE 429 ON READER-SERVICE CARD FOR MORE INFORMATION

Gurley Standard Binary Code Discs Now Available in Four Versions

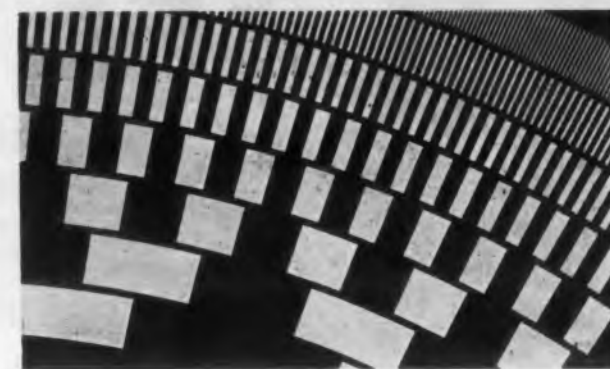

Gurley, manufacturer of the standard binary code disc for the electronics industries, is now able to supply four versions for use in either photo-electric, magnetic or contact types of pickups.

Containing concentric zones of information in the gray (reflected) code, the Gurley discs contain alternate clear and opaque sectors. Thin annular rings separating adjacent zones are opaque. Varying patterns record up to 8192 bits of information (65,536 on special designs!).

Four coatings are available: "Type T"—photoengraver's glue with colloidal (black) silver, essentially grainless; "Type R" with etched metal coating, for reflectivity and transmission contrast; "Type M" with chemically deposited ferrous alloy possessing both magnetic and optical transmission contrast; and "Type C"—metal bonded on glass for electrical contact use as well as in contrast of optical transmission. WRITE FOR BULLETIN 7000.

W. & L. E. GURLEY • 525 Fulton Street, Troy, N. Y.

GURLEY since 1845

CIRCLE 430 ON READER-SERVICE CARD FOR MORE INFORMATION

Increased Insulation BETTER CONNECTIONS JONES BARRIER TERMINAL STRIPS

Leakage path is increased—direct shorts from frayed terminal wires prevented by bakelite barriers placed between terminals. Binder screws and terminals brass, nickel-plated. Insulation, BM 120 molded bakelite. Finest construction. Add much to equipment's effect.

Jones Means Proven Quality



Illustrated: Screw Terminals—Screw and Solder Terminals—Screw Terminal above Panel with Solder Terminal below. Every type of connection.

Six series meet every requirement: No. 140, 5-40 screws; No. 141, 6-32 screws; No. 142, 8-32 screws; No. 150, 10-32 screws; No. 151, 12-32 screws; No. 152, 1/4-28 screws.

Catalog No. 20 lists complete line of Barrier Strips, and other Jones Electrical Connecting Devices. Send for your copy.



CIRCLE 431 ON READER-SERVICE CARD FOR MORE INFORMATION

ELECTRONIC DESIGN • September 1955

3 Soldering Operations in 1 Easy as ABC with KESTER "SOLDERFORMS"

A Solder screws and stud to can cover.
"Solderform" Disc & Rings 5% Silver
—95% Lead Alloy. Melting Point 600°F.

B Solder glass terminals to cover.
"Solderform" Rings 63% Tin—37%
Lead Alloy. Melting Point 361°F.

C Hermetically seal cover on can.
"Solderform" Ring 20.5%
Bismuth—20.5% Tin—43%
Lead Alloy. Softening Point 250°F.

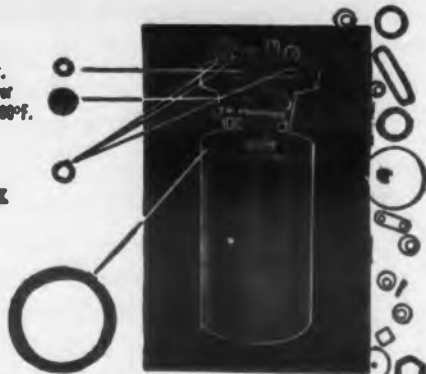

Here's a typical example of a tough resistance soldering job involving progressively lower melting temperatures. Kester "Solderforms" made sure this high precision oscillator coil came through every test successfully.

WRITE TODAY for free "Solderform" samples and literature.

KESTER
SOLDER COMPANY

4266 Wrightwood Avenue • Chicago 39, Illinois
Newark 5, New Jersey • Brentford, Canada

CIRCLE 434 ON READER-SERVICE CARD FOR MORE INFORMATION

Dispersions

436

A revised 4-page booklet lists 44 colloidal and semi-colloidal dispersions for electronics, electrical manufacturing, and related industries. These products include dispersions of graphite, molybdenum disulfide, mica, vermiculite, zinc oxide, and acetylene black. Carriers and diluents are given for each product, along with typical applications and physical data. Acheson Colloids Co., Div. of Acheson Industries, Inc., 1950 Washington Ave., Port Huron, Mich.

Molding Compound

437

Molding characteristics and physical properties of Plaskon Nylon 8200 are presented in a new booklet. The booklet, containing tabular data and charts, discusses the ease of moldability of this material, its relatively low molten viscosity, and its controllable crystalline structure. It is suitable for electrical insulation applications. Barret-Div., Allied Chemical & Dye Corp., 40 Rector St., New York 6, N. Y.

Development Facilities

438

"Specialized Development" is the title of a brochure which illustrates the scope of development problems solved by this company in the field of electrical and mechanical controls and components. Curtis Development & Mfg. Co., 3266 N. 33rd St., Milwaukee 16, Wis.

New Miniature POWER OUTLETS

For Small Electrical and Electronic Units
SHOWN FULL SIZE

- SMALLEST MADE
- TAKE STANDARD PLUG
- MOUNT FROM TOP OR BOTTOM OF FLAT BRACKET
- CHOICE PRE-WIRED STYLE, OR WITH SOLDERING TERMINALS
- PHENOLIC BLOCK HAS BARRIER TO PREVENT SHORTS
- AC and DC

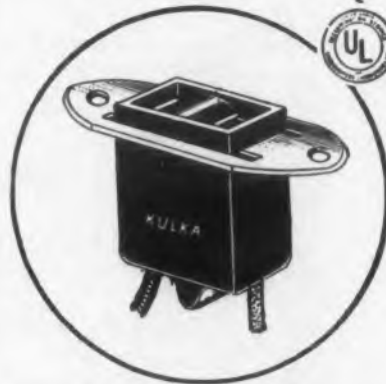
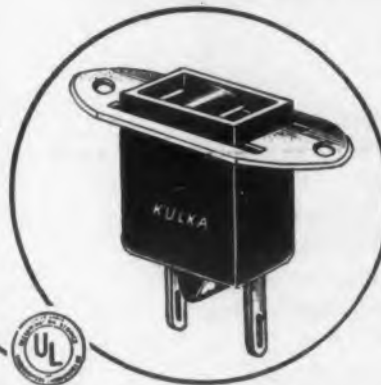

No. 221 (above) with soldering terminals and steel bracket with #6 clearance mounting holes. Also No. 222 with 6-32 tapped mounting holes. No. 223 (left) with 8" #14 or #16 plastic wire leads and steel bracket with #6 clearance mounting holes. Also No. 224 with 6-32 tapped mounting holes.

KULKA ELECTRIC MFG. CO., Inc.
Manufacturers of Electrical Wiring Devices
MOUNT VERNON, N. Y.

CIRCLE 439 ON READER-SERVICE CARD FOR MORE INFORMATION

WANTED!

tough
miniature
transformer
problems

FOR AIRCRAFT AND
MISSILE APPLICATIONS



Celco designs and produces miniature transformers and magnetic amplifiers to give better performance with less weight and space.

"Miniaturization" and inspection techniques developed at Celco using new materials . . . grain oriented nickel alloys . . . Teflon, polyester film and silicone insulation . . . assures high quality at a minimum of cost in your end product.

Put the Celco experience to work on your tough design problems! Send today for Celco design sheets and prompt quotations.

Celco

CONSTANTINE
ENGINEERING LABORATORIES CO.
P.O. BOX 471 MAHWAH, N. J.

CIRCLE 440 ON READER-SERVICE CARD FOR MORE INFORMATION

STRIP WIRE . . .

✓ FASTER
✓ CLEANER
✓ WITHOUT
CRUSHING!

WITH THE

Speedex

**AUTOMATIC
WIRE STRIPPER**

Now . . . save at least 50% of your wire stripping time. New Speedex Automatic Wire Stripper strips both solid and stranded wire. Heavy duty for shop or production use. "Delayed return action" prevents crushing. Range of models for every requirement. See your distributor or write direct for information.

Model 766-B

Net Price
\$4.95
(\$0.25 list)

Wood Specialty MANUFACTURING CO.
DIVISION OF GENERAL CEMENT MFG. CO.
928 Taylor Avenue Rockford, Illinois

CIRCLE 435 ON READER-SERVICE CARD FOR MORE INFORMATION

ELECTRONIC DESIGN • September 1955

HICKOK

LABORATORY

**MODEL
770
'SCOPE**



- Wide Band . . . DC to 5 megacycles
- High Sensitivity 10 millivolts per inch RMS

- Features Illuminated Calibrated Screen.
- Contains all late design features proven most desirable for industrial electronic work.
- Built-in Voltage Calibrator.

Write today for complete technical details.

THE HICKOK ELECTRICAL INSTRUMENT COMPANY

10525 Dupont Avenue • Cleveland 8, Ohio

CIRCLE 441 ON READER-SERVICE CARD FOR MORE INFORMATION



This typical Hetherington T1000 Switch designed for MIL-S-6745 uses reduces size by 25%.

Built to meet your
TOUGHEST
PERFORMANCE STANDARDS
...with weight and space savings
in the bargain...

- Switch Types for**
Fire detection indicators
Trim tab control
Seat positioning
Auto pilot release
Tank jettison
Microphone circuits
Audible signal silencers
Equipment testing
Fire detection test
Canopy release
Seat ejectors
Bomb or rocket firing mechanisms
Auto pilots (holding coil types)
Instruments
Appliances . . .
and many others

Whether for MIL or for the toughest commercial uses, Hetherington Switches and Switch-Pilot Light combinations are designed to do the job—with safety margin to spare. Unique, patented design provides positive switching (to exceed military life cycle requirements) in less space with less weight. Dozens of special aviation types in the 15-50 ampere range plus adaptations for exacting commercial jobs.

HETHERINGTON
Switches

HETHERINGTON, INC. • SHARON HILL, PA.
 West Coast Division: 8568 W. Washington Blvd., Culver City, Calif.
 CIRCLE 444 ON READER-SERVICE CARD FOR MORE INFORMATION

Wire Stripping 445

The use of high-frequency induction heat generators in conjunction with many wire stripping operations is discussed in this 4-page bulletin. Types of wires and strippings are described and combinations of strippers and heat generators in actual use are illustrated. Rush Wire Stripper Div., The Eraser Co., Inc., 1068 S. Clinton St., Syracuse 4, N. Y.

Flexible Electrical Insulations 446

A revised catalog describes this firm's line of flexible electrical insulation materials. The catalog is divided into three categories: coated products, varnishes, and plastic products. Included are charts and conversion tables. Irvington Varnish & Insulator, Div. of Minnesota Mining & Manufacturing Co., Irvington, N. J.

Magnetic Cores 447

Magnetic properties of Ferramic "H" cores are given in a series of graphs in this bulletin. A table of comparisons with other Ferramic bodies is also included. General Ceramics Corp., Keasbey, N. J.

Panel Instruments 448

Catalog No. A38B illustrates and describes ruggedized and sealed panel instruments, a-c, d-c, r-f, and thermo, in both commercial and military types. Information is included on design and construction and on test procedures. Weston Electrical Instrument Corp., Newark 5, N. J.

Socket Screws 449

A data file contains complete information on seven types of socket screws plus hex-socket keys. Data is provided on dimension standards, standard sizes, physical properties, recommended tightening torque, applications and uses. Mac-it Screw Div., Strong, Carlisle & Hammond Co., 1392 W. 3rd St., Cleveland 13, Ohio.

Industrial Fibers 450

Industrial fibers for thermal insulation, filtering agents, fillers, and reinforcing are described and illustrated in Bulletin No. F-39A1. Physical and chemical properties are charted and potential applications outlined. Pacific Lumber Co., 100 Bush St., San Francisco 4, Calif.



How can YOU use this simple, rugged SNAPSLIDE FASTENER?

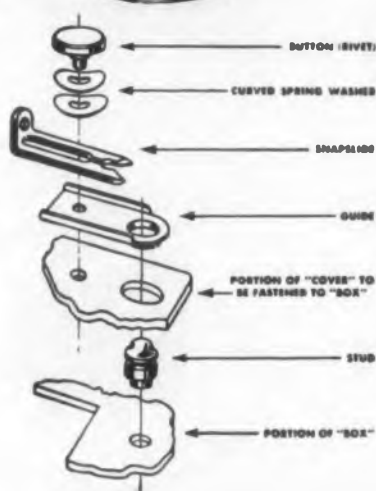

This positive, quick-action fastener was originally developed to hold airborne equipment with security—even under severe stress and shock of carrier-based aircraft operations—and yet permit equipment replacement in a matter of seconds.

A wide variety of industrial uses has been found for the fastener. Perhaps you can use it profitably. It requires no tools; thumb and finger fasten and release. Even with repeated use no adjustments are necessary. Available in two sizes, with parts to match different thicknesses of mounting plates.

Write for details.

Dependable Airborne Electronic Equipment Since 1928

AIRCRAFT RADIO CORPORATION
BOONTON, NEW JERSEY



CIRCLE 451 ON READER-SERVICE CARD FOR MORE INFORMATION

ELECTRONIC DESIGN • September 1955

Panel Instruments 454

A new series of ruggedized panel instruments designed for size and weight reduction in electronic equipment subject to shock, vibration, or temperature extremes is described in a 2-page, 2-color bulletin. DeJur-Amsco Corp., 45-01 Northern Blvd., Long Island City 1, N. Y.

Forming Sheet Metal 455

A bulletin describes in detail methods of fabricating boxes, brackets, and chassis from sheet metal. The bulletin should be of particular interest to designers and experimenters. Television Accessories Co., Dept. L, 1412 Great Northern Bldg., Chicago 4, Ill.

Epoxy Resin Selection Chart 456

A new epoxy resin selection chart will enable manufacturers to choose an epoxy resin for impregnating, insulating, or potting requirements. The chart is divided into room temperature, moderate temperature, and high temperature setting systems. Furane Plastics, Inc., 4516 Brazil St., Los Angeles 39, Calif.

Control Instruments 457

This condensed catalog describes this firm's line of signal generators VSWR indicators, incidental FM meters, and digital pressure gages and accessories. Information given includes instrument model number, frequency range, characteristics, and uses. Byron Jackson Co., Electronic Div., 492 E. Union St., Pasadena, Calif.

Hand Riveter 458

Bulletin No. 86P illustrates and describes each of the five models in this firm's series of spinner-riveter hand guns. Applications and specifications are given. Lennert Engineering Co., Inc., 204 E. Jefferson St., Plymouth, Ind.

Production Facilities 459

These companies' facilities for the production of precious and non-precious laminated metals and fabricated precision parts are described and illustrated in a 2-color, 8-page brochure. Forms of laminated sheets, alloys, wires, and tubing are discussed and examples of various precision parts are shown. Leach & Garner Co., and General Findings and Supply Co., Attleboro, Mass.

a highly stable
dual power supply



DRESSEN-BARNES
Model D3-300D

You get two high-voltage output ranges—each widely useful... each independent of the other—on one compact chassis. Appearance of the unit meets highest laboratory standards. All components are de-rated for long, trouble-free service life. Write for literature on Model D3-300D.

Output Voltages:

1. 0-300 V.D.C. continuously variable without switching... current 300 MA. max. load.
2. 0-300 V.D.C. continuously variable without switching... current 150 MA. max. load.
3. DC variable bias: 0-150 volts @ 5 MA. max. load (regulated by VR tube).
4. AC unregulated 0-10 V.A.C. @ 10 amps. max. load (variable with Powerstat control).

Regulation:

1. For line voltage 115 V.A.C. \pm 10%, the output voltage change is .15%.
2. D.C. regulated high voltage: less than 30 MV. change N.L. to F.L.

Ripple — both high voltage outputs less than 500 microvolts RMS.

Grounding — both pos. or neg. of either high voltage outputs may be grounded.



dressen-barnes

DRESSEN-BARNES CORP., 250-A N. Vinedo Ave., Pasadena 8, Calif.

LIKE 400 U.S. NAVY-SERVICE CARD FOR MORE INFORMATION

What is YOUR RELAY PROBLEM?

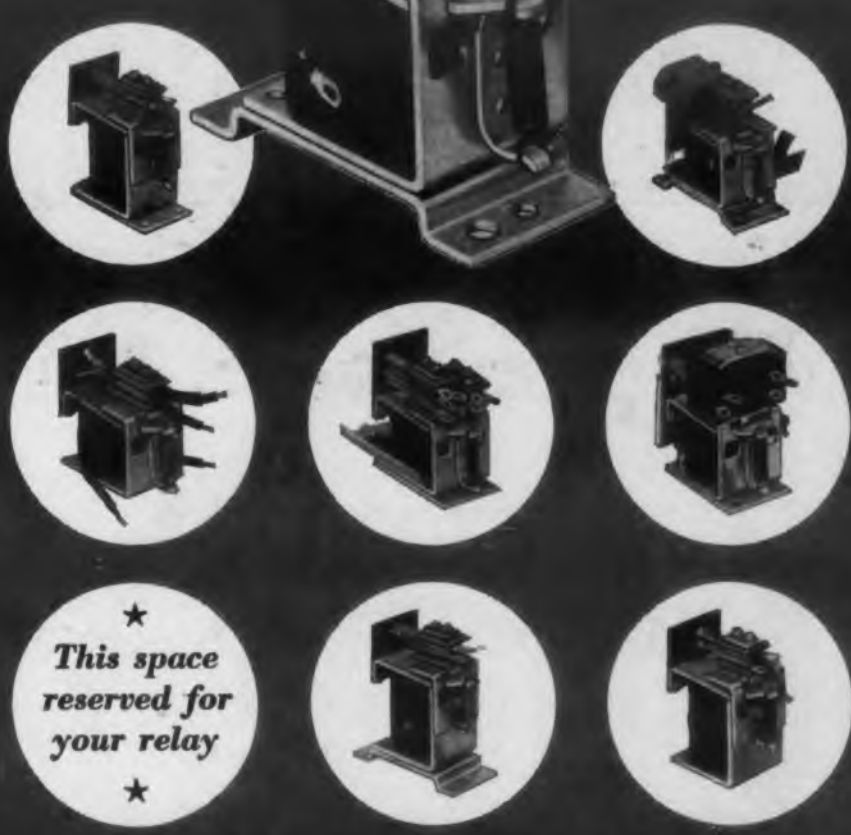

★
This space
reserved for
your relay
★

R·B·M General Purpose Relays..

have solved many specific relay problems with no development or tooling cost to the customer. RBM has produced hundreds of thousands of magnetic relays from standard parts—designed and initially produced over seven years ago—to fulfill the need for dependable relays at low cost.

The many variations of contact form and ratings, as well as ter-

minal arrangements and mounting brackets, may well provide just the right relay for you. WRITE FOR BULLETIN 570— or better yet, tell us your requirements. Bulletin 570 shows only a few of the many variations.

Whether a single relay or a relay panel complete with wire assemblies and cord sets, RBM may help you lower your costs.

R-B-M DIVISION
ESSEX WIRE CORPORATION
Logansport, Indiana

*Controls for Electronic,
Refrigeration, In-
dustrial, Appliance,
Communication and
Automotive Industries*



CIRCLE 461 ON READER-SERVICE CARD FOR MORE INFORMATION



NEWEST PRINCIPLE

No wonder the new Silic-O-Netic Time Delay Relay has aroused such interest. It offers basic advantages as a delay device unequalled in its low price range.

The Silic-O-Netic Relay provides delay with no mechanical linkages . . . no mechanism to speak of. . . only one moving part, and that part is hermetically sealed, forever free of dirt and dust. It operates on a positive change in magnetic flux which is sharply defined as the movable core touches the pole piece. Moreover, the new Type A model has high speed contacts, affords good contact pressure.

in TIME DELAY RELAYS

Heinemann Silic-O-Netic Relays are already being used in dozens of volume applications where absolute dependability is essential. They are well worth your investigation.

Write for Bulletin T-5002

IT'S DIFFERENT...

No thermal elements . . . no aging, no fatigue . . . long-life stability.

Small size . . . Overall dimensions: $2\frac{1}{16}''$ x $1\frac{1}{16}''$ x $2''$.

Delay periods . . . $\frac{1}{4}$ to 120 seconds.

Low cost . . . achieved in 20 years of solenoid manufacturing experience.

HEINEMANN

ELECTRIC COMPANY

156 Plum St., Trenton 2, N. J.



CIRCLE 464 ON READER-SERVICE CARD FOR MORE INFORMATION

Drafting Equipment

465

A new 32-page illustrated catalog features a line of drafting equipment. It provides a buying guide for drafting machines, drawing boards, T-squares, parallel rules, triangles, templates, curves, and lettering aids. Frederick Post Co., 3650 N. Avondale Ave., Chicago 18, Ill.

Recording

466

A new company paper describes recording techniques and applications. Visual recording, monitoring recording, curve plotting, facsimile recording, etc., are discussed and applications illustrated. Alfax Paper and Engineering Co., Alden Research Center, Westboro, Mass.

Viscosity Measurement

467

This folder describes a viscosity measurement instrument for continuous process quality control. The instrument may be used as a sensing element in an automatically controlled process. Brookfield Engineering Laboratories, Inc., 240 Cushing St., Stoughton, Mass.

Microwave Equipment

468

A series of catalog sheets describes this firm's line of ferrite microwave equipment. Curves and characteristics, dimensional drawings, and specifications for unidirectional transmission lines and microwave amplitude modulators are given. Features and applications are discussed and illustrated. Cascade Research Corp., 53 Victory Lane, Los Gatos, Calif.

Hermetic Seals

469

Hermetic seals for withstanding high-temperatures and severe thermal shock are illustrated and described in this booklet. Illustrations, dimensional drawings and ratings are given. Advanced Vacuum Products, Inc., 18 Liberty St., Stamford, Conn.

Resistance Welding

470

A new bulletin describes "Three Phase", a new power-saving principle of resistance welding operation. The advantages, operating principles, and applications are discussed and illustrated. Sciaky Bros., Inc., 4915 W. 67th St., Chicago, Ill.

For those
"problem"
cutting jobs
on hard, brittle
materials



"Trimming" resistance elements on printed circuits



Cutting fragile crystals into accurate cylinders



Cutting spiral grooves on film-type resistors



S. White INDUSTRIAL "AIRBRASIVE" UNIT

With the "Airbrasive" Unit you can cut, shape, drill or etch wafer-thin sections of hard, brittle materials without danger of shattering, chipping or crazing. And you can also remove deposited surface coatings safely and accurately. Successful applications include work on printed circuits, carbon film resistors and parts made of germanium, glass, ceramics and crystalline materials.

We'll be glad to test the process on your sample parts or give you a demonstration at our New York or California Office. Write or call today.

BULLETIN 5411 has full details. Send for a copy. Address Dept. 10.

AS
THE *S. White* INDUSTRIAL DIVISION
DENTAL MFG. CO.



10 East 40th Street
New York 16, N.Y.

Western District Office • Times Building, Long Beach, California

CIRCLE 471 ON READER-SERVICE CARD FOR MORE INFORMATION

ELECTRONIC DESIGN • September 1955

Standard Broadcasts 474

Bulletin No. G-2 discusses the uses of standard time and frequency broadcasts. Diagrams show the transmission cycle of stations WWV and WWVH, calibration of f signal source, methods of audio comparison, and method of extrapolating WWV standards. Specific Products, 14515 Dickens St., Sherman Oaks, Calif.

Selenium Rectifier Units 475

Catalog No. 127, "A Guide to Better Plating Power", describes selenium rectifier units and the use of selenium rectifiers to provide d-c power for electroplating, electropolishing, electrocleaning, and other electrochemical needs. Bart Messing Corp., 229 Main St., Belleville 9, N. J.

Portable Gear Tester 476

A portable precision gear tester for rapid production check of helical, spur, and worm gears is described in a 4-page bulletin. Charts of test runs are shown and the various models are illustrated. Arch Instrument Co., Inc., 101 Holmes St., North Quincy, Mass.

Electrical Connectors 477

A new bulletin on AN electrical connectors describes the fields of application for this type of electrical connector, and provides general information on performance requirements, size and capacity, basic parts, and the numbering system used. Deutsch Co., 7000 Avalon Blvd., Los Angeles, Calif.

Miniature Relay 478

A catalog sheet gives technical data, specifications, and dimensional drawings of a double-pole double-throw miniature sensitive hermetically sealed relay. The relay is built to comply with MIL-R-5757-B specifications. Magadyne Co., 84 S. Water St., Port Chester, N. Y.

Seals 479

A new catalog, "Designed for Sealing", illustrates and describes this firm's line of fluid fitting, orifice, closure, fastener, and electro-fluid seals and "O" rings. Dimensions, specifications, features, and applications are given. Franklin C. Wolfe Co., Inc., 3644 Eastham Dr., Culver City, Calif.

NEW MANUAL X-Y PLOTTER KEYBOARD

IMPROVED PERFORMANCE
IN SUPPLYING INPUT
SIGNALS FOR AUTOMATIC
POINT PLOTTERS



LIBRASCOPE INCORPORATED

A major innovation in this new Librascope manually operated decimal keyboard eliminates sticking switch contacts and high contact resistance. Self-wiping slide-type contacts eliminate necessity for any switch and contact adjustments. Resistance potentiometers are simulated by two voltage dividers—one each for the X and Y axes. All keys are released automatically after point is plotted. A variety of contact configurations available for manual feeding of decimal or binary coded decimal inputs to computer or other systems.

Write for catalog information.

FEATURES

DIMENSIONS—8½" wide;
11" deep; 16" high.

WEIGHT—12 pounds.

POWER—Energized by voltage
from recorder. No external
source required.

Computers and Controls

LIBRASCOPE

A SUBSIDIARY OF GENERAL PRECISION EQUIPMENT CORPORATION

1607 FLOWER ST. • GLENDALE, CALIF.

CIRCLE 480 ON READER-SERVICE CARD FOR MORE INFORMATION

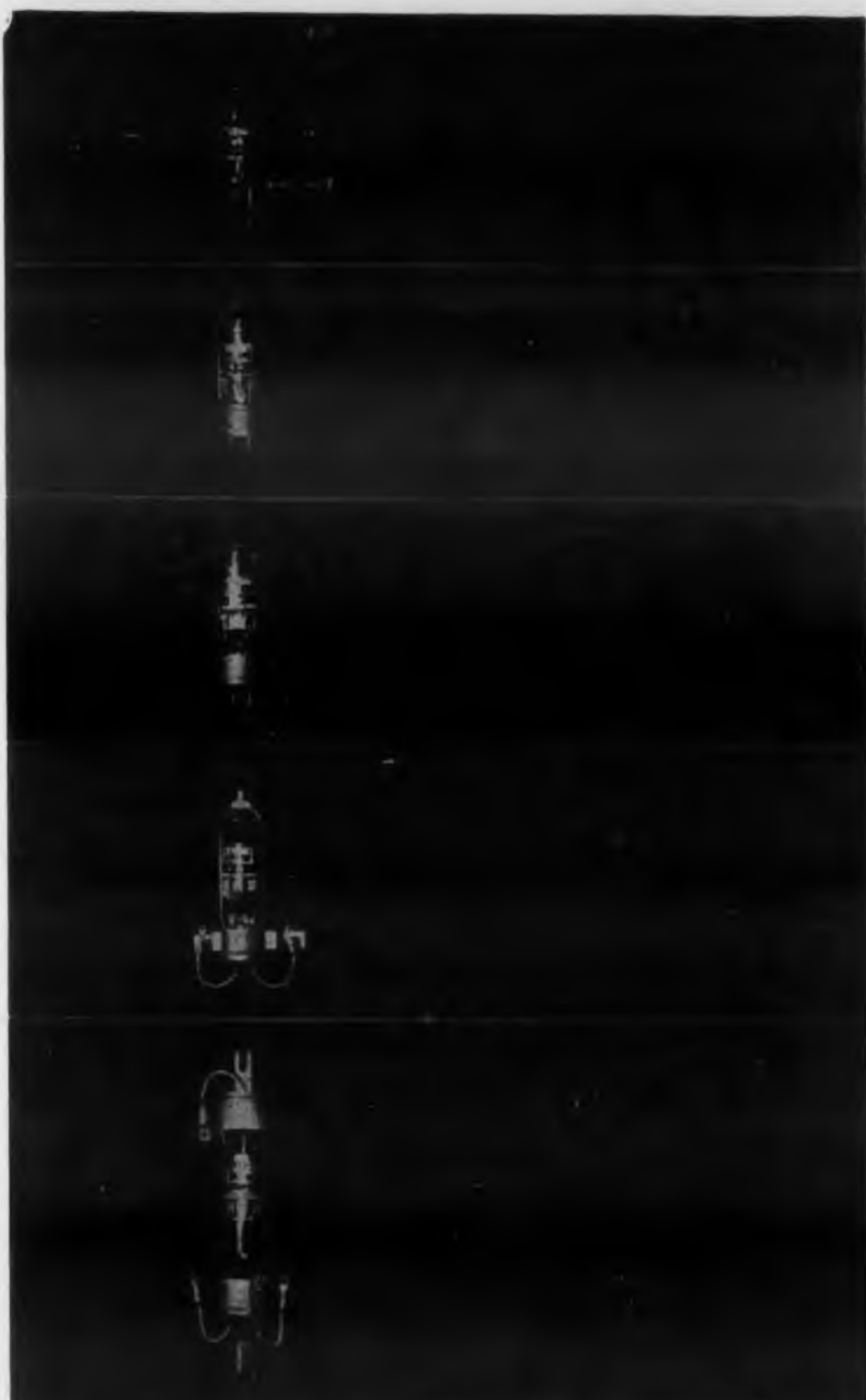

ELECTRONS, INCORPORATED

127 SUSSEX AVENUE

NEWARK 3, N. J.

*These 1 to 16 ampere inert gas-filled rectifiers are rugged,
used throughout industry and preferred by leading
electronic equipment manufacturers.*

CIRCLE 481 ON READER-SERVICE CARD FOR MORE INFORMATION

new concept of dependability and convenience



**WHY DYNACORD IS THE NEW
STANDARD OF PROFESSIONAL RECORDING**

**Finest
for custom
installation,
exacting
Industrial
use**

Push-buttons actuate computing interlock which cycles Dynacord through "stop" into any operating position automatically. Direct capstan drive . . . 3 motors . . . exclusive dynamic braking, fast, fool-proof . . . reversible reel seats . . . frequency response: ± 2 DB 30-15,000 CPS at 15 in./sec. . . signal to noise ratio: better than 55 DB. For standard rack mounting or installation in console. Specifications on request.

Model DTM Tape Transport Mechanism, \$395.00 net
Model DP-100 Broadcast Amplifier, \$150.00 net
Model DS-10 Audiophile Amplifier, \$90.00 net



Thousands have heard Dynacord's fabulous performance as a 6-channel stereophonic recorder in the All-Electronic Orchestra.

Now Dynacord Recorders are available for many critical industrial applications upon special order (from 1 to 6 channels on $\frac{1}{4}$ " tape).

THE PENTRON CORPORATION

785 South Tripp Avenue, Chicago 24, Ill.

Canada: Atlas Radio, Ltd., Toronto

**Largest Exclusive Maker of Tape Recorders and Accessories
SEND FOR DETAILED BULLETIN TODAY!**

PENTRON

CIRCLE 484 ON READER-SERVICE CARD FOR MORE INFORMATION

Patents

John Montstream

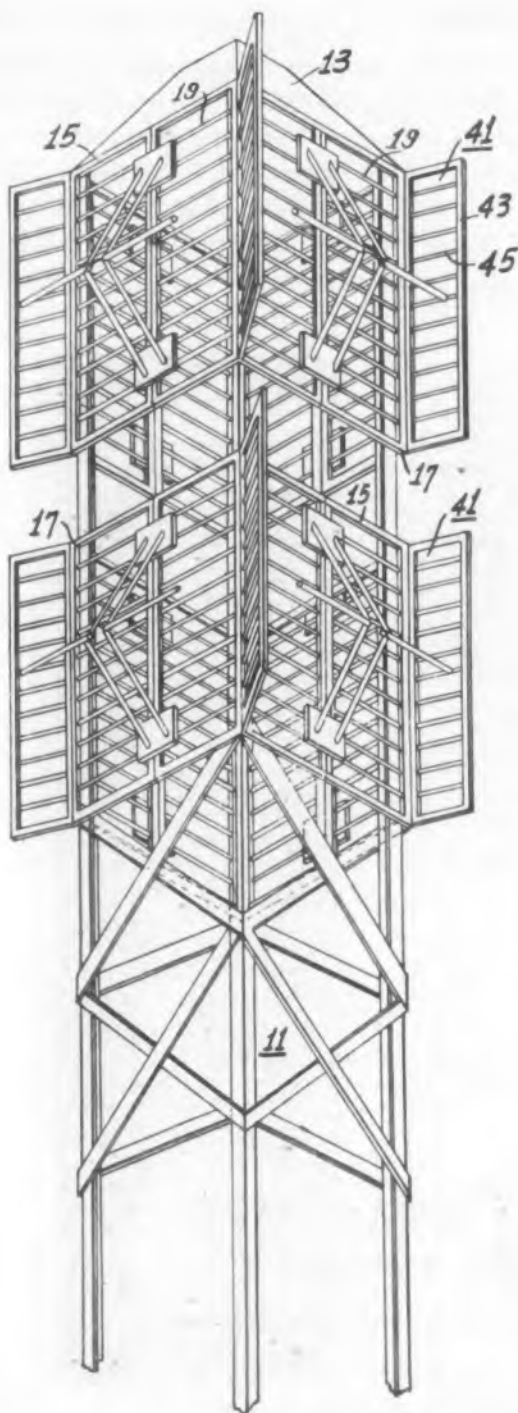

High Gain VHF Antenna System . . .
Patent No. 2,691,102. R. W. Masters. (Assigned to Radio Corp. of America, New York, N. Y.)

The tower structure for v-h-f antennas described in this patent avoids interaction between the radiator elements. The illustrated antenna tower includes the usual type of framework. Reflectors of conductive material are mounted on the periphery of the tower, which may be a permanent part of the tower structure. It is more desirable, however, if the reflectors are screens having rectangular framework (17) with horizontal bars (19) welded to the frame. The screens are provided on all sides of the tower even though an antenna is not to be mounted on each side. These screens should be $1/2$ wavelength wide and about $5/8$ wavelength high. It is important that the width be accurate with respect to the wavelength. In addition to the screens (15), wings (41) are provided extending at an angle with respect to screens 15 serving to stop interaction between dipoles.

A dipole antenna shown at right is carried by screens 15 and spaced therefrom by about 0.25 to 0.30 of a wavelength. The dipoles (21, 22) are fastened to the screen by inclined pairs of braces (23, 24 and 25, 26). Shorting bars (31 and 32) are adjustable between the respective pairs of inclined supporting bars to trim the impedance of the radiators. For a square tower, four assemblies make up one turnstyle layer, and since they are all identical, they are easily made and assembled by unskilled workers. Antennas may be placed on any of the faces of the tower, and in that manner secure various directional patterns. By

prop
may
to in
lar a
to th
it, b
supp
the c
by s

ELI

Presenting New MICROWAVE FILTERS AND PRESELECTORS

by
**FREQUENCY
STANDARDS**

Miniature Gang Tuned Filters and Preselectors

These new filters and preselectors feature a wide tuning range, single shaft tuning, Tschebycheff response and extremely compact design. They are usable over wide temperature ranges and can be furnished hermetically sealed.

Components manufactured by Frequency Standards are the accepted standard of accuracy in the field of microwave frequency measurement and control. Engineering, design and manufacturing facilities are available for the solution of problems involv-



ing frequency measurement, frequency stabilization, frequency control and discrimination. Consult Frequency Standards engineers on your requirements for filters, preselectors, oscillator cavities, AFC cavities and frequency meters for special applications.

TYPICAL SPECIFICATIONS FOR PRESELECTORS AND FILTERS

	L	S	C	X
Tuning Range (KMC)	1.2-1.5	2.8-3.3	4.8-5.3	8.5-9.6
Bandwidth (MC)	10±2	10±2	10±2	10±2
Insertion Loss (db) (4 sections)	≤2.0	≤2.0	≤2.0	≤2.0
Coupling	TYPE N	TYPE N	TYPE N	WAVEGUIDE

Write for free booklet containing complete information on Microwave Filters, Preselectors

and Oscillator Cavities, AFC Cavities, Frequency Meters, and Frequency Stabilizers and Test Equipment

Frequency Standards
ASBURY PARK, NEW JERSEY

Please address
inquiries to BOX 504 A

CIRCLE 486 ON READER-SERVICE CARD FOR MORE INFORMATION

NEW

CHEMELEC CONNECTORS

Aluminum Base Type CNA

**Compression Mounted,
TEFLON-Insulated Terminals**

2 to 34 Pins

Lower Cost . . . High Performance

These Chemelec Connectors are designed for low loss, high frequency service in interconnection of radio, radar and other electronic equipment—where connectors must be unaffected by a wide range in ambient temperatures, pressure altitudes, humidity and mechanical shock and vibration.



Current rating is 3 amp. for .040 pins and 5 amp. for .063 pins. Voltage rating is 3,300 V. RMS (short time test at sea level).

The TEFLON insulation is serviceable at temperatures from minus 110°F to plus 500°F, for operation in pressure altitudes from 0 ft. to 60,000 ft. Water absorption is zero by ASTM Test.

TEFLON will not carbonize under arcing, and will not support combustion. Its dielectric strength is greater than 500 Volts/Mil.

Lower prices are accomplished by individual compression-mounted, TEFLON-Insulated Terminals in low-cost aluminum bases.

These same terminals are also available for compression-mounting, directly into drilled or punched holes in the chassis itself, without need of additional hardware. (see below).

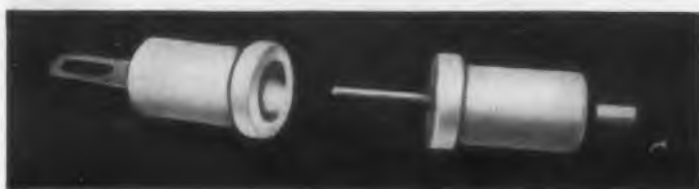

*Write for
Catalog EC-455.*

Fluorocarbon Products, Inc. Division of
UNITED STATES GASKET CO., CAMDEN 1, NEW JERSEY



**FABRICATORS OF FLUOROCARBONS
AND OTHER PLASTICS**

Representatives in principal cities throughout the world

CIRCLE 487 ON READER-SERVICE CARD FOR MORE INFORMATION

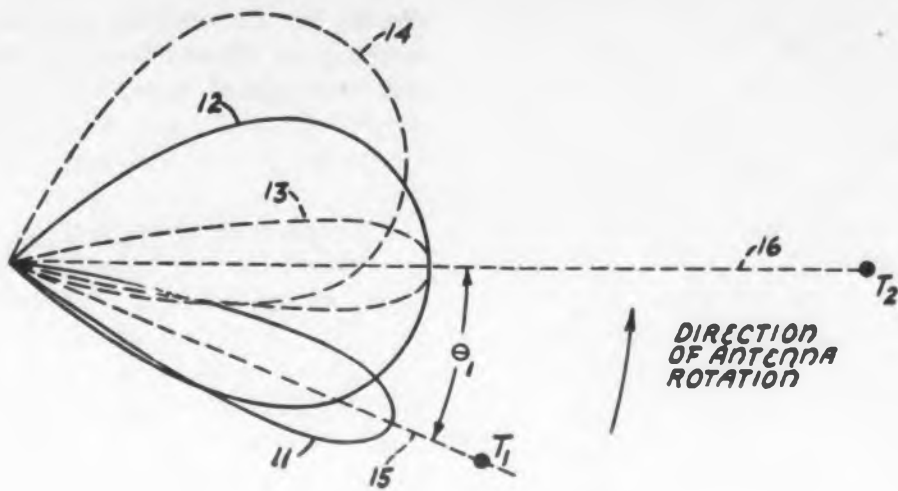

tenna has turned to a position where its sensitivity pattern or response is low or indeed to a position where the reflected signal is incapable of energizing the antenna. The patentee overcomes this difficulty by the design of an antenna with a transmitting horn having a wide directional pattern (12 and 14).

Another form of the invention may use horns of such shape that they have a highly directive characteristic. The receiving horn, however, is so shaped that its maximum

reception characteristic or pattern lags or is angularly displaced with respect to the pattern of the transmitting horn. The antennas can be rotated at high speed and still secure an accurate and clear response from a distant target. This characteristic is particularly important with respect to moving target radar systems.

The impulses emitted radiate outwardly from the reflector (21). A separate receiving horn (34) is mounted with horn 33 and receives the echo or reflection from the



This is a Birtcher Type 22 TUBE CLAMP. It serves to securely hold tubes and electronic components in place throughout the range allowed by JAN specifications in base diameters. For further information and a catalog describing Type 22 TUBE CLAMPS write the Birtcher Corporation, Industrial Division, 4371 Valley Blvd., Los Angeles 32, California.

CIRCLE 488 ON READER-SERVICE CARD FOR MORE INFORMATION

ELECTRONIC DESIGN • September 1955

target. This receiving horn is relatively narrow and, therefore, has a narrow directional pattern 11 and 13. The horn 34 is located relatively to horn 33 so that its response pattern follows that of the latter in recognition of the fact that the reflected signal is delayed some time after the transmitted signal. Preferably it has a high directive characteristic and its pattern overlaps part of the transmitting pattern as shown.

The antenna structure including horns 33 and 34 and the reflector 21 are rotated at a constant speed by motor 30. The transmitter (40) and receiver (41) are connected with the antenna through a rotary coupling. This coupling uses a stationary waveguide (36) from the transmitter which passes the transmitted signal to circular track 49 of relatively large diameter and a waveguide 31 on the rotating antenna structure is coupled to circular track 49 throughout the rotation. The receiving horn (34) is coupled by the waveguide (32) to circular track 48 of smaller diameter in the stationary member (27) of the rotary coupling. The circular track and waveguide 37 transmits the received reflection signal to receiver 41.

Oscillation Generator . . . Patent No. 2,692,337. R. L. Hanson (Assigned to Bell Telephone Laboratories, Inc., N.Y.C.)

The oscillation frequency of this transistor circuit is independent of the values of the residual resistances in this circuit. As a result it does not require additional circuit elements to hold the frequency constant as in many other oscillation circuits. Two circuits are shown on the next page.

The circuit uses a transistor (1) having a base electrode (2), an emitter electrode (3), and a collector electrode (4). A battery (5) with suitable resistances (6, 7) in the base and emitter connections provides proper operating bias for these electrodes. The resistor (14) in the collector connection with resistor 7 prevents excessive direct current flow through the transistor. The output may be connected with the load through a transformer (13) in the collector circuit as shown in the left-hand illustration or a coil (22) may be coupled to the coil (12) in the feedback circuit as shown in the other circuit.

Oscillation of the circuit is secured primarily by a series resonant circuit comprising the capacitor (11) and coil 12 which connects the collector with the emitter.



MINIATURE PULSE TRANSFORMERS

The wealth of experience that Acme Electric engineers have gained in more than 37 years of transformer designing, becomes apparent in the performance and high quality construction of this line of Miniature Pulse Transformers. Send us your specifications.







ACME ELECTRIC CORPORATION

909 WATER STREET • CUBA, N. Y.

WRITE FOR
CATALOG
PT-301



T R A N S F O R M E R S

CIRCLE 489 ON READER-SERVICE CARD FOR MORE INFORMATION

Exhaustive Analysis of blower performance leads to expert design

Rotron has one of the country's
finest equipped laboratories continually
working on customer cooling projects

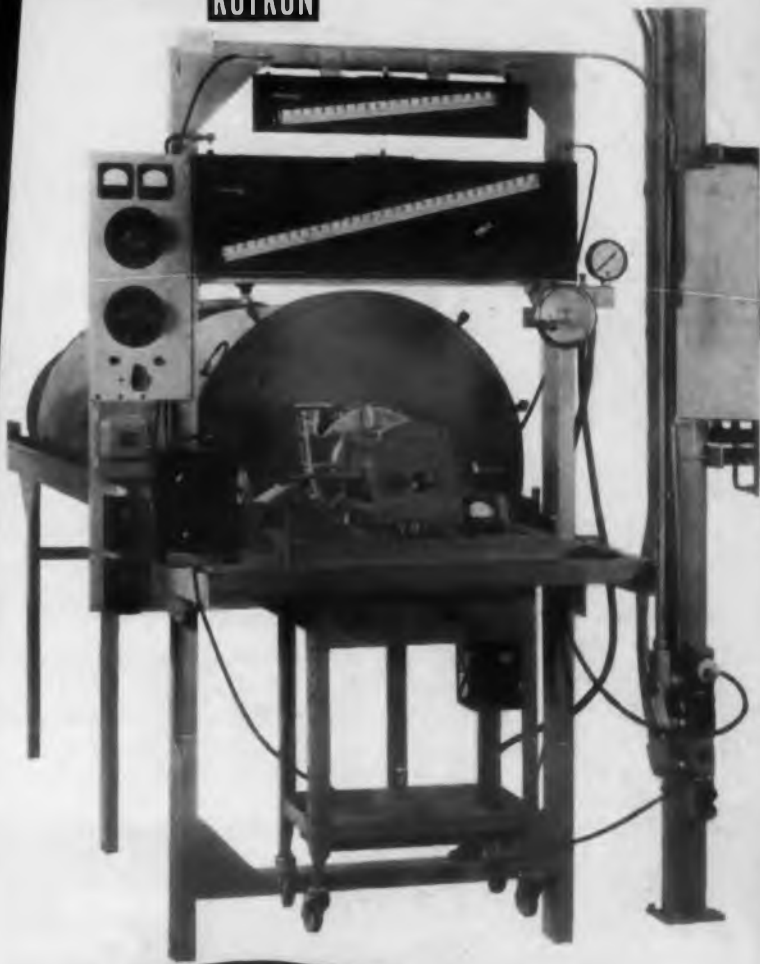

ROTRON MANUFACTURING CO., INC.

SCHOONMAKER LANE WOODSTOCK • NEW YORK

CIRCLE 490 ON READER-SERVICE CARD FOR MORE INFORMATION



OUR **SERVO MOTORS**

**ARE HIGH-TEMPERATURE
AND CORROSION-RESISTANT**

E-P Servo Motors are designed and built to meet specifications for high-temperature operation . . . corrosion can't touch 'em either, for they're completely resistant to humidity and salt spray.

If you're concerned about maintaining optimum performance under unusual conditions, find out about E-P Servo Motors.

Write, wire or call us for information on standard and special types . . . prices . . . and deliveries. **ECLIPSE-PIONEER DIVISION, BENDIX AVIATION CORPORATION, TETERBORO, N. J.**

*Eclipse-
Pioneer*
DIVISION

Bendix
AVIATION CORPORATION

West Coast Office: 117 E. Providencia, Burbank, Calif. • Export Sales: Bendix International Division, 205 E. 42nd St., New York 17, N. Y.

CIRCLE 491 ON READER-SERVICE CARD FOR MORE INFORMATION

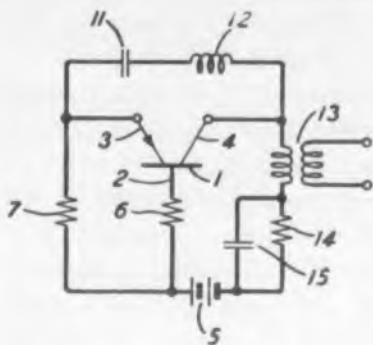

Collector circuit (left) and feedback circuit (right) for oscillation generator.

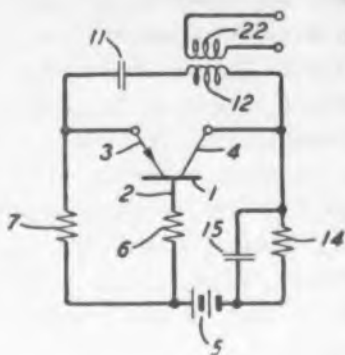

Any electrical disturbance in the emitter circuit will set the generator into oscillation. At the selected oscillation frequency, which is the resonant frequency of the feedback connection, the feedback impedance is only the residual value of the resistance of the capacitor and coil, which is negligible. So long as the feedback current is equal to the input current, the oscillator becomes self oscillating. In this transistor amplifier, electrode current in the emitter circuit is amplified. So long as this current is greater than the emitter current, sufficient current may be fed back to the emitter to maintain oscillations. The balance of the current in the collector circuit is sup-

plied to the load. The oscillation, therefore, continues even though the current source to the emitter is removed.

At frequencies higher or lower than the resonant frequency of the back coupling connection, the feedback is reduced substantially because of the increased impedance of the tuned circuit at these other frequencies and also because a phase shift is introduced with respect to the emitter current. The oscillation is maintained, therefore, at the frequency to which the coupling connection is tuned. With this oscillator any variation in the magnitude of residual resistances such as caused by changes in temperature is of no effect.

1000 CYCLE MINIATURE

NEW, MINIATURIZED JK-G7J "GLASLINE" CRYSTAL UNIT IN 1.0 TO 2.5 KC RANGE

Specially processed and sealed in a glass enclosed vacuum this new JK-G7J provides extreme stability and miniaturization in the very low frequency range. Write for application engineering data.

When combined with the JK09T Oven the JK-G7J provides temperature stability of $\pm .0001\%$ over an ambient range of -55° to $+55^\circ$.



THE JAMES KNIGHTS COMPANY
Sandwich, Illinois



1. Higher Merit Factor: Vacuum enclosure increases Q of crystal.

2. Secular Stability: Less than .01% per year.

3. Temperature Stability: $\pm .012^\circ\text{C}$ over temperature range of -40° to $+70^\circ$.

Also available: JK-H17T version mounted in MIL type HC-13U holder.

Crystals for the Critical

CIRCLE 492 ON READER-SERVICE CARD FOR MORE INFORMATION

ELECTRONIC DESIGN • September 1955

Transistor System for Translating Signals in Two Directions . . . Patent No. 2,691,073 R. V. Lowman (Assigned to Hazeltine Research, Inc., Chicago, Ill.)

A single transistor is the amplifier in this two-way signal translating circuit suitable for an inter-office communications system. Each electrode (13 and 14) serves alternately as an emitter and collector electrode. A high impedance circuit including the transformer windings (27 and 28), the

rectifier (19) and the entire winding (18), which is connected with electrode 13 when it is an emitter. A low impedance circuit is provided for electrode 13 when it serves as a collector in winding 28, rectifier 20 and that portion of winding 18 between the tap and electrode 13. Electrode 11 is part of an identical high impedance circuit when it serves as an emitter and an identical low impedance circuit when electrode 11 is a collector.

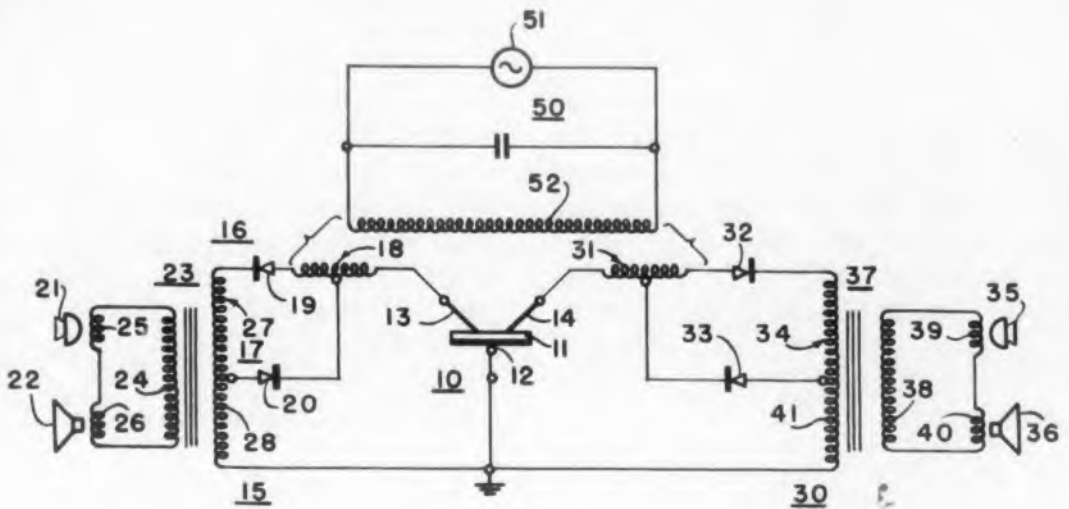

Machlett ML-6422 & ML-6423

Rugged Coaxial Triodes for 10-15kW Equipments

Machlett Laboratories offers the designer ML-6422 and ML-6423 coaxial-terminal triodes, employing thoriated-tungsten filaments, for industrial and broadcast equipments of 10-15kW power output. As replacements for types 892 and 892R, 5668 and 5669, as well as types 6446 and 6447, the new triodes provide improved performance ratings, safety margins and strength. New thoriated-tungsten filaments greatly reduce power requirements while offering life increases to 100%. Plate current ratings are increased by 25%, grid current ratings by 20%; terminal inductances are very low; high transconductance characteristics, up 70%, assure stable operation, low grid drive and high plate efficiency.

ML-6422 uses standard Machlett water jacket and is rated for 30kW input, 20kW anode dissipation. ML-6423 employs unique aluminum radiator to reduce weight to 16 pounds as compared with 52 pounds for conventional type; ML-6423 is rated for 30kW input, 12.5kW anode dissipation. Full ratings on both tubes to 30mc; reduced ratings to 90mc.



Incorporating a rugged, coaxial terminal structure, heavy-wall anode, self-supporting thoriated filament and large, ring-seal connections, each of these heavy duty triodes will give excellent performance and low-cost service.

MACHLETT LABORATORIES, Inc., 1063 Hope Street, Springdale, Connecticut

CIRCLE 493 ON READER-SERVICE CARD FOR MORE INFORMATION



for

Transformers

*miniature
or massive*

THERMADOR

More than seven million Thermador transformers of every size, for every purpose, are in use by industry and government the world over.

The quick short-cut to transformer delivery and satisfaction, is Thermador.

Thermador is the only company on the West Coast with all the equipment necessary to manufacture transformers, magnetic amplifiers and voltage regulators, under one roof—from drawing board to final laboratory test.

Whatever you need in transformers, whether from stock or specially built to order, it will pay you to call Thermador.

Thermador transformers exceed your own specifications and MIL requirements... Technical consultation is available without obligation... Write, phone or wire Thermador today.



Electronics Division, Dept. TT-855
THERMADOR ELECTRICAL MANUFACTURING CO.
Division of Norris-Thermador Corporation
2000 South Camfield Avenue, Los Angeles 22, California
Parkview 8-2105

3-1039

CIRCLE 494 ON READER-SERVICE CARD FOR MORE INFORMATION

positions available at KOLLSMAN

These are permanent positions with Kollsman, designers of America's finest aircraft instruments . . . a progressive, growing organization in which the atmosphere is friendly, the facilities of the best, and the employee benefit program liberal.



PLEASE SUBMIT COMPLETE RESUMES, PRELIMINARY TO CONFIDENTIAL INTERVIEW, TO THOMAS A. DeLUCA.

kollsman INSTRUMENT CORPORATION

80-08 45th AVENUE, ELMHURST, NEW YORK • SUBSIDIARY OF *Standard* COIL PRODUCTS CO. INC.

UHF RECEIVING EQUIPMENT ENGINEER Capable of creative work on advanced UHF amplifiers and oscillator circuits.

VIDEO CIRCUITS ENGINEER For creative work with multi-vibrator, gate and pulse circuits.

SENIOR ELECTRONIC ENGINEERS For development of component systems and test equipment or for research and development of pulse circuitry, computing components and servo systems.

DESIGNERS

Electronic, Electro - Mechanical, Mechanical

1. Electronic or electrical packaging. Knowledge of sub-miniaturized techniques. Work is associated with servos, amplifiers and components.

2. Mechanical or electro-mechanical packaging of precision flight instruments.

**designed
for the
user**



Other Shasta Quality Instruments
Expanded Scale Frequency Meters and Voltmeters • Log Scale Voltmeters • Audio Oscillators Square Wave Generators • Power Supplies • Wide Band Amplifiers Bridges • WWV Receivers • Decade Inductors.

S-8

by **Shasta** *division*



ARGA MODEL 101 EXPANDED SCALE VOLTMETER

features:

- ★ $\pm 0.25\%$ accuracy
- ★ True rms reading
- ★ Easier, error-free reading
- ★ Direct connection for 1 ma recorder
- ★ Special high or low base voltages, scale expansions, panel or switchboard mountings available on order.

brief specifications:

Accuracy: $\pm 0.25\%$ of input voltage
Voltage indicated: True rms
Voltage Range: 100-500 (or 50-250)
Frequency Range: 50-2,000 cps
Scale Range: 12 v. (smallest div. 0.2v)
Dimensions: 7½" W x 8½" H x 9½" D
Price: \$360.00 f.o.b. factory

Write today for Technical Bulletin 101A; please address Dept. SE-9.

Shasta

division

BECKMAN INSTRUMENTS INC.

P.O. BOX 296, STATION A • RICHMOND, CALIFORNIA
TELEPHONE LANDSCAPE 6-7730

CIRCLE 495 ON READER-SERVICE CARD FOR MORE INFORMATION

A source of alternating potential (51) is applied to a winding (52) that is coupled to windings 18 and 31 so that electrodes 13 and 14 are of opposite polarity and the conductivity is constantly changing. The alternating potential is at least twice that of the highest audio frequency to be transmitted. When a positive potential is applied to electrode 13, it serves as an emitter. This positive potential also biases rectifier 19 so that the high impedance circuit becomes operative. At the same time, the potential on electrode 14 is negative so that it functions as a collector. This negative potential also biases rectifier 33 so that the low impedance circuit is operative. It will be seen, therefore, that for each full wave of the potential applied to winding 52, electrodes 13 and 14 serve alternately as emitter and collector electrodes and the circuits operative as a result are alternately high impedance and low impedance circuits. The circuit, therefore, will carry transmission in both directions so that a two-way conversation may be held.

Frequency Multiplication System . . .
Patent No. 2,698,385. E. F. Carter (Assigned to Sylvania Electric Products, New York, N. Y.)

Meeting carrier frequency needs, this circuit generates a signal frequency with a high fifth harmonic content. The circuit can be designed so that the output frequency is some other large numbered multiple of the fundamental frequency.

The circuit consists of a well-known oscillator such as a pentode tube (1) and an oscillating circuit (3, 5) which generates a frequency (f_1). This oscillator is designed to produce multiple harmonic frequencies such as the second and third harmonic. The output circuit of the pentode includes a coil (7) and capacitor (9) having a low Q and broadly tuned to pass the second and third harmonic, but to suppress the fundamental frequency. These harmonic frequencies are mixed in a pentode (13) that serves as a mixer, a heterodyne detector, or a cross modulator. This mixer circuit is non-linear in its characteristics so that the

NEW



We invite your inquiries on these and other wire, cord sets, and cables.

Columbia

WIRE & SUPPLY CO.

2850 Irving Park Road Chicago 18, Illinois

3-WIRE GROUNDING CAP

This uniquely designed molded-on cap is ideal for power tools, appliances, industrial signs, industrial lighting and countless other applications. Much smaller than other types of 3-wire grounding caps, it is Underwriters' Laboratories approved for 15 amps — 125 volts.

Now available for production, with exceptional quality and the usual "Columbia" fine service . . . write for samples.

"SURE-GRIP"

Molded-on plastic male cap with unusual design . . . samples available upon request.



CIRCLE 496 ON READER-SERVICE CARD FOR MORE INFORMATION

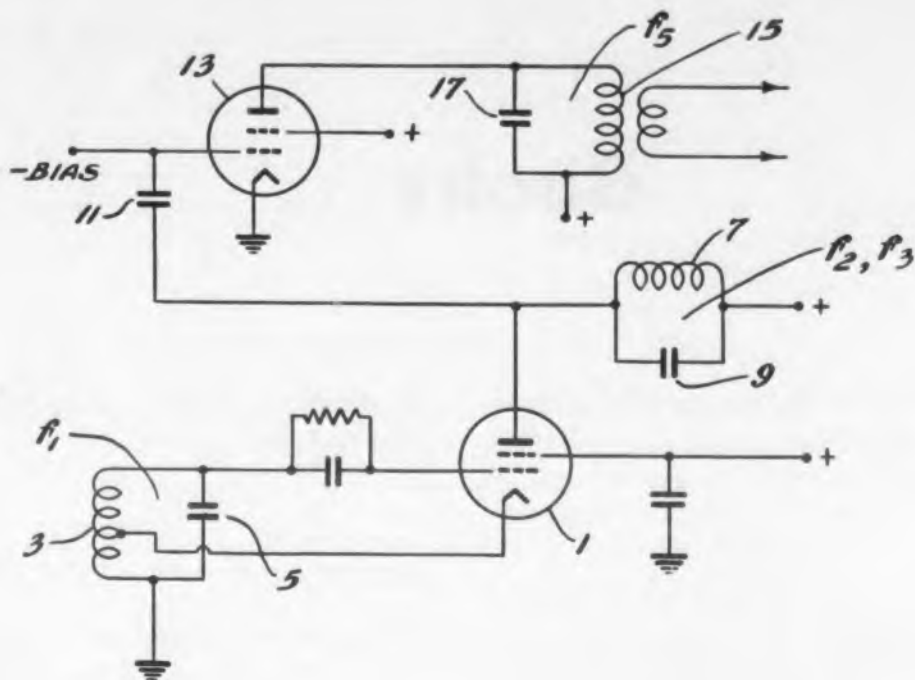

output frequency is the sum of the second and third harmonics, which results in an output frequency of the fifth harmonic of

the fundamental. The output circuit of tube 13 is a sharply tuned circuit that passes the fifth harmonic only.

**RUGGED
COMPACT
FLEXIBLE
LIGHTWEIGHT
ECONOMICAL**

**TYPE 650
CHATHAM
ELECTRONIC
SWITCH**

OVERALL
DIMENSIONS:
6" x 7" x 8"
WEIGHT:
Approx. 10 lbs.

Chatham Electronic Switch Type 650 is a portable instrument which makes possible simultaneous observation of two recurrent patterns on the screen of a single cathode-ray oscilloscope. Relative positions of the patterns on the oscilloscope may be varied so that they are superimposed on each other, or separated by a desired amount. Direct comparison of amplitudes, wave-forms, frequencies, and phase relationships may be observed. A square-wave voltage of variable frequency and amplitude is available at the output terminals for use as a test signal. Direct-coupled inputs to the amplifiers are alternately operative and inoperative at a rate determined by the switching frequency. The instrument is therefore effective for chopping a d-c signal, making it suitable for transmission through the a-c amplifiers which are usually found in cathode-ray oscilloscopes. Write for new Bulletin.



**CHATHAM
ELECTRONICS**
Division of Gera Corporation
LIVINGSTON, NEW JERSEY

CIRCLE 497 ON READER-SERVICE CARD FOR MORE INFORMATION

**PRECISION
ATTENUATION
TO 3000 mc!**



Protected under Stoddart Patents

six-position
TURRET ATTENUATOR

featuring **PULL-TURN-PUSH** action

FREQUENCY RANGE: dc to 3000 mc.
CHARACTERISTIC IMPEDANCE: 50 ohms.
CONNECTORS: Type "N" Coaxial female fittings each end.
AVAILABLE ATTENUATION: Any value from 1 db to 60 db.
VSWR: 1.2 max., dc to 3000 mc/s, values from 10 to 60 db. As value decreases below 10 db, VSWR increases to not over 1.5.
ACCURACY: ± 0.5 db.
POWER RATING: One watt sine wave power dissipation.

**SINGLE "IN-THE-LINE" ATTENUATOR PADS
and 50 ohm COAXIAL TERMINATIONS**

This new group of pads and terminations features the popular Type C and Type N connectors, and permits any conceivable combination of the two styles. For example, the two connector types, either male or female, can be mounted on the same attenuator pad, with or without flanges, so that it may serve as an adapter as well as an attenuator. Frequency range, impedance, attenuation, VSWR, accuracy and power rating are as designated above. Send for free bulletin entitled "Measurement of RF Attenuation."



STODDART AIRCRAFT RADIO Co., Inc.

6644 J Santa Monica Blvd., Hollywood 38, California • Hollywood 4-5294

CIRCLE 498 ON READER-SERVICE CARD FOR MORE INFORMATION

YOU CAN PROFIT

with the **BEAD CHAIN**

**ECONOMICAL
MULTI-SWAGE
METHOD**



this
FREE
catalog
can help
you to...

LOWER PRODUCTION COSTS on Tiny Metal Tubular Parts

Bead Chain's exclusive multi-swage method automatically swages almost any type of tiny metal tubular part from flat stock into precision forms with positive, tight seams. High-volume production can be delivered speedily and at far less cost than with conventional methods of manufacture! Parts can be beaded, grooved, shouldered and made of almost any metal. Diameters up to $\frac{1}{4}$ ", lengths to $1\frac{1}{2}$ ".



WRITE
TODAY!

**THE BEAD CHAIN
MANUFACTURING CO.**

58 Mountain Grove St., Bridgeport, Conn.

CIRCLE 500 ON READER-SERVICE CARD FOR MORE INFORMATION

U.S.C. PRINTED CARD RECEPTACLES *are Specified for Modern Design*

CHANNEL STRENGTH
CONTACTS
*
SNAP-IN CONTACT
CONSTRUCTION
*
FATIGUE PROOF
*
EASY CARD INSERTION
*
PROPER CONTACT
RETENTION FORCES
*
WIDE TOLERANCE
RANGE CARD
OPERATION
*
RUGGED COMPACT-
LIGHTWEIGHT

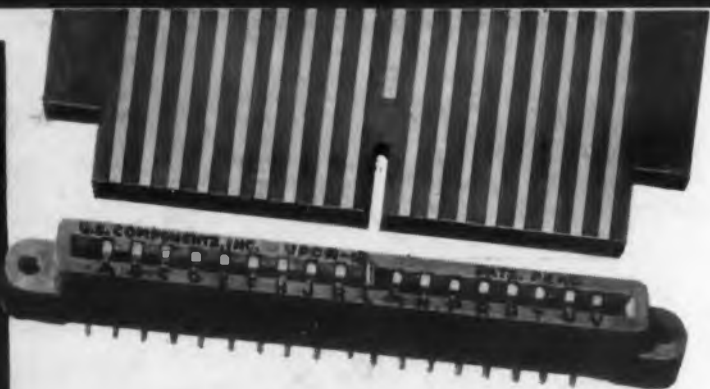

Single Row—UPCR—6, 10, 15, 18, 22
Double Row Wire Solder UPCR—D6, D10, D15, D18, D22
Double Row Wire Wrap UPCR—DW6, DW10, DW15, DW18,
DW22
Double Row Taper Tab—UPCR—DT6, DT10, DT15, DT18, DT22
Double Row Taper Pin—UPCR—DTP6, DTP10, DTP15, DTP18, DTP22

AVAILABILITY

**Insulating body available in Mineral Filled Melamine, Alkyd 440 A
and Diallyl Phthalate
Contacts — Beryllium Copper — Silver Plated with Gold Flash**

 **U. S. COMPONENTS, Inc.**
Associated with U. S. Tool and Mfg. Co., Inc.
154-462 Ea + 148th Street, New York 55, N. Y. CYPRESS 2-6525-6

CIRCLE 501 ON READER-SERVICE CARD FOR MORE INFORMATION

Books . . .

The Elements of the Theory of Real Functions, third edition. . . . *J. E. Littlewood, 71 pages, Dover Publications, Inc., 1780 Broadway, New York 19, N. Y. \$1.35 paper-bound, \$2.85 cloth-bound.*

Every so often the electronic engineer finds there are no nomographs or tables available to help solve a mathematical problem. At this point the engineer must rely on his mathematical training. This slim volume provides a ready means of reviewing the nature of functions. It is based on notes for a series of lectures to senior undergraduates at Cambridge University.

Chapter headings are: "Classes and Cardinal Numbers", "Well-ordered Series", "Other Types of Series", and "Elements of the Theory of Sets of Points".

Applications of Transistors to Electronic Counting Equipment . . . *Richard E. Kimes, 75 pages, paper-bound. Available from Office of Technical Services, Department of Commerce, Washington 25, D. C. (Publication No. PB 111610) \$2.00.*

This report covers the development of a transistorized counter that would duplicate the performance of an existing vacuum-tube model. Unfortunately, the work was performed in 1952 and early 1953 when less reliable transistors were available. However, electronic design engineers using or planning to use transistors will find much valuable information and many useful switching and counting circuits.

The vacuum-tube counter incorporates 45 tubes and consumes 175w. The much

DELAY LINES

Designed for you!

- ★ VERY COMPACT
- ★ CHOICE OF MOUNTINGS
- ★ TUBULAR OR PACKAGE
- ★ ECONOMICALLY PRICED



All Technitrol Delay Lines are continuously wound for minimum pulse distortion . . .
are covered and impregnated to protect the winding . . .
are extremely stable with temperature and environmental variations.

Write for complete
information. Send
your specifications.

NEW—TYPE DD:
VERY WIDE BAND PASS

TECHNITROL

ENGINEERING COMPANY

2751 N. 4th St., Philadelphia 33, Pa.

CIRCLE 502 ON READER-SERVICE CARD FOR MORE INFORMATION

ELECTRONIC DESIGN • September 1955

more compact transistor version required 85 2N23 and three 2517 point contact transistors and consumes 15w. The development work was undertaken at the Berkeley Div., Beckman Instruments, Inc., Richmond, Calif.

International Radio Tube Encyclopedia: 2nd Edition . . . edited by Bernard B. Babani, 501 pages. Bernards Ltd., London, England. Available from British Industries Corp., 164 Duane St., New York 13, N. Y. \$9.00.

Designers of electronic equipment for overseas sale will find this work to be of great value. Among the 18,000 tubes listed, are many foreign equivalents to American types. The tubes listed—receiving, transmitting, rectifiers, thyratrons, regulators, tuning indicators, cathode ray, and photo—are the products of 101 different manufacturers from nearly 20 nations, including Japan and Russia.

In addition to the vital characteristics of each tube, the base connections are given. The bases are illustrated in a separate section. Another section lists equivalents for

rare types. The addresses of the manufacturers, if available, are also listed.

Since the first edition of this work was published in 1949, some three thousand new tubes have been developed. These are placed in a supplement at the end of the book. It is hoped that diodes and transistors will be listed in the next revision. This work is recommended for every design laboratory library.

Dictionary of Television, Radar and Antennas . . . Compiled by W. E. Clason. 760 pages. Elsevier Press, Inc., 2330 Holcombe Blvd., Houston, Tex. \$21.50.

This volume defines television, radar, and antenna terms and lists them in six languages. The basic word list is English (British and American usages being clearly distinguished), and definitions in English are included for each subject. The other languages have alphabetical word lists numerically keyed to the English list. Languages have been arranged in Anglo-Saxon, Latin, and Germanic groups. The dictionary is in English/American, French, Spanish, Italian, Dutch, and German.



Generating enthusiasm

NEW AM-FM SIGNAL GENERATOR

MODEL 995A/1

Our enthusiasm will be shared by you when you use this superbly designed instrument.

Model 995A/1 is designed to cover both IF and Carrier Frequencies. This new Marconi generator together with the Marconi Deviation Meter Model 934/2 are the basic instruments for developing and maintaining FM systems.

Make no mistake, specify Marconi . . . for Bridges, Audio & RF Power Meters, VTVM's, Deviation Meters, etc. Write to:

MARCONI
Since 1897



MARCONI Instruments

44 New Street, New York 4, N. Y.
HANover 2-0197-8



MODEL 995A 1

- Frequency Range 1.5-220Mc
- Crystal Standardized to 0.02 %
- Leakage: below 0.1μV
- Deviation Ranges: 0-25kc, 0-75kc, and up to 600kc
- Deviation Accuracy: ± 5 % of f.s.d.
- Tubes: 6AK6, 6AK5, 6AU6, 12AT7, 5Z4G, OA2
- Compact and Portable
- Price: \$850.00 Immediate Delivery

CIRCLE 503 ON READER-SERVICE CARD FOR MORE INFORMATION

LESS NOISE please!



Let us tell you about the simplest, most effective and inexpensive way to stop RF LEAKAGE. This method has been used extensively and successfully in many fields, best proving its worth in military aircraft where lack of space and close proximity of equipment can make interference a major reason for undesirable performance. Before you design your next electronic equipment—commercial or military—learn about

METEX ELECTRONIC WEATHER-STRIP AND RF GASKETS

the inexpensive method of stopping RF interference.

Send for your copy of the 16-page METEX book on shielding. It has a helpful section on design which gives the answers to all your questions on how best to stop interference-producing RF leakage.

METAL TEXTILE CORPORATION

Knitters of Wire Mesh for more than a Quarter Century

Main Office and Factory:
ROSELLE, NEW JERSEY
Dept. ED



METAL TEXTILE CORPORATION OF CANADA, LTD.,
Hamilton, Ontario

CIRCLE 504 ON READER-SERVICE CARD FOR MORE INFORMATION

WEBBER CASE HISTORY

No. 237
WESTINGHOUSE CORP.

TEMPERATURE and Humidity Control . . . features of Webber Environmental Test Unit!



Webber designed fully automatic control of temperature and humidity into this test unit for Westinghouse Electric Corp.,

Pittsburgh. While this unit required control from -80 F. to +200 F. and 20%-90% relative humidity, Webber can provide a complete high-low temperature and humidity control range. Webber designs and manufactures a full line of Standard Environmental Test Units, as well as special application equipment.

If you have an Environmental Test problem of any kind, Webber Engineers want to be of service to you. Send coupon for brochures on new Chest-Type Unit and Environmental Test Equipment.

Write today and give us your request . . . for engineering assistance, quotations, your specifications, or your order.

TRADE MARK



Webber Manufacturing Co., Inc. • 2740 Madison Ave. • Indianapolis 3, Ind.

Webber Mfg. Co., Inc.
2740 Madison Ave., Indianapolis 3, Indiana
Please send Environmental Test Equipment Brochures
Chest Type _____ General Equipment _____ to:
Name _____
Address _____
City-State _____
Company _____ Title _____

CIRCLE 505 ON READER-SERVICE CARD FOR MORE INFORMATION

Abstracts

Pertinent condensations from foreign journals, house organs, reports, and periodicals of related technologies that frequently miss the attention of electronic designers.

USSR Transistor Data Chart

Ratings of Electrolytic Capacitors

Temperature Limits of Materials (US)

Soviet Editorial on Creativeness

Light Locator for Blind

Transistor Radio Schematic

Last month (ED Aug 1955, p. 20) we featured Russian translations of articles appearing in USSR electronic journals. We announced our plans of performing this service regularly so that our readers could get some insight into the status of USSR technology. On these pages are a variety of topics taken from several scientific and technical journals. The more theoretical articles, which often are mathematical analyses of hypothetical or practical circuits, have been passed over in favor of information which appears to reflect information put to use or available for use by electronic designers. Also included this month is an editorial which indicates some of the persistent emphasis put on efficiency and technological progress.

USSR Transistor Data Chart

SEVERAL Soviet radio circuits employing transistors have been included last month and again this month. It is interesting to compare the Russians' ratings of transistors and circuit design with US practice. To further aid in the comparison, the chart at the right should help. So far as we know this chart, which appeared in Radio, June 1955, list all types available for consumer products. Both the variety available and the ratings can be checked against our own types included in the ED Transistor Data Chart, July 1955. Symbols and footnotes which explain various ratings found in the chart are included in the extreme-right-hand column. The following paragraph includes operating instructions:

The maximum allowable temperature of the surrounding environment is $+50^{\circ}\text{C}$. The maximum allowable ratings of voltage, current and power dissipated by the collector must not be exceeded in all static, dynamic and non-fixed operations (as for example, switching). In switching, the base contact must be joined first. Transistors must not be placed near to parts that heat up. A good heat tap from the body of the transistor is desirable. Solder that melts below 150°C is used.

Point Contact Transistors

Type	Application	Operation Ratings ³		Parameters						Maximum Ratings				
		I_c ma	V_c v	R_{11} ohm max.	R_{12} ohm max.	R_{22} Kohm min.	α min.	α max. f	PG ² db	VG	I_c^3 ma	I_c^3 ma	V_c^3 v	W_c mw
S1A	Amplification to 500 kc.	0.3	-20	750	200	7	1.2	1.0	15-19	—	10	10	-40	100
S1B	Amplification to 500 kc.	0.3	-20	750	200	7	1.5	1.2	18-22	—	10	6	-40	50
S1V	Amplification to 1500 kc.	0.3	-20	750	200	7	1.5	1.2	15-19	—	10	10	-40	100
S1G	Amplification to 1500 kc.	0.3	-20	750	200	7	1.5	1.2	18-22	—	10	6	-40	50
S1D	Amplification to 5000 kc.	0.3	-20	750	200	7	1.5	1.2	15-22	30	10	6	-40	50
S2A	Oscillator to 500 kc.	0.3	-10	1500	1000	7	1.5	1.2	—	—	10	10	-30	100
S2B	Oscillator to 1500 kc.	0.3	-10	1500	700	7	1.6	1.5	—	—	10	6	-20	50
S2V	Oscillator to 5000 kc.	0.3	-10	1500	1000	7	1.6	1.5	—	—	10	6	-20	50

Junction Transistors

Type	Application	Operation Ratings			Parameters			Maximum Ratings										
		I_c^3 ma	I_c^3 ma	V_c^3 v	R_c ohm	R_b meg-ohm max.	α^5	α max. f	PG ⁶ db	NF ⁴ db	PG ⁷ mw	DF ⁷ %	C_c mmf	I_c^3 ma	I_c^3 ma	V_c^3 v	W_c mw	
P1A	amplification to 100 kc	1.0	—	-10	30	min 0.3	—	min 0.9	0.7	30	—	—	—	—	5	5	-20	50
P1B	amplification to 100 kc	1.0	—	-10	30	0.5-1.2	400	0.93-0.97	0.7	33	35	—	—	—	5	5	-20	50
P1V	amplification to 100 kc	1.0	—	-10	30	min 0.1	400	0.93-0.97	0.7	37	35	—	—	—	5	5	-20	50
P1G	amplification to 100 kc	1.0	—	-10	30	min 0.5	600	min 0.96	0.7	37	—	—	—	—	5	5	-20	50
P1D	amplification to 100 kc	1.0	—	-10	30	min 0.5	600	min 0.94	0.7	33	18	—	—	—	5	5	-20	50
P1E	amplification to 465 kc	1.0	—	-10	30	min 0.3	1000	0.94-1.0	0.7	30	35	—	—	60	5	5	-20	50
P2	amplification of r-f	—	-5	-50	—	—	—	min 0.85	—	17	—	100	15	—	10	10	-100	250

Footnotes

(1) Parameters are measured with the base grounded for class "A" amplification operation at a frequency of not more than 20kc, $+20^{\circ} \pm 5^{\circ}\text{C}$.

(2) With generator resistance 500 ohms, R_L 10K.

(3) Direction of current from the emitter and collector to the base is taken as positive.

- (4) Parameters are measured at a temperature of $+20^{\circ} \pm 5^{\circ}\text{C}$.
- (5) α is measured with grounded base at a frequency of 1000ey.
- (6) DF and NF are measured with grounded emitter for class "A" amplification operation at a frequency of 1000ey with internal generator resistance of 600 ohms and load resistance of 30K.
- (7) PO and DF are measured in a circuit with a grounded base at a frequency of 400ey with internal generator resistance of 100 ohms and load resistance of 10K.

Abbreviations:

I_e	emitter current
I_c	collector current
V_c	collector voltage
R_{11}	input resistance with open output
R_{12}	resistance of reverse coupling with open input
R_{22}	output resistance with open input
R_e	resistance of emitter
R_c	resistance of collector
R_b	resistance of base
α	current amplification factor with shorted output
α_{max}	α measured at highest operating frequency
PG	power amplification factor
VG	voltage amplification factor
PO	power output
W_c	maximum power dissipated by collector
NF	noise factor
DF	non-linear distortion factor
C_c	collector capacitance

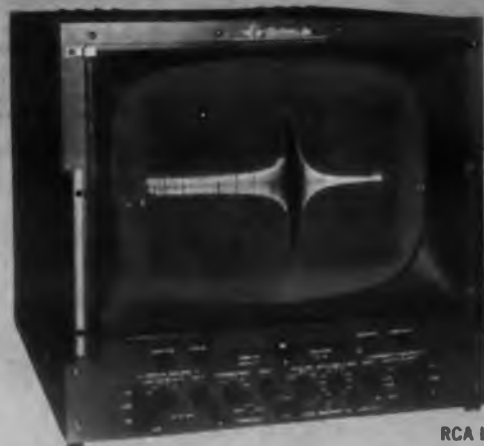

RCA Licensed

LARGE SCREEN OSCILLOSCOPES—17" and 21" CRT

Precision engineered for Production Testing, Waveform Analysis, Display and Instrumentation.

- High Resolution
- $\pm 2\%$ Overall Linearity
- Calibrated Time Base—10 micro-sec./in. to 1 sec./in.
- Gain controls calibrated in volts/in.
- 10 milli-volt or 1 milli-volt peak to peak/in. sensitivity



SWEPT FREQUENCY GENERATOR

Provides instantaneous and continuous visual display of a device under test.

- Range 20 cps to 200 kc or any increment thereof
- Output voltage constant within 2%
- $\pm 0.1\%$ frequency marker circuit
- Internally generated linear or exponential saw-tooth, triangular or square wave modulation

now...
Electromec



LARGE SCREEN MULTI-CHANNEL OSCILLOSCOPE

Continuously indicates amplitudes of a large number of input signals. Adaptable for strain gage, thermocouple, differential transformer, and other forms of instrumentation readout.

(40 Channel Model shown).

- Bar Graph Display
- Rapid and accurate readability
- Large Screen 17 inch rectangular CRT
- Ultra-stable circuitry

CONSOLE TYPE LARGE SCREEN OSCILLOSCOPE

All Electromec 1700 Series Oscilloscopes are available in modern console cabinets for greater convenience of the operator. Desk height work shelf is useful for production test set-ups. The high resolution and accuracy of these precision instruments provides easy readability of large quantities of data or complex signals.

Write or call today for complete Engineering Data, Prices and Delivery.



Electromec, Inc.

A SUBSIDIARY OF ELECTRONIC SPECIALTY CO.

5121 SAN FERNANDO ROAD • LOS ANGELES 39, CALIFORNIA
TELEPHONE: CHapman 5-3771

FIELD REPRESENTATIVES:

GERARD G. LEEDS CO. 12 CRAMPTON LANE GREAT NECK, NEW YORK HUNTER 2-7784 AND SYRACUSE 2-1167	RUSSELL F. HARDY HULMAN BUILDING DAYTON 2, OHIO HEMLOCK 1265	TECH. INSTRUMENTS, INC. 971 MAIN STREET WALTHAM 54, MASS. WALTHAM 5-8445	ELECTRO-MEC ASSOC. 108 EAST NINE MILE RD. FERDALE 20, MICH. LINCOLN 7-1422	W. A. BROWN & ASSOC. 3610 MT. VERNON AVE. ALEXANDRIA, VA. OVERLOOK 3-8100	BING CROSSBY ENTERPRISES INC. 8028 SUNSET BLVD. LOS ANGELES 46, CALIF. CREStVIEW 1-1171
JAMES E. WOOD 136 ENGER AVE. PITTSBURGH 14, PA. ROSEWOOD 1-9600	R. E. SALTER 208 SIDNEY STREET HOUSTON 3, TEXAS WALNUT 3-8720	HUGH MARSLAND & CO. 6405 NO. CALIFORNIA AVE. CHICAGO 45, ILL. AMBASSADOR 2-1555	HUGH MARSLAND & CO. 5860 NORWALDO AVE. INDIANAPOLIS 20, IND. GLENDALE 3803	HUGH MARSLAND & CO. 711 WEST LAKE ST. MINNEAPOLIS 8, MINN. COLFAX 7948	ELECTROMECHANICAL PRODUCTS WARDEN AVENUE AGINCOURT, ONT., CANADA AGINCOURT 493-R-2

CIRCLE 506 ON READER-SERVICE CARD FOR MORE INFORMATION

precision instruments by DeJUR

SERIES BC-200-E
(Extended Terminal Board)



BC-200
(Typical Cross-Section)

Linear and non-linear function Ball Bearing Potentiometers

- External phasing
- Starting torque: 0.5 oz. in. max.
- Backlash: 0.05° max.
- Logarithmic, sine-cosine and other functions
- Multiple, adjustable taps
- Unitized design for universal coupling
- Precision machined aluminum housing
- Servo or single hole mounting

Our engineering department can supply prototypes quickly to meet unusual design specifications for tests and approval. Write for complete technical literature. No obligation.

DeJUR

Electronic Sales Division

DeJUR-Amsco Corporation

45-01 Northern Blvd., Long Island City 1, N. Y.

- **Fully enclosed precision ganging types**
- **Standard and power types**
- **High resolution precision types**

"You're always sure with DeJUR potentiometers."

CIRCLE 507 ON READER-SERVICE CARD FOR MORE INFORMATION

Temperature-Frequency Characteristics of Electrolytic Capacitors

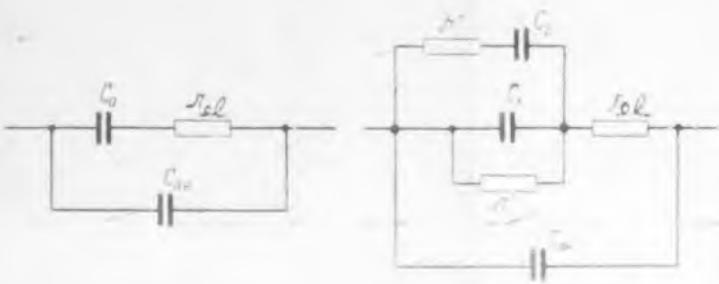

Large changes of capacitance and loss angle are observed in aluminum electrolytic capacitors of the dry type, within the operating temperature range of -60 to $+60^{\circ}\text{C}$, and in the frequency range of 50cy to 20kc. Thus, at a frequency of 50cy with -60°C temperature, capacitance is diminished by 30 to 50% and the loss angle reaches a value of 0.5 to 1. At a frequency of 20kc with $+20^{\circ}\text{C}$ temperature, capacitance is diminished by 15 to 40% and the loss angle reaches a value of 0.2 to 0.5. These changes cannot be ascribed to properties of the dielectric, the thin layer of aluminum oxide. The influence of the lining with the viscous operating electrolyte is doubtlessly significant in this variation.

Since the conventional equivalent circuit (left) fails to explain observed phenomena, a new equivalent circuit (right) is proposed. It is consistent with qualitative explanations describing the dependence of capacitance and loss angle on temperature and frequency to 20kc. C_0 is the capacitance of the layer of alumina, C_{AK} is the capacitance of the lining between the anode and cathode, and r_{el} is the resistance of the lining with the electrolyte. In the new circuit, C_0 is divided into two parts: capacitance C_1 of the smooth surface, shunted with resistance r' , equivalent loss in the oxide layer on account of porous leakage of current; and capacitance C_2 resulting from contact of the electrolyte in shallow pores and micropits in the layer of oxide, with the associated "resistancer" of the electrolyte.

Observations showed that the general capacitance of the aluminum anode, $C_0 = C_1 - C_2$, depends not only on the thickness of the layer of alumina, the state of the anode surface and area, but also on the kind of working electrolyte and lining. Bearing in mind the temperature dependence of C_0 , that is peculiar to the given system "layer of oxide—lining with electrolyte" and the new equivalent circuit, the observed dependence of capacitance and loss angle on temperature and frequency of alternating current can be explained.

It is concluded [after tests with various electro-



IF YOU ARE OVER 45 and your wife keeps insisting that you should have *two chest x-rays every year...* don't blame her. *Thank her!* Semi-annual chest x-rays are the best "insurance" you can have against death from lung cancer.

The cold fact is that lung cancer has increased so alarmingly that today you are six times more likely to develop lung cancer than a man of your age 20 years ago. Our doctors know that their chances of saving your life could be as much as ten times greater if they could only detect lung cancer before it "talks"... before you notice any symptom in yourself. That's why we urge you to make semi-annual chest x-rays a habit—for life.

To see our new life-saving film "The Warning Shadow" call the American Cancer Society office nearest you or simply write to "Cancer" in care of your local Post Office.

**American
Cancer
Society**



SPEED UP



AUDIO WAVE FORM ANALYSIS

PANORAMIC SONIC ANALYZER LP-1

Many engineers find that Panoramic's LP-1 expedites their entire measurements program. LP-1 analyzes sound vibrations and electrical waveforms quickly, conveniently, accurately. Designed to eliminate the tedious problems commonly associated with audio waveforms analysis, the Panoramic technique provides valuable visual information in seconds!

- Visualizes frequency and amplitude of waveform components between 40 and 20,000 cps; magnifies small portions of spectrum for detailed analysis; displays easily photographed; scans spectrum in 1-second; analyzes changing and static phenomena.

It will pay you to investigate the many unique advantages of LP-1.

- SPECIAL APPLICATIONS

- Investigations of closely spaced sound and vibration frequencies. Harmonic analysis of waveforms having low frequency fundamentals. Spectrum analysis requiring constant band width.

- Panoramic's LP-1 offers scores of unique advantages; it will pay you to check their application to your problems.

WRITE TODAY for

Complete Specifications



Made by the makers of Panadaptor, Panalyzer, Panoramic Sonic Analyzer, and Panoramic Ultrasonic Analyzer

15 South Second Ave., Mount Vernon, N.Y.
Phone: MOUNT VERNON 4-3970

CIRCLE 508 ON READER-SERVICE CARD

ELECTRONIC DESIGN • September 1955

lytes, and anode smoothnesses,] that the efficiency of the active surface of the layer of oxide diminishes with the rise in frequency, but in a different degree for every system: that is, component C_2 is diminished with a rise of frequency. With rise of frequency the reduction of capacitance is especially marked at temperatures of -40°C and -60°C . In such cases, the component C_2 practically is absent, but the component C_1 also diminishes because of contact breaks of the lining with the layer of oxide along the smooth surface. The marked rise of lining resistance r_{el} has a substantial influence on reduction of capacitance with rise of frequency.

High-voltage electrolytic capacitors (300 to 500v) with smooth anodes and linings of cloth saturated with frost-resistance electrolyte of ethylene-glycol and alcohol give the most favorable dependence of capacitance and loss angle on temperature and frequency. At 60°C at 50cy, their effective capacitance is reduced by 40 to 45%. The worst dependence is found in low-voltage capacitors (up to 100v) with corroded anodes and linings of paper. At -40°C at 50cy, their effective capacitance is diminished two to three times.

At frequencies higher than 20kc, the reduction of effective capacitance of electrolytic capacitors is accompanied by the influence of self-inductance. The particular inductance of electrolytic capacitors depends primarily on the spread of leads of anode and cathode. If the spread of leads be minimal, within the limits of 0.5 to 1cm, which is fully possible and permissible in design, then minimal inductance (0.03 to $0.06\mu\text{h}$) results and the resonance is displaced to the side of higher frequencies. In this case the frequency of resonance is higher than 200kc for capacitors with capacitance up to $100\mu\text{fd}$.

At high frequencies the permissible magnitude of capacitance is determined from the conditions that with a particular inductance of $0.060\mu\text{h}$ there be no resonance. In the range of low frequencies the permissible magnitude of capacitance is limited by the condition that impedance cannot be less than 0.1 to 0.2 ohm in practice. In the regions of low temperatures and high frequencies, the effectiveness of electrolytic capacitors sharply drops since z rises.

Electrolytic capacitors can be applied in high frequency interference-shielding filters, connected in parallel to paper capacitors of the by-pass type. In these cases, the following demands must be made on the electrolytic capacitors: they must have smooth anodes; the lining thickness must be minimal for the given working voltage (use of thin cloth lining is desirable for capacitors of 300 to 500v); the working electrolyte for the capacitor must be frost-resistant to the maximum; the spread of leads from anode to cathode must be minimal, within limits of 0.5 to 1 cm.

These demands can be met in the process of producing standard types of capacitors. *Condensed from an article by member I. I. Morozov, Radiotekhnika, No. 5, 1955, page 69-75.*

MIL-T-27 Power and Audio
 MS (Military Standard)
 MIL-T-27 400 Cycle
 Pulse Transformers
 Molded Toroidal Inductors
 High Fidelity Transformers
 Transistor Transformers
 Link Replacements



You'll find them all in the new

CHICAGO CATALOG
 of
the World's Toughest Transformers

These are just a few of the popular types of transformers for military, new equipment, general replacement, control and power circuit applications listed in CHICAGO's new Catalog . . . over 500 transformers, with complete physical and electrical specifications on each unit.

And more important—they are all *in stock* for quick delivery from your local CHICAGO distributor.

**Write Now FOR YOUR FREE COPY
 OF THIS VALUABLE REFERENCE.**

Ask for Catalog CT-554

CHICAGO STANDARD TRANSFORMER CORP.

3501 ADDISON STREET • CHICAGO 18, ILLINOIS



EXPORT SALES:
 Roburn Agencies, Inc.,
 431 Greenwich Street,
 New York 13, N. Y.

CIRCLE 509 ON READER-SERVICE CARD FOR MORE INFORMATION

VARIABLE DELAY NETWORKS

by **ESC**

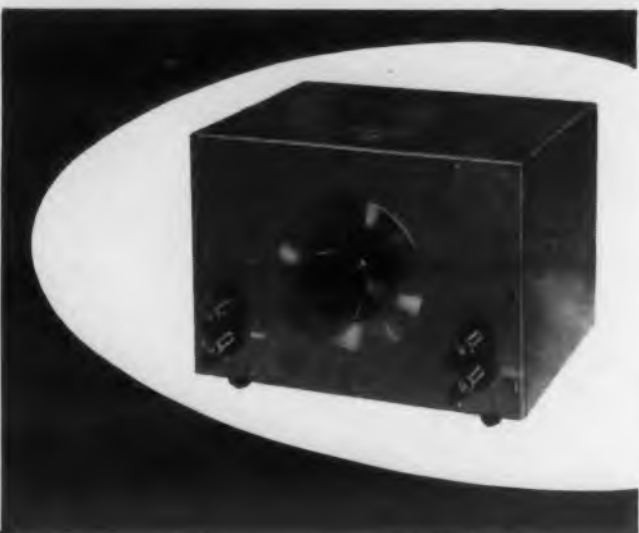

Unlike conventional tapped delay lines (which must be terminated in a high impedance at the selected tap), the #300 series provides a variable delay between matched impedances. Available in ranges of 2 μsec to 2000 μsec ; the #300 series delay networks afford flexibility in obtaining long delays, with time delay proportional to angular rotation of the control shaft.

Write for complete, new catalog!

C O R P O R A T I O N

534 Bergen Blvd., Palisades Park, New Jersey



ESC

CIRCLE 570 ON READER-SERVICE CARD FOR MORE INFORMATION

YOUR PRODUCT
DESERVES THE BEST



Consultation - Design - Engineering - Production

These services are available to you on all applications involving use of

PANELS — DIALS — NAMEPLATES — SPECIALTIES

Screening • Lithography • Etching • Engraving
Photographic Reproduction — LACKON — MIL-P-7788

**RADIOACTIVE SOURCES — LUMINESCENT MATERIALS
— PROCESSED ISOTOPES —**

Sealed Sources • Radiations Standards • Radioactive Foils • Safety Markers
Self-Luminous Compounds • Luminous Markers • Radium Products • Light Sources
Neutron Sources • Radiographic Sources • Light Standards • Radioactive Batteries
Ionization Sources • Ionotron Static Eliminators

PHOSPHORS — X-RAY SCREENS

Television Phosphors • Phosphorescent Powders • Fluorescent Powders

for further information address Dept. ED-9

UNITED STATES RADIUM CORPORATION

Eastern Sales Office: 535 Pearl St., New York 7, N. Y.

Western Sales Office: 5420 Vineland Ave., N. Hollywood, Calif.

Plants and Laboratories at:

Bloomsburg, Pa., Whippany, N. J., Bernardsville, N. J., North Hollywood, Calif.

CIRCLE 571 ON READER-SERVICE CARD FOR MORE INFORMATION

Temperature Limits For Various Materials In °F

Synthetic mica melts	2550	Lead melts	621
Electrical porcelain—firing temperature	2400	Cadmium melts	610
Glaze for porcelain—firing temperature	2250	Silicone-glass heat distortion	575
Raw lead pottery glazes—firing temperature 2000-2060		Cold-molded plastic (organic)—sustained service	500
Copper melts	1981	Polytetrafluoroethylene—sustained service, no load	500
Furnace temperatures in glass manufacture 1900-2800		Silicone-glass sustained service	480
Natural phlogopite mica—maximum heat resistance	1800	Tin melts	450
Silver melts	1762	Silicone rubber—sustained service	425
Aluminum melts	1220	Cold-molded plastic (organic) heat distortion	400
Silver solders melt	1165-1450	Polyester-glass heat distortion	400
Supramica 500—maximum heat resistance	1000	Cellulose-filled melamine heat distortion	400
Cold-molded refractory and phosphoasbestos—maximum heat resistance	900-1300	Polymonochlorotrifluoroethylene—sustained service, no load	390
Calcium aluminum silicate—maximum heat resistance	900	Mercury boils	357
Aluminum alloy melting points	850-1225	"Hottest spot"—Class H insulation	356
Muscovite mica—maximum heat resistance	800-1000	Polyester, mineral-filled, putty—heat distortion	375-425
Supramica 555—maximum heat resistance	950	Alkyd: polyester, mineral-filled, granular—heat distortion	350-400
Zinc melts	786	Epoxy-glass cloth—maximum temperature	315
Mycalex 400—sustained service	700	Silicone elastomer—sustained service	300-500
Magnesium alloy melting points	650-1200	Nylon (polyamide) heat distortion (66psi)	300-360
Mycalex 410—sustained service	650	Casein heat distortion	300
Mycalex 410X—sustained service	650	Urea-formaldehyde heat distortion	275
		Polytetrafluoroethylene heat distortion (66psi)	270
		"Hottest spot"—Class B insulation	266

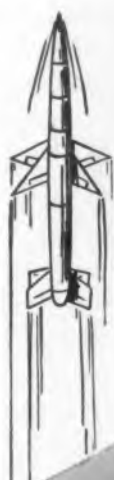

Microwave
Assemblies,
Radar Components,
and Precision
Instruments . . .
manufactured and
designed to your
specifications.

N.R.K. MFG. & ENGINEERING CO.
4601 W. Addison St., Chicago 41, Ill., SPing 7-2970
West Coast Representatives
TUBERGEN ASSOCIATES, 2232 W. 11th St., Los Angeles 6, Calif.



CIRCLE 572 ON READER-SERVICE CARD FOR MORE INFORMATION

ELECTRONIC DESIGN • September 1955

621	
610	Melamine-formaldehyde (filled) heat
575	distortion266-400
500	Diallylphthalate (alpha cellulose filler) heat
500	distortion265-310
480	Phenol-formaldehyde (mica) heat distortion ..260-350
450	Phenol-formaldehyde (wood flour) heat
425	distortion260-340
400	Hard rubber (mineral-filled) heat distortion260
400	Sulfur (rhombic) melts235
400	"Hottest spot"—Class A insulation221
	Paper/Phenolic laminate—sustained service ..212-250
390	Styrene elastomer—upper limit212
357	Epoxy—maximum recommended use212
356	Water boils212
425	Polyvinyl carbazole heat distortion210-300
	Vulcanized fiber—upper limit200
400	"Hottest spot"—Class O insulation194
315	Polydichlorostyrene heat distortion185-230
500	Polymonochlorotrifluoroethylene heat
360	distortion (66psi)160
300	Polystyrene heat distortion152-210
275	Methyl methacrylate heat distortion150-210
270	Styrene copolymer heat distortion148-235
266	Vinyl chloride heat distortion140-185
	Cellulose nitrate heat distortion140-160

Hard rubber (no filler) heat distortion140
Vinylidene chloride heat distortion130-150
Cellulose acetate butyrate heat distortion120-210
Cellulose acetate heat distortion115-235
Ethyl cellulose heat distortion115-190
Vinyl butyral heat distortion115-140
Polyethylene heat distortion (66psi)107
Temperature of human body98
Normal room temperature72
Water freezes32
Lower limit for ethyl cellulose0
Lower limit for vinyl chloride elastomer-38
Mercury freezes-38
Silicone elastomer loses flexibility-60
Lower limit for polyisobutylene-80
Lower limit for polytetrafluoroethylene-90
Lower limit for polychlorotrifluoroethylene-100
Dry ice (CO ₂) sublimates-109

This table was abstracted from a bulletin of the Mycalex Corp. of America, Clifton, N. J., written by J. Harry DuBois, vice-president, engineering, entitled "Use the Right Material".

Revolutionary new RELAYS



with "TAPER-PIN" TERMINALS
for SOLDERLESS
CONNECTION



HERMETICALLY SEALED

Our hermetically sealed "taper-pin" relays are available for immediate delivery, in two, three and four pole models. These units surpass MIL Spec. 5757B and 6106A. They are currently being used in jet aircraft, guided missiles, and other airborne equipment.

NOW... ready with a new

2 PDT SUBMINIATURE RELAY



to meet the rugged standards of today's needs
VIBRATION: 10-500 CPS at 10 G's minimum, and
withstand 50 G's minimum shock.

HERMETICALLY SEALED AND DRY NITROGEN
FILLED.

TEMPERATURE: -65°C to +125° C.

RATING: 5 amp. resistive at 28V DC or 115V AC.

SIZE: .656 in. dia. x 1.500 max. O/A.

WEIGHT: 2 ounces maximum.

Satisfies test requirements of Spec. MIL-R-6106A

for further information write

ELECTRO-MECHANICAL SPECIALTIES, INC.
6819 MELROSE AVENUE • LOS ANGELES 38, CALIFORNIA

CIRCLE 573 ON READER-SERVICE CARD FOR MORE INFORMATION

WINCHESTER ELECTRONICS, INC.

PRECISION CONNECTORS

with Wire Connections

"TAILORED"

to meet your needs!

Whether your Connector requirements call for speedy production line wiring, or multi-wire single contact connections... you can depend on Winchester Electronics to have the exact contact terminal to meet your need.

New wiring methods like AMP taper pins, wrap & solder connections, and solderless wire wrappings... in addition to conventional solder cup wiring... can now be applied to several standard connector series in the miniature, quick-disconnect, printed circuit, and small power class.

Your letterhead inquiries are invited for complete information, engineering assistance or consultation on special design problems—all without obligation.



AMP
TAPER PIN
TERMINAL

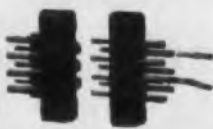

Internally-tapered terminal available on our Series A, SA, RE and QRE.



TURRET
TERMINAL

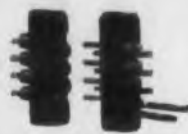

For wrap and solder connections of two or more wires per contact—on our Series A, SA, M, MRE, RE and QRE.



EYELET TERMINAL



For hook, twist and solder connections—on our Printed Circuit Series KM and KKM.



WIRE WRAP TERMINAL

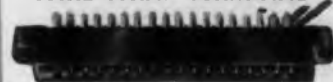

Post terminal for solderless wire-wrap connections. Available on Printed Circuit Series K and KKM.

**WINCHESTER
ELECTRONICS**
INCORPORATED

NORWALK, CONNECTICUT

West Coast Branch:

1729 WILSHIRE BLVD., SANTA MONICA, CALIF.

WINCHESTER ELECTRONICS, Inc. PRODUCTS
and DESIGNS ARE AVAILABLE ONLY
FROM WINCHESTER ELECTRONICS, Inc.

CIRCLE 574 ON READER-SERVICE CARD FOR MORE INFORMATION

Announcing

.. MICROTOROIDS ..

by MECTRONICS

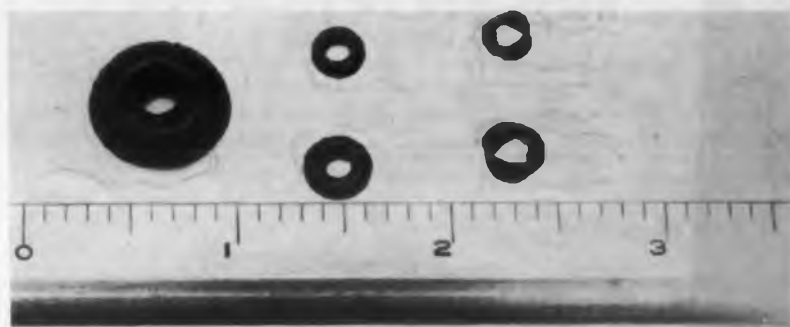

TINY TOROIDS WOUND TO YOUR SPECIFICATIONS IN ANY QUANTITY

Mectronics new winding technique permits extreme miniaturization of toroidal inductors and transformers. Specialists in fine wire winding—not limited to subminiature toroids. We can put No. 50 wire on cores up to 2 in. diameter and are prepared to develop sizes under 0.110 in.

MECTRONICS NOW PRODUCES TO THESE MINIATURIZATION SPECIFICATIONS

- Minimum finished inside diameter, 0.110 in. with a one-piece wire capacity of 0.6 grams of H.F. wire in AWC sizes No. 38—No. 50.
- Minimum finished inside diameter of 0.160 in. with a one-piece wire capacity of 7.5 grams of H.F. wire in AWC sizes No. 30—No. 50.
- Continuous uniform winding for single circuit coils—no gaps.
- Sector-winding or superimposed winding of multicircuit coils.
- Simultaneous winding of two, three or four circuits in more than one size of wire for perfect matching.

Send your specifications for toroidal winding quotations to: _____

MECTRONICS

RIDGECREST

CALIFORNIA

CIRCLE 575 ON READER-SERVICE CARD FOR MORE INFORMATION

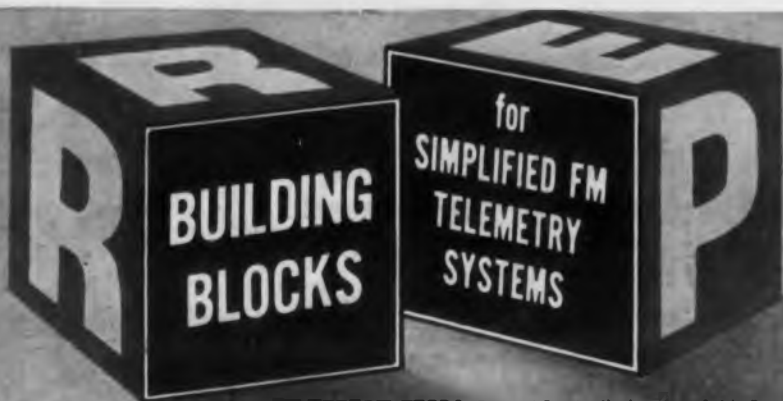

Assembly of these rugged building blocks into an integrated system is a simple and easy process. Analyze your telemetry requirements, sketch your block diagram, and select the required units from RREP's full line of FM transmitting equipment. You've then got the finest airborne system available.

TRANSMITTERS. Crystal Controlled and variable Reactance

RF AMPLIFIERS for boosting R.F. signal strength

SUBCARRIER OSCILLATORS. Voltage Controlled, Bridge Activated, and Variable Reactance

COMMUTATORS AND DYNAMOTOR-COMMUTATOR GATING UNITS for expansion of system capacity by subcarrier commutation

UNIVERSAL MOUNTING ASSEMBLY:

UNERAC (Universal Regulator, Amplifier and Calibrator) and **UNIVERSAL MOUNTING UNITS** for mounting all RREP Oscillators

DYNAMOTORS for high voltage supplies

Technical Bulletins giving complete information on these units are available on request.



RAYMOND ROSEN ENGINEERING PRODUCTS, INC.

32nd and Walnut Streets, Philadelphia 4, Pennsylvania
Western Regional Office: 15166 Ventura Blvd.,
Sherman Oaks, Los Angeles, California

CIRCLE 516 ON READER-SERVICE CARD FOR MORE INFORMATION

"MCO" ... "PROCESSED"
MILLIUM COVER SPRINGS

helps you to prove your design

- The I-S "Short-Run" department handles pilot-runs and small production requirements as its regular output—instead of treating them as costly "Special orders". This allows you to check your design against production criteria—without the expense of ordering production quantities.
- You save in testing time and development—as well as in elimination of regular production waste.
- In addition, you are ready to go into million-plus production—without the time-consuming engineering usually involved in the transition from bench-made prototypes to full line production.
- For further information on how our "Short-Run" service can help you prove your design, write or call today.

Instrument Specialties Co. Inc.
270-F Bergen Boulevard, Little Falls, N. J.
Telephone Little Falls 4-0280

CIRCLE 517 ON READER-SERVICE CARD FOR MORE INFORMATION

Invention and Creativeness

An editorial in *Vestnik Svyazi* (Communication Herald) has this to say on the increase of invention and creative initiative:

"Mass invention and rationalization work are the inexhaustible source of technical progress. The number of inventions, technical improvements and rationalization proposals [suggestion-box ideas] effected in industry, construction and transport amounted to 900,000 in 1954 alone. At many big plants every sixth worker is a rationaliser."

The Minister of Communications USSR, says the editorial, pointed to further development of inventive work as among "the basic tasks of soviet communication workers in 1955." The 1954 summary of activity in this field showed a 4% increase in the number of creative people to reach 17,300, who made 30,500 proposals for technical improvements in communications. Many of these have been put into practice, including uses of mechanical cable-layers, experimental automation of relaying telegrams, automatic underground cable-line amplifiers, etc. But, the editorial criticizes shortcomings. Branch offices neglect to check up and follow through on proposals, and fail to "pay enough attention to carrying out directives" of the minister. The ministry itself is charged with failure to review all proposals within the established four-month period, allowing some to be pigeon-holed for eight months to a year.

The editorial demands that administrators of communication and trade-union leaders combine efforts to promote mass rationalization work through technical conferences and exchange of experiences in the field.

Light Locator for the Blind

CONVERTING light variations into variable sounds for earphone reception, these devices are walking aids for the blind. It helps a blind person to distinguish walls, fences, trees, stones and other obstacles in his path.

Two models are illustrated and described briefly. Model *a* (upper) has no light source of its own and uses reflected light. It operates on the principle that light reflected from an obstacle has a changing modulation as the distance from the obstacle changes. If the teeth of disc 5 are placed exactly in the plane of a sharp image, the depth of modulation is a maximum. The compounding of the disc teeth along the optic axis of the lens to any side relative to the sharp image results in an unfocused bundle of light rays passing through the disc and the depth of modulation diminishes. The teeth of the disc are placed as illustrated along a screw line so that the frequency of modulated lights changes with a change in the distance from the obstacle. This unit made with miniature parts weighs 2 lb and needs 100mw.

Model *b* (lower) has its own light source, a 3w lamp that triggers specific earphone signals fixing distances from the obstacle

at 1.5, 2, 3, and 6 meters from the person. By moving the device up and down and sideways, some idea of the proportions of the obstacle are obtained. [We're not sure that this gives practical clues to the blind but the idea sounds clever.]—*Short article by N. Chechik, Radio, June 1955, p 63.*

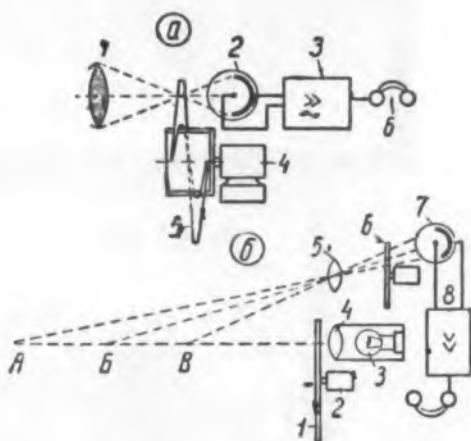

Upper: 1 lens, 2 photo-cell, 3 amplifier, 4 motor, 5 toothed disc, 6 ear phones. Lower: 1 modulating disc, 2 motor, 3 light source, 4 lens of light source, 5 lens of reflected light, 6 coding disc geared to motor 2, 7 photo cell [described as a gas-filled oxygen cesium type], 8 amplifier, 9 earphones.

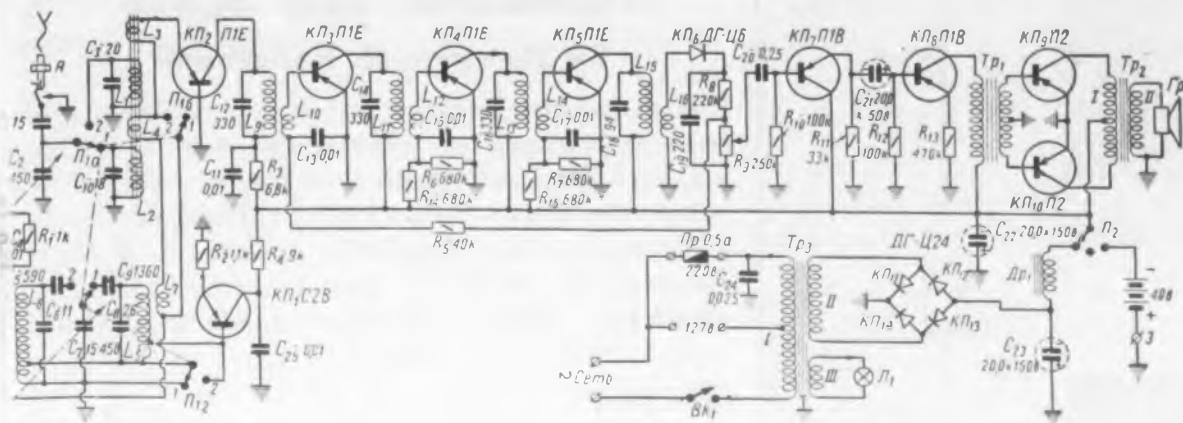

Transistor Receiver Circuit

This transistor superheterodyne receiver is intended for reception of radio stations working on long waves (150 to 420kc) and medium waves (520 to 1600kc). Its sensitivity is in the range of 50 to 80 μ v and 20 to 160 μ v respectively. The frequency response, based on sound pressure, is nominally 200-300cy. The last three digits of transistor nomenclature refers to type. *N* is translated *P* in the table on p. 162; *C* is *S*. The first two digits refer to location in the circuit. The article describing the superhet receiver (see last month's issue of ED for a complete story on a t-r-f transistor radio) is headed "Amateur Design." It is taken from *Radio*, June 1955. p26.

Quality  Capacitors

That Which Follows

Getting to the bottom of things

The impregnation of capacitors is a very critical operation. This operation is divided into two phases. The first phase is to dry and degas the assembled unit. The second phase is to saturate the winding completely and fill the container with the impregnating liquid. The better the job of impregnation, the higher the quality of the capacitor.

John E. Fast & Co. assures the superior quality of its capacitors because of the uniformly high standards which must be met at each stage of operation. After the units are placed in tanks and the tanks sealed, the heating cycle is started. The next step is to evacuate the tanks. This cycle continues until there is a vacuum of 100 microns or lower. (Our usual is 50 microns.) This completes the first phase of the operation.

While the vacuum cycle is progressing, the liquid (Aroclor) is being filtered and treated. We have an electronic device which controls this filtering process and records the continuous test results. The liquid must meet the specified requirements of dielectric constant, power fac-

tor, and purity before this device opens the valve to allow the liquid to enter the tank.

Capillary action draws the impregnant to the center of the windings, therefore eliminating any chance of dry spots. After the windings are completely saturated, pressure is used to force the liquid into every corner and crevice of the unit. Next comes another temperature cycle, during which the units are maintained at the proper sealing temperature for a period of hours, after which they are quickly sealed.

It must be apparent, from the process-outline above, that the quality of a capacitor can be no better than the precise control maintained in the impregnation cycle . . . irrespective of the excellence of materials used in the assembly.

The FAST organization rigidly adheres to the highest standards from basic materials to processing, through life-testing to the finished product, as was covered in the three earlier items in the series "Getting to the Bottom of Things"—thus substantiating our claim to being *Capacitor Specialists*.

AVAILABLE LITERATURE:

Tubular Capacitors in Cardboard Tubes
Tubular Capacitors in Molded Phenolic Cases
Polystyrene Film Capacitors
Hermetically-Sealed Tubular Capacitors
Subminiature Hermetically-Sealed Capacitors
High-Reliability Hermetically-Sealed Capacitors
Mil-C-25A Approved Capacitors: Refer to "Mil-C-25A Specifications"

JOHN E. FAST & CO.

Capacitor Specialists For Over A Third of A Century

3185 N. Pulaski Road, Chicago 41, Ill.

"WHEN YOU THINK OF CAPACITORS . . . THINK FAST"

Quality  Capacitors

CIRCLE 536 ON READER-SERVICE CARD FOR MORE INFORMATION

ELECTRONIC DESIGN • September 1955

new

development in—

SOLDER PREFORMS

lower cost
more exacting precision standards

● The new Art Wire Solder Preforms reduce your costs, eliminate variability in soldering, insure sounder, stronger joints, and minimize hand labor. Precision made to every specification including Military and Federal for soft solder . . . in shapes that meet the requirements

of your induction soldering operation.

Complete information on request. Send blueprints or samples for estimates.

ART WIRE & STAMPING CO.

2 N. Boyden Place

Newark 2, N. J.

CIRCLE 518 ON READER-SERVICE CARD FOR MORE INFORMATION

CUSTOM-BUILT and MIL-T-27

"In-Plant" Tested Transformers



- Government Pulse ● Commercial Aircraft ● Toroidal ● Class H
- Miniature-Transistor ● Melded Grade 1, Class A ● Sub-Audio
- Audio ● Power ● Vibrator ● Atlantic-Seal

MODERN FACILITIES

In-Plant Testing ● Complete Pulse Magnetron Test Equipment ● Extensive Research and Measurements Laboratory ● RETMA and UL Specifications.

COMPLETE SERVICES

Design Engineering ● Rapid Estimating ● Immediate Sample Delivery ● Top quality — at competitive prices ● Production

Write or phone for detailed information

Broadband Amplifier

- Increases oscilloscope and voltmeter sensitivity
- Amplifies short pulses without objectionable distortion
- Provides high gain—60 db
- Makes ultrasonic delay line measurements

This New London Broadband Amplifier features a maximum gain of approximately 60 db over the entire 15 Kc—50 mc. frequency range. Rise time is approximately 0.010 microseconds.

Write for catalog

CIRCLE 519 ON READER-SERVICE CARD FOR MORE INFORMATION



MODEL 160

NEW LONDON INSTRUMENT

Company INC.

82 Union Street
New London 2, Conn.

Highest
quality...
reliability...



HUGHES SILICON JUNCTION DIODES

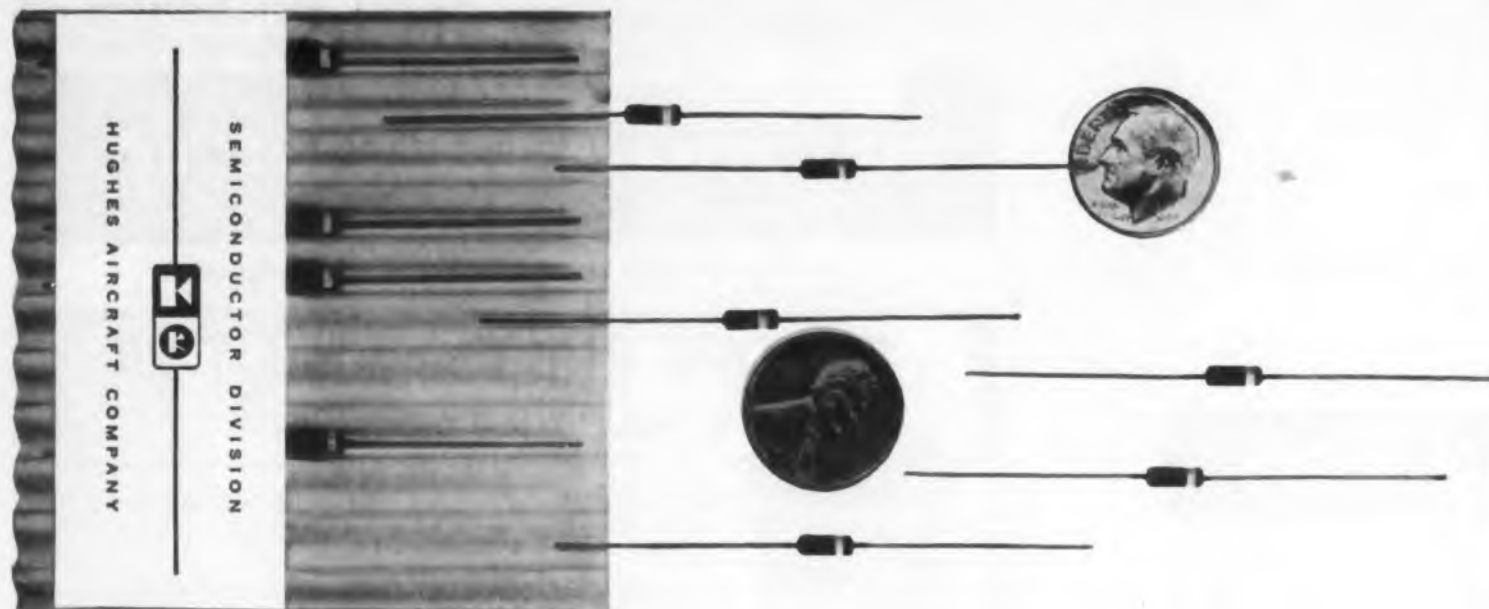

Actual Size

features:

HIGH TEMPERATURE OPERATION*
EXTREMELY HIGH BACK RESISTANCE
VERY SHARP BACK VOLTAGE BREAKDOWN
NO VOLTAGE DERATING AT HIGH TEMPERATURE
EXCEPTIONALLY STABLE CHARACTERISTICS
ONE-PIECE, FUSION-SEALED GLASS BODY
AXIAL LEADS FOR EASY MOUNTING
SUBMINIATURE SIZE**

The one-piece, fusion-sealed glass body is impervious to penetration by moisture or other external contamination—ensures electrical and mechanical stability. Shipments—in quantity—of all types of Hughes Silicon Junction Diodes are now being made in new, compact volume packaging. When your circuit requirements call for diodes with high temperature or high back resistance characteristics, be sure to specify Hughes Silicon Junction Diodes. They are first of all—for RELIABILITY. Listed and described in Bulletin SP4.

*Characteristics rated at 25°C and at 150°C. Ambient operating range, -80°C to +200°C.
**Actual dimensions, diode glass body—Length: 0.265-inch, max. Diameter: 0.105-inch, max.

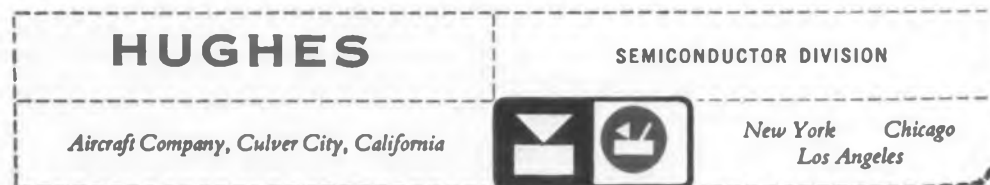

CIRCLE 522 ON READER-SERVICE CARD FOR MORE INFORMATION

Standards and Specs

By Sherman H. Hubelbank

This department surveys new issues, revisions, and amendments, covering military and industry standards and specifications. Our sources of information include the Armed Services Electro-Standards Agency (ASESA), the cumulative indexes to Military Specifications, Vols. II, IV, American Standards Association (ASA) and other standards societies.

Capacitors

MIL-C-25A, CAPACITORS, FIXED, PAPER-DIELECTRIC, DIRECT CURRENT (HERMETICALLY SEALED IN METALLIC CASES) AMENDMENT 2, 14 APRIL, 1955 . . . The list of referenced specifications and publications, the requirements for packing, packaging and marking for shipment have been revised. The characteristic table is now included in the spec proper and has been deleted from the spec sheets. Supplement 1D to spec sheets MIL-C-25/1C, MIL-C-25/2A through MIL-C-25/7A was issued at the same time as a revision.

R-F Lines

ASESA INFORMATION BULLETIN 46, CROSS-INDEX OF R.F. TRANSMISSION LINE COMPONENT NOMENCLATURES VERSUS APPLICABLE SERVICE DRAWINGS AVAILABLE FROM ASESA, 31 MAY, 1955 . . . This bulletin lists the latest types of RF transmission line components for which Service drawings are available from ASESA. The index lists the components by type number and drawing number. This bulletin supersedes ASESA Bulletin 31, dated 31 January 1955.

Waveguides

MIL-W-287A, WAVEGUIDE ASSEMBLIES, FLEXIBLE, 17 MAY 1955 . . . This revision supersedes JAN-W-287. A new type designation has been adopted which indicates the matching waveguide system into which the flexible guide is designed to operate, the performance characteristics, and the lengths. These waveguides have been standardized so that equivalent sizes correspond with standard rigid waveguide sizes specified in spec MIL-W-85, and mate electrically and mechanically with the standard flanges specified in spec MIL-F-3922. In addition, the assemblies are now available in standard lengths in multiples of 6 inches from 6 to 72 inches and one length of 96 inches. Two spec sheets were listed with this revision.

Television

55IRE23.S1 DEFINITIONS OF TELEVISION SIGNAL MEASUREMENT TERMS, 1955 . . . This newly released standard lists and defines all the technical terms used in the broadcasting of television signals. Copies of this standard may be obtained from IRE, 1 East 79th St., New York 21, N. Y. for \$1.00 per copy.

Resistors

MIL-R-94A RESISTORS, VARIABLE, COMPOSITION 17 JUNE 1955 . . . This revision supersedes JAN-R-94. Provision has been made so that locking and sealing type bushings may be added to the resistors. The type designation has been changed to include a letter covering bushings immediately after the style designation (for example: RV1NATSD103B). Style RV1 has been reinserted in the spec, but its size is physically smaller than the previous version. Style RV3 has been deleted. Switch type "C", DPST, for attachment to these variable resistors has been deleted. Temperature and moisture-resistance characteristic U has been deleted and characteristics V and Y have been added. Qualification Approval submission and test procedure has been completely revised so that it is in accord with current standard practices for other components.

Electrical Indicators

MIL-M-17275A METERS, ELECTRICAL INDICATING DIRECT CURRENT, ONE INCH, 16 MAY 1955 . . . This issue supersedes MIL-M-17275(SHIPS) and is now a three service spec. One-inch barrel diameter, round flange, d-c meters of low current and voltage magnitudes, in the order of millivolts, milliamperes, and microamperes, are covered. The requirements, tests, and pertinent details of this spec closely parallel those of spec MIL-M-6A. Only one MS standard MS-90212, covering five types of meters, is included with this spec.

Preferred Parts List

ASESA 49-1, ARMED SERVICES PREFERRED PARTS LIST . . . A new index to the Preferred Parts Lists, dated 16 May 1955, has been issued by ASESA. The following sheets were also revised:

Component	PPL No. & Date
Capacitors, Fixed Ceramic	11015-CK 16 May 1955
Capacitors, Fixed, Mica	5-CM 16 May 1955
Capacitors, Fixed, Mica (Button Style)	10950-CB 16 May 1955
Capacitors, Fixed, Paper, Metallic Case	25-CP 16 May 1955
Insulators, Glass	9-NA 1 April 1955
Insulators, Porcelain	21-NP 1 April 1955
Insulators, Steatite	8-NS 1 April 1955
Resistors, Fixed, Film	10509-RN 16 May 1955
Wire and Cable, Hook-Up	76-HF 16 May 1955

Specifications listed on these pages are for information only and government contractors should be guided by their contracts. Copies of military specs should be obtained from sources recommended by procuring officers. ASESA bulletins may be obtained from Fort Monmouth, N. J. ASA standards may be obtained from American Standards Agency, 70 E. 45th St., New York 17, N. Y., unless otherwise noted.

Pulse Transformer Kit

Simplifies
Circuit
Design

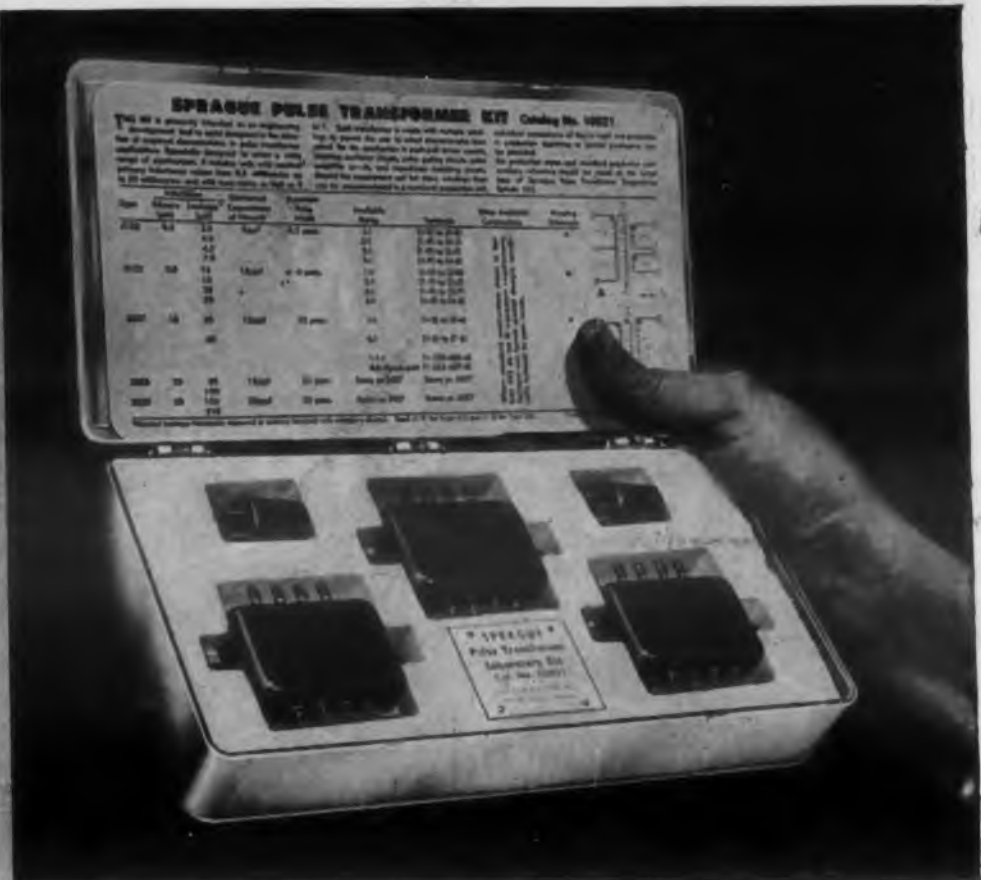

HERE'S THE IDEAL TOOL FOR
ENGINEERING DEVELOPMENT
OF CIRCUITS USING
PULSE TRANSFORMERS

CHARACTERISTICS OF KIT TRANSFORMERS

Type	Induct. Pri. (μH)	Leakage (μH)	Dist. Cap. of Pri. (μF)	Max. Nom. P.W. Range (μsec)	Avail. Ratios
4122	0.5	2.5 4.0 4.5 7.0	5	0.5	1:1 2:1 3:1 5:1
4123	5.0	13 15 25 30	15	6	1:1 2:1 3:1 5:1
2027	10	20 40	12	12	1:1 8:1 1:1:1 8:8:1
2028	20	50 150	15	25	same as 2027
2029	50	150 210	20	50	same as 2027

Sprague on request will provide you with complete application engineering service for optimum results in the use of pulse transformers.

Sprague's new Type 100Z1 Pulse Transformer Kit contains five multiple winding transformers, each chosen for its wide range of practical application.

Complete technical data on each of the transformers is included in the instruction card in each kit so that the circuit designer may readily select the required windings to give transformer characteristics best suited for his applications . . . whether it be push-pull driver, blocking oscillator, pulse gating, pulse amplifier, or impedance matching. The electrical characteristics of the transformers in the kit have been designed so that they may be matched by standard Sprague subminiature hermetically-sealed pulse transformers shown in engineering bulletin 502B.

For complete information on this kit, as well as the extensive line of Sprague pulse transformers, write to the Technical Literature Section, Sprague Electric Company, 347 Marshall Street, North Adams, Massachusetts.

SPRAGUE®

VIBRATION ISOLATION FOR HIGH FIDELITY

"Vibration Isolation" has helped solve the increasing problem of mechanical vibrations in high fidelity reproduction of sound.

For years, sound engineers have been plagued by mechanical vibrations caused by movement of grips, dollies and other studio equipment. And the progressive development of the high fidelity microphone has increased the importance of eliminating the adverse effects of these disturbances.

Faced with this problem, design engineers of a leading manufacturer of microphones and related electronic equipment consulted with LORD engineers. LORD's 30 years of experience and knowledge in vibration control resulted in a bonded tube-form joint of live rubber which effectively isolated mechanical vibrations from the microphone head.

"Vibration Isolation" is the answer to only one of the many problems presented to and solved by LORD engineers. If you are interested in producing tape recorders, microphones and other types of reproduction equipment, LORD engineers are ready to consult with you. Let them help you produce equipment of the most exacting professional standards with LORD rubber bonded products.



LORD Bonded
Tube-Form Joint
For Microphone Heads



DESIGNERS AND PRODUCERS OF BONDED RUBBER PRODUCTS

SINCE 1924

CIRCLE 524 ON READER-SERVICE CARD FOR MORE INFORMATION

Meetings

Sept. 23-24: *Fifth Annual Symposium of the IRE Professional Group on Broadcast Transmission Systems*, Hamilton Hotel, Washington, D. C. "New Perspectives in the Field of Broadcasting" will be the theme of the meeting. The technical program will be built around the new techniques developing in the field of broadcasting and a consideration of TV signal propagation factors as related to TV allocation engineering. For information, write to IRE, 1 E. 79th St., New York 21, N. Y.

Sept. 26-27: *Sixth Annual Meeting and Conference of the IRE Professional Group on Vehicular Communications*, Multnomah Hotel, Portland, Ore. An industrial exhibit will be held in conjunction with the technical sessions. For information, write to IRE, 1 E. 79th St., New York, N. Y.

Sept. 26-27: *Symposium on Electronics for Automation and Automation for Electronics*, Irvine Auditorium, University of Pennsylvania, Philadelphia, Pa. Sponsored by the Radio-Electronics-Television Manufacturers Association. Papers will be presented on the status of development of systems, machinery, and components to aid in automatic fabrication of electronic equipment and the parts played by electronics in automation of other industries. For information, write to RETMA, 777 14th St., N. W., Washington 5, D. C.

Sept. 26-30: *Meeting on Marketing the Products of Atomic Energy and Trade Fair*, Sheraton-Park Hotel, Washington, D. C. Sponsored by the Atomic Industrial Forum. The Fair will demonstrate the extent to which atomic energy has been advanced, with displays of control systems, package power, reactors, and components. For information, write to Atomic Industrial Forum, Inc., 260 Madison Ave., New York 16, N. Y.

Sept. 28-29: *Industrial Electronics Conference*, Rackham Memorial Auditorium, Detroit, Mich. Sponsored jointly by the Michigan Section of the AIEE and the Professional Group on Industrial Electronics of the IRE. Sixteen papers have been scheduled for the four technical sessions which will discuss automation, industrial measurement problems, and new control system applications. For information, write to AIEE, 33 W. 39th St., New York, N. Y.

ELECTRONIC DESIGN • September 1955

Sept. 29-Oct. 1: Fourth Annual Meeting of Standards Engineers Society, Statler Hotel, Hartford, Conn. Sessions will discuss potentials of standards, standards in automation, national strength and standards, and the future of standards. For information, write to S. H. Hubelbank, 30 Cumpstone Dr., Hamden, Conn.

Sept. 30-Oct 2: High Fidelity Show, Palmer House, Chicago, Ill. Exhibits will include tuners, amplifiers, speakers, recorders, turntables of both American and foreign manufacturers. For information, write to International Sight & Sound Exposition, Inc., 1 N. La Salle St., Chicago 2, Ill.

Oct. 3-5: Eleventh Annual National Electronics Conference, Hotel Sherman, Chicago, Ill. Ninety-six technical papers and 180 exhibits will be featured. For information, write to C. G. Miller, c/o Weston Electric Instrument Co., Chicago 6, Ill.

Oct. 3-7: AIEE Fall General Meeting, Morrison Hotel, Chicago, Ill. Sessions are planned on electronics, computing devices, nucleonics, feedback control systems, and aural and TV broadcasting. For information, write to AIEE, 33 W. 39th St., New York, N. Y.

Oct. 5-9: World Plastics Fair and Trade Exposition, National Guard Armory, Los Angeles, Calif. Oct. 6 will be Electronics, Military and Industrial Day, featuring applications of plastics in electronics, including tooling, instruments, and machinery. For information, write to Philip M. Kent, managing director, World Plastics Fair and Trade Exposition, 8762 Holloway Drive, Los Angeles 46, Calif.

Oct. 6-7: Eleventh Annual Meeting and Design Conference of the Society of Industrial Designers, the Woodner, Washington, D. C. The impact of automation on industrial design will be among the topics discussed. For information, write to the Society of Industrial Designers, 48 E. 49th St., New York 17, N. Y.

Oct. 12-15: 1955 Convention and Audio Fair, Hotel New Yorker, New York, N. Y. Sponsored by the Audio Engineering Society. The convention will include panel discussions on transistors, amplifier design, and tape recording. For information, write to G. K. Dahl, 230 W. 41st St., New York 36, N. Y.

Oct. 17-19: 1955 Radio Fall Meeting, Hotel Syracuse, Syracuse, N. Y. Sponsored by the Engineering Dept. of RETMA and the Professional Groups Committee of the IRE. For information, write to RETMA, 777 14th St., N. W., Washington 5, D. C.

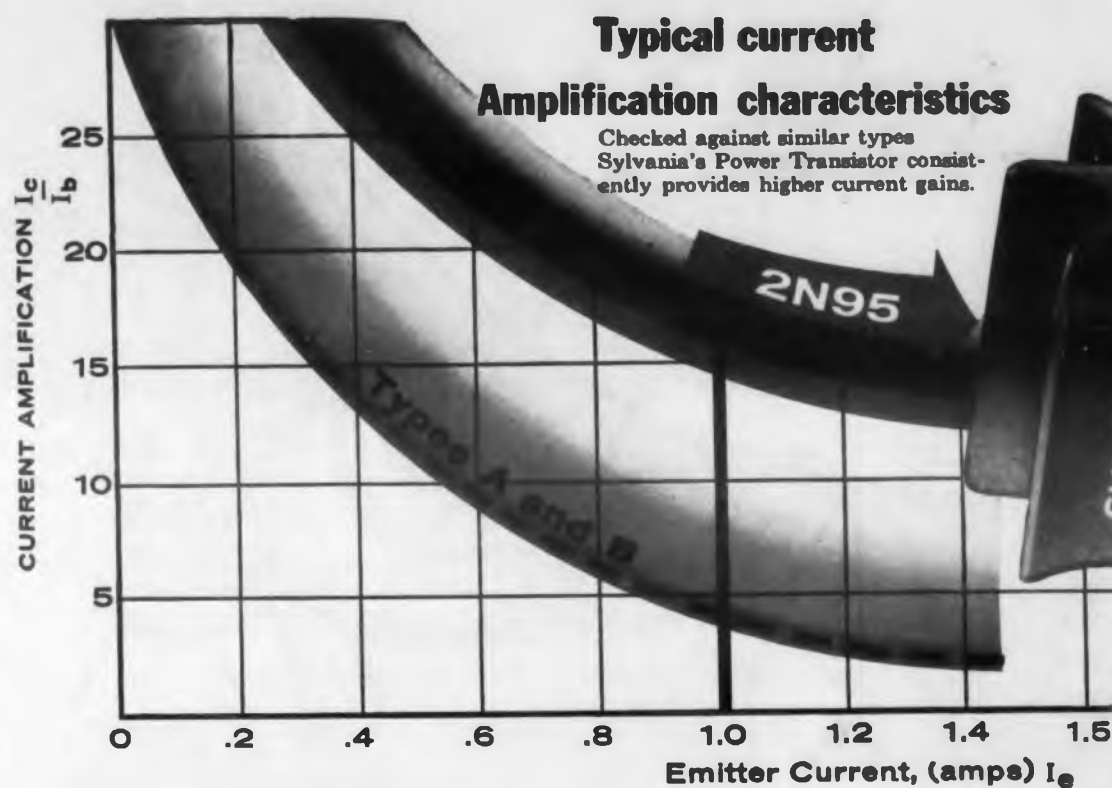

Sylvania NPN Power Transistor 2N95 Exhibits

3 1/2 times more gain

Operated at 1.0 amp emitter-current, the Sylvania 2N95 Transistor typically provides a current gain of 17... 3 1/2 times that of comparable types A and B. Even at 1.5 amp emitter current the 2N95 typically exhibits a high gain of 13... in fact, as the curve shows, the Sylvania 2N95 provides the highest gain over the widest range of operating current conditions.

In addition, Sylvania's 2N95 com-

bines all the important features you want in a power transistor, whatever your application. If, for example, yours is a switching application, the 2N95 offers high gain at high currents.

Designed for low thermal resistance, the Sylvania 2N95 Transistor provides dissipation up to 2 1/2 watts without an external heat sink and up to 4 or more watts with a suitable heat sink. This insures stable operation in high ambient temperatures.

*"another reason why it pays
to specify Sylvania"*

SYLVANIA®

SYLVANIA ELECTRIC PRODUCTS INC.
1740 Broadway, New York 19, N.Y.
In Canada: Sylvania Electric (Canada) Ltd.
University Tower Building, Montreal

LIGHTING • RADIO • ELECTRONICS • TELEVISION • ATOMIC ENERGY

CIRCLE 525 ON READER-SERVICE CARD FOR MORE INFORMATION

You compare

Check the Sylvania 2N95 against similar Transistor types yourself—for current gain as well as all of these important power Transistor features.

Does the Sylvania 2N95 offer—	answer
1. lower cost	yes ✓
2. low input impedance	yes ✓
3. low thermal resistance	yes ✓
4. high current switching	yes ✓
5. high current gain	yes ✓
6. mounting for air cool or heat sink	yes ✓
7. hermetic seal	yes ✓

A smaller version for heat sink mounting, the Sylvania 2N102 is also available with the above features.

Check your application for complete data on other Sylvania Transistors

- High gain, low frequency
Types 2N34 and 2N35
- High power, low frequency
Types 2N95 and 2N88
- High frequency
Types 2N94 and 2N94A
- High power, low frequency
Types 2N101 and 2N102

Dept. J22R

Sylvania Electric, 1740 Broadway, New York 19, N.Y.

Name _____

Company _____

Address _____

Our Mr. Smith supervises
Multi-Header design . . .

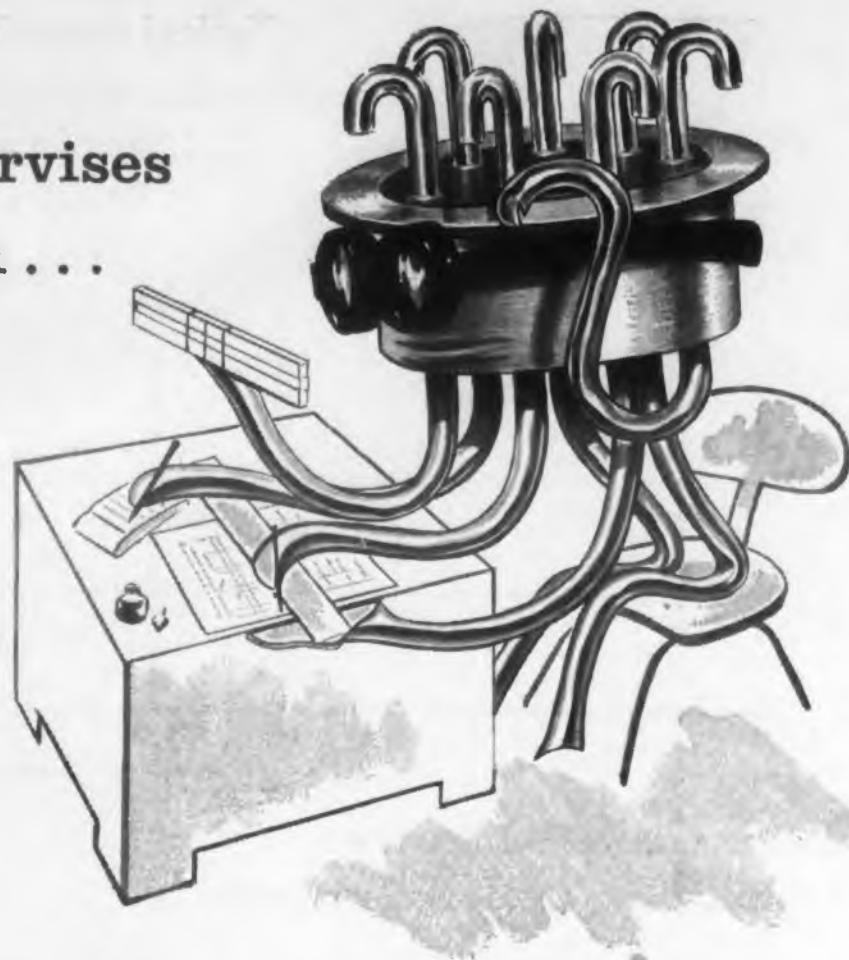

the most versatile glass-metal seal

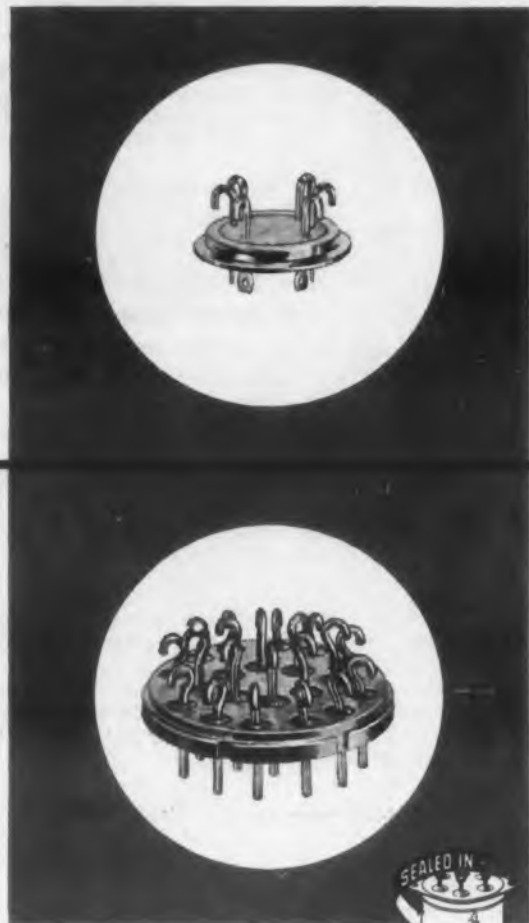

Constant Multi-Header design development enables Hermetic to offer a Vac-Tite* Compression Multi-Header to suit every design and application requirement.

If requirements call for 4 to 28 solid or tubular terminal Multi-Headers with O.D.'s that range from .375 to 1.125 diameters, Hermetic Headers of "all-glass" or "individual-glass" construction can be supplied. However, to meet the most difficult specifications, Hermetic can provide Multi-Headers as large as you specify with as many terminations as is required in "individual-glass" construction and solid metal body.

Consult Hermetic for standard, as well as specially designed headers, with or without mounting studs, that act as cover and seal.

Write for your new addition to "Encyclopedia Hermetica" . . . a 16 page catalog containing the most diversified selection of Multi-Headers ever offered.

*VAC-TITE is Hermetic's new vacuum-proof, compression construction, glass-to-metal seal.

Hermetic Seal Products Company

39 South Sixth Street, Newark 7, New Jersey

California Associate: Glass-Solder Engineering, Pasadena

FIRST AND



FOREMOST IN MINIATURIZATION

CIRCLE 526 ON READER-SERVICE CARD FOR MORE INFORMATION

Oct. 20-Nov. 3: *International Atomic Energy Exhibit*, Carnegie Endowment International Center, New York, N. Y. Sponsored by the Atomic Industrial Forum, the Fund for Peaceful Atomic Development, and the Carnegie Endowment for International Peace. The exhibit will be entitled "Man, the Atom, and the Future" and will stress the use of atomic energy for the advancement of human welfare. For information, write to Atomic Industrial Forum, Inc., 260 Madison Ave., New York 16, N. Y.

Oct. 24-25: *First Annual Technical Meeting of the Professional Group on Electron Devices of the IRE*, Shoreham Hotel, Washington, D. C. Developments and applications of electron tubes and transistors in radio, TV, business machines, and military equipment will be discussed. For information, write to IRE, 1 E. 79th St., New York, N. Y.

Oct. 24-26: *Sixth National Conference on Standards*, Sheraton Park Hotel, Washington, D. C. Sponsored jointly by the American Standards Association and the National Bureau of Standards. Co-ordination of Government and industry requirements for manufactured products will be discussed. A series of exhibits will show how standardization programs may be coordinated. For information, write to the American Standards Association, 70 E. 45th St., New York 17, N. Y.

Oct. 31-Nov. 1: *1955 East Coast Conference on Aeronautical and Navigational Electronics*, Lord Baltimore Hotel, Baltimore, Md. Sponsored by the Baltimore Section of the IRE and the IRE Professional Group on Aeronautical and Navigational Electronics. For information, write to IRE, 1 E. 79th St., New York 21, N. Y.

Nov. 1-5: *World Symposium on Applied Solar Energy*, Westward Ho Hotel, Phoenix, Ariz. Sponsored by the Association for Applied Solar Energy, Stanford Research Institute, and the University of Arizona. Conversion techniques and applications of solar energy will be discussed. An exhibit is planned. For information, write to W. C. Estler, Stanford Research Institute, Stanford, Calif.

Nov. 2-4: *Classified Symposium on Guided Missile Reliability*, Wright Air Development Center, Wright-Patterson Air Force Base, Ohio. Topics to be covered include problems in establishing and implementing missile reliability programs; responsibilities for reliability during development and production; establishing requirements for predicting and measuring the reliability of systems and components. Organizations or indi-

viduals desiring to present papers at the symposium should contact R. L. Dingle, Directorate of Weapon Systems Operations, Wright Air Development Center, Wright-Patterson Air Force Base, Ohio.

Nov. 3-4: *Eighth Annual Electronics Conference*, Town House, Kansas City, Kans. Sponsored by the Kansas City Section of the IRE. The conference will discuss components, microwave, automation, and audio. For information, write to IRE, P. O. Box 391, Kansas City, Mo.

Nov. 7-9: *Eastern Joint Computer Conference and Exhibition*, Hotel Statler, Boston, Mass. Sponsored by the AIEE, IRE, and the Association for Computing Machinery. Theme of the conference is "Computers in Business and Industrial Systems". Papers will be presented covering the role of computers in business, trends in system design, and communication and compatibility among electronic computers in business and industrial use. Exhibits will include data processing systems, process control systems, input-output equipment, conversion devices, sensing devices, and storage devices. For information, write to AIEE, 33 W. 39th St., New York, N. Y.

Nov. 14-17: *Second International Automation Exposition*, Navy Pier, Chicago, Ill. The exhibition will feature automatic controls, materials handling devices, etc. The electronic computer clinic will be repeated. For information, write to Second International Automation Exposition, 845 Ridge Ave., Pittsburgh 12, Pa.

Nov. 17: *Conference on the A-B and Industry—a Prescription for Survival*, Illinois Institute of Technology, Chicago, Ill. Sponsored by Armour Research Foundation of Illinois Institute of Technology. Subjects scheduled for discussion include economics of A-bomb and H-bomb protection, protection possibilities, and industry operations under emergency conditions. For information, write to Illinois Institute of Technology, 35 W. 33rd St., Chicago, Ill.

Dec. 12-17: *Nuclear Engineering and Science Congress and Atomic Exposition*, Cleveland Municipal Auditorium, Cleveland, Ohio. Fifty technical sessions will cover every phase of peace-time uses of atomic energy and its by-products. Nuclear developments for applications in industry, science, and agriculture will be exhibited. For information, write to Atomic Exposition, 931 Book Bldg., Detroit 26, Mich.

NOW

$\frac{1}{8}$, $\frac{1}{4}$ and $\frac{1}{2}$ watt Molded Precistors

IRC molded Deposited and Boron Carbon

Precistors are now available in $\frac{1}{8}$, $\frac{1}{4}$ and $\frac{1}{2}$ watt sizes. These 1% precision film type resistors combine the advantages of high stability, small size and low cost in either deposited carbon or boron carbon units.

Ratings are based on full load at 70°C. ambient.

The molded plastic housing provides complete mechanical protection, minimizes the effect of moisture and improves load life characteristics.

Equivalent in Size To IRC's Popular Types BTS • BW $\frac{1}{2}$ • BTA

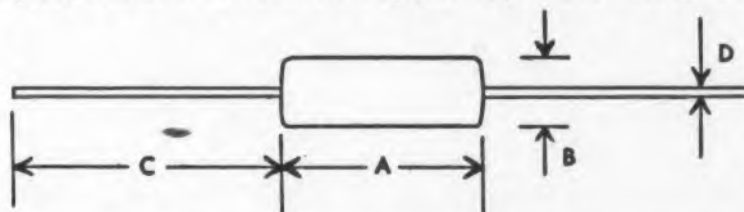

Precistor Types	IRC Size Equivalent	Dimension			
		A	B	C	D
MDA — MBA	BTS	$1\frac{3}{16}$ "	$\frac{1}{8}$ "	$1\frac{1}{2}$ "	.025"
MDB — MBB	BW $\frac{1}{2}$	$\frac{5}{8}$ "	$\frac{3}{16}$ "	$1\frac{1}{2}$ "	.025"
MDC — MBC	BTA	$2\frac{3}{16}$ "	$\frac{1}{4}$ "	$1\frac{1}{2}$ "	.032"

MOLDED DEPOSITED CARBON PRECISTORS

Type MDA — $\frac{1}{8}$ Watt

Type MDB — $\frac{1}{4}$ Watt

Type MDC — $\frac{1}{2}$ Watt

MOLDED BORON CARBON PRECISTORS

Type MBA — $\frac{1}{8}$ Watt

Type MBB — $\frac{1}{4}$ Watt

Type MBC — $\frac{1}{2}$ Watt

Precision Wire Wounds • Ultra HF and Hi-Voltage Resistors • Low Value Capacitors • Selenium Rectifiers • Insulated Chokes • and Hermetic Sealing Terminals

Wherever the Circuit Says

Voltmeter Multipliers • Boron & Deposited Carbon Precistors • Controls and Potentiometers • Power Resistors • Low Wattage Wire Wounds • Germanium Diodes • Insulated Composition Resistors



INTERNATIONAL RESISTANCE CO.

Dept. 265, 401 N. Broad St., Philadelphia 8, Pa.

In Canada: International Resistance Co., Ltd., Toronto, Licensee

Send me data on:

- Molded Deposited Carbon Precistors
 Molded Boron Carbon Precistors

Name _____

Company _____

Address _____

City _____ State _____

CIRCLE 527 ON READER-SERVICE CARD FOR MORE INFORMATION

RCA WT-100A Electron-Tube MICROMHOMETER

NEW VERSATILE TUBE TESTER!



RCA-WT-100A

Electron-Tube MICROMHOMETER
Suggested User Price: \$795.00

Practical for:

- Radio, Phonograph, and TV Set Manufacturers
- Electronic Equipment Manufacturers
- Electronic Research and Development Groups
- Electronic Maintenance and Service Groups
- Communication and Broadcast Stations
- Tube Manufacturers

... has accuracy approaching that of tube-factory equipment for measuring true gm

The new RCA-WT-100A Electron-Tube MICROMHOMETER is especially suited for laboratory and production-line testing, and circuit design engineering. Unique design makes possible the testing of receiving tubes, receiving-type tubes for industry and communications, and small transmitting tubes under actual operating voltage and current conditions. This feature permits *direct correlation* of test results with tube manufacturers' published data—and, in design work, permits the determination of a tube's performance under a given set of current and voltage conditions. The MICROMHOMETER is manufactured in accordance with the same rigid standards of high quality that account for the outstanding reputation of RCA tubes. The WT-100A weighs only 50 pounds; measures 23½" x 8" x 18½".

CIRCLE 528 ON
READER - SERVICE
CARD FOR MORE
INFORMATION



RADIO CORPORATION of AMERICA
TUBE DIVISION
HARRISON, N. J.

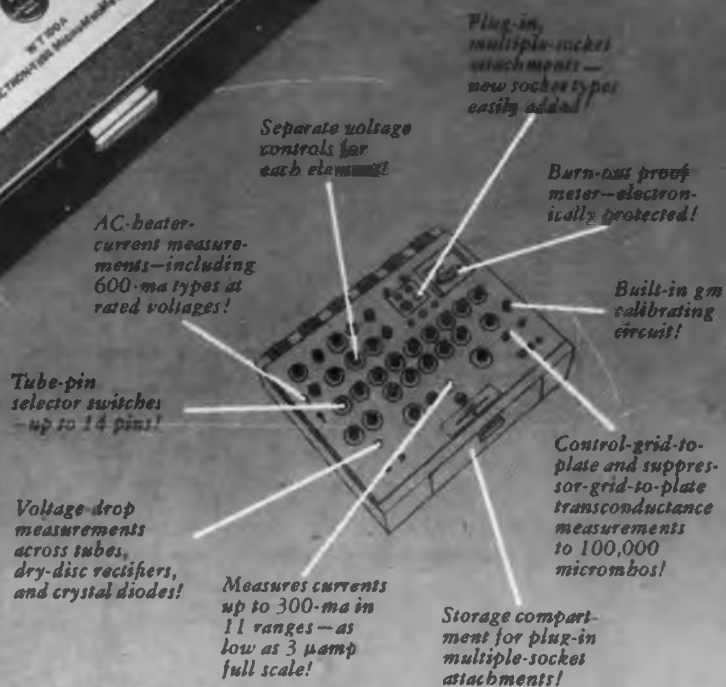

Separate voltage controls for each element!

AC-heater-current measurements—including 600-ma types at rated voltages!

Tube-pin selector switches—up to 14 pins!

Voltage-drop measurements across tubes, dry-disc rectifiers, and crystal diodes!

Measures currents up to 300-ma in 11 ranges—as low as 3 µamp full scale!

Plug-in, multiple-socket attachments—new socket types easily added!

Burn-out proof meter—electronically protected!

Built-in gm calibrating circuit!

Control-grid-to-plate and suppressor-grid-to-plate transconductance measurements to 100,000 micromhos!

Storage compartment for plug-in multiple-socket attachments!

No inconvenient patchcords—no external null indicators required! Highly accurate, repeatable measurements! Built-in voltage-regulated power supply provides voltages to 300 volts; provides currents to 300 ma!

For descriptive information, call or write your RCA Representative or write Commercial Engineering, RCA, Section 118Q, Harrison, N.J.

HAYDEN PUBLISHING COMPANY, INC.
19 East 62nd Street, New York 21, N. Y.

ELECTRONIC
DESIGN

VICTOR C. CLARK, JR.
CH. ENGR. TERM. AEGG BLDG.
CIV. AERO. ADMIN.-TR. BLDG.
17TH & CONSTITUTION NW
WASHINGTON 25 D. C. AEG7