

ELECTRONIC

design

ELECTRONIC

REV 21/1/54
Pen

COPYRIGHT DEPOSIT

Solderless "Taper Terminals", convenience, and simplicity are features of this compact patchcord system. Designed for programming computers, business machines, testing operations, etc., it consists of program boards, patchcords, and a frame into which a board with a program setup is inserted to make wiping contact with knife-like connectors as shown below.

THE LIBRARY OF
CONGRESS
SERIALS ACQUISITION
MAY 24 1954

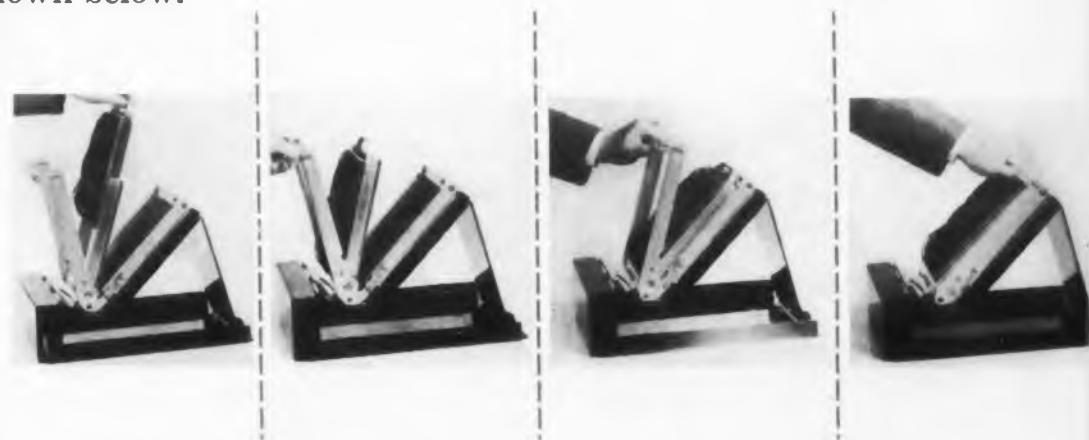
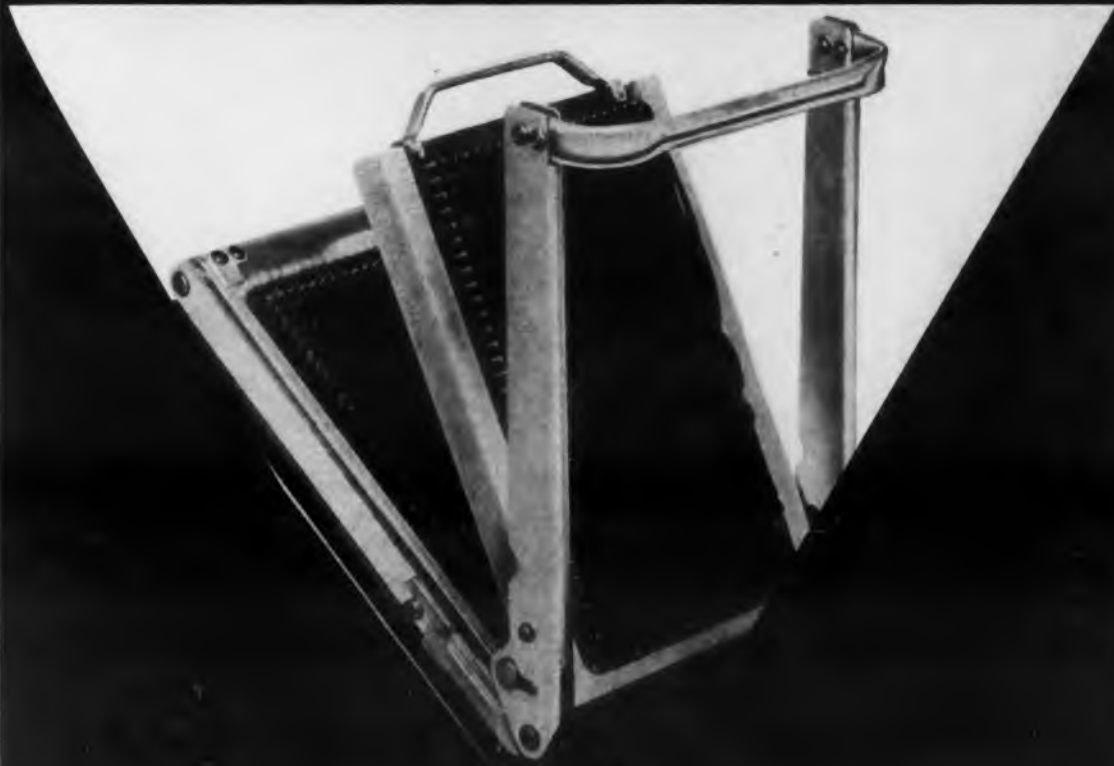

May 1954

Amperex NOW BRINGS YOU **2** NEW RUGGEDIZED TRIODES

**SPECIALLY
DESIGNED FOR
HEAVY DUTY RF
INDUSTRIAL
APPLICATIONS**

TYPE 6333 (WATER COOLED)

Plate Dissipation 10 kilowatts. Furnished with grid connector for direct interchangeability with type 892 without any equipment modifications. Suitable for communications as well as industrial applications. Available in air-cooled version, Type 6445.

TYPE 6446 (WATER COOLED)

A heavy wall triode capable of dissipating 20 kilowatts continuously. Massive anode (7/16" thick), provides high heat storage capacity for heavy intermittent duty. High dissipation reserve allows extreme mismatch of load to tube impedance. The tube is therefore protected against maladjustment or misuse of equipment. Uses only 1/2 the water flow required for type 892, for equivalent anode dissipation. Available in air-cooled version, Type 6447.

OPERATING DATA, 6333 RF POWER AMPLIFIER and OSCILLATOR CLASS C TELEGRAPHY

	MAXIMUM RATING per tube	TYPICAL OPERATION one tube
AC Filament Voltage	—	22 volts
DC Plate Voltage	15000	12000 volts
DC Grid Voltage	3000	1600 volts
Plate Load Resistance	—	3500 ohms
Peak RF Grid Voltage	—	2600 volts
DC Plate Current	2	1.55 amps
Plate Input	30	18.60 kw
Plate Dissipation	10	4.35 kw
DC Grid Current (approx.)	400	165 ma
Driving Power (approx.)	—	420 watts
Plate Power Output	—	14.25 kw
Tube Power Output	—	745 BTU/min.

OPERATING DATA, 6446 RF INDUSTRIAL OSCILLATOR

(3 PHASE, FULL WAVE, UNFILTERED SUPPLY)
Plate Volts and Input—Max. 100 75 50%
For Frequencies Indicated 5 12.5 20(mc.)

	MAXIMUM RATING per tube	TYPICAL OPERATION one tube
AC Filament Voltage	—	22 volts
DC Plate Voltage	15000	15000 volts
DC Grid Voltage	— 3000	— 1250 volts
Peak RF Grid Voltage	—	2400 volts
Plate Current	2	2 amps
Plate Input	30	30 kw
Plate Dissipation	20	10 kw
DC Grid Current (approx.)	400	250 ma
Drive Power (approx.)	—	620 watts
Plate Power Output	—	20 kw
Tube Output	—	1138 BTU/min.

DIRECT INTERELECTRODE CAPACITANCES

Grid to Plate 32 $\mu\mu\text{f}$
Grid to Filament 17 $\mu\mu\text{f}$
Plate to Filament 1.8 $\mu\mu\text{f}$

LIST PRICES:

6333 (Water Cooled)	\$230.00
6445 (Forced Air Cooled)	375.00
6446 (Water Cooled)	255.00
6447 (Forced Air Cooled)	400.00

ACCESSORIES

Tube Type	Water Jacket	Grid Connector
6333	DW-1580	Y-13326 (Supplied with tube without charge)
6446	S-15096	Y-13326 (Supplied with tube without charge)

Complete technical data available from our Application Engineering Department

POWER TUBE SELECTION CHART

... yours for the asking! Comprehensive colored chart shows ratings in power output and frequency for typical applications. Also gives a correlated table of FCC frequency allocations. Helps you find, in a moment, the tube or tubes that will fit your industrial and communication jobs.

AMPEREX tubes give you better performance and longer life, Physically and Electrically, through these exclusive RUGGEDIZING techniques:

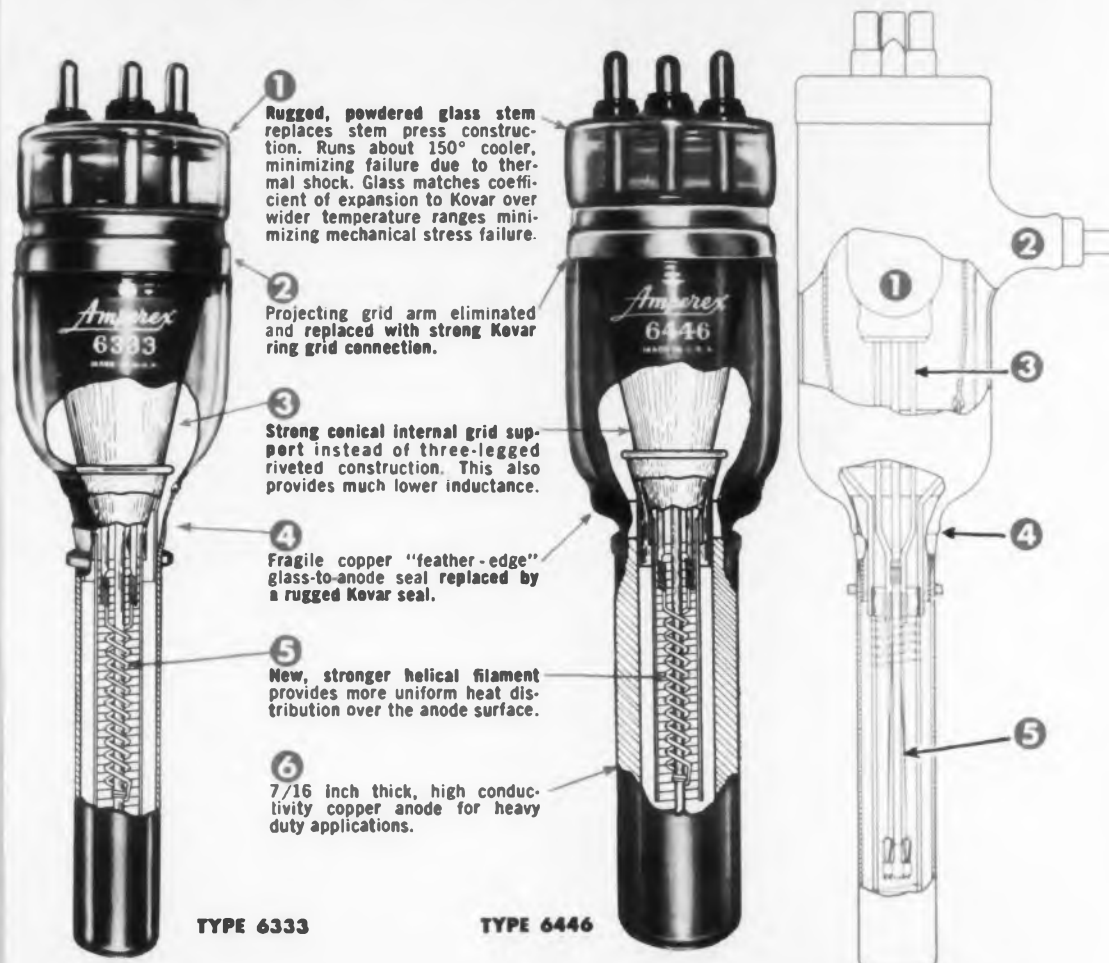

TYPE 6333

TYPE 6446

CONVENTIONAL TUBE STRUCTURE

Staff

Edward E. Grazda..... Editor
M. Mandell..... Associate Editor
M. J. Friday..... Assistant Editor
R. Graham..... Assistant Editor
P. L. Canfield..... Editorial Assistant
N. Asto..... Production Manager
E. Dadinis..... Assistant Production Manager
H. W. Schlager..... Business Manager
J. B. Gilchrist..... Circulation Manager

Co-Publishers

T. Richard Gascoigne
James S. Mulholland, Jr.

Advertising Representatives

New York: T. Richard Gascoigne,
James S. Mulholland, Jr.,
Blair McClenachan
127 East 55th St.,
New York 22, N. Y.
PLaza 3-8677

Chicago: Thomas P. Kavooras
664 No. Michigan Ave.
Chicago 11, Ill.
SUperior 7-8054

Los Angeles: Robert E. Ahrens Dorf
1140 Wilshire Blvd.
Los Angeles 17, Calif.
MAdison 9-2811

Circulation Policy

ELECTRONIC DESIGN is circulated only to qualified electronic design engineers of U. S. manufacturing companies, industrial consultants, and government agencies.

If design for manufacturing is your responsibility, you qualify for a subscription without charge provided you send us the following information on your company letterhead: your name and title; your company's name, address, and main product. Electronic, research, development, project, electrical, and chief engineer are typical qualifying titles.

If you have a design responsibility not indicated by your title, add a description of those responsibilities.

Any job change requires requalification.

Hayden Publishing Company, Inc.
127 East 55th Street
New York 22, New York

Back issues of **ELECTRONIC DESIGN**, when available, may be obtained at a charge of \$1.00 per copy.

◀ CIRCLE ED-1 ON READER-SERVICE CARD

Available At Your Local Parts Store

AMPEREX ELECTRONIC CORP.

320 Duffy Ave., Hicksville, Long Island, N. Y.

In Canada: Sargent Electrical Supplies Ltd.
11-15 Bessville Road, Toronto, Ontario M7P

ELECTRONIC *design*

Vol. 2
No. 5
May 1954

Contents

Cover	(see page 28)
Staff	2
Table of Contents	3
Editorial	4
Engineering Review	5
Features	
Circuit Breaker Considerations, by Richard S. Kurtz	14
A New Indicator Tube	16
Miniature Sealed-Contact Relays	20
Miniature Servo Amplifier	22
Circuit Design With Controllable Inductors—II, by Arthur L. Kaufman	24
A Versatile Patchcord System	28
Design Forum	
Vertical Chassis TV Receiver	18
Ideas for Design	
3-D Printed Circuits	26
Departments	
New Products	30
New Literature	68
Patents	72
Books	76
Advertisers' Index	78

BPA

NBP

ELECTRONIC DESIGN is published monthly by Hayden Publishing Company, Inc. at 127 E. 55th Street, New York 22, N. Y., T. Richard Gascoigne, President; James S. Mulholland, Jr., Vice-President & Treasurer; and Ralph E. Marson, Secretary. Printed at Publishers Printing Company, New York, N. Y., ELECTRONIC DESIGN is circulated monthly without charge to men in the electronic industries who are responsible for the design and specification of manufactured devices, including development and design men of consulting laboratories and government agencies. Acceptance under section 34.64 P. L. & R. authorized. Copyright 1954 Hayden Publishing Company, Inc. 24,000 copies this issue.

NOW

HIGHER TAPE SPEEDS
WIDER TAPE WIDTHS
HANDLES TELETYPE TAPE

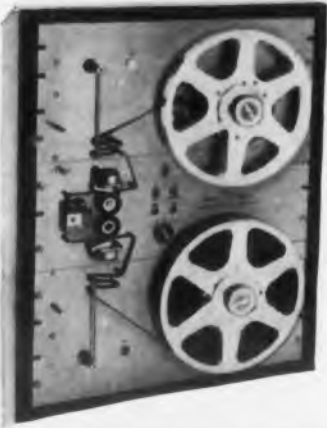

0 TO 60 INCHES/SEC.

IN **5** MILLISECONDS

WITH THE **NEW**

Potter

DIGITAL MAGNETIC-TAPE HANDLERS

SPECIFICATIONS

Model Number	901A	901B	902
Tape Speeds (in./sec.)	30/15	30/15	60/15
Tape Widths	1/2"	1/4"	1/4", 1/2", 5/8"
Number of Tracks	6	2	2 6 8
Start-Stop Time	5 msec	5 msec	5 msec
Reel Capacity	2,400'	2,400'	1,200'
Reel Size	10 1/2"	10 1/2"	8"

High-speed magnetic-tape recorders having low start-stop times give a new dimension to data handling by absorbing digital information when and where it is made and making it available when and where it is needed.

Digital information corresponding to any phenomenon can be recorded as the phenomenon occurs, continuously or intermittently, fast or slow, and later fed at optimum speed into reduction devices such as computers, punch cards and printers.

Speeds of 60 inches per second with 5-millisecond start-stop times permit digital techniques to be applied to jobs that previously required more expensive but less reliable methods. Typical applications include business machine problems, control of machine tools and other high-speed industrial processes, study of fast-moving missiles and telemetering.

Potter Magnetic Tape Handlers offer, in addition to the new higher tape speeds mentioned, wider tape widths for more channels with lower tape tension controlled by photoelectric servos. And, the price is but a fraction of that of much less versatile recorders. Other data handling components and complete systems are also available for special problems.

FOR FULL INFORMATION, WRITE DEPT. 4-J



POTTER INSTRUMENT CO., INC.

115 CUTTER MILL ROAD

GREAT NECK, N. Y.

121

CIRCLE ED-2 ON READER-SERVICE CARD FOR MORE INFORMATION

Compare Machlett High Vacuum Rectifier Tubes with any other make



ML-102A
ML-5575/100
ML-5576/200
ML-199*

75 PKV, 0.75 max anode amps; 750 watts anode dissipation.
100 PKV, 1.00 max anode amps; 750 watts anode dissipation.
150 PKV, 2.00 max anode amps; 1000 watts anode dissipation.
110 PKV, 10.00 max anode amps; 1500 watts anode dissipation.

*Thoriated Tungsten Filament.

For complete data write to:
MACHLETT LABORATORIES, INC.
Springdale, Connecticut



Over 55 years of electron tube experience!

CIRCLE ED-3 ON READER-SERVICE CARD FOR MORE INFORMATION

ML-5575/100 compared with competitive high vacuum rectifiers having conventional design features and identical peak ratings.

Conditions: Bridge-type rectifier circuit.

Waveform: Square, where

Anode Dissipation = $\frac{\text{Forward Volts} \times \text{Amperes}}{2}$

Filament Volts, each tube, 20.

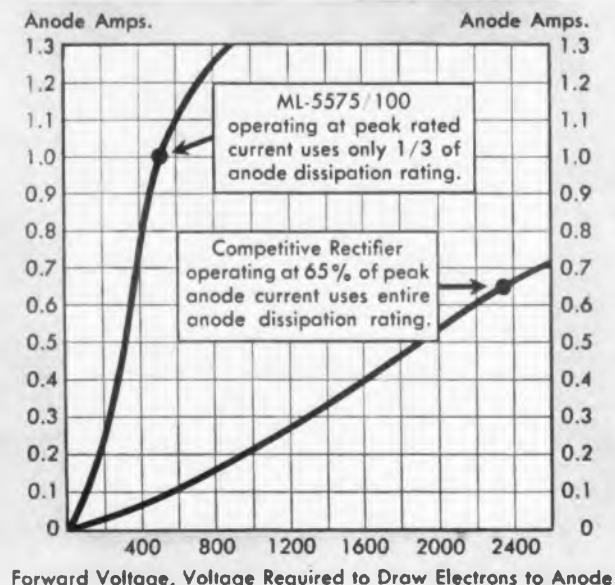

ML-5575/100 operates at 100% of current rating with 300% safety factor for anode dissipation. Competitive high vacuum rectifier tube operating at 65% of peak anode current is at limit of anode dissipation.

Machlett High Vacuum Rectifier Tubes give maximum rectification efficiency and high working load capacity with no increase in anode dissipation requirements, because . . . unique Machlett catenary type filament, eliminating need for electrostatic shielding, gives . . .

Highest Operating Efficiency
Cooler Running Anode
Highest Working Power Level
Highest Overload Capacity
Longest Life

For particle precipitation, chemical recovery, hold-off diode application and general high voltage requirements, a broad range of Machlett High Vacuum Rectifier Tubes are available. Included among the higher power tubes are:

Editorial . . .

Help the Reader

One of the great weaknesses in many engineering articles is their apparent lack of purpose. The author carefully explains how to measure, calculate, or design something, and includes tables, charts, or equations to illustrate his points. Too often, however, he fails to tell the reader why this particular method is important or what are the possibilities of the device he is describing.

Engineers are aware that the function of a technical article is to present information. The mere recital of facts, however, is not the whole story. The most important part of the article from the reader's point of view is not what is said, but what the information means to him.

Why should I take time to read this article? What can I do with this knowledge? How can I adapt it to help solve my problem? Can I go a step further and extrapolate from the author's results? . . . These are some of the questions in the reader's mind when he looks at an article.

It is up to the author to provide the answers clearly and forcefully. Failure to do so can result in losing the reader's interest, because the really interesting implications inherent in many stories are not apparent at first glance—or even after the first casual reading.

In these days of many publications and other demands on a potential reader's time, many articles get only a glance or a quick first reading. If the author has not made the importance of his information apparent, the reader will skip to the next story in the magazine. It takes a lot of hard work to write an article. A little care, thought, and imagination in bringing out the significance of the information being presented will help prevent the author's efforts from being wasted.

Ideas for Design

The article called "3-D Printed Circuits" that appears on pages 26 and 27 in this issue is labelled "Ideas for Design". It is the first in a series of stories that will appear from time to time on new techniques or variations in old methods that can be used by electronic design engineers.

The present story tells how designers can save chassis space and permit the use of high-speed production for individual stages in a TV receiver. This is done by employing printed circuits in three planes instead of two as in conventional printed circuitry. Greater ease of servicing is also gained.

The technique, a combination of old and new methods, shows promise for many mass produced electronic devices. It represents an "idea for design".

Solar Ba

another a
of the su
Laborator
with a ju
in a tran
square ya

As sho
consists o
to light,
about 1/
tional to
the sun's
hel or se
light is
current o

With a
the batte
to electr
favorabl
engines,
that hav

The p
in the il

The sc
physicist
electrica
tories, I
stration
equipped
a few hu

Nothing
conversi
(see p.
forever.
not the
small an
battery.

Other
electrici
power p
to drive
develop
moccup
sq yd o
could n

As in

Engineering Review ...

Solar Battery . . . A light-powered solar battery, another approach to utilizing the vast, unused power of the sun, has been developed by the Bell Telephone Laboratories. Essentially a p-n silicon junction device with a junction area many times the size of the one in a transistor, the solar battery produces 50w per square yard of sunlight surface.

As shown in the photograph at right, the battery consists of rectangular wafers of silicon. On exposure to light, each wafer produces a steady voltage of about 1/2v, with current varying directly proportional to the area of the wafer and the intensity of the sun's rays. The wafers may be connected in parallel or series as required. The speed of response to light is instantaneous, and the wafers will generate current over a wide ambient temperature range.

With a theoretical top conversion efficiency of 22%, the batteries are presently able to convert sunlight to electricity with an efficiency of 6%. This compares favorably with the efficiency of steam and gasoline engines, in contrast with other photoelectric devices that have never been rated higher than 1% efficient.

The principle of operation of the battery is shown in the illustration at the right.

The solar battery was developed by G. L. Pearson, physicist, C. S. Fuller, chemist, and D. M. Chapin, electrical engineer, all of the Bell Telephone Laboratories, Inc., New York, N. Y. In an initial demonstration of the battery, it powered a transistor-equipped transmitter that broadcast a voice message a few hundred yards.

Nothing is consumed or destroyed in the energy conversion process as in standard or atomic batteries (see p. 10), so the battery should theoretically last forever. The atomic battery, which has a long, but not theoretically infinite useful life, produces very small amounts of power in comparison to the solar battery. However, the latter requires regulation.

Other devices that convert the sun's energy into electricity are the photoelectric cell, a European power plant that uses the sun's heat to produce steam to drive turbines, and the thermocouple. A recently developed experimental device utilizing banks of thermocouples (*ED, March, '54, p. 5*) develops 60w per sq yd of heated surface. Unlike the solar battery, it could not operate in cold climates.

As in the manufacture of semiconductor materials

for transistors and diodes, minute quantities of an impurity are introduced into one surface of the battery silicon to a depth of less than 1/10,000". This process is accomplished at high temperature in a gas atmosphere. The wafers do not have to be much thicker than the above depth, but are actually 40 mils thick. Connections to the wafer may be made in various manners.

An obvious application of the battery is to supply

the low power required by transistor-equipped devices. The Bell Laboratories are considering applying the battery as battery-chargers for transistorized amplifiers used on an experimental rural telephone line (see *ED, April, 1954, p. 6*). It has many military applications, particularly in portable equipment.

Firefighting by TV . . . Small TV cameras equipped with telephoto lenses and mounted on fire control towers are being used for forest firewatching. Rotating once every two minutes, the cameras and their transmitters are connected by microwave relay to a central firefighting headquarters 50 miles away. The cameras' bearings are also transmitted, providing a means of pinpointing any fire by cross-bearings from two separate cameras.

The first installation was made in Alexander State Park in Louisiana. The system was conceived by Carl Le Blanc and Bill Maser, Baton Rouge, La., television distributors utilizing new equipment produced by Raytheon Manufacturing Company, Waltham, Mass.

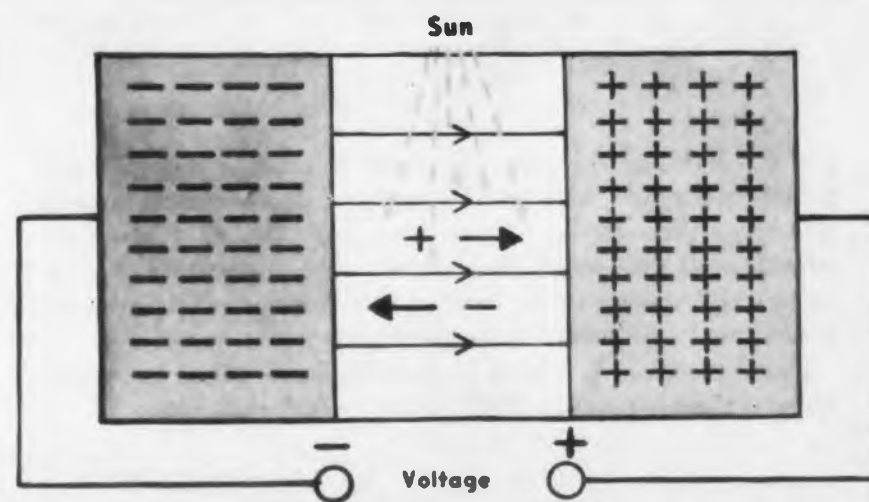

The principle of operation of the solar battery illustrated in the photograph is shown in this diagram (above) of a p-n junction. When light is absorbed, electrons and positive charges are liberated in the barrier region. The built-in electric field at the barrier forces the positive charges to the p-side, making it positive; and forces the electrons to the n-side, making it negative. This charge displacement results in a potential difference between opposite sides of the crystal. Each wafer produces 1/2v, current varying with light intensity. To meet any given power requirement, the wafers may be arranged in series or series-parallel, as shown at the right. The battery is essentially a low-impedance source.

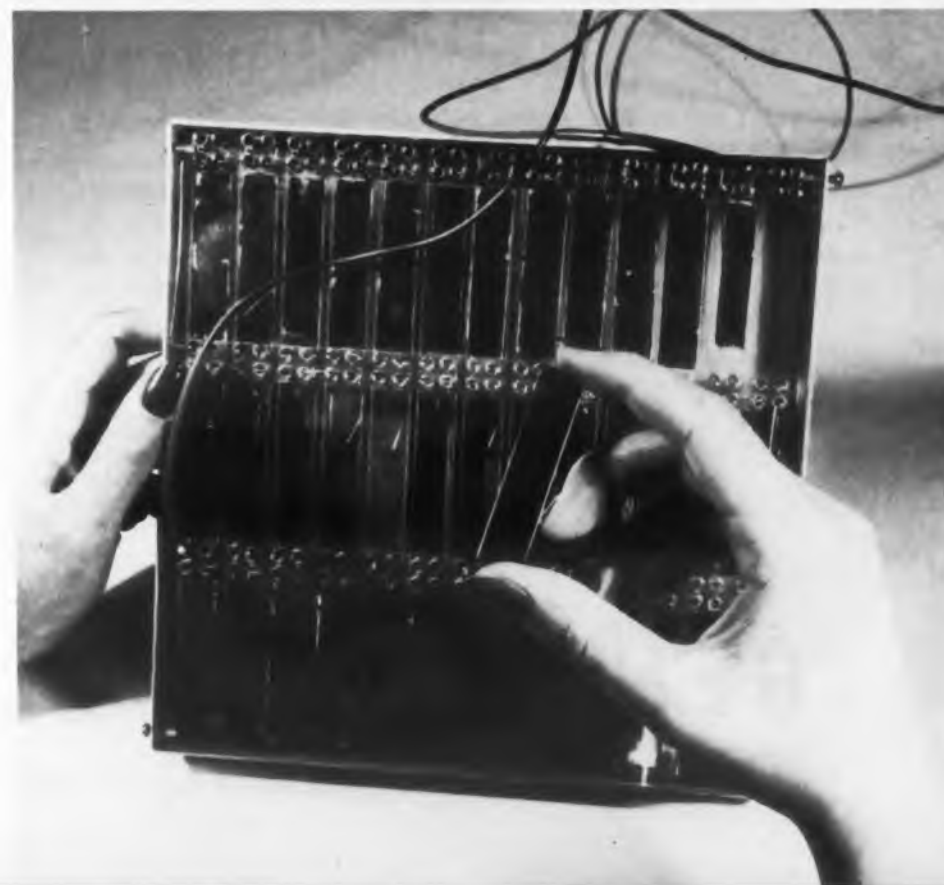

SAME PRICE . . . NEW PERFORMANCE!



HERMETICALLY SEALED Germanium Diodes

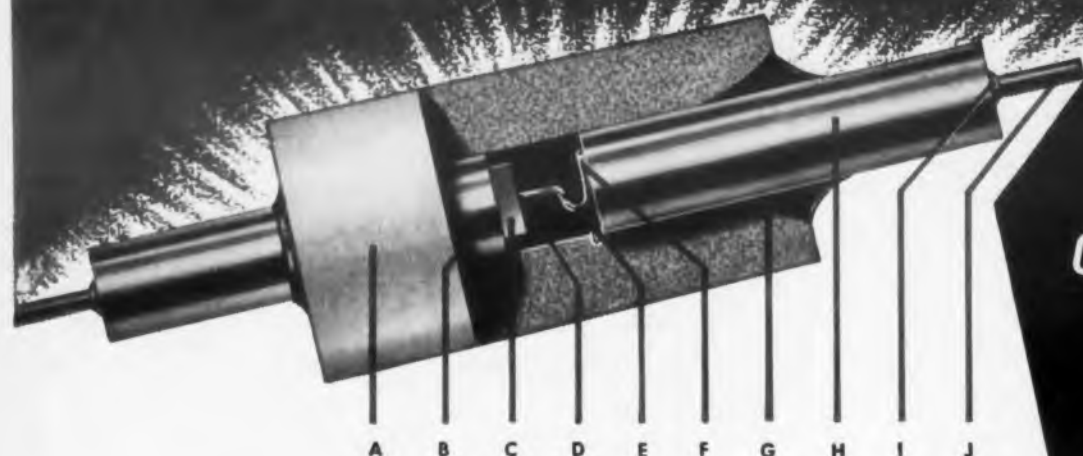

SPECIAL
NON-POROUS
CERAMIC CASE!
GAS TIGHT!

JAN
TYPES

- A. Ceramic Case
- B. Solder
- C. Germanium Pellet
- D. Weld
- E. Platinum-Rhuthenium Whisker
- F. Weld
- G. Solder
- H. Nickel Pin
- I. Weld
- J. Leaded Copper Clad Wire

IN General Electric, research aimed at product improvement never stops. And, here are the results of that effort...a special, non-porous ceramic case diode plus perfection of a metal to ceramic seal! This ceramic has already been successfully applied to seal high quality tubes. Used in G-E diodes, it voids gas contamination...adds many years of efficient performance!

Order the types you need *in quantity now!* Phone or write: General Electric Co., Sec. X4854, Electronics Park, Syracuse, N. Y.



COMPLETE METAL TO CERAMIC SEAL. Gas-tight ceramic cases with metalized ends permit solder seal to nickel pins.

MOISTURE PROOF. These new diodes exceed the requirements of JAN humidity specifications.

REQUIRED ELECTRICAL PROPERTIES. More than two years of development were necessary to perfect this combination of hermetic seal and superior performance.

MECHANICAL STABILITY. Platinum-rhuthenium whisker is welded to the germanium pellet.

LONG-LIFE. The elimination of moisture effects adds years to the life of your equipment!

You can put your confidence in—

GENERAL ELECTRIC

CIRCLE ED-4 ON READER-SERVICE CARD FOR MORE INFORMATION

Engineering Review . . .

Simplified Voice Transmission . . . A system of coding the human voice in a form that is considerably simpler than the original speech, transmitting it, and then reconstructing it in a receiver is under development at the Rutgers Bureau of Engineering Research, New Brunswick, N. J.

By reducing the voice to the minimum number of linguistic elements that can be incorporated in a high-speed, interference-free system of radio and telephone communications, the proposed system would overcome static and other noises, even deliberate jamming, and increase channel capacity by decreasing the required frequency bandwidth. Proposed for military uses, the system would prove invaluable for intercontinental radio-telephone, long-distance telephone, and even police car radio systems.

The problem of simulating the sender's voice or, for that matter, characterizing the "average" voice is extremely difficult. The simplest word is pronounced in many ways. Charts showing the dominant voice frequencies and analyzing its sounds in detail are now being recorded at Rutgers. The tests are progressing from letters to syllables to words seeking to establish the basic linguistic elements—such as larynx frequency or pitch.

Electronics Sells Electronics . . . Television replaced an expensive exhibition hall and enabled visitors to "visit" booths without the usual fatigue resulting from walking about a crowded hall at a recent Special Conference on "Integrating the Office for Electronics." At the conference, sponsored by the American Management Association, various electronic office "automation" equipment was demonstrated in one room, scanned by closed-circuit TV, and projected on a large screen before a 1000 industrial leaders in a nearby auditorium. The demonstrator then answered questions from the audience by two-way wire.

The conference dealt with the necessary conditions preliminary to automation of the office. In order to use electronics there, standard methods of presenting information to the machines must be agreed upon. The five-channel punched tape is the likeliest candidate. Methods of linking machines in remote offices must be designed for existing communications and communication equipment.

The conference also considered devices for converting one form of coded information to another, i.e., punched tape to punched card. This transformation is necessary in order to integrate presently used valuable machines into an automation system. Mechanization of the office could halt the trend towards an increasing proportion of office workers to production workers resulting from increasing automation of factories and refineries.

MAXIMUM RATINGS (AT 25 °C)

Hermetically Sealed DIODES	1N69	1N70	1N81*
Peak Inverse Voltage	75	125	50
Continuous Operating Inverse Voltage	60	100	40
Min. Forward Current (MA) at +1V	5.0	3.0	3.0
Max. Inv. Current (u a)			
At -50V	850	300	—
At -10V	50	25	10
AV Rectified Current (MA)	40	30	30
Peak Rectified Current (MA)	125	90	90
Surge Current (MA)	400	350	350

*JAN approval applied for

Electronic Soundproofing . . . By creating counter-waves that reduce or cancel noise sound waves, a newly developed electronic sound absorber can eliminate low-frequency sound waves that are not absorbed by conventional porous material soundproofing. The units can either be placed near the source of sound or near the person who is bothered by the noise.

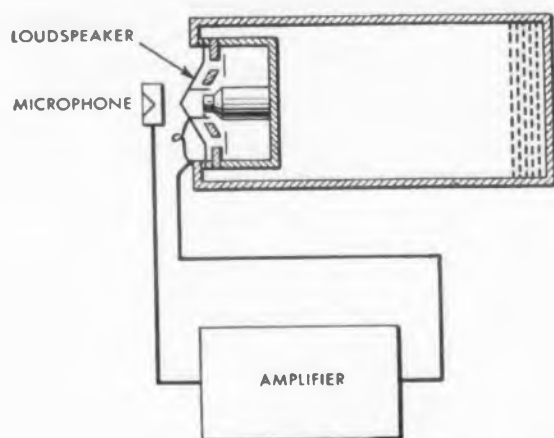

The sound absorber consists of three parts: a special electronic microphone, an amplifier, and a specially designed small speaker. The signal produced in the microphone by the noise waves is amplified and applied to the speaker, where sound waves are produced of equal amplitude but opposite phase to that of the noise. The effect, within a few feet of the speaker, is a substantial levelling of the changes in air pressure and hence a reduction or even elimination of the oncoming sound.

The speaker is mounted directly behind the microphone, as shown. Since the loudspeaker must operate in an enclosed space, a speaker with a cone of only 3-1/2" diam was designed to keep the enclosure small. The microphone utilizes a subminiature tube called a "mechano-electronic transducer" that contains a rod connecting one element of the tube through the tube enclosure directly to the diaphragm of the microphone. The vibration of the diaphragm by the noise waves is transferred directly to one of the tube elements, thereby developing the signal.

The unit was developed by Dr. Harry F. Olson of the RCA Laboratories Division, Radio Corporation of America, Princeton, N.J. The sound absorber can operate on either batteries or house current.

The absorber also can be used in the same manner as conventional wall materials in a room to handle the low-frequency waves. Three of them placed at the intersection of two walls with a ceiling, for example, would catch oncoming low-frequency sounds before the waves could reach the surface to rebound as echoes. To absorb the low-frequency noise produced by motors, etc., conventional soundproofing must be very thick and often is impractical. The absorber solves this problem very neatly.

Hughes Diodes for Computer Applications

Types 1N191 and 1N192



Actual dimensions
of diode body:
0.265" x 0.130"

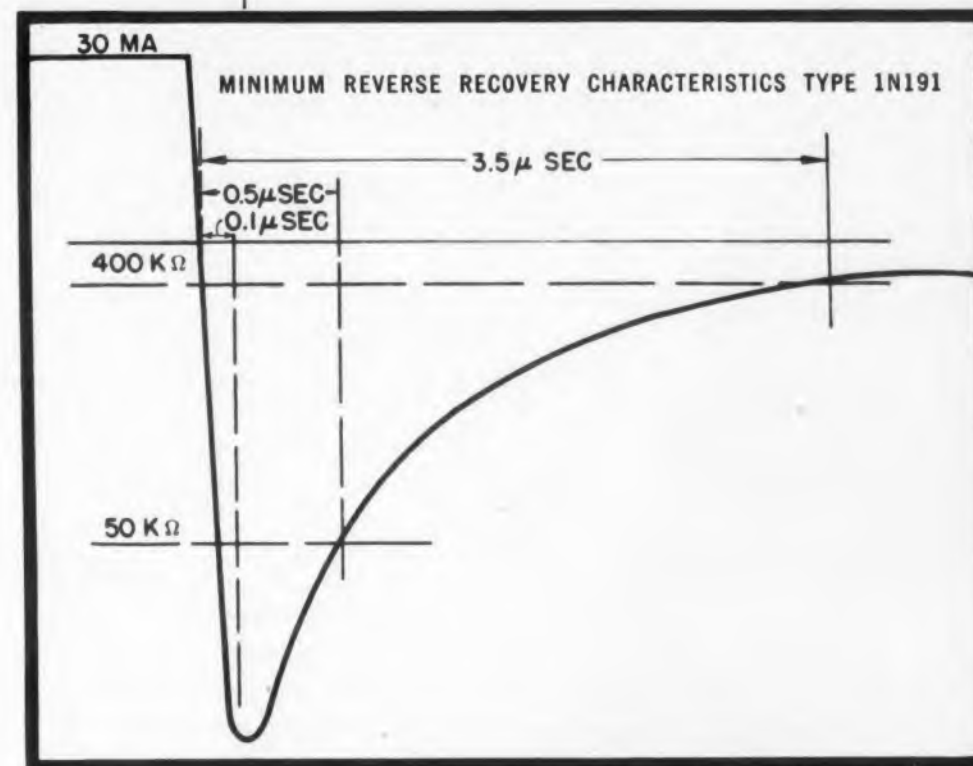

Recovery Time Characteristics

at 25° Centigrade

Type 1N191

50 KΩ @ 0.5 μsec and 400 KΩ @ 3.5 μsec maximum

Type 1N192

50 KΩ @ 0.5 μsec and 200 KΩ @ 3.5 μsec maximum

Maximum Back Current

at 55° Centigrade

Type 1N191

400 KΩ min. between -10 and -50V

Type 1N192

200 KΩ min. between -10 and -50V

To measure pulse recovery for both types, diodes are pulsed at 30 mA in the forward direction and then a back voltage of -35 volts is applied.

Now, as part of the continuing program to meet the expanding requirements for computer components, Hughes announces the registration of *Diode Types 1N191 and 1N192*. Both are selected for their outstanding performance in computer service.

These computer type diodes, like all Hughes diodes, are designed to ensure extremely high moisture resistance... thermal stability... electrical stability... subminiature size... thorough dependability. These features mean long life with minimum maintenance.

If you need special computer type diodes, chances are that we can furnish them on a production basis—because we are constantly producing and providing many types to meet literally hundreds of electronics and communications applications. Among these are high forward conductance, low-voltage diodes, used for certain computer applications.

Just Off the Press

A new, eight-page descriptive brochure. Lists and describes all the more widely-used RETMA, JAN and special types in the Hughes line. Just write for your copy of Bulletin SP-2.

Hughes



NEW YORK CITY CHICAGO

CIRCLE ED-5 ON READER-SERVICE CARD FOR MORE INFORMATION

A month or so ago we ran this advertisement. We've had a lot of replies - a lot of dollar bills and 5 dollar bills. Yet, we've had a certain amount of confusion that we'd like to straighten out.

SIGMA SENSITIVE RELAY FACTS

MECHANICAL CONSTRUCTION
OPERATING CHARACTERISTICS
FORCE CURVES
OPERATING TIME CHARACTERISTICS
HOLD TIME CHARACTERISTICS
SENSITIVITY • ADJUSTMENTS
MOUNTINGS • ENCLOSURES
DIMENSIONS • WIRING DIAGRAMS
STANDARDS • OPERATING LIFE
SALT SPRAY • TEMPERATURE CYCLING
HUMIDITY • IMMERSION
BAROMETRIC PRESSURE
MOISTURE RESISTANCE • VIBRATION
ACCELERATION • DIELECTRIC
FINISH • ETC.

The Sigma Relay Manual is frankly preferred after the RCA Tube Hand Book which in our view is one of the best things in the industry. It will be a long time before the Manual, even in its much more limited field of usefulness, achieves anything like the near perfection of its model.

However, there are here assembled all known facts about each Sigma relay, type, series, and adjustment. Each available combination is tabulated so that it can be selected with foreknowledge of all important attributes, usually including ratings under all use conditions selected for regular proof testing.

Doubtful important is the fact that in the Sigma Relay Manual is provided a means whereby - through the regular supplement service - new information can be easily accumulated and disseminated.

The Sigma Manual Service consists of the basic loose leaf manual of approximately 200 pages and additional and replacement pages in groups as issued.

SUBSCRIPTION PRICE IS FIVE DOLLARS, YEARLY RENEWAL, ONE DOLLAR.

for the sake of those who had only one reason for reading the above and who are disappointed, we have another book for sale more to their taste. "Sigma Instruments Talk" (Ads and selected mail)
Price \$2.00 postpaid

SIGMA
SIGMA INSTRUMENTS, INC.
PEARL ST., SO. BRAintree, BOSTON 85, MASS.

In the first place, we don't require that you pay five dollars for the privilege of buying a Sigma relay. The manual is designed to make available all we know about our products and their application. It is a basic user's manual for Sigma relays (not relays in general - we had to give one man's money back on that one). If you do have use for such a manual, the price includes one year's subscription to whatever additional pages are issued. After the first year, renewal is one dollar.

For those that don't know how interested they are in our products, we have a free four page bulletin highlighting the basic Sigma relay types. The next step from this is that, in response to a specific inquiry we will send, also free, the specific manual pages that we believe will apply to your problem.

The "Ink" offer stands. You get for one dollar a collection of our favorite correspondence which easily outdoes anything in the ads. (We get the opportunity to expose you to our ads again.) So far, no one's asked for his dollar back.

SIGMA INSTRUMENTS, INC., 91 PEARL ST., SO. BRAintree, BOSTON 85, MASS.

CIRCLE ED-6 ON READER-SERVICE CARD FOR MORE INFORMATION

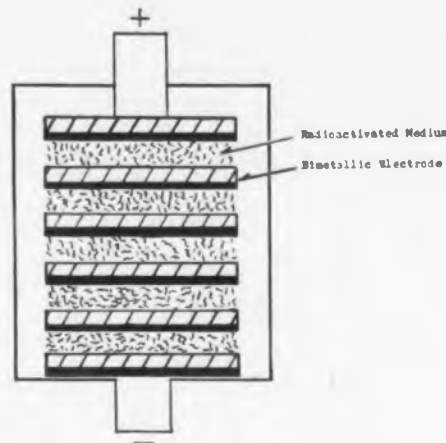

The cross section above illustrates the simple construction of the atomic batteries shown below.



Engineering Review . . .

Atomic Battery . . . Radioactive tritium is the source of beta rays in a newly developed atomic battery shown below. Producing up to 400v at very low currents, the batteries have an optimum useful life of 18 years. During this time a constant circuit voltage would be generated, although the current would gradually decline at a known rate.

The simple construction of the battery utilizes pairs of metal plates surrounded by the tritium isotope, all enclosed in cylindrical containers. The plates attract the electrons produced by the radioactive material, and the voltage produced is proportional to the difference in the surface electrical characteristics of the plates. The amount of tritium



The mutual-inductance type micrometer used to detect thrust bearing wear.

contained
to \$100 at
to 1.0μw or

Developed
Inc., Boston
be used in
and other
long-life p
from the
beta rays
pletely ab
the batter
it can be
30 years.

While v
that a rad
and dem
English s
that had
English s
tium-90 is
atomic ba

Noncont
tacting d
type micr
ment of a
caused by
turbine. Y
limit, the
ating per
the instr
amount o
for its fu
soon. The

The m
by M. L.
ards, Wa
sisting o
mounted
disk on t
ance bet
longitudi
ceives an

The in
relative
quasi-sta
placement
from 50
acy of 3

For r
in "I
to t

contained in the batteries ranges in cost from \$1.00 to \$100 at present prices, and will produce 0.01 μ w to 1.0 μ w of power.

Developed by Alexander Thomas of Tracerlab, Inc., Boston, Mass., the batteries could conceivably be used in transistorized hearing aids, alarm devices, and other sensitive instruments requiring a low-level, long-life power supply. There is practically no danger from the tritium used in this battery, because the beta rays it gives off are so weak they can be completely absorbed by a piece of newspaper. Although the battery has an optimum useful life of 18 years, it can be designed for a useful life of from 10 to 30 years.

While working on the project, Mr. Thomas found that a radioactive battery apparently had been made and demonstrated in 1924 by J. B. Cramer, an English scientist, who followed a line of experiments that had previously been performed by the noted English scientists Faraday, Kelvin, and Lodge. Strontium-90 is employed in another recently announced atomic battery (see *ED*, Feb. '54, p. 15).

Noncontacting Distance Gage . . . A new noncontacting distance gage employs a mutual inductance-type micrometer to indicate the longitudinal movement of a high-speed rotating shaft, such as might be caused by failure or wear of the thrust bearing of a turbine. When the displacement exceeds a prescribed limit, the indicator actuates an alarm, warning operating personnel of imminent machine failure. Since the instrument also gives a direct indication of the amount of bearing wear, a bearing may now be used for its full useful life and need not be replaced too soon. The detecting element is shown at the left, below.

The mutual inductance micrometer was developed by M. L. Greenough of the National Bureau of Standards, Washington 25, D. C. A transducer probe, consisting of two coils wound on a dielectric core, is mounted on the turbine frame near the shaft. A brass disk on the turbine shaft changes the mutual inductance between the windings when the shaft moves longitudinally, thereby actuating an alarm that receives an amplified signal from the secondary coil.

The instrument can also be applied to indicate the relative positions of oscillating, reciprocating, or quasi-stationary members over a wide range of displacements, since the micrometer will measure lengths from 50 microinches to several inches with an accuracy of 3%.

For more information on developments described in "Engineering Review", send inquiries directly to the address given in the individual item.



New Instruments and Components to Aid in Design and Reduce Costs

by
TECHNITROL

Unique Variable Pulser is Valuable Laboratory Aid

The Technitrol Variable Pulser is a reliable, versatile instrument which converts the output of a laboratory oscillator into a series of pulses.

One use has been as a low pulse rate device to study the response of components and networks to isolated pulses. Another use has been as a variable pulse rate source to study P.R.F. sensitivity. Still another use has been as a constant high frequency source for a temporary clock pulse generator.

Characteristics

- Wide range of frequencies from 2 cps. to over 2.0 mcs.
- Pulse characteristics optimized with rise and fall times approximately 0.04 μ s. and 0.06 μ s. respectively.
- Duration of pulse variable from 0.2 μ s. to 5.0 μ s. in steps of 0.1 μ s.
- Accurate, stable pulse duration controlled by electric delay lines.
- Amplitude continuously variable without distortion from 0 to 45 volts.
- Trigger pulse precedes output pulse to synchronize oscilloscopes, etc.

Very Compact Delay Lines Designed to Fit Your Need

A Technitrol Delay Line—with not more than $\frac{1}{4}$ " diameter and $6\frac{1}{4}$ " length, or in a package—will be designed for your particular circuit application. A variety of mountings offers you a wide choice.

- Delay: 0.01 to 1.6 μ s.
 - Characteristic Impedance: 400 to 2500 ohms.
 - Wide Frequency Response: 0.5 μ s. at 1200 ohms.
3 db down at 5 mcs
6 db down at 8 mcs
10 db down at 10 mcs
- Continuing intensive research and development is expected to make available even greater band-widths.
- Linear Phase: to 9 mcs and beyond

Tiny Encapsulated Pulse Transformers Wound to Your Requirements

Technitrol Pulse Transformers are wound on ferrite cores and cast in resin to form a $\frac{3}{4}$ " sealed unit.

Type TE has 2-inch pigtail leads of No. 20 wire. Type TP has 7-pin plug-in for miniature tube sockets. Lends itself admirably to printed circuits where holes can be drilled in the circuit board, the transformer plugged into these and the pins soldered to the circuit leads on the side opposite the body of the transformer.

MORE INFORMATION ON REQUEST

TECHNITROL ENGINEERING COMPANY

2751 N. 4th St., Philadelphia 33, Pa.

Send Bulletin

- 186 Variable Pulser
- 166 Pulse Transformers
- 174 Delay Lines

Write Dept. D-5

NAME _____
COMPANY _____
ADDRESS _____
CITY _____ ZONE _____ STATE _____

CIRCLE ED-7 ON READER-SERVICE CARD FOR MORE INFORMATION

SILICONDUCTORS

(TRADE MARK)

ARE

PRECISION

PRODUCED

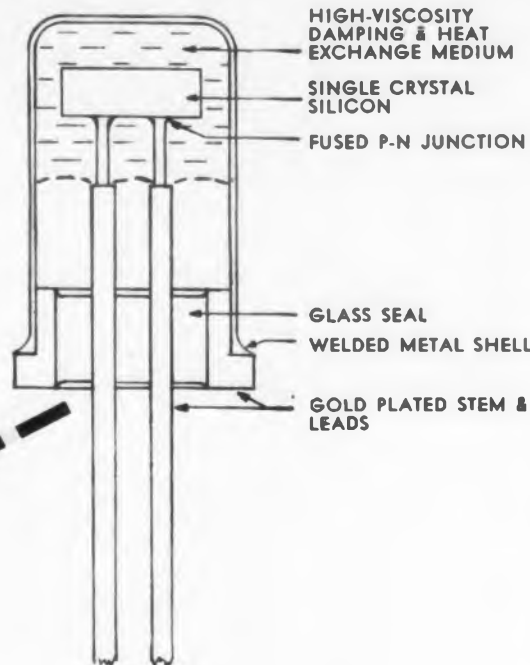

ACTUAL SIZE

SILICON JUNCTION DIODES

by

NATIONAL SEMICONDUCTOR PRODUCTS

930 Pitner Avenue • DAvis 8-0800 • Evanston, Illinois

DIVISION OF NATIONAL FABRICATED PRODUCTS, INC.

Engineering Review . . .

New AIEE Secretary . . . Nelson S. Hibshman of Brooklyn, N. Y., has been appointed Secretary of the American Institute of Electrical Engineers. He succeeds H. H. Henline, who held the post since 1932. Mr. Hibshman, who has been assistant secretary since January 1, 1953, was formerly Dean of Engineering at Pratt Institute of Technology, Brooklyn, N. Y.

Transistor Course . . . Transistors and their applications will be the subject of a special, two-week summer program offered at the Massachusetts Institute of Technology from 19 to 30 July. The program will aim to help engineers evaluate transistors in relation to electronic circuit problems.

The course will cover physical principles, general performance and equivalent circuits, ending with specific applications. Laboratory sessions demonstrating both physical principles and circuit applications of the transistor will supplement each lecture topic.

Leading transistor experts from industry will assist the Institute's research staff in the instruction. Tuition for the course is \$160. Full details and application blanks may be obtained from the Summer Session Office, Room 7-103, M.I.T., Cambridge 39, Mass. Academic credit will not be offered.

Sterilization by Radiation . . . High-voltage or cathode rays, X-rays, and radiation from atomic fission products are being studied extensively for their sterilization qualities as a means of replacing the traditional method of sterilization, application of extremes of temperature, according to a report from the Battelle Memorial Institute, 505 King Avenue, Columbus 1, Ohio.

Radiation sterilization has the advantages of not weakening materials or causing drugs to lose their potency, sterilizing after packaging in plastics, and ease of application to a continuous production-line.

A number of problems must be solved before radiation sterilization becomes commercially practicable. Changes in flavor, color or texture may result from irradiation of foods, for example.

Tubes Replaced Needlessly . . . A survey of 80,000 tubes rejected by technicians maintaining military equipment revealed that approximately 25% had no defects when tested on a tube tester. This figure indicates poor training of these technicians, according to a paper ("The Effect of Maintenance on Reliability of Complex Military Electronic Equipment") by J. B. Arnold of Aeronautical Radio, Inc., 1520 New Hampshire Ave., N.W., Washington 6, D. C., presented at the recent IRE Convention in New York.

The unnecessarily high replacement rate was ascribed to two factors. First, because of the complexity of some present military equipment, technicians re-

This foot other as fo struc form by 5 lb of

sort to The re that tu of serv call for as a r of tube In ad to det circuit itself s

To urged and th rowed. solution a few ment p

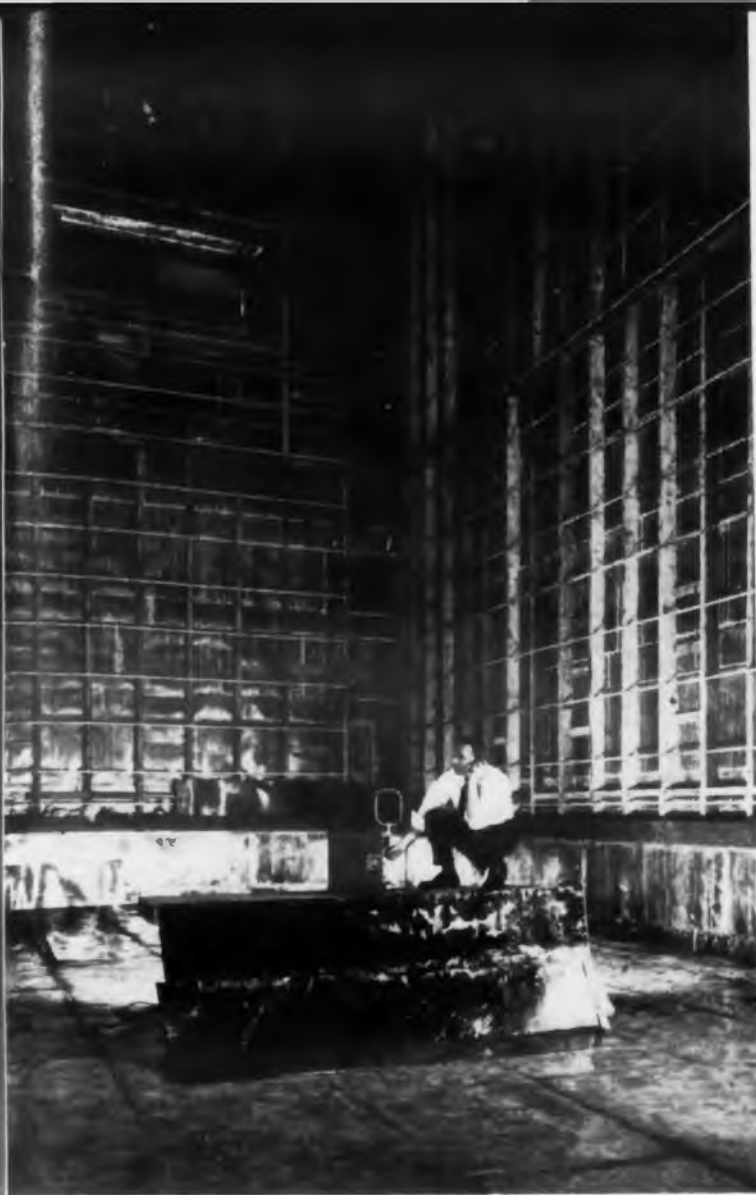

Huge Shielded Room

This completely copper-lined room with its four-foot thick walls was built to test transformers and other equipment for the noise they create as well as for radio and TV interference produced. Constructed at the General Electric Company transformer plant at Pittsfield, Mass., the room is 68 ft by 58 ft and 60 ft high, and it is lined with 20,900 lb of copper. Noise can be measured to 1/2 db.

sort to wholesale tube replacement to remedy failures. The replacement may only mask the real trouble, so that tubes soon fail and the equipment is again out of service. Secondly, maintenance procedures often call for testing large numbers of tube periodically or as a means of trouble-shooting. Continual removal of tubes from their sockets can damage many tubes. In addition, reliance is placed on the tube checker to determine whether the tube will operate in the circuit, when, actually, performance in the circuit itself should be the criterion.

To correct this wasteful situation, Mr. Arnold urged that the gap between equipment complexity and the educational level of the technician be narrowed. Greater use of subchassis design is another solution. The subchassis would be repaired only by a few highly trained technicians, with actual replacement performed by relatively unskilled personnel.

**For improved
potting...**

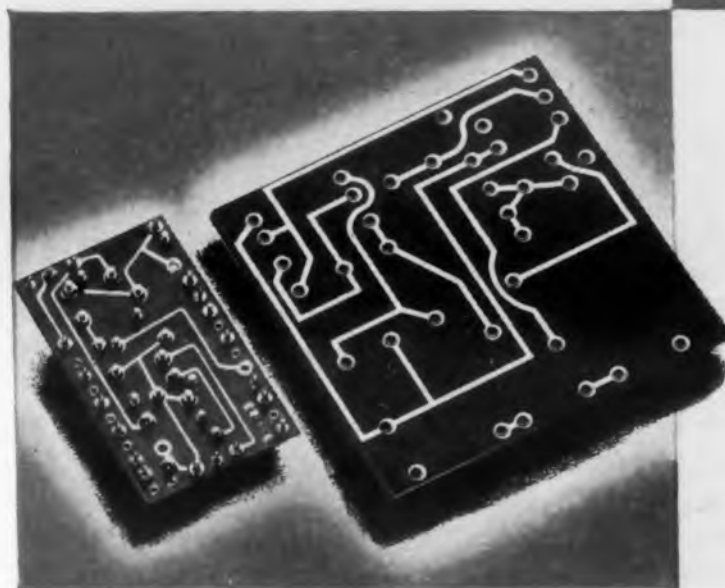

**...for improved
printed circuits**

EPON[®] RESIN

—newly available dielectric material with outstanding advantages

Because of their excellent electrical properties, high moisture resistance, and mechanical strength, Epon resins are solving many problems in modern electronic "packaging."

As potting materials—The extreme dimensional stability of Epon resins and their adhesion to metals and glass assures air-tight enclosure of delicate components and vacuum tubes. Easy to use, Epon resins can be cast at low temperatures—cured in a short time.

For laminates and printed circuits—Epon resins may be bonded to inert fibrous fillers, producing a laminate that may be sheared, punched and drilled . . . that may be bath-soldered without delaminating . . . that maintains high electrical resistance under extremes of temperature and humidity.

You are invited to write for information on the use of Epon resins in electrical and electronic applications.

SHELL CHEMICAL CORPORATION

CHEMICAL PARTNER OF INDUSTRY AND AGRICULTURE

EASTERN DIVISION: 380 Madison Avenue, New York 17 • WESTERN DIVISION: 100 Bush Street, San Francisco 6
Atlanta • Boston • Chicago • Cleveland • Detroit • Houston • Los Angeles • Newark • St. Louis
IN CANADA: Chemical Division, Shell Oil Company of Canada, Limited, Toronto • Montreal • Vancouver

CIRCLE ED-9 ON READER-SERVICE CARD FOR MORE INFORMATION



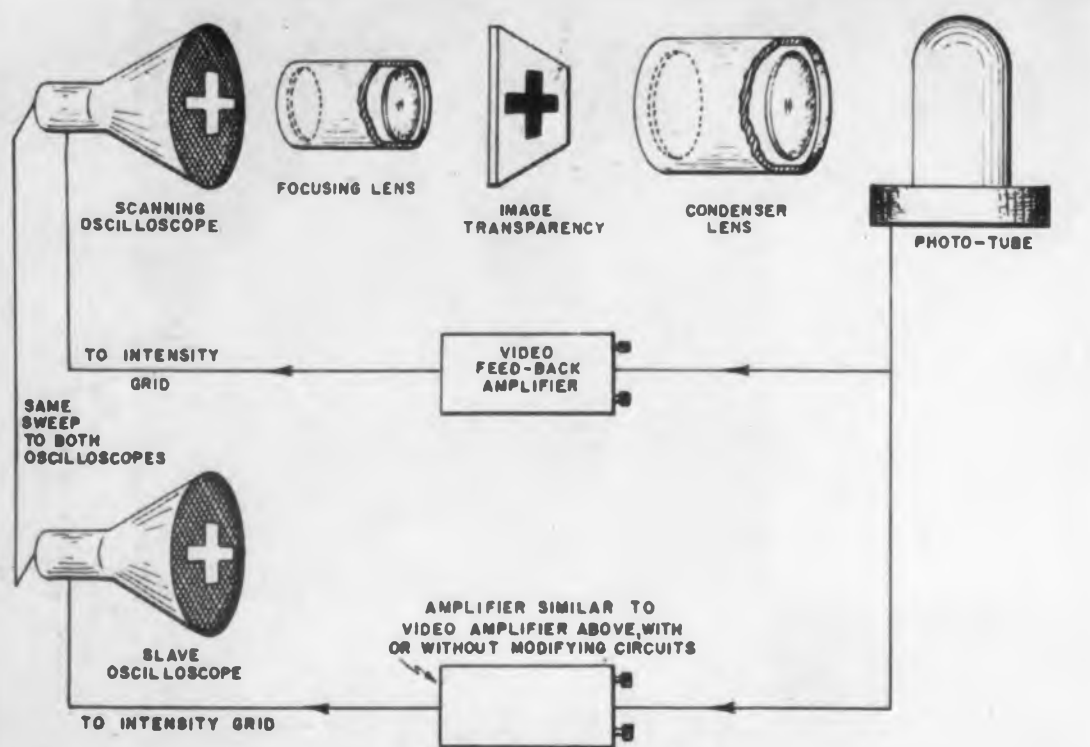

Image enhancement or pattern recognition is accomplished by the opto-electronic system whose block diagram is shown at the left.

Engineering Review . . .

Image Improvement Device . . . A recently constructed opto-electronic system may have many commercial possibilities in TV, photo transmission, and medical research. The experimental device can clarify blurred images or produce outline pictures or line drawings from photographs. A block diagram of the system is shown above.

This image processing system was developed by H. M. Joseph of the National Bureau of Standards, Washington 25, D. C., and Dr. L. S. G. Kovasznay, Johns Hopkins University, Baltimore, Md., who suggested the basic design. The system operates on patterns in the form of photographic transparencies placed as shown. The signals resulting from scanning the picture are amplified and fed back to the intensity control of the cathode ray tube and produce a picture on its screen.

The negative feedback obtained in this way improves the tonal rendition of the picture. The same signal is also applied to another amplifier and the resulting signal is used to control a monitor cathode-ray tube that reproduces the same image. Altering the monitor for image processing is accomplished by introducing modifying circuits between the phototube and the monitor. This freedom to modify the picture on the monitor is the essence of the system.

Any scanning pattern may be used, but it greatly simplifies the electronic circuits if the scanning velocity is the same in two orthogonal directions.

The system has been used to date in the study of the enhancement of contours in photographs and to make outline pictures from photos. The process of

contour enhancement is essentially that of increasing the abruptness of tone transition at contour lines. A similar phenomenon occurs in the "brightness contrast" in human vision.

The outlining process may be used for automatic production of sketch maps from terrain photos or the display of contours on X-ray pictures. In picture transmission where line drawings are acceptable, economies in bandwidth are possible through reduction in the information that must be transmitted. Contrast enhancement may also be used in TV to reduce the effects of low transmission bandwidth. The suggestion has been made that the system would be useful in analog computers as an aid to the solution of some types of differential equations.

This simple block diagram of the Video Tape Recorder shows the functions of the 12 tape channels in recording images on magnetic tape.

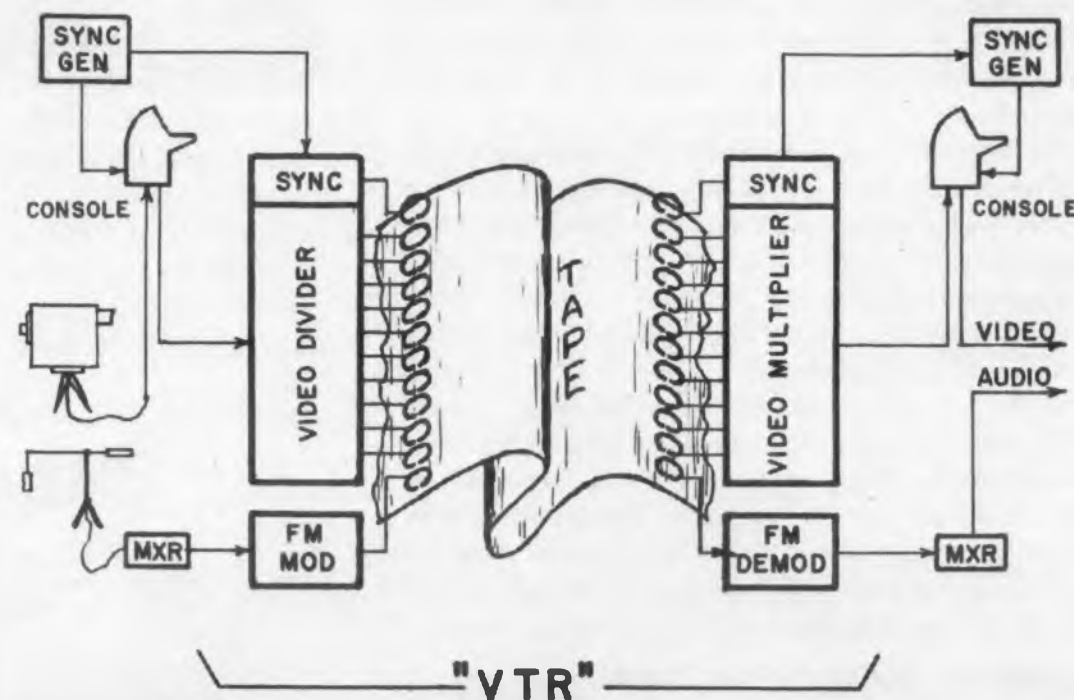

Movies on Magnetic Tape . . . By extending the top frequency at which magnetic tape recorders can operate, the recording of TV pictures on magnetic tape has been brought close to commercial use. A newly developed Video Tape Recorder can "film" a 20-minute monochrome TV program on ordinary size reels of 3/8" Mylar tape at 100" per second.

The tape is divided into 12 channels. The top channel carries the horizontal and vertical synchronization signals. The next 10 channels carry the video signal broken down into bits of information. The last channel carries f-m sound.

Ten magnetic recording heads of special design record 339,000 bits per second each on their respective channels for a total of 3,390,000 bits per second. The picture is divided for presentation to the 10 heads by a pulse-forming, delay line and electronic switch circuit. On playback the picture signal is re-assembled by a similar circuit.

Another method of recording pictures on magnetic tape (see *ED*, December, '53, pp. 8-9) uses two channels on 1/4" tape for monochrome and five channels on 1/2" tape for color recording.

Developed by the Electronic Division of Bing Crosby Enterprises, Los Angeles, Calif., the Video Tape Recorder has been offered for military use. It may eventually replace photographic methods in the making of motion pictures and kinescopes. It can provide a recording and many simultaneously produced copies all of which are ready for immediate playback without further processing. Unlike film, the magnetic tape can be erased and reused.

Considerable flexibility in motion picture making could be gained by use of the system, since several TV cameras could be employed simultaneously, with the director continuously choosing the best image for recording on the one reel.

A color recorder based on the same principles as the monochrome unit is now under construction.

Meetings

May 17-20: *Basic Materials Conference and Exposition:* International Amphitheatre, Chicago, Ill. For information contact Clapp & Poliak, Inc., 341 Madison Ave., New York 17, N. Y.

May 17-20: *Electronic Parts Show,* Conrad Hilton Hotel, Chicago, Ill.

May 24-26: *Conference on Telemetry.* Morrison Hotel, Chicago, Ill. This gathering is under the joint sponsorship of IRE, AIEE, Institute of Aeronautical Sciences, and the Instrument Society of America. Subject matter will be of wider scope and deeper interest as a result of the considerable amount of telemetry and remote control recently developed. General Chairman, W. J. Mayo-Wells of the Applied Physics Laboratory of Johns Hopkins University. Contact AIEE, 33 West 39 Street, New York 18, N. Y.

June 7-10: *National Plastics Exposition and Technical Conference.* Public Auditorium, Cleveland, Ohio. For information contact E. L. Frantz, Society of the Plastics Industry, Inc., 67 W. 44 Street, New York, N. Y.

June 16-18: *High Vacuum Symposium.* Sponsored by Committee on Vacuum Techniques. Berkeley Carteret Hotel, Asbury Park, N. J. For information write to P. O. Box 1282, Boston, Mass.

June 21-25: *AIEE Summer and Pacific General Meeting.* Los Angeles, Calif. Contact AIEE, 33 West 39 Street, New York 18, N. Y.

June 21-July 2: *Seminar on Analog Computers.* Conducted by the Dept. of Electrical Engineering, Pennsylvania State Univ., in cooperation with various industrial organizations. State College, Pa. For information, write to Engineering Seminar Registration, General Extension Bldg., Pennsylvania State Univ., State College.

June 23-25: *IRE Symposium on Global Communications.* Washington, D. C.

June 23-26: *Acoustical Society of America, 25th Anniversary Meeting.* Hotel Statler, New York, N. Y. For information contact W. Waterfall, 57 East 55 Street, New York 22, N. Y.

September 1-16: *Golden Jubilee Meeting of the International Electrotechnical Commission,* University of Pennsylvania, Philadelphia, Pa.

September 13-24: *First International Instrument Congress and Exposition,* Commercial Museum and Convention Hall, Philadelphia, Pa.

November 29-December 3: *First International Automation Exposition,* 242nd Coast Artillery Armory, New York, N. Y. For information, write to First International Automation Exposition, 845 Ridge Ave., Pittsburgh 12, Pa.



ARE YOU READY FOR
Guaranteed
Shield Performance?

MAGNETIC SHIELDS

Are you ready for a major electronic and electrical first—Magnetics, Inc. "Performance-Guaranteed" Shields for shielding of standard cathode ray and other tubes against moderate and high flux external fields . . . and custom-designed "Performance-Guaranteed" Shields for specific shielding problems?

Here are shields which eliminate waste . . . are guaranteed to your performance specification . . . and are sold at standard prices.

THE WIDEST CHOICE IS YOURS

MATERIALS . . . Premium quality Performance-Guaranteed Shields are usually made from Mumetal or A.E.M. 4750, dry-hydrogen annealed for optimum isolating properties. Shields can be made from any other commercially available magnetic and non-magnetic materials when required by performance specifications.

METHOD OF MANUFACTURE . . . Performance-Guaranteed Shields can be fabricated or drawn by Magnetics, Inc., depending upon which is most economical for your requirements.

FINISH . . . Performance-Guaranteed Shields can be furnished painted, lacquered or unfinished, as your requirements dictate. Paint color can be matched to any equipment shade you select. Pre-painting by Magnetics, Inc. eliminates danger of damage to shields in painting operations in your plant . . . provides you with shields immediately ready for your assembly operations.

FREE ENGINEERING DESIGN . . . Our Engineering Department will carry out all phases of your shield design . . . including magnetic analysis . . . mechanical design . . . and production engineering to your cost requirements.



write on company letterhead

MAGNETICS inc.

DEPT. ED-9, BUTLER, PENNSYLVANIA

CIRCLE ED-10 ON READER-SERVICE CARD FOR MORE INFORMATION

HYDRAULIC-MAGNETIC circuit breakers offer electronic designers an excellent means of providing extremely close protection for electronic components without causing unnecessary power interruptions. They can also be used to perform many auxiliary control functions, permitting great design flexibility.

Essentially, the problem of applying protective equipment is three-fold: (1) to provide circuit interruption fast enough and at a sufficiently low current value to protect the circuit and components; (2) to prevent unnecessary power interruptions; and (3) to use the protective device most economically in terms of the additional functions it may perform. While these are the overall objectives, the design engineer will be aided in matching protective equipment to the application by considering each of the following essential factors:

- a. Proper ratings
- b. Inrush characteristics and overload tolerances
- c. Ambient temperature effect
- d. Frequency considerations
- e. Most advantageous circuitry
- f. Special mechanical and physical features

The hydraulic-magnetic circuit breaker meets these six considerations. Fig. 1 illustrates its construction. A solenoid-type, over-current sensing element with either instantaneous or time-delayed response is the entire electrical phase of the circuit breaker. Through an armature, it connects with the mechanical phase

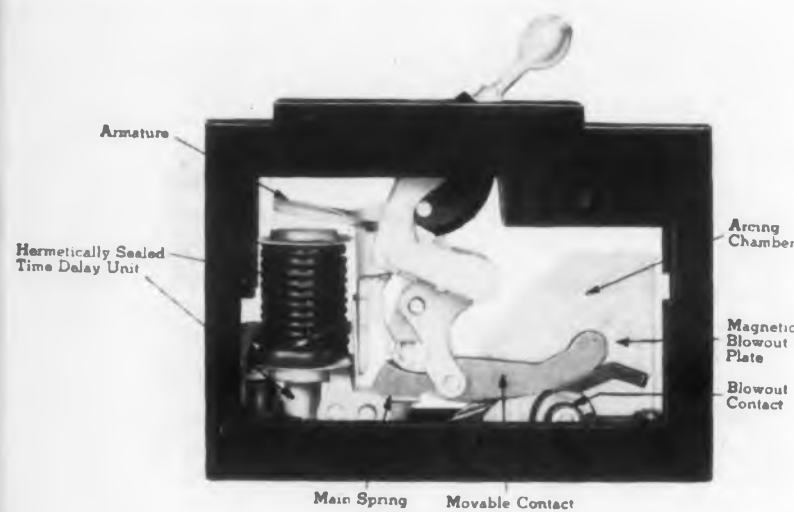

Fig. 1. Exposed view of a hydraulic-magnetic circuit breaker.

which is essentially a toggle link with a high-speed latch, a moving contact and a stationary contact equipped with a magnetic arc-blowout assembly.

For time delayed response, the sensing element has a hermetically sealed, nonmagnetic tube instead of the solid core characteristic of most solenoids. The tube extends through and beyond the coil and contains a spring-loaded movable iron core, shown in black in Fig. 2, as well as a silicone damping liquid. Under normal loads, the core does not move (A, Fig. 2).

When an overload occurs, the movable core is

Circuit Breaker Considerations

Richard S. Kurtz

Heinemann Electric Company, Trenton, N. J.

drawn into the magnetic field, but the silicone liquid slows down its travel (B). This provides the time delay to allow for inrush or harmless overload conditions. As the core moves into the coil, it reduces the air gap, thus reducing the reluctance in the field.

When the core touches the pole piece, the magnetic circuit is complete and the armature is actuated, tripping the circuit breaker (C). On overloads of greater magnitude, the magnetomotive force will be sufficient to actuate the armature before the core reaches the pole piece. Thus, inverse time delay characteristics are provided. On short circuits and extreme overloads of ten times the circuit breaker rating or more, the movable core is not a factor and tripping is instantaneous.

Proper Ratings and Inrush Effects

A good basic principle is to rate the protective device as close as possible to the current capacity of the circuit. Electronic circuits have very slight ability to withstand overloads. Due to the critical nature of electronic components, use of so-called standard ratings is impractical. Take a circuit, for example, that should be rated at 16.5amp. Obviously, 15amp circuit protection will not suffice, but neither will the next "standard" rating of 20amp since more than a 20% overload would have to occur before the current even reaches the rating of the protective device. Under such conditions, not only would circuit interruption be too slow on large overloads, it would also permit continuous small overloads with excessive heating and long-range deterioration. In this case, the circuit breaker should be rated actually at the 16.5amp value.

In establishing the rating one should simply take the maximum normal operating current of the circuit or any particular component that limits the circuit. Hydraulic-magnetic circuit breakers are available with precise ratings, even fractional ratings, for any continuous current value from 10ma to 150amp, and precise ratings should be specified if adequate protection is to be attained.

Since the hydraulic-magnetic type of circuit breaker does not employ thermal elements, it is not necessary to employ any derating factor to compensate for changes in ambient temperature.

It is readily apparent that on large, harmful overloads and short circuits maximum speed in circuit

interruption is important. In some circuits where there are no surge currents with which to contend, instantaneous circuit breakers are used. In most circuits, however, there are inrushes or high initial pulses and there are harmless, temporary overload conditions that should not needlessly interrupt service by tripping the circuit breaker. For this reason, inverse time delay is provided.

An important specification that the electronic design engineer must provide pertains to time delay. Time delay must be long enough to prevent unnecessary service interruptions and short enough to protect critical electronic components. Several variables in hydraulic-magnetic circuit breakers, including the viscosity of the silicone fill and the movable core construction, allow the response curve (time vs. percent load) to be varied. A selection of response curves is available for each model of circuit breaker so that the response characteristics may be matched to the equipment being protected.

Fig. 4 shows a typical set of time delay curves for 60cy a-c operation. The difference among the curves is the time delay provided for a given value of overload. Curve 1 allows for a long inrush or overload period. It is designed principally for motor protection where the circuit breaker is rated at the full-load current of the motor. Curve 2 represents a shorter time delay, generally used for mixed circuits consisting of motors, lights, etc. Curve 3 has been developed especially for electronic applications. It passes the larger, flash inrushes characteristic of electronic circuits. At the same time it is an extremely fast response curve which does not tolerate any degree of prolonged inrush or overload. Protection of some electronic components, particularly instruments, is so critical that a special breaker with a response curve, not shown but designated as Curve 3X, is used. It has t-d characteristics about one-half of Curve 3.

Temperature Effects

The manner in which ambient temperature should and should not be compensated for in the overload protection device is often misunderstood. There are three fixed characteristics that should not change with temperature. They are: the current carrying capacity; the minimum current value at which the circuit breaker must trip with time delay; and the instan-



Fig. 2. Curves of time delay of different types of circuit breakers.

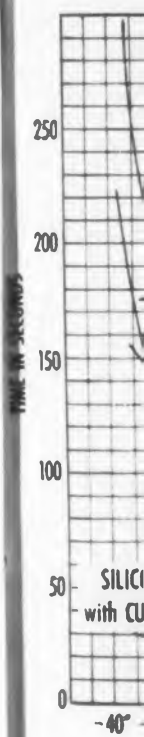

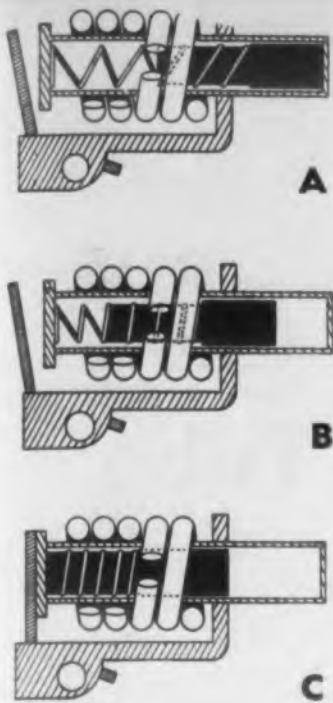

Fig. 2. Operational sequence of the circuit breaker. The magnetic core is in black.

Fig. 3 (below). These curves illustrate how the time-delay characteristics of the breaker vary with different hydraulic fluids.

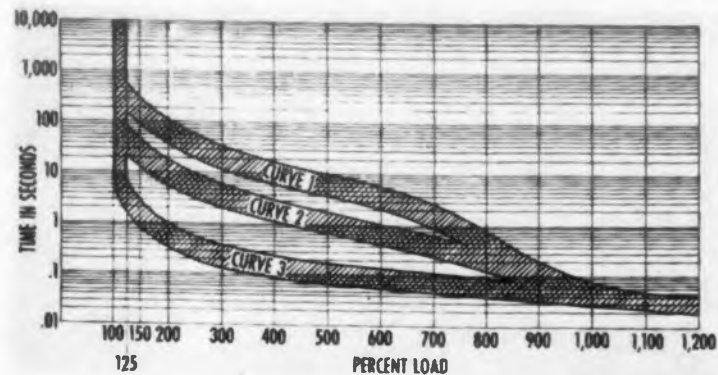

Fig. 4. Time-delay characteristic curves for a long inrush for motors (curve 1), shorter overload (2), and quick closing for electronic units (3)

without damage to circuits or equipment. The variation in time delay is provided in hydraulic-magnetic circuit breakers by the change in viscosity of the liquid fill within the time delay tube. The effect over a temperature span of -30 to 150°F for a fixed overload condition (250% load) is shown in Fig. 3. This chart shows how ambient temperature affects the 250% load point on Curves 1 and 2 in Fig. 4.

Silicones are the standard liquid fill for the time delay tube and they are relatively stable in viscosity with respect to temperature. There are applications, however, where a greater temperature-time variation is highly desirable. For these applications, hydraulic oils may be used instead of the silicones, increasing the variation manyfold as shown in Fig. 3.

can meet these special current conditions. Specify ripple factor for rectified current applications.

Circuitry and Special Features

Adaptability of the circuit breaker goes beyond precise ratings and a variety of response characteristics. They also lend themselves to unique circuit arrangements and permit economical use of a single breaker for several functions in a circuit. It is quite common for a single circuit breaker to serve as the power switch, as overload and short circuit protection, and as the means of control interlock.

Aside from the virtually unlimited special forms, which are beyond the scope of this article, there are four standard circuits which can be arranged in any combination in one, two or three-pole circuit breakers. These circuits, with explanations, are given in Fig. 5.

In making circuit calculations, the circuit breaker should be considered in exactly the same manner as other components. Circuit breaker manufacturers will furnish data on voltage drop, impedance, wattage loss and other pertinent factors as well as the minimum voltage required for circuit breaker operation.

Among the special features that should be considered in specifying circuit breakers are some that are similar to other components such as fungus and moisture-proofing and some that apply particularly to circuit breakers such as non-trip-free construction. Use of alarm contacts, vibration-resistant constructions and other special features, as well as the most suitable physical design, should be planned with the circuit breaker manufacturer.

Frequency Considerations

Very common errors in the application of circuit breakers are due to a failure to consider frequency effects or a failure to differentiate in specifications between direct current and rectified direct current. The circuit breaker solenoid for d-c operation requires a greater ampere-turn ratio than for alternating current. When a circuit breaker is tripping on alternating current, the power acting on the armature is pulsating at a frequency twice as great as the frequency of the current. Thus, a series of strikes are applied by the armature against the latch to effect tripping. In the tripping process on direct current, there are no pulsations of power and, therefore, tripping must be accomplished in one stroke.

Since the magnetic circuit is more efficient on 60cy a-c, it might be supposed that the same or greater efficiency would be achieved at 400cy. This is not the case due to additional losses which are proportional to the frequency, namely, hysteresis, eddy-currents, and "skin effect." Circuit breakers for higher frequencies must incorporate design modifications such as lower latch loadings to compensate for these losses.

When circuit breakers are specified for d-c operation, they are calibrated for battery or generator sources of supply, not rectified direct current. Experience has shown that rectified d-c is entirely different in its action as far as tripping is concerned. Half-wave rectified d-c is actually a series of pulses resembling the effect of alternating current. Variations in design and calibration of the circuit breaker

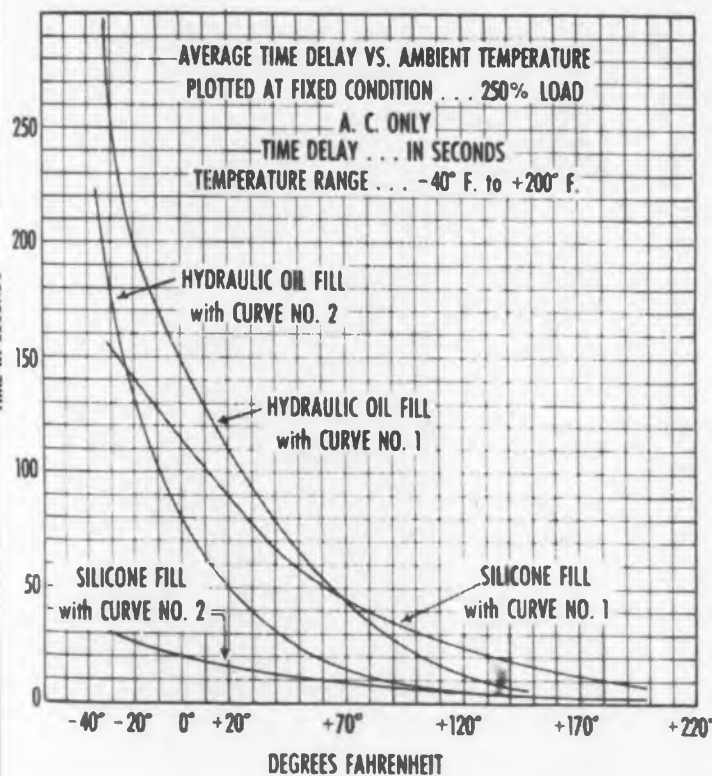

aneous trip value. With these definite characteristics, there is no danger of the circuit breaker tripping needlessly when hot, or not tripping when cold.

It is some times desirable, however, to compensate for a change in temperature by adjustment of the time delay. At higher ambient temperatures, it is still necessary to carry the rated load, but overloads cannot be tolerated for as long a period. With lower ambient temperatures, overloads can be more prolonged



Fig. 5. Circuit setups.

Series Trip. The conventional arrangement in which over-current sensing and circuit interruption are in the protected circuit. Can protect supply voltage wiring or individual components.

Shunt Trip. For control interlock. The shunt circuit through the solenoid connects with high- or low-limit safety switches. Shunt trip breakers trip at the rated circuit voltage.

Relay Trip. The solenoid and the switching element are in separate circuits. Useful for control interlock applications, with the control circuit at a different (usually lower and more economical) voltage, a-c or d-c.

Calibrating Tap. Provides additional tap between switching element and coil. Shunting the coil with a resistor, raises the trip point of the breaker. Also permits two loads from same power source to be controlled by overcurrent in one.

new! Integral core and coating design

castohm[®]

FIXED WIREWOUND POWER RESISTORS

**OUTPERFORMS ALL CONVENTIONAL
POWER RESISTORS**

- Higher Wattage Ratings — smaller sizes
- 25% lighter in weight
- 350°C hot spot operation
- Closer Tolerances — to 1% (5% standard)
- Better heat conductivity
- Exceptional resistance to thermal shock
- Designed to MIL-R-10566 specifications



New Shallcross Castohm power resistors surpass all previous standards for high wattage fixed power resistors. Thoroughly tested and designed to MIL-R-10566 specifications, Castohms offer unique opportunities for saving space and weight while improving the reliability and efficiency of modern industrial and military equipment. Specifications on all types from 8 to 225 watts are yours for the asking. SHALLCROSS MANUFACTURING COMPANY, 526 Pusey Ave., Collingdale, Pa.

Shallcross

CIRCLE ED-11 ON READER-SERVICE CARD FOR MORE INFORMATION

A New Indicator Tube

ANY NUMBER from 0 to 9 can be made to appear on the "Inditron", Type G10, a new indicator tube shown in Fig. 1. A gas discharge device similar to ordinary glow lamps, the tube can be operated at high speeds to serve as a read-out device for computers, electronic counters, game machines, electronic clocks, and many other applications. In computer indicating registers, it can replace the array-of-ten glow lamps commonly used in these devices.

The Type G-10 Inditron is a 10-element tube containing the decimal numeral forms 0,1,2,3,4,5,6,7,8 and 9, stacked one behind the other with close spacing. Any interference to the display of a character in the rear of the stack by those in front is minimized by making all the character forms of extremely fine wire. The cathode glow completely surrounds the selected character with a brilliant illumination several times the diameter of the wire form. Viewed at a distance of several feet, there is no apparent change in depth and there is very little difference in clarity with the changing levels.

A product of National Union Radio Corp., 350 Scotland Road, Orange, N.J., the tube employs a T-6-1/2 bulb and has a seated height of about 2". The 10-pin base fits into any standard 9-pin miniature tube socket having a center shield element. Pin No. 10, located in the center of the tube's base, is equipped with a side spring which makes contact with the center shield element of the standard socket.

A given character is caused to glow by lowering its potential with respect to all

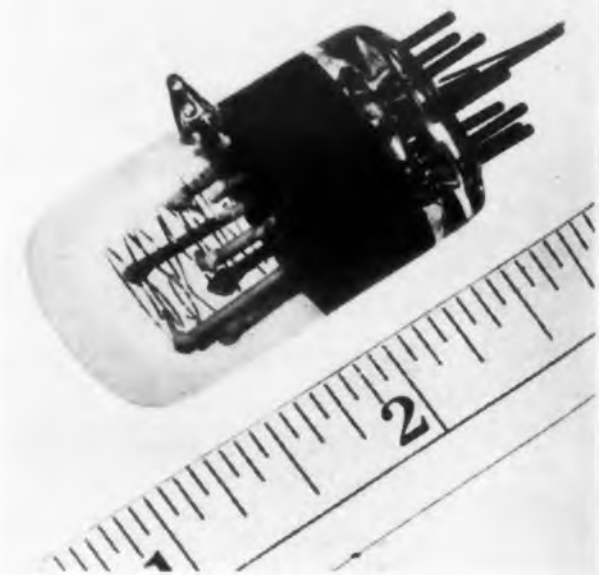

Fig. 1. The "Inditron", an indicator tube which can display numbers from 0 to 9.

other elements by the value of the breakdown voltage. A basic operating circuit is shown in Fig. 4. Switch SW can bring any selected element to B- potential while all the other elements remain at B+ until ignition starts. Then the potential of all the remaining elements adjusts to the natural tube drop. The discharge current distributes itself equally across the resistors and therefore each resistor is nine times the value for a single resistor setup.

The switch can be any manually or mechanically operated rotary switch, or any vacuum tube switching circuit capable of delivering the required voltage change and operating current. The power supply for the circuit in Fig. 4 can be used to operate up to 10 Inditrons.



Fig. 3. Basing diagram of the "Inditron". The number 10 pin is connected to a center prong on the tube's standard 9-pin miniature base.

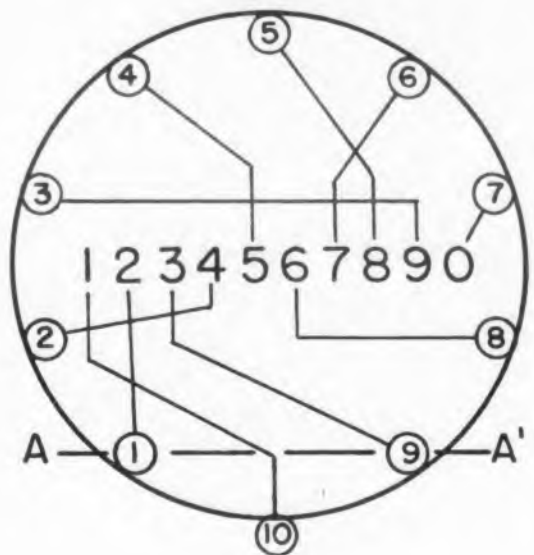
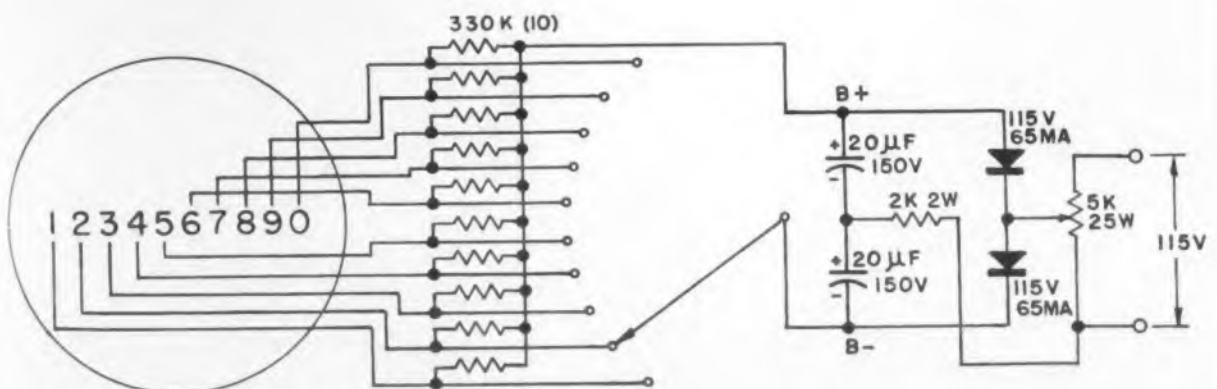
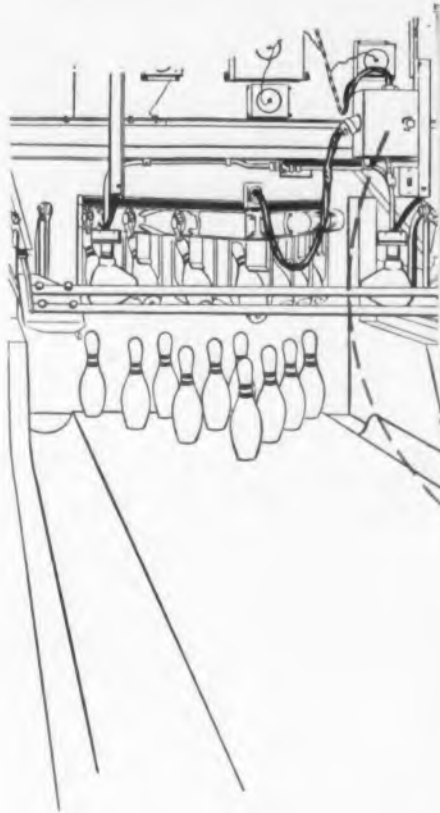

Fig. 2. (left). This is the way the numbers look when different elements of the indicator tube are energized.

Fig. 4. Circuit for operating the indicator tube. The power supply shown is capable of operating 10 "Inditrons".



Automatic Pinspotters too, rely on **STERLING RELAYS**



for—

- fast, sure operation
- compact, rugged construction
- long, trouble-free service

These amazing machines perform *automatically* every pit function in bowling, on a 17-second cycle, 24 hours per day! Six STERLING Relays in the machine's "brain" reliably coordinate a multiple series of electric and electronic circuits which actually enable it to "remember" and act with almost human intelligence... and superhuman accuracy!

To meet their exacting requirements, the manufacturers of Pinspotters rely on STERLING Type PS Relays—one of the many types of STERLING Relays used by leading manufacturers of electrically- and electronically-controlled equipment.

General Specifications: Sterling Type PS Relay

COIL—single wound to 220 volts AC or DC • POWER CONSUMPTION—2.5 watts DC—4.5 V.A. AC • OPERATE TIME—approx. .025 sec. • RELEASE TIME—approx. .010 sec. • SPRING COMBINATION—2C (DPDT). #10 (1/4" silver) contact is standard. Contact Codes 3, 9, 11 and 12 are also available. • MOUNTING—4 #6-32 stop nuts on 1/2" x 1-5/16" centers; four 7/32" clearance holes on same centers also available. • DIMENSIONS—1 1/2" x 1 1/8" x 1-13/16" high. • WEIGHT—approx. 4 oz.

May we send you the STERLING Relay Catalog or make up a test relay to fit your specific needs? Write STERLING ENGINEERING COMPANY, INC., 54 Mill St., Laconia, N. H. (Subsidiary of American Machine & Foundry Company, New York.)



CIRCLE ED-12 ON READER-SERVICE CARD FOR MORE INFORMATION

Fig. 1. The "Super V" Receiver (right) compared with a conventional set.



Vertical-Chassis TV Receiver

MERCHANDISING advantages, small size and weight, and ease of servicing are the results of the clever thinking that went into the design of the Crosley "Super V" TV Receiver shown in Fig. 1. A 17" receiver, it occupies about 1/3 less cabinet space and weighs about 40% less than conventional models.

By employing a vertical chassis arrangement instead of the conventional horizontal box, and by placing the controls at the side instead of at the front of the cabinet, the designers were able to produce a set whose front is practically "all screen". This feature provides the manufacturer with many merchandising advantages—a cabinet that occupies only 2.5 cu ft (14"x18"x19"), low weight, "portability", "an uncluttered cabinet", a perfect "second set", etc.

The most spectacular advantage of this radical departure in TV chassis design is the ease of servicing the set. It is really designed for service. For example,

by removing the back of the set, all the tubes are made easily accessible for rapid checking and replacement, as can be seen in Fig. 4. If the serviceman needs to replace a capacitor or resistor in a conventional receiver, he has to remove a chassis weighing about 50 lb or so from the cabinet to get at the damaged component. To get at the entire chassis in the "Super V" receiver, the serviceman removes four screws, lifts off the bonnet-type cabinet, exposing all the components for quick service or rapid replacement of the faulty parts. Fig. 4 also shows the front or underside of the chassis with the picture tube removed to expose the component arrangement. Note that the vertical chassis also supports the focus and deflection coils for the picture tube.

Another unusual feature of the set is that it employs only 15 tubes (including the picture tube), instead of the 18 to 22 tubes used in most receivers.

Seven of these are dual purpose tubes. The tube complement includes: 6BC5 (r-f amplifier), 6J6 (v-h-f oscillator and mixer), 6CB6 (1st i-f amplifier), 6BC6 (2nd amplifier), 6AM8 (3rd i-f amplifier and video detector), 6AN8 (video amplifier and sync clipper), 6U8 (4.5Mc i-f amplifier and sync amplifier), 6BN6 (limiter-discriminator and audio amplifier), 6SN7GT (horizontal afe and horizontal oscillator), 25L6GT (audio output), 25BQ6GT (horizontal output), 12BH7 (vertical oscillator and vertical output), 12AX4GT (horizontal damper), 1X2B (high voltage rectifier), and 17HP4 (picture tube).

The tube heaters are connected in series, and a resistor is used to limit the initial current surge, thereby reducing tube failures caused by filament heat shock. This arrangement also eliminates the need for a filament transformer or heavy filament windings on the power transformer and reduces weight, heat, and cost.



Fig. 2. The unique chassis construction and component arrangement of the unit compared with a standard receiver.

Fig. 3. To service the receiver, the cabinet is lifted off the chassis instead of pulling the chassis out of the cabinet.



Design Forum

IDEAS that started in a HEAT EXCHANGER

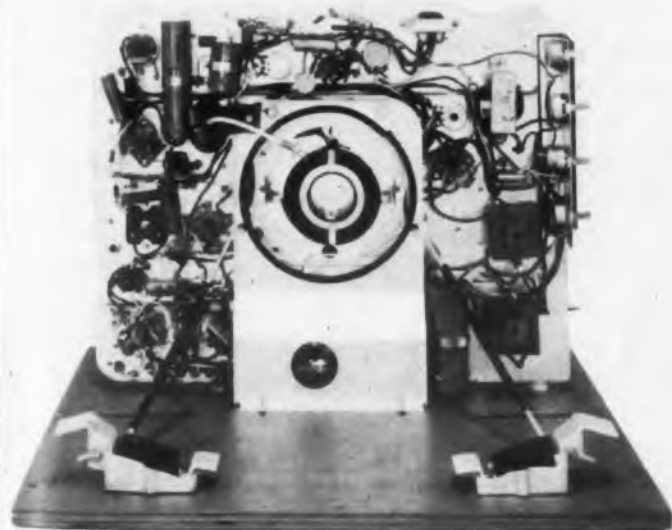
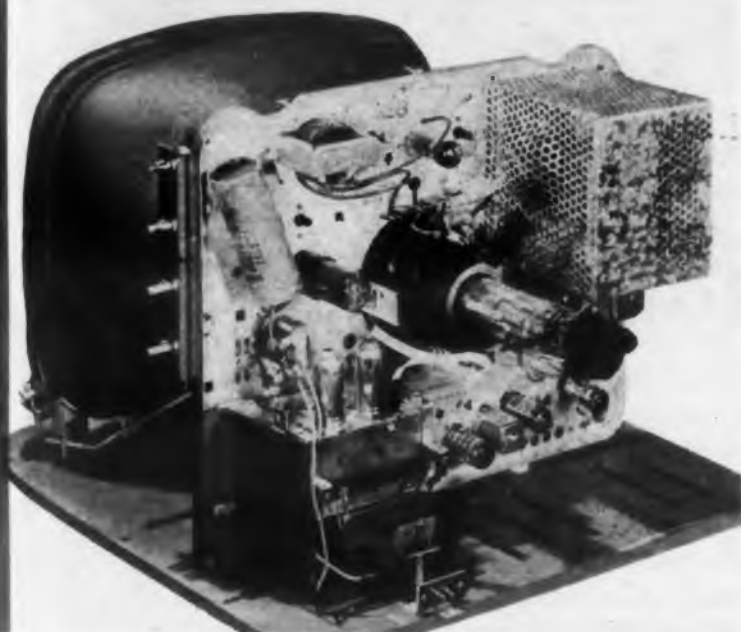
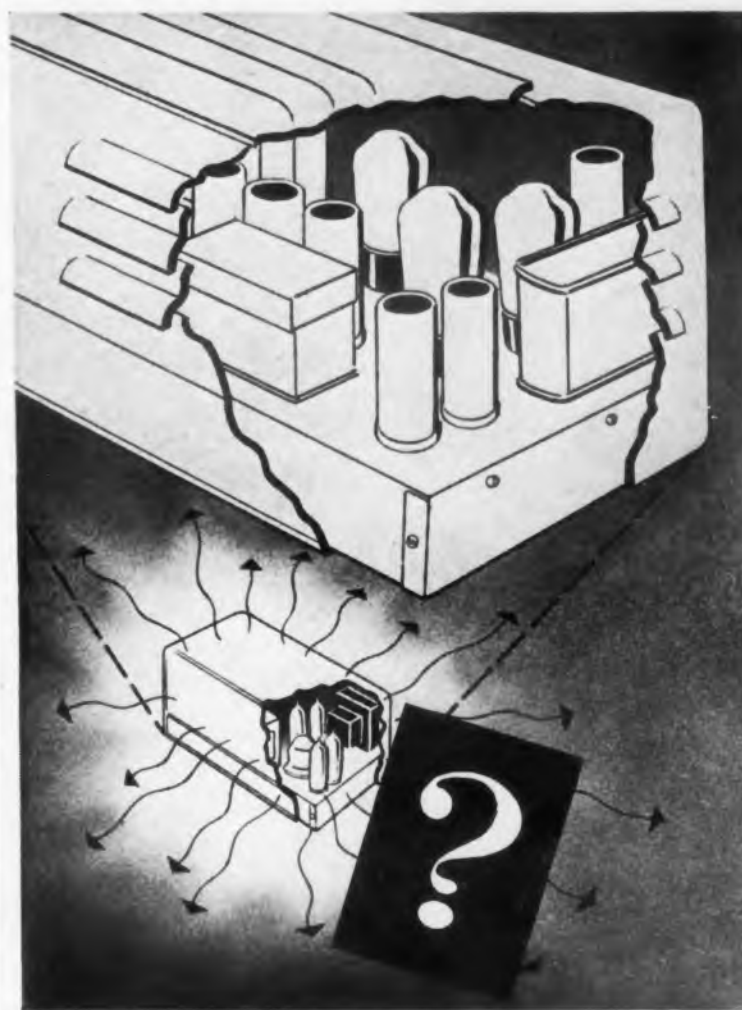
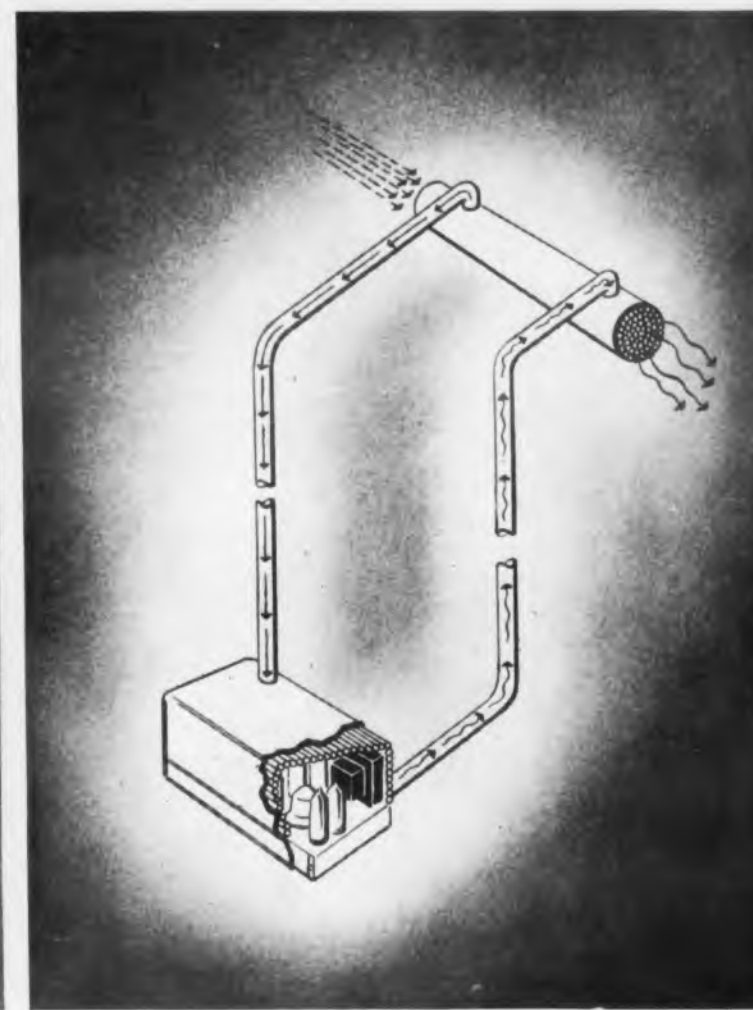

Fig. 4. All components are easily serviced as shown by these front (below, with picture tube removed) and back views.



THE PROBLEM

New high-efficiency electronic units (lower unit in above panel) occupy as little as one-twentieth the space of older, air-cooled types (upper unit) — but they generate just as much heat. And since their hermetic sealing prevents direct cooling by air flow, temperatures would rise far beyond safe limits unless the heat were removed and dissipated elsewhere. At the same time, cooling equipment must be kept light and compact enough for aircraft use.



THE SOLUTION

Working with a leading manufacturer of electronic equipment, Clifford engineers designed the case of this aircraft electronic unit as a liquid heat exchanger. Heat is extracted by connecting with a second exchanger of the air-flow type, as shown. In jet-engined planes, however, heat is preferably dissipated by a liquid-to-liquid cooler — thereby reducing drag on the plane. Made entirely of aluminum, these Clifford heat exchange units combine thorough cooling with minimum size and weight.

You may have a cooling problem

Your own manufacture may or may not include aircraft applications. But now or later you may be looking for the best way of dissipating heat generated by high wattage elements in small spaces.

Then it will pay you to talk things over with Clifford engineers. These experts in a highly specialized field have developed successful liquid coolers for every type of aircraft — which includes some of the severest and most unusual working conditions any cooler is ever required to meet.

Clifford Feather Weights, for example, are the only all-brazed type of oil cooler. Their superior weight-strength ratio is the result of a patented brazing method and pre-testing in Clifford's wind tunnel laboratory — largest and most modern in its field.

Take advantage of Clifford's long

record of finding the most efficient and economical answers to the toughest cooling problems. Write to Clifford Manufacturing Company, 134 Grove Street, Waltham 54, Massachusetts. *Division of Standard-Thomson Corporation.* Sales offices in New York; Detroit; Chicago; Los Angeles; Waltham, Massachusetts.



Fig. 2. The three models of single-pole sealed-contact relays.



Fig. 1. Cutaway of a single-pole Magseal exposing the sealed motor element.

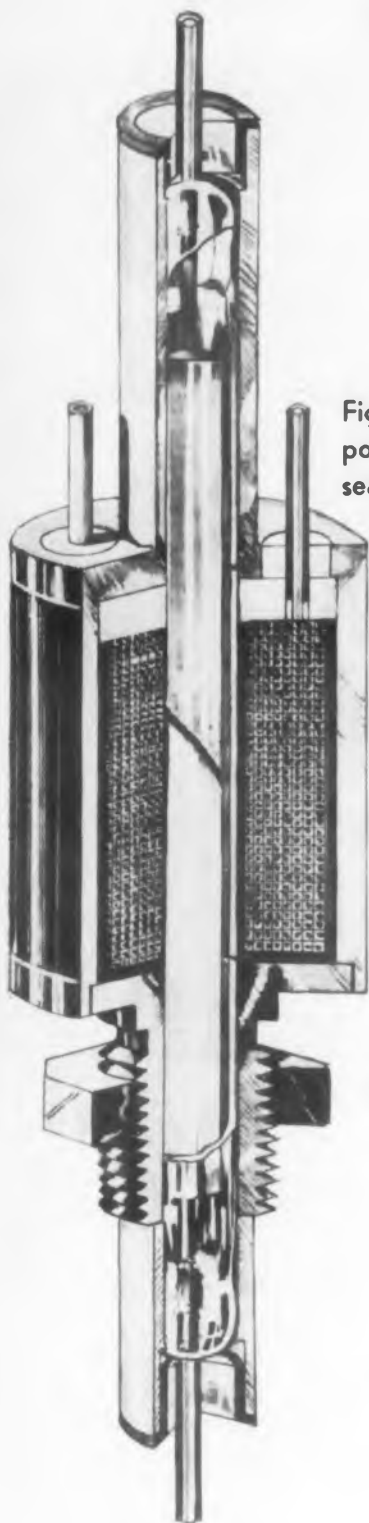

Fig. 3. Multi-pole units in 7- and 61-pole models.

Miniature Sealed-Contact Relays

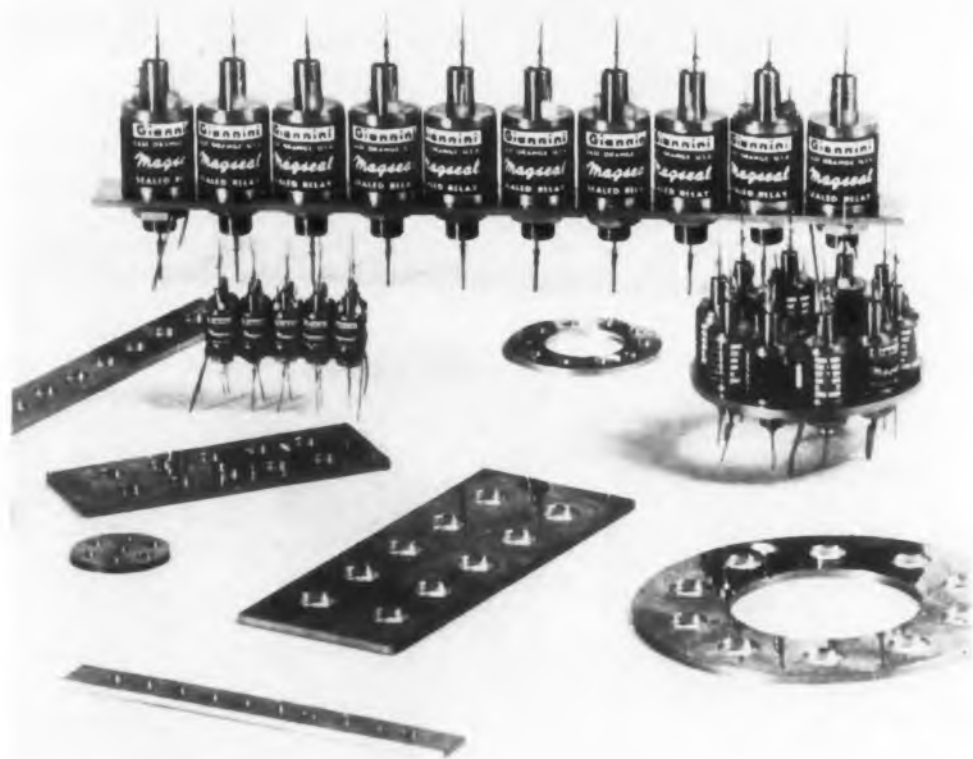

Fig. 4. Various "feedthrough" mounting arrangements for single-pole Magseals.

HIGH operating speed and sensitivity, low contact resistance and capacitance, and a mechanical life of more than one billion cycles of operation are outstanding features of the "Magseal" hermetically sealed contact relays shown in Figs. 2 and 3. These characteristics, combined with the unusual construction of the units affords electronic designers a wide range of circuit and space-saving possibilities. For example, as many as 1296 of the smallest relay in Fig. 2 can be mounted in an area only one foot square.

The relay consists of a standard contact and motor element assembly hermetically sealed in a glass envelope and a core and coil. As shown in the cutaway view illustrated in Fig. 1, the motor element consists of two equal-sized magnetic alloy cylinders separated by a narrow gap, and rigidly attached to flexible rods extending outside the glass envelope. The circuit to be controlled is connected to these rods. The envelope fits inside a hole in a metal core around which the coil is wound. Application of current to the coil produces a magnetic field which brings the magnetic cylinders together and closes the gap between them.

In multiple-pole types, such as those shown in Fig. 3, a larger core with many holes to accommodate up to 109 motor elements for the largest model is employed. Current in the coil closes all contacts together.

The contact and motor element is sealed in a gas atmosphere, affording protection from the effects of

corrosion
for sing

The T
a typic
2", weig
hole. Co
is 60cps
an 8000

It wi
damage
Operati
tion of
range o

The r
motor o
control
model.
affordin
differen

Oper
ple-pole
a millis
ferent
can be
levels i
is about

Man
Eastern
these l
switchi
chines,
devices

A th
ing on
selectin
10-pole
consist
first, s
and 1v
mount

corrosion, dirt, and moisture. The units are designed for single-hole mounting in any position.

The Type 5 spst Magseal (center unit in Fig. 2), a typical relay in the series, measures 1/2" diam x 2", weighs 0.5 oz, and requires a 1/2" diam mounting hole. Contact rating is 0.5amp at 30v; switching rate is 60cps; and operating time is 2 milliseconds. It has an 8000 ohm coil rated 63v, 1/2w max, 100mv min.

It will withstand 50g shock in any plane without damage, and withstand 10g without causing failure. Operation is satisfactory to 60,000 ft without reduction of any rated values. Operating temperature range of the relays is -65°C to 125°C .

The multipole units can be operated with as many motor elements as are required by the circuit to be controlled up to the maximum number for each model. Single or double coil construction is available, affording great circuit flexibility including biased or differential operation of the relays.

Operation and release of all contacts in the multipole models is simultaneous within a fraction of a millisecond. Motor elements, however, made of different types of wrought iron for different sensitivities can be used, affording operation at several current levels in one relay structure. Operating ampere-turns is about the same for any number of motor elements.

Manufactured by G. M. Giannini and Co., Inc., Eastern Division, 39 Main Street, East Orange, N. J., these long-life relays should find uses in all types of switching devices, including computers, business machines, totalizers, relay amplifiers, and signaling devices.

A three-stage multibranch selecting tree for selecting one of a thousand outputs with a decimal digit selecting circuit is shown in Fig. 5. It uses single-pole, 10-pole, and 100-pole Magseal relays. The assembly consists of 30 relays with a total of 1,110 contacts. The first, second, and third stages require 0.1w, 0.3w, and 1w, respectively. The whole assembly requires a mounting surface of only 85 sq. in.

1st Stage	2nd Stage	3rd Stage
10 Relays	10 Relays	10 Relays
1 Make	10 Makes	100 Makes
Per Relay	Per Relay	Per Relay

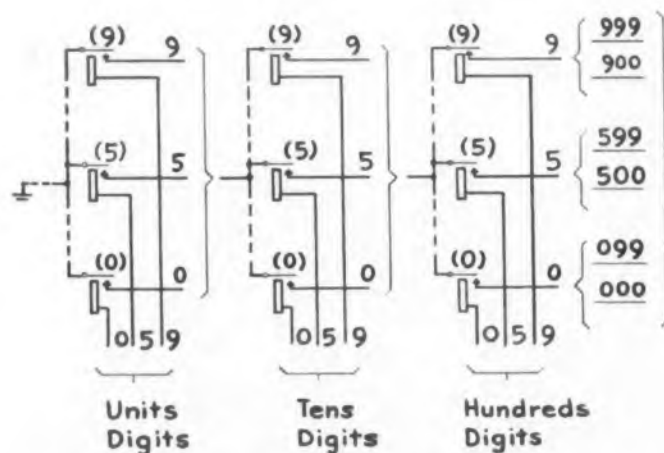
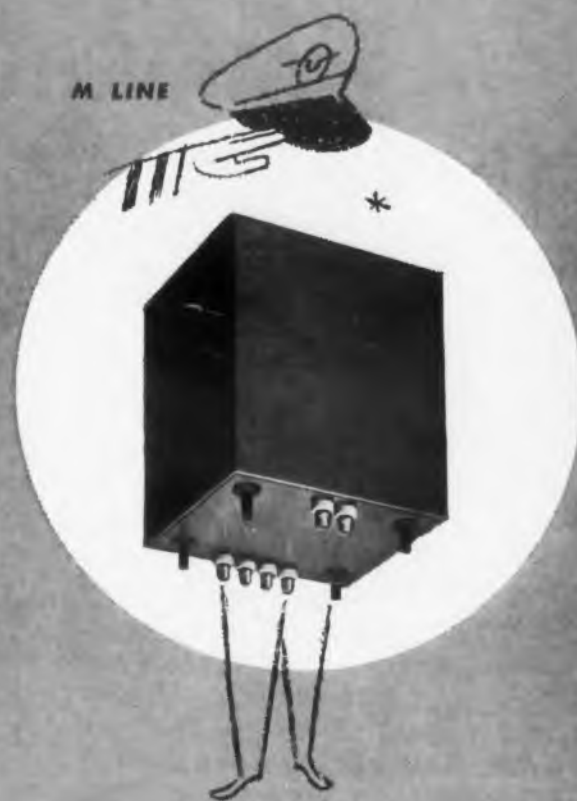

Fig. 5. Only 1.4w is needed to operate this Magseal circuit that selects one of 1000 outputs.

ELECTRICALLY AND MECHANICALLY INTERCHANGEABLE

THE Kenyon TWINS



MEETS ALL MIL-T-27 REQUIREMENTS

Completely hermetically sealed to meet MIL-T-27 specifications. Military Standard types are included. Catalog Listing M L

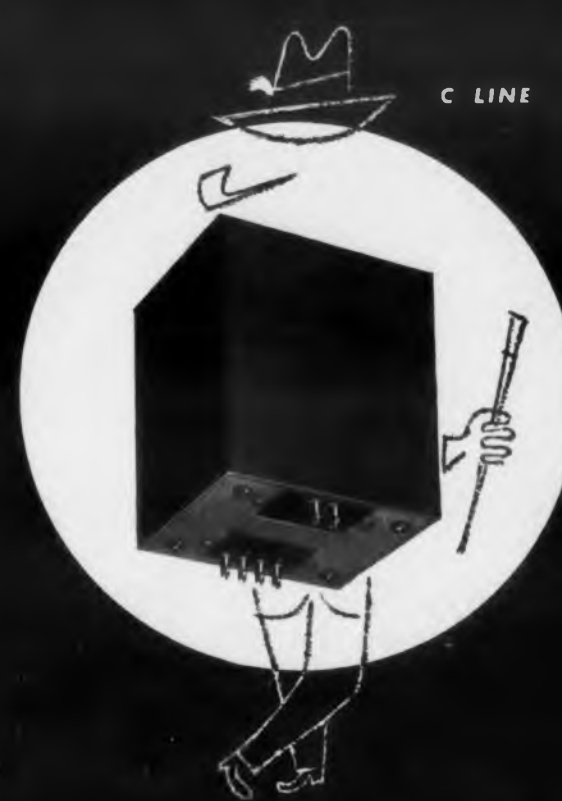

MEETS ALL CIVILIAN REQUIREMENTS

A complete line to MIL electrical specifications, housed in conventional cases. Satisfactory performance at substantial savings. Catalog Listing C L

HOUSED IN CASES WITH STANDARD MIL-T-27 DIMENSIONS, BOTH LINES CARRY THE USUAL KENYON GUARANTEE



The new Kenyon Military and Commercial Lines feature the very latest practice, using the best class "A" wire and insulation now available, and the latest types of core material, to obtain minimum size at reasonable cost. . . . Cases are identical to the requirements in the MIL-T-27 specification and standard units are finished in a smooth, durable medium gray. Other colors are available on special order. Full rating information and schematic is furnished in the form of a stencil on each case. . . . Special units with other ratings and the same or similar cases are available on short delivery, in any quantity. Class B, class C, and class H units can also be delivered no special order. Where casing is not required yet sealing is important, we recommend our "Ken-Seal" molded transformers, available on special order. Write for catalog. Your inquiry will receive prompt attention.

KENYON TRANSFORMER CO., INC., 840 Barry St., New York 59

CIRCLE ED-14 ON READER-SERVICE CARD FOR MORE INFORMATION

KEARFOTT DEVELOPED VERTICAL GYROS



...in production

KEARFOTT vertical gyros providing continuous vertical reference within two minutes of arc under bench conditions typify the engineering knowhow and production skills available to you in the field of precision gyros for airborne control applications.

Designed for particular applications with stringent performance requirements, a wide variety of vertical gyros now in production are being used extensively in aircraft and missile control systems demanding the most precise gyro reference obtainable.

Kearfott gyros incorporate many unique features permitting operation under extreme operational or environmental conditions. A true hermetic seal in dry inert gas provides positive environmental protection. Synchro pick-offs and rigid structural elements assure performance during adverse conditions of vibration or shock.

TECHNICAL DATA SHEETS

Complete technical data in tabular form on Kearfott Precision Vertical Gyros are available on request. Send for copies for your files. Write today.

KEARFOTT COMPONENTS INCLUDE:

Gyros, Servo Motors, Synchros, Servo and Magnetic Amplifiers, Tachometer Generators, Hermetic Rotary Seals, Aircraft Navigational Systems, and other high accuracy mechanical, electrical and electronic components.

Technical Data on these and other components is available on request.



KEARFOTT COMPANY, INC., LITTLE FALLS, N. J.

Sales and Engineering Offices: 1378 Main Avenue, Clifton, N. J.
Midwest Office: 188 W. Randolph Street, Chicago, Ill. South Central Office: 6115 Denton Drive, Dallas, Texas
West Coast Office: 253 N. Vinado Avenue, Pasadena, Calif.

A GENERAL PRECISION EQUIPMENT CORPORATION SUBSIDIARY

CIRCLE ED-15 ON READER-SERVICE CARD FOR MORE INFORMATION

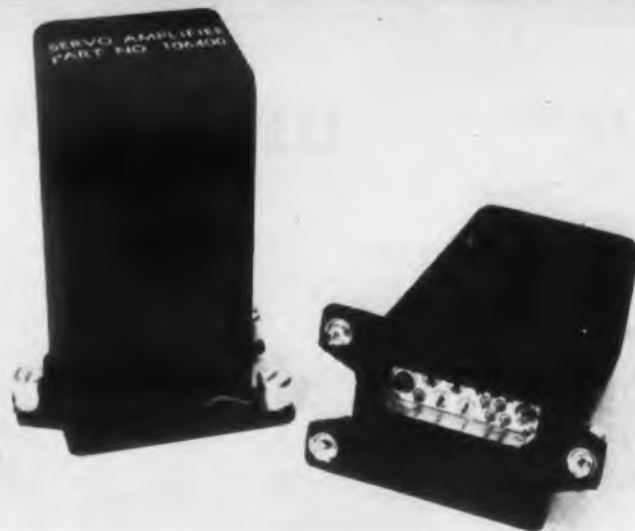

Fig. 1. The fluid-filled, hermetically-sealed Type SA118H Servo Amplifier showing its plug-in base.

Miniature Servo Amplifier

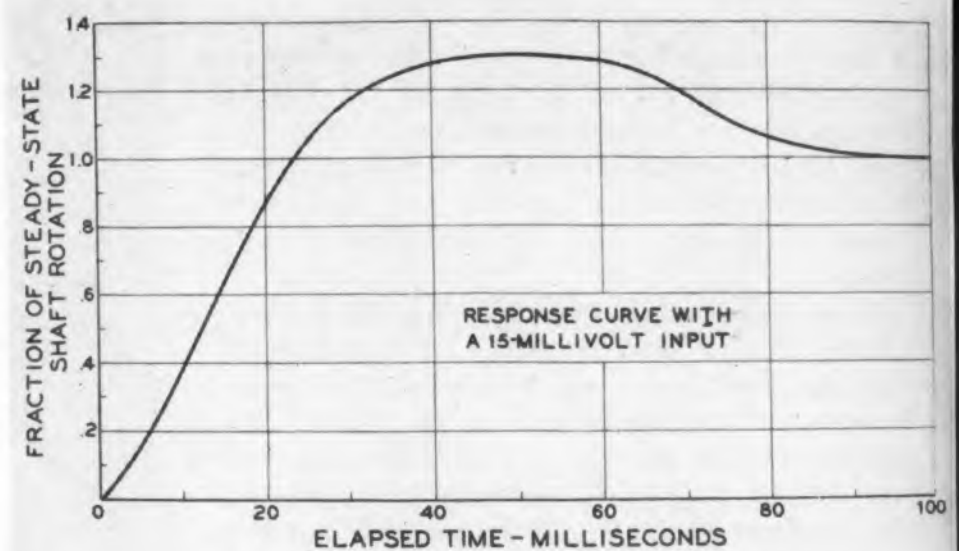
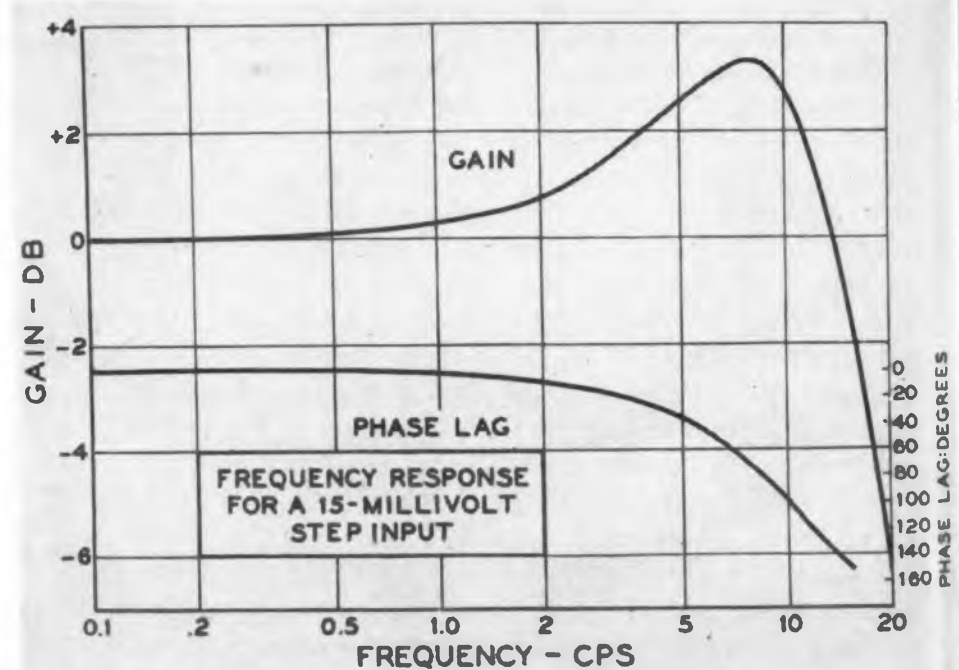

Fig. 2. The various response characteristics of the Amplifier shown in these two graphs demonstrate its high efficiency.



WEIG
ized
plifier Ty
for analo
will deliv
motor and
tapped tr
quired. T
ployed m
The se
greater h
of hot sp
teristics
Servomee
bury, N.
tion and
Design
amplifier
impedanc
is 100v.
at 6.3v, 4
5641 tub



integra
rection.
The E
the amp
of a 580
A single
ply mul
Speci
tion con
phase s
torque,
input si
the req
A P
Damped
been de
Amplif
ELECTR

WEIGHING less than a pound, the miniaturized, hermetically sealed, plug-in Servo Amplifier Type SA118H, shown in Fig. 1, is designed for analog-computer servo loop applications. It will deliver up to 2w to a 400cy, 2-phase servomotor and operates directly from the output of a tapped transformer. No external d-c supply is required. The amplifier can also drive servos employed in military aircraft.

The sealed enclosure is filled with fluid for greater heat dissipation and consequent elimination of hot spots. Fig. 2 shows various response characteristics of the unit, which is manufactured by Servomechanisms, Inc., Post & Stewart Aves., Westbury, N. Y. It has three stages of voltage amplification and a power output stage.

Designed to operate between 380 and 420cy, the amplifier has a gain of $7300 \pm 25\%$ and an input impedance of over one megohm. Maximum output is 100v. Filament power requirements are 2.1amp at 6.3v, 400cy, for its one 6112, one 5687, and two 5641 tubes. A tuning capacitor is provided as an

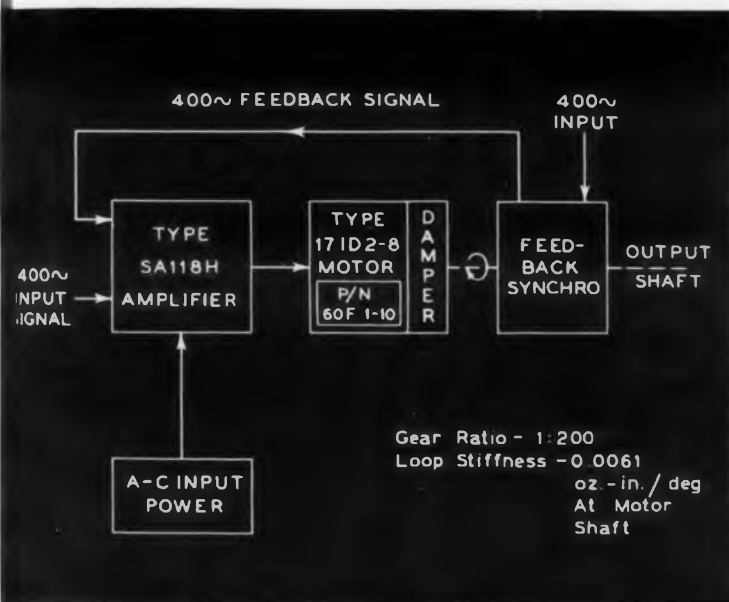

Fig. 3. Typical servo loop block diagram.

integral part of the amplifier for power-factor correction. The unit is 2" x 1-1/2" x 4-1/8" in size.

The high-voltage power input requirements of the amplifier are 5 to 17ma d-c from either side of a 580v, 400cy supply, center-tapped to ground. A single input-power winding is sufficient to supply multiple amplifiers.

Special consideration has been given to saturation conditions in the design of the amplifier. No phase shift or distortion, which reduces motor torque, will occur for input signals up to 10v. The input signal should not exceed 30v. The unit meets the requirements of specification MIL-E-5400.

A Power Supply, the Type PS134, and a Damped Control Motor, the Type 171D2-8, have been designed to operate with the Type SA118H Amplifier, as shown in the block diagram in Fig. 3.

Choose Sylvania PLATED GRID WIRES...

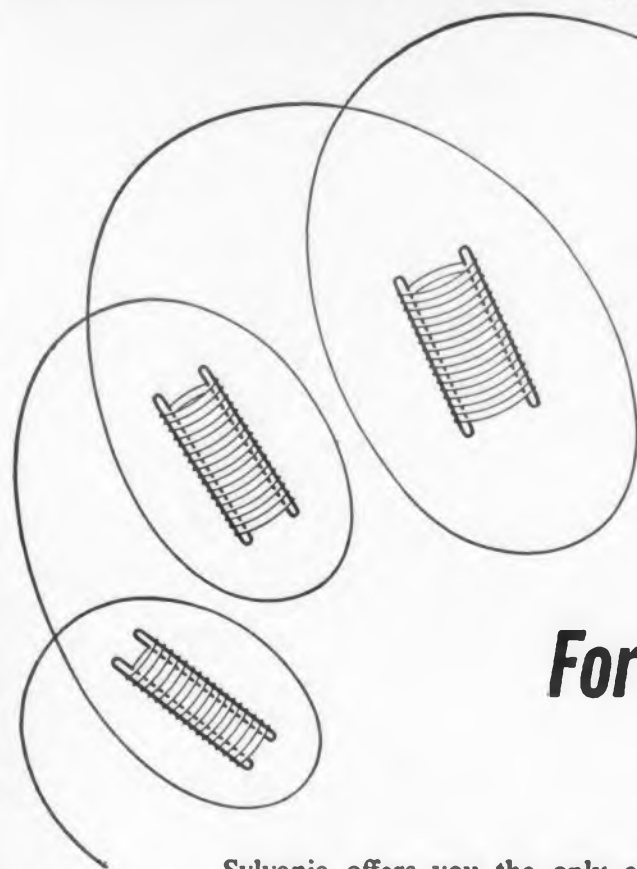

For Maximum Performance... Minimum Shrinkage

Sylvania offers you the only complete line of plated grid wires... made to meet the most exacting requirements of tube manufacturers. Only Sylvania controls the physical properties of both the basic wire and the finished plated wire.

Here are tungsten wires, molybdenum wires, 50-50 tungsten and molybdenum, and D-nickel, in a full range of sizes plated with either gold, rhodium, silver, or nickel.

From this complete line, Sylvania can furnish

tube manufacturers plated grid wire of the proper combination of materials necessary for peak performance and minimum shrinkage for any tube type.

Precision manufactured and quality controlled through drawing and plating, Sylvania wires have the characteristics known to be needed for producing the world's finest radio tubes. For full information, write to Sylvania, Dept. 4T-1405, today!



Sylvania employs the most critical test equipment to assure that physical characteristics are held within precise limits. Above is the Instron Tester which registers tensile strength, elongation and yield.

ONE MANUFACTURER — ONE RESPONSIBILITY

SYLVANIA



Sylvania Electric Products Inc., 1740 Broadway, New York 19, N. Y.

In Canada: Sylvania Electric (Canada) Ltd.,
University Tower Bldg., St. Catherine St., Montreal, P. Q.

LIGHTING • RADIO • ELECTRONICS • TELEVISION

CIRCLE ED-16 ON READER-SERVICE CARD FOR MORE INFORMATION

Circuit Design With Controllable Inductors—II

By Arthur L. Kaufman, Project Engineer

C.G.S. Laboratories, Inc., Stamford, Conn.

BECAUSE of its unusual characteristics, which were discussed in Part I of this article last month, the "Increductor" Controllable Inductor can be used for a wide range of applications. A number of these uses are illustrated in the circuits shown on the opposite page.

Fig. 2 shows the Increductor in a typical high frequency Colpits oscillator circuit with associated control tube circuitry for sweep frequency or f-m applications. Fig. 3 shows an alternate oscillator circuit for use at lower frequencies. Here R_2 and R_3 in conjunction with C_3 and R_1 can be adjusted to give a flat output amplitude characteristic over an extended frequency range. This is required when the Q of the Controllable Inductor no longer rises with frequency and tank impedance, therefore, begins to drop. For applications where some sacrifice in range can be tolerated to gain increased stability, an oscillator may be used where the Increductor unit is tapped across a section of a fixed tank coil.

Another common application of the Increductor is in tuned amplifier stages. Fig. 4 shows a typical wide-band tuned circuit. Constant gain and bandwidth over the frequency range can be achieved by operating the unit in the upper right-hand region of the Q map and appropriately loading the tank circuit. Several similar stages can be cascaded into a tuned r-f receiver or used in conjunction with an Increductor-tuned oscillator stage for a superheterodyne receiver.

Typical control circuitry necessary to track the above tuned amplifier stages to each other and the local oscillator is shown in Fig. 5. Note that additional bias resistors are sometimes necessary to prevent an effective short from appearing across this winding. If this occurs, it would act as a shorted secondary to the associated control winding with consequent loss in control current sweep. The capacitors C_t in Fig. 5 are used to raise or lower their associated tank frequencies. The inductances L_s and the control circuit potentiometers are used as independent parameters to adjust the high end of the frequency range. The bias potentiometers and the inductance L_p are most

effective for tracking at the low-frequency end.

In any application where it is desired to make static adjustments of control current and to achieve up to 10 to 1 reduction in hysteresis and temperature drift, an appropriate, low-frequency "Bellwether" circuit shown in Fig. 6, may be employed. In this circuit the output voltage of the oscillator is integrated by the 100K resistor and the 82mmfd capacitor combination and then rectified by the following diode to give a direct voltage inversely proportional to the oscillator frequency. The oscillator voltage is also sampled by the upper diode and a portion of the resultant direct voltage is then added in series with the integrated signal. The portion to be added is determined by the position of the slider on the 250K pot.

This resultant voltage drives the grid of the control current tube after going through a high-gain amplifier stage. The control current rapidly arrives at a value such that the oscillator frequency produces an error voltage at the grid of the amplifier just sufficient to maintain itself. It may be seen that the position of the potentiometer determines the voltage at the grid of the current driver and hence the current through

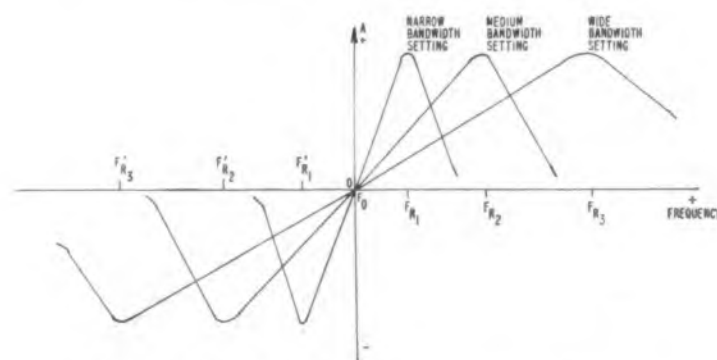

Fig. 1. F-m discriminator response curves.

the control winding. Since there can be only one such frequency for each setting of the potentiometer, the closed loop has acted to eliminate frequency hysteresis effects encountered when approaching a given value of control current from different directions. If control windings of other Increductors are connected at the

"Current Out" terminals they will all follow the lead of this "Bellwether" oscillator unit having only one value of signal winding inductance for any setting of the 250K pot. It may easily be seen that these other units could be tuned stages of the receiver, sections of a filter, etc.

In swept applications where linearity of frequency versus control current is desirable, a circuit such as that shown in Fig. 7 is often helpful. The sawtooth sweep voltage may be divided into as many portions of discreet slopes as is necessary to produce the required frequency linearity. The tube characteristic of rapidly increasing plate current with less negative grid voltages helps in making the frequency of the output signal versus time more linear.

A means of temperature compensation is given in the circuit shown in Fig. 8. Here a temperature sensitive resistor network is shunted across the bias (or control) winding. It is necessary that its temperature coefficient be equal and opposite to that of the Controllable Inductor over the range of operation.

Automatic frequency control characterized by wide pull-in range can be adapted to an oscillator by a circuit such as that shown in Fig. 9. In this circuit the Increductor has a balanced control winding that may be driven from the discriminator circuit in addition to the bias winding. The latter may now carry direct current to adjust operation of the unit to the point of zero temperature coefficient, the center of the linear region, or to the region of maximum sensitivity for frequency-modulation use. If sufficient gain is not available, it may be desirable to directly couple the discriminator voltage to the grid of the current driver tube along with the modulating signal.

One application of the Increductor has been in variable bandwidth f-m receivers where a variable sensitivity discriminator tracked to the bandwidth adjustment of the receiver makes it possible to increase discriminator gain at narrow bandwidth settings. Fig. 10 shows a typical discriminator circuit of this type, which can be operated for wide, medium and narrow receiver bandwidth settings. Fig. 1 shows a plot of frequency response vs. amplitude for these three different settings. When the receiver bandwidth is narrower, a wide-band discriminator is no longer necessary. Hence, the resonant peaks can be brought closer together to give the steeper slope at the center. It should be mentioned that either a band-pass filter or overlapping low-and-high-pass filters of standard design can be used to vary the receiver's bandwidth. If Increductors are employed in these filters, their control windings as well as those of the variable bandwidth discriminator can all be controlled by the "Bellwether" circuit illustrated in Fig. 6.

Other uses of the Increductor not described here include phase modulators, antenna tuners, delay lines and magnetic switches. In all these applications the advantages of ruggedness, long-life and having a remotely tuned component are available.

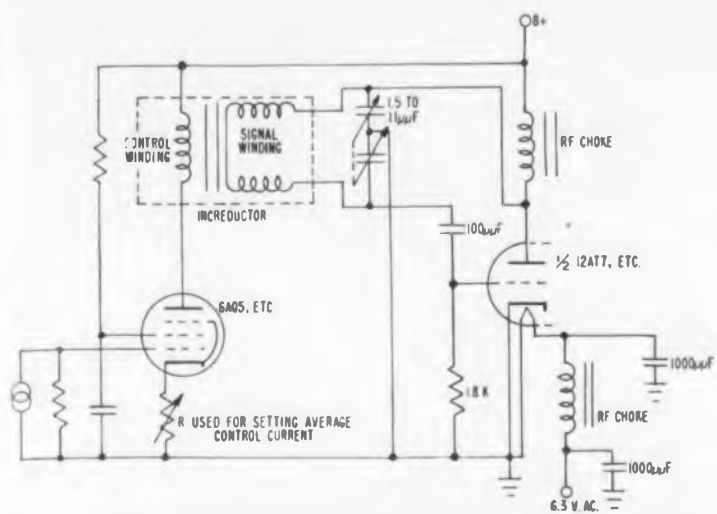

Fig. 2. High-frequency oscillator and control.

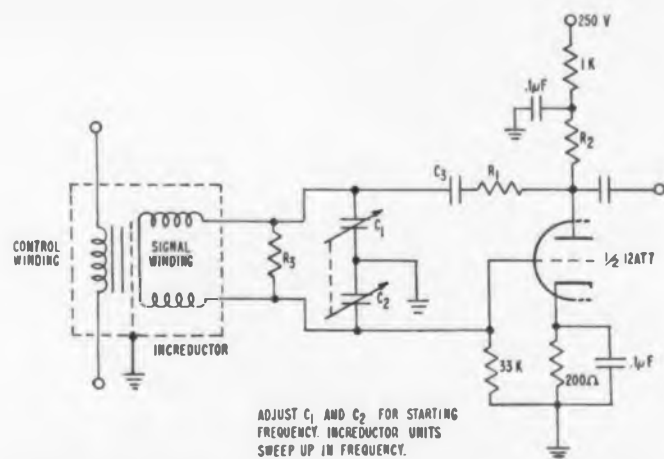

Fig. 3. Low-frequency oscillator.

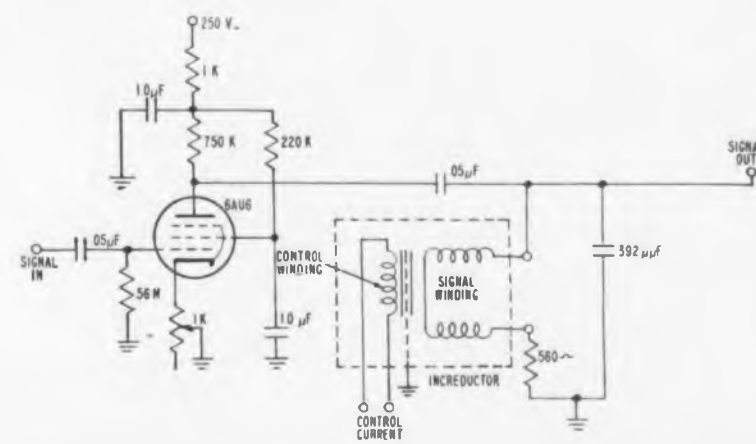

Fig. 4. Wide-band tuned amplifier stage.

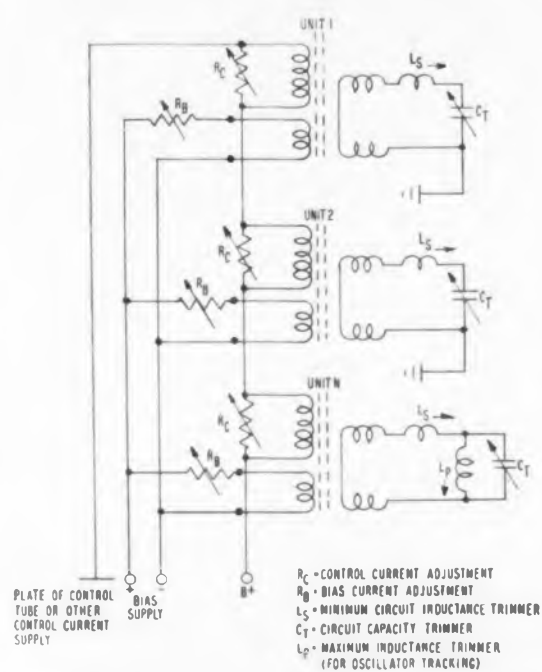

Fig. 5. Tracking circuit.

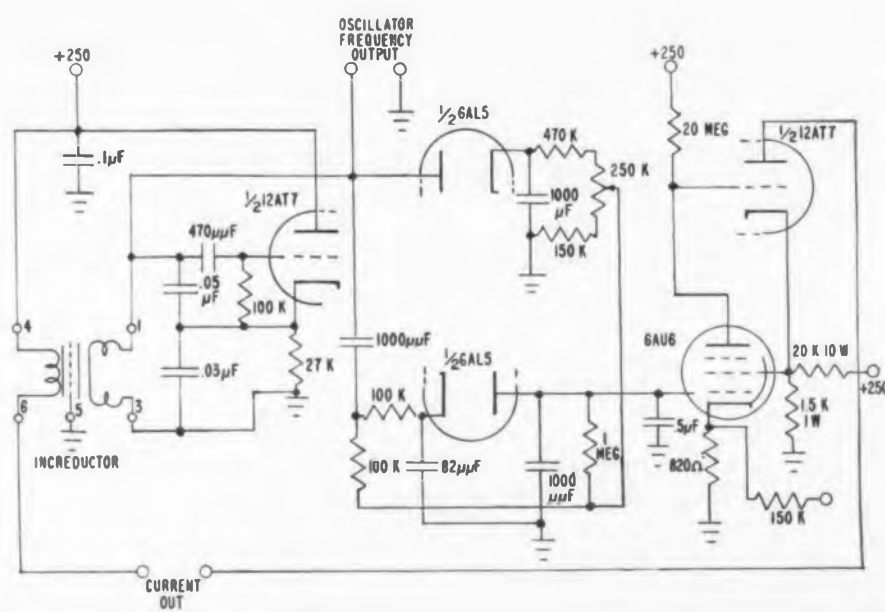

Fig. 6. Low-frequency closed-loop feedback control.

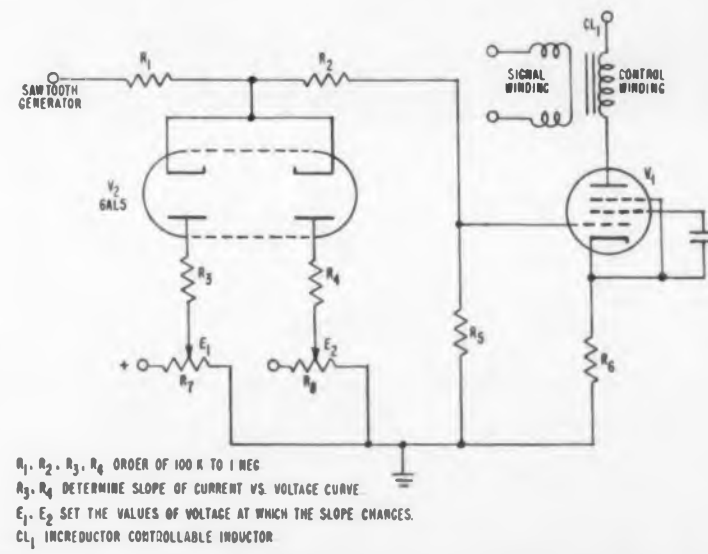

Fig. 7. Sawtooth generator.

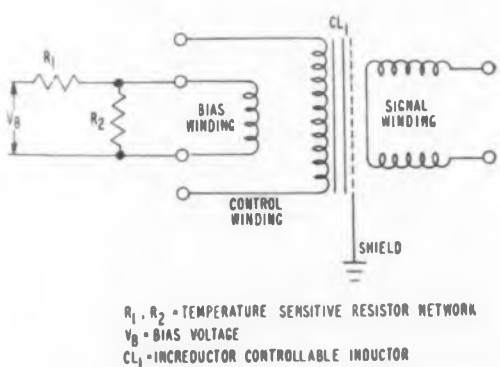

Fig. 8. Temperature compensating network.

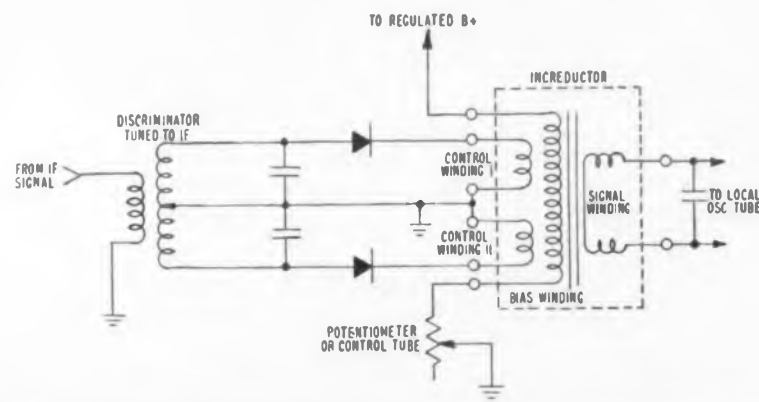

Fig. 9. Automatic frequency control.

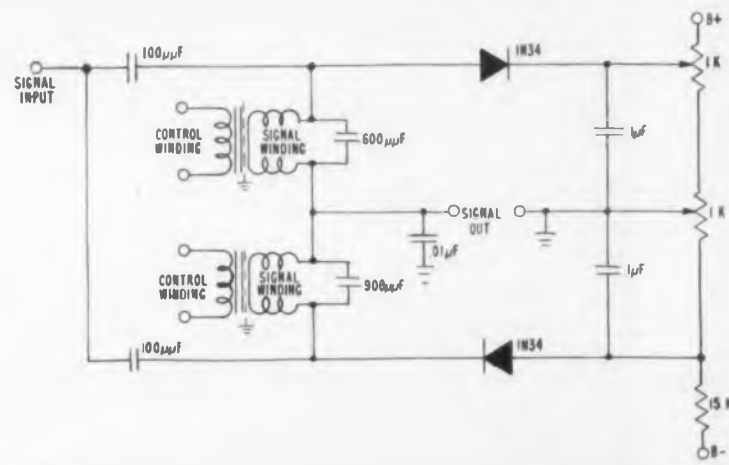

Fig. 10. Frequency-modulated discriminator.

Fig. 1. The standard circuit of this 21" TV set was replaced by "Reliplates."



3-D Printed Circuits

ADDING A THIRD DIMENSION to printed circuits by means of "Reliplates" is an important new concept in electronic design and construction. Its significance to the electronic design engineer is demonstrated by the 21" TV monochrome receiver shown in Fig. 1, which is composed entirely of printed circuits assembled by the new technique. Among the advantages are space savings, lower production costs compared with conventional type construction, ease of servicing, and a nominal cost to the manufacturer adopting the new technique. "Reliplates" were developed by Sanders Associates, Inc., Nashua, N. H.

Fig. 2. Space-saving effected by using three-dimensional printed circuit construction.

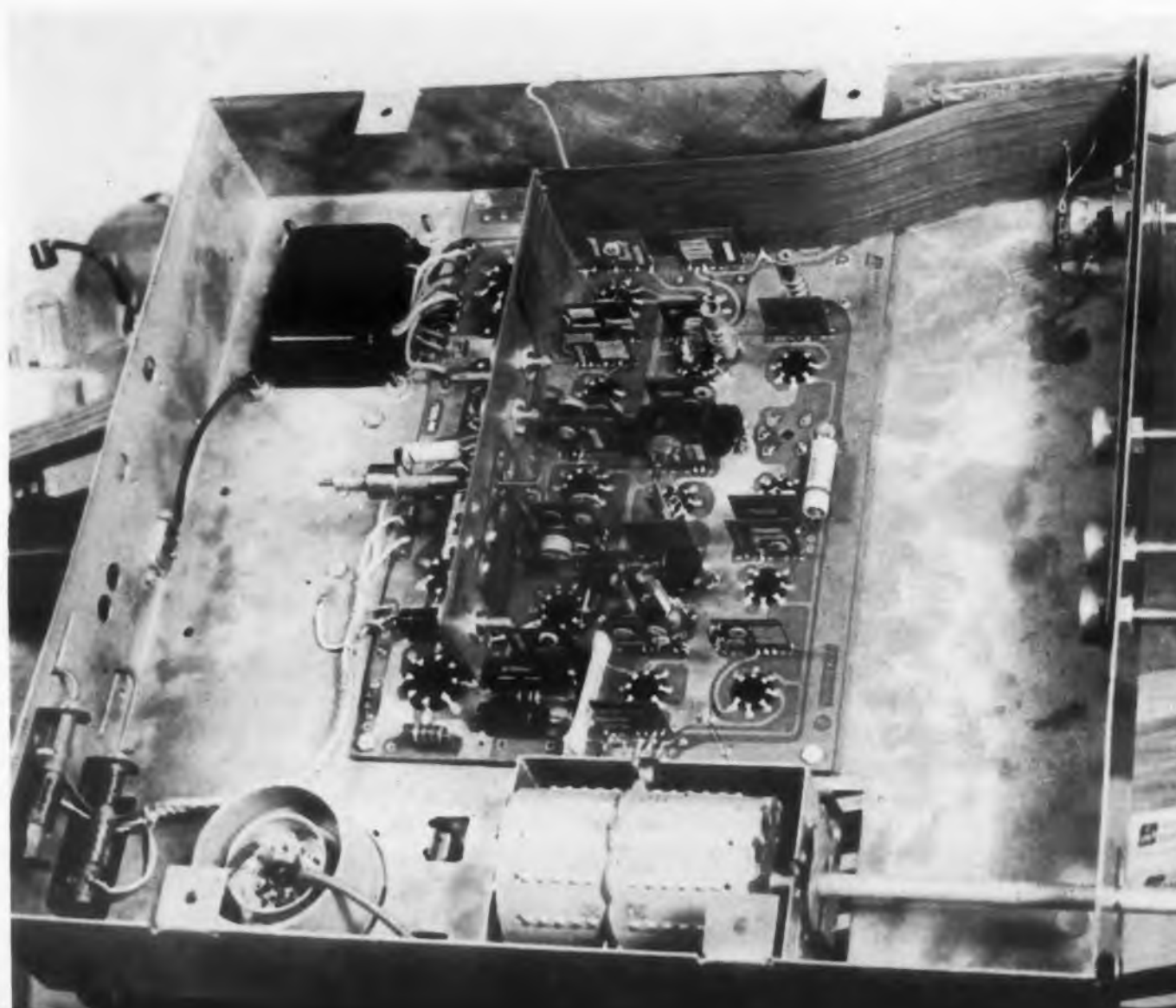

Essentially the technique involves the use of small panels called "Reliplates" which are about one inch square. These panels, containing printed or conventional circuits, have small comb-like teeth plugged into a row of mating holes on the master etched circuit. Connection and mounting of the panels is effected by only one dip-soldering operation.

The panels can use either tape or conventional resistors, and either ceramic or conventional capacitors, as shown in Fig. 4. They are suitable for large-scale production because many "Reliplates" can be printed on a standard size sheet of copper clad plastic or laminate. For example, a 3 ft square sheet can be cut into almost 1000 panels. The 21" set shown in Fig. 1 requires only 19 panels, and therefore a standard-size sheet could furnish enough material for over 50 such receivers. After printing the circuitry on the sheet, the components can be added at high speed.

Initial cost studies indicate savings of from \$5.00 to \$10.00 at the manufacturer's level for a 21" TV set. Another production advantage is the elimination of handling of hundreds of individual components and many soldering operations. Repair of the receiver is quickly effected by simply soldering a new panel in place of the defective one.

The space savings afforded by the new technique permit the set designer to either reduce the size of his chassis, or standardize on a relatively small sized chassis for several receivers using different size picture tubes. It is conceivable that with development, the printed circuit might even constitute the entire chassis itself. The space savings will be especially important in color TV sets. Using "Reliplates", a color TV receiver with over twice the circuitry of a monochrome TV set can be built on the same size chassis.

The technique, now available to manufacturers, can be installed at a nominal cost, with full-scale production being realized within a few months using standard components, and in a little over 12 months using the more economical nonconventional components. It is adaptable to a wide range of electronic equipment. The designer can take advantage of the space-saving possibilities for portable equipment, or the mass production possibilities for other devices, TV sets, portable receivers, and kitchen radios, where space and high-speed production are both important.

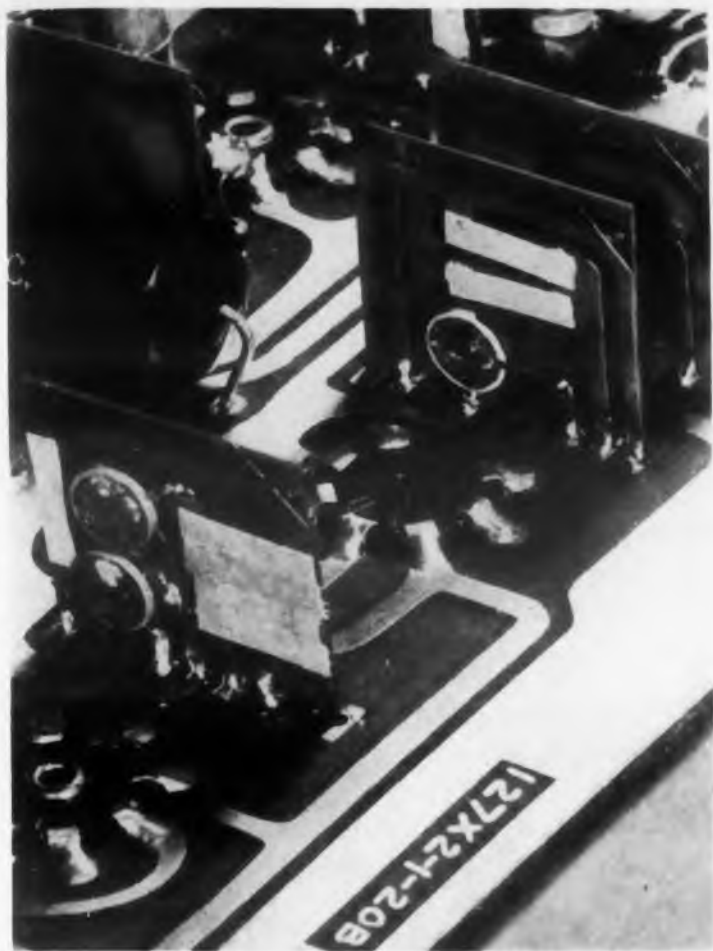

Fig. 3. Closeup of the mounted "Reliplates," which are easily replaced by soldering.



Fig. 4. Either nonconventional components (top) or standard components (bottom) can be used.

As a high frequency dielectric for high altitude service . .



SILASTIC works where other materials fail!

The klystron tube is the heart of a modern beacon or airborne radar system. However, today's experimental aircraft and guided missiles reach altitudes as high as 80,000 feet, where air pressure drops off to a near-vacuum. Corona problems increase permitting short circuits and possible flashover to develop at the klystron's cathode and reflector connections. Humidity intensifies the problem, while the tube itself reaches surface temperatures as high as 150°C.

One way to maintain frequency stability is to enclose the tube in a heavy and space-consuming pressure system. Varian Associates, of Palo Alto, California, one of the world's largest manufacturers of klystrons, accomplishes the same effect by molding Silastic* around the connections and lead wires. Flexible, light-weight and no larger than the tube itself, the Silastic withstands high operating temperatures and mechanical abuse. Moisture is sealed out and corona trouble is entirely eliminated.

The remarkable resistance of Silastic to corona discharge is confirmed by severe laboratory tests. In one test, for instance, lengths of 5mm Silastic and organic rubber-covered ignition cables were coiled around glass rods and wrapped with copper screen. A full 14,000 volts was applied continuously between the screen and conductor. Within 30 minutes the organic cable broke down from corona cutting, as illustrated (inset). The Silastic was still unaffected after 12,000 hours.

That's the kind of performance that makes Silastic, the Dow Corning silicone rubber, unique among rubbery materials. When you need excellent dielectric properties in a rubbery material that retains its resilience at temperatures as high as 500°F and as low as -130°F, **Specify Silastic.**



* T.M. REG. U.S. PAT. OFF.

MAIL COUPON
Today!
for data on the
properties of Silastic

DOW CORNING CORPORATION, Dept. DA-17 Midland, Michigan

Please send me:

- Silastic Facts 10a, properties and applications of Silastic stocks and pastes.
- List of Silastic Fabricators.
- "What's A Silicone?", your new 32-page booklet on silicone products and applications.

Name _____ Title _____

Company _____

Address _____

City _____ Zone _____ State _____

DOW CORNING
CORPORATION

Atlanta
Chicago
Cleveland
Dallas
Detroit
MIDLAND, MICHIGAN
Los Angeles
New York
Washington, D. C.
(Silver Spring, Md.)

Canada: Dow Corning Silicones Ltd., Toronto
England: Midland Silicones Ltd., London
France: St. Gobain, Paris

CIRCLE ED-17 ON READER-SERVICE CARD FOR MORE INFORMATION

A Versatile Patchcord System

The prepared patchboard is inserted in the frame (right) and all the contacts are made at once by closing the frame by its handle (right, below). The back of the patchboard showing the contact pins sticking through it is illustrated below. The frame is mounted on a demonstration stand.



The removable problem patchboard mounted in the frame.

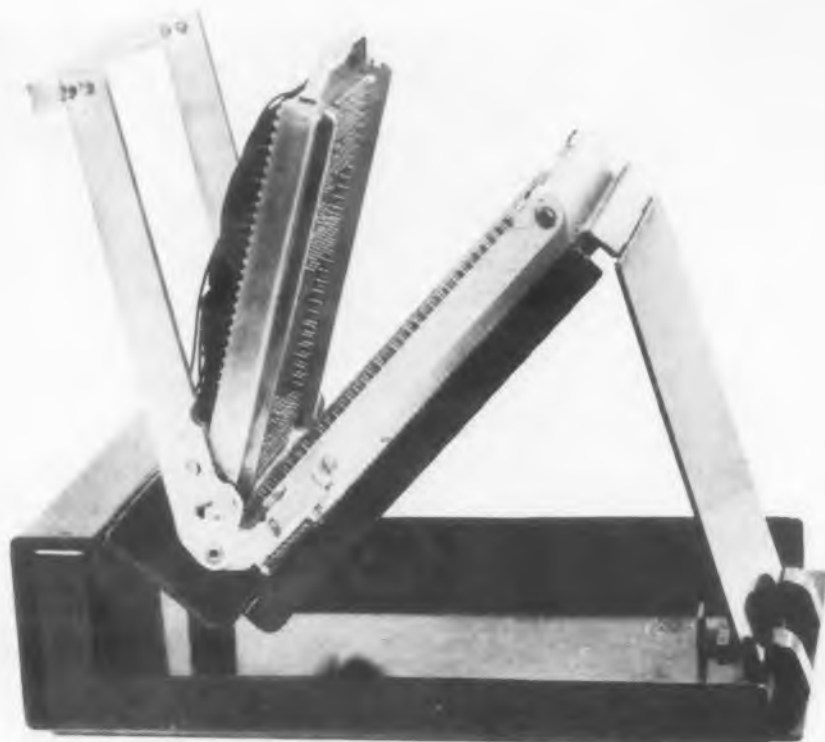

In cross-section, this sequence shows two pairs of contacts before contact, making contact, and in contact.

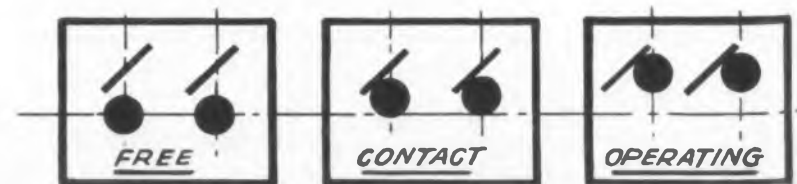

ELECTRONIC DESIGN • May 1954

SIMPLI
lation
features
these pag
ment fro
can recei
thereby
soldering
The sy
board wi
permaner
with its
entire as
Products

The I
slotted f
are mad
problem:
while th
The boa
The s
trates t
tapered
nectors.
connecto
low-re
filled-st
ELECTR

SIMPLIFIED design and operation, ease of installation, and the use of solderless connections are features of the complete patchcord system shown on these pages. The system permits a unitized arrangement from standard 680 hole program boards, which can receive "AMP Taper Terminals" for lead off, thereby eliminating time-consuming and expensive soldering operations.

The system is made up of a removable program board with a handle, shown at the left, above, the permanent board with 680 wiping contacts, the frame with its cam mechanism, and 340 patchcords. The entire assembly is manufactured by Aircraft-Marine Products, Inc., 2100 Paxton Street, Harrisburg, Pa.

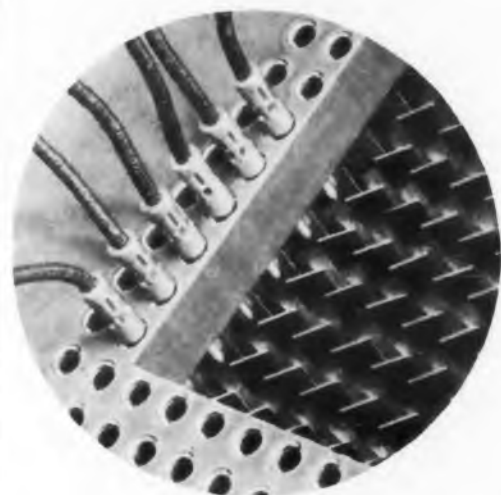

Closeup of the patchcord pins in contact with the mating connectors below.

The prepared program board is inserted in the slotted frame, as shown at the left. All the contacts are made at once by simply closing the frame. Other problems can be set up on additional program boards while the machine utilizing the system is in operation. The board is made of BM 120 phenolic bakelite.

The sequence of three drawings at the left illustrates the mechanical contact action between the tapered contact pins and the knife-like mating connectors. Note the physical displacement of the female connector that insures thorough wiping and results in a low-resistance contact of 6 to 8 oz pressure. The rolled-steel pins travel 0.90" on contact.

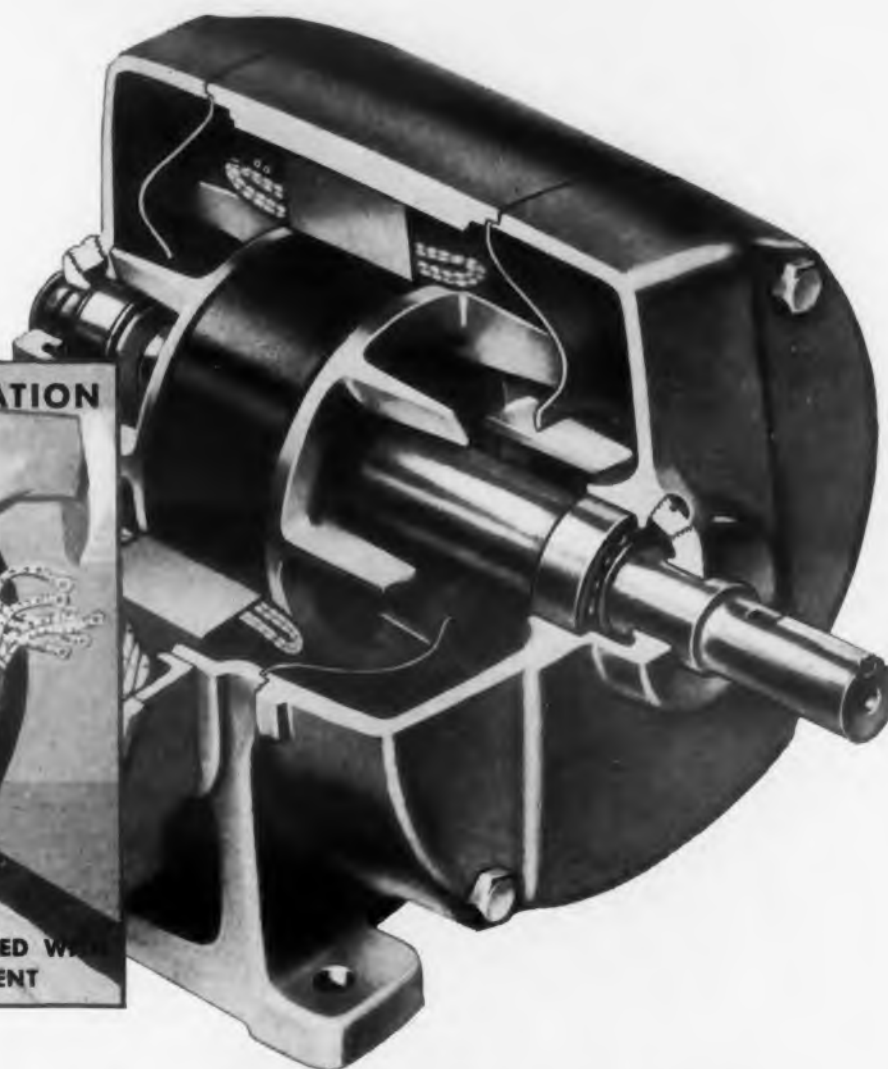

STATOR WINDINGS IN G.E.'s NEW TRI/CLAD® '55' MOTORS ARE SILICONE-SEALED BECAUSE LABORATORY TESTS SHOW

DRI-FILM 88 may extend insulation life up to 6 times

General Electric's new Tri/Clad '55' motors feature a coating of DRI-FILM 88 on their stator insulation systems. This new water-repellent silicone resin virtually eliminates insulation breakdown due to moisture or salt spray. Accelerated life tests indicate that DRI-FILM 88 may extend insulation life up to six times. Moreover, air-drying DRI-FILM 88 provides these benefits without complicated baking cycles—often with only a single dip!

Where can you use DRI-FILM 88?

This application of DRI-FILM 88 in G-E Tri/Clad motors marks the first major use of silicones in conjunction with Class A or B insulation. Designers

G-E silicones fit in your future

GENERAL  ELECTRIC

familiar with the new Class H insulation made possible by silicones will appreciate the tremendous opportunities offered by this new insulating material. Where can *you* use it to improve performance and lengthen the service life of electrical equipment? Send the coupon for complete product data!

CLIP AND MAIL TODAY!

General Electric Company
Section 462-2B
Waterford, New York

Please send me product data on G-E DRI-FILM 88 and a free copy of *G-E Silicones for Industry*. I want this for
() Reference purposes only () An immediate application on _____

Name _____ Position _____

Firm _____

Street _____

City _____ Zone _____ State _____

IN CANADA: Mail to Canadian General Electric Company, Ltd., Toronto



CIRCLE ED-18 ON READER-SERVICE CARD FOR MORE INFORMATION

ceramics and metal

permanently combined



Stupakoff assemblies

Your production procedure is simplified when you use high-precision Stupakoff ceramic-to-metal assemblies. Extensive experience in the field of electrical and electronic ceramics, thorough familiarity with methods of metallizing, and the use of modern precision manufacturing methods insure the high quality and uniformity of Stupakoff Assemblies.

Among the assemblies made by Stupakoff are: rotor shafts, strain and spreader insulators, stand-offs and trimmers. Ceramic bodies are specially formulated for the intended service; metals used include silver, copper, brass, stainless steel and monel. Stupakoff's broad experience in this field insures the selection of a method of assembly best suited to meet service conditions.

A few types of Stupakoff Ceramic-to-Metal Assemblies are illustrated in the photograph above.



STUPAKOFF CERAMIC & MANUFACTURING CO.

LATROBE, PENNSYLVANIA

CIRCLE ED-19 ON READER-SERVICE CARD FOR MORE INFORMATION

30

New Products . . .

Indicating Amplifier Measures Low D-C Signals



This Type 2H-LA-3 D-C Indicating Amplifier will amplify very low d-c signals sufficiently to drive a pen recorder or galvanometer. By using a second-harmonic magnetic converter

instead of mechanical choppers, the unit achieves high linearity and low drift. The amplifier is useful for null detection and for operation off photocells, strain gages, or ionization chambers.

Ranges for direct indication on the unit's voltmeter are 1, 3, 10, 30 and 100mv. Gain is 10^4 divided by full-scale range in millivolts. Zero drift is less than 1% of full scale on all ranges after a 10-minute warmup. There is no drift for line variations from 105 to 125v or 50 to 70cy.

Input impedance is one megohm per volt, and amplifier linearity is $\pm 1\%$ of full scale on all ranges. Frequency response is from d-c to +20cy. The amplifier is 12" x 7-3/4" x 9-3/4" in size and weighs 20 lb. Doelcam Corporation, Dept. ED, 1400 Soldiers Field Road, Boston 35, Mass.

CIRCLE ED-20 ON READER-SERVICE CARD FOR MORE INFORMATION

Ultrasonic Delay Lines 3.051 or 6.102 μ sec Delay



is in an hermetically sealed case.

These solid ultrasonic delay lines, provide precise delay intervals: Type SDL-15, 1000 yards, 3.051 μ sec; and Type SDL-16, 2000 yards, 6.102 μ sec. Each unit

Carrier frequency is 30Mc. Attenuation is 26db into 1000 ohms. The bandwidth is 8Mc. Bliley Electric Co., Dept. ED, Union Station Bldg., Erie, Pa.

CIRCLE ED-21 ON READER-SERVICE CARD FOR MORE INFORMATION

Non-Linear Dielectrics Have Wide Application Range

These non-linear dielectric materials are available in thin sheets from 0.002" to 0.025" thickness, or as finished units complete with electrodes, leads, and protective coatings. Narrow loop materials have low losses and are suitable for high frequency applications. Square loop bodies have high remanent polarization necessary for memory work.

Typical applications include dielectric amplifiers, memory devices, modulation, voltage tuning, frequency doubling, sweep circuits, and variable filters. Glenco Corp., Dept. ED, Metuchen, N. J.

CIRCLE ED-22 ON READER-SERVICE CARD FOR MORE INFORMATION

Power Triodes 3kw and 6kw Ratings



Two power triodes have been made available for use in new equipment designed for the electronic heating, broadcasting, and communications fields. The F-6366 (illustrated) is an industrial oscillator with a 3kw output and filament characteristics of 11v, 29amp. The F-6367 is a 6kw tube designed for use as a modulator, amplifier, and oscillator; it has a

filament voltage of 13v and filament current of 36amp.

Both tubes feature thoriated tungsten helical-type filaments, and kovar grid and filament seals, contributing to ruggedness and more dependable operation. Relatively wide spacing between elements makes the tubes especially suitable for industrial applications, presenting high protection against filament-grid shorts.

Rated filament voltage may be applied to cold filaments, eliminating step starting and the need for high-resistance transformers. Maximum d-c plate voltage ratings of 5500v for the F-6366 and 6200v for the F-6367 apply up to 30Mc. Operation up to 50Mc is permissible at reduced ratings. Both types may be operated anode up or anode down. Federal Telephone and Radio Co., Dept. ED, 100 Kingsland Rd., Clifton, New Jersey.

CIRCLE ED-23 ON READER-SERVICE CARD FOR MORE INFORMATION

ELECTRONIC DESIGN • May 1954

Portable Wheatstone Bridge

Five Scales from 0.05—50,000 ohms



The Normameter Model 185R is an inexpensive portable d-c Wheatstone Bridge. It measures resistances from 0.05 ohms to 50,000 ohms in five ranges with built-in multipliers. Accuracy on three scales (0.5-50 ohms, 5-500 ohms, 50-5000 ohms) is $\pm 0.5\%$. On the 0.05-5 ohm scale, accuracy is $\pm 2\%$. On the 500-50,000 ohm scale is $\pm 5\%$. The null indicating galva-

nometer has a sensitivity of $4\mu\text{amp}$ per scale division. To operate, push button switch to connect the voltage source across the bridge.

The unit, made in Austria, operates on a replaceable 4.5v battery from an external source of 4v, or with adapter, on 115v, 60cy. Size is only 6-7/8" x 3-15/16" x 2-5/32". Weight is 1.5 lb. United Optical Manufacturing Corp., Dept. ED, 202-4 E. 19th St., New York 3, N. Y.

CIRCLE ED-24 ON READER-SERVICE CARD FOR MORE INFORMATION

CRO Electronic Switch

For Viewing Two Patterns



This portable Electronic Switch makes possible simultaneous observation of two patterns on the screen of a single cathode-ray oscilloscope. The relative positions of the pat-

terns may be varied so that they are either superimposed or separated, as desired. Direct comparison of amplitudes, waveforms, frequencies, and phase relationships are thus possible.

A square wave voltage of variable frequency and amplitude is available at the output terminals for use as a test signal in studying the transmission characteristics of vacuum tube amplifiers and other circuits. The switch incorporates direct-coupled amplifiers which are alternately operative and inoperative at a rate determined by the selected chopping frequency. The instrument is therefore effective for chopping a d-c signal, making it suitable for transmission through the oscilloscope amplifiers.

Switching rate is continuously variable from 10 times to 2000 times per second. The instrument is entirely self-contained in a metal cabinet measuring 13" x 8-3/4" x 10". Chatham Electronics Corp., Dept. ED, Livingston, N. J.

CIRCLE ED-25 ON READER-SERVICE CARD FOR MORE INFORMATION

ELECTRONIC DESIGN • May 1954

INTERNATIONAL RECTIFIER

C O R P O R A T I O N



EL SEGUNDO
CALIFORNIA

Germanium Diodes

for

High

Temperature

Applications
from

-60°C to +100°C

AVAILABLE NOW!

INTERNATIONAL RECTIFIER CORPORATION's newly developed "RED DOT" series of germanium diodes with superior forward and reverse characteristics at temperatures to 100 C.

For complete information on "RED DOT" high temperature germanium diodes to meet your particular specifications, write Dept. C for Bulletin ER-191.

INTERNATIONAL RECTIFIER

C O R P O R A T I O N

Executive Offices: 1521 E. Grand Ave., El Segundo, Calif. • Phone: OREGON 8-6281
Chicago Branch Office: 205 West Wacker Drive • Phone: Franklin 2-3889
New York Branch Office: 501 Madison Avenue • Phone: Plaza 5-8665

CIRCLE ED-26 ON READER-SERVICE CARD FOR MORE INFORMATION

EDISON TIME DELAY RELAY'S New Products . . .

Basic Extras at No Extra Cost

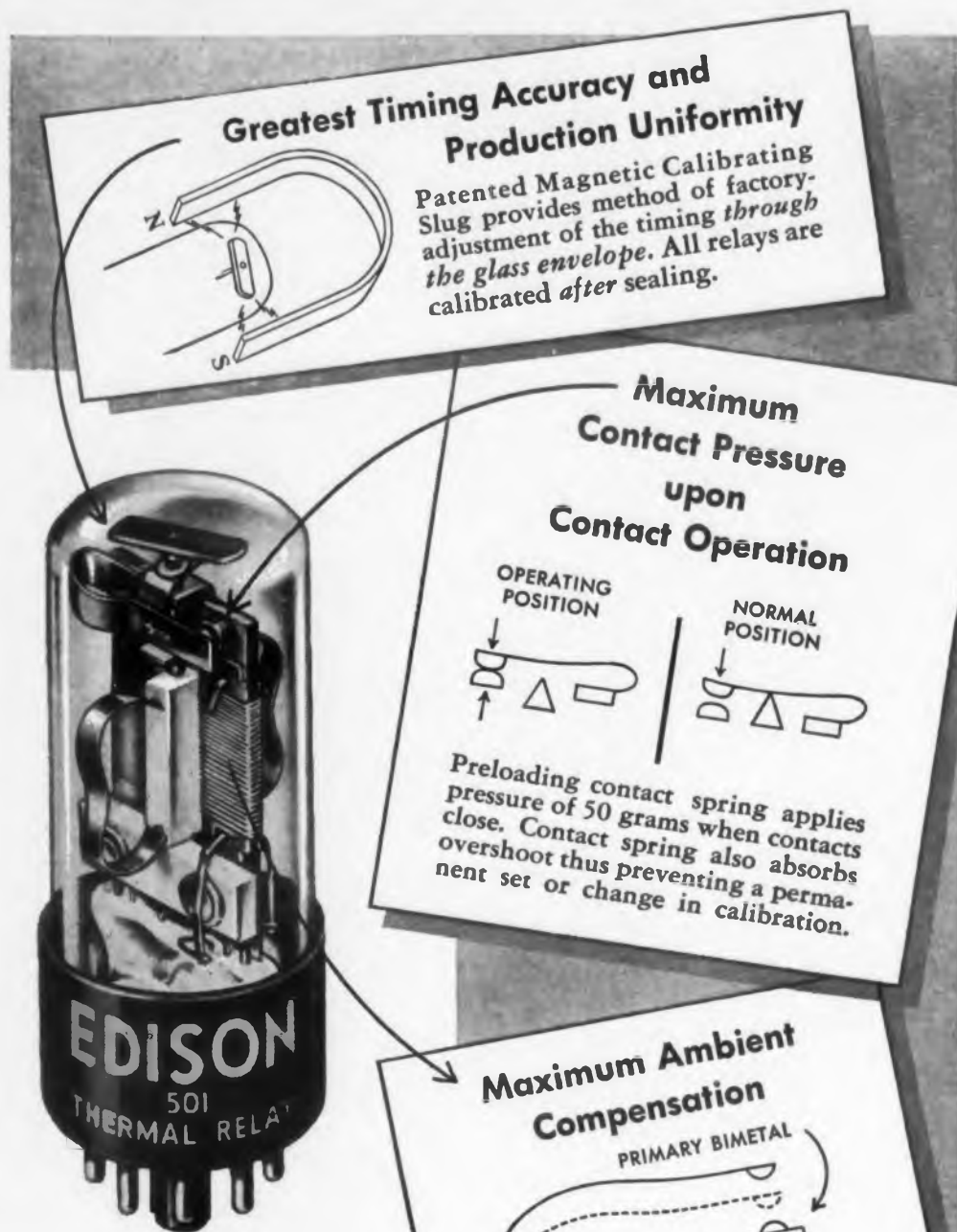

Greatest Timing Accuracy and Production Uniformity

Patented Magnetic Calibrating Slug provides method of factory adjustment of the timing through the glass envelope. All relays are calibrated after sealing.

Maximum Contact Pressure upon Contact Operation

Preloading contact spring applies pressure of 50 grams when contacts close. Contact spring also absorbs overshoot thus preventing a permanent set or change in calibration.

Maximum Ambient Compensation

Ambient affects both bimetals exactly alike. Contact gap maintains relative position independent of ambient temperatures from -60°C to $+85^{\circ}\text{C}$.

GENERAL SPECIFICATIONS

Standard Types

Operating Time: 2 to 300 seconds
Heater: 5 watts continuous excitation at 6.3, 26.5 and 117 V. AC/DC
Contact Rating: 6 Amps Max.
Vibration & Shock: $1/16$ " overall amplitude at 55 cps. 50 g.

Features

Hermetically Sealed
 Micanol base is standard on all types
 Over 400 variations to choose from
 Delivery from a stock of many types
 Greatest range of time delays available in any thermal relay.

YOU CAN ALWAYS RELY ON EDISON

CIRCLE ED-27 ON READER-SERVICE CARD FOR MORE INFORMATION

Thomas A Edison
 INCORPORATED
 Instrument Division

55 Lakeside Ave., West Orange, New Jersey

Helium-Filled Switch Hermetically Sealed Button-Type



This hermetically sealed switch "button" consists of a set of movable contacts in an accordion-like diaphragm enclosure filled with helium under pressure. The switch can be produced in any size. It will reduce arcing and pitting and will perform at any altitude and in a vacuum. It is also useful where ordinary exposed contacts are likely to be affected by dirt and dust, and in applications where combustible materials are present.

The product can also be used in solenoid-actuated contactors, replacing the usual silver contacts. The high pressure helium gas cuts down ionization and oxidation, thereby reducing arcing and pitting. Slater Electric & Mfg. Co., Inc., Dept. ED, Woodside, N.J.

CIRCLE ED-28 ON READER-SERVICE CARD FOR MORE INFORMATION

Compact Relay For Small Split-Phase Motors

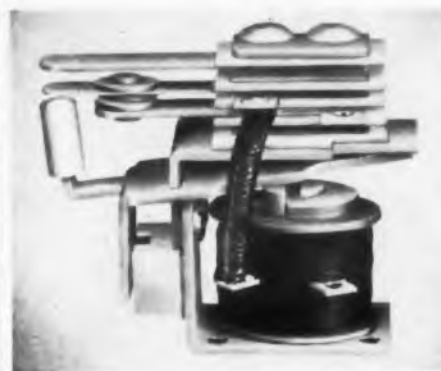

The type "MS" relay is for use with fractional horsepower split-phase motors. Voltage operated, it can be used in certain applications where operating conditions make undesirable the conventional centrifugal switch. When mounted in a dust-tight, gas-tight enclosure, it precludes interference from foreign matter and reduces the hazard of explosions from centrifugal switch arcing.

Characteristics include: cut-out nominal operating range 120-130v a-c; cut-back nominal range 50-70v a-c; positive toggle provided by an Alnico magnet; low loss (approximately 3v a-c); and operation in any position. Mounting is by two or four No. 6-32 tapped holes. Overall size is $2-3/16$ " x $1-13/16$ " x $1-1/8$ ". Weight is approximately 4 oz.

The relay can be supplied with coils for other voltages or for d-c. It is also available as a conventional relay with 1 Form C spring assembly. For general relay applications, it can be furnished without the toggle magnet for increased sensitivity. Sterling Engineering Co., Inc., Dept. ED, Laconia, N. H.

CIRCLE ED-29 ON READER-SERVICE CARD FOR MORE INFORMATION

teflon *
 . . . and We Can Deliver!



EXTRUDED & MOLDED ROD and TUBE Small Machined Parts! Sheets!

Heavy demand has put many TEFLON fabricators in a "back ordered" condition. The effect—stymied or crippled production on your end. At FLEXROCK we have licked this problem. New TEFLON producing equipment has been added. We have substantially increased capacity. We can't take on all things just yet. But soon we will be ready to "throw the book at you" with a complete range of TEFLON services. RIGHT NOW we are set to ship you TEFLON Rod and Tube, extruded or molded, Sheets, and small parts—no matter how intricate—machined from Rod and Tube. We can promise good delivery—yes, FAST DELIVERY . . . with closest possible tolerances on your small parts. Tell us your needs—we will be happy to quote delivery and price.

*DuPont trade-mark for tetrafluoroethylene resin



SEND US YOUR "SPECS" LET US QUOTE!

FLEXROCK COMPANY
 3608-B Filbert St., Phila. 1, Pa.
 We are enclosing sample, specs, and quantity for our TEFLON requirements. Please furnish quotation.
 Please send us your TEFLON Bulletin including stock list.

Name
 Company
 Address
 City Zone State

CIRCLE ED-30 ON READER-SERVICE CARD

ELECTRONIC DESIGN • May 1954

Phenolic Stampings

On Low-Cost, Short-Run Basis

Phenolic stampings to meet requirements for radio of electronic frames, insulators, panels, socket bases, mechanical gaskets and spacers, or cams, are offered on a low-cost, short-run basis by this firm. Any size or shape up to 9" x 12" x 1/8" can be produced for experimental projects, pilot runs, or limited quantity production.

Stampings are die-cut to client specifications by methods holding tolerances to ± 0.002 , under standard condition. Other non-metallic materials, such as vulcanized fibres, plastics, and insulation paper (fish paper), can also be used. Federal Tool & Manufacturing Co., Dept. KP, 3600 Alabama Ave., Minneapolis 16, Minn.

CIRCLE ED-31 ON READER-SERVICE CARD

Rust-Proofing Treatment Provides Extreme Protection

"Endurion" is a chemical immersion treatment for the rust-proofing of iron and steel articles. It provides a rust proofing durability on both oiled and un-oiled surfaces so great, as measured by the salt-spray test, as to reach into the range of protective values previously covered only by electro-plated coatings. Products withstand standard salt-spray tests from 12 to 24 times as many hours as those treated by standard phosphate-coating methods.

The treatment provides uniform protection on every surface the fluid can reach. Protection is provided without "building up", an advantage in the rust-proofing of threaded parts and close-fitting assemblies. The surface provides a superior base for bonding paint, permitting one coat to provide the protection of several coats. It also can be applied in integral colors, ranging from gray and black through blue, green, and olive drab—of value for articles too complicated to paint. Rust-Proofing and Metal Finishing Corp., Dept. ED, 75 Commercial Ave., Cambridge, Mass.

CIRCLE ED-32 ON READER-SERVICE CARD

CIRCLE ED-33 ON READER-SERVICE CARD >

ELECTRONIC DESIGN • May 1954

are you fighting space?

connect
with
cannon!

Are you looking for complete electrical circuit dependability in a very, very small space?

If so, you should use Cannon carefully engineered miniature and sub-miniature multi-contact connectors. In $\frac{1}{2}$ or $\frac{1}{3}$ the usual space, they give you up to 50 contacts, the same number as a standard connector, and still retain all the factors of utility, reliability, and mechanical strength found in Cannon's standard size connectors. They are very rugged, easy mating, unusually versatile, neat and compact.

Miniatures—Maximum Dimensions Only 1" x 2"!



High resistance insulation, shock proof, flame retardant, chemically resistant, and plugs, standard, protected, or hermetically sealed. — 100% wall, ground mount, 100% for wiring, control, and instrument use. — and 11 sub-miniature have steel shells. GPM and H miniature have die-cast shells. Frequent gold plated contacts are found in all miniature and sub-miniature, excepting U-resistorless, which have steel contacts. Large contacts having light contact strips, and steel contacts are an asset of design.

MINIATURES—MAXIMUM DIMENSIONS ONLY 1" x 2"!



Write for Cannon Miniature and Sub-Miniature Bulletins

Please refer to Dept. 143

CANNON ELECTRIC COMPANY, 3209 Humboldt Street, Los Angeles 31, California.

Factories in Los Angeles, East Haven; Toronto, Canada; London, England.

Representatives and distributors in all principal cities at your service.

TUNG-SOL®

5881



BEAM POWER AMPLIFIER

for the ultimate in reliability where the 6L6 is called for...

Absolute reliability!

There, in two words, is the net result of all the engineering which TUNG-SOL has put into the 5881. This completely new tube is designed to operate in circuits for which the 6L6 is specified and is completely interchangeable wherever the 6L6 is now in use. Full utilization of the design and production techniques which have proved themselves over the past 15 years, has created this exceptionally reliable tube.

The 5881 is manufactured under laboratory conditions accompanied by the most severe tests. It is rugged both mechanically and electrically, with tremendous overload capacity. The 5881 maintains high efficiency throughout its life and provides low cost operation through reduced maintenance.

Where reliable service is essential in audio circuits, the TUNG-SOL 5881 is a "must." Order it from your regular TUNG-SOL supplier.

The TUNG-SOL engineering which has produced the 5881 is constantly at work on a multitude of special electron tube developments for industry. Many exceptionally efficient general and special purpose tubes have resulted. Information about this and other types are available on request to TUNG-SOL Commercial Engineering Department.



Tung-Sol Electric Inc., Newark 4, N. J.

Sales Offices: Atlanta, Chicago, Columbus, Culver City (Los Angeles), Dallas, Denver, Detroit, Newark, Seattle.

TUNG-SOL makes All-Glass Sealed Beam Lamps, Miniature Lamps, Signal Flashers, Picture Tubes, Radio, TV and Special Purpose Electron Tubes and Semiconductor Products.

TUNG-SOL ELECTRON TUBES

CIRCLE ED-36 ON READER-SERVICE CARD FOR MORE INFORMATION

New Products . . .

Hermetically Sealed Pots

5- and 10-Turn Types



This 10-turn, nitrogen-filled potentiometer, 1" in diameter and weighing only 1-3/4 oz, has been tested at 100 psi at -55°C, 100°C and after 100,000 revolutions. The rear header is solid metal with glass inserts through which the tin dipped terminals project, and all static metal-to-metal joints are solder sealed.

The new series "II" potentiometers have a power rating of 4w at 40°C and a maximum torque between 0°C and 100°C of 2 oz-in. Five-turn units, 1/4" shorter than the 10-turn units, are also available. Ford Engineering Co., Dept. ED, 129 East "A" Street, Upland, Calif.

CIRCLE ED-34 ON READER-SERVICE CARD FOR MORE INFORMATION

Precision Capacitors

For Substitution Measurements

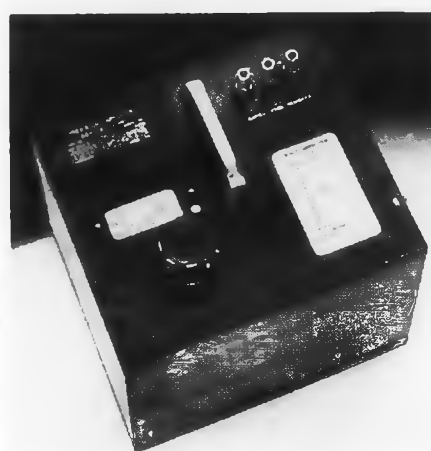

Intended for use in substitution methods of measurement, the Types 722-MD and 722-ME Precision Capacitors are calibrated in terms of capacitance difference rather than terminal capacitance. For convenience in use, the scales read directly in capacitance removed from the circuit. Each model has two sections, one section having 1/10 the range of the other. The type 722-MD has capacitance-difference ranges of 0-1050mmfd and 0-105mmfd, while the 722-ME has 0-105mmfd and 0-10.5mmfd ranges.

The assembly is mounted in a cast aluminum frame for rigidity. Plates and other parts are also made of aluminum so that all parts have the same temperature coefficient of linear expansion. A worm drive is used to drive the rotor. Low-loss steatite stator insulation or silicone treated quartz insulation is available. Where extreme accuracy is required, a worm-correction calibration can be supplied at extra charge. General Radio Co., Dept. ED, 275 Massachusetts Ave., Cambridge 35, Mass.

CIRCLE ED-35 ON READER-SERVICE CARD FOR MORE INFORMATION

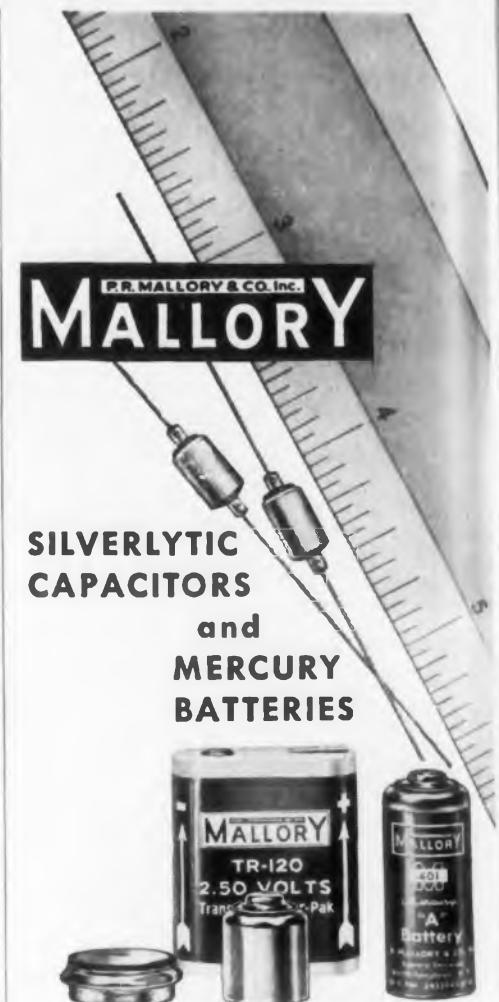

SILVERLYTIC CAPACITORS

and MERCURY BATTERIES

Ideal for TRANSISTOR CIRCUITS

If you are designing equipment around transistor circuits, Mallory Mercury Batteries will deliver the constant-current, constant-voltage needed for best performance. There is no significant deterioration or loss of energy even after long periods of storage.

Mallory Silverlytic Capacitors are also designed to meet the special requirements of transistor and other low voltage circuits.

For complete data, write to P. R. Mallory & Co. Inc., Indianapolis 6, Indiana.

Available NOW
in production quantities

MALLORY

CIRCLE ED-37 ON READER-SERVICE CARD

ELECTRONIC DESIGN • May 1954

A Revolutionary New Relay Development

of utmost importance to electrical and electronic design engineers

The Mullenbach Capaswitch uses an entirely new and different concept in relay design to transfer the contacts; provides extreme sensitivity, low power requirements, high current-carrying capacity.

The revolutionary new Capaswitch is basically an ultra-sensitive relay with unusual current carrying capacity. It will perform all of the jobs of conventional magnetic-coil relays, within the same current carrying capacity, plus many jobs that magnetic-coil relays cannot do. However, in design it departs radically from conventional relays. Instead of the usual electromagnetic armature, a unique electrostrictive capacitive element provides the mechanical energy to open and close the contacts. Only 0.5 milliwatt-seconds of operating power (150 volts d.c.) is required to close the contacts. To keep them closed requires less than 0.1 milliwatt, or less than one-hundredth the power required to keep a conventional magnetic-coil relay closed! This low power requirement opens up a vast new field of applications, eliminating need for much pre-amplified equipment.

How the Capaswitch works—Application of an actuating voltage creates a bending moment in the electrostrictive capacitive element, closing the contacts. Removal of the actuating voltage and discharge of the electrostatic element through external circuits or through a resistor, removes the bending moment, opening the contacts.

Time Delay Function—If appropriate resistances are applied in the circuit, the Capaswitch will function as a time delay relay to open or close the contacts. For longer time delays a larger condenser may be paralleled to the capacitive element.

Pulse Characteristics—Initial closing time of the Capaswitch is 10 milliseconds. However, it can be actuated by pulses as short as 10 microseconds or less. The electrostatic element may also be used to store low power pulses until sufficient voltage has been accumulated to operate the relay. However, present models cannot be used for accurate counting.

High Overvoltage Capacitance—Absence of a coil enables the Capaswitch to withstand wide voltage variations. As much as 200% overvoltage may be applied to the electrostatic element without damage. Low power requirements virtually eliminate heat and resulting dissipation problems, and reduce the number of needed components, saving space and weight.

Available now—Until recently the Capaswitch has been available only in limited quantities. Now, however, stepped-up production schedules assure increasing supplies.

OVERALL DIMENSIONS:

Length: 3½"

Width: 1-7/16"
including solder terminals

Depth: 11/16"

Weight: 1.7 ounces

THE MODEL A-150 CAPASWITCH

a single pole, double throw relay, rated at 1 amp., 110 v., A.C. non-inductive load. Normal operating voltage 150 volts D.C.



Write today
for complete
specifications
and prices!

Mullenbach

ELECTRICAL MANUFACTURING CO.
Established in 1927

2300 East 27th Street • Los Angeles 58, Calif.

CIRCLE ED-38 ON READER-SERVICE CARD

ELECTRONIC DESIGN • May 1954

All-Purpose Dolly Makes Test Equipment Portable



The basic Model OD-1 Dolly consists of two steel shelves 24" x 24" (19-3/4" between shelves) rigidly mounted on a framework of chrome-plated tubular steel. Four 3" casters, two with brakes, provide mobility.

A number of accessories make the dolly readily adaptable to a wide variety of laboratory requirements. They include: a rugged drawer assembly (with provision for lock) which is easily attached to either or both shelves; a five position lift bar which tilts the scope or other equipment for easier observation, and a power outlet strip with four outlets. The dolly has a green crackle finish. Browning Laboratories, Inc., Dept. ED, Winchester, Mass.

CIRCLE ED-39 ON READER-SERVICE CARD FOR MORE INFORMATION

Microwave Frequency Multiplier Output Up to 12.5 KMc



The Model FM-4 Microwave Frequency Multiplier measures and generates stable frequencies in the microwave region as high as 12,500Mc, with continuous coverage. The basic fundamental range is 500-1000Mc. Utilizing harmonics of the basic fundamental oscillator, frequencies up to 12,500Mc can be measured and generated. Frequencies as low as 100Mc can also be measured by dividing by harmonic numbers.

If the external reference standard included in the unit is used, the FM-4 contributes a maximum error of 0.000005%. If an external reference is used, error contribution of the FM-4 is zero. It can be driven from any source which generates frequencies within the 500-1000Mc range, or generates harmonics within that range, or has sufficient output to generate harmonics (within the FM-4) in that range.

Completely self-contained, the unit can be operated directly from a 105-27v, 60cy line. It is enclosed in a 16" x 12" x 21-1/2" aluminum carrying case. Weight is 40 lb. Gertsch Products, Inc., Dept. ED, 11846 Mississippi Ave., Los Angeles 25, Calif.

CIRCLE ED-40 ON READER-SERVICE CARD FOR MORE INFORMATION

WIDE BAND POCKETSCOPE

by

Waterman

Size: 12" x 6" x 7"
14 Pounds

MODEL S-14-B

**DC COUPLED
REPETITIVE OR TRIGGER
1.8 μ S RISE**



ANOTHER EXAMPLE OF **Waterman** PIONEERING...

The **WIDE BAND POCKETSCOPE**, model S-14-B, hits a new high in frequency response for light, compact, truly portable oscilloscopes. The response extends all the way from DC to 700 KC within -2 db without peaking. Thus providing a pulse rise time of 1.8 microseconds. Furthermore, sensitivity has not been unduly compromised in order to accomplish such fidelity. The vertical sensitivity is 50 millivolts rms/inch. The sweep is operated in either a repetitive or trigger mode and covers a range from 0.5 cycles to 50 KC with synchronization polarity optional. Other essential vertical and horizontal amplifier characteristics include non-frequency discriminating attenuators and gain controls as well as individual calibration voltages. Additional provisions for direct access to all the deflection plates, the second anode, and the amplifier outputs help to make the S-14-B a standout instrument of flexibility and utility. All this plus portability! The incredibly small size and light weight of the S-14-B now permits "on-the-spot" use of the oscilloscope in all industrial, medical, and electronic fields. Its rugged construction assures "laboratory performance" regardless of environment.

WATERMAN PRODUCTS CO., INC.

PHILADELPHIA 25, PA.

CABLE ADDRESS: POKETSCOPE

WATERMAN PRODUCTS INCLUDE

S-4-C SAR PULSESCOPE®
S-5-A LAB PULSESCOPE
S-6-A BROADBAND PULSESCOPE
S-11-A INDUSTRIAL POCKETSCOPE®
S-12-B JANized RAKSCOPE®
S-14-A HIGH GAIN POCKETSCOPE
S-14-B WIDE BAND POCKETSCOPE
S-15-A TWIN TUBE POCKETSCOPE
RAYONIC® Cathode Ray Tubes
and Other Associated Equipment

MEMO...
Write for
details
today!

W

WATERMAN PRODUCTS

CIRCLE ED-41 ON READER-SERVICE CARD FOR MORE INFORMATION

The LFE OSCILLOSCOPE Model 401 FEATURES:



PRICE \$895

- LINEARITY OF VERTICAL DEFLECTION
- HIGH SENSITIVITY AND WIDE FREQUENCY RESPONSE OF Y-AXIS AMPLIFIER
- ACCURATELY CALIBRATED SWEEP DELAY
- BUILT-IN TRIGGER GENERATOR

Linearity of Vertical Deflection. The vertical amplifier provides up to 2.5 inches positive or negative uni-polar deflection with negligible compression.

High Sensitivity and Wide Frequency Response of Y-Axis Amplifier. The vertical amplifier of the LFE Model 401 provides high sensitivity, 15 Mv./cm. at D-C and A-C, and wide band response to a 3 db. point at 10 Mc. Alignment of the amplifier is for best transient response, resulting in no overshoot for pulses of short duration and fast rise time.

Accurately Calibrated Sweep Delay. The accurately calibrated delay of the LFE 401 provides means for measuring pulse widths, time intervals between pulses, precisely calibrating sweeps and other useful applications of time measurement.

The absolute value of delay is accurate to within 1% of the full scale calibration. The incremental accuracy is good to within 0.1% of full scale calibration.

Built-In Trigger Generator. Provides triggers from 500 — 5,000 cps. for internally triggering sweeps. These triggers are simultaneously available, delayed or undelayed, for external use.



For complete information and specifications write:

LABORATORY for ELECTRONICS, INC.
75-5 Pitts Street • Boston 14, Mass.

CIRCLE ED-42 ON READER-SERVICE CARD FOR MORE INFORMATION

New Products . . .

Anchor Nut Assembly Meets AN366 Specs



Composed of a steel self-locking hex nut, a spring clip and an aluminum retainer base, this assembly meets all AN366 envelope dimensions. This series was developed when conventional anchor nuts suffered damages during the cleaning process on aircraft sub-assemblies prior to painting.

The bottom anchor plate is welded or riveted to the sub-assembly before cleaning. After painting, the nut and spring are snapped into place in the anchor plate. This unit allows the removal of the nut without necessitating removal of the rivets from the anchor plate. Available in thread sizes 8-32 NC-2, 10-32 NF-3, and 1/4-28 NF-3. Nutt-Shel Co., Dept. ED, 811 Airway, Glendale 1, Calif.

CIRCLE ED-43 ON READER-SERVICE CARD FOR MORE INFORMATION

R-F Relay

Low Inter-Contact Capacitance



The "MC" Relay is especially applicable to r-f circuitry where inter-contact capacitance losses are critical. It is made with high dielectric ceramic insulation and has an inter-contact capacitance in the order of 1.5mmfd. It is available with a maximum of three movable and three fixed arms which permit many arrangements. Contacts are pure palladium, rated 1amp, 28v d-c, or 115v, 60cy, non-inductive load. Gold alloy contacts can be supplied on order to handle low-voltage, light-current loads.

Coil windings can be provided for operation from 50/60cy a-c or d-c with a maximum 22,000 ohms resistance. The power requirement is 150mw minimum per movable pole.

Contacts will not chatter under 10G vibration up to 300cps and 25G shock with coil power of 500mw or more per movable pole. The relay is insulated to withstand 1000v rms between open contacts, contacts to coil, and contacts to frame; and 500v rms from coil to frame. Hermetically sealed units are also available. Maximum dimensions of open units are 25/32" x 1-1/2" x 1-5/16". Sealed units are 1-13/32" x 1-5/8" x 2-3/32" in size. Potter & Brumfield, Dept. ED, Princeton, Ind.

CIRCLE ED-44 ON READER-SERVICE CARD FOR MORE INFORMATION

FASTER, MORE ACCURATE INSPECTION WITH FLASH-O-LENS Illuminated Magnifiers



In industrial inspection departments, on production lines, in foundries and laboratories, wherever close visual inspection is important, FLASH-O-LENS gets the job done better, faster. FLASH-O-LENS spots minute defects by spotlighting the area it magnifies.

Battery models, powered by standard flashlight cells, and AC-DC plug-in models are available with 5, 7, 20 or 40 power precision lenses to meet a wide range of inspection needs. Prices start from \$10.65.



WRITE TODAY
for literature showing
applications, types, prices.

E. W. PIKE & COMPANY, Inc.

492 NORTH AVENUE

ELIZABETH 3, N. J.

CIRCLE ED-45 ON READER-SERVICE CARD FOR MORE INFORMATION

ANOTHER NEW FAIRCHILD POTENTIOMETER



TYPE 754
2" LINEAR

New internal clamp ring design of the Type 754 permits ganging up to eight cups on a single shaft without increasing the 2" over-all diameter. All metal case construction. Depth is 1" with .594" added for each cup section ganged. Supplied with standard AIA servo mount. Resistance range from 800 to 100,000 ohms. Standard linearity of the Type 754 is $\pm 0.15\%$. Terminals are gold-plated for easy soldering and resistance to corrosion.

SAMPLES AVAILABLE

The Type 754 is another reason why Fairchild can help you solve all your precision potentiometer problems. For more information, write Fairchild Camera & Instrument Corp., Potentiometer Division, 225 Park Avenue, Hicksville, L. I., N. Y., Department 140-48 N.

FAIRCHILD
PRECISION POTENTIOMETERS

CIRCLE ED-46 ON READER-SERVICE CARD FOR MORE INFORMATION

Hook-Up Wire

For Class H Service or Better

"Temprone" stranded copper, silver-plated, hook-up and lead-in wire is supplied in 11 solid colors and over 100 combinations of striped insulation. Standard sizes range from 10AWG to 28AWG, in both thin and heavy wall thicknesses.

Insulated with Teflon, the wire is capable of continuous duty at -100° to $+260^{\circ}\text{C}$ without deterioration. Dielectric strength is 1000v/mil; volume resistivity is 10^9 meg/cm. The dielectric constant is 2.0 to 2.05 at frequencies from 60cy to 30,000Mc. There is no known solvent for the insulation. It is non-flammable, will not support fungus growth, and has zero water absorption rate. The wire conforms to the requirements of MIL-W-16878 (ships).

More than 20 combinations of stranding are available as standard, depending on the gauge required. Other strandings and wall thicknesses can be supplied on request. This firm will also furnish hook-up wire with shielding or Teflon impregnated glass fiber braids. Hitemp Wires, Inc., 26 Windsor Rd., Mineola, L. I.

CIRCLE ED-47 ON READER-SERVICE CARD

Silicone Enameled Wire

For High Temperature Use

This silicone enameled wire is intended for use in electrical equipment operating at temperatures of at least 130°C . It has good abrasion resistance, is smooth, and is not attacked by common solvents. The enamel will not craze when exposed to solvents, and will not crack when subjected to temperatures as low as -65°C .

Dielectric strength is 1500v/mil. Wires insulated with the varnish are furnished in single and heavy grades. The film is easily removed by "chemical strippers" such as those used for "Formvar", or by wire brushes. In general, the wire has much the same appearance as other synthetic resin insulated wires. Anaconda Wire & Cable Co., Dept. ED, Muskegon, Mich.

CIRCLE ED-48 ON READER-SERVICE CARD

CIRCLE ED-49 ON READER-SERVICE CARD

STILL LEADING THE BIG

Electronics Parade!

E-I

HERMETICALLY-
SEALED

miniature closures

—FOR TRANSISTORS
AND OTHER COMPONENTS



NO. 1
SERIES

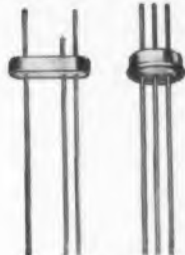

TRANSISTOR CLOSURES

(SHOWN
ACTUAL SIZE)

WRITE FOR THESE CATALOGS

- BULLETIN 949-A On hermetically sealed terminals. Discusses cushioned glass construction, thermal shock resistance, preferred types and special terminals.
- BULLETIN 950-A On hermetically sealed multiple headers. Explains vacuum tight feature, cushioned glass construction, strain-free qualities.
- BULLETIN 951 With complete information on actual type plug-in and multiple headers. Solid metal blanks insure maximum mechanical strength and rigidity.
- BULLETIN 952 Complete information on E-I end seals for hermetic sealing condensers, resistors and other tubular electronic and electrical components.
- BULLETIN 953 Individual, color-coded hermetically sealed terminals. Available with glass inserts colored in standard, easily identified RMA color codes.

- BULLETIN 960 Compression type multiple headers. Super rugged, absolutely rigid and practically indestructible. Guaranteed vacuum-tight.

New EI Miniature Closures can be supplied in various standard types or economically produced to your exact specifications for all electrical and electronic applications. The EI closure types illustrated are typical examples of the many miniature designs now in production. Cases can be supplied in round, rectangular or square shapes with hermetically sealed terminations to your order.

FOR COMPLETE
DATA AND PRICES
ON SPECIFIC TYPES
OF MINIATURE
CLOSURES, CALL
OR WRITE,

twice
actual
size

*PATENT PENDING
ALL RIGHTS RESERVED

DIVISION OF AMPEREX
ELECTRONICS CORPORATION



ELECTRICAL INDUSTRIES

44 SUMMER AVENUE, NEWARK 4, NEW JERSEY

EXPORT AGENTS: PHILIPS EXPORT CORP., 100 EAST 42nd STREET, NEW YORK 17, N. Y.



Pulse Forming Networks

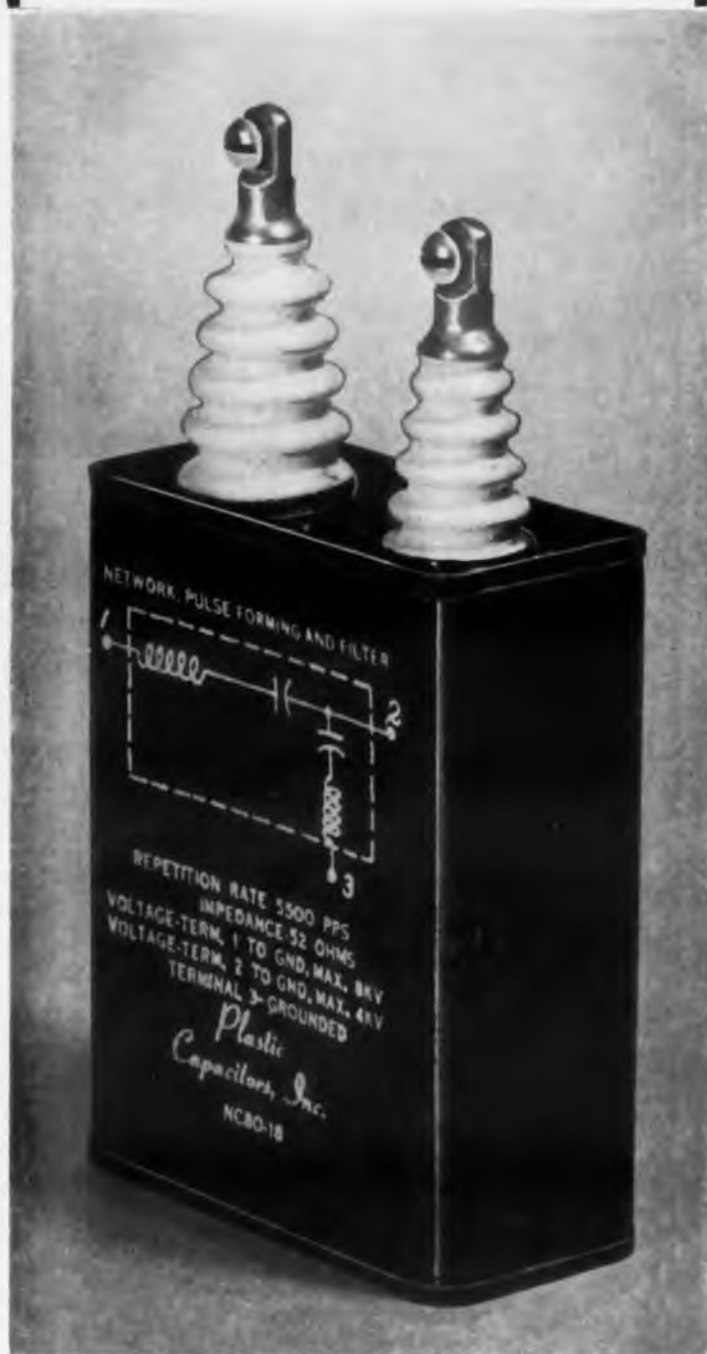

We are specialists with many years of experience in engineering and producing PULSE FORMING NETWORKS

We invite your inquiries. Ask for our complete catalogue on your company letterhead

- PLASTIC FILM CAPACITORS
- HIGH VOLTAGE POWER PACKS
- PULSE FORMING NETWORKS



CIRCLE ED-50 ON READER-SERVICE CARD FOR MORE INFORMATION

New Products . . .

Instrument Servo Gear Train Has Slip Clutch and Limit Stops

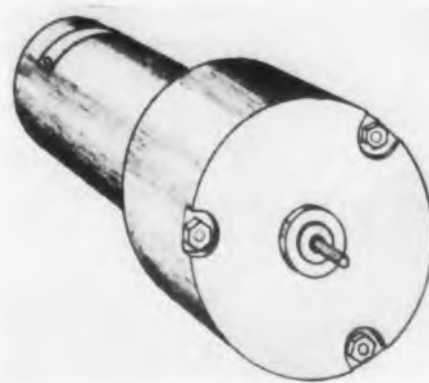

This stock item gear train can be supplied for any practical ratios from 1:1 to 7200:1 for applications in fire control, simulation, analog computers, and automatic systems. It features integral housing of the

gearing, a slip clutch, and rotational stops.

The slip torque may be varied from 1/2 in-oz to 20 in-oz. The limit stop may be set for data shaft rotation from 10° to 40° turns. Backlash is less than 10 minutes and maximum starting torque is less than 0.05 in-oz.

Ball bearing construction is used throughout although bushings may be used in the larger ratios. The housing may be mounted on any servo requested. Feedback Controls, Inc., Dept. ED, 503 Rhode Island Ave., N.E. Washington 2, D.C.

CIRCLE ED-51 ON READER-SERVICE CARD FOR MORE INFORMATION

Temperature Detector Has Fast Response

This hermetically sealed electrical Resistance Temperature Detector Model 221 N90A has an exponential time-constant of 0.8 sec or better in an agitated water bath. Designed for use with temperature recording, indicating and control equipment, its useful temperature range is from -70°C to +200°C. Temperature accuracy is +1.0% or better in mid-scale region.

The sensing element is a nickel winding having a basic resistance of 90.38 ohms at 0°C. Sealed in a stainless steel housing with a glass-to-metal sealed base thru which the connection is made, the new detector offers maximum resistance to corrosion and is not affected by most forms of destructive radiation. Thomas A. Edison, Inc., Dept. ED, West Orange, N.J.

CIRCLE ED-52 ON READER-SERVICE CARD FOR MORE INFORMATION



Write today for your **FREE** copy of this technical paper, reprinted from **Product Engineering: Annual Handbook of Product Design for 1954.**

The Precision Potentiometer as a Voltage Divider

By H. A. Schmidt
Sales Engineer,
Helipot Corporation

Write for Data File 524

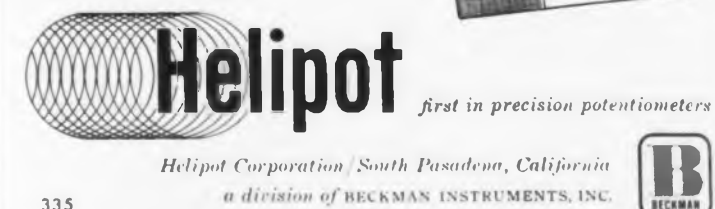

335
CIRCLE ED-53 ON READER-SERVICE CARD FOR MORE INFORMATION



MODEL "Y" ELECTRIC PRODUCTIMETER

on the MACHINE
or at CONTROL CENTER

The flexibility of the Model "Y" Electric Productimeter offers versatility of application to suit individual needs. Panel mounts grouped at control center give immediate production figures of many machines in different plant departments. Operates accurately over wide current fluctuations. Totally enclosed.



Hi-Speed, Compact, Accurate, Durable. Adaptable to panel or base mounting.

Send for Catalog No. 55

DURANT MANUFACTURING CO.
1993 N. Belfum St. Milwaukee 1, Wis.
193 S. Water St. Providence 3, R. I.
Representatives in Principal Cities



CIRCLE ED-54 ON READER-SERVICE CARD FOR MORE INFORMATION

Custom

These cu
should save
ed to draw
over and
are made
from origin
in 0.030 ple
the tracing
Inc., Dept.
Place, New

CIRCLE ED-

Coni

Meets
A new c
ial known
tured in gr
net finishe
company's

It is a c
Specificati
Its are re
dielectric c
high resist
fungus, a
Electric C
Humboldt

CIRCLE ED-

Tro

Imm
"CR-39
scratch an
ial devel
resins offe
ical prop
in glass
plastics.
acteristic
plate glas
clarity. I
action an

The ma
drilled, t
special "l
ighting"
cepts per
process o
ing, whic
economic
faces. T
Dept. ED
mington,

CIRCLE
ELECTR

CIRCLE E

ELECTR

Custom-Made Templates

Made of Plexiglas

These custom-made templates should save time for designers required to draw the same unusual shape over and over again. The templates are made according to specifications from original blueprints, and are cut in 0.030 plexiglas with a 15° bevel for the tracing pencil. Hermes Engravers, Inc., Dept. No. 88, 13-19 University Place, New York 3, N.Y.

CIRCLE ED-55 ON READER-SERVICE CARD

Connector Insulation

Meets Military Specifications

A new connector insulation material known as Diall 51-01 is manufactured in gray to blend with gray cabinet finishes. It will be used on this company's plugs.

It is a diester material, and meets Specification MIL-P-14D, type MDG. Its arc resistance is 135sec and its dielectric constant at 1kc is 5.2. It has high resistance to moisture, chemicals, fungus, and thermal shock. Cannon Electric Company, Dept. ED, 3209 Humboldt St., Los Angeles 31, Calif.

CIRCLE ED-56 ON READER-SERVICE CARD

Transparent Plastic

Immune to Chemical Action

"CR-39", a clear, transparent scratch and abrasion resistant material developed from thermosetting resins offers high optical and mechanical properties not generally available in glass or the more common clear plastics. The plastic has surface characteristics comparable to polished plate glass in smoothness, lustre and clarity. It is immune to chemical action and has high resilience.

The material is readily machined, drilled, threaded, or routed, and has special "light-piping" and "edge-lighting" qualities. The product accepts permanent printing by a special process other than engraving and filling, which should make it useful and economical for panels and instrument faces. The Homalite Corporation, Dept. ED, 14 Brookside Drive, Wilmington, Del.

CIRCLE ED-57 ON READER-SERVICE CARD

CIRCLE ED-58 ON READER-SERVICE CARD ➤

ELECTRONIC DESIGN • May 1954

New Switch

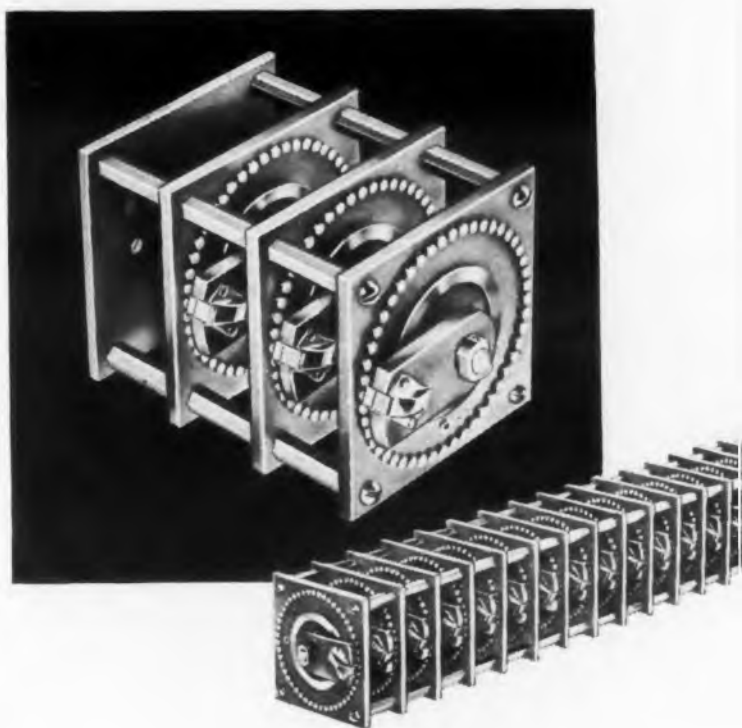

THE **DAVEN** CO.

169 CENTRAL AVENUE
NEWARK 4, NEW JERSEY



on SWITCHES

by **DAVEN**



DAVEN not only supplies switches from its hundreds of standard units, but can also effect quick changes from standard units to special switches by using components at hand.

As a result, you are able to select, from thousands of variations, the right switch for your particular requirements.

And . . . here's a new switch for problems that defy solution with standard components. If your prototype is that of an unusual piece of equipment and requires a switch not yet developed, DAVEN will engineer it for you.

This is a service which DAVEN is singularly well qualified to perform by reason of its skilled engineering staff and exceptional facilities. For more than a generation, DAVEN has built up a Development Department that is second to none in solving difficult switch problems.

Furthermore, because only DAVEN has the patented "knee-action" rotor, units can be produced with a greater number of switch positions and poles in a smaller space than was ever possible before.

Why not call on DAVEN today to assist with your development project, especially if you need switches that must render maximum performance in minimum space.

It's FREE

Write for your copy of DAVEN's new, 28-page brochure on SWITCHES.

BIG STRAY ROUNDUP

for balky r.f. frequency drift

Pard: you've roped yourself a winner!
 Centralab Temperature Compensating
 HI-KAPS put the strays in their place
 ...for keeps!

Use this size-capacity chart to pick the right
 Centralab TC HI-KAP® tubular capacitors to
 stabilize your circuits.

T.C.	CC20		Tube Size				
	Min.	Max.	CC25	CC30	CC32	CC35	CC45
P120	4.5	22	60	45	99	199	301
PO30	4.5	22	60	45	99	199	301
NPO	1	22	60	45	99	199	301
NO30	1	22	60	45	99	199	301
NO80	1	22	60	45	99	199	301
N150	1.5	22	60	45	99	199	301
N220	1.7	31	81	60	152	263	399
N330	2.5	36	94	69	152	304	461
N470	3.6	44	114	84	185	369	558
N750	4.2	63	163	120	275	550	795
N1500	9.5	95	244	120	396	791	1197
N2200	24.5	133	343	170	558	1113	1685
N3300	37	204	524	259	852	1699	2572
N4700	59	323	832	412	1352	2695	4080
N5250	73	401	1031	510	1675	3340	5055

Capacities shown are in mmf and (except for CC20 size) are the maximum values obtainable on the respective size tubular. All capacitor bodies are standard construction and price. Lower capacities than minimum shown can be obtained by special capacitor bodies (at extra cost). *Extended range from N1500 to N5250 available only at Centralab.*

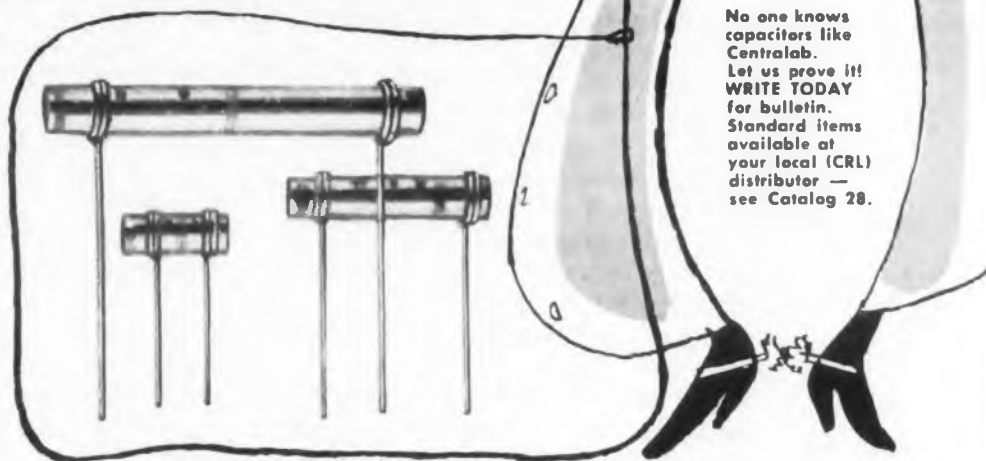

No one knows capacitors like Centralab. Let us prove it! **WRITE TODAY!** for bulletin. Standard items available at your local (CRL) distributor — see Catalog 28.

Centralab

A Division of Globe-Union Inc.
 952E E. Keefe Avenue • Milwaukee 1, Wisconsin
 In Canada: 804 Mt. Pleasant Road, Toronto, Ontario



Industry's greatest source of standard and special electronic components

CIRCLE ED-59 ON READER-SERVICE CARD FOR MORE INFORMATION

New Products . . .

Thermistor Kits

With 18 or 104 Units



These two special kits enable research and design engineers to conduct exploratory studies in adapting thermistors for temperature detection uses, and for

applications in electrical and electronic circuits. Kit No. 1, the smaller of the two, includes 18 thermistors, two each in three styles and three sizes.

Kit No. 2 contains 104 thermistors, including four styles and 26 sizes. This larger kit also contains an assortment of steel, lead, and fiber washers as well as tubing to facilitate building assemblies. Carboloy Dept., General Electric Co., Dept. ED, Detroit 32, Mich.

CIRCLE ED-60 ON READER-SERVICE CARD FOR MORE INFORMATION

Folded Hybrid Junctions

For 2.8 to 35 KMc

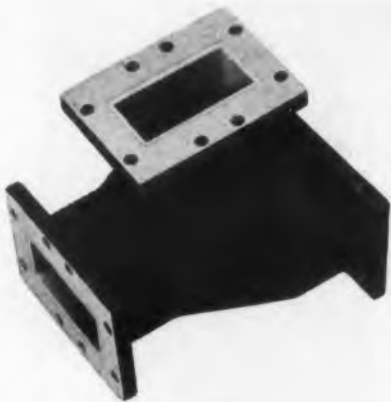

"Guideline Standard" Folded Hybrids are essentially a modification of the familiar "tee" outlet in that the two side arms have been folded back to share a common wall. Further compactness is attained by the use of miniaturized contact flanges at the series and shunt arms, and

a dual contact flange for the outlet arms.

These hybrid junctions, by permitting design of more compact mixers, power splitters, and phase shifters make possible simpler equipment layout, construction, and servicing. Sizes are available covering useful frequencies from 2800Mc to 35,000Mc. All types feature a bandwidth of 12% around the design center frequency, terminated vswr's less than 1.30, and a minimum 30db isolation of the E and H plane arms.

Units are available in silver-plated brass or in iridized aluminum finished in zinc chromate and black enamel. Optional for the complete series are E and H plane adapters consisting of dual contact flanges in the inputs, with standard AN flange outputs. Airtron, Inc., Dept. H, Linden, N. J.

CIRCLE ED-61 ON READER-SERVICE CARD FOR MORE INFORMATION

Important SAVINGS

to VOLUME users of small parts

..like these



SHOWN TWICE SIZE

thanks to MULTI-SWAGE

If you need small tubular metal parts like these in large VOLUME, Bead Chain's MULTI-SWAGE Process can mean important savings to you.

Much Cheaper Than Solid Pins

Many prominent users of solid pins for electronic and mechanical purposes have cut costs by switching to Multi-Swaged tubular pins . . . without sacrificing strength or accuracy.

Typical Applications—

As terminals, contacts, bearing pins, stop pins, male-female connections, etc., in a wide variety of products such as Business Machines, Ventilator Louvers, Toys, Radio and Television Apparatus, Terminal-boards, Electric Shavers, Phonograph Pickups, etc.

Send part (up to 1/4" dia. and to 1 1/2" length) and your specs for a quotation or write for DATA BULLETIN.

B[®]

THE BEAD CHAIN[®] MFG. CO.

58 Mountain Grove St., Bridgeport 5, Conn. Manufacturers of BEAD CHAIN—the kinkless chain of a thousand uses, for pull and retaining chains and other industrial uses; plumbing, electrical, jewelry, fishing tackle and novelty products.

CIRCLE ED-62 ON READER-SERVICE CARD

Wear a
ng are r
lubricatio
tions. A
Servo Lu
minutes.

Surface
face lay
aluminum
test kit q
1315 Jer

CIRCLE ED-



The T
band os
posite v
is conti
receiving
delay, a
any des
vides in
occurs a
output
positive
composi
num to
wave.

The
minimum
are sup
marker
0.005H
ously v
position

To n
lescope
method
Weight
Box 83

CIRCLE E

ELECT

Servo Lubricant

Corrosion Resistant

Wear and "striction" problems for aluminum gearing are reduced with "Servo Lube", an anti-corrosive lubrication prepared for low-inertia servo applications. A formulation of purified molybdenum sulfide, Servo Lube is brushed on and then air dried in a few minutes.

Surfaces treated remain absolutely dry with a surface layer of lubricant chemically bonded to aluminum components. The product is available in test kit quantities. Electronic Products Co., Dept. ED, 1315 Jericho Turnpike, New Hyde Park, N.Y.

CIRCLE ED-63 ON READER-SERVICE CARD FOR MORE INFORMATION

Oscilloscope Adaptor

For Observation of TV Signals



The Type 124 Adaptor adapts any triggered wide-band oscilloscope to the observation of the TV composite video signal. The unit's delayed-trigger output is continuously variable from 0 to 25 millisecc after receiving a vertical sync pulse. By adjusting the delay, an oscilloscope can be triggered at the start of any desired line in a field. A panel pushbutton provides instant shift to the opposite field. Triggering occurs at half the TV vertical rate. Duration of the output pulse is less than 1 μ sec, and amplitude is 2v positive. Triggering may be accomplished by the composite video signal of either polarity, 0.5v minimum to 20v maximum, peak-to-peak, or a 60cy sine wave.

The time-marker generator requires a gate of 20v minimum to 60v maximum, peak-to-peak. Markers are supplied for the duration of the gate. Time marker intervals are 1 μ sec, 0.1 μ sec, 0.05 μ sec, and 0.005H (200 per TV line). Amplitude is continuously variable from 0 to 30v. Phase control permits positioning the markers on the trace.

To make use of the time-marker output, the oscilloscope should have a positive gate output and a CRT anode terminal. Size is 6-3/4" x 12-3/4" x 12-1/2". Weight is 20 lb. Tektronix, Inc., Dept. ED, P. O. Box 831, Portland 7, Ore.

CIRCLE ED-64 ON READER-SERVICE CARD FOR MORE INFORMATION

ELECTRONIC DESIGN • May 1954



WRITE FOR
NEW CATALOG
Address requests for your copy of the new catalog to Department D-5 — no obligation.

PRECISE
TEST EQUIPMENT

Microwave TEST COMPONENTS

PRD offers a complete line of test equipment for precise measurements in the Microwave region. This equipment, the finest obtainable anywhere, includes Frequency Measuring Devices, Signal Sources and Receivers, Attenuators and Terminations, Impedance Measurement and Transformation Devices, Detection and Power Measurement Equipment, Bolometers and Accessories.

When you test,
be the best—

PRD

QUALITY
DEPENDABILITY
ACCURACY



TYPE 250-A BROADBAND PROBE — Frequency range of 1 to 12.4 Kmc/s; two tuning knobs permit precise adjustment for maximum power transfer from the probe tip to the crystal or bolometer detector; third knob controls depth of probe tip insertion.



TYPE 275 VSWR AMPLIFIER — Featuring high gain; A.G.C. to maintain output constant for slow variation in r-f power source; low input noise level of 0.03 microvolts; wide VSWR ranges of 1:1.3, 1:3, 3:10, 10:30, and 30:100; greater accuracy because VSWR scale on meter is linear.

SLOTTED SECTIONS—The mechanical and electrical design of PRD slotted sections emphasizes these important features: Instrument accuracy assured indefinitely by virtue of three bearing carriage suspension to minimize wear; waveguide section machined from solid aluminum alloy stock, to avoid warpage no castings are used.



Polytechnic **RESEARCH
& DEVELOPMENT COMPANY • Inc**



55 JOHNSON STREET, BROOKLYN 1, NEW YORK
WESTERN SALES OFFICE:
741½ NO. SEWARD ST., HOLLYWOOD 38, CALIF.
MIDWEST SALES OFFICE:
1 SO. NORTHWEST HWY., PARK RIDGE, ILL.

CIRCLE ED-65 ON READER-SERVICE CARD FOR MORE INFORMATION



THERE'S
NO CATCH
TO
Koiled Kords
SAYS
STROBO RESEARCH

"A great convenience, a tremendous impetus to sales", says Edward Farber, of Strobe Research, Milwaukee. Koiled Kords are now used on all the STROBOFLASH® units made by this company and Mr. Farber claims the retractile cord "adds that certain additional look of quality and efficiency."

On all electrical equipment that moves, Koiled Kords eliminate long trailing wires. They are safe, long lasting, convenient and attractive. Whether your problems concern consumer or industrial products, Koiled Kords may prove a tremendous asset.

Write for booklet 1052-G that shows many applications for Koiled Kords. It's free and full of ideas.

Koiled Kords
INCORPORATED

BOX K, NEW HAVEN 14, CONN.

CIRCLE ED-66 ON READER-SERVICE CARD FOR MORE INFORMATION

42

New Products . . .

Instrument Servo Package Gear Train, Clutch, Limit Stops, etc

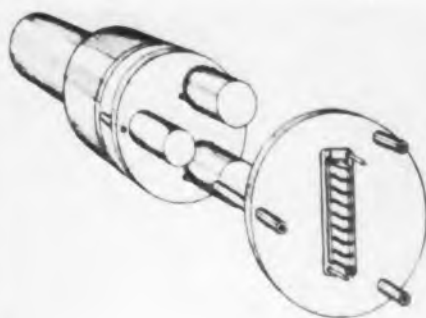

Simplification of servo instrumentation is made possible by utilizing this Instrument Servo Package, which includes a gear train, slip clutch, limit stop and data output units. Its construction permits components to be mounted on the servo to allow data elements of varying rotational speeds to be combined for desired solutions. It may be supplied with a motor-generator set and amplifier. Feedback Controls, Inc., Dept. ED, 503 Rhode Island Ave., N.E., Washington 2, D. C.

CIRCLE ED-67 ON READER-SERVICE CARD FOR MORE INFORMATION

Resonant Relays

Operate at 60 to 442cy



A 60cy model has been added to this firm's line of Resonant Relays, which includes 11 other relays operating at standard frequencies from 153cy to 442cy. These relays use a vibrating reed mechanism; adjusted at the factory to respond to a narrow band of frequencies and to reject all others. The contacts in turn are connected in series between the power supply and the circuit to be controlled. When the relay operates, the current is delivered to the circuit in pulses at the resonant frequency of the relay. In "on-off" applications, a conventional slow acting relay is used as an auxiliary. In electronic applications, the grid of a thyatron is triggered directly from the vibrating contacts.

The design makes remote control possible at low costs wherever there are existing wires to permit transmission of carrier current frequencies or where there is a radio circuit. At the normal operating level of 3v, band width is $\pm 1\%$ minimum. Only 20mw are required to operate a relay at this normal level. Contact rating is 110v d-c, 1/4amp maximum. Contacts are closed 5% of the time or 1/20th of a cycle.

The relays are enclosed in a standard metal radio tube envelope with an octal base; seated height is 2-3/4". Stevens-Arnold, Inc., Dept. ED, 22 Elkins St., South Boston, Mass.

CIRCLE ED-68 ON READER-SERVICE CARD FOR MORE INFORMATION

is this your
timing
problem?



Sorry . . .
A. W. HAYDON CO.
can't help you.

Only instruction, practice, and patience can improve your score!

But...if your problem is PRECISION TIMING

you may save time, trouble and money by investigating what our timing engineers have done for others. Our A.C. and D.C. achievements may already include the solution of your most complex problem. Why not find out?

Send for
latest
catalog
manual



CIRCLE ED-69 ON READER-SERVICE CARD FOR MORE INFORMATION

NEW SUB MINIATURE Metallized Paper CAPACITORS



FUNGINERT PLASTIC
ENCASED

In sizes to fit your exact need! Save space!

- ✓ Resin impregnated and rectangular shaped for maximum space conservation
- ✓ Completely encased in a non-nutrient plastic for maximum fungus and humidity protection
- ✓ Operating temperature range -55°C to $+100^{\circ}\text{C}$
- ✓ Temperature coefficient $+0.07\%/^{\circ}\text{C}$
- ✓ Excellent capacity retrace

HOPKINS
Engineering Co.

Phone,
Write
or wire
TODAY!

Dept. W., 2082 Lincoln Ave.
Altadena, Calif. SYcamore 8-1185
Offices in WASHINGTON, D.C.
and DETROIT

CIRCLE ED-70 ON READER-SERVICE CARD FOR MORE INFORMATION

ELECTRONIC DESIGN • May 1954

Miniature Sealed Relay

Withstands 50G Shock



For aircraft and missile applications, the type "MRH" relay has dimensions approaching those of miniature tubes. Useful at 50G shock and 20G vibration up to 500cy, it provides 2amp contacts in dpdt com-

bination. It is available for use at ambients of 85°C or up to 200°C for special purposes.

All contact insulation is ceramic and glass, making the relay valuable for high frequency switching applications. It occupies a volume of 0.75 cu in, and weighs 1.4 oz. Coil resistances up to 10,000 ohms are available. The relay can be supplied in a plug-in arrangement as well as a new ferrule mounting. Branson Corp., Dept. ED, Boonton, N. J.

CIRCLE ED-71 ON READER-SERVICE CARD FOR MORE INFORMATION

Motor-Driven Commutator

For Telemetry, Sampling, etc.

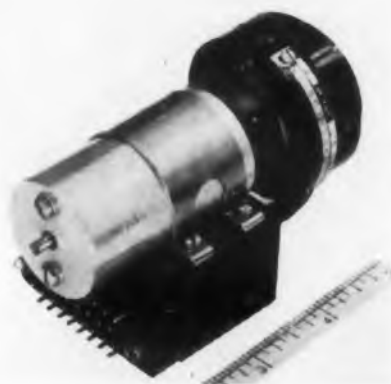

The Model 85562 multi-channel motor-driven telemetry commutator has many applications in radio and wired telemetry, automatic programming, sampling, and monitoring. It incorporates such features

as rhodium-plated printed circuits to meet individual customer requirements, and high speed sampling with as many as 1800 contacts per second. Switching can be "break-before-make" or "make before-break", with a phase adjustment feature provided on the 2-pole model.

Special features are dust proof construction and a unique contact cleaning system that keeps the switch free of noise throughout the design life of the instrument. The commutator is currently in production using two drives with gear reducers, a constant-speed governor-controlled motor, or a variable speed motor in which the speed varies linearly with the applied voltage. Rated voltage of both drives is 24-29v d.c. G. M. Giannini & Co., Inc., Dept. ED, 39 Main St., East Orange, N. J.

CIRCLE ED-72 ON READER-SERVICE CARD FOR MORE INFORMATION

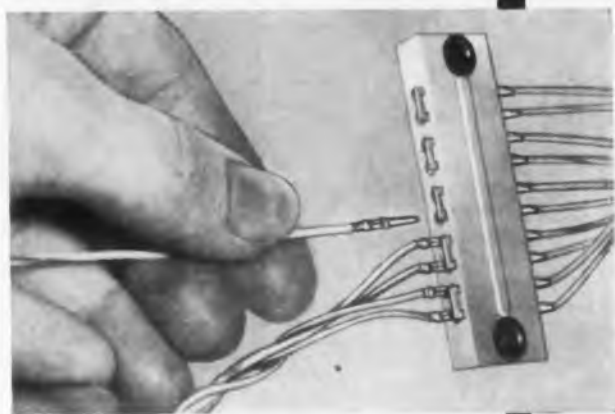

BASIC 10 CONNECTOR TAPER-BLOK WITH DUAL CONTACTS

Photo shows TAPER-BLOK with A-MP TAPER PINS in place. Strip measures only .610" x 2". Blocks, made of NYLON 10001, can also be stacked to accommodate hundreds of circuits.



TAPER PINS FOR MULTIPLE CONNECTORS, AND OTHER TYPES

Amphenol, Cannon, Continental and Winchester Connectors now are available with tapered receptacles for A-MP self-locking TAPER PINS. Saves over 80% of your wire assembly time and provides uniformly higher quality connections at lower cost.



TAPER TAB RECEPTACLE APPLICATIONS

More and more flat tabs on relays, switches and other components are being tapered to receive A-MP TAPER TAB RECEPTACLES. Fast easy assembly reduces costs and provides higher quality connections.

ELECTRONIC DESIGN • May 1954

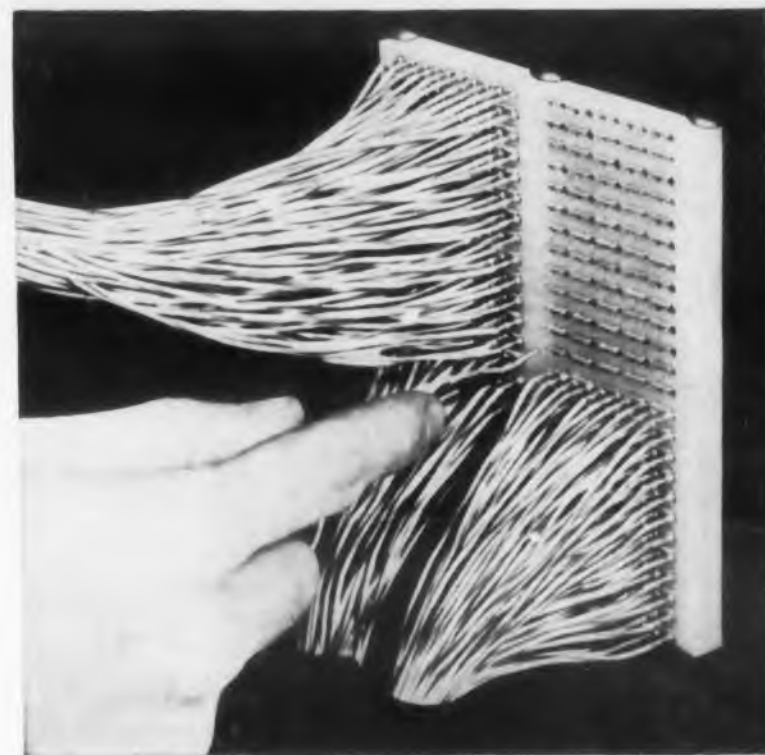

NEW **A-MP**

MINIATURE

TAPER-BLOK

For AMP Taper Pins

(Wire Ranges: #26 to #16)

NEW TAPER-BLOK FOR A-MP'S TAPER PINS HELPS YOU SAVE SPACE AND WEIGHT, SPEEDS UP WIRING ASSEMBLY, SIMPLIFIES DESIGN, AND REDUCES COST!

The TAPER-BLOK shown has receptacles for 1000 connections, yet measures only 4" x 5" x 3/8"! Receptacles are designed to receive A-MP self-locking Taper Pins which can be easily pushed in place with A-MP's CERTI-LOK measured energy insertion tool.

Extremely high contact pressure assures dependable, uniform, low resistance connections for electric and electronic circuits.

Assembled TAPER-BLOKS are available in 10 and 20 connector sizes with single or dual receptacles. TAPER-BLOK strips can be assembled by stacking to provide the number of connections required for your design. Write for specific information and latest prints.

AMP Trade Mark Reg. U.S. Pat. Off. © AMP



AIRCRAFT-MARINE PRODUCTS, INC.
2100 PAXTON STREET, Harrisburg, Pennsylvania

In Canada — AIRCRAFT-MARINE PRODUCTS, INC.
1764 Avenue Road, Toronto 12, Ontario, Canada

CIRCLE ED-73 ON READER-SERVICE CARD FOR MORE INFORMATION

electromechanical
ENGINEERS

for research in and development of electro-mechanical radar and computing equipment.

THE MOST ADVANCED DEVELOPMENTS IN ELECTRONICS ARE BEING MADE IN THE SPHERE OF AIRBORNE RADAR AND ALLIED FIRE CONTROL SYSTEMS BECAUSE OF MILITARY EMPHASIS. FURTHER APPLICATIONS OF ELECTROMECHANICAL TECHNIQUES IN THESE FIELDS ARE CREATING NEW OPENINGS IN THE RADAR DIVISION OF HUGHES RESEARCH AND DEVELOPMENT LABORATORIES.

Engineers who have demonstrated ingenuity and inventive ability will find interest in the areas of work that call for devising reliable, maintainable, manufacturable designs for precision equipment developed in the Hughes Radar Division.

Equipment includes mechanical, electronic and microwave devices and systems to be manufactured in quantity. The equipment designs require use of such advanced techniques as subminiaturization, unitized "plug-in" construction, with emphasis on design for volume production. Knowledge of electronic components, materials, finishes and military specifications is useful.

ENGINEERS EXPERIENCED IN THE FIELD OF ELECTROMECHANICAL DESIGN FOR PRODUCTION, OR THOSE INTERESTED IN ENTERING THIS ORBIT, WILL FIND OUTLETS FOR THEIR ABILITIES AND IMAGINATION IN THESE ACTIVE AREAS.

Scientific and Engineering Staff

HUGHES

RESEARCH AND DEVELOPMENT LABORATORIES

Culver City, Los Angeles County, California

Assurance is required that relocation of the applicant will not cause disruption of an urgent military project.

New Products . . .

Latching Relays
Positive Action Despite Wear



Designed for electronic and electrical control applications, these compact light-weight relays are resistant to vibration and shock, and

incorporate angle mounting of the coil mechanism. A new wedge action feature insures positive action regardless of wear or play in the armature hinge joints. They are designed to give dependable action in any position.

Contacts in these relays are rated at 8amp, 115v a-c, or 8amp, 29v d-c. The coil is capable of continuous or intermittent duty with resistance to 10,000 ohms. Maximum voltage is 120v a-c, or 120v d-c. The relays measure 3-11/16"x1-7/8"x1-11/16". Leach Relay Co., Dept. ED, 5915 Avalon Blvd, Los Angeles 3, Calif.

CIRCLE ED-76 ON READER-SERVICE CARD FOR MORE INFORMATION

Electronic Counter

Counts up to 10,000 digits/Min



The model RC precision, direct readout cold cathode electronic counter operates at speeds up to 10,000 counts per minute and has a total counting capacity of 9,999,999. It consists of an electronic decimal unit preceding a six digit electromagnetic register. Complete independence from line voltage variations and fluctuations is featured. Illumination of the direct reading decimal scale is derived directly from the associated cold cathode tubes rather than from the auxiliary light circuit. Decimal unit numbers are large for easy reading.

The counter is used for such applications as totalizing linear footage, timing, and life testing. It can be used in conjunction with photoelectric or capacity operated equipment, and can function with practically any transducer pick-up. Haledy Electronics Co., Dept. ED, 57 William St., New York 5, N.Y.

CIRCLE ED-77 ON READER-SERVICE CARD FOR MORE INFORMATION

CURTIS TERMINAL BLOCKS
for —

- Experimental work (Build-up)
- Feed-thru applications
- High current requirements
- Control wiring
- Locked-in connections
- Combination terminals

in —
Factory assembled and kit form
Tell us your terminal block problems — for engineered recommendations

CURTIS DEVELOPMENT & MFG. CO.
3236 North 33rd Street, Milwaukee 16, Wisconsin

CIRCLE ED-78 ON READER-SERVICE CARD FOR MORE INFORMATION

FORMULA 602
VS.
CARBON TETRACHLORIDE
(report by independent test laboratory)



FORMULA 602

Ten healthy adult albino rats inhaled 125 parts FORMULA 602 per million parts air in an inhalation box for 30 minutes. This was repeated daily for 14 days. At the end of this time ABSOLUTELY NO ILL EFFECTS OR DEATHS OCCURRED!



CARBON TETRACHLORIDE

After 30 minutes exposure to 125 parts carbon tet per million parts air in an inhalation box, seven out of ten rats died. The following day, the remaining 3 rats died after another 30 minutes exposure. CARBON TET KILLED ALL THE RATS!

FORMULA 602 CLEANS MOTORS AND ALL ELECTRONIC EQUIPMENT

FORMULA 602 cleans without leaving a residue, corroding metals or damaging electric insulation. Use it wherever carbon tet is used for cleaning!

SEND FOR FULL INFORMATION TODAY

the PENETONE co.
BOX ED-554, TENAFLY, NEW JERSEY

CIRCLE ED-79 ON READER-SERVICE CARD FOR MORE INFORMATION

Soldering Iron

Weighs only 1/2 oz.



Weighing only 1/2 oz, the "Oryx" soldering instruments should be valuable to the designer as well as the production engineer. Only 6" long, these robust units have no ceramic or mica formers to break or flake. They require only 20 or 30sec to heat.

A wide variety of operating voltages is available as well as tips for precision soldering. The units are imported from England. Television Accessories Co., Dept. 1, Box 6001, Arlington 6, Va.

CIRCLE ED-80 ON READER-SERVICE CARD FOR MORE INFORMATION

Cathode-Ray Oscillograph

Wide-Band, General-Purpose Unit



The Type 323 Oscillograph features high precision measurement of both time and amplitude over the entire range of general laboratory applications. Its direct-coupled 10Mc (3db down) vertical amplifier enables display of very-low-frequency phenomena, as well as high speed

pulses, together with their d-c level. Sweeps are directly calibrated by means of a front-panel dial; recalibration, if ever needed, is easily accomplished. Sweep range extends from 1 sec to 0.1μsec per inch.

The scale of the Type 323 may be calibrated to read directly in volts by means of internally generated voltage standards. Eleven ranges, from 0.2v to 400v full-scale. Other features include a new type cathode-ray tube based upon the mono-accelerator principle which minimizes spot and field distortion; and electronic regulation of all power sources, including critical heaters. Allen B. DuMont Laboratories, Inc., Dept. ED, 760 Bloomfield Ave., Clifton, New Jersey.

CIRCLE ED-81 ON READER-SERVICE CARD FOR MORE INFORMATION

precision electronic instruments by DeJUR



PANEL INSTRUMENTS

1. 2 1/2" Ruggedized Meter. Meets MIL-M-10304. Model R210
2. 3 1/2" A.S.A. Meter meets MIL-M-6A. Model S312
3. 1 1/2" Meter. Conserves space. Built to SC-73-3. Model 112
4. 1 1/2" Meter. Metal Case. Single Hole Mounting. Model 120
5. 1 1/2" Ruggedized Meter. Meets MIL-10304. Model R112

PRECISION POTENTIOMETERS

6. Multiple ganging and external phasing 2" Diameter Model C200
7. Single hole mounting Model C200
8. Single Sine-Cosine Model C200
9. Dual Unit Model L402
10. 1-11/16" Diameter Center tapped Model L402
11. 3" Diameter 11 watt JAN-R-19 Const. Model 275
12. Dual Concentric Model 282
13. 3" Diameter 8 watt JAN-R-19 Const. Model 260
14. Non-Linear Card C200
15. Sine-Cosine Card C200

Actual performance records prove that these DeJUR components withstand adverse conditions of vibration, heat and moisture. Each is engineered and manufactured to meet rigid government requirements. In addition to its wide variety of stock instruments, DeJUR offers top-flight laboratory, engineering and manufacturing facilities for production of these precision units adapted to your specifications. Inquiries are invited.

Write for more detailed information on any of the products shown on this page to Dept. EDMPS.



DeJUR-AMSCO CORPORATION

45-01 NORTHERN BOULEVARD, LONG ISLAND CITY 1, N. Y.
MANUFACTURERS OF SCIENTIFIC PRECISION EQUIPMENT FOR OVER 30 YEARS

CIRCLE ED-82 ON READER-SERVICE CARD FOR MORE INFORMATION

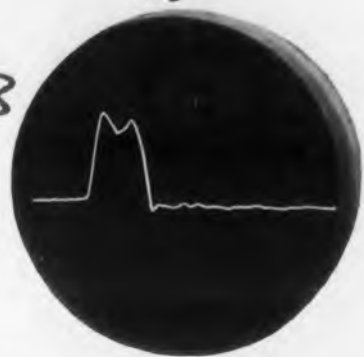

measuring
re-trace time
assures

FLYBACKS designed to your
exact specifications—

built for **EXTRA** years of trouble-free performance.

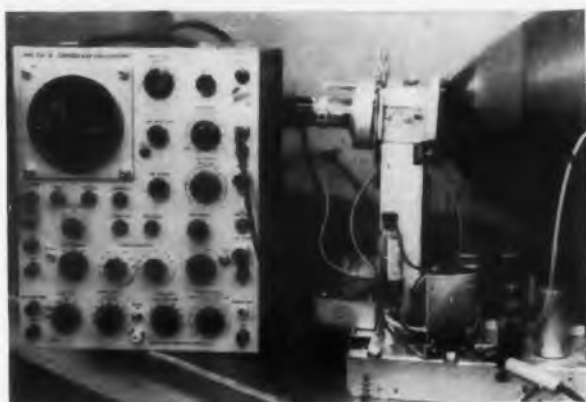

FAST SERVICE

on your requirements: Heppner has



2 airplanes and 6 pilots in the

Sales and Engineering Departments.

SPECIALISTS IN ELECTRO-MAGNETIC DEVICES

HEPPNER
MANUFACTURING COMPANY

Round Lake, Illinois (50 Miles Northwest of Chicago)
Phone: 6-2161

Representatives: **John J. Kopple**
60 E. 42nd St., New York 17, N. Y.
James C. Muggleworth
506 Richey Ave., W. Collingswood, N. J.
Ralph Haffey
R. R. 1, U. S. 27, Coldwater Rd.,
Ft. Wayne 8, Indiana
Irv. M. Cochrane Co.
408 So. Alvarado St., Los Angeles, Calif.

CIRCLE ED-83 ON READER-SERVICE CARD FOR MORE INFORMATION

New Products . . .

Self-Generating Accelerometer

Sensitive to $\pm 0.003G$



Comparable to a walnut in size, this Self-Generating Accelerometer is especially designed to determine frequency and amplitude at high voltages. Power output is as high as 2v, without external excitation. Sensitivity is as low as $\pm 0.003G$, and frequency response is from 2 to 350cy. The unit operates with extreme accuracy at temperatures up to 550°F.

Produced in a wide range of ratings, it can be used for many types of impact acceleration studies, vibration analyses, and a range of other applications for aircraft, guided missiles, and general industry. General Scientific Corp., Dept. ED, Los Angeles, Calif.

CIRCLE ED-84 ON READER-SERVICE CARD FOR MORE INFORMATION

Voltage Standard

Also Provides Regulated Power



This "Regatron" series provides in one unit a variable d-c voltage standard, a high-powered super-regulated power supply, and a research voltage source with small signal modulation—in a single chassis, standard relay rack, or table models. D-c voltage is 0-600v vernier calibrated on a 10-turn precision potentiometer to 0.25% (or better where required).

Current ratings available are 0-600ma or 0-1000ma. Regulation is 0.05% or better where required. Usefulness of low voltages for transistor work is increased by a 0.3v electrical vernier and an injection circuit for small signal modulation of the output. Auxiliary bias and filament potentials are included. Electronic Measurements Co., Inc., Dept. ED, Lewis St. and Maple Ave., Eatontown, N. J.

CIRCLE ED-85 ON READER-SERVICE CARD FOR MORE INFORMATION

**YOU CAN'T
SHAKE 'EM LOOSE!**
BUT YOU CAN COOL 'EM OFF...



With BIRTCHER

KOOL KLAMPS

BIRTCHER KOOL KLAMPS will help keep your subminiature tubes COOL... and hold them firm and secure, regardless of how they are shaken, or vibrated.

KOOL KLAMPS are made of a specially developed heat treatable alloy 99 1/2% pure silver of high thermal conductivity.

KOOL KLAMPS under certain conditions are able to reduce bulb temperatures as much as 40° C. KOOL KLAMPS have proved of particular value in miniaturized electronic equipment.

Where heat conditions are less critical, beryllium copper KOOL KLAMPS are available.

The BIRTCHER CORPORATION

4371 Valley Blvd.
Los Angeles 32, California

Dept. ED-5-4

Please send Bulletin which describes and illustrates Kool Klamps in detail.

Company
Attention of
City State

CIRCLE ED-86 ON READER-SERVICE CARD

ELECTRONIC DESIGN • May 1954

Low-Noise Transistors

For Use in Hearing Aids



Designed for use in hearing aids, the compact HIA-1, HA-2, and HA-3 junction transistors are tested to meet the low-noise requirements of hearing-amplifiers. The HIA-1 and HA-2 are high-gain units for the low-level stages. The HIA-2 was designed for the power output stage. The three units together

provide sufficient gain and output for a three-stage hearing aid amplifier.

The units are impregnated with a moisture-resistant compound. They are contamination-proof, light-proof, and humidity-proof. CBS-Hytron, Dept. ED, Division of the Columbia Broadcasting System, Danvers, Mass.

CIRCLE ED-87 ON READER-SERVICE CARD

Subminiature Crystal

For 15-100Mc Range



The "Bantam BX" Crystal provides a subminiature crystal unit for precision frequency control. Hermetically sealed with wire leads, it has a 15-100Mc range. It has the same performance characteristics as MIL types CR-23 or CR-32.

The unit can be applied wherever precision performance is required, for example, in multi-channel communications operations. It may be wired into a miniature socket or soldered to a printed circuit terminal board. Bliley Electric Co., Dept. ED, Union Station Bldg., Erie, Pa.

CIRCLE ED-88 ON READER-SERVICE CARD

CIRCLE ED-89 ON READER-SERVICE CARD ➤

ELECTRONIC DESIGN • May 1954



Here's Another Reason Why G.E. Can Supply the Aircraft Motor You Need

EXPERIENCE GAINED by General Electric engineers in the design, testing, and manufacture of this permanent-magnet motor is one more reason why G.E. is best equipped to supply the aircraft motor you need. And this motor is just one of the latest of hundreds of aircraft and armament motors supplied by G.E.

THIS PARTICULAR MOTOR, rated 1/100 hp and gear-reduced to 130 rpm, operates on 27.5 volts. Designed for dynamic brak-

ing, it can be stopped in 1/10 revolution by a fast-acting relay. Such performance makes it ideal for radar tuners, actuators, and blowers.

YOUR SPECIFICATIONS are all that G-E motor engineers need to begin applying their years of experience to your aircraft or armament motor problems. Contact your G-E Apparatus Sales Office today. Or write: General Electric Co., Section 704-28, Schenectady 5, N. Y.

GENERAL  ELECTRIC



for rugged, moisture-proof
High Compression
**MULTI-PIN
CONNECTOR PLUGS**
specify

Constantin

These quality-engineered high compression glass-to-metal vacuum sealed connecting plugs are ideal for generator filters, position indicators, tachometers, direction finding equipment, or almost any equipment which must be sealed against moisture or pressure changes. Construction is of glass and metal fused together to make a sturdy vacuum tight seal.

Available in a wide variety of pin configurations, these connectors may be furnished in many plating finishes for ease of soldering, appearance, and corrosion tests such as salt spray and humidity. Truly fine connectors—specified by leading manufacturers.

SEALS AVAILABLE IN EITHER HIGH COMPRESSION
OR HARD GLASS TO KOVAR TYPES.

L. L. Constantin & Co.

MANUFACTURING ENGINEERS

Rt. 46 and Franklin Ave., Lodi, N. J.

Also manufacturers of
MULTI-PIN HEADERS
TERMINALS
END SEALS
TRANSISTOR MOUNTS
CRYSTAL HOLDERS
VACUUM COATING EQUIPMENT

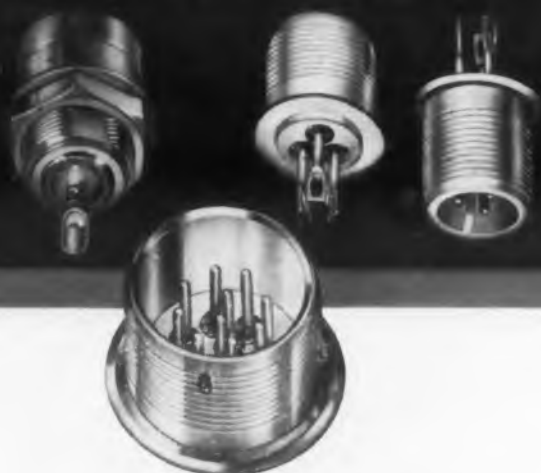

CIRCLE ED-91 ON READER-SERVICE CARD

New Products . . .

Instrument Cabinet

For Vertical or Horizontal Stacking



Constructed of cold rolled welded steel, this instrument cabinet is finished with a two-tone metallic gray finish. Top, bottom, back, and both end panels are easily removed with a

screwdriver, allowing complete accessibility.

Cabinets can be stacked vertically or horizontally and locked together in minutes by Tinnerman Speed Nuts with a screwdriver. The design accommodates chassis with 8-3/4" x 19" front panel and 15" depth. Chassis guide supports are adjustable to any chassis up to 17" wide. Standard RETMA and WE mounting holes are on front, back, top, and bottom for fastening panels. Four rubber feet are included. There is a choice of three different ventilating panel systems. Elgin Metalformers, Corp., Dept. ED, 906 N. Liberty St., Elgin, Ill.

CIRCLE ED-92 ON READER-SERVICE CARD FOR MORE INFORMATION

Electric Counter

Operates Switches



A valuable automation component, the Model "SP" Predetermined Electric Counter is actuated by electrical impulses and closes or opens at any preset count

from 1 to 99,999. The unit is available in two models with four or five figures for counts of 1 to 9999 or 1 to 99,999, respectively. A metal hinged cover provides quick access to the predetermined count wheels for easy setting.

Switch capacities are 5amp at 125v or 250v a-c, 0.5amp at 110v or 200v d-c, noninductive load, and 0.3amp at 110v or 220v d-c, inductive load. Standard operating voltage is 105 to 120v, 60cy. Other operating voltages are available on request. Switch contacts are normally open in the standard counter. Normally closed contacts can be supplied.

The counter is 4-3/8"x2-1/8"x2-5/8" in size, and weighs 1-3/4 lb. Top counting speed is 600 counts per minute. Durant Manufacturing Company, Dept. ED, 1993 N. Buffum St., Milwaukee 1, Wis.

CIRCLE ED-93 ON READER-SERVICE CARD FOR MORE INFORMATION

NEED THESE?

Get them all from
COMAR

Comar's complete engineering, manufacturing and sealing facilities all coordinated in one modern plant, offers you a fast convenient source for your electronic control components. Units are custom-made to your specifications...yet cost no more. When you need relays, solenoids, coils, switches, transformers, hermetic sealing, it will pay you to contact Comar.



comar ELECTRIC COMPANY
3349 ADDISON STREET
CHICAGO 18, ILLINOIS

RELAYS • SOLENOIDS • COILS • TRANSFORMERS • SWITCHES • HERMETIC SEALING

CIRCLE ED-94 ON READER-SERVICE CARD FOR MORE INFORMATION

ALLIED world's largest distributor of ELECTRON TUBES FOR INDUSTRY

IMMEDIATE DELIVERY FROM STOCK

ALL BRANDS
IN STOCK
AMPEREX • G.E.
EIMAC • RCA
RAYTHEON
SYLVANIA
TAYLOR • TUNGSO
VICTOREEN
WESTINGHOUSE
and others

ALLIED stocks for quick shipment the world's largest distributor inventory of special-purpose electron tubes. We specialize in supplying the needs of industrial, broadcast, governmental and other users. To save time, effort and money—phone, wire or write to ALLIED for fast shipment.

ALL TYPES
IN STOCK
Power Tubes
Rectifiers • Phototubes
Radiation
Sub-Miniature
Oscillograph
Transistors
Ignitrons • Thyratrons
Image Orthicon
Klystron
All Special
Purpose Tubes

Refer to your ALLIED Catalog for all electronic supplies. Write today for a FREE copy of the complete 268-page 1954 ALLIED Electronic Supply Guide.

ALLIED RADIO

100 N. Western Ave.
Dept. 39-244, Chicago 80, Ill.

Everything in Electronics from
One Dependable Source

CIRCLE ED-95 ON READER-SERVICE CARD FOR MORE INFORMATION

ELECTRONIC DESIGN • May 1954

RMS Voltmeter

Measures Complex Waves



The Model 320 True RMS Voltmeter is an instrument of the ultra-sensitive type to measure true root-mean-square values of highly complex wave forms in addition to sinusoidal waves.

It operates over a range of $100\mu\text{v}$ to 320v and in a band of 5cy to 500ke . Accuracy is better than 3% between 15cy and 150ke for any reading regardless of scale position.

Other features include a 10 megohm input impedance, a provision for simultaneously observing the voltage reading and monitoring the amplified signal with phones or CRO, and a built-in calibrator unit for correcting the effects of advanced aging of tubes. Accessories are available for extending voltage range to $20\mu\text{v}$ and 10kv , and for measuring rms currents from $0.1\mu\text{amp}$ to 10amp . Ballantine Laboratories Inc., Dept. ED, Boonton, N.J.

CIRCLE ED-96 ON READER-SERVICE CARD FOR MORE INFORMATION

Miniature Magnetic Amplifiers

For Voltage or Current Measurement



These miniature, Low-Level Magnetic Amplifiers, Models M-21 and M-22 were designed for current and voltage measurements, respectively. Inexpensively priced, they feature high gain, fast response and high stability. The Model M-21 is suitable for current measurement from high impedance sources such as photomultiplier tubes, photovoltaic cells, etc.

It includes a half-wave rectifier. An input current of $50\mu\text{amp}$ d-c produces a linear output of 5ma with a 100 ohm load.

The Model M-22 is suitable for voltage measurement from thermocouples, strain gages, resistance thermometers, etc. It is of the self-balancing type, and includes a full-wave bridge rectifier. The dynamic impedance of the control loop is as high as 100 to 500 times the actual d-c resistance. An input voltage of 10mv d-c produces a linear output of 5ma d-c with a 1000 ohm load. The supply voltage for both models is $50 \pm 10\text{v}$, 60cy . Dimensions are $2'' \times 2-1/4'' \times 2-1/2''$, with the rectifier outside the can. Magnetic Controls, Inc., Dept. ED, 119 West 63 St., New York, N.Y.

CIRCLE ED-97 ON READER-SERVICE CARD FOR MORE INFORMATION

ELECTRONIC DESIGN • May 1954

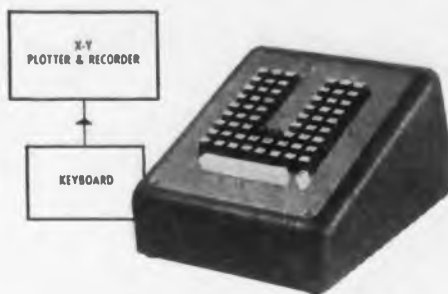

DECIMAL KEYBOARD: Consists of a three-decimal bank for each axis with associated plus-minus keys. Depressing plot bar initiates plot and clears keyboard automatically. Also manual clear button. Size: $8\frac{1}{2} \times 11$ in., Weight: 12 Lbs.

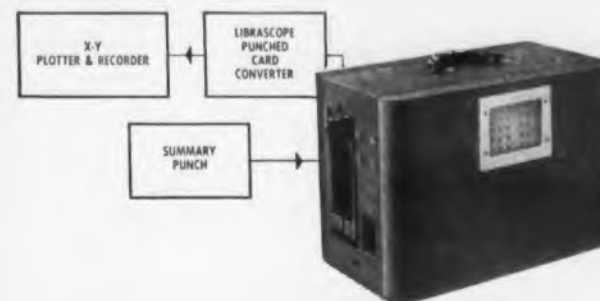

PUNCHED CARD CONVERTER: Converts punched card data to an analog form suitable for input to X-Y Plotter from Gang Summary or Reproducing punches. Display Monitor. Total tube complement 26 tubes.

X-Y plotter and recorder

simplified recording of two independent variables with greater selection of input devices

A compact, desk-size unit that accepts either analog or digital inputs. Standard digital converters: Decimal keyboard, Decimal punched card, and Binary for Computer Outputs. Handles remote mechanical shaft rotations directly without modification. Modifications available to customer specifications. Full chart visibility allows observer to view curve generation at all times. Unique pen travel for fast, dependable performance. Write for full catalog information.

Engineers, physicists and mathematicians in search of interesting assignments, rapid advancement, and job security are requested to write Dick Hastings, Personnel Director.



Computers & Controls

LIBRASCOPE

A SUBSIDIARY OF GENERAL PRECISION EQUIPMENT CORPORATION
LIBRASCOPE, INCORPORATED 1607 FLOWER STREET, GLENDALE, CALIFORNIA

DESCRIPTION:
Desk or Rack Mounted (RCA or RMA)
Accuracy: .1%
Weight: 70 lbs.
Uses Standard Graph Papers: $11'' \times 16\frac{1}{2}''$, or $8\frac{1}{2}'' \times 11''$
Power Consumption: 150 watts, 115 volts, 60 cycles

CIRCLE ED-98 ON READER-SERVICE CARD FOR MORE INFORMATION

trifles make PERFECTION . . .
but PERFECTION is no trifle
3 1/2% of perfection
. . . is VITAL to 61 TONS of
MAGNIFICENT PERFORMANCE

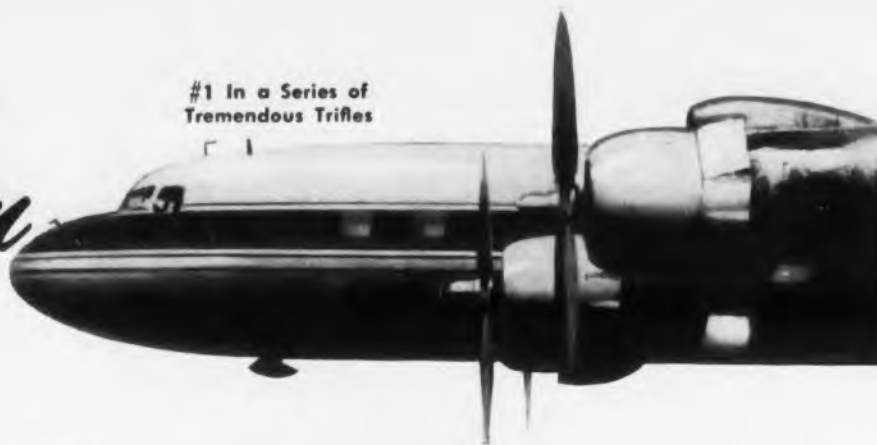

#1 In a Series of
Tremendous Trifles

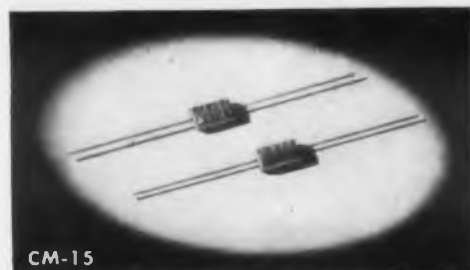

CM-15

Smallest Molded Mica Capacitors 9/32" x 1/2" x 3/16"

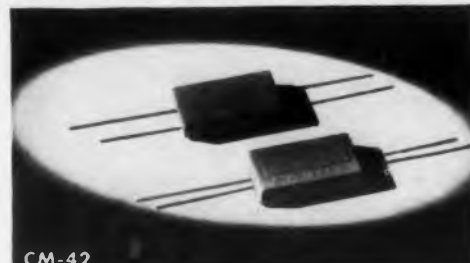

CM-42

Made to Meet All MIL-C-5 Requirements. Largest Molded Mica Capacitors of Wire Terminal Type 13/16" x 1 1/2" x 5/16"

Jobbers and distributors are requested to write for information to Arco Electronics, Inc., 103 Lafayette St., New York. Large stocks on hand—spot shipments for immediate delivery. Sole Agent for Jobbers and Distributors in the United States and Canada.

WRITE FOR FREE SAMPLES AND CATALOG ON YOUR FIRM'S LETTERHEAD

When the mighty giants of the air lift their massive wings to fly, a thousand and more "tremendous trifles" instantly go to work in harmonious unison to give life and power. It is the perfection of these "trifles" that makes possible the magnificent performance of today's luxurious air liners.

The EL Menco Capacitor — CM-15 — is one of these "tremendous trifles" that plays such a vital part in the efficient operation of aircraft communication.

EL Menco IS THE ONE OUT OF MANY CHOSEN FIRST

Whether you use our high capacity CM-42 (10-25,000 mmf) or our midget low capacity CM-15 (2-525 mmf) you have guaranteed assurance of job-tested, job-rated capacitors — tremendous trifles of perfection so vital to the magnificent performance of YOUR product.

ELECTRO MOTIVE is now supplying special silvered mica films for the electronic and communication industries — just send us your specifications.

MOLDED MICA **El-Menco** MICA TRIMMER
CAPACITORS

Foreign and Electronic Manufacturers Get Information Direct from our Export Dept. at Willimantic, Conn.

THE ELECTRO MOTIVE MFG. CO., INC. WILLIMANTIC, CONN

CIRCLE ED-99 ON READER-SERVICE CARD FOR MORE INFORMATION

New Products . . .

Precision Resistor

Tolerances of 1%, 1/2% or 1/4%



This highly compact precision resistor is simply a pure noble-metal film coated on the inside of a rugged, heat-resistant glass tube. The resistor is hermetically sealed. Characteristics include high stability, low temperature coefficient, negligible effective resistance change to frequencies as high as 10Mc. The typical 1w size measures 1" long x 5/16" diam.

Ratings of 1/2w, 1w, and 2w are available in values from 10 ohms to 100,000 ohms (higher values on special order), with tolerances of 1%, 1/2%, 1/4%. The resistors exceed the requirements of MIL-R-10509A. Balco Research Laboratories, Dept. ED, 49-53 Edison Pl., Newark, N.J.

CIRCLE ED-101 ON READER-SERVICE CARD FOR MORE INFORMATION

Dual Cathode Follower

Output Impedances of 100 ohms



The Type M1523 Dual Cathode Follower is specially designed for coupling low-output impedances with high input impedances. It utilizes the properties of the Type 5687 tube to provide two independent cathode followers within a single unit. Miniature and resin encapsulated, it is designed for plug-in operation.

The unit is valuable for joining high-impedance sources, such as flip-flops, oscillators, and voltage amplifiers, with low-impedance devices, such as transmission lines, matrices, filters, or capacitive circuits where fast rise times are desired. The input grids, provided with 100K return resistors, may be connected to an external bias source or left floating. In the latter case, the input can be coupled directly to the grids.

Each cathode output impedance is 100 ohms, tapped at 1000 ohms, with the signal amplitude at the tap approximately 65% of the cathode signal amplitude. Output impedances of approximately 50 ohms and 500 ohms are available by paralleling the two sections.

Size of this unit is only 1-1/4" diam x 3-7/8" seated height. It is based on an 11-prong, octal-style plug, with the tube accessible. The Walkirt Co., Dept. ED, 145 W. Hazel St., Inglewood, Calif.

CIRCLE ED-102 ON READER-SERVICE CARD FOR MORE INFORMATION



Here is a pair of "Problem-Solvers"
For Designers of Electrical Control Systems

FRAHM® REED RELAYS

FRAHM® OSCILLATORS

Frahm Resonant Reed Relay is an electro mechanical device which responds to an alternating signal having frequency and amplitude values that lie within specified bands. A number of control signals over a single circuit is possible with all types of communication circuits, including radio. A signal is transmitted either on a wire line, or as a modulated carrier to some remote location

where it operates a reed relay to indicate the control function at that point. Since each reed relay will respond only to a narrow band of frequencies, it is possible to operate a number of relays simultaneously by making use of an equal number of source generators arranged so that none of the operating frequency bands overlaps. In a range of 200 to 500 cycles it is possible to operate up to 16 channels with no interference.

Frahm Oscillator controls are miniature tuning forks for use in electronic oscillators to provide stable output frequencies. By their use good sine wave signals with output better than 1 volt can be obtained. They are available for any frequency in the range of 50 to 1000 cps with accuracies better than 0.2%. A series of standard units is available to match the standard Frahm Reed Relays.

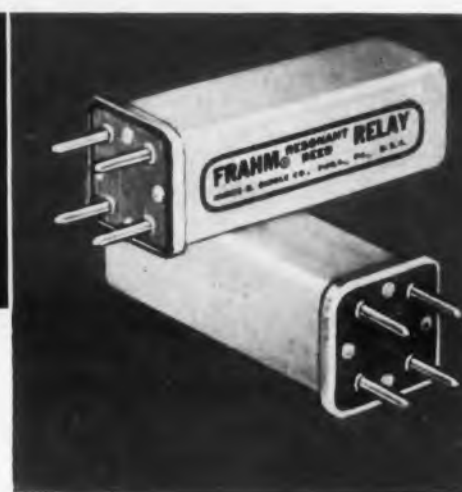

Frahm Reed Relay and Oscillator combinations may be used for controlling, signalling, monitoring, and protection and frequency matching. Check coupon for new bulletin on Frahm Relays and Frahm Oscillator Controls.

James G. Biddle Co.
1316 Arch St., Phila. 7, Pa.
Gentlemen:
Please send me Bulletin 33-ED—
Frahm Relays
 Bulletins 34-10-ED—Frahm
Oscillators

NAME

JOB FUNCTION

COMPANY

ADDRESS

JAMES G. BIDDLE CO.

• ELECTRICAL TESTING INSTRUMENTS
• SPEED MEASURING INSTRUMENTS
• LABORATORY & SCIENTIFIC EQUIPMENT

1316 ARCH STREET
PHILADELPHIA 7, PA.

CIRCLE ED-100 ON READER-SERVICE CARD FOR MORE INFORMATION

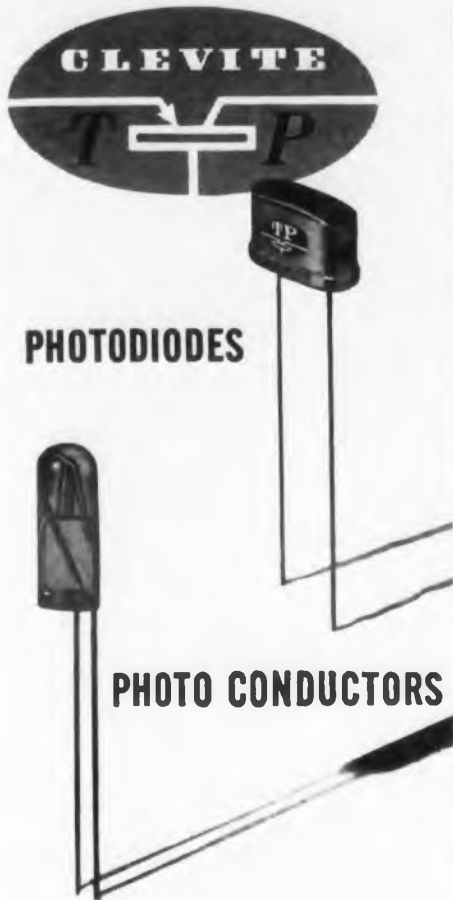

Offer These Important Features

- SMALL POWER CONSUMPTION
- MINIMUM POWER LOSS
- OPERATE AT EXCEPTIONALLY LOW VOLTAGES
- LOW NOISE LEVEL
- GOOD OPTICAL SENSITIVITY
- MICRO-SIZE
- HIGH OPTICAL RESOLVING POWER
- SIMPLE ASSOCIATED CIRCUITRY
- RUGGED — LONG LIFE — LOW COST

Hundreds of Applications!

In Photoelectric Controls — Optical Tape Read Out — Punch Card Optical Read Out — Telegraphic Optical Read Out — Infra-red Burglar Alarms — Liquid Level Controls — Automatic Automobile Headlight Dimmers — Moving Picture Variable Density Sound Read Out — Automatic Brilliance Controls on TV Receivers — and many others.

Write for free report — *Photodiodes and Phototransistors* — describing mechanics of operation, circuits, photovoltaic cells, etc.

For data sheets and complete information on CLEVITE transistors, diodes and transistor test set, write Dept. D.



TRANSISTOR PRODUCTS, INC.

320 AND UNION STREETS, BOSTON 35, MASSACHUSETTS

AN OPERATING UNIT OF
CLEVITE CORPORATION

CIRCLE ED-103 ON READER-SERVICE CARD

Magnetic Amplifier

For Flight Control Systems



This magnetic amplifier was developed especially for flight control systems using artificial "feel". It affords simple, reliable means of amplifying feeble

electrical signals generated by the dynamic air pressure instrument of the servo system sufficiently to operate equipment or energize relays.

Illustrated is the saturable reactor of the amplifier. Its laminated core is a pile of thin rings of magnetic material, wrapped with toroidal windings of magnet wire connected to the appropriate number of leads. Covered with a thermosetting compound, it will withstand extreme abuse. Airborne Accessories Corp., Dept. ED, Hillside 5, N. J.

CIRCLE ED-104 ON READER-SERVICE CARD FOR MORE INFORMATION

Precision Timer

Measures 0.01-999 μ sec Intervals

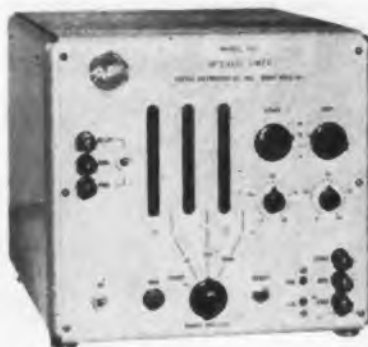

The Model 432 Interval Timer is a precision instrument for measuring short time intervals. Three ranges are provided: 0.01-9.99 μ sec, 0.1-99.9 μ sec, and 1-999 μ sec. In addition the instru-

ment serves as a high-speed totalizing counter with a count capacity of 999, and as a secondary frequency standard with outputs of 100kc, 10kc, 1kc, 100cy, 10cy, and 1cy.

In making a time-interval measurement, three electronic decades count the number of time-base pulses occurring during the unknown interval. A choice of three different time-base frequencies is provided: 100kc, 10kc, and 1kc.

Control of start and stop for time-interval measurements may be achieved by any of the following: positive pulse, negative pulse, contact closure, contact opening, or any combination thereof. Counters may be reset at the end of each interval measurement or allowed to accumulate a number of intervals for averaging. Counts are indicated by neon lamps that show through transparent numbers from 0 to 9 arranged in vertical columns, one column for each digit. Potter Instrument Co., Inc., Dept. ED, 115 Cutter Mill Rd., Great Neck, N.Y.

CIRCLE ED-105 ON READER-SERVICE CARD FOR MORE INFORMATION

CUSTOM-ENGINEERED TRANSFORMERS



produced under
ONE RESPONSIBILITY
from copper wire to final test...

- Wheeler transformers are custom-engineered to meet your specific requirements. Your needs come first with us.
- Wheeler makes its own magnet wire . . . from the copper rod to the finished, insulated and tested product . . . with quality under our control every step of the way.
- Wheeler uses the most modern winding techniques and equipment.
- Wheeler's facilities for the production of intricate coils and assemblies are unexcelled.
- Wheeler affords fullest protection to its transformers with latest techniques in wax and varnish impregnation and FOSTERITE® encapsulation.
- Wheeler transformers are subject to specially devised engineering and test procedures throughout manufacture, and must individually undergo a final comprehensive test before shipment.

To learn what these advantages can mean to you, write:

THE WHEELER INSULATED WIRE COMPANY, INC.

Division of The Sperry Corp.

1131 East Aurora St., Waterbury 20, Conn.



WHEELER

INSULATED WIRE COILS
COMMUNICATIONS EQUIPMENT
TRANSFORMERS

®The WESTINGHOUSE encapsulating material that gives a high degree of protection to small transformers. Applied by Wheeler under license.

WHEELER MAKES THESE PRODUCTS A *Specialty*

CIRCLE ED-106 ON READER-SERVICE CARD FOR MORE INFORMATION

NOW AVAILABLE

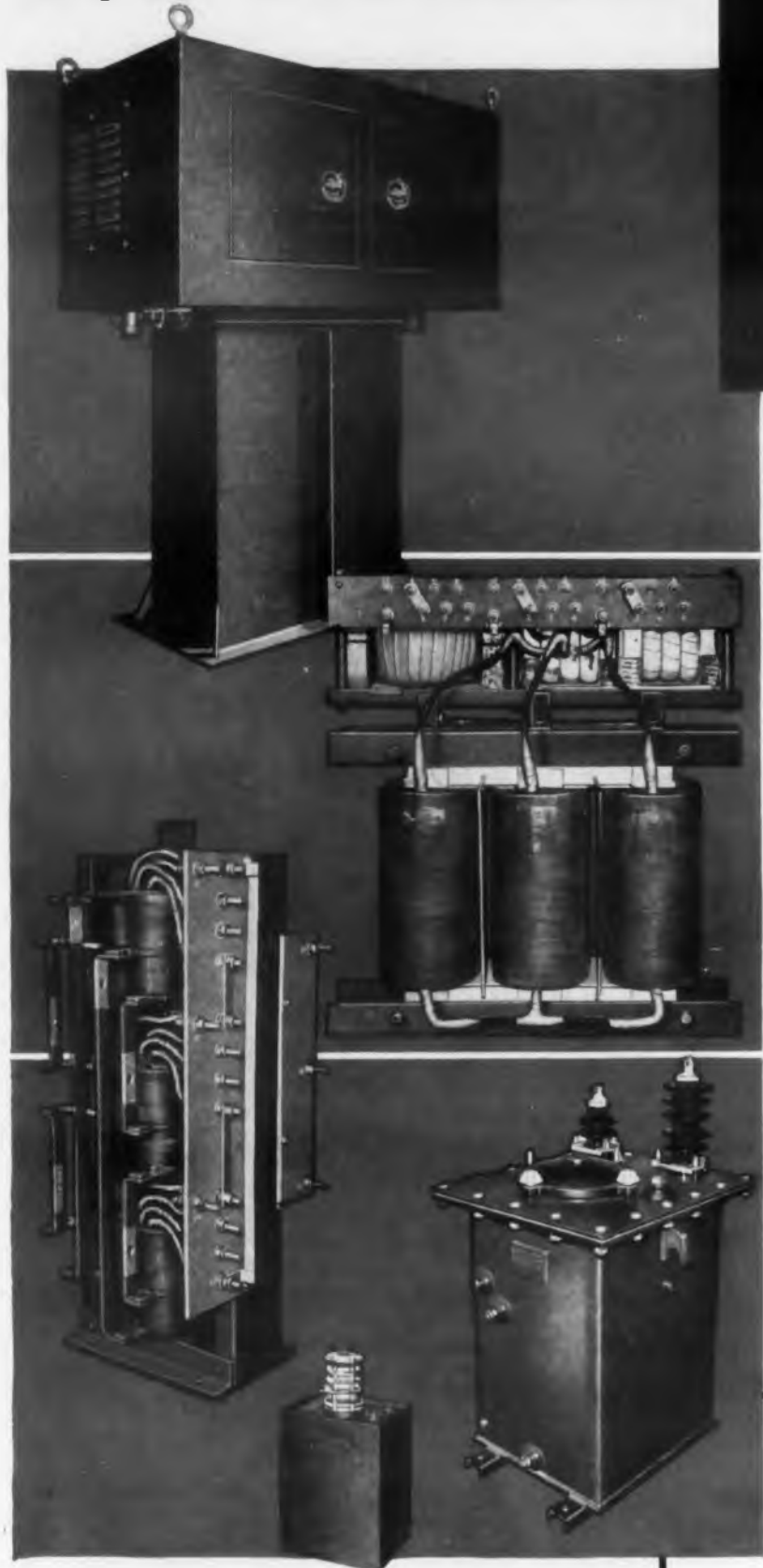

COMPLETE
ASSEMBLIES
or SUB-ASSEMBLIES
for your
**POWER
SUPPLIES**

- UNITIZED RECTIFIERS
- PLATE-FILAMENT-REACTOR ASSEMBLIES
- PLATE TRANSFORMERS
- FILAMENT TRANSFORMERS
- FILTER REACTORS

Moloney now offers complete power supplies custom built to your needs. Complete power supplies or any sub-assembly can be had, manufactured to your most rigid specifications.

High Power or High Voltage offers no problem to Moloney, long experienced in the manufacture of quality transformers. Moloney, supplying transformers to the electrical industry for over 58 years, stands ready to apply this experience to the manufacture of your most exacting requirement for power supplies.

Per { RETMA } Standards
MIL-T-27

OIL • ASKAREL
DRY (Class A, B & H.)

Write today for Bulletin ST-3505
describing Specialty Transformers

MES4-13

MOLOONEY ELECTRIC COMPANY

Power Transformers • Distribution Transformers • Step Voltage Regulators • Regulating Transformers • Load Ratio Control Transformers • Unit Substations • Network Transformers • Constant Current Transformers • Capacitors • Transformers For Electronics

SALES OFFICES IN ALL PRINCIPAL CITIES • FACTORIES AT ST. LOUIS 20, MO. AND TORONTO, ONT., CANADA

CIRCLE ED-107 ON READER-SERVICE CARD FOR MORE INFORMATION



New Products . . .

Sensitive VTVM Lowest Scale 0-1mv D-C



This series of redesigned vacuum-tube volt and ampere meters for a-c and d-c measurements includes the Model MV-17C d-c millivoltmeter which has a 0-1mv sensitivity (illustrated); the Model MV-11B d-c micromicroammeter; and several a-c voltmeters.

The Model MV-17C has 13 ranges from 0-1mv to 0-1000v, d-c. Its accuracy is $\pm 3\%$ of full scale. Dimensions for all models are 7" wide x 12" high x 7" deep.

The units feature an improved re-tunable d-c modulator, and redesigned amplifiers assure higher accuracy and stability. Millivac Instrument Corp., Dept. ED, 444 Second St., Schenectady 6, N. Y.

CIRCLE ED-108 ON READER-SERVICE CARD FOR MORE INFORMATION

Resistance Analyzer Measures 1k to 111meg



This Resistance Analyzer accurately measures the voltage coefficient of a wide range of resistances. Primarily a high-precision, general-purpose, resistance measuring laboratory instrument, it measures over the range of 1000 ohms to 111Meg to within 0.1%. The voltage coefficient of any resistor up to a capacity of 1.5w can be determined down as low as 0.0002%/volt.

The voltage across the measured resistance is continuously variable in two ranges from 0 to 500v by a self-contained regulated power supply. Sensitivity of balance is within 0.04% on all ranges. The unit is designed for 115v, 60cy operation. The Kuljian Corporation, Dept. ED, Broad and Gerard Streets, Philadelphia, Pa.

CIRCLE ED-109 ON READER-SERVICE CARD FOR MORE INFORMATION

ELECTRONIC DESIGN • May 1954

Miniature Blower

Supplies 24cfm



An unusually compact miniature type motor-blower assembly, designed to occupy a space no larger than 2-1/4" x 2-1/4" x 4", supplies 24cfm free air under continuous duty.

Blower or suction operation is afforded by the unit's two-blade propeller-type fan, powered by a powerful permanent magnet motor rated at 6v to 115v d-c.

Speed is 10,000 to 13,000rpm, with 0.50amp current consumption. The housing of the assembly is made of cast aluminum, and it can be supplied with a radio noise filter. Pioneer Electric and Research Corp., Dept. ED, 743 Circle Ave., Forest Park, Ill.

CIRCLE ED-110 ON READER-SERVICE CARD FOR MORE INFORMATION

Fixed Frequency Oscillators

From 300 to 10,000cy



These fixed frequency, low-distortion Model DK-1 audio oscillators feature zero impedance output of 10v at 2w, and a variable voltage output at low impedance. The

Model DK-1 provides an inexpensive source of essentially pure, highly stabilized sine wave power for general lab use and production testing. Amplitude and frequency stability under difficult load and line conditions make this model an ideal a-c power supply for magnetic amplifiers and precise measurements at simulated line frequencies.

In stock are frequencies from 300cy to 10,000cy, in increments of hundreds; or, on special order, from 301cy to 9999cy, without additional cost. Harmonic content is less than 0.08% total, and amplitude shift between no load and full load or line voltage variation of 10v is less than 0.18%. Frequency shift between load and no-load is less than 0.16%, shift due to 10v of line fluctuations is zero, and frequency drift is negligible after warm-up. Housed in a ventilated case 4-3/8" x 3-3/4" x 8-1/2", the circuit is an L-C, bridge type, incorporating a high Q toroid, a mica capacitor, and an air trimmer, combined with a self-balancing feedback amplifier. The Nuclid Corp., Dept. ED, 45 West Union Street, Pasadena 1, Calif.

CIRCLE ED-111 ON READER-SERVICE CARD FOR MORE INFORMATION

Burnell TOROIDS and FILTERS

"SHRUNK to FIT"



Courtesy of Visart, Inc. Actual Size

Keeping ahead of the game is our specialty and with our newest sub-miniature line of toroidal filters and toroids in actual production, we are living up to our reputation for progressiveness.

The tiny "cheerio" toroids are already being employed in filters small enough to hide with your thumb. Although the applications for these are myriad, the "cheerios" lend themselves perfectly to printed circuit applications as illustrated and are being sold at a cost comparable to standard miniature toroids.

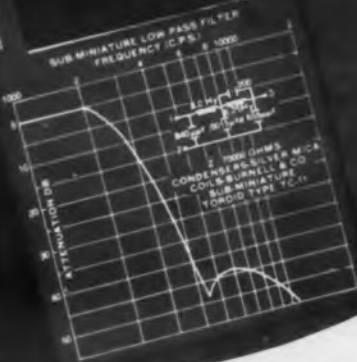
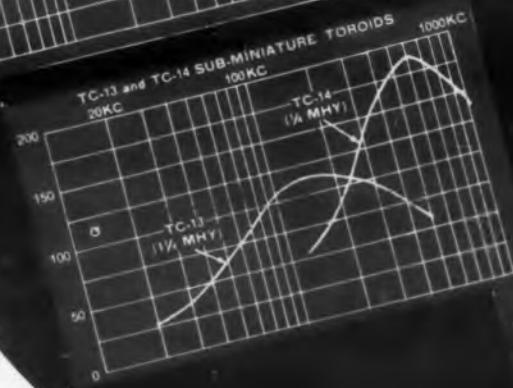
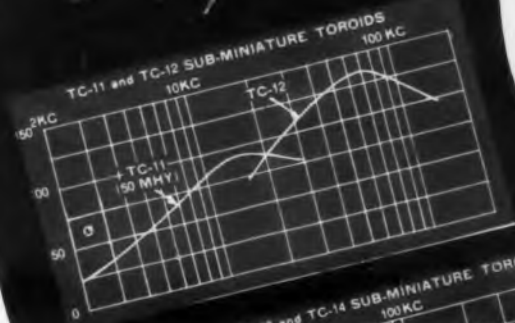

Write for new and enlarged 16 page catalog 102A
Exclusive Manufacturers of Communications Network Components

Burnell & Co., Inc.
YONKERS 2, NEW YORK
CABLE ADDRESS "BURNELL"

CIRCLE ED-112 ON READER-SERVICE CARD FOR MORE INFORMATION

SURGICAL INSTRUMENTS EASIER TO MAKE WITH SQUARE TUBING



The two instruments above are (left) for spreading, and (right) for returning ribs to a normal position after an operation.

The maker, George P. Pilling & Son Co., Philadelphia, was looking for a design of the pinion rod support (arrows) that would meet all specifications and save money. Broaching a square hole from a solid bar was costly.

They found their answer in Superior type 304 stainless steel square tubing. It is corrosive resistant; can be silver-soldered; and made to close I.D. tolerances by Superior.

Superior offers you round or shaped tubing in up to 55 analyses—with experience just as broad and varied. Write for Data. Superior Tube Company, 2050 Germantown Ave., Norristown, Pa.

Superior
THE BIG NAME IN SMALL TUBING

All analyses .010" to 3/8" O.D.
Certain analyses in Light Walls up to 2 1/2"

CIRCLE ED-113 ON READER-SERVICE CARD FOR MORE INFORMATION

STAINLESS STEEL
RIGHT OFF THE SHELF
ALL TYPES OF STAINLESS STEEL FASTENINGS

STAINLESS SCREW COMPANY

WRITE, WIRE or PHONE FOR YOUR CATALOG Today

- BOLTS & CAP SCREWS
- SOCKET, SET & CAP
- NUTS, WASHERS
- MACHINE SCREWS
- SHEET METAL SCREWS
- WOOD SCREWS
- PIPE FITTINGS

- Class 3 Screws
- AN Drilled Fillister Heads
- AN WASHERS
- Studs, Standard & Special
- Special Screw Machine Products

Star Stainless screws have
CLEAN, BRIGHT-AND-SHINY HEADS

Star STAINLESS SCREW CO.

ARMory 4-1240
240 Union Avenue • Paterson 2, N. J.
Direct New York Telephone: Wlconsin 7-9041

CIRCLE ED-114 ON READER-SERVICE CARD FOR MORE INFORMATION

New Products . . .

Multiple Headers With Hermetic Silicone Terminals



Series 2M1 Multiple Headers are available with two hollow tube, turret head, or slotted head type terminals. These hermetic silicone terminals are supplied attached and ready for use. The headers also have two 6-32 x 1/4" steel studs. All metal parts are hot tin dipped to assure good soldering to cans.

Diameter of this type cover is 0.950". Electrical specifications are the same as the firm's No. "0" Hermetic Terminal. Strat-O-Seal Manufacturing Co., Dept. ED, 3039 W. Fullerton Ave., Chicago 47, Ill.

CIRCLE ED-115 ON READER-SERVICE CARD FOR MORE INFORMATION

Frequency Meter

Counts Electrical and Mechanical Events

The Model DS-660 Frequency Meter is an economical lightweight unit designed for portability and accuracy. It will count and display an electrical or mechanical event that can be converted into a vary-



ing voltage of sufficient amplitude. It counts 20 to 100,000 events per second. It derives its time base from the 60cy line, which in turn determines the accuracy of approximately 0.1%.

Features include automatic and manual reset; self-checking; basic unit read-out to 10kc (four decades); and a new decade plug-in unit. Size of the complete unit is only 7-1/2" x 9-3/4" x 14-1/4", with a weight of only 16 lb. Accessories offered include a tachometer pickup and a photo cell, both available at slight extra cost. Additional decade units to increase count capacity are also available. The Detec-tron Corp., Dept. ED, 5420 Vineland Ave., North Hollywood, Calif.

CIRCLE ED-116 ON READER-SERVICE CARD FOR MORE INFORMATION



Need a relay for AUTOMATION controls?

Whether it's for automation, traffic, elevator or instrument control, Ward Leonard's Bulletin 110 relays provide the millions of trouble-free operations required.

Our mechanical design, quality-controlled manufacturing methods and materials, and ample safety factors (both electrical and mechanical) insure this exceptionally long life.

Write today for Relay Bulletin 110. Ward Leonard Electric Co., 77 South St., Mount Vernon, N.Y.

4.11

WARD LEONARD ELECTRIC CO.

Result-Engineered Controls Since 1892

RHEOSTATS • RESISTORS • MOTOR CONTROLS • CHROMASTER



CIRCLE ED-117 ON READER-SERVICE CARD FOR MORE INFORMATION

ENGINEERS ARE DEMANDING MILWAUKEE

RIBWOUND RESISTORS

SIZES FROM 50 TO 2000 WATTS
FIXED • ADJUSTABLE • TAPPED

MILWAUKEE'S production has stepped up to meet demand for RIBWOUNDS! These are MILWAUKEE'S answer to space-saving applications where high wattage and low resistance is required. Accurate — built for high performance.

Write, wire or phone today for quotations—samples.

All other types of wire wound resistors are available — specials are made to your specifications.

MILWAUKEE RESISTOR CO.
170 W. Virginia Street, Milwaukee 4, Wisconsin

CIRCLE ED-118 ON READER-SERVICE CARD FOR MORE INFORMATION

Bonded Germanium Diodes

With High Back Resistance

The CK739 and CK742 are gold bonded germanium diodes designed for magnetic computer and similar applications where extremely low forward resistance and high reverse

resistance characteristics are important. The flexible terminal leads may be soldered or welded directly to the terminals of the computer components without the use of sockets. Standard subminiature sockets may be used by cutting the leads to a suitable length.

The diodes have plastic and glass cases. They are characterized by forward resistances of 10 ohms or less at 1v, and back resistances of several megohms at negative voltages as great as 125v. The major difference between the two types is that the peak inverse voltage rating of the CK742 is 125v, double that of the CK739. Raytheon Mfg., Dept. ED, 55 Chapel St., Newton 58, Mass.

CIRCLE ED-119 ON READER-SERVICE CARD FOR MORE INFORMATION

Precision Potentiometers

Single-Turn Type



These single-turn, all-metal, precision, wire-wound potentiometers can be used in a wide variety of military and general computer applications. All models are available with either low-torque bronze sleeve bearings or

class 5 stainless steel ball bearings. Both linear and non-linear windings can be furnished in each size, and multi-section units are supplied with external ganging rings.

Models are available with resistance ranges (linear) of 90-140,000 ohms, 120-178,000 ohms, and 180-283,000 ohms, with resistance tolerances of $\pm 5\%$ or $\pm 1\%$ (on specification). Resistance ranges of non-linear units depend on the particular function; their resistance tolerances are $\pm 5\%$. Linear accuracies are as close as $\pm 0.075\%$ of input voltage, depending on the model. Non-linear accuracies go down to $\pm 0.3\%$. George Rattray & Co., Inc., Dept. ED, 116-08 Myrtle Ave., Richmond Hill, N. Y.

CIRCLE ED-120 ON READER-SERVICE CARD FOR MORE INFORMATION

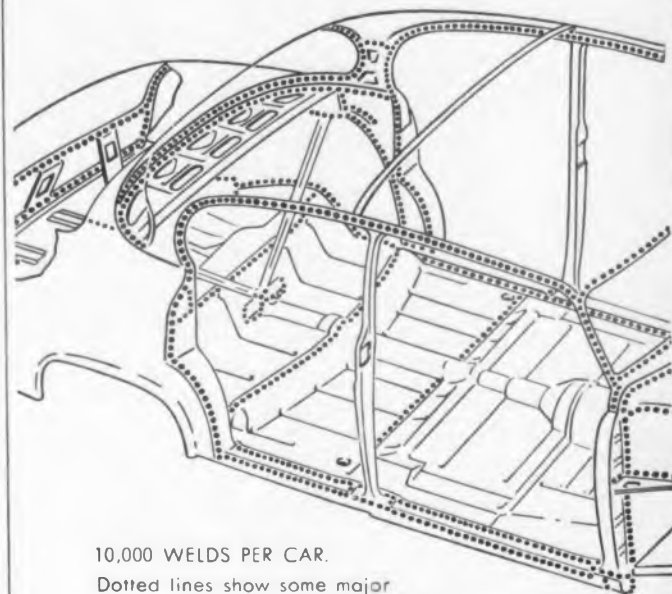

10,000 WELDS PER CAR.

Dotted lines show some major areas joined by resistance welding.



In Production-Minded Detroit,
Westinghouse Ignitrons Deliver Up to...

400 Perfect Welds A Minute

In industrial Detroit, high-speed uniform resistance welding is a key tool of the automotive industry. Serving this production-efficient market is the Robotron Corporation, one of the outstanding manufacturers of all-electronic resistance welding controls built around Ignitrons and thyratrons.

"The automobile you drive today would cost considerably more if it weren't for this completely electronic control system made possible by the Ignitron tube," states Charles Buhler, an officer of Robotron.

The average car has about 10,000 welds. Production line demands calling for 100,000 welds an hour are a reality only because of the Ignitron.

"We have been using Westinghouse Ignitrons and thyratrons in various types of electronic equipment ever since our business started," says Mr. Buhler. "Considering the tough operating schedules in many factories, it is amazing to find that life expectancy of Westinghouse Ignitrons is outstandingly high, frequently three years of continuous high production operation. Westinghouse's national program of prompt tube replacement by local distributors has paid big dividends in confidence, too."

If your equipment calls for Ignitrons or thyratrons, call Westinghouse. For full information about the new Westinghouse THERMOSTATIC Ignitrons, write to Dept. P-1054 at the address below.

YOU CAN BE SURE...IF IT'S
Westinghouse

RELIATRON® TUBES

WESTINGHOUSE ELECTRIC CORPORATION, ELECTRONIC TUBE DIVISION, ELMIRA, N. Y.

CIRCLE ED-121 ON READER-SERVICE CARD FOR MORE INFORMATION

Why has **G-V** in
3 Years Become the
Preferred Supplier of



Thermal Time Delay Relays?

Because **G-V OCTAL & MINIATURE RELAYS** have been...
adopted as production components
by hundreds of principal producers
of electronic, electrical and
aviation equipment.

Delivered
for use on
over 250
Government
contracts.

G-V ENGINEERING OFFERS A NEW APPROACH TO THERMAL RELAY DESIGN

- Stainless steel mechanism welded into a single integral structure and supported at both ends for unequalled resistance to vibration and shock
- Heater built inside expanding member for maximum efficiency and protection
- Rolling contact action for positive operation
- Easy adjustability where desired
- Precise operation never before available in thermal relays
- Time ranges: 3 seconds to 5 minutes
- Hermetically sealed in metal shell
- Heater voltages up to 230 volts
- Fully temperature compensated
- Suitable for military and industrial use
- Unequalled for ruggedness and precision

U. S. and Foreign Patents Pending

Only G-V offers complete
technical data and helpful
engineering cooperation on
THERMAL TIME DELAY RELAYS.

Write for bulletin and help with
your particular problems.

G-V CONTROLS INC.
18 Hollywood Plaza
East Orange, New Jersey

Greatly expanded production facilities assure prompt deliveries.

CIRCLE ED-122 ON READER-SERVICE CARD FOR MORE INFORMATION

New Products...

Ceramic-Metal Terminals For Temperatures to 1400°F



A line of high-temperature terminals and insulators of metallized ceramic is rated for brazing and service temperatures up to 1400°F, yet priced competitively with lower-temperature units. They are for hard-solder applications and are of use wherever a wide range of temperatures and severe thermal shock are encountered. The type illustrated is available as a standard item with diameters from 7/32" through 1/2" and ratings from 3400v to 14,000v. Larger sizes can be specified.

This firm's service includes full cooperation on design of the terminals or insulators and the related equipment in respect to the metal alloys used, as well as performing the actual brazing of the units into the metal closures or other parts.

A similar line of soft-solder terminals in the same sizes as the hard-solder units are also available. Advanced Vacuum Products, Inc., Dept. ED, 22 Liberty St., Stamford, Conn.

CIRCLE ED-123 ON READER-SERVICE CARD FOR MORE INFORMATION

Sensitive Galvanometers For Recording Oscillographs



Series M Galvanometers measure only 1/8" diam x 2-21/32" long. The magnet bank, which holds 12 active galvanometers and two static-trace galvanometers, measures 4-5/8" high x 2-1/4" wide x 3-1/4" deep, including galvanometers, heater elements, thermostat, etc.

Galvanometers are inserted directly into numbered holes, making all electrical connections automatically; they are isolated from each other and from ground. The bank has individual adjusting screws which permit each galvanometer light to be adjusted in the vertical plane; in the horizontal plane, the entire galvanometer is rotated. It is not necessary to insert dummy galvanometers into vacant positions of the magnet bank to maintain the magnetic field. The standard optical lever for the Series M Galvanometers is 11.8" (30cm). Heiland Research Corp., Dept. ED, 130 E. 5th Ave., Denver 9, Colo.

CIRCLE ED-124 ON READER-SERVICE CARD FOR MORE INFORMATION

Complicated Electronic Parts Now

Ep Co

INVESTMENT CASTINGS



Base plate for super-sensitive measuring device which must be dimensionally stable at wide variations in temperature.

Material—Invar



Wave Guide

Material—Aluminum #356T6



Lever arm for an Electronic Computer

Material—Stainless Steel type 303

Send Us Your Drawings For
Quotations On Parts Where
**EXTRA QUALITY Must Be
Maintained.**

Ep Co

**ENGINEERED
PRECISION CASTING CO.**

MATAWAN-FREEHOLD ROAD
MORGANVILLE, N. J.

CIRCLE ED-125 ON READER-SERVICE CARD



OVER 12 YEARS EXPERIENCE

**in Specialization
and Standardization**

Ask "OLYMPIC" to apply its Accumulated Knowledge, Skills and Techniques to YOUR Design Problems.

Use OLYMPIC'S "complete coordination" from design to delivery. It's to your advantage now to consolidate your speculations or your specifications with OLYMPIC.

- **ENGINEERING and DESIGNING** . . . of housings and hardware.
- **PRODUCTION** . . . with prompt, scheduled deliveries.
- **FINISHING** . . . centrifugal hot-tin dipping, cadmium plating, and black oxide finish.
- **SAMPLE SHOP FACILITIES** . . . in addition to production facilities.
- **TOOL and DIE SHOP** . . . fully equipped.

*****OLYMPIC Plans Today for Your Products of Tomorrow*****



OLYMPIC

**METAL PRODUCTS COMPANY, INC.
ALPHA, NEW JERSEY**

CIRCLE ED-126 ON READER-SERVICE CARD

Expanded-Scale A-C Voltmeter

Covers 100-500v in 39 Steps



This a-c voltmeter features both scale expansion and recording over the 100-500v range. It covers the range in 39 easy-to-read steps, full scale. True rms readings are obtained with accuracies better than $\pm 0.25\%$ of input voltage. Frequency

response is uniform between 50 and 2000cy, eliminating the need for delicate or specially built laboratory voltmeters to measure a-c voltages accurately.

The voltmeter offers built-in recorder connections for continuous recording of line voltage fluctuations with a 1ma d-c recorder, simplifying problems of voltage regulation or stabilization in a-c systems. Arga Division, Beckman Instruments, Inc., Dept. ED, 220 Pasadena Ave., South Pasadena, Calif.

CIRCLE ED-127 ON READER-SERVICE CARD FOR MORE INFORMATION

High-Current D-C Supply

Magnetic-Amplifier Regulated



Utilizing no vacuum tubes or moving parts, the "Stabvolt" Type A line of power supplies is designed for ruggedness, reliability, and maintenance-free operation. Dual magnetic regulation effectively isolates line voltage transients from the d-c output voltage. The response to a-c line variations of 95-135v is practically instantaneous, with dynamic line regulation better than 0.2%.

These low-voltage, high-current supplies have many possible applications in the field of d-c measurement, instrumentation, testing, communication, and control. Standard sizes are available in 6v, 12v, and 28v at current ratings up to 100amp. From no load to full load, regulation is better than $\pm 1\%$, and the response to extreme conditions of loading is faster than 0.2sec. Ripple is less than 0.5% rms. Magnetic Research Corp., Dept. ED, 318 Kansas St., El Segundo, Calif.

CIRCLE ED-128 ON READER-SERVICE CARD FOR MORE INFORMATION



*Career-chance
of a lifetime
for*

Senior

ELECTRONIC

Engineers

in Lockheed's expanding Missile Systems Division

Recently formed from other Lockheed engineering organizations, the Missile Systems Division has a few openings for highly-qualified engineers in various phases of electronics.

The Division's expansion program — along with the type of work involved in its contracts — makes these openings outstanding opportunities for achievement. Engineers who qualify have probably worked on missile, radar-computer, counter-measure, IFF, AMTI or similar projects.

Lockheed has openings for:

- **Senior Electronic Engineers** with experience in the development, packaging, and specification of small, rugged components including resistors, capacitors and all types of magnetic parts.
- **Senior Servomechanisms Engineers** with circuit, auto-pilot or electro-mechanical experience (aircraft or missile experience preferred).
- **Senior Electronic Design Engineers** with experience in sub-miniature packaging techniques. Previous experience with potted plug-in units, etched and printed circuits is desirable.
- **Senior Electronic Engineers** with development and analysis experience in one or more of the following fields:

- A. Guidance systems analysis
- B. Microwave antennas
- C. Radome design
- D. Microwave transmitters
- E. Advanced packaging techniques
- F. Waveguide components
- G. Component specification
- H. IF receivers and FM discriminator circuits

- I. Synchronization and timing circuits
- J. Memory circuits (tubes, magnetic drums, delay lines, etc).
- K. High voltage power supply and CRT display circuits
- L. Analogue computers
- M. Video pulse, delay, gating, range and range rate tracking circuits



In addition to outstanding career opportunities, the Missile Systems Division offers you excellent salaries commensurate with your experience, generous travel and moving allowances, an unusually wide range of employee benefits and a chance for you and your family to enjoy life in Southern California.

Coupon below is for your convenience.

L. R. Osgood Dept. ED-M-5

LOCKHEED MISSILE SYSTEMS DIVISION
7701 Woodley Avenue, Van Nuys, California

Dear Sir: Please send me information on the Missile Systems Division.

name

field of engineering

street address

city and state

CIRCLE ED-129 ON READER-SERVICE CARD FOR MORE INFORMATION

Before you tape-see PERMACEL®



Pressure-Sensitive
Electrical Tapes

Get the *Right* tape
for *Each* job



BECAUSE PERMACEL pressure-sensitive tapes speed the assembly and simplify the design of electrical equipment, they are being used for more and more jobs. All this is possible due to a new, more complete variety of tape materials which give full protection for each application.



WHEN YOU WANT A STRONG, flexible tape for holding down heavy wires or filling space, use a Permacel cotton cloth electrical tape. The same features, plus higher resistance to heat, require a glass cloth tape. If a job demands excellent dielectric strength and insulation resistance, besides thinness, stretchability, and good strength, use an acetate film or acetate cloth tape or combination film-cloth tape. Extreme thinness, heat resistance, and high dielectric strength requirements are met with Permacel "Mylar" film tape. Perhaps you need the versatile balance of strength and thinness offered in a flat-back electrical tape. Or maybe the job calls for a crepe paper tape which can stretch around odd shapes. There also is Permacel vinyl film plastic tape which will mold itself to irregular surfaces to save space and also provide excellent dielectric strength and insulation resistance.



IDEAL INSULATING and fastening properties for particular purposes are further assured because of the pure adhesives tailored to each Permacel tape. You're certain of fast, sure adhesion with just a "feather" touch. And, since most tapes have heat curing adhesives, you're assured of permanent holding at elevated temperatures when needed.



ALL PERMACEL TAPES are made with their particular function in view. And they're all sold by IMC. They are used for all kinds of electrical and electronic fastening and insulating work, such as anchoring leads, coil windings, or insulation parts. Splicing wires, wrapping coils, edging slot insulators, binding wire harnesses, wrapping cables and bus bars, and protecting against chemicals and physical abuse, are other uses. Ask your nearest IMC office for prices, technical information, and samples.

INSULATION

MANUFACTURERS
CORPORATION



*CHICAGO 6
565 W. Washington Blvd.
Phone Central 6-7320

*CLEVELAND 14
1231 Superior Ave., N. E.
Phone Superior 1-2310

DAYTON 2
120 W. Second St.
Phone Michigan 1391

MILWAUKEE 2
312 E. Wisconsin Ave.
Phone Broadway 6-5359

PITTSBURGH 22
535 Smithfield Street
Phone Grant 1-7100

DETROIT 2
Harry B. Brothen
15 Lawrence Ave.
Phone Townsend 8-2577

PEORIA
W. C. Johnson
101 Heinz Court
Phone 2-7786

*Local Stocks Available

CIRCLE ED-130 ON READER-SERVICE CARD FOR MORE INFORMATION

New Products . . .

Illuminated Magnifier For Designers and Inspectors



The "Flash-O-Lens" Illuminated Magnifier has been redesigned with a new housing that facilitates loosening and tightening of the ring that holds the lenses in the housing. The housing is now molded of durable, heat-resistant polystyrene.

This unit is valuable both in the laboratory and on the production line. E. W. Pike and Co., Inc. Dept. ED, 492 North Avenue, Elizabeth, N.J.

CIRCLE ED-131 ON READER-SERVICE CARD FOR MORE INFORMATION

Slotted Line

1120Mc-1740Mc Range

The Model SL-28 "L" Band Slotted is a laboratory instrument for the frequency range between 1120Mc and 1740Mc. It measures the voltage standing wave ratio in Type RG-69/U, RG-103/U, and other wave guides of equal dimensions (6-1/2" x 3-1/4"). From

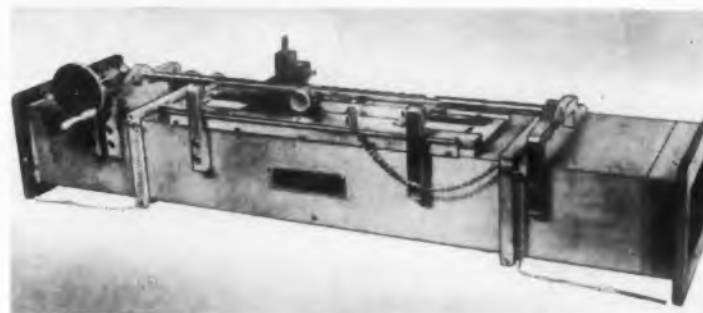

the standing wave pattern, the amount of mismatch between line and load may be accurately determined, the impedance of the load can be obtained, and the wave length can be measured directly. The line mates with UG-417/U and UG-418/U flanges.

The probe carriage is suspended on three widely separated ball bearings riding in precision ground "V" races. The scale is calibrated from 22cm to 54cm, and may be read to within 0.01cm.

Residual vswr is less than 1.05 with probe at maximum insertion. Slope and leakage are negligible. Size of the unit is 30" x 8-3/4" x 8-1/4". Weight is 38 lb. Press Wireless Laboratories, Inc., Dept. ED, 25 Prospect Pl., West Newton 65, Mass.

CIRCLE ED-132 ON READER-SERVICE CARD FOR MORE INFORMATION



* TARRYTRON TIME DELAYS by Diaphlex have introduced new techniques and standards in the art of measuring time increments for controlling the sequencing, programming, actuating, and deferring of aircraft and missile component operations.

* TARRYTRON TIME DELAYS employing the exclusive Rock Shaft Motion require fine instrument technology, the watchmaker's art, and the most advanced engineering standards to perform satisfactorily.

* TARRYTRON TIME DELAYS operate in the range from one tenth to ninety seconds ($\pm 15\%$) when subjected to temperature (-65°F to $+200^{\circ}\text{F}$) and vibration extremes, high impact, a wide range of environmental conditions and when positioned in any attitude.

We invite your inquiry.

Cook Electric Company

Established 1897

2700 Southport, Chicago 14, Illinois

Diaphlex—Aircraft Components and Accessories • Wirecom—Wire Communications, Protection & Distribution Apparatus • Magnilastic—Expansion Joints, Heavy Industry Equipment, and Airframe Structures • Cook Research Laboratories—8100 Monticello Avenue, Skokie, Illinois • MetalFusion—Heat Treating, Brazing and Annealing • Inland Testing Laboratories—1457 Diversey Parkway, Chicago 14, Illinois • Electronic Systems Division—3413 W. Belmont Avenue, Chicago 18, Illinois • Subsidiary: Canadian Diaphlex Limited—Aircraft Components and Accessories, Toronto, Ontario, Canada

CIRCLE ED-133 ON READER-SERVICE CARD
ELECTRONIC DESIGN • May 1954

Reference Cavities

Max Frequency Drift of $\pm 0.4\text{Mc}$



Three reference cavities, weighing only about 8 oz each, are of the fixed-frequency, vacuum-sealed, transmission type for service as frequency determining references in microwave systems. The three types are the GL-1Q26-A (resonant frequency 9280-Mc), the GL-6301 (resonant frequency 9270-

Me), and the GL-6453 (resonant frequency 9350Mc).

These small-size, lightweight units can be used in pressurized systems. They will withstand 10G vibration with only $\pm 0.1\text{Mc}$ frequency drift, and temperature changes from -40° to $+100^\circ\text{C}$ with only $\pm 0.4\text{Mc}$ drift. Maximum drift is only $\pm 0.15\text{Mc}$ under ambient pressures varying from 15-45psi absolute. Tube Dept., General Electric Co., Dept. ED, Electronics Park, Syracuse, N. Y.

CIRCLE ED-134 ON READER-SERVICE CARD FOR MORE INFORMATION

Miniature D-C Instruments

Self-Shielded, Portable Design



Accurate within 1%, these Model 281 Miniature Portable D-C instruments incorporate a self-shielded mechanism. Shielding is such that the magnetic field created by a conductor carrying 15,000amp at a distance of 3' from

the instrument causes a temporary error in indication of less than 1%. The instrument can also be used in close proximity to magnetic materials without affecting accuracy.

The instruments use a large moving coil with high torque-to-weight ratio. Scales are hand calibrated, with mirror and knife edge pointers combined to eliminate parallax errors. The instruments are furnished in complete Bakelite cases, in a wide variety of ranges in single and multi-range voltmeters, ammeters, and volt-ammeters. Size is about $4\frac{1}{2}'' \times 4\frac{1}{2}'' \times 1\frac{1}{2}''$. Weston Electrical Instrument Corp., Dept. ED, 614 Frelinghuysen Ave., Newark 5, N. J.

CIRCLE ED-135 ON READER-SERVICE CARD FOR MORE INFORMATION

ELECTRONIC DESIGN • May 1954



MECHANICAL FILTERS

Compact, permanently tuned band pass filters for intermediate frequency amplifier applications. Mechanical elements of the filter provide characteristics close to the ideal rectangular selectivity curve. It is a hermetically sealed component requiring no adjustments. Selectivity curves for two of the 23 standard Mechanical Filters are reproduced at right.

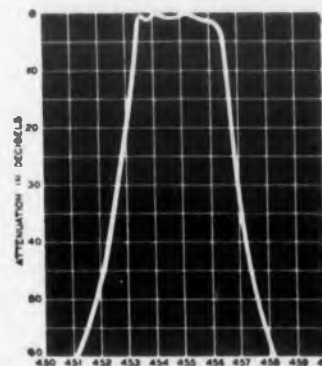

Type F455B-31 Center frequency, 455 kc; band-width, 3.1 kc; plug-in terminal arrangement.

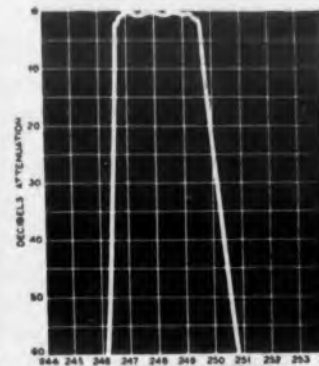

Type F250Z-2 - Center frequency, 248.2 kc; band-width, 3.2 kc; solder terminal arrangement.



Collins HYSTERESIS MOTORS

Useful for driving timing devices, facsimile equipment, commutators, or any device which must rotate at an absolutely constant speed regardless of load or line voltage variations. Type 370A-1 Wide Band Synchronous Motor is illustrated . . . produces synchronous rotation from motionless to 30,000 RPM.



Collins OSCILLATORS

Long famous for their accuracy and stability, Collins Variable Frequency Oscillators are now available. They give transmitters, receivers, frequency standards or test equipment accurate linear dial calibration and superb stability. Collins Oscillators are available in a number of frequency ranges.



Collins AUTOTUNES AND AUTOPOSITIONERS

Collins Autotunes, the basis for both remotely and directly controlling automatic tuning of high quality communication equipment, are suitable for many industrial applications. Collins Autopositioners are used where up to 20, or more, pre-determined, fixed positions are needed. Available as individual units or in complete systems.

COLLINS RADIO COMPANY

Cedar Rapids, Iowa

11 W. 42nd Street, NEW YORK 36

1930 Hi-Line Drive, DALLAS 2

2700 W. Olive Avenue, BURBANK

COLLINS RADIO COMPANY OF CANADA, LTD.

74 Sparks St., OTTAWA, ONTARIO



CIRCLE ED-136 ON READER-SERVICE CARD FOR MORE INFORMATION

INDUSTRIAL COMPONENTS

During the past 20 years Collins Radio Company has pioneered many of the outstanding advancements in the radio-communications and electronics industry. Collins engineers had to develop unique and unusual systems and components to meet the superior standards of Collins equipment. These components, plus application recommendations, are now available to the electronics industry. Collins industrial components can help you. Send the coupon below for complete information.

Please send me complete information on:
 Mechanical Filters Autotunes Oscillators
 Hysteresis Motors

NAME _____

ADDRESS _____

FIRM OR COMPANY _____

CITY _____ STATE _____



GUIDE TO VOLTAGE SPEED CURRENT SERVO CONTROL

ON REQUEST

This new 12-page illustrated bulletin describes the wide variety of control situations to which the REGOHM electro-mechanical controller is adaptable.

Learn how REGOHM will provide sensitivity, speed of response and system stabilization under severe operating conditions in your control system.

Circuit diagrams illustrating the many applications of this versatile, automatic controller, are given.

Text and illustrations describe the functions, design advantages, operation and control characteristics of this small size, lightweight, plug-in device.

Write for Bulletin 505.00. Address Dept. G, Electric Regulator Corporation, Norwalk, Conn.

REGOHM



CIRCLE ED-137 ON READER-SERVICE CARD FOR MORE INFORMATION

New Products . . .

Axial Lead Resistors

Rated 5, 7 or 10w

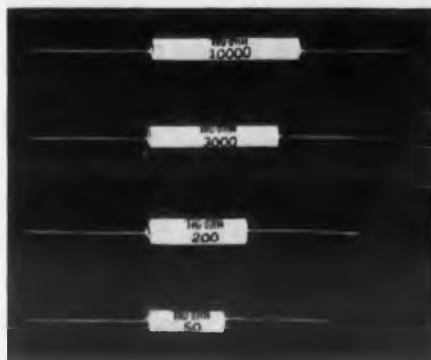

These Axial Lead Resistors are supplied in standard ratings of 5w, 7w, and 10w, and to maximum resistance values of 1000 ohms, 5000 ohms, and 7500 ohms, respectively. They are wound on fibre

glass cord in continuous lengths. The cord is cut to required length, and then the leads are securely clamped to each end. The core is then coated with silicone cement and inserted in a ceramic tube for maximum mechanical protection and high dielectric strength.

Ends of the resistors are sealed with silicone cement to exclude moisture. Tru-Ohm Products, Division of Model Engineering & Mfg., Inc., Dept. ED, 2800 N. Milwaukee Ave., Chicago 18, Ill.

CIRCLE ED-139 ON READER-SERVICE CARD FOR MORE INFORMATION

High-Efficiency Flashtubes

Flash Up to 100,000 Times

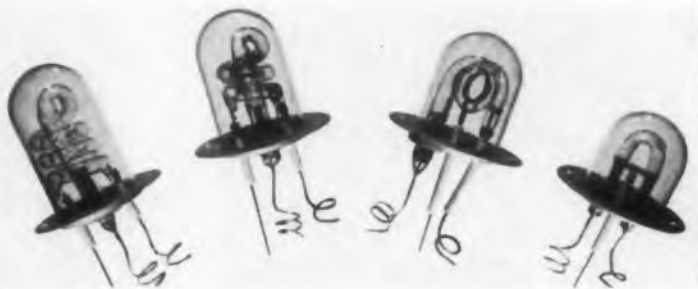

These flashtubes give the laboratory photographer more light for the same power through the use of ultra-high efficiency light sources and an increase in the working area of their reflectors. They can utilize lightweight power packs. Five new models of this trigger-type flashtube are available.

Tube focal point is adjustable without removing the Pyrex cover glass. The design of the flashtube permits construction of extremely shallow, lighter weight lampheads and eliminates the large, light-absorbing area common to the older type of basing.

New electrode developments have made higher power ratings possible, and also extended tube life so that 50,000 to 100,000 flashes from the same tube is not unusual. Tubes are available for operation at 180-300v, 450v, 900v and 2000-2500v. Amglo Corp., Dept. ED, 2037 W. Division St., Chicago 22, Ill.

CIRCLE ED-140 ON READER-SERVICE CARD FOR MORE INFORMATION

Better Performance . . .

WITH THIS NEW HERMETICALLY SEALED RELAY

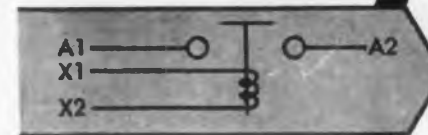

No. A-53-110

Developed to meet exacting specifications for a current aircraft equipment application, this hermetically sealed, solenoid-type relay combines high contact rating and large contact area in a lightweight, compact envelope.

CHARACTERISTICS

DESCRIPTION: SPST, NO., bracket mounted.
COIL DATA: Nominal voltage 24-28 VDC; maximum operating voltage 29 VDC; maximum pick-up voltage 18 VDC; drop-out voltage 7 VDC, plus 0, minus 5.5 VDC; standard coil 160 ohms, maximum coil current .180 amps.
CONTACT RATING: 25 amp. resistive; 20 amp. inductive; 15 amp. motor.
RATED DUTY: Continuous.
WEIGHT: 6.25 ounces.
MAXIMUM DIMENSIONS: Width 1 1/32", length 1 1/16", height 2 3/4".

RELAY
DIVISION

Brochure and specifications
available upon request.

Electrical Products CORP.

1100 North Main Street, Los Angeles 12, California

CIRCLE ED-141 ON READER-SERVICE CARD FOR MORE INFORMATION

Need a complete complement*
of High Voltage Capacitors
for developmental color TV?

Leaders for over two years in experimentation with component parts for color TV. Jeffers Electronics has developed this first complete complement of high-voltage capacitors.

Drawings and additional technical information furnished on request. Complete kits of high-voltage capacitors listed below available at nominal cost.

Each kit includes the following units:

No. per kit	Capacity	Voltage Rating
1	10,000 MMFD	6KV
1	2,000 MMFD	30KV
1	500 MMFD	30KV
2	1,000 MMFD	10KV
3	1,200 MMFD	15KV

* Typical quantities proposed

Other Divisions: Speer Resistor
International Graphite & Electrode



CIRCLE ED-142 ON READER-SERVICE CARD FOR MORE INFORMATION

ELECTRONIC DESIGN • May 1954

Ford

Multipot

Helical Type Precision Potentiometers

• THE MARK OF QUALITY

We specialize in FAST, personalized service to our customers, and in the design of special resistance devices of this type to your own specifications if you do not find any of our standard types suitable. In addition, you will find that our prices compare favorably with those of competing products. Let a trial convince you. Delivery on sample quantities can usually be made within two or three weeks.



FORD ENGINEERING COMPANY
UPLAND, CALIFORNIA
PHONE YUKON 322-321

CIRCLE ED-138 ON READER-SERVICE CARD FOR MORE INFORMATION

KULKA Single and Double Pole "Toggle" Handle Type
AIRCRAFT SWITCHES
For Electronic and Communications Use



Made to JAN specs for DC, or AC circuits up to 1600 cycles. Available with screw terminals and with soldering lugs. Switching characteristics provide for changes in electric circuits by use of SPST, SPDT, DPST and DPDT. Has bakelite housing and only one mounting hole.

TERMINAL BLOCKS

Barrier type, made of molded bakelite in varied styles & sizes up to 26 terminals. Send for catalogue.



KULKA ELECTRIC MFG. CO., Inc.
MOUNT VERNON, N. Y.

CIRCLE ED-143 ON READER-SERVICE CARD FOR MORE INFORMATION

RESINITE

GIVES YOU THE HIGHEST INSULATION RESISTANCE OF ANY RESINATED PRODUCT



Performance data—compiled from laboratory tests, actual field operations and reports from manufacturers—prove the outstanding operating characteristics of Resinite. In volume resistivity... low moisture absorption... excellent thermal properties... low power factor... and resistance to voltage breakdown... Resinite outperforms all other resinated products.

Resinite Coil Forms are available with inside or outside threads—slotted, punched or embossed. Special three-row threaded design permits axial pressure in excess of 25 lbs. Torque controllable to + or - 1 inch oz.

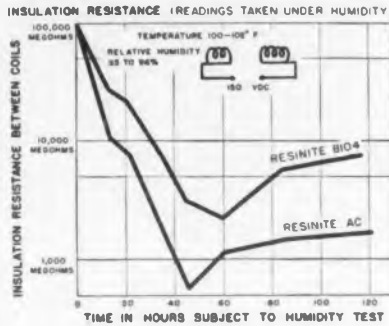

Tests conducted on .253 I.D. x .283 O.D. tubes used on coil forms for television receivers.

- RESINITE 8104—very high dielectric properties under extreme humidity.
- RESINITE "AC"—very high dielectric properties—completely immune to electrolytic corrosion.
- RESINITE 104—for stapling, severe forming and fabricating.

Write today for Full Details and Technical Information

RESINITE CORPORATION
DIVISION OF PRECISION PAPER TUBE

2035C West Charleston Street, Chicago 47, Illinois
79 Chapel Street, Hartford, Conn.

CIRCLE ED-144 ON READER-SERVICE CARD FOR MORE INFORMATION

Versatile VTVM

Has Illuminated Probe Vacuum Tube



The Model 201 Vacuum Tube Voltmeter serves as a general purpose laboratory or service voltmeter for the measurement of d-c or a-c voltages, and resistances.

D-c voltages are covered in seven full scale ranges of 1.5-1500v at an impedance of 11-Meg. A-c ranges are calibrated both in rms values of sine waves (1.5-1500v, full scale) and peak-to-peak values of 4-4000v. Separate scales are provided for the 0-4v peak-to-peak and the 0-1.5v ranges for greater accuracy. Resistance values from 1000 ohms to 1000-Meg, full scale, are covered in seven ranges. Maximum accuracy is at mid-scale, which is calibrated in multiples of 10 ohms for convenience.

Standard probes include the new "Illumi-probe", with a miniature lamp built into the plastic end of the probe, providing extra light for measurements in dark corners. Also furnished is a set of "Klipzon" probes for resistance measurements. High-voltage and high-frequency probes are available as accessories. Shasta Division, Beckman Instruments, Inc., Dept. ED, P. O. Box 296, Sta. A, Richmond, Calif.

CIRCLE ED-145 ON READER-SERVICE CARD FOR MORE INFORMATION

Wire-Wound Resistors
With Welded Terminals



This firm's entire line of wire-wound resistors now is available with all-welded terminal construction. In this construction, the resistance wire is welded to the

terminal band, and the band itself is held permanently around the core by means of welding. Every weld is tested.

The design produces permanent connections that are not affected by vibration or high temperature. The fusion of resistance wire and terminal lug provides a stable electrical connection, important in eliminating noise or instability in sensitive circuits. Terminal bands are of a special alloy whose coefficient of expansion is properly related to that of the resistance wire, ceramic core, and vitreous enamel coating. The resistance wire is welded flush to the band. Ohmite Manufacturing Co., Dept. ED, 3601 Howard St., Skokie, Ill.

CIRCLE ED-146 ON READER-SERVICE CARD FOR MORE INFORMATION

Fielden

RESISTANCE
THERMOMETER
RECORDER



- * Ideal for measurement of temperatures up to 950° F.
- * Inherent accuracy $\pm 0.5\%$ of Full Scale
- * Linear scale on all spans up to 600° F.

* Recorder has interchangeable measuring unit which permits change in range or measurement without rewiring. Up to 4 simultaneous inputs permit addition, subtraction or averaging.

This new, low-cost Fielden self-balancing type recorder uses an AC actuated bridge circuit that eliminates direct current source and replacement of dry cells. Measures spans of 50° F. or less if required. Full scale pen travel in 3.5 sec. Sensitivity $\pm 0.5\%$ of full scale, dead spot 0.1% of full scale. Recorder adaptable to many uses. Write today for detailed information to Dept. Q.

Robertshaw-Fulton
CONTROLS COMPANY



FIELDEN INSTRUMENT DIVISION
2920 N. 4th St., Dept. Q, Philadelphia 33, Pa.

Dollar for Dollar—
Your Best
Instrument Value

CIRCLE ED-147 ON READER-SERVICE CARD FOR MORE INFORMATION

Self-Locking Fasteners
for Electronic Applications



When weight reduction, space limitations, and vibrations in electronic equipment are problems, use Elastic Stop nuts, with the famous red insert collar. The nylon collar grips bolt threads—damps out severe shock and vibration—permits accurate bolt loading—maintains adjustment. Elastic Stop nuts are reusable many times. Instrument nuts (top) are for mounting instruments in panel faces; clinch nuts for pre-positioning in thin section metal components. Hex nuts in sizes from .109 across flats.



For information on any electronic fastener problem write: Elastic Stop Nut Corporation of America, 2330 Vauxhall Road, Union, N. J. Address Dept. N59-557.

ELASTIC STOP NUT CORPORATION
OF AMERICA

DESIGN HEADQUARTERS FOR SELF-LOCKING FASTENERS
CIRCLE ED-148 ON READER-SERVICE CARD FOR MORE INFORMATION

Lower installed costs,
more installations per hour . . . with
**COMPRESSION TERMINALS, TERMINAL BLOCKS,
AND DISCONNECT CLASPS**
for all electronic applications



Space-saving, economical, dependable connectors designed for quality performance, Burndy FERRULES, HYLUGS, INSULUGS, CRABLOKS, HYCLASPS and HYCLASP lugs have wide application in the field of electronics. Burndy FERRULES, easily-installed by crimping, provide quick and efficient terminations for shielded cable.

FERRULES may also be used as anchors to prevent shields from fraying or slipping. HYLUGS, compression-installed terminals adaptable to practically every electrical product, are widely used in terminating all sizes of solid, stranded or flexible cables. HYLUGS with Nylon-insulated connector barrels, INSULUGS have extensive use in terminating wire in the electronic gear of aircraft. Designed with spring-loaded socket connectors, Burndy CRABLOKS, lightweight molded phenolic terminal blocks, provide quick plug-in connections and disconnections that speed terminating and testing procedures. For equipment requiring a quick-disconnect, Burndy compression HYCLASP disconnect splices and HYCLASP lug disconnect terminals are available. All Burndy HYCLASPS remain locked under tension. HYTOOLS and HYPRESSES, Burndy installation tools for compression-type connectors, provide efficient connections at minimum cost.

For detailed information, write

Department 149, BURNDY, Norwalk, Connecticut.

54-9

CIRCLE ED-149 ON READER-SERVICE CARD FOR MORE INFORMATION

New!

**MODEL 411
Extended Range
Audio Oscillator**



- Wide Range—20 cycles to 1000 KC
- Compact Size—6" Wide x 8½" High x 8½" Deep
- Light Weight—13½ lbs.
- Low Distortion—less than 1% over most of range
- High Stability
- Uniform Output—±.5 db. to 100 KC
- Vernier Driven Dial
- 48" of Dial Calibration
- Competitively Priced

Write for literature and prices



THE CLOUGH-BRENGLER CO.

6014 BROADWAY
CHICAGO 40, ILLINOIS

CIRCLE ED-150 ON READER-SERVICE CARD FOR MORE INFORMATION

62

New Products . . .

Portable Temperature Tester

Tests from -65° to $+350^{\circ}$ F



This portable TC-2 Temperature Test Chamber is a new version of this firm's Model TC-1. The range has been

extended 75° , permitting tests from -65° to $+350^{\circ}$ F. A rugged Weston industrial thermometer is permanently mounted on the front panel. A loading port at the top of the chamber permits the addition of dry ice during extended operation at low temperature.

The working space is $7'' \times 15'' \times 7\frac{1}{2}''$ in size. The test load is carried in a removable tray provided with $15\text{-}3\frac{3}{8}''$ diam openings for connections to objects under test. The chamber may be plugged into any standard electrical outlet and requires 5amp at 115v, 50-60cy. Overall dimensions are $48'' \times 16\frac{1}{2}'' \times 12''$. Statham Development Corp., Dept. ED, 12411 W. Olympic Blvd., Los Angeles 64, Calif.

CIRCLE ED-151 ON READER-SERVICE CARD FOR MORE INFORMATION

High-Voltage Rectifier

For Color TV Receivers



Specially designed for use in the scanning system of color TV receivers, the 3A3 may be employed in any rectifier application where high peak-inverse plate voltage and high peak plate current characteristics are necessary. Maximum peak-inverse plate voltage is 30,000v and max peak plate current is 80ma for a max pulse duration of 10microsec (15% of a scanning cycle). Maximum seated height in its octal base is $3\text{-}1\frac{1}{2}''$.

The 3A3 also incorporates a special, insulation-coated bulb to equalize bulb charge. The coating on the inside of tube also reduces the possibility of bulb puncture due to electron bombardment. The filament voltage of 3.15v is designed for a more effective match with the fly-back system. CBS-Hytron, Dept. ED, Division of the Columbia Broadcasting System, Inc., Danvers, Mass.

tage of 3.15v is designed for a more effective match with the fly-back system. CBS-Hytron, Dept. ED, Division of the Columbia Broadcasting System, Inc., Danvers, Mass.

CIRCLE ED-152 ON READER-SERVICE CARD FOR MORE INFORMATION

AVAILABLE FROM STOCK FOR IMMEDIATE DELIVERY

acrylic rods and tubes

SIZES AVAILABLE

RODS

1/8"	9/16"
3/16"	5/8"
1/4"	3/4"
5/16"	7/8"
3/8"	1"
7/16"	1 1/8"
1/2"	1 1/4"

TUBES

1/16" wall	1/8" wall
1/4" O.D.	1/2" O.D.
5/16" "	3/4" "
3/8" "	1" "
1/2" "	1 1/4" "
5/8" "	1 1/2" "
3/4" "	1 3/4" "
1" "	2" "
1 1/4" "	

**CLEAR CRYSTAL METHYL
METHACRYLATE—Rods
and tubes for industrial,
novelty, display, models
and all other fields.**

Write for price lists and samples today

Special sizes
to order



ACE PLASTIC COMPANY
Precision Extruders and Fabricators

91-58 VAN WYCK EXPRESSWAY • JAMAICA 35, N. Y.

CIRCLE ED-153 ON READER-SERVICE CARD FOR MORE INFORMATION

it's NEW!

it's PORTABLE!

it's ECONOMICAL!

**DS-660
FREQUENCY
METER**

Designed for portability and low-cost as well as accuracy, the newly developed DS-660 will count and display any electrical or mechanical event which can be converted into a varying voltage of sufficient amplitude — from 10 to 100,000 events per second. Derives its time base from the 60 cycle line — which determines the accuracy — approximately .1%. Here is new and amazing reliability and circuitry available in one unit.

Write TODAY for full technical information

FEATURES:

- SELF CHECKING
- AUTOMATIC and MANUAL RESET
- DISPLAY from 1 to 10 SECONDS
- LIGHTWEIGHT — only 16 lbs.
- UTILIZES STANDARD PLUG-IN DECADES
- BASIC UNIT READS OUT TO 10 KC (4 decades)
- AIR COOLED (Fan)

THE Detectron CORPORATION, Dept. 76
5420 VINELAND AVE., NO. HOLLYWOOD, CALIF.

CIRCLE ED-154 ON READER-SERVICE CARD FOR MORE INFORMATION

ELECTRONIC DESIGN • May 1954

VIBR
pro



Type 275

Light-w
easy to
tion. Th
electron

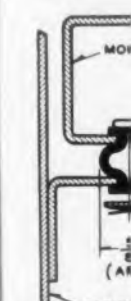

CIRCLE ED-155

TYPE	FR
*IN218	
*IN21C	
*IN150	
*IN160	
*IN23B	
*IN23C	
*IN149	
IN78	
IN26	
IN53	
IN32	

* Also available

Design
achieving
plus long
silicon di
able for a
For su
at X-bar
adjusted
S-band.

Write
silicon di
nington

CIRCLE ED-1

ELECTR

MINIATURE VIBRATION ISOLATORS

protect light-weight components



Type 275 Type 372 Type 302 Type 371

Light-weight instrument Barrymounts are extremely easy to use, and require very little space for installation. They provide a high degree of vibration protection for small instruments, sensitive relay assemblies, electronic sub-chassis, small motors, and similar light-weight units. Available in four types, they will support up to 9 lbs. per unit isolator. Vibration frequencies as low as 30 cps are isolated in all directions, for maximum rated load. For further information, write to The Barry Corporation, 775 Pleasant St., Watertown 72, Massachusetts.

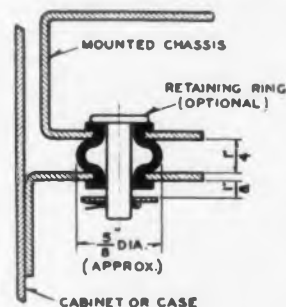

Light-weight instrument Barrymounts are extremely easy to use, and require very little space for installation. They provide a high degree of vibration protection for small instruments, sensitive relay assemblies, electronic sub-chassis, small motors, and similar light-weight units. Available in four types, they will support up to 9 lbs. per unit isolator. Vibration frequencies as low as 30 cps are isolated in all directions, for maximum rated load. For further information, write to The Barry Corporation, 775 Pleasant St., Watertown 72, Massachusetts.

CIRCLE ED-155 ON READER-SERVICE CARD FOR MORE INFORMATION

New Silicon Diodes Lower Noise, Broader Bandwidth

TYPE	CENTER FREQUENCY (mc)	MAX CONVERSION LOSS (db)	MAX NOISE RATIO (times)	VSWR (max)	IF IMPEDANCE (OHMS)
*1N21B	3060	6.5	2.0	-	200-800
*1N21C	3060	5.5	1.5	-	200-800
*1N150	6750	6.0	2.0	1.5	250-500
*1N160	6750	6.5	2.7	-	200-800
*1N23B	9375	6.5	2.7	-	200-800
*1N23C	9375	6.0	2.0	1.5	325-475
*1N149	9375	5.5	1.5	1.5	325-475
1N78	16000	7.5	2.5	-	325-625
1N26	23984	8.5	2.5	-	300-600
1N53	>30000	8.5	2.5	-	400-800
1N32	3295	Fig. Merit > 85	Video Impedance 4K-22K		

* Also available with reversed polarity



Designers and producers of microwave receivers are achieving lower noise figures over broader bandwidths plus longer life by specifying Microwave Associates, Inc., silicon diodes. High quality, low cost diodes are available for all microwave bands.

For super low noise performance, specify the 1N149 at X-band and the 1N21C at S-band. The new RF adjusted 1N32 outperforms the field for video use at S-band.

Write for catalog ED 54S, describing our complete silicon diode line. Microwave Associates, Inc., 22 Cummington Street, Boston 15, Mass. Tel., COpley 7-4441.

CIRCLE ED-156 ON READER-SERVICE CARD FOR MORE INFORMATION

Pulse Transformer Kit

Includes Three Types



A sample package, designated SP-1, containing three different pulse transformers, is offered at a reasonable price for experimentation by design engineers. These

transformers are of the octal tube base plug-in construction with cores of high quality magnetic material. They may be used for blocking oscillators, coupling, impedance matching, etc.

Contained in the package is a type PT-1 with a characteristic impedance of 100 ohms and a rise time of $0.04\mu\text{sec}$; type PT-2 with a characteristic impedance of 100 ohms and a rise time of $0.04\mu\text{sec}$; and a type PT-3 with a characteristic impedance of 120 ohms and a rise time of $.03\mu\text{sec}$. Berkshire Laboratories, Dept. ED, 578 Beaver Pond Rd., Lincoln, Mass.

CIRCLE ED-157 ON READER-SERVICE CARD FOR MORE INFORMATION

WWV Receiver

For Checking Local Standards

The Model ME-117 WWV Receiver compares a local standard to the WWV-5Mc standard. After demodulation, the 5Mc carrier is doubled to 10Mc and displayed on a 2" CR tube as a circular pattern. A 10Mc multiple of the local standard modulates the



intensity of this pattern. The speed and sense of rotation of the pattern indicate the amount and direction of the deviation from the WWV-Standard.

The receiver will accommodate any local standard frequency in the range 50kc to 10Mc equal to a sub-harmonic of 10Mc, 2Mc, or 400kc. A second channel receives the audio modulation and time signals of the WWV-Standard. The bench model is 19-1/2" x 10" x 17" and weighs 40 lb. Matawn Electronics Co., Inc., Dept. ED, 236 Creek Rd., Keansburg, N. J.

CIRCLE ED-158 ON READER-SERVICE CARD FOR MORE INFORMATION

This fastener works through thick and thin!



Spring-Lock works whether panel thicknesses run over or under specifications! Spring wire deflects automatically to handle greater or lesser thicknesses. Spring-Lock's design flexibility makes it more than a fastener: it can be adapted as a shelf support, door strike, knob or any similar panel-mounted device. Many standard shapes and sizes of Simmons Spring-Locks are available from stock.

SIMMONS FASTENER CORPORATION
1763 North Broadway, Albany 1, N. Y.
Spring-Lock • Quick-Lock • Roto-Lock

CIRCLE ED-159 ON READER-SERVICE CARD FOR MORE INFORMATION

HERE'S HOW SPRING-LOCK WORKS



1. Insert fastener. 2. Half-turn to lock.

- Installation is BLIND
- Installation is EASY: no special tools are needed
- Installation is QUICK: a half-turn locks it in place
- Installation is SECURE: the spring steel locks the fastener, resists vibration

Send for details and samples, or write us about your fastening problem.



Get This Informative Free Booklet on New Uses for Straits Tin

New, 20-page booklet tells important story of Straits Tin and its many new uses today. Fully illustrated. Includes sections on new tin alloys, new tin solders, new tin chemicals. Covers tin resources and supply, Malayan mining. Booklet is factual, informative—could well prove profitable to you. Mail coupon now.

THE MALAYAN TIN BUREAU

Dept. C, 1028 Connecticut Ave., Washington 6, D.C.

Please send me a copy of your free booklet on new uses for Straits Tin.

Name _____

Firm Name _____

Street _____

City _____ Zone _____ State _____

CIRCLE ED-160 ON READER-SERVICE CARD FOR MORE INFORMATION

Want **MAXIMUM Performance**
in **MINIMUM SPACE and WEIGHT?**



Among the wide variety of *Standard Phil-Trol Relays* you will find many designed to solve your "special" problems . . . like the types 4BQA and 4BQA POWER shown above. While both are small, compact, lightweight units, each is designed to perform its job best.

These are but two of the many unusual Phil-Trol designed relays that will help you solve the "tough" application problems as well as the simpler ones . . . and with security in knowing you will always have dependable performance. Send for a new Phil-Trol Catalog — today!

Phil-trol

Is the Registered Trade Mark of
PHILLIPS CONTROL CORP., DEPT. ED, JOLIET, ILLINOIS
A Thor Corporation Subsidiary—Offices in All Principal Cities

CIRCLE ED-161 ON READER-SERVICE CARD FOR MORE INFORMATION

precision

parts
components
assemblies



...to your specifications

**ELECTRONIC • ELECTRO-MECHANICAL
AIRCRAFT • AUTOMOTIVE**

We are staffed and equipped to give you every assistance in the design and manufacture of those tough small parts and assemblies. Long experience in miniaturization and weight reduction qualify us for your most intricate problem.



Complete
cooperation
assured . . .
Try us!

47 N. SAXON AVE., BAY SHORE, LONG ISLAND, N. Y.

CIRCLE ED-162 ON READER-SERVICE CARD FOR MORE INFORMATION

New Products . . .

Resistance Meter

Also Measures Leakage



The Model C-6 Resistance Meter has a range from 0 ohms to ten million megohms covered in 10 decade steps. All measurements may be made to an accuracy of 3% of full-scale deflection.

Through the use of a "Quick Charge" switch and a "Charge Adjust" control, it is possible to preset an ac-

ceptable value of capacitor leakage resistance into the meter and then determine almost instantaneously whether or not a capacitor meets the requirement, thus using the instrument as a "go-no-go" gage.

Either 50v or 500v d-c may be used in measuring resistance in the megohm range. The 500v test meets JAN and MIL specifications for insulation testing, while 50v is provided in order that condensers may be tested for leakage without exceeding their voltage limitations. A 1.5v battery is used for the ohms range. Southwestern Industrial Electronics Co., Dept. ED, 2831 Post Oak Rd., P.O. Box 13058, Houston 19, Tex.

CIRCLE ED-163 ON READER-SERVICE CARD FOR MORE INFORMATION

Transformers and Reactors

Encapsulated in Plastic

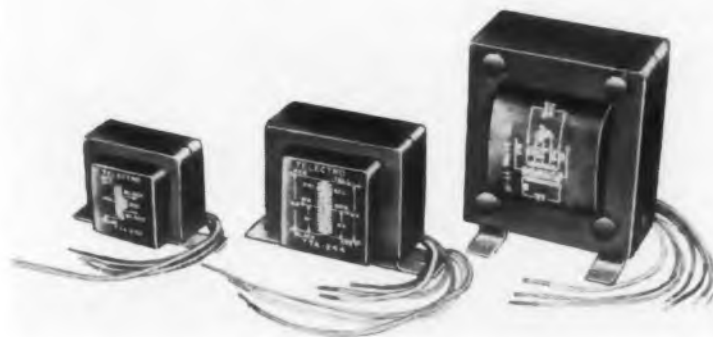

Using a new method of plastic encapsulation, these "Teletran" transformers and reactors have been approved by the Signal Corps Engineering Laboratories (SCEL) and meet the requirements of Spec MIL-T-27, Grade 1, Class A. The units are made with sealed, flexible leads that can be supplied to any length and with any type of termination.

The transformers and reactors can be custom designed for all types of audio, power, and r-f applications. They are available in sample quantities, short-runs, and in long-run production numbers. Telectro Industries Corp., Dept. ED, 35-18 37th St., Long Island City 1, N. Y.

CIRCLE ED-164 ON READER-SERVICE CARD FOR MORE INFORMATION

ENTIRELY NEW



POWERSTAT Variable Transformers TYPE 136 AND 236

provide new higher ratings . . . smaller size . . . easier installation and servicing . . . smoother operation and longer life . . . greater overload characteristics.

POWERSTAT types 136 and 236 are all new . . . new design . . . new performance . . . new ratings. Incorporated into each unit are all the features essential for the ultimate in variable transformers.

Types 136 and 236 are offered for manually-operated and motor driven duty in 120, 240, 480 volt ratings. Here are the reasons they are superior:

Higher Ratings: Type 136 is rated 120 volts, 50/60 cycles input; 0-120/140 volts, 20.0 amperes output.

Smaller Size: "Pancake" coil design provides compactness for bench or panel mounting.

Easier Installation: Three sets of mounting holes suit all needs. Binding post type terminals provide all connection methods.

Easier Service: Simply remove plate block for access to brush assembly.

Brush easily removed and replaced.

New Rhodium Plated Commutator: The one best answer to smooth performance and long life. The contact surface remains forever free of oxides. Corrosion is reduced. Uniform contact drop maintained and greater overload characteristics allowed.

There is a complete standard line of POWERSTAT variable transformers type 136 and 236 to suit individual requirements. Write for Bulletin P354.

The SUPERIOR ELECTRIC Company

1705 Clarke Ave., Bristol, Conn.

CIRCLE ED-165 ON READER-SERVICE CARD FOR MORE INFORMATION

MILITARY

FANS

• BUILT TO GOV'T.
SPECIFICATIONS

• COMPACT • LIGHT • SELF-CONTAINED

ROTRON Models DF, MF, NF and HF axial-propeller FANS with propeller diameters ranging from 3" to 8" diameter, are specifically designed for military applications. Withstand conditions of shock, vibration, humidity cycling, fungus, sand and high temperatures. Highest quality, totally enclosed, permanently sealed ball bearing construction. Also available with ROTRON "ALTIVAR", variable-speed motors, giving constant cooling efficiency at high altitudes.

• 30—1000 CFM (NAFM)

• 25—50—60

400 CPS,

VAR. FREQ., DC

• 1φ—3φ



ROTRON MANUFACTURING CO.
7 Schoonmaker Lane, Woodstock, N. Y.

CIRCLE ED-166 ON READER-SERVICE CARD FOR MORE INFORMATION

LET PERKIN BUILD YOUR

AIRBORNE HI-VOLTAGE POWER SUPPLIES



TYPICAL MODEL No. M1139D

6000v. @ 100μamps.
115v., 400cps., 1 phase input
Built to MIL specs.
Potted with specially
developed epoxy resin

Units up to 50kv. can be built to your specs.

MAGNETIC AMPLIFIER REGULATED POWER SUPPLIES

1% REGULATION AND RIPPLE

Model	Volts	Amps	Model	Volts	Amps
MR532-15	5-32	15	MR1032-50	10-32	50
MR1040-30	10-40	30	MR2432-200	24-32	200

Write or phone factory for literature or quotations. Samples of M1139D can be loaned for your testing purposes!

Phone: Oregon 8-7215

PERKIN ENGINEERING CORP.

345 Kansas Street • El Segundo, Calif.

CIRCLE ED-167 ON READER-SERVICE CARD FOR MORE INFORMATION

CORRECT COMBINATION OF SIZE & POWER RATING FOR A SPECIFIC APPLICATION offered by Jennings Vacuum Capacitors

The wide choice of size and power ratings for a given capacity range is illustrated by these four units all having maximum capacities of 1000 mmfd. JENNINGS functional designs thus permit you to select the smallest vacuum capacitor that will meet your voltage and current requirements.



Please let us suggest the capacitor that will best meet your specific circuit conditions.

Literature mailed upon request.

JENNINGS RADIO MANUFACTURING CORPORATION • 970 McLAUGHLIN AVE.
P.O. BOX 1278 • SAN JOSE 8, CALIFORNIA

CIRCLE ED-168 ON READER-SERVICE CARD FOR MORE INFORMATION

ELECTRONIC DESIGN • May 1954

Tubeless Power Supply

Uses Magnetic Amplifier



The Model MR1040-30 Regulated Power Supply uses a magnetic amplifier in the regulation circuit. It is rated 10-40v d-c at 30amp continuously and has a regulation accuracy of $\pm 1\%$

(a) from 10-40v d-c, (b) from 100-130v a-c input, (c) from 3-30amp. Ripple is 1% rms and the unit is designed to receive an a-c input of 100-130v, single phase, 60cy.

The amplifier has a response time of 0.2sec maximum and the response is independent of the output voltage setting. The supply is provided with a 4-1/2" ammeter and voltmeter, weighs approximately 175 lb, and measures 22"x15"x23". This unit contains no tubes and utilizes magnetic materials plus low leakage selenium rectifier stacks. Perkin Engineering Corp., Dept. ED, 345 Kansas Street, El Segundo, Calif.

CIRCLE ED-169 ON READER-SERVICE CARD FOR MORE INFORMATION

Announcing TAYLOR HEAVY-DUTY C3J/A

The new Taylor 5684/C3J/A is a superior version of the C3J/A Xenon Thyatron.

Taylor's exclusive gold flow process grids maintain sharp cut off characteristics throughout tube life.

FEATURES

- 3 Ampere Average Anode Current
- Metalized Graphite Anode
- Large Overload Capacity
- High Shock Design

As always, Taylor is producing tubes of superior quality and outstanding performance for industrial and commercial applications. We invite your inquiry on standard or special tube types.

WRITE FOR LITERATURE ON FULL XENON TUBE LINE

Taylor HEAVY CUSTOM BUILT DUTY Tubes

TAYLOR TUBES INC., 2312-18 WABANSIA AVE., CHICAGO 47, ILL.

Canada: Atlas Radio Corp., Ltd.
560 King St., W., Toronto 2-B
Cable: ATRADCO

Export: Royal National Company
75 West St., New York 6, N. Y.
Cable: NATVARNCO

CIRCLE ED-170 ON READER-SERVICE CARD FOR MORE INFORMATION

Metron BANTAM SPEED REDUCERS

- Complete!
- Compact!
- Adaptable!

The New Bantam combines power capacity and toughness with small size.

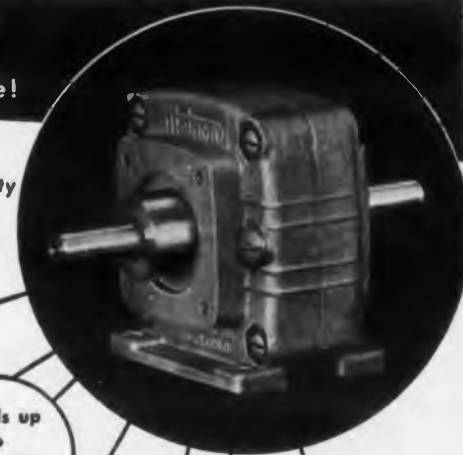

130 oz./in.
output
torque

Sealed
oil bath
lubrication

Speeds up
to
10,000 RPM
input

Coaxial
shafts for
in-line
construction

Available in
642
STANDARD
ratios

1/2
ACTUAL
SIZE

Quick
delivery —
1 or 1000
units

Save design,
production, and
assembly costs by
using ready-to-go
Bantams as package
components in your product.

Write for Data Sheet 10 and 11 for details

Metron INSTRUMENT COMPANY
450 Lincoln St. • Denver 3, Colorado

CIRCLE ED-171 ON READER-SERVICE CARD FOR MORE INFORMATION

Laminated INSUROK® PLASTICS



SHEETS
RODS, TUBES
PUNCHINGS
GEAR BLANKS
FABRICATED
PARTS

All NEMA and
other Special Grades

Write for
Descriptive
Folder

The RICHARDSON COMPANY

FOUNDED 1858

2682-D Lake St., Melrose Park, Illinois (Chicago District)

CIRCLE ED-172 ON READER-SERVICE CARD FOR MORE INFORMATION



TEST THEM FREE!

SEND FOR YOUR SAMPLE KIT OF
SHAKEPROOF
T.M. REG. U.S. PAT. OFF.
LOCK WASHERS

Only SHAKEPROOF Lock Washers give you the powerful, positive locking action of tapered-twisted teeth. They actually bite deeper as vibration increases! A complete line of standard types and sizes meets nearly every fastening need.

WRITE FOR FREE
SAMPLE KIT TODAY

SHAKEPROOF
"Fastening Headquarters"

DIVISION OF ILLINOIS TOOL WORKS
St. Charles Road, Elgin, Illinois
Offices in principal cities

CIRCLE ED-174 ON READER-SERVICE CARD FOR MORE INFORMATION

new designs on the board?

GRC
TINY MOLDED
NYLON PARTS
may be the difference between "problems" and profits!



Gries' unique single cavity molding facilities are flexible—provide the practical answer to countless problems of product design and improvement. No matter how tiny, or how intricate, GRC molds nylon parts to meet your exact specifications, with precise tolerances and uniform quality. And, because GRC methods are completely automatic, costs are surprisingly low—GRC tiny nylon parts are produced, completely trimmed and ready for use, in one high-speed, money-saving operation!

Send prints for quotation; write today for Bulletin and Samples.

GRC MOLDS ALL THE MOPLASTICS SWIFTLY, DEPENDABLY, ECONOMICALLY!

Automatic Continuous and Individual Inserts! Single Parts!

Quick deliveries on quantities of 25,000 to millions.

NO SIZE TOO SMALL! MAXIMUM SIZE .025 oz.—1" long NO MINIMUM SIZE!

LOW MOLD COSTS!

GRIES REPRODUCER CORP.
World's Foremost Producer of Small Die Castings
40 Second St., New Rochelle, N. Y. Phone: NEW Rochelle 3-8600

CIRCLE ED-175 ON READER-SERVICE CARD FOR MORE INFORMATION

New Products . . .

Small Trimmer Potentiometers

1000 ohm to 1 Megohm Models



Type 3A7341 subminiature trimmer potentiometers are intended for use as preset adjustable resistors in miniaturized equipment. They are readily attached to chassis or printed circuits by means of convenient mounting lugs.

Each component measures only 0.530" diam x 0.281" deep. Adjustment is made by means of a concentric tool which incorporates a central screwdriver for locking and unlocking the contact arm. The outer sleeve of the tool is provided with two key pins that fit and permit the setting of the contact arm for the value desired. The track is carbon composition and has linear characteristics.

Nominal rating is 1/10w at 70°C, ambient. Values range from 1000 ohms to 1 Meg. Tolerance is $\pm 20\%$. Shelf stability is less than 10% after 1000 hours under normal conditions. Rockbar Corp., Dept. ED, 215 E. 37th St., New York 16, N. Y.

CIRCLE ED-176 ON READER-SERVICE CARD FOR MORE INFORMATION

High-Voltage Beam Triode

For Color TV



Designed for voltage regulation of the anode and convergence supplies of color TV receivers, the 6BD4 is a high-voltage, low-current, sharp-cutoff beam triode that can be employed for any similar voltage regulation requirements. Maximum d-c plate voltage is 20,000v and maximum d-c plate current is 1.5ma. with a maximum plate dissipation of 20w.

The large bulb of the tube provides long leakage paths and prevents corona effects. The high-voltage, electron-gun type construction of the 6BD4 incorporates a double-ended structure for high-voltage insulation. Maximum seated height is 4-5.8" in an octal base. CBS-

Hytron, Dept. ED, Division of the Columbia Broadcasting System, Inc., Danvers, Mass.

CIRCLE ED-177 ON READER-SERVICE CARD FOR MORE INFORMATION

NEW VARIACS

for 350 to 1200 Cycles



TYPE M-2 VARIAC: \$15.50
350-1200 Cycle Line
2 amperes, rated
3 amperes, maximum
Weight: 1-7/8 pounds

Electrical equivalents of the popular 60-cycle Types V-2 and V-5. New design with cast aluminum construction. Lighter, much smaller, more rugged.

Type M-2 (2 ampere model) has 400 turns of wire, giving adequate resolution for many computing and control operations.

Type M-5 (5-ampere model), with rated current of 5 amperes and maximum of 7.5, weighs 3 1/4 pounds and is priced at \$22.50.

Both units available in 2- and 3-gang assemblies for polyphase operation or for controlling several circuits simultaneously.

Exclusive DURATRACK contact construction for longer life, ability to withstand 10 times overload momentarily, and requiring much less maintenance.

GENERAL RADIO Company 275 Massachusetts Ave.
Cambridge 39, Mass.
90 West St. NEW YORK 6 920 South Michigan Ave. CHICAGO 5
1000 North Seward St. LOS ANGELES 38

CIRCLE ED-178 ON READER-SERVICE CARD FOR MORE INFORMATION



Fact-filled folder on request . . . showing how economies in costs, labor and time are achieved with the GREEN ENGRAVER.

Routs Models
Profiles Engraves

Etching attachment and other special equipment for industrial uses are available.

Mark your own symbols, numbers, lettering, on your small parts, tools, identification and name plates . . . easily, simply, quickly . . . tracing from a master with the GREEN ENGRAVER.

Widely used in electronic and plastic fields, in machine tool shops and wherever permanent marking is needed. The GREEN ENGRAVER engraves equally well on metals, plastic, wood, hard rubber and glass.

Green Instrument Co.
INCORPORATED

361 PUTNAM AVE., CAMBRIDGE, MASS.

See us at Booth 243 at the IRE Show

CIRCLE ED-179 ON READER-SERVICE CARD FOR MORE INFORMATION

Terminal Boards Custom-built or standard

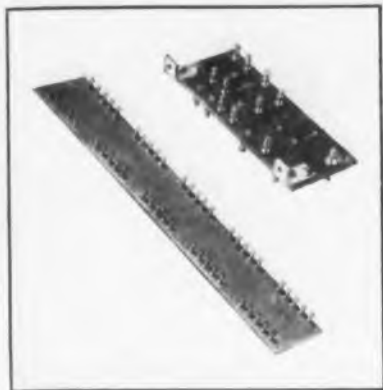

Whatever your needs, you can rely on C.T.C. to give you terminal boards that meet your specifications — and that are *guaranteed* by quality manufacturing.

We design and fabricate special boards of cloth, paper, or glass laminates (phenolic, melamine, epoxy or silicone resin) imprinted as required — rubber stamp, silk screen, hot stamp or engraving. Boards are lacquered or varnished to specifications MIL-V-173 and JAN-T-152. Terminals, feed-throughs, hardware and all other fixtures meet all applicable government specifications. We welcome sub-contracts for electronic parts and assemblies. Standard type boards are also available — in cotton fabric phenolic, nylon phenolic or grade L-5 silicone impregnated ceramic.

Boards and assemblies are furnished in any quantity. Write direct for complete information on the type of boards you need. Cambridge Thermionic Corporation, 457 Concord Ave., Cambridge 38, Massachusetts.

CIRCLE ED-180 ON READER-SERVICE CARD FOR MORE INFORMATION

NEW SUB-MINIATURE UNIMAX® SWITCH

Type U S M



ACTUAL SIZE

for easy wiring in miniaturized apparatus.

- Sturdy, standard flat terminals are widely spaced for rapid wiring and easy soldering.
- Case size 25/32" x 23/64" x 1/4".
- Long life.
- Available in plain or leaf-actuator style.
- Rated 5 amperes at 125/250 volts, a-c. or 2 amperes at 30 volts d-c.; SPDT.

Write for data sheet.

UNIMAX SWITCH

DIVISION OF THE W. L. MAXSON CORPORATION

460 WEST 34th ST. NEW YORK 1, N.Y.

CIRCLE ED-181 ON READER-SERVICE CARD FOR MORE INFORMATION

High-Power Transistor Diffused-Junction Type



The "Experimental Type X78" is a p-n-p diffused junction transistor of unusual capabilities. A high-power unit, it is useful principally when used in matched pairs in Class B audio amplifier applications. Subminiature matching transformers have been made available for use in such a circuit.

Although the unit is derated when used above 80°F, it has still found widespread laboratory use. It is not represented to be of high alpha, but the manufacturer guarantees minimum power gain of 10db at room temperature when used in the recommended circuit. Transistor Products, Inc., Dept. ED, Snow & Union Sts., Boston 35, Mass.

CIRCLE ED-182 ON READER-SERVICE CARD FOR MORE INFORMATION

Low-Ripple Power Supply For Resistance-Type Transducers



The Type 3-132 Power Supply furnishes an output of 0-15v d-c at a maximum of 1amp. It is designed for the excitation of multiple strain gages and other resistance-type transducers, and it may be used as a secondary reference voltage source in many other research, calibration, and measurement applications.

Continuously adjustable over the 0-15v range, output voltage is indicated on a front-panel meter and may be varied with a 10-turn voltage-setting control. Output impedance is less than 0.1 ohm; output drift is less than 5mv per hr; and ripple is less than 1mv peak-to-peak. A 10v change or transient in a 105-125v a-c line voltage causes less than 10mv change in the output. A 0-1amp change in load causes less than 20mv change.

Completely self-contained in a metal carrying case which measures only 8-3/4" x 11" x 19", the 45-pound unit may be operated from any 105-125v, 50/60/400cy line. Front panel and chassis configuration permit standard rack-type mounting if desired. Consolidated Engineering Corp., Dept. ED, 300 N. Sierra Madre Villa, Pasadena 15, Calif.

CIRCLE ED-183 ON READER-SERVICE CARD FOR MORE INFORMATION

3 Soldering Operations in 1 Easy as ABC

with

KESTER "SOLDERFORMS"

A Solder screws and stud to can cover. "Solderform" Disc & Rings 5% Silver — 95% Lead Alloy. Melting Point 680°F.

B Solder glass terminals to cover. "Solderform" Rings 63% Tin—37% Lead Alloy. Melting Point 361°F.

C Hermetically seal cover on can. "Solderform" Ring 28.5% Bismuth—28.5% Tin—43% Lead Alloy. Softening Point 250°F.

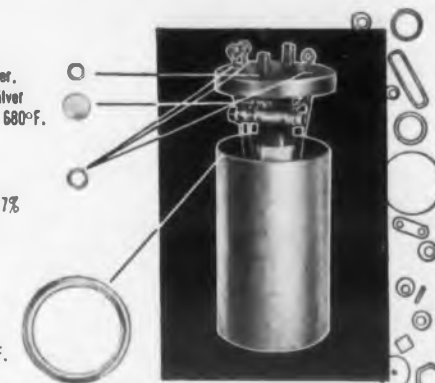

Here's a typical example of a tough resistance soldering job involving progressively lower melting temperatures. Kester "Solderforms" made sure this high precision oscillator coil came through every test successfully.

WRITE TODAY for free "Solderform" samples and literature.



CIRCLE ED-184 ON READER-SERVICE CARD FOR MORE INFORMATION

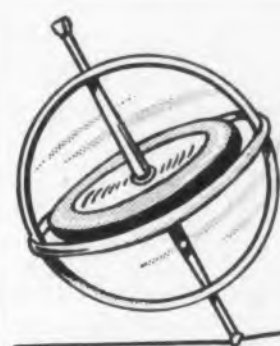

CASTELL
push button
LOCKTITE
lead holder has
PERFECT BALANCE

Perfect balance makes Push Button CASTELL LOCKTITE Holder the king of its class.

Exclusive collet holds lead in bull dog grip, preventing slipping or turning.

No graphite dust stains your fingers —because with one-hand push-button action you extend and retract the lead. No need to touch graphite. Comfortable "wood-pencil" feel—not metallic.

Equipped with easily-replaced clutch, giving your LOCKTITE indefinite life.

Imported CASTELL 9030 Lead inserted in your LOCKTITE Holder gives you the combination for brilliant results on your drawing board. Ask your Dealer for both—LOCKTITE Holder and Imported CASTELL 9030 Lead in 19 degrees, 7B to 10H.

AW FABER-CASTELL
PENCIL COMPANY, INC., NEWARK 3, N. J.

CIRCLE ED-185 ON READER-SERVICE CARD FOR MORE INFORMATION



Another First for



The complete **MS** (Military Standard) line of Hermetically-Sealed Power & Filament Transformers

CHICAGO TRANSFORMER now offers all units in the Military Standard (MS) line, as established jointly by the three armed forces (Army Signal Corps, Navy Bureau of Ships, and Air Force) working through ASES (Armed Services Electronic Standards Agency) and in cooperation with the transformer industry. The complete line is housed in CHICAGO's one-piece drawn-steel cases. Outside case dimensions and mounting dimensions are within the tolerances of the Military Standard specification. Terminal arrangements and markings are also in accordance with the same specification. Tests conducted in the CHICAGO TRANSFORMER laboratories indicate that all units will meet the requirements of Grade 1, MIL-T-27 specifications for Class A operation. The Military Standard line should find wide usage in military airborne, marine, and ground communication equipment, and particularly for research and development applications, pilot runs and pre-production models.

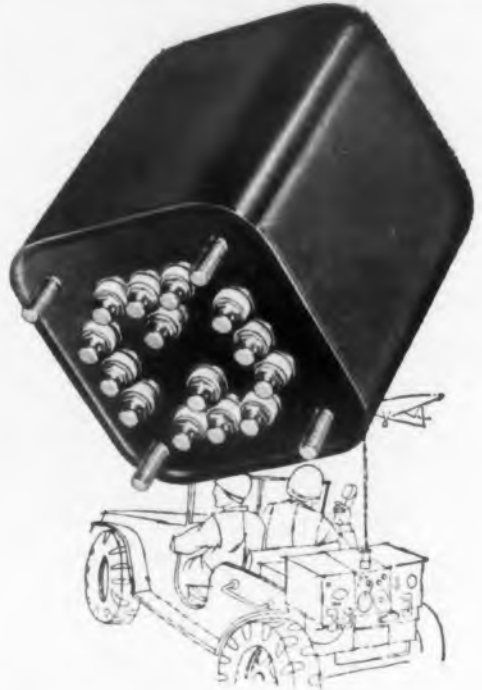

POWER TRANSFORMERS—INPUT REACTOR SYSTEMS (PRIMARY—105/115/125 V.—Frequency 54-66 cycles)

CATALOG NUMBER	MIL-T-27 PART NO.	HIGH VOLTAGE A-C Volts	SECONDARY D-C MA.	D-C V OUTPUT	RECT. FIL. Volts	RECT. FIL. Amps.	FIL. NO. 2 Volts	FIL. NO. 2 Amps.	WT. LBS.	
PMS-70	MS-90026	200-100-0-100-200	70	385	6.3	5	2	6.3	3	4
PMS-70A	MS-90027	325-0-325	70	260	6.3	5	2	6.3	4	5
PMS-150	MS-90028	325-0-325	150	245	6.3	5	5	3	7 1/4	
PMS-175	MS-90029	400-0-400	175	318	5	3	6.3	8	10	
PMS-250	MS-90030	450-0-450	250	345	5	3	6.3	8	13	
PMS-350	MS-90031	350-0-350	250	255					7 1/2	
PMS-550	MS-90032	550-0-550	250	419					11	
PMS-800	MS-90036	800-0-800	250	640					16 1/2	

FILAMENT TRANSFORMERS (PRIMARY:—105/115/125 V.—Frequency 54-66 cycles)

CATALOG NUMBER	MIL-T-27 PART NO.	SECONDARY Volts	SECONDARY Amps	INSULATION VOLTS RMS	WT. LBS.
FMS-23	MS-90016	2.5	3.0	2500	1 1/2
FMS-210	MS-90017	2.5	10	2500	2 1/2
FMS-53	MS-90018	5.0	3.0	2500	1 3/4
FMS-510	MS-90019	5.0	10	2500	4
FMS-62	MS-90020	6.3	2.0	2500	1 3/4
FMS-65	MS-90021	6.3	5.0	2500	2 3/4
FMS-610	MS-90022	6.3 CT	10	2500	5
FMS-620	MS-90023	6.3	20	2500	8
FMS-210H	MS-90024	2.5	10	10000	4 3/4
FMS-510H	MS-90025	5.0	10	10000	7



Free "New Equipment" Catalog

You'll also want the full details on CHICAGO'S New Equipment Line of famous "Sealed-in-Steel" Transformers. Write for Free Catalog CT-153 today, or get it from your electronic parts distributor.



CHICAGO STANDARD TRANSFORMER CORP.

3501 W. ADDISON ST., CHICAGO 18, ILL.

CIRCLE ED-186 ON READER-SERVICE CARD FOR MORE INFORMATION

New Literature . . .

Deflection Amplifier

187

A 2-page data sheet describes the performance of the 6CU6 horizontal deflection amplifier. This TV receiver tube is designed to be interchangeable with the 6BQ6GT and is especially suited for heavy-duty use. Mechanical and electrical data, characteristic curves, ratings, and numerous other information is included. CBS-Hytron, Danvers, Mass.

I-F Transformer

188

A new catalog page available gives detailed information on Type TX100 Miniature I-F Transformer for any application requiring a $3/4$ I-F transformer. The unique single end tuning which permits tuning of both coils from the same end from top or bottom is clearly illustrated. Also included is a complete line of TV coils, including 40Mc I-F Coils, Trap Coils, Sound Take-Off Coils, and Ratio Detector Coils. Six standardized coils available for immediate delivery are illustrated. Electrometric, Inc., Woodstock, Ill.

Variable Resistors

189

A 20-page catalog (Form No. 79-7) is devoted to carbon and wire-wound potentiometers and rheostats. It contains electrical and mechanical characteristics of available designs, line drawings with dimensions, and illustrations. Also provided are charts and graphs, as well as data on available hardware (such as knobs, extension shafts, and shaft couplers). The catalog also contains descriptions and values of potentiometers which can be manufactured in compliance with MIL Spec JAN-R-19. P. R. Mallory & Co., Inc., Resistor Division, Frankfort, Ind.

Power Supplies

190

This eight-page, three-color catalog presents five standard models in the company's line of power supplies for voltage regulation, including a miniature unit measuring 8" x 5" x 5-1/2" overall. Illustrations and specifications are given for each type of supply. The specifications outline input voltage requirements, voltage and current outputs, percent regulation, ripple, ambient temperature operating range, standard meters supplied, and complete mechanical specifications. Included in the manual is a detachable specification sheet for those who wish price quotations on custom-built power supplies and adaptations of standard units to meet user requirements. Allied Engineering Division, Allied International, Inc., Connecticut and Richards Aves., South Norwalk, Conn.

Kits and Instruments

191

A 12-page catalog lists and illustrates 30 kits and 33 instruments. It includes voltmeter, oscilloscope, tube tester, r-f signal generator, decade resistance box, and numerous other types of kits, and instruments of the same types, but factory wired. Also described are this firm's facilities. Electronic Instrument Co., Inc., 84 Withers St., Brooklyn 11, N. Y.

Plastic Film Capacitors

192

A four-page, two-color brochure presents in detail the electrical specifications of the company's new Type MH plastic film capacitors for close tolerances. Additional information includes dimensions, construction, applications, voltage ratings, operating temperature ranges, and capacitance tolerances, as well as complete test data. Electronic Fabricators, Inc., 682 Broadway, New York 12, N. Y.

Molec

A 4-
applica
theory
tailed
gauge
the 1/2
externa
gauge
Genera

Tube

A 57
ring bi
cover is
incorpor
on the
tail ch
each t
cross-re
tube ty
indicat
Write
Sales E
Duffy

Molecular Vacuum Gauge 193

A 4-page bulletin (GEC-986) contains application information, specifications, theory of operation, and many other detailed data on a new molecular vacuum gauge designed to measure pressures in the 1/2 micron to 20mm range without external detectors. Weighing 5 lbs., the gauge is a complete instrument in itself. General Electric Co., Schenectady 5, N. Y.

Tube Manual

A 578-page manual bound in a loose-leaf ring binder with a permanent plasticized cover is available to engineers. The catalog incorporates all general and operating data on the company's tubes, with specific detail charts and complete descriptions of each tube, so that there is no need for cross-reference. Sections are classified by tube type, and separated with protruding indicators. Price of the handbook is \$2.00. Write direct to Amperex Electronic Corp., Sales Engineering Division, Dept. ED, 230 Duffy Ave., Hicksville, N. Y.

Selective Calling Equipment 195

Detailed information on selective calling equipment for individually controlling radio-equipped vehicles is available in a two-color, four-page folder. The literature describes both the push-button type of equipment by which contact with a two-way radio equipped vehicle or fixed station can be made within 0.8sec, or the economical dial operated system. The equipment is designed to help eliminate the confusion caused by overcrowded radio spectrum and skip-distance reception. Hammarlund Manufacturing Co., Inc., 460 West 34 Street, New York 1, N. Y.

Relays

196

Wiring arrangements, dimension diagrams, and tables showing differential currents of a new line of Miniature Sensitive Relays are included in a 2-page, 2-color data bulletin (No. 100). The relays measure only 1" x 1" x 1-3/4" and are extremely sensitive to low input. Signal Engineering & Mfg. Co., 154 W. 14th St., New York 11, N. Y.

2 1/2 times as accurate as others!

New G-E REFERENCE CAVITIES

have temp frequency drift of only ± 0.4 mc!

BUILD more reliable radar equipment with aid of G.E.'s new reference cavities! They narrow by 60% the temperature-drift limits of ± 1 mc (-40 C to $+100$ C) that apply with other cavities.

● Whether operating in heat or cold, your airborne radar will receive beacon signals accurately when G-E reference cavities are used. Vibration (up to 10 g's) and air-pressure changes (15 up to 45 PSIA, or down to 5" mercury) affect frequency only ± 0.1 mc and ± 0.15 mc respectively.

● G-E cavities weigh only 8 ounces. They are compact, with slotted corners for secure 4-bolt mounting. Designed for pressured waveguide systems. Get full information! Wire or write for Bulletin ETD-885, just off the press! *General Electric Company, Tube Department, Schenectady 5, N. Y.*



New

GL-6301.....9270 mc

GL-1Q26-A....9280 mc

GL-6452.....9350 mc

G-E X-band cavities can also be supplied for other frequencies.

GENERAL  ELECTRIC

102-187

CIRCLE ED-197 ON READER-SERVICE CARD FOR MORE INFORMATION

ELECTRONIC DESIGN • May 1954

**EAD**

sine wave
alternators
give you
less than 2%
distortion!



Whether your needs are for an extremely pure sine wave voltage or for appreciable power output, EAD will make an alternator tailored to your requirements. Models are available from 30 to 1000 cps at voltages from 6 to 115 volts and in a wide range of frame sizes.

DUAL OUTPUT UNITS AVAILABLE WITH PHASE ANGLE OF ANY SPECIFIED VALUE HELD TO 1° OR BETTER

In addition to standard single frequency types, forms can be made with two separate outputs of either the same or integrally related frequencies. Phase angles between these two output waves can be held to extremely close tolerances.

Eastern Air Devices is a pioneer in the field of small permanent magnet alternators. No matter what your requirements may be, check with EAD first!

FEATURES

1. **Low Distortion:** Less than 2% distortion of open circuit voltage wave even in smallest sizes.
2. **Dual Frequency:** Models available with two separate, yet integrally related output frequencies. Phase angle between two outputs can be any specified value.
3. **Wide Size Range:** Compact design. Models available in sizes as small as 1 inch in diameter.
4. **High Power Output:** Several hundred watts available in larger models where distortion is not critical.
5. **Military Specifications:** EAD alternators can be manufactured to meet the most exacting military specifications.



EASTERN AIR DEVICES, INC.

SOLVING SPECIAL PROBLEMS IS ROUTINE AT EAD



INDUCTION MOTORS



CENTRIFUGAL BLOWERS



TACHOMETER GENERATORS



TRANSFORMERS



ALTERNATORS



GEAR MOTORS

391 CENTRAL AVENUE—DOVER, NEW HAMPSHIRE

CIRCLE ED-198 ON READER-SERVICE CARD FOR MORE INFORMATION

New
WHAT'S IN SCOPE
...for RADAR?



CUBIC'S New VSWR INSTRUMENTATION SYSTEM
for continuous . . .
automatic . . .
measurement of VSWR

The New Model 620 is CUBIC'S contribution to higher efficiency and higher economy in that new RADAR design you may be planning. Designed for field and production use—where frequent VSWR measurements of radar, and other amplitude modulated microwaves are required, it has certain important features entirely new:

- Measurement of VSWR is continuous and automatic over two calibrated ranges, covering ratios 1.02 to 1.2, and 1.2 to ∞.
- Can be used with CUBIC'S matched directional coupler—permanently or temporarily installed in waveguide run.
- Available too as JAN AN/UPM-12 Military version.
- And available in Model 621, for VSWR measurements at signal generator levels.
- For x-band only, at present. RF components will be ready shortly for operation on S thru Ku band.

New designs make new demands. CUBIC engineers are constantly conducting research to develop new products to enable those new Electronic designs—still on the drafting boards, to become reality. In this connection, our Engineering and service departments are always at your disposal on any Electronic problem.

Write for latest edition of our catalog of microwave instruments



CUBIC
CORPORATION

ELECTRONIC EQUIPMENT
RESEARCH...DEVELOPMENT
SAN DIEGO, 6, CALIFORNIA

New Literature . . .

Rubber Parts 200

A 4-page, 2-color brochure describes this firm's facilities for formulation and manufacture of molded, lathe-cut, die-cut, and bonded-to-metal products of many types, shapes, and sizes from natural, synthetic, and silicone rubber compounds. Numerous products and production facilities are illustrated. Goshen Rubber Co., Inc., Goshen, Ill.

Industrial Felt Products 201

A 12-page, two-color booklet describes and illustrates the firm's wool felt wheels, bobs and sheets, and hair felt sheets and wheels. In addition, there are a number of tables on felt wheel selection and specifications, application hints, and physical and chemical properties for each size and grade felt. The booklet should serve as a good source for manufacturers using felt in their products or processes. Bacon Felt Co., West Water Street, Taunton, Mass.

Aluminum Foil 202

A well illustrated, interesting tract on the development and production of aluminum foil is available in reprint form from *Connecticut Industry* where it originally appeared. The material covers the beginning of the growth of aluminum foil in the post-war period to the present time, giving improvements in qualities, applications, and processing, and the gradual replacement of aluminum for lead and tin foils. Republic Foil & Metal Mills, Inc., Danbury, Conn.

Engraving Machines 203

A 24-page catalog, "Tracer Guided Engraving", describes the applications of various models of tracer guided engraving machines. It covers engraving of plastics, metal, glass, and wood, and also illustrates methods of calibrating, profiling, and slotting. Machines range in size from a small portable model the size of a typewriter, to a large bench type engraver and profiler. New Hermes Engraving Machine Corporation, 13-19 University Place, New York 3, N. Y.

For easier-to-tie knots that will not slip!



HEMINWAY
& BARTLETT

Fungus-Proof

NYLON LACING CORDS and FLAT BRAIDED TAPES

- Revolutionary synthetic resin coating prevents knots from slipping.
 - Laces faster and tighter with less effort. Unique "plastic memory" actually causes lacing to tighten *itself* after knot is made!
 - Its greater strength means minimum breakage — minimum rejects.
 - The synthetic resin coating retains the desirable malleability of wax and yet has a melting point of over 190°F. It is non-toxic to humans.
 - Complies with ALL construction and fungus-proof requirements of Govt. Spec Jan-T-713 and Jan-T-152.
- Cords and tapes are also available with wax finish.*

For FREE SAMPLES and prices write:

The Heminway & Bartlett Mfg. Co., ELECTRONICS DIVISION, 500 Fifth Ave., New York 36, New York
Sales Offices: Chicago, Philadelphia, Boston, St. Louis, Cincinnati, San Francisco, Los Angeles, Charlotte, N.C.,
Gloversville, N.Y. Foreign Agent: Turner, Halsey Co., Inc., 40 Worth St., New York. Cable Address: THECOTEX

CIRCLE ED-204 ON READER-SERVICE CARD FOR MORE INFORMATION

Measuring Instruments 205

This 12-page bulletin (108) describes electrical measuring and electronic instruments for the laboratory. It includes Wheatstone bridges, potentiometers, resistances, resistance standards, capacitances, frequency meters, fluxmeters, electrometers, oscilloscopes, audio frequency oscillators, and other precision-built laboratory measuring instruments. Central Scientific Co., 1700 Irving Park Rd., Chicago 13, Ill.

Audio Connectors 207

A 4-page, 2-color bulletin (XL8-1953) covers the XL series of low-level sound connectors. Fully illustrated with dimensional sketches, sectional drawings, and exploded views, the bulletin contains detailed technical information. Seventeen different assemblies and two insert arrangements are catalogued. Cannon Electric Co., 3209 Humboldt St., Los Angeles 31, Calif.

Electronic Relay 206

An electronic relay which is highly sensitive to resistance changes and can be varied by a stepless dial, is described and illustrated in 4-page, 2-color Bulletin GEA-5893. Applications described include liquid-level control, sorting of small parts, operation of lights, solenoids, contactors, and fractional horsepower motors. Features of the unit are covered, as well as data on operation, dimensions, and specifications. General Electric Co., Schenectady, N. Y.

Vibration Isolator 208

The two-page Bulletin 527 presents detailed technical and application information on the Series 262 and Series 633 Barrymounts. These isolators are especially designed for use in light industrial applications, rotating and reciprocating machinery, and motors or motor-driven equipment. Information on dimensions and load ratings, installation procedure, variation of natural frequency with load, and percent efficiency of isolation is also delineated. The Barry Corp., 875 Pleasant St., Watertown, Mass.

WELMEG

**Vacuum-Sealed RESISTORS
50 to 1,000,000 MEGOHMS**

Welmeg resistors were developed specially for nuclear and related research. They are particularly suitable for use with electrometer tubes, ionization chambers, and in all other applications which indicate high resistance values with close tolerance and good stability.

Welmeg resistors are vacuum-sealed in glass. They are then subjected to stabilization processes. After they are individually inspected and measured for temperature and voltage coefficients, and noise, they are stored for long periods to insure absolute stability.

The behavior of any Welmeg resistor for any determined conditions can be predicted with reliable accuracy. Each Welmeg resistor bears a serial number which enables the user to obtain an exact history of the unit with accurate data regarding its electrical properties.

*For complete data
write to Dept. HE-1*

*Factories in
England and Canada*

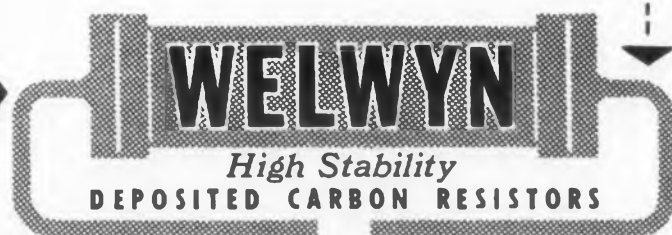

ROCKBAR CORPORATION, 215 East 37th Street, New York 16, N. Y.

CIRCLE ED-209 ON READER-SERVICE CARD FOR MORE INFORMATION

**NEW . . .
U. S. C. PRINTED
CARD RECEPTACLES FEATURING
INGENUITY OF CONTACT DESIGN**



UPCR 18 Contact
Printed Card Receptacle
Illustrated

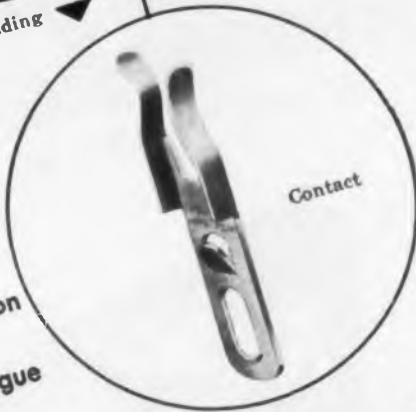
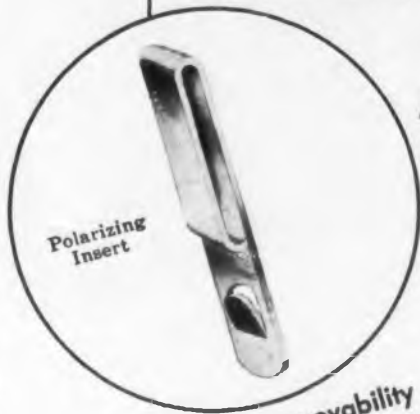

Patents Pending

- Ease of removability and position changeability
- Snap in on insertion — Pinch tongue and push out for removal

- Channel Strength
- Dependability for repeated insertion over ranges of card thickness from .061 to .071
- Designed for high production
- Designed for Multi-Wire connection on terminals

Insulating body available in Mineral Filled Melamine, Alkyd 440 A and Diallyl Phthalate
Contacts — Phosphor Bronze — Silver plated with Gold Flash

Catalogue Numbers:
15 Contact — UPCR 15
18 Contact — UPCR 18
22 Contact — UPCR 22

Other designs to your specifications
Your specific inquiries will receive our prompt attention.

U.S.C.'s complete engineering, tooling and production facilities are geared to produce quality connectors, allied components and assemblies.

REPRESENTATIVES IN PRINCIPAL CITIES
BUFFALO • BOSTON • CHICAGO • NEW YORK • PHILADELPHIA
BALTIMORE • LOS ANGELES

U. S. COMPONENTS, Inc.
Associated with U. S. Tool and Mfg. Co., Inc.
454-462 East 148th Street, New York 55, N. Y.
CYpress 2-6525-6

CIRCLE ED-210 ON READER-SERVICE CARD FOR MORE INFORMATION

Close
Tolerance
is
Standard
Tolerance



with **EFCON**[®]

MINIATURE PLASTIC FILM CAPACITORS

The new EFCON[®] plastic Film Capacitor, Type MH, is produced with tolerances of $\pm 5\%$, $\pm 2\%$ and $\pm 1\%$ in standard production! High stability without derating. DuPont's "Mylar"[®] polyester film with low dielectric absorption. Leads soldered directly to foil.

Hermetically sealed in metal cases.

Also available: Type MC—"Mylar" polyester film capacitor in wax impregnated cardboard tubes; Type S—Molded silvered mica capacitor.

Write Dept. A for informative brochure.

ELECTRONIC FABRICATORS, INC.

682 Broadway, New York 12, N. Y.

* DuPont Trademark

CIRCLE ED-211 ON READER-SERVICE CARD FOR MORE INFORMATION

New...
RELAYS

- SUB-MINIATURE
- ANTI-VIBRATION
- SUPER-RUGGED

WIDE SELECTION OF RELAY TYPES...

Sensitive from .010 watts. Hi temperature and temperature compensated. Fast operate or time delay. Frequency tuned (vibrating reed type).

Designed to meet or exceed
MIL R 5757B

Vibration: Withstands to as high as 20 Gs to 1000 cycles per second. Temperature range: -65° to 200° C. Life: Into the millions of operations. Open or hermetically sealed. Optional plug-in or solder terminals. Variety of mounting arrangements. High contact current.

SEND FOR CATALOG AND ENGINEERING DATA

NEOMATIC INC.

9010 BELLANCA • LOS ANGELES 45, CALIF. • OREGON 83614

CIRCLE ED-212 ON READER-SERVICE CARD FOR MORE INFORMATION



Patents . . . By John Montstream

Inverted Grounded Emitter Transistor Amplifier . . . Patent No. 2,659,773. Harold L. Barney, Madison, N. J. (Assigned to Bell Telephone Laboratories, Inc.).

This transistor amplifier utilizes effects discovered when the emitter instead of the base was grounded. In Fig. 1, a circuit is shown in which the input (10) is fed to the collector (4) and the output circuit is connected with the base electrode (2). The emitter electrode (3) is common to both the input and output circuits. The usual emitter bias of a fraction of a volt is supplied by the resistors (6 and 7) and the usual negative collector bias of 40 to 100v is provided by a battery (5). A capacitor (8) may shunt resistor 7 for signal frequency purposes.

Several novel results can be secured when the values of the circuit elements are

properly selected. The amplification characteristic of a transistor may be represented by the relation that the output voltage is equal to the product of the mutual resistance of the transistor and the collector current. By selecting a transistor having a mutual resistance which is greater than the sum of the resistances of the collector, the emitter and the external resistance in series in the emitter circuit, proper adjustment of the value of a resistor in the input circuit will make the output impedance appear to be infinite. Therefore, the output current will depend upon the magnitude of the input voltage but the current will be independent of the load impedance. Such circuit has particular usefulness as a constant-current source.

By selection of proper values the circuit may be made to present essentially a zero input impedance, as shown in the circuit in Fig. 2, which has value for current measuring equipment. A circuit is also described by which substantially equal power amplification in both directions may be secured. This circuit is suitable for two-way communication with a two-wire line and repeater equipment without requiring switching apparatus.

Pulse Rectifier Circuit . . . Patent No. 2,659,007. Eugene P. Halpin, South Bend, Ind. (Assigned to Bendix Aviation Corp.).

In order to improve the spectrum as well as the power output of the klystron tube, a network of simple form for connection to the repeller of the tube has been developed and patented. The signal from an antenna goes to a grid (14, Fig. 3) of a thyratron tube that serves as a switch. When it fires, a pulse is generated that energizes the primary winding of a transformer (20). The transformer has two secondary windings. Winding (26) applies a high positive voltage to the cavity reso-

Fig. 1. Constant-current circuit.

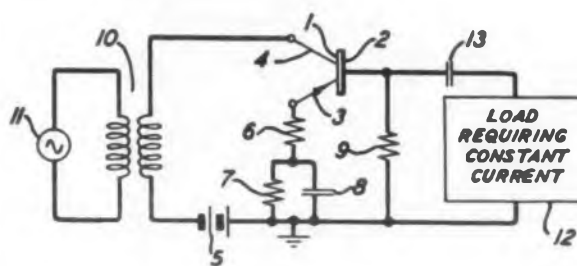
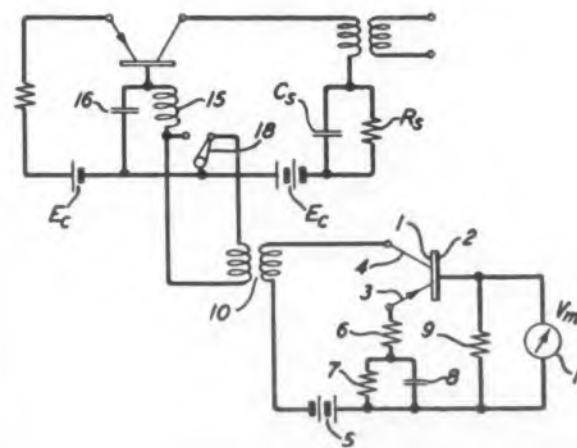

Fig. 2. Zero input impedance circuit.



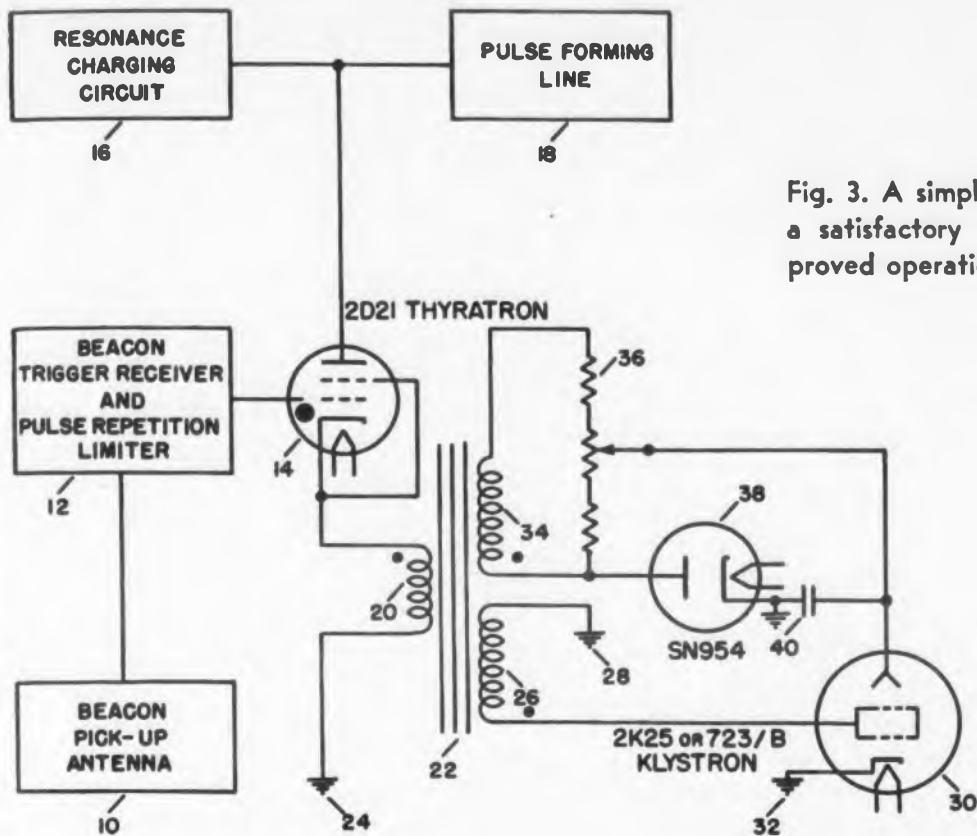

Fig. 3. A simple circuit affording a satisfactory spectrum and improved operation for the klystron.

nator of the klystron tube. The other secondary winding (34) is connected across a potentiometer (36) and generates a high voltage negative pulse which is rectified

by the diode (38) and applied to the repeller of the klystron tube. A capacitor (40) in series with the rectifier smooths out this negative pulse.

PREMIER SLIDES INTO FIRST

**with
the FIRST
SLIDING DRAWER!**

PREMIER pioneers again — with a new SLIDING drawer made to fit standard 19" enclosed relay rack cabinets. You just *slide* your equipment out whenever necessary! Ideal for record changers, telephone work, and other industrial applications.

STAR FEATURES

- ★ Unit Mounted on Ball Bearing Suspension Slides
- ★ Drawer Extends 11" and Sustains 40 lbs.
- ★ Supplied Knocked Down for Easy Assembly
- ★ Available in 2 Sizes

**SEND FOR
FREE CATALOG**

PREMIER METAL PRODUCTS COMPANY
PRECISION BUILT METAL HOUSINGS
3160 WEBSTER AVENUE • BRONX 67, NEW YORK

CIRCLE ED-213 ON READER-SERVICE CARD FOR MORE INFORMATION

**EVEN I CAN REPLACE
RECTIFIERS!**

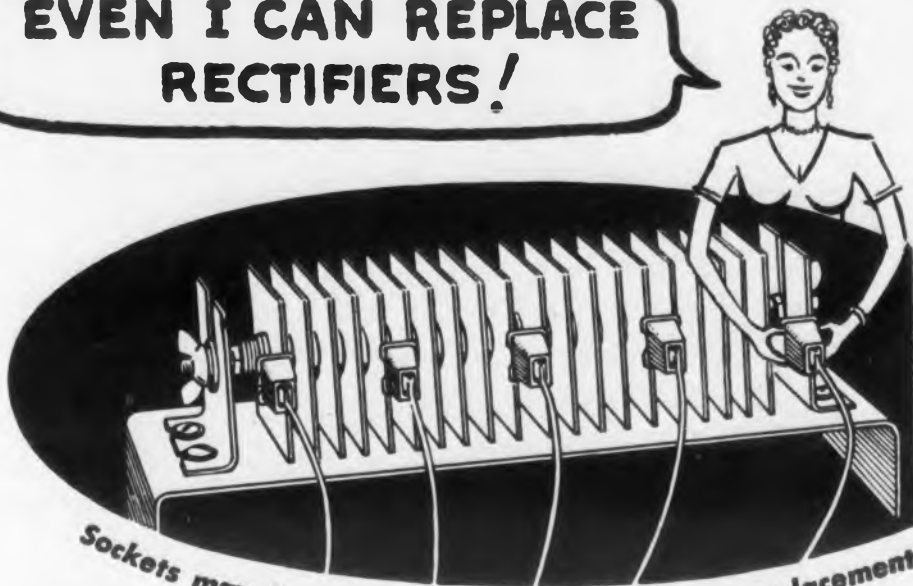

Sockets may be used like grid caps for easy replacement

Request **PLUG-INS**

THE UNIVERSAL SELENIUM RECTIFIERS

Rectifier failures are infrequent—**BUT**—here is a power rectifier that can be replaced on a moment's notice without tools. Bring your equipment up to date by installing Sarkes Tarzian Plug-In Rectifiers. Our engineers will design these rectifiers for your application. Please send us your requests.

▶ *New 72-page Selenium Rectifier Handbook Available. Latest Engineering Information. Send For Your Copy.* ◀

**Sarkes
Tarzian**, INC.

RECTIFIER DIVISION

415 N. College Ave., Dept. C-2, Bloomington, Indiana

In Canada - 50 St. Clair Ave., N. W., Toronto

CIRCLE ED-214 ON READER-SERVICE CARD FOR MORE INFORMATION

New!

KELLOGG



CROSSBAR SWITCH

for Automatic
Control Systems and Computers

FAST!

**LOW INITIAL
COST!**

**MANY CIRCUIT
APPLICATIONS!**

Kellogg Crossbar Switch provides the fast, low-cost means of interconnecting or selecting many different circuits common to large-scale switching required by automatic control systems or computers. Its many applications include, for example, connecting any 3 of 60 circuits to any of 75—or choosing 1 circuit from as many as 936. It provides circuit connections in 50 milliseconds by energizing two specific coils. For optimum fidelity of signal and prevention of corrosion, palladium contact points are used. Mounted for drawerlike removal from its rack. Get the complete facts — Write Dept. 68-E today.



KELLOGG SWITCHBOARD AND SUPPLY COMPANY

A Division of International Telephone and Telegraph Corporation
SALES OFFICES: 79 W. Monroe Street, Chicago 3, Illinois

CIRCLE ED-220 ON READER-SERVICE CARD FOR MORE INFORMATION

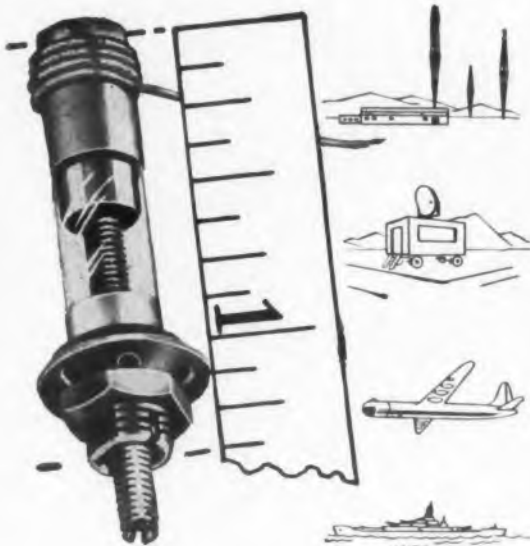

NO OTHER LIKE IT!

- Approximately ZERO TEMPERATURE COEFFICIENT FOR QUARTZ AND INVAR construction.
- Approximately ± 50 PPM per degree C. for Glass and INVAR construction.
- One-piece SPRING LOADED PISTON and screw prevent backlash.
- SILVER BAND fused to exterior of precision drawn quartz or glass tube serves as optimum stationary electrode.
- "Q" of 1,000 at 1 mc.
- DIELECTRIC STRENGTH equals 1,000 volts DC at sea level pressure and 500 volts at 3.4 inches of mercury.
- 10,000 megohms INSULATION RESISTANCE MINIMUM.
- OPERATING TEMPERATURES, -55 C. to $+125$ C. with glass dielectric. -55 C. to $+200$ C. with quartz dielectric.
- Over 100 megohms MOISTURE RESISTANCE after 24 hours exposure to 95% humidity of room temperature.
- PISTON DIMENSIONAL ACCURACY is held to close tolerance maintaining minimum air gap between piston and cylinder wall.

Write for Form No. 199

leading manufacturers use

JFD PISTON TYPE VARIABLE TRIMMER CAPACITORS

in both civil and military equipment

- No. VC 1 G (0.7 to 6.0 mmf.) Glass Dielectric
- No. VC 5 (1.0 to 10.0 mmf.) Quartz Dielectric
- No. VC 11 (1.0 to 10.0 mmf.) Quartz Dielectric
- No. VC 11 G (1.0 to 12.0 mmf.) Glass Dielectric
- No. VC 20 (0.5 to 1.9 mmf.) Glass Dielectric

JFD MFG. CO.

BROOKLYN 4, N. Y.
BENSONHURST 6-9200



world's largest manufacturer
of tv antennas & accessories

CIRCLE ED-215 ON READER-SERVICE CARD FOR MORE INFORMATION

Patents . . .

Transistor Amplifier Circuits . . . Patent No. 2,652,460. R. L. Wallace, Jr., Plainfield, N. J. (Assigned to Bell Telephone Laboratories, Inc.).

Transistors have been thought of as substitutes for, or analogs of vacuum tubes. Hence in their use it was customary to use essentially known vacuum tube circuitry and substitute a transistor for the vacuum tube. Results achieved with such circuits were below expectations and it was thought that the achievement of better results lay in improving the transistor. The patentee points out that a transistor approximates the dual counterpart of a vacuum tube much more closely than the analog of the tube as illustrated by the characteristics of a vacuum tube and a transistor, as shown in Fig. 4, in which the roles of currents and potentials in the transistor are interchanged by comparison with their roles in the vacuum tube. The curves are closely identical in shape. As examples of

what is meant by duality, the dual quantity of voltage is current, of resistance is conductance, and capacity for inductance.

With an appreciation of the dual rather than the analog character of a transistor as compared to a vacuum tube, the patentee describes improved transistor circuits for multistage amplifiers, interstage coupling networks for such amplifiers, automatic adjustment of emitter bias current of an amplifier and an efficient class B push-pull translating circuit. Illustrative of the results which can be achieved by utilizing circuits which are designed in recognition of the dual character of transistors, a push-pull amplifier circuit so designed delivered 20 to 40 times as much power as an analog transistor amplifier.

The patent sets forth each of the vacuum tube circuits mentioned above and then applies the mathematical solution by which a counterpart transistor circuit may be determined. The mathematical solutions are readily comprehended but too extensive to treat in this brief discussion. Even though a limited number of circuits are described, the theory provides a method



Microwave
Assemblies,
Radar Components,
and Precision
Instruments . . .
manufactured to
your Blueprints
and Specifications.

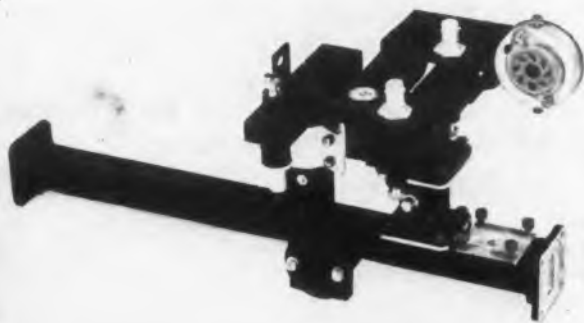

N.R.K. MFG. & ENGINEERING CO.

4601 WEST ADDISON STREET • CHICAGO 41, ILL. • SPring 7-2970

CIRCLE ED-216 ON READER-SERVICE CARD FOR MORE INFORMATION

ELECTRONIC DESIGN • May 1954 ELECTR

15

10

ip
ma

5

0

of deter
cuits. Th
those us

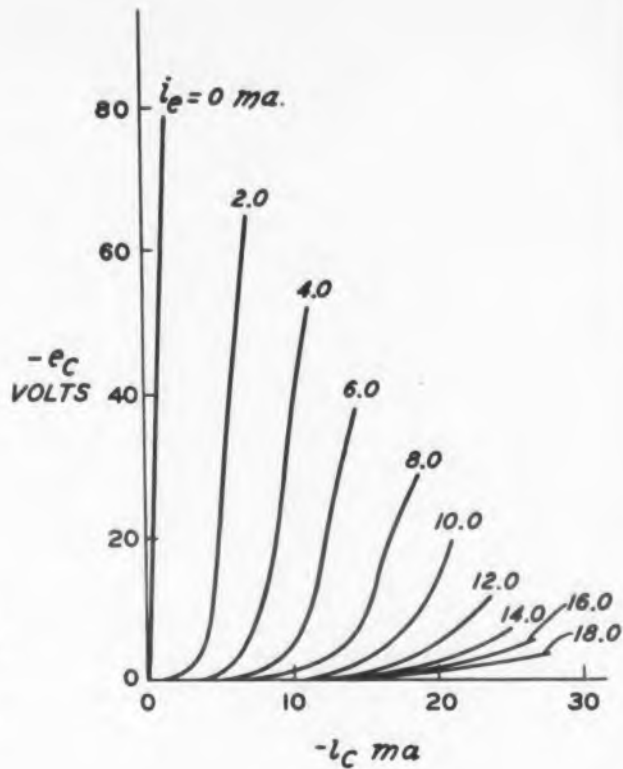
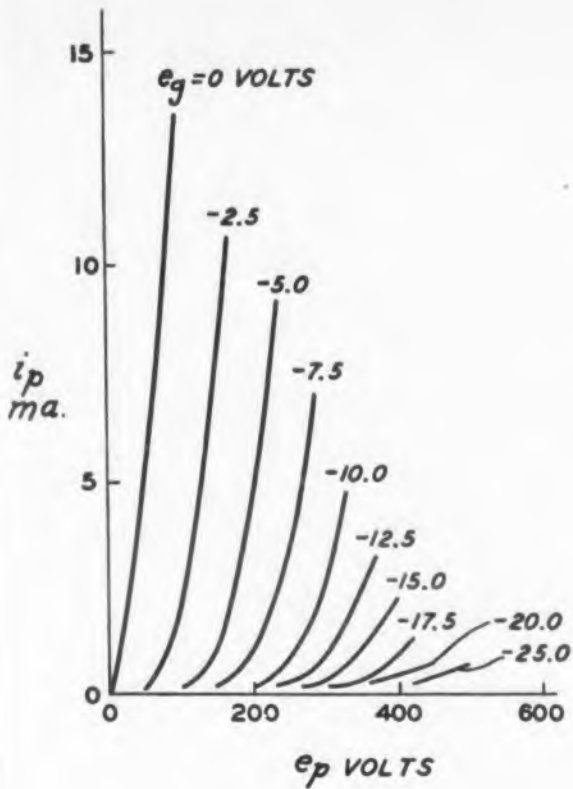

of determining many other transistor circuits. The patent is worthwhile having for those using or planning to use transistors.

Fig. 4. A comparison of vacuum-tube (left) and transistor characteristics.

the **NEW**

1/8" MECHANICAL DIFFERENTIAL

from
**FORD INSTRUMENT
COMPANY**

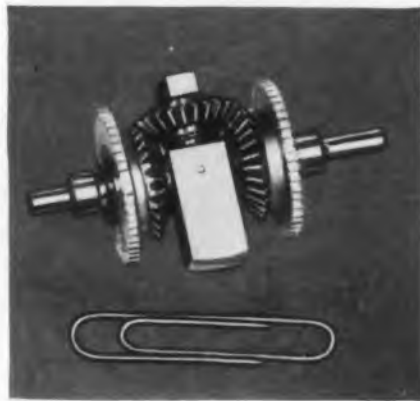

- Operates in working circle of 1.000" max. diameter
- Lost motion does not exceed 12 mins.
- High sensitivity
- Stainless steel throughout; resistance to wear and corrosion
- Uses Zerol bevel gears.
- Weight, with typical end gears, is less than one ounce

The 1/8" differential is the latest and smallest addition to the Ford Instrument line of single spider gear differentials. Engineered to highest military and commercial standards, this highly reliable unit provides extreme accuracy in additive and subtractive operations, while functioning with minimum friction and backlash.



FORD INSTRUMENT COMPANY
31-10 THOMSON AVENUE
LONG ISLAND CITY, N. Y.

21



WRITE FOR FULL DETAILS

Fully illustrated data sheet gives performance curves and characteristics. Please address Dept. ED.

VISIT OUR BOOTH No. 533
AT THE DAYTON IRE SHOW

CIRCLE ED-217 ON READER-SERVICE CARD FOR MORE INFORMATION

Precision DC Power Supply

for Electronic Equipment



◆ Efficient, closely regulated selenium rectifiers for all types of computers, business machines and other electronic equipment.

Low initial cost . . . low maintenance, units have no moving parts or vacuum tubes.

Compact, completely self-contained, protected . . . magnetic amplifier controls . . . fully regulated DC power supply.

Optional steel cabinets for floor-standing, wall or caster-mounted.

Output ratings from 5 to 500 VDC at 5 to 200 Amps continuous.



Complete engineering specifications available upon request.

DIVISION OF LEACH CORPORATION
4441 Santa Fe Ave., Los Angeles 58, Calif.
Telephone LOgan 8-4771

CIRCLE ED-218 ON READER-SERVICE CARD FOR MORE INFORMATION

LESS LEAKERS with NICORO BRAZING ALLOY



A Wesgo developed nickel bearing gold-copper alloy that possesses—

- ★ Improved wetting and flow characteristics
- ★ Greatly diminished tendency toward brittleness
- ★ Smaller grain size
- ★ Higher tensile strength

Vacuum tube manufacturers report a material reduction in number of leakers when conventional gold-copper alloys are replaced by Nicoro.

Write for circular on Nicoro and other Wesgo brazing alloys.

WESTERN GOLD & PLATINUM WORKS
589 Bryant • San Francisco 7, Calif.

CIRCLE ED-219 ON READER-SERVICE CARD FOR MORE INFORMATION

Another

CHATHAM

Exclusive Design!



Type VC-1258 MINIATURE HYDROGEN THYRATRON

*with 10KW
peak rating!*

MANY OTHER TYPES
AVAILABLE—

This tube is one of many CHATHAM thyratrons ranging in size to 40 megawatts, all of which represent an advantageous departure from conventional designs and are the result of several years of concentrated development work. Full information on request.

MAX. PEAK ANODE VOLTS	1200
MAX. PEAK ANODE AMPS	20
MAX. AVER. ANODE AMPS	0.05
NOMINAL FILAMENT WATTS	12.6

Specifically designed for pulse generating applications, this tube handles peak pulse power up to 10 KW. Repetition rates in excess of 10,000 pps are possible at lower power. Type VC-1258 operates at zero bias, fits a standard ceramic miniature socket, and is designed to withstand all shock and vibration tests of a ruggedized electronic tube.



CHATHAM ELECTRONICS CORP.

Executive and General Offices: LIVINGSTON, NEW JERSEY
Plants and Laboratories: NEWARK and LIVINGSTON, NEW JERSEY

CIRCLE ED-221 ON READER-SERVICE CARD FOR MORE INFORMATION

GOLD INLAY KNOBS IN ANY QUANTITY!

... and Never a Tool Charge

NEW *Gee-Lar* GOLD INLAY KNOBS

You can get beautiful gold inlay knobs, pointers, instrument controls . . . thousands of styles and varieties . . . in any quantity from GEE-LAR—The House of Knobs. They're available in both knurled and spring types, in either walnut or ivory backgrounds. For faster service and lower cost . . . plus the widest selection . . . get your Gold Inlay Knobs from GEE-LAR!

WRITE TODAY
for Gee-Lar Catalog
IT'S FREE!



THE HOUSE OF KNOBS

GEE-LAR MANUFACTURING COMPANY

824 Elm Street • Bushford, Illinois



CIRCLE ED-222 ON READER-SERVICE CARD FOR MORE INFORMATION

Books . . .

Magnetic Amplifier Circuits . . . By William A. Geyger, 277 pages. McGraw-Hill Book Co., Inc., 330 West 42nd Street, New York 36, N. Y. \$6.00.

Written for the circuit designer, this book presents the fundamental principles, characteristics, and applications of the magnetic amplifier type of circuit. It covers the basic as well as more complex circuits and emphasizes experimentally observed phenomena without going into extended mathematical considerations and proofs. Descriptive and graphical methods are widely employed for qualitative and quantitative interpretation.

The first chapter presents a classification of saturable-core devices and reviews the history of magnetic amplifiers. Chapter 2 describes magnetic core materials, various types of core construction, winding arrangements, and various types of rectifiers

employed in magnetic amplifier circuits. There follows in Chapters 3 to 16, a discussion of the numerous kinds of magnetic amplifier circuits including nonfeedback circuits, single-stage and multi-stage circuits with internal or external feedback, and special circuits that make use of critical regeneration or derivative feedback. The last two chapters cover the technical properties, transient response, and typical applications of magnetic amplifiers, particularly those in instrumentation, servomechanisms, regulators, and automatic control devices.

The numerous references at the end of each chapter include many important European patents which have not been discussed in previous presentations of the magnetic amplifier art, according to the author. Engineers working in this field will find the detailed information presented useful in solving special problems.

High Voltage Resistors Now specified for COLOR TV



RPC High Voltage Resistors are being used in quantity by foremost manufacturers, laboratories and government agencies where stable dependable resistors are required. These resistors are now being specified for color TV. Special designs available where spacing requirements or corona presents a problem.

Type B High Voltage Resistors can be furnished in values to 100,000 megohms. Standard tolerance is 15%. Closer tolerances

available. These resistors are protected against corona and mechanical damage by a high dielectric plastic jacket. They are readily mounted and can easily be assembled to make tapped resistors. Lengths from 1" to 6 1/2". Voltage ratings to 40 KV. Power ratings up to 10 watts.

Type D High Voltage Resistors are larger tubular units and are available for voltages to 125 KV. Power ratings up to 90 watts. Sizes to 18 1/2" long. Available with lug or ferrule terminals.



RESISTANCE PRODUCTS Co.

714 RACE STREET

HARRISBURG, PENNA.

Makers of Resistors—High Megohm, High Voltage, High Frequency, Precision Wire Wound

CIRCLE ED-223 ON READER-SERVICE CARD FOR MORE INFORMATION

X Com
proble
pany
cusse
appro
engin
idly
prov
draw
CAC
ered
clos

Filter

All typ
special
sharp
sign an
possible
hermeti

COMMUN
NO 4

ATTENUATION IN DB

S

NEW YO
286 Fitt
PHILADE
Hillview
BALTIMO
(L. G. Ka
CHICAGO
6349 N.
KANSAS
6315 Br
LOS ANG
13537 A
HAMBUR
P. O. Bx.
SYRACU
State Ta
MERIDE
(Henry L
NEEDHAM
(Robt. V
CLEVELA
8905 Lal
COMM
Hickma

CIRCLE
ELECTR

CASE HISTORY #0237

X Company phoned—had a toroid and filter problem. Two CAC engineers visited company via CAC airplane following day. Disputed the problem, suggested engineering approach—returned to CAC plant. Next day engineering started—sample completed rapidly—prototype air-xed. Company X apudly proved prototypes, completed production drawings and specs. Bid requests circulated. CAC low bidder, as usual. Shipments delivered on schedule. These are the facts. Case closed.

Filter Problems?

SEE A C-A-C MAN

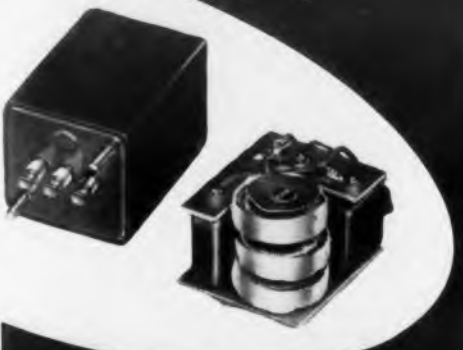

All types of filters—toroidal inductors and special capacitors for maximum stability, sharpness and attenuation—advanced design and printed circuit techniques make possible high degree of miniaturization—hermetically sealed construction.

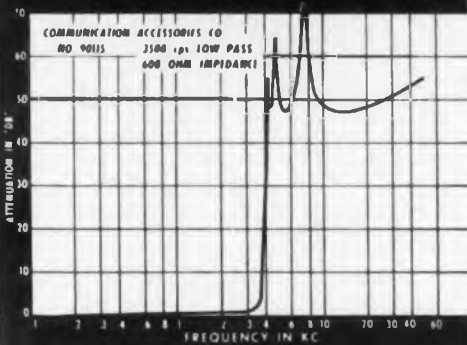

SEE A CAC MAN

NEW YORK—Harold Gray Assoc.—LA. 4-4258
286 Fifth Ave., New York, N. Y.
PHILADELPHIA—Charles R. Hile Co.—Elgin 6-2266
Hillview Rd., Bx. 144, Paoli, Pa.
BALTIMORE—Charles R. Hile—Boulevard 12021
(L. G. Korman) 5006 Kenwood, Baltimore 6, Md.
CHICAGO—Gassner & Clark Co.—Rogers Pk. 4-6121
6349 N. Clark, Chicago, Ill.
KANSAS CITY—E. W. McGrade Co.—Delmar 9242
6315 Brookside Plaza, Kansas City, Mo.
LOS ANGELES—Samuel O. Jewett—State 9-1214
13537 Addison St., Sherman Oaks, Calif.
HAMBURG—Cooper-Morgan, Inc.—Emerson 3405
P. O. Bx. 152, Hamburg, N. Y.
SYRACUSE—Naylor Electric Co.—2-3894
State Tower Bldg., Room 317, Syracuse 2, N. Y.
MERIDEN—Henry Lavin Assoc.—7-4555
(Henry Lavin) P. O. Bx. 196, Meriden, Conn.
NEEDHAM—Henry Lavin Assoc.—3-3446
(Robt. V. Curtin) 82 Curve St., Needham, Mass.
CLEVELAND—Ernie Kohler Assoc.—Olympic 1-1242
8905 Lake Ave., Cleveland 2, Ohio
COMMUNICATION ACCESSORIES CO.
Hickman Mills Missouri

CIRCLE ED-224 ON READER-SERVICE CARD

Proceedings of the National Electronics Conference 1953, Vol. 9 . . . 992 pages. National Electronics Conference, 84 E. Randolph Street, Chicago 1, Ill. \$5.00.

This book is a compilation of the papers presented at the 1953 National Electronics Conference. It contains all of the 98 technical papers as well as the luncheon addresses presented at the conference.

As usual, the papers cover a wide range of subjects. These include reports on electronic research, development, and application in audio, circuits, communication, computers, electron tubes, engineering management, filters, instrumentation, magnetic amplifiers, materials and components, microphonics, microwaves, network synthesis, nucleonics, servomechanisms, television, transistors, and ultrasonics. It definitely deserves a place on the designer's book shelf. Readers wishing to complete their file of previous volumes in this series may still obtain Nos. 2, 4, 5, 6, 7, and 8 which are available at \$5.00 per copy.

Timing Engineering . . . By Myrten G. Saake, 255 pages. Ribble Engineering Co., Publishers, 74-80 Montgomery Street, Jersey City 2, N. J. \$5.00.

This reference book on industrial timers covers basic design, construction, and application of timers in relation to automation of machinery and processes. The electronic designer will find little in the way of electronic timers in this book. However, since many electronic engineers are concerned with process control systems in which nonelectronic timers play an important part, this book should serve as a source of information on the workings of these devices.

The subjects covered include industrial timing devices; synchronous motor driven repeating cycle timers; synchronous motor driven automatic reset timers; "Cycl-Flex", "Timoflex", and multiple circuit automatic reset timers; "Microflex" automatic reset counters, direct current timers, and timers which are not synchronous motor driven. The book is well illustrated with pictures of timers and installations employing timers, as well as timing circuits.

Symposium on Electro-Magnetic Relays . . . 70 pages. Published by Potter & Brumfield, Princeton, Ind., available without charge.

This booklet contains a selection of 13 papers presented at a Symposium on Electro-Magnetic Relays, given at Oklahoma Institute of Technology, Stillwell, Okla. Of particular interest to electronic design engineers are: "A Comparison of Sealed and Unsealed Relays", "Dielectric Strength and Insulation of Relays", "Relay Reliability Required by the Signal Corps", "Construction and Operational Features of Magnetic-Contact Relays", "Military Specifications", and "Appraisal of Relay Design".

MINIATURE ^{Wire-Wound} POTENTIOMETERS

that don't NEED incoming check

Problem: To find a potentiometer that —

- Dissipates 3 watts continuously at 80° C, through 50,000 ohms total resistance.
- Occupies no more space than absolutely necessary.
- Weighs as little as possible.
- Maintains accurate resistance settings, over a wide range of temperatures.
- Will not require YOU to do production-control checking for the manufacturer.



Solution: Waters Series RT-7/8 and RTS-7/8 —

- Precision wire-wound construction.
- Three watts continuous, to 80 degrees C.
- Resistances from 10 ohms to 50,000 ohms.
- Diameter 7/8", depth 3/8".
- Weight about 1/2 ounce per section — multiple ganging easily provided.
- Temperature coefficient of resistance 0.00002 parts per degree C.
- Individually checked through a production quality control system that guarantees you full performance from EVERY unit in your order.

WATERS MANUFACTURING, inc.

Waltham 54, Massachusetts

APPLICATION ENGINEERING OFFICES IN PRINCIPAL CITIES

Write today for technical details and price information.



CIRCLE ED-225 ON READER-SERVICE CARD FOR MORE INFORMATION

OK UNDER MIL-E-5272 TESTS for extreme temperatures
humidity-salt spray-vibration
Aerohm wire-wound trimmer potentiometers

Micro-miniature Series AP 1/2

- Two watts continuous at 80° C.
- Resistances from 10 to 20,000 ohms.
- Diameter 1/2 inch, depth 1/2 inch.
- Temperature coefficient 0.00002/degree C.
- Weight 1/4 ounce.
- Sealed well enough to permit potting.



Series AP 1/2

Series AP 1 1/2

- Four watts continuous at 80° C.
- Resistances from 10 to 100,000 ohms.
- Diameter 1 1/8 inch, depth 1/2 inch.
- Weight less than 3/4 ounce.
- Temperature coefficient 0.00002/degree C.

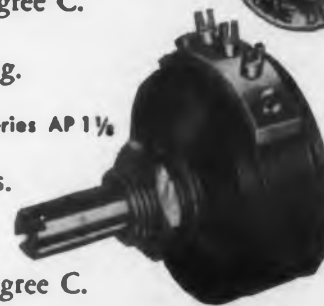

Series AP 1 1/2

All Aerohm potentiometers are individually checked through a quality-control system that guarantees you full performance from every unit in your order.

Write for full details and prices.

Aerohm CORPORATION
282 MOODY STREET, WALTHAM MASSACHUSETTS

CIRCLE ED-226 ON READER-SERVICE CARD FOR MORE INFORMATION

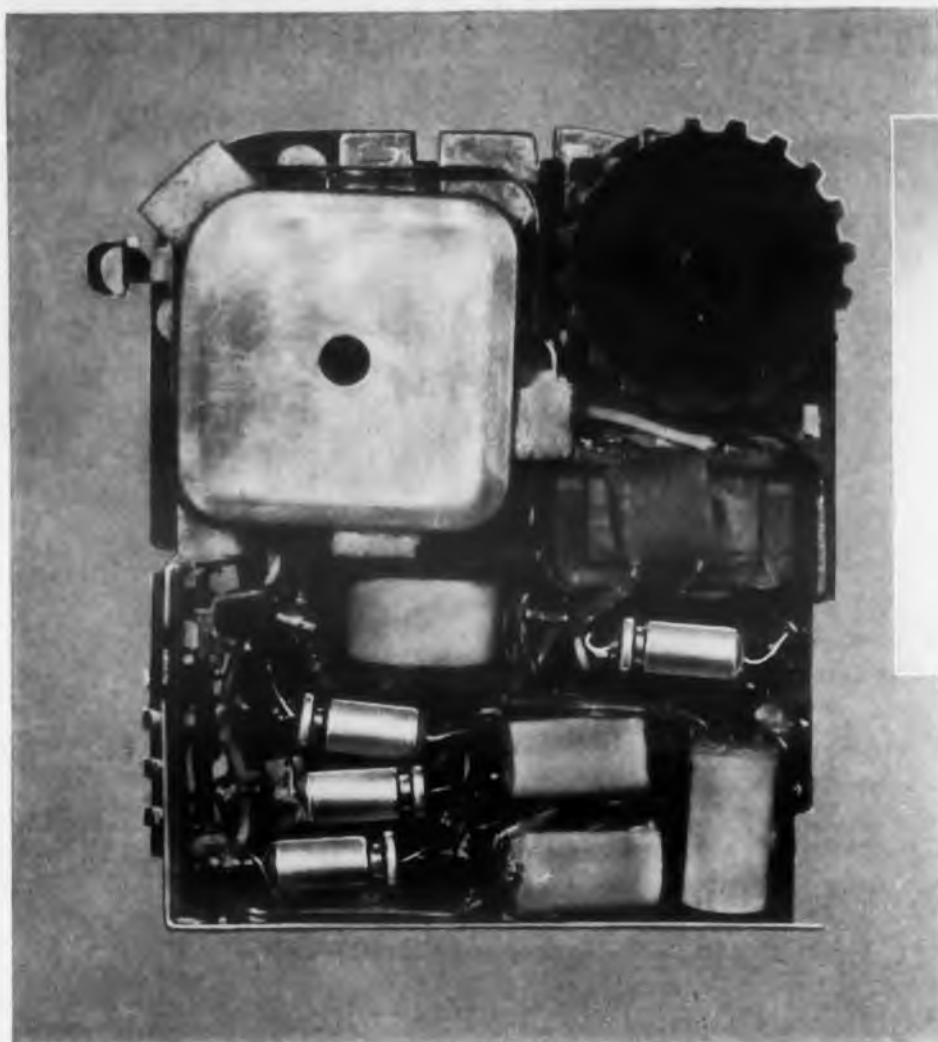

Four G-E Micro-miniature Tantalytic capacitors easily fit into small space provided in this new all-transistor hearing aid. Man above adjusts volume control.

Other applications now being investigated:

WALKIE-TALKIES
WRIST RADIOS
PAGING SYSTEMS

How Tantalytic Capacitors Are Used In Miniaturized Hearing Aids

Four G-E Micro-miniature Tantalytic capacitors are used in this new all-transistor hearing aid. These high-capacitance, small-size units are necessary due to the low-impedance characteristics of transistors, as compared with the vacuum tubes formerly used. Ceramic and paper dielectric capacitors cannot supply sufficient capacitance in the small size desired, according to hearing aid design engineers.

Pictures, circuit diagram, application information courtesy Sonotone Corp.

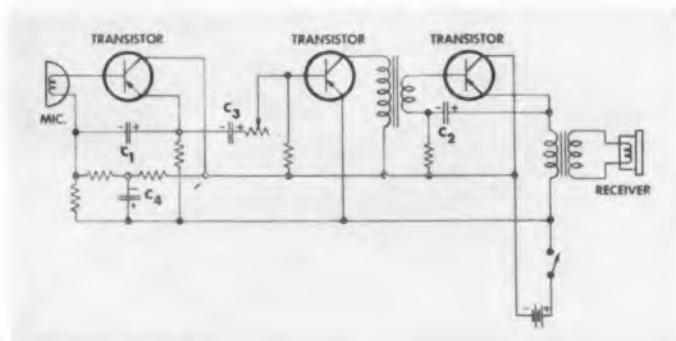

Simplified schematic diagram of Sonotone all-transistor hearing aid, showing location of G-E Micro-miniature Tantalytic capacitors.

Operating at a battery voltage of 2.5 volts, this hearing aid uses two units rated at 2 microfarads each for by-pass, C_1 and C_2 (see diagram). They give a low-impedance signal path from the source to the input of the transistor. Two 1-microfarad units, C_3 and C_4 , are used for coupling and filtering respectively, where their low leakage current of .18 microamperes/uf/volt at 25 deg. C is especially important.

G-E Micro-miniature Tantalytics can be obtained in ratings up to 20 volts, or, up to 8 uf in a $\frac{5}{16}$ -in. long by $\frac{1}{8}$ -in. dia. case size, higher capacitance in a $\frac{1}{2}$ -in. long by $\frac{1}{8}$ -in. dia. case size. Capacitance tolerance is -0% to $+100\%$.

For more information about G-E Micro-miniature Tantalytic capacitors, contact your G-E Apparatus Sales Office or write for bulletin GEA-6065 to General Electric Company, Section 442-15, Schenectady 5, New York.

GENERAL ELECTRIC

CIRCLE ED-228 ON READER-SERVICE CARD FOR MORE INFORMATION

Advertising Index

May 1954

Inquiry No.	Advertiser	Page
153	Ace Plastic Co.	62
226	Aerohm Corp.	77
73	Aircraft-Marine Products, Inc.	43
95	Allied Radio Corp.	48
1	Amperex Electronic Corp.	2
155	Barry Corp., The	63
62	Bead Chain Mfg. Co., The	40
100	Biddle, James G., Co.	50
86	Birtcher Corp., The	46
149	Burndy Engineering Co.	62
112	Burnell & Co.	53
180	Cambridge Thermionic Corp.	67
33	Cannon Electric Co.	33
59	Centralab, Div. of Globe-Union Inc.	40
221	Chatham Electronics Corp.	76
186	Chicago Standard Transformer Corp.	68
13	Clifford Mfg. Co.	19
150	Clough-Brengle Co.	62
136	Collins Radio Co.	59
94	Comar Electric Co.	48
224	Communication Accessories Co.	77
91	Constantin, L. L., & Co.	48
133	Cook Electric Co.	58
199	Cubic Corp.	70
78	Curtis Development & Mfg. Co.	44
58	Daven Co., The	39
82	DeJur-Amsco Corp.	45
154	Detectron Corp., The	62
17	Dow Corning Corp., The	27
54	Durant Mfg. Co.	38
198	Eastern Air Devices, Inc.	69
27	Edison, Thomas A., Inc.	32
148	Elastic Stop Nut Corp. of America	61
49	Electrical Industries	37
141	Electrical Products Corp.	60
137	Electric Regulator Corp.	60
99	Electro Motive Mfg. Co., Inc.	50
211	Electronic Fabricators, Inc.	72
125	Engineered Precision Casting Co.	56
185	Faber-Castell, A. W., Pencil Co., Inc.	67
46	Fairchild Camera & Instrument Corp.	36
147	Fielden Instrument	61
30	Flexrock Co.	32
138	Ford Engineering Co.	60
217	Ford Instrument Co.	75
122	G-V Controls, Inc.	56
222	Gee-Lar Mfg. Co.	76
228	General Electric Co., Apparatus Sales	78
89	General Electric Co., Apparatus Sales	47
4	General Electric Co., Electronics Div.	6
18	General Electric Co., Silicones	29
197	General Electric Co., Tube Dept.	69
178	General Radio Co.	66
179	Green Instrument Co., Inc.	66
175	Gries Reproducer Corp.	66
69	Haydon, The A. W., Co.	42
53	Helipot Corp.	38
204	Heminway & Bartlett Mfg. Co., The	70
83	Hepner Mfg. Co.	46
70	Hopkins Engineering Co.	42

Inquiry No.	Advertiser	Page
5	Hughes Aircraft Co.	7
	Hughes Research & Development Labs.	44
218	Inet, Div of Leach Corp.	75
130	Insulation Mfg. Corp.	58
26	International Rectifier Corp.	31
229	International Resistance Co.	79
168	Jennings Radio Mfg. Corp.	65
215	JFD Mfg. Co., Inc.	74
15	Kearfott Co., Inc.	22
220	Kellogg Switchboard & Supply Co.	74
14	Kenyon Transformer Co., Inc.	21
184	Kester Solder Co.	67
66	Koiled Kords, Inc.	42
143	Kulka Electric Mfg. Co., Inc.	61
42	Laboratory for Electronics, Inc.	36
98	Librascope, Inc.	49
129	Lockheed Aircraft Corp., Missile Systems Div.	57
3	Machlett Laboratories, Inc.	4
10	Magnetics, Inc.	13
160	Malayan Tin Bureau, The	63
37	Mallory, P. R. & Co., Inc.	34
171	Metron Instrument Co.	65
156	Microwave Associates, Inc.	63
118	Milwaukee Resistor Co.	54
107	Moloney Electric Co.	52
38	Mullenbach Electrical Mfg. Co.	35
8	National Semi-Conductor Products	10
212	Neomatic, Inc.	72
216	NRK Mfg. & Engineering Co.	74
126	Olympic Metal Products Co., Inc.	57
79	Penetone Co., The	44
167	Perkin Engineering Corp.	65
161	Phillips Control Corp.	64
45	Pike, E. W., & Co., Inc.	36
50	Plastic Capacitors, Inc.	38
65	Polytechnic Research & Development Co., Inc.	41
2	Potter Instrument Co., Inc.	3
213	Premier Metal Products Co.	73
250	Radio Corp. of America, Tube Dept.	80
144	Resinite Corp., Div. of Precision Paper Tube	61
223	Resistance Products Co.	76
172	Richardson Co., The	65
209	Rockbar Corp.	71
166	Rotron Mfg. Co., Inc.	64
214	Sarkes Tarzian, Inc.	73
174	Shakeproof, Div. of Illinois Tool Works	66
11	Shallcross Mfg. Co.	16
9	Shell Chemical Corp.	11
6	Sigma Instruments, Inc.	8
159	Simmons Fastener Corp.	63
142	Speer Carbon Co., Jeffers Electronics Div.	60
114	Star Stainless Screw Co.	54
162	Staver Co., The	64
12	Sterling Engineering Co.	17
19	Stupakoff Ceramic & Mfg. Co.	30
165	Superior Electric Co., The	64
113	Superior Tube Co.	54
16	Sylvania Electric Products, Inc.	23
170	Taylor Tubes, Inc.	65
7	Technitrol Engineering Co.	9
103	Transistor Products, Inc.	51
36	Tung-Sol Electric, Inc.	34
181	Unimax Switch, Div. of The W. L. Maxson Corp.	67
210	U. S. Components, Inc.	71
117	Ward Leonard Electric Co.	54
4	Waterman Products Co., Inc.	35
22	Waters Mfg. Co.	77
21	Western Gold & Platinum Works	75
12	Westinghouse Electric Corp., Electronic Tube Div.	55
10	Wheeler Insulated Wire Co., Inc., The	51

NOW

an IRC VARISTOR

non-linear
resistor

New IRC VARISTORS are voltage sensitive, non-linear resistors. They provide a sharp variation of resistance with applied voltage.

They are supplied in 5 convenient cell sizes with a complete choice of enclosures, including hermetic seals.

Minimum voltage is less than .25V, and continuous currents may range up to 110 ma. IRC VARISTORS are stable, have low shunt capacitance, and can be furnished within close tolerances.

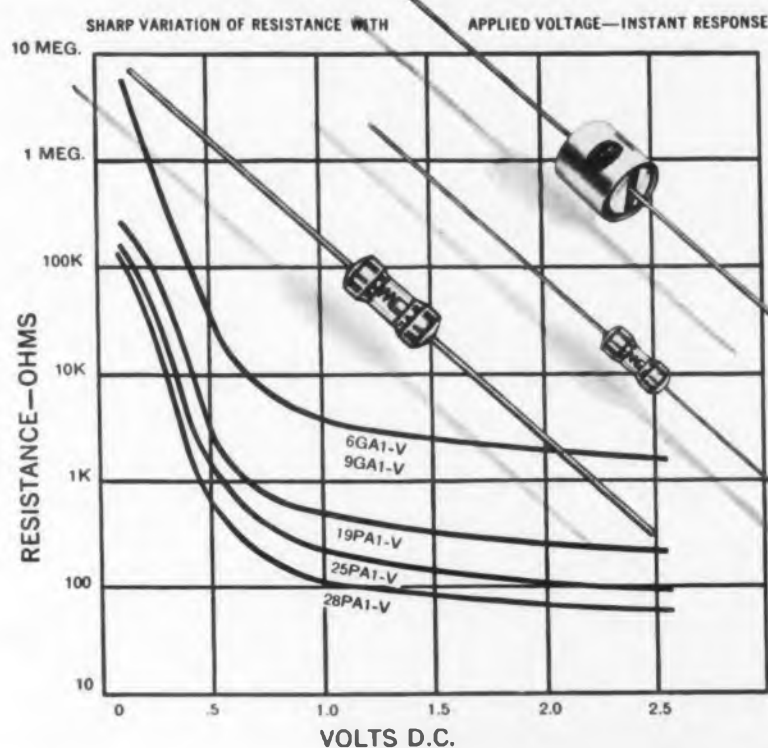

TYPICAL APPLICATIONS

VOLTAGE REGULATION OR SIGNAL CLIPPING.

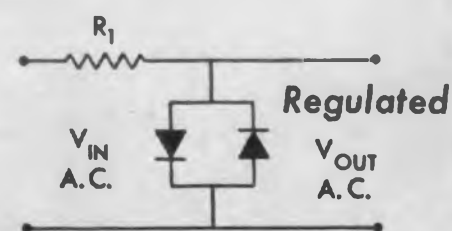

LOGARITHMIC CONVERTER. Large changes in output voltages are obtainable with small changes in input voltages.

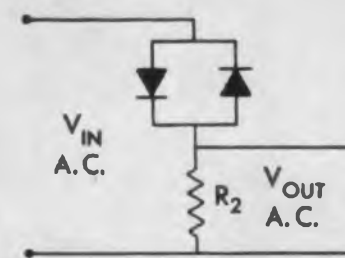

TYPICAL COSTS

Type 25PA1-V, in lots of 500: 25c each. Type 9GA1-V (hermetically sealed in glass) in lots of 500: 45c each.

SEND COUPON FOR 6 PAGE DATA BULLETIN SHOWING ADDITIONAL APPLICATIONS, PLUS CHARACTERISTICS AND SPECIFICATIONS.

Boron & Deposited Carbon Precistors • Power Resistors • Voltmeter Multipliers • Low Wattage Wire Wounds • Insulated Composition Resistors • Volume Controls •

Precision Wire Wounds • Ultra HF and Hi-Voltage Resistors • Low Value Capacitors • Selenium Rectifiers • Insulated Chokes • Hermetic Sealing Terminals •

INTERNATIONAL RESISTANCE CO.

Dept. D 401 N. Broad Street, Philadelphia 8, Pa.
In Canada: International Resistance Co., Ltd.,
Toronto, Licensee

Send Bulletin describing IRC Varistors:

Name _____

Title _____

Company _____

Address _____

City _____ State _____

CIRCLE ED-229 ON READER-SERVICE CARD FOR MORE INFORMATION

How RCA Makes

RCA Receiving Tubes

YOUR BEST BUY

BEST BECAUSE...

Gold-plated Grid No. 1—minimizes grid emission

BEST BECAUSE...

Special mica insulator processing—minimizes picture "jitters" caused by charging effects and leakages

BEST BECAUSE...

Carbonized Grid No. 2 runs cooler, reduces stray emission



BEST BECAUSE...

Higher quality, lead-glass bulb insures better performance at higher tube voltages

BEST BECAUSE...

Specially processed glass bulb minimizes electrolysis, improves tube life

You get more for your money when you buy RCA receiving tubes because RCA makes extra effort to keep pace with new requirements for tube applications. For instance, the 1B3-GT and 6BQ6-GT illustrate how RCA makes improvements in tube type designs . . . makes RCA receiving tubes best for top performance in your TV-receiver designs.

The RCA-1B3-GT rectifier has been improved to handle the higher voltages required by "big-picture" TV sets. Tube safety factors have been increased.

The RCA-6BQ6-GT horizontal output tube is another improved tube. Its improvements minimize grid emission, stray emission, and TV picture "jitters."

The improvements built into RCA receiving tubes give you: (1) Superior tube performance, (2) fewer factory-line rejects and "in-warranty" failures, (3) substantially greater tube value.

For circuit application help, call your nearest RCA Field Office:

(EAST) Humboldt 5-3900
415 S. 5th St., Harrison, N. J.

(MIDWEST) Whitehall 4-2900
589 E. Illinois St., Chicago 11, Ill.

(WEST) Madison 9-3671
420 S. San Pedro St., Los Angeles 13, Cal.

FOR COLOR-TV, SPECIFY RCA TUBES

RCA PIONEERED AND DEVELOPED COMPATIBLE COLOR TELEVISION



RADIO CORPORATION of AMERICA

ELECTRON TUBES

HARRISON, N. J.

CIRCLE ED-250 ON READER-SERVICE CARD FOR MORE INFORMATION

Postmaster: Form 3547 Requested

HAYDEN PUBLISHING COMPANY, INC.
127 East 55th Street, New York 22, N. Y.

ELECTRONIC
design