

# ELECTRONIC

*design*

# 425111

ELECTRONIC

The Type 90901 Miniature Cathode-ray Oscilloscope shown here combines miniaturized components and the new Type 1CP1 cathode-ray tube in an unusually versatile and compact instrument. Only 2-3/4" x 2-3/4" x 4-5/8" long, it occupies the same space as that taken by a standard 2" milliameter, thereby lending itself to a wide variety of monitoring applications where space is limited. Horizontal and vertical deflection sources as well as heater and acceleration voltages are taken from the equipment being monitored.



June 1953

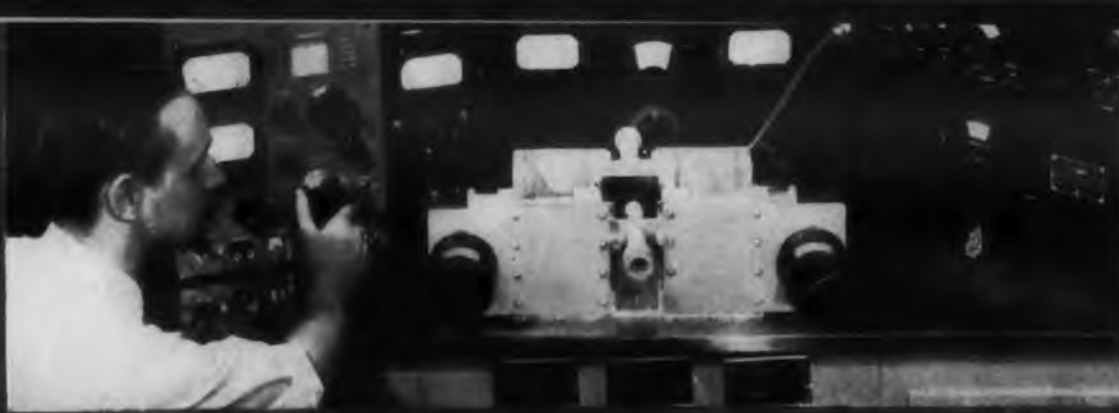

# for SPECIALIZED FILTERS

Details of engineering in the design and production of specialized filters have resulted in UTC being a first choice for difficult filter filterings. Over 100 years ago UTC was already the largest and most progressive manufacturer in the world of filters for the telephone system. Present designs include a wide variety of case materials, dimensions, and winding methods to provide maximum performance to specified requirements and stability. Illustrated herein are a few of the thousands of special filter designs in present production.



These low frequency band pass filters are held to 1 DB tolerance at the 3 DB crossover... 600 ohm... 4 filters per 7½" rack panel.

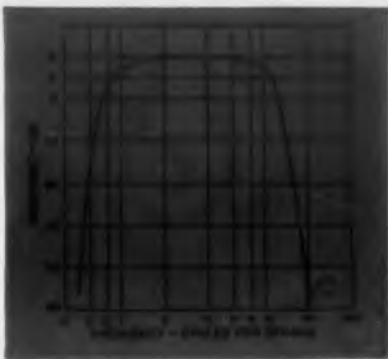
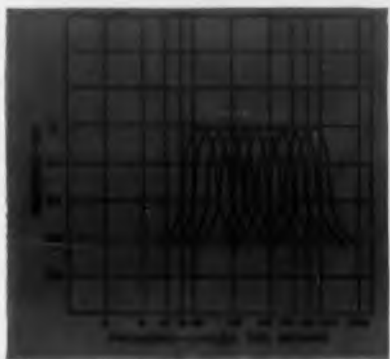

This ultra low frequency filter has a band pass range of one cycle to 10 cycles... 50,000 ohms... 700 cubic inches.



This 600 ohm miniaturized 1 KC band pass filter is housed in a case only 1" x 1¾" x 2½".



This 600 ohm miniaturized low pass filter is housed in a case only 1" x 1¾" x 2½".

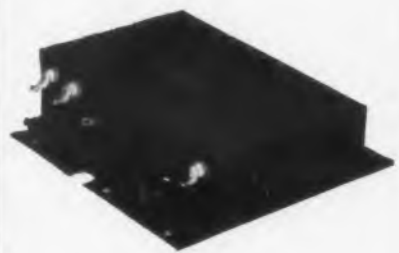

This power line filter provides correct output voltages from sources of 50 to 400 cycles... noise attenuation is from 14 KC to 400 MC... 29 cubic inches.



This band pass filter is designed for sharp cut-off at both ends of the range... 10,000 ohms... case dimensions 1¾" x 2½" x 3¼".



## Staff

Edward E. Grazda..... Editor  
E. Cookish..... Assistant Editor  
N. Asto..... Production Manager  
H. W. Schlager..... Business Manager  
K. L. Lohr..... Circulation Manager

## Co-Publishers

T. Richard Gascoigne  
James S. Mulholland, Jr.

## Advertising Representatives

**New York:** T. Richard Gascoigne,  
James S. Mulholland, Jr.  
127 East 55th St.,  
New York 22, N. Y.  
PLaza 3-8677

**Chicago:** Thorpe Covington  
Thomas Kavooras  
677 No. Michigan Ave.,  
Chicago 11, Ill.  
SUpper 7-8054

**Los Angeles:** Robert W. Walker Co.  
2330 West 3rd St.,  
Los Angeles 5, Calif.  
DUnkirk 7-4388

**San Francisco:** Robert W. Walker Co.  
57 Post St.,  
San Francisco 4, Calif.  
SUTter 1-5568

## CIRCULATION POLICY

ELECTRONIC DESIGN is circulated only to qualified electronic designers of U. S. manufacturing companies, industrial consultants, and government agencies.

If design is your responsibility, you qualify for a subscription to ELECTRONIC DESIGN without charge. The following information is required: your name and title, your company's name, address, and main product.

These are some typical qualifying titles: chief engineer, chief designer, electronic engineer, electronic technician, project engineer, development engineer, research engineer, and electrical engineer.

If you have a design responsibility, not indicated by your title, please add a description of those responsibilities.

Send the required information on your company letterhead.

◀ CIRCLE ED-1 ON READER-SERVICE CARD

*United Transformer Co.*

150 VARICK STREET NEW YORK 13, N. Y.  
EXPORT DIVISION 13 EAST 40th STREET, NEW YORK 16, N. Y. CABLES: PARLAB

# ELECTRONIC *design*

Vol. 1  
No. 6  
June 1953

## Contents

<b>Cover</b> . . . . .	(see page 12)
<b>Editorial</b> . . . . .	4
<b>Engineering Review</b> . . . . .	5
<b>Features</b>	
"_tolerance Considerations in Electronic Product Design—2", by Raymond C. Miles . . . . .	6
"Transistor-Magnetic Servo Amplifier" . . . . .	8
"Self-Locking Taper Terminals Simplify Electronic Design" . . . . .	10
"A Miniature Cathode-Ray Oscilloscope" . . . . .	12
<b>Departments</b>	
New Products . . . . .	14
New Literature . . . . .	26
New Books . . . . .	31
Patents . . . . .	32
<b>Product Inquiry Guide</b> . . . . .	34
<b>Advertiser's Index</b> . . . . .	35

ELECTRONIC DESIGN is published monthly by Hayden Publishing Company, Inc. at 127 E. 55th Street, New York 22, N. Y., T. Richard Gascoigne, President; James S. Mulholland, Jr., Vice-President & Treasurer; and Ralph E. Marson, Secretary. Printed at Publishers Printing Company, New York, N. Y. ELECTRONIC DESIGN is circulated monthly without charge to men in the electronic industries who are responsible for the design and specification of manufactured devices, including development and design men of consulting laboratories and government agencies. Acceptance under section 34.64 P. L. & R. authorized. Copyright 1953 Hayden Publishing Company, Inc. 23,100 copies this issue.

425111

# G-V MINIATURE THERMAL RELAY

## Not Only a

# TIME DELAY RELAY...

*Advanced  
Engineering  
Features!*

- Miniature and Octal Sizes
- Hermetically Sealed in Metal Shell
- Adjustable and Non-Adjustable
- Heater Voltages up to 230 Volts
- Fully Temperature Compensated
- Suitable for Military and Industrial Use
- Unequaled for Ruggedness and Precision

.. with performance features that surpass larger octal relays.

**More and more engineers are finding other uses for these precise and rugged units—jobs which thermal relays of the usual bi-metal design often cannot do... such as:**

- TUBE HEATER VOLTAGE REGULATION
- POWER SUPPLY OVERLOAD PROTECTION
- OVER- OR UNDER-VOLTAGE ALARM OR CUT-OFF
- LOW OR HIGH FREQUENCY CUT-OFF

To receive technical information on these new applications, as it comes off the press, and our bulletin on Time Delay Relays, just mail the coupon below.



## G-V

CONTROLS INC.

18 Hollywood Plaza  
East Orange, New Jersey

G-V CONTROLS INC. ● 18 Hollywood Plaza, East Orange, N. J.

Please send me your bulletin on Thermal Time Delay Relays and information on new thermal relay applications. I am particularly interested in

Name \_\_\_\_\_ Position \_\_\_\_\_

Company \_\_\_\_\_

Address \_\_\_\_\_

CIRCLE ED-2 ON READER-SERVICE CARD FOR MORE INFORMATION



Your best buy is **E-I** - for every

**SEALED TERMINAL REQUIREMENT!**

### E-I Compression Type Headers

A new series of super-rugged, practically indestructible headers made by an exclusive E-I process. Feature non-flexing solid metal blanks - no stampings. Many standard types available. Silicone treated and tin-dipped.

For details, request  
BULLETIN 960

### E-I Hermetically Sealed Terminals

A complete line of standard terminals that fill practically any need with mass production economy. Strain-free glass for highest thermal and mechanical shock resistance.

For details, request  
BULLETIN 949-A

### E-I GS Series Multiple Headers

Includes a wide assortment of standardized headers featuring a single overall glass insert for longer leadage paths and to permit closer spacing of terminals. Most all types can be furnished with exhaust tabs. All are silicone treated and tin-dipped.

For details, request  
BULLETIN 960

### E-I Tubular End Seals

The ideal end closures for resistors, capacitors and other tubular components. All commonly used sizes and types are available as standard stock items for maximum economy.

For details, request  
BULLETIN 952

### E-I Color Coded Terminals

Supplied with glass inserts colored in RMA code colors. Coloring is in the glass. No surface coatings of color to fade or impair insulating qualities.

For details, request  
BULLETIN 953

**STANDARD TYPES—**  
Available from stock, E-I standard sealed terminals offer a ready solution to problems involving hermetic sealing. Hundreds of types, with many optional features, include sealed leads, multiple headers, octal plug-ins, tubular end seals and color-coded terminals.

**SPECIAL TYPES—**for applications requiring special designs, custom types can be supplied to specification at prices reflecting mass production economies. Recommendations will be made promptly on receipt of your requirements.

**E-I . . . your headquarters for hermetically-sealed terminations of every type. Over 10 years of specialized experience insures highest quality at lowest cost.**

DIVISION OF AMPEREX ELECTRONIC CORP.

**ELECTRICAL INDUSTRIES**

44 SUMMER AVENUE, NEWARK 4, NEW JERSEY

EXPORT AGENTS:

PHILIPS EXPORT CORP., 100 EAST 42nd STREET, NEW YORK 17, N. Y.

## Editorial . . .

Some time ago at a technical gathering we overheard an engineering executive express concern over a perennial problem he had with electronic designers. It seems that they did not know when to stop designing.

He had a good strong group of men who were perfectly willing to tackle any project assigned to them, regardless of how difficult it might be. He had no fault to find with their technical competence, their approach to the problem at hand, or even the execution of their ideas. But when the project deadline was at hand, it always was a job of major proportions to pry loose from the group a workable design that could be made ready for production. They were continually "improving", "refining", or "revising" the design, and if left alone, they would go on "designing" indefinitely.

Of course, from the designers' point of view it could be argued that they were interested in delivering the best possible design consistent with economic considerations and performance requirements. Since no design is "perfect", they could logically go on improving what they had achieved at any given time. From the company's point of view however, a design on the drafting board or in the laboratory (regardless of how good it might be) means nothing as far as sales are concerned . . . and sales pay the bills and salaries.

All of which poses the question "When is a design ready for production?" Is it possible to formulate a general set of rules that would indicate a reasonable "cutoff point" for designers? We would like to hear from our readers on this subject, and promise that such information will receive editorial attention in the pages of ELECTRONIC DESIGN.

*Edward E. Grayda*

◀ CIRCLE ED-3 ON READER-SERVICE CARD

# Engineering Review . . .

**Microwave Path Testing . . .** Erection of permanent towers for microwave radio relay systems involves substantial sums of money. Therefore extensive tests of possible paths are necessary before final sites are selected.

Although selection of sight-to-sight relay paths largely depends on observation and study of contour maps and terrain over which the waves will pass, other factors have to be considered also. These include trees, buildings, water, the type of land involved, and atmospheric conditions.

The problems involved and the results of tests between New York City and New Egypt, N. J. (53 miles air distance on the New York-Philadelphia-Washington TD-2 radio relay route) are described in an AIEE technical paper called "Path Testing for Microwave Radio Routes", by R. D. Campbell of the American Telephone and Telegraph Co., New York, N. Y. These types of tests are very valuable in determining optimum tower heights for the microwave relay sites, and help to avoid problems which might arise after permanent construction is completed.

**Portable TV Microwave Equipment . . .** Two new TV microwave equipments have been developed to make possible a wider variety of programs by making the TV camera more independent of studio facilities. Manufactured by Raytheon Mfg. Co. of Waltham, Mass., the units are designed for picking up picture-and-sound simultaneously in remote places and relaying it back to the studio without the use of wires. They also can serve as TV relay stations.

One of the units is the KTR-100 "Microlink", a compact, light weight relay developed for use as a studio transmitter link, remote, inter connecting, radar relaying, or other broadband requirements. It provides audio and video services and includes a special cable compensating switch allowing use of up to 500' of cable. It operates in the frequency range of 6875Mc to 7125Mc with a power output of 0.1w, and the entire system (consisting of four suitcases and two parabolas) weighs less than 200 lb.

The other unit is the MTR-50 "Magnalink", which is a much larger link with great power for extended range and maximum fade protection. It operates in the 2000Mc frequency range and is powered by a 50w magnetron. By virtue of normal gain factors through a 10' parabola, the 50w tube output is multiplied to an effective radiated power of 50,000w.

**Aerosol Record Spray . . .** A special aerosol spray unit is used to spray a very thin layer of long-wearing lubricant in the grooves of phonograph records to make the records, as well as needles, last longer. Known as "Record Spray" (a product of Injection Molders Supply Co., Penton Building, Cleveland 13, Ohio), the unit employs Du Pont "Freon" as the propellant.

The spray also serves as an insulator to reduce static electricity noise caused by friction and helps fill in abrasion imperfections in the record. It constantly cleans dust and dirt particles from the grooves by acting as a lubricant and "floats" these particles onto the needle as the record revolves. They then can be removed by the fingers at the end of each playing. These features are intended to help get more of the original tonal range and quality out of the recording.

**Jet Ignition System . . .** A capacitor-discharge ignition system for aircraft jet engines is capable of starting at top jet speeds and altitudes. Applicable to most jet power plants, the system is being made in several sizes to cover a variety of input and output power requirements. A development of the General Electric Company (Aeronautic and Ordnance Systems Division, Schenectady, N. Y.), the unit provides constant spark energy at the plugs at all altitudes over a 2:1 range of input voltages.

**Resonance-Type Vibration Calibrator . . .** A resonance-type vibration calibrator, designed by Frank C. Smith of the National Bureau of Standards sound laboratory (Washington 25, D. C.), combines simplicity and economy of construction with pure waveform and high sensitivity.

The device consists essentially of a system of mechanically resonant beams excited by an ordinary 8" loudspeaker. The transducer being calibrated is fastened rigidly to the mechanical system, and the amplitude of vibration is observed optically with reference to a fixed point in space. The instrument has been used to calibrate moving-coil type velocity gages over a frequency range from 10cps to 250cps, at displacement amplitudes of as little as 50 microinches. It can be used to calibrate sensitive transducers at low levels of acceleration, of the order of 0.05 to 5G's.

**Radar for Europe . . .** Aircraft radar warning units to be used for the defense of the perimeter of Western Europe are being manufactured by an Italian company (Microlambda of Rome and Fusaro, Italy). Raytheon Manufacturing Co., of Waltham, Mass., furnishes the designs and the manufacturing "know-how", and the Italian company builds the units under a licensing agreement. The radar equipment is similar to various types used in the United States to sweep the skies continuously in search of aircraft. Most of the specialized electronic parts are obtained from European NATO countries, and critical items involved in the making of the radar (about 10% of the total material) are furnished by Raytheon.

**Electronic Elevator Supervising . . .** Two buildings in the Loop area in Chicago are installing new "Autronic" elevators, made by Otis Elevator Co., which are designed to keep elevator service continually in step with changing traffic demands. The electronic control system responds to the changing traffic patterns by changing over to the appropriate dispatching program: "balanced up-down", "heavier up", "heavier down", or "intermittent". It also detects any tendency of the elevators to bunch together and takes steps to keep service uniformly distributed.

Should people fill an elevator ahead of the dispatching interval, an automatic device called the "load weigher" starts the car when it is completely filled. To avoid unnecessary stops, the load weigher causes a full car to by-pass a landing call, which then is answered by the next available car. Doors close automatically after a predetermined interval, but an electronic detector automatically reverses them if they come within distance of a passenger's body.

**X-Ray Image Amplifier . . .** Images 800 to 1200 times brighter than those obtained with conventional fluoroscope are produced by a new X-ray Image Amplifier developed by the Phillips Laboratories of Eindhoven, Holland. The device consists of an evacuated glass tube (18" x 7"diam) with one flat end and the other hemispherical, curving outward. Inside the hemispherical end is a curved fluoroscope screen in direct contact with a photocathode. On the inside at the flat end is a second fluorescent screen reduced nine times in size. Outside the glass tube, but mechanically coupled to it, is a simple optical microscope with a magnification power of about nine.

In use, the x-rays pass through the hemispherical end to the curved internal screen which then fluoresces, creating an electronic image. By means of an electrostatic lens, the electronic image is reproduced on the viewing screen, reduced nine times in size. This reduced image is viewed through the microscope and is seen erect and in its original size, but about 1000 times brighter. The device is useful in conjunction with film cameras as a practical solution to the problem of x-ray cinematography.



(Editor's Note: The first part of this article which appeared in the May issue, presented the tolerance problem in terms of elementary probability theory. Part 2 is concerned with specific methods for solving tolerance problems in practice.)

**E**QUIPPED with an understanding of the principles of probability theory as they apply to tolerance problems, the product engineer can proceed to the solution of actual problems which arise in practice. The process of solution generally will involve the following steps, though not always necessarily in the order of listing.

1. *Express Equipment Performance Criteria in Terms of Component Values.* First, of course, it is necessary to know the manner in which the values of individual components combine to determine equipment performance. In a simple case, this may amount to no more than amplifier gain as the product of tube transconductance and load resistance. In more complicated cases, it frequently can be determined by inspection that the effect of tolerances in certain components is negligible in terms of the equipment performance variations which they can introduce. Such component values are treated as constants.

Because of the simplicity of the resulting mathematics of probability, it is preferable wherever possible to express performance as sums of values. This can be done in many cases by dealing with the logarithms of values whose effect in the equipment is multiplicative, with the inverse of values which combine in the manner of parallel resistances, and by similar tricks of mathematics.

2. *Establish Rejection Criteria for Equipment.* If not given as part of the problem, the limits of acceptable performance and the percentage of cases in which performance can be allowed to fall outside of limits may be established by the designer. Establishment of these rejection criteria permits determination of both mean value (from the nominal equipment performance) and standard deviation (from performance limits and allowable frequency of rejections) of an assumed normal distribution of overall performance values. Thus the designer has an almost immediate clue to the order of magnitude of component tolerances needed to achieve a desired result.

3. *Establish Probability Density Distributions for the Values of Individual Components.* In most practical instances, it will be impossible to achieve more than an educated guess of component value distributions. Grounds on which such a guess may be based include familiarity with the component manufacturing process, data supplied by the manufacturer, and actual measurements on a sample quantity of components.

In the absence of better information, a common assumption is that the distribution of component values is normal with a mean equal to the nominal component value and a standard deviation equal to one-third the absolute (half) tolerance; i.e.,  $\sigma = 1/3 V_N T$ . As Fig. 7 shows, such assumptions correspond to a rejection ratio of about one component per 350.

4. *Solve the Problem by Probability Techniques.* Once the three preliminary steps have been taken, the designer is in a position to solve the problem by detailed application of the probability theory of tolerances. If conditions justify a relatively rigorous mathematical approach, then the theory of probability can be applied in detail. If not, mere qualitative knowledge of the manner in which component values combine on a probability basis will still be quite helpful.

5. *Implement the Solution by Proper Choice of Component Types, Values, and Tolerances.* This step is probably the one requiring the greatest amount of experience and the highest degree of judgment. The design must be implemented in such a manner that the assumptions made in the preceding steps will be borne out in practice. The principal danger is that the component value distributions assumed in the third step will

# Tolerance Considerations in Electronic Product Design—2

Raymond C. Miles

Airborne Instruments Laboratory, Inc.  
Mineola, N. Y.

not prove to be the actual case, with the result that the solution will be invalid in practice.

If either rectangular or normal distribution of component values has been assumed, the designer must beware of components whose history may indicate a distribution of some other form. Components which may have been subjected to selection at any point in their past history are immediately suspect.

A second point of caution concerns components of identical nominal characteristics which contribute to the same overall performance effect. Such components may well have a common history which indicates a much closer correlation of individual characteristics than has been assumed.

The salvation for the product designer in such cases often lies in selection of components such that their histories must necessarily differ. For example, series resistances of 900 and 1100 ohms may be used to obtain a total resistance of 2000 ohms instead of a pair of 1000 ohm resistors.

## Use of Curves

In performing steps 2, 3 and 4 of the tolerance design procedure, the designer will frequently find it helpful to refer to curves such as those of Fig. 7.

For a normal distribution of values, Fig. 7 gives the probability that a particular value will fall between the limits  $V_N + \tau V_N$  and  $V_N - \tau V_N$ , which are symmetrical about the mean value  $V_N$ . This probability is given as a function of  $\tau/T$ , the ratio of allowable variation to absolute tolerance of the normally distributed values. The standard deviation,  $\sigma$ , of the distribution appears as a parameter in Fig. 7. Thus it can be seen from Fig. 7 that, in the case of a normal distribution whose absolute tolerance is  $\pm 10\%$  ( $V_N T = 0.1$ ) and whose standard deviation is one-fifth the absolute tolerance ( $\sigma = 0.2 V_N T$ ), the probability is 0.987 that a particular value will actually lie within  $\pm 5\%$  of the mean value ( $\tau/T = 0.5$ ).

As an added convenience in solving certain special problems which arise frequently in practice, Fig. 7 also includes a parametric scale in terms of the number of individual values which contribute equally to a sum distribution. The "s" scale of Fig. 7 assumes a standard deviation of the individual values which is one-third their absolute tolerance.

Thus if a value  $V_s$  is the sum of two individual values  $V_1$  and  $V_2$  whose distributions are each normal with the same mean value  $V_N$ , same absolute tolerance  $\pm T$ , and same standard deviation  $\sigma = V_N T/3$ ,

the value  $s = 2$  on the parametric scale may be used as a basis of interpolation to find the probability that the sum  $V_s$  will be within a tolerance  $\pm \tau$  about its nominal value  $V_{Ns} = 2V_N$ . For example, the probability that the sum of two nominally equal values will be within  $\pm 5\%$  of the nominal sum when the individual values have an absolute tolerance of  $\pm 10\%$  and a standard deviation of one-third this amount is about 0.965 ( $s = 2$ ,  $\tau/T = 0.5$ ).

## Typical Problem

A multistage pentode amplifier is required to have an overall gain of at least 112db. The tube type selected has a minimum transconductance of 6000 and a maximum of 11000 micromhos. Frequency response considerations indicate that the plate load resistance should not exceed 3500 ohms per stage.

From the maximum and minimum values of tube transconductance, a nominal transconductance of 8500 micromhos may be inferred, with resulting nominal stage gain of  $3500 \times 8500 \times 10^{-6} = 29.75$ . This suggests that a four-stage amplifier, with nominal overall gain of  $(29.75)^4$ , or about 118db, might be adequate to provide the required gain. However, if all four tubes in a four-stage amplifier had the minimum transconductance of 6000 micromhos, the overall gain would be only 106db, below the required limit of 112db minimum. Is it therefore necessary to resort to a five-stage amplifier, or will four stages suffice? What will be the effect of tolerance of the plate load resistors? The solution follows:

*Step 1.* The absolute tolerance on tube transconductance amounts to  $\pm (2500/8500) \times 100 = \pm 29\%$ . Thus use of plate load resistors of  $\pm 5\%$ , or even  $\pm 10\%$ , tolerance will render stage gain relatively independent of load resistor tolerance. Thus tolerance of the plate load resistors may be neglected in the remainder of the problem.

Individual stage gain will lie between a lower limit of  $6000 \times 3500 \times 10^{-6} = 21$ , or 26.5db, and an upper limit of  $11000 \times 3500 \times 10^{-6} = 38.5$ , or 31.7db. Assuming nominal stage gain equal to the mean value in db, stage gain may then be expressed as  $V_1 = V_{N1} \pm V_{N1} T_1 = 29.1 \pm 2.6$ db.

The overall gain of the four-stage amplifier in db can be expressed as the sum of the individual stage gains, or  $V_4 = V_{N_4} \pm V_{N_4}T_4 = 4V_1 = 116.4 \pm 10.4$ db.

*Step 2.* The terms of the problem include the specification of 112db minimum gain. The problem is to solve for the remaining rejection criterion, frequency of rejections, whose value will determine whether a four-stage amplifier can be considered satisfactory.

*Step 3.* Either of two assumptions may be made as to the component value distributions; the assumption of normal distribution of stage gain with a mean value of 29.1db and standard deviation of  $\sigma_1 = (V_{N_1}T_1)/3 = 0.87$ db, or the assumption of normal distribution of tube transconductance with a mean value of 8500 micromhos and standard deviation of  $2500/3 = 833$  micromhos. Since the two assumptions are approximately equivalent because of the nearly linear relation between transconductance and db gain over a narrow range, the first assumption will be adopted as a matter of convenience.

*Step 4.* The standard deviation of overall gain may be calculated as the square root of the sum of the squares of the individual stage gain standard deviations. Thus:  $\sigma_4 = \sqrt{4\sigma_1^2} = 1.74$ db  $= (1.74/10.4) (V_{N_4}T_4) = 0.167V_{N_4}T_4$ . (In this case, use of the  $s$ -scale of Fig. 7, with  $s=4$ , would eliminate the necessity for calculating the value of  $\sigma_4$ .) The ratio  $\tau/T$  can be found from the difference between nominal gain and required gain divided by the absolute tolerance on overall gain or  $\tau/T = (116.4 - 112)/10.4 = 0.423$ . With these values of  $\sigma_4$  and  $\tau/T$ , Fig. 7 indicates a probability of about 0.988 that overall gain will be between the limits  $V_{N_4} + \tau V_{N_4}$  and  $V_{N_4} - \tau V_{N_4}$ , or between 112 and 120.8db. Since the distribution of overall gain is symmetrical about its mean, the probability that the gain will exceed 112db, without regard for any upper limit, is  $0.988/2 + 0.5 = 0.994$ . Thus a four-stage amplifier should be adequate.

*Step 5.* The principal pitfall in implementing the solution to this problem lies in the danger that the individual amplifier stages will have a mean gain considerably lower than the assumed value of 29.1db. Such a situation could result from the use of tubes whose mean transconductance was significantly lower than the nominal 8500 micromhos. That this may be the case can be seen from Fig. 4 (Part 1).

Fortunately, it appears from Fig. 4 that a lower (or higher) mean value of transconductance will be accompanied by a decreased value of the standard deviation, so that the effect on probability of gain exceeding the minimum value may not be serious. For a case equivalent to lot C of Fig. 4, for example, in which the mean transconductance is  $0.28 V_{N_1}T_1$  less than its nominal value and  $\sigma_1 = 0.130 V_{N_1}T_1$ , the rejection ratio on the basis of 112db minimum gain may be estimated as less than one amplifier per 10,000. Thus a four-stage design appears safe.

Fig. 7. (right) Probability curves which are employed in the tolerance design procedure outlined above.

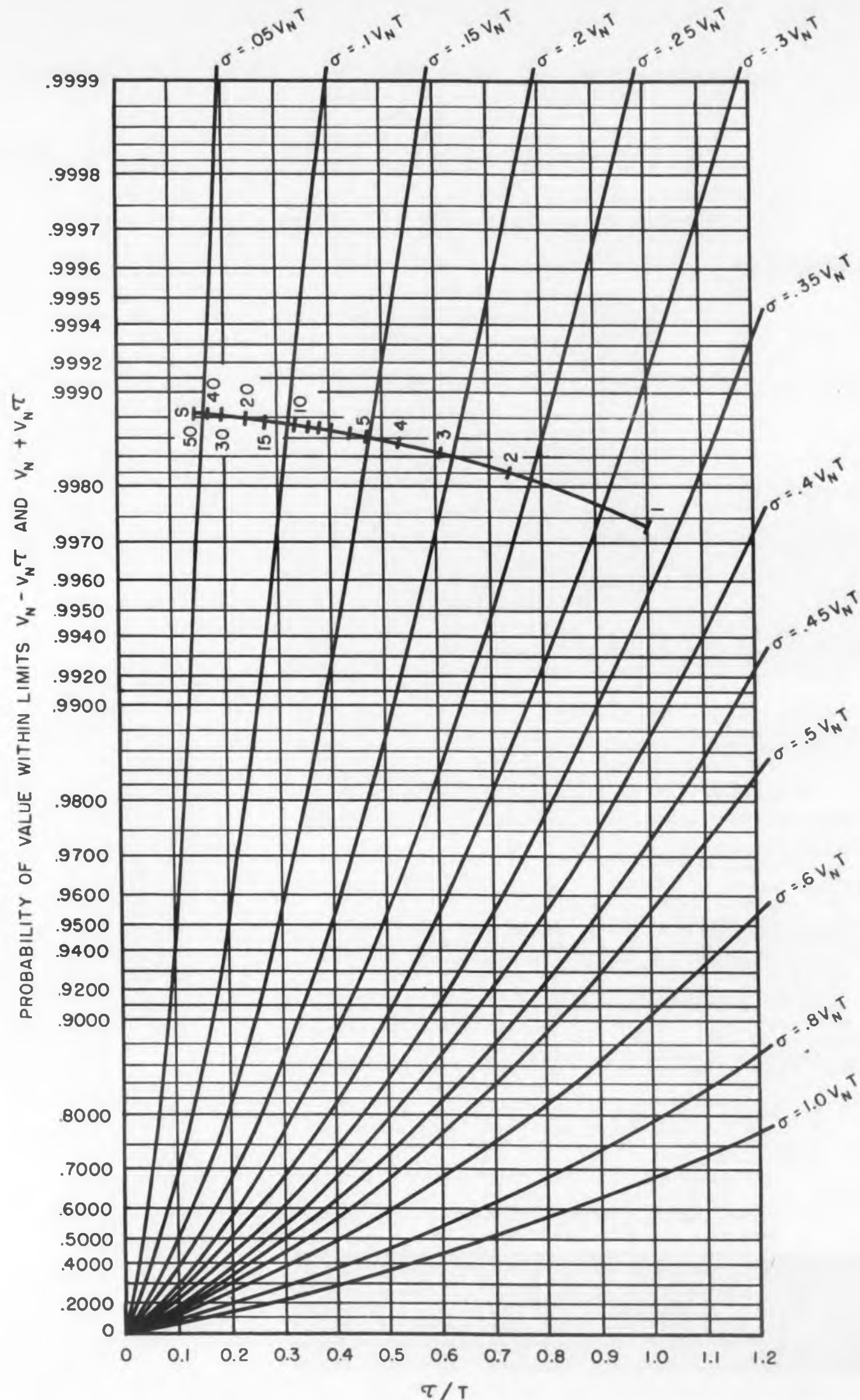



*The right bandwidth for your work*

**DC** to 5 MC  
5 cycles to **10** MC

These

2

Browning

'scopes

give

you these valuable features



**Model OA-16** . . . an extremely versatile instrument having d.c. amplification with extended high-frequency response and sweeps ranging from seconds to microseconds.

**FEATURES**

- Bandwidth—from d.c. to 5 megacycles
- Deflection sensitivity—50 peak-to-peak millivolts per inch
- Internal provision for balancing out d.c. components
- Trace position remarkably independent of line voltage
- Sweep speeds 0.4  $\mu$ sec. per cm. to 1 sec. per cm.
- All sweeps below fastest range expandable 5 times for detailed examinations
- Sweep may be recurrent, or triggered by positive or negative external pulses or by vertical amplifier signals.

**Model OL-23** . . . combines the functions of an oscilloscope and a synchroscope for observing repetitive phenomena or single transients. Broadband amplification, fast sweeps, and high beam-accelerating potential make this 'scope particularly desirable in observing and measuring steep wavefronts and fast pulses.

**FEATURES**

- Bandwidth—from 5 cycles to 10 megacycles
- 4000-volt accelerating potential
- Sweeps expandable up to the maximum writing rate of the sweep circuits
- Fast sweeps—to 0.1  $\mu$ sec. per cm.
- Step-controlled attenuation continuously adjustable between steps
- Calibration accurate to 5%
- Sweep delay ranges of 100, 1000, and 10,000  $\mu$ sec.

Each instrument is contained in a blower-cooled steel case 13 $\frac{1}{4}$ " wide, 15 $\frac{3}{4}$ " high, and 22" deep. Case and panel are finished in green, with knobs and markings in frosted aluminum. Prices, complete with tubes:

Model OA-16 .....\$745.00  
Model OL-23 .....\$890.00

Prices are net F. O. B. Winchester, Massachusetts

**WRITE TODAY FOR FULL TECHNICAL INFORMATION**

ENGINEERED  
FOR  
ENGINEERS



**BROWNING**  
Laboratories, Inc.  
Winchester, Mass.

CIRCLE ED-4 ON READER-SERVICE CARD FOR MORE INFORMATION

# Transistor-Magnetic Servo Amplifier

**A** NUMBER of interesting design possibilities are suggested by the Type 434-B Servo Amplifier, which combines in one rugged unit a transistor preamplifier with a magnetic amplifier. This arrangement results in a combination that has the power output capacity of the magnetic amplifier and the sensitivity and speed of response of the transistor.

Manufactured by Industrial Control Company (Wyandanch, N. Y.) in the form of a lightweight (17 oz), compact (2" x 2-1/4" x 3-1/8"), hermetically sealed unit, the Type 434-B servo amplifier shown in Fig. 1 features zero maintenance, very long



Fig. 1. Transistor-Magnetic Servo Amplifier.

life, and low power drain. It can operate at extremely high accelerations and under a wide variety of severe environmental conditions. Because of these features, it can be readily used in many types of industrial as well as military applications where dependable operation is important.

The unit drives various 400cy servo motors such as the BuOrd MK14 and MK7

servo motors or their commercial equivalents, in medium performance servo loops from single speed autosyn data. It is completely self-contained and requires no power supply or damping tachometer. Fig. 2 illustrates a typical setup, and the circuit shown in Fig. 3 indicates the simplicity of the wiring, only six connections to the amplifier unit being required.

The MK14 and MK7 motors have stall torque ratings of 0.63 oz-in and 1.45 oz-in respectively; and the amplifier drives them to slightly reduced stall torque. Single-speed autosyns are the recommended data system, with voltage gradients between 0.25 and 1.0v/degree, at carrier phase shifts between 0 and 15° leading. The gain is adjustable and performance can be peaked to match a broad range of gear ratios.

Specifications for the amplifier include a saturation signal of 0.30v rms; an input resistance of 5000 ohms or higher; and power consumption is under 20w. The null point drift is negligible from 100v to 130v at 360cy to 440cy, and maximum operating ambient is 50°C.

The characteristics of the type 434-B make it especially useful for critical applications such as military fire control gear, atomic energy installations, as well as in a wide variety of industrial control apparatus. For example, in a MK14 servo loop with 50:1 gearing to the Type AY-201 autosyn, the following performance is obtained: a load gradient of 7 oz-in/degree and a velocity error constant of 200sec<sup>-1</sup> at 30rpm load speed.

Fig. 4 shows an oscillogram of the output transient response to a 3° input step, with a damped natural frequency of 13cps measured against the 1.0sec sweep, and a first overshoot of 30%.

The potted construction provides a void-free, homogeneous structure, highly resistant to shock and vibration. This feature, together with hermetic sealing, assures a very low probability of system failure in applications where critical pro-

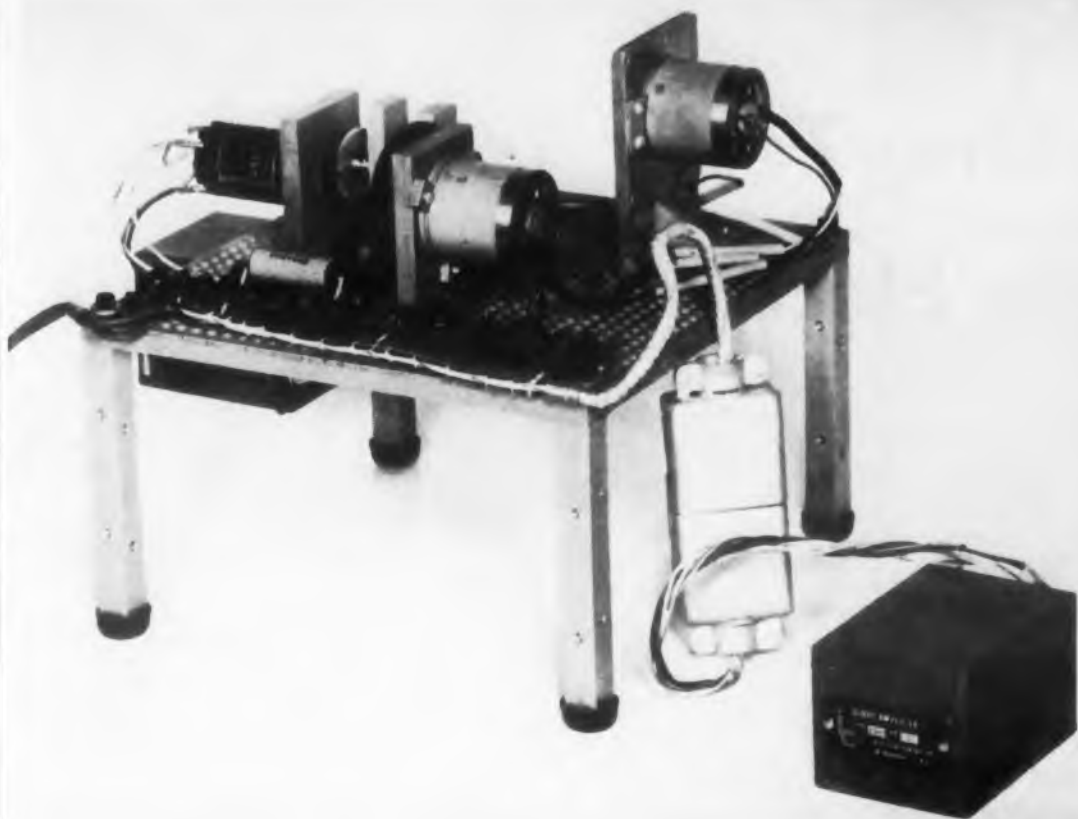

Fig. 2. (above) Typical servo setup using the new amplifier.

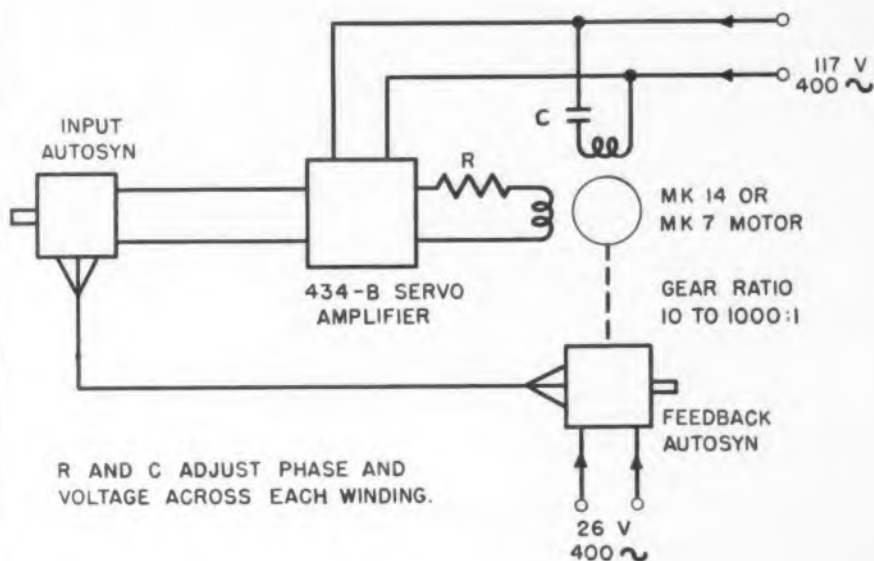
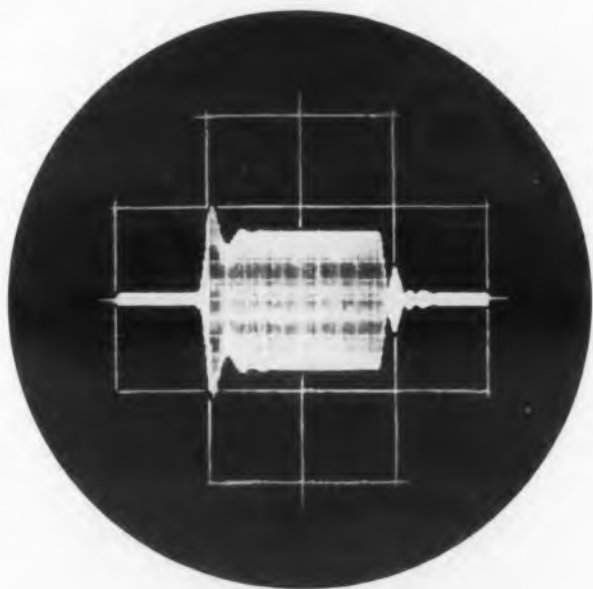

Fig. 3. (left) Schematic diagram of the setup shown above.

Fig. 4. (below) Output transient response to a  $3^\circ$  input step.

cesses must be monitored and controlled over long periods of time with absolute reliability. In addition, its circuitry can be modified to drive other servo motors, or for speed and temperature controllers, clutch amplifiers, alarm devices, etc.

At present, higher performance (higher velocity error constant, lower positional errors, and wider frequency transmission) can be obtained with vacuum tube servo amplifiers than with the transistor-magnetic amplifier type. However, in a great many automatic control applications, medium performance units can be employed. Here the transistor-magnetic amplifier can be employed to good advantage.





**maintenance and replacement  
are simplified with Fairchild**



## **plug-in potentiometers**

These plug-in type ganged potentiometers are another excellent example of Fairchild's service in meeting the special requirements of customers. The problem was to provide ganged precision potentiometers that would simplify maintenance of airborne fire control equipment through quick and easy replacement. A series of packaged plug-in units like that shown was the answer.

An entire gang can be replaced in a few minutes because only the end mounting plates are fastened down. There are no wires to disconnect or solder. Test points are provided on the top of each potentiometer so it can be checked quickly.

Maximum rigidity of the gang is assured by mounting the individual units on a single shaft. These plug-in potentiometers have the same mechanical and electrical tolerances and performance characteristics that have made the Model 746 unit the first choice for many critical applications.

Use the coupon below to get full information.

**FAIRCHILD**  
**PRECISION POTENTIOMETERS**

**THIS COUPON MAY HELP SOLVE YOUR POTENTIOMETER PROBLEMS!**

Potentiometer Division, Department 140-34NI  
Fairchild Camera and Instrument Corporation  
Hicksville, Long Island, New York

Gentlemen:

Please send me complete information about Fairchild Precision Potentiometers and tell me how you might solve my potentiometer problems.

Name \_\_\_\_\_

Position \_\_\_\_\_

Company \_\_\_\_\_

Address \_\_\_\_\_

CIRCLE ED-5 ON READER-SERVICE CARD FOR MORE INFORMATION

**TECHNIC INC.**  
enables you to do  
**GOLD PLATING**  
with scientific accuracy

\*  
With gold plating methods developed by Technic Inc., you can now achieve accurate control of quality, evenness, thickness, color, and hardness of gold deposits. Through cycle plating that is practically automatic in operation, we have virtually converted the old art of plating gold to an exact science.

\*  
Factors in successful application of our methods are the absolute stability of quality of our gold plating solutions and specification of standards for automatic control of replenishing the bath, coupled with an automatic timing device which ensures precision in operation and eliminates human error.

\*  
When you refer plating problems to Technic Inc., we solve them by application of a thorough service — consisting of specifications for a complete installation or correction of faults in your present installation, schedules for solutions and timing, assignment of an engineer who stays with the job until your installation is working at full efficiency.

Write for  
**"ELECTROPLATED GOLD"**  
Technical Data Sheet

Without obligation, write for our informative new Data Sheet which details fully the advanced Technic Inc. gold plating methods and services for platers outlined above.

For reference, you will also receive a list of leading industrial concerns — many with production problems resembling your own — which rely on Technic Inc. controlled gold plating installations to improve production while reducing cost.

Our Controlled Gold Plating methods result in complete dependability, elimination of waste of precious metal, high increase in production, better appearance of product — together with significant reduction in operating personnel, rejects and all-over costs. Send us your plating problems for review, or call in a Technic engineer for consultation. No obligation is involved.

**TECHNIC INC.**



JACKSON 1-4200

39E Snow Street, Providence, R. I.

THE LARGEST ENTERPRISE OF ITS KIND IN THE WORLD

CIRCLE ED-6 ON READER-SERVICE CARD FOR MORE INFORMATION

# Self-Locking Taper Terminals Simplify Electronic Design

**P**ROVIDING for electrical connections to equipment has always been something of a problem for the electronic design engineer, especially when many connections have to be made and space is limited. By making use of a self-locking taper design in mating parts, Aircraft-Marine Products, Inc. (2100 Paxton St., Harrisburg, Pa.) has developed a series of Self-Locking Taper Terminals which greatly simplify this problem. Designed especially for electronic applications, these connectors are simple, miniature in size, and their self-locking action eliminates the need for soldering—a highly desirable advantage when a large number of connections have to be made.

These terminals, shown in Fig. 1, are of two basic types: the round taper pin (male) and the flat taper tab receptacle (female). All the electronic designer need do to make use of these units is to adapt the

blocks, receptacles, or tabs on his equipment to accept the Taper Pin or Taper Tab. Typical dimensions for taper pin and taper tab applications are indicated in Fig. 2. (Both receptacles and tabs that will take the new pin and tab receptacle are being developed.)

The Taper Pins are almost as small as the wire itself (only a few thousandths thicker than the insulation diameter of the wire). When inserted into the receptacle, there is no movement normal to the wire which permits very close spacing of terminations without the danger of causing short circuits. Similarly, the Taper Tab receptacles also can be used in closely spaced relay and switch tabs.

In one electronic device made by Remington Rand, Taper Tab receptacles were developed to attach more than 1000 individual wires to flat taper tabs in a space measuring about 5" x 9". Formerly, each wire had to be carefully soldered by hand, an operation that required about 100 hours under extremely tedious working conditions. Fig. 3 shows the sensing switch disconnect block which required this effort, and the insert shows a disconnect unit from the sensing block after adopting the Taper Tab receptacles. This conversion afforded a 20:1 reduction in installation time and cost of application. When a wire has to be changed, it can be pried loose and reattached.

Taper Pins and Tabs can be developed for wire sizes from No. 16 to No. 26 for solid or stranded wires. The crimp type gathers wire strands and

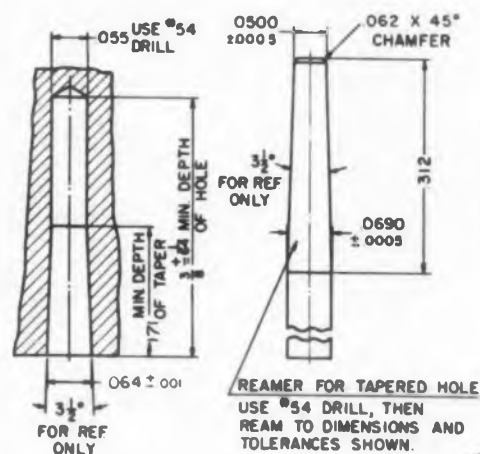
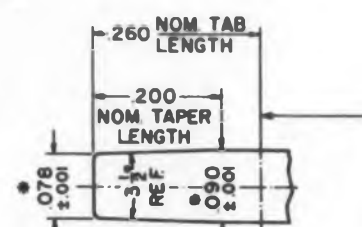
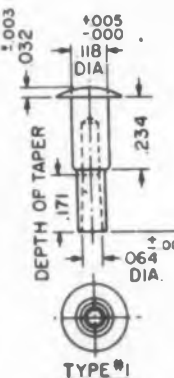
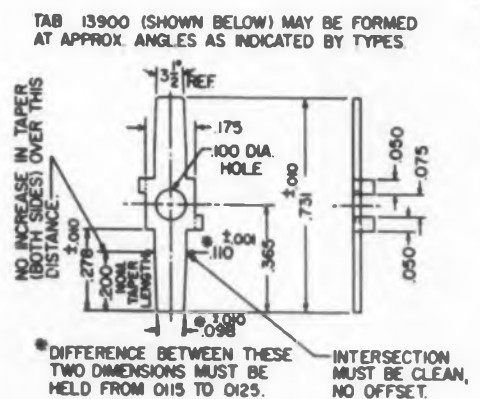
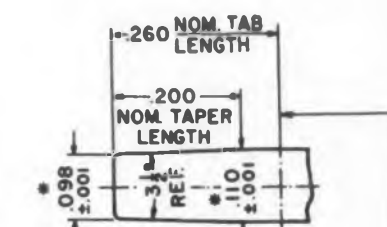

Fig. 2. Design data for applying the new taper terminals.



INTERSECTION MUST BE CLEAN, NO OFFSET & NO INCREASE IN TAPER (BOTH SIDES) OVER THIS DISTANCE.

• DIFFERENCE BETWEEN THESE TWO DIMENSIONS MUST BE HELD FROM .0115 TO .0125.



INTERSECTION MUST BE CLEAN, NO OFFSET & NO INCREASE IN TAPER (BOTH SIDES) OVER THIS DISTANCE.

• DIFFERENCE BETWEEN THESE TWO DIMENSIONS MUST BE HELD FROM .0115 TO .0125.



Fig. 1. The Taper Pin (left) and Taper Tab receptacle (right).

presses the barrel and strands into a predetermined volume. The taper pins, rolled from strip stock to very close tolerances, are wound on reels, ready for use in "AMP" Automatic Wire Terminators. Pins can be crimped at rates as high as 4000/hr. Certain types are made in an "insulation piercing" form so that wires need not be stripped. As the taper pin is applied to the wire, the insulation is pierced to provide the electrical contact.

As for performance of these connectors, the following data on Taper Pins and Taper Tab Receptacles (10-15 lb force of insertion) taken from company, as well as customer test runs, are indicative:

*Contact Resistance* . . . Approximately 1.5 milliohms for pins or tabs on No. 22 AWG wire size.

*Current Carrying Capacity* . . . Equal to, or better than, equivalent wire size on which normally used.

*Resistance Performance under Corrosion* . . . Variations in electrical resistance caused by corrosion are only a few milliohms (usually negligible in communications circuits).

*Vibration* . . . Average mechanical pull-out tends to increase under vibration.

The simplicity and unusual characteristics of these connectors make them useful in a wide range of applications as is indicated in Fig. 4. Primarily, they are intended to be connectors for individual wires. They can be used as permanent connections or disconnects because they are easily separated and reinserted without special tools. Because they remain secure under severe vibrations, they find ready use for attaching wires to multiple connector plugs, and relays.

Low cost and high application speed make them attractive as antenna and speaker disconnects, and as connectors for volume control and i-f transformer tabs. They permit components such as germanium diodes and TV high voltage fuses to be plugged in rather than soldered into circuits. Taper pins can be pressed into laminated base printed circuits using dip-soldering technique (or no solder) to terminate u-h-f antenna filters and tuners, clock radios, etc.

In the electronic computer and business machine field Taper Pins are used for permanent wiring and terminal blocks. Taper Tab connectors are used on close spaced relay, switch, and socket tabs. Inexpensive patch card boards can be built up with Taper Pins and rivet type receptacles.

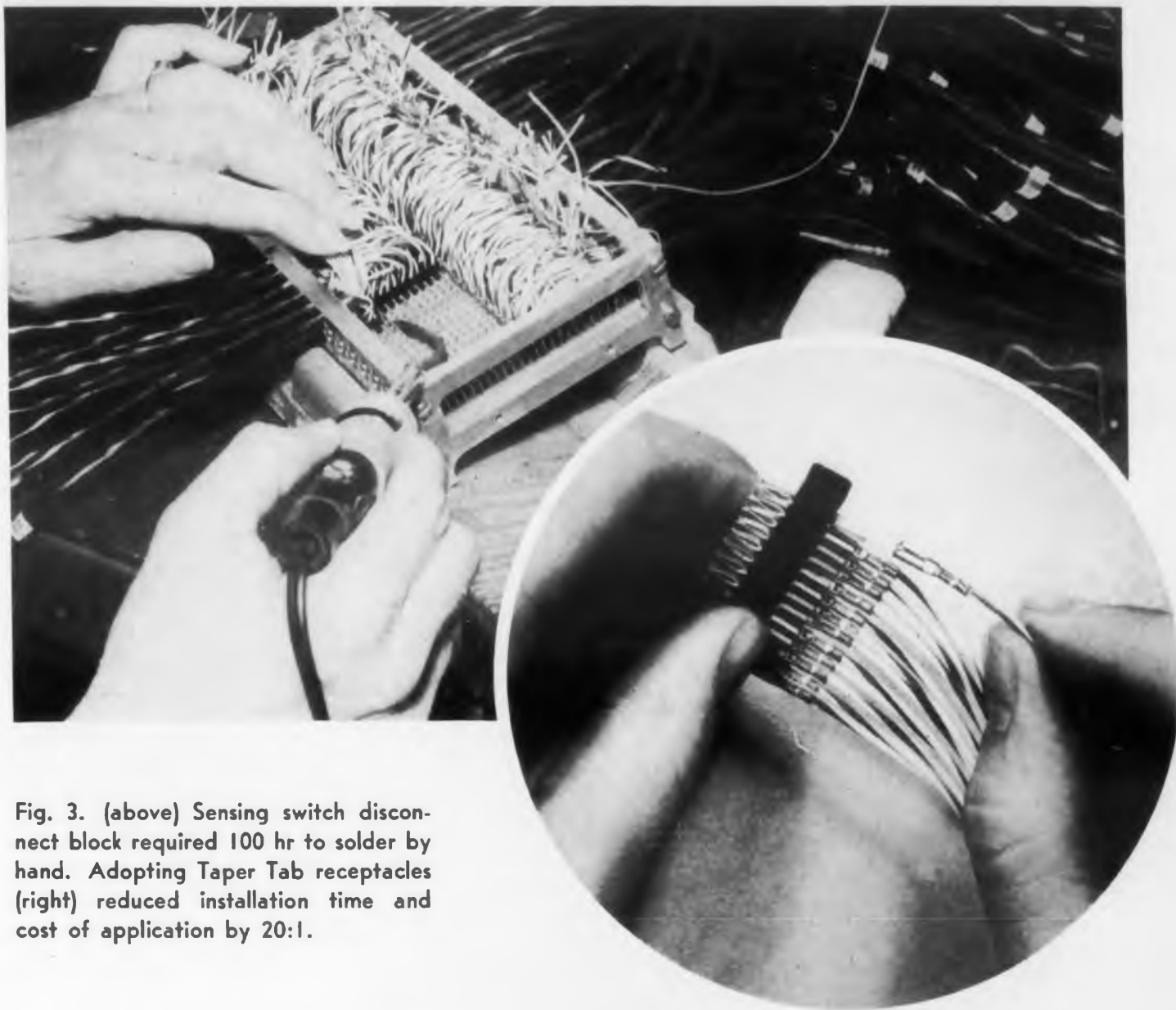

Fig. 3. (above) Sensing switch disconnect block required 100 hr to solder by hand. Adopting Taper Tab receptacles (right) reduced installation time and cost of application by 20:1.

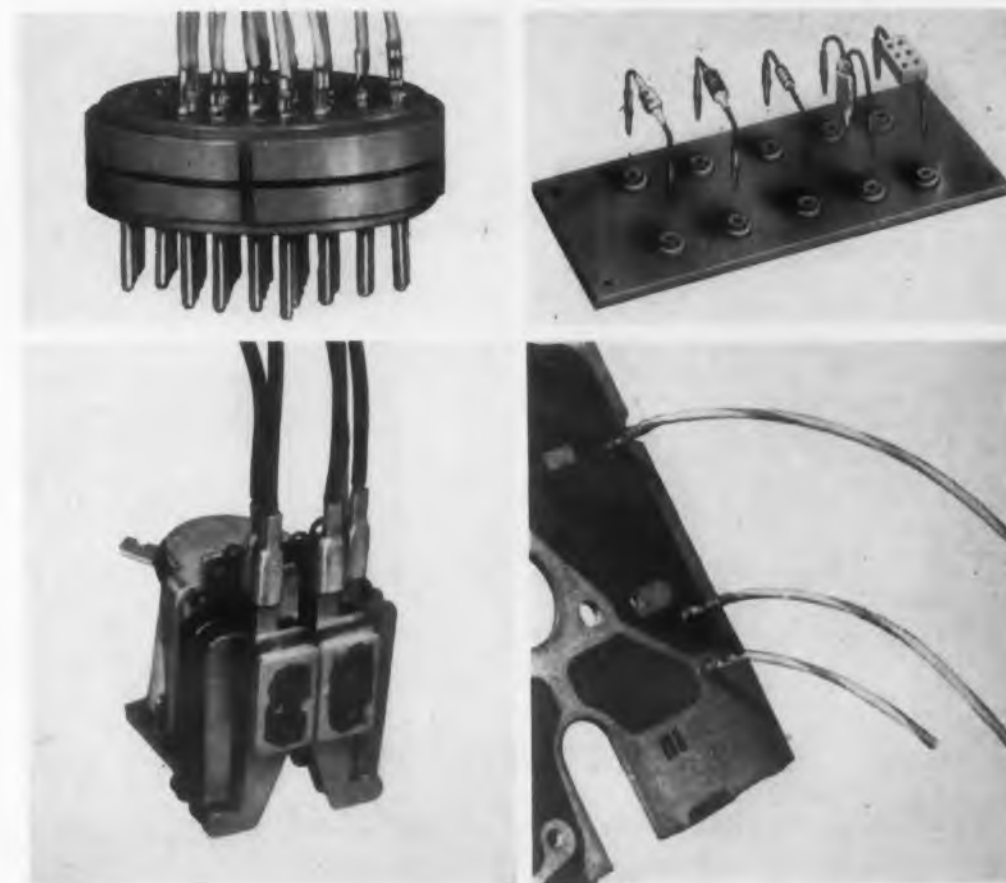

Fig. 4. Typical Taper Tab applications include multiple connector plugs and relays (upper left and lower left). The Taper Pins can be used to plug in, rather than solder, TV and other components on terminal boards (upper right) or to printed circuits (lower right). Both types of terminals are easy to install and they help to simplify difficult terminating problems.





RMB pivot bearings, in this Angle DC timing motor, assure accuracy under extremes of temperature, vibration, and acceleration.

## RMB MINIATURE PIVOT BALL BEARINGS

for applications requiring

- Shock and vibration resistance • High load capacity
- Long life • Ease of assembly • Self-alignment • Low cost

Designers of precision instruments, small motors, and miniature mechanisms of all kinds are specifying RMB pivot bearings.

# RMB

5 TYPES, MANY SIZES  
from .043" to .423" O.D.  
Shaft sizes as small as .010"

WRITE FOR FULL INFORMATION

LANDIS & GYR, INC. 43 W. 45th St., New York 36

CIRCLE ED-7 ON READER-SERVICE CARD FOR MORE INFORMATION

## New Fenwal Miniature THERMOSWITCH® Control Saves Space

Free bulletin gives details

If your product or project calls for temperature control that is exact and reliable but space saving is an important consideration, you will want to know more about the new Fenwal Miniature THERMOSWITCH unit. It incorporates in a small temperature control many characteristics previously found only in much larger controls.

This dependable little device can be adjusted anywhere within the range of 0°F to 200°F. It is extremely sensitive to temperature variations and positive in action . . . maintains normal control characteristics under vibrations of up to 5 G's . . . is as rugged as it is tiny. It lends itself perfectly to electrical, electronic, radio, radar and other protective uses where space is at a premium.

For complete information on the new Fenwal unit, send for your FREE copy of the Miniature THERMOSWITCH control bulletin. Write Fenwal Incorporated, 96 Pleasant St., Ashland, Mass.



### THERMOSWITCH®

Electric Temperature Control and Detection Devices  
SENSITIVE...but only to heat

CIRCLE ED-8 ON READER-SERVICE CARD FOR MORE INFORMATION

# A Miniature Cathode-Ray Oscilloscope

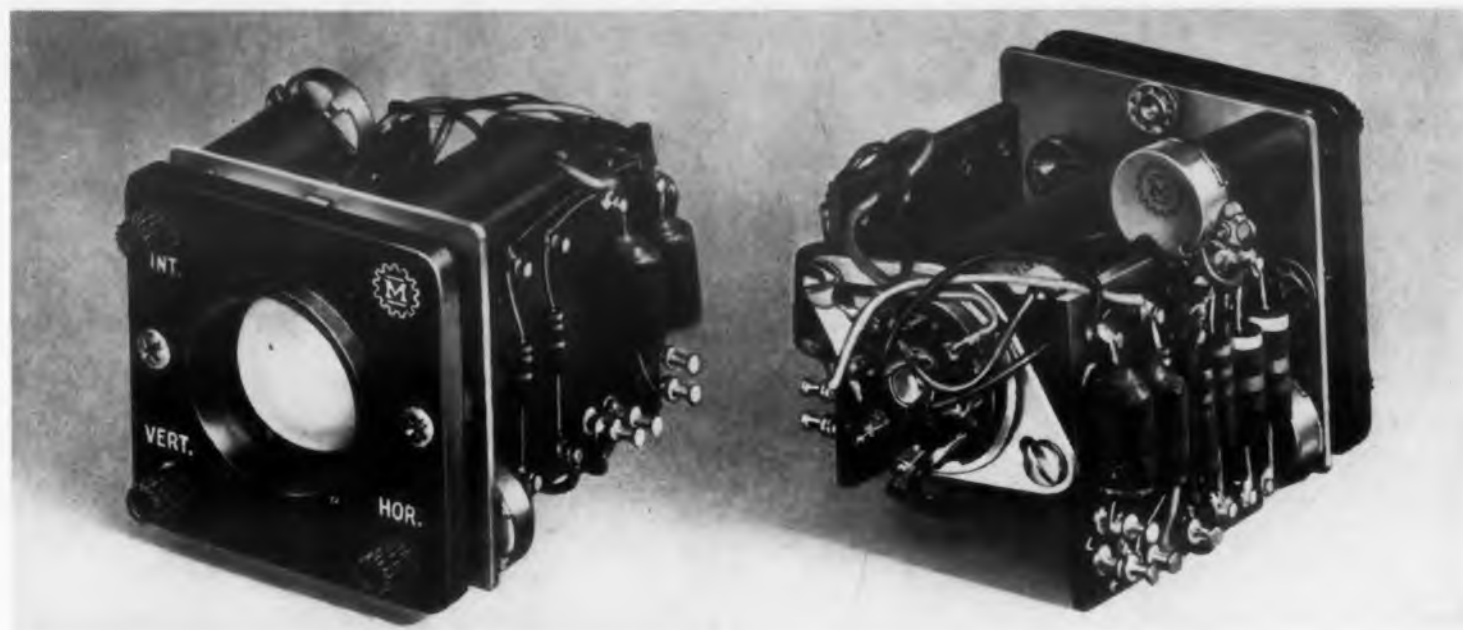

Fig. 1. Front and rear views of the Type 90901 miniature cathode-ray oscilloscope, showing its simple, compact construction. Overall dimensions are only 2 3/4" x 2 3/4" x 4 5/8" long.

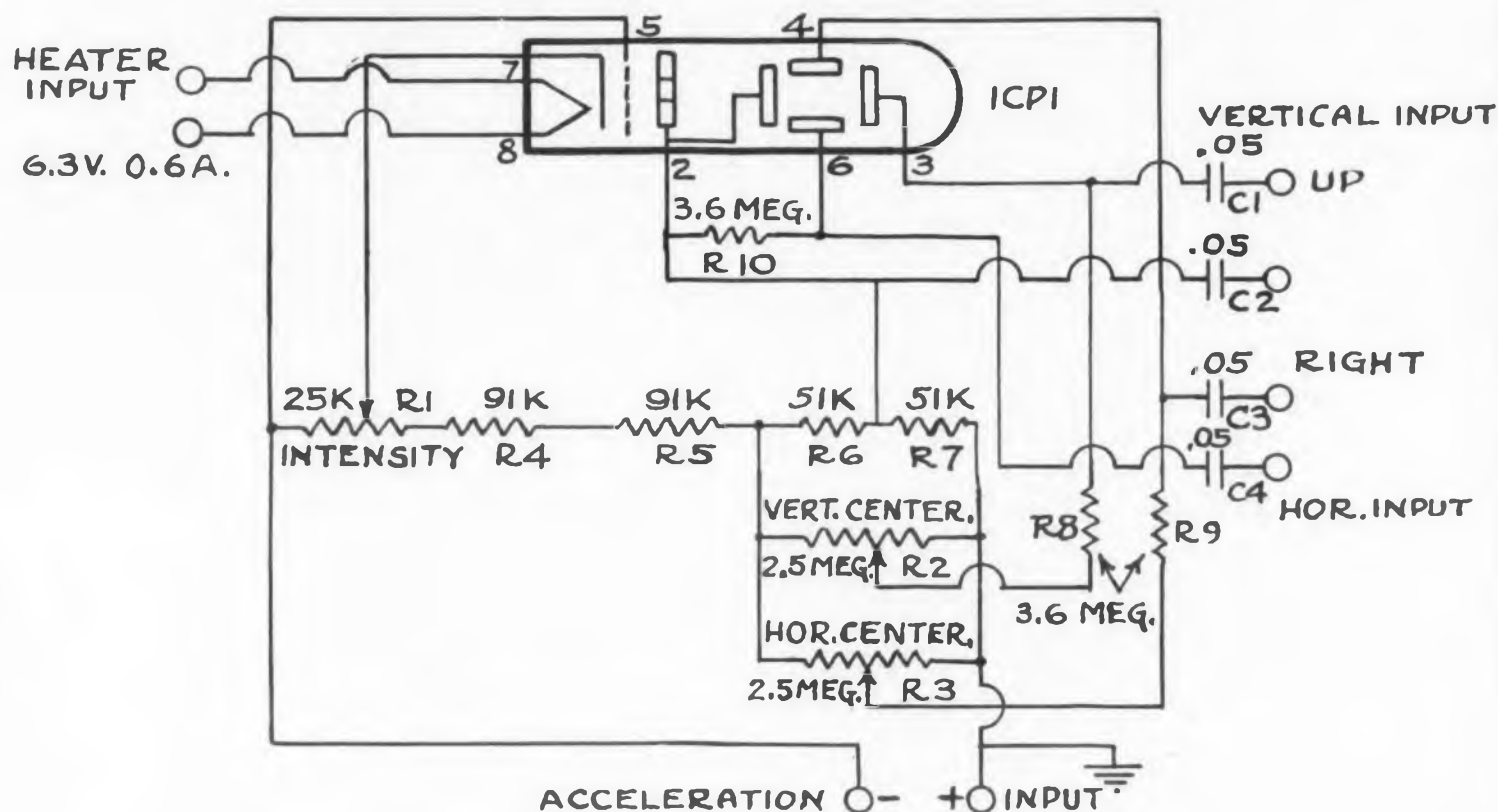

Fig. 2. Circuit diagram of the new unit. Because it is a "basic scope", it can be used in a wide range of monitoring applications.

ELECTRONIC designers wishing to incorporate Cathode-Ray oscilloscope monitoring into their electronic equipment can make use of the Type 90901 miniature, panel-mounting cathode-ray oscilloscope shown in Fig. 1, developed by James Millen Manufacturing Co., Inc. (150 Exchange St., Malden, Mass.). Complete with bezel and panel control of intensity, vertical centering, and horizontal centering, the instrument makes use of the recently developed Type 1CP1 fixed-focus cathode-ray tube (see Feb. 1953 issue, page 1), which requires no focus control and produces an extremely sharp trace.

Panel space required for the unit is the same as that needed by standard 2" square case instruments. The panel bezel is 2-11/32" square, and overall dimensions are 2-3/4" x 2-3/4" x 4-5/8". The compact design is made possible through use of the company's new subminiature knobs and insulated shaft couplings, as well as very small size potentiometers. Use of the company's efficient Mu-metal magnetic shield assures a sharp cathode-ray trace on the screen.

As can be seen from the circuit diagram shown in Fig. 2, the device is a basic oscilloscope with intensity and centering controls, but with no amplifier, sweep, or power supply. Both horizontal and vertical deflection sources, as well as heater and acceleration voltages, are to be taken from the equipment on which the oscilloscope is mounted. Since no amplifiers are normally furnished with the oscilloscope, the frequency response is good to the u-h-f band.

Vertical deflection sensitivity is 4.7v d-c or peak volts per millimeter of deflection. Horizontal deflection sensitivity is 6.9v d-c or peak volts per millimeter of deflection. Power requirements include 6.3v at 0.6amp for the heater, and 600v to 950v d-c at 32ma acceleration voltage.

The instrument is intended for a wide variety of monitoring applications. Since an oscilloscope indicates wave shape as well as amplitude, the device can be used in many applications where voltmeters and millimeters have had to suffice in the past because of size and cost limitations of oscilloscopes. Typical applications include Lissajous frequency comparison, and indication of such phenomena as null voltages, klystron mode, pulse jitter, neutralization, tuning, voltage output, power output, percent modulation, distortion, modulation, and phase shift.

One of the chief advantages of an oscilloscope over a moving-coil meter is that the former can be used for many indications, whereas, the latter usually is used for indicating only one phenomenon. Now that the size of the scope has been reduced to the small proportions of the Type 90901, electronic designers should have little difficulty in incorporating this versatile instrument into their equipment. Also, because the device is a "basic" oscilloscope, its cost is kept to a minimum. The designer can readily add any auxiliary circuits that may be required for his particular application without having to carry the cost of unnecessary circuit refinements.

# Ultra High Quality Sockets

## FOR UHF APPLICATIONS

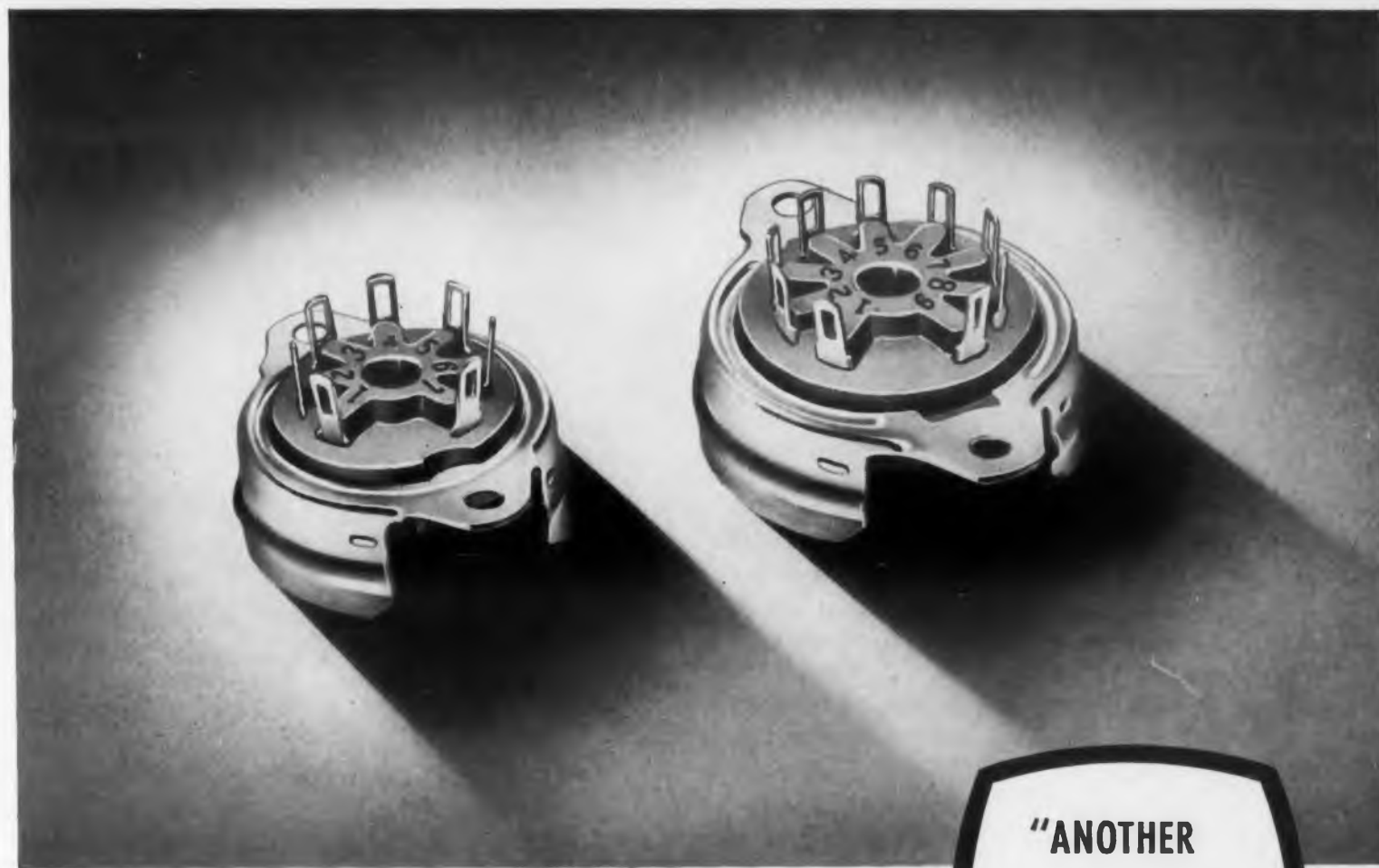

Sylvania now offers you highest quality sockets especially designed for UHF applications. Precision engineered throughout to assure minimum inductance.

Shielded bases and contacts are cadmium plated. Low-loss phenolic castings completely inclose tube pins to prevent shunted circuits.

You'll find it pays to insist on Sylvania ultra high quality parts for all your ultra high frequency requirements. For additional information and specifications, write: Sylvania Electric Products Inc., Dept. 3A-4006, 1740 Broadway, N. Y. 19, N. Y.

"ANOTHER  
IMPROVED  
PART...  
BY SYLVANIA"



# SYLVANIA

In Canada: Sylvania Electric (Canada) Ltd.  
University Tower Building, St. Catherine Street, Montreal, P. Q.

LIGHTING • RADIO • ELECTRONICS • TELEVISION

CIRCLE ED-9 ON READER-SERVICE CARD FOR MORE INFORMATION



# New Products . . .

## P-N-P Junction Transistors

Useful From D-C to Low Radio Frequencies

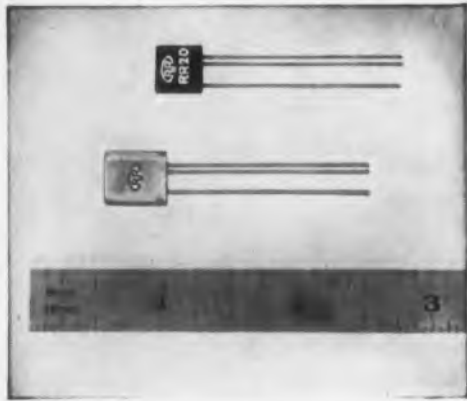

Three p-n-p Junction Transistors (RR 14, RR 20, and RR 21) for use from d-c to low radio frequency in high gain amplifiers, oscillators, and shaping circuits have been added to the

company's line. They provide excellent performance with as little as 0.5ma at 1.5v of collector voltage.

Under these conditions, the high gain type RR 20 has a current amplification of 40 and a power gain of 36db. The general purpose type RR 14 and the economy type RR 21 have a current amplification of 25. The Type RR 14 and Type RR 20 have cut-off currents of only 10 $\mu$ amp and a noise figure of 22db (1000cy). These miniature units are sealed in a thin plastic shell only 0.120" x 0.343" x 0.375". Leads may be soldered in, or clipped to plug into a standard transistor or hearing aid socket, and the asymmetrical lead spacing assures polarity and fits the standard subminiature socket. Radio Receptor Co., Inc., Dept. ED, 251 West 19th St., New York 11, N. Y.

CIRCLE ED-10 ON READER-SERVICE CARD FOR MORE INFORMATION

## Magnetic Deflection Yoke

For Push-Pull Applications



The Type Y15-5 Magnetic Deflection Yoke has been designed for military and oscilloscope applications and is especially suited to push-pull applications requiring maximum resolution and high

efficiency. It is available in normal, high, or extremely high sensitivity ranges, and fits 1-1/2" neck diameter cathode-ray tubes.

Special features of the unit include a fast recovery and minimum starting delay; exceptionally low astigmatism; minimized ringing and cross coupling oscillations; elimination of spot shift due to residual magnetism; and the reduction of effective inductance at high frequencies. Deflection angle is up to 50°.

The unit is available over a wide range of impedances in single ended or push-pull combinations. Typical specifications include an inductance of 140mh, a resistance of 145 ohms, a sensitivity of 80ma per radius of -25° at 10kv accelerating potential (sensitivities as low as 7ma are available, and a 99% recovery in 40 $\mu$ sec. Syntronic Instruments, Inc., Dept. ED, 100 Industrial Rd., Addison, Ill.

CIRCLE ED-11 ON READER-SERVICE CARD FOR MORE INFORMATION

## Sensitive Inverter

Can Be Used as a Transducer



The Model 700 Sensitive Inverter has been designed for use with vacuum tube voltmeters, oscilloscopes, voltage amplifiers, multi-meters, and servo-amplifiers to permit accurate measurements of small d-c potentials. It also can be used as

an ultra-sensitive transducer in servomechanisms and telemetering systems. Applications for the instrument include precise temperature measurements, servomechanisms, ultrasensitive null detection, computing devices, insulation measurements, telemetering, and stress analyses.

The unit can be adapted for any a-c voltage measuring device which is sensitive to 60cy voltages in the 100 $\mu$ v to 10v range, and which has an input impedance of 50,000 ohms or more. A built-in calibrator for the combined inverter and a-c measuring device assures high accuracy.

Specifications include voltage ratios (d-c input to a-c rms output) of 1:100 and 10:1, a calibrator accuracy of 0.25%, an input noise level of 3 $\mu$ v, a maximum a-c output level of 10v rms, a maximum distor-

tion in output of 2%, and a response time of 0.25sec. Ballantine Labs., Inc., Dept. ED, 700 Fanny Rd., Boonton, N. J.

CIRCLE ED-12 ON READER-SERVICE CARD FOR MORE INFORMATION

## Hook-Up Wire Kit

Is Available in 14 Colors

Manufactured to meet rigid government requirements, "Tensolon" Hook-Up Wire has been made available in 14 colors in a handy sampling spool kit for laboratories, research projects, and testing applications. The wire is furnished in sizes No. 30 through No. 20 AWG, stranded silver-plated copper conductors with a special covering that eliminates pin holes and other irregularities.

Features of the wire include extra flexibility, free stripping, high dielectric, and a temperature rating of -55°C to  $\pm$ 250°C. Tensolite Insulated Wire Co., Dept. ED, Tarrytown, N. Y.

CIRCLE ED-13 ON READER-SERVICE CARD FOR MORE INFORMATION

## Precision Potentiometers

Provide 0.002% Resolution



The Model DP-211 "Dekapot" Panel Mounting Precision Potentiometers are designed to provide a new solution to the problem of precise variable resistors for computers, control circuits, measuring instruments, and similar applications where

maximum accuracy and linearity are required. The instruments have a linearity of better than  $\pm$ 0.01% and a total resistance of better than  $\pm$ 0.05%.

Instead of the conventional single resistance element, the units have two decades of fixed resistors and an interpolating slidewire to accomplish the voltage division. The dial arrangement provides an effective scale length of 390", which is approximately the equivalent of a 100-turn helical potentiometer.

Features of the instrument include a resolution of more than 0.002%, a frequency response good to supersonic frequencies, an easily read dial, rapid settings, convenient installation, small size (3"diam x 3-1/2" to 6" deep), and a long life (more than 500,000 cycles). The units can be furnished in total resistances of 10,000 ohms, other values being available on order. Brown Electro-Measurement Corp., Dept. ED, 4635 S. E. Hawthorne Blvd., Portland 15, Ore.

CIRCLE ED-14 ON READER-SERVICE CARD FOR MORE INFORMATION



## Digital Voltmeter

### Provides 100 Readings/Sec



The Digital Voltmeter has been designed to indicate (in decimal or binary numerical digits) voltages with secondary standard accuracy over a wide range of inputs. The unit features a speed of up to 100 readings/sec and a 4-digit in-line read-out to indicate the measured voltage with an error of less than 0.1% of the input reading, or 0.00075v, whichever is greater.

Input impedance is 10 megohms and the shifting of the decimal point is accomplished automatically with no manual range switching, to provide a continuous range from 0.001v to 999.9v. The device is non-cyclic in operation and provides instant verification of calibration by means of a front panel switch which momentarily connects an internal standard voltage cell to the voltmeter input.

The unit compares the input voltage with a discreetly variable reference system, and if a difference occurs, the reference is made to balance the input through a logically sequenced millisecond relay computer. Non-Linear systems, Dept. ED, Del Mar Hotel, Del Mar, Calif.

CIRCLE ED-15 ON READER-SERVICE CARD FOR MORE INFORMATION

## Miniature Terminal Blocks

### Rugged, Meet Spec MIL-P-14C

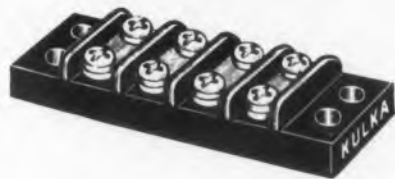

Designed to meet the need for Miniature Terminal Blocks, these units have the electrical characteristics and physical stability of blocks twice their size. They have application in electronic assemblies and meet specification MIL-P-14C.

Measurements include an overall length of 6", a height of 5/16", and a width of 5/8". Terminals are completely separated by the high barriers, which increase creepage distance between live parts and eliminate possible shorts from frayed wires.

Constructed of molded thermosetting plastics, the units can be furnished with 1 to 22 terminals (44 binder screws). Also available are marker strips of fibre or bakelite for placing beneath blocks for designating terminals and for extra insulation.

Kulka Electric Mfg. Co., Inc., Dept. ED, 633 So. Fulton Ave., Mt. Vernon, N. Y.

CIRCLE ED-16 ON READER-SERVICE CARD FOR MORE INFORMATION

## Telephone Relay

### Compact, Sensitive Unit



The Type 6QA Telephone Relay is a compact, sensitive unit of interest to the electronic design, development, and research engineer. A large cubic area is provided for winding (maximum 20,000 ohm coil), and its construction makes possible mounting and wiring from under the chassis. The unit is also available with a plug-in and dust cover adaptation for use in panels and annunciator racks. Phillips Control Corp., Dept. ED, Joliet, Ill.

CIRCLE ED-17 ON READER-SERVICE CARD FOR MORE INFORMATION

## Subminiature Power Supplies

### Compact, Plug-in Units



Four Subminiature Power Supplies (Models 115, 116, 120, and 121), for use in engineering and research laboratories, have been added to the company's line. These plug-in units have a 100% salvage value because when a project is complete, they may be unplugged and used elsewhere.

Common characteristics of the four units include the chassis isolated from the circuit, so that either polarity of the high voltage may be grounded; an input of 105v to 125v a-c, 60cy; and a net weight of 1 lb. Model 115 has a regulated d-c output of 150v at 12ma (max); and Model 116, a regulated d-c output of 108v at 12ma. Model 120 has an unregulated d-c output of 310v at 5ma and 230v at 20ma; and Model 121, an unregulated d-c output of 170v at 5ma and 100v at 35ma. In all units filament voltage is 6.3v a-c at 0.9amp. C. J. Applegate & Co., Dept. ED, 1816 Grove St., Boulder, Colo.

CIRCLE ED-18 ON READER-SERVICE CARD FOR MORE INFORMATION

## Germanium Transistors

### Point Contact and Junction Types

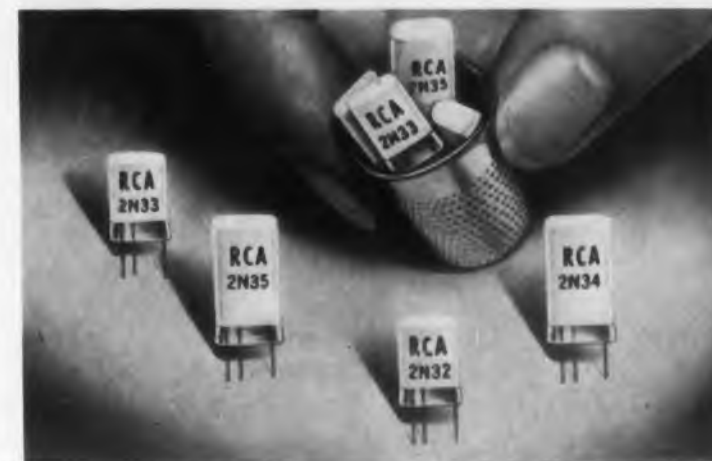

Four types of Germanium Transistors (two point-contact and two junction types) have been added to the company's line. Suggested applications include pulse or switching service, electronic computers, counters, and on-off control devices, as well as for low power, audio-frequency applications, and in oscillator circuits at frequencies up to 50Mc.

Type 2N32, a point-contact unit, is intended for use in pulse or switching applications where an operating frequency for voltage-gain cutoff of 0.9Mc, an operating frequency for current-gain cutoff of 2.7Mc, and a high current amplification factor are important design considerations. Another point-contact type, the Type 2N33, is intended for use in oscillator service at frequencies up to 50Mc.

The Types 2N34 and 2N35 are junction transistors of the p-n-p and n-p-n types respectively, and both units have been designed for use in low power, audio-frequency applications. Characteristics include extremely low voltage operation; a current amplification factor less than, but approaching, unity; and a high operating power gain. Radio Corp. of America, Dept. ED, Harrison, N. J.

CIRCLE ED-19 ON READER-SERVICE CARD FOR MORE INFORMATION

## Miniature Connector Kit

### For Any Number of Circuits

A "Varicon" Connector Kit contains all the parts necessary for assembling a wide variety of connectors with any number of circuits required. The kit has many applications for the electronic design engineer, especially on prototype models of electronic equipment.

Variations in arrangement of contacts at the time of assembly make possible the construction of connectors with the same number of contacts, but with different polarity. Features of the "Varicon" connector include identical male and female components, only 4 basic parts, high current and voltage rating, and low resistance and capacitance. Elco Sales Co., Dept. ED, 190 W. Glenwood Ave., Philadelphia, Pa.

CIRCLE ED-20 ON READER-SERVICE CARD FOR MORE INFORMATION

MOTOR & CONTROL

KEYING

TELEPHONE

ROTARY

MIDGET

Relay Sales  
1958 CATALOG

Write for New  
16 Page Catalog

Send us your relay requirements.  
You will receive immediate quotations.

samples on request. Phone, Wire or Write

**Relay Sales**

SEeley 8-4146

4721 W MADISON STREET

DEPT. 14 CHICAGO 44, ILLINOIS

CIRCLE ED-21 ON READER-SERVICE CARD FOR MORE INFORMATION

ELASTIC STOP NUT CORPORATION OF AMERICA  
Dept. R17-657 2330 Vauxhall Road, Union, N. J.

Please send me free design information on



... the slotted tubular steel pin  
with chamfered ends  
used for production economies in replacing

- |                                      |   |
|--------------------------------------|---|
| <input type="checkbox"/> a rivet     | <input type="checkbox"/> a set screw    |
| <input type="checkbox"/> a hinge pin | <input type="checkbox"/> a bolt and nut |
| <input type="checkbox"/> a stop pin  | <input type="checkbox"/> a cotter pin   |
| <input type="checkbox"/> a taper pin | <input type="checkbox"/> a dowel        |

NAME \_\_\_\_\_ TITLE \_\_\_\_\_

FIRM \_\_\_\_\_

STREET \_\_\_\_\_

CITY \_\_\_\_\_ ZONE \_\_\_\_\_ STATE \_\_\_\_\_

CIRCLE ED-22 ON READER-SERVICE CARD FOR MORE INFORMATION

## New Products...

### Precision Potentiometer Kit Speeds Servo Design Work



This Potentiometer Kit "B", consisting of "vairitized" Type RVC2 potentiometers, mounting plates, clamp rings, servocalculator, and brochure, provides maximum flexibility in "bread-

boarding". The kit helps to speed design work for the experimenting servo engineer by permitting single or ganged precision potentiometers to be assembled quickly as required.

In addition to one 360° sine potentiometer, the additional 14 units in the kit are linear, provided with 3 taps equally spaced along the winding, so that, in effect, the winding comprises 4 equal sections. With shunt resistors properly connected across the taps, these 4 sections may be used to simulate non-linear functions. A "Servocalculator" is provided with the kit to speed and simplify computations. Servotrol Co., Dept. ED, Framingham Centre, Mass.

CIRCLE ED-23 ON READER-SERVICE CARD FOR MORE INFORMATION

### Glow Discharge Tube Tester Also Tests Selenium Rectifiers



This Tester is an instrument designed for checking the condition of glow discharge tubes or selenium rectifiers. Other uses for the instrument include the forming of electro-

lytic condensers, testing of high impedance relays for closing and opening currents and voltages, as a continuity meter or ohmmeter, etc.

The unit will test the following tubes: OA2, OA3, OB2, OB3, OC3, OD3, 874, 1265, 1266, 5787, 6073, 6074, 1B46, 1B47, 991, 5651, 5783, 6213, NE16, NE32, VXR130, etc. Although the instrument will test primarily the 130v rms and 160v rms types of selenium rectifiers, it is possible also to test other types. Power requirements are under 50w, 115v, and 60cy. Lloyd's Enterprises, Dept. ED, Box 313, Altadena, Calif.

CIRCLE ED-24 ON READER-SERVICE CARD FOR MORE INFORMATION

C-D-F makes it!

## Silicone TAPES and SHEETS

**VARNISHED FIBERGLAS**  
High temperature resistance  
High dielectric strength  
Low dielectric loss  
Resistant to moisture  
High tensile strength  
Good flexibility

**SILICONE RUBBER FIBERGLAS**  
High temperature resistance  
High dielectric strength  
Low dielectric loss  
Resistant to moisture  
High tensile strength  
Extreme flexibility



C-D-F Silicone Varnished Fiberglass cloth, and Silicone Rubber-coated Fiberglass cloth meet A.I.E.E. Class H electrical insulation requirements. They resist mild alkalis, non-oxidizing acids, mineral oils, oxygenated solvents. Silicone Rubber Fiberglass is recommended for many applications where a flexible material with good thermal conductivity is required. C-D-F Silicone tapes and sheets are available in a wide range of sizes in continuous rolls. For complete details, write for Technical Bulletin #47.

THE NAME TO REMEMBER... SILICONE TAPES AND SHEETS

*Continental-Diamond Fibre Company*  
NEWARK 107, DELAWARE

CIRCLE ED-25 ON READER-SERVICE CARD FOR MORE INFORMATION

(Advertisement)

### New Wide-Range Capacitor



C.T.C.'s new CST-50 capacitor surpasses the range of others many times larger in physical size. This is due to a new and unusual tunable\* element that practically eliminates losses due to air dielectric. As a result, a large minimum to maximum capacity range (1.5 to 12  $\mu\text{fd}$ ) is realized. Yet the CST-50 stands only 19/32" high when mounted, is less than 1/4" in diameter, and has an 8-32 threaded mounting stud. The mounting stud is split so that the tuning sleeve\* can be securely locked without causing an unwanted change in capacity.

The CST-50 is provided with a ring terminal having two soldering spaces. The tuning sleeve\* is at ground potential. All C.T.C. materials, methods and processes meet applicable government specifications. Send for details. Cambridge Thermionic Corporation, 457 Concord Avenue, Cambridge 38, Mass.

\*Patent Applied For

CIRCLE ED-26 ON READER-SERVICE CARD FOR MORE INFORMATION



## Wire-Wound Resistors Performance Beyond MIL-R-93A



“Durameg” Wire-Wound Resistors have performance characteristics which are above and beyond the requirements of military specification MIL-R-93A. They can be used up to a hot temperature of 150°C instead of the usual 105°C hot spot limit, and full wattage ratings at 105°C of the units are four to five times the 85°C MIL ratings for conventional resistors.

Features include a high mechanical ruggedness to give full protection against handling and high G shock damage, imperviousness to moisture and salt water immersion, resistance to electrolysis failures, and the lug terminals are molded as an integral part of the winding form.

These resistors are suitable for full-load operation at any ambient temperature up to 105°C and with appropriate wattage derating, may be used up to 150°C. Standard resistance tolerances are  $\pm 1\%$ ,  $\pm 0.5\%$ ,  $\pm 0.25\%$ , and  $\pm 0.1\%$  at 25°C  $\pm 1^\circ\text{C}$ . Sprague Electric Co., Dept. ED, North Adams, Mass.

CIRCLE ED-27 ON READER-SERVICE CARD FOR MORE INFORMATION

## Subminiature Delay Line Provides Delay of 2.5 $\mu\text{sec}$

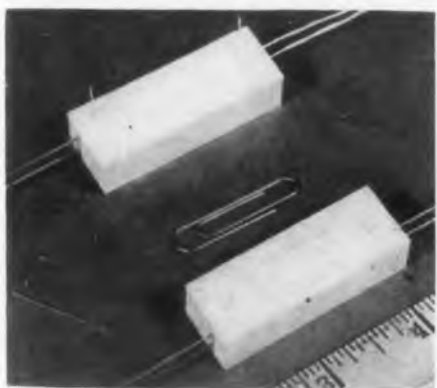

The Type A1557 Subminiature Delay Line is a compact, potted unit designed to be mounted easily and firmly on a panel of any type. It is of lumped-constant design.

Characteristics of the unit include

a time delay of 2.5  $\mu\text{sec}$  (or 5  $\mu\text{sec}$  if a reflection is used), and an attenuation of 2db. A number of these units can be used in series to give any integral multiple of the basic 2.5  $\mu\text{sec}$  delay. Characteristic impedance is 2800 ohms. The unit is sealed in a very stable thermosetting resin. The rise time of 0.5  $\mu\text{sec}$  is achieved in a very compact construction by the use of mutual inductance between elements. Working voltage ranges up to 500v. The unit measures 1-31/32" x 11/16" x 1/2" and weighs 0.68 oz. Jacobs Instrument Co., Dept. ED, Bethesda 14, Md.

CIRCLE ED-28 ON READER-SERVICE CARD FOR MORE INFORMATION

# When you test— USE THE BEST!



# PRD

## VHF-UHF- Microwave Test Equipment

The PRD line of RF Test Equipment is the most complete line available today covering the entire frequency range from .01 to 40 kilomegacycles per second. Every unit in the line is rigorously engineered and meticulously manufactured to the highest standards attainable. The excellence of PRD equipment, in quality, dependability and accuracy is well attested by use in the leading laboratories throughout the world. For consultation on the application of standard or special PRD equipment to your problems call or write our skilled staff of engineers today, without obligation.



a direct reading noise source permits measurements of noise factors up to 20 db for r-f amplifiers and receivers operating in the range from 10 to 1000 mc/s. A TT-1 coaxial diode with a nominal input impedance of 50 ohms is used. VSWR is approximately 1.25, housed in handsome steel cabinet.

THE NEW EXPANDED PRD LINE OF RF TEST EQUIPMENT INCLUDES — Frequency Measuring Devices, Signal Sources and Receivers, Attenuators and Terminations, Transmission Line Components, Impedance Measurement and Transformation Units, Bolometers, Detection and Power Measurement Equipment.

✓ WRITE TODAY  
FOR YOUR COPY  
OF THE NEW  
PRD CATALOG —  
NO OBLIGATION



## Polyscience RESEARCH & DEVELOPMENT COMPANY · Inc



55 JOHNSON STREET, BROOKLYN 1, NEW YORK  
WESTERN SALES OFFICE: 741 1/2 N. SEWARD ST.  
HOLLYWOOD 38, CALIFORNIA

CIRCLE ED-29 ON READER-SERVICE CARD FOR MORE INFORMATION



## Another FLASH-O-LENS at work ...checking soundness of welds at INTERNATIONAL HARVESTER



By lighting and magnifying welded parts with FLASH-O-LENS, International Harvester Company's Memphis Plant guards against the most minute cracks in the welds.

FLASH-O-LENS offers a quick, simple way of detecting defects—of maintaining product quality. Built-in bulb brightly illuminates the inspection area—accurately ground lenses give sharp, detailed enlargement.

Battery and plug-in models from \$10.65. Write for free literature on applications, types, prices.

### E. W. PIKE & COMPANY

NORTH AVENUE

ELIZABETH 3, N. J.

CIRCLE ED-32 ON READER-SERVICE CARD FOR MORE INFORMATION



**INSTANT, ACCURATE  
READINGS AND SETTINGS ...**

*Distinctive Appearance  
for your instruments!*

NOW you can give your instrument panels distinctive appearance—as well as greater convenience and accuracy—with the new easy-to-read RA Precision DUODIAL ...

▶ Designed for accurate readings on multi-turn rotational devices (such as helical potentiometers, coils, threaded positioning devices, etc.) the RA provides two scales ... an inner to show rotational position in a full 360° circle, and an outer to show number of turns (up to 15) completed from "zero" point.

▶ Unique jump mechanism allows outer dial to remain stationary until inner dial has completed full revolution—then dial "jumps" to next numeral. Assures quicker readings—greater accuracy. Together, dials give a direct decimal reading—without interpolation—for 10-turn components such as Model A Helipot.

▶ Vibration-proof lock is instantly set to hold reading—as quickly released for new setting.

▶ Completely pre-assembled. Installation is quick and simple. Fits both thick and thin (1/8" and less) panels.

The precision "feel" and handsome appearance of the RA DUODIAL—recessed black numerals on satin chrome dial with non-metallic parts of black nylon—add quality and distinction to the finest instrument panels.

Write for Data File #624

**THE Helipot CORPORATION**  
A subsidiary of Beckman Instruments, Inc.  
SOUTH PASADENA, CALIF.

The new turns—indicating  
**MODEL RA**  
*Precision*  
**Duodial**

See one... try one... get complete details on the Model RA Precision DUODIAL from your nearest HELIPOT representative. Or write direct!

CIRCLE ED-33 ON READER-SERVICE CARD FOR MORE INFORMATION

## New Products ...

### Variable Transformer Rated 0-135v, 3.0amp, 400VA



The Type 300 BU Variable Transformer has been designed for use as a laboratory and industrial instrument, or a component. Its variable output voltage ranges from zero to 17% above the input voltage. Ratings include a 115v input, and 0-135v, 3.0amp (max), and 400VA (max) output.

Features of the unit include smooth, continuous control, no waveform distortion, high efficiency, rugged construction, excellent regulation, 50/60cy operation, standard mountings, and a new type of brush construction. The device also can be used in stacked assemblies for series-parallel or 3-phase operation. Standard Electrical Products Co., Dept. ED, 2240 E. Third St., Dayton 3, Ohio.

CIRCLE ED-34 ON READER-SERVICE CARD FOR MORE INFORMATION

### Multi-Scale Meter Exposes One Scale At a Time



The "Multi-Dialer" is a Multi-Scale Meter available with five self-contained ranges in volts, milliamperes, and amperes, or custom engineered to specifications. Only one scale is exposed to view at a time; and at the same time the unit automatically switches the appropriate internal or external circuitry associated with that scale. This simplification of multi-scale minimizes the chance of error.

The unit may be used as a panel instrument, mounting to standard JAN 3-1/2" dimensions, or as a complete self-contained portable instrument for field or laboratory use. A combination handle and stand permits its use on or above the bench as well as installed in equipment panels. Marion Electrical Instrument Co., Dept. ED, Manchester, N. H.

CIRCLE ED-35 ON READER-SERVICE CARD FOR MORE INFORMATION

Yes ... of course Radio Receptor Co.  
is producing ...

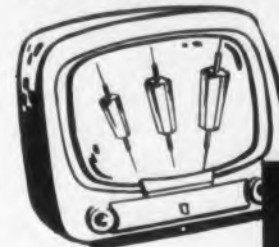

### MIXER DIODES For U.H.F. — TV Tuners

The taper of the diode case allows polarity identification at a glance or at a touch thus speeding up assembly and reducing the possibility of error in connecting the diode into the circuit.

Featuring  
polarity at  
a glance!

current  
flow

**1N72** Germanium Noise figure as a mixer better than 15DB @ 750 MC with 43.5 MC-IF circuit having a noise bandwidth of 3 MC and a noise figure of 4 DB.

**1N82** Silicon Noise figure as a mixer better than 12DB @ 750 MC with 43.5 MC-IF circuit having a noise bandwidth of 3 MC and a noise figure of 4 DB.

**1N110** Germanium Noise figure as a mixer better than 12DB @ 750 MC with 43.5 MC-IF circuit having a noise bandwidth of 3 MC and a noise figure of 4 DB.

Supplied with or without pigtail leads.

Let Radio Receptor Co. Standard U.H.F. Diodes figure in your N.F. problems ... Send us your specifications!

SELETRON & GERMANIUM DIVISION  
**RADIO RECEPTOR COMPANY, INC.**  
Since 1922 in Radio and Electronics  
SALES DEPARTMENT: 251 WEST 10TH STREET • NEW YORK 11, N. Y.  
FACTORY: 84 NORTH 9TH STREET • BROOKLYN 11, N. Y.

CIRCLE ED-36 ON READER-SERVICE CARD FOR MORE INFORMATION

*Wider* **CAPACITY RANGES**  
THAN EVER BEFORE

With *Jennings* **RADIO** NEW vacuum variable capacitors having ratios of capacitance change **BETTER THAN 150:1**



Maximum capacities as high as 2000 mmfd.  
Minimum capacities as low as 1 mmfd.

JENNINGS UC-230  
50-250 mmfd., 20 KV  
RATIO OF 5:1

JENNINGS UCSM  
3-500 mmfd., 15 KV  
RATIO OF 167:1

JENNINGS UCSL  
315-1000 mmfd., 35KV  
RATIO OF 183:1

WRITE US FOR INFORMATION. LITERATURE MAILED ON REQUEST

JENNINGS RADIO MANUFACTURING CORP. - 970 McLAUGHLIN AVE. - P. O. BOX 1278 - SAN JOSE 8, CALIF.

CIRCLE ED-37 ON READER-SERVICE CARD FOR MORE INFORMATION

## Miniature Thermostat

Meets Government Specifications



The Type VAL 90 is a Miniature, hermetically sealed Thermostat, designed to meet government specifications. Close tolerances in setting and differential are possible without delay in deliveries. The unit holds its setting permanently and is especially useful in sealed components where a failure would be costly and inconvenient.

One terminal is the pin of an eyelet hermetic header, and the cylindrical brass capsule is the other terminal. The unit is a friction couple snap action type with the bimetal being thermally a part of the capsule, making it quite sensitive to changes of temperature. Both the temperature and differential settings are adjustable. The unit can be used without the capsule for on-the-job adjustment.

Settings are furnished to 260°C, with a capacity of 40w, 30v d-c or a-c and 100w, 120v d-c or a-c. Valverde Labs., Dept. ED, 252 Lafayette St., New York 12, N. Y.

CIRCLE ED-38 ON READER-SERVICE CARD FOR MORE INFORMATION

## Slide Rails

For Rack and Panel Applications

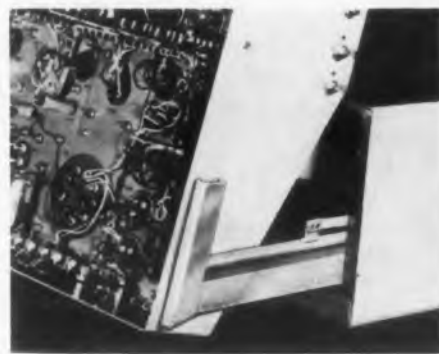

The "Servislides", designed and approved for military use for all rack and panel applications, are now available for civilian use. The units can handle equipment up to 75 lb, with capacities to

50 lb for applications subject to shock and vibration.

Positive and self-locking, the units permit complete withdrawal or "tilt-up" of the apparatus for top and bottom inspection, and service and adjustment under operating conditions. The devices are available in a choice of sizes and are constructed with formed and welded stainless steel and chrome-plated brass rollers mounted on stainless-steel slides. Remler Co., Ltd., Dept. ED, 2101 Bryant St., San Francisco 10, Calif.

CIRCLE ED-39 ON READER-SERVICE CARD FOR MORE INFORMATION

# TRANSFORMERS

The Keystone Products Company is a leading producer of all types of custom engineered transformers to the rigid government standards.

We pride ourselves in our modern methods and facilities, which makes it possible for us to maintain a prompt delivery schedule.

Your inquiry will have our prompt attention.



# MAGNETIC AMPLIFIERS

Keystone has standard magnetic amplifiers available for immediate delivery. These packaged magnetic amplifiers known as "Moto-Mags" are meeting with welcome approval by design engineers who find that they are saved valuable design time and cost. At present the stock line of "Moto-Mags" are for use with 400 cycle excitation. Send today for descriptive literature giving models available and prices. There may be a "Moto-Mag" to fill your need.



## KEYSTONE PRODUCTS COMPANY

UNION CITY 9, NEW JERSEY • CALL UNION 6-5400

CIRCLE ED-40 ON READER-SERVICE CARD FOR MORE INFORMATION





# PRECISION paper tubes

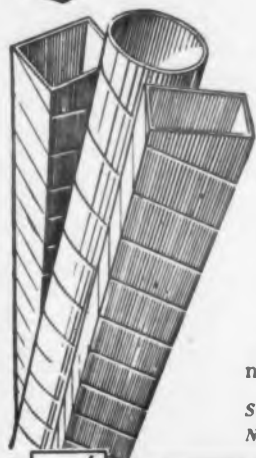

Rigid manufacturing standards are employed in the construction of Precision Paper Tubes to provide high quality and cost economy. Close tolerance control insures exacting adherence to your specifications, plus maximum insulation, moisture-resistant and heat dissipation characteristics.

Precision Paper tubes are spirally wound and die-formed under pressure for increased strength (15 to 20%) and lighter weight. Available in kraft, fish paper, acetate, combination, phenol impregnated . . . any shape, length, ID or OD.

Send specifications for free sample and ask for New Arbur List of over 1500 sizes.



## PRECISION PAPER TUBE CO.

2055 W. Charlestan St. Chicago 45, Ill.  
Plant No. 2, 79 Chapel St., Hartford, Conn.  
Also Mfrs. of Precision Coil Bobbins

CIRCLE ED-41 ON READER-SERVICE CARD FOR MORE INFORMATION



## Checks Electrical Characteristics SPEEDILY . . . ACCURATELY

Resistive, capacitive or inductive characteristics of products or components are rapidly and accurately checked by the Brush Model BL-1502 Deviation Test Bridge. This instrument indicates percentage of deviation of value of a tested component from a standard on a large, easily read dial. The very high indicating speed permits testing at rates up to 4,000 elements per hour. Write for a BL-1502 catalog sheet. Brush Electronics Company, Department J-6, 3405 Perkins Avenue, Cleveland 14, Ohio.

BRUSH ELECTRONICS COMPANY

formerly  
The Brush Development Company.  
Brush Electronics Company  
is an operating unit of  
Cleveland Corporation



CIRCLE ED-42 ON READER-SERVICE CARD FOR MORE INFORMATION

## New Products . . .

### Rotary Relay Can Withstand 125G's Shock



The Type A52-111 is a compact, "High G", rotary type hermetically sealed Relay designed to satisfy the requirements of specification MIL-R-6106. This dpdt unit incorporates the identical rotary armature structure, with balanced design and unique contact linkage, which has been AN approved in larger and heavier enclosures.

The unit features a two-coil magnetic circuit with balanced rotary armature, and a close-coupled contact linkage involving no flexible leads, which provides high resistance to shock, vibration, and acceleration. Specifications include a rating of 10amp resistive and inductive; a 6amp motor load at 29v d-c or 115v a-c, with a maximum 400cy; a coil of 0.160amp max continuous duty; an operating period of 3 hours minimum; and a weight of 4.8 oz. The device can operate 50,000 cycles (min.) and it withstands 125G's of shock without damage. Electrical Products Corp., Dept. ED, 1100 North Main St., Los Angeles 12, Calif.

CIRCLE ED-43 ON READER-SERVICE CARD FOR MORE INFORMATION

### Variable Transformer With Special Brush Track Surface

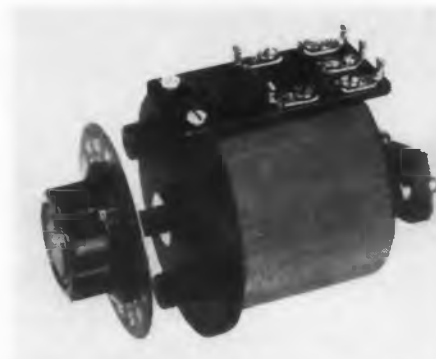

"Duratrak", a brush-track surface, is now being applied on all of the company's "Variac" autotransformers. This silver alloy coating, applied to the brush track, prevents contact surface deterioration even when operation at fixed brush settings is carried on continuously.

With this coating the autotransformer has been found to be as durable as a fixed-ratio autotransformer. Long and trouble-free life is assured even in many types of severe industrial applications. General Radio Co., Dept. ED, 275 Massachusetts Ave., Cambridge 39, Mass.

CIRCLE ED-44 ON READER-SERVICE CARD FOR MORE INFORMATION

## AMGLO DC MOTOR

FOR ACCURATE  
TIMING CONTROL  
FROM BATTERIES  
OR DC LINE



### SPEED

Magnetic reed drive provides constant speeds with instantaneous self-start to full speed. Speeds from 1 REV. PER DAY to 900 REV. PER MINUTE.

### SIZE

3 1/2" x 2 1/2" x 1 5/8", Wght.—10 oz. and 2" x 3 1/2" x 3 3/4", Wght.—15 oz.

### VOLTAGES

From 3 to 110 Volts. These units are custom built to your requirements: voltage—current—speed—torque.

Write for details and recommendations

## AMGLO CORPORATION

2037 W. Division St., Chicago 22, Illinois

CIRCLE ED-45 ON READER-SERVICE CARD FOR MORE INFORMATION

*Top-liner*  
for Top Designers

PUSH BUTTON CASTELL  
LOCKTITE HOLDER AND  
CASTELL IMPORTED LEAD

- One-hand clutch operation avoids touching lead, smearing fingers or drawing.
- Exclusive collet holds lead in bulldog grip, prevents it slipping back into holder.
- Clean, balanced, efficient for every type of drawing, sketching, rendering, coloring.

**CASTELL Imported Lead**

18 degrees, 7B to 9H—gives more prints — cleaner and sharper prints — than any other drawing lead. Lasts 25% to 33 1/2% longer. Black or colored. Your Drawing and Art Supply Dealer has them.

the drawing pencil with the Master Degrees

AW. FABER-CASTELL  
PENCIL COMPANY, INC., NEWARK, N. J.

CIRCLE ED-46 ON READER-SERVICE CARD FOR MORE INFORMATION



## Repeat Cycle Timer

Stable, Versatile Unit



This electronic Repeat Cycle Timer has been designed for use in tube testing, heat cycling, life testing, sampling, flight testing, and in similar applications. The unit employs a single electron tube to charge a resistance-capacitance network. The ON cycles are adjustable from 0.2sec to 200sec and OFF from 0.1sec to 60sec.

Operation of the instrument is such that one cycle initiates the next cycle without any moving parts or external operation. It operates on 105v to 120v, 60cy, and incorporates a relay of rugged construction with high resistance to shock and vibration, and dpdt contacts rated 10amp at 115v, or 2amp at 460v, non-inductive. G. C. Wilson & Co., Dept. ED, 2 North Passaic Ave., Chatham, N. J.

CIRCLE ED-47 ON READER-SERVICE CARD FOR MORE INFORMATION

## WWV Receiver

With  $1\mu\text{v}$  Sensitivity on All Frequencies



The Model WWVR Receiver makes it possible to refer instruments to standard WWV transmissions at any time without special setup. It is of special interest to electronic design, development, and research engineers who wish to check their equipment against these standard transmissions.

Features include three plug-in front ends which permit instantaneous switching to optimum frequency for reception of Standard Radio Frequency transmissions; a highly selective audio system which can be switched in for noise-free presentation of standard audio frequencies; three individual inputs for tuned antennas, and one common input for broad-band antenna use (either balanced 300 ohm or unbalanced 72 ohm input may be used); and four tuned circuits at signal frequency, with a sensitivity better than  $1\mu\text{v}$  on all frequencies. Specific Products, Dept. ED, 5864 Hollywood Blvd., Hollywood 28, Calif.

CIRCLE ED-48 ON READER-SERVICE CARD FOR MORE INFORMATION

# RAYTHEON

## for TRANSISTORS

Raytheon PNP Germanium Junction Transistors uphold the reputation for high quality and fine performance which Raytheon has earned during 14 years as the leading designer and producer of sub-miniature tubes and 5 years as a foremost manufacturer of germanium diodes.

Raytheon Junction Transistors are now in quantity production. Call or write the Raytheon office nearest you for newly revised and expanded data as well as price and delivery information.

Transistor Operation Racks — A Step in Raytheon Junction Transistor Production

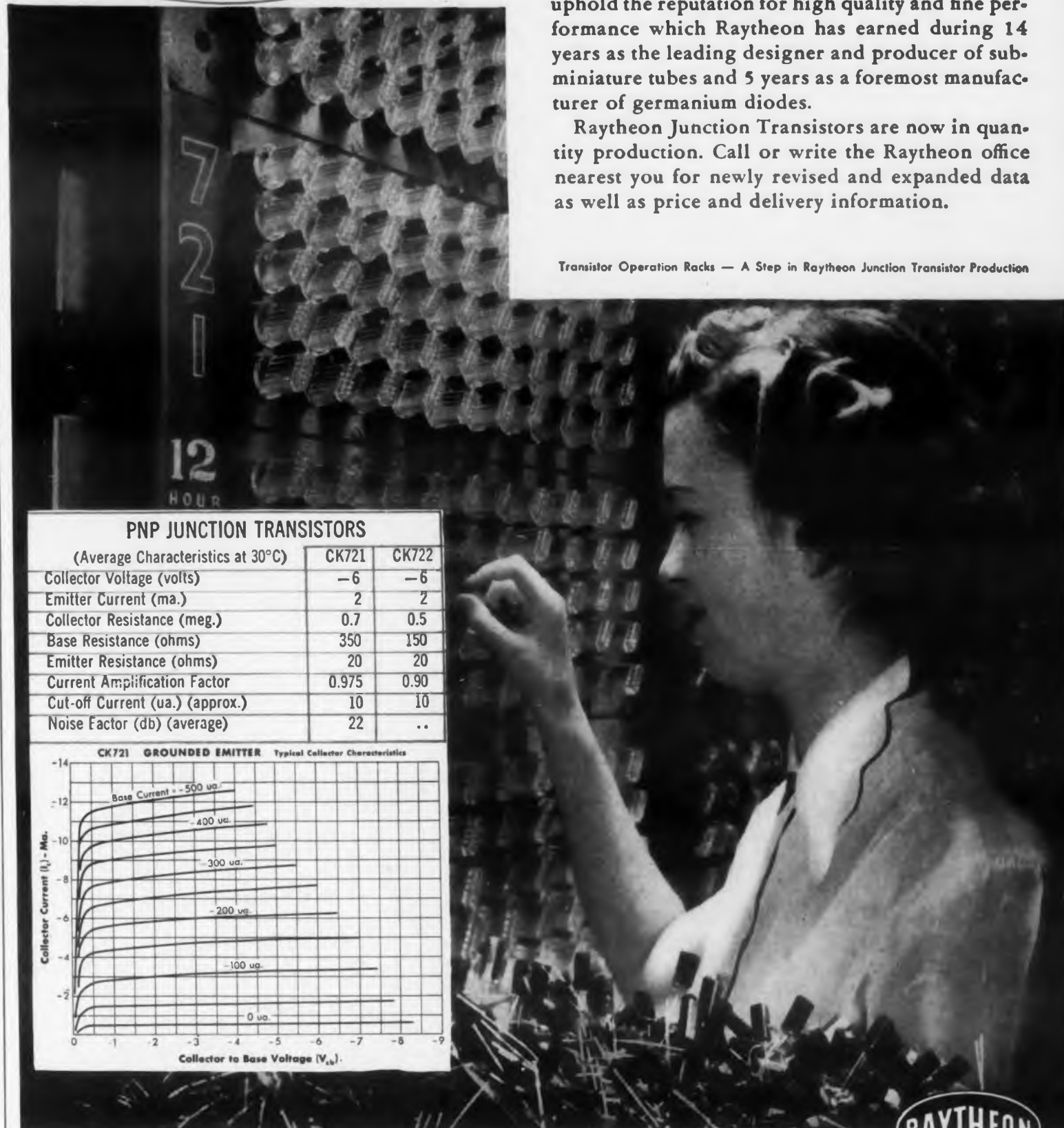

### PNP JUNCTION TRANSISTORS

(Average Characteristics at 30°C)	CK721	CK722
Collector Voltage (volts)	-6	-6
Emitter Current (ma.)	2	2
Collector Resistance (meg.)	0.7	0.5
Base Resistance (ohms)	350	150
Emitter Resistance (ohms)	20	20
Current Amplification Factor	0.975	0.90
Cut-off Current (ua.) (approx.)	10	10
Noise Factor (db) (average)	22	..

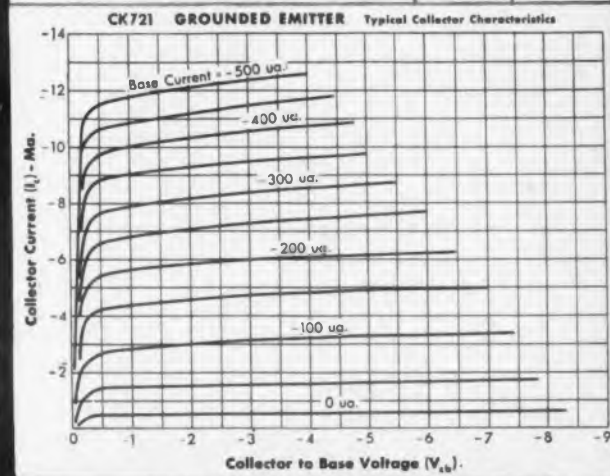

RAYTHEON MANUFACTURING COMPANY

Newton, Mass. Signal 4-7500 • Chicago, Ill. MA 1-3270 • New York, N.Y. UN 1-4800 • Los Angeles, Calif. WA 1-2024

RAYTHEON MAKES ALL THESE:

RELIABLE COMMERCIAL AND INDUSTRIAL TUBES • VACUUM TUBES AND TRANSISTORS • SPECIALTY TUBES • RECTIFIERS • RECTIFIER AND FILTER TUBES

CIRCLE ED-49 ON READER-SERVICE CARD FOR MORE INFORMATION

## Design Simplified...



### with the **Metron** VARIABLE SPEED DRIVE

- Permanently lubricated
- Your choice of 6 controls
- Speeds up to 10,000 RPM
- Nominal output .025 HP

• For further information about how Metron units can simplify your costly speed changing problems, write for Bulletin 99.



**Metron**

Model 3 B lever  
type control

Design engineers at Century Geophysical Corporation make use of the Metron Variable Speed Changer to give them continuously adjustable chart speeds in their miniature oscillograph.

Century engineers find that it is simpler and more economical to use Metron Miniature units as components than to design and build their own.

Metron Variable Speed Changers are designed into countless products that call for changes in speed. The units are small—only 4 3/16" long—to fit minimum space. They are smooth and accurate in operation and cover infinitely variable output speeds from 5:1 step down thru 1:1 to 1:5 step up.

**INSTRUMENT COMPANY**  
450 LINCOLN ST., DENVER 9, COLO.

CIRCLE ED-50 ON READER-SERVICE CARD FOR MORE INFORMATION

## PLASTIK-707

THE NEW  
*Spray-On*

ONLY  
\$125  
per 12 oz.  
CAN



**PROTECTIVE  
AND  
INSULATING COATING**  
For GENERAL and  
INDUSTRIAL USES

ONE  
COAT  
LASTS  
indefinitely

DRIES  
IN 10  
minutes

A CRYSTAL CLEAR - WATER WHITE  
ACRYLIC RESIN  
There are hundreds of uses  
**HERE ARE A FEW:**

- On electrical, television, and ignition components to prevent leakage and reduce corona.
- On all polished silver, brass, copper, chrome to prevent tarnish and corrosion.
- On steel parts and hardware to prevent rust and deterioration.
- On record cards, labels, important papers, documents, prints, drawings to moisture-proof and prevent smudging.
- On canoes, boats, model aircraft to replace dopes and varnishes.
- On sports equipment, outdoor furniture, auto chrome to preserve against moisture.

Unusually inert to attack by acids, alkalis, alcohols, mineral and vegetable oils, salt spray, chemical fumes, sun and weather.

TRY A 12-OZ. CAN TODAY ON OUR  
MONEY-BACK GUARANTEE

At your local distributor

Write us for FOLDER 214

**UNITED TECHNICAL LABORATORIES**

Engineers • MORRISTOWN N.J. • Manufacturers

CIRCLE ED-51 ON READER-SERVICE CARD FOR MORE INFORMATION

## New Products...

### Vibration Mount For Guided Missile Applications



The Model 9302 Double-Acting Unit Mount has been designed for guided missile applications to cope with extremely severe vibration and acceleration. Load ranges can be furnished for 1 to 7 lb per mount.

Features of the device include non-linear deflection characteristics, high damping, low amplification at resonance, and ability to withstand any conditions of temperature and environment. It is suitable for the isolation of vibration and shock for positive, negative and radial loads.

Recommended location for mounting the unit is in the plane of the center of gravity for maximum efficiency. A range of natural frequencies above 10cy can be furnished, depending upon load and performance requirements. Robinson Aviation, Inc., Dept. ED, Teterboro, N. J.

CIRCLE ED-52 ON READER-SERVICE CARD FOR MORE INFORMATION

### Electronic Resistance Analyzer Has High Accuracy and Wide Range



This Electronic Resistance Analyzer has been designed with a high accuracy and wide range for precision measurement of resistors. It is particularly adapted to the selection and measurement of resistances used in analog computers.

Available in either a rack or bench model, the instrument has a balance of 0.02% over almost the entire range. It is designed for 115v a-c operation. Range and accuracy specifications are 0.5% accuracy for 1000 ohms to 10,000 ohms, 0.15% for 10,000 ohms to 11 megohms, and 1% for 11 megohms to 111 megohms. Kuljian Corp., Electronics Div., Dept. ED, 1200 N. Broad St., Philadelphia 21, Pa.

CIRCLE ED-53 ON READER-SERVICE CARD FOR MORE INFORMATION

when better **SYNCHROS**  
are required  
**SPECIFY**

*Telesyn*

**FORD**

- Proved Precision Accuracy
- Meet Government Specifications
- Corrosion Resistance
- Fungus Resistance
- Available in wide selection of sizes

WRITE FOR NEW  
TELESYN BROCHURE



**FORD INSTRUMENT COMPANY**

Division of the Sperry Corporation  
31-10 Thomson Avenue  
Long Island City 1, N. Y.

CIRCLE ED-54 ON READER-SERVICE CARD FOR MORE INFORMATION

**KULKA**

Single and Double Pole "Toggle" Handle Type  
**AIRCRAFT SWITCHES**  
For Electronic and Communications Use



Made to JAN specs for DC, or AC circuits up to 1600 cycles. Available with screw terminals and with soldering lugs. Switching characteristics provide for changes in electric circuits by use of SPST, SPDT, DPST and DPDT. Has bakelite housing and only one mounting hole.

### TERMINAL BLOCKS

Barrier type, made of molded bakelite in varied styles & sizes up to 26 terminals. Send for catalogue.



**KULKA ELECTRIC MFG. CO., Inc.**  
MOUNT VERNON, N. Y.

CIRCLE ED-55 ON READER-SERVICE CARD FOR MORE INFORMATION







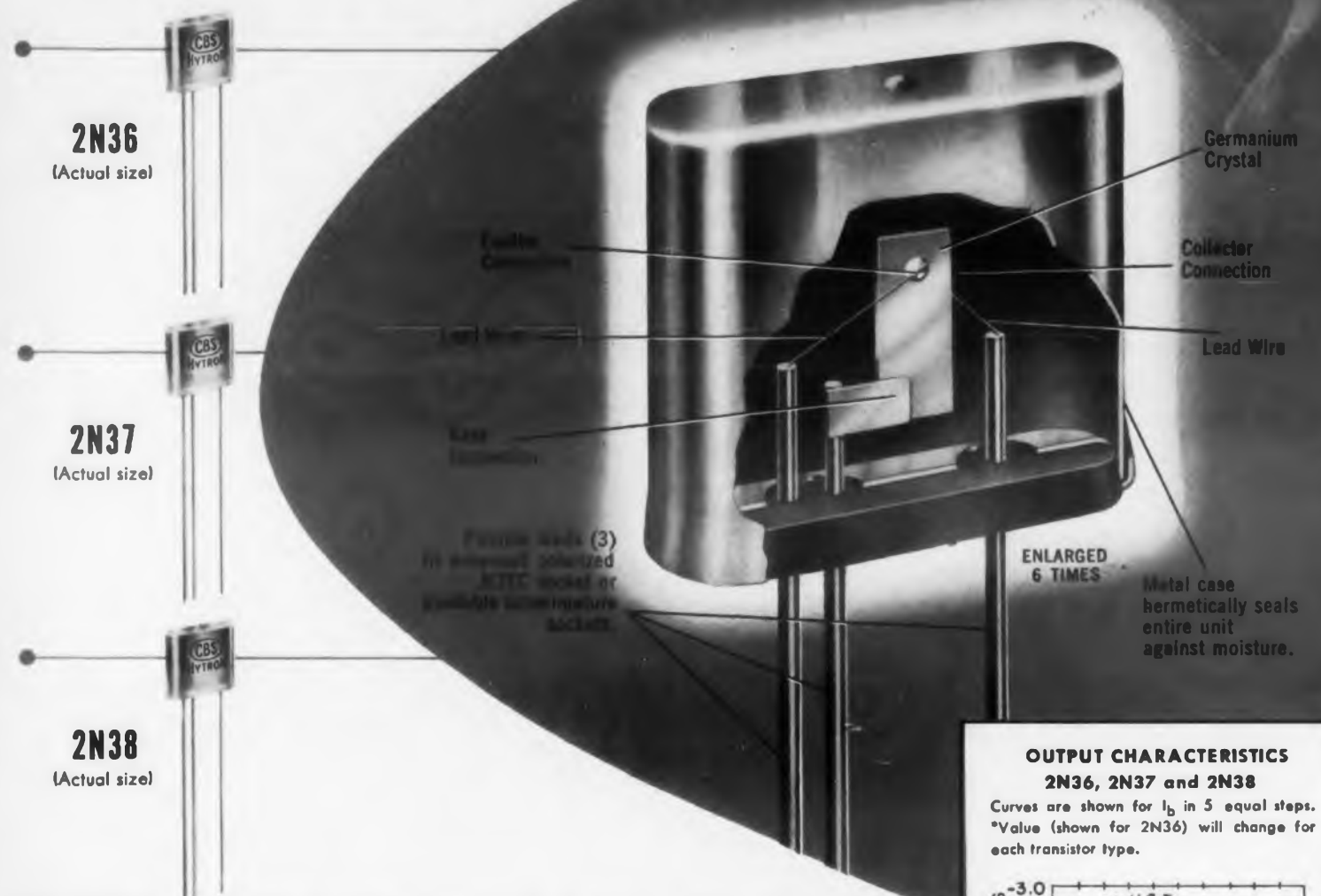

## NOW...HERMETICALLY SEALED CBS-HYTRON JUNCTION TRANSISTORS

In junction transistors, the surfaces are extremely sensitive to moisture. For dependability, they must be completely moisture-proofed. CBS-Hytron, recognizing this, is the first to offer you the new *hermetically sealed* 2N36, 2N37, and 2N38 junction transistors. Each is uniquely sealed in a metal case . . . moisture-proof, contamination-proof, light-proof. (See drawing.)

You can buy these new hermetically sealed P-N-P junction types immediately. All are amplifier types. Have similar characteristics, except for current amplification and power gain. You may operate the 2N36, 2N37, 2N38 up to 55°C. Their in-line design gives you: Compact, flat mounting . . . easily identified polarity . . . solder-in or plug-in (with clipped leads) convenience.

In addition to their unique moisture-proof feature, these CBS-Hytron junction types offer: (1) High gain. (2) Low noise figure. (3) Operation at low voltages. As well as other advantages characteristic of transistors: Compactness . . . light weight . . . ruggedness . . . instantaneous operation . . . and long life.

Remember, CBS-Hytron hermetically sealed 2N36, 2N37, 2N38 transistors are available at once. Write for complete data. Or order now for prompt delivery.

### OUTPUT CHARACTERISTICS 2N36, 2N37 and 2N38

Curves are shown for  $I_b$  in 5 equal steps. \*Value (shown for 2N36) will change for each transistor type.

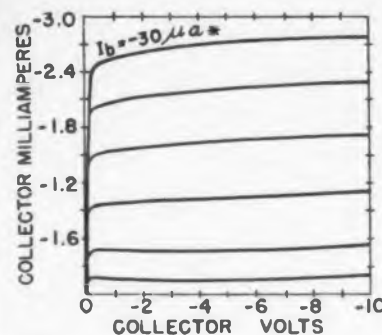

### ELECTRICAL CHARACTERISTICS† CBS-Hytron P-N-P Junction Transistors

Characteristic	2N36	2N37	2N38
Collector voltage	-6	-6	-6
Collector current	-1	-1	-1
Current amplification factor $\beta$	45	30	15
Power gain $\beta$	40	36	32

†Typical values at 25°C. ‡Grounded emitter connection.



**NOW 3 CBS-HYTRON TEST ADAPTERS.** By popular demand. Three sizes now available at these net prices: 7-Pin Miniature, \$1.45; 8-Pin Octal, \$2.25; 9-Pin Miniature, \$1.75. Take advantage of e-a-s-y "topside" testing. Order your Test Adapters today from your CBS-Hytron jobber.

**CBS-HYTRON** Main Office: Danvers, Massachusetts

A Division of Columbia Broadcasting System, Inc.

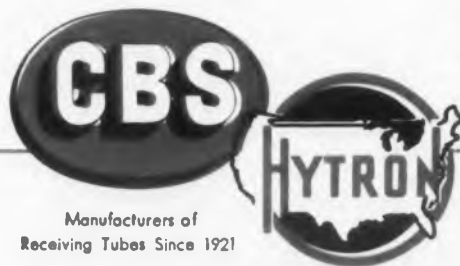

RECEIVING . . . TRANSMITTING . . . SPECIAL-PURPOSE AND TV PICTURE TUBES • GERMANIUM DIODES AND TRANSISTORS

CIRCLE ED-60 ON READER-SERVICE CARD FOR MORE INFORMATION

## New Products...

### Hydrogen Thyratrons For Pulse Modulator Applications



Two Hydrogen Thyratrons with positive control characteristics designed for long-life pulse modulator applications, have been added to the company's line. Designated as types 6268/AX-9911 and 6279/AX-9912, they are completely inter-

changeable with standard types 4C35 and 5622 respectively.

The Type 6268 has a tube drop of 150v (max), a trigger rise time of 0.5 $\mu$ sec (max), a peak anode voltage of 8.0kv, and a maximum cathode current of 90amp (peak) and 100ma (av).

The Type 6279 has a tube drop of 175v (max), a trigger rise time of 0.5 $\mu$ sec, a peak anode voltage of 16kv, and a maximum cathode current of 325amp (peak) and 200ma (av). Life expectancy of the tubes is over 1000 hours. Amperex Electronic Corp., Dept. ED, 230 Duffy Ave., Hicksville, L. I., N. Y.

CIRCLE ED-61 ON READER-SERVICE CARD FOR MORE INFORMATION

### Foil Clad Laminates For Printed Circuits



These Foil-Clad Laminates have been designed for use in complex printed circuits for electronic equipment, hearing aids, automatic signalling devices, etc.

Possessing an excellent bond strength of from 4 to 6 lb, this copper or aluminum clad material is available in 36" x 36" sheets, with foil thicknesses ranging from 0.00068" to 0.0094". Even in thin sheets, the paper-base grade plastic combines excellent electrical properties with good machinability.

Accurate circuit reproduction on the laminate can be achieved by any commercial printing process. Synthane Corp., Dept. ED, Oaks, Pa.

CIRCLE ED-62 ON READER-SERVICE CARD FOR MORE INFORMATION

**TEFLON NOW  
IN 14 COLORS\***

*Featuring*

**Tensolon  
HI-TEMP  
HOOK-UP WIRE**

- EXTRA FLEXIBILITY
- FREE STRIPPING
- HIGH DIELECTRIC
- RATING -90 TO +250°C

\*Black, brown, red, orange, yellow, green, blue, violet (purple), grey (slate), white, tan, pink (flesh), light green, light blue.

Built to meet rigid government requirements, Tensolon Hook-up Wires are available in sizes from AWG30 through 20 with stranded silver-plated copper conductors and the patented Tensulated Teflon® covering which eliminates pin holes and other irregularities.

**TEFLON KIT FOR LABORATORY REQUIREMENTS—**

Twelve 100 ft. rolls of AWG 22, in assorted colors in convenient compact container **\$124.00**



WRITE FOR ILLUSTRATED LITERATURE

**TENSOLITE INSULATED WIRE CO., INC., TARRYTOWN, N. Y.**

CIRCLE ED-63 ON READER-SERVICE CARD FOR MORE INFORMATION

**In large scale production NOW!**

**American  
Electronic**



Model 140  
**SYNCHRO  
GENERATORS**



Model 141  
**SYNCHRO CONTROL  
TRANSFORMERS**

A pair with an established reputation.  
The heart of modern two-speed systems.

**IN MASS PRODUCTION THIS SPRING!**



Size 15  
**UNIVERSAL-FREQUENCY  
PRECISION RESOLVER**  
Minimum noise, highest accuracy. Basic to all trigonometric operations.

Size 15  
**UNIVERSAL-FREQUENCY  
PRECISION POTENTIOMETER**  
Continuous rotation, induction type. Accuracy comparable to resolver.

Model 171  
**SERVO COMPUTING  
TACHOMETER**

Companion to Model 172 Servomotor. Superior linearity and signal-to-noise ratio



**READY FOR FALL DELIVERY:**

Size 11 Induction Resolvers, and Potentiometers • Sizes 11 and 15 Servo Control Motors and Computing Tachometers • Model 293 Brushless Potentiometers.



Model 172  
**SERVO CONTROL  
MOTORS**  
"Standard" in many modern computers and controls. Thousands in use

**FEATURES**

- Maximum accuracy, signal-to-noise ratio, range of linear operation.
- Minimum noise, size and friction.
- Total magnetic shielding.
- Internal winding or external network compensation.
- High temperature resistant models.
- Corrosion and fungus resistant.
- Complete line of "packaged" compensating isolation driver-amplifiers.
- Reliable delivery commitments.

**American Electronic Mfg., Inc.**  
9503 W. Jefferson Blvd., Culver City, Calif.

CIRCLE ED-64 ON READER-SERVICE CARD FOR MORE INFORMATION

**Transistors**

**For Amplifier, Oscillator, and Switching Uses**

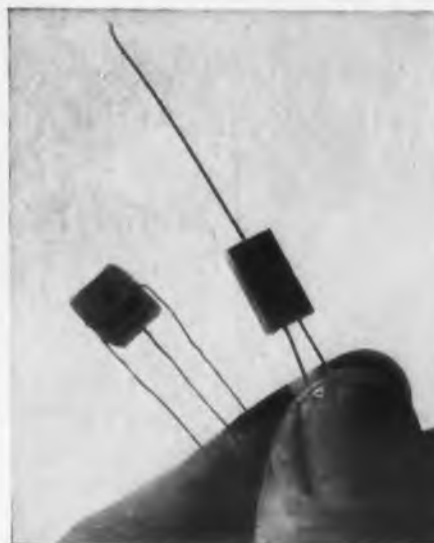

These two Transistors, Type WX-3347 and Type WX-4813, are intended for developmental use in amplifier, oscillator, and switching circuits. Both types are provided with leads for wired-in installation.

The Type WX-3347, a point-contact type, has

typical operating characteristics (when used as a grounded-base amplifier under small signal conditions) of: a collector current of 2ma to 3ma, a power gain of 18db, and a 2Mc cutoff frequency (3db down).

The Type WX-4813, a p-n-p junction type, has typical operating characteristics (when used as an amplifier with grounded emitter and base input) of: collector current of 1ma to 2ma, a power gain of 30db, and a cutoff frequency (3db down) of 0.5Mc. Westinghouse Electronic Tube Div., Westinghouse Electric Corp., Dept. T-194, Box 284, Elmira, N. Y.

CIRCLE ED-65 ON READER-SERVICE CARD FOR MORE INFORMATION

**Miniature Delay Relays**

**Provide 2-60sec Delays**



These Miniature Delay Relays have been designed to withstand altitude or any other climatic conditions, and their rugged construction also makes them vibration-proof. Hermetically sealed, these units are useful in many electronic design applications.

They can be furnished for all standard heater voltages, such as 2.5v, 5v, 6.3v, 26v, and 115v. Delays are available from 2sec to 60sec. Wattage consumed by the heater is about 2w, and the contact rating is 115v, 2amp a-c. The units are ambient compensated for temperatures from -50°C to +70°C, and are available in a T6-1/2 bulb, with a 9-pin base. Amperite Co., Inc., Dept. ED, 561 Broadway, New York 12, N. Y.

CIRCLE ED-66 ON READER-SERVICE CARD FOR MORE INFORMATION

CIRCLE ED-67 ON READER-SERVICE CARD >

*Do you need*



**SIE**

**RESISTANCE  
ANSWER**

**SOUTHWESTERN INDUSTRIAL  
ELECTRONICS COMPANY**



# Amazing New Surge Classifier with Synchronized De-Tensing!

...made possible with **TEFLON\***

by **ETHYLENE**

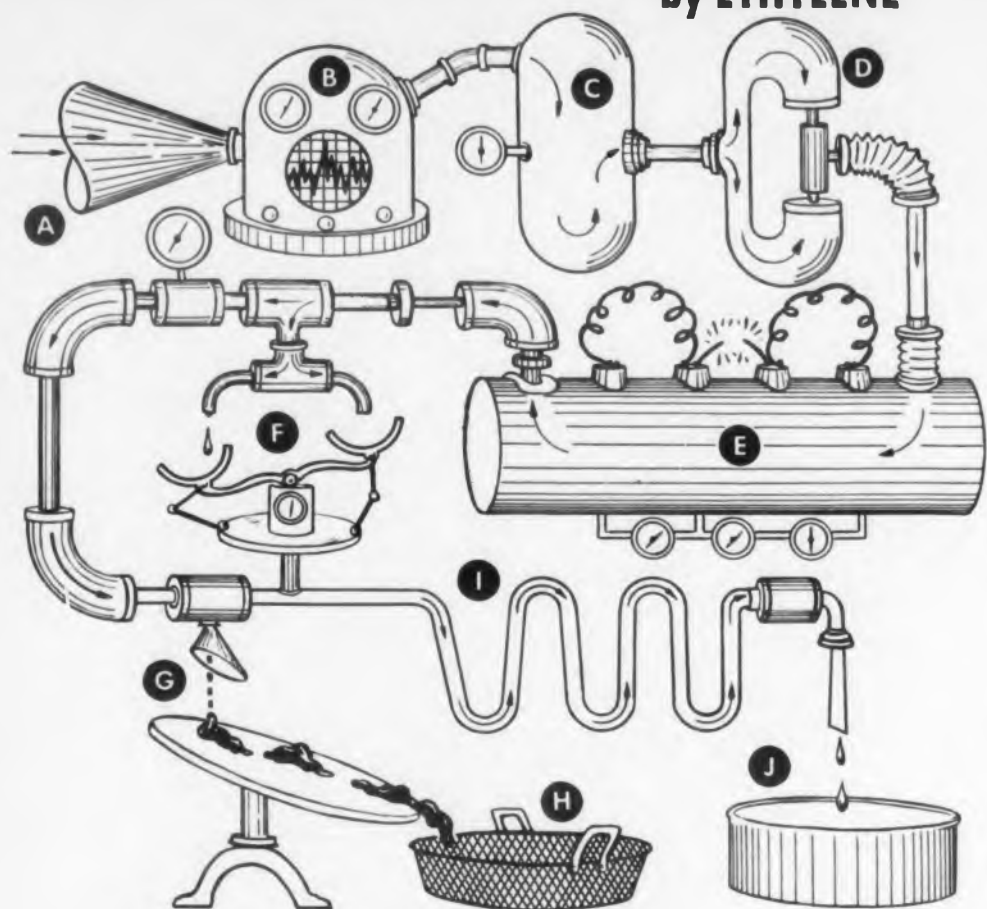

Alternately very hot and very cold ionized gases enter TEFLON tube A <sup>1</sup>, Magnetic pulse de-energizer B liquefies heavy elements and ejects extremely corrosive gas stream into acid chamber made of TEFLON C <sup>2</sup>. After scrubbing in counterphase retort D, product is degaussed in 30,000,000 megacycle field E <sup>3</sup> and flip-flop counter F records number of abstaining groups. Unpledged macro-elements hit TEFLON baffle plate G <sup>4</sup> and slip off into basket H. Remaining particles, being committed, pass through vibratory flexible TEFLON hose I <sup>5</sup> into can J.

<sup>1</sup>TEFLON used here for its wide thermal range, -100°F. to 550°F.

<sup>2</sup>TEFLON is the only material sufficiently inert for acid chamber construction.

<sup>3</sup>TEFLON used in degausser because of its remarkable dielectric strength and constant—and extremely low loss factor.

<sup>4</sup>TEFLON'S non adhesive character ideal for baffle.

<sup>5</sup>TEFLON'S excellent flexural strength disqualified all other material.

## EXTRUDED OR MOLDED RODS, TUBES, AND SPECIAL SHAPES

- STRESS-RELIEVED OR HIGH-TENSILE SHEETS AND MOLDINGS
- PRECISION MACHINED COMPONENTS AND FILLED PRODUCTS

Send for  
Catalog  
54  
and  
Price Lists.



"Pioneers and Specialists in TEFLON products"

**ETHYLENE CHEMICAL CORPORATION**

245 Broad St. • Summit, New Jersey

\*DuPont Trade Mark for tetrafluorethylene resin

CIRCLE ED-68 ON READER-SERVICE CARD FOR MORE INFORMATION



# New Literature . . .

## Silicon Diodes

69

Catalog 53S is a 4-page, 2-color booklet containing a description of the company's silicon diodes. The brochure outlines the applications of these units in microwave superheterodyne receivers. Various types are described, including diode pairs for balanced mixer use, other mixer diodes, and special types. Microwave Associates Inc., 22 Cummington St., Boston 15, Mass.

## Variable Transformer

70

A 12-page, 2-color brochure describes the company's "Variac" continuously adjustable transformer, and "Duratrak", a coating on the brush track which provides increased reliability and even longer life. Specifications for the various types of units are listed and include such information as input voltage, load rating, output voltage, and driving torque. Photographs and diagrams illustrate each unit, and a chart lists all models of the instrument, their specifications, and various assemblies. General Radio Co., 275 Massachusetts Ave., Cambridge 39, Mass.

## Printed Circuit Components

71

An 8-page bulletin describes a series of printed circuit i-f components, designed for use in TV receivers utilizing inter-carrier-sound systems. Each of the six available types is described and illustrated by a dimensional outline diagram. Charts depict the response characteristics, applications, and alignment data. RCA Tube Dept., Commercial Engineering, Harrison, N. J.

## Plastics

72

A 4-page, 2-color brochure with accompanying data sheets, describes the company's "Teflon" and "Rulon", plastic materials, for use in tube sockets, insulator bushings, spacers for coaxial cables, radar, TV, and other equipment to be used in high temperature, and high frequency service. Specifications and applications for the materials are presented. Dixon Saddle Co., Bristol, R. I.

## Insulation

73

Helpful information on the features and uses of fiber and plastic for electrical insulation (reinforced sheets, rods, and fabricated parts) are incorporated in two catalogs. The company's line of reinforced plastics are described in an 8-page catalog, while laminated plastics, vulcanized fiber, and fishpaper products are covered in a 32-page catalog. Both folders provide complete descriptions, tabular data, and other information on grades, properties, and fabricating techniques for sheets, rods, tubes, and fabricated or molded parts. Insulation Manufacturers Corp., 565 W. Washington Blvd., Chicago 6, Ill.

## Control Instrument Motors

74

A 20-page illustrated catalog describes a line of miniaturized, hysteresis synchronous, control, and damped control instrument motors. These units offer the designer various frame sizes, speeds, and input voltages for military and commercial applications. Typical uses include analog computers, aircraft fire control systems, differential analyzers, remote indicating systems, and telemetering devices. Specification data are provided, and charts indicate the typical load characteristics of these units. Servomechanisms Inc., Post and Stewart Aves., Westbury, L. I., N. Y.

## Attenuators

75

A 64-page brochure features a wide variety of controls, including r-f attenuators, special units for precision measuring equipment, tone compensating attenuators, stereophonic controls, "T" attenuators, Balanced "H" attenuators, as well as ladder and potentiometer type audio attenuators. The description of each unit is accompanied by photographs, charts, and diagrams. These units have application in broadcasting, TV, recording, sound motion picture control installations, and research laboratories. Daven Co., Dept GI, 191 Central Ave., Newark 4, N. J.

## Germa

This  
ains a  
eral a  
diodes.  
and a  
view.  
cation  
design  
are als  
quiring  
ratio.  
E. Gra

## Quar

Quan  
applica  
sign a  
scribed  
tronic  
presen  
and pl  
commo  
mic ele  
acousti  
ture p  
siderat  
eally c  
electric  
convers  
Co., 34

## Ceran

A 4-  
"Titon  
mic ph  
the "T  
use in  
tion d  
sented,  
feature  
grams  
ford, N

## Ball E

Cata  
descrip  
ball be  
0.025"  
Dimens  
vice ar  
on loa  
toleran  
ment b  
ous typ  
nomogr  
ings, I

## Germanium Diodes

76

This 4-page, 2-color Bulletin, GD-1, contains a description of the company's general and special types of germanium diodes. Features of the units are listed, and a diagram provides a cross sectional view. Other information includes specification data. The special purpose units, designed for use in magnetic amplifiers, are also useful in many other circuits requiring high reverse-to-forward resistance ratio. International Rectifier Corp., 1521 E. Grand Ave., El Segundo, Calif.

## Quartz Crystal Data

77

Quartz crystals, the characteristics and applications of piezoelectric materials, design and equivalent circuit data, are described in a 28-page booklet titled "Piezoelectric Technical Data". Information is presented on piezoelectric materials, cuts and plate designations, basic plate actions, common plate applications, common ceramic element applications, mechanical and acoustical impedance considerations, moisture protection for crystals, circuit considerations for mechanically and electrically driven devices, properties of piezoelectric materials, equivalent circuits, and conversion chart data. Brush Electronics Co., 3405 Perkins Ave., Cleveland 14, Ohio.

## Ceramic Turnover Pickup

78

A 4-page, 2-color brochure describes the "Titone Turnover", a newly designed ceramic phonograph pickup. Also described is the "Titone Playall", a single cartridge for use in playing all speed records. Specification data for both these items are presented, along with a description of their features. The units are illustrated by diagrams and charts. Sonotone Corp., Elmsford, N. Y.

## Ball Bearings

79

Catalog No. 53 (28 pages), contains a description of the company's 137 "Micro" ball bearings, available in bore sizes from 0.025" to 5/16", with 0.100" to 1/2"OD. Dimensional and design data for each device are included, along with information on loads, speeds, mounting, lubrication, tolerances, gaging, and handling of instrument bearings. Photographs illustrate various types, as well as charts, diagrams, and nomographs. New Hampshire Ball Bearings, Inc., Peterborough, N. H.

## Receiving Tubes

80

This 24-page revised edition of the quick-reference booklet (No. 1275-F) entitled "RCA Receiving Tubes for A-M, F-M, and Television Broadcast", was designed to serve as a guide in the selection of the most suitable tube for a given application. Contained in the booklet are characteristics of each of 495 tube types, together with socket connection diagrams. Also provided is a classification chart which facilitates the selection of the proper tube type for a desired purpose. Radio Corp. of America, Commercial Engineering, Harrison, N. J.

## Transformers, Delay Lines

81

A 4-page bulletin and data sheets describe the company's pulse transformers and delay lines. Over 100 designs in pulse transformers are available, and many of these are described, with information including their features and dimensions. The delay lines, all instruments with a characteristic impedance of 1000 ohms, are described in terms of their characteristics, types of construction, and dimensions. A table provides specification information. Electronic Computer Div., Underwood Corp., 35-10 36th Ave., Long Island City, N. Y.

## Electron Tubes

82

Leaflet Form No. 253 (2-pages) provides interchangeability data on several of the company's electron tubes. Each tube is briefly described, and list price information, as well as a tabulation of the existing tube types, with which it is interchangeable, is presented. Lewis and Kaufman, Ltd., 124 El Rancho Ave., Los Gatos, Calif.

## Breadboard Components

83

Brochure No. 41 is a 4-page, foldover, multi-color bulletin containing information on the company's miniaturized breadboard components, designed for use with the miniature 400cy equipment found in servos, computers, and similar applications. Circuit and assembly diagrams of the units are enclosed in the bulletin, along with directions for making up instrumentation on the breadboard. A plate assembly provides further information, and a parts list also is included. Reeves Instrument Corp., a subsidiary of Claude Neon Inc., 215 E. 91st St., New York 28, N. Y.

WATERS

# Miniature



POTENTIOMETERS for your

# Toughest Requirements



RT-7/8  
standard



RT-7/8  
special



RTS-7/8  
3-gang  
standard



RTS-7/8  
special



Packed into 1/4 of a cubic inch are all these features:



- 10 to 50,000 ohms resistance range.
- 0.002% per degree C temperature coefficient.
- -55 degrees C to +85 degrees C ambient temperature range.
- 3 watts dissipation at 80 degrees C.
- 1000 volts dc dielectric strength.
- 1,000,000 revolutions rotational life.
- *complete reliability.*

Write for full technical information and prices.



WATERS MANUFACTURING, inc.

Waltham 54, Massachusetts

APPLICATION ENGINEERING OFFICES IN PRINCIPAL CITIES

CIRCLE ED-84 ON READER-SERVICE CARD FOR MORE INFORMATION



# NEW BLOOD IN THE PULSE RACKET

It is gratifying to note that within a month of our attack on relays for the pulse market, a favorite competitor has done the impossible and brought out an impulse relay. It is improbable that our implications impelled him to such an important step, but the impression, though implausible, adds impetus to our plans.

The purpose of a pulse (or impulse) relay is either to make round pulses square, or, to make little square pulses big. Relays are not usually used to make narrow pulses wide or wide pulses narrow, although some do, willy nilly.

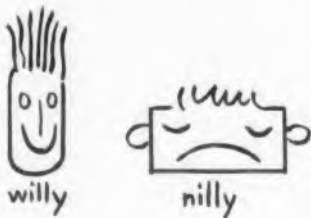

Relays like our Type 7, which eat a couple of milliseconds off a pulse and then bite out a nick in the form of a half-millisecond bounce,

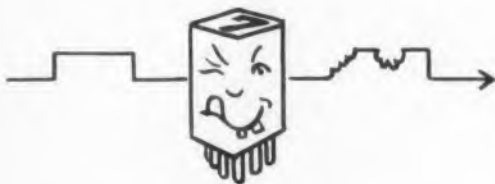

are no better than rumor-mongers as repeaters of information. That new impulse relay certainly beats it all hollow because it operates twenty times as fast, and doesn't bounce.

If our new relay could do that, as well as what it already does, we wouldn't have to advertise for long. To be specific, it is SPDT, and it will operate in about .0006 seconds, transfer taking

as little as .00025 seconds off your pulse. It never bounces, of course, and will handle substantial contact loads such as a teleprinter for over 100,000,000 operations. It looks like this:



Both these wonderful relays are pretty hard to get. You can have *one* of ours right away, if you convince us that you need something a lot better than our "7" (if not, *that's* what you'll get). Furthermore, you'll have to answer a lot of questions about your gadget and its purpose (how else can we learn about "new frontiers"?). Finally, you'll have to settle for commercial quality and finish; no leak proof, salt proof, fire proof, fungus proof; so far all we've tried is to make it goof proof.

## FEATURES OF THE NEW PULSE RELAYS

	SIGMA	COMPETITOR
Operating characteristics	Two coil polarized	Single coil neutral
Contact Arrangement	SPDT	SPST
Contact load and life rating	10 <sup>8</sup> @ 60 ma (contacts easily replaced)	5 x 10 <sup>8</sup> @ .075 ma
Contact separation	.004"	.0005"
Max. Aperiodic pulse rate	400 cps	1000 cps
Max. Following pulse rate	1200 cps	2500 cps
Signal for good operation	+20, -20, +20 ma	40, 0, 40 ma
Coil resistance	150 Ω each	135 Ω
Height and diameter above octal plug	2 1/2" x 1 9/32"	1 21/32" x 1 15/16"

**SIGMA INSTRUMENTS, INC.**  
107 Pearl Street, So. Braintree, Boston 85, Mass.

# New Literature ...

## Printed Circuits 85

A 48-page hard covered book entitled "Technograph Printed Circuits" covers the processes, uses, and applications of printed circuits. Fully illustrated, the book contains four chapters: Origin and Early Development; Description of the Technograph System; Advantages of Printed Circuits; and Economic Aspects of the Technograph System. Possibilities for future electronic products using printed circuitry are discussed. Additional information includes preparation of the raw materials, cleaning and neutralizing the etched circuits, the foldable circuits, printed capacitors and resistors, circuits required to function at high temperatures, and printed mechanics. The book may be had for \$1.00 from Dept. T, Technograph Printed Electronics, Inc., 191 Main St., Tarrytown, N. Y.

## Diode Checker 86

A 2-color data sheet describes the company's Type ST-12A portable germanium diode checker. Information includes electrical and mechanical specifications, and photographs illustrate the machine in operation. General Electric Co., Electronics Div., Electronics Park, Syracuse 1, N. Y.

## TV and Radio Components 87

Catalog No. 20 (8-page, 2-color) describes the company's TV and radio components, including slip-on ion traps, snap-on ion traps, centering devices, correcting magnet, speakers, ferrite rod antennas, fly-back transformers, and focus magnets. A description of the features of these items is included, along with specifications and illustrations. Heppner Mfg. Co., Round Lake, Ill.

## Microwave Measurements 88

The January 1953 issue (Vol. 1 No. 4) of "PRD Reports", a quarterly publication, contains an article called "Microwave Power Measurements". It describes the use of bolometers and other power detectors, pulse power measurements, and power measuring bridges. Polytechnic Research & Development Co., Inc., 202 Tillary St., Brooklyn 1, N. Y.

## Liquid-Level Control 89

A 4-page, 2-color brochure, Form No. LL4-453, describes a single-thyratron electronic liquid-level control, that operates without radio frequency from a single capacitive type probe. The device is illustrated, along with the probe and two schematic arrangements for installation. Special applications and specifications are described. Thermo Instruments Co., 1166 El Camino Real, Belmont, Calif.

## Power Supplies 90

A data sheet describes the company's line of electronically regulated, d-c constant current power supplies, whose applications include calibrating current indicating instruments, operation of nonlinear devices (thermistors, silicone diodes, germanium diodes, transistors, gas discharge tubes, etc.), and in current backing circuits. Applications, specifications, and features of the units are covered. Associated Specialties Co., 1751 Main St., Orefield, Pa.

## Electronic Voltmeters 91

The general features of the company's electronic voltmeters are described in Catalog 15A (12-page). Various models are featured, with sections on wave form vs. accuracy, logarithmic scale, range switching, overload characteristics, use as a microammeter, extension of voltage range, and use as an amplifier. Specifications are provided for each model, along with photographs and charts. Special instruments are also described. Ballantine Labs., Inc., Boonton, N. J.

## Electronic Scale 92

Instrumentation Data Sheet No. 10.18-2 describes the "Ametron" electronic scale, a device employing the servo technique for industrial and commercial weighing. The operation and application of the equipment are described, along with information on the instrument's functions and utilities, installation requirements, electrical theory, automatic temperature compensation, overloading, hermetically sealed load cells, zero adjustment, range changing, unit replacement, computation, etc. Minneapolis-Honeywell Regulator Co., Brown Instruments Div., Station 64, Wayne and Windrim Aves., Philadelphia 44, Pa.

## Permanent Magnets 93

A 12-page catalog, No. SM-1252, lists the company's complete line of standard permanent magnets. These devices, available in "Alnico" 2, 3, and 5, for use in a wide range of applications, are described according to their types: bars, bars and rings, rotors, channel bars, horse shoe magnets, and magnet charger. A chart indicates dimensional limitations and magnet finishing. Thomas and Skinner Steel Products Co., Inc., 1157 East 23rd St., Indianapolis, Ind.

## Ceramics 94

Mechanical and electrical properties of the company's "Alsimag" ceramics are described in a 4-page, 2-color data sheet, Chart No. 531. The materials, grouped according to vitrification, include vitreous ceramic materials, lava, and refractories. Values and properties for each material are included, as well as charts indicating thermal expansion, dielectric strength, and variation with temperature. American Lava Corp., Chattanooga 5, Tenn.

## Capacitors, Networks 95

A 24-page, 3-color brochure provides design and test data on the company's line of "Capitron" capacitors and pulse forming networks, for use in radar, missile control, and similar guided systems. Fabricated with "Amplifilm", a synthetic dielectric, chemically similar to mica, the various types of units are described and illustrated with numerous charts and diagrams. Aircraft-Marine Products, Inc., Chemicals and Dielectrics Div., 2100 Paxton St., Harrisburg, Pa.

## Tuning Fork Resonator 96

The 4-page folder, No. 2, describes the Model J tuning fork resonator, which, because of its high-Q factor, provides a means for generating a very accurate fixed audio frequency. Information includes data on construction, frequencies, accuracies, operation, and installation. Philamon Lab. Inc., 5717 Third Ave., Brooklyn 20, N. Y.

CIRCLE ED-97 ON READER-SERVICE CARD ➤



### NEW 38-PAGE ILLUSTRATED CATALOG

Describes Electrical and Mechanical Characteristics, Special Features and Construction of a complete line of variable resistors for military and civilian use. Includes dimensional drawings of each resistor. Write today for your copy.

**TYPE 44, (JAN-R-94, Type 44D)**  
1/4 watt, 1 1/2" diameter variable composition resistor. Also available with other special military features not covered by JAN-R-94 including concentric shaft remote construction. Attached switch can be applied.



**TYPE 31, (JAN-R-94, Type 31H)**  
1/2 watt, 1 1/8" diameter variable composition resistor. Also available with other special military features not covered by JAN-R-94 including concentric shaft remote construction. Attached switch can be applied.



**TYPE 23, (JAN-R-19, Type 23B)**  
2 watt, 1 17/32" diameter variable wirewound resistor. Also available with other special military features not covered by JAN-R-19 including concentric shaft remote construction. Attached switch can be applied.



**TYPE 15, (JAN-R-19, Type 15B)**  
(May also be used as Type 23B) 4 watt, 1 17/32" diameter variable wirewound resistor. Also available with other special military features not covered by JAN-R-19 including concentric shaft remote construction. Attached switch can be applied.



# COMPLETE MILITARY LINE

Immediate delivery from stock on 189 types including JAN-R-94 and JAN-R-19 types of variable resistors.

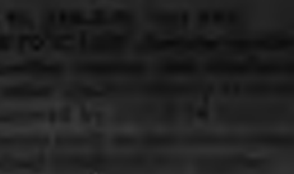

RESISTOR TYPE	WATTAGE	DIAMETER	CONSTRUCTION
TYPE 44	1/4	1 1/2"	Variable composition
TYPE 31	1/2	1 1/8"	Variable composition
TYPE 23	2	1 17/32"	Variable wirewound
TYPE 15	4	1 17/32"	Variable wirewound

### UNPRECEDENTED PERFORMANCE CHARACTERISTICS

Resistors designed for military precision requirements and tested to meet the most exacting standards of reliability.

CHICAGO TELEPHONE SUPPLY Corporation

Specialists in Precision Mass Production of Variable Resistors



THE *Mayhill* **PLATING PROCESS**

**GUARANTEES**

**ACCURATE PLATING  
IN  
ELECTRONICS!**



Since 1946, M-W LABORATORIES has electroplated precious metal for suppliers to the U. S. Army, U. S. Navy, Atomic Energy Commission and to leading manufacturers in the electronics industry.



M-W LABORATORIES, featuring their Mayhill Plating Process, are equipped to plate these precious metals: gold, silver, rhodium, palladium, albaloy and indium.



Controlled thickness, smoothness, color, hardness and adhesion of plating is assured through constant testing by our own chemists and engineers, in our chemical and metallographic laboratory.



Contact us for a no-cost-to-you consultation on your plating problems.



**M-W Laboratories, Inc.**  
1824 N. Milwaukee Ave.  
Chicago 47, Illinois

CIRCLE ED-98 ON READER-SERVICE CARD FOR MORE INFORMATION

**New Literature ...**

**Composite Metal Bond 99**

Technical Data Bulletin No. 702C (5-page) describes "Alcuplate", a composite metal consisting of a layer of aluminum on which a relatively thin layer of electrolytic copper is clad on either one or both sides. The metals are bonded by a solid phase process without the use of any brazing alloy or other intermediate material. The advantages, typical applications, forms and sizes, and weight values of the material are indicated, along with other technical data. Metals and Controls Corp., General Plate Div., Attleboro, Mass.

**Electronic Instruments 100**

Short Form Catalog No. 5302 is an 8-page, 2-color booklet containing descriptions of such electronic instruments as oscilloscopes, square wave generators, amplifiers, preamplifiers, time mark generator, and waveform generators. Each model is described and illustrated. Tektronix, Inc., P. O. Box 831, Portland 7, Ore.

**Wire and Cord 101**

A 48-page, 2-color revised catalog (January, 1953) contains information on the company's "Besto-Wire". The types described include fixture wire, flexible cord, appliance cable, apparatus and motor lead wire, thermostat cable, aircraft and electronic, radio hook-up, and transmission lead wires. Specifications are included. Rhode Island Insulated Wire Co., Inc., 624 So. Michigan Blvd., Chicago 5, Ill.

**Quality Report Booklet 102**

A 12-page booklet, entitled "The Quality Report and its Advantages", discusses the quality report, its interpretation and value to users of springs and other products. The quality report, a frequency distribution of the critical characteristics of a product, is prepared during final inspection by the manufacturer as graphic verification of conformance to specifications. The booklet describes, with detailed and illustrated examples, the preparation of a frequency distribution in variables inspection by either user or manufacturer. A section, "Interpreting the Quality Report", gives 15 typical frequency distributions and states for each what product condition it represents and what action is indicated. Hunter Spring Co., Lansdale, Pa.

**Miniature Tube Guide 103**

The 6th Edition of the company's Reference Guide for miniature electron tubes is an informative booklet listing all types of miniature tubes to date, regardless of make. Pertinent characteristics data are provided for 250 miniatures, 87 of which were developed after the fifth edition of the guide. Also included are 111 basing diagrams and indications of similar, larger prototypes. Operating conditions for individual tube types are indicated. CBS Hytron, Danvers, Mass.

**Hermetic Terminals 104**

Ten features of the company's hermetic terminals are discussed in Catalog C-6, an 8-page, 2-color brochure with data sheet inserts. General specifications and soldering suggestions for the terminals are provided. The terminal types discussed include single and multiple terminal panels, whose applications include meters, capacitors, transformers, relays, rectifiers, switches, motors, thermostats, and controls for electronic instruments. Numerous photographs and diagrams illustrate each item. Fusite Corp., 6000 Fernview Ave., Cincinnati 13, Ohio.

**Computer Potentiometers 105**

"Characteristics of Precision Servo Computer Potentiometers" is the title of a technical paper by D. C. Duncan, which is being made available at no charge. Originally presented at an AIEE Conference on Feedback Control Systems, the paper describes briefly problems encountered in building precision potentiometers and defines linearity, noise, loading error, and other characteristics important to the potentiometer user. Circuits for testing linearity and noise are described in detail. Helipot Corp., 916 Meridian Ave., South Pasadena, Calif.

**Flexible Shafts and Joints 106**

Bulletin 5194 and Bulletin 5375 describe the company's light duty flexible shafts and couplings and precision universal joints, respectively. Typical applications, specifications, and properties are indicated, along with recommended design data. Circuit diagrams illustrate typical standard end fittings. Kupfrian Mfg. Co., 350 State St., Binghamton, N. Y.

# Now 1-INCH SCREEN

SELF-FOCUSING

## Cathode Ray Tube

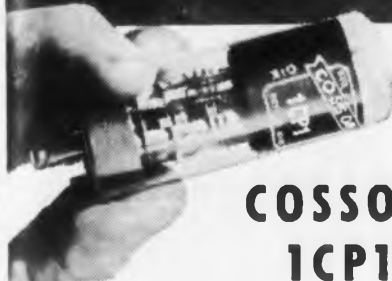

### COSSOR 1CP1

Here at last is a precision-built miniature cathode ray tube, for monitoring applications in a wide variety of electronic equipment. Particularly valuable for observing wave forms in complex circuitry. The COSSOR 1CP1 is self-focusing, requires only one anode potential for operation. One-inch green screen uses electrostatic deflection and focusing. Heater voltage 6.3V, current .6 amp. Anode voltage 500-800V. WRITE FOR TECHNICAL DATA SHEET AND COMPLETE DETAILS TODAY.

## COSSOR

**BEAM INSTRUMENTS CORP.**  
SOLE U. S. AGENTS  
350 FIFTH AVE., NEW YORK 1, N. Y.

## PRECISION READINGS INSTANTLY ANYWHERE!



### Cossor Portable OSCILLOSCOPE

Here's a light, fast, rugged, precision oscilloscope—a must for quick, accurate readings at the bench or in the field. Features: mechanical protection of C.R. tube; recessed sockets for access to X and Y plates, amp, synch and ground connections; hi-frequency amplifier 25 cps to 3.5 mcs in 2 ranges; variable gain control; flexible switching arrangements; many other features for maximum utility. The ideal portable, 5½" x 4½" x 11½". See your jobber or write for further information today. Net \$167.50

## COSSOR

**BEAM INSTRUMENTS CORPORATION**  
Department EJ  
350 FIFTH AVENUE • NEW YORK, N. Y.  
In Canada: Cossor Canada, Ltd. • Halifax, N. S.

CIRCLE ED-107 ON READER-SERVICE CARD

# New Books...

**The Conductance Curve Design Book . . .** By Keats A. Pullen. Paper bound, 22 pages. Distributed by Kann-Ellert Electronics, Inc., 9 S. Howard St., Baltimore 1, Md. \$1.00.

This booklet consists of tube characteristic curves designed to provide both static and dynamic data on the operating characteristics of a number of popular tubes. The curves facilitate design for minimum power dissipation and maximum reliability. Tubes covered include 6AG7, 6AH6, 6AK5, 6AS7, 6BH6, 6BJ6, 6BQ6, 6CB6, 6J5, 6J6, 6L6, 6SL7, 6V6, 6Y6, 12BH7, 12BY7, and 12BZ7.

The triode curves include dynamic contours of constant transconductance and constant plate conductance, as well as the usual constant bias contours. From these, distortion data and amplification can easily be determined. The pentode curves, which provide constant bias contours and constant transconductance contours as a function of screen voltage, make possible dynamic design at any screen voltage within the rating of the tube. Brief application notes and the basic equations for the most commonly used circuits are included. Three typical sample problems are worked out.

**Joint AIEE-IRE Conference on Telemetry and Remote Control . . .** Paper bound, 142 pages. American Institute of Electrical Engineers, 33 West 39th Street, New York 18, N. Y. \$3.50.

The papers presented at the Joint AIEE-IRE Conference on Telemetry and Remote Control, which was held at Long Beach, Calif., August 26-27, 1953, have been compiled into a convenient booklet and made generally available. In doing this, the sponsoring organizations have rendered a valuable service to the engineering profession in making possible a wide distribution of valuable information on these important and timely subjects.

The papers are grouped according to subject matter as presented at the conference. The first section includes six papers on telemetry pickups and covers new units, as well as accuracy and stability problems of pickups in general. The second section deals with telemetry techniques and includes three papers on the problems of f-m/f-m telemetry systems. The last two sections comprise eight papers on the general topic of telemetry and remote control. One of these groups includes a paper on the problems encountered in telemetry data required for upper atmosphere research. The other group of papers deals with wire telemetry and discusses the problems of power systems, telephone systems, and petroleum production operations with regard to telemetry.

# Heldor

## ASSEMBLY SERVICE for hermetic seal components

save  
money

speed  
delivery

insure  
quality

Heldor's assembly service is currently saving money for producers of electronic components. The components to be sealed are supplied . . . and Heldor does the rest . . . assembly of Heldor compression-type bushings in Heldor can covers (to military or your specifications) and filling and sealing the cans. These facilities are also available for partial assembly at substantial savings!

Get the facts! Send your "specs" or prints today for an "eye-opening" quotation.

**IF YOU MAKE . . .**  
● TRANSFORMERS ● RECTIFIERS  
● CONDENSERS ● CAPACITORS  
● OR YOUR OWN SPECIAL  
ELECTRONIC PRODUCT REQUIRING  
HERMETIC SEALING  
**IT WILL PAY YOU TO USE**

*Heldor*  
**CANS, BUSHINGS and  
ASSEMBLY SERVICE**

WRITE  
FOR  
NEW CAN  
CATALOG!

**HELDOR MANUFACTURING CORP.**

**HELDOR BUSHING & TERMINAL CO., INC.**

225 Belleville Ave., • Bloomfield, N. J.



CIRCLE ED-108 ON READER-SERVICE CARD FOR MORE INFORMATION

## PERMANENT BINDERS

to hold one year's copies of ELECTRONIC DESIGN  
are now available for your engineering file.

"ELECTRONIC DESIGN" and your name  
are plainly embossed in gold on the cover.

Overall size: 12 inches square.

Price includes postage and mailing.

Please send \$5.00 to:

Business Manager  
ELECTRONIC DESIGN  
127 East 55th Street  
New York 22, New York



# Miniaturization Engineers

**FOR RESEARCH,  
DEVELOPMENT  
AND APPLICATION  
OF  
SUBMINIATURIZATION  
TECHNIQUES**

*Significant advancements in the fields of guided missiles, airborne electronic systems and commercial electronic computers are requiring further applications of miniaturization techniques in the Hughes Advanced Electronics Laboratory. Positions are open for engineers qualified in this work.*

## **THE COMPANY**

Hughes Research and Development Laboratories, located in Southern California, form one of the nation's leading electronics organizations. The personnel are presently engaged in the development and production of advanced electronic systems and devices.

## **AREAS OF WORK**

Techniques involved are those dealing with printed and etched circuits, encapsulation, plastics, metallurgy, dip-soldering, spot-welding, electrochemistry and materials. Development activities are concerned with plug-in units, auto-assembly techniques, potted units, new wiring methods, electromechanical de-

vices, hardware and production techniques. These techniques are used to achieve compactness, reliability, ease of manufacture, serviceability and interchangeability.

## **THE FUTURE**

Engineers who enjoy a variety of developmental problems find outlets for their abilities and imaginations in these activity areas. New semiconductor components are opening new avenues of miniaturization and are certain to have widespread application commercially in the next few years. Hughes engineers will have full benefit of working experience in this fundamental development.

*How to apply*

Write today, giving details of qualifications and experience. Assurance is required that relocation of the applicant will not cause disruption of an urgent military project.

*Scientific and Engineering Staff*

# Hughes

RESEARCH  
AND DEVELOPMENT  
LABORATORIES

*Culver  
City,  
Los Angeles  
County,  
California*

# Patents . . . By John Montstream

## Tuned Vibrating Reed Selective Circuit . . . Patent No. 2,630,482. L. G. Bostwick, Chatham, N. J. (Assigned to Bell Telephone Laboratories, Inc.).

The patent describes frequency selective circuits which use a tuned vibratile reed or fork having one coil only in association with the vibratile element. Some of the advantages secured by the circuits are sharply selective frequency characteristics, the ease with which the frequency can be changed merely by changing the vibratile element, use of simple bridge circuits, and band pass filters can easily be provided by using two vibratile elements of different frequencies. Circuits of a plurality of vibratile elements are also useful.

The basic circuit is shown in Figure 1 with the selectivity curve shown alongside. When a tuning fork is placed in a driving coil (10) carrying a sinusoidal current, the electrical impedance of the coil is essentially made up of a damped impedance and a motional impedance. The damped impedance is the impedance of the coil when the coil is blocked or does not vibrate because the frequency of the current in the driving coil is different from the resonant frequency of the fork. The motional impedance is the change in the impedance of the coil brought about by the vibration of the fork. The coil (12) is a balancing coil which preferably has the same resistance and number of turns as the driving coil. The core (13) of the balancing coil is adjusted so that the impedance of this coil is equal to the damped impedance of the

coil (10) and fork (11). The two coils are connected in adjacent arms of a bridge circuit.

By placing vibratile element coils in other arms of a bridge circuit and selecting the resonance frequencies close together a wider band of frequencies may be passed than that secured by either element alone. Two circuits for selective signalling are also described indicating the wide application of the circuits.

## Electron Tube . . . Patent No. 2,629,066. W. W. Eitel, Woodside, Calif., et al. (Assigned to Eitel-McCullough, Inc.).

Electron tubes having cavity resonators such as klystrons have been made of metal and glass and using glass to metal seals. The improved construction of the patent makes the tube of ceramic sections two sections of which form side walls and a third section forms a spacer wall between the side sections. Ceramics of the alumina or zircon type are particularly satisfactory because they are strong mechanically and have low electrical loss characteristics.

Electrical conductivity along the inner surfaces of a ceramic tube is secured by a metallic coating. A coating of powdered metal is first sintered to the ceramic to provide a good bond therewith after which the surface is electroplated with a metal of good electrical conductivity. A vacuum tight seal between the joints of the ceramic sections is made by metallizing the adjacent edges of the sections and brazing the edges together with a suitable metal. In

Fig. 1. Tuned vibrating reed selective circuit.

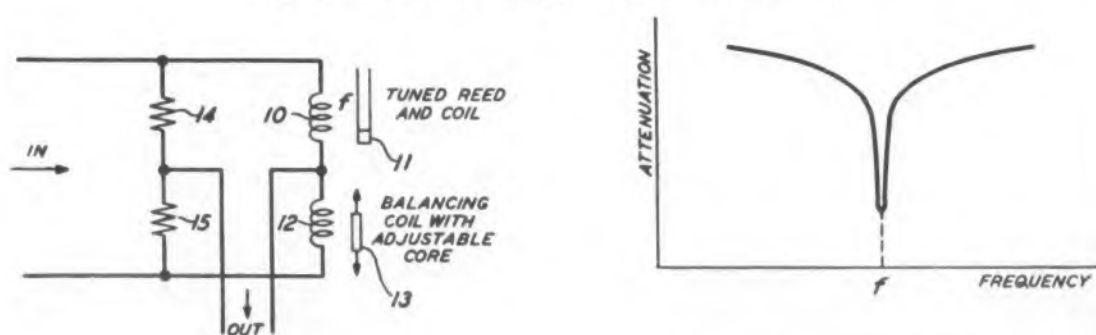

In this way a strong bond is secured as well as an electrical connection between the internal and external cavity portions of the resonator which may be provided for tuning purposes. For a fixed frequency resonator cup shaped ceramic sections may be used.

**Microwave Detector . . . Patent No. 2,624,840.** *W. D. Hershberger, Princeton, N. J. (Assigned to Radio Corp. of America).*

A microwave detector, which is a variation of one disclosed in prior patent (No. 2,483,768), provides an interesting construction. The detector is a cavity resonator proportioned to electrically resonant to the carrier frequency of the signal and acoustically resonant to the microwave modulation frequency. The resonator is closed with a microwave permeable window at the input connection so that the resonator may be filled with a microwave absorptive gas such as ammonia. Conductive

projections in the resonator substantially reduce microwave coupling between the resonator ends but provides efficient acoustical coupling.

The output connection which closes the other end of the resonator may be a crystal having an electrode upon its cavity face which electrode is grounded to the resonator and the electrode on the other face is connected with an amplifier. The output connection may be a Rochelle salt crystal driven by a diaphragm which closes the output end of the resonator or it may be a conventional type of microphone.

The input signal generates acoustic or mechanical pressure variations within the resonator due to microwave irradiation of the enclosed gas and the mechanical pressure variations are converted by the output connection into potential variations in known manner. The detector provides a rugged indicator for radar receiving systems and which may have an efficiency as high as thirty-four per cent.

## Royalty-Free AEC Patents Released

A number of patents owned by the U. S. Government and held by the Atomic Energy Commission have been transmitted to the U. S. Patent Office for registry and listing in the official register of patents. These are being released for use by industry, and the Commission will grant non-exclusive, royalty-free licenses on the listed patents upon application. Of the 20 patents released, five are of particular interest to electronic design, development, and research engineers. They are listed below:

*High-Frequency Shunt; (Patent No. 2,634,307); Q. A. Kerns, inventor.* This patent covers the improved design of a high frequency shunt capable of effectively isolating a meter connected thereto from inductive voltages produced therein and thereby providing a voltage signal independent of frequency variations.

*Pocket Radiation Meter; (Patent No. 2,634,374); F. R. Shonka, inventor.* This patent describes a pocket radiation measuring device, and more particularly an improved electrometer and an improved charging switch adaptable for use therein. The combination of an adjustable electrometer employing preformed scale in conjunction with a charging switch providing a seal which is gas-tight at all times, makes it possible to mass produce a reliable and accurate pocket type radiation dosimeter.

*Pulse Equalizer; (Patent No. 2,636,118); B. Smaller, inventor.* This patent describes a device for measuring the coincidences of electrical pulses comprising in part means for transforming pulses of random amplitudes into pulses of equal amplitude, in which the delay time for all pulses is essentially constant.

*Ion Source Unit; (Patent No. 2,636,990); J. D. Gow and J. S. Foster, inventors.* This patent describes the design of a new and improved ion source unit employing a magnetic field to influence the electron discharge therein and utilizing an effective arrangement for the removal of ions from the center of ion density.

*Fast Counting Circuit; (Patent No. 2,636,993); M. J. Jakobson, inventor.* This patent describes an improved electronic counter capable of high speed counting and having double coincidence circuits for identifying particular pulses in the presence of high background noise. The counter utilizes a pair of scintillation crystals aligned in the path of the beam of particles to be counted, a pair of photomultiplier tubes connected one to each of the scintillation crystals, and associated circuitry and recording means.

Applicants for licenses should apply to the Chief, Patent Branch, Office of the General Counsel, U. S. Atomic Energy Commission, Washington 25, D. C., identifying the subject matter by patent number and title. Copies of these patents may be obtained from the U. S. Patent Office.



# this is a SHRUNKEN HEAD

Making them from the heads of their enemies is a tribal custom among the Jivaro Indians of Ecuador.

**STANCOR ENGINEERS** have no tribal customs... but they're pretty good at shrinking transformers... like the transistor transformers shown below.

These five Stancor ultra-miniature transformers, designed especially for transistor applications, are available through your local Stancor distributor. The smallest weighs 0.07 ounce and measures  $\frac{1}{4}$ " x  $\frac{3}{8}$ " x  $\frac{3}{8}$ ". The largest weighs only 0.10 ounce and measures  $\frac{3}{8}$ " x  $\frac{3}{8}$ " x  $\frac{3}{8}$ ".

Part No.	Application	Pri. Imp.	Sec. Imp.	Pri. DC Res.	Sec. DC Res.
UM-110	Interstage	20,000	1,000	1675	285
UM-111	Output or matching	1,000	50/60	120	9.0
UM-112	High imp. mic. input	200,000	1,000	4000	195
UM-113	Interstage	20,000	1,000	1350	205
UM-114	Output or matching	500	50/60	70	9.0

Special Stancor ultra-miniature transformers, designed and built to your specifications, can be supplied in quantities of five or more.

Write for Stancor Bulletin 462R listing complete data and performance curves on these units.



## STANDARD TRANSFORMER CORPORATION

3576 ELSTON AVENUE • CHICAGO 18, ILLINOIS

EXPORT SALES: Roburn Agencies, Inc., 39 Warren Street, New York 7, N. Y.

CIRCLE ED-110 ON READER-SERVICE CARD FOR MORE INFORMATION

## Product Inquiry Guide

Page	Item	Inquiry No.	Page	Item	Inquiry No.	Page	Item	Inquiry No.	Page	Item	Inquiry No.
2.	Specialized Filters .....	1	18.	Inspection Equipment .....	32	24.	Junction Transistors .....	60	28.	Microwave Measurements .....	88
3.	Miniature Thermal Relay .....	2		Multi-turn Dial .....	33		Hydrogen Thyratrons .....	61		Liquid-Level Control .....	89
4.	Headers, Terminals, Seals.....	3		Variable Transformer .....	34		Foil Clad Laminates .....	62		Power Supplies .....	90
8.	Oscilloscopes .....	4		Multi-Scale Meter .....	35	25.	Hook-Up Wire .....	63		Electronic Voltmeters .....	91
9.	Plug-In Potentiometers .....	5		Mixer Diodes .....	36		Generators, Transformers, Motors..	64		Electronic Scale .....	92
10.	Controlled Gold Plating .....	6		Vacuum Variable Capacitors .....	37		Transistors .....	65	29.	Permanent Magnets .....	93
12.	Miniature Ball Bearings.....	7	19.	Miniature Thermostat .....	38		Miniature Delay Relays .....	66		Ceramics .....	94
	Thermal Switch .....	8		Slide Rails .....	39		Resistance Meter .....	67		Capacitors, Networks .....	95
13.	U-H-F Tube Sockets .....	9		Magnetic Amplifiers, Transformers..	40	26.	"Teflon" Plastic .....	68		Tuning Fork Resonators .....	96
14.	P-N-P Junction Transistors .....	10		Paper Tubes .....	41		Silicon Diodes .....	69		Variable Resistors .....	97
	Magnetic Deflection Yoke .....	11	20.	Test Bridge .....	42		Variable Transformer .....	70	30.	Plating Process .....	98
	Sensitive Inverter .....	12		Rotary Relay .....	43		Printed Circuit Components .....	71		Composite Metal Bond .....	99
	Hook-Up Wire Kit .....	13		Variable Transformer .....	44		Plastics .....	72		Electronic Instruments .....	100
	Precision Potentiometers .....	14		D-C Motor .....	45		Insulation .....	73		Wire and Cord .....	101
15.	Digital Voltmeter .....	15		Drafting Pencils .....	46		Control Instrument Motors .....	74		Quality Report Booklet .....	102
	Miniature Terminal Blocks .....	16	21.	Repeat Cycle Timer .....	47		Attenuators .....	75		Miniature Tube Guide .....	103
	Telephone Relay .....	17		WWV Receiver .....	48	27.	Germanium Diodes .....	76		Hermetic Terminals .....	104
	Subminiature Power Supplies .....	18		P-n-p Junction Transistors .....	49		Quartz Crystal Data .....	77		Computer Potentiometers .....	105
	Germanium Transistors .....	19	22.	Variable Speed Drive .....	50		Ceramic Turnover Pickup .....	78		Flexible Shafts and Joints .....	106
	Miniature Connector Kit .....	20		Insulating Coating .....	51		Ball Bearings .....	79	31.	C-R Tube and Oscilloscope .....	107
16.	Relays .....	21		Vibration Mount .....	52		Receiving Tubes .....	80		Hermetic Sealing Service .....	108
	Fastening Devices .....	22		Electronic Resistance Analyzer .....	53		Transformers, Delay Lines .....	81		Ultra-Miniature Transformers .....	110
	Precision Potentiometer Kit .....	23		Synchros .....	54		Electron Tubes .....	82	33.	Relays .....	111
	Glow Discharge Tube Tester .....	24		Aircraft Switches .....	55		Breadboard Components .....	83		Voltage Regulator .....	112
	Glass Fiber Insulation .....	25	23.	Sprocket Drive .....	56		Miniature Potentiometers .....	84		Transformers and Instruments .....	113
	Wide-Range Capacitor .....	26		Super-Sensitive Relays .....	57	28.	Printed Circuits .....	85		Hermetic Seals .....	114
17.	Wire-Wound Resistors .....	27		Tantalum Foil Capacitor .....	58		Diode Checker .....	86	35.	Oscillograph Tubes .....	115
	Subminiature Delay Line .....	28		Magnetic Tape Handler .....	59		TV and Radio Components .....	87			
	Microwave Test Equipment .....	29									

### 'DIAMOND H' RELAYS

pack more  
performance  
into less space ...



Rating for rating, "Diamond H" Series R hermetically sealed, miniature aircraft type 4PDT relays are smallest (1.6 cubic inches), lightest (3.76 ounces), have widest temperature range (-65° to +200°C.), greatest operating shock resistance (to 50 "G" and higher) and excel all others in their field in ability to break high currents and high voltages.

Ideal for high frequency switching, their inter-electrode capacitance is less than 5 micro-microfarads contacts to case, less than 2½ mmf between contacts, even with plug-in type relay and socket. Vibration range is from 0 to 500 cycles per second and upward at 15 "G" without chatter. Coil resistances up to 50,000 ohms are available, with contact loading through 10 A. resistive for 100,000 cycles (30 A. resistive for 100 cycles) at 30 V., D.C., or 115 V., A.C. Sensitivity approaches 100 milliwatts at 30 "G" operational shock resistance. They meet all requirements of USAF Spec. MIL-R-5757 ... and far surpass many. Various standard mounting arrangements available. Write for Bulletin R-150 or ask for "Diamond H" technical assistance.

**THE HART MANUFACTURING COMPANY**  
210 Bartholomew Avenue, Hartford, Connecticut

CIRCLE ED-111 ON READER-SERVICE CARD FOR MORE INFORMATION

### EXACTLY RIGHT For the most EXACTING CONTROL

#### STABILINE

TYPE **IE** INSTANTANEOUS  
ELECTRONIC  
*Automatic*

#### VOLTAGE REGULATORS



- **COMPLETELY ELECTRONIC** ... with no moving parts.
- **INSTANTANEOUS CORRECTION** ... complete correction is effected in 3 to 10 cycles.
- **EXCELLENT STABILIZATION and REGULATION** ... output voltage is held to within ± 0.1 volts for input voltage variations — to within ± 0.15 volts of nominal for any load or power factor change from lagging .5 to leading .9.
- **MINIMUM WAVEFORM DISTORTION** ... never exceeds 3%.
- **STANDARD and SPECIAL MODELS for EVERY NEED** ... Wherever the most exacting control is required, there's a STABILINE Automatic Voltage Regulator to do the job — and do it better. Send now for engineering information and your copy of STABILINE Bulletin S351.

WRITE TO:  
1706 MAE AVE.

**THE SUPERIOR ELECTRIC CO.**  
BRISTOL, CONNECTICUT



CIRCLE ED-112 ON READER-SERVICE CARD FOR MORE INFORMATION

## — FREED —

### TRANSFORMERS

### INSTRUMENTS

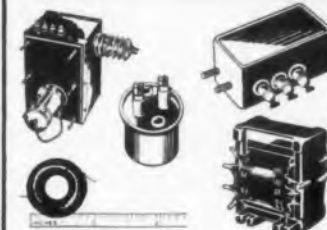

MILITARY COMPONENTS TO  
SPECIFICATIONS MIL-T-27 & ANE-19  
AND COMMERCIAL TYPES

Pulse Transformers  
Filter Reactors  
Charging Reactors  
Saturable Reactors  
Toroid Inductors  
Low Pass Filters  
High Pass Filters  
Band Pass Filters  
Discriminators  
Plate Transformers  
Power Transformers  
Filament Transformers  
Vibrator Transformers  
Input Transformers  
Interstage Transformers  
Driver Transformers  
Output Transformers  
Modulation Transformers  
Blocking Oscillator Transformers  
Band Elimination Filters



NO. 1020 B  
MEGOhmmeter  
DIRECT READING



NO. 1010  
COMPARISON  
BRIDGE

Self-contained and A.C. operated with electronically regulated supply. 1 megohm to 2 million megohms.

Self-contained and A.C. operated. For rapid and accurate test of resistors, condensers and inductors.

**OTHER FREED INSTRUMENTS**  
NO. 1030 Low Frequency G. Indicator  
NO. 1110A Incremental Inductance Bridge  
NO. 1150 Universal Bridge  
NO. 1170 D.C. Supply  
NO. 1210 Null Detector and Vacuum Tube Voltmeter  
NO. 1140 Null Detector Amplifier  
NO. 1040 A.C.—V.T. Voltmeter  
NO. 1250 Decade Condenser  
NO. 1410 Harmonic Distortion Meter  
and Decade Inductors

SEND FOR COMPLETE CATALOG DESCRIBING ALL  
FREED INSTRUMENTS AND TRANSFORMERS

**FREED TRANSFORMER CO., INC.**  
1727 Weirfield St., Brooklyn (Ridgewood) 27, N. Y.

CIRCLE ED-113 ON READER-SERVICE CARD FOR MORE INFORMATION

# Advertising Index

June 1953

Inquiry No.	Advertiser	Page
44	American Electronic Mfg., Inc. Agency: Clyde D. Graham Advertising	25
45	Anglo Corp. Agency: Merchandising Advertisers, Inc.	20
56	Bead Chain Mfg. Co., The Agency: Norman D. Waters & Associates, Inc.	23
107	Beam Instruments Corp. Agency: Salow & Associates	31
4	Browning Laboratories, Inc. Agency: Engineered Advertising	8
42	Brush Electronics Co. Agency: The Griswold-Eshleman Co.	20
60	CBS-Hytron Agency: Bennett, Walther & Manadier, Inc.	24
26	Cambridge Thermionic Corp. Agency: James Thomas Chirurg Co.	16
97	Chicago Telephone Supply Corp. Agency: Burton Browne Advertising	29
25	Continental-Diamond Fibre Co. Agency: Geare-Marston	16
12	Elastic Stop Nut Corp. of America Agency: G. M. Basford Co.	16
3	Electrical Industries, Inc. Agency: George Homer Martin Associates	4
68	Ethylene Chemical Corp. Agency: Mercreeady, Handy & Van denburgh	26
46	Faber-Castell, A. W., Pencil Co., Inc. Agency: J. M. Kesslinger & Associates	20
5	Fairchild Camera and Instrument Corp. Agency: G. M. Basford Co.	9
8	Fenwal Inc. Agency: James Thomas Chirurg Co.	12
54	Ford Instrument Co. Agency: G. M. Basford Co.	22
113	Freed Transformer Co., Inc. Agency: Franklin Advertising Service	34
2	G-V Controls Inc. Agency: Art-Copy Advertising	3
111	Hart Mfg. Co., The Agency: Wilson, Haight & Welch, Inc.	34
108	Heldor Mfg. Corp. Agency: Corbin Advertising	31
33	Helipot Corp., The Agency: Dozier-Eastman and Co.	18
114	Hermetic Seal Products Co. Agency: Art-Copy Advertising	35
	Hughes Research and Development Laboratories Agency: Foote, Cone & Belding	32
37	Jennings Radio Mfg. Corp. Agency: L. H. Waldron Advertising	18
40	Keystone Products Co. Agency: W. H. Watt Advertising	19
55	Kulka Electric Mfg. Co., Inc. Agency: L. D. Biehart Co.	22
7	Landis & Gyr, Inc. Agency: Bertram Coren	12
98	M-W Laboratories, Inc. Agency: Schoenfeld, Huber & Green, Ltd.	30
50	Metron Instrument Co. Agency: Wayne Welch, Inc.	22
32	Pike, E. W., & Co. Agency: The Franklin Fader Co.	18
29	Polytechnic Research & Development Co., Inc. Agency: George Homer Martin Associates	17
59	Potter Instrument Co., Inc. Agency: J. B. Roberts, Inc.	23
41	Precision Paper Tube Co. Agency: Symonds, MacKenzie & Co., Inc.	20
115	Radio Corp. of America Agency: J. Walter Thompson Co.	36
36	Radio Receptor Co., Inc. Agency: Walter J. Zimmerman Associates	18
49	Raytheon Mfg. Co. Agency: Walter B. Snow & Staff, Inc.	21
21	Relay Sales Agency: A. F. Marthens and Associates, Inc.	16
	Sigma Instruments, Inc. Agency: Meissner & Culver, Inc.	28
67	Southwestern Industrial Electronics Co. Agency: Rives, Dyke and Co.	25
110	Standard Transformer Corp. Agency: Burnet-Kuhn Advertising Co.	33
112	Superior Electric Co., The Agency: Hugh H. Graham Associates, Inc.	34
9	Sylvania Electric Products Inc. Agency: Cecil & Presbrey, Inc.	13
6	Technic Inc. Agency: George T. Metcalf Co.	10
63	Tensolite Insulated Wire Co., Inc. Agency: George Homer Martin Associates	25
51	United Technical Laboratories Agency: Seward Jackson Advertising	22
1	United Transformer Co. Agency: Shappe-Wilkes Inc.	2
54	Waters Mfg., Inc. Agency: Engineered Advertising	27

to use

Hermetic's New

**Vac-tite**  
Compression Seals



and

vacuum tightness is a requisite, HERMETIC's proven compression seals are guaranteed to be vacuum tight, as evidenced by Mass Spectrometer Test.

The following styles of proven VAC-TITE compression seals are available:

Individual terminals and feed-throughs with a full range of hooked, flattened and pierced, turret and lug-type terminations for every application.

All-glass construction multi-terminal headers featuring larger leakage paths and an absence of moisture pockets.

Individually glassed plates available in a multiplicity of standard designs and easily adaptable to special designs in a variety of shapes and sizes for every requirement.

Plugs for standard sockets in several mounting types . . . such as octal, 7-pin miniature, noval as well as rectangular shapes.

Write for complete information on how HERMETIC engineers can apply "All-Glass" Compression Seals to your regular or special applications. Available, too, is HERMETIC's Brochure CS on Compression Seals, as well as a 32-page catalog on its standard line.

**HERMETIC SEAL PRODUCTS CO.,**

\*VAC-TITE is HERMETIC's new vacuum proof compression-construction glass to metal seal.



CIRCLE ED-114 ON READER-SERVICE CARD FOR MORE INFORMATION



New flat-face, for easier, more accurate hand-tracing of waveforms



New high-brilliance fluorescent spot. You "see" more—even in work with high-speed phenomena



Higher sensitivity for vertical deflection. Ideal for wide-band amplifier work

## FLAT-FACED

### —for modern Oscillography!

**3 new RCA 5" oscillograph tubes feature very high sensitivity and fine trace detail**

You are looking at three new RCA tubes designed specifically for work with wide-band amplifiers. • High vertical-deflection sensitivity offsets the inherently low-signal output of such amplifiers. • Low-capacitance vertical-deflection electrodes offer the type of load into which wide-band amplifiers work best. • High horizontal-deflection sensitivity, plus full-screen scan. • New high-brilliance pin-point spot produces

finer trace detail. • And note this: *The flat faceplate makes it easier to "hand-trace" waveforms ACCURATELY!*

RCA-5ABP1 (medium-persistence) is ideal for wide-band vertical amplifier measurements—and for general oscillographic work requiring high-intensity tracing. RCA-5ABP7 (long-persistence) is suited to applications where No. 1 grid is pulse-modulated at low frequency—as in radar indicator services.

RCA-5ABP11 (short-persistence) is especially designed for photographic recording without blurring.

For improved oscillograph tube performance, consider the advantages of the 5AB-types. These tubes generally can be substituted for the corresponding 5C-type. For technical data write RCA Commercial Engineering, Dept. 72FR, Harrison, N.J. Or write your nearest Field Office:

(East) Humboldt 5-3900, 415 S. 5th St., Harrison, N. J.

(Midwest) Whitehall 4-2900, 589 E. Illinois St., Chicago, Ill.

(West) Madison 9-3671, 420 S. San Pedro St., Los Angeles, Cal.



**RADIO CORPORATION of AMERICA**  
ELECTRON TUBES  
HARRISON, N. J.

# ELECTRONIC

# DESIGN

ELECTRONIC

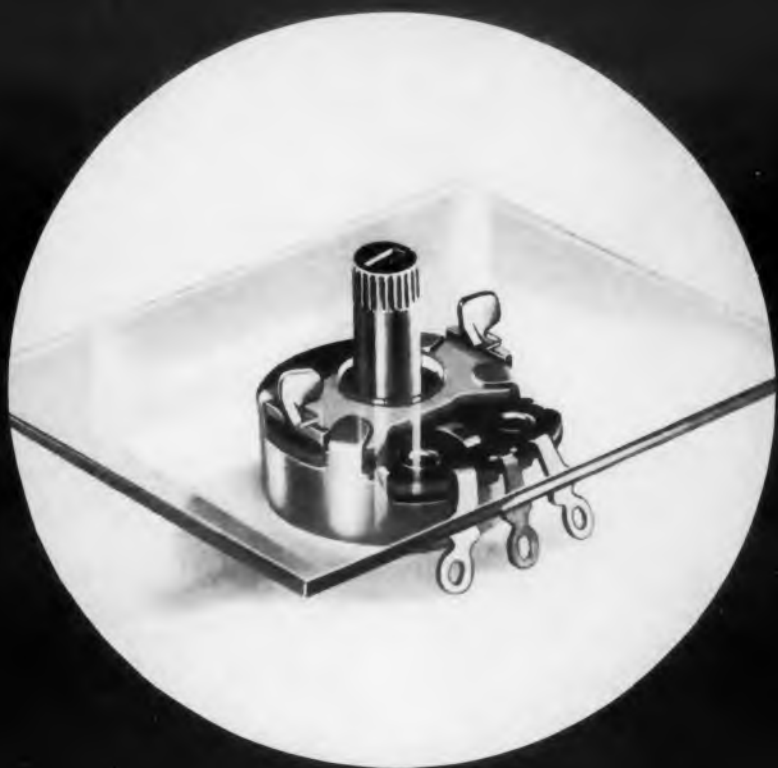

THE LIBRARY OF  
CONGRESS  
SERIAL RECORD

AUG 6 1953

**T**HESE new developments in potentiometers for mass production use such as in TV receivers have several interesting design features. The unit at the top may be furnished with an insulated shaft for hot chassis applications and is held rigidly to the panel by twisting two mounting ears. The usual threaded mounting bushing and nut are eliminated. Shown below is a similar potentiometer which can be used for screwdriver adjustment only or with a detachable shaft that can be purchased separately in varying lengths and plugged into the control after installation in the chassis.

July 1953

*First Commercial  
Transistor Chart - page 11*