

ELECTRONIC

DESIGN

Vol. 1

JAN 21 1953

JANUARY, 1953

No. 1

THE LIBRARY OF
CONGRESS
SERIAL RECORD

JAN 23 1953

89PY

Press Fit Teflon Terminals

Mount in Pre-Drilled Chassis Holes

An inexpensive hand tool or drill press is all that is required to install these "Press Fit" Stand-off and Feed-through Electrical Terminals which are "Teflon" insulated. No hardware is needed because the resilient "Teflon" provides a secure fit.

Useful in high frequency radio and TV equipment, the terminals provide excellent performance and greatly simplify design problems in miniaturized equipment. They can be installed in inside corners and in many other locations with very little difficulty.

The high thermal stability of "Teflon" which retains its very good electrical properties from extremely low temperatures up to about 480°F makes it especially valuable for use with these terminals when they are used in miniaturized systems where high operating temperatures usually exist. In addition, "Teflon" will not support the growth of fungi and its electrical properties are not affected by high humidity. Sealectro Corp., Dept. ED, 186 Union Ave., New Rochelle, N. Y.

CIRCLE ED-1 ON READER-SERVICE CARD FOR MORE INFORMATION



Hermetically Sealed Subminiature Relay

Suitable for Military or Industrial A-C Applications

Although this dpdt hermetically sealed Subminiature Relay is especially suited for aircraft electronic applications, it also can be used for remote control mechanisms in almost all military or industrial equipment. It is shown here alongside an ordinary standard size cigarette to indicate its small size (1.00" diam x 1.71" long).

Operating on an input of 115v, 50- 1000cy, the relay is available in two models depending upon the contact rating desired. Model 10220 has a contact rating of 1amp, noninductive, and Model 10320 has a contact rating of 4amp, noninductive. All units are hermetically sealed with dry air or an inert gas.

Optimum operation is possible over a temperature range of -55°C to +85°C, and weight is 1.51 oz (43 grams). The unit connects with a 9-hook or 9-pin header. It can withstand 20G at 300cy vibrations (contacts normally closed, unenergized), as well as steady state acceleration up to 50G. Neomatic, Inc., Dept. ED, 9010 Bellanca Ave., Los Angeles 45, Calif.

CIRCLE ED-2 ON READER-SERVICE CARD FOR MORE INFORMATION

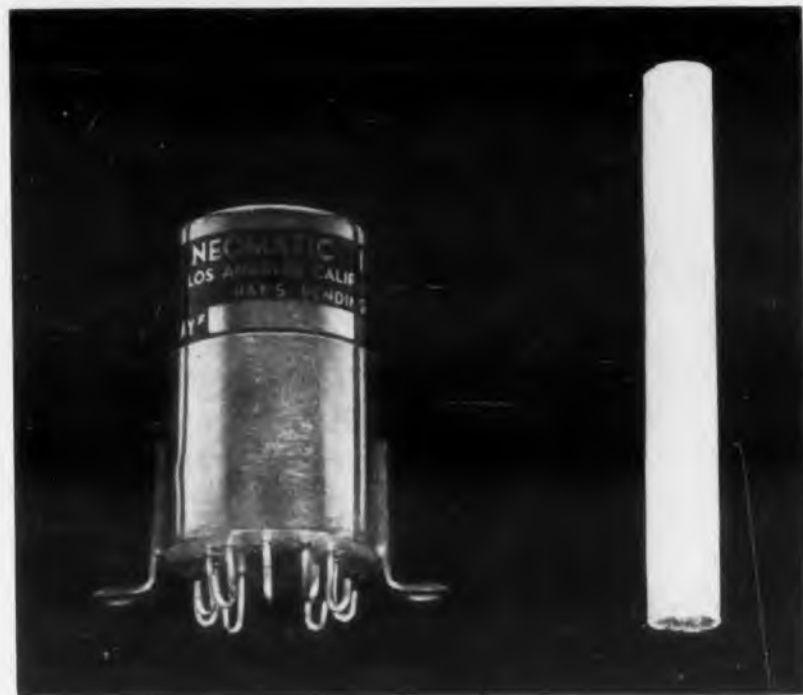

edwin i. guthman & co., inc.

15 s. throop st. chicago 7, CH 3-1600 • also attica, indiana

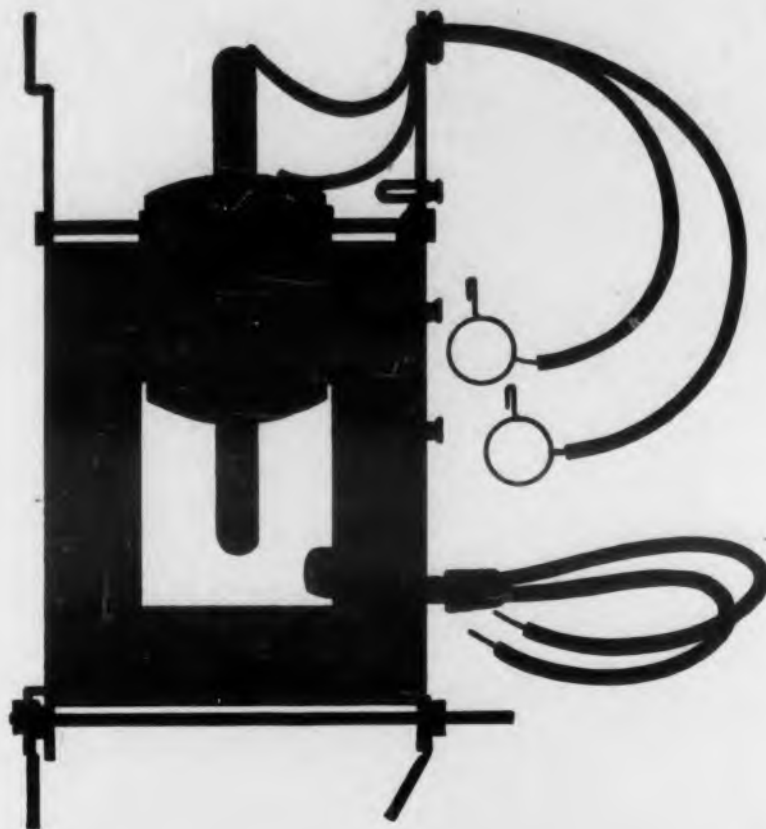

flyback transformers

For reliability in high voltage specify Guthman Flybacks—they won't break down even under the most severe voltage requirements. Wire used in Guthman Flybacks is fabricated in our own plant and is quality controlled from raw material to finished product guaranteeing a superior uniformity of performance. The excellent linearity and voltage regulation characteristics of Guthman Flybacks aids in preserving picture quality.

Coils used in Guthman Yokes are form wound. Complete isolation between vertical and horizontal coils achieved by a molded nylon piece permits a yoke rating of 5,000 volts pulse maximum. Anti-magnetic core retainer band and brass mounting nut assures no magnetism in Guthman Yokes.

DELAY LINES
SHIELD CANS
ANTENNA COILS
OSCILLATOR COILS
COMPRESSION TYPE
MICA TRIMMERS
I.F. TRANSFORMERS
LOOP ANTENNAS
R.F. TUNERS

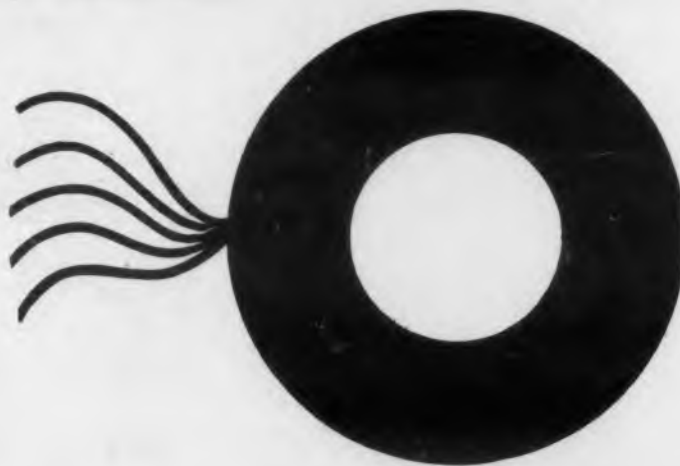

yokes

BURTON BROWNE ADVERTISING

CIRCLE ED-3 ON READER-SERVICE CARD FOR MORE INFORMATION

Staff

Edward E. Grazda Editor
E. Cookish Assistant Editor
N. Asto Production Manager
H. W. Schlager Business Manager
B. S. Morris Circulation Manager

Co-Publishers

T. Richard Gascoigne
James S. Mulholland, Jr.

Advertising Representatives

New York: T. Richard Gascoigne,
James S. Mulholland, Jr.
127 East 55th St.,
New York 22, N. Y.
PLaza 3-8677

Chicago: Thorpe Covington
677 No. Michigan Ave.,
Chicago 11, Ill.
SUperior 7-8054

Los Angeles: Robert W. Walker Co.
2330 West 3rd St.,
Los Angeles 5, Calif.
DUnkirk 7-4388

San Francisco: Robert W. Walker Co.
57 Post St.,
San Francisco 4, Calif.
SUtter 1-5568

CIRCULATION POLICY

ELECTRONIC DESIGN is circulated only to qualified electronic designers of U. S. manufacturing companies, industrial consultants, and government agencies.

If design is your responsibility, you qualify for a subscription to ELECTRONIC DESIGN without charge. The following information is required: your name and title, your company's name, address, and main product.

These are some typical qualifying titles: chief engineer, chief designer, electronic engineer, electronic technician, project engineer, development engineer, research engineer, and electrical engineer.

If you have a design responsibility, not indicated by your title, please add a description of those responsibilities.

Send the required information on your company letterhead.

ELECTRONIC DESIGN • January 1953

Co

Edit

Eng

Fea

Dep

Pro

Adv

ELEC
York
Ralph
tronic
velop
34.64

ELEC

ELECTRONIC *design*

Vol. 1
No. 1
January 1953

Contents

Editorial	4
Engineering Review	5
Features	
"Designing for Service Increases Product Acceptance", by Eugene A. Anthony, General Electric Co.	6
"Etched Circuits"	8
"Vacuum Tube Voltmeter Design"	10
"Two New p-n-p Junction Transistors"	12
"A High Sensitivity Rugged Meter Movement"	13
Departments	
New Products	1, 14-20
New Books	21
New Literature	23
Meetings	28
Patents	29
Product Inquiry Guide	30
Advertiser's Index	31

ELECTRONIC DESIGN is published monthly by Hayden Publishing Company, Inc. at 127 E. 55th Street, New York 22, N. Y., T. Richard Gascoigne, President; James S. Mulholland, Jr., Vice-President & Treasurer; and Ralph E. Marson, Secretary. ELECTRONIC DESIGN is circulated monthly without charge to men in the electronic industries who are responsible for the design and specification of manufactured devices, including development and design men of consulting laboratories and government agencies. Acceptance under section 34.64 P. L. & R. authorized. Copyright 1953 Hayden Publishing Company, Inc. 23,500 copies this issue.

4 NEW

Potter

FREQUENCY-TIME COUNTERS...

Automatically READS
FREQUENCY, TIME INTERVAL
AND PERIOD



NEW

COMPACT DESIGN
CIRCUITS
FEATURES
LOWER PRICES

USE THEM FOR

FREQUENCY MEASUREMENTS

PERIOD MEASUREMENTS

TIME INTERVAL MEASUREMENTS

FREQUENCY RATIO MEASUREMENTS

SECONDARY FREQUENCY STANDARD

TOTALIZING COUNTER

DIRECT RPM TACHOMETER

Every known need in frequency and pulse measurement is now satisfied by four completely new designs of Potter frequency-time counting equipment.

The simplified Potter 100 KC Frequency, Models 820 and 830, are suitable for rapid and precise production line applications. The versatile Potter 100 KC and 1 MC Frequency-Time Counters, Models 840 and 850, include all gating, switching, timing and counting circuitry required for any conceivable counting-type measurement.

All models feature the convenience of smaller size, lighter weight, and functional panel layout. And, optional readout indication—either the dependable Potter 1-2-4-8 decimal readout or the conventional 0-9 lamp panels—is available.

Tells All

about Frequency-Time Counters—both laboratory and industrial applications.



For further data or engineering assistance write Dept. 1-F.

Potter

POTTER INSTRUMENT COMPANY, INC.

115 CUTTER MILL ROAD
GREAT NECK, N. Y.

CUT MANUFACTURING COSTS

With high quality Sylvania Tungsten and Chemical Products



Section of the metallurgical laboratory of our engineering department.

General view of Sylvania tungsten wire drawing department at our Towanda, Pa. plant.

You take no chances—save time and money—when you use Sylvania tungsten and chemical products. Sylvania tungsten is quality controlled from ore to finished product, tested in the laboratory, in the field. Suppliers to all leading manufacturers in the radio and television industry, Sylvania offers you tungsten and chemical products that meet the highest standards of purity, precision, and uniformity.

To help you work out any special high quality product or solve your toughest manufacturing problems, Sylvania maintains large metallurgical and chemical laboratories. If it's a question of anything from a precision, custom-made tungsten component, a special high-purity phosphor, chemical or compound, to silicon or germanium for crystals, put it up to Sylvania. A note on your letterhead brings you full particulars. Address: Sylvania Electric Products Inc., Dept 3T-4001, 1740 Broadway, New York 19, N. Y.

SYLVANIA

TUNGSTEN & CHEMICAL PRODUCTS; RADIO TUBES; TELEVISION PICTURE TUBES; ELECTRONIC PRODUCTS; ELECTRONIC TEST EQUIPMENT; FLUORESCENT TUBES, FIXTURES, LIGHT BULBS; PHOTOLAMPS; TELEVISION SETS

Editorial . . .

We often think that a good designer is one who designs a product so that it can readily be manufactured on mass production type machines or by means of high speed assembly line techniques. This is especially true of the electronic designer whose end equipment often contains hundreds or even thousands of individual parts, and any time-saving arrangement of components greatly affects production costs.

Not too long ago, this skill—designing for high speed production—used to be the most important (if not the only) talent a designer possessed. Today however, another skill is rapidly assuming major importance on the electronic designer's horizon—designing for product acceptance.

The industrial designer tries to achieve public acceptance of commercial products by changing their color, shape, or size to produce a pleasing appearance that will induce the public to buy. Unfortunately, a good-looking product is not always one that is easy to repair when some malfunction occurs.

Here is where today's electronic designers can make a contribution to product acceptance. They can arrange their circuitry, components, and controls so that service and maintenance are easily effected, thereby reducing maintenance costs and keeping the customer happy with his product. Mr. Anthony develops this theme for the TV receiver field (see pages 6 and 7 in this issue).

In the industrial electronic field, the two most important factors that make for product acceptance are dependability and ease of maintenance. It is easy to see that if a production machine or a processing line has to be shut down for hours at a time in order to repair an electronic control, the plant superintendent is not going to be too happy with his electronic device. It also doesn't help matters any if it takes a graduate electronic engineer to locate the trouble and make the necessary repairs.

Designing products to take full advantage of mass-production techniques is now an accepted part of an electronic designer's stock in trade. By re-thinking, re-examining his circuits and arranging them with ease of service and maintenance in mind he can add greatly to the general acceptance of electronic devices in industry.

Incidentally, during World War II and since, much has been learned about how to make electronic equipment easy to service. Those companies making devices for the military have had to incorporate ease of maintenance and service in their designs. This "know how" can be applied in civilian electronic equipment to the great advantage of both manufacturer and user.

Trans
going
first a
cial j
applic
aid. T
use n
tiny
"micr
transi
batter
the co
is tw

Casti
mater
poner
cost
readi
and
quenc
stren
0.013
and 5
thick

Mea:
new
ancec
used
and
ment
resul
taine
ties c
to ar
form
fact
wave
short
end
Furt
the a
sible
tion

Engineering Review . . .

Transistors in Commercial Product . . . Just before going to press, ELECTRONIC DESIGN learned of the first application of junction transistors to a commercial product available to the general public. This application is in the power output stage of a hearing aid. The unit employed is an n-p-n transistor, and its use makes possible a life of over six months for the tiny "B" battery. The circuit incorporates two "micro-miniature" (sub-sub miniature) tubes and the transistor. Weight of the hearing aid complete with batteries is only 3 oz, it is 25% to 30% smaller than the company's previous model, and its power output is twice as great as that of comparable instruments.

Casting Resin . . . "AN-5" Casting Resin is a new material for embedding or potting electronic components and assemblies. Easily manufactured at low cost from available raw materials, the material is readily stored and it has good physical properties and electrical characteristics at high and low frequencies. Tensile strength is 4600psi, compressive strength is 15,300psi, water absorption (24hr) is 0.013%, dielectric constant (dry) is 2.61 at 10⁴cy and 2.55 at 8.6 x 10⁵cy, and dielectric strength (0.070" thick) is 1430v/mil. Shrinkage during cure is 9.8%.

Measuring Transmission Line Attenuation . . . A new method for measuring the attenuation of balanced, unshielded transmission lines such as those used in TV and F-M receivers is simple and rapid, and only requires easily obtainable laboratory equipment. By using a grid-dip meter and a microammeter, results reproducible to better than 10% can be obtained. With more elaborate apparatus reproducibilities of better than 1/10th of 1% and attenuation values to an estimated accuracy of 1% are possible for uniform sections of line. The method is based on the fact that if a section of line (a number of half-wavelengths long) is resonated when both ends are shorted, the standing wave ratio at the receiving end will be greater than that at the input end. Furthermore, the change in SWR is caused only by the attenuation in the line. This fact makes it possible to determine the attenuation merely as a function of the standing wave ratio.

Electronic Printer . . . A nonphotographic electronic printer operating from a coded signal can print at high speed the outputs from electronic computers, insurance premium notices, utility bills, addresses on magazine labels as well as on cards and envelopes. It also can be used for high speed printed communication because it can be operated by remote control, without synchronization. The coded signal can be furnished from any suitable source such as from the holes in automatically-fed punched cards, film, perforated tape, magnetic tape, magnetic wire, radio, coaxial cable, electronic computer, electronic storage systems, etc. It releases a predetermined sequence of operations to print the entire built-up rectangular-dot character automatically.

Noise-Free Cable . . . Spurious signals or electrical noise produced by instrument cables which are subjected to shock or vibration can be eliminated for practical purposes by having continuous electrical conduction between both surfaces of the insulating dielectric and the adjacent conductors. Using a simple procedure it is possible to construct short lengths (6' or less) of this kind of cable for laboratory use. Applications include its use with piezoelectric accelerometers and pressure gages; in crystal-type microphones, hearing aids, and phonograph pickups; and wherever the cable may be subject to shock, vibration, pressure, or stress, and the terminating impedance of the cable is not very low.

"Atomic" Road Testing . . . Atomic radiation and a scintillation counter are being used to help test materials for producing better highways. Typical road stone is soaked in radioactive calcium chloride and dried. Then it is coated evenly with asphalt, which may contain additives to improve the adhesive characteristics, and the mixture is covered with water for a specified period of time. If the asphalt separates from the stones, the radioactive calcium chloride dissolves into the water. After evaporation, the radioactivity of the residue is measured with a scintillation counter. A correlation between the radioactivity count and previously prepared charts tells engineers the quality and adhesive characteristics of the asphalt.

Radiation Detector . . . An instrument for detecting nuclear radiation employs a photovoltaic cell as its sensitive element. Extremely simple, it requires no external source of voltage, permitting the design of a compact, rugged, and reliable unit. The detector consists of a phosphor in close contact with one or more photovoltaic cells. Under nuclear radiation, the phosphor emits light which falls on the photovoltaic cells which then deliver a current that can be read on a microammeter or galvanometer. The instrument has been used to detect X-rays and gamma rays with the recording meter located 2000' from the detector with negligible loss of information. If sensitivity requirements are not too severe, the detector can be made very small. The smallest unit made so far is a cylinder which measures 1" diam x 1" high.

Computer-Controlled Miller . . . A milling machine that is controlled by a digital computer and operated by means of servomechanisms has been developed. Instructions to the machine are inserted on punched paper tape, stored in relay registers, processed by computer-type circuitry, converted into shaft rotations by pilot servomechanisms, and executed by power servomechanisms which move the cutting tool over the work.

Electronic Stencil Cutter . . . At the recent Business Show in New York City an electronic stencil cutting machine capable of doing continuous tone work without any intermediate screening was demonstrated. It employs a photoelectric pickup which scans the photo to be reproduced (at a rate of 500 lines per inch) and sends a signal to a special conducting stylus that etches or burns an impression on a metallic stencil by means of electric sparks. It takes about 22min to make an 8" wide stencil, which then can be run on a special mimeograph machine to produce 6000 copies per hour.

Long Distance V-H-F Propagation . . . A new type of v-h-f propagation by means of the ionosphere has been observed at distances as great as 1200 or 1300 miles from the transmitter. Early results of an investigation reveal the uninterrupted presence of weak but observable signals over a 774 mile test path, and suggest that the signals are returned from a part of the E region of the ionosphere (between 50 and 70 miles above the surface of the earth) near or just below the absorption region for high-frequency radio waves. A striking characteristic of the received signal is the presence of random heterodyne whistles (mostly descending in pitch) at all times of day.

Designing For Service Increases Product Acceptance

Eugene A. Anthony

General Electric Company, Marketing Services Division

THE BUSINESS of producing radio and television receivers for the American home is an involved enterprise comprised of many widely different functions which, when properly integrated, establish a pattern of commercial success. In the process, the public benefits through improvement in living standards and certain producers distinguish themselves and thereby strengthen their position in the industry. That is one of the major objectives of almost all manufacturing organizations. The activities which must be properly integrated include employee relations, finance, manufacturing, marketing, engineering, and many more. There are varying degrees of commercial success, of course, and these are determined by the manner in which functions are related to the overall job.

Design Engineer's Role

The designing engineer is an important part of this pattern. Unfortunately, there is much evidence pointing to the fact that design work is often poorly related to the real problems at hand—sometimes the objectives are narrow and unrealistic. Much can be done to increase the effectiveness of the designer's work if his sights are readjusted to include problems which yield readily to solution and which contribute to the general health of his organization. There is a fertile field for improvement in design work and that field is product service. The purpose of this article is to direct the designer's attention to the possibilities open to him.

The designer's work can easily result in a losing battle if his objectives are so narrow that they include only maximum performance at lowest production cost. This is, of course, a necessary objective, but one which must be pursued philosophically. We can't all be best, and we recognize that we are all faced with "major league" competition in this field. In a practical sense, all major manufacturers realize this objective to very nearly the same degree; the variation is only academic. Usually, it is only with tremendous effort, and at great expense that a significant step can be made ahead of competition.

Not so in the field of product service. The designer's effort in this direction can easily produce results which

can have a profound effect upon the marketability of a product. This is true, not so much because the problems are simpler but because there are so many possibilities which have been ignored. Perhaps this is true because the product designer has given little thought to the subject through a lack of appreciation of its importance.

Importance of Component Quality Generally Appreciated

There is little need to point out the undesirable effect of component failures or of the importance of keeping these at a minimum. A great part of engineering effort is spent in the improvement of component quality so as to reduce failures. To this extent, product service problems are adequately taken into account in engineering. This is probably true because persistent component failures are considered to be the direct responsibility of engineering. Component weaknesses, in other words, are assumed to be the result of poor engineering.

Even if there were no other reason, engineering in its own "defense," must devote time and effort to the improvement of component quality and to improvement in application techniques.

This form of engineering effort is *preventive*—it deals with preventing product breakdowns. Despite this effort, however, breakdowns *do* occur, sometimes for reasons which could not have been avoided (in a practical sense) in the product design stage. But there are things which can be done in the design stages to reduce the impact of failures when they do occur. These are probably best illustrated by examples, and several are offered below.

The Importance of the Serviceman's Problems

In a broad sense, the reputation of a product, hence its commercial success, is based upon its performance. If we attempt to look further into this situation, however, the facts cease to remain simple. Performance, we reason, is not absolute; it is really an impression to a large extent and is modified by many small but important things. There is little need to investigate each and every element but rather to isolate those which we, in our design work, can influence beneficially.

It is most important to recognize the fact that when product performance problems arise, the serviceman plays a profound part in keeping your customer happy with your product. Thus, the serviceman is important to you—he can help you if you permit and encourage him to do so. In spite of this, it frequently appears as if the designer has no interest whatever in his problems and has made no attempt to make things easier for him.

The serviceman is a human being like you and me. He instinctively seeks the easiest solution to a problem; is constantly called upon to compromise his efforts. He deals with one major commodity—his time—which he has to sell profitably. Thus he must do his work quickly and efficiently in order to do the right kind of a repair job at what the customer will think is a fair price.

If your product is difficult to service because simple operations are necessarily time consuming—you pay the price in the long run. The serviceman must, of course, pass on the cost to your customer. The customer doesn't like to pay big repair bills to keep his set going. He blames either your product or believes the serviceman to be incompetent or dishonest. In the former case you suffer directly; in the latter, the serviceman feels the impact and, in turn, loses some of his respect for your product.

The damaging effect of poor customer acceptance or poor serviceman acceptance should not be underestimated. It is easy to see why poor customer acceptance can hurt—but have you thought about the effect of poor acceptance on the part of the serviceman? He enjoys the position of an authority in his community. Both dealers and customers look to him for the "real dope". If he dislikes your product, your sales suffer—and in his mind, with good reason; he feels that you have designed trouble *into* your product.

Let's look at some specific cases about which you can do something.

"Bank-Vault" Back Covers

Television sets usually employ a cabinet back to comply with Underwriter's requirements for safety. Even without specific Underwriter's requirements, it's good common sense to keep out the hands of children or laymen. But back covers are sometimes an acoustic

problem; they exhibit resonances so that they rattle and vibrate unless securely fastened.

A simple solution is to secure the back cover with many screws—the more, the better. This is considered good engineering practice, but is it really good?

The removal of the back cover ceases to be a simple job when there are many screws involved. You don't like to do it—and the serviceman doesn't—unless he has to. It is obvious that the time required to perform this operation becomes part of the legitimate charge for service—but the problem doesn't end there.

A serviceman may (and often does) for example, complete the reassembly of a repaired television set, push it back into position, and then turn it on as a final check, only to notice that things aren't quite right. Perhaps the centering, focus, or horizontal speed need a little touching up to make things completely right and the back has to be removed to do so. Does he do it? Not always. Very often the adjustment is not considered worth the effort and it remains undone. Your product performance suffers.

The solution is obvious, once the problem is recognized as a *design* problem. If the designer appreciates the damaging effects of this "nuisance" he *can* do something about it. He can devise simple systems of providing quick back removal while eliminating resonance effects, if they exist. Simple half-turn fasteners may provide the solution—or push-pin fasteners; the precise method is not important. What is important is that the operation be possible quickly and conveniently so as to permit and encourage servicemen to do a good repair job. It will pay dividends.

Evidence of the nuisance value of too many back cover screws is found in the examination of television receivers which have been serviced several times. More often than not, only the minimum number of screws are replaced. If resonance rattles were the effect to be eliminated by these screws, this situation won't help your product performance.

Chassis, Cables, Plugs and Hours

Perhaps the television receiver design in which the serviceman believes his problem has been most flagrantly ignored is one which is composed of two or more basic units so interconnected by cables that it is almost impossible to operate it in an exposed service position. Many such receivers have been produced and are responsible for the expenditures of many, many hours of unproductive service labor.

The problem is more serious than that of time, which is serious enough. It places the servicemen in a most disadvantageous position right at the outset and seems to defy him to do a good repair job. It is presumed, of course, that the serviceman is not equipped with special cables, jigs, etc.—a valid assumption in most cases, in view of the plethora of television models which the average serviceman is called upon to service. Furthermore, it is highly impractical to carry such equipment in a service car as a regular practice—thus service in

the home is almost always ruled out. Simple repairs are therefore expensive and your product loses some of its practical appeal.

The degree to which a serviceman is handicapped by such assemblies is evident in the grim humor of the scene he sometimes creates in the performance of his work. He may utilize a combination of bridgechairs, telephone books, clip leads, and mirrors, while lying prone and watching a test instrument hanging by its handle from a bridge lamp. Exaggerated? Hardly! Such tactics are sometimes the only answer.

Under such conditions, the serviceman has little inspiration to do a good job. His only object is to "get it working". It is easy to figure out what his action will be after he has finished his repair, reassembled the set, and finds that further work is needed to do a good job.

What is the solution?

There are many solutions but their attainment requires an initial interest in the problem. In some cases, the simple relocation of one or two connections would make service far easier. In other cases, a bracket would do the trick. The most important factor in providing a solution, however, is including ease of service as a design criterion, as suggested earlier.

Bolts

Television and radio chassis are often secured by means of bolts which, while well adapted to production tools, are not easily handled with ordinary tools. Some bolts, although provided with screwdriver slots are not cut deeply enough to be driven satisfactorily with an ordinary screwdriver. Often these bolts are self-tapping and are so tightly secured that appreciable force is needed to release them.

Many servicemen boast injured fingers caused by the slipping of gas pliers which are used to remove these bolts when a screwdriver fails to do the job. The use of such bolts is, of course, not a serious problem, but it does create a nuisance situation and contributes its share to non-productive service time.

Alignment Screws

Some television sets are so designed that the alignment screws can be adjusted only after removal of at least the cathode ray tube. This poses no special problem in production since the processes are developed around this requirement. To the serviceman, however, this introduces an unnecessary time-consuming inconvenience.

Many sets are repaired in shops where alignment equipment is available. The decision to align a set is often influenced by the ease with which this can be done.

A set in service for a year, for example, and particularly one in which several tube replacements have been made, could easily be in need of at least minor realignment. The performance may be good enough to get by without it but it may be bypassed if the cathode ray

tube has to be removed to do the job. On the other hand, if alignment can be done simply by connecting the equipment to the chassis, it may be performed as an "extra" service. This puts a better operating receiver in the hands of your customer.

Here again, the solution is obvious. It is not a difficult job to design a receiver with all alignment screws in accessible positions. A good example of this principle is a particular model which located all screws below the chassis and also included a special built-in bracket on the chassis so that it could be stood securely on edge without other support.

Wiring and Component Identification

The serviceman is called upon to service many models of varied manufacture and cannot develop more than a casual acquaintance with most sets. Thus, he finds himself involved in frequent circuit tracing during his service work.

It is recommended that design engineers recognize this fact and design circuit-tracing facility into the product to the greatest practical degree. The discreet selection of wire colors, their placement, and the layout of terminal boards can do much to help in this respect. Components can be kept fully in view when this is reasonable and "rat's-nests" avoided.

This practice will pay dividends in faster, better service jobs at lower cost to your customers. An added helper is the distinct marking of component values or characteristics where these are not otherwise evident and do not materially add to the cost of production.

Conclusion

There is much that can be done by the design engineer in improving the quality of his product in terms broad enough to encompass the real factors involved in establishing product reputation. A profound factor in this regard is product service.

Thus, the design engineer falls short of doing his best if he fails to take into account the problems of the serviceman in performing routine service work.

There are many product service problems which fall within the scope of solution or alleviation right on the designer's drawing board. He and his company are missing a good bet if they fail to recognize this.

There are many specific ideas in this connection which are worth studying and applying. Some are offered herein as a guide, to start the wheels turning, as it were; others will suggest themselves.

The specific ideas suggested herein call for the design engineer to place on his drawing board:

- Simplified cabinet-back removal
- Simpler multiple-chassis interconnections to permit on-the-spot service
- The use of hardware which can be handled with common tools
- More convenient location of alignment adjusters
- More traceable wiring and clearer component identification

Etched Circuits

PRI NTED circuits have long attracted the attention of electronic designers because of their great design advantages in effecting miniaturization of circuits and production cost savings. The usual printed circuit consists of an insulating base material on which conductive lines are superimposed to form the circuit. Several methods are employed for obtaining these conductors. Electrically conductive inks or paints are applied by printing or silk screening. In other instances adhesives are printed or silk screened on to the base material, and then electrically conductive powders are applied to the adhesives. Electroplating techniques also can be used to produce the required patterns.

All of these techniques produce circuits which have relatively low current carrying ability, and it is difficult to obtain a consistently perfect electrically conductive pattern. To overcome these limitations, the Signal Corps and Etched Products Corp. of Long Island City have jointly developed a new technique for making these printed circuits, and the end product is known as an "etched circuit" (see Fig. 1).

The Etched Circuit

An etched circuit consists of a metal foil wiring circuit laminated on an insulating base material. There may be a circuit on either one or both surfaces

Fig. 1. Typical examples of etched circuit for several different kinds of applications. The bright surfaces are silver plated and the dull surfaces are plain copper.

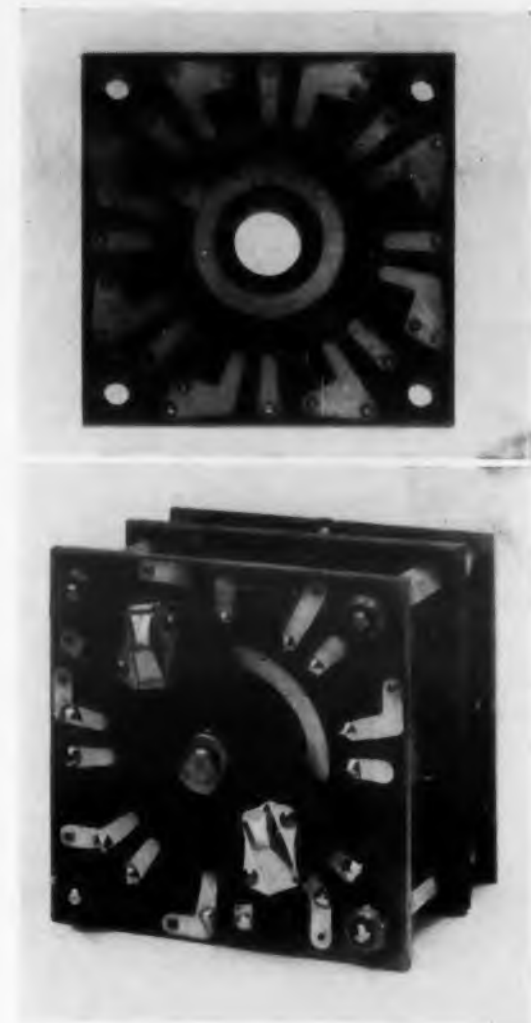
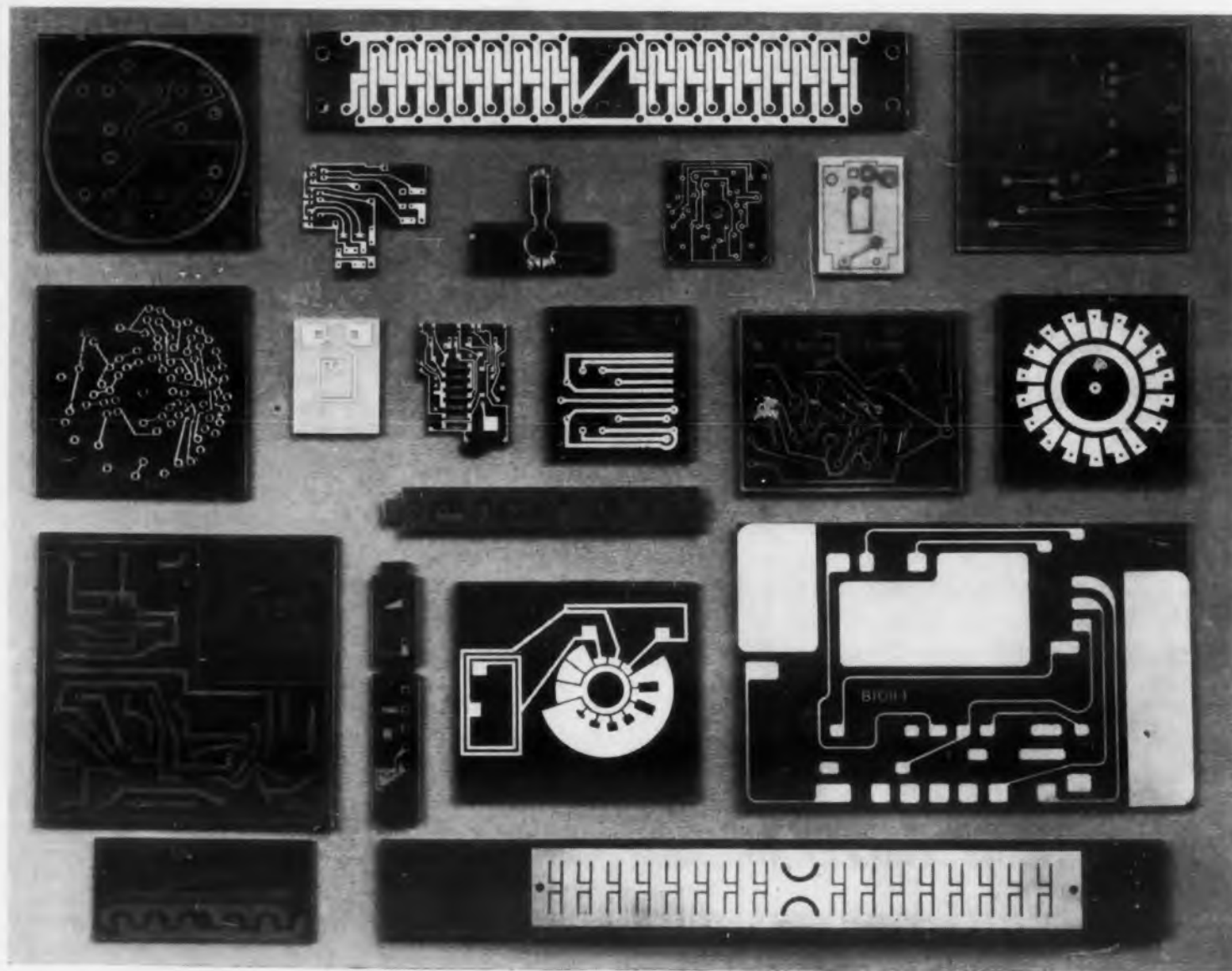

Fig. 2. A switch wafer (above) and a ganged assembly (below) made by means of etched circuit techniques.

of the assembly with connections made between two opposite surfaces by means of eyelets if desired. Holes for assembly of other components to this circuit also are provided.

The manufacturing method is simple. The circuit starts out as a lamination of a copper or aluminum foil on one or both surfaces of an insulating thermosetting laminate. A circuit pattern is then printed on the surfaces. Next, an acid-resisting powder is adhered to the wet printing ink and fused under heat, producing an acid-resisting coating. Groups of these sheets then are immersed in etching solutions which remove the unwanted portions of the copper foil. After removal of the acid resisting coatings and the mechanical punching of required patterns and holes into the material, the circuit is ready for assembly operations or for inspection, packing, and shipping.

It is interesting to note that this method of manufacture is entirely equivalent to that used by the company in manufacturing name plates. This permits fitting etched circuit production into the regular flow of etched work at a minimum cost. Where very small runs or samples have to be made, a photo-etched process is employed. The metal clad laminate is photographically sensitized and then exposed to light

through a negative containing the required pattern. The acid resistant light sensitive plate then is developed and etched in the usual manner.

Materials Used

The most frequently used conducting material is 0.000135" to 0.0027" copper foil laminated to Type XXXP-26 phenolic laminate. The plastic sheet is available in thicknesses from 0.010" to 2", and the most commonly used thicknesses are 1/32", 1/16", 3/32", and 1/8". Copper foil laminates also are available in thicknesses of 0.00405" and 0.005".

Other thermosetting plastics such as melamine, silicone, teflon, and polystyrene glass fabrics can be used if desired. For high temperature applications a silicone "Fiberglas" laminate is available that can withstand 200°C for four hours or longer. It also is possible to obtain metal foils laminated to flexible bases including paper, nylon, and glass cloth for special applications. Maximum sheet size presently obtainable is about 3' x 4'.

Design Advantages

Like any other printed circuits, etched circuits combine in one compact assembly both the chassis and the wiring, making possible many opportunities for great savings in weight, volume, and the cost of finished assemblies. Electronic components, including tube sockets, can be readily assembled to these circuits by soldering, and circuit lines on opposite sides of an assembly are connected to each other by eyelets.

However, because they start out with a solid conductor (the metal foil), and solid conductor circuits remain after processing, etched circuits assure positive continuity and low resistance. They afford higher current carrying capabilities for many applications where such characteristics are needed.

The following table indicates approximate overload currents for copper circuits.

Line Width	Copper Thickness	
	0.00135"	0.0027"
1/4"	23amp	35amp
1/16"	10amp	15amp
1/32"	5amp	8amp
1/64"	3amp	5amp

Etched circuits can be provided with a variety of electroplated surfaces including silver, tin, lead tin solder, gold nickel, and rhodium. This feature, together with the fact that they can be fabricated to have the top surfaces of the metal circuit components perfectly flush with the insulating material, makes the circuits useful in switching and commutating applications (See Fig. 2).

In high frequency work (about 200Mc) the etched technique can be used to produce capacitor and coil combinations having a high Q. Where r-f circuits rule out the use of nickel because of its ferromagnetic properties, rhodium can be plated on silver instead of nickel in switching applications.

Magnetic Amplifiers

Keystone is one of the nation's foremost suppliers of magnetic amplifiers. Effective immediately we have available for prompt delivery the first of five "stock" magnetic amplifiers. Engineers may now design units around these "pre-designed" magnetic amplifiers. Inquiries are invited on the

"Moto Mag"
Registered Trademark
of Keystone Products Co.

In place of the conventional output transformer and power amplifier tubes, the KP10-400 utilizes a phase sensitive vacuum tube demodulator and magnetic amplifier output stage which eliminates the need of rectifiers, thus assuring greater reliability. Each unit built in accordance with MIL specifications. KP10-400 operates from an input voltage of 115 volts, 400 cycles single phase. Output is 10 watts, reversible phase. KP10-400 operates from a minus 55° to plus 70° C with minimum variation. An input signal of 2 volts AC or DC working into a high impedance is required for a maximum of 110 volts, 10 watts, 400 cycles. The unit is 4 inches high, 3½ inches wide and 2½ inches deep. Weight—only 1 lb, 13 ounces.

Your inquiry will have our prompt attention.

KEYSTONE PRODUCTS CO.

904-6 TWENTY-THIRD ST., UNION CITY 9 NEW JERSEY

UNION 6-5400

The resistance between grid and the common cathode return is kept equal by using an ordinary ganged switch with two wafers; one used for the cathode return and the other for the high grid input. The divider chain is unusual in that it must be arranged to give the desired ranges and also keep the common cathode return midway in resistance between the two grids. This can be accomplished for any divider network by using two resistances which total up to the value of each original divider resistance. The resistor nearest the high grid should have a value half that of the total resistance remaining in the divider below the tap tied to the high grid. Such a divider is shown in Fig. 2 along with an ordinary divider for comparison. In Fig. 3, the setting for the 15v range on such a divider is indicated.

The tubes operate very satisfactorily with a heater supply of 5.5v. This reduced heater voltage extends the tube life considerably and adds to the stability of the circuit in general.

Only the d-c portion of the circuit is shown in Fig. 1 as this is the basic circuit of most vacuum tube voltmeters. Peak-to-peak or rms reading diodes for a-c scales and an additional divider for ohmmeter scales can easily be added to the basic circuit.

A constant input resistance of 10 megohms can be maintained through all ranges and the source resistance of the voltage makes practically no difference in the reading obtained. There is no difficulty in using the power supply above ground potential because ordinary power transformers have sufficient insulation resistance for this type of application.

The information used in this article has been provided through the courtesy of the commercial engineering department of CBS Hytron, Danvers, Mass. A patent on the circuit discussed has been applied for in the name of Joseph Giuffrida, inventor, and project design engineer in the commercial engineering department of the company.

Fig. 3. The center-tapped divider with the switch set for the 15v range.

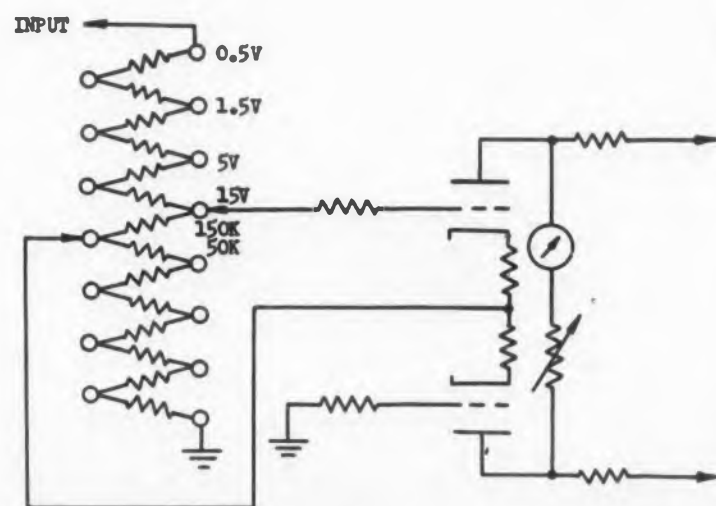

There was no time to stop, see? She comes running out from behind this parked car right under my wheels. Her hair is in pig-tails, and with the sun shining on it, she might have been *my* kid. We got her to the hospital. It took 3 pints of blood to bring her around. All I have to do is remember the sound of those screaming tires—and I know

why I'm giving blood."

Yes, all kinds of people give blood—truck drivers, office workers, salesmen. And—for all kinds of reasons. But whatever *your* reason, this you can be sure of: Whether your blood goes to a local hospital, a combat area or for Civil Defense needs—this priceless, painless gift will some day save an American life!

Business Executives! ✓ Check These Questions!

If you can answer "yes" to most of them, you—and your company—are doing a needed job for the National Blood Program.

- Have you given your employees time off to make blood donations?
- Has your company given any recognition to donors?
- Do you have a Blood Donor Honor Roll in your company?
- Have you arranged to have a Bloodmobile make regular visits?
- Has your management endorsed the local Blood Donor Program?
- Have you informed your employees of your company's plan of co-operation?
- Was this information given through Plant Bulletin or House Magazine?
- Have you conducted a Donor Pledge Campaign in your company?
- Have you set up a list of volunteers so that efficient plans can be made for scheduling donors?

Remember, as long as a *single* pint of blood may mean the difference between life and death for *any* American . . . the need for blood is *urgent!*

Give Blood Now
CALL YOUR RED CROSS TODAY!
NATIONAL BLOOD PROGRAM



Two New p-n-p Junction Transistors

IMMEDIATE AVAILABILITY of two p-n-p germanium junction transistors has been announced by the Receiving Tube Division of Raytheon Manufacturing Company. These are the Type CK721 and Type CK722. Although the Type CK722 can be obtained in production quantities, the Type CK721 will be limited in quantity until April 1953.

The units are intended for use where economy of operation and small size are important. Both types have noise factors which average 22db at 1000cy. Type CK721 has an average power gain of 38db and Type CK722 averages 30db. The units are very compact, requiring a volume of only 0.03 cu. in. Their leads can

be soldered or welded directly to the terminals of circuit components without the use of sockets. Standard subminiature sockets can be used by cutting the 0.016" tinned leads which normally are 1.5" long to a 0.20" length.

The data listed in the table are especially useful for portable, battery operated audio amplifier applications. The grounded emitter circuit allows the use of one battery for the power supply, whereas grounded base connections require either two batteries or a single battery with a tap.

The units can be expected to perform at the lower i-f and r-f frequencies as well as at audio frequencies. Maximum frequency limits have not yet been determined. With respect to power gain, the width of the limits is comparable, but no greater than that for vacuum tubes.

Tentative electrical characteristics for the two transistors are listed in the table below.

	Type CK721	Type CK722
<i>Ratings—Absolute Maximum Values</i>		
Collector Voltage	-20v	-20v
Collector Current	-5ma	-5ma
Collector Dissipation (at 30°C)	30mw	30mw
Emitter Current	5ma	5ma
Ambient Temperature	50°C	50°C
<i>Average Gain Characteristics— Grounded Emitter (at 30°C)</i>		
Collector Voltage	-1.5v	-1.5v
Collector Current	-0.5ma	-0.5ma
Base Current	-6μamp	-20μamp
Current Amplification Factor ..	40	12
Power Gain (1000 ohm source; 20,000 ohm load) ..	38db	30db
Noise Factor at 1000cy (-1.5v, -1.0ma to the collector)	22 db	22 db
<i>Average Output Characteristics— Grounded Emitter (at 30°C)</i>		
Collector Voltage	-3v	
Collector Current	-2ma	
Base Current	-30μamp	
Load Resistance	1250 ohms	
Distortion	8%	
Power Output (with 6μw driving power from 1000 ohm source)	2.8mw	

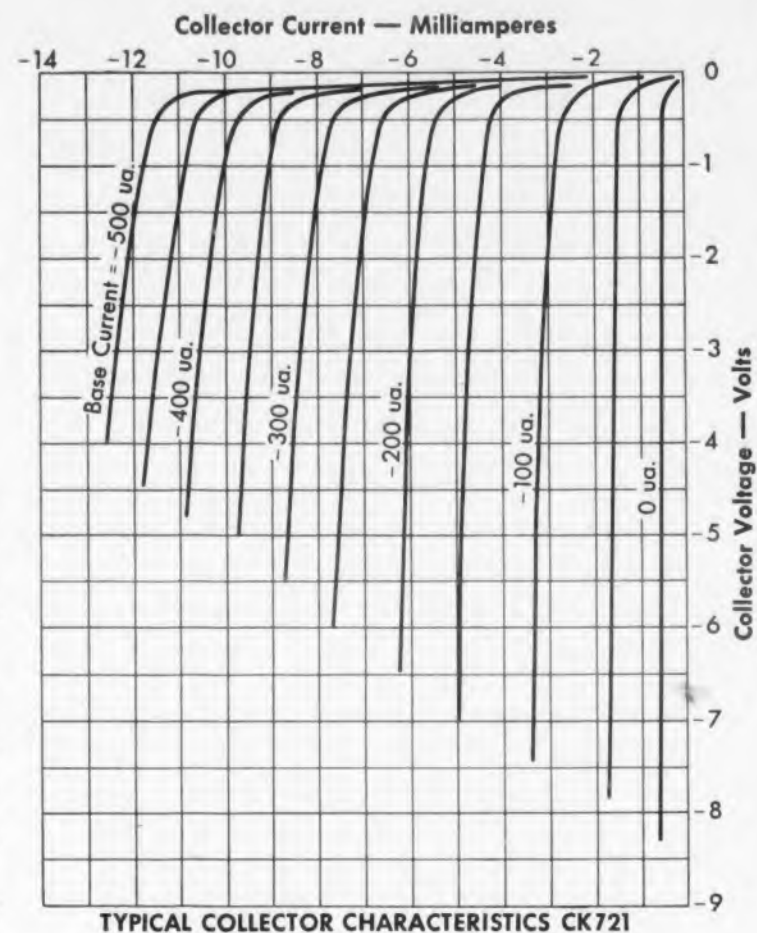

TYPICAL COLLECTOR CHARACTERISTICS CK721

Fig. 1. Typical collector characteristic curves for the Type CK721 and the Type CK722 transistors are shown above and below.

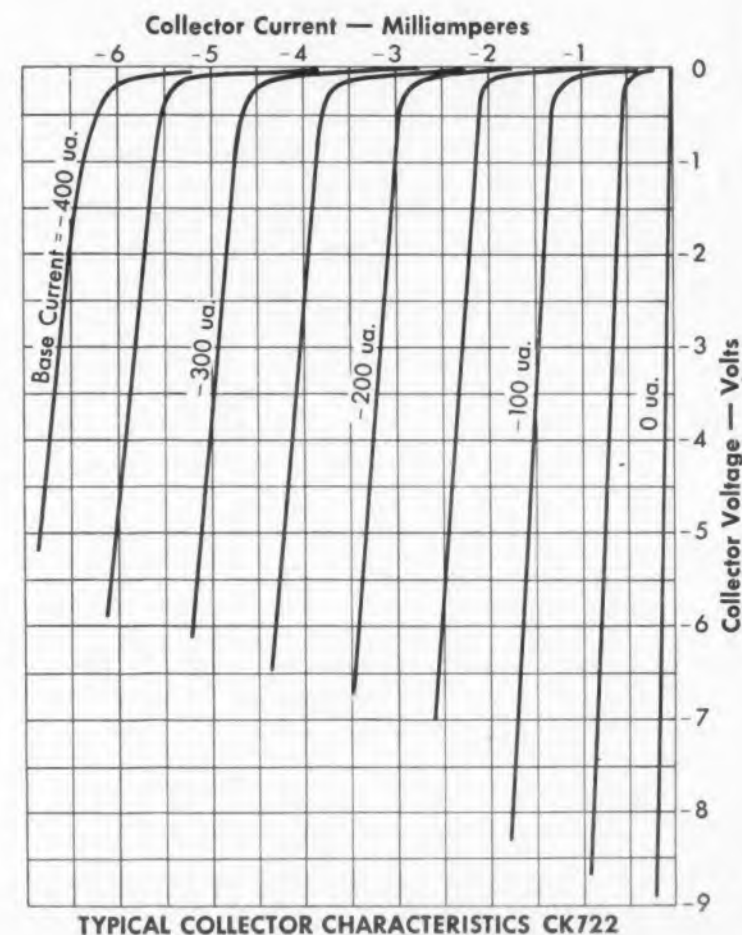

TYPICAL COLLECTOR CHARACTERISTICS CK722

Design information—



dia. from 1/16" to 1/2"

ROLLPIN

... the slotted tubular steel pin with chamfered ends

- Easily driven into holes drilled to normal production tolerances
- Self-locking . . . exerts constant pressure against hole walls
- Easily removed with drift or pin punch
- Fits flush . . . is reusable

Offers assembly-time savings over rivets, set screws, straight, serrated or cotter pins, dowels, hinge pins and many others.

WRITE for detailed catalog—Elastic Stop Nut Corporation of America, 2330 Vauxhall Road, Union, N. J. Address Dept. R18-157.

CIRCLE ED-8 ON READER-SERVICE CARD FOR MORE INFORMATION

A High Sensitivity Rugged Meter Movement

REQUIREMENTS for a satisfactory electrical meter include accuracy, stability, high sensitivity, and ruggedness. These characteristics are achieved in an unusual instrument known as the "Greibach" meter by means of certain refinements in the classical D'Arsonval meter movement. Of special interest to electronic designers is the fact that the high sensitivity of this unit permits the meter to be used directly for checking and measuring transistor and vacuum tube circuits, and the movement can be incorporated in MIL-M-6 meters. The instrument (available from Columbus Products Corp. of Yonkers, N. Y.) can be used as a voltmeter of 1 megohm per volt resistance, and by adding suitable rectifiers, super-sensitive, extra-rugged a-c/d-c meters can be readily constructed.

The meter movement is contained in a convenient, self-contained, removable and replaceable cartridge shown in Fig. 1. A simplified diagram of the system components is shown in Fig. 2. Its unusual characteristics are achieved through use of bifilar or twin wire suspension for the moving coil and a special tensioning technique which causes the bifilar wires always to return to zero position when no current flows. Such zero positioning never changes.

As can be seen in Fig. 2, the taut wires (*B*) fasten to the suspended coil (*A*) and are anchored to precisely tensioned spiral disc springs (*C*). These bifilar wires are flexed in their parallel alignment as the coil rotates in the magnetic field provided by the pole pieces (*D*) and the center piece (*E*) in response to

torque produced by current flow. The two spiral-disc springs are deflected from their normal plane towards one another as the bifilar suspension flexes. When current ceases to flow in the coil, the springs exert the required tension to bring the twin wires back to parallel alignment which determines the zero position of the coil. This zero positioning never changes.

The spiral-disc springs are actually circular metal wafers and are very rugged in contrast to conventional hair springs. They retain their accurate spring properties indefinitely and assure that the calibration and accuracy of the meter will be stable.

Because the coil is freely suspended and has no rigid supports, friction is practically absent. This feature coupled with an efficient magnetic system provides the high sensitivity of the movement. The absence of restraining pivots or jewels and the bifilar suspension also protect the coil from direct shock or vibration.

Another interesting feature is that the four suspension wires are insulated from each other and afford a means of making four connections to taps on the suspended coil. This makes possible meters having three ranges of sensitivity without the use of a universal shunt. In addition, differential meters having a moving coil with two separate and opposing windings can be constructed without the need for additional conducting strips.

Because the coil supporting system has no frictional drawbacks, both panel and table model instruments of equal sensitivity can be made. Conventional

Fig. 1. (Below) A cut-away view of the Greibach meter cartridge showing the internal construction of the unit.

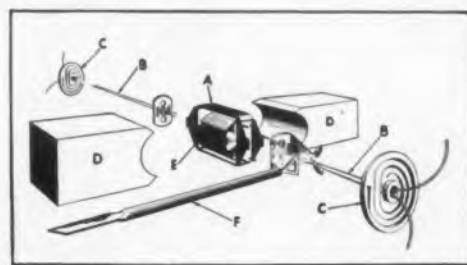
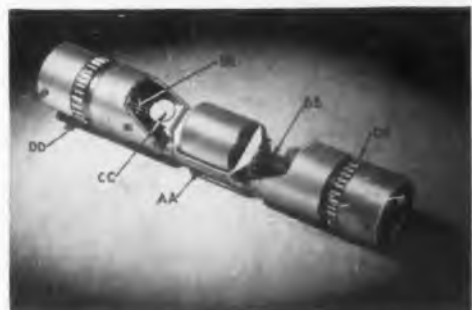
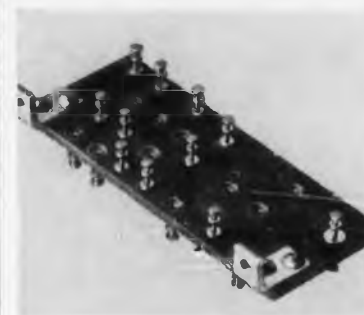

Fig. 2. (Above) Diagram of the meter movement.

Fig. 3. (Right) Portable laboratory type instrument.



(Advertisement) TERMINAL BOARDS



Name your needs . . . C.T.C. will design and build your special terminal boards of cloth, paper, nylon or glass laminates (phenolic, melamine or silicone resin). Terminals, feed-throughs, hardware and all other fixtures meet

all applicable government specifications including: MIL-P-3115A; MIL-P-15037; MIL-P-15035A; MIL-P-15047; MIL-P-997A. Varnish or lacquer finishes meet specifications: JAN-C-173; MIL-V-173; JAN-T-152. Lettering or numbering done by rubber stamp, silk screen, hot stamp, engraving.

Government sub-contracts invited. C.T.C. can furnish boards and assemblies in any quantity. Take advantage of C.T.C.'s long experience with government specifications. Write direct for information on special boards . . . or standard "All Set" Boards (scribed for separation) available in cotton fabric phenolic to specification MIL-P-15035A or nylon phenolic per MIL-P-15047A.

CAMBRIDGE THERMIONIC CORPORATION
457 Concord Avenue, Cambridge 38, Massachusetts.

CIRCLE ED-10 ON READER-SERVICE CARD FOR MORE INFORMATION

panel instruments usually are less sensitive than table units because jewel-bearing instruments have less friction when used in the horizontal position. A laboratory type "Greibach" meter is illustrated in Fig. 3. This type of instrument has a full scale sensitivity of $1\mu\text{amp}$, and a coil resistance of under 4500 ohms, and an accuracy of $1/2\%$ is maintained even after long hard usage.

An important feature of the meter is that it has a momentary overload factor of 100 times (10,000%) for the mechanical-pointer type because of the elimination of delicate hair springs. Conventional instruments usually are damaged by such overloads and require costly repairs.

The bifilar suspension system is also well adapted to the design of MIL-M-6 meters. Such instruments retain their calibration even after being subjected to shock and tumbling tests. A typical 3" panel unit has a full scale sensitivity of about $20\mu\text{amp}$ and a coil resistance of only 500 ohms, and compares favorably with conventional meters in size, weight, and cost.

The light-pointer model incorporates a light source and optical system for projecting a luminous center-line oval on the meter scale, eliminating parallax difficulties. The light source operates on a-c power by means of an attachment cord that includes a transformer, or it can be operated on self-contained dry batteries for portable applications.

New Products...

Wire Wound Resistors Miniature Oval Type Units



Higher wattage ratings within small space limitations are afforded by these miniature oval type Wire Wound Resistors. They are equipped with an aluminum mounting strip to provide cooler operating temperatures and greater

dissipation of heat caused by intimate contact with the ceramic core.

Spacers attached to the ends of the aluminum strip permit easy stack mounting and better heat conduction to the mounting surface. Available in 10w (3/8" x 3/4") and 15w (3/8" x 1") sizes, the resistors are wound on oval steatite cores with silver soldered connections and are coated with a high grade vitreous enamel. Milwaukee Resistor Co., Dept. ED, 700 W. Virginia St., Milwaukee 4, Wis.

CIRCLE ED-11 ON READER-SERVICE CARD FOR MORE INFORMATION

Selenium Rectifier Cell Rated 36v rms

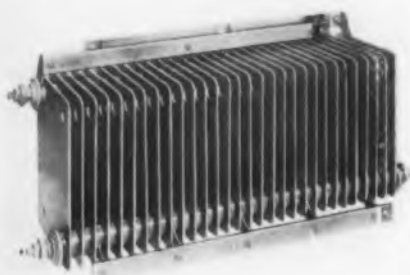

Designed especially for applications where size and weight are primary considerations, this Selenium Rectifier Cell is particularly well adapted for use in aircraft and many

other types of military and commercial electronic equipment. Because the individual cells are rated at 36v rms, a rectifier stack made up of these cells will withstand a higher reverse voltage and will require fewer cells for the same voltage output compared

with ordinary type cells having lower ratings.

Losses also are proportionately less, and the efficiency of the stack is considerably increased. Other features include rugged construction, long life, and a high operating temperature which results in less derating. Federal Telephone and Radio Corp., Dept. ED, Clifton, N. J.

CIRCLE ED-12 ON READER-SERVICE CARD FOR MORE INFORMATION

Precision Oscillograph With "Cathode-Ray Voltmeter" Feature



Voltages from zero to 1000v can be measured directly on the screen of the Type 304-A Precision Oscillograph by means of a built-in calibrating system and a precision attenuator. This "cathode-ray voltmeter" feature is made possible through use of the company's Type

5ADP- flat-face "Tight Tolerance" cathode-ray tube (see ED, Dec. 1952, pages 6 and 7).

Sensitivity of the instrument is 100mv peak-to-peak full scale and 25mv peak-to-peak/inch max. for the Y amplifier; and for the X amplifier it is 0.3v peak-to-peak/inch. Both X and Y amplifiers are down less than 10% at 100ke and 50% down at 300ke in frequency response.

Recurrent and driven sweeps (variable in frequency from 2 to 30,000cps) are provided as well as sweep expansion up to six times useful screen diameter for study of high frequency components of low frequency signals. Other features include provision for balanced input on the Y axis, stabilized synchronization, and terminals for intensity modulation from external signals. Allen B. DuMont Laboratories, Inc., Dept. ED, 1500 Main Ave., Clifton, N. J.

CIRCLE ED-13 ON READER-SERVICE CARD FOR MORE INFORMATION

Miniature Knobs For 1/4" Shafts



Miniature "Constrict-O-Grip" Knobs, designed for use with 1/4" diam shafts, have been added to the company's line. They provide the designer with a much-needed component for miniaturized equipment.

Type KNP-1 (upper unit) has a pointer radius of 21/32" and a skirt diameter of 1-1/16". Type

KNI-1 (lower unit) has a skirt diameter of 1-1/16". A plain style unit, designated Type KN-1, which has no pointer, also can be furnished. The knob height is 11/16". Technology Instrument Corp., Dept. ED, 531 Main St., Acton, Mass.

CIRCLE ED-14 ON READER-SERVICE CARD FOR MORE INFORMATION

Plastic Sandwich Boards Reinforced with "Fiberglas"

This Reinforced "Fiberglas" Plastic Sandwich Panel was originally designed for prefabricated shelters to house electronic equipment in the arctic region. Rugged and capable of withstanding rough handling, the material also is light in weight and fungus resistant for tropical climate applications.

Curved or flat panels can be furnished in any size up to 48" x 96" and in any thickness. Keller Products, Inc., Dept. ED, 41 Union St., Manchester, N. H.

CIRCLE ED-15 ON READER-SERVICE CARD FOR MORE INFORMATION

High Voltage Rectifiers For Industrial Applications



Two high-vacuum Diodes, Type 6102 and Type 6103, intended for use in industrial high voltage rectifier applications, have been added to the company's line. Their compact, efficient design is particularly useful in equipments where weight and space savings are of special

importance, such as in industrial equipment.

The Type 6102 tube is designed for use in rectifier applications involving peak inverse voltages up to 40kv. Maximum average current is 150ma and peak current is 900ma. It is intended for oil-immersed operation, and is only 2-13/16" long x 2-3/16" diam.

The Type 6103 (right) is designed for rectifier applications with peak inverse voltages up to 20kv. Maximum average current is 150ma and peak current is 900ma. The tube is provided with an integral radiator for forced-air cooling. It measures 2-3/16" diam x 2-15/16" long and weighs 8-1/2 oz. Westinghouse Electronic Tube Div., Dept. T-390, Box 284, Elmira, N. Y.



CIRCLE ED-16 ON READER-SERVICE CARD FOR MORE INFORMATION

Miniature Paper Capacitor

Operates at 125°C

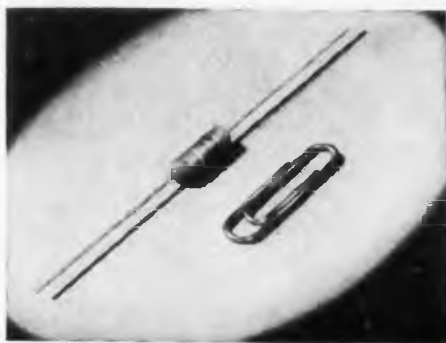

Ability to operate continuously at temperatures up to 125°C is an important feature of the Type 85P miniature, molded Paper Capacitor. Originally developed for military

use, this unit is now available for precision electronic equipment requiring high quality components such as computers and special amplifiers.

The unit is impregnated with "Pokar", a high temperature organic material which is polymerized to a solid resin. The resulting dielectric is completely solid and permits considerable size reduction with extreme stability under all conditions. The impregnated sections are molded in a mineral-filled, high temperature plastic.

The capacitor is available in two mold sizes: 0.175" diam x 5/8" long and 0.200" diam x 5/8" long. Standard RTMA 20% and 10% capacitance decade values can be furnished as well as 5% values at slightly extra cost. Sprague Electric Co., Dept. ED, Marshall St., North Adams, Mass.

CIRCLE ED-17 ON READER-SERVICE CARD FOR MORE INFORMATION

Decimal Counting Unit

Counts up to 40,000cps

The Model 730 Preset Decimal Counting Unit is a direct reading electronic counter capable of producing output information at any selected count. It can operate at speeds up to 40,000 counts per second and resolve pulse pairs separated by as little as 5μsec, making the device very useful for many measurements.



Each counter is a plug-in unit designed for easy replacement and low maintenance in high speed counting equipment. The units are completely interchangeable. They count from zero to the preset number and then produce an output pulse. With additional circuits, this pulse can be used to reset the unit electronically.

Presetting is accomplished by depressing one of the ten pushbutton switches mounted at the side of the unit, and any number of units can be connected in cascade to provide any range of preset counts. Power requirements are 6.3v at 2.1amp, 300v at 15ma, and -150v at 2ma. Berkeley Scientific Div. of Beckman Instruments, Inc., Dept. ED, 2200 Wright Ave., Richmond, Calif.

CIRCLE ED-18 ON READER-SERVICE CARD FOR MORE INFORMATION

Drawing Pencil

Pushbutton, Flat Lead Type



need for sanding or sharpening the lead. This arrangement, with the ribbon-like flat lead, affords great savings in drafting time, and a new point is

The "Locktite" Holder equipped with No. 9040 Lead permits designers to draw thin continuous lines of unvarying width without the

quickly obtained by simply pushing a button on the end of the holder and extending the lead to suit the user's needs.

The lead is held securely by a special internal section in the holder which also protects it against breakage under normal drawing pressure. Dimensions of the lead are 0.017"-0.018" thin x 0.096"-0.098" wide x 4" long. It is available in several degrees including HB, F, H, 2H, 3H, 4H, 5H, 6H, 7H, 8H, 9H, and 10H. A. W. Faber-Castell Pencil Co., Inc., Dept. ED, Newark, N. J.

CIRCLE ED-19 ON READER-SERVICE CARD FOR MORE INFORMATION

Liquid Plastic

Insulated Components, Leads, etc.

"Plastic-707" is a crystal clear liquid methyl methacrylate Plastic available in pressurized containers so that it can be sprayed on electronic components, wiring, etc. In this manner it is used to reduce electrical leakage and to provide protection for electronic equipment.

The plastic is unaffected by exposure to acids, alkalies, chemical fumes, weather, or salt spray. It also can be used to coat important drawings and for preserving bright metal finishes. United Technical Laboratories, Dept. ED, Morristown, N. J.

CIRCLE ED-20 ON READER-SERVICE CARD FOR MORE INFORMATION

Step-Type Attenuator

Miniature, 20-Step Unit



Electronic designers working on commercial electronic equipment requiring a compact step-type attenuator can make use of this Series 120 Miniature Attenuator. Only 1-

3/8" diam x 1-29/32" deep, the unit's small size and weight make it particularly suitable for use in portable equipment as well as other devices where space is limited.

The control is available in 20 steps having a ladder or potentiometer network. All standard decibel steps and various impedances up to 500,000 ohms can be furnished. Resistor accuracy is ±5% and power dissipation rating is 0.6w. Daven Co., Dept. A, 191 Central Ave., Newark 4, N. J.

CIRCLE ED-21 ON READER-SERVICE CARD FOR MORE INFORMATION

New Products . . .

Frequency Meter

Covers 125Mc to 4000Mc

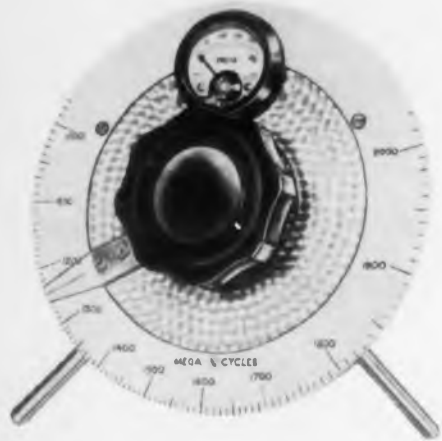

The Type TF 1026 Series of High Frequency Wavemeters are direct reading instruments designed to cover the frequency range from 125-Mc to 4000Mc. They are capable of measuring either a pulse or sine wave, and provide accuracies up to

0.1% for a wide range of engineering applications.

Basically, the devices consist of a tuned concentric line controlled by a variable capacitor with a 9" scale dial calibrated directly in frequency. Visual indication is afforded by a 250 μ amp meter. A type N fitting equipped with probe antenna permits measurement of transmitter frequency either through radiation or directly coupled by a coaxial connector.

Frequency discrimination capabilities of the instrument range from ± 0.25 Mc for 125Mc to 250Mc, to ± 4.0 Mc for the 2000Mc to 4000Mc range. The size of the unit is 6-1/2" x 6-1/2" x 4-1/2" over projections. Marconi Instruments Ltd., Dept. ED, 23-25 Beaver St., New York 4, N. Y.

CIRCLE ED-22 ON READER-SERVICE CARD FOR MORE INFORMATION

Industrial TV Camera

Research and Design Tool



This highly portable, completely self-contained Industrial TV Camera is provided with all adjustments on the unit, and its small size (14" x 9-3/8" x 4-5/8") allows great flexibility in placing the unit for viewing almost any operation in any

location. For research, design, and development engineers, the instrument provides a means of observing equipment in action (also various electrical or physi-

cal phenomena taking place) from a remote location for reasons of safety or convenience.

For remote viewing, any standard TV receiver can be connected to the camera by means of a single inexpensive coaxial cable. A single camera can be hooked up with more than one TV receiver if desired, or several cameras set at different locations can televise to one or more receivers.

The camera can be operated with any standard 16mm lens, and is fitted for mounting to a standard camera tripod or a fixed mounting. No special lighting other than normal room illumination is required, and once set for viewing, remote control is accomplished simply by ON-OFF power switching. Dage Electronics Corp., Dept. ED, 69 North 2nd St., Beech Grove, Ind.

CIRCLE ED-23 ON READER-SERVICE CARD FOR MORE INFORMATION

D-C Power Supply

1kv to 30kv, 5ma Rating



The Model 33-HRR D-C Power Supply has been developed to provide research and development engineers with an r-f high voltage supply not subject to the usual current limitations of such units. It has an output ranging from below 1kv to 30kv at 5ma in three ranges, and

up to 400w of regulated a-c power is available simultaneously from outlets on the front panel.

Regulation is 0.1% at all voltages, and line stabilization is 0.1% from 105v to 130v a-c. Ripple voltage is less than 0.05% of the d-c output voltage, and the output polarity is reversible. Metering provided includes an output kilovoltmeter with 0-5kv, 0-15kv, and 0-30 kv ranges; a current meter with 0-0.5ma, 0-1ma, and 0-5ma ranges; and final stage plate voltage and current.

Typical applications are capacitor testing, projection TV power supply, dust precipitation, insulation testing, and electrostatic spraying as well as nuclear and atomic research. A number of safety features are provided to guard personnel from the danger of high voltage shock. Neutronic Associates, Dept. ED, 83-56 Vietor Ave., Elmhurst 73, N. Y.

CIRCLE ED-24 ON READER-SERVICE CARD FOR MORE INFORMATION

Duplex Signaling Unit Transmits and Receives Signals



This Duplex Signaling Unit consists of a tone transmitter and frequency selective receiver designed to operate over wire lines, telephone or power line carrier, and radio or microwave communication circuits. It can be used to transmit and receive signaling, dialing, telemetering, teleprinting, supervisory controls, or other information for field research investigation and development work.

It also can control remote ON-OFF switching of equipment under test, or to furnish continuous indication of operating conditions. Transmitters and receivers are available on the same or different frequencies between 2000cy and 6025cy. Up to 33 channels can be used over a single circuit. Hammarlund Manufacturing Co., Inc., Dept. ED, 460 West 34th St., New York 1, N. Y.

CIRCLE ED-25 ON READER-SERVICE CARD FOR MORE INFORMATION

Bobbin Coil Winder

Box-Type, Cam Operated Machine



A new calibrated 2" economy box-type cam which provides any winding traverse from 0 to 2" is a feature of the Model 119-A Bobbin Coil Winder. Calibrations allow instant

adjustment of winding traverse to the desired winding width, and substantial savings are effected because only one cam is needed instead of an entire set.

Because the machine winds all types of random wound bobbin coils, solenoids, repeater coils, and resistors up to 2" wide and 3" OD, it permits great flexibility in coil design. A model 92-6 De-Reeler Tension is furnished for handling wire sizes No. 24 to No. 44 and spools up to 6" diam. Model 92-6d Tension can be specified for wire sizes ranging from No. 18 to No. 24.

Winding speed is up to 7000rpm, and a predetermined counter registers the number of turns wound

(up to 99,999) in conjunction with an automatic stop feature. This stop eliminates a main cause of coil rejection by winding accurately to the specified number of turns and then stopping automatically. The operator's attention is unnecessary during the winding cycle and he also is free to run more than one machine if the cycle is long enough. Geo. Stevens Mfg. Co., Inc., Dept. ED, Chicago 30, Ill.

CIRCLE ED-26 ON READER-SERVICE CARD FOR MORE INFORMATION

Electronic Timer

Compact, Quick-Starting



Improvements incorporated in the Type CK Electronic Timer (Models C and D) now make it possible to start the unit by either a momentary or sustained contact. This greatly widens the application possibilities for the unit, and the momentary starting feature is obtained without sacrificing any of the desirable features obtained

by using a cold-cathode trigger tube.

The timer requires no filament current, there is no tube wear during standby periods, and timing is instant and accurate without warmup being required. The unit can be re-cycled immediately with no delay for re-charging a timing capacitor. A separate set of spst (NO) contacts that close at the start and open at the end of the timed cycle also are provided. These contacts can handle 8amp and may be used to control a separate load as well as for momentary starting duty.

Four time ranges are available: 1.5, 3, 6, or 12sec; and a dial with 100 graduations allows easy setting for any desired percentage of the total range. The unit operates directly from 105-125v, 60cy, and its delay relay is rated 8amp noninductive load at 125v a-c in a spdt circuit with no intermediate OFF. Farmer Electric Co., Dept. ED, 21 Mossfield Road, Waban 68, Mass.

CIRCLE ED-27 ON READER-SERVICE CARD FOR MORE INFORMATION

TV Picture Tube

27" Rectangular Glass Type

Type 27EP4 is a 27" rectangular, 90°, all-glass, magnetically focused TV Picture Tube which provides an effective area of over 400 sq in. It features a single ion-trap gun design, a neutral density spherical face plate and an aluminized screen.

Overall length is 23-1/32" \pm 3/8" and the outside measurements are 26-13/16" (diagonal), 25-9/32" (width), and 20-7/32" (height). Maximum ratings (design-center values), include 20,000v anode voltage, 500v grid No. 2 voltage, 125v grid No. 1 voltage (negative bias value), and 180v peak heater-cathode voltage. Basing is according to JETEC designation 12D and the tube can be mounted in any position. CBS Hytron, Dept. ED, Salem, Mass.

CIRCLE ED-28 ON READER-SERVICE CARD FOR MORE INFORMATION

Indicator Light

For Edge-Lit Aircraft Panels



The problem of edge lighting AN-P-89 aircraft panels is readily solved by means of the Type L2000 Indicator Light. The unit flange-mounts on the backup plate and the socket extends through the edge-lit panel.

The plastic lens (available in amber, blue, green, red, or white colors) screws into the light socket from the front of the panel. The light is 1-1/4" long overall, weighs less than 1/4 oz, and is of nickel-plated brass finished in black to match standard edge-lit panels. A Type 327 miniature lamp is used for 6v, 12v, or 28v operation. Hetherington, Inc., Dept. ED, Sharon Hills, Pa.

CIRCLE ED-29 ON READER-SERVICE CARD FOR MORE INFORMATION

D-C Meter Tester

Checks Sensitivity and Resistance



ments without exceeding their full scale rating.

The Model M-2 "Metertester" is designed for testing and calibrating d-c instruments used in laboratories and engineering departments. It checks sensitivity and also can be used to measure the internal resistance of sensitive instru-

The instrument features a regulated power supply, a stepless vacuum tube voltage control, an illuminated and hand calibrated 8-1/2" scale standard instrument, a ruggedized null indicator movement for bridge balance indication, 0.1% accurate Manganin wire wound resistors, and a direct reading bridge circuit. It has 25 μ amp to 10ma full scale and 0-100v ranges, and an overall accuracy of better than 1/4 of 1%. Resistance range is 0 to 5000 ohms and the unit operates on 115v, 60cy.

It also can be used as a precise source of d-c current and voltage, and as a precision Wheatstone bridge in the 0 to 5000 ohm range. Another application is that of a limit bridge for selecting and testing resistance values from \pm 1/2% to \pm 20% over the range from 0 to 5000 ohms. Marion Electrical Instrument Co., Dept. ED, Manchester, N. H.

CIRCLE ED-30 ON READER-SERVICE CARD FOR MORE INFORMATION

C-R Oscilloscope Tube

Sharp Focus, High Brightness Trace

This 7" C-R Oscilloscope Tube, designated as Type 7VP1, is designed to provide sharp focus and high brightness of trace for general oscillographic applications. It utilizes electrostatic focus and electro-



static deflection, and has a small, brilliant spot and high deflection sensitivity for its relatively short length.

Because it has the same shape, dimensions, basing, and deflection factors as the Type 7JP1, this tube can be used in place of the Type 7JP1 to give superior performance in all oscilloscopes having a high voltage supply up to 4000v. Other features include a bulb face with minimum curvature consistent with bulb strength requirements; separate base-pin connections for each of the four deflection electrodes; and well-balanced deflecting-electrode input capacitances. The tube is especially suitable for use in balanced electrostatic-deflection circuits and gives best definition when so used. It also can be used with unbalanced deflection. Radio Corp. of America, Dept. ED, Harrison, N. J.

CIRCLE ED-31 ON READER-SERVICE CARD FOR MORE INFORMATION

New Products . . .

Signal Generator

Has 300Mc to 1000Mc Range

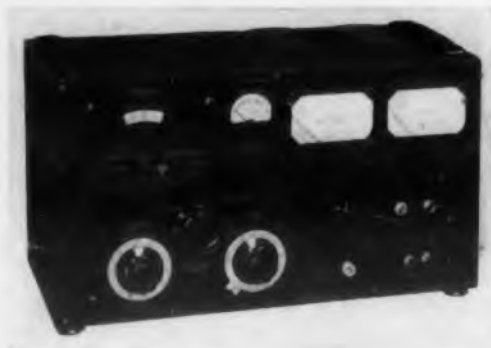

The Model 84-TV Standard Signal Generator has a 300Mc to 1000Mc frequency range, making it useful for many measurements in the u-h-f

range on TV receivers, r-f amplifiers, and mobile communications receivers operating in the u-h-f range. Output voltage is continuously variable from 0.1 μ v to 1v across a 50 ohm load; output impedance is 50 ohms, and the VSWR is 1.3:1 or better.

Provision is made for operating the filament of the oscillator tube from an external d-c supply to remove residual hum. Modulation, continuously variable from 0% to 30% may be obtained from an internal 400cy oscillator, and external modulation from 50cy to 20kc also can be accommodated.

The high output of the instrument can be used to drive slotted lines or other impedance measuring devices. Its low harmonic content makes possible measurements of u-h-f filter, trap, antenna, and matching network characteristics without the use of selective detectors. Measurements Corp., Dept. ED, Boonton, N. J.

CIRCLE ED-32 ON READER SERVICE CARD FOR MORE INFORMATION

Variable Capacitor

Concentric, 1mmfd-35mmfd Unit



This concentric, high ratio, variable air Capacitor is especially useful for those circuits that require low minimum capacity, high Q, and stability. Because its ratio of capacity is 35 to 1 (35mmfd to

1mmfd), the unit has many applications in electronic equipment where capacitive adjustments have to be made over a wide range with great accuracy.

The capacitor is constructed of silver-plated brass and "Pyrex" glass, providing it with excellent per-

formance characteristics at higher frequencies. It is a high Q capacitor at 200Mc and higher frequencies.

The friction spring that locks the rotor assures that the capacitor setting will remain constant even under severe operating conditions. A typical application for the unit is in 10-channel transceivers. Johanson Manufacturing Corp., Dept. ED, Boonton, N. J.

CIRCLE ED-33 ON READER-SERVICE CARD FOR MORE INFORMATION

Germanium Rectifiers

Diffused Junction Type



Diffused junction type Germanium Rectifiers for use in computers, magnetic amplifiers, TV receivers, and telephone switchboards have been added to the company's line. The series includes four models (Types 4JA1A1, 4JA1A2, 4JA1A3, and 4JA1A4), hermetically sealed and very small in size.

Originally developed for military applications, the units meet stringent humidity, shock, and vibration requirements. Their forward resistance is very low (less than 2 ohms at rated load), and back resistance and peak inverse voltages are high (from 100v to 400v).

Output currents into a resistive load range from 75ma to 500ma d-c. Full load voltage drop is 0.5v in three of the models and 0.7v in the fourth. Glass-to-metal seals are employed to seal hermetically the rectifiers against deteriorating elements. General Electric Co., Dept. N-13, Electronics Park, Syracuse, N. Y.

CIRCLE ED-34 ON READER-SERVICE CARD FOR MORE INFORMATION

High Impedance Delay Cable

Has Low Loss Magnetic Core

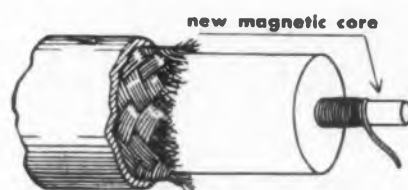

The Type HH-1500 Delay Cable features a flexible, low-loss magnetic core of uniform structure which nearly triples the inductance of the cable

assembly. This effectively increases the characteristic impedance and the time delay of the cable while substantially maintaining the dimensions and attenu-

ation characteristic of conventional high-impedance cables such as the Type RG-65/U.

The cable is suited for many electronic applications such as delaying signals up to a few microseconds in pulse generating and oscilloscope circuits, measuring time intervals in radar and loran systems, and as a transmission line with high characteristic impedance to match load impedances in the order of 1500 ohms.

The delay per foot afforded by the cable is 0.073 μ sec compared with 0.042 μ sec provided by commonly used RG-65/U cable. Thus, for a given time delay, about 40% in cable length can be saved, and since the attenuation per foot (6.0db/100' at 1Mc) is similar to that of RG-65/U, greater signal amplitude and fidelity can be realized. Other characteristics include a capacitance of 49mmfd/ft, a d-c resistance of 7.0 ohm/ft, and a maximum operating voltage of 2000v rms. Columbia Technical Corp., Dept. ED, 5 East 57th St., New York 22, N. Y.

CIRCLE ED-35 ON READER-SERVICE CARD FOR MORE INFORMATION

Miniaturized Plug-In Amplifier

Power Output is 3w



Intended for application in audio and servomechanism applications, this miniaturized Plug-In A-C Feedback Amplifier employs three tubes and provides an output of about 3w. It is especially useful for driving

2-phase servo motors in systems where space is limited and ease of maintenance is a necessity.

The feedback resistor is connected to terminals on the receptacle so that any desired gain can be achieved with a single basic amplifier employing JAN components. Tubes employed include two Type 6AU6 pentode voltage amplifiers and one Type 6AQ5 beam power output tube. Power requirements are 6.3v at 1amp for the heaters and 300v at about 32ma for the plates.

Using a closed loop gain of 1000, the signal required for full output is 0.155v, assuming an 8000 ohm load. Amplifiers are furnished with mating receptacles, and models employing voltage or current feedback can be furnished. L & O Research and Development Corp., Dept. ED, 315 S. 15th St., Philadelphia 2, Pa.

CIRCLE ED-36 ON READER-SERVICE CARD FOR MORE INFORMATION

Diode Clip

Mounts Without Fasteners

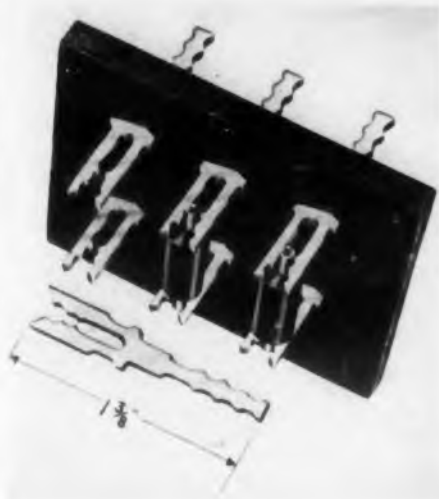

This Diode Clip, which will accommodate most types of diodes now in use, permits quick, easy insertion and removal of diodes. Structurally strong, the clip permits versatility in design because it requires no rivets or other fasteners for mounting.

The clip is simply pressed into a hole on the diode board as shown above. Spring tension holds the diode securely in the clip, and a special plating assures excellent surface contact.

The clip provides greater ease in removing defective units, faster assembly of diode boards, and quicker initial check-out of finished equipment. It facilitates preventive maintenance tests and keeping performance records on individual diodes, affording savings in time and money, especially in computers, radar equipment, or other electronic equipment where large numbers of diodes are employed. Computer Research Corp., Dept. ED, 3348 W. El Segundo Blvd., Hawthorne, Calif.

CIRCLE ED-37 ON READER-SERVICE CARD FOR MORE INFORMATION

Magnetic Amplifier

Output is 10w at 100v

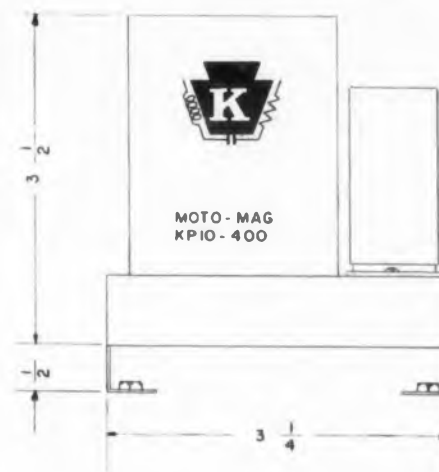

First in a series of "stock" Magnetic Amplifiers, the "Moto-Mag" KP10-400 unit is designed for applications requiring an output of 10w at 100v. In place of the conventional output transformer and power amplifier tubes, the unit utilizes a phase

sensitive vacuum tube demodulator and magnetic amplifier output stage, eliminating the need for rectifiers.

It operates from an input voltage of 115v, 400cy, single phase, and the output is 10w at 100v, reversible phase. An input signal of 2v a-c or d-c working

into a high impedance is required for a maximum output of 110v, 10w, 400cy. The unit can operate over a temperature range from -55°C to $+70^{\circ}\text{C}$ with minimum variation.

The magnetic amplifier is hermetically sealed and has a built-in power supply providing all plate and filament voltages to the demodulator. The compact size of the assembly is indicated in the illustration which shows the magnetic amplifier mounted on a chassis and the demodulator tube at the right. Keystone Products Co., Dept. ED, 904 23rd St., Union City, N. J.

CIRCLE ED-38 ON READER-SERVICE CARD FOR MORE INFORMATION

Hermetic Seal Sub-Assemblies

Available in Many Designs



Illustrated is a typical unit (in the company's line) of Hermetic Seal Sub-Assemblies for applications requiring dirt- and moisture-proof electrical terminals. It is part of a discriminator i-f transformer used in government "walkie-talkies".

Available in a wide variety of designs, these sub-assemblies are fabricated with careful soldering and assembly work. They make possible the release of the user's facilities and skilled personnel for other production operations. Sealtron Co., Dept. ED, Box 72, 9701 Reading Road, Cincinnati 15, Ohio.

CIRCLE ED-39 ON READER-SERVICE CARD FOR MORE INFORMATION

R-F Coil Forms

Have Adjustable Cores



This series of adjustable "Vari-Form" R-F Coil Forms are intended for development and research in the design of r-f coils and transformers. Designed

for one-hole mounting, they consist of a high dielectric cosmolute form and an adjustable ferrite core with a threaded stud attachment.

Four sizes are available: No. C-1 (1/4" diam x 1-1/8"), No. C-2 (1/4" diam x 2"), No. C-3 (3/8" diam x 1-1/8"), and No. C-4 (3/8" diam x 2"). Two solder terminals for making connections to the coil are provided. Grayburne Corp., Dept. ED, 103 Lafayette St., New York 13, N. Y.

CIRCLE ED-40 ON READER-SERVICE CARD FOR MORE INFORMATION

Twin Diode-Triode

Miniature, Multi-Unit Tube



Type 12BF6 is a multi-unit Miniature Tube of the heater-cathode type which contains two diodes and a medium- μ triode in one envelope. It is designed primarily for use as a combined detector, amplifier, and a-c tube in automobile radio receivers operated from a 12v storage battery.

The characteristics of the triode are such that it can be impedance-coupled or transformer-coupled to the output stage. In either instance, the triode can furnish more than ample output with low distortion to drive a pair of 12V6-GT's operating at maximum plate voltage in the output stage of a receiver.

Maximum electrical ratings for the triode include a plate voltage of 300v, a plate dissipation of 2.5w, and a peak heater-cathode voltage of 90v. Heater ratings are 12.6v at 0.150amp, and the diode has a plate current rating of 1.0ma max. Radio Corp. of America, Dept. ED, Harrison, N. J.

CIRCLE ED-41 ON READER-SERVICE CARD FOR MORE INFORMATION

Coil Bobbin Kit

Includes Eight Different Types

Electronic designers who wind their own coils to meet specific circuit requirements will be interested in the No. 75A047 Coil Bobbin Kit which contains 24 assorted bakelite coil bobbins. The kit contains three bobbins each of eight different types, and all sizes are available from the company in production quantities.

The bobbins also can be used for rewinding coils for various relays. They are made of one-piece general-purpose bakelite and can withstand 85°C rise and more than 1000v a-c. Potter & Brumfield, Dept. ED, Princeton, Ind.

CIRCLE ED-42 ON READER-SERVICE CARD FOR MORE INFORMATION

Germanium Diode For TV Video Detector Use

The Type IN64 is a Germanium Diode, especially designed to meet the requirements for video detector applications in TV receivers. It features a wax-filled phenolic case which assures optimum performance under adverse humidity conditions, and the unit is



application tested at both low (25Mc) and high (40Mc) intermediate frequencies.

Electrical ratings include a peak inverse voltage of 20v, an ambient temperature range of -50°C to $+75^{\circ}\text{C}$, a maximum shunt capacity of 2.0mmfd, and a d-c output current of 100 μ amp (min). Overall length of the unit is 3/4" (excluding the leads), and it has a 1/4" diam. CBS Hytron, Dept. ED, Salem, Mass.

CIRCLE ED-43 ON READER-SERVICE CARD FOR MORE INFORMATION

Toggle Switch Miniature, Aircraft Type



The cylindrical design of this aviation type (MIL-S-6745) Miniature Toggle Switch (Model T1000) reduces its size about 25% as compared with conventional rectangular switches. It is designed

to conform fully with MIL-S-6745 specifications and can be used in military and civilian aircraft applications as well as any other electronic application calling for a compact, sturdy, and positive-acting toggle unit.

The unit is housed in an anodized aluminum case and utilizes approved plastic materials for its interior construction. Standard No. 6 screw terminals are employed and the switch is conservatively rated at 10amp and easily passes standard overload tests. Four circuit arrangements are available. 'ON-OFF' and spdt maintained contact types, momentary ON or momentary OFF, and ON-momentary-ON types. Contact surfaces are heavily silvered, and cam operation on a roller contactor greatly reduces contact

wear or arcing damage. Hetherington, Inc., Dept. ED, Sharon Hill, Pa.

CIRCLE ED-44 ON READER-SERVICE CARD FOR MORE INFORMATION

Casting Resins Liquid Plastics

A complete line of liquid plastic Casting Resins now is available to research and development engineers for use in casting or embedding electronic equipment, or for prototype construction applications. They are furnished in low cost, balanced test outfits which include instructions.

"Chemiglas" is a liquid, water-clear polyester resin which can be made to harden quickly (by adding two chemicals) into a glass-hard solid. "Chemiflex" is a viscous liquid vinyl plastisol which hardens into a resilient solid when baked at about 350°F . "Co-Syl" Aerogel is a white powder of very light weight and high absorbing power. When mixed with "Chemiflex" plastisol in equal volume, it forms a putty-like plastigel which can be shaped with inexpensive tools to form many useful shapes. When heated at about 350°F this mixture becomes a resilient solid with many properties useful in electronics. Technicraft Supply Co., Dept. ED, 1156 Commonwealth Ave., Boston, Mass.

CIRCLE ED-45 ON READER-SERVICE CARD FOR MORE INFORMATION

Half-Wave Rectifier For TV Damper Service



Type 6AX4-GT is a Half-Wave Vacuum Rectifier Tube of the heater-cathode type, intended particularly for use as a damper tube in horizontal deflection circuits in TV receivers. Designed to withstand negative peak pulses between heater and cathode of as much as 4000v with a d-c component up to 900v, it provides flexibility in the choice of deflection circuits.

Heater ratings for this 5-pin octal base tube are 6.3v at 1.2amp.

Maximum ratings for damper service (design-center values) include 4000v peak inverse plate voltage, 600ma peak plate current, 3.0amp hot-switching transient plate current (for 0.2sec duration max), and 125ma d-c plate current. Peak heater-cathode voltage with the heater positive with respect to cathode is 100v max. Radio Corp. of America, Dept. ED, Harrison, N. J.

CIRCLE ED-46 ON READER-SERVICE CARD FOR MORE INFORMATION

Vacuum Gage Covers Very Wide Range



The Type PHG-09 Vacuum Gage covers a range of 8,000,000:1 on a single meter from a single pickup. It can be used to read vacuums from 0.50mm to 10^{-7} mm of mercury, and the all

metal pickup tube which handles this range works on the glow discharge principle.

In the tube, permanent magnets provide a field which lengthens the electron paths into tight spirals that give high ionization per electron, with a cascade effect. With no filament to burn out, the tube can be operated at full atmosphere with no damage, and the circuit is insensitive to line voltage fluctuations.

Because the magnets are external to the ionization chamber, there is no problem involved with outgassing the magnets or removing stray iron particles. The tube also is self-cleaning because when operated at the higher pressure in the lowest sensitivity range, it rids itself of deposited film. Distillation Products Industries, Dept. ED, Ridge Road West, Rochester 3, N. Y.

CIRCLE ED-47 ON READER-SERVICE CARD FOR MORE INFORMATION

Magnetic Probe Fountain Pen Size



The fountain-pen size "Little Giant" Magnet is made of a super-magnetic alloy and the point of the magnet can be retracted or extended by turning

the end-knob. The strength of the magnet can be controlled by the amount of the extension and a pocket clip is provided for safe, easy carrying.

This device is particularly useful for removing steel or iron particles from areas where such foreign matter is harmful such as the operating area of electrical instruments or delicate mechanisms. It also removes sharp particles of steel, iron, or nickel from holes and similar hard-to-reach places. General Scientific Equipment Co., Dept. ED, 2700 W. Huntingdon St., Philadelphia 32, Pa.

CIRCLE ED-48 ON READER-SERVICE CARD FOR MORE INFORMATION

New Books...

Essentials of Microwaves . . . By Robert B. Muchmore. 236 pages. John Wiley & Sons, Inc., 440 Fourth Ave., New York 16, N. Y. \$4.50.

By stressing physical pictures and presenting concepts in words rather than in mathematics (though mathematics is not entirely neglected), the author presents the basic concepts of microwaves in a manner most readily understood by newcomers to the field. This type of brief but comprehensive review also is of value to the practicing engineer for regaining a better perspective of his field.

Following a brief introduction the fundamental empirical laws of electricity and magnetism are given, and by combining and extending them, the author shows how they govern all microwave phenomena. The rules governing wave propagation and reflection are presented and applied to wave guides, cavity resonators, filters, etc. Later chapters cover electronic devices where the same principles are applied again, and some applications of microwave equipment in physical research.

The last chapter in the book is concerned with microwave measurements, and in it all the phenomena and apparatus previously discussed are interpreted, described, and judged on the basis of the measurements that can be made. An appendix on the physical meaning of the mathematical symbols in the text (mostly an explanation of some vector terms) and an appendix on units, as well as an index, also are presented.

Modern Plastics Encyclopedia and Engineer's Handbook . . . (16th edition) . . . 848 pages. Plastics Catalogue Corp., 575 Madison Ave., New York 22, N. Y. \$2.00.

This well known encyclopedia is a compilation of a great deal of information on all phases of the plastics industry. Because plastics are so widely used in many phases of the electronic field the book may well find a place on the electronic designer's reference book shelf.

Processing methods for all the main plastics materials are presented in an "Engineering and Methods" section in a series of detailed operating manuals pre-

pared by specialists in compression and transfer molding, injection molding, extrusion, laminates, and reinforced plastics, as well as plastisol molding, foamed plastics, and casting plastics.

Under the "Machinery and Equipment" section, basic information on the type of equipment used for each type of plastics processing and details on advances in equipment design and manufacturing during 1952 are presented. Some 26 articles in the "Resins and Molding Compounds" section cover every phase of plastics resin use in molded, extruded, laminated, and cast form, as well as adhesives, coatings, fibers, film, and sheeting, modified woods, and industrial resins.

"Chemicals for Plastics" and "Fillers and Reinforcements" sections also are included, as well as a large folded "Plastics Properties Chart" for wall hanging. The "Directory" section lists dealers, distributors, and manufacturers of all kinds of equipment and materials associated with the plastics industry. The book is bound in a hard cover, and is a bargain at the low price of \$2.00.

Thermionic Vacuum Tubes and Their Application . . . By W. H. Aldous and Sir Edward Appleton. 160 pages. Methuen & Co., Ltd., London; John Wiley & Sons, Inc., 440 Fourth Ave., New York 16, N. Y. \$2.00.

Another in the series of Methuen monographs on physical subjects, this book is in its sixth edition and has been completely revised and rewritten to bring the earlier work up to date. Though directed mainly at readers with a general physics background who have not made a special study of r-f phenomena, the book serves as an excellent brief review for the practicing electrical engineer.

The book is divided into three main parts: a discussion of the internal action of a particular tube and an explanation of static characteristics in terms of physical laws governing electron motion; an explanation of tube behavior in an application in terms of its static characteristics; and special properties and applications of high frequency tubes.

ANOTHER FAMOUS MARKET PLACE — D'Étaples (Calais)

ELECTRONIC

... brings New Application Information to

You

and to a select group of key Electronic Designers!

It helps make your work easier, more efficient and more productive by providing valuable data on new products, parts, materials, components, and test equipment that influence design.

* Market Place for Electronic Design Innovations

FELLOW READERS . . . One of the fastest developing scientific fields today—full of opportunities for employment, discovery, achievement and success—is the field alluded to in the words:

COMPUTING MACHINERY — ROBOTS — CYBERNETICS — AUTOMATION

As you may know, our new magazine **THE COMPUTING MACHINERY FIELD** publishes articles, a Roster of Organizations, a Who's Who (in sections) and other information. We hope to make it easy for all people interested in this field to get in touch with each other in appropriate ways.

To improve your Who's Who listing, if you have any interest in this field, would you please fill in and return the coupon promptly. Your listing does not depend in any way on your subscribing to the C M F, although, of course, your subscription will be welcome.

We are EDMUND C. BERKELEY & ASSOCIATES—New York and Boston

PUBLISHERS (*The Computing Machinery Field*)—**AUTHORS** (*Giant Brains or Machines that Think*, Wiley—1949, etc.)—**WRITERS** (*Machine Intelligence*, ASF—Jan. '52, etc.)—**INSTRUCTORS—CONSULTANTS—MAKERS** and **EXHIBITORS** of **SMALL ROBOTS** (Simon, mechanical brain—Squee, robot squirrel—see *Radio Electronics*, Oct. '50 & Dec. '51)

To: Edmund C. Berkeley, Editor, THE COMPUTING MACHINERY FIELD

R 54, 36 West 11th Street, New York 11, New York

Name (please print)

Address

Organization

Title

Year of Birth

MAIN INTERESTS: () Sales () Programming

() Design () Electronics () Others (specify):

() Construction () Mathematics

() Applications () Business

College or last school

Years of experience in the computing machinery field

Occupation

(Enclose more information about yourself if you wish—it will help in your listing)

GUARANTEED OFFER

() Please send me on approval a copy of the quarterly **THE COMPUTING MACHINERY FIELD**. I will subscribe at \$3.50 a year (U. S. & Canada; \$4.50 elsewhere) if I like it—or return the copy within 7 days.

FREE 236-PAGE
ALLIED 1953
ELECTRONIC SUPPLY
CATALOG

WORLD'S LARGEST STOCKS OF
ELECTRONIC SUPPLIES FOR INDUSTRY

Send today for ALLIED's complete Electronic Supply Catalog. Simplify and speed your procurement—send all your orders to ALLIED—the reliable, one-supply-source for all your electronic needs. Depend on ALLIED for quick shipment from the world's largest stocks of special-purpose electron tubes, test instruments, audio equipment, electronic parts (transformers, capacitors, controls, etc.)—everything for industrial and communications application, for research, development, maintenance and production. Our expert Industrial supply service saves you time, effort and money. Send today for your FREE copy of the 1953 ALLIED Catalog—the only complete, up-to-date guide to Everything in Electronics for Industrial and Broadcast use.

Complete Expert Industrial Service

EVERYTHING IN ELECTRONICS FROM ONE SOURCE

SEND FOR FREE CATALOG

ALLIED RADIO
 833 W. Jackson Blvd., Dept. 69-A-3
 Chicago 7, Illinois

CIRCLE ED-51 ON READER-SERVICE CARD FOR MORE INFORMATION

New Books...

Automation—The Advent of the Automatic Factory . . . By John Diebold. 181 pages. D. Van Nostrand Co., Inc., 250 Fourth Ave., New York 3, N. Y. \$3.00.

Although this slim volume contains no diagrams, circuits, technical discussion, mathematical derivations, curves, charts, or other electronic data, it is very rewarding reading for the electronic engineer. This is especially true for those engineers whose attention is focused on the purely electronic or technical aspects of computers, servomechanisms, and the many other devices which are daily bringing closer to reality the engineer's dream: the automatic factory.

Mr. Diebold has written a thought-provoking study of the possibilities, limitations, and social and economic consequences of automatic machinery and the allied devices that control this machinery. His title "Automation" is a new word denoting both automatic operation and the process of making things automatic. In the latter sense it includes such areas of industrial activity as product and process re-design, the theory of communication and control, and the design of machinery.

Our present knowledge of automatic techniques is

fairly extensive, and is growing all the time. However, in order to realize the maximum possibilities of these techniques we should not use them merely to add "gadgets" to existing processes. Instead, we should rethink our basic objectives and redesign the process to fit the techniques.

As an example, the author poses the problem of making the New York Stock Exchange automatic. A faster ticker tape, walkie-talkie radios for sending messages from the office to the floor broker, and conveyor belts for handling the vast quantities of papers, all are workable devices for speeding up exchange operations, but they really amount to no more than adding gadgets to the existing process. They can save manpower, but they represent no basic improvement in the process itself.

By realizing that the basic function of the exchange floor is to provide a means for interchange of information about the sale and purchase of stocks and bonds the entire process is reduced to fundamentals which can be related to existing techniques. Then it is easy to see that this basic function (the interchange of information) can easily be performed by computers, for they are designed primarily to receive, manipulate, and communicate information. Properly applied, they provide a means of eliminating the exchange floor completely.

Another interesting idea proposed is that of replacing the individual control boxes used for a series of similar machines (that employ similar controls) with a central control unit, using a single relay or electronic control for the entire series. Such a scheme would utilize the control to a much greater percentage of its full capacity than is now the case. This is cited as an example of using control devices more efficiently and more cheaply by using them in a new way.

It is not the devices the author describes that makes this book interesting, for many of these have been publicized in the technical press and are known to engineers. It is this attitude of examining basic functions in any process, and redesigning the product or process for making the product in such a way that maximum effectiveness of automatic techniques can be realized.

Many problems are yet to be solved in the automation field. Existing devices have to be improved and completely new components need to be developed. However, we have only scratched the surface in applying the devices and techniques we already know at present.

Filter Design Data for Communication Engineers . . . By J. H. Mole. 252 pages. John Wiley & Sons, Inc., 440 Fourth Ave., New York 16, N. Y. \$7.50.

This book is concerned with a discussion of the Zobel method of filter synthesis. In about 1923 Campbell and Zobel developed a practical method of synthesis of filters containing an unlimited number of

reactors in which attention is focused on the image parameters which are only approximately equal to the effective parameters of the networks. It also contains a restriction (that of matching image impedances) which would not appear in a general method.

However, in most instances, the limitations implicit in the design of Zobel filters are not serious, and compared with general methods of synthesis, much labor is saved. The last chapter of the book is devoted to the exact design of the simpler filters on a general basis, and the results given there can be applied to the design of transformers.

Tables, charts, and formulas, selected and constructed to lighten the task of calculation as much as possible, are included. With their help, the time required for designing filters is greatly reduced.

In order to keep the book reasonable in size, derivations of formulas have been omitted except where they clarify the presentation, and usually the results are simply stated with an explanation of design methods. An elementary knowledge of the principles of line transmission and of filters as is given in university courses in electronics or telecommunications has been assumed.

The range and selection of the scales for the charts have been chosen so that they can be used as conveniently and accurately as possible. For example, in Chapter 8, from the charts provided in Chapter 8, the number of elements, the structure and the m -values of low-pass and high-pass filters of almost any specified stop-band attenuation can be obtained in a few minutes. A simple method for finding the optimum location of the cut-off frequency is given in Chapter 1. Brief accounts of a number of recent extensions to the theory of Zobel filters also are presented. In one section, the detailed and the statistical effects of small changes in element values are considered.

Chapters cover low-pass, high-pass, symmetrical band-pass and band-stop sections; dissymmetrical band-pass filters; impedance transformation; junction losses; calculation of effective loss; design of terminal sections; Techebycheff behavior of stop-band attenuation; the effects of dissipation; tolerances on element values; and simpler filters with Techebycheff behaviour of pass-band loss. Chapter 11 contains tables of function which are useful in filter design and not readily available. With the exception of a table of hyperbolic functions, the tables have been specially calculated, and the errors in calculation have been detected and corrected from the irregularity of the first and second differences.

Almost all electronic equipment contains some sort of a filter, and often the synthesis of such networks is quite lengthy and difficult. By gathering together an extensive amount of practical information, the author has produced an excellent "working handbook" for electronic designers.

New Literature . . .

Capacitors, Filters, Resistors

52

The 24-page, 1952-53 Catalog presents an expanded listing of ceramic disk capacitors. The listings range from 0.00001 to 0.01mfd. for single-section units; from 0.001 to 0.004mfd. for 2-section units; and 0.0015 and 0.002mfd. for 3-section units. The capacitors described come in seven sizes for by-passing, blocking, and coupling applications, and are also available for temperature compensating where high Q and stability of capacitance are essential. Charts and photographs present specifications for most of the types listed. Aerovox Corp., New Bedford, Mass.

Microwave Assemblies

53

This 6-page, 2-color foldover brochure illustrates and describes microwave components and precision assemblies for application by manufacturers of military radar systems and telecommunication equipment; by laboratories performing design and research work on electronic apparatus; and by the Armed Forces, including the Atomic Energy Commission. Prototype work and production runs on microwave assemblies are featured: waveguide assemblies, electrical testing, precision casting, and engineering service. N.R.K. Mfg. & Engineering Co., 5644-50 N. Western Ave., Chicago 45, Ill.

Electronic Components

54

"Ideas, Techniques, Designs" is the title of a handbook which provides a complete listing of this company's electrical and electronic components. The products listed, described, and illustrated include plug-in components, plugs and connectors, miniature plugs and sockets, c-r tube and tuning eye sockets, dial light and lamp sockets, tube cap connectors, test equipment, electrical components, government specification components, and computer components. Construction features, specifications, and design features of these products are included and are further illustrated by circuit diagrams and photographs. The handbook is available without charge upon request. Alden Products Co., 117 No. Main St., Brockton 64, Mass.

Selenium Diodes

55

This 4-page, 2-color bulletin, No. SD-1, presents technical information on the company's sub-miniature selenium diodes. Among the applications for these units are bias supplies, sensitive relays, digital and analog computers, hearing aids, electronic organs, and many types of compact airborne electronic equipment. Technical specifications for available diodes are listed. International Rectifier Corp., 12 W. 32nd St., New York 1, N. Y.

DC Motors and Timers

56

Reed-Controlled DC Motors and Timers are described in this 4-page pamphlet. Specifications, including operating voltage, output shaft speed as required, power input, torque, weight, and frame size, are provided. Also presented are performance curves. Anglo Corp., 2037 W. Division St., Chicago 22, Ill.

Pressure Pickup

57

Bulletin 1534 describes and illustrates the Type 4-310 Flush-Diaphragm Pressure Pickup, whose applications range from turbulence investigations in wind-tunnel work to surveys of hydraulic-system pulsations and pressure-surge patterns in pumps and processing equipment. Photographs and circuit diagrams illustrate the construction, installation, and performance of the unit. Consolidated Engineering Corp., 300 North Sierra Madre Villa, Pasadena 15, Calif.

Magnetic Amplifiers

58

Amplifications of 1,000,000 are possible with the magnetic amplifiers described and illustrated in this 4-page, 2-color brochure. A listing of applications for these amplifiers is included, among which are control and positioning of variable speed motors, regulation, time delay control, servo systems, automatic battery chargers, and arc welding controls. Typical specifications (which vary according to application) are provided, and graphs and charts further illustrate the performance of these amplifiers. Karl-Douglas Associates, 3160 W. El Segundo Blvd., Hawthorne, Calif.

Metallized-Paper Capacitors

59

The higher temperatures (-55°C to $+125^{\circ}\text{C}$) and interesting applications of Aerolene-impregnated metallized-paper capacitors are presented in this 4-page, 2-color Bulletin, Form No. HTMP252. Some of the applications for these units are aircraft, electronic and electrical equipment, guided missiles, and similar military and commercial uses. The bulletin lists the standard numbers of the modified plastic tubular Type P92ZN, the "Bathtubs" Type P30ZN, and the metal-cased tubulars with vitrified ceramic terminal and seals Type P123ZNG. The latter units are available with such modifications as insulating plastic sleeve, threaded terminal mounting, and tangential brackets. Drawings and dimensions are included, as well as information on performance characteristics and specifications. Aerovox Corp., New Bedford, Mass.

Fastening Service

60

A service for manufacturers of all kinds of assembled products is announced in this 12-page, 2-color brochure. The service described includes fastener research to determine the exact requirements in individual cases, the development of designs for the fastener and dies to produce it, laboratory testing of samples, tooling of machines for setting the fasteners, and final checking in actual production for quality and strength. Milford Rivet & Machine Co., 900 Bridgeport Ave., Milford, Conn.

Gas Tubes

61

"Gas Tubes in Industry", an 8-page brochure, presents a brief history of the development and application of hot-cathode inert gas-filled rectifier and thyatron tubes. Nonmathematical in style, the treatise presents an introduction to the use of these industrial type tubes, pointing out their importance and applications in industry. Electrons, Inc., 127 Sussex Ave., Newark 4, N. J.

Hermetic Seals

62

This 32-page, 5-color brochure presents a listing of hermetic seals that cover every important innovation in standard headers, multi-terminal headers, plugs and seals, and headers for miniature and sub-miniature programs. Circuit diagrams and photographs illustrate the various types of seals. Tolerance and finish information, and special applications are provided for each type. Hermetic Seal Products Co., 29-37 S. Sixth St., Newark 7, N. J.

New Literature . . .

Electronic Components 63

Catalog No. 28 (34 pages, 2-colors) provides a listing of such electronic components as volume controls, switches, ceramic capacitors, printed electronic circuits, and steatite insulators for various electronic applications. A guide page simplifies finding the page location of each component described. Photographs, circuit diagrams, and charts illustrate such factors as control taper and resistance curves. Specifications for each component type are included, and in many instances applications are indicated. This catalog is punched to fit into a standard notebook for convenient reference filing. Centralab, Division of Globe-Union Inc., 900 E. Keefe Ave., Milwaukee 1, Wis.

Coaxial Switches 64

Data Sheets 202B to 208B present descriptions, applications, electrical characteristics, and available variations of eight models of coaxial switches. Units described include spdt, sp3t, sp4t, sp5t, sp6t, dpdt, and double-pole transfer types. Transco Products, Inc., 12210 Nebraska Ave., Los Angeles 25, Calif.

Fine Wire 65

This 6-page, 2-color, foldover 1952 catalog provides specifications, including size, diameter, area, weight, length, and resistance of all types of this company's bare and insulated wires from No. 14 to No. 50 AWG. Hudson Wire Co., Winsted, Conn.

Set Screws 66

A new 20-page, 2-color catalog on set screws contains illustrations and descriptions of standard and self-locking set screws, accompanied by data on dimensions, prices, heads, points, and materials. The catalog covers all of the company's lines: "Setko" for regular set screw applications, "Zip-Grip" self-locking screws for those applications where excessive vibration is a factor or close precision setting is desirable, and the "Nu-Cup", made from alloy steel and featuring a design that provides increased holding power with the same setting torque. Other information includes thread standard tables, standard fit definitions, and decimal charts, valuable to design engineers. Set Screw & Mfg. Co., Bartlett, Ill.

Magnetic Alloys 67

An 8-page, "what is it," "where to use it" booklet has been prepared on magnetic alloys. The alloys covered include "Hipernik", "Hipernik V", "Conpernik", and "Hiperco". The first three are iron-nickel alloys, and the last is iron-cobalt. Physical and magnetic property tables, along with the availability of each alloy, are included. The booklet also presents a discussion of individual alloy heat treatment techniques. Also included are 15 core loss and magnetization curves, facilitating the matching of the correct alloy with a specific application. Westinghouse Electric Corp., Box 2099, Pittsburgh 30, Pa.

Resistance Meter 68

A 4-page brochure describes this company's Model C-3 Resistance Meter, which is designed for checking leakage and continuity of electrical components. A particularly important application of this meter is the making of rapid checks of the insulation resistance of transformer windings, condensers, and electrical wiring, as well as measuring the ohmic value of resistors and windings. Information in this brochure includes resistance ranges, circuit description, and electrical and mechanical specifications. A chart provides a simplified schematic wiring diagram. Southwestern Industrial Electronics Co., P. O. Box 13058, Houston 19, Texas.

Mechanical Recorders 69

A 4-page, 2-color brochure, "Mechanical Recorders for Science and Industry", presents recording mechanical counters actuated by electrical impulses. Applications for these counters are machine shops, airports, hospitals, and scientific laboratories. Specifications are provided, and photographs illustrate various models. Streeter-Amet Co., 4101 Ravenswood Ave., Chicago 13, Ill.

Servo Equipment 70

"Precision Components", a 12-page, 2-color brochure, describes servo equipment for industrial applications where highly precise, dependable, and fully automatic control is required. Various precision servo components are pictured and listed: control motors, induction generators, motor-gear train, servo amplifiers, etc. Photographs, charts, and graphs illustrate the construction and specifications of the various components. Transicoil Corp., 107 Grand St., New York 13, N. Y.

Audio Signal Generators 71

The Volume 3, Number 12 issue of the *hp Journal* describes several of the company's audio signal generators. The basic function of these generators is to provide an accurately known audio frequency at an accurately-known and adjustable output level. The generators described are specially arranged to simplify gain and response measurements on both high- and low-level equipment. Diagrams and photographs graphically illustrate the construction of various models of generators. Also indicated are the applications, specifications, and special features of these generators. Hewlett-Packard Co., 395 Page Mill Rd., Palo Alto, Calif.

Tubular Paper Capacitors 72

Catalog IMP-1 (4-page, 2-color) lists and describes general features, specifications, and test data of "IMP" molded tubular paper capacitors. These capacitors are molded in a rugged thermo-setting plastic which provides maximum protection against humidity. Test data include dielectric strength, insulation resistance, standard capacity tolerance, power factor, life test information, etc. Charts further illustrate specifications of these capacitors. Pyramid Electric Co., 1445 Hudson Blvd., North Bergen, N. J.

Engraving Machine 73

This 2-color, 6-page foldover, illustrated brochure describes engraving machines that simplify the task of engraving name plates, panels, dials, scales, etc. Standard and special accessories and advantages are listed and described. A series of photographs point out various steps in the process. Green Instrument Co., 385 Putnam Ave., Cambridge 39, Mass.

Locknuts 74

Designed to serve as a means of assisting in the effective use of locknuts, this new 24-page brochure, entitled "Locknuts", includes an illustration, a description, and a short explanation of the principle of operation of 36 representative types of locknuts. This brochure can serve as a guide to assist users in selecting from the various types of locknuts available, the one best suited for each application. The information for each of the 36 locknuts includes a description of the nut, its principle of operation, the names of firms manufacturing it, and photographs and drawings of the product. Industrial Fasteners Institute, 3648 Euclid Ave., Cleveland 15, Ohio.

ANOTHER FAMOUS MARKET PLACE
D'Étaples (Calais)



ELECTRONIC

*...brings New
Application
Information
to*

you

*and to a
select group
of key
ELECTRONIC
DESIGNERS!*

*It helps make your
work easier, more
efficient and more
productive by pro-
viding valuable data
on new products,
parts, materials,
components, and test
equipment that
influence design.*

* *Market Place for
Electronic Design Innovations*

Geiger-Mueller Tubes

76

The No. 45 issue of "Tracerlog" contains a table of Geiger-Mueller tubes, giving the comparative characteristics of such types as mica end-window tubes with organic and halogen quench, glass wall tubes, high-efficiency gamma tubes, industrial gamma tubes, area survey tubes, etc. Applications and specifications for the various tubes are listed. Tracerlab, Inc., 130 High St., Boston 10, Mass.

Precision Bearings

77

This 4-page, 2-color brochure lists and describes precision bearings with diameters from 1/10" to 5/16". Specifications for these bearings are included in a series of charts, and typical applications are indicated. Miniature Precision Bearings, Inc., Keene, N. H.

Tape Recording

78

This 8-page booklet entitled "Tape Recording for Telemetry and Data Analysis" covers the advantages of tape for studies of guided missiles, aircraft and vehicular operation, shock and vibration tests, and computers. Numerous photographs illustrate various models and provide close-up views of these instruments. Audio & Video Products Corp., 730 Fifth Ave., New York 19, N. Y.

Transformers

79

Custom and special types of transformers are described in this 16-page catalog. Charts illustrate the various specifications of each transformer. Included are an index and price list. A wide variety of transformers is covered, with many types included in the general classification of audio, power, and "20-20 plus" transformers. Peerless Electrical Products Div., Altec Lansing Corp., 161 Sixth Ave., New York 13, N. Y.

Connectors

80

This 4-page, 3-color brochure describes various types of "Blue Ribbon" connectors. Photographs and drawings illustrate the construction of each rack and panel type. A section in this brochure devoted to general design features is useful in obtaining a brief survey of the construction advantages of these "Blue Ribbon" connectors. American Phenolic Corp., 1830 So. 54th Ave., Chicago 50, Ill.

to the

**ELECTRICAL
ENGINEER**

or

PHYSICIST

with experience in

RADAR

or

ELECTRONICS

Hughes Research and Development Laboratories, one of the nation's leading electronics organizations, are now creating a number of new openings in an important phase of their operations.

Here is what one of these positions offers you:

THE COMPANY

Hughes Research and Development Laboratories, located in Southern California, are presently engaged in the development and production of advanced radar systems, electronic computers and guided missiles.

THE NEW OPENINGS

The positions are for men who will serve as technical advisors to government agencies and companies purchasing Hughes equipment—also as technical consultants with engineers of other companies working on associated equipment. Your specific job would be essentially to help insure successful operation of Hughes equipment in the field.

THE TRAINING

On joining our organization, you will work in the Laboratories for several months to become thoroughly familiar with the equipment which you will later help users to understand and properly employ. If you have already had radar or electronics experience, you will find this knowledge helpful in your new work.

WHERE YOU WORK

After your period of training—at full pay—you may (1) remain with the Laboratories in Southern California in an instructive or administrative capacity, (2) become the Hughes representative at a company where our equipment is being installed, or (3) be the

Hughes representative at a military base in this country or overseas (single men only). Compensation is made for traveling and moving household effects, and married men keep their families with them at all times.

YOUR FUTURE

In one of these positions you will gain all-around experience that will increase your value to our organization as it further expands in the field of electronics. The next few years are certain to see large-scale commercial employment of electronic systems. Your training in and familiarity with the most advanced electronic techniques now will qualify you for even more important future positions.

How to apply:

HUGHES

**RESEARCH AND
DEVELOPMENT LABORATORIES**

*Engineering Personnel Department
Culver City,
Los Angeles County, California*

If you are under thirty-five years of age, and if you have an E.E. or Physics degree, write to the Laboratories, giving resumé of your experience.

Assurance is required that relocation of the applicant will not cause disruption of an urgent military project.

New Literature ...

Analog to Digital Converter 82

This 12-page bulletin, No. 3002, provides data on the company's Type 33-102 "SADIC", which is constructed for analog-to-digital conversion. A circuit diagram illustrates the operating features of this equipment. Also listed are components, with such information as their functions, construction, and service features. Consolidated Engineering Corp., 300 No. Sierra Madre Villa, Pasadena 15, Calif.

Variable Resistors 83

Catalog 70 presents this company's line of resistors for military and civilian applications. Data sheets provide technical information on the resistors, and specification sheets are also included. Performance characteristics for the line of military variable resistors are presented, including wattage rating, voltage rating, humidity characteristic, leakage resistance, rotational life, and voltage coefficient. Electrical, mechanical characteristics, special features and constructions are described for both military and civilian variable resistors. Chicago Telephone Supply Corp., Elkhart, Ind.

Insulating Tapes and Sleeveings 84

Cotton, glass, and asbestos woven tapes, braided sleeveings, and cords for electrical insulating purposes are described in this 28-page catalog. Information on applications, properties, technical data, sizes, types, and packaging is included. Characteristics are explained of the basic cotton, glass, and asbestos fibers, whose applications are in coils, TV sets, transformers, and other electrical and electronic units. Insulation Manufacturers Corp., 565 West Washington Blvd., Chicago 6, Ill.

Control Component 85

A 10-page, 2-color Bulletin (No. 505.00) describes "Regohm" control component, which has application as a voltage, current, or speed regulator for control functions in servo systems of many types. Functions and design advantages of "Regohm" are listed, along with its industrial application and system characteristics. Circuit diagrams illustrate features and performance of the equipment. Electric Regulator Corp., Pearl St., Norwalk, Conn.

Transformers and Reactors 86

This 8-page, 2-color catalog provides information on this company's Low Frequency Transformers and Reactors, including their new miniature line. Applications of these products are described, as well as their construction, terminals, core, coils, impregnation, shielding, and matching. The various type numbers of interstage and output transformers are listed. Southwestern Industrial Electronics Co., Inc., 2831 Post Oak Rd., Houston 19, Texas.

Flexible Cord 87

This 24-page, 3-color bulletin includes all the new Underwriters' classifications of the company's flexible cords. Featuring catalog data on "Dynaprene" and rubber jacketed cords, as well as braid covered types, the bulletin also gives information on cord selection, how-to-order specialties, and technical data of interest to users of wire and cable. Included also are applications of these various cord types, wire tables, conversion equivalents, etc. Whitney Blake Co., New Haven 14, Conn.

Controls and Resistors 88

Catalog No. 52, 20-page, 2-color, provides a listing, with description, of the various types and series of controls and resistors. Charts, graphs, and photographs provide specifications. Items illustrated include a high-voltage coupler, rotary switches, wire-wound controls, constant impedance controls, constant impedance output attenuators, universal and standard ballast resistors, power rheostats, etc. Clarostat Mfg. Co., Inc., Dover, N. H.

Mass-Spectrometer 89

Bulletin 3001A provides a description of the "Spectro-SADIC" and Analytical Mass Spectrometer combination, which is used in mass spectrometer computations. A description of the automatic conversion of mass-spectrometer data into digital form also is included. The Model 34-104 "Spectro-SADIC" is described: its operational features, such as time, digital data, visual indication, power, and accuracy. How this model works, its construction and service features, and operating controls are discussed. Consolidated Engineering Corp., 300 North Sierra Madre Villa, Pasadena 15, Calif.

Insulation Test Set 90

This 4-page, 2-color brochure describes the "Ionization Test Set Type 105 PMIE", which serves as a breakdown tester and leakage indicator, a measurement of high resistance, and for life testing of components. Details of design, specifications, outstanding features, and operation are discussed. Hivolt Ltd., 34a Pottery Lane, London, W. 11, England.

Polyester Resin 91

This 4-page, 2-color brochure describes a thermosetting polyester resin, epoxy in nature, for application in potting, casting, molding, sealing, bonding, or impregnating electronic units. In addition to a description of this compound, a chart presents its properties: dielectric strength, power factor, insulation resistance, moisture absorption, water vapor permeability, vibration test, thermal conductivity, coefficient of linear expansion, etc. Acme Wire Co., New Haven, Conn.

D-C Solenoids 92

Bulletin DCS3-1952 presents a 72-page catalog covering the company's line of D-C Solenoids. 82 distinct types in five shell diameters, and 25 coil windings for intermittent and continuous duty are listed. Photographs, dimensional sketches, sectional views, and various types of charts are presented together with photographs of applications. The basic engineering data include duty cycle, rated voltage, stroke, current drain, ambient temperature, and tractive force of each type. These solenoids have application for aircraft and general industrial d-c uses: aircraft power supplies, rocket launching, fuel tank releases, door, landing gear and throttle locks, etc. Cannon Electric Co., 420 West Ave. 33, Los Angeles 31, Calif.

Mechanical Filter 93

A 4-page brochure describes this company's mechanical filter, for use in the electronic industry where a compact and permanently tuned band pass filter for operation at 455kc. is required. Specifications for this filter are presented, including operating frequency, peak-to-valley ratio, insertion loss, overload input power level, operating temperature range, vibration, case size, and input and output impedance. Collins Radio Co., Cedar Rapids, Iowa.

Rectifiers

94

This 4-page, 3-color brochure, illustrated by charts, describes the features and specifications of the company's rectifiers. Types, life expectancy, applications, and advantages of these units are presented. American Rectifier Corp., 103 Walker St., New York 13, N. Y.

Electrical Contacts

95

Composite metals and precious metals are listed in this 12-page, 3-color catalog as sources for contact-spring applications in television tuners and for use in chassis and electronic component cases or cans. Photographs and text illustrate and describe the typical metals used, along with several specific applications. Items covered include button and rivet contacts and contact assemblies, as well as wave guide tubing for transmission lines, "Truflex" thermostat metals, and collector or slip rings, for the diverse requirements of the electronic industry. Metals & Controls Corp., General Plate Div., Attleboro, Mass.

Magnetic Ceramic

96

This 4-page, 2-color brochure describes "Croloy", this company's magnetic ceramic core material with such applications as TV horizontal output transformers; TV deflection yokes; permeability tuning cores; toroidal coil cores; AM radio antennas; power, audio and output transformers; ignition coils; saturable reactors; filters; and magnetostriction devices. A chart indicates the characteristics of "Croloy": permeability (maximum differential), saturation flux (density), residual magnetism, coercive force, etc. Photographs and circuit diagrams further illustrate this magnetic ceramic material. Henry L. Crowley & Co., Inc., 1 Central Ave., West Orange, N. J.

Industrial Electronic Instrumentation

97

A compact 32-page booklet briefly describes electronic instruments, providing direct-reading digital presentation of information, and the principal industrial applications of these instruments. Included in this booklet are high-speed counting, counting plus control, precise interval timing, measurement of rpm, pressure, temperature flow, viscosity, velocity, frequency, distance, etc. All these specifications are illustrated by diagrams. Berkeley Scientific, Div. of Beckman Instruments Inc., 2200 Wright Ave., Richmond, Calif.

Industrial X-Ray

98

Seven types of x-ray equipment for industrial application are described in a 4-page, 2-color folder entitled "Seven Industrial Eyes". The folder contains pictures of each type of x-ray equipment with a brief description of how each is used. Units presented are: single-column tubestand, industrial jib crane, ultra high-speed radiograph, mobile, equipment for mass inspection of parts, wall-mounted industrial x-ray, and thickness gauge. Westinghouse Electric Corp., Box 2099, Pittsburgh 30, Pa.

Recording Systems

99

This 5-page, 2-color foldover brochure, illustrated with diagrams and photographs, presents an applicability table for the various recording systems offered by this company. A description of the basic recording models is included, along with performance data and specification tables. Charts illustrate the frequency response of the various models. Another feature of these models, that of the interchangeability of the amplifiers and preamplifiers, also is presented. Sanborn Co., Cambridge 39, Mass.

Retractable Cords

100

This 8-page bulletin on retractable cords for general communication and power applications discusses the company's "Kooled Kords". Contained in the bulletin are catalog data and information helpful in selecting cords, as well as photographs of actual applications. The bulletin explains how the cords are made, where they are used, and what are the specific features that make their use advantageous. Charts and circuit diagrams further illustrate the construction of the cords. Kooled Kords, Inc., Box K, New Haven 14, Conn.

Photoelectric Counters

101

Bulletin PA 506 (4-page, 2-color) describes several models of photoelectric counting sets with applications in the counting of small, fragile, and light objects, which are not heavy enough to actuate a mechanical counter; freshly painted objects; and heavy objects which would bruise a mechanical counter. Specifications, including power requirements, output, speed of operation, adjustment, contact ratings, maximum sensitivity rating, operating range, and installation and maintenance, are listed for each counter type, and circuit diagrams illustrate the construction. Photoswitch Inc., 77 Broadway, Cambridge 42, Mass.

Electron Multiplier Photometer

102

This 4-page Bulletin describes a new electron multiplier photometer, a highly sensitive, line-operated meter using a stabilized, direct-connected amplifier with two independent power supplies. Specifications and information on accessories are given. Photographs illustrate some of the various attachments, with brief application data on each. A graph provides spectral sensitivity characteristics of the various Photomultiplier tubes that are available for the instrument. Ultrasonic Engineering Co., P. O. Box 46, Maywood, Ill.

Illuminated Magnifier

103

This new 2-color, 4-page illustrated catalog features the "Flash-O-Lens", a portable instrument that illuminates the area it magnifies. Battery and electric models are pictured, along with prices and sizes. Possible applications are mentioned. Also featured is an electric reader of precision ground and polished glass for those with poor eyesight. E. W. Pike & Co., 492 North Ave., Elizabeth 3, N. J.

A NEW SOURCE OF SUPPLY FOR



IRC Insulated Chokes are relatively inexpensive and offer savings over ordinary types. Available in two sizes, they are fully insulated against high humidity, abrasion, damage during assembly, and danger of shorting to chassis.

Miniature IRC MICRO-STAK Selenium Rectifiers are superior quality units available in a wide variety of types. Special IRC technique provides low capacitance cells as small as .060" diameter with unit area characteristics equal to high-grade plates of standard size.



INTERNATIONAL RESISTANCE COMPANY

Dept. D-401, N. Broad St., Philadelphia 8, Pa.

In Canada: International Resistance Co., Ltd., Toronto, Licensee

Please send full data on the items checked below:—

- IRC Insulated Chokes
 IRC Microstak Selenium Rectifiers

Name _____

Company _____

Address _____

Whenever the Circuit Says 

CIRCLE ED-104 ON READER-SERVICE CARD FOR MORE INFORMATION

New Literature . . .

Antenna Systems

107

Catalog No. 52 presents "Vee-D-X", this company's Video Distance antenna systems. All-channel antennas, single-channel antennas, broad band antennas, boosters, lightning arresters, towers, MDOB (multiple dwelling antennas), and accessories are listed and described here, with features, various specifications, etc. Applications for the various components in these systems are given. LaPointe Plasemold Corp., Windsor Locks, Conn.

Electronic Components

108

Bulletins No. 99-200 list, illustrate and describe this company's tachometers, speed changers, and comparator gages. Data sheets contain charts, circuit diagrams, and a description of each type. General specifications are also included, as well as applications. A table indicates all the standard integral ratios of the miniature speed changers. Bulletin No. 200 lists and describes comparator gage accessories. Metron Instrument Co., 432 Lincoln St., Denver 9, Colo.

Hermetically Sealed Relay

109

This 4-page, 2-color brochure describes the Type CR2791G Hermetically Sealed Relay, which has been designed to meet all provisions of MIL-R-6106 military specifications for relays. The relay can be used in aircraft, aboard ship, and on portable units, for all electronic applications requiring hermetic sealing. Specification features and performance data are fully listed. General Electric Co., Schenectady, N. Y.

Potentiometer

110

"Industrial Bulletin 100" provides a 2-color, 2-page description of the "Series C-200 External Phasing Potentiometer". Photographs and diagrams illustrate the construction of this model. Also featured are general specifications, including power rating, torque, and weight information. This "C-200" series has been designed and engineered specifically for precision instrument, computer and military applications. DeJur-Amsco Corp., Northern Blvd. at 45th St., Long Island City 1, N. Y.

Tape Recorders

111

The Vol. 8, No. 6 issue of "Audio Record" contains a section called "Quick Facts on Magnetic Tape Recorders", a complete chart listing all makes of tape recorders, price, frequency response, data specifications, and tape information. Each model is pictured, and all manufacturers' addresses are listed. Also included are charts listing the recording time for various tape speeds and reel sizes, and information on the complete "Audiotape" line. Audio Devices, Inc., 444 Madison Ave., New York 22, N. Y.

Cathode-Ray Equipment

112

This 16-page catalog describes the various cathode-ray equipment of this company. Photographs illustrate the types. Specifications, including vertical deflection, sinusoidal frequency response, maximum allowable input potential, horizontal deflection, linear sweeps, intensity modulation, maximum photographic writing rates, tube complement, etc. are listed and explained for each instrument. Also included in this catalog is a listing of various accessories, such as a viewing hood, a bezel, and a step-down transformer. Allen B. Du Mont Laboratories, 1500 Main Ave., Clifton, N. J.

Mass Spectrometer

113

Bulletin CEC-1800B (20-page, 2-color) presents technical information on mass spectrometry, which has application in control, complex mixture, and exploratory analyses, purity determinations, and research investigations. The method of analysis, including a description of the company's Model 21-103A spectrometer, performance characteristics, service, and features are explained, and further illustrated by circuit diagrams. Accessories also are described. Consolidated Engineering Corp., 300 No. Sierra Madre Villa, Pasadena 15, Calif.

Recording Equipment

114

"7 Advantages of Direct-Writing Recorders" is a 16-page, 2-color booklet illustrating and describing direct-recording equipment for industrial users. The booklet briefly discusses such aspects of complete systems as against separate instruments, torque movement, choice of speeds and channels, code and time markings, and inter-changeability of amplifiers and preamplifiers. Sanborn Co., 38 Osborne St., Cambridge 39, Mass.

Meetings

- Jan. 14-16: Joint AIEE-IRE Conference on High Frequency Measurements, Washington, D. C.
- Jan. 19-23: AIEE Winter General Meeting, Hotel Statler, New York, N. Y.
- Jan. 26-30: IAS-IRE-RTCA-ION Symposium on Electronics in Aviation, New York, N. Y.
- Feb. 4-6: Western Computer Conference, Hotel Statler, Los Angeles, Calif.
- Feb. 5-7: IRE Southwestern Conference and Electronics Show, Plaza Hotel, San Antonio, Texas.
- Feb. 5-7: West Coast Audio Fair, Los Angeles, Calif.
- Mar. 9-12: NEMA (National Electrical Manufacturers Assn.) Edgewater Beach Hotel, Chicago, Ill.
- Mar. 16-18: IEE (Institute of Electrical Engineers) Symposium on Insulating Materials, London, England.
- Mar. 23-26: IRE National Convention, Waldorf-Astoria Hotel and Grand Central Palace, New York, N. Y.
- Apr. 11: NEREM (New England Radio Engineering Meeting), University of Connecticut, Storrs, Conn.
- Apr. 16-17: 9th Joint Conference of RTMA of United States and Canada, Ambassador Hotel, Los Angeles, Calif.
- Apr. 18: IRE Seventh Annual Spring Technical Conference, Cincinnati, Ohio.
- Apr. 26-30: SMPTE (Society of Motion Picture and TV Engineers) 73rd Convention, Hotel Statler, Los Angeles, Calif.
- Apr. 28-May 1: NARTB (National Assn. Radio and Television Broadcasters) 1953 Convention, Biltmore Hotel, Los Angeles, Calif.
- Apr. 29-May 1: Electronic Components Symposium, Shakespeare Club, Pasadena, Calif.
- May 11-13: 1953 National Conference on Airborne Electronics, Hotel Biltmore, Dayton, Ohio.
- May 18-21: 1953 Electronic Parts Show, Conrad Hilton Hotel, Chicago, Ill.
- May 24-28: NAED (National Assn. of Electronic Distributors) 45th Annual Convention, Conrad Hilton Hotel, Chicago, Ill.
- Aug. 19-21: WESCON (Western Electronic Show and Convention), San Francisco Municipal Auditorium, San Francisco, Calif.
- Oct. 26-28: RTMA-IRE Radio Fall Meeting, Toronto, Ontario, Canada.

Patents . . .

By John Montstream

Bohleber, Fassett & Montstream, New York, N. Y.

Electron Tube Protective System

Patent No. 2,615,147. M. V. Hoover, Mountville, Pa.

(Assigned to Radio Corp. of America)

Circuits for the protection of a high power oscillator or amplifier tube against internal shorts or internal arcs are known. Such protective circuits are connected with the igniting electrode of a normally non-conducting tube connected in shunt across the power supply line, and having sufficient gas or vapor therein, so that when a high current fault occurs in the protected tube,

protected tube, and it generates a positive pulsating voltage proportional to the current through the protected tube. This positive voltage is applied to the control grid (60) of a gas tetrode tube (58), and the negative voltage of the first section is applied to the screen grid (64) of the tetrode. As long as the protected tube is operating normally, the positive voltage pulses on the control grid will be overcome by the negative voltage impulses from the first section applied to the screen grid. Should a fault occur in the protected tube, the positive voltage pulses at the control grid of the tetrode will increase in amplitude and the negative voltage pulses at the screen grid will decrease in amplitude, and the gas tetrode will fire quickly after a fault begins to develop.

The gas tetrode is connected with the igniting electrode (42) of the short circuiting gas tube (33). In the system particularly described the gas tetrode is connected with a diode (84) which is connected with a second gas tetrode (72). This second tetrode is connected with the igniter of the short circuiting gas tube to fire the latter when the former fires. The diode may have a plurality of sections so that fault detection circuits for other protected tubes may be connected through the sections to the second gas tetrode, so that a fault occurring in any protected tube will fire the second tetrode and the short circuiting gas tube.

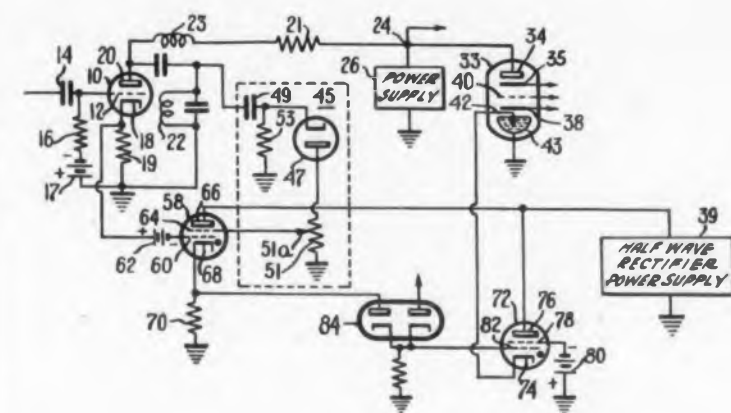

the gas tube is ignited and becomes conducting to short circuit the power supply. The voltage drop across the gas tube when conducting is of a low and substantially constant value, making it suitable for this purpose. The protective circuit of the patent gives improved performance of the fault detecting function in that the circuit differentiates between a high current fault and other non-injurious changes in operation. Since a tube can be damaged before a slow fault detecting circuit triggers the gas tube, it is important that such circuit functions quickly. The circuit described provides an extremely fast-acting circuit as well.

The fault detecting circuit includes two sections, the first section or network generating a pulsating voltage, which is proportional to the output voltage of the protected tube (10). It comprises essentially a half wave rectifier (45) coupled to the output circuit of the protected tube, and having a potentiometer (51) connected in series therewith. A negative pulse of voltage is generated across the potentiometer during each positive half cycle of voltage at the grid (12) of the protected tube.

The second section of the fault detecting circuit is a resistor (19) connected in the cathode circuit of the

Beam Type Electron Tube

Patent No. 2,615,138. A. C. Grimm, Lancaster, Pa.

(Assigned to Radio Corp. of America.)

Deflection circuits of cathode ray tubes used in television and radar circuits are subject to undesirable oscillations because of sudden interruptions of current in the transformer and deflecting yoke windings of the cathode ray tube. Such oscillations occur during the retrace time and have been inadequately damped by the provision of external damping means. This invention secures effective damping of such oscillations by providing a damping path or circuit within the deflection circuit tube itself so that external damping means are unnecessary.

The suppression of these undesirable oscillations is secured by providing one or more auxiliary cathodes

within a tube constructed to focus the stream of electrons into a divergent beam. The auxiliary cathode (or cathodes) may be located adjacent to the anode and is electrically connected therewith. The auxiliary cathode is bombarded by the electrons of the beam, so that it is heated sufficiently thereby to become electron emissive and an independent source of electrons.

One or more auxiliary anodes are provided for the auxiliary cathodes, and these anodes are outside of the electron beam and may be connected to the main cathode within the tube or to terminals for an external connection. In a tube having beam focusing electrodes at cathode potential these may serve as the auxiliary anodes for collection of electrons from the auxiliary cathodes. Each auxiliary cathode and its associated anode forms a diode which provides within the tube a unidirectional damping path in shunt with the anode cathode of the tube.

Electromagnetic Transducer Head

Patent No. 2,615,097. M. Camras, Chicago, Ill.

(Assigned to Armour Research Foundation of Illinois Institute of Technology)

An electromagnetic transducer head for magnetic recording apparatus is described which reduces the leakage flux that by-passes the gap at the confronting pole tips below the record wire or tape and increases the effective flux operating on the record. This result is secured by using a secondary circuit, the magnetic field of which opposes the field of the leakage flux and is additive to the field of the transducer head winding.

The secondary circuit is a short-circuited secondary of a double loop or figure 8 configuration made of high conductive, non-magnetic metal. One loop of the circuit is wound about a leg of the magnetic circuit and the other loop is flattened and passes through the air gap of the magnetic circuit. The cross-over point in the double loop configuration of the secondary circuit is insulated to prevent short circuiting at this point.

The current flowing in the secondary circuit creates a secondary field around the conductor particularly in that portion of the secondary circuit which lies within the gap. This field opposes the field of the leakage flux below the gap, thereby reducing the total amount of leakage flux in the head, and is in an additive sense with the field of the main winding for the head. The loop of the secondary circuit which is wrapped around the leg of the magnetic circuit aids in reducing the flux immediately below the main coil, which overcomes a tendency of the core material to saturate at this point. An eddy current member within the erase gap of a transducer head also produces similar beneficial effects.

Product Inquiry Guide

Page	Item	Inquiry No.
1.	Press Fit Terminals	1
	Hermetically Sealed Relay	2
2.	Flyback Transformers and Yokes	3
3.	Frequency-Time Counters	4
4.	Tungsten and Chemical Products	5
9.	Magnetic Amplifiers	6
12.	Fastenings	8
13.	Terminal Boards	10
14.	Wire Wound Resistors	11
	Selenium Rectifier Cell	12
	Precision Oscillograph	13
	Miniature Knobs	14
	Plastic Sandwich Boards	15
	High Voltage Rectifiers	16
15.	Miniature Paper Capacitor	17
	Decimal Counting Unit	18
	Drawing Pencil	19
	Step-Type Attenuator	20
	Liquid Plastic	21
16.	Frequency Meter	22
	Industrial TV Camera	23
	D-C Power Supply	24
	Duplex Signaling Unit	25

Page	Item	Inquiry No.
17.	Bobbin Coil Winder	26
	Electronic Timer	27
	TV Picture Tube	28
	Indicator Light	29
	D-C Meter Tester	30
	C-R Oscilloscope Tube	31
18.	Signal Generator	32
	Variable Capacitor	33
	Germanium Rectifiers	34
	High Impedance Delay Cable	35
	Miniaturized Plug-In Amplifier	36
19.	Diode Clip	37
	Magnetic Amplifier	38
	Hermetic Seal Sub-Assemblies	39
	R-F Coil Forms	40
	Twin Diode-Triode	41
	Coil Bobbin Kit	42
20.	Germanium Diode	43
	Toggle Switch	44
	Casting Resins	45
	Half-Wave Rectifier	46
	Vacuum Gage	47
	Magnetic Probe	48
21.	Computing Machinery	50
22.	Electronic Supplies	51

Page	Item	Inquiry No.
23.	Capacitors, Filters, Resistors	52
	Microwave Assemblies	53
	Electronic Components	54
	Selenium Diodes	55
	DC Motors and Timers	56
	Pressure Pickup	57
	Magnetic Amplifiers	58
	Metallized-Paper Capacitors	59
	Fastening Service	60
	Gas Tubes	61
	Hermetic Seals	62
24.	Electronic Components	63
	Coaxial Switches	64
	Fine Wire	65
	Set Screws	66
	Magnetic Alloys	67
	Resistance Meter	68
	Mechanical Recorders	69
	Servo Equipment	70
	Audio Signal Generators	71
	Tubular Paper Capacitors	72
	Engraving Machine	73
	Locknuts	74
25.	Geiger-Mueller Tubes	76
	Precision Bearings	77
	Tape Recording	78
	Transformers	79
	Connectors	80
	Employment	81
26.	Analog to Digital Converter	82
	Variable Resistors	83
	Insulating Tapes and Sleeveings	84
	Control Component	85
	Transformers and Reactors	86
	Flexible Cord	87
	Controls and Resistors	88
	Mass-Spectrometer	89
	Insulation Test Set	90
	Polyester Resin	91
	D-C Solenoids	92
	Mechanical Filter	93
27.	Rectifiers	94
	Electrical Contacts	95
	Magnetic Ceramic	96
	Industrial Electronic Instrumentation	97
	Industrial X-Ray	98
	Recording Systems	99
	Retractable Cords	100
	Photoelectric Counters	101
	Electron Multiplier Photometer	102
	Illuminated Magnifier	103
	Insulated Chokes, Selenium Rectifiers	104
28.	Antenna Systems	107
	Electronic Components	108
	Hermetically Sealed Relay	109
	Potentiometer	110
	Tape Recorders	111
	Cathode-Ray Equipment	112
	Mass Spectrometer	113
	Recording Equipment	114
31.	Miniature Thermal Relay	117
32.	Tubes and TV Components	118

If you wish to receive ELECTRONIC DESIGN every month, free of charge, and you feel that you qualify as a reader according to specifications on page 2, please fill out below and mail.

ELECTRONIC DESIGN
127 East 55th Street
New York 22, N. Y.

I would like to receive ELECTRONIC DESIGN every month, free of charge. Please add my name to your circulation list.

NAME (Print or type all information)

TITLE

COMPANY

COMPANY ADDRESS

CITY ZONE STATE

MAIN PRODUCTS

Please fill in completely. Be sure to give your title and main products.

Reader's Service Inquiry Card

These cards have been provided to make it easier for you to secure more information from the manufacturers about advertised products or those items reviewed editorially.

The requirements are simple:

1. Circle number (from bottom of ad or editorial).
2. Fill out name and other information required.
3. Mail. NO POSTAGE NECESSARY.

• These inquiries will be processed only if all the information is supplied. Please note that the card expires April 1, 1953.

Advertising Index

January 1953

Allied Radio	22
Agency: George Brodsky Agency	
Berkeley, Edmund C., & Associates	21
Agency: Battistone, Bruce and Doniger, Inc.	
Cambridge Thermionic Corporation	13
Agency: James Thomas Chirurg Company	
Edison, Thomas A., Incorporated—Instr. Div.	31
Agency: Gotham Advertising Company	
Elastic Stop Nut Corp. of America	12
Agency: G. M. Basford Co.	
Guthman, Edwin I., & Co., Inc.	2
Agency: Burton Browne Advertising	
Hughes Research and Development Laboratories	25
Agency: Foote, Cone & Belding	
International Resistance Company	27
Agency: John Falkner Arndt & Company, Inc.	
Keystone Products Co.	9
Agency: W. H. Watt Advertising Agency	
Potter Instrument Company, Inc.	3
Agency: J. B. Roberts Incorporated	
Radio Corporation of America	32
Agency: J. Walter Thompson Company	
Sylvania Electric Products Inc.	4
Agency: Cecil & Presbrey, Inc.	

Advertising Representatives

New York:	T. Richard Gascoigne James S. Mulholland, Jr. 127 East 55th Street New York 22, New York PLaza 3-8677
Chicago:	Thorpe Covington 677 North Michigan Avenue Chicago 11, Illinois SUperior 7-8054
Los Angeles:	Robert W. Walker Company 2330 West 3rd Street Los Angeles 5, Calif. DUnkirk 7-4388
San Francisco:	Robert W. Walker Company 57 Post Street San Francisco 4, Calif. SUtter 1-5568



SCARCELY LARGER THAN YOUR DOOR KEY

FOR . . .

- Cathode Protection**
- Gyro Erection**
- Motor Starting**
- Integration**
- Holdovers**
- Overload Protection**
- Current Interruptions (Flashers)**
- Cycling Durations**
- Emergency Circuit Switchovers**

SPECIFICATIONS • MODEL 207

Sealed-in-glass	Standard Heater Voltages:
Arc quenching atmosphere	115v, 27.5v, 6.3v
Precision timing — Final adjustment made after sealing by patented feature	Contact Ratings:
Weight: ½ oz. (approx.)	2.5 amps @ 125v ac.,
Diameter: ¾" (approx.)	1.0 amp @ 125v dc.
Height: 2¼" maximum (seated)	Ambient Compensation:
	—60 to +85°C
	Nominal Heater Input:
	2 watts
	Mounting: Miniature Button
	7-pin
	Range of Delay Periods:
	5 secs. to 120 secs.

OTHER INSTRUMENT DIVISION PRODUCTS

- Sealed Thermostats*
- Sensitive Relays*
- Temperature Monitors*
- Electrical Resistance Bulbs*

YOU CAN ALWAYS RELY ON EDISON

Announcing ... a NEW Miniature by EDISON

EDISON announces its new Model 207 Miniature Thermal Relay — designed to meet the need for a space-saving time-delay relay.

Into the design and development of this sealed-in-glass miniature, EDISON has applied the experience of over 20 years in the thermal engineering field and has built into it many of the quality features of the widely-used EDISON Model 501 Thermal Relay. In numerous applications the two relays have similar operating characteristics.

Pilot production started in December 1951. For free bulletin, just clip coupon and mail.

Thomas A Edison
INCORPORATED

Instrument Division • West Orange, N. J.

To: *Instrument Division, THOMAS A. EDISON, INC.*
55 Lakeside Avenue, West Orange, New Jersey

We may have an application for your Miniature Thermal Relay to _____

Please send bulletin to: _____

Name and title: _____

Company: _____

Address: _____

IN PRODUCT IMPROVEMENT RCA NEVER STANDS STILL

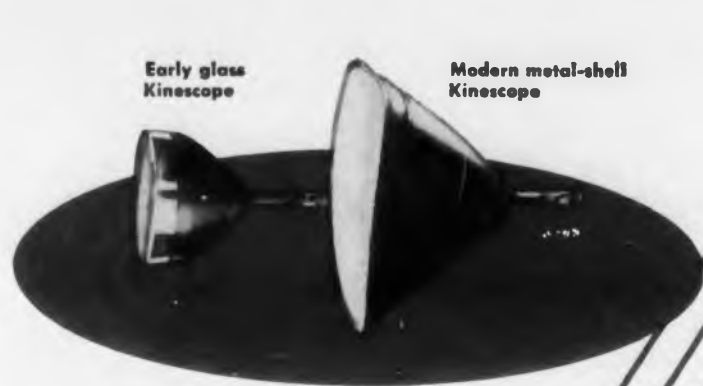

Early glass Kinescope

Modern metal-shell Kinescope

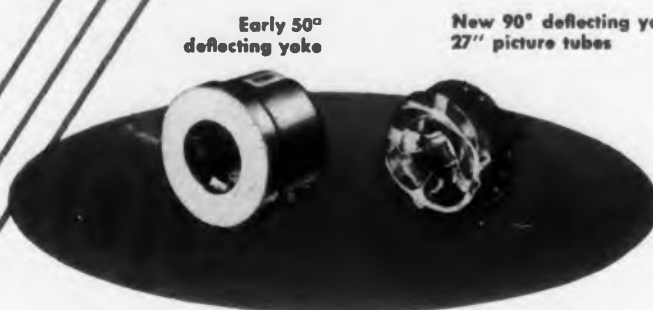

Early 50° deflecting yoke

New 90° deflecting yoke for 27" picture tubes



Early radiator design used on RCA-7C24

Improved design of radiator now used on similar type, RCA-5762, cools with only one-half the air flow



Early vacuum rectifier for receivers

Improved RCA-5U4G has greater stability, longer life.

IT IS ONE THING to develop new products for the market. It's another thing to improve them . . . to conceive advanced designs . . . after they are on the market.

RCA engineers take nothing for granted—even after design has been "frozen." RCA engineers continue to work closely with equipment designers to solve problems dealing with the performance of tubes and components. RCA engineers never "let go" in their efforts to provide the ultimate in useful performance of the product.

Take the tubes and components illustrated here.

- The improved rectangular kinescope features a metal shell which permits use of a reflection-free faceplate having uniform thickness and high quality; it weighs less; it allows new flexibility in chassis layout.
- The improved plate radiator of the power tube reduces operating temperature, increases tube life, saves customers' money.
- The improved deflecting yoke provides beam deflection through a diagonal deflection angle of 90°—with inherent compensation for deflection defocusing.
- The improved rectifier tube has a greater reserve of emission, greater stability, longer life . . . is better suited for TV receiver requirements.

You can rely on RCA engineering leadership for continuous product improvement.



RADIO CORPORATION of AMERICA
ELECTRON TUBES
HARRISON, N. J.