

Aug.

RADIO PHONE
WRNY
STATION

25 Cen.

Science and Invention

With which is combined
The EXPERIMENTER

40
NON-TECHNICAL
RADIO
ARTICLES



**HOW TO BUILD A
ROWMOBILE**

See Page 338

HOWARD BROWN



Afraid of My Own Voice

But I Learned to Dominate - Others Almost Overnight

SUDDENLY the boss turned to me and queried, "Well, Conroy, what's your opinion?" They all listened politely for me to speak and in the silence I heard my thin, wavering voice stammering and sputtering a few vague phrases. Like a flash Stoddard interrupted me and launched on a brilliant description of his plan. All sat spell-bound as he talked—my views were forgotten—and yet I have been studying the problem for months and I was prepared to suggest a sound, practical plan which I knew would solve all our difficulties.

And that was the way it always was—I was always being given opportunities to show my ability and always failing miserably. I was bashful, timid, and nervous—I never knew how to express myself, how to put my ideas across. In fact, I was actually afraid of my own voice! Constantly I saw others with less ability, less experience than I being promoted over my head—simply because they had the knack of forceful speech, self-confidence, and personality—the very qualities I lacked.

In social life, too, I was a total loss—I was always the "left-over"—the one who sat back and watched the others have a good time. I seemed doomed to be an all around failure unless I could conquer my timidity,

my bashfulness, my lack of poise and inability to express myself.

In 15 Minutes a Day

And then suddenly I discovered a new easy method which made me a powerful speaker almost overnight. I learned how to bend others to my will, how to dominate one man or an audience of thousands. Soon I had won salary increases, promotion, popularity, power. Today I always have a ready flow of speech at my command. I am able to rise to any occasion, to meet any emergency with just the right words. And I accomplished all this by developing the natural power of speech possessed by everyone, but cultivated by so few—by simply spending 15 minutes a day in the privacy of my own home to this most fascinating subject.

There is no magic, no trick, no mystery about becoming a powerful and convincing talker. You, too, can conquer timidity, stage fright, self-consciousness and bashfulness, winning advancement in salary, popularity, social standing and success. Today business demands for the big, important high-salaried jobs, men who can dominate others—men who can make others do as they wish. It is the power of forceful, convincing speech that causes one man to jump from obscurity to the presidency of a great corporation; another from a small, unimportant territory to a sales-manager's desk; another from the rank and file of political workers to a post of national importance; a timid,

retiring, self-conscious man to change almost overnight into a popular and much applauded after-dinner speaker. Thousands have accomplished just such amazing things through this simple, easy, yet effective training.

Send for this Amazing Book

This new method of training is fully described in a very interesting and informative booklet which is now being sent to everyone mailing the coupon below. This book is called, *How to Work Wonders With Words*. In it you are shown how to conquer stage fright, self-consciousness, timidity, bashfulness and fear—those things that keep you silent while men of lesser ability get what they want by the sheer power of convincing speech. Not only men who have made millions but thousands have sent for this book—and are unstinting in their praise of it. You are told how to bring out and develop your priceless "hidden knack"—the natural gift within you—which will win for you advancement in position and salary, popularity, social standing, power and real success. You can obtain your copy absolutely free by sending the coupon.

**Now
Sent
FREE**



NORTH AMERICAN INSTITUTE
3601 Michigan Ave., Dept. 142C, Chicago, Ill.

NORTH AMERICAN INSTITUTE,
3601 Michigan Ave., Dept. 142C
Chicago, Illinois

Please send me FREE and without obligation my copy of your famous book, *How to Work Wonders With Words*.

Name

Address

City..... State.....

What 15 Minutes a Day Will Show You

- How to talk before your club or lodge
- How to propose and respond to toasts
- How to address Board Meetings
- How to tell entertaining stories
- How to make a political speech
- How to make after-dinner speeches
- How to converse interestingly
- How to write letters
- How to sell more goods
- How to train your memory
- How to enlarge your vocabulary
- How to develop self-confidence
- How to acquire a winning personality
- How to strengthen your willpower and ambition
- How to become a clear, accurate thinker
- How to develop your power of concentration
- How to be the master of any situation.

Electrical Experts are in Big Demand!

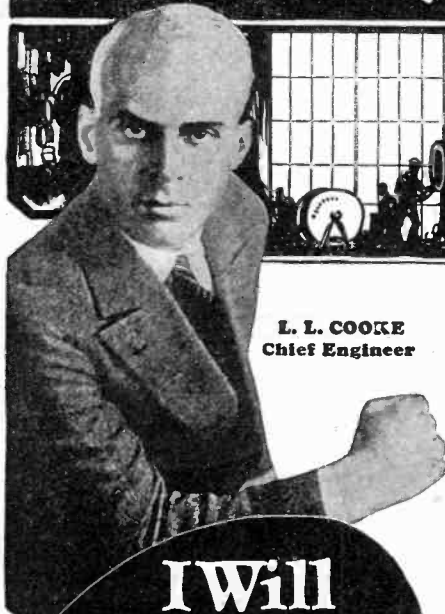

L. L. COOKE
Chief Engineer

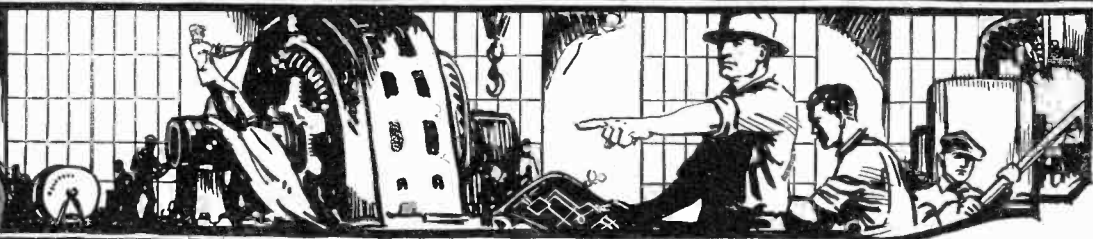

It's a shame for you to earn \$15 or \$20 or \$30 a week, when in the same six days as an Electrical Expert you could make \$70 to \$200—and do it easier—not work half so hard. Why then remain in the small-pay game, in a line of work that offers no chance, no big promotion, no big income? Fit yourself for a real job in the great electrical industry. I'll show you how.

Be an Electrical Expert Earn \$3,500 to \$10,000 a Year

Today even the ordinary Electrician—the “screw driver” kind—is making money—big money. But it's the trained man—the man who knows the whys and wherefores of Electricity—the Electrical Expert—who is picked out to “boss” the ordinary Electricians—to boss the big jobs—the jobs that pay \$3,500 to \$10,000 a year. Get in line for one of these “Big Jobs.” Start by enrolling now for my easily learned, quickly grasped, right-up-to-the-minute, Spare-Time Home-Study Course in Practical Electricity.

Age or Lack of Experience No Drawback

You don't have to be a College Man; you don't have to be a High School Graduate. As Chief Engineer of the Chicago Engineering Works, I know exactly the kind of training you need, and I will give you that training. My Course in Electricity is simple, thorough and complete and offers every man, regardless of age, education or previous experience, the chance to become, in a short time, an “Electrical Expert,” able to make from \$70 to \$200 a week.

Your Satisfaction Guaranteed

So sure am I that you can learn Electricity—so sure am I that after studying with me, you, too, can get into the “big money” class in electrical work, that I will guarantee under bond to return every single penny paid me in tuition, if, when you have finished my Course, you are not satisfied it is the best investment you ever made. And back of me in my guarantee, stands the Chicago Engineering Works, Inc., a two million dollar institution, thus assuring to every student enrolled, not only a wonderful training in Electricity, but an unsurpassed Student Service as well.

Free Book on Electricity

I want to send you my Electrical Book and Proof Lessons, both Free. These cost you nothing and you'll enjoy them. Make the start today for a bright future in Electricity. Send in Coupon—Now!

L. L. COOKE,
Chief Engineer

Chicago Engineering Works
2150 Lawrence Ave.
Dept. 2-C Chicago

Get Started Now!
Mail Coupon

L. L. COOKE, Chief Engineer
Chicago Engineering Works
Dept. 2C, 2150 Lawrence Ave. Chicago

Send me at once without obligation your big illustrated book and complete details of your Home Study Course in Electricity, including your outfit and employment service offers.

I Will Train You at Home for a Big Pay Job
L.L.C.

5 Big Fine Outfits to work with No Extra Charge



With me, you do practical work—at home. You start right in after your first few lessons to work at your profession in the regular way and make extra money in your spare time. For this you need tools, and I give them to you—5 big complete working outfits, with tools, measuring instruments, and a real electric motor—5 outfits in all.

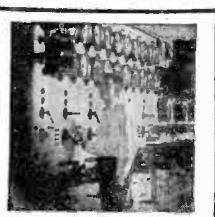

Pay Raised 150%

“I was a dumbbell in electricity until I got in touch with you, Mr. Cooke, but now I have charge of a big plant including 630 motors and direct a force of 34 men—electricians, helpers, etc. My salary has gone up more than 150%.”
GEO. ILLINGWORTH,
63 Calumet Road,
Holyoke, Mass.



\$700 in 24 Days

“Thanks to your interesting Course I made over \$700 in 24 days in Radio. Of course, this is a little above the average but I run from \$10 to \$40 clear profit every day, so you can see what your training has done for me.”
FRED G. McNABB,
7 W. 16th St., Atlanta, Ga.



\$20 a Day—for Schreck

“Use my name as a reference and depend on me as a booster. The biggest thing I ever did was answer your advertisement. I am averaging better than \$500 a month from my own business now. I used to make \$18 a week.”
A. SCHRECK,
Phoenix, Arizona



GET MY FREE BOOK!

The Cooke Trained Man is the “Big Pay” Man

Name.....
Address.....
Occupation.....

Vol. XIV.
Whole No. 160

August, 1926
No. 4

Science and Invention

FORMERLY
ELECTRICAL EXPERIMENTER

COMBINED WITH "THE EXPERIMENTER"

Member Audit Bureau of Circulations

EDITORIAL & GENERAL OFFICES: 53 Park Place, New York City
GENERAL ADVERTISING DEPT.: 53 Park Place, New York City

Published by Experimenter Publishing Company, Inc.
(H. Gernsback, Pres.; S. Gernsback, Treas.; R. W. DeMott, Sec'y).

Publishers of **SCIENCE & INVENTION**, **RADIO NEWS**,
RADIO INTERNACIONAL, **RADIO REVIEW** and **AMAZING STORIES**

EDITORIAL STAFF

HUGO GERNSBACK, *Editor-in-Chief.*
H. WINFIELD SECOR, *Managing Editor.*
T. O'CONNOR SLOANE, Ph.D., *Associate Editor.*
JOSEPH H. KRAUS, *Field Editor.*
JOSEPH LIEBOWITZ, E. E., *Radio Editor.*
S. GERNSBACK, *Wrinkles Editor.*
M. ESSMAN, *Art Director.*

CONTRIBUTING EDITORS

Astronomy—
Dr. Donald H. Menzel, Ph.D., Ohio State University.
Isabel M. Lewis, M.A., of the U. S. Naval Observatory.
Entomology and Allied Subjects—
Dr. Ernest Bade, Ph.D.
Physics—
Dr. Harold F. Richards, Ph.D.
Ernest K. Chapin, M. A.
Dr. Donald H. Menzel, Ph.D., Ohio State University.
Automotive Subjects—
Tom C. Plumridge.
George A. Luers.
Chemistry—
Raymond B. Wailes.
Radio—
Dr. Ernest Bade, Ph.D.
Sylvan Harris.
Leon L. Adelman.
Magic and Psychic Phenomena—
Joseph Dunninger.
Joseph F. Rinn.
Edward Merlin.
Foreign Correspondents—
Dr. Alfred Gradenwitz, Germany.
Dr. H. Becher, Germany.
C. A. Oldroyd, England.
S. Leonard Bastin, England.
Count A. N. Mirzaoff, France.
Hubert Slouka, Czechoslovakia.
P. C. van Petegem, Holland.
Richard Neumann, Austria.

IN SEPTEMBER ISSUE

What Happens When You Dream?

Science has discovered some new and interesting things that happen in the human body when you dream, and a popular illustrated article on this subject will appear in the next issue.

World's Greatest Cataclysm*

What was it? Don't fail to read this specially illustrated article in the next issue of SCIENCE AND INVENTION Magazine.

Lord's Prayer on Head of a Pin

Microscopic writing and engraving has always been one of the most interesting and marvelous stunts in science. Leading expert in this country describes with pictures in the next issue just how microscopic writing is accomplished.

How to Build a Cone Loud Speaker

Progressive views of a very efficient cone loud speaker will be given in an article on this important instrument, of interest to all radio fans.

Who Will Win Next Model Cup?

Another handsome silver trophy cup will be given away next month for the best model submitted. Four of these have been won by lucky contestants.

Contents for August

Editorial 295 <i>By Hugo Gernsback</i>	Scientific Problems and Puzzles 324 <i>By Ernest K. Chapin, M.A.</i>
Philadelphia Sesquicentennial 296 <i>By Joseph H. Kraus</i>	How to Build a Day-Bed 325 <i>By William Butterfield</i>
"Potash and Perlmutter" Defy Death in Latest Movie 298	Model Department—Model of "Con- stitution" Wins Cup 326
Could the Whale Swallow Jonah? 300 <i>By H. Winfield Secor</i>	Experimental Chemistry Department 329
1,000,000 Horse-Power Electric Plant 302	Experimental Electrics Department 331
A Cookless Household 304	Junior Electrician 333
How Matches Are Made 305 <i>By J. Kay London</i>	How to Build Your Own Airplane (Conclusion) 335
Recent News in Science 306	How to Build a Rowmobile 338
Light Rays Make Records 307	How to Make It 339
Photographing Aircraft Bombs in Flight 308 <i>By S. R. Winters</i>	Wrinkles, Recipes and Formulas 340 <i>Edited by S. Gernsback</i>
Electric Ostrich Tamer 309	Readers Forum 341
Ancient Torture Methods 310 <i>By T. O'Connor Sloane, Ph.D.</i>	Radio Department 342
Illuminated Eiffel Tower 312	About "Cavalleria" and WRNY 343 <i>By Charles D. Isaacson</i>
No-Glare Head-lights 313	Kinks for the Radio-Bug 344 <i>By Raymond B. Wailes</i>
Illinium—A New Element 314	An All-Purpose Voltmeter Switch 345
Our Spiritualistic Investigations 315 <i>By "Dunninger"</i>	Something New in Super-Hets 346
The Home Scientific 316	Reflex Circuits 348
Matchcraft—Monthly Prize Awards 317	Radio Oracle 350
Month's Scientific News Illustrated 320 <i>By George Wall</i>	Scientific Humor 351
Magic 321 <i>By "Dunninger"</i>	Latest Patents 352
Tarrano the Conqueror—14th Install- ment (Conclusion) 322 <i>By Ray Cummings</i>	Oracle 353
	Patent Advice 358

HOW TO SUBSCRIBE FOR "SCIENCE AND INVENTION." Send your name, address and remittance to Experimenter Publishing Co., 53 Park Place, New York City. Checks and money orders should be made payable to Experimenter Publishing Co., Inc. Mention the name of the magazine you are ordering inasmuch as we also publish **RADIO NEWS**, **RADIO INTERNACIONAL**, **RADIO RE-**

VIEW and **AMAZING STORIES**. Subscriptions may be made in combination with the other publications just mentioned at special reduced club rates. Send postal for club rate card. Subscriptions start with the current issue unless otherwise ordered. **ON EXPIRATION** of your subscription we enclose a renewal blank in our last number to you, and notify you by mail. Then unless we receive your

order and remittance for a renewal, delivery of the magazine is stopped. **CHANGE OF ADDRESS:** Notify us as far in advance as possible, giving your old address as well as the new one to which future magazines are to go. It takes several weeks to make an address change on our records.

SCIENCE AND INVENTION is published on the 10th of each month. There are 12 numbers per year. Subscription price is \$2.50 a year in U. S. and possessions. Canada and foreign countries \$3.00 a year. U. S. coin as well as U. S. stamps accepted (no foreign coin or stamps). Single copies, 25 cents each. A sample copy will be sent gratis on request. All communications and contributions to this journal should be addressed to Editor, **SCIENCE AND**

INVENTION, 53 Park Place, New York City, N. Y. Unaccepted contributions cannot be returned unless full postage has been included. ALL accepted contributions are paid for on publication.

SCIENCE AND INVENTION, Monthly. Entered as second class matter May 10, 1924, at the Post Office at New York, N. Y., under the act of March 3, 1879. Additional entry at Long Island City, N. Y., and

San Francisco, Calif. Title Registered at the Patent Office. Copyright, 1926, by E. P. Co., Inc., New York. The Contents of this Magazine are copyrighted and must not be reproduced without giving full credit to the publication. **SCIENCE AND INVENTION** is for sale at all newsstands in the United States and Canada. European Agents, S. J. Wise & Co., 40 Place Verte, Antwerp, Belgium.

New England Advertising Representative Western Advertising Representatives Pacific Coast Advertising Representatives Kansas City Advertising Representatives
T. F. Magrane Finucan & McClure A. J. Norris Hill Co. Davies & Dillon
Park Square Bldg., Boston, Mass. 720 Cass St., Chicago, Ill. San Francisco, Cal., 5 Third St. Los Angeles, Cal., 412 W. 6th St. 15 W. 10th St., Kansas City, Mo.

Chemistry paves the road to Success!

Some people measure success in terms of money and others in degree of knowledge and culture. Chemistry is the one uncrowded profession today that offers both. America, always a land of amazing opportunities, is especially so now in the field of applied Chemistry. Industries have developed within eight years more rapidly than the output of trained men to conduct them. Every big industry needs chemists and there is a real demand for them immediately.

Earn a Bigger Salary from now on—

Good Chemists Command High Salaries; you can make yourself independent for life by unearthing one of Chemistry's Undiscovered Secrets!

Do you remember how the tales of pirate gold used to fire your imagination and make you want to sail the uncharted seas in search of treasure and adventure? And then you would regret that such things were no longer done. But that is a mistake. They *are* done—today and everyday—not on desert islands, but in the chemical laboratories throughout your own country. Quietly, systematically, the chemist works. His work is difficult, but more adventurous than the blood-curdling deeds of the Spanish Main. Instead of meeting an early and violent death on some forgotten shore, he gathers wealth and honor through his invaluable contributions to humanity. Alfred Nobel, the Swedish chemist who invented dynamite, made so many millions that the income alone from his bequests provides five \$40,000 prizes every year for the advancement of science and peace. Herman Frasch, who showed how to extract sulphur built up a huge fortune. C. M. Hall, the chemist who discovered how to manufacture aluminum made millions through this discovery. F. G. Cottrell, who devised a valuable process for recovering the waste from flue gases, James Gayley, who showed how to save enormous losses in steel manufacture, L. H. Baekeland, who invented Bakelite—these are only a few of the men to whom fortunes have come through their chemical achievements.

NOW IS THE TIME TO STUDY CHEMISTRY

Not only are there boundless opportunities for amassing wealth in Chemistry, but the profession affords congenial employment at good salaries to hundreds of thousands who merely follow out its present applications. These applications are innumerable, touching intimately every business and every product in the world. The work of the chemist can hardly be called work at all. It is the keenest and most enjoyable kind of pleasure. The days in a chemical laboratory are filled with thrilling and delightful experimentation, with the alluring prospect of a discovery that may spell Fortune always at hand to spur your enthusiasm.

YOU CAN LEARN AT HOME

To qualify for this remarkable calling requires elaborate specialized training. Formerly it was necessary to attend a university for several years to acquire that training, but thanks to our highly perfected and thorough system of instruction, you can now stay at home, keep your position, and let us educate you in Chemistry during your spare time. Even with only common schooling you can take our course and equip yourself for immediate practical work in a chemical laboratory.

EASY MONTHLY PAYMENTS

You don't have to have even the small price of the course to start. You can pay for it in small monthly amounts—so small that you won't feel them. The cost of our course is very low, and includes everything, even the chemistry outfit—there are no extras to buy with our course. Our plan of monthly payments places a chemical education within the reach of everyone.

SPECIAL 30 DAY OFFER

Besides furnishing the student with his Experimental Equipment, we are making an additional special offer for a short while only. You owe it to yourself to find out about it. Write today for full information and free book "Opportunities for Chemists." Send the coupon right now while it is fresh in your mind. Or just write your name and address on a postal and mail it to us. But whatever you do, act today before this offer is withdrawn.

DON'T WAIT—MAIL COUPON NOW!

CHEMICAL INSTITUTE OF NEW YORK, Inc.

Home Extension Division 8

66-Z West Broadway

New York City



LETTERS

From Students Who Have Taken This Course

You will probably be pleased to learn one of the lessons gave me an idea to turn my chemical knowledge to profitable account. I am now making a varnish and paint which undersells the other type products by \$2.60 a gallon, in some cases more. Have been receiving gallon orders from painters during past week which has netted me a profit of \$12.50 for my "spare-time chemical industry." Many thanks for your training thus far.

J. J. KELLY.

I am but half way through your course and am certain that I have saved my Company many times the cost of the course and raised myself in the Share Holders estimation. The knowledge obtained has its immediate practical application and I do not hesitate in saying your course and the personal attention you give is invaluable to the practical man in any business where chemistry plays a part. You may use this letter and my name and address to the furtherance of your good work.

JOHN WALTER.

I have not written since I received the big set. I can still say that it far exceeded my anticipations. Since I have been studying with your school I have been appointed chemist for the Scranton Coal Co., testing all the coal and ash by proximate analysis. The lessons are helping me wonderfully, and the interesting way in which they are written makes me wait patiently for each lesson.

MORLAIS COUZENS.



T. O'CONOR SLOANE,
A.B., A.M., LL.D., Ph.D.

Noted Instructor, Lecturer and Author. Formerly Treasurer American Chemical Society and a practical chemist with many well known achievements to his credit. Not only has Dr. Sloane taught chemistry for years but he was for many years engaged in commercial chemistry work.

EXPERIMENTAL EQUIPMENT FURNISHED TO EVERY STUDENT

We give to every student without additional charge this chemical equipment, including forty-nine pieces of laboratory apparatus and supplies, and forty different chemicals and reagents. These comprise the apparatus and chemicals used for the experimental work of the course. The fitted heavy wooden box serves not only as a case for the outfit but also as a useful laboratory accessory for performing countless experiments.

CHEMICAL INSTITUTE OF NEW YORK
Home Extension Division 8
66-Z West Broadway, New York City

Please send me at once, without any obligation on my part, your free Book "Opportunities for Chemists," and full particulars about the Experimental Equipment given to every student. Also please tell me about your plan of payment and your special 30 day offer.

NAME

ADDRESS

CITY STATE

S.T.-Aug.

INDEX TO ADVERTISERS

INDEX TO ADVERTISERS

<p>A</p> <p>American Bazaar, Inc. 379</p> <p>American Correspondence School of Law 360</p> <p>American School of Aviation 375</p> <p>American School of Correspondence 365, 377</p> <p>American Telephone & Telegraph Co. 369</p> <p>Anita Company, Inc. 366</p> <p>Arrow Battery Co. 362</p> <p>Audel & Co. Theo. Inside Back Cover</p> <p>Auto-Strop Safety Razor Co. 367</p> <p>B</p> <p>Balda Art Service 364</p> <p>Blandin, E. W. 360</p> <p>Bliss Electrical School 368</p> <p>Bogue Institute for Stammerers. 362</p> <p>Brinkler School of Eating 381</p> <p>Buescher Band Instrument Co. ... 362</p> <p>C</p> <p>Capitol Candy School 381</p> <p>Chemical Institute 291</p> <p>Chicago Engineering Works 289</p> <p>Chicago Solder Co. 373</p> <p>Chicago Technical College 366</p> <p>Churchill Hall 372</p> <p>Coleman, Watson E. 358</p> <p>Conn, Ltd., C. G. 369</p> <p>Conrad Co., Inc. 384</p> <p>Coyne Electrical School 370</p> <p>Crown Minute Camera Co. 381</p> <p>D</p> <p>Douglas, Lyle 377</p>	<p>E</p> <p>E. I. Company 372, 374</p> <p>Eagle Tire & Rubber Co. 362</p> <p>Elto Outboard Motor Co. 373</p> <p>Erie Fixture Supply Co. 364</p> <p>Evans, Victor J. 361</p> <p>F</p> <p>Fawcett Publications, Inc. 293</p> <p>Federal Mail Order Corp. 364</p> <p>First Hawaiian Conservatory of Music 377</p> <p>Fisher Mfg. Co., Adam 360</p> <p>Franklin Institute 371</p> <p>G</p> <p>Gilson Slide Rule Company 381</p> <p>Givens Chemical Co. 366</p> <p>H</p> <p>Hardin-Lavin Co. 360</p> <p>Hobart Bros. 371</p> <p>I</p> <p>International Body Works 371</p> <p>International Correspondence Schools 360, 379, 381</p> <p>International Studios 381</p> <p>Irwin Aircraft Company 366</p> <p>J</p> <p>Johnson Smith & Co. 355</p> <p>K</p> <p>Kenilworth Inn 375</p>	<p>L</p> <p>Lacey & Lacey 360</p> <p>Lancaster & Allwine 358</p> <p>La Salle Extension University. 375</p> <p>Liggett & Myers Tobacco Co. ... 371</p> <p>Lincoln Standard Aircraft Co. ... 371</p> <p>Loftis Bros. 379</p> <p>Mc</p> <p>McGraw-Hill Book Company.... 363</p> <p>M</p> <p>Math Pony Publishing Co. 370</p> <p>Mead Cycle Company 360</p> <p>Mellinger Tire & Rubber Co. ... 381</p> <p>Metal Cast Products Co. 364</p> <p>Mid-West Radio Corp. 381</p> <p>Miller, Monroe 360</p> <p>Modelmaker 364</p> <p>Munn & Company 360</p> <p>N</p> <p>National Radio Institute 356</p> <p>New England Novelty Co. 377</p> <p>Newman-Stern Co., The 373</p> <p>New York Electrical School 368</p> <p>North American Institute</p> <p> Inside Front Cover</p> <p>N. Y. Institute of Music 379</p> <p>O</p> <p>O'Brien, Clarence A. 359</p> <p>Owen, Richard B. 358</p> <p>Ozment, C. J. 379</p> <p>P</p> <p>Parker, C. L. 360</p> <p>Parks Ball Bearing Machine Co. 362</p> <p>Pennsylvania Hotel 374</p> <p>Physical Culture 380</p>	<p>Pittle & Co., Charles 381</p> <p>Plymouth Rock Squab Co. 375</p> <p>Polachek, Z. H. 360</p> <p>Polk & Co., R. L. 370</p> <p>Porter Chemical Co. 369</p> <p>Press Company 366</p> <p>Press Guild, Inc. 370</p> <p>R</p> <p>Radio Association of America ... 379</p> <p>Radio Specialty Co. 357</p> <p>Randolph & Co. 358</p> <p>S</p> <p>Sasnett, Edward C. 360</p> <p>School of Engineering</p> <p> 373, Back Cover</p> <p>Scientific Apparatus Co. 370</p> <p>Sea Arts Guild 362</p> <p>Seaver Williams Co. 362, 366</p> <p>Shipman-Ward Co. 364</p> <p>Strongfort, Lionel 364</p> <p>Swift & Anderson, Inc. 377</p> <p>T</p> <p>Tamblyn School 360</p> <p>Tompkins Guaranteed Oils, Frank 366</p> <p>W</p> <p>Washington School of Art 366</p> <p>Washington School of Cartooning 364</p> <p>Washington Show Card School ... 379</p> <p>Western Airplane Corp. 377</p> <p>Witte Engine Works 375</p> <p>World Battery Co. 364, 366</p> <p>Y</p> <p>Young Typewriter Co. 366</p>
---	---	---	--

SCIENCE and INVENTION READERS' BUREAU

TEAR ALONG THIS LINE

Time and Postage Saver

IN every issue of SCIENCE AND INVENTION you undoubtedly see numerous articles advertised about which you would like to have further information. To sit down and write an individual letter to each of these respective concerns, regarding the article on which you desire information, would be quite a task. As a special service to our readers, we will write the letters for you, thus saving your time and money. Just write the names of the products about which you want

information, and to avoid error the addresses of the manufacturers, on the coupon below and mail it to us. If the advertiser requires any money or stamps to be sent to pay the mailing charges on his catalog or descriptive literature, please be sure to enclose the correct amount with the coupon. We will transmit to the various advertisers your request for information on their products. This service will appear regularly every month on this same page in SCIENCE AND INVENTION.

S&I 8-26

TO: READERS' SERVICE BUREAU,
EXPERIMENTER PUBLISHING CO., Inc., 53 Park Place, New York, N. Y.

FROM WRITE YOUR NAME and ADDRESS HERE:

NAME CITY, STATE

ADDRESS

Gentlemen: Please advise the firms listed below that I would like to receive detailed information on their product as advertised in the issue of SCIENCE AND INVENTION.

 This form should not be used for technical questions.

NAME	ADDRESS (Street—City—State)	List here specific article on which you wish literature.	If Catalogue of complete line is wanted check in this column.
.....
.....
.....

Check here if you are a dealer

Your Dealer's Name

Address

You can't afford to miss this splendid Western story in Triple-X Magazine

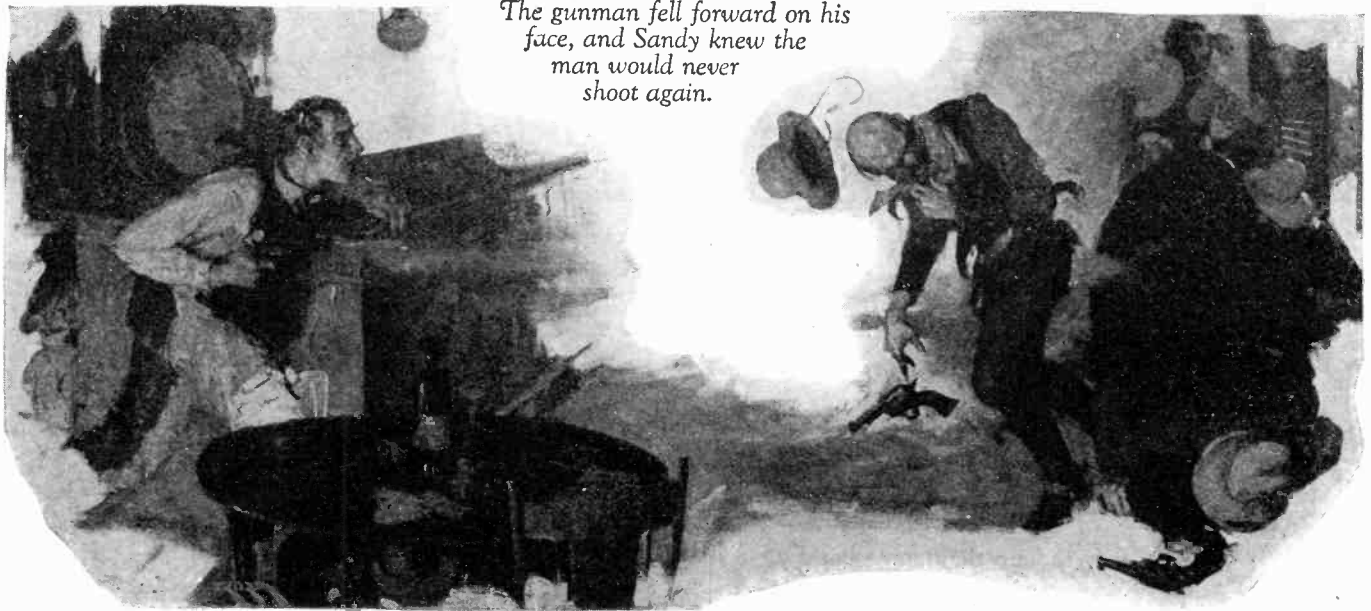

The gunman fell forward on his face, and Sandy knew the man would never shoot again.

The NEVADA DEMON

By FRANK C. ROBERTSON

A gripping tale of a cowboy's bravery and undying loyalty to his pal. A story that pulsates with hair-raising incidents, life, and action!

READ IT IN THE AUGUST

Out Today
25
CENTS

FAWCETT'S
Triple-X^{25¢}
MAGAZINE

On All
News-
stands

FIVE OTHER GREAT STORIES OF THE ADVENTUROUS WEST!

NORTH OF THE BORDER

An unusual story of cattle-rustlers

By ARCH JORDAN

THE CASE-ACE

How a game of stud revealed a criminal

By RICHARD A. MARTINSEN

THE SIXTH NOTCH

Second instalment of a three-part Western serial

By J. CLETUS STAMBAUGH

OUTLAW BLOOD

What happened when Mary Powell's stock was rustled, and Black Martin's son stood accused

By JACK SMALLEY

THE RABBIT'S FOOT

A city ne'er-do-well gets range-broken

By J. H. HAMLIN

Fawcett Publications, Inc., Robbinsdale, Minn. (A-E)

Inclosed find \$1.00 (check or bill) for a five months' subscription to Triple-X Magazine. Or inclosed find 25c for one copy of the August issue.

Name

Address

City State

AMAZING!

A human-brain in a moulded wax head is kept alive for days, for months, and in communication with the world

The TALKING BRAIN

One of the most amazing scientifiction stories ever written

A brilliant professor almost mad with the discovery of a scientific means to keep the human brain alive stumbles upon an opportunity. A blind student hopelessly injured in an automobile accident is brought to the professor for medical assistance. Seizing an opportunity the professor performs his Talking Brain experiment. The blind student—But to reveal the outcome will spoil the story. Read the amazing ending in the August issue of AMAZING STORIES now on all Newsstands. You will not be disappointed.

READ THIS ASTOUNDING STORY IN THE AUGUST ISSUE OF

FREE

With every special 5 months subscription to AMAZING STORIES, we are now offering FREE one regulation size VALET AutoStrop Safety Razor.

This shaving outfit consists of a highly polished, nickel-plated, self-stropping razor; one blade, leather strop especially prepared. The razor case is of metal, finished in maroon, crystallized effect. Lined throughout with velvet, harmonizing with the pleasing color scheme of the entire package.

For \$1—you can get AMAZING STORIES for five months and one Razor FREE. Send in your subscription today—to

EXPERIMENTER
PUB. CO., Inc.
DEPT. S.I. 8
53 PARK PLACE,
New York City

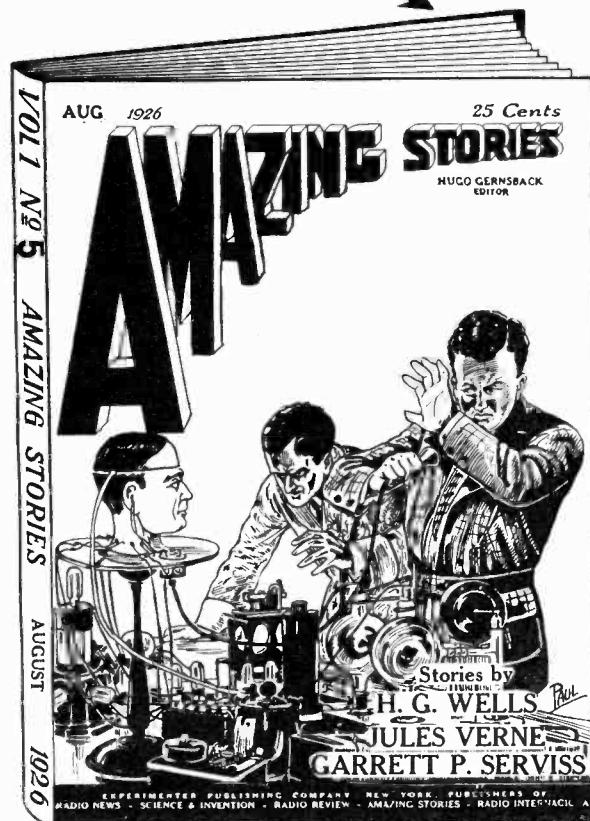

OTHER August Features

THE MOON HOAX, by Richard Adams Locke, is a classic scientifiction story containing excellent science along with some obvious mistakes, which were not detected even by a scientific audience. It is probably the greatest scientific hoax that was ever perpetrated upon a credulous public.

SOLANDER'S RADIO TOMB, by Ellis Parker Butler, in which the author proves that even a graveyard can be made a subject for most delightful humor—this time with the help of a radio and a rich man's eccentricities.

BLASPHEMER'S PLATEAU, by Alexander Snyder, wherein some eminent scientists successfully experiment with infinite secrets, until they become drunk with their power. Then another scientist arrives on a friendly visit. It is a powerful and gripping story which is sure to hold your interest.

STATION X, by G. McLeod Winsor, (2nd instalment).

THE TELEPATHIC PICK-UP, by Samuel M. Sargent, Jr. A gripping story about a new invention which could pick up the thoughts of an escaped prisoner and some extremely interesting theories about electro-troction. It is gruesome and thrilling.

THE LORD OF THE WINDS, by Augusto Bissiri, wherein is shown the devastating ruins effected by the misuse of a marvelous apparatus. An amazing scientifiction story, beautifully written.

THE SCIENTIFIC ADVENTURES OF MR. FOSDICK, by Jacques Morgan, in which he makes another stride in the scientific world and organizes "The International Electro-Galvanic Undertaking Corporation".

25^C---ON ALL NEWSSTANDS

Science and Invention

HUGO GERNSBACK, *Editor-in-Chief*

H. WINFIELD SECOR, *Managing Editor*

DR. T. O'CONNOR, SLOANE, Ph.D., *Associate Editor*

Editorial and General Offices, - - - 53 Park Place, New York

"Those Who Refuse to Go Beyond Fact Rarely Get As Far As Fact" - - - HUXLEY

SUN SPOTS AND RADIO

By HUGO GERNSBACK

AS is well known, the sun goes through an 11-year cycle of sun spots. This phenomenon has been observed for several centuries, and while there is also a major cycle, the minor 11-year cycle seems to be pretty well proved by the observations of many generations of investigators.

The sun, according to the latest researches, is composed of a molten interior and a gaseous envelope. This gaseous envelope, composed of heated gases, much hotter than anything we have here on earth, is not a uniform envelope at all times, but occasionally rifts appear in it, which seen through a powerful enough telescope have the appearance of dark holes. They are in fact, vortexes of swirling gases and volatilized metals, making it possible for us to see the underlying surface of the sun's sphere. These holes are called *sun spots*, and can be observed at the present time with the naked eye, by using darkened glasses.

The sun itself is known to be a variable star. That is, it does not give out the same heat at all times. At periodical times it gives off about ten per cent. more heat than at other times; thus at the maximum of the sun spot cycle the earth receives more heat than at the minimum cycle. We are now approaching the maximum of the cycle and 1928 will witness such a maximum. In about 1933 there will be a minimum.

One would at first think that when the sun sends us more heat it would be hotter on earth. The converse is actually true. When the sun sends us more heat there is faster evaporation of the waters of our planet, which, naturally, gives rise to more clouds, and more clouds mean rainy weather and a lowering of the temperature on the planet. For that reason, at the height of the sun spot cycle the weather on the earth is usually appreciably cooler than at the minimum of the sun spot cycle. The next two years will therefore probably witness cooler and more rainy weather, if previous experiences may be taken as a guide.

There is also a popular misconception that we receive heat rays from the sun. No such thing happens. It has been definitely proved that between the sun and the earth there is no appreciable atmosphere. The two bodies, along with the rest of the universe, are in a pretty good vacuum. Now we know that heat rays can not be transmitted through a vacuum, otherwise we would not have the principle of the thermos bottle. No heat can be sent across a vacuum. The sun, however, does send us electro-magnetic waves, and we do receive light from the sun, but no heat is actually received until the light rays strike the earth's atmosphere; where, by impact, the light rays undergo a certain change, with a result that makes itself perceptible as heat.

Another phenomenon takes place at the same time, and that is the retention

of heat by the atmosphere, which acts as a storage reservoir for the heat thus generated. An aviator going up to about seven miles above the surface of the earth must be wrapped in furs and must take heat along with him if he does not wish to freeze, even on the hottest summer day, although only seven miles above the surface of the earth. The sun is still shining there and the rays are still striking the airplane, but there is no heat, because the atmosphere is so thin and attenuated here that no heat can be stored by the sun's light rays.

But the light rays of the sun are really electro-magnetic waves, as demonstrated by Clerk Maxwell. All ether waves that we know of are electro-magnetic, whether they be light waves, X-ray waves, or radio waves. The rays differ in frequency, that is in the length of the waves. They are all of the same family. So when there is increased solar activity, as at present, the effect makes itself felt on earth, not only in the resultant weather changes, but in various other ways, and these various ways will make themselves felt more as science progress goes on.

Before the advent of radio broadcasting there was no known effect on radio due to sun spots. Today there is. It makes itself felt in poor radio reception, particularly as to long distance reception. In 1922, at the minimum of the sun spot cycle, it will be remembered that a 1-tube regenerative receiver had no trouble in picking up signals from 1,000 to 1,500 miles distant. This was an everyday occurrence. Today when we are going towards the sun spot maximum, radio reception is extraordinarily poor, and only very seldom may conditions be called fair for DX (long distance) radio reception.

In 1922 such radio reception was good, summer and winter, when the usual static did not interfere too much. Now reception, even in the winter, is notoriously bad, as witness the last international radio tests in February, which were most disappointing for this reason. The explanation lies in the fact that the increased solar activity, by sending us more electro-magnetic waves, tends to ionize the atmosphere on our planet to such a degree that it amounts to something akin to a short-circuit.

The atmosphere through which the radio waves must pass is now of such high conductivity that the waves soon become absorbed and consequently do not travel as far as they do when the air is less ionized. This is the present accepted theory, and if this theory is correct we should not have real excellent radio reception again until 1933. The maximum of atmospheric conductivity is supposed to be 1928, after which conditions probably will not improve till 1933.

THE GOLDEN AGE OF SCIENCE

is symbolized by the golden cover
OF SCIENCE & INVENTION,
LOOK FOR THE GOLD COVER
every month!

Mr. Hugo Gernsback speaks every Monday at 9 P. M. from Station WRNY on various scientific and radio subjects.

PHILADELPHIA SESQUICENTENNIAL

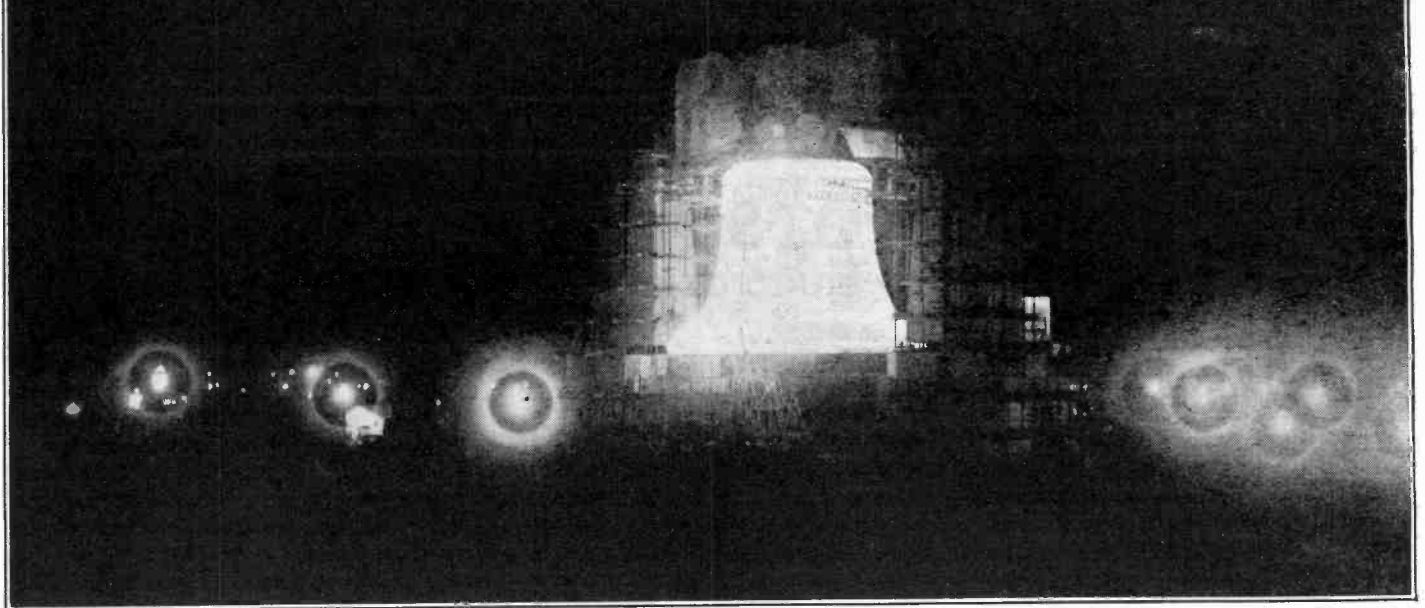

WELL, it has happened. On May 31st, 1926, the Philadelphia Sesqui-centennial, celebrating the nation's one hundred and fiftieth birthday, opened with great pomp. Of course, all of the exhibits were not in place and as this magazine goes to press there is still a great amount of work to be done there, but when everything has been finally settled, the Exposition

will be the greatest the world has known. The above photograph shows a picture of the gigantic Liberty Bell, erected at the entrance to the Sesqui grounds. This bell is sixty feet across and contains approximately 26,000 lights. The bottom is illuminated by flood lights projected from the interior of the clapper. The scaffolding has been removed.

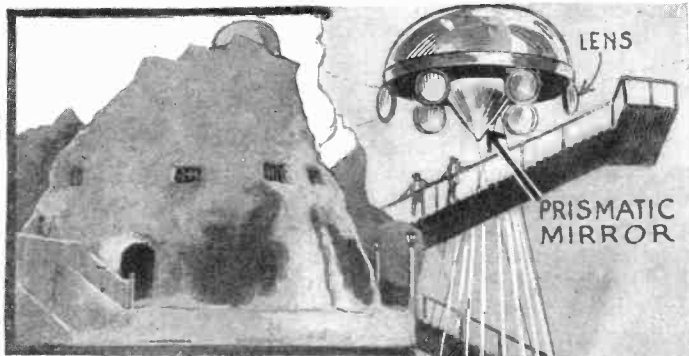

AT the Exposition we find Treasure Island. This was first tried out at Wembley during 1925 in the Second Year of the British Empire Exposition. Here children may meet in the flesh the pirates, princesses, heroes, heroines and the villains of the greatest story books. At Philadelphia, Treasure Island occupies about five times as much space at it did at the Wembley Exposition. Two Canadian-Pacific Railway trains operate on a 12-inch gauge track and reproduce in miniature a journey across Canada.

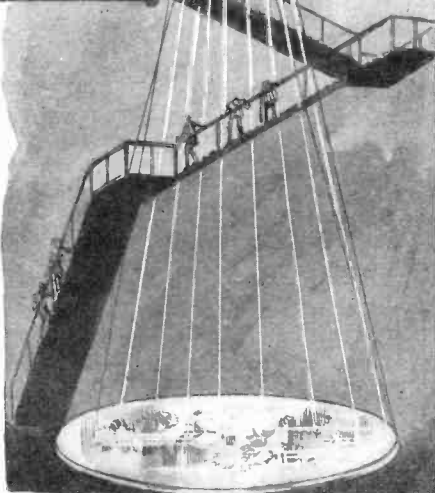

HERE the children will see the pirates' caves and the magic pool. The pirates' cave is illustrated in the photo above, although at the time this photo was taken, the cave was not completed. At the top of the cave there will be a conical mirror and surrounding this a series of lenses will cast their images on a large mirror at the bottom of the cave. The system is identical with the camera obscura, except that one composite picture of approaches on all sides is given.

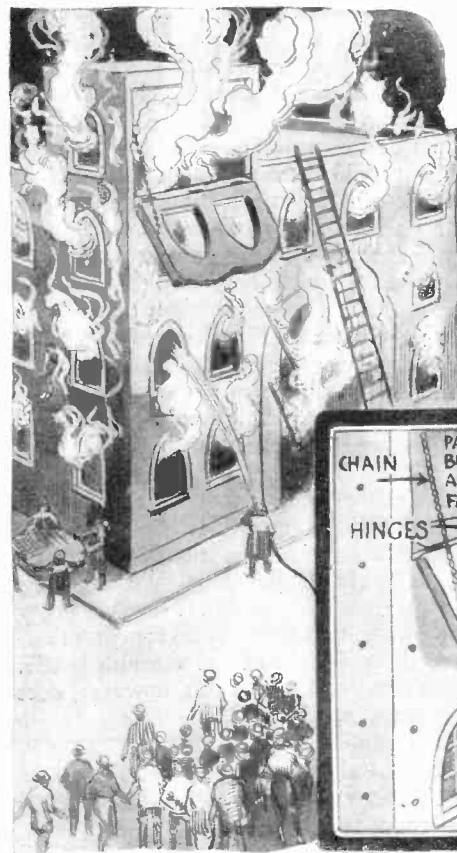

BETWEEN the building called the Market Place of Nuremberg and the Gettysburg building, a rather unique structure is to be erected. A fire-proof construction will be put up and will be so arranged that portions of it will apparently fall down. The walls are to be perforated with holes from which flames will spring. The crowds are to be given a daily treat by watching people leaping from the burning building and watching the Philadelphia Fire Department battle with the flames.

VARIOUS portions of the building illustrated above will be permitted to drop down. Of course, they do not actually fall, but are merely released on hinges. Gas flames are to be used because the gas is under constant control. Here and there a log will drop down from the building and seemingly narrowly miss a fireman. The battle with the flames is to be as realistic as can possibly be staged and the leaps from the burning building will greatly enhance the effect. Drawing shows probable construction.

The Sesqui's Giant Organ

By JOSEPH H. KRAUS

THE world's greatest organ is to be found at the Philadelphia Sesqui-centennial Auditorium. This organ, built by the Austin Organ Co., contains over 11,000 pipes. The largest of the pipes is thirty-four feet long and the smallest three-eighths of an inch long. The air supply for the organ is obtained from two blowers, one operated by a 40-h.p. motor and another by a 2-h.p. motor. The diagram at the right showing the construction of the organ shows only a small part of this immense structure. Beneath the pipes one finds an immense chamber, access to which is obtained through doors four and five. Inasmuch as the air pressure in the interior of the chamber is greater than atmospheric pressure, the valve immediately above the number four on the door, must be opened before you can enter the air-lock. After door 4 closes, door 5 may be opened by permitting the pressure to enter the air-lock by lifting the valve on the door. Looking up toward the ceiling one sees masses of wires, magnets and valves and on the floor one finds several accordion-like boxes which slowly or rapidly move up and down. These are indicated by numeral 1. These devices control the louvres or swell shutters.

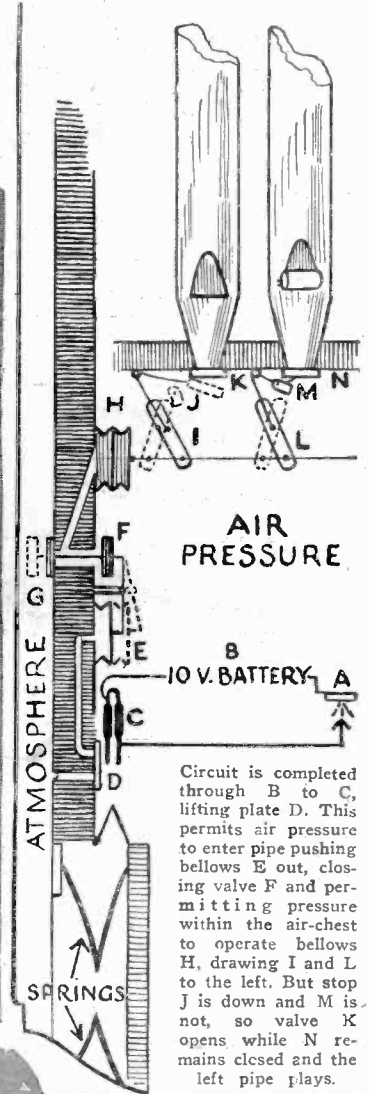
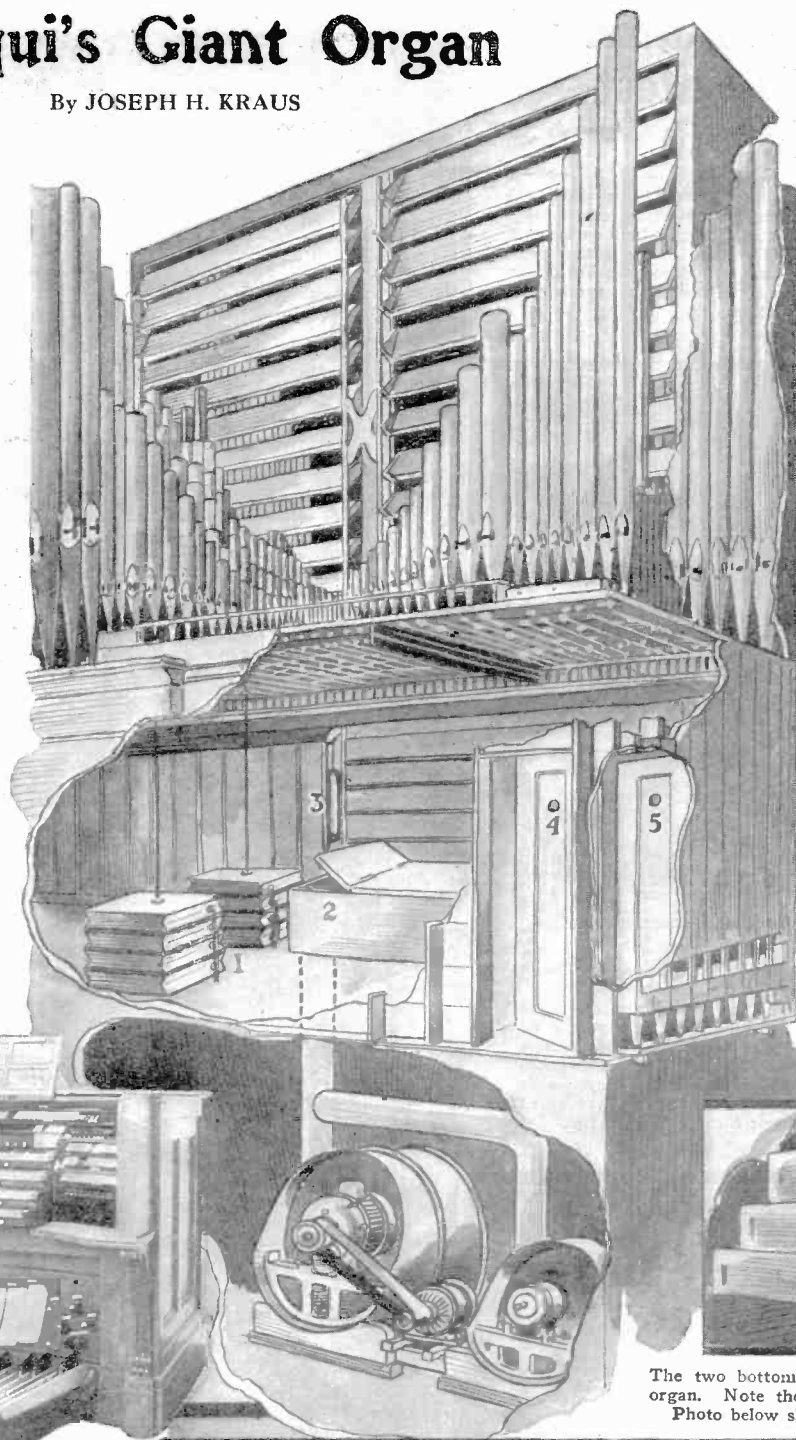

Circuit is completed through B to C, lifting plate D. This permits air pressure to enter pipe pushing bellows E out, closing valve F and permitting pressure within the air-chest to operate bellows H, drawing I and L to the left. But stop J is down and M is not, so valve K opens while N remains closed and the left pipe plays.

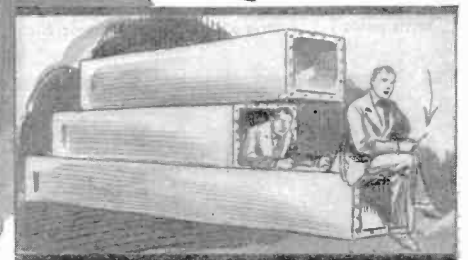
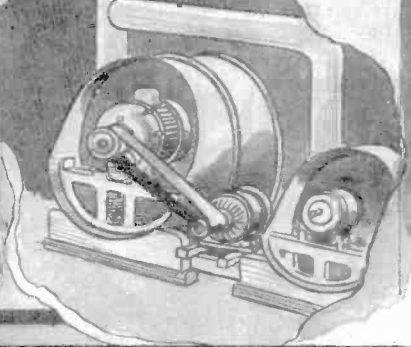
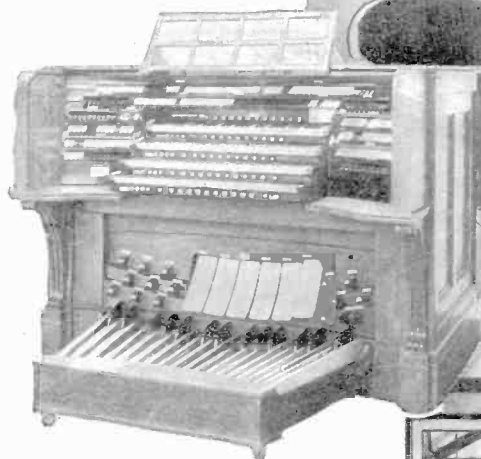

The two bottom sections form the largest pipe of this organ. Note the smallest pipe being held in the hand. Photo below shows size of the world's largest organ.

THE beauty of this universal air-chest system, as this large room into which the pipes open is called, is that repairs may be effected while the organ is in actual operation. In addition to that the rear wall indicated by 3 in the upper diagram is movable. Its purpose is to take up the space when a very large quantity of air is suddenly withdrawn from the air-chest. It will be noted in the detailed diagram in the upper right hand corner of this page, that this wall projects into the room and is held by a group of springs. Now, as the room becomes filled with air, the wall is pushed out. Should ten or more keys be suddenly depressed, immediately a great volume of air will escape. This moving wall permits of a sustained note of consistent volume. The photograph above shows the keyboard.

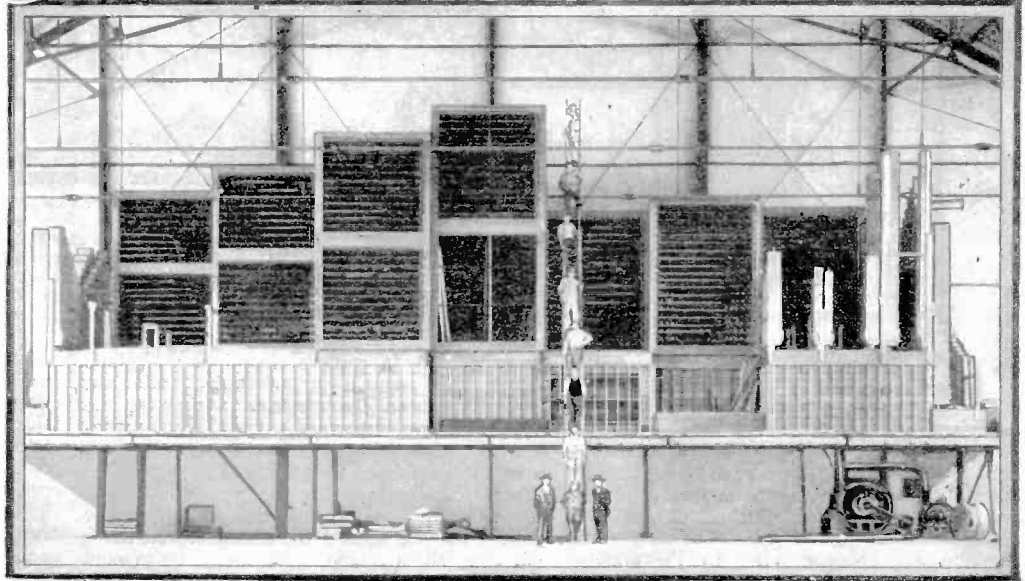
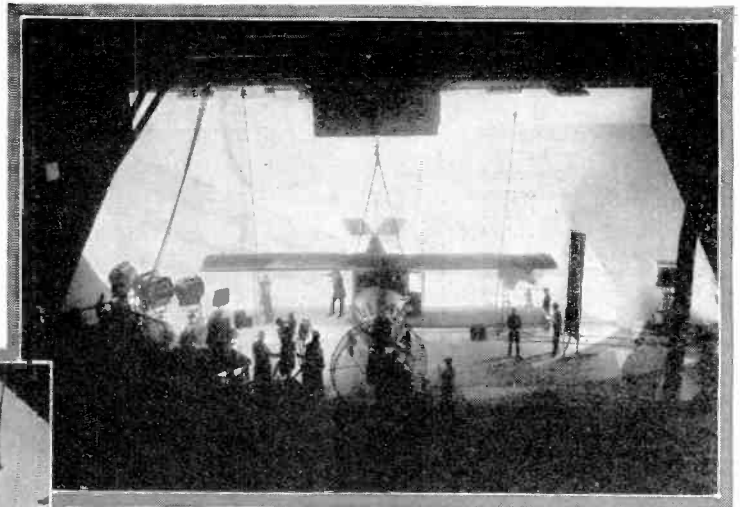

Photo courtesy Austin Organ Company.

"Potash and Perlmutter" Defy Death In Latest Movie

One of the most remarkable photographs ever published appears at the right, this photo showing full size airplane suspended by cables from ceiling of huge movie studio. Powerful electric spotlights both on the ceiling and arranged in a circle on the floor, will be noted, while in the center foreground is a "wind machine," comprising an airplane propeller driven by an electric motor. At the left of the scene you will see the movie cameras and the operators.



Those who have seen Potash and Perlmutter in "Partners Again" will at once recognize the scenes shown herewith. Note the photo at the extreme left where one of the partners is attempting to rescue the other as he hangs suspended by the tail of his night shirt, on the edge of the speeding airplane's wing. Note the studio attaché indicated by the arrow, who is about to spin the propeller. As the movie cameras grind away, the airplane swings dizzily in the air as the actors go through their performance.

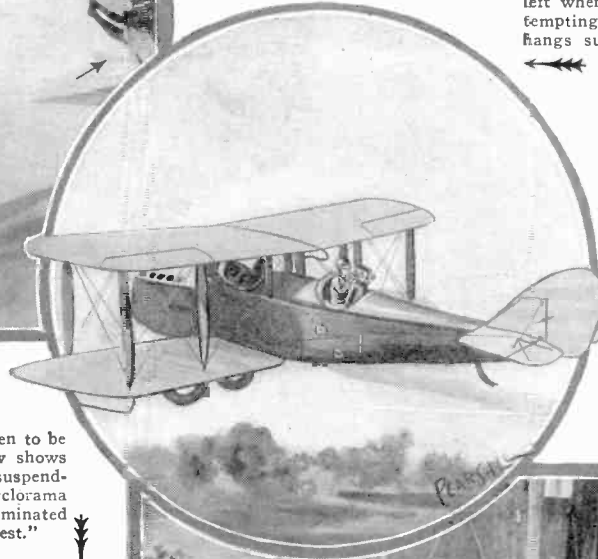

Picture in circle shows movie camera and operator taking actual panorama scene in flying plane, this scene being super-imposed on the studio view of actors and dummy plane. The super-imposing of two scenes is done in one of several ways, as explained in detail below.

Those who have witnessed the screamingly funny movie comedy "Partners Again," featuring the well-known actors George Sidney and Alexander Carr, will remember the scene where one of the partners falls from the airplane and shortly thereafter he is seen to be falling through space, clouds flying by, etc. The picture below shows how the "flying angel" stunt was accomplished. The actor was suspended by a wire attached to a suitable harness, while a moving cyclorama was caused to move vertically behind him. The scene was illuminated with powerful electric lights and the movie camera "did the rest."

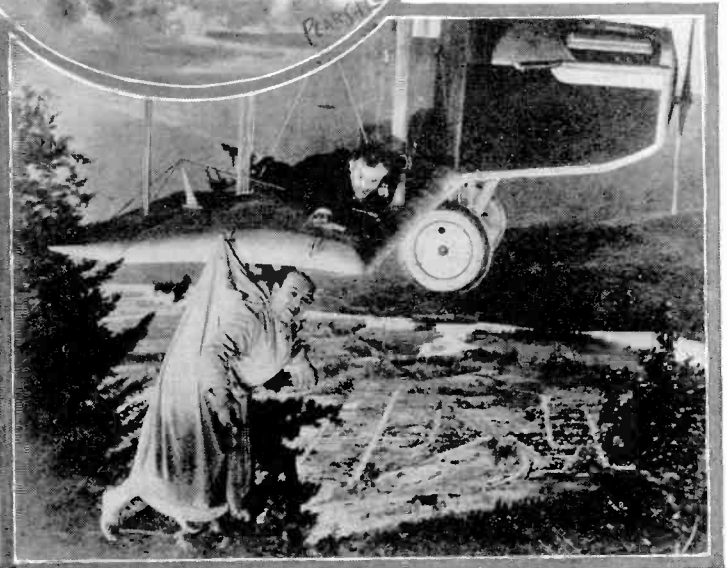
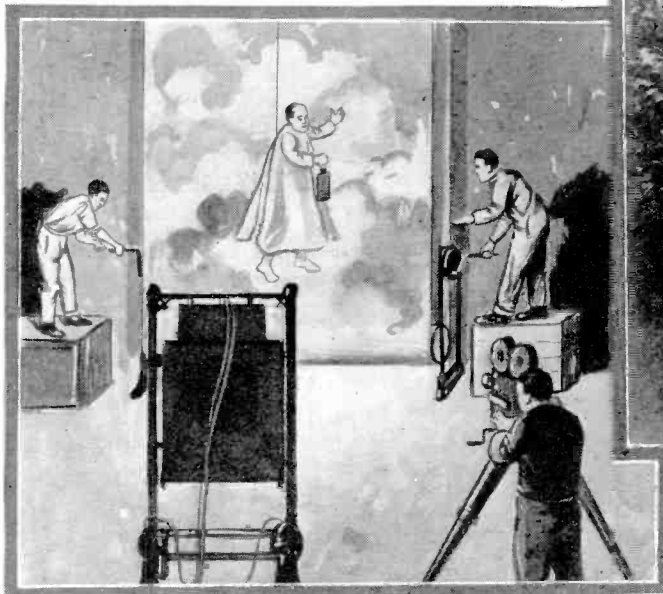

Above we see the finished movie scene where the actor is about to fall from the speeding airplane as it flies along over an "honest to goodness" landscape. The life-like landscape was photographed from a real airplane, as shown in the circle above, this panorama being super-imposed on the film showing the actors and dummy airplane in the studio by double-printing. That is, the two different negatives were printed on top of one another to form the positive film.

"PARTNERS AGAIN," featuring the witty characters of Potash and Perlmutter, has made a big hit with American movie-goers. The writer saw this very entertaining film comedy and was willing to swear that all the scenes were actually taken flying in the air, but the present photos and descriptions prove that he was "fooled again." Practically all the scenes aboard the airplane were photographed by the double-printing process. The background was pho-

tographed by a camera man in an airplane while this was in actual flight, and then the players on the airplane setting in the studio were superimposed. They consequently worked in perfect safety—at the most only about fifteen or twenty feet above the floor. Some shots for the picture were of course taken on location, those showing the actors getting aboard the airplane, and those showing the airplane rising from the ground above the automobile as these two are ap-

proaching each other. The runaway auto in the early part of the picture was photographed, the movie camera being turned slowly so that the car (on screen) seemed to move much more rapidly than it really did. The camera was placed on a platform provided on a truck running in front of those in the touring car. The scene where the car runs out on the drawbridge which rises, is accomplished with the aid of a cable secured to the auto.

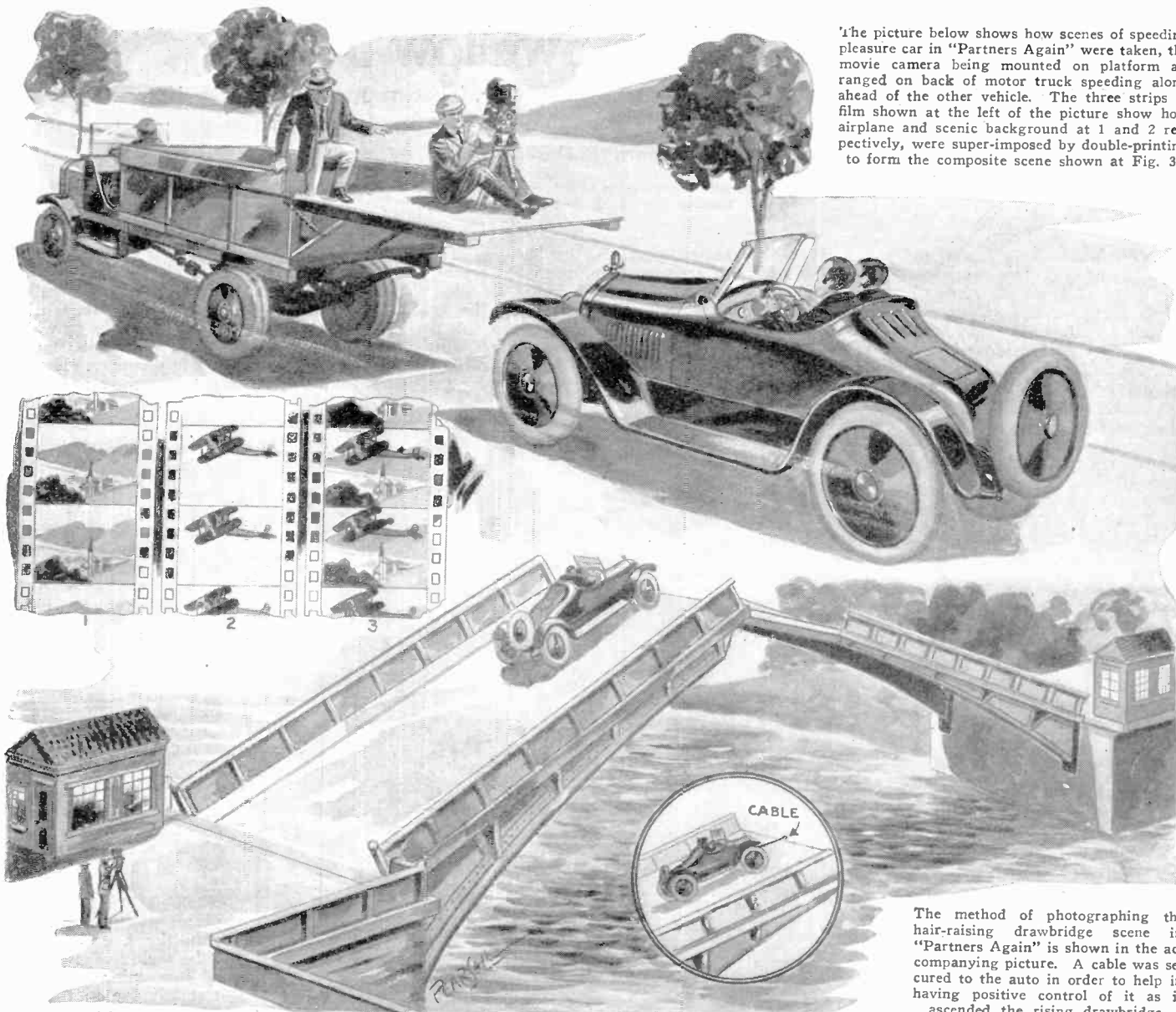

The picture below shows how scenes of speeding pleasure car in "Partners Again" were taken, the movie camera being mounted on platform arranged on back of motor truck speeding along ahead of the other vehicle. The three strips of film shown at the left of the picture show how airplane and scenic background at 1 and 2 respectively, were super-imposed by double-printing to form the composite scene shown at Fig. 3.

The method of photographing the hair-raising drawbridge scene in "Partners Again" is shown in the accompanying picture. A cable was secured to the auto in order to help in having positive control of it as it ascended the rising drawbridge.

The apparent high speed of the auto as it lets go the top of the bridge and descends, was obtained by turning the movie camera slowly. The car was

made to reverse end for end, with the help of a slippery bridge, caused by wetting with a hose, together with cable. The actors really took chances.



New Yardstick for Jokes



The truth of the old adage "he who laughs last, laughs best" was tested recently in the Riverside Theatre in New York City. "Topics of the Day," a film of jokes and gags, was shown during the test and with the aid of the machine it was determined exactly what jokes the public laughed the most at. The machine used for measuring the volume of applause or laughter was the same one recently used in measuring the degree of sound in various parts of large cities. Thus science has produced a new "yardstick for jokes."

Could the Whale Swallow Jonah?

Among the Many Miraculous Feats Mentioned in Biblical History, That of Jonah Being Swallowed by a Big Fish Has Perhaps Caused as Many Arguments as Any of the Miracles

By H. WINFIELD SECOR

(The information in this article has been obtained by the kind co-operation of Dr. Frederick A. Lucas, expert on whales at the American Museum of Natural History, New York City.)

"SO they took up Jonah, and cast him forth into the sea; and the sea ceased from her raging . . . Now the Lord had prepared a great fish to swallow up Jonah. And Jonah was in the belly of the fish three days and three nights . . . Then Jonah prayed to the Lord his God out of the fish's belly. . . . And the Lord spake unto the fish, and it vomited out Jonah upon the dry land."

Thus runs the Biblical version of Jonah's experience in the belly of the great fish, as the scriptural writers have called it. One of the usual arguments in favor of this tale of Jonah and the big fish is that the Bible does not say that Jonah was swallowed by a whale, and therefore, the fish could have been of tremendous size, far larger perhaps than a whale,* and, therefore, it is argued Jonah could have found plenty of room in the stomach or belly of so large a fish. The usual phrase heard in connection with this Biblical story is of course about "Jonah and the Whale," and there is nothing extraordinary that could happen in favor of Jonah's existence in the whale's belly, simply because we happen to revert to the Biblical phraseology and called the organism that swallowed Jonah a *big fish*.

It does not make any difference, looked at from the viewpoint of a scientist, whether Jonah was swallowed by a *great fish* or a *whale*. Jonah would be faced by the same conditions of existence inside the stomach of either one, regardless of its size, as we shall see presently.

Therefore with this fact established we might as well take up the question of Jonah in connection with a whale, for the very good scientific reason that in the whole history of the world, that we have any record of, there has never been another animal as large as a whale. One of the reports published by the American Museum of Natural History states that "*whales are the largest animals that exist or ever have existed*, the blue whale reaching a length of 103 feet. They are members of the order called Cetacea, which includes the whales, dolphins and porpoises. Although living in the water and somewhat fish-like in form, all Cetaceans are true mammals. They have warm blood, breathe air by means of lungs, bring forth their young alive, and nourish them with milk. Whales are thought to have originated from land mammals, but from what particular group they descended is unknown."

The writer spent considerable time at the American Museum of Natural History with Dr. Frederick A. Lucas, expert on whales, and had the pleasure of visiting the new Whale Hall at the museum, which will not be opened for some time to the public, as the skeletons of several large whales are now being mounted and made ready for pub-

up was the fact that the sperm whale could swallow a man, and this point is controlled by the size of the gullet or opening from the back of the mouth, which leads to the whale's stomach. Practically all other whales, which feed on small fish, have a gullet no larger than five or six inches in diameter. Having no teeth they could not even chew up a morsel as large as a man nor possibly get away with it, but the sperm whale, in the larger specimens, could swallow a man in one gulp. The brain of such a whale is about as large as a water pail, and his eyes are about 2 inches in diameter. As Jonah, or his hapless successor, slid along the whale's gullet into the stomach, he would find himself in a spherical shaped compartment or sack about six feet in diameter. The skin comprising the whale's stomach is about $\frac{1}{2}$ inch thick and tough as leather, stated Dr. Lucas.

Now come some facts concerning just what kind of an experience Jonah had to face when he found himself in the whale's belly. In the first place, as this authority pointed out, it is doubtful if he could live more than a few minutes in the stomach due to the lack of air, and it would seem that he would have died from suffocation ordinarily, unless by miraculous good fortune as ordained by the Deity, he was able to get sufficient air to keep alive. He need not necessarily have been fully conscious during his sojourn in the *fish's* stomach. Besides the practical impossibility of obtaining sufficient air to breathe, a man finding himself inside a whale's stomach ordinarily would find himself attacked by the powerful gastric

juices which are to be found in the stomach, besides gases which would tend toward suffocation. Besides, as every physician knows, the stomach when filled with food or any foreign object begins a spasmodic contraction and expansion, and you can imagine from this how violently a person inside a whale's stomach would be bounced about.

It seems to be the opinion of modern scientists that a man could not live in a conscious state inside a whale's stomach more than a few minutes, but he might live a much longer time in an unconscious state. Whether the Biblical writers have slipped up on the facts concerning Jonah, no one will ever know, but a period of three days and three nights seems a very long time for a man to exist under these conditions, to say the least. As one churchman put it, there is just



"So they took up Jonah, and cast him forth into the sea; and the sea ceased from her raging . . . Now the Lord had prepared a great fish to swallow up Jonah. And Jonah was in the belly of the fish three days and three nights. . . . Then Jonah prayed to the Lord his God out of the fish's belly. . . . And the Lord spake unto the fish, and it vomited out Jonah upon the dry land."

lic exhibition. This exhibition will no doubt draw more visitors than probably any other exhibit thus far arranged, excepting possibly the Hall of Man and that containing the pre-historic monsters, such as the dinosaurs.

Dr. Lucas showed the writer the various anatomical features of the different whales and demonstrated that there is but one whale that has a gullet or throat large enough to swallow a man, and that is the sperm whale. The skeleton of a very fine specimen is already mounted in the Whale Hall, and the writer had the extreme pleasure of seeing every detail of the whale's bony structure, and also had a chance to see excellent reproductions of whales with the outer skin covering in place.

The most important point that he checked

*Matthew 12th Chapter, verse 40, says Jonah was in whale's "belly." Either way, the same technical argument holds true.

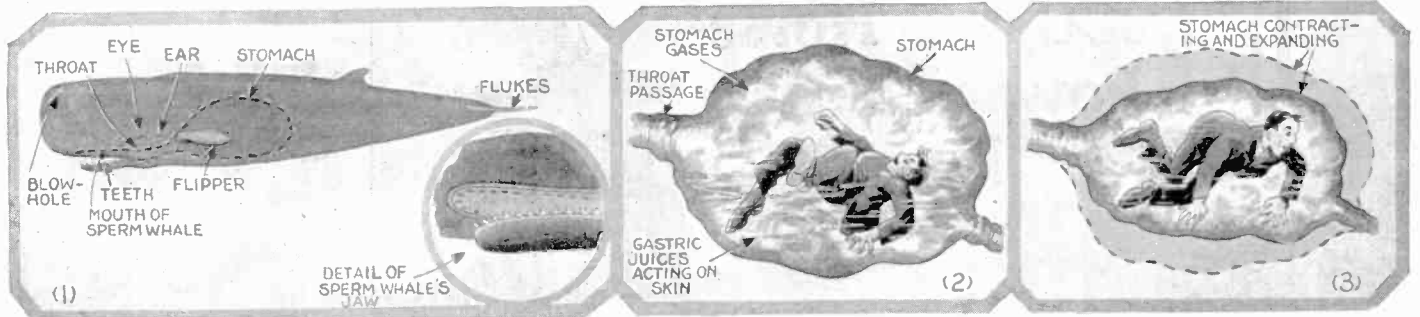

Contrary to popular opinion, there is one whale known as the Sperm Whale, which is capable of swallowing a man. The arrangement of teeth on the lower jaw, the location of stomach, eye and ear, as well as throat are shown in the picture above. If a man was swallowed

under ordinary conditions by a Sperm Whale he would be confronted with the action of the powerful gastric juices in the whale's stomach, together with gases which would suffocate him, not to mention the tossing around caused by the contractions and expansions of the whale's stomach.

about two things to do with the matter of Jonah and the big fish; that is, either accept it, or reject it. If we accept it, the story is finished and one need go no further. But it makes a very interesting question to consider just what would happen to a man like Jonah today, if he happened to be swallowed by a great big fish or a whale, the two being popularly synonymous.

As one student of the subject stated in an interview with the writer, there is no doubt a basic thread of fact behind each of the Biblical miracles; and it is very probable that the events that actually did occur, often being handed down by word of mouth for generations before they were written by the scribes of those times, have become much distorted and in many cases no doubt unduly exaggerated. As many modern preachers have stated in this respect, we should not forget the fact that in Biblical times most of the happenings took place in an oriental country or countries, and the people of that section of the world, the same as today, have a different type of mind than the Anglo-Saxon. They desire to have things painted large, as

we might say, and these great preachments of Biblical lore could not do any harm but only good.

In studying the chapter of Jonah in the Bible, one finds that Jonah sailed from the seaport of Joppa on a ship bound for Tarshish, at the western end of the Mediterranean. Shortly after sailing, a mighty

tempest broke over the sea and at Jonah's suggestion, the men on the ship threw him into the sea and the waves subsided. At this time the great fish mentioned in the Bible swallowed Jonah and three days and three nights later, he was vomited forth on dry land. This fish, if it was a whale or resembled a whale, might have been driven

toward the land or shoal water by some of his enemies, such as the killer whale, or possibly other fish of an extinct species. The killer whales are the terrors of the deep, so far as the big whales are concerned today, and those who are familiar with whale fishing state that frequently the big 70 and 80 foot whales will beach themselves in shoal waters in their efforts to get away from the killer whales, which attack the big whale and then tear his tongue out.

It might be interesting to state at this point that the average whale feeds on small fish, but the sperm whale, the one capable of swallowing a man feeds mostly on squid. These squid vary in size from 6 to 9 feet, and can be chewed with the aid of the powerful teeth on the lower jaw of the sperm whale, this being

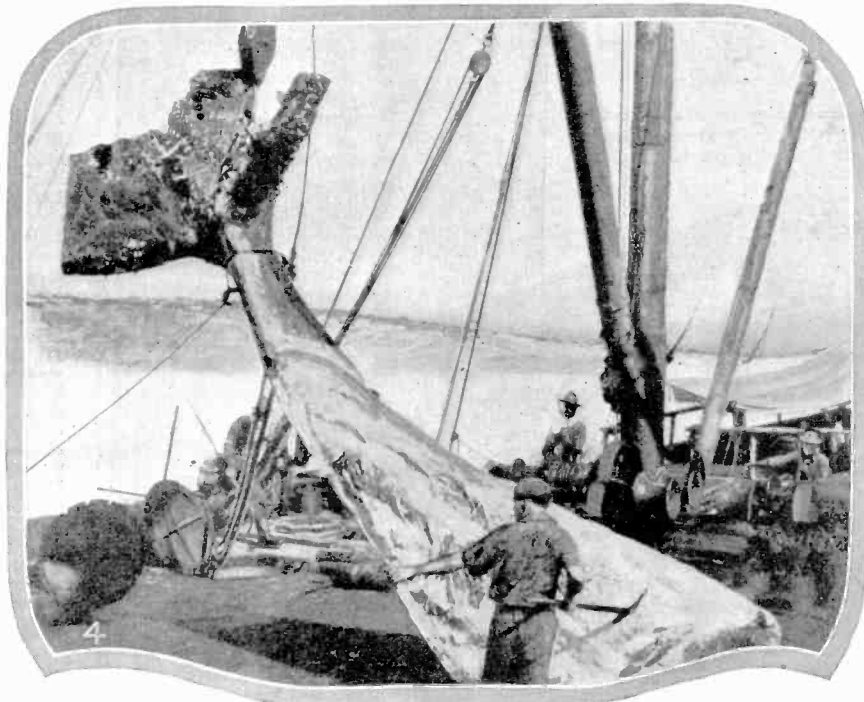

Some idea of the huge size of the flukes and tail of a whale is obtainable from the photograph above, which shows a whale being cut up on board a whaling boat.

The whale, which is a mammal and not a fish, is very powerful and has been known repeatedly to tow a 90-ft. steam-driven whaling boat ahead at 10 to 12 miles an hour, while the vessel's engine and propeller were in reverse. Fig. B: How a whale sometimes fools men in small boats, coming up under them to blow. Fig. C: How a whale killed a man with one blow of his tail. Fig. D shows how twelve men could stand in the open mouth of a blue whale.

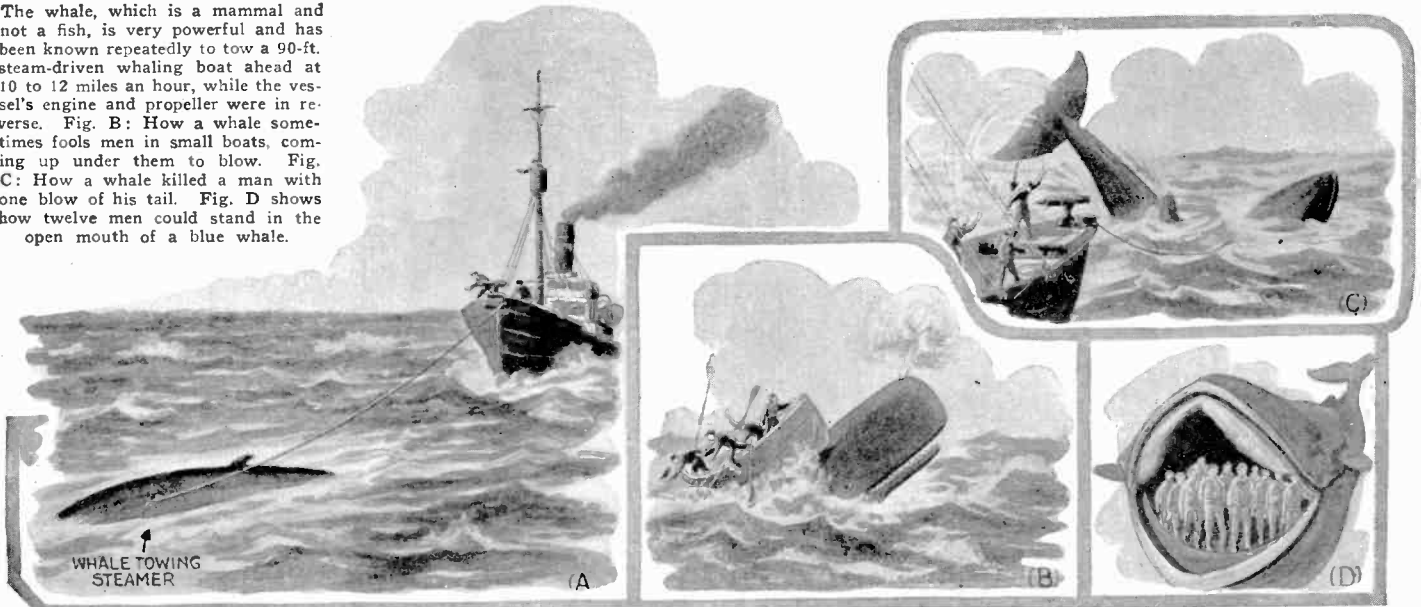

1,000,000 Horse-Power Electric Plant

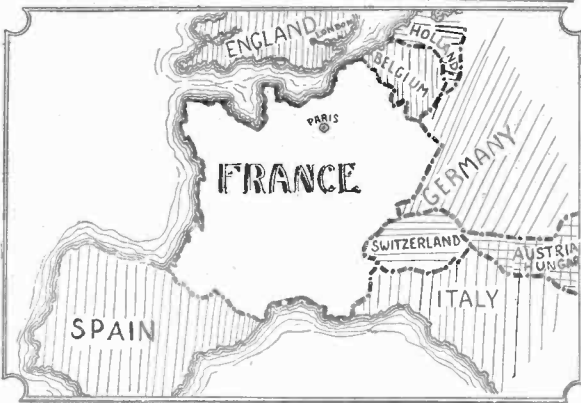
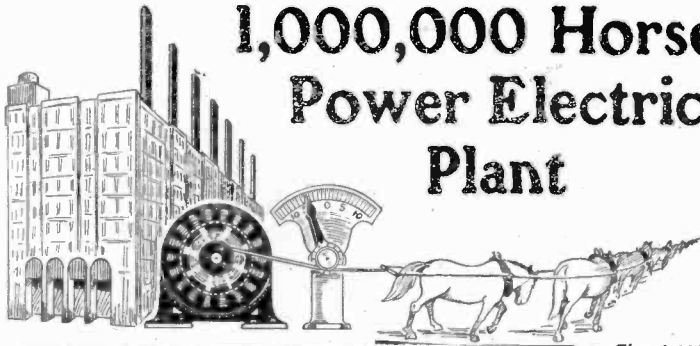

The 1,000,000 H. P. central station of the New York Edison Co. now building, could outpull 2,000,000 horses in U. S.

The new East River central station will produce as much power as that used in France last year; France is the best lighted country in Europe.

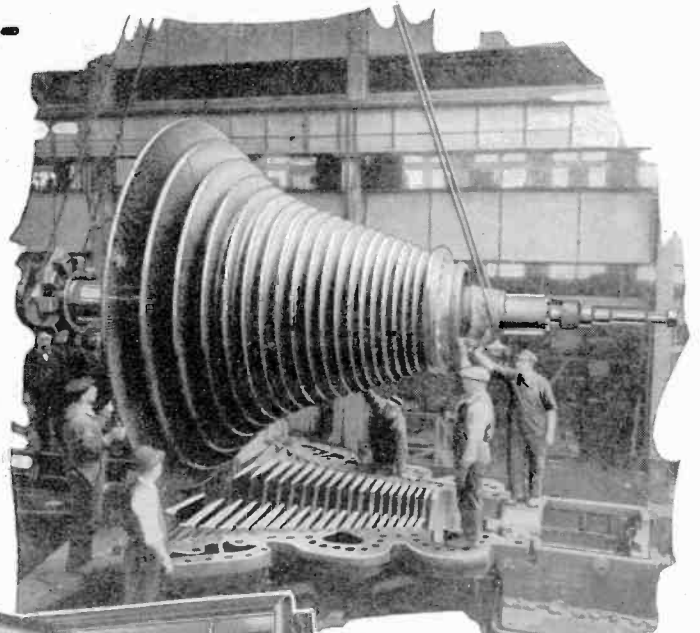
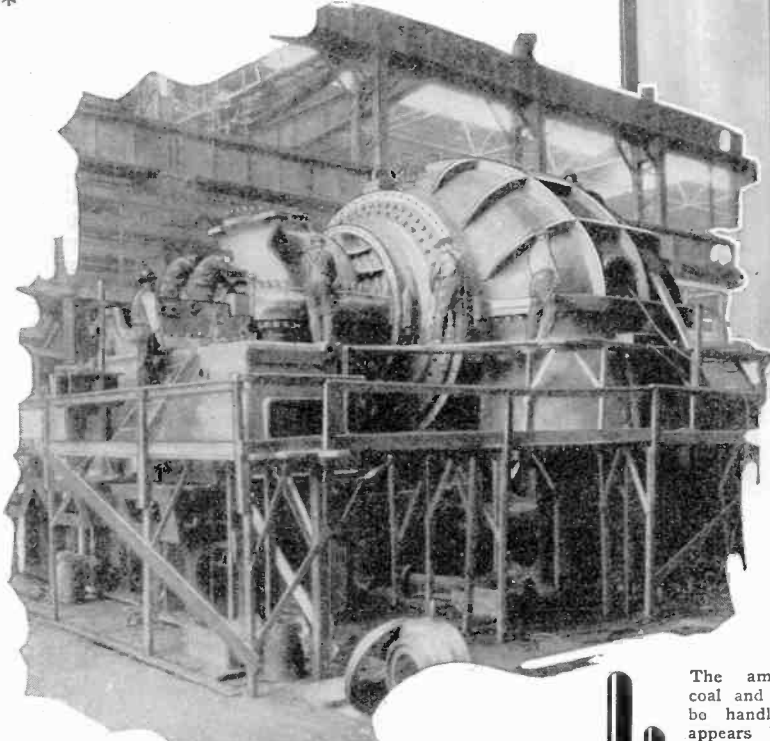

The photo above, is a very exceptional one in that it shows clearly the remarkable steam turbine blades and relative size as compared with a man; these steam turbines will drive the huge electric generators in the new East River station of the New York Edison Company. The station will contain nine of these gigantic steam turbo-generators, each having a capacity of 60,000 kilowatts or 80,000 horse-power; together with additional equipment which will give a total capacity of 700,000 kilowatts, or 1,000,000 horse-power.

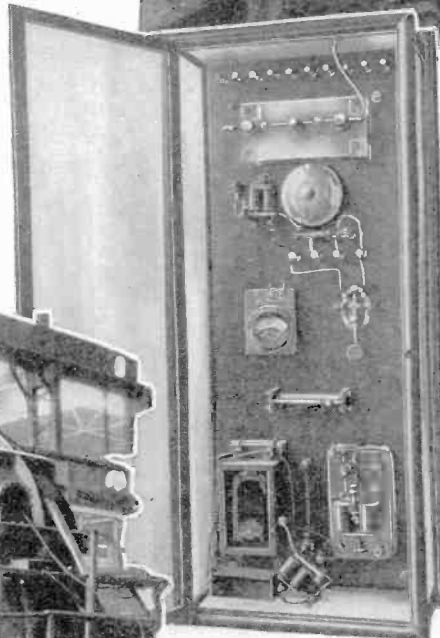

The photo at the extreme center left shows the relative size of a man in comparison to one of the huge 60,000 kw. steam turbines, which is shown under test. These mighty steam turbines will be the biggest units of their kind ever built. The glass door cabinet at the immediate left shows radio coherer, de-coherer, relays, etc., used for detecting the approach of thunder-storms when several miles away. This enables boilers to be fired up in time for extra load.

The new 1,000,000 H. P. central station of the New York Edison Company will produce 100,000 more kilowatts than Musche Shoals' main plant.

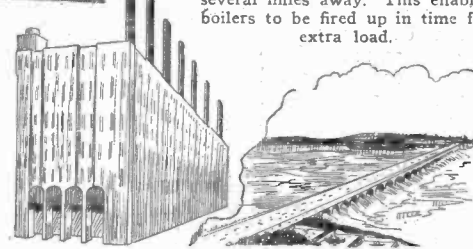

The amount of coal and ashes to be handled daily appears below. Volume of steam condensing water per minute and per day.

COAL
165 TONS PER Hr.
ASH VOLUME PER 24 HRS. 600 TONS
50' SQ. BY 3 FT. HIGH
120 OR 7 STORIES
100' COAL PER 24 HRS. 4000 TONS

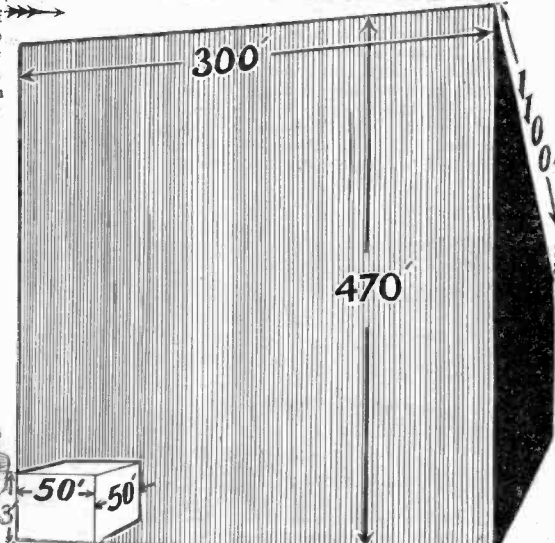
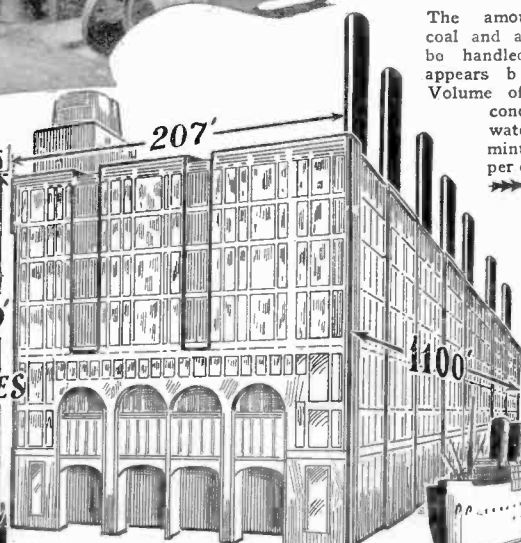

For steam condensing purposes the new central station will borrow and return 800,000 gallons of water from the East River each minute; volume 50x50x43 ft.

Building for 1,000,000 H.P. Central Station 1100 Feet Long

The picture below shows what the new East River station of the New York Edison Company can do when it comes to lighting six room homes. This station could light 3,000,000 six room homes, figuring 250 watts per house, this number of houses being sufficient to line both sides of a street running clear around the world. This figure considers 100 feet separating the center lines of the houses.



Photo below shows comparative size of men and end casting of huge 60,000 K. W. steam turbine, a number of which are to be installed in the new 1,000,000 H. P. central station of the New York Edison Co.

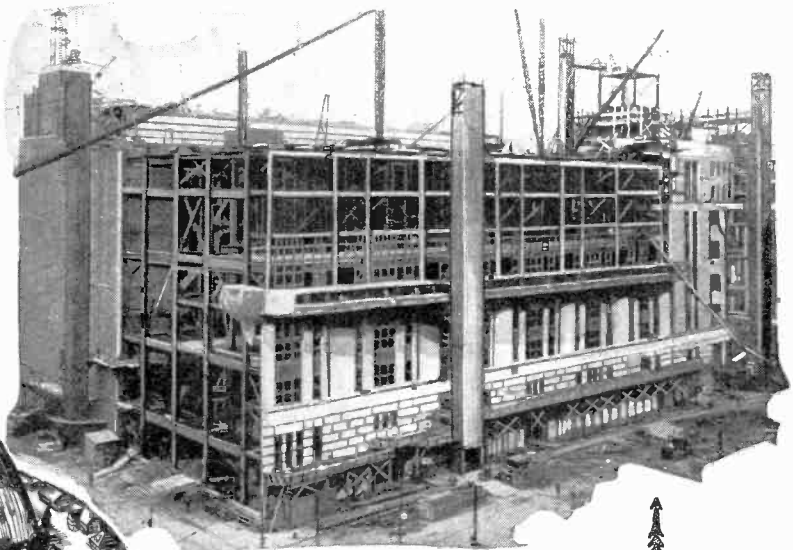
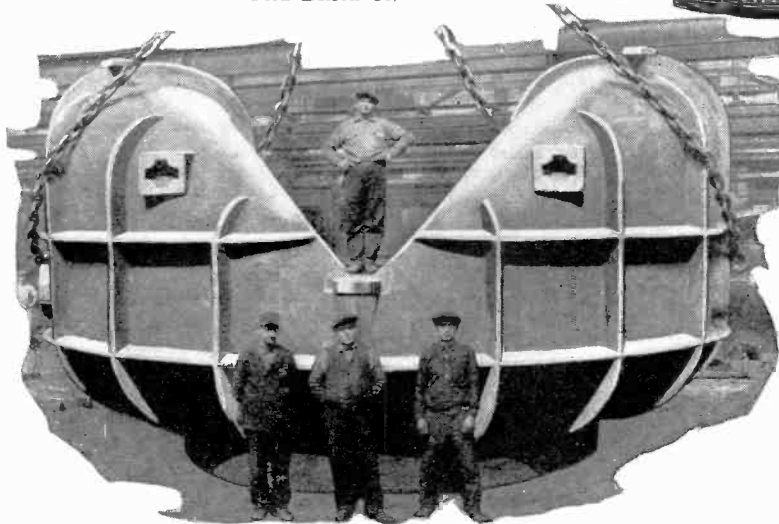

The photo above shows the first unit of the new East River station of the New York Edison Company taken a short time ago. When this gigantic steam-electric power plant is completed in 1930, it will comprise a building 1100 ft. long or about one-fourth mile; 207 ft. wide; and seven stories, or 120 ft. high. As shown on the opposite page, two ocean steamships could stand end to end along the side of this huge central station. Seven giant smoke-stacks will appear along one side of the building, but thanks to modern scientific firing methods, and also to the keen eye of the observer who watches the tops of the smoke-stacks all day long for any sign of smoke, there will be no complaint from smoke on the part of the public or city officials.

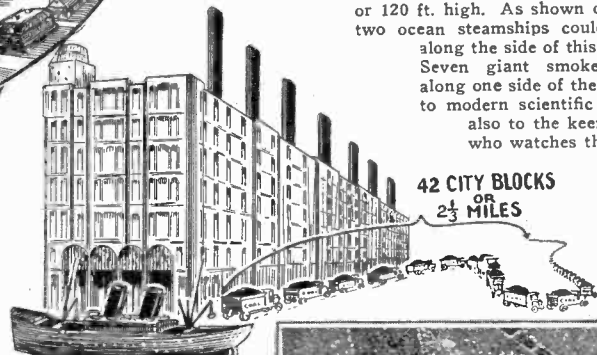

Picture above illustrates how coal will be brought to central station by ocean-going vessels; ashes will be carted away on barges. If this were not the case, New York's streets would be cluttered up with more than 500 large coal trucks which would extend for about 2 1/3 miles or 42 blocks.

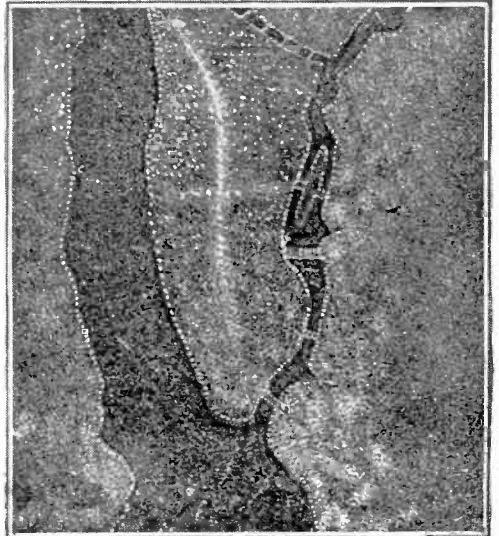

To signal Mars would be a simple matter with the new 1,000,000 H. P. central station at our command. It would light 14,000,000 50-watt lamps spaced ten feet apart, lighting an area 7.1 miles square.

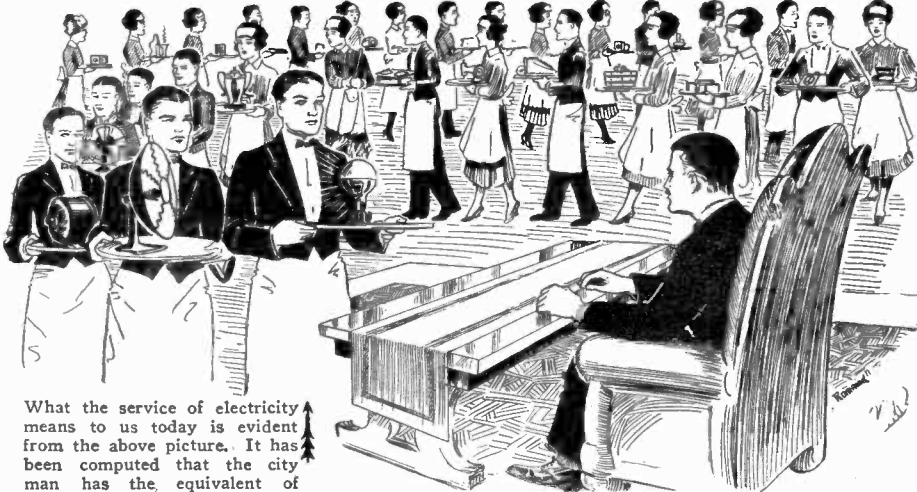

What the service of electricity means to us today is evident from the above picture. It has been computed that the city man has the equivalent of 30 servants working for him.

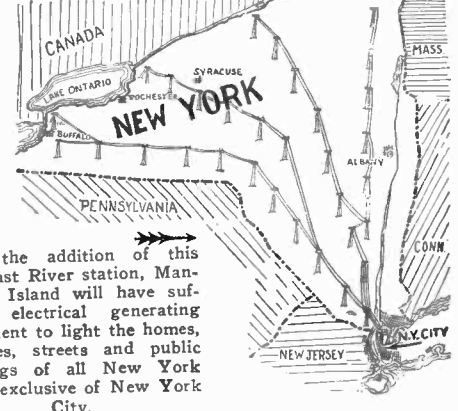

With the addition of this new East River station, Manhattan Island will have sufficient electrical generating equipment to light the homes, factories, streets and public buildings of all New York State, exclusive of New York City.

A Cookless Household

By KAY WILLIAMS



The above photograph shows the food being loaded into holders before the entire meal is placed in an outer container, preparatory to shipment out to any one of the five thousand families which are being supplied by this English firm with hot meals. At the right heated coals are being put in the outer container.



After the pans have been thoroughly scoured and dried the order is filled by one of the chefs.



The homes supplied by this organization need no longer fill their apartments with disagreeable cooking odors. The meals, piping hot, are delivered to your table.



AT Finchley, England, an enterprising firm of caterers has come to the rescue of tenants in apartments which are not equipped with facilities for cooking meals, those who do not care about fussing in their kitchens and those who are unable to spare the necessary time. Orders for the meals are taken by way of phone and are delivered within an hour to over 5,000 families. The food is kept hot by means of a small charcoal fire which is found in the bottom of each outer container, the food itself being placed in a group of pans stacked one upon the other and held together in a suitable rack. Even the task of washing the dishes is eliminated, as they are later picked up and returned.

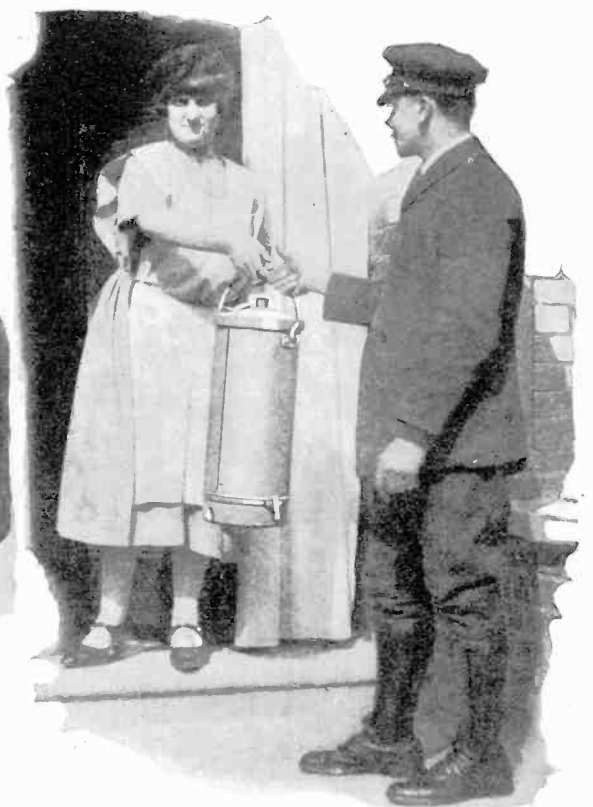

In the above photograph the heated containers are being loaded in a motor truck preparatory to delivery to the homes, and at the right the piping hot delicately prepared finished meal is being delivered to the mistress of the house or the maid as the case may be. Notice the clasps holding the bottom heating chamber in place.

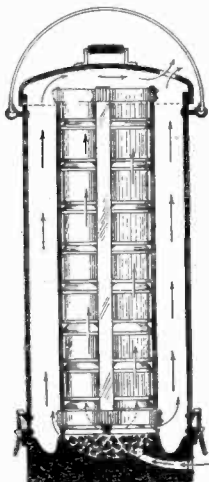

This is a diagrammatic view through the food carrier; note that the air enters through a vent, passes through charcoal and escapes at the top.

How Matches Are Made

How Strike Everywhere Safety Matches Are Made

By J. KAY LONDON

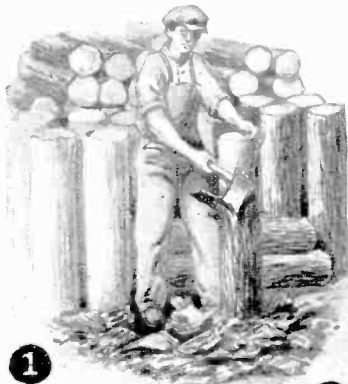
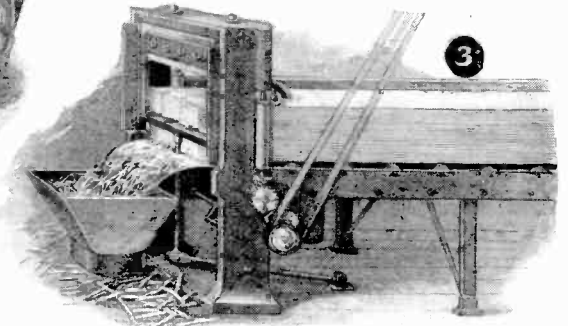
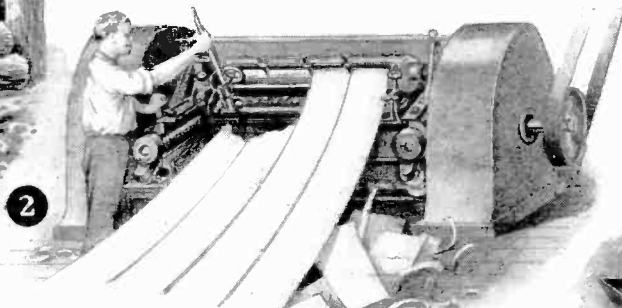
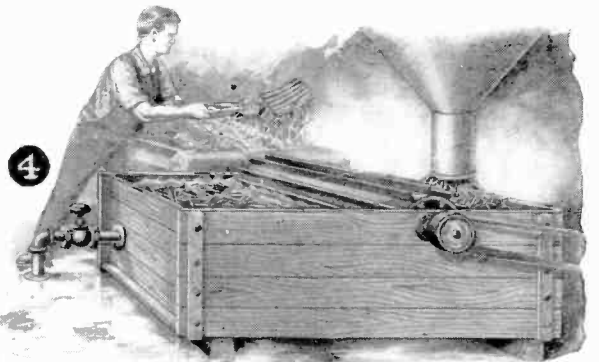

Figure 1, above shows one method of barking logs before putting them into the veneering machine, shown in illustration 2.



THE story on this page shows how matches are made. After the crude lumber arrives at the match company, it is cut in two-foot lengths and is barked in either mechanical barkers or by hand. The lumber is then placed in a lathe-like veneering machine, where it is held between two jaws and rotated while a horizontal knife gradually feeds in toward it and shaves off a layer of veneer of the thickness of a match. Three vertical knives cut the veneer into strips six inches wide. These strips are examined and placed in the machine, 3, which again cuts each strip into three pieces and gives us the square match stick. The matches are blown to the hopper, 4, from which they fall into an impregnating bath, heated by steam. The purpose of the bath is to prevent afterglow. The paddle wheel insures complete submergence. They are raked out of this bath to the endless belt passing through a steam heated dryer as illustrated in back of Fig. 4 and again in 5. From the end of the dryer they fall into a violently agitated box, 6, having parallel wooden partitions and thin metal partitions between. The matches are thus prevented from falling in a haphazard manner and drop into cells all facing in the same direction. On lifting the cover, the trays are removed and placed in the match machine 12. Here a metal comb jams them into other perforated trays whence they pass respectively to a paraffin bath, 9, and then over the rollers which apply the ignition head, 10, then the striking head, 11, and thence out to the front of the machine, finished.



In illustration 6 a mechanism is indicated which piles up the matches. The headless matches can only fall into the cells in a parallel position.

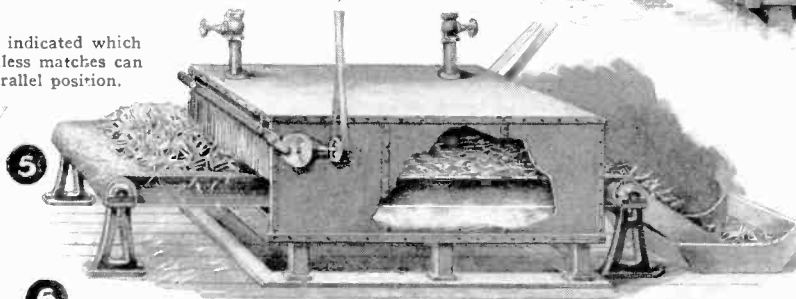

In illustration 3 the veneer is being shaved by a guillotine-like knife. The eighty or more pieces of veneer six inches wide, are cut into 240 or more individual match sticks. These fall into a hopper and by means of air are blown upstairs into an impregnating solution shown in illustration 4.

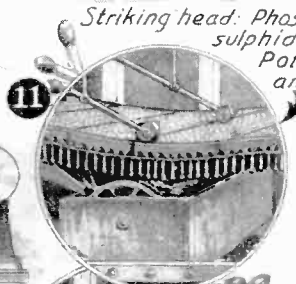
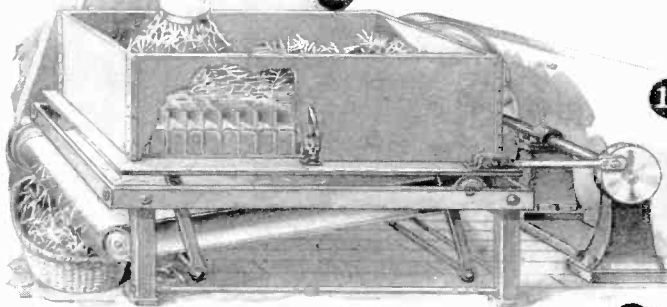

Striking head: Phosphorous Sesqui-sulphide, Chlorate of Potash, Glue and Filler.

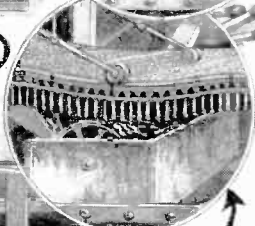
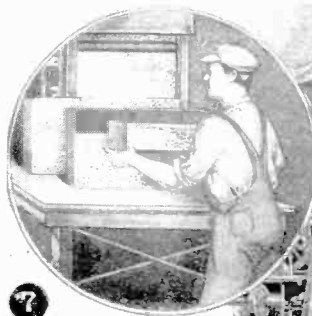

Thick, molasses-like substance, same as striking head except very little sesqui-sulphide of Phosphorous and different Filler.

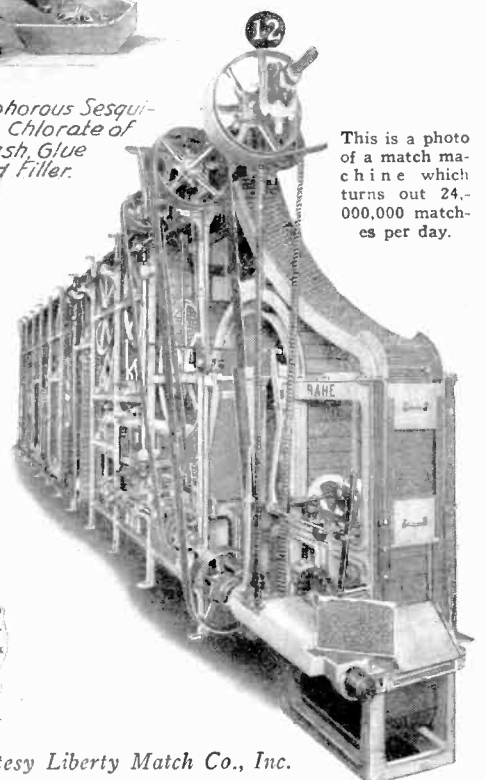

This is a photo of a match machine which turns out 24,000,000 matches per day.

Photo courtesy Liberty Match Co., Inc.

Recent News In Science

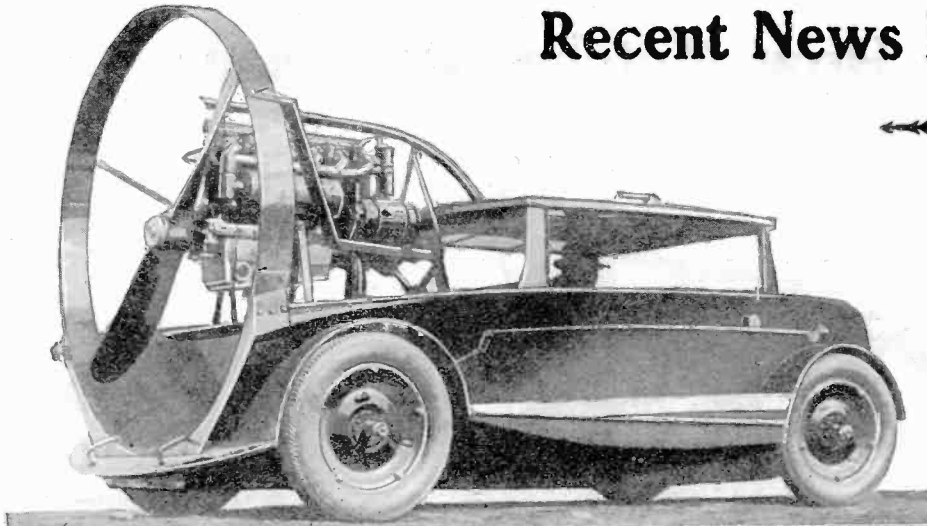

← **A**UTOMOBILE which travels on snow, ice, water or ground. George McLaughlin, a Bangor, Maine, automobile expert, has invented and built this machine illustrated at the left. It is equipped with a seventy horse-power airplane motor and the machine will make sixty miles an hour on the road. It has air-tight pontoons on both sides under the running boards, and the top is constructed of boards crossed in two layers, with waterproof canvas between them. The machine is steered by the front wheels, when operated on either land or water. This freak auto will carry five passengers comfortably and it is large and roomy. The airplane motor spins a six-foot propeller which is protected by a guard in the manner here illustrated. The propulsion of the vehicle is similar to that of an airplane.

MARINE men at Los Angeles, California, are trying to solve the mystery of the strangest craft that has yet visited that port; a three-balled water velocipede. It has a single girder across which is placed a small auto chassis, the engine of which propels the craft; while steering is effected by lateral changes in the position of the forward sphere. The inventor of the craft, although he has made several public trial trips with the vessel, refuses to divulge his name or his future plans for his weird invention. →

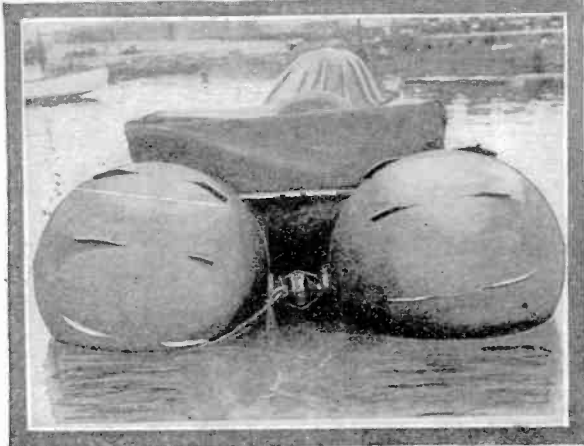
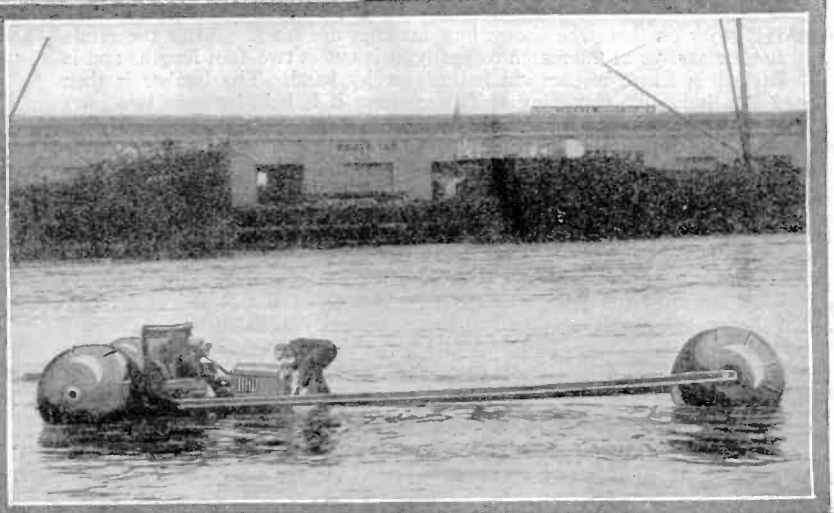

↑ The picture above shows rear view of the three-balled water velocipede, the differential gear of a small automobile driving the two rubber covered rear spheres, the surface of these spheres being provided with vanes in order to afford propulsion. The balls may be made from metal or wood framework covered with heavy rubberized cloth.

Flettner invented the rotor ship and here at the right we see the latest scientific idea in windmills, the rotor windmill, devised by one George Jacobs of New York City. This rotor windmill generates considerably more power than the ordinary design.

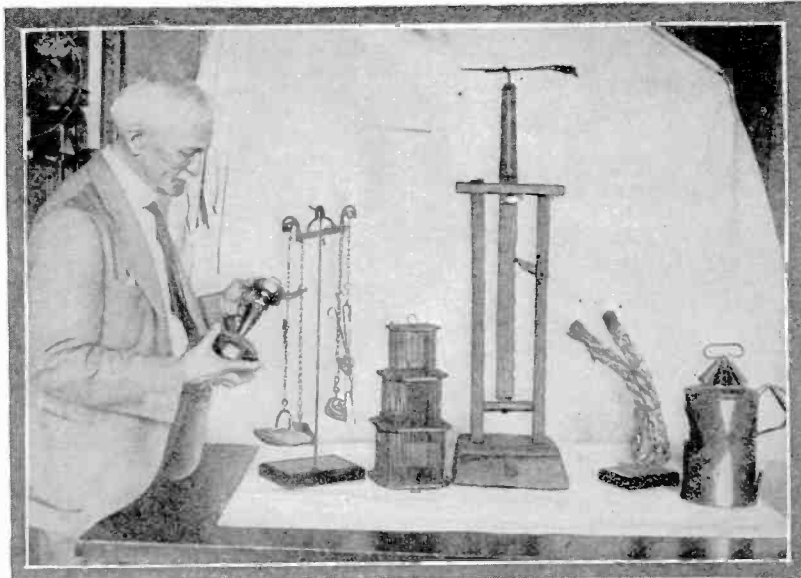
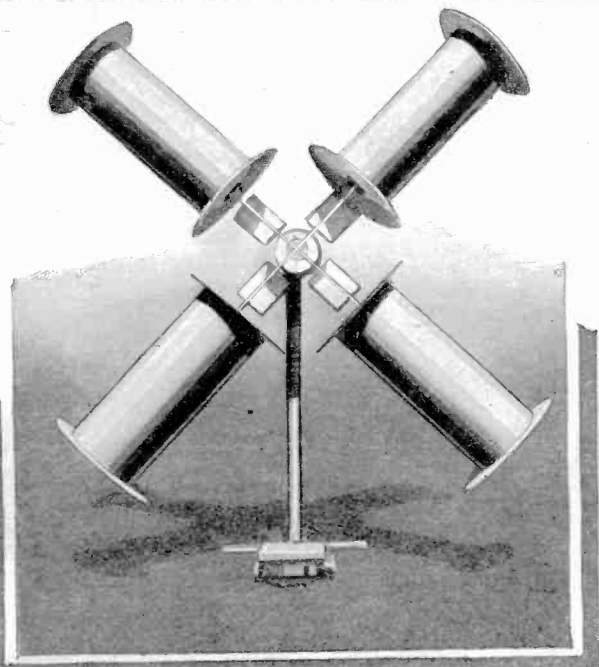

← **D**R. HOUGH, a scientist in the National Museum, Washington, D. C., is shown here with a collection of artificial lighting objects on which he has devoted years. On the table from left to right can be seen: "Revolutionary" horn, dark lantern of copper, used in 1776; Spanish resin torch used in the Middle Ages; Finnish splint holder in which a piece of pine splint was used to light the home of the Iron Age; fire-fly lantern used by natives of the West Indies a century ago, lamp beam of a crude boat shape used 900 years ago. In Dr. Hough's hand is classic shaped lantern, eighteenth century, English type. Our grandfathers would be amazed at modern lighting fixtures.

Making Records With Light Rays

Photo-Electric Cell Improves Phonograph Recording



The above photograph shows an orchestra under the leadership of Louis Katzman recording for phonograph records, using the new photo-electric cell mechanism to give purer and better results.

A PHOTO-ELECTRIC cell for making phonograph records has been put into operation by the Brunswick Recording Laboratories. So sensitive is this recorder that it actually responds, if desired by the operator, to a person's heartbeats at a distance of thirty feet from the instrument. The weight of the entire mechanism which responds directly to the sound waves is only .02 milligram. If the sensitivity of the instrument is to be decreased, the rheostat controlling the lamp filament is turned down, thus producing a weaker beam of light. The photo-electric cell used is of the potassium type rather than of selenium, because the former is much more sensitive. The cell has been tested to respond to 72,000 vibrations or interruptions per second, which is a much greater pitch than the human ear can possibly hear. In actual practice, three stages of audio-frequency amplification are employed, although but two are shown in the diagram illustrated at the bottom of this page. This particular type of recording apparatus may be used in part for transmitting purposes in radio broadcasting stations. Not only is the transmitter better than the standard form of microphone, but it is far more sensitive, yet under constant control and is not subject to the same defects as the regular carbon microphones now used.

THE possibilities of using the photo-electric cell for recording and other purposes were again demonstrated for making phonograph records. Instead of singing into a large megaphone as has been the case in the past, the voice of the singer or the strains of the music of an orchestra now impinge on a small aluminum cone. This aluminum cone is affixed to a thin wire and a small V-shaped steel sliver and a mirror. The V-shaped piece of steel is mounted on a V, formed by two pieces of sapphire and is held in place by the magnetic attraction of the permanent magnet. The mirror, itself, moves a maximum distance of one two-millionth of an inch, and the weight of mirror, cone and wedge is .02 of a milligram. The light from a small twelve-volt concentrated filament lamp reflects on the mirror after passing through a condensing lens and again is condensed by another lens before entering the photo-electric cell.

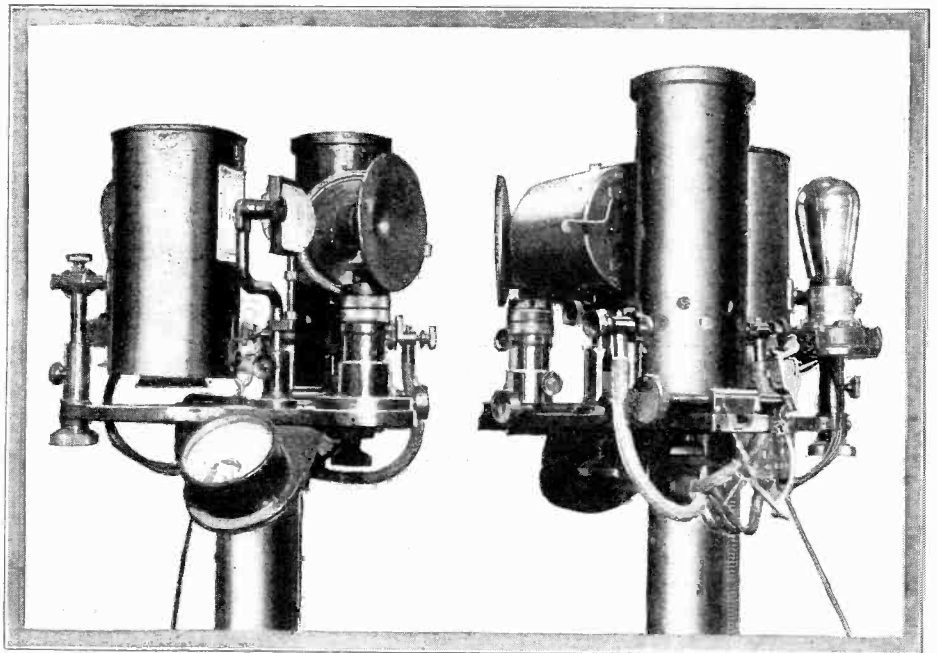

The above two photographs show a front and back view of the photo-electric cell recording instrument now being employed to make phonograph records. With this mechanism it is possible to obtain finer graduations in sound and to record more faithfully both voice and music. With such a system there is practically no inertia on the part of the recording diaphragm and due to the fact that the cutting stylus receives plenty of energy from the vacuum tube amplifier very minute changes in sound are faithfully cut into the record. A similar system is used for broadcasting work and this outfit may be found at Station WGY, Schenectady, in place of the usual microphone.

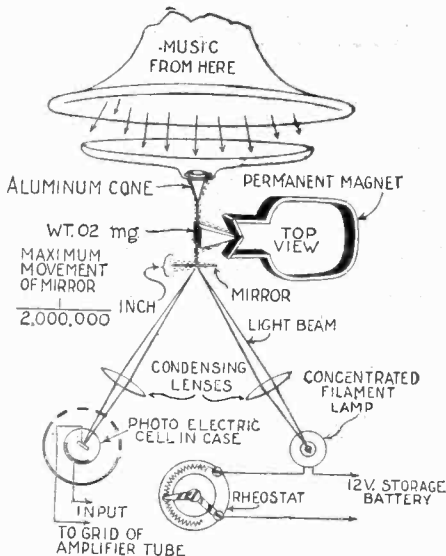

The above diagram illustrates in picture form how the light recorder is used. Music causes a small aluminum cone to vibrate back and forth shifting the beam of light to the photo-electric cell.

When the mirror is at rest, the reflected light does not enter the photo-electric cell, but is cut off by a portion of the surrounding container, the front of which is slotted to permit the light to enter. It will be noted in the photographs that a vacuum tube is mounted on the stand holding the photo-electric cell, the lamp and the mirror. The purpose of mounting the tube there is to permit of a very short grid lead from the photo-electric cell to the tube.

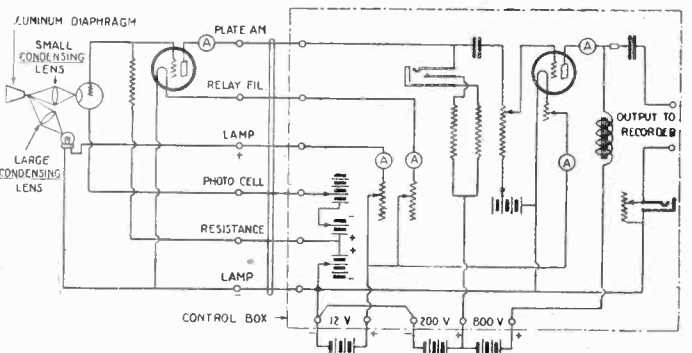

The above diagram is a complete plan layout of the photo-electric cell recording apparatus and the amplifier.

Photographing Aircraft Bombs in Flight

By S. R. WINTERS

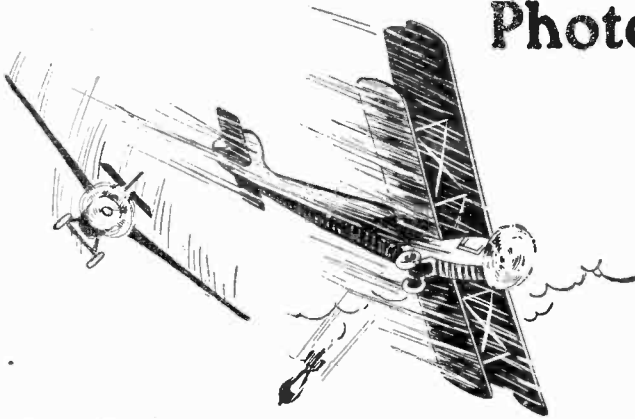

A CAMERA that can visually follow an airplane in its course of flight and make photographic notations of a bomb in flight, are among the remarkable achievements to be credited to an invention of the Ordnance Department of the United States Army. Just as the theodolite enables the Weather Bureau to keep tab on kites sent on upper-atmospheric errands for weather data, this new mechanical eye of the Ordnance Department will make possible a minute study of the behavior of aircraft in flight and the attendant conditions of releasing and exploding bombs.

This camera obscura consists of two cameras—one vertical and the other oblique or slanting in focus. That is to say, the vertical camera makes possible the securing of the image of an object flying directly overhead and the camera slanting to an angle of about 45 degrees enables the taking of a picture of an airplane at any height and at angles

different altitudes. That is, the small lens would be unable to make a satisfactory impression, if any at all, of an airplane at a relatively great height. The oblique or slanting camera is mounted with its

(Continued on page 377)

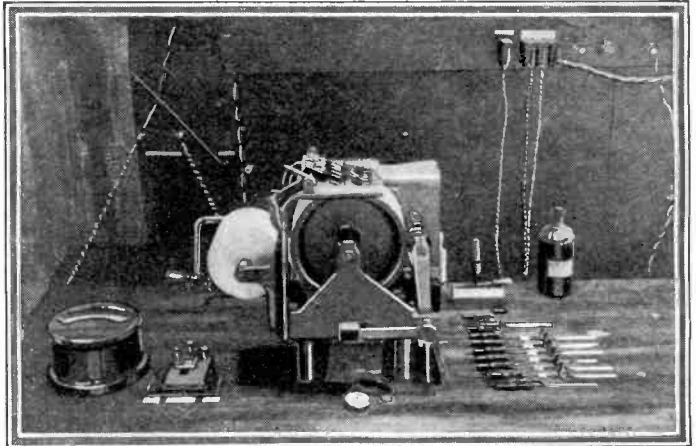

Photo above shows electric chronograph apparatus which records the time elapsing between dropping the bomb and the moment of explosion.

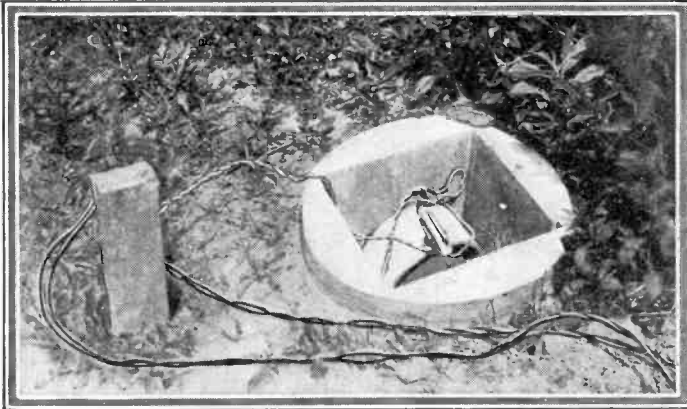
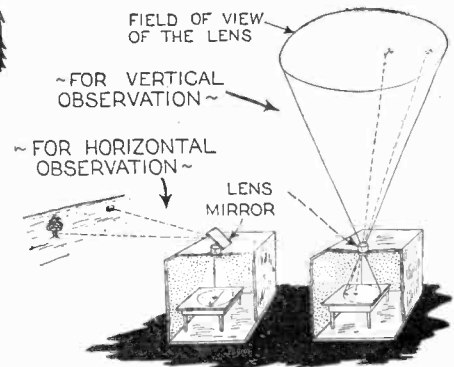

Photo at left shows pit containing microphone used to record sound and hence time of burst.

The arrangement of the two cameras for photographing vertical and horizontal views appear at right.



deviating from a vertical position. This duplex camera, unlike the theodolite in following the course of a weather-observing balloon, is stationary during the observation period. It is permanently mounted at the Aberdeen Proving Grounds, and its advantages over previously designed cameras, in the main, are threefold; the power of the lens may be large, the field of vision of the lens is wide, and a permanent record is obtained of aircraft in flight or other moving object.

The vertical camera is equipped with three lenses of varying focal lengths, namely, 30 inches, 10 feet, and 20 feet, respectively, each mounted on a separate table. The field or range of vision of the small lens is 60 degrees, that of the 10-foot lens 30 degrees, and that of the 20-foot lens not over 20 degrees. It is necessary for the object under surveillance to be nearly directly over the camera; the varying sizes of the lenses being necessary for making images of aircraft at

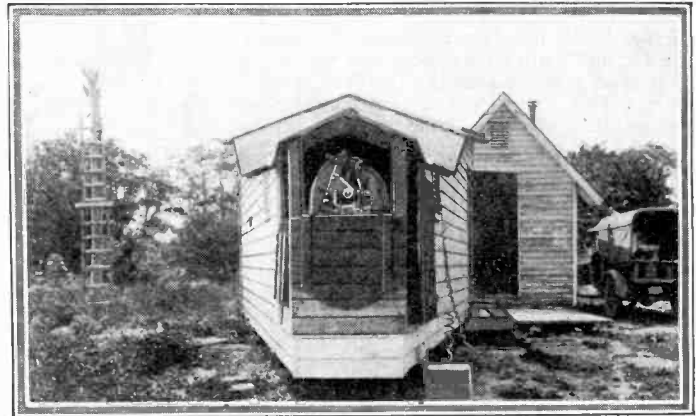
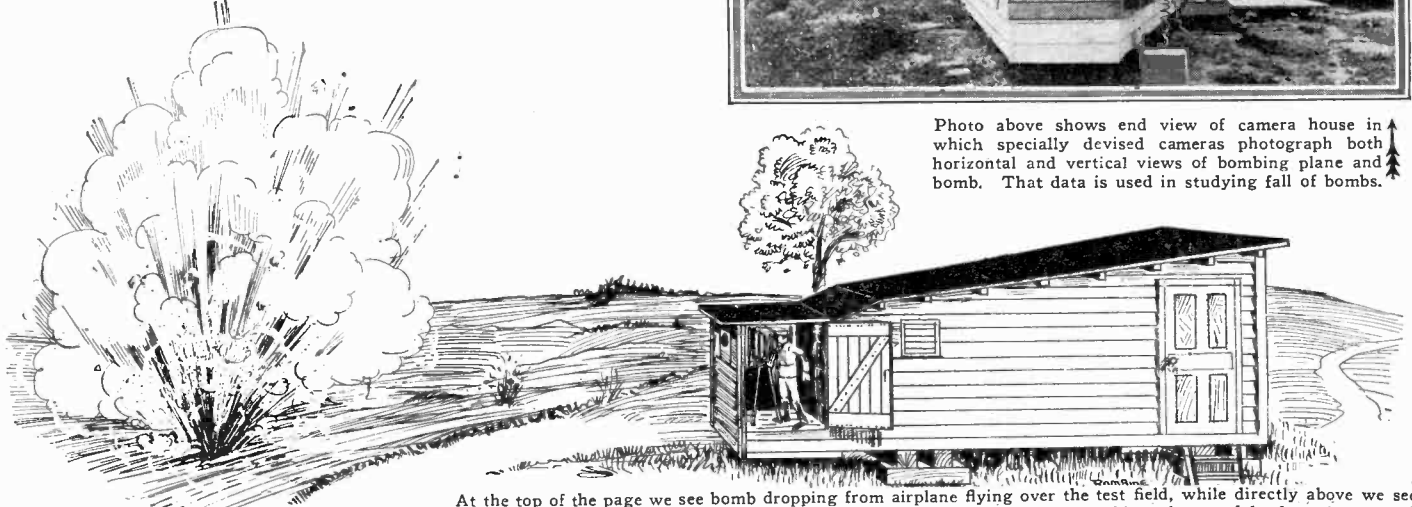
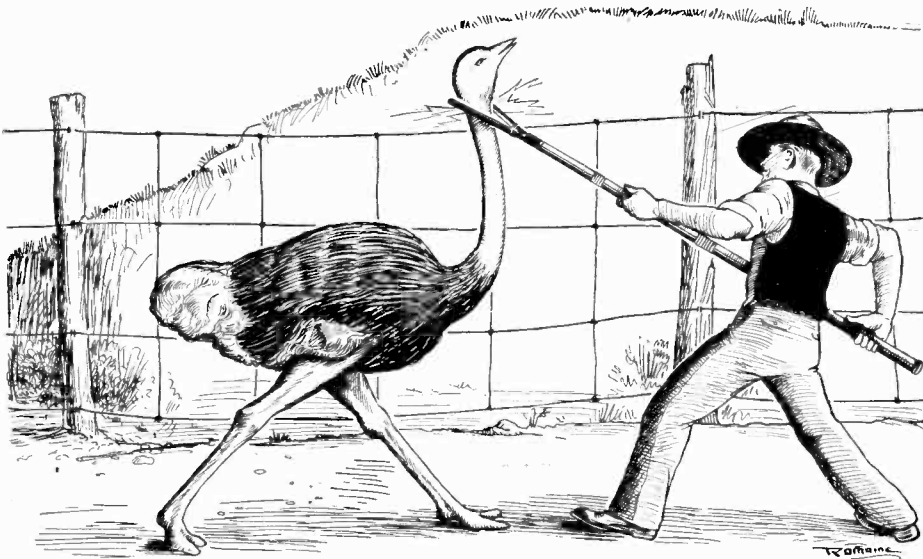

Photo above shows end view of camera house in which specially devised cameras photograph both horizontal and vertical views of bombing plane and bomb. That data is used in studying fall of bombs.



At the top of the page we see bomb dropping from airplane flying over the test field, while directly above we see camera house containing both horizontal and vertical cameras for photographing plane and land smoke signals.

Electric Ostrich Tamer



The ostrich is a ferocious fighter when once aroused and some ostriches are naturally of a scrappy nature. Above we see in use a new electric ostrich tamer and it was used recently by a man who had charge of a car load of these birds shipped from Los Angeles, California, to Newark, N. J. The device is made from a bamboo pole with suitable shocking coil and batteries.

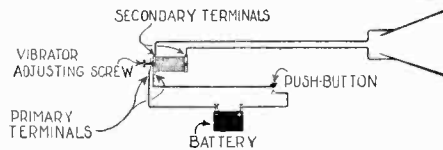
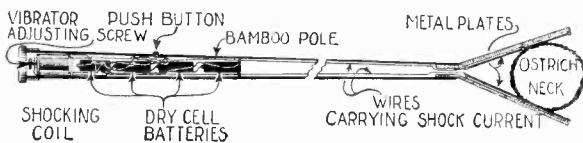

Above and at the left details are given of the electric ostrich tamer. A powerful induction coil such as used for ignition and similar purposes is used in connection with several flashlight cells, the circuit being closed with a pushbutton.

Heavy Oil Engine

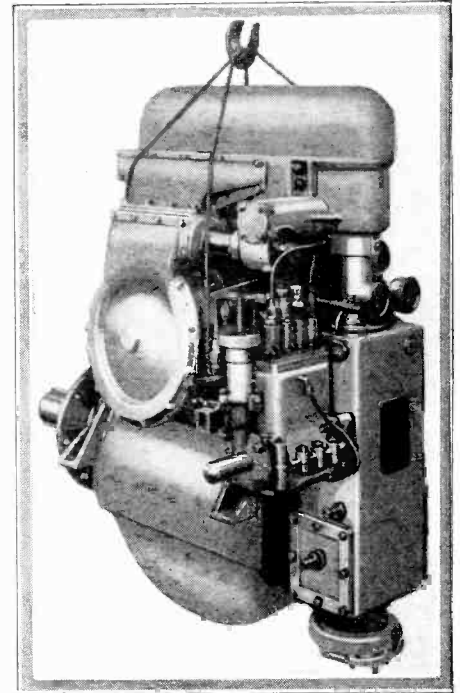

The new heavy oil engine for aircraft shown is under development by the U. S. Navy experts. This engine was designed and built by Mr. A. P. Attenu, of Montreal, Canada. It is a two cylinder, two stroke cycle solid injection auto-ignition aircraft engine, having a bore of 5½ inches and a stroke of 6½ inches, designed to develop 125 H.P. on 3.5 lbs. per H.P. hour. The engine operates at 1800 R.P.M. burning 23° Baume oil.

Four Cylinder Engine for Small Airplanes



In the July and the present numbers of this magazine there is described a speedy sport plane and herewith is a picture of a similar sport plane fitted with the powerful, yet light airplane engine described and pictured below. The light weight of the four-cylinder airplane engine here described is apparent from the way the young lady at left holds it. This engine weighs sixty pounds with carburetor, magneto and propeller hub, yet develops 25 H. P.

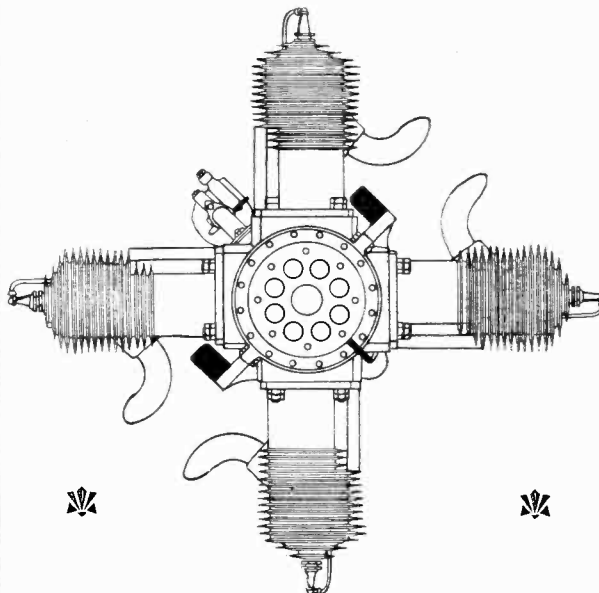
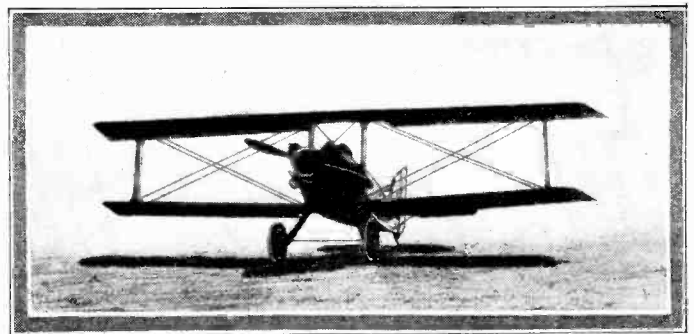

THIS four cylinder airplane motor installed in a sport plane of the type here shown, has produced a maximum speed of nearly one hundred miles per hour, and a ceiling of 15,000 ft. The weight of this motor complete, including carburetor, magneto, propeller-hub, etc., is only 60 lbs., yet this little four cylinder motor is capable of developing 20 to 25 H.P. and only consumes 1½ gallons of gasoline and ½ pint of oil per hour, making the little sport plane very economical to operate, as the total operating expense averages 50 cents per 100 miles. This engine is very easily mounted as the greatest diameter is 23 inches. It is very accessible and any of the units may be dismantled without taking the motor out of the frame. Cylinders are gray iron, crankshaft is of chrome vanadium steel, while crank case is of silicon aluminum.

IN THE BASTILLE

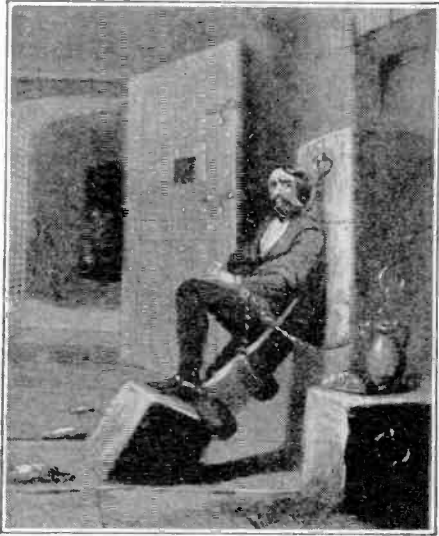

A prisoner in the Bastille. In its last days there were very few prisoners in it. The revolutionary mob seem to have destroyed it as a symbol.

As the Ancients Gave "Third Degree"

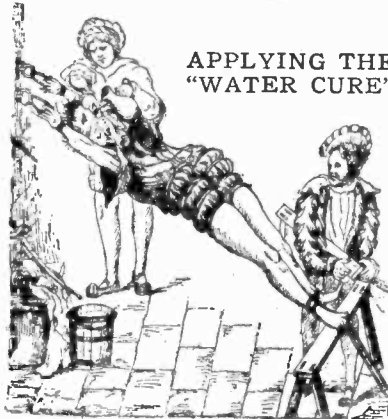

APPLYING THE "WATER CURE"

The victim stretched in a position involving the torment of the rack is having water poured into him. It will be remembered that during the Spanish American War the "water cure" was inflicted.

TORTURE IN RECENT DAYS



THE "WATER CURE"

THE HUMAN TURNSPIT

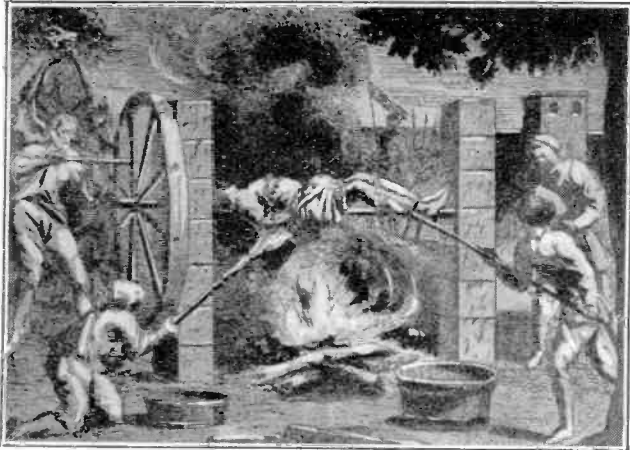

A victim roasted on the spit as if he were a joint from the butcher shop.

Upper right, a prisoner in Auburn State Prison in this state was subjected to the water torture, and died under the effects. The inquest and trial each had the aspect of a "whitewash." Many of the ancient tortures involved the use of water in various ways. Some of these water tortures were described in previous articles of this series.

Here we have an example of the "water cure" plain and simple. It is supposed to have been a very severe torture.



THE WITCH'S BRIDLE



A CAGE
A cage in which the victims were locked up and exposed in public. It was often mounted so as to be turned by hand. The torture was in the direction of the character of mortification and disgrace.

LAPIDATION



The victim is dragged over the ground by a horse, while stones are thrown at him so as to kill him eventually perhaps by an accidental Coup-de-Grace. The Jewish lapidation was very specifically regulated.

TORTURE ON THE RACK

The illustration needs no description. It is the famous stretching the victim on the rack. Among the historical victims was the celebrated Guy Fawkes. His signature after the torture was so affected that it told the story.

These cage-like metal masks were used on other criminals than witches, although they were given the title of Witch's Bridle. Here a modicum of torture was combined with the mortification and disgrace of the exposure.

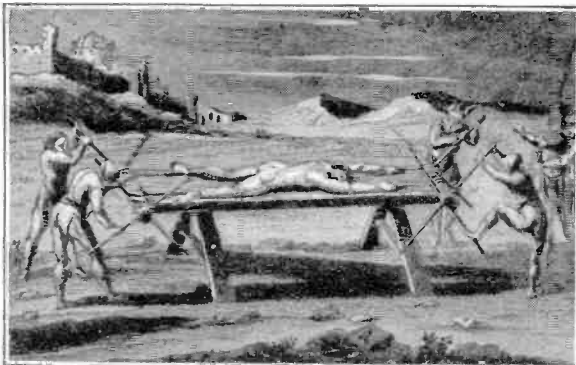

Ancient Torture Methods

Part III

By T. O'CONNOR SLOAN, Ph.D.

THERE is little doubt that if everyone followed at least the leading moral precept as formulated in the religious codes of the different peoples of the earth, or even if the golden rule would be literally carried out, government and statutory legislation might properly cease, but the awful crimes which are chronicled day by day in this country, Chicago's daily murder, lynchings and the infliction of torture ranging from flogging to burning alive inflicted by mobs whether named or nameless, indicate the necessity for statute law. A lawyer friend of the writer defines law as the "rules of the game," just as we have rules for playing card games. Within a few days of this writing, a foreigner who had been in prison for eight years for an alleged murder, which he never committed, and whose condemnation was due to the fact that the interpreter who served in court did not understand the dialect in which he spoke, has had his innocence recognized and published, and now society, often a monster of injustice, proposes to deport him, but not a word has been published of any proposal to remunerate him in any way, or give him any compensation for what was done to him.

Some years ago we could read in the papers of the burning of an unfortunate negro, alive, and it is said that he got free from the bonds enough to try and escape from the flames and was pushed back by the crowd, so it seems that legal statutes are insufficient to prevent crime, that the golden rule is held sacred by so few people that its effects are but slight, and that religion with its spiritual code has not yet reformed the world. And it is, at this epoch in the world's history, when such deeds as these are perpetrated over and over again, when the modified torture of the third degree is practised by the police that people go back four, five and six hundred years in the world's history and attack the methods of those days without apparently thinking of what is done in this 20th century in a civilized country.

The mixture of religion and politics is a bad one. This is pretty generally conceded, but the mixing process goes on at the present day and when our criticism of past eras is based largely on the specific desire to criticize unfavorably different religious tenets, the criticisms are not worth very much.

The most extraordinary discrepancies occur in the detail of the number of victims, so much so that one is forced to the conclusion that the statistics are of very little value and that the large numbers are grossly exaggerated. Thus it is stated that between 1308 and 1323 only 42 who were convicted of heresy were handed over to the secular authority which means that they were executed, and that in the same period of time only 930 were convicted of heresy.

The Ducking Stool. This may fairly be termed one of the milder tortures of our forefathers, although the feeling of utter helplessness when immersed in water and going through the agony of suffocation made it no light punishment. It seemed to have been applied usually to women.

Here a man is the sufferer.

Now suppose that every murderer in the United States was executed, remembering that for one of our cities a murder a day is claimed, the deaths in the United States per annum as inflicted by law would run up into the thousands.

In the middle ages, religion and politics were very closely united, probably as closely as they are today in the State of Tennessee. So those who wish to condemn the ways of the Church of the Middle Ages, depict the dreadful doings of the Spanish inquisition. The doings of the Spanish inquisition were those which had been done since the centuries preceding the Christian era—torture for the purpose of eliciting confession or getting testimony from witnesses had been the custom for centuries, and is practically approved of by many people of the present day. The number of victims of the Spanish inquisition is not known, so it presents a convenient field for exaggeration and it is hard to abuse the customs of that day without dragging in the church, even if it were desired to do this.

In preceding articles of this series,



some attempt was made to reveal the psychology of what is on the whole a rather dreadful subject. And we said something about the numbers affected by the wretched system, but it is probable that if people were asked at what period of the world, and for what cause or causes, the greatest number of victims were tortured and killed by fire, the first off-hand answer would be—in Spain, in the 13th and 14th centuries, and perhaps later. But there was an era when the burning alive of innocent people was carried out to a greater and frightful extent—when the law tortured and burned alive countless innocent victims and when a wave of it swept across the Atlantic and for what was fortunately a very brief period, stained the history of New England. The system was upheld as it was by the grim and celebrated clergyman of the period, the son of the President of Harvard University, the Puritan writer, Cotton Mather. We are alluding to the so-called "witchcraft."

The belief in witchcraft was widely spread in the early centuries and in the 16th and 17th century, superstition and the civil law, united in a firm union and attacked this subject. In carrying out the iniquitous proceeding, the old, illogical theory of extorting a confession by torture was applied right and left to numberless victims. If a person was accused of being a witch, or if suspicion attached to him or her, this was enough to justify in the iniquitous code of the time, the application of torture to extort a confession, and the confession meant hanging or burning alive. A person who was accused was supposed to plead guilty or not guilty. If he or she pleaded "not guilty," the victim could be tortured to extort a confession. In England, if an accused person refused to plead, the law, recognizing the hopelessness of doing anything, crushed the accused one under great weights, apparently with some

(Continued on page 371)

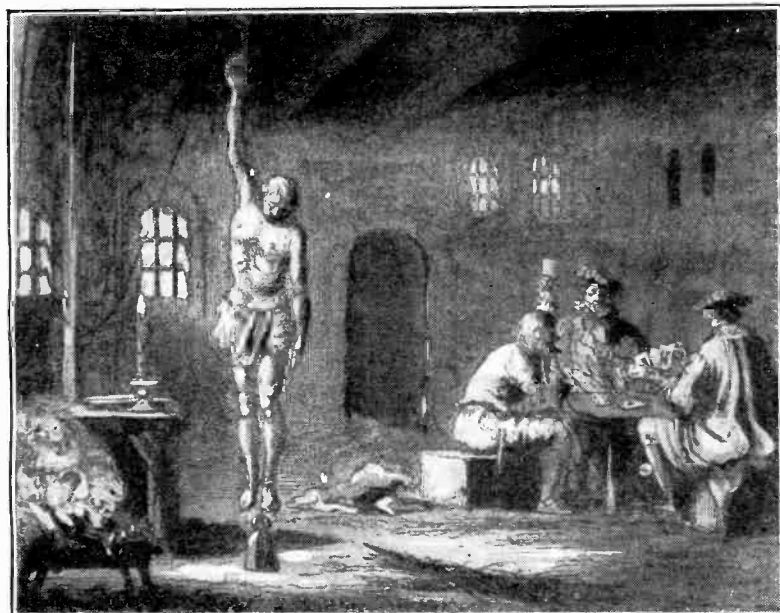

This is a variation on the Strapado, but a little in the direction of mercy. In the strapado both arms were dislocated at the shoulders, but here the agony is concentrated on one. The guards are enjoying themselves in the background.

The Illuminated Eiffel Tower

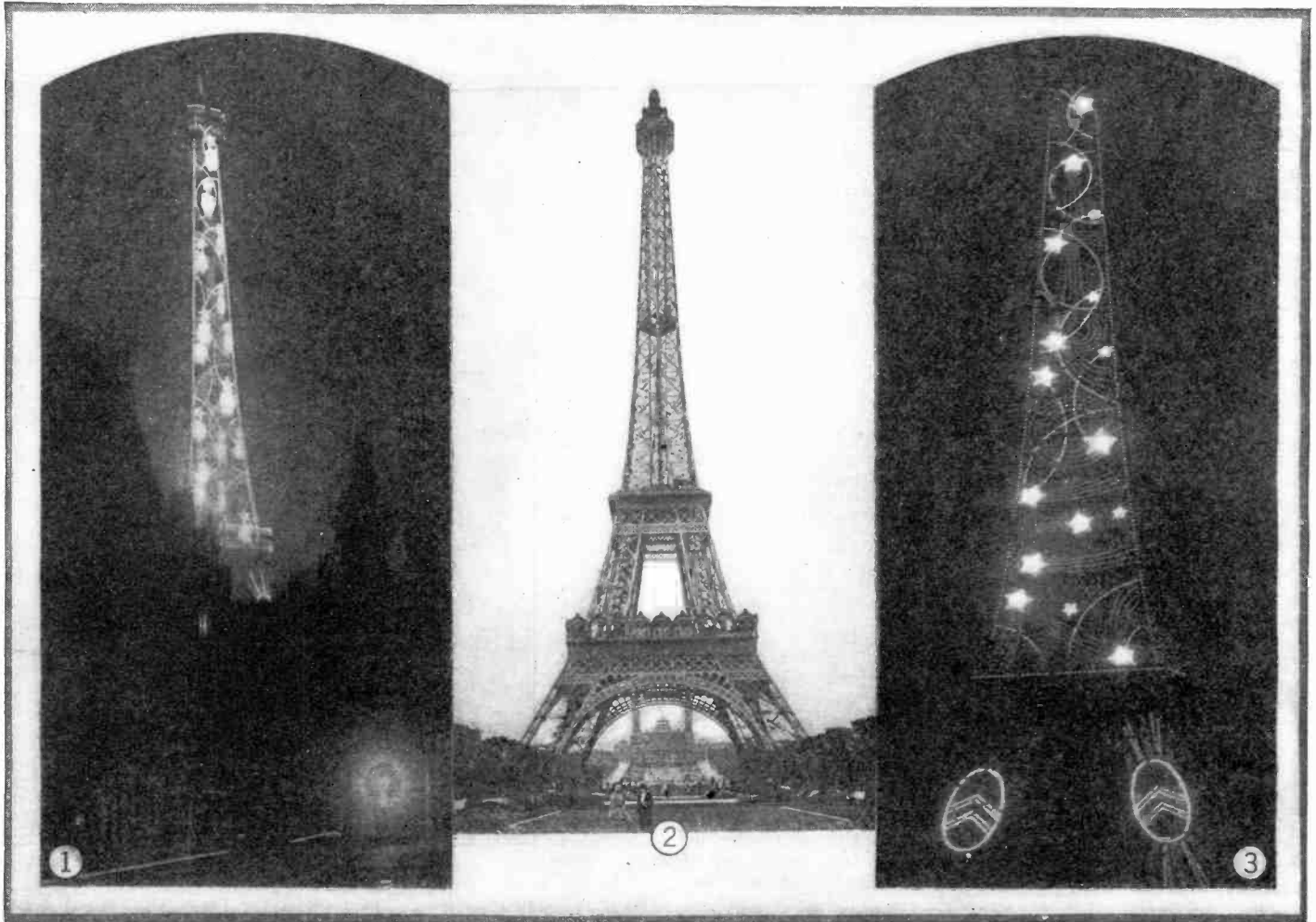

Three views of the Eiffel Tower are given above. It is now illuminated at night, sometimes for advertising purposes. Fig. 1 gives a view of one side of it as illuminated, and in Fig. 3 there is shown another aspect of its lighting up. The wonderfully graceful structure is shown in Fig. 2.

IN 1889, more than a third of a century ago, the Eiffel Tower was erected in Paris, in the Champs de Mars. March 31st was the date of its completion. There was an exposition in progress in Paris and the Tower was one of the features.

It rests on a base as defined by its corner pillars, about 330 feet square. Where the pillars terminate and where the second section of the Tower may be said to begin, a considerable height is attained. We refer to the central picture. This point is marked by the second horizontal platform or division. The height of the structure is 300 meters

or 984 feet, and 7,000 tons of steel were used in its construction. It cost over a million dollars and the majority was supplied by the constructor, the famous French engineer, Alexandre Gustave Eiffel.

Among the various functions of the Tower, the present one where it is used for the advertisement of the Citroen cars, seems too much of an everyday one. Two different phases of the illumination are shown in our illustration. The word "Citroen" is spelled out on the tower by the lamps and each letter is 92 feet high. There are 600,000 lamps in the display which is maintained

on three sides of the Tower. The cables alone are 32 in number, over 500 feet in aggregate length, and weigh about 15 tons.

During the exposition restaurants were maintained on the lowest platform, whose area was nearly an acre in extent, and the profit for the year 1889 nearly paid for the cost of the Tower. It now forms the tallest radio mast in the world, and of all the structures erected by man none approaches it in height except radio masts at some of the great stations.

Considerable use has been made of the Tower for scientific investigations.

Tele-Photos Trap Fruit Thieves

MOTOR-car excursionists of all classes seem unable to resist orchard-robbing, and repeated fines and prosecutions have no apparent effect. But ingenuity has turned this curse into a blessing for the struggling fruitgrower. A telephoto camera is now part of the orchardist's outfit, and it is liable to click at any moment from ambush when raiders are about. The idea is that the culprit, learning from the indig-

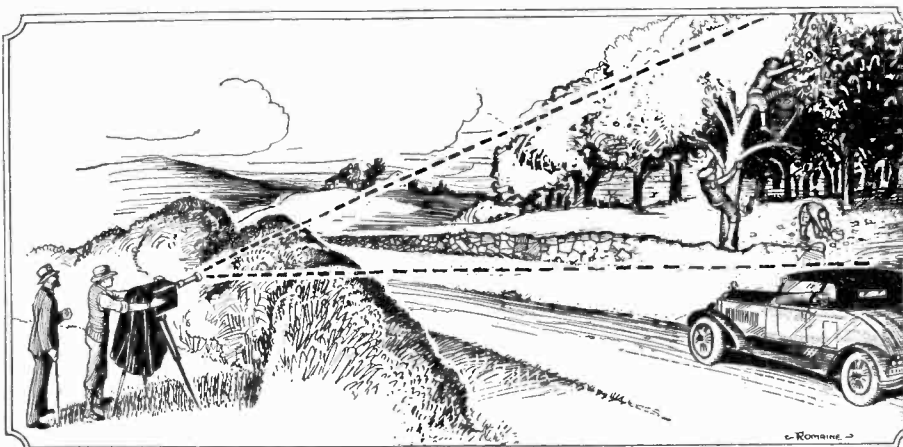

nant photographer that his picture is "took," will be ready to pay a fancy price for the film, and he generally is. Certain apparently lonely and unprotected orchards near a motor-road are now proving highly productive. It is a poor Sunday or holiday that doesn't see some orchard-pilager paying up to destroy the evidence against him. The photograph along with the car number noted gives unpleasant certitude for the motorist.

New No-Glare Headlights

Many automobile accidents each year are caused by glaring headlights. The engineers of the great General Electric Company have devised a new non-glare headlight for automobile use. The photo at the right shows Mr. W. D'Arcy Ryan, well-known illumination engineer, demonstrating these new headlights. The photo below shows how the beam is thrown down to the ground, while the side illumination lights up signs as well as pedestrians very clearly.

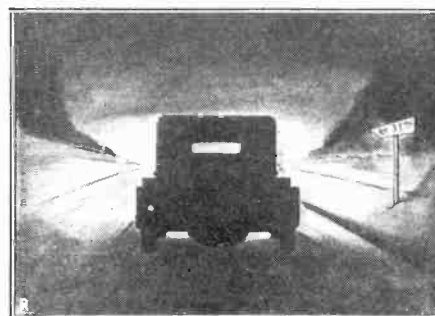
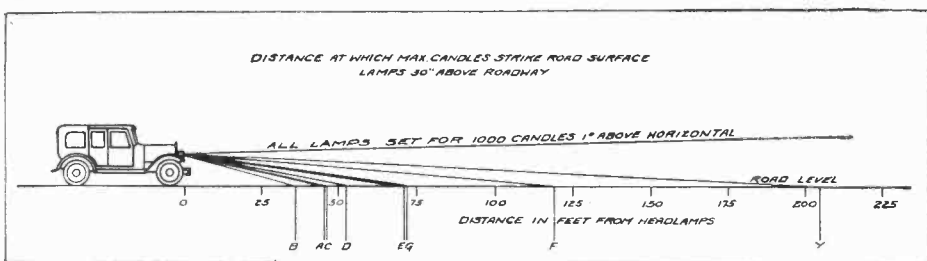
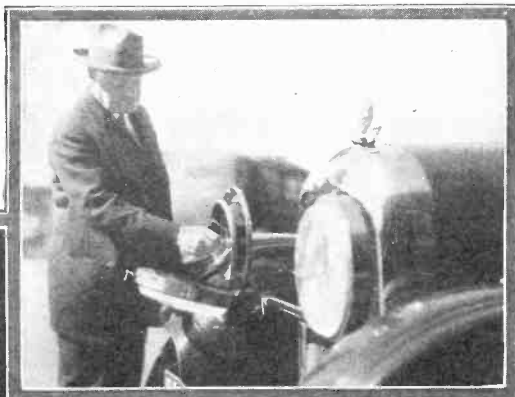

Besides the wide side-illumination enabling pedestrians and signs to be seen readily, the chassis and front wheels are also illuminated.

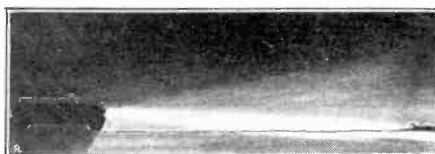

In the laboratory tests of the new headlight there was absolutely no glare observable, unless one placed their head on the floor at the 100 ft. mark.

The diagram above shows the distance at which the maximum candle-power of the new no-glare headlights strikes the road surface, with the lamps mounted thirty inches above the roadway. It is practically impossible for the driver of an approaching vehicle to be blinded by the beam from these headlights, while the side illumination obtained is remarkable.

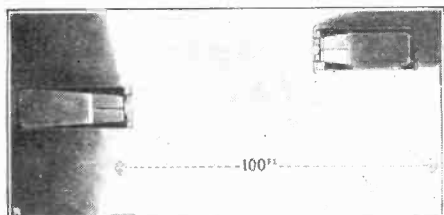

In actual tests persons standing 3 feet back of the light and 5 feet to either side, could be seen by persons 100 feet in front.

THE present no-glare headlight projects a double crescent from but one incandescent bulb in the lamp. Two important features of this new lamp are the non-focusing element and the beam adjusting element. By the first, lamps can be changed without focusing, and in states where they permit either 21 or 32 candle-power lamps, the fixed adjustment feature is all that is required. Have some one take about 100 paces in advance, while the depressing screw is given a few turns until the observer sees no glare.

Radio Television at Last?

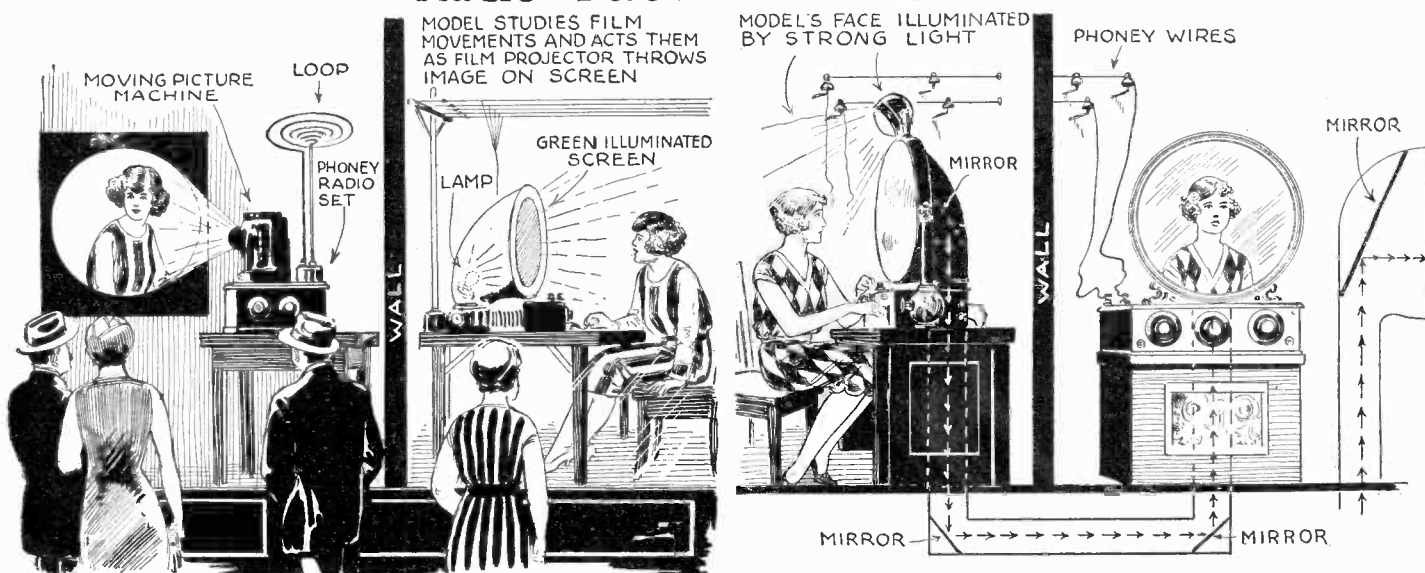

Radio or wire television is the goal toward which scientists all over the world are striving. The pictures above illustrate a show window attraction which will demonstrate television in an interesting manner. The picture at left shows "phony" radio apparatus and a small movie projector, the model

at right studying and going through the actions thrown on screen at left. In the scheme shown at right the model's image is projected by mirrors through a hidden pipe on to a screen covering the opening at the end of the pipe, as the illustration shows.—E. Wolf.

American Chemist Discovers New Element

By C. F. SCHURCH, B. Sc., M. Sc.

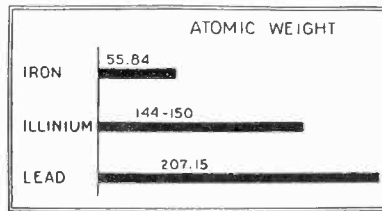
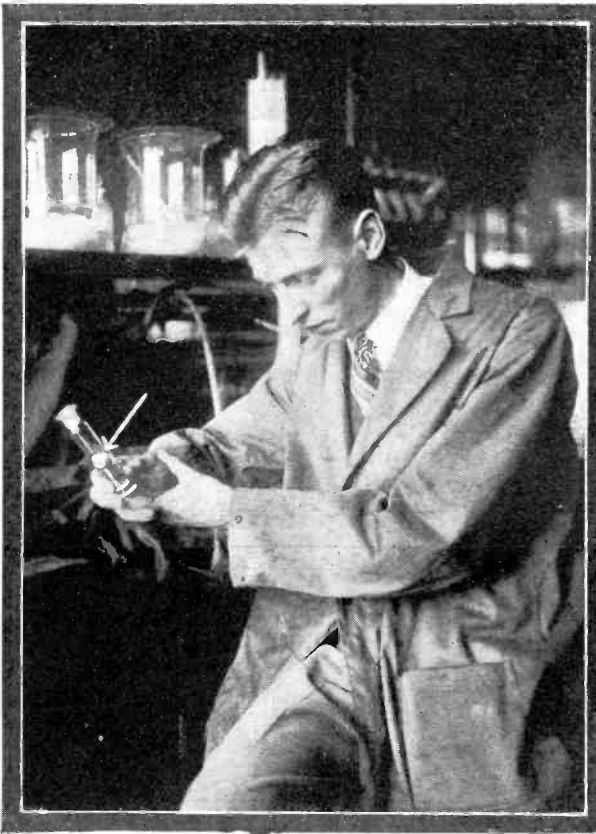
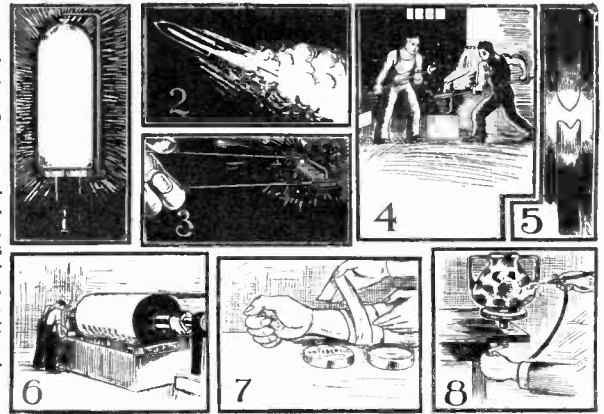

Diagram above shows position of new element "Illinium" in scale of atomic weights.

At left: expert holding tube containing all available "Illinium" in the world at the present time.

Probable uses of illinium: 1, in Welsbach gas mantles; 2, tracer bullet; 3, gas lighter; 4, purifier for iron and aluminum; 5, improved arc lamp; 6, mordant in dyeing fabrics; 7, antiseptic; 8, for coloring porcelain.



THE discovery of *illinium* at the University of Illinois marks the first American contribution to the list of chemical elements, of which ninety have thus far been discovered. The value of the discovery cannot be reckoned now, but the important thing is that a new material has been placed in the hands of the scientist and that whatever valuable properties it may possess now can be studied to see if it can be put to use.

All matter in this universe of ours is made up of 92 chemical elements—possibly more. In 1914 a young British scientist, Moseley, showed that all the known elements can be arranged in a sort of chemical ladder, from hydrogen, the lightest element, as the first rung, to uranium, the heaviest, at the very top, as shown in the table herewith. The position of each element in this ladder is determined by the wave-lengths which it transmits under the action of X-rays. Each element has a characteristic X-ray spectrum.

But in the ladder of known elements which was constructed according to Moseley's Law there were six gaps—six missing rungs. Numbering from hydrogen these occupied the positions 43, 61, 72, 75, 85 and 87.

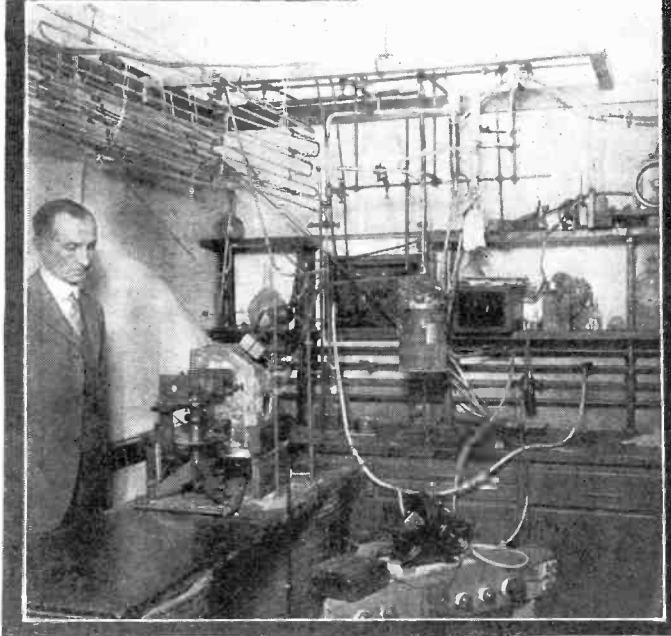

X-ray and other apparatus in laboratory where illinium was first produced.

dicted from the spectra of the neighboring elements. With this knowledge to guide them scientists in several parts of the world undertook the examination of various materials with the X-ray spectrograph for evidence of these missing elements.

In 1923 element number 72 was isolated by two Danish scientists, who named it hafnium after the ancient name for Copenhagen. A year ago Dr. Noddack of Berlin announced the discovery of numbers 43 and 75, which he named masurium and rhenium respectively. With the discovery of illinium, number 61, only two elements remain unknown—unless we consider the possibility of finding others below hydrogen or above uranium in the ladder.

The new element was found in monazite

sands, the mineral from which the oxides for Welsbach gas mantles are procured. These sands are very rich in a number of elements that are known as the rare earth elements, and it is to this group that illinium belongs. Several of these elements are really rare, but the manufacture of millions of gas mantles each year from the rare earth oxides, ceria and thoria, has caused the accumulation of great heaps of residues rich in

these elements. Four hundred pounds of these residues were concentrated and purified to give half an ounce of the new element, illinium.

Nothing is known as yet of the properties of the new element but it is assumed to resemble in some degree its nearest neighbors in the atomic series, neodymium, number 60, and samarium, number 62. Compounds of neodymium impart beautiful colors to porcelain, and are used for such widely different purposes as the manufacture of blue optical glass and the preparation of antiseptic dressings.

ORDER OF THE ELEMENTS IN THE CHEMICAL LADDER:

Name Atomic Number	Name Atomic Number
1. Hydrogen	48. Cadmium
2. Helium	49. Indium
3. Lithium	50. Tin
4. Beryllium	51. Antimony
5. Boron	52. Tellurium
6. Carbon	53. Iodine
7. Nitrogen	54. Xenon
8. Oxygen	55. Caesium
9. Fluorine	56. Barium
10. Neon	57. Lanthanum
11. Sodium	58. Cerium
12. Magnesium	59. Praseodymium
13. Aluminium	60. Neodymium
14. Silicon	61. Illinium (the new element) 1926
15. Phosphorus	62. Samarium
16. Sulphur	63. Europium
17. Chlorine	64. Gadolinium
18. Argon	65. Terbium
19. Potassium	66. Holmium
20. Calcium	67. Dysprosium
21. Scandium	68. Erbium
22. Titanium	69. Thulium
23. Vanadium	70. Ytterbium
24. Chromium	71. Lutecium
25. Manganese	72. Hafnium (1923)
26. Iron	73. Tantalum
27. Cobalt	74. Tungsten
28. Nickel	75. Rhenium (1925)
29. Copper	76. Osmium
30. Zinc	77. Iridium
31. Gallium	78. Platinum
32. Germanium	79. Gold
33. Arsenic	80. Mercury
34. Selenium	81. Thallium
35. Bromine	82. Lead
36. Krypton	83. Bismuth
37. Rubidium	84. Polonium
38. Strontium	85. (missing)
39. Yttrium	86. Niton
40. Zirconium	87. (missing)
41. Columbium	88. Radium
42. Molybdenum	89. Actinium
43. Masurium (1925)	90. Thorium
44. Ruthenium	91. Uranium X
45. Rhodium	92. Uranium
46. Palladium	
47. Silver	

Our Spiritualistic Investigations

By "DUNNINGER"

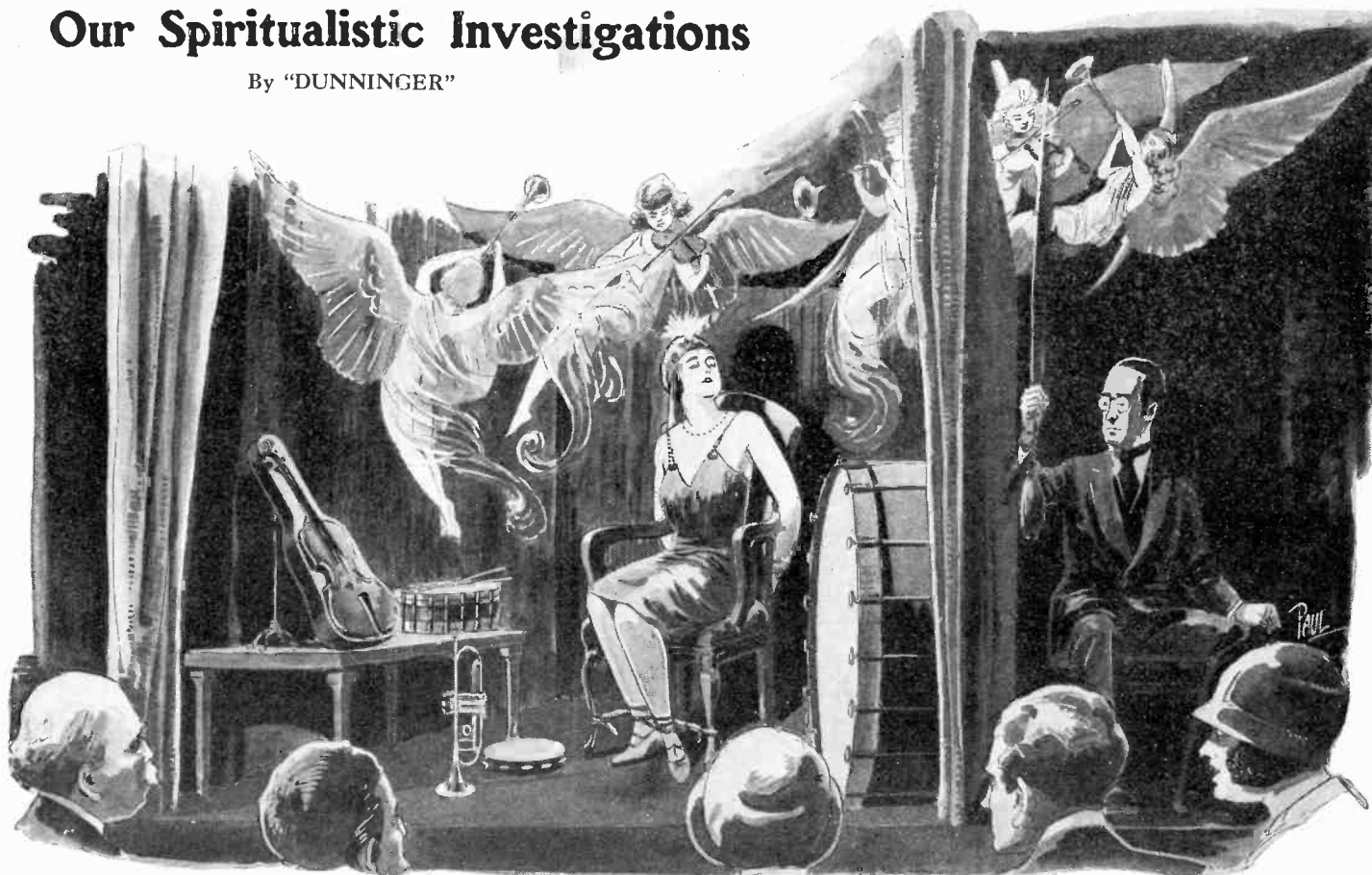

"An assistant pulled the curtain aside quickly. The medium was seated in a chair apparently still in a trance. The curtains were again closed and several sharp notes were blown on the clarinet . . . And on the air floating from the top of the cabinet came the sweetest bit of violin playing I have ever had the pleasure of hearing. And from a violin without a bow." The secret of the effect is explained in the article.

INVESTIGATING the so-called *spiritualistic phenomena* accredited to mediums, has for many years been a hobby with me. It is an interesting hobby and an enjoyable one, too. At times what has been written to me by investigators in this country and abroad has made me laugh and then again has made me think. These trained men, who are well acquainted with the tricks employed by magicians, are too wise to be fooled easily. The layman attends a séance and naturally, if the medium has a good showman, he or she well satisfies the onlooker and the dupe tells his friends and the medium shortly has money flowing into his or her pockets.

In this series of articles, I am going to describe a number of séances I have attended in various parts of the country. I will also explain the methods employed by these fakers of modern times.

During a recent visit to Boston where I was playing, a friend of mine telephoned "the Lorraine," where I was stopping, and said he had found a medium in a nearby hotel and had arranged for a special sitting or séance, after my show. He explained that the medium was informed that a party of friends would call on her after they had attended the theatre.

With the applause of my audience still ringing in my ears, I went to meet my friend. We took a party of six beside ourselves. Piling them into my car, off we went to the next block. This was done in case any of the spotters of the medium happened to be watching through the windows of their hotel so that no suspicion would be aroused as each one would step from the car and silently, as becomes such occasions, file into the hotel.

Entering the lobby one of the gentlemen of our party was asked by a man with a slight foreign accent if we were the people

\$21,000.00 for Spirits

More than two years ago **SCIENCE AND INVENTION** Magazine offered a prize of \$11,000.00 to anyone who could demonstrate his or her ability to communicate with the spirits or to give some definite form of a psychical demonstration which in itself was not trickery.

The result has been that mediums and spiritual organizations have been afraid to place proofs before us. Those weak attempts which have been made to demonstrate psychical phenomena were almost instantly proven fraudulent, and no medium has dared to contradict our findings.

In view of these facts, should we not consider all mediums fraudulent? Should we not consider every psychical manifestation as being trickery pure and simple, intended primarily to fleece those who visit the circle and who find solace in the words from the worst forms of charlatans, namely those who are being permitted to practise upon the poor, seeking words from loved ones?

To the \$10,000.00 which has been offered by Joseph F. Rinn through this publication for Spiritual proofs and the \$1,000.00 in addition offered by **SCIENCE AND INVENTION** Magazine, we now add another \$10,000.00.

Dunninger, who writes exclusively for **SCIENCE AND INVENTION** Magazine and who is the Chairman of our **PSYCHICAL INVESTIGATION** Committee will personally pay \$10,000.00 to any medium or spiritualist who can present any psychical manifestation in so-called spiritualism, that he will not explain or that he cannot reproduce by natural means.

So now we have a total of \$21,000.00 offered for proofs of Psychical Manifestations. Spiritualists—get busy.

Madame Vesta was expecting. He said we were. We all stepped into an elevator and were taken to a floor . . . the nearest to heaven any medium will ever get.

Ushered by the medium's secretary, or whatever mediums call their faithful, into one of the regular suites of the hotel, we were asked if the ladies would care to remove their wraps. It was a bit chilly for a summer evening.

"Ha, ha!" thought I, "Same old stuff. Get at our pockets and get our names and the rest of the usual stuff." But I was mistaken.

This séance was one quite a bit different.

We were now led into a larger room. Taking a quick glance around, I saw the usual floors, walls and ceiling, eight or ten chairs and at the opposite side of the room a large cabinet with curtains tossed back over the top. The cabinet was made of nickel plated uprights and top pieces and the covering was a sort of black satin. There was no air of mystery about the place. A small hotel chair was in the center of the cabinet of mystery and on either side of this were arranged a number of musical instruments which one sees in orchestras every day. There was a saxophone, a cornet, clarinet, bass drum, trap- or snare-drum, a large bell and a violin lying in its case with the cover open. I looked for the bow, but from where we were, I could see none. This was odd. Who ever heard of a violin without a bow?

My friends seated themselves and I carefully looked around to see if there was anything in or about the room that would suggest at all the slightest bit of trickery. But there wasn't a thing. I strained my eyes to look back of the cabinet, but could see nothing and there isn't the slightest doubt in my mind that had there been a trap, no matter how carefully camouflaged, I would have seen it.

(Continued on page 370)

The Home Scientific

Ironing Board in Closet Door

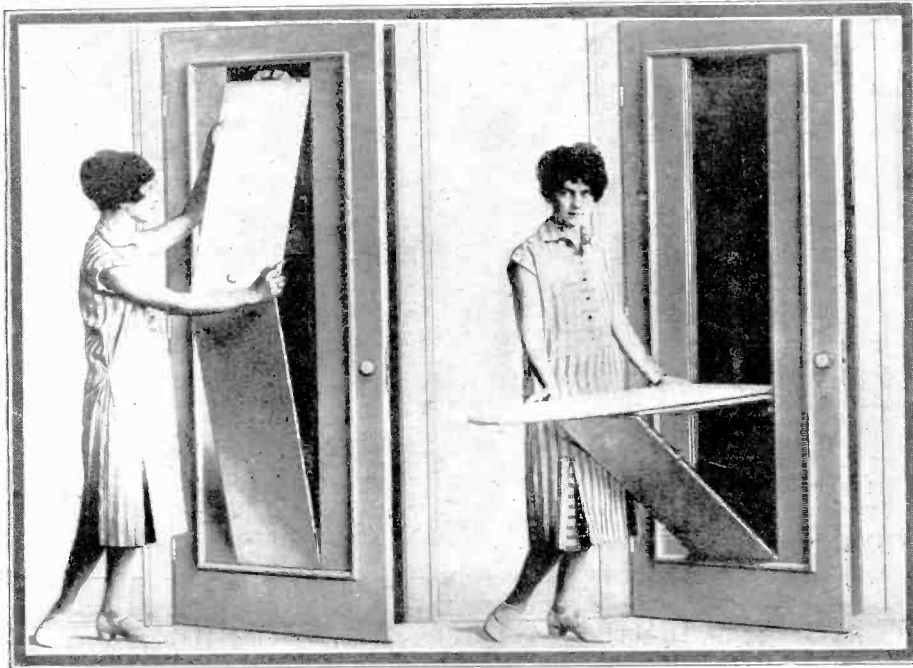

Instead of placing the ironing board in the wall, this new layout may be fitted to any closet door. Photos show two views of the arrangement.

Electric Lighter

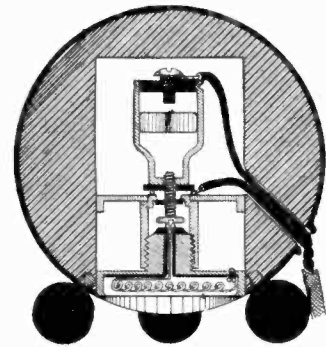
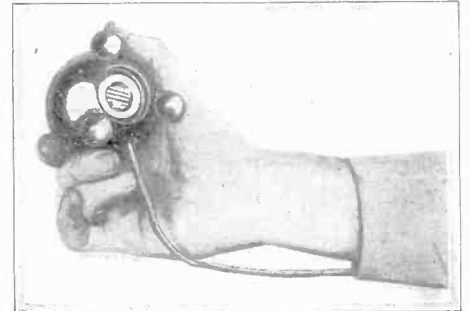

This electric cigar lighter turns on automatically when inverted. A small weight slides down, making contact with a screw. The

jams.
Courtesy
Aldredge
Company

Socket Converter



Any kind of a socket can be converted into a pull chain socket by screwing the adapter here shown into it. The advantages of the pull chain can thus be obtained without the need of re-wiring the fixture.
Courtesy
Bryant

Cut Out

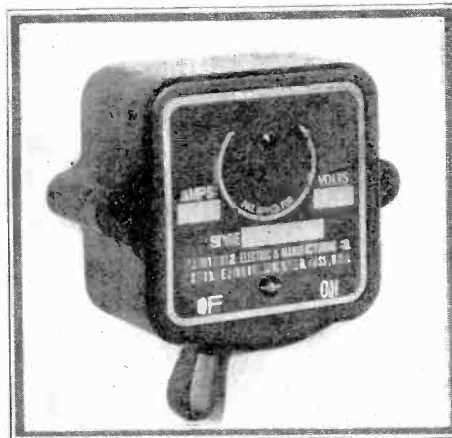

This is an automatic cut out for washing machines, and motors, and turns off current on overload.
Courtesy Westinghouse.

Permanent Waver

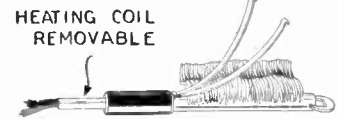

HEATING COIL
REMOVABLE

It is possible for every one to permanently wave their own hair with this system.

Hair is curled on a small nickel-plated tube, which being cold permits of its facile handling. The heating coil is then inserted and current turned on.—
Courtesy Permway.

Water Faucet Egg Beater



A small water motor in the top of this beater rotates the beating blades, making it possible to whip cream, mix drinks or make dressings. The device is simply attached to the kitchen faucet. No water can get into the whipping compartment.—Allen P. Child.

Addresses of any of the above manufacturers will be sent on inquiry. Mention article, issue and page of device that interests you.

AWARDS IN \$5,000.00 MATCHCRAFT CONTEST

Locomotive Wins First Prize. Clare H. Myers of Detroit, Michigan Wins This Month's \$100.00 Award

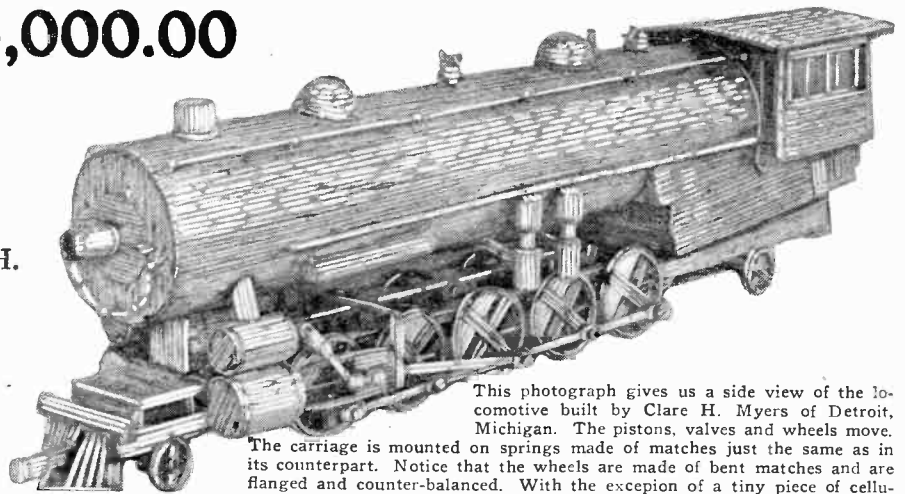

This photograph gives us a side view of the locomotive built by Clare H. Myers of Detroit, Michigan. The pistons, valves and wheels move. The carriage is mounted on springs made of matches just the same as in its counterpart. Notice that the wheels are made of bent matches and are flanged and counter-balanced. With the exception of a tiny piece of celluloid located in the headlight, nothing but matches and glue entered into the construction of this model.

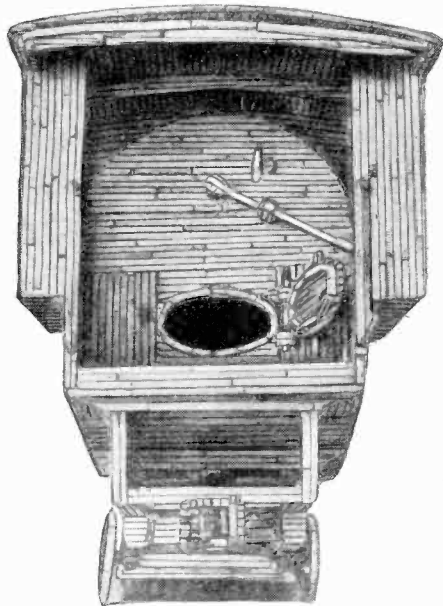

The above photograph shows the back of the prize-winning locomotive and particularly illustrates the hinge construction on the door of the fire box. At the bottom of the photograph, midway between the two wheels an automatic coupler, also made of matches can be seen. Brake and throttle are operated from within the cab.

THE locomotive which won the first prize in this month's Matchcraft Contest is 27 inches long and 7 $\frac{3}{4}$ inches high. Approximately 5,000 matches were used. The boiler is made by gluing one single layer of wood to perfectly circular rib constructions found within the boiler. These were made first and were then mounted upon a trussed skeleton frame-work. The boiler was then built up around the frame-work and after having been completed was carefully sanded. The steam domes were constructed of matches by nicking them between the

finger nails and in this way making them assume the proper shapes for this spherical dome construction. The carriage of the locomotive presented the greatest difficulty, inasmuch as the builder tried to get as nearly accurate results as could be obtained with matches. The wheels of the forward truck are pivotally mounted and those immediately under the cab are similarly affixed. An interesting and ingenious feature is the automatic coupler with which this particular locomotive is fitted.

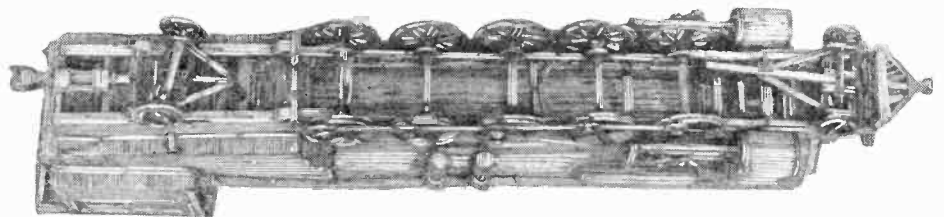

THIS photograph gives us a view of the frame of the locomotive looking up from the bottom. Note the spring hanger and

the equalizing bars. The truck wheels have been purposely turned to the limit of their lateral movement.

\$5,000.00 Prize "Matchcraft" Contest

WATCH FOR PRIZES IN SEPTEMBER ISSUE

FOR the present year, SCIENCE AND INVENTION magazine will award a total of \$5,000 in prizes, in a new contest. You are asked to make models, fashioning the same entirely from safety matches. Please observe the following simple rules:

- (1) Models submitted must contain at least 90 per cent. safety matches in their construction.
- (2) Models made of toothpicks, paper matches, or non-safety matches, are not eligible in this contest.
- (3) Models can not be built around boxes or other supporting articles. Walls, roofs, etc., must all be self-supporting and made of matches.
- (4) All liquid adhesives, such as glue, shellac, cements, etc., are permissible.
- (5) Models may be painted, gilded or silvered.
- (6) Models may be of any size.
- (7) In order to win a prize, it is necessary that either models be submitted, or, if this is not practical, owing to their size, a 5"x7" photograph of the model may be sent in lieu

of the model itself. The best models submitted each month will be awarded the prizes scheduled herewith.

16 Monthly Prizes	
First Prize	\$100.00
Second Prize	75.00
Third Prize	50.00
Fourth Prize	35.00
Fifth Prize	25.00
Sixth Prize	20.00
Seventh Prize	15.00
Eighth Prize	12.50
9th to 16th Prizes of \$10.00 each	\$80.00

(8) All models submitted to SCIENCE AND INVENTION Magazine will be promptly returned to the builder, who will prepay all charges.

(9) Where SCIENCE AND INVENTION has any doubts as to the model (where photos only are submitted) complying with all the regulations, the judges may, at their discretion, request that the actual model be sent in for inspection, paying transportation charges both ways.

(10) This is a monthly contest, lasting for twelve months, each monthly contest closing on the first of the month following date of issue. Thus the contest for the month of August will close September 1, 1926, and prize winning announcements will be made in the November, 1926, issue. The September issue will contain June prize winning entries.

(11) Models must be shipped in a strong wooden box, never in a cardboard box, as SCIENCE AND INVENTION can not be held responsible for breakage in transit due to models having been improperly packed.

(12) When models are sent, be sure to affix tag, giving your name and address, to the model itself. In addition, put name and address on outside wrapper of package.

(13) Address all letters, packages, etc., to Editor, "Matchcraft" Contest, care SCIENCE AND INVENTION Magazine, 53 Park Place, New York.

Caution—Soak or cut heads from matches before building your model so that the models may be expressed or mailed. The strike-everywhere square cut Liberty matches can be used if the heads are cut off.

This contest started Dec. 1, 1925, and will terminate Dec. 1, 1926.

REMEMBER— This is a monthly contest offering sixteen prizes every month. Don't hesitate, send in your model now!

MATCHCRAFT AWARDS

(Matchcraft Contest Now International)

Model From Japan—The Gate of a Japanese Temple Wins Second Prize of \$75.00.

Model of House and Dome From South Africa Wins Third Prize of \$50.00.

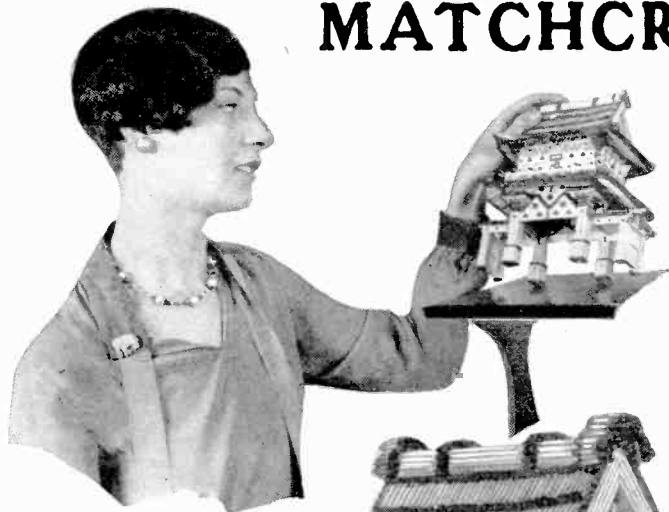

SECOND PRIZE—\$75.00 is awarded this month to S. Fuwa of Tokyo, Japan, for his model of a gate of a Japanese Temple illustrated above and to the right. Japanese safety matches are thinner and shorter than the American matches. Consequently, the model appears much more trim and unique. More than 5000 matches were used to make this model, which is 8 1/4 inches high, 8 1/2 inches long and 6 inches wide in its greatest dimensions. Photo posed by Miss Dorothy A. McGarity.

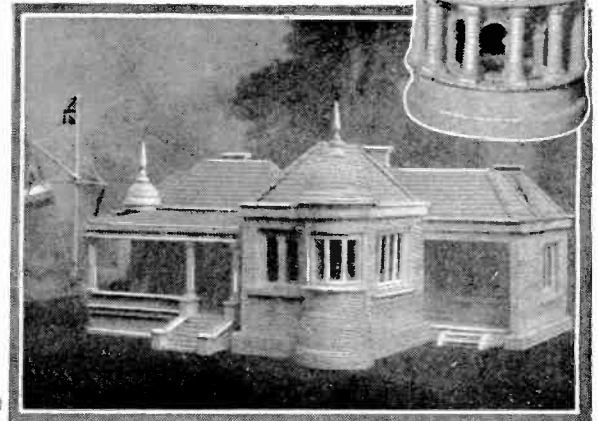
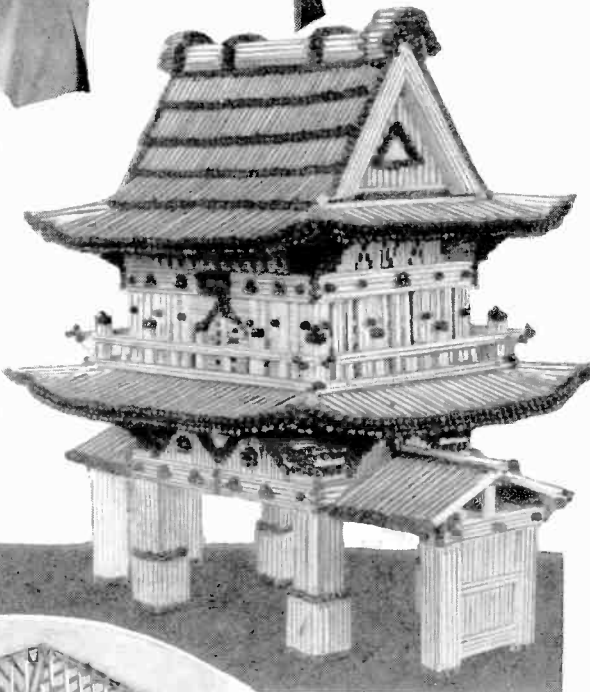

THIRD PRIZE—\$50.00 is awarded to A. R. Power, of Johannesburg, Transvaal, South Africa, for the constructions illustrated above. The matches were cut 1/4 of an inch long, in order to produce the brick-like construction. Domes were built upon lead-covered rubber balls later removed.



The above photograph gives us another view of the Temple Gate which won the Second Prize in this month's Contest. Note use of match heads.

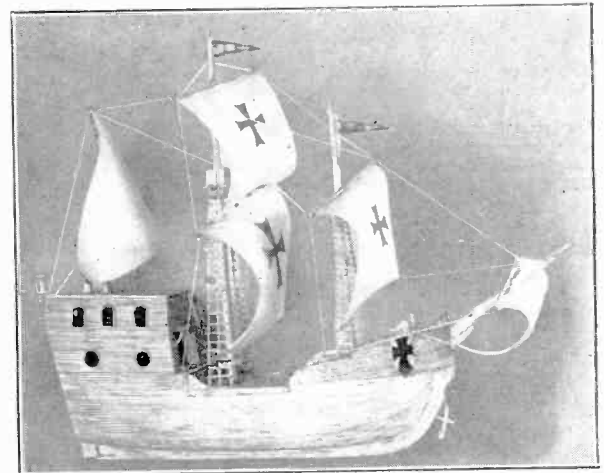
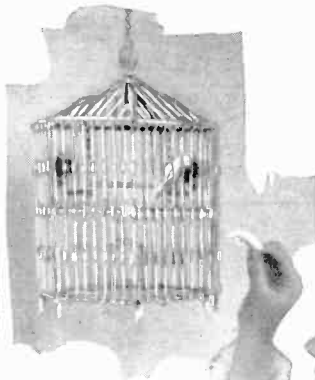

THE FOURTH PRIZE—\$35.00 was awarded to Joe Janssen of Chicago, Illinois, for his model of a ship. This model weighs nine ounces. Three-quarters of an ounce is the weight of the sails and rigging. Only 4,150 matches were used in the construction. The construction is hollow inside and each of the matches was cut with a razor blade at an angle of 45 degrees and then glued to its neighbor, giving the appearance of thin, strip planking. The ladders were built of split matches. The entire model was carefully sandpapered giving it a glass-like finish. The workmanship is excellent.

THE FIFTH PRIZE—\$25.00 is awarded to John Wagner, Sr., of Leonia, N. J., for his very fine example of the Matchcrafter's art illustrated in the photo above and to the right. This bird cage was built entirely of matches, the heads of which had been removed. The perch and chain swing were likewise constructed of the same material. Notice that the bottom of the cage hinges on a match hinge. The food cups are illustrated in the foreground. Photo at the right posed by Miss Margaret Corcoran.

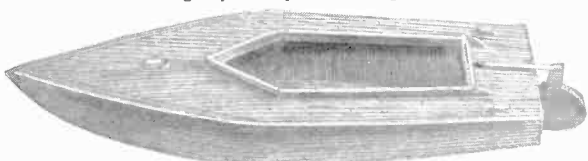
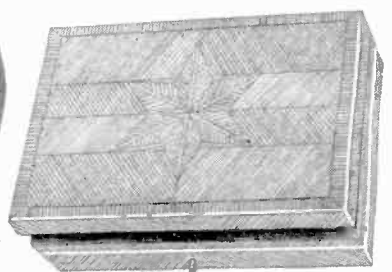

EIGHTH PRIZE—\$12.50. A young lad, Sam Uhl of Richmond Hill, N. Y., was awarded the Eighth Prize for his model of a Motor Boat. Mr. Uhl took great care in laying up the matches.

SIXTH PRIZE—\$20.00 was awarded in this month's Contest to Andrew J. Jurau of Pittsburgh, Pa., for the inlaid Jewelry Box.

More Matchcraft Winners

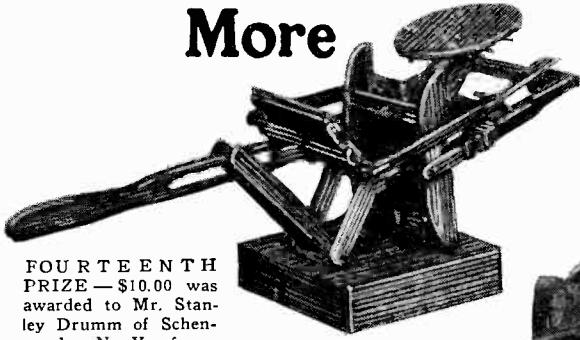

FOURTEENTH PRIZE—\$10.00 was awarded to Mr. Stanley Drumm of Schenectady, N. Y., for a working model of a printing press, illustrated in this photograph. The ink table and rollers move realistically. Model is eleven inches long over all.

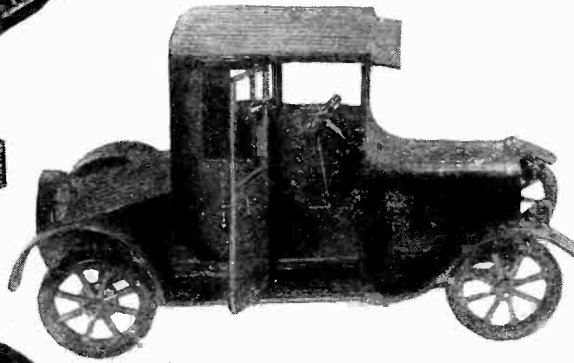

ELEVENTH PRIZE—\$10.00 was awarded to the Ford Coupe made by John Ciesielski of Antigo, Wisconsin. The model was shellacked.



SIXTEENTH PRIZE—\$10.00 was won by Miss Dorothy Mosher of Springfield Gardens, L. I., for the Lawn Swing depicted in the photograph at the right.



NINTH PRIZE—\$10.00 was awarded to Mr. Leo A. Wall of New York City for his model, Cape Hatteras Lighthouse. The model is eighteen inches high and the spiral band running up the side is formed of match heads.

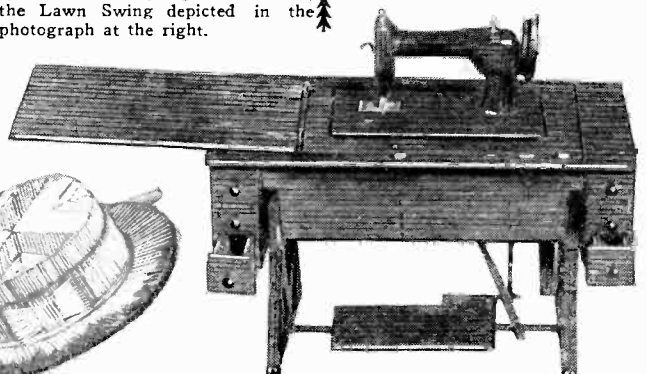

FIFTEENTH PRIZE—\$10.00 was the award decided upon by the judges for the Sewing Machine made by H. Conklin of Jersey City, N. J. When the head is dropped the machine measures 4 3/4 inches long and 3 1/4 inches high.

CAUTION—We have repeatedly instructed Matchcrafters to cut the heads from their Matchcraft models and our rules specify that safety matches must be used. This beautiful model came near causing a costly fire. "Strike Everywhere" matches were employed from which the heads had not been removed, with the result that although the model came from San Diego, California, the inevitable fire occurred in a Jersey City Transfer Station.

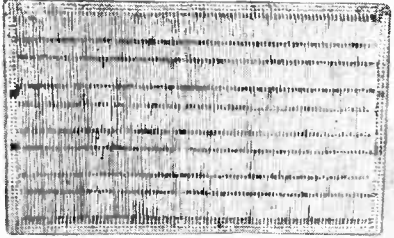

SEVENTH PRIZE—\$15.00. It took six weeks to complete the serving tray, 18" long and 14" wide, with 6,550 matches. Bottom view above. Made by G. Richards, Rochester, N. H.

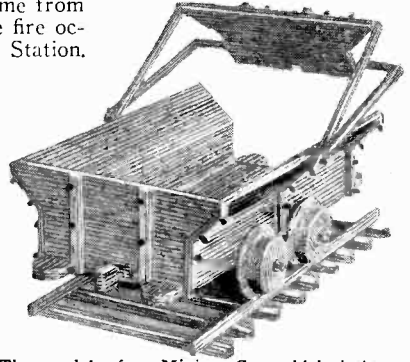
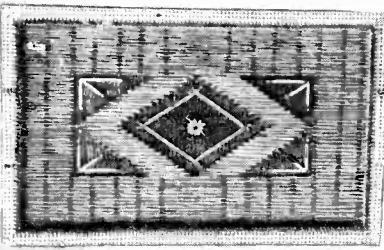

TWELFTH PRIZE—\$10.00. The model of a Mining Car which is used to send coal to the top of the mine is faithfully reproduced here. There is a nail on the door to hold the check number of the man who loads the car. The model holds a surprising amount of really heavy material, and no wonder it was awarded a prize when you consider that H. E. Match, of Hubbard, Ohio, made it.

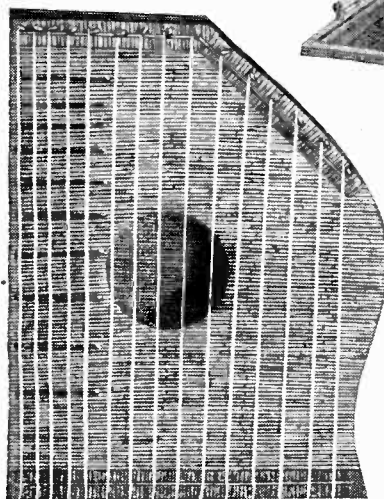

TENTH PRIZE—One can secure some tuneful music from the instrument depicted in the photograph at the left. The only difficulty is that it will not stay in tune long due, perhaps, to the fact that the screw eyes, used as tuning keys, slip in the soft match wood. The model was built by John Zeleznick of Bridgeport, Ohio.

THIRTEENTH PRIZE—\$10.00. The model of a Canadian-Pacific Railway Bridge, illustrated above, was made by R. L. Gillespie of Brooklyn, N. Y. The representation is quite an accurate replica.

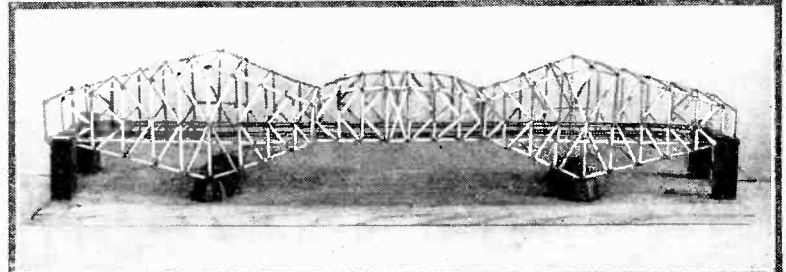

The Month's Scientific News Illustrated

By GEORGE WALL



Indianapolis maintains a watch tower on top of a skyscraper. Here three veteran firemen, working in shifts, scan the skyline for the first wisp of smoke. As many as three hundred fires are sighted from this tower annually.

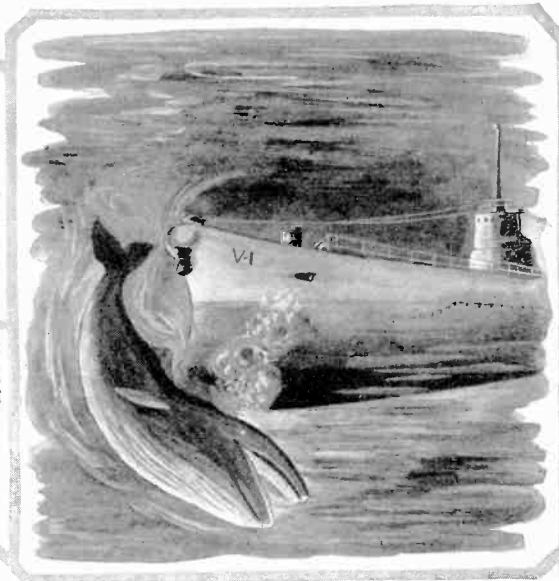

The U. S. submarine V-1 broke the back of a whale into which it crashed while running submerged off Cape Cod. The submarine submerged off Long Point and as she was coming to the surface a strange jar was felt by the crew. When the surface was reached a whale fifty-eight feet long was found bent about the bow of the V-1. The whale was towed into Provincetown, and later sunk at sea.

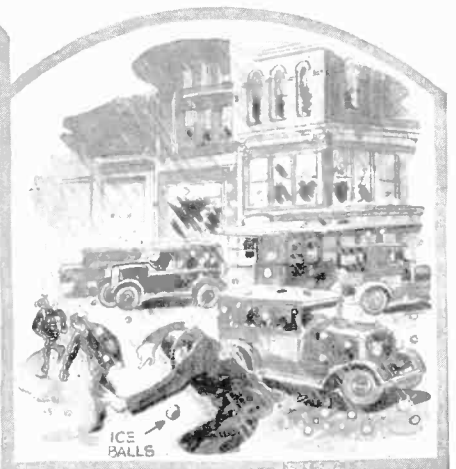

A hail storm damaged property to the extent of approximately \$1,000,000 at Dallas, Texas. Thirty persons were injured although none seriously and plate glass was broken and automobile tops perforated. The barrage lasted ten minutes and the stones were two inches in diameter.

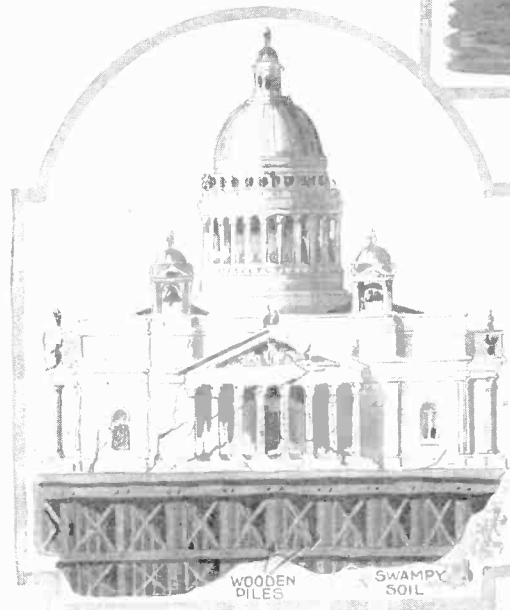

The report has just come from Leningrad that serious fissures have developed in the great granite monolithic columns of the Cathedral of St. Isaac, which is the largest and finest church in Russia. This Cathedral cost \$15,000,000 to build and it was erected on submerged wooden piles as are most of the buildings in Russia. Repairs and shoring which have progressed for fifty years were stopped after the Bolshevist revolution.

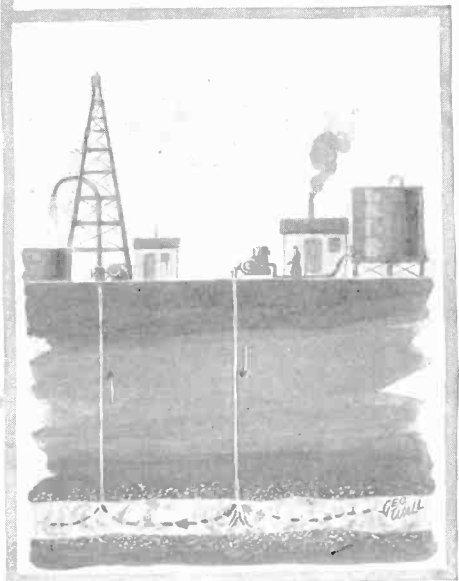

It is estimated that between twelve billion to thirty-two billion gallons of oil will be recovered from exhausted oil-sands by new recovery methods, using artificial pressure of compressed air, gas and water.



The laboratory of the General Electric Company at Schenectady has just announced a method of egg preservation which consists of immersing eggs in an oil bath maintained at a temperature of 235 deg. Fahrenheit. The oil is said to fill the pores in the egg shells and prevent air from entering the shells. The machine is electrically equipped and accommodates 360,000 eggs per day.

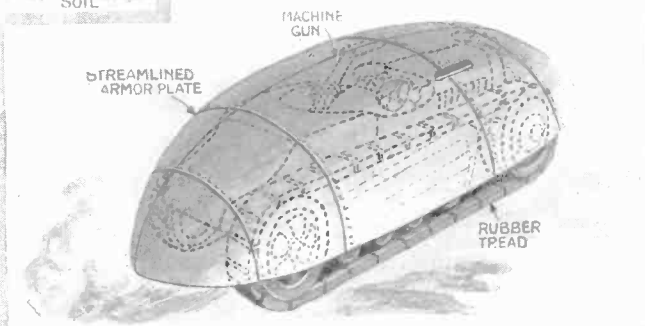

An apparatus for searching the employees of metal working establishments when they are leaving the premises has recently been devised. This consists of a testing disc containing a pair of coils. A distinct sound is heard in the headphones when the disc passes over metal. The method is undoubtedly similar to a Hughes Balance.

A small one-man tank has been devised in England by Major Martel. It is built of auto parts and runs on rubber treads which absorb machine gun bullets and prevent the danger of jams so prevalent in metal treads, which kink and distort.

A strange accident happened at Labonne, near Lausanne, Switzerland, when a sheep dog ran down to the river for a drink and was electrocuted. Examiners touching the dog were also shocked. Current had to be turned off at a nearby factory to stop the leak.



The proprietor of the factory is to be sued for the loss of a dog strangely electrocuted.



MAGIC "DUNNINGER"



THE MAN WHO MYSTIFIED
 Pres. Coolidge
 Prince of Wales, Ex-President
 Harding, Taft, Roosevelt,
 and other celebrities
 Writes Exclusively for
SCIENCE AND INVENTION



NO. 41 OF A SERIES

New Pipe Trick

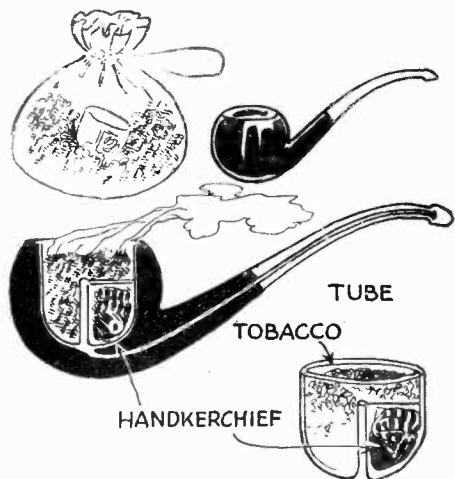

From a seemingly unprepared pipe which is smoked by the performer, a colored handkerchief is removed.

Tricks with seemingly unprepared articles always are the most mystifying. In this one the wizard passes his pipe for inspection and fills the same with tobacco from his pouch. He lights the pipe and puffs away. A small silk handkerchief is now vanished by any of the popular methods and is immediately reproduced out of the bowl of the pipe. This silk of course is a duplicate of the one originally disappeared and is contained within a cup previously concealed in the tobacco pouch and introduced into the mouth of the pipe during the innocent action of filling the same.

Jumping Peg Pencil

This trick differs from the usual and impractical method (in which the pencil could not be passed for inspection) inasmuch as the holes in the present offering actually penetrate the wood. The end of the pencil which is examined, however, is secreted in a brass sliding pencil cap of the ordinary type. This action brings to view the holes of the pencil constructed as indicated in our diagram which holes are primarily responsible for the effectiveness of the trick. Notice that the two end holes are only bored half way through the pencil.

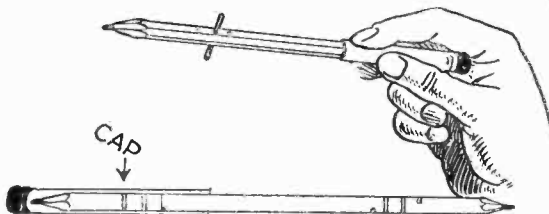

In the jumping peg pencil illustrated above care should be taken in drilling the holes properly. The cap should also fit this pencil tightly so that it will not be removed during cursory examination.

Placing the peg in the center hole on one side of the pencil makes the other side of the peg appear to be in the end hole. In presenting the trick both sides of the pencil are seemingly shown, but during the waiting movement the pencil is twisted between the fingers showing the same side again. To make the peg jump the pencil is not twisted under cover of one of these movements. The peg is now again shifted to the end hole, making it appear in the center hole on the opposite side.

Rubber Band Palm

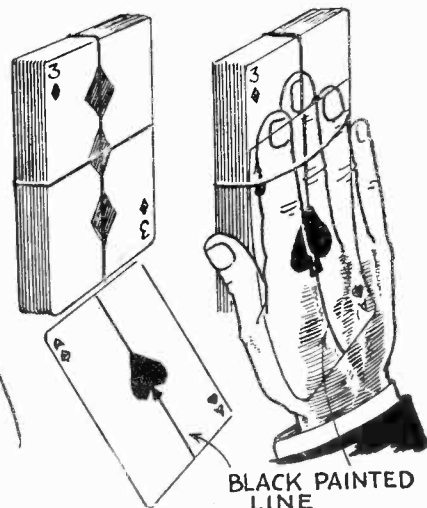

At first glance the above trick will appear very ineffective, yet it is actually an interesting stunt.

After the magician has been changing cards by any of the well known sleight of hand methods, he places a rubber band crosswise around the entire deck, thereby "preventing the possibility of card palming," yet in passing his hand over the surface of the card, its suit mysteriously changes. The effect is accomplished by painting a black line longitudinally down the faces of two or more cards, producing the illusion of a rubber band being strapped across the face in two directions. When the cards are passed for examination, those on top which are marked are palmed off from beneath the band.

The Patriotic Liquids

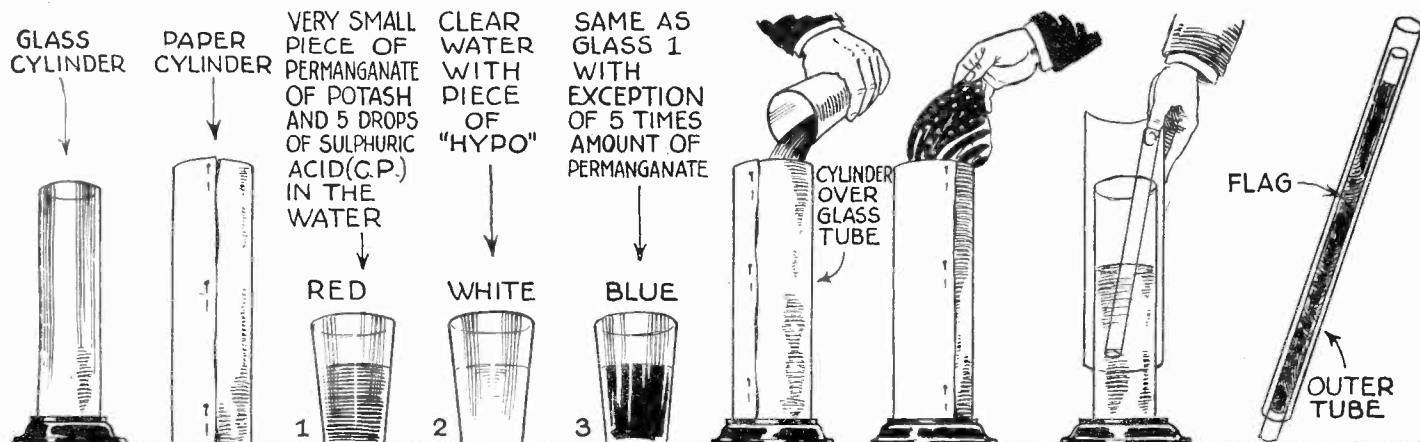

A transparent glass cylinder is covered by an opaque paper cylinder and red, white and blue liquids from three glasses are poured into the cylinder. The contents are stirred and on removing the rod an American flag is taken from the cylinder and the solutions become transparent. Formulae for

making these solutions are given in the diagram which also shows that the stirring rod really consists of two tubes the outer one being first removed and the inner one being extracted at the time the paper cylinder is lifted. The flag is concealed in the stirring rod.

Tarrano the Conqueror

FOURTEENTH INSTALLMENT (Conclusion)

By RAY CUMMINGS



A luminous blur became visible in the nearer sky—moving blobs of silver luminosity in the mud-brown light of the Zed-ray. A hundred or more moving silver blobs. They were taking form. The silvery phosphorescent look faded, became grey-white. Took definite shape. Waving arms and legs!

Bones bereft of flesh. Human skeletons! Limbs waving rhythmically. Bony arms, with fingers clutching metal weapons. Assaultants coming at us through the air, stripped by the Zed-ray of cloth, skin, flesh, organs, to the naked bones.

SYNOPSIS

IN the spring of the year 2325, all of the rulers of the various countries of the earth are mysteriously murdered. Jac and Grayson, employees of a large news organization, find that the murders are the result of a plot on the part of the inhabitants of Venus. Tarrano, an erstwhile lower official of the Cold Country of Venus is found to be at the head of a plot to rule the universe.

Dr. Brende, a friend of Jac's, has discovered a medical method whereby human beings may be kept from growing old. The Doctor is killed by a group of "Venus-Men" and Jac, Elza, the Doctor's daughter and Georg, the Doctor's son, are captured and taken to Venia, a city on the earth inhabited by people of Venus.

The next day, Tarrano offers to return the papers and models of the invention made by Georg's father, which he has confiscated and brands young Brende as an impostor. To offset this accusation, Georg is to tell his story to the earth as well as to Venus and Mars by radio and helio. He and Princess Maida go to the station but there they disappear.

Jac, Wolfgar and Elza, still captives, are removed from their prison and taken to the top of an enormous tower. Here, in the instrument room, where communication with the various planets is held, they view the disappearance of the Princess Maida and Georg by television. The abduction has been done by Tarrano's agents. On Mars, Tarrano's followers are attacking the ruling class and Tarrano offers Dr. Brende's secret to the public if they will surrender to his cohorts. They agree. Tarrano then announces to the Earth people, that he will not give them the Brende secret and declares war upon them. Wolfgar is a guard in disrepute.

The air war vessels of the Earth government start to attack Venia, but Tarrano sends up a bomb of surrender and then, with Elza, Jac and Wolfgar, he escapes through an underground passageway to a

space-flyer. They go on board and are taken to Venus to where Georg and the Princess Maida have previously been transported. They are royally welcomed and go to the palace of the Princess Maida. Here they are attacked by Argo, one of Tarrano's men, who shoots a violet-colored beam of light across the room, separating Maida from the rest of the party. He threatens to kill her, when suddenly Wolfgar throws himself into and through the violet beam.

Wolfgar dies soon after he confesses to Maida that he loves her and Maida has made a similar declaration.

The evening after the burial of Wolfgar, Jac chances to be alone in a small boat near the palace and he is warned by a "slaan," a Venus man, to guard himself well. He also sees below the surface of the water and encased in a diver's cap, the face of an Earth man. Later that evening, preparations are rushed through for the great Water Carnival of Venus and to it proceed Georg and Maida; Elza and Tarrano; and Jac without a partner.

At the carnival all of the inhabitants of the planet are seemingly given over to the pursuit of pleasure and love. However, there is a vicious undercurrent of events noticeable to Jac but which does not seem to claim the attention of Tarrano. At one place there is a swimming pool in which girls are constantly sporting themselves. Watching them, Jac sees one of them drag a Tarrano guard to the edge and with him grasped in her arms, plunge into the pool. A few seconds later the girl comes to the surface but the man is never seen again.

Toward the climax of the celebration, a notorious Venus character, the Red Woman, performs a dance particularly for the benefit of Tarrano. In the midst of it, the large hall in which it is being held, suddenly is darkened and rays of death shoot out over the place. Jac, forewarned, drops to the floor out of their range and throughout the entire assembly, "slaans" in the employ of Princess Maida wreak havoc with their long

knives. The cry goes up, "Down with Tarrano. Loyalty, everyone, to your Princess Maida." The Venus people, followers of Maida, have revolted; the Red Woman is dead, but Tarrano—?

Tarrano escapes. Taking Elza with him he travels via aircraft to the Cold Country.

Back at Maida's palace, the tide has been turned against the "slaans." Maida and Georg are married and rule a section of Venus. Jac suddenly receives a telepathic message from Elza who warns him of danger and rushing to the top of one of the buildings they behold a huge black cloud rolling toward the city. Elza's message to Jac says:

"Death, Jac! Death to all the city! The black cloud of death!"

Tarrano showed the man-side of his nature at last when he invaded Lady Elza's sleeping room. Lady Elza was greatly surprised to wake up suddenly and to behold Tarrano. He made passionate love to her against her will, and finally after being repulsed, Tarrano turned ironical and bade her rise from her bed and get dressed at once, as they were going on a trip. Tarrano, accompanied by Elza, flew to the outskirts of the Great City, where Jac Hallen, Maida and Georg were, and here he attempted to destroy the inhabitants by causing a heavy black poisonous smoke to envelope the city. Those in the city are awakened in time and flee; Jac wanders through the forest and finally discovers Elza who has escaped from Tarrano.

Jac Hallen killed a hideous animal which threatened to annihilate Elza. Elza declares her love to Jac. Two days later they are rescued by the Rhaal Patrol and taken to Industriana. Here everything was hustle and bustle, armies being trained for an attack on Tarrano. The guiding spirit of the military activities in Industriana is Geno-Rhaalton. The last scene in the previous installment shows the warriors in their flying craft departing for the attack on Tarrano's stronghold.

CHAPTER XXXIII

The First Attack

OUR spies had informed us that of recent weeks there had arisen about the City of Ice a huge wall behind which Tarrano would make his stand. It was our plan to approach within

range of this and establish our power plant as a base from which to direct our offensive. The trip from the Great City was not long. After a few helans our girls ceased flying individually and boarded their appointed vehicles.

In a long single line, armament platforms, the towers, our instrument room, with the

power plant bringing up the rear, we sailed forward. There were in our instrument vehicle, Maida, Georg, Elza and myself, the vehicle manned by two pilots and two mechanics—a Slaan, a Marsman, and two Earthmen. We were in constant communication with Geno-Rhaalton. And though he enjoined upon us all the necessity for sleep-

ing or resting during the trip, himself sat alert at his desk, unrelaxing. The little mirror on our table showed him sitting there, smoking his arant-cylinders, watching every move we made.

We laid down to rest, but sleep was impossible. Through the panelled transparent floor, I watched the country changing as we advanced; vegetation dwindling; the soil changing to rocky barrenness at the border of the Cold Country. And then the snow-plains, the mute frozen rivers of ice, the mountains.

In the twilight of the Cold Country autumn, we sailed up to the mountains and approached the City of Ice. Alert, all of us now, as at an altitude of a few thousand feet we circled about, marking time until the power plant had selected its base and landed.

Throughout the trip we had expected—had anticipated the possibility—of a surprise attack by Tarrano; an ambush in the open air, perhaps by some means strange to us. But the vision magnifiers, the microphones—encompassing every known range of sight and sound—showed us nothing. Especially at the mountains we had thought to meet opposition. But at first none came. It seemed somehow ominous, this lack of action from Tarrano; and when the leader of our line—a tower vehicle—rose sharply to scale the jagged peaks of the Divide, the flare of a hostile electronic bomb rising came almost as a relief. From the instrument room—forewarned an instant by the hiss of our microphones—I saw the bomb start upward. Slowly as a rocket it mounted—a blurred ball of glowing violet light, quite plain in the dim twilight. I knew that the tower platform at which it was directed would have time to throw out its insulation; I knew that the insulation would doubtless be effective—yet my heart leaped nevertheless. At my hand was a projector; but in those few seconds the tower just in advance of us in the line was quicker. Its ray darted at the violet ball; the soundless explosion threw a wave of sparks about the menaced tower. Like a puff—a pricked bubble of soap-film—the violet ball was dissipated. But I saw the

menaced tower rock a trifle from the shock. Geno-Rhaalton's face in the mirror beside me was very solemn. I heard him murmuring something to the other towers, saw their light flash downward, searching the mountain defiles. And as I watched that little image of Rhaalton, I chanced to notice a mirror on Rhaalton's desk. Rhaalton himself was looking at it—a mirror which had been dark, but which now flashed on. An outlaw circuit! The mirror imaged the face of Tarrano. Tarrano grinning ironically!

CHAPTER XXXVII
Invisible Assailants

We did not locate the source of the bomb, and no others rose to assail us. The mountain defiles, so far as our lights could illumine them, seemed deserted. We passed over

If you have enjoyed "Tarrano the Conqueror," which concludes in this issue, you cannot miss the next tale, which the editors have selected for you.

the Divide, and on the plateau beyond, we landed. A region of rolling country beneath its snow and ice. The mountains came down sharply to the inner plain—a crescent of mountain range stretching off into the dimness of distance, half encircling this white plateau in the center of which stood the City of Ice. We could just see it at the horizon, the glittering spires of its Ice Palace.

Around the city, completely enveloping it, was a thick circular wall of ice twenty times the height of a man. We were too far away to see it plainly—a turreted wall doubtless armed with projectors throughout its circular length. Our finders would not show it, for it was insulated against them. It stood there grey-white, bleak and apparently deserted.

Georg said: "It's the man's accursed inactivity! Is he going to do nothing? . . ."

Our power plant has landed, Jac—there in the foothills—see it drop?" A call from Rhaalton took his attention.

We landed our entire force in the foothills of the mountains. The power plant was there; it looked like a squat industrial building set upon a ledge of ice—a shining cliff-face behind it, a precipice in front. At the foot of the precipice our other vehicles were clustered.

We were there throughout three entire times of sleep, hours strangely the same in that unaltering polar twilight. During them, with the tower platforms set in a ring about us to make an armed camp, we unloaded our apparatus, erected our power controls, prepared the individual circuits, making ready for our offensive. And still—though we were alert for it—no move from Tarrano.

They were hours during which, with my lack of technical knowledge, I found myself often with nothing to do. Our camp was bustling with activity, but among the now idle girls and many of the young men, there was an air of gayety. They laughed, shouted, played games amid the rocks from which we had long since melted the snow. Once, in what would have been early evening had not the Sun in these latitudes held level like a burned-out ball near the horizon, Elza and I wandered from the camp to climb the cliffs nearby.

Beyond the circle of the camp's heat, the deadly cold of the region assailed us. We had not wished to equip with the individual heating, which for battle would leave us free of heavy garments; in stead we swathed ourselves in furs, with the exercise of climbing to aid us in keeping warm.

It was wonderful to be again alone with Elza. Even with what was impending we were young enough to put it momentarily from our minds. Like young lovers clandestinely stealing away to a tryst, we left the camp and hand in hand, climbed up amid the crags. A few hundred feet to one side of the power house, and about the same distance above it, we sat down at last to rest.

The scene from here was picturesque in the extreme. Across the flat, shadowless
(Continued on page 356)



Then Tarrano played his last card. The cubical building of metal with the cables depending from it, still hung motionless. It now burst into sound. A low electrical hum; then louder to a whine—a scream. Our men and girls were in the air around it. I too was there. Tarrano's men—the re-

maining few who were desperately fighting—had suddenly withdrawn. And then we knew the purpose of this hanging room. A strange form of some tremendous electro-magnet. I could feel it pulling at me. My power to guide myself in the air was wavering.

Scientific Problems and Puzzles

By ERNEST K. CHAPIN

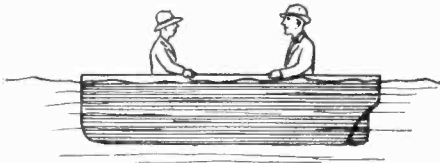

We have all heard the story of three men in a boat; this is a story of two men in a boat.

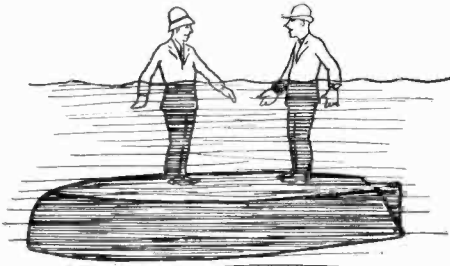

The two men in a light metal boat just sink it to the water's surface. If the boat should become inverted, without filling with water, is there any possibility that it could support the men in the manner indicated in the picture above?

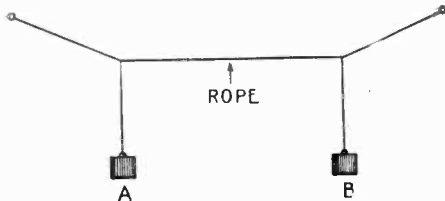

Weights A and B are supported at equal distances from a slack rope. If A is set swinging back and forth, will it set B moving? If so, will B ever swing as vigorously as A? The size of the weights A and B is immaterial.

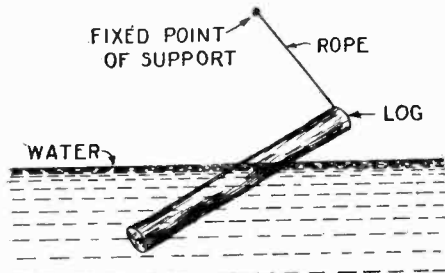

Here is an interesting experiment just in time for the summer campers to cogitate upon. Mr. Chapin propounds the problem as follows: Could a log secured by a single rope and resting in the water, be supported indefinitely in the manner indicated in the diagram?

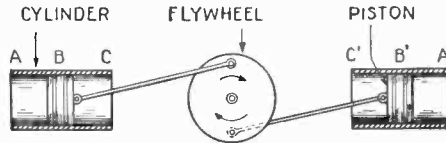

The heavy fly-wheel W operates pistons A and B in two cylinders that are open at both ends. Does the fly-wheel lose any energy in starting and stopping the pistons, at the beginning and end of each stroke? If the friction of the bearings and cylinders were zero, would the fly-wheel, if spun, be able to keep the pistons moving indefinitely?

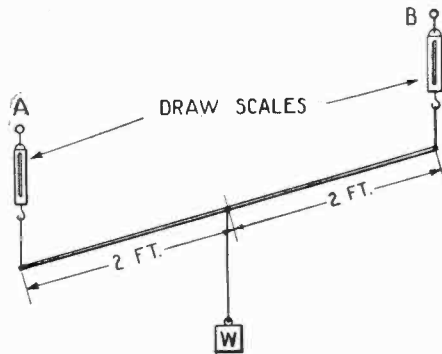

The uniform bar carrying a load W at its center is supported from the ends at an angle to the horizontal by two scales. If the supporting cords are vertical which scale, if either, will show the greater reading?



Scientists from time to time have threatened to shake the earth with electric charges or else atomic disintegrations. Here's a new one: If all the trains of the earth were heavily loaded and then moved eastward at full speed, would it have any effect whatever on the length of the day? Would the effect, if any, be temporary or permanent? Is there any way in which the people of the earth could permanently lengthen or shorten the day?

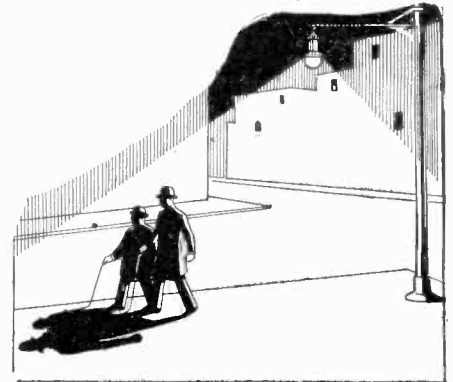

Two men about town have just turned a corner and are in the beam of a street lamp. The two men are of different heights and the question is, will their shadows increase in length at the same rate? Also will the rate of increase be the same at all distances?

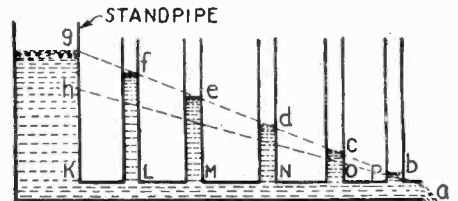

Here is an interesting problem in hydrostatics. With water running freely from the open end of the tube at "A", would the water levels in the various tubes lie along a straight line such as a-g?

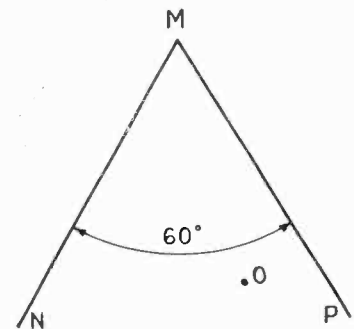

Here is an interesting problem in multiple images. Two mirrors, MN and MP are set at an angle of sixty degrees. An observer at E will see how many images of an object at O reflected in the mirror? How will they be distributed? (Answers to these problems appear on page 373.)

Rowing Movement Operates Propeller

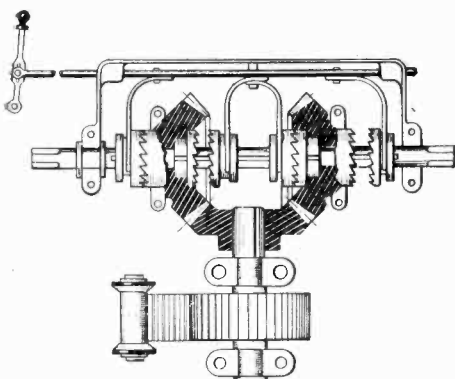

Above is a diagrammatic view of gears and clutch mechanisms of the device at the right.

Operating the two small handle bars back and forth moves a rack which engages with a gear and causes another gear in the housing to rotate back and forth. By a peculiar construction of toothed clutches both backward and forward movements are utilized for rotating the propeller. The fly wheel causes the propeller to continue its spinning even when the ends of the stroke have been reached. A reverse lever is provided to permit the boat to be driven toward the rear. Model built by Manuel C. Sanchez.

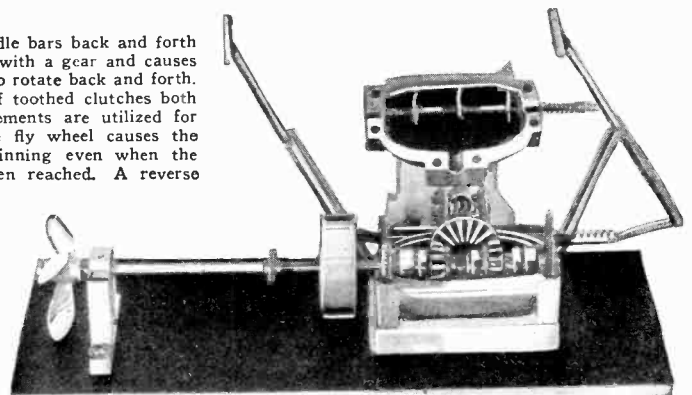

How to Build a Day-Bed

By WILLIAM M. BUTTERFIELD

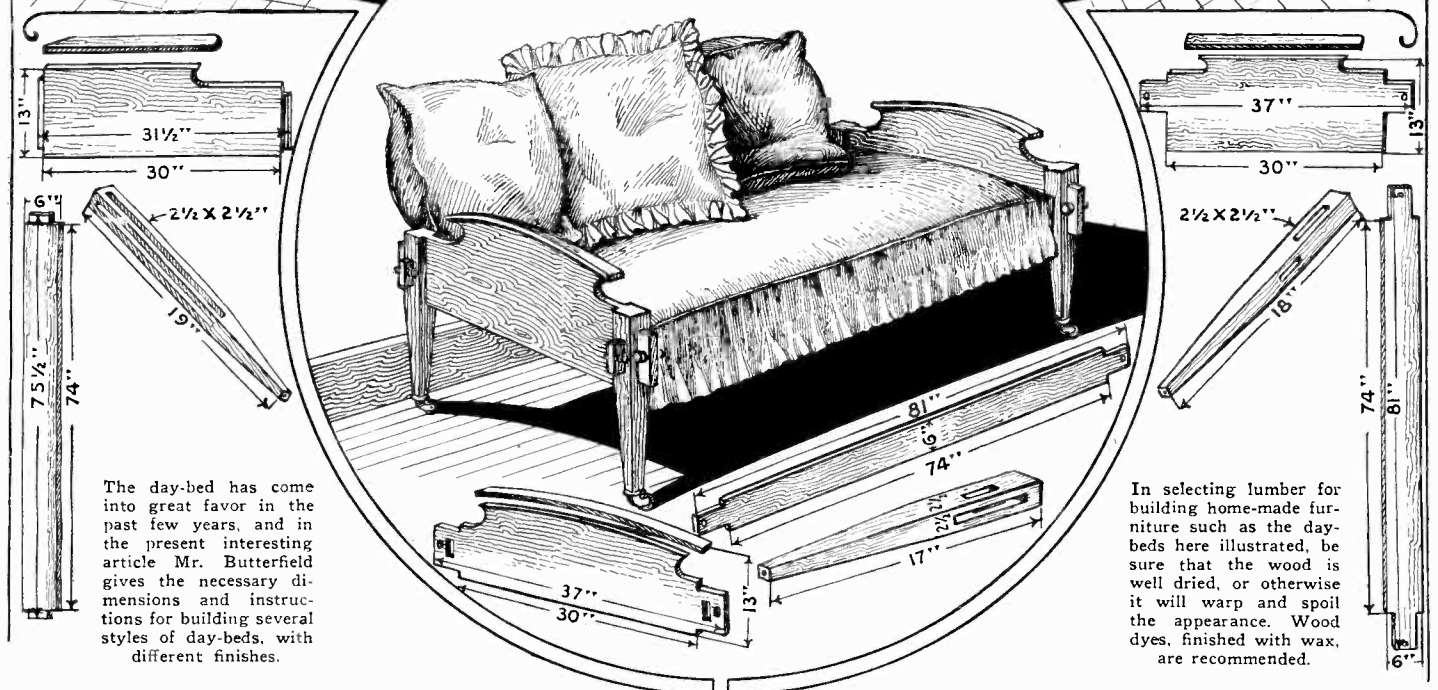
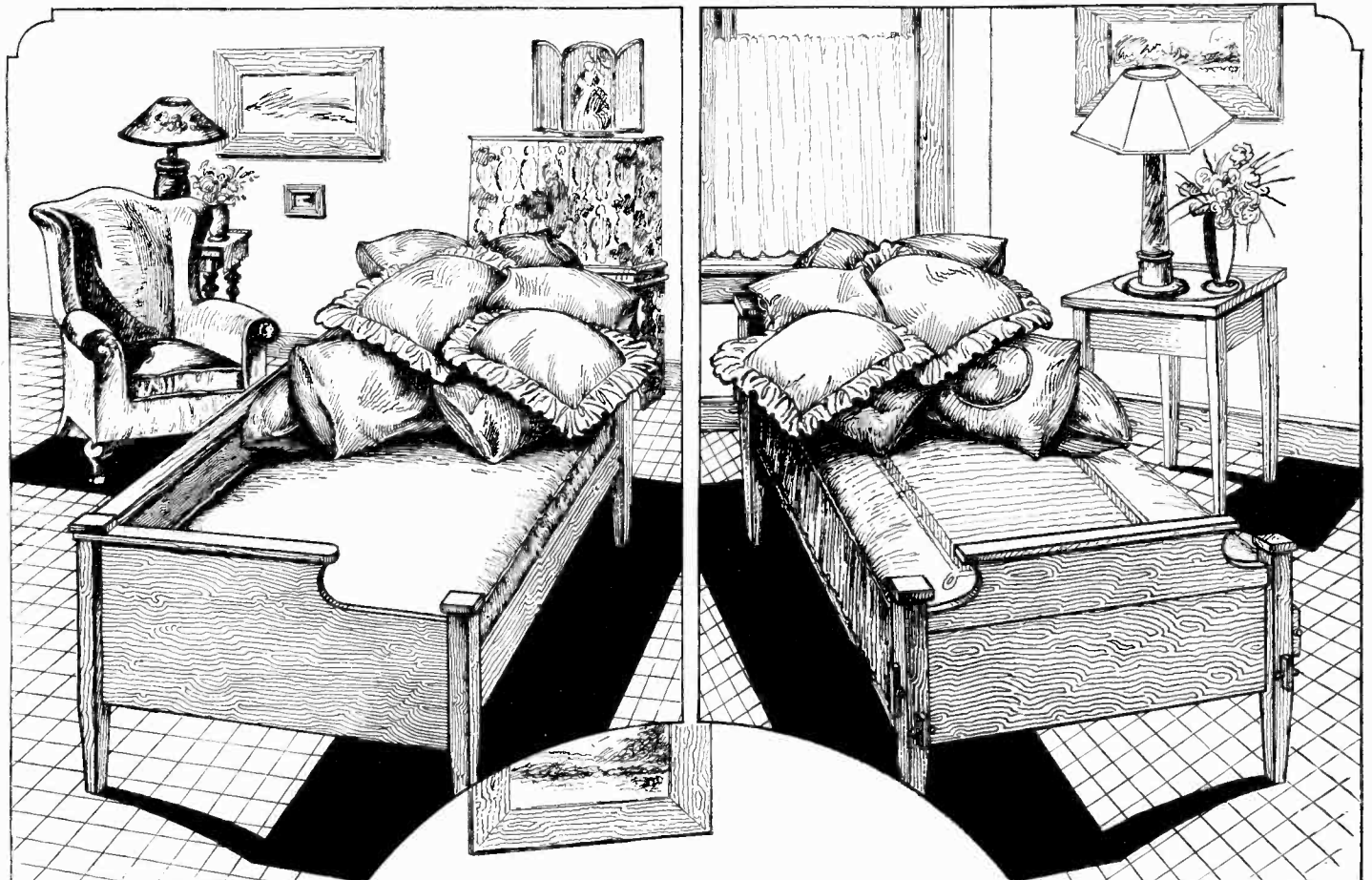

The day-bed has come into great favor in the past few years, and in the present interesting article Mr. Butterfield gives the necessary dimensions and instructions for building several styles of day-beds, with different finishes.

In selecting lumber for building home-made furniture such as the day-beds here illustrated, be sure that the wood is well dried, or otherwise it will warp and spoil the appearance. Wood dyes, finished with wax, are recommended.

THREE designs for a day-bed are shown on this page. They all have an inside measurement of 30" x 74". The first design is 35" x 79" over all and 20 1/2" high without castors, the second and third are 37" x 81" from end to end of tenons and 19 3/4" high. Mortise and tenon joints, either with or without glue, are used in all three designs. Where glue is used, as in the first of the three, the tenons are the width of the stock (3 1/4") and 3/4" deep, they are glued into mortises of similar size. When used with-

out glue the mortises extend clear through the corner pieces and the tenons extend 1" beyond and are secured with slightly tapered wooden pins. The first design is for a wide (13") back rail or one full width of the end boards. This rail carries at each end a tenon 3 1/4" wide, 3/4" deep and 11" long—these engage mortises in the back corner pieces of the same proportions. The front rail is 6" wide, 3/4" thick, and the same length as the back rail (75 1/2"). It also has tenons at each end, these are 3 1/4"

wide, 3/4" deep and 5" long—they engage mortises in the front corner pieces. The end boards are 31 1/2" long, 13" wide and 3/4" thick, they carry tenons 3/4" wide, 3/4" deep, 11" long at the back and 9" long at the front—these engage mortises in back and front corner pieces. The corner pieces are 2 1/2" square with 6" legs tapered to 1 1/2" at bottom end, the back corner piece is 19" long, the front piece 17" long. For any of the three beds it will be necessary to screw 1" x 2" cleats, with slots to hold slats, to the
(Continued on page 381)



MODEL DEPARTMENT

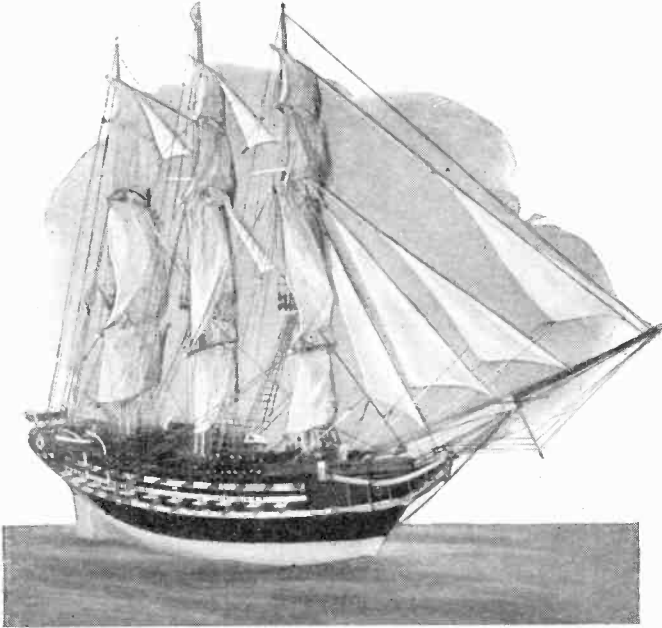

Model of U. S. Frigate "Constitution" WINS Science & Invention Trophy Cup No. 4

The Louis Daniel Entry Is This Month's Best

Mr. Louis Daniel of New York City entered two models in this month's Cup Contest. The first was a model of the "Flying Cloud," a clipper ship, photographs of which, due to a lack of space, we were forced to omit from this issue. His model which won the cup is shown in the photographs and the drawings on this and the accompanying pages.

The above photograph shows a three-quarter view of the model of the "Constitution". It will be noted from the photograph that the drawings are not identical with the construction shown above. The reason of this is that the data concerning the "Constitution" varies considerably and our drawings were corrected in accordance with official records and are as nearly accurate as we have been able to obtain them.

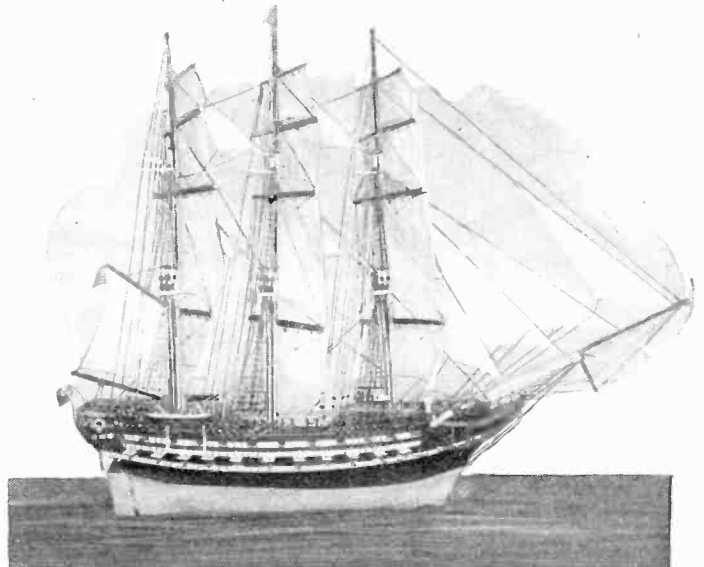

The photograph above gives us a side view of the "Constitution," which is this month's Cup winner. It will be noted in all of these photographs that the water line on the frigate is considerably higher than the water line washed in by our artist. The explanation of this is quite obvious, this method being resorted to in order to show more clearly the hull details, the rudder and other points of interest which the model maker may require.

?
 ?
 ?
WHO
 ?
 ?
Will Win the Next
 ?
Trophy Cup?
 ?
Why Isn't Your Model Entered?
 ?
 ?

Rules for Model Contest

- A handsome trophy cup engraved with your name, will be awarded as the prize for the best model submitted during the month. The decision of the judges will be final and will be based upon, A—novelty of construction; B—workmanship; C—operating efficiency of the model as related to the efficiency of the device which the model simulates, and D—the care exercised in design and in submitting to us sketches and other details covering the model.
- Models of all kinds may be entered. They may be working models or not, according to the subject that is being handled.
- Models may be made of any available material, preferably something that is cheap and easily obtainable. Models made of matches should not be submitted to this department but should go to our Matchcraft Contest Editor.
- Models must be submitted in all cases. Good photographs are also highly desirable and where the maker does not desire the model to be taken apart, legible drawings with all dimensions covering parts that are not accessible must be submitted.
- Models should be securely crated and protected against damage in shipment and sent to us by parcel post, express or freight, prepaid. Models will be returned when requested.
- Models for entry in any particular contest must reach this office on or before the 25th of the third month preceding date of publication. For instance, models for the October contest must reach us on or before the 25th of July.
- Address all entries to Editor Model Department, c/o Science and Invention Magazine, 53 Park Place, New York City.

According to official records from the "Old Ironsides" Committee and official Navy Department records, the "Constitution" did not have a forecastle and a poop deck, so in order to be more accurate those building this model may omit these decks. On the gun deck the "Constitution" carried thirty long 24 pounders. Then there were two long 24 pounders in the eyes of the ship. On the spar deck there were 22 thirty-two pound caronades distributed 8 forward and 14 aft. The ship itself was rated as a 44 gun frigate though she carried 54 guns.



The model itself is 5½ feet long and 4½ feet high and the photograph shows Mr. Daniel making final adjustments in the rigging and sails. Photographs of his other entry will be published next month if space permits.

A Cup Is Awarded Every Month. Are You Next?

Model "Constitution"



Above is a photographic reproduction of the Cup that was awarded to Mr. Louis Daniel, the winner of this month's Contest. The Cup itself is 17½ inches high and weighs nearly five pounds. Is it not worth striving for?

Data concerning the U. S. Frigate "Constitution," later nicknamed "Old Ironsides," is difficult to obtain. The old prints of this ship show different arrangements of guns and sails. This vessel, under command of Captain Isaac Hull, passed out to sea on the 12th of July, 1812, and on the 17th of July Captain Hull met four ships and later a fifth, the "H. M. S. Guerriere." At this time there was almost a dead calm and Captain Hull, knowing he would be outnumbered with ships and guns, sent his men ahead with a kedge anchor and a mile of rope. By dropping the anchor and hauling on the rope the men gradually drew the "Constitution" ahead and out of danger. A month later on August 19th, he met with the "Guerriere" and so badly damaged that vessel that she had to be set on fire. "Old Ironsides" appearance and the sail plan underwent many changes and the drawings of the vessel as given here are very accurate.

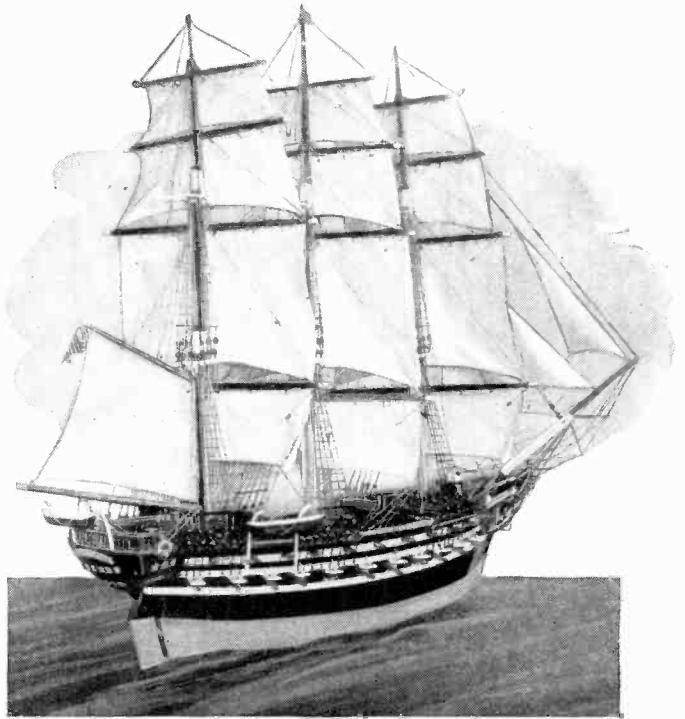

Above is a photograph of the prize-winning entry in this month's Cup Contest. According to official documents, the first figure-head on the "Constitution" was that of Hercules, which was probably intended for a representation of Neptune. This was knocked to pieces in the battle with the "Guerriere" and owing to shortness of time a scroll was substituted. In 1843 a full length figure of Andrew Jackson was substituted, but a party of political fanatics sawed Jackson's head off in Boston Harbor. Originally, the "Constitution" carried no sky-sail, as the photo above indicates, but because of a desire for greater speed a sky-sail was later adopted, as our drawings indicate.

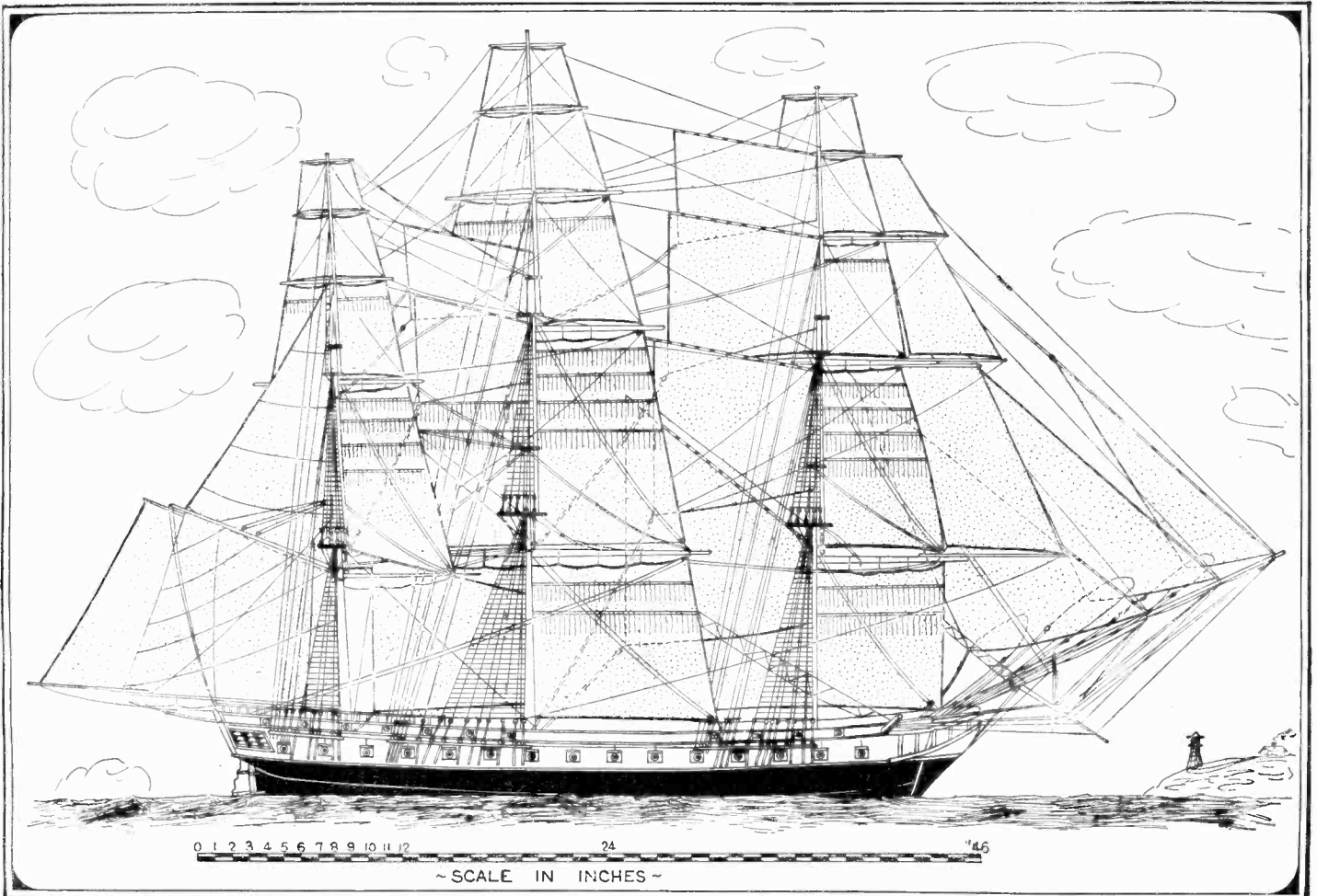

Above is a side view of the "Constitution" giving her sail construction and rigging. Notice how peculiarly the mainstays are constructed. Even in those days when one had to be right on top of the enemy ship before the guns were fired, it was found that the mainstays were extremely important

to the safety of the ship. Consequently, they were put on in duplicate and cross-braced, so that if a portion was shot away, the mast would not remain without support. Notice also that the position of the guns as indicated in our prints vary slightly from those in the model.

BLUEPRINTS MAY BE OBTAINED FROM THE MODEL DEPARTMENT AT \$1.00 FOR THE COMPLETE SET.

Further Details of Cup Winner

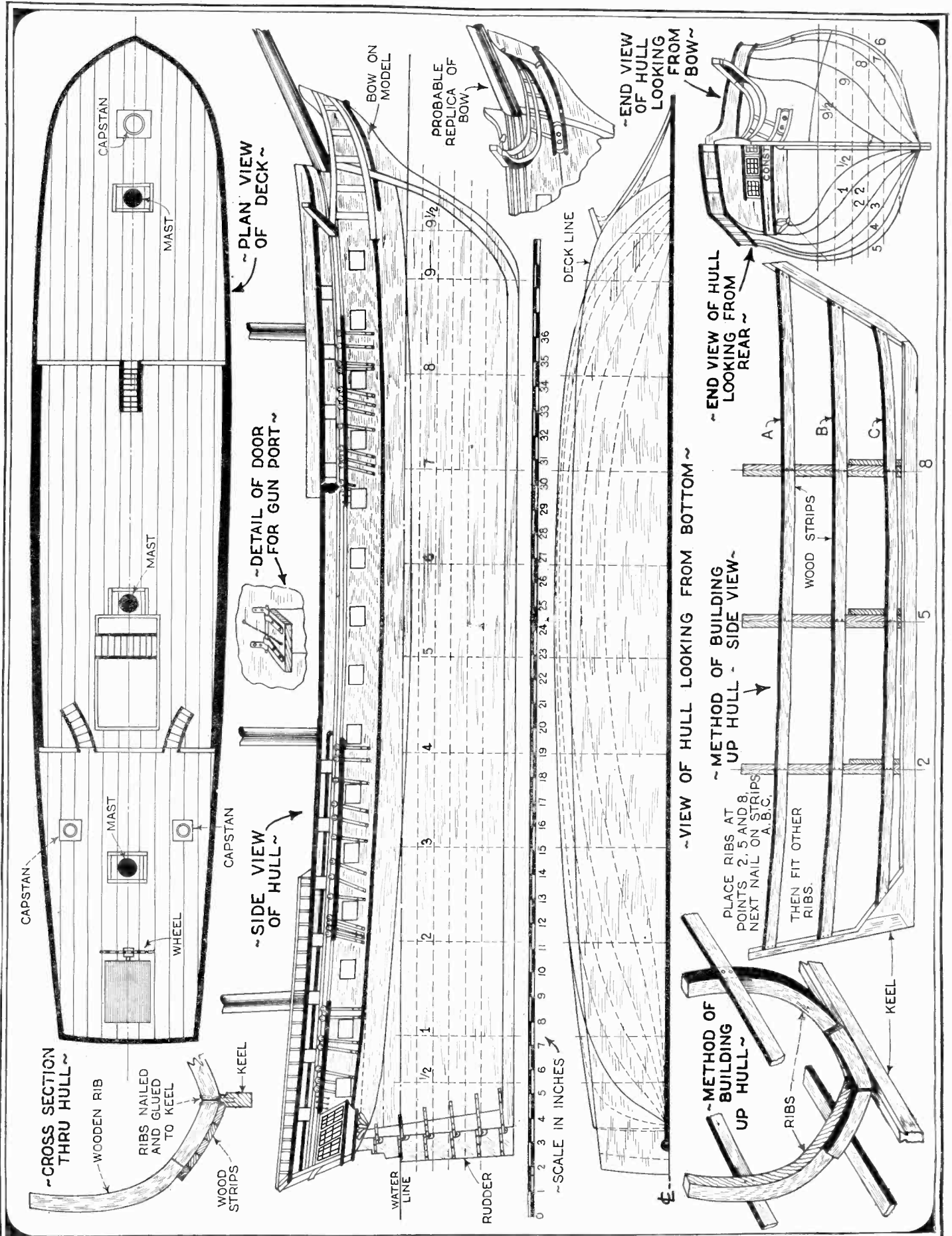

On this page we show further diagrams for the construction of this month's Cup winner in the monthly SCIENCE AND INVENTION Magazine Model Contest. These drawings are slightly different than the

original but have been corrected in accordance with official drawings of the ship as it originally appeared; instead of as many sources of information describe it.

Blueprints of the Constitution may be secured from the Model Department at \$1.00 for the complete set.

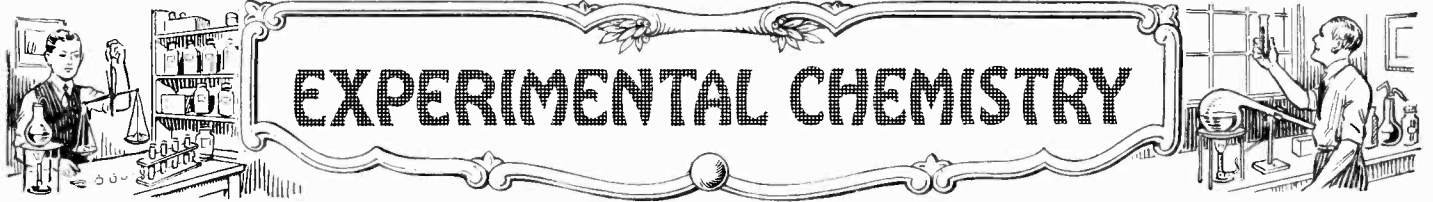

Carbonic Acid Gas

J. G. SCHUMAKER, A.B., M.S.

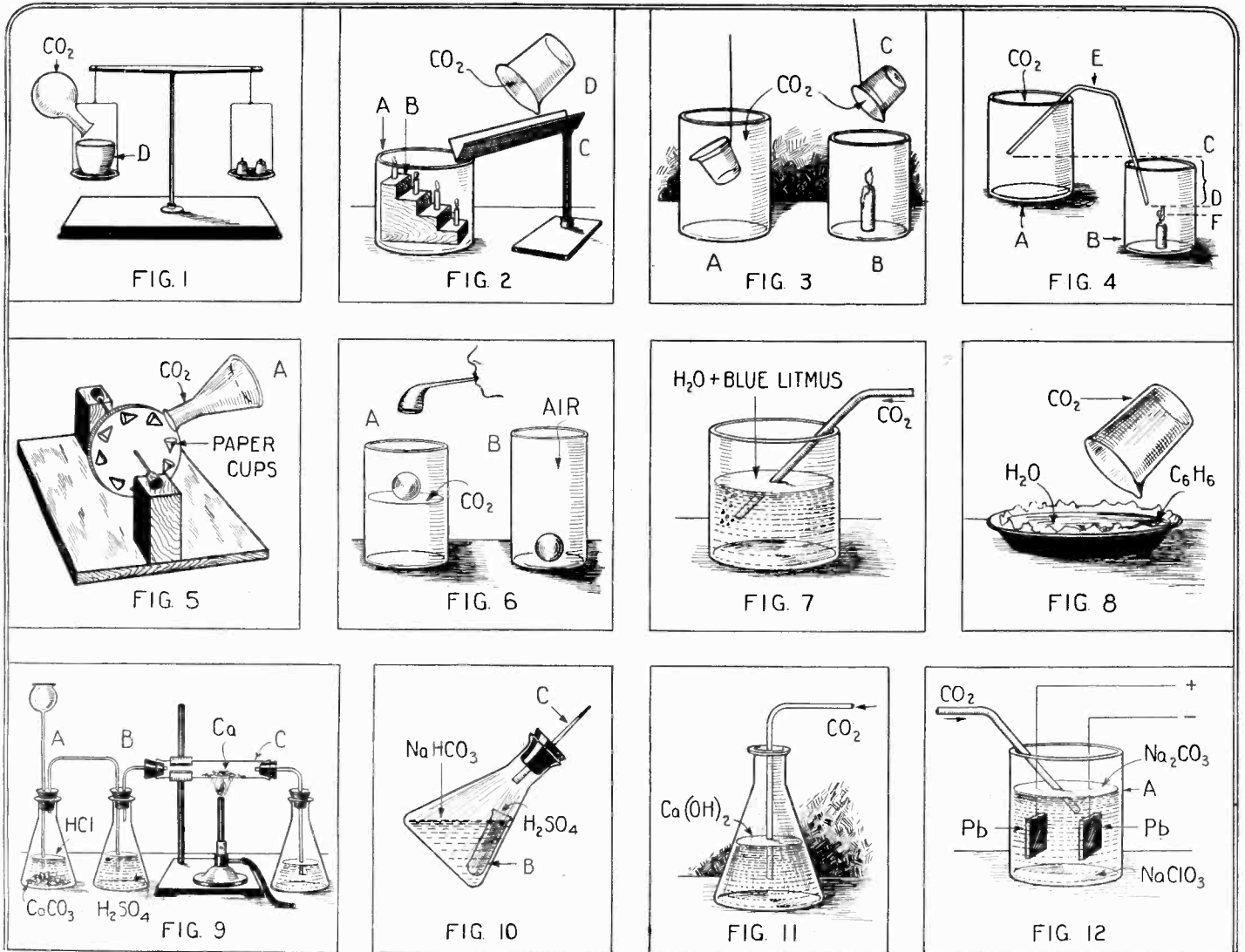

Fig. 1, Weighing a vessel full of carbon dioxide. Fig. 2, the carbonic acid stairway, putting out candles. Fig. 3, dipping the gas out of one vessel and pouring it into another so as to put out the candle. Fig. 4, siphoning the gas as if it was water. Fig. 5, turning a mill with the gas. Fig. 6, floating a soap bubble upon the gas. Fig. 7, blue litmus solution is turned red by carbonic acid gas bubbles. Fig. 8, putting out a flame of benzene with the

gas; only use a few drops of the benzene. Fig. 9, passing the gas over an alkali-metal or alkaline earth-metal the metal will be oxidized and black carbon will be precipitated. Fig. 10, on inclining the flask so that the acid will escape into the solution of sodium bicarbonate the liquid will be expelled many feet. Fig. 11, the carbon dioxide from the lungs precipitates calcium carbonate. Fig. 12, making white lead from the metal.

CARBON dioxide gas was known as early as the sixteenth century as one of the products which were formed during the combustion of carbon, the action of acids upon chalk, and alcoholic fermentation. Helmont called it "gas sylvestre" or "gas carbonum." In 1757 Joseph Black discovered its solubility in caustic alkalis and gave it the name of "fixed gas." Joseph Priestley, the English chemist, discovered its presence in the air and Lavoisier showed that it is exhaled during respiration and also formed when metallic oxides are reduced by heated carbon. Carbon dioxide gets into the atmosphere through the combustion of fuels, the decay of organic material and the fermentation of liquids.

Fermentation will convert almost any sub-

stance rich in sugar and starch into carbon dioxide and ethyl alcohol. If the raw material is starch $C_6H_{10}O_5$, molds like *Mucor* will convert it into sugar.

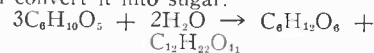

If this material is then mixed with yeast and kept at a temperature of 80°F. (27° C.), the yeast will decompose the starch into ethyl alcohol and carbon dioxide.

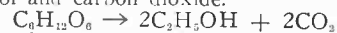

If a flask is filled with 500 c.c. of water and 100 c.c. of molasses and a yeast cake is added to the mixture, fermentation will set in after the sucrose has been converted into glucose and fructose. CO_2 will be generated and will do for any of the experiments described here in this article.

In the laboratory the gas is easily pre-

pared by adding dilute hydrochloric acid to marble chips ($CaCO_3$). Immediately a vigorous effervescence sets in and continues until either the acid or the marble is completely used up. The gas being only slightly soluble in water may be collected in bottles in the pneumatic trough, or by the upward displacement of air. The gas so collected contains a little air. If sulphuric acid is used, the marble becomes quickly coated with a layer of insoluble calcium sulphate ($CaSO_4$), which prevents the acid from further attacking the marble and evolution of the gas practically ceases.

Carbon dioxide is a colorless gas. It has a slightly acid taste, and a somewhat pungent smell. It has a stimulating effect upon the mucous membrane which is both agree-

able and refreshing and for this reason carbonated drinks are highly esteemed. The gas is 1.529 times as heavy as air. At 15° C. and 760 mm. pressure approximately 100 volumes of the gas are soluble in 100 volumes of water. It neither supports combustion nor respiration.

Carbon dioxide (CO₂) is much heavier than air and is therefore inclined to collect in deep wells, valleys and other depressions in the neighborhood of volcanoes and fissures in the ground. The relative weights of carbon dioxide and air can readily be demonstrated by placing two beakers on the opposite pans of a balance and counterpoising the pair. Fill a large jar C with carbon dioxide gas and pour it into the beaker D. The balance index will be deflected toward the right. Therefore the gas is heavier than the air.

The specific gravity of carbon dioxide, the invisibility of the gas and its ability to quench a flame enable us to arrange many interesting and attractive experiments.

Take a large battery jar (Fig. 2) A and saw out a series of steps in the board B, so that it fits the jar. Place a wax candle on each step and light them. Place the trough C so that it is inclined about 45°. Fill a large battery jar with carbon dioxide and pour it into the trough C. In a short time the lower light will begin to flicker and go out. Gradually light after light will be extinguished until the top one is reached. This demonstrates that ordinary combustible material will not burn in it.

Next fill a large battery jar A with carbon dioxide. Place a lighted candle in a 500 c.c. beaker B. Tie a string around a 400 c.c. beaker and lower it into the jar of carbon dioxide and allow it to remain for a short time. Then raise it and pour the contents into B. The heavy gas will displace the air. The candle will at once be extinguished showing that the carbon dioxide has been transferred from A to B. Fig. 3.

Fill a battery jar A with carbon dioxide and raise it above jar B. Then fill the siphon E with carbon dioxide and close both ends and place in the jars. Light the candle F. The gas will gradually flow into the lower jar and extinguish the flame.

A very novel and fascinating way of illustrating the specific gravity of carbon dioxide

is to construct a "gas mill." Cut out a cardboard disc 15 to 20 inches in diameter. Thrust a knitting needle through the center of the disc and put a cork at each end so that it offers as little resistance as possible when it rests on its support. Fasten 8 or 10 paper cups equal distances apart near the edge of the disc, so that when the disc rests upon its support it is in perfect balance. Fill a large bell jar with carbon dioxide gas and pour it into the cups near the top of the wheel. The heavy gas will displace the air in the cups and cause the disc to move slowly, rolling along on the corks.

A very fascinating experiment for the young experimenter to perform is what seems to the casual observer the suspension of soap bubbles in mid-air. Take two large battery jars, filling one with carbon dioxide and the other with air. Blow some soap bubbles and drop them into jar B. They will sink to the bottom. When similar bubbles are formed and allowed to drop gently into jar A, they will descend until they reach a certain level. They will remain stationary at this point as if they were suspended in mid-air, but it is the heavy carbon dioxide gas which supports the weight of the soap bubbles.

Carbon dioxide is slightly soluble in water, forming carbonic acid. At 15° C. and standard pressure, water will dissolve its own volume of the gas and form a weak, unstable acid, carbonic acid. If a beaker (Fig. 7) is filled about half with blue litmus solution and carbon dioxide gas is passed through it, some of the gas will go into solution and turn the blue litmus solution red. In moist air carbonic acid hastens the corrosion of metals and the weathering of rocks. It is used very extensively in the manufacture of soft drinks and sold under such names as carbonated water, soda water and pop.

This gas will act as an oxidizing agent when it is brought in contact with certain active metals like sodium, potassium, calcium, and even in contact with iron and zinc under proper conditions. Fill a large battery jar with carbon dioxide gas. Light a piece of magnesium ribbon and hold it in the jar of the gas. The carbon dioxide will give up its oxygen to the magnesium.

The gas is generated in flask A and

passed through a wash bottle B, containing sulphuric acid, and then through a hard glass tube C into water. Place a few pieces of any of these metals in the hard glass tube and when all the air has been expelled, heat the glass tube. The carbon dioxide is decomposed vigorously forming black carbon and a carbonate of the metal.

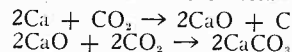

Iron and zinc are less active and will form an oxide of the metal and carbon monoxide.

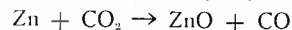

If a little ammonium hydroxide is added to water in a beaker and a few pieces of amalgamated zinc are immersed in it, a small quantity of formaldehyde is formed when a rapid stream of carbon monoxide is passed into the solution.

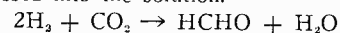

In Fig. 10 fill a flask about one-quarter full with sodium bicarbonate solution and put about 5 c.c. of concentrated sulphuric acid in the small tube B. Close the large test tube with a one-hole rubber stopper containing a short glass tube drawn to a point. Incline the test tubes slightly so that the two solutions mix and the water will be forced out for ten or fifteen feet.

By exhaling some air through some lime-water (Fig. 11) we can show the presence of carbon dioxide in our breath. If we continue the passage of the gas through the lime-water, the precipitate will gradually dissolve forming calcium bicarbonate.

The salts of carbonic acid are more important than the acid itself. Lead carbonate can be easily made by electrolysis. Dissolve about 15 grams of sodium chlorate and 5 grams of sodium carbonate in 300 c.c. of water. Pour the solution into a beaker A and insert two lead electrodes. Connect them with a storage cell and then direct some carbon dioxide through the electrolyte against the cathode. Better results are obtained if the electrolyte is continually stirred while the experiment is in progress. A thick cloud of white lead carbonate (PbCO₃) will be precipitated at the cathode and sodium carbonate will form at the anode. The lead carbonate is insoluble and can be removed by filtration. Fig. 12.

A Hydrometer for Solids

STUDENTS of physics and engineers working with solid substances who have scrawled sheets full of figures in an effort to determine the specific gravity of solids have a deliverer in Dr. Ernest A. Vuilleumier, head of the Chemistry Department at Dickinson College, Carlisle, Pa.

Doctor Vuilleumier has announced the invention and perfection of a solid hydrometer, a simple, direct-reading apparatus which will give the exact specific gravity of solid materials without the usual calculations. The hydrometer for determining the specific gravity of liquids has been regarded for a long time as a convenient instrument because of its accurateness and simplicity, and the new hydrometer for solids is still more simple in construction and equally so in operation.

The apparatus consists of a single graduated glass cylinder which is marked in such manner that the specific gravity of ores, minerals, rocks, metals or any other solids may be determined with ease. The cylinder is about seven inches high with a diameter of one-fourth inch. To determine the specific gravity of any solid substance, one hundred c.c. of water is placed in the cylinder, filling it to a zero mark about four inches from the base. One hundred grams, or about four ounces of the solid under observation, is placed in the cylinder containing the water.

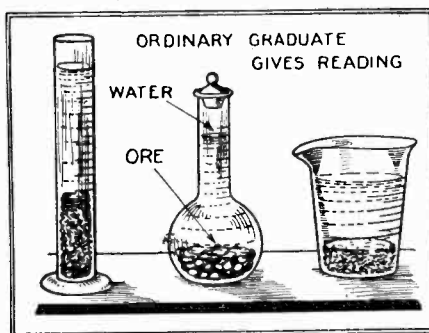

A simple method for the chemist to determine the specific gravity of solids or even of liquids if the latter are not miscible with water.

Without waiting for precipitation, the exact specific gravity of the solid can be determined by reading the figure on the cylinder which has been reached by the water.

A solid with a specific gravity of 2.0 would cause the water to rise in the cylinder a distance of 5.0 cm. above the zero mark, while a solid with a specific gravity of 10.0 would cause a rise of water for a distance of only 1.0 cm. The secret of the device lies in a table of reciprocals of 100 as shown in the following table:

Specific Gravity	Vol. of 100 g. in ml.
2.0	50.0
2.5	40.0
3.0	33.3
5.0	20.0
7.0	14.3
9.0	11.1
10.0	10.0

The device because of its size and simplicity of operation promises to be an invaluable addition to the kit of metallurgists, mining engineers, builders or others having to deal with solid materials on locations where laboratory apparatus does not lend itself readily for use in determining specific gravity or where time is an important element to be considered. After blasting ore from the side of a hill, the engineer needs only to gather a small amount of the substance, break it into pieces small enough to fit into the cylinder filled to the zero mark with water, weigh out exactly 100 grams of the ore, put it into the water and read directly the specific gravity of the material just blasted a few minutes previous.

Dr. Vuilleumier has waived all royalties on the instrument in the interest of science. That the invention is scientifically correct is shown by its acceptance by the American Chemical Society; that it is of practical value is proved by the willingness of one of the largest laboratory equipment firms in the country to place it on the market.

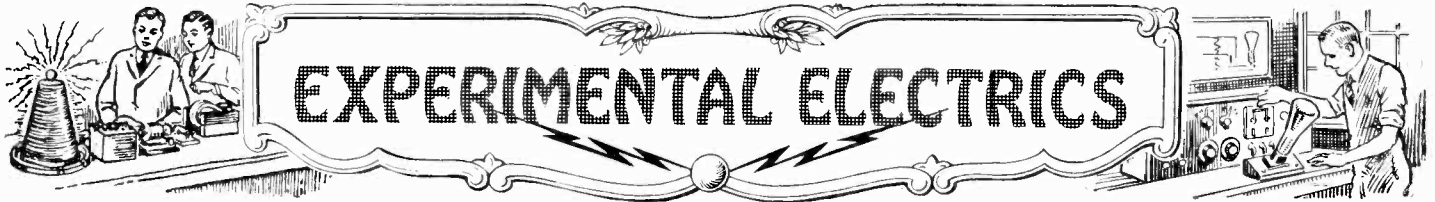

Experiments with an Electroscope

By RAYMOND B. WAILES

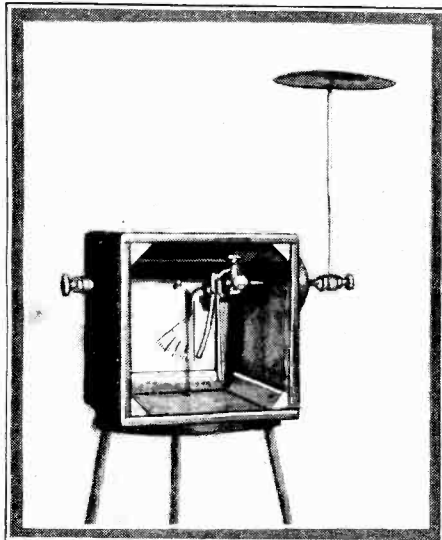

The finished gold leaf electroscope. It is made from a small square box and has a glass front, through which the movements of the gold leaf over the face of the scale can be observed.

HOW would you measure the voltage upon the rubber comb which you used to comb your hair this morning? Surely the radio voltmeter would be worthless here.

But this little box-shaped apparatus, the electroscope, will enable you to detect the presence, and if calibrated, measure the degree of static electricity on many objects.

The electroscope consists of a housing of wood such as a cigar box or a cabinet radio of the small crystal variety. It is lined on the inside with "tin" or copper foil, the metallic lining being connected with a binding post shown at left of instrument.

The sensitive indicating leaves on the inside of the box are of gold or aluminum leaf.

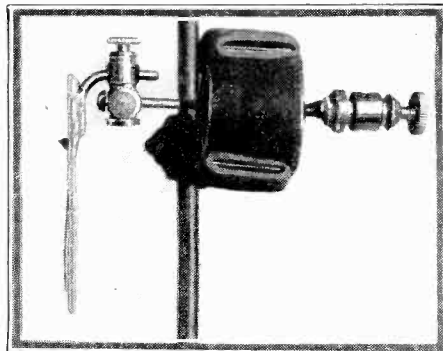

The acting members of the electroscope.

This can be had from a sign painter for the asking, as a strip an inch long by a quarter of an inch wide is all that is required. The leaf is fastened to a strip of brass two inches long and half an inch wide by means of a minute drop of mucilage taken from a postage stamp. The brass strip is suspended vertically and is carried by an L-shaped piece of wire soldered to it, the free end being thrust through the hole in an insert-type of binding post, the binding post being in turn carried by a brass bolt about four

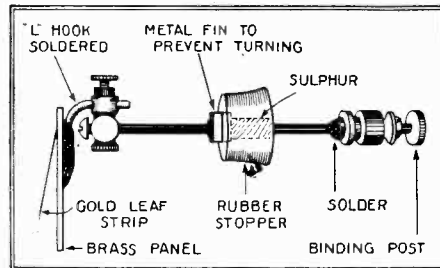

Gold leaf strip does not show in preceding photo but occupies the position shown above.

inches long which passes through an inch hole in the side of the electroscope and through a rubber stopper inserted therein. The end of the bolt or machine-screw carries

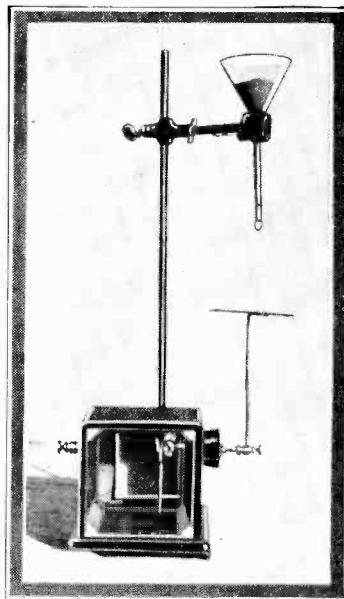

Sand becomes electrified when shaken. "Bird sand" in the funnel causes a movement in the leaf when it trickles through the funnel and falls upon the charging plate.

another insert type binding post through which an umbrella shaped metallic receiver can be inserted for receiving the electric charges from outside influences.

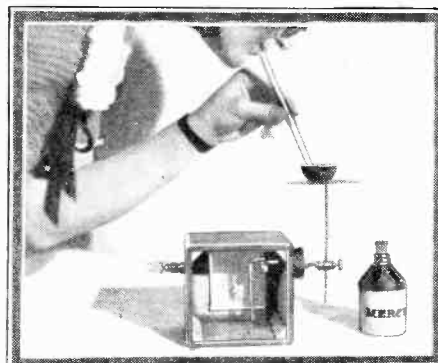

No, this is not a soda fountain but a little electrical generator. Blowing the breath through mercury agitates it, thus creating an electrical potential as indicated by the electroscope.

Rubbing a hard rubber comb will electrify it upon touching it to the receiver or umbrella on the right of the electroscope, and then touching the finger to the disc and removing the finger, then the comb, the leaf will be seen to diverge from the brass strip

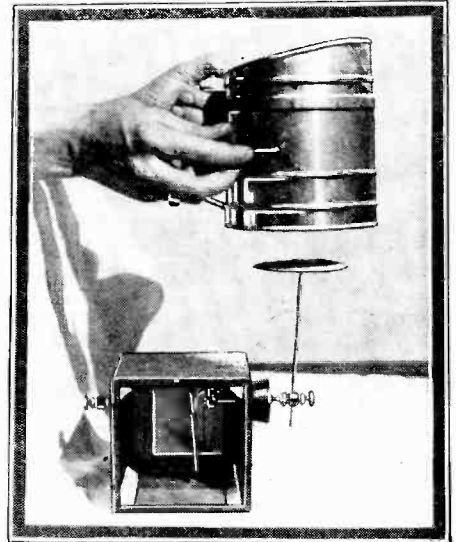

Every kitchen a power-plant. Flour sifted upon the receiving plate instantly causes the leaf to move, due to the electrical charge produced upon the flour particles when agitated.

to which it is attached, showing that electricity has really been imparted to it. The leaf will slowly collapse, in time, due to the leakage caused by imperfect insulation.

Drops of water or grains of sand falling upon the receiving plate will cause a divergence of the leaves.

If mercury be agitated it will become electrified as can be shown by blowing the



Friction produces electricity, as can be seen by the divergence of the gold leaf when the connecting post is smartly whipped with a dry handkerchief.

breath through a bit of the liquid element placed in a metallic dish resting upon the receiving plate. The leaves will diverge. Use a non-metallic tube, such as a glass tube or soda straw. A curious fact has been observed here. If the mercury is contaminated with the smallest amount of baser metals such as zinc, cadmium or sodium impurities,

the charge of the current will be positive in character, while if the metal be pure the sign of the charge will be negative. It should be remembered, however, that you might be charging the leaf with positive or negative electricity according to the type of electrified body placed on the receiving plate, either type diverging the leaf.

Touching a charged electroscope will allow the current to pass off through the operator. A candle flame held near the receiving plate of a charged electroscope will allow the current to leak off through the layer of ionized gas produced around it by the burning candle.

The electroscope can be charged, if desired, by means of a variable condenser and several large size radio "B" batteries. The scheme of connections is easily understood.

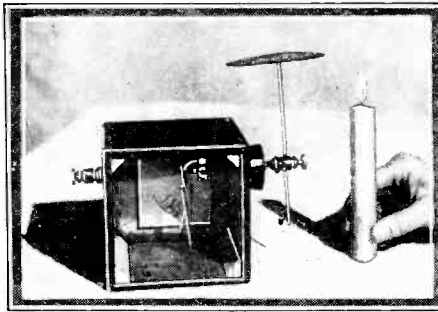

A candle flame ionizes the air and affords a path of escape for the current, so the leaf falls back and excitation ceases.

Simple Electric Welder

By WILLIAM ANDERSON

THE electric welder described in this article is very convenient for quite a variety of mending, although its construction is quite simple. It can be used for such heavy work as mending a cracked cylinder head on an automobile, and for various other purposes.

A carbon is taken out of an old dry cell. One should preferably be selected which is round. One end of this is pointed; it may be filed down or ground off on a grindstone or emery wheel. A copper wire is attached to the other end. If it has no cap it is plated with copper and the wire is soldered to the copper plating. It is designed for use with welding wire or welding rod.

One of the illustrations shows the apparatus in use. The piece to be mended is attached to one of the electric terminals, and the carbon is attached to the other. A bit of India rubber tubing slipped over the end will

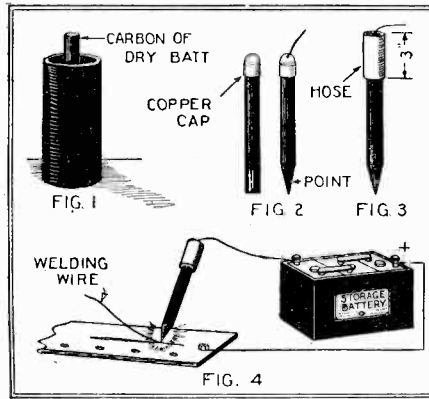

The welding is done by striking an arc between the piece to be welded and a carbon. A welding wire is fed down to fill the joint.

make it more convenient to handle on account of the heat which will inevitably be developed. It is to be held in one hand and the welding wire is to be held in the other hand, its end touching the crack, and the arc is started. The wire will rapidly fuse, run into the crack and fill it. If the carbon is a large one, a piece of garden hose may be used to form a sort of handle.

One has to know how to weld, and with this apparatus you can experiment very successfully and soon catch the knack of it.

Often it is well to chip out the crack to a sort of bevel, and if the crack is an open one extending right through the metal, fire clay or asbestos cement may be used to close the bottom so that it will hold the metal of the rod as it drops into it in a state of fusing.

The welding wire will get hot and must be held in pliers.

Making a Simple Photo-electric Cell

By RAYMOND B. WAILES

MAKING a Simple Sun Battery could probably be another title for this article. The experimenter has often thought that the only device which would actuate a circuit or even indicate the presence of some

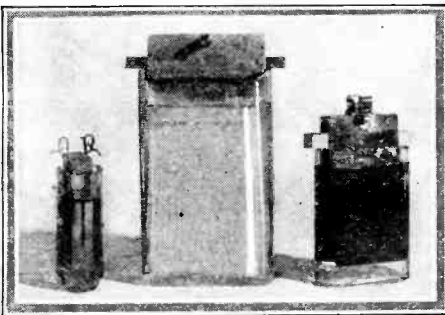

The construction of a simple photo-electric cell based on the action of light on an oxidized copper plate.

source of light is a photo-electric cell which is used with a battery and a relay or other device. The cells described here do not need a source of current to operate them. They produce a current, however small, by the direct action of light falling upon the active plates of the cell. The light generates a current itself.

The cells are extremely simple to make. There is no processing, sensitizing, annealing, etc., of the plates; no critical temperatures to follow in their construction. The materials can be had about the average home shop.

Essentially, the cells consist of two plates of the same metal immersed in a solution of a salt of the metal. For instance if copper

plates are used for the electrodes or elements of the cell, a solution of copper sulphate in water can be used for the electrolyte. If nickel plates are used, a solution of some nickel salt such as the nitrate or sulphate is used with them. The plates can be as large as desired. The larger they are the greater will be the current produced. A good size is three by five inches. Two plates are used for a cell. They are fastened parallel to one another by screwing or otherwise to a wooden strip which is supported upon the glass vessel in which the electrolyte is contained. The screw ends must not touch. A space of about half an inch separating the plates is desirable. The plates should be thoroughly cleaned with steel wool and then washed with some caustic solution such as lye, to remove the grease, after which they are washed with water to remove the caustic.

The electrolyte should not be made too strong. For copper plates a solution of copper sulphate of a very light blue color

should be used. Too strong a solution produces a smaller current than a weaker or more dilute solution. The plates should remain in the copper sulphate solution for at least a week before the cell is used. Do not stopper the solution away from the air. This immersion forms a copper oxide coat-

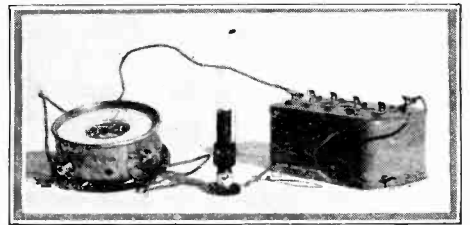

The couple prepared for experimental demonstration, and ready for insertion into the cell.

ing upon the surfaces of the plates. This coating gives the photo-electric action.

After a week the cell is ready to use. Connect a galvanometer or millivoltmeter to the plates, using no battery whatever, taking care not to allow the plates to touch each other either in or outside of the electrolyte. Now expose one plate to a strong light. A deflection of the index of the indicating instrument will immediately be noted. The illuminated plate will always be of the same polarity, irrespective of the metal comprising the plate or which of the two plates are illuminated. One of the plates should always be in the dark. This can be accomplished by giving the side of the container or vessel next to the unexposed plate a coat of black paint such as asphaltum, or even stove pipe enamel.

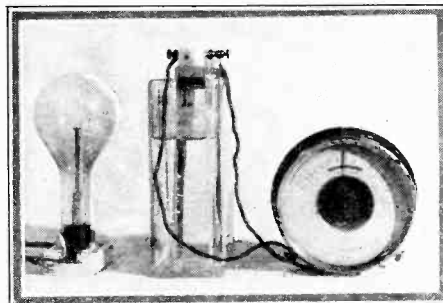

The couple in the cell, with a 100 watt incandescent lamp is set up for experimental work.



JUNIOR ELECTRICIAN

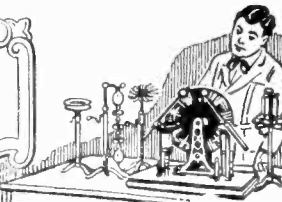

A One-Half Kilowatt Welding Transformer

By EDGAR B. CONES

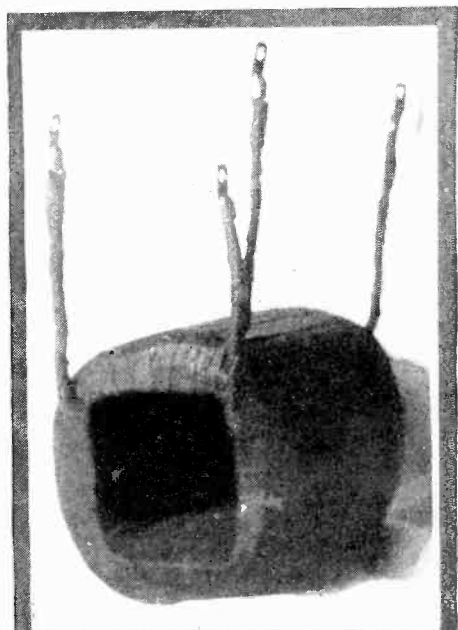

the metals to be joined are held and compressed between two copper electrodes. The current is then turned on until the metals reach the proper temperature, at which point pressure is applied by means of a lever connected to one of the electrodes. The weld results exactly like a rivet. If the machine is for continuous duty, as in commercial work the electrodes are cooled by means of a stream of water forced through a piece of tubing, which is built into the electrode in such a manner that cold water is constantly circulating therein. For welding of this kind five hundred to one thousand amperes, at from three to five volts potential is used and is furnished by a transformer or a dynamo.

Butt welding is used where it is desired to connect metals end to end such as pipes or bars. The stock is supported in copper dies which also serve as the connecting electrodes. The ends are put together and the current turned on until the metals are heated

iron or silicon steel. The remains of some old transformer can usually be found in the junk yard or local shops of your power company. Great care should be taken in cutting the iron for laminations, because the efficiency of the transformer partly depends upon the manner in which the legs of the core join up. You will save time and patience by taking the iron to the tin shop for cutting. The core is two and one-half inches square and when assembled measures ten and three-quarters by seven and three-quarters inches, with a five and one-half by two and one-half inch window in the center. By assembling the core as shown in Fig. 5 it is only necessary to cut the laminations in two different sizes; five and one-quarter by two and one-half, and eight and one-quarter by two and one-half inches, a stack five inches high of each being sufficient. In order to minimize the eddy current losses the laminates should be insulated from

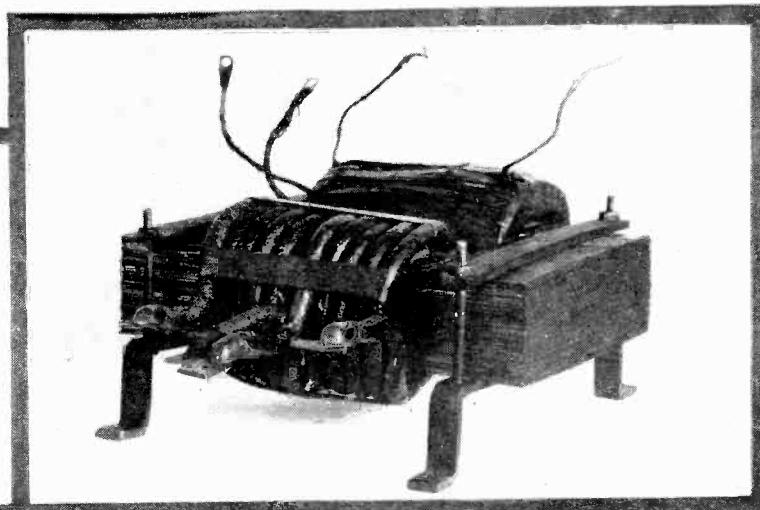
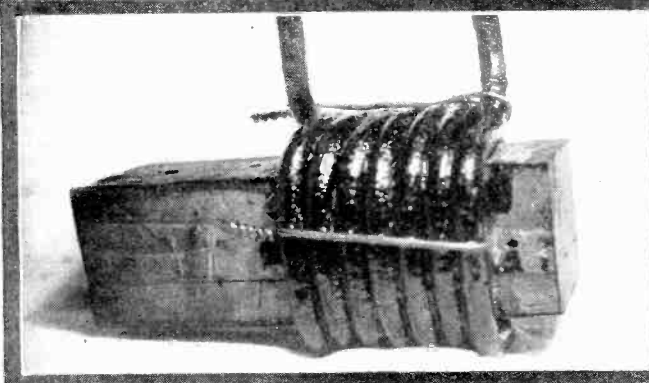

The upper left-hand illustration shows a coil of the welding transformer with four terminals to give two steps of transformation. The lower left hand cut shows the use of a wooden form for winding the coils. The other illustration on the right shows the transformer fully mounted.

EVERY experimenter has many and varied uses for an electric welder. Yet the different voltages and amperages required for the two classes of welding ordinarily make two transformers usually necessary.

Current is conducted to the weld by heavy copper cables of relatively very low resistance. By using a heavy conductor of this kind practically all the heating in the circuit is utilized at the weld. For example, the stock to be welded is of iron which offers a high resistance to the flow of current. Since the resistance is in the iron to be welded and all other parts of the circuit have a high conductivity, the heating will take place directly at the weld.

The two types of welding used most commercially are contact and arc. Under contact welding, we have spot and butt welds. Spot welding is used mostly in sheet metal work and is mechanically equivalent to riveting. It is much faster, however, in that the punching of holes is not necessary; neither are there rivets to be heated and headed down. In welding by this method,

sufficiently. Pressure is then applied which forces the metals together in a sound weld. By this method all burned metal or foreign matter is forced out, bringing the pure metal faces together, so essential for perfect union.

Arc welding is used chiefly for filling in holes or cracks in metal castings. It is very useful in any place where the building up of metal is required. This type of welding employs from twenty-five to one hundred amperes at from thirty to eighty volts. As mentioned above one wire from the source of current supply is connected to the work, while the other wire is attached to the copper die. This die holds, by means of a set screw, a wire of welding material. By touching the work with the wire and pulling it away again, an arc is started, which deposits beads of metal from the wire upon the metal being worked on.

Now that we have slightly touched on the principles involved in electric welding, we can go into the details of construction of a transformer which will do light welding work.

The core should be made from transformer

each other. This can be done by coating one side of each with thin shellac. When the shellac is thoroughly dry the core is to be assembled, leaving one end out, so that the transformer winding may be slipped over their respective legs.

The transformer has four windings. Number one which is the primary and energizes the core, number two which is wound under the primary and supplies the current for arc welding, and numbers three and four which furnish the heavy amperage and low voltage required for butt welding. These last two coils operate in parallel and are so arranged that they cover the entire transformer leg and still only give a low voltage owing to the small number of turns.

Construct a core from wood two and one-half inches square and twelve inches long. It may be mounted in a lathe or between two points so it can be rotated easily. Wind evenly on this form a layer of heavy string and tack its ends securely in place. Cut a piece of empire cloth one-half inch longer than the coil and wind four or five layers

around the string. Each layer should be shellacked in place, being careful not to get any shellac between the string and the empire cloth. The length of the winding is five and one-half inches. It should be started one-half inch from the end of the empire cloth and wound to within one-half inch of the other end. This winding is made up of sixty turns of number six double cotton covered (D.C.C.) magnet wire. Be sure to insulate all layers from each other with a layer of empire cloth. This is very important as a shorted turn means fireworks and lots of it. The turns can be secured in place by heavy taping. The two leads from this secondary arc coil should be brought out and covered with flexible insulating tubing. Ordinary silk shoe string clipped over the wire will do very well. This is the number two coil which supplies the current for arc welding. After winding three layers of empire cloth over this coil

the number one or primary coil should be wound. It consists of one hundred and eighty turns of number ten D.C.C. wire wound directly over the number two coil. Be sure to wind the number one and number two coil in the same direction. The general precautions as to insulation, et cetera should be observed. The coils may be removed from the form by loosening one end of the string upon which they are wound and unwinding it from under them. The coils should be taped as shown, common friction tape serving very well for this purpose. This coil can now be shellacked and hung up to dry.

The secondary coils, numbers three and four, consist of five turns each and may be wound either with number 00 flexible wire such as that used in moving picture booths or with number 00 solid wire. If solid wire is used it is advised that the constructor screw the wooden form in a vise, for it takes lots of tugging and sometimes a mallet

to make the turns stay in place. The coils should then be shellacked and allowed to dry. A clamp of strap iron as shown in the photograph is placed on the assembled end of the core, as it will aid in holding the core while the windings are being slipped into place. The core must now be closed by adding laminations one at a time. This end must also be clamped into position. The clamps also act as transformer supports as shown by the photograph. Any blacksmith will make them for about fifty cents. The transformer is now complete and ready for use. Caution: thirty ampere fuse plugs should be screwed into the fuse block at the lighting meter. The load drawn by this transformer will blow any smaller fuse.

If instructions have been followed the builder will be rewarded by a transformer which will give very good results and will more than pay for itself with services rendered.

Extemporized Furnace

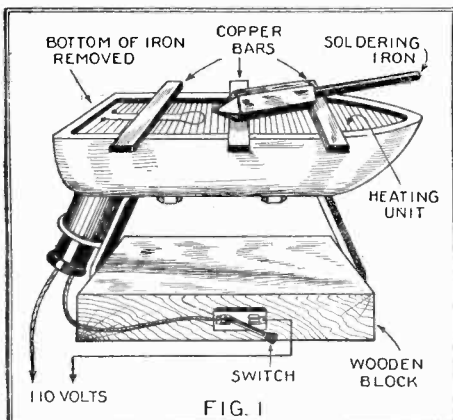

A flat iron, inverted, with the coil exposed, is a convenient heater for a soldering iron or for light cooking, heating glue and similar purposes.

A FURNACE for heating a soldering iron can be quickly extemporized from a common flat-iron in the method shown. The flat-iron in one way or another is dismantled, as to expose the heating element. In the flat-iron shown, the bottom is supposed to be removed. The flat-iron is turned upside down, mounted on a block of wood as shown, and to concentrate the heat, a cover or hood is made of tin, which is shown in Fig. 2. A soldering iron resting on some copper or iron bars reaching across the iron and covered by the hood, will soon be brought to the soldering temperature. One advantage of this arrangement is that the iron will never be heated too hot, and overheating the soldering iron is an error perpetrated by many people. It must be remembered that the day of the old-fashioned soldering iron has not yet expired. The electric iron has not entirely replaced it.

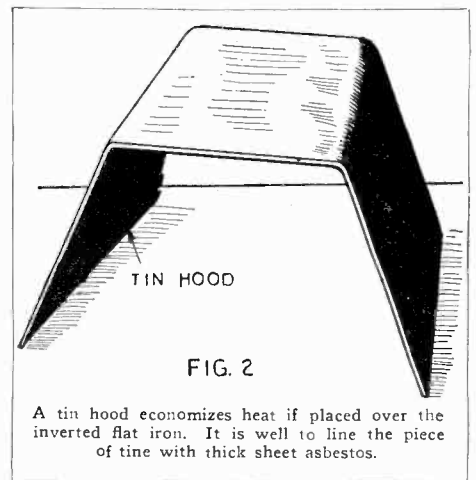

A tin hood economizes heat if placed over the inverted flat iron. It is well to line the piece of tins with thick sheet asbestos.

FAHNESTOCK CLIPS FOR THROUGH CONNECTION

THE illustration shows a method of using two Fahnestock Clips to give a through connection for a Bakelite or other insulating panel. On each side of the panel, exactly opposite each other, two clips are secured by a brass bolt which goes through the bakelite. It will be seen that if terminals of a circuit are caught in these two clips, the circuit will be closed. This gives a very convenient way of getting a first-class connection in the simplest possible way, for this type of clip has proved its value for giving a low-resistance terminal.

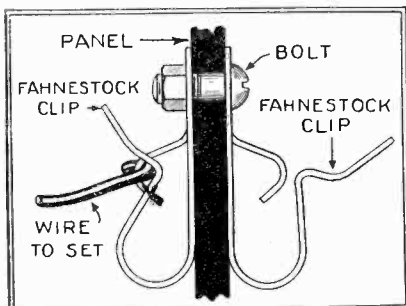

The well-known Fahnestock connections are connected in pairs on opposite sides of a panel. Thus employed they form excellent through connectors.

LEAD PENCIL ARC LIGHT

Scrape the wood away from the ends of two pencils till the carbon is exposed. Then connect a wire to each pencil, then to a

How to make High Frequency Coils

SEE NEXT ISSUE

Full Details for Building Large Oudin Coil

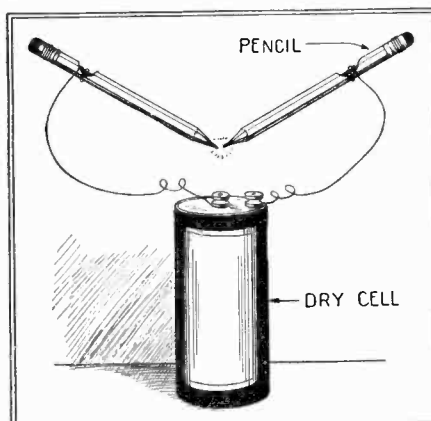

A simple arc lamp; pencil leads are the electrodes and the pencils can be held in the hand as the wood cuts off the heat.

battery. Then press the two pencils together and draw slightly apart. A tiny glow will show. If this is done in a dark room better results will be obtained.

By Conrad Ruppert.

MAGIC BOAT

Place an electro magnet and a battery in a box, put a switch on the outside of the box. Fasten the box beneath the table top. Place a wooden or porcelain basin on the table, fill with water. Whittle a boat out of cork or wood. Place a piece of steel inside. Then switch the current on and off.

By Conrad Ruppert.

By shifting the magnet about mechanically, or by having several magnets, various effects can be produced. If a magnet is substituted for the ordinary steel in a boat, other curious effects can be produced.

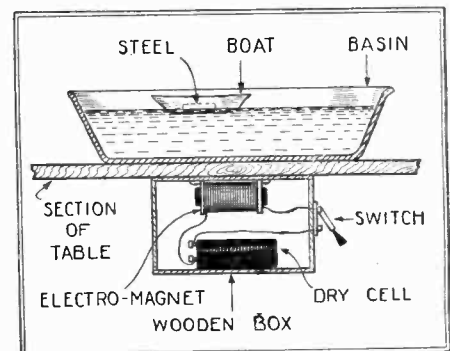

A very simple application of the electro magnet gives an excellent window show mystifying, although simple in principle.



THE CONSTRUCTOR



How To Build a Hydrocycle

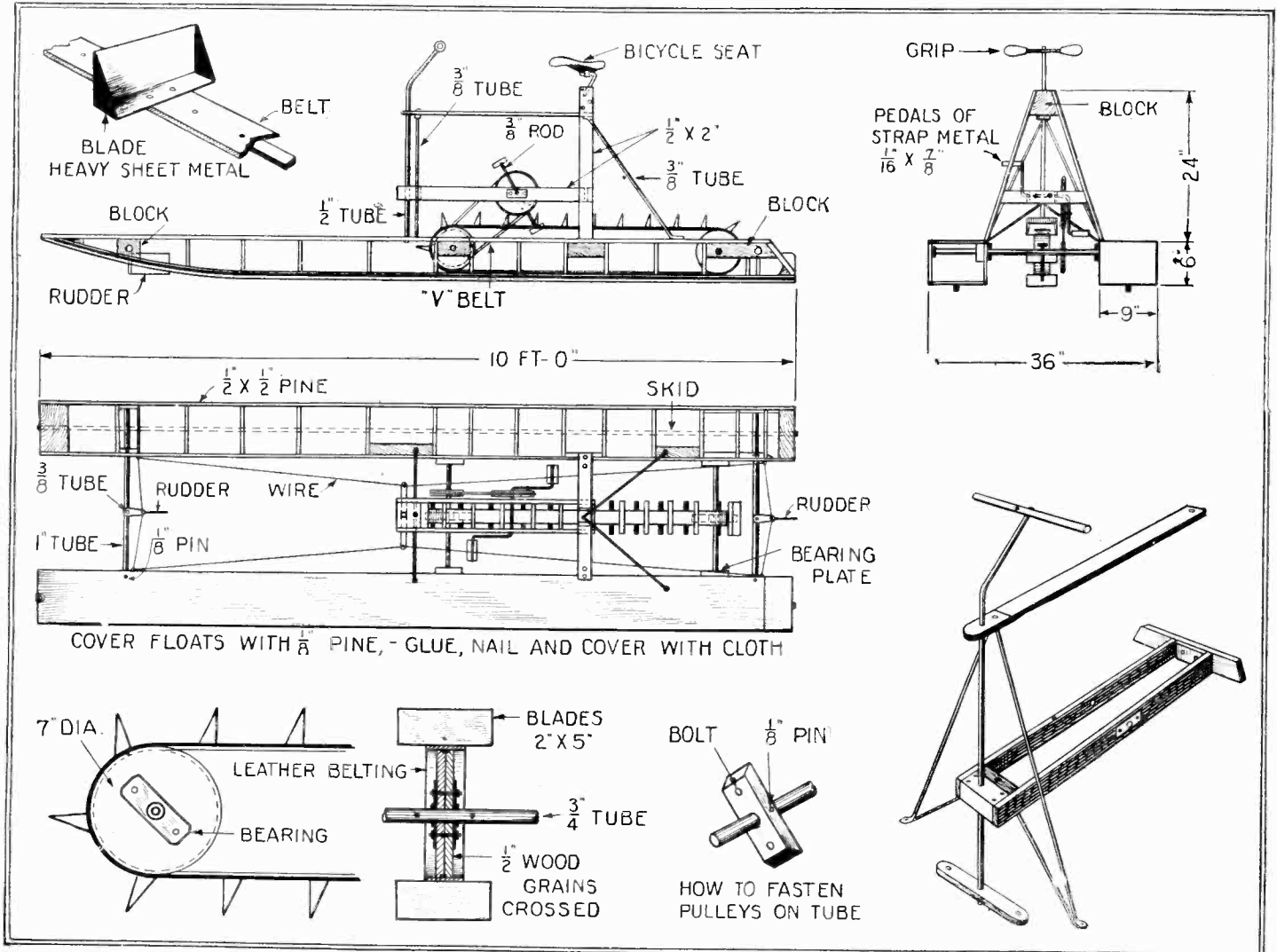

The Hydrocycle illustrated in the diagrams here may easily be built and with it an endless amount of amusement may be obtained. Such a device develops very good speed in the water and by varying the size of the buckets the speed may be increased and also the power required to drive it will have to be proportionately greater. A bicycle sprocket and chain may be substituted for the "V" belt illustrated. Note that there are two rudders. These

enable the craft to maneuver on crowded lakes. The steering bars or grips operate the rudders. The interior of the floats should be given a good coat of varnish, the edges of the wood should be sandpapered and then a layer of unbleached muslin is fastened to the float structure with marine glue. Paint cloth with shellac, two coats of paint and then spar varnish.—A. J. Maguire and D. W. Clark.

How To Build Your Own Airplane

(Conclusion of article published in July Number. Drawings on next two pages.)

THE drawings published in this concluding article on how to build a model sport plane suitable for carrying one passenger, illustrate the details on wing covering and also the control scheme whereby the operator is enabled to manipulate the ailerons and horizontal rudder or elevator. Referring to the control method for the moment, we see that the aileron members as well as the horizontal rudder members are raised and lowered, *i.e.*, swung up and down on their hinged joints by steel wire cables about 3/16 inch in diameter. These cables are secured to the ends of horns securely fastened to the aileron and rudder members, as the diagram clearly shows. Before you attempt building an airplane, you

should if possible go to the nearest flying field and study the planes to be seen there as closely as possible, and make a few notes and sketches. By talking to the pilot or mechanic on the flying field, you will be able to gain some valuable information. The vertical rudder is turned to right or left by pushing with one foot or the other respectively on the rudder bar. The right and left ailerons are moved up and down by swinging the joy stick sidewise. The horizontal rudders or elevators are moved up and down by pushing the joy stick back and forth.

The wing covering may consist of a good grade of cotton cloth, but regular airplane linen is preferred. The wing coverings are made in the form of bags, so as to slip over

the complete wing frame, and as will become clear from the drawings, the linen covering is to be sewed to the ribs in the manner indicated, using a strong linen cord, as supplied by airplane manufacturers. This sewing is done with a lock stitch, as one of the detail drawings illustrates, and over the stitching at each rib position is placed a strip of linen or cotton tape well doped. After applying several coats of dope to the linen wing covering, it shrinks and draws up tightly between the ribs.

Those interested in building their own airplane can purchase a Course on Flying at \$5.00, or a complete set of blueprints giving all details, for \$15.00 from this Department.

How to Build Your Own Airplane

PART II — CONCLUSION
(First Half of Article Appeared in July Issue)

DIAGRAM OF CONTROLS ON SPORT PLANE

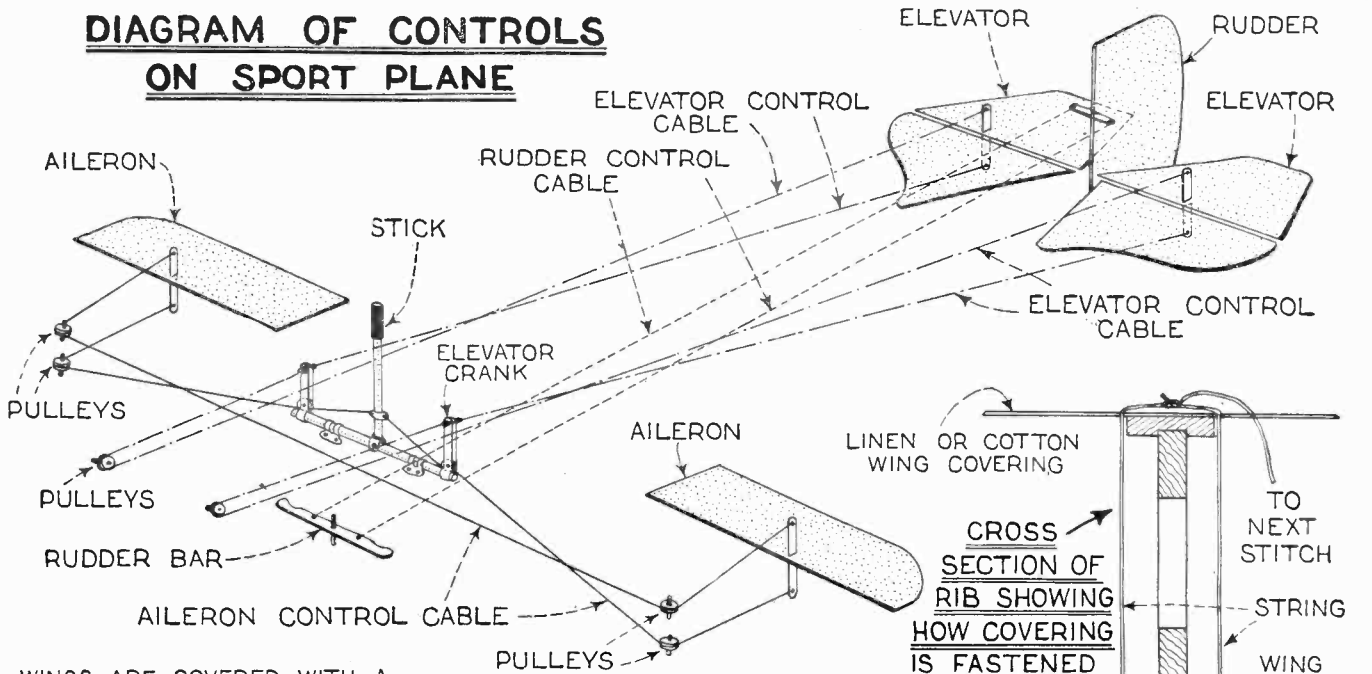

WINGS ARE COVERED WITH A GOOD GRADE OF LINEN OR CLOTH. THE CLOTH IS SEWED IN THE FORM OF A SACK CONFORMING WITH THE SHAPE OF THE WING.

STRIP ALSO DOPED TO ENTERING AND TRAILING EDGES.

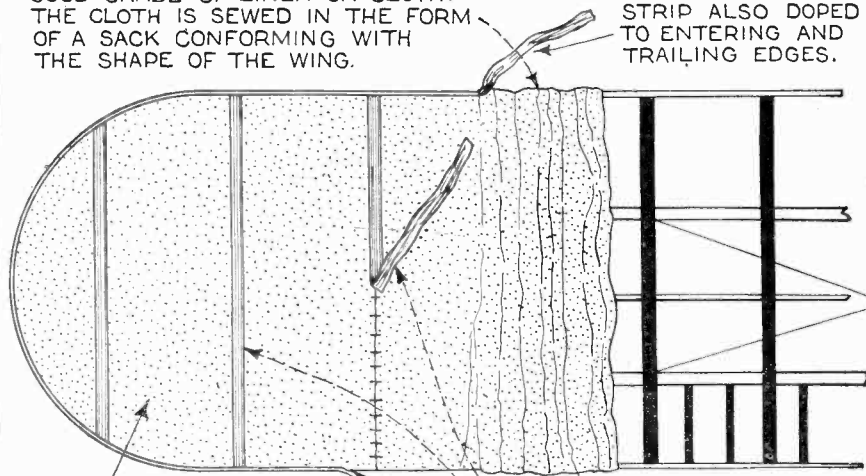

WHEN WINGS ARE COVERED WITH CLOTH AND SEWED APPLY ONE OR TWO COATS OF DOPE.

AFTER APPLYING ONE OR TWO COATS OF DOPE, A CLOTH TAPE ABOUT 1 1/2" WIDE IS DOPED ONTO EACH RIB TO COVER STITCHING.

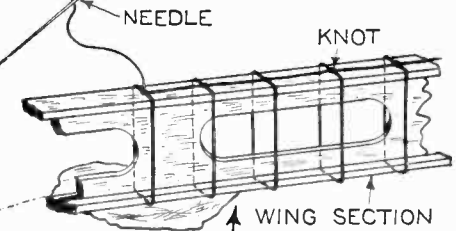
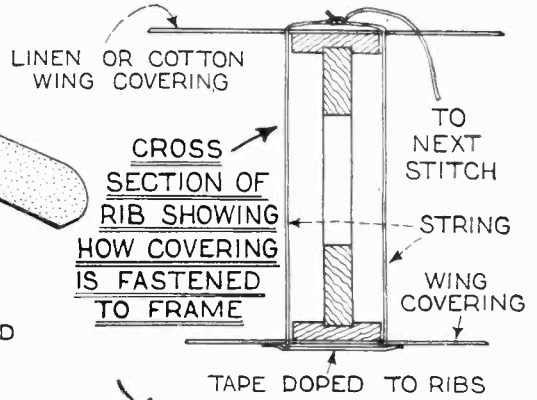

METHOD OF COVERING WINGS, AILERONS, FUSELAGE, RUDDER AND ELEVATORS.

FINISH WITH FOUR COATS OF DOPE AND TWO OR THREE COATS OF A GOOD GRADE OF SPAR VARNISH.

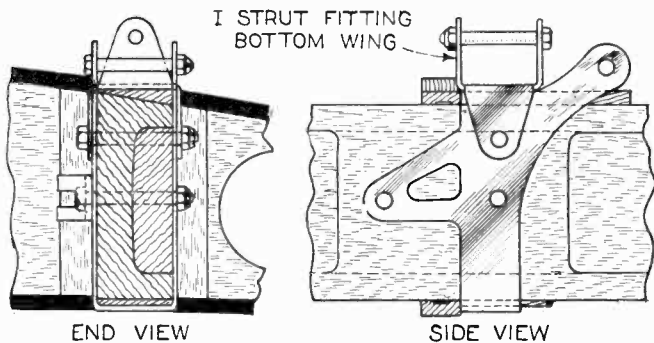

LOWER REAR SPAR FITTING

MAKE TWO No. 16 GAUGE STEEL

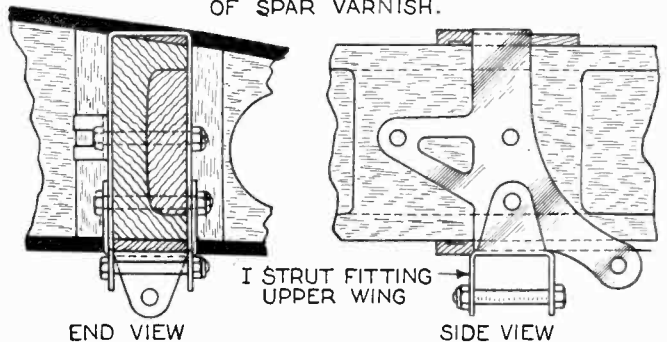

UPPER REAR SPAR FITTING

MAKE TWO - No. 16 GAUGE STEEL

The control scheme for the home-made sport plane is shown in the drawing above. The cables leading from the control stick to the ailerons and tail rudders are composed of about 3/16" diameter standard steel cable. The horizontal and vertical rudders as well as the ailerons are constructed with a number of ribs to give them strength, and also to which the airplane cloth

can be sewn, in the same manner as that shown for covering the wings. These control members have their cloth coverings treated with several coats of airplane dope, to shrink and also strengthen the cloth; this being followed with two to three coats of good spar varnish. Lower figures show details of spar fittings. Complete detail blueprints supplied at \$15.00.

Further Details of Home-Made Airplane

This "Sport-plane" can be purchased complete, ready to fly, at the same cost as a cheap automobile

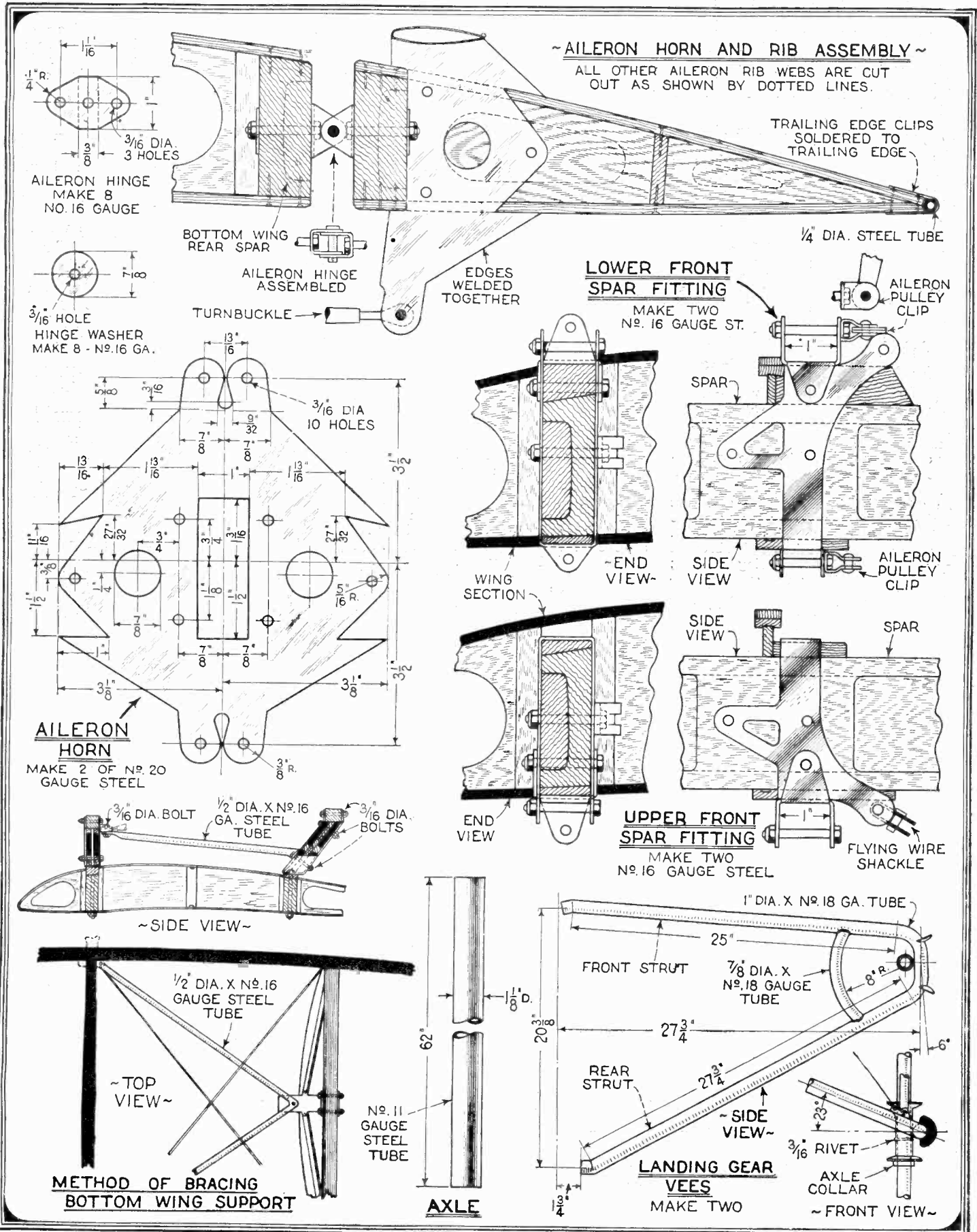

The drawings shown at the top of the page make quite clear the details of aileron horn and rib assembly. The drawing at the center left shows how to cut out an aileron horn from No. 20 gauge sheet steel, the horn being formed by bending the steel to the necessary shape. Details of the lower and upper front spar fittings are shown at the right center of the plate herewith. The

tubular construction shown in the lower right hand corner of the plate is that for the landing gear vees, the axle being resiliently mounted at the lower ends of the vees, by means of airplane rubber. This rubber can be purchased in 3/4" diameter round form. Complete detail blueprints, \$15.00; order from this department. Flying course \$5.00.

How to Build a Rowmobile

IF we compare the operation of a one horse-power motor on a rowboat with the operations of the same motor on a vehicle, we can see from the low speed of the motor boat which is only 2½ miles (four kilometers) an hour from the high speed of the motor shaft, while with the same horse-power as much as 30 miles per hour (50 kilometers) can be obtained on land, it shows how great is the resistance to be overcome in the water. Now if we compare a normal rowboat that does 1 to 2 miles (two to three kilometers) an hour to a shell or racing boat that attains a velocity of twelve miles (twenty kilometers) an hour, the thought forces itself upon us that in the first place the utilization of power in the racing boat must be of superior order, for it, in spite of the great resistance of the water, to attain so high a speed.

The secret lies in the sliding seat that gives the oarsman besides the power of his arm also the utilization of his leg muscles. These were the considerations which brought Curry to the invention of rowing on land; that is to say, to bring the same utilization of muscles shown on the shell or racing boat to the land vehicle. A bicycle is driven by the power of the legs. This power can only represent the utilization of one-third of the muscular power in speed, because the utilization is only complete when the pedal

arm is in a horizontal position. These considerations make it clear that a vehicle which is driven by full leg power as well as arm power, plus the power of the body, must attain a much higher speed.

Now we come to the Curry landboat or Rowmobile; a vehicle with two to three

only with the legs, and so let the upper body rest. The body of the vehicle presents a great advantage. The little vehicle can be constructed as a closed limousine so as to be used in any weather. The air-resistance of the aluminum body built in streamline shape, is considerably less than the resistance offered by the air to a bicyclist. We all remember how hard it is to drive a bicycle against the wind.

Those desiring to build this interesting vehicle which is capable of an average speed of fifteen to twenty miles an hour, will find the accompanying drawing gives the necessary principles and details on which the machine is built. The four wheels may be of the bicycle type, while the axles may be made from steel tubing or iron pipe.

One idea for a simple brake is shown in the drawing, but other schemes may be used by the builder if desired. The greater the diameter of the belt drum, the easier will the vehicle be propelled, but at the sacrifice of speed, unless gearing is used. A fair diameter for the belt drum is six inches, the belt being two inches wide by one-eighth inch thick. The front seat rolls on wheels so as to give free motion to the legs as well as the arms. The vehicle is steered by pushing the toe against either side of the foot bar.

The parts for building the device can be found on the scrap pile or at bicycle shops.

In this interesting street scene taken in Berlin, Germany, the latest vehicle, the Land-skiff, is to be seen. The Land-skiff or Rowmobile employs no engine but is propelled by the arm and leg action of the driver. Full details are illustrated below.

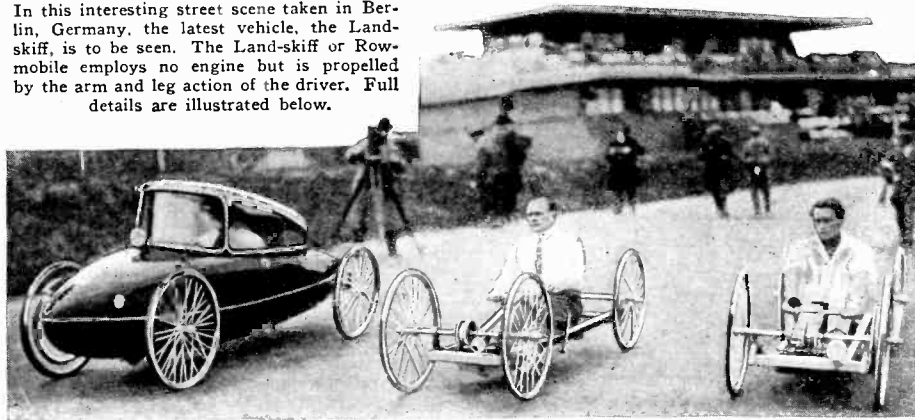

gearing attains a speed of 30 miles an hour, a true sport machine for devotees of all kinds, especially for oarsmen as a training apparatus. From now on they can have their rowing races upon the open highway. The vehicle is equally well adapted for light athletics, for boxers, for reducing weight, and for medical application.

Moreover as a means for transportation, this machine is a rival to the bicycle. Not only is a much greater speed to be attained by better application of muscular power, but the muscles can be called upon separately in turn. For instance, one can work for a while with the arms only, or

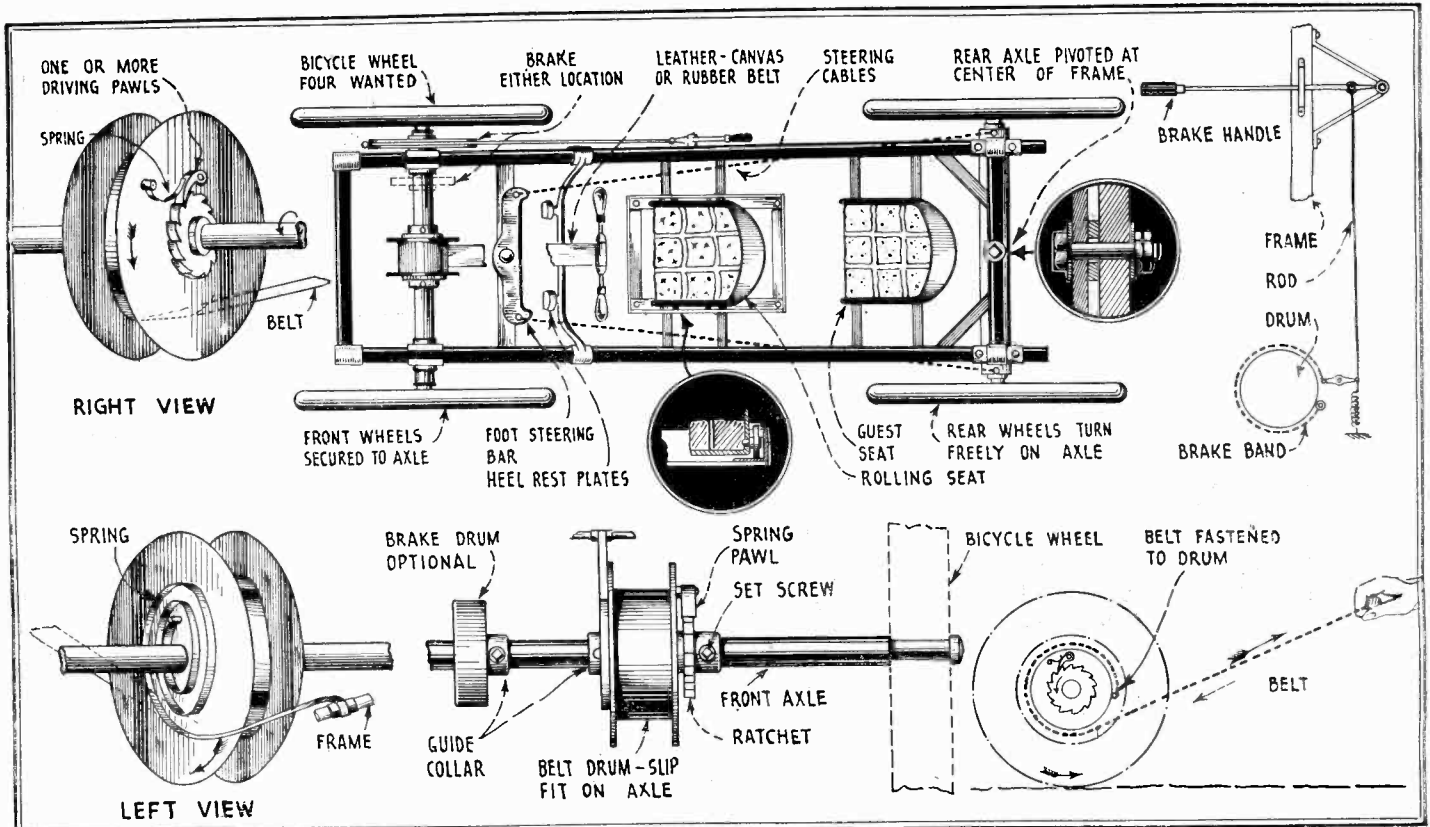

The Rowmobile can be made in many different ways, according to the material available to the constructor. The vehicle is propelled by means of a belt secured to a spring ratchet drum. As you pull on the belt handle, the

pawls rotate the ratchet, which is rigidly secured to the front driving axle. Then the spiral spring retracts the belt, and the pawls slip over the teeth of the ratchet wheel freely, without exerting power on the axle.



HOW TO MAKE IT



ARTIFICIAL MIRAGE

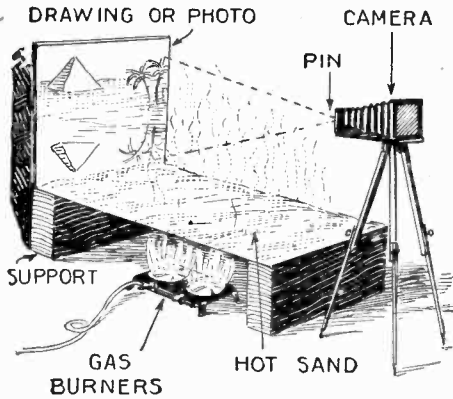

An artificial mirage can be produced by mounting a photo in back of a bed of hot sand and taking a picture of the photo. A pin hole camera can be used.—G. H. Waetjen.

BALANCE INDICATOR

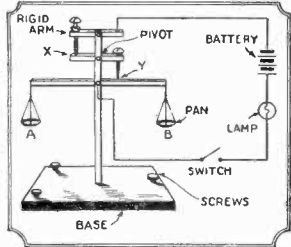

A scale constructed as illustrated will light the bulb only when perfectly balanced. Circuit is closed through X and Y.—W. C. Wilhite.

RAIL ANVIL

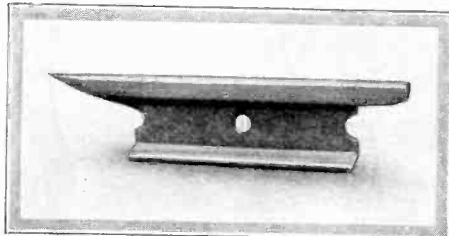

A piece of an old steel rail twenty inches long was heated in a slow fire and the fire allowed to die out, thus softening the metal. This was then cut with a hack saw and chisel to conform with the shape shown. It was then heated to a cherry red and dropped in oil and has been in use as an anvil for twelve years without being damaged. Weight is twenty-two pounds.—Dale R. Van Horn.

OIL CAN EXTENSION

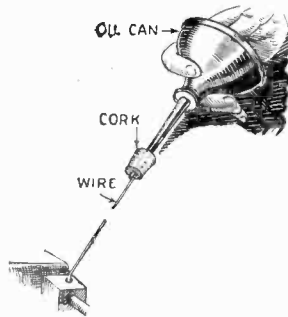

Quite often the spout of an oil can is not long enough to reach into machinery. To extend it bore a hole in a cork, insert spout of can and stick a wire into the cork immediately under the spout.—S. Leonard Bastin.

PHOTOGRAPHIC DUPLICATOR

You can take photographs of your friend shaking hands with himself by using the duplicator here illustrated. The variable mask feature will help you to get perfect results.—J. M. Crippen, Rep. No. 6814.

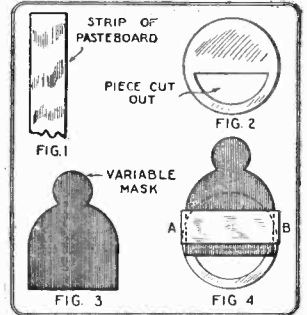

LAPEL VASE

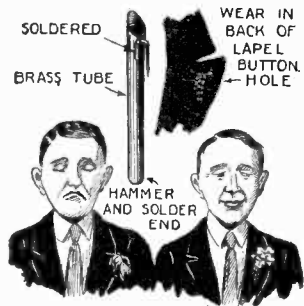

This little device attached to the underside of a lapel of a coat will keep the most delicate flower fresh all day. The tube is filled with water.—Leighton Powell, Reporter No. 8620

MAKING AN AQUAPLANE



THE photograph above shows an aquaplane which was built and which was actually used with a small power boat. It is buoyant enough to support a person when the plane is standing still and it works very well when carried along at low speed. The aquaplane is six feet long and two feet wide; it is two inches thick at the sides and two and one-half inches thick at the centre. The front is one and one-half inches at the sides and two inches at the centre.—P. H. Werner.

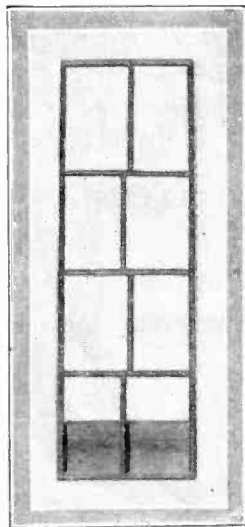
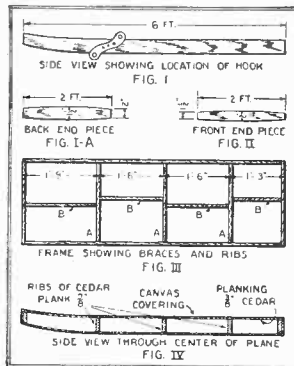

Above we show the diagram for the frame of the aquaplane which is made of seven-eighths inch cedar. Fig. 1 is a side view showing the upward curve at the front rising two inches in one and one-half feet. Fig. 3 is a top view. After building the frame it is planked over with 3/8-inch cedar planking fastened with galvanized or copper nails. The joints are filled with white lead and canvas is then spread over the whole. Copper tacks fasten the canvas in place, which is then treated with a filler. The canvas is joined at the edges. It will

UNIQUE TOASTER



If you have no electric toaster you can easily improvise one if an electrical heater is available. Our only requisite is a holder for the toasting fork. This holder consists of a piece of brass tubing 3/4 inch in diameter and about one foot long, plugged with a wooden plug at both ends. The lower end is

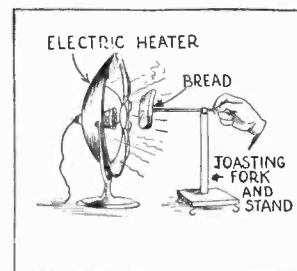

secured to a baseboard by a wood screw and a flat hook is screwed down into the top to hold the toasting fork.—C. A. Oldroyd, Reporter No. 4433.





WRINKLES

RECIPES & FORMULAS



Edited by S. Gernsback

INK ERASERS

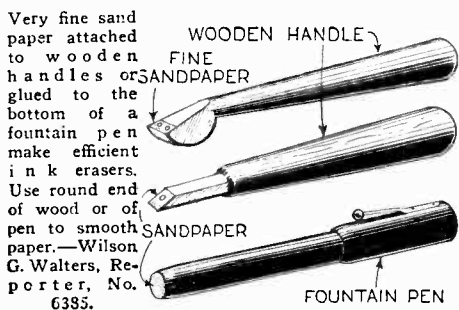

Very fine sand paper attached to wooden handles or glued to the bottom of a fountain pen make efficient ink erasers. Use round end of wood or of pen to smooth sandpaper.—Wilson G. Walters, Reporter, No. 6385.

FLOOR PROTECTORS

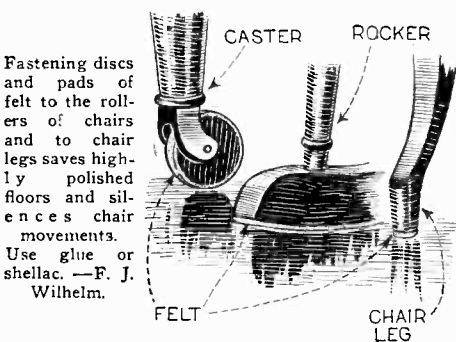

Fastening discs and pads of felt to the rollers of chairs and to chair legs saves highly polished floors and silences chair movements. Use glue or shellac.—F. J. Wilhelm.

REPAIRING SCISSORS

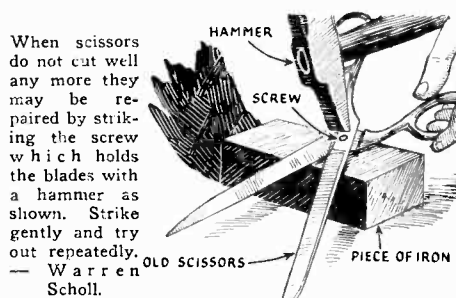

When scissors do not cut well any more they may be repaired by striking the screw which holds the blades with a hammer as shown. Strike gently and try out repeatedly.—Warren Scholl.

WOOD CARRIER

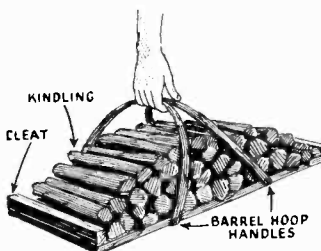

A fuel carrier made as indicated in the sketch will permit one to carry twice the usual armload. The carrier may be made as long as is convenient to handle.—Warren Scholl.

DRILLING CLAY

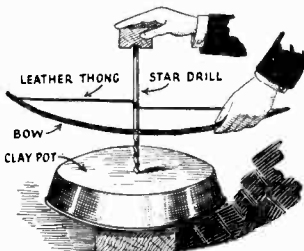

Striking a star drill with a hammer when drilling a clay vessel invariably fractures the clay wall. The hole may be easily cut by twirling the drill with a bow made as shown.—J. Harold Byers.

BLOT PREVENTER

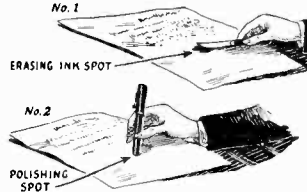

After erasing the new ink generally tends to spread. This can be prevented by rubbing surface smooth with the back of a fountain pen or a spoon.—J. Lasalata, Reporter No. 24271.

LOOSENING GLASS STOPPERS

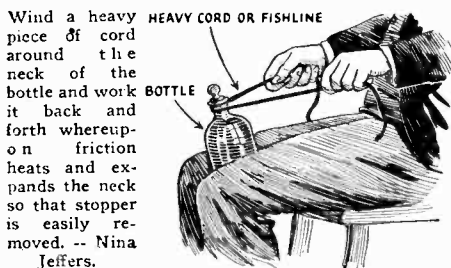

Wind a heavy piece of cord around the neck of the bottle and work it back and forth whereupon friction heats and expands the neck so that stopper is easily removed.—Nina Jeffers.

CLEANING GLASS TUBING

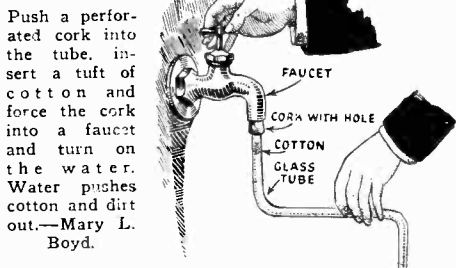

Push a perforated cork into the tube, insert a tuft of cotton and force the cork into a faucet and turn on the water. Water pushes cotton and dirt out.—Mary L. Boyd.

SPOON HOLDER

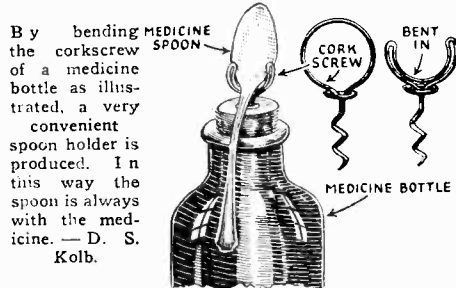

By bending the corkscrew of a medicine bottle as illustrated, a very convenient spoon holder is produced. In this way the spoon is always with the medicine.—D. S. Kolb.

LEATHER HANDLES

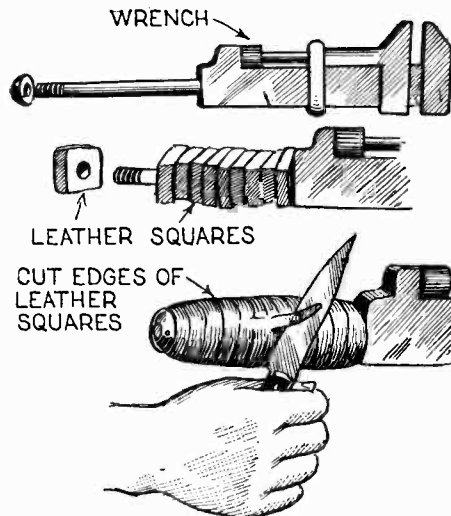

Very convenient handles for wrenches and tools may be made of washers of leather all strung on the metal tangs of the handles and then shaved down with a sharp knife and finished with sand paper. These handles will not split.—Loren J. Husted, Reporter No. 26527.

BOIL-OVER PREVENTER

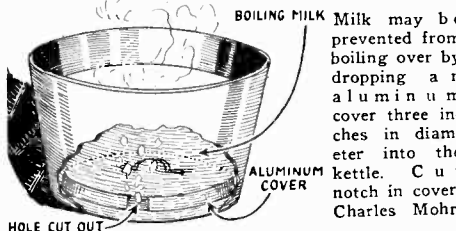

Milk may be prevented from boiling over by dropping an aluminum cover three inches in diameter into the kettle. Cut notch in cover.—Charles Mohr.

STAPLE PULLER

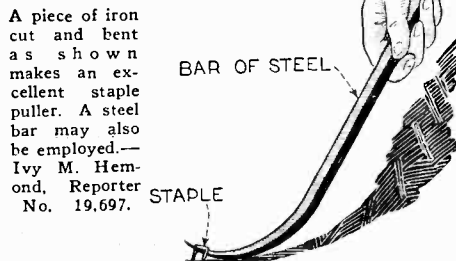

A piece of iron cut and bent as shown makes an excellent staple puller. A steel bar may also be employed.—Ivy M. Hemond, Reporter No. 19,697.

KEY RING

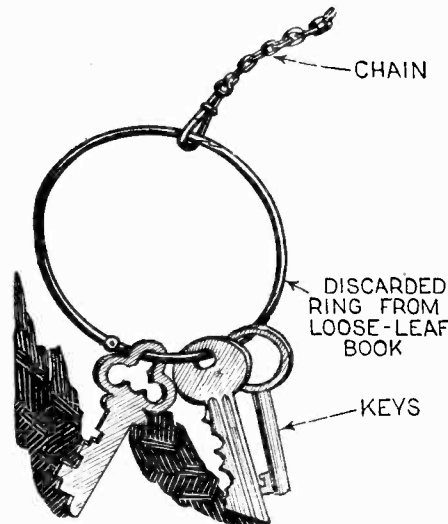

An excellent ring for a large bunch of keys may be secured from an old discarded loose-leaf book. Distend halves slightly to make them grip each other more tightly.—I. Schwartz, Reporter No. 22823.

THE HUMAN AURA

Editor, SCIENCE AND INVENTION:

I have just finished reading the article by Mr. Fenn Germer on the \$25.00 Prize for Human Aura Photo, published in your July issue of Science and Invention. While I am not in a position to send you a photograph of the human aura, I think the following suggestions offered as an aid with that end in view will not be amiss, which of course does not make me eligible for the prize offered.

Assuming that the human aura is enhanced greatly by a source of ultra-violet rays, it would be very difficult to photograph it by means of such photographic paraphernalia as is found in the hands of the average experimenter, because of the absorption of the higher radiations by the glass lens.

Furthermore, should a time exposure be required, it too would make the process a difficult one.

A simple and inexpensive procedure is to first construct a "pin hole camera" or the adjustable or focusing type. Such a device can be built of a wooden or paper box, blackened inside and out. The hole through which the light is admitted to the sensitive photographic plate or paper is made by a pin or needle.

An ordinary photographic plate or paper is now treated with a ten per cent solution of paraphenylene diamine, an organic reducing agent and intermediate used in the manufacture of dyestuffs. Prof. R. W. Wood of John Hopkins University, the eminent worker in ultra violet light, many years ago discovered that plates (photographic) treated with a solution of this compound were made much more sensitive to ultra-violet rays. This fact can be substantiated by papers published by Prof. Wood in 1915 on the subject of Photography with Ultra Violet Rays. Assuming that this is the case, then a pin hole camera and a sensitive plate or paper (photographic) treated with the paraphenylene diamine and the source of ultra-violet ray is all that is needed to successfully produce photographs of the human aura.

SAMUEL WEIN,
New York City, N. Y.

(We are greatly indebted to you for this information concerning photographic aids and the method of sensitizing plates so that they will give better results. We hope that the method here outlined will help some of our experimenters to get the results for which they are striving.—EDITOR.)

HE WON A CUP

Editor, SCIENCE AND INVENTION:

I take pleasure in advising you that I have received the SCIENCE AND INVENTION Cup, No. 2, which was awarded to me as winner of the Model Building Contest for the month of June. This beautiful Cup, so elegantly engraved with my name and mechanical devices was altogether beyond my expectations. At some future date I intend to have a photo made of the Cup, the Prize-winning model and myself. These are to occupy a place of prominence in my bungalow, which, by the way, I also built.

I trust that the monthly contest will be successful each issue and I predict that if the contestants could see my trophy, your Model Building Department would be a prominent feature of Science and Invention Magazine.

GEORGE BRIDGE,
Plainfield, N. J.

(We are glad that you like the cup which SCIENCE AND INVENTION Magazine awarded you. Now it remains for some of the other model makers to get busy. Remember, that the Science and Invention Model Contest offers a cup monthly. This cup and certificate is given to the best model entered in any one month. The conditions for entering the model are simple and easily complied with, and the model itself may be a steam engine, a locomotive, a replica of an electric railway, an airplane, a submarine, any type of ship, or in fact anything.)

Those of you who have already completed your models, send them in now! There is no time like the present, and to paraphrase the old saying, we add, "Procrastination is the Thief of Trophy Cups." There are enough model-engineering societies in America to make this contest interesting. Members in these societies are not barred from the contest.—EDITOR.)

FINDING A JOB TO WHICH WE ARE FITTED

Editor, SCIENCE AND INVENTION:

My attention has been called to a statement of yours in the June issue of the SCIENCE AND INVENTION Magazine in which you say that it is your personal opinion that a boy when he reaches the age of sixteen should know for what he is best fitted.

In the several years that Antioch College has been established it has had an unusual opportunity to study this phase in the development of the average boy and girl. When a student enrolls at Antioch he is asked to select the three jobs which he likes best and those for which he is, in his opinion, best fitted. We find that the majority of students seem to have a preference to electrical engineering and technical pursuits of a like nature, very largely, I think, because of the fact that in their earlier years they have become interested in a radio or have taken up some other more or less



SCIENCE AND INVENTION desires to hear from its readers. It solicits comments of general scientific interest, and will appreciate opinions on science subjects. The arguments pro and con will be aired on this page. This magazine also relishes criticisms, and will present them in both palatable and unpalatable forms. So if you have anything to say, this is the place to say it. Please limit your letters to 500 words and address your letters to Editor—The Readers Forum, c/o Science and Invention Magazine, 53 Park Place, New York City.

technical pursuit at home. It is the freshman's honest conviction that the pursuit that he is most deeply interested in at the time shall constitute his life work, but it is found that a slight acquaintance with the more technical side of his hobby is nearly always enough to make the job lose its attractiveness. In fact so uncertain is the college student as to what shall constitute his life work that it is made a regular policy of this college not to allow any student to specialize in any course for the first three years of the regular six-year course.

AMAZING STORIES

THE new scientific fiction magazine, **AMAZING STORIES**, will be on the newsstands July 10th. Here is a magazine after your own heart. Readers of this magazine who have read the scientific fiction stories for years will welcome **AMAZING STORIES** with open arms.

The next issue of **AMAZING STORIES** contains, among others, a well known story by Jules Verne, a powerful story propounding new thoughts as to how a brain can live detached from its body, by M. H. Hasta; "The Moon Hoax," probably the greatest scientific hoax ever perpetrated, and other "amazing" scientific stories.

AMAZING STORIES has secured the sole rights to all of Jules Verne's stories, written by this, the greatest of all scientific fiction writers.

Be sure to get your copy today.

The magazine is edited by Hugo Gernsback.

PRICE 25c PER COPY.

We find that most of the students preferring electrical engineering end up in some form of business management, and only a strikingly small percentage follow out their original plans. However, as you say, it is true that students after they have been given a chance to experiment for three years quickly find out what they intend to make of themselves.

The average freshman's idea of chemistry before he has taken a college course consists of the idea that is being fostered by manufacturers of chemical sets and also in your Department of Everyday Chemistry, i. e., that being a chemist consists of pouring a yellow mixture into a blue one and getting a red color. It is obvious that a youth of sixteen cannot be expected to accurately express his liking for chemistry or any other like technical pursuit.

It has also been found that placing students on jobs which they do not like, contrary to your statement, is beneficial to both the college and the worker not only because it tends to widen the student's interests and give him a chance to experiment but also because it tends to develop his ability to work at a job that he is not interested in. On this account nearly all freshman during their first year in Antioch work for a time in some factory on the same terms

Dr. Hackensaw Is Back

THE Clement Fezandíé "Hackensaw" stories which have run for a long time in **SCIENCE AND INVENTION** will now be found in **AMAZING STORIES**.

They will be regularly published in that magazine, and the August number may now be found on all newsstands.

with the employer as those of the other laborers.

WALTER W. PRICE,
Yellow Springs, Ohio.

(We will grant that the arguments in the first portion of your letter are substantially correct, but we do not see how it is possible that students are benefited by placing them in jobs which they do not like; such an action can only breed discontent and disgust. Most of our Red agitation and propaganda is due primarily to discontent and dissatisfaction. Of course, there is the other side of this discontented nature which must be considered, in that when a man is dissatisfied with certain things he changes them, improves them and invents something to take their place. The cotton gin was invented because Whitney was dissatisfied with the way cotton was previously hand-treated. Slavery was abolished because of the discontent on the part of our Northern States. The Kaiser was made to abdicate because of similar feeling. It is thus seen that in either case there are uprisings, sometimes detrimental to those occupying governmental positions and other times for the benefit of humanity.—EDITOR.)

OUR BLUEPRINTS

Editor, SCIENCE AND INVENTION:

I have just received the blueprints of the 880-ton bark. This is one of the best prints I have ever used. It compares quite favorably with other prints that I have, that have cost me ten times as much. Needless to say I am starting work on this model at once, and I will be glad to send you a snapshot of it when it is completed. I intend to make the under part of the hull of mahogany and upper part of white pine, finishing the wood natural. I have used this method before and find it makes a quite striking combination, to say nothing of ease of finishing.

WILTON FISHER,
Tulsa, Okla.

(Monthly, the Blueprint Department of SCIENCE AND INVENTION Magazine increases in size. The same nominal fee is made for all prints which this department furnishes. Thus, the blueprint for the 880-ton bark costs only 50c and that is the average price for every large single blueprint. Where two prints are furnished for any one particular model, the cost is also in the nature of 50c a print, making the total price \$1.00 for the combination. The Model Department is becoming very popular, more so every month. Nevertheless, we cannot make it too popular, so it behooves all model makers to get busy.—EDITOR.)

LIKES POPULAR MAGIC

Editor, SCIENCE AND INVENTION:

Having read your magazine "Popular Magic," prepared by the staff of SCIENCE AND INVENTION, under the direction of Prof. Dunninger, I must say it is one of the most interesting magazines of its kind published for the public, for the price you ask for it.

ANDREW YONCONISH,
Bolling Field, Washington, D. C.

(Your letter is but one of the many which we have received in which the writers praise Popular Magic. There are a few letters which have arrived, some reporting to come from magical societies and others from magicians, who believe that we are making a mistake in putting out a publication similar to Popular Magic, inasmuch as it would injure magicians who are trying to make a living by mystery. To these magicians we always answer that nearly all of the tricks in Popular Magic are original. If they are being used on the stage by legitimate performers, then they are being used without permission of the inventor. We exclude from this category of original illusions the simple parlor tricks which everyone knows and which are not being employed on the stage.—EDITOR.)

WANTS SHORT STORIES

Editor, SCIENCE AND INVENTION:

Since Dr. Hackensaw has disappeared from the pages of SCIENCE AND INVENTION, and the story of "Tarrano the Conqueror" is the only bit of scientific fiction that appears in your magazine, it seems that the magazine has lost some of its interest. I had bought the magazine on that account. I have always liked this form of scientific fiction and when I found that only one story was running in SCIENCE AND INVENTION, I began to have serious thoughts of discontinuing it. But, just at the moment of greatest trouble appears a remedy in the form of "AMAZING STORIES." I am surely thankful for your timely contribution, and I am sure it will be received by others with as great thankfulness.

KLARENCE KISSINGER,
Lititz, Penna.

(It depends entirely on our readers as to whether or not SCIENCE AND INVENTION Magazine is to run a short-story monthly in addition to the serial, or whether the publication is to continue the present policy. We would appreciate hearing from our readers as to whether they want a monthly short-story in addition to a serial. A great many short-stories as well as novelettes are found in every issue of AMAZING STORIES and for those on the look-out for scientific fiction, this monthly magazine will prove a veritable gold mine.—EDITOR.)

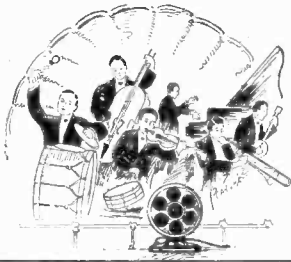

RADIO

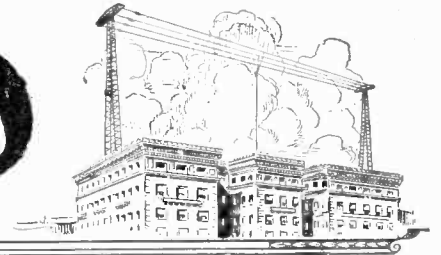

Radio Amateur Talks With Polar Fliers

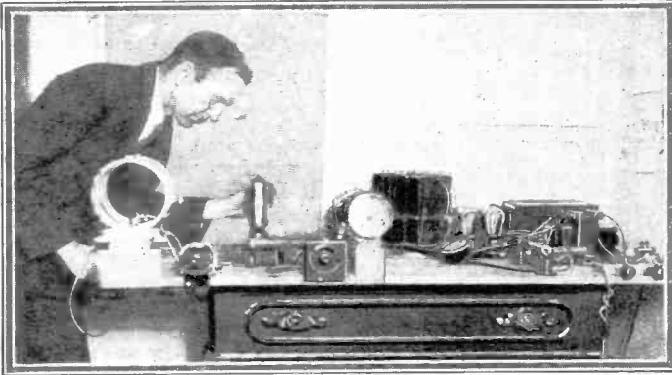

The owner of 2NZ adjusting the transmitter.

North Pole Expedition when the intrepid flyers made their recent trip to the icy regions. A two-way conversation was carried on between the New York radio enthusiast and the Eskimo birdmen on seventeen different occasions. The total power used at 2NZ is 50 watts, this being the energy drawn by the single transmitting tube used in the sending apparatus. The circuit employed in the transmitter is the reliable tuned grid and plate



Mr. E. J. Strout, Jr., copying a message.

Mr. E. J. Strout, Jr., who owns and operates the amateur Radio Station 2NZ, located in New York City, succeeded in keeping in constant communication with the "Byrd"

circuit. The receiving set consists of a three-circuit regenerator short-wave tuner. To boost up weak signals, a single stage of audio frequency amplification is employed. Simplicity of

apparatus and the avoidance of complicated wiring have largely been responsible for the success which has been obtained with both the transmitter and receiver.

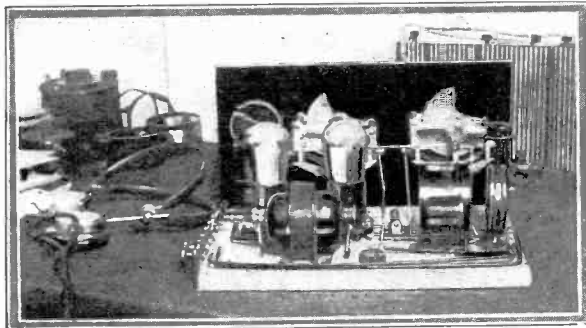

The short-wave receiver with which the signals from the polar expedition were picked up is here shown. It uses a regenerative detector with one stage of A.F. amplification.

Radio Station 2NZ boasts of a 50-watt transmitter employing the tuned grid and plate circuit. The apparatus is laid out in breadboard fashion, giving easy access to the instruments.

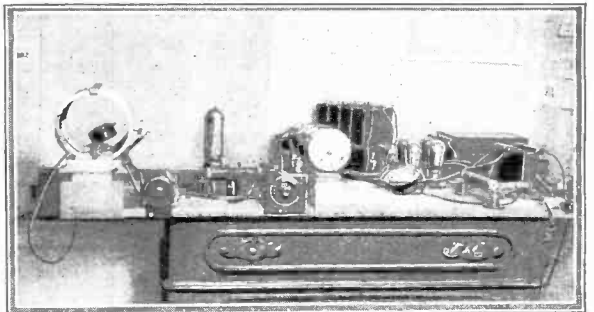

Static Is Directional!



That static has directional properties has been definitely proven by a series of tests made by the Bureau of Standards. By means of the loop shown in the photograph, it has been demonstrated that static ordinarily comes from a southwesterly direction, unless storm areas cause a shift to other points of the compass.

Miss Jane Wymore, of the Bureau of Standards, is shown here adjusting the static loop, with which directional tests are carried out. A radio receiving set installed in a lunch wagon, not only attracts trade but makes the food much more attractive and more enjoyable.

Radio a la Lunch Cart

An enterprising Englishman has recently produced a sensation by installing a radio receiving set in his lunch wagon. His patronage has greatly increased as a result, and his popularity is growing daily. While partaking of food the customers enjoy a concert or other form of radio entertainment and are thus put in a rather pleasant humor. When a man is in this frame of mind, he usually eats more heartily than he would ordinarily.

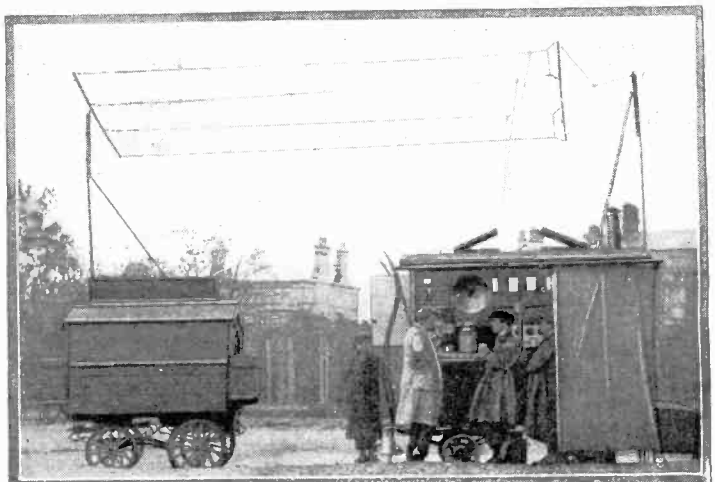

About "Cavalleria" and WRNY

By CHARLES D. ISAACSON, Program Director WRNY



"LA MOINEAU"
The Sparrow, from Montmartre, France—the wild-est who ever went on the air over WRNY.

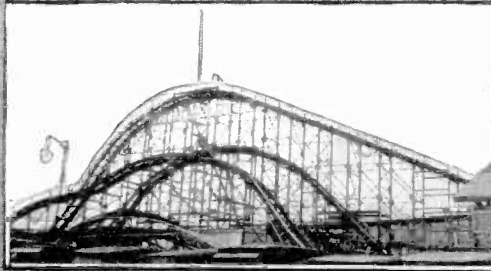

THE THRILLING "THUNDERBOLT"
The roar of this Coney Island attraction went on the air over WRNY.

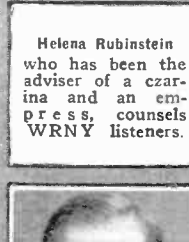

Helena Rubinstein who has been the adviser of a czar-ina and an em-press, counsels WRNY listeners.



Hon. Joab B. Banton District attorney of New York, who delivered an address on the con-stitution in WR-NY's legal series.

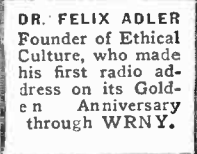

DR. FELIX ADLER
Founder of Ethical Culture, who made his first radio ad-dress on its Gold-ten Anniversary through WRNY.



Berton Churchiff "Alias the Dea-con," is a delight to WRNY fans in his interesting charac-ter sketches.



Ferruccio Corradetti Veteran singer and instructor, who re-tains a youthful voice at 65, a reg-ular at WRNY.



VIOLA BLANCHEY
Fine coloratura so-prano, who is frequently heard over WRNY.

INTERMEZZO from Cavalleria Rusticana—requests come again and again for that famous melody to WRNY. Hand organs grind it out and everybody sings it. And so Mascagni's fame goes on and on. Recently we included a whole scene from "Cavalleria" in the Edison Hour, when the Edison Ensemble, Maude Morgan, harpist, and Judson House, American tenor, gave it over the air. So I am going to tell you something about this famous opera. It has only one act, but it brought immortality to its composer over-night.



Vladmir Graffman Genius of the violin, and his artist students, are a fortnightly treat broadcast by WR-N. Y.

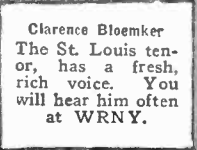

Clarence Bloemker The St. Louis ten-or, has a fresh, rich voice. You will hear him often at WRNY.



Pietro Mascagni, a disappointed dreamer, eking out a mere existence teaching music, heard of a contest for one-act operas. Urged on by his ever hopeful wife, Mas-cagni, a failure, determined to try again. He rushed out the score, and knowing that it was his greatest effort, he dared to im-agine he might win. And he did. Heard at Rome, "Cavalleria" was acclaimed by the Italian public. "Rustic Chivalry" (the Eng-lish translation), was heard all over the world; and little Mascagni found his name alongside Verdi, Beethoven, Mozart. While Mascagni has written many operas since, he has never equalled "Cavalleria." But his fame will endure through this true mas-terpiece of genius.



MARCELLA GEON Well known for her fine accompani-ments and instru-ction, is directing a concert series at WRNY



RENE FONCK French ace of aces, who is flying from New York to Par-is, spoke at WR-NY, coming and going.

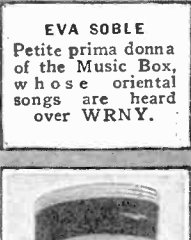

EVA SOBLE
Petite prima donna of the Music Box, whose oriental songs are heard over WRNY.

STORY OF THE OPERA
The scene is laid in Sicily on an Easter morning. Facing the cathedral is the inn of
(Continued on page 375)



JUDSON HOUSE
who starred in "Cavalleria Rusti-cana" during the Edison Hour at WRNY.

FRANCE AND AMERICA MEET AT WRNY
WRNY's radio ambassador, Georgette Nyrielle, with France's consul-general, Maxime Mogendre, and Mr. Isaacson.

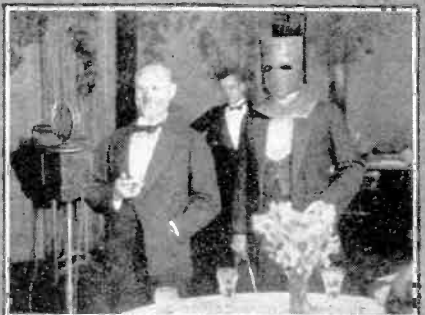

Will Irwin, the famous author, with the Man of Mystery, before WRNY's micro-telephone at the McClure's dinner.

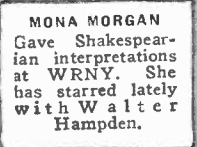

MONA MORGAN
Gave Shakespear-ian interpretations at WRNY. She has starred lately with Walter Hampden.



Kinks for the Radio Bug

By RAYMOND B. WAILES

A Few Practical Hints

Trouble Lamp

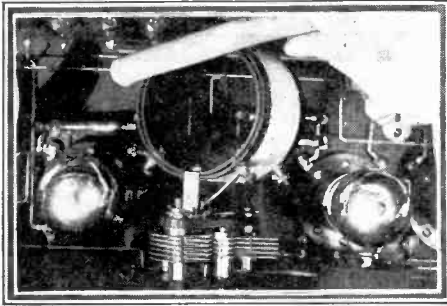

A "proboscope" consisting of a small flashlight bulb having two wires soldered to its terminals and forced into the end of a piece of rubber tubing is useful in tight places.

Sanding Wheel

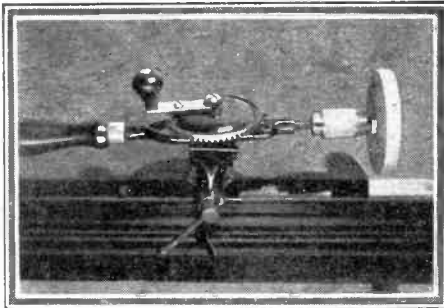

A strip of sandpaper glued or tacked on the periphery of a wooden disk held in the chuck of a hand drill makes a good sand wheel.

Drill Stand

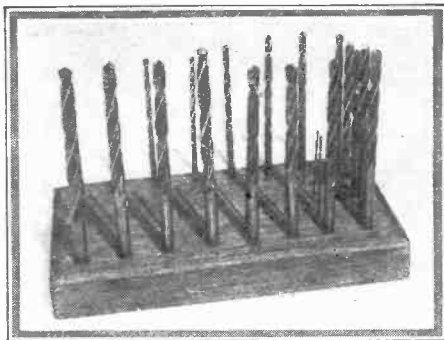

Drills may be kept handy if held in a drill stand. This may be easily made out of a block of wood 7/8"x3"x5", using each drill to make its own hole. Beside each hole stamp into the wood the number of the drill. Shellac or varnish the stand.

Sodion Hook-up

HERE is a hook-up with which I have had exceptionally good results. A Sodion D-21 detector is used. Although it is said that a Sodion tube does not oscillate, when using this circuit, I could pick up stations by the heterodyne whistle and they would come in louder, and I could cover longer distances than with the standard circuit.

I am using a specially wound variometer. The plate variometer has 128 turns and the grid variometer 96 turns. The actual hook-up is shown in the illustration.

Contributed by EVIN ZANE.

Extension Meter Leads

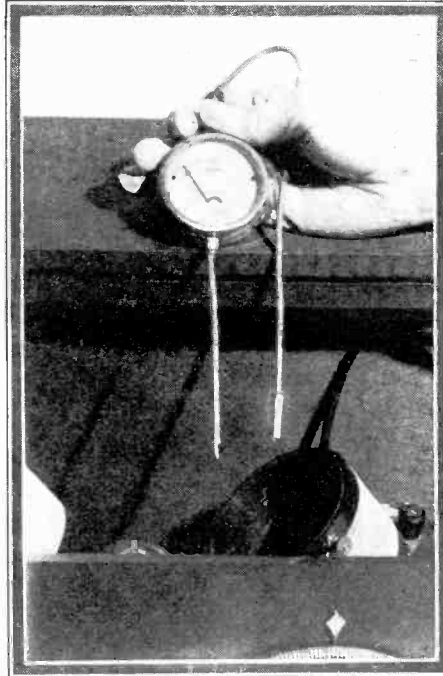

Convenient extension leads for the pocket voltmeter are made by soldering two pieces of bus bar, one to the meter case and one to the end of the flexible terminal. The bus bar is covered with spaghetti almost to the extreme tip.

Battery Brush

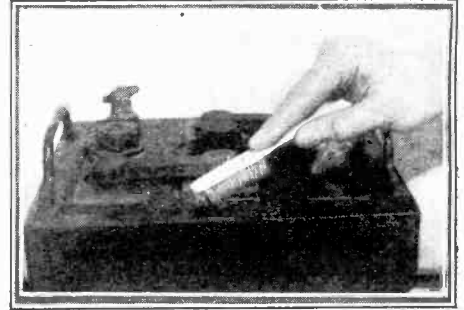

An old tooth brush is very handy for cleaning the tops of storage batteries.

Air Drier

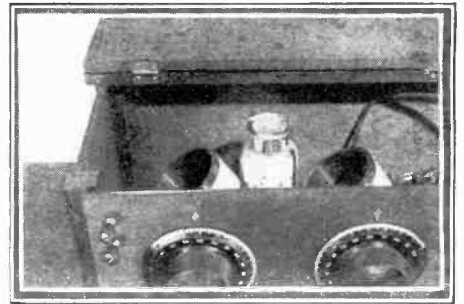

A bottle of calcium chloride or slaked lime inside the set keeps the air free from moisture and thus improves reception.

Table Condenser



A panel type condenser may be adapted for table mounting by fastening it inside of a piece of cardboard tubing by means of a pair of brass brackets. Connections are made to binding posts and a cardboard top is put on the tube.

A Curious Effect

A Spanish correspondent informs us of a very curious experiment tried with some carrier pigeons at the radio station of Paterna, near Valencia, Spain. Several birds were released near to the aerial mast at the moment when the station was transmitting, and it was observed that the pigeons lost their sense of direction. The tests were repeated many times, and in all cases the electro-magnetic waves appeared to destroy the pigeons' sense of direction. This would indicate that a severe lightning storm would also destroy their sense of direction. It would be interesting to determine which wave-length produces the greatest effect.

Practical!

That is what we aim to make the Radio Department of

SCIENCE & INVENTION.

Every set described in this section is carefully tested before it is considered for publication. Descriptive articles with photos and diagrams of sets desired.

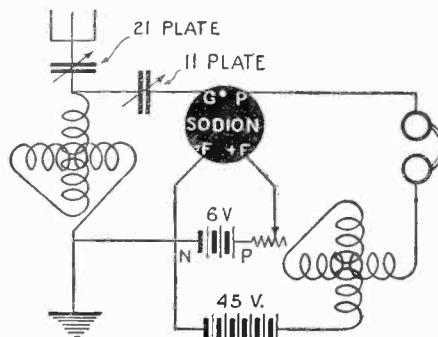

An experimental hook-up using the sodion detector.

All-Purpose Panel Voltmeter

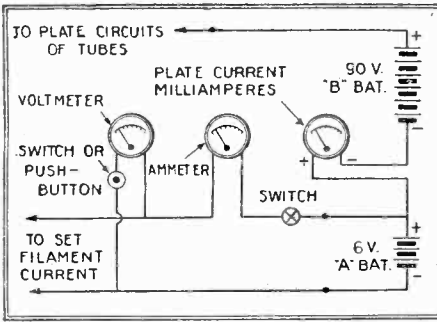

The above diagram shows how a milliammeter, filament ammeter and filament voltmeter are connected in the circuit of a receiving set. The milliammeter is connected to read the total plate current drawn by the set, the ammeter the total filament current and the voltmeter the voltage of the "A" battery.

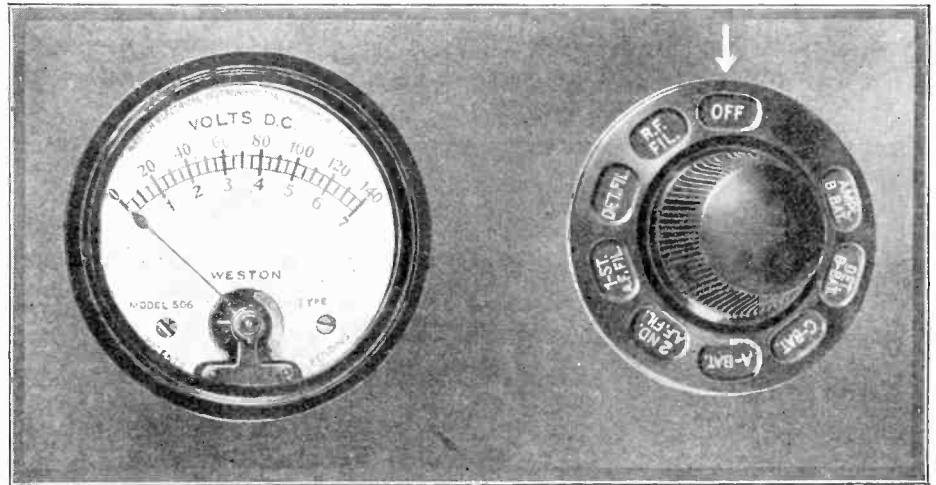

The voltmeter, together with the controlling switch, is depicted in this photograph. The pointer indicates which voltage is read.

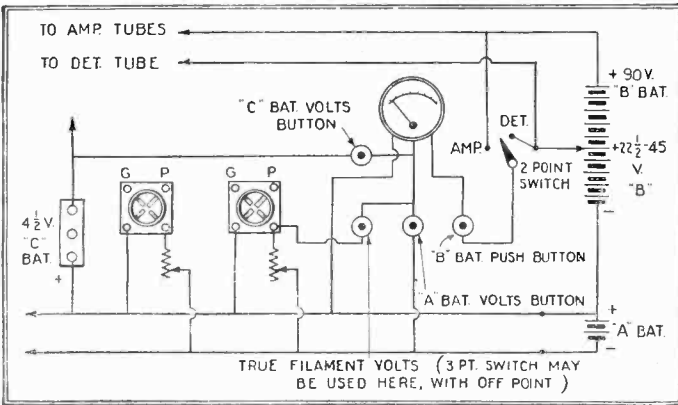

A voltmeter is shown here connected to read the voltages of the "C" battery, the "A" battery, and the detector and amplifier "B" battery. Readings are taken by pressing the various buttons indicated in the diagram.

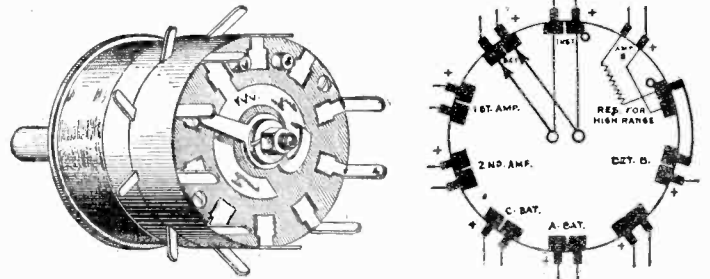

A rear view of the controlling switch showing the soldering tabs.

Internal connections of the controlling switch.

THE use of a voltmeter in a radio set tells at a glance the exact voltage condition in any part of the circuit. In the past, in order to give accessibility to all parts of the circuit it has been necessary to use several meters. This procedure is quite expensive and necessitates the use of a larger panel than would ordinarily be required for the set. The voltmeter and controlling switch shown herewith do the work of half a dozen or more meters practically at the price of a single meter and only occupy slightly more room. The controlling switch is essentially a two-pole multiple throw switch, having two moving arms and several pairs of contacts, by means of which the meter may be connected to any part of the circuit where a voltage reading is required. A "built-in" resistance is used in series with the meter for reading "B" battery voltages.

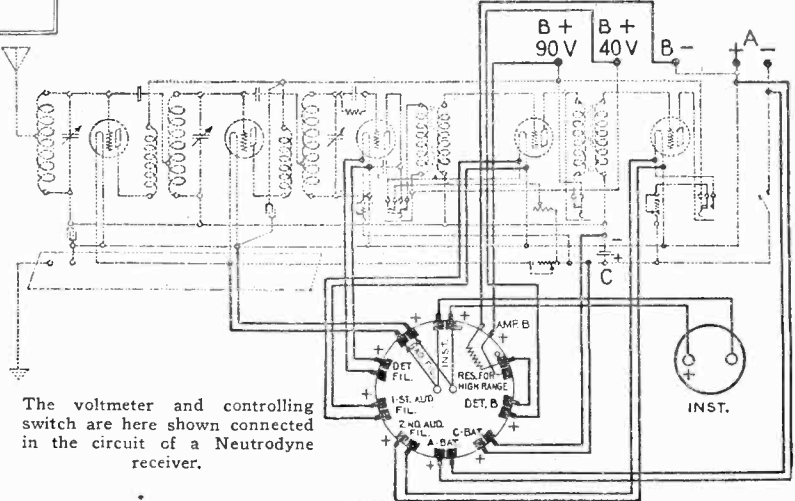

The voltmeter and controlling switch are here shown connected in the circuit of a Neutrodyne receiver.

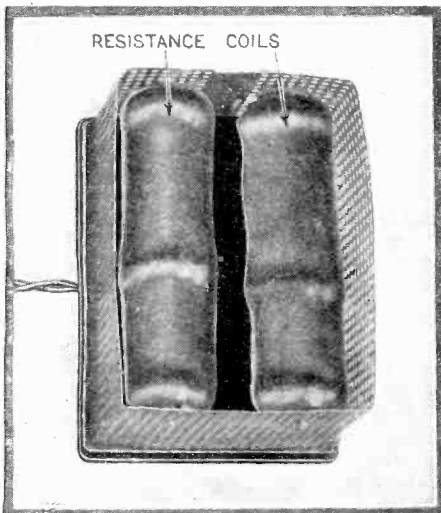

Tube Flasher

THE "full-emitter" type of tube such as the 201-A or 199 depends for its efficiency upon the thorium with which the filament is impregnated. An excessive plate or filament voltage removes much of the thorium from the surface of the filament, and the tubes becomes inoperative, or nearly so. In many cases tubes may be restored to their original activity by a process known as "flashing." This boils out some of the thorium in the filament and brings it to the surface. The two photographs show a tube flasher which operates directly from the 110-volt A.C. or D.C. lighting circuit.

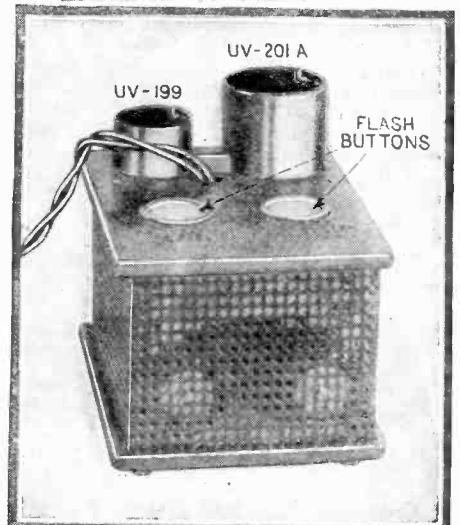

Something New in Super-Hets

A New Eight-Tube Super-Heterodyne Which Has Achieved Trans-Continental Reception on a Loop Without Ground or Aerial. Accurately Tuned Air Core Transformers Are Used As Well As Several Other New Features.

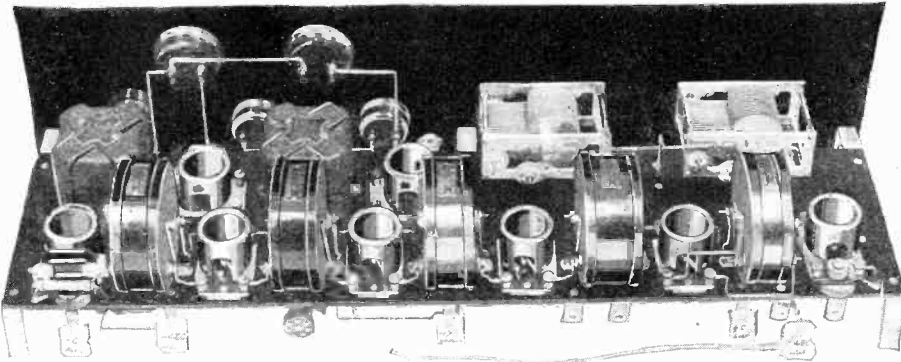

Rear view of new eight tube Super-heterodyne here described. The heteroformers all have metal shields which are grounded to negative A, thus eliminating body or other capacity effects entirely.

THE accompanying photos and diagrams show the full construction details of the very latest super-heterodyne, which has achieved trans-continental reception this spring on a loop, without using any ground or aerial whatever. The president of the concern sponsoring this super-heterodyne received Los Angeles on the loud speaker in his New York hotel room this April at 8:00 o'clock in the evening. Some of the remarkable features of this new super-heterodyne are that there are no body capacity or other inductive effects or pick-up, due to the fact that all of the accurately tuned air core transformers employed are shielded, all of the metal shields being grounded to the negative A terminal of the circuit.

The oscillator is specially designed and connected in an entirely different manner than heretofore, the pick-up coil being placed in the plate circuit of the first detector, as the diagram shows. This helps to eliminate noise and other effects due to placing the pick-up coil in the grid circuit, and moreover it eliminates the usual super-het annoyance of tuning in a station on two or more points on the dials of the condensers.

No potentiometer is employed in this super-heterodyne circuit, and no "C" battery is used on the intermediate frequency amplification tubes, as is the case in other previous circuits where the potentiometer was eliminated. A potentiometer may be inserted in the circuit for controlling the grid bias on the intermediate frequency tubes if desired. One source of noise, namely, the grid leak and grid condenser in the first detector circuit is eliminated by the use of the $4\frac{1}{2}$ -volt "C" battery, connected in series with the loop and grid, as the diagram clearly shows.

High resistance rheostats are used on the tubes in order to give accurate and smooth control over a considerable range, the tubes having to burn only at a dim brilliancy, thus eliminating another source of noise. The

writer has found that it is best to use shock-proof sockets for all tubes, or else to mount the sockets on a piece of bakelite, suspended on rubber bands. The metal shields on all the air core transformers constituting the super-het proper, are grounded to the negative A terminal, except in the case of the No. 5 unit, which has a wire running from negative A to the lug on the shield. A radio frequency choke coil is placed in series with the primary of the first audio transformer. The iron cores or shells of the transformers are grounded to the negative A, as well as the rotary plates of the two main

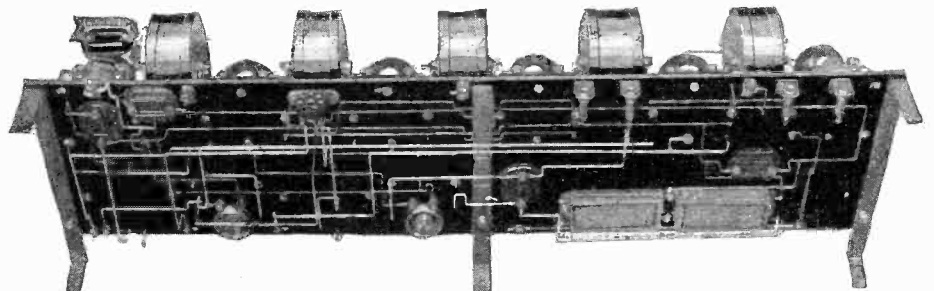

View under the sub-base of eight tube Super-heterodyne showing fixed by-pass condensers and neat arrangement of wiring. Sockets used should be of the resilient type and tuning condensers of SLF type.

tuning condensers. It is best to place one of the new protective fuses in series with the negative "B" battery line. If fairly strong signal or voice is desired on the loud speaker, a tube such as a UX 112 can be used in the second audio stage, using a 9-volt "C" battery, as shown in the diagram. The $4\frac{1}{2}$ -volt "C" battery is sufficient for both A.F. tubes if UX 201-A tubes are employed throughout. UX 199 three-volt tubes can be used in this super-het, the manufacturers supplying specially designed tuned air core transformers for these tubes. The small tubes can be used with the transformers supplied for use on the UX 201-A, but not as satisfactory re-

sults are obtained as when the proper impedance transformers are used for the type of tube selected.

The volume control comprising a graphite compression unit giving 25,000 to 250,000 ohms' range, is connected across the secondary of the first A.F. transformers. The voltmeter and milliammeter may be dispensed with if the constructor does not care to purchase them. Only the best grade of rheostats and by-pass condensers should be purchased as these are two particular sources of noise, especially in super-heterodynes. The rheostat used to control the oscillator tube should be of the very highest quality, as variations in the resistance due to a faulty rheostat will cause changes in the frequency, and the signal will fade and the set will not be satisfactory. Cheap by-pass condensers are another bad offender, in that they begin to leak perhaps, and the operator never suspects that these are the source of the noise, which may resemble a steady steaming sound.

As one of the diagrams herewith shows, the tuned air core transformers of the shielded type utilized in this set, may be placed about 3 inches apart in a row at the rear of the base, with six of the tube sockets spaced in between them. When using these shielded transformers, there is no danger of picking up noises from house lighting circuits, etc., and unlike other super-heterodynes of the unshielded type; it is also impossible to pick

up a station unless the loop is actually connected to the set. When this is not the case, it shows that the various intermediate transformers are doubtlessly picking up radio waves, and it can readily be seen that a set which does this is not likely to tune sharply, and also there is liable to be trouble in picking up more than one station at a time, as well as interference from nearby lighting and power circuits. The transformers used in this new super-heterodyne are wound and calibrated with the very highest precision in the radio engineering laboratory connected with the manufacturer's establishment, the secondary of each transformer being shunted by a fixed condenser of the highest quality. Unlike some super-hets, the transformer condenser is not varied to tune the transformer, in connection with an oscillator and wave meter, but the number of turns on the secondary are changed until the circuit is balanced to within a fraction of one per cent. accuracy.

Note that the grid return of the second detector goes to the filament plus instead of battery plus. Be sure to test all rheostats and all condensers, including the fixed unit, to see that they are not short-circuited or open-circuited before you install them. It is important to keep the "A" battery always well charged in operating super-heterodynes and a storage "B" battery is desirable.

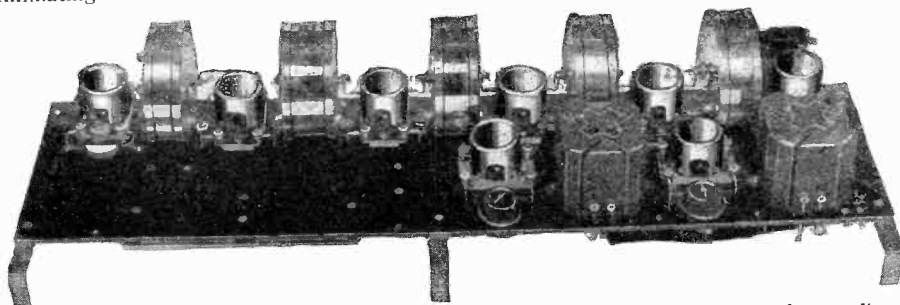

Front view of Super-heterodyne showing eight sockets, heteroformers and the two extra large audio frequency transformers employed. Under most conditions one such stage of audio is sufficient.

The Very Latest In Super-Heterodynes

This Eight Tube Super-Heterodyne Employs Accurately Tuned Air-Core Transformers

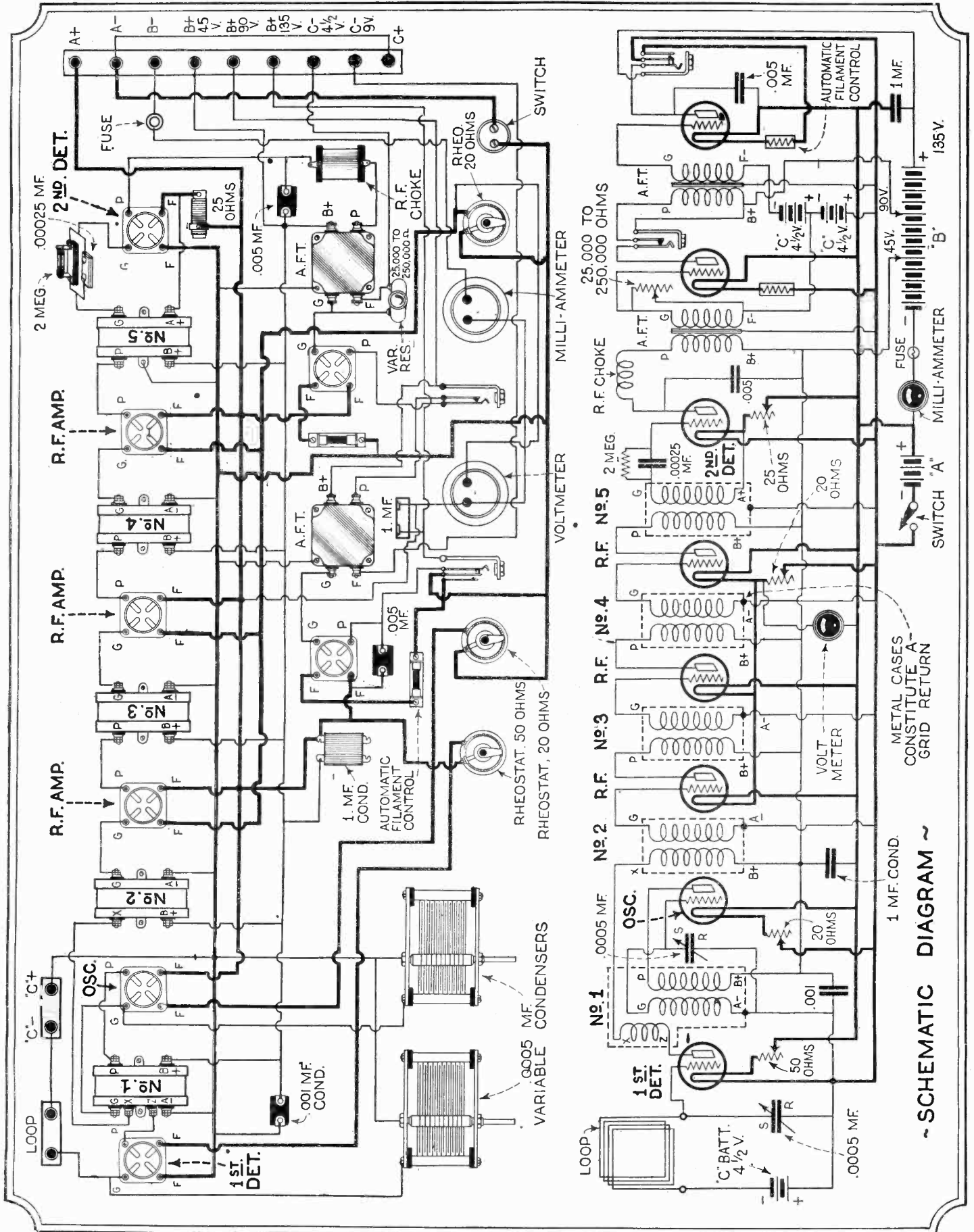

This new type of super-heterodyne employs accurately tuned air core transformers for the oscillator and intermediate stages of radio frequency amplification. This circuit and the specially built heterodyners are arranged in a new and novel manner. As will be seen by studying the circuit, the pick-

up coil of the oscillator is placed in the plate circuit instead of the grid circuit of the first detector. No potentiometer or "C" battery is used on the grids of the intermediate frequency tubes, and also no grid leak or grid condenser are used for first detector, 4 1/2 volt "C" battery taking their place.

Some Experimental and New Reflex Circuits

By L. W. HATRY, 10X

IN DEVELOPING some reflex circuits that looked good on paper a good deal of experimenting with arrangements and hook-ups was not particularly necessary but was decidedly interesting. Exact measurement of inductances, capacities and resistances being of minor importance, was not attempted. No sort of laboratory work was done that required advanced knowledge or equipment; so an account of this sort of pastime that merely paves the way for more exact work might be of interest to the man no better equipped than was the writer.

An old panel, two years old to be exact, and bearing the call letters 5XV, which was the writer's designation as an amateur when in Texas, full of holes but of 7" x 18" dimensions, looked just about right for a handy mount, so three condensers were attached.

Two sizes of condensers were used, one of .0005 microfarad and two of .00025 microfarad. All of the condensers were straight line wave-length type.

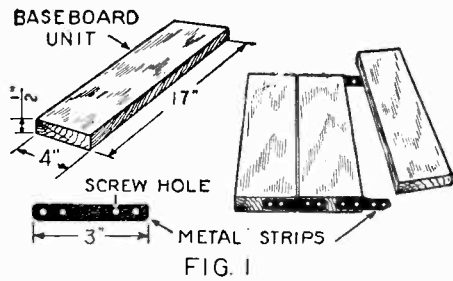

FIG. 1
If it is not possible to obtain a baseboard large enough to hold all of the parts the board may be built up of units as shown above.

A great deal has been said in recent articles regarding the importance of sufficient primary turns in the R.F. transformers. Yet we know that the ratio between the number of primary and secondary turns is approximately our voltage step-up, and this voltage step-up is important to gain amplification. Assuming that we demand a primary winding of 20 turns, then we want as many turns in the secondary as possible. A .0005 microfarad variable will use 45 turns of secondary, with a given coil diameter and wire size, to tune from 200 to 600 meters, or 180 to 550, approximately; but the necessary wave range can be obtained with a .00025 microfarad condenser and 70 turns of winding, with a certain size of wire and diameter of form. In the first case our winding ratio of S:P is 2½:1 and in the second 3½:1. The latter is therefore preferable, which is the reason for the .00025 mfd. variables. The antenna capacity, "butting" in on the tuned circuit of the first tube, interferes with the tuning range expected; so that, to compensate, more variable shunt capacity must be used. This explains the .0005 mfd. condenser.

Coils, the method of mounting, sockets, resistances necessary, transformers, and so on, all these vary according to the state of mind of the manufacturer, what is on hand or the builder's whims. Therefore, the baseboard, to match with the panel unit, must be variable in size. Accordingly, a length of ½" x 4" board was obtained. This was cut up into several 17" lengths, the length fitting nicely behind the panel. The baseboard, by the use of metal strips and screws, could then be deepened in 4" steps to any area necessary to mount any quantity of apparatus without crowding. Fig. 1 shows the baseboard arrangement.

CIRCUITS EXPERIMENTAL

In this hodge-podge, no untried arrangements will be found. Those presented are combined of practical and effective arrangements which are also theoretically sound.

Those included in the group in the article are becoming more or less known, although none of them have been published by another writer. All of them have been tested by myself. All of them will work with varying degrees of satisfaction—depending entirely upon the builder's patience.

In Fig. 2A is shown a one-tube reflex with a crystal detector. The essentially new features of this reflex circuit are in shunt-feeding the audio-energy into the R.F. amplifying tube and arranging the rotary plates of the variable condenser so as to be grounded. This method of coupling up the audio frequency and radio frequency energies has been called the *Hartford Times Reflex Circuit*. Practical constants for the circuit are: L1, 3" diameter, 50 turns No. 24 D.C.C. wire; L2, 20 turns wound between the two halves of L, which makes 40 turns in all, same diameter and same wire; C1 and C are

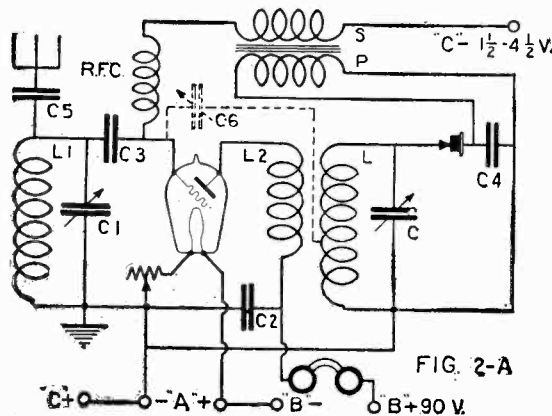

FIG. 2A shows a 1-tube reflex, the outstanding feature of which lies in the shunt feeding of the audio frequency energy into the radio frequency amplifying tube. If it is desired to use a tube detector in preference to a crystal, then connections should be made as in Fig. 2B.

.0005 mfd. variable condensers; C2 and C4 are .006 mfd. and .001 mfd. respectively; C3 is .00005 microfarad, fixed or variable or made according to Fig. 5; C5 is .0001 to .0005 mfd., depending upon the antenna, and the R.F.C. is 1500 turns of wire jumble-wound on an ordinary thread spool or else a ½" diameter dowel, the wire being 34 D.C.C. or D.S.C., or smaller. The R.F. choke winding should be mixed and not layer wound, for a layer wound choke is often useless. The condenser C3 must be .00005 mfd. or less to avoid distortion, if a good audio transformer is used. Should it happen that the audio transformer is bad, or guilty of distortion, it may be found to pay to experiment with various sizes of C3 since a size can be found that will materially help to smooth out the performance of a poor transformer and make it produce fairly even amplification over the audible range of frequencies. This effect will be noticed when the bass notes seem to become unusually em-

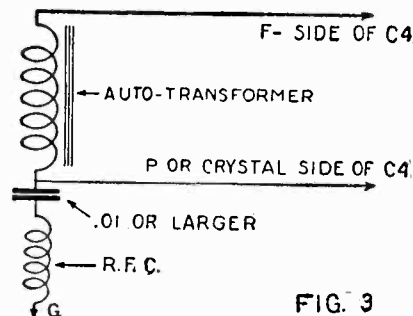
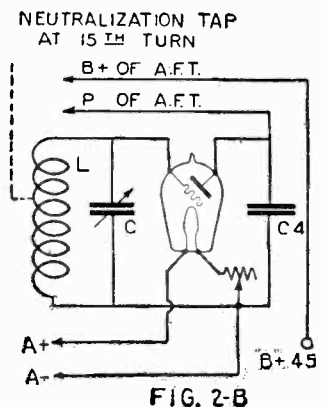

FIG. 3
Impedance coupling may be used in place of a transformer by following the above connections.

phasized. Variation in the R.F. transformer dimensions is possible, of course. In fact, if other than .0005 mfd. variable condensers are on hand such a variation will be necessary; with .00035 mfd. size, the secondary winding changes to 60 turns and with .00025 mfd. to 75 turns, if the previously specified coil diameter and wire-size are adhered to. The antenna coils cannot be satisfactorily tuned with a .00025 mfd. condenser with some antennas, but it is not necessary that an experimental set cover the wave-length band exactly as one would expect of a finished set.

As you probably know, the crystal detector is essentially a current-operated device. For that reason, the performance of the crystal is best when the ratio of turns between L and L2 is low. However, the size of L2 will determine the stability of the reflexed tube unless some means of neutralization



are provided. The connection of the neutralization components are indicated by the dotted line. The small condenser C6 can be any type of midget variable capacity. The tap on L is determined by the number of turns in L2, the 35th turn from the crystal connection being found satisfactory.

Fig. 2B shows the tube detector connections, if a tube is to be used in preference to the crystal. The addition of regeneration will result in something on the order of the so-called Roberts' circuit. A tickler coil for regeneration would have relation to L, of course, and would have to be about 18 turns. In 2B, it is noticeable that no grid-condenser is used. The detector in a reflex set, if a tube, is more certain to be effective if the tube is used as shown; *i. e.*, without a grid-condenser, with 45 volts of "B" battery and with the filament return to the negative side of the "A" battery. It sometimes happens that the performance of the detector tube is improved under these conditions if the use of from 1½ to 4½ volts of "C" battery is experimented with.

Fig. 3, applying a change in Fig. 2, shows the use of impedance audio-coupling in place of an audio transformer. This is the first time a reflex circuit has been shown that could use impedance-coupling. The impedance can be an old audio transformer secondary winding with the primary left free. The quality of musical reproduction that results from the proper size of impedance is nearly perfect, and most A.F. transformer secondaries are right for the type 01A tube. *Don't forget the R.F. choke.*

FIGURE FOUR

In Fig. 4 is illustrated a more complicated circuit. The amplification resulting is that of four tubes, while the crystal acts as detector. The sets assembled from it

give two stages of R.F. amplification, detector and two stages of audio-amplification. If it were neutralized it could be considered very similar to the five-tube neutrodyne.

An unusual arrangement of the audio and radio circuits makes all of the audio circuits to be shunt-fed through R.F. chokes. Such an arrangement makes certain of the highest grade of stability throughout the set.

If self-neutralization is depended upon, the primaries of the R.F. transformers will have to be of six or eight turns. Fig. 6 indicates the correct connections of the R.F. transformers if the windings are wound in the same direction. If the set is neutralized, the primaries can be from 10 to 15 or 20 turns; the more turns there are, the less the selectivity, but the greater the volume and sensitivity—L2 and L3 being the coils concerned. The antenna and secondaries' coils, L1, L4 and L, are made as described before, to fit the size of variable condenser on hand to be used.

C3 and CC3 are again very small condensers *a la* Fig 5, or else purchased in a

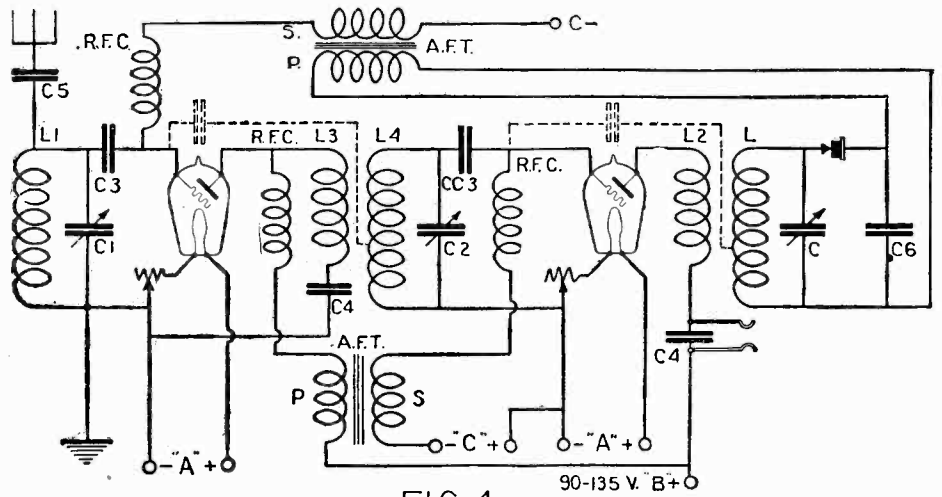

FIG. 4
This circuit, while more complicated than the one shown in Fig. 2A, gives an amplification equivalent to four tubes, the crystal acting as a detector. There are two stages of R.F. and two stages of A.F. If neutralized, the hook-up becomes equivalent to a five tube Neutrodyne.

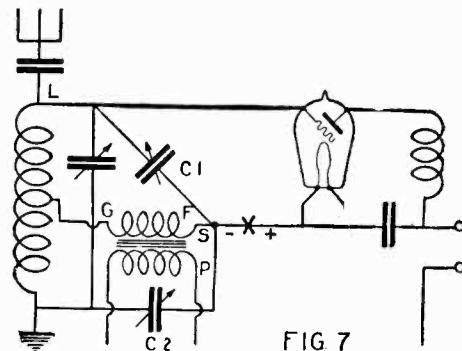

FIG. 7
Another type of reflex circuit is shown in Fig. 7. The Wheatstone Bridge principle is used here.

capacity of .00005 mfd. C4 is .002 mf. and C5 is adjusted for the size of antenna on hand. C6 is .006 mfd.

Again it is important that the primary L2 shall be adjusted to fit with the crystal detector, although the ratio L2:L is not very important, provided sufficient energy does get from L2 to L.

The crystal detector in a reflex set is best chosen for stability, which limits one to a fixed detector preferably, and very likely to a carborundum crystal. An adjustable detector will be stable enough.

If the Hazeltine or neutrodyne method of neutralizing is employed, it will be found relatively easy to neutralize the set. Due to the fact that a reflex set couples up the audio and R.F. ends so thoroughly, it is inevitable that audio oscillation should start up, especially in this set. That is what happens when the set howls. When it is neutralized, it becomes stable and quiet. The business of adjusting thus thoroughly smooths it out.

FIGURE SEVEN

In Fig. 7 is illustrated another method of reflexing that does the things accomplished in the *Times* circuit with perhaps neither

less nor more complication. As a preliminary, it is necessary to mention what does occur in the *Times* circuit that makes it preferable to the normal reflex circuit.

The condenser normally in shunt to the secondary of the audio transformer can or can not cause bad distortion, depending upon

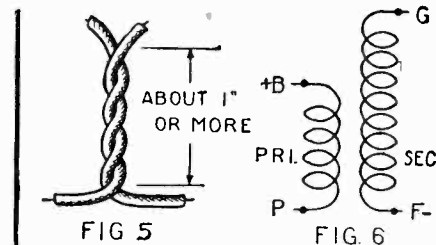

FIG. 5
FIG. 6
If the windings of the R.F. transformers are put on in the same direction, then the connections should be made as in Fig. 6.

its size. To avoid distortion, the condenser should be .00005 mfd., or less, in a reflex circuit using ordinary audio transformers, and up to .0001 mfd. if usually good audio transformers are on hand. In any case, this capacity must be small. When a small capacity is used in the usual reflex circuit it permits excessive instability because R.F. energy will go into the A.F. transformer, and from there wander into other tubes and their circuits and so be the beginner of useless and annoying feed-back. It is necessary to use a small condenser and at the same time eliminate the feed-back. The R.F. choke does that trick. It prevents the feed-back so that the condenser can be of any size desired, which has proved proper. Then it becomes exceedingly useful to have the rotary plates of the variable condenser connected directly to the filament lines, and to have the filaments grounded, to prevent capacity effect. This stunt puts the condenser mentioned, the fixed one, necessarily at the grid end of the R.F. transformer.

It also gains another valuable quality. Since the high-potential electrostatic fields are not confined to the stator plates, and from stage to stage these are out of phase, it prevents an electrostatic or condenser coupling from existing between stages of the R.F. amplification and so improves the notoriously bad selectivity of the usual reflex by removing the cause. Although the R.F. transformers have been built with entire respect for radio-engineering data, the R.F. electrostatic feeds provide free coupling that allow the R.F. to cavort about with entire disregard of the conventions.

Experiments with reflex circuits will more than repay the constructor for his trouble. The trend in present-day sets is to use a large number of tubes, little or no regard

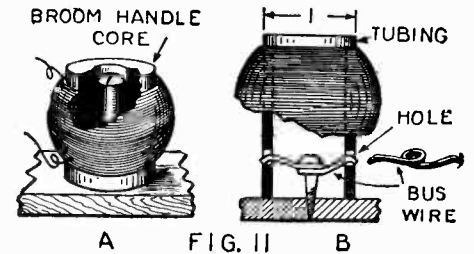

FIG. 11
The R.F. chokes are jumble-wound to minimize distributed capacity. Two winding forms are shown.

being given to economy of current consumption. In practically every circuit but the reflex, each tube is required to perform but one duty, whether it be that of a detector, oscillator, radio frequency amplifier or audio frequency amplifier. However, a vacuum tube can be made to act in a dual capacity without sacrificing very much in either efficiency or quality. If there is a slight depreciation in quality due to reflexing, it is more than compensated for in the reduction of the total number of tubes necessary.

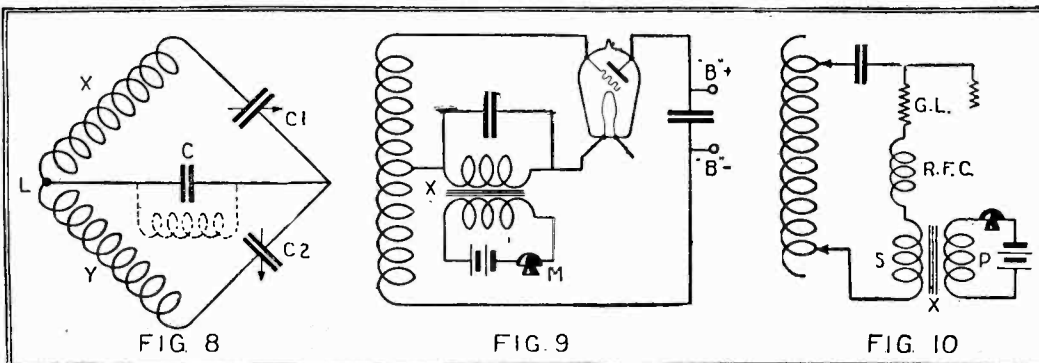

FIG. 8
FIG. 9
FIG. 10
The hook-up shown in Fig. 7 is indicated in its equivalent ideographic form in Fig. 8. C1 and C2 are midget condensers forming the arms of a Wheatstone Bridge and are used for balancing the radio frequency currents out of the audio frequency transformer, the distributed capacity of which is represented by the condenser C (the secondary winding being indicated by the dotted inductance across C.) This method effectively prevents undesirable feed-back. Figs. 8 and 9 show the equivalent transmitting circuits which tend to introduce distortion in a reflex set because of the occurrence of modulation. The similarity between these circuits and the normal reflex arrangement is immediately obvious.

RADIO ORACLE

In this Department we publish questions and answers which we feel are of interest to the novice and amateur. Letters addressed to this department cannot be answered free. A charge of 50c. is made for all questions where a personal answer is desired.

PREVENTING OSCILLATION

(483) Q. 1. William Klein, Bronx, N. Y., desires to know what methods may be used to prevent a tuned radio frequency set from oscillating.

A. 1. The two most popular methods of preventing a tuned radio frequency set from oscillating are the following:

1. The coils are placed very close to the metal

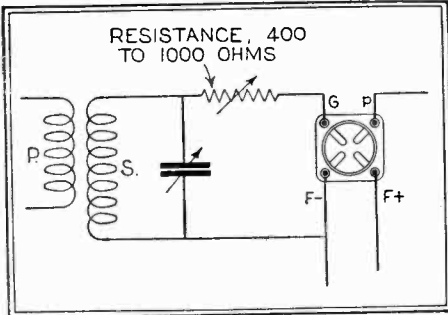

A variable resistance will prevent oscillation if connected in the R.F. and detector grid circuits.

end-plates of the tuning condensers, thus introducing eddy current losses in the circuit. These losses in many cases will entirely suppress any tendency on the part of the set to oscillate.

2. Another method is to connect a resistance of from 400 to 1,000 ohms in the grid circuit of the radio frequency tubes, as shown in the diagram on this page. The function of this "damper" resistance, as it is called, is to absorb some of the power flowing in the grid circuit. If the damper resistance is of the proper value, the oscillations will be completely suppressed.

CAPACITY GROUND

(484) Q. 1. V. A. Bower, Shelburne, Canada, writes that he has been able to receive signals on his set by substituting for the regular ground a wire dipped in a glass of water. He desires to know whether he has discovered a new type of ground.

A. 1. It is entirely possible to receive radio signals and to transmit them without using a direct ground connection. It is only necessary to have a capacity effect between the receiving or transmitting set and the ground. This is undoubtedly the situation that was found in the experiment you outline, but the glass of water had nothing to do with it.

Capacity grounds are also frequently used in airplane transmission and reception. The counterpoise used by the average amateur transmitter is a very good example of what might be termed a capacity ground.

CHARGING STORAGE "B" BATTERIES

(485) Q. 1. Geo. G. Abernethy, Toñfeld, Alta., Canada, desires information on how to use a Ford generator in conjunction with a step-up transformer, equipped with a vibrator similar to a spark coil for charging a 100-volt storage "B" battery.

A. 1. We would most certainly advise against your attempting to proceed as you have outlined. Charging storage "B" batteries from such a source would be a very expensive proposition and would require quite a complicated layout of apparatus. The best thing for you to do would be to obtain a small high-voltage generator, capable of delivering up to 1/4 of an ampere. If this is obtained in such a size as to deliver approximately 120 volts, it could be used for charging storage "B" batteries.

Q. 2. Can the step-up transformer and vibrator, in conjunction with a filter, be used in place of a "B" battery?

A. 2. A device of this sort would not be practical to replace a "B" battery. If the correct filter is used in conjunction with the generator mentioned in the answer to your first question, the arrangement may be successfully used for supplying the "B" potential to your radio set.

"DX" CRYSTAL SET

(486) Q. 1. Marcus McCoy, Dallas, Texas, wants us to tell him how to hook up a crystal set capable of receiving over long distances.

A. 1. There is really no such thing as a "DX" crystal set because of the fact that the same set will give results differing very much when used in various localities. Location as well as length and height of aerial has a very great deal to do with the "DX" qualities of any receiver whether it employ a crystal detector or a multitude of tubes. We would suggest that you use any standard type of crystal detector circuit, preferably loosely coupled to the antenna.

NOISY BATTERIES

(487) Q. 1. Raymond J. King, Lincoln, Neb., asks if it is possible for a dry "B" battery to cause noises in a radio receiving set.

A. 1. This is sometimes possible and is more often noticed in cheaper types of batteries than in those of standard well-known manufacture. Some authorities claim that it is impossible for a dry "B" battery to cause noises in a radio receiving set due to any intermittent or interrupted chemical action that may take place within the cells. It is, however, very true that a mechanically poor connection may exist within a "B" battery due to insecure soldering and then this joint causes fluctuations of the current which, of course, will give rise to disturbing noises in the reproducing element. This, however, is a rather rare case, but must be taken into consideration.

LOOP

(488) Q. 1. Richard Hays, Altoona, Canada, asks how many feet of and what kind of wire should be used in winding a loop for broadcast reception. Also how large a form should be used for supporting this wire?

A. 1. Use about 100 feet of wire. No. 18 bell wire or some similar type will be found quite satisfactory. A good many constructors prefer stranded wire, such as lamp cord. Wind this on a 3 1/2- or 4-foot frame, either of the box type, otherwise known as the solenoid, or in a spiral form, on a set of four or more radial arms. Various loops of different types have been illustrated in past issues of this magazine and you can get a very good idea of their construction from these articles.

SELF-NEUTRALIZATION

(489) Q. 1. H. L. Burmeister, Holyrood, Kan., has made up a tuned radio frequency receiver in which various adjustments of the neutralizing condenser do not affect reception. He asks why this is so.

A. 1. There are few receivers that will self-neutralize; your receiver seems to be one of the few.

Q. 2. How can a tuned radio frequency set of this nature be made to oscillate or regenerate?

A. 2. Slightly changing the angles of your neutroformers should enable you to make the set oscillate, if you wish it to, or to only regenerate.

Q. 2. Where should the grid returns of the radio frequency and detector tubes be connected.

A. 3. Be sure your radio frequency tubes do not have the grid return leads connecting to the A +; this return should be to A - on all tubes but the detector tube, when it should be at A +.

TANDEM TUNING

(490) Q. 1. R. L. Gordon, Los Angeles, Calif., asks: Is it possible to tune two stages of radio frequency with one condenser of .001 mf. capacity? I notice that in the tandem condensers now on the market the sets of rotating plates are usually connected together, and in some, the stationary plates also.

A. 1. In the standard tandem condenser the rotary plates are usually connected together but the sets of stationary plates are insulated from each other. If the stator sets were all connected together, the grids of the tubes in the R. F. circuits would all automatically be placed at the same potential and no amplification would result.

CHOKE COIL AMPLIFIER

(491) Q. 1. James W. Johnson, Milwaukee, Wis., asks: Can an audio frequency transformer, the primary of which has been burnt out, be used in any way in the amplifier circuit of a receiving set?

A. 1. Yes, the secondary may be used quite successfully as a choke coil of an impedance coupled amplifier by connecting as shown in the diagram.

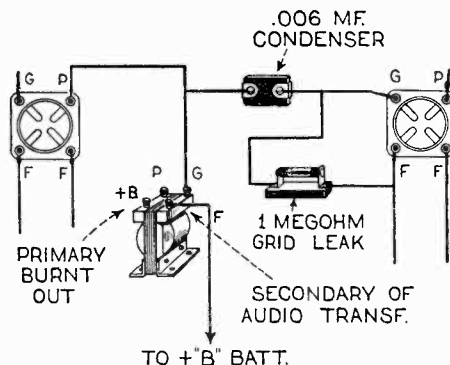

The secondary of an audio transformer in which the primary has been burnt out, may be successfully used in an impedance-coupled amplifier.

This will not give as much volume as the original transformer connection, but the quality will be greatly improved.

IMPEDANCE COIL DATA

(492) Q. 1. C. D. McGarity, St. Louis, Mo., wishes to construct a power amplifier using impedance coupling and would like to have the necessary data for constructing the 30 henry choke coils.

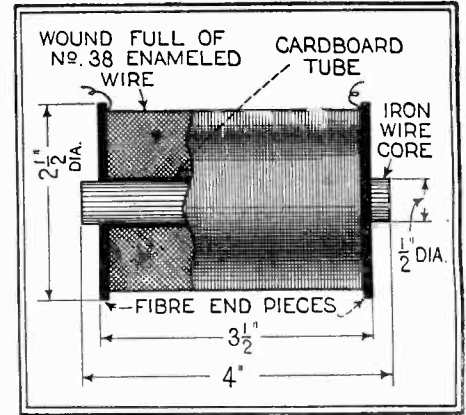

The construction data for an impedance coil to be used in a power amplifier is given in the above diagram.

A. 1. The core for the coil should consist of a bundle of iron wires, 4 inches long and 1 1/2 inches in diameter. A cardboard tube is slipped over the core and fiber washers 2 1/2 inches in diameter are glued to both ends of the cardboard tube. The spool thus formed is then wound full of No. 38 enameled wire. After the winding has been completed, the coil should be carefully taped and flexible leads brought out.

SUPER-HET—T. R. F.

(493) Q. 1. David Sinclair, San Jose, Calif., asks: Why is a Super-Heterodyne receiver employing only two stages of intermediate or radio frequency amplification considered to be superior to a two stage tuned radio frequency amplifier?

A. 1. The main reason for this can be readily seen when it is thoroughly understood that radio frequency amplification takes place at its greatest efficiency at a certain wave-length, and when the transformers carrying the current are so designed as to operate at their greatest efficiency at the particular wave-length or frequency to be amplified. In the Super-Heterodyne receiver, all incoming signals are acted upon by an oscillator and as a result, they are all changed, regardless of their original wave-length, to one certain fixed wave-length and are then amplified by the intermediate stages. By proceeding in this manner, the two requisites of efficient radio frequency amplification are obtained. First, the signals are amplified at a wave-length where the greatest building up of signal strength is possible and second, since all signals are heterodyned to a specific frequency, the intermediate amplifying transformers can be so tuned as to pass this frequency with the greatest efficiency and the least loss.

In the tuned R. F. receiver, it is obvious that the transformers, being variable, will work at a greater efficiency at certain wave-lengths than at others and in consequence it would be necessary to change the electrical constants of the respective circuits for each wave-length in order to regain the loss, which is quite impractical. From these statements, it can be readily seen that the Super-Heterodyne is justly considered superior to a tuned radio frequency amplifier, providing, of course, that the Super-Heterodyne is properly designed, built and operated.

TUBE REJUVENATION

(494) Q. 1. J. K. McVicker, Mansfield, Ohio, wants to know: Is tube rejuvenation practical?

A. 1. This process is entirely practical and is in wide use today. It is one that will give excellent results if it is rightly carried through, but which may result in failure if the apparatus used is not properly designed. Furthermore, when rejuvenating tubes by the flash process, it is necessary that the high voltage be applied to the filament of the tube only through a short and definite period of time. Then too, the aging process must be finished for a period of time sufficient for the purpose and during this time, the plate voltage must not be applied. The editor of this department has used a tube rejuvenator in his laboratory for some time and has had excellent results with both the 199 and the 201A types of tubes. It must be noted here that tube rejuvenation is practical only for those tubes having thoriated filaments.

Scientific Humor

WE ARE GOING TO TRY THIS

"Ah!" said an old chemist to a friend who had just called at the laboratory, "I was hoping you'd look in. I want your help."

"Certainly," was the reply. "What can I do for you?"

"This is what's bothering me," continued the old man as he produced a sheet of paper covered with a quantity of white powder.

"My tongue has become so vitiated through continually tasting things that I can't trust it any longer. Just put a little of this on your tongue and tell me what it tastes like."

The friend complied while the chemist gazed intently at him. "Do you notice any effects?" he asked.

"No."

"Is it unpleasant?"

"No," said the other, "but rather bitter."

"I thought so," was the reply.

"But what is it?" asked the friend.

"I don't know," said the old man. "That's what I'm trying to find out; someone round here has been poisoning horses with it."—*William Short.*

TOO NATURAL

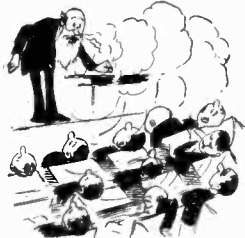

—*Irvin Litinsky.*

FIRST STUDENT: "I can't see why you fell asleep when the professor made the talk so realistic."

SECOND STUDENT: "That's just it, he talked on 'Chloroform and Ether as Anesthetics!'"

MINUS 273° C.

During the Great War (1914-18) the personnel of the British Meteorological Services was sometimes recruited from strange sources.

One well known officer, on receiving instructions from G. H. Q. concerning the correct reading of the meniscus was known to have hunted all around the Air Station "for the bally instrument."

On another occasion, with unconscious humor, he reported the state of the weather in his locality as "Humility 90%!"—*H. W. Fortescueclong.*

HALITOSIS?



SURGEON (applying the anaesthetic to boy): "Sonny, do you mind the gas?"

LITTLE BOY: "It's all right! You kin keep right on talking."—*William A. Heitler, Reporter No. 11783.*

REACTION IN A LOOK

Why did Lot's wife turn to a pillar of salt?

She gave the city of Sodom an acid look. It was base of her to do this and because of that she neutralized.—*Albert Hall.*

A CORKER

Pat went to the druggist to get an empty bottle. Selecting one that answered his purpose he asked, "How much?"

"Well, said the clerk, "if you want the empty bottle it'll be five cents, but if you want something put in it we won't charge anything for the bottle."

"Sure, that's fair enough," observed Pat, "put in a cork."—*Mrs. G. J. De Litterst.*

TU-BE OR NOT TU-BE

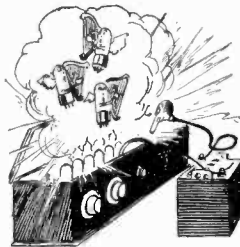

post
And a flock of tubes gave up the ghost,
So I'm making a Crystal Set.

—*Norman I. Schiller.*

I sold my Reflex Four and built a Super het. How many tubes? Well, I just forget; But a B plus wire kissed an A plus

HADN'T HE TWO TEMPLES?

JAKE: "What was Solomon's temple covered with?"

PETE: "Hair."—*N. Compton.*

WE receive daily from one to two hundred contributions to this department. Of these only one or two are available. We desire to publish only scientific humor and all contributions should be original if possible. Do not copy jokes from old books or other publications as they have little or no chance here. By scientific humor we mean only such jokes as contain something of a scientific nature. Note our prize winners.

Write each joke on a separate sheet and sign your name and address to it. Write only on one side of sheet. We cannot return unaccepted jokes. Please do not enclose return postage.

All jokes published here are paid for at the rate of one dollar each, besides the first prize of three dollars for the best joke submitted each month. In the event that two people send in the same joke so as to tie for the prize, then the sum of three dollars in cash will be paid to each one.

THE THERMOCAT

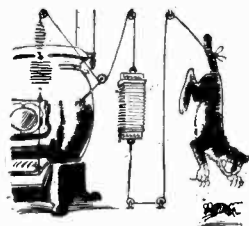

I have just completed a most marvelous and stupendous invention. In fact it is the most important and revolutionary invention that I have invented this week. A thermostat is a device which controls the temperature of a room, etc. They are very costly and apt to get out of order. My new invention, THE THERMOCAT, is very cheap, low initial cost, hardly any upkeep and easily replaced. The device consists of a stove, a piece of string (any color), and a cat. The cat's tail is very necessary, so a bob-tailed one will not work. The cat must be trained to sleep on top of the stove, the string connects his (or her), tail to the draft control. When the cat feels that the stove is too warm a place to stay, he (or she), jumps off the stove, thereby closing the draft. As the room gets cooler the cat feels the need of a warmer climate. So he (or she), jumps up onto the stove, thus opening the draft. The action continues until the cat wears out. Warning to the public and others: Patent not applied for.—*W. O. Milligan.*

THEY DON'T CALL IT A BATH!

DOCTOR: "Sambo, I can think of but one thing that will cure you and that is an electric bath."

SAMBO: "Naw, sah, Doctah, yu' ain't talkin' to dis here nigger. I had a friend what took one of them things down in Sing Sing an' it drowned him!"—*Weldon Morphew.*

OUR RESTAURANT FRIES IT THAT WAY!

FIRST SCOTCHMAN, putting Lux in a frying pan and tossing it about.

SECOND SCOTCHMAN: "Say, what's the idea of frying that bacon in Lux?"

FIRST SCOTCHMAN: "H'mm, I don't want the bacon to shrink."—*Joseph Cada.*

COARSE

LADDY: "Why are you painting the inside of the chicken coop?"

"DADDY: "To prevent the chickens from eating the grains in the wood."—*F. O'Connell.*

THE CLINCHING POINT

LECTURER (in restaurant): And so I have convinced you of the truth of the theory of evolution? Can you tell me what you consider the deciding factor in my argument?

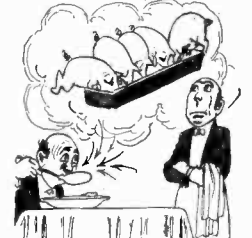

WAITER: "Hearing you eat the noodle soup, sir."—*W. W. Hatfield.*

THE LEAD ACTS AS A GRID LEAK

JESSIE: "Why does he tune with the end of a pencil?"

MARY: "To secure remote control, you dumbbell."—*Harvey Thompson.*

EASY TO CONTROLLER NOW

JOHN: "I hear you have a very wicked daughter."

PETE THE RADIO FAN: "Not any more, John. I managed to transformer and it is now hard to detector faults."—*Harvey Thompson.*

CRACKED CACKLES

Little Willie came into the house much excited and shouted for Dad.

"Well, what is it?" said Dad.

"Pa, if a chicken sits on cracked eggs will the little chicks be crazy?"—*Harold Hoyt.*

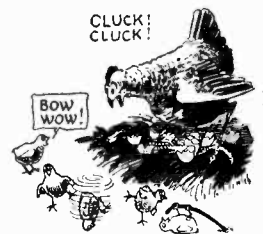

DON'T PULL THIS GAG

GEORGE (Exalted Leader): "Say, fellers, you'd all better look out for snares and pitfalls! This mornin' I says to Pop, 'Say, Pop, can you spare two-bits? I want to get one of them Scientific Magyzines.' Pop reached up to the top shelf, pulled down a old dusty book, and says: 'Here's something you might like to look over.' I took it eagerly and read what the front says: 'Grammar as a Science—By Sisk.'"—*Anne S. Oughton.*

QUARTZ IT'S NOT

TEACHER: "Johnny, what is quartz glass?"
JOHNNY: "Milk Bottles."—*D. S. Kolb.*



LATEST PATENTS

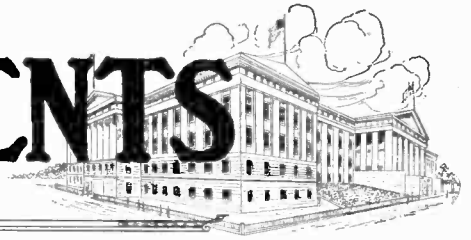

GYROSCOPIC TOY

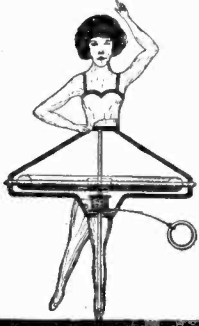

No. 1,584,979, issued to William C. Clausen. In this invention we find a gyroscope top constructed in the frame upon which is mounted a doll. The figure is caused to rotate upon one of its lower limbs and the other limb being articulated will swing freely outward, giving the appearance of pirouetting. At the bottom of the leg upon which the doll pivots a ball bearing is affixed to reduce friction.

LOUD SPEAKER

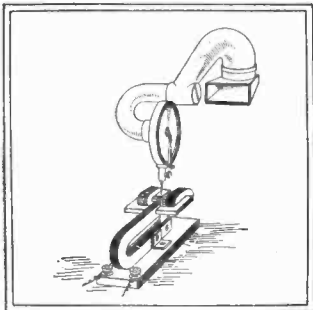

No. 1,581,107 issued to Robert W. Erickson. In this loud speaker the inventor attempts to utilize the sound-producing mechanisms of the ordinary types of talking machines or phonographs now in general use and he thus secures the advantages of a loud speaker without the necessity of installing extra equipment, except the unit itself. It will be noted that the needle of the phonograph reproducer is mounted upon an armature or reed located between two electro magnets.

TWO-FILAMENT LAMP

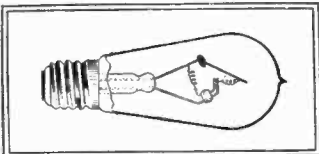

No. 1,581,690 issued to Arthur L. Powell. The filament in this lamp is double and so arranged that only one filament is in the circuit. Should this filament break or fuse the lead-in wire automatically closes the circuit to the other filament.

WATERING SYSTEM

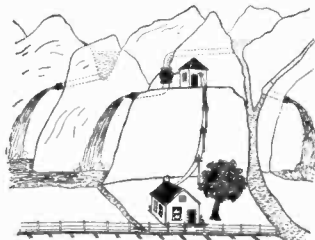

No. 1,585,182, issued to Edwin V. Blankenship. This invention relates to irrigation systems and to a system for conserving the water of mountain streams for irrigation purposes, or at least, so the inventor claims. We do not know whether we should smile at the invention or whether the inventor intended to be absolutely serious. It follows that the inventor intends to employ water coming from a mountain reservoir and that he intends to lead this water through a pipe fitted with a spray. The water being broken up into fine particles will be frozen by the cold climate and it will remain as snow or ice until spring to be then lead down for irrigation purposes. Why ice or snow should be stored in a reservoir in preference to water itself is something we cannot understand.

The inventor may be trying to arrive at some particular result which is not disclosed in his patent, but in his claims we fail to find anything of value. It is obvious that a pile of snow forming at one end of a reservoir will occupy much more space than the water from which that snow was formed.

ASH TRAY

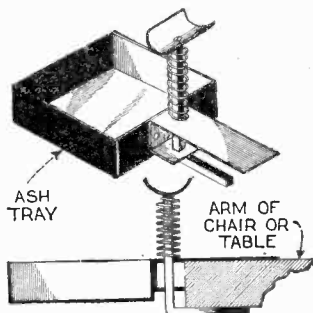

No. 1,580,788 issued to James B. Lingard. This invention is a novel device adapted to serve as an ash tray and a cigar support. It will be seen that by depressing the cigar support the arm beneath the tray is forced downward and in this manner the tray can be attached to or removed from the top of the table or the arm of a chair, to which, when it is attached, it is firmly held. The rod holding the cigar receptacle is square and is contiguous with the clamping member, which being square, will not shift laterally.

WINDSHIELD CLEANER

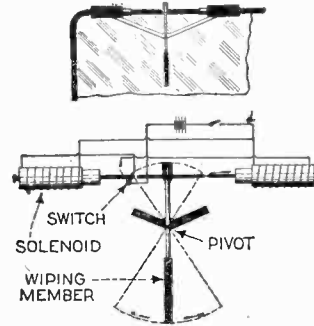

No. 1,584,821, issued to Henry G. Sparks. In the electrical windshield wiper illustrated here, two solenoids are employed to operate the wiper and a switch is so arranged that when the wiping member is in one extreme position, it flips the switch energizing the companion solenoid. The cores of the solenoids serve as pistons in a sort of dash pot arrangement which allows for regulation of speed.

RUBBER TOOTHBRUSH

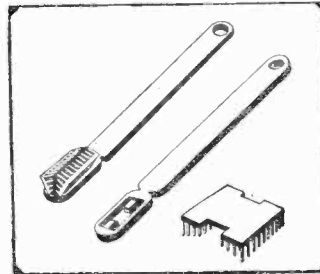

No. 1,578,074 issued to Germain Chandler. In this rubber toothbrush we find a highly sanitary article having no crevices or pockets, yet one which can be cleaned easily and in which the bristles can immediately be replaced. Note the unique design.

PORTFOLIO

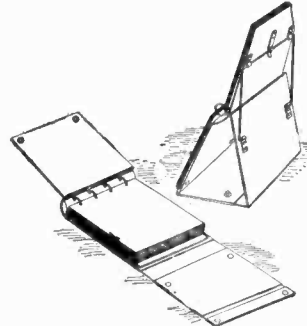

No. 1,577,697 issued to James D. Douglas. In this portfolio which may be converted into a stand, the upper element acts as a support for the upturned leaves and the downturned leaves rest on the lower cover member. Both may be observed at the same time.

SUBMARINE VESSEL

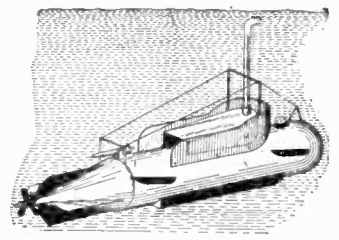

No. 1,581,580 issued to Frank Laski. This invention relates primarily to a toy submarine which is filled with compressed air. It will be noted that to the bottom end of periscope a chamber is attached. This chamber is like a pill box open at the back. Compressed air from the submarine passing from a valve into the pill box very slowly, increases the buoyancy of the submarine and causes it to rise to the surface. When arriving at the surface the weight of the periscope tips the pill box raising the back end and permits the air to escape; the submarine then again sinks beneath the surface. The inventor has claimed that an actual model operated for five hours with but fifty pounds of initial pressure with a submergence every five minutes.

CHEMICAL GARDEN



No. 1,584,779 issued to George C. Krug. We do not wish to be called authorities on patent situations but it certainly surprises us to find that the time-worn stunt of producing chemical gardens which has been illustrated in this magazine time and again, and which is found in every chemical book, intended for the amateur, has been granted a patent. Whether or not the claims would ever stand the test of court litigation is something which we cannot decide. Without a doubt the inventor's first claim is strong, but he must have known that he was not the first one to produce a chemical garden. Of course, he uses a few sea shells and sea beans in his chemical garden, but this combination is not new inasmuch as it has been advocated before and sand and small pebbles are generally always employed. Well, as the old saying goes, you can get a patent on anything, even on perpetual motion, if you don't call it that.

NOTICE TO READERS. The above illustrated and described devices have recently been issued patent protection but are not as yet to our knowledge available on the market. We regret to advise that it is impossible to supply the names and addresses of inventors of the above devices to any of our readers. The only records available, and they are at

the Patent Office at Washington, D. C., give only the addresses of the inventors at the time of application for a patent. Many months have elapsed since that time, and those records are necessarily inaccurate. Therefore, kindly do not request such information. —EDITOR.



THE ORACLE



The "Oracle" is for the sole benefit of all scientific students. Questions will be answered here for the benefit of all but only matter of sufficient interest will be published. Rules under which questions will be answered:

1. Only three questions can be submitted to be answered.
2. Only one side of sheet to be written on; matter must be typewritten or else written in ink; no penciled matter considered.

3. Sketches, diagrams, etc., must be on separate sheets. Questions addressed to this department cannot be answered by mail free of charge.

4. If a quick answer is desired by mail, a nominal charge of 50 cents is made for each question. If the questions entail considerable research work or intricate calculations, a special rate will be charged. Correspondents will be informed as to the fee before such questions are answered.

SHOCKING MACHINE

(2088) Q. 1. John Dowalo, Donora, Penna., asks for a simple method of making an electrical shocking machine.

A. 1. About the simplest method of making an electrical shocking machine is to connect the electrodes to the contacts of an ordinary electric bell or buzzer as shown in the diagram. The electrodes may be small metal cylinders or metal-handled knives. By grasping the electrodes when the bell is ringing, a distinct shock can be felt which will not be too severe. If it is desired to increase the effect of the shock, the hands should be wetted before grasping the electrodes.

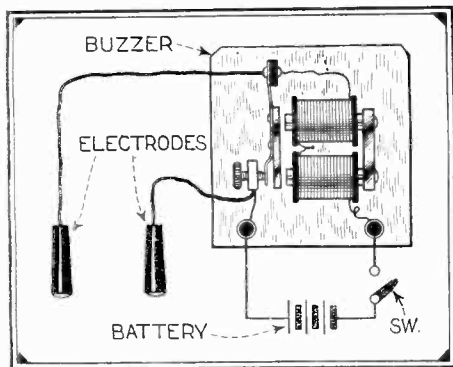

An ordinary house buzzer to which a pair of electrodes are connected, as indicated in the diagram above, makes an excellent shocking machine.

ALKALINE VS. LEAD BATTERY

(2089) Q. 1. J. M. Vertrees, Sonora, Ky., desires to have a comparison between the Edison alkaline storage battery and the lead plate battery.

A. 1. The voltage of the Edison alkaline storage battery is less than that of the standard lead cell, being approximately 1.5 volts when fully charged. The average discharge voltage is about 1.2.

The space per kilowatt-hour capacity of the standard lead storage battery is slightly less than that of the Edison. The Edison cell requires four or five times as much water to replace that lost by evaporation.

The normal watt-hour efficiency of the lead storage battery is from 75 to 80%, and that of the Edison cell is from 60 to 75%. At high discharge rate, the lead cell is much superior to the Edison cell. In ability to take recharge at a high initial rate, the lead cell is superior. The initial cost of the Edison cell is greater. In serviceability at temperatures below 40° Fahrenheit, the lead cell is superior to the Edison cell.

In spite of several apparent advantages of the lead cell over the alkaline cell, the latter is nevertheless much more rugged and will stand up much better under abuse. The Edison cell may be left standing idle for extended periods of time without being harmed; may be overcharged without being seriously damaged and has a longer life than the lead plate battery. A short-circuit does not have the same bad effect upon the Edison cell as upon the lead plate cell.

STAIN-REMOVING SOAP

(2090) Q. 1. Stephen H. Ward, Springfield, Mass., asks what preparation will quickly remove vegetable stains from the hands without injury.

A. 1. The following composition will make a soap which will remove vegetable stains from the hands.

Cocoonut oil.....	300 parts
Tallow.....	200 "
Caustic soda lye.....	150 "
Fresh ox-gall.....	100 "
Oil of turpentine.....	6 "
Ammonia (sp. gr. 0.91).....	2 1/2 "
Benzine.....	2 1/2 "

Sanonify by heat, cool, add the ox-gall, and the volatile liquids, and mold.

PREPARING STEEL SURFACES

(2091) Q. 1. Richard B. Jones, New York, City, wants to know: How may the surfaces of

hard steel plates be prepared so that scratch marks may be easily made upon them?

A. 1. Reference marks, etc., may be made on even the very hardest steel plates by first swabbing the surface with a concentrated solution of copper sulphate. This plates the surface with metallic copper which is soft and readily takes scratch marks and center-punch marks.

BATTERY CHARGING RECTIFIER

(2092) Q. 1. William Siegfert, Akron, Ohio, desires to know how a transformer with a variable step-down ratio can be used for charging low voltage batteries with a lead-aluminum rectifier in series.

A. 1. The transformer you mention is not very suitable for charging batteries, since the lead-aluminum rectifier operates only at a fairly high voltage. Probably the simplest thing for you to do would be to make up an ordinary four jar aluminum and lead electrolytic rectifier, hooking it up according to Fig. 1. One quart jars should be used and should be filled with a saturated but not super-saturated solution of borax in water. The number of lamps in the lamp bank will depend upon the rate at which you wish to charge your battery and for general purposes about five 100-watt lamps will be amply sufficient. This will allow your battery to charge at slightly less than five amperes.

The tantalum rectifier can be operated against a counter emf of from 2 to 14 volts, and may therefore be used in conjunction with a step-down transformer, as shown in Fig. 2. The electrolyte is a solution of sulphuric acid of specific gravity 1.100, with the addition of a slight amount of ferrous sulphate.

Q. 2.—What kind of a resistance should be used in conjunction with a six-volt auto horn motor in order that it may be operated from a thirty-two volt line?

A. 2. A variable resistance having a range of approximately from 2 to 10 ohms and a current carrying capacity of about 8 amperes.

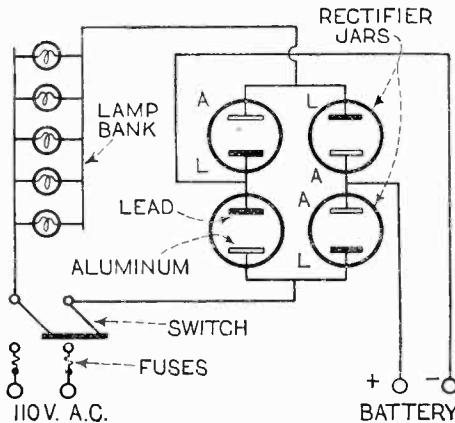

The connections for a chemical rectifier battery charging are shown above. Fig. 1

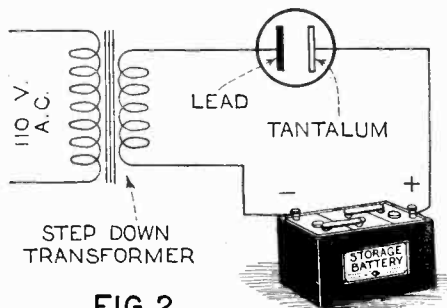
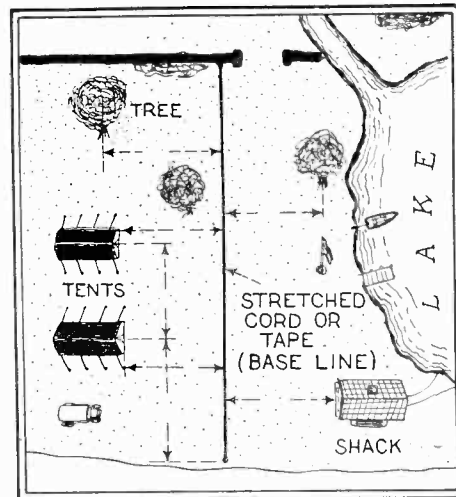

FIG. 2

A tantalum rectifier operates satisfactorily at low voltage, and may therefore be used with a step-down transformer.

SURVEYING WITHOUT INSTRUMENTS

(2093) Q. 1. Paul Strong, Cleveland, Ohio, desires to know how a plot of ground such as a camp containing a lake, trees and several small buildings may be surveyed without the use of instruments other than a compass, a measuring tape and a triangle.



It is not difficult to survey a camp or other similar plot of ground without the use of surveying instruments, if the procedure given herewith is followed.

A. 1. This may be easily accomplished by laying out a base line through the center of the area to be surveyed and measuring off at right angles to this base line the distances of the various objects such as trees, buildings, etc. This base line or reference line may be set up by tightly stretching a length of twine or tape from one boundary of the grounds to the other. Distances from the base line to the trees and buildings may be measured at right angles with the aid of a right triangle or by the "3, 4 and 5 rule" used by builders. In addition to measuring the distances from the base line, a measurement is also taken in each case from one end of the base line to that point on the base line from which the right angle measurement is taken. As each reading is made, it is noted down in a book together with a little sketch. From the results obtained in this manner, a fairly reliable map can be plotted.

SOLIDIFYING OF WATER

(2094) Q. 1. A. H. Tacquard, Jr., San Antonio, Texas, writes that he recently heard the statement that water would reach a temperature lower than the freezing point without freezing, provided the water was kept absolutely motionless. He mentions an experience which was described to him as follows: There was a bottle full of water on a window sill and the observer was surprised to see that the water was in a liquid state when he knew that it should be frozen solid. The bottle was picked up out of curiosity and immediately the water froze solid and broke the bottle. Mr. Tacquard is of the opinion that the water was already frozen and the bottle cracked, but not broken and that upon being disturbed, the bottle fell to pieces.

A. 1. It is frequent for water to remain in a liquid state at a temperature lower than the freezing point, provided that it is kept perfectly still. As soon as it is slightly agitated, or if a bit of ice is dropped into it the water will at once crystallize into ice, expanding nearly ten percent in volume with irresistible force. The same phenomenon can be experienced with a saturated solution of sodium thiosulphate. If a crystal of "hypo," as it is known, is dropped into such a solution, the solution will at once crystallize, becoming very cold. This can be accounted for only by the assumption that the molecules composing the solution are in a state of unequilibrium.

SHINE REMOVER

(2095) Q. 1. William Wagner, Drums, Penna., asks: What substance can be used to remove shine from blue serge suits and yet not harm the material?

A. 1. If blue serge material is steamed when it is being pressed, it will not become shiny. Furthermore, when pressing by hand, a small quantity of vinegar added to the water in which the pressing cloth is moistened will assist in preventing shine.

As to the removal of shine after it has become evident, we would advise that this is a rather difficult thing to do. No liquid of which we have any record will perform this work. You must realize that the reason for shine on blue serge material is because of the fact that the nap has been worn off the cloth. Sometimes this nap can be partially restored by brushing. It is also said that rubbing the shiny parts lightly with sandpaper will remove the shine by restoring the nap. In any event, we do not believe that there is a liquid in existence that will perform this work.

AUTOMATIC CIRCUIT BREAKER

(2096) Q. 1. Homer Montague, Dormont, Pa., desires to have explained the principle of the automatic circuit breaker?

A. 1. The principal demand for circuit breakers is to have them open the circuit when the current reaches a certain predetermined value and circuit breakers are designed with this end in view. They are also built for underload conditions, to open on minimum current; for overvoltage, to open when the voltage exceeds a certain value; for undervoltage, to open when the voltage falls below a certain minimum value; for reversal when the current flows in the opposite direction through the breaker iron, that which was intended. It is of course possible to combine the various features of overload, underload, reversal, etc., in one and the same breaker.

Breakers are usually made adjustable so that they can be set to operate at any predetermined current. In the ordinary type of carbon circuit breaker, an excess of current through the solenoid causes a plunger to be drawn into the solenoid, tripping the breaker and opening the circuit. The circuit is opened in two stages. The copper electrodes on the circuit breaker are separated first and then the carbon electrodes. The object of this procedure is to confine the inevitable instant of arcing when the circuit is opened to the carbon electrodes in order to prevent the copper electrodes from being burnt away.

AILERONS

(2097) Q. 1. Victor J. Oppenheim, Tampa, Fla., asks: Of what purpose are the ailerons or small movable sections of the wings of an airplane?

A. 1. These sections are used for the purpose of enabling the pilot to turn sharp corners by banking or to make it possible for him to quickly place his airplane upon a level keel when thrown out of that position by sudden gusts of air. The operation of these ailerons will be made obvious by reference to the accompanying drawings. At 1 is shown an airplane tilted off level keel. The pilot manipulates the aileron controls to the position shown by A and A1 and causes the ship to regain the position shown at 2. In case the tilt is in the opposite direction as at 3, the ailerons are also set in the opposite direction so as to counteract the inclination. In the case of using ailerons for banking when turning the ship, the action is obvious. When an aileron is tilted so that its angle is above that of the horizontal plane of the wings, it tends to force that side of the plane downward. When it is tilted at an angle so that its angle is downward from the wing, it tends to force that side upward. These forces are indicated by

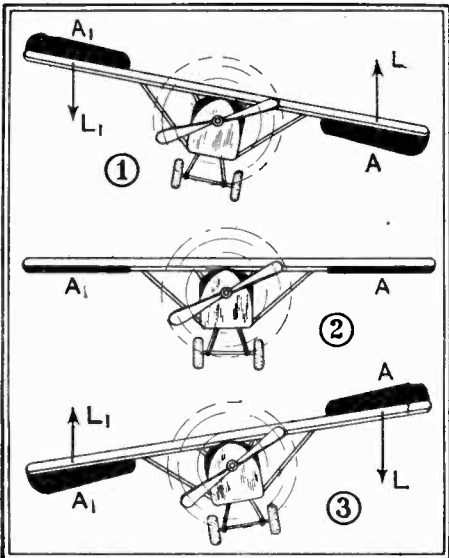

By manipulating the levers controlling the ailerons, the airplane is directed as desired.

the arrows L and L1 in 1 and 3. Ailerons are used in connection with the vertical rudder for turning and maneuvering the airplane.

STREAM-LINING

(2098) Q. 1. Raymond Williams, Kansas City, Mo., asks: What is the effect of stream-lining a body that is to travel rapidly through the air?

A. 1. The reason for stream-line shapes on high speed automobiles and airplanes will become obvious upon a short consideration of the conditions under which any such body has to travel. By reference to the drawing in this column it will be seen that a body traveling through the air such as B causes the air to stream around it in the direction of the arrows. As the body continues to rush, the air stream closes up in back of it and if there is a flat rear section, the air directly in the rear of the body will be very turbulent, reduced in pressure, giving a suction effect, and will tend to retard its travel. By forming the body as shown in the drawing, there is very little turbulence at T and, therefore, there is little retardation effect. The principal resistance to the travel is due to friction with the air on the sides of the body which of course can be reduced to a considerable degree by proper smooth finishing of the surfaces.

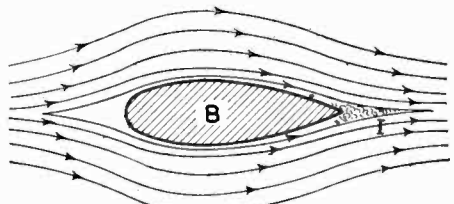

The effect of stream-lining a body is to reduce the air resistance when the body is in motion. The path of the air currents against a stream-lined airplane or automobile is here indicated.

TANTALUM RECTIFIER

(2099) Q. 1. John B. Anderson, Chicago, Ill., asks: What is the lowest voltage that will be rectified by an electrical instrument using a tantalum electrode?

A. 1. A rectifier of this nature will operate particularly well on voltages of from 2 to 14 volts, maximum efficiency being at about 14 volts.

Q. 2. What solution is used with a tantalum rectifier?

A. 2. A sulphuric acid solution of about the same density as used in storage batteries is usually used for this purpose. In a certain manufactured type of tantalum rectifier, a small amount of ferrous sulphate is added. This latter mentioned composition is fully covered by patents.

VISCOSITY

(2100) Q. 1. Harold Vickers, Greenwich, Conn., asks: What is viscosity?

A. 1. This term may be considered as a kind of internal friction between adjacent layers of a heavy liquid. The energy spent in overcoming viscosity appears as heat. In a fluid such as tar or syrup, both of which are called viscous and may be cited as examples, one layer slides over the adjacent layer with a velocity depending on the stress to which the liquid is submitted and also on the viscosity of the substance. The slower the motion of the layers of the material for a given stress, the greater is said to be the viscosity of it.

DRILLING CHINAWARE

(2101) Q. 1. Paul L. Webb, Huntington, W. Va., desires to know a safe method of drilling holes in delicate chinaware.

A. 1. Any method that we could recommend for drilling holes in genuine China would be accompanied by great danger. It is practically impossible to use a perfect method that is not liable to break the material being used. In general, we would advise a triangular file, the end of which has been ground off at an angle and which is clamped to a low speed drill press and used as a drill. Use turpentine for a lubricant. Proceed slowly and apply very light pressure.

Another method which has recently come to our attention but which we cannot guarantee, although we have seen it work on some fragile materials, is to sharpen an ordinary center punch until the point is very sharp. This point is placed directly on the piece of material that is to be punched and the other end of the center punch is hit a sharp blow. The writer has personally seen this method work perfectly upon a thin sea shell, which material is extremely hard to drill with any of the ordinary methods. For further information we refer you to the August, 1924 issue of this magazine.

LEAP YEAR QUERY

(2102) Q. 1. George Benson, Astoria, L. I., says: From the year 1 up till the present time, there has been a leap year every four years, making a gain of 1 day for each 4 years. The total time gained is 475 days or 1 year and 110 days over. Would this not be 1927 instead of 1926? Are the years longer? What has become of the days gained since the year 1 up till the year 1926?

A. 1. You evidently do not take into account the fact that a year is actually 365 1/4 days long rather than 365 days. 365 1/4 days represent the time necessary for the earth to make one com-

plete revolution about the sun. It is more convenient to add one complete day to the year after four years than to add one-quarter of a day every year. This artificially makes the leap years one day longer than the ordinary years. We are therefore living in 1926 rather than in 1927 as you suggest.

HARDNESS OF METALS

(2103) Q. 1. James B. Riese, Jersey City, N. J., asks: How is the degree of hardness of metals determined?

A. 1. There are several methods for testing the hardness of metals in use at the present time. The two most reliable ways of doing this are by means of the Shore scleroscope and the Brinell hardness machine. The latter operates in the following manner:

A steel ball, 10 m.m. (0.3937 in.) in diam., is forced with a pressure of 3000 kg. (6614 lbs) into a flat surface on the sample to be tested, so as to make a slight spherical indentation, the diameter of which may be measured by a microscope or the depth by a micrometer. The hardness is defined as the quotient of the pressure by the area of the indentation. From the measurement the "hardness number" is calculated by one of the following formulas:

$$H = K \left(r + \sqrt{r^2 - R^2} \right) \div 2\pi r R^2, \text{ or } H = K \div 2\pi r d$$

K=load, = 3000 kg., r = radius of ball, = 5 mm., R = radius and d = depth of indentation.

The following table gives the hardness number corresponding to different values of R and d.

R	H	R	H	R	H
1.00	945	2.40	156	3.80	54.6
1.20	654	2.60	131	4.00	47.8
1.40	477	2.80	111	4.20	41.7
1.60	363	3.00	95.5	4.40	36.4
1.80	285	3.20	82.5	4.60	31.4
2.00	229	3.40	71.6	4.80	26.5
3.20	187	3.60	62.4	4.95	22.2

d	H	d	H	d	H
1.00	95.5	2.20	43.4	3.60	26.5
1.10	86.8	2.40	39.8	3.80	25.1
1.20	79.6	2.60	36.7	4.00	23.9
1.40	68.2	2.80	34.1	4.50	21.2
1.60	59.7	3.00	31.8	5.00	19.1
1.80	53.0	3.20	29.8	5.50	17.4
2.00	48.0	3.40	28.1	6.00	15.9

The hardness of steel, as determined by the Brinell method, has a direct relation to the tensile strength, and is equal to the product of a coefficient, C, into the hardness number. Experiments made in Sweden with annealed steel showed that when the impression was made transversely to the rolling direction, with H below 175, C=0.362; with H above 175, C=0.344. When the impression was made in the rolling direction, with H below 175, C=0.354; with H above 175, C=0.324. The product C X H, or the tensile strength, is expressed in kilograms per square millimeter.

The scleroscope is the name of an instrument invented by A. F. Shore for determining the hardness of metals. It consists essentially of a vertical glass tube in which slides freely a small cylinder of very hard steel, pointed on the lower end, and called the hammer. This hammer is allowed to fall about 10 inches on the sample to be tested, and the distance it rebounds is taken as a measure of the hardness of the metal. A scale on the tube is divided into 140 equal parts, and the hardness is expressed as the number on the scale to which the hammer rebounds. Measured in this way the hardness of different substances is as follows: Glass, 130; porcelain, 120; hardest steel, 110; tool steel, 1% C., may be as low as 31; mild steel, 0.5% C., 26 to 30; gray castings, 39; wrought iron, 18; Babbitt metal, 4 to 10; soft brass, 12; zinc, 8; copper, 6; lead, 2.

Science and Invention

CORRESPONDENT
REPORTER'S
IDENTIFICATION

NO. 10000

L. W. Shackner

THE BEARER OF THIS CARD IS AN AUTHORIZED CORRESPONDENT-REPORTER OF SCIENCE AND INVENTION MAGAZINE. THE PUBLISHERS OF SCIENCE AND INVENTION WILL APPRECIATE ANY COURTESY EXTENDED THEIR REPRESENTATIVE.

EXPERIMENTER PUBLISHING CO.
Alfred Ball

REPORTER

IN ORDER to present to the public the very latest scientific details, SCIENCE AND INVENTION maintains a large staff of field reporters. Any one of our readers is eligible to join this staff and, upon request, a reporter's card will be forwarded, together with complete instructions for gathering material. The reporter's card is illustrated above, and its use will gain admittance to many places that would otherwise be closed to the ordinary person. You need not have any special ability to obtain one of these cards other than a desire to help others to gain knowledge. Address Field Editor, SCIENCE AND INVENTION. Submitted manuscripts cannot be returned unless accompanied by postage.

LUMINOUS PAINT

Make Your Watches, Clocks, Etc., Visible by Night The very latest discovery in the world... tically unobtainable except at an exorbitant price, we have at last succeeded in producing this remarkable LUMINOUS PAINT, which, applied to the surface of any object of white light... in the dark. THE DARKER THE NIGHT, THE MORE BRILLIANT IT SHINES. Quite simple to use. Anyone—you can do it. A little applied to the dial of your watch or clock will tell the time by night. You can coat the push buttons or switch plates of your electric lights, match boxes, and innumerable other articles; make your own Luminous Crucifixes, Luminous Rosaries, etc. Bottle contains sufficient to coat several small articles. Price 25c. Larger sizes 50c and \$1 postpaid. Johnson Smith & Co., Dept. 346 Racine, Wis.

The "Little Giant" Typewriter

A First Class Writing Machine For \$1.50
A perfect little typewriter for \$1.50. There are thousands of persons who would like to use a typewriter, but whose needs and business do not warrant the expense attached to the purchase and use of a fifty or seventy-five dollar machine. So such persons were confidently recommended our "Little Giant." It is strongly made, but simple in construction, so that anyone can quickly learn to operate it, and write as rapidly as they would with pen and ink. The letters of the alphabet quickly learn to operate it, and write as rapidly as they would with pen and ink. The letters of the alphabet quickly learn to operate it, and write as rapidly as they would with pen and ink. The letters of the alphabet quickly learn to operate it, and write as rapidly as they would with pen and ink.

Every Boy His Own Toy Maker
Greatest boys' book written. Tells how to make a Pinhole Camera, a Canoe, model Railroad, a Telephone, Boomerang, Telegraph, Instrument, Box Kite, Talking Machine, Microscope, Electric Motor, Electric Door Bell, Water Wheel, Paddle Raft, a pair of Skis, a Dog Sled, Bird House, Rabbit Yard, etc. 64 pages, 150 illustrations. PRICE, 10c postpaid; 3 for 25c.

REAL PISTOL Miniature Watch Charm Pistol
Exact reproduction of a real pistol; actually fires REAL BLANK CARTRIDGES of miniature size. Illustration in actual size. 1 1/4 inches long, with ring at end for attaching to watch chain. Loads like a regular pistol. Pull the trigger and it goes off with a loud bang. Pistol in break-open type; illustration shows position for loading. Made entirely of high grade steel, nickel plated, octagon barrel, handsomely engraved handles, complete in box with cleaning rod. PRICE \$1.75. Also furnished with pearl handles, \$2.50. BLANK CARTRIDGES, 50c per box of 25.

BOYS! BOYS! BOYS! THROW YOUR VOICE

Into a trunk, under the bed or anywhere. Lots of fun fooling the teacher, policeman or friends.
THE VENTRILO
A little instrument, fits in the mouth out of sight, used with above for Bird Calls, etc. Anyone can use it.
Never Fails. A 32-page book on ventriloquism, and the Ventrilo, ALL FOR 10c postpaid.

MIDCET BIBLE GREAT CURIOSITY
Smallest Bible in the world. Size of a postage stamp. 200 Pages. Said to bring good luck to the owner. A genuine work of art. Must be seen to be appreciated. Make good money selling them to friends, church acquaintances, etc. PRICE 15c each, 3 for 40c, 12 for \$1.35, 100 for \$7.50. Also obtainable in Leather Binding, with gold edges. Price 50c each, 3 for \$1.25, \$4.50 per doz. Magnifying Glass for use with Midcet Bible. 15c

KU KLUX KLAN
Everything about the Ku Klux Klan told in a clear, fearless manner. Book tells all how it started and was suppressed in 1871—The New Ku Klux Klan—How organized—How members are enrolled—Oath of the Klan—Questions for Candidates—Creed—Objects of the Order—Obedience—Pledge of Loyalty—Ku Klux Klan and the Masons—The Jews—The Masons—Real K. of C. Oath—The Negro Ku Klux Klan, etc., etc. Latest and most complete book on the Klan published. Price, 35c, postpaid.

Female SEX INDICATOR
Hold the MAGIC INDICATOR over a man's hand—Instantly it moves in a straight line backward and forward. Hold it over a woman's hand and it describes a complete and continuous circle. The same action can be obtained over a letter written by a man or woman, etc. It is fascinating; baffling. We have never been able to figure out how it's done—but we've never seen it fail. Many novel and entertaining feats may be performed with the Sex Indicator. For example, similar results can be obtained with animals, cats, dogs, rabbits, over birds, etc., etc. Also used to predetermine the sex of chickens and birds, etc., in fact it is sold as a patented egg tester in Europe. Price 25c, or 3 for 65c, postpaid.

DeLuxe Edition of our new 1926 CATALOG
 mailed on receipt of 1c. Contains 120 pages of all the latest tricks in magic, the newest novels, puzzles, games, sports, codes, interesting song books, curiosities in seeds and plants, etc., etc. Obtainable elsewhere.

STAGE MONEY

With a bunch of these bills, it is easy for each person of limited means to appear prosperous by flashing a roll of these bills a proper time and peeling off a genuine bill or two from the outside of the roll, the effect created will be found to be all that can be desired. Prices, postpaid: 40 Bills 20c, 120 for 50c, or \$3.50 thousand postpaid.

Wonderful X-Ray Tube

A wonderful little instrument producing optical illusions both surprising and startling. With it you can see what is apparently the bones of your fingers, the lead in a lead pencil, the interior opening in a pipe stem, and many other similar illusions. A mystery that no one has been able to satisfactorily explain. Price 10c, 3 for 25c, 1 dozen 75c. Johnson Smith & Co.

Good Luck Ring
Quant and Novel Design
A VERY striking and uncommon ring. Silver finish, skull and crossbones design, with two brilliant, flashing gems sparkling in the eyes. Said by many to bring Good Luck to the wearer, hence its name, Good Luck Ring. Very unique ring that will take a pride in wearing. ONLY 25 CENTS.

Exploding Cigarettes

JUST LIKE ORDINARY CIGARETTES. BUT SUCH REAL STARTLERS! The box contains ten genuine cigarettes of excellent quality. They appear so real, but when each cigarette is about one-third smoked, the victim gets a very great surprise as it goes off with a loud BANG! A great mirth provoker yet entirely harmless! Price 25c per box.

Popular Watch Charms

15c
ONLY 3 for 40c; \$1.35 doz.
Very pretty little curiosities and decidedly novel. Fitted with Magnifying Lenses that enlarge the pictures to a surprising degree; in fact, it seems almost incredible that a clear picture could be taken through a small compass, and how sharp and distinct they show up when you look through. Come in assorted views—Admiral, the great Panama Canal, Lord's Prayer in type, etc.

CIGARETTE MAKER

Roll your own and save money. Makes them better and quicker besides saving more than half. Use your favorite brand of tobacco. Neat, useful and handy. Pocket size, weighs 1 1/2 oz. Made entirely of metal, nickel-plated. Price 25c postpaid.

MAGIC FLUTE

Wonderfully Sweet Toned and Musical
The Magic Flute, or Human Harmonium, is a unique and novel musical instrument that is played with nose and mouth combined. There is just a little knack in playing it which, when once acquired after a little practice will enable you to produce very sweet music that somewhat resembles a flute. There is no fingering, and once you have mastered it you can play all kinds of music with facility and ease. When played as an accompaniment to a piano or any other musical instrument, the effect is as charming as it is surprising.

Novelty Badges

KISSING PERMIT 10c **Garter Inspector 10c**
plated, that you can wear, giving you fun out of all proportion to their trifling cost. 10c, each badge, 3 for 25c, or 75c per doz., postpaid.

BLANK CARTRIDGE PISTOL

This well made and effective Pistol is modelled on the pattern of the latest type of Revolver, the appearance of which alone is enough to scare a burglar, whilst, when loaded, it will probably prove just as effective as a revolver with real bullets, without the danger to life. It takes the standard .22 Calibre Blank Cartridges, that are obtainable most everywhere. Even the most timid women can use it with perfect safety and frighten a thief without risk to herself or anyone else. A Great Protection Against Burglars, Tramps and Dogs. You can have it lying about without the danger attached to other revolvers. We sell large numbers around the 4th of July. Well made of solid Metal. PRICE ONLY \$1.00 Postpaid. Blank Cartridges 22-cal. shipped by express only, 50c per 100. Johnson Smith & Co. Dept. 346 Racine, Wis.

Sneezing Powder

Place a very small amount of this powder on the back of your hand and blow it into the air, and everyone in the room or car will begin to sneeze without knowing the reason why. It is most amusing to hear their remarks, as they never suspect the real source, but think they have caught one of the laughing and sneezing you yourself will be having the time of your life. For parties, political meetings, car rides, or any other all where there is a gathering of people, it is the greatest joke out. Price 10c or 3 for 25c.

Microphone Transmitter Button

You can easily make a highly sensitive detectophone by using this Transmitter Button to collect the sound waves, record your own utterances, and transmit the equipment. It is simple and inexpensive. You can install an outfit in your home and hear conversations being held all over the house. You can connect up with several rooms of a hotel. This outfit was used by secret service operatives during the war. It is being used on the stage. It is ultra-sensitive and is the greatest invention in microphones. You can mount the button almost anywhere—hard board boxes, stove pipes, still candles, on the wall behind a picture frame, etc. Button is so light and small it cannot be detected. Persons can be overheard without suspecting it. You can listen in on conversations in another room. A deaf person in the audience can hear the speaker. Connected to phonograph, piano or other musical instrument, music can be heard hundreds of feet away. Button may be used to renew telephone transmitters; often makes an old line "talk-up" when nothing else will. The ideal microphone for radio use; carries heavy current and is extremely sensitive. Amplifies radio signals. Countless other similar uses will suggest themselves. Experimenters find the Button useful for hundreds of experiments along the lines of telephony, amplifiers, loud speakers, etc. Many fascinating stunts may be devised, such as holding the button against the throat or chest to reproduce speech without sound waves. \$5.00 is given to anyone who sends in a new suggestion for the use of the Button providing the manufacturer find it suitable for use in their literature. PRICE \$1.00 POSTPAID ANYWHERE.

ANARCHIST BOMBS

One of these glass vials dropped in a room full of people will cause more consternation than a limburger cheese. The smell even disappears in a short time. 10c a Box, 3 Boxes for 25c.

INVISIBLE INK

The most confidential messages can be written with this ink, for the writing is invisible to the naked eye. MARK. Cannot be seen unless you know the secret. Invaluable for many reasons. Keep your postals and other private memoranda away from prying eyes. Great fun for playing practical jokes. Only 15c Bottle.

ITCHING POWDER

This is another good practical joke; the intense discomfort of your victims to everyone but themselves is thoroughly enjoyable. All that is necessary to start the ball rolling is to deposit a little of the powder in a person's hand and the powder can be relied upon to do the rest. The result is a vigorous scratch, then some more scratch, and still some more.

LOOK 35c

Wonderful Instrument. Greatest thing yet. Nine separate articles in one. Everybody delighted with it. Odd, curious and interesting. Lots of pleasure as well as very useful. It is a double Microscope for examining the wonders of nature. It is also an Opera Glass, a Stereoscope, a Burning Lens, a Reading Glass, a Telescope, a Compass, a Pocket Mirror, and a Laryngoscope—for examining eye, ear, nose and throat. It is worth all the cost to locate even one point of interest in the eye. Holds flat and fits the pocket. Something great—you need one! Don't miss it. Sent by mail, postpaid. Price, only 35c or 3 for \$1.00 postpaid.

RESURRECTION PLANT

One of the most wonderful plants known. Possesses the strange power of turning in a few minutes from an apparently lifeless fern to a BEAUTIFUL LIVING FERN-LIKE PLANT of a dark green color. Simply place the plant in saucer of water, it will open up and start to grow in 20 minutes. When taken out it will dry up and go to sleep until placed in water again. Fine house plant—summer or winter. 10 cents each. 3 for 25c. Agents Wanted postpaid.

ADDRESS ORDERS FOR ALL GOODS ON THIS PAGE TO
JOHNSON SMITH & CO., DEPT. 346, RACINE, WIS. Postage Stamps Accepted

Here's Work That is Almost ROMANCE!



Many EARN \$50. to \$250. a Week in RADIO

Get into the great new BIG-Pay Industry—Radio. If you're earning a penny less than \$50 a week, clip coupon now. Send for AMAZING FREE BOOK. Be a Radio Expert, and draw down big money for the easiest and most fascinating work in the world. Positions everywhere. Need for Radio Experts in every community. Short hours. BIG PAY. Free book gives all the facts.

Learn Quickly And Easily At Home

Master Radio Engineers will show you how to qualify, quickly and easily at home, for Radio's fine jobs. We guarantee to train you successfully. Every day N. R. I.-trained men are taking good places in the Radio field. Thousands of openings now awaiting the trained man. FREE EMPLOYMENT SERVICE. Many other big features. Get the facts—CLIP COUPON.



"My charges for consultation \$2.50 per hour. All success due to you." R. W. H. I. K. H. I. I., Brooklyn.



"Radio a gold mine—your course worth thousands." A. R. H. E. R. K. O., Winnipeg.

Get This Free Book!

Send coupon below for FREE BOOK—"Rich Rewards in Radio." Read for yourself. No previous experience needed. Common schooling enough. WRITE NOW.



Receiving sets, from simplest kind to thousand mile receiver, included to help you learn. An UNEQUALLED OFFER. Other special features for limited time only, so ACT QUICK!

NATIONAL RADIO INSTITUTE
Dent. HX-5, Washington, D. C.

MAIL COUPON

National Radio Institute,
Dept. HX-5, Washington, D. C.
Without obligating me in any way, please send me your free book, "Rich Rewards in Radio," also complete information on your practical, home-study Radio course.

Name..... Age.....

Address.....

Town..... State.....

Tarrano the Conqueror

By RAY CUMMINGS

(Continued from page 323)

snowy plain was the wall of ice with the city wherein our enemy was entrenched; and there were no lights, no movement that we could see. In that drab twilight, it seemed almost unreal.

The plain too, was empty. A few palpably deserted huts, nothing else. Beneath us, snugly anchored there on the ledge, was our power house. No unreality here. Its aerials were mounted; its external dynamos were visibly revolving; from its windows blue shafts of light slanted out; and from it rose the low hum of active power.

Below it, spread over the slightly sloping area of foothill beneath us, lay our encampment. A ring of our tower vehicles, with their projectors mounted and ready, their colored search-beams slowly sweeping the white plain and the dead grey sky. Within their ring, the camp itself. Lighted by the blue-white tubes set upon quadrupods at intervals; heated by strings of red-glowing wire and the red wire-balls used on Venus. The snow and ice on the ground within the camp had melted, exposing the naked rock.

A scene of blue and red lights and shifting shadows; bustling with activity—figures, tiny from this height, hurrying about. The sounds from it rose to us; the low hum and snap of the weapons being tested; the shouted commands; and sometimes, mingled with it, the laughing shout of a light-hearted girl.

Elza clung close to me. "Everything will be ready soon."

I nodded. "They're going to mount a ray up here on the cliff. Grolier was telling me, for permanent protection—to stay here with the power house when we go out to the attack."

Silent with her thoughts she did not answer me. Sidewise, I regarded her solemn little face encased in its hood of fur. And then clumsily, for our furs were heavy and awkward, I put my arm about her.

"I love you, Elza. It's worth a great deal to be here alone with you."

"Jac, what will he do?" Her gaze was to the far-off City of Ice. "It seems so—so sinister, Jac, this silence from him. This inactivity. It is not like him to be inactive." "He's there," I said. "Rolltar the Marsman—boastful fellow, blow-hard—he was telling some of us that in his opinion Tarrano had already run away."

"Never!" she exclaimed. "This is his last stand. He'll make it here—defeat us here—"

"Elza!"

She glanced momentarily at me, smiled a queer smile, and then gazed once more over the distant plain. "I do not mean I think he'll defeat us, Jac. I mean, that is his reasoning—make his last stand here—"

"He hasn't run away," I repeated. "I told Rolltar so. We got an outlaw connection into the Ice Palace today. For a moment only, and then it was discovered and broken off. But we had the image for a moment—it chanced to show Tarrano himself. But he's isolated now. Bretan said his isolation power—around the Ice Palace and the wall anyway—is greater than any image-ray we can send against it."

My heart leaped suddenly, for I saw Elza's eyes widen, fear spring to her face; heard the sharp intake of her breath, and felt her hand grip my arm.

"Jac! There's something wrong! See there? And you hear it?"

From the instrument room I heard a vague

drumming. A hiss, and then a drumming growing louder. It was not a new sound, for now I remembered I had been conscious of it for several moments past. Our encampment was awake to it! A confusion down there; people running about; a figure dashing wildly into the instrument room. And the aerials on the power house began to snap viciously.

"Jac! What is it?"

"I don't know. See there, Elza? The sub-ray lights!"

The search-beams from our towers were inordinately active. Sweeping the empty snow-plain and the empty sky. Empty? To my fevered imagination they were peopled with enemies. And then one of the towers

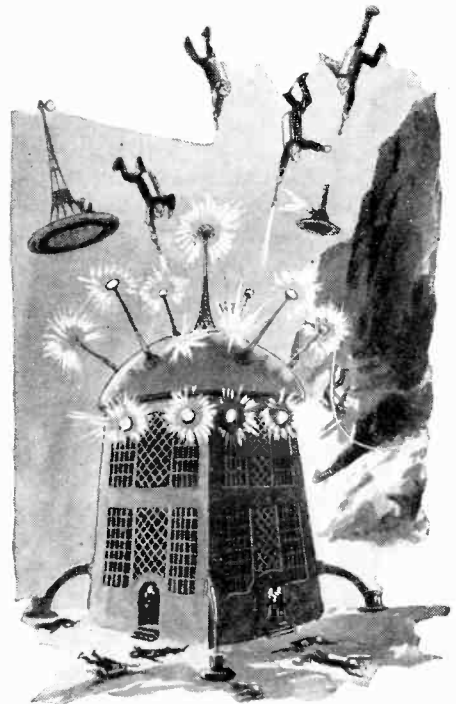

"Suicides!" Whether Elza said it, or merely thought it I do not know. One of the figures came down as though falling. A few seconds only; but though our search-beams showed it, the smaller rays for those seconds missed it. Down—until no more than five hundred feet above us, it checked its fall. A giant of a man; and with his hand cylinder—in range now—he shot a bolt at our power house. It struck.

flashed on a sub-ray—the dull infra-red for envisaging the slow rays below the power of human sight. And another tower with its faint purple beam was using the ultra-violet.

"That drumming, Elza! That's a microphone—the big one they just erected near the instrument room. There's something coming! That's the magnified sound of some distant rush of air. Very faint sound, but they must have heard it on the ear-phones long ago. That microphone must have just been connected—"

Something coming? We could see nothing.

"Let's go down, Jac! We must get back—"

"I've got infra-red glasses—" I fumbled beneath my furs. But I did not have them.

"Jac—"

"Wait, Elza."

My glasses would have been useless, for the sub and ultra beams from the towers were disclosing nothing. I could tell that

(Continued on page 360)

"BUILD YOUR OWN" WITH "RASCO" PARTS!

Buy from the Oldest and Original Exclusive Radio Parts House in the United States
We pay ALL transportation charges in U. S. ALL GOODS SENT PREPAID IN 24 HOURS

Order direct from this page

NEW PRICES FOR AUGUST

Money refunded if goods do not satisfy

 <p>Dial Marker The big little thing you have been waiting for. Just drill a hole in the panel and mount the marker above the dial. Nickel plated and polished. G7788 Dial Marker, three for\$0.10</p>	 <p>Patent S.L.F. Condensers The famous Patent S.L.F. Condenser. The latest word in condensers. Sturdy, compact, take up less room than most others. Minimum insulation used. G4432 .00015 mf. 17-plate \$3.95 G4433 .0005 mf. 23-plate\$2.95</p>	 <p>S.L.F. Condensers Lowest prices ever offered. Despite this low price, these condensers are made with precision aluminum stampings, hard rubber insulation. Money back if not satisfactory. G3513 .00025 13 pl. \$1.06 G3517 .00035 17 pl. 1.20 G3523 .0005 25 pl. 1.35</p>	 <p>"Guaranteed" Vacuum Tubes We consider the "Guaranteed" tube one of the best on the market. Any tube replaced if defective, providing filament lights. Calibrated curve goes with each tube. G701A 5v. 0.25 amp. \$1.25 G799 3 volt. .06 amp. 1.25</p>	 <p>Audio Transformer This is the famous Patent Audioformer. Nickel case is grounded to base. Extra high degree of amplification. Minimum distortion and reaction. Binding posts and solder lugs. Ratio 3½ to 1 G2811 Mounted type \$4.50 G2812 Unmounted .. 3.15</p>	 <p>Audio Frequency Transformer No better Transformer made. Highest class materials. Impregnated coils. Silicon steel stampings used. Save 50 per cent by assembling it yourself. G1100 Ratio 4½-1 \$1.40 G1150 Ratio 6½-1 1.00</p>	 <p>Sponge-Rubber Cushions Get rid of tube noises due to vibration. Softest sponge rubber made. Size 2½"x3", ¾" thick. G8989 Sponge-rubber cushions, each\$0.12 Six for 0.60</p>
 <p>Universal Socket Takes new "X" type tubes as well as old standard "UV" and "C" types. Made entirely of Isolantite. No capacity effect between plate and grid. New phosphor bronze wiping contacts. Standard mounting type. G6514\$0.49</p>	 <p>Rasco Vernier Why use a vernier dial when a vernier attachment will do anything and everything a vernier dial accomplishes? Cleverest vernier made. Can be used with any dial. Soft rubber ring engages dial. Nothing to come apart. G1450 Vernier\$0.12</p>	 <p>FONEKUSHIONS Made of sponge rubber. Make wearing your receiver a pleasure. Positively exclude all noises and make reception a pleasure. Sponge rubber will last for years. Light as a feather. Sanitary. G3550 Fonekushions, set of two\$0.35</p>	 <p>Dial Button Made in blue enamel and gold. To be worn in button hole. Every radio fan wants one. ¾" diameter. Best gold plate. Perfect reproduction of radio dial. G7799 Dial Button, Each\$0.25</p>	 <p>Vacuum Tube Shell Nickel plated shell for the man who builds his own. 4 holes to attach to sub-base. Each shell comes complete with 4 phosphor bronze socket contacts. See illus. 4748. G4747 Vacuum Tube Shell and Contacts\$0.16</p>	 <p>Cord Tip Jack Takes place of binding posts. Cord tip firmly gripped by jack. Made of brass, nickel plated. Screw to attach lead wire. No soldering necessary. G1500 Cord tip jack, Each\$0.15</p>	 <p>Brass Nickel Brackets All Illustrations ¾ size. G1505 Bracket, each \$0.05 G1507 Bracket, each .05 G1509 Bracket, each .04 G1476 Bracket, each .05 G1506 Bracket, each .05 G1460 Bracket, each .04 G1575 Bracket, each .03 G1508 Bracket, each .05</p>
 <p>Microvern The vernier dial for extra sharp tuning. No backlash. Special finish permits logging of stations on dial. Beautiful appearance. Comes in gold or silver finish. State which wanted. G3066 Microvern, any finish\$1.76</p>	 <p>Rasco 180° Variocoupler Silk wire wound on bakelite tubes. Six taps. Wire length, 150 to 600 meters. For panel mounting. ¾" shaft. Your money refunded if it is not all we claim. G3100 Variocoupler pre-paid\$1.05</p>	 <p>Copper Ribbon .0005" thick. G700 ¾" wide; G701 ¾" wide; G702 3-16" wide. All sizes per foot...\$0.01 Copper Foil .001" thick. 4" wide. G5025 Copper Foil, per foot\$0.10 10-foot length 0.80</p>	 <p>Rasco Clip Leads Invaluable for experimental work. Clip lead hooks in a jiffy onto any wire, binding post or conductor. Safest experimental connection. Brass clips, 1 foot silk wire, green or red. G7887 Clip leads, ea \$0.12 Dozen lot1.35</p>	 <p>Adapter Patent Improved Adapter. Takes 199-type tubes. Fits standard 201A sockets. Phosphor bronze springs. Short circuits impossible. Bakelite molded. G6521 Adapter\$0.36</p>	 <p>PUSH-PULL Push Pull Transformer for many new circuits. See any radio magazine. Made of best materials. Coils impregnated. Silicon steel laminations. Save 50 per cent by assembling yourself. Simple instructions furnished. G1159 Push-Pull Transformer, ratio 6½ to 1 \$2.95</p>	 <p>Hard Rubber Panels Highest dielectric strength as per Bureau of Standards. Beautiful high finish. G7100 7x10x3-16 \$6.65 G7120 7x10x3-16" 9.75 G7140 7x14x3-16" 0.89 G7180 7x18x3-16" 1.15 G7210 7x21x3-16" 1.31 G7240 7x24x3-16" 1.46</p>

RASCO 5-TUBE TUNED RADIO FREQUENCY RECEIVER \$17.95

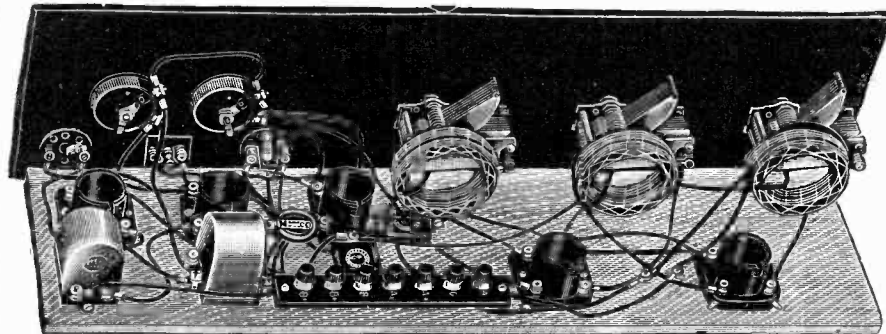

G9216A

Build Your Own Receiver—

It's Easy The "No-Sod-er Way"
Revolutionary Improvement in Assembling Radio Sets

No solder—No bare wires—No poor connections—No dissatisfaction. No tools needed except a common screw-driver and common pliers. All connections are made by the use of our flexible, insulated eyeletted connecting wire in place of bus bar or wire, and solder. And in a fraction of the time usually required when building the old fashioned way. And when the job is done it is neat and your connections are tight.

We Furnish a Special Blueprint Free With Each Kit
Connections Always Perfect

PARTS INCLUDED IN THIS RECEIVER

Cabinet, mahogany finish, 7x26x3\$5.31	Switch, A battery, Patent36
Panel, drilled and engraved, Bakelite-Dielecto, 7x26 3.50	Fixed grid condenser and mounting, Micamold 0002535
Baseboard, laminated40	Grid leak, 2 megohm, Patent32
Coils, tuned transformers, our No. 2629 1.05	Fixed condenser, .002 mfd Micamold31
3 Variable condensers, .00038 Capacigrad @ 5.10	Binding post strip, Rasco (with binding posts)35
3 4-Inch Pilot Dials75	No-Sod-er connecting wires, full set 1.75
2 Transformers, audio frequency, Patent @ \$3.75 7.50	Necessary hardware, screws, angles, etc.25
2 Rheostats, 20-ohm, Pilot92	Blueprint and instruction sheet 1.00
Sockets, low loss, Bakelite, Pilot, @ 25c 1.25	Total Price of Set.....\$32.24
Jack, single circuit improved80	Our price, Catalog No. G9216.....\$22.95
Jack, double circuit improved70	No. G9216A, same kit, but without cabinet...\$17.95

BIGGEST VALUE IN AMERICA

If you wish the finest 5-tube set to be had, you have it in this model. No better set made in popular-priced receivers. Low cost compared with results obtained.

This is not a small set thrown together with questionable parts that no one knows and made only to sell. All our parts are listed by name and standard merchandise—nothing else.
This is a BIG SET, measuring 7 x 26 inches, and there is no one in the country today who can compete with us in this particular outfit.

Note particularly that the condensers which we use are brass plate condensers of the new straightline frequency type, not obsolete straight wave-length type, which are so hard to tune on the lower waves.

NEW ADJUSTABLE COILS (Patents Pending)

In this set we use adjustable coils, which can be moved up and down, away from the condenser, until the right balance is found. This makes for an unheard of and really incredible degree of sensitivity which has not been realized heretofore in sets of this kind.

Note also that the panel comes to you all drilled, with all holes drilled in position, and that any child can put together this wonderful receiver in less than an hour.

This set is highly efficient for bringing in the greatly-desired long range reception. 3,000 miles has been covered repeatedly. This has been accomplished by using two stages of tuned radio frequency with detector and two stages of audio frequency.

The tuning is done by three large dials; the first dial controls the antenna tuning, the center dial the first radio transformer, and the last dial the second radio transformer.

Make Big Money by assembling and selling them complete to friends and business houses who need a First Class Radio. Many of our customers sell these completed sets from \$30.00 upwards.

New 1926 "Rasco" Catalog No. 16

CONTAINS 75 VACUUM TUBE HOOK-UPS, 446 ILLUSTRATIONS, 500 ARTICLES

Also Logbook of all Broadcast Stations

FREE

A POSTAL CARD BRINGS IT

Just to name a few of the circuits: The V.T. as a detector and one-step amplifier; all Armstrong circuits; one-step radio frequency amplifier and detector; three stage audio frequency amplifier; short wave regenerative circuits; 4-stage radio frequency amplifiers; radio and audio frequency amplifier; inductively coupled amplifier; all Reflex Circuits.

RADIO SPECIALTY COMPANY, 100 Park Place, New York City
Factories: Brooklyn, N. Y. Eldridge, Md.

U.S. PATENTS



SEND FOR THIS FORM

Don't Lose Your Rights

Before disclosing your invention to anyone send for blank form "Evidence of Conception" to be signed and witnessed. A sample form together with printed instructions will show you just how to work up your evidence and establish your rights before filing application for patent. As registered patent attorneys we represent hundreds of inventors all over the U. S. and Canada in the advancement of inventions. Our schedule of fees will be found reasonable. The form "Evidence of Conception" sample, instructions relating to obtaining of patent and schedule of fees sent upon request. Ask for them,—a post card will do.



Registered Patent Attorneys in U.S. and Canada
255 Ouray Bldg., Washington, D. C.
"Originators of form Evidence of Conception"

PATENTS

TO THE MAN WITH AN IDEA

I offer a comprehensive, experienced, efficient service for his prompt, legal protection and the development of his proposition.

Send sketch, or model and description, for advice as to cost, search through prior United States patents, etc. Preliminary advice gladly furnished without charge.

My experience and familiarity with various arts frequently enable me to accurately advise clients as to probable patentability before they go to any expense.

Booklet of valuable information and form for properly disclosing your idea, free on request. Write today.

RICHARD B. OWEN, Patent Lawyer
164 Owen Building, Washington, D. C.
41V Park Row, New York City

TRADE-MARKS REGISTERED

PATENTS

BOOKLET FREE HIGHEST REFERENCES
PROMPTNESS ASSURED BEST RESULTS
Send drawing or model for examination and report as to patentability

WATSON E. COLEMAN, Patent Lawyer
644 G Street, N. W., Washington, D. C.

INVENTORS PROTECT YOUR IDEAS

Send for our Guide Book, **HOW TO GET A PATENT**, and Evidence of Invention Blank, sent Free on request. Tells our terms, methods, etc. Send model or sketch and description of your invention for **INSPECTION** and **INSTRUCTIONS FREE. TERMS REASONABLE. BEST REFERENCES.**

Name

Street

City

RANDOLPH & CO.
Dept. 172, WASHINGTON, D. C.

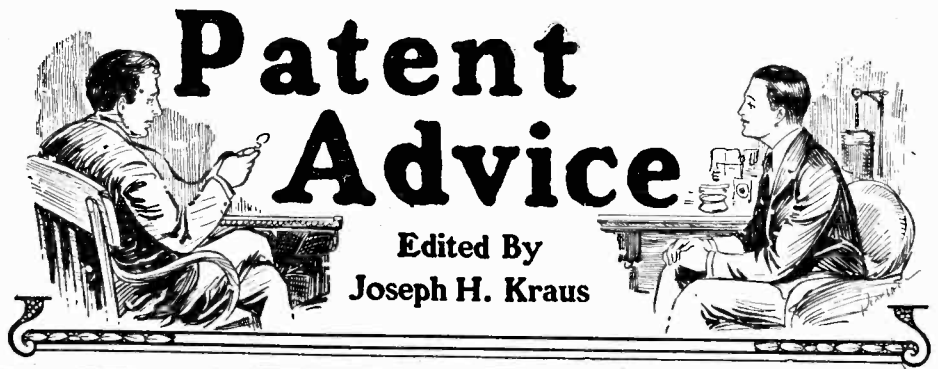

Edited By
Joseph H. Kraus

In this Department we publish such matter as is of interest to inventors and particularly to those who are in doubt as to certain patent phases. Regular inquiries addressed to "Patent Advice" cannot be answered by mail free of charge. Such inquiries are published here for the benefit of all readers. If the idea is thought to be of importance, we make it a rule not to divulge all details, in order to protect the inventor as far as it is possible to do so.

Should advice be desired by mail a nominal charge of \$1.00 is made for each question. Sketches and descriptions must be clear and explicit. Only one side of sheet should be written on.

NOTE:—Before mailing your letter to this department, see to it that your name and address are upon the letter and envelope as well. Many letters are returned to us because either the name of the inquirer or his address is incorrectly given.

EXPLODING DYNAMITE

(949) Q. 1. Ronald F. Thompson, Greene, Iowa, says that he has developed a system for exploding dynamite and other like substances by radio at a distance of from 1000 to 2000 feet. He asks if it would be advisable to patent this idea.

A. 1. We cannot advise you on your proposed device for exploding dynamite from a distance unless we have details upon the same. Of course, electrical detonating devices have been proposed and used before and are in extensive and practical use today.

We hope that prospective clients of this department will take heed from the above answer. It is obviously impossible for us to comment fully and in detail upon any system or device unless complete information on the same is submitted to us at the time the queries are asked relative to it.

Q. 2. Would a crystal detector type of radio receiving set incorporated in a candle holder be patentable?

A. 2. You might possibly be able to obtain a design patent on a candle holder crystal set, although we are quite sure that you could not obtain a patent on the set or circuit itself.

AIRPLANE CONTROL

(950) Q. 1. Paul Michaux, Greensboro, N. C., has conceived the idea that it might be possible to place the gasoline throttle control of an airplane directly on the end of the joy stick instead of at the side of the pilot as is usual. He asks if in our opinion this system would be feasible and patentable.

A. 1. We do not believe that it would be practical to place the gasoline throttle control of an airplane on the elevator and rudder control stick. In the first place, there is no necessity for combining these two controls as the operator has nothing more to do with his hands than to manipulate the gas, spark and "joy stick." It would seem to us to be unnecessary complication to attempt to combine these two controls and we would certainly advise against it. Furthermore, perfect control could not be had at all times. The motor speed must be critically controlled when indulging in aerial acrobatics and this control could not be had with the throttle in the place you mention. For instance, suppose that the aviator was manoeuvring for a sharply banked turn and suddenly lost flying speed. In order to open the throttle quickly and regain his speed, it becomes necessary to twist the end of the "joy stick." When this is done, it is very likely that the stick would be pushed too far ahead, throwing the nose of the plane down and possibly resulting in a nose dive. We would certainly not advise you to proceed further with attempting to patent this combination for the reasons mentioned above.

ENVELOPE

(951) Q. 1. C. W. B. Bullock, Halifax, N. S. Canada, has designed a type of folding envelope which is to enclose a letter and which does not need sealing in order to hold its shape when being carried through the mails. He asks us what we think of a design of this nature.

A. 1. Folding envelopes such as the one you have designed and described in your letter of recent date are not at all new. Very similar envelopes have been in use for some time in the past and we have seen several of them that are far simpler to fold and use than the one that you have outlined. We do not believe that it would be a profitable venture for you to attempt to patent and manufacture these envelopes and, therefore, we would certainly advise against such a procedure.

ERASER

(952) Q. 1. Morris Bernstein, New York City, proposes the placement of a small reservoir for holding liquid ink eradicator in the end of a fountain pen. He asks our opinion.

A. 1. We do not believe that your proposed idea for attaching an ink eraser to fountain pens constitutes patentable material. This is a very old idea and we are sure that you would find much opposition in attempting to patent such a device. Various fountain pens have been placed on the market having containers for liquid ink erasers and for solid abrasives. In view of this fact, we would not advise you to proceed further.

CHAIR

(953) Q. 1. T. G. Boggs, White Salmon, Wash., wants to know how he can protect a novel design for a chair that is particularly adaptable to children's nurseries.

A. 1. There are two things that you could do to protect your particular design and they are as follows. The design of the chair itself can be covered by what is known as a design patent and you could also invent a name or medallion to describe the chair which could be registered as a trademark.

LICENSE HOLDER

(954) Q. 1. J. J. Bormida, Jersey City, N. J., has evolved a design for a combination license plate holder and light. This necessitates equipping an automobile with a special bracket and issuing license plates with the letters cut out of the metal. A ground glass is then placed in back of the plate and an electric light bulb is situated in back of the ground glass. The light shines out through the cut-out portions of the plate and the result is supposed to overcome many of the objections that are found with present types of license plates and lights.

A. 1. Careful consideration of your proposed license plate and bracket fails to disclose anything new or novel in the construction of the same. The system in its entirety has been proposed heretofore and many attempts have been made to obtain favorable legislation that would necessitate the use of such devices on each and every automobile in operation. These attempts, however, have failed up to the present time and in view of the failures we would not advise you to proceed further with the idea.

MOTORCYCLE HELMET

(955) Q. 1. R. Best, Abu-Sueir, Egypt, has conceived a motorcycle helmet which is so constructed that parts of it can be removed so as to leave a cap and so that the user can wear the cap under ordinary conditions, but can convert it into a motorcycle helmet when such a necessity arises. He asks our opinion.

A. 1. We do not see any very great advantage in this device that is not contained in other motorcycle helmets on the market today.

MY PATENT
LAW OFFICES



JUST ACROSS
STREET FROM
U.S. PAT. OFF.

PATENTS

INVENTORS Write for these FREE BOOKS!



At the left is a view of my drafting and specification offices where a large staff of experienced experts are in my constant employ. All drawings and specifications are prepared under my personal supervision.

PROTECT YOUR IDEAS Take the First Step Today—Action Counts

If you have a useful, practical, novel idea for any new article or for an improvement on an old one, you should communicate with a competent Registered Patent Attorney AT ONCE. Every year thousands of applications for patents are filed in the U. S. Patent Office. Frequently two or more applications are made for the same or substantially the same idea (even though the inventors may live in different sections of the country and be entirely unknown to one another). In such a case, the burden of proof rests upon the last application filed. Delays of even a few days in filing the application sometimes mean the loss of a patent. So lose no time. Get in touch with me at once by mailing the coupon below.

No Charge for Information on How to Proceed

The booklet shown here contains valuable information relating to patent procedure that every inventor should have. And with it I will also send you my "Record of Invention" form, on which you can sketch your idea and establish its date before a witness. Such evidence may later prove valuable to you. Simply mail the coupon and I will send you the booklet, and the "Record of Invention" form, together with detailed information on how to proceed and the costs involved. Do this NOW. No need to lose a minute's time. The coupon will bring you complete information entirely without charge or obligation.

Prompt—Careful Efficient Service

This large, experienced organization devotes its entire time and attention to patent and trademark cases. Our offices are directly across the street from the U. S. Patent Office. We understand the technicalities of patent law. We know the rules and requirements of the Patent Office. We can proceed in the quickest, safest and best ways in preparing an application for a patent covering your idea. Our success has been built on the strength of careful, efficient, satisfactory service to inventors and trademark owners located in every state in the Union.

Clarence A. O'Brien

Registered Patent Attorney

Member of Bar of: Supreme Court of the United States; Court of Appeals, District of Columbia; Supreme Court, District of Columbia; United States Court of Claims

Practice confined exclusively to Patents, Trademarks, and Copyrights

Strict Secrecy Preserved—Write Me in Confidence

All communications, sketches, drawings, etc., are held in strictest confidence in strong, steel, fireproof files, which are accessible only to authorized members of my staff. Feel free to write me fully and frankly. Your case will have my personal attention. It is probable that I can help you. Highest references. But FIRST—clip the coupon and get my free book. Do THAT right now.

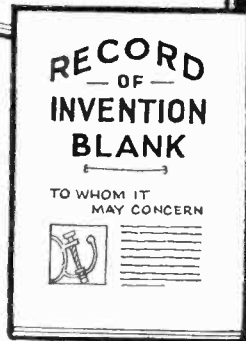
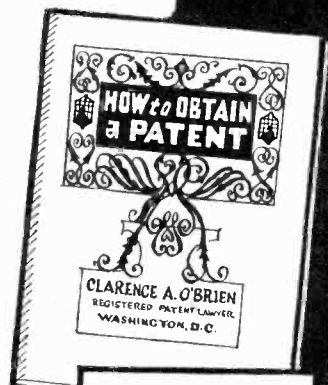

Mail this Coupon NOW.

CLARENCE A. O'BRIEN
Registered Patent Attorney,
53-K Security Savings & Commercial Bank Bldg.,
Washington, D. C.

Please send me your free book, "How to Obtain a Patent," and your "Record of Invention" form without any cost or obligation on my part.

Name

Address

(Important: Print or Write name clearly)

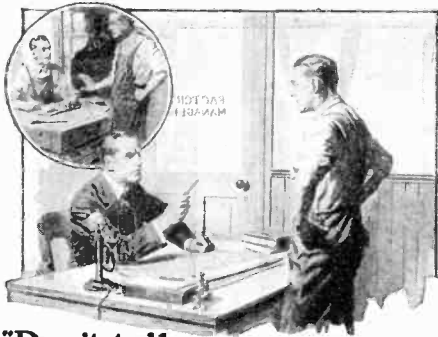

"Don't tell me you never had a chance!"

"Four years ago you and I worked at the same bench. I realized that to get ahead I needed special training, and decided to let the International Correspondence Schools help me. I wanted you to do the same, but you said, 'Aw, forget it!' You had the same chance I had, but you turned it down. No, Jim, you can't expect more money until you've trained yourself to handle bigger work."

There are lots of "Jims" in the world—in stores, factories, offices, everywhere. Are you one of them? Wake up! Every time you see an I. C. S. coupon your chance is staring you in the face. Don't turn it down.

Right now over 180,000 men and women are preparing themselves for bigger jobs and better pay through I. C. S. courses.

You can join them and get in line for promotion. Mark and mail this coupon, and find out how.

INTERNATIONAL CORRESPONDENCE SCHOOLS
Box 6249-D, Scranton, Penna.

Oldest and largest correspondence schools in the world. Without cost, please tell me how I can qualify for the position or in the subject before which I have marked an X:

- | | |
|---|---|
| <input type="checkbox"/> Business Management | <input type="checkbox"/> Salesmanship |
| <input type="checkbox"/> Industrial Management | <input type="checkbox"/> Advertising |
| <input type="checkbox"/> Personnel Organization | <input type="checkbox"/> Better Letters |
| <input type="checkbox"/> Traffic Management | <input type="checkbox"/> Show Card Lettering |
| <input type="checkbox"/> Business Law | <input type="checkbox"/> Stenography and Typing |
| <input type="checkbox"/> Banking and Banking Law | <input type="checkbox"/> Business English |
| <input type="checkbox"/> Accountancy (including C.P.A.) | <input type="checkbox"/> Civil Service |
| <input type="checkbox"/> Nicholson Cost Accounting | <input type="checkbox"/> Railway Mail Clerk |
| <input type="checkbox"/> Bookkeeping | <input type="checkbox"/> Common School Subjects |
| <input type="checkbox"/> Private Secretary | <input type="checkbox"/> High School Subjects |
| <input type="checkbox"/> Spanish | <input type="checkbox"/> Illustrating |
| <input type="checkbox"/> French | |

- TECHNICAL AND INDUSTRIAL COURSES**
- | | |
|---|--|
| <input type="checkbox"/> Electrical Engineering | <input type="checkbox"/> Architect |
| <input type="checkbox"/> Electric Lighting | <input type="checkbox"/> Architects' Blueprints |
| <input type="checkbox"/> Mechanical Engineer | <input type="checkbox"/> Contractor and Builder |
| <input type="checkbox"/> Mechanical Draftsman | <input type="checkbox"/> Architectural Draftsman |
| <input type="checkbox"/> Machine Shop Practice | <input type="checkbox"/> Concrete Builder |
| <input type="checkbox"/> Railroad Positions | <input type="checkbox"/> Structural Engineer |
| <input type="checkbox"/> Gas Engine Operating | <input type="checkbox"/> Chemistry |
| <input type="checkbox"/> Civil Engineer | <input type="checkbox"/> Automobile Work |
| <input type="checkbox"/> Surveying and Mapping | <input type="checkbox"/> Airplane Engines |
| <input type="checkbox"/> Metallurgy | <input type="checkbox"/> Agriculture and Poultry |
| <input type="checkbox"/> Steam Engineering | <input type="checkbox"/> Mathematics |

Name.....
Street.....
Address.....
City..... State.....

Occupation.....
If you reside in Canada, send this coupon to the International Correspondence Schools Canadian Limited, Montreal

BUY DIRECT
SAVE HALF
GRADE A QUALITY GOODS
at WHOLESALE

Any handy man can install his own plumbing and heating by our new, easy method. **FREE** installing plans show you how. You save waste and high labor cost with our cut-to-fit system. Fifty years of economy service to home owners, farmers, builders and mechanics. Million dollar plants behind our guarantee. **FREE BOOK** shows everything in plumbing and heating fixtures and supplies. Write today for copy.

HARDIN-LAVIN COMPANY
104-14 West Pershing Road, Chicago, Ill.

30 Days FREE Trial
Rangers direct from our factory, express prepaid. Save \$10 to \$15. Many models. Easy payments—only \$5 a month. Write today for bicycle catalog and marvelous offers.

MEAD Cycle Co., Dept. B-107 CHICAGO

Tarrano the Conqueror

(Continued from page 356)

by the hasty searching sweeps they made. And then from the big Wilton tower, the newly connected Zed-ray flashed on. I could hear the load of it in the deepened, throaty hum from the power house. Its dirty brown beam sprayed out over the plain; then swung to the sky, caught something, hung motionless, narrowed into great intensity. The powerful Zed-ray, capturing the visibility of dense solids only.*

There was something up there in the sky! The Zed-ray met resistance; we could see the sparks, and hear the snap of them coming like a roar from the microphone above the drumming. Met the resistance and conquered it; the snapping roar died away, but the drumming came on.

"Jac! I see something! Something there—don't you see it?"

A luminous blur become visible in the nearer sky—moving blobs of silver luminosity in the mud-brown light of the Zed-ray. A hundred or more moving silver blobs. They were taking form. The silvery phosphorescent look faded, became grey-white. Took definite shape. Waving arms and legs! Bones bereft of flesh. Human skeletons! Limbs waving rhythmically. Bony arms, with fingers clutching metal weapons. As-

Articles in Radio News for August

- Double-Grid Sets, by Hugo Gernsback.
- \$300.00 Prize Hook-Up Contest.
- Vacuum Tubes and Their Uses, by M. L. Muhleman.
- A Batteryless Receiver (with complete construction data).
- Broadcasting the Sounds of Atoms, by H. P. Cady and John Strong.
- Are Portable Sets Practical? by A. P. Peck.
- Making a Business of Inventions, by L. T. Parker.
- The Broadcasting of Pictures, by Dr. Walter Friedel.
- Let's Use Extra Short Waves, by Henry Lamonte.
- The Short-Wave Set that Brought in the Byrd Expedition, by G. W. Linn, Jr.
- A Vacation Set, by Joseph Bernsley.
- An Inverse Duplex Receiver for the Home Constructor, by Florian J. Fox.
- More About A.F. Amplifiers, by Sylvan Harris.
- New Developments in Radio Apparatus, by G. C. B. Rowe.
- Chemical Condensers, by Clyde J. Fitch.

sailants coming at us through the air, stripped by the Zed-ray of clothing, skin, flesh, organs, to the naked bone. Skeletons with skulls of empty eye-sockets and set jawbones to make the travesty of human faces grim with menace!

CHAPTER XXXV

The Attack on the Power House

Stricken with surprise and awe, Elza and I sat there motionless. Our encampment was in a turmoil of confusion—chaos, out of which very soon order came. The skeleton figures in the air—I saw now that there were nearer two hundred than one hundred—were perhaps two thousand feet away, and at an altitude of about the cliff-ledge where Elza and I were sitting.

They swept forward, bathed in the Zed-ray with all our other search-beams darkened to give it full sway. Momentarily I saw them clearer; metallic cylinders in bony fingers, and a metal mechanism of flight encasing, yet not touching the ribs.

"Jac! Why don't our rays—"
As though to answer Elza's unfinished question, one of our towers turned a disintegrating ray upon them. A narrow pencil-

*Similar doubtless to our present-day X-ray.

PATENTS
TRADE MARKS · DESIGNS
FOREIGN PATENTS

MUNN & Co.
PATENT ATTORNEYS

Associated since 1846 with the Scientific American

1518 Scientific American Bldg., New York City
525 Scientific American Bldg., Washington, D.C.
1314 Tower Building, Chicago, Ill.
667 Hobart Building, San Francisco, Cal.
522 Van Nuys Building, Los Angeles, Cal.

Books and Information on Patents and Trade Marks by Request.

Book on Law Free

Write today for this new book. It tells you how a law training will shorten your road to success. It also carries a vital and inspiring message to every ambitious man. Find out about the opportunities that await the law trained man. Find out how you can learn law right in your own home. No obligations. The book is absolutely FREE. Write Today—now while we are making a special reduced tuition offer.

American Correspondence School of Law
3601 Michigan Ave. Dept. 142C Chicago, Ill.

INVENTORS who derive largest profits know and heed certain simple but vital facts before applying for Patents. Our book Patent-Sense gives those facts; sent free. Write

LACEY & LACEY
644 F STREET, WASHINGTON, D. C.
Established 1869

PATENTS PROMPTLY PROCURED. SEND A SKETCH OF YOUR INVENTION. FREE INVENTION RECORDING BLANK.

Z. H. POLACHEK
PATENT ATTORNEY
CONSULTING ENGINEER
70 WALL ST. NEW YORK

NAME.....
ADDRESS.....
MAIL TODAY

C. L. PARKER
Ex-Examiner U. S. Patent Office
Attorney-at-Law and Solicitor of Patents
McGill Building, Washington, D. C.
Patent, Trade Mark and Copyright Law

INVENTIONS Commercialized
ON A CASH OR ROYALTY BASIS
PATENTED or UNPATENTED

In Business 25 Years - Complete Facilities - References.
Write **ADAM FISHER MFG. Co.,**
205D Enright Ave. St. Louis, Mo.

BLUE BOOK ON PATENTS
and Priority Record blank gratis.
MONROE E. MILLER, PATENT LAWYER,
411-6 Ouray Building, WASHINGTON, D. C.
ELECTRICAL AND MECHANICAL EXPERT

PATENTS TRADE-MARKS
Edward C. Sasnett, Attorney at Law
Ex-Principal Examiner U. S. Patent Office;
Electrical Expert Personal Service
544 MCGILL BLDG. WASHINGTON, D. C.

TELESCOPES
Amateur astronomers, here is an opportunity to own a good telescope.
PRICES \$12.00 AND UP
Send 10 cents for further information
E. W. BLANDIN
1207 Columbia Terrace Peoria, Ill.

Learn to Write

Begin Today—Write for My FREE BOOK. I can make a good penman of you at home during spare time. Write for my FREE BOOK, "How to Become a Good Penman." It contains specimens and tells how others mastered penmanship by the Tamblin System. Your name will be elegantly written on a card if you enclose stamp to pay postage. Write today for book.

F. W. TAMBLIN, 224 Ridge Bldg. Kansas City, U.S.A.

point of light, barely visible in this flat daylight. It swung up into our Zed-ray, searched and clung to one of the skeleton figures. Had it penetrated, the man would have been dissipated like a puff of vapor. But it did not; and then I knew that for that distance at least, this enemy's isolation power—individual barrage—was too great.

Yet the assailed figure wavered! Our amplifier gave out his shout—half fear, half admonition. The line of skeletons swung upward. Came on, but mounted so that I saw that they were making for the summit of the cliff above us—above our power house.

Their defense—invisibility, and a mere isolation barrage so that we could not harm them with our tower rays while they kept beyond range. But what was their means of attack. Why would Tarrano . . .

"The power house," Elza answered; and I realized then that she had read my thoughts. The power house, if they could demolish it . . .

Our thoughts, questions and answers unspoken, flew fast; but the drama before us unfolded faster. With the knowledge that we could see them, these invaders cast aside a portion of their equipment to give them greater freedom. We could see the metal

portions of the trappings falling like plumbets. The skeleton images faded; and then as our tower withdrew the Zed-ray and our search-beams picked them up, we saw our enemies as they really were. Men clothed in a casing of cylindrical garments with the flying mechanisms strapped to their chests; some with visors and head-pieces, nearly all with small weapons in their hands.

Keeping well away, they continued to mount. They were striving for the pinnacle of cliff-tops above us; but as our rays darted at them they halted, wavered; and now when nearly above the camp, they began mounting straight up.

"Jac! Look there!"
One of our tower vehicles was preparing to rise. Its ray, following the search-beams upward, was aimed at the invaders, but they were beyond its effective range. Their weapons of attack? I knew now.

"Suicides!"
Whether Elza said it, or merely thought it I do not know. One of the figures came down as though falling. A few seconds only; but though our search-beam showed it, the smaller rays for those seconds missed it. Down—until no more than five hundred feet above us it checked its fall. A giant of a man; and with his hand cylinder—in range now—he shot a bolt at our power house. It struck; I could see the flash, saw an aerial shatter before the charge went harmlessly into the body of the building. Then one of our rays caught the man; his figure crum-

PATENTS TRADE-MARKS AND COPYRIGHTS

OUR OFFER: FOR THE PROTECTION OF YOUR INVENTION

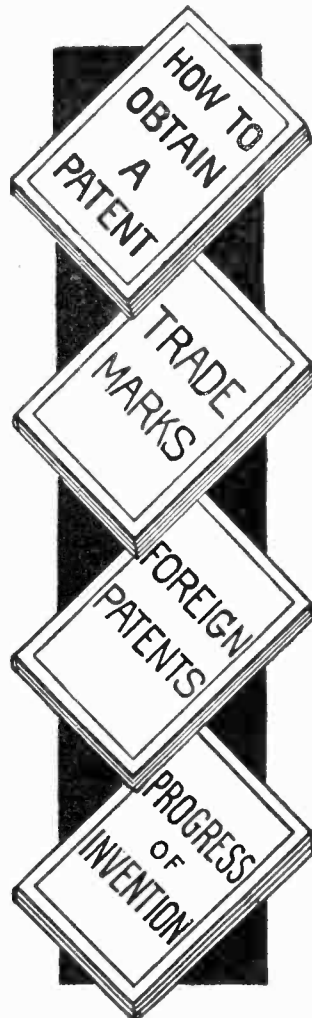

YOUR FIRST STEP before disclosing an invention. The inventor should write for our blank form—

"Record of Invention"

This should be signed and witnessed and returned to us together with model or sketch and description of the invention for **INSPECTION** and **INSTRUCTIONS**.

NO CHARGE FOR THE ABOVE INFORMATION

Our Four Books Mailed Free to Inventors

Our Illustrated Guide Book

HOW TO OBTAIN A PATENT

Contains full instructions regarding U. S. Patents. Our Methods, Terms, and 100 Mechanical Movements illustrated and described.

OUR TRADE MARK BOOK

Shows value and necessity of Trade Mark Protection. Information regarding *Trade Marks and unfair competition in trade*.

OUR FOREIGN BOOK

We have Direct Agencies in Foreign Countries, and secure Foreign Patents in shortest time and at lowest cost.

Progress of Invention

Description of World's Most Pressing Problems by Leading Scientists and Inventors.

IMPORTANT

Do not submit your invention to anyone before you furnish proof that the invention is patentable or application has been filed. **IN ORDER TO HAVE YOUR CASE MADE SPECIAL TO AVOID DELAY YOU SHOULD TAKE THE PRECAUTION OF HAVING YOUR CASE MADE SPECIAL IN OUR OFFICE** to secure protection, save correspondence and secure early filing date in Patent Office. To secure special preparation of your case send \$25.00 on account with model, sketch and description of your invention.

All communications and Data Strictly Confidential. Interference and Infringement Suits Prosecuted. Our Organization offers **PERSONAL SERVICE** by Experienced Patent Solicitors and Draftsmen.

We Regard a Satisfied Client as our best advertisement, and furnish anyone, upon request, lists of clients in any state for whom we have secured patents.

Highest References—Prompt Attention—Reasonable Terms

WRITE TODAY

FREE COUPON

VICTOR J. EVANS & CO., Patent Attorneys

New York Offices Philadelphia Offices Pittsburgh Offices
1007 Woolworth Bldg. 714-715 Liberty Bldg. 514 Empire Bldg.
Chicago Offices, 1114 Tacoma Bldg. San Francisco Offices, Hobart Bldg.
Main Offices, 779 Ninth Street, Washington, D. C.

Gentlemen: Please send me **FREE OF CHARGE** your books as described above.
Name..... Address.....

DISCOVER NEW WORLDS

CONQUER DISTANCE! Lend wings to your eyes!—magnify your eyesight—discover new thrills—new joys—new worlds—new beauties of Heaven and Earth. Own a Genuine IMPORTED "Celestia" Telescope!

SEE BELTS OF JUPITER! RINGS OF SATURN! CRATERS OF MOON! SURFACE OF MARS! Explore Them With This Big, Powerful 3 1/2 Foot

35-POWER "CELESTIA" TELESCOPE

4 sections, heavy brass stock, beautifully polished, tarnish- and rust-proof; rich Morocco leather body. Powerful "Celestia" lenses of brilliant illumination, great light-gathering power; magnificent 35-power! 56 - Millimeter objective lenses. Length closed 12 1/2 inches; extended 42 1/2 inches (3 1/2 ft.). Disappearing slide on eye-piece makes it dust - proof, moisture-proof. Removable objective cover over lenses.

FREE Trial for 10 Days

TELESCOPES are becoming increasingly popular because they are adapted to so many uses—rifle or target practice; hunters; ranchmen; forest rangers; mariners; big game hunters; locating forest fire study of stars; general outdoor uses.

Preferred by Eminent Scientists

WE supply "Celestia" Telescopes to Explorers, Big Game Hunters, Globe Trotters, Universities, Scientific and Research Departments, etc. Delivered in sturdy case container. Regularly sells for \$10. Our price (while limited importation lasts) **\$26.50**

"Our Plan is Different"

WE ASK FOR NO MONEY IN ADVANCE. NOTHING ON DELIVERY. See, Try, Use, ENJOY "Celestia" Telescope for 10 DAYS' FREE TRIAL. If you're pleased, you may pay on BUDGET PLAN.

\$6.00 MONTHLY

or, if you wish to pay cash at end of 10 DAYS, deduct \$1.75 and send Check or Money Order for \$24.75 in FULL SETTLEMENT. Otherwise return them. Order NOW! Send NO Money! Pay Nothing on Delivery. **\$24.75**

"2 Generations of Honorable Dealings"

SEEVER-WILLIAMS CO.

Importers, Exporters, National Mail Order House
365 WASHINGTON ST., BOSTON, MASS.

Sole Distributors of "Celestia" Telescopes
Gentlemen—Send me the 35-Power "Celestia" Telescope for 10 Days' FREE Trial on the above plan.

NAME _____

ADDRESS _____

Tear out and mail this coupon NOW! If you wish to tell us something about yourself, it will be appreciated—simply write on separate slip of paper. THANK YOU! S. I. 8-26

\$1000.00 Travel Accident Insurance FREE!

6,000 to 12,000 MILES

Goodyear, Goodrich, Firestone, Fisk, Mason, etc. Thousands of satisfied customers. A. J. Weber, Galena, Ill. got 12,000 miles service. Buy from an old established concern. Best used tires re-manufactured by our own secret process.

GUARANTEE!

Every tire guaranteed to give satisfaction. Will replace any tire failing to do so at one-half purchase price. Send only \$1.00 deposit for each tire ordered, pay postman balance on delivery. 5 per cent discount allowed for all cash in advance. Orders filled promptly. Not necessary to order 2.

You can order 1 tire or tube at above prices without penalty. Send age, height, name, address.

NEW NET LOW PRICES

Size	Tires	Size	Tires
30x3	\$3.25 \$1.50	33x4 1/2	\$6.25 \$3.00
30x3 1/2	3.65 1.75	34x4 1/2	6.50 3.25
32x3 1/2	3.95 1.95	35x4 1/2	7.00 3.35
31x4	4.50 2.00	36x4 1/2	7.25 3.40
32x4	4.95 2.25	33x5	7.50 3.50
33x1	5.45 2.50	35x5	7.75 3.75
34x4	5.75 2.65	37x5	8.25 4.00
32x4 1/2	6.00 2.95	20x1.10	5.45 2.75

Buy Now! You take no chance. Our Guarantee Protects You!

EAGLE TIRE & RUBBER COMPANY
Dept. 192
3445 S. Michigan Ave., Chicago, Ill.

Ship Model Plans

and instructions. Easy to build and sell models. Magellan's Ship, 77c—Hudson's "Half Moon," 92c—Clipper, 82c—Santa Maria, \$1.02—Pirate Ship, 52c—all for \$3.90.

SEA ARTS GUILD

405X ELEVENTH AVE. MILWAUKEE, WIS.

pled; the shower of sparks as his barrage was broken, exploded like a tiny bursting bomb; and as the sparks died, there was nothing where the man had been.

A suicide; but one of our aerials was shattered. And then others came down—not many, for it was grim business and the courage of them must have failed at the last. Falling bodies; tiny bolts striking the power house; the sparks—then empty air where living men had been.

Our tower left the ground. Some of our men, with small flying platforms strapped to them, were crowding its top. Its beams preceded it—but I saw the beams breaking intermittently as the bolts struck the power house. The invaders wavered with indecision. Some of them came down to voluntary death; others strove for the cliff-top; some took flight. Our tower swept into them; one of them, injured but not annihilated, fell with a crash into the encampment.

Above Elza and me was a maze of flashing beams; futile bolts; the puffs of myriad sparks. A bolt seemed to strike quite near where we were sitting; I drew Elza back and we crouched in the hollow of a rock. A body came hurtling down, crashed to the cliff-ledge almost at our feet with the sickening thump of mangled flesh and broken bones—hung an instant to give me a momentary glimpse of a face contorted in death agony; then rolled over and fell further down the jagged cliff.

Then above us presently there was silence and the drab empty sky. Our tower was back beyond the cliff-top. Soon it appeared; apparently unharmed, it came dropping down to its former place on the ground.

The first attack was over. And off in the distance a few solitary figures were winging their way back to the City of Ice.

CHAPTER XXXVI

Investing the City

We were not greatly harmed by this surprise attack; the power house was superficially damaged, but soon repaired. That night—I call it that though the constant weak daylight made the term incongruous—activity showed in the City of Ice.

It came with a vertical spray of light rising from the ice wall which encircled the city. Spreading light beams rising from points a hundred feet apart along the wall. The beams spread fan-shape, so that within fifty feet above their source they met and merged into a thin sheet of effulgence rising into the sky. Tarrano's barrage.

It seemed then that beyond suicidal sorties of the kind we had just repulsed, Tarrano was planning to stand purely on the defensive. It was our own plan to surround the city with our towers; even those on the further side would be within range of our power house; and with the city thus beleaguered, we would attack the wall from every side at once.

We tested now this barrage Tarrano had thrown up. Sprays of its insulated area came down to protect the wall in front; and protected also the triangular spaces between the sources of the main beams. Tentatively one of our towers approached within range; but our rays only beat into the barrage with the hiss of molten metal plunged into water, and with a burst of interference sparks. Even at a horizontal thousand feet we could do nothing. Then we tried altitude. Our projectors, mounted individually on small platforms automatically controlled to fly without human pilot, went up and we strove to get them over the barrage.

At five thousand feet one went over safely. But the electronic bomb it dropped into the city was an easy mark for Tarrano's watchful defense rays. He exploded it harmlessly when it was still high above him.

After the next time of sleep we invested the city. Our towers were set in a ring

A new Parks!



Cabinet Shop Special
No. 10
\$290

AS ILLUSTRATED WITH MOTOR

THE MOST POPULAR MACHINE PARKS EVER BUILT! A winner from the start. A real machine, yet convenient size for the small shop. Does everything in woodworking. Has circular rip and cut-off saw, 6-inch jointer, 16-inch bandsaw. Lathe and shaper attached if desired at small cost. Operates from any light socket. Just plug in and go to work!

Write for interesting circular

The Parks Ball Bearing Machine Co.
1553 Knowlton St., Cincinnati, Ohio
Canadian Fac: 200 Notre Dame East, Montreal, Can.

PARKS

WOODWORKING MACHINES



WRITTEN 2-YEAR GUARANTEE

Battery Prices SMASHED!

To Consumers Only

Here is a real battery quality, guaranteed to you at prices that will astound the entire battery-buying public. Order Direct From Factory. Put the Dealer's Profit in your own pocket. You actually save much more than half, and so that you can be convinced of true quality and performance, we give a **Written 2-Year Guarantee**. Here is your protection! No need to take a chance. Our battery is right—and the price is lowest ever made. Convince yourself. Read the prices!

Auto Batteries **Radio Batteries**
6 Volt, 11 Plate, \$8.50 6 Volt, 100 Amp, \$8.50
6 Volt, 13 Plate, \$10.25 6 Volt, 120 Amp, \$10.25
12 Volt, 7 Plate, \$11.75 6 Volt, 140 Amp, \$11.75

Buy Direct—Send No Money

We ask no deposit. Simply send name and address and style wanted. Battery will be shipped same day we receive your order Express C.O.D. subject to your examination on arrival. Our guarantee accompanies each battery. We allow 5% discount for cash in full with order. You cannot lose! Send your order today—NOW!

ARROW BATTERY CO.
Dept. 9 1215 So. Wabash Ave., Chicago

You Can Play It



If It's a Buescher Saxophone

We give 3 free lessons with each new instrument. They start you. Teach yourself. It's great fun practicing because you learn so quickly. Even though you have failed with some other instrument, you can learn the Buescher Saxophone. And it will make you the most popular person in your set. 6 days' free trial in your own home, any instrument. No obligations. Easy terms if you decide to buy. Send now for beautiful free literature. A postal brings liberal proposition.

Address:
Buescher Band Instrument Co. (5)
1538 Buescher Block Elkhart, Indiana

You can be quickly cured, if you

STAMMER

Send 10 cents for 288-page book on Stammering and Stuttering, "Its Cause and Cure." It tells how I cured myself after stammering 20 yrs. B. N. BOQUE
8131 Boque Bldg., 1147 N. III. St., Indianapolis

about it, two thousand feet from the wall. They were mobile units, ready to sail forward or back or upward at any moment. Georg stayed in command of the instrument room. It was never placed, but sailed continuously in slow circular flight around the city above our line. The power house remained in its place, with our largest projector mounted on the cliff for defense beside it.

They were solemn moments as we broke our encampment. The girls, far more agile in the air than men, were lightly dressed, with the supporting mechanism strapped to them. The heating units enveloped them in an invisible cloak of warm air. To their left arms a strapped cylinder gave off a fan-shape area of insulation—an almost invisible shield of protective barrage some five feet long. It showed as a faint glow of light; and in flight their left arms could swing it like a shield to protect their bodies. They had telephonic ear-pieces available; a tiny mirror fastened to their chests to face them, upon which Georg or Geno-Rhaalton could project images; a mouthpiece for talking to Georg; and a belt of offensive weapons,

**IMPORTANT
TO NEWSSTAND READERS**

IN order to eliminate all waste and unsold copies it has become necessary to supply newsstand dealers only with the actual number of copies for which they have orders. This makes it advisable to place an order with your newsdealer, asking him to reserve a copy for you every month. Otherwise he will not be able to supply your copy. For your convenience, we are appending herewith a blank which we ask you to be good enough to fill in and hand to your newsdealer. He will then be in a position to supply copies to you regularly every month. If you are interested in receiving your copy every month, do not fail to sign this blank. It costs you nothing to do so.

To Newsdealer

Address

Please reserve for me copies of **SCIENCE & INVENTION** every month until I notify you otherwise, and greatly oblige.

Name

Address

useful within a range of five hundred feet but no further.

Very alert and agile, twisting and turning in the air were these girls. We men were similarly equipped, but our movements in the air were heavier, clumsier. Elza and I had practiced with the others for days; and with our harmless duelling rays I had found that I could never hope to hit her while frequently she had dealt me mortal blows.

Elza, commanding a squad of twenty girls, was assigned to a portion of the line some helans from me. My own place, with a hundred men under me, was near a tower almost on the opposite side from the power house.

It was a solemn parting from Elza. I wrapped her in my arms, tried to smile. "Be very—careful, Elza."

She kissed me, clung to me; then cast me off and was gone.

With the city invested, we rested idly for another time of sleep. Occasionally we made a tentative tower attack which came to nothing. Tarrano waited; his barrage remained the same. We tried to provoke a move from him, but could not.

The snow-plain where I was stationed here



Know Electricity As Experts Know It and Get An Expert's Pay

DON'T be satisfied to worry along in little jobs with little pay. Master the finer points of electrical practice and bring

the big pay job within your reach. Croft will show you how. Through his famous books he will teach you electricity as experts know it and put you in line for an expert's pay. Forty thousand men are using these books to step ahead—**WHY NOT YOU?**

FREE

—If you act **NOW**

Bishop's **ELECTRICAL DRAFTING AND DESIGN**—the great book you get free—tells you everything you want to know about the preparation, reading and use of all kinds of electrical drawings and diagrams. It tells you how to handle electrical plans and blue-prints. It shows you how to put your own ideas into correct drawing form. It explains everything you want to know about reading the drawings and diagrams of others.

The Sure Way to Big Pay

No course, no set of books offers a quicker, surer method of mastering electricity than the Croft Library. It is founded on practice—on work as it is actually done. It is jammed from cover to cover with the kind of hard-headed, pay-raising facts you want. Written so that the beginner can easily understand it, yet so sound, so thorough that it is the daily guide of thousands of highly paid electrical workers and engineers. Croft teaches you electricity as experts know it and puts you in line for an expert's pay.

Croft's Library of PRACTICAL ELECTRICITY

A Combined Home Study Course and Reference Library
8 Volumes—3000 pages—2100 illustrations—flexible Keratal binding
Was \$27.00—Now \$19.50

Starting right in with the ABC's of modern electrical practice. Croft takes you through his books in easy steps. He gives you the secrets of success in electricity in plain words, figures and illustrations.

Croft teaches you electrical practice complete—inside and outside work—central stations and the whole subject. He takes you in quick, easy steps from the simplest principles to the complete and economical operation of a great central station.

He tells you things you need to know about motors, generators, armatures, commutators, transformers, circuits, currents, switchboards, distribution systems—electrical machinery of every

type, installation, operation and repair—wiring for light and power—how to do it mechanically perfect, in accordance with the National Electrical Code—wiring of finished buildings—Underwriters' and municipal requirements—how to do a complete job, from estimating it, to completion—illumination in its every phase—the latest and most improved methods of lighting—lamps and lighting effects, etc.

Big Pay for You by September

**Examine
it for
10 days
FREE**

We want you to test our statements—we want you to compare the Croft books with others. Fill in and mail the coupon attached

and we will send you the entire set of eight volumes for ten days' Free Examination. We take all the risk—pay all charges. You assume no obligation—you pay nothing unless you decide to keep the books. Then \$1.50 in 10 days and the balance at the rate of \$2 a month. Send the coupon NOW and see the books for yourself!

**MAIL THIS
COUPON
NOW**

McGraw-Hill Book Co., Inc.
370 Seventh Avenue
New York.

A few hours a week this summer spent with these eight great books will prepare you to go out and get a bigger and better job in September. It has been done. It's being done. You can do it. You owe it to yourself to try. You owe yourself this backing—this small but tremendously important investment. On you alone depends what you will get out of life. On you alone depends your success, your advancement, your happiness. Invest in yourself! Can you think of any investment that will pay you as much? No investment will ever pay you more!

Costs You Nothing to Try It Out Try It for 10 Days FREE

The proof of all we have said is in the books themselves, and it costs you N-O-T-H-I-N-G to examine them. We send the books to you for 10 days' examination and let you be the sole judge as to their value. If you decide to take this sure road to promotion, you need send only \$1.50 in ten days and buy the balance at the rate of \$2 a month. You do not have to send any money to see the books. On receipt of your first payment of \$1.50 we will send you your free copy of Bishop's **ELECTRICAL DRAFTING AND DESIGN**.

Name
Address
City State
Position
Name of Company S.I. 8-1-26

Start today—Mail this Coupon NOW!

**Give
Yourself
Some
Backing**

Free
Examination
No Money Down
Small Monthly
Payments

**Only
7c
a Day**

You Can Insure Real Love In Marriage



Don't commit a crime against the girl you love by plunging into marriage if you are not physically fit—if you are dissipated and weak through fast living and excesses. Don't do it. She will find you out only too quickly. Then comes the crash—affection lost, happiness impossible! Why take such a chance? Why not wait just long enough to take up

STRONGFORTISM

and through it get yourself into fine physical and mental condition and make your wife love you and be proud of you. I will help you restore your health and strength by natural methods, as I have helped thousands of men—no dope or drugs or apparatus. Just give me the opportunity. Write today. **DON'T DELAY.**

Get MY FREE BOOK

SEND THIS COUPON FOR IT
—FREE CONSULTATION COUPON—

Mr. Lionel Strongfort
Strongfort Institute, Dept. 193, Newark, N. J.
Please send me absolutely free my copy of your book, "PROMOTION AND CONSERVATION OF HEALTH, STRENGTH AND MENTAL ENERGY." I have marked (x) before the subjects in which I am most interested.

..Colds	..Weak Eyes	..Vital Losses
..Catarrh	..Flat Chest	..Lung Troubles
..Asthma	..Dependancy	..Poor Circulation
..Headache	..Emaciation	..Round Shoulders
..Rupture	..Rheumatism	..Youthful Errors
..Thinness	..Nervousness	..Manhood Restored
..Pimples	..Constipation	..Skin Troubles
..Insomnia	..Night Losses	..Stomach Disorders
..Impotency	..Short Breath	..Increased Height
..Overweight	..Weak Heart	..Muscular
..Weak Back	..Great Strength	..Development

Name

Age

Occupation

Street

City

State

was similar to the other side, save that there were no mountains. From the power house to Tarrano's wall there was a dip, so that the wall stood upon higher ground. On my side, however, the reverse was true. The wall lay in a hollow in one place, with a steady upward slope back from it to uplands behind us, as though in some better day a broad watercourse had flowed down here, now long since buried in solid ice and snow.

I mention this topography because it had a vital bearing upon what so soon was to transpire.

Rhaalton desired that Tarrano come out and attack us; but Tarrano would not. We thought perhaps that his offense was inadequate and the one move that he made strengthened that belief. From the city beside the palace, a rectangle of black metal some fifty feet square, rose slowly up. In aspect it was a square, windowless room—a room without a ceiling, open at the top. It rose to a height of five hundred feet and hung level. And from it depended dangling power cables connecting it with the ground.

It was the presence of these cables that made us feel Tarrano was offensively weak. He could not aerially transport his power; hence, for offense he could only rely upon individual batteries which, unless permanently stationed within the city, we knew would have a short range at best. We watched this thing in the air for hours. It did not move; it was soundless. What was its purpose? We could not guess.

And then at last, Geno-Rhaalton ordered us all to the attack.

CHAPTER XXXVII

The Battle

I found myself in the air; with my men around me we hovered. Then Georg's command from the instrument room sounded in my ears. I gave the signal; and flying wedge-shaped, we hurled ourselves forward. It was like lying on the air, diving head foremost. The rush of wind sang past me; the ground a hundred feet below, was a white surface flowing backward.

We were heading for the base of one of Tarrano's barrage projectors. It was mounted within the wall; but the wall itself was protected merely by a fan-shaped subsidiary beam—a weaker barrage over that small area, which by concentrated effort we hoped to break.

From a helan away on both sides of me I saw other wedges of our men coming slanting in to assail the same point; overhead a corps of girls was hovering. Our towers, three of them concentrated here, had risen to a moderate height; their rays were playing upon the threatened area; a steady fountain of sparks showed where they were striking the barrage.

A silent bombardment of flashing beams and sparks. At five hundred feet we added our own smaller rays to the turmoil. If the barrage would break at this point . . .

The instrument room, watchful of everything, sailed over me. On my mirror I saw Georg's intent face; his voice said: "Careful, Jac! They may come out."

Prophetic words! The segment of barrage here suddenly vanished. A ray darted out. Beside it, a cloud of flying figures came out of the city like insects from a hive.

An inferno of almost hand to hand fighting. It was everyone for himself; and I gave the order for my men to break formation. Ordered them to get up close to the wall if they could . . . to strike, with the closest possible range at the base of the enemy ray.

I flung myself forward. Tarrano's men soon were around me. Twisting, darting figures . . . tiny beams of death to be fended off with my shield.

A body fell past me in the air . . . others, while I looked at them, in the blink



\$3

and its
Yours!

TYPE WRITE
Letters, lessons, homework and stories.

CLIP THIS NOW! It's your own fault if you go without a typewriter now. There is a bargain price on this Underwood! Totally rebuilt; new type; new platen; new finish; and a five-year guarantee. Easiest terms ever—\$3 and it's yours.

FREE BOOK! Typist Manual and complete catalog explains whole plan. To first fifty who answer, instructions free in touch typewriting. Mail now to the Shipman-Ward Mfg. Co. 6216 Shipman Bldg., Chicago.

Name

Address



LEARN CARTOONING

At Home—It's Easy

Just think—\$50 to over \$250 a week paid to good cartoonists for work that's fun! And YOU can easily learn cartooning at home—no matter if you've never touched a drawing pencil. Write for interesting FREE book describing our easy simplified method. Also details of special Outfit Offer! Send postcard today to Washington School of Cartooning, Rm. 268-D 1113—15th St., N. W., Washington, D. C.

Men wanted to manufacture Metal Toys and Novelties

NO SALESMANSHIP NECESSARY

Demand exceeds supply and we co-operate with you in selling goods, also buy them from you. We put you in touch with the buyers. Guaranteed casting forms with complete outfit furnished for speedy production of Toys, Novelties, Ash Trays, Bookends, and other big all-year sellers. Absolutely no experience or machinery necessary. No special place needed. Small investment puts you on road to success. You do the manufacturing and we take care of the selling. Act immediately if you want to handle the big 1926 wholesale orders now being placed. Strictly a business proposition. Catalog and information mailed on request.

METAL CAST PRODUCTS COMPANY
1696 Boston Road New York

MODELMAKER

A new magazine for all interested in making

WORKING MODELS

Send 10 cents for Sample Copy

MODELMAKER, 120 S. Liberty St., New York



"LIGHTING FIXTURES"

READY TO HANG

Direct from the manufacturer. Completely wired including glassware. Send for new Catalogue No. 27 (Just reduced prices)

Special Proposition to Dealers

ERIE FIXTURE SUPPLY CO.
Desk B Erie, Pa.



Cut to \$5.95

4 or 6" Barrel

6-Shot Finest Long Range Revolver

This gun "free" if you can beat our price anywhere—4 or 6 in. barrel, blue or nickel—32, 38-or 22 caliber. Powerful, accurate, hard hitting. Money back guarantee. Pay on delivery \$5.95. Federal Mail Order, 414 Broadway, New York, Dept. X80.

Insure your copy reaching you each month. Subscribe to **SCIENCE & INVENTION**—\$2.50 a year. Experimenter Publishing Co., 53 Park Pl., N. Y. C.



FREE!

12-Cell—24-Volt Storage 'B' Battery

Positively given free with each purchase of a WORLD "A" Storage Battery. You must send this ad with your order. WORLD Batteries are famous for their guaranteed quality and service. Backed by years of successful manufacture and thousands of satisfied users. Equipped with Solid Rubber Case, an insurance against acid and leakage. You save 60 per cent and get a

2-Year Guarantee

Bond in Writing. WORLD Battery owners "tell their friends." That's our best proof of performance. Send your order in today.

<p>Solid Rubber Case Radio Batteries</p> <p>6-Volt, 100-Amperes \$11.25</p> <p>6-Volt, 120-Amperes 13.25</p> <p>6-Volt, 140-Amperes 14.00</p> <p>Solid Rubber Case Auto Batteries</p> <p>6-Volt, 11-Plate \$11.25</p> <p>6-Volt, 13-Plate 13.25</p> <p>12-Volt, 7-Plate 16.00</p>	<p>Approved and Listed as Standard by Leading Authorities</p> <p>including Radio News Laboratories, Popular Science Institute of Standards, Popular Radio Laboratories, Radio Broadcast Laboratories, Radio in the Home, and Lefax, Inc.</p>
---	---

Send No Money. Just state battery we will ship day order is received, by Express C. O. D. subject to your examination on arrival. **FREE "B" Battery** included. Extra Offer: 5 per cent discount for cash in full with order. Buy now and get a guaranteed battery at 60 per cent saving to you.

WORLD BATTERY COMPANY
1219 So. Wabash Ave., Dept. 19 CHICAGO, ILL.

Set your Radio Dial at 210 meters for the new 1000 w. World Storage Battery Station, W5BC, Chicago. Watch for announcements.

World

STORAGE BATTERIES

KDKA WEAF WJIN WJS RHD KGO KFAF WJY KOP



"BECOME A LIGHTNING TRICK CARTOONIST"

Send \$1.00 for Beginners Instructions with laugh producing Program of 25 Comic Trick drawings. Catalog of Chalk Talk Supplies Free.

BALDA ART SERVICE, Dept. 4, Oshkosh, Wisconsin.

of an eyelid, vanished into nothingness . . . One of our towers sailing high, suddenly went dark, turned over, wavered down, dismembered with leprous missing parts—and then in a puff was obliterated.

I found myself nearly up to the wall, and higher than its top. The segment of barrage remained broken. I could see into the city—the Ice Palace, still seemingly deserted. And near it, the base of the powerful ground ray which was assailing our towers . . . If I could get past the wall, unnoticed, get within range of that projector . . .

Most of the fighting was now behind me. We seemed to be holding our own . . . the squad of girls was coming down; I prayed that Elza might not be among them . . .

The instrument room had vanished beyond my sight; but Georg's voice said:

"We're sending reinforcements! Gather your men—hold off for a moment!"

From every part of our line other units

\$5,000 for Perpetual Motion

When SCIENCE AND INVENTION Magazine was still in its infancy, the editors denied the possibility of constructing a perpetual motion machine using those forces of nature as we now know them.

Since that time the editors have received thousands of different designs for perpetual motion devices, and have received hundreds of circular letters soliciting finances for the building of perpetual motion machines.

The editors know that if they receive these letters, there are thousands of others in this country who get similar letters and who fall for the claims made in the numerous prospectuses giving the earning capacities of the various machines.

Most of the shares of stock for these perpetual motion machines are being sold at a rate of \$1.00 per share, although some inventors are trying to sell shares of stock at \$100.00 per share.

Therefore the editors of this publication say, "Just come in and show us—merely SHOW us—a working model of a perpetual motion machine and we will give you \$5,000.00. But the machine must not be made to operate by tides, winds, waterpower, natural evaporation or humidity. It must be perpetual motion."

of men and towers were coming. We had broken through the barrage here. If we could now, by a concerted rush, get our force over the wall, into the city . . .

Within the instrument room, Georg sat watching. The inactivity of his own part, the comparative lack of personal danger, galled him. But he was too occupied with his duties to give it more than passing thought. We had broken the barrage at one point . . . from every quarter he was rushing reinforcements there to take advantage of the break.

And then Tarrano's trickery became apparent. We had not broken his barrage; he had deliberately withdrawn it, to encourage us, to bring our other units to the spot . . . Our power house, neglected, was momentarily comparatively defenseless. The enemy barrage at the point of the wall nearest it, suddenly lifted. Beams darted from the opening . . . men came out in a cloud . . .

I held back momentarily from the wall and gathered my remnant of men about me. Only half my former strength; but with sinking heart I tried to assure myself that the others had not heeded my call. The fighting here had slackened; Tarrano's men had risen high, engaged at long range by our girls,

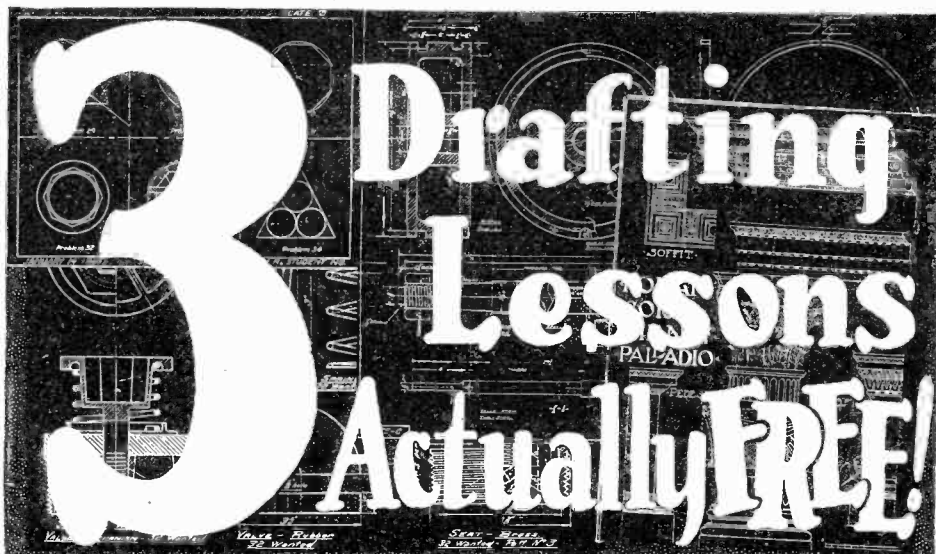

to prove you can learn at home in spare time!

We have invented a new, simplified way to teach Drafting—the first real improvement in Drafting home-instruction in history. We want you to see it, try it—without one penny of cost or obligation. We want to show you how we get away from the copying methods used in the past. See how we make you think, solve problems, do actual drafting room jobs from the first lesson!

I will make this contract with you:

- 1. Complete Drafting training, by the new Practice-Method.
- 2. Professional Drafting Outfit, as illustrated.
- 3. We will help you get a good Drafting position at a substantial increase in pay.
- 4. Or we'll refund every cent of your money.



O'Malley

The American School, a million dollar Non-Profit Educational Institution now offers men a double service—training for a specific job, then finding the job. For one small price, on terms of only \$5 a month, you are now assured of definite benefits, both in position and salary.

Draftsmen WANTED!

70,000 fine jobs advertised this year, many at \$60 to \$125 a week. Get ready to fill one. Get out of the rut. Make something of yourself. Plan your future in Drafting. Even if you have only common schooling, even if you know nothing of Drafting, we guarantee to make you a real Draftsman or to refund your money! Special surprise offer right now to the first 500 men who answer this ad—reduced price, easy terms. Coupon brings complete information.

A new, rapid, simplified way

This new "Job-Method" gives you actual drafting-room jobs in a new one-step-at-a-time way. With pictures which you can understand almost without reading the "lessons." And that is why American School-trained Draftsmen can qualify for a good job at big pay when they graduate.

Coupon brings complete details of this sensational offer!



5 HIGHWAYS TO SUCCESS!

The big money in Drafting goes to men who specialize in Machine Design, or Electrical Drafting, or Architectural Drafting, or Structural, or Automotive. It isn't enough merely to know general Drafting practice. You must know how to calculate and design and plan original work. You need many Engineering subjects to fill the kind of a Drafting position that pays \$60 to \$125 a week. The American School now includes this specialized training in its Drafting course.

COUPON

Brings 3 Lessons Free

Get them. Test your own ability to learn Drafting and get ready for a fine job and big pay. Coupon also brings surprise offer, and complete information about your opportunities for success in Drafting. MAIL IT TODAY!

**Chief Drafting Engineer
AMERICAN SCHOOL
Dept. DC-26
Drexel Ave. & 58th St., Chicago**

Rush 3 Free Drafting Lessons, surprise offer, complete information, money-back guarantee, etc. to prove I can become a real Draftsman at home in spare time.

Name.....
Street No.....
City.....State.....

Job Service Free to Students and Graduates:

THE AMERICAN SCHOOL now offers its students and graduates, without cost, the services of an efficient Employment Department which keeps in touch with the employers of Draftsmen all over the United States. We have placed hundreds of men in good Drafting positions. We have made this training so complete, so practical, so easy to master, that our students are bound to make good. And, so, because the demand for real Draftsmen continues to exceed the supply and because this training actually prepares men for good Drafting positions, we back it with a Free Employment Service, free to employers, students, graduates.

Professional Outfit Given

Fine, imported instruments help you learn Drafting easily and quickly. These standard quality, full size instruments, including board, table, triangles, T-square, ink, protractor, etc. given without extra charge to students.

Chief Drafting Engineer
American School Dept. DC-26 Chicago, Ill.

SHOCK-PROOF!

STRAP WATCH

WALTHAM
or
ELGIN

FREE Trial



Send NO Money!

"wonderful! SHOCK-PROOF" Jeweled Movement, made for us by Elgin and WALTHAM Watch Co's. Designed for hunting, camping, golfing, fishing, strenuous outdoor sports, office use. Has double-strength main-spring; steel wheels, plates, escapement. Impervious to weather and shocks. Sizzling swiftness, weathering, exposure do not affect its time-keeping. **DUST-PROOF. MOISTURE-PROOF CASE.**

We have sold hundreds to professional men, business men, sportsmen, globe-trotters—they are amazed at its marvelous performance under most grueling conditions. CASE is gold-filled, double stack, handsome cushion shape that wins admiring glances. Radium dial tells time vividly in pitch darkness. STRAP is genuine pleekin. A sturdy Strap Watch for RED-BLOODED MEN—sturdy enough for smartest functions, sturdy enough for most strenuous sports. Regular price, \$30.00. **\$23.75** (our "Direct-to-user" price)

Our Plan is Different!

We ask for NO MONEY in advance! NOTHING on Delivery! See, Try, Test, Use, ENJOY this SHOCK-PROOF Strap Watch for 10 Days' Trial ABSOLUTELY FREE.

If pleased you may pay on Budget Plan **\$5.00 MONTHLY** **\$22** or, if you wish to pay cash within 10 days, deduct \$1.75 and send Check or Money Order for \$22. Otherwise return it. Send NO Money! Pay NOTHING on Delivery! Order NOW! Check below make desired.

ELGIN WALTHAM
SEAWER-WILLIAMS CO.

"2 Generations of Honorable Dealings" Importers, Exporters, National Mail-Order House
365 WASHINGTON STREET, BOSTON, MASS.
Sole Distributors of the SHOCK-PROOF Strap Watch. Clip and mail this Ad. NOW! Please tell us something about yourself. We will appreciate and respect the information. **PLEASE PRINT YOUR NAME** S.I. 8-26



\$25 to \$100 for one drawing.

Learn to Draw at Home

Simple Method Makes It Amazingly Easy
Trained artists earn from \$50 to over \$250 a week. Tremendous demand right now for good art work. Magazines, newspapers, advertisers, printing houses, etc.
Become an artist through this quick, easy method—right at home in spare time. Learn Illustrating, Designing and Cartooning. Actual fun learning this way. Individual attention by mail from one of America's most famous artists. Learn to draw and earn big money.

Send for FREE BOOK

Just printed—a new book which describes the latest developments and wonderful opportunities in Commercial Art, and gives full details of this quick, easy method of learning to draw. Tells all about our students—their successes—what they say—actual reproductions of their work—and how many earned big money even while learning. Write for this Free Book and details of special offer. Mail postcard or letter now.

WASHINGTON SCHOOL OF ART
Room 268-D, 1115—15th St., N.W., Washington, D. C.

RESHAPE YOUR NOSE!
You can safely reshape your nose to beautiful proportions with **ANITA NOSE ADJUSTER**—painlessly, comfortably. Results speedy and guaranteed. Physicians praise it highly. No metal to harm soul. Winner of Gold Medal, 1923. **FREE BOOKLET** Write for it today.
THE ANITA CO., Dept. 873 ANITA Building Newark, N. J.

from whom they were slowly, trickily retreating as though to lure the girls above the city; and my heart was thankful when I heard the relayed order from Rhaalton for the girls to withdraw—not to pass above the wall, even at high altitude. The order came just in time; the barrage here flashed on again, trapping a few—but only a few—of our men behind it.

I was aware of this new attack on the power house. Our units were hurriedly being ordered back. Georg in desperation, had flung his instrument vehicle at the enemy ray. . . . My connection broke; and then another connection brought me someone's voice with the report that the instrument room had darkened that main enemy ray, but had itself crashed to the ground. . . . I wondered if Georg were killed. . . . later, I heard someone say that he was safe within the power house

I disobeyed my final orders; I did not swing back toward the power house; instead, with my men around me, we fled back from this segment of the wall to the higher lying white plain behind it.

I have spoken of the down-grade of this land here, culminating in the depression which marked this part of the wall. It was that depression which gave me my idea. Our heat-ray cylinders had so far been useless. They had a range of only two hundred feet, and no power to attack a barrage. Some of them had futilely been used; the snow and ice on the ground above our recent fighting was melted in patches—pools of boiling water lay on the naked rock; and the water, flowing down the depression, had reached the ice-wall—a tiny stream of it, eating into the wall, slowly, surely

With my men I flew up the slope. The ice and snow here melted under the close-range play of our heat-cylinders. Rivulets of boiling water began creeping toward the city. Other men at my call joined us. Two hundred of us soon were melting the ice. The rivulets merged into brooks, to streams—and soon a river torrent of hissing, boiling water gathering volume as it went, was surging at the wall. The wall began melting—its feeding this monster which was eating at its vitals. . . . a yawning hole began opening at the base of the wall. . . . it began sagging at the top. . . . crumbling

The segment of barrage here went dark. No trickery now: the barrage at this point actually was broken. The boiling river went through the wall, swept down the slope into the city. Through the great clouds of steam I could see the Ice Palace with its brittle outlines softening under the heat. . . . one of its thin spires broke off and fell. . . .

Feverishly we added to the river source. The whole area here was grey with steam. Girls had joined us. Elza was not among them. . . . Elza! With my triumph there lay always in the background of my consciousness the weight of my fear for Elza

The fighting in the other sector had continued desperately. Our power house was hopelessly damaged; the towers, with their power gone, were using their batteries; soon they would be exhausted. But now we abandoned that sector; our remaining towers—all our flying forces—came to this melting area where the vanishing city lay defenseless before us. . . . We hurled ourselves into it, using only our heat-rays. Everywhere we added to the boiling torrent; even the interference heat of the fighting was to our advantage. This brittle city which owed its very existence to the congealing cold, lay enveloped in a cloud of steam.

Then Tarrano played his last card. The cubical building of metal with the cables depending from it, still hung motionless. It now burst into sound. A low electrical hum; then louder to a whine—a scream. Our men and girls were in the air around it,

FOR CLEAR, QUIET "B" POWER



RADIO Storage "B" Battery

12 Cells 24 Volts Lasts Indefinitely—Pays for Itself
Economy and performance unheard of before. Recharged at a negligible cost. Delivers unfailing power that is clear, pure and quiet. Approved and listed as Standard by leading Radio Authorities, including Pop. Radio Laboratories, Pop. Sci. Inst. Standards, Radio News Lab., Lefax, Inc., and other important institutions. Equipped with Solid Rubber Case, an insurance against acid and leakage. Extra heavy glass jars. Heavy rugged plates. Order yours today!
SEND NO MONEY Just state number of batteries is received. Extra offer: 4 batteries in series (96 volts), \$10.70 Pay expressman after examining batteries. 5 per cent discount for cash with order. Mail your order now!

WORLD BATTERY COMPANY
1219 So. Wabash Ave., Dept. 83 Chicago, Ill.
Makers of the Famous World Radio "A" Storage Battery
Prices: 6-volt, 100 Amp. \$11.25; 120 Amp. \$13.25; 140 Amp. \$14.00. All equipped with Solid Rubber Case.

World STORAGE BATTERIES
Set your Radio Dials at 210 meters for the new 1000 watt World Storage Battery. WGN, Chicago. Write for announcements.
KDKA WEAF WGN WJS KHJ KGO KFAF WJY KOP

IS YOUR CLOCK STOPPED?
One bottle of my clock oil sent on approval to any part of the world. Simple directions tell how to put the clock in running condition and keep running clocks in working order. Also good for cornets, saxophones and all valve instruments.
Send me 50c only if this makes your stopped clock run.
FRANK TOMPKINS GUARANTEED OILS
7A Highland Avenue, White Plains, N. Y.

PIMPLES
Cleared Up—often in 24 hours. To prove you can be rid of Pimples, Blackheads, Acne Eruptions on the face or body, Barbers' Itch, Eczema, Enlarged Pores, Oily or Shiny Skin, simply send us your name and address today—no cost—no obligation. **CLEAR-TONE** tried and tested in over 100,000 cases—used like toilet water—is simply magical in prompt results. You can repay the favor by telling your friends; if not, the loss is mine. **WRITE TODAY.**
E. S. GIVENS, 468 Chemical Bldg., Kansas City, Mo.

FREE For Ten Days Trial
Special Summer Prices
Real Bargains. All standard makes—Young Processors—manufactured, like new—good as new—without a flaw. Guaranteed 5 years—no money down—easy terms. Extra for beginners.
Complete Course in FREE touch typewriting.
Write for illustrated catalog, free trial offer, low summer prices now.
YOUNG TYPEWRITER COMPANY
654 W. Randolph St., Dept. 1168 Chicago Big Saving

Chicago TECH College [Engineering Architecture Electricity Drafting]
Enter any time. Opportunities for self-support while studying.
DAY and EVENING CLASSES 2-yr. diploma; 3-yr. B. S. degree; and short courses, 25d year.
Write for copy of our 72 page "Blue Book," mailed free.
Dept. K-52
118 East 26th St. Chicago Technical College

FLY Young man, learn aviation. Build this classy plane and learn to construct and operate aircraft. Use your motorcycle engine or our "Meteor" 20 h.p. motor. We furnish parts very reasonable to build this wonderful little "Meteorplane," the World's first successful Light Plane. Send \$3.50 for complete set of blue prints and parts price list of this latest Model M-T-2.
IRWIN AIRCRAFT COMPANY
130-O Street, Sacramento Calif.

Print Your Own
Cards, Stationery, Circulars, Paper, etc. Save money. Print for others, big profit. Complete outfits \$3.55. Job press \$12.35. Rotary \$15. All easy rules sent. Write for catalog presses type etc. **THE PRESS CO., Y 47, Meriden, Conn.**

Insure your copy reaching you each month. Subscribe to **SCIENCE AND INVENTION**—\$2.50 a year. Experimenter Publishing Co., 53 Park Place, N. Y. C.

I too was there. Tarrano's men—the remaining few who were desperately fighting—had suddenly withdrawn.

And then we knew the purpose of this hanging room. A strange form of some tremendous electro-magnet. I could feel it pulling at me. My power to guide myself in the air was wavering.

From my height I could see down into this ceilingless rectangle. It was un-manned by humans. A room of whirling, flashing knives! Above it, even then some of our men were struggling in its magnetic grip . . . being drawn down into it . . . a girl's power must suddenly have collapsed; she was sucked in with a rush—torn to fragments by the whirling knives. . .

The area of magnetism seemed to spread for a helan or more. Everywhere around me I saw our men and girls struggling with it, fighting to keep away, but closing in a ring around it . . . faster, continually more helpless until at last, their bodies out of control whirling end over end, they were sucked in like water rushing into a turbine . . .

One of our weakened towers attacked it; but some of the remnants of Tarrano's projectors caught the tower and darkened it.

Through the rising clouds of steam I could see the magnet vaguely now. But I could feel it pulling; and soon, in spite of myself, I was fairly close above it. I strove to keep my wits. The others who were meeting their death lost control of their bodies at the last and could not use their cylinders. I had some battery power remaining; I snapped on my disintegrating ray to test it. It still held

To Readers of
"THE EXPERIMENTER"

You will find the best features of THE EXPERIMENTER preserved in SCIENCE & INVENTION, besides a brand new "Model Department". See the beautiful Silver Trophy cup for best model each month described elsewhere in this issue.

strength for very close range. It was my last desperate recourse.

I righted my body, and yielding to the magnetic pull, ceasing to struggle, I dove head first at that yawning rectangle. A gleaming blur of knives . . . blood-stained now . . . within these rectangular walls' horrible carnage. . .

A second of despair; but my ray struck true. . . Around me was chaos; my senses reeled, went black for an instant. But I recovered, found myself whirling in the empty air. . .

The city was melting into a turmoil of boiling water and surging steam. The fighting everywhere had ceased. Wavering figures were rising—fugitives struggling away. With my senses still confused, I righted myself, undecided where to go or what to do. Above me two figures were still in combat. One of them—a man—assailed by a heat-ray, came hurtling down past me. The other wavered—a girl with her flying mechanism out of control. She was a hundred feet or more above me, wavering downward. Elza! I shot myself up to her, seized her in my arms, my own supporting mechanism sustaining us both. Elza, spent, but uninjured, I held her close.

"Elza dear! My Elza!"
We hung there in the air. From out the vanishing city, rising through the steam came a small metal vehicle. A pointed cylinder, in height no more than twice that of a man. It came up slowly. Its rectangular door was open. As it reached our level and went past us quite close. I saw a man's figure standing there. Tarrano! Tarrano alone! From the wreckage of his city, making his escape alone!



Science in Shaving

Here's the razor that embodies all the principles known to experts in matters pertaining to shaving. It is the only razor in the world that sharpens its own blades—a razor and stropping machine in one.

Sharpen it, then shave, then clean—all in a jiffy, and without removing the blade from the razor. A speedy, comfortable shave every time—uniformly perfect.

Each Valet AutoStrop Razor outfit is a complete shaving service, consisting of Case, Razor, Strop and Blades. Price \$5.00 to \$25.00. Popular models \$1.00.

Valet Auto-Strop Razor

—sharpens its own blades

AutoStrop Safety Razor Co.

656 First Ave., New York

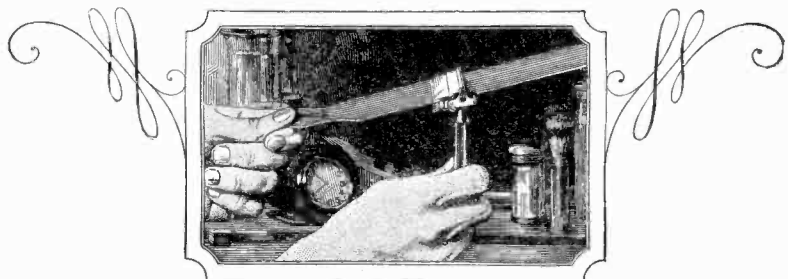



Master Electricity By Actual Practice

The only way you can become an expert is by doing the very work under competent instructors, which you will be called upon to do later on. In other words, *learn by doing*. That is the method of the New York Electrical School.

Five minutes of actual practice properly directed is worth more to a man than years and years of book study. Indeed, Actual Practice is the only training of value, and graduates of New York Electrical School have proved themselves to be the only men that are fully qualified to satisfy EVERY demand of the Electrical Profession.

The Only Institution of the Kind in America

At this "Learn by Doing" School a man acquires the art of Electrical Drafting; the best business methods and experience in Electrical Contracting, together with the skill to install, operate and maintain all systems for producing, transmitting and using electricity. A school for Old and Young. Individual instruction.

Over 10,000 Graduates are Successful Men in the Electrical World

No previous knowledge of electricity, mechanics or mathematics is necessary to take this electrical course. You can begin the course now and by steady application prepare yourself in a short time. You will be taught by practical electrical experts with actual apparatus, under actual conditions.

The N. Y. E. S. gives a special Automobile Ignition Course as an advanced training for Auto Mechanics, Garage Men and Car Owners. The course covers completely all Systems of Ignition, Starters, Lighting and other electrical equipment on automobiles, motor boats, airplanes, etc.

Let us explain our complete course to you in person. If you can't call, send now for 64-page book—it's FREE to you.

New York Electrical School
29 West 17th Street, New York

New York Electrical School
29 W. 17th St.,
New York, N. Y.

Please send FREE and
without obligation to me
your 64-page book.

..... Name
..... Street
..... City

Without thought—holding Elza tightly within my arms—I flung us upward. Tarrano saw us, recognized us. He slackened his upward pace. With my sober reason gone, I strove to overtake him; saw the sardonic leer on his face but did not realize that he was waiting for us. We caught up with his vehicle; he pulled us through the doorway, to the floor of the narrow circular room with its heavy translucent panes.

He was bending over me, leering. "Jac Hallen! And my little Lady Elza! How fortunate!"

I cast off Elza and gained my feet. For an instant we stood—Tarrano and I—measuring each other. He seemed calm; his face bore a slow sardonic smile; he was unarmed, drawn back against the concavity of the wall, watching me with his steady, keen eyes. Behind him through the low window, I saw the white ground now far below us; we were rising swiftly.

"So you brought my Lady Elza back to me, Jac Hallen?"

He got no further, for with a leap I was upon him. To use my weapons in these narrow quarters would have been suicide. My body pinned him against the wall as I lunged; my fingers strove for his throat.

He was no larger than I, but the strength of him was extraordinary. His body stiffened to resist my impact; one of his hands gripped my wrist; his other hand—the heel of it—came up beneath my chin, forcing my head back.

He fought silently, with movements that seemed almost deliberate. Into the center of the room we struggled. I saw that Elza was upon her feet, a hand pressed to her mouth in terror.

"Elza!"

I had meant to tell her to use the control levers which were on a small table nearby—to bring us back to the ground; but with this momentary diverting of my attention, Tarrano's fist struck me full in the face. I staggered back. Elza screamed—called something to Tarrano. I staggered, but I did not fall; and as Tarrano stood there, still with his slow smile. I recovered myself and was again upon him. Locked together we swayed to the control table. My back was to it. Tarrano's slender fingers with a grip like alenite, had found my throat. Slowly, irresistibly he forced me backward over the table. I was helpless; my breath was stopped; Tarrano's triumphant face bending over me was fading with my senses.

"In just a moment, Lady Elza. . ."

He was telling her calmly that in a moment he would be finished with me. Did the man's egotism, here at the last, delude him into the belief that Elza wanted him to conquer me? With all the weapons of science discarded—this primitive struggle of man against man with the woman as prize—did the thought of that delude him into the belief that her love was his, now that he was killing me?

I never knew. But beneath the roaring of my head, I heard his gentle words to her. And then, behind him, I saw her coming forward. A heavy metal object which she had picked up from the floor was in her hand. Tarrano saw her also—in a mirror on the table—saw her raise the jagged weapon. Raise it to strike; not at me—at himself. His face was close above mine. In that second, I saw in his expression the realization that Elza was attacking him.

Whatever his emotions, like a flash he acted. His grip on my throat loosened. His arm, swinging backward, warded off Elza's trembling, hesitant blow. The metal block, intended for his head, was knocked from her hand; it fell clattering to the floor. And reaching over, Tarrano gripped the vehicle's control lever, wrenched it bodily from its fastenings! Control of the vehicle was irrevocably lost! We were falling!

BLISS ELECTRICAL SCHOOL



A special technical school with concise but comprehensive course in Electrical Engineering. Non-essentials eliminated. Thorough knowledge of underlying principles emphasized. Theory and practice are closely interwoven in class-room and laboratory.

Electrical Engineering in One Year

The course is designed for earnest, ambitious young men of limited time and means. Curriculum includes mathematics, mechanical drawing and intensive shop work. Students construct motors, install wiring, test electrical machines. Graduates are qualified to enter the electrical field at once.

Bliss men hold responsible positions throughout the world. Thoroughly equipped fire-proof dormitories, dining hall, laboratories and shops. Prepare for your profession in the most interesting city in the world. School established 1893. Send for catalog. Address

BLISS ELECTRICAL SCHOOL 448 Takoma Avenue Washington, D. C.

Breathless moments! Tarrano idly stood apart; his face a mask. My breath restored, I was recovering. I drew myself erect.

Death! But my confused thoughts went to Elza. Her flying mechanism was partially sustaining; my own probably was still effective. Before Tarrano was aware of my purpose, I had pushed Elza forcibly through the doorway. Into the rush of air her figure disappeared. But Tarrano gripped me as I tried to follow her. Gripped me and clung. A breathless, dizzy instant. Locked together, our bodies shifted crazily. I tried to get him out the doorway with me, but he fought against it. . . . Smiling—always smiling.

Elza fell safely. But they told me that Tarrano and I hovered for days unconscious on the borderland between life and death, living finally, for our vehicle had plunged into a tremendous snow-bank, to break its fall.

The Exile

Last scene of all . . . They would not have Tarrano on any of the three worlds. While still living, the very personality of him was a menace. With his woman Tara, who refused to leave him and whom he tolerated, they banished him to that tiny asteroid which pursued its solitary way between the orbits of Mars and Jupiter.

A lonely, barren little world, with its single, primitive race of spindly beings—timid, frail beings, half-human, half insect. We took him there—Maida and Georg, Elza and I. He anticipated his dislike of the asteroid's slight gravity, and demanded weighted shoes so that he might walk with the normal feeling of Earth and Venus.

"You give me too much freedom," he told us solemnly.

And there amid the rocks, with Tara we set him down. As we parted, he turned to Elza. She and I were joined in marriage by then. He faced her, took one of her hands and pressed its palm to his forehead, the gesture of homage and respect.

"Goodbye, Lady Elza. I wish for you all life's happiness." He smiled, but it was a very wistful smile. And then he swung away abruptly.

"Tara! Prepare me food. Leave me—I would be alone." His imperious gesture dispersed also the crowd of natives who were curiously regarding him. Here, in his last little domain, he would still be master.

Our vehicle slowly rose. From its windows we watched him. Ignoring us utterly, weighted down by his heavy shoes, he paced his barren rocks, head lowered, alone with those thoughts he never shared with anyone.

Tarrano, the Conqueror!
THE END.



Joining the wires in a great trunk nerve between New York and Chicago

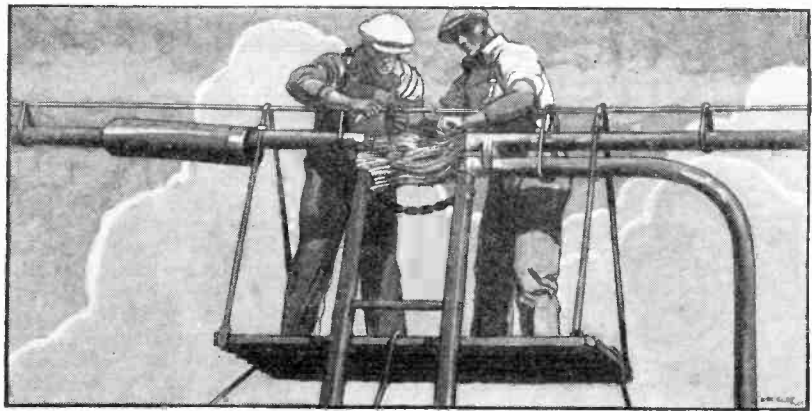

The Nerves of a Nation

THE magnitude of our present system of telephone communication was beyond the thoughts of men fifty years ago. While at that time Bell, the inventor, had a prophetic vision of places and houses and factories connected by telephone, even he could not have foreseen the American city of skyscrapers with more telephones in one building than are to be found in many a foreign country.

The massed multitudes of the modern city can no longer be served by wires strung in the air. We now have telephone cables

no bigger than a man's wrist each containing 2400 thread-like wires, carrying beneath the city streets their millions of spoken messages. Long distance cables overhead and underground connect cities with one another by storm-proof conductors, now being extended into a country-wide network.

At the present time nine-tenths of the 45,000,000 miles of telephone wire in the Bell System are in cable. The service of each telephone user has become more and more reliable with the extension of this cable construction.

AMERICAN TELEPHONE AND TELEGRAPH COMPANY
AND ASSOCIATED COMPANIES



BELL SYSTEM

IN ITS SEMI-CENTENNIAL YEAR THE BELL SYSTEM LOOKS FORWARD TO CONTINUED PROGRESS IN TELEPHONE COMMUNICATION

Amaze Your Friends With Chemical Tricks

The Boy's Hand Book of Chemistry

Price 15 Cents

Write secret letters with invisible ink; pour blue, brown and black liquid from a glass of water; make a magic pitcher of bluing; make your own magic writing paper, your own ink and dyes. It's all easy if you have Chemcraft Junior—the pocket Chemical outfit. Get yours now. Order right away and get a FREE Copy of The Boy's Handbook of Chemistry; 100 pages of experiments, formulae, interesting chemical information, money-making suggestions and catalog of supplies.

BOTH 25¢

CHEM-CRAFT JUNIOR CHEMICAL OUTFIT
PRICE 25 CENTS

THE PORTER CHEMICAL CO.
107 Washington,
Hagerstown, Md. POSTPAID

A Free Trial will prove You Can Play A Conn

EXCLUSIVE, easy-playing features enable you to master a Conn Saxophone quickly; play popular tunes in a few weeks; entertain yourself and your friends. Get the details of our FREE TRIAL; Easy Payment plan on any Conn instrument—choice of the world's great artists. Catalogs free; no obligation.

C. G. CONN, Ltd.
856 Conn Bldg.
Elkhart, Ind.

Write today!

CONN BAND INSTRUMENTS

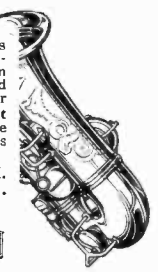

Insure your copy reaching you each month. Subscribe to Science & Invention—\$2.50 a year. Experimenter Publishing Co., 53 Park Place, N. Y. C.

Thousands Use These Ingenious TRANSMITTER UNITS

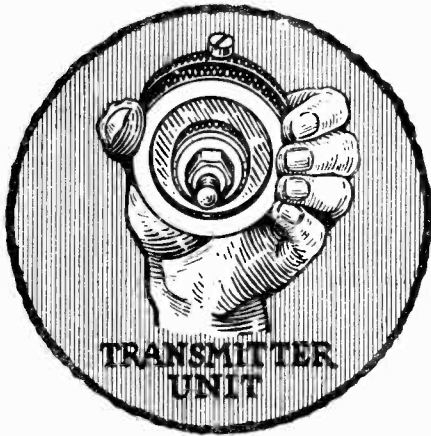

Here's a marvel of Engineering design—a practical miniature transmitter, used by thousands of radio fans and experimenters for amplification purposes. It is a most novel unit, having hundreds of uses. Every amateur should have two or three of these amplifiers in his laboratory.

A FEW USES FOR THESE UNITS

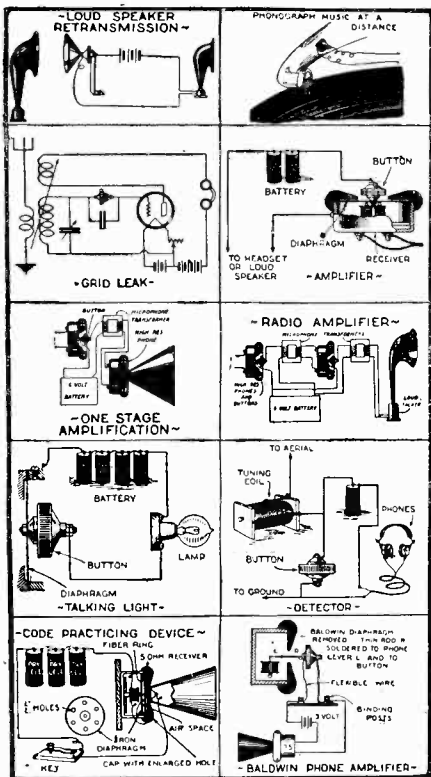

With each unit is mailed an eight-page instruction pamphlet containing suggestions for innumerable uses. Our supply is limited; avoid disappointment by ordering today. The coupon below is for your special convenience.

SPECIALLY PRICED
While they last— **95c**
(or Two for \$1.75) per unit

THE PRESS GUILD,
66-S West Broadway, New York, N. Y.
Enclosed find 95c/\$1.75 for which send me postpaid one/two amplifier units as advertised.
Name
Address
City, State

Our Spiritualistic Investigations

By "DUNNINGER"
(Continued from page 315)

The medium's usher, or whatever you care to call him, who had left us with our thoughts, now re-entered the room.

Without any show of theatricalism, he announced, "Madame Vesta."

The madame did not walk into the room, she glided. She carried an air of mystery about her. She was of average height, becomingly dressed in modern style; an air of superiority rested on her unconsciously. She was attractive in an oriental way and had the most piercing pair of black eyes I have ever seen. Her black hair, not bobbed, was coiled high on top of her shapely head, held by a gleaming dagger of gold. And when she spoke, her voice sounded like the splashing of pebbles over a rivulet somewhere up in a dream-country where one goes to make an effort to materialize castles in the air. If you follow me.

She began by telling us that she had control of a number of musical spirit-guides and that they loved music.

Another time, she promised, she would give materializations, but on this evening only "spirit music."

Seating herself on the chair in the cabinet, she asked that one of the party blindfold her. This was done with my own handkerchief. Then a piece of rope was handed out for examination and the assistant requested one of us to tie the medium's hands securely to the chair. I undertook that job. It gave me an opportunity of examining the cabinet at close range. I was satisfied that everything looked ship-shape. The medium then requested us to softly sing any well known song. The assistant dropped the curtains on the back and both sides of the cabinet. The medium, after a few coughs, seemed to be growing rigid. Her lips were slowly moving as if mumbling a prayer. She was supposed to be entering a trance.

Several of the side bracket lights were snapped off by the attendant, but the room was sufficiently lighted so that one could see everything that was going on.

Then the curtain in front of the cabinet was dropped. Silence for a second, followed by a hissing sound coming from the cabinet. We strained our eyes, but could see nothing. A low moan. Then the voice of a child singing some sort of a song. We could not make out the words. Following this came a screech; the bell was rung sharply and thrown to the floor rolling outside the cabinet. An assistant pulled the curtain aside quickly. The medium was seated in the chair apparently still in a trance.

The curtains were again closed. Several sharp notes were blown on the clarinet, immediately followed by several hard blows on the base drum. A strange oriental fragrance pervaded the room, and on the air floating from the top of the cabinet came the sweetest bit of violin playing I have ever had the pleasure of hearing. And from a violin *without a bow!*

A crash. Music ended. Curtain whisked aside. Madame still communing with the other world.

Again the curtain is closed. The snare drum, played by some spirit hand, plays a roll; there is a sharp blast of the bugle. A voice issues from the cabinet . . . a deep bass voice declaring that the Spirit of Music hovers around and is good to the Madam this evening. Immediately several sharp toots of the clarinet; a resounding smash of the bass drum, a roll of the snare drum and a dozen bars, well played, on the saxophone of one of the latest jazz numbers. A crash as if the instrument had been thrown

FOUNDED 1899

LEARN IN 12 WEEKS ELECTRICITY

Earn \$60 to \$200 a Week!

FREE Railroad Fare!

Why work for \$25.00 or \$30.00 or even \$40.00 a week when as a **Coyne Trained Expert** you can make \$60.00 to \$200.00 a week. *Coyne Trains You On Actual Electrical Machinery. No books or lessons, all practical experience. You don't need education or experience. We Will Assist You To Part Time Job While Learning And Free Employment Service For Life After Graduation. Free courses in Radio and Auto Electricity and I'll pay your railroad fare. Write Now for Free Book.*

COYNE 1300-1310 West Harrison St. CHICAGO, ILL. Dept. C-533

H. C. Lewis,
Coyne Electrical School, Dept. C-533
1300-1310 W. Harrison St., Chicago

Dear H. C.: Please send me free your big catalog and full particulars of your special offer.

Name

Address

Town

State

Free 60-page Reference Book

POLK'S REFERENCE BOOK FOR DIRECT MAIL ADVERTISERS

Mailing List Catalog No. 55

Get Business by Mail

60 pages of vital business facts and figures. Who, where and how many your prospects are.

8,000 lines of business covered. Compiled by the Largest Directory Publishers in the world, thru information obtained by actual door-to-door canvass. Write for your FREE copy.

R. L. POLK & CO., Detroit, Mich.
880 POLK DIRECTORY BLDG.
Branches in principal cities of U. S.

Magnified 225 Diameters

This is what the tip of a fly's leg is like when seen through the

ULTRALENS MICROSCOPE

At last a high powered microscope is within the means of all who wish to study, observe and experiment with the vast world of minute objects invisible to the naked eye. Such fun it is, as well as educational. No technical training required, yet hundreds of scientists and teachers are using this instrument. Gives enormous magnification and perfect definition. Send \$7.50 for complete outfit. Send for descriptive literature.

Scientific Apparatus Corp., Dept. 203, Milton, Pa.

\$7.50 for Complete Outfit Prepaid

THE MATH PONY

A table of partial products which saves time and mental effort in multiplication and division. To multiply—add. To divide—subtract. Absolutely accurate. Invaluable for students.

25c

MATH PONY, 229 N. Harvey Ave., Oak Park, Ill.

to the floor. Curtain pulled aside and there sits Madame, with head hanging to side as if she had fainted.

An assistant immediately pulls off the blindfold and puts smelling salts to her nose. I step forward to examine and cut the bonds; she opens her eyes; gets her bearings and then smiles as she says, "I trust you have enjoyed the spirit world music."

I pick up my handkerchief from the floor where the assistant has tossed it. We are near the cabinet now. There is nothing to see. There are the instruments and the violin reclines majestically in its case and still without a bow!

One of the men of our party pays the assistant while Madame chats amiably with the ladies and we are ready to go, maybe to call some other time.

The bonds that held the Madame throughout her manifestations which took longer than it takes to tell of them were the same as I had tied them. And I know rope ties. The truth was that the medium's hands throughout the séance were never unbound. That I'll vouch for any time.

Impossible? Dreams?

What mysterious force played those instruments?

Whisper . . . a secret; there was a midget concealed in the bass drum. He had a violin bow also concealed in the drum and this he used in playing the violin. The trap in the drum was on a spring working both ways. The midget was well trained and a clever little musician by the way. And, dear reader, for a little fellow not more than two and one-half feet in height, *how he could cat.*

Ancient Torture Methods

PART III—(Conclusion)
(Continued from page 311)

idea that this was not a direct killing process, but that the inevitable death, was a sort of an incident attached to it.

Among the early emanations of witchcraft, we hear that Richard II, King of England from 1377 to 1399, used witchcraft accusations against his enemy. Of course he knew that the allegations were absolutely false. The supposed doings of the witches are commemorated in Goethe's "Faust," where Walpurgis night festivities are portrayed and we find in "Tam-o-shanter" a humorous description of a witches' gambol. Now the superstitious, and they were very numerous, believed that these things were done; they believed that witches went through the air on broomsticks; they believed that their family and business trouble were often due to the incantations of the witches; the law acted on the superstition, and eventually in England, Germany, Switzerland and eastern France, the number of victims was frightfully large. The numbers given are so great that it is hard to believe them, and we may hope that they are exaggerated. In 15 years of the 16th century, it was said there were 30,000 executions for witchcraft. This was in France. Then the superstition went over to Germany, and in the 17th century in one place, it is said that 20% of the population were executed as witches—100,000 convictions of witchcraft are credited to Germany in a period of 50 years. England was far from innocent. Under the Long Parliament during the Puritan revolution, it is said that 3,000 people came under the capital charge of witchcraft, and were either tortured, burned or hanged. Probably few were hanged or burned alive without preliminary torture.

The witches' bridle, a minor (?) instrument of torture is thus described:

"A barbarous contrivance made of iron and so fashioned that a spike having four prongs—in shape like a quadruple fishhook—

Who wouldn't?

FOR THAT perfect "balance" of fine Turkish and American tobaccos, that extra delicacy of taste and aroma which are Fatima's and Fatima's alone—who wouldn't pay a few cents more?

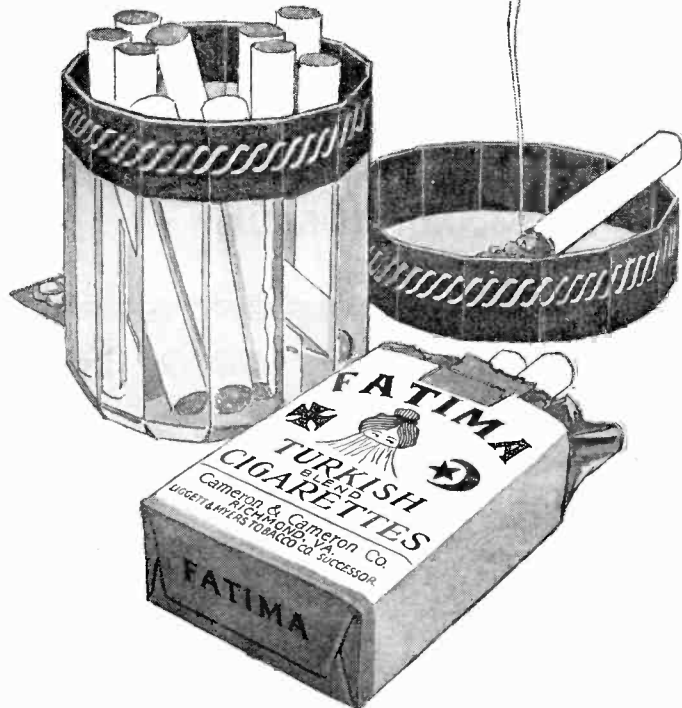

What a whale of a difference just a few cents make

LIGETT & MYERS TOBACCO CO.

Work for "Uncle Sam"
RAILWAY POSTAL CLERKS
MAIL CARRIERS
\$1700 to \$3000 Year

TRAVEL—See your country on government pay
MEN—BOYS, 17 UP SHOULD MAIL COUPON IMMEDIATELY
Steady Work. No Layoffs. Paid Vacations.



FRANKLIN INSTITUTE,
Dept. W-178, Rochester, N. Y.

Sirs: Rush to me without charge: (1) Specimen Railway Postal Clerk Examination questions; (2) FREE 32-page book describing U. S. government positions open to men and boys and full particulars telling how to get them.

Name
Address

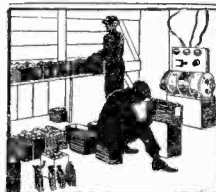

150 to \$300 PROFIT MONTHLY with ONE DAY BATTERY CHARGING
Charge batteries in 1/3 the time required by others and get the business. Latest method recommended by the leading battery companies and approved by the U. S. Bureau of Standards. **BIG YEAR ROUND PROFITS.** Best paying business in automotive field. Requires no special experience, uses small space. **30 DAYS' FREE TRIAL** at our risk under absolute money back guarantee. Write today for Bulletin X, giving full particulars.
HOBART BROS. CO., Box 58 TROY, OHIO
ONLY \$16.00 MONTHLY PAID BY INCREASED PROFITS

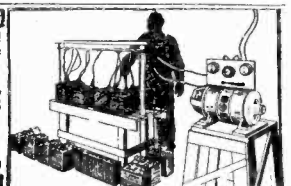

SEND FOR THE INTERNATIONAL CATALOG
Our net price list.



FOR FORD—Prices from \$27.85 up. Factory to consumer direct—Pay only One Profit.
International Body Works, 914 W. Ohio St., Dept. 4, Chicago, Ill.

THE LINCOLN SPORT PLANE BUILD AND FLY IT YOURSELF



100 Miles per hr.
30 H. P. Motor
Blue prints and material now ready for builders.
Send 25c for illustrated book. It tells you how. Lincoln Standard Aircraft Co., Lincoln, Nebr. Dep. I
New flying school opens June 1st. Earn your way through.

STAMFORD

IN THE CATSKILLS.

The Land of Legend and Romance ~
The Joy of Trampers, Golfers and Fishermen

REXMERE CLUB HOTEL

AND

CHURCHILL HALL

STAMFORD, N. Y.

TWO HOTELS WITH A SELECTED CLIENTELE
BOOKLET WITH PICTURES SENT FREE

H. H. MASE, MANAGING DIRECTOR
WILLIAM J. LOWE, ASSOCIATE MANAGER

NOV. 1ST TO MAY 1ST
MIAMI, FLORIDA



A Book for Every Radio Set User

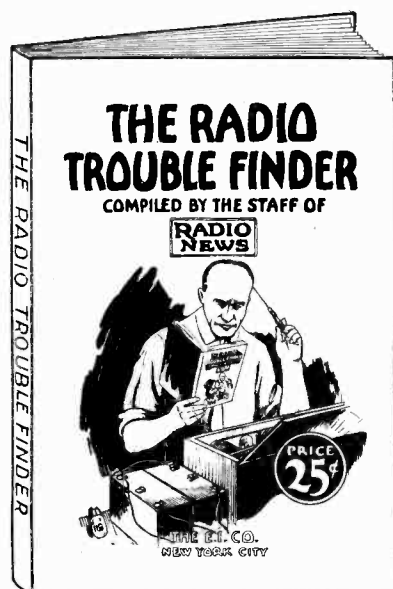

The Radio Trouble Finder

No matter how much or how little you know of your radio receiver, this new "Radio Trouble Finder" book is going to be a big help.

It explains the common and special faults of all the standard receivers of today; tells how to recognize instantly, by various sounds, where the trouble lies and also gives special simple tests by which you can determine what is wrong with your receiver. Then for each particular fault there is explained the proper procedure for correcting it.

All troubles and their remedies are arranged in simple charts so that even the most inexperienced radio user will have no trouble in keeping his set at all times in first class condition.

All parts of the radio set are illustrated to show the layman how to proceed in correcting faults.

PRICE
25¢

The Copy

*200 Illustrations
Size 6 x 9 Inches*

SOLD ON ALL NEWSSTANDS

Published by THE E. I. COMPANY, Inc.

Distributed by

THE CONSRAD CO., Inc., 64 Church St., New York, N. Y.

would be forcibly thrust into the mouth, the prongs penetrating the palate, tongue and cheeks. The whole thing was then secured by a padlock. By means of a ring attached to the collar part the wearer could be secured to a staple in the wall of a cell."

In a well known story by the German author, called in its English version, "The Amber Witch," we read of a quantity of flax being given to the unfortunate victim to be wrapped around the body to bring about a quicker death in the fire.

In some of the illustrations the victims are seen wearing a strange costume. Accounts of this garb called the "Sanbenito" vary somewhat.

In conclusion it must be said that the stories of the cruelties of these days are undoubtedly exaggerated, that personal prejudice of writers has had its effect in the bringing out exaggeration both of numbers and of cruelty. In contradiction of this spirit it is of interest to note, that it is said in Torquemada's day the victims condemned to be burned as a rule were strangled before hand. This was a bit of mercy. Then coming down to present times, it is only in 1808 that Napoleon when he got into Spain abolished the whole system of torture there, and it was only in 1834 that it definitely disappeared in Spain, and this is about the latest date that can be found.

And now we come to our own country. Nearly 70 years ago, the discipline at Auburn prison, in the State of New York, included a modicum of torture. One man was subjected to the pouring of cold water in a shower upon his head. This seems a very light punishment, but it killed the victim; he was tortured to death. Of course, a trial had to follow and that took the shape decidedly, of a "white-washing." In the illustrated paper of this city which published a picture of the torture, there are other illustrations of punishments, as well, which were inflicted in Auburn prison. In one of them a man's hands are drawn up into the air as far as possible, one foot is drawn up and out to the level of the waist, leaving only one foot to touch the ground.

In a book just published by a Russian noblewoman, who escaped from a Soviet prison, she tells the horrors of a cork-lined, airtight cell, in which you can stand the suffocation and pounding of the temples but 20 minutes. It is sound-proof and pitch dark.

In Evelyn's Diary, and Evelyn was of particularly mild and gentle personality, he remarks *en passant* very coolly, that he saw Titus Oates being flogged through the streets of London. When we consider that Oates, according to Partridge's Almanac, received 2,256 blows with a six-lash whip, and was credited with 13,536 stripes, that the first day he was led through London, receiving part of the punishment, and a couple of days later he was drawn through the streets on a hurdle, for the rest of the beating, it shows how these things were taken as a matter of course.

Judge Jeffreys, for many years a judge in England, was inhumanely cruel in his sentences. In one case when he ordered a woman to be led through the streets and flogged, he said to the sheriff that the weather was cold, and that he should therefore see that he warmed "my lady's back."

Today the pendulum has swung too far probably in the other direction. A few weeks ago a man was flogged in Delaware under judicial sentence, for wife-beating and received only five lashes. And more recently we read of people being rather horrified at the idea of someone being condemned to receive forty lashes. Compare this with Titus Oates' punishment. According to some very recent revelations that have come into the courts, Great Meadows Prison, in the State of New York, figures as almost a pleasant resort.

(END)

GERMAN ARMY OFFICERS' FIELD GLASSES

Exactly As Used In The Great World War POST-PAID—ONLY

Absolute Satisfaction or Money Back

\$ **9⁸⁵**



\$20.00 VALUE

8-Power 40 MM. Objectives

Manufactured by most prominent of German optical factories. Many were received direct from the Allied Reparations Commission. Conservative \$20.00 value.

Finest achromatic day and night lenses, 40 mm. objectives. Dust and moisture proof. Pupillary adjustment. Built for service regardless of cost according to strictest military standards. All glasses guaranteed to be in perfect condition.

They meet the most exacting optical tests, and for sportsmen, autoists, hunters, tourists, and boat owners cannot be excelled. **A RARE BARGAIN.** Enclose Check, Money Order, or order C. O. D. A very limited quantity. Do not delay.

Genuine Sole Leather Carrying Case extra. \$1.75

THE NEWMAN-STERN COMPANY
Ohio's Greatest Sporting Goods Store
Newman-Stern Bldg., Cleveland, O.

Answers to Scientific Problems

(Continued from page 324)

THE MEN AND THE BOAT

THE fact that the men and boat just barely float in water shows that the boat alone displaces a weight of water equal to that of the boat and men together. Now if the boat be inverted and submerged in such a way that very little water enters, the buoyancy of the boat will be almost as much as before and since the men are now partly submerged it is highly probable that they will displace enough water in addition to make up for what enters the boat. If this is the case the boat will support them in the manner indicated.

THE TWO SHADOWS

If the men were directly below the lamp when they started to walk away from it their shadows would be beneath their feet and evidently of equal length. As soon as they get any appreciable distance from the lamp, however, their shadows will be of unequal length.

The rate of increase in the length of the shadows will not be constant, the rate being very slow when the gentlemen are close to the lamp and very rapid when they are at a considerable distance. In this connection note that shadows do not lengthen appreciably at noon when the sun is overhead even in the course of an hour whereas at sunset the growth of shadows is very striking.

THE PROBLEM OF THE PISTONS

Let us consider that the pistons are first at the ends of the strokes at A and A' respectively. At this instant the pistons are momentarily at rest and all of the energy of the system is to be found in the kinetic energy of the flywheel. Now as they approach the middle of the stroke at B and B' the speed of the pistons is increased at expense, evidently, of the flywheel. That is, the pistons in this part of the stroke are absorbing energy from the flywheel. But as they move from B and B' to C and C' their speeds will be decreased. Because of their inertia, however, they will tend to maintain the speed they had at B and B'. Hence in this part of the stroke they will drive the flywheel and thus give back the energy which they absorbed from it during the first half of the stroke. At C and C' the process is begun again. If no energy is lost in this process the energy taken from the flywheel while the pistons are approaching the midpoint should exactly equal the energy contributed to it while receding from the midpoint and therefore the motion should continue indefinitely.

Starting and stopping the pistons, retarding and accelerating the flywheel means a varying pressure on the bearing surfaces which will intermittently compress the metal. Unless, then, the metals are perfectly elastic, the bearings will get warm during the process just as a nail and a hammer head get hot under impact. Whatever kinetic energy is thus converted into heat will be lost and eventually the system will stop.

THE SWINGING WEIGHTS

If A is set swinging back and forth the motion which it imparts to the rope will gradually set B swinging also. As B is set in motion it gains energy which, obviously enough, must have come from A. A's motion will then decrease as B's increases. Soon A will be nearly at a standstill and B will be swinging vigorously. When this stage is reached the process will be reversed.

Jobs for Home Trained Men in ELECTRICITY

\$65 a WEEK AND UP!

Get into a field that's not crowded. Draw real pay! If you can be taught by mail, we can train you for success in electricity.



A few hours a week's work with a kick in it.

ELECTRICAL EXPERTS are needed now as never before. Even electrical trades are making record money. But men with expert electrical training such as we give you, are earning \$3250 a year and up by the thousands. And the big modern electrical "boom" has only started. Jobs by the hundreds are opening up. Electrical refrigeration, power plants, battery stations. A profitable business for yourself. The kind of job you've always wanted. Where you do the bossing and let the other fellow do the \$25 a week hard work.



Charles Steinmetz, A. M. Ph. D., "Electric wizard" of General Electric was for the last six years of his life on the Advisory Board of School of Engineering.

FREE EMPLOYMENT SERVICE and it doesn't cost you a penny. Thousands of firms look to us for men. General Electric, Harnischfeger Corp'n., Commonwealth Edison are only a few places where S. of E. men get rapid advancement. Hundreds have been helped by us in selecting the right place to go into business for themselves. Coupon brings you big FREE book with all details.

WHATEVER YOUR AGE OR EXPERIENCE

we can train you for success and big pay in electrical work. Hundreds of our most successful students are not even high school graduates. You don't need to know a single fact about electricity. In 22 years of teaching men to be successful we have found just what you should know and how to teach it to you to insure the quickest success when you go on the job. Earn \$65 a week and up. It's "in the cards" for you if you act and send the coupon.



Hundreds of S. of E. men locate in business for themselves. With our help it's easy to get started.

SATISFACTION GUARANTEED OR MONEY BACK is the way we stand behind S. of E. training. We can afford to because S. of E. men make good. They have the prestige for some of the biggest electrical men in America are S. of E. men. A signed money-back guarantee bond is yours the minute you enroll. Your training must satisfy you or every penny is returned.

GET STARTED—MAIL THE COUPON NOW. A big 72 page book in colors and illustrated with pictures of successful S. of E. men and their jobs will be rushed postpaid. Full details on S. of E. home training and the big opportunities that await you. **Mail Coupon Right Now.**

\$50 Outfit FREE

An electrical expert's outfit complete, of finest materials when you enroll.

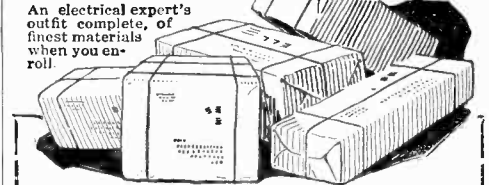

SCHOOL OF ENGINEERING OF MILWAUKEE
Dept. 5-C., Box 572, Milwaukee, Wisconsin

Send me FREE and postpaid without obligation your big 72-page book telling about S. of E. training and opportunities for me in electrical work. Also details of your employment service and money back guaranty.

Name.....
Address.....
City.....State.....

Anybody Can Use It

KESTER

READY TO USE

METAL MENDER

The Household Solder

Here's why thousands use Kester Metal Mender.

Simple—Requires *Only Heat*! Anyone can use it.

Safe—No messy pots or dangerous acids.

Sure—Genuine Solder makes firm metal joints.

Satisfactory—Works equally well on light or heavy, old or new work.

Economical—Saves many times its price.

Your Dealer Can Supply You

Soldering Booklet "It's a Clutch to Solder" Upon Request

CHICAGO SOLDER COMPANY
4201 345 Wrightwood Ave., Chicago, U.S.A.

This Year—make it a Real Vacation!

Thrilling, foaming speed with the Super Elto outboard motor! Instantly attached to any rowboat. Easily portable. World famous for easy starting. Multiplies the pleasures of fishing, racing, vacationing. Write today for new catalog—beautifully illustrated—intensely interesting.

The Super Elto

Elto Outboard Motor Co.
One Evinrude, Pres.
Dept. 45, Mfrs. Home Bldg.
Milwaukee, Wis.

"Starts With a Quarter Turn"

Insure your copy reaching you each month. Subscribe to **SCIENCE & INVENTION**—\$2.50 a year. Experimenter Publishing Co., 53 Park Pl., N. Y. C.

HERE'S A BRAND NEW BOOK!
To delight every Hookup Fan.

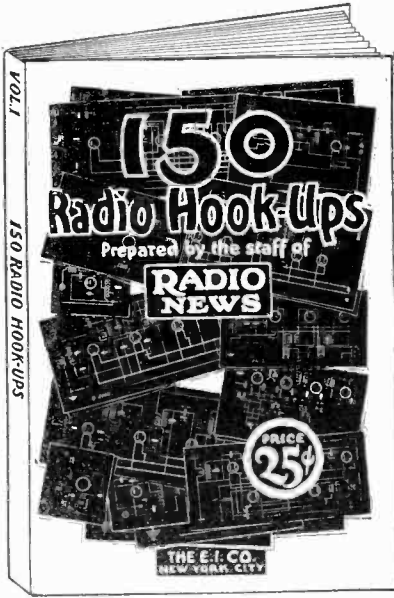

150 Radio Hookups

What more could you ask?—
 150 of the very finest, selected
 hookups most popular today.
 Each one completely ex-
 plained and fully illustrated
 so that a complete receiver can
 be constructed from the in-
 formation. No out-of-date
 Hookups—all the finest and
 best in common use today.



The Copy

64 PAGES
 ILLUSTRATED
 LARGE SIZE
 6 x 9 INCHES

Don't miss this opportunity—
 All Radio and news dealers
 have fresh copies *Now*. If
 there is no dealer near you
 write us direct enclosing 25
 cents.

SOLD ON ALL NEWSSTANDS

Published by THE E. I. COMPANY, Inc.
 Distributed by

THE CONSRAD CO., Inc., 64 Church St., New York City

B will lose its energy to A and eventually
 A will be swinging most vigorously again.

THE DRAWSCALE PROBLEM

Since the cords supporting the system are
 vertical the sum of their readings will equal
 the weight of the bar and object together.
 And since the downward weight is applied
 midway between the scales it will affect both
 scales equally and they will read the same.

THE STANDPIPE

As water flows along the pipe, l, m, n, o,
 p, the pressure decreases progressively ac-
 cording to the friction of the pipe. The pres-
 sure at points l, m, n, etc., is measured by
 the height of the water columns lf, me, etc.
 If the friction is uniform the decrease in
 pressure between any two points along the
 pipe will be proportional to the distance be-
 tween the points and hence the tops of the
 water columns will lie along a straight line
 a, b, c, d, e. They will not, however, be in
 line with the surface of the water in the
 standpipe for this reason: The water in the
 standpipe is at rest; it has no kinetic energy,
 or energy of motion whereas the water in the
 pipe has been set in motion. In setting the
 water in motion in the pipe there is a certain
 loss of pressure called the "velocity head,"
 the magnitude of which depends upon the
 speed with which the water emerges from the
 bottom of the standpipe. In an actual case
 it would be found that the levels a, b, c, d,
 e, f would be in line with some point such
 as h and the difference in level gh would
 represent the pressure required to set the
 water in motion.

THE FLOATING LOG

The log could not remain in the position
 indicated in the diagram, for as long as the
 rope is not vertical it will exert a pull
 which will tend to move the log sidewise in
 the water until the rope is perpendicular to
 the surface of the water.

CHANGING THE LENGTH OF THE DAY

If all the trains of the earth were heavily
 loaded and started eastward together at full
 speed they would exert, while gaining that
 speed, a force tangent to the surface of the
 earth which would slow down the speed of
 its rotation. Thus they would lengthen the
 day. The effect, however, would be only tem-
 porary, for as soon as the trains put on their
 brakes to stop they would exert an equal
 force in the opposite direction and thus speed
 up the earth's rotation to its original rate.

MULTIPLE IMAGES

The ray diagram below shows how two
 mirrors MN and MP at an angle of 60
 degrees would show five images symmetrically
 placed with respect to the mirrors and
 to their point of intersection. Incident and
 reflected rays must, of course, make equal
 angles with the mirror.

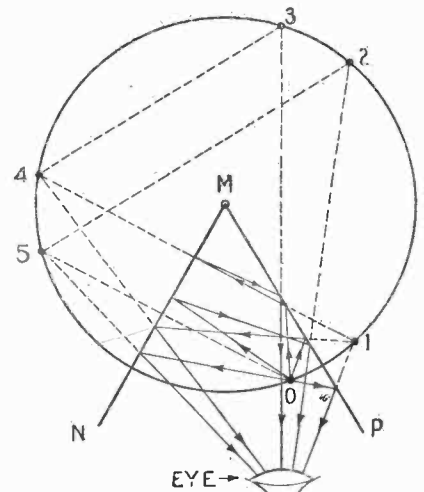

PHILADELPHIA

CHESTNUT AND 39th STREET

HOTEL PENNSYLVANIA

Fireproof—Unrestricted Parking—Garage

600 Rooms

500 Baths

Rooms with running water
 from \$2.50 per day

Rooms with private Bath
 and Shower
 from \$3.50 per day

FOOD AND SERVICE THE BEST

Near West Philadelphia Sta.
 Pennsylvania Railroad

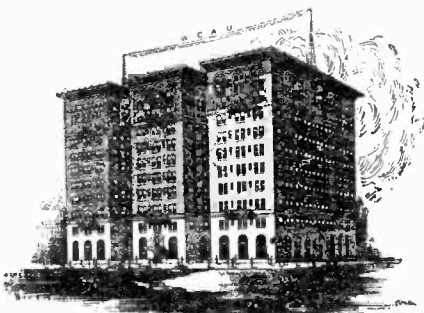

OSCAR W. RICHARDS, Manager

The Most Modern Up-to-Date Engine—the WITTE

\$5 Down Buys Any Standard WITTE Engine—The One-Profit Engine—From 1½ to 7 H.P. NO INTEREST CHARGES

The Standard WITTE engine which has revolutionized farm power, can do your jobs cheaper and in a fraction of the time. This new WITTE delivers super-power, steady and reliable at any speed, on either kerosene, gasoline, gas-oil, distillate or gas. Trouble-proof. All sizes, 1½ to 30 H.P. Completely equipped with WICO Magneto, square, protected tank, die-cast removable bearings, speed and power regulator and throttling governor.

Makes All Power Work Easy and Cheap

Write me today for full details of this amazing new all-purpose engine sold direct-to-you at a low factory price and easy terms. Thousands of users in all parts of the world say it's "BEST".

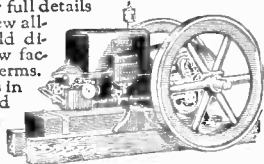

Write me personally for my big new catalog and full details, absolutely FREE and no obligation. Or, if interested, ask about our Log and Tree Saws, 3-in-1 Saw Rigs or Pump outfits. ED. H. WITTE, Pres.

WITTE ENGINE WORKS

3753 Witte Bldg., KANSAS CITY, MO.
3753 Empire Bldg., PITTSBURGH, PA.
3753 Witte Bldg., SAN FRANCISCO, CAL.

Quick shipments also made from nearest of these warehouses: Minneapolis, Minn., Atlanta, Ga., Trenton, N. J., Richmond, Va., Tampa, Fla., New Orleans, La., Dallas, Tex., Laredo, Tex., Denver, Colo., Billings, Mont., New York, N. Y., Albany, N. Y., Bangor, Me., Portland, Ore., and Los Angeles, Calif.

Kenilworth Inn

Asheville N.C.

Comfortable rooms - best sports excellent food REASONABLE RATES

Write for Booklet

ROSCOE A. MARVEL
Manager



The HOME of HOSPITALITY
"In The Land of The Sky"

LAW STUDY AT HOME
Become a lawyer. Legally trained men win high positions and big success in business and public life. Be independent. Greater opportunities now than ever before. Big corporations are headed by men with legal training. Extra \$5,000 to \$10,000 Annually during spare time. Degree of LL.B. conferred. LaSalle students found among practicing attorneys of every state. We furnish all text material, including fourteen-volume Law Library. Low cost, easy terms. Get our valuable 108-page "Law Guide" and "Evidence" books free. Send for them NOW.
LaSalle Extension University, Dept. 8384-L Chicago
The World's Largest Business Training Institution

SQUAB BOOK FREE
Breed squabs and make money. Sold by millions. Write at once for free 40-page book beautifully printed in colors telling how to do it. You will be surprised. PLYMOUTH ROCK SQUAB CO. 506 H St., Melrose Highlands, Mass.

About "Cavalleria" and WRNY

By CHARLES D. ISAACSON
(Continued from page 343)

Mamma Lucia. Turridu, her son, has been absent ostensibly to buy grapes at Brancofonte, but in truth making love to Lola, the wife of Alfio, the teamster. Santuzza, who loves Turridu, alone understands. While the peasants pour into the church and the organ peals, Santuzza weeps out her heart to Mamma Lucia and tells of her woe. For this is her story: Turridu and Lola once were lovers, but when Turridu went away, Lola married Alfio. Broken-hearted, Turridu returned and Santuzza comforted him and won his love. She gave her all. Now, Lola, jealous and angry, had won Turridu back to her side and in secrecy steals him from Santuzza and gives of the love, which belongs to Alfio. When Turridu appears, Santuzza pleads with him, but brazenly he throws her aside and enters the church with the shameless Lola. Vengefully, cruelly, Santuzza tells Alfio the truth, and after the service, Alfio challenges Turridu to a duel and kills him.

The Edison Ensemble did full justice to the Prologue, and Judson House to Turridu's serenade. This great weekly feature at WRNY holds high place in the musical life of the air. Speaking of the Edison Hour, reminds me that you probably heard the Edison prize play "The Return of Diogenes." You may recall that Arthur Williams, of the New York Edison Company, offered prizes for the best radio play devoted to the surprising changes of the world through electricity. The first prize effort was given over WRNY by the Radio Theatre Players, directed by Alfred Rigali. The big surprise was the engagement of Grant Mitchell, star of "One of the Family" and formerly with the "Tailor-Made Man"—an engagement which sets a new precedent in broadcasting. Mr. Mitchell played the role of "Diogenes" and gave verisimilitude to the old searcher for the honest man, returned to earth. Others in the cast were Mr. Rigali and Miss Isabel Dawn, then leading woman in "The Bells." Of course it is too late to notify you, but Alice Brady is to be the guest star in the second prize play, and Olive Wyndham and Louise Closser Hale in the third play. The success of "Diogenes" was tremendous, and not the least credit was given to the noises—which were real.

The most exciting thing which has happened during the month probably was the appearance of Norman Thomas. This famous radical had been invited by most of the metropolitan stations, but mysteriously cancelled at the last minute. Thomas pleaded for freedom of speech on the air. WRNY invited him to speak and, as programmed, he did speak. Introducing him I said: "Right or wrong, we concede to Mr. Thomas and others the right to address themselves to the radio public." After Mr. Thomas finished, Hugo Gernsback did some eloquent work in answering two of his most serious accusations.

And did you listen in on that famous night when Mona Morgan recited from Shakespeare, Marguerite Namara sang, Virginia Howell of "Alias the Deacon" read the verses of John B. Hymer and the whole cast of "One of the Family" had a party, with Grant Mitchell, Louise Closser Hale and the rest; and folks from "Pinafore" and others all joined hands.

CONCERTS FROM THE ROOSEVELT

Do you ever come to New York? Be here on a Wednesday, and then you can come to the Roosevelt Hotel and in an entirely informal manner make yourself at home in the

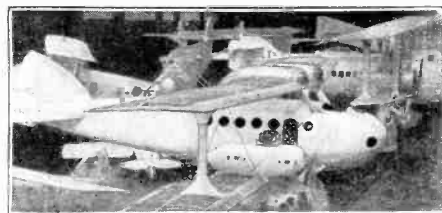

Aviation Brings Quick Success

TO young men of daring no other field of work offers such a fascination, such high pay, nor such opportunities for quick success as the field of Aviation. As yet, aviation is practically in its infancy. But now is the time to get in.

Amazing Opportunities in Airplane Industries

In the automobile industry and in the moving picture business hundreds of men got rich by getting in at the start. They made their success before others woke up. Today, these lines offer no greater opportunities than a hundred and one others. BUT AVIATION IS NEW. Get in while the opportunities are big. All over the country there will be a clamor for trained men. It will not be a question of pay but of getting capable men.

Become an Aviation Expert \$50 to \$100 per Week

The study of aviation is almost as fascinating as the actual work. Every lesson is full of interest. That is why it is easy to learn aviation. You do not have to make yourself study—it is like reading an interesting book that tells you things you have always wanted to know. Only one hour each evening will give you the basic training in a surprisingly short time.

One student, S. F. McNaughton, Chicago, says: "Your lessons are like a romance, and what is more, after one reading, the student gets a thorough understanding. One never tires of reading them." James Powers, Pa., another student, says, "I am indeed surprised that such a valuable course can be had from such practical men for so little cost."

Fascinating—Daring—Big Paying

Prepare Now for One of These Positions

- Aeronautical Instructor \$60 to \$150 per week
- Aeronautical Engineer \$100 to \$300 per week
- Aeronautical Contractor Enormous profits
- Acroplane Repairman \$60 to \$75 per week
- Acroplane Mechanician \$40 to \$60 per week
- Acroplane Inspector \$50 to \$75 per week
- Acroplane Salesman \$5000 per year and up
- Acroplane Assembler \$40 to \$65 per week
- Acroplane Builder \$75 to \$200 per week

Personal Instruction

by Experienced Men

Men who have had actual experience give you personal attention. They select the lessons, lectures, blueprints and bulletins. They tell you things that are essential in everyday practice. Each lesson is easy to read and understand.

Get Big FREE Book—Now

Send coupon below for New Book, just out, "Opportunities in the Airplane Industry." It is interesting and instructive. It will show you many things you never knew before about aviation. We have but a limited supply of these books—send the coupon before they are all gone.

American School of Aviation
3601 Michigan Ave., Dept. 1426 Chicago, Ill.

American School of Aviation
3601 Michigan Ave., Dept. 1426 Chicago, Ill.
Without any obligation, send me your Free Book, "Opportunities in the Airplane Industry", also information about your course in Practical Aeronautics.

Name.....
Street.....
City..... State.....

A Brand New \$300 Radio Prize Contest!



Test your skill in assembling a prize winning circuit—

OPEN TO ALL

RADIO NEWS, Radio's Greatest Magazine, has something new for every Radio Fan. It's a big prize contest; \$300 cash prizes given. All you need to do to get in on this contest is to beg, borrow or buy an August issue of this great magazine now on sale everywhere. In it are printed certain symbols for Radio Parts as are used in drawing circuits. Hook the parts together to form the best circuit you can make from them—and let the judges of the contest decide whether or not your hook-up is

worthy of a prize. Try it—you have just as much chance to win as anyone else. Remember \$300 gold in prizes. Get a copy of RADIO NEWS today.

FREE

As a special offer to subscribers Radio News will be sent to your door for five months for only \$1 (regular newsstand price \$1.25) and also we will give free with this offer 1 copy of the great 116 page book "How to Make It," containing hundreds of illustrated articles on how to make useful things at home.

EXPERIMENTER PUB. CO., Inc.
53 Park Place, New York, N. Y.

Gentlemen: I enclose \$1 for 5 months' subscription to RADIO NEWS and one FREE copy of "HOW TO MAKE IT."

Name
Address
City, State

**The Experimenter
Publishing Co., Inc.**
53 Park Place New York, N. Y.

**SOLD ON
ALL
NEWSSTANDS**

Grand Ball Room while listening to the free concerts.

If not listen in to WRNY.

JEST AND EARNEST

Things I remember especially in recent programs:

Johnny Hines acting as master of ceremonies and doing it wonderfully; that funny man, Harry Hirshfield, telling us all about his famous character, Abie Kabibble.

One evening the Hon. Joab H. Banton, District Attorney of New York, came over to speak on the Constitution.

We had lots of fun the nights we did the RADIO NEWS poem "Degenerative Sets;" (it appeared in the June issue).

TO PANDEMONIUM ITSELF!

And speaking of noises, there was the Novelty Night feature, "The Inferno." First time any remote-control line was ever instituted from Satan's domain. Other stations may claim to have been the first to have been anywhere on earth, but WRNY holds the record for getting to hell. North Pole next! The Irvine Players helped and did beautifully.

And here let me record with reverence, that we broadcast the Fiftieth Anniversary of the founding of Ethical Culture, and that Dr. Felix Adler, its founder and leader, at the age of seventy-five, made his first radio address. Dr. Stephen S. Wise also spoke.

There have been many famous speakers at WRNY this last month. At the Police Dinner of the Legion of Honor, Mayor Walker of New York and Police Commissioner McLaughlin were installed via WRNY. At the Postal Supervisors' dinner, Governor Bartlett, First Assistant Postmaster General, spoke; so did John J. Kiely, Postmaster of New York; Sir Gilbert Parker, the Canadian romantic novelist, and other celebrities.

History in music was made the night Pauline Watson played the new Morse violin, the first revolutionary change in violins since the days of Stradivarius.

The most beautiful ensemble ever to be broadcast, came to the studio one night recently, when Helene Romanoff appeared with Kathleen Karr, Miss Schweinert and others, all recruited from the Follies, Vanities, etc.

Lots of information about camps went out this month over the air through the help of the American Schools Association, and Coney Island's opening was celebrated with the Thunderbolt over WRNY. Did you hear it? The Thunderbolt is the newest, wildest, thrillingest ride at the Island.

DISCOVERING MANY COMING STARS

Along with all of these were the regular features of popular, classical and semi-classical music, brought by WRNY's favorite ensemble, Ben Bernie's Orchestra, Herbert Soman's Orlando's Roosevelt Orchestra, Johnny Camp's boys, and all the rest.

For the sake of history, I'd like you to note these new fine artists who have been heard over WRNY:

David Putterman, youngest cantor and wonderful tenor; Hans Merx, great Wagnerian baritone; Rose Black, soprano; Frances Sper, "pop" singer de luxe; Hardman Male Quartette, destined to fame; Dickie Hughes, one of the best singing ukelele stars on the air; Winthrop Wayne, actress of the Irvine Players; Edith Pollack, gifted member of the Drawing Room Players; La Verne Ellsworth, marvelous contralto; Marta Elizabeth Klein, prize-winning organist; Wilma Fekete, who plays violin and piano, with one even better than the other; Clarence Bloemaker, the brilliant new tenor from St. Louis; Mary Howard, the unforgettable soprano from San Antonio; George Magis, the French lyric tenor.

German War Glasses



8 POWER \$9.85 POSTPAID

These genuine German War Glasses purchased at exceptionally advantageous rates of exchange.

Manufactured by most prominent of German optical factories. Many were received direct from the Allied Reparations Commission. Conservative \$20.00 value.

Finest achromatic day and night lenses. 40 m.m. objective. Dust and moisture proof. Pupillary adjustment. Built for service, regardless of cost, according to strictest military standards. All glasses guaranteed in perfect condition. We have sold 90,000 pairs of this model to date.

Shipped promptly on receipt of check or money order for \$9.85. Positive guarantee of full cash refund if not satisfied. Order your field glasses to-day.

SWIFT & ANDERSON, Inc.

Successors to
HENDERSON BROTHERS

Largest importers of field glasses in America
916 FEDERAL STREET - BOSTON, MASS.

Could the Whale Swallow Jonah?

By H. WINFIELD SECOR

(Continued from page 301)

one of the few members of the whale family provided with teeth. The Finback whale, for example, has no teeth. The average length of the sperm whale is 65 feet, and the narrow under jaw carrying two rows of large teeth, each tooth being about 2 inches in diameter and 7 inches long, is about 10 to 12 feet in length.

As aforementioned, there are many different things that could have happened to Jonah besides his having been swallowed for three days and nights by a whale or big fish. He might have floated toward shore on the back of a whale, and also it is not impossible, that under the special conditions obtaining in the case, he might have been carried in the whale's mouth. In a different species of whale, as for instance, in the mouth of a blue whale, twelve men could stand in the mouth, but this whale has a throat not more than 8 inches in diameter, and could not swallow a man whole. He might have floated ashore on the back of a dead whale, especially in view of the fact that the waves subsided directly after he was thrown into the sea by the men on the ship. In the case of a sperm whale, there is no room for a man to live in the mouth, and he would no doubt be crushed by the teeth which are present on the lower jaw, these teeth fitting into the gum sockets in the upper jaw. Taking the other class of known large fish, namely, the great whales of the Finback and the Right species, a man would find himself in a "living hell" inside the whale's mouth, if he stayed there for any length of time. The mouth is filled with a powerful tongue on the lower jaw, and in the high arched upper jaw depends strips of whale bone covered with hair on the lower extremities. If he was not tickled to death with the hair, he would be suffocated by whale bone barriers in the mouth.

New York newspapers recently carried a weird tale of a man supposed to have been swallowed by a whale and having existed in his stomach for a day and a half. Dr. Lucas said, "it's a good story," but his opinion of just what chances an ordinary man today has inside a whale's belly is made clear from the above. There is much food for thought in these facts about whales, and doubtless the great fish mentioned in the Bible was a great whale or a very similar specimen. Both the fundamentalists and the modernists can make deductions in their favor from these considerations.

(Read more about whales in the September issue—a most interesting article.)

Photographing Aircraft Bombs in Flight

By S. R. WINTERS

(Continued from page 308)

axis horizontal and is provided with a plane mirror set at 45 degrees in order to give the lens axis a bend of 90 degrees.

The structural features of this camera system fade into relative insignificance in comparison with the things it must perform to satisfy the critical tests of officials of the Ordnance Department. We are told that it must make either directly, at least thirteen observations, or afford the basis for their mathematical calculations. These are as follows: height of airplane, speed of airplane, direction of flight both with respect to vertical and horizontal positions, point of release of the bomb, time of release of bomb,

(Continued on page 379)

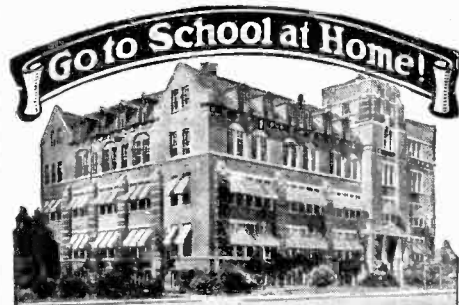

Go to School at Home!

HIGH SCHOOL COURSE IN TWO YEARS

YOU ARE BADLY if you lack **HANDICAPPED** High School training.

You cannot attain business or social prominence. You are barred from a successful business career, from the leading professions, from well-paid civil service jobs, from teaching and college entrance. In fact, employers of practically all worth-while positions demand High School training. You can't hope to succeed in the face of this handicap. But you can remove it. Let the American School help you.

FIT YOURSELF FOR A BIG FUTURE This course,

which has been prepared by some of America's leading professors, will broaden your mind, and make you keen, alert and capable. It is complete, simplified and up-to-date. It covers all subjects given in a resident school and meets all requirements of a High School training. From the first lesson to the last you are carefully examined and coached.

USE SPARE TIME ONLY

Most people *idle* away fifty hours a week. Probably you do. Use only one-fifth of your wasted hours for study and you can remove your present handicap within *two years*. You will enjoy the lessons and the knowledge you will gain will well repay the time spent in study.

Check and mail the coupon NOW for full particulars and Free Bulletin.

American School

Dept. HC-26

Drexel Ave. and 58th St., Chicago

American School

Dept. HC-26 Drexel Ave. & 58th St., Chicago
Send me full information on the subject checked and how you will help me win success.

- | | |
|------------------------------|------------------------------|
|Architect |Lawyer |
|Building Contractor |Machinery Shop Practice |
|Automobile Engineer |Photoplay Writer |
|Automobile Repairman |Mechanical Engineer |
|Civil Engineer |Shop Superintendent |
|Structural Engineer |Employment Manager |
|Business Manager |Steam Engineer |
|Cert. Public Accountant |Foremanship |
|Accountant and Auditor |Sanitary Engineer |
|Bookkeeper |Surveyor (& Mapping) |
|Draftsman and Designer |Telephone Engineer |
|Electrical Engineer |Telegraph Engineer |
|Electric Light & Power |High School Graduate |
|General Education |Fire Insurance Exper. |
|Vocational Guidance |Wireless Radio |
|Business Law |Undecided |

Name.....
Address.....

Play the HAWAIIAN GUITAR
Just as the Natives Do

FREE \$15 HAWAIIAN GUITAR and Case when you enroll

Only 4 Motions used in playing this fascinating instrument. Our native Hawaiian instructor teaches you to master them quickly. Pictures show how. Everything explained clearly.

Play in Half Hour
After you get the four easy motions you play harmonious chords with very little practice. No previous musical knowledge necessary.

Free Guitar and Outfit in Genuine Seal Grain Fabrikoid Case as soon as you enroll. Nothing to buy—everything furnished. No delay.

Write at Once
You'll never be lonesome with this beautiful Hawaiian Guitar. Write for Special Offer and easy terms. A postcard will do. ACT!

FIRST HAWAIIAN CONSERVATORY OF MUSIC, Inc.
9th Floor, Woolworth Bldg., Dept. 140, New York, N. Y.
Approved as a Correspondence School Under the Laws of the State of New York.

The Famous KON-VER-TER Slide Rule
Instantly adds, subtracts, divides, multiplies, converts fractions or decimals of an inch. Gives sines, cosines, versed sines, covered sines, tangents, co-tangents, secants co-secants of angles directly. Gives square roots, squares, cube roots, cubes and fifth roots and powers of all numbers. Logarithms, co-logarithms, anti-logarithms. Instructions with rule. DeLuxe Model \$3. Cash or C.O.D. New England Novelty Company Wakefield, Mass.

Aviation

Take a W. A. C. Course in Applied Airplane Engineering. Many men earn \$2000 to \$10,000 a year. Big Free outfit of airplane parts. Write for Free catalog.

WESTERN AIRPLANE CORPORATION
"Dept S-8" Monadnock Bldg., Chicago, Ill.

500 Tricks

BIG BOOK 10c!
Be a Man of Mystery! Amaze and Mystify your friends. Easy to learn. This New \$0-page Copyrighted Book tells how. Large Catalog of Magic Tricks, Jokes, Puzzles and Imported Novelties included. Send 10c today!

LYLE DOUGLAS
Station A 3, Dallas, Texas

Insure your copy reaching you each month. Subscribe to **SCIENCE & INVENTION**, \$2.50 a year. Experimenter Publishing Co., 53 Park PL, N.Y.C.

Books that Instruct and Entertain!

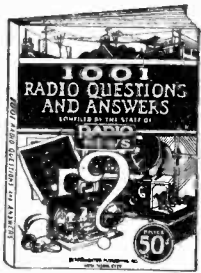

1001 Radio Questions And Answers

—by the Staff of
"RADIO NEWS"

A Book Full of Everyday Radio Problems and How to Solve Them

In presenting this most valuable assortment of questions and in answering them in the best and most understandable way, the staff of "RADIO NEWS" feels that it has created a book in which appears the cream of every radio man's problems and the best method of coping with them. There is contained invaluable information on every phase of radio. Information on hundreds of simple and complex hookups is given in clear and concise language. Information on practically every type of receiving set, manufactured receivers, vacuum tubes, miscellaneous circuits, and in short just what the radio enthusiast needs as an unerring guide and aid. This book abounds in priceless data that is worth far more than the nominal price at which it sells.

116 PAGES 300 ILLUSTRATIONS.
SIZE 9 x 12 INCHES.



500 Radio Wrinkles

A Veritable Storehouse of Prac- tical Short Cuts and Hints on Radio Equipment

The 500 RADIO WRINKLES BOOK is a very comprehensive compilation of the best time and money saving hints that can be effected. Under fifteen separate and distinct headings, the entire field of radio apparatus and instruments has been covered in simple, understandable language. There are no ifs nor buts to complicate directions. The Beginner as well as the more advanced radio man will soon find that this book contains a veritable storehouse of practical, inexpensive hints toward improving his radio apparatus.

100 Pages. Illustrated. Size 9x12 Inches.

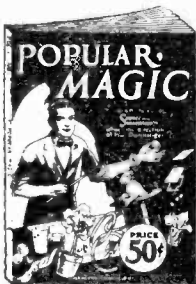

Popular Magic

Surprise Your Friends with a Mastery of Mystery

Be the popular man in your circle of friends. You can entertain them and hold their attention with a thousand surprises and novelties.

POPULAR MAGIC is a book for you, for everybody, young or old. But especially for those who want popularity, those who want to realize how much the admiration of friends helps toward making life worth more.

POPULAR MAGIC contains thousands of simple, entertaining parlor tricks, as many puzzling magical stunts and a whole book full of mystic spirit novelties. A new set of tricks for every day of the year. Compiled from the great magazine "Science and Invention." 300 Illustrations. Size 9x12 Inches.

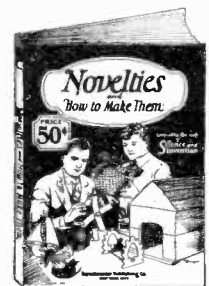

Novelties How to Make Them

Make Hundreds of Re- markable Things at Home

Almost every home has an old clock around—Do you know that a great many surprising, fun making and useful novelties can be made just from the old springs, the gears, etc.

NOVELTIES, the new book, compiled by the staff of SCIENCE & INVENTION shows you how to make hundreds of wonderful Novelties, mostly out of old scrap things laying around the house. 116 Pages, in this book, show pictures, diagrams and explanations of remarkable, interesting things to make in your spare time.

116 Pages. 300 Illustrations.
Size 9 x 12 Inches.



SOLD ON ALL NEWSSTANDS

If your newsdealer cannot supply you, order direct.

Published by
EXPERIMENTER PUBLISHING CO.
53 PARK PLACE, NEW YORK, N. Y.

\$75 A WEEK BUILDING RADIO SETS

In Your Spare Time

Join the Radio Association of America. Learn how to build and repair sets. The Association will train you—start you out in business, if you wish. Be the radio "doctor" of your community. \$3 an hour upwards easily made.

EARN \$500 IN SPARE HOURS

"I have at last found myself," writes Lyle Follick, Lansing, Mich. "I have already made over \$500." Werner Eichler, Rochester, N. Y., writes, "... have made over \$50 a week in my spare time." Our members are starting radio stores, increasing their salaries, securing better positions, passing radio operator examinations, earning big money in spare time.

JOIN ASSOCIATION NOW!

Are you interested in Radio for pleasure or profit? Join now because we have a Special Plan whereby your membership need not cost you a cent. Only limited number of these memberships acceptable. Write now for details—before it is too late.

MAIL THIS COUPON

Radio Association of America.
 Dept. 62, 4513 Ravenswood Ave., Chicago
 Send me details of your Special Radio Association Membership Plan.
 Name
 Address
 City State



A Cinch to Make \$25 a Week

In Spare Time

Amazing new home-study method makes it easy to learn to make big-paying clever show cards. Great demand. No talent needed. Write for special offer and illustrated Free book to Washington Show Card School, Room 268-D, 1115-15th St., N. W., Washington, D. C.

ATTENTION!



The Ross Radio ring is a miniature crystal radio receiving set. Wear it as a ring—use it as a radio. With a phone and aerial brings in local stations clearly and distinctly. Results guaranteed or money refunded.

PRICE 50c. POSTPAID

AMERICAN BAZAAR, INC.
 Radio Department
 640 BROADWAY, NEW YORK CITY

Chords on the TENOR BANJO

Special Summer Rate
 Learn chords and jazz as used by professionals. A special course on chord work written so plain anyone can learn quickly. by John Martell, author of many books. Write for free information. N.Y. INSTITUTE of MUSIC (Dpt. S), 143 E. 34th St., N.Y.C.

Wonderful, new device, guides your hand; corrects your writing in few days. Big improvement in three hours. No failures. Complete outline FREE. Write C. J. Oment, Dept. 44 St. Louis, Mo.

Amazing Stories

The Amazing Magazine of Scientifiction
 Stories that grip the imagination, interesting from cover to cover.
 25c THE COPY
 SOLD ON ALL NEWSSTANDS

Photographing Aircraft Bombs in Flight

(Continued from page 377)

inclination of bomb when released, state of oscillation of bomb, velocity of wind with respect to speed and direction at the height of the airplane, point and time of impact of the bomb, and both the wind and atmospheric conditions.

Of course, there are many accessories or assisting agencies, which may be said to aid and abet these two cameras in their ambitious program of achievement. For instance, there is a chronograph, specially designed, consisting of a drum driven by clockwork, which keeps time records. Time signals from the Naval Observatory are a source of precise checking of the pens on this time-recording device. The pen recording the release of the bomb from the airplane in flight is actuated by a radio receiving set which receives a signal from the flying craft automatically when the bomb shackles is opened. Also, the release of the bomb sets off a smoke puff on the airplane which warns the camera plotters of the moment of the release. Smoke from this ignited puff of powder shows which way the wind is blowing, thus affording data relating to the velocity and direction of the wind.

The time of impact of the bomb is relayed to the chronograph by its explosion actuating a microphone, the latter being located in a pit in the bombing field of the Aberdeen Proving Grounds. The visual signal from the tower, shown in one of the photographs reproduced with this article, is sent by pressing a button at the instant when an observer notes the bomb leaving the airplane. This, however, is not a reliable index to the time of the release of the bomb. Waste and extravagance in exploding bombs, when the airplane is beyond the range of vision of the camera system, is avoided by flashing a smoke signal when conditions for operation are opportune. This smoke signal is touched off when the release is desired and the bomber is thus put on the alert. That is, the bomb must be released at once; otherwise a slight delay would cause the bomb to light at a point too far away to actuate the microphone in the pit.

The Ordnance Department, by means of this ingenious apparatus, is planning to drop bombs from an altitude of 20,000 feet. The recording of visual images of aircraft and bombs at such relatively great heights requires accurate adjustments of the camera system.

In leveling the range of the vertical camera a clever arrangement has been devised. Taking the designation of a bird cage, the principle of operation involves an optical arrangement for obtaining a reflection from each surface of the lens. That is, in order to level the lens, the reflections of a white ring are brought concentric. Adjustment of the oblique camera is not quite so complicated, it only being necessary to adjust the rotating axis of the mirror to horizontal and at right angles to the base line. Then the mirror is adjusted to 45 degrees with the lens-axis, thus obtaining the zero reading when the line reflected by the mirror into the lens is horizontal.

Probably no camera system ever designed has had imposed upon it so many functions that must be performed simultaneously and with scrupulous accuracy. It seems well-nigh incredible that this mechanical eye of the Ordnance Department can faithfully record the moment as well as the point of release of a bomb from an airplane and at the same time render it possible to calculate the velocity of the wind, speed and direction of the airplane and make ten or more other painstaking and accurate observations.



"What would I do if I lost my job?"

SUPPOSE your employer notified you to-morrow that he didn't need you any longer? Have you any idea where you could get another position?

Don't have this spectre of unemployment hanging over your head forever. Train yourself to do some one thing so well that your services will be in demand. Employers don't discharge such men. They promote them!

Decide to-day that you are going to get the specialized training you must have if you are ever going to get—and keep—a real job at a real salary. It is easy if you really try.

Right at home, in the odds and ends of spare time that now go to waste, you can prepare for the position you want in the work you like best. For the International Correspondence Schools will train you just as they are training thousands of other men—no matter where you live—no matter what your circumstances.

At least find out how, by marking and mailing the coupon printed below. There's no cost or obligation, and it takes only a moment of your time, but it may be the means of changing your whole life.

Mail the Coupon To-day!

INTERNATIONAL CORRESPONDENCE SCHOOLS

Box 6248-D, Scranton, Penna.

Oldest and largest correspondence schools in the world. Without cost, please tell me how I can qualify for the position or in the subject before which I have marked an X.

- BUSINESS TRAINING COURSES**
- Business Management
 - Industrial Management
 - Personnel Organization
 - Traffic Management
 - Business Law
 - Banking and Banking Law
 - Accountancy (including C.P.A.)
 - Nicholson Cost Accounting
 - Bookkeeping
 - Private Secretary
 - Spanish
 - French
 - Salesmanship
 - Advertising
 - Better Letters
 - Show Card Lettering
 - Stenography and Typing
 - Business English
 - Civil Service
 - Railway Mail Clerk
 - Common School Subjects
 - High School Subjects
 - Illustrating
- TECHNICAL AND INDUSTRIAL COURSES**
- Electrical Engineering
 - Electric Lighting
 - Mechanical Engineer
 - Mechanical Draftsman
 - Machine Shop Practices
 - Railroad Positions
 - Gas Engine Operating
 - Civil Engineer
 - Surveying and Mapping
 - Metallurgy
 - Steam Engineering
 - Radio
 - Architect
 - Architects' Blueprints
 - Contractor and Builder
 - Architectural Draftsman
 - Concrete Builder
 - Structural Engineer
 - Chemistry
 - Pharmacy
 - Automobile Work
 - Airplane Engines
 - Agriculture and Poultry
 - Mathematics

Name.....
 Street.....
 Address.....
 City..... State.....
 Occupation.....

If you reside in Canada, send this coupon to the International Correspondence Schools Canadian Limited, Montreal.

BIG VALUES IN GENUINE DIAMONDS

CASH OR CREDIT

Blue-white quality gems at lowest possible prices. We import our Diamonds direct from Europe and sell direct to you. You get most value for your money when you deal with Loftis, the Direct Importer. Satisfaction Guaranteed or Money Back.

Terms: All goods delivered on payment of one-tenth purchase price. Balance weekly, semi-monthly, or monthly at your convenience.

Big Catalog Free! Write for it today!

LOFTIS

BROS. & CO. 1550
 Dept. C22, 108 N. State St., Chicago, Ill.
 The Old Reliable Original Credit Jewelers

Several special 18-K white gold rings set with blue-white Diamonds, \$37.50. Terms \$1.00 a week; others \$25 and up.

You Can Add 15 Years to Your Life!

At least 60% of physical and mental misery is preventable and curable. In fact the life of the average person would be prolonged 15 years if people knew how to rule their health as they do their actions.

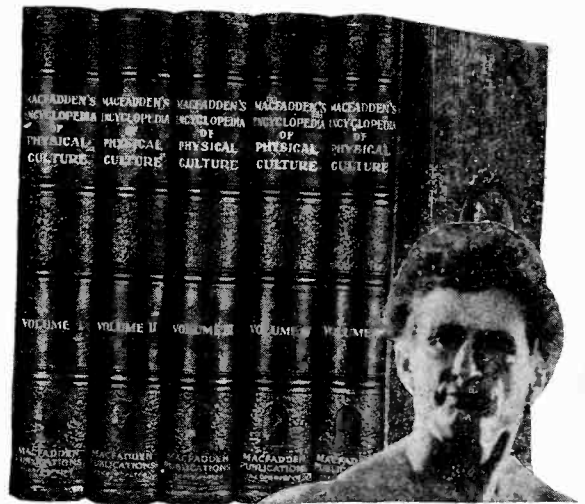

ENCYCLOPEDIA of PHYSICAL CULTURE New 6th Edition ~ Completely Revised

FROM maturity to old age the breaking down or wearing out of vital organs is in process. But because there is no pain or noticeable symptoms the victim ignores the little signals of warning which nature is constantly issuing until face to face with a dangerous disease.

When one is easily exhausted, even with a moderate amount of work—or suffers from headache, loss of appetite, a cold in the head or on the chest, a dull ache across the back, spots before the eyes, ringing in the ears, these are all signals, the neglect of which may lead to serious—perhaps fatal—illness.

Yet the cause of degenerative changes are preventable if taken in time. In fact, you can rule your health as surely as you rule your actions. Bernarr Macfadden, the world's outstanding exponent of physical culture, has, perhaps, had more experience than any other one person in guiding thousands from physical weakness and ill health back to wonderful health and vigor. Out of this great experience he has built

The Encyclopedia of Physical Culture

This marvelous work gives invaluable information on fasting, diet, exercise, and hydrotherapy for both health and beauty building. It gives thorough and extensive treatment of the laws of sex, the attainment of virile manhood and womanhood, and happy successful parenthood, together with details for correct diagnosis and treatment of all sexual diseases. It contains many handsome charts on anatomy and physiology.

It is neither dull nor technical, but is

comprehensive and complete in every sense. It is the crowning effort of Bernarr Macfadden's rich, full experience in the science of health and physical culture. You haven't any idea how valuable it will be to you, or how many dollars it will help you save each year. What, for instance, would it be worth in actual dollars to you to be able to instantly identify in its earliest stages any sickness that might overtake you or any member of your family. What would it mean to you to have glorious health, almost complete freedom from sickness or disease, no doctor's bills to meet, no hospital bills to pay, no days of suffering or worry, no salary lost through absence from business?

"One of the Best Works on Health Ever Published," says one writer

Thousands of letters have been written to Bernarr Macfadden commending his Encyclopedia of Physical Culture. One (name furnished upon request) says "Permit me to thank you for the great work by Mr. Macfadden—The Encyclopedia of Physical Culture—which I got from you some time last month. I have read much of it already, and consider it to be one of the best books on health ever published. I wish to thank Mr. Macfadden for his great work. The Encyclopedio is going to be my best doctor now and always."

Another man writes: "I cannot express the wonderful value of these great books and feel they will lead me to a successful married life, as I have recently married. They are a plain, sensible and priceless guide to a perfect physical life."

A New Edition Just Off the Press

Five big editions of this popular work have been exhausted. And now the sixth edition—greatest of all—has just come off the press. This edition has been completely revised at great expense. Scores of new illustrations have been inserted. The binding has been changed to a beautiful all Fabrikoid, more durable than leather. Altogether it is the finest edition of the Encyclopedio ever issued.

10 Days' Free Examination of Entire Set—No Money Needed

This is the most liberal offer we have ever made on the Encyclopedia—10 days' examination of the entire set at no expense to you. There is no money needed—no deposit to pay. Just fill in the coupon and we will send the five volumes to you, all shipping charges prepaid, for your inspection.

Take ten days to examine the set. Then if you decide to purchase send us only \$2.00 as your first payment. Additional payments may be made at the rate of only \$3.00 a month until the total cost of \$35.00 has been paid.

If you care to pay cash you may do so by sending us only \$31.50. This represents a 10% discount.

If you purchase the set we will include with it membership in our Special Advice Department, maintained and equipped to serve you. This service alone may well be worth the price of the Encyclopedia.

Remember, no money now, and no obligation to purchase. You simply agree to return the books at the end of ten days in case you decide not to keep them.

A Complete Education in Physical Culture

THIS set of five volumes contains a complete education on Physical Culture and Natural Curative Methods—the equivalent of twenty comprehensive books on the following phases of health and vitality building:

- (1) A complete work on Anatomy fully illustrated.
- (2) A Physiology in plain language, and embracing many illustrations.
- (3) A reliable and comprehensive handbook on Diet.
- (4) A complete Cook Book.
- (5) A book on Exercise in its Relation to Health.
- (6) A handbook on Gymnastics, with full instructions on drills and apparatus work of every sort, with hundreds of illustrations.
- (7) A book illustrating and describing every form of Indoor and Outdoor Sports and Exercises—complete courses in Boxing, Wrestling, etc.
- (8) Handsome colored charts and instructions for Developing a Powerful Physique.
- (9) A complete handbook on Beauty-Culture.
- (10) The most complete and extensive work on Fasting ever published.
- (11) A comprehensive work on Hydrotherapy, including water treatments of every variety.
- (12) A book on Mechanical Therapeutics giving full details and scores of pages of illustrations of physiotherapeutic treatments.
- (13) A thorough work on First Aid with drugless methods.
- (14) A lavishly illustrated work on Diagnosis, giving plainly written instructions for detecting diseases of every sort, and finding their cause.
- (15) A comprehensive illustrated book on Home Treatment for All Diseases, alphabetically arranged and written in plain language.
- (16) An Anatomy of the Sexual Organs.
- (17) Sexual Weakness and Disease, their Cause and Cure.
- (18) Rules for Happy Marriage and Parenthood.
- (19) A complete work on Childbirth—how to make it safe and comfortable.
- (20) A practical work on the Training of Children.

MACFADDEN PUBLICATIONS, INC.
Dept. SC-8, Macfadden Building
1926 Broadway, New York City

SPECIAL OFFER

Send me for 10 Days' inspection the five volumes of the Encyclopedia of Physical Culture. If I find the set satisfactory I will either send \$2.00 in ten days and \$3.00 a month until \$35.00 has been paid, or \$31.50 cash. If I decide not to keep the books I will return them in 10 days postpaid. I understand this offer includes membership in your Advice Department.

Foreign orders—Cash in advance

Name

Occupation

Residence

Employed by

Business Address

MACFADDEN PUBLICATIONS, Inc.
Dept. SC-8, 1926 Broadway, New York

Make Money Taking PICTURES



Tremendous, big-paying opportunities are open for ambitious men in Modern Photography. This is the picture age. Magazine and newspaper publishers buy thousands of photographs each year. Every manufacturer sends out high priced pictures of his products. Every home wants portraits. Photography is a business running into millions of dollars each year. And there is a great shortage of trained photographers.

Got \$100 for Flood Pictures

I took pictures of a flood and sold them for \$100. I have been able to buy my house and lot from the sale of pictures.

C. M. Cole, Washington.

\$97 in 2 Days!

I made \$285 in December. Went out two days last week on home portrait work and made \$97.

A. G. Hughes, Kentucky.

Earn \$3,000 to \$10,000 a Year

Hundreds of men are earning big money and establishing their own businesses. Even during spare time, while training, you can make \$75 a week easily—no matter where you live!

Amazing New Easy Method

I show you at home, how to do the kind of work turning out by the big studios in New York and Chicago! I show you how to make big money within 30 days! C. M. Cole bought a home with money he had made when only half way through his training. So well do I know what I can do for you that I guarantee

under bond to return every cent of your tuition if you are not thoroughly satisfied.

Professional View Camera FREE!

Write at once for Free Camera Offer. I give you, free, a splendid professional view camera. You will be astonished and delighted. This offer open for short time only—so act quick! No obligation.

INTERNATIONAL STUDIOS, Inc.
Dept. 142C
3601 Michigan Ave., Chicago, Ill.

SENT ANYWHERE ON 10 DAYS FREE TRIAL

5 TUBE GUARANTEED RADIO

MIRACO UltraS

Users everywhere report it gets programs coast to coast. Canada to Gulf, loud and clear on speaker; outperforms \$100 to \$250 sets. Many \$59.50



FACTORY PRICES—SAVE 1/3 TO 1/2. Smaller Sets \$13.75. FREE literature on latest 10-tube models. Agents new low prices and SPECIAL OFFER! Write! MIDWEST RADIO CORPORATION, Pioneer Builders of Sets, 409 S.E. 8th St., Cincinnati, Ohio

Tire Agents Wanted

Use and Introduce MELLINGER CORD TIRES 15,000 MILES GUARANTEED. Lowest Wholesale Prices in America. Shipped prepaid on approval. Make big money all over part time. No capital or experience. Sample sections furnished. YOUR TIRES FREE! Simply send name today for FREE BOOK, tells how thousands do big business. Special Agents Offer, Wholesale Prices and FREE Sample Kit. MELLINGER TIRE & RUBBER CO.



WRITE TO NEAREST OFFICE

Home Made Candies for Profit

Turn kitchen, basement or spare room into a small candy shop and make handsome income from very first day. New up-to-the-minute home-study course, prepared by man who made a big success in the candy business himself, gives tested recipes and complete instructions. Free book explains. Send for copy today.

THE CAPITOL CANDY SCHOOL
Dept. KB, 631 Penn. Ave., Washington, D.C.

CAMERA SENSATION!

Regular Black and White Photo Finished Quickly Inside the Camera. The "Keller-Camera" is absolutely new. Inexpensive Keller-cards are used as negatives from which any number of regular black and white photos can be made in the camera on these same Keller-cards. No films—no plates—no dark-room necessary. Objects are not reversed on these pictures which are 3 1/2 x 5 1/2 inches. Cards, developer and fixing solution cost little. You can make big money taking and selling photos, selling these cameras or doing both. CROWN MINUTE CAMERA CO., 439 Canal St., Dept. 334, NEW YORK. (Factory and home office, Norwalk, Conn.)

Brainy Diet

"Fat, oil, butter, cream and eggs certainly caused my catarrh and deafness, but your diet of lean meats, green vegetables, fruits, etc., restored me in a few weeks. My brain power and complexion improved tremendously, and I succeeded financially." Educational Booklet No. 1. BRINKLER SCHOOL OF EATING, Dept. 61H 131 West 72nd St., New York.

How to Build a Day-Bed

By WILLIAM M. BUTTERFIELD

(Continued from page 325)

inside lower edges of the front and back side rails to support the spring frame.

The second design calls for end boards 37" long with tenons 6" long, 3/4" wide and 3 1/2" deep. These boards are 13" wide and 3/4" thick with a capping piece 3/4" x 2" set in a straight line above 5" x 2" cut outs at either end of sash board. The side rails are 6" wide, 3/4" thick and 81" long, each have tenons 3/4" wide, 3 1/2" deep and 3 1/2" long at each end. The corner pieces are 18" long 2 1/2" square, with legs 6" long tapered to 1 1/2" at lower end. They have mortises cut to fit tenons on end boards and side rails as shown in layout. Each is set 1" above cut outs on the end boards and is capped with 3/4" x 3" blocks.

The third style is the same as the second with the exception that the capping pieces on each end board is curved to a radius of four feet, with the boards cut to fit the capping pieces. The corner pieces are 17" long, 2 1/2" square, with legs 6" long tapered to 1 1/2". The corner piece top set flush with the bottom of the 5" x 2" cut outs on the end boards.

The tenons on the end boards are cut, fitted and pinned fast in their mortises in the corner pieces before the mortises in the side rails are cut—the mortises are then cut as though the joined parts were solid wood, afterwards the tenons on the side rails are fitted into and through the tenons on the end boards. The measurements for tenons, mortises, side rails and end boards are the same as those given for the second style of bed.

Any desired style of wire spring is used for these day-bed designs. They are designed for a single size (72" x 28"), this size leaves 1" clear space all around between the frame and spring. It will be necessary to order the spring made especially for the beds. This can be done at any furniture store and the extra cost will be about one dollar over the regular price of any better make of bed spring—it should not be over \$1.50 at the most.

The mattress should fit the inside of the bed very closely, and may be in the form of a cushion or thin mattress, either with or without ruffles sewed at their upper edges to the top of the mattress at the front and back sides. A cushion covering made in this way will stay in place with the greatest amount of hard usage, for it fits into and below the upper edges of the frame just as a mattress fits into any bedstead.

The accompanying furniture should govern the choice of wood, stain and finish for the bed, just as it should the choosing of mattress or of cushions.

Perhaps it may be necessary to glue narrow pieces together, using tongue and groove joints, to obtain the specified widths of back rail or end boards. If it is done care must be taken to put the pieces together with the heart side reversed so as to prevent warping as much as possible, and not to use joined places for tenons or mortises—making two mortises or tenons instead of one if necessary. For a better finished job have grain of wood at different angles at the joints.

NEW "AUTO KINK" DEPARTMENT

EDITED BY WELL-KNOWN EXPERT WILL APPEAR IN EARLY NUMBER. WATCH FOR IT.

BUILDING TRADES NEED TRAINED MEN

Thousands of good positions at good salaries

THE building trades are still booming. Trained men are in demand at good salaries. Government experts estimate that billions of dollars will be spent for construction this year.

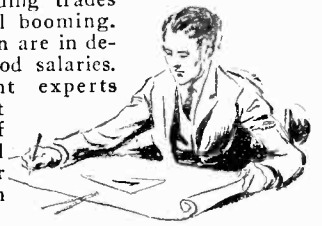

Today the most vital need of this great building program is men—trained men—men who can step right in and do the skilled work that building construction requires.

There is a simple, easy, practical way by which you can prepare for a better position, at a bigger salary. You can do it right at home, in spare time, no matter where you live, through the International Correspondence Schools.

A recent investigation of 13,928 students enrolled in I. C. S. Building Trades Courses showed that 1921 had become Architects; 246 had become Designers; 494 had become Chief Draftsmen; 2827 had become Draftsmen; 1845 had become Contractors; 211 had become Assistant Foremen; 4030 had become Foremen; 2354 had become Superintendents.



You, too, can have the position you want in the work you like best; an income that will give you and your family the home, the comforts, the luxuries you would like them to have.

Mail the Coupon for Free Booklet

TEAR OUT HERE ——— INTERNATIONAL CORRESPONDENCE SCHOOLS Box 6250-D, Scranton, Penna.

Oldest and largest correspondence schools in the world

Explain, without obligating me, how I can qualify for the position or in the subject, before which I mark X.

- | | |
|--|---|
| <input type="checkbox"/> ARCHITECT | <input type="checkbox"/> Plumber and Steam Fitter |
| <input type="checkbox"/> Architectural Draftsman | <input type="checkbox"/> ELECTRICAL ENGINEER |
| <input type="checkbox"/> Architects' Blueprints | <input type="checkbox"/> Electric Lighting and Rys. |
| <input type="checkbox"/> Contractor and Builder | <input type="checkbox"/> MECHANICAL ENGINEER |
| <input type="checkbox"/> Building Foreman | <input type="checkbox"/> Show Card and Sign Painting |
| <input type="checkbox"/> Concrete Builder | <input type="checkbox"/> BUSINESS MANAGEMENT |
| <input type="checkbox"/> Structural Engineer | <input type="checkbox"/> Private Secretary |
| <input type="checkbox"/> Structural Draftsman | <input type="checkbox"/> Business Correspondent |
| <input type="checkbox"/> Heating and Ventilation | <input type="checkbox"/> BOOKKEEPER |
| <input type="checkbox"/> Plumbing Inspector | <input type="checkbox"/> Stenographer and Typist |
| <input type="checkbox"/> Foreman Plumber | <input type="checkbox"/> Higher Accounting |
| <input type="checkbox"/> Sheet Metal Worker | <input type="checkbox"/> COMMERCIAL LAW |
| <input type="checkbox"/> CIVIL ENGINEER | <input type="checkbox"/> Common School Subjects |
| <input type="checkbox"/> Surveying and Mapping | <input type="checkbox"/> Mathematics |
| <input type="checkbox"/> Electric Wiring | <input type="checkbox"/> GOOD ENGLISH |
| <input type="checkbox"/> Telephone Engineer | <input type="checkbox"/> ILLUSTRATING |
| <input type="checkbox"/> Telephone Work | <input type="checkbox"/> Railway Mail Clerk |
| <input type="checkbox"/> Mechanical Draftsman | <input type="checkbox"/> CIVIL SERVICE |
| <input type="checkbox"/> Toolmaker | <input type="checkbox"/> Mining Engineer |
| <input type="checkbox"/> Machine Shop Practice | <input type="checkbox"/> Gas Engine Operating |
| <input type="checkbox"/> CHEMIST | <input type="checkbox"/> STATIONARY ENGINEER |
| <input type="checkbox"/> Pharmacy | <input type="checkbox"/> Textile Overseer or Supt. |
| <input type="checkbox"/> Navigation | <input type="checkbox"/> TRAFFIC MANAGER |
| <input type="checkbox"/> SALESMANSHIP | <input type="checkbox"/> AUTOMOBILES <input type="checkbox"/> Spanish |
| <input type="checkbox"/> ADVERTISING | <input type="checkbox"/> AGRICULTURE <input type="checkbox"/> French |
| <input type="checkbox"/> Window Trimmer | <input type="checkbox"/> POULTRY RAISING <input type="checkbox"/> Radio |

Name..... Occupation..... Business & Employer..... Address.....

Street and No..... City..... State.....

Canadians may send this coupon to International Correspondence Schools Canadian, Limited, Montreal, Canada

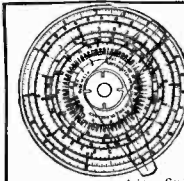

THE MIDGET SLIDE RULE instantly adds, subtracts, multiplies, divides, solves proportion, gives all roots and powers. Logarithms, Sines, Cosines, Tangents, Cotangents, Etc. Also gives decimal equivalents, letters and numbered drill and tap sizes. More than 110,000 sold, more than 2000 unsolicited testimonials. The Engine-divided scales are on white finished aluminum and are grease and waterproof. Diameter 4". Price with Instruction Book, \$1.50. Pocket Carrying Case, 50c extra. Cash or C. O. D. Catalogue free. Your money back if you are not satisfied. GILSON SLIDE RULE COMPANY, - NILES, MICH.

CONCERTINA--Plays by Rolls

Played by Anyone with-out Knowledge of Music



Pamphlets Free Postpaid Latest Music

CHARLES PITTLE & CO., New Bedford, Mass

Opportunity Ad-lets

YOU will find many remarkable opportunities and real bargains in these columns. It will pay you to read and investigate the offerings made every month by reliable firms, dealers and amateurs from all over the country. No matter what you may be seeking, whether supplies, automobile accessories, the opportunity to make money, or anything else, you will find listed here the best and most attractive specials of the month.

Advertisements in this section twelve cents a word for each insertion. Name and address must be included at the above rate. Cash should accompany all classified advertisements unless placed by an accredited advertising agency. No advertisement for less than 10 words accepted. Ten per cent discount for 6 issues, 20 per cent discount for 12 issues. Objectionable or misleading advertisements not accepted. Advertisements for the October issue must reach us not later than August 10th.

The Circulation of Science and Invention is over 150,000 and climbing every month

EXPERIMENTER PUBLISHING CO., INC., 53 Park Place, New York City, N. Y.

Advertisers

Interesting Advertisers, clubs, big savings. Pay when replies received. Spenceview Agencies, West Los Angeles, Calif.

Agents Wanted

Agents—Best seller; Jem Rubber Repair for tires and tubes; supercedes vulcanization at a saving of over 800 per cent; put it on cold. It vulcanizes itself in two minutes and is guaranteed to last the life of the tire or tube; sells to every auto owner and accessory dealer. For particulars how to make big money and free sample, address Amazon Rubber Co., Dept. 601, Philadelphia, Pa.

Big money and fast sales. Every owner buys gold initials for his auto. You charge \$1.50; make \$1.35. Ten orders daily easy. Write for particulars and free samples. American Monogram Co., Dept. 71, East Orange, N. J.

If I send you a Suit made in the latest style from the finest goods, will you keep it, wear it, and show it to your friends as a sample of my sensational \$23.50 suits guaranteed regular \$30.00 values? Could you use \$3.00 an hour for a little spare time? If so, write me at once for my wonderful new proposition. Just write your name and address on a card and mail to Dept. 350, Salesmanager, 153 So. Peoria St., Chicago.

\$60—\$200 a week. Genuine Gold Letters for store windows. Easily applied. Free samples. Liberal offer to general agents. Metallic Letter Co., 411 B., North Clark, Chicago.

\$10 daily silvering mirrors, plating and refinishing lamps, reflectors, autos, beds, chandeliers by new method. Outfits furnished. Write Gunmetal Co., Ave. D, Decatur, Ill.

Bankrupt and Rummage Sales. Make \$50.00 daily. We start you, furnishing everything. Distributors, Dept. 171, 609 Division, Chicago.

Wash clothes the new way. Use the Torrent Automatic Washer. You will be delighted. Special offer to one in each locality. Storm Royalty Co., 3602 Enright Ave., St. Louis, Mo.

Make Money Silvering Mirrors, refinishing auto headlights, tableware, metal plating, bed stands, chandeliers. Outfits furnished. International Laboratories, Dept. 69, 309 Fifth Ave., New York.

Over 100% Profit. Self Lighting Gas and Cigar Lighters. Everybody interested, repeat business. Sell individuals, dealers, subagents. Particulars FREE. S. I. Bernhardt, 127 West 30th, New York.

New Camera finishes regular black and white photographs inside camera quickly. Make money taking photos, selling cameras. Crown, 439 Canal, Dept. 510, New York.

Agents—New Plan, makes it easy to earn \$50.00 to \$100.00 weekly, selling shirts direct to wearer. No capital or experience needed. Represent a real manufacturer. Write now for FREE SAMPLES. Madison Company, 666 Broadway, New York.

Vaculite, supreme Auto Trouble Light. Vacuum base sticks anywhere. Greatest seller conceivable. Two dozen sales daily are easy and net you over \$1000 monthly. Literature free. Write, Vaculite Co., Santa Monica, Calif.

General Agents Wanted for marvelous Ford lubricator. Perfected by mechanical engineers of University of Washington. Energetic men with vision, first to apply, will reap big profits. Write Universal Lubricator, Lewiston, Idaho.

Salesmen Selling to Men. We have logical side line for you that will sell along with any other line you may now be handling and probably make more money for you, provided you are now selling to men. Get full facts at once by addressing Sales Manager, 850 West Adams, Dept. 918, Chicago.

Agents wanted. To sell Ray-O-Lite cigar and gas lighters. Big earnings. Sample 50c. Rapid Mfg. Co., 799-L Broadway, New York.

Agents: Mendez, Mendis all fabrics and hosiery. Mendez Mfg. Co., 520 N. 78 St., Birmingham, Ala.

Would you risk a 1c postal against the chance to make \$5 to \$15 daily during the next four months introducing an absolutely new line of Insured Hosiery—guaranteed 12 months. **YOUR PAY DAILY.** Monthly bonus extra. Magnificent sample outfit furnished. If so send name and address to Macabee Textile Company, Card 6708, Cincinnati, Ohio.

Real Selling Sensation! Tremendous earnings whole or part time! Patented Hot Water Bottle Invention needed everywhere. Big commissions. Extra bonus. We deliver. Write quick. CS19 Lobl Corn, Middleboro, Mass.

Agents: Be my partner. Make \$15.00 daily: ride in Chrysler closed car; show samples; distribute teas, coffee, spices, extracts, things people eat. This unusual offer to the first person answering in your locality. Write or wire Health-O-Quality Products Co., Dept. 30H, Cincinnati, Ohio.

Agents: Our new household cleaning device washes and dries windows, sweeps, cleans walls, scrubs, mops. Costs less than brooms. Over half profit. Write Harper Brush Works, 504-3rd St., Fairfield, Iowa.

Agents: 90c an hour to advertise and distribute samples to consumers. Write quick for territory and particulars. American Products Company, 6120 American Bldg., Cincinnati, Ohio.

Agents Wanted (Continued)

Steady income forming magazine clubs. Lists, literature, testimonials free. Spenceview Agencies, West Los Angeles, Calif.

Thaxly Formulas, Processes, Trade-Secrets produce perfect products. Latest, fast-selling specialties in all lines. Send for interesting catalog, circulars, money-back guarantee and "What Our Clients Say." D. Thaxly Co., Washington, D. C.

Gold Initials, easily applied on Automobiles. Biggest money-maker today. Cost 5c, you get \$1.50. No experience needed. Free Samples. "Raleco" Monograms, 1013 Washington, Boston, Mass.

Ten Dollars A Day. Six days a week selling McNeess Products. The repeat business does it. Qualify for Resident Manager and add as much or more to your own earnings. A Big Opportunity for a real worker. Write First-McNeess Co., 508, Sunlight Bldg., Freeport, Ill.

Airplanes, Aviation

Three foot flying model aeroplanes, 12 inch mounted propeller for 25c. Aero Shop, 3050 Hurbit Ave., Detroit, Mich.

Learn to Fly! Write for booklet. Robertson Aircraft Corp., Anklam, Mo.

Curtiss Pulitzer Racer construction set, including plans and genuine Curtiss Reed propeller \$1.00 postpaid. Special offer: Scientific airglider with ground launching device 50c postpaid. Curtiss plans 35c. S. E. V. 73c—Leoning 75c. Big catalog listing latest types of model airplanes, boats and supplies 5c. Phillips Company, 307 Wilson Ave., Brooklyn, N. Y.

—PROOF—

That Classified Advertising in
Science & Invention
Pays

Printing Presses. Machinery. Type. Paper. Cards
Supplies

THE KELSEY PRESS COMPANY

Meriden, Conn.

April 29, 1926

SCIENCE & INVENTION:
We have advertised under the name of The Press Co. in SCIENCE & INVENTION for quite a number of years. We check results very closely and we know that it is a profitable medium to use.

Yours very truly,
THE KELSEY PRESS CO.

—still another one

Magic Tricks Books Novelties

GOERGES PELTIER

58 Skeele Street, Willimansett, Mass.

SCIENCE & INVENTION:

Advertising in SCIENCE & INVENTION surely brings the desired results. I have been advertising for a few months in your magazine and, I am very satisfied.

Sincerely yours,
GOERGES PELTIER.

**See Rates at Top Opposite
Page Then Send Your Order.**

Automobile Owners

Put a Gold Monogram on your car. 10 cents per initial. State initials desired. Linden Specialty Co., 110 West 112th Place, Chicago, Ill.

Battle Photos and War Relics

For Dens: Relics Collected from Europe's Battlefields. Firearms, medals, helmets, etc. Illustrated catalogue and sample War photographs 25c. Lieut. Welch, 1889 Albany Ave., Brooklyn, N. Y.

Business Opportunities

Free Book. Start little Mail Order business. Pier, 996 Cortland Street, New York.

You can have a business-profession of your own and earn big income in service fees. A new system of foot correction; readily learned by anyone at home in a few weeks. Easy terms for training, openings everywhere with all the trade you can attend to. No capital required nor goods to buy, no agency or soliciting. Address Stephenson Laboratory, 18 Back Bay, Boston, Mass.

Stop Plodding! Be Successful. Operate a Tire Repair Shop. Make big profits in any locality. We teach you and furnish complete equipment \$100 up. Book of Opportunity free. Haywood's, 1312 South Oakley Avenue, Chicago.

Responsible Manufacturer wants competent men to manage office and salesman. \$300 to \$1500 necessary; will allow expenses to Trenton if you qualify. Address Manager, 536 Forst Richey Bldg., Trenton, N. J.

Make \$50-\$100 weekly. Spare or full time. 74 business plans, 500 trade secrets. \$1. Lavan Service, 20A, 241 West 22nd Street, New York City.

Stocks—Bonds, Domestic-Foreign, bought-sold. Dealers in all marketable securities. Frank X. Everett & Co., 20 Broad St., New York.

Succeed—Our twenty scientific processes put you wise. Excellent. 50c. No stamps. Holland, Box C-473, Astoria, Oregon.

There is big money making soap, Shoe polishes, Laundry bleach, Hair dyes, Tooth paste, Iron, China and Leather cements, How to engrave on steel, and many other dependable formulas. Full particulars how to make and sell. Can be made at home. 50 cents. No stamps. Ward, 1020, Trail, B. C., Canada.

Business Service

Representation in Washington, D. C., mail address. Manufacturers, Accountants, Patent Attorneys and others, write. Service 517 Kresge Bldg., Washington, D. C.

Chemistry

Experimenters, Chemical Apparatus—Radio catalogs. 1000 illustrations. Price 25c refunded on \$5.00 order. Laboratory Materials Company, 635 East 71st St., Chicago.

Radium salts priced to suit every experimenter's purse. Also carnotite and phosphorescent materials. Enclose nickel for descriptive price-list, refunded on \$5.00 order. S. Sayers, 10 Mansion Ave., Atlantic City.

Correspondence Courses

Used correspondence school courses. All kinds. Sold on repurchase basis. Big saving. Money back guarantee. Lists free. (Courses bought). Lee Mountain, Pisgah, Alabama.

Successful Speaking and Reading by famous Robert Downing (Shakespearean Actor). Complete course reduced from ten to five dollars cash. Limited time. Dietz Press, Richmond, Virginia.

Educational

Correspondence courses. All schools. Lowest prices. Terms, Catalog Free. Mention Subject. Fred Goetz, 440-H Sansome, San Francisco.

Be a Laboratory Expert. Earn \$300 to \$500 monthly. Study Microbiology, Sanitation, Day, Evening Classes. Diplomas, Degrees Granted. Free 71-Piece Outfit to Students. Write for Free Prospectus Today. International College of Microbiology, 7204 Grand Ave., Chicago, Ill.

Farms, Land, Etc.

Ozark Land; 10 acres near White River and proposed Dixie Lake, \$100, \$5 monthly. Asa Zimmerman, 1800 N. Fifth, Kansas City, Kansas.

For Ford Owners

Ford Owners, Distributors. Our Tinner Bracket raises timer up from grease and dirt. With wipe contact rotor \$3.50, 10 days' free trial. Croft Automotive Sales, Montpelier, Ohio.

For Inventors

Unpatented Ideas Can Be Sold. I tell you how and help you make the sale. Free particulars (Copyrighted). Write W. T. Greene, 808 Jenifer Bldg., Washington, D. C.

For Inventors (Continued)

Your Chemical problems solved and working process furnished for Five Dollars. Write me, W. Steidman Richards, Consulting Chemist, Box 2402, Boston, Mass.

Inventors—Get this pamphlet, "What to Invent." No theory or guess work, but things actually asked for by manufacturers. Sent prepaid for only \$1.00. Inventor's Syndicate, 22 Paladium Bldg., St. Louis, Mo.

U. S. and foreign patents, trademarks, moderate rates, 23 years experience. George C. Heinicke, 32 Union Square, New York, registered in U. S. and Canada.

For Sale

For Sale: Watchmakers' Lathe at a bargain. R. Jaegermann, 5815 Easton Ave., St. Louis, Mo.

Gift of Orient

Send "Flowers of Paradise" incense. \$1. Blossom Gift Shoppe, Southwest Bldg., Los Angeles, Calif.

Help Wanted

Silvering Mirrors, French plate. Easily learned, immense profits. Plans free. Wear Mirror Works, Dept. 35, Excelsior Springs, Mo.

Detectives Earn Big Money. Travel. Excellent opportunity. Great demand everywhere. Experience unnecessary. Particulars free. Write. American Detective System, 1974 Broadway, N. Y.

Be a Detective. Work home or travel. Experience unnecessary. Particulars free. Write. George Wagner, former Government Detective, 1968 Broadway, N. Y.

Firemen, Brakeman, Baggage-men. (white or colored), sleeping car, train porters (colored), \$150-\$250 monthly. Experience unnecessary. 897 Railway Bureau, East St. Louis, Ill.

\$300.00 per year for your spare time refinishing furniture, radio cabinets, etc. My simplified instructions tell how to get and do this easy profitable work. Write for the trade, formulas, etc. Price complete \$1.00 postpaid. F. L. Jackson, 716 W. Exchange, Owosso, Mich.

\$95.00 to \$250.00 Month. Men-women 18 up. U. S. Government Jobs. Steady work. Life positions. Short hours. Paid vacation. Common education sufficient. 32 page book with sample coaching and full particulars—Free. Write today sure Franklin Institute, Dept. W19, Rochester, N. Y.

All men-women, 18 to 60, wanting to qualify for Government Positions, \$140-\$250 monthly. Local or traveling, write. Mr. Ozment, 294, St. Louis, Mo.

Insects Wanted

Why Not Spend Spring, Summer and Fall gathering butterflies, insects? I buy hundreds of kinds for collections. Some worth \$1 to \$7 each. Simple outdoor work with my instructions, pictures, price-list. Send 10 cents (not stamps) for my illustrated Prospectus before sending butterflies. Mr. Sinclair, Dealer in Insects, Dept. 41, Box 1424, San Diego, Calif.

Machinery and Tools

Concrete Building Block Machines and Molds. Catalogue free. Concrete Machine Co., 5 N. First St., St. Louis, Mo.

Magic and Games

Free with \$25 order our large die box. Send 20c for our large catalogue of tricks, puzzles, wigs, sensational escapes. Oaks Magazet Co., Dept. 549, Oshkosh, Wis.

Books—Magic, Mysteries, Magic Tricks, Novelties, Catalogue Free. Singer, 200, Hancock, Wis.

Magic Tricks, Puzzles, Books, Catalog Free. Interesting magic novelty. 10 cents. Z. Burdick, Hart, Mich.

Learn to entertain! New book explains all forms of mystery entertaining. \$1.00. "Clayton," 7605 Linwood Ave., Cleveland, Ohio.

Manufacturer Wanted

"S. O. S." Game. Wanted manufacturer produce and market, royalty basis. E. M. Wrightson, Ashland Place, Mobile, Ala.

Manufacturing

To Order—Mechanical work, all branches. Models. Experimenting. Quantity production. Parma Engineering Works, Brooklyn Station, Cleveland, Ohio.

Manuscripts Wanted

Earn \$25 weekly, spare time, writing for newspapers, magazines. Experience unnecessary. Details Free. Press Syndicate, 987, St. Louis, Mo.

Miscellaneous

Beautiful registered bull pups \$15. Bulldogs, 501 Rockwood, Dallas, Texas.

Catch From 45 to 60 foxes in from 4 to 5 weeks' time; can teach any reader of this magazine how to get them. Just drop me a card for particulars. W. A. Hadley, Stansstead, Quebec, Canada.

Miscellaneous (Continued)

Gears and Model Supplies of every description. Catalog 5 cents. Experimenters Supply House, Box 10, Station V, New York City.

Fool your friends. 10 Maine cards 3 dimes. Return to me stamped, addressed to friends, for mailing here. B. K. Bentzen, Box 1081, Portland, Me.

Art Photos 4—\$1.00. Ben Meyer, 35 West 31st New York.

Mr. Manufacturer, layman or veteran—Side Dump Scrap-er Hoist, loads wagons, does ditching. E. B. Hawkins, Applegate, Ore.

Three Collection Letters That Actually Collect; product, 23 years' experience, \$2.50. Address J. A. Hillsman, Lynchburg, Va.

Bargains. Big envelope full 10c. Joachim Valigorski, Cohoes, N. Y.

Motorcycles—Bicycles

Don't buy a Bicycle Motor Attachment until you get our catalogue and prices. Shaw Mfg. Co., Dept. 6, Galeburg, Kansas.

Musical Instruments

Violins—Deep, Mellow, Soulful—on easy credit terms. High grade, wonderful instruments of my own make. Development of many years' experience. Write for book. Gustav A. Henning, 2424 Gaylord St., Denver, Colo.

Old Coins

California Gold, quarter size, 27c; half-dollar size, 53c. Columbian nickel and catalogue, 10c. Norman Shultz, Box 146, Colorado Springs, Colo.

German Govt. Bond, 100,000 Mk. 1923 \$1.40, 5,000,000 Mk bond 1924 \$1.50, 100,000 Mk. bill and catalogue 10c. Norman Shultz, Colorado Springs, Colorado.

Bargains in Commemorative Half Dollars. Lincoln, \$1.33; Pilgrim, \$1.29; Alabama, \$1.13; Maine, \$1.33; Monroe \$1.19; Husenot, \$1.33; Lexington, \$1.09; California, \$1.23; Vancouver, \$1.23; Earle Cent and bargain price list 10c. Marey, Box 483, Muskogee, Oklahoma.

Old Money Wanted

\$2 to \$500 Each paid for hundreds of Old or Old Coins. Keep all old money, it may be very valuable. Send 10c for new illustrated Coin Value Book, 4x6. Guaranteed Prices. Get Posted, We pay Cash. Clarke Coin Company, 14 Street, LeRoy, N. Y.

Patent Attorneys

Patents. Send for free booklet. Highest references. Best results. Promptness assured. Send model or drawing for examination and opinion. Watson E. Coleman, Patent Attorney, 641 G Street, N. W., Washington, D. C.

Unpatented Ideas Can Be Sold. I tell you how and help you make the sale. Free particulars (Copyrighted 1924). Write W. T. Greene, 809 Jenifer Bldg., Washington, D. C.

Get your own patents. Application blanks, complete instructions \$1. Cutting Bros., Cambell, Calif.

Patents. Time counts in applying for patents. Don't risk delay in protecting your ideas. Send sketch or model for instructions or write for Free book, "How to Obtain a Patent" and "Record of Invention" form. No charge for information on how to proceed. Communications strictly confidential. Prompt, careful, efficient service. Clarence A. O'Brien, Registered Patent Attorney, Security Bank Building (directly across street from patent office), Washington, D. C. See page 359.

Patents Procured; Trade Marks Registered—A comprehensive, experienced, prompt service for the protection and development of your ideas. Preliminary advice gladly furnished without charge. Booklet of information and form for disclosing idea free on request. Richard B. Owen, 129 Owen Bldg., Washington, D. C., or 41-T Park Row, New York.

Patents: Trade-Marks. Ten years experience in Patent Office. Consultation invited. Booklet. Geo. Deeler, 2001, 150 Nassau St., New York.

Patent-Sense—As one of the oldest firms in America we give inventors, at lowest consistent charge, a service noted for results, evidenced by many well-known Patents of extraordinary value. Book, Patent-Sense, free. Lacey & Lacey, 64 F St., Washington, D. C. Estab. 1899.

Millions spent annually for ideas. Hundreds now wanted! Patent yours and profit! Write today for free booklet: how to protect yourself, how to invent, ideas wanted, how we help you sell, etc. American Industries, Inc., 242 Kresge Bldg., Washington, D. C.

Patents—Send for form "Evidence of Conception" to be signed and witnessed. Form, fee schedule, information free. Lancaster and Alwine, Registered Patent Attorneys in United States and Canada, 242 Ouray Bldg., Washington, D. C.

Monroe E. Miller, Ouray Bldg., Washington, D. C. Patent Lawyer, Mechanical, Electrical Expert. Booklet and priority record blank gratis.

Patents: My fee in installments. Frank T. Fuller, Washington, D. C.

Richard E. Babecek, Patent Lawyer, Washington Loan & Trust Bldg., Washington, D. C. Booklet.

"Inventor's Advisor," the valuable Patentbook with 129 Mechanical movements and Illustrations, sent free upon request. M. I. Labiner, Patent Attorney, 3 Park Row, New York.

Patents

Inventions commercialized. Patented or unpatented Write Adam Fisher Mfg. Co., 205 Enright, St. Louis, Mo.

Two Inventions—an automaton and a plaster paris process. Beware inventor's rights. William Haines, Habana, Cuba.

Photography

Send Us Your Films. We develop, print, enlarge. Careful attention to details that make superior quality pictures. Rolls developed 9c, prints 3c each, trial 6"x8" enlargement in folder 40c. Wellington Photo Services, Riverdale, Md.

Have you a Camera? Write for free sample of our big magazine, showing how to make better pictures and earn money. American Photography, 118 Camera House, Boston, 17, Mass.

Photoplays Wanted

\$\$\$ For Ideas. Photoplay Plots considered in any form. Write for free booklet. Universal Scenario Company, 223 Security Bldg., Western and Santa Monica Blvd., Hollywood, Calif.

Printing Outfits and Supplies

Print your own cards, stationery, circulars, paper, etc. Complete outfits \$8.85; Job Presses \$12, \$35; Rotary \$150. Print for others, big profit. All easy, rules sent. Write for catalog, presses, type, paper, etc. Press Company, A-3 Meriden, Conn.

Gummed Labels. Name and Address, 500, 2 lines 30c. 3 lines 50c. Catalogue, Eastern Label Co., Y, Clintonville, Conn.

Radio

A two dollar bill will bring you a 50H-40 MA Filter choke coil. Write for list. Radio Parts Sales Co., Box 24, Orange, N. J.

Salesmen Wanted

Salesmen: Go into business without investing a penny. No rent to pay. No stock to carry. Yet you make bigger profits than regular storekeepers. Write for facts at once. Address Dept. 518, Goodyear Chicago, Inc., 841 W. Adams St., Chicago.

Sells for \$9.75. Prints ad on wrapping paper, envelopes, etc. \$1.00 commission. Send 10c for sample work. Automatic Ad-Stamper, Joplin, Mo.

Take orders for coffee, sugar, flour, meats, canned goods, staple groceries, also paints, radio sets, tires, auto and tractor oils. No capital or bond required. We deliver and collect. Permanent business. Big pay. Write at once. Hitchcock-Hill Co., Dept. 83, Chicago.

Minutes Pay Dollars demonstrating wonderful three pound calculator. Details \$12.00. Work equals \$300 machines. Adds, subtracts, multiplies, divides automatically. Five year guarantee. Big demand; large profits, experience unnecessary. Write quick for liberal trial offer and protected territory. Lightning Calculator Co., Dept. W, Grand Rapids, Mich.

We have a line of goods for which every man in America is a prospect. It has everything any competing line has and something besides. It can be handled profitably by tailoring, shirt, hosiery, necktie, shoe, raincoat, and other salesmen new selling to men. For full facts, address Madison Bros., 135 So. Peoria, Dept. 13, Chicago.

\$100-\$200 weekly. Retailers live wire specialty. \$10 weekly guaranteed against cost. Reliable house. Guarantee dealers turnover or money back. Pay you to investigate. Appleton Novelty Co., Cedar Rapids, Iowa.

Song Poems

Song Poem Writers—Send for proposition. Ray Hibbeier, D24, 2401 N. Keystone Ave., Chicago.

Song Poem Writers: Stamp brings, "Song Writers Guide". Wm. Van Beaver, B24, 1239 Elm St., Green Bay, Wis.

Stammering

St-Stu-T-T-Tering and Stammering Cured at Home. Instructive booklet free. Walter McDonnell, 105 Arcade, 1126 Granville Ave., Chicago, Ill.

Stop Stammering. All speech defects successfully corrected. Samuel Robbins, 399 Baylston St., Boston.

Stamps and Coins

Stamps 100 All Different 3 cents. S. I. Quaker Stamp Company, Toledo, O.

Typewriters and Ribbons

Used Typewriters, \$16.50 Guaranteed. Ribbons 3 for \$1.00. Wm. Phelps, 4 Franklin Street, New York.

Ventriloquism

Ventriloquism taught almost anyone at home. Small cost. Send 2c stamp today for particulars and prof. Geo. W. Smith, Room 8-109, 125 N. Jefferson Ave., Peoria, Ill.

Wanted

Detectives Earn Big Money. Work home or travel. Experience unnecessary. Write. George Wagner, former Government Detective, 1968 Broadway, N. Y.

Radio's biggest, finest Call Book—and more

PRICE
50¢

JUNE
NUMBER

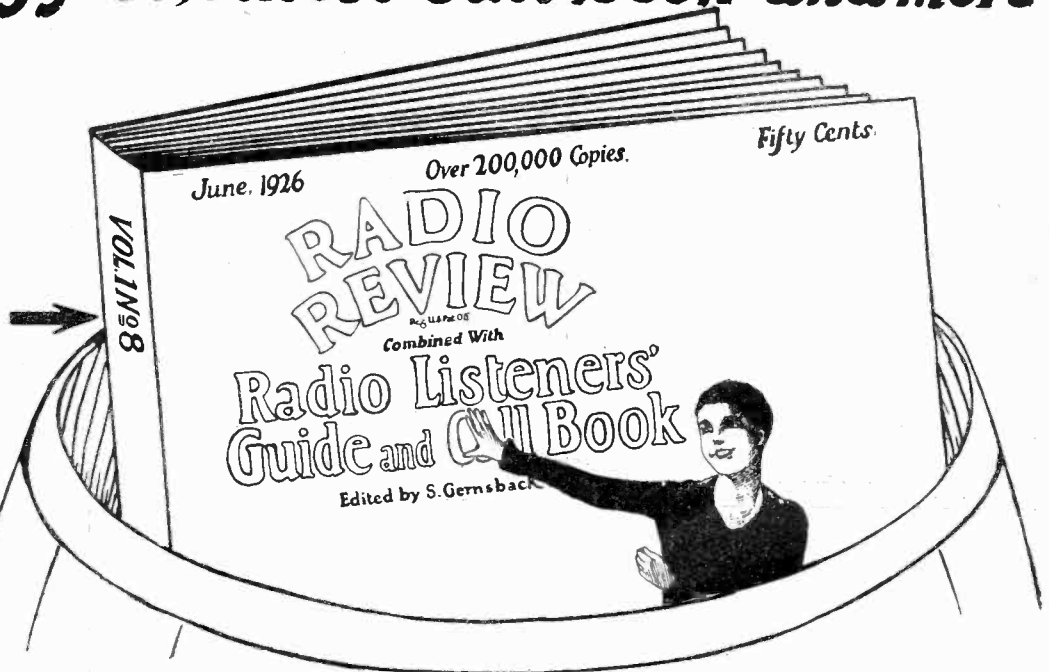

A Whole Barrellful of Useful, Valuable Information for Set Users

Don't operate your Radio Set in the dark. Here's a big magazine that gives you the name, the call letters, the power, the wave length, etc., of every Broadcast Station in the United States—and the hours they operate too. It gives plenty of new hookup information, General Radio information and carries in every issue a supplement of S. Gernsback's Radio Encyclopedia.

It is divided into four parts, each complete, authentic and up-to-the-minute.

The first part contains the finest and most up-to-date list of Broadcast stations obtainable—listed by Call Letters, Wave Length and cities, together with the broadcast schedule of each station for every day of the week. The book also lists all Canadian and Foreign Broadcast stations.

The second part of the magazine is devoted to articles of interest to the Radio Set Owner, giving him information on all subjects he ought to know, to

better understand the operation of his Radio Set.

The third part contains a great number of constructional articles to delight the fancy of the hookup fan on many modern receivers.

The fourth part contains a new supplement of S. Gernsback's Radio Encyclopedia, profusely illustrated and complete in every respect.

In all a tremendously valuable book to have on hand by every user of a radio receiver. The *Call Book* for ready reference to stations received. The *constructional articles* for data on your new set. The *Encyclopedia* for an intimate and authentic knowledge of Radio and the *Listeners' information* for first hand knowledge on how to care for your set and operate it properly.

This big June issue is now sold everywhere by 60,000 newsdealers and radio dealers. *Buy a copy NOW.*

Published and Distributed by

The CONSRAD COMPANY, Inc.

64 Church Street
New York, N. Y.

50¢—SOLD ON ALL NEWSSTANDS

Let These Guides

Solve Your Problems

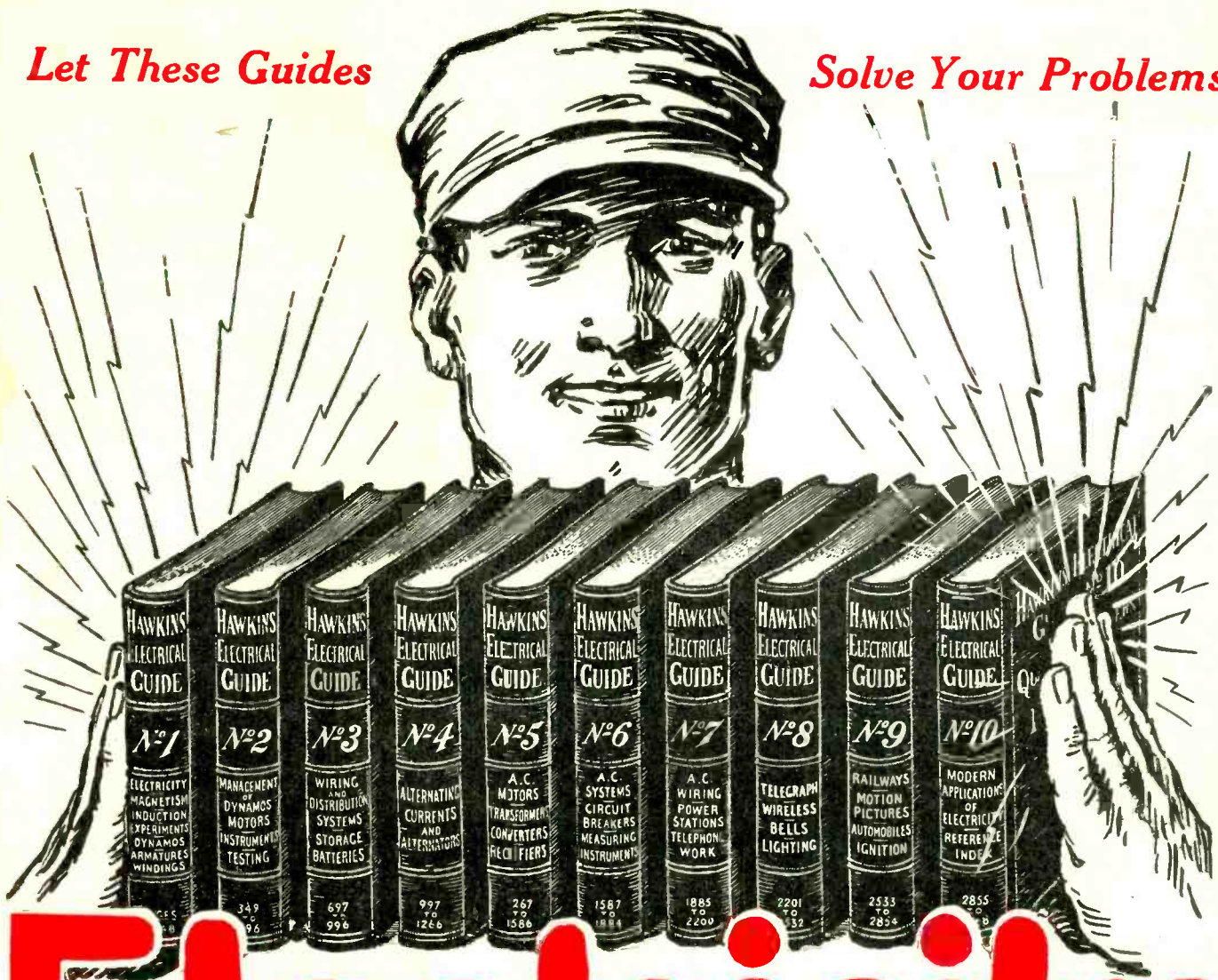

Electricity at your finger ends

HAWKINS ELECTRICAL GUIDES **IN TEN VOLUMES**

3500 PAGES
4700 PICTURES

\$1 A VOLUME
\$1 A MONTH

SEND NO MONEY—SEND ONLY THIS COUPON

Know the facts in Electricity. They mean more money and better position for you. Hawkins Guides tell you all you need to know about Electricity. Every important electrical subject covered so you can understand it. Easy to study and apply. A complete, practical working course, in 10 volumes. Books are pocket size; flexible covers. Order a set today to look over.

LEARN ALL ABOUT

Magnetism—Induction—Experiments—Dynamometers—Electric Machinery—Motors—Armatures—Armature Windings—Installing of Dynamometers—Electrical Instrument Testing—Practical Management of Dynamometers and Motors—Distribution Systems—Wiring—Wiring Diagrams—Sign Flashers—Storage Batteries—Principles of Alternating Currents and Alternators—Alternating Current Motors—Transformers—Converters—Rectifiers—Alternating Current Systems—Circuit Breakers—Measuring Instruments—Switchboards—Wiring—Power Stations—Installing—Telephone—Telegraph—Wireless—Bells—Lighting—Railways. Also many Modern Practical Applications of Electricity and Ready Reference Index of the ten numbers.

SHIPPED FREE

Not a cent to pay until you see the books. No obligation to buy unless you are satisfied. Send Coupon now—today—and get this great help library and see if it is not worth \$100 to you—you pay \$1.00 a month for ten months or return it.

THEO. AUDEL & CO.

65 West 23rd Street, New York City

Please submit me for free examination, HAWKINS ELECTRICAL GUIDE (Price \$1 a number). Ship at once prepaid, the 10 numbers. If satisfactory, I agree to send you \$1 within seven days and to further mail you \$1 each month until paid.

Name

Occupation

Employed by

Home Address

Reference

S. I. Aug

PRACTICAL EDUCATION IN ELECTRICITY

**Complete
in Three
Months**

Even the United States Government endorses S. of E. training. At right is shown huge generating unit made by the Nordberg Mfg. Co., for Panama Canal for which S. of E. students made the Acceptance Test by special request.



BOOK FREE—SEND COUPON

Great concerns want S. of E. men. Get ready in a few weeks of fascinating training for a big career in **ELECTRICITY!**

22 YEARS TEACHING THE ONE RIGHT WAY

DON'T WASTE another minute getting into the fascinating field of electricity. Never before has there been so many amazing opportunities. Electrical refrigeration, radio battery work, central stations, power plants, are combing the country for men with electrical training.



CHARLES P. STEINMETZ
"electrical wizard" of General Electric was for the last 42 years of his life on the Advisory Council of School of Engineering.

\$3200 AND UP with amazing opportunity for advancement awaits you in this most fascinating business of all. S. of E. training will prepare you in a few weeks time to step into a fine electrical job in a big corporation like General Electric, Western Electric, Commonwealth-Edison, Harnischfeger Corporation.

THE BIG CONCERNS are the ones who offer the big opportunities. And they prefer S. of E. men because 20 years experience has shown that they are the ones who succeed. The finest engineering talent available directs your work in classroom and laboratory. Our staff is not excelled. They are big men like Prof. John D. Ball, for six years assistant to Dr. Steinmetz, the electrical wizard.

THREE MONTHS FASCINATING training fits you to enter the big job with one of these concerns or go into business

for yourself. Thousands of opportunities exist in every section for men with a little training to do house-wiring, operate battery service stations, to do automotive electrical work. In three months time S. of E. training gets you ready for the amazing opportunity of a lifetime.

S. of E. MEN GET PREFERENCE

everywhere that men are hired for electrical work. For in nearly every electrical concern in America S. of E. men will be found holding big jobs. They are on the lookout to help you succeed when you come in. In one of the 10 largest American cities the 3 biggest electrical jobs are all held by S. of E. men. To be an

S. of E. man means prestige—preference!

ACT NOW BEFORE CLASSES FILL UP. Due to the enormous amount of personal attention given to each man, S. of E. classes fill up rapidly. Employers ask first for the S. of E. man. We suggest immediate action to avoid disappointment.

SPECIAL BOOK NOW FREE— Act! Clip and mail the coupon right away. A big 72 page book telling all phases of S. of E. training will be rushed to you. Get it by all means to help make up your mind. The most complete book on opportunities in electricity ever offered. **CLIP AND MAIL COUPON NOW!**

A PERSONAL CHALLENGE TO YOU

"Whatever your previous education our training will make you successful in Electricity! Put yourself in my hands for a few weeks and the big job is yours."

OSCAR WERWATH, Faculty President.



You will find and enjoy a different spirit among S. of E. Students than you find in the "trade schools." Good times are mixed with work. Fraternities, daily broadcasting from Station WSOE. Above is photo of the student band. Below one of Milwaukee's famous beaches. Enjoy a real summer in a real lakeside city. Boating, bathing, etc.



SCHOOL of ENGINEERING of Milwaukee
Founded 1905 Dept. 9C 415-17 Marshall St., Milwaukee, Wis.

SCHOOL OF ENGINEERING OF MILWAUKEE
Dept. 9C 415-17 Marshall St., Milwaukee, Wis.

Without obligating me in any way, please mail free 72-page illustrated book, "Electricity and the One Best Way to Learn It," and particulars regarding the course I have marked with an X.

.....Commercial Electrical Eng.Armature Winding
.....Elec. Eng. B. S. Deg. in 3 yrs.Light, Heat, Power Wiring,
.....ElectrotechnicsTesting
.....Junior Electrical Eng.Practical Electricity
.....Automotive ElectricityHome Laboratory Service
.....Radio Sales, Service and BroadcastingI am interested in your "Earn While You Learn" Plan

Name..... Age.....
Address.....
City..... State.....
Education.....