

November

THE NEW

25 Cents

Science and Invention

IN PICTURES

HEARING THROUGH
YOUR TEETH

WITH THE OSOPHONE

See Page 649

IN
PRIZES
\$12,000.00
FOR
PICTURES

*See Page
636*

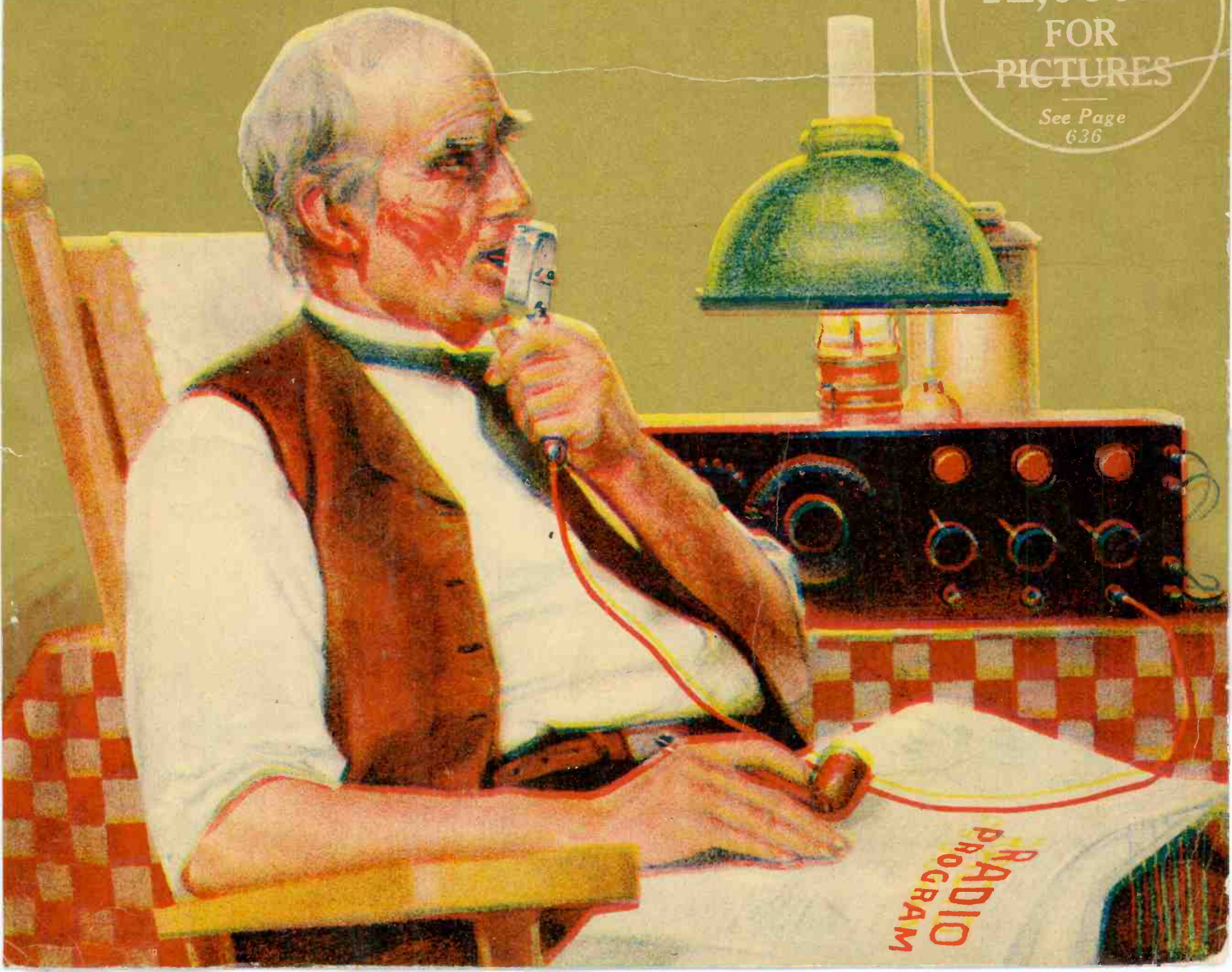

**YOU
can boss
this job**

*Put yourself
in this man's place*

**Earn \$75 to \$200 a week
as an Electrical Expert**

YOU can do it! Electricity is the biggest, fastest growing industry in the world today. Hundreds of millions of dollars being spent in development yearly! Millions of dollars to be paid for TRAINED BRAINS. A big, high-pay job waiting for you just the minute you are ready. Earnings of \$15 to \$35 and up per day by trained electrical experts are common.

Independence and Success for You in Electricity

Don't plod along on low pay, futureless work when the magical field of Electricity beckons. We train you quickly at home for big-pay electrical construction and service jobs and guarantee your success.

Thousands of men starting Electrical Contracting, Electrical Specialty, Radio or Automotive Electrical businesses "on a shoestring" are becoming wealthy. You can do it, too! We will help you do it. Resolve now to get in on the ground floor in the beginning of the great Electrical Age.

Send for Our Big 64-page Illustrated Book on Electricity

Learn all about the Associated Electrical Engineers—the most remarkable Electrical Training Organization on earth. Not a mere school, but a great National Organization of real Electrical Experts and Specialists. As a member of the Associated Electrical Engineers you will get the finest, most complete and easily mastered electrical training on earth right at home, in your spare time. And in addition we help you to "cash in." We show you how to make big money on the side while learning; how and where to find and hold the big money electrical jobs; how to establish your own electrical business without capital. We stand squarely behind you until you have made a BIG SUCCESS.

You Have Education Enough

You do not need a high school or college education to make a big success in Electricity by our EXCLUSIVE and COPY-RIGHTED method. We start you right "off the ground" and build you up into the big-money class of Electrical Experts.

A Wonderful Experimental Outfit FREE

You start on practical work with our big FREE working outfit of electrical appliances, so you are not delayed in getting into actual money-getting work. Associated Electrical Engineers Training includes the complete courses in RADIO and AUTOMOBILE ELECTRICITY—the best to be had anywhere—given under the direction of

SPECIALISTS, who show you how to make big money in these limitless fields.

Backed by a Legal Guarantee of Satisfaction

You get back every penny of the small membership fee you pay if you are not thoroughly satisfied when you finish your training. We both must make good before it is a deal.

Mail the Coupon NOW

No matter what you are thinking of doing to increase your earning power and insure your success, YOU OWE IT TO YOURSELF to investigate the great Electrical Field and the WONDERFUL MESSAGE WE HAVE FOR YOU. Our big illustrated 64-page book on Electricity is FREE! Send for it NOW.

**Opportunity's
wide-open door**

Send for Our 64-page Book Today

ASSOCIATED ELECTRICAL
ENGINEERS of AMERICA

Dept. C-1, 537 South Dearborn Street
Chicago, Illinois

Without any obligation, please send me FREE, your 64-page book on Electricity and full details of how I can make big money as a member of the Associated Electrical Engineers.

Name _____

Address _____

Associated Electrical Engineers

Dept. C-1 537 S. Dearborn Street, Chicago



Makes Sensational Advance in Teaching Electricity

The achievement of Chief Engineer Smith, of the S. & H. Electrical Works, Chicago, is a great step forward in fitting men for the big jobs in electricity. He has invented the Shop Type Training System of teaching actual shop practice of electricity right in your own home. Mr. Smith is turning out expert electricians in an amazingly short time and by a brand new method that makes it the most fascinating study in the world.

Fits Men for \$3,000 to \$10,000 Jobs By New Plan of Home Training

IT is now made possible for an average man, regardless of education or experience, to be trained for the really big pay jobs in electricity. Everyone knows that a man must know shop methods to fill an electrical job. He must have the real practical experience such as our Shop Type System of Home Training gives him. At the end of this course he can be the confident, efficient electrical man at home in the largest electrical plant. He is trained, experienced and fitted to step in where a man of authority and responsibility is needed to direct others. No wonder the electrical men are uniting in praise of Mr. Smith's accomplishment. Electricity needs these Shop Type trained men and jobs are waiting that pay all the way from \$3,000 to \$10,000 a year and even higher.



Men Needed

You can easily realize why Mr. Smith has constant requests for men trained by this new method. An employment service has been developed to take care of this demand, and this service is given free to S. & H. graduates.

Never before has there been such an opportunity offered to get into the big pay field of electricity—that fascinating work that lifts men above the common rut, pays them big salaries, sends them to the most interesting parts of the world, gives them an unlimited opportunity for advancement and a place in the affairs of the world.

Mr. Smith has made it all so easy. You can easily qualify by spare time study in a few short months. Everything is so thoroughly explained and so wonderfully illustrated by original cuts, pictures, diagrams, plans and designs—and Mr. Smith's own personal supervision is so thorough—that you cannot help but grasp every step of the work. Mr. Smith is so anxious that every ambitious man who really wants to learn electricity be given the opportunity that this course is offered at no advance in cost over the older methods.

Every Branch of Electricity

No matter what phase of electricity you want to learn or what field you expect to enter, you will find it in S. & H. Shop Practice of Home Study. You are taught all types of electrical work, such as house wiring (paying \$3.00 a day up); central and sub-station operating and maintenance (\$2,500 to \$10,000 a year); automobile and tractor start, lighting and ignition (\$35.00 to \$85.00 per week); electrical jobs and battery station service (\$40.00 a week to \$10,000 a year). You are taught motor maintenance, armature winding, illuminating engineering and lighting construction. You are fitted to start right out and make good at any of these jobs. Best of all you are fitted for the big pay jobs at the top of your profession.

FREE OUTFIT

To all who send the coupon below at once, Mr. Smith is now offering free a complete outfit of S. & H. Shop Type electrical apparatus, instruments and appliances for experimental and practical home shop work. By sending the coupon below you will be entitled to this offer—but you must send it immediately. You do not want to lose a day's time in taking this Shop Type

Training and equipping yourself for electrical work, and when you enter this profession you cannot afford to be without the prestige and backing of the S. & H. Electrical Works, where we actually do all the things which we teach you. Now is the time to act—don't take a chance to lose this big free offer. Get the information that will open a wonderful career to you. Mail the coupon now for big free book, "How to Get the Better Job in Electricity."

S. V. SMITH
S. & H. Electrical Works

Dept. N-2, 1422 W. Monroe Street,
Chicago, Ill.

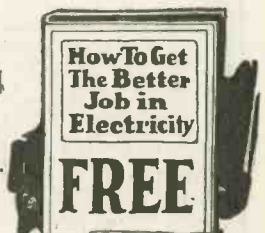

S. & H. ELECTRICAL WORKS,
Dept. N-2, 1422 W. Monroe St.,
Chicago, Illinois.

Please send me free electrical book and full particulars of your course of Shop Type Training in practical electricity and full details of your free offer to those who enroll now. I understand this is free of charge and does not obligate me in any way.

Name

Address

City State

Vol. XI
Whole No. 127

Science and Invention

November, 1923
No. 7

FORMERLY
ELECTRICAL EXPERIMENTER

PUBLICATION OFFICE: 542 Jamaica Ave., Jamaica, N. Y.
EDITORIAL & GENERAL OFFICES: 53 Park Place, New York City
Published by Experimenter Publishing Company, Inc. (H. Gernsback, Pres.; S. Gernsback, Treas.; R. W. DeMott, Sec'y).
Publishers of SCIENCE AND INVENTION, RADIO NEWS, and PRACTICAL ELECTRICS

Table of Contents for November

POPULAR SCIENTIFIC ARTICLES		PRIZE CONTESTS	
EDITORIAL	631	\$12,000 OR MORE IN GOLD	636
ELECTRIC FINDER SALVAGES \$30,000,000 IN GOLD	632	\$50.00 PRIZE CONTEST—PSYCHIC MOTOR	651
EARTHQUAKES AND THEIR CAUSES	633	HOW-TO-MAKE-IT DEPARTMENT — \$30.00 IN PRIZES	667
By Edward H. London.		WRINKLES, RECIPES & FORMULAS—\$5.00 MONTHLY PRIZE	668
HOW ARTIFICIAL PEARLS ARE MADE	634	SCIENTIFIC HUMOR—PRIZES FOR BEST JOKES	682
By Ismar Ginsberg, B.Sc., Chem. Eng.			
PARLOR MOVIE MACHINE FITS ON YOUR PHOTOGRAPH	635		
MOVING OBJECTS ON STILL SCENES	636	AUTOMOBILES	
\$12,000 OR MORE IN GOLD PRIZES	636	AUTOMOBILE SLED—NON-SINKABLE BOAT	640
ANTIQUÉ ORGANS	637	AIDS TO THE MOTORIST	658
By Charles Beecher Bunnell.		MOTOR HINTS — NO. 1 — HOW CARBURETORS WORK	
MEDICAL HOKUM EXPOSED	638	By Tom C. Plumridge, Automotive Expert.	
By Joseph H. Kraus, Staff Medical Expert.			
WORLD'S ENERGY FROM ATOMIC FORCE	639	ELECTRICITY	
WEIRD DEATHS FROM STRAY CURRENTS	639	ELECTRIC FINDER SALVAGES \$30,000 IN GOLD	632
AUTOMOBILE SLED—NON-SINKABLE BOAT	640	HEARING THROUGH THE TEETH	649
CAN YOU BE A MOVIE STAR?	640	By H. Gernsback.	
THE NEWEST RADIO PHOTO-PLAY	641	TYPEWRITING BY WIRE	656
AROUND THE UNIVERSE—5th INSTALLMENT	642	HOW TO MAKE A SHORT LINE TELEPHONE	665
By Ray Cummings.		By T. W. Heine.	
DR. HACKENSAW'S SECRETS—NO. 23—WHAT DR. HACKENSAW FOUND ON THE MOON	644	RADIO ARTICLES	
By Clement Fezandé.		RADIO OPERATORS LEARN CODE WHILE ASLEEP	669
HEIGHT TEST FOR AVIATORS	646	RADIO AND LOUD-SPEAKER IN BOYS' CAMP	670
SKY-WRITING—AN EXACT ART	647	FIGHT RETURNS TO ARGENTINE BY RADIO	671
By W. B. Arvin.		By H. Winfield Secor.	
ELECTRICALLY DRIVEN FERRYBOAT	648	RADIOPHONE ON FRENCH TRAINS	673
CAMERA USED TO JUDGE HORSE RACES	648	By A. N. Mirzaoff.	
HEARING THROUGH THE TEETH	649	BROADCAST RELAY ON 100 METERS	674
By H. Gernsback.		By Howard Allen Duncan.	
ARMY AIRPLANE REFUELS IN FLIGHT	650	GOOD SINGLE CIRCUIT RECEIVER	675
HOW RUBBER ARTICLES ARE MADE	650	COCKADAY FOUR-CIRCUIT TUNER	676
By Ismar Ginsberg.		By Leroy Western.	
SHEET METAL AIR PROPELLER	651	AN EXPERIMENTAL CIRCUIT PANEL	677
\$50.00 PRIZE CONTEST—PSYCHIC MOTOR	651	By R. D. B. Washburne.	
OFFICE EQUIPMENT OF ANCIENT TIMES	652	HANDY "BOOTLEG" TUBE SLEUTH	677
By Charles B. Bunnell.		CRYSTAL DETECTORS	678
BITING FLIES THAT SPREAD DISEASE	653	By A. P. Peck.	
COMPRESSED AIR IN BUILDING CONSTRUCTION	653	RADIO FOR THE BEGINNER—ONE WIRE AERIALS	679
By Raymond Wardell.		By Armstrong Perry.	
COMPRESSED AIR IN SUBWAY OPERATION	654	RADIO ORACLE	680
By R. H. Tingley.		RADIO WRINKLES—Edited by A. P. Peck	700
MONSTER ARMY TANK DESTROYER	655	CONSTRUCTOR ARTICLES	
By S. D. Rockenbach, Commandant U. S. Army Tank School.		HAND-PROPELLED ICE SKIFF	663
GOLD-LEAF—HOW IT IS MADE	656	SOME INTERESTING FOUNTAINS	664
POPULAR ASTRONOMY—STAR MAP FOR NOVEMBER	657	HOME-MADE LABORATORY APPARATUS	664
By Isabel M. Lewis, M.A., of the U. S. Naval Observatory.		CHEMISTRY ARTICLES	
AIDS TO THE MOTORIST	658	EXPERIMENTAL ELECTRO-CHEMISTRY	661
MAGIC FOR EVERYBODY—NO. 8 OF A SERIES	659	By Raymond B. Wailes.	
By Prof. Joseph Dunninger.		PERFUME MAKING FOR AMATEURS AND HOW TO RESTORE DRY BATTERIES	666
POPULAR SCIENTIFIC ERRORS	660	By Raymond B. Wailes.	
By Raymond B. Wailes.		ASTRONOMY ARTICLES	
EXPERIMENTAL ELECTRO-CHEMISTRY	661	POPULAR ASTRONOMY—STAR MAP FOR NOVEMBER	657
By Raymond B. Wailes.			
EXPERIMENTS WITH SPAR CRYSTALS	662		
By O. Ivan Lee.			

HOW TO SUBSCRIBE FOR "SCIENCE AND INVENTION." Send your name, address and remittance to Experimenter Publishing Co., 53 Park Place, New York. Mention the name of the magazine you are ordering. We also publish RADIO NEWS and PRACTICAL ELECTRICS. RATES AND TERMS. The subscription rate for SCIENCE AND INVENTION is \$2.50 per year. (12 numbers.) When remitting do so by check, money order or registered letter, if cash is enclosed. Avoid sending cash through the mail if possible. Subscriptions for less than one year are not accepted. Subscriptions may be made in combination with RADIO NEWS or PRACTICAL ELECTRICS with considerable saving. Send postal for special rates. Subscriptions start with the current issue, unless otherwise ordered. POSTAGE. We prepay postage in all parts of the United States, Mex-

SCIENCE AND INVENTION is published on the 25th of each month. There are 12 numbers per year. Subscription price is \$2.50 a year in U. S. and possessions. Canada and foreign countries \$3.00 a year. U. S. coin as well as U. S. Stamps accepted (no foreign coin or stamps). Single copies, 25 cents each. A sample copy will be sent gratis on request. Checks and money orders should be drawn to order of EXPERIMENTER PUBLISHING CO., Inc. If you change your address notify us promptly, in order that copies are not misrouted or lost.

All communications and contributions to this journal should be addressed to Editor, SCIENCE AND INVENTION, 542 Jamaica Avenue, Jamaica, New York, or 53 Park Place, New York City, N. Y. Unaccepted contributions

New York City.
General Advertising Dept.,
53 Park Place.

Western Advertising Representatives,
Finucan & McClure,
720 Cass St., Chicago, Ill.

Pacific Coast Advertising Representatives,
A. J. Norris Hill Co.,
Hearst Bldg., San Francisco, Calif.

Kansas City Advertising Representative,
George F. Dillon,
Republic Building, Kansas City, Mo.

and island possessions. For foreign or Canadian subscriptions we require 50 cents in addition to the subscription price for additional postage charges.

CHANGE OF ADDRESS. Notify us as far in advance as possible. It requires several weeks to make an address change on our records. Always write clearly, giving your old address as well as your new.

ON EXPIRATION of your subscription we enclose a renewal blank in our last number to you and notify you otherwise. Unless we receive your order for a renewal, with your remittance, we stop our delivery to you on expiration.

COMMUNICATIONS to us should always bear your full name, address and when possible the number which appears on your wrapper every month."

cannot be returned unless full postage has been included. ALL accepted contributions are paid for on publication. A special rate is paid for novel experiments: good photographs accompanying them are highly desirable.

SCIENCE AND INVENTION. Monthly. Entered as second-class matter at Jamaica, N. Y., Post Office, under act of Congress of March 3, 1879. Title Registered at the Patent Office. Copyright, 1923, by E. P. Co., Inc., New York. The Contents of this Magazine are copyrighted and must not be reproduced without giving full credit to the publication.

SCIENCE AND INVENTION is for sale at all newsstands in the United States and Canada; also at Brentano's, 37 Avenue de l'Opera, Paris. Member of the Audit Bureau of Circulation.

How much money do inventors make—or lose?

Raymond Francis Yates

American Society of Mechanical Engineers
 American Institute of Electrical Engineers
 Institute of Radio Engineers
 American Physical Society

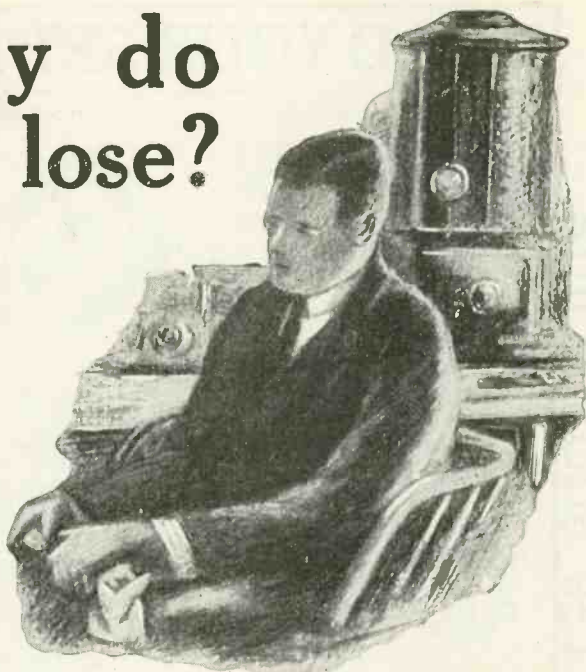

OVER 70,000 patents were allowed in this country last year, but only about 3500 had any real commercial value. Most of the 3500 practical inventions were developed by professional inventors, while most of the impractical inventions were the work of "free-lance" inventors—men and women who suddenly decided that they had an idea for an invention, and immediately set about to perfect it.

Of course there must be some reason why the trained inventor is so uniformly successful in his inventions, while the untrained inventor so often fails. Probably the greatest cause is that most people believe invention to be a "hit or miss" proposition—an out-and-out gamble. That is why so many would-be inventors waste years of effort, eat deep into their savings to work on inventions which can never bring them a penny, why still others who do produce worthwhile inventions lose their rights in them or receive only a pittance for their hard work.

However, Inventive Science is easy to learn, because everybody—every man, every woman—is born with the inventive instinct. You will understand better what I mean when you realize that an invention is only a device which "fixes" or improves something.

All inventions are made just this way. First some need is seen and recognized—new amusements, better light, better power, cheaper transportation, better automobile accessories—any one of a thousand needs which are impressed upon you every day. The next step is to find some idea which will answer the need—either through some mechanical, physical or chemical law. Finally comes the actual work of invention where you develop your ideas along the simple, exact lines of Inventive Science, and then protect and market your invention for your greatest profit.

who wants to invent can take advantage of a remarkable new course, devised by fifteen of America's inventors (I am one of them), which shows the right way to practical, successful invention. For the first time, the laws of invention used by Edison, Marconi, Sperry, De Forest and every other great inventor are explained in such simple, easy-to-learn language that everybody can learn to use them.

No longer is it necessary to spend years in useless effort learning the simple secrets which make invention easy. No longer need you waste time on inventions which will never bring you a penny. No longer need you be the victim of unscrupulous persons because you don't know how to protect your rights.

In a fascinating, easy course of 25 "common sense" lessons you are told how to look for ideas for practical money-making inventions, and where they are most likely to be found. You are informed how to develop these ideas quickly and at the least expense. You learn how successful inventors work, the materials they use, where and how they collect their information, the short-cuts they use.

Most important of all you learn how to keep records of your invention to prove priority of origin, how to get patents in the United States and in foreign countries, how to select and deal with patent attorneys, how to protect your patent rights. Finally you are told about that part of Inventive Science which finally makes for success or failure. You are given hints as to the best way to dispose of your patents—how to sell it outright or on royalty, how to organize a company or form a partnership to properly sell your invention so you will get greatest protection and make greatest profits.

All these facts and hundreds of others have been learned by other inventors only after paying a terrific price in long years of uncessing labor, of discouragement and of failure. Now you can get them, without effort, without discouragement or failure, in just a few minutes each day through this absorbingly interesting home-study course.

Everything Explained in New FREE Book

A wonderful book has just been written explaining this course in further detail. If you are genuinely interested, write for it today, and it will be sent to you free. Learn more about this new course in Inventive Science. Find out how you can learn the secrets of successful invention in a remarkably short time, right in your own home. Learn how you can become an inventor, how you can turn a simple little idea into a fortune. It doesn't cost you a penny, so mail the coupon now. The Bureau of Inventive Science has no connections with patent attorneys, manufacturers or promoters. Its only purpose is to give ambitious men and women the facts which help them make invention pay.

BUREAU of INVENTIVE SCIENCE
 Dept. 711, Wisner Bldg., Rochester, N.Y.

Bureau of Inventive Science, Dept. 711
 Wisner Bldg., Rochester, N. Y.
 Please send me your free book, "The Science of Invention."
 Name Age.....
 Address
 City State.....

What Invention Is

It doesn't require much thought to see that invention cannot be a matter of pure luck. Neither is it, as some people seem to think, something which only a genius can do. As a matter of cold fact, invention—successful invention—is nothing more or less than the careful, methodical use of certain fundamental facts, which anybody can learn easily.

It may seem strange to you that invention can be learned exactly as you learned reading, writing and arithmetic. Yet proof of this is easy. You will admit that if, as I have said, invention can be studied like any other profession—like mechanics, law, book-keeping, medicine—then those who do learn it should be able to produce many different kinds of inventions.

Of course you are familiar with Edison's inventions. Here are additional examples of less known inventors. Christopher N. Spencer first invented the breech-loading repeating rifle, which he followed by inventing the thread-spooler, the automatic turret lathe, the automatic screw-machine, the "pump action" repeating rifle. He was also part-inventor of the drop hammer. B. T. Babbitt, of soap fame, invented the process of wrapping and pressing laundry soap in cakes, besides inventing the first commercial baking powder, floating white soap, commercial chemicals, and several railroad devices. Henry Gaisman, inventor of the Auto-Strop Safety Razor, is also the inventor of the Autographic Kodak which he sold outright for \$300,000.

EDISON SAYS

Invention should be taught as a science

Could you ask the advice of any greater authority than Thomas A. Edison. Is there any other man in the world to whom you would rather go for advice than this master of invention? Listen to what he says: "INVENTION IS A SCIENCE AND SHOULD BE TAUGHT AS A PROFESSION."

And now, for the first time, you can actually learn invention as a profession. You can profit by Edison's advice. The Bureau of Inventive Science, founded by Raymond Francis Yates, together with fourteen other great inventors, now offers you the first course in practical invention ever devised for home study.



Raymond F. Yates, who with fourteen other famous inventors, now makes it easy for you to learn how to invent in your spare time at home.

More Inventions Needed Now

I said before that an invention is merely a device for satisfying some need, or improving some other device so that it will work better, faster or cheaper. And, because the world today needs vastly more things than it needed 500 years ago, the demand for inventions is so much more urgent.

It isn't necessary that you must invent something like the steam-engine to make money. Little inventions, such as the crimped hair-pin, the metal bottle-cap, the rubber tip on the pencil have all brought their inventors great fortunes. Gillette, it is reported, has received \$2,500,000 a year for his invention of the Gillette Safety Razor.

To show you what a little invention can bring you in real money, let me tell you the story of two very simple inventions. The man who invented the Kiddie-Kar (which he produced in his search for a new cheap amusement for his children) is now worth, it is said, more than \$5,000,000. Success Magazine, a few months ago, told the story of a woman who, bothered by a shaky table, fixed up a little wedge-shaped piece of wood. Out of that simple idea she developed an invention which has brought her amazing success.

It doesn't matter what work you do, what your education has been or where you live—you can learn to develop successful inventions. Like the man who invented the Kiddie-Kar you may win a fortune through some device to amuse your children. Even a new kind of kitchen knife to make your wife's work easier can make big money for you. Your daily occupation in the office, in the factory, on the farm; your experiences at home or traveling gives you thousands of ideas every day which can be completed as wonderful inventions. And remember that the world is waiting for more inventions now and will pay big money for even the simplest idea.

You Can Learn Invention at Home

Hitherto the average person has had little chance of success in invention, because he lacked the necessary instruction in the few essential points of Inventive Science. Now, however, everybody

How Inventions Are Made

That, you will agree, answers the question: "How much money do inventors make—or lose." If the inventor knows what he is doing, if he has studied the principles of invention and uses them, he is bound to make money. But if the would-be inventor merely takes a chance without any real thought of what he is doing or how to do it, the chances are a hundred to one that he won't make a cent.

BUILD YOUR SET BETTER-AT LOWER COST

BUILD YOUR SET WITH BARAWIK STANDARD RADIO GOODS

EXCEL 180° VARIOCOUPLER
E520 Each\$1.79

Properly designed and well made. Green silk windings on yellow genuine bakelite tubes. Primary has taps every 7 turns and last 6 turns tapped every turn. Cast aluminum support with producers best results in any type circuit for 175 to 625 meters.



SUPER 180° VARIOCOUPLER
E521 Each98c

A wonderful value. Produces excellent results. Green silk windings on black fibre tubes. Rigid mounting support for table or panel mounting. Primary tapped for fine tuning. 1/4 inch shaft. Range 200 to 600 meters.

E522 Variometer—same style. Each...98c



SUPERIOR VARIOCOUPLER
E523 Each\$3.15

A handsome instrument of superior design and construction. Stator tube and rotor ball of moulded red brown bakelite. Large size green silk windings insure highest efficiency. Table or panel mounting. 1/4 inch shaft. Superior results in circuits for 180 to 650 meters. Tapped primary for finest tuning. Noiseless contacts. E526 Special single circuit type...\$3.60



SUPER MOULDED VARIOMETER
E412 Each\$2.60

Polished black moulded rotor and stator forms. Maximum inductance with greatest efficiency and minimum distributed capacity. A high grade instrument that will get the best results. Wave length 180 to 600 meters.



EXCEL MOULDED VARIOMETER
E524 Each\$3.68

A wonderful value at our price. Properly designed and constructed. Polished black bakelite rotor and stator forms. Large size green silk wire insures greatest efficiency. 1/4 inch shaft. Noiseless pigtail connection. Table or panel mounting.



SUPERIOR VARIOMETER
E525 Each\$4.45

Forms moulded of red brown bakelite. A neat handsome instrument. Green silk windings calculated for highest efficiency. 1/4 inch shaft. Noiseless pigtail connections. Table or panel mounting. Produces superior results in any type circuit 180 to 650 meters.



RADIO INDUCTANCE COILS

Carefully made—fine looking coils. Highest efficiency. Low distributed capacity effect, low resistance—high self inductance. Very firm impregnation. Range given is in meters when used with .001 variable condenser. Mounted coils have standard plug mountings. Art. Not Art. Price

Turns	Range	No. Mtd.	No. Mtd.	Price
25	120-250	E301	\$0.39	E320 \$0.85
35	175-450	E302	.42	E322 .95
50	240-720	E303	.49	E323 1.02
75	390-910	E304	.54	E324 1.08
100	500-1450	E305	.58	E325 1.13
150	600-2000	E306	.63	E326 1.17
200	800-2500	E307	.72	E327 1.26
250	1300-3500	E308	.78	E328 1.35
300	1700-4500	E309	.82	E329 1.36
400	2000-5000	E310	.97	E330 1.57
500	2800-6100	E311	1.12	E331 1.63
600	4000-10000	E312	1.27	E332 1.78
750	5000-12000	E313	1.43	E333 1.93
1000	7800-15000	E314	1.70	E334 2.25
1250	9750-19500	E315	1.92	E335 2.45
1500	14500-26500	E316	2.18	E336 2.60

INDUCTANCE COIL MOUNTINGS

E340—3 Coil. Ea.\$3.40

E341—2 Coil. Ea.2.75

Sturdy, rigid durable construction. Made of polished black bakelite. Mount on front of panel.

BACK OF PANEL MOUNTING

Mounts back of panel, with knobs or dials on front of panel. Helps make a neat efficient set.

E342—3 Coil Back of Panel Mounting\$4.45

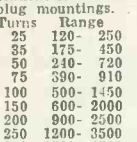

BRASS ROD

Supplied only in 8 inch lengths.

E961 Threaded 6-32, per 8 in. length 8c

E963 Threaded 8-32, per 8 in. length 8c

E965 Solid 3-16 in., per 8 in. length 6c

E967 Solid 1/4 in., 8 in. length... 9c

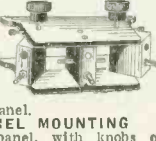

OUR SPECIAL VARIOMETER AND VARIOCOUPLER

Build into your set reliable instruments. You can depend on this variometer and variocoupler to give you the best results in any circuit working from 180 to 650 meters. In design and construction they are the best. Only the highest grade materials are used. The prices quoted save you 30 to 40 per cent. Why pay more?

E418 Variocoupler. Each.....\$2.45

The most efficient type of coupler, insures better tuning and louder signals. Primary and secondary wound on natural uncolored genuine bakelite tubes. Handsome green silk windings. Primary tapped for fine tuning. Can be panel or table mounted. 1/4 inch shaft.

E419 Variometer. Each.....\$2.10

Perfect in design and construction. Accurate wood forms thoroughly seasoned. Correct inductive ratios. Solid baked windings. Plenty of large sized wire insures highest efficiency. A durable high grade instrument that will give you lasting service. 1/4 inch shaft.

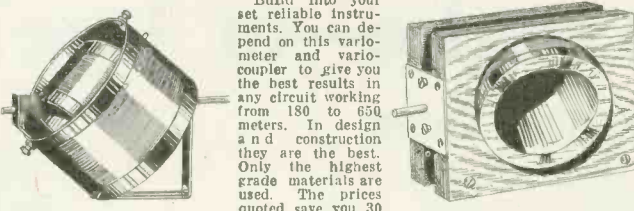

COIL MOUNTING PLUGS

Made of genuine bakelite.

E344 Plug for mounting "honeycomb" inductance coils39c

E345 Stationary plug to fasten mounted coil stationary to panel42c

E346 Movable plug to fasten mounted coil to panel so it can be rotated.....89c

E343 Fibre strip to hold coils for mounting. Two foot piece15c



MAGNET WIRE

Insulated copper wire. Best quality even drawn wire, one piece to a spool. Prices quoted are for 8 oz. spools unless otherwise stated.

Double Cotton	Enameled Insulation	Green Silk Covered
Number E990	Number E992	Number E991
Gauge Price	Gauge Price	Gauge Price
1843c 2039c 20\$0.78	2055c 2250c 2295	2270c 2455c 241.10
2430c 2660c 261.38	2690c 3065c 30 (4 oz.) 1.25	28\$1.05 3270c 32 (4 oz.) 1.65
301.45 3690c 36 (4 oz.) 2.20		

ANTENNA INSULATORS

E260 Size 1x3/4. Composition, metal eyelets. Two for17c

E264 Size 1 1/2 x 1. Two for69c

E266 Size 1 1/2 x 1 1/2. For large aerials. Two for.....\$1.28

E263 Ribbed Porcelain insulator. 2 1/2 in. long. Ea. 6c Dozen55c

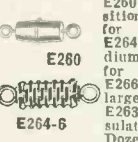

LEAD-IN INSULATORS

E270 For 4 inch walls or less.....42c

E271 For 9 inch walls or less.....69c

The only practical lead in insulator for aerial wires. Small, neat, effective, durable. Fits 1/4 inch hole. Securely locked by two adjustable nuts.

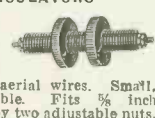

OUTDOOR LIGHTNING ARRESTER

E980 Price\$1.55

Protect your instruments with this lightning arrester. Weatherproof porcelain case. Air gap type. Permanent. Durable. Underwriters approved.



HIGH-GRADE LIGHTNING ARRESTER

E981 Each79c

A dependable protector, always on guard. Small and compact. Weatherproof porcelain case. Easily fastened and connected. Underwriters approved.



REINARTZ INDUCTANCE

E298 Each.....\$1.15

Made of green silk covered wire, spiderweb wound to produce greatest efficiency and lowest losses. 21 taps so arranged that crossing is avoided. Two fibre strips and wooden rod furnished permit various styles of mounting. With this coil a high grade set can be built at a low cost. Directions included.



PANEL MOUNTING VARIABLE CONDENSERS

These are especially high grade condensers and we guarantee them to be mechanically and electrically perfect. Fine polished end plates of heavy bakelite. Shafts 1/4 inch diameter. Sturdy, heavy aluminum alloy plates perfectly spaced to insure smooth, even, reliable capacity. Our low prices save you money. These condensers are of the very best make and are not to be compared with many inferior, cheap condensers offered. We guarantee them to please you or your money back. The vernier style has one separately controlled plate which permits of the finest tuning.

REGULAR STYLE

E815—5 plate65c

E816—5 plate97c

E814—11 plate .00025 mfd.\$1.28

E813—21 plate .0005 mfd.1.35

E812—43 plate .001 mfd.1.58

VERNIER STYLE

Including Dial and Knobs

E825—14 plate .00025 mfd.\$2.45

E824—26 plate .0005 mfd.2.75

E826—46 plate .001 mfd.3.15

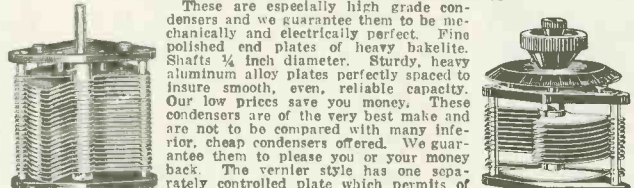

SUPER BLOW TORCH

E544 Each39c

Burns denatured alcohol. Vest pocket size. Blowing on tube produces a hot pointed flame. Lights with a match. Works fast. Burns 10 minutes on one filling. Easy to solder joints in hard places. 3 in. high. 7/8 in. cylinder. Long rubber tube. Produces fine joints with Tlnol listed above.



ENCLOSED VARIABLE CONDENSERS

One of the best made condensers. Rigid, accurately spaced aluminum plates. Formed ends. Engraved scale. Knob and pointer. Clear transparent case.

E806 43 plate .001 Mfd.\$2.83

E808 21 plate .0005 Mfd.\$2.45



OUR SPECIAL AUDIO FREQUENCY AMPLIFYING TRANSFORMERS

E550 Each\$2.15

The result of years of research work and experienced engineering. In quality of tone and volume of sound the things a transformer is built for, we guarantee it to equal or surpass any other transformer. Neat in appearance. Carefully made. Fully mounted with plainly marked binding post connections. 5 to 1 Ratio. Wonderful results on one, two or three steps without distortion or howling. A quality item in every respect. Not to be compared with articles built for price only.



OUR SPECIAL SHIELDED TRANSFORMER

E551—3 1/2 to 1 Ratio. Each\$2.75

E552—6 to 1 Ratio. Each\$2.75

The same high grade style of transformer as above enclosed in a metal case which completely shields it from any outside magnetic influences. Very attractive appearance and sturdy construction. Free from howling and local disturbances.



THORDARSON AUDIO FREQUENCY AMPLIFYING TRANSFORMERS

E232 Ratio 3 1/2 to 1. \$3.40

E233 Ratio 6 to 1. 3.80

Recognized by leading radio engineers as the best balanced and most efficient transformer. Correct characteristics for any standard tube. Wonderful results without distortion on one, two or three steps. Plainly marked binding post connections on bakelite panel.

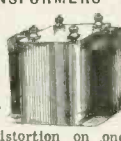

TINNED COPPER "BUS BAR" WIRE

Size 14 tinned copper wire. For wiring sets. Best size for neat job and easy soldering.

E957 Round. Ten feet for12c

E958 Square. Ten feet for14c

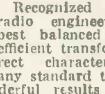

SPAGHETTI

For covering connecting wires in sets. For 12 and 14 wires.

E955 Finest quality braided and saturated with best baked lustrous transparent insulating varnish, 3 feet for19c

E956 Best quality braided and covered with black insulating compound, 3 feet for. 9c

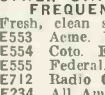

RADIO SOLDERING IRON

E540 Each\$1.50

Soldered connections in radio sets produce better results. This guaranteed iron is exactly right for radio work. A neat solid connection quickly and easily made. Operates on any lighting socket 100 to 120 volts. 6 ft. cord with attaching plug. Length 13 inches. Heats quickly, will not overheat.

Heavier irons for general repair or manufacturing work. Wonderful values at our prices.

E541 Medium size\$3.48

E542 Larger size4.25



RADIO FREQUENCY AMPLIFYING TRANSFORMER

E560 For 201A or 301A Tubes\$1.70

E561 For 199 or 11 or 12 Tubes\$1.70

Range 175 to 600 meters. Try it. If you are not satisfied return it and get your money back.

Due to its special design this transformer will produce wonderful results in any type of regular or reflex radio frequency circuit. While low in price we believe it equal or superior to higher priced transformers. Perfect for one, two or three stages. Compact, convenient form, easily mounted. Range 175 to 600 meters. Try it. If you are not satisfied return it and get your money back.

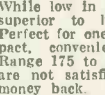

OTHER STANDARD BRANDS RADIO FREQUENCY TRANSFORMERS

E568 Our special—as good as any of them\$.48

E562 Muller. Each4.45

E563 Coto. Each4.45

E564 Raala. Each4.45

E565 Ame. First stage. Each4.45

E566 Ame. Second stage. Each4.45

E567 Ame. Third stage. Each4.45

E714 Radio Corp. Each5.95

E995 All American. Each3.95

E575 Erla. First stage. Each3.55

E576 Erla. Second stage. Each3.55

E577 Erla. Third stage. Each3.55

E578 Erla. Reflex. Each4.45



NEUTRODYNE TRANSFORMERS

E571 Per set of three\$1.95

An air core transformer for use in neutrodyne method of reception. Can also be used for tuned radio frequency or as a fixed coupler with condenser across secondary. Proper design for results and efficiency. Green silk windings on bakelite tubes with adjustable mounting brackets to fit most any condenser.

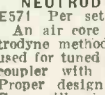

NEUTRALIZING CONDENSERS

E572 Per set of two40c

Simple, inexpensive, effective precision type. Micrometer adjustment is attainable. Easily mounted in circuit.

SPECIAL

E573 Neutrodyne Jack. Each89c

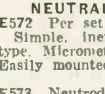

WITH BARAWIK STANDARD RADIO GOODS

VACUUM TUBES

Standard Brands—Cunningham, Radiotron. Every one guaranteed new and perfect. We will ship brand in stock unless you specify otherwise.

- E105 Detector, UV200 C300 Each \$4.30
- E112 Amplifier, UV201A C301A. 5.75
- E118 5 Watt Transmitter. . . 7.70
- E107 WD11 C11. Each. . . . 5.75
- E101 WD12 C12. Each. . . . 5.75
- E102 UV199 C299. Each. . . . 5.75
- E104 UV199 Adapter fits 199 tube to standard socket.42
- E108 WD11 Socket. Each.35
- E109 WD11 Adapter. Each. . . .48

STANDARD TUBE SOCKET

E140 Each39c
Moulded of genuine red brown bakelite. Binding post connections. For table or panel mounting. Neat and strong.



METAL TUBE SOCKET

E146 Each42c
A strong durable socket for panel or table mounting. Metal tube and base. Plainly marked binding post connections, well insulated.



TWO AND THREE GANG SOCKETS

These sockets make it easy to build detector and amplifier units and make a neat, compact workmanlike job. Perfectly made of high grade materials. Quickly mounted on panel or base.

- E147 Two-gang socket95c
- E149 Three-gang socket \$1.30



199 SOCKET

E145 Each49c
Moulded of high insulating material. Sponge rubber base prevents rattling in tube. Plainly marked binding post connections. Neat and compact.



FILAMENT CONTROL RHEOSTATS

- E132 6 ohm. Each.45c
- E129 20 ohm. Each.52c
- E131 30 ohm. Each.59c
- E135 6 ohm Vernier.95c

Best grade. Will give real service. Durable and lasting. High heat resisting base, diam 2 3/4 in. Tapered polished black knob 1 1/4 in. diam. Potentiometers. Match above rheostats. Same high grade construction.

- E151 200 ohm. Each.79c
- E152 400 ohm. Each.79c



SUPERIOR RHEOSTATS

- E153—6 ohm. Each.69c
- E154—20 ohm. Each.76c
- E155—30 ohm. Each.83c

The finest rheostat. Smooth, even action. Best design, best workmanship. Supplied with attractive dial and knob. A rheostat for high grade sets. Potentiometers to match above rheostats with dial and knob.

- E156—375 ohm98c

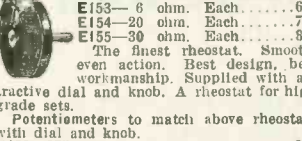

QUICK ACTING RHEOSTAT

- E124—6 ohm. Ea.79c
- E125—15 ohm. Ea.88c
- E126—30 ohm. Ea.99c

Vernier adjustment at every degree of resistance. Pushing knob in turns off the filament.

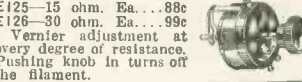

THREE INCH DIAL

- E923 For 3-16 inch shaft. Each.19c
- E924 For 1/4 inch shaft. Each.19c

A handsome neat looking dial moulded in one piece of polished black composition. 180° scale marked 0 to 100 finely engraved in contrasting white enamel. Diameter 3 inches.

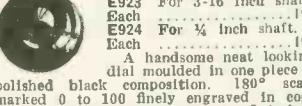

TWO INCH DIAL

- E921 For 3-16 inch shaft. Each.16c
- E922 For 1/4 inch shaft. Each.16c

A handsome dial moulded in one piece of polished black composition. 270° scale marked 0 to 100 finely engraved in contrasting white enamel. Fine for rheostat or switch control. Diam. 2 in.

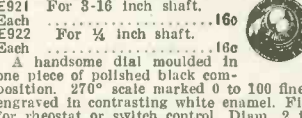

VERNIER DIAL ADJUSTER

E941 Each19c
Easily installed at edge of dial, gives finest vernier adjustment of condenser or inductance. A great value. Polished black knob.



DETECTOR CRYSTAL CAREFULLY TESTED

- E736 Galena, Arlington tested, piece 19c
- E738 Silicon, Arlington tested, piece 18c
- E735 Tested, Galena, Mounted, piece 9c
- E737 Tested, Silicon, per piece. . . .9c
- E739 Genuine millon point crystal. Ea.29c

"B" BATTERY METER

E109 Each98c
Reads 0 to 50 volts. Accurately tells you the exact condition of your B Battery. Convenient watch size. Polished nickel case with wire lead.

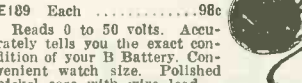

WE PAY TRANSPORTATION CHARGES EAST OF THE ROCKIES

PRESERVE THESE PAGES—ORDER FROM THEM AND SAVE MONEY
FAST SERVICE—TRY US AND BE CONVINCED
THE PRICES QUOTED DELIVER THE GOODS TO YOUR DOOR

OUR GUARANTEE PROTECTS YOU—We handle only the best goods, carefully tested and checked by expert radio engineers. You are assured of getting guaranteed apparatus that will give superior results. And while our goods are best, our prices are lowest. Our goods equal or surpass the claims we make for them. We do not attempt to deceive or mislead. Our reputation for fair dealing is our most valued asset.

HOW TO ORDER—Write your Order plainly, state Article Number, Description and Price of items wanted. Send Postoffice or Express Money Order, Certified Check or Bank Draft for Total of Order. Prompt Shipment is assured when these directions are followed.

GREWOL CRYSTAL DETECTOR

E742 Each \$1.69

BAKELITE DIALS

- E931—2 in. Diam. for 3-16 in. shaft. Each. . . .32c
- E932—2 in. Diam. for 3/8 in. shaft. Each. . . .32c
- E933—3 in. Diam. for 3-16 in. shaft. Each. . . .33c
- E934—3 in. Diam. for 1/2 in. shaft. Each. . . .33c

E935—4 in. Diam. for 1/2 in. shaft. Ea.40c
Moulded in one piece of genuine bakelite in polished black finish. Finely engraved scale in contrasting white enamel. Sure grip knob that fits the fingers. Higher grade dials for good sets. Sizes match perfectly.



ENCLOSED DETECTOR

One of the finest crystal detectors on the market, supersensitive galena crystal enclosed in heavy glass shield. Quick, positive adjustment. Brass parts polished nickel finish.

E730 Each89c



GALENA DETECTOR

Easy fine adjustment. Crystal mounted in cup. Moulded base and knob. Brass parts polished nickel finish. An unequalled value.

E732 Each59c



SUPERIOR VARIABLE GRID RESISTANCE

- E167 Each80c
- E168 With .00025 Condenser95c

Eliminates hissing, clarifies signals. Capacity smoothly varied from 0 to 6 megohms by half turn of knob. Easily mounted on any panel.

E171 Freshman panel mounting variable grid leak with .00025 condenser. Each 69c

E172 Durham variable grid leak with mounting. Each89c

D173 CRL Variable grid leak. Each \$1.19

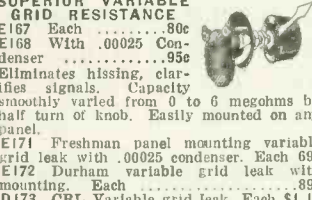

TUBULAR GRID LEAKS AND CONDENSERS

Very convenient. Permit of quick change of leaks or condensers of varying capacity. Cut shows leak mounted. Leaks and condensers have same appearance. Each part priced separately.

E849 Grid Leaks. Each18c

Resistances—1/2, 1, 1 1/2, 2, 3, 5, 7, and 10 megohms. Specify which size is wanted.

E831 Grid and Plate Condensers. Ea. 39c

Capacities—.00025, .001, .00025, .0005 mfd. Specify which size is wanted.

Mountings. Bakelite base.

E840 Single mounting. Each.29c

E842 Double mounting. Each. . . .49c

E844 Triple mounting. Each. . . .69c



VARIABLE GRID LEAKS

E160 Standard style.15c

E161 De Luxe style with extra heavy screw top finely finished.32c

Pencil mark type for panel mounting. Resistance may be varied exactly as needed.



GRID CONDENSERS

E162 Well insulated. Paper covering. Each8c

E163 Highest grade. Mica insulated. Polished nickel case. Each23c

Fit over posts of above leaks. The combination makes an efficient unit. Cap. .00025 mfd.



BARAWIK QUALITY HEADSETS

E770 Per Set, 2000 ohms. \$3.25

These headsets have proven on rigid tests to be one of the very best on the market. The tone quality is excellent with an unusual volume. Skilled workmen make them from only the best selected materials. The receiver cases are fine polished finish with polished black ear pieces. Fabric covered head band comfortably and quickly fitted to the head. Supplied with 5-foot cord. These sets were designed to sell for much higher prices than we ask, and at our price are a wonderful bargain. We guarantee that you will be pleased with them and agree that they are the best value by far yet offered. If they don't suit you we will cheerfully return your money.



STANDARD BRAND HEADSETS

- E754 Baldwin Type C with universal jack plug \$11.75
- E756 Red-Head, 3000 ohm. 5.78
- E768 Brandes, 2000 ohm 5.35
- E769 Brandes, 3000 ohm 6.95
- E751 Murdoch 56, 2000 ohm. \$3.59
- E752 Murdoch 56, 3000 ohm 3.95
- E764 Frost, 2000 ohm 3.59
- E76C Frost, 3000 ohm 4.45
- E758 Western Electric 9.50

SUPERIOR RADIO JACKS

Finest grade jacks. Improved design. Best materials. Phosphor bronze springs. Silver contact points. Nickel finish. Mount on panels 3/8 to 1/2 in.

- E390 Open circuit. Each.38c
- E391 Closed circuit. Each. . . .46c
- E392 Two circuit. Each.55c
- E393 Single circuit filament cont. . . .59c
- E394 Two circuit filament cont. . . .76c

COMPETITOR JACKS

- E387 Open circuit. Each.27c
- E388 Two circuit. Each.35c

Well made, durable, smooth working, nickel finished frame. Well insulated.

SUPERIOR RADIO PLUGS

- E395 With set screws for fastening cord. Each35c
- E397 Two-way style cords. Each.59c

Highest grade plugs. Fit any standard jacks. Polished round barrels.

SWITCH CONTACT POINTS

Brass polished nickel finish. All have 1/4 in. long size 6-32 screws and two nuts. All prices the same.

- Dozen 18c
- Hundred \$1.05

Order by Article Number

- E360 Head, 1/4" diam.; 1/4" high
- E362 Head, 3-16" diam.; 3/4" high
- E363 Head, 3-16" diam.; 1-16" high

Solder lugs to fit Contact Points
Also for connecting wires to binding posts, etc.

- E365 Dozen 8c
- Hundred 30c



SWITCH LEVER STOP

Brass polished nickel finish.

- E386 Dozen 18c
- Hundred \$1.05



SWITCH LEVERS

Very neat polished black composition knob. Exposed metal parts polished nickel finish. Pitted with panel bushing and two set nuts. A high grade switch.

E381 1 1/2 in. Radius. Ea. 15c



INDUCTANCE SWITCH

E385 Price including knob and dial. \$1.29

Mounts switch points and contact lever behind panel. Only one hole needed to mount. 15 switch points, any number of which may be used. Smooth wiping contacts. Attractive tapered knob.



SUPERIOR INDUCTANCE SWITCH

E384 Each79c

Quickly and securely mounted by drilling one hole. Only knob and pointer show in front of panel. Connections can be soldered before fastening switch, making assembly much easier.

Metal parts nickelplated. Bakelite knob and supporting base.



HYDROMETER

E190 Each48c

Accurately tells you the condition of your storage battery. Helps you keep your battery in better condition.

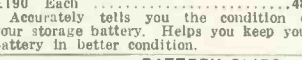

BATTERY CLIPS

E198 Two for28c

Clip onto storage battery terminals, lead coated. Make positive non-corrosive contact at all times.

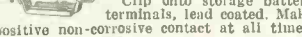

BINDING POSTS

Brass, polished nickel finish. Washer and 6-32 in. screw extending 3/4 in.

- E370 Large size—barrel and knob 3/4" long. Dozen.85c
- E372 Smaller size—barrel and knob 9-16" long. Dozen.70c

- E374 Large size with composition knob. Dozen.45c
- E376 Large size with hole for phone tip or wire. Dozen.80c
- E378 Small size with hole for phone tip or wire. Dozen.35c

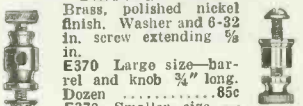
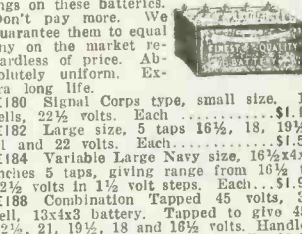

PLATE CIRCUIT "B" BATTERIES

You can make real savings on these batteries. Don't pay more. We guarantee them to equal any on the market regardless of price. Absolutely uniform. Extra long life.

- E180 Signal Corps type, small size, 15 cells, 2 1/2 volts. Each. . . . \$1.10
- E182 Large size, 5 taps 16 1/2, 18, 19 1/2, 21 and 22 volts. Each. . . . \$1.59
- E184 Variable Large Navy size, 16 1/2 x 4 x 3 inches 5 taps, giving range from 16 1/2 to 22 1/2 volts in 1 1/2 volt steps. Each. . . \$1.95
- E188 Combination Tapped 45 volts, 30 cell, 13x13 battery. Tapped to give 45, 22 1/2, 21, 19 1/2, 18 and 16 1/2 volts. Handles both detector and amplifier tubes. Ea. \$3.65



STORAGE "A" BATTERY

A very high grade battery made especially for radio service. Guaranteed for three years. Properly cared for will give many more years of service for filament lighting. Made of best new materials. Full capacity. The best battery buy on the market. Try one of these batteries on your set for 10 days. If at the end of that time you are not fully satisfied with the battery return it and we will refund the purchase price.

- E194 6 volt, 40 ampere size. Each \$10.75
- E196 6 volt, 80 ampere size. Each 13.25



HOMECHARGER BATTERY CHARGING RECTIFIER

Charge your battery at home overnight for a few cents. Simply connect to any 110 volt 60 cycle light socket, turn on current and rectifier does the rest automatically. Will work for years without attention. Simple connections. Gives a tapering charge which batteries should have. You can make it pay a profit charging your friends' auto batteries. Long connecting cords with pair of battery clips.

- E201 For 6 volt battery. \$12.95
- E203 For 12 volt battery. . . . \$19.95

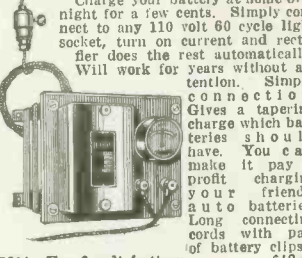

RADIO "BAKELITE" PANELS

Notice our very low prices on this fine quality material. Others ask as much for hard rubber panels which are worth much less. We supply genuine Bakelite. Consists of Ceteron or Formica, all of which are materials with practically identical mechanical, chemical and electrical properties. Machines well without chipping. Won't warp. Water-proof. Highest mechanical and dielectric strength. Attractive natural polished black finish which can be sanded and oiled.

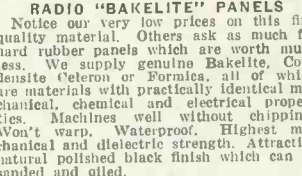

Panel Size Inches	1/4" thick		3-16" thick		3/4" thick	
	Art. No.	Price	Art. No.	Price	Art. No.	Price
6x7	E450	\$0.57	E460	\$0.86	E470	\$1.15
6x10 1/2	E451	.86	E461	1.27	E471	1.73
7x14	E458	1.38	E468	2.07	E478	2.76
7x18	E453	1.78	E463	2.65	E473	3.56
7x21	E457	2.05	E467	3.05	E477	5.10
7x24	E459	2.42	E469	3.56		
9x14	E454	1.85	E464	2.65	E474	3.56
12x14	E455	2.42	E465	3.56	E475	4.78
12x21	E456	3.62	E466	5.35	E476	7.13

CABINETS

Fine looking cabinets solidly built. Elegant hand rubbed dark mahogany finish. You will be proud of your set mounted in one of these cabinets. Hinged tops. Front rabbeted to take panels. Panels not included. Prices are transportation paid.



Panel Size	Inside Dimensions			Art. No.	Price Each
	High	Wide	Deep		
6x7	5 1/2"	6 1/2"	7"	E420	\$2.15
6x10 1/2	5 1/2"	10"	7"	E422	2.65
7x14	6 1/2"	13 1/2"	7"	E423	3.20
7x18	6 1/2"	17 1/2"	7"	E426	3.45
7x21	6 1/2"	20 1/2"	7"	E425	3.85
7x24	6 1/2"	23 1/2"	7"	E429	4.65
9x14	8 1/2"	13 1/2"	10"	E428	3.55
12x14	11 1/2"	13 1/2"	10"	E430	4.65
12x21	11 1/2"	20 1/2"	10"	E432	5.45

THE BARAWIK CO. Chicago's Original Radio Supply House Beware of Imitators 102 South Canal St., Chicago, Ill.

BUILD YOUR SET WITH BARAWIK STANDARD RADIO GOODS

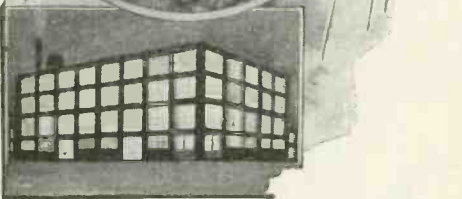
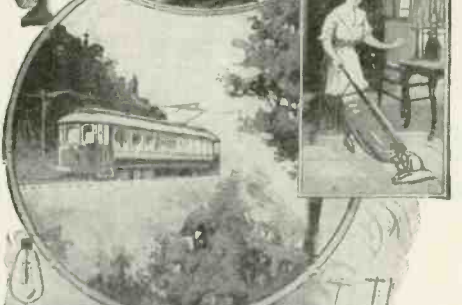
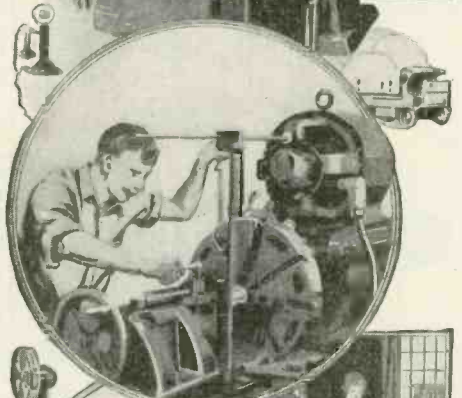
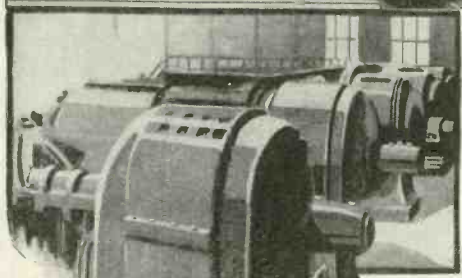
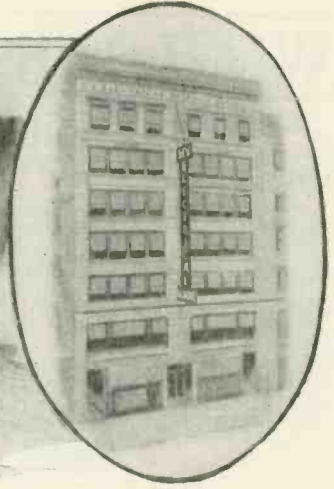
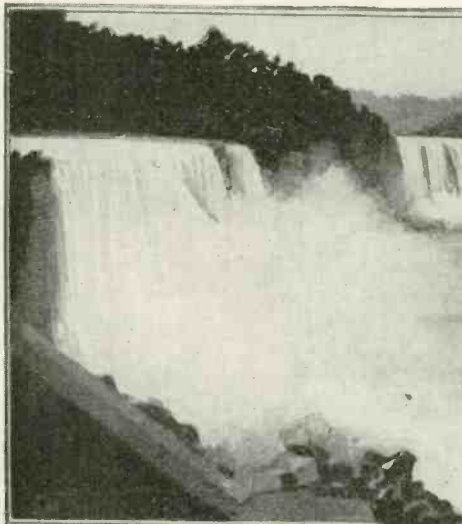

Master Electricity By Actual Practice

The only way you can become an expert is by doing the very work under competent instructors, which you will be called upon to do later on. In other words, *learn by doing*. That is the method of the New York Electrical School.

Five minutes of actual practice properly directed is worth more to a man than years and years of book study. Indeed, Actual Practice is the only training of value, and graduates of New York Electrical School have proved themselves to be the only men that are fully qualified to satisfy EVERY demand of the Electrical Profession.

The Only Institution of the Kind in America

At this "Learn by Doing" School a man acquires the art of Electrical Drafting; the best business methods and experience in Electrical Contracting, together with the skill to install, operate and maintain all systems for producing, transmitting and using electricity. A school for Old and Young. Individual instruction.

Over 8,000 Graduates are Successful Men in the Electrical World

No previous knowledge of electricity, mechanics or mathematics is necessary to take this electrical course. You can begin the course now and by steady application prepare yourself in a short time. You will be taught by practical electrical experts with actual apparatus, under actual conditions.

The N. Y. E. S. gives a special Automobile Ignition Course as an advanced training for Auto Mechanics, Garage Men and Car Owners. The course covers completely all Systems of Ignition, Starters, Lighting and other electrical equipment on automobiles, motor boats, airplanes, etc.

Let us explain our complete courses to you in person. If you can't call, send now for 64-page book—it's FREE to you.

New York Electrical School
29 W. 17th St., New York, N. Y.

Please send FREE and without obligation to me your 64-page book.

..... NAME
..... STREET
..... CITY STATE

New York Electrical School

29 West 17th Street, New York

Science and Invention

H. GERNSBACK, EDITOR AND PUBLISHER
H. WINFIELD SECOR, ASSOCIATE EDITOR
T. O'CONOR SLOANE, Ph.D., ASSOCIATE EDITOR

Editorial and General Offices, - - - 53 Park Place, New York

"Those Who Refuse to Go Beyond Fact Rarely Get As Far As Fact" -- HUXLEY

Are We Intelligent?

By H. GERNSBACK

THE members of the human race, who think themselves preeminent on this planet, have long since come to the conclusion that the human animal is a superior living being, quite distinct and far above all other living creatures. This conclusion, so general that it seems to be inborn, has been handed down through the ages, mainly for the reason that we imagine all of our acts and thinking are based upon intelligence. For instance, we say that a dog or a cat cannot think and reason. They are, therefore, with intelligence. It in a better way, animal or in the way we do. our arrogance, they are inferior

I BELIEVE

¶ THAT a patent in the shop is worth three in the patent office.

We have subdued nearly all of the larger animals to our will and have either turned them into domestic servants or else have nearly exterminated them.

But are these proofs that we are intelligent? Intelligence among other things should call for a thorough understanding of every subject. Every human being, however, will admit that we comprehended practically nothing. We cannot fathom the simplest acts of the animals that we class beneath us. Our mentality is such that we cannot even interpret the simplest "thoughts" or instincts of a dog. But when we come to such creatures as insects, which have existed on this planet hundreds and thousands of years longer than we have, we are forced to admit the fact that certain species are far more intelligent than we are.

Take the ants for instance! With them the welfare of the nation is preeminent. Everything is subordinated to this thought; call it instinct if you wish. The ant does not require newspapers to get the news, as all news is transmitted instantaneously by a sort of "radio" system that reaches every ant in a fraction of a second. Similar cases prevail with the bees, as well as many other highly civilized insects.

Only because our senses are as poor as they are, do we find it necessary to use such artifices, as the printed page, railroads, the telephone, the telegraph, and nearly every other artifice that you can think of. You can imagine, perhaps, a million years hence, a central "radio" station broadcasting the news of the day, not in the spoken word, but in thought waves, so that everyone on the planet will get the news instantaneously. This does not mean intelligence only, but pictures and everything. In other words, intelligence

will be transmitted by thought waves which will bring into our minds the exact news or information transmitted. Naturally, if we ever reach this stage, the telephone and telegraph will be unnecessary because we will be able to transmit our thoughts direct to our friends in a less cumbersome way than we do today. We need our railroads and transportation systems in the present era, simply because we have not learned to live as does the ant, for instance. We still must roam the planet in order to find the food and clothing we need. We may be sure years hence, such a situation will be able to convert every piece of gold is as a brick, and ter is the same as Science knows that all kinds of matter are alike and that they appear differently only because their electrons are grouped in a different way. It will even be possible for us to make our own food without first planting the seed, which grows into the plant, which is eaten by the animal, so that we in turn may eat the animal. Synthetic food made from rocks found at our doors 100,000 years hence will be far more palatable, far more nutritious, and less poisonous, than anything we eat today.

I BELIEVE

¶ THAT invention and science are directly responsible for nearly all of our great industries today.

The next few centuries will bring about a great era of simplification. Everything we are doing now is too cumbersome. Everything will be freed from complexity. Our lives are entirely too crowded. Where we used to have countless wires and cables, slowly these are making way for radio, where no wires are required. Railroads will be discontinued when aerial navigation comes into general use. Reading and studying of books is already on the wane due to the greater educational and entertaining force of the motion picture. The printed page is being supplanted by the picture everywhere.

In some quarters, it is thought that this is a sign of retrogression of the race. Nothing could be more erroneous. The scientific explanation is very simple. Our lives are crowded to such an extent, that it is impossible to read as much as our grandfathers could. We are constantly being speeded up mentally and if a picture can tell the story in two seconds why should one read a typed story which might occupy 10 or 15 minutes of one's time. This, by the way, is the answer to the unprecedented popularity of the New SCIENCE AND INVENTION magazine.

THE GOLDEN AGE OF SCIENCE

is now symbolized by the golden cover of SCIENCE & INVENTION. LOOK FOR THE GOLD COVER every month!

Electric Finder Saves \$30,000,000

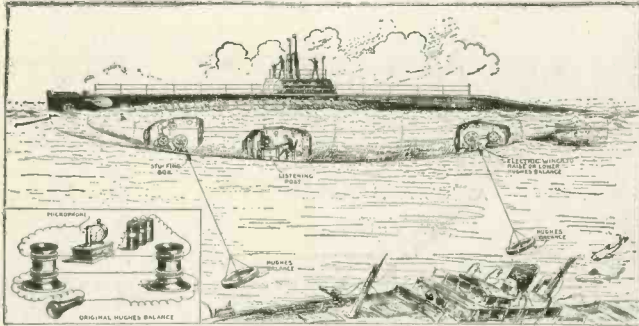

As Our Front Cover Illustration Shows, this New Invention for Locating Sunken Ships Can Be Operated Without the Aid of Divers or Diving Machines. It is Based on the Hughes Induction Balance, Where a Slight Change in the Induction Between Four Balanced Coils Causes a Sound to Be Heard in One of the Circuits.

Treasure Ships Located Electrically

By H. GERNSBACK

THE salvage of 400 vessels and the recovery of property valued at \$250,000,000 is the record in four years of the British Admiralty Department, which under Rear-Admiral Philpotts has been conducting salvage operations in home and foreign waters. Then reads a recent newspaper clipping. But the \$250,000,000 worth of property recovered represents only a very small percentage of the ships that had been sunk during the present war as well as during the past century.

The record is dotted with sunken ships containing such fabulous treasures that it is difficult for the mind to grasp the enormous figures. It runs way up into billions, and claimants are everywhere.

A ship has been sunk, this was one square for square miles or more, and if the ship is located in any channel or sunk parts of the ocean where there are heavy under-currents, such a ship will soon be covered over with sand, moss, barnacles, etc. which effectively hide the ship and make it very difficult for the divers to locate it.

Many a salvaging company has found to its regret that it is one thing to obtain a commission to raise a sunken ship and quite another to actually locate it.

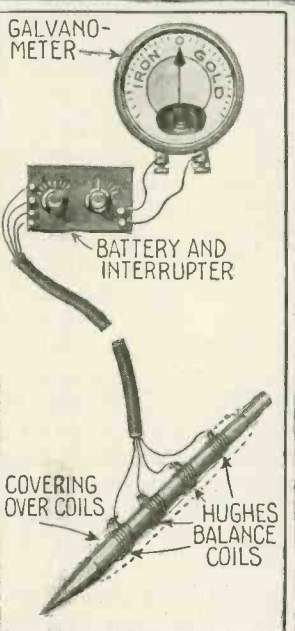

A recent cable dispatch from London states that thirty million dollars in gold bullion was successfully raised by divers working ninety feet below the surface of the sea. The divers used a special electric spear and indicating device, which showed whether the spear point was touching gold or base metal. Such an electric diving rod was foretold and described by H.

Gernsback in the October 1919 issue of this journal, then called the ELECTRICAL EXPERIMENTER, part of this article appearing in the upper left hand corner of the picture. The four coils of the Hughes balance are carefully balanced electro-magnetically, so that the galvanometer needle points to zero. Metals brought near the coils disturb this balance.

AN APPRECIATION

AS this issue is going to press, we are in receipt of literally thousands upon thousands of letters from our readers enthusiastically endorsing our new policy of "Science in Pictures." It is impossible to answer each and every one of these wonderful letters and the Editor takes this occasion to convey his thanks to the thousands of our friends who have taken the trouble to write us. We have made a number of improvements in this issue which we trust you will notice—but we are not as yet satisfied. We hope to increase the size of this magazine very shortly and to give you a good deal more material than we are giving you now.

You will note also that with this issue we have improved our cover so that the Gold will not rub off. This improvement has been made at a very high cost but we simply must satisfy our readers.

In the meanwhile, all we ask of our friends is to show SCIENCE AND INVENTION to their friends, and we shall thank you for doing this.

EDITOR.

A FEW OF THE GOOD THINGS IN DECEMBER SCIENCE AND INVENTION.

- | | | |
|---|--|--|
| Fossilized Extinct Animals,
By Dr. W. A. Luz | A Marvelous Self-Propelling Ship,
By Edward H. London. | "Bob Cat"—A Wind Sled Driven by Motor-cycle Engine,
By G. A. Luers. |
| Salvaging Sunken Ships by Freezing Them in Ice,
By Charles Martin. | Tricks With Matches,
By Walter B. Gibson. | How Miniature of Actor Appears in Same Movie,
By Phil Gersdorf. |
| An Airplane-Helicopter Flyer,
Magic for Everybody,
By Joseph Dunninger. | What Famous Magicians Think of Spiritism.
Measuring the Heat from Distant Stars,
By Edison Pettit, Astronomer at the Mt. Wilson Observatory. | Combined Self-Feed Drill Press and Lathe,
By F. G. Marsa. |
| Steam Driven Airplane Now Practical,
By Dr. A. Demuth. | How to Make Your Own Storage Battery. | Butterfly Trays—How to Make Them,
By Dr. Ernest Bade. |

Earthquakes and Their Causes

By EDWARD H. LONDON

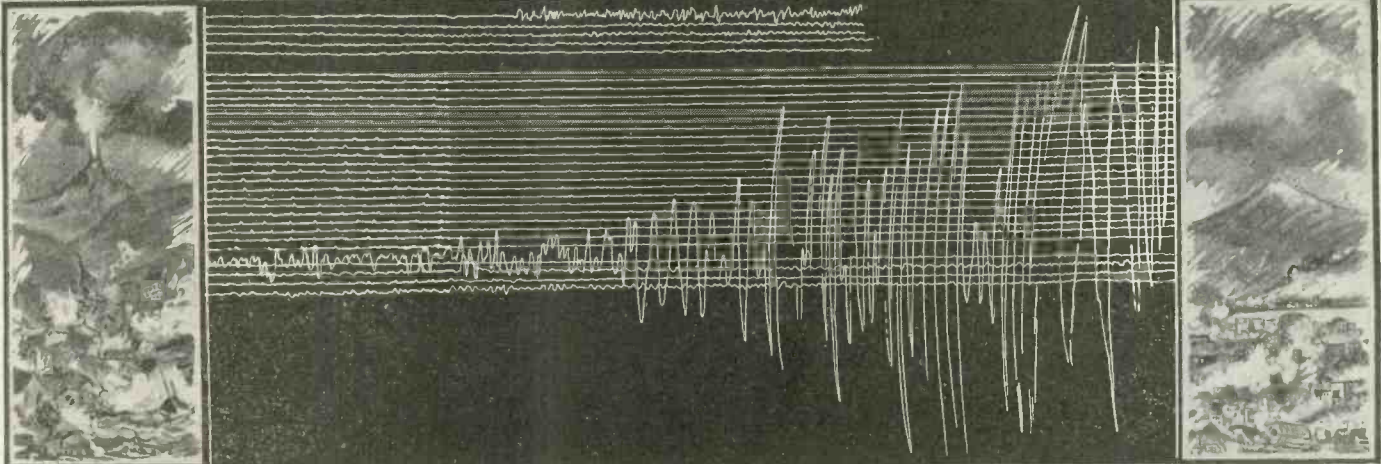

In the above diagram we see the record of the earthquake as made by the seismograph at the Saint Maur Park Observatory in Paris, France. The rumblings here recorded were those of the earthquake in Japan occurring on the first of September, lasting three hours, eleven minutes and twenty-three seconds. The seismograph is so sensitive that it can faithfully record earth tremors thousands of miles away.

curring on the first of September, lasting three hours, eleven minutes and twenty-three seconds. The seismograph is so sensitive that it can faithfully record earth tremors thousands of miles away.

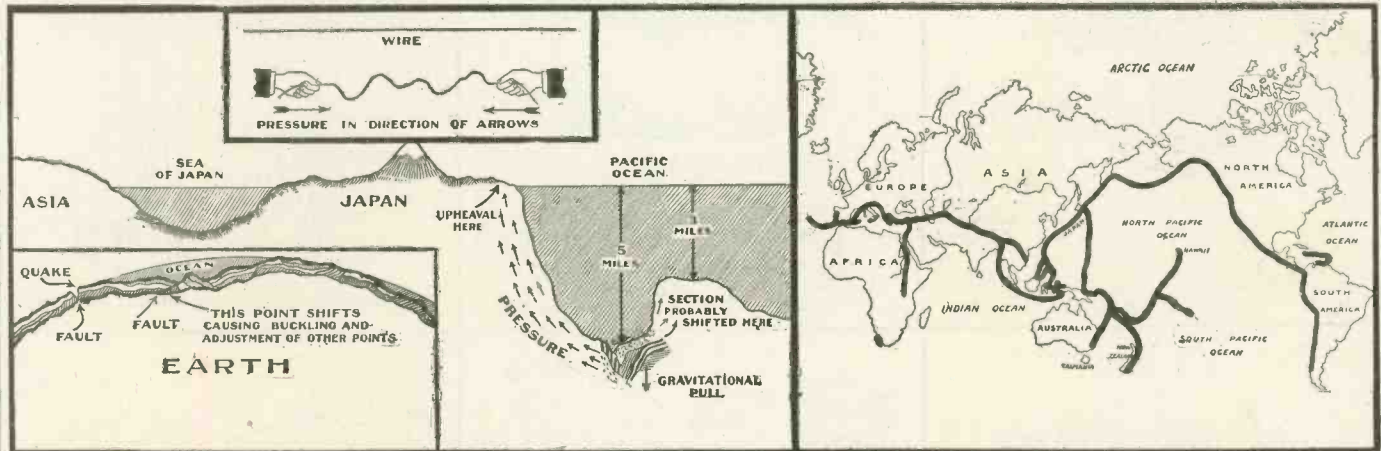

The simple demonstration of how earthquakes "work" is shown above. A straight piece of wire (or a sheet of paper) is held in the hands and pressed as shown in the illustration. As a result the wire buckles. Geologists believe a wedge of rock shifted near the foundation of the volcanic island of Japan. This caused pressure producing the upheaval and loss of life. Regions where most earthquakes occur are illustrated above.

ologists believe a wedge of rock shifted near the foundation of the volcanic island of Japan. This caused pressure producing the upheaval and loss of life. Regions where most earthquakes occur are illustrated above.

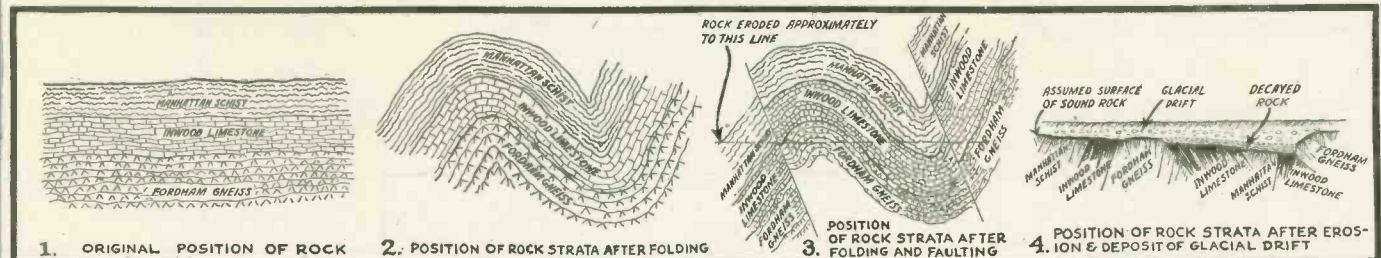

1—The earth originally was one smooth layer of rock resting on another. 2—Then the earth cooled and the surface became wrinkled and furrowed like a dried apple. The surface layers of rock folded. Great stresses

were brought to bear on the rocks, causing faults. 3—The position of rock after faulting. 4—Shows the position of rock after erosion and the action of glaciers for many thousands of years.

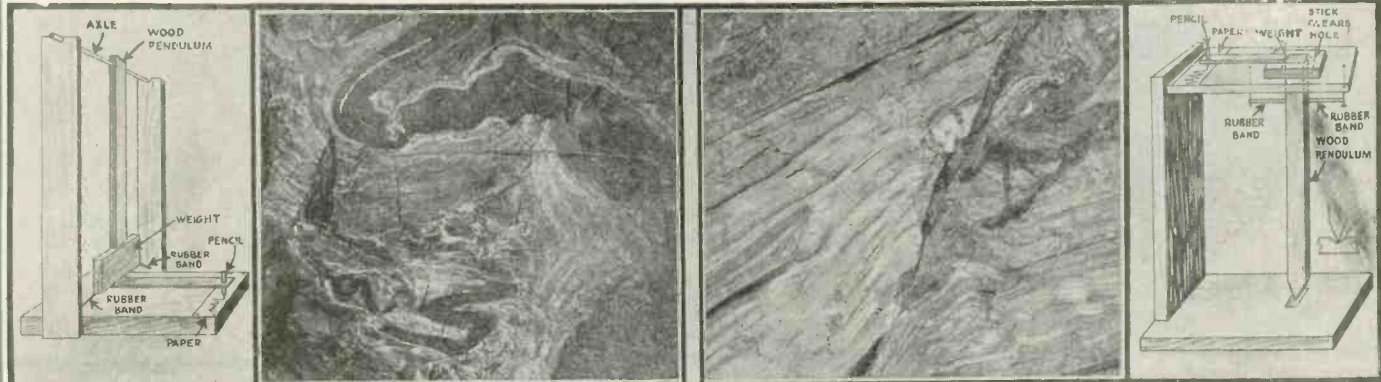

At the right and left end of the above illustration, two simple methods of making a seismograph at home are illustrated. Both weights are held in place by rubber bands. A pencil attached makes the record on a mov-

ing paper. The photo at the left shows folded rock strata. The right shows a fault. Rock sliding along the line of this fault may cause an earthquake by pressing surrounding rock.

How Artificial Pearls Are Made

By ISMAR GINSBERG, B. Sc. Chem. Eng.

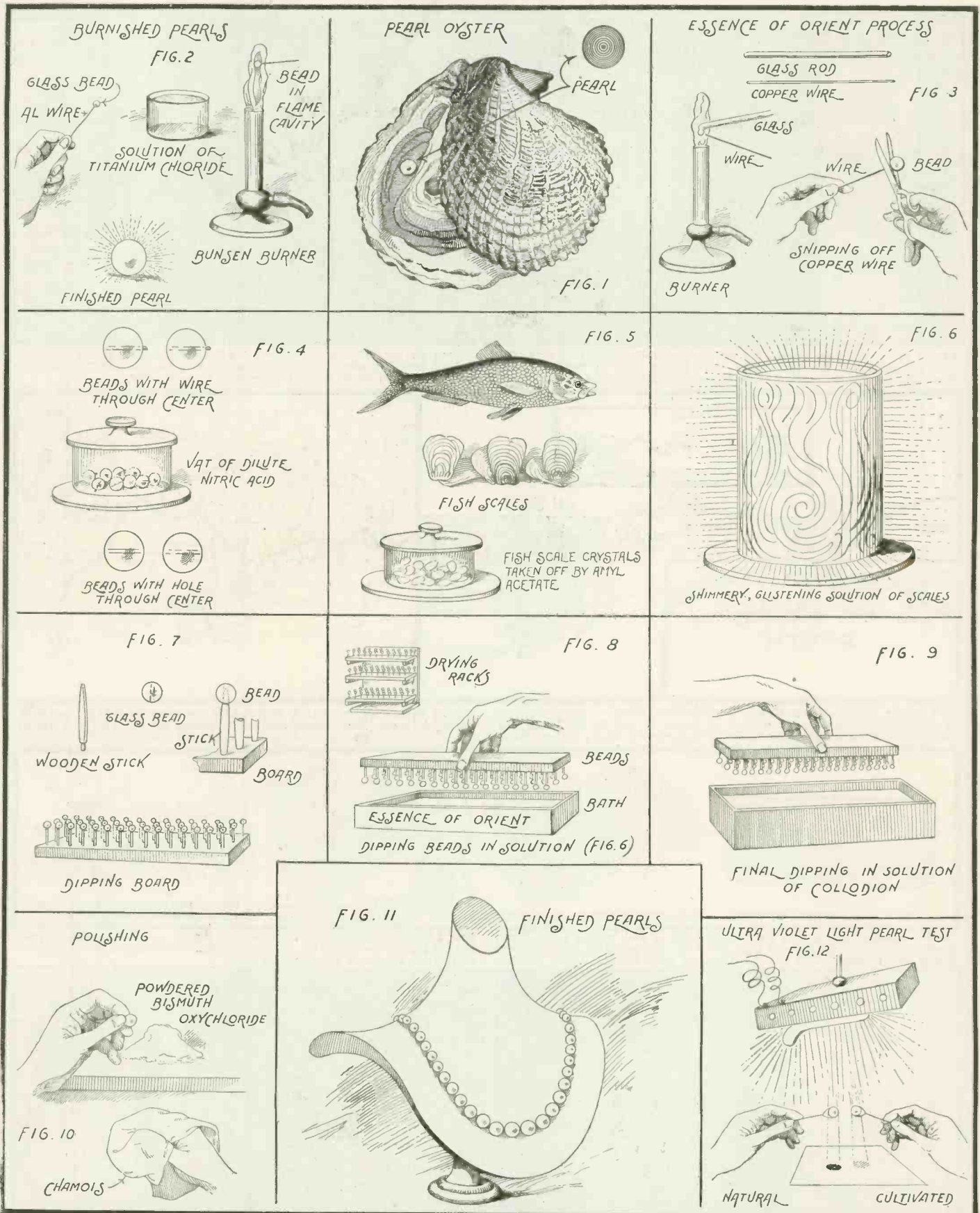

Nature's own method of making pearls is shown in Fig. 1. A grain of sand or other foreign substance becomes embedded in the flesh of a mollusc. A secretion takes place and covers up the nucleus. Years are required to make a pearl by this method. Science, however, does it more quickly. At Fig. 2 is shown the method of manufacturing cheap imitation pearls. A bead of glass is made opaque and covered with an iridescent material, usually titanium chloride. After being dipped into the substance the bead is held in the flame of a Bunsen burner. It is then furnished. Beginning at Fig. 3 is shown the method of making the bet-

ter artificial pearls. A glass nucleus is made on a fine copper wire which is later removed with nitric acid. A small stick is inserted into the hole. Many of these nuclei are then made fast to a board and dipped into "Essence of Orient" which is made by dissolving bleak and shad fish scales in amyl acetate. The film is allowed to dry and the process repeated until the pearl is built up. The completed pearl is then polished with powdered bismuth oxychloride. Pearls made by this method can only be distinguished from the genuine by splitting them or with the aid of ultra-violet light rays, as shown in the last figure on the page.

Movies from Your Victrola

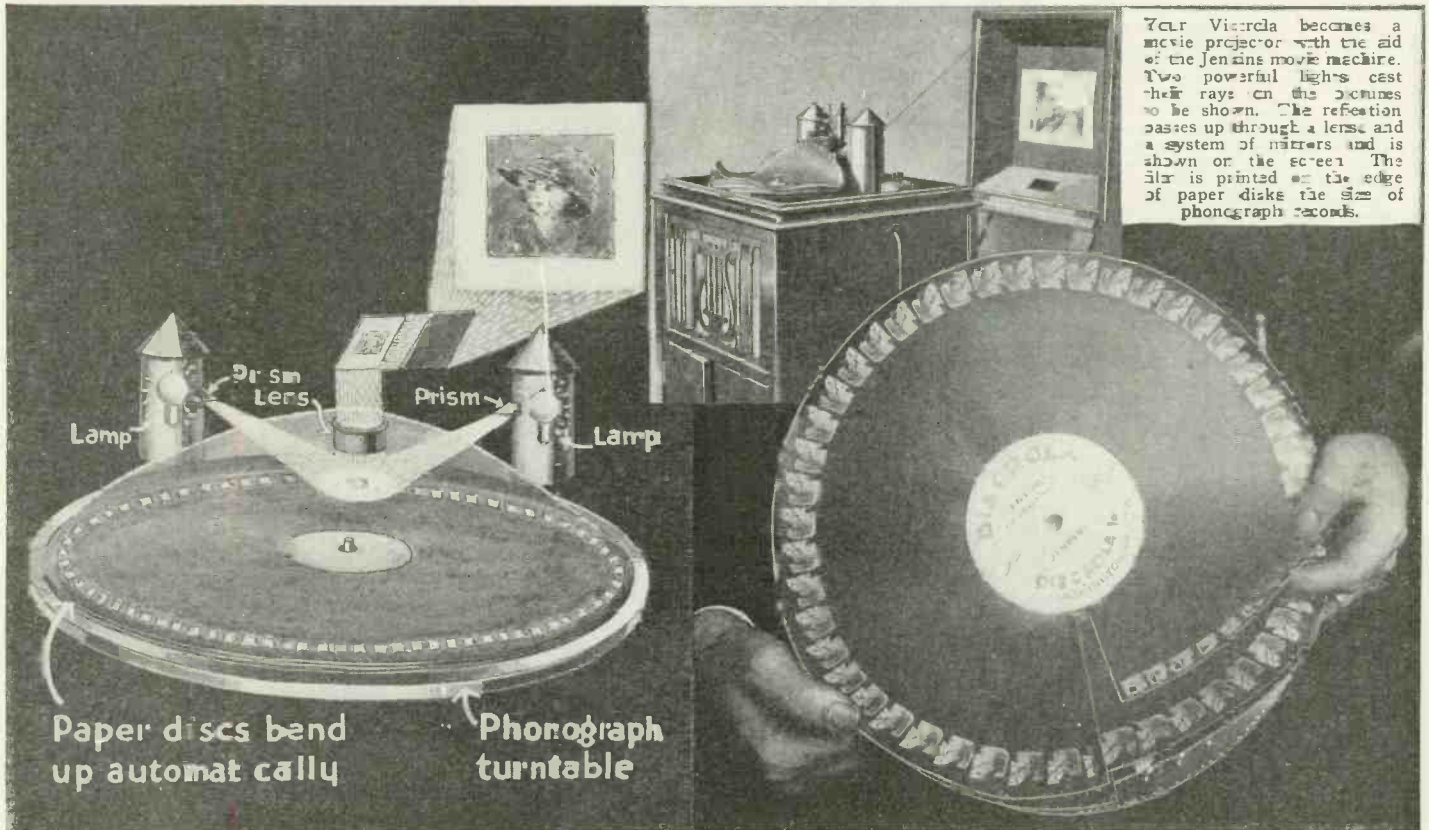

This movie machine works on the same principle as the old-time post card projector. The heavy light falling on the pictures reflects them onto the screen. Several disks are used. The pictures are printed in a circle around the edge. As each disk is shown it is raised and the one below it is projected.

Night Plane Altitude Indicator

By S. R. WINTERS

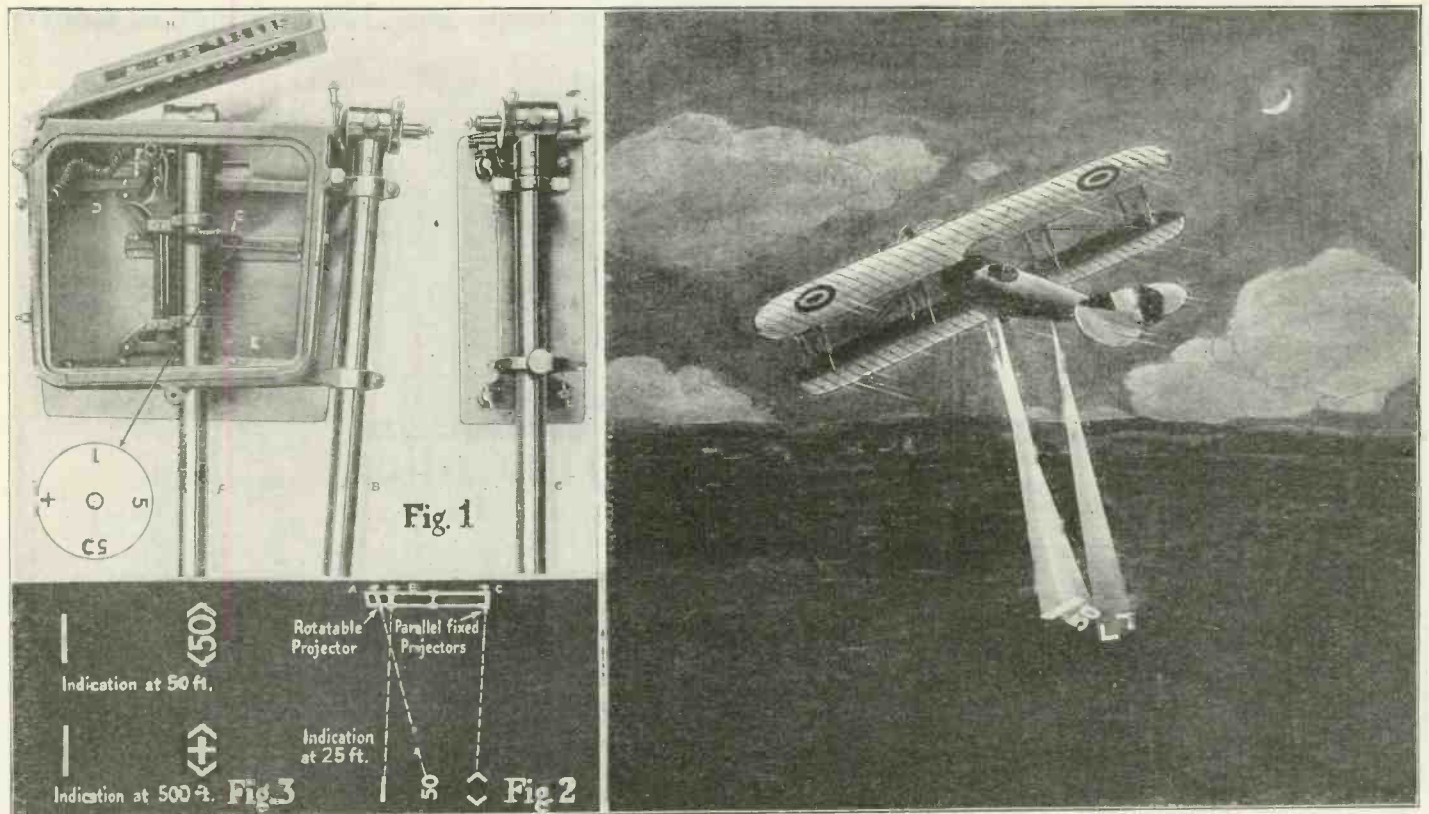

The hazard is taken out of night flying with the device shown above. With it a pilot can tell his exact height when he is flying within 500 feet of the ground. The movable beam of light shows a number. When this number falls between the arrow-heads the plane is above the ground the number of feet indicated by the beam. As he comes closer the beam travels toward the

front bar of light. When it reaches the front bar it disappears and a second numeral, fifty feet less than the other, appears between the arrow-heads, indicating a new distance. So if "100" appeared midway between the two marks it would indicate that the plane was half way between 100 and 50 feet, or 75 feet high. Invented by C. Francis Jenkins.

Moving Objects On Still Scenes

A device recently brought out whereby the necessity of costly scenery for amateur motion pictures is eliminated appears here. The scene is taken and worked into a stereoptican slide in colors if desired. All the scenes in the picture are made up in slides and fitted into a wheel that rotates in front of the stereoptican lens. The scenes are changed with the aid of an electro-magnetic control. This scene is projected on a mirror which in turn reflects it on a gauze screen, giving the same effect as a ground glass. The audience sees a large plate glass in place of the regular screen. This glass takes the image of the scene from the gauze. The moving figures are taken with a regular movie camera against a flat black background. This is projected against a cheesecloth coated with paraffine which stands just behind the glass. A phonograph is connected with the movie camera. In the darkened house the moving figures are superimposed on the scene so they cannot be told apart. One operator controls all.

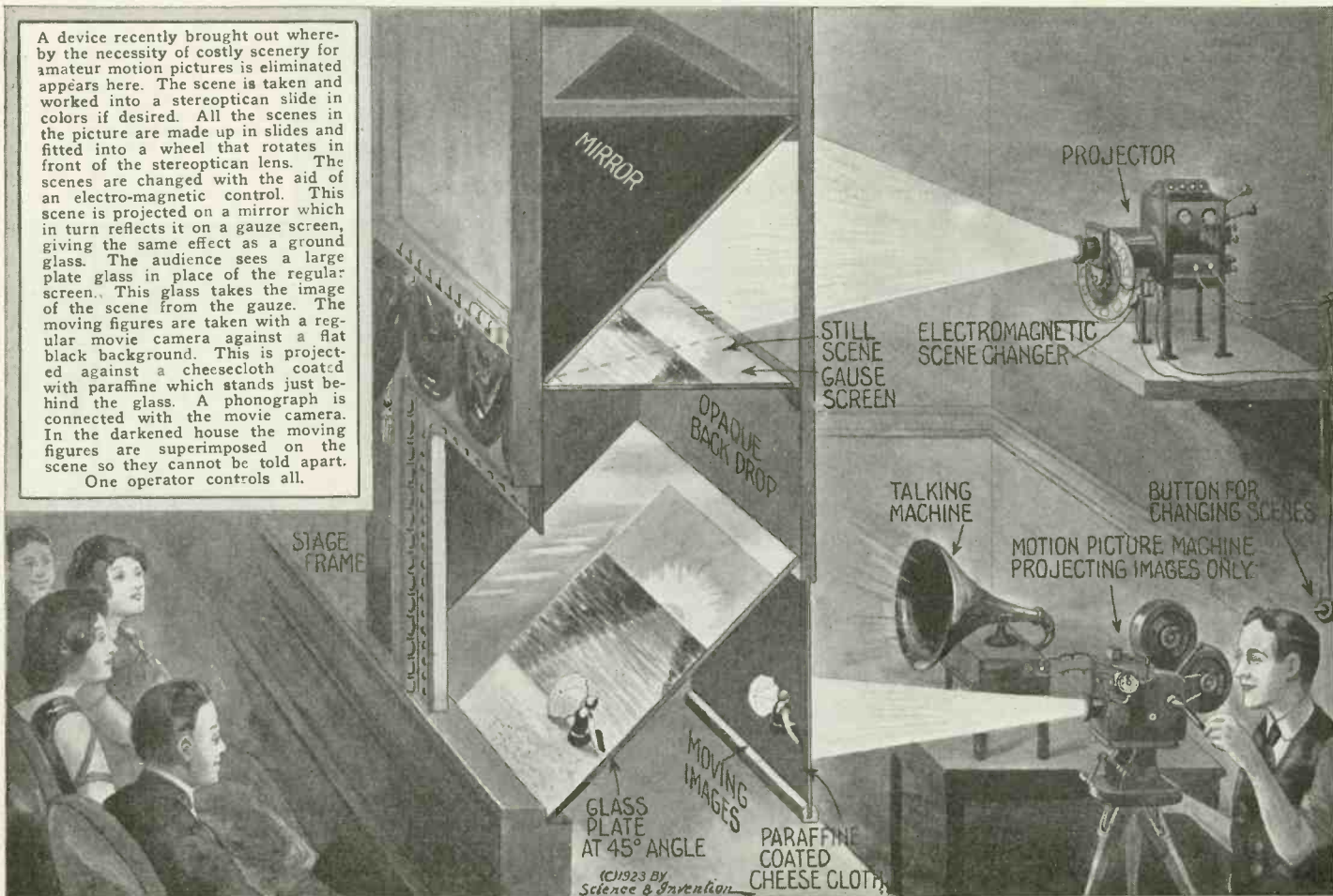

\$12,000 or More in Gold

Beginning with the January issue, SCIENCE AND INVENTION will pay \$1,000.00 or more each month of the year in prizes. Every article published in the regular news section will receive one of them. (The departments have awards of their own which they will continue to give.)

Ideas are what the editors want. They must be told simply—so your mother or sister can understand them—in pictures and sketches. Be sure they are NEW and have something to do with science or invention. The editors want pictures and sketches—

88 monthly prizes will be given as follows:

	FIRST PRIZE	\$100.00	
	2 PRIZES	of \$50.00 each	
10	" "	25.00	"
5	" "	20.00	"
10	" "	15.00	"
20	" "	10.00	"
10	" "	5.00	"
20	" "	2.00	"
10	" "	1.00	"

\$12,000 or More in Gold

must have them—but ideas are wanted most of all.—And they will be handsomely paid for. The rules of the contest will be found on page 534 of the October issue. If you haven't a copy, one will be mailed you free on receipt of your name and address. It will give full details of the rules and hints on submitting articles. The closing date for all prize contributions will be the 15th of the month preceding date of issue, i.e., 15th of December for the February number; the 15th of January for the March number, etc.

WILL YOU BE OUR REPORTER?

IN connection with our \$12,000.00 prize contest announced last month, it goes without saying that you will have to hustle to win a prize. The Editors do not wish to make it hard for you; quite the contrary. We want the pictures and want them badly. Herewith is reproduced our reporter's card. We shall be glad to send it to anyone who makes an application. By means of this card, you will be able to secure entré into industrial plants, business houses, motion picture studios, steamships, mines, etc. This card will prove an open sesame to you in many instances. Each card is numbered and only one is given to a correspondent. A postal card from you and a request for this reporter's card is all that is necessary for obtaining one. It will be sent you by return mail. Address Field Editor, SCIENCE AND INVENTION, 53 Park Place, New York City.

REPORTER

Science and Invention

CORRESPONDENT
REPORTER'S
IDENTIFICATION

NO 999

John Doe

THE BEARER OF THIS CARD
IS AN AUTHORIZED CORRESPONDENT-REPORTER OF
SCIENCE and INVENTION MAGAZINE
THE PUBLISHERS OF SCIENCE AND INVENTION WILL
APPRECIATE ANY COURTESY EXTENDED THEIR
REPRESENTATIVE.

EXPERIMENTER PUBLISHING CO

James Balk
PRESIDENT

(over)

Antique Organs

By CHARLES BEECHER BUNNELL

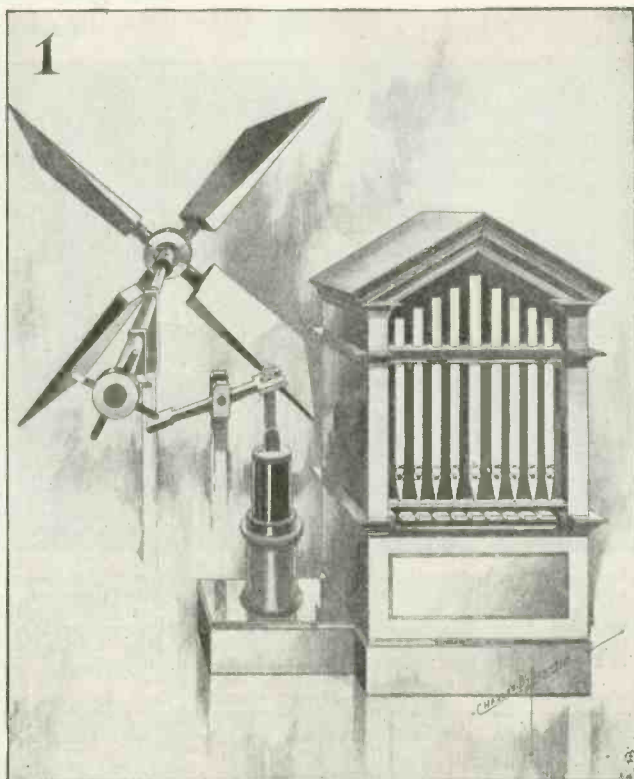
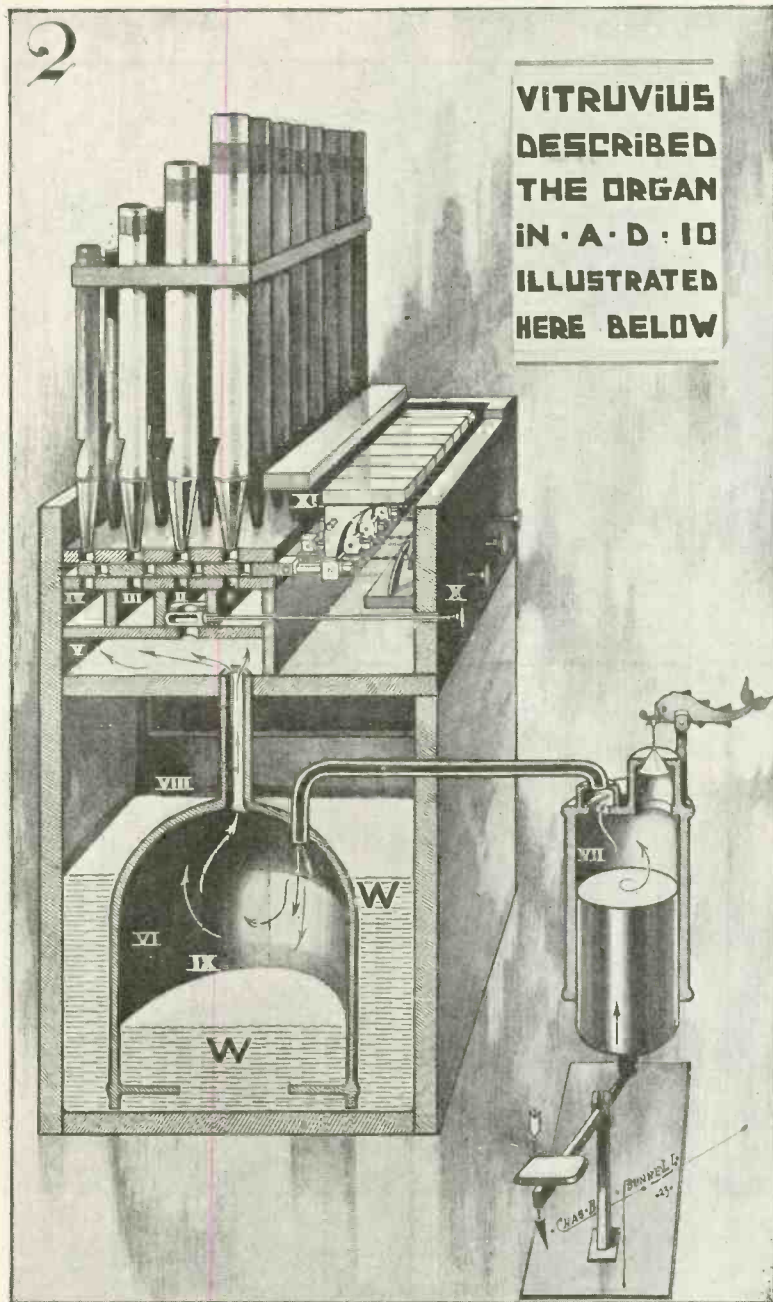

THAT the organ is a very old instrument is testified to by the fact that it is mentioned in the early chapters of the Bible (Genesis iv, 21). The first specific account of it, giving full mechanical details of its construction, however, is that set down by Hero of Alexandria, 280 B. C. In this account, Hero's father, Ctesibus, is credited as having evolved the invention. The sketch shown above (Fig. 1) is a reproduction made from Hero's description of the instrument. Although the drawing illustrates the organ as being operated by wind power, passages in the account tell of instances where the instrument was run by water wheels as well as by man power. The valves governing the tones and key-board are omitted from the drawing since more than forty different varieties of them are mentioned in the written account of the instrument.

AT the left is shown a drawing depicting full mechanical details of the instrument as set out in one of the accounts by Vitruvius, a Roman engineer, obtained from the Alexandrian Library when the city was captured. As shown, it was equipped with a foot pump, a hydraulic reservoir, and valves to the pipes which had a range of four octaves. The push-button-like affairs on the front of the organ opened the air ducts I, II, III, or IV which governed which of the four octaves were to be played. Each key of the key-board was a four-way affair and played the same note in each octave. The octaves could be combined or played separately. A horn spring kept the keys up in place when they were not pressed. Differences in volume were obtained in varying the openings of the octave keys which governed the amount of air admitted to the pipes. The water reservoir kept the pressure of the air constant while the organ was being played.



Nero may have played his fiddle while Rome burned but when he wanted a soothing quiet hour at one of the 856 public baths he listened to organ music. The baths were only one-tenth bath. The other nine-tenths was club, according to all accounts, for they were equipped with courts, wine rooms, restaurants, lounges and even organs. After a hard day at martyring Christians and feeding his enemies to the royal tigers he would retire to a bath for a quiet evening. And that he enjoyed music on the bath organ on these occasions is attested by the fact that he had a coin struck (left) showing one of these instruments. This coin was found by antiquaries and is now in the British Museum.

Want More Information?

IF YOU want additional information concerning any of the subjects illustrated and described in this number of **SCIENCE AND INVENTION** we shall be glad to give you any other data we have at our command if you will send 50c. for such work as may be required. To make this work as easy as possible for our editors, please be brief. Write only on one side of the paper and state exactly, in a few words, just what further information you wish. We have the original manuscripts and drawings of many of these articles in our files and can furnish complete outline of facts and figures in most cases. Send stamped and self-addressed envelope together with 50c. remittance in stamps, money order or certified check.

Address all inquiries of this nature to **INFORMATION EDITOR**, Science and Invention, 53 Park Place, New York City.

Medical Hokum Exposed

By JOSEPH H. KRAUS

STAFF MEDICAL EXPERT

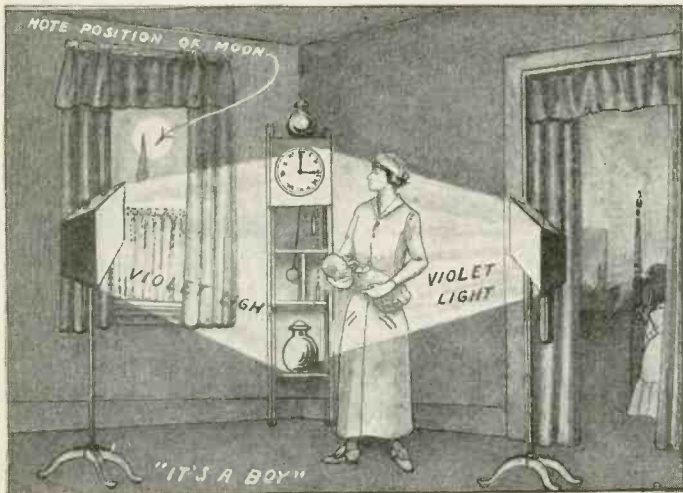

Unless the moon hung in exactly the right quadrant and the proper shade of light was available at the time of your birth you had small chances to live, according to Dr. J. C. Burnett, president of the alleged Burnett-Timpken Research Laboratory, who made public these somewhat startling if hardly probable facts in a New York lecture recently. Comes the doctor and relates the fact that green light will kill an embryo, just following the formation of the heart.

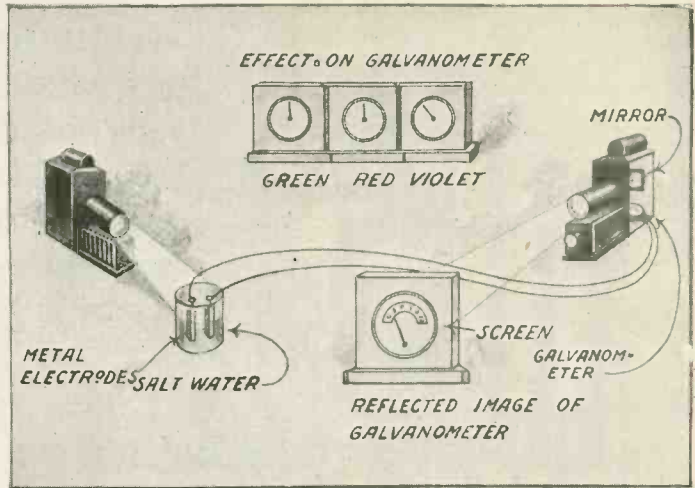

Further, this medical gent deposes and says that all chemical reaction is merely electro-magnetic change in matter, and that, such being the case, electrical currents should be used in the treatment of disease. By way of proving this fact the brother stuck two electrodes in a dish of water (salt was undoubtedly added to it) and turned different colored lights on it. The galvanometer registered differently for each, which undoubtedly proves that colored lights do cure (?) diseases. It does—not.

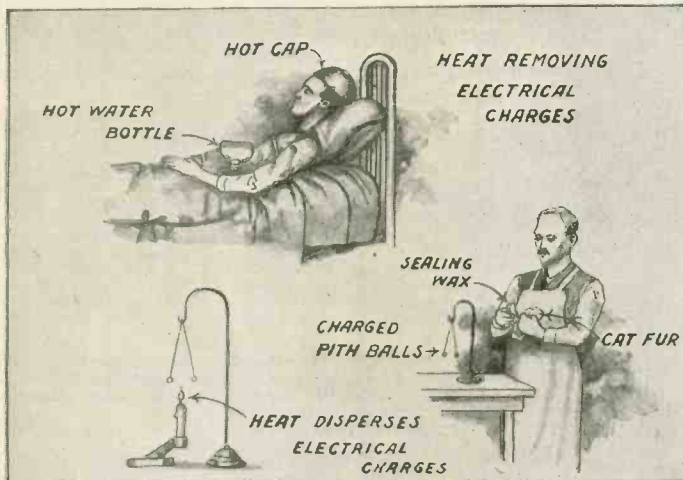

But the doctor gets the beautiful 7 1/2" x 5 1/4" custard pie as a prize for this excellent piece of whim-wham: The reason, says he, that hot appliances cure diseases is that the heat applied tends to remove electrical charges from the affected parts. By way of proving this scientifically the doctor suspends two pith balls that have been charged and then brings a lighted candle near them. The balls come together. Presto, all proved. Heat disperses the juice therefore cures disease. See photo above.

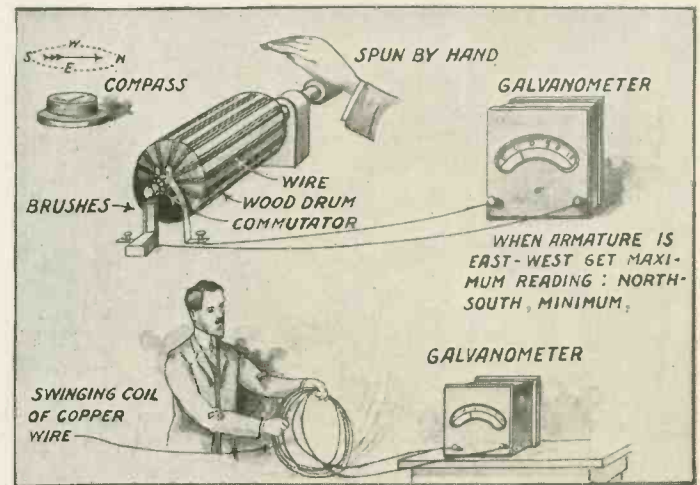

But hold, quoth the hangman. The most epochal discovery from this bag of flim-flam is the device for detecting earth magnetic currents. Note the amateur armature in the above sketch. By setting it east and west, across the earth's magnetic field a deflection is obtained on the galvanometer. Wonderful! Bravo, doc,—that is, bravo if every high school physics text didn't contain this experiment. You certainly are the great little discoverer—of physics texts.

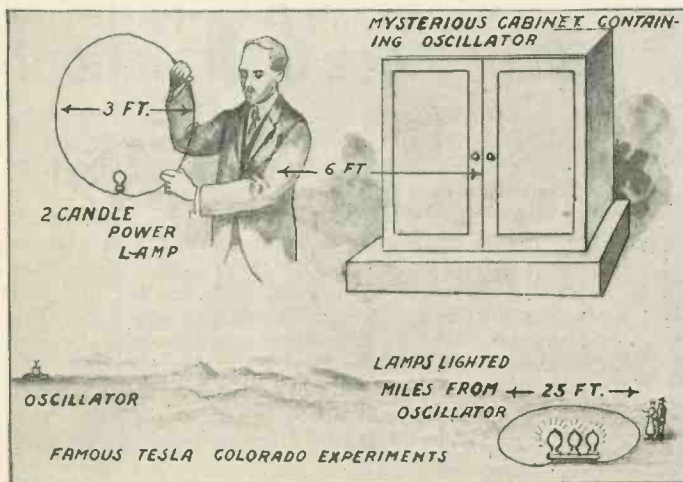

The assembled sages of the American Osteopathic Association, before whom these far-reaching discoveries were dispensed gave a howl of applause at this one (shown above) that would make Valentino jealous. The doctor lighted a light without connections. The mystery maker was a Tesla resonator.

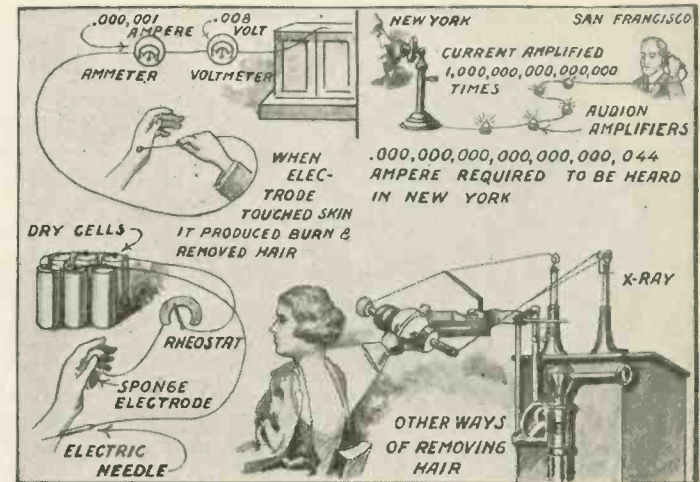

Above is some of the "laboratory's" finest measuring instruments made." See the readings of the Volt- and Ammeters and then consider the telephone amplification for fineness. He found out that electricity would kill hair but he didn't know what the X-rays would do. He'll discover that in a couple of years, let's hope.

World's Energy From Atomic Force



The Energy Released by the Disintegration of One Gram of Gold Would Yield Enough Electric Power to Light 21,666 Homes for One Year According to Dr. Paul D. Foote, Member of the U. S. Bureau of Standards.

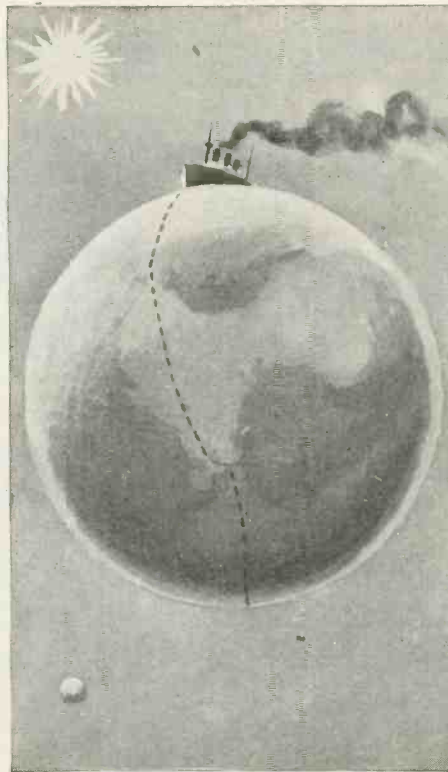

The Transmutation of the Same Gram of Gold Would Be Sufficient to Propel a Transatlantic Liner Around the Globe. The Energy Thus Liberated Would Reduce the Gold to a Base Metal Similar to Lead.

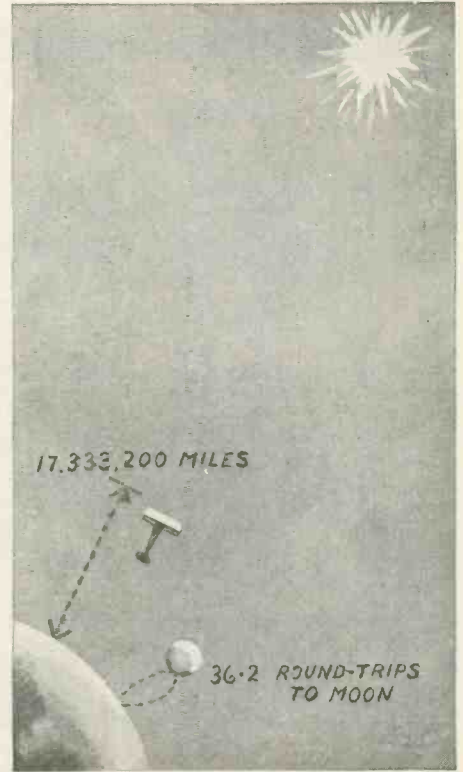

The Old Alchemists Sought to Make Gold, the New Ones Seek to Destroy It and Use Its Energy. The Atomic Force of a Gram of Gold Also Would Drive an Airplane to the Moon and Back 36 Times or 17,333,200 Miles.

Weird Deaths From Stray Currents

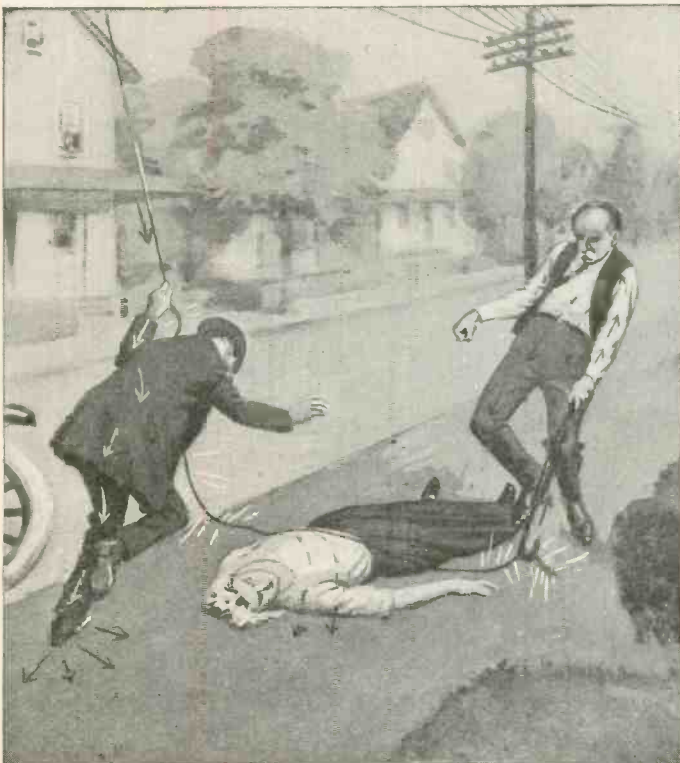

Trying to Save a Friend, a New Jersey Man Recently Lost His Life When He Tried to Remove a Feeder Wire from the Friend's Body with the Aid of an Umbrella. He was Standing on the Pavement and the Moment He Touched the Cable He Was Instantly Killed. The Umbrella Was Burned Up.

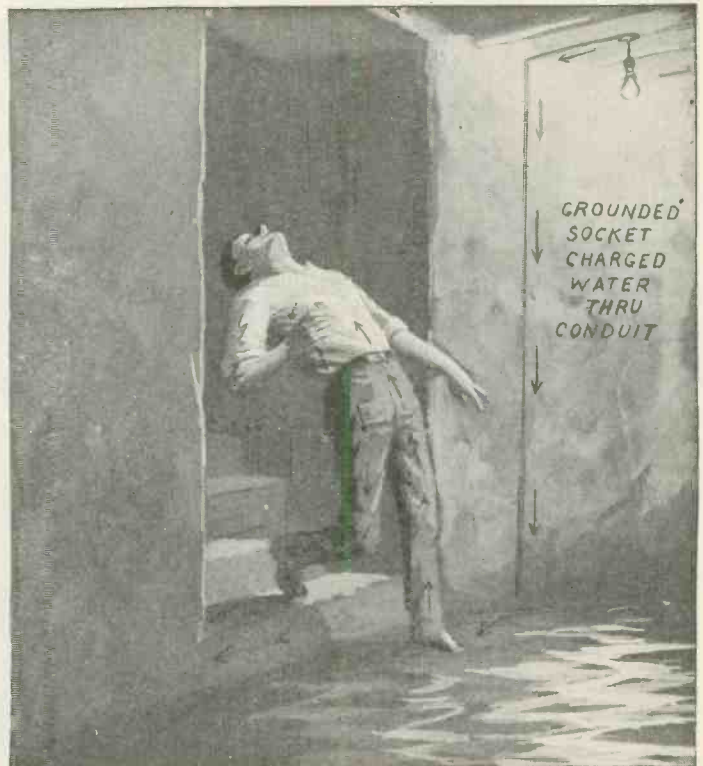

A Light Circuit Grounded to Its Conduit Caused the Death of a Brooklyn Householder When He Stepped Into Water that Covered the Floor of His Basement. The Cellar Floor Was Insulated but the Steps Were Not, So the Current Shunted Through His Body and Instantly Killed Him.

Automobile Sled—Non-Sinkable Boat



An auto truck equipped with runners and a spiked drum at the rear, which enables it to travel over deep snows.



By removing the rear wheels from a touring car and substituting a spiked drum and runners, a winter pleasure car is made.



This neat row boat, constructed entirely of Duraluminum, was made by a German aircraft company.



Because of specially constructed air chambers with which the row boat is equipped, it is impossible to sink it.



Can You Be a Movie Star?







Have you a camera face? If you are not sure and want to know, get the old T-square, dividers and yard-stick and find out for yourself. If you would portray the trials of Tessie or exploit the story of the rising young district attorney, you must first have a face conforming with rigid specifications. According to Allan Dwan, producer and director, the selection of actresses for the movies has become a thing of pure science. Here are some of the specifications determining the filming qualities of a face. The lines of the chin must form an obtuse angle when looked at squarely, and the distance from the point of the chin to the base of the nose, must equal the distance from the tip of the nose to a point exactly midway between the eye-brows.

Above—The distance from ear to ear over the forehead measured with a tape measure must equal the distance from the apex of the chin to the exact crown of the head. The separation between the eyes should equal the size of one eye. The top of the ear should be even with the eye-brow. The shape of the nose has nothing to do with the screening of a star.

Left—The nose of a star should not project any more than $\frac{1}{4}$ of an inch maximum. Pictures were posed by Mary Thurman, well-known photoplay star. —By Harry Van Demark.

The Newest Radio Photo-Play

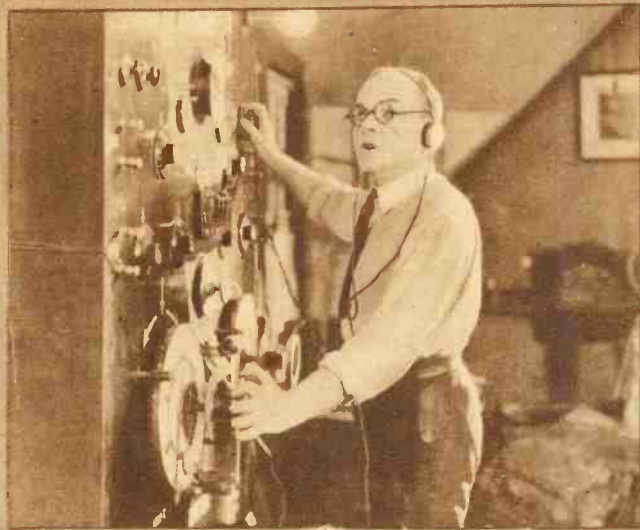

Ambition to communicate with Mars by radio is the central reason for the existence of "Radio-mania," just completed Hodkinson picture starring Grant Mitchell, shown above at his radio station.

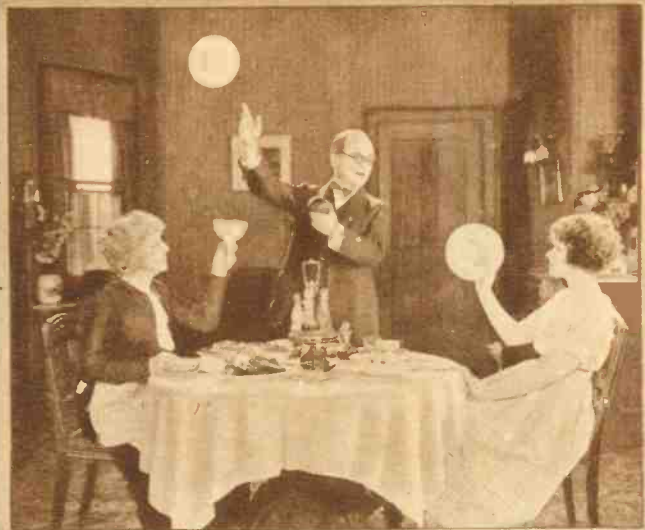

A couple of plates, with the assistance of his fiancée and hoped-to-be mother-in-law serve to demonstrate the workings of the solar system.



A Martian radio station, as depicted by the picture. The radio apparatus used in the photo-play was all especially built by the Western Electric Co. Note the large ears on the Martians.



A typical Martian home is shown above. Before Mitchell communicates with the planet, he invented a tickless alarm clock and made a fortune with which he built the radio set he used.



That the Martians are interested in monstrosities just as inhabitants of the earth are is shown by the fact that they have elaborate museums—according to the picture.



The tense moment. Martian radio operators, doing a little "DX" stuff at their station, pick up the earth on the loud speaking phones.

Around the Universe

By RAY CUMMINGS

5TH INSTALLMENT

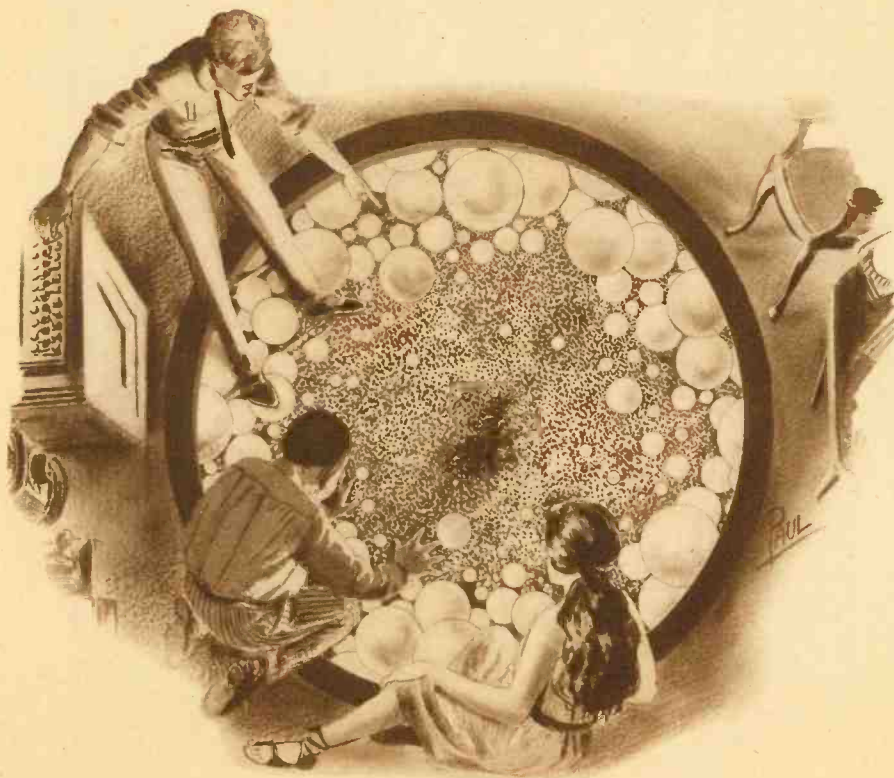

They entered the Milky Way on the seventh day after passing Alpha Centauri. Though their actual entrance into the Galactic Plane was unmarked, the firmament simply blazed with bright stars.

CHAPTER IX.

In which the voyagers plunge into the darkness of space beyond the milky way, and two most felicitous events occur simultaneously.

THE car passed between the component stars of Alpha Centauri during the early afternoon of the following day. The two gigantic blazing suns were four times our own sun in apparent diameter. Their light was intolerable to the naked eye. Even with the shades of the side windows drawn, the interior of the vehicle was disagreeably bright.

SYNOPSIS OF FOUR PRECEDING INSTALLMENTS OF "AROUND THE UNIVERSE."

WATCHING a game of cards, "Tubby" suddenly finds himself out in the open under the stars, endowed with a power of wishing. He wishes for a knowledge of astronomy and is confronted by a Professor Isaac Swift DeFoe Wells-Verne. They start for Venus in the Professor's space flyer.

Arriving, they meet Ameena, an inhabitant of Venus and she tells them that the earth is going to be attacked by Martians and the Twilight People of Mercury. The three decide to set out to the various planets to solicit aid, in behalf of the earth. They land on Jupiter and are interviewed by the Great Mogul who laughs at them and refuses help.

Leaving Jupiter they head out into space, passing near the rings of Saturn. Arriving at Uranus, they find that it is not inhabited. The same condition is found on Neptune. Therefore, in hopes that some of the stars are inhabited, they head toward Alpha Centauri.

In the last installment the Professor is left figuring out a most abstruse mathematical problem.

The heat was tremendous—almost stifling. All that morning the temperature had been rising, until, at lunch time the two men again appeared in their white flannels, and Ameena was back to her charming native costume.

During the morning the two stars that compose Alpha Centauri had visually separated, and Sir Isaac laid his course between them—a thing that was possible only because the vehicle's tremendous velocity precluded even these gigantic masses from drawing it aside and into them.

The actual passage between the stars was very brief, fortunately, or the voyagers would have perished in the intolerable heat. Sir Isaac estimated the stars to be some 3,600,000 miles apart. He professed ignorance as to what figure the earthly astronomers had set, and admitted his estimation probably was greatly in error since he had nothing to judge it by save the stars' apparent flight upward past the side windows. It was indeed, only a few seconds before they were above the vehicle and visually again drawing together.

When it was over, Sir Isaac, trembling at the keyboard, turned his white face to his companions and smiled weakly.

"I should not have tried that," he said. "It was too dangerous, attempting to pass through that little space. How I ever managed it—"

He broke off, adding:

"Well, we're past now, at all events. I did not want to slow down—but suppose—just suppose we had run too close to one of those stars—suppose we had collided with one of Alpha Centauri's planets?"

"Was there any planets?" asked Tubby. "I didn't see none."

"Neither did I," Sir Isaac confessed. "I did not see anything. There might have been—I do not know." He took a swallow of water from the carafe on the table, lighted a cigarette—he was smoking incessantly—and went back to the mathematics in which he was now constantly engaged.

Tubby watched him timidly for a moment. Then, encouraged by a glance from Ameena, he said, hesitatingly:

"Where we goin' next, professor?"

Sir Isaac looked up, frowning. "Eh? What's that?"

"I said, where we goin' next? You said this mornin' we wouldn't stop at Alpha Centauri, but you forgot to tell us why."

Sir Isaac, still working on his plans, had made a brusque statement to that effect. He had promptly immersed himself in his mathematics again, so Tubby and Ameena had thought it best to let him alone temporarily. They had spent almost the entire morning together in the little observatory upstairs, where, through the small telescope they had tried to locate the Solar System.

Sir Isaac, during the morning, had reached a definite conclusion; and now in the face of Tubby's ingratiating attitude, his austerity melted a little, and he retailed his plans.

SIR ISAAC TELLS HIS PLANS

"I did not stop at Alpha Centauri," he said, "because I calculated that the time



"There is our Sun," said Sir Isaac—"and there is Betelgeuse. Our Sun is about 15½ light years from here—Betelgeuse is about 150.

we would lose in checking our present high velocity and starting again, would, after a very few stops, exhaust all the time at our command." He smiled in friendly fashion, and explained in detail.

"But then," protested Tubby, "if we don't never stop, how are we goin' to get any help?"

Sir Isaac hesitated. "To be quite frank with you, my friends, I have about concluded we cannot get any help."

"Oh," said Tubby.

"Oh dear," Ameena echoed faintly.

Sir Isaac continued.

"I think we can save our earth alone—through our own efforts—without any outside assistance."

Coming from such a meticulous person as Sir Isaac this was good news indeed. Tubby and the girl vociferously demanded details.

Sir Isaac raised his hand. "I have not worked it out yet. That's why I didn't want to tell you anything about it. The plan involves a tremendous, a very abstruse and delicate mathematical calculation. If I can secure complete and exact enough figures the execution of my plan will be very simple. I am working on the calculation now. I worked all last night—all this morning. It may require many days—I do not know. But if only my strength holds—"

"You go right ahead," encouraged Tubby. "We won't bother you none. And meantime—"

"In the meantime," Sir Isaac supplied, "I thought we might as well go onward." He smiled with just a touch of embarrassment. "To tell you the truth, I am very curious about these outer realms of space. I have lots of good theories—but I really *know* very little about this portion of the Universe."

"Me neither," Tubby declared liberally.

"And," Sir Isaac went on, "since we have attained this high velocity, and are each moment accelerating it, I thought we might as well utilize our spare time to—well just to satisfy our curiosity. I have a theory regarding the edge of Space—"

"Ah! The edge of Space!"

"Yes, the very ultimate edge of this Space we are traversing. If we could reach it and return with my calculation completed, and then save our Earth, it would—"

"Great!" cried Tubby.

"We can! We will!" cried the girl.

"Well," said Sir Isaac, "that was a gigantic building alongside of which we went down—a building fifteen or twenty miles high. Those huge yellow rectangles were its lighted windows. That ball of fire was a street light. We descended directly into a city street and collided, probably with the coat sleeve of a pedestrian."

"—it would gratify me very much," Sir Isaac finished.

Thus it was arranged. Tubby and Ameena returned to the observatory—the only part of the vehicle where they could sing with abandon and without fear of disturbing Sir Isaac.

Two hours later they came quietly down to indulge in afternoon tea. In the instrument room, sprawling in his chair, with his arms on the table and his head upon them in the midst of a litter of papers covered with algebraic hieroglyphics, sat Sir Isaac, fast asleep.

"Poor dear man," murmured Ameena. "He is completely worn out."

"Yeh, he's all in," agreed Tubby. "Let's get him to bed."



They awakened him gently, and ordered him up to one of the bedrooms. Like a child, he obeyed. On the stairs he roused himself sufficiently to caution Tubby.

SPEED AND DANGER INCREASE APACE

"I want you to look ahead through the floor window at least once every minute," he declared. "We have very little room, even out here, at this velocity. I have several times barely avoided collisions that I haven't told you about. If we approach closer than 900,000,000 miles—or even as close as that—to any celestial body of sufficient mass to deflect us, we are lost. Will you promise?"

Tubby promised; and this time, with Ameena's assistance, he kept his word.

As Sir Isaac explained to them the following morning, the danger of collision in one way was now very great, though in another way it had lessened. They had passed Alpha Centauri at a velocity per second of something like 275,000,000 miles. This, by steady acceleration, now approximated 740,000,000. Any very gigantic celestial body in front of them would deflect them aside and into it. It was this danger that they must avoid. But of course, so enormous a body would be visible an enormous distance away and so could be seen in time to be avoided.

On the other hand, there was now little danger to be apprehended from smaller bodies such as the asteroid with which they had so nearly collided back in the Solar System. Even if one of these should separate itself from the proximity of the larger worlds, its comparatively minute mass could not exert sufficient attractive force to make the slightest deflection in the course of the vehicle. For a collision to occur, therefore, one of these smaller bodies would have to lie *exactly* in the vehicle's path—a space of some forty feet which was the vehicle's width. And, as Sir Isaac remarked, any particular forty feet in these vast realms of outer Space was too small to be considered. Sir Isaac also pointed out that any asteroid would be invisible until it was only a

(Continued on page 715)



Sir Isaac: leaped back to the keyboard just as the vehicle struck something soft and yielding. There was a gigantic swish; the room tilted and trembled—then silence.



"Yes," explained the Lunar queen, "it is a movie of the murder as it really occurred. . . . We obtained the pictures through the slowness of light."

She waved her hand. A mirror appeared on the wall and the whole scene of the tragedy was enacted in natural colors.

Doctor Hackensaw's Secrets

By CLEMENT FEZANDIÉ

No. 23

What Dr. Hackensaw Found on the Moon

PREPARING TO LAND ON THE MOON

So saying, the doctor pressed a button. The walls of the room opened, pivoted around, and Pep and the doctor found themselves each snugly ensconced in a thick cushion of spring mattresses that filled the apartment. Then the doctor pressed a second button. A violent detonation followed. The front of the car shot off toward the moon like a cannon-ball, and the doctor was pleased to observe that the speedometer showed an appreciable reduction. Of course, the concussion was great, but the mattresses preserved the doctor and Pep from injury.

Finally, the last explosive was fired. The speed of the car, however, was now terrific, and the doctor was expecting the final crash to be fatal, when, to his astonishment, the speed gradually diminished. Objects in the car regained their normal weight, and the car landed as softly on the moon as if it were a feather.

Doctor Hackensaw was hugely astonished at this unexpected turn of affairs, and did not learn until later that he was indebted to the Selenites or inhabitants of the moon, for checking the speed of his fall and thus saving his life and that of his companion.

MOON'S LACK OF ATMOSPHERE

The doctor, however, lost no time. Calling Miss Pep, the two soon arrayed themselves in the special suits prepared for exploring the moon. These suits were an absolute necessity. There being little or no air on the moon, a supply of compressed air had to be taken along. The absence of air, also, implied the absence of air-pressure. If the body were left unprotected, serious injury to the internal organs would result. Also, there being no atmosphere, the heat and light of the sun were not diffused, and

the glare and heat would be intolerable. Protection from both was necessary.

"You see, Miss Pep," explained the doctor, "the moon's days and nights are not like ours. One day and one night make a month here. The sun shines here for fourteen days at a stretch, with an unbearable heat and glare, though the sky is dark in all other directions and the stars shine brilliantly. Then follow fourteen days of night, and the cold is intense. Without our suits we could not live an instant here, and without our goggles we should lose our eyesight!"

THEIR FIRST VIEW OF A LUNAR LANDSCAPE

By this time the pair had emerged from the car and were viewing the new world. To Pep, who had looked at the moon through a telescope, the idea of a lunar landscape was a series of dead volcanic cones. But there was, in fact, luxuriant vegetation. Although there were some green plants among the number (if they could be truly called plants), the other colors of the rainbow seemed to predominate. As to the shapes, they were the most fantastic imaginable. Animals, too, of the most peculiar sort, could be seen playing about among the plants.

Pep was especially interested in one curious creature that had legs radiating from its body in six different directions and could roll in any direction by using four of these legs like the spokes of a wheel. Pep called these creatures the "Jacks" from their resemblance to the metal jackstones that children play with. There were also balloon-shaped creatures that floated about in the rare atmosphere, directing their course by means of paddles or fins. Another peculiar animal progressed by prodigious bounds in the air.

"DOC" AND "PEP" FIND THEY WEIGH ABOUT 20 POUNDS ON MOON

At the very first step the pair made on the moon, Pep, too, found herself bounding high in the air. It was almost like the jour-

ON, on sped the car through space, and still Doctor Hackensaw and Pepita Perkins lay unconscious in their respective couches. It was not until the car was nearly at the end of its journey that the doctor's automatic devices awakened him from his profound sleep. Pepita, too, or "Pep," as she insisted on being called, awakened at the same time.

"In three hours, Miss Pep," observed the doctor, "we shall land on the moon."

"Yes, and in the form of burnt pancakes. You told me that already. Why did you wake me up?"

"Because we must be prepared for any emergency. There is one chance in a thousand of our reaching the moon alive, and we must be prepared to grasp that chance. I have done all that was humanly possible to break the fall. Instead of shooting the car straight at the moon, I shot it so as to pass a little beyond the moon, thence to be pulled back by the lunar attraction to the side of the moon opposite to the earth. The car has thus a much shorter distance to fall. I also arranged that the moon should be speeding away from the car, hence the rapidity of the car's fall will be still further diminished, since it will be the difference between its own speed and the speed at which the moon is departing from it. Then, too, the attraction on the moon is considerably less than that on the earth. I have also arranged special devices for retarding the car at the proper moment.

"The front of the car, that is, the side turned toward the moon, is made in a series of compartments, each containing an explosive. Whenever I wish to decrease speed, I shall ignite the explosive in this front compartment. The compartment is shot off toward the moon, and its reaction shoots the car backwards a little, or, to speak more accurately, retards the car's speed. Each compartment can be exploded in turn. In fact, here goes the first. But I shall fill this room with mattresses to deaden the shock for us."

ney in the car when objects had no weight at all. There, bodies had some weight, but much less than on earth.

"You see, Miss Pep," explained the doctor, "the moon is smaller than the earth and less dense, hence its attraction is less. On the other hand, bodies on the moon are nearer the center of attraction than bodies on the earth. This compensates to some degree for the lesser attraction. But, all told, bodies on the moon weigh only about one-sixth what they do on earth. You, for example, weigh 120 pounds on earth, but only twenty pounds here. Similarly, if you can lift 100' pounds on earth, you could lift six hundred pounds here with the same effort."

"Gee! Is that so? Let me see!" cried Pep. And irreverently picking up the doctor, she threw him up into the air. Up he went, twisting around and sputtering, his dignity even more upset than his person. He fell lightly, however, and in retaliation threw Pep into the air in the same manner.

At this instant, however, the doctor caught sight of one of the lunar machines, and instantly bounded towards it. Here at last the dream of his life was to be realized—he was viewing a machine such as mankind will not invent for hundreds of thousands of years to come! The machine was not of metal nor yet of wood, nor of flesh. It resembled no substance known to the doctor. The main part of the machine consisted of a series of spheres rotating about each other. They were not connected together in any way, but rotated somewhat as the planets rotate about the sun.

Doctor Hackensaw was overjoyed. "It must be a gravitation machine!" he cried gleefully. The Selenites have discovered the secret of gravitation and can work their machines without gears, connections, or bearings. "Oh, if I could only discover the secret!"

Close by the main machine was an auxiliary part. This bore some resemblance to a steam radiator with balls ascending and descending in spiral lines around the pipes. Long and closely did the doctor scrutinize the two machines without being able to understand either how they worked or what object they accomplished.

Then he felt himself pulled away by some

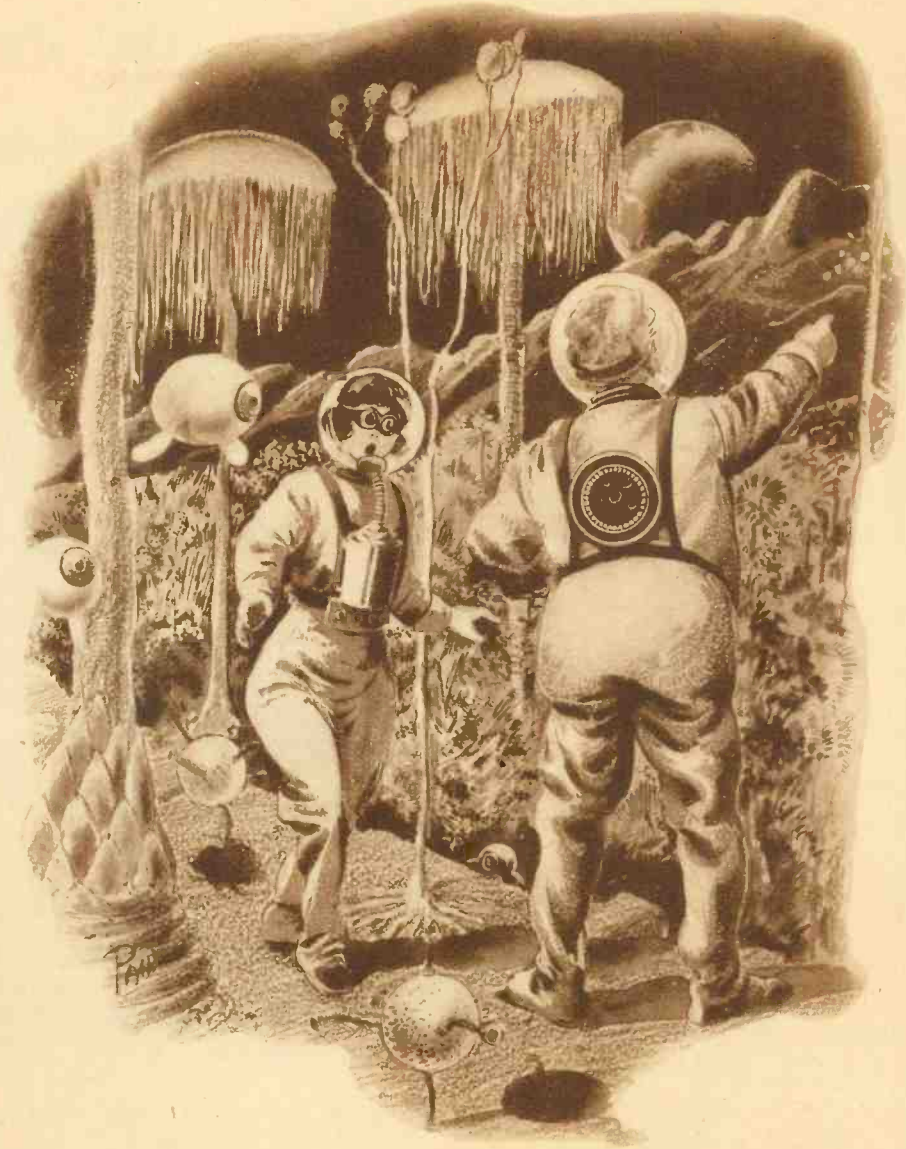

The Lunar landscape proved to support a great, luxuriant vegetation. Although there were some green plants among them the other colors of the rainbow predominated.

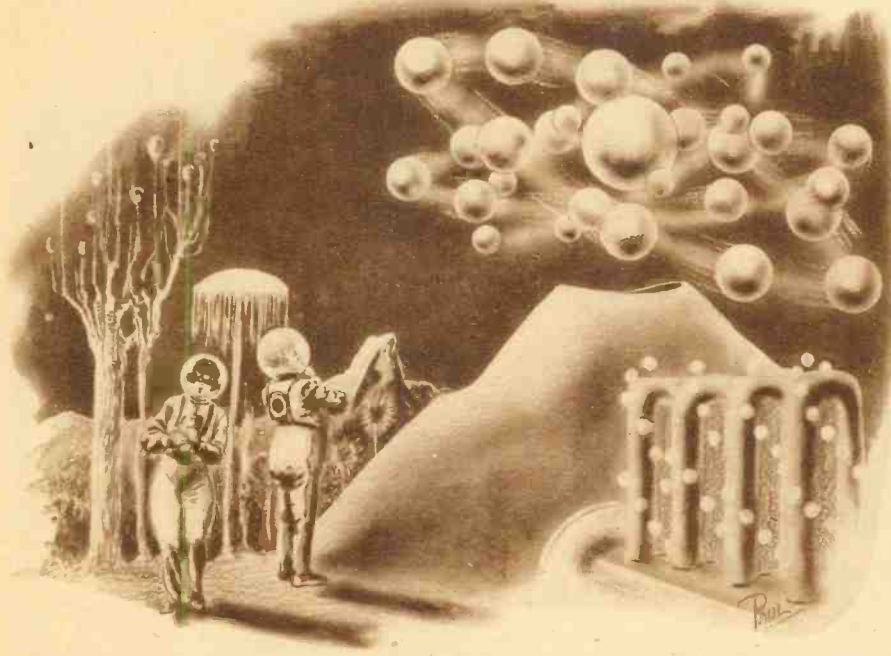

Close by the main machine, which consisted of a number of unconnected spheres rotating about each other, there was an auxiliary part. The doctor examined it long but could not discover its purpose.

invisible force, and as he turned he found that his companion was sobbing.

"Why, what's the matter, Pep!" he exclaimed. "You're surely not crying? I felt all along that your gayety was unnatural. Tell me, what is the trouble. Is it the fear that we shall never get back to earth again?"

"No, no, no," cried the young girl in agony. "I never want to get back to earth again. Doctor Hackensaw," she added, "I'll tell you all. You were surprised to see me in the car, but the fact is, I had to get away from the earth. In plain words, I am accused of murder, and there's a warrant out now for my arrest! But, doctor, I swear that I am innocent. I confess that many a time I've wanted to kill the man who ruined my life, but I never had the courage to do the deed. It was probably some other victim of his that did it. But she used a knife that belonged to me, and I was known to have threatened him. Luckily I learned of my danger in time to make my escape. I knew I should not be safe on earth, so I decided to accompany you to the moon, and here I am!"

Doctor Hackensaw shook his head. "You ought to have stayed at home and trusted to finding proofs of your innocence. You certainly won't find them here on the moon." A rather rash statement, however, as the sequel was to prove.

(Continued on page 710)

Height Test for Aviators

For testing the reaction of muscles and nerves in prospective aviators, a closed cylinder in which all atmospheric conditions of airplane flight can be duplicated has just been put into service by French aeronauts. The cylinder is shown in the large central circle. With this device the pilot's physical adaptability is safely tested

Air can be extracted or admitted to the cylinder in such a way as to give an exact replica of a rising or falling plane. The future aviators wear oxygen masks and recording instruments that give a record of all their reactions to the synthetic flights and falls. All instrument wires, air and cooling pipes come in under the floor

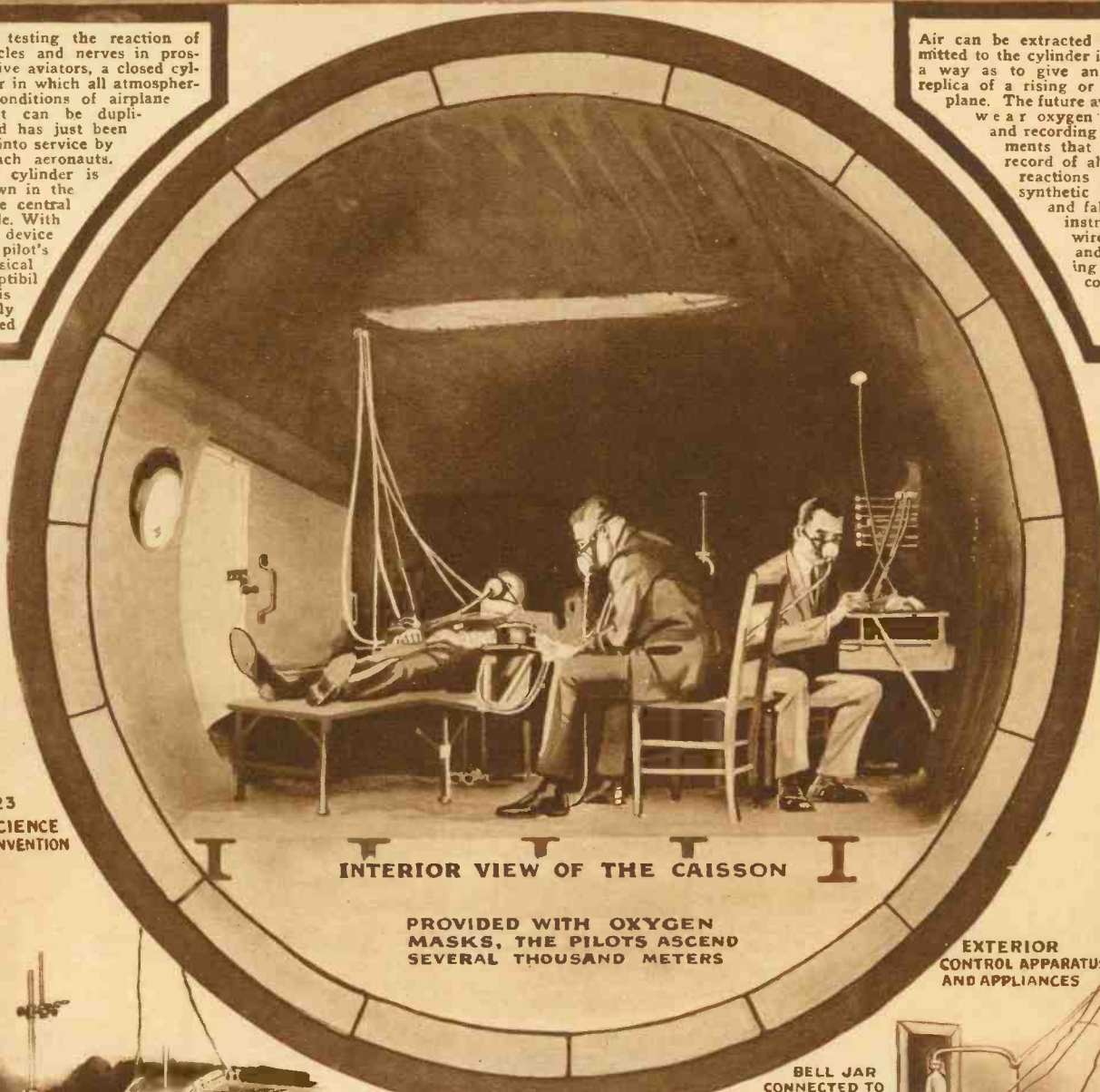

© 1923
BY SCIENCE
AND INVENTION

INTERIOR VIEW OF THE CAISSON

PROVIDED WITH OXYGEN MASKS, THE PILOTS ASCEND SEVERAL THOUSAND METERS

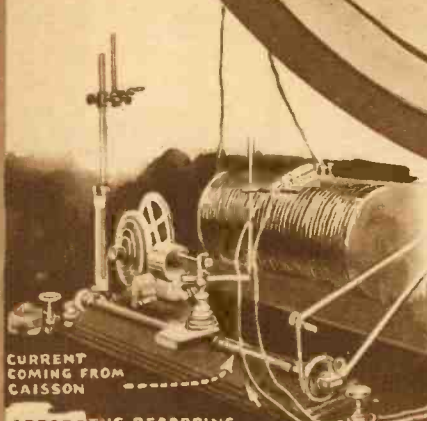

APPARATUS RECORDING THE PSYCHOMOTIVE REACTIONS AND THE RESISTANCE OF THE PILOT AT DIFFERENT ALTITUDES (IN THE PHYSICIAN'S OFFICE)

BREATHING MASK FOR THE OXYGEN

CONNECTING TUBES TO OXYGEN CYLINDER

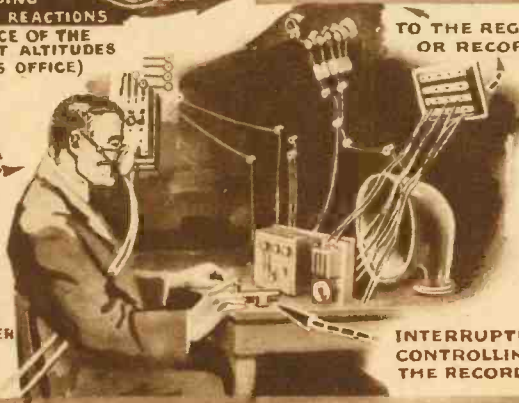

TO THE REGISTER OR RECORDER

INTERRUPTER CONTROLLING THE RECORDER

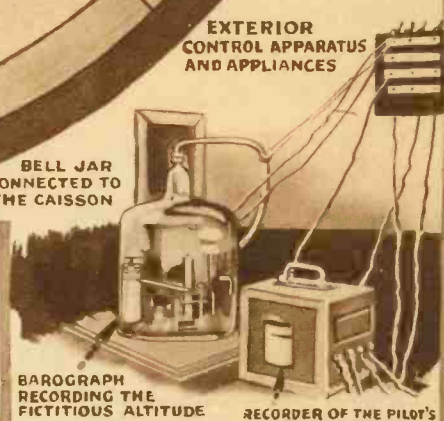

EXTERIOR CONTROL APPARATUS AND APPLIANCES

BELL JAR CONNECTED TO THE CAISSON

BAROGRAPH RECORDING THE FICTITIOUS ALTITUDE

RECORDER OF THE PILOT'S MOVEMENTS

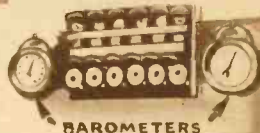

BAROMETERS

VALVE FOR REGULATING THE TEMPERATURE

EXHAUST CONNECTION (THE ASCENT)

AIR INLET (THE DESCENT)

IN THE CAISSON - THE CONTROLS



The operator sitting with the men under test observes their actions. He controls connections to the instruments, one of which records the rarity of the air corresponding to altitude, another the fall in temperature. A third records the pilot's movements. The most important one is shown to the left. It records the effect of height on the pilot's ability to act quickly; tests the response of his motor nerves which is of utmost importance.

Sky-Writing--An Exact Art

By W. B. ARVIN

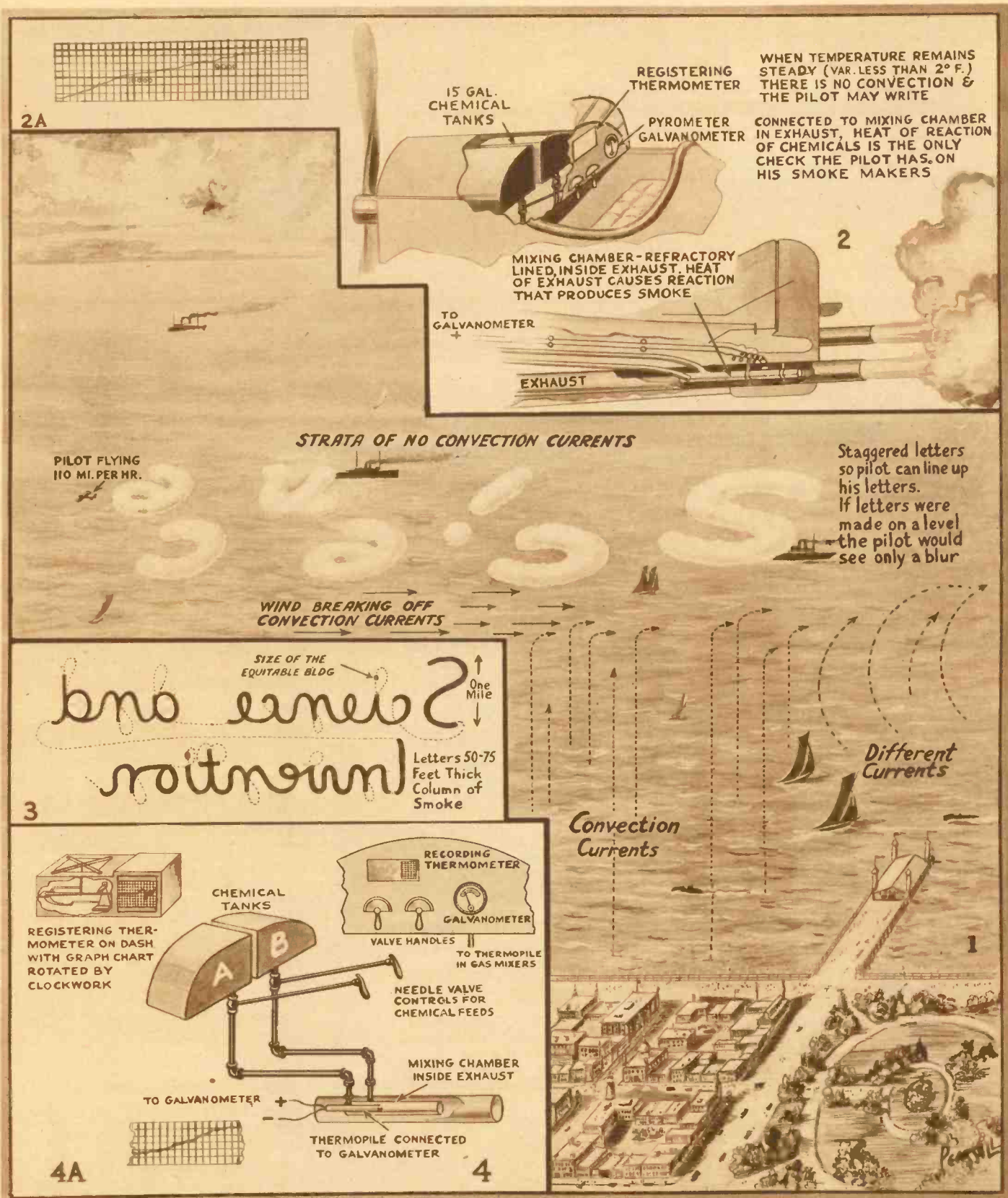

Writing 10,000 feet in the air with a column of smoke 75 feet thick using letters a mile high, and at the same time driving a light airplane at 110 miles an hour around sharp corners requires exactness at the very least. You may take the word of the inventor, Major Jack Savage, for it. First the sky-writer has to find a strata of air where there is no convection. This is done with a recording thermometer, (detail in sketch 4A). When the graph paper shows a flat stretch (Fig. 2A) there is no change in temperature and therefore no convection and the pilot may write—if there is a heavy wind, for the letters are written at a distance from the point of the observers and then allowed to be blown into their vision by the wind. Major Savage told the writer he does his best writing in a seventy-five mile an hour gale. Fig. 1 illustrates the method of staggering the letters 100 feet over each other.

Fig. 3 shows the way the writing is done—backwards. The dot on the “i” is the size of the Equitable Building in New York. At Fig. 2 is shown the chemical writing apparatus and the instrument board installed in the light plane which is used. Fig. 4 shows in detail the two mixing tanks from which the smoke-producing chemicals flow back to the mixing chamber in the exhaust where the heat causes them to combine into 250,000 cubic feet of smoke per second. It requires about 15 gallons of the two mysterious chemicals which the Major calls “A” and “B” to write the name SCIENCE AND INVENTION. In day-time white letters are used. Or three colors may be used together, such as red, white and blue. Luminous letters are used at night. The writing will last from ten to forty minutes, depending on the condition of the air.

Electrically Driven Ferryboat

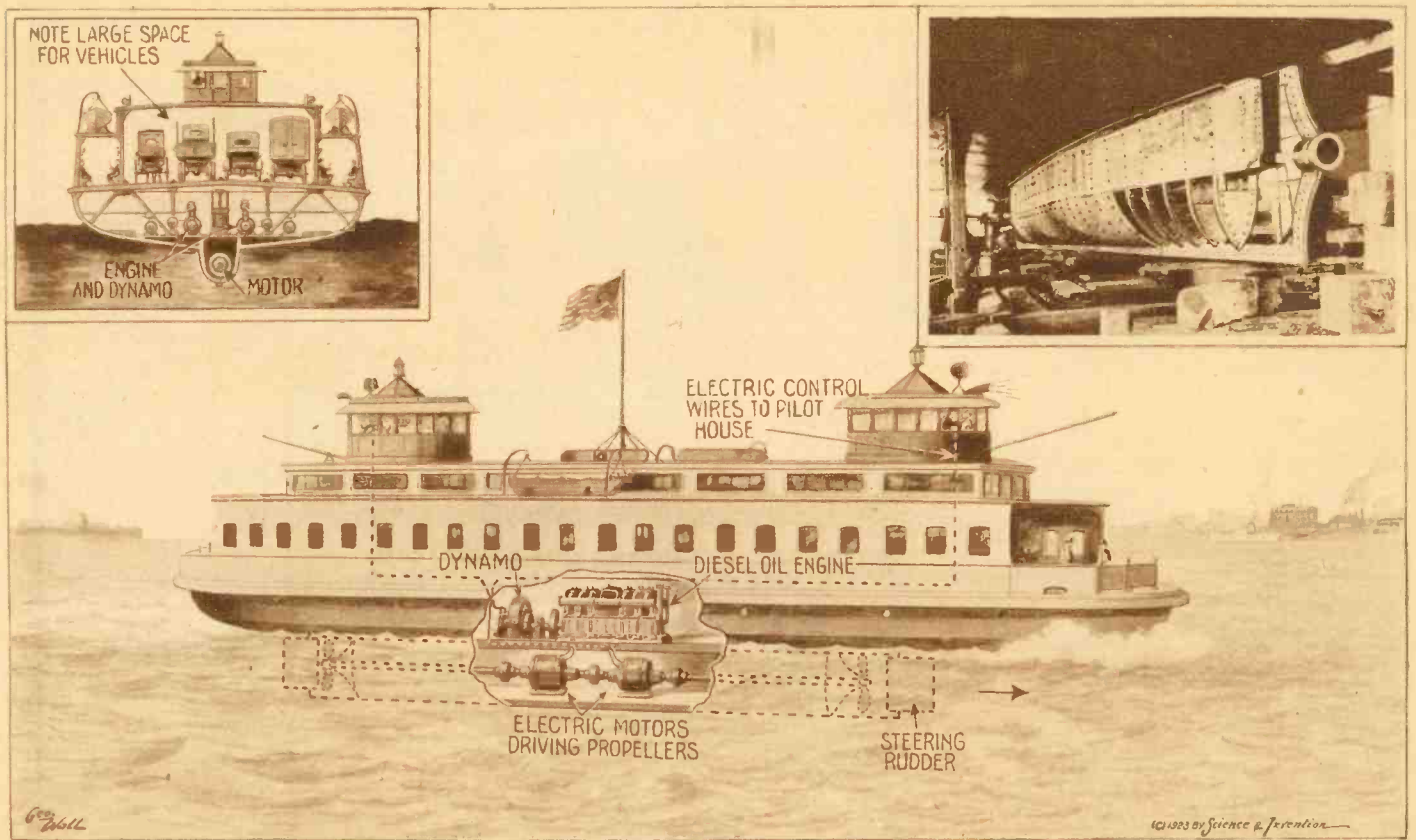

An electrically driven ferryboat with much larger carrying capacity than the old type steam-driven boats has just been put in service by Captain Samuel

Golden, the inventor. The boat is entirely controlled from either pilot house. It can be easily maneuvered and is stable in ice and rough weather.

Camera Used to Judge Horse Races

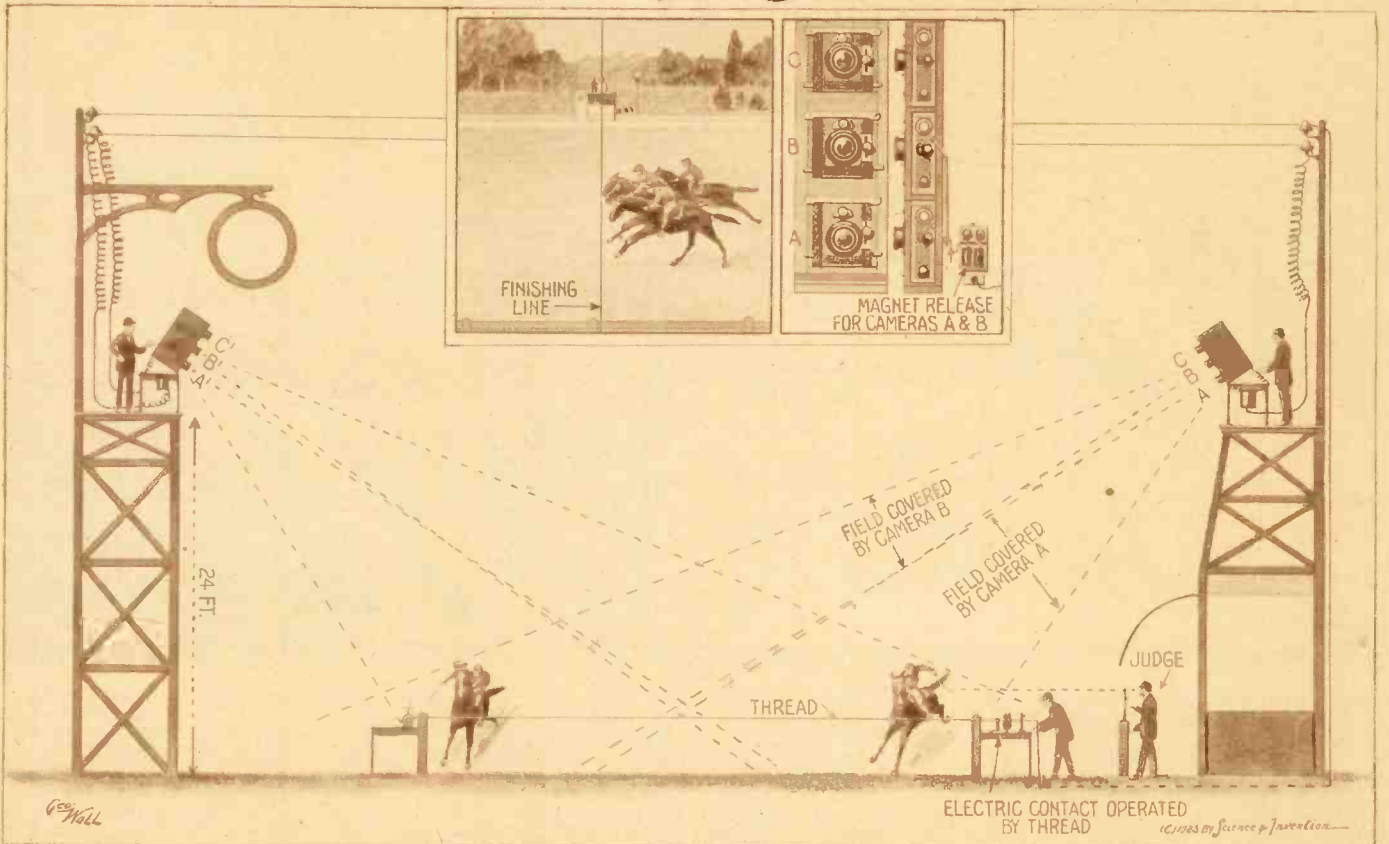

To take the guessing out of deciding a close race, the Maisons-Laffitte course near Paris uses cameras placed above the finish wire. The horses coming to

the wire break a thread which trips the camera shutters. The pictures are finished four minutes after the race. Camera C catches the "place" horses.

Hearing Through the Teeth

By H. GERNSBACK

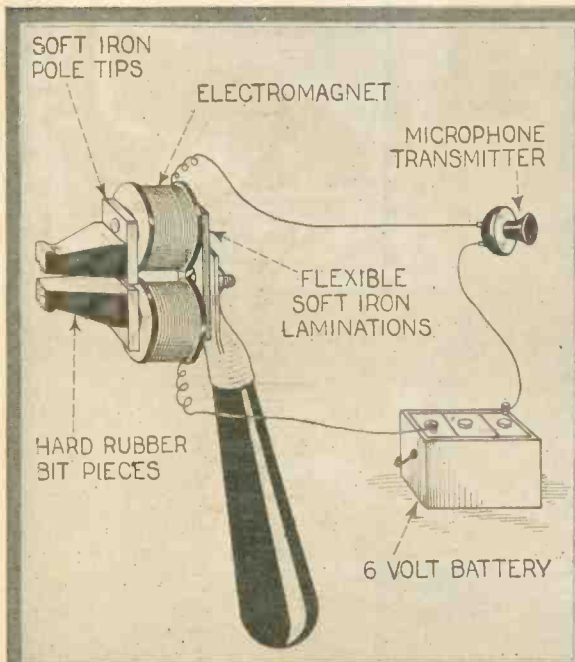

How the Osophone, a new invention of Mr. H. Gernsback, is used. This instrument makes it possible for the hard of hearing to enjoy radio concerts and other sounds. The sound is conducted from the Osophone through the teeth and bony structure of the head to the auditory nerve. If this nerve functions at all, the Osophone will partly restore the hearing, although deaf people cannot hear with it.



The Osophone consists of two electro-magnets mounted on flexible soft iron laminations. Two hard rubber bit pieces are placed between the teeth. The instrument works best when not bitten too hard. The two soft iron pole tips move to and fro when the Osophone is in operation and the sounds are thus transmitted.

At left is shown a close-up of the Osophone. It can be hooked up either to a radio outfit; to the telephone; to a phonograph; or to a pocket transmitter such as is used with pocket dictaphone used by the hard of hearing. The Osophone is particularly useful in cases where the diaphragm of the ear has been destroyed and the auditory nerve still remains. Experiments at the New York Institute for the Deaf showed that the instrument worked well for those hard of hearing, but not for the deaf or near deaf.



How to talk to a friend hard of hearing. Mr. H. Gernsback at the right demonstrates the instrument to a person of normal hearing. In order to hear with the Osophone a normal person must close his ears tightly; then the sound transmission is entirely through the teeth. A person hard of hearing using the Osophone would not, of course, have to close his ears.

Hook-up of Osophone to a radio outfit. An ordinary 1000 ohm telephone receiver has mounted in the center of diaphragm one of the well-known microphone buttons. The Osophone is then connected in series with the microphone button and with the battery. The resistance of the Osophone is only about $5\frac{1}{2}$ ohms in order to pass powerful currents. Sound coming through the telephone receiver operates the microphone which in turn energizes the Osophone.

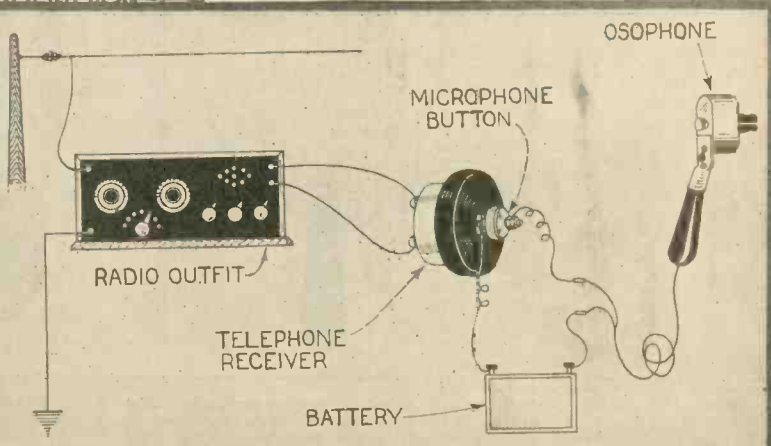

Army Airplane Refuels In Flight

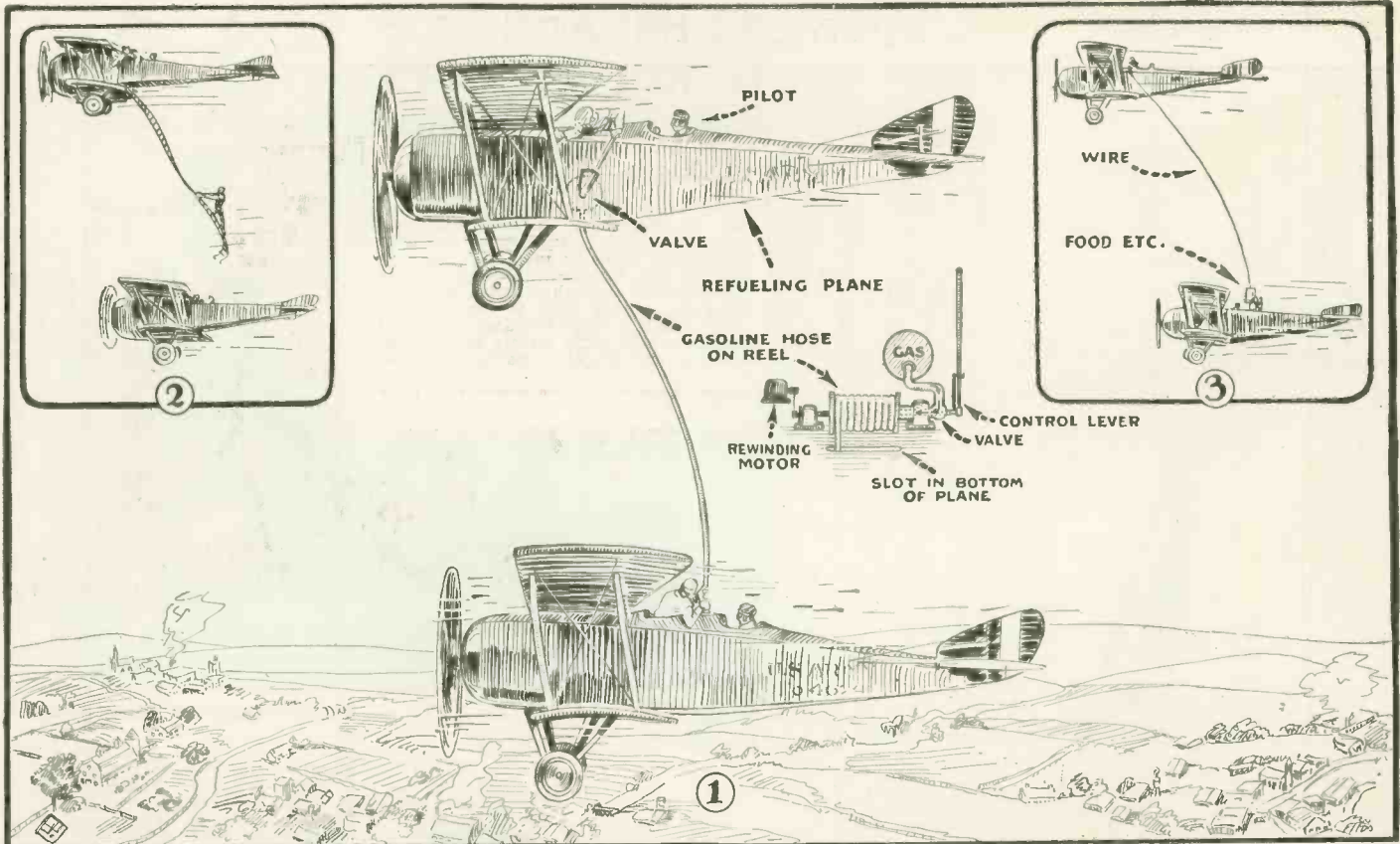

Refueling Airplanes in Flight Was Demonstrated Successfully by Two Army Flyers Recently. The Method Used in Transferring Gasoline from the Refueling Plane to the Plane Below is Shown in Fig. 1; Both Planes

Flew at the Same Speed, of Course. Fig. 2 Shows Another Means of Communication Between Planes in Flight Demonstrated Several Times Already. Fig. 3 Shows Packages Being Sent from One Plane to Another.

How Rubber Articles Are Made

By ISMAR GINSBERG

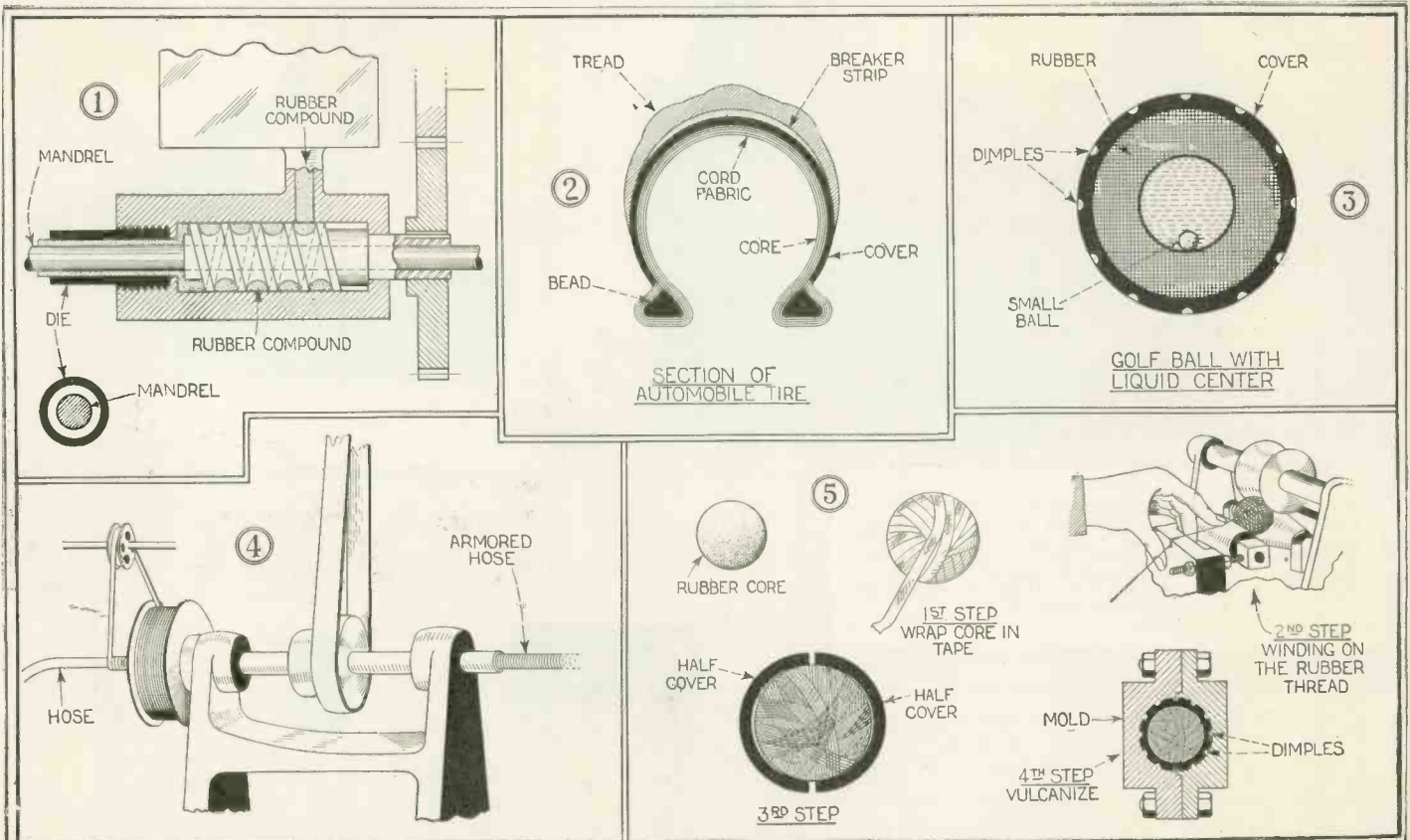

The Making of Rubber Articles is of Interest to Everyone Today. Fig. 1 Shows How Moulded Rubber Compound is Fed Through a Worm Feed Device and Forced Out Over a Mandrel to Form Hose or Tubing. Fig. 2 Shows Various Component Parts of an Automobile Tire, the Rubber Com-

ound Being Moulded Around the Cord or Fabric. Fig. 3 Shows a Rubber Golf Ball Having a Liquid Center. Fig. 4 Shows How Wire Armored Hose is Made; The Hose Passes Through the Axis of Spool Containing Wire. Fig. 5 Shows Successive Stages in Making Golf Ball.

Sheet Metal Air Propeller

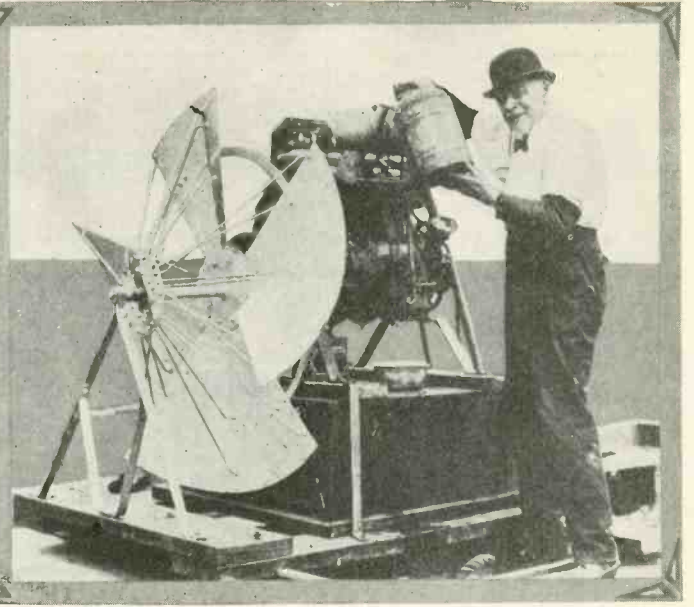

Rudolph Schmidt, eighty years old, has the work of a lifetime bound up in the nautical air propeller shown in the photos above. He began work

on it in 1874. Now completed, it will drive a small barge fifteen miles an hour against a stiff river current, it was demonstrated recently.

\$50.00 Prize Contest - Psychic Motor.

AT the right we have what is called a "psychic motor," or a motor to demonstrate what has been termed "animal magnetism." Of course there is no magnetism to it. A magnet does not effect the instrument at all.

The device shown in the illustration is easily constructed. A piece of writing paper two and one-half inches wide is glued so as to form a cylinder approximately two inches in diameter. Two holes are made diagonally opposite each other and a piece of straw or tooth-pick should extend on either side approximately a quarter of an inch. A minute drop of glue secures it to the cylinder. A needle is passed down through the center of the straw. The entire cylinder is pivoted on the needle point on top

of a glass stoppered bottle. When the right hand approaches the cylinder it will be

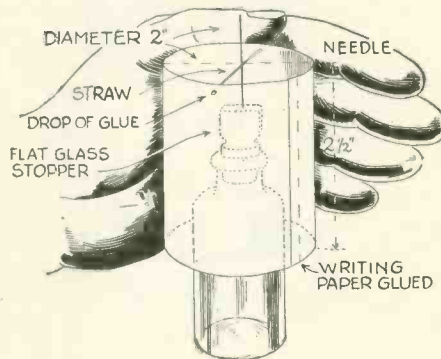

found to rotate in one direction, and when the left hand is held near the cylinder it will rotate in the opposite direction.

For the best letter explaining why the cylinder rotates, which explanation should be made in pictorial form, as nearly as possible, a first prize of \$20.00 will be paid. For the second best an award of \$15.00 will be made. For the third, a prize of \$10.00 will be given, and for the letter ranking fourth there will be a check for \$5.00. Contestants are not limited to the number of answers they may send.

In event of a tie, an identical prize will be given each. This contest closes in New York on January 10th, and all material must be in our hands by that time. Address answers to "Psychic Motor" Editor, care of this magazine.

The Month's Aeronautical Novelties

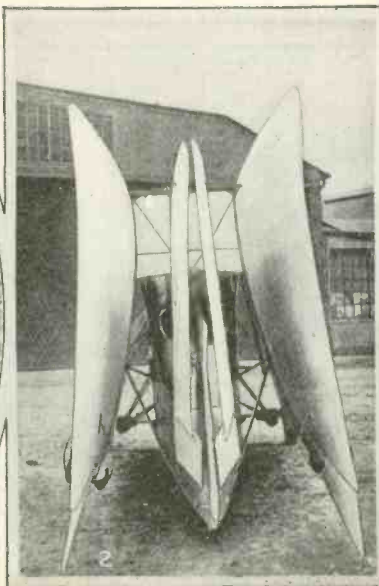

STARTED, and steered while in midair, by radio control, the airplane shown above made a successful flight without a human being aboard her recently at the Villesauvage Aerodrome. The engine stops automatically when it lands.

THE "vest-pocket" edition airplane shown in the center photo is the German idea of an airplane fliiver. It is made collapsible so that it requires the minimum of space for storage. Envision the commuter folding his plane for the night and storing it in the family garage.

WITH the ever-increasing importance of the airplane in naval warfare—as attested by the recent bombing tests off Newport News—the Navy Department has set engineers to studying more closely types of boat carriers for planes at sea. At the extreme left is shown such a carrier, the U. S. S. Langley.

Office Equipment of Ancient Times

By Charles B. Bunnell



Illustration Above from the British Museum Shows an Ivory Stylus of the Fifth Century B. C., Centuries Before Augustus. The Broad End Was used to Chisel Wax Out, While the Curved Side Burnished It In. The Point Incised the Letters in Wax.



Perspective View of One Single Leaf of a Day-Book Countersunk and Waxed with its Letters Showing Distinctly Although 188 Years Old, (British Museum). Shows One-Half of the Original Table as Inscribed by a Greek.

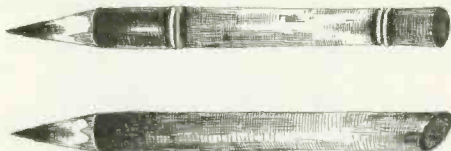

This Drawing Shows an Unsplit Bamboo Pen (Calamus Chartarius) for Fine Work, and an Unsplit Reed Pen (Calamus Scriptorius) for the Coarse Black Work on Papyrus. And Being Tubular Like the Grape Vine it Absorbed Ink Like a Fountain Pen.

An Ink Stand of the Generally Accepted Roman Design of the Days of Augustus. It Was Inlaid with Six Silver Vine Sprays, While the Hinged Cover Had an Inlaid Edge.

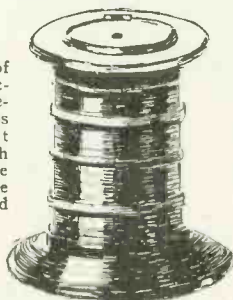

A Perspective View of the Classic Papyrus, Which is Generally 11" x 18" in Size. Note the Columnar Manner (Newspaper Style) of the Most Efficient Papyrus Writing.

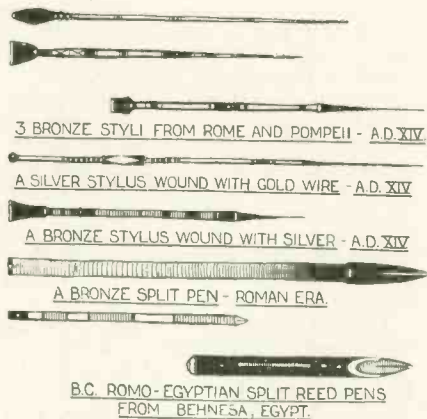

3 BRONZE STYLI FROM ROME AND POMPEII - A.D. XIV
 A SILVER STYLUS, WOUND WITH GOLD WIRE - A.D. XIV
 A BRONZE STYLUS WOUND WITH SILVER - A.D. XIV
 A BRONZE SPLIT PEN - ROMAN ERA
 B.C. ROMO-EGYPTIAN SPLIT REED PENS FROM BEHNEFA, EGYPT.

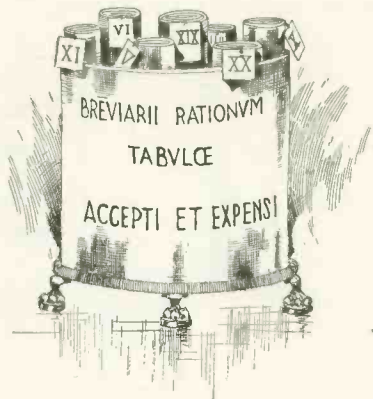

Sketch Shows the Papyrus (Account Books) Rolls Tagged in Their Circular Case or Scriptorium.

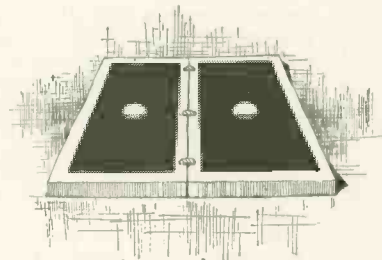

This Figure Illustrates a Day-Book (diurni) of Two Wooden Leaves, with a Button in the Center of Each to Prevent Rubbing. These Board Leaves Suggest the Modern Book Formation.

Above We Show Four Bronze Styluses for Wax Writing, a Split Bronze Pen for Ink Work on Papyrus, Two Split Reed Pens for Ink Work Also, and a Silver Stylus Wound with Gold Wire.

Liquid Air Jack

Double-Decked One-Man Bus

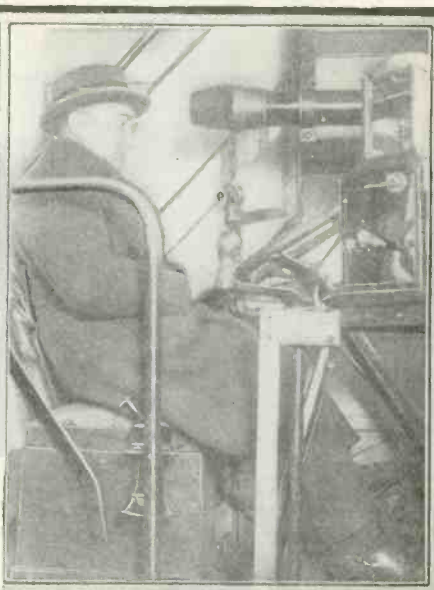

New Liquid Air Jack Shown at Left Will Lift 30,000 Pounds. It Was Invented by Walter S. Josephson of New York Who is Demonstrating it.

Center and Right Hand Photos Show New One-Man Fifth Avenue Bus. It is a Double Decked Affair; a Periscope Enables the Driver to See the People on the Upper Deck.

Biting Flies That Spread Disease

By DR. ERNEST BADE

Right:—The Blood-Sucking, Biting, House Fly, Slightly Smaller Than the Common House Fly, is the Insect Which, According to Recent Investigations, is Responsible for the Transmission of Infantile Paralysis. Is Quite Common in Moist Woodlands and Its Bite is Quite Painful

Below:—The Deer Fly, Which is $\frac{3}{8}$ of an Inch in Length, Has Black Marked Wings and is Most Often Met in Woodland Sections and Grassy Meadows, Where a Few Trees Are Found. It Also Has a Painful Bite, But It is Only the Female Which Inflicts the Wound. A Poisonous Substance Is Generally Not Introduced Although Disease Germs May Be Transmitted.

Lower Center Photo Shows the Biting Parts of the Deer Fly's Mouth, the Parts Consisting of a Number of Very Thin and Pointed Hornlike Stilettes, Which Are Arranged in Pairs. After Entering the Skin, the Blood is Pumped from the Veins Into the Mouth and Digestive Tract of the Insect.

Below:—The Beach Fly is a Large Biting, Blood-Sucking Fly Attaining a Length of Nearly $\frac{1}{2}$ of an Inch. Its Painful Bite is Only Too Often Felt on the Beaches When the Weather is Hot and Sultry. Only the Female of the Species Bites.

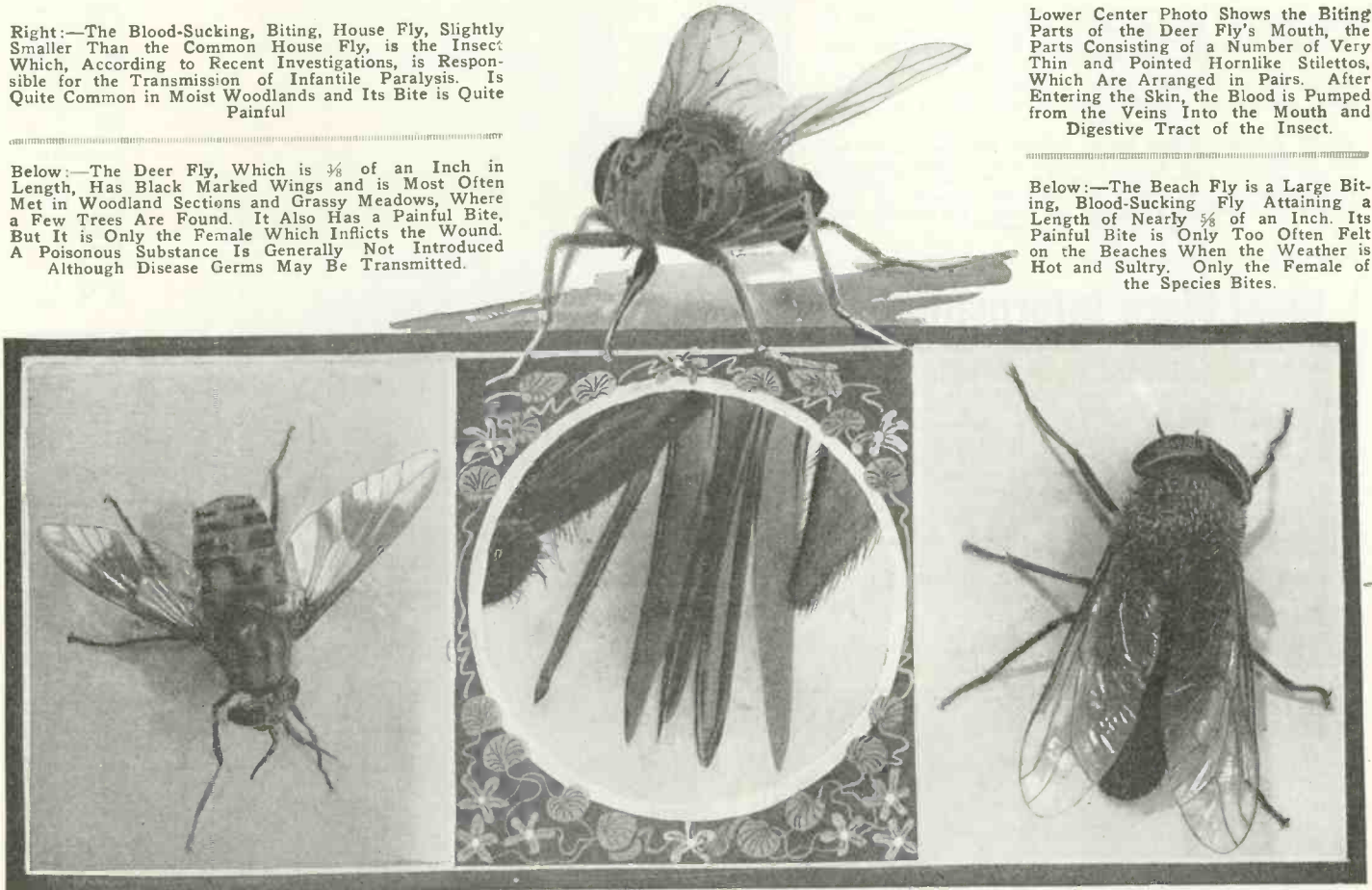

Compressed Air in Building Construction

By RAYMOND WARDELL

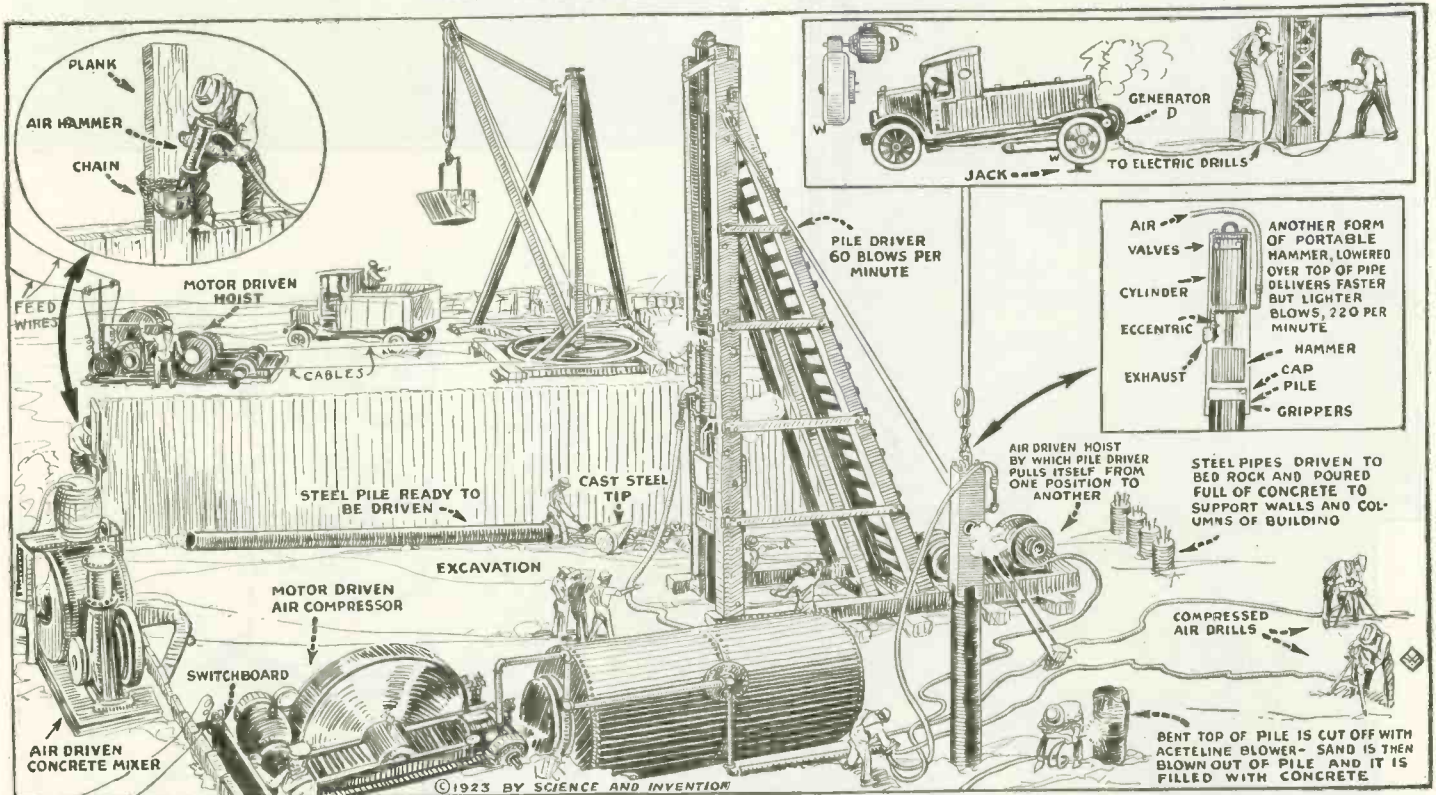

Compressed Air and Electricity Are Two of the Biggest Factors Involved in Modern Building Construction. Above, We See an Electric Hoist Operating a Derrick and Scoop Shovel, Also Electric Drills Operated from a

Dynamo Driven by Friction from the Rear Truck Wheel, the Truck Being Jacked Up. Compressed Air Operates the Concrete Mixer Shown in the Lower Part of the Scene, as Well as the Pile Driver and the Rock Drills.

Compressed Air in Subway Operation

Top Illustration in Lower Group—Front View of a Typical Block Signal in the Subway, Showing Lights, Position Indicators, Instrument Case Upon the Post in Advance, and Also the Track Train Stop.

Lower Illustration—Mechanism for Operation of the Pneumatic Track Train Stop, Showing Trigger Elevated to "Stop" Position.

Should a Signal Which Shows "Stop" Be Disregarded by the Motorman, His Train Will Be Automatically Stopped by the Action of the Trip in the Track Which is Shown in the Illustrations. This Trip Automatically Engages an Arm on the Train Which Shuts Off the Power and Applies the Brakes.—By R. H. Tingley.

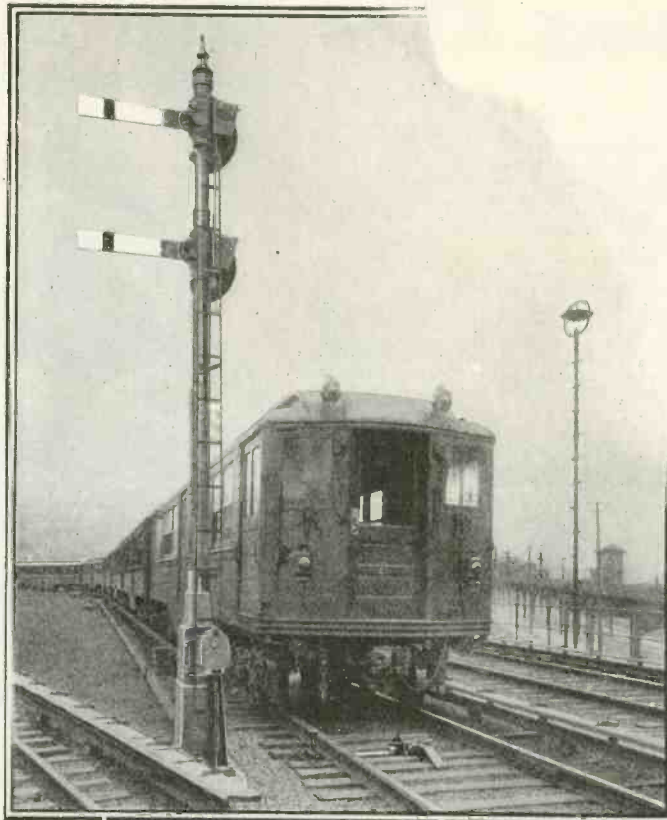
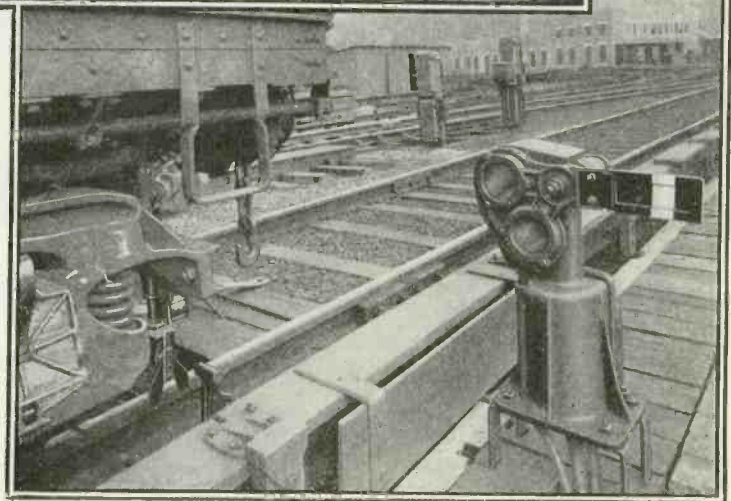
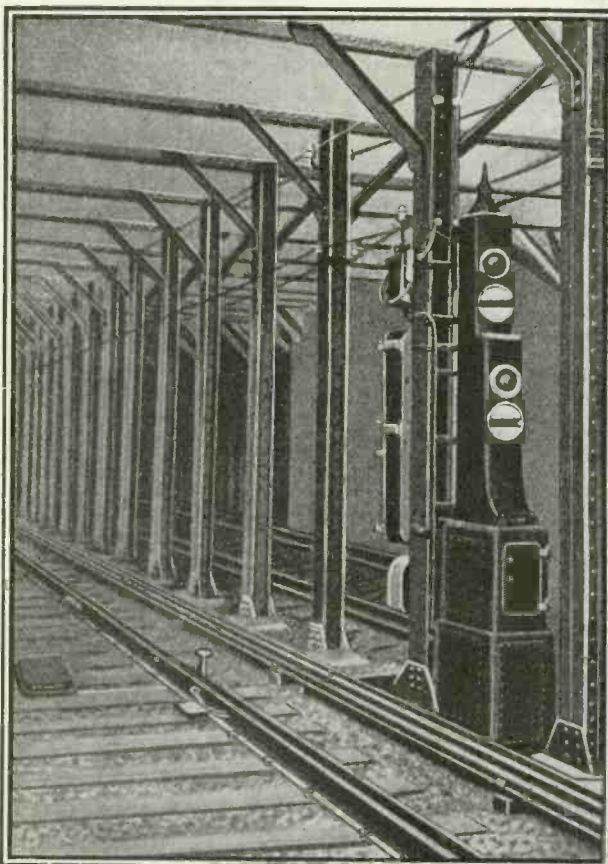

Illustration at Left—Automatic Stop Mechanism in Track at Van Cortlandt Park. Lower Illustration—Dwarf signal and Automatic Train Stop—Electro-pneumatic Interlocking, at 228th Street Yard of the Interborough Rapid Transit, N. Y. City.

Want More Information?

If you want additional information concerning any of the subjects illustrated and described in this number of **SCIENCE AND INVENTION** we shall be glad to give you any other data we have at our command if you will send 50c. for such special data. To make this work as easy as possible for our editors, please be brief. Write only on one side of the paper and state exactly in a few words just what it is you desire further information on. We have the original manuscripts and drawings of many of these articles in our files and can furnish much additional data in most cases. Send stamped and self-addressed envelope together with 50c. remittance in stamps, money order or certified check.

Address all inquiries of this nature to **INFORMATION EDITOR**, c-o Science and Invention, 53 Park Place, New York City.



Simplified Working Diagram of the Electro-pneumatic Interlocking Subway Switch. Switches Are Pneumatically Unlocked and Again Locked by This Device. Fig. 1—Switch in Normal Position. Fig. 2—Switch Bar Unlocked by Movement of Air Piston. Fig. 3—Switch Thrown to Reverse Position. Fig. 4—Final Movement With Switch Bar Locked in Reversed Position by D-2.

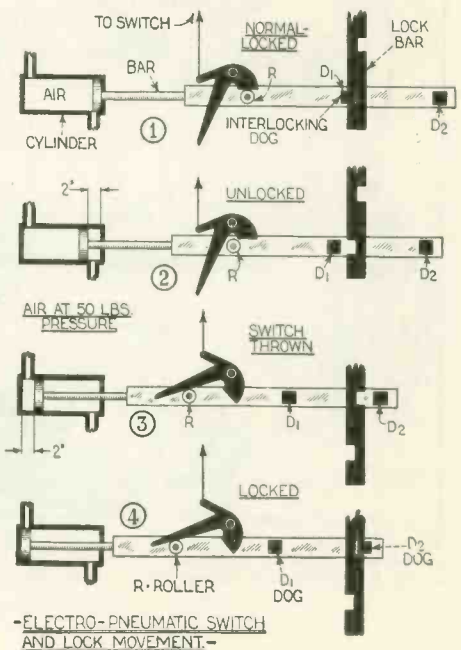

ELECTRO-PNEUMATIC SWITCH AND LOCK MOVEMENT.

Monster Army Tank Destroyer

By S. D. ROCKENBACH, Commandant U. S. Army Tank School

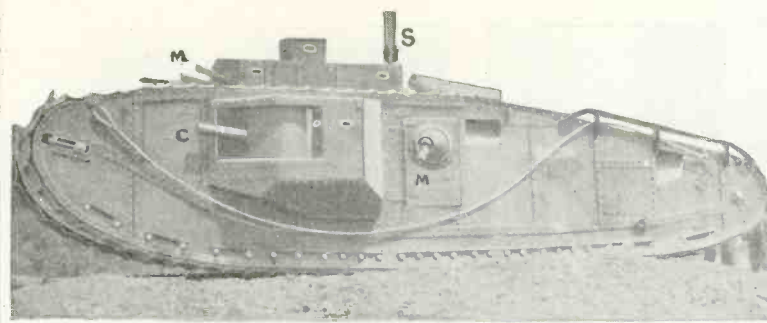
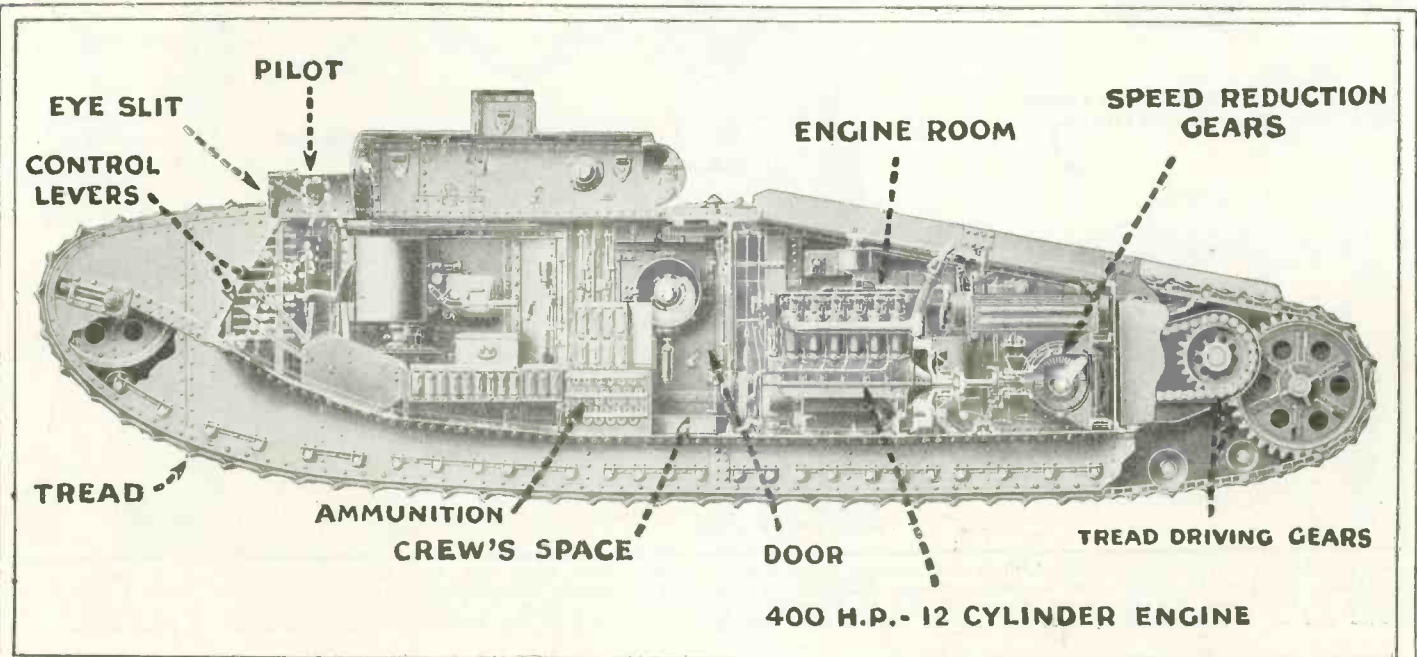
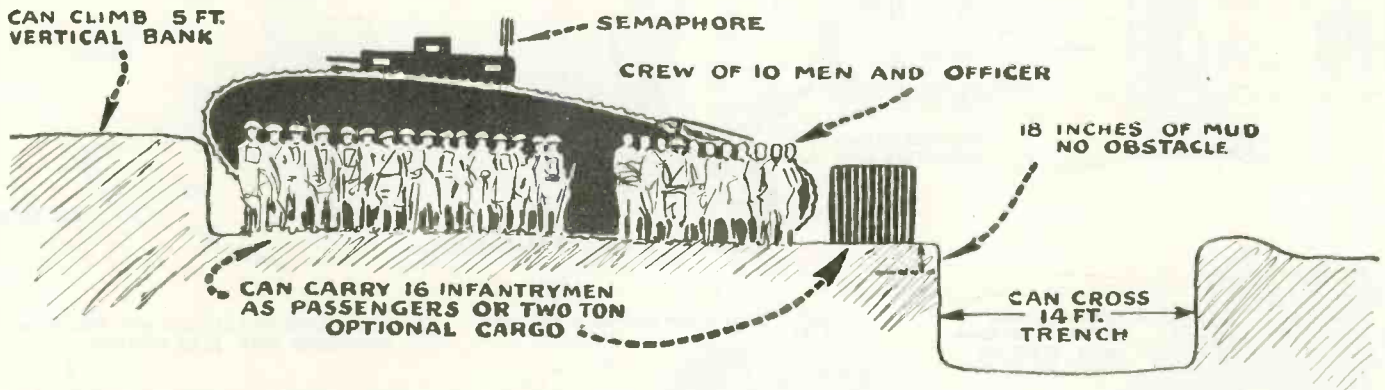

Ordinary Houses and Trees 12 Inches in Diameter Are Knocked Down by the New Mark VIII Tank. Its Path is Readily Followed by the Light Tanks and Infantry and Can Easily Be Made Usable by Supply Vehicles. The Engine is a 400 H.P., 12 Cylinder Liberty Type Geared Down. Lower Left Picture—Radio Controlled Tank—of To-Morrow.

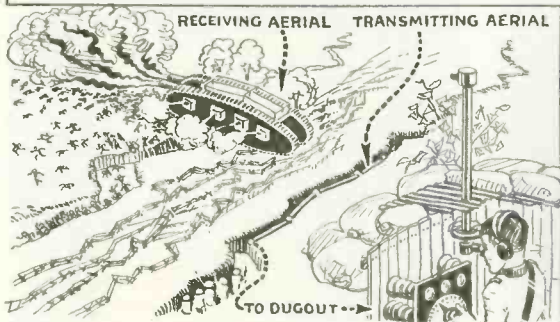

The General Specifications for the Mark VIII Were as Follows: Weight: 35 Tons. Length: 34 Feet, 2½ Inches. Width: 12 Feet (With Sponsons Out, 8 Ft. 8 In. Folded). Height: 10 Feet, 3 Inches. Armor: Proof Against All Small Arm Bullets Including Armor Piercing. Armament: 5 Machine Guns of Which 4 Can Be Fired at Once. 2 Six-Pounders (2.24" Bore). Speed: Maximum, 6 Miles Per Hour. Power 10 H.P. Per Ton of Weight. Trench Crossing Ability: 14 Feet. Ability To Climb Vertical Bank: 5 Feet. Flotation: 4.5

Pounds Per Square Inch—Any Ground That Will Support a Man. Communication: Every Tank Carries Two Pigeons and Signal Flags. Every 16th Tank Has a Radio Set. Every Company Has Messengers. Cargo: 16 Infantry or Machine Gunners in Addition to Crew, or Cargo of Two Tons. Wire: No Obstacle. Radius of Action on One Fill: 50 Miles. Mud: 18 Inches of Mud No Obstacle. Obstacles Readily Overcome: Forest, Stumps, Boulders, Shelled Areas Soaked With Water and Tank Pits.

Gold Leaf—How It Is Made

By ISMAR GINSBERG

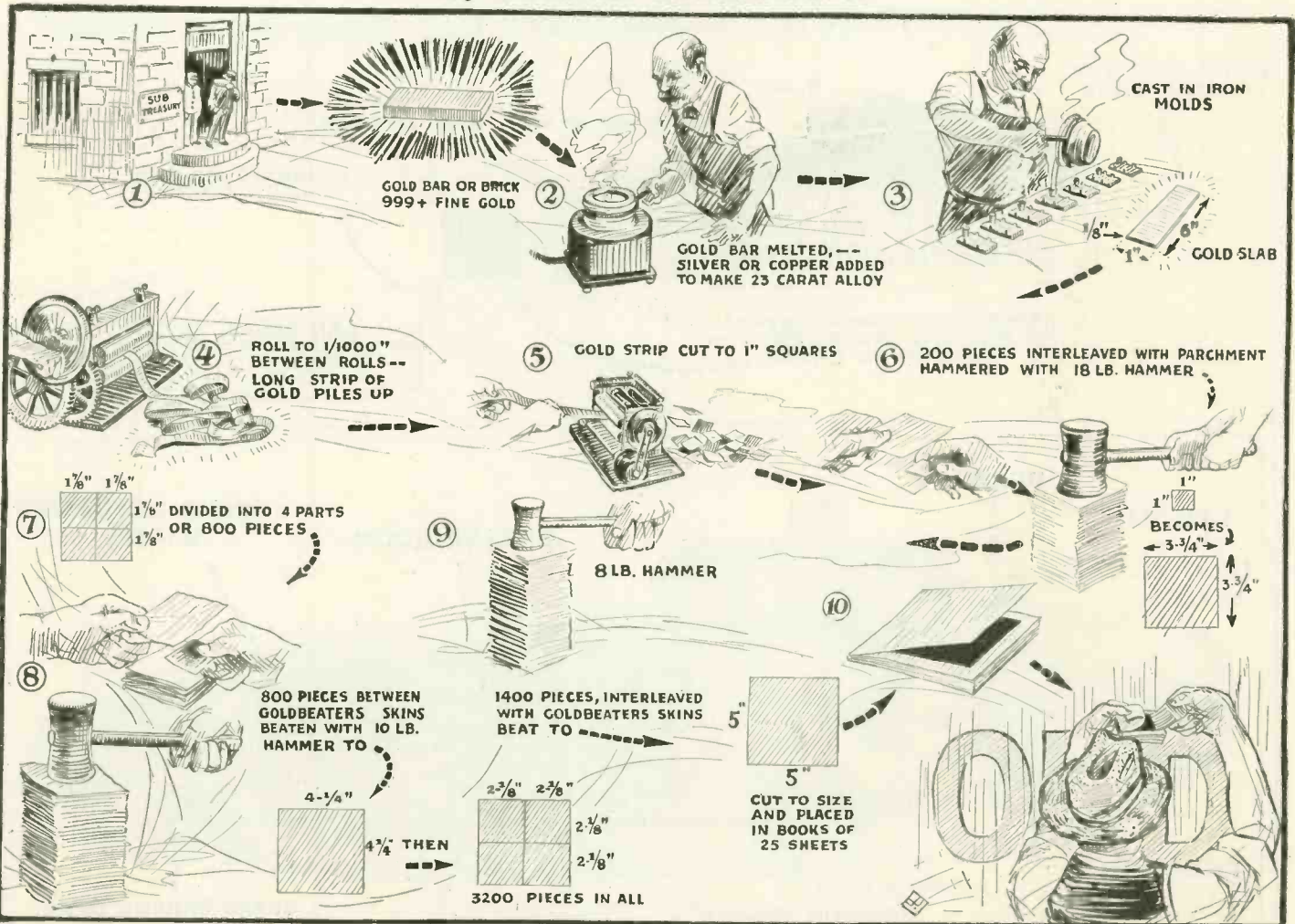

Gold Leaf is One of Those Rather Rare Articles of Commerce Which Few of Us Have Occasion to Use. The Successive Stages Followed in the Making of Gold Leaf Are Illustrated Above. A Bar of Pure Gold is Melted and an Appropriate Alloy Added. This Is Then Rolled Into a

Long, Thin Strip and This Strip is Then Cut Into Small Squares. By Repeatedly Hammering the Gold Leaf, Placed Between Gold-Beaters' Skins (Made from the Large Intestines of an Ox). It is Finally Cut Into Squares and Placed Between Paper Leaves in Book Form.

Typewriting by Wire



New Intercommunicating Electric Typewriter Invented By Dr. George A. Cardwell of Yonkers, New York. A Station With Such a Typewriter May Communicate By Wire With a Similar Station.

Drawing Made Easy

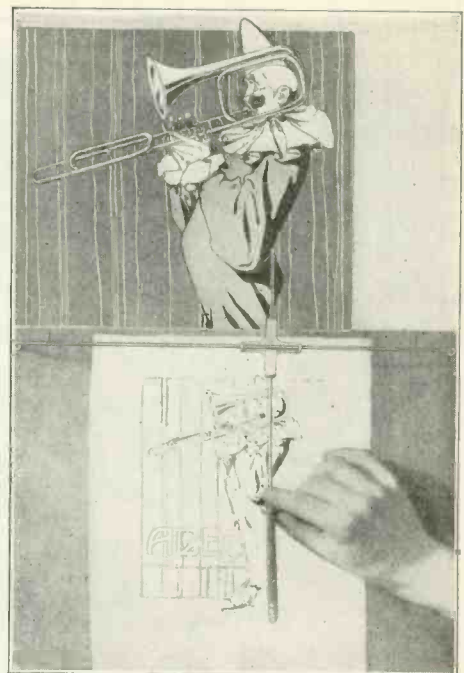

By Means of This "Patient Teacher" Drawing Machine Together With a Pantograph Apparatus Also Supplied by Its Inventor, Art Students Can Make Rapid Headway. This Device Can Be Used For Checking Up Free-Hand Drawings Once They Have Been Executed.

Popular Astronomy

By ISABEL M. LEWIS, M.A.

OF THE U. S. NAVAL OBSERVATORY

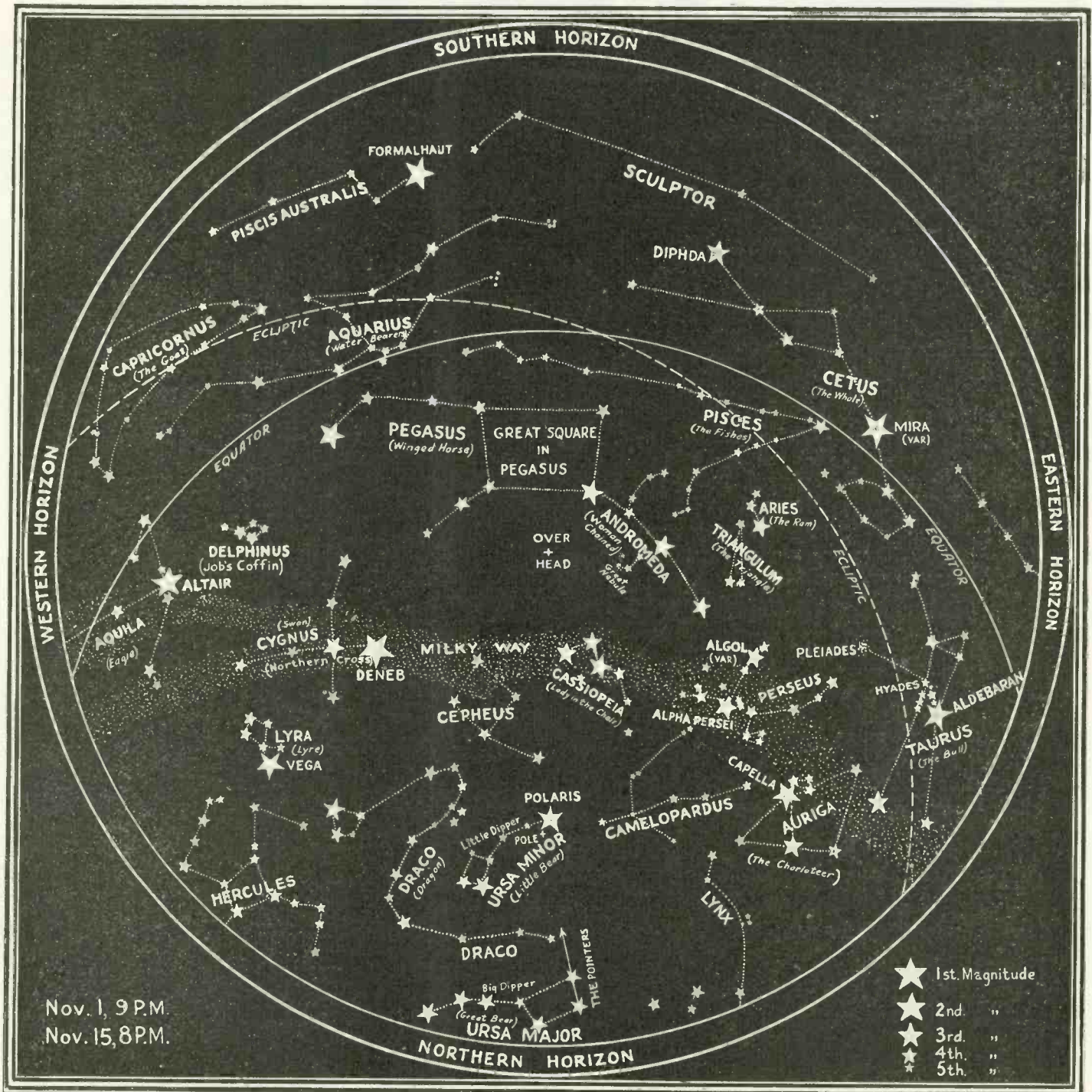

Above is the map of the heavens for November. The location of the stars shown will coincide exactly with their positions in the heavens at nine P. M., November 1, or eight P. M., November 15. To use the map, hold over the head with the top of the map to the south.

CHART OF THE HEAVENS FOR NOVEMBER

THE last of the summer groups, Hercules, Lyra and Aquila are approaching the western horizon. In the east and northeast are appearing the vanguard of the brilliant constellations of winter, Taurus the Bull, with its famous groups of the Hyades and the Pleiades, and Auriga, the Charioteer with its beautiful Capella.

Directly on the meridian at this time and to the south of the zenith is the Great Square in Pegasus and adjoining it on the east is Andromeda.

In the north we find Cassiopeia and Cepheus close to the meridian and in the west the Northern Cross in Cygnus is still con-

spicuously in view. Cetus, the Sea-monster, now rears his huge form above the eastern horizon and its second magnitude star Diphda, or Beta Ceti, is the brightest star in this part of the heavens. It will be recognized by the fact that it stands in an isolated position far over to the southeast. In the southwest, also in solitary splendor, is the beautiful Fomalhaut in the constellation of the Southern Fish, Piscis Australis.

In Cetus we have one of the mysteries of the heavens called Mira. In a period of about eleven months it changes very irregularly in brightness from a telescopic star

of the tenth magnitude to a star of the second magnitude. It is usually visible to the naked eye for less than two months. Though Mira has been observed through more than three hundred of its cycles of light changes the cause of its peculiar and irregular variations still remain a mystery.

This month we also have in fine view for observation another of the mysteries of the heavens, the Great Nebula in Andromeda. It will be easily found in the position indicated as a faint, cloudy patch of light.

The Andromeda Nebula belongs to the large class of spiral nebula whose distances are unknown.

Aids To The Motorist

SPEEDOMETER

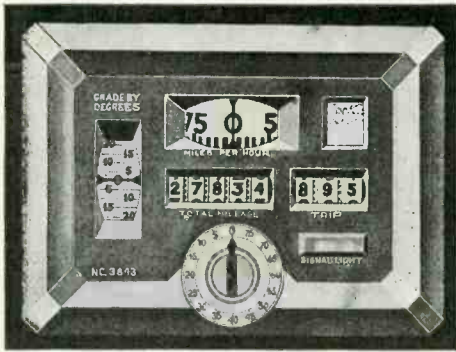

A Speedometer Which Records Speed, Trip Mileage, Season Mileage, and Grade on Which the Car is Traveling. A Speed Signal Light and an Ignition Lock Are Included in the Instrument.

TURNING SIGNAL

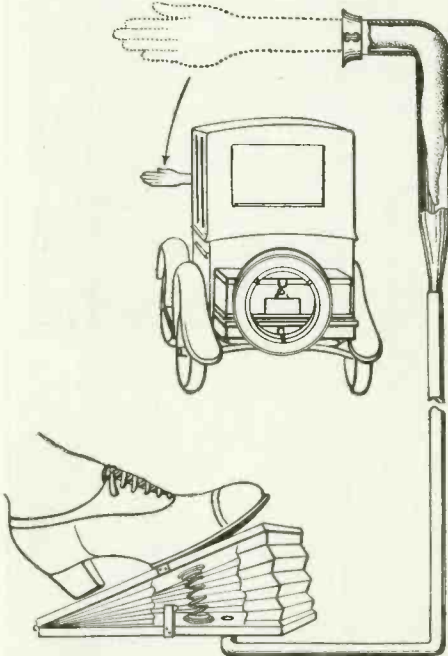

An Auto Signal Which Operates by Air Pressure, Furnished by Pressing a Small Bellows with the Foot. This Causes the Rubber Hand to Extend as Shown.

TIRE PROTECTOR

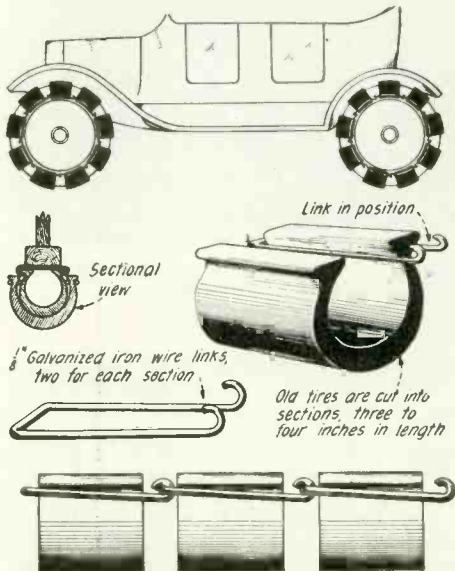

This Tire Protector Which is Designed to Be Placed Over Standard Pneumatic Tires. They Consist of Sections of Old Tires About 3 or 4 Inches Long, Held Together by Means of Galvanized Iron Wire Links as Shown.

OILING SYSTEM



The Oil Cups Above Are Designed to Replace the Standard Cups Used on Cars and Are to be Used with the High-Pressure Oil Gun Illustrated Below. This System of Oiling is Superior to Those Using the Old Style Grease Cup.



The Oil Gun Illustrated Above, Forces Oil Under High Pressure Into Cups Illustrated at the Head of This Column. The Force Used Presses the Oil Into All Parts Which Makes for More Thorough Lubrication. This Gun Produces a Pressure of 2000 Pounds to the Square Inch at the Nozzle.

At the Right is Illustrated a Model of an Engine of the Knight or Sleeve Valve Type. This Model is Only 3 1/2 Inches Wide by 4 Inches High. However, by Turning the Motor by Hand, the Pistons and Sleeves Operate Exactly as They Do in the Real Engine. This Was Designed for Use as a Salesman's Model.

ENGINE MODEL

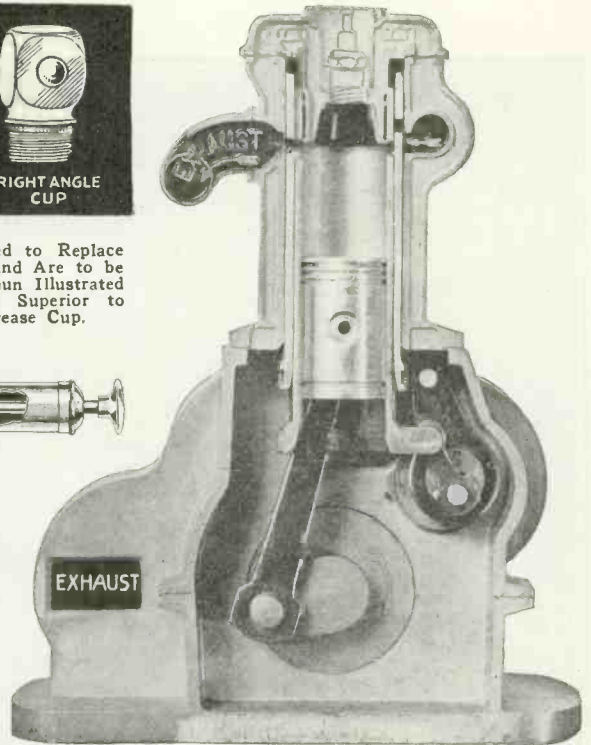

MOTO-METER LIGHT

At the Right: A Combination of a Moto-meter and Luminous Radiator Cap. Two Small Lights Serve as Emergency Driving Lights and Also to Illuminate the Moto-meter When Driving at Night.

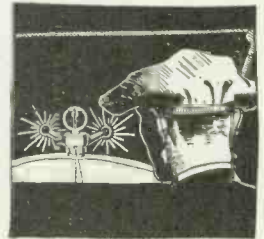

TRAFFIC SIGNAL

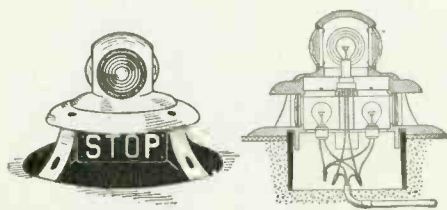

A Unique Traffic Signal Which Stands Only 8 1/2 Inches Above the Street Level and is Designed to Automatically Regulate Traffic at Crossings.

PISTON GAGE



By Means of the Device Illustrated Above it is Possible to Measure the Outside Diameters of Objects Such as Pistons, Directly in Thousandths of an Inch. This Device is Nothing More Than a Flexible Strip of Steel But It Will Measure Diameters from 2 3/8ths to 5 1-16ths Inches Very Accurately.

TIRE REMOVER

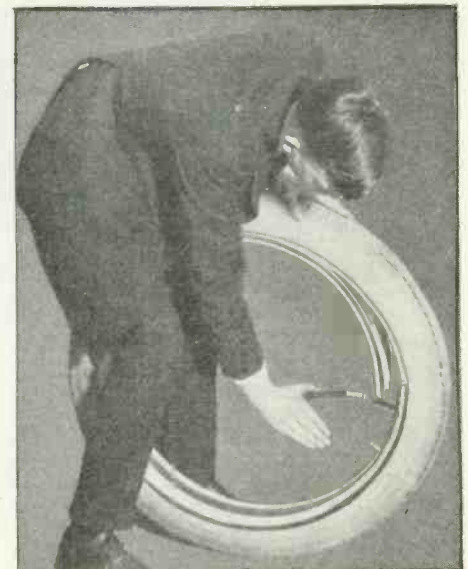

By Means of the New Device Illustrated Above it is Possible to Change Tires in a Very Short Space of Time. The Device is Applicable to Any Type of Standard Rim.

Magic for Everybody

By PROF. JOSEPH DUNNINGER

NUMBER 8 OF A SERIES.



The magician pours liquid from the bottle, then wraps it in newspaper and tears it in two. A rabbit jumps out on the table. The Professor throws the crumpled wrapper off stage. It's all very simple when the apparatus used

is explained. The shank of the bottle is made of lacquered paper. A false top is made of light metal laquered the same color. The top contains the liquid; the bottom the rabbit.



The magician has a solid King Tut figure examined. He then places it in a red colored glass, puts a paper cover over it and—Behold—the glass is clear and there is a red King Tut figure in it. The red figure is then placed

in a blue glass—the glass becomes colorless and the figure blue. The color of the glass is imparted by a false celluloid tumbler inside. The colored figures are of cloth with a spring inside.

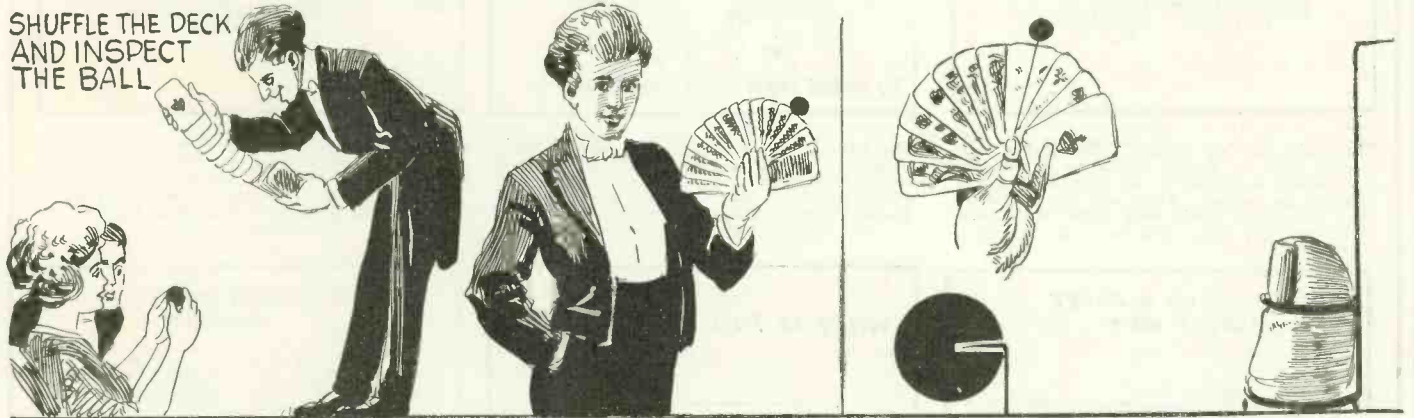

Professor hands out a deck of cards to be examined, also a billiard ball. He then shuffles them, balances the ball on top and it rolls from side to side.

Wonderful, his sense of equilibrium. But, look closely, the ball has a small hole and the professor depends on a small spring wire to hold the ball.

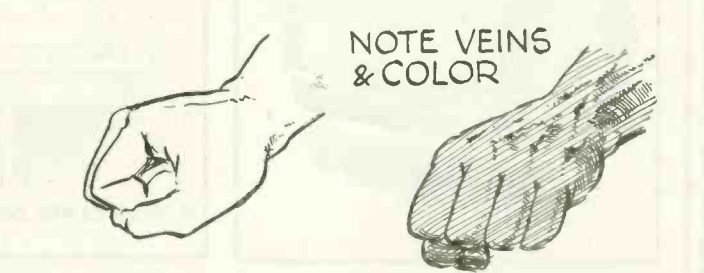
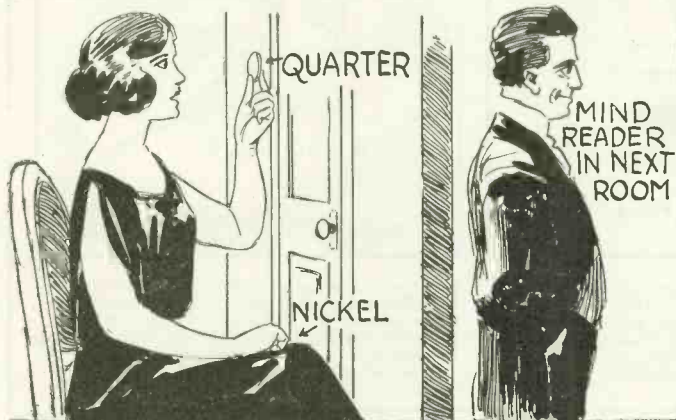

Two coins are held in the hands resting on the knees. The professor leaves the room. The observer is asked to hold one of the coins up in front of his eyes for a count of twenty. The Professor returns to the room and tells which coin was observed. While holding the coins on the knees the blood rushes to the hands and colors them slightly. In the hand that holds the coin in front of the eyes the blood recedes and leaves it lighter than the other. Try it.

Popular Scientific Errors

By RAYMOND B. WAILES

IS SEALING WAX
"WAX"?

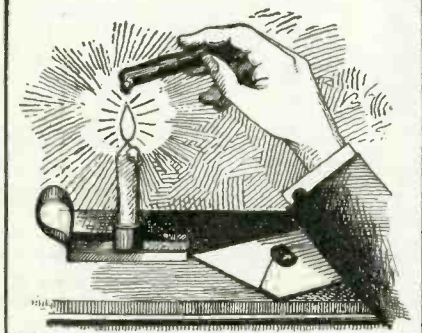

One of the most common articles which bears a name that is scientifically incorrect is sealing wax. It contains no wax at all but is a compound of shellac and turpentine with coloring matter added. In some of the cheaper grades rosin is substituted for some of the shellac.

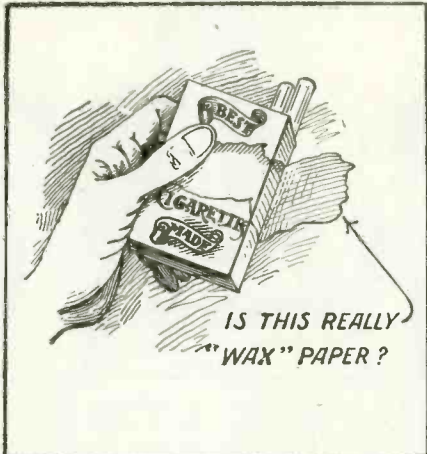

IS THIS REALLY
"WAX" PAPER?

A very small amount of the so-called waxed paper is really waxed. The "glassine" papers, the clear and brittle varieties, are made by over-cooking the paper pulp while it is being prepared for the rolls in the paper mills. Good waxed papers are costly.

DOES GERMAN SILVER
CONTAIN SILVER?



German Silver contains no silver at all. It is an alloy consisting of approximately eighteen per cent nickel and the remainder copper and zinc. The United States five cent piece called a nickel, is made of fifteen per cent nickel and eighty-five per cent copper.

IS THIS REALLY A SNAKE'S
"STINGER"?

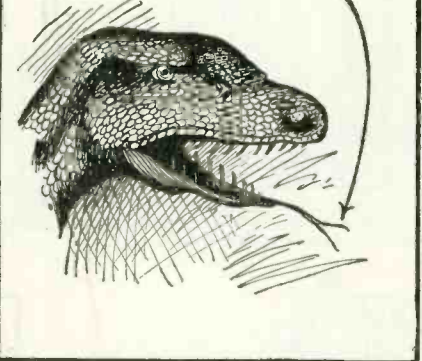

The snake has "no stinger." The forked projection from its mouth is simply its tongue. The snake's poison is not injected into the bite through the tongue. There are special glands over its upper teeth that force the poison through the teeth and into the wound.

ARE FIRE-SPITTING CIGAR-
ETTES DOPED WITH SALTPETRE



TO MAKE THEM "FREE-BURNING"?

The natural composition of the tobacco plant contains a goodly percentage of potassium and nitrate in various forms. Any saltpetre in cigarettes is the natural product put there by Mother Nature. Bits of stems that are left in the tobacco often cause "fire-spitting."

IS THIS REALLY
"TIN" FOIL?



Tin foil is very little used for wrapping on account of its cost. Lead foil is substituted. Lead foil always has a waxed paper attached to its back when it is used in wrapping foods. Real tin foil is more brittle than lead foil and crinkles when bent.

DOES AN ICE BLANKET
"SAVE" ICE?

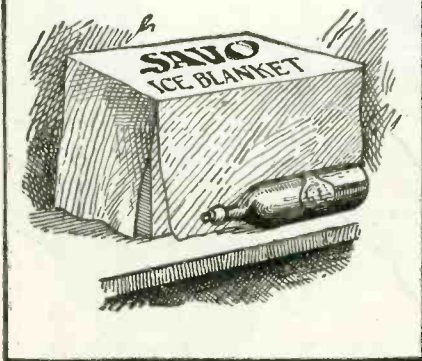

Ice blankets do save ice by keeping it from absorbing the heat in the surrounding air. The use of such a blanket in an ice-box reduces its efficiency because it does not allow the ice to cool the objects put in the box. Ice cools surroundings only when it melts.

WHAT IS THIS

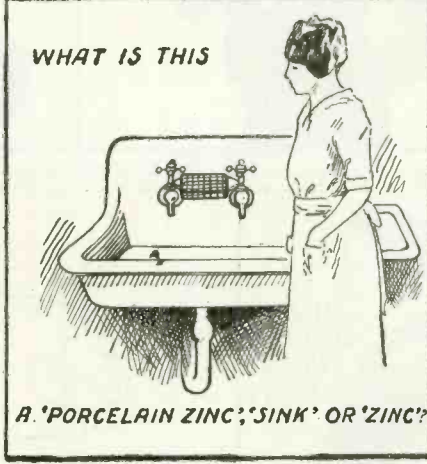

A. 'PORCELAIN ZINC'; 'SINK' OR 'ZINC'?

Solid, or real, "Zincs" are seldom used for laundry and wash basins. Iron "sinks" are often coated with it as in galvanized ware. More often they are simply enameled. Ask the plumber—he will tell you "but, yes, we have no zincs in the kitchen."

ARE ALL ERASERS MADE OF
RUBBER?

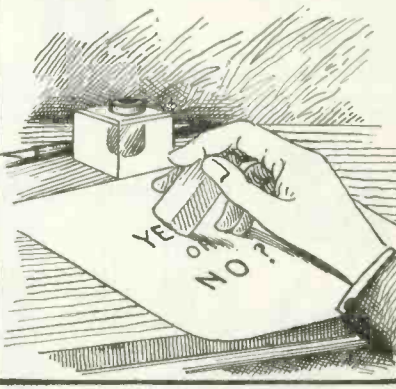

Some of the so-called "ink erasers" contain rubber. The more common variety, however, sometimes known as "soap erasers" are made by specially treating the products of corn oil. The product is then sulphonated. Most of the popular art-gums are made by this process.

Experimental Electro-Chemistry

By **RAYMOND B. WAILES**
SOME EASILY MADE ELECTRIC FURNACES

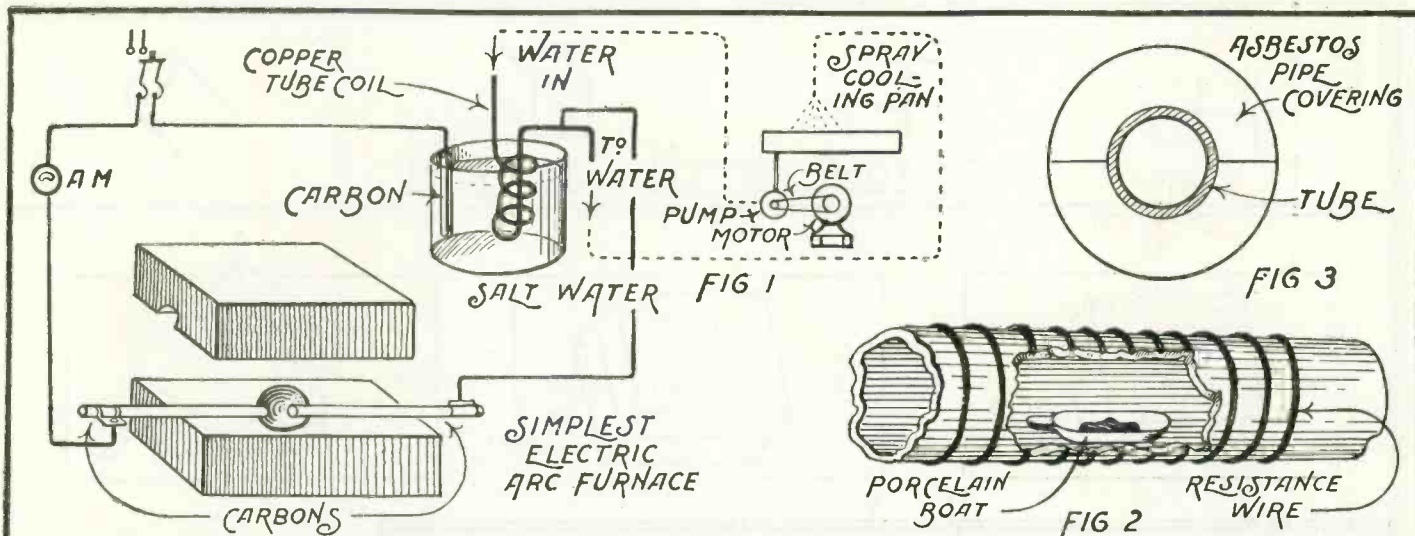

The structural details of two very simple electric furnaces are shown in the sketches above. Two fire bricks hollowed to take carbon electrodes and a water cooled rheostat are all that is necessary for its construction. In some cases the rheostat may be unnecessary and the furnace con-

nected directly to the lighting mains. The other furnace is of the tube variety. It consists of a porcelain insulator of the lead-in type wound with high melting point resistance wire. The tube and resistance are covered with asbestos. A porcelain boat holds the substance.

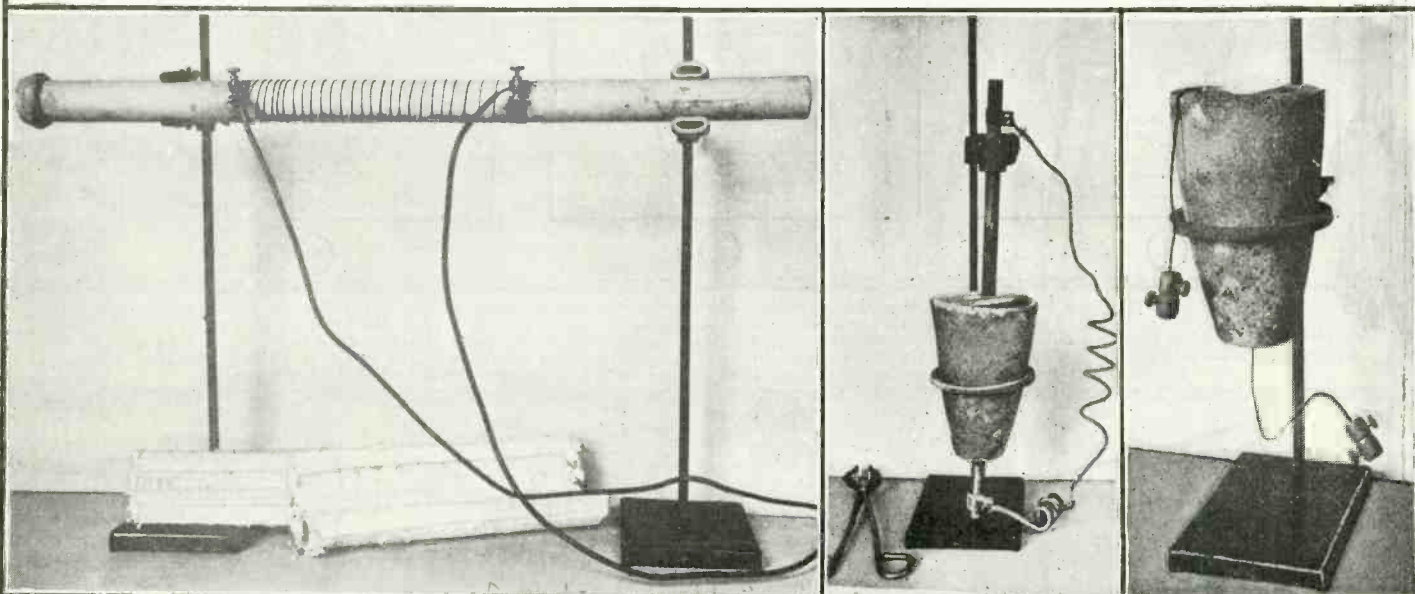

The photo to the left above shows the tube furnace as it stands ready to receive the outside coating of asbestos. At the center is shown a furnace of the arc type installed in a crucible. A lid is made fast around the top carbon that fits over the top of the receptacle when

the arc is drawn. The whole is supported on a ring stand. At the extreme right is shown another furnace of the resistance type. It will lend itself very well to ignition work. A crucible is placed inside the large container and surrounded with the resistance unit.

MACHINE FOR PAINTING ROAD SAFETY-LINES

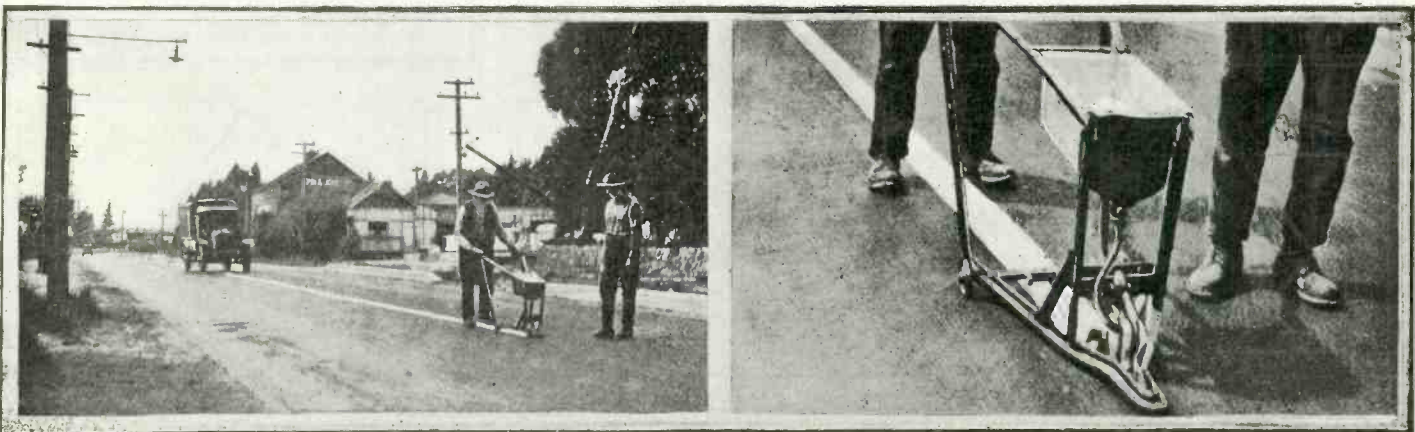

The machine shown above is being used extensively by the highway commission of California to paint white lines in the center of its paved highways.

The paint flows down the hose in front of one spreading brush; a second brush behind the first evens up the line. —C. W. Geiger.

Experiments With Spar Crystals

By O. IVAN LEE

Iceland spar crystals can be obtained from scientific supply houses.



TRY YOUR CRYSTAL ON THESE

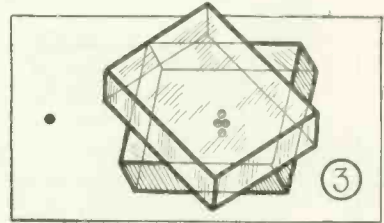
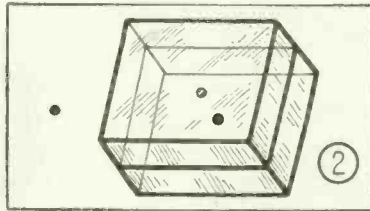
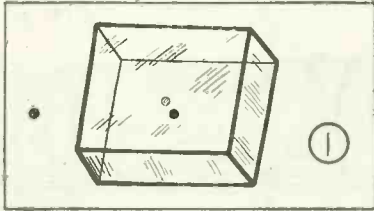

Very interesting experiments showing the double refraction of light can be performed with Iceland Spar crystals or cleavages. In Fig. 1, if the crystal is placed over a black dot on a card the dot will appear double. If the crystal is rotated with the dot as a center the second dot will turn round the first.

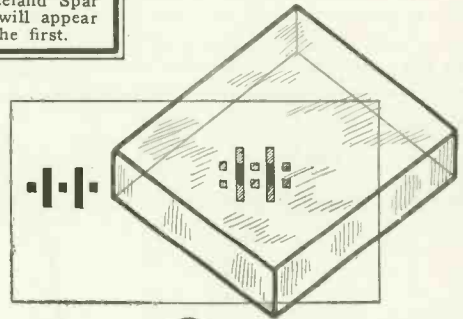
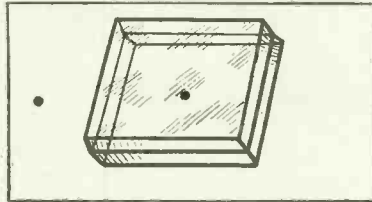
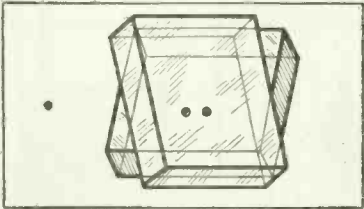

④

⑤

⑥

The second or shadow dot always lies in the direction of the crystal's slope. Also, its distance from the first dot is directly proportional to the thickness of the crystal, hence in Fig. 2 where two crystals are used the dot is twice as far away. In Fig. 3 when the top crystal is at an angle of 45 degrees with the bottom one, four dots appear. On rotating the crystal further, 90 degrees, in the same direction only two dots will be visible. (4) Continuing to 180 degrees total, only one dot is visible, the second crystal counteracting the refraction of the first (5). In Fig. 6 another pattern is taken. The single dots become double and the lines become shaded when they are viewed through the crystal.

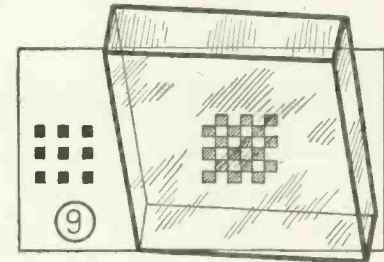
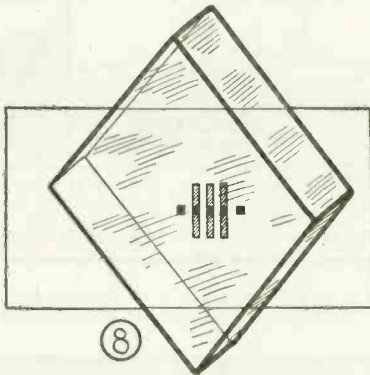
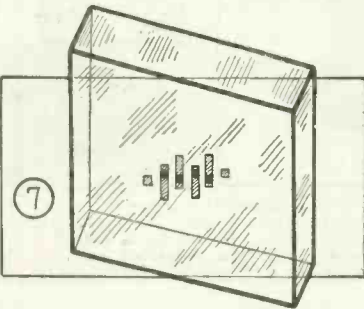

⑦

⑧

⑨

Above, the same design is subjected to the crystal set at a different angle. One of the dots disappears and a fourth line is added in its stead. The lines are shaded.

The design used in Fig. 6 is used in Fig. 8. When nine squares, as shown in Fig. 9 are used, the resultant diagram is a checkerboard. The squares should be made equidistant.

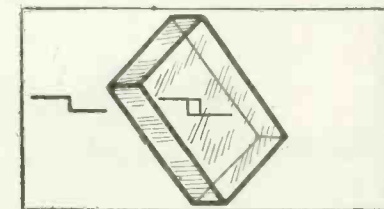
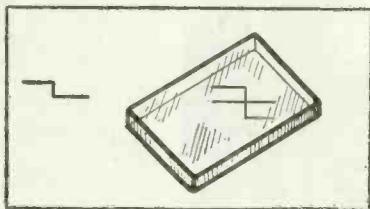
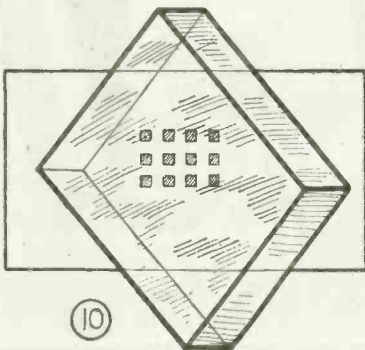

⑩

⑪

⑫

For the best effect in using the squares pattern, the diagonal of the squares should equal the displacement of the crystal used. At the 45 degree angle as in Fig. 10 the nine squares become twelve. When the broken line in Fig. 11 goes under the crystal the figure is an incomplete swastika. At the 90 degree angle it becomes a sort of socket wrench. Other designs for the use of the experimenter are printed at the extreme top of the drawings.

THE CONSTRUCTOR

Hand-propelled Ice Skiff

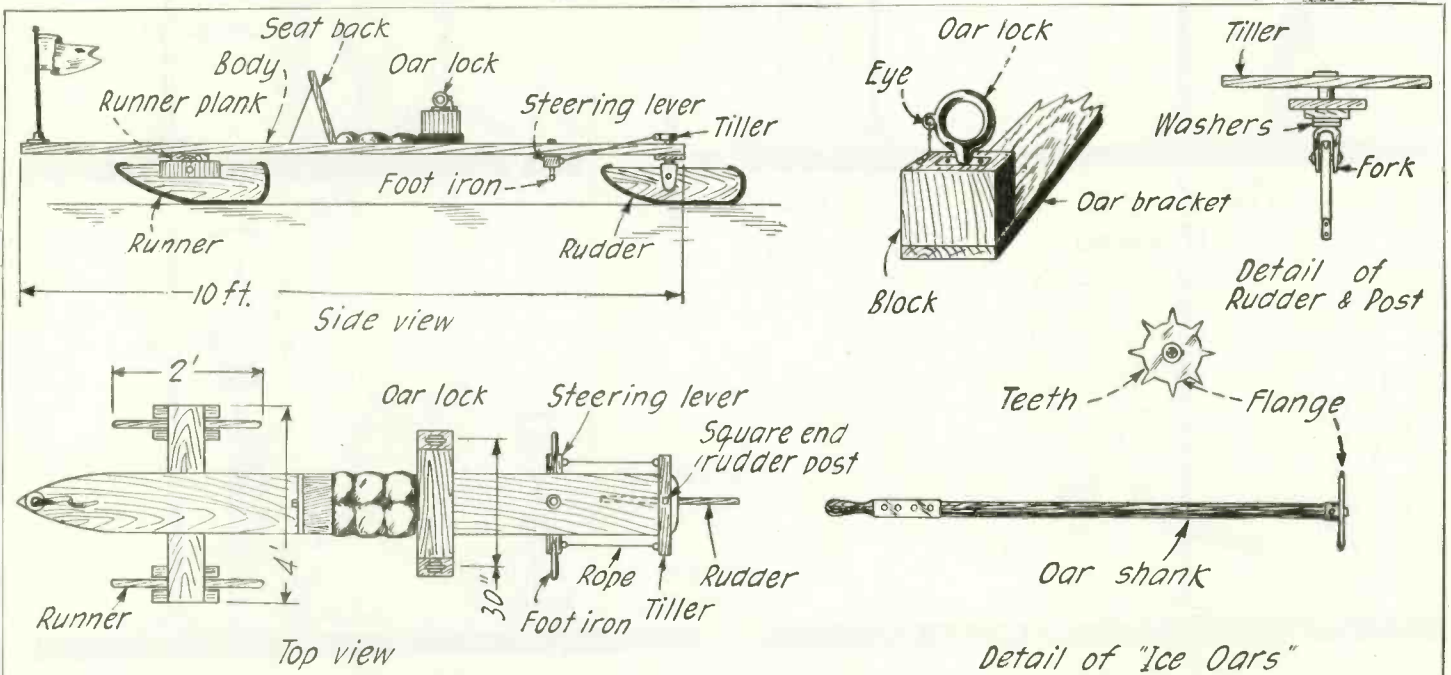

The above shown skiff is very similar in design to the regular ice boats. The principal difference is that it is hand rowed. The "oars" are of wood with a spiked wheel at the end that grips the ice. All wood construction should be of oak or hickory. —L. B. Robbins

Coil Bed Spring as General Handy-man

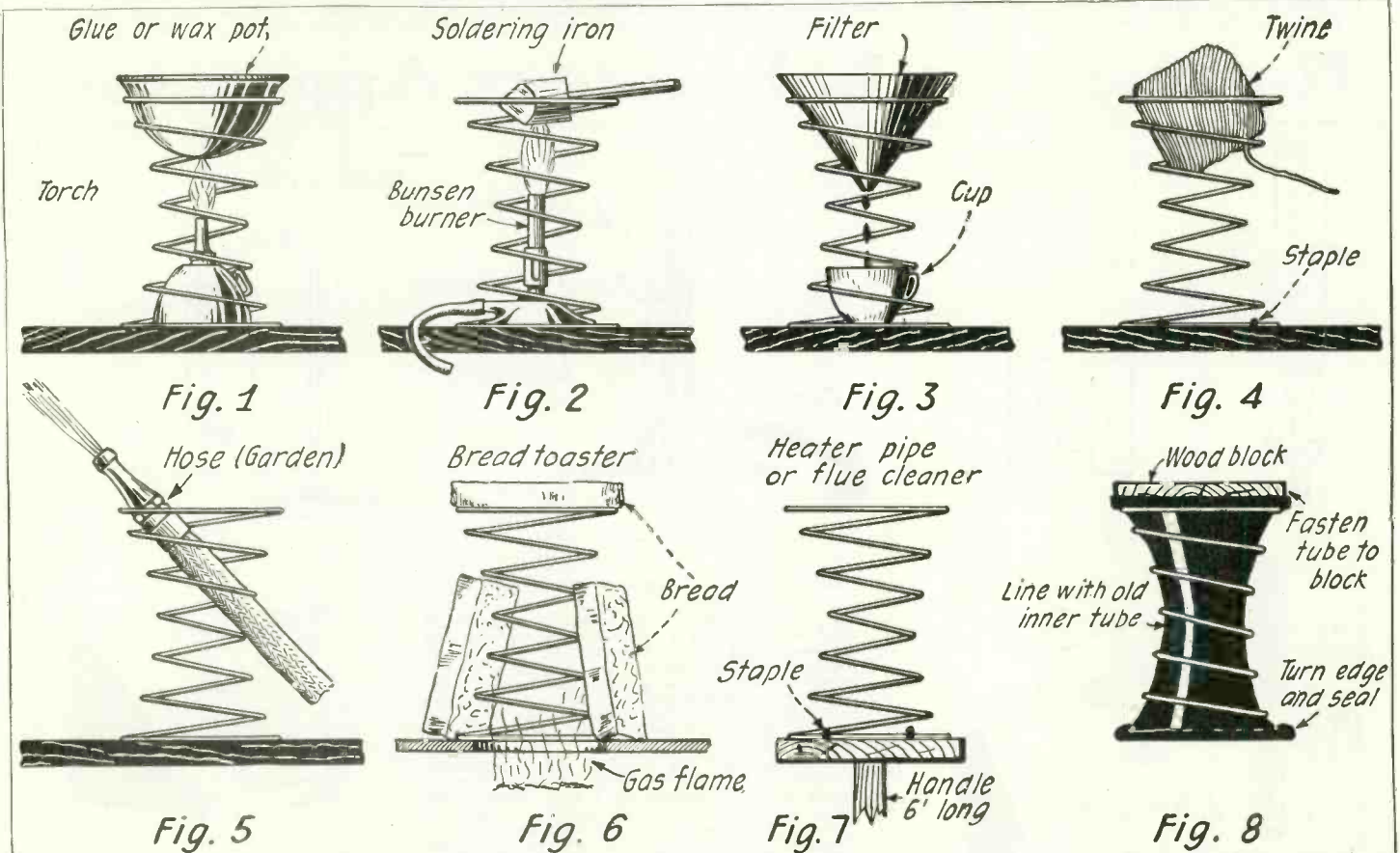

Nothing is quite so handy as a coil bed spring. One of its most valuable uses is as a force pump for cleaning drains. (Lower right corner). Place the bottom of the spring, lined with an inner tube, over the mouth of the pipe and pump. —W. T. Markowski.

Some Interesting Fountains

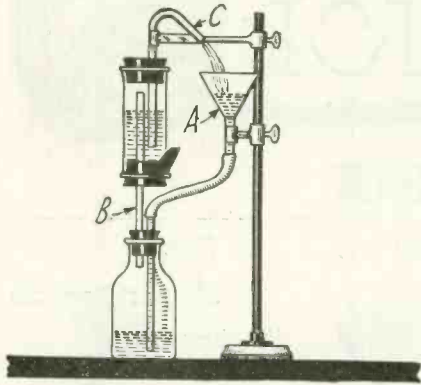

Fig. 1

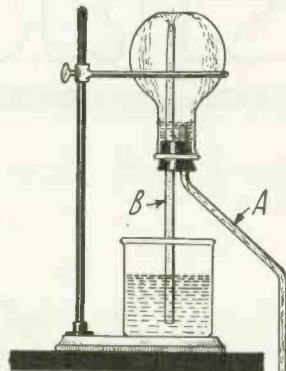

Fig. 2

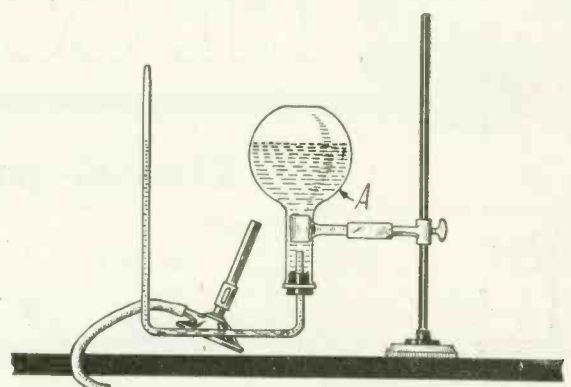

Fig. 3

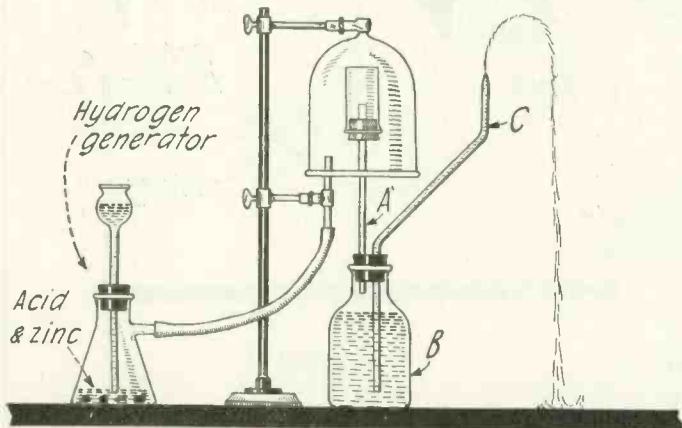

Fig. 4

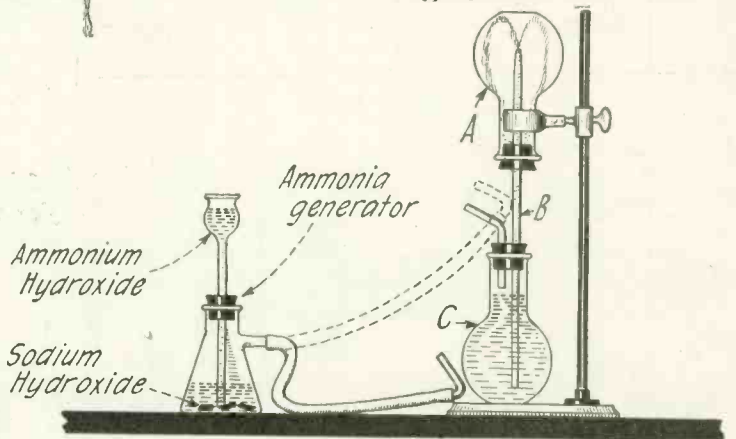

Fig. 5

Fig. 1.—In this Hero's fountain the column of water in the funnel A and tube compresses air in the bottle. This pressure causes flow through C, back into A. The fountain will operate until water in the upper vessel is exhausted. Fig. 2.—In this siphon fountain the partial vacuum caused in the flask by the water escaping through tube A, causes an inrush through B. Fig. 3.—This illustration shows a steam fountain. Rapidly accumulating steam pressure on the surface of the water in the flask A causes the water to be forcibly ejected from the tube. Fig. 4.—This fountain operates on the varying diffusion

rates of gases. Hydrogen introduced into the bell jar diffuses through the walls of the unglazed porcelain cell supported on the tube A much faster than the air in the cell escapes. This causes an internal pressure which causes water to be ejected through C. Fig. 5.—An absorption fountain, started by blowing a little water from C into A, the latter filled with ammonia gas. The water dissolves some of the ammonia, producing a partial vacuum. More water rushes in, and the fountain continues until A is almost filled and the water absorbs all of the ammonia. —Chas. D. Tenney.

Home-Made Laboratory Apparatus

Fig. 1

Fig. 2

Fig. 3

Fig. 4

Fig. 5

Fig. 1.—This simple burette holder is made of cigar-box wood. It is easily adjusted by means of the wedge and is entirely practical. Fig. 2.—A jeweler's blowpipe soldered or wired to a Bunsen burner as shown makes a useful soldering or blowing device that leaves both hands of the operator free. Fig. 3.—This pipette is useful for recovering spilled mercury or handling poisonous liquids. There is no danger of sucking the liquid into the mouth. Fig. 4.—This simple pinchcock is easily made from two strips of brass bent as shown and held together by a bolt. Two rubber bands supply the necessary tension. Fig. 5.—Pocket types of ammeters and voltmeters may be simply and inexpensively converted into desk types with aid of a bit of sheet metal and some cigar-box wood.

Cheap Level

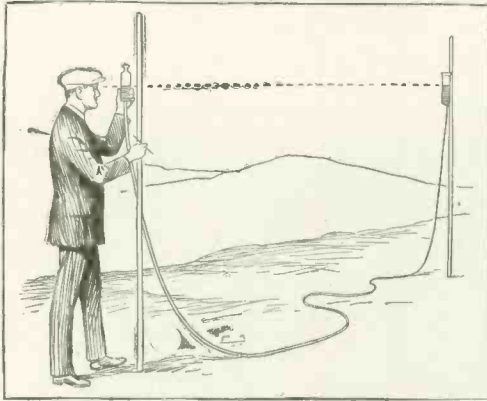

The leveling device shown in the sketch is one devised by Korean contractors. It is constructed of two glass tubes and a length of rubber hose. By mounting one of the tubes on a stick, as shown in the sketch, and raising the other until the water appears in the glass, then sighting over the surface of the water of the second at the column in the first tube a perfect level is produced.—C. A. Sauer.

Short Line Telephone

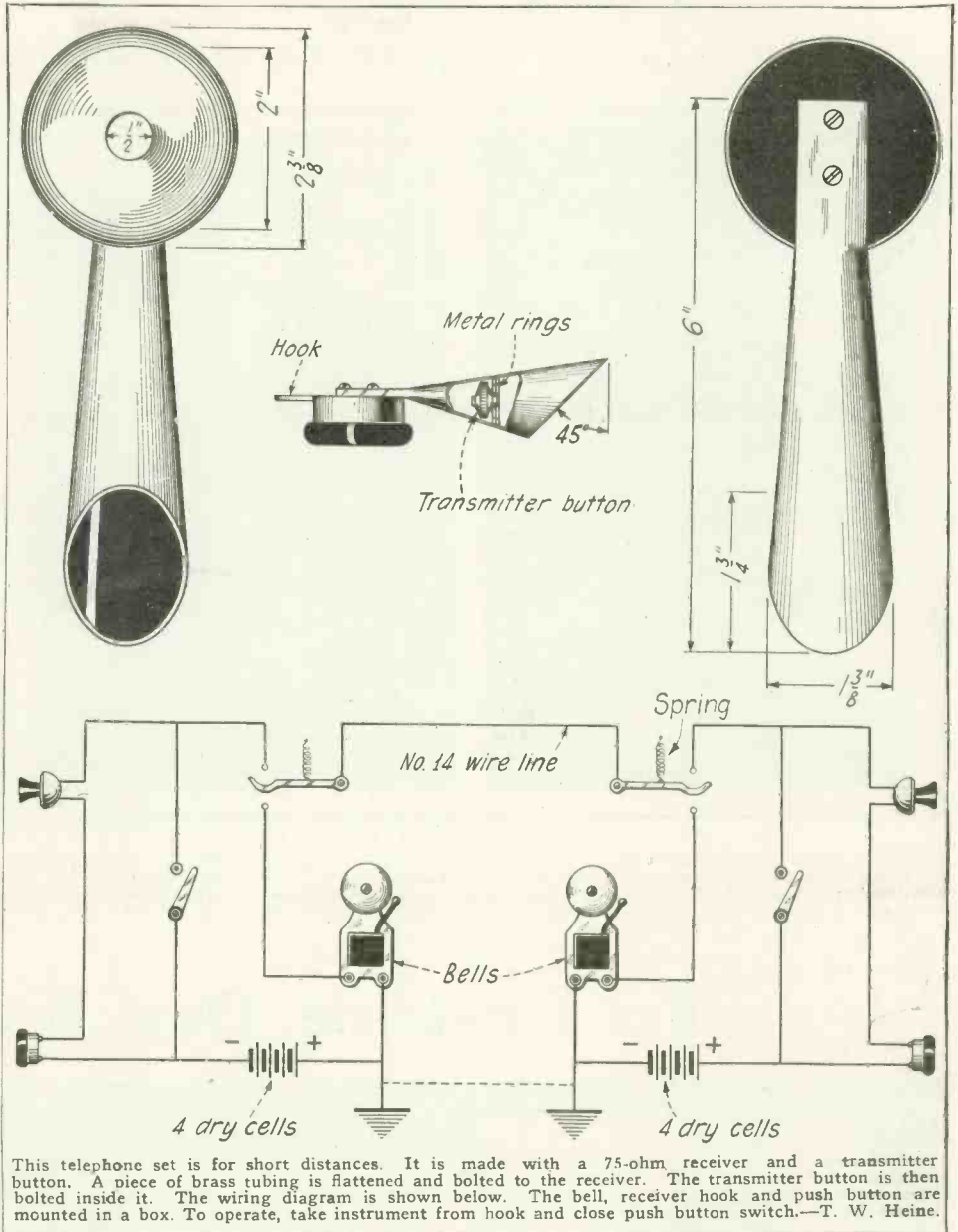

This telephone set is for short distances. It is made with a 75-ohm receiver and a transmitter button. A piece of brass tubing is flattened and bolted to the receiver. The transmitter button is then bolted inside it. The wiring diagram is shown below. The bell, receiver hook and push button are mounted in a box. To operate, take instrument from hook and close push button switch.—T. W. Heine.

For Hot Days

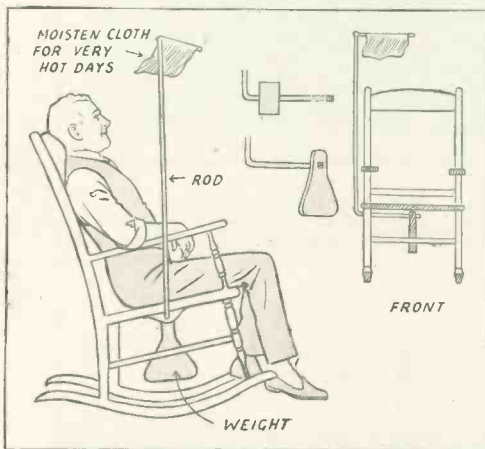

A fan that will operate with the motion of a rocking-chair is shown in the sketch above. Beneath the chair are placed two blocks, bored to be used as bearings for the rod that supports the counterweight. This weight can be of wood. The fan at the top is simply a large cloth slipped over the bent end of the rod.—John F. Pasick.

Alarm Clock Chicken Feeder

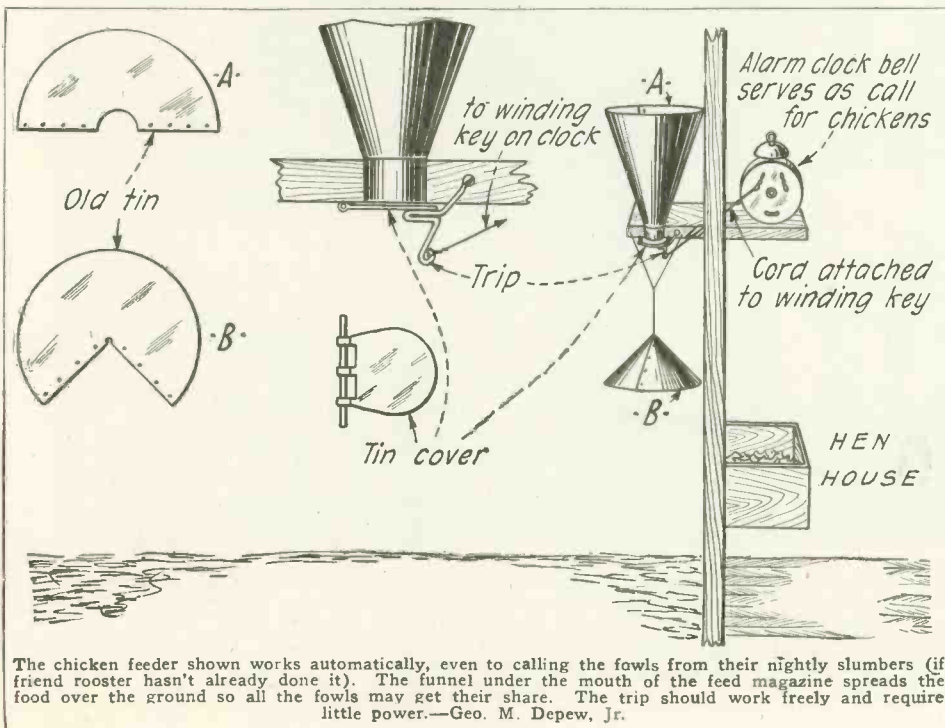

The chicken feeder shown works automatically, even to calling the fowls from their nightly slumbers (if friend rooster hasn't already done it). The funnel under the mouth of the feed magazine spreads the food over the ground so all the fowls may get their share. The trip should work freely and require little power.—Geo. M. Depew, Jr.

Spring Hinges

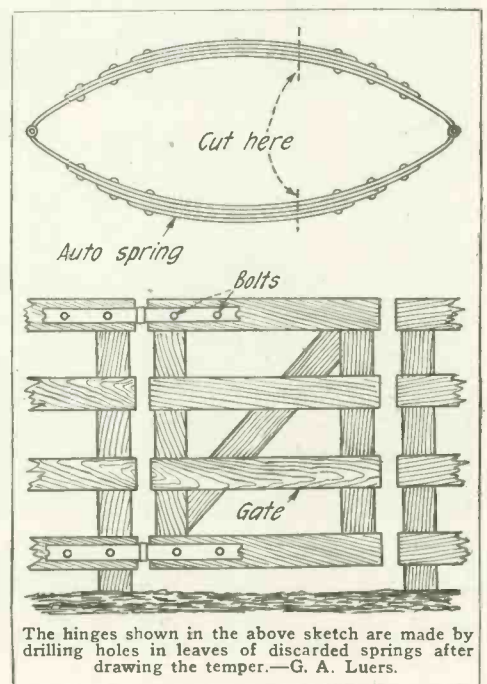

The hinges shown in the above sketch are made by drilling holes in leaves of discarded springs after drawing the temper.—G. A. Luers.

Perfume Making for Amateurs

By DR. ERNEST BADE

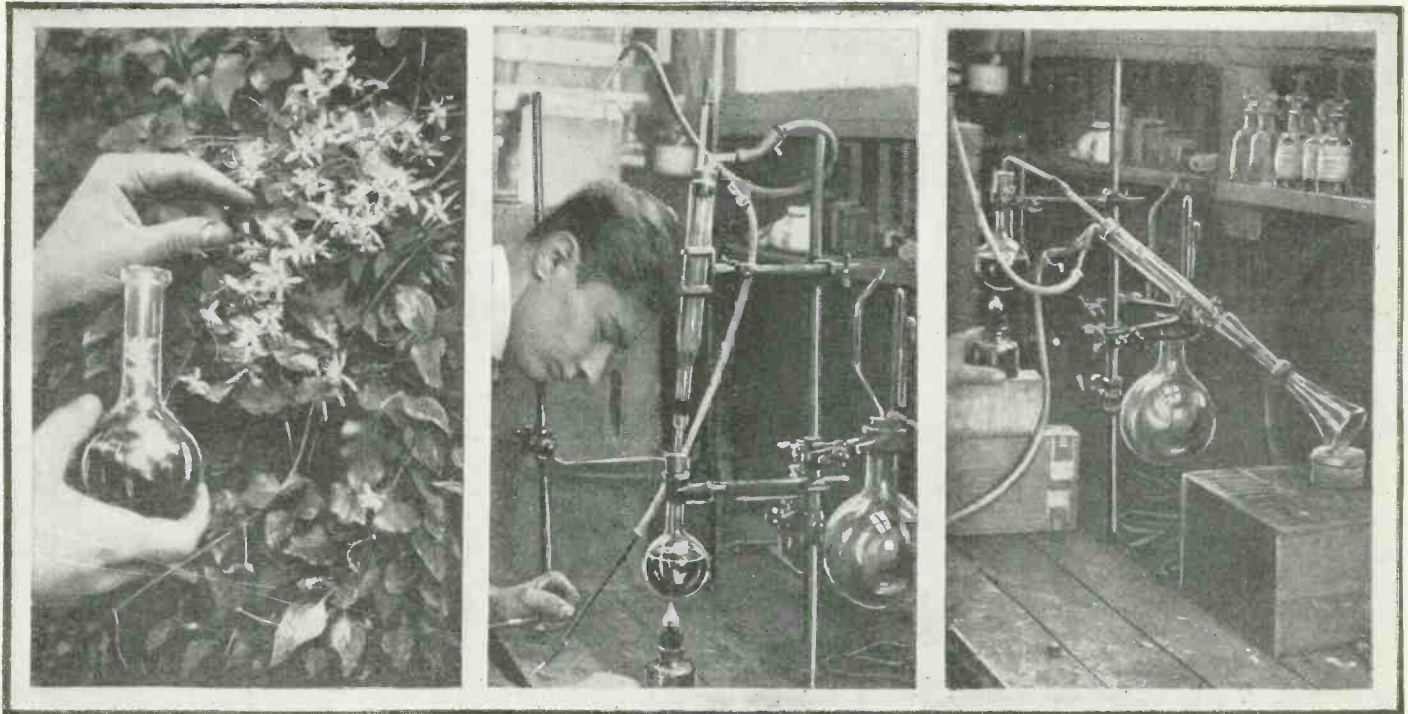

The above photos illustrate clearly how any amateur chemist may manufacture his own perfumes. The flowers are gathered early in the morning just after the dew has disappeared. The flower is dropped into a flask and the whole covered with alcohol. The flask is then connected with a condenser, vertically

placed, and the mixture is heated slowly for six or seven hours. Then filter the contents of the flask through filter paper. Distill the alcohol from the precipitate and the perfume is left. If it is not strong enough, use more flowers and repeat the process.

To Restore Dry Batteries

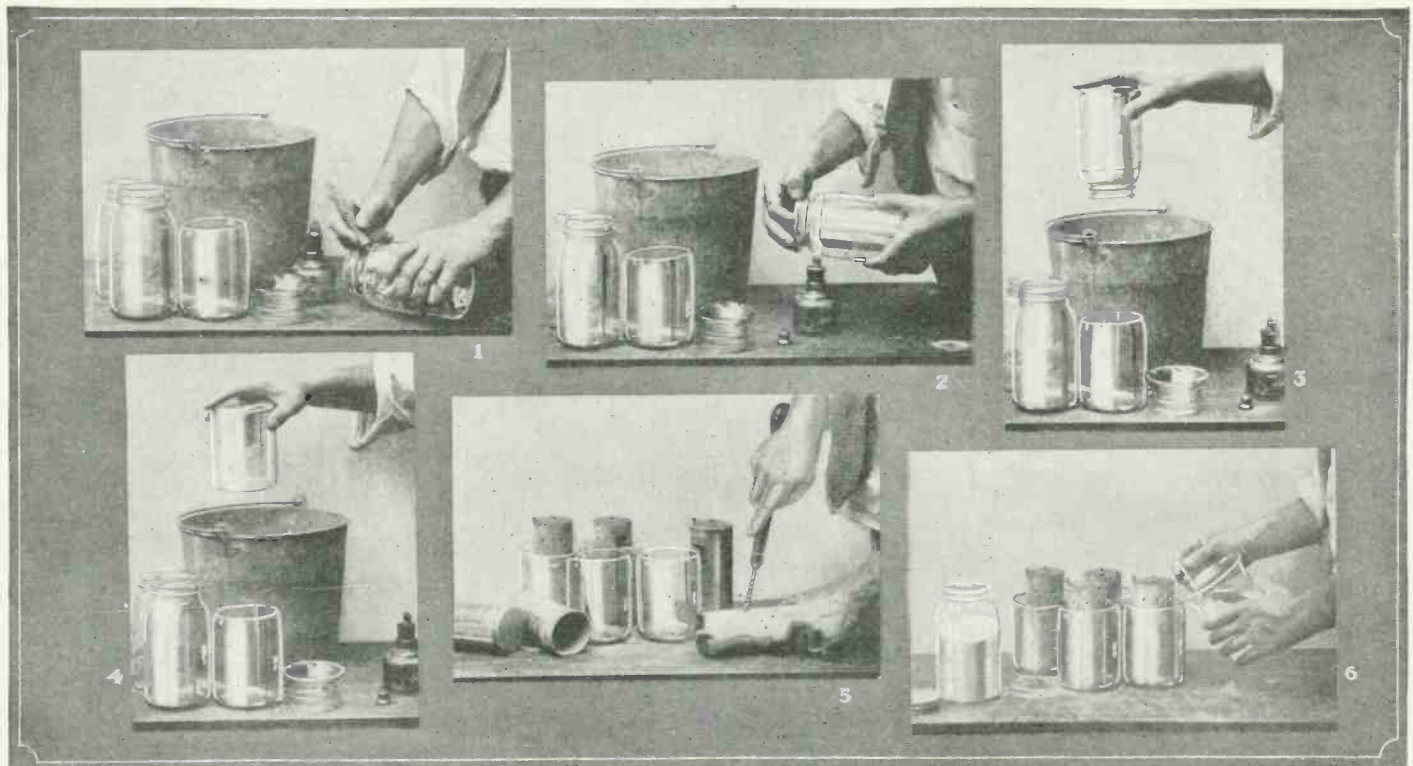

Since the dry battery is simply a modified form of the old Leclanche cell, it may easily be brought back into service by placing it in a solution of ammonium chloride or sal-ammoniac. If this chemical is not obtainable, photographers' hypo, sodium thiosulphate, may be used, but the results will not be quite so good. It is only necessary to drill (not punch) holes in the sides of the old cell and place it in a twenty per cent solution of the salts mentioned to gain the results. This trick of bringing them back will be especially use-

ful to radio amateurs who operate vacuum tubes with them. The first row of holes in the wall of the cell should be bored half an inch from the bottom, then two other rows are bored at about the same intervals above the first. A row is also bored around the top, above the solution, to allow for the escaping gas. A convenient jar for holding the cells can be made by nicking a mason jar below the shoulder with a file or glass cutter, heating the nick and then plunging it in cold water.

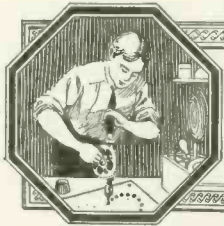

HOW-TO-MAKE-IT

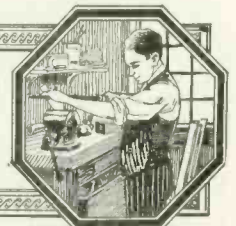

This department will award the following monthly prizes: First prize, \$15.00; second prize, \$10.00; third prize, \$5.00. The purpose of this department is to stimulate experimenters toward accomplishing new things with old apparatus or old material, and for the most useful, practical and original idea submitted to the Editors of this department a monthly series of prizes will be awarded. For the best idea submitted a prize of \$15.00 is awarded; for the second best idea a \$10.00 prize, and for the third best a prize of \$5.00. The article need not be very elaborate, and rough sketches are sufficient. We will make the mechanical drawings. Use only one side of sheet. Make sketches on separate sheets.

Shoe Scraper

1st Prize \$15.00

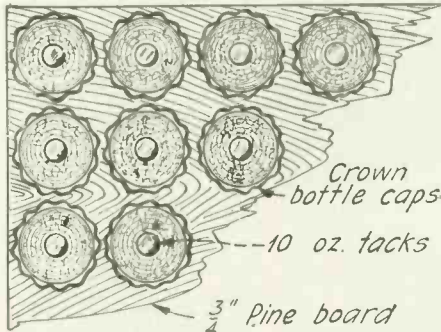

A cheap shoe scraper, much more effective than a fibre or rubber mat, can be made with a few crown bottle caps and 10 oz. tacks as shown in the above illustration. Fasten the base board to the floor. —W. T. Markowski.

Scratch-Awl

2nd Prize \$10.00

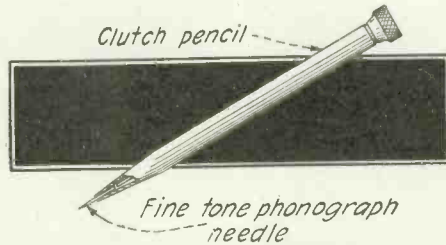

In working metals and radio panels a scratch-awl, or stylus, is a necessary part of the workman's equipment. A very handy and serviceable instrument of this type can be made by inserting a phonograph needle in a metal chuck pencil that may be obtained cheaply at any hardware store. —W. H. Holland.

Barometer

3rd Prize \$5.00

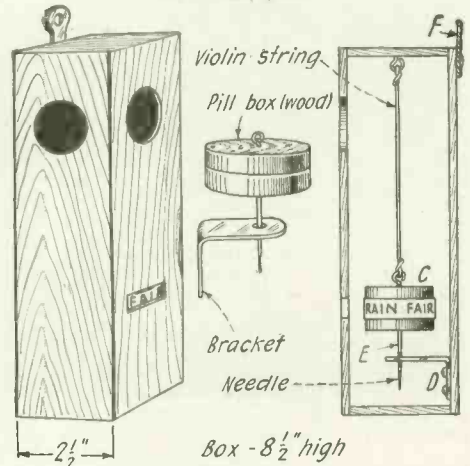

A cat-gut violin string fitted with an indicator as shown makes an excellent barometer. To calibrate it, on a dry day, mark "Fair". Then let a drop of water soak the string and mark "Rain". —Elder Schaffner.

Snake Drill

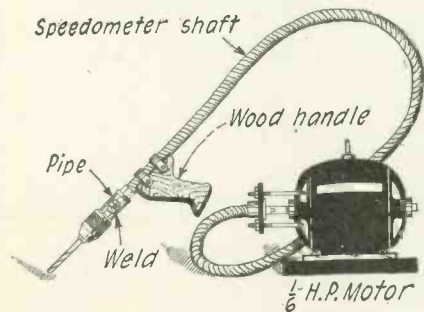

By using an old speedometer shaft and a cast-off drill chuck, a snake drill may be made that will be serviceable in inaccessible places. The motor shaft is slotted to take the speedometer shaft and the chuck is welded to the other end. The pipe just behind the chuck takes up the thrust. —Harold Jackson.

Blow Torch Boiler

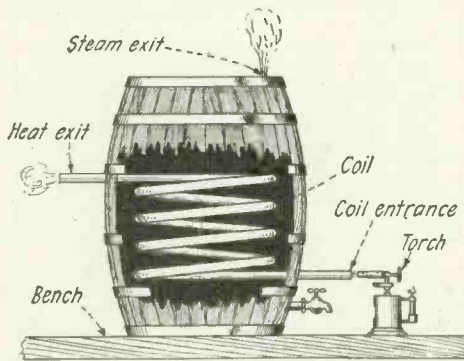

A length of one and one-half inch pipe coiled and inserted in a barrel as shown makes a fifty gallon boiler. If a three-inch nipple about six inches long is fitted over the end of the coil taking the blow torch so that the head of the torch may be inserted into it, better results may be gained. A cock is fitted to the bottom of the barrel for drawing off the water. —L. M. Jordan.

Door Bell Circuit

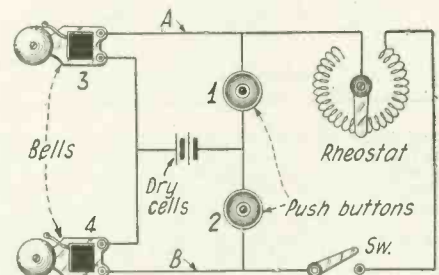

In the double door bell circuit shown both bells may be rung with either button. The resistance inserted in one of the circuits gives each of the bells a different tone. The switch separates circuits. —S. S. Peszel.

Washbasin Forge

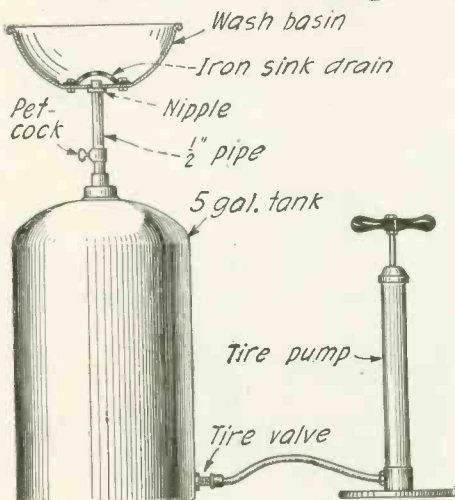

By drilling a hole through the bottom of a discarded wash-basin and covering it with a sink drain and inserting the air lead, a very handy small forge can be constructed. The petcock regulates the flow of air from the tank. —John F. Pascik.

Small Lathe from Breast Drill

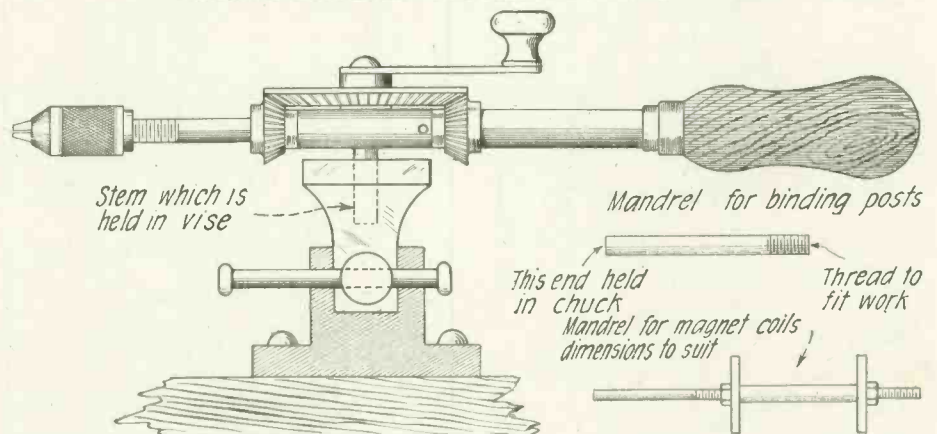

If the small handle, opposite the large gear wheel on a breast drill, is removed and the stem is supported in a vise, a small lathe is the result. A motor may be attached to the large gear for running it. This lathe will find many uses in winding coils, dressing round work and polishing. In winding coils with its aid, a mandrel, such as the one shown should be constructed. In polishing or finishing binding posts, another is used. A couple of pieces of copper facing the vise jaws will save the drill spindle. —Harry Lubcke.



WRINKLES

RECIPES & FORMULAS



Miniature Volcano Eruption Scene

THIS MONTH'S \$5.00 PRIZE TO ORHAN R. COBLENTZ.

MOUNTAINS PAINTED ON CANVAS

VOLCANO

CARBDOARD BUILDINGS

BATTERY **RED LIGHT** **RED LIGHT** **TO SPARK COIL**

SULPHURIC ACID FEW DROPS TO IGNITE

PAN OF POWDER - SAME AS #2 ELECTRICALLY IGNITED IN TABLE

LOOSE SOIL

SULPHUR AND IRON FILINGS

TEST TUBE

SAND

ONE FORM OF MINIATURE VOLCANO

PLASTER OF PARIS 4" 1 1/2" CARDBOARD TUBE

MIX CHEMICALS CAREFULLY WITH SPATULA. DON'T RUB

Parts by Weight: No. 1—Sulphur 2, Charcoal 1/2, Magnesium (powder) 1, Iron (filings) 1, Sugar 1/2, Potassium Chlorate 2. No. 2—Sulphur 2, Charcoal 1, Potassium Nitrate 2, Strontium Nitrate 3. No. 3—Sulphur 2, Charcoal 1, Potassium Nitrate 2, Barium Nitrate 3. No. 4—Sulphur 1, Potassium Nitrate 2, Charcoal 1 1/2. No. 5—Sugar 1, Iodine 1/2, Sodium Nitrate 1/4. No. 6—Sugar 2, Potassium Chlorate 2 1/2.

A miniature volcanic eruption that will produce all the details and thrills of the real explosion can easily be made with the help of a few chemicals. First construct the stage setting as shown in the top sketch. The houses are of painted cardboard. They are set in front of a background painted on canvas. Lights are placed inside the houses as shown. The volcanic mountain is made of plaster of Paris into which the cardboard tube, shown in the drawing at the extreme left, is placed. The chemicals listed above are placed in the tube as follows: One inch of number one, one-half inch of number

two, three-quarters of an inch of number three, three-quarters of an inch of number four, one-fourth of an inch of number five, and lastly three-quarters of an inch of number six. To set off pour 5 c.c. sulphuric acid (C.P.) on the top, keep the face at a distance. The scene will be realistic, according to its originator. —Orhan R. Coblentz. Another volcano, more easily constructed is shown in the right hand sketch. The mound is filled with a mixture of iron filings, dampened, and flowers of sulphur. It explodes automatically. —A. D. Turnbull.

Adz from Wagon Wheel

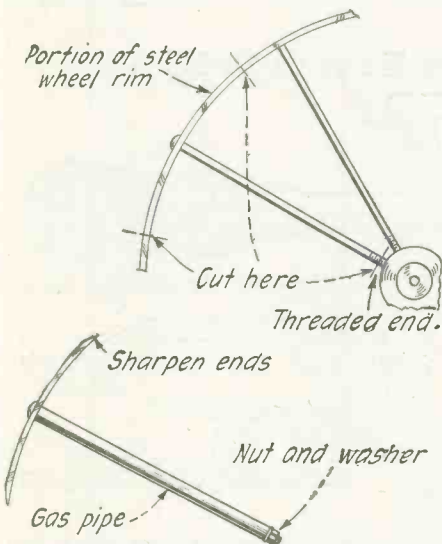

By cutting the rim of an iron wagon wheel about twelve inches from the spoke and then straightening and sharpening it, a good adz can be constructed. One end of the spoke is threaded. A piece of gas pipe is fitted over the spoke and made fast with a nut. —Dale R. Van Horn.

Lead Carbonate Reduction

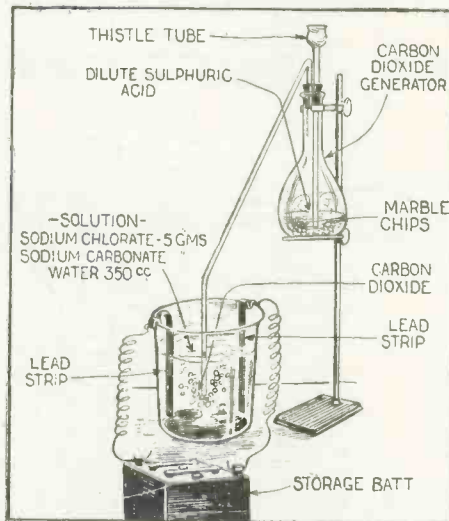

The electrolysis in the experiment above allows direct reduction of lead carbonate, from which white paint is made. For best results the solution in electrolysis, should be made of 15 grams of Sodium Chlorate and 5 grams of Sodium Carbonate and 350 cc. of water. It should be stirred while the experiment is in progress. —Orhan R. Coblentz.

Bleaching Flowers by Dipping

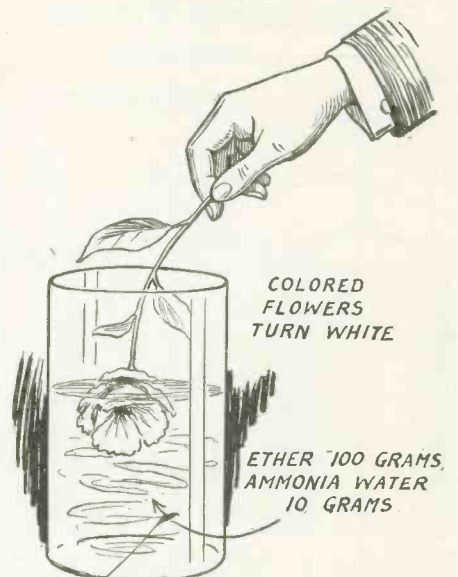

By dipping any colored flower into a solution of 100 grams of ether to which 10 grams of ammonia water has been added the flower will slowly bleach. —Elmer Garbella.



RADIO



Students Learn Code While Asleep

By S. R. WINTERS

'Learn and Work While You Sleep

By H. GERNSBACK

Member American Physical Society

COMING INVENTIONS

THE normal human life covers a period of some seventy years. During this time, the average adult sleeps about a day,

and he will not wake up. He has become accustomed to the disturbance. But let a rat or mouse start nibbling at a corner of his room, and he awakes immediately.

Try the experiment of switching on an electric light close to a sleeper's face. He will awake almost immediately because the lids are used to protect the eyes from the light.

...the speech being recorded on a steel wire passing between two electro-magnets.

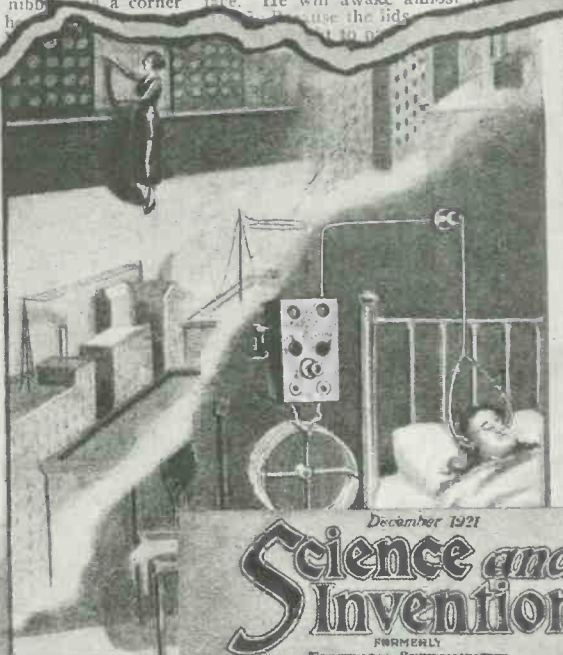
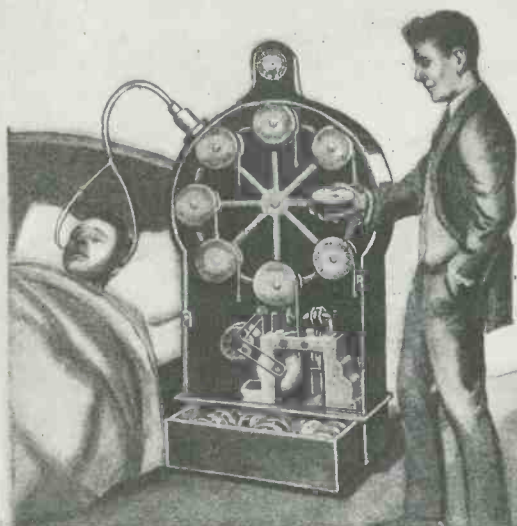

December 1921
Science and Invention
FORMERLY
ELECTRICAL EXPERIMENTER

WORK AND LEARN
WHILE YOU SLEEP

See Page 74

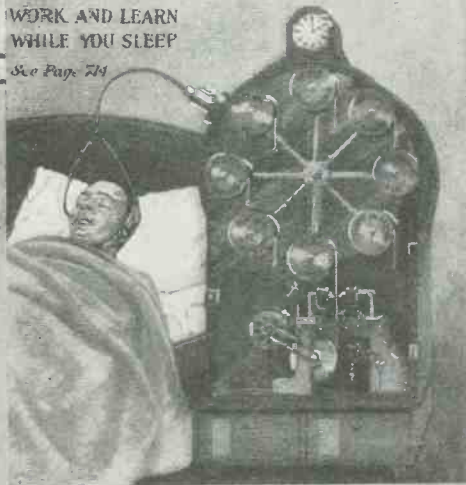

Another prophecy comes true! In the December, 1921 issue of SCIENCE AND INVENTION, there appeared an article by the editor stating that, due to the fact that the sub-conscious mind never sleeps, it would soon be possible to use the sleeping hours for study. Today that prophecy is a fact. At the bottom of the above cut is shown the interior of the Naval Radio Training School for airplane pilots at Pensacola, Florida, where students receive code practice while asleep. Twelve students who had difficulty in mastering the code in the regular way began practice in this way and in two days showed improvement. If there was a change in speed or mistakes in sending they tossed about in their sleep. If an SOS distress signal is sent they immediately awake. They learned through this method where all others failed. The device was put into practice by Chief Radio Mate Phinney.

ceive code practice while asleep. Twelve students who had difficulty in mastering the code in the regular way began practice in this way and in two days showed improvement. If there was a change in speed or mistakes in sending they tossed about in their sleep. If an SOS distress signal is sent they immediately awake. They learned through this method where all others failed. The device was put into practice by Chief Radio Mate Phinney.

Radio and Loud Speaker in Boys' Camp



Scenes at Boy Scout Camp "Glen Gray" Oakland, N. J., where a receiving set and loud speaker are installed. Above is shown Director F. F. Gray reading to the Scouts, for literature is not neglected in their curriculum.

Reveille at camp is shown in the center picture. Note microphone on the table. Above "Dave the cook" turns from artichokes to art and regales the camp with jazz. Center below shows installation of horns for the addresser.

Radio in the Open Balloon Race

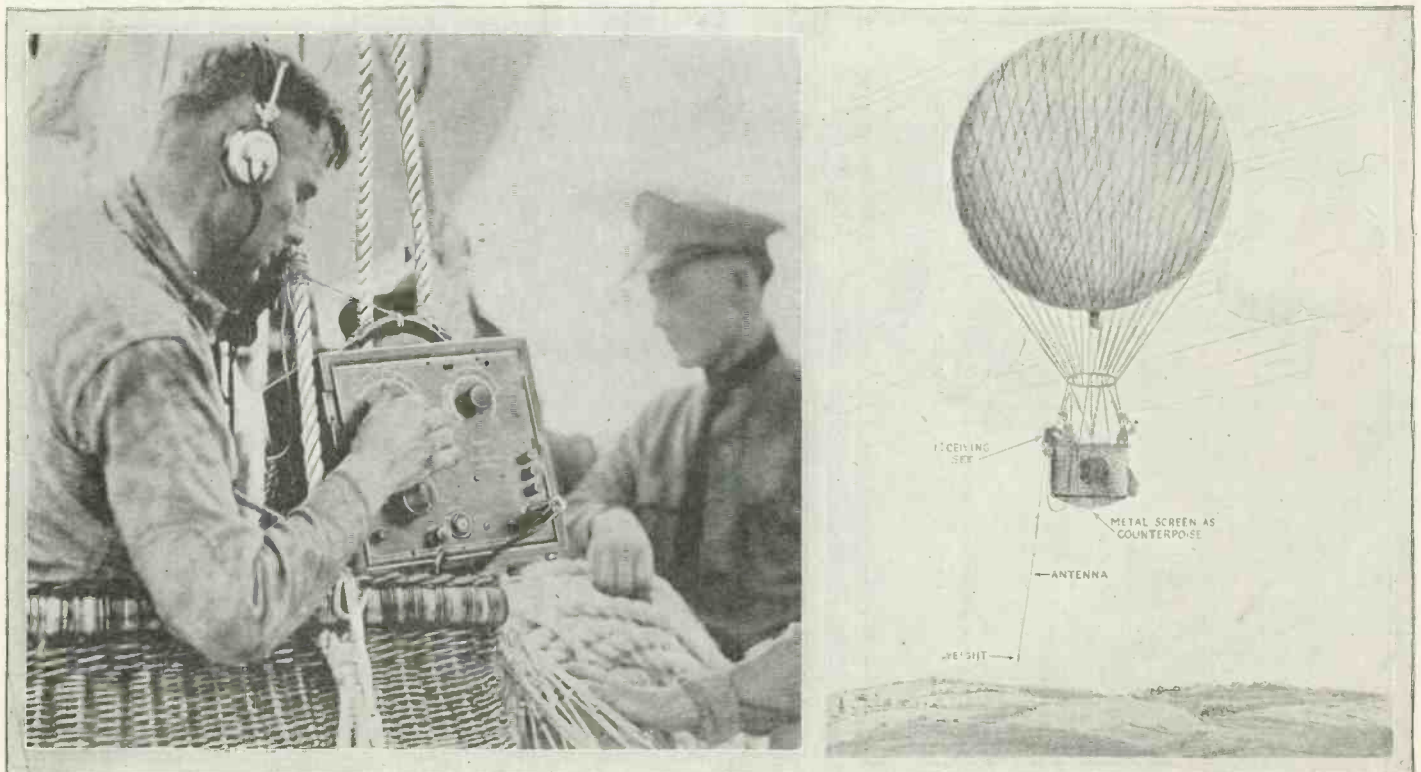

Official Photo, Army Air Service

To while away the long tedious hours of the open balloon race, held at Indianapolis recently, one of the Army teams swung out an antenna and installed a counterpoise on the bag and so listened to the broadcast programs. The

radio set also enabled the team shown to take the race since they were kept advised of weather conditions and the locality and distance of their opponents at all times during the race.
—Capt. Frank Lemrah, A. S. R.

Fight Returns to Argentine by Radio

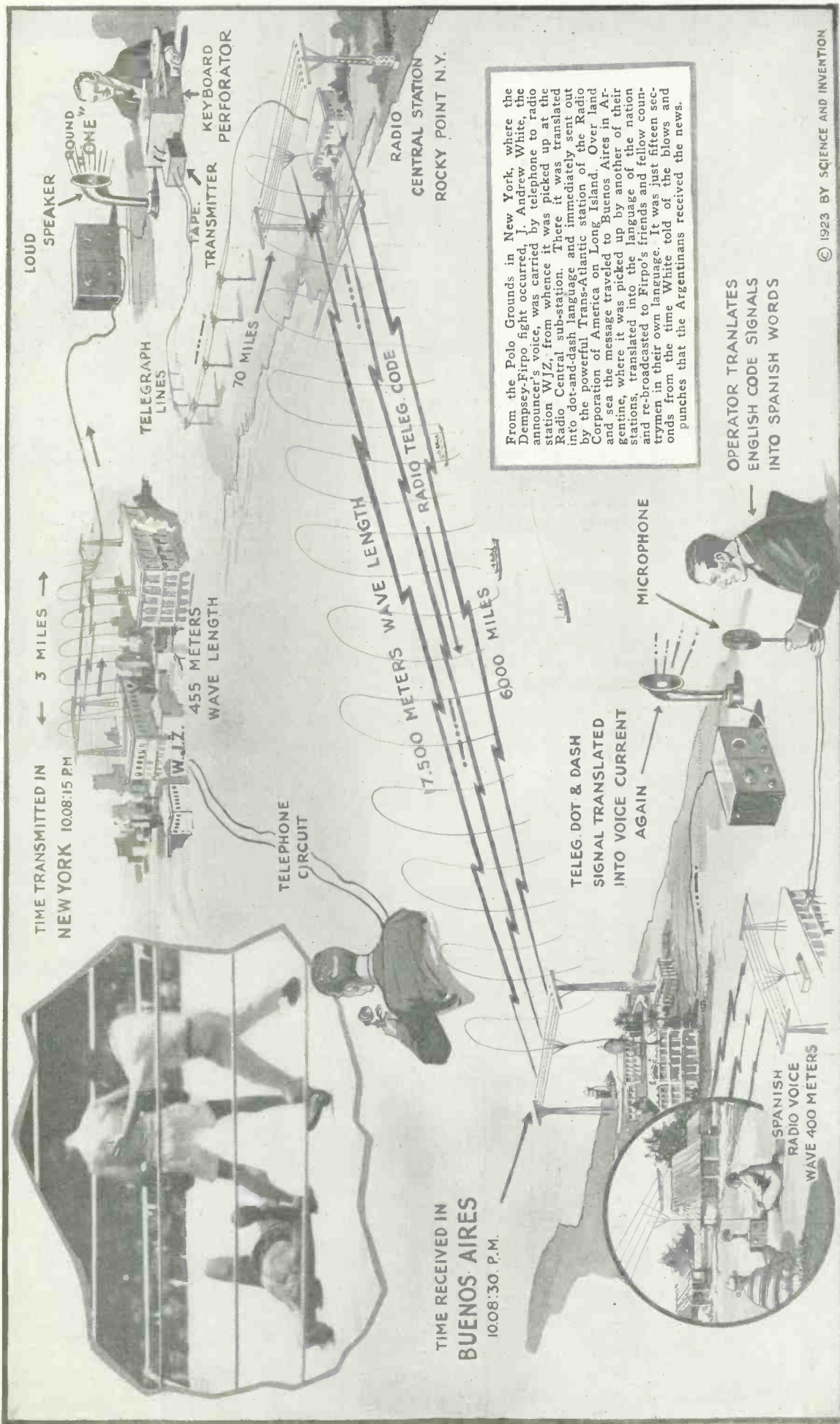

From the Polo Grounds in New York, where the Dempsey-Firpo fight occurred, J. Andrew White, the announcer's voice, was carried by telephone to radio station WJZ, from whence it was picked up at the Radio Central sub-station. There it was translated into dot-and-dash language and immediately sent out by the powerful Trans-Atlantic station of the Radio Corporation of America on Long Island. Over land and sea the message traveled to Buenos Aires in Argentine, where it was picked up by another of their stations, translated into the language of the nation and re-broadcast to Firpo's friends and fellow countrymen in their own language. It was just fifteen seconds from the time White told of the blows and punches that the Argentinians received the news.

By H. WINFIELD SECOR, F. E.

THE 85,000 spectators at the ringside who saw Dempsey knock Firpo to the canvas for ten counts, constituted only an infinitesimal part of the audience that enjoyed one of the liveliest clashes in ring history. Six thousand miles from the ringside some of the most eager fight fans listened tensely to a blow by blow description of the fistic engagement. This invisible

audience was Firpo's own. They listened over their receiving sets through the intermediary of the most powerful radio station in the world, Radio Central, located at Rocky Point, Long Island. The manner in which the transmission was carried out is represented schematically in the drawing. During the period of the bout Radio

Central's signals were picked up by the high power receiving station at Buenos Aires. Thus, 6,000 miles away, through Monte Grande, over great expanses of water and long stretches of land the progress of the big bout, described by J. Andrew White, journeyed to the native land of Firpo. The range of Radio Central is sufficient to carry the news of the battle at New York

not only to radio fans in the Argentine, but to Chile, Paraguay and Uruguay. From the moment the referee reached his tenth count while Firpo lay upon the canvas after a blow delivered by his opponent, only 15 seconds were consumed in transferring the news from New York City to the countries in South America.

Radio--All Over the Place

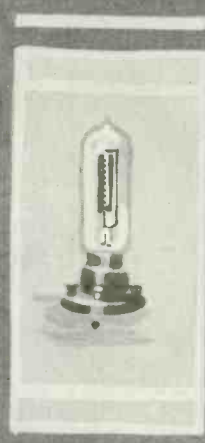

Romany doesn't depend upon a scratchy old fiddle in the back of the caravan for the evening's entertainment any more. These Gypsies camped recently in New Jersey and threw up an antenna almost before they fed the horses. They ate their supper by campfire and the music of WOR and WMAB.

© by Western Electric Co.

Even the farm lighters the boredom of hay making with a couple of grand opera arias. Note the fair driver on this Vermont farm enjoying selections from Pagliacci while she collects Dobbins' winter food.

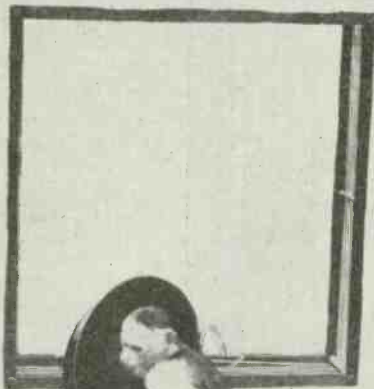

"Ritzzy" doesn't know quite what it is all about but he figures that if his owner, the enthusiast who spends his salary on tubes and "B" batteries, stays away long enough he will find out. In the photo to the left he is just giving the loud speaker the final O. K. before starting an investigation of the variables and honey-comb coils.



An English firm doing a large retail radio business decided that the overhead of delivering "B" batteries and 10 feet of bus-bar wire could be lowered by having the office sign painter do his stuff on the side of the delivery cart. The antenna is by the office boy; the variable knobs by the carpenter.

Condenser Vernier

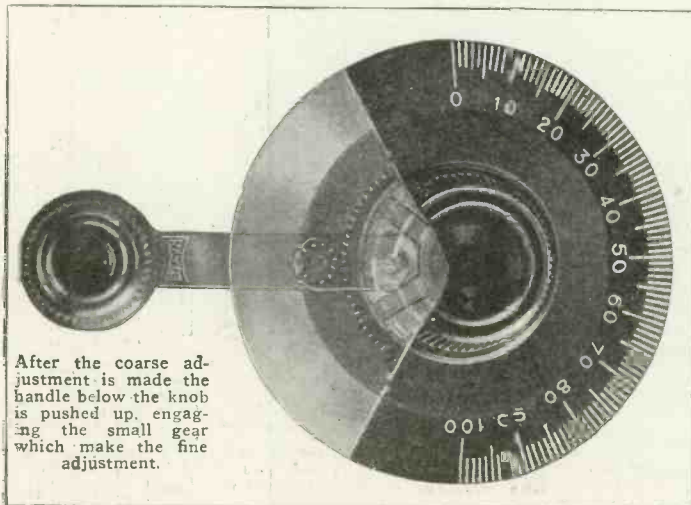

After the coarse adjustment is made the handle below the knob is pushed up, engaging the small gear which make the fine adjustment.

New Loud-Speaker

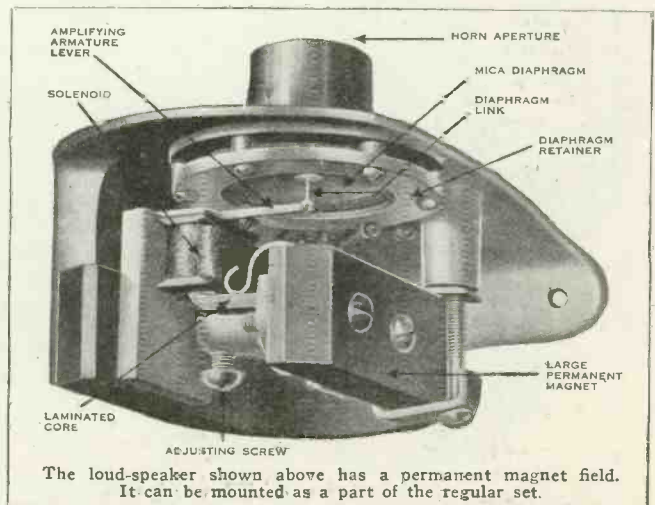

The loud-speaker shown above has a permanent magnet field. It can be mounted as a part of the regular set.

Radiophone on French Trains

By A. N. MIRZAOFF

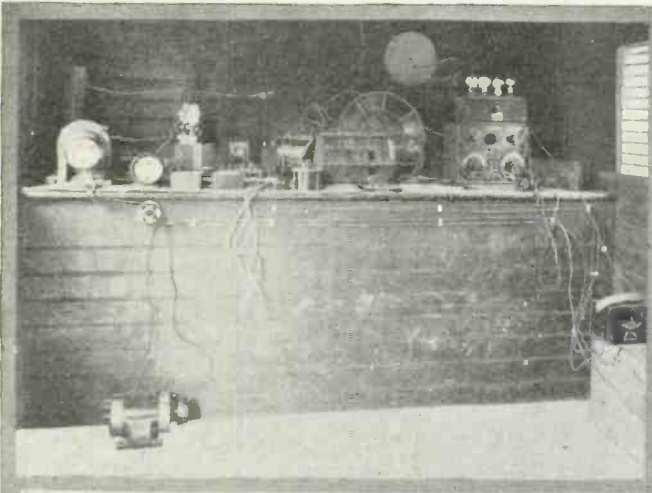

Above is shown one of the "fixed" radiophones receiving and transmitting stations installed by the French State Railways with which they have been making extensive tests. The "fixed" stations, installed in cars, are set on sidings and used to communicate with the "moving" sets aboard trains. The "fixed" stations are moved from point to point as the experiments require.



At the right is seen the exterior of the car housing the "fixed" station and the method of installing the antenna upon the adjacent telegraph poles, on a cross-arm.

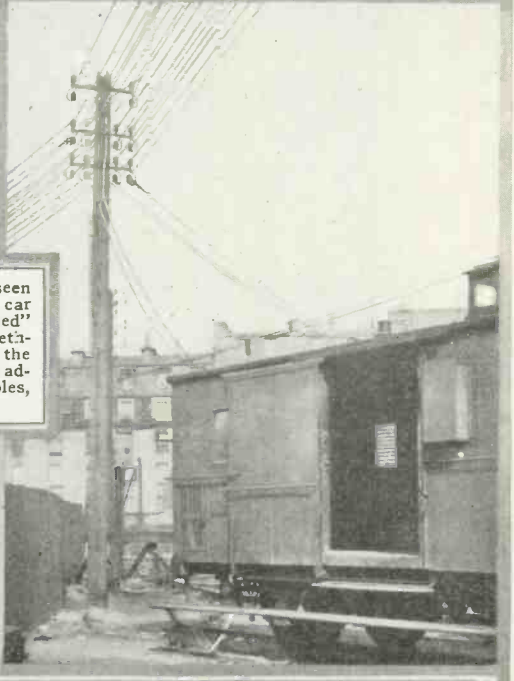

Here are shown engineers representing the Compagnie Telegraphique making experiments at the "fixed" station shown in the photo at the top of the page. Power for operating the transmitting set was obtained from a small motor-generator working on a storage battery. A number of different circuits were used and the results obtained with each were carefully tabulated.

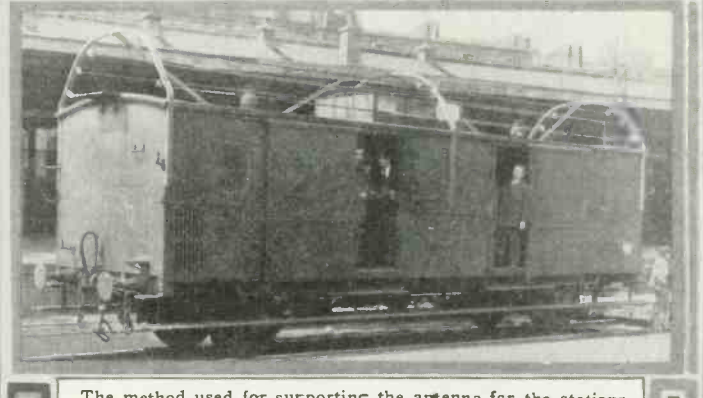

The method used for supporting the antenna for the stations attached to moving trains is shown in the photo above. The stretcher across the top of the car is of metal and is insulated from the body of the car. The lead-in is taken from the end of the car where the instruments are installed.



To the right is shown one of the engineers making tests from one of the movable stations while the train to which it was attached was running from Paris to Lyons. Communication was maintained practically all through the journey between the cities.

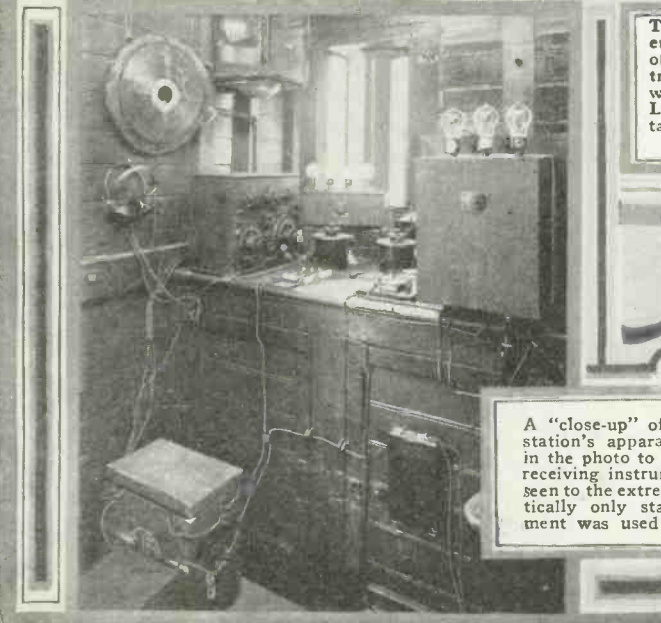

A "close-up" of the movable station's apparatus is shown in the photo to the left. The receiving instruments may be seen to the extreme left. Practically only standard equipment was used in the tests.

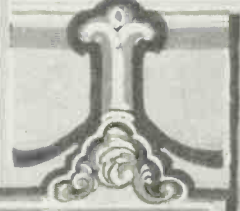

Broadcast Relay on 100 Meters

By HOWARD ALLEN DUNCAN

©1923 BY SCIENCE AND INVENTION

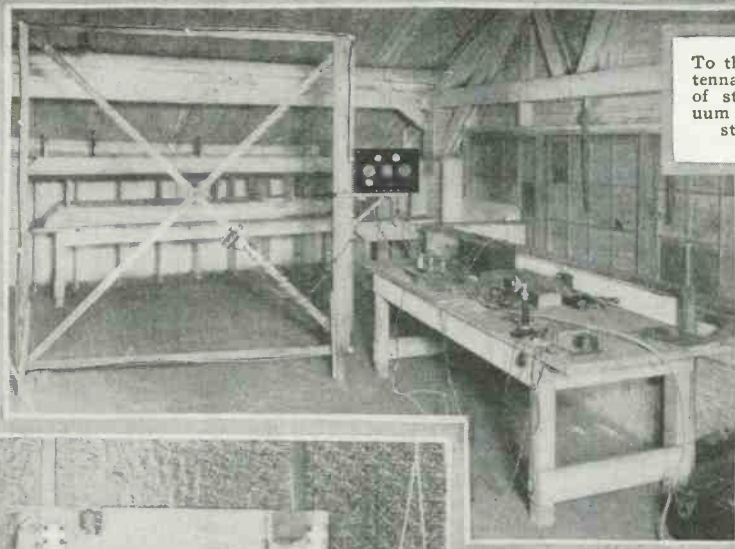

To the left is shown loop antenna and receiver consisting of standard one-circuit vacuum tube detector and two stages of amplification.

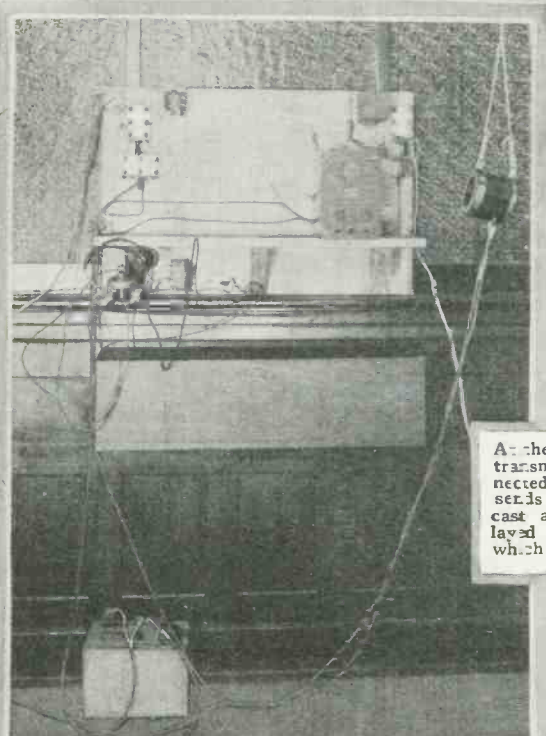

At the left is shown the 250-watt transmission set—directly connected to the receiver—which sends out the 100 meter broadcast at KDPM, Cleveland, relayed from East Pittsburgh, which originates the program.

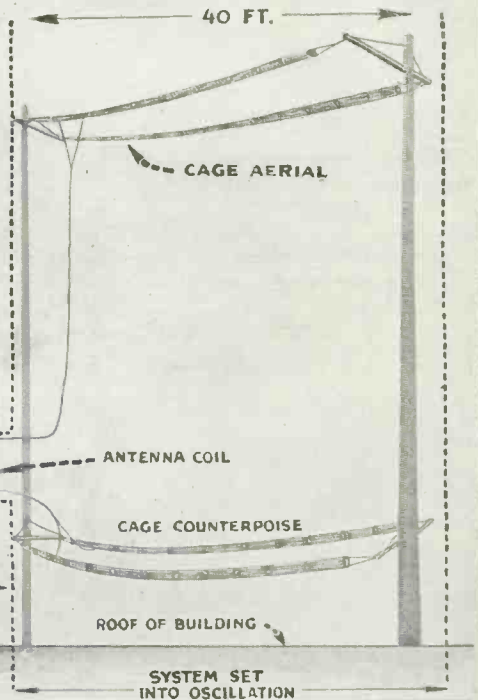
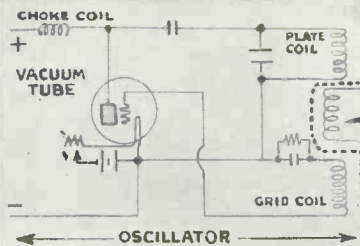

Above diagram shows the aerial arrangement used to relay the 100 meter waves. The counterpoise keeps the tuning sharp. The sketch also shows the wiring diagram for the transmitter, which uses one oscillating and one modulating tube. This system is used at all sub-stations.

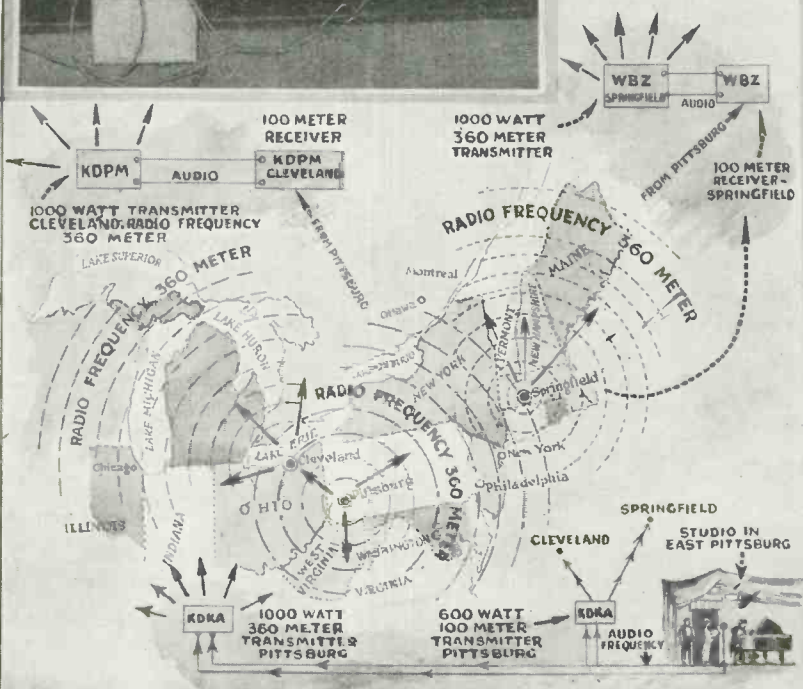

Map shows how broadcast on 360 and 100 meters simultaneously at KDKA was picked up and relayed at Cleveland (KDPM) and Springfield (WBZ). At right is seen the counterpoise and antenna on KDKA.

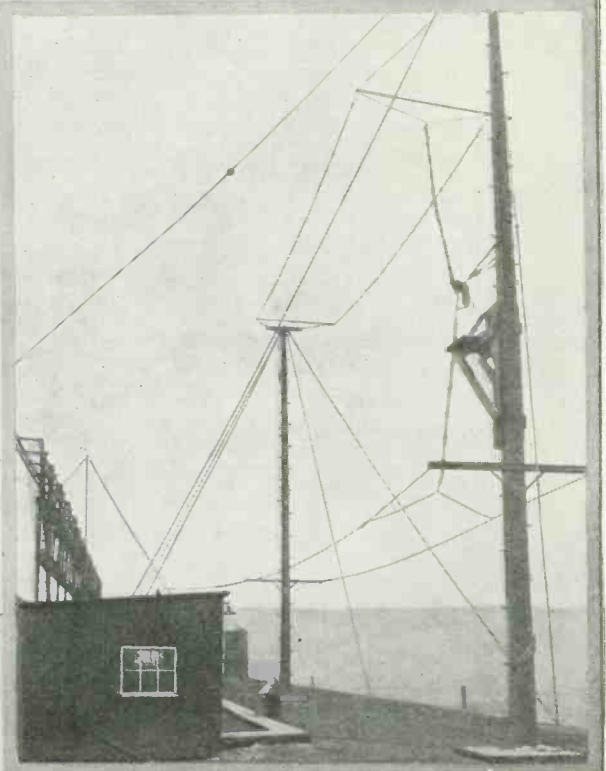

Good Single Circuit Receiver

By H. ALLEN DUNCAN

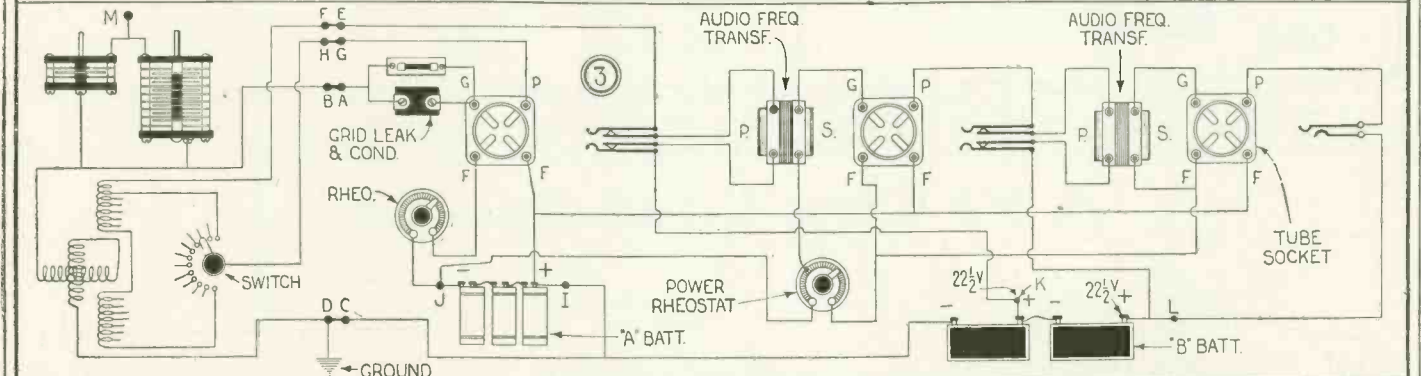
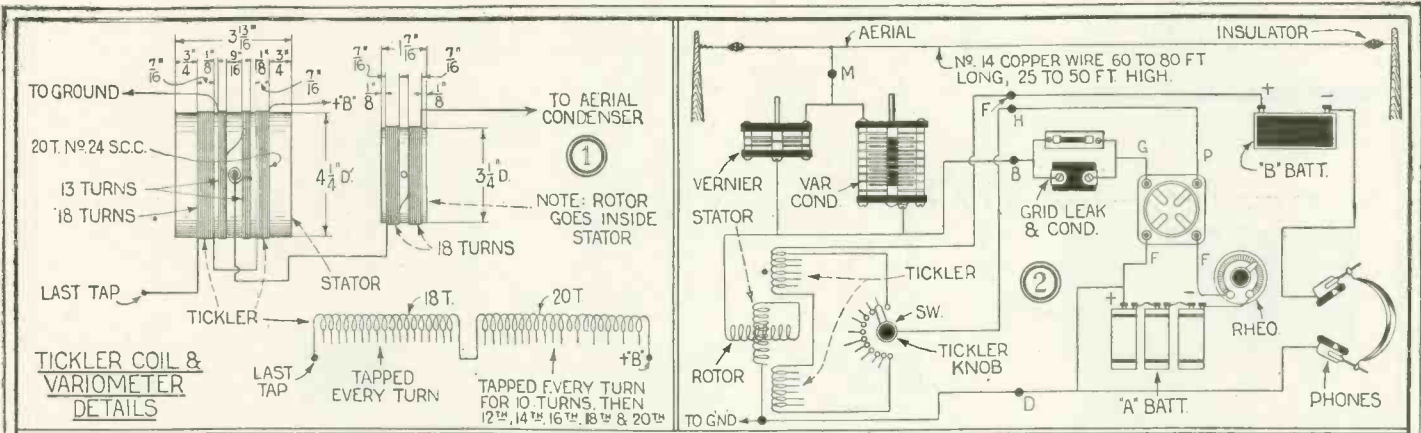

This standard receiver, wiring diagram of which is shown above, has the advantage of a fairly wide range of wave-lengths and simplicity of control. In Fig. 1 is shown the details of the tickler and variometer. Fig. 2 gives the wiring of the set used as a regenerative receiver. Fig. 3 shows the hook-up of the complete apparatus using audio amplification.

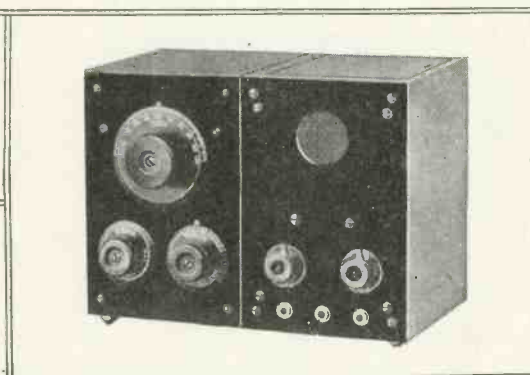

Below is shown one of the many hook-ups obtainable with the outfit. By building the tuner and the detector-amplifier units in separate cases and making them independent of each other, the set lends itself easily to experimental uses. By mounting the variable condenser and the variometer on the same shaft the tuning control is vested in one knob. Behind the main panel at the front of the set is mounted a second smaller panel which is used to support the condenser, vernier condenser and the variometer as well as the taps for the tickler. Connections between the two units are made by binding posts at the rear of the cabinets. The tuner will cover waves from 170 meters to 800 meters. With a loading coil which may be installed without disturbing the wiring of the remainder of the set, 2,800 meters can be tuned in. Jacks for detector, one and two steps of amplification are furnished.

Above is shown the exterior of the set. The cabinets contain the tuner, detector and amplifiers.

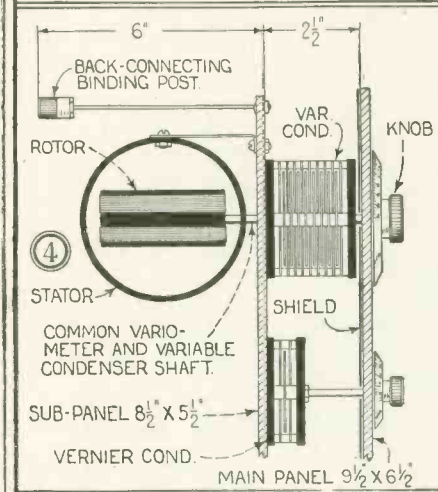

Above is shown the double panel method of mounting. All binding posts are mounted on the rear of the cabinet.

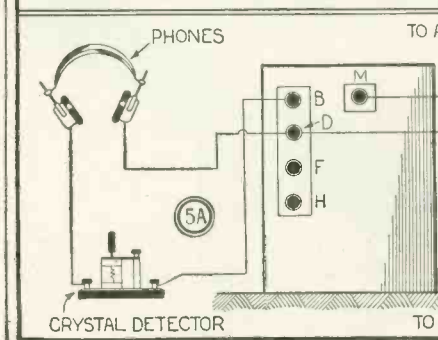
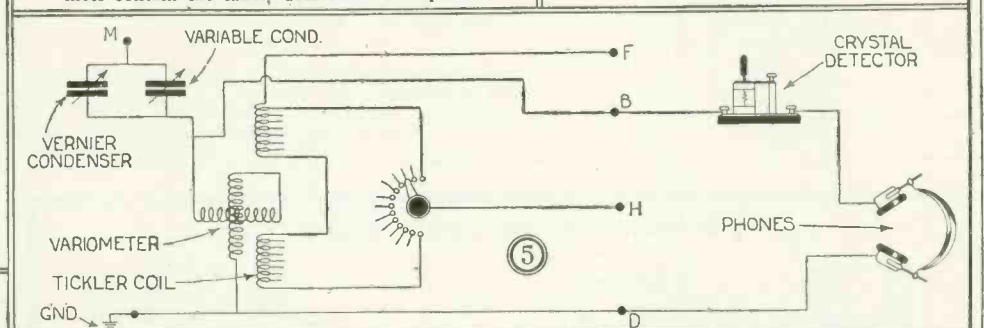

At left is shown connections for using the tuner unit in connection with a crystal detector. At right is shown complete hook-up when both units are used. Aerial for this set should be between sixty and eighty-five feet in length for reception of broadcast waves. For best results, it should be placed as high as possible and away from all surrounding objects.

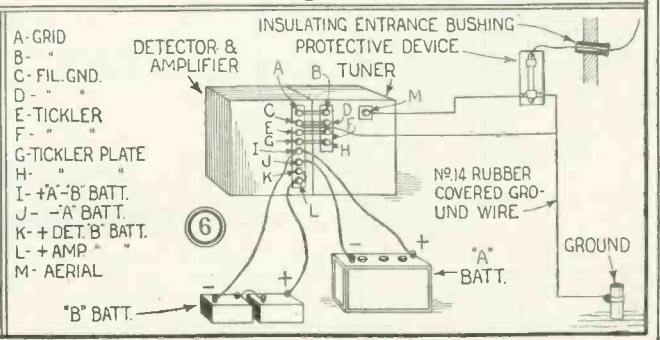

Cockaday Four-Circuit Tuner

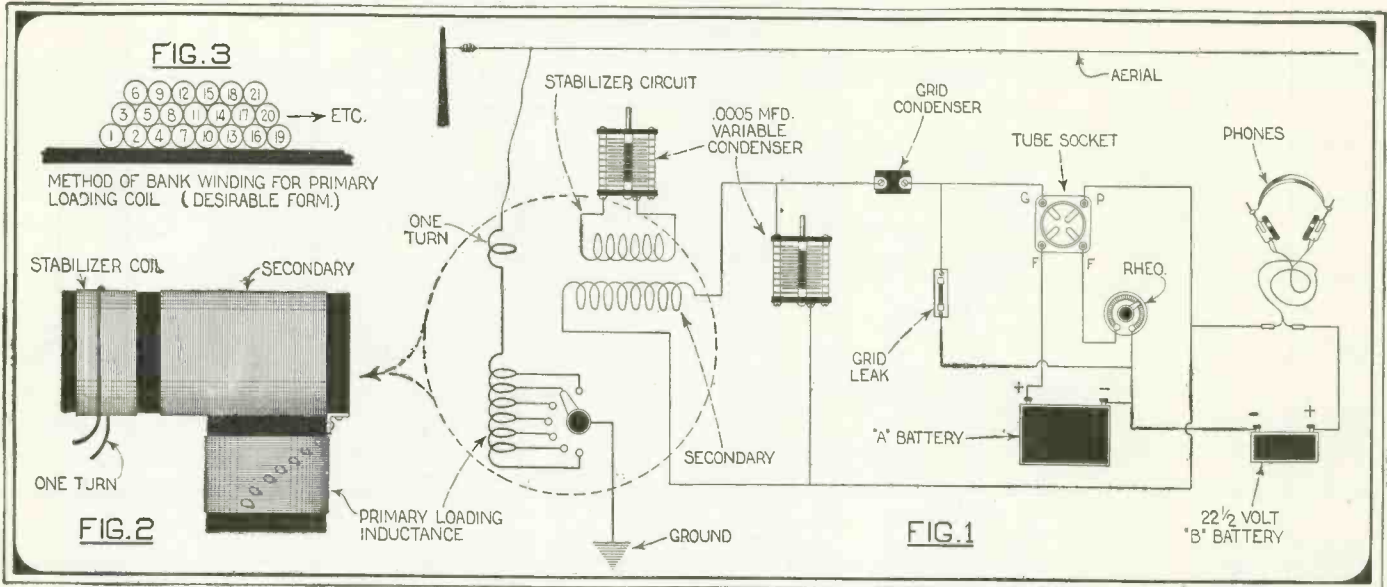

Fig. 1; Circuit of the Very Selective Cockaday Four-Circuit Tuner. Fig. 2; Position of the Coils, All Wound on 3 1/2 Inch Tubes. The Stabilizer Coil Consists of 35 Turns of No. 18 S. C. Wire, the Secondary 65 Turns of the Same Size and the Primary 43 Turns, Bank Wound. (Fig. 3) Tapped at the First, Fourth, Eighth, Fourteenth, Twenty-Second, Thirty-Sixth and Last Turns. The One Turn is of Square Bus Bar Wire. —By Leroy Western.

A 50 Cent Loud Speaker

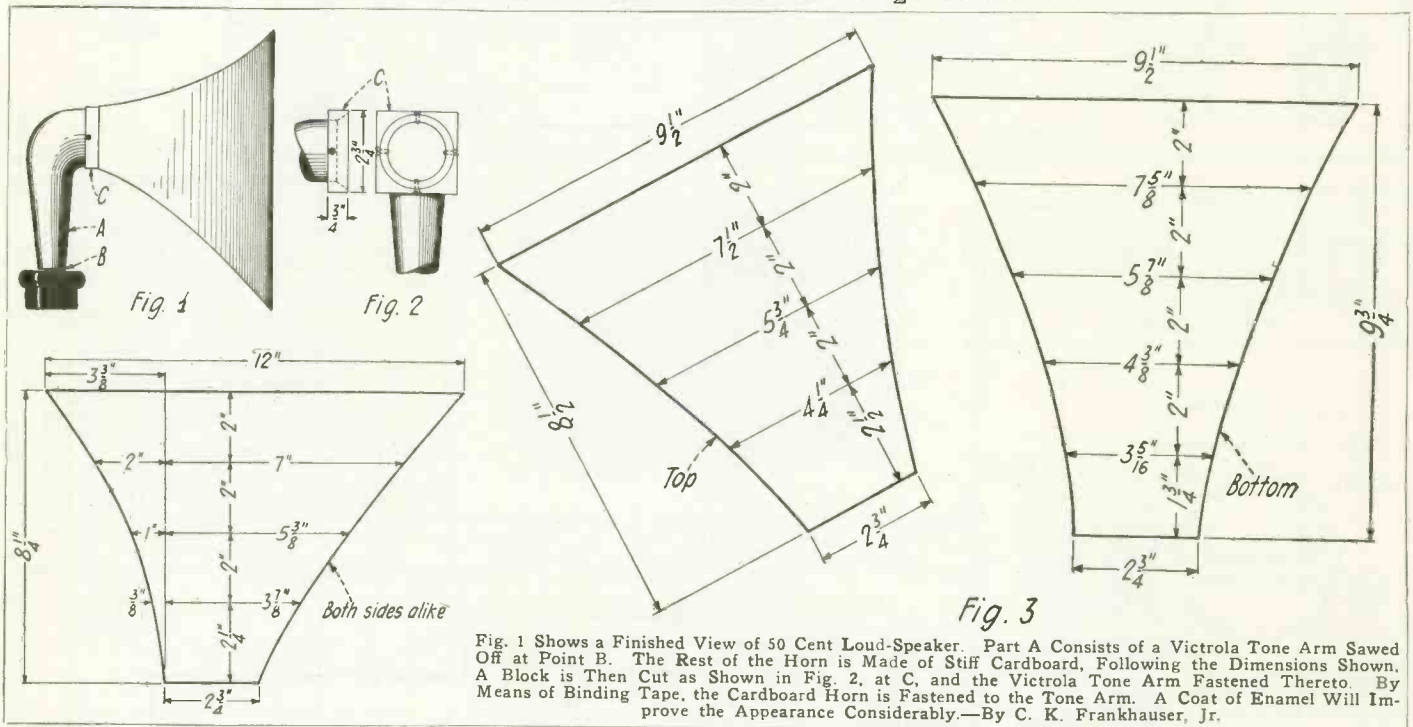
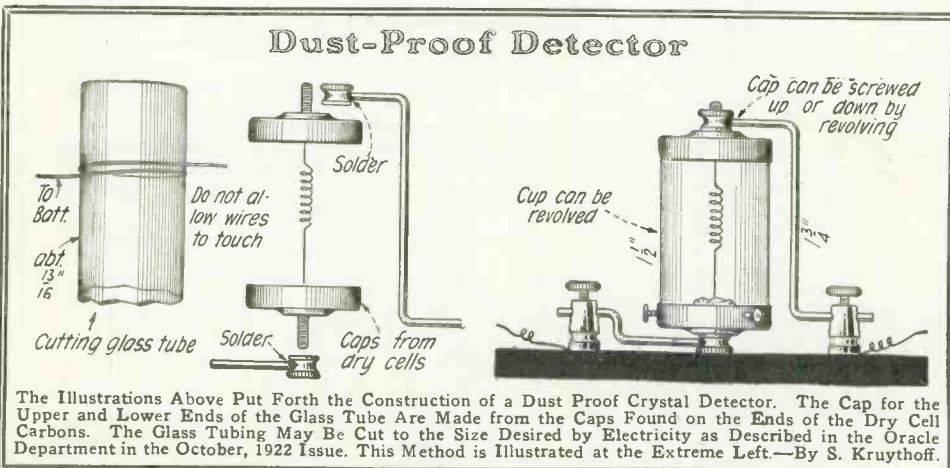

Fig. 1 Shows a Finished View of 50 Cent Loud-Speaker. Part A Consists of a Victrola Tone Arm Sawed Off at Point B. The Rest of the Horn is Made of Stiff Cardboard, Following the Dimensions Shown. A Block is Then Cut as Shown in Fig. 2, at C, and the Victrola Tone Arm Fastened Thereto. By Means of Binding Tape, the Cardboard Horn is Fastened to the Tone Arm. A Coat of Enamel Will Improve the Appearance Considerably.—By C. K. Frankhauser, Jr.

Dust-Proof Detector



The Illustrations Above Put Forth the Construction of a Dust Proof Crystal Detector. The Cap for the Upper and Lower Ends of the Glass Tube Are Made from the Caps Found on the Ends of the Dry Cell Carbons. The Glass Tubing May Be Cut to the Size Desired by Electricity as Described in the Oracle Department in the October, 1922 Issue. This Method is Illustrated at the Extreme Left.—By S. Kruythoff.

Lightning Gap

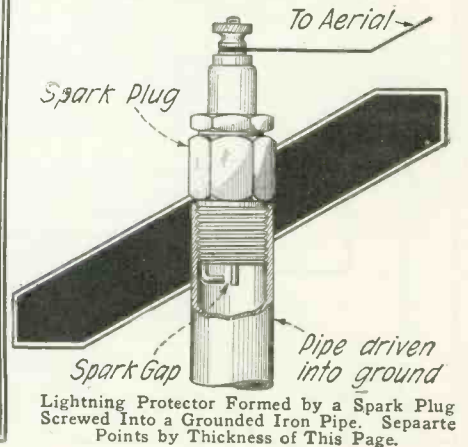

Lightning Protector Formed by a Spark Plug Screwed into a Grounded Iron Pipe. Separate Points by Thickness of This Page.

An Experimental Circuit Panel

By R. D. B. WASHBURNE

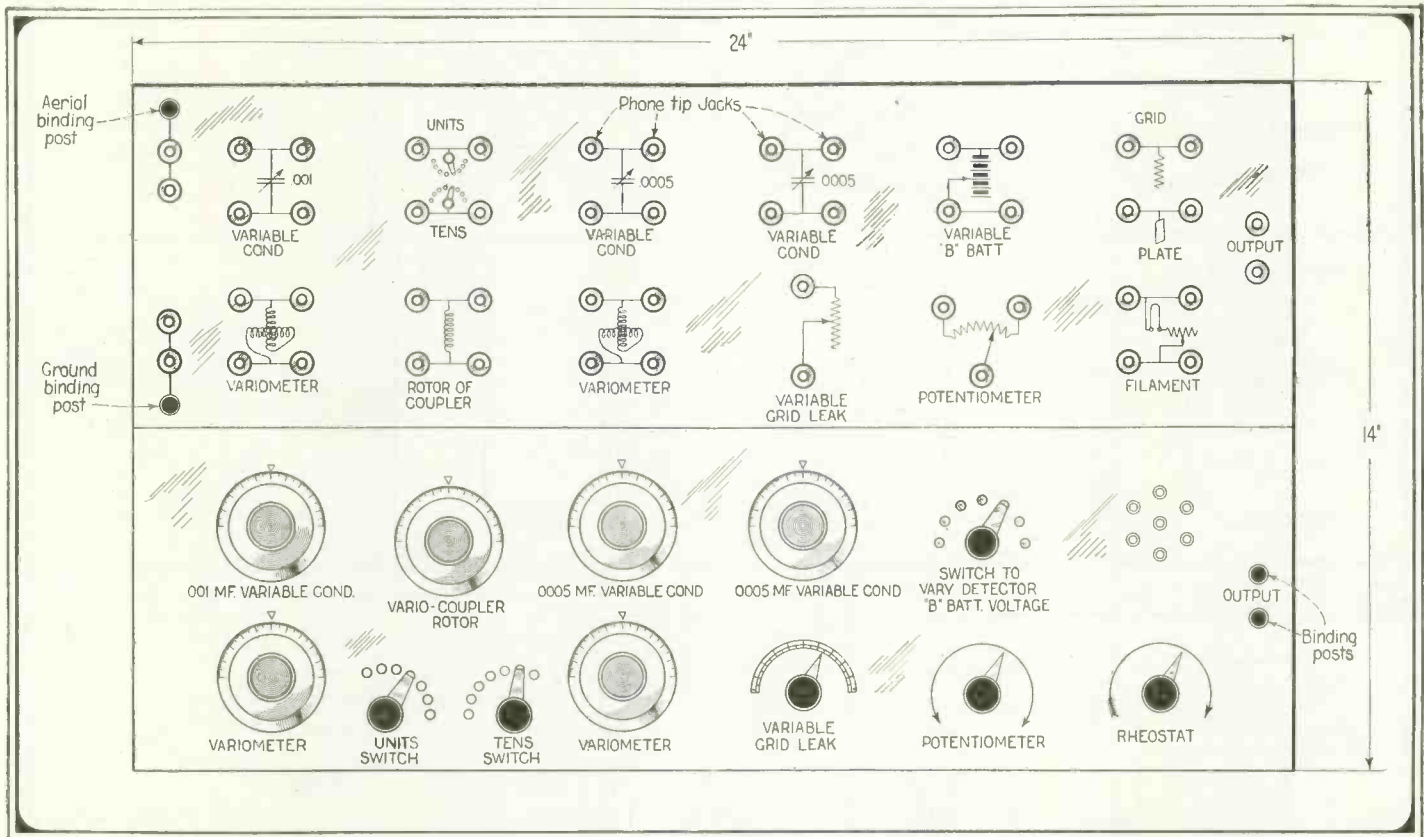

By using a panel twice as wide as the ordinary radio receiving set panel and placing a number of phone tip jacks on the upper half, as illustrated above, practically any known circuit may be tried out. The jacks are connected

to the instruments as illustrated and connections between them are made by means of flexible wires on the ends of which are phone cord tips. Many other variations of this principle will suggest themselves to the constructor.

Handy "Bootleg" Tube Sleuth

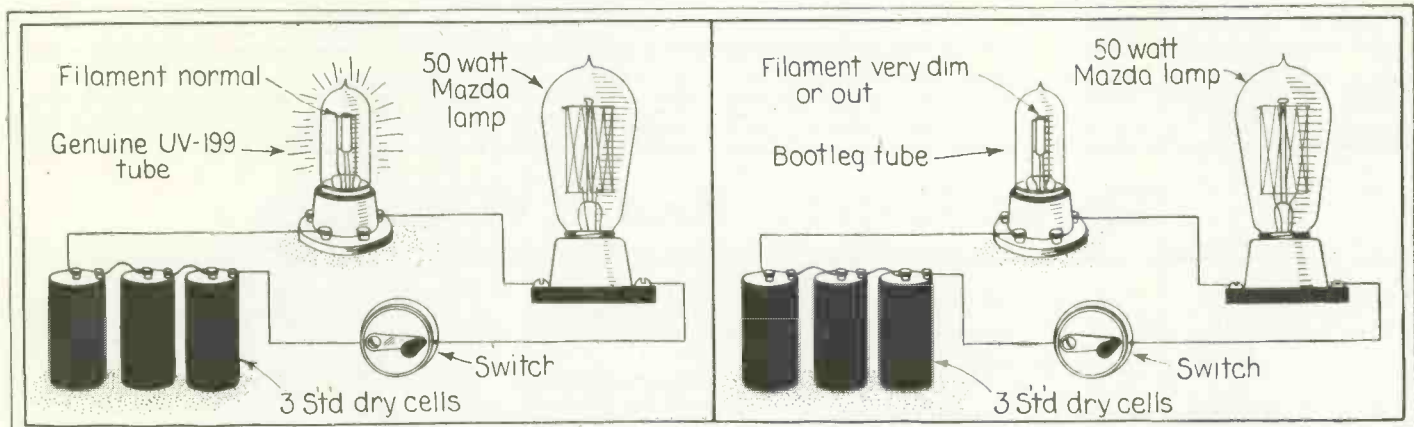

The difference between a bootleg tube and a standard U.V.-199, may be readily ascertained by means of the connections shown above. If the tube is genuine, the filament will light to a normal brilliancy, while if it is of

the bootleg type, which draws a greater amount of current, the filament will not light to normal. This is because the 50-watt Mazda lamp does not allow sufficient current to pass to light the bootleg filament.

THE GREAT RADIO AMATEUR NUMBER!

DO NOT FAIL to read the November issue of RADIO NEWS, which is the biggest "Amateur" number ever put out by any radio magazine since the beginning of the art. It contains articles by some of the foremost amateurs in the country.

THE AUTOPLEX CIRCUIT

The latest thing in radio. Uses only two variometers, one honeycomb coil and single bulb. And brings them in on a loud-talker! The greatest hook-up of the year. All in the November issue.

PRINCIPAL ARTICLES TO APPEAR IN THE NOVEMBER ISSUE OF RADIO NEWS (AMATEUR NUMBER)

- Vacuum Tubes for the Amateur,
By Jesse Marsten.
- The Autoplex Circuit,
By M. L. Muhleman.
- Loop Antennae for Transmission,
By Allan R. Kenworthy.
- 100-Meter Continuous Wave Transmission,
By S. R. Winters.

- High Frequency Resistance,
By D. R. Clemons.
- My Moduloscope,
By John L. Reinartz.
- Design of an Audibility Meter,
By Ralph R. Batcher, E.E.

- Also articles by:
- A. L. Groves,
 - Howard S. Pyle, Asst. U. S. Radio Inspector of the 8th Radio District.
 - Edward T. Jones.
 - Paul G. Watson.
 - Kenneth M. Swezey.

Crystal Detectors

By A. P. PECK

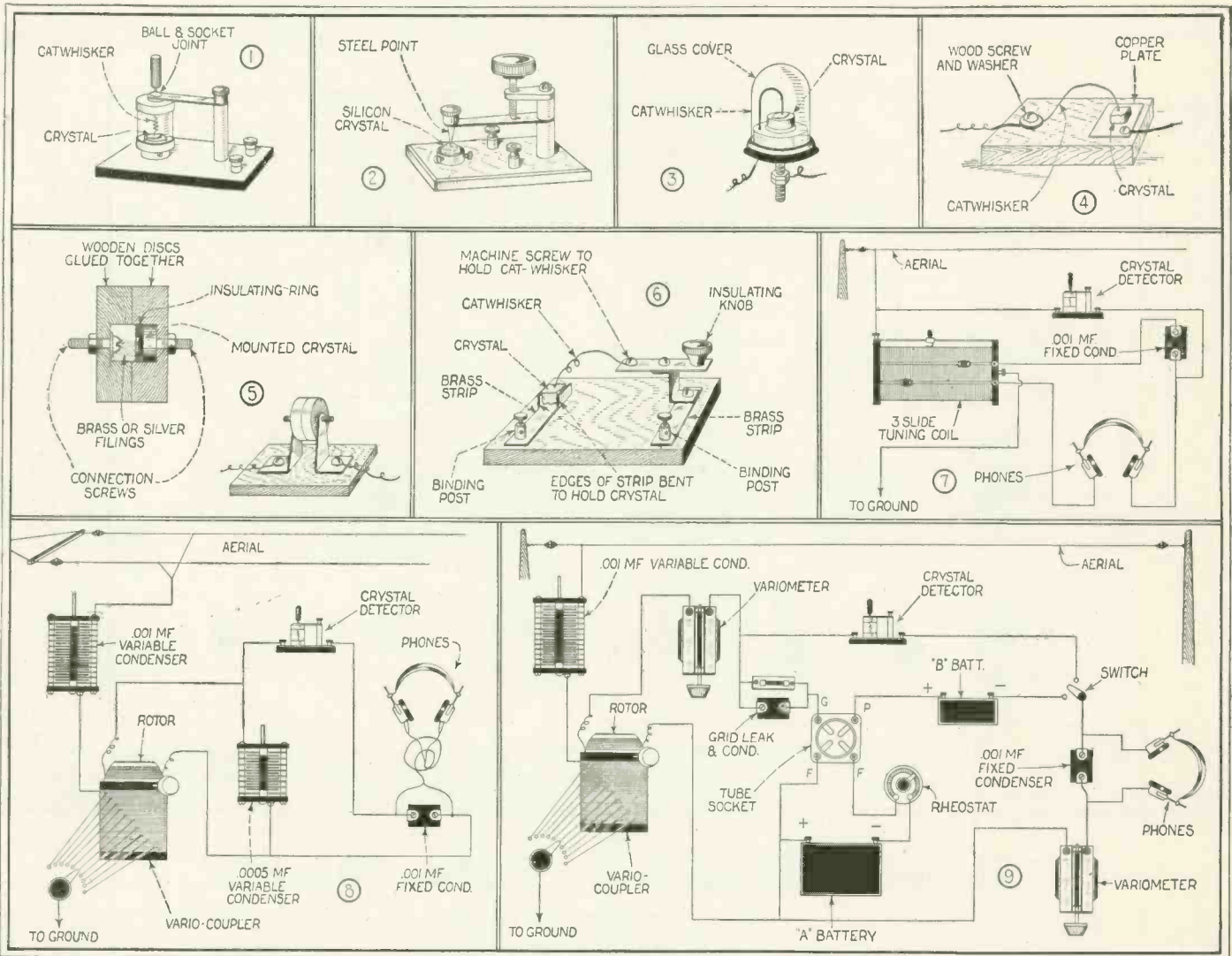

Figs. 1, 2 and 3 show various types of commercial crystal detectors. They also illustrate principles which should be followed in the construction of such apparatus. In Fig. 4 is illustrated one of the simplest crystal detectors which it is possible to make. Fig. 5 shows an enclosed crystal detector in which the cat-whisker is replaced by filings. In Fig. 6 is shown a crystal detector

with a universal cat-whisker adjustment. A very selective circuit for use with a crystal detector is shown in Fig. 7. A crystal detector may be used with a variocoupler as shown in Fig. 8. By means of a two point switch, a crystal detector may be used with a standard short-wave regenerative tuner, when the vacuum tube detector is not used. Connections are shown in Fig. 9.

Three Handy Radio Wrinkles

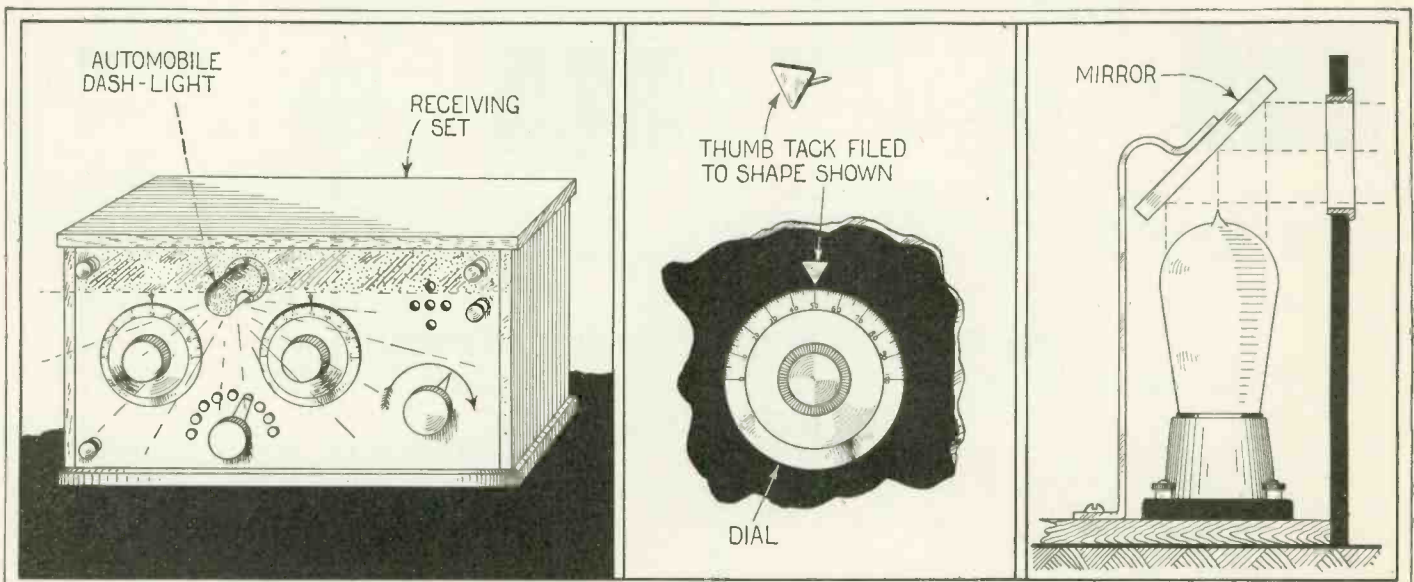

By placing an automobile dashboard light on a radio receiving set as shown at the left, the set may be operated in a dark corner. This addition also saves electric lighting bills for "DX hounds." A novel indicator for dials may be

made from a thumb tack as shown in the center above, according to Mrs. Luella B. Lyons. By using a mirror as shown at the extreme right, it is easy to ascertain whether a silvered bulb vacuum tube is lit.—H. W. S.

Radio for the Beginner

By ARMSTRONG PERRY

NO. 21—ONE WIRE AERIALS.

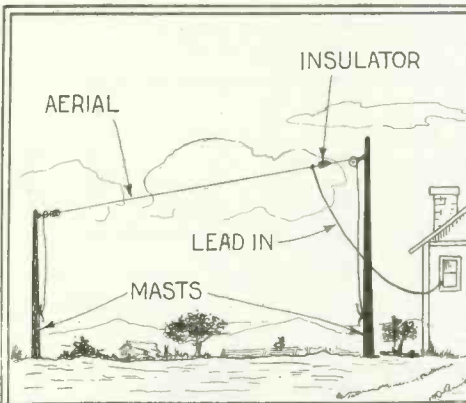

Where long poles are plentiful, it is a good idea to erect two masts, from 30 to 70 feet in height, and 80 to 150 feet apart.

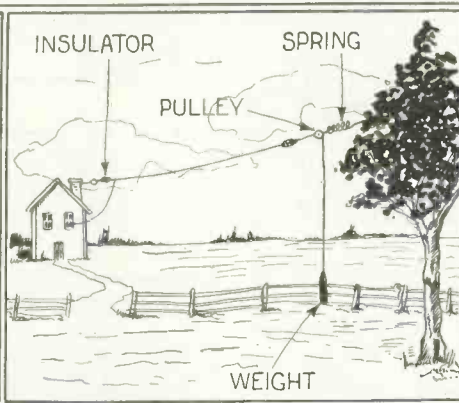

If one end of the aerial is fastened to a tree a heavy spring should be placed in the supporting rope or a weight and pulley used.

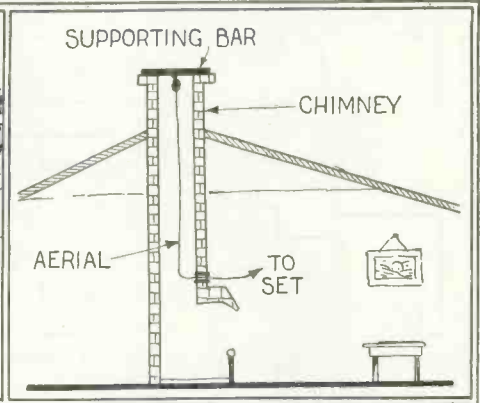

In a house equipped with an open fire place, an aerial may be strung in the chimney as illustrated above. This is fairly efficient.

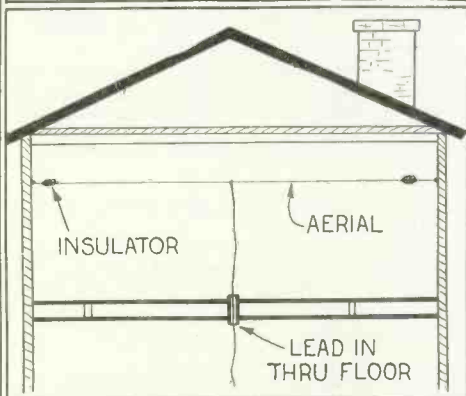

An aerial may be strung in the attic, and a lead-in taken off in the exact center as illustrated. Lead-in may come through the ceiling.

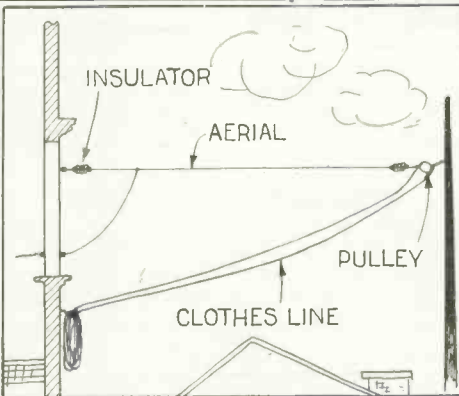

When an amateur lives in an apartment house, an aerial may be run out to a clothes pole as shown above.

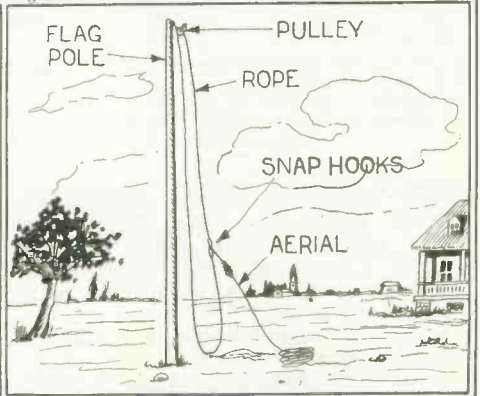

When the flag pole is not in use, an aerial may be run up by means of the rope as shown above. The other end may be fastened.

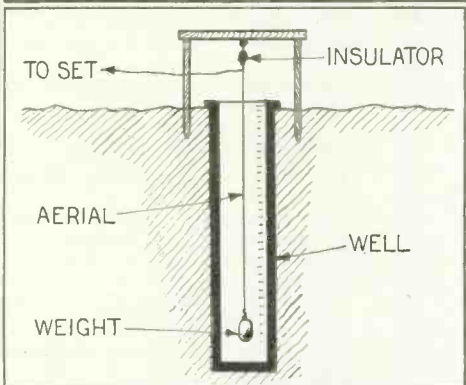

Underground aeriels are said to reduce static to a great extent. The simplest way to make this aerial is to suspend it in well.

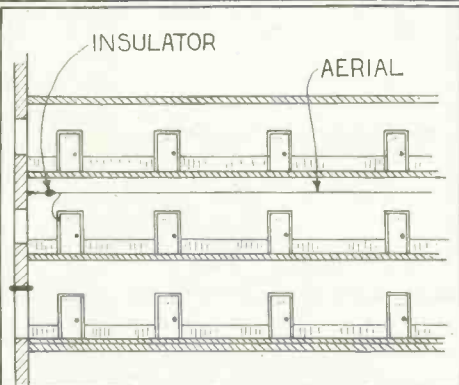

An aerial may be strung along a hall of an apartment and the lead-in brought through the door or woodwork. This gives good results.

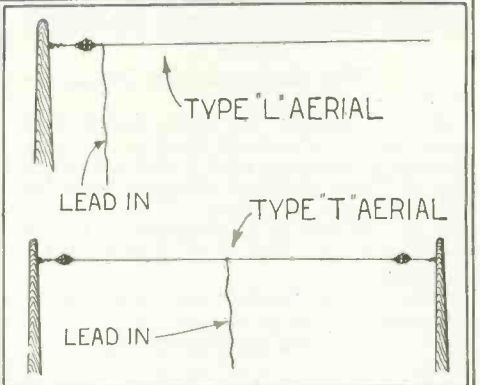

The difference between the "L" and "T" type aeriels. In the latter the wave-length is equal to an "L" aerial twice the length.

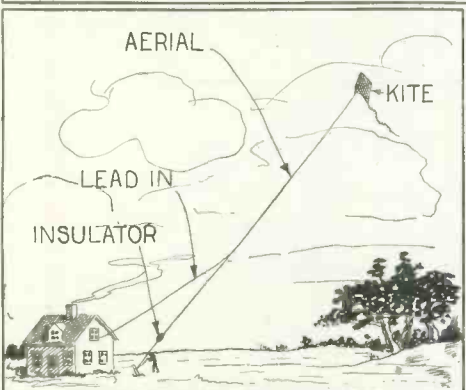

During kite weather, a temporary single wire aerial may be raised with a large box or other type of kite. Note how insulator is used.

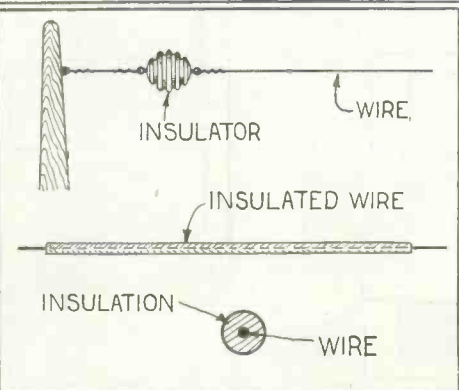

A method of insulating an antenna wire is shown in the upper part of the illustration while insulated wire is shown below.

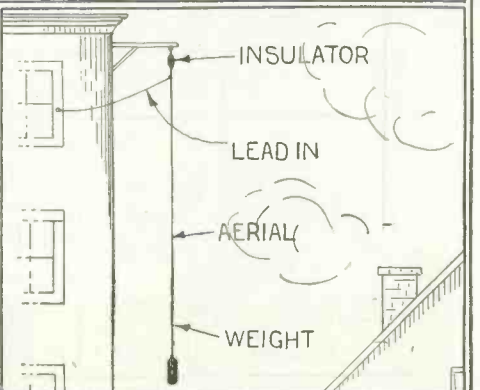

From the upper floors of a tall building a vertical aerial may be made by dropping a wire out the window. If stormy, pull aerial in.

Radio Oracle

In this Department we publish questions and answers which we feel are of interest to the novice and amateur. Letters addressed to this Department cannot be answered free. A charge of 25c is made for all questions where a personal answer is desired.

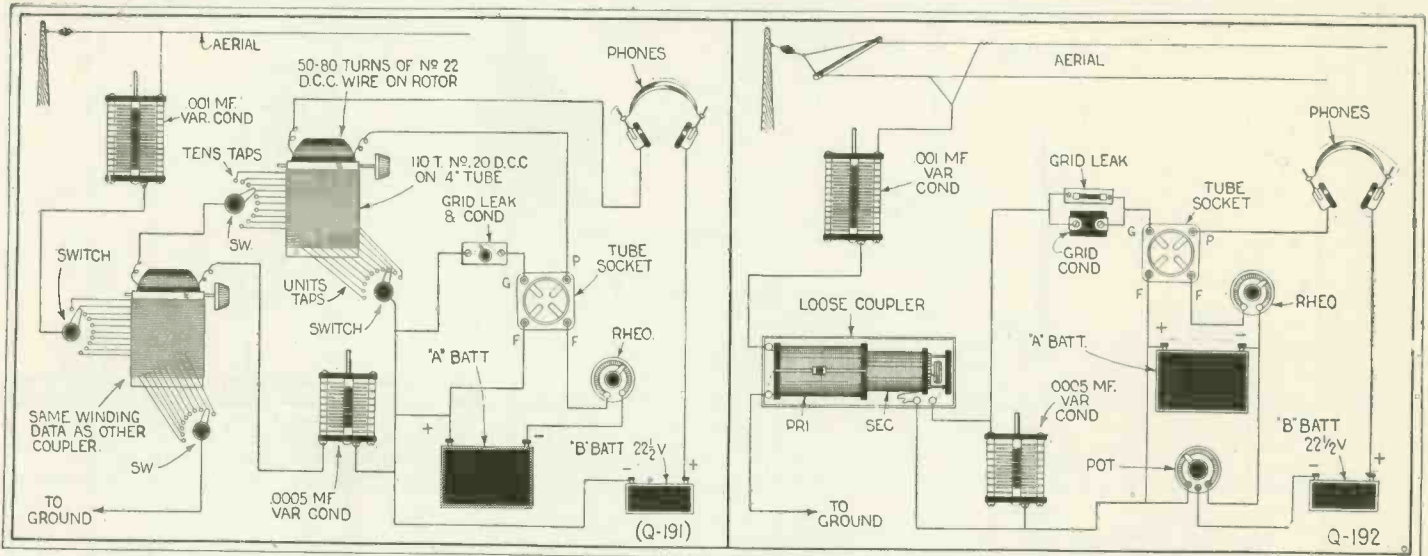

In the above circuit diagram, two variocouplers are used for tuning. Exceedingly sharp results may be expected. Regeneration is accomplished through the rotor of the second coupler. The rotor of the first tuning coupler is wound the same as the rotor of the second.

A standard loose coupler may be used in connection with an audion detector, connecting up the instruments as illustrated above. Any size loose coupler may be used here, but if a very large one is employed, the resulting circuit may not be able to receive the shorter broadcasting wave-lengths.

TWO-VARICOUPLER CIRCUIT

(191) James H. Alley, Waterville, Maine, requests of the Radio Oracle:

Q. 1. Can you give me a hook-up for two vario-couplers in connection with a vacuum tube?

A. 1. The required diagram will be found in these columns.

Q. 2. How should the vario-couplers be wound?

A. 2. This information is given on the diagram.

LOOSE COUPLER WITH VACUUM TUBE

(192) Billy Arkin, Easton, Penn., requests:

Q. 1. What is the best circuit diagram for using a loose coupler and two variable condensers with a vacuum tube?

A. 1. The required diagram will be found in these columns.

Q. 2. Would a potentiometer be of any assistance and how should it be connected?

A. 2. The instrument mentioned might aid somewhat in reception and connections for the same are shown on the diagram.

SINGLE CIRCUIT TUNER

(193) F. H. Alderman, Ensign, Kansas, requests a circuit diagram of a single circuit tuner and asks:

Q. 1. May the vario-coupler be wound

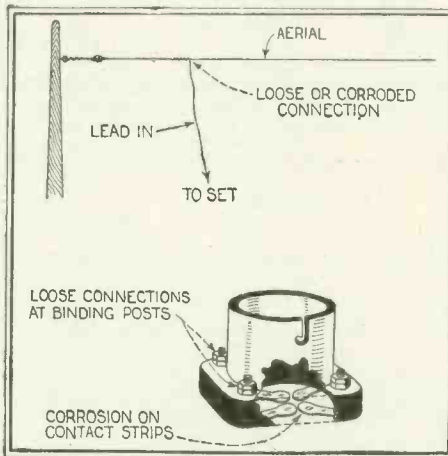

Scratching noises and weak signals may very often be traced to loose or corroded connections. The two places illustrated above are very susceptible to such conditions. Query No. 195.

on a four inch tube and kindly give all data on the same?

A. 1. The stator of a vario-coupler may be wound on the size tube you mention. Data is given in the illustration of a single circuit tuner to be found in these columns.

A MAKE-SHIFT TUNER

(194) L. J. Denmire, Montrose, Iowa, requests:

Q. 1. How may I hook up a tapped tuning coil with two sets of taps, a variable condenser and a vacuum tube detector using an "A" battery potentiometer?

A. 1. The desired diagram will be found in these columns.

SOURCES OF TROUBLE

(195) A. R. Carter, Marfa, Texas, asks:

Q. 1. At times my signals become very weak, but not as in "fading," and scratching noises are heard. Can you suggest the cause?

A. 1. Loose connections at some point in your set are probably the cause. Two of the worst offending places are illustrated herewith.

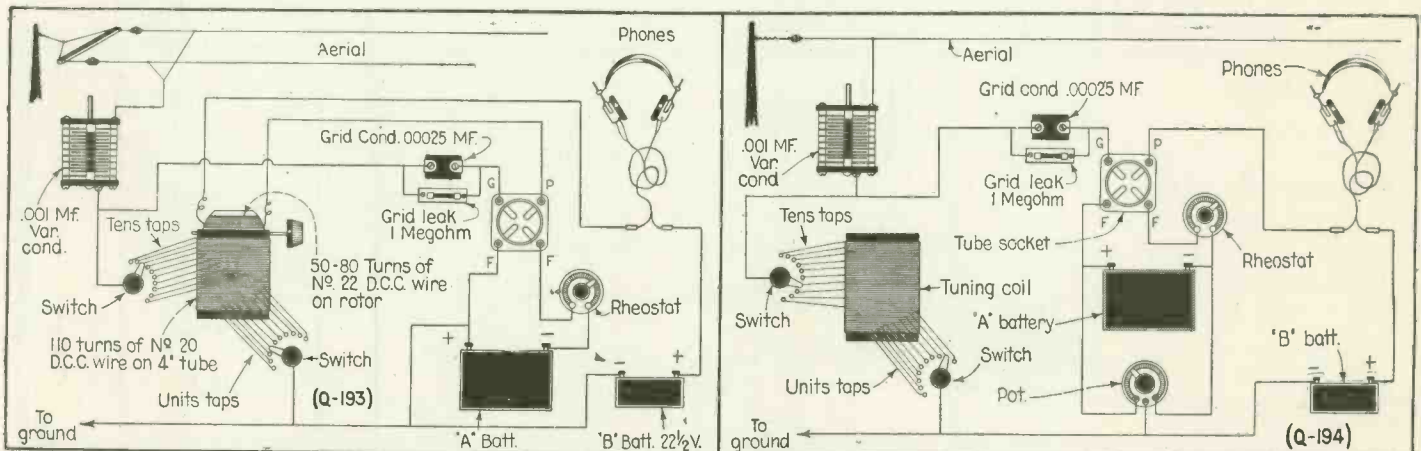

The connections for the so-called standard single circuit tuner are shown above. The vario-coupler may be wound as indicated or a standard type used. This circuit gives loud signals, but has little selectivity.

The tuning coil in the above circuit may be very readily wound, or the stator of a standard vario-coupler may be employed. This circuit will not give very loud signals, but may be arranged in a compact portable form if desired.



LATEST PATENTS

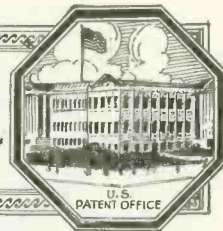

Helicopter-Airplane

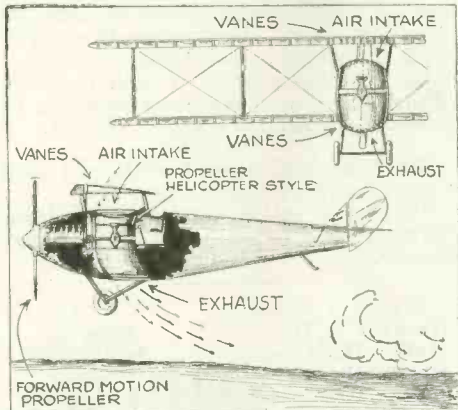

The helicopter idea is here applied to a more or less typical airplane. The vertical propeller is used only to assist in raising the machine from the ground. It is not used to keep the plane suspended while in flight. The vanes regulate the speed of rise.

Postman's Umbrella



Spare your pity for the postman in rainy weather now. This new umbrella (above) saves his uniform as well as his temper. Strapped to his back, it is out of the way. Instead of folding down, as usual, the top slides down the handle, making it take up the minimum space.

Wrist Vanity Case

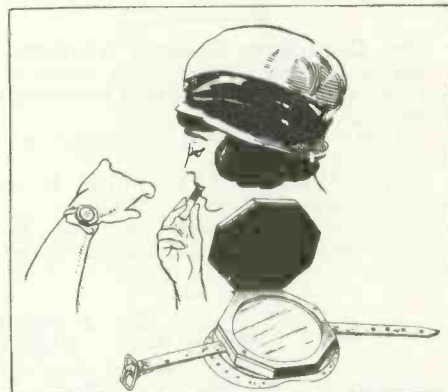

We have the wrist watch, why not the wrist mirror and the vanity case? Now comes an invention of the former. Strapped lightly with a chic black velvet ribbon to a lady's wrist, there is no need for men's pockets being cluttered with vanity cases.

Water Turbine

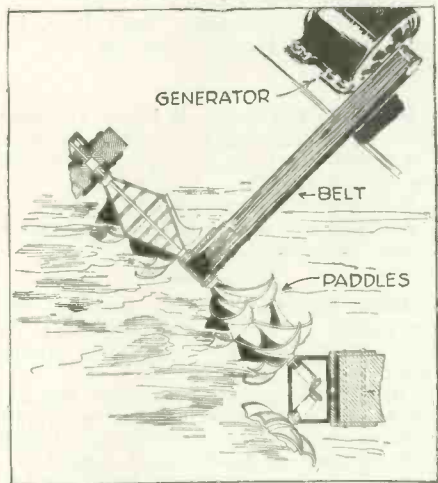

This very simple turbine will utilize the current of small streams without the necessity of constructing costly dams and sluice-ways. The force of the current directly against the vanes turns the pulley, which is connected with an electric generator above.

Garage System

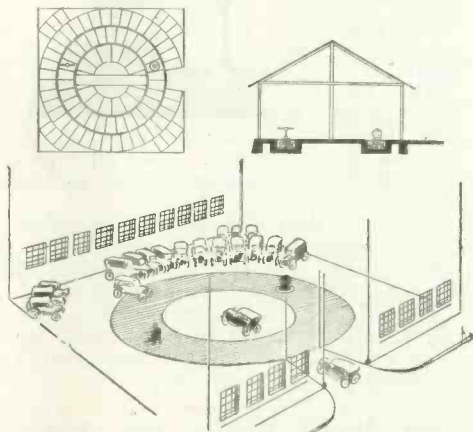

For solving the garage parking problem, the above illustration shows a method where turn-tables are used. With their aid, a car may be placed on any part of the floor and can always be removed without disturbing the others.

Amusement Device

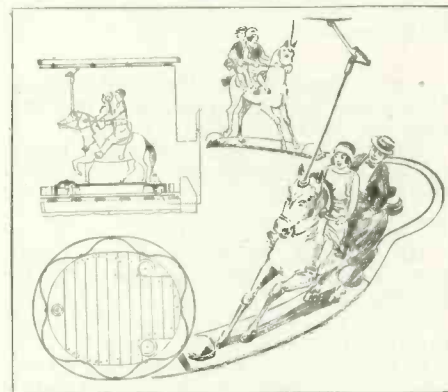

This new amusement ride is a combination of the old merry-go-round and the scenic railway. The horses are mounted on individual cars equipped with motors. The trolley feeding the current from above furnishes the necessary power for propulsion.

Fly-paper Holder

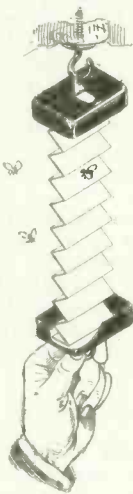

This fly paper holder combines the maximum of adhesive surface with protection for individuals. The cup at the bottom keeps the adhesive from dripping and the ear on the top cup allows the whole thing to be hung up out of the way.

Ship Pontoon

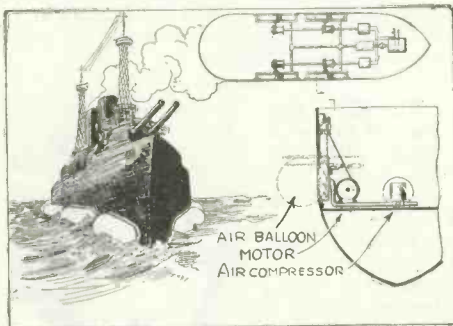

When a ship at sea equipped with this device is threatened with sinking, the motors are turned on and compressed air is run into the balloons fastened around the sides of the vessel. The balloons form pontoons which will keep the ship afloat.

Cable Dredge

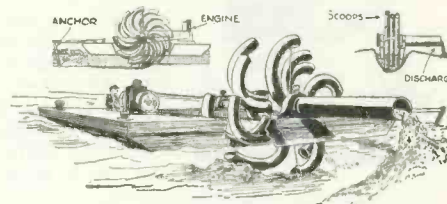

For dredging small channels, for laying submarine cables and pipe, the machine shown above rotates the smaller pipes through the water, digging up the bottom. The water flushes the waste through the discharge pipe to removal conveyors.

Amphibious Auto

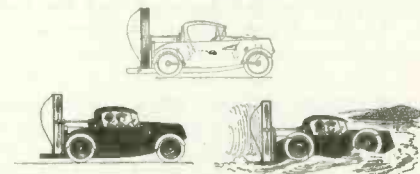

The amphibious auto illustrated above goes from one element to the other with the minimum changes. On land the wheels propel the car. In the water the air screw is turned on and pushes the erstwhile auto to the other shore.

Scientific Humor

Applied Astronomy.—SOUTHERN PLANTER: "Why, Mammy, what ails you?"
 MAMMY ROSE: "Lawdy, Boss, Ah's a-rackin' wid de Sci'ntific rheumaticks."
 SOUTHERN PLANTER: "Sciatic rheumatism, eh? Now that's too bad, sure."
 MAMMY ROSE: "Dis is Sci-ntific rheumaticks, Boss, Ah shore does sees stahs."—*Marion Jones.*

One Good Turn Deserves Another.—LITTLE ARTHUR: "Isn't it an eclipse of the sun, Mama, when the day is turned into night?"
 MAMMA (not much of an astronomer): "Yes, dear, certainly."
 LITTLE ARTHUR: "Then what is an eclipse of the moon?"
 MAMMA: "The moon? Oh, when the night is turned into day, of course."—*Henry Wachulski.*

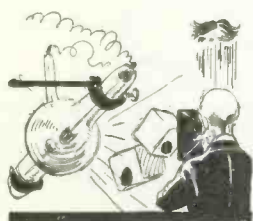

The Hospital Was Hospitable.—RASTUS: Ah sittinly is glad to see yo' out of dat hors-pittle, Sam. What done happen to yo' in dar?
 SAMBO: "Ah done had ma bones X-rayed. 'An' Ah bets a five-spot dey was loaded."—*Judge.*

Dum, Head Over Heels.—LINEMAN: "Say young fellow, don't stand on that bare wire, you are liable to get a shock."
 SMART ALECK: "That's all right, I wear rubber heels that absorb the shocks."—*Peter Horwot, Jr.*

He Panted Painfully.—FIRST CHEMISTRY STUDENT: "What did you do in the laboratory today?"
 SECOND CHEMISTRY STUDENT: "We were experimenting on hydrochloric acid."
 F. C. S.: "What results did you get?"
 S. C. S.: "Two holes in my pants and a bad headache."—*Peter P. Udre.*



conversation."—*Judge.*

The Right "Spirit."—FIRST STUDENT (In Chemistry Class): "What is the method used for the formation of alcohol?"
 SECOND STUDENT: "Nothing doing, old chap. I had an uncle who once told a stranger the method he used, and the next day he found out that the fellow was a prohibition agent."—*Keeling Adams.*

It'll Work 'Ether' Way.—A. BROAD: "I have just read that doctors are going to discard the old method of putting their patients to sleep while operating on them, and have then listen to radio concerts instead. What do you think of the idea?"
 CASS STER: "Well, it may please some, but for me, I would prefer my ether straight."—*Keeling Adams.*

First Prize \$3.00



Wire You Insulate!—PROFESSOR: "James what is used to conduct electricity?"
 JAMES: "Why 'er."
 PROFESSOR: "Correct. What is the unit of electric power?"
 JAMES: "The what? sir."
 PROFESSOR: "Correct. What is the unit of resistance?"
 JAMES: "Oh-um."
 PROFESSOR: "Correct. You may take your seat."—*James W. Allen.*

Succor for the Sucker!—TEACHER IN SCIENCE: "Johnny, what is the principle of drinking through a straw?"
 JOHNNY: "Seeing how quick you can get a chocolate soda from the glass into your mouth."—*Hartridge Miller.*

WE receive daily from one to two hundred contributions to this department. Of these only one or two are available. We desire to publish only scientific humor and all contributions should be original if possible. Do not copy jokes from old books or other publications as they have little or no chance here. By scientific humor we mean only such jokes as contain something of a scientific nature. Note our prize winners. Write each joke on a separate sheet and sign your name and address to it. Write only on one side of sheet. No letters acknowledged unless postage is included.

All jokes published here are paid for at the rate of one dollar each, besides the first prize of three dollars for the best jokes submitted each month. In the event that two people send in the same joke so as to "tie" for the prize, then the sum of three dollars in cash will be paid to each one.

Yes, But Power Plants Give "Currents."—An electrical expert was visiting the country and, while passing a farm saw an old farmer burying what looked to him to be perfectly good dry cells. The electrician asked the meaning of this sheer waste and the farmer answered: "I've had good luck with nearly every kind of plant in this soil, so I thought I'd bury these batteries and grow a power plant."—*George Panter.*

He Made Her See Stars!—JOHN: "Hello, Jim, you look pretty mad today."
 JIM: "You bet I'm mad."
 JOHN: "What happened?"
 JIM: "Well, I had a telescope and my wife wanted to use it. She took a can-opener and broke the top right off it."—*Alfred Stawarz.*



Practical Astronomy.—GRECIAN MAID: "Professor, why is it that you see more shooting stars on a warm summer night than at any other time?"
 PROFESSOR ARISTOTLE: "Because you sit out more on those nights."—*Vanderbilt Jade.*

Quite Simple.—THE DOCTOR (to patient): "You go to your druggist and ask him for some iodhydrargyrate of iodide of potassium, some ankydroglucochloral and some dioxyamidoarseno-benzol—and I should not be surprised if with those we shall be able to triumph over your loss of memory."—*Le Journal Amusant (Paris).*

He Wasn't Grounded.—"Do you keep your ear to the ground?"
 "Not now," said Congressman Swayback. "I gotta radio outfit."—*Louisville Courier-Journal.*

Hope He Doesn't Get Hula Hella!—I joined the multitude. I became a radiophan.



While receiving one night the phone rang. It was the wife. "Are you getting anything to-night?"
 "Yes, I am getting some very fine Hawaiian right now—"
 "Aw Dear," she said, "don't joke, you know you can't reach that far."—*J. W. Schoonmaker.*

Polite to the Last.—WARDEN (to murderer in electric chair)—"Is there anything you would like to do or say before I push the fatal button?"
 THOUGHTFUL MURDERER—"Yes, kind sir. I would like to get up and give my seat to a lady."—*Punch Bowl.*

Some Nerve.—"Tell me, doctor," said the patient in the hospital, nervously, "is there any chance of this operation proving fatal?"
 "Really, young man," protested the doctor, haughtily, "considering that we are experimenting on you free of charge, I think your curiosity is hardly good form."
 —*Tit Bits (London)*

"Over" Her Head.—The younger generation of the Smith family had been exposed to the "radio bug" and received a bad case of it.



The family went outside to select the best place for the aerial, closely followed by Mrs. Smith. They all agreed on a tall 2½ story barn as the most suitable place. "What?" asked Mrs. Smith, astounded, "you're going to put it up there?!"
 "Why sure mother," answered one of the sons, "that's the best place for it."
 "Well!" she replied, scornfully, "you might be big enough fools to climb up there and listen, but you'll never catch me doing it."—*Gretchen Dorner.*

We Should Re-fuse This Joke.—"What is the Load-Factor of your Ohm-Brew?"
 "About 7%, but it doesn't Phase me."—*I. L. Henderson.*



THE ORACLE



The "Oracle" is for the sole benefit of all scientific students. Questions will be answered here for the benefit of all, but only matter of sufficient interest will be published. Rules under which questions will be answered:

1. Only three questions can be submitted to be answered.
2. Only one side of sheet to be written on; matter must be typewritten or else written in ink, no penciled matter considered.

3. Sketches, diagrams, etc. must be on separate sheets. Questions addressed to the department cannot be answered by mail free of charge.

4. If a quick answer is desired by mail, a nominal charge of 25 cents is made for each question. If the questions entail considerable research work or intricate calculations a special rate will be charged. Correspondents will be informed as to the fee before such questions are answered.

TELEPHONE INDUCTION COIL

(1564) Stuart D. Pike, Holden, Mass., asks:
Q. 1. How can I make an induction or re-pating coil similar to that used in telephone circuits?

A. 1. You may make an induction coil similar to that used in a telephone as follows: On a core composed of a bundle of iron wires one-half inch in diameter by five inches long, wind two layers of No. 18 D. C. wire. After insulating this winding with oiled silk or oiled paper, wind thirty layers of No. 20 S. C. C. wire thereon. The former is the primary, the latter the secondary.

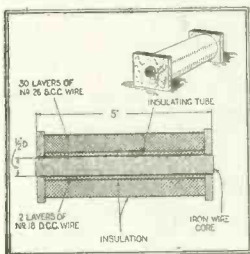

The sketch shows the construction of a small induction coil, such as used in telephone work and sometimes called "re-pating coils." A layer of insulation should separate the two coils.

STORAGE BATTERY PLATE PASTE

(1565) Charles Petrie, Canada, refers to an item in the Oracle Department in May 1923 issue. on paste for storage battery plates and asks:

Q. 1. Why is barium sulphate and ammonium sulphate used in mixing the paste for the plates?

A. 1. The two chemicals you mention are used in making up the paste for storage battery plates so that the filling will not crumble and fall out of the spaces in the plates. A very small amount of both is all that is necessary, probably 1-20th of the amount of active material, that is litharge or red lead.

DYNAMIC BRAKING SYSTEM

(1566) Raymond W. Platt, Akron, Ohio, says that he has successfully used a dynamic braking system on a D. C. motor and asks:

Q. 1. Can this same system be used on an A. C. motor?

A. 1. It would not be wise to use the brake system that you mention on an A. C. motor as is done on a D. C. motor. Such a system would, undoubtedly, be very damaging to the former.

AMPERAGE OF LIGHTS

(1567) H. H. Parker, Oakland, Calif., asks:
Q. 1. What is the approximate amperage of the ordinary string of Christmas tree lights rated at 14 volts each with eight in series to be used on a 110 volt circuit?

A. 1. The amperage drawn is about one-fourth of an ampere.

Q. 2. What would these lamps draw in amperage if they were connected in parallel?

A. 2. If eight of them were connected in parallel they would draw approximately two amperes at fourteen volts.

Q. 3. I wish to design a step-down transformer to light these bulbs in parallel. How should I design the secondary?

A. 3. We would advise you to design your transformer to deliver fourteen volts and three amperes on the secondary side to allow for all losses.

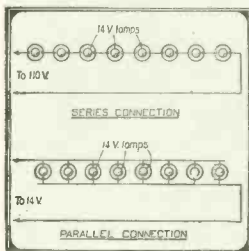

To the left is shown the method of connecting ordinary Christmas tree lights in parallel and also in series. The series connection will work directly on 110 volt lighting mains.

STAGE SMOKE

(1568) F. W. Puhl, Washington, D. C., asks:
Q. 1. What combination of chemicals should I use to produce great quantities of dense white smoke for stage work, without any violent chemical action whatsoever?

A. 1. If the fumes arising from ammonia be allowed to mingle with those of hydrochloric acid, the result will be dense clouds of white smoke. No violent chemical action will occur. This is probably the very best way to produce the result you desire. If a solid and a liquid be of such composition that when brought into contact with each other they will produce clouds of smoke, there will almost invariably be violent chemical action.

ELECTRICAL WELDING

(1569) Jorge Rodriguez, San Pedro, Cuba, wants to know:

Q. 1. How should the polarities of an electric lighting circuit be connected when used for welding?

ELECTRICITY?

HOW many ways do you know in which electricity can be produced? If you are a radio man or are interested in radio, you should know ALL the methods as to how this mysterious force can be produced. There are 8 little known methods that will surprise you. It will probably help you in your work.

Telephone receivers that fit into your ears, that have no diaphragm, no magnets, and which work.

All of these things and many more interesting ones of great interest to the student in radio will be found in the November issue of PRACTICAL ELECTRICS.

Highly Interesting Articles to Appear in November Issue of Practical Electrics

- ELECTRO VENTRILOQUISM
- PERFECTED X-RAY INSTALLATION
- HIGH TEMPERATURE RESISTANCE FURNACE
- By Allan P. Kenworthy
- THERMIC TELEPHONES (Concluded)
- DARK OR BLACK LIGHTNING
- By Ferdinand Ellicman
- MERCURY VAPOR ARCS
- LITTLE KNOWN METHODS OF PRODUCING ELECTRICITY
- By Raymond B. Wailes

A. 1. If you use direct current for welding, the positive side should be connected to the work, and the carbon rod to the negative side. If alternating current is used, of course, it will not be necessary to discriminate, as the polarity is constantly changing.

Q. 2. What precautions must be used in electric welding?

Here is shown the method used in connecting the carbon and the work for welding with electricity. When using direct current always connect the work to the positive side.

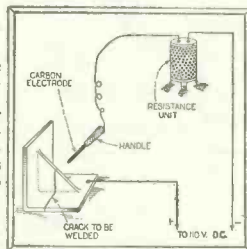

A. 2. In all welding, the parts to be joined should be perfectly clean. The methods of welding various kinds of iron differs with the composition of the same, and whether it is cast or malleable. In any case, aluminum is very difficult to solder, and special preparations and precautions are necessary. This subject is so broad that we would advise you to purchase one or more books on the subject.

ASBESTOS CEMENT

(1570) Will Stone, South Bend, Ind., asks:
Q. 1. How may I fasten sheet asbestos securely to steam pipes?

A. 1. Make a thick paste of ground asbestos mixed with a solution of sodium silicate. After the two substances have been thoroughly mixed, add a small amount of calcium chloride. This will make the cement insoluble after it has once set.

COMMERCIAL USE OF A. C.

(1571) G. Orville Pyle, Belair, Md., asks:
Q. 1. Why is alternating current used on near-

ly all commercial electrical lighting systems instead of direct current?
A. 1. Alternating current is better adapted to long distance transmission purposes because it can be transformed very easily to high potentials, resulting in lower current values, and smaller conductors.

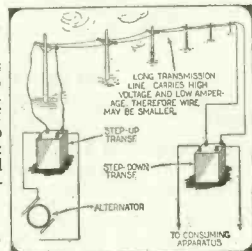

DISSOLVING NITRATE OF SILVER

(1572) W. J. Pettigrew, Rainsville, N. C., wants to know:

Q. 1. Can nitrate of silver be dissolved in alcohol so that it can be spread over a plate surface?

A. 1. Nitrate of silver may be dissolved in either water or alcohol.

ELECTRIC BELTS.

(1573) G. L. Rasnuissen, San Francisco, Calif., requests:

Q. 1. Can you give me information on how to make an electric belt for curing rheumatism?

A. 1. Medical science has proven that the so-called electric belts are a fraud. Therefore, we cannot give you any data on the construction of one which will cure rheumatism.

THE THERMOPHONE AND RECTIFIER SOLUTIONS

(1574) F. P. Ronnan, Halifax, N. S., Canada, wants to know:

Q. 1. Is not the principle of the thermophone telephone receiver based upon the variations of heat in a wire?

A. 1. The principle of the thermophone is based upon the variations of heat in a fine resistance wire, which gives rise to vibrations in the atmosphere which correspond with the voice spoken in the transmitter.

Q. 2. What solutions may be used in an electrolytic rectifier?

A. 2. The following solutions may be used in an electrolytic rectifier. A saturated solution of sodium phosphate, a saturated solution of bicarbonate of soda, a 10 percent solution of sulphuric acid, or a 10 per cent solution of hydrochloric acid. A strong solution of ordinary brine will also give satisfaction.

A wiring diagram for connecting an electrolytic rectifier to a lighting circuit for charging a storage battery is shown here. The series parallel lamp bank controls amperages.

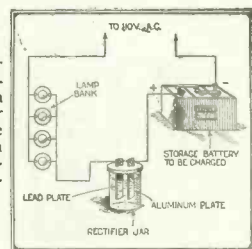

VENTURI ACTION

(1575) Walter S. Camp, Long Valley, N. J., asks:
Q. 1. What is meant by a Venturi opening

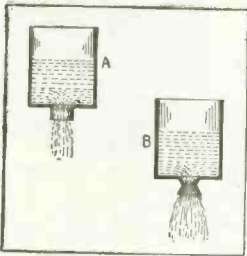

At the left is illustrated the Venturi shaped opening. The peculiarity of this tube is that it admits a greater flow per unit time than a plain opening of similar size. It is used in carburetors for greater admittance of air.

and of what value is it in a gasoline engine carburetor?

A. 1. The Venturi action which you mention is illustrated here. We have two pails of water, one with a circular one-inch opening cut in the bottom in the ordinary manner, but the other, with the same sized opening, has a Venturi-shaped tube secured to the one-inch hole. If each vessel is filled with an equal quantity of water, it will be found that vessel B will empty itself before vessel A, due to the peculiar action of the Venturi tube. The drawing shows the shape of a Venturi tube.

This action is taken advantage of in automobile or gasoline engine carburetors around the spray nozzle in the mixing chamber where the gasoline vapor and air are mixed. The purpose of such an opening in the spray nozzle is to obtain a greater volume of air through a certain size hole in a shorter period of time.

HAIR TONIC

(1576) C. L. Swain, Hayden, Ariz., wants to know:

Q. 1. Can you give me a hair tonic which will stop dandruff and falling hair?

A. 1. We are giving you herewith the formula for making a hair tonic such as you request. It should be used for the first time after the hair has been thoroughly shampooed.

- Salicylic acid, 1 part.
- Precipitated sulphur, 2 1/2 parts.
- Rose water, 25 parts.

This is to be applied every night for a week, whereupon the hair is again shampooed. Usually such applications continued in this rotation for a period of six weeks will completely check falling hair and eliminate dandruff. After this treatment the shampoo should be taken less frequently.

OBTAINING OXYGEN

(1577) Stephen E. Cervia, Latrobe, Pa., asks:
Q. 1. How can oxygen be obtained from mercuric oxide?

A. 1. Regarding the obtaining of oxygen from mercuric oxide, we would advise you to set up the apparatus as illustrated. The jar for the oxygen should be filled with water and a glass plate or the hand placed over its mouth. It should then be inverted with the mouth below the surface of the water, and the hand or glass plate is removed. Do not place the mouth of the jar over the rubber tube as yet. Now gently heat the test tube containing the mercuric oxide, while the open end of the rubber tube is kept below the surface of the water. Bubbles will pass out from the tube and after they have done so for a few seconds, place the jar, still full of water, over the end of the tube. The jar will then become filled with oxygen by displacement of the water. Do not at any time remove the heat from the test tube while the open end of the rubber tube is under water, otherwise, upon the cooling of the air in the test tube, a partial vacuum will be formed and water will be drawn back up the tube into the test tube. After obtaining a jar full of oxygen, leave it in the water with its mouth downward. Remove the rubber tube from the water, whereupon the flame heating the test tube may be extinguished. It will probably be necessary to hold it down to prevent it from turning over. Now light a splinter of wood with a match, and blow it out so that the end is only allowed to glow. Quickly take the jar of oxygen from the tank and insert the glowing splinter into the mouth of the jar. It will burst into flame, indicating the presence of oxygen.

After heating for a considerable length of time, the mercuric oxide will become a dull gray color. By exposing to the air, it will again reach its normal red color. It can then be used over again for performing the above experiment.

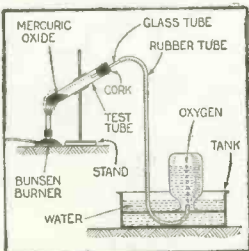

The set-up of apparatus for obtaining oxygen from mercuric oxide. After each batch of oxygen is drawn off by heat the residue may be exposed to the air, whereupon it will absorb oxygen therefrom and the experiment may be repeated.

TESTING ARMATURES

(1578) Geo. W. Ross, Huntington Park, Cal., wants to know:

Q. 1. How can armature coils be tested, using a telephone receiver and a dry cell?

A. 1. To test out armature coils with a telephone receiver, merely connect one side of the receiver to a dry cell, and with the other lead from the receiver and the dry cell, go from bar to bar of the commutator. If a click is heard, the coil is O. K.; if not, the circuit is open.

Q. 2. Is this method as good as the growler method of testing armatures?

A. 2. This method is not as good as the growler method, inasmuch as the latter indicates whether any of the turns in the coil are "shorted." This is determined by the loudness of the sounds heard in the receiver, which is used in connection with the growler.

In testing armatures with a dry cell and telephone receiver, the simple hook-up shown at the right is used. If a loud click is heard after the connection is made at the commutator the armature coil is in good condition. If not, it is open.

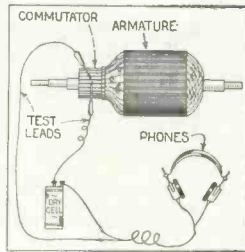

IMPORTANT

TO NEWSSTAND READERS

IN order to eliminate all waste and unsold copies it has become necessary to supply newsstand dealers only with the actual number of copies for which they have orders. This makes it advisable to place an order with your newsdealer, asking him to reserve a copy for you every month. Otherwise he will not be able to supply your copy. For your convenience, we are appending herewith a blank which we ask you to be good enough to fill in and hand to your newsdealer. He will then be in a position to supply copies to you regularly every month. If you are interested in receiving your copy every month, do not fail to sign this blank. It costs you nothing to do so.

To Newsdealer

Address

Please reserve for me copies of **SCIENCE & INVENTION** every month until I notify you otherwise, and greatly oblige,

Name

Address

ELECTRIC SOLDERING IRON

(1579) A. A. Sadler, Bowic, Texas, asks:
Q. 1. Will you kindly give me data on the construction of an electric soldering iron to be used on 110 volts A. C.?

A. 1. The required data will be found in the accompanying illustration.

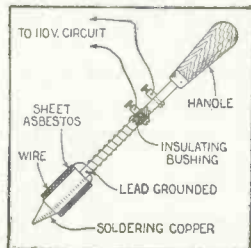

A home-made electric soldering iron is illustrated in the drawing to the left. One side of the winding should be grounded to the handle of the iron. The resistance of the wires allows the iron to be directly connected to a lighting circuit.

BAKELITE

(1580) Joseph J. Schwab, Columbus, Miss., wants to know:

Q. 1. Would it be possible for an amateur to compound a substance such as bakelite for use in making radio panels?

A. 1. Materials similar to bakelite and celeron are so difficult in details of preparation that it is practically impossible for the amateur to make them at home. Their manufacture is so complicated that it would by no means be worth while for you to attempt to make such materials.

"SPIRIT" WRITING

(1581) L. Nichols, Duluth, Minn., says that he has seen a so-called fortune teller expose a piece of paper to the fumes arising from a jar, whereupon writing appears upon the paper. He asks:

Q. 1. Can you tell me how this is accomplished?

A. 1. The "spirit" writing which you mention may be done as follows:

Write the message with a very weak acid solution of iron (ferric) chloride. This solution must be so weak that when written with, the writing will be invisible when dry. If paper written upon

Here is illustrated one method of "spirit" writing. The writing is done with a weak solution of ferric chloride. When it dries it is subjected to the fumes of sulphuric acid acting on potassium sulphocyanide which makes the writing visible.

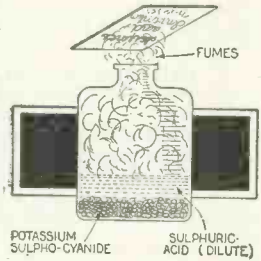

with this ink is subjected to a vapor arising from the action of sulphuric acid on potassium sulphocyanide, the writing will become visible, taking on a red color. It will then disappear if subjected to the fumes of ammonia and may alternately be made to appear and reappear by means of these two vapors.

Another method is as follows: Sulphate of copper in a very dilute solution will produce an invisible writing which may be turned to a light blue color by exposing to the vapor of ammonia. The paper may be written on with lead acetate solution and exposed to sulphuretted hydrogen gas, the latter generated by the action of dilute sulphuric acid of iron sulphide. Use as little as possible as the odor is that of rotten eggs.

TANNING HIDES

(1582) H. L. Roady, Sunnyside, Wash., asks:
Q. 1. Can you give me the necessary information for tanning cow hides?

A. 1. We are giving you herewith the information on tanning hides as requested by you. The hides are soaked in a solution of sodium carbonate of 10° Bé for three to six hours. After washing with water they are allowed to remain for five hours in a bath of caustic soda, the strength of which may vary from 2° to 30° Bé. From this they are transferred to a bath of hydrochloric acid (1 to 5° Bé) in which they remain for two hours. Finally the hides are washed and the hair removed. The tannage consists of a special bath of sodium or ammonium sulphuricinate (2 to 30 per cent) and sumac extract. The strength of this bath is gradually raised from 4° to 30° or 40° Bé.

AVIATION PROBLEM

(1583) Robert W. Spicer, Lexington, Ky., presents a problem as follows:

"An observer in a balloon measures the angle of depression of an object on the ground and finds it to be 63 degrees 58 minutes. After descending vertically for 582 feet he finds the angle of depression of the same object to be 74 degrees 49 minutes. From these he is to calculate his height in the air." He asks:

Q. 1. Would the pilot ever encounter any such problem under actual flying conditions?

A. 1. The modern pilot of a balloon does not encounter such a problem as you mention for the simple reason that he uses an aneroid barometer to calculate his height above sea level. This is an instrument which will be found described in any physics text-book and which indicates the atmospheric pressure encountered at any given point. This instrument is checked up continuously and corresponds with the standard instrument on the ground and all calculations are made to account for changes in atmospheric pressure due to storms and for other reasons.

Of course, however, your trigonometrical problem is very simple. All the angles and one side of the upper triangle are known, as shown herewith. Therefore, the length of side A can be calculated, and with this data side B can be determined.

The problem of the balloonist illustrated here is one of simple trigonometry. Two of the angles of the triangle are known as well as the length of one of the sides, so the solution involves the sines and cosines of the known angles.

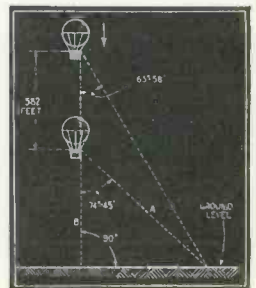

Tighten Your Grip on a Trade

Be An Electrical Expert At \$75 to \$200 a Week

Every up-to-date fellow knows what a future there is in electricity. Big pay—fascinating work on land or sea—rapid advancement in a field where jobs are ten times more numerous than trained men to fill them, where \$75.00 a week is just a fair starter, where top notchers pull down ten thousand dollars or more a year—in a field, where any man if he wishes, can easily have a business of his own, have men working for him, be his own boss! But what the average young man does NOT know, is what a simple, easy, A-B-C sort of a job it is to get started.

You Can Start Right Now!

Yes, you. You don't need a thing you don't already have! You can read. You can write. You can figure. You can think. And in your breast is the fire of ambition—the desire to get ahead! All right, that's all you need—we can help you just as you are—just as we have helped scores, yes, thousands of other two-fisted young fellows determined to get out of the rut and into the electric field—into work that will be pleasant—easy—and all in your home, during spare time.

Fascinating Home Study As You Hold Your Old Job

With the help we will give you, you can slip right into one of these big pay—he-man jobs and never lose a day's work. After a few weeks' start, you can earn enough in installation and electric repair jobs alone to more than pay for the Course and lay a foundation for an Electrical Contracting or Repair Shop Business of your own. When the proper time comes, we will tell you the easy way to go about doing it.

The Most Practical, Thorough and Condensed Electrical Course Ever Written

This is the only home study electrical course that gives you the combined practical and theoretical training you must have before you can be a successful electrician without which you cannot succeed—with which you cannot fail.

Written not by ONE man, with the narrow one-man viewpoint, but by 22 of the brainiest, most successful, electrical experts ever drawn from the field of practice and theory. Gives you the complete mastery of the subject—qualifies you as electrical expert to boss jobs—fits you right into the kind of a job you want—and does it in shortest time—at lowest cost—with the

Most Binding Guarantee of Results Ever Offered!

Satisfaction guaranteed or no sale! We not only SAY we can make you an electrical expert, we Guarantee it! If you are not absolutely satisfied when you have finished our Practical Electrical Course, we will refund every nickel you sent us.

FREE! Experimental Outfit Worth \$30
Drafting Course Worth Another \$30
Big Electrical Library Worth \$25

Find out all about our offer. Find out about the thousands who have taken this course in preference to all others and MADE GOOD. Find out about the Electric Library—four elegant volumes—worth \$25, but free. About the free Drafting Course worth another \$30. The free Experimental and Demonstration Outfit, including a real, not a make-shift Electric Motor, Wheatstone Bridge, etc.—the most scientific, high-grade and complete Experimental Outfit ever supplied with a Course in Electricity. Get all the facts without obligation, without expense! Just send the coupon!

American School

Dept. E-826

Drexel Ave. and 58th Street, Chicago

FREE Electrical Coupon

American School, Dept. E-826, Chicago
Please rush all information relative to your Course in Electricity. This obligates me in no way whatever.

Name.....

Address.....



Be Your Own Boss



Be a Leader

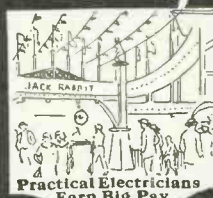

Practical Electricians Earn Big Pay

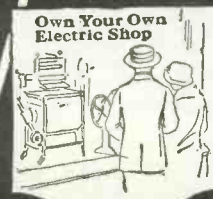

Own Your Own Electric Shop



Big Money As Power House Boss



Ignition Experts

Head the Pay-Roll

Big Money in Music

A Conn instrument offers you a profitable career or a well-paying side-line, as you choose. Thousands are making big money with Conns; so can you. The demand for players of saxophone, trombone, cornet, trumpet, tuba—in fact all wind instruments—is increasing. Popular orchestras for dance, vaudeville, phonograph recording and similar engagements need players. Directors search constantly for new material.

Choosing a Conn instrument is your first step in winning recognition. For Conns are known everywhere as the "instruments of the artists." They are easier to blow; perfect in scale; most reliable in action; beautiful in tone. Let us explain to you fully their exclusive features. Conns cost no more than others.



Some Famous Conn Artists

Upper Left: John Philip Sousa, Director Sousa's Band. Right: Bohumir Kryl, Director Kryl's Band. Lower Left: Isham Jones, Director Jones Orchestra. Right: Paul Biese, Director, Biese's Orchestra.

FREE TRIAL: EASY PAYMENTS. Send postcard for details. Highest honors at world expositions. Dealers and agents throughout the country. Factory branches in principal cities.

C. G. CONN, Ltd., 1156 Conn Bldg., Elkhart, Ind.



WORLD'S LARGEST MANUFACTURERS OF HIGH GRADE BAND AND ORCHESTRA INSTRUMENTS

Motor Hints Carburetor Action Explained By TOM C. PLUMRIDGE

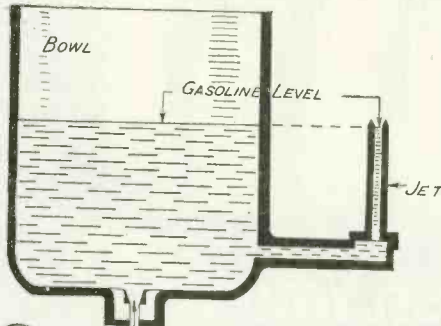

(A) NEEDLE VALVE SEAT

An essential part of good carbureting is a correct gasoline level. Sketch "A" shows the correct level. The gasoline level should be just below the top of the jet.

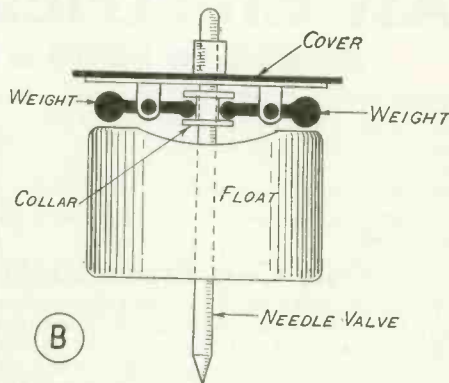

(B) NEEDLE VALVE

Sketch "B" shows the controlling unit of the gasoline level. As the level drops, the float does also. The weights will also descend and they in turn raise the needle valve, allowing more gasoline to flow into the bowl. To lower the gasoline level, the needle must be lengthened below the collar. This can be accomplished by resting the collar on something solid, and lightly tapping the top of the needle. If the gasoline level needs raising, reverse the process.

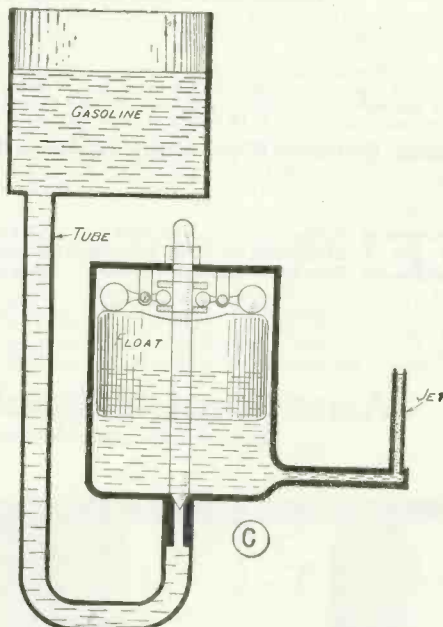

To correctly check the gasoline level some arrangement must be made so that there is a good pressure of gasoline in the float bowl and also to allow the jet to be seen. Sketch "C" shows a very easy and satisfactory method of checking this level. In most carburetors it is possible to remove the body so that it leaves the jet exposed. In others the removal of the butterfly valve will allow of this examination.

(Continued on page 688)

We Teach COMMERCIAL ART

Meyer Both Company, the largest Commercial Art Organization in the World offers you an unusual opportunity for practical training, based upon twenty-three years of success. This nationally known organization each year produces and sells to advertisers over 15,000 commercial drawings. Meyer Both instruction is the difference between successful fact and experimental theory. This well paid profession equally open to men and women. Home study instruction.

Get Facts Before You Enroll in Any School

Ask the Advertising Manager of the leading newspapers in your city, anywhere in the United States, Canada, England or Australia about the Meyer Both Company—let them tell you about us. Write for our illustrated book telling about the success of our students—for one-half the cost of mailing—four cents in stamps

MEYER BOTH COMPANY

Department of Art Instruction

Michigan Ave. at 20th St., Dept. 64 CHICAGO, ILL.

Note—To Art and Engraving Firms: Secure practical artists among our graduates. Write us.

Make Money Taking PICTURES



Tremendous big-paying opportunities are open for ambitious men in Modern Photography. This is the picture age. Magazine and newspaper publishers buy thousands of photographs each year. Every manufacturer sends out high priced pictures of his products.

Got \$100 for Flood Pictures
"I took pictures of a flood and sold them for \$100. I have been able to buy my house and lot from the sale of pictures."

C. M. Cole, Washington.

\$97 in Two Days!
"I made \$285 in December. Went out two days last week on home portrait work and made \$97."

A. G. Hughes, Kentucky.

Every home wants portraits. Photography is a business running into millions of dollars each year. And there is a great shortage of trained photographers.

EARN \$3,000 to 10,000 a Year
Hundreds of men are earning big money and establishing their own businesses. Even during spare time, while training, you can make \$75 a week easily—no matter where you live!

Amazing New Easy Method
I show you, at home, how to do the kind of work turned out by the big studios in New York and Chicago! I show you how to make big money within 30 days! C. M. Cole bought a home with money he had made when only half way through his training. So well do I know what I can do for you that I guarantee under

bond to return every cent of your tuition if you are not thoroughly satisfied.

Professional View Camera FREE!



Write at once for Free Camera Offer—I give you, free, a splendid professional view camera. You will be astonished and delighted. This offer open for short time only—so act quick. No obligation.

INTERNATIONAL STUDIOS, Inc.
Dept. 7458
3601 Michigan Ave., Chicago, U.S.A.

SEND NO MONEY FOR THESE AUTOMATICS

LOWEST PRICES
IN THE COUNTRY

20 SHOT
MILITARY MODEL \$8.95
32 cal. with Extra
Magazine FREE



25 Cal. 6-shot Blue Steel \$6.25
25 Cal. 8-shot Mauser \$11.95
32 Cal. 7-shot Mauser \$12.96
30 Cal. 9-shot Luger \$16.25

SWING OUT
CYLINDER



38 or 32-20 Cal. \$17.25
HAND EJECTOR

32 or 38 Cal. \$8.25
Break-Open
REVOLVER

32 cal. 6 shot \$16.25
HAND EJECTOR

Brand New Guns
Use Standard
Ammunition.

Satisfaction Guaranteed or Money Back.

Pay Postman Our Price, Plus Postage.

EDWARDS IMPORT TRADING CORP.

258 Broadway Dept. 94-11 New York

Radio Catalogue Free—

**Write us
a post card—
Address Dept. 40-R**

and we will send you free this 52 page catalogue of radio sets and parts. It also contains explanation of radio terms, map and list of broadcasting stations and much radio information, including an explanation of successful hook-ups and circuits.

You will be amazed at the low prices Ward's quote. A complete tube set having a range of 500 miles and more, including tubes, head set, batteries, and antenna equipment, as low as \$23.50.

This catalogue contains everything for the expert and amateur. Complete sets and every improved part for building sets, all the most up-to-date devices—at the lowest possible prices.

Headquarters for Radio

Montgomery Ward & Co. is headquarters for Radio, selling everything direct by mail without the usual "Radio-profits." Why pay higher prices? Ward quality is the best and the prices will often save you one-third. Everything sold under our Fifty Year Old Guarantee,—Your Money Back if You Are Not Satisfied. Write today for your copy of this complete 52-page Radio Book.

Write to our house nearest you. Address Dept. 40-R
Chicago Kansas City St. Paul Portland, Ore. Ft. Worth

Montgomery Ward & Co.

The Oldest Mail Order House is Today the Most Progressive



You Can Stain It Any Color You Wish



ATTICS are full of old pieces of furniture — out of style, perhaps, but they can easily be made attractive and useful at practically no expense. All you need is a little time, a brush and

JOHNSON'S WOOD DYE

Johnson's Wood Dye is very easy to apply—it goes on easily and quickly, without a lap or a streak. It penetrates deeply bringing out the beauty of the grain without raising it—dries in 4 hours and does not rub off or smudge. Made in fourteen beautiful shades.

FREE-This Book on Home Beautifying

This Book tells how to finish wood in artistic stained and enameled effects. Gives practical suggestions on making your home artistic, cheery and inviting. Tells just what materials to use and how to apply them. Includes color card—gives covering capacities, etc. Use coupon below.

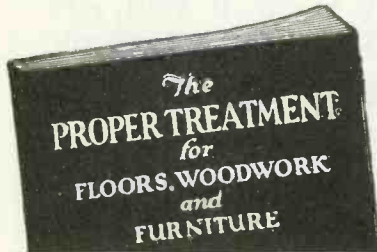

S. C. JOHNSON & SON, Dept. S.1.-11.
 Racine, Wis. (Canadian Factory—Brantford)
 Please send me free and postpaid your Instruction Book on Home Beautifying and Wood Finishing.
 The best dealer in paints here is.....
 MY NAME
 MY ADDRESS
 CITY & STATE

Motor Hints CARBURETOR ACTION EXPLAINED

(Continued from page 686)

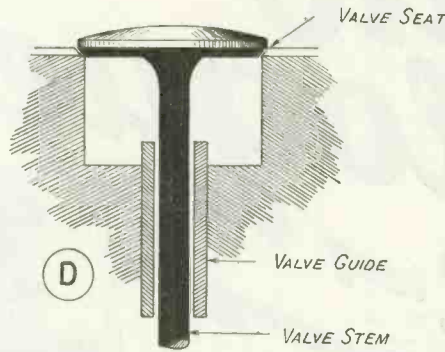

Air leakage is found in worn intake valve guides and valve stems. On the down stroke of the piston air is drawn into the combustion chamber through the space between the valve stem and the valve guide. This impoverishes the mixture and will cause spitting through the carburetor because of lean mixture. Guide or stem should be renewed. Sometimes it is necessary to renew both before this trouble can be cured. Oversize valve stems often cure it.

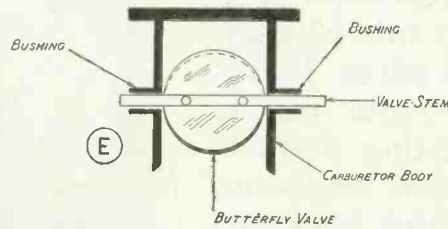

Air leaks also are found at the point where the butterfly valve stem passes through the body of the carburetor. This has the same effect as worn valve stem and guide. Renewal of the bushings and butterfly valve stem will cure the trouble at this point.

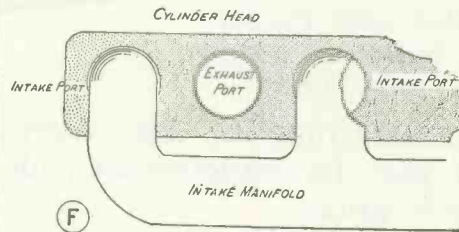

After a short while the gaskets between the intake manifold and cylinder block will compress. Unless carefully examined the air leak at this point will escape detection. A good test is to squirt gasoline around the joint and see if there is any difference in engine operation when this is done.

IN REFERENCE TO "PHONO-GRAPH EVOLUTION"

It may be that some readers received erroneous impression from the article entitled "Phonograph Evolution," appearing in the August issue of this magazine. The first phonograph for recording and reproducing sounds by means of a wax record such as is used today on dictaphones was patented in 1886 by Chinchester A. Bell and Sumner Tainter. This was the first commercially practical machine. The experimental work done by Thomas A. Edison in 1878 was carried out on machines using tin-foil as the recording medium. This machine was not used commercially, but gave quite satisfactory results, which resulted in hundreds of press notices at the time and in many exhibitions of the apparatus. A complete account of the wonder which was expressed by the people of this country at Mr. Edison's first phonograph will be found in the volumes entitled "Edison: His Life and Inventions."

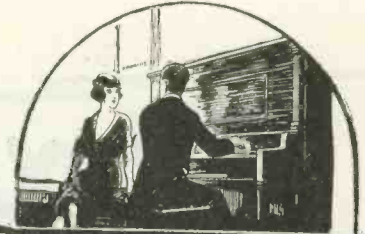

Play PIANO By Ear

No matter how little you know about music, if you can just remember a tune, I teach you to play Jazz, Ragtime, Popular Songs BY EAR, easily, quickly. Beginners and even those who could not learn by the old fashioned method grasp the Niagara idea readily. Self-instruction—no teacher required. You learn many new styles of bass, syncopation, blues, fill-ins, breaks, trick endings, etc. Why spend years studying tiresome scales and finger exercises when I teach you

At Home in 90 Days to Be a Master of JAZZ and RAGTIME

and play any tune you can remember, by ear—without notes. Original method, wonderful, easy. No do-re-mi—no scales—just a few simple rules, a little practice—results are amazing. Letters from hundreds of enthusiastic pupils and interesting book SENT FREE. No other course like it—fully protected by copyright. Simply write your name, address. State if you have ever taken piano lessons.



Ronald G. Wright, Director,
 NIAGARA SCHOOL OF MUSIC
 Dept. 601 Niagara Falls, N. Y.

Send for this Free Book

NEW TIRE GUARANTEE!

ACT NOW

30x3 1/2 200 CORD

WRITTEN GOLD BOND GUARANTEE WITH EACH TIRE

Greatest tire sale in America now on! Goodyear, Goodrich, Firestone, Fisk and other fine makes of tires going at record-breaking prices. These almost new tires will easily give thousands of miles of satisfactory service.

GUARANTEED 9 MONTHS

TIRES	NEW TUBES	TIRES	NEW TUBES
30x3	\$1.90	32x4 1/2	\$3.75
30x3 1/2	2.00	33x4 1/2	3.75
32x3 1/2	2.50	34x4 1/2	4.00
31x4	2.75	35x4 1/2	4.25
32x4	3.00	36x4 1/2	4.25
33x4	3.25	35x5	4.25
34x4	3.50	37x5	4.25

Just send \$1.00 deposit for each tire ordered. Balance satisfactory service or another tire will be given at half price. Shipment made same day order is received. Order today—NOW.

INTERNATIONAL TIRE CORP.
 214 EAST 14th STREET CHICAGO, ILLINOIS

FORDS run 34 Miles



on Gallon of Gasoline
 Low Gear Seldom Used
 with Air Friction Carburetor

We guarantee all other cars nearly double present mileage, power and flexibility, make hills on high formerly difficult on low. Models for any car, truck, tractor, marine or stationary engine. Makes old cars better than new. See wonderful mileage guarantees for other cars.

Ford..... 34ml.	Reo..... 24ml.	Chevrolet... 32ml.
Buick 4... 30ml.	Chalmers... 23ml.	Maxw(25) 30ml.
Buick 6... 24ml.	Olds 6... 23ml.	Nash 6... 25ml.
Hudson... 20ml.	Paige 6... 20ml.	Lincoln 8... 17ml.
Hupp... 25ml.	Oakind 6... 24ml.	Stbkr/Lt6 23ml.
Dodge... 28ml.	Over'd 4... 32ml.	Cole 8... 17ml.

If your car is not mentioned here send name and model for particulars and our guarantee on it. AGENTS WANTED SENT ON 30 DAY'S FREE TRIAL You can drive any car in heaviest traffic without shifting gears. Starts off on high in any weather without priming or heating—no jerking or choking. No more foul spark plugs or carbon in cylinders. No leaking of gas into crank case. Try it 30 days on our guarantee of money back if not entirely satisfied. No strings to our guarantee. YOU ARE THE JUDGE. Anyone who can handle a wrench can attach it. No boring of new holes or changing of operating mechanism. Write today. AIR-FRICTION CARBURETOR CO. 384 Raymond Bldg. Dayton, Ohio, U. S. A.



SENSATIONAL SALE

GUARANTEED TYPEWRITERS Limited quantity fully guaranteed standard make typewriters. Five Days Free Trial. Lowest prices ever offered. Easy monthly payments. Send today for FREE booklet of Valuable Typewriter Information and Special Sale Bulletin. SMITH TYPEWRITER SALES CO. 303-360E. Grand Ave. Chicago, Ill.



Thousands

Now
Find
It

EASY

To
Make

MUSIC

BUESCHER

True-Tone Saxophone

Everyone has a perfectly normal desire to produce music, but the average person has not the time nor patience to spend months or years in learning to play. Heretofore, the making of music has been the privilege of the talented few.

But now it is different. With this wonderful new saxophone, Buescher has made music a universal accomplishment, and has placed it within the possibility of practically everyone.

See How Easy It Is

The new Buescher Saxophone is a marvelous instrument. It is one of the most beautiful of all musical instruments—by the range and wealth of its tones it takes the place of almost every other instrument—yet it is so perfected and simplified that it is the easiest of all instruments to play.

With the aid of the first three lessons, which are sent free (upon request) with each new Saxophone, the scale can be mastered in an hour; in a few weeks you can be playing popular music. Practice is a pleasure because you learn so quickly. You could even take a place in a band or orchestra in 90 days, if you so desired.

Wins a Welcome Everywhere

You are always welcome with a sweet-toned Buescher Saxophone. Thousands of men and women, of all ages, have found it an infallible key to social popularity. For home entertainment, for church, school or lodge affairs, the Saxophone is the most popular and adaptable instrument. Saxophone players enjoy, also, many opportunities of earning money. They are always in demand for dance orchestras.

Free Trial Six days Free Trial of any Buescher Grand Saxophone, Cornet, Trumpet, Trombone or other instrument. Easy terms of payment arranged. Mention instrument interested in and complete catalog will be mailed free.

A Remarkable Saxophone Book—Free!

We have prepared a very interesting book on the history and development of the Saxophone. It tells which saxophone takes violin, cello and bass parts, and many other things you would like to know. Also illustrates first lesson. It is sent free on request. Just send a postcard or clip and mail the coupon.

BUESCHER BAND INSTRUMENT CO.

Everything in Band and Orchestra Instruments
6099 Buescher Block, Elkhart, Ind.

Buescher Band Instrument Co.
6099 Buescher Block, Elkhart, Ind.
Gentlemen: I am interested in the instrument checked below:

Saxophone... Cornet... Trombone... Trumpet...
(Mention any other instrument interested in)

Name

Street Address

Town State.....



Tom Brown
Director
Six Brown Brothers
Saxophone Sextet
Victor Records



Ben Selvin
Director
Selvin's Orchestra
Acolian-Vocalion
Records



Dan Russo
Director
Orfo Orchestra
Brunswick Records



Bennie Krueger
Director
Bennie Krueger and
His Orchestra
Brunswick Records



Clyde C. Doerr
Director
Clyde Doerr's
Orchestra
Victor Records



Jascha Gurewicz
Former Soloist
with Sousa's Band
Electric Records



Nathan Glantz
Director
Nathan Glantz and
His Orchestra
Edison and
Other Records



Anthony Dortenzio
Lanin's
Roseland Orchestra
Edison and
Other Records

These Famous Saxophone Players

whose portraits are shown—use and recommend Buescher True-Tone Saxophones. Almost without exception, the great Professionals use Buescher Instruments exclusively. They are so flawless in scale, so perfect in tone and so accurate mechanically that more than 75 per cent of the popular Phonograph Records are played with them.

Price Cut 1/2 On World's Greatest Reference Books



For Any Line of Work

Latest Edition

Let experts work for you—in these books you will find the most remarkable collection of practical job experience and vital knowledge that was ever assembled in book form. More than 200 of the greatest engineers, lawyers, business men, and practical experts—all of them men who have gone through the mill—give you in these books a life-time of valuable inside information on the line of work in which you want to get ahead. Make their knowledge and experience your own. Let them show you all the newest methods—the best ways of doing things. This very minute you may be up against some tough problem—if you had these books you would solve it instantly. Send the coupon for

A Week's Free Trial

Just fill out the coupon and we will immediately send you any one of these libraries express collect. Read the books over carefully. Test them out thoroughly for seven days. If you do not want them, they will do for you what they have done for 280,000 other men to whom they brought more money and success, pay \$2.80 within one week and \$3.00 a month thereafter until the special price is paid. This amounts to only 10c a day. Mail the coupon NOW if you want a bigger, better job and bigger pay.

Free Consulting Membership

A resident staff of from 15 to 20 practical experts is waiting to solve for you any difficulty that you may have.

Your Choice 75c a Week

- 5 vols. Carpentry and Contracting—was \$37.50 now \$19.80
- 12 vols. American Law and Practice (including free reading course and 250 page book of standard legal forms)—was \$97.50 now \$49.80
- 8 vols. Applied Electricity—was \$60.00 now \$29.80
- 6 vols. Aut. Engineering—was \$45.00 now \$21.80
- 9 vols. Civil Engineering—was \$67.50 now \$34.80
- 8 vols. Business Management—was \$52.50 now \$29.80
- 7 vols. Steam and Gas Engineering—was \$52.50 now \$24.80
- 4 vols. Sanitary Heating and Ventilating—was \$30.00 now \$14.80
- 4 vols. Fire Prevention and Insurance—was \$30.00 now \$14.80
- 6 vols. Modern Machine Shop Practice—was \$45.00 now \$21.80
- 4 vols. Telephone and Telegraphy—was \$30.00 now \$14.80
- 4 vols. Drawing—was \$30.00 now \$14.80

A letter or a wire to American Technical Society will bring you an immediate answer and the solution to you, problems. This advisory staff of practical men plus your working and reference library will enable you to handle successfully any job in your line. These men know all the latest methods and the newest and best ways of doing things. Let this pay-raising consulting staff be YOUR SILENT PARTNER.

This free consulting membership offer is good for a limited time only and can be withdrawn without notice.

Send No Money

Here is your opportunity if you want to earn more money. Remember we are taking all the chance—you pay nothing until you are thoroughly convinced that these books will help you to greatly increase your pay. Isn't this about the fairest proposition that was ever made you?

American Technical Society

Dept. X-825 Chicago, Ill.
© A.T.S. 1922.

AMERICAN TECHNICAL SOCIETY,
Dept. X-825 Chicago.

Please send me a set of for seven days' FREE EXAMINATION, shipping charges collect. I will examine these books thoroughly, and if satisfied will send \$2.80 within seven days and \$3.00 a month until I have paid the special price of \$..... If I decide not to keep the books, I will return them within one week at your expense. It is understood that if I keep the books I am entitled to a FREE Consulting Membership in the American Technical Society.

Name.....
Address.....
Reference.....
(Please fill out all lines, give local merchant, banker, or employer as reference.)

Book Review

ELECTRIC FURNACES IN THE IRON AND STEEL INDUSTRY. Fully illustrated. Hard covers, size 5 1/2"x9". Published by John Wiley & Sons, Inc., New York City.

Three authors unite in the production of this treatise, a German, an Austrian, and a representative of American metallurgy. The electric furnace, it is not too much to say, is revolutionizing metallurgy. For a long time it was devoted to a special line of work, such as the manufacture of aluminum alloys, abrasives, and other specialties, but now it is coming into the great field of the metallurgy of steel, and it already is doing a vast amount of work in that division of the science of metallurgy. By the induction furnace a metal can be melted without coming in contact with the fuel. Again a furnace of comparatively small dimensions can be worked economically, so as to do the work, which in old times required a great blast furnace. Sweden, almost a coalless country, depends largely on the electric furnace for its metallurgical work. Norway is in the same position, and both of them are using year by year, more and more of their great hydraulic powers. So it is not too much to say that the revolutionizing of the field of metallurgy is in active progress now, and this book describes the present aspect of the movement.

LETTERS OF A RADIO ENGINEER TO HIS SON. By John Mills. Profusely illustrated. Hard covers, size 5 1/2"x8 1/4". Published by Harcourt, Brace and Co., New York City.

This is a very nice presentation in book form of the elements of wireless engineering. The readers of our columns have followed the progress of the wireless art from step to step, and many of them have gleaned from the columns of *Radio News* practically all the interesting matter which has evolved in the science up to date, and here we have a resumé of the science, which while supposed to be addressed to young people, takes cognizance of the fact that the young person of the present day is a very serious proposition, and the books written for him have to be correct.

DIE AQUARIENKUNDE. By Dr. E. Bade. Fully illustrated. Paper covers, size 6"x9 1/4". Published by Creutzische Verlagsbuchhandlung, Magdeburg, Germany.

Dr. Bade is an old time contributor to the columns of *SCIENCE AND INVENTION*. We have been honored by his interesting articles presenting natural history in its various phases in popular and attractive style to our readers. In this book the author goes deeply into the subject of the aquarium, the art of the construction and of the care thereof. The German publishers of books of this type have the art of making them wonderfully interesting by the illustrations. They seem to get at the root of things better than the publishers of other nations, and this book is most interestingly illustrated with the appliances of the aquarium, and with numerous half tone illustrations of its inhabitants. Two very beautiful color plates, one on the cover, and the other facing the title page, make one wish that there were more. The book is well worth an index, which we regret to say is missing, but the table of contents is so good that the index is hardly needed. Many of the illustrations are from the matchless hand of Dr. Bade. The book is in its fourth and fifth editions.

A SHORT COURSE IN THE TESTING OF ELECTRICAL MACHINERY. By J. H. Morecroft, E.E., and F. W. Hehre, E.E. 111 illustrations. Hard covers, size 5 1/2"x8 3/4". Published by D. Van Nostrand Co., New York City.

The title of this book expresses its contents. In it there is described in full detail the testing of electrical machinery, which while stated to be for non-electrical students like many other alleged elementary books, is so well presented, that the advanced electrician will find it of use in his work. The great advance of the science makes it a little saddening sometimes to look at books of this character, for if this is what the non-electrical student is supposed to know perfectly, how much will be expected of the electrical student. In a general way, we cannot do more than commend the book, which with its rather restricted use of mathematics and its numerous illustrations and practical hints, is very much to the point, as regards carrying out the matter suggested by its title.

A TEXT BOOK OF MINERALOGY. By Edward Salisbury Dana. Fully illustrated. Hard covers, size 6"x9 1/4". Published by John Wiley & Sons, Inc., New York City.

The honored name of Dana appears in the title page of this book of mineralogy. Of this classic of science, Dana's Mineralogy, as we always called it, no less than twenty-seven thousand copies have been issued. The first edition appeared in 1877. The great merit of the book which immediately became the leader of all standards, is shown in the fact that it held the field for twenty years, and it was only in 1898 that the second revised edition was published. Now after nearly twenty-five years the third edition appears. It is pleasant to read that the general character and form of the book have been retained unchanged. Professor Dana has written the preface, and it is very interesting to realize that when a young man of some twenty-eight years, he acquired a world-wide fame by his Mineralogy, which held the field for nearly a generation before the second edition was required. Any attempt to review it is futile, it is so large and so elaborate, and what we have said must be considered a tribute to the personality of the most distinguished author, but is not a review of this exhaustive book. It has a very good general index, followed by an index of species, and it is liberally illustrated with crystallographic and other diagrams, as well as illustrations of apparatus, and to those practicing the science, it is simply a *sine qua non*.

PRINCIPLES OF ELECTRICAL ENGINEERING. By William H. Timbie and Vannevar Bush. Illustrated. Hard covers, size 5 1/4"x7 3/4". Published by John Wiley & Sons, Inc., New York City.

The Massachusetts Institute of Technology in a way may be taken as responsible for this work, written by two of its Faculty, Associate Professors of Electrical Engineering. It is quite an admirable book for study, as each chapter, of which there are thirteen, is followed by a series of problems to be solved, the total number of which is some five hundred. Some very excellent tables of electrical data are given in the last few pages, and the book is indexed. It is designed for college students, and it is said to presume a knowledge of calculus and physics on the part of the student, but this need not frighten anyone, as the use of mathematics in it is far from exhausting, and the subjects in general are most intelligibly presented.

THE ROMANCE OF COAL. By Charles R. Gibson. Illustrated. Hard covers, size 5"x8". Published by J. B. Lippincott Co., Philadelphia, Pa.

The interest attached to the present work is not at all lessened by the fact that it is an English production with numerous illustrations and much history. It includes all the practical points of mining, explosions in the mines, the condition of the workers and animals therein, all of which makes the book excellent reading. It treats of the Davy safety lamp, of gas and dust explosions. He tells of the condition of the workers, citing an eighty-year-old woman who worked in a mine in perfect contentment. He brings out the fact that the miners do not regard their life as a disagreeable one, and says that pitying the miners whose incomes in some cases surpasses those of highly educated men, is decidedly far fetched.

THE BOOK OF WIRELESS TELEGRAPH AND TELEPHONE. By A. Frederick Collins. Cloth covers, size 5"x7"x1/2". 217 pages. Fully illustrated.

A good book for the beginner. It is written in a comprehensive manner covering the fundamental principles of wireless telegraph and telephone and contains necessary information for constructing, operating and maintaining both receiving and transmitting stations. Some of the more advanced types of receivers and transmitters are clearly explained. In the back is included a list of the definitions of words and terms commonly used throughout the book. Mr. Collins has succeeded in putting forth the facts of radio in an interesting and practical fashion.

(Continued on page 692)

"BUILD YOUR OWN" WITH "RASCO" PARTS!

THE Radio Specialty Company—"RASCO" for short—now in its third year, is unquestionably the oldest and most unique radio parts supply house in the United States, if not in the whole world. This Company makes a specialty of small orders. No order is too small to get immediate and prompt attention. The reason is simple: 80% of our orders are small. The reputation of this house was built upon service. Ask any of your radio acquaintances what they think of "RASCO" service, "RASCO" promptness. Thousands of unsolicited testimonials are in our files, to prove that we serve the public as it has never been served in radio merchandise before. Be sure to get our great 84-page catalog, containing over 550 different parts. Catalog contains over 350 illustrations. "WE CAN ONLY DISAPPOINT YOU ONCE." Try us with a 50c. order and make us prove what we say. Prices include delivery to your door.

We pay all transportation charges in U. S. ALL GOODS SENT PREPAID IN 24 HOURS

Order direct from this page.

NOTE BIG PRICE REDUCTIONS THIS MONTH

Money refunded if goods do not satisfy

RADIO STORAGE BATTERIES

These batteries are guaranteed for two years and any battery becoming defective during that time will be replaced. All of our batteries are made of new materials and are positively not rebuilt as some inferior makes. Acid proof terminals, patent vents, indestructible impregnated cabinets. Strong carrying handles.

N2400 Two volt, 40 ampere hours...\$3.90
 N640 Six volt, 40 ampere hours... 7.25
 N666 Six volt, 60 ampere hours... 9.50
 Due to low price and weight of storage batteries, shipped express collect only.

TAPPED "B" BATTERIES

We positively guarantee these batteries to be of long life. We carry only fresh stocks. Discharge very uniform. Noiseless too. We guarantee results.

N2250 Small size, 22½ volt\$.85
 N2251 Medium Navy size, 22½ volt\$ 1.20
 N4500 Large size, 45 volt.....\$ 2.30

MOLDED DIALS

We handle only the very best molded grades. Bushings absolutely true; dials cannot wobble. All dials for ¼" shaft. Letters inlaid in fast white enamel.

N3074 Dial 2"\$.20
 N3075 Dial 3"\$.25
 N3076 Dial 4"\$.40

"RASCO" SILVER DIALS

Metal dials, silver surface, black enamel, inlaid lettering. Made for ¼" shaft. No set screw required. Held by friction. Positive fit that will not come loose. All dials 2½" dia.

N800 Plate variometer;
 N801 Primary Condenser; N802 Secondary Condenser; N803 Coupler; N804 Filament Rheostat; N805 Grid Variometer. Each style, \$.20 each. Set of six.....\$1.15

SERIES PARALLEL SWITCHES

Quick change from one circuit to another. Black composition knob, nickel plated fittings. Blade radius 1¼".

N2950 Series parallel switch.....\$.25

SOFT RUBBER EAR CAP

At last! Ear caps that will relieve headaches, earaches, and undue pressure on the ears. Fit all receivers. Exclude all outside noises. Ear touches soft rubber only.

N3500 Ear caps; per pair.....\$.50

THE RADIOGEM

The simplest radio outfit made. The prize winner of the age. Lowest priced complete radio outfit on the market. Includes all parts for tuning: coil, tapped switch, crystal, catwhisker wire. A child can assemble outfit in half hour.

N5353 Radiogem, no aerial or phone.....\$.75
 N5354 Radiogem, with 1000 ohm phone and 3' cord.....\$ 2.00

SPAGHETTI TUBING

We only handle varnished flexible cambric tubing. No substitute. 319 takes No. 22 wire; 320 takes No. 18 to 20 wire; 321 takes No. 18 to No. 18 wire; 344 takes No. 22 to No. 28 wire.

N319-320-321 Spaghetti, per foot.....\$.06
 N344 Flexible soft rubber tubing; 10 feet for.....\$.20

SPRING CLIPS

New! This nickel clip has a new handy lug to slip under binding post. 1½" long.

N2222 Clip.....\$.12

TUNED (Adjustable) LOUD-SPEAKER PHONE

This "Rico" loud-speaker phone has a rubber gasket underneath diaphragm, making phone fully adjustable. This phone gives amazing results as a loud-talker on 1 and 2 stages of amplification. Must be heard to be appreciated. Money refunded if not satisfactory.

N2252 "Rico" tuned Loud-Speaker Phone with 5 ft. cord.....\$3.75

CRYSTAL DETECTOR STAND

Has universal swivel joint, adjustable crystal cup. All parts nickel plated and polished. For mounting on base or panel.

N1350 Detector stand.....\$.35

THROW SWITCHES

Mounted on composition block. Small enough for all radio purposes.

N4100 Single pole.....\$.25
 N4101 Double Throw S.P.....\$.35

BINDING POSTS

N030 Is our small size, used for phone connector. ½" high, nickel plated and polished. Each.....\$.04

INITIALED BINDING POSTS

N122 Antenna; N123 "B" Bat. -; N124 "A" Bat. +; N125 "B" Bat. -; N126 "A" Bat. -; N127 Ground; N128 Phone. Letters in white enamel. Black composition 9-16" dia.; ¾" high. Each style.....\$.12

SPRING BINDING POSTS

Nickle plated. Positive connection. Particularly useful with bus bar wire.

N45 for panel mounting and N41 is tapped for N45 spring post
 N45 Spring Post.....\$.40
 N44 Post, Each.....\$.07. Dozen.....\$.70

TIN FOIL

Best grade only. N850 has 1500 sq. inches per lb. N851 700 sq. inches to lb.

N850 Tin foil.....lb \$.35
 N851 Tin foil.....lb \$.35

SWITCH KNOB

N199 Knob is a favorite. 1½" dia.; height ¾"; 8-32 screw. N4451 has 8-32 or 10-32 bushing, no screw.

N199 Knob.....\$.10
 N4451 Knob.....\$.06

BRASS STRIP AND TUBING

Brass strip ½" wide; 1-16" thick; 6" long.

N1430 Per length.....\$.10
 N1431 Brass tubing, ¼" dia.; inside dia. 3-16"; 6" long; per length.....\$.15

COPPER RIBBON

Used for connecting purposes .005" thick.

N700 ¾" wide; N701 ½" wide; N702 3-16" wide. All sizes per foot.....\$.01

SILICON STEEL

Used practically in all audio-frequency transformers. Better than iron. Extremely soft. 2¾" wide and .007" thick.

N4900 Silicon steel per foot.....\$.06

BAKELITE 180° COUPLER

Tubes are natural color bakelite, wound with green silk. Aluminum bracket, Fahnestock connectors; ¼" shaft. Primary 13 taps. 180 to 550 meters.

N3150 Coupler.....\$2.45

MOLDED VARIOCOUPLER

Best molded variocoupler parts made in this country. Rotor is 3½" dia.; width 1¾". Primary tube 4¼" dia., 2½" wide. Complete with all brass fittings but without wire. This coupler usually sells from \$4 to \$6.

N2700 Molded variocoupler.....\$1.85

RHEOSTATS AND POTENTIOMETERS

Well made in all respects. These rheostats come with metal dial and composition knob. Good merchandise despite low price.

N4210 6 ohm rheostat.....\$.27
 N4211 30 ohm rheostat.....\$.30
 N4212 200 ohm potentiometer.....\$.45

SOLDERING IRON

The smallest and handiest soldering iron made. Fits any flat iron, toaster or percolator plug. Plug then becomes handle. Size 5" long. Complete but without plug or wire. Extremely useful for soldering radio connections.

N2200 Soldering iron.....\$1.45

GROUND CLAMP

Best ground clamp on the market. Fits all pipes from ¼" to 3". No soldering necessary. Non-rusting metal strip. Will give most positive connection.

N2236 Ground clamp.....\$.15

SKINDERVIKEN BUTTON

Famous Microphone For Transmitters. Sold all over for \$1. This is the genuine article. No imitation. Smallest and most sensitive microphone made.

N9595 Microphone.....\$.75

COPPER FOIL

Thinnest copper foil made; .001" thick, 4" wide.

N5025 Copper foil; per foot.....\$.10
 N5025 Copper foil; per 10 ft. length.....\$.80

NICKLE PLATED BRASS SCREWS

At last! Fully nickel plated screws for the experimenter. We have the following sizes: 4-36; 6-32; 8-32; 10-32 flat and round head styles: ¼", ⅜", ½", ¾" and 1" lengths.

Price all size threads ¼":
 ¾", ½". Per dozen.....\$.15
 ¾" and 1". Per dozen.....\$.20

MAGNET WIRE

The following come on 8-ounce spools:

N2500, Double Cotton No. 18.....\$.50
 N2501, Double Cotton No. 20.....\$.60
 N2502, Double Cotton No. 22.....\$.75
 N2503, Double Cotton No. 24.....\$.85
 N2504, Double Cotton No. 26.....\$.95
 N2505, Double Cotton No. 28.....\$ 1.15
 N2506, Double Cotton No. 30.....\$ 1.65

The following come on 4-ounce spools:

N2507, Green Silk No. 20.....\$.50
 N2508, Green Silk No. 22.....\$.55
 N2509, Green Silk No. 24.....\$.60
 N2510, Green Silk No. 26.....\$.65
 N2511, Green Silk No. 30.....\$ 1.05
 N2512, Green Silk No. 32.....\$ 1.37
 N2513, Green Silk No. 36.....\$ 1.85

The following come on 8-ounce spools:

N2514, Enameled No. 20.....\$.45
 N2515, Enameled No. 22.....\$.55
 N2516, Enameled No. 24.....\$.60
 N2517, Enameled No. 26.....\$.65
 N2518, Enameled No. 30.....\$ 1.05
 N2519, Enameled No. 32.....\$ 1.37
 N2520, Enameled No. 36.....\$ 1.85
 N2521, Enameled No. 38, 4 oz.....\$ 1.00
 N2522, Enameled No. 40, 4 oz.....\$ 1.15

MELOTONE LOUD SPEAKER

The best popular loud speaker on the market. Has tuned feature the same as all "Rico" phones. Fibro horn, heavy nickel base, five foot cord. Neckle goose-neck. Greatly est tuned loud talker. Compares favorably with most expensive speakers. Size overall 14½"; horn length 11½"; bell 6"; total height 9".

N255 Melotone Speaker.....\$4.90

REINARTZ COIL

Hard rubber center; double silk wire; 15 taps and 3 leads; with screw for panel or board mounting. 4½" diameter; ¾" thick. Duo-spider web wound.

N2660 Coil; 220-600 meters.....\$1.90
 N2661 Coil; 150-300 meters.....\$1.90

DILECTRYTE PANELS

Latest and best panels. Better than phenolic materials as per report of Bureau of Standards. Highest dielectric strength. Smallest water absorption.

N7100 Panel 7x10x3-16".....\$.90
 N7120 Panel 7x12x3-16".....\$ 1.05
 N7140 Panel 7x14x3-16".....\$ 1.20
 N7180 Panel 7x18x3-16".....\$ 1.60
 N7210 Panel 7x21x3-16".....\$ 1.85
 N7240 Panel 7x24x3-16".....\$ 2.10

ALCOHOL BLOW TORCH

Best small torch made. Gives intense hot flame. Needle flame can be directed on any spot. Great for finest work.

N8981 Torch 5x1".....\$.85
 N8982 Torch 3x¾".....\$.43

BAKELITE SOCKET

Octagon shape. Four nickel binding posts, phosphor bronze contact springs. Best bakelite.

N6510 Bakelite socket.....\$.40

"MONODYNE" TYPE SOCKET

This socket takes up less room than any socket on the market. Made for panel or base mounting. It occupies 25 percent less room than all other sockets. Nickel plated and polished tube, fibre plate and 4 sockets. Guarantees noiseless tubes. Wonderful action.

N6503 Socket with four sockets.....\$.45

ROSIN CORE WIRE SOLDER

A non corrosive solder with flux inside.

N4104 Solder per 18" length.....\$.10

JUST OUT THE "RASCO" CATALOG

CONTAINS 75 VACUUM TUBE No.10 HOOK-UPS. 350 ILLUSTRATIONS, 550 ARTICLES, 84 PAGES

All Armstrong Circuits:

These important circuits are explained clearly, all values having been given leaving out nothing that could puzzle you.

Just to name a few of the Vacuum Tube circuits: The V.T. as a detector and one-step amplifier; Armstrong circuits; one-step radio - frequency amplifier and detector; three stage audio - frequency amplifier; short wave regenerative circuits; 4-stage radio - frequency amplifiers; radio and audio - frequency amplifier; inductively coupled amplifier; Armstrong superautodyne, etc.

Catalog mailed only upon receipt of 15 CENTS IN STAMPS OR COIN



RADIO SPECIALTY CO. DEALERS
 100 Park Place, New York City
 Oldest and Original Exclusive Radio Parts House in U. S.
 Get Our Special Proposition
 Factories: Brooklyn, N. Y. Elkridge, Md.

Learn Electricity



In the Great Shops of
Coyne

Student Winding a Stator

Chicago

The Electrical Center of the World

Come to Coyne—learn electricity in 3 months in the largest electrical school in the country. Get a complete training so you can make big money as Power Plant Operator, Superintendent, Telephone man, Construction worker, auto, truck or tractor electrician, battery man, radio expert, or you can go into business for yourself as electrical contractor, dealer, auto ignition or battery expert and make from \$3,000 to \$20,000 a year. Hundreds of our graduates today are making big money and you can do the same if you grasp this opportunity—act now.

Learn in 3½ Months

No books or useless theory. You are trained on \$200,000 worth of electrical equipment. We give you FREE a complete course in Radio—the marvel of the age. Constructing, installing and operating. We also give you FREE a life Membership which enables you to stay as long as you want or come back for further training at any time without charge.

Earn \$150 to \$400 a Month!

You work on motors, generators, housewiring, autos, batteries, radio, switch-boards, power plants—everything to make you an expert ready to step right into a position paying from \$45 to \$100 a week. You get a complete practical training in Circuits, Housewiring, D. C., A. C., Armature and Stator Winding, Drafting, Auto, Truck and Tractor Electricity, Battery Building and Repairing, and Radio.

Earn While You Learn!

We help students to secure jobs to earn a good part of their expense while studying.

Send Coupon Now

Don't delay a minute—send that coupon right now for our big free catalog and full particulars of special offer. Act now!



Endorsed by Electrical Industry

1300-1310 W. Harrison St., Dept. 53-38 Chicago

Coyne Electrical School, Dept. 53-38
1300-1310 W. Harrison St., Chicago

Dear Sir: Please send me free your big catalog and full particulars of your special offer.

Name.....

Address.....

Book Review

(Continued from page 690)

CHEMISTRY OF TODAY. By P. G. Bull, M.A. More than 150 illustrations and diagrams. Hard covers, size 5"x8". Published by J. B. Lippincott, Philadelphia, Pa.

Again we are face to face with an English work, which is a very popular presentation of the study of chemistry, a subject which day by day is becoming more recondite, so that it is fair to say, that those interested in it at all, should lose no time in taking it up. Such books as the present, make it an interesting subject, and we cannot compliment the author more highly than by saying that his work really reminds us of Slosson's writings. There are over one hundred and fifty illustrations and diagrams, and many of these are by no means the old friends of early days, but are suggestive and new presentations of the subject. We note particularly the plate facing page 80, illustrating the relations of helium and hydrogen as the fillers of balloons. The chapter on the "Romance of Radium" with suggestive illustrations, including one of a radium engine, if the keeping of a strip of gold leaf in motion can be treated as the movements of an engine. The use of chemically produced colors in photography, the spectroscopy in application to the sun, and to other heavenly bodies, and the story of carbon compounds, the relations of chemistry to plant and animal life, are but a few of many subjects most interestingly treated.

RADIO RECEPTION. By Harry J. Marx and Adrian Van Muffing, C.E. Illustrated. Hard covers, size 5"x7½". Published by G. P. Putnam's Sons, New York City.

With its clear type and its simple diagrams this text-book appears on the face to be preeminently simple and elementary. It is a definite fact that much can be done in wireless communication, reception and transmission alike, by very simple apparatus, much of which has been presented in the columns of this magazine, but while this book in its first 173 pages, which terminate with the eleventh chapter devoted to a series of "don'ts", appears to be of the simple order on its face, it really makes an exceedingly compact and easy presentation of the subject. In the appendix is given a touch of the real science and formulae of radio work, the calculation of tuning apparatus, and following some twelve tables a quantity of hook-ups, each one illustrated by very clear diagrams, is given. There is an index to the hook-up diagrams and this is followed by a general index of the book, which we are very glad to recommend to our readers.

HOW TO MAKE THINGS ELECTRICAL. Profusely illustrated. Hard covers, size 4"x7". Published by the U. P. C. Book Co., Inc., New York City.

This book, little in appearance at least, printed on thin paper, contains over four hundred pages, liberally illustrated, and devoted to electric experimenting of the simplest order. There seems to be no end of what can be done by the ingenious electrician in the way of simple experiments, and this book presents in a very agreeable way a great many of such things. It is really a collection of articles published originally in the *Popular Science Monthly*, and the preface states that the book is for those who desire to build their own electrical apparatus—experimenter, student and teacher. No author's name is given. The book is liberally illustrated, and describes in the text any quantity of things to be done for the exploitation and utilization of the electric current. One chapter is devoted to radio work. It is well indexed.

THE GLAND STEALERS. By Bertram Gayton. Hard covers, size 8"5½". Published by J. B. Lippincott Co., Philadelphia, Pa.

The author of this book delves into the gland problem in a very humorous manner. He takes a 95-year old man and implants in him the thyroid glands of a gorilla. Promptly grandpa is rejuvenated, but he does not stop there. He organizes an expedition of nearly one hundred ancients like himself, who are conveyed to Africa, where he establishes an aeroplane base, and with his trusted assistants makes his way into the jungle, where a number of gorillas are captured alive. Science enters into the capture of the gorillas, as they are gassed by means of an unnamed gas, and are promptly put into irons. What happens after the expedition has been equipped with the new glands we would rather leave to the reader to find out.

This is an excellent story, written by an English author of ability, who knows how to keep the reader smiling from beginning to end.

(Continued on page 694)

You, Too, Can Play the HAWAIIAN GUITAR Just as the Natives Do—



After Your FIRST LESSON You Will Play "ALOHA". We Guarantee That—

Our method is so simple, interesting and appealing that you begin in your first lesson to learn the famous Hawaiian Folk Song "ALOHA". Think how happy you will be when you surprise your friends by playing the fascinating Hawaiian Guitar just as the natives do!

Only Four Motions—and You Master Them Quickly!

In a few minutes you acquire the four motions necessary to play any piece—after that a short period of practice and you will have mastered this weirdly sweet music. Complete course of 62 lessons includes FREE Beautiful Hawaiian Guitar, necessary picks, steel bar, etc. No extras.

No Previous Musical Knowledge Necessary
If you never read a musical note in your life—if you haven't even the slightest knowledge of music, we can quickly and positively teach you to play this wonderfully popular instrument. Don't be just a "listener" when you can easily be the center of interest among your friends.

Just Mail a Post Card for Details of our remarkable FREE Hawaiian Guitar Offer—simply write: "I am interested"—but do it today!

Address
First Hawaiian Conservatory of Music, Inc.,
Desk 40—233 Broadway
(Woolworth Bldg.)
New York City

FREE
A Beautiful Hawaiian Guitar

Standard Spanish ARMY



Used by French During World War

Buy direct from sole U. S. importers and SAVE ½ on this

GENUINE ASTRA AUTOMATIC

Your chance to have the finest European pistol—the equal of any similar American gun—at about ½ the price. Order direct at these special prices.

- \$7.75 25 calibre—7 shot—C. O. Q. Automatic.
- 8.95 25 calibre—7 shot—Astra Automatic.
- 9.95 25 calibre Astra with triple safety.
- 10.95 32 calibre—10 shot Astra, extra magazine.
- 16.95 32-20 and 38 cal. swing-out cyl. revolvers.

We guarantee every gun against defective workmanship; brand new; of Drop Forged Steel Through-out. Before buying any weapon INSIST on this guarantee. SEND NO MONEY unless you wish. State model desired—pay postman on delivery plus postage. Satisfaction guaranteed or money refunded. Write for new firearms catalogue.

CALIFORNIA TRADING CO.

Dept. 2511, Terminal Bldg., Los Angeles, Cal.

New Single Phase A. C. Motors

¼ H.P. — 110 volt, 60 cycle 1725 speed, complete with cord, plug and grooved pulley ... \$13.00
Same motor equipped with buffer and grinder \$27.50



ONE YEAR GUARANTEE

REBUILT MOTORS

All sizes, direct and alternating. We repair and exchange motors and generators. Let us quote on your needs.

Satisfaction guaranteed or money refunded
Illustrated Catalog of Motors and Supplies FREE

HYRE ELECTRIC CO.

631-H So. Dearborn St., Chicago, Ill.

LOOK 50¢ Look

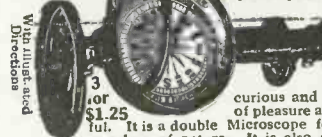

Wonderful Instrument. Great thing yet. Nine separate articles in one. Everybody delighted with it. Odd, curious and interesting. Lots of pleasure as well as very useful. It is a double Microscope for examining the wonders of nature. It is also an Opera Glass, a Stereoscope, a Burning Lens, a Reading Glass, a Telescope, a Compass, a Pocket Mirror, and a Laryngoscope—for examining eye, ear, nose and throat. It is worth all the cost to locate even one painful cinder in the eye. Folds flat and fits the pocket. Something great—you need one. Don't miss it. Sent by mail, with 800 page Novelty Catalog, ONLY 50c or 3 for \$1.25

JOHNSON SMITH & CO., Dept. 13, Racine, Wis.

EARN MONEY AT HOME

YOU can make \$15 to \$60 weekly in your spare time writing show cards. No canvassing or soliciting. We instruct you by our new simple Directograph system, pay you cash each week and guarantee you steady work. Write for full particulars and free booklet.

WEST-ANGUS SHOW CARD SERVICE LIMITED
Authorized Capital \$1,250,000.00
67 Colborne Building Toronto, Can.

Apparatus of Simplicity and Perfection

The Monodyne circuit is one of the most radical advances in Radio engineering. Parts heretofore considered essential are omitted. One simple tuning control gives selectivity, equal if not superior to sets costing hundreds of dollars.

All Wave Lengths

2 coils are furnished with each set.

NATIONAL INTERFERENCE ELIMINATOR

The National Interference Eliminator can be used with any and all radio outfits no matter what make, tube or crystal sets. Will bring in stations you never heard before. Nothing else required with set as illustrated. Just connect it with two short wires to your outfit.

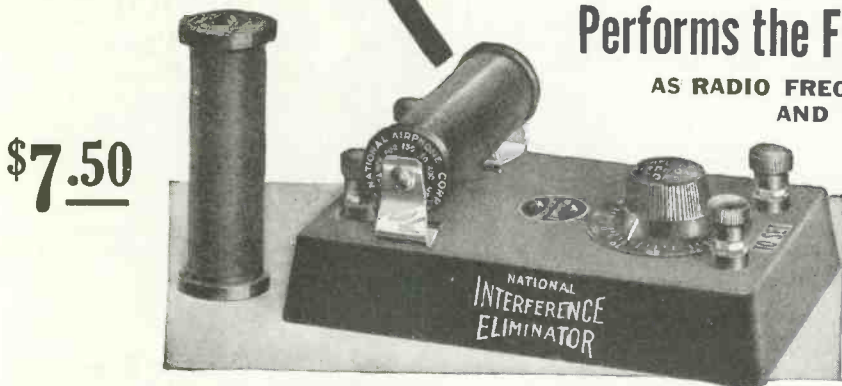

\$7.50

An Absolute Necessity to Clear Reception
Eliminates broadcasting and code-signal interference
Can be used to increase or shorten wave lengths

Dealers, Jobbers and Distributors—Send for Samples and Prices

NATIONAL AIRPHONE CORPORATION
20 HUDSON ST. NEW YORK

NATIONAL "GOLD-GRAIN" DETECTOR

For Reflex and Crystal Sets

\$1.00



Actual Size FOR PANEL MOUNTING

Entirely New Circuit
No Storage Batteries

NATIONAL MONODYNE TUBE SET MODEL GT-1

\$10.00

Including Two Inductance Coils Without Tube



Amplifies As It Detects
ONLY ONE CONTROL!

THE SINGLE TUBE Performs the Function of 2-Tubes
AS RADIO FREQUENCY AMPLIFIER AND DETECTOR

OVER 1000 Miles

Dear Sirs:—When your Monodyne sample arrived, to be entirely frank, we did not believe it capable of doing very much on long distance work. After carefully testing the set, we feel that we owe you an apology.

The National Monodyne naturally percolated all over the place; we heard Davenport, Chicago, Dallas, Texas and Atlanta, Ga. The next night we took it to the home of Mr. McCreary, President of the Western Radio Company here, and we heard another string of stations, using the WD-12 tube with two 22½ "B" batteries.

Your Monodyne is certainly a wonder and we should be very glad to stock and advertise it locally.

We are enclosing our initial order, which kindly rush.

Yours very truly,

The Radio-Electric Shop, Inc.
225 East Tenth St., Kansas City, Mo.

SEND NO MONEY

National Airphone Corporation
20 Hudson Street, New York City, N. Y.

S. I. 11-23

Gentlemen:

Please send me prepaid the articles crossed, for which I will pay postman upon delivery the advertised price.

One National Monodyne
One Interference Eliminator
One Panel Detector

NAME

STREET

CITY STATE

MAIL THIS COUPON TO-DAY

INTERNATIONAL CORRESPONDENCE SCHOOLS
Box 6211-C, Scranton, Penna.

Without cost or obligation on my part, please tell me how I can qualify for the position or in the subject before which I have marked an X.

BUSINESS TRAINING COURSES

<input type="checkbox"/> Business Management	<input type="checkbox"/> Salesmanship
<input type="checkbox"/> Industrial Management	<input type="checkbox"/> Advertising
<input type="checkbox"/> Personnel Organization	<input type="checkbox"/> Better Letters
<input type="checkbox"/> Traffic Management	<input type="checkbox"/> Show Card Lettering
<input type="checkbox"/> Business Law	<input type="checkbox"/> Stenography and Typing
<input type="checkbox"/> Banking and Banking Law	<input type="checkbox"/> Business English
<input type="checkbox"/> Accountancy (Including C.P.A.)	<input type="checkbox"/> Civil Service
<input type="checkbox"/> Cost Accounting	<input type="checkbox"/> Railway Mail Clerk
<input type="checkbox"/> Bookkeeping	<input type="checkbox"/> Common School Subjects
<input type="checkbox"/> Private Secretary	<input type="checkbox"/> High School Subjects
<input type="checkbox"/> Spanish <input type="checkbox"/> French	<input type="checkbox"/> Illustrating

TECHNICAL AND INDUSTRIAL COURSES

<input type="checkbox"/> Electrical Engineering	<input type="checkbox"/> Architect
<input type="checkbox"/> Electric Lighting	<input type="checkbox"/> Blue Print Reading
<input type="checkbox"/> Mechanical Engineer	<input type="checkbox"/> Contractor and Builder
<input type="checkbox"/> Mechanical Draftsman	<input type="checkbox"/> Architectural Draftsman
<input type="checkbox"/> Machine Shop Practice	<input type="checkbox"/> Concrete Builder
<input type="checkbox"/> Railroad Positions	<input type="checkbox"/> Structural Engineer
<input type="checkbox"/> Gas Engine Operating	<input type="checkbox"/> Chemistry <input type="checkbox"/> Pharmacy
<input type="checkbox"/> Civil Engineer	<input type="checkbox"/> Automobile Work
<input type="checkbox"/> Surveying and Mapping	<input type="checkbox"/> Airplane Engines
<input type="checkbox"/> Metallurgy <input type="checkbox"/> Mining	<input type="checkbox"/> Agriculture and Poultry
<input type="checkbox"/> Steam Engineering <input type="checkbox"/> Radio	<input type="checkbox"/> Mathematics

Name.....
Street.....
Address..... 0-3-23
City..... State.....
Occupation.....

Persons residing in Canada should send this coupon to the International Correspondence Schools, Canadian, Limited, Montreal, Canada.

"The \$3700 Coupon"

"When I enrolled with the I. C. S., I was making \$25 a week. To-day I am earning \$5000 a year. That's a difference of \$3700 a year—all due to spare-time study. Do you wonder that I am glad I took up that I. C. S. course? It was the best investment I ever made."

Every mail brings letters from students of the International Correspondence Schools telling of advancement and larger salaries. The increases voluntarily reported in a single year totaled more than two million dollars. And there were thousands of increases not reported.

How much longer are you going to wait before taking the step that is bound to bring you more money?

The "\$3700 coupon" is printed above. It doesn't cost you a penny or obligate you in any way to cut it out and mail it to Scranton. Yet that one simple little act may be the means of changing your whole life. Do it now!

INTERNATIONAL CORRESPONDENCE SCHOOLS
Box 6211-C, Scranton, Penna.

MAKE MONEY AT HOME

YOU CAN earn \$1 to \$2 an hour writing show cards at home in your spare time. Quickly and easily learned by our new simple "Instructograph" method. No canvassing or soliciting. We show you how, guarantee you steady work at home, no matter where you live, and pay you cash each week. Full particulars and booklet free. Write to-day.

AMERICAN SHOW CARD SYSTEM LIMITED
Authorized and Fully Paid Capital, One Million Dollars
110 Adams Bldg. Toronto, Canada.

LEARN WATCH REPAIRING



You can learn by our modern and original system of instruction every part of the Watch Repairing Trade at home as good or better than at a shop. You can earn money while learning and secure a well paying position or start in business after completing our course of instruction. Good watch repairers are always in demand and earn from \$30 to \$65 per week. For particulars apply to the

MILWAUKEE SCHOOL OF WATCH REPAIRING, 166 Mason St., MILWAUKEE, WIS.

Book Review

(Continued from page 692)

DIRECTION AND POSITION FINDING BY WIRELESS. By R. Keen, B. Eng., A.M., I.E.E. Cloth covers, size 5½" x 8½". 376 pages. Illustrated. Over 250 photographs and diagrams.

This book completely covers every phase of the principles and practice of direction and position finding developed in wireless. From early experiments up to the present improved system, nothing has been left out. This treatise not only deals with the principles of the subject but also with the construction details of direction finding installations for shore service and for the navigation of ships and aircraft; also with such subjects as the use of special maps for D. F. work, the freak phenomena which cause errors in bearing peculiar to the D. F. receiver. The last chapter on field and nautical astronomy is very useful in connection with the practical application of direction finding.

THE BOOK OF THE SKY. By M. Luckiesh. Illustrated, hard covers, size 5¾" by 8½", 236 pages. Published by E. P. Dutton & Co., New York City.

The General Electric Company has attracted to its service some of the most eminent scientists of America, among them Dr. Luckiesh, who is the Director of Applied Science at the Nela Research Laboratories. The book is not devoted, as its title might seem to indicate, to astronomy, but to meteorological phenomena and to aviation. Most picturesque descriptions of the practical work of aviation and the performance of feats, take many pages and give most interesting reading. The book is so good, so handsomely printed, and so beautifully illustrated, that it is with regret that we state it has no index.

ASTRONOMY FOR YOUNG FOLKS. By Isabel M. Lewis. Fully illustrated, hard covers, size 5¼" x 8½", 267 pages. Published by Duffield and Co., New York City.

It was with no small feelings of interest and friendship that we opened this book. Mrs. Lewis is a true friend of our readers. Her most interesting papers have been one of the great attractions of SCIENCE AND INVENTION. She has the art of presenting what seem to be the abstruse parts of astronomy in so popular a way, as to make it all thoroughly good reading. Much of the text of this book is made up from articles which have appeared in "St. Nicholas" and in SCIENCE AND INVENTION, and revision has been used where necessary to simplify the treatment, so as to bring the topics within the comprehension of a child. It is not too much to say when this is done with so difficult a subject as astronomy, that its degree of success measures the ability of the author. It is curious to read in the light of a paper at a recent meeting of the Association for the Advancement of Science, the uncertainty that exists surrounding the temperature of meteorites. So many of our readers have followed with deep interest Mrs. Lewis' papers as they have appeared in our columns that the book will be of special interest to them. We regard it as a great pity that it has no index, for it certainly contains a mass of information.

THE BOOK OF RADIO. By Charles William Taussig. Profusely illustrated, hard covers, size 5½" x 8¾", 447 pages. Published by D. Appleton and Co., New York City.

The descriptive title page in this book states that it is a complete simple explanation of radio reception and transmission, and an interesting comment on the development of radio would seem to be deducible from the fact that its alleged simple explanation fills upwards of four hundred octavo pages. When we examine the book, the impression made is certainly one of clearness and simplicity, and its numerous illustrations and diagrams, nearly two hundred in number, tell its story in very good shape. The section devoted to radio amateurs, in which very many instances are given of true service to the Government by amateurs is interesting. So it would seem that the American system, not so much of favoring amateurs, as of letting them alone, has had an excellent effect. The War brought out the fact that the army of amateur radio operators was a thoroughly loyal one and they are to be credited with good war work. The book is adequately indexed.

(Continued on page 696)

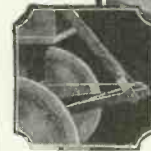

Sharp turns are easy for the Auto Wheel

Sharp turns are easy for the Auto-Wheel Coaster even with the heaviest load. The special hound brace which runs from the tongue through the steering pivot to the bed of the wagon gives you the supporting strength which you need for easy steering.

Auto-Wheel Coasters and Auto-Carts

This special hound brace is only one of the features which make Auto-Wheel Coasters sturdy, substantial, easy to control. Other features are: rubber-tired disc wheels; steel-tired disc or wood spoke wheels—all wheels interchangeable; hand brake; special hub cap and locking pin; sides mortised as well as nailed; self-contained roller bearings.



Auto-Cart

Write for catalog which shows all models of the Auto-Wheel Coaster and the Auto-Cart, the Auto-Wheel's junior companion for little brother and sister. Send the names and addresses of three local coaster wagon dealers and we will give you a year's subscription FREE to the "Auto-Wheel Spokes-man" a dandy magazine for boys.

AUTO WHEEL COASTER CO., Inc.
North Tonawanda, N. Y.

FINE OLD VIOLINS

On Easy Payments 30 Days Free Trial

allowed, no matter where you live. If not more than pleased with our values return violin AT OUR EXPENSE—and no harm done. Ability to play the violin brings social and financial success. Get a violin with a rich, mellow tone and it will create in you a desire to master it.

Free! Magnificent Album-Catalog

containing portraits of the world's greatest violinists since Paganini's time, a half-tone of "Stradivarius in his Workshop" and the romantic story of the King of Musical Instruments. A postal brings all to you FREE—no obligations.

Old Violins Bought, Sold, Exchanged and Repaired

Send in your old violin by insured parcel post for examination. We may be able to make a very valuable instrument out of it at small cost. Many violins that were considered worthless brought high prices after they left our repair shop. No charge for estimates.

CREMONA VIOLIN SHOP, CHICAGO
FORTY-THIRD & SHIELDS AVE., DEPT. M-51

BATTERY CHARGING RECTIFIER and LARGE STORAGE BATTERY \$20

Battery Charger of well known make connects to any lamp socket. Recharges battery overnight at 5 amp. rate. Furnished with long charging cable with battery clips. Battery is 6 volt, large capacity. Specify whether used for auto or radio. Guaranteed for one year. Act at once, as we have only a limited number of this combination offer at this bargain price. Send money order, or will ship C. O. D. on 25% deposit.

BELMONT BATTERY CO.

3231 Sheffield Ave. Dept. 2. Chicago, Ill.

This ONE-TUBE Set Operates a LOUD TALKER

Build It With Consrad Pattern No. 8



How to Make an Autoplex Receiver

The "Autoplex Receiver" is the long expected one-tube set that will work a loud speaker. This circuit was invented by M. L. Muhleman of the Radio News Staff and is bound to become popular because it will operate wherever placed and requires but a ground connection. Every station within its range is amplified sufficiently for a loud speaker. Tuning is very simple, there being but two controls. It is inexpensive as to parts and easy to construct. Any tubes from the "peanuts" up to the "big ones" can be used. This receiver knows no such thing as "critical filament adjustment." It will receive the high powered trans-Atlantic stations without any changes in the circuit; a twist of the dials and the broadcast stations come in.

The complete plans for the construction of this set are contained in a three-colored, heavy manila packet, 9x12 inches and consist of full sized blue print for wiring and drilling and also a four-page instruction pamphlet giving complete details even as to tuning. Price complete..... **50c.**

Other Popular Patterns of the Consrad Line

How to Make a Neutrodyne Receiver—50c.

This pattern gives the complete assembly, wiring, adjusting and tuning of a five-tube Neutrodyne receiver. This type of receiving outfit was brought out after extensive experimenting and is noted for its very efficient radio frequency amplification. All the disadvantages of ordinary radio receivers, such as distortion and re-radiation are eliminated. The circuit is also noted for keeping the tubes from oscillating. Put up in heavy manila packet, 9x12, cover in three colors, full size blue prints for drilling and wiring and four-page instruction pamphlet.



How to Make a Reinartz Receiver

The original Reinartz Receiver is the most popular type of set in existence today. It gained its popularity through its simplicity of operation and capability of long-distance reception. Full directions for building this receiver are given in this folder. The construction of the coil—the most difficult part—is made easy with the concise instructions we furnish. The connections of the set are shown plainly, so that the novice will have no trouble in following them.

50c.

14 Radio Formulae and Diagrams

With this packet of radio knowledge you need never worry about schematic wiring diagrams, measurements and radio tables. All formulae and diagrams are printed on heavy paper in black and blue; and contained in two-color printed envelope, 9x12 inches.

50c.

How to Make a Cockaday Receiver

The Cockaday four-circuit tuner is one of the latest advancements in radio. Its main advantage lies in the fact that the set can be adjusted to the highest point of regeneration, and tuning accomplished over a wide band of wave-lengths without the necessity for readjusting the regeneration control. The set described in our folder was designed and built at our own shop. All dimensions, size of wire, number of turns, etc., are given, leaving nothing to the imagination.

50c.

AM About Aerials and their Construction

These blue prints were made after practical erection of each aerial, and point out how simple it is to erect not only the proper aerial for your particular need, but how to erect this aerial in the most practical manner and at the least expense. Consists of 12 blue prints 8½x11 inches and one four-page instruction pamphlet 8½x11 inches.

50c.

How to Make a Reflex Receiver

The plans for the reflex receiver were gotten out only after considerable research work by our engineers. Most people have trouble with reflex receivers. It takes an expert to build one that will work satisfactorily. The trouble lies in the values of condensers, etc., in the circuits. If they are incorrect, the set is a dismal failure. The constructional details of a reflex receiver, contained in this folder, are the results of their successful efforts.

50c.

20 Radiophone Diagrams and Hook-Ups

These diagrams show how to get the best possible efficiency from the instruments you make or purchase. They cover hook-ups from the simplest to the most complicated, in a way that any amateur can understand and follow without difficulty. Printed on heavy paper, 8½x11½ inches, and together with KEY CHART OF SYMBOLS and pamphlet "How to READ DIAGRAMS", are contained in a heavy two-color envelope.

50c.

For other patterns we publish see page 718 of this issue

If your dealer cannot supply you, order from us, giving his name and address

The Consrad Co.
INC.
Formerly The Consolidated Radio Call Book Co.

233 Fulton Street, New York City
Publishers of Consolidated Patterns and Sales Agents for E. I. Co. Books

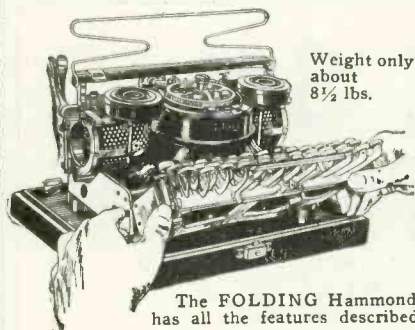

Weight only about 8½ lbs.

The FOLDING Hammond has all the features described

Revolutionizing the Entire World's Conception of Typewriter Performance

THIS is the most important and only radical advance in typewriter design since visible writing was developed some thirty years ago.

While revolutionary in its accomplishments, the New Hammond is proved to its smallest detail, for it is the natural outgrowth of James B. Hammond's original invention and is the culmination of over 50 years' development of the Hammond principle of typewriter construction.

It would be impossible to incorporate the New Hammond's striking improvements in any typewriter of conventional design.

The Wonderful New Variable Spacing Feature

makes possible the use of interchangeable types of various styles and sizes because the spacing between characters can be instantly adjusted to conform to the width of type employed.

2 Styles of Type or 2 Languages always in the machine; changed at the turn of a knob.

Interchangeable Type Shuttles, placing at the disposal of every Hammond owner 17 different styles and sizes of type and special characters for more than 50 languages.

Variable Spacing Feature giving uniform spacing between letters for all the different sizes of type.

Automatic Touch assuring uniform impression of each character—like a printing press—whether the key is touched lightly or pressed heavily.

Ball Bearing Carriage.

Writes Index Cards Without Bending Them. Takes Paper of Any Width.

THE NEW Hammond VARIABLE SPACER TYPEWRITER

Write for Descriptive Booklet illustrating the many unusual uses of the New Hammond, and giving name of nearest Branch or Dealer, who will gladly demonstrate the machine to you.

Hammond Typewriter Corporation
544A East 69th Street New York

Book Review

(Continued from page 694)

ICE AGES. By Joseph McCabe. Hard covers, size 5" x 7½", 134 pages. Published by G. P. Putnam's Sons, New York City.

This little work is quite interesting. It is written entirely from a popular standpoint, the author attempting to cover the subject in one hundred and thirty-four pages. It is quite an interesting presentation of a subject, which might be a very dry one; the comparatively few illustrations are quite to the point. The author upholds the work of Darwin, bringing out the point that his original views on animated nature are only too often misunderstood.

THE NEW AIR WORLD. By Willis Luther Moore, Sc.D., LL.D. Illustrated, hard covers, size 5½" x 8½", 326 pages. Published by Little, Brown and Co., Boston, Mass.

This is preeminently a practical little book, enough science being mingled with it to give it a pleasant aspect. The taking of weather observations, how the atmosphere is explored by small balloons, which are liberated with automatic registering instruments, light, heat and temperature, and humidity, and the general branches of meteorology, are given. A considerable space is given to the forecasting of the weather, and in this same section some illustrations of the work of tornadoes, such as the driving of common straws, fragile as they are, one-half inch into wood. A shovel driven into a solid tree to a depth of six inches, is an example of what the wind can do. One chapter is devoted to how climate is controlled. This does not mean that man can control it of course, but it tells how the features of the earth's surface do it. The question of the change in climate comes in, something which people are never tired of discussing, and an interesting chapter is devoted to climates for health and pleasure. An exceptionally good index closes this very interesting book.

ORGANIC CHEMISTRY. By W. H. Perkin, Ph.D., and F. Stanley Kipping, Ph.D. Illustrated, hard covers, size 4¾" x 7¼". Published by J. B. Lippincott Company, Philadelphia, Pa. Two volumes, total pages 666.

If our readers are interested in Tetramethyl-p-diaminotriphenyl-methane and other such luminous products of the chemist's art, he will find himself well taken care of in this little work. It is in two volumes, with six hundred and sixty-six pages of text. It is simply impossible to review it in the space allotted to us for individual books, but we can only say that it seems to be very well arranged and certainly is very full. The equations are given with the old-fashioned equality sign instead of arrows, a feature, which to the older chemist is not unwelcome, for some of the recent improvements are more or less disconcerting to the graduates of the last century. Although this is all we can say of the book in this hasty review, we certainly do strongly recommend it. The two volumes in which it appears, make it exceedingly convenient for a reference, and in it we get the usual view of the science. Speaking of carbohydrates, the author remarks on the change of nomenclature, which has been brought about by the inclusion in the group of nearly related compounds, in which the hydrogen and oxygen no longer exist in the proportions as in water.

LABORATORY GLASS BLOWING. By Bernard D. Bolas. Fully illustrated, hard covers, size 5" x 7¾", 106 pages. Published by E. P. Dutton & Co., New York City.

There is something fascinating in watching a glass blower at work, one always desires to do the same, and it is for people having that ambition, that this book is written. It is designed absolutely for the chemist, and amateur, yet it is fair to say that anyone who masters its contents to the degree of being able to make what is shown in it, will be a skillful operator. It takes skill to make even simple potash bulbs. No two people work glass in exactly the same way, so we find certain discrepancies from our own point of view. The art of working glass consists in instinctively "feeling" it, so as to know just how to support it, so that it will not drag out too thin. A rather interesting part tells of using a mouth blow pipe for glass work, which certainly seems to be quite a feat. As small as the book is, it is indexed, so that it is an example to publishers and authors in that regard.

ELEMENTARY DETERMINANTS FOR ELECTRICAL ENGINEERS. By H. P. Few. Illustrated, hard covers, size 4¾" x 7½", 95 pages. Published by D. Van Nostrand Co., New York City.

Determinants on their face represent a very interesting and curious mathematical process;

SEND NO MONEY

THE WILD CAT

Regular Swing-Out, Hand-ejecting, Left-Hand Wheeler Revolver



32.20 or 38 Cal.

6 Shot

\$14.50

A powerful six shot gun; made specially for Rangers, mountaineers and men working in unprotected places, requiring a safe and efficient weapon. Quick as a flash, with great penetrating power and true marksmanship. Made of best blue steel, rifled barrel. Hammer with safety. Fires regular, short and long 32.20 or 38 caliber ammunition. \$14.25.

20 Shot Automatic Pistol



\$8.50

20 Shot—32 Cal.

The biggest bargain ever offered. Built of best blue steel, checkered grip, safety. Every one brand new and inspected. Shoots all standard .32 cal. cartridges. 10 shot, with extra magazine, making 20 quick, hard and straight shots. Buy several while they last, at our unheard of price, \$8.50 (regular \$85). Pocket size, .25 cal. 7 shot, \$7.80.

Send No Money Pay on arrival, our bargain price, plus few cents postage. Satisfaction guaranteed or money back. Order today. NOW.

THE PRICE CUTTING CO., Dept. 725, 55 B'way, N.Y.

MASTER ELECTRICITY AT HOME

A practical man will lead you to success. Write only if you are in earnest. Our FREE Book plainly tells how Burgess Home Training enables men and boys to get good jobs and hold them. Shows world-wide opportunities in electricity. Tells how fellows like you have stuck and studied until now they are on top. Write for your copy TODAY. Romance of real success on every page.

Practical Course Easily Applied

No frills or feathers; no mystery; no bunk. Just honest, helpful instruction, which any one can understand and follow. For the man high in the profession as well as for the beginner. All branches of electricity covered: Hydro-Electricity, Alternating Current, Motors, Power-Plant Practice, Slide Rule (30 additional lessons), Automotive Electricity, Electrical Drafting, Etc. We help you to a position during and after instruction.

Endorsed by Leading Engineers

For Instance: Twelve electrical Engineers of Big Public Utility Corporation critically examined our course—approved it thoroughly. Result: Fifty-five young men in that plant became students. The course for you if you mean business. Write for fully illustrated book TODAY.

New Radio Course Now Ready

BURGESS ELECTRICAL SCHOOL
YORKE BURGESS, Superintendent
Dept. 11, 745 E. 42nd St. CHICAGO
Canadian Branch: 201 B. Crawford Street, TORONTO

BLANK CARTRIDGE PISTOL

PRICES
50c.
\$1.00

Well made and effective; modeled on latest type of Revolver; appearance alone is enough to scare a burglar. When loaded it may be as effective as a real revolver without danger to life. It takes standard .22 Cal. Blank Cartridges obtainable everywhere. A Great Protection Against Burglars, Tramps and Dogs. You can have it lying about without the danger attached to other revolvers. PRICE 50c Postpaid; Better make and superior quality for \$1.00. Blank Cartridges .22 cal., shipped express 50c per 100. JOHNSON SMITH & CO., Dept. 13, Racine, Wis.

Build It Better—Quicker—Easier

with a JUNIOR BENCH SAW



Does your ripping, mitering, grooving, rabbeting, tenoning, sanding, grinding and many other operations with surprising ease and accuracy. Top 10"x13". Saws 1½" stock. Dadoes ½"x½". Machine built entirely of metal. Driven by ¼ or 1/3 h.p. motor. Portable. Attaches to any light socket. Extremely accurate. Descriptive circular tells many things of interest to workers in wood and soft metals.

W. & J. BOICE, Dept. S. I. 11, Toledo, Ohio

their evaluation as applied to the solving of simultaneous equations, is exceedingly interesting, and here we have them applied to electrical problems. They are supposed to be a short road to answers and we find them applied to such problems as the finding of the resistance of a net, and applied to Maxwell's classic rule for net works, which in its simplicity, and power of solving most difficult problems of net-works, is an exceptionally interesting method of real numerical solutions. We are glad to say that the ninety-five pages of this little book, which may be said to be unusually full for its size, are indexed.

HOW TO MAKE LOW-PRESSURE TRANSFORMERS. By Prof. F. E. Austin. Fully illustrated, hard covers, size 4½" x 7¼", 22 pages. Published by Professor Austin, Hanover, N. H.

This book is printed in green ink, and for that reason presents a rather peculiar appearance. It is very short but quite to the point, with numerous illustrations, considering its very limited size, and certainly quite businesslike in its aspect. The colored ink presumably is used to spare the reader's eyes, although it is an open question whether it does so. We are sure our readers will appreciate it.

GRAVITATION VERSUS RELATIVITY. By Charles Lane Poor. Illustrated, hard covers 5½" x 8¼", 277 pages. Published by G. P. Putnam's Sons, New York City.

Professor Poor, the very distinguished Professor of Celestial Mechanics in Columbia University, has in this book presented a most interesting treatise on astronomy. In thus defining it, the reviewer feels he is not going a step too far, for it includes any quantity of detail as to the practical work of astronomers, the limits of accuracy of their determinations, and so much general information on the subject of observatory work, that it is a most interesting book even from that standpoint alone. When we hear so much of the Michelson-Morley experiments, it is very interesting to find presented here photos of the interferometers as used to test ether drift. The frontispiece shows the site on Mount Wilson where the interferometer house is situated and here at an elevation of 6,000 feet indications of ether drift were actually obtained, which goes to invalidate the Einstein theory. The book is written specifically to combat Einstein and Professor Poor gives a wonderfully good description of the experimental and observational basis of the Einstein theory. The illustrations are quite to the point. For those of us who cannot quite swallow everything in the Einstein theory, who find it hard to believe that according to the Lorentz-Fitzgerald contraction theory, a Pullman car is shorter when in motion than when standing still, it is refreshing to find it contested by so high an authority. The diagrams in the book are especially illuminating, and a very interesting reproduction of the photograph of the 1921 interferometer is especially to be noted. The book will repay not only one but several careful perusals. It has an excellent index and is very well made up. Professor Poor makes a very usual mistake in taking the Pythagorean proposition of the square of the hypotenuse as being the Pons Asinorum. The Century Dictionary notes this as a mistake frequently made.

THE GLANDS REGULATING PERSONALITY. By Louis Berman, M.D. Hard covers, size 8½"x5½", 300 pages. Published by The Macmillan Company, New York City.

Dr. Berman's book, GLANDS REGULATING PERSONALITY, is certainly a triumph in the field of humanizing technical discoveries regarding the human body. The author leads one by easy stages into a comprehensive knowledge of the deep influence our glands of internal secretion exert over our every action.

According to Dr. Berman, there are at present known to be eight major glands in the human body, which divide among themselves absolute control of not only the growth and development of the body, but also of the activities in which the body will most naturally find its greatest energy expression.

They are, then, the Thyroid (Gland of energy production), the Pituitary (Gland of energy consumption and utilization—continued effort), the Adrenals (Gland of combat), the Pineal (Gland of brain and sex development), the Thymus (Gland of childhood), the Interstitial (Glands of secondary sex traits), the Parathyroids (Controllers of lime metabolism), and the Pancreas (Controller of sugar metabolism). The relative strength and weakness of these glands provide the pattern upon which individual human personality is built.

In fact, Dr. Berman calls the Glands of Internal Secretion the "Interlocking Directorate" of our daily affairs. To quote:

"Behind the body, and behind the mind is this board of governors. Indeed, from the administrative and legislative points of view, the body-mind may be said to be governed by the House of Glands. It is the invisible committee behind the

No Matter What Your Vocation

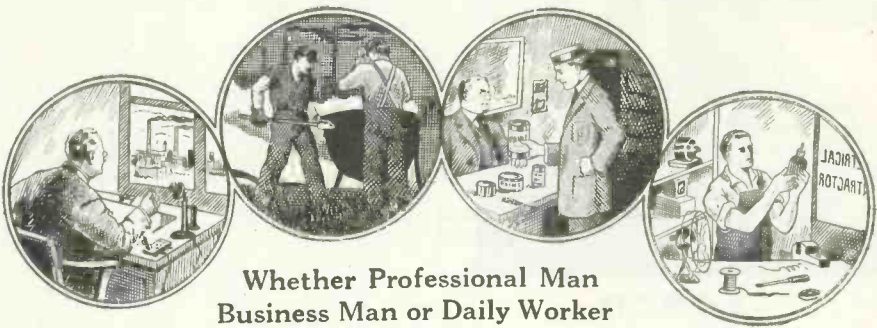

Whether Professional Man
Business Man or Daily Worker

A Thorough Training In CHEMISTRY Will Help You To Get Ahead

TO be successful today is to know Chemistry! Every line of business, every branch of industry depends upon Chemistry in some form. You may not realize it, but your own proficiency in whatever work you are doing would be increased by a knowledge of Chemistry. In many lines such knowledge is absolutely essential. In others it is a guarantee of promotion and more money.

The keen competition that exists in every commercial activity today requires that a man know all there is to know about his vocation. If you have something to sell—no matter what—Chemistry enters into its make-up. The salesman who knows the chemical composition of his article can talk about it more intelligently than the one who lacks this information, and his sales are proportionately larger. In the building trades Chemistry is of prime importance. The mason, electrician or painter who knows something about Chemistry can do better work and command more money than the one who does not. Through Chemistry a shop-keeper learns how to attract the most trade, and even in clerical positions one can capitalize his chemical skill.

Chemistry should be as much a part of your mental equipment as the ability to calculate or to write correct English. The world is paying a thousandfold more for ideas than for actual labor. The big rewards go to the man who can show how to turn out a little better product at a little lower cost. And Chemistry will give you the ideas that will save money for your self or your firm in the very fundamentals of your business. There is nothing remarkable about this; it is going on every day. If you have not heard of it before, it is because the general public has been slow to recognize the tremendous value of chemical training. People have been content to leave Chemistry in the hands of a few trained chemists who could not possibly develop the subject to anywhere near its greatest extent.

Now we are on the eve of a great awakening. Our heritage from the World War has been an intense development of the chemical industries in the United States and a tremendous interest in all the applications of Chemistry. People are taking up the subject merely for the good it will do them in their own line of business.

It is no longer necessary to enter college in order to learn this fascinating science. Our Home Study Course trains you just as thoroughly, and with the same assurance of success, as those who took the longer way. And our methods are so simple that we can teach you no matter how little previous education you may have had. Many of our graduates now hold responsible positions or have materially increased their incomes from private enterprises as a result of taking our course. Hundreds of letters from students testifying to the benefits they have derived from our training are here for your inspection.

Remember that you do not need to study Chemistry with the idea of actually practicing as a chemist, although a great many of our students are taking our course with this object in view. If you want to know more about what Chemistry will do for you, if you want to know what our home study course offers, sign and mail the coupon today for FREE BOOK "Opportunities for Chemists."

**Chemical Institute
of New York, Inc.**

Home Extension Division 11

66-D West Broadway, New York City

**DR. T. O'CONOR SLOANE Will
Teach You Chemistry In
Your Own Home**

The Chemical Institute of New York, of which Dr. T. O'Conor Sloane is Educational Director, was founded to fill the need of ambitious, far-sighted men who realize and recognize the splendid future Chemistry offers them, but who cannot spare either the time or the money to attend college. Dr. Sloane, a foremost authority on Chemistry, will teach you and will give you any individual help you may require. He will personally go over your papers, correct them, point out your faults, teaching you in a practical and interesting way. No special education required other than the ability to read and write English. One student has characterized our lessons as "The course that takes the mystery out of Chemistry."

**Read What One of Our Recent
Graduates Reports**

"I thought I would let you know of my success. I finished your course about two months ago and now have a fine position as chemist at the DuPont Dye Works. I am getting along fine with my work and like it very much. It was through your course alone that I have been so successful. It is wonderful and I hope you have great success with it.

(Name and Address on request).

Easy Monthly Payments

You do not have to have even the small price of the course to start. You can pay for it in small monthly payments—so small that you won't feel them. The cost is very moderate, and includes everything, even the Laboratory Equipment—there are no extras to buy with our course. Our plan of monthly payments places a chemical education within the reach of everyone.

**Laboratory Equipment Given
To Every Student Without
Additional Charge**

We give to every student without additional charge his chemical equipment, including forty-two pieces of laboratory apparatus and supplies, and seventeen different chemicals and reagents. These comprise the apparatus and chemicals used for the experimental work of the course.

Special 30-Day Offer

For a short period we are making a special offer that will be worth your while to take advantage of. Write for particulars, using the coupon below or simply a postal card. This will not obligate you in the least. Do not wait until to-morrow. Send the coupon now while you think of it.

**Sign and Mail the Coupon for
FREE BOOK**

CHEMICAL INSTITUTE OF NEW YORK, Inc.
Home Extension Division 11,
66-D—West Broadway, New York City.

Please send me at once without any obligation on my part, your Free Book "Opportunities for Chemists," and full particulars about the Laboratory Equipment furnished to every student. Also please tell me about your plan of payment and your special 30 day offer.

NAME

ADDRESS

CITY

STATE

S&I 11-23



Learn Electricity

How would you like to earn two or three dollars every evening after school and prepare yourself for a fine big job at the same time? Here's the opportunity of a lifetime for you fellows who like Electricity. Begin right now to prepare yourself for a regular man's size job in this fascinating field. Your chances for a big success are simply wonderful—the pay is big (\$70 to \$200 a week) and advancement comes swift and sure.

I Will Train You at Home

Look What This Boy Is Doing

"Although the School term is coming to a close, and I am pretty busy with my examinations, I manage to keep up with my electrical studies and work."
"I guess I forgot to tell you I am now in business for myself. Am doing fine, but I owe it all to you. If it had not been for your Course, I, being under age, could not have secured my license in this town. But I got it, and now have all the work I can do, averaging \$20 to \$30 a week thru spare time work."
"I went out on a job tonight after school, on which I made \$3 and brought home another on which I made \$2.50—\$5.50, for 4 hours' work and no material furnished by me."
— Roger Smith, 1215 Chestnut St., Greenville, N. C.

With my easily learned, spare time Electrical Course I will train you at home like I have trained hundreds of other boys who are now big successful men. It will not interfere with your school work and you can earn more than the small cost of the course doing odd electrical jobs in your spare time. The Course pays for itself. I will show you how to get this work and how to do it. Some of my boy students make \$10 to \$15 a week this way.

Tools, Apparatus and Radio Course FREE

Send me the coupon below and I will tell you all about the big outfit of tools, apparatus and instruments and a new Radio Course that I am giving to my students for a limited time. I will send you my big interesting Electrical Book and a sample lesson, too—all Free. You will be tickled with the things I will send you Free. Mail the coupon right now.

L. L. COOKE, Chief Engineer
Chicago Engineering Works
Dept. A-28, CHICAGO

Use this Free Outfit Coupon!

L. L. COOKE, Chief Engineer,
Chicago Engineering Works,
Dept. A-28, 2150 Lawrence Ave., Chicago
Send me your Free Outfit Offer, your big Electrical Book, Sample Lesson and particulars of your Electrical Course and Free Radio Course. This will not obligate me in any way.

Name

Address

For use of boys 15 years old or more.

\$4.00 ADDING MACHINE



The GILSON ADDER will do your figuring easily, quickly and with absolute accuracy. It adds, subtracts, multiplies and divides and automatically carries from one column to the next. Capacity 109,999,999 or 1,099,999.99. Size 3 1/2" x 6" x 1 1/4". Made with aluminum case and steel operating parts. Written Two-Year Guarantee. Catalogus free.

Price, postpaid, \$4.00
Your money back if you are not satisfied.

GILSON SLIDE RULE CO., NILES, MICH.

A THRILLING CAREER

Become a reporter and news writer at home. Practical New York newspaper men quickly teach you this fascinating, well-paid work. Personal instruction in Reporting. Writing for Out-of-Town Papers, Sports, Publicity, Society, etc. You can earn \$100 to \$400 monthly, part or whole time. Men and Women. Metropolitan School of Journalism, 40 East 42nd St., Dept. 115 New York, N. Y.

Become A Reporter! FREE BOOK Tells All

throne. Upon the throne is what? Man, the most baffling of complexities. Man who is not a mind, but owns a mind—Man who is not a body, but possesses a body, just as he might have a motor car, a fortune or a calamity. Back of all his daily activities, behind the life of body-mind is the mysterious unique individuality, the Ego, the Psyche or the Soul. Lately a competitor with these ancient and honorable terms has come upon the scene as the Subconscious. In that darkened No Man's Land is determined a man's destiny. The endocrine association stands out as at least the most important physical detriment of the states and processes of the subconscious."

PRACTICAL RADIO. By Henry Smith Williams. Stiff covers, size 5" x 7 1/2". Published by Funk & Wagnalls Company, New York, N. Y.

The book is an excellent treatise on radio from the amateur's standpoint, and beginning with the very simplest installation of receiving apparatus; antennae and grounds, the author leads the reader up to the more complicated sets, employing many stages of amplification. The action of the various instruments in a radio receiving outfit is very clearly shown, and the functioning of both crystal and audion detectors is made very plain by means of diagrams.

Aside from showing how to hook up, various types of radio sets, the author enters into the construction of several of them, giving the electrical characteristics and all other necessary data.

The book is up-to-date in every way and fully illustrated. A complete table of contents and cross index aid materially in locating any particular item desired.

IM KAMPF UM DEN GIPFEL DER ERDE. By Walther Flaig. Hard covers, size 7 3/4" x 5 1/4", 76 pages. Profusely illustrated. Published by Kosmos, Stuttgart, Germany.

We have often had occasion to comment on the very attractive little series of books published by the German scientific journal "Kosmos." In the present one it treats of the Himalaya Mountains, and puts the question as to whether Mt. Everest or Tschomo-Mungma is the higher, or is to be called the apex of the earth. It describes the attempt to reach the summit, and with numerous very picturesque little cuts, makes most interesting reading. Many animals are shown and a number of the illustrations are devoted to features on the life of the country, and the costumes of the inhabitants, while the representations of the approach to the summit are quite impressive. The book is certainly to be warmly commended to our readers. The portraits of the explorers, General Bruce, Dr. Mallory and Lieutenant Finch, show very determined looking faces. The book gives credit to General Bruce as being the leading authority on the practical attack on the Himalayas. The highest credit is given to the English climbers, and a picturesque description of their hardships on the mountains included.

X-RAYS. By G. W. C. Kaye, O.B.E. Hard covers, size 5 1/2" x 8 3/4", 319 pages. Fully illustrated. Published by Longmans, Green & Co., New York City.

This very excellent work is specially to be commended for its very first page and its last pages. The first page gives in tabular form the data, nature, and properties of the various kinds of rays, based on electrical considerations and taking them as carriers of positive or negative electricity in some cases, such as cathode and Leonard rays, and in other cases as electrically neutral, such as Hertzian rays, visible light rays and X-rays; the one table contains an astonishing array of data. The last pages which we commend so highly, are an eighteen-page index. We have no room here to review the book at all adequately. It takes up the X-ray largely from the practical standpoint, its production and uses, different kinds of X-ray tubes, precautions to be used by the operator, radiography in detail with many wonderful examples of radiographs. The book is so concise, and so well arranged, that nothing short of a perusal will do it the slightest adequate justice, and we unhesitatingly recommend it to our readers. The tables are of great interest and are admirably selected as are the other appendices, in which various other subjects are covered, besides the data contained in the table.

METALS AND THEIR ALLOYS. By Charles Vickers. Hard covers, size 6" by 9 1/4", 767 pages. Many illustrations. Published by Henry Carey Baird & Co., Inc., New York City.

The old name of Henry Carey Baird holds an honored position among scientific book publishers. For many years he was identified with Philadelphia, but now the publishing house has moved to New York and is devoted as always to the rather serious line of technical books. The writer well

NEW-TREAD TIRES AT 40¢ ON THE DOLLAR



Send No Money!

Here is a real opportunity to cut your season's tire bill notwithstanding advances in prices. For a limited period only we offer our famous New-Tread Tires—as illustrated—at less than 1/2. Made of NEW LIVE RUBBER and built on the best carcasses money can buy.

Special Sale Prices

Size	Tire	Tube	Size	Tire	Tube
28x3	\$4.95	\$1.25	36x4	\$8.65	\$2.35
30x3	4.95	1.35	32x4 1/2	8.85	2.40
30x3 1/2	5.85	1.40	33x4 1/2	9.00	2.45
32x3 1/2	6.50	1.50	34x4 1/2	9.15	2.50
31x4	7.00	1.60	35x4 1/2	9.25	2.60
32x4	7.50	1.85	35x4 1/2	9.45	2.70
33x4	7.85	2.15	35x5	9.75	2.80
34x4	8.10	2.25	37x5	9.85	2.90

ALL OUR TUBES ARE NEW FRESH STOCK and Guaranteed for One Year. Shipment made same day order is received. Pay on arrival and if not satisfied, return AT OUR EXPENSE. Specify whether straight side or clincher wanted. FIVE PER CENT DISCOUNT when cash accompanies order. DEALER AGENTS WANTED IN EVERY LOCALITY.

STANDARD TIRE & RUBBER CO.
3280 S. Morgan St., Chicago, Illinois

Novelty



Musical Instruments

Not toys—but high-grade practical instruments for Symphony or Jazz orchestras. Great for solo work at Club, Lodge or Legion gatherings or home entertainments. Anyone can play with a few simple lessons, furnished with each instrument.

Musical Pitch Fork Glassophone Jazz-O-Nette
Mando-Zi Harp Musical Saw Honner Sax

Free Trial Try any of these instruments for 15 days. If not satisfied, if you can't learn to play it quickly and easily, return at our expense. Remarkably low prices. Easy Time Payments. Send today for new, illustrated catalog describing complete line.

MUSSEHL & WESTPHAL
436 S. Water Street Ft. Atkinson, Wis.

Electrical Engineering

men with training are in demand. For more than a quarter of a century this school has been training men of ambition and limited time for the electrical industries. Condensed course in Electrical Engineering enables graduates to secure good positions and promotions. Theoretical and Practical Electricity, Mathematics, Steam and Gas Engines and Mechanical Drawing. Students construct dynamos, install wiring and test electrical machinery. Course with diploma complete.

In One Year

Over 3000 men trained. Thoroughly equipped fireproof dormitories, dining hall, laboratories, shops.
Free catalog. 31st year begins Sept. 26, 1923
BLISS ELECTRICAL SCHOOL
308 TAKOMA AVE., WASHINGTON, D. C.

13 WEEKS FOR 15 CENTS

The Pathfinder

SHOWS THE WAY THROUGH THE JUNGLE OF EVENTS

You've heard your neighbor praise the Pathfinder, the wonderful weekly news and story magazine with over half a million subscribers. Unbiased digest of national and world affairs. Check full of just the kind of reading you want. Fun, fashions, question box, books, health—entertainment and instruction for all. Exciting serials and short stories. Send 15c (coin or stamps) today for this big \$1 paper 13 weeks. Money back if not satisfied. Sample copies free.

PATHFINDER, 555 Langdon Sta., Washington, D. C.

25 Cal. AUTOMATIC SEVEN SHOTS

\$5.90 POSTPAID

No. 635 (as illustrated). Blued steel; small, compact. Wonderful bargain. Other 25 cal. Automatics \$6.25, \$9, \$9.50; "Express," 32 cal., \$11.50; Double Action Pistols, 22, 32, 32-20, 38 cal., \$6 to \$18.75. Every article guaranteed new and perfect. Satisfaction or money back. Send \$1. Pay postman balance due. Write for folder—Shotguns, Rifles, Knives, Holsters etc. PACIFIC IMPORT CO., A-4 Hanover Sq., New York

remembers how Mr. Baird himself once told him that he and one of his assistants were the best of all index makers, and the index to this book certainly looks like one of the old Baird indexes, and really would seem to do justice to the exhaustive text. Now turning back we find in the text a great number of alloys treated, entirely up to date. Such subjects as electric furnaces, which are the great development in modern metallurgy, may supply an example of what is spoken of. Numerous illustrations are given. The division of the book takes up one metal after another, one alloy after another, and gives all their properties, the manner of making the different alloys and their qualities. It is more than a book brought up to date, although it is based on the third edition of Brandt's well-known book "Metallic Alloys." We note that such things as aluminum alloys for cooking vessels, for crank cases, for Zeppelin and airplane construction, for piston alloys are included under the one heading of "Aluminum," and in the same chapter, numerous other aluminum alloys are given. Monel metal is treated, white brass is given under the section entitled, "Manganese Bronze and White Brass," and there is an entire chapter on amalgam and other mercury alloys, and another on die casting. It will be seen how extensive is the scope of the book. The analysis of Babbitt metals has an entire chapter devoted to it, and the last chapter gives foundry data, even to such details as first aid in the foundry and treatment of bruises, sprains, burns and gassing.

INDUCTION COILS IN THEORY AND PRACTICE. By Prof. F. E. Austin, E.E. Hard covers, size 5½" x 8½", 64 pages. Illustrated profusely. Published by Professor F. E. Austin, Hanover, N. H.

This is a very brief treatise on its titular subject, all arranged in numbered paragraphs, and taking the shape of practical details of construction and calculations for construction of coils. In spite of its brevity, it is really quite interesting; a section devoted to interrupters, although but a few pages, is very good reading. The mathematical theory is treated of to a certain extent; constructional features, data of copper magnet wire, and various examples of the construction of coils for different purposes, is given.

DAS SCHOOPSCH METALLSPRITZ-VERFAHREN SEINE ENTWICKLUNG UND ANWENDUNG.—By Hanns Gunther and M. U. Schoop. Fully illustrated, 263 pages, size 5¾" by 8¾". Published by Franck'sche Verlagshandlung, Stuttgart, Germany.

Although this book does not seem very large, yet when it is found to contain two hundred and sixty-three pages of close printing, it will be realized that it is actually a full treatise on its title subject, and the title subject is the deposition of metals by spraying. It is a version of the air brush in which melted metal is substituted for the pigment. Very remarkable results are achieved by this process, and many illustrations throughout the book elucidate the matter very thoroughly. We are not prepared to give it an adequate review as the space at our disposal is insufficient, but it is enough to say that it has technical illustrations of the apparatus, as well as of examples of the products, and of the accessories used in carrying out the process. Just as in the case of the air brush, there is involved a certain contamination of the air of the workshop, and this point is not overlooked in the book, one of the illustrations showing a cabinet for carrying off the fumes. The metal spray is produced by melting wire at the apex of the blow pipe, and in a very clear illustration on page 117 two such wires fed at right angles into the flame are shown. Many other illustrations give different ways of effecting the result, some showing the use of the electric arc for producing the melted metal, which, dropping down into the tip of the blast, is atomized and deposited as desired. The familiar liquid-gas tanks appear in some of the illustrations, bringing the air brush vividly before us, and the pistols, as the Germans term the blowpipes, are also well illustrated.

THE QUANTUM THEORY.—By Fritz Reiche. Translated by H. S. Hatfield, B.S., and Henry L. Brose, M.A. Illustrated, 183 pages, size 5" x 7½". Published by E. P. Dutton & Co., New York City.

We should certainly be very slow to attempt to review a work on so abstract a subject. The book in brief is devoted to the exposition of the Quantum theory and allied theories. It is hardly too much to say that the work consists of a mass of mathematics with elaborate explanations accompanying the formulas. The introduction says that the Quantum theory is yet comparatively young, and first saw light in 1900, and the writer depicts the Quantum theory as being absolutely revolutionary. The translation reads very smoothly and it is not too much to say that it is so well done that one would hardly suspect it of being a translation from the very definite German language.



Now Only \$19.50

Recently we clipped \$8.00 off the price of this popular electrical library—made it \$19.50 instead of \$27.50. And more than that, we are offering the easiest terms we have ever made on the Croft books. You now pay \$1.50 in ten days and the balance at the rate of only \$2 a month.

Think of getting this great Home Study Course and Reference Library at \$19.50—a saving of \$8.00! This is a real opportunity! No electrical worker who wants to fill a bigger job can afford to miss it.

You save \$8.00 and have 10 months to pay

Raise your pay with these books

BIG salaries are paid in the electrical field for expert knowledge. The man who knows electricity in all its many phases—the man who has completely mastered the subject from A to Z—can pick his own job and name his own salary. The only way you can earn more is to learn more. Small knowledge means small pay. Learn the way to bigger pay. Become an expert. Croft will show you how.

Croft Library of Practical Electricity

8 volumes—3000 pages—2100 illustrations—flexible keratol

EVERYWHERE the Croft Library is acknowledged as the standard—the leader—in practical electrical training. In the Croft books you will find complete, detailed and up-to-the-minute information on all phases of electricity, motors, generators, armatures, commutators, transformers, circuits, currents, switchboards distribution systems—electrical machinery of every type—wiring for light and power—how to do it mechanically perfect, in accordance with the National Electrical Code—wiring of finished buildings—underwriters' and municipal requirements—how to do a complete wiring job, from estimating it, to completion—illumination in its every phase—the latest and most improved methods of lighting—lamps and lighting effects, etc.

Know electricity as experts know it and get an expert's pay

Fit yourself for a bigger position by knowing electrical practice complete—inside and outside work—central stations and the whole subject. Croft will teach you. He will take you in quick, easy steps from the simplest principles to the complete and economical operation of a great central station. The Croft-trained man wins because he knows the "why" and the "how" of modern electrical practice. Croft has been through the mill. His

knowledge has been gained by shirt-sleeves contact with electrical problems. He has worked his way up from the bottom to the top—from apprentice lineman to electrical engineer for one of the great electrical manufacturing companies. Now he heads his own consulting company, and his name is known in every corner of the electrical world. He is the one man above all others who can show you the way to permanent success.

EXAMINE THEM FREE!

We want you to test our statements—we want you to compare the Croft books with others. Fill in and mail the coupon attached and we will send you the entire set of eight volumes for ten days' Free Examination. We take all the risk—pay all charges. You assume no obligation—you pay nothing, unless you decide to keep the books. Then \$1.50 in ten days and the balance at the rate of \$2 a month. Send the coupon NOW and see the books for yourself.

Send No Money—Just the coupon

Small Monthly Payments—No Money Down

FREE EXAMINATION COUPON

McGraw-Hill Book Co. Inc., 370 Seventh Ave., New York

Gentlemen:—Send me the LIBRARY OF PRACTICAL ELECTRICITY (shipping charges prepaid), for 10 days' free examination. If satisfactory, I will send \$1.50 in ten days and \$2 per month until the special price of \$19.50 has been paid. If not wanted, I will write you for return shipping instructions. (Write plainly and fill in all lines).

Name

Home Address

City and State

Employed by

Occupation

S&I-11-23



A SIX MONTHS' SUBSCRIPTION For Only 25c (This is 1/4 the regular price)

An Army of Boys more than 400,000 strong

are regular readers of THE BOYS' MAGAZINE. This army is gaining recruits every day because this splendidly illustrated magazine contains just the sort of reading every red blooded American boy wants.

We give away \$132.00 in Cash Prizes for the best amateur short stories, drawings, cartoons, articles or radio, mechanics, electricity, etc.

Just think of it! A SIX MONTHS' subscription for only 25 CENTS. Surely you would like to invest this small amount in giving your boy, or boy friend, six solid months of pleasure, entertainment and instruction.

Remit in stamps if more convenient. (On sale at all newsstands 10c a copy.)

THE SCOTT F. REDFIELD CO., INC., 7228 Main St., Smethport, Pa.

I enclose 25 cents for a six months' subscription to THE BOYS' MAGAZINE as per your special half price offer. Enter my subscription promptly and send me my first copy of THE BOYS' MAGAZINE by return mail.

You agree to return my 25 cents at once should I not be more than pleased with THE BOYS' MAGAZINE.

My Name is My Address is (Please write plainly)

3 Brings you a Genuine UNDERWOOD TYPEWRITER. 10 DAYS FREE TRIAL. GREAT PRICE SAVING. EASY MONTHLY PAYMENTS. FREE BOOK OF FACTS. Act Today! Mail Coupon. 5 Year Guarantee. Shipman Ward Mfg. Company. 2168 Shipman Building. Montrose & Ravenswood Aves., Chicago.

Radio Wrinkles CONTINUATION OF RADIO DEPARTMENT

Under this heading we are going to publish items of interest to everyone who likes to build radio instruments. In order to continue this department it is necessary for our readers to tell us about their latest experiments. So write us a short description of some time- or money-saving kink you have discovered and send it to us along with a few sketches.

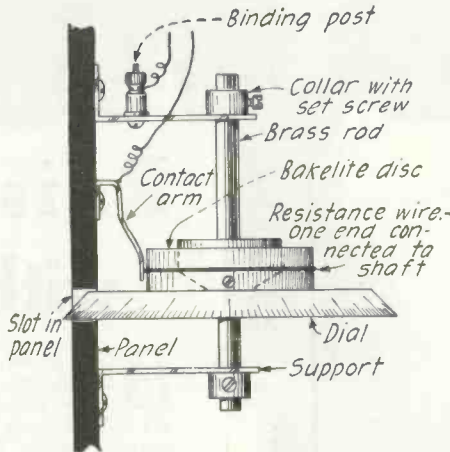

A vernier rheostat with professional appearance may be made from a bakelite knob and dial as shown above. The rheostat is actuated from the front of the panel by turning the edge of the dial. Use in series with a standard rheostat. —Merrill Bolyard.

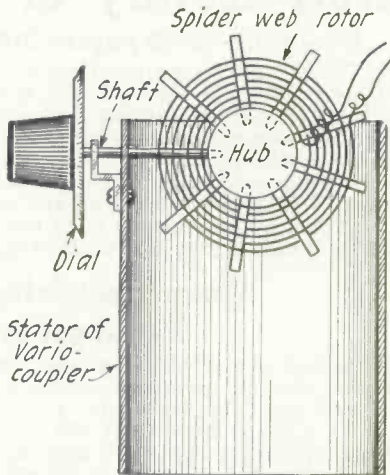

A simple method of winding and mounting a spider web coil rotor in a variocoupler is illustrated above. Both bearings are located on one side of the stator. For standard work, 40 to 60 turns of wire should be wound on the rotor. —Verl A. La Vanway.

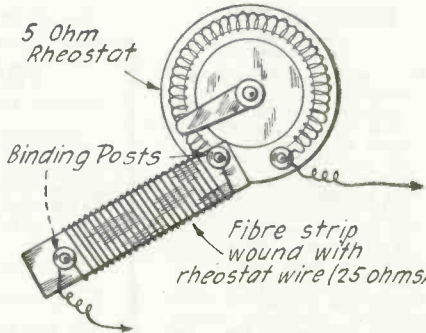

By winding several turns of resistance wire on a fibre strip, a handy addition to a standard five-ohm rheostat may be made. It can be made an integral part of the instrument by fastening one end to the binding post as illustrated above and making the connections as shown. This is useful with the new low-voltage tubes.—Fred Stroberg.

Earn Big Money Learn the Automobile Business PUT YOUR NAME HERE. Think of the repair work on thirteen million cars! Engines, electrical systems, batteries, tires, etc. There are not nearly enough trained men to do this work. Graduates of this School (all over the world) are successful, making money in this business, either in good jobs or shops of their own.

UNLIMITED OPPORTUNITIES FOR TRAINED MEN

Study autos, trucks, engines, auto electricity, tractors. Learn on best equipment, all in good condition, up-to-date; expert instructors to teach you, a thorough complete course that slights nothing. Plenty of time in every department to learn it right.

COME TO DETROIT THE AUTO CENTER

Here you have wonderful advantages. Visit the great plants, Ford, Cadillac, Packard, Lincoln, Dodge, Hupp, Hudson, Studebaker, many others. These great companies also endorse this school because they know our course trains you right. Get factory endorsed training at Detroit, the Auto Center. Be Successful!

Write today for 100-page catalog describing school, Detroit, opportunities. Address A. G. Zeller, President. Write today.

MICHIGAN STATE AUTOMOBILE SCHOOL 671 Auto Building Detroit, Michigan

Everybody NOW Can Dance

Learn in ONE HOUR at Home

There's now no need of being a wall-flower. In one hour—at home—by mail—I can make you an easy, confident dancer—popular in any ballroom.

NEW EASY METHOD

No Partner Needed—No Embarrassment

Over 60,000 men and women have become popular dancers of Fox Trot, One Step, Waltz and all the latest up-to-the-minute society dance steps through my new Photo-tell and Fono-tell Method set to music. Amazingly easy—fascinating. No other course like it. I teach you perfect time and rhythm—the secret of good dancing. Your success Guaranteed.

SENT FREE ON TRIAL

—No Deposit. Convince yourself at my expense how amazingly easy it is to learn modern dancing with my new method. For a short time only I'll send the first six lessons of my course (in plain wrapper), including 10-inch dance instruction record, free and prepaid for five days trial. See, test and prove this remarkable new method in your own home. Then, if not delighted at your success, simply return record and lessons within five days and you'll owe me nothing. Write quick before this unusual offer expires. Please mention make of photograph you have.



WILLIAM CHANDLER PEAK, M. B. Studio 251 4601-4611 Broadway Chicago, Ill.

FREE FIRST LESSON RECORD

Learn to Play

Violin, Mandolin and Banjo-Mandolin quickly. No embarrassment. You learn to play or pay nothing. Play for money in two months.

Beautiful Instrument FREE

No charge for instrument to one pupil in each locality. Few cents a week pays for lessons. Write for First Record—Sent without cost on 1 weeks' approval with complete details of Personal Instruction Record Course.

SCHNEIDER SCHOOL OF MUSIC Dept. G 11, 238 Vermont Street, Blue Island Ill. (A suburb of Chicago)

Ukulele Free!

Genuine Koa Wood finish Hawaiian Ukulele. Sweet ringing tone. Given free with Short-Cut Ukulele Instruction Course. Teaches you to play in one hour! Play popular! Play latest hits.

Send No Money for course and FREE Ukulele outfit. On arrival deposit with postman only \$2.98 plus a few pennies postage. We guarantee complete satisfaction or money refunded. Send now. FERRY & CO. 75 W. Van Buren, Dept. 1256 Chicago, Ill.

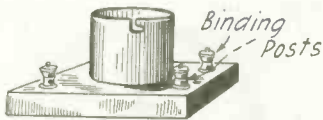
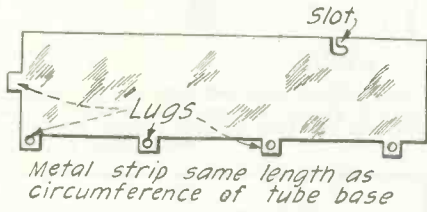
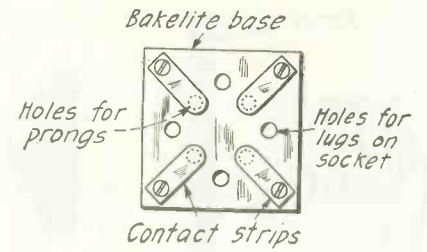

In trying out a new circuit, an extra socket is very often desired and one may not be on hand at the time. When this happens, you can make an efficient socket from a scrap of bakelite and a few strips of brass or even a piece of an old tin can. The constructional details are shown above. —Loran Black.

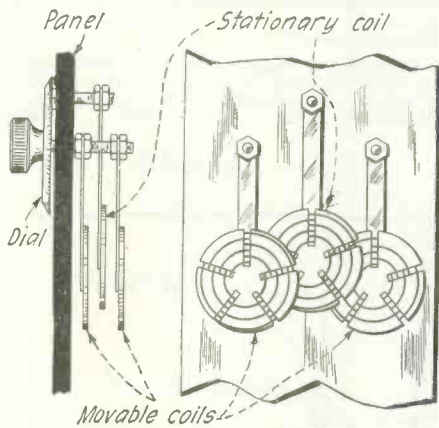

Three spider web coils may be readily mounted on the back of a panel and controlled from the front by using the method of mounting illustrated. The coils are fastened to three bakelite strips which are in turn bolted to shafts which extend through the panel and are turned by handles. One coil is stationary while the other two may be moved. —John D. Davis.

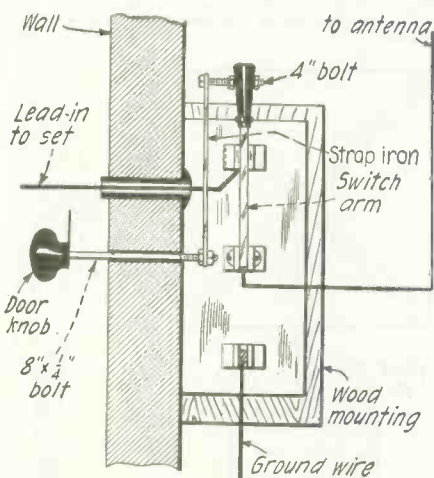

Very often an amateur desires to control his lighting switch from within the house. By installing a switch as shown above this can very readily be accomplished. A fairly stiff length of strap iron must be used in order to make the working of the switch positive. —Harlow Rouse.

MEN OF ACTION!

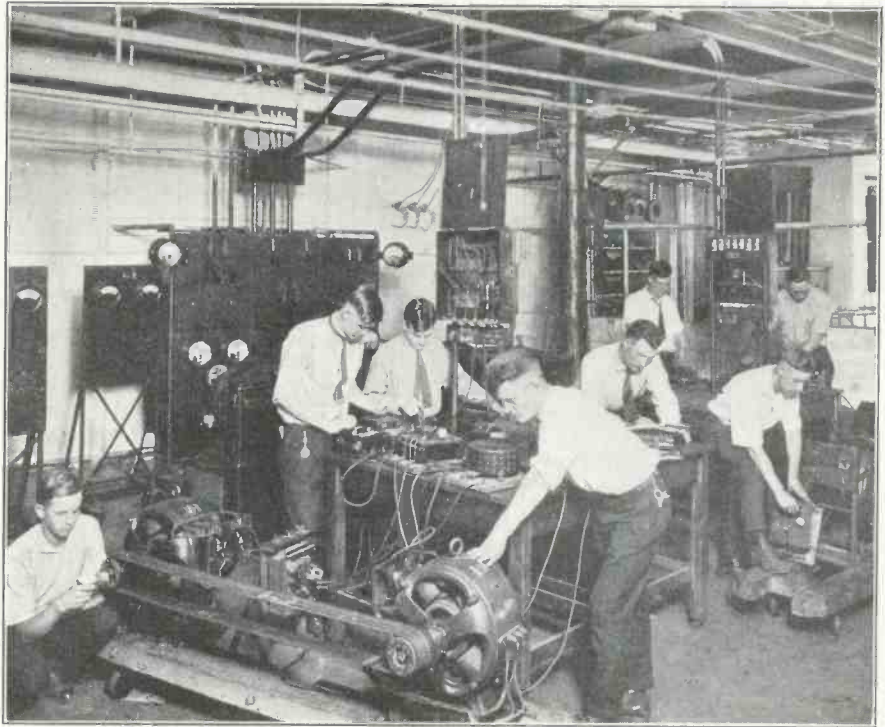

Are Wanted for 12 Months' Intensive Practical Electrical Training

Takes you out of the class of the common laborer of which there is always an over plentiful supply at cheap rates of pay.

Makes you a GRADUATED ELECTRICIAN, ELECTROTECHNICIAN, or COMMERCIAL ELECTRICAL ENGINEER in 12 short months. Puts you in line for a job where big manufacturers are actually pleading for trained men and glad to pay BIG SALARIES ranging from \$2000 to \$10,000 a year.

Not a dream—A DEAD SURE FACT!

For 18 years we have trained men for the electrical profession, and OUR GRADUATES HAVE SUCCEEDED IN ALL PARTS OF THE WORLD. Our 12 months' intensive training is the boiled down essence of what WE KNOW fits men for big paying positions. It is work you'll love. NO LIMIT to advancement.

Practical engineers teach you. They know WHAT to teach and HOW to teach it, so you can earn money with it. Hundreds of thousands of dollars worth of actual commercial electrical machinery to work on in this school.

OUR GRADUATES SUCCEED! They are always in demand at good salaries. "School of Engineering Grads are Men of Action."

No matter what your education. Fill out and mail the coupon TODAY. Get our 72-page book FREE. Learn how thousands of others have gone up to big pay in short time. Learn how you can do it. New term opens very soon. Part time employment for students who need it.

SCHOOL of ENGINEERING
of Milwaukee

SI-1123

415-417 Marshall Street,
Milwaukee,
Wisconsin.

SCHOOL OF ENGINEERING,
SI-1123, 415-417 Marshall St., Milwaukee, Wis.

Please send me your 72-page book for "Men of Action", telling me how to get into a big paying electrical position in 12 months.

Name

Address

City State.....

Age Education.....

Study and Experiment with the **ULTRALENS MICROSCOPE** || **\$5.00**

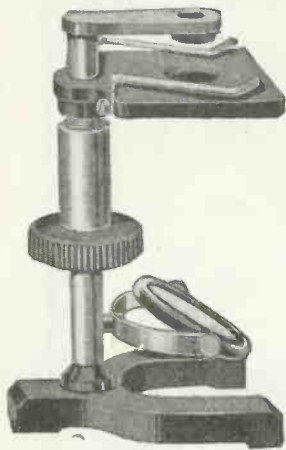

TYPE MS-11

**Magnifies 225 Diameters or
50,625 Times Surface Area**

The ULTRALENS MICROSCOPE is a practical instrument made possible by the recent development of a new system of lens construction. Powers from 125 to 325 diameters (15,625 to 100,625 times surface area) are available. Microscope is a marvel of simplicity, perfection and compactness, giving enormous magnification an clear definition. Quantity production brings price within the reach of all.

The MS-11 type of ULTRALENS MICROSCOPE is a complete outfit as it includes everything necessary to conduct numerous experiments. A 225 diameter objective is standard equipment. Extra ULTRALENS objectives of either 125 or 325 diameters can be furnished for \$1.00 each. Objectives are only sold to owners of ULTRALENS microscopes.

This type is well finished throughout. Stage, knob, and mirror casing are of black moulded bakelite. Brass work finished in gold lacquer. Die-cast enameled horse-shoe base. Micrometer screw focusing arrangement. Objectives are interchangeable and plug in top of pillar. Outfit furnished in brown moulded bakelite case which is provided with places for holding slides and extra objectives.

By means of a special attachment microscope can be securely clamped to outside of case thus making it serve as a sub-base.

A HIGH POWERED MICROSCOPE AT ONE-TWELTH USUAL COST

Common Objects As Seen Through An Ultralens Microscope

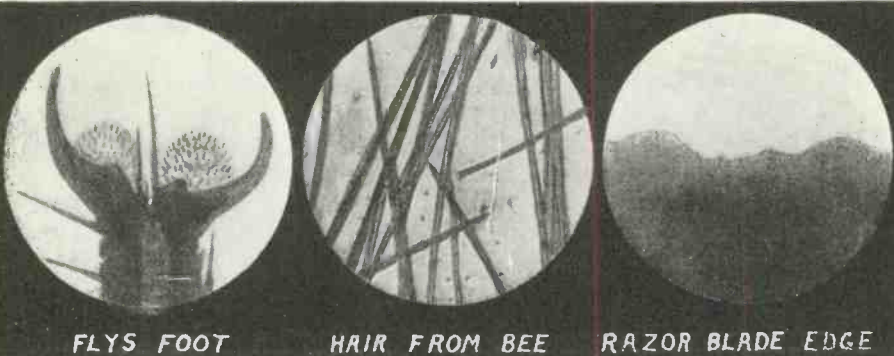

FLY'S FOOT

HAIR FROM BEE

RAZOR BLADE EDGE

An ULTRALENS MICROSCOPE will be shipped prepaid to any part of the United States and Canada on receipt of \$5.00 Foreign countries \$6.00.

EXTREMELY INTERESTING CATALOG IS FREE ON REQUEST

DEALERS, JOBBERS, AGENTS, and SALESMEN—Get Our Distributors Proposition.

SCIENTIFIC APPARATUS CORP., Milton, Pa., U. S. A.

Send For
Christmas
Catalog

**"SYLVIA"
Diamond Ring**
Blue white, radiant,
perfect cut Diamond.
The ring is 18-k Solid
White Gold, curved and
pierced. Special at
\$100. Only \$10
down, then
\$2.50
A WEEK
Also bargains at
\$75 to \$600

LOFTIS Genuine
BROS. & CO. ESTD 1858 Diamonds
GUARANTEED

DIAMONDS WATCHES

Cash or Credit

**17-Jewel
ELGIN**
No. 16—Green
Gold engraved,
assorted pat-
terns, guaran-
teed 25 years.
1 1/2 Size, \$32
gold dial.
Terms \$3.25
Down, then
\$1.00 a Week
until paid.

Satisfaction Guaranteed or Money Refunded

LOFTIS BROS. & CO. National Jewelers
Dept. F22 108 N. State St., Chicago, Ill.

Insure your copy reaching you each month. Subscribe to Science and Invention—\$2.50 a year. Experimenter Publishing Co., 53 Park Place, N. Y. C.

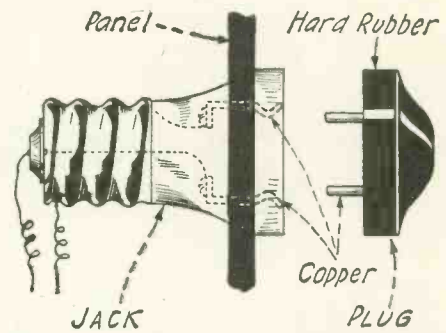

A very efficient plug and jack may be made as illustrated above. A large hole is drilled in the panel, and the base fastened therein by shellac. —Raymond Anderson.

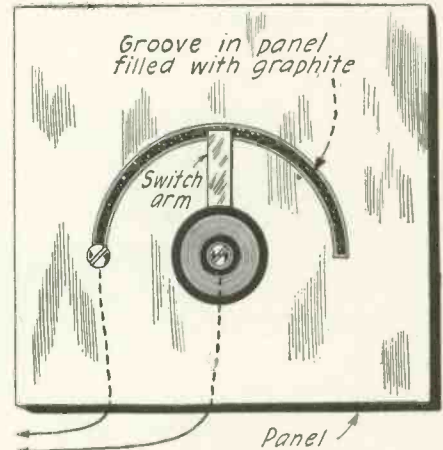

By scratching a deep groove in a semi-circular form on the surface of a radio panel and filling the groove with graphite from a soft pencil, a grid leak is made. —Clifford Haltalin.

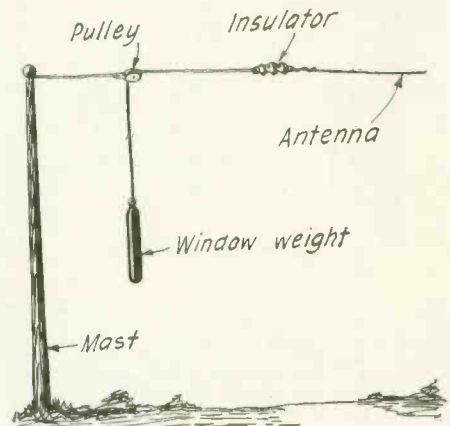

When an antenna is fastened to a slender pole, the swaying of the support often breaks a wire. This can be avoided by a window weight arranged as shown. —Samuel H. Emmes.

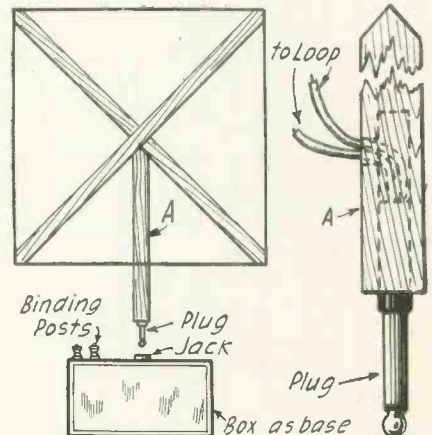

A good support for a loop aerial may be made as shown. An open circuit jack is mounted in a box base. The loop can be swung in any direction without tangling connection wires. —Romain Peters.

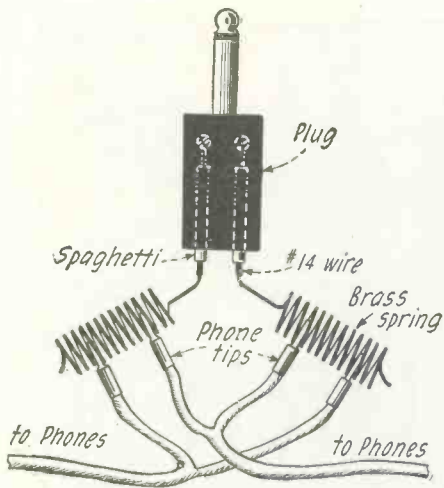

By winding two small coils of spring brass wire and connecting them to a standard telephone receiver plug as shown any number of sets of phones may be connected to a single plug.—John Hetzel.

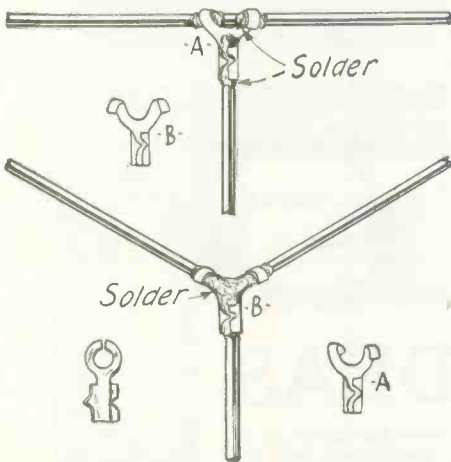

Ordinary soldering lugs such as used in connecting wire to binding posts in radio sets can be used in other ways. Two methods of using these lugs for soldering wire or bus bar connections are shown above.—A. L. Porch.

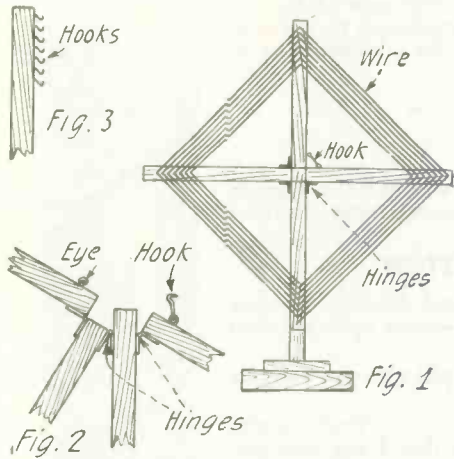

A loop antenna may be made so that it can be readily folded for transportation by using three hinges and a hook and eye as shown. The wire should be wound on hooks as indicated so as to be readily removable.—W. A. Waddell.

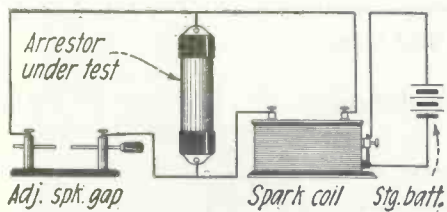

Lightning arresters of the vacuum tube type may be tested as shown above. If a small stringy spark discharge is observed it is not satisfactory, but if a peculiar characteristic glow is perceptible, the arrester is in good condition.—John M. Avery.
(Continued on page 708)



Multiplying Man-power

To the man with pick and shovel the digging of holes for telephone poles is a slow and arduous task. Under favorable soil conditions three to five holes are for him an average day's work. Under adverse conditions perhaps he can account for only one. When the hole is dug, eight or ten men are required to raise the pole with pikes.

But the hole-borer with derrick attached, operated by only three men, can erect as many as eighty poles in a day—releasing for other telephone work upwards of forty men.

Hundreds of devices to quicken telephone construction, to increase its safety to the employee, and to effect economies are being utilized in the Bell System. Experiments are constantly being made to find the better and shorter way to do a given job. Each tool invented for the industry must be developed to perfection.

In the aggregate these devices to multiply man-power mean an enormous yearly saving of time, labor and money throughout the whole Bell System. Without them telephone service would be rendered neither as promptly, as efficiently nor as economically as it is to-day.



"BELL SYSTEM"

AMERICAN TELEPHONE AND TELEGRAPH COMPANY
AND ASSOCIATED COMPANIES

One Policy, One System, Universal Service, and all directed toward Better Service

Big Profits in 8 Hour Battery Charging

START YOUR OWN MONEY-MAKING BUSINESS
You can make big profits charging batteries with HB Constant Potential 8-Hour System. No experience needed. You Can Clear \$150 to \$300 Every Month. HB outfit comes complete, ready to connect and operate. New Built-in Patented HB Voltage Regulating Winding Absolutely Eliminates Reversing. Saves current and labor; runs all night without attention. Charges 6, 12 or 24 volt batteries. Better, longer-lived charge than old 3-day system. Quick service builds trade, satisfies customers, makes big, steady profits for you. **\$20 MONTHLY PAYS FOR YOUR HB CHARGER.** Small cash payment brings your HB Constant Potential Charger. Easy Terms of Only \$20 Monthly Quickly Pay Balance from Your Profits. 30 Days' Free Trial on Money-Back Guarantee Lets You Try HB Outfit at Our Risk. Oversize HB construction insures 1-3 More Output Than Any Other Outfit of Similar Rating. Start now to make big battery charging profits. Write today for information. Ask about other HB money-makers—air compressors, buffers, motors, etc. All sold on easy payments. HOBART BROS CO. Box 511, Troy, Ohio.

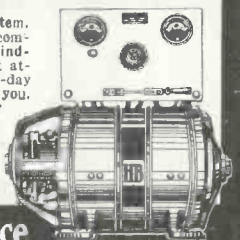

Small Cash Payment - Your Profits Quickly Pay Balance

Insure your copy reaching you each month. Subscribe to Science and Invention —\$2.50 a year. Experimenter Publishing Co., 53 Park Place, N. Y. C.



PATENTS **PATENTS**

EXPERIENCE SERVICE

CLARENCE A. O'BRIEN
PATENT ATTORNEY

REGISTERED IN UNITED STATES PATENT OFFICE
 MEMBER OF THE BAR OF
 SUPREME COURT OF UNITED STATES, COURT OF APPEALS DISTRICT OF COLUMBIA,
 SUPREME COURT DISTRICT OF COLUMBIA. UNITED STATES COURT OF CLAIMS.
 PRACTICE CONFINED TO PATENTS AND TRADE MARKS.

PATENTS

PROTECT YOUR IDEAS

ANY NEW article, machine, design or improvement thereof, or any new combination of parts or improvements in any known article which increases its efficiency or usefulness, may be patented, if it involves invention.

IF YOU HAVE ANY NEW IDEAS

which you feel are useful, practical and novel, take prompt action to protect your rights. If you have invented any new machine, or new combination of parts of improvement, or any new design or process, SEND DRAWING, MODEL OR DESCRIPTION of it for information as to procedure to secure protection.

WRITE TODAY FOR BLANK FORM
"Record of Invention"

USE THE COUPON attached, and immediately upon its receipt I shall send you this form to be returned to me with drawing, description or model of your idea; promptly upon receiving your idea I shall write you fully as to procedure and costs.

NO CHARGE FOR THE ABOVE INFORMATION

All communications are held in strict confidence. My personal, careful and thorough attention is given to each case. I offer you efficient, reliable and prompt service—based upon practical experience. Highest references.

WRITE TODAY for free book "How to Obtain a Patent." This book will give you valuable information, and it may save you much time and effort. Send for it, NOW.

My practice is devoted exclusively to United States and Foreign Patents and Trade Marks. Write me freely, frankly and with full confidence; it is very probable that I can help you. Write TODAY.

CLARENCE A. O'BRIEN, Registered Patent Attorney

304 Security Savings & Com'l Bank Bldg., Directly across street from Patent Office. Washington, D. C.

CLARENCE A. O'BRIEN, Patent Attorney, 304 Security Savings & Com'l Bank Bldg.
 Directly across street from Patent Office, Washington, D. C.

Please send me your free booklet "How to Obtain a Patent" and blank form "Record of Invention" without any obligation on my part.

Name

Address

(IMPORTANT: WRITE OR PRINT NAME CLEARLY)

SCIENCE
INVENTION
INDUSTRY

ECONOMY
EFFICIENCY
INITIATIVE





PATENT ADVICE

Edited by
Joseph H. Kraus

In this Department we publish such matter as is of interest to inventors and particularly to those who are in doubt as to certain Patent Phases. Regular inquiries addressed to "Patent Advice" cannot be answered by mail free of charge. Such inquiries are published here for the benefit of all readers. If the idea is thought to be of importance, we make it a rule not to divulge all details, in order to protect the inventor as far as it is possible to do so.

Should advice be desired by mail a nominal charge of \$1.00 is made for each question. Sketches and descriptions must be clear and explicit. Only one side of sheet should be written on.

NOTE:—Before mailing your letter to this department, see to it that your name and address are upon the letter and envelope as well. Many letters are returned to us because either the name of the inquirer or his address is incorrectly given.

COMBINATION TAP AND DRILL

(741) A. R. Mandon, Ouray, Colo., asks for our advice concerning a combination drill and tap.



The combination drill and tap idea shown above is very old. It has been found inefficient.

A. There is no need of attempting to obtain a patent on the combination tap and drill, as many of these have been upon the market and have been discarded, because of their comparative inefficiency. The device is not patentable, as we know positively of its previous use.

GARMENTS

(742) John D. Colvin, Parsons, Penn., requests our advice on under-garments made in such a manner that a body belt causes a blouse effect on the part of the upper section of the garment, the intention being to prevent the ripping of the underwear when they are saturated with perspiration, as the looseness will not cause such great friction on the skin, permitting the garment to slide over the parts of the body in movement.

A. We do not believe that you can possibly obtain a patent on the idea of which you wrote. The suggestion is extremely old, and is of no intrinsic value. We doubt if there are any shirt manufacturers who would undertake the construction of such a shirt. We do not advise patent procedure.

FLAT IRON SWITCH

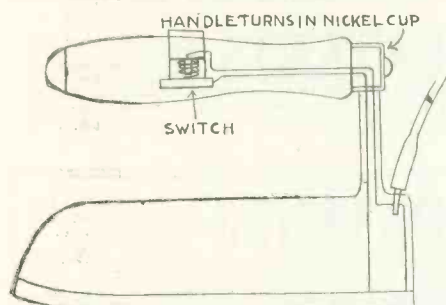

The switch for flat irons shown here could not pass the Fire Underwriters' rules.

(743) Laurence Burns, Hoosick Falls, N. Y., asks for our advice regarding a switch in the handle of a flat iron to control the current.

A. We do not believe that the switch you have designed for flat irons, will pass the Underwriter's rule and regulations. Hence, we do not advise applying for a patent.

ROYALTIES AND PATENT SALES

(744) H. R. Borchardt, Phoenix, Ariz., requests our advice concerning maximum and minimum royalties and cash payments on inventions, particularly with reference to two of his own patents—an automobile headlight and an automobile signal.

A. There is no question of maximum royalties and maximum cash payments on inventions. Some inventions bring practically nothing. Royalties on some are less than one quarter of 1 per cent, and yet the total amounts run into millions. In other inventions the royalties may be several hundred dollars on each device, the in-

ventor may be fortunate indeed if his bank-roll increases to the amount of \$200.00 or \$300.00 a year. Ten per cent is a very good royalty, although we know of some individuals who receive as high as 52 per cent.

On smaller devices, such as stoplights for automobiles, spark plugs, fountain pens, household utility devices and such things which sell extensively, the royalties can be considerably smaller, one to five per cent being very fair. The proposition is to try to get as much as you possibly can, and if the concern absolutely refuses to talk at your figure, ask them for their proposition, and tell them that you will think it over, and then try to place it with other individuals. If you can receive no better offer, take the best one given. Cash payment, plus a royalty, is quite the usual method of procedure.

We believe that for the headlight lenses you should receive \$5,000 to \$10,000 in cash, if of course, they are as good as you claim. On the royalty basis, \$1,000 with 20 per cent royalties would be a very fine proposition. Even a 5 per cent royalty here could be considered fair, providing the concern will agree to manufacture a definite number of the headlights, so that your returns will not be less than \$5,000 a year. The auto signal should sell for much less, as it is a relatively poor proposition.

TICKLESS CLOCK

(745) David Bone, Somerset, Pa., requests our advice on a tickless clock enclosed in vacuum sound-proof chamber.

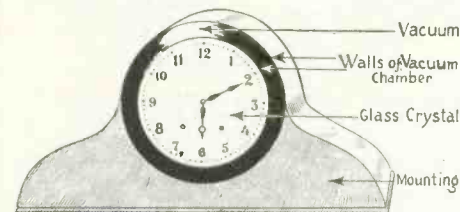

Manufacturing cost of the tickless clock makes it valueless for commercial purposes.

U.S. PATENTS



**SEND FOR
THIS FORM**

Don't Lose Your Rights

Before disclosing your invention to anyone send for blank form "Evidence of Conception" to be signed and witnessed. A sample form together with printed instructions will show you just how to work up your evidence and establish your rights before filing application for patent. As registered patent attorneys we represent hundreds of inventors all over the U. S. and Canada in the advancement of inventions. Our schedule of fees will be found reasonable. The form "Evidence of Conception" sample, instructions relating to obtaining of patent and schedule of fees sent upon request. Ask for them.—a post card will do.



255 OURAY BLDG.,
WASHINGTON, D. C.

"Originators of form Evidence of Conception"

PATENTS

TO THE MAN WITH AN IDEA

I offer a comprehensive, experienced, efficient service for his prompt, legal protection and the development of his proposition.

Send sketch, or model and description, for advice as to cost, search through prior United States patents, etc. Preliminary advice gladly furnished without charge.

My experience and familiarity with various arts frequently enable me to accurately advise clients as to probable patentability before they go to any expense.

Booklet of valuable information and form for properly disclosing your idea, free on request. Write today.

RICHARD B. OWEN, Patent Lawyer
164 Owen Building, Washington, D. C.
2276-8 Woolworth Bldg., New York City

PATENTS TRADE-MARKS AND COPYRIGHTS

Before disclosing an invention, the inventor should write for our blank form, "RECORD OF INVENTION." This should be signed and witnessed and if returned to us together with model or sketch and description of the invention we will give our opinion as to its patentable nature. Radio and Electrical cases a specialty.

Our illustrated Guide Book, "HOW TO OBTAIN A PATENT," sent Free on request. Highest References Prompt Attention Reasonable Terms

VICTOR J. EVANS & CO., Patent Attorneys

Chicago Offices: 1114 Tacoma Bldg. Pittsburgh Offices: 514 Empire Bldg. Philadelphia Offices: 714-715 Liberty Bldg. San Francisco Offices: Hobart Bldg.
New York Offices: 1001 Woolworth Bldg.
MAIN OFFICES: 779 NINTH, WASHINGTON, D. C.

Name..... Address.....

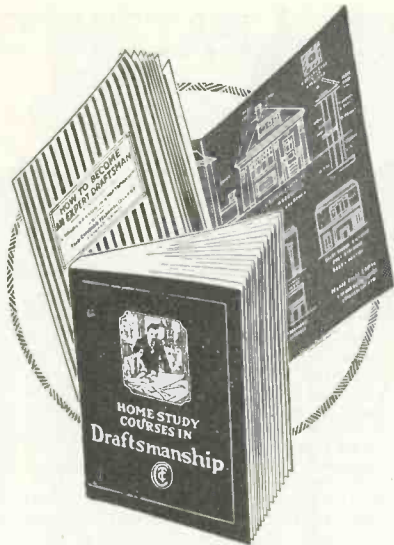

FREE Trial Lesson DRAFTING

Mail the coupon and we will send you this Free Trial Lesson which will show how well prepared you are to master Drafting. No obligation on your part, nothing to pay. While other schools ask you to enroll and pay a fee at once, we send you this lesson first. Before you pay a cent or even decide about enrolling—test your ability and learn about the Chicago Tech. Method of teaching Drafting by mail.

Double Your Earnings

Big concerns everywhere are seeking expert Draftsmen. Top notch salaries are paid to experts. This is your chance to step ahead just as R. L. Cory did who reports 300% salary increase since training with Chicago Tech.; or as J. A. Da Costa did who was doing manual labor and rose to an executive position.

Train by Mail

By the Chicago Tech. Method you can become an expert Draftsman by home study. Practical men will give you the training that brings highest pay. No useless theories—you learn how to handle actual problems. Direct personal instruction. We furnish full size professional **FREE Drawing Outfit** (retail price \$25) free or credit you on fees if you already have one.

Send the Coupon

Ask now for the Trial Lesson. We will send catalogs and full information about the Chicago Tech. Method. No obligation—no promise on your part. Send today.

CHICAGO TECHNICAL COLLEGE
1145 Chicago Tech. Bldg., Chicago, Ill.

Without cost or obligation on me please send instructive matter about opportunities in line I have marked with "X".

- DRAFTING.** (The Big Salary Course). No experience necessary. Free Lesson sent now.
- BUILDING TRADE COURSE.**
- For men in the building lines.

Name

Address

Post Office State

Play this Jazzy Sax Without Practice

Any one can play this imported Jazzy Sax right away. No knowledge of music required, no lessons. Play by numbers instead of notes. All instructions and 15 songs free! Be popular at parties, dances, picnics, entertainments. **Gifts**—polished brass and silver, except nickel mouthpiece. Looks just like regular saxophone, the same size.



Send No Money

Send just your name. When the Sax arrives pay the postman only \$5.98 plus a few pennies postage. Play Jazzy right away. Guaranteed or money refunded. Don't delay, act now!

FERRY & COMPANY, Dept. 1255
75 W. Van Buren Chicago, Illinois

Print Your Own
Cards, circulars, labels, book, paper. Press \$12. Larger \$35. Job press \$150. Save money. Print for others, big profit. All easy, rules sent. Write factory for press catalog, TYPE, cards, etc. **THE PRESS CO., D-47, Meriden, Conn.**

A. The idea is poor. The possibility of making a clock operate, enclosing the same in a vacuum space or sound-proof chamber is not new, the various space would cause the cost of the clock to mount so high that individuals would prefer the more or less quiet tick, to the expense which such a clock would incur.

We certainly would not advise applying for a patent upon this idea, as the possibility of placing the same upon the market is negligible.

SUBMARINE

(746) George Beyer, Minneapolis, Minn., states that submarines are located by the sound of the propellers as they beat the water. He, therefore, desires to substitute pumps for the propellers, draw the water in at the front end of the submarine, and expel it forcibly from the rear, in this way eliminating the sound.

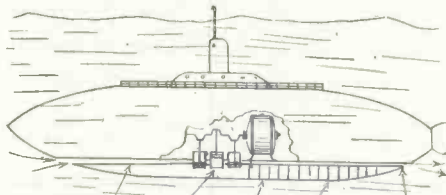

INLET PIPE PUMPS STORAGE BATTERIES OUTLETPipe
Erroneous idea as to noise of submarine makes the idea shown above valueless.

A. Your noiseless propelling device for submarines is of no value since the electric motors which are used to drive the submarine below the surface, create the hum, which is picked up by the sub-sea microphones of destroyers. It is an impossibility to operate a Diesel engine below the surface with any degree of safety, and one cannot eliminate the hum of a motor as it revolves driving the craft ahead or operating pumps. The propellers of the submarine could be disconnected from the motor driving mechanism entirely without disturbing in any way the microphonic sound as long as the motors are in operation.

MOTOR CAR

(747) Walter Bell, Detroit, Mich., takes exception to our "Motor Car of the Future" and sends in his own design of a futuristic motor car.

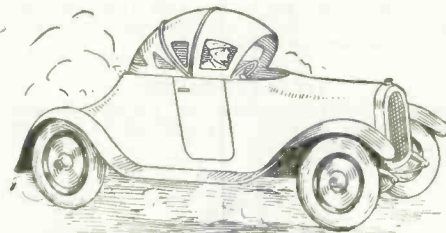

Auto body designer fails to consider stream-line effect in the above model hood and top.

A. We do not hold that the motor car of the future will look anything like your automobile. You have not taken streamline effects into consideration, but merely protected the occupant with a different style of hood. Speed is the forthcoming thing, and that must be coupled with aviation. The future method of transportation will be via the air.

GAS VALVE, NEEDLE SHARPENER, ETC.

(748) Hyman Biegeleisen, New York City, requests our opinion on a gas valve to regulate the flow of gas; a phonograph needle sharpener; a microphone reflex relay; and an X-ray tube for converting sound vibrations into light waves.

A. Regarding the gas valve of which you spoke, we would advise that quite a few patents on this same subject have been taken out, some of them dating back as far as 1898, which patents of course, have since expired. There seems to be very little hope for the gas jet I described some time ago in the article to which you refer and even this device was patented, if we recall correctly, about five or six years ago.

With regard to the phonograph needle sharpener, we would suggest that an idea very similar to yours was published about four years ago in this journal. This device was already patented. There were several other phonograph needle sharpeners also published, one of which had a revolving oscillating wheel or grindstone with a soft iron core which is used for polishing the needle. We doubt if the phonographic turn table will develop enough power to sharpen the needle, but even if it did your device would have to be more complicated than you show it. The

CAN YOU

think of a simple, practical idea that will fill one of the many requests we have on file for new inventions? It may mean a fortune for you. Thousands of things are needed Right Now. Your brains can help. Send today for our great new book—"Inventions and Trade Marks, Their Protection and Exploitation" and learn more about making money from ideas than you ever knew before. It tells many things that are wanted, too.

A postal will do—
it is free.

We help our clients, without charge, to get the dollars out of their ideas—having facilities none others possess.

Advice Free.
Don't delay—get the book at once.

AMERICAN INDUSTRIES, INC.
225 Patent Dept., WASHINGTON D.C.

PATENTS ADVERTISED For SALE FREE

Invention and Manufacturing Supplement.

Published for the man with an idea. Send for free sample copy. One year's subscription 50c.

PATENTS

Hand Books on Patents, Trade Marks, etc., sent free. Our 77 years of experience, efficient service, and fair dealing assure fullest value and protection to the applicant. The Scientific American should be read by all inventors.

MUNN & CO.
618 Woolworth Building, New York
Tower Bldg., Chicago, Ill.
Scientific American Bldg., Washington, D. C.
Hobart Bldg., 682 Market St., San Francisco, Cal.

PATENTS

BOOKLET FREE HIGHEST REFERENCES PROMPTNESS ASSURED BEST RESULTS
Send drawing or model for examination and report as to patentability.

WATSON E. COLEMAN, Patent Lawyer
624 F Street N. W., Washington, D. C.

PATENTS

As one of the oldest patent firms in America we give inventors at lowest consistent charge, a service noted for results, evidenced by many well known Patents of extraordinary value. Book, Patent-Sense, free.

Lacey & Lacey, 644 F St., Wash., D. C. Estab. 1869.

PATENTS

C. L. PARKER
Formerly Member Examining Corps, U. S. Patent Offices.
PATENT LAWYER
McGill Bldg., Washington, D. C.

Patents, Trade Marks, Copyrights, Patent Litigation
Handbook for Inventors. "Protecting, Exploiting and Selling Inventions," sent upon request.

PATENTS

Trade-Marks, Copyrights and Patent Litigation
Write for advice and instructions how to proceed, costs, etc.
Hand Book with illustrations of 100 Mechanical Movements sent free on request.

ALBERT E. DIETERICH
Patent Lawyer and Solicitor
Successor to Fred G. Dieterich & Co.
601 OURAY BLDG. WASHINGTON, D. C.

PATENTS, TRADEMARKS PROTECT YOUR INVENTION!

If in doubt as to patentability send me description of invention for FREE OPINION.
New Booklet "PATENTS" sent FREE to every inventor upon request.

AMBROSE T. BUCKLEY
150 NASSAU ST. NEW YORK CITY

READ!!

WORLD OF INVENTION

A Monthly Magazine
INSTRUCTIVE and ATTRACTIVE

THE MARKET PLACE—a department of immense possibilities—aims the sale of inventions and furnishes information of inventions needed—it is here that the minds of the seller and buyer meet.

Interesting contributions from scientists, inventors and prominent writers.

ENGINEERING DEPARTMENT is especially valuable to inventors.

Many other very desirable features.

Subscription \$2.50 for one year

Advertising rates on request.

For full particulars address

World of Invention Company

Three Thirty-four Fifth Avenue
New York City, U. S. A.

needle would have to be turned as it is sharpened, and a system for polishing would have to be employed. If you are in a position to market this device, however, at a very reasonable figure, about \$1.00 or \$1.50, it might be a good idea to develop the same.

Your microphone reflex relay will not operate properly, and consequently we would suggest that you forget this idea.

Why use an X-ray tube for converting sound waves into light waves? An X-ray tube is the least efficient of any device yet designed for this purpose? Dr. de Forest has a device which automatically converts sound waves into light fluctuations, and which he calls the "Photion" or "Luxion." There are many other similar devices using a small straight incandescent filament.

PERPETUAL MOTION

(749) H. N. Bagley, Stockton, Calif., requests our opinion on a perpetual motion machine.

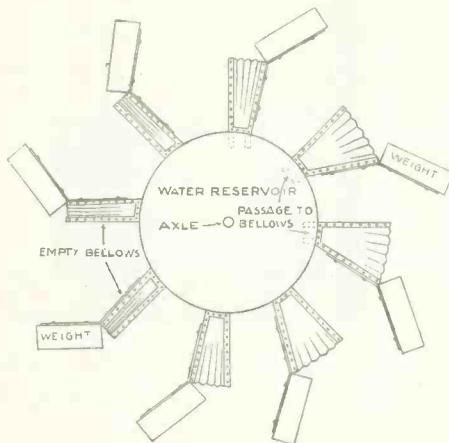

This design of perpetual motion machine has been "invented" regularly for 200 years past.

A. The idea is not original. If you will purchase a copy of the book called "Perpetual Motion," by Percy Verance, you will find that your suggestion originated more than two hundred years ago.

PERPETUAL MOTION AGAIN!

(750) Lois J. Brune, Algiers, La., asks our opinion on a perpetual motion machine, shown in the accompanying diagram.

A. There is less possibility of your perpetual motion machine working, than the one described by Mr. Hooks. It is true that air if under pressure can be made to operate a turbine, the turbine can, in turn, be made to operate a generator. It is also true that the generator can operate a motor, and that the motor can compress the air. The best known air compressor on the market today develops about 54 per cent efficiency, and for each 100 horsepower put into the motor which drives the air compressor, you can but obtain 54 horsepower of work by utilizing the compressed air. This energy is then transmitted to a turbine. This develops 80 per cent efficiency, reducing the total efficiency up to this point to a little more than 40 per cent. The turbine operates a dynamo having a maximum efficiency of 90 per cent, further reducing the efficiency to 36 per cent. The dynamo operating a motor (again 90 per cent efficient), bringing down the total figure to 32 per cent.

So you see by means of only four stages, you require 100 horsepower regardless of what the form is which it may assume, in order to produce at the end of the chain a horsepower rating of but 32, neglecting all friction and losses in gearing and other transmissions. Therefore, for each hour that your device runs, you will have to continually supply it with excess of power.

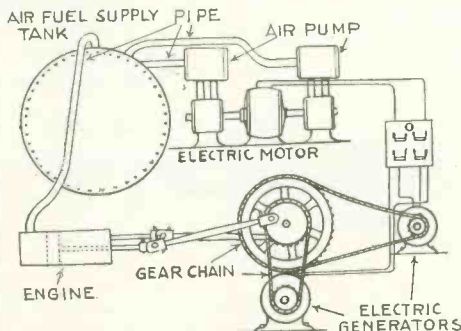

This perpetual motion will not work since it delivers only 32 per cent of energy used.

A Short-Cut to Your Success In Electricity

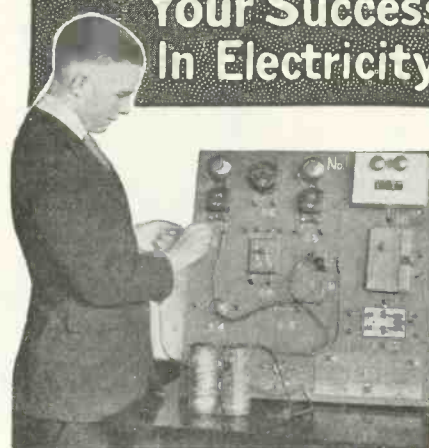

FREE \$500.00 ELECTRICAL LABORATORIES

Sent to Your Home

NOT toys—but real actual-size, expensive units of electrical apparatus are mailed to you without extra charge while learning. The illustration shows one of the new home-laboratory outfits. As fast as you have completed the work of one laboratory, another is sent, until you have mastered the entire field. You, therefore, advance step by step, from simple electrical experiments to complicated, intricate, important practical work.

Learn Electricity this New Quick Way

You can get the finest electrical training at home in your spare time. You need not leave your job, your friends, your home. This wonderful new home-laboratory training course in Practical Electricity brings this great, big technical school to your very door—into your very room. It develops ability, step by step, and leads you to every reward the great field of electricity can offer.

Just Like Going to School

Our large faculty of experts offer you a short cut that combines theory and practice, eliminating all the non-essentials. The plan is so simple—so logical—so carefully arranged, and also so interesting, that in a surprisingly short time you will have made yourself a master of technical electricity.

Earn Big Pay

Billions of dollars are invested in this great industry. Trained experts are in demand and handsome salaries are paid. You can easily master the work through our personal coaching and "home-laboratory" plan so that you can step immediately into the industrial field. WE ASSIST ALL OUR GRADUATES TO POSITIONS WITH THE LEADING ELECTRICAL FIRMS IN THE UNITED STATES.

Free—Electrical Apparatus

In addition to the free use of our 9 large electrical experimental boards we will give you all materials and apparatus needed for experimental work with the 9 outfits, absolutely free and ship it with the first laboratory shipment. No materials to be purchased by you. We furnish everything needed.

SCHOOL of ENGINEERING of Milwaukee

415 Marshall Street Milwaukee, Wis.

Extension-Division, School of Engineering, Dept. F-11, 415 Marshall St., Milwaukee, Wis.

Please send me full details of your "new wonderful laboratory method" of home-study in Practical Electricity. This request obligates me in no way.

Name

Address

Town State

PATENTS

If you have an invention and desire to secure a patent, send for our Free Guide Book, HOW TO GET YOUR PATENT. Tells our Terms, Methods, etc. Send model or sketch and description for our opinion of its patentable nature.

RANDOLPH & CO.

Dept. 172 Washington, D. C.

MODEL MAKING

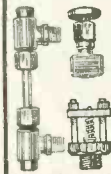

When you have made your Model Boiler, you will naturally wish to mount it with the best Steam Fittings obtainable. We can supply accurately made miniature Steam and Water Gauges, Steam Valves, Pumps, etc., also finished Engines and Boilers suitable for Model boats and stationary purposes. Special work to order. Large illustrated catalog 20c (refunded on first order).

BATHE MFG. CO., Dept. 2, 5214 Woodland Ave., Phila. Pa.

LATHES

9 to 18-inch Swing
List price \$135.00 and up, according to size. When ready to buy, send for Lathe Catalog and prices.

W. F. & John Barnes Co., 442 Ruby Street, ROCKFORD, ILLINOIS

Selenium Cells

ENTIRELY IMPROVED

Porcelain base, Platinised wire permanent action up to 2000 per second instantly, 3-year guarantee. We manufacture selenium cells since 1905. We also manufacture a very small sensitive, quick acting polar relay.

Write for circular.

F. V. MADALER, Hampton Bays, L. I., N. Y.

STUDY AT HOME

Directed by

The University of Chicago

Courses in English, History, Chemistry, Business, Mathematics, Education, Psychology, and 35 other subjects command credit toward a Bachelor degree. Begin any time. Address 27 Ellis Hall, University of Chicago, Chicago, Ill.



Posed by Miss Ann Forrest, Famous Movie Star, and Arthur Murray, the Vanderbilts' instructor

Why Good Dancers Are Popular

THOUSANDS of men and women are compelled to pass up many a good evening's fun just because they don't know how to dance. Yet there is no need for anyone to be a wallflower. Arthur Murray, America's foremost authority on social dancing, has perfected a method by which you can learn the steps of any of the latest dances in a few minutes. You don't need to go to a dancing class—you don't need to take private lessons—you don't need to bore your friends by getting them to teach you. Through Arthur Murray's method of easily understood diagrams and simplified instructions you can quickly learn to become a perfect dancer right in the privacy of your own room without either music or partner. And just as quickly as you have mastered the steps you can dance perfectly on any floor to any kind of music and keep step or follow correctly with the best dancer in your set.

FIVE DANCING LESSONS FREE

Even if you don't know one step from another, send for these five free lessons and let them prove that you can learn to dance at home in one evening through Arthur Murray's new methods. More than 90,000 persons have learned this way and there is no reason why you should not do as well.

The five free lessons are How To Gain Confidence, The Secret of Leading, A Lesson in Fox Trot, the Correct Dancing Position, and How To Follow. These lessons are sent free, but to pay for mailing and wrapping just enclose 25 cents. Learn in private—surprise your friends—write today for the FREE LESSONS.

ARTHUR MURRAY, Studio 883, 290 Broadway, N. Y. City

\$2 AND 10 MONTHS TO PAY

DOWN

NEW LOW PRICES—SAVE 1/3

You can now buy on credit at lower prices than even cash jewelers charge, because we import our diamonds from Antwerp and sell at wholesale prices. Your dealings with us are strictly confidential. There is no red tape nor delay. Your credit is good.

30 DAYS FREE TRIAL

Select article desired and send deposit to show good faith. If you are not satisfied we will return your money. This is the most liberal offer ever made. You cannot lose.

ORDER FROM THIS LIST

A—\$99.00	Send \$10.00 Down
B—\$39.00	" 2.00 "
C—\$48.00	" 2.00 "
D—\$98.00	" 10.00 "
E—\$59.00	" 5.00 "
F—\$67.00	" 7.00 "

14 In. PEARLS—DIA. GLASP

WRITE FOR CATALOG NO. 1245.

It brings a big jewelry store right into your home

14 Kt. Gold

PLATINUM FINISH \$16.00	4 Genuine Diamonds \$42.00
\$32.00	Only \$2.00 Down

Address Div. 1245

STERLING DIAMOND & WATCH CO.

63 PARK ROW WORLD BLDG. NEW YORK

Ford Runs 57 Miles On Gallon Of Gasoline

A new automatic and self-regulating device has been invented by John A. Stransky, 650 Fourth St., Pukwana, South Dakota, with which automobiles have made from 40 to 57 miles on a gallon of gasoline. It removes all carbon and prevents spark plug trouble and overheating. It can be installed by anyone in five minutes. Mr. Stransky wants agents and is willing to send a sample at his own risk. Write him today.—Adv.

Radio Wrinkles

(Continued from page 703)

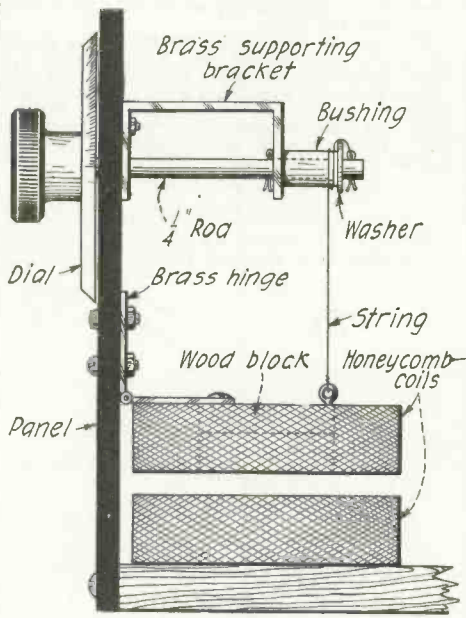

In a two-coil honey-comb tuner the coils may be mounted back of the panel and the movable coil adjusted by means of a device arranged as shown above.

—Don B. Smith.

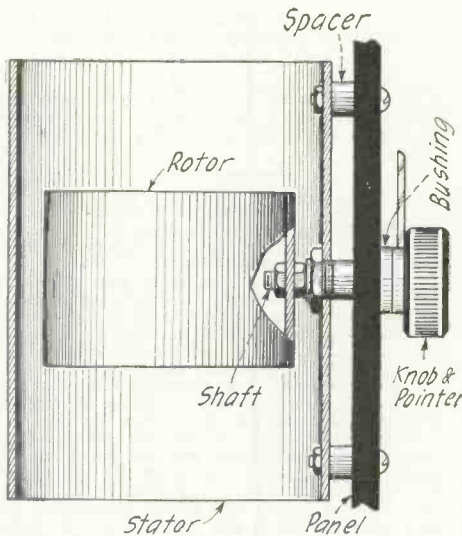

A satisfactory mounting for the rotor of a variocoupler may be made from a standard switch arm as shown above. The contact arm should be removed and replaced by a pointer.—Leonard Lowe.

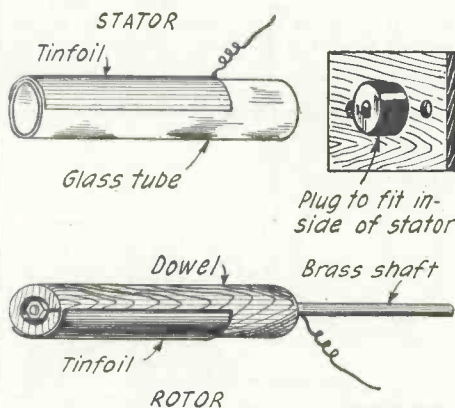

A vernier condenser may be made from a glass tube and dowel as shown above. Two pieces of tin-foil are placed thereon and mounted upon a plug. The tin-foil on the dowel is connected to the shaft.

—I. D. Hunter

Learn to Write

I TEACH BY MAIL

I can make a good penman of you at your home during spare time, no matter where you live or how poorly you write. My simplified system has shown thousands the way to good penmanship during the past twenty-five years—it CAN and WILL do the same for YOU.

My beautifully illustrated 32-page Book, "How to Become a Good Penman," FREE!

It contains many beautiful specimens of penmanship showing what others have accomplished by the Tamblin System, with testimonials and general information about our courses. (Your name elegantly written on a card if you enclose stamp for postage.) Ladies taught as successfully as men. Write Today. Address

F. W. TAMBLIN,
424 Ridge Bldg., Kansas City, Mo., U.S.A.

F. W. Tamblin

Ear-Joy

\$1.00 a Pair

HEADPHONE CUSHION

HUDSON-ROSS

123 WEST MADISON ST. CHICAGO

AGENTS: \$6 PER DAY AND UP

Selling concentrated, non-alcoholic food flavors. Always fresh. Put up in collapsible tubes. Ten times the strength of bottled flavors. Guaranteed under U.S. pure food laws. All flavors. Sells in every home. Used every day. Not sold in stores. Big demand. Big repeat-er. 100% profit.

Men or Women

can make big money. Fast sold over \$300 in one month. You will find this a big, easy seller and a sure taker. Must satisfy customers or money back. Write for territory and sample outfit. Get a big line of customers. Get repeat orders every month and have a steady income. Write quick.

American Products Co.
4818 American Bldg., Cincinnati, O.

ACT QUICK WRITE TO-AY

"ELECTRO-CONDITE"

STARTLES THE WORLD

Thousands of people are marveling at the wonderful performance of the "Electro-Condite" Converter. Clarifies, purifies, sterilizes, matures and mellow most kinds of beverages. Makes hard water soft, etc. May prevent poisoning. Send \$5.00 for device with 5 days' trial money-back guarantee or ask for circular.

Best grade Proof Hydrometers, \$1.00 each prepaid.

A-B-C LABORATORIES, INC.
Dept. X., 100 Lawrence St.,
(W. 126th St.) New York

\$8.00 a Day

Write quick for new proposition. You can earn \$8.00 a day in spare time and get fine new Buick touring car. Be the representative for Comer All-Weather Rain-coats. No experience required. Sample outfit free. Write now.

Comer Mfg. Co., Dept. 12-BR, Dayton, O.

Quick
TOURING CAR
GIVEN

STAMMER NO MORE

Kill the fear of stammering. Re-education the key. The widely famed Hatfield Method fully outlined in an accurate, dependable, worthwhile book—"HOW TO STOP STAMMERING." It has inspired thousands. Free copy today.

THE HATFIELD INSTITUTE, 199 N. Dearborn, Chicago, Ill.

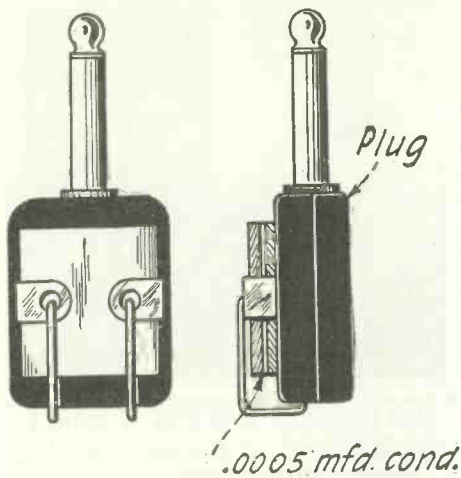

Many times in the operation of a radio receiving set, the amateur desires to increase the capacity of a variable condenser but does not wish to add another variable. By connecting an open circuit jack in parallel with the variable condenser and mounting a fixed condenser on a plug as shown, the illustrated unit may be plugged into the circuit in parallel with the standard condenser, thereby increasing the capacity to any desired degree.
—J. H. Rouse.

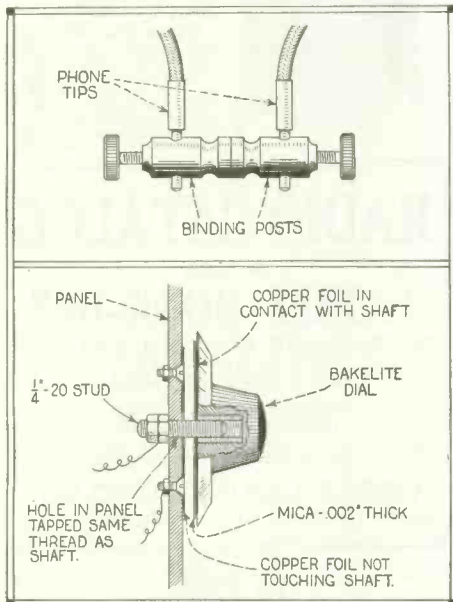

By connecting two binding posts together with a stud, or by soldering, a very efficient phone tip connector may be made, as shown in the upper illustration.
—Bernard N. Brown.

An excellent vernier variable condenser which may be mounted directly on a panel is constructed with the use of a standard 3 or 3 1/2 inch dial as shown above.
—Sydney Bond.

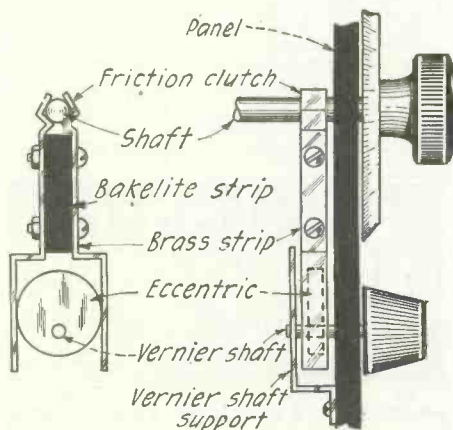

By means of a few scraps of material which are usually available, any condenser may be made into a vernier in a very workmanlike manner as shown in the above illustration. The frictional connection between the vernier and the shaft should not be too tight as it will prevent the shaft from turning freely, but it should be just tight enough to enable it to grip the shaft when the vernier is being operated.
—James Gordon.

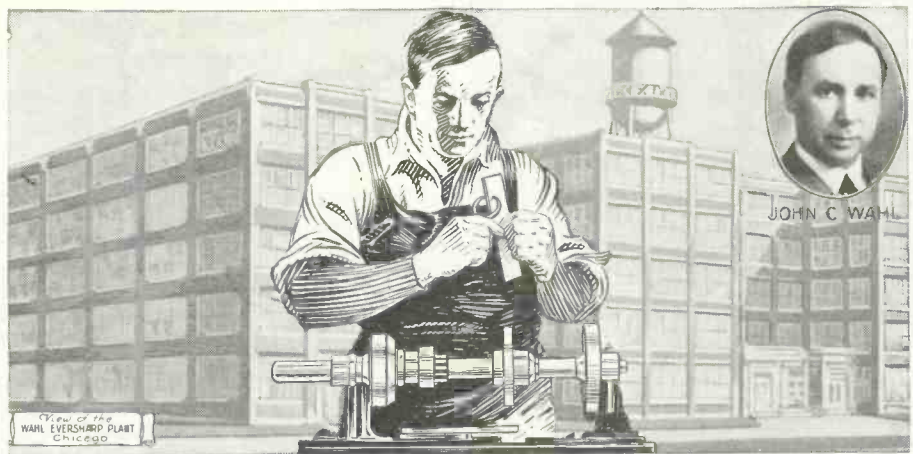

The \$12 a week mechanic who became a millionaire!

TWENTY-THREE years ago, John C. Wahl was working as a mechanic in Peoria, Illinois, at \$12 a week.

To-day, he is a millionaire—having an income that runs into six figures—nationally and internationally known as the inventor of the Wahl Adding Machine, the Wahl Fountain Pen, and president of The Wahl Company, manufacturers of the famous Eversharp pencil.

It is interesting to note that the change for the better in the life of John C. Wahl came the day he saw an advertisement that hit him straight between the eyes. As he puts it, "it told how the International Correspondence Schools could make a draftsman of a fellow without interfering with his daily work." That day, John C. Wahl enrolled and started to build for the future. His present success is proof that he builded well.

"Pick the line of work you like best," he said the other day, "and stick to it. Study hard and success will take care of itself. Nothing is impossible when a man really makes up his mind that he's going to get ahead."

John C. Wahl is just one of thousands of I. C. S. students who have made good in a big way. The lives of

such men should be an inspiration and a guide to every man who wants a better job and a bigger salary.

If the I. C. S. can smooth the way to success for other men, it can help you. If it can help other men to go forward to better jobs and bigger salaries, or to success in businesses of their own, it can help you, too.

At least find out *how* by marking and mailing this coupon. It doesn't obligate you in any way to do this, but it may be the means of changing your entire life.

MAIL THE COUPON TO-DAY!

INTERNATIONAL CORRESPONDENCE SCHOOLS

Box 6210-C, Scranton, Penna.

Without cost or obligation on my part, please tell me how I can qualify for the position or in the subject before which I have marked an X:

BUSINESS TRAINING COURSES

- | | |
|---|---|
| <input type="checkbox"/> Business Management | <input type="checkbox"/> Salesmanship |
| <input type="checkbox"/> Industrial Management | <input type="checkbox"/> Advertising |
| <input type="checkbox"/> Personnel Organization | <input type="checkbox"/> Better Letters |
| <input type="checkbox"/> Traffic Management | <input type="checkbox"/> Show Card Lettering |
| <input type="checkbox"/> Business Law | <input type="checkbox"/> Stenography and Typing |
| <input type="checkbox"/> Banking and Banking Law | <input type="checkbox"/> Business English |
| <input type="checkbox"/> Accountancy (including C.P.A.) | <input type="checkbox"/> Civil Service |
| <input type="checkbox"/> Cost Accounting | <input type="checkbox"/> Railway Mail Clerk |
| <input type="checkbox"/> Bookkeeping | <input type="checkbox"/> Common School Subjects |
| <input type="checkbox"/> Private Secretary | <input type="checkbox"/> High School Subjects |
| <input type="checkbox"/> Spanish | <input type="checkbox"/> Illustrating |

TECHNICAL AND INDUSTRIAL COURSES

- | | |
|---|--|
| <input type="checkbox"/> Electrical Engineering | <input type="checkbox"/> Architect |
| <input type="checkbox"/> Electric Lighting | <input type="checkbox"/> Blue Print Reading |
| <input type="checkbox"/> Mechanical Engineer | <input type="checkbox"/> Contractor and Builder |
| <input type="checkbox"/> Mechanical Draftsman | <input type="checkbox"/> Architectural Draftsman |
| <input type="checkbox"/> Machine Shop Practice | <input type="checkbox"/> Concrete Builder |
| <input type="checkbox"/> Railroad Positions | <input type="checkbox"/> Structural Engineer |
| <input type="checkbox"/> Gas Engine Operating | <input type="checkbox"/> Chemistry |
| <input type="checkbox"/> Civil Engineer | <input type="checkbox"/> Pharmacy |
| <input type="checkbox"/> Surveying and Mapping | <input type="checkbox"/> Automobile Work |
| <input type="checkbox"/> Metallurgy | <input type="checkbox"/> Airplane Engines |
| <input type="checkbox"/> Steam Engineering | <input type="checkbox"/> Agriculture and Poultry |
| <input type="checkbox"/> Radio | <input type="checkbox"/> Mathematics |

Name.....

Street..... 8-3-23

Address.....

City..... State.....

Occupation.....

Persons residing in Canada should send this coupon to the International Correspondence Schools Canadian, Limited, Montreal, Canada

WANTED Railway Postal Clerks \$1600 to \$2300 Year

MEN—BOYS 18 OR OVER
SHOULD WRITE IMMEDIATELY

Steady work. No layoffs. Paid vacations. FRANKLIN INSTITUTE, Dept. C183, Rochester, N. Y.
Travel—See the country on Government time. Sirs: Send me without charge (1) Sample Railway Postal Clerk Examination questions; (2) List of Government jobs obtainable; (3) Tell me how I can get a position.
Common education sufficient: Name.....
Send coupon today—SURE Address.....



Wrestling Book FREE
Be an expert wrestler. Learn at home by mail. Wonderful lessons prepared by world champions Farmer Burns and Frank Gotch. Free book tells you how. Secret holds, blocks and tricks revealed. Don't delay. Be strong, healthy. Handle big men with ease. Write for free book. State age. Farmer Burns School, 1258 Railway Bldg. Omaha, Neb.

"BECOME A LIGHTNING TRICK CARTOONIST"
Make money chalk talking. Send \$1.00 for snappy program of trick drawings, with instructions by a professional cartoonist. Satisfaction guaranteed. Circular free. Balda Art Service, Dept. 4, Oshkosh, Wis.

Let Me Send You These Fine Shell Rim Spectacles
ON
10 DAYS' FREE TRIAL



SEND NO MONEY

JUST SEND THE COUPON I will send you on Ten Days' Free Trial a pair of my famous "True Fit" Shell Rim Spectacles. Hundreds of thousands now in use everywhere. These splendid Glasses will enable anyone to read the smallest print, thread the finest needle, to

See Far or Near and prevent eyestrain or headaches. If after trying them for 10 days and nights you are amazed and delighted, and think them equal to glasses sold elsewhere at \$16.00, send only \$4.98; if you don't want to keep them, return them and there will be no charge. Send no money; Pay no C.O.D.; simply your name, address and age. A beautiful velvet lined, gold lettered Spectacle Case FREE.

..... Cut and Mail Coupon Today

U. S. SPECTACLE CO.
1528 W. Adams Street, Chicago, Ill. Dept. A315

Send me a pair of your spectacles on 10-day free trial. If I like them I will pay you \$4.98; if not, I will return them and there will be no charge.

Name Age.....
St. & No. Box No. R.F.D. No.....
Post Office State.....

SMASHING SALE
By Oliver Typewriter Co.

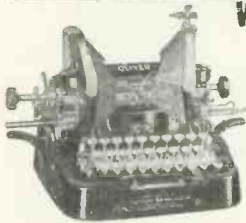

While They Last
1000 No. 9
Olivers
Rebuilt like new, right in Oliver Factory, only
\$44.50

\$2.00 DOWN Never before an offer like this, and probably never again! Only the great Oliver Company itself could do it. Famous Model No. 9 Oliver at the slashed price of only \$44.50—and a year to pay! Genuine No. 9 Oliver with standard keyboard and all late improvements, rebuilt throughout like new right in our own factory. The equal—yes the superior, we say, of any \$100 typewriter on the market. And yours for only \$44.50 on this special sale of 1,000 machines.

Free Trial—A Year to Pay

Act quick before the 1,000 machines are gone. Try, however before you buy. We give you 5 days free trial. Return or keep the Oliver as you decide. No cost to you whatever for the free trial. A year to pay if you buy. Write today for full particulars of this sale. Mail coupon or postal.

Oliver Typewriter Co.
(Rebuilt Machine Dept.)
Oliver Typewriter Bldg., Chicago

Oliver Typewriter Co.
(Rebuilt Machine Dept.) 617
Oliver Typewriter Bldg., Chicago

Please send me full particulars of your sensational sale of 1,000 No. 9 Olivers.

Name.....
Address.....

A WONDERFUL BOOK

A Book that's different from other books that you read. It's a book that will help you in business. It will give you ideas on how to make money, how to invest it systematically and build a fortune in a short time with little effort on your part.

It deals with various subjects such as Insurance, Banking, Investing, Divorce Laws of all the States. How to promote inventions, and many other subjects just as important. In fact it's the most valuable book ever published, and if you miss it you might as well quit reading BOOKS.

300 pages written by Gilbert, ex-sub-treasurer of the U. S. Price One Dollar, and your dollar back if not satisfied.

PERGANSON NOVELTY CO.
108-N, 5th Street Springfield, Ill.

Dr. Hackensaw's Secrets
By CLEMENT FEZANDIÉ
(Continued from page 645)

In spite of the rarefied atmosphere on the moon, which rendered all sounds almost inaudible, this conversation was carried on with ease by means of a special instrument—a miniature radiophone—the doctor had provided in the suits. Otherwise talking would have been out of the question. In fact, dead silence reigned all around them.

The pair walked on in silence for a while, and then Doctor Hackensaw suddenly stopped, for before him yawned a large opening in the moon's surface—an enormous well into whose depths he peered without being able to see the bottom.

THEY BOARD A MYSTERIOUS ELEVATOR

"Miss Pep," said he, "this must be the entrance to the habitations of the intelligent beings on the moon. And see! Here is one of their elevators, with the doors open, waiting to take passengers down! It's curious that we happened just to strike this place, but I felt a kind of leading in this direction, some invisible force pulling me here. However, let's get into the car and wait. Passengers are certain to come, sooner or later."

Pep followed the doctor into the car, and then gave a little cry.

"Look!" she cried. "The seats in the car are just like arm-chairs! There must be men here in the moon. Perhaps we're not the first people who have come to the moon."

Doctor Hackensaw was puzzled. The arm-chairs certainly seemed to indicate the presence of man. And yet, to believe that man was evolved independently on the earth and on the moon was against all the laws of probability. If men were here, they must have come from the earth at some previous period—perhaps the Chinese, the Hindoos or some other early civilized race had found means in bygone ages to send men to the moon. In no other way could he account for their presence. Intelligent creatures, yes—but men, no! Intelligence, like wings, could be evolved by natural selection from different organs.

Pep and the doctor seated themselves on the chairs, prepared for a long wait, but scarcely were they settled in their places when the doors closed automatically and the car, leaving the ground, started to fly down into the well.

"Hello!" cried Doctor Hackensaw in amazement. "It appears that we are the passengers expected. Our arrival has been seen and prepared for. Unquestionably, the Selenites are intelligent beings. It would have been a little more courteous of them to have sent somebody to bid us welcome. It may be a good sign, though, that they are not too anxious for our arrival. If they had meant to harm us they would certainly have sent an escort to meet us."

The car in which they found themselves was not provided with wings or visible apparatus of any sort, and yet it was descending rapidly into the bowels of the moon, as though endowed with intelligence. It touched neither wall, but descended, as if in flight, straight down the center of the passage. After fifteen minutes of this rapid descent, it changed its course and followed a horizontal passage. But here, also, it did not touch the ground, but flew a few feet above it.

To the doctor's surprise, although they were now several miles below the surface of the moon, the passages were all illuminated by a diffused light very much like the daylight on our earth.

Tycos Thermometers All the Family feels Better when the Temperature is at **68°**



Taylor Instrument Companies
Rochester, N. Y.
There's no Run and Get Thermometer for Every Purpose T-166

30 DAYS FREE TRIAL
\$10 Worth of Records FREE

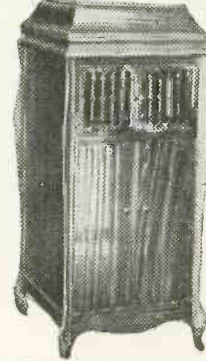

Simply wonderful! The limit of value giving! Just think! A GENUINE DAVIS PHONOGRAPH on 30 Days' Free Trial, and on terms as low as **\$2 A MONTH** in case you decide to buy. Magnificent instruments in quartered oak or mahogany piano finished cases, equipped with the finest worm gear motors, rich toned machines—at less than half the standard prices—and \$10 worth of records FREE.

Send No Money Just a postal with your name and address. Only a limited number of machines shipped on this extra-liberal offer. Better act quickly. This is a life-time opportunity. **DAVIS, 314 West 43rd St. Dept. M-51 CHICAGO**

RADIO CATALOG

Containing

LATEST HOOK-UPS

14 UP-TO-DATE HOOK-UPS AND LIST OF STANDARD QUALITY PARTS AT REDUCED PRICES

SEND 10c. TO COVER COST OF MAILING

Service and Quality Goods Built This House

GREAT LAKES RADIO CO.
136 W. LAKE ST., Dept. S, CHICAGO, ILL.



Wonderful Opportunities in CIVIL SERVICE

THOUSANDS of men and women appointed every year as Income Tax Auditors, Book-keepers, Railway Mail Clerks, Postmen, Deputy Collectors, etc. Generous salaries, short hours, liberal vacations. Positions open in Washington and in every other city of the country as well as in Porto Rico, Alaska, Hawaii and the Philippines. Write for 48-page FREE BOOKLET on CIVIL SERVICE, which tells you how you can get a good-paying position with the U. S. Government.

INTERNATIONAL CORRESPONDENCE SCHOOLS
Box 6212-C, Scranton, Penna.

Sell Shirts



Sell Madison "Better-Made" Shirts, Pajamas, and Nightshirts direct from our factory to wearer. Nationally advertised. Easy to sell. Exclusive patterns. Exceptional values. No experience or capital required. Large steady income assured. Entirely new proposition. **WRITE FOR FREE SAMPLES.**
MADISON SHIRT CO., 603 B'way, N.Y. City

Send To-day for the "Electrical Worker's Friend"

An electrical book of 66 motor drawings with complete instructions for rewinding and reconnecting A. C. motors. **\$3.00**
Special at
Or write for full particulars of this valuable book.
SMITH & SMITH PUBLISHING CO.
Dept. B., 7428 Hermitage St., Pittsburgh, Pa.

THE FIRST MEETING WITH THE MOON'S INHABITANTS

A moment later the car stopped, the doors opened and Doctor Hackensaw and Pep felt themselves impelled, as if by some stronger will than their own, to leave the car and enter an apartment, where they found the most peculiar set of living creatures they had ever set eyes upon. Some bore a faint resemblance to our earthly mammals or to plants, but most of them bore a greater resemblance to our invertebrates or to the microscopic forms of life with which we are familiar.

To his great surprise and joy, however, the doctor found that the entire assembly was dominated by a human being—a wonderfully beautiful white woman, with a kind though majestic look on her countenance. She seemed to possess the ability to read what was going on in the minds of her two visitors. More wonderful still, she was able to answer their thoughts in such a way that they understood her perfectly, though she did not know any earthly language. The conversation, if such it may be called, translated into English, was somewhat as follows:

The Lunar queen evidently knew all about the pair. "Yes," she said, seeing their surprise, "We keep track here of all that goes on in the other planets. Consequently, we knew from the very start all about Doctor Hackensaw's plans for visiting the moon. In fact, we hesitated whether or not to let him arrive here. However, we concluded that no harm could come of your visit, so we not only allowed you to come, but even prevented your car from dashing to pieces.

"No, we are not afraid of mankind, though perhaps we are wrong in our confidence, for inferior organisms are often a great menace to higher ones. But the Lunar beings are so superior to mankind, having had several million more years for their evolution, that we fear you no more than you would fear so many fleas. We have progressed far beyond the stage reached by you on earth."

"Tell me," interrupted Pep, not in words, but in thought, "Are there men as well as women here on the moon?"

NO SEX QUESTION ON THE MOON

"No," replied the queen. "As a matter of fact we have neither men nor women here. We abolished sex completely thousands of years ago. Sex is nothing but a cause of endless trouble and worry, as you must know, for all your habits, customs, and daily thoughts, your whole life in fact, is shaped by marriage and the relations between the sexes. We have found it much more satisfactory to create our children synthetically from the chemical elements that compose them. We are then sure of getting what we want."

"But you yourself," cried Pep, "are a woman!"

"No indeed. In truth we Selenites can scarcely be said to possess a definite shape, but we have the power of changing our appearance at will. I thought it would be pleasanter for you if I received you in the form of a woman, and I wish to be pleasant for I have a disagreeable communication to make to you."

"A disagreeable communication?"

"Yes. We Selenites do not like the idea of your visiting the moon. We believe that others of your race of savages may come over, and that nothing but trouble will arise from their visits."

"Race of savages!" cried the doctor. "Do you mean to say that you regard mankind as savages?"

The queen smiled contemptuously, and taking something apparently from the air, she handed it to the doctor. It was a copy of that morning's issue of a New York daily newspaper. Pep glanced at it eagerly and saw it was full of comments on the message she had wirelessly from the car.

New Easy Way to Become a Cartoonist

By this amazing new method it is possible for *anyone* to learn Cartooning in a remarkably short time. Many of our students could hardly draw a straight line before they began to study with us. Now hundreds of them are making splendid incomes. And they learned it all *at home—in spare time!*

THE simplicity of this truly wonderful method will astonish you. Although you never leave your own fireside, you receive the personal attention of one of America's foremost Cartoonists. It is almost the same as if you were working in his studio. Your mistakes are not only pointed out, but each correction is illustrated right before your eyes. You see exactly where your faults lie and you never make the same mistakes twice. The speed with which you progress will amaze you. Through this wonderful method many of our students are now making handsome incomes, and the same opportunity to enter this splendid profession is now yours.

No Talent Is Needed

The most astounding part of this wonderful method is that you don't have to know anything about drawing to begin with. The old idea that only those with "inborn talent" could be successful Cartoonists is exploded. *If you can hold a pencil you can learn Cartooning this new easy way.* Starting with first principles—straight lines and curves—you progress step by step through shading, action, composition, etc., until you find yourself qualified for a splendid position as Cartoonist almost before you realize it.



Work That Is Play at a Big Profit

Right now there is an increasing need for Cartoonists. We cannot train men fast enough to meet the demand and the result is high salaries. \$50 to \$75 a week is not at all unusual for a beginner—many make much more. And there is absolutely no limit to what you can do. But aside from the big pay is the wonderful fascination of the Cartooning game. There is no "9 to 5" daily grind. And it really is not "work" at all, but the most delightfully interesting play. You meet interesting people, work in pleasant surroundings, and, best of all, you are practically your own boss. And then, think of the fun of creating your own characters, of being able to make quick, catchy little sketches at home, at a big dinner party, at the theatre! Our students say it is the most fascinating profession in the world.

low-pay run now. Get your start in this high-paid interesting profession at once. Clip the coupon below and mail it to us today.

Washington School of Cartooning
Room 2611, 1113-15th St., N. W.
WASHINGTON, D. C.

WASHINGTON SCHOOL OF CARTOONING
Room 2611 1113-15th St., N. W., Washington, D. C.

Gentlemen: Please send me your free booklet, "How to Become a Cartoonist," and tell me about the big opportunities for me in this field.

Name (State whether Mr., Mrs., or Miss)
Address
City State

Write for Free Booklet

"How to Become a Cartoonist" explains this amazing new method in detail; shows you how it works; tells you about our students and what they have accomplished; about the tremendous opportunities in this great field and how you can qualify for one of them this very year. Get out of the

HEALTH

Is the Greatest Joy of Life. Only the robust, vigorous and healthy can enjoy life to its fullest. The complaining, ailing, sickly ones are unhappy, discontented, dejected, failures. For 25 years I have been making people well through Strongfortism. I have helped tens of thousands to become strong. No matter what ails you, write me fully about it, and I will prove to you I can help you. The experience and research of a lifetime are contained in my wonderful FREE BOOK "Promotion and Conservation of Health, Strength and Mental Energy." Send a ten cent piece (one dime) to cover postage.



LIONEL STRONGFORT
Physical and Health Specialist
1263 Strongfort Institute, Newark, N. J. Lionel Strongfort Perfect Man

STRONGFORTISM

Prices Reduced On All Standard Make TYPEWRITERS

Lowest Prices in Years
We will ship any make you choose for one week's trial. Underwood, Royal, L. C. Smith, Remington, Oliver, etc.
Easy Terms Pay less than rent each month and own a typewriter. Guaranteed as good as new. Perfectly rebuilt by experts—the famous "Young Process." Send for our free trial offer and new low price list now. WRITE TODAY.

Young Typewriter Co.
World's Largest Dealers in Standard Typewriters
654 W. Randolph St., Dept. 116B, Chicago, Ill.

TRADE MARK REG.
WURLITZER
SUPREMACY IN MUSICAL INSTRUMENTS

Quality

Wurlitzer instruments are known the world over for unusual tone quality and excellence of workmanship.

They are used by the greatest musicians, bands, and orchestras. Thousands of amateur musicians are playing on Wurlitzer instruments.

Wurlitzer is the world's greatest music house, with stores and dealers in all parts of the country. But no matter where you live, you receive the same service by mail as though you were next door to the factory.



Try Any Instrument in Your Own Home At Our Expense

You may now have any known musical instrument for a week's free trial in your own home. Play it as much as you wish. See how easy it is to learn. There is no obligation to buy — no expense for trial. You may return the instrument at the end of a week if you decide not to keep it.

Easy Payments

If you decide to buy, the Wurlitzer plan makes it easy for you to own the instrument you want. Payments are conveniently arranged in small monthly sums — a few cents a day will pay.

Special combination offers on complete outfits — velvet lined case, all accessories, self-instructor, etc. — everything you need at practically the cost of the instrument alone.



Send for **Free Catalog**

The greatest musical catalog ever published — over 3000 articles — every known instrument described and illustrated; many of them shown in full colors. Gives you lowest prices and all details of the Wurlitzer plan.

The Rudolph Wurlitzer Co., Dept. 1258

117 E. 4th St., Cincinnati 329 So. Wabash Ave., Chicago
120 W. 42nd St., New York 250 Stockton St., San Francisco

Send me, absolutely free, your new illustrated catalog of musical instruments. Also tell me how I may try any instrument in my own home at your expense and how the Wurlitzer Plan makes it easy for me to buy. No obligation.

Name.....

Address.....

City..... State.....

Instrument.....
(State instrument in which you are interested)

"There!" said the queen. "Look at that newspaper, one of your best dailies, yet full of accounts of murders, thefts, strikes, wars and all such things! Could any but a nation of savages tolerate things of that sort? And not only tolerate them, but gloat over them? Do you wonder that we do not wish to run the risk of being contaminated by your presence among us? Not that we are afraid of you, but we might be forced in self-defense to exterminate your race."

"Why do not some of the Selenites come to earth to teach us better?" asked Doctor Hackensaw.

"For the same reason that you do not attempt to teach your microbes civilization. The task would be hopeless. It is the work of millions of years, and countless generations of slowly progressing individuals. As for colonizing the earth, we may possibly do that some day, but it will mean the extermination of the race of man. Reassure yourselves, however. If such a thing ever happens it will not be for thousands of years to come. But now for the point in hand. You must both of you return at once to the earth."

"But how can we return?"

"I will attend to that. You will be back in less than an hour."

"But how about me?" asked Pep, on the verge of tears. "I am accused of committing a murder, and, although perfectly innocent, I have no means of proving my innocence."

"I will attend to that, too," replied the queen. "Take this box. In it you will find proofs that will convince the most skeptical."

Pep tore off the cover of the box and perceived a roll of movie film.

LUNAR "MOVIES" OF EARTHLY HAPPENINGS.

"Yes," explained the queen. "It is a moving picture of the murder as it really occurred. Look in this mirror on the wall and you will see the whole scene depicted."

Sure enough, a mirror appeared on the wall as if by magic, and in it the whole tragedy was enacted in natural colors. It was as Pep had surmised. One of the murdered man's victims had shot him in a fit of desperation.

"How did you get this film?" inquired the doctor, curiously.

"I had it sent from one of the nearest dead stars," replied the queen. "As you know, light travels only 186,000 miles per second. Hence the light that left the earth at the time of the murder had not yet reached the star when they received my message. They therefore made this moving picture of the murder as soon as the light rays reached them."

Doctor Hackensaw was perplexed.

"How could you send a message and receive a film faster than light can travel?"

"Because light is not the fastest thing in the universe," replied the queen. Gravitation travels much faster than light. To you on earth, gravitation seems to act instantaneously. As a matter of fact it is really slow, but it travels from the earth to Sirius in less than one second, a speed immensely superior to that of light. I sent a wireless message by gravitation and received the film here almost instantaneously by the same means. . . Here is an older film which shows the earth as it appeared before the advent of man."

As she said the words there appeared on the mirror a prehistoric landscape with the brontosaurus and other paleolithic monsters browsing in the primeval forests, while the ichthyosaurus and plesiosaurus sported in the waters and the pterodactyl flew overhead.

How to Hook - Up A Transmitter Button to Make an Efficient Loud Talker

A Transmitter button with a few dry cells and a telephone receiver will make a remarkably simple and efficient loud talker. A Microphonic amplifier of this type is just the thing for use with a radio set. The weak music and signals may be amplified many times their original value. It is possible to entertain a large audience with a simple radio equipment if a transmitter button is used in the circuit as explained in diagram A.

The cost is extremely low and the results are comparable with those produced by highest grade of expensive loud talkers.

As may be seen in the diagram, two dry cells or a small storage battery are connected in series with the transmitter button and a 4 to 75 ohm telephone receiver. The transmitter button is secured to the diaphragm of the telephone in the radio receiving set. To accomplish this properly, scrape off the enamel (if diaphragm is enameled) on the face of the diaphragm and solder the small hexagon nut supplied with the button to the exact center. Care should be taken that the thin diaphragm is not bent or otherwise

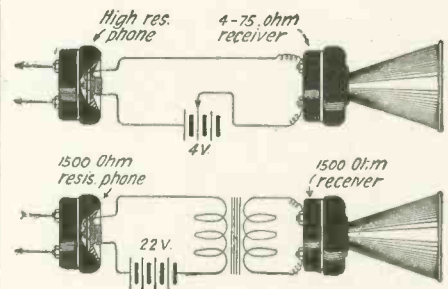

harmed. The transmitter button is then screwed into place. Connections, as shown in the diagram, are made with flexible wire. A horn may be placed over the low resistance receiver if desired. When the radio set is properly tuned and signals are being received, the transmitter button is operated by the vibration of the diaphragm of the receiver. As the receiver diaphragm vibrates, the mica diaphragm on the transmitter button also vibrates. The carbon grains are compressed at varying pressure; the current flowing through the local battery circuit is thus varied and results in an amplification of the sounds in the low resistance telephone loud-talker.

Diagram B, which includes a step-up transformer, is to be used with loud talking receivers of high resistance. The primary of the transformers should have a resistance of about 75 ohms. An ordinary telephone induction coil will serve as the transformer in this circuit.

You can get the above-described transmitter button FREE in subscribing to "Practical Electrics Magazine" at \$2.00 per year (12 months). Send your subscriptions today.

Make all remittances payable to Practical Electrics Co., 53 Park Place, New York City.

Doctor Hackensaw gazed at the pictures with interest, and then asked: "How about the planetary machine that we saw on our way here? What is its object?"

"Its function is to utilize the sun's heat," explained the queen. "Half of the moon is always brightly illuminated by the sun. The heat thus received is stored up automatically in the body of the moon. From here it works the planetary machine which sends wireless waves wherever we happen to need power. The radiator-like instrument serves as the regulator."

"Would you allow me to have a description of the machine so I can construct one like it?"

"No indeed. Your knowledge is insufficient and you would be sure to kill yourself in the attempt to control these forces. Besides, too much knowledge would make you miserable. The world has no use for a man who is too far ahead of his time. But enough of this. You can have dinner here, and then you must go."

"What do you eat?" inquired the doctor, curiously.

LUNAR BEINGS DO NOT EAT

"We Selenites do not eat at all. We breathe in the carbon, oxygen and hydrogen that are necessary for life. We see to it that our atmosphere contains these elements in the proper proportions."

"But carbon is a solid," exclaimed Pep in surprise. "You cannot breathe charcoal?"

"Carbon is a gas in the form of carbon dioxide, and we are able to utilize it in our bodies in this form, decomposing it into its carbon and oxygen. But here is your meal," she continued, as a table appeared loaded with all sorts of delicacies.

Pep, who had been expecting a meal of carbon, oxygen and hydrogen, gave a squeal of delight when she saw the wonderful meal that was served. There were soups, meats, vegetables, fruits, pastry and sweets of the kind she liked the best.

The pair ate heartily, but some narcotic must have been in the food, for scarcely was the last mouthful eaten when they both felt themselves overpowered by a heavy sleep.

BACK TO MOTHER EARTH

When they awoke they found themselves back in the couches in the car. Doctor Hackensaw threw open the door of the vehicle and gave a cry. And well he might cry out! Here he was back again on earth, in his own New Jersey estate.

The queen had kept her word. The return journey to the earth had lasted less than one hour!

THE END

FINISHING TOUCHES FOR HOME-MADE RADIO SETS

After completing the set give all of its wood work a coat of stain followed by two coats of good varnish. If the panel is made of bakelite or some similar substance, if it is stained or varnished, a high polish can be given it by rubbing briskly with a cloth dampened with olive oil.

To copper coat iron. Clean the iron with a mixture of fifty parts of hydrochloric acid and one part nitric acid. Next immerse the iron in a solution of one part of copper sulphate in ten parts of water. This gives only a thin coating, little more than a color. Battery plating is much better and is very simple for copper deposition.

Bronzing iron and brass. Mix a solution of one ounce of hyposulphite of soda and two ounces of acetate of lead in two pints of water. Bronzing is done by dipping the articles in the solution until well bronzed. Iron when so treated shows a blue tint and brass becomes either a redish or bluish color when immersed in the solution.

Contributed by J. H. PAULSON.

Learn Radio At Home

Earn \$2,400 to \$10,000 a Year

The man who would be a success in business today must be a specialist. The market is already crowded with clerks, stenographers, accountants and detail men of every description. That

is why the chances are so strongly against their getting big pay. But look at the men who are earning real big money today. In practically every case we find them to be specialists!

RADIO NEEDS TRAINED MEN

There is probably no other field today where specialists are needed more than in Radio. Trained men are needed in every branch of this fascinating, profitable profession. And the opportunities for trained men are great—almost without limit. Even in this field, the men who stand the best chance of landing big are those who enter this field NOW while Radio is growing so rapidly.

the same work you are—get out of the rut into a big paying profession. Learn Radio at home. A short course of training will quickly enable you to be independent, to travel and see the world if you care to, or to establish a business of your own. It will make you a specialist with the unlimited opportunities that are open to a specialist in this tremendous uncrowded field of Radio.

FREE BOOK—Describes Opportunities

To any man who is eager to better his condition, and is interested in the remarkable opportunities in Radio, we will gladly send a copy of our newly published book on radio—*absolutely free*. You assume no obligation whatever in sending for this interesting helpful book. It is yours for the asking.

Send for your copy of "How to Learn Radio at Home" and learn all about the wonderful opportunities that are opening in Radio, how we train men for them and help them to the best positions. Read actual experiences of many of our students since we have trained them. "Tune in" on a real job. Mail the coupon for this interesting Free Book today. It will pay you!

National Radio Institute, Dept. 14L, Washington, D. C.



You Can Qualify at Home Easily and Quickly

If YOU are sick of plodding along in the daily grind of monotonous office routine—held down by thousands of men doing

Pick Out the Job You Want—We Will Help You Get It

- This is a brief list of the positions in the Radio field today, and the salaries paid—
- Radio Mechanic, \$1,500 to \$4,000 a year.
- Radio Inspector, \$1,800 to \$4,500 a year.
- Radio Salesmen, \$2,000 to \$10,000 a year.
- Radio Engineer, \$3,500 a year and up.
- Radio Executives up to \$15,000 a year.
- Radio Instructor, \$200 to \$500 a month.
- Radio Draftsmen, \$7 to \$15 a day.
- First Class Ship Operator, \$105 a month, all expenses paid.
- Second Class Ship Operator, \$95 a month, all expenses paid.
- Third Class Operator, \$85 a month all expenses paid.
- Commercial Land Station Operator, \$150 a month and up.
- Broadcasting Station Operator, \$125 to \$250 a month.

National Radio Institute
Dept. 14L, Washington, D. C.

Without any obligation on my part, please send me a FREE copy of your book, "How to Learn Radio at Home." Also tell me how your Free Employment Service will help me to a position and send details of your special short-time offer.

Name

Street

City

State

RUSONITE

CRYSTAL RECTIFIER

(Patent Pending)

THE PERFECT SYNTHETIC CRYSTAL DETECTOR SENSITIVE OVER ENTIRE SURFACE No Hunting for "Spots." Loud and Clear. Endorsed by Thousands of Satisfied Users.

Sensitiveness Guaranteed Price Mounted **50c**

14 K. Gold Supersensitive RUSONITE CATWHISKER. Price Permanent. Will not Oxidize. **25c**

RUSONITE REFLEX CRYSTAL Manufactured Expressly for Reflex Circuits Will Stand Up Under Heavy Plate Voltage

Guaranteed Price Mounted **\$1.00**

Order from your dealer or direct from RUSONITE PRODUCTS CORP. 15 Park Row New York, N. Y.

The Real Metal Solder in Paste Form

SOLDERALL

Introducing Our New SOLDERALL BLOW TORCH of Heavy Solid Brass

Indispensable in the Home, Garage and to the Electrician. For Soldering Radio, House Wiring, Jewelry, Ignition, Kitchen Utensils, Etc.

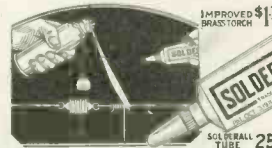

SOLDERALL CO. Dept. S Newark, N. J.

JUST OFF THE PRESS

12th Edition

WIRELESS COURSE IN 20 LESSONS

By S. GERNSBACK, A. LESCARBOURA and H. W. SECOR

Very Greatly Enlarged

Price
\$2.00
Postpaid

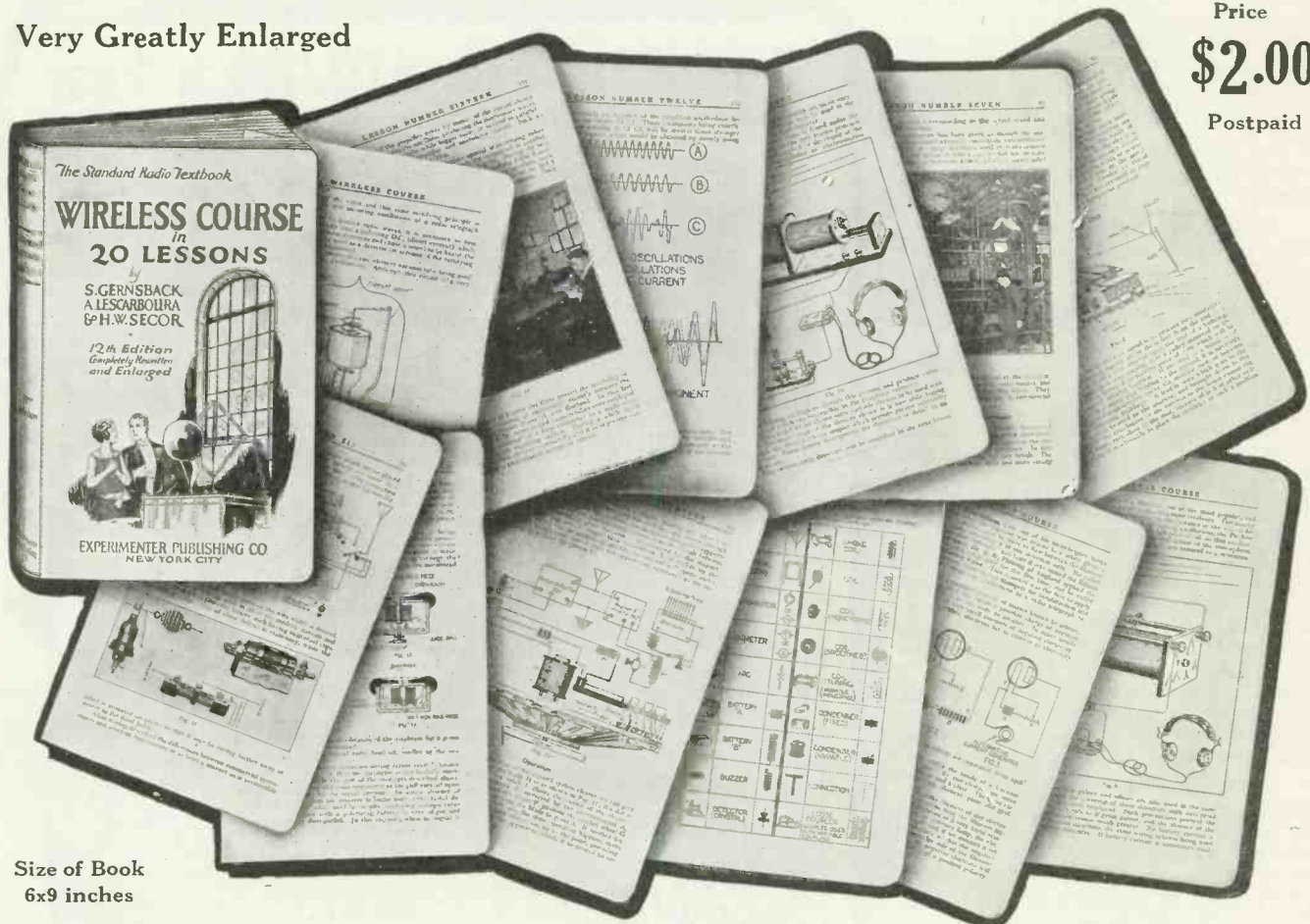

Size of Book
6x9 inches

264 pages. 500 illustrations, diagrams and photographs. Binding de luxe; black leatherette cover, genuine gold stamped; red edges; round corners; semi-flexible covers; multi-colored jacket.

This new edition contains over 100 pages more than the previous editions, of which over 100,000 were sold. It is printed in a larger type, on better paper and has better and more illustrations.

- Lesson No. 1: Principles of Electricity:
History and Explanation of Electricity, etc.
- Lesson No. 2: Principles of Magnetism:
The History and Explanation of Magnetism, etc.
- Lesson No. 3: Dynamos, Motors, Generators, and Wiring:
Explanation of Construction and Operation of each of the above, etc.
- Lesson No. 4: Principles of Wireless Telegraphy:
History and Explanation of the Wave Transmission and those concerned in the development of early radio, etc.
- Lesson No. 5: Amateur Transmitting Sets and Apparatus:
Apparatus and Circuits used by Amateurs in the early days of radio telegraphy, etc.
- Lesson No. 6: Transmitting Sets (Continued):
Apparatus and Circuits of Transmitting Apparatus, etc.
- Lesson No. 7: Commercial Transmitting Systems:
Apparatus and their operation, etc.
- Lesson No. 8: Aerials and Underwriters Installing Regulations:
Explanation of the Antenna System and Constructional details of the various types used. Official regulations, etc.

- Lesson No. 9: Radio Receiving Apparatus:
Description of the Various Types of Receiving Apparatus with an explanation of their operation, etc.
- Lesson No. 10: The Detector:
An explanation of the various types of detectors used for reception purposes, including circuits, etc.
- Lesson No. 11: The Vacuum Tube as a Detector:
Principles of operation of the vacuum tubes, etc.
- Lesson No. 12: Regenerative Receiving Set:
Description and explanation of various vacuum tube circuits, etc.
- Lesson No. 13: The Vacuum Tube as an Amplifier:
Operation of the types of amplifiers as in conjunction with tuners. Loud Speakers, etc.
- Lesson No. 14: Practical Vacuum Tube Circuits:
An explanation of various up-to-date Circuits used in Radio, etc.
- Lesson No. 15: Super-Regenerative Receiver:
Operation of the Super-Regenerative Receiver, etc.
- Lesson No. 16: Vacuum Tube Transmitter:
Vacuum Tube Transmission and Broadcasting Systems, etc.
- Lesson No. 17: Radio Compass—The Wavemeter—Radio Control:
The Radio Compass. Principles and operation of the Wavemeter and Radio Control, etc.
- Lesson No. 18: Learning to Operate—The Codes—The Wireless Law:
Methods of learning the International Code. Appendix: Detailed regulations of the wireless law, etc.
- Lesson No. 19: History of the Development of Radio:
A progressive history of radio and those concerned in its progress, etc.
- Lesson No. 20: Mathematics of Wireless Telegraphy and Appendix:
Formulas for the Calculation of Wave-length, Inductance, Capacity, and other measurements, etc.

Sent postpaid upon receipt of \$2.00

If your Dealer cannot supply you, order direct from us, giving Dealer's name and address

Experimenter Publishing Co., 53 Park Place, New York, N.Y.

Around the Universe

BY RAY CUMMINGS

(Continued from page 643)

fraction of a second away at this velocity. A collision with one was a blind chance which they could not avoid taking.

Twenty-four hours after passing Alpha Centauri the voyagers found themselves distant from the Earth some 15½ light-years. Sir Isaac left his mathematics for an hour that afternoon to point out to his friends places of interest in the Heavens.

The firmament now shone with dazzling brilliancy, though the faint stars of the Milky Way still seemed as far away as ever. The sun of the Solar System—its planets quite invisible—had dwindled to one of the faintest of all the stars in that region. Alpha Centauri, visually quite near the sun, was infinitely brighter, but still it was surpassed by many of its fellows.

TUBBY GETS A FEW COMPARISONS

Sir Isaac, passing from one window to another, pointed out the red stars—Antares, most deeply colored of all—Betelgeuse, Aldebaran and Arcturus. Tubby wondered if any of these stars were as large as the Sun, or whether it was only on account of their closeness they looked so much brighter. Sir Isaac laughed with genuine amusement.

"They are somewhat larger," he said ironically. "Take Betelgeuse, for instance. There's our Sun—there's Betelgeuse. Our Sun is about 15½ light-years from here—Betelgeuse is about 150 light-years!"

"He—he must be lots bigger, then," Tubby concluded after a moment of amazement.

"He is," said Sir Isaac. "Professor Albert Michelson measured the diameter of Betelgeuse in the autumn of 1920. His figures show that star to be equal in size to 27,000,000 Suns like ours!"

Tubby was staggered. Sir Isaac went on calmly.

"The diameter of Betelgeuse is 260,000,000 miles. Let me show you how really enormous that is. You remember our trip from the Earth to Venus, and to Mercury? Well, if Betelgeuse were a hollow globe and you put our Sun suspended in its center, Mercury, Venus and the Earth would all have plenty of room to traverse their orbits inside it! Even the orbit of Mars would only be a short distance outside!"

Neither Tubby nor Ameena could think of anything to say.

"Professor Michelson found all that out by what he calls the 'Interference Method.' I won't bother you by explaining it," Sir Isaac raised his hand despairingly. "Of course Michelson deserves a lot of credit. I never had occasion to work on just that particular problem, or I would, of course, have been able to—"

"Show us somethin' else," Tubby interposed.

Sir Isaac pointed out several binaries that now were visually separated. It was all a most wonderful sight; the multiple stars—"clusters"—and the curious spiral nebulae, the still faint, far-off Milky Way. It was indeed a stupendous, awe-inspiring sight, though Tubby and Ameena were now sufficiently used to it, to be comparatively unimpressed.

For nearly a week the vehicle, with steady acceleration, dropped into Space, while Sir Isaac worked almost incessantly at his computations and Tubby and Ameena engrossed themselves in each other's companionship.

They entered the Milky Way on the seventh day after passing Alpha Centauri. Though their actual entrance into the Galactic Plane was unmarked by any visual phenomena—the firmament blazed with stars



The World's Most Popular Battery Charger

Nothing speaks so eloquently of HOMCHARGER satisfaction as the fact that thru sheer merit alone it has become the *standard* by which all other battery chargers are judged. Over 125,000 HOMCHARGERS already in use offer the most convincing proof that it is the most efficient, economical and fool-proof battery charger at any price.

A NEW TRADE-MARK FOR A TRIED AND PROVEN PRODUCT

Its phenomenal success has led to the introduction of many inferior and make-shift imitations. To insure our reputation and protect the buying public against substitution, the Radio De Luxe HOMCHARGER henceforth will be sold under a new Trade-Mark, viz.:



Retaining the same fundamentally correct operating principle and beautiful appearance of our Radio De Luxe model, it is a step nearer ultimate perfection through adoption of several construction refinements dictated by the policy of Progress.

HOMCHARGER'S 10 POINTS OF SUPERIORITY

1. **Simple**—Only one moving and wearing part, replaceable after thousands of hours use for \$1.00. Will last a lifetime.
2. **Efficient**—Uses less than one-half the current of any bulb or liquid type rectifier. Will charge any radio or automobile battery for a nickel.

3. **Quick**—Its high charging rate of 7 amperes eliminates long waiting for battery to become charged. Will charge any "A" or "B" battery over night, or three times as fast as a 2-ampere machine.
4. **Clean**—No expensive bulbs to break or acids to spill or replace. No acid fumes. Charges without muss, fuss or bother.
5. **Dependable**—Tungsten contacts insure continuous operation—prevent sticking and stopping.
6. **Fool-Proof**—Can be operated by anyone. Attach to lamp socket and connect battery either way, it will always charge. High-grade ammeter eliminates guess work.
7. **Safe**—No danger of shock or fire. Tested and approved by Fire Insurance Underwriters everywhere. Gives tapering charge—will not overheat or injure battery.
8. **Beautiful**—Mahogany and Gold Finish.
9. **Unqualifiedly Guaranteed.**
10. **Popularly Priced**—Retail at \$18.50 complete (\$22.00 Canada). No extras to buy. Sold by all dealers.

FREE BROADCASTING LIST. Send today for Free List of Broadcasting Stations, and Circular Describing the Gold Seal Homcharger.

DEALERS! JOBBERS!

GOLD SEAL HOMCHARGERS will outsell any other radio device this season. "GOLD SEAL Business Builders" illustrates many attractive sales helps and explains how we are prepared to cooperate with the Trade in making this a "HOMCHARGER Year." Send for your copy and Trade Discounts, TODAY.

Insist on the GOLD SEAL

LOOK FOR IT



It is your protection against substitution. When buying order by name and verify by the GOLD SEAL, which appears on the carton as well as the nameplate.

The Automatic Electrical Devices Co., 116 West Third St., Cincinnati, O.

Largest Manufacturers of Vibrating Rectifiers in the World

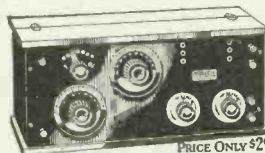

MIRACO GETS 'EM 1500 MILES AWAY

At the low prices shown below you get the efficiency of sets costing three times as much. These radio frequency receivers—pick up stations over 1500 miles away under good conditions—everywhere. Operate either on DRY CELLS or storage battery. Cabinets of solid mahogany and workmanship the finest throughout. Order direct or send for bulletin.

Two tube outfit, as shown above, headphones only \$29.50
Four tube outfit for loudspeaker or headphones 54.50

DEALERS—AGENTS
Write for proposition quickly—its a winner.
THE MIDWEST RADIO COMPANY
809 Main St. Cincinnati, Ohio

LEARN RADIO

Here's your opportunity. Radio needs you. Win success in this fascinating field. Trained men in demand at highest salaries. Learn at home, in your spare time.

Be a Radio Expert

I will train you, quickly and easily, to design, construct, install, operate, repair, maintain, and sell all forms of Radio apparatus. My new methods are the most successful in existence. Learn to earn

\$1,800 to \$10,000 a Year

FREE Wonderful, home-construction, tube receiving set, of latest design. Write for "Radio Facts" free. Engineer Mohaupt.

American Electrical Association
Dept. 611 4513 Ravenswood Ave., Chicago

Insure your copy reaching you each month. Subscribe to Science & Invention —\$2.50 a year. Experimenter Publishing Co., 53 Park Place, N. Y. C.

What's in a Name?



TIMES have changed since the Bard of Avon put his famous query, "What's in a name?" In Shakespeare's day the most successful merchant was the biggest skinflint. His name meant nothing. You entered his shop with your eyes open and your fingers crossed. You haggled and you bargained. And if you were especially astute, perhaps you retained your eye teeth.

Modern business ideals and modern advertising have wrought the change. To-day, the biggest asset of any successful business is a good name built up through fair dealing, fair policies and a good product.

Advertising creates reputation. Makers of advertised products frequently value the names at millions of dollars. They cannot afford to jeopardize the worth of these names by selling anything but good merchandise of full measure and fair price.

A manufacturer does not dare to advertise wares that will not give service. He has his good name to protect.

Bank on this. *Advertised goods must be as advertised.* That's why it pays you to deal with advertisers and to buy advertised goods.

Advertising is your protection. Read it.

Big 3-Ft. Telescope Useful and Entertaining (In Five Sections)

See people and objects miles away, on land or sea, as if they were close. Wonder Telescope gives new pleasures to home, farm, camp, travel, sport. See moon and stars as never before. Opens out over 3 feet long; measures 12 inches closed. Brass bound; has powerful lenses. Thousands pleased—"Could tell color of aeroplane 4 miles away."—Mrs. Yarbrough. "Saw Provincetown Light, 28 miles away, as clear as if in front of me."—Clyde Scribner.

SEND NO MONEY

"I have been watching submarines 3 miles off the coast."—F. Grush. "Can see children playing in school yard 6 miles away."—P. H. Hennington. "Read the numbers on freight cars mile away, see mountains on moon."—A. G. Palmer.

Because of a fortunate purchase from a large European manufacturer we can give you a big bargain. Be first in your neighborhood; entertain your friends. **Send no money; send only name and address for telescope complete by parcel post. On arrival deposit with Postman only \$1.85 plus a few pennies postage. Satisfaction guaranteed or money refunded. Order today while the supply lasts.**

FERRY & CO., 75 W. Van Buren St. Dept. 1257 Chicago, Ill.



Insure your copy reaching you each month. Subscribe to Science and Invention—\$2.50 a year. Experimenter Publishing Co., 53 Park Place, N. Y. C.

as usual—a different set of stars were now brightest, but to the non-technical observer there was no marked change.

During this week an apparent star motion had gradually increased, until now, looking down through the lower windows, the stars could be seen opening up as the vehicle dropped into them—separating themselves, passing upward, across the side windows, and closing together again overhead.

"How fast we goin' now, pefessor?" Tubby asked once.

It was at supper time. Sir Isaac hastily masticated a huge mouthful of cheese sandwich and washed it down with a swallow of coffee, before replying.

"I cannot tell you in miles," he answered. "In light-years I estimated it this morning to be about 1/120 a second. That is, 1/2 light-year a minute, or about 720 a day. We are now about 3,500 light-years from the Earth."

Tubby had by this time made up his mind never to be surprised again at anything.

"That's an awful lot faster than we used to go, ain't it?" he remarked. "Around Mercury or Venus, f'r instance."

Sir Isaac's smile was condescending.

TUBBY GETS DOPE ON REAL SPEED

"The diameter of the entire Solar System, from Neptune's orbit, across the Sun, and out again to Neptune's orbit on the other side is a mean distance of 5,593,056,000 miles. We are traveling that distance now just about once every second!"

Probably no other statement of Sir Isaac's was so amazing. And, as Tubby and the girl pondered it, the immensity of this Space through which, day after day, night after night, they were plunging at this almost inconceivable rate, was made clear to them.

Sir Isaac added laughingly:

"The Solar System isn't very large. Why, that star Betelgeuse could hardly turn around in it. A mere 5,500,000,000 miles,—it's only a few times the diameter of that one star."

How Sir Isaac ever avoided the stars of the Milky Way, even with the gigantic distances separating them, he never understood. All that night, his still elusive calculation neglected, he sat at the floor window in the instrument room. From time to time he leaped to the keyboard to alter their course. It was a nerve-wracking, horrible night. But in the morning, when Tubby, and a little later, Ameena appeared, the Milky Way lay glistening above them. Below, only a few stars showed; beyond that, darkness—blank, unfathomable.

Sir Isaac greeted his friends with a wan smile; he was on the verge of physical exhaustion, but his spirit remained undaunted.

"We are beyond the stars," he said. "It is as I always thought. Even from Earth I have telescopically observed a perceptible thinning out of the Celestial bodies. We have reached the limits of our Celestial Universe on this side. We have now below us only empty Space—unless we encounter another Universe."

Sir Isaac quite evidently had his own theories as to what lay beneath them in that void of darkness. But he smilingly resisted all Tubby's efforts to make him talk about it.

Finally in desperation, Tubby exclaimed: "We ain't got no business goin' much farther. The opposition of Mars comes off in forty-two days from 6 P.M. tonight—an' we're gettin' a fair distance away from the excitement."

Sir Isaac smiled confidently. "We shall return without a stop—quite in time, even at our present speed. That isn't worrying me. It's—"

"Your calculations?" supplied Ameena. Your great plan of which you will tell us nothing? How are they progressing, Sir Isaac?"

His face clouded. "I have been so busy," he said somewhat anxiously. "But I'm making progress. Now that we are beyond the stars, I will have more freedom—will redouble my efforts."

Poor Sir Isaac, for all his eagerness to work, was forced to retire immediately after breakfast for a few hours of much needed rest. They awakened him for luncheon—which he gobbled in haste—retreating at once to the instrument room, where by the light of the table electrolier, he became instantly immersed in his interminable figures.

Thus, in similar fashion, while the vehicle plunged onward through Space at a velocity sufficient to take it across the 5,593,056,000 mile diameter of the Solar System in very much less than one second, fifteen more days and nights of interminable voyaging went by!

EXPLORING OUTER SPACE

The Universe of which our Solar System is so minute a portion, had long since faded into invisibility. Others had been distantly sighted on both sides, and passed overnight—reduced by comparison into mere nebular regions, though each may have been as large, or larger than our own Universe.

On the fifteenth day, skirting alongside a smaller Universe—possibly no more than a thousand light-years in diameter, Sir Isaac announced that they were approaching the end of their outward voyage.

The vehicle was still dropping into that vast void of silence and darkness with a velocity now quite beyond calculation. It was a decreasing velocity, now, however, for, sometime since, Sir Isaac had begun to retard it.

Overhead, the last starry firmament was visible, though every hour with perceptibly lessening brilliance. Tubby and Ameena sat together in the observatory, watching the receding stars, and wondering how, among all these Universes, Sir Isaac would ever set his course going back, in order to reach that particular one of the Solar Systems to which they belonged.

The temperature of the vehicle was now, curiously enough, very comfortably warm—so warm indeed, that Tubby wore his white clothes and Ameena that dainty costume in which he had first seen her on Venus. This paradox of temperature—for here in outer Space it should have been insufferably cold—Sir Isaac had explained to them the evening before. Their velocity was so great, he said, that even the minute, widely separated atoms of the ether, pounding against the vehicle's base, were heating it—just as it had been heated before when passing through the atmospheres of the several planets upon which they had landed.

Sir Isaac, alone in the instrument room, worked over his figures incessantly, feverishly, all that afternoon. It was nearly five o'clock when, with a cry of triumph, he dropped his pencil and staggered to his feet.

"I've solved it! Tubby, Ameena, my friends, at last the problem is completed. We shall save our Earth now—nothing can prevent us!"

With head reeling, he groped his way out into the dim hallway and up the stairs, looking for his companions. In the starlight of the observatory he found them—Tubby lying prone with his head in Ameena's lap, she stroking his hair gently, singing softly a tender love-song of Venus.

"I've solved it!" Sir Isaac cried. "We cannot fail now to save the Earth! My calculation is completed at last, down to the smallest decimal."

Tubby turned his head slightly; Ameena's song died away.

"Oh, is that you, professor? Come on in an' congratulate us. Ameena an' me just got engaged!"

(Continued on page 719)

RADIOGEM

The Dollar Radio Receiving Set

The Simplest Radio Outfit Made—Yet as Practical as the Most Expensive!

You need know absolutely nothing about wireless to operate and enjoy the RADIOGEM. It is so sturdy, so simply constructed that it is small wonder radio engineers who have tested it have pronounced the RADIOGEM a brilliant achievement. The RADIOGEM is a crystal radio receiving set for everyone at a price anyone can afford.

Why The RADIOGEM Can Be Sold For Only \$1

Here's the secret: The RADIOGEM Construction eliminates all unnecessary trimmings, cabinets and the like, which do not play any part in the operation of a set. You receive the RADIOGEM unassembled, together with a clearly written instruction book, which shows you how to quickly and easily construct the set, using only your hands and a scissor. The outfit comprises all the necessary wire, contact points, detector mineral, tube on which to wind the coil, etc., etc. The instruction book explains simply and completely the principles of radio and its graphic illustrations make the assembling of the RADIOGEM real fun. Remember the RADIOGEM is a proven, practical radio receiving set and will do anything the most expensive crystal set will do.

The RADIOGEM is the Prize Winner of the Age

Out of hundreds of radio models submitted recently in a great nation-wide contest, radio engineers, the judges, unanimously chose the RADIOGEM as the winner—the simplest radio-receiving set made! And the RADIOGEM costs you nothing to operate; no form of local electricity is required.

Send Postage Prepaid on receipt of \$1—stamps, money-order or check.

Order Your Radiogem To-day—
or send for Free Descriptive Circular

DEALERS

The RADIOGEM is the wonder item of the radio age. It is storming the country, for the RADIOGEM'S price is so low everyone is able to buy one. Write immediately for full particulars before that shop across the street beats you to it.



Hear the programs of the Broadcasting Stations on the RADIOGEM



\$1 without PHONE or AERIAL
(Patent Pending)

What They Say About RADIOGEM

I am enclosing herewith \$1.00 to pay for the Radiogem. I had it carefully wound by our wireless operator and find that it works beautifully—fully as good as any crystal set we know of.

Radiogem received, which we assembled and were very much astonished at results obtained and the clearness and volume of tone produced.

The greatest distances I heard on one of your sets is 1000 miles, having heard WGY at Schenectady, N. Y. I think your set is the best I have ever sold at any price.

On an aerial 160 feet long and 20 high one of my customers has heard WOC and WBB, KSD, WMC on one of your sets using a Peerless headset.

Herewith P.O.M.O. amt. \$1.00 for another "RADIOGEM." The one received is O.K. Placed about 15 ft. of picture cord under front porch and grounded to a gas meter, and heard the Sacramento Bee and Sacramento Broadcasting Union much better than with my large crystal set.

Your RADIOGEM RECEIVER is a wonder. I have received every station in Philadelphia with it much louder than with a high-priced crystal set.

Your two Radiogem sets received last night, and one was wired up for testing. WOC is about 40 miles away, and their signals could be heard with headphones on table. After they quit KYW at Chicago about 170 miles east was heard. Every word could be plainly heard here. WMC at Memphis, Tenn., could also be easily heard and understood.

We find that this set does a great deal more than you claim for it. We took WEAR on our audion set last night; this being the Baltimore American Broadcasting station, and then cut in the Radiogem and got excellent results. After the Baltimore concert was over, we continued to use the audion set and about ten o'clock were listening to WEAF—New York—and a little later we disconnected the audion set entirely and hooked up the Radiogem, very clearly hearing both piano music and announcement of name of station and its location.

You claim a radius of 20 miles over your "Radiogem" is sometimes a possibility. You should adhere to the truth. I constructed one for my mother, installed it with an aerial, and she listens not once in a while, but at her will, to Schenectady, Newark, New York, or Providence, R. I., and her home is Attleboro, Mass. I can't give your set too much praise.

(Names and Addresses on Request)

FREE VACUUM TUBE RADIO SET

Can receive 100 miles and more. RUSH your name to learn how you can get a Vacuum Tube Radio Set **ABSOLUTELY FREE** Don't delay, write today for FREE RADIO PLAN. HOME SUPPLY CO. Dept. 19 131 Duane St., N.Y.C.

IMPROVED GROUND CLAMP

Equipped with Fahnestock Patent Wire Connectors Easily Attached

No Soldering—For Radio Use Only

AT YOUR DEALERS. FAHNESTOCK ELEC. CO. Long Island City, N. Y.

MONEY for You—Add to your Salary—Make extra Pin Money. Start a lucrative business of your own. Spend an hour each day taking subscriptions for the "Science & Invention." We'll pay you well and you'll enjoy the work. Write for full particulars. Circulation Dept., SCIENCE & INVENTION, 53 Park Place, N. Y. C.

Thousands Have Built Their Own Radio Apparatus

With Consrad Patterns Nos. 1 and 2

Read What They Say

"I built one of your No. 1 Short-Wave Radio Constructor Sets with detector amplifier units and I wish to inform you of the splendid results that anyone can get if properly constructed and operated.

"I use a Magnavox and the following stations are heard clear, distinct and throughout our entire house:

Newark, New York, Pittsburg, Columbus, Indianapolis, Anacostia, B. C., Kansas, Milwaukee, Missouri Stations, Havana, Cuba, Fort Worth, Texas, Other Texas Stations, St. Louis, Schenectady, Springfield, Mass., Detroit, Minneapolis, Ohio Stations, Atlanta, West Virginia, Indiana Stations, Chicago, Fall River, Mass., Memphis, Anthony, Kansas, Louisville, Iowa stations.

and many more too numerous to mention. "These stations can be gotten any time they are in the air, weather conditions excepted.

"I can also tune out completely, WLW the 250 Watt Station and hear Detroit, G. E. Schenectady, Newark and all other high power stations.

"This set if properly built is the equal of any on the market today and good enough for any beginner to have.

"E. STOCK, 795 Delta Ave., Cincinnati, O."

"Some time ago I received from you a set of patterns Nos. 1 and 2 and closely following them I have put up a radio set with which I was able to hear distinctly voices from Kansas City and Davenport, Iowa; and this during a heavy rainfall, high wind, lightning in the air, and with the additional handicap of not having my antenna up any higher than the top of the garden fence.

"C. R. MINCER, Zwolle, La."

"I cannot refrain from writing you to let you know what wonderful success I am having with a radio set built from your drawing, 'The Radio Constructor' No. 1 and No. 2. I

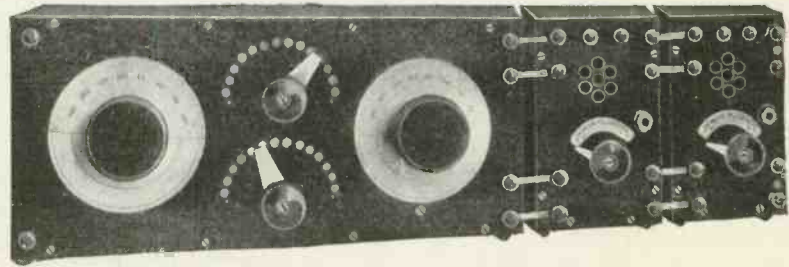

have a one-wire aerial (stranded wire) less than 100 ft. long, two 1500 ohm Rec. (3000); one Vac. Tube UV200, and five Dry Cells, and let me say now that both parts worked on first trial.

"What prompted me to write, is that I decided to construct the set and when finished I was so pleased that I decided to take my next step and build the amplifier for volume of tone. The completed outfit proved to be all that can be claimed for it.

"EDW. A. RICHARDSON."

"I have just completed a new receiving set from your plans No. 1 and I thought you might be interested in hearing about it.

"I have already received from New York to Los Angeles, and Seattle, Minneapolis, Memphis, Tenn., Fort Worth, and San Antonio, Texas.

"There is a high priced set here that I think was ordered from New York. My little home-made set is so much better than that—there is hardly any comparison.

"WM. L. BOSTOCK, Palisade, Nebr."

These Are The Two Most Popular Patterns of Our Whole Line

Each Pattern Packet contains complete instructions and blue print patterns which enable you to construct the apparatus with only a screw driver and a pair of pliers.

Pattern No. 1—How to Make a Short Wave Regenerative Receiver

This set was designed by a foremost radio engineer to fulfill the wants of an all-round broadcast receiver. It covers wave-lengths up to 800 meters. **50c**

Pattern No. 2—How to Make Detector and Amplifier Units

This pattern was designed for detector and amplifying units especially adapted for use with our regenerative receiver. It is strongly recommended when the attachment of a loud speaker to that set is desired. **50c**

Both Patterns for Sale at All Dealers

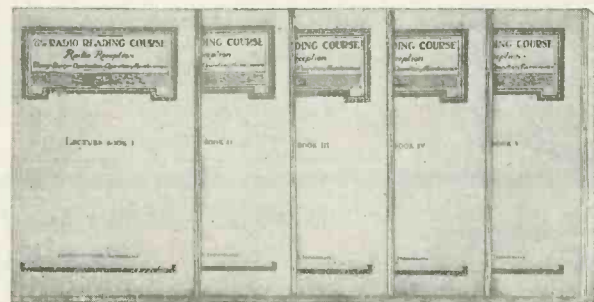

This set of five handsome Lecture Books are a complete radio library. To own them is like having a trained engineer or instructor at your side, answering questions, pointing the way. No matter what your interest in radio, take advantage of this attractive special offer and be the owner of this fine set of books.

Learn All You Can About Radio

Take this short reading course

All the technical details and a thorough explanation of radio reception, written in easily understood, non-technical language by a foremost radio engineer and inventor. The five Lecture Books with over 100 graphic drawings give you the knowledge to intelligently buy, design, build, operate and maintain radio receiving apparatus. Tells you how to locate and correct troubles, how to make your apparatus more efficient and gives you a thorough knowledge of radio science.

SEND NO MONEY

By special arrangement you can own this \$10 Course comprised in the set of five books for only \$1.97—if you act at once. Simply send us your name and address. Upon receipt pay the postman only \$1.97 plus postage and the books are yours. The supply is limited so order at once.

A Complete Radio Reading Course—Order Direct From Us

The Consrad Co
INC.

233 Fulton Street, New York City

Formerly
The Consolidated Radio Call Book Co.



World Radio and Auto Batteries
SAVE YOU 50%
WRITTEN 2 YR. GUARANTEE

We maintain the same high quality material and workmanship found on the most expensive batteries and still are able to allow our remarkably low sale price by greatly reducing our overhead and sale costs.

COMPARE THESE PRICES

Auto Prices	Radio Prices
6 Volt, 11 plate ... \$12.25 Ford, Chev., Mitchell, Hup., Grant, Elgin, Velie, Saxon.	Special 2-volt Storage Battery \$5.00 For WD11 and WD12 tubes. Will run 200 hours on one charge. Rechargeable.
6 Volt, 13 plate ... \$14.00 Overland, Buick, Reo, Paige, Hudson, Nash, Stude., Dort.	Special 4 volt Storage Battery For UV199 tubes. Same features as 2 volt.
12 Volt, 7 plate ... \$17.00 Maxwell, Dodge, Regal, Franklin, Briscoe and Crow-Elkhart. Give year and model of car.	6 volt, 60 amp. \$8.50 6 volt, 80 amp. 10.00 6 volt, 100 amp. 12.50 6 volt, 120 amp. 14.50 6 volt, 140 amp. 16.00

SEND NO MONEY!

We ship C.O.D. subject to inspection or will allow 5 percent discount for cash with order. Shipment made same day order is received. Save 50 percent on your next battery and get better service and longer life. Written 2-year ironclad guarantee is your proof of satisfaction. Order NOW!

WORLD BATTERY CO.

Dept. 19, 1219 S. Wabash Ave. Chicago, Ill.

NEON SIMPLEX RECEPTOR

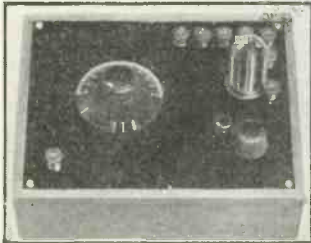

\$8.50

Tube and Head Phone Not Included

**Vacuum Tube Receiver for Price of Crystal Set
NEW INVENTION REVOLUTIONIZES RADIO**

Have heard stations 1500 miles. This set after a rigid test by the New York Tribune Institute was given the Certificate of Approval. One dial controls everything. Uses an ordinary dry cell battery. So simple can be worked by a child. Start receiving 10 minutes after arrival. Iron Clad guarantee. Will exchange if not satisfactory.

\$15.00 set for ... \$8.50 Complete instructions
NEON Phones ... \$5.00 accompanies each set.
Special Tube ... \$5.00

SPECIAL OFFER Send \$15.00 and we will send you complete outfit, including phones and tube. Send \$3.00 with order, pay Postman balance upon delivery. Order yours today.

ROYAL MFG. CO. WORLD BLDG. NEW YORK



"Read'em" Binding Posts
With Knobs That Won't Come Off
Anyone can "read 'em." All popular styles—Antenna, Ground, Fones, A and B Battery plus and minus—abbreviations of different names engraved on knobs. Ask your dealer for "Read 'em"—the kind for real Radio fans. If your dealer does not have them—write direct. Set of 10 sent for \$1.50 postpaid.
The Marshall-Gerken Co. Manufacturers Toledo, Ohio



RADIO FANS
Rejoice when using these pneumatic phone cushions. They gently hug the ears, shutting out all room noises. Fits any type headset Money back guarantee if you are not satisfied.
FREE List of Bargains
RADIO BARGAINS
17 N. LA. SALLE ST - CHICAGO

Around The Universe

(Continued from page 717)

CHAPTER X.

IN WHICH THE VOYAGERS REACH THE INNER SURFACE AND SPEEDILY DEPART THEREFROM AFTER A MOST AMAZING EXPERIENCE.

The silent, lonely, little vehicle plunging through the darkness of Space, a world to itself, now rang with the gay laughter of its three inhabitants. Sir Isaac had successfully completed his complex calculation, using therein every intricate device known to higher mathematics, with a verified result correct to seventeen decimals. Tubby and Ameena were engaged to be married. What stupendous events to have occur simultaneously. No wonder the little Celestial wanderer was the scene of rejoicing.

It was an evening of the gayest festivity. Sir Isaac, proud and happy as a boy, kissed the radiant Ameena, fending off Tubby who tried to stop him. Then the girl went into the kitchen and prepared the evening meal. And such a dinner it was. For two hours they sat over it, laughing and discussing their plans.

"We must hasten now," Sir Isaac said in a moment of comparative quiet. "Nothing remains but for me to show you the edge of Space, which I want very much to do. Then we must hurry back and put my plan for the downfall of Mars and his allies into operation. I fear nothing now. We cannot fail."

"You can't get back to quick for us," Tubby declared. "This here outer Space ain't no place to go lookin' for a minister in. Where we goin' to get married, Ameena? The Earth or Venus?"

The girl had not yet made her choice; and the question was left open.

The penny-ante poker game in the instrument room—a game at which Ameena had now become extremely proficient—lasted well into the night. When it was over Sir Isaac made a brief calculation and concluded that the "Edge of Space"—as, with a slight smile he still insisted on calling it—was still considerably below them. The vehicle therefore, needed no attention.

After this pleasant discovery, Ameena lingeringly parted from Tubby and retired to the upper floor. The two men made up their beds in the instrument room. Within fifteen minutes all three were fast asleep.

Evidently nothing unusual occurred during the night, for when the three voyagers awoke about ten o'clock next morning they found themselves still silently dropping into the abyss of blackness. Overhead the stars of that last Universe were still visible, though now extremely faint.

SOCIAL LIFE BEGINS

During a lazy breakfast the three friends fell to talking personalities.

"You got a lot of names, ain't you pefferor?" Tubby said.

"Quite a good many," responded Sir Isaac pleasantly. He was obviously pleased at the question. "I am usually known merely as Sir Isaac Swift DeFoe Wells-Verne—but I have other names—Stockton, for instance."

"What's the 'Isaac' for?" Tubby asked. "I ain't never seen that on your books."

Sir Isaac frowned. "Well, to tell you the truth, my friends, I am just a little ashamed of that. Even in my early infancy my marked scientific bent was apparent, and my grandfather insisted on my being named

Let an Experienced Newspaper Man Show You How to Break Into the Newspaper Field

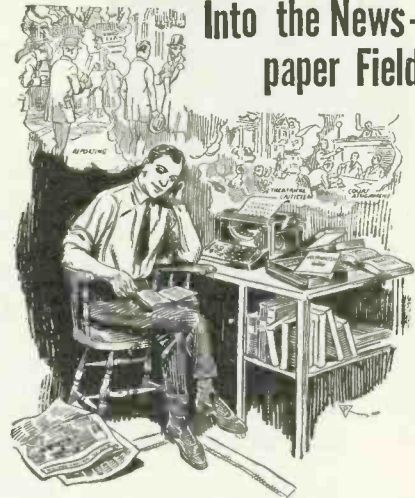

NEWSPAPER work offers countless opportunities for the young man or the young woman who really wants to amount to something. The history of Journalism shows innumerable instances where bright young Reporters have been graduated from newspaper staffs to high places in the industrial and political world. Ex-President Harding was an old newspaper man. Thomas W. Lamont, one of the senior partners of J. P. Morgan & Company, was a reporter on the New York Tribune. Senator Walter E. Edge of New Jersey was, and is, an editor; so is ex-Senator James K. Vardeman of Mississippi. Augustus Thomas, America's foremost playwright, was a reporter on the St. Louis Post Dispatch. Arthur Hopkins and Brock Pemberton, theatrical producers, were newspapermen. Arthur Woods, executive commissioner of New York, was a reporter. Newspaper work, in itself, is a field that offers unlimited opportunity—and it often leads to better things.

FASCINATING WORK

Salaries of \$40 to \$125 a week

There isn't any profession that offers the thrill that Journalism does and there is always room for a live, wide awake young fellow in this exciting field. Regular Reporters earn from \$40 to \$125 a week. Good deskmen on a daily paper are paid from \$60 to \$100 a week. A "Star" Reporter can command his own salary.

Part Time If You Prefer

Hundreds of ambitious men and women make extra money by corresponding for newspapers or writing for magazines in their spare time. Many of the most successful reporters of today started in this way. If you have the ability to write, there is always a market for your efforts.

We Will Teach You Journalism At Home

Henry J. Brockmeyer, Assistant City Editor of the New York Evening Post, will give you a thorough training in Journalism in six short easy lessons. Mr. Brockmeyer is well qualified to teach you. He has trained hundreds of men and women, many of whom have, under his guidance, developed into front rank reporters or feature writers. Mr. Brockmeyer's course in Practical Journalism will teach you what it would take months of actual newspaper work to learn. The course is complete, authoritative, easy to understand. In it Mr. Brockmeyer has incorporated everything that his long experience of over thirty years in the newspaper field has taught him. It shows not only the way a newspaper is run, giving a detailed explanation of the reportorial and administrative staffs, with the duties of each, but it trains the student in every phase of Journalism, instructing him how to develop a "nose for news", how to write, how to prepare his copy and edit it for publication and drills into him the development of style, with countless references and actual examples. The complete course comprises six comprehensive lessons just brimful of everything a reporter or correspondent must learn. And it's all interesting reading—more fascinating than any novel. You won't want to stop studying once you start.

Five Days Trial

To actually prove to you the merits of the course we will send it to you on five days' trial. If at the end of that time you do not feel that you have received more than your ten dollars' worth (the price of the complete course is only \$10) you may return it to us at our expense and your money will be immediately refunded. We won't even ask you for an explanation—we guarantee to refund your money in full within twenty-four hours after receiving the lessons back.

Just pin a check, money order or ten dollar bill to the coupon below and mail it to us. Then take five days after the course arrives to decide whether you want to keep it or not. You, alone, will be the judge. We know that you will find the course worth many times its price.

THE PRESS GUILD, Inc., 66-R-W. B'way, N. Y.

THE PRESS GUILD, Inc., 66-R-West Broadway, New York City.

Enclosed find \$10 for which you are to ship me at once, prepaid, Henry J. Brockmeyer's complete course in Practical Journalism with the distinct understanding that if I return the course in five days my full \$10 will be refunded and no questions asked.

(Name)
(Address)
(City) (State)



MARKO "A" BATTERY

90 AMP. HRS.

IN RUBBERLITH CASE

Highly Ornamental As Well As Efficient

The Rubberlith case is a composition case with a high gloss giving the appearance of ebony. It is moulded in one piece, including handles and cells—no jars to break—and is practically indestructible. A worthy addition to your set.

ALL SIZES, FROM 2 VOLT BATTERIES UP, CARRIED IN MAHOGANY FINISH CASES

SOLD BY

MANHATTAN ELECTRICAL SUPPLY CO., 17 Park Place, New York, N. Y.

STANLEY & PATTERSON, 23 Murray St., New York, N. Y.

J. H. BUNNELL & CO., 32 Park Place, New York, N. Y.

PACENT ELECTRIC CO., 22 Park Place, New York, N. Y.

ALSO RADIO SUPPLY STORES AND ALL MARKO SERVICE STATIONS

MADE BY

MARKO STORAGE BATTERY CO.

1402 ATLANTIC AVENUE, BROOKLYN, N. Y.

Branch, Jefferson at Bedford Ave., Brooklyn, N. Y.

210 W. 54th St., New York, N. Y.

RICO

Tuned Head Phones and Loud Speakers

Super Sensitive Clearer than a Bell.

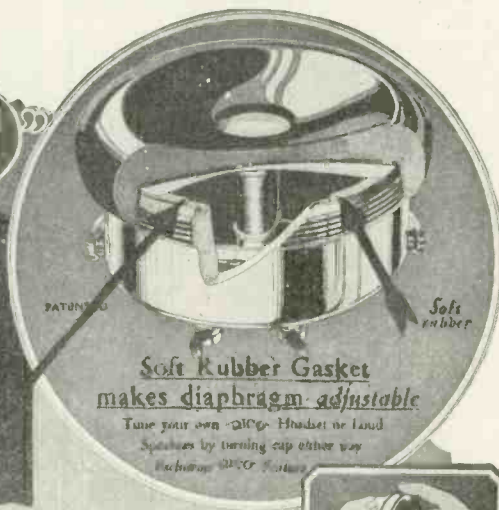

RICO TRI-POLE Tuned Phones Instantly adjusted for Loud or Weak Sounds

Rico Tunable Phones and Loud Speakers sold by all thoroughly reliable dealers. If your dealer cannot supply you, send us his name. We will parcel post direct to you, prepaid.

Manufactured by Radio Industries Corporation 131 DUANE STREET NEW YORK CITY

"THERE'S MONEY IN IT"

AT HOME LEARN TELEGRAPHY AT HOME MORSE AND WIRELESS

TEACH YOURSELF

in half usual time, at trifling cost, with the wonderful Automatic Transmitter THE OMNIGRAPH. Sends unlimited Morse or Continental messages, at any speed, just as an expert operator would. Adopted by U. S. Government, and leading Universities, Colleges and Telegraph Schools. 3 styles. \$14 to \$30. Catalog free.

If you own a Radio Phone Set and don't know the Code, you are missing most of the fun.

OMNIGRAPH MFG. CO.

22 Hudson St., NEW YORK

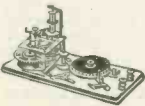

5 Master Keys

Work like magic in emergencies or prove whether your door or padlocks are burglar-proof. Open and test thousands of different locks. Recommended by users in ten different nations. Most wonderful and only keys of their kind. Send \$1 today. Novel key chain FREE with set.

MASTER KEY CO., 8 Manhattan Block, Milwaukee, Wis.



Wonderful, new device, guides your hand; corrects your writing in few days. Big improvement in three hours. No failures. Complete outline FREE. Write C. J. Ozment, Dept. 44 St. Louis, Mo.

Isaac. He was a great admirer of Isaac Newton, you see. Of course Newton was, in a way, a brilliant man. I would have preferred Jules, or Herbert George however. I often use both those names. I think Herbert George is rather natty, don't you?"

Ameena agreed that it was.

Sir Isaac might have pursued this interesting topic indefinitely, but Tubby cut him short.

"Won't you please tell us about this here Edge of Space we're headed for?"

Sir Isaac, in view of their imminent arrival at the Edge of Space, evidently considered that the proper dramatic moment had come to tell them about it.

"I'm sorry you are not familiar with my scientific narrative, the 'Golden Atom,'" he began somewhat pompously. "However, that is immaterial. . . . In it I explained that every atom of the Universe is really a world in itself. Its interior is a void of ether, an infinitesimal core of Space, surrounded by a shell of matter. That is an atom. I do not mean the old-fashioned word atom, but the inner nucleus which the professional scientists of Earth have just managed to discover. Do you follow me?"

"Sure," declared Tubby. "An atom is like a coconut, only with ether where the milk ought to be."

Sir Isaac beamed; Ameena regarded Tubby with admiration.

SIR ISAAC'S THEORY UNFOLDS

"Exactly," agreed Sir Isaac. "There are electrons, of course, which Sir Ernest Rutherford most doggedly insists are particles of disembodied electricity—negative, you know—spontaneously liberated from the atoms. However, in this Golden Atom which I described, there revolved, in its central void of ether, an infinite number of minute worlds, stars, planets, comets; a complete little Universe of its own. Do you still follow me?"

His two auditors nodded somewhat dubiously.

"What's this got to do with the Edge of Space?" Tubby demanded.

"I'm coming to that. You must understand now, that just as all distances and all motions are relative one to the other, so also is size. I have brought to your imagination the golden atom containing a minute Universe in its central void of Space. That to our minds, is almost infinite smallness."

Sir Isaac hesitated impressively.

"Now, my friends, remember, size is only relative. Conceive now another atom, an almost infinitely large atom. Within this gigantic atom, revolving in its central void of ether, place a Celestial Universe—the Celestial Universe in which you and I live, the stars and planets among which we have been voyaging for many days past."

"Yes," said Tubby faintly. "An' then—"

"Then you will realize that we are soon to reach the limits of this atomic void. We shall land upon the inner, concave surface of the atom which contains us!"

Sir Isaac's smile was triumphant.

"Is that not wholly logical that we shall land upon this inner surface shortly? But we will not stay there, or proceed further. We must return at once to our own tiny little planet. So much for facts. If you wish to imagine beyond that, I shall say that were we able enormously to increase our bodily size, we might pass through the shell of our Atom, which possibly is as thick through as it is across its central void of Space. Then we should emerge on the convex outer surface. By still further increasing our bodily dimensions, we would outgrow this Atom and find ourselves in another world, an infinitely larger, inconceivably large world, of which this Atom of ours may quite well be an atom of somebody's wedding ring, or the atom of a column in a King's castle, or the minute fragment of a grain of sand in a vast desert.



\$4.00
Postpaid

\$4.00
Postpaid

National Audio Frequency Transformers

National Audio Frequency Transformers must not be compared with ordinary Transformers. "National" stands as the emblem of perfection in the Transformer field. Unequaled volume, perfect amplification, no interaction between fields. These are some of the reasons that Radio authorities have selected Nationals as being most desirable for use on any stage, with any type of tube. See your dealer or order direct. Jobbers and Dealers write for sales proposition.

NATIONAL TRANSFORMER MFG. CO.
Dept. 1115, 154 Whiting St. Chicago, Ill.



\$1
Postpaid with Instructions



Transmitter Button For Loud Speaker — Experiments — Amplification — Radio — Etc.

K ELECTRIC CO.

15 Park Row New York

I have used the Skinderviken Button for many years, it gives good results.

E. Boudreault, Ottawa, Canada.
Works fine for a detectophone and loud talker, etc.
C. Roth, Winthrop, Minn.
It's a wonder for radio work.
Geo. Tarnon, Chicago, Ill.

FREE LITERATURE

FREE



RADIO SET WITH DOUBLE HEAD PHONES

This wonder RADIO SET in special metal cabinet with double head phones complete ready to hook up **ABSOLUTELY FREE**

LISTEN in on concerts, sports, lectures, singing, etc. **QUICK!** Send only your name to-day for wonderful **FREE RADIO PLAN.**

GUARANTEE SALES CO.
26 Washington Place, Dept. 118, New York

ELECTRIC SOLDERING IRON



EVERY RADIO FAN has been looking for this iron for both radio and home use. Operates on A. C. or D. C. current.

GUARANTEED one year. Sent anywhere in U.S. or Canada Parcel Post prepaid on receipt of money order for \$2.28.

FANS Send 2c stamp for our list of **RADIO BARGAINS**

RADIO BARGAINS
17 N. LA SALLE ST. CHICAGO

CHARGE

YOUR OWN BATTERY

You can do it—without removing your battery or even disconnecting terminals. The Valley Battery Charger will end your battery troubles. Plugs in on lamp socket; clamps to battery. Cannot overcharge or harm battery. Price \$18.00. Send for booklet.

Valley Electric Company
Department 3. ST. LOUIS, MO.



You asked me about absolute motion. Suppose our atom is in a grain of sand of some vast desert and is now being blown in a storm—or that—

"Never mind any more," Tubby cried. "We got the idea, ain't we Ameena?"

"It is very wonderful," the girl declared slowly. "But a little difficult to follow, just at first."

"You'll get used to it," said Sir Isaac. "Just keep on thinking about it a while. It's my own theory. I'm going to tell Sir Ernest about it because my atom is really that inner nucleus, that portion, around which his electrons revolve. So you see this theory of mine will help him out a lot

Ameena, you do make very good coffee. Can I have another cup?"

When, after breakfast, they gazed down through the floor window, a very faint luminous glow seemed growing in the blackness far below them. Sir Isaac regarded it intently a moment, then with a cry of satisfaction hastened to the keyboard.

"That is light diffused throughout the atmosphere of the Inner Surface," he said, as he altered the positions of several of the keys.

"I am checking our velocity very rapidly now," he added as he straightened up. "We will arrive at our destination this evening."

His prediction was correct. All that afternoon the luminous glow beneath them grew in intensity. By supper time it gleamed like a pale phosphorescence, spreading out in all directions to the visual limits of the floor window. Shortly after supper they entered the atmosphere of the Inner Surface at an altitude which Sir Isaac calculated to be several hundred thousand miles.

It was nearly nine o'clock when Tubby, peering downward, saw what might have been the broad plateau of a mountain-top coming up out of the yellowish, luminous haze. It was a flat surface extending out of sight in three directions. But its fourth side, almost directly beneath them, ended in a sharp line with a dimly yellow abyss beside it.

"Look at the cliff," Tubby called to Sir Isaac. "You better slow up some more an' figure out where we're going to land."

They were then some ten thousand feet above the top of this "cliff," as Tubby called it. Sir Isaac, after a careful inspection of it which was difficult in the very dim, hazy yellow light, finally decided to descend very slowly close beside its perpendicular face and thus reach the lower level of land adjacent.

They made the descent in the dim starlight in an increasing yellow glare from below a thousand feet away from the face of the precipice. The wall of rock extended in a direct line as far as they could see as straight as though it were hewn by a rule.

AT THE OUTER SURFACE

It was a descent of some fifteen miles. Tiny points of light now showed beneath them. Through the side window of the instrument room, the dim face of the huge rocky wall slid swiftly upward, as though the vehicle were a silently dropping elevator car. Occasionally, rectangular openings in the rock wall went up past the window, openings five hundred feet long, from which a lurid glare of yellow-red light blazed with blinding force out into the night.

"Say," whispered Tubby, awe-struck. "What sort of a place is this?"

A brilliant ball of fire, seeming hardly more than a hundred feet away, came vertically up past the side window, a ball of blazing flames ten times the size of the vehicle itself. The heat from it was tremendous. From the lower window an even brighter though diffused light was streaming in; and a deafening, roaring noise filled the room.

(Continued on page 723)

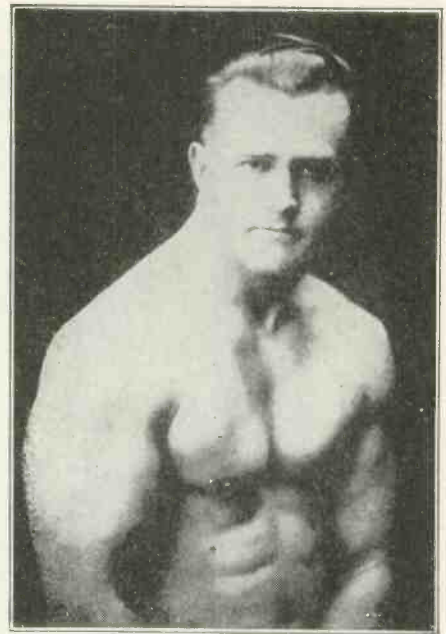

Earle E. Liederman as he is to-day.

If You Were Dying To-night

and I offered you something that would give you ten years more to live, would you take it? You'd grab it. Well fellows, I've got it, but don't wait till you're dying or it won't do you a bit of good. It will then be too late. Right now is the time. To-morrow or any day, some disease will get you and if you have not equipped yourself to fight it off, you're gone. I don't claim to cure disease. I am not a medical doctor, but I'll put you in such condition that the doctor will starve to death waiting for you to take sick. Can you imagine a mosquito trying to bite a brick wall? A fine chance.

A Re-built Man

I like to get the weak ones. I delight in getting hold of a man who has been turned down as hopeless by others. It's easy enough to finish a task that's more than half done. But give me the weak, sickly chap and watch him grow stronger. That's what I like. It's fun to me because I know I can do it and I like to give the other fellow the laugh. I don't just give you a veneer of muscle that looks good to others. I work on you both inside and out. I not only put big, massive arms and legs on you, but I build up those inner muscles that surround your vital organs. The kind that give you real pep and energy, the kind that fire you with ambition and the courage to tackle anything set before you.

All I Ask Is Ninety Days

Who says it takes years to get in shape? Show me the man who makes any such claims and I'll make him eat his words. I'll put one full inch on your arm in just 30 days. Yes, and two full inches on your chest in the same length of time. Meanwhile, I'm putting life and pep into your old back-bone. And from then on, just watch 'em grow. At the end of thirty days you won't know yourself. Your whole body will take on an entirely different appearance. But you've only started. Now comes the real work. I've only built my foundation. I want just 60 days more (90 in all) and you'll make those friends of yours who think they're strong look like something the cat dragged in.

A Real Man

When I'm through with you' you're a real man. The kind that can prove it. You will be able to do things that you had thought impossible. And the beauty of it is you keep on going. Your deep, full chest breathes in rich pure air, stimulating your blood and making you just bubble over with vim and vitality. Your huge square shoulders and your massive muscular arms have that craving for the exercise of a regular he man. You have the flash to your eye and the pep to your step that will make you admired and sought after in both the business and social world.

This is no idle prattle, fellows. If you doubt me, make me prove it. Go ahead. I like it. I have already done this for thousands of others and my records are unchallenged. What I have done for them, I will do for you. Come then, for time flies and every day counts. Let this very day be the beginning of new life to you.

Send for My New 64-Page Book "MUSCULAR DEVELOPMENT"

This will show you some of my remarkable achievements. Sixty-four pages with dozens and dozens of full-page photographs of myself and a number of my pupils. Read what they say about my system. Don't take my word for it. This book will be an impetus, an inspiration to every red-blooded man. All I ask is the price of wrapping and postage—10 cents. Remember, this does not obligate you in any way, so don't delay one minute. This may be the turning point in your life. Tear off the coupon and mail at once—now, while it is on your mind.

EARLE E. LIEDERMAN

Dept. 211, 305 Broadway, New York City

EARLE E. LIEDERMAN,
Dept. 211, 305 Broadway, New York City

Dear Sir:—I enclose herewith 10 cents for which you are to send me, without any obligation on my part whatever, a copy of your latest book, "Muscular Development." (Please write or print plainly.)

Name

Address

City

State

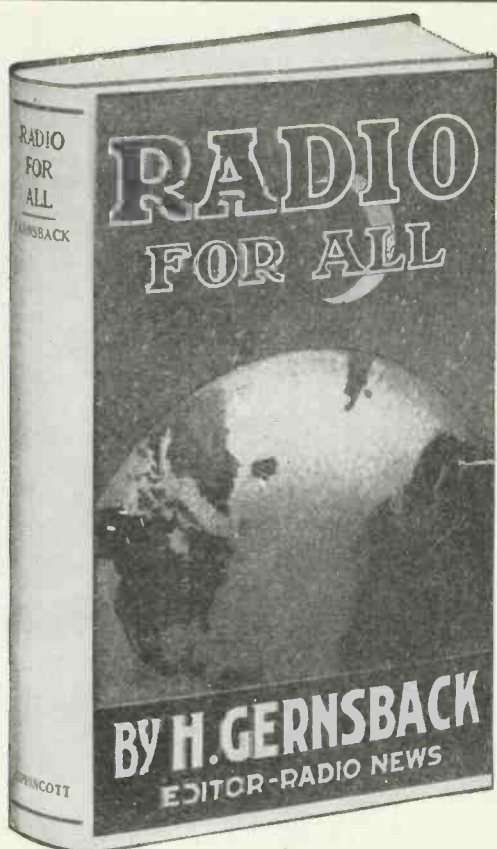

The Complete Book of All Radio Information
PRICE POSTPAID \$2.00

PRACTICAL ELECTRICS COMPANY

RADIO FOR ALL

By H. GERNSBACK

Editor "Radio News," "Science and Invention" and "Practical Electrics"

With over 130 illustrations and diagrams, and 12 photographs, 300 pages, size 8 1/4" x 5 1/2".

What the novice in radio needs is a book in which he can get all the information necessary for him to understand radio telephony and telegraphy, to make or buy a receiving set suitable to his means, to know how to operate his set, and after he has an understanding of the radio art, information that will enable him to advance and get the most out of his outfit. All this must ordinarily be dug out of text-books, pamphlets and government publications, but the aim of this book is to have all the data and information that the beginner will need from the time that he takes up radio. It is a permanent, comprehensive reference book for the dyed-in-the-wool dabbler in Radio.

What the Book Is.

A combination of a radio course for the novice in radio telegraphy and telephony with a reference book for the more experienced amateur. Half a dozen books in one.

For the Beginner.

- The theory of radio carefully explained with drawings.
- Description of and instruction for operating instruments of receiving and sending sets, with all picture diagrams of the wiring of the apparatus.
- How to make your own receiving set, costing from \$3.00 to \$50.00.
- How to read diagrams; for every picture diagram there is a corresponding technical diagram using the symbols instead of drawings.
- How to tune sharply and eliminate interference from other stations.
- How to protect your set from lightning and the laws regarding installation.
- Explanation of time and weather signals.

For the More Experienced Amateur.

- How to make a practical vacuum tube detector, two stage amplifier set costing less than \$50.00 that will work.
- How the radio compass works.
- All about underground aerials, loop aerials and directional aerials.
- Formulae for finding wave length; miscellaneous formulae for finding capacity of condenser and other instruments. Tables of wire resistances, wave lengths and their corresponding frequencies, approximate wave lengths for different aerials, tuning coil data, and much more invaluable information.

Special Features.

- Lists of all the broadcasting stations in the United States and Canada for concerts, time signals, weather reports, press, stock market reports, etc., with their call, wave length and time of sending.
- Detailed description of Washington weather signals and their translation.
- Description of a modern broadcasting station and its operation.
- Large map showing location of all U. S. radio telephone broadcasting stations suitable for hanging up in radio room.
- Collection of miscellaneous radio information for the amateur.

In Other Words.

The information that you ordinarily have to dig out of government publications, text-books, pamphlets, etc., is handily combined in this one book.

53 PARK PLACE, NEW YORK CITY

Each a Leader In Its Field

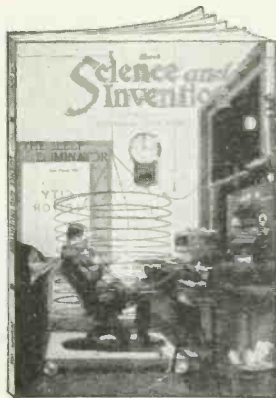

Science & Invention

Is one of the most interesting magazines published. It is more interesting than fiction. It is profusely illustrated and covers in word and picture the latest achievements in the sciences—in Invention, Astronomy, Physics, Chemistry, Electrics, Mechanics, etc.

It has a large section devoted exclusively to Radio. SCIENCE & INVENTION has the distinction of being more often quoted than any other magazine in the world.

More than 100 large pages—with over 300 illustrations, drawings, etc.

Special prize contests are offered each month, On all newsstands, 25c a copy.

Radio News

"The 100 Per Cent Wireless Magazine"

The Largest Radio Magazine in the World

Is read by more than a million. Radio enthusiasts each month.

Its position as the leader of all Radio publications is universally recognized by dealers, radio manufacturers and every branch of the radio industry and its pages reflect their confidence.

RADIO NEWS contains more articles by Radio Experts—more specific information—detailed drawings—illustrations and news—than is published in any other magazine.

More than 200 large pages monthly. Profusely illustrated.

On all newsstands, 25c a copy.



Subscription Prices

Science & Invention	} One Year 12 Issues
Radio News	
	\$2.50 Each

(Add 50c to the cost of each magazine for Canada or Foreign)

FREE PRESENTS FOR SUBSCRIPTION RAISERS.

Write for our Premium Catalog containing valuable rewards given away FREE.

Premium Dept.
 Experimenter Pub. Co.
 53 Park Place, N. Y.

Experimenter Publishing Co., Inc., 53 Park Place, New York, N. Y.

Send for FREE-story

Interesting, illustrated folder "How to get Greater Desk Efficiency" shows how to keep your desk cleared for action. Thousands of Kleradesks are giving entire satisfaction. Saves time locating, distributing or sorting papers. Takes less space than a tray. Sent FREE trial.

Kleradesk



Steel Sections
90¢ ea.

ROSS-Gould Co
309 N. 10th
ST. LOUIS

This model
\$6.80

Free Mailing Lists

Will help you increase sales. Send for FREE catalog showing details covering names of your best prospective customers. Counts and prices are given on thousands of different mailing lists. 99% Guaranteed 5¢ each by refund of

ROSS-Gould Co
100 N. 10th Street
St. Louis

CHRISTMAS DINNERS

and Winter's Relief Work among the poor

The Volunteers of America under the personal supervision of General Balington and Mrs. Maud Booth, are conducting Rescue Missions; Children's Homes; Rescue Homes; Helping Hand Homes for Mothers and their babies; Prison work, Relief departments where the sick and destitute are given assistance.

Will you have a part in this great work by mailing your check today for any amount you may desire to contribute. Make check payable to the Volunteers of America, and mail to the

VOLUNTEERS OF AMERICA

District Headquarters,

271 LENOX AVENUE, NEW YORK CITY.

CATALOG E19-112 PAGES FREE

EVERYTHING IN RADIO

One of the largest complete stocks in the world. 40 diagrams of latest Hookups.

DEALERS ALL OVER THE U.S.

Making big profits handling our supplies. 24-hour service. Goods shipped same day order received.



WHOLESALE RADIO DISTRIBUTORS

Dept. F. 107 E. 13th St. Kansas City, Mo.

Make \$10 a Night

Be a Drummer Professional drummers in demand everywhere and make big money. You can quickly and easily learn to play band, orchestra and dance music through my home study course. Write for particulars Today, NOW! Write for folder of special snare drum offer.

The Herman H. Rinne Correspondence School of Modern Drumming
3156 Park Ave. Indianapolis

ANYBODY CAN PLAY

So simple a child can play—by numbers instead of notes.

"FUN" at parties, entertainments, etc.

SEND NO MONEY, just your name. Pay postpaid only \$2.79 on arrival. We pay postage.

PUBLIC TRADING CO.
263-5th Ave., Dept. 445 New York

FREE—15 SONGS!

Around The Universe

(Continued from page 721)

It all happened within the space of a few seconds. Sir Isaac, who had been hovering anxiously between the windows and the keyboard, became suddenly confused. He started toward the table, then changed his mind and leaped to the side window, half falling over Ameena, who was in his path.

"Look!" shouted Tubby, above the roar. "Hey, look out, perfessor! Let's get up out of here!"

An enormous, swiftly moving black surface, completely obstructing the side window for an instant, went past close outside. Sir Isaac leaped back to the table just as the vehicle struck something soft and yielding—a glancing, sidewise blow. Tubby and Ameena were hurled to the floor. Sir Isaac, clinging desperately to the table, fumbled for the keyboard, and altered several of the keys. There was a gigantic swishing noise; the room trembled—tilted sidewise. Then silence.

Tubby raised his aching head. "Where's Ameena? Ameena! You ain't hurt?"

Her faint voice reassured him. He raised himself to a sitting position. "Oh, perfessor—you hurt? What happened? Where are we?"

They were none of them more than badly shaken up. The room was level again, vibrationless, soundless. Through the floor window shone the faint stars; out of the side window, high above, the yellow glare of the Inner Surface was fading. The vehicle had turned over, and was again dropping out into Space!

Tubby lifted Ameena to a chair and kissed her reassuringly. "Sall right. We ain't hurt none. What happened, perfessor? What was all that?"

Sir Isaac did not know. For an hour they compared notes on what they had seen. It had all happened so quickly; it was so confusing, so unexpected. Their view through the little windows at near objects was so limited they found that each of them had seen things differently.

"Well, anyhow," Tubby declared with a shrug, "we landed on that there Inner Surface, an' we got away again without gettin' smashed up. Now let's get home an' fix this Mars business. We only got twenty-six days left."

With the entire repellent force of the Inner Surface above it, and the attraction of several of the celestial universes at its base, the vehicle rapidly gained velocity. It was nearly midnight when Sir Isaac, coming out of a profound meditation, suddenly exclaimed.

"I know what happened to us on the Inner Surface! Fancy that! How I could have been so stupid?"

"What?" demanded Tubby. Ameena, who just at that moment was preparing to retire to bed, stood poised with a bottle of liniment in her hand.

Sir Isaac said excitedly: "The inhabitants of the Inner Surface, relative to us, must be gigantic in size. How silly of me not to have realized that!"

"Well?" "Well," Sir Isaac continued, "that was a gigantic building alongside of which we went down—a building fifteen or twenty miles high! Those huge, yellow rectangles were its lighted windows! That ball of fire was a street light! We descended directly into a city street, and collided, probably, with the coat-sleeve of a pedestrian!"

(To Be Continued.)



HIGH SCHOOL COURSE IN TWO YEARS

You Want to Earn Big Money!

And you will not be satisfied unless you earn steady promotion. But are you prepared for the job ahead of you? Do you measure up to the standard that insures success? For a more responsible position a fairly good education is necessary. To write a sensible business letter, to prepare estimates, to figure cost and to compute interest, you must have a certain amount of preparation. All this you must be able to do before you will earn promotion.

Many business houses hire no men whose general knowledge is not equal to a high school course. Why? Because big business refuses to burden itself with men who are barred from promotion by the lack of elementary education.

Can You Qualify for a Better Position?

We have a plan whereby you can. We can give you a complete but simplified high school course in two years, giving you all the essentials that form the foundation of practical business. It will prepare you to hold your own where competition is keen and exacting. Do not doubt your ability, but make up your mind to it and you will soon have the requirements that will bring you success and big money. YOU CAN DO IT.

Let us show you how to get on the road to success. It will not cost you a single working hour. It costs you nothing but a stamp.

American School

Dept. H-826 Drexel Ave. & 58th St., Chicago

American School

Dept. H-826 Drexel Ave. and 58th St., Chicago
Send me full information on the subject checked and how you will help me win success.

- | | |
|------------------------------|----------------------------|
|Architect |Lawyer |
|Building Contractor |Machine Shop Practice |
|Automobile Engineer |Photoplay Writer |
|Automobile Repairman |Mechanical Engineer |
|Civil Engineer |Shop Superintendent |
|Structural Engineer |Employment Manager |
|Business Manager |Steam Engineer |
|Cert. Public Accountant |Foremanship |
|Accountant and Auditor |Sanitary Engineer |
|Bookkeeper |Surveyor (& Mapping) |
|Draftsman and Designer |Telephone Engineer |
|Electrical Engineer |Telegraph Engineer |
|Electric Light & Power |High School Graduate |
|General Education |Fire Insurance Expert |
|Vocational Guidance |Wireless Radio |
|Business Law |Undecided |

Name.....

Address.....

Opportunity Ad-lets

YOU will find many remarkable opportunities and real bargains in these columns. It will pay you to read and investigate the offerings made every month by reliable firms, dealers and amateurs from all over the country. No matter what you may be seeking, whether supplies, automobile accessories, the opportunity to make money, or anything else, you will find listed here the best and most attractive specials of the month.

Advertisements in this section twelve cents a word for each insertion. Name and address must be included at the above rate. Cash should accompany all classified advertisements unless placed by an accredited advertising agency. No advertisement for less than 10 words accepted.

Ten per cent. discount for 6 issues, 20 per cent. discount for 12 issues. Objectionable or misleading advertisements not accepted. Advertisements for the January issue must reach us not later than November 15.

The Circulation of Science and Invention is over 160,000 and climbing every month

EXPERIMENTER PUBLISHING CO., INC., 53 Park Place, New York City, N. Y.

Agents Wanted

Agents—Best seller; Jem Rubber Repair for tires and tubes; supercedes vulcanization at a saving of over 800 per cent; put it on cold. It vulcanizes itself in two minutes, and is guaranteed to last the life of the tire or tube; sells to every auto owner and accessory dealer. For particulars how to make big money and free sample, address Amazon Rubber Co., Dept. 601, Philadelphia, Pa.

Big money and fast sales. Every owner buys gold initials for his auto. You charge \$1.50; make \$1.35. Ten orders daily easy. Write for particulars and free samples. American Monogram Co., Dept. 71, East Orange, N. J.

Make \$25 to \$50 week representing Clows' Famous Philadelphia Hosiery, direct from mill—for men, women, children. Every pair guaranteed. Prices that win. Free book "How to Start" tells the story. George Clows Company, Desk 27, Philadelphia, Pa.

Success in Business and Personal Affairs! Read character by handwriting and features. Conlin System. Low price for entire course. Write H. E. Conlin, Dept. G, 21 St. John's Place, Buffalo, N. Y.

Men's Shirts. Easy to sell. Big demand everywhere. Make \$15.00 daily. Undersell stores. Complete line. Exclusive patterns. Free samples. Chicago Shirt Manufacturers, 241 W. VanBuren, Factory, 115, Chicago.

Wonderful invention—Eliminates all needles for phonographs. Saves time and annoyance. Preserves records. Lasts for years. 12,000,000 prospects. \$15.00 daily. Free sample to workers. Everplay, Desk 117, McElurg Bldg., Chicago.

We want Salesmen and Agents, either whole or side line, to sell our low priced radio books to the trade. Excellent proposition for live wires. The E. I. Company, Publishers, 233 Fulton Street, New York City.

Write and learn how to start profitable business without capital or experience. Silvering mirrors, refinishing auto headlights, tableware, plating. Outfit furnished. International Laboratories, Dept. 25, 309 Fifth Ave., New York.

Earn big money fast applying gold initials to autos. Every owner buys—\$1.35 profit on \$1.50 sale—particulars and samples free. Write quick. Lithogram Co., Dept. 10, East Orange, N. J.

Only one sale a day means \$200 per month! Five sales, \$1,000 per month! Marvelous new adding machine. Retail \$15. Work equals \$350 machine. Adds, subtracts, multiplies, divides automatically. Speedy, accurate, durable, handsome. Five-year guarantee. Offices, stores, factories, garages, buy one to dozen. A fortune for live agents. Write quick for protected territory and free trial offer. Lightning Calculator Co., Dept. W., Grand Rapids, Mich.

Big Fast Profits For Agents. Repeater Six Fuse Plugs sell on sight wherever there is electricity. Do away with lighting troubles. Welcomed everywhere. Get details. Sample 25c. Moss-Schury Manufacturing Company, Inc., 18-A Detroit, Mich.

\$50—\$200 a week. Genuine Gold Letters for store windows. Easily applied. Free samples. Liberal offer to general agents. Metallic Letter Co., 433 B, North Clark, Chicago.

Sell Madison "Better Made" Shirts direct from our factory to wearer. No capital or experience required. Easily sold. Big profits. Write for Free Samples. Madison Mills, 503 Broadway, New York.

Agents—\$15 a day—Easy, quick Sales—Free Auto—Big weekly bonus—\$1.50 premium Free to every customer. Simply show our Beautiful, 7-piece, Solid Aluminum Handle Cutlery Set. Appeals instantly. We deliver and collect. Pay daily. New Era Mfg. Co., 803 Madison St., Dept. F, Chicago.

Agents—Big returns, fast office seller; particulars and samples free. One Dip Pen Co., 12 Daily Record Bldg., Baltimore, Md.

Rummage Sales make \$50.00 daily. We start you. Representatives wanted everywhere. Wholesale Distributors, Dept. 32, 609 Division Street, Chicago.

Earn \$10 daily silvering mirrors, plating and refinishing metalware, chandeliers, bedsteads, headlights. Outfits furnished. N. Deete Laboratories, 1133 Broadway, New York.

Agents—Our soap and toilet article plan is a wonder; get our free sample case offer. Ho-Ro-Co., 119 Locust, St. Louis.

Live Agents make \$10 Day selling Eureka Strainer and Splash preventer for every water faucet. Takes on sight. Widely advertised and known. Get details today. A. J. Seed Filter Co., 73 Franklin, New York.

Start your own business as our sole agent, selling 100 famous home products. All or spare time. Dr. Blair Laboratories, Dept. 535, Lynchburg, Va.

300 Percent Profit; Free Auto. Whirlwind Seller. Tremendous Repeater. Sample Free. Bestever Products Co., 1943-K Irving Park, Chicago.

Agents Wanted—(Continued)

We pay \$50 a week taking orders for **INSYDE TYRES** inner armor for automobile tires. Guaranteed to give double tire mileage. Any tire. Prevents punctures and blowouts. Big demand. Low priced. Write quick for territory. American Accessories Co., B384 Cincinnati, Ohio.

Agents—Quick Sales, Big Profits, Outfit Free. Cash or credit. Sales in every home for our high class line of pure food products, soaps, perfumes, toilet articles, etc. Write today for money-making plans. American Products Co., 9865 American Bldg., Cincinnati, Ohio.

Agents—Free sample Dr. Elliott's Vegetable Oil Soap—19 Full-sized packages right out of stock. Tea, Coffee, Extracts, Spices, Food Products, Laundry and Toilet Soap samples. Everything furnished. Send postal today. Department 64, Harley Company, Dayton, Ohio.

Agents—\$4.25 Profit on every sale of Nibco Service Set. Needed in every home and building. Get particulars quick. A. F. Silver-Chamberlin Company, Clayton, N. J.

American Made Toys

Manufacturers on large scale, also homeworkers, wanted to manufacture Metal Toys and Novelties. Millions needed of Barking Dogs, Wag-Tail Pups, Wild Animals, Automobiles, Indians, Cow-Boys, Baseball Players, Cannons, Toy Soldiers, Growing Rooters, Statues of Liberty, Miniature castings of Capital, Bathing Girl Souvenirs and others. Unlimited possibilities. Guaranteed Casting forms furnished manufacturers at cost price from \$5.00 up, with complete outfit. No experience or tools necessary. Thousands made complete per hour. We buy goods all year and pay high prices for finished goods. Cash on Delivery. Contract orders placed with manufacturers. Catalog and Information free. Correspondence invited only if you mean business. Metal Cast Products Co., 1696 Boston Rd., New York.

Automobiles

Automobile owners, garagemen, mechanics, send for free copy America's popular motor magazine. Contains helpful, money-saving articles on repairing, overhauling, ignition, carburetors, batteries, etc. Automobile Digest, 541 Butler Bldg., Cincinnati.

Business Opportunities

Dollars yearly in your spare time. Indoors or outdoors I'll show you how. Particulars free. S. I. Metz, 313 East 89th, New York.

Sell us your spare time. You can earn Fifteen to Fifty dollars weekly writing show cards at home. No canvassing; pleasant profitable profession, easily, quickly learned by our simple, graphic block system, artistic ability unnecessary; we instruct you and supply work. Wilson Methods, Limited, Dept. 51-L, Toronto, Canada.

You can have a business-profession of your own and earn big income in service fees. A new system of foot correction readily learned by anyone at home in a few weeks. Easy terms for training, openings everywhere with all the trade you can attend to. No capital required or goods to buy, no agency or soliciting. Address Stephenson Laboratory, 18 Back Bay, Boston, Mass.

Stop Plodding! Be Successful. Operate a Tire Repair Shop. Make big profits in any locality. We teach you and furnish complete equipments \$100 up. Book of Opportunity free. Haywood's 1312 South Oakley Avenue, Chicago.

Money Making Opportunities—particulars free. Lemke, Box 572, Cincinnati, Ohio.

Succeed With Your Own Products—Formulas, Processes, Trade-Secrets. Different, dependable, profitable. Catalog free. D. Thaxly Co., Washington, D. C.

Get ahead of the other fellow. Start a manufacturing business. Very little capital needed. Write for particulars. Universal Scientific Laboratories, Box 1871, Richmond, Va.

Free Book. Operate little Mall Order business home evenings, Pier, 288-A, 74 Cortland St., N. Y.

\$10 daily silvering mirrors, plating and refinishing lamps, reflectors, autos, beds, chandeliers by new method. Outfits furnished. Write Gunmetal Co., Ave. D, Decatur, Ill.

Wanted—County Distributors for World's Fastest Selling Automobile Accessory. Write A. Benross Co., 384 East 144th Street, New York.

Make Big Money. Spare or full time. Everybody loves Popular Music. Few hours a day with unique plan builds cumulative income. Representatives cashing in Reserve territory. Get particulars quick. Crocker-Steinkamp, Dept. E-11, Quincy, Ill.

Books

Free—Upon request will send you my literature illustrating the following books. Astrology, Character, Clairvoyance, Concentration, Healing, Hypnotism, Magnetism, Mediumship, Personal Magnetism, Personality, Physlognomy, Salesmanship, Seership, Success, Sex, Will, Yogi Philosophy, Gazing Crystals, etc. A. W. Martens, E.E. 6, Burlington, Iowa.

"Lights, Colors, Tones and Nature's Finer Forces," including Vibrations; Odic-Auras; Electro-Magnetics, Cold-lights; Radio; Coming Inventions, 270 pages. Satisfaction Guaranteed; \$2.00, Circulars Free. Stevens Research Laboratories, 242 Powell Street, San Francisco, Calif.

Perpetual Motion, by Percy Verance. A history of the efforts to discover same from earliest days to the present, together with a scientific discussion regarding the possibility of its ultimate achievement. Profusely illustrated, 337 pages. Price postpaid, \$2.00. The Enlightenment Specialty Co., 305 Fourth St., Edwardsville, Ill.

Send for New Illustrated Catalog of Books on Mechanical Subjects Free. Spon & Chamberlain, 122 S Liberty Street, New York.

"Master Key" \$2.50. "Power of Will" \$3.00 Couss's Free. Phipps, 1014 Belmont, Chicago.

Chemistry

Experiments—Book of over 100 chemical experiments only 25c. Oliver Stalter, Oshawa, Ontario, Canada.

Learn Chemistry at Home. Dr. T. O'Connor Sloane, noted educator and scientific authority, will teach you. Our home study correspondence course fits you to take a position as chemist. See our ads on pages 697 and 719 of this issue. Chemical Institute of New York, 66 W. Broadway, New York City.

"Popular Chemistry." "The Experimenter's Monthly." Six months' trial—50c. A. Wright Laboratory, Caldwell, New Jersey.

Chemical Laboratory Supplies. Catalog 5 cents. Union Laboratory Supplies, 518 Syms St., West Hoboken, New Jersey.

Correspondence Courses

Used correspondence courses bought and sold. Bargain catalogue 1000 courses free. Students' Exchange, Dept. 4, 47 West 42d St., New York.

Dollars Saved. Used correspondence courses of all kinds sold, rented and exchanged. List free. (Courses bought.) Lee Mountain, Pisgah, Alabama.

Duplicating Devices

"Modern" Duplicators save Time, Labor and Money. Gots Business. Reproduces Typewritten or penned letters, Drawings, Lessons, Music, Menus, Bids, Notices, Specifications, Maps or anything in one or more colors. Prints two per minute. Special Sale On. 30 Days' Free Trial. \$2.25 up. Booklet Free. E. J. Durkin-Reeves Co., Pittsburg, Pa.

Exchange

Gibson Tenor Banjo, with plush case, value \$132.50. Will take \$75.00 or exchange for a Telescope, will pay difference. John Urast, 1009 Meadow Ave., Charleroi, Pa.

For Advertisers

25 words—355 Rural Weeklies, \$14.20. Ad-Meyer Agency, 411281 Hartford, St. Louis.

Ford Owners

Sport Cars. Fast, saucy, hug the turns and stick to the road—make you glad you're a Ford owner. Can easily be built by aid of life size "Red-i-Kut" patterns and picture instructions. The "Pal" system delivered complete with pressed metal streamline tail for \$6.40. Garage men make big money building them. Send for prospectus on making sport cars—Jiffy Tons and Gosum windshields. Kuempel Co., 1100 Kuempel Bldg., Gettysburg, Iowa.

Games and Entertainment

Tricks, Puzzles, Jokes, Magical Apparatus, Plays, Stage Supplies, Mind-Reading, Acts and Sensational Escapes. Send 10c for 160-page illustrated 1922 professional catalogue. Oaks Magical Co., Dept. 549, Oshkosh, Wis.

For Inventors

Get your own patents. Application blanks, complete instructions \$1. Cutting Bros., Campbell, Calif.

Patent application blanks, sample drawing, complete instructions all for \$1. Will Watt, Box 31 South Pasadena, Calif.

If you have a practical, useful invention to sell (patented or patent pending), write us today. American Patents Corporation, Barrister Bldg., Washington, D. C.

Invention Magazine. Helpful advice. Send for circular. M. K. Burckett, 1430-I University Ave., New York City.

Commercialize your ideas according to My Cooperative Plan. Booklet free. Ralph Burch, Patent Lawyer, Jenifer Building, Washington.

Inventions Developed to Commercially practical shape. Machine Designing. Working Drawings for Models. Patent Drawings. H. Wettstein, M.E., 150 Nassau St., New York.

Your Chemical problem solved and working process furnished for Five Dollars. Write me. W. Stedman Richards, Consulting Chemist, Box 2402, Boston, Mass.

Formulas

Moneymaking Books, Plans, Formulas. Catalog Free. Ideal Book Shop, 5501-E, North-Robey, Chicago.

Health

Free to Men—Information of a scientific nature that has brought physical vigor and happiness to thousands. No charge; no obligation. Enclose stamp for reply. C. I. Wood & Co., Colorado Springs, Colorado.

Asthma and Hay Fever Cured to Stay Cured. Write for particulars. A. Butterworth, 374 DeWitt, Belleville, N. J.

"Christians-Red-Food-Salt"—For Stamina and Pep. \$1. \$2 sizes, postpaid. Guaranteed. Vegetarian Food Co., St. Louis, Mo. Literature Free.

Help Wanted

We want Salesmen and Agents, either whole or side line to sell our low priced radio books to the trade. Excellent proposition for live wires. The E. I. Company, Publishers, 233 Fulton Street, New York City.

Detectives Earn Big Money. Travel. Excellent opportunity. Great demand everywhere. Experience unnecessary. Particulars free. Write, American Detective System, 1974 Broadway, N. Y.

Be a Mirror Expert. \$3 to \$10 a day; spare time home at first; no capital; we train, start you making and silvers mirrors French method. Free prospectus. W. B. Derr, Pres., 25 McKinley St., Baldwin, N. Y.

Be a Detective; Excellent opportunity; good pay; travel. Write C. T. Ludwig, 1417 Westover Bldg., Kansas City, Mo.

Make Money in spare time mailing letters. Rare opportunity now. Men, send addressed envelope for special plan. Normande II, 147 W. 23d St., New York.

All men, women, boys, girls, 17 to 65, willing to accept Government positions, \$117-\$250, traveling or stationary, write Mr. Ozment, 293, St. Louis, Mo., immediately.

Silvering Mirrors, French plate. Easily learned, immense profits. Plans free. Wear Mirror Works, Excelsior Springs, Mo.

Earn \$25 Weekly, spare time, writing for newspapers, magazines. Experience unnecessary; details free. Press Syndicate, 5665 St. Louis, Mo.

Railway Postal Clerks—Start \$133 month. Railroad pass; expenses paid; questions free. Columbus Institute, H-4, Columbus, Ohio.

Firemen, Brakemen, Baggage-men, Sleeping car, train porters (colored). \$140-\$200. Experience unnecessary. 897 Railway Bureau, E. St. Louis, Ill.

Earn \$110 to \$250 monthly, expenses paid as Railway Traffic Inspector. Position guaranteed after completion of 3 months' home study course or money refunded. Excellent opportunities. Write for Free Booklet G-57 Stand. Business Training Inst., Buffalo, N. Y.

U. S. Government wants Railway Mail Clerks. Commence \$133 month. Steady positions. Travel—see the country. List positions free. Write immediately. Franklin Institute, Dept. C24, Rochester, N. Y.

\$300 Profit Weekly—Installing automatic advertising directories in hotels, etc. The 12 ads sell quickly. Automatic information of train schedules—road maps, etc. Flash illuminated on opaque glass. Secure particulars and booklet. Sterling Specialty Service, Oceanview, Virginia.

Languages

World-Romie System, Masterkey to All Languages. Primers, 23 languages, \$1.94 each language: English, French, German, Italian, Portuguese, Spanish. Pronunciation—Tables. 102 languages, 30c each language. Languages Publishing Company, 8 West 40th Street, New York.

Machinery and Tools

Concrete Building Block Machines and Molds. Catalogue free. Concrete Machine Co., 305 South Third St., St. Louis, Mo.

Manufacturing

Something special in metal? Models. Tools. Patterns. Experimenting. Manufacturing. Inventions developed. Parma Engineering Works, Brooklyn Station, Cleveland, Ohio.

Improved Made Toys

We show you how to earn big money easily with our casting forms making Whistling Birds, Wild Animals, Crowing Roosters, Automobiles, Baseball Players, Statue of Liberty, Indians, Toy Soldiers, Cowboys, Barking Dogs, Wag Tail Pups, Miniature castings of Capitol, Bathing Girl Souvenirs and others. No experience necessary. We furnish you with molds and necessary outfit from \$3.50 up. We buy large quantities of finished goods at highest prices. Spot cash. Send for catalogue and information free. The Improved Metal Casting Co., 342 East 145th St., New York.

Instruction

Instruct Yourself for desired Successes. Illustrative chart shows Success(ive) Steps. Postpaid 50 cents. J. E. Morrey, Box 304, Madison Sq. Sta., N. Y.

Learn Chemistry at Home. Dr. T. O'Connor Sloane, noted educator and scientific authority, will teach you. Our home study correspondence course fits you to take a position as chemist. See our ads on pages 697 and 719 of this issue. Chemical Institute of New York, 66 W. Broadway, New York City.

Miscellaneous

Radio! Mystery of the 20th Century Complete, simple explanation of this mysterious communication, with instructions for making sets. Cloth bound, 350 pages. Special \$1.10. Avery Co., Zionsville, Ind.

Questions Answered. \$1.00 each, any subject. If answer impossible, money returned. Dept. 2, 31 N. E. 14th Street, Miami, Florida.

\$50 to \$150 Weekly Writing Jokes, Epigrams and Humorous Stories for publications. Write for details. American Institute of Humor, Office E, 414 Park Bldg., Cleveland, Ohio.

Questions Answered on any Subject. One dollar each. Money returned if answer cannot be given. Fee for elaborate investigations and reports arranged by correspondence. Technical Associates, P.O. Box 1478, Boston, Mass.

Phrenology Taught—Become an expert character analyst in short time. Write Ernest Headley, 980 Eddy St., San Francisco.

Tricks, Magic, cards, books, novelties, puzzles. Catalogue free. Clifford Fenner, 2401 Jefferson, Louisville, Ky.

Motion Picture Business

\$35 Profit Nightly. Small capital starts you. No experience needed. Our machines are used and endorsed by Government institutions. Catalog free. Atlas Moving Picture Co., 470 Morton Bldg., Chicago, Ill.

Motorcycles—Bicycles

Don't buy a Bicycle Motor Attachment until you get our catalogue and prices. Shaw Mfg. Co., Dept. 6, Galesburg, Kansas.

Orchard Lands

Big returns from Pecan, Orange, and Fig Groves. Guaranteed care. Small monthly payments. Dept. I, Suburban Orchards Co., Biloxi, Mississippi.

Patents

Inventions Commercialized. Patented or unpatented. Write Adam Fisher Mfg. Co., 205 St. Louis, Mo.

Unpatented ideas can be sold. I tell you how and help you make the sale. Particulars free. Write W. B. Greene, Jenifer Building, Washington, D. C.

Patents For Sale

Brush's Pad for cleaning and spotting any garments, etc. No. 1,224,581 for \$16,000.00. C. B. Twyford, 617 Bailey, Zanesville, Ohio.

Personal

Exchange Interesting Letters with new friends. Write Dolly Gray Club, Box 186K Denver, Colorado.

Exchange Cheery Letters with new friends. Write Betty Lee, Inc., 4234 Broadway, New York City. Stamp appreciated.

Popularity—Pleasure—Profit—for you. Be a Handcuff expert. Make big money, travel and see the world. Send for free circular. J. Meilo, 376 Central St., Lowell, Mass.

Exchange jolly letters with new friends. Lots fun! Send stamp. Eva Moore, Box 908, Jacksonville, Fla.

Correspondence Club—Many wealthy members everywhere. Fascinating particulars free. Smith, Box 1187Y, Denver, Colo.

Lonely Hearts, join our Club, be happy; correspondence everywhere; many wealthy, descriptions, photos free. Standard Club, Box 608, Grays Lake, Ill.

Phonographic Supplies

Build Your Phonograph. Quality phonoparts. Famous Serenado Motors. Also original Perfection Motors. Electric Motors, tonearms, reproducers, amplifiers, case material, accessories. Free blueprints and building instructions. Big Savings. Wonderful results. Prompt delivery. Catalog mailed for ten cents. Hoosier Mfg. & Supply Company, 321 Baldwin Block, Indianapolis, Indiana.

Patent Attorneys

Inventors—Send for form "Evidence of Conception" to be signed and witnessed. Form, fee schedule, information free. Lancaster and Allwine, 242 Ouray Bldg., Washington, D. C.

Millions spent annually for ideas! Hundreds now wanted! Patent yours and profit! Write today for free books—tell how to protect yourself, how to invent, ideas wanted, how we help you sell, etc. 212 Kresge Bldg., American Industries, Inc., Washington, D. C.

Patents. Send for free booklet. Highest references, best results. Promptness assured. Send model or drawing for examination and opinion. Watson E. Coleman, Patent Attorney, 624 F Street, Washington, D. C.

Inventors write me about patents. My fees payable monthly. Booklet free. Frank Fuller, Washington, D. C.

Herbert Jenner, Patent Attorney and Mechanical Expert, 624 F Street, Washington, D. C. I report if patent obtainable and exact cost. Send for circular.

Lacey Patent-Sense. "The book the inventor keeps." Free. See page 706.

Patents Procured, Trade Marks Registered. A comprehensive, experienced, prompt service for the protection and development of your ideas. Preliminary advice gladly furnished without charge. Booklet of information and form for disclosing idea free on request. Richard B. Owen, 130 Owen Bldg., Washington, D. C., or 2278-T Woolworth Bldg., New York.

Inventors! Record invention legally before disclosing to others. Our Invention Record and Data Sheet shows how. Sent free and valuable information given on patent procedure, costs, etc. Report on patentability includes copies of patents nearest your idea. O'Connell & O'Connell, 400 Jenifer Building, Washington, D. C.

Monroe Miller, Ouray Building, Washington, D. C., patent attorney, mechanical and electrical expert. Best quality of work and results. Moderate charges.

Inventors. Send sketch or model of invention for opinion concerning patentable nature and exact cost of patent. Book, "How to Obtain a Patent," sent free. Tells what every inventor should know. Established twenty-eight years. Highest references, prompt service, reasonable charges. Chandler & Chandler, 455 Seventh Ave., N. W., Washington, D. C.

"Inventors' Guide" free on request; gives valuable information and advice for all who have original ideas or improvements. Frank Ledermann, Registered Attorney and Engineer, 15-E Park Row, New York.

H. F. Lowenstein, Registered Patent Attorney, Radio Expert, 825 McLachlen Building, Washington, D. C.

Unpatented ideas can be sold. I tell you how and help you make the sale. Particulars free. Write W. J. Greene, Jenifer Building, Washington, D. C.

Inventors: Protect your invention by Experts, skilled in Radio-Electrical, Chemical, and Mechanical fields. New illustrated Booklet, giving much necessary and very useful information which every inventor should know, sent free upon request. Write today to A. M. Wilson, Inc., (Radio 3ARE) 312 Victor Building, Washington, D. C.

Before or after filing your application for patent, it will pay you to read over my "Inventors Advisor No. 4." Free for asking—Write: M. Labiner, Registered Patent Attorney, 3 Park Row, New York.

Photoplays, Stories, Etc.

Wanted. Men and women ambitious to make money writing Stories and Photoplays. Send for wonderful Free Book that tells how. Authors' Press, Dept. 131, Auburn, N. Y.

\$ \$ \$ For Ideas. Photoplay Plots accepted, any form; revised, criticized, copyrighted, marketed. Advice free. Universal Scenario Corporation, 223 Security Bldg., Santa Monica & Western Ave., Hollywood, Calif.

Big Money in Writing photoplays, short stories, poems, songs, etc. Send today for free copy America's greatest magazine for writers. Filled with practical help in writing and selling. Writer's Digest, 637 Butler Building, Cincinnati, Ohio.

Printing

Printed Stationery: 200 Letterheads and Envelopes printed with your name and address for only \$2.00, prepaid. State whether plain or English letters wanted. Cash with order. Address King Supply Co., 335 Taylor Street, Topeka, Kansas.

Radio Equipment

Genuine Edison Elements (new) for making "B" Batteries, obtained from U. S. Government. A positive and negative element—6c; glass tube—3c; all other parts at reasonable prices. Postage, etc. 50c extra per order. Free instructions. Todd Electric Company, 109 West 23rd St., New York.

Salesmen Wanted

\$742 Last Month for Beck of Buffalo introducing latest advertising plan; nothing else like it; every merchant wants it; easy sales; no deliveries; no collections; specialty salesmen write quick for offer. National Adv. Service, P.O. Box 43, La Grange, Ind.

Short Stories, Manuscripts Wanted

Earn \$25 Weekly Spare Time writing for newspapers, magazines. Experience unnecessary; details free. Press Syndicate, 568 St. Louis, Mo.

Stories, Poems, Descriptive Articles, Plays, etc. Are Wanted for Publication. Monthly cash prize. Submit Mrs. or write Literary Bureau, 165, Hannibal, Mo.

Deafness



Perfect hearing is now being restored in every condition of deafness or defective hearing from causes such as Catarrhal Deafness, Relaxed or Sunken Drums, Thickened Drums, Roaring and Hissing Sounds, Perforated, Wholly or Partially Destroyed Drums, Discharge from Ears, etc.

Wilson Common-Sense Ear Drums
"Little Wireless Phones for the Ears" require no medicine but effectively replace what is lacking or defective in the natural ear drums. They are simple devices, which the wearer easily fits into the ears where they are invisible. Soft, safe and comfortable. Write today for our 168 page FREE book on DEAFNESS, giving you full particulars and testimonials. WILSON EAR DRUM CO., Incorporated 231 Inter-Southern Bldg. LOUISVILLE, KY.

PIMPLY SKIN

When a few applications of this wonder working lotion has cleared faces of pimples, blackheads, acne eruptions on the face or body, enlarged pores, oily or shiny skin, you can realize why CLEAR-TONE has been tested and approved in over 100,000 Test Cases. The simplicity of the treatment, The Story of How I Cured Myself are all explained in my free booklet. Write for your copy today and learn of the results gotten by thousands of men and women. E. S. GIVENS 168 CHEMICAL BLDG. KANSAS CITY, MO.



SEX

Facts other sex books don't dare discuss are plainly told in "Where Knowledge Means Happiness." Creates a new kind of married love. One reader says: It contains more real information than all other sex books put together.

From "Where Knowledge Means Happiness" Sent in plain cover, by return mail, for \$1.00, cash, money order, check or stamps Copyright 1921 Dept. 39 COUNSEL SERVICE, 257 W. 71st St. N. Y.



SEXUAL KNOWLEDGE
320 Pages ILLUSTRATED Cloth By Winfield Scott Hall, M.D., Ph.D. **SEX FACTS MADE PLAIN**
What every young man and Every young woman should know What every young husband and Every young wife should know What every parent should know Table contents and commendations on request
\$1.00 Postpaid, Mailed in plain wrapper. AMERICAN PUB. CO., 1145 Winston Bldg., Philadelphia

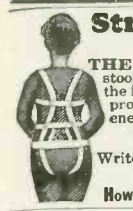

Straightens Shoulders - Increases Pep
THE NATURAL BODY BRACE—Corrects stooping shoulders, straightens the back, gives the lungs chance for normal expansion, induces proper breathing. Brings restful relief, comfort, energy, and pep. For men and women. Costs nothing to try it Write for 30 days free trial offer and free book. NATURAL BODY BRACE CO. Howard C. Rash, Pl. 286 Rash Bldg., Salina, Kansas



DEAFNESS IS MISERY
I know because I was Deaf and had Head Noises for over 30 years. My invisible Antiseptic Ear Drums restored my hearing and stopped Head Noises, and will do it for you. They are Tiny Megaphones. Cannot be seen when worn. Effective when Deafness is caused by Catarrh or by Perforated, Partially or Wholly Destroyed Natural Drums. Easy to put in, easy to take out. Are "Unseen Comforts" - Inexpensive. Write for Booklet and my sworn statement of how I recovered my hearing. A. O. LEONARD Suite 369, 70 5th Avenue -- New York City

ARE YOU SELF-CONSCIOUS?
Embarrassed in company, lacking in self-control? Let me tell you how you can overcome these troubles. VERITAS, Desk 15, 1400 Broadway, New York City

ADULTS! SEX KNOWLEDGE BOOKS
Instructive, authoritative, profusely illustrated in natural colors, etc. Not the cheap sort. Contains everything one should know both before and after marriage to insure health and happiness. Large catalog free. L. F. SMETANA & COMPANY, OWOSSO, MICH.

Song Poems Wanted

Write the Words for a Song. We compose music. Our Chief of Staff wrote many big song-hits. Submit your song-poem to us at once. New York Melody Corp., 412 Romax Bldg., New York.

Prominent London Music Publisher is open for available songs by American Writers, Amateur or Professional; Songs judged on merit—not writers' reputations. For further particulars Write to American Representative, Jack Mahoney Dept. I, 145 West 45th St., New York.

Stammering

St-Stu-t-t-tering and Stammering cured at home. Instructive booklet free. Walter McDonnell, 105 Potomac Bank Bldg., Washington, D. C.

Stamps and Coins

Stamps Free—Variety Packet, Foreign Stamps with Catalogue—2c postage. Gray Stamp Company, Station E5, Toronto, Canada.

Free packet. Ukrania, Bulgaria, Turkey, etc., with request for 50 percent, 60 percent sheets. Enclose 2c postage. 50 Var. S. America, Australia, etc., 10c. George Flagg, 270 Wyoming Ave., Melrose, Mass.

Stamps—20 Unused. All different. Free. Postage 3c. Mention paper. Quaker Stamp Co., Toledo, Ohio.

California Gold, quarter size, 27c; half-dollar size, 53c. Columbian nickel and catalogue, 10c. Norman Schulz, Box 146. Colorado Springs, Colo.

Free 10 different unused stamps. sent to approval applicants at 66-2/3. J. de Jong, 516 West 182 Street, New York City.

Typewriters

Typewriters sold on payments. Free trial. Payne Company, Rosedale, Kansas.

All standard makes, \$10 up. Fully guaranteed. Free trial. Write for complete illustrated lists. Northwestern Exchange, 320 Goethe St., Chicago.

Wanted

Detectives Earn Big Money. Work home or travel. Experience unnecessary. Particulars free. American Detective System, 1974 Broadway, N. Y.

Battle Photos and War Relics

For Dens: Relics Collected from Europe's Battlefields. Firearms, medals, helmets, etc. Illustrated catalogue and sample War Photographs 25c. Lieut. Welch, 2117 Regent Place, Brooklyn, N. Y.

Wireless

Cunningham, Radiotrons. Detector Tubes \$4.95. Amplifier Tubes \$5.50. Guaranteed new. Harold Lynn, Cheboygan, Mich.

Battery Generators—500 Volt 100 Watt \$28.50 each Battery Chargers \$12.50—High Speed Motors, Motor-Generator Sets all sizes. Motor Specialties Co., Crafton, Penna.

Motors—G. E. ¼ HP. \$15.00—½ HP. \$32.50—1 HP. \$62.50. Generators 8 volt 10 amp \$15. 32 volt 500 watt \$30. Other sizes. Low prices. Motor Specialties Co., Crafton, Penna.

Attention! 50 Vacuum Tube Hook-Ups. The greatest collection of Vacuum Tube Circuits ever brought under two covers at such insignificant cost. These diagrams will be found in the great "Rasco" catalogue which contains raw materials and parts in a greater profusion than any other catalogue. 15c in stamps or coin will bring the catalogue to you. Radio Specialty Company, 100 Park Place, New York City.

Boys, don't overlook this! The "Rasco" Baby Detector. Greatest detector ever brought out with molded base. Fully adjustable. See former advertisements in this publication or our catalogue. Detector with Galena Crystal complete, 50c; the same Detector with Radiocite Crystal, 75c, prepaid. Send for yours today. Radio Specialty Co., 100 Park Place, New York City.

The How and Why of Radio Apparatus, by H. W. Secor, E. E. This newest book on radio matters fulfills a distinct gap in wireless literature in that, while the treatment is made as understandable and as free from mathematical possibilities. It at the same time incorporates a wealth of technique and instruction for the Radio Amateur—the Radio Operator—the Installation and Designing Expert—as well as teachers and students of the subject in general. A very broad field has been covered by the author, at the same time giving a great deal of information not found in other text books. If you are engaged in any branch of the Radio or allied arts at all you will surely need this latest contribution to radio literature, which is destined to be found on every radio man's book shelf before long. A glance at the following list of chapters gives but a very scant idea of the extensive and useful radio knowledge provided in its text: The Induction Coil; The Alternating Current Transformer; Radio Transmitting Condensers; The Spark Gaps; Radio-Transmitting Inductances; Radio Receiving Tuners; Radio Receiving Condensers; Detectors; Telephone Receivers; Radio Amplifiers; Construction of a Direct Reading Wavemeter and Decimeter; Antenna Construction; The Calculation and Measurement of Inductances; Appendix containing very useful tables, covering all subjects treated in this very unusual book. This newest of Radio Works, cloth bound in Vellum de Luxe, Gold Stamped Hand Sewed, has 160 pages. Size of book, 8x9 inches. The How and Why of Radio Apparatus. Postpaid, \$1.75. Experimenter Publishing Co., Book Dept., 53 Park Place, New York City.

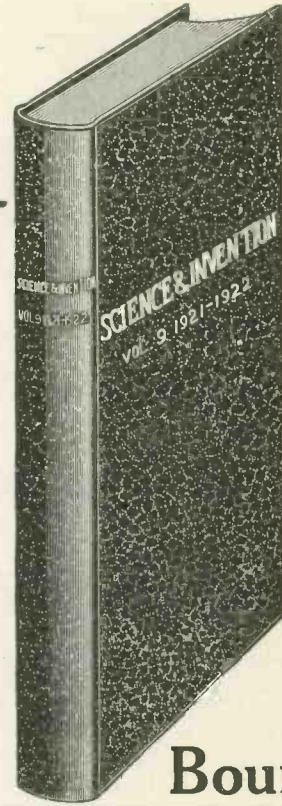

Bound Volume No. 9

May, 1921—April, 1922
CONTAINS
1200 Pages with over 1500 Illustrations
and
Over 700 Articles by the Foremost American and Foreign Writers

We have also a limited amount of the following Bound Volumes of Science and Invention (Electrical Experimenter):

Vol. No. 6—May, 1918, to April, 1919.

Vol. No. 8—May, 1920, to April, 1921.

Each volume bound in stiff board covered with green vellum and gold stamped.

Price for vol. No. 9.....\$2.25
Price for vol. 6 or 8..... 2.00

ALL THREE VOLUMES 6.00
Send Express Collect.

EXPERIMENTER PUBLISHING Co.
53 Park Place, N. Y.

Gentlemen:
Enclosed find \$..... for which send me bound vol. of S. & I. No. 6 (), No. 8 (), No. 9 (), by express collect.

Name

Address

Town State

CIRCULATION 60,000 COPIES



This magazine is edited by
H. GERNSBACK
 also Editor of
RADIO NEWS
 and
SCIENCE and INVENTION

100 Articles
 Over
 100 Illustrations

FOR SALE AT
 ALL NEWS STANDS

20c. the Copy
 \$2.00 a Year
 Canada and Foreign
 \$2.50 a Year

SEND FOR
FREE
 SAMPLE COPY
 TODAY

See Coupon Below
 for SPECIAL OFFER

"The Electrical Magazine for Everybody"

PRACTICAL ELECTRICS is probably the most novel magazine of its kind ever conceived. It is personally edited by H. Gernsback, editor of SCIENCE & INVENTION and RADIO NEWS. Mr. Gernsback, who founded the old "Modern Electrics" as well as the "Electrical Experimenter," knows thoroughly what his readers want and have wanted for many years. PRACTICAL ELECTRICS, the 100% electrical magazine eclipses the best that was in "Modern Electrics" and "Electrical Experimenter."

Electricity covers such a tremendous field that the man who does not keep abreast with it does himself a great injustice. PRACTICAL ELECTRICS covers that field from every angle. It is written in plain every-day language that all can understand. It portrays the entire electrical development of the month faithfully in non-technical language. It caters to everyone interested in electricity, be he a layman, an experimenter, an electrician or an engineer—each will find in this magazine a department for himself and plenty more.

The November issue now on the news-stands contains 48 pages, over 100 different articles and over 100 illustrations, with an artistic cover in three colors. Professor T. O'Connor Sloane, Ph.D., is associate editor of the magazine.

- INTERESTING ARTICLES IN NOVEMBER
"PRACTICAL ELECTRICS"
 Electro-Ventriloquism
 Perfected X-Ray Installation
 High Temperature Resistance Furnace
 By Allan P. Kenworthy
 Thermic Telephones. (Concluded)
 Dark or Black Lightning
 By Ferdinand Ellerman
 Mercury Vapor Arcs
 Little Known Methods of Producing Electricity
 By Raymond B. Wailes

PRIZES

This magazine offers a number of prizes, as follows:

Our \$50.00 Prize Contest for Junior Electricians and Electrical Experimenters includes as its elements simplicity, as great a degree of novelty as possible, and practicability.

Also a new prize contest giving four prizes amounting to \$37.50 for the best account of an odd electrical experience.

\$3.00 for the best article on Elec-Tricks, the new department.

\$3.00 for the best "short-circuit," the semi-humorous department.

In addition to this, the magazine pays high prices for all electrical experiments, electrical articles, etc. See current issue for full details.

This issue also contains articles by some of the greatest electrical writers, workers and students. The magazine will prove a revelation to any one interested in electricity.

Every issue besides its many other features contains the following departments:

- "New Things Electric"
- "Experimental Electrics"
- "Electrical Digest"
- "Junior Electrician"
- "Elec-Tricks"
- "Motor Electrics"
- "Short Circuits"

"How and Why" (Questions and Answers.)

Make all checks payable to: "Practical Electrics Co."

S.I. 11-23

SPECIAL OFFER

Gentlemen:
 Although your regular price is \$2.00 per year, you will accept my subscription at \$1.75 per year (Canada and foreign \$2.25). I enclose the money herewith and I have written my name and address in margin below.

PRACTICAL ELECTRICS CO., 53 Park Place, New York

What Radio Problems Have You?

You'll Find the Answer In This New Book

Radio Questions Answered

By A. P. PECK, A.M.I.R.E.

Radio Editor, SCIENCE & INVENTION

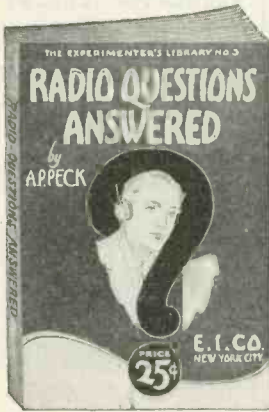

This book will prove as welcome to the radio public as our "100 Radio Hook-ups", which is now the fastest selling radio publication on the market. "Radio Questions Answered" was gotten up after a thorough canvass of dealers to find out which topics troubled most of the amateurs. Almost 100 questions are answered very fully and in language so simple that even the most inexperienced layman can easily understand. Put up in the style which has made the E. I. books famous all over the world.

25c

52 pages, 2 Color Cover, 25 Illustrations

100 Radio Hook-ups

By M. L. MUHLEMAN

A book for both the novice and advanced radio amateur containing a varied selection of hook-ups from the simple crystal to the more elaborate circuits, with a circuit for every requirement. Crystal hook-ups, combined crystal with radio and audio frequency amplifiers, non-regenerative, and regenerative vacuum tube circuits with and without radio and audio amplifiers. Amplifier units, with straight jacks, filament and switching arrangements, power amplifiers, choke coil, resistance coupled and transformer coupled radio frequency amplifiers.

Includes all of the latest one and multi-tube hook-ups including the numerous types of Reflex, super-regenerative, super-Heterodyne, Neutrodyne, Reinartz, Flewelling, and Bishop. The values and constants of all apparatus employed in the hook-ups are given. A list of radio symbols is included, which is of material help to the reader in determining the meaning of the conventional hook-up diagrams. The text includes much helpful information.

25c

52 Pages—Two-Color Cover

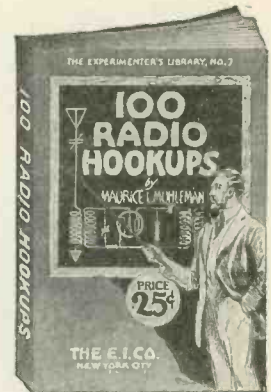

This book covers in comprehensive form the fundamental principles of tuning. The characteristics of radio waves are fully described and illustrated. Illustrations are used so that the non-technical reader can easily understand the identical actions as applied to radio. Several chapters are devoted to the use and functions of all radio apparatus. The book describes how to tune such sets as the Reinartz, Flewelling, Neutrodyne, radio frequency amplifier receivers and others.

52 pages, 25 Illustrations
Prepaid **25c**

A non-technical book for the beginner. Gives complete constructional data on the building of a complete Crystal Detector Set, Tuning Coil, Loose Coupler and a Single Audion Tube Set with Amplifying Units. It furnishes all dimensions and working drawings of every part that must be constructed by the amateur. Written in plain, simple language that anyone can understand. The opening chapter gives a complete description of the theory of radio and tells what it's all about, teaching the principles of wireless so that the constructor knows what he is doing.

48 Pages, 26 Illustrations
Bound in Beautiful Two-Color Cover. Size, 5 1/2 x 7 1/2 in. Prepaid **25c**

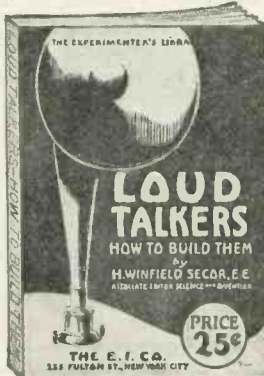

This book describes and gives complete data for building two distinct types of loud talkers. One chapter deals with improvised loud talkers, and gives complete instructions on how to build suitable horns for use in loud receivers of the Baldwin and other types. In preparing these designs, the point has been constantly kept in mind to use the simplest parts possible, so that anyone can build a successful loud talker, equivalent to the commercial types, costing \$40.00 or more.

48 pages, Profusely Illustrated
Prepaid **25c**

This book is for the more advanced amateur, showing the construction of the Radio Frequency Amplifying Transformer and giving complete constructional data. It shows the application of Radio Frequency to amplifying units that the amateur may already possess and gives 15 hook-ups showing practically every use Radio Frequency Amplifying Transformers can be put to.

32 Pages, 15 Illustrations
Bound in Beautiful Two-Color Cover. Size, 5 1/2 x 7 1/2 in. Prepaid **25c**

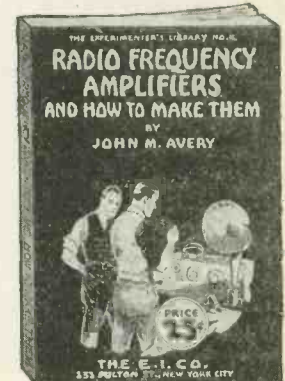

If your dealer cannot supply you—order direct from us—giving dealer's name and address.

THE E. I. COMPANY (THE CONSRAD CO.) 233 Fulton St., N. Y. City

ENGINEERS

JUST OUT

A \$10,000

MASTER SET

ON LATEST

ENGINEERING



AUDEL'S ENGINEERS & MECHANICS GUIDES 4750 pages—8754 Illustrations—Pocket Size—Flexible Binding

\$1 Per Month

Every Engineer, Mechanic and Electrical Worker will welcome this new Master Set. It will answer your problems. It will help you with your daily work. A sure source of advancement and higher pay. Complete up-to-date information that is thoroughly and easily explained on every branch of Modern Engineering and Electrical Practice.

A dollar a month is all it costs to have in your possession all the latest information on engineering.

\$12 Complete

THE GUIDES TELL YOU ALL ABOUT

Theory, Practice and Operat'n of ALL Steam Engines, Valve, Motions, VALVE SETTING; CORLISS ENGINES, UNIFLOW and POPPET VALVE ENGINES, LOCOMOBILES—Locomotive—Marine Engines; Turbines; Rotary Engines—the Indicator—Lubrication—PRACTICAL MANAGEMENT. How to use Indicator—GAS, OIL and DIESEL ENGINES—Aeronautics, Aviation—HOW TO SELECT AN ENGINE. STEAM ENGINE DESIGN. Theory and Construction of ALL Steam Boilers; Heat-Combustion; Fuel and Flue Gas Analysis—CO₂ Recorders—Characteristics of Boilers—

Materials, Boiler Construction—Mechanical Stokers—Oil Burners—Setting—Chimneys—Mechanical Draught—HOW TO SELECT A BOILER, BOILER DESIGN based on A. S. M. E. BOILER CODE—OPERATION of Steam Boilers—Pipes and Pipe Fitting—Heating and Ventilation—Refrigeration—Cooling Towers—Condensers—Distilling Apparatus—Elevators—Cranes and Hoisting Machinery—Ropes and Cables—Splicing—Compendium of Practical Electrical Engineering—Ready Reference Index, covering entire field of Modern Electricity.

SHIPPED TO YOU FREE!

Not a cent to pay until you see the books. No obligation to pay unless you are satisfied. Send coupon now—today, and get this new Master Set for Engineers and see if it is not worth \$100 to you. Pay only \$1.00 a month.

Theo. Audel & Co., 72 Fifth Ave., New York City. Please submit me for free examination Audel's "New Eight" Master Set for Engineers and Mechanics. If satisfactory I agree to send you \$1 within seven days, and to further mail you \$1 each month until \$12 is paid.

Name.....
 Occupation.....
 Employed by.....
 Home Address.....
 S.-I. Nov.

Radio Course

FREE

My new \$45.00 Radio Course, just completed, given FREE when you enroll for the Electrical Course.

BE A CERTIFICATED ELECTRICAL EXPERT

You, Too, Can Learn To Boss This Job

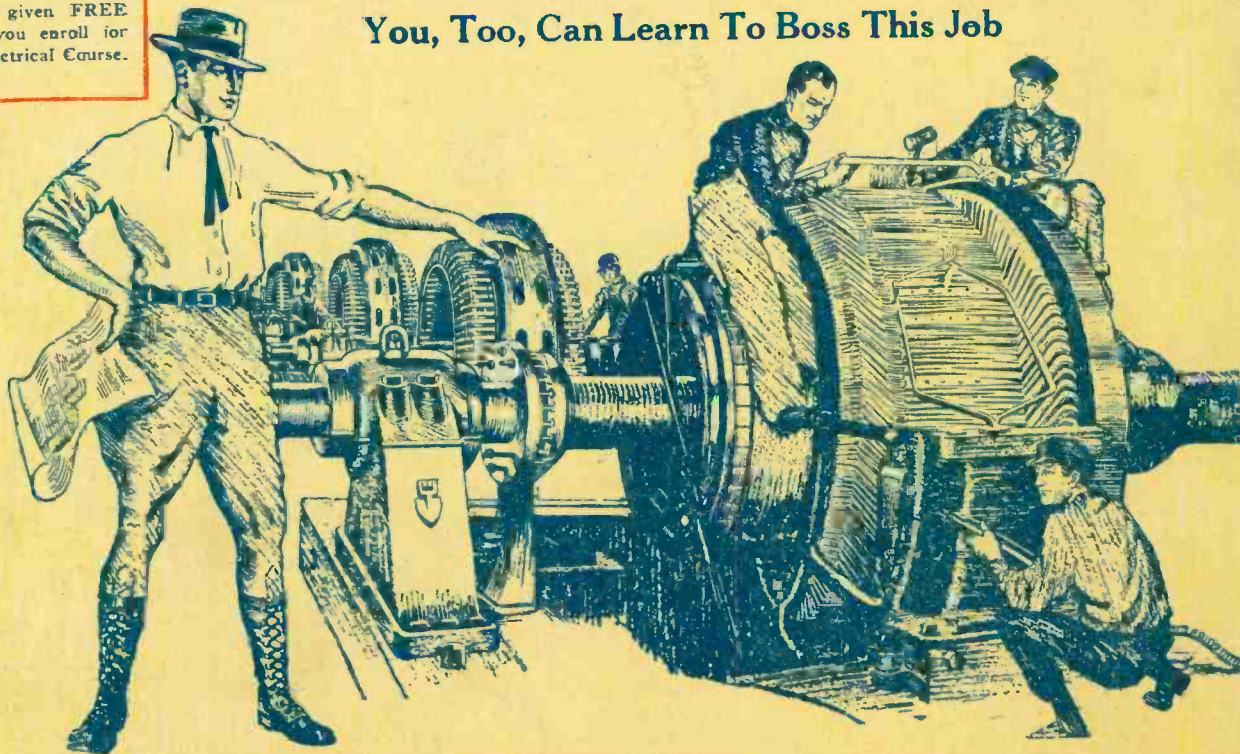

“ELECTRICAL EXPERTS” Earn \$12 to \$30 a Day WHAT'S YOUR FUTURE?

Trained “Electrical Experts” are in great demand at the highest salaries, and the opportunities for advancement and a big success in this line are the greatest ever known. “Electrical Experts” earn \$70 to \$200 a week. Fit yourself for one of these big paying positions.

Be an “Electrical Expert”

Today even the ordinary Electrician—the “screw driver” kind—is making money—big money. But it's the trained man—the man who knows the whys and wherefores of Electricity—the “Electrical Expert”—who is picked out to “boss” ordinary Electricians—to boss Big Jobs—the jobs that pay.

\$3,500 to \$10,000 a Year

Get in line for one of these “Big Jobs” by enrolling now for my easily learned, quickly grasped, right-up-to-the-minute, Spare-Time Home-Study Course in Practical Electricity.

Age or Lack of Experience No Drawback

You don't have to be a College Man; you don't have to be a High School graduate. My Course in Electricity is the most simple, thorough, and successful in existence, and offers every man, regardless of age, education or previous experience the chance to become, in a very short time, an “Electrical Expert,” able to make from \$70 to \$200 a week.

I Give You a Real Training

As Chief Engineer of the Chicago Engineering Works I know exactly the kind of training a man needs to get the best positions at the highest salaries. Hundreds of my students are now earning \$3,500 to \$10,000. Many are now successful ELECTRICAL CONTRACTORS.

Satisfaction Guaranteed

So sure am I that you can learn Electricity—so sure am I that after studying with me, you, too, can get into the “big money” class in electrical work, that I will guarantee under bond to return every single penny paid me in tuition, if, when you have finished my course, you are not satisfied it was the best investment you ever made.

FREE—Electrical Working Outfit—FREE

I give each student a Splendid Outfit of Electrical Tools, Materials and Measuring Instruments absolutely FREE. I also furnish them with all supplies, examination paper, and many other things other schools don't furnish. You do PRACTICAL work—AT HOME. You start right in after the first few lessons to WORK AT YOUR PROFESSION in a practical way.

Save \$45.50 By Enrolling Now

You can save \$45.50 in tuition by enrolling now. Let me send you full particulars of my great Special Offer, and my Free booklet on “How to Become An Electrical Expert.”

L. L. COOKE, Chief Engineer

CHICAGO ENGINEERING WORKS

Incorporated

Dept. 28

2150 Lawrence Avenue

Chicago, Ill.

Use This Free Outfit Coupon

L. L. COOKE, Chief Engineer
Chicago Engineering Works
Dept. 28, 2150 Lawrence Ave., Chicago, Ill.

Dear Sir: Send me at once full particulars of your great Special Offer; also your Free booklet on “How to Become An Electrical Expert.” No obligation on my part.

Name

Address

Occupation Age.....

The “Cooke” Trained Man is the “Big Pay” Man