

Vol. VIII
Whole No. 89

Science and Invention

September, 1920
No. 5.

FORMERLY
ELECTRICAL EXPERIMENTER
233 FULTON STREET-NEW YORK

Published by Experimenter Publishing Company, Inc. (H. Gernsback, Pres.; S. Gernsback, Treas.; R. W. DeMott, Sec'y), 233 & 236 Fulton Street, New York.

Artificial Diamonds

THE diamond as is well known is a crystallized form of pure carbon. The diamond is not acted upon by the strongest acids or alkalies exactly like carbon. If heated to a high temperature in the presence of oxygen it burns, as does ordinary carbon.

Ever since it became known that the diamond is carbon, chemists and physicists have labored incessantly to produce this precious stone artificially—synthetically in other words. Many precious stones have been actually thus produced, as for instance the ruby, the emerald and the sapphire, but as for the diamond, it has so far baffled all our most able researchers.

We might state here that these men who labor so incessantly to produce the diamond realize full well, that the minute the discovery is made, the diamond market will be demoralized, just as happened when artificial rubies were made first. Today not even a jeweler can tell a real ruby from a synthetic one, altho the real one might have cost \$5,000, while the artificial one can be had at \$10. The same thing will happen in the near future to the diamond—you can be sure of that. What then? Will we continue to adorn ourselves with diamonds? Perhaps. But the greater and larger field will be found for industrial purposes. On account of their remarkable hardness diamonds are used for rock-drilling, glass cutting, wire drawing and hundreds of other uses, far more important than for personal adornment.

Let us now see what has been done to produce the diamond synthetically. Perhaps the greatest authority on the subject is the Frenchman Moissan, who actually produced microscopic diamonds by means of tremendous pressures. Graphite—a pure form of carbon—is usually

subjected to extraordinary high pressures running all the way up to 15,000 atmospheres and higher. While under such compression the graphite is treated by means of electric currents as well as high temperatures. Thus Sir Charles A. Parsons used a 200-ton hydraulic press and a current from a storage battery that gave 80,000 amperes! But no diamonds were produced. In some of his experiments Sir Charles actually succeeded in *melting* graphite six times over, but the only result was a slight alteration in the structure of the graphite.

Having found that pressures by means of the hydraulic press had their limitations, Parsons then set about to obtain very much higher pressures on graphite than had ever been thought possible. He simply fired a rifle or gun bullet into a tapered hole drilled into a block of steel. At the bottom of the hole was a small quantity of graphite. By firing a steel bullet into such a hole the net pressure on the graphite was calculated to be 2,000 tons per square inch! So tremendous is such a pressure that the bottom of the hole was enlarged to almost twice its original size! But still the graphite did not change.

Substituting a tungsten steel block tempered glass hard and firing a bullet into a tapered hole by means of a high powered rifle, pressures as high as 5,000 tons per inch were recorded—but still the graphite refused to become a diamond.

It is of high interest to note that Stanley Cook calculated that during such experiments the final pressure must be at least 15,000 atmospheres, while a temperature (caused by the tremendous pressure) of between 15,250° and 17,700° Centigrade must have been reached. In other words, a temperature—tho momentary, of course—as high as that which prevails in the sun!

H. GERNSBACK.

CONTENTS FOR SEPTEMBER, 1920

THE ELECTRICAL MEAL.....	Front Cover
From a painting by Harold V. Brown	
MOVING PLATFORMS FOR STREET CROSSINGS.....	471
By Edwin F. Linder, M.E.	
LIQUID AIR.....	By T. O'Connor Sloane, Ph.D. 472
PLANT OR ANIMAL—WHICH?.....	By William M. Butterfield 475
ELECTRICAL MEALS.....	By Jacques Boyer 476
TIMING SUNLIGHT FOR PLANTS.....	477
HOW DO WE TASTE?.....	By Joseph H. Kraus 478
WHAT'S WRONG WITH THE MOTOR CAR?.....	479
By H. Winfield Secor	
ARCHIMEDES—THE WORLD'S FIRST GREAT INVENTOR.....	480
UNDERSEA AMUSEMENT PARK.....	By F. E. Loudy, A.E. 482
THE UNKNOWN AVENGER.....	By Harold F. Richards, Ph.D. 483
THE AIRPLANE OF THE FUTURE.....	By H. Gernsback 484
THE WHIRLING EYE.....	487
By Thomas W. Benson and Charles W. Wolfe	
MOVIE CAMERA COPIES BOOKS AND LEGAL PAPERS.....	By O. C. Roos 489
THE ROMANCE OF TUNGSTEN.....	By E. W. Davidson 492

SYNTHETIC AMMONIA.....	By Lucien Fournier 493
ECLIPSES—HOW CAUSED.....	494
By A. M. Harding, Ph.D., University of Kansas	
HOME MECHANICS.....	Conducted by William M. Butterfield 496
HOME ELECTRICS—ELECTRIC BELL CIRCUITS.....	497
By G. L. Hoadley, M.E.	
MOTOR-HINTS PRIZE CONTEST.....	498
"WHAT TO DO WITH YOUR OLD PHONOGRAPH" Contest.....	499
POPULAR ASTRONOMY—IF THE EARTH SHOULD STOP!.....	500
By Isabel M. Lewis, M.A. of the U. S. Naval Observatory	
PRACTICAL CHEMICAL EXPERIMENTS—CHEMICAL EFFECTS OF LIGHT.....	By Prof. F. L. Darrow 502
BUILDING "YOUR OWN" PHONOGRAPH—PART I.....	506
By H. Winfield Secor	
A GIANT 2000 KW. RADIO CENTRAL STATION ON LONG ISLAND.....	511
HOW TO BECOME A PROFESSIONAL RADIO MAN—PART I.....	By Pierre H. Boucheron 514
WHAT TO INVENT.....	By Jay G. Hobson 517

SCIENCE AND INVENTION is published on the 15th of each month at 233 Fulton Street, New York. There are 12 numbers per year. Subscription price is \$3.00 a year in U. S. and possessions, Canada and foreign countries, \$3.50 a year. U. S. coin as well as U. S. stamps accepted (the foreign coin or stamp). Single copies, 25 cents each. A sample copy will be sent gratis on request. Checks and money orders should be drawn to order of EXPERIMENTER PUBLISHING CO., Inc. If you change your address notify us promptly, in order that copies are not mis-carried or lost. All communications and contributions to this journal should be addressed to: Editor, SCIENCE AND INVENTION, 233 Fulton Street, New York. Un-accepted contributions cannot be returned unless full postage has been included. ALL accepted contributions are paid for on publication. A special

rate is paid for novel experiments; good photographs accompanying them are highly desirable.

SCIENCE AND INVENTION. Monthly. Entered as second-class matter at the New York Post Office under Act of Congress of March 3, 1879. Title registered at the Patent Office. Copyright, 1920, by E. P. Co., Inc., New York. The contents of this magazine are copyrighted and must not be reproduced without giving full credit to the publication.

SCIENCE AND INVENTION is for sale at all newsstands in the United States and Canada; also at Breteau's, 37 Avenue de l'Opera, Paris. Sole British Agents—Goffrey Parker & Gregg, 62 and 8A The Mall, Ealing, London. Member of the Audit Bureau of Circulation.

\$20 for a complete electrical education will soon be ancient history

The price of the CROFT LIBRARY OF PRACTICAL ELECTRICITY must be advanced.

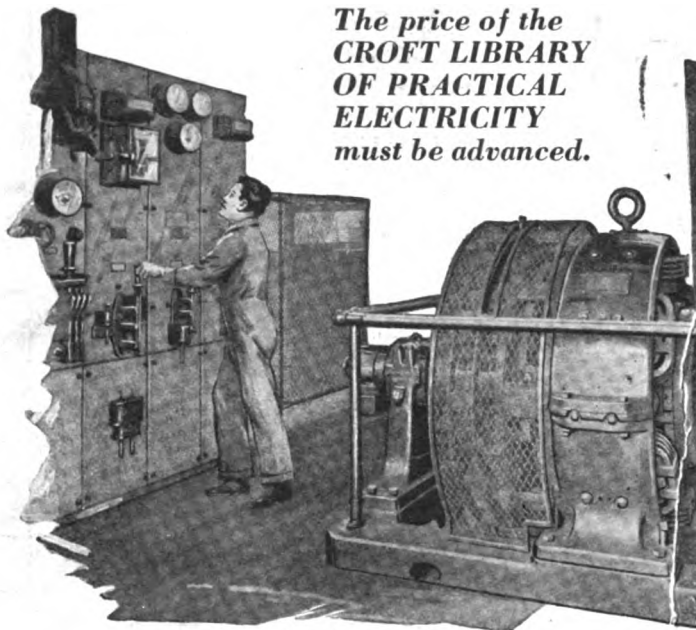

We detest the profiteer. We detest the tactics of the company or individual which raises prices of commodities without just cause.

The new price which must soon be placed on the Croft Library of Practical Electricity finds no favor with us. We have persistently fought against increases in the prices of our books. We have succeeded in keeping these advances down to a minimum. Whereas most other commodities today are sold at advances over former prices of 100% to 500%.

Technical book prices have remained nearly the same. But the present abnormal costs of paper and materials going into the manufacture of the Croft Library compels us to raise the price. Paper is going up daily. It is hard to get at any price. Usually only small quantities are procurable. With the unheard of shortage of wood pulp there can be no drop in prices.

So \$20 for a complete electrical education will soon be a thing of history. We must stop publication of the Croft Library—or raise the price.

Still time to act

The advance will take place very soon. You still have an opportunity to procure the meat of up-to-date electrical practice in America at a fraction the cost of the same information procured from any other source. You still have the chance to possess the most vitally important electrical data in print today, at a very low price.

Records of actual electrical practice

Records of actual practice, written by a practical man, written so you can understand, illustrated so that nothing remains a mystery.

The coupon brings the entire set to you

Use the coupon below today. Let us send you for absolutely free examination a set of books, the only aim of which is to place you in a higher paying position, and to make you master of whatever branch of electricity interests you.

Not a cent in advance—small monthly payments if you're pleased

Examine these wonderful books—use them ten days in connection with your work. Then send them back at our expense if you are not satisfied. If wanted, send us \$2 in ten days, and then \$3 per month for six months.

McGraw-Hill Book Co., Inc.
239 West 39th Street, New York
Publishers of Books for Engineers since 1876

Read This—

Electricity, from the simplest principles to complete and economical operation of a central station—

Motors, generators, armatures, commutators, transformers, circuits, currents, switchboards, distribution systems.

Electrical machinery of every type, installation, operation and repair.

Wiring for light and power. How to do it mechanically perfect, in accordance with the National Electrical Code.

Wiring of finishing buildings. Underwriters' and municipal requirements. How to do the complete job, from estimating it to completion.

Illumination in its every phase. The latest and most improved methods of lighting. Lamps and lighting effects.

A complete course in mathematics as applied to work. A course which refreshes your mind, and gives you mastery of all the short-cuts in figuring.

Electrical practice complete. Electrical practice as experts know it. Electrical practice by experts.

FREE EXAMINATION COUPON

McGraw-Hill Book Co., Inc.
239 West 39th St., New York.

Gentlemen: Please send me the Library of Practical Electricity (shipping charges prepaid), for 10 days' free examination. If satisfactory, I will send \$2 in ten days and \$3 per month until \$20 has been paid. If not wanted, I will write you for return shipping instructions.

Name

Home Address

City and State

Where Employed

Occupation

Moving Platforms for Street Crossings

By EDWIN F. LINDER, M. E.

NOT so many years ago, when the country folks visited the city, they would stand at the curb of the sidewalk and patiently wait for a chance to cross to the other side of the street. The city people would glance at the confused expressions on the faces of these country cousins and dart in and out among the cabs, trucks and horse-cars

abusely by the electric motors which drive them, it is obvious that there need be no delay in getting quickly to the other side of the crossing. At the same time, the discontinuance of the use of the ground level as a means of crossing by pedestrians gives a much freer scope to the movements of motor-driven conveyances. In some cases, for the better distribution of the people, it

rotary platform is reached from the sidewalks either by stairways or moving inclines such as described before. The outer edge of the platform travels close to the corner stations and thus the person using it steps aboard at once on reaching the lower level. Conspicuous signs electrically illuminated designate the *Avenue* and *Street* in the same manner as on the surface overhead and as the rider arrives at the corner

desired a step from the platform brings him to the exit used to ascend to the surface.

At first it may seem like going to a great deal of trouble and expense to make instal-

Left: Why Not Use a Rotary Turntable For Street Cross-Overs at Busy Traffic Centers in the Larger Cities, Like New York, Chicago or Philadelphia? Mr. Linder Tells All About It in the Accompanying Article.

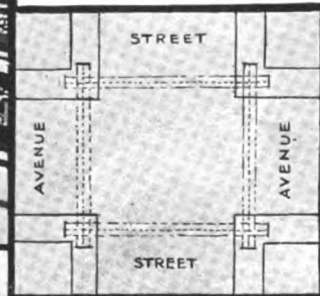
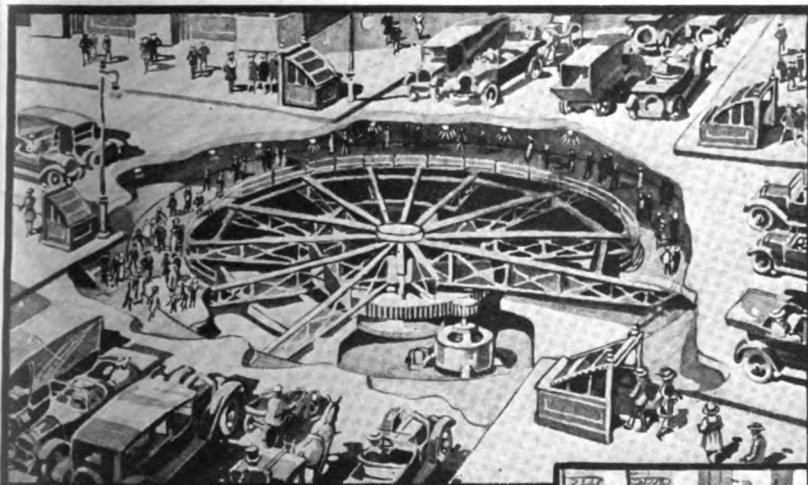

View Below: This Illustrates a Second Idea For Moving Platforms Under Busy Street Cross-Overs. Two Platforms Move in Opposite Directions Between Every Two Corners. See Plan at Left.

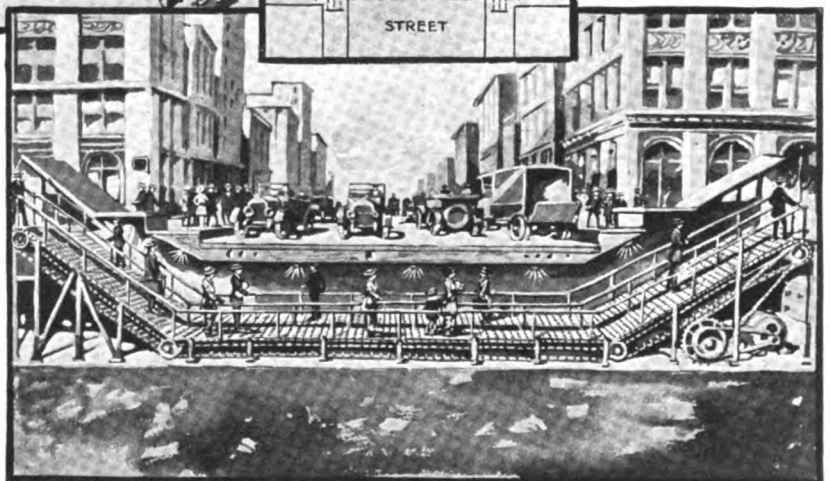

and leave the astonished visitors to wonder how so many reckless persons were able to run across the streets at will, without being trampled under hoof or ground to death under the thousands of fast spinning wheels.

The ever-increasing number of automobiles operated in the large cities has necessitated the building of a police corps of traffic experts to regulate the movements of the pedestrians as well as that of the vehicles. Much valuable time is lost at present by the halting of one and then the other at centers of congestion. To aid in keeping the movements of the rolling stock and also the steady stream of those on foot more uniform, it is suggested that moving platforms, electrically operated, be installed to carry the pedestrians from one side of the street to the other.

One scheme is to have the entrances to these underground conveyors located at a distance of about thirty feet from the street corners, from whence an inclined moving platform carries the people below the street and across to another incline operating upward to an exit similarly situated on the opposite side. This type of conveyor would serve most efficiently by the construction of eight moving endless chain platforms, placed in pairs, each working in opposite directions. The four street corners are thus connected by these sub-surface passages and as the platforms are kept in motion continu-

might be suitable to install a set of moving platforms in the center of the blocks either at right angles to the street or possibly sometimes diagonally, should the crossing be narrow and requiring greater length to accommodate the necessary inclines.

Another idea for the purpose of accomplishing the same end is the erection of an underground "Merry-go-round." A large circular platform rotates about a center post which is geared to the driving mechanism and connected to an electric motor. This

lutions of this kind. Some may even think that ordinary passages built underneath the street surface reached by the usual stairways plenty good enough. Why all these electrically controlled mechanisms?

The answer is that the latter serve as the stern and strict regulators of the moving masses. In both schemes suggested the people are kept moving along in certain definite directions, being transported at all times safely and rapidly without delay to their proper destinations.

Liquid Air

By PROF. T. O'CONOR SLOANE, Ph.D.

DR. JOHN AYRTON PARIS, the biographer of Sir Humphrey Davy, had been invited to the great scientist's house to meet the Rev. Uriah Tonkin. On his way he past the Royal Institute and dropt in to see what was going on in the laboratory. There he found Faraday engaged on an experiment with chlorine hydrate. Dr. Paris noticed some oily drops in the compression tube and intimated that the young experimenter should exercise more care in keeping his apparatus clean. Going on to his dinner, not realizing that he had been talking to one of the world's greatest genius', he mentioned the oily drops, which he had noticed, to his host. The latter looked thoughtful and said he would inquire into the experiment the next day. Early the next morning Dr. Paris received the historic note: "Dear Sir: The oil you noticed yesterday turns out to be liquid chlorine. Yours faithfully, Michael Faraday."

Dr. Paris had seen Faraday's liquefaction of chlorine gas. The laboratory of the same Royal Institute since that time, March 5th, 1823, has seen Dewar's great work on the liquefaction of air and other of the old-time "permanent gases."

This Daring
Experimenter Is
Taking



Liquid
Air Into
His
Mouth.

goes on until liquid air runs off in large quantities. In the early days the production of enough liquid air to be seen as it lay in a minute quantity in a glass recipient was a triumph of science: now it is liquefied by the ton and can be poured from buckets like water, and can be shipt in barrels and milk cans.

In the above the existence of steps in the operation are indicated, but it is perfectly clear that a uniform progression of cooling and compression could be made to give the same result, and this is done in some apparatus, perhaps in most of the modern ones. But now we come to a very important thing in the phenomena of gases. If air is compressed and then expanded, a reduction of temperature occurs. If air were a perfect gas the change of temperature due to expansion would be exactly equal to that produced by the same degree of compression: But this is not the case; the expanded air is slightly cooler than it ought to be. This phase plays an important part in modern liquefaction apparatus.

MODERN METHODS.

It is fair to say that the names of Linde and Claude express the modern development of the liquefaction industry on the manufacturing scale. As an example of the theory of construction of a liquefaction

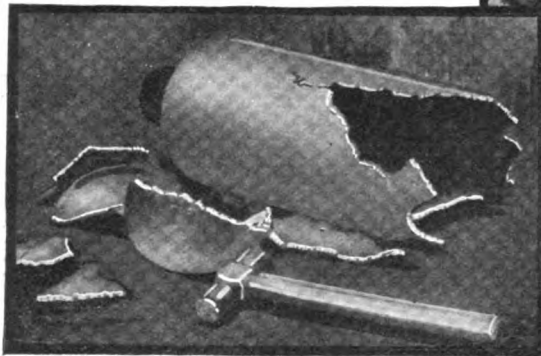

An Iron Flask Cooled By Liquid Air Can Be Broken As Easily As a Glass Bottle.



Ice Is Hot Compared to Liquid Air. To Boil the Liquid Air in the Tea-Kettle, Put It On a Cake of Ice.

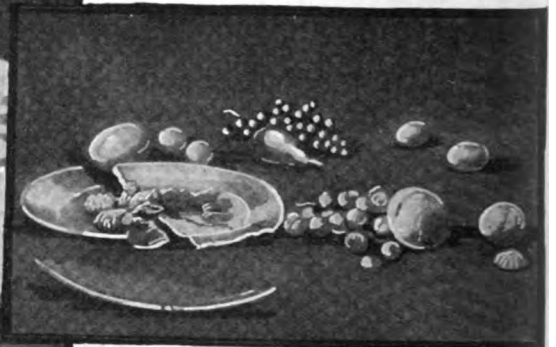

Fruit, a Beefsteak, a Plate Can All Be Broken Like Glass After Immersion in Liquid Air. Don't keep Your Finger in It For Any Length of Time.

EARLY EXPERIMENTS.

A liquid, evaporating, produces cold. If the finger is moistened with water, and is exposed to the air it feels a chill, which is intensified by blowing against it. Prof. Dewar prepared quantities of liquid nitrous oxide and of liquid ethylene. By passing the latter thru pipes surrounded by evaporating nitrous oxide it was chilled to a very low temperature—130° F. The evaporation of the cold ethylene gave a temperature of—229° F. Air at a pressure of 50 atmospheres past thru a tube surrounded by the ethylene was liquefied in quantity. But on drawing it off from this high pressure system nine-tenths of it was lost. Dewar's work was the legitimate following out of Faraday's researches, and was made possible by the expenditure of the great resources of the Institute.

The modern methods of liquefying air use no other gas than the air itself. It is compressed and allowed to expand and in its expansion cools another portion of air previously compressed. This in its expansion cools more air to a still greater degree and the cumulative action

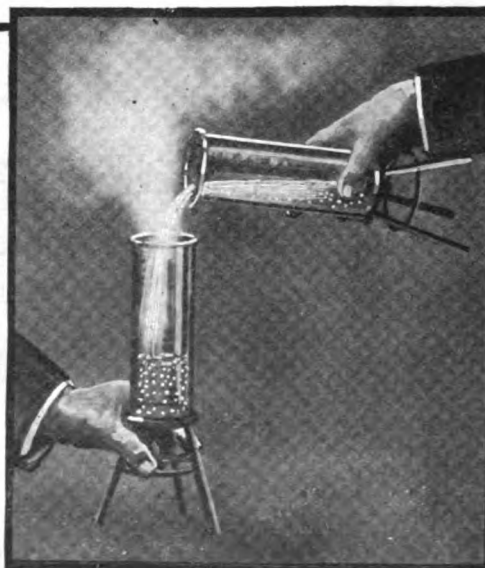

Liquid Air Is Poured About Like Water—it Boils a Little But Will Not Scald You As It Is Colder Than Ice.

apparatus, Georges Claude's method is cited. Air is pumped into the apparatus thru a pipe cooled by the escaping air which has been cooled by expansion. The compressed air does more than merely expand; it is made to drive an air engine. This gives back some of the power which would otherwise be lost and also localizes and intensifies the cooling effect of the expansion. There is a regeneration of the cold as the expanded air escapes; the entering compressed air is cooled more and more as the operation continues, until presently liquid air begins to accumulate in the receptacle. This is of course the merest outline of a description; there may be a number of the air engines in the same machine but the apparatus is wonderfully compact.

Claude worked at the problem of making liquid air in quantity sufficient for the economical manufacture of oxygen gas on a commercial scale. He never dreamt that the inert and supposedly useless nitrogen, "the ashes of air" as it has been aptly called, was eventually to be the valuable product. For in the

fixation of nitrogen, involving the production of fertilizer chemicals and other compounds, pure nitrogen is an essential, and this is most economically produced by liquefaction of air. The oxygen being more easily liquefied is almost perfectly separ-

Dewar, acting on an old device of d'Arsonval, constructed most ingenious vessels; these consisted of two concentric glass bulbs or flasks, with a vacuous space between them. This prevented the heating of the inner vessel by the atmosphere and convec-

"KEEPING" LIQUID AIR.

While Dewar was thus obtaining valuable results in the preservation of the elusive fluid, an American inventor, Charles E. Tripler of New York, had succeeded in making liquid air in large quantities and,



Above: Liquid Air Is Poured Into Water. At First the Globules Float, But as the Nitrogen Evaporates They Become Heavier and Eventually Sink.



A Metal Ball Has Been Cooled in Liquid Air. Placed in the Flame of a Bunsen Burner It Freezes the Carbon Dioxide and Produces Carbonic Acid "Snow."

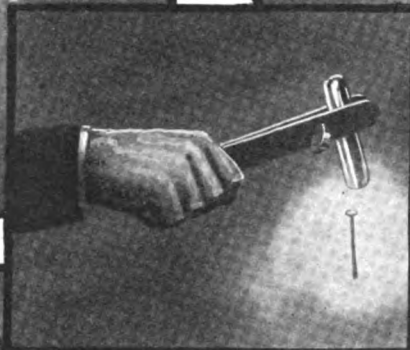

Below: A Lead Wire After Immersion in Liquid Air Is Very Elastic and Strong. By Blowing On It You Warm It and It Looses Its Elasticity and Straightens Out.



At Right: Liquid Air Is Poured Over the Bare Hand. It Does Not Touch it—if It Did the Result Would Be Disastrous.

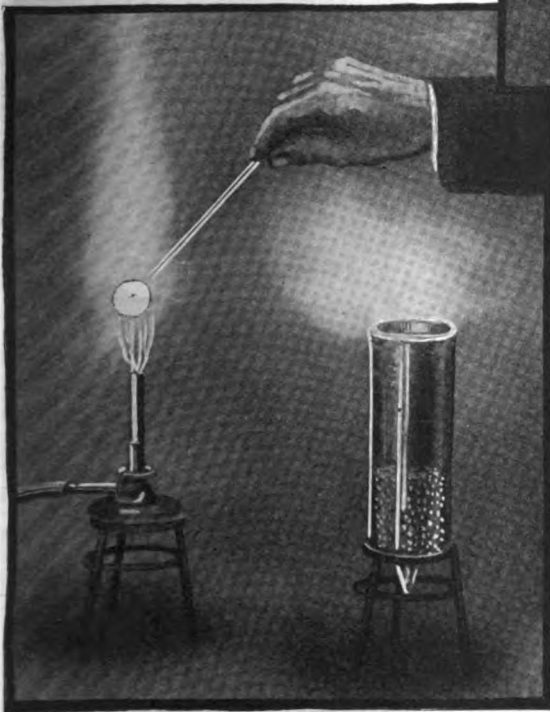

Above: Mercury Frozen in a Test Tube of Liquid Air Can Be Used to Drive a Nail. Grapes Became Hard As Marbles and When Shot From a Gun, Will Penetrate a Pine Board.



ated from air, the four-fifths of the air is collected as pure nitrogen, and the life-giving oxygen, the supporter of combustion, without which all life on our planet would cease in a few moments, appears as a side product.

As soon as liquid air was produced in any quantity the problem of how to keep it arose; it was assumed that it would evaporate rapidly from any ordinary receptacle.

To make the insulating effect still greater the outer side of the inner vessel was sometimes silverplated, or a drop of mercury was introduced into the vacuous space. This deposited a mirror of mercury on the inner vessel. The effect of these metallic depositions was to reflect any heat, thereby making the insulating quality of the bulb still greater.

without presumably reasoning out the why or wherefore of it, had carried it about in buckets, and had shipped it to distant points in tin cans wrapt in felt. It was found, that while it would evaporate and in doing so became richer in oxygen, yet, in large receptacles especially, it would "keep" for an astonishingly long time. It is fair to say that this fact could not well have been anticipated. The reason for it is not far

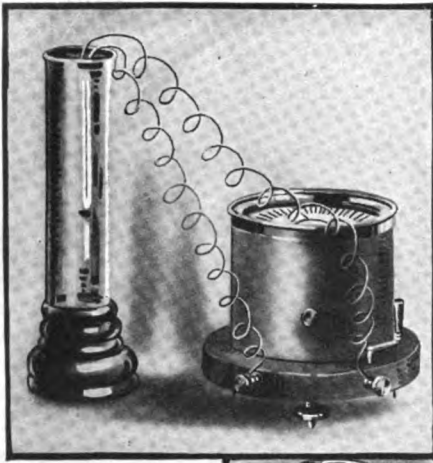

Above: A Coil of Special Wire Is in Circuit With a Current Meter; the Coil Is Immersed in the Liquid Air. The Current Increases As the Temperature is Lowered, and the Reading Gives the Temperature.

to seek; it is due to the assumption of the spheroidal state, so called, by the liquid.

If water is dropt on a moderately hot plate of iron or other material it will boil. But let the plate be red hot; the water will gather itself into a little spheroid or flattened ball, and will evaporate with extreme slowness. A few drops of water in a hot spoon may be made to illustrate the spheroidal state, as it is termed, on account of the shape taken by the fluid. A drop of water on a red hot cover plate of a cooking stove shows it; the laundry maid tries the heat of her flat iron by touching it with her moist finger; if the iron is sufficiently hot the water will be repelled and will not wet the iron nor boil. A sort of cushion of steam forms between the water and the hot surface, which prevents contact, so that the fluid is only slowly heated. If the heat is insufficient to form this cushion, the liquid will come into contact with the hot surface and will boil violently.

In the case of liquid air all other objects exposed to the atmosphere are hot compared to it, and if it is brought for an instant into contact with such a surface, it assumes the spheroidal state, and rests quietly on a layer of gas produced from itself. The surrounding atmosphere acts like a furnace and keeps the receptacle hot, at least hot with reference to the temperature of the liquid air within the vessel.

SURPRISING EXPERIMENTS

Liquid air can be poured over the hand without injury, and the hand may be dilt into it without harm if not left in too long. A frightful freezing effect would result from more than the shortest immersion, because the moment the hand became cold the liquid air would touch it and the hand would be frozen thru and thru instantly.

The double flasks or bulbs used with liquid air may have various shapes. The

inner flask is made of very thin glass, and is fused to the outer one at the upper end or opening of the neck. The inner vessel is therefore very fragile and the weld or joining at the neck is liable to crack when liquid air comes in contact with it. If such a flask is filled with the fluid it is evident that a considerable side strain will come upon it in pouring, as the inner flask is only held in position by the joint at the neck. The thermos bottle is made on the same lines, and many of us have had experience in the breaking of these convenient picnic accessories. How to avoid the danger of thus breaking the inner vessel is shown in one of the illustrations. Air is forced in thru a tube and the liquid

there is no vacuum between the two concentric flasks, the intense cold of the hydrogen soon makes one by freezing the air in the space. It would be perfectly easy to carry out this idea for liquid air by filling the space with the vapor of some readily frozen substance—even carbon dioxide might answer. But there is this difficulty about it: the carbon dioxide is almost sure to contain enough air to seriously impair a vacuum so produced. The inner vessel in the Dewar flasks is made extremely thin.

At low temperatures charcoal absorbs air and other gases with great avidity. A double walled vessel such as shown in the illustration is provided with a tube projecting into the inner vessel. Some charcoal is placed in the tube and the annular space is pretty thoroly exhausted. If liquid air is put into the inner vessel it chills the charcoal which absorbs completely the last traces of air in the outer space and a Dewar flask results. Claude proposed to make such recipients of metal. This however is very brittle when at such temperature, so there would be a chance of breakage after all.

It has been aptly said that a piece of iron or other metal cooled to the temperature of liquid air is more dangerous than liquid air itself. This is because there can be no spheroidal state for the metal to protect anyone touching it, it would at once produce a so-called "burn."

If cotton or some other organic substances are saturated with it a powerful explosive is produced. This can be detonated readily and used for blasting. The explosive must be used as soon as made, because the air evaporates rapidly leaving it inert. But this is a great element of safety, as if a cartridge fails to explode an hour or less of delay makes it innocuous. Many accidents occur in blasting operations by the explosion of such cartridges when loaded with permanent explosives.

But at the present time the all important use of liquid air is for the production of nitrogen and oxygen. The latter gas is acquiring increased importance for cutting iron and steel in the acetylene or blau gas blowpipe, and it is impossible to foresee how far the fixation of nitrogen may be carried,

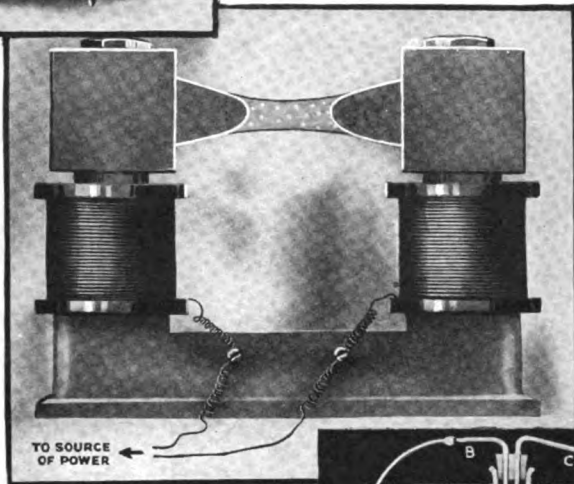

At Right: The Bulb, A, Forces Air into the Dewar Flask, D, Thru the Tube, B; the Liquid Air Is Forced Out Thru the Tube C, and Is Filtered Thru the Filter Paper, E, into the d'Arsonval Tube, F. Do Not Leave the Rubber Cork in the Neck of the Dewar Flask or It Will Get as Hard as Stone.

At Left: A Quantity of Liquid Air Is Supported Between the Poles of a Powerful Electro-Magnet. It Is the Oxygen That Does It.



Dewar Glass Flasks With Double and Triple Walls For Holding Liquid Air.

flows out by the other tube into any desired receptacle. Both tubes pass thru holes in a cork which tightly fits the mouth of the flask. This saves all strain and exposure of the glass weld at the neck to differences and change of temperature.

LIQUID HYDROGEN

Liquid hydrogen is of much lower temperature than that of liquid air. It can manufacture its own Dewar container. For if

requiring enormous quantities of nitrogen. In the line of scientific investigation the

Below: A Flask for Holding Liquid Air Using a Vacuum Produced By the Wonderful Absorbing Qualities of Charcoal.

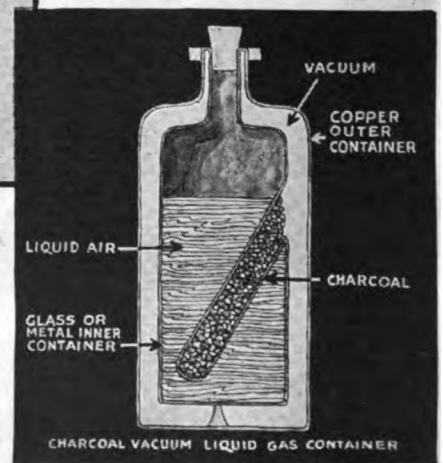

Plant or Animal—Which?

On the Border Line Between the Animal and Vegetable Kingdoms

By WILLIAM M. BUTTERFIELD

THE border line between the animal and vegetable kingdoms has for the past fifty years been placed among a rather unsatisfactory group of minute organisms that may be classed in the vegetable groups, and under the animal groups. These forms are supposed to be the lowest expression of life, as it is very reasonable to believe they are.

And altho a vast amount of work is being accomplished, both professionally and by the enthusiastic, hard-working amateur, yet it more often than otherwise raises a question in the minds of students as to what constitutes the difference between an ANIMAL and a PLANT, as each are found represented by these simple yet puzzling forms.

member of the fungi, to which the mushroom and puff-ball belong, the plant part was alone studied, without any consideration of the true life-history. The plant, ranging in size from 1/64 to 1/8 of an inch in height, resembles for the most part, tiny puff-balls or similar fungi, and is found inhabiting dead wood bark, grass or dead leaves. The chief interest to-day is in the portion of the life spent as an animal, and the portion where it changes into the plant.

These conditions and changes are easily observed by

a single nucleus placed immediately behind and connected with the whip-tail and a pulsating cavity.

To a large extent the swarm-cells feed on bacteria which are caught by a filament projected from the hind end of the body. The bacteria are conveyed into the body substance where they are digested in cavities which form around them; there may be one or more such digestive cavities, each containing several bacteria at one time.

The swarm-cells rapidly increase in numbers by dividing into two parts. When this occurs the whip-tail is first withdrawn and the swarm-cell assumes a globular form. Meanwhile the nucleus is passing thru the

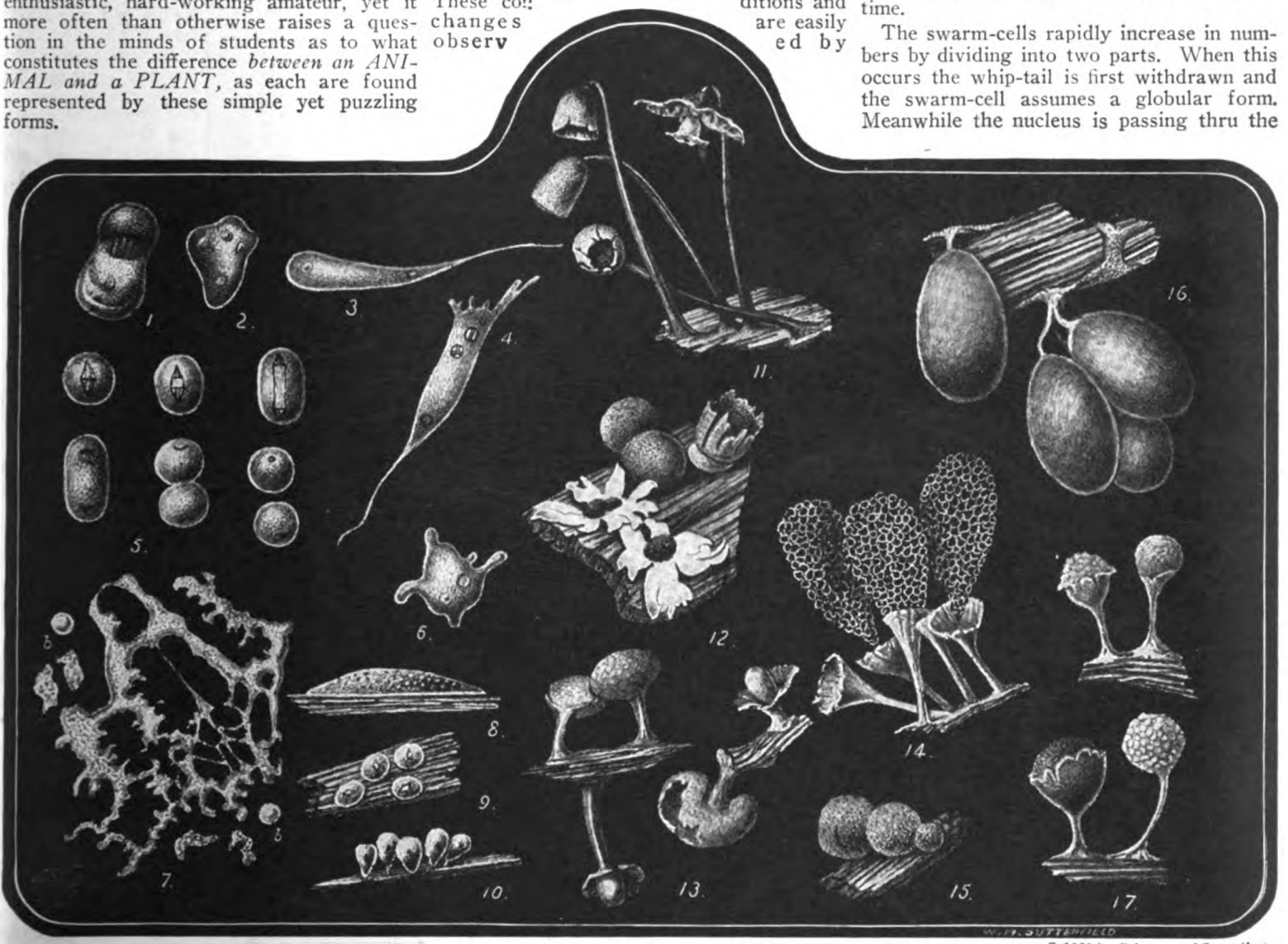

This Plate Shows Actual Development of an Animal Into a Plant of the Kind From Which the Animal Was Originally Evolved.

1. Swarm-Cell Escaping From Seed-Case.
2. Young Swarm-Cell with Nucleus and Three Cavities.
3. Swarm-Cell with Its Whip-Tail.
4. Swarm-Cell Swimming with the Aid of Whip-Tail and Producing a Filament at Rear End, by Which Aid It Captures Swimming Bacteria For Food.
5. The Process of Double Partition by Which a Single Swarm-Cell Becomes Two Individuals; Perfect Swarm-Cells.
6. Lowest Animal Swarm-Cell Ready to Join with Others in Forming Jelly-Like Mass.
7. Jelly Mass Composed of Many Animal Swarm-Cells Creeping and Feeding as a Single Organism. (bb) Animal Cells Budding in Diminutive Pouches.
8. Concentrating Jelly Mass Before the Individuals at Last Divide into Centers, From Which the Plants Develop.
9. Individuals Forming Centers.
10. The Plants Developing.
- 11-17. Various Plant Specimens, All of Which Were in an Animal State Previously.

A British museum publication appeared about a dozen years ago describing the life histories of a few members in a group of fungoid plants, and portrayed them as organisms which are at one stage of their lives *animal*; and at another, *plant!* The study of the group has since become popular with microscope workers both in this country and abroad, probably because the problems referred to above seem solved by these easily obtained and observed groups. Considered for a long time a doubtful

anyone using a microscope and are about as follows:

After a period of immersion in the water of a pool or pond, the *swarm-cells* emerge from the spores as amoeboid bodies (the lowest form of animal) (see plate of drawings, figures 1 to 10); they soon acquire a long whip-like end and creep in a linear form with this whip extended in advance, or swim in the surrounding water with a dancing motion occasioned by the lashing movement of the whip-tail. Each possess

process of division, and in the course of a few minutes the halves of the nucleus separate and retreat to the opposite ends of the constricted cell, which now divides into two; each segment soon acquires a whip-tail and resumes the former active state.

A few days after the germination of the spores, the process of dividing into two parts, by which the number of swarm-cells has greatly increased, ceases. The majority of swarm-cells now withdraw the

(Continued on page 538)
Digitized by Google

Electrical "Meals"

By JACQUES BOYER

PARIS CORRESPONDENT "SCIENCE AND INVENTION"

HERE is indeed a unique remedy to combat the high cost of living. To replace meats and other victuals which are at present almost out of reach, by means of the electric fluid—which by the way is a menu worthy of Hapagon—is the method very seriously proposed to us by Professor Bergonié, of the Bordeaux Faculty of Sciences.

As the result of numerous methodically conducted experiments, this scientist has demonstrated, in effect, that it is possible to partially sustain the human body by means of electricity served in the form of low as well as high frequency currents. It is, of course, understood that these "repasts" are of a nature designed to relieve a suffering organism by furnishing it, in a natural way,

same photograph the ampere-meter in front of the scientist's hand indicates that the proper electrical intensities of from 2 to 3 amperes traverse without harm the relaxed body of the subject stretched out on the long chair. With a potential difference varying between 150 to 2,500 volts, the patient receives in the neighborhood of

meters without assistance and in addition to being incapable of any physical or intellectual work had become considerably emaciated, his weight having been reduced to 49½ kilograms. Under the influence of high frequency currents for a period of 35 days, giving the patient two treatments each day, this man, at the end of the treatments,

regained the normal weight of 63.2 kilograms. He was able to walk for many hours without fatigue and had regained a really remarkable bodily vigor.

In brief, the diathermic method actually seems to be the one most efficacious for the relief of organs in low physical condition no matter what cause, whether it be cancer of the liver, stomach, or the intestines, large hemorrhages, blood poisoning, critical periods

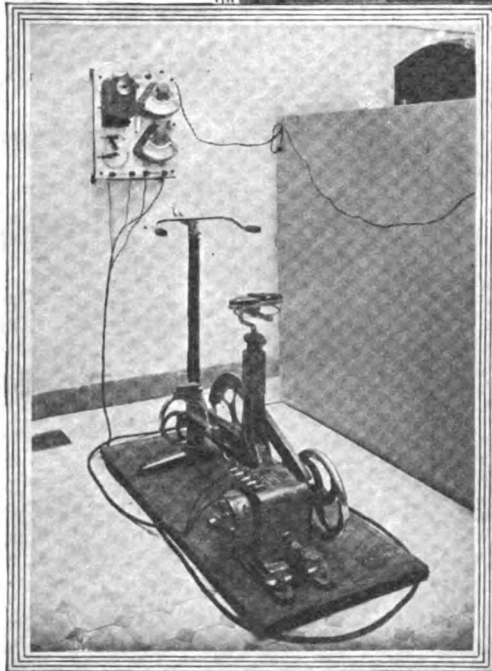
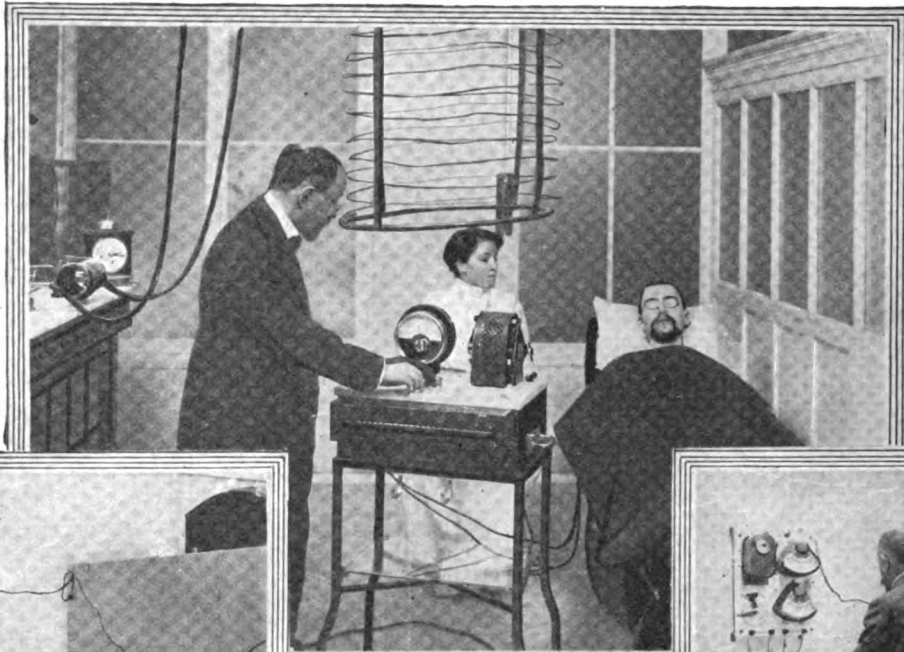

Professor Bergonié, the famous French Researcher, Has Discovered That It Is Possible by Means of Certain Electric Currents to Convey Calories Into the Human Body. Calories Being the Equivalent of Food, Will Increase the Patient's Weight.

The Professor Has Also Constructed a Machine Which He Calls "the Ergometer," Shown at the Left. This Machine Makes Stout Persons Work Their Muscles.

To the Right, We See the Same Machine in Actual Use, and After the Patient Has Worked for a Certain Length of Time and Delivered the Prescribed Energy Into the Machine a Bell Rings and the Machine Stops.

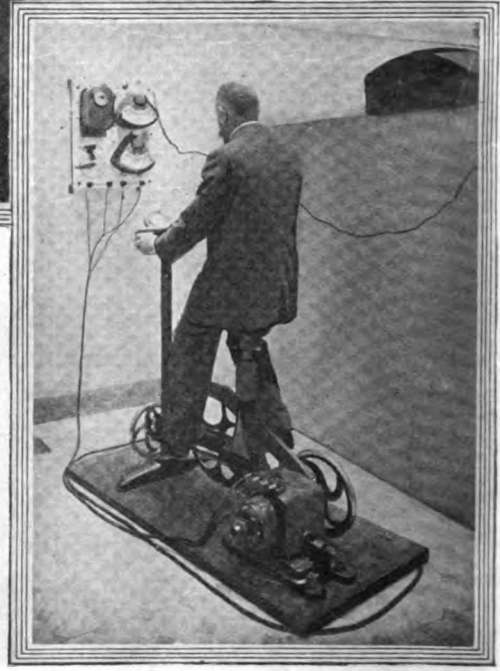

with a complement of heat indispensable to its existence. Such medication in truth cannot replace all nourishment, for cellular life must draw necessary energy from various foods having very complex chemical compositions, which the blood makes use of thru the intermediary of the digestive tract.

Lefevre has estimated that for a normal man the equivalent of 1,500 calories for each twenty-four hours is the minimum alimentation necessary to sustain and properly function normal activities.

In order to make this heat penetrate into the organism M. Bergonié makes use of the diathermic method accredited to d'Arsonval. By means of the Nagelschmidt apparatus, in addition to a Telefunken spark gap which may be seen on the table illustrated in our photograph and which is a method described in all physiotherapeutic treatises, currents of high frequency are thus produced. By referring to the

3,000 calories every hour; that is to say, in addition to his daily organic ration. The electric current enters into his body thru the metallic electrodes, which may consist of lead, tin or thin sheets of aluminum, and which are placed in good contact with the arms and legs. These are firmly adjusted by means of adhesive tape and sometimes the sharp edges of the electrodes are insulated by means of wide bands of tape.

In a general diathermic application having for its object nutrition by means of heat, the electrodes are distributed to the number of 6 for each pole in the following manner: Three on the limbs of the left side for the one pole and 3 on the limbs of the right side for the other pole. An example permitting the appreciation of the marvelous results obtained by Mr. Bergonié is perhaps not out of place.

A subject very much weakened by chronic enteritis was absolutely unable to walk 100

following serious sickness, etc. This method will furnish to the body, in the form of natural heat, a sufficient ration which while supplementing its energy deficit, accomplishes a desirable result without the assistance of the digestive apparatus.

This same practitioner has also demanded of electricity that it reduce the avoirdupois of his too obese clients. Instead of recommending the practise of sports or various forms of gymnastics, like many of his colleagues are in the habit of doing, he has invented the ergometer which is designed for the use of stout citizens. This apparatus is a sort of bicycle electrically propelled which will permit them to re-establish the equilibrium of energy necessary to the proper functioning of their organs. This is accomplished by means of forced exercises regulated in a scientific and rational man-

(Continued on page 568)

Timing Sunlight for Plants

SCIENTISTS have known for generations that sunlight was necessary for normal growth of most kinds of plants, and, altho the summer sun might occasionally become too hot, they have understood that it could not cause any injury except perhaps the injury due to *burning*. A recent discovery by W. W. Garner and H. A. Allard, of the Bureau of Plant Industry in U. S. Department of Agriculture, demonstrates that entirely apart from any effect of burning it is possible for plants to *have too much daylight* or, in other words, too many hours of daylight in comparison with the number of hours of darkness. Too long a day as well as too short a day will prevent many kinds of plants from ever reaching their stage of *flowering and fruiting*.

FLOWERING AND FRUITING PERIODS OF PLANTS CAN BE CONTROLLED.

Furthermore, the intensity of the light has very much less significance upon the growth of the plant than has usually been supposed. Greenhouse experiments prove that the flowering and fruiting period of practically any plant can be made to take place *at any time of the year* by darkening the greenhouse in the morning and evening if the day is too long, or by lengthening the day by artificial light if the day is too short! This new theory of controlling flowering and fruiting of plants undoubtedly will be used by florists and other greenhouse operators. For example, violets bloom only during the comparatively short days of spring; but if violet plants are covered with light-proof boxes at night and not uncovered until the sun is about half an hour high each morning during the summer-time, violets can be forced to bloom again in the summer. Spring flowers and spring crops happen to be spring

Too Long a Day Stops Flowering, Scientists of the Department of Agriculture Discover

forms of plant life, and that it is probably applicable to animal life as well.

REPRODUCTION DEPENDS ON DAY LENGTH.

The plant cannot attain sexual reproduction, it has been shown, except when it is exposed to a favorable length of day. The requirements, however, differ widely with species and varieties. But a length of day that is unfavorable to reproduction may be favorable to growth. Under that condition, the plant continues its vegetative development profusely and indefinitely without bearing fruit. A length of day may be found that is favorable both to sexual reproduction and vegetative growth. That tends to bring about the "ever-bearing" type of fruiting.

By employing *dark chambers* to shorten the period of light and artificial lights to extend it, scientists of the Department have shortened or lengthened the life cycle of plants, have made some of them complete two cycles in a single season, have brought others into flower and fruit months in advance of their regular time and, with still others, have greatly delayed and even completely prevented fruiting.

Long series of tests have been made with soy beans, tobacco, wild aster, climbing hempweed, beans, ragweed, radish, carrot, lettuce, hibiscus, cabbage, violets, golden-rod, spinach, cosmos, iris, beggartick, buck-wheat, and various other plants.

A test made with Biloxi soy beans will show how the principle works. For the test plants the day was shortened by several hours. That is, they were exposed to the light only from 10 o'clock in the morning till 3 o'clock in the afternoon. They

were first placed in the dark house on May 20. Control plants, otherwise treated exactly like the test plants, were left exposed to the light from dawn till dark. The first blossoms appeared on the dark-house plants on June 16. No blossoms appeared until September 4 on the plants that were left in the light all day. But the dark-house plants averaged only 6 or 7 inches high, while the plants that were left in the light all day grew to an average height of 57 or 58 inches.

These plants required a short day and a long night for flowering and seed bearing. In tests with other plants, just the opposite was found to be true. The plants that were left in the light all day did not grow luxuriantly, but produced flowers and seed, while those that were kept in the dark a part of the day made abundant growth, but produced no seed or else were greatly retarded in producing seed.

TEMPERATURE HAS LITTLE INFLUENCE.

Temperature appeared to exert no influence in these tests. The results were the same, even when the temperature was higher in the dark house than on the outside. Another striking illustration of the relative unimportance of temperature is the fact that plants kept in the dark for a part of the day underwent, in midsummer, the changes that in Nature come in the fall and have always been attributed to lower temperatures. This, also, was true even when the dark houses registered a higher temperature than that of the outside summer atmosphere.

The results obtained by artificially extending the period of light are just as interesting as those obtained by artificially shortening it. The artificial illumination, in a test with iris, was so arranged as to give 18 hours of continuous light in a greenhouse during the winter. Control plants

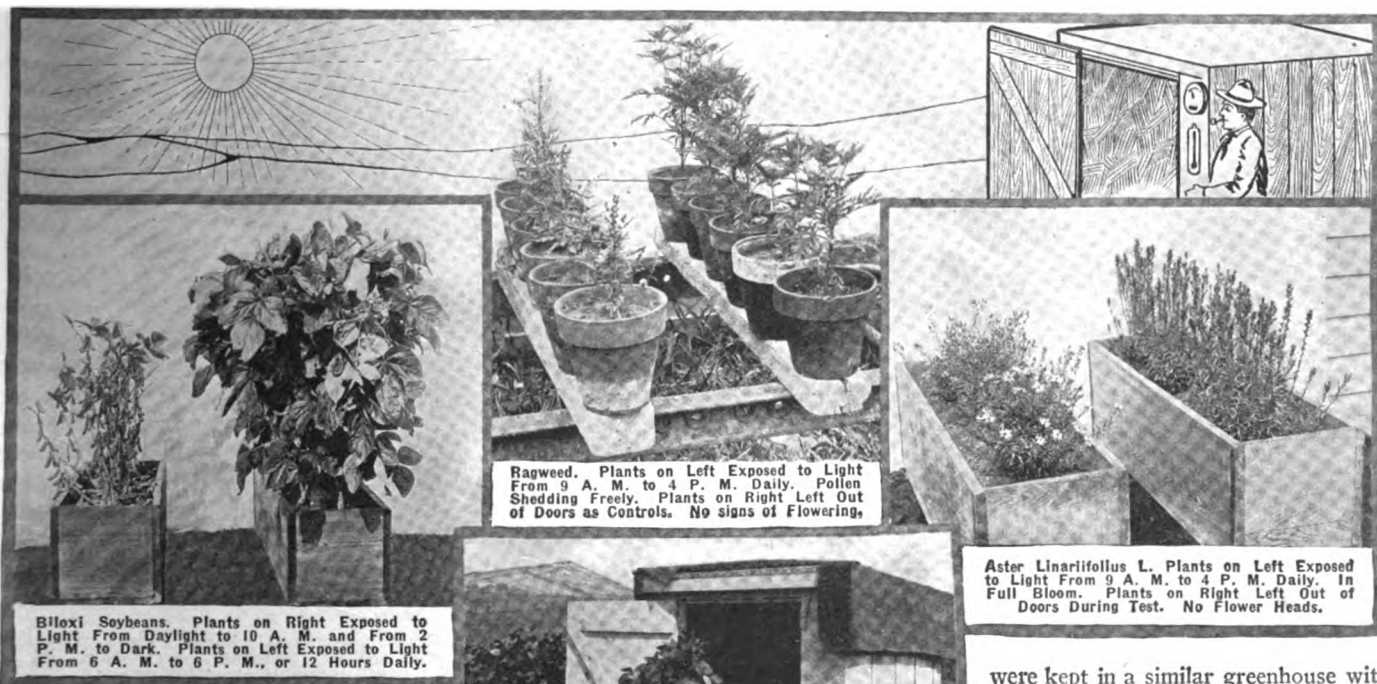

flowers and spring crops because the days at the season of their flowering and fruiting have the proper number of hours of daylight. Correspondingly, the early summer flowers and crops must have a longer period of daylight. This has been proved as to a large number of plants, and the scientists believe that the principle will hold throught the higher

Small "Dark Chamber" Used in the 1918 Sunlight Experiments.

were kept in a similar greenhouse with no artificial light. The test was begun on October 20, 1919. In the greenhouse where daylight was supplemented with electric light the plants made rapid growth, soon attained normal size and produced blossoms on Dec. 24. The plants in the greenhouse where no artificial light was used, tho it was kept at the same temperature, remained practically dormant and (Cont. on page 536)

How We "Taste"

By JOSEPH H. KRAUS

ONE of our most important functions (without which much of the pleasure of existing in this sphere would be lost), is our ability to detect differences and similarities of foods and beverages or in other words, differences in taste. This we owe to the brain and its communicating nerves travelling to the cells relegated to perform that duty. These end organs in the human being are found in the tongue and represented as *taste-buds*, tiny oval single cell structures imbedded in the upper cell epithelium (skin covering of the tongue). This epithelium is arranged in layers. A few of these taste-buds are scattered on the hard palate, in the throat, the tonsils, the inner surface of the cheek, and other surrounding tissues.

On the tongue, they are found chiefly in the grooves around certain hill-like structures, called vallate, or circumvallate, papillae (a small nipple). If the tongue is examined on close range, it will be found to be extremely rough, due to these hill-like structures and the four distinct types of hills dependent on their shape can readily be ascertained, even by aid of an ordinary magnifying glass.

First, we have the vallate papillae or otherwise known as circumvallate papillae. These contain the greatest number of taste-buds. Each bud has an elongated pore opening on the surface in the groove surrounding these papillae of which there are seven to twelve in number and so arranged as to form the two limbs of the letter "V."

The formation can be readily seen in examination of the tongue, even without the aid of a lens. In form the vallate papilla is a broad and nearly cylindrical "pimple,"

altho it is slightly narrower at its base than at the top and is, so to speak, sunk into a pit. It is thus surrounded by a trench or groove, much resembling the cross-section of a moat surrounding a castle.

Second, we find the fungiform papillae much smaller but greater in number than the former. They are found chiefly at the tip and sides of the tongue, altho a few are scattered elsewhere. They can readily be distinguished by their bright red color. The conical papillae are smaller in size and are found even to a greater extent than the fungiform. They are minute conical projections tapering toward the free ends; and lastly, the filiform papillae which are similar to the above but the epithelium or skin on the surface is broken up into threadlike filaments.

Scattered thru the tongue are the taste-buds each of which, on examination under the microscope, will be found to consist of one cell with a tube-like projection running to the surface of the tongue. Around this cell, if the specimen has been properly stained, will be found the tree-like terminal nerve endings which do not enter the cell itself, but surround that cell.

This is the typical taste-cell depicted in our illustration. In order, however, to determine the presence of any taste we must have a substance which will stimulate these taste-buds, and therefore, the substance must be soluble in some liquids or if not already in solution and in powder form, it must be soluble in the saliva contained in the mouth.

Altho at first this may be difficult to comprehend, it can easily be demonstrated in the following manner.

Quinine in powder form, due to the fact that it is *insoluble* in neutral or slightly alkaline solutions, is practically tasteless, although in reality, if dissolved in some solution slightly acid as for instance saliva, the sensation produced is very bitter and disagreeable.

Strange to say, the number of different tastes which we recognize is very limited, six being the maximum number. We recognize sweet, sour, bitter, salt and alkaline and a metallic taste, and altho many authorities claim that other substances when taken into the mouth, would give us a marked sensation, such a sensation is due not to the stimulation of the taste-buds, in the tongue, but to the fact that the foods stimulate in addition to these taste-buds, the nerve ending of *Smell!* Another strange feature is that one solution can neutralize the taste of another, for instance a solution of salt is rendered almost tasteless by the addition to it of a few grains of sugar. On the other hand, if these primitive tastes are taken in strong enough quantities, we get a mixed sensation in which salt and sweet are distinctly noticeable. And altho we get no such sensation as in the eye, where a white light may result from stimulation of the retina by two complementary colors, we can very often neutralize the tastes, in the ways before described, deceiving ourselves.

Distilled water, as is well known, is absolutely free from all impurities, and is both tasteless and odorless; yet if the mouth (Continued on page 533)



Above We See a Representation of the Tongue on Which Are Found in Great Numbers the Organs of Taste, or Better Known as "Taste Buds." The "Vallate Papillae" Are Small Hill-Like Structures Each Completely Surrounded by a Groove and Are Arranged in Inverted "V" Formation. Into the Bottom of These Grooves, the Pores of a Great Many Taste-Buds Open. Each Taste-Bud is Completely Surrounded by Tree-Like Ramifications of Nerves, Ending in Very Fine Delicate Fibers.

Assuming Then That the Condenser-Like Action Between a Cell and Nerve Takes Place, We Have a Very Clever Analogy

Simply Seen in the Condenser Effect, Which Everyone Has Already Noticed, and the Reason Why the Nerve Terminal is More Sensitive at Its Fine Filamentous End. Is Because of the Fact That the Insulating Membrane, Known as Krause's Membrane, is Not Present in That Region and in Addition, Electricity Concentrates at Pointed Ends. This is Noticed in the Tesla Coil, the Secondary of Which in Operation, Will Have

a Greater Brush Discharge at the Pointed End of a Wire, Than at Any Other Portion. On the Tongue Itself, With the Aid of a Magnifying Glass, the Hill-Like Structures Can Readily Be Likened to Those Shown Enlarged in the Above Diagram. Here We Have the Papillae Already Mentioned, Then in Addition, a Conical, a Flat, and a Fine Thread-Like Set. The Complete Structure of the Taste-Bud is Clearly Depicted in the Upper Right Hand Corner. Here, the Group of Taste-Cells is Seen to be Firmly Supported by Surrounding Tissues, the Cellular Structure Running Off Into the Skin and Muscle Coats of the Tongue.

What's Wrong with the Motor Car?

By H. WINFIELD SECOR

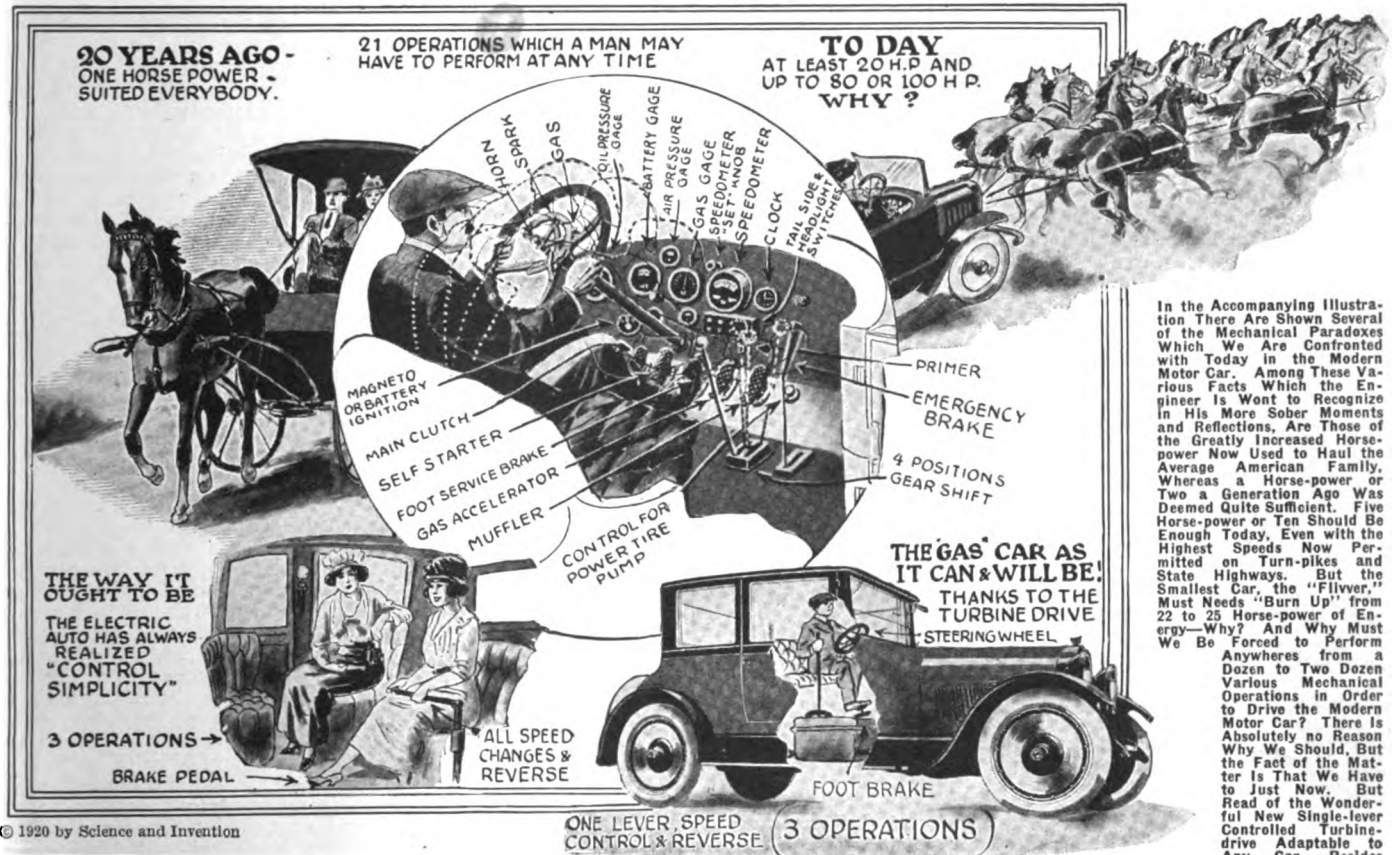

In the Accompanying Illustration There Are Shown Several of the Mechanical Paradoxes Which We Are Confronted with Today in the Modern Motor Car. Among These Various Facts Which the Engineer Is Wont to Recognize in His More Sober Moments and Reflections, Are Those of the Greatly Increased Horse-power Now Used to Haul the Average American Family, Whereas a Horse-power or Two a Generation Ago Was Deemed Quite Sufficient. Five Horse-power or Ten Should Be Enough Today, Even with the Highest Speeds Now Permitted on Turn-pikes and State Highways. But the Smallest Car, the "Flivver," Must Needs "Burn Up" from 22 to 25 Horse-power of Energy—Why? And Why Must We Be Forced to Perform Anywhere from a Dozen to Two Dozen Various Mechanical Operations in Order to Drive the Modern Motor Car? There is Absolutely no Reason Why We Should, But the Fact of the Matter Is That We Have to Just Now. But Read of the Wonderful New Single-lever Controlled Turbine-drive Adaptable to Any Car. Besides Other Automobile Improvements Which Are Bound to Come.

As you sit behind the wheel of your new Hudson Super-Six or your twelve-cylinder Packard, you undoubtedly entertain, and for very good reasons, the idea that here indeed, is one of man's finest mechanical productions. But while it looks all very fine and beautiful to see a string of modern motorcars moving along at a speed of from 20 to 30 miles an hour on our interurban turnpikes and boulevards, the engineer looks at this same line of moving horseless vehicles from an entirely different point of view from the layman. Some of the ideas and reflections which constantly revolve in the mind of the trained technician, as he watches the performances of the twentieth century automobile, are presented in the following.

TWENTY-FIVE TO ONE HUNDRED HORSE-POWER INSTEAD OF ONE!

Twenty years ago, back in the good old horse days, when the obituary column of the daily newspapers did not contain several dozen notices of automobile casualties, when Old Dobbin was King of all he surveyed and the gasoline-engine propelled vehicle, a thing of mystery and novelty indeed, you and I and our fathers and mothers were glad enough to have a ride along the public highways with a horse and wagon. If several people were going out driving, then we generally had recourse to two horses, or a team.

Now bear in mind that in those palmy days you went out driving in a one H.P. or two H.P. vehicle. Most probably, you do not reconcile the value of the one live horse-power as developed by Old Dobbin plodding jauntily down the road with the evaluated horse-power developed by the modern automobile engine. But such is the case nevertheless, and the fact of the mat-

Altho we believe the modern motor car to be nearly perfect, there is a vast field for improvement

ter is that when you step into your "Flivver" and start feeding the gas to the engine, you are warming up a mechanical horse with a power equivalent to 22 Old Dobbins—just think of it!

This statement is based on the fact that the horse-power, as it is usually expressed, is the amount of energy required to lift 33,000 pounds one foot per minute. (This was originally determined upon and evaluated by taking a number of measurements on several big London draft horses, back in the days when the first steam engines were being built, and when the need of a unit of work or energy was badly wanted.) It was then found that one of these big draft horses such as were used to pull heavy drays, could lift a weight of 240 pounds thru a height of 138 feet in one minute. This is the same as lifting 33,000 pounds one foot in one minute's time; or lifting one pound thru a distance of 33,000 feet in one minute. Thus, the horse-power is evaluated as the equivalent of 33,000 foot-pounds exerted thru one minute of time. A man working steadily, can, for a limited period, exert about 1/5th H.P. A professional strong man might perform a feat of weight lifting and exert momentarily, one H.P. of energy.

And so it comes to pass that when we start to analyze the modern motor car, we find that we are paying for gasoline at a good, fat price to feed the mechanical horse rated at anywhere from 20 to 30 H.P. and

even up to 100 H.P., such as possessed by big engines like the 12-cylinder motors used in some of the highest powered motor cars, all for the purpose of flying along main thoroughfares and highways at speeds of anywhere from 15 to 60 miles an hour! Not only is this the cause of many accidents, (which the writer predicts will eventually have to be curtailed by a law, either state or national, which will prohibit the building and operating of such high power cars, or else to enforce the emplacement of an automatic speed governor when it is licensed); but the present gasoline shortage is one of the answers to this problem. Incidentally, the cost of owning and operating an automobile today is very far beyond what it should be for the average American citizen or family.

Why is this? There are several reasons, pro and con, but we come face to face with facts which prove, to begin with, that a high horse-power motor car is nothing else but a nuisance and danger to the community. Even a 25 H.P. car is usually much stronger than one needs.

"But," you will say, "if they put a smaller engine than the 22 H.P. type in my car, I cannot climb a steep hill." Perhaps this may be so under the conditions by which you prefer to ride. What are these conditions? Simply this: Instead of having a light vehicle like that you used to ride in twenty years ago, i. e., a buggy or phaeton, you now demand luxurious and heavily upholstered leather cushions, on a heavy chassis, supported by some more unnecessarily heavy wheels and big rubber tires; besides carting along a quarter to half a ton of dead weight in the form of a gasoline engine—and for all these things, and also due to the loss of power in friction and gearing; and furthermore due to the

(Continued on page 526)

Archimedes—The World's First Great Inventor

ARCHIMEDES was undoubtedly the first real, scientific inventor of our world. According to history, he was born about 287 B. C. and died at the age of 75, having perished in the sack of Syracuse, 212 B. C. Archimedes was the son of Pheidias, the Greek astronomer, and was on very intimate terms with (if not related) to King Hieron and his son Gelon. In his early years he spent considerable time at Alexandria in carrying on some of his intensive studies. Later he returned to the city of Syracuse, where he lived a life practically entirely devoted to researches in mathematics.

We of today are quite wont to think that the mathematics and kindred laws of today are solely the work of mathematicians who have lived in the past few hundred years, but when we come to examine the remarkable and extensive amount of mathematical work done by Archimedes we are astonished indeed. Archimedes undoubtedly had very clear conceptions regarding some of the foremost mathematical problems and laws upon which we still base some of our major calculations today. His researches, especially in his later life, branched out now and then into some of the more utilitarian applications of science; but it was a well-known trait of Archimedes, oft repeated by his friends and recorded in the history of his life, that he scorned wasting any time on practical everyday affairs. He devoted all of his time and energy solely to the more deeper and philosophical aspects of earthly problems. However, be that as it may, it is because of his very ingenious and mechanical practical inventions that the average person of today knows anything at all concerning Archimedes; and not because of his more abstract mathematical theories, which have been to a great extent quite lost sight of except to students of ancient history and particularly the older history of mathematics and inventions.

In the words of Plutarch—"Archimedes possess so high a spirit, so profound a soul, and such treasures of scientific knowledge that, tho these inventions had obtained for him the renown of more than human sagacity, he yet would not deign to leave behind him any written work on such subjects, but, regarding as ignoble and sordid the business of mechanics and every sort of art which is directed to use and profit, he placed his whole ambition in those speculations in whose beauty and subtlety there is no admixture of the common needs of life." As a matter of fact Archimedes wrote only one mechanical book on "Sphere-Making."

During the siege of Syracuse by the Romans, however, many ingenious devices were invented or contrived by Archimedes and used with overawing effect. When the Romans attacked the city, he contrived giant catapults so cleverly constructed that they would hurl heavy projectiles in the form of rocks and other objects over both long and short ranges, and he devised as well powerful machines for discharging showers of missiles thru holes made in the walls of the forts.

THE ARCHIMEDES' PUMP.

Among the many accomplishments in the realm of inventions by Archimedes we find his famous *water-screw*, or *pump*. This perhaps is one of the best known today of this early philosopher's work. Even yet, one may find in far parts of the world, water pumps operating on the principle of

the Archimedes spiral screw. This pump is simplicity itself and merely comprises a tube wound around a central axle in a spirular formation, as shown in the accompanying illustration. When the handle on the upper end of the pump axle is turned, either by man-power on small pumps, or by horse or cattle on the larger pumps used to irrigate land in Egypt and other countries, the water is forced up thru this tubular spiral and flows from the upper opening in a constant stream.

THE "BLOCK AND FALL."

Archimedes found from his extensive study of the many and varied problems of geometry that there was undoubtedly a very close relation between those geomet-

familiar to students the world over today is the Archimedian spiral. Archimedes worked out all of the mathematical relations and factors having to do with the building of this spiral and, of course, when once this was done, architects and others could easily work out this curve of any size desired. The drawing of the Archimedian spiral and Latin text describing it, shown on the opposite page, were photographed from an old book dated 1500.

ARCHIMEDES DISCOVERS "SPECIFIC GRAVITY" RATIO.

"Specific gravity" is defined as the ratio of two bodies of different densities determined by various physical means, one method of determining which is to divide the weight in air by the loss of weight in water, which gives the specific gravity of the object. Hiero, King of Syracuse, once commissioned Archimedes to discover, if he could, whether the gold which he had given to an artisan to work into a crown for him had been worked up with baser metal. This puzzled Archimedes for some time, until one day as he was stepping into his bath he observed the water running over, and it at once occurred to him that the bulk occasioned by the addition of an alloy could be measured by placing the crown and an equal amount of gold separately into a vessel filled with water and observing the exact difference of overflow. It is recorded that he was so enthused and overjoyed with this discovery that he ran home without his clothes, shouting, "Eureka, Eureka! (I have found it, I have found it!)"

It is believed that this eventually led to his establishing the great fundamental principle of hydrostatics, which is still known by his name—that a body immersed in a liquid exerts an upward pressure equal to the weight of liquid displaced.

BURNING OF SHIPS BY HUGE MIRROR AND LENS.

One of the stories which has been repeated a million times, but which historians are generally wont to discredit since there seems to be no authentic record by the ancient historians—nor modern proof—is that describing how Archimedes designed and built a huge *burning mirror* with suitable reflectors, which projected such a powerful ray of sunlight that it set fire to Roman ships when they were within a bow-shot away from the fortress wall. It is thought by later historians that such a principle had been worked out and demonstrated for philosophical and other reasons by Archimedes; and that it is not so probable at all that this had anything to do with the setting on fire of the Roman ships. However, there is a possibility that such an effect could have been attained under the stress of war, as the bits of history and writings which have come down to us regarding the work of Archimedes are very meagre and scattered indeed.

The wonderful possibilities and the various operating principles of the lever were first discovered and shown in their application to mechanics by Archimedes. His own estimate of the capabilities and possibilities of the lever is shown in his expression, "Give me a fulcrum on which to rest and I will move the Earth."

ASTRONOMICAL DISCOVERIES.

One of the principal philosophical studies in which Archimedes indulged was that of

(Continued on page 563)

For "October"

Photographing Flight of Bullets.
By Pierre H. Boucheron.

Weighing Light Beams. By Dr. Alfred Gradenwitz.

Radio Transmission of Power. The real Thing with photos of the Actual High-power Apparatus. By Samuel Cohen.

Velocity of Light. By Prof. James S. Stevens.

Electricity and the Weatherman.

A Day with "Central"—Written by a "Hello Girl." Illustrated.

What you Should Know About Electric Lamps—Watts, Voltage and Candle-Power Explained.. Written by an Illuminating Engineer.

The Sun's Unknown Rays. By Rogers D. Rusk, M.A.

A Miniature Electrical Universe. The Startling work of Dr. Birkeland. Fully Illustrated.

Simplest Long Wave Radio Receiver. Full Specifications and Drawings. By Elliot A. White.

How Big are Molecules? By Rogers D. Rusk, M.A.

rical laws and the everyday problems of moving large weights or loads with small forces, etc. The lifting tackle, or "block and fall," illustrated herewith, suspended from a tripod, represents the discovery of the multiple sheave lifting tackle by Archimedes. This marked a great advance in the accomplishment of mechanical work in the early years of history, as may be readily imagined. Thanks to the multiplying power of the "block and fall," one man could lift as great a weight as a dozen men, providing 12 ropes were used, with a corresponding set of pulleys in the two blocks, and Archimedes successfully demonstrated that he could move a large vessel with one of his multiplying blocks or mechanisms single handedly! The King and the people were amazed at this remarkable demonstration, and special commendation was accorded to Archimedes for this spectacular demonstration of applied science.

One of the most famous mathematical problems worked out by Archimedes and

DISCOVERED THE PRINCIPLE OF THE LEVER

"EUREKA"

HE DISCOVERS THE PRINCIPLE OF SPECIFIC GRAVITY.

THE FIRST "BLOCK & FALL" WITH MULTIPLYING PULLEYS

CATAPULTS FOR STORMING ROMAN FORTS

ARCHIMEDES' WATER SCREW

ARCHIMEDES

THE WORLD'S FIRST GREAT INVENTOR

BURNING SHIPS WITH MAGNIFYING GLASS AND SUN'S RAYS.

TOMB OF ARCHIMEDES

COMPOUND GEAR FOR MULTIPLYING POWER

ARCHIMEDES' SPIRAL AND PAGE FROM BOOK DATED 1500

INVENTED VARIOUS INSTRUMENTS FOR MEASURING SIZE AND ANGULAR POSITION OF THE HEAVENLY BODIES

ΠΡΟΒΑΗΜΑ.
Spiralem describere.

ARCHIMEDES' PLANETARY SYSTEM

DEATH OF ARCHIMEDES

tante longitudinis,
in linea spiralis: &
B. A. describat
circumferentia diuis
les: quo plures
gortio. Tum a
dij agantur, &
& reliqui
tem partes,
proximo
in quar
ter in fe
re pacto
radij,
idem per hac excepta punda B.C.D. E.

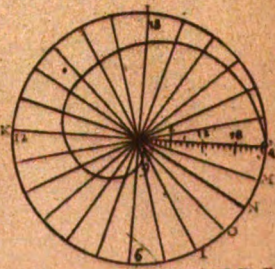

celeritate ferri, temponibus
tempore decurre

Undersea Amusement Park

By F. E. LOUDY, A. E.

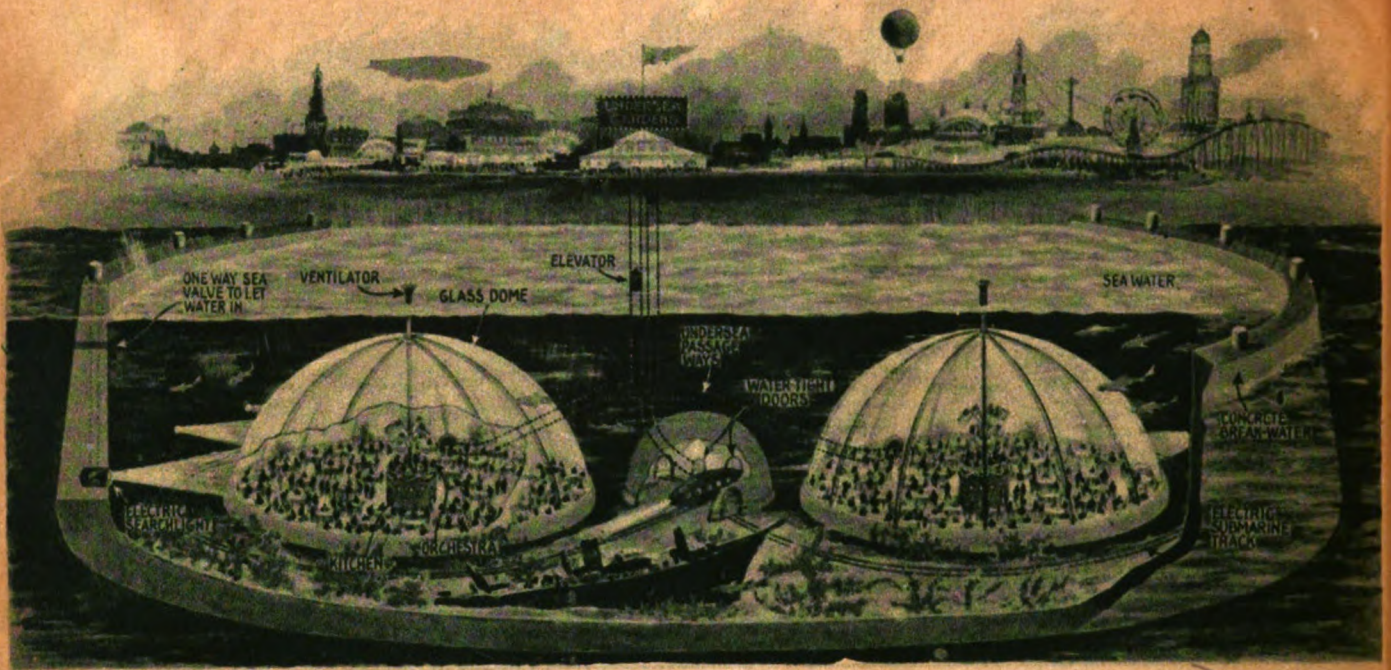

© 1920 by Science and Invention

The Newest Innovation in Pleasure Resorts and Amusements is the "Undersea Amusement Park," Here Proposed by Mr. Loudy. The Cost of Building Such an Amusement Feature at Our Seaside Resorts Would Not Be So Great as It Might at First Be Imagined. The Electrical Illuminating Features Are Very Spectacular and Entrancing, and Those So Disposed Can Enjoy All the Thrills of a Submarine Trip Under the Ocean in the Small Submersible Boat Which Runs Along the Rails Propelled by Electric Motors Geared to the Wheels on Which It Runs. Electric Elevators Take the Pleasure-Seekers Down to the Sub-Sea Restaurant and Amusements.

THE Prince of Monaco may descend to the bottom of the ocean at the base of a cliff, sixty feet below the surface of the Mediterranean, and here thru a large window he may view the fauna and flora of the sea. It may not be long before we may all enjoy these pleasures at our sea or lake resorts. It is proposed to erect a large horseshoe breakwater adjoining the shore, and dredge to a depth of fifty feet. The breakwater will act as a cofferdam, wherein the two glass-domed observation stations and the submarine chamber will be erected, as well as a railway for the submarine. When this park is ready for operation the water will be admitted, and everything will be submerged.

The breakwater keeps boats out, prevents the waves from damaging the park, as well as keeping ice from breaking things up in the winter. One-way valves are located at intervals around the breakwater to allow the water to enter, but not to escape with the rise and fall of the tides.

A visitor to the Subsea Park will first enter a concrete elevator shaft, protruding above land, and will descend to the concrete tubular walkway to either observation station. Here he may seat himself at a table and order all of the choicest seafoods. The galley or kitchen is located in the center of the station above which is the orchestra. At the top of the glass dome is a ventilating tube, extending above the surface of the water. The visitor may observe all the different forms of subsea life as fish from all parts of the ocean will be placed inside of the breakwater, where they cannot escape.

Next he will go thru the subterranean passageway into the submarine chamber, and take his seat near a large portlight. The door on the submarine is closed. Next the entrance door to the chamber is closed. The chamber is then filled with water, and the four large doors opened. The navigator turns his controller and the electric motors turn the propeller. The boat begins to move

along the track, first passing a sunken ship. The illuminated observation stations present a gorgeous spectacle thru the water. Searchlights are also placed at intervals along the base of the breakwater. Here again the visitor observes the fishes as they swim around. The submarine, after traveling once around the figure eight track, returns to its chamber. The large doors are closed, the water removed by compressed air, the passageway door opened. The visitor then walks to the elevator shaft, and is then taken from the coolness of the ocean bottom to the torrid heat of the world above once more.

SOME MECHANICAL FEATURES AND PROBLEMS.

We have now considered some of the interesting and extremely novel pleasure features of this new undersea amusement resort, and probably, a few words as to the building of the subsea resort will be of interest. Most probably, the glass dome chambers shown will not be built of a particularly great height or depth which ever you want to call it, as for every foot that you go down beneath the surface of the water, the pressure increases 4 lb., or nearly $\frac{1}{2}$ a pound per square inch.

Thus at a depth of 50 feet, the water pressure is about 20 pounds per square inch, and at a depth of 100 feet, it is about 40 pounds per square inch. Thus it will be seen what the engineering features met with in building such a pleasure resort, are. Great care must be taken to see that the steel frame-work and the glass plates used in building the domes and side walls are made thoroly water-tight, and also sufficiently thick to withstand the water pressure at the lower depths.

A very interesting feature which has already been touched upon, is the chamber housing the submarine. The entrance door to the central submarine housing chamber is shut just before the submarine takes its passengers on board, and prepares to make a trip over the figure eight track around

the glass domed restaurants. After closing the doors on the submarine, it is then a simple matter by the aid of an electrical or pneumatic mechanism, to cause the sea doors to open, so that the submarine can move along on its electric motor-propelled wheels over the rails provided.

The submarine will contain the usual apparatus for supplying fresh air for the short period in which the passengers are en route. When the submarine arrives back in its central disembarking chamber, several interesting things occur. There are numerous ways in which the sea doors opening out of this chamber can be closed and the water removed from the chamber, such as by pumping out the water with large electrically driven pumps, or else by blowing out the water by means of compressed air, supplied by large, electric motor-driven air compressors.

Assuming that one or the other methods are used, the sea doors are closed as soon as the submarine has entered the chamber; and by means of signal lights or else by observing the conditions of the chamber thru one of the thick glass port windows in the submarine, the Captain in charge of it will know when it is safe to open the door of the latter, and discharge his passengers. Special means will be provided, of course, for quickly drying out the chamber and draining the water from the floor, which effect may be hastened to a great extent by making the floor in the form of a grill or lattice work.

SPLENDORS OF UNDERSEA ILLUMINATION.

Not only will such an undersea amusement resort present features of unusual attraction and enchantment to those patronizing it, but it will also be a thing of wonder and awe to those on shore, who can look down into the water and see the flickering shadows and flashing lights thru the rippling waters covering the resort.

The extraordinary lighting effects which can be obtained very easily in such an un-

(Continued on page 542)

The Unknown Avenger

By HAROLD F. RICHARDS, Ph. D.

IT was a strange group that stood on a broad, flat rock which formed a little open space at the water's edge on the barren coast of Iceland. Four there were in the party, and in the eyes of three of them gleamed the look of evil satisfaction that comes into the eye of the hunted tiger when he has finally turned at bay and placed his paw safely upon the neck of his prostrate enemy. Slim Kelly, crack ferret of the Secret Service, calmly leveled a deliberate glance at the three. His hands were trussed behind his back, his automatic no longer occupied its familiar place at his hip and his silver emblem of the Service had just been tossed into the cold waters of the sea. But he was game.

"What are you going to do?" he questioned in exactly the same tone that he would have used in asking for a cigarette.

Jacob von Hernholtz stood erect before the prisoner. German spy that he was, he possessed a dignified bearing, which was enhanced by his long fur coat. His face was that of the aristocrat accustomed to the best that wealth can afford. His close-set blue eyes seemed to glow with a greenish glint as he contemptuously surveyed the captive. His voice was velvety and as smoothly modulated as the liquid tones of a contralto as he address Slim Kelly.

"First of all, Mr. Kelly, I think that we

had better make a little bonfire of those papers which you just took from my desk on the yacht." His eyes turned to the elegant steam yacht riding easily off the shore.

Carefully, with every regard for the comfort of the prisoner, von Hernholtz extracted from Kelly's inner pocket several official-looking documents, and his eye revealed his satisfaction as he deliberately looked thru them. He handed the papers to Lendorff, whose face lighted as he scanned their contents. Lendorff had every appearance of the scholar, and as Slim watched his sharp, black eye, academic severity of countenance and brow much furrowed as if by close application to many abstruse manuscripts, he wondered mentally at the many types of men whom the German diplomatic service had been able to enlist in the nefarious plots that circulated as an undercurrent thruout the length and breadth of the land. At length Lendorff seemed satisfied and, crushing the red-sealed papers in his hand, he placed them in a little heap on the rock at their feet. Turning to the third member of the group, he bowed deferentially, and said:

"And you, Madame Holt, shall have the pleasure of destroying these little souve-

nirs which Mr. Kelly has so assiduously sought for the last ten months."

Elaine Holt smiled in acknowledgment. It was not a pretty smile, but rather one which revealed a hardness that seemed out of place on her beautiful face. Her features were perfectly modeled, giving to her countenance the distinguished look of a patrician of undiluted extraction, but the cold, calculating expression in her black eyes suggested at once those qualities which had made her one of the most valued agents of the whole German service. Beautiful, polished, resourceful and unrelenting in her pursuit of any information that might prove of value to the government which paid her so extravagantly, she had ferreted out many, valuable secrets. Many an officer or diplomatic attaché had felt the power of her magnetic personality, had succumbed to her overpowering attractions, and waked from his dream of love only to find himself hoodwinked and disgraced, with no recourse but to resign his position and start anew in some spot far removed from Washington.

Withdrawing one gloved hand from the warm depths of her luxurious black seal muff, she took the embossed gold case which Lendorff extended, twirled with a dainty

(Continued on page 553)



"Too Bad That Madame Will Have to Wear a Heavy Veil All Her Life. New York's Gatherings Will Regret the Loss of One of Their Loveliest Women" . . .

The Airplane

By H.

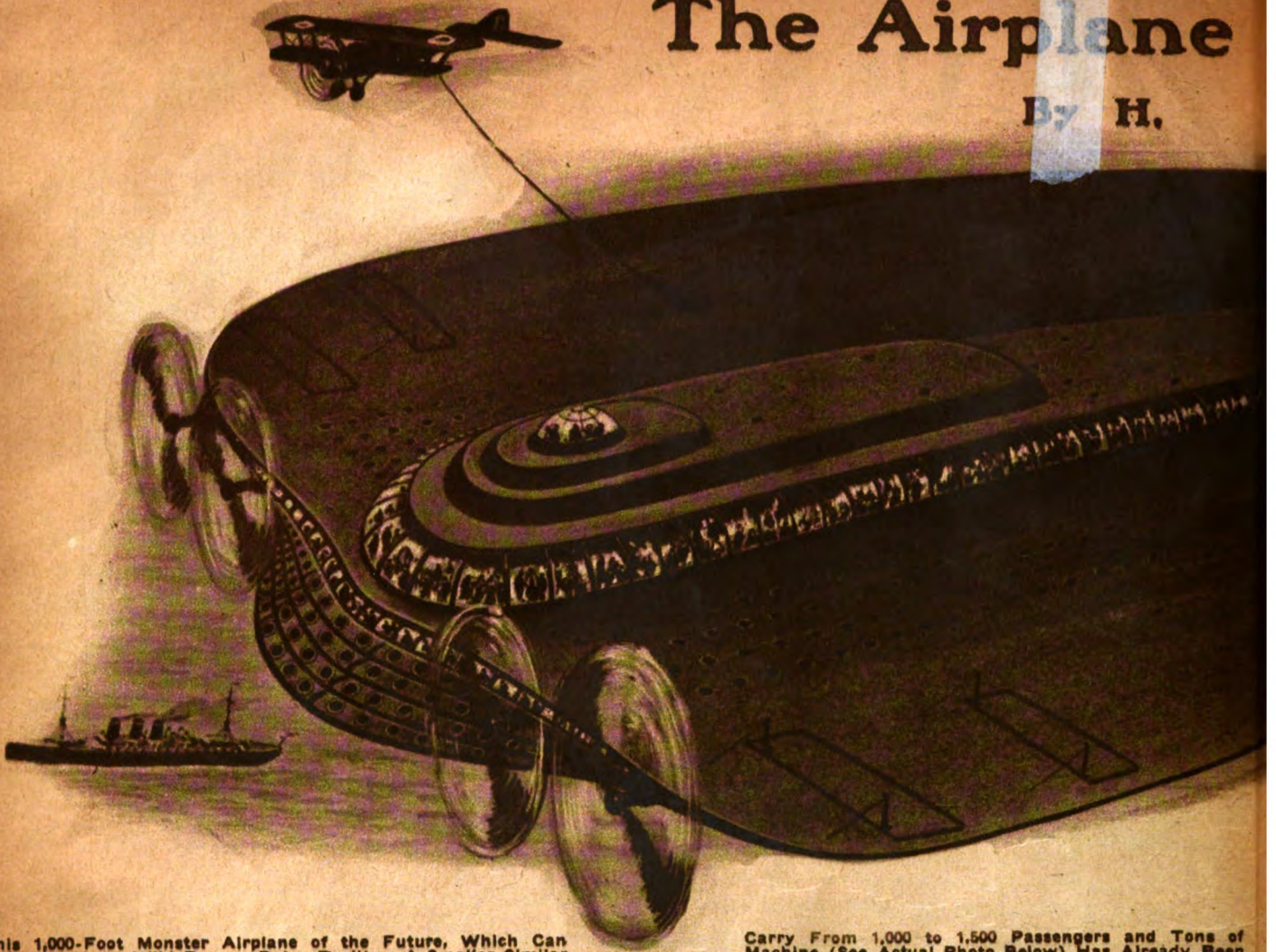

This 1,000-Foot Monster Airplane of the Future, Which Can Carry From 1,000 to 1,500 Passengers and Tons of Cargo, is Not a Wild Dream, But a Reality. A Smaller Similar Machine (See Actual Photo Below) Has Already Been Built by Mr. Wm. B. Stout. This Future "Batwing" Will Fly at the Tremendous Speed of 500 Miles an Hour. In Other Words, the Trip From New York to London Will Take But Six Hours!

Carry From 1,000 to 1,500 Passengers and Tons of Cargo, is Not a Wild Dream, But a Reality. A Smaller Similar Machine (See Actual Photo Below) Has Already Been Built by Mr. Wm. B. Stout. This Future "Batwing" Will Fly at the Tremendous Speed of 500 Miles an Hour. In Other Words, the Trip From New York to London Will Take But Six Hours!

WE are about to witness a great revolution in airplane construction in the very near future. The present airplane as far as its construction is concerned has about reached its limit for a number of reasons. One of the most important reasons is that the extra bracing and struts required to give strength to the present day giant airplane retards its speed due to the greatly added air resistance. The other chief reason is the limited passenger and cargo space available even in our huge, present day machines. Every pound of cargo that we add increases the spread of the wings and again makes it necessary to use more and larger

struts, which in turn decreases the speed of the machine.

During the war William B. Stout, an American aeronautical engineer, formerly with the Air-Craft force in Washington, produced a wonderful new airplane, a photograph of which appears on this page. He was assisted by Orville Wright, the inventor of the airplane, as well as the U. S. Government. The machine is known as the *hollow wing type*, and it is claimed that this machine anticipates the German machine of the same type recently put into use in the United States. Mr. Stout built his original machine at Dayton, Ohio, during the war and the first flight of the new air-

plane was made in the year 1918.

The plans had been kept secret and more than 1,000 men located in different cities made the various parts of the machine inasmuch as the Government wished to keep the design secret. However, photographs and blueprints were stolen during the war and thus found their way into German hands, thus giving them the idea for their airplane.

The revolutionary feature of the Stout "Batwing" is nothing but a giant double wing with all the machinery, trussing, etc., housed right inside of the hollow wings. The engines are placed in the front edge, while the passengers and cargo are enclosed between the wing surfaces. The important point is that every part of the machine exposed to the air is designed with the sole idea to LIFT.

Altho the new airplane has 480 square feet of wing surface, or 40 square feet more than an army two-seater, it only weighs half as much as the latter. In other words, 1,550 pounds as against the 3,220 pounds of the army machine!

The "Batwing" has been tested in a wind tunnel for a speed of 217 miles an hour, and it is claimed that it can rise easily to 32,000 feet. It can climb a mile in 2 1/4 minutes and all this is accomplished with a little 180 horsepower motor. An unexpected result of the new construction is that inasmuch as the radiators are housed inside of

Below: Actual Photo of the Hollow-Wing "Batwing" Airplane Invented by Wm. B. Stout, Who Was Assisted by Orville Wright and the U. S. Government. The Machine Was Built in 1918.



Above: A Side View of the Airplane of the Future. The Lower Surfaces of the Wing Are Curved Downwards to Obtain a Better Purchase on the Air. Note That Such a Machine Has No Struts or Wires. Everything is Inside of the Metallic Envelope.

of the Future

GERNSBACK

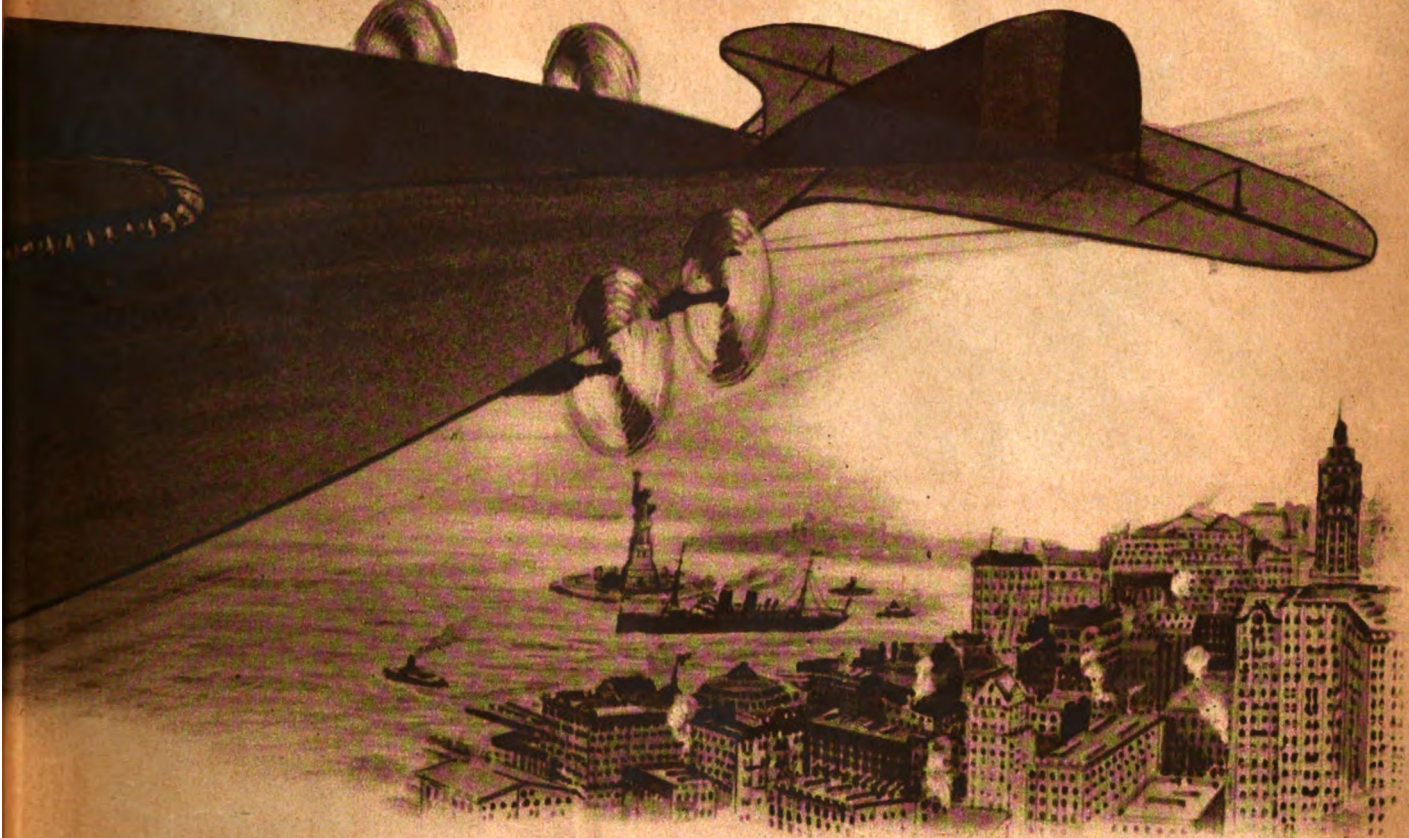

© 1920 by Science and Invention
 Eight 100-Foot Monster Propellers Drive the Huge Air Liner, Which is Entirely Enclosed Within a Metallic Envelope Made of Magnesium, a Metal Thirty Per Cent Lighter Than Aluminum. Altho This Airplane Does Not "Look Safe," Experiments Have Shown That it is SAFER Than the Present Type Airplane. Due to Its Huge Surface, Such a Machine Acts Like a Parachute, and Actually Prevents the Air Monster From Making a Too Rapid Descent.

the wings, the passengers and pilot are easily kept warm when the machine rises to high altitudes.

Another novel idea presents itself in the larger types, where the landing gear is made to pull into the wing so as to give less air resistance. So much for the machine that has been actually built and is in existence. We now get a good conception of what the huge aerial liner of tomorrow will look like. We have tried to show in our large illustration just how such a new aerial monster will appear in ten or fifteen years from now. All of our preconceived ideas as to what an airplane should look like are swept away by Mr. Stout's revolutionary invention.

The important and outstanding fact as well as the revolutionary possibilities which made the "Batwing" possible are best explained in the following:

The lifting power of an airplane wing depends solely on its curve and it is not affected by its thickness. You will have to ponder awhile over this seemingly impossible statement, which is not a theory by any means but has been brought out by actual tests of Mr. Stout's "Batwing." In other words, this means that the future airplane will be constructed, not like a frail kite-like machine, such as our present day airplanes,

but rather like an ocean greyhound built on sound engineering principles. Once our struts and braces are enclosed between two parallel surfaces nearly all our wind resistance vanishes and the plane can be pushed ahead at a very much smaller expenditure of power. Not only this, but the size of the future airplane is no longer of consequence as long as we have sufficient power to propel the airplane. Furthermore, if we provide sufficiently large landing fields or air ports, the airplane of the future can be built in unbelievably large proportions. A thou-

sand-footer will be nothing to wonder at tomorrow and will be as common as the 200-foot steamship is today.

We have tried to show in our large illustration how such a thousand-foot monster appears winging its way homeward from its European trip. A machine of this kind driven by a great many propellers easily averages 500 miles an hour and for that reason can make the trip from Europe readily in six or seven hours. In other words, a man can transact business in New

(Continued on page 576)

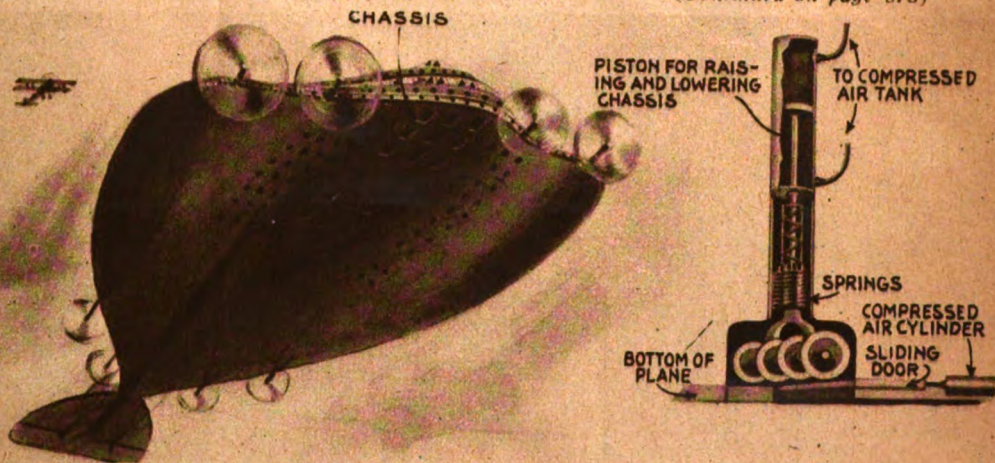

© 1920 by Science and Invention
 Bottom View of the Machine. Note Particularly the Chassis or Landing Gears Withdrawn Within the Machine—Just Like a Bird Draws Its Feet Close to the Body to Cut Down Air Resistance. The Landing Skids, Too, Withdraw, But Are Pushed Outward Just Before Landing. The Circular Holes in the Lower Surface of the Machine Are Glass-Covered Portholes. Insert Shows How Chassis Is Lowered by Means of Compressed Air.

SCIENCE NEWS

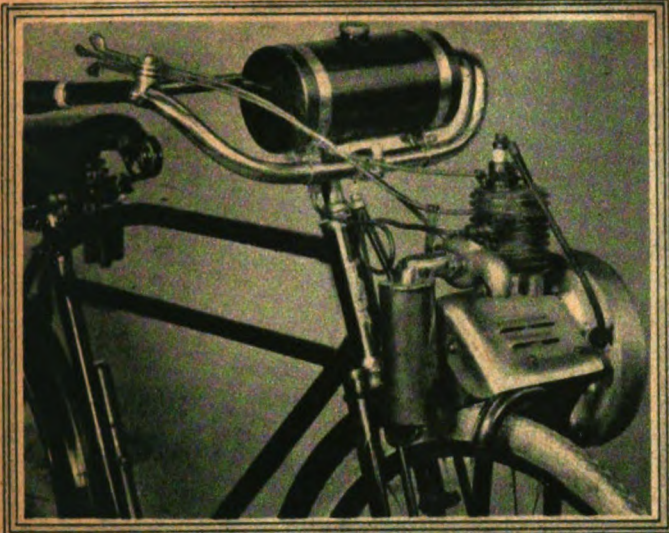

Latest Gasoline Motor Converting Any Bicycle into a Motorcycle Capable of 20 Miles Per Hour.



'Safety-First' Electric Sign 2 Miles Under-ground in Western Gold and Silver Mine. The Latest Idea in 'Safety-First' Mine Work.



Above—First Electrical Apparatus Built and Used by Benjamin Franklin in 1754. It is a Static Electrical Generator.



Latest Curtiss 'Booster' Driven by Aerial Propeller and 408 H.P. Airplane Motor. Draws but 3 Inches Water at 50 Miles Per Hour.

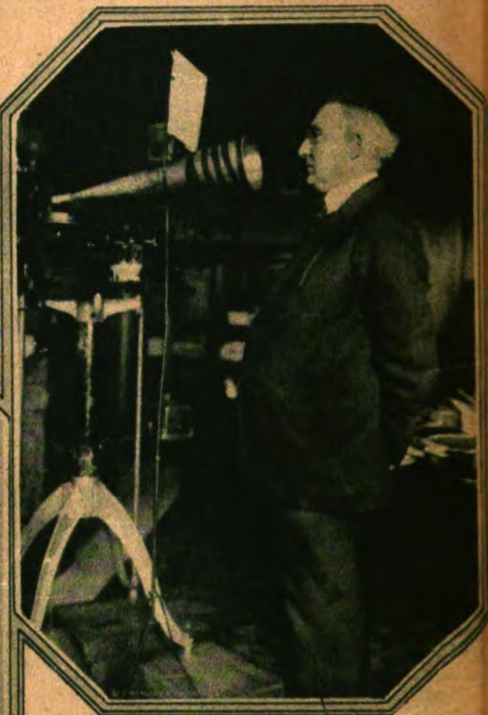

Above—Senator Harding, Republican Nominee for President, Delivering His Phonograph Speech Being Recorded by the Apparatus Shown. His Subject Was "Americanism."

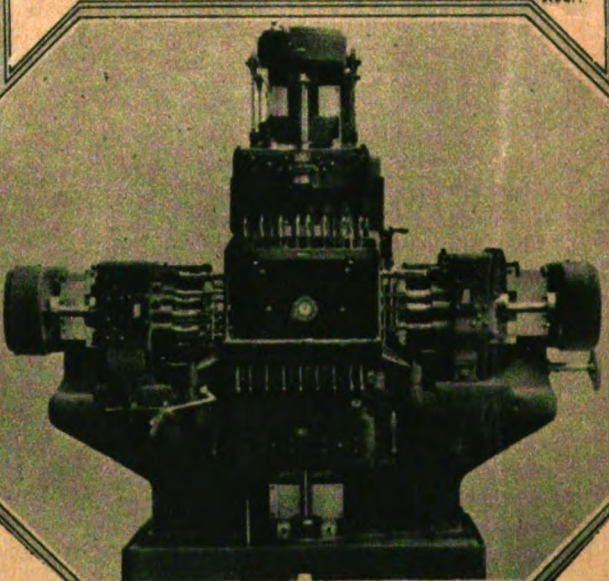

At Left—Wonderful Electric Drilling Machine Boring 4 Holes at One Time in the Top, Bottom and Two Ends of Automobile Engine Bloc.

Below—Latest Electric Motor Car Being Built by the Thousand in Germany. It is Run by a Dry Battery Renewable Every 4 Hours. Speed 17 1/2 Miles Per Hour.

Below—Mr. J. Larsen (with Cane) and All Metal Monoplane, in Which He Recently Broke the American Non-stop Record by Flying 1200 Miles.

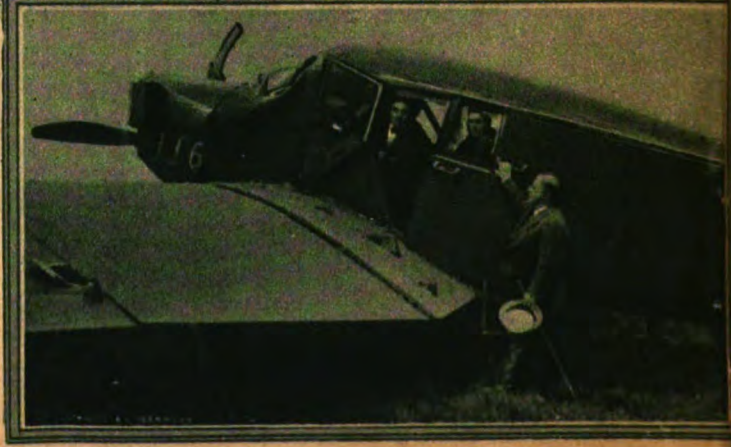

The Whirl

By THOMAS W. BENSON and

NIGHT had fallen over the big institution as I crossed the connecting bridge between ward seven and ward six. The chill breath of late autumn swept thru the partly open bridge, and I shivered as I strode hastily toward the door of six. Just that ward to do, and my evening rounds were over, my day's work practically done.

As resident of this big state asylum for the insane it was my duty to make daily inspection of the wards, interview the patients, listen to complaints from them and receive the reports of the captains in charge of the wards.

It was my most irksome task. Nine out of every ten patients had some grievance to pour into my ear, and possibly seven out of the nine were purely imaginary, specters of poor, disordered brains. It is truly remarkable how much the average insane man can imagine has happened to him in a day.

The captain of six met me at the door. "Complaints run high tonight, Peters?" I asked with feigned sternness in my voice. I pitied this overworked man who had charge of the institution's receiving ward. Getting them all as they came in, the good, bad and the violent, he averaged a particularly nasty lot of patients, and his position was far from being a sinecure.

Peters shrugged at my question. "Usual run, I guess, doctor," he replied, resignedly. "So many brutally beaten, so many starved and a few tortured."

I laughed. "Restrains?" I queried, perfunctorily, for it was my business to know how many patients had been forcibly prevented from injuring someone or themselves.

"Four," replied the captain; "absolutely necessary, of course."

"Of course," I agreed, assentingly, and moved on to the inspection.

It was over at last. I paused before the door of the last of the rooms, or cells, all them what you please. "This one is occupied, isn't it?" I asked, for it had been empty for the last week.

"No," replied Peters. "There's a new one in there. Man named Mehlman, brought in this morning."

"Oh!" I replied, and moved toward the door. "How is he?"

"Quiet," returned the captain. "If he turns nasty, I'll send him over to this week yet, with your permission." "If you think he's fit," I rejoined, callously. "Needn't wait for me here, captain; run along and get your supper. I'll let myself out." Peters looked his relief. "Thanks," he said, laconically, and started down the hall.

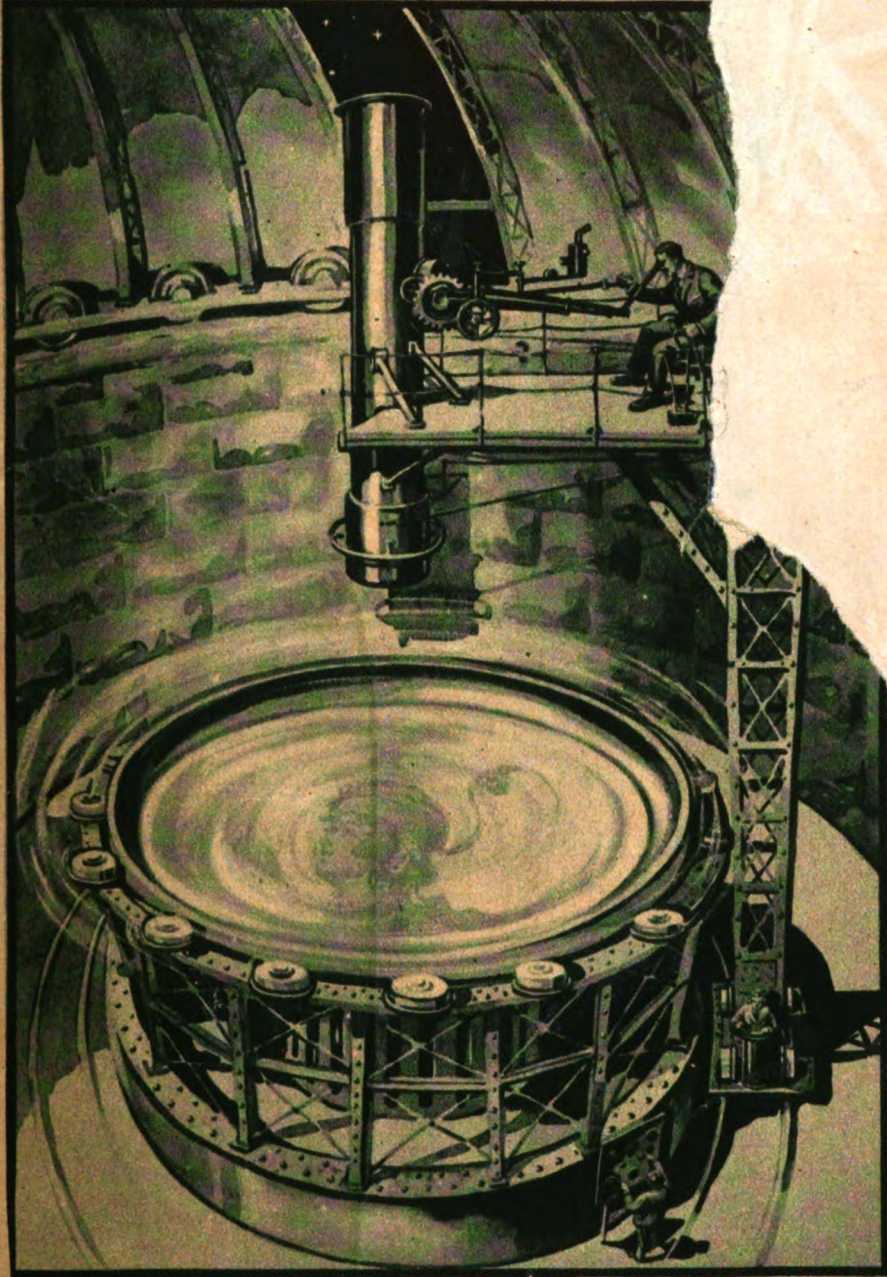

"And Rose, Those People Are Centuries Ahead of Us." His Voice Sank to a Whisper. "Night After Night I Watched Them; Night After Night I Followed Them Thru the Streets of Their Cities, at Their Daily Tasks, As They Assembled in Their Big Open-Air Auditoriums."

"And, Rose, There's a 'Girl' Up There I Want. I Never Had One Down Here, You Know . . ."

I drew my keys and opened the door of the new patient's room.

Years of work in institutions for the insane have rendered me very nearly immune to surprise. In asylums the unexpected happens with such monotonous regularity that your veteran is only thrown off poise with difficulty. But the shock that awaited me behind that plain and unprepossessing cell door was too much for my *sang froid*.

myself. Likely as not I am. For that matter, I've always thought that we all are to an extent. But if you mean in the conventional sense of the term, I don't believe that I am. It is for you, not me, to answer that question. Three of the State's best have assured me that I am. At their salary, they shouldn't make mistakes."

I winced. It was a quiet jab at my

(Continued on page 544)

all
Sk
return
regard
looking for the
tell-tale signs that be-
tray the demented to
the practised observer;
those little breaks and
slips that stamp a man
who is to all intents
and purposes as sane as
you or I, as, in truth,
out of his mind.

"Well, are you?" I
asked deliberately, and
waited tensely for the
reply. For this ques-
tion, put to an average
insane man, will bring
forth a gushing torrent
of indignant denial and
self-pity.

But no emotional
outburst followed. In-
stead, Mehlman regard-
ed me steadily, quizzic-
ally. "I don't know,
old man," he said
finally. "I'm not sure

THRILLERS

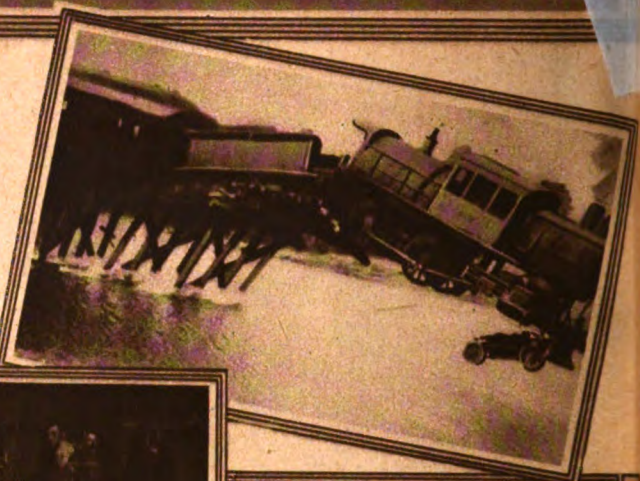

Probably No More Fascinating Story Has Ever Appeared, Nor a More Thrilling Scene Rendered, Than That in "The Juggernaut," Where a Full Size Railroad Train Leaps from a Ricketty Bridge (After the Piling Had Collapsed Under Its Weight) into a River. Actors Were Actually in the Train When It Leaped from the Trestle, and Fought Their Way Out of the Cars into Six Feet of Water in the River.

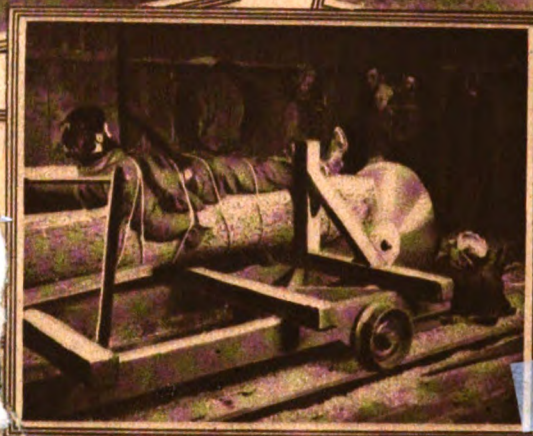

One of the Favorite Methods of Torture and Death in the "Movies" is the Buzz-saw Arrangement Shown Above Wherein the Old Sawing Machine Gradually Draws Its Victim into a Certain Death. But, Never Fear; the Hero Will Surely Be Snatched from Death's Clutches, without Even Having His Hair Singed.

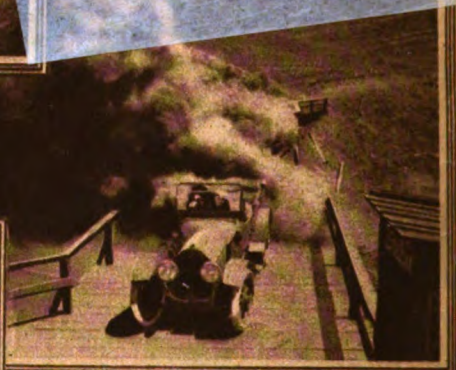

William Duncan Again Furnishes Us with a "Thriller" by Traveling Across a Burning Bridge, at Full Speed in an Auto. The Bridge Was so Arranged That It Would Collapse Immediately Upon His Trip Across It. If It Had Collapsed Beforehand, Bill Would Undoubtedly Have Been One of Those "Heroes" of the Movie World of Days Gone By.

Leap in an Auto Across a Broken Bridge. Above, The Auto Is Given a Very Start Due to a Steep Incline Which Leads Down to the Trestle. The Latter Was so Arranged That the Auto Was Sure to Leap the Air Gap Between the Two Ends, Much Like Those at Amusement Resorts. Even Then the Impact Created Great Anxiety When the Trestle Started to Sway, and the Auto Hesitated a Moment—but Luckily for the Driver, It Proceeded Safely on Its Way.



Antonio Marino, in the "Invisible Hand," Produces Some Stunts Which Are Not at All Short of Miraculous! Above He is Seen Tied to a Lodge While the Diver Attempts His Rescue from a Submarine Cave. The Instant the Glass Was Broken, the Submarine Cave Filled with Water. Simultaneously, the Diver's Life Lines and Air Hose Were Cut, so That It Meant a Mad Rush for the Shore Entrance Before the Onrushing Waters. The Cave Shown Was Actually Constructed at Great Expense, at the Low Water Line and the Movies Taken at High Tide, Insuring an Effective Flooding at the Opportune Moment.



Comedy Could Very Often Be Transformed into Tragedy and Seemed Such as This, in Which a Genuine, Honest-to-goodness Automobile with Three Occupants Plunges from a Dock. It is Necessary, of Course, for the Occupants to Free Themselves Before the Auto Turns Over Upon Them, as Otherwise Death by Drowning. Unless Speedy Assistance Presented Itself, Would Occur.



"Bill" Duncan, as His Favorites Call Him, Playing in the "Silent Avenger," Is Shown Here Executing a Very Difficult Stunt. In His Escape from Gangsters, He Leaps to the Structure, and Suddenly Releases Himself to Go Flying Thru Space Several Hundred Feet into a Net Stretched as Shown. Of Course, the "Movie Fans" Never See the Net, but Even so, the Leap is Fraught with Danger.

—Photos Courtesy Vitaphone Film Co.

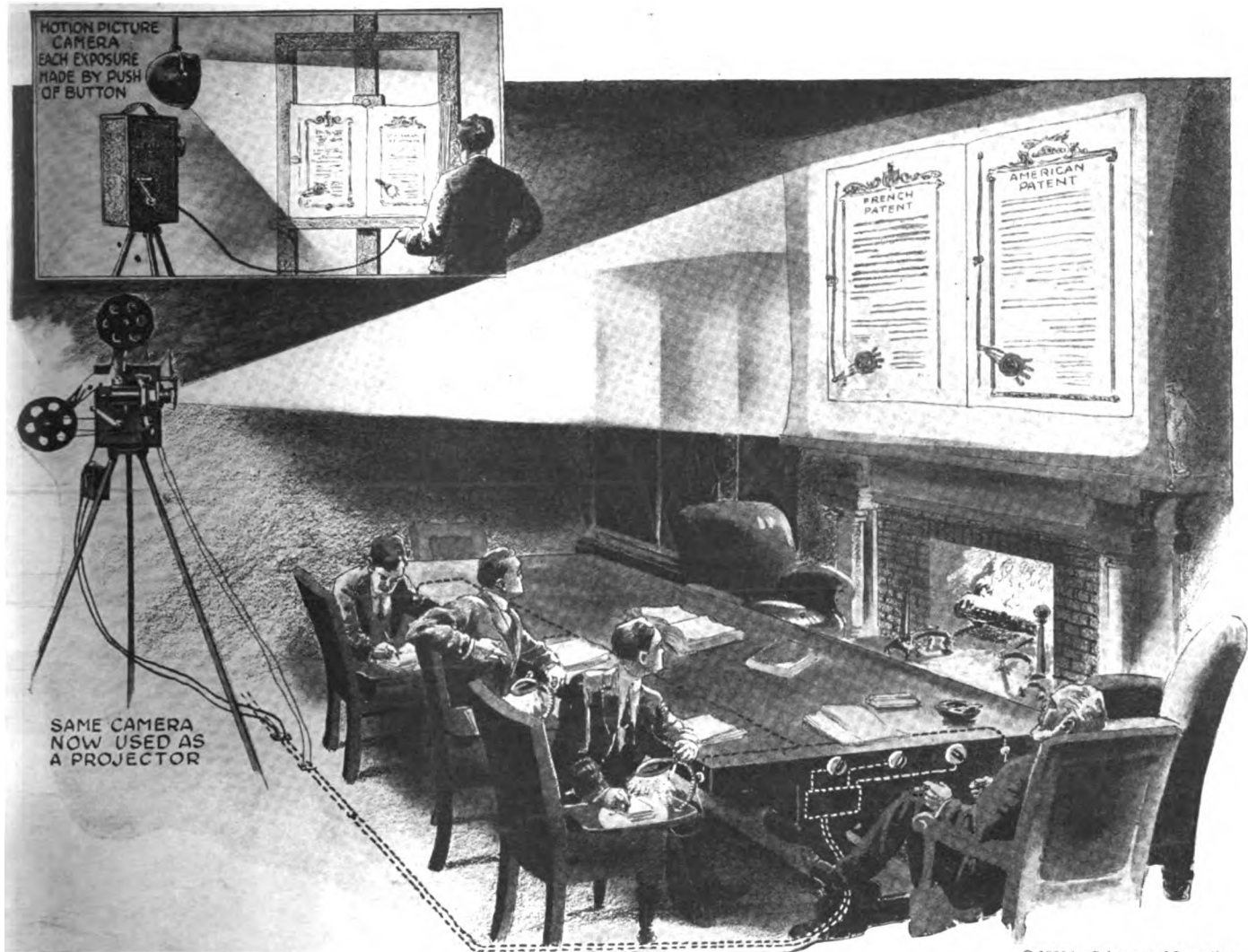

© 1920 by Science and Invention

Instead of Using Photographs of Books, Legal Papers and Other Documents, the Idea Here Suggested by the Author is to Make Use of the Standard Motion Picture Camera in Such a Way That Practically Anyone Can, with the Proper Arrangements Made at Libraries, Photograph Many Hundred Pages in a Few Hours on the Small Film of the "Movie" Camera. These Small Pictures Can Afterward Be Flashed Up in the Library or Study Room, Lecture Halls, Etc., and Discussions Held on the Subjects in Question. A Clever Arrangement of Interlocking Push-Buttons is Suggested by the Author, Whereby the Next Picture Cannot Be Flashed Upon the Screen Until Everyone Present Has Closed His "Release" Push-Button.

"Movie" Camera Copies Books and Legal Papers

By O. C. ROOS

PROLOGUE.

A PUBLIC library "photostat-room" in 1925. Place—Any up-to-date large city of over 20,000.

Dramatis Personae—An engineer, a promoter and their two legal advisers.

Properties—One film camera "snapping" 60 pages a minute, when worked by cable or bulb control; in its new rôle of photographing rare records at library by an operator turning pages.

First Lawyer to Engineer—"You say, George, that we can take these things as fast, or faster than they can turn the pages?"

Engineer—"Yes, it's certainly saved me hundreds of dollars personally in one year, just to be able to come here and have photographed, or do it myself, a whole book in from ten minutes to half an hour."

Promoter—"I wish I had seen the possibilities of this thing five years ago. It beats any lecture circuit subscription scheme I ever met with. Why, it must cost next to nothing to record a whole patent which is out-of-print, thru competitors' efforts in keeping it bought up. That's an old dodge, you know."

Promoter's Lawyer—"It costs about 1 cent per unit exposure, including develop-

ment and printing, and this is a very high estimate."

Engineer (watching operator "snap-snap-snap" bulb as he turns pages of evidence taken from patent records in library)

—"The beauty of the thing is the compactness of the result. Ten feet of film and close to thirty exposures, each of two pages! Then you get at least a 12-fold linear magnification on a study screen, when you project your film with a 20-foot throw."

Promoter—"But what is the size of your picture at that distance?"

Engineer—"Well, to be very conservative, say 20 by 16 inches. Small print type is about $\frac{3}{8}$ inch high at that distance."

First Lawyer—"You'll see for yourself when we go to the club and examine this evidence on the screen over our cigars, how easy it is to study it at leisure, and manipulate it."

Second Lawyer—"I'm surprised the film doesn't burn up when we lawyers dawdle over the fine points in the patent claims we're trying to break."

Engineer—"Well, you see, it's a fact that even in 1920 there were films which could be used on Mazda lamps, projecting say this documentary positive 60 feet, with a five by four foot picture for half an hour, without harming the film, even to the extent of warping it!"

First Lawyer—"That gives plenty of time to make our notes and then we really don't have to keep the current on when we're discussing a mooted point."

Engineer—"Here comes our film. 640 pages and 10 feet of it! Costs about \$1.00. Well, it's certainly a great convenience. Now we're off for the club."

ACT 1.

Misc en Scene—Exhibit or projection room of any first class professional club, in same city as the Prologue. It might perhaps be in the library or a branch thereof.

Each chair is arranged so as to give an intimate atmosphere and yet a clear, uninterrupted view of the screen. Pear-shaped, hand-push switches are hanging at the chair positions. The club projection room operator takes the film from the engineer and inserts it in the projector—then darkens room, leaving the observers by themselves.

Promoter—"Well, I can grasp the *modus operandi* of everything here, except those push switches near each chair. Will we use them?"

Engineer—"Probably not, as we are more particularly interested in a single page to-night than in series-groups, you know. That is, a party of a certain number of persons, say five, would be given five (Continued on page 540)

Argon—The New-Old Gas

By E. W. DAVIDSON

ONE of the most useless of the constituent elements of the air we breathe was turned to a highly valuable use for mankind when argon gas was first injected into incandescent lamp bulbs. By filling lamps with this gas, which is among the laziest of all gases, and by observing certain precautions, the efficiency of the lamp thus made was greatly increased. Furthermore, argon gas has helped the larger sizes of incandescents up to the huge 1500 watt lamp to displace arc lamps for street lighting purposes.

Sir William Ramsay first discovered argon in 1894 which he found to constitute about one per cent of the atmosphere. By this discovery he filled out one of the "blanks" in the chemical periodic system. Previously it has been noted that nitrogen extracted from the atmosphere was heavier than nitrogen produced by chemical process. The search for an explanation of this led to the discovery of argon. But he found absolutely no practical use for the new gas. For 20 years this valuable element was permitted to continue in its happy state of desuetude.

How This Laziest of All Elements in the Air We Breathe Has at Last Been Put to Work to Help Light the World

ment from air, but nobody used any argon on a large scale until about 1914. At lamp factories the oxygen is thoroly removed by passing the mixed gases thru a tubular furnace nearly filled with copper filings at red heat, and about 90 per cent of the nitrogen is extracted in another furnace. Then the argon, about 90 per cent pure, is injected into lamp bulbs.

The very inertness which once stamped argon as absolutely useless has proved to be its valuable quality. The facts that it is relatively stubborn in its refusal to serve as a conductor of heat and that its density discourages the evaporation of tungsten filaments even at tremen-

dous heat, have therefore made it possible to increase the temperature of lamp filaments with a consequent increase in lamp efficiency beyond the point which was the previous maximum.

Altho it has not been economically advantageous to use argon in the lowest current lamps, its use renders the higher current lamps more brilliant and efficient. Large argon-filled lamps equal in efficiency the magnetite arc, so as to serve for any sort of street lighting except to produce the brilliant glare needed for "white ways." Argon-filled incandescents, which can be mounted in various sizes on a single circuit to meet varying needs as arcs cannot be, and whose glow never flickers as does the glare of arcs, have established their supremacy for general outdoor lighting as well as for other medium and high-power illumination needs. Thus argon gas has at last been put to work.—Photos courtesy General Electric Co.

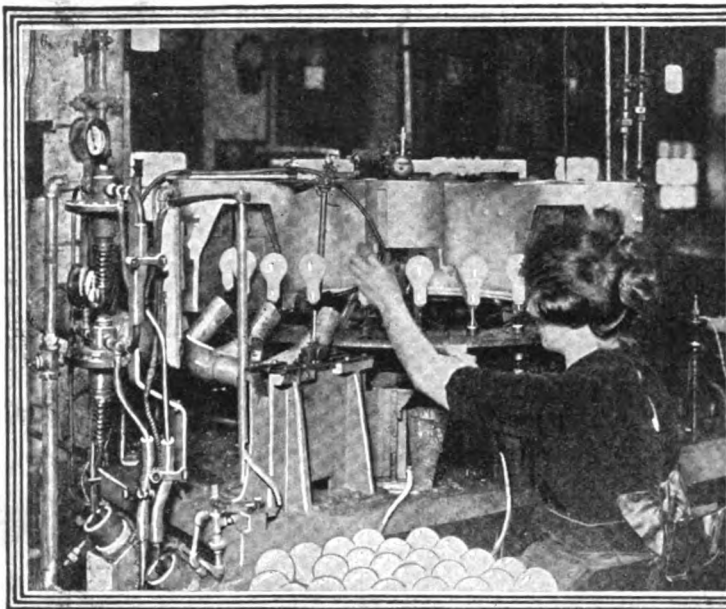

Above:—Here the Lamps Are Thoroughly Exhausted on the Turn-table Which Carries Them Thru the Oven. As They Come Out (Left) They Are Cooled by Three Blasts of Air. The Argon Is Injected From Beneath When the Lamp Reaches the Position at the Operator's Left Hand. The Bulb Is Sealed and Ready for Use—an "Argon Filled" Lamp.

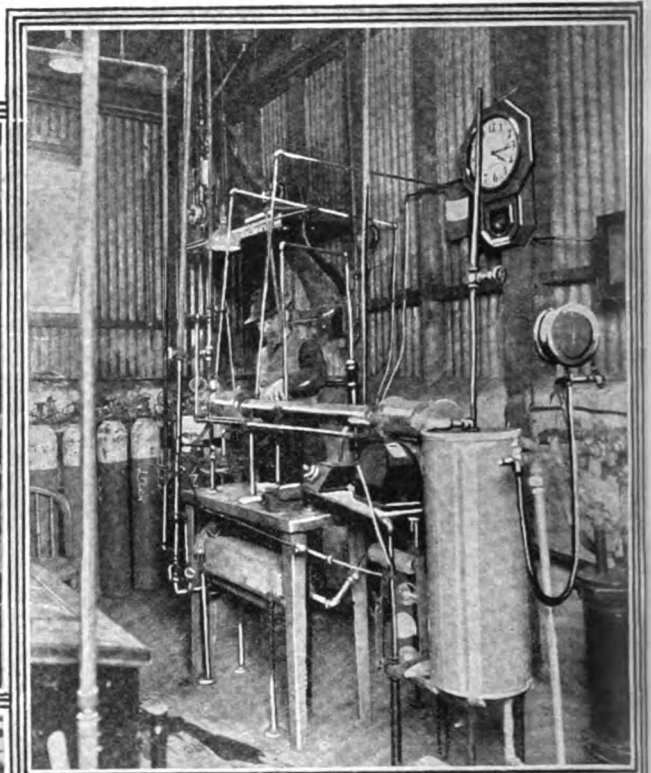

Above:—First Step in the Lamp Factory. Here the Approximate 30 Per Cent of Oxygen in Commercial Argon Shipped in the Cylinder at the Left Is Burned Out in a Hydrogen Flame, Leaving Argon and Nitrogen.

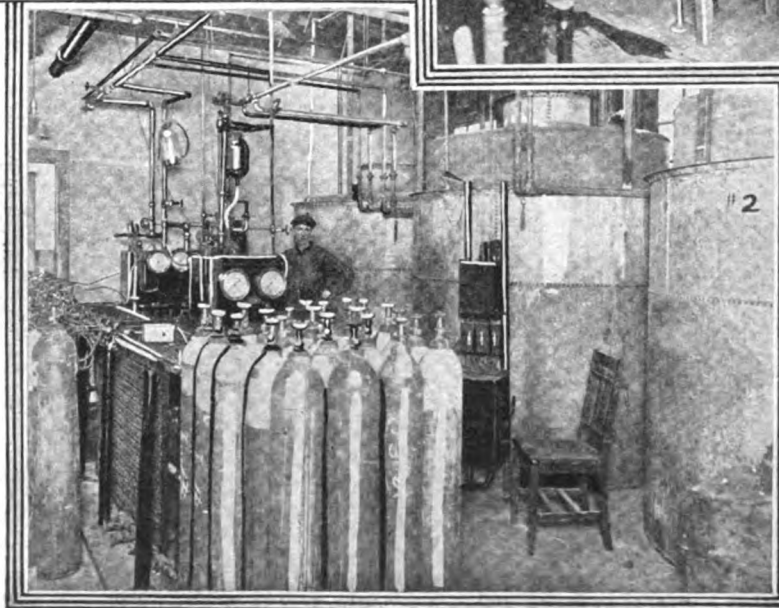

The Purified Argon Is Pumped Into the Big Gasometers from Which It Is Drawn Into the Cylinders. These Are Connected to the Machine Which Injects the Argon Into the Lamps. (At Left) The Fact That It Is Relatively Stubborn in Its Refusal to Serve as a Conductor of Heat Has Made It Possible to Increase the Temperature of Lamp Filaments with a Consequent Increase in Lamp Efficiency.

Nobody used argon until Dr. Irving Langmuir in the Research Laboratory of the General Electric Company at Schenectady discovered the increased efficiency to be gained in incandescent lamps by filling them with inert gas instead of merely making them vacuous. He used both nitrogen and argon.

Nitrogen was promptly put to use in lamps because it is comparatively easy to extract so prevalent an ele-

All Aboard! On Model Railroad

EVER feel like getting away from things in general and go back to your boyhood pranks? That's what a New York broker felt like and he did it in style—a style which you and I can follow and get a world of fun from. Mr. Cecil Gage was the former New York broker who left

teriorating. He dismantled the hen house and from the wood alone he built a miniature railroad, tracks, car and engine that now runs around the entire acreage of his farm. During the week he travels around his farm gathering the products and on holidays he totes visitors around in his train. Some of the many wonderful features of the system are: The tracks, ties and signals, trains, engine

and tender are built of wood. The passenger cars are capable of carrying two passengers with seats built in them; one double-decker car is five and one-half feet high with regulation glass windows built after the fashion of the foreign railroad coaches. The tracks pass thru the new hen house from which he gathers his poultry, eggs, etc. The engine seats one engineer and is driven by a four h.p. Fairmont hand car engine. Special flat cars are on hand to carry the vegetables, etc., and everything is an exact duplicate of a regular locomotive and train. The photo shows the engine.

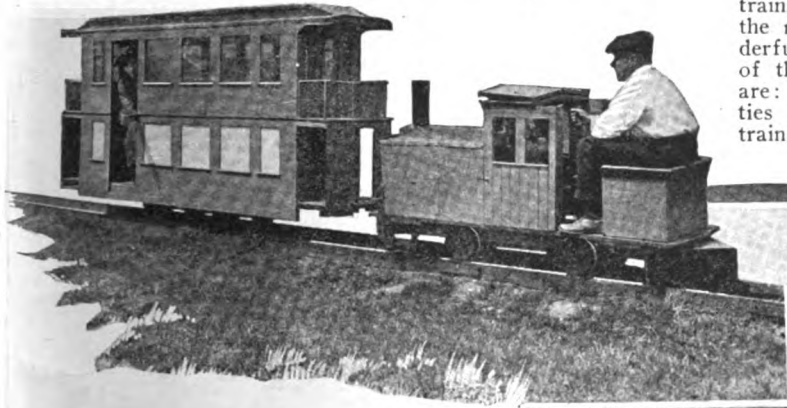

Who Wouldn't Like to Have a Model Railway Running Around Their Backyard Just Like This—and You Can Have One at Small Expense. If You Just Want to Have a Small Locomotive, Either a 1/4- or 1/2-H.P. Engine Will Do. The Engine Here Shown, Pulling a Trailer Car and All, Is Provided with a 4-H.P. Gasoline Engine.

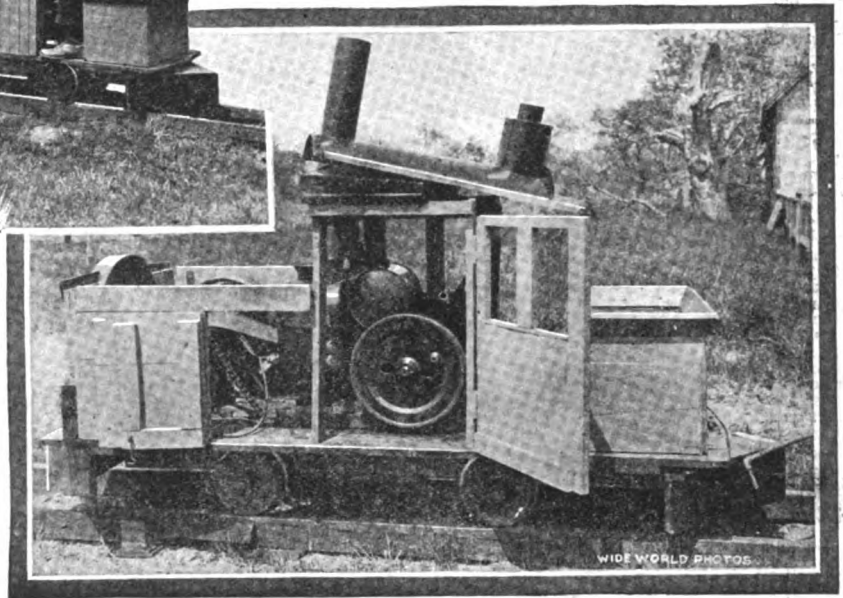

the noises of the "big city" to enjoy the peaceful routine of his farm at Fishkill, N. Y. He grew weary of walking around the farm to gather his products and thought up a scheme of mechanical locomotion. He had a hen house 251 feet long that was not being used and the wood was already de-

"Live Wire" Window Display

It being a well-known fact that in advertising that light and a movable object will always attract attention, especially if the movable objects can be so arranged that they will move in the out of the ordinary way, and also to have more than one object to observe.

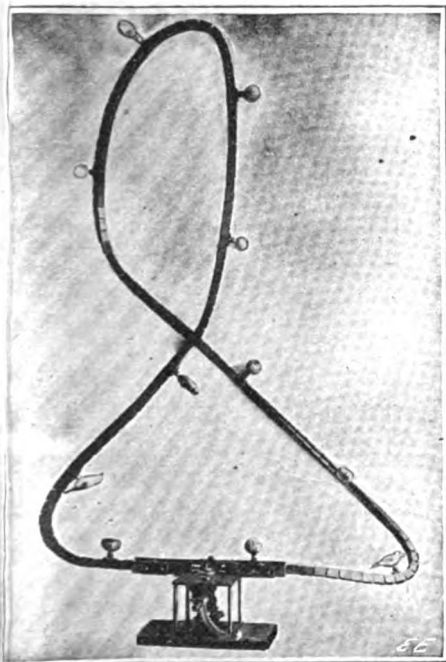

Moving Electric Lights, Such as in This Display, Fitted with a Remarkable Flexible Shaft and Guide Frame, Provides Entirely New Possibilities in Show-Window Trimming.

Therefore, the combining of these four features in such a manner that the device can be used in practically every field of commercial enterprise; by simply placing that particular object in transparent miniature form over the lighted bulbs and made to travel in any position that the flexible guideway has been placed as clearly shown in the photographs. It being quite evident that the guideway can be readily concealed, easily handled, as the same can be laid, placed, hung, swung or suspended in any position to suit the conditions.

Then if we are to advertise say in an automobile supply store a tire, can of oil, spark plug, etc., is placed over the lighted bulb in miniature form of a transparent material—or in a grocery store a can of peas, box of biscuits, etc.—or in a tobacco store various brands of cigars or cigarettes, etc., etc.—in a music store, various records, etc.—and in this way we could go thru the entire list of our daily wants, all being brought before us in miniature, illuminated and moving form.

As a toy it could be used on a Christmas tree and birds and other objects of that character placed over the bulbs and made to travel in and around the tree, thereby causing a very beautiful as well as novel effect, and an object of interest to both young and old. The devices can also be used as a scenic railway, roller coaster, loop the loop, ad infinitum.

The whole effect is accomplished in the most simplest manner by means of a suitable flexible slotted housing or guideway, a flexible shaft carrying the various objects and the electrical conductors, the said flexible shaft being driven by a pair of friction rollers from a small electric motor.

EDWARD A. DIETERICH.

Foot Warmer For Police

This electric foot warmer is designed for outdoor service and makes it possible, in winter weather, greatly to relieve outdoor workers obliged to remain in one spot for long periods of time from the discomfort of cold feet. Investigation as to how this relief could be furnished by means of an electric heater resulted in the development of an electric foot warmer different from anything previously on the market.

The amount of power consumed can be regulated to 200, 100 and 50 watts respectively, at 120 volts, for the different positions of the switch. Six feet of cord with a snap switch is supplied with each warmer. The rubber insulated cable enters the de-



Electric Foot Warmer For Policemen and Others Stationed at Outdoor Posts. The Device Is Thoroughly Water-proof.

vice through a bell-mouthed waterproof fitting mounted in the middle of one end.

The resistance which constitutes the main element of the heater is of the slotted ribbon type distributed uniformly over the entire surface. The ribbons are assembled between two plates of built-up mica 0.025 inch thick, cemented together to form a unit. —Photo courtesy Westinghouse E. & M. Co.

The Romance of Tungsten

By E. W. DAVIDSON

This Hardest and Heaviest of Metals Was Brittle and Therefore Unworkable in Its Pure State for More Than a Century After Its Discovery Until Dr. W. D. Coolidge Made It Ductile. Tungsten Saves This Nation Alone a Billion Dollars on Its Annual Electric Light Bill and Otherwise Benefits Mankind.

A CASUAL look at the filament of the incandescent lamp in your library or at the tiny spark coil contacts on your automobile brings no suggestion of the romance of science which lies back of those devices. It is the Romance of "Tungsten," one of the heaviest of metals, a metal nearly 140 years old, but

devel- oped to a useful and dependable point. With it phonograph needles are being made more than 50 times as good as the steel and the fiber needles, heretofore the best that could be produced.

hard enough to work at high speed even tho red hot. Tungsten was required as an alloy to make such steel.

The price rose steeply when the supply diminished before the sudden demand until it reached \$7 or \$8 a pound. The world's

Right:— One Step in Making Lamp Filaments. Squirting Pulverized Tungsten Ore Into 2,200 Fahrenheit Degree Furnace Which Removes Oxygen and Produces Pure Tungsten in Powder Form Ready for Compression Into Bars Which Are Hammered and Then Drawn Into Finest Wire.



Below We See the Last Process in Using Tungsten in Lamps—Winding the Fine, Tangle Wire on the Lamp Mount by Hand.

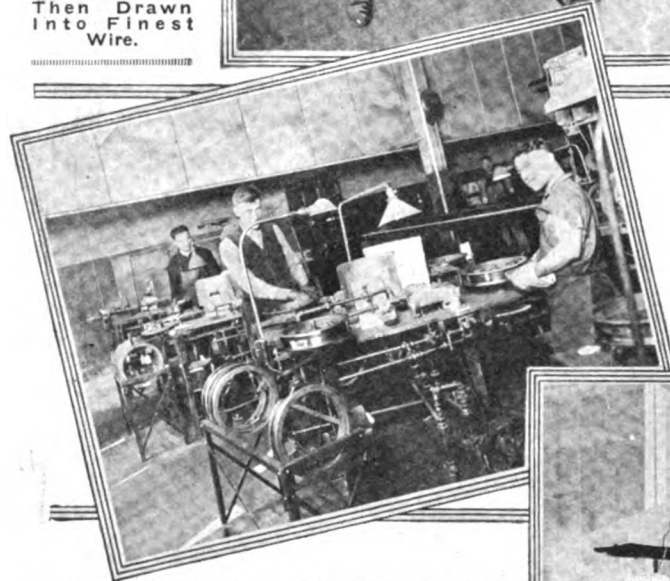

Above:—After Tungsten Has Been Swaged Down to Heavy Wire, the Drawing Process Begins. Here It Is Being Drawn Thru a Gas Flame and Then Thru a Die Reducing It From 0.030 to 0.014 Inches. It Is Tough and Thoroughly Ductile by This Time, But Is Far Too Large for Lamp Filaments.

At Right:—Putting Red Hot Tungsten Bar Thru One of the Many Swagers, Whose Revolving Hammers Chatter on All Sides of the Bar, Reducing It to Smaller and Smaller Diameter.

Above:—Drawing Tungsten Down to Finest Proportions, About Four Ten-Thousandths of an Inch or One-Sixteenth of the Size of Fine Human Hair, and Which Cannot Be Seen Except Against a Background of Exactly the Right Color. It Is Used as Filament in the Smallest "Bug" Lamps. The Thread of Tungsten Unwinds From the Spool at Extreme Right, Passes Thru Small Box of Lubricant, Then Thru Gas Furnace Which Has a Diamond Die at Its End Nearest the Operator. The Wire Then Winds on a Receiving Spool and Is Ready to Be Put Into the Tiniest Lamps.

which resisted the efforts of mankind to make use of it in its pure state for about 130 years.

But the service pure tungsten has rendered the world in the last decade since it was "conquered" is almost too great for calculation. Tungsten in its various forms reduced America's electric light bill a billion dollars a year and more than doubled the usefulness of the incandescent lamp. Ductile tungsten kept the automobile industry alive during the war. It helped make possible the Coolidge X-ray tube with tungsten targets which tremendously increased the value of the X-ray machine to mankind. With it the plitron was built so that wireless telephony could be dev-

the recent war as projectiles hard enough to pierce the heaviest armor the Germans could put on their aircraft, for a few were made to prove their usefulness in that capacity, but the plan to use them was given up after a less expensive way to accomplish the result was discovered.

Before the war only a few thousand tons of tungsten ore were mined in all the world and the price of raw tungsten ranged around 90 cents a pound; but with the war came a tremendous demand for tool steel,

production in 1918 mounted to 35,800 tons. The control over the sources of it was 59 per cent American, and 35 per cent British. The price and production slumped with the end of the war until today raw tungsten can be bought for a little over a dollar a pound.

TUNGSTEN MADE DUCTILE.

Most of the adaptations for tungsten are due to a discovery made by Dr. W. D. Coolidge, of the General Electric Company.

(Continued on page 558)

SYNTHETIC AMMONIA

By LUCIEN FOURNIER

is still another Frenchman to whom the entire world gives thanks for one of the most useful of discoveries. For this reason it is but natural that he has earned the sobriquet of "Father of Synthetic Ammonia."

TWO GASES REQUIRED TO MAKE AMMONIA.

In order to manufacture ammonia it is necessary to make use of two gases: nitrogen and hydrogen. The first is obtained from the air of the ordinary atmosphere at low temperature after which it is placed in tanks under pressure similar to oxygen. As for the production of hydrogen this can be accomplished by several methods, viz.: by an electrolytic process which furnishes a very pure gas but, however, at a cost too great for practical purposes; by the reaction of an acid upon iron or zinc; generally, however, it is secured from an inferior gas or from a water gas, so that it is possible to procure it at plants where coke is manufactured and where it is mixed with other gases. However, it is necessary to bear in mind that the hydrogen gas

must be very pure, and that in order to furnish ammonia in large quantities it must sequentially be itself manufactured at a low cost. The two gases are, therefore, manufactured in proper proportions, after which they are submitted to a very high pressure. The mixture is then directed thru the catalyzer at a reasonable temperature and from which is generated ammonia vapors which are condensed and thus liquefied. After passing thru the condenser the result is liquid ammonia.

The German company, *Badische Anilin Werke*, which previously manufactured large quantities of ammonia, utilized pressures of 200 atmospheres. This is a very satisfactory industrial result since it was by this means that the liquefaction of air was obtained. It was here that Georges Claude arrived at the conclusion that much greater pressures could be secured without greater expense and by which the synthesis of ammonia could be obtained under very economical conditions. Thus, thanks to the use of a final compressor having a piston of small diameter, it was found that if we use the quantity 2 as the necessary mechanical energy to produce the pressure of 200 atmospheres, the quantity 3 may represent the necessary energy for a pressure of 1000 atmospheres. In other words, 1000 additional atmospheres are obtained at an additional expense of only 1/3 of the energy necessary to obtain 200 atmospheres!

It is therefore seen that there exists a direct relation between the temperature under which the catalyzer must be submitted and the pressure. The value of this relation has been placed by Georges Claude by the reaction $Az_2 + 3H_2 = 2AzH_3$. The catalyzer tank fills to a length of 10 centimeters a tube having the length of 80 centimeters and a diameter of 8 millimeters, the latter being heated by electricity. The inventor has stated that while under pressures of 200, 400, 600, 800 and 1000 atmospheres, special temperatures are necessary in order that the catalytic phenomena be produced under conditions favorable to large production. However, beginning with 200 atmospheres, the practical temperatures must not be lower than 500 degrees, nor higher than 700°.

(Continued on page 561)

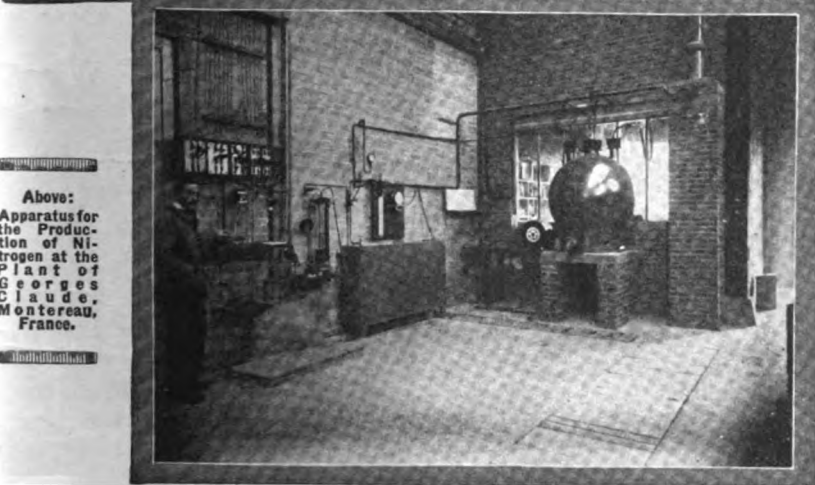
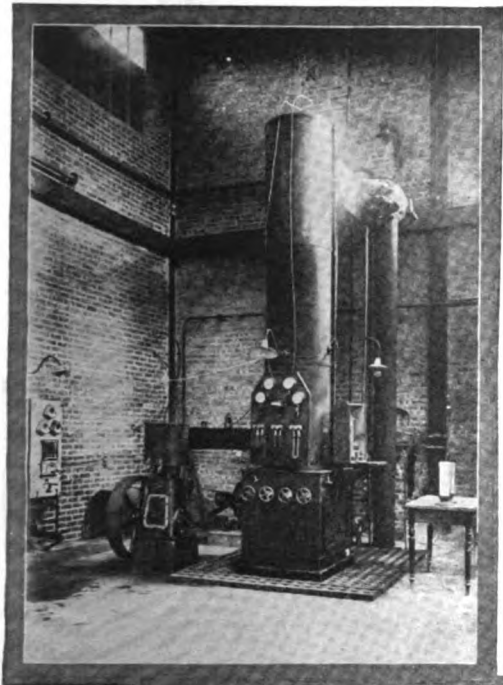

Above:
Apparatus for the Production of Nitrogen at the Plant of Georges Claude, Montereau, France.

Liquefaction of Ammonia. To the Left May Be Seen the Attendant Who Watches the Electric Current Which Maintains the Catalyzer at the Desired Temperature. To the Right is Seen the Cylinder in Which is Received the Liquid Ammonia: While in the Center is the Glass Gage Thru Which the Liquid Ammonia Falls.

ORDINARILY ammonia is produced in large quantities by Nature during the process of decomposition of organic matter. Industry generally extracts it from waste waters and gas plant waters which are charged with ammonia during the distillation of coke. This distillation is possible for the reason of the easy separation of ammonia from water steam. However, it would decidedly be much more advantageous to produce ammonia by synthesis thru the separation of the two elements, nitrogen and hydrogen.

The German organization, *Badische Anilin*, while exploiting the patents of Haber, has for several years manufactured synthetic ammonia. Mr. Georges Claude, already known thruout the entire world for his wonderful work with liquid air, has enriched science by the discovery of new elements destined to give them a very economic industrial character.

Previous to this, however, as well as to another Frenchman, Charles Tellier, who is known as the "Father of the Cold," there

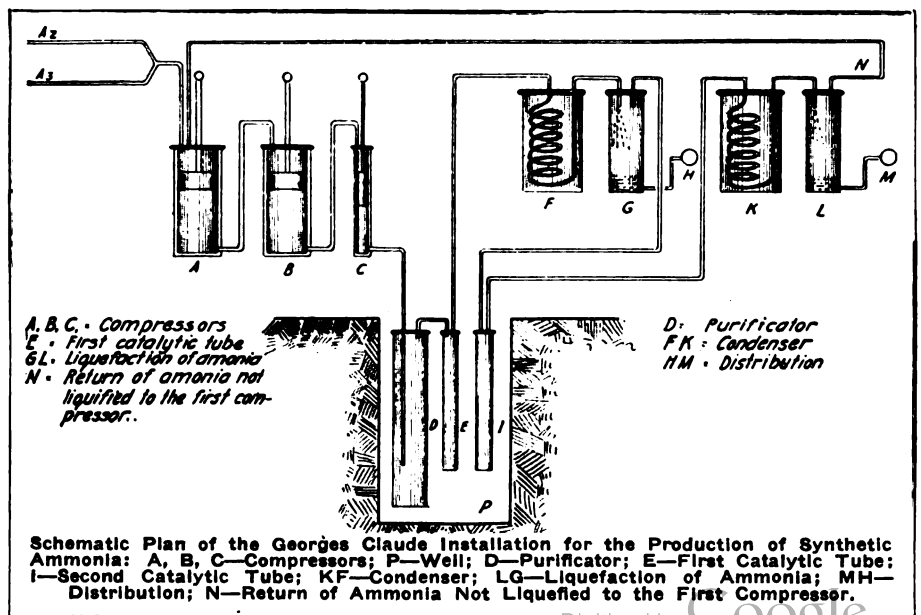

"Eclipses"--How Caused

By A. M. HARDING, Ph. D.

University of Arkansas

MAN, in ancient times, considered his own little city as the center of the world and his own world the center of the universe. He thought the sun, moon and stars shone for his benefit, and that were it not for him they would have no reason for existence. The sun furnisht him heat and light, the moon serving as its substitute, while the sun was not visible. Every star was supposed to have been placed in the sky for some definite purpose, altho just what this purpose was may not have been evident in every case.

These celestial objects soon became of such importance to man that they were considered as "Gods." In fact, several ancient nations worshipt the sun, moon, and

or three hours, they are sure to succeed. For the scientific man of today, an eclipse has no terrors. It is a phenomenon which can be predicted years in advance and when it arrives on scheduled time it is just another evidence to him that mathematical law reigns supreme in the universe.

There will be four eclipses in the year 1920, two of the sun, and two of the moon. The data for these eclipses, which are taken from the American Ephemeris, are given below. The time in each case is Central Standard Time.

TOTAL ECLIPSE OF THE MOON, MAY 2, 1920.

All of the inhabitants of the United States, except those in the extreme north-western portion, saw the last part of this

were peacefully slumbering, ignorant of the fact that anything was wrong with the appearance of the sun, the sailors on the Indian Ocean and the people of Australia watched the moon's disk creep over the sun until ninety-seven per cent of its surface was covered up.

TOTAL ECLIPSE OF THE MOON, OCTOBER 27, 1920.

The moon enters the shadow and the eclipse begins at 6:25 a. m. The total eclipse begins at 7:28 a. m. and ends at 8:54 a. m. The moon leaves the shadow at 9:57 a. m. Since the full moon will set at sunrise it is evident that this eclipse will not be visible in the eastern half of the United States. The first part of the eclipse will be visible in the western portion of North America.



© 1920 by Science and Invention

Eclipses of the Sun and Moon Have Caused in Years Gone By, Some of the Greatest Perturbations Among the People of the Earth, As One Can Well Imagine. Probably There Is Not One of Those Instances Which Is More Interesting to Americans Than That of Christopher Columbus and the Indians. Christopher Columbus Used His Knowledge of Eclipses to Free Himself and His Companions From the American Indians, Who Held Him Prisoner and Had Reduced Him Almost to Starvation. He Happened to Remember That an Eclipse of the Moon was Due to Occur On March 1, 1504, and He Told the Indians That He Would "Cause the Moon to Go Out if They Did Not Bring Him Food." They Paid Very Little Attention at First, But When the Moon Disappeared They Brought Him Plenty of Food and Worshipt Him As a "God."

stars. Our attention is called to this fact by the writer of the second book of Kings, who tells us that Josiah, king of Judah, destroyed all those who worshipt the sun, the moon, and all the host of heaven.

Man soon became familiar with the motions of the sun, moon, and stars, but was always thrown into a panic by the appearance of an eclipse, a comet, a meteor, or a shooting star. These phenomena were generally considered as omens of evil.

Even at the present time we find some peoples who believe that when the moon is eclipsed it is fighting with a great dragon. They beat on drums and tin pans in order to frighten the dragon and rescue the moon. Of course, if they keep up the noise for two

eclipse. The moon entered the shadow of the earth and the eclipse began at 6:01 p. m. The moon went deeper and deeper into the shadow until 7:15 p. m. when the entire disk was obscured. At 8:27 p. m. the moon began to come out of the shadow and at 9:41 p. m. the eclipse ended.

Since the moon must be full when it is eclipsed, it rose at sunset, and those who had a clear view of the eastern horizon saw the moon rise as a round disk with part of its surface obscured by the shadow of the earth.

PARTIAL ECLIPSE OF THE SUN, MAY 17, 1920.

This eclipse began on May 17, at 10:17 p. m. and ended on May 18, at 2:13 a. m. While we inhabitants of the United States

PARTIAL ECLIPSE OF THE SUN, NOVEMBER 10, 1920.

This eclipse which begins at 7:47 a. m. and ends at 11:57 a. m. reaching its maximum (74%) at 9:52 a. m., will be visible in the eastern and north central parts of the United States.

The sun's rays are scattered in every direction thruout space. Some of these are intercepted by the earth and give us light and heat. Thus the earth excludes the sunlight from a small part of space; that is, the earth has a shadow.

Most of us, when we see our shadow on the ground, think of it as something flat like a leaf. As a matter of fact a shadow is the space from which the light is ex-

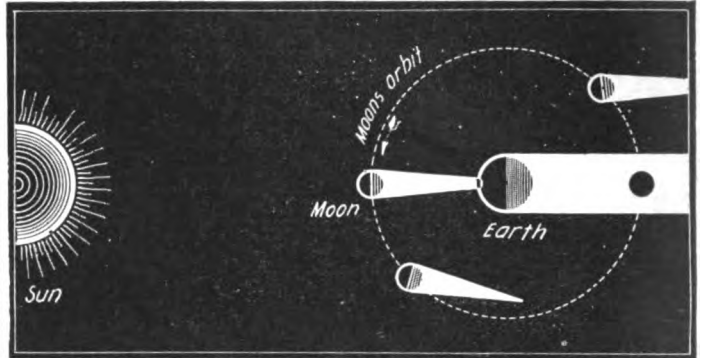
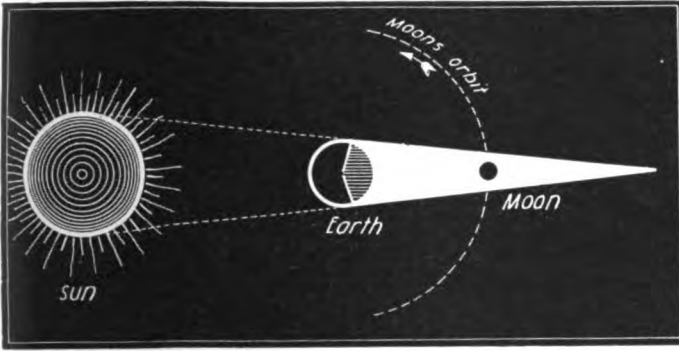

In This Illustration We See the Rays of the Sun Cast Upon the Earth. The Side of the Earth Turned Away From the Sun Casts a Black Shadow Out Into Space Which Envelops the Moon Whenever It Enters This Shadow, Causing a Moon Eclipse.

In Its Orbit Around the Earth, the Moon Has Many Phases as Is Well Known. If the Moon Is Directly Between the Sun and the Earth As Shown Above, We Have a Solar Eclipse On Earth. The Shadow of the Moon Is Shown Above in White. It Is Shown in a Few Positions Covering Several Phases of the Moon's Orbit.

cluded by an intervening object. Since the sun is very much larger than the earth, the shadow of the earth will end in a point; that is, it is a cone.

As the earth moves around the sun year after year it is accompanied by its shadow, which, of course, always remains on the side of the earth away from the sun. The shadow moves thru space at the rate of 18½ miles per second but most of us are not aware of its existence except when it passes over some celestial body.

The ancients used to think that the light of the sun was put out every evening and rekindled every morning. In this way they were enabled to account for the alternation of light and darkness on the earth. We know that darkness is due to the fact that we are in the shadow of the earth, and that the succession of night and day is caused by the rotation of the earth which carries us into the shadow every evening and brings us out again every morning.

When we call to mind the fact that this shadow is not something flat which covers the earth like a layer of snow, but that it is a cone whose base is the earth and whose vertex is somewhere out in space in the di-

rection opposite to that of the sun, the questions arise, "How long is this shadow? How far does it reach?" We know that when night comes it is just as dark upstairs as it is downstairs. If we climb to the roofs of our highest buildings we find darkness there. The birds of the air when they fly at night are invisible, no matter how high they may be. Aviators may destroy a city by dropping deadly bombs from a purring aeroplane while they remain invisible, protected by the shadow of the earth. No matter how high they may go they are still in the shadow.

The answer to our question is furnished by the astronomer. He tells us that the average length of the earth's shadow is 857,000 miles and that its length varies about 14,000 miles on account of the fact that the earth is not always at the same distance from the sun.

The moon makes a complete circuit around the earth every month and, since the distance to the moon (240,000 miles) is less than the length of the earth's shadow, it may happen that the moon will go into the shadow and be eclipsed. There are, in fact, three possibilities:

(1) The moon may pass above or below the shadow. In this case there is no eclipse.

(2) The moon may go into the shadow but pass so far above or below the center that only a portion of her disk is in the shadow. This is said to be a *partial* eclipse.

(3) The moon may pass near enough to the center of the shadow that her entire disk is buried in the shadow. This is said to be a *total* eclipse.

Since the moon and the sun are on opposite sides of the earth only at the time of full moon, every lunar eclipse must occur when the moon is full. How amusing is the following statement which once appeared in a daily newspaper at the end of a paragraph describing a recent eclipse of the moon! "This eclipse was especially beautiful since it occurred at the time of full moon."

On May 2, and again on October 27, the moon will pass near the center of the shadow and her entire disk will be shaded.

The diameter of the earth's shadow at the point where the moon crosses it is about 5,700 miles, which is about *two and two-thirds* times the diameter of the moon.

(Continued on page 522)

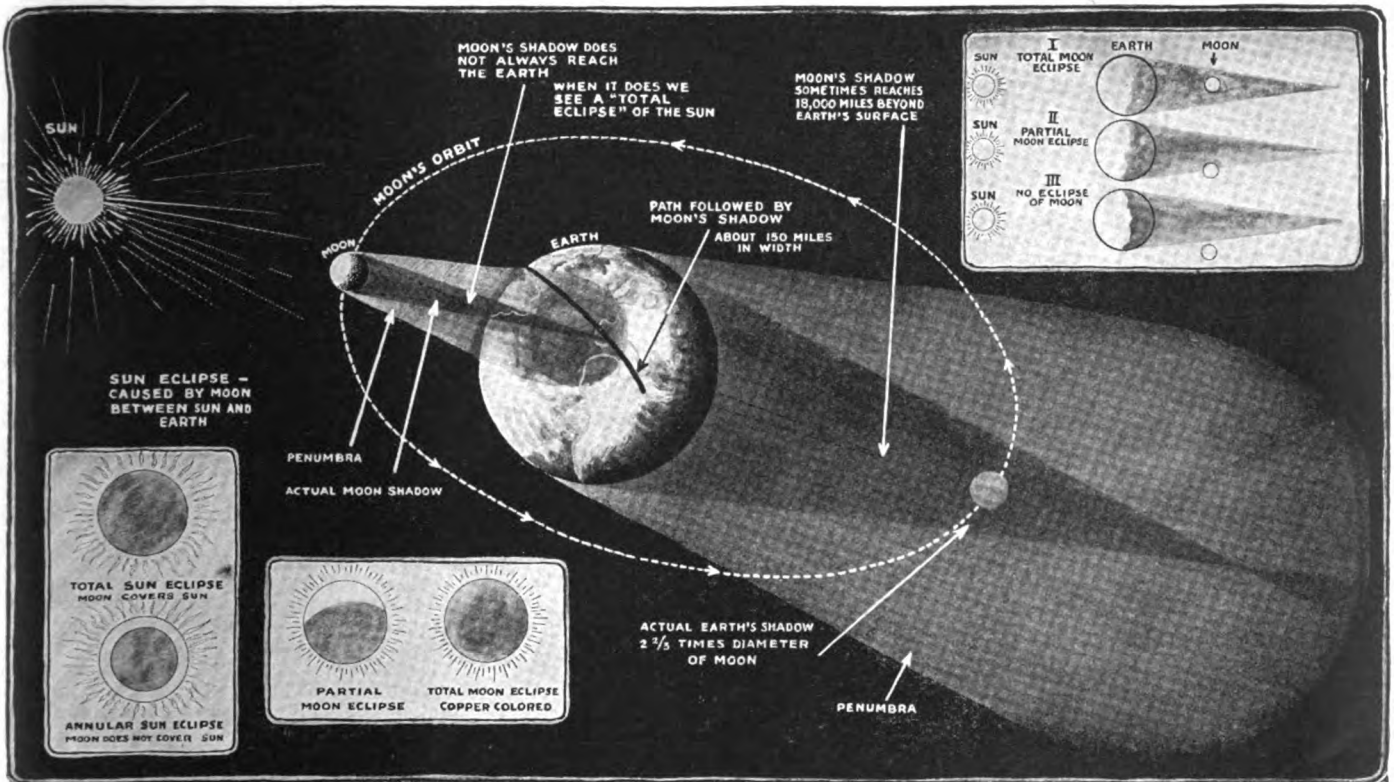

The Center Drawing Shows What Happens As the Moon Moves Along Its Orbit Around the Earth. It Shows In Perspective What Has Been Explained in the Two Diagrams on the Top of the Page. Note Particularly That When There is a Solar Eclipse, the Moon is Between the Sun and the Earth As Shown in the Illustration. If the Moon Comes Close Enough to the Earth as Sometimes Happens, We Have a Total Eclipse, Because to the Observers Who Are in the Path of the Moon's Shadow, the Sun is Blotted Out Entirely by the Body of the Moon. If, however, the Distance Between the Moon and the Earth Increases During an Eclipse, the Body of the Moon is Then Not Large Enough to Cover Up the Entire Disc of the Sun, and for That Reason We Have an Annular Sun Eclipse. (See Left-Hand Insert For Phase of the Solar and Lunar Eclipses Which Are Also Graphically Represented.)

© 1920 by Science & Invention

Home Mechanics

Conducted by WILLIAM M. BUTTERFIELD

PLATE RACK FOR THE SINK.

THESE are sinks and sinks, so the admirable device here shown must be constructed in dimensions to fit each particular case. It is devised to meet a particular want common with all wooden draining racks, that of being taken apart for cleaning when incrustated with grease. And this hitherto faulty part of rack construction is important in the eyes of careful housewives, for the so-called grease is not caused altogether by carelessness, but it is an accumulation of soap which it has been impossible to remove in the racks as in those heretofore constructed. This device is made of hard wood, and, fastened with pins that are quickly removed or replaced, can be got at and thoroughly cleaned.

It consists of end pieces (8"x8"), rather ornate in the matter of handle holes (3"x1½") and feet; and their 1½" holes bored in the sides (4" from top or bottom with centers 1¼" from the sides) for the tenons on the side rails. There is also a piece of wood screwed with copper screws to the inside of each end piece to keep the

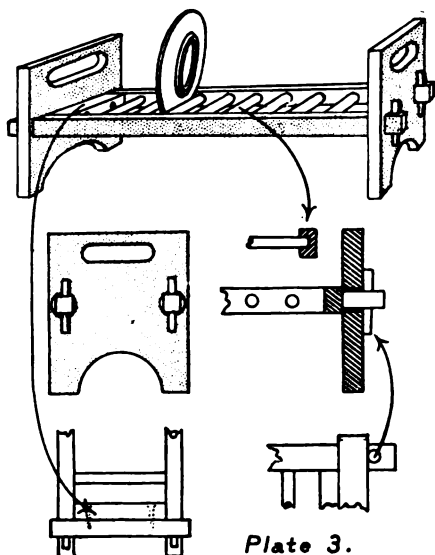

Plate 3.

The Principal Advantage of This Useful Plate Rack For Use in the Sink is That It Can Be Readily Pulled Apart and Thoroughly Cleaned, Which is Not the Case with the Average Rack That is Nailed or Glued Together Rigidly.

rack from twisting when the side rails are in place. These pieces fit between the rails as shown in cut. The side rails are 1½"x2" and as long as required. The tenons are 1½" square by 2" long and have a 5/8" hole bored with centers 1¼" from shoulder of tenon, the sides being 3/4" thick. Round tapered binding pins are used for locking the end pieces. Half inch holes are bored 1¼" apart, part way thru the side rails, to hold the 7/16th" glass rods in the manner illustrated.

MAGAZINE AND NEWSPAPER RACK.

The tall, narrow, bookcase-like piece of furniture designing illustrated is particularly useful in the porch room of the modern suburban home, but will be found desirable in any room occupied by members of the family who wish to keep their "pet" periodicals in presentable condition. The height of such a rack (5 feet) and its small lateral dimensions (16½"x10½", inside measure) make the building of it important in two respects, namely, a solid reinforced base and a top construction that will hold together when the rack is moved with its load of books. It will be seen from the illustrations that the base is con-

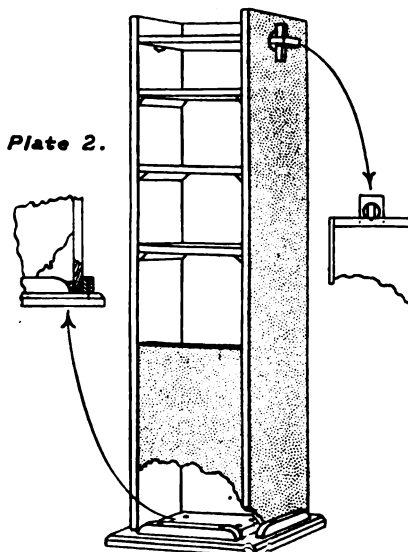

Plate 2.

Here's How to Make a Simple, Yet Exceedingly Strong and Useful Magazine or Newspaper Rack, Suitable For That "Odd Corner" on the Porch or in the Reading Room and Library.

structed of a bottom board, a second inside board and three pieces of moulding placed outside of the sides and front, thus forming a deep groove to hold the upper part of the rack. The sides and front are fastened with nails to the second inside piece in the usual manner.

The top is formed by boring one hole (2" in diameter) with center 3" from on the top in the middle of each side. Tenons are then formed (1½" wide) on the top piece by sawing four corners out of a board (22½"x10½"), as shown. The top will then be 16½"x10½" with a 1½" tenon, 3" long at each end. As the lumber for the rack is 3/4" thick, we should allow 1/8" for the binding pins to squeeze the side when put thru the tenons, therefore bore their holes 1" in diameter with centers 1½" from the shoulder, or inside corner of the notch. A round tapered pin (3" long and 1" at the big end) forms each pin. The back can be of thin wood (3/16" thick or of that thickness in straw-board, known as "wall-board") and nailed on when the rack is otherwise completed.

BEACH SEAT AND LUNCH BOX COMBINED

A home-made beach seat with a convenient lunch box attachment is shown in the illustration herewith. In the top view

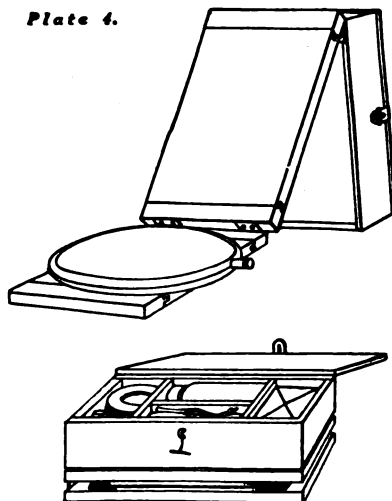

Plate 4.

A Beach Seat with a Lunch Box Attachment, Which Everyone Will Find Useful.

this handy device is seen in a conventional position with the box forming a back brace for that part of the seat, and a pneumatic (air-inflated) cushion on the lower section. The three parts are hinged as shown. In the lower view the lunch box is shown open, with the back and seat folded, inclosing the cushion. A shawl-strap or series of straps permanently attached to the box can be used for carrying.

The thickness of the seat should be 5/8 inch, the back 1/2 inch and the box lumber 3/8 inch. Both the back and seat to be reinforced with end pieces as shown. The ordinary breadboard sold in department and hardware stores will answer for these parts, one 5/8 inch thick and 14 by 20 inches is about the size required. A straw pad of the Japanese variety can be used in place of the pneumatic cushion. If the complete device is painted a light blue, yellow or green, it will have an increased appearance of lightness.

CLEANING KIT-BOX.

Many an ink-stain, drop of paint or grease-spot could have been instantly re-

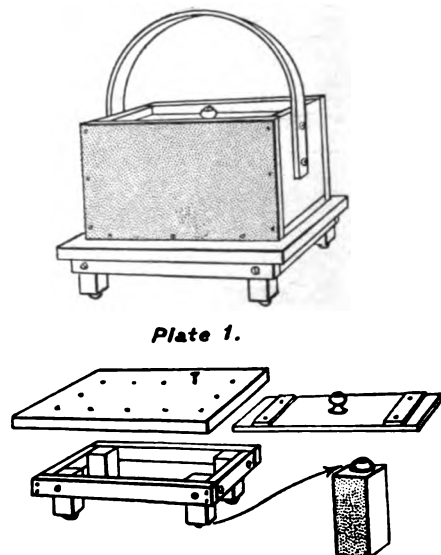

Plate 1.

Here is Something That You Probably Have Never Thought of—a Neat Little Box Provided with a Handle and Rubber Feet, Not Forgetting a Cover to Contain Cloths and Chemicals for Cleaning Woodwork, Etc.

moved with the proper use of such an outfit. A little book of first aid recipes for doctoring house or furniture ailments such as the above, or water or heat stains on varnish, for instance, could be a part of the outfit. One can see that a white spot on the dining table, caused by an overheated teapot, would succumb to this treatment very nicely.

In the interim we show a plain device for plain people, one which anyone, plain or otherwise, can make from a common packing box, a wooden barrel hoop and a little odd lumber, all of which can be obtained from a grocer or druggist with very little persuasion or trouble. The idea is to have the outfit box so easily obtained or made that it will be in every home; a kind of national institution for reducing the high physical or mental asset of house-cleaning as we now know it. This original, only institution of its kind is shown in the figure herewith. The object of raising the box on legs is to allow air to circulate beneath it, thus keeping its contents from becoming damp. Rubber chair leg buttons are put on the legs so that the box can be set on wood or tile floors without scratching them. The illustrations show the details.

"Home Electrics"

By G. L. HOADLEY, M. E.

SIMPLE BELL CIRCUITS

THE four main items necessary to put up an electric bell are the bell, the battery or other source of current, the push button, and the wire. The simple bell circuits will be shown first. Figure 1 illustrates the simplest type of circuit. Pressure on push button PB,

Two Bells and Buzzer.—An arrangement suitable for a residence is shown in Fig. 6. Both the front and back door bells are usually located in the kitchen and have different sounds to indicate from which door the call comes. The push for the dining room buzzer is within that room, and the

Lighting Circuit.—About 0.1 ampere is required to operate the ordinary bell, and in operating a bell from the electric lighting circuit, enough incandescent lamps should be used to cut down the current to this value. Fig. 10 shows the proper connections. Care should be taken to have at least

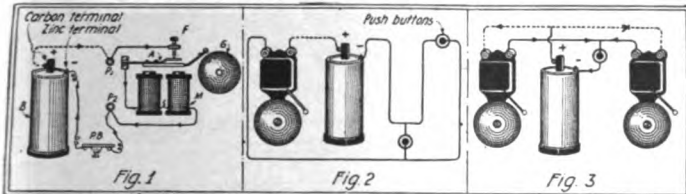
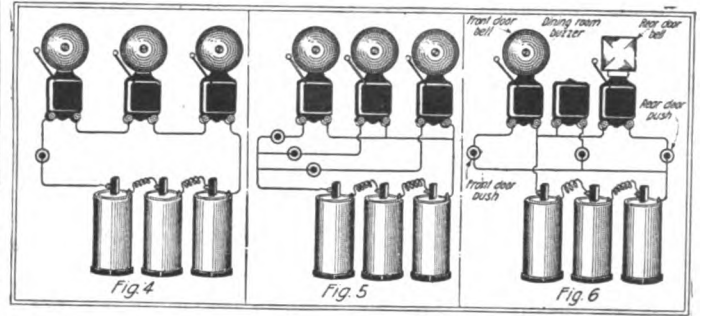

Fig. 1—Showing Dry Battery "B," Push-Button "PB" and Vibrating Bell "M," as Well as Path Taken by Current. Fig. 2—How to Ring One Bell From Two Different Push-Buttons. Fig. 3—Two Bells Rung From One Push-Button.

Fig. 4—Shows Several Bells Connected in Series. All of the Bells, Except One, Are Made "Single Stroke." Fig. 5—Shows Three Distinct Bell Circuits Operated From "Common Battery." Fig. 6—Shows Three House Signals on Common Battery.



closes the circuit and current travels as indicated by the arrows from the positive post of the battery to binding-post, P₁, thru the spring contact of the vibrating armature A, and tip of the contact screw F, thence thru the magnet M, and out at binding-post P₂, back to the battery.

One Bell and Two Pushes.—In Fig. 2 is shown how a single bell can be made to ring from two (or more) pushes situated in different rooms, for example, or at the front and back doors of a house. Even if both pushes be operated, the bell rings because the carbon or positive terminal is connected to each pusher.

Bells in Multiple.—Fig. 3 shows how two (or more) bells may be rung from one push button. Since the bells are in "parallel" here, the current divides itself between the two bells and larger batteries or more cells are required to supply the extra current needed. Vibrating bells will operate satisfactorily in multiple under these conditions.

Bells in Series.—In Fig. 4 is shown the wiring for bells in series with each other. This arrangement requires more current to operate than the parallel circuit in the previous diagram because the resistance of the circuit is larger. Vibrating bell and one or more single stroke bells will work satisfactorily when so connected. A number of vibrating bells can be made to operate in series if a short circuit be placed round the make-and-break contacts on all the bells except one. Then the master bell will make and break the circuit for all of them and all the bells will vibrate together.

Bells in Parallel With Common Return.—Fig. 5 shows how three bells may be connected up in multiple using a common return wire.

buzzer is located in the kitchen or pantry.

Note.—In the above sketches the dotted line wire may be replaced by the earth if desired. A saving in wire is effected by using the earth as the return circuit. As a general proposition, however, the ground return circuit is undesirable, as one ground on one of the normally ungrounded wires will render the system inoperative. In cities and towns and near electric railway circuits "stray" currents are likely to interfere with the normal operation of the bell circuits.

Parts of Bell Circuit.—A knowledge of the construction of the various parts of the circuit is necessary to master the operation of the more complex bell circuits and follows herewith.

Push Button.—In Fig. 7 are shown the details of a very commonly used "push" which makes a single contact. This type is generally used for the simple bell circuits previously described. For return call systems (see Fig. 13), a "Double contact" push is necessary. This type is shown in detail in Fig. 8 and is also termed the "three-point" or "return call" push button. Typical applications are shown later in Fig. 13.

Source of Current, Battery.—The dry cell is most generally used for door bell circuits as it is more convenient and reliable than the wet battery and really cheaper in the long run. The dry cell lasts a long time for ordinary bell work and is quickly replaced. Where several bells are to be operated or where a circuit of considerable length is operated, several dry cells are connected either in series or in parallel or in series-parallel; the proper connection being a matter of "cut-and-try" to see which gives the best results. Fig. 9 shows a series-parallel connection of two batteries, each having two cells in series.

one lamp in series with each side of the circuit at the cut-out to prevent trouble in case of an accidental ground on the bell circuit. The ordinary trembling bell arcs too much at the vibrating contacts unless a lamp is connected in shunt with it as shown in Fig. 10. A differential bell will work very satisfactorily, however, with lamps in series as shown in Fig. 11. There is, of course, a waste of power in the added resistance and the necessity of renewing broken globes are two disadvantages to this source of power.

Bell-ringing Transformer.—Wherever alternating current is available the bell transformer should be used for operating the bells. Such a transformer properly installed will give service at all times and need never be replaced. The cost of operating a well designed bell ringing transformer is practically nothing, as the current for operating 1 or 2 bells is not sufficient to start an ordinary watt-hour meter, such as is used in residences. There are no losses whatever, therefore, that the owner bears in a transformer installation. The installation of the transformer requires a little care on the part of the electrician or wireman. The National Electrical Code rules require that the primary side of the transformer, with the wiring shall be in accordance with the regular rules for the installation of lighting wires. The secondary circuit of a transformer may be installed in accordance with the Code rules for signal systems. Fig. 12 shows the bell ringing transformer connected to the lighting mains, with the bell wiring circuit attached.

(Continued on page 522)

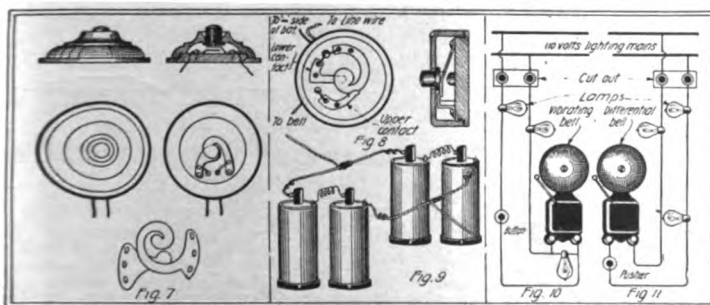

Fig. 7—Shows Plan, Section, Elevation and Metal Contacts of a "Push-Button." Fig. 8—Shows Plan and Section of Double Contact Push. Fig. 9—Battery Cells Connected in Series-Parallel. Figs. 10 and 11—Bells Being Operated From Lighting Mains.

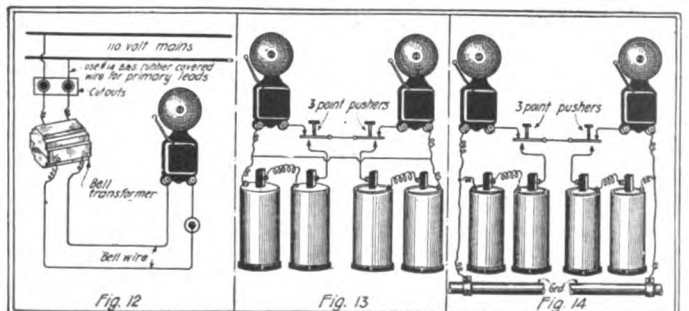

Fig. 12—Shows Connections of Step-Down Bell-Ringing Transformer. Fig. 13—Two-Line "Return Call" Bell System with Two Sets of Batteries. Fig. 14—Illustrating a "Grounded" Return Call System; Separate Batteries For Each Circuit.

MOTOR HINTS

1st Prize \$25.00.

A HAND-CONTROLLED CAR

Some time after receiving a bullet-wound that disabled my legs, I read a newspaper announcement to the effect that the judges in a certain competition had declared me a successful participant, and had wished onto me two of the chief prizes—specifically, a

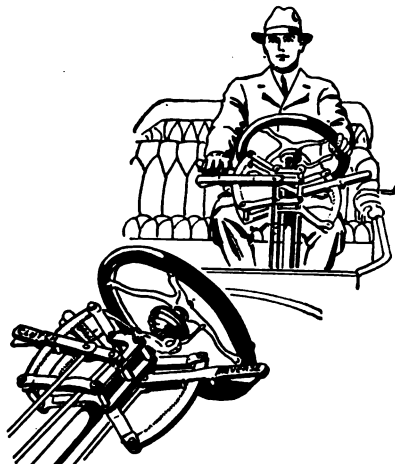

By Means of These Three-Toothed Quadrants and Handles Anyone Who Has Lost the Use of the Lower Limbs Can Readily Steer and Control the Car.

player-piano; and a touring-car with four sturdy cylinders behind its radiator and four name-letters in front.

Two mechanisms, both workable only with the feet—and my feet helpless! What ironical luck!

But not for long. Taking the contest judges at their full word that I was "a winner," I put aside for a while the simpler problem of converting the foot-power piano into a *hand-pumper*, and focused my thought upon contriving some means to control the car with the hands alone!

Several of the necessary parts I fashioned in my own garage; for the rest, drilling and forge work, I submitted my drawings to a machinist. Briefly, the device consists of three toothed quadrants bolted to the steering column. Each quadrant carries a lever; and each lever, pawls to engage the teeth at any point in its up-and-down throw. Three oblique rods run from the levers down thru the dash to a trio of bell-cranks—small L-shaped pieces each pivoted at its corner to the engine-base. From these, in turn, run three more rods, horizontally beneath the floor, to the extended pedal-shafts. Tension springs from dash to bell-cranks cause the levers under the steering-wheel to return automatically; and the brake lever, when prest, interacts very simply with the clutch, releasing it without resort to the clutch lever itself.

Twenty thousand miles of city and mountain motoring have taught me that the advantages of driving thus by hand instead of by foot are many, while I have yet to discover a single disadvantage. I have none of these hand-control appliances for sale. But if any "Buddy" injured in the late World War, or anybody else, is earnestly curious, I shall gladly supply further details *gratis* in response to inquiries forwarded to my address by the editor.

Contributed by A. B. TRIPP.

2nd Prize \$15.00.

EMERGENCY GASOLINE SUPPLY.

The experienced motorist always carries a spare can of gasoline in the expectation of the time he will be caught without gas in his tank. But too often he forgets to fill the spare can and he is as bad off as ever. Herein is described a can that it is impos-

\$50.00 IN PRIZES.

Paid for "Motor Hints."

Most of our readers have a car of their own, and any number of them have made certain improvements on that car. We want to know about these improvements. What we want are PRACTICAL ideas, not freak stunts. The idea should be simple enough, so that anyone handy with tools can duplicate it. Note that the idea does not necessarily have to be electrical in any way.

We would like to have a photograph of the stunt showing that it was actually tried, but this is not absolutely necessary to win a prize. A simple sketch will do showing the essential parts, etc.

We will pay the following prizes each month:

FIRST PRIZE.....\$25.00
SECOND PRIZE.....15.00
THIRD PRIZE.....10.00

All other accepted articles, which win no prizes will be paid for at the rate of \$2.00. Articles submitted should not be long ones. About one hundred to two hundreds words will suffice. Address all manuscripts to Editor, "Motor Hints," care of this publication.

sible to forget to fill for it fills itself every time the tank is filled.

A tin tube is soldered to the cap of the gasoline tank long enough to reach to the bottom of the tank. A hole is cut in the tube just below where it is attached to the cap. The bottom of the tube is closed by a disk of tin having the valve taken from a bicycle tire soldered in the center. The function of this valve is to permit gasoline

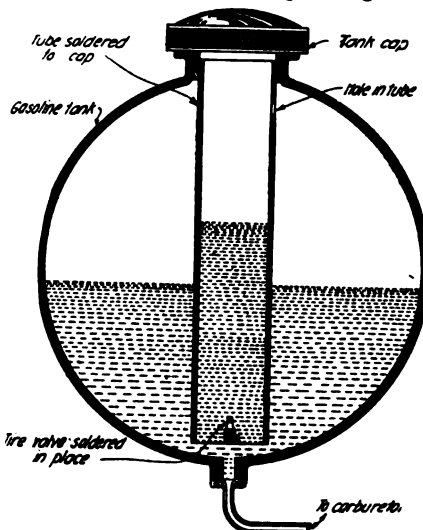

Ever Been Stuck 20 Miles From Home with the "Gas" All Gone? Here's a Clever Idea For an Emergency "Gas" Supply.

to flow up into the tube when the tank is filled and then to retain it there as the tank empties.

This reserve supply of gasoline is usually sufficient to reach the next gas station. The tube can also be used as a gage by properly marking it.

Contributed by THOMAS W. BENSON.

Third Prize, \$10.00.

REAR SIGNAL LIGHT.

The accompanying photograph and diagram show how I constructed and installed a rear signal lamp and sign on my automo-

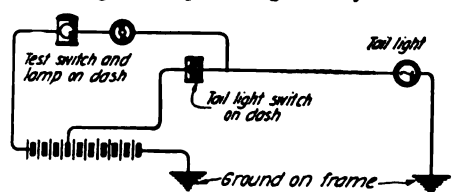

A Good Idea—a Telltale Signal Light to Indicate Whether the Tail Light Is On.

bile. The diagram is practically self-explanatory—a three point switch is mounted in a convenient position for the driver and current for lighting the lamps is obtained either from a car battery or from dry cells, or magneto.

The lamps used may be all white ones or colored as the owner wishes. The best way

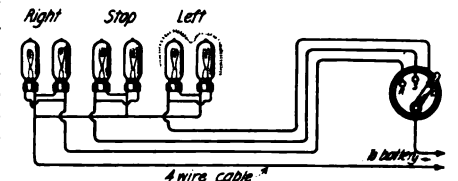
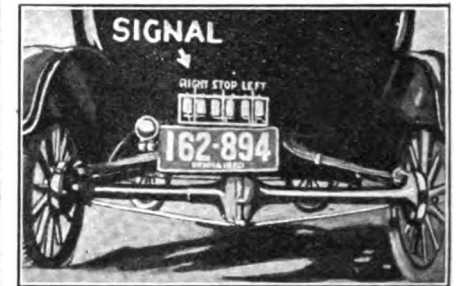

A Simple Yet Positive Electric Signal For the Rear of Your Automobile. It Is Operated From the Seat.

of course, is to build a small sheet iron box, water-tight, and paint letters on the front of the box for the corresponding lamps or sets of lamps. But one signal is flashed at a time, either RIGHT, STOP, or LEFT.

The wires used in installing this signal in a car should be rubber covered and the heavier the better, if you want to make it real trouble-proof.

The second diagram shows a scheme which I have used successfully to indicate when the tail-light is out, without having to get out of the car. In other words, it serves as a tell-tale signal.

Contributed by JOHN J. SLANINA.

DO NOT "RIDE" THE CLUTCH.

One of the commonest faults of auto drivers is that of keeping their feet on the clutch pedal while driving. There are different kinds of clutch throw-out collars which are brass, bronze, ball-bearing and some of wood.

By keeping the foot on the clutch pedal as a rest, no matter how gently you press on the pedal, you will always put a pressure on the throw-out collar which causes great friction, causing the parts to heat up and the lubricant to thin up and run off; this friction wearing off the throw-out collar.

It is a good practise to learn to drive with the foot off the clutch pedal!

The best way to operate the clutch pedal is to have from one-eighth to five-sixteenths inch play from foot-boards, thus insuring removal of all possibilities of any friction.

Contributed by C. C. MOREAU.

FILLS CRANK-CASE WITH WATER IN EMERGENCY.

How many of us, that drive Fords, have run out of lubricating oil just where it is unobtainable? I have had it happen several times, but it never worries me. I simply fill my crank-case with water until oil flows out of the top pet-cock. This has always brought me home. In fact I have made as much as fifty miles this way.

Contributed by HOWARD SUTTLE.

PHONOGRAPH PRIZE CONTEST

What Can You Do With Your Phonograph?



The Phonograph Needle Sharpener is the Latest Invention of Mr. J. G. Hobson. It is a Small Attachment Which Screws to the Top of a Phonograph, and by Means of a Friction Wheel Rotates an Abrasive Stone, Sharpening the Needle in a Jiffy.

THERE is a phonograph of some sort or other in almost every home nowadays and it is of course used chiefly for musical purposes; or, from the viewpoint of the man who does *not* own one, for the purpose of annoying him and keeping him awake when he wants to sleep. At any rate phonographs are built primarily to dispense music.

Has it however, occurred to you that the phonograph might be used for other purposes besides playing records?

In the modern phonograph we have a powerful silent spring motor and we have also a speed regulator. In other words we have here a motive power of no little force which is constant and which can be utilized for a variety of other purposes than for merely whirling the black disks.

The purpose of this contest is to test the ingenuity of our readers and to ascertain whether or not something real useful and practical can be discovered for the purpose of utilizing the motive energy of the phonograph.

On an average a phonograph works hardly more than one hour, seldom running as long as two hours per day. In other words for a considerable time it is idle, when it might be doing some useful work or per-

haps amuse someone. What can our readers do by way of suggestions?

Let us give a few illustrations to show just what we are after. The editor has a little girl who used to be afraid to go to sleep in the dark, and even with the light burning it always took her from three-quarters to one hour to fall asleep. So the editor one day hit upon a novel means to artificially bring about sleep in a harmless manner. He took a pasteboard box, as shown in the illustration, and cut a dozen slots about four inches long and about a half inch wide equally spaced apart into the cardboard. Then he pasted thin strips of colored tissue paper inside the round box so that the slots were covered up. Four colors were used: red, white, blue and green. The pasting of these pieces of paper was done so that the colors alternated from slot to slot. This box was then placed on top of the turntable after having pushed a hole into the bottom to fit the stud on which the phonograph records are so placed.

An electrical lamp from a nearby fixture was hung within the box which was open at the top and the phonograph, after having been wound up was started at its slowest speed.



Dancing Toys Attached to the Top of a Phonograph Have Been Very Popular For Amusing Children. There Are at Least Four or Five Different Styles on the Market.

ture showing a different pose from the preceding one. The box is then rotated and the picture is viewed by looking into the inside thru the narrow slots which are about $\frac{1}{4}$ inch wide and four inches high. As the box rotates a true animated picture is seen exactly as our present day moving pictures. This movie-scope can be placed upon the phonograph turn table and will work very well. Toy dealers have been selling such movie-scopes for some time.

A very original idea is shown in our next illustration and this is the invention of Mr. J. G. Hobson who conducts the department *What To Invent* in this publication. Recently M. Hobson sent a little machine to the editor and there seems to be a great demand for such a device. Mr. Hobson reports that his factory is behind with about 4,000 of these needle sharpeners and that they have sold over 50,000 so far. The device is a small affair which screws to the phonograph and is for the purpose of re-sharpening the worn-out phonograph needles instead of throwing them away. The device is very simple and sells at a low cost. It consists of a friction turn-wheel, the shaft of which has a small abrasive stone. As the wheel turns this stone presses against the phonograph needle which is inserted into a small top hole and held in place. In a few seconds the needle is re-sharpened. In ten minutes' time a great many needles can thus be re-sharpened.

(Continued on page 533)

\$50.00 IN PRIZES

We want original ideas on how to use a phonograph for other, besides musical purposes. Every phonograph has a powerful spring motor, a regulator and a rotating turntable. **WHAT DOES THIS SUGGEST TO YOU?** Read this article for suggestions—and note particularly that if the idea is patentable you will be protected for two years.

We will pay the following prizes:

FIRST PRIZE \$25.00
 SECOND PRIZE 15.00
 THIRD PRIZE 10.00
 —Editor.

The little girl whose room was adjoining just managed to see the rotating box and being in a dark room her eyes were naturally fixt on the whirling colored box. After watching the box for five or six minutes she usually fell asleep after which the device was stopt and the light turned off.

A second idea is shown in another one of our illustrations, which shows a coon jigger dancing up and down on the record and which may be bought at most novelty stores. At one time this was a quite popular device selling from about 50c to 75c, and it is reported that hundreds and thousands of these were sold for the amusement of children; thousands are in use today. This device of course can be used while the phonograph is playing, or it can be used without a record using the rotating turntable only. It just gives an idea what can be done along such lines.

In our next illustration we have the *movie-scope* called the Zoetrope. This toy is well known and was the forerunner of the present day "movies." It is simply a cardboard cylinder open at the top; it is about seven to eight inches in diameter and about five inches high. Different strips of paper are placed along the inner circumference of the cylinder and on these strips are printed various pictures such as a jumping cat or a running horse, each pic-



If Your Little Boy or Girl Is Afraid of the Dark, Take an Old Hat-Box, Cut Slots in the Sides and Paste Colored Papers Over the Slots. An Electric Light Inside Completes the Device. Rotate It on the Phonograph. It Will Put Any Child to Sleep.



Here We Have the Moviescope, Which Was the First Moving Picture Machine in Existence. It is a Great Favorite with Children From Four to Ninety Years Old. It Can Be Placed upon the Phonograph and Works Well.

Popular Astronomy

By ISABEL M. LEWIS, M.A.

Of U. S. Naval Observatory

WHENEVER a moving body is brought to rest its energy of motion or kinetic energy is transformed into heat. The amount of heat evolved depends on the mass of the body and on the velocity with which it was moving.

An astronomical example of this transfer of energy of motion into heat is afforded us in the stoppage of millions of meteoric particles daily by friction with the earth's atmosphere. These particles average less than a grain in weight and are moving with an average velocity of twenty-six miles per second when they enter our atmosphere. The amount of heat evolved when these "shooting stars" are stopt by friction is hundreds of times greater than would be afforded by burning an equal quantity of coal in pure oxygen and is more than sufficient to fuse the most refractory substances. Tho the particles are extremely minute the intensity of their light arising from friction with the air makes them visible to us at distances of sixty miles or more. Anyone who has observed the passage thru the air of a large meteor, or fireball, weighing possibly a pound or so, knows what terrific explosions are produced and what blinding

Collision of the Earth with Heavenly Bodies

flashes of light, indicative of the tremendous amount of energy suddenly released from such an insignificant mass.

It can be shown by simple computation that the amount of heat evolved in arresting the motion of a kilogram of matter (2.2 pounds) entering the earth's atmosphere with a velocity of twenty miles per second, is about 125,000 calories.

The amount of heat received from the sun per square meter of the earth's surface per minute is thirty calories, and if one hundred tons of meteoric matter fell daily with a velocity of twenty miles per second over every square mile of the earth's surface *as much heat would be furnished to us from this source alone as we receive from the sun!*

In view of the fact that such a tremendous amount of heat is evolved in arresting the motion of matter it was believed at one time that possibly the radiant energy of the sun might be replenished by the falling of meteoric matter onto its surface.

A kilogram of matter falling to the sun from the distance of the planets would ac-

quire a velocity of 380 miles per second by the time it reached the surface of the sun and the amount of heat released in arresting its motion would be 45,000,000 calories. Now the sun radiates from every square meter of its surface per minute about 1,400,000 calories, and computations showed that a quantity of meteoric matter equal to one-seventy-fourth of the earth's mass, or a little more than the mass of the moon, hurled against the solar surface *every year* with a velocity of 380 miles per second would suffice to maintain the sun's energy of radiation. We may say in passing that this theory of the source of the solar energy fails for the reason that if such a quantity of meteoric matter were actually striking the solar surface yearly it would imply that there existed within the solar system such a tremendous total mass of meteoric matter that the planets as well as the sun would be bombarded by meteors to a far greater extent than they actually are and thru its gravitational effect it would seriously perturb the motions of all the members of the solar system. That a certain small per cent of the solar energy is replenished by the fall of meteoric matter to the surface of the sun there can be no doubt, but it must be extremely small.

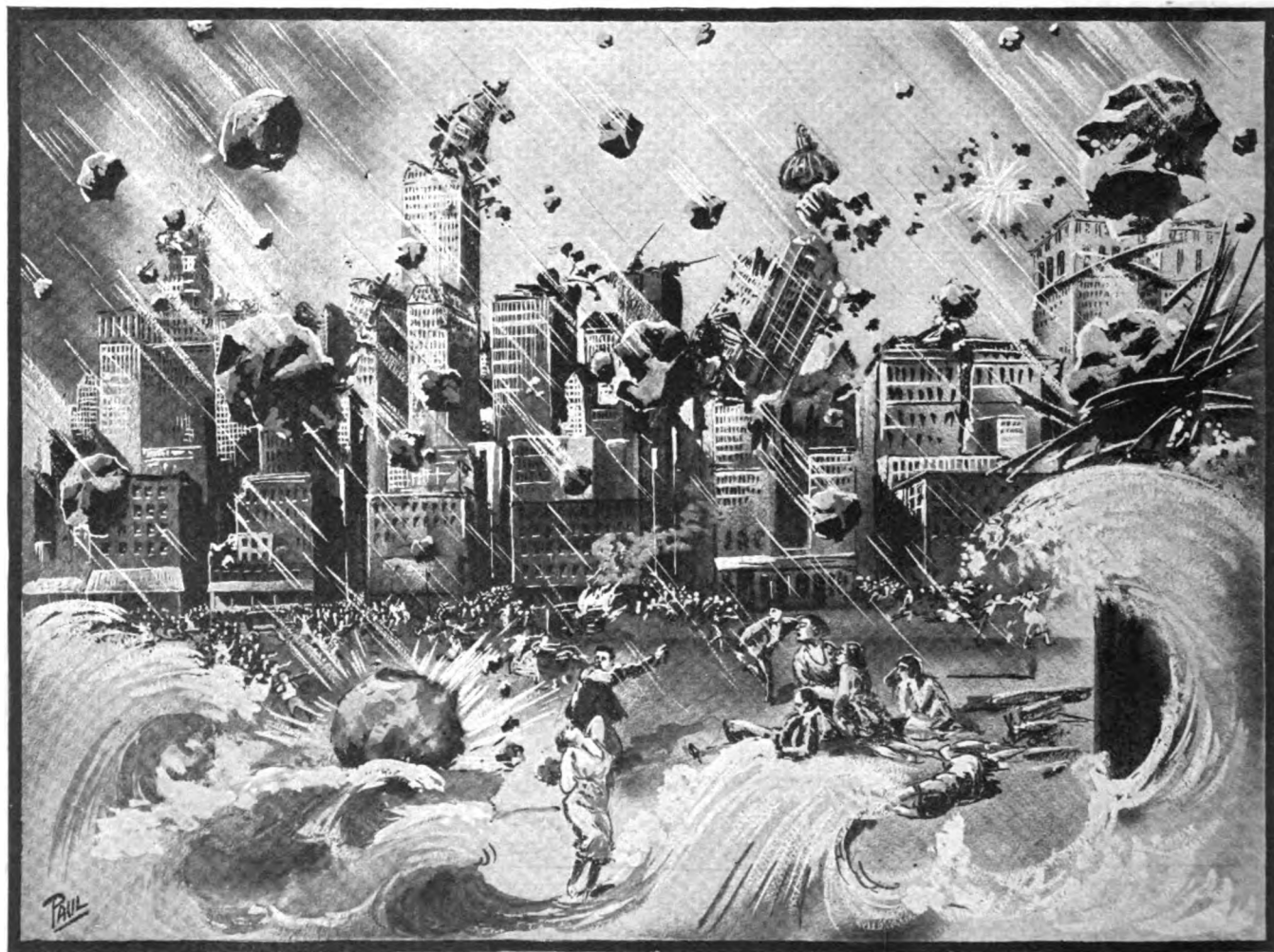

The Earth Has Past Many Times Thru the Tail of a Comet, and This Happened Only a Few Years Ago. The Tail of the Comet, However, is So Fine That We Were Not the Wiser for It, and Only Astronomers Knew That the Earth Past Thru the Comet's Tail. In This Illustration is Shown Graphically What Would Happen If the Earth Would Plow Its Way Thru the Head of a Comet. Such a Head Measures About 100,000 Miles in Diameter, and is Not at All Solid as Has Been Thought for a Long Time. It Has Been Calculated That the Head of a Comet Has Only About One Hundred Millionth Part of the Mass of the Earth and Therefore While Such a Collision Would Be Disagreeable, it would Not Destroy the Earth.

Outside of Doing Local Damage in Various Parts of the Earth, Killing Cattle and People, and Wrecking Buildings, the Earth Would Emerge Practically Intact After Such a Collision. It is Interesting to Note That a Head-On Collision With the Comet's Nucleus Occurs Only Once in Fifteen Million Years.

If a mass of matter equal to that of the moon falling into the sun yearly would actually account for its entire radiation during that period, one can imagine what disastrous results to the solar system would follow if a body the size of our planet were to fall into the sun from outer space or from the distances of the planets.

If the earth's orbital velocity should suddenly be completely arrested, the earth would fall to the sun in a period of sixty-four and a fraction days! The sudden stopping of the earth in its orbit would be attended by a tremendous evolution of heat and light and by explosions of the earth material. Particles of the earth material thrown from the parent mass by the force of explosions would revolve about the sun in orbits intersecting at the scene of the catastrophe and particles that were ejected with equal velocity would return at the same time whatever their direction of ejection. The remnant of the shattered world possessing no velocity of translation would fall into the sun under gravitational attraction and bring about a second catastrophe by suddenly increasing the intensity of the solar radiation. If all the energy produced by arresting the motion of a mass equal to that of the earth and moving with a velocity of 380 miles per second should be instantly available, it would amount to as much as the sun radiates in seventy-odd years and would probably turn our sun into a *Nova* (new star) and our solar system into a chaotic nebulous mass in place of the orderly family of planets with their satellites that now encircle the sun in orbits, that are almost perfect circles and in periods of time that remain practically invariable for millions of years.

If the earth were moving thru a resisting medium instead of thru a vacuum, its speed of axial rotation would be gradually diminishing, just as the rate of rotation of a spinning top is continually decreased by the resistance of the air, and as a result the length of the day would be increasing continually. Moreover, the earth's speed of revolution around the sun would decrease and it would therefore be constrained to move in an orbit of smaller size and its distance from the sun would accordingly decrease. In the course of ages it would draw in nearer and nearer to the sun until finally it would be torn asunder by tidal strains and its pulverized remains would fall upon the solar surface.

Judging from the invariability of the rates of axial rotations of the planets and also of their periods of revolution around the sun there exists within the solar system no extensive resisting medium that retards to the slightest degree the movements

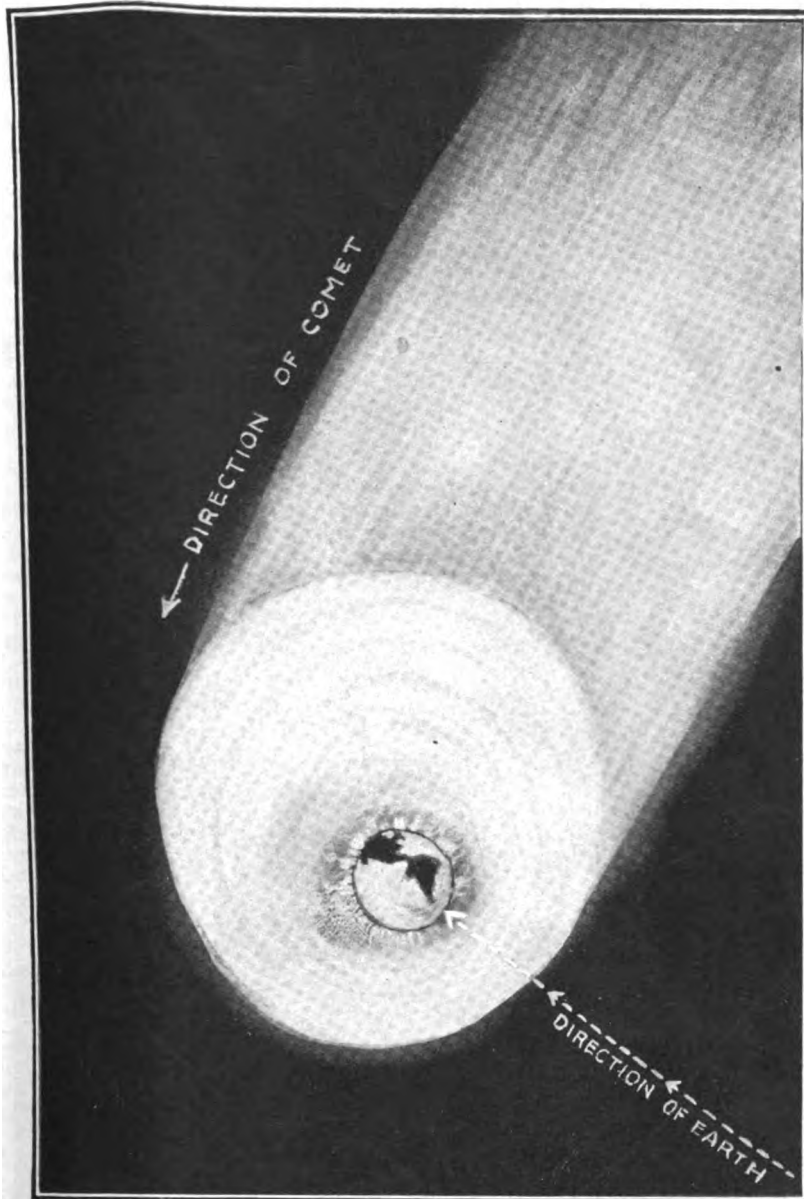

A Distant View Taken From Space Shows How the Earth Would Plow Thru the Head of a Comet. Note That the Head of the Comet Measures About 100,000 miles. It Would Take About 40 Minutes for the Earth to Traverse Thru the Nucleus of the Comet for the Reason That the Two Bodies Move at the Rate of 40 Miles per Second.

of any of the planets or their satellites or even the tenuous comets with one or two remarkable exceptions.

Enck's comet, which revolves about the sun in the shortest of all known cometary periods, shows at times a peculiar acceleration of motion, of about two and one-half hours in a revolution of 3.3 years that can be explained only by assuming that it encounters some form of resisting medium at some point in its path. Such a medium would be incapable of checking in the slightest degree the speed of the more massive members of the solar system and may be effective in slacking the speed of this comet only because it is composed of matter in an extremely tenuous form.

Comets are in proportion to their mass the bulkiest of all celestial bodies. Their heads are anywhere from ten thousand to a million miles in diameter, and their tails, which develop only when they are comparatively near to the sun, may be millions of miles in length. We know next to nothing regarding the total mass of a comet tho we can set an upper limit that it cannot exceed. Comets have past so close to the planets at times that were their individual masses as great as one hundred-thousandth part of the mass of the earth they would have produced measurable disturbances in the motions of the planets

and no such disturbances have ever been observed. It has also been observed frequently that stars have shone thru the tails of comets and even in some instances thru the heads without any appreciable diminution of brightness, tho a few observers have suspected at times a slight decrease in the brightness of a star when viewed thru the head of a comet.

It is therefore probable that the total quantity of matter in the average comet does not exceed one-millionth part of the mass of the earth and it may be far less. Probably by far the greater part of this mass is collected in the nucleus and head of the comet. The tail, which consists of minute particles driven off from the head by the pressure of radiant light and electrical repulsion, having a density about the same as that of the solar corona or of the best vacuum man can produce.

The individual particles in the nucleus of the comet may be no larger than grains of sand or they may be of the size of hens' eggs, or possibly they may be boulders weighing tons, separated from one another by hundreds of feet.

Now, if the earth's surface were weighed at its surface piecemeal it would total six times ten to the twenty-first power tons—that is, six followed by twenty-one ciphers (6,000,000,000,000,000,000,000 tons). Assuming that there is in the nucleus and denser portions of the

head of the average comet a quantity of matter equal to one hundred-millionth part of the mass of the earth, we find that this gives the quite considerable quantity of six followed by thirteen ciphers tons for the amount of meteoric matter thus assembled. If we take as the diameter of the head of the average comet one hundred thousand miles and assume that this quantity of matter is distributed with fairly uniform density thruout a sphere of this diameter, we find that the average amount of matter in the head per cubic mile would be about one-tenth of a ton.

What would be the effect of a head-on collision of the earth traveling at the rate of eighteen miles per second, with the head and nucleus of this comet, which we will assume is traveling at the rate of twenty-two miles per second?

The relative velocity of the two bodies at the time of impact would be forty miles per second! The earth would pass thru the head of the comet in a little over forty minutes. The forward or day side of the earth only would feel the direct effects of the encounter. Every square mile of this hemisphere of the earth would be bombarded with four tons of meteoric matter per second for a period of two thousand five hundred seconds (forty-one and a

(Continued on page 570)

Practical Chemical Experiments

By PROF. FLOYD L. DARROW

CHEMICAL EFFECTS OF LIGHT



Producing Oxygen By the Action of Sunlight on the Chlorophyll of Green Leaves.

TO a vastly greater degree than many of us are aware this planet and its inhabitants are dependent upon the chemical effects of Light for the energy we use and the pleasures we enjoy. It is the energy transmitted in the chemical rays of the sun that takes the carbon dioxide breathed in from the air, and the water absorbed thru the roots, and builds them into the woody fiber of the tree. Many other processes of life and decay are directly or indirectly dependent upon the chemical energy of sunlight, while the chemical effects of the violet rays of the spectrum upon the silver salts of photography are among the marvels of modern science.

Effect of Sunlight upon a Mixture of Hydrogen and Chlorine: Set up apparatus in exactly the same way as was described in the article of this series for July. Select a small thick-walled bottle — one holding not over two ounces, for a small quantity of the gases produces a big explosion. Fill the bottle with water and invert in a basin of water. Then start the hydrogen generator and fill the bottle full of hydrogen by displacement of water. Fill the remainder of the space with chlorine, collecting it over water in the same way as the hydrogen. Be sure this is done in a well-shaded room and that no direct sunlight falls upon the bottle. Slip a glass plate under the bottle, remove it and tightly stopper with a solid rubber stopper. Place it under a heavy thick-walled battery jar raised on quarter-inch blocks from the table. In front of this mount a substantial glass screen. See Figure 1. Have at hand a flash powder made by mixing equal parts of magnesium dust and pulverized potassium chlorate. Place a small quantity of the powder on an asbestos square at a distance of

six or eight inches in front of the glass screen. Ignite the powder with a long wax taper. As the intensely bright white light, especially rich in violet chemical rays, falls upon the mixture of gases they combine with explosive violence and the liberation of great energy. It is the chemical effect of the violet rays that produces the change.

An interesting modification of this experiment can be had by placing between the battery jar and the flash powder a screen of red glass. In this case the chemical rays are cut off and no explosion occurs. If, however, a screen of blue glass is used the gases will combine just as readily as they did in the first case.

Effect of Sunlight on Cuprous Chloride: Prepare a concentrated solution of cupric chloride and immerse in it a sheet of polished copper. The copper will become coated with a layer of insoluble cuprous chloride, the metallic copper reducing the cupric salt to cuprous form. The cuprous compound is white in color. Now wash the copper in running water and place over it some design cut from heavy paper. Upon exposure to the light the uncovered portion will turn a dark purple while the part covered by the paper will remain white. This action again is due to the chemical effects of light.

The Effect of Sunlight upon Green Leaves: Arrange apparatus as shown in Figure 2. In a two-liter flask place green leaves, not too closely packed, and fill with water thru which carbon dioxide has been allowed to bubble for some time. In the neck of the flask insert a one-holed rubber stopper carrying a funnel and so firmly prest in that the water will rise and fill the stem of the funnel. Then fill the funnel two-thirds full of water and invert in it a small cylinder filled with water. Place the whole apparatus in strong sunlight and leave it for a few hours. When examined again the cylinder will be found partly full of gas. Place a glass plate beneath it and remove the cylinder in the usual way. Upon introducing a glowing splint into the gas it will burst into a flame, showing the gas to be oxygen. The same

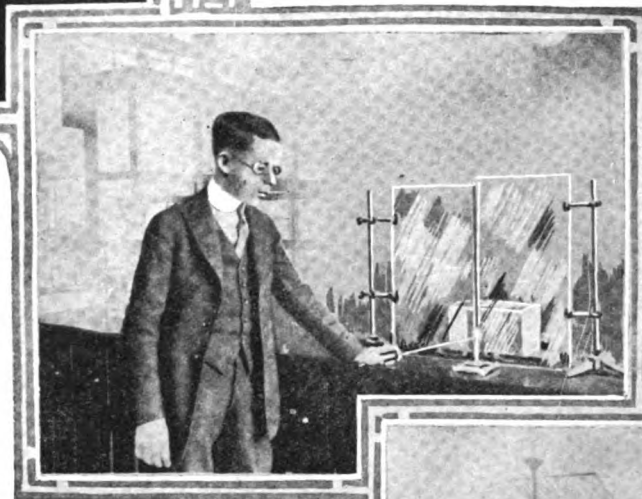

Exploding a Mixture of Hydrogen and Chlorine by the Chemical Rays of a Flashlight. (A Very Small Bottle of the Mixture Is Placed Under the Heavy Battery Jar Behind the Glass Screen.



Preparing Blue Print Paper By Lightly Drawing a Piece Over the Sensitizing Solution.

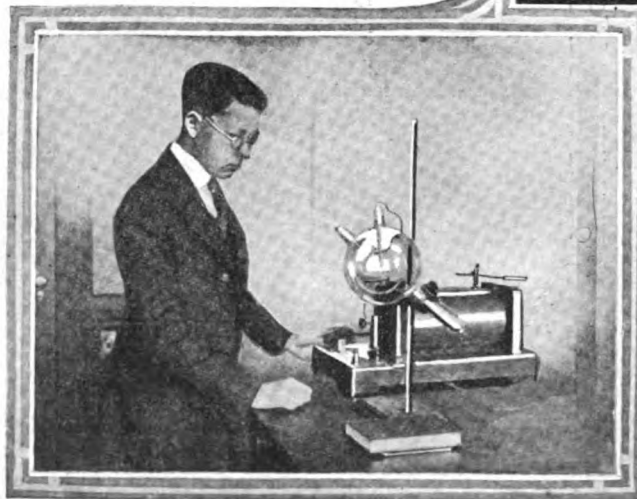

At Left: Making a Radio-graph of a Key Placed in a Book Which Lies upon a Photographic Plate, Wrapt in Black Paper.

chemical action has taken place here that occurs in the leaves of a growing plant. The chlorophyll of the leaves, aided by the chemical effects of the sun's rays has caused the water and carbon dioxide absorbed by the leaves to unite to form cellulose, accompanied by the liberation of oxygen.

In Nature, plant life is all the while breathing in carbon dioxide from the air and giving off oxygen. When the woody fiber of these plants decays or undergoes combustion, carbon dioxide is given back to the atmosphere and oxygen is absorbed. Thus the carbon and oxygen cycle completes itself.

Blue Printing: One of the simplest and most practical applications of the chemical effects of light is found in the process of blue printing. Blue prints are made by the action of light on certain salts of iron.

To learn the chemistry of this process prepare two very dilute solutions of ferric chloride and ferrous sulfate respectively. To each of them add a few drops of a solution of potassium ferricyanide. Note that the color of the ferric salt is greenish, while that of the ferrous salt is a deep blue.

Now prepare a test tube of dilute ferric chloride solution and add to it 3 or 4 cubic centimeters of a saturated solution of oxalic acid and a few drops of potassium ferricyanide solution. Mix thoroughly and expose the test tube to strong sunlight. Almost immediately you will observe streaks of blue color in the tube, and very shortly the solution will have changed to a deep blue thruout. It is evident from these tests that the ferric salt has been reduced to ferrous form, for the ferric salt does not give a blue color with potassium ferricyanide.

To show that light is essential to this change prepare another test tube exactly similar to the previous one, but this time keep it in the dark. No change of color will be observed.

To make a blue print on paper prepare a mixture of a dilute solution of ferric chloride and a saturated solution of oxalic acid, using 3 parts of ferric chloride to 1 of oxalic acid. Place the mixture in a tray and in another tray prepare a dilute solution of potassium ferricyanide. Place these trays in a dimly lighted room. Then secure some good quality of unglazed paper and taking a square 3 by 4 inches, draw it lightly across the surface of the ferric chloride and oxalic acid solutions. Place in the center of it a coin or some other opaque object and expose to the sun light for two or three minutes. Upon floating the paper face down on the solution of potassium ferricyanide a blue color will appear over the surface except in the center where the opaque object was placed.

Preparation of real Blue Print Paper: First prepare two solutions as follows:

Solution I
 Ferric ammonium citrate....20 grams
 Water100 cc.
 Add ammonium hydroxide until a decided color appears.

Solution II
 Potassium ferricyanide....20 grams
 Water100 cc.

Make a mixture of equal parts of the two solutions and to 10 parts of the mixture add 3 parts of a saturated solution of oxalic acid.

In a dark room draw squares of good quality unglazed paper across the surface of the prepared mixture, distributing it as evenly as possible and keeping the upper side of the paper from getting wet. Dry these squares of paper in the dark. Press them if you like between the pages of some large book and they will be ready for use. The paper, like all blue print paper, will have a greenish cast when freshly prepared and before exposing to the light.

Place upon the paper some opaque object and expose to the light for a few minutes. A bluish tinge will begin to appear. Then immerse the paper in water and a deep blue will at once come wherever the paper has been exposed to the light. Wash the print long enough to remove the sensitive salts from the unexposed part. Then dry and the impression will be permanent.

Silver Salts in Photography: To learn the action of light on silver salts and the chemical action which takes place in the developing and "fixing" of a plate, film or print four solutions will be required as follows:

Silver nitrate—17 grams per liter of water.
 Potassium bromide—36 grams per liter of water.
 Hypo—250 grams of sodium thio-sulfate per liter of water.
 Developer—10 grams hydrochinone, 20 grams sodium sulfate, 1 gram potassium bromide, 1 gram citric acid, 20 grams sodium carbonate.

Keep the silver nitrate and developer in dark colored bottles or in a dark room.

Wrap a test tube in heavy dark paper and fill it one-fourth full of water. Then either from burettes, as in Figure 3, or small measuring cylinders add 1 cc. each of silver nitrate and potassium bromide solutions. This will precipitate suspended silver bromide. Mix well by very gentle shaking and carrying the test tube to a window remove the paper and expose the silver bromide to the action of the sunlight for a few minutes. In doing this turn the test tube about and gently shake it so as

the intensity of the light falling upon it. Therefore those portions of the film upon which are focused the white parts of the object will be dark and vice versa. Hence we have a negative. In the printing of the

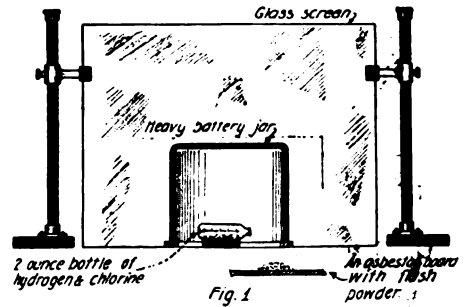

Figure 1—Exploding Hydrogen and Chlorine by the Chemical Effects of Rays of a Flashlight. A Small 2-ounce Bottle Containing the Gases is Placed, as Shown, Under a Strong Glass Jar Behind a Protective Glass Screen, the Jar Being Raised on Wooden Blocks

negative these lights and shades are again reversed and the result is a positive. The silver bromide is made wonderfully more sensitive by the presence of organic matter, as gelatine.

Photographing without a Camera: At first thought a proposition of this sort seems impossible, but as we shall see it is not. For this work it will be necessary for you to obtain from a dealer in photographic supplies a dozen sheets of "self toning" paper. One excellent kind of such paper is known as "Aristotype" paper. Self toning paper requires no developer. It prints out in the sunlight and needs only to be placed in the fixing bath and then washed. To learn its action hold a small piece in the sunlight. It will begin to darken almost immediately and quickly change to a deep brown color. But the part covered by your thumb will remain white.

Now suppose you want to make a reproduction of some picture in a book. Select a picture which is white on the reverse side of the sheet, having no printing or pictures on that side. If you will hold this up to the light with the white side toward you, you will notice that the picture can be clearly seen thru the paper. The light passes thru the white portion more readily than it does thru the picture itself.

To make a picture place a sheet of the self toning paper underneath it with the glossy side up and over the two place a piece of glass. Now put your book on the bright sunlight and leave it exposed for five to ten minutes, according to the thickness of the paper and the brightness of the light. Upon removing the paper you will find a clear print of the picture. But in order to keep it from becoming dark all over you must fix it. Therefore immerse it for ten minutes in a hypo bath. Then wash it and dry it. This print, however, will be a negative. In order to get a positive place the negative face down on another piece of the self toning paper and expose it to the sunlight as before. Then fix it, wash it and dry it.

Self toning paper contains silver chloride suspended in egg albumen.

Making an X-Ray Picture: If you have a spark coil that will give a 2 to 5 inch spark you will be able to use it on an X-ray tube. The expense, too, of a small or medium sized X-ray tube is not prohibitive. The photographic action of the rays given off from the cathode of an X-ray tube is among the most marvelous of all the chemical effects of light.

Set up your apparatus in a dark room in accordance with the accompanying photo. So mount the X-ray tube that the X-rays will be thrown down upon the table

(Continued on page 533)

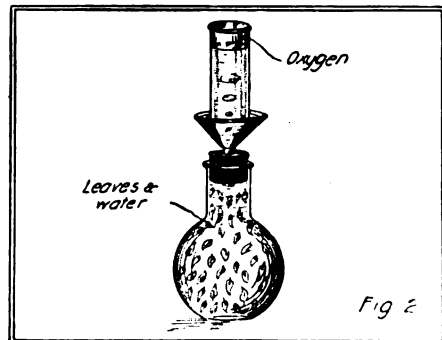

Figure 2—Liberating Oxygen From Green Leaves by the Action of Chlorophyll and Sunlight

to expose all parts equally. If there is no organic matter present there should be but little discoloration.

Now add about 5 cc. of the developer to the exposed bromide and allow the action to continue for two minutes. Note the darkening of the contents of the tube. Then add 10 cc. of the hypo and shake the tube well. Hold it to the light and you will notice that the contents are no longer opaque, but that little fine black particles seem to be floating in the liquid. These are particles of metallic silver.

In order to convince yourself of the necessity of light in bringing about this action prepare another test tube of silver bromide, keeping it well protected from the light, and add 5 cc. of developer. Keep the tube in the dark for five minutes and then add hypo as before. You will observe that the silver bromide entirely dissolves and that there is no reduction of metallic silver.

The chemical action of light in photography is simply this: The sunlight initiates a latent change in the silver salt, not apparent to the eye, but one which the developer is capable of taking up and continuing. This latent change undoubtedly consists in the reduction of an infinitesimal amount of metallic silver and this acts as a so-called "catalyzer" to start the action of the developer. On a film or plate the amount of silver deposited will be in proportion to

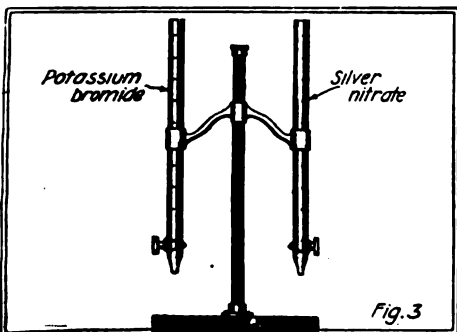
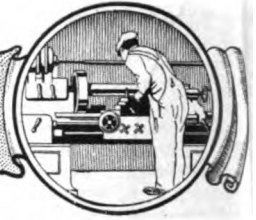

Figure 3—Apparatus From Which to Measure Solutions for the Preparation of Silver Bromide



THE CONSTRUCTOR



The Rogers Printing Telegraph

By H. WINFIELD SECOR

SOME time ago, while on a visit to Washington, D. C., the writer had the pleasure of visiting the radio and electrical laboratory of Dr. James

Harris Rogers, the inventor of the new world-famed underground and undersea radio system, whereby the antenna wires are buried underground or laid under water, instead of being elevated above the earth.

While visiting Dr. Rogers' laboratory, the writer was greatly impressed with several large machines having giant fly-wheels mounted in them, as well as typewriter keyboards, perforated tape reels and several other electrical devices, and, upon inquiring of the good doctor, the latter interestingly explained how he had developed this, his *rapid printing telegraph*, a good many years ago, and how it had transmitted the first printed telegraph letters between Baltimore and Washington on March 14, 1895.

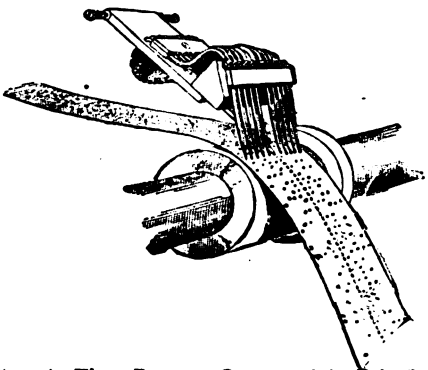

Fig. 1—The Rogers Commercial Printing Telegraph Employed a Perforated Tape, a Set of Insulated Metallic Fingers Making Contact Thru the Perforations Onto the Metal Drum, as the Tape Moved Along.

Altho you will not find mention of the Rogers Printing Telegraph System even in the most elaborate and sumptuous reference books on telegraphy, probably (at least in those with which the writer is familiar) it is of remarkable interest, both to the experimenter and to those who like to read the true history of the advance of electricity, to learn how simply Dr. Rogers eventually worked out his system.

The accompanying illustrations will aid in showing how, with eight simple marks or characters on his magnetic printing machine, he was able to form any letter of the English alphabet, as the sample of printing herewith clearly shows. A close study of the letters in this facsimile message (as transmitted over the Rogers system for considerable distances and for which purpose a corporation was formed over a quarter of a century ago to install this system thruout the country, after many

successful trials on long circuits) demonstrated what a great amount of research work had to be devoted to the development of such a system in order that the various

THIS INVENTOR ABANDONED THE TYPE WHEEL OR STEP BY STEP MOVEMENT OF PRINTING TELEGRAPHY ABOUT EIGHTEEN YEARS AGO AND SOUGHT FOR RAPID PRINTING TELEGRAPHY—STUDYING OUT THE ELEMENTARY CHARACTERS OF THE ROMAN ALPHABET HE FOUND WITH EIGHT MARKS OR TYPE WHICH PRINT SINGLY AS FOLLOWS — · · · · · HE COULD IN PROPER COMBINATION CONSTRUCT THE ALPHABET THUS— A B C D E F G H I J K L M N O P Q R S T U V W X Y Z— THEN HE SOUGHT AND DISCOVERED, WHILE EXPERIMENTING WITH SENDING OF PHOTOGRAPHS OR OBJECTS BY TELEGRAPH SYNCHRONISM— BY THE AID OF A VISUAL INDICATION, AN ELECTRIC SPARK HE IS ABLE TO MAINTAIN SYNCHRONISM OF MOTORS AND THUS TRANSMIT 200 WORDS PER MINUTE OVER ONE WIRE AND RECEIVE THEM PRINTED READY FOR DELIVERY AS PER THIS SAMPLE—

E - S - NORTON-

A Good Idea of Just How the Different Letters of the Alphabet Are Formed by the Rogers Eight-Character Type. This Message Was Sent From Washington to Baltimore by the Rogers System.

component parts of each letter could be transmitted over a single telegraph wire with earth or full metallic return circuit at a very high speed. We will content ourselves with a consideration of a simple working system of the Rogers type, which may be experimentally used by amateur telegraphers and which may prove useful to those interested in electrical and wireless typewriters.

It may be said here that in the complete Rogers Rapid Printing Telegraph System he employed heavy rotating wheels which carried contacts around stationary commutators or segmental switches mounted on the machines, each of the segments connecting to a different pair of electromagnets actuating a certain mark or part of the letter on the printing head. In order that the successive signals should be transmitted and received at the proper fraction of a minute, Dr. Rogers devised a simple, yet effective, *spark synchronizer*, whereby the two machines could be operated in absolute synchronism.

The signals were not transmitted by hand to write or print each component part of a letter, but were transmitted at very high

speed over the telegraph circuit by means of a perforated paper tape, such as shown at Fig. 1. The transmitting current was past thru the various contact fingers on to a metal drum thru the perforations in the paper tape, this tape having been previously perforated by a keyboard machine resembling the typewriter.

The experimenter will not be interested in all these elaborate apparatus, but undoubtedly will find of constructional and historical interest the simplest working form of such a machine, even tho he has to push a different key to actuate each of the eight type-bar magnets. A simple transmitting keyboard can be constructed of wood, with ordinary small strap keys fastened on to it, as shown at Fig. 2. There are nine keys instead of eight, the last key being used to space the letters after each individual letter has been completely formed. To use this system the embryo operator, who, of course, thoroly memorizes the different po-

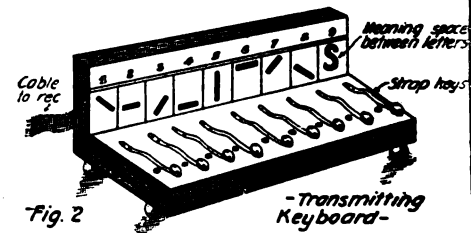
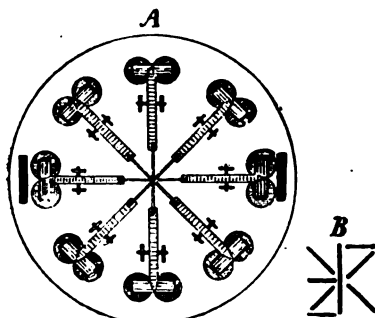

Fig. 2 The Experimenter Can Make a Simple Keyboard For a Printing Telegraph After the Fashion Illustrated. Each Key Prints One Part of the Eight-Character Composition, with One Key For "Spacing."

sition of the eight component parts of the type-printer, by having these placed either in front or in back of each key, as shown at Fig. 2, he will soon be able to gain quite a headway in transmitting the proper sequence of currents over the cable line to the receiving station.

The system may look quite complicated when looking at the diagram, Fig. 3, but many house and office telephone systems are many more times complicated than this indeed, and but nine wires are required in the cable. This may even be ordinary double cotton-covered magnet wire, about No. 20 gage, or even finer, if fairly high voltage is available, or twenty to thirty volts. Of course, the longer the cable, the greater the voltage, and the proper voltage can be determined by trial or by calculation taking into consideration the ohmic resistance of the line. For ordinary telegraphic voltages, the type-bar actuating magnets



A—Plan view of type arms. B—Face of type magnified. Fig. 4—How the Eight Pairs of Electro-magnets and Type Bars Are Arranged on the Rogers Printing Telegraph. Also Close-Up View of Type Components.

of which eight pairs are required, can easily be made or may be ordinary telegraph sounder magnets. The nine-bladed reversing switches throwing the connections from "send" to "receive" may be easily constructed either in the form of a drum switch, or else from small pieces of copper bar about one-quarter inch by one-sixteenth inch mounted on an insulating rod, such as wood, fiber, etc., and provided with a handle at the end, in the manner shown.

The nine cable wires at each station are secured thru flexible cord, such as small lamp cord, to the nine moving blades of the reversing switch in either case. Ordinary small size switch jaws or contacts could be purchased from any electrical supply house and these can be suitably mounted on either side of the switch, and each side of the nine contacts connected, respectively, to the magnets and spacer relay of the receiving apparatus, and also to the nine keys of the transmitter keyboard.

We find it interesting to next consider the arrangement of the printing head, with its various electro-magnets for controlling their respective components of the letters, as shown at Figs. 4 and 5. The simple eight-character, magnetically operated printing head devised and used by Dr. Rogers marks the earliest successful rapid printing telegraph, see Fig. 4.

A later development comprising ten characters and ten pairs of electro-magnets for operating each type-bar is shown at Fig. 5. In the lower part of Fig. 5, or in the side view, may be seen a spacing relay which also rotates the typewriter ribbon drum so as to keep the ribbon moving in one direction or the other, the same as on a typewriter, and this causes a fresh surface of the ribbon to be successively presented before the type.

A very good arrangement of the typewriter ribbon and relay for spacing the letters or advancing the paper tape, etc., is shown at Fig. 6. The paper tape is here held on a freely moving reel, the same as on the regular telegraph tape registers, this tape passing along underneath the type-bars, each of the eight type members being centrally supported at a common focus or center, as shown in Figs. 4 and 5. A spring or electric motor may be easily rigged up to turn the fiber or other roller, which can be moved into or out of contact with the idler roller, so as to bind the paper tape between them and pull it, whenever the spacer relay causes the two rolls to be prest together, as becomes clearly evident upon inspection of Fig. 6. It is best to place a guide plate with a hole in it slightly larger than necessary to accommodate all of the type members just over the back-up plate and in front of the moving paper tape, the same as on modern typewriters. This helps to prevent the ribbon from smudging the paper. As shown in the apparatus at Fig. 5, the spacer relay may be arranged so as to have its armature operate a pawl or ratchet acting on one or the other of the typewriter ribbon reels, or a gear fastened to the latter, so as to continuously move the ribbon for the purpose aforementioned.

The operation of the system will now be quite clear, here, we believe. For instance, if you wish to transmit a letter from Station A to Station B (at Fig. 3), then the long central line of the type members; the letter "U" will be composed of the No. 5 line, and then imprint 4 and then 5; the letter "N" is composed of number 5, then

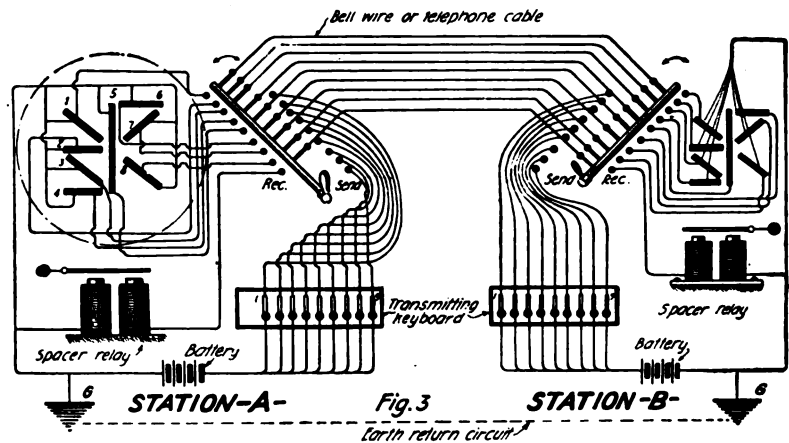

Fig. 3—Simplified Circuit For Printing Telegraph of the Rogers Type. Each Part of the Letter is Formed by Pressing the Proper Strap Keys at the Transmitting Station, the "Receiver" Being Switched Into Circuit, of Course.

A operator throws his nine-blade reversing line switch to the "send" position to call the B operator (the line-reversing switches are always left in the receiving position normally) by sending Morse code signals or any prearranged dot or dash combination of signals by means of the spacer relay and its corresponding No. 9 key. But as

1 and 8, then character 5 again. With a little ingenuity this system can be worked out and adapted to many different requirements which the average electrical experimenter may have in mind.

One of the things which has not been worked out in the arrangement shown at Fig. 3 and on which the experimenter can exercise some good gray matter is the development of an accurate interlocking and spacing arrangement, so that he can form the letters properly without too great a space in between them or between the component parts of the letter, and also a scheme whereby he has a tell-tale system so as to know just how the letter looks which he has printed in this way. In other words, like the ordinary telegraph system, where the home station sounder clicks out the dots and dashes as the operator transmits the message.

Those who are particularly interested in the complete operation of the Rogers Printing Telegraph System and the method whereby the transmitter and receiver instruments were synchronized and maintained in synchronism, and also the method of perforating the paper tape with the proper sequence of signals in order that the correct and consecutive impressions of the type characters are formed, will do well to look up some of the patents on this system. Dr. Rogers originally discovered and provided a simple synchronizing means between the transmitting and receiving instruments, placed at the opposite ends of long telegraph lines, and which proved very successful in their trials, which consisted in causing each motor at every revolution to record its movements on the rim of the opposite revolving wheel by the appearance of an electric spark, thus furnishing the visual indication of the synchronous or non-synchronous position of the motors. The U. S. Patent covering this most ingenious invention bears the number 358,753.

The electrical apparatus for punching holes in the paper tape and which is adjustable to any ordinary typewriting machine bears U. S. Patent No. 412,001. Patent No. 420,358 covers the printing device made of eight primary type members and electro-magnets for actuating the same in the manner outlined in the present article. Patent No. 524,118 describes the automatic moving carriage which holds and turns the paper page; also many improvements in the manner of operating the eight type arms with a single electric relay, instead of one relay for each type arm. Those interested in machines of this type will do very well indeed to procure copies of these patents from which they will learn a great deal.

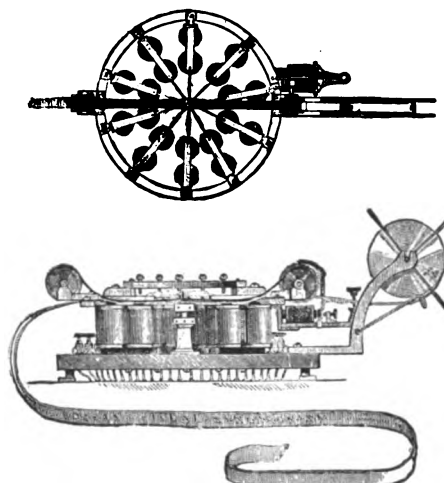

Fig. 5—A Rogers Type Printing Telegraph Having 10 Characters Instead of 8, Together with 10 Pairs of Operating Electromagnets, "Spacing" Relay Magnets, Paper Reel For Tape, Etc.

the B Station apparatus is normally always in readiness to receive messages, it is not necessary to call the B operator unless desired. The A operator will then proceed as follows: Suppose the letter "I" is to be reproduced on the tape at the receiving end of the line, he would then have to press the key No. 5, corresponding to the

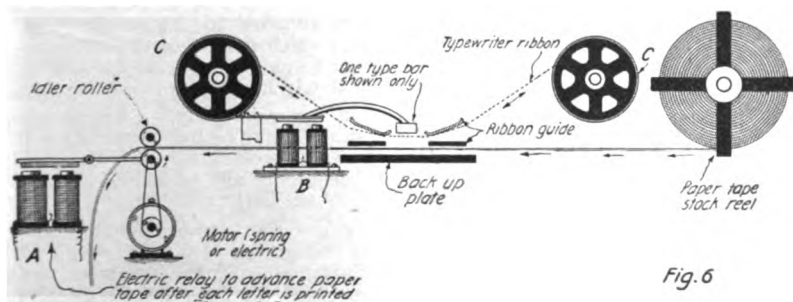

Fig. 6—Working Diagram Showing the Principal Parts of the Printing Telegraph, Here Described, in Detail. Only One of the Eight Printing Type Bars is Shown For the Sake of Simplicity.

Building "Your Own" Phonograph

Part I

TODAY, the phonograph or talking machine has become so much simplified and standardized, and there are such a great variety of parts available on the market, that many people have found great pleasure in building their own phonographs.

In the present article, the writer will endeavor to present the practical aspects of building one's own phonograph, which he has learned thru considerable experience in building several of his own, one of which is used for parlor use and two others for laboratory experimental work, where "looks don't count."

One of the main things to be considered in building your own phonograph, usually, is that you do not want a cheap looking machine so far as external appearance is concerned, if it is to be used in the parlor or living room for family entertainment. It is very simple now to purchase a small table cabinet at a cost of a few dollars, up to a full size 50" floor cabinet with sound chamber already built in it for the price of anywhere from \$25.00 up to \$50.00 or more, depending upon how ornate a cabinet you may desire. Then to tickle the heart of the "how-to-make-it" bug, there are dozens of different makes of motors, tone arms and what not, available from numerous dealers.

However, an effort will be made in the present treatise to provide sufficient instruction and detail so that those who like to feel the real thrill and enjoyment of building the "whole works" and perhaps the cabinet too, can do so; as the only things you cannot make just yet, are the records.

SOMETHING ABOUT PHONOGRAPH MOTORS.

A typical high grade phonograph motor is shown at Fig. 1, and if you are not already familiar with the operating features of such a motor, you can learn a great deal by carefully studying this drawing. Practically all regular phonograph motors are of the spring propelled type, and contain anywhere from one to four or more barrels or cylinders in which are placed powerful steel springs about the size of those in an 8-day clock, but somewhat longer, which are packed in graphite and oil. The power is transmitted from the springs once they have been wound by means of the handle and ratchet in the well-known manner, to a train of toothed gears and which include an automatic speed governor and regulator. Details of this speed governor which you may want to build yourself, if you already have some other form of power such as an electric motor or a gravity motor for the purpose of rotating the turn-table, are given at Fig. 2.

Phonographs, like every other piece of machinery, should be kept oiled at all of the bearing points and about once a year it is well to see that the springs are thoroly lubricated and packed in graphite and oil, which mixture is available from phonograph manufacturers. New springs are also available from these companies or thru phonograph dealers. It is important to note in connection with the phonograph motor shown at Fig. 1, that the main turn-table shaft doesn't rest on its regular shoulder bearing, but has a foot-step or pivoted bearing placed under it, which is fastened to the main frame.

It is surprising what a difference this makes, as the writer found in improving a small spring motor which he used in his first experimental machine. When the motor would run a 10-inch record scarcely at all, the same motor ran off the record in

Full Details Describing How to Build Motor, Turn-Table, Tone Arm, Reproducer and Sound Chamber

fine style, when a polished steel plate bearing was rigidly secured under the lower end of the main turn-table shaft, the end of this shaft being rounded off or crown shaped. And of course, if you take the trouble to make a cup-shape bearing under the shaft, and place a ball-bearing on it, you will get still better results.

With regard to the automatic speed regulator and governor you will soon learn, if you are not already familiar with phonograph matters and phonographs in general, that one of the most important things is that the speed of the turn-table must be as constant as possible, and further—that you will want to change the speed now and then

MAKING PHONOGRAPHS

TO build your own phonograph, may sound like a very difficult problem to those who have never experimented in this direction before, but once you have started and succeeded in building your first model, you will find it one of the most fascinating and interesting endeavors you have yet ventured into. Just to build your own phonograph is not the whole story, as there is a good opportunity to build phonographs for others. There is one fine feature about building your own phonograph today, and that is you do not have to experiment and develop your own motor, or in fact your own tone arm or anything else among the machine parts proper, as these can be readily obtained from the innumerable phonograph supply companies advertising in this and other publications.

The future of the phonograph is thoroly assured, but not with the present type of machine. It is prophesied by scientists and engineers; who predict that the talking machine of tomorrow will be a marvelous mechanism indeed, not only for its simplicity but for its purity of note and fidelity of reproduction of the human voice. The experimenter of today, therefore, has one of the finest opportunities ever given to anyone to invent something "real new" in the realm of talking machines. The present talking machine is not perfect by any means, and the "germ" of the perfect talking machine which everyone desires, has yet to be discovered.

for various records. The average speed for flat disc type records, is about 68 revolutions per minute. This can be timed either by means of a speed indicator held in contact with the center stud of the turn-table as it revolves, or else by placing a chalk mark on the felt cover of the turn-table and counting the revolutions for a half or full minute by means of your watch. If you cannot procure a governor to use in connection with your electric or gravity motor, or perhaps to regulate the spring motor such as that from a large discarded clock movement, etc., you can, with a little ingenuity, readily build one. Details of the standard three-ball governor are shown clearly at Fig. 2.

Two brass collars are usually made, which fit the shaft with a very even clearance. One of these has a set screw threaded thru it so that it can be secured tightly to the governor shaft, while the other collar has a perfectly flat brass or steel disc about 1/16" thick and 1 1/2" in diameter, rigidly secured to it. Both hubs should have three

spots filed on them at exactly 120 degrees apart, and three holes drilled and threaded in each for about No. 6-32 thread machine screws, to be used to hold the ends of the three steel governor springs as shown in the figure. For a small size governor, these springs may be pieces of corset steel, etc., and may measure about 5/32" in width by 1/64" thick. The weights on them may be round or of cylinder shape and if made of lead, steel or iron, they may measure about 7/16" in diameter by 3/16" in thickness. These weights must be secured to the exact center of the three governor springs, either by riveting or by means of a 6-32 screw threaded into the weights.

The speed control lever with its felt brush is shown clearly in the drawing and this presents no difficulty in construction. The action of the governor is now quite apparent, the three balls or weights tending to fly outward and make a larger circle as the motor speeds up, and vice-versa by moving the speed regulator screw. The felt shoe bearing against the brass disc mounted on the free hub of the governor will retard the further movement of this disc, so that the weights can only fly out a certain distance and thus keep the speed down to whatever limit may be desired. The hub at the opposite end of the governor is tightly secured to the shaft and it is best to "spot" the shaft with a drill or file where the set screw it to rest.

BUILDING A GRAVITY MOTOR.

One of the finest motors used in telegraph recorder and similar work, is the gravity operated motor. This motor, for one thing, possesses the characteristic of giving very constant speed, more so than the spring motor where the power of the spring is constantly decreasing as the motor unwinds. The force of gravity or pull exerted on a given weight is constant, and thus, as long as the weight is in action, the pull exerted on the gears and turn-table or other devices propelled by the gears, is constant also.

Fig. 3 shows the principal parts which may be used in building a gravity motor. The gears may be the same or in fact the identical gears in an old phonograph motor, or other mechanism. You will require either the two-ball or preferably the three-ball governor to keep the speed under control, and even. The weight used to actuate the motor may comprise one large size boulder (Belgian blocks will do just as good work) also pig-iron or any other good heavy scrap. Even a large can of water, etc., or pail full of sand can be used.

The whole secret of the gravity motor is this: You wind up the heavy weight, say 50 to 75 pounds, slowly, by means of the handle attached to the ratchet and drum, but no ratchet is required if you do not happen to have one, and this weight moves very slowly in its downward descent.

You can usually figure out the ratio of the gear teeth and the comparative drop or fall of the weight for any train of gears, by consulting any machine shop or mechanics' manual.

The governor can be mounted on its own shaft and geared to the main train of gears as shown in one of the figures, or it may be mounted on the main turn-table shaft; and there are several other ways in which it can be connected to the main gear train so as to regulate the speed.

(Continued on page 572)

BUILDING "YOUR OWN" PHONOGRAPH

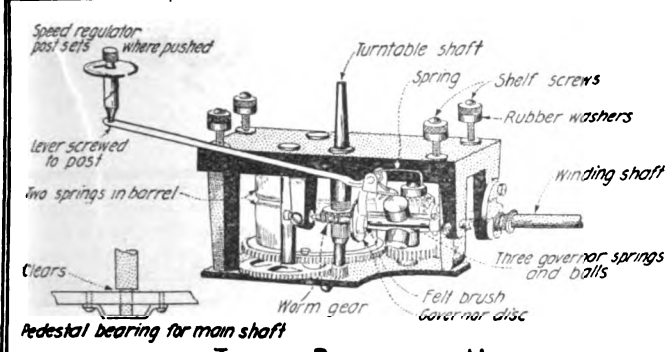

TYPICAL PHONOGRAPH MOTOR -1-

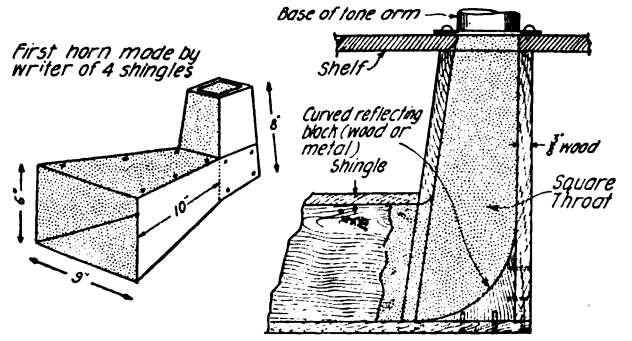

THE SHINGLE SOUND CHAMBER -6-

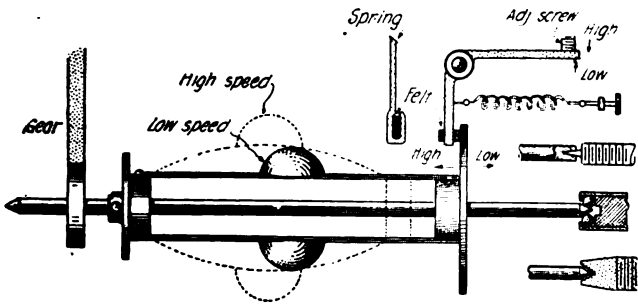

DETAIL OF PHONOGRAPH GOVERNOR -2-

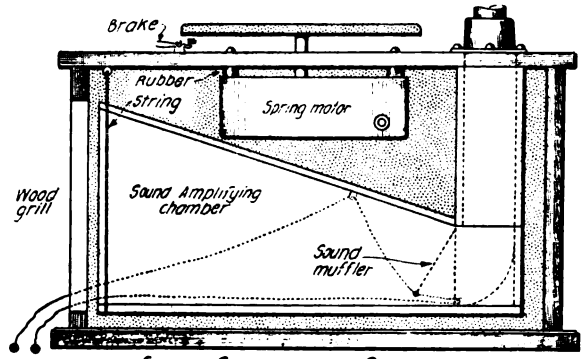

SOUND CHAMBER IN CABINET -7-

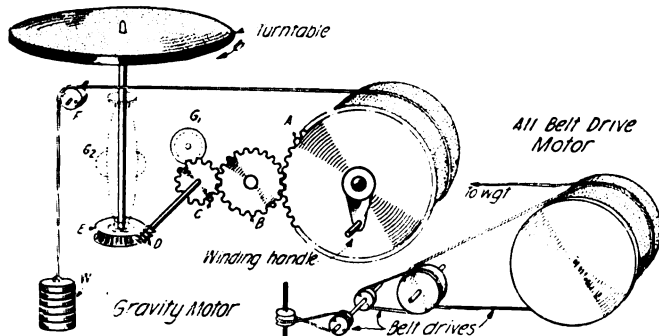

GRAVITY MOTOR -3-

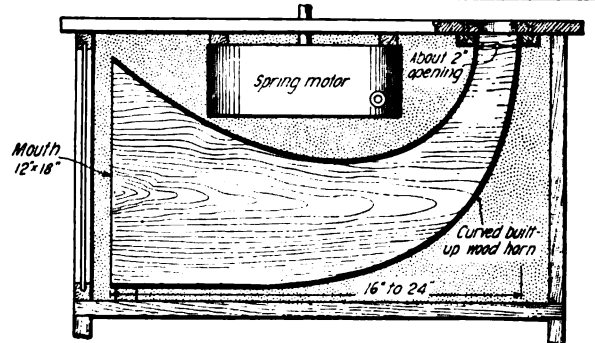

BEST SHAPE FOR WOODEN HORN -8-

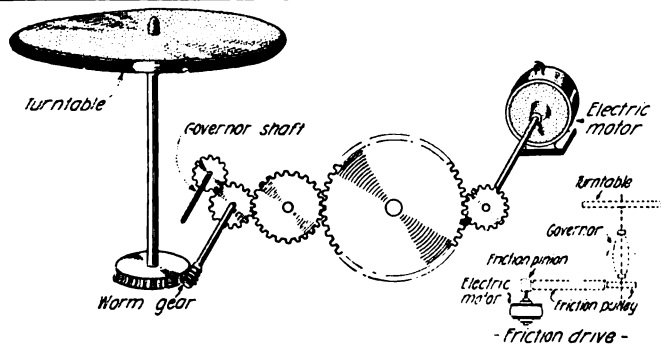

ELECTRIC PHONOGRAPH MOTOR -4-

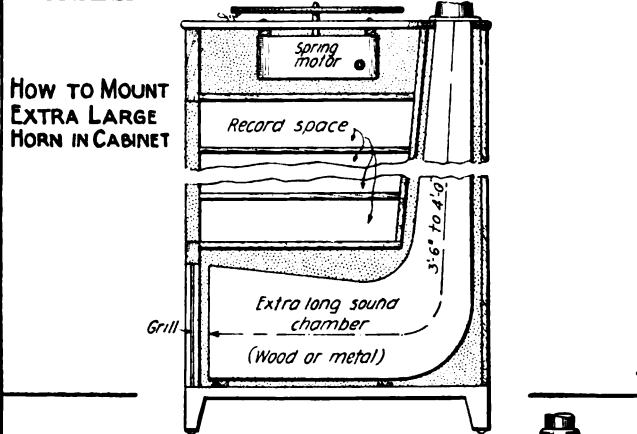

HOW TO MOUNT EXTRA LARGE HORN IN CABINET -9-

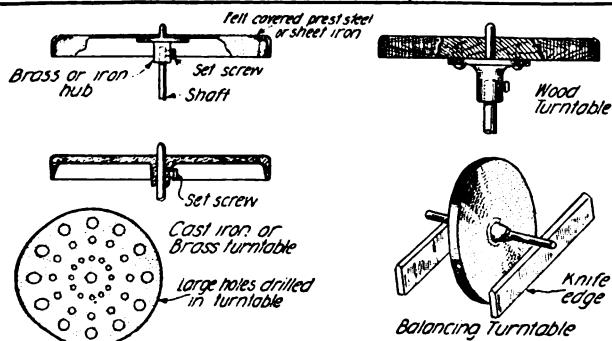

VARIOUS STYLES OF TURNTABLES -5-

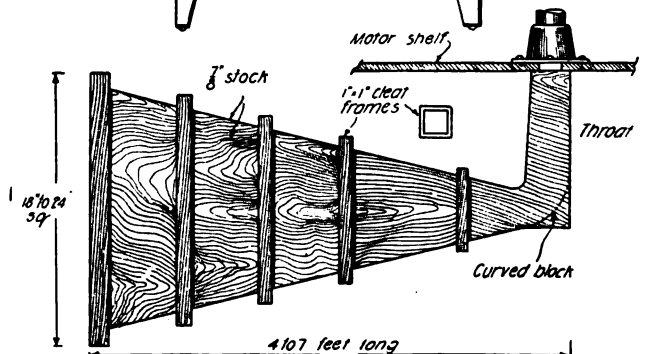

LARGE EXHIBITION STYLE HORN BUILT OF WOOD -10-

Electrical Machinist

By H. WINFIELD SECOR

NO. 11—REPAIRING ELECTRIC FANS.

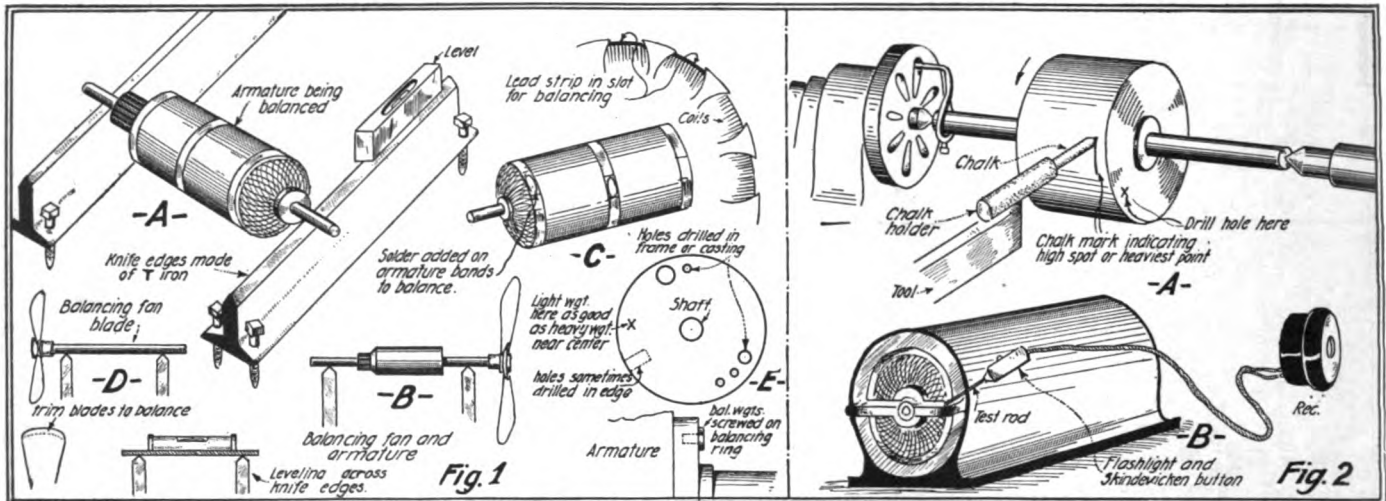

Fig. 1. Shows Some of the Various Operations and Methods Employed in Balancing Fan and Motor Armatures in General. The Armature Is Balanced By Placing It On Two Leveled Knife Edges, and Weighted Until It Will Remain in Any Position.

Fig. 2. Two Other Methods of Balancing Rotating Masses Are Here Shown at "A" and "B". Method "A" Involves the Rapid Rotation of the Mass in a Lathe and a Chalk Marker, While Method "B" Utilizes the Principle of Vibration and a Stethoscope.

THE following remarks on the repairing of electric fan-motors would also apply to the repairing and assembly of small motors of all types, particularly those of the fractional horsepower class. There are many interesting points to be watched in the repairing of even such small electric motors as those used for driving fans, and by watching these various important factors, much dissatisfaction is avoided—both on the part of those having repairs made, and also with regard to those wishing to realize the highest efficiency and noiseless operation of fans.

BALANCING ARMATURE AND FAN BLADES.

In many electrical repair shops, no attention is given to the proper balancing of such small armatures as those found in ceiling and desk fan-motors, rated at approximately $\frac{1}{8}$ and $\frac{1}{16}$ horsepower, respectively, but if this is not done, then the fan is very likely to make a considerable noise and operate unsatisfactorily in other ways. Of course, the fan blade itself must be balanced also, and preferably it should be balanced when mounted on the shaft of the armature as shown at Fig. 1.

At Fig. 1-A may be seen how two knife edges, constructed from short lengths of "T" iron and provided with 3 or 4 leveling screws threaded thru the lower web, are arranged on the bench so that they can be leveled up in both directions, with an accurate machinist's level. By means of a steel straight edge, if the level itself will not span across the two knife edges when set at the proper distance apart to receive the armature, the two edges are lined up perfectly level with respect to one another, i. e.—crosswise. The two knife edges should then be lined up individually with the level by adjusting the four screws in the manner apparent. The armature shaft rests on the two knife edges as shown at Fig. 1-A and pieces of flat lead may be pushed or driven into the tops of the slots as shown at "C", care being taken to see that a piece of thin fibre or heavy paper rests on top of the coil, so that the wire in the slot will not be cut, and these balanced weights are placed on the light side of the armature repeatedly, until it will rest on the leveled knife edges in any position to which it may be turned by hand. When it will rest at any point along the

knife edges when turned to successive positions by hand it may be considered as properly balanced.

At B is shown how the fan blade is balanced simultaneously with the armature. At D, a single fan blade is balanced by mounting it on a steel shaft and then placing it upon the leveled knife edges. Fan blades are balanced either by placing solder on the hub on the light side, or else by trimming the metal off the outer end of the heavy blade with a pair of tin-snips. Small holes are sometimes drilled in the hub or in the outer end of the blade on the heavy side. If the end of the blade is cut off, this of course also occurs on the heavy side, that is, the side which tends to swing to the bottom each time.

After carefully watching the blade and adjusting the weight by cutting or soldering, etc., you will find that the blade will rest in any position you may place it without turning to a new position by itself. It is then balanced and under proper conditions will rotate at the speed for which the fan was designed with the minimum of

(Continued on page 528)

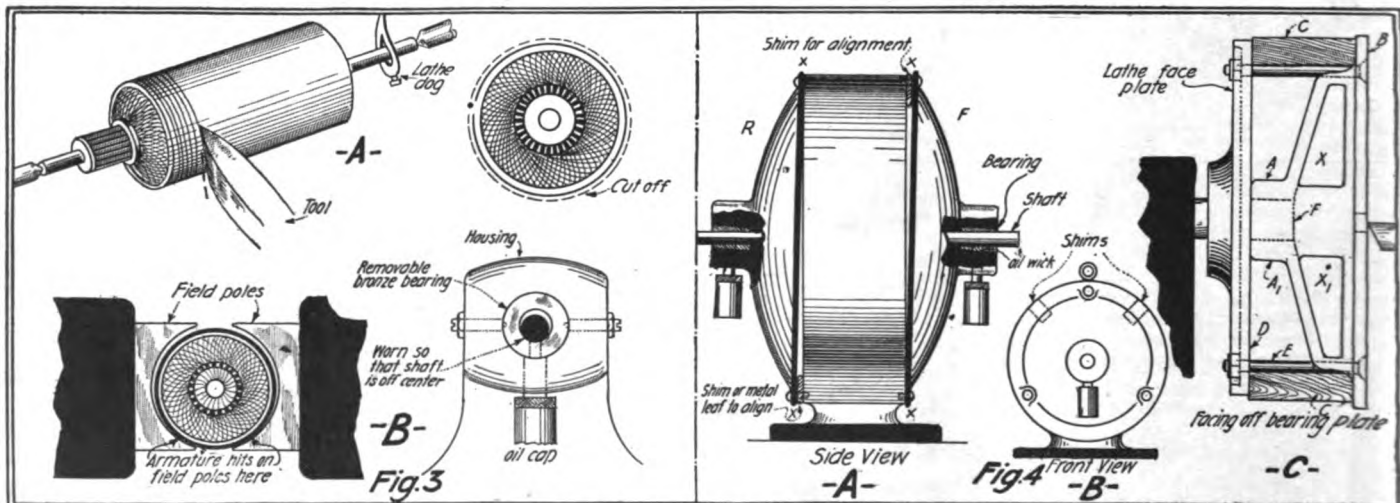

Fig. 3. Some of the Things That Happen When an Armature Strikes the Field Poles and the Methods of Overcoming This Trouble Are Here Illustrated. Small Armatures Are Often Placed in the Lathe and a Cut Taken Across the Periphery of the Core as Shown at "A". Fig. "B" Shows How Worn Bearings Cause the Armature to Drop and Hit the Pole-Shoes.

Fig. 4. This Drawing Illustrates at "A" How the Bearing Frames on Electrical Machines Sometimes Have to Be "Shimmied" Out in Order that the Armature Can Turn Freely. At "C" is Shown a Method of Mounting a Bearing Frame on the Lathe Face-Plate For Machining.

The "Vibro Whip"

A Motor Freak

By O. C. ROOS

IT is a long time since most of us used the whip-top of childhood days. We can easily remember how hard it was to give it the initial spinning twist with the right hand, to prevent a wobble and sudden spin on its side! At last it stood shakily for a precious half second, and we whipped it with frenzied haste only to knock it down again. We had to repeat the performance until bitter experience taught us moderation, and we finally kept the top spinning with short, rapidly repeated "wiping" strokes. It was a lesson in life.

Who would think that this toy would give a new prime mover to the scientific and engineering world. Yet it is a fact that small motors are now being tried out for phonographs and other small moderate speed machines, and these motors are really "whip-top" motors.

It is the purpose of this article to show the final elements first, giving in Fig. 1 the essential parts of the apparatus and then showing their relation to the whip-top in bare outline, so that the principle under-

Here is the Very Latest Toy Motor and It Has no Armature or Induction Motor Parts, Nor Anything Like Them; Simply a Small Magnet Coil and a Cloth Band Passing Around the Main Shaft. The Vibration of This Band Turns the Shaft.

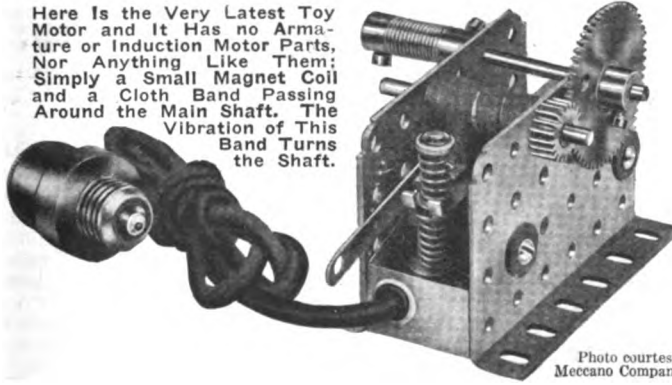

Photo courtesy Meccano Company

2nd—This motion must be so arranged when in Fig. 1 the point A reaches A₁ and starts to return toward A again, that the whole band will loosen up around OTC, or at least a part of that distance before A₁ reaches A. It must not be so slow that the rotating shaft will catch and "bind" it before A₁ reaches A. In other words the suddenness of the necessary "crack-the-whip" effect at A₁ on the return to A depends on the speed of the shaft S to some extent.

If we did not specify these requirements, Fig. 1 would not work. That's all there's to it! We would have, with simple harmonic motion at AA', the conditions shown at Fig. 2, where the friction band BB is held continuously against the shaft by the spring action of the band, represented by an "equivalent spring" P fastened to the band B and the fixed point F. When A' moves to A and back there is simply oscillation of the shaft, and nothing more. A fine motor that would make!

It is realized that the above description is only general in character and that the younger experimenter wants to know the real mechanism of the whip-top before the above results can be made perfectly clear to him. For his benefit then the following non-technical analysis of the whip-top is given, followed by a still simpler analysis of the actual operation of the "crack-the-whip" phenomenon on a driving-shaft.

THE WHIP-TOP.

In Fig. 3 we have five views of a whip-top, S, giving a "moving picture" story of

its behaviors and that of the whip, with handle at H. We see the first whip-stroke at view 1, where the small curved arrow in S shows the initial twist given to the top, as the whip in position 1 strikes it. The second view shows the top moving bodily to the left, as indicated by the arrow at S, with increased rotation and changed direction of the handle H, more toward the bottom of the page.

The third view shows the tip of the whip quite curled up around the top, whose rotation is increased, but whose bodily motion along the ground is now almost in the same direction as that of the whip handle H. The fourth view shows this last motion fully accomplished with the top rapidly spinning and moving toward the bottom of the page.

The final view shows the top asleep—no bodily motion—and the whip being properly applied with a small motion at point toward the top, and a large "wiping" motion of the whip as shown by the large arrow. The handle has now practically a vertical motion relative to the page.

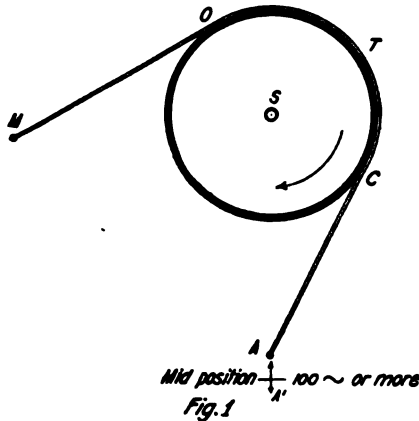

Fig. 1

Fig. 1—The "Vibro Whip," Described by Mr. Roos, is Based on the Principle of the Old "Whip-Top," Which We Used to Spin in Our Boyhood Days, and the Action of Which is Partly Shown in the Above Figure—the Band Around the Drum "S" Being Pulled and Released Alternately in the Direction A-A'.

lying this very curious prime mover may be rendered obvious, when the mechanics of the whip-top are understood.

In Fig. 1 are shown the essential parts of the apparatus. They are:

- 1st—A fixed rotatable shaft—S.
- 2nd—A flexible partly extensible, friction-band MOTCA.
- 3rd—A vibratory motion in the point A, of such a periodic character that it causes the band MOTCA to alternately grip and release the shaft S several hundred times per second. There are strict requirements prompting the special motion of the point A.

These can best be presented by showing how and how not to construct the elements in Fig. 1.

1st—The point A must have a special type of motion, otherwise its power to drag

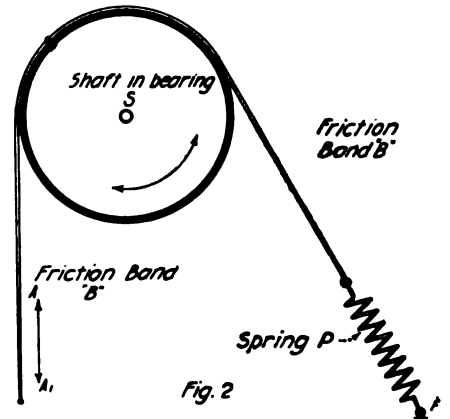

Fig. 2

Fig. 2—The Motion Required to Cause the Whip-Top Action to Take Place Must Not Be Harmonic, But Irregular in a Fashion. The Arrangement Shown Here Would Give Simple Harmonic Motion, and the Shaft "S" Would Simply Oscillate and Not Revolve.

Now, if in the last view, we could suddenly fasten the spinning top in ball bearings and could move H back and forth—as shown in this same view—with a proper motion, keeping the other end of the whip fastened somewhat as in view III, we

would have the general arrangement of the vibro-whip elements, which we have shown in Fig. 1.

By having the shaft S, fixed, we have a fixed top, and can follow the action by studying Fig. 4 by taking a heavy fork with an electrical driver as shown, we see that the driven fork whips the shaft so that at each complete vibration of the fork the band MOTCA advances the shaft thru an arc equivalent to a small circular motion—about .02" in some cases.

(Continued on page 560)

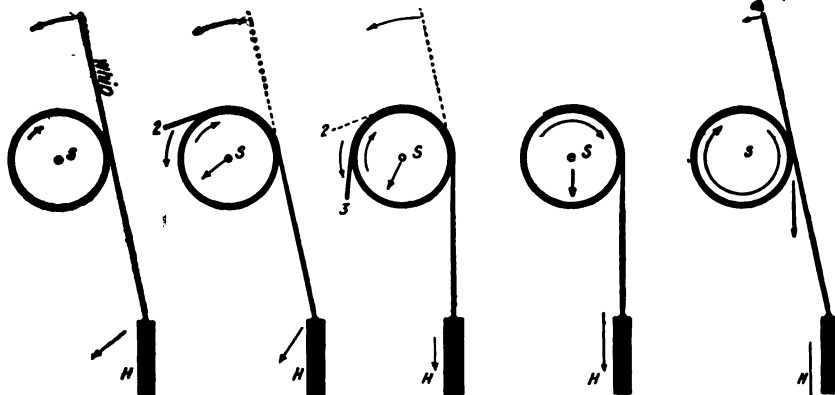

Fig. 3

Fig. 3—This Shows Five Successive Stages of the Whip-Top "S," Giving a Motion Picture Story of Its Behavior and That of the Whip with the Handle at "H."



HOW-TO-MAKE-IT



This department will award the following monthly prizes: First prize, \$5.00; Second Prize, \$3.00; Third Prize, \$2.00. The purpose of this department is to stimulate experimenters toward accomplishing new things with old apparatus or old material, and for the most useful, practical and original idea submitted to the Editors of this department, a monthly series of prizes will be awarded. For the best idea submitted a prize of \$5.00 is awarded; for the second best idea a \$3.00 prize, and for the third best a prize of \$2.00. The article need not be very elaborate, and rough sketches are sufficient. We will make the mechanical drawings. Use only one side of sheet. Make sketches on separate sheets.

FIRST PRIZE, \$5.00

AN ELECTRIC CARPET SWEEPER.

I found that when a Victor record was rubbed with cat's fur, it had the power to attract any small articles which were found on a rug.

The static wheel (see Fig. 1) is made of a number of ten-cent records and is rotated the opposite way from the wheels which propel it. The static wheel has a charge producer on both sides which is

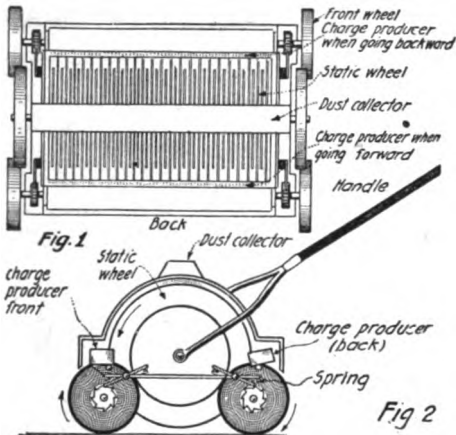

Here's How to Make an Electric Carpet Sweeper of the Static Type. It is Readily Built From Old Phonograph Records, and the Small, Ten-Cent Variety Will Do.

made of cat's fur and rubs the static wheel giving it an electric charge. At the top of the sweeper there is a dust collector which collects the dust from the wheel. The dust collector is a brush with cotton wool wound around the bristles. The charge producers are changed as the carpet sweeper goes backward and forward (see diagram 2). This carpet sweeper is used like any other one would be; only when the cotton wool is dirty it must be changed for a new one.

Contributed by
JOHN BATLES SWANN.

"SAFETY-PIN" SWITCH.

I give herewith a rough sketch of a "safety-pin" switch for the "How to Make It" hounds. It is simple and saves the

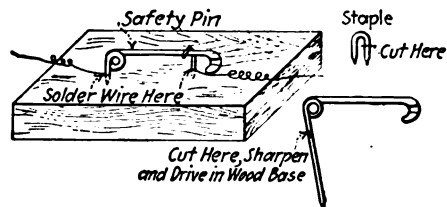

A Nifty Little Battery Switch Suitable For Bell and Other Circuits and Which Creates a Positive Contact; It is Made From the Ladies' Greatest Friend—the Safety Pin.

worry of how to close battery circuits when no suitable switches are available. Excellent for bell circuits, and mind that the contact is positive, owing to the spring tension exerted by the pin bar.

Contributed by
REUBEN HORN.

SECOND PRIZE, \$3.00

AUTOMATIC GAS STOVE IGNITER.

This device is designed for a gas stove, so that when a kettle is set upon it, the

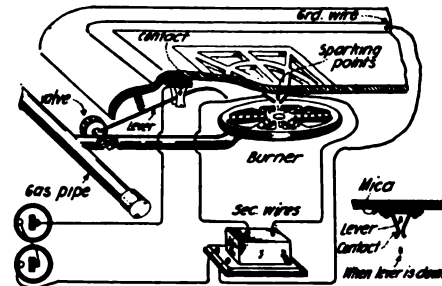

This Automatic Electric Igniter For Gas Stoves Employs a 1/4- to 1/2-Inch Spark Coil, the Primary Circuit of Which is Momentarily Energized as the Gas Valve and Its Attached Contact Lever is Turned to the "On" Position.

burner lights automatically without a match. The principal thing about this device is that when putting the kettle on the gas stove it pushes down a lever that makes it come in contact with two springs, as shown, thus putting the coil in circuit whose secondary spark ignites the gas. The secondary wires are run thru insulators in the side of the stove. When the receptacle is removed a spring pulls the lever back, cutting off the gas and the current. When the lever is pushed down it turns on the gas at the same time it passes (momentarily) thru the contacts, so that the coil is only used for a second or two. Time should be allowed for the gas to get to the burner and so to the points.

Contributed by
ROOSEVELT STONER.

A SIMPLE CARTRIDGE FUSE PULLER.

This useful device can be constructed from a piece of wood with dimensions as follows: 10" x 1 1/2" x 1 1/2". First a hole is drilled a quarter of an inch in diameter, an eighth of an inch from the top. The next thing to do is to make a rectangular opening six inches below the hole and half an inch from each side. This opening should be half an inch long and quarter of an inch wide. The piece of wood is then sawed in two, lengthwise. Next these two pieces are put together by means of a hinge three inches below the hole at the top. After this a strong spring is fitted in the rectangular opening and a nail five eighths of an inch long is driven in from each side to hold the spring in place. The ends may be rounded out to make a convenient handle. This simple device will be found handy for store and home use.

Contributed by
MORRIS WALLERZ.

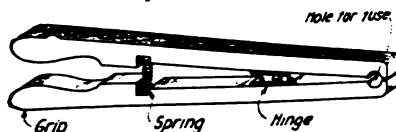

It is Ticklish Business at Best to Remove Cartridge Fuses on "Live" Circuits, and This Suggestion of a Wooden or Fibre Fuse Remover Is, Indeed, Welcome.

THIRD PRIZE, \$2.00

MOTOR FOR STIRRING LIQUIDS.

I am sending in to the "How to Make It Department" an idea that I have used successfully. All those who have had to stir catsup or other preserves while boiling down will appreciate it. I am giving sketches for two kinds. A small toy (series wound) motor was used. The long end of the shaft is threaded.

An eight-volt motor will make about 32 R.P.M. in catsup. The motor needs no more support than shown, as it revolves so slowly.

If the motor windings are soaked in paraffine the steam will not injure them.

Contributed by
JOHN ROTCHKA.

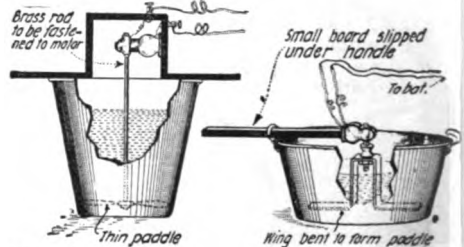

Why Not Put That Small Battery Motor to Work? Here is an Ideal Purpose For Which Mother and the Girls Will Surely Bless You. Rig It Up to Serve as a Motor "Stirring" Handyman by Means of a Small Paddle, as Shown.

A FUSE PLUG MICROPHONE.

Herewith I submit a plan for a simple telephone transmitter which when used gives a very clear tone. The shell is a discarded fuse-plug without a contact end on it, and the hole in which the fuse metal enters should be cleaned out, the brass screw shell on the outside having been removed.

Remove the mica cover and brass cap, without injuring them so they can be put on again. The carbon discs are made by sawing them off from battery carbons and shaping them to fit. The shell is then filled with carbon grains (buy them at any electrical supply house or visit your local telephone exchange and get acquainted with the "wire chief"—don't bother with broken up carbon bits) and the fuse cap and mica put on. The wire from the upper carbon disc goes out thru the hole in the shell.

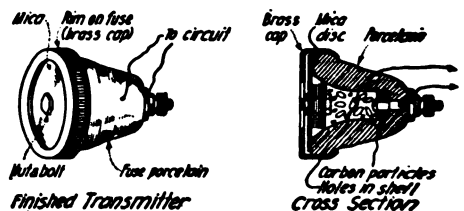

A Clever Wrinkle in Building Your Own Microphones. This Particular One is Built From a Porcelain Fuse Plug. If You Want Success, Use Polished Carbon Granules and "Not" Pieces of Broken Arc Light Carbons.

Ground coke has been used satisfactorily in the transmitter.

The lower part can be punched out very easily.

Contributed by
ARTHUR A. HUMPHREY.

A Giant Radio Central Station

FOR more than two decades the wonders of wireless have so unceasingly intrigued the public imagination that it would appear little remained to be accomplished in developments of revolutionary character. Yet, once again, it is disclosed that a startling conception in wireless communication has been quietly brought to a point of realization. On the north shore of Long Island, near New York, the Radio Corporation of America is about to begin construction of a super-powered radio station that will simultaneously send to and receive messages from five great nations of other continents.

Description of a 2000 Kilowatt Radio Station To Be Erected on Long Island

of Port Jefferson, with a long frontage on Long Island Sound. The preliminary engineering studies have been completed, contracts for all the construction materials are being let, and a force of radio experts, after months of preparation, will immediately take the big job in hand.

with a corresponding receiving station located nearby. *All five transmitters and the five receivers will operate simultaneously and will transmit and receive messages over thousands of miles continuously during day and night.*

"New York will be the direct focal point of world's intelligence in an entirely new sense under this communication scheme," he continued. "As soon as the station is completed immediate message service will be established with France and Germany to supplement the existing commercial circuits; ultimately, radio from this station will connect up Buenos Aires and other

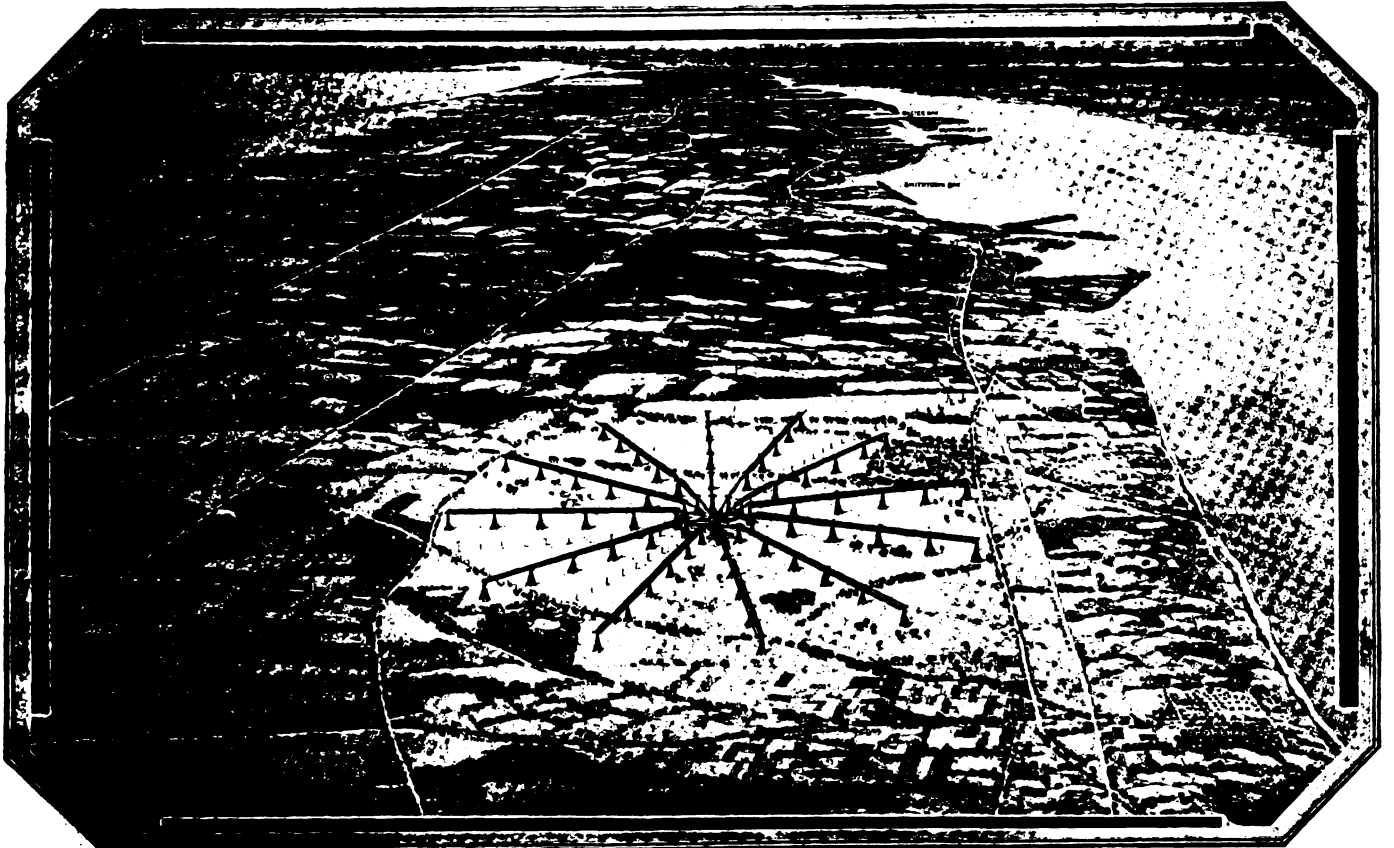

The World's Most Powerful Central Radio Station, Rated at 2000 Kilowatts, To Be Constructed at Port Jefferson, Long Island, by the Radio Corporation of America. View Looking Toward New York City, Showing Giant Antenna System Supported on 400-Foot Masts.

The bare announcement presages a new era in commercial radio communication. It is one conceived in the convention-defying spirit which, coupled with engineering skill, has brought about the expansion of wireless to its present status as a world-wide public utility. Instantly obvious is the fact that the plan will result in the contribution of an important means of breaking down America's isolation from the peoples of certain other continents and open up visions of communication possibilities which, thru inherent limitations, could never be realized by the undersea cables.

The new and great medium of far-reaching economic and political influence will bear the name of *New York Radio Central Station*, the steel towers of which will arise on a 6,400-acre tract, comprising nearly ten square miles of land lying east

A definite idea of the ultra-modern character of this radio plant may be gained from the observations of Edward J. Nally, president of the Radio Corporation of America, under whose direction the world-wide wireless system has emerged from an idea into a reality. "Everyone at all familiar with wireless," said Mr. Nally, "knows that at Nauen, Germany, and Bordeaux, France, are two of the largest stations in the world. Up to now they have been viewed with admiration; consider, then, the tremendous advance represented in this latest step; the New York Radio Central Station in the aggregate, *will be five times more powerful than either of these.*"

He explained that there will be five complete transmitters, each one a duplex unit

points in South America, and ether-wave messages will be flashing to and from Poland, Sweden, Denmark and other European countries. Like the ripples that race in circles over a pond when a stone is dropt in the water, the electromagnetic waves from this station will soon encompass practically the whole of the civilized globe. It is a plant that dwarfs all existing wireless stations into insignificance.

AERIAL TWO INCHES IN DIAMETER.

The form of aerial construction, too, is wholly a new departure. From the central power house six spans of aerial wire will radiate out in a star pattern, to a distance of more than one mile from the center. The wires of this huge antenna will be

(Continued on page 567)
Digitized by Google

New De Forest Buzzer Radiophone

A NEW buzzer Radiophone transmitter for operation on two six-volt storage batteries is the latest feature which has recently been placed on the market. This requires no "B" or secondary battery of a high voltage whatsoever, and will prove ideal for all small portable work, the set being readily placed upon motorcycles, and very small power boats or automobiles as well as on the larger craft. The total weight is about sixty pounds which is, we believe, the nearest approach to a practical commercial light-weight set ever before seen. Dr. de Forest, who has originated the device, has given a demonstration of it and claims a range of at least 10 miles, altho it will talk much further; and the speech heard is clearer than with his well-known 110-volt A. C. set.

The operation of it is quite simple. He incorporates into the device a transformer which operates on one of the storage batteries as do likewise the two rectifier bulbs which are the ordinary vacuum tubes procurable wherever radio instruments are sold. This transformer is slightly different from the regular spark coil type inasmuch as the vibrator is of a rocker-arm style and two cores are in the transformer proper. Thus when



The Very Latest in Radiophone Sets. It Talks on Two Six-Volt Storage Batteries—No "B" Battery Required. Just the Thing for Motorboats, Camping Parties, Motorcycle, Automobile or Airplane.

one side of the vibrator is attracted, the other side is away from the magnet. Whereupon the other side is immediately attracted and the first side moves away, just like the two pans on a balance or scale; when one is up the other is down. In this way a complete difference in phase of 180 degrees is obtained. The current is then stepped up and rectified by the two audion bulbs which act here as rectifiers. One bulb only is used for transmitting purposes and is not of any special type. A lever on the side of the cabinet is thrown to the position marked "talk" whereupon the buzzer commences to vibrate and the outfit is placed in use for transmission purposes. When the switch handle is thrown in the opposite direction and the buzzer stops and the rectifying tubes suddenly go out, then the complete conversation from the distant wireless 'phone station can be heard. With an antenna having a capacity of .002 M.F. to .007 M.F. a radiofrequency current of 200 milliamperes is actually put into the antenna.

On the front of the cabinet are mounted the transmitter, the three tubes, a stopping condenser, a variable condenser and a milliammeter, together with a switch for changing the connections quickly.

A Direct-Reading Microfaradmeter

The increased use of condensers for a great variety of purposes has created a demand for a means of determining their capacity accurately and quickly. There has been a long-felt want for a more satisfactory means of determining the capacity of telephone, telegraph and power lines and cables, and altho many methods have been devised for measuring electrostatic capacity, some of them dating back to the pioneer days in the electrical art, there has not been a completely satisfactory means of accurately determining the capacity with ease and rapidity demanded by numerous commercial requirements, until this microfaradmeter was produced.

When the facility and precision with which capacity measurements may now be made with this new instrument is appreciated by engineers, much more attention will undoubtedly be devoted to them than has been commercially possible in the past.

To use this meter, it is only necessary to connect two of the four binding posts on its top to a suitable source of alternating current and the other two binding posts to the capacity to be measured, press the contact key and note the deflection of the pointer exactly as in the case of a voltmeter or ammeter. The movable system does not have springs or any other control, therefore the pointer may rest at any part of the scale when the instrument is not being used.

Variations in the voltage or frequency of the supply do not affect the accuracy appreciably, unless they amount to more than 15 per cent from the normal, and even much greater variations would not cause large enough errors to be of importance in most work. Two forms of this instrument are

made. One is for operation on 60-cycle circuits and the other on 500-cycle circuits.

This direct-reading microfaradmeter is supplied with scales reading from .05 microfarad with 100 scale divisions, up to 10 microfarads with 100 scale divisions, for 130-volt circuits with 60-cycle frequencies. Other types of these meters are made for 500-cycle circuits of 100 to 130 volts potential.

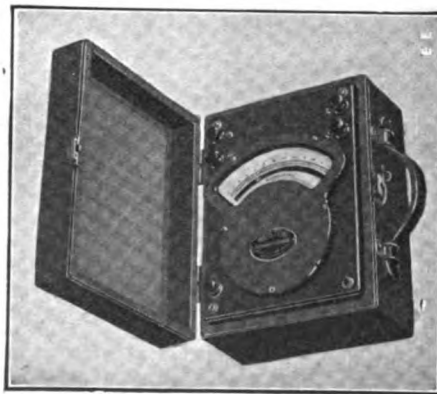

Measure Your Condenser Capacities with This Direct-Reading Microfaradmeter—Don't Spend Hours Calculating It, Which is Only Approximate, Anyway.

THE HAM'S COMPLAINT.

There is a certain class of radio amateurs, fortunate enough to own high power stations, who seem to take great delight in knocking, threatening and brow-beating "ham" operators. For the benefit of the uninitiated we will say that the "hams"

are that odd group of air-hogs who operate those confounded little spark coils. According to the aforesaid amateurs, the "ham" is an unnecessary nuisance, and has positively no right to occupy any portion of the ether with his feebly propagated energy. The "ham's" side of the question has not been made public as yet. The spark coil ham was the first exponent of amateur wireless, not the 1 K. W. know-it-all. The deep roar of a power station is far more obnoxious to the fellow who is trying to copy some distant commercial station than the faint squawk of a one-inch coil. There are two reasons why all amateurs cannot have transformers. One is the lack of commercial current; the other, the size of the pocketbook. The fellows who think they are the whole cheese in a certain relay league suggest that the smaller stations keep quiet for a specified period every night. They do not offer in turn to shut up themselves once in a while, and give the spark coil a chance. One of these "bosses" gives portions of his log where he has written something as follows. "BVD BVD BVD BVD BVD BVD de de de XX XX XX XX XX XX XX ?? ? ? ? sore neck gukrslm slt eggs for breakfast krrr krrrrr awk ssssss."

Even this is better than to hear a 1 K. W. eight miles away call a station in New York State for five full minutes, only to ask him—*what time it was!* Now, some agreement must be obtained or the "hams" will rebel. They will all bring their spark coils and batteries to a centrally located point, hook them all together and then proceed to sit on the key for six months!

M. C. MATHISON.

Glen Ellyn, Ill.

Digitized by Google

AUDION POEM CONTEST



THE poems which we publish on this page are a continuation of the Audion Poem Awards from our August issue. Dr. de Forest personally selected the poems which we already publish as well as the poems which we publish herewith; they were considered the best ones from the 460 submitted to the Editor.

In closing this contest we wish to thank our poet readers for their whole-hearted and earnest co-operation in connection with this contest. It has shown us that our readers are not only interested in scientific matters but can become first class poets as well. It speaks well for their versatility.—EDITOR.

5TH HONORABLE MENTION. THE FRAIL SURVIVE THE STRONG!

Man-blown bubble of glass and wire!
Thy thread-fine filament
Still glowing with the God-like fire!
What has thy coming meant?

Whither on the crest of angry wave
Thy silent way pursue?
From what far shore dared ye to brave
The leagues of ocean thru?

Have you once felt the glowing juice
Thy filament enfold?
Did grid and plate the electrons loose
To sing their message bold?

Has worldly gossip filled thy mouth
Far on the lonely sea?
Or ghostly ship, to North or South,
In passing, spoke thru thee?

Have you, Triode, thrilled at the touch
Of one, a master's hand,
Who worked and nursed you overmuch,
To hear the distant land?

Have you the vigil kept with him
Thru dark and awful night,
While waves roll high and stars grow dim?
Have you been thru the fight?

Most fragile and most delicate
Of all things on that trip,
By what untold caprice of fate
Escaped the sinking ship?

O! Did nerveless hands out-thrust it
With purpose to confound?
Or did they perhaps entrust it
With a message never found?

Man-blown bubble of glass and wire!
Thy thread-like filament
Still glowing with the God-like fire!
What has thy coming meant?

No answer comes but this I know
From living over-long:
The frailest tube that man may blow
Oft times survives the strong!

Composed by
WALTER ELMO CHORPENNING.

Articles to Appear In September Issue of "Radio News"

- "Wired Wireless" in the U. S.
By J. W. Kean
- Radio Frequency Amplification
By A. S. Blatterman
- A Trans-Oceanic Receiver
By Frederick J. Rumford
- "Wired Wireless" in Germany
By Dr. Alfred Gradenwitz
- Radio Telephony Simplified
By H. L. Beedenbender
- The Arc or C. W. Transmitter
By J. Donald Haig
- Ideas—Sixth Spasm
By Thos. W. Benson
- "One of the Gang"
By Marianne C. Brown
- Construction of a Loud Speaker
By H. Winsfeld Secor

6TH HONORABLE MENTION. TO AN AUDION.

Little audion, washed ashore
By the billows of the deep,
Where you once kept watch all o'er,
Guarding thousands in their sleep;
Thru long watches you, just you,
A guardian angel's beacon light,
Assured the passengers and crew
Their folks were safe, that all was right.

In the days of buccaneers,
Pirates, and the Spanish main,
Brave men's hearts were filled with fears
'Till their ships reached port again.
But now, thru you, we know each hour
What transpires on land and sea,
From a distant aerial tower,
Sending word to you and me.

You tell of fortunes lost and won,
Of prices on the stock exchange,
A mother who has lost her son;
Your work is varied, weird and strange.
You ofttimes play the villain's rôle,
Telling when a soul departs;
"The expedition's reached its goal,"
Bringing joy—breaking hearts.

How came you here, come—speak to me;
Why so silent, cold and pale,
You always spoke while on the sea,
Think you of a mighty gale,
A foundered ship and blackened skies
And lightnings like a mighty hell,
Which heeded not the terror cries
As a doomed ship creaked and rose and fell?

Trembling, dainty, little globe,
Let your terror now subside,
I'll send you to a safe abode,
A recompense for all you've cried.
No more I'll question you, I'll swear,
Of suffering and pain you've seen,
And you will have a home up there,
With playmates drest in red and green.

(Continued on page 574)

How to Become a Professional Radio Man

Part I

By **PIERRE H. BOUCHERON**

FOREWORD.

Many letters are received by the editors of this and other magazines giving space to radio matters from young men asking the whys and wherefores of radio operating as



Snap-Spot of the Author Taken Some Years Ago While He Was Attached to the S. S. Mexico as Senior Operator.

a profession. That is to say queries of this nature: "How Shall I Go About It In Order To Become A Radio Man?" "What Books Shall I Buy?" "What School Shall I Attend?" "What Instruments Shall I Buy?" "How Much Money Does It Cost?" "What Are The Salaries And What Is The Status Of A Radio Man On Board A Ship?" "How Can One Secure A First Grade Commercial Radio License?" "Where Shall I Apply?" "What Are The Chances For Promotion?" "Can An Operator Learn Navigation And Eventually Become A Merchant Marine Navigating Officer?", Etc., Etc.

From this, it would seem that an article written by one who has experienced many of the stages incidental with this profession, in other words, one who has been "thru the mill" would prove timely indeed to the many young men who are at the present day casting long and copious glances in the direction of large seagoing vessels "equipt with the latest system of radio telegraphy".

The writer, in this case, has personally been thru many of the ups and downs, thrills and glooms, connected with this fascinating game. He began as a deep-dyed-in-the-wool "amateur." One day, armed with a letter of introduction to THE CAPTAIN (a mighty being was he, you may bet) and a ninety-eight cent papier-maché suitcase containing a nice new uniform with sparks and everything, plus a rather colossal quantity of nerve,—for he did not even know how to start a motor-generator set (no operating licenses were needed in those days)—he boarded a miserable tramp steamer loaded above her Queen's mark with bridge iron,

Inside Information Concerning the Ups and Downs of One of the Most Fascinating Vocations of Modern Times

which to him looked like a Mauretania, and thereupon embarked upon a sea of enlightenment and adventures lasting the best part of six years. Two years later he secured an assignment to his first passenger ship, and four years afterwards quit the sea for good—his education in the great university of experience being that much ahead of many more conservative landlubbers.

Should his attempt to throw a little light and encouragement on the subject interest some who are about to make the step to the point where they may wish to ask brief questions, he shall be glad to answer, providing a self-address and stamp envelope accompanies his letter.

THE PROSPECTS.

NO, I am not going to start out by telling you that "A lot has been written in various magazines about radio operating, but very few if any have attempted to—etc., etc." It is going to be a straight-from-the-shoulder talk concerning those who are eligible to become professional radio operators, what is to be expected when one starts out, when these facts are established, how to go about it in order to become one, and finally, just exactly *how long* one should remain as such.

For as the young man in his teens or in his early twenties who contemplates securing a license in order to become a *seagoing radio man*, the proposition as to whether or not he shall do so is indeed a vital and most important one and may be said to depend upon three basic facts. Is the young man just out of school and about to cast his lot into the great commercial maelstrom—or has he gone thru that period and is he now engaged in some sort of occupation which,—owing to its constant grinding and monotonous nature, is beginning to pall on him—to the extent that he is now wondering perhaps whether or not he is not a square peg in a round hole. Or, on the other hand, is he now engaged as an apprentice in some sort of a profession or trade and has decided that the pace is too strong for him and that the proverbial easy (?) life of a

Sleeping Berth in the Radio "Shack" of a Typical One-Man Freight Ship, So-Called Because There Is Only One Operator and the Complete Radio Equipment Is Installed in the Same Room. Comfort Seems To Be the Keynote in These Well-Furnished Quarters.

radio operator would be one of least resistance?

The first two cases are the only ones we will consider. The third is probably that of a quitter. We are not concerned with him, for he is not wanted; seagoing radio being indeed a *man's* game. Therefore, let our prospects weigh well their present status and future chances in their employment of today. To be sure, being hemmed in by four walls all day does not appeal to everyone. If they cannot see any future advancement, or if at best it is a hit-or-miss affair, or if they feel they must give vent to an inborn feeling of *wanderlust*, professional radio operating offers a possible solution. There are several bona fide, tried and proven reasons for this.

First, any young man from 18 to 25 years of age, possessed of a common school education and average intelligence may learn radio within a comparatively short time. By this is meant a matter of months, not weeks as some would have us believe.

Second, owing to the fact that an operator has the opportunity of traveling to many foreign parts of the world, he will, if he keeps his eyes open and his camera and note-book within easy reach, learn many things having to do with the broadening of his mind, wisdom and experience.

Third, by making profitable use of the great amount of spare time at his disposal between ports of call, he may study subjects allied with his chosen work and thereby prepare himself. Remember the words of Lincoln, "I will study and get ready and maybe my chance will come". It is needless to say that these should be uppermost in a young radio man's mind.

Fourth, one's *wanderlust* may be given full sway, for tell me of the man with red blood running thru his veins who is not *blest* with a certain amount of it. Romance, adventure, excitement and danger beckon to one at every new port visited. The open sea, the never-ending sky line, the approaching storm—one is ever wondering what is going to happen next!

Five, radio telegraphy, like land telegraphy, has its Carnegies, Edisons, Hills and others who started their careers as telegraphers and became famous. Many high officials and well-known engineers of the foremost radio companies began as *seagoing* operators.

NECESSARY PREPARATION.

There is no great secret about learning radio. Particularly is this true of the seagoing operator. As previously mentioned the average young man possess of an ordi-



nary education and a keen interest will take to radio like a fish does to water, literally speaking. If he intends to see the game thru, however, and wishes to eventually become a radio engineer, that is another matter. For the latter, a high school education or some technical college work will prove of great advantage when he enters the realm of radio mathematics. Still, even this is not absolutely necessary. There are today many foremost radio engineers who have done much for the development of the art as well, of course, as many others masquerading under the title of R. E. whose mathematical knowledge was practically nil at the beginning of their careers. Some of these men, by burning the midnight oil on long sea trips and by keeping a close watch on opportunities eventually won minor positions on shore and, the game being in its infancy, soon won recognition in a comparatively few years. Even today, however, there is plenty of room for development and advancement and many radio problems remain still to be solved.

It may be said, incidentally, that there are certain individuals who find it comparatively easy to break into professional radio operating. These gentlemen are land line telegraph operators familiar with either the Morse or Continental Codes; the radio amateurs or experimenters who have had several years experience with their home instruments, and finally but not least, the ex-Army or Navy men who had the good fortune to be taught the rudiments of radio communication in either the Signal Corps or some of the great naval radio training stations so often mentioned in the newspapers.

I quote below an excellent paragraph taken from a typical letter recently sent in by a young man who has given some attention and thought to the matter:

"One of the best and most used means to enter this field is to get a commercial license and enter the Merchant Marine. It also pays exceedingly well and there is abundant opportunity to learn the art from the practical side. The most practical way to pass this examination if one cannot go off to a school is to procure an omnigraph and a few good text books and study by one's self, especially if he happens to be an amateur. However, in doing this several great difficulties present themselves."

This young man has sensed the right idea. There are indeed several difficulties which present themselves to one who is contemplating this study when not properly counseled. These difficulties and the way to overcome them will be given full attention in Part III of this article. That is to say, the proper procedure in learning to receive, to send, the theory of radio, and finally, the practical operating conditions.

Unlike most articles of this kind it is the mission of this one to first tell you about the external consideration connected with radio, telling you just what to expect and not to expect, its joys and sorrows,

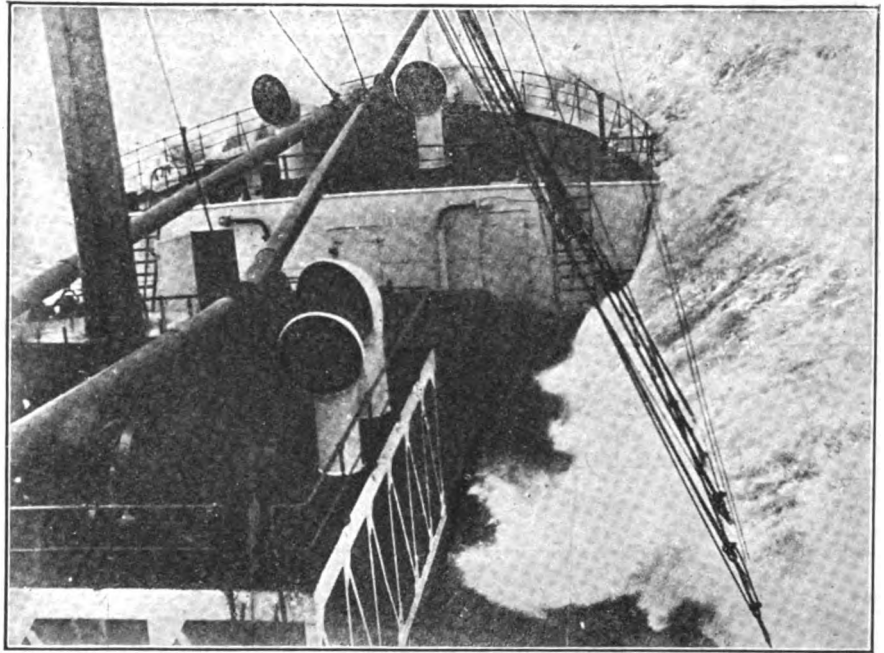

If You Have a Weak Heart or a Tendency Towards Chronic Seasickness, Keep Away From the Sea, For There Will Be Times When the Pouring of Tons of Water into the Main Deck of a Ship is Very Likely to Prove Unpleasant and Cause a Sudden Dismal Feeling in the Pit of Your Stomach. (Actual Photograph Taken at Sea During a Severe Storm.)

then when all these have been presented before you, if you still believe that the game will appeal to you, you will be in a more receptive frame of mind to tackle the serious business of the less interesting details of technical preparation. As a matter of fact some of the remarks mentioned here might well be taken to heart by full-fledged seagoing radio operators who still have a lot to learn concerning the business of getting along and making a real success of their work.

THE AMENITIES ON BOARD SHIP OR "HOW TO GET ALONG."

Many otherwise bright young men go to sea as operators with the idea that they are the *finisht* product of a popular and desirable profession. Some do not complete their first voyage before the realization comes to them that it is not so very amusing after all; and after a year or so of service resign with the firm conviction that the game is not worth while and that the experience has been so much wasted time.

Let us look into this business of going to sea a little deeper than seems to have previously been done. How many operators have started on their first voyage with even the most primary knowledge of what constitutes ship etiquette and discipline?

First there is the matter of discipline which often differs among ships of various companies and nationalities. Then there is the difference in the authority of various ship's officers. On some vessels the Purser seems to have considerable prestige; on others

pens that friction is often caused between these officers and operators due to varying and conflicting conceptions of what is right and wrong. Since operators are frequently transferred from one vessel to another, it would be well to remember the great need of politeness and tact toward officers with a view of adapting themselves to the conditions existing on that particular ship.

For no apparent reasons, new operators often meet with coldness, even snubbing at the hands of some of the ship's crew. A volume might well be written as to the cause for this initial unfriendliness.

Suffice it to say that this is suggestive enough in itself and the reason not hard to find if one cares to inquire into the record of former operators of that particular ship. For instance, there is the case of a certain operator who, after his ship had left port bound on a three months' voyage to South America, went up to the British skipper and between flippant puffs of his cigarette coolly told him that if he had known beforehand he was being sent on such a small vessel he would not have sailed; he had thought it was one of the new and larger vessels of that particular line. The captain in a tone full of contempt at such stupendous arrogance answered that he could very well have done without him, and the result was that this operator, instead of being invited to the various social functions that prevail on this class of ships, was practically ostracized for the remainder of the voyage by most of the officers and passengers—the captain saw to that.

Another operator of 18 summers or less, upon being civilly requested by the Chief Officer to "stop sending" for a few minutes, while a sailor went aloft to fasten a guy-stay, thought he would demonstrate his independence from the rest of the ship's personnel by sending back a note to the officer saying, "Sorry old man can't stop now —piled up with biz".

As a matter of fact this cargo vessel was at the time many hundred miles from the nearest coast station with remote possibilities of the wireless man being "piled up" with traffic. Still another operator contested the right of the captain asking for the name of a passing ship, and so they go.

These may be extreme cases of ill-judgment and lack of tact on the part of opera-

(Continued on page 578)



The Crew Went on Strike at a Foreign Port So the Ship's Officers, Consisting of Chief Officer, Doctor, Purser, Two Engineers and the Radio Man "Turn-To" in Order to Coal Ship. Note Author at Extreme Right.

the Chief Steward is quite "some pumpkins," still others the Chief Mate, and so it hap-



WITH *The* AMATEURS



Our Amateur Laboratory Contest is open to all readers, whether subscribers or not. The photos are judged for best arrangement and efficiency of the apparatus. To increase the interest of this department we make it a rule not to publish photos of apparatus unaccompanied by that of the owner. Dark photos preferred to light-toned ones. We pay \$5.00 each month for the best photo or photos and \$2.00 to each "Honorable Mention." Address the Editor, "With the Amateurs" Dept.

"Amateur Electrical Laboratory" Contest This Month's \$5.00 Prize Winner—Stewart S. Perry

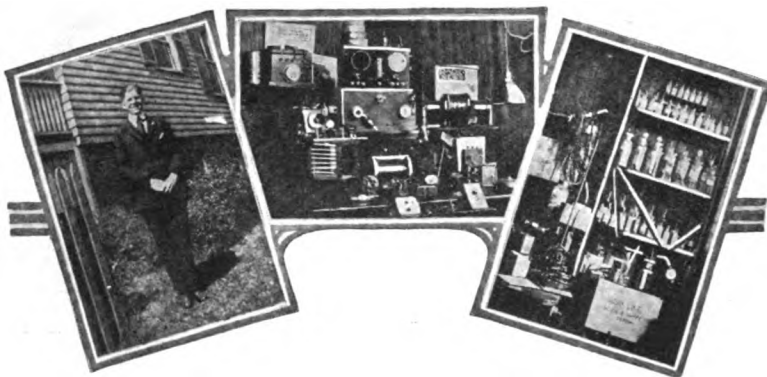

I AM sending three "shots" of my Electrical "Lab.," which is the result of three years' work. Most of the apparatus I have built myself, with the help of plans and suggestions in the *ELECTRICAL EXPERIMENTER*, to which I attribute much of my success in building apparatus.

The first photo shows the chemical end of the "Lab." Most of the chemicals are for use in electrical processes, as for example, distilled water and sulfuric acid for storage batteries, and nickel nitrate for nickel plating. I have, besides, quite a few solutions of acids, bases, and salts, and a complete developing and printing outfit for photographic work.

Another picture shows my wireless set, most of which I made myself. I am using an original hook-up which permits me to use either a crystal detector or audion bulb, and to shift readily from either of my small loose couplers to the large coils for undamp waves. I have two aerials, one

a four-strand antenna about forty feet long, and the other a loop aerial. The large coils for undamp waves can be seen at the top of the picture. With a 42-plate condenser across the secondary, these coils will tune up to twenty thousand meters. Using them with an Audion vacuum tube detector, I have heard Lyons, France (YN). I use a "break-in" key which allows me to listen in even while sending, as long as the key is not actually prest so as to complete the sending circuit.

Another photo shows some of my miscellaneous electrical gear. At the top of the picture is an Audion control box. Directly below it is a step-down transformer. To the left (in front of the *ELECTRICAL EXPERIMENTER*) is my AC rectifier, which I use to charge storage batteries. The Tesla coil I use for experimenting.

There are a number of electrical apparatus which I use in some of my experiments and investigations which are not shown in the photograph here published. This includes electromagnets, condensers and rheostats, galvanometers, etc. I have carried on experiments with X-rays, radio and also experimented with high frequency currents developed from the Tesla coil shown in the second photograph. I have telephone instruments also which are distributed thru the house, as well as telegraph sounders, keys, etc. Most of my instruments and apparatus, particularly my radio instruments, are mounted up in neat hard wood cabinets.

I also have two three-cell storage batteries, several step-up and step-down transformers, several small motors, wave meter coils, telephones, etc. I am always after new ideas and would be glad to exchange "dope" with any amateur in the good old U. S. A. or elsewhere.—Stewart S. Perry, 38 Pleasant St., Winthrop, Mass.

Honorable Mention—Bernard P. Mulcahy, \$2.00 Prize

HEREWITH are represented a few photographs of my laboratory and workshop, constructed in an attic. Ingenuity was necessary in the building of the same, on account of the shape of the attic. While the photographs show simply the chemical department, I have, like most Amateurs, a large quantity of electrical apparatus, stowed away. Being greatly interested in Electro-chemistry, I work mostly along these lines.

It will be seen by the accompanying photographs, my workshop has in addition to the regular tools found everywhere, a lathe made from an old sewing machine. This lathe has a saw attachment whereby I can do small scroll saw work. All tools have to be arranged in as orderly a manner as possible, and yet be out of the way, lack of space not permitting my having extensive tool chests.

My chemistry outfit consists of a well equipped set of chemicals, almost 200 in number. In addition to the chemicals, the apparatus usually found in chemical laboratories serves its purpose. By being careful and keeping my break-age list down, I am able to keep this well sup-

plied with all kinds of paraphernalia needed in my work. A delicate balance which is essential for good work is also contained in the outfit. At present, my electrical laboratory is not so elaborately equip, except for the purpose of Electro-chemistry, but I intend to broaden out later.

Wishing you a successful future for your exceptional publication.—Bernard P. Mulcahy, 305 Pultney St., Geneva, N. Y.



What To Invent

By JAY G. HOBSON

OF all the important improvements needed around the home to lighten a mother's or wife's work and save their patience for cheerfully serving the men folk's whims, nothing is more in evidence than a burnless cloth for ironing boards.

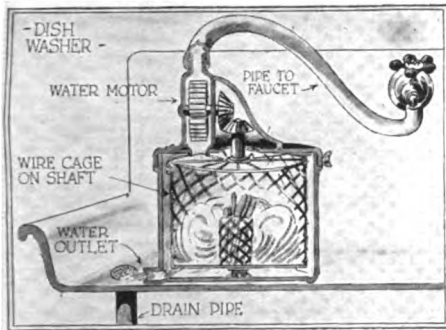

What the American Housewife Needs by All Means Is a Cheap and Efficient Dish-Washing Machine. One Driven by a Water Motor From the Spigot Is Here Suggested.

An old sheet or piece of muslin is generally used which soon becomes scorched, dirty and torn, making linen and fine wearing apparel discolored and smell burnt when ironed. Silk goods are badly roughened on such and in addition to considerable waste in ironing board cloth there is no little loss in clothes ironed on the same. This unsatisfactory condition suggests a new kind of cloth for the purpose. One that I believe would prove acceptable to the great army of American housewives could be constructed in the cotton mills where muslin is woven. Asbestos fiber closely woven between and with the cotton fabric into finish cloth should serve the need amply.

In other words a cloth woven of both cotton and asbestos fiber, arranging the asbestos so it overlaps the surface of the cloth. Then when woven run this non-burn material thru warm steel rollers to polish and press the surface down smoothly, which will prevent roughing silks and the like when ironed.

There is great need for a cloth of this kind in every home. It could be used for many purposes besides ironing boards, such as dining table covers, match pockets for men's clothes, lamp shades, electric insulation and numerous places where a burnless cloth of light, flexible texture is desirable. A large profitable industry could be quickly built from the sale of this invention, and it would be as substantial as the need is practical.

LAUNDRY MARKER.

I have a reputation for being a normal person with a love for fairness to all and malice to none, but I must confess that my balance of mind has recently been sorely tried with the confounded laundry markers now in use for men's sox. No doubt many of my readers fully sympathize in this predicament but to be more explicit I had better tell you all about it so you may help us disgruntled fellows invent something to eradicate this great annoyance.

Only yesterday I skinned a perfectly good leg on these rough metal markers while pulling on my sox in a hurry. The inventor who reduced this tormentor to a reality, certainly had a grievance against laundries

in general, and chose this way to get revenge. History repeats itself again—the innocent must suffer for the mistakes of the guilty. Why any laundry uses this device is beyond my comprehensive powers.

It is a flat, sharp edged, shark toothed piece of non-rustable metal clampd over the top rim of the sock with a pair of pliers, there to stay until the owner gets so disgusted with them he either cuts that part of the sock off; or throws them away with a sigh of relief. This device is the most impractical invention I have seen and yet, many laundries keep right on using them as if they were a boon to mankind instead of a bore. A different marker is sorely needed for men's sox. One that will no tear them nor the flesh upon which they are worn must be invented to take the place of the inefficient kind now in use. An arrangement like the illustration would serve the purpose splendidly and should easily replace the present design, proving very profitable commercially.

This improvement would be so constructed that it can be quickly secured to the sox very much as the eye is put into the shoe. Being round, smooth and made of copper it is non-rustable, doesn't tear nor feel weighty in use.

SOFT DRINK DISPENSER.

Millions of bottles of Coca Cola, Ginger Ale, Grape Juice and similar soft drinks are sold over fountains paying fancy rents for good business locations. Many bulk dispensers for these beverages have been introduced, but so far a practical dispenser for bottled drinks to be installed on busy street corners, in stations and public places has failed to appear. In my opinion here is the "germ" of a mighty valuable idea.

To perfect such a device to keep the product cool in Summer without ice, to remove the cap from the bottles, pour the drink into paper cups and issue it to the customer promptly, means a whole lot of hard study and work but it is not impossible for many reasons. To begin with the cooling problem is already solved in a new automatic electric cooling system now being nationally introduced by a large Chicago corporation for installation on refrigerators to entirely replace ice.

One of these could be used for cooling

the drinks in the dispenser. The bottles could be stood on end with caps resting in individual cork pullers operated by the motor that runs the cooling machine. Paper cups are arranged directly beneath the bottle

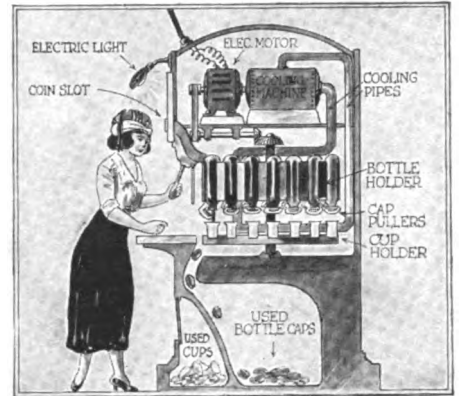

Why Doesn't Some Genius Give Us Public Soda Fountains Which Will Dispense Bottles of Soft Drinks After a Coin Has Been Deposited?

openings to catch the liquid as sold. The operation of this dispenser can be so timed that paper cups containing the drinks will not be pushed out to the customer until contents of bottle has had enough time to run out into the cup, and this entire operation should happen in less time than is now required to receive a drink at the fountain.

To operate such a dispenser the customer places the coin required in the slot, pulls a small lever that swings a full bottle into position, waits a second, and then a paper cup containing the soft drink comes out thru serving opening within easy reach. Paper cups once used are thrown into receptacle at bottom of dispenser as illustrated.

AUTOMATIC HOME DISHWASHER.

To my knowledge there have been several unsuccessful inventions for washing the dishes of the average family. All of them have failed because they either were too expensive to own or operate, broke more dishes than they cleaned—or, worse still, never cleaned them at all.

There are several important items that enter into the construction of a successful dish washer. The retail cost must be within reach of the average family, the device must be as simple as possible, it must not break dishes in operation, water must be employed economically, it must not require the hands to be placed in the water, and above all it must *thoroly* cleanse the dishes and also dry them if possible.

One in the form of a round case, with another case made of wire to revolve inside the outer case, a small water motor secured on top to supply the power necessary and the outlet of the motor furnishes the hot water for cleaning the dishes as it rotates them. This constant agitation of the water and the revolution of the dishes in the water should thoroly clean them. When clean they could remain in the washer until dry.

A fortune of first magnitude will reward the successful efforts of the inventor who perfects a device for this purpose, but the greatest satisfaction will come from knowing the good accomplisht for the millions of women now washing their dishes by hand.



There Is Not a Single Satisfactory "Laundry Marker" For Hoisery on the Market—Why Not Invent a Good One and Make a Small Fortune?



LATEST PATENTS



Doll.

(No. 1,343,422, issued to Robert A. Thomson and Gordon Alvis.)

An ingenious idea indeed is this one whereby in a doll the eyes will close gradually when the doll is placed in a recumbent position, resembling very closely the appearance of a living child gradually closing its eyes as if going to sleep. The doll, of course, must be rocked from side to side in order to cause this effect. On awakening, or when the doll is placed into an upright position, its eyes open practically instantly. The structure consists of a toothed slot in which a pendulum

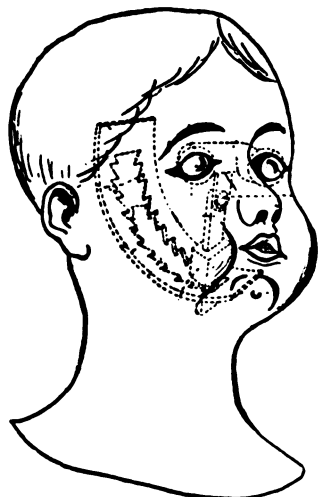

weight moves. This pendulum weight is directly connected to the eyes. When the doll is rocked from side to side the toothing arrangement allows the pendulum weight to slip a tooth in the guide with each rocking motion till finally the eyes of the doll are closed.

Sound Magnifying Phonograph.
(No. 1,329,928, issued to Edwin Stewart Pridham and Peter Lauritz Jensen.)

This novel device is a machine for magnifying phonograph records in large halls, auditoriums and out-of-door gatherings. The results are

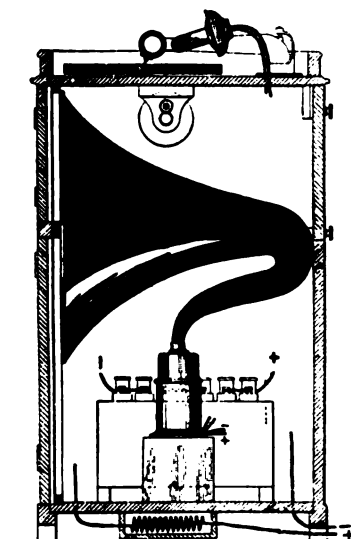

accomplish thru the application of a microphone transmitter, together with the ordinary sound box. The sound from the microphone transmitter is then carried thru to a magnetic amplifier thru an induction coil.

Rotary Engine.

(No. 1,343,115, issued to George E. Current.)

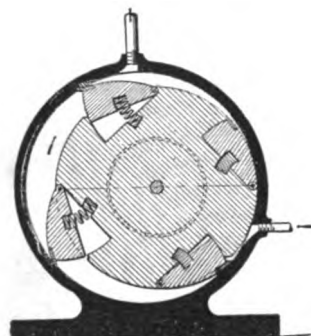

The engine casing shown has two tubes leading into it, one to admit the fluid and another for the exhaust of that fluid. Within this is mounted the rotor, eccentrically, leaving a chamber which is wider at one end than at the other. This rotor has formed in the periphery recesses or pockets, four such pockets being shown in the accompanying diagram. Each of these is mounted pivotably and is of considerable weight, so that it will swing outwardly from the respective pockets by centrifugal force and upon passing the inlet of the liquid will be held in that position by the force of the fluid.

Electric Socket and Lamp Protector.

(No. 1,336,761, issued to Frederick Stolzenwald.)

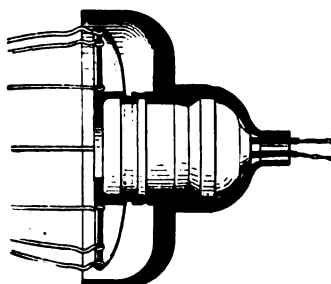

Two soft rubber protectors fit over the socket. When the socket is then pushed together into place and locked, the soft rubber pieces are joined together. Should the socket be dropt no injury to the lamp can be sustained, due to the bell-shaped guard surrounding the lamp and this elastic covering over the socket. In addition, the elastic medium is of exceptional insulating merit

Nitrogen Fixation.

(No. 1,334,590, issued to Jacob E. Bloom.)

Hot surfaces of metal, grounded in the proper manner, so that either only positive or negative discharges

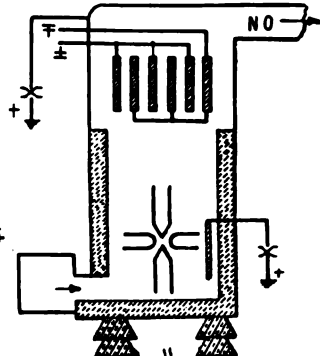

are produced are used, and hot refractory granules or crystals employed as absorbents until the proper oxidation is attained. A single phase A. C. current not exceeding 440 volts is employed and upon this is superimposed a direct current whose voltage is about 1 1/4% of the A. C. voltage. In the tower for the purpose of obtaining nitric acid from gases and having them absorb by water, an electro-positive absorbent is used.

Windmill.

(No. 1,341,045, issued to Charles Fremont Currey.)

This invention relates to windmills in which the vanes are in an upright position so that the rotor turns about an upright axis, the vanes themselves being so constructed as to give maximum power

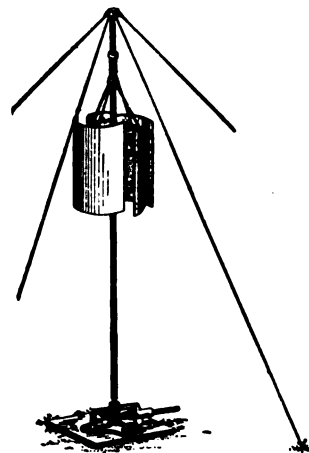

for a given wind velocity. By extending the blades it is possible to provide a rotor with a very large area of effective surface, and yet the fact that they hinge (so that a portion of the vane would turn inwardly while another turns outwardly), a very large effective area is possible without placing the mill in danger of collapsing or striking any guys which hold it in an upright position.

Storage Battery Indicator.

(No. 1,301,516, issued to Franklin G. Smith.)

This is a very ingenious application of the hydrometer to the

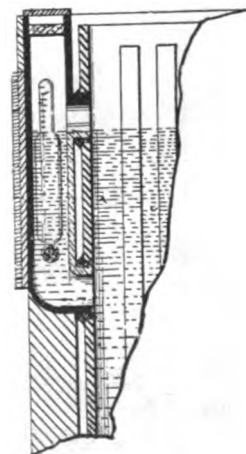

storage battery wherein the hydrometer is permanently mounted in the face of the storage battery so that it cannot get lost, and at all times renders a visual reading of the battery condition, a matter of a mere second.

Electric Hair Curler.

(No. 1,340,738, issued to Arnaud Pausser.)

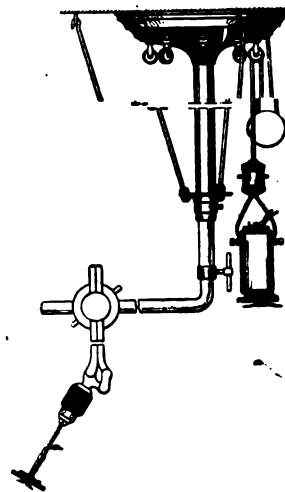

The hair is first twisted upon a rod and held in position by a nut on each end which grips the hair. The hair after having been moistened either with hot or cold water and wrapt with a moistened pad, is inclosed in an asbestos tube provided with electric heating units.

Telephone Set.

(No. 1,339,814, issued to Henry C. Egerton.)

The transmitter is mounted at the front of a metallic cabinet by the mouth-piece, and the receiver is

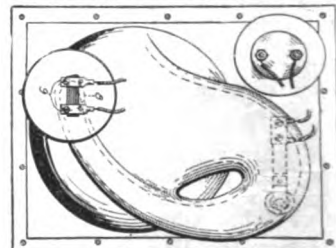

likewise mounted by its horn in the same cabinet. In this way the set, which can readily be placed into the wall of a vessel or a room, and particularly submarine vessels, is not subjected to the excessive vibration generally found in these vessels.

Water-Motor.

(No. 1,339,012, issued to William H. Ammons.)

The floats are so arranged as to create a deflecting pocket so that the moving water will be concentrated upon the wheel. By changing the depth of wheel immersion the speed and power can be regulated.

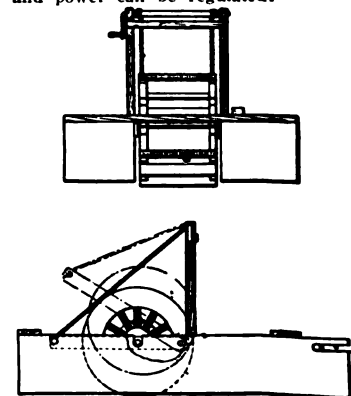

Scientific Humor

The Difference Between Thine and Mine.—Two mine engineers were discussing deep mine shafts, and one had told in glowing terms about mines in which he had worked.

"Jump into my car and I'll show you a regular mine," said the other.

Arriving at the mine they saw the hoisting engine revolving at a terrifying rate. The engine-man was asleep. Rushing to the sleeping man, they cried:

"Wake up man! You'll pull the cage thru the roof!"

"What day is this?" the engine-man asked sleepily.

"It's Tuesday, but stop the engine, quick!"

"Aw g'wan," he replied, disgustedly, settling himself back in his chair. "She won't be up till Friday."—*J. H. Schalk.*

FIRST PRIZE \$3.00

Filming the Pup.—"Father! Father! The bull-pup is chewing up the roll of films I got for my camera and won't let go!"

"Go and get some of that toothpaste that removes the film from the teeth!"—*J. H. Schalk.*



Solid Ivory.—**PROF.:** "What is density?"
STUDENT: "I can't define it but I can give a good illustration."

PROF.: "The illustration is good, sit down!"—*Sterling R. Decker.*

Holy Smoke!—**JOHNNY:** "Mother, how old is that lamp?"

MOTHER: "About three years."

JOHNNY: "Turn it down then, it's too young to smoke."—*Carl Brecht, Jr.*

Alas—'Tis True.—**STAFF PHOTOGRAPHER:** "I've caught a snapshot of the fleeing gambler!"

CITY EDITOR: "Good! Now take a time exposure of the police in pursuit."—*No Name.*

Cheap, If It Keeps Her Beautiful.—

"Since when have you become interested in chemistry?"

"Nonsense, that's my wife's toilet table."—*Daniel Blair.*



Probably on the Pension List.—"Are there no more babies in this town?"

"Why do you ask such a question?"

"Well I noticed a card in a repair shop window: 'Baby carriages Retired.'"
—*W'alla ce R. Harris.*

A Tidy Answer.—"Why do they have knots on the ocean instead of miles?"

"If there were no knots there wouldn't be any tide."—*Everett Brooks.*

Not at Present Prices.—**INQUISITIVE PUPIL:** "Will electricity cure a person of anything?"

TEACHER: "It will if enough of it is taken."—*No Name.*

A Slip Twixt Cup and Lip.—A small boy rusht into a drug store and excitedly called for some liniment and cement. When asked why he desired them both at once he said nervously, "Pa hit Ma with a cup."
—*W. R. Windham.*

So That's Why It Smells So!—**BEN ZEEN:** "I know a good joke about crude oil."

CARRY SEEN: "Spring it."

BEN ZEEN: "It's not refined."—*J. H. Schalk.*

Besides It Gets Less!—**TEACHER:** "What kind of a change is there from water to ice, John?"

HOPEFUL STUDENT: "Change of price, Sir."—*Harold L. Schrock.*

Personal Magnatism.—**MOLLIE:** "Jane certainly attracts all the young men around here."

GERTIE: "Sure, her father is a big steel magnate."—*Martin F. Keane.*



How About Peaches and?—

1ST FARMER: "I have made a plant that produces strawberries and cream."

2ND FARMER: "How?"

1ST FARMER: "By grafting a strawberry plant on a milk-weed."
—*Floyd G. Kirkham.*

ALL jokes accepted and published here are paid for at the rate of one dollar each, besides the first prize of three dollars for the best joke submitted each month. In the event that two people send in the same joke so as to "tie" for the prize, then the sum of three dollars in cash will be paid to each one.

Perfectly Logical.—**PROFESSOR:** "Young man, what is 'Mineral Wool?'"

FRESHMAN: "The shearings from a hydraulic ram, sir."—*W. Buck.*

Next They'll Cross Ham and Eggs.—

1ST FARMER (With big idea): "Do you know what I am going to do?"

2ND FARMER: "No, what?"

1ST FARMER: "I am going to graft beans, red pepper and tomatoes together and raise ready made Chili Con Carne."—*Theodore Streeter.*

"Applied" Astronomy.—**SHE:** "There goes a shooting star."

HE: "You know that when a girl says she sees a shooting star, it means she wants to be kist."

SHE: "There goes a constellation."—*Sterling R. Decker.*

She'd Fetch a Good Price Today.—**SUNDAY SCHOOL TEACHER:** "Now who can tell me what happened to Lot's wife when she looked back at Sodom?"

SMALL BOY WITH LARGE SPECTACLES: "Please, teacher, she was transmuted into chloride of sodium."—*C. C. Sabin.*

Try This on Your Girl.—The chemist has a scene with his wife who finally breaks into tears.

"Your tears don't have any effect on me, —for what are they? A mighty small percentage of phosphorous salts and a trace of chloride of sodium—all the rest is water."—*C. C. Sabin.*

A Smashing Hit.—A lady who had her hand in a sling was explaining to a friend that the hurt was due to reckless driving.

"Of your auto?" asked the friend.

"No," said the sufferer, "Of a Nail."—*Ralph McRobert.*



Some Clock.—"Do you mean to tell me that clock will run eight days without winding?"

"Yes."

"Well, then how long will it run if you wind it?"—*Martin F. Keane.*

So That's Why We "Boil."—"What is steam?"

"Water in a high state of perspiration."
—*A. G. Kalmbach.*



"Pointed" Wireless.—**ASK-IT:** "What do you think of this scheme of telegraphing without wires?"

TELLIT: "That's nothing new. My wife has been kicking my shins

under the table for the last twenty years."—*J. H. Schalk.*

This One Hails From London.—**SIGN IN LONDON SHOP:** Experienced Electrician for large Butcher's store used to mincing machinery and hooking up the lights.—*Geo. Heasman.*

Mr. Logwood Please Note!—**INQUISITIVE LAYMAN:** "Is it true, they are using trees now for receiving radio messages?"

RADIO BUG: "Yes, De Forest wireless is getting to be very popular!"—*Paul Brinotte.*



THE ORACLE

The "Oracle" is for the sole benefit of all electrical experimenters. Questions will be answered here for the benefit of all, but only matter of sufficient interest will be published. Rules under which questions will be answered:

1. Only three questions can be submitted to be answered.
2. Only one side of sheet to be written on; matter must be typewritten or else written in ink, no penciled matter considered.
3. Sketches, diagrams, etc., must be on separate sheets. Questions address to this department cannot be answered by mail free of charge.

4. If a quick answer is desired by mail, a nominal charge of 25 cents is made for each question. If the questions entail considerable research work or intricate calculations a special rate will be charged. Correspondents will be informed as to the fee before such questions are answered.

LAMP COLORING FORMULA.

(1055) Prince Alhagini, New York City, N. Y., asks for:

Q. 1. A good coloring formula for lamp bulbs.

A. 1. Two of the best substances which suggest themselves as excellent vehicles of color and which are at the same time soluble in water are water-glass, its chemical name being potassium and sodium silicate; and gelatine. Into solutions of these substances in water are added some anilin water soluble colors.

The thickness of this solution must be tried and ascertained by experiment. The globes prior to dipping, should be made as free of dirt, grease, etc., as possible. In using gelatine, it is not advisable to make it very thick, so that no appreciable layer will form, it being best that some non-drying material, such as glycerine be added, so as to prevent cracking.

WHY ISN'T THE EARTH UNBALANCED?

(1056) William H., Newark, N. J., writes:

Q. 1. Would like to ask you why the earth apparently continues to rotate without any appreciable variation when one half is possibly heavier than the other.

When large cities like New York are built heavy material is taken from one part of the earth's surface and added to the other part, this would make one part heavier.

Coal is taken from the earth and burned, don't this make the part of the earth lighter where the coal is taken? The burning of the coal still lightens the surface.

Why is it that this changing of weight does not effect the cycles of rotation?

Does the center of gravity change when great quantities of matter are transferred?

The above has got me thinking and thought I would like to hear what had occurred to others along the line.

A. 1. In our opinion, the amount of coal that is taken from different places of the earth and burnt in cities like New York, where the material is massed in one spot, is really so insignificant compared to the total mass of the earth that it would cut no more figure than the smallest fly speck would on the largest orange. That would be about the proportion.

While there is a difference in weight, this amount is so small that it would never be able to make any tangible difference. As a matter of fact, very much greater differences occur every day of the year due to rain or snow. These amount to tremendous proportions as compared to the weights of buildings in large cities. Still these differences are so small as compared to the total weight of the earth that they really amount to nothing at all in the long run.

DATA ON 2 K. W. RADIO TRANSFORMER.

(1057) M. E. Hulderman, Akron, Ohio, writes the Oracle:

Q. 1. Please give data for building a 2 K. W. radio transformer for laboratory work.

A. 1. Data on 2 K. W. 18,000-volt radio transformer for use on 110-volt, 60 cycle A. C. circuit:

Laminated Sheet Iron Core: The core should measure $17\frac{1}{2}$ inches long by $8\frac{3}{4}$ inches wide, outside dimensions, and have a cross-section of $2\frac{1}{4} \times 2\frac{1}{4}$. Both the longer legs should be well insulated with several layers of oiled linen.

Primary Winding: The primary winding will comprise three layers of 13 $\frac{1}{2}$ lbs. No. 8 D.C.C. magnet wire. The primary contains 244 turns, and is wound on one of the longer legs.

Secondary Winding: The secondary winding will comprise 21 lbs. of No. 28 D.C.C. magnet wire, wound in 30 pies or coils, each $\frac{1}{4}$ inch thick, with suitable insulating discs placed between them in assembly. Each coil should contain 920 turns, or a total of 27,600 turns for the whole secondary. The secondary potential can be varied by bringing out taps on the end of the first, second and third layers of the primary. The secondary voltage with all primary turns cut in, is 12,440 volts; with 200 primary turns in the circuit, the secondary potential is 15,180 volts, and with only 100 primary turns in circuit, the secondary voltage equals 30,360.

HEATING OF TWISTED WIRE.

(1058) Armistead Andrews, of Memphis, Tenn., asks:

Q. 1. The reason for the violent heat generated when a piece of wire of large gage is vigorously twisted.

A. 1. The explanation of this phenomenon is due to the compression of the molecules that go to make up this iron wire and likewise the friction that results, causes the heating of the wire.

The wire need not be twisted vigorously to obtain this heat but can be obtained by merely bending the wire back and forth at short intervals.

POWER OF ELECTRIC LOCOMOTIVE VERSUS STEAM TYPE.

(1059) A. L. Simmonds, S. S. Caribbean, Cristobal, Canal Zone, writes:

The members of our ship are patrons of your magazine. A heated discussion has arisen in regards to an article in your June, 1920, number. This article, appearing under the title of "Electricity Triumphs Over Steam." Please answer these questions:

The General Electric Company, Engineering Department, advises as follows:

Q. 1. How heavy was the electric locomotive?

A. 1. 265 tons, of which 458,000 lbs. was on drivers.

Q. 2. How heavy was each steam locomotive?

A. 2. Passenger locomotive, 421,000 lbs. total weight, including tender; 173,000 lbs. on drivers. Freight locomotive 509,500 lbs. total weight including tender; 234,000 lbs. on drivers.

Q. 3. Was it at all necessary for the electric locomotive to be heavier than the two steam locomotives?

A. 3. An electric locomotive of the same total weight will outpull a steam locomotive because of the larger proportion of its total weight being on drivers.

Q. 4. What would happen were two locomotives of equal weight, but one having more power, to meet in such a contest?

A. 4. If the steam and electric locomotives were of the same total weight, the electric locomotive would outpull the steam for the reason given in question 3. If they have the same weight upon the drivers in each case the electric locomotive would still outpull the steam, as its motors deliver to the drivers a perfectly uniform turning motion, while the reciprocating steam engine with quartering cranks delivers about 88 per cent uniform turning motion to its drivers; hence with equal weight upon the drivers there is about 12 per cent differential in favor of the electric locomotive.

MAKING GUN COTTON.

(1060) D. M. Scott, Oakland, Cal., inquires of the Oracle:

Q. 1. For the formula used in making gun cotton.

A. 1. We give herewith the necessary data for the making of gun cotton.

Take one part by volume nitric acid, two parts sulfuric acid. Pour the nitric acid very slowly into the sulfuric acid, stirring constantly. Be sure to do this in the open, as the nitrous acid fumes are very dangerous and deadly. This will be found to heat up rapidly and must now be left in the open air to cool to normal atmospheric temperature.

Some cotton or celluloid is now obtained. After having washed it of its impurities in sodium hydroxide, and then in water until not even the slightest trace of the hydroxide remains, a test being made with litmus paper, it is dried. When thoroughly dried, it is put into the sulfuric nitric solution, this being also done in open air. It is allowed to remain in said solution from ten to fifteen minutes, timing by a watch, then removed and placed in a running water bath. It is again washed in running water, until not the slightest trace of acid shows its presence, dried, and is ready for use. This will not explode if struck by a hammer, nor will it ignite, unless it is placed in a confined space or container.



Santa Fe Special WATCHES

“Meet Every Test
Where Seconds Count”



The TEST

Standard Railroad Accuracy, Marvelous Beauty, Unsurpassed Life-Long Dependability

The **ILLINOIS** Famous \$
Santa Fe Special
21 JEWEL RAILROAD WATCH **3.50**
A MONTH

—are all combined in the highest possible degree in the famous **Santa Fe Special** Watch.

The Standard Railroad Watch that is **GUARANTEED TO LAST A LIFETIME AND GIVE SATISFACTORY SERVICE. SAVE ONE-THIRD TO ONE-HALF OF YOUR MONEY** by purchasing one of these famous “Santa Fe Special” Watches at our Rock Bottom price. **MOST LIBERAL OFFER EVER MADE.**

Our “Direct-to-You” low wholesale terms and **Extra Special Distribution Plan** is fully explained in the new **Santa Fe Special Watch Book** in full colors which shows the newest case designs and tells facts you should know before buying a Watch. The “Santa Fe Special Plan” means a big saving of money to you and you get the **BEST** watch value on the market today. **WATCH SENT FOR YOU TO SEE WITHOUT ONE PENNY DOWN.**

The extraordinary sale prices we are now making mean a tremendous sacrifice on our part, owing to the advancing cost of materials and skilled labor. All we ask is that every man who takes advantage of these low prices will tell his friends about the “Santa Fe Special” and the **BUNN SPECIAL** Watches.

The Santa Fe Watch Co.
980 Thomas Bldg. Topeka, Kans.

In the intense heat of engine service, with the shock and vibration of the train, with varying climatic conditions encountered around the world, the Famous “Santa Fe Special” watch has proved absolutely dependable to the last degree.

New Case Designs

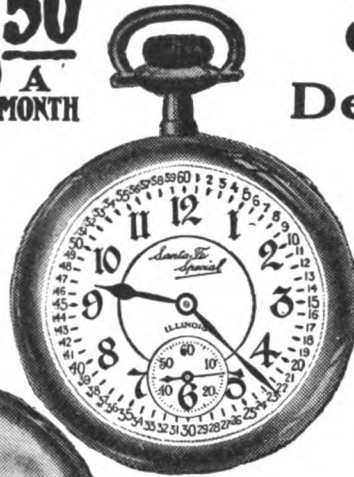

You must see these remarkable watches in order to fully realize the marvelous beauty of these **NEWEST DESIGNS**; see the 3-color inlay work, think how distinctive your watch will be with your own name or monogram or an emblem inlaid in the solid gold. See the special **New French Art** designs in watch cases, or any special emblem or monogram combined to suit your own ideas.

Write today and receive the **free watch book** postpaid. All the **newest watch case designs** are shown. **Read our easy payment offer.** Wear the watch 30 days **Free.** Watch sent for your examination and approval without a penny down. **Nothing to risk. See the Watch** before you buy.



HON. CHAMP CLARK
House of Representatives
Washington, D. C.

“I have carried a ‘Santa Fe Special’ for three or four years and find it to be an admirable timepiece.

Champ Clark.”

A letter, post card or this coupon will bring my Free Watch Book

SANTA FE WATCH CO.,
980 Thomas Bldg., Topeka, Kansas.

Please send me your New Watch Book with the understanding that this request does not obligate me in any way.

Name.....

Address.....

State.....

BOYS



Learn Drafting

Employers everywhere are looking for skilled draftsmen. They are offering good salaries to start with splendid chances for advancement.

Drafting offers exceptional opportunities to a young man because drafting itself not only commands good pay, but it is the first step toward success in Mechanical or Structural Engineering or Architecture. And drafting is just the kind of work a boy likes to do. There is an easy delightful way in which you can learn right at home in spare time. For 28 years the International Correspondence Schools have been giving boys just the training they need for success in Drafting and more than 200 other subjects. Thousands of boys have stepped into good positions through I. C. S. help, but never were opportunities so great as now.

Let the I. C. S. help you. Choose the work you like best in the coupon, then mark and mail it. This doesn't obligate you in the least and will bring you information that may start you on a successful career. This is your chance. Don't let it slip by. Mark and mail this coupon now.

TEAR OUT HERE

INTERNATIONAL CORRESPONDENCE SCHOOLS BOX 6161B, SCRANTON, PA.

Explain, without obligating me, how I can qualify for the position, or in the subject, before which I mark X.

- | | |
|---|---|
| <ul style="list-style-type: none"> <input type="checkbox"/> ELECTRICAL ENGINEER <input type="checkbox"/> Electrician <input type="checkbox"/> Electric Wiring <input type="checkbox"/> Electric Lighting <input type="checkbox"/> Electric Car Running <input type="checkbox"/> Heavy Electric Traction <input type="checkbox"/> Electrical Draftsman <input type="checkbox"/> Electric Machine Designer <input type="checkbox"/> Telegraph Expert <input type="checkbox"/> Practical Engineer <input type="checkbox"/> MECHANICAL ENGINEER <input type="checkbox"/> Mechanical Draftsman <input type="checkbox"/> Ship Draftsman <input type="checkbox"/> Machine Shop Practice <input type="checkbox"/> Toolmaker <input type="checkbox"/> Gas Engineer <input type="checkbox"/> CIVIL ENGINEER <input type="checkbox"/> Surveying and Mapping <input type="checkbox"/> PIPE FOREMAN OR ENGINEER <input type="checkbox"/> ARCHITECT <input type="checkbox"/> Architectural Draftsman <input type="checkbox"/> PLUMBING AND HEATING <input type="checkbox"/> Sheet Metal Worker <input type="checkbox"/> Navigator | <ul style="list-style-type: none"> <input type="checkbox"/> CHEMICAL ENGINEER <input type="checkbox"/> SALESMANSHIP <input type="checkbox"/> ADVERTISING MAN <input type="checkbox"/> Window Trimmer <input type="checkbox"/> Show Card Writer <input type="checkbox"/> Outdoor Sign Painter <input type="checkbox"/> RAILROAD ENGINEER <input type="checkbox"/> ILLUSTRATOR <input type="checkbox"/> DESIGNER <input type="checkbox"/> BUSINESS MANAGEMENT <input type="checkbox"/> Private Secretary <input type="checkbox"/> BOOKKEEPER <input type="checkbox"/> Stenographer and Typist <input type="checkbox"/> Cert. Pub. Accountant <input type="checkbox"/> Traffic Management <input type="checkbox"/> Commercial Law <input type="checkbox"/> GOOD ENGLISH <input type="checkbox"/> STATIONARY ENGINEER <input type="checkbox"/> CIVIL SERVICE <input type="checkbox"/> Railway Mail Clerk <input type="checkbox"/> Textile Overseer or Supt. <input type="checkbox"/> AGRICULTURE <input type="checkbox"/> Poultry Raising <input type="checkbox"/> Automobiles <input type="checkbox"/> Spanish <input type="checkbox"/> French <input type="checkbox"/> Italian |
|---|---|

Name _____ 7-25-19

Present Occupation _____

Street and No. _____

City _____ State _____

A NECESSITY

For the Home, Shop, Garage, Automobile, Moving-Picture and Wireless Operators

25c

PER TUBE

\$1.25

TORCH

Solder

A PASTE THAT TURNS INTO METAL WHEN HEATED

A match will do it. Requires no acid or soldering iron. Joins or repairs wires, metals or metalware. Sold by hardware and electrical stores, or sent by us postpaid.

SOLDERALL CO. Dist. E9
129 Success Ave., Newark, N.J.

COMBINATION SET
Torch and Tube Complete **\$1.50**

Dealers Send for Quantity Prices.

Home Electricians

By G. L. HOADLEY, M. E.
(Continued from page 497)

Return Call Bell Circuits.—By a return call system is meant a circuit in which the home push button will ring the distant bell and the distant push button will ring the home bell. With such a system when a station is signaled, the party called can signal back by pressing his push button.

Fig. 17, the single stroke bell if used at the calling station shows the caller that the distant station is ringing because the single stroke bell is operated only by the ringing of the vibrating bell at the distant station.

Master Call System.—An installation suitable for a school building is shown in Fig.

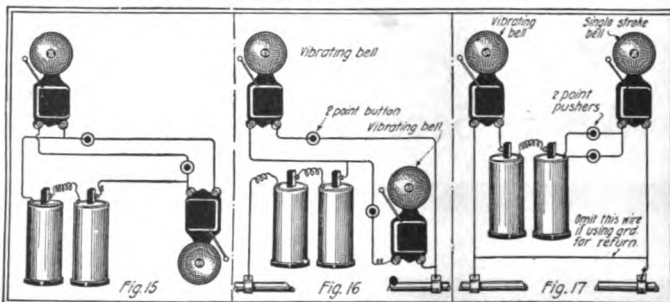

Fig. 15. Three-Line "Return Call" Bell System, — One Battery Ringing Either Bell. Fig. 16. Two-Line Grounded Return Call System With Common Battery. Fig. 17. Three-Line Return Call System, Common Battery.

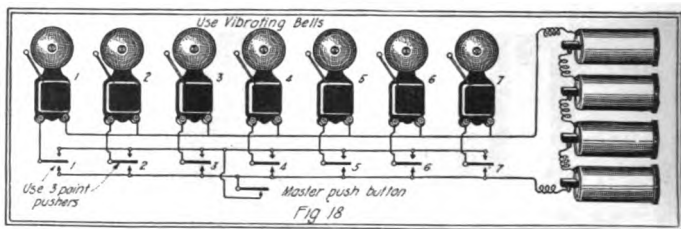

Fig. 18. Below Shows a Very Good "Master Call" Electric Bell System, Suitable for Schools and Other Institutions or Large Houses. Double Contact Push Buttons are Used in Order That All of the Bells May Be rung in Case of Fire or Drills, Etc., By Depressing the Master Push Button.

Two Line Return Call.—Fig. 13 shows this type of circuit. Two batteries are required. The double contact push buttons needed have the line wire connected to the strap or spring in the button, the bell wire is connected to the upper contact. One line wire may be eliminated by using the earth for the return path as shown in Fig. 14. By using the ordinary push button in either Fig. 13 or Fig. 14 both bells will ring simultaneously.

Three Line Return Call.—Only one battery is needed for this circuit which is illustrated by Fig. 15 and ordinary two-point push buttons are satisfactory. An extra third wire is necessary, however, between the two locations. This third wire can be eliminated by using the ground for the return path of the current as shown in Fig. 16. With a circuit wired as shown in

Fig. 17, the single stroke bell if used at the calling station shows the caller that the distant station is ringing because the single stroke bell is operated only by the ringing of the vibrating bell at the distant station.

Bell System With Relay.—Fig. 19 illustrates the use of the relay to operate bells at a distance. Installing such a system, place the relay close to the distant bells and the local battery C as shown. Then, adjust the relay to work from line battery A. On pressing any one of the push buttons, a, b, c, current from battery A passes thru the relay at the distant station, making contact at y. This throws into circuit local battery C, which rings the bells, at the distant station. Only a very small current is needed to operate the relay itself and the weak current supplied from the distant battery, A, is amply sufficient.

Illustrating the Use of a Relay for Ringing Bells Over Long, High Resistance Circuits. Only a Small Current is Required to Work the Relay.

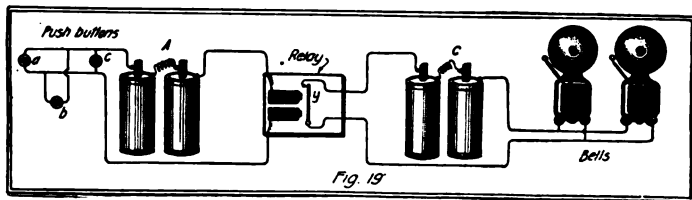

Eclipses--How Caused

By A. M. HARDING, Ph.D.
(Continued from page 495)

Since the moon moves its own diameter every hour, it follows that an eclipse of the moon, when central, may continue total for about two hours. The refraction of the atmosphere of the earth deflects the sunlight around the earth into the shadow. Consequently, after the moon has buried itself in the shadow it is usually visible, shining with a reddish or copper colored light.

There is nothing mysterious about an eclipse of the moon. There is nothing between us and the moon at the time of an eclipse. The light has merely been turned out. The computation of a lunar eclipse is not at all complicated. These computations are made in advance and are published in the American Ephemeris and Nautical Almanac. Washington, D. C.

As the moon moves around the earth it cuts out the sunlight from a certain portion of space. That is, it has a shadow which moves along with it, remaining always on the opposite side of the moon from the sun. The average length of the moon's shadow is 232,150 miles. However, since the moon is not always at the same distance from the earth, this length varies from 228,000 miles to 236,000 miles. The average distance of the moon from the earth is 240,000 miles. Its shadow will, therefore, usually not reach the earth, altho it may sometimes reach 18,000 miles beyond the earth's surface! When it does reach the earth, those of us who happen to be in the shadow see a total eclipse of the sun.

Dig (Continued on page 524)

DETROIT

The Auto Center is the Logical Place



Training for Head and Hand

LEARN AUTOMOTIVE ELECTRICS

MEN WANTED

Factories, service stations, repair shops and garages are calling for automotive electricians and mechanics faster than we can supply them. In addition to the handsome salaries and quick advancement offered by employers there is a wide-open opportunity to start a business of your own. Ten million or more automobiles, trucks and tractors throughout the United States and Canada have created a tremendous demand for service stations, repair shops and garages — thousands of openings in good territory are awaiting you. Very little capital is required—but, of course, it is absolutely necessary that you know your business. Train in 10 to 12 weeks at the M. S. A. S.

WHAT WE TEACH



Showing part of electrical dept.



Showing cars for electrical repairs.



Showing corner in block test dept.

AUTOMOBILES AND TRACTORS

WE teach the automobile and tractor business from A to Z. Very thorough and complete training is given in electrics, starting, lighting, ignition, wiring, testing, repairing, including batteries, etc.

Our equipment and instruction are positively the best. We give actual factory experience in assembling, block testing, bearing scraping, valve grinding road testing, etc. **LIGHTING PLANTS, TRACTORS, BRAZING AND WELDING AND TIRE REPAIRING** are also thoroughly

taught. The student learns how to conduct a business of his own successfully, and is a life member of the school, including all service privileges without any extra charges.

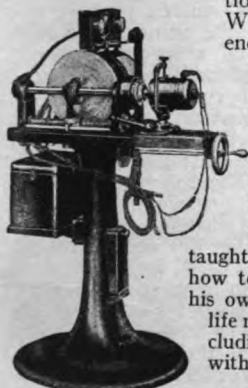

One of the Electrical Test Tables used at M. S. A. S.



Electrical Test Table. These are but small parts of the vast electrical equipment at M. S. A. S.

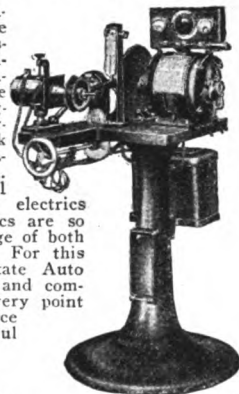

Electrical Test Table from M. S. A. S. Electrical Dept.

LEARN THE AUTOMOBILE and TRACTOR BUSINESS

PUT your electrical experience to work in the world's greatest industry. Automotive electricians are the most valuable men in the automotive field. They earn the largest salaries. The importance of electrical work in the automotive industry is well recognized. Every electrician is well aware that automotive electrics and automotive mechanics are so entwined that a knowledge of both is absolutely necessary. For this reason the Michigan State Auto School gives a thorough and complete course covering every point of knowledge and practice required of a successful automobile expert.

EQUIPMENT

The M. S. A. S. is by far the best equipped school in America. Get our Free Catalog.

TRAIN IN DETROIT

Train in Detroit, the Heart of the Automotive Industry. You get a training here that is not possible elsewhere. More than 180 of the leading automobile and accessory factories are located in Detroit, 94% of all automobiles are manufactured within a radius of 100 miles around Detroit, and 71% are made right in this City.



The greatest automotive experts in the world are in Detroit and they helped outline our courses for you. The latest and best equipment is here.

All leading manufacturers endorse our school. Many of the leading manufacturers in each line assisted in outlining our Course and they give our students the fullest cooperation possible. They have placed their machines in our school for students' instruction. They are constantly calling on us for graduates because they know the type of men we turn out. Everywhere in the automotive industry M. S. A. S. graduates are given the preference because ours is the Factory Endorsed School.

FREE: BIG 124-PAGE CATALOG

Send the coupon today for big 124-page illustrated catalog and copy of latest "Auto School News." They tell about Courses—show more than a hundred pictures of equipment—give letters from big factories and tell of successful graduates and point out opportunities for you. Use coupon now.

MONEY-BACK GUARANTEE

We guarantee to qualify you for a position as chauffeur, repair man, demonstrator, auto electrician, garage man, automobile dealer, tractor mechanic and operator or farm lighting expert, paying from \$1,500 to \$5,000 a year or refund your money. Many of our graduates are making twice our guarantee.

SEND THIS COUPON TODAY

MICHIGAN STATE AUTO SCHOOL
668 Auto Building, 687-89-91 Woodward Ave.
DETROIT, MICH.

Gentlemen: Please send me absolute FREE New 124-page Illustrated Catalog "Auto School News," and information as checked below.

Auto and Tractor Course
 Tire Repairing
 Brazing and Welding
(Mark each course you are interested in. Or, better still, you can expect me about

Name
Street
City State

MICHIGAN STATE AUTO SCHOOL

"The Detroit Auto School" ————— "Endorsed by all Leading Manufacturers"

668 Auto Building
687-89-91 Woodward Ave. **DETROIT, MICH., U.S.A.**

Eclipses—How Caused

(Continued from page 522)



Choose as Your Profession Electrical Engineering

Electricity offers a brilliant future to the young man who is about to choose his career. Never before has there been such wonderful opportunity in this great field. Big paying positions in electrical work the world over are open to trained men—men who possess specialized, practical knowledge. Come to the School of Engineering of Milwaukee—the largest and best equipped electrical school in America. Here you are trained in both theory and practice by a faculty of over 90 experts. You learn in large, finely equipped laboratories.

If you have 14 high school credits or equivalent, you can become an Electrical Engineer with a Bachelor of Science degree in 3 years. If you lack these credits they can be made up in our Institute of Electrotechnics in a short intensive course.

Earn While You Learn

By our special system you may earn your way while learning. Our Employment Department will secure you a position to which you may devote a part of each day, spending the remainder at the school. This plan both solves the students' financial problems and provides splendid experience at the same time. Low tuition fee and Fraternity House for all students who wish to secure board and room at cost.

Fall Term :
Begins
October 1st

Write for Catalog

Write today for our free, illustrated catalog. Read about this wonderful institution and the great opportunities that lie before you. Find out about our specialized method of training and the details of our "Earn While You Learn" plan.

SCHOOL OF ENGINEERING OF MILWAUKEE
Dept. 1-J—373 Broadway, Milwaukee, Wis.

School of Engineering of Milwaukee,
Dept. 1-J—373 Broadway, Milwaukee, Wis.
Please send me your free illustrated catalog on Electrical Engineering and give me full details of your "Earn While You Learn" plan.

Name

Address

Town..... State.....

Age..... Experience.....

**Send To-day for the
"Electrical Worker's Friend"**

An electrical book of 66 motor drawings with complete instructions for rewinding and reconnecting A.C. motors. Special at \$4.00

Or write for full particulars of this valuable book
SMITH & SMITH PUBLISHING CO.
Dept. B. 1524 Lowrie St., N. S., Pittsburgh, Pa.

Big Band Catalog sent free

Whatever you need—from a drumstick to the highest priced cornets in the world. Used by the Army and Navy. Send for big catalog; liberally illustrated, fully descriptive. Mention what instrument interests you. Free trial. Easy payments. Sold by leading music stores everywhere.

LYON & HEALY 62-86 Jackson Blvd. Chicago

MATHEMATICS MADE EASY

The Arcscope—the Combination Triangle with a Brain—will multiply, divide, figure percentage and proportion, solve all problems in trigonometry and geometry, draw symmetrical figures, plot arcs, etc. Superior to any slide rule. Simple to operate. Also includes a TRANSPARENT TRIANGLE, PROTRACTOR and THREE RULES. Used at Columbia University, West Point, U. S. Aeronautic Schools, etc. Only 85 cents Postpaid. Order today before you forget.

Dept. J. L. J. LEISHMAN CO., Ogden, Utah

It is evident that an eclipse of the sun is something entirely different from an eclipse of the moon. In the case of a *lunar eclipse* the moon is in the earth's shadow and we cannot see it, altho there is nothing between us and the moon. In the case of a solar eclipse we are in the moon's shadow and we cannot see the source of light, the moon being between us and the sun. When one thoroly understands the reason for an eclipse of the sun he cannot help but laugh at the following "headline" which once appeared in a daily paper of wide circulation on the day after a solar eclipse: "The moon casts its shadow on the sun!"

To the average person the sun and the full moon appear about the same size. This is due to the fact that, altho the sun is 400 times as large as the moon, it is 400 times as far away. Consequently, when the moon gets between us and the sun it is usually just large enough to cover the face of the sun and, since it is moving very rapidly, the sun is not hidden very long. In fact, the moon's shadow passes an observer near the equator with a velocity of 1,000 miles per hour. The speed is much greater in higher latitudes.

Since the moon is sometimes closer to the earth than at other times, it will sometimes appear larger than the sun. In this case a total eclipse may last longer than usual. For an observer near the equator an eclipse of the sun may remain total for seven minutes and 58 seconds, while in latitude 36° it cannot last longer than six minutes and 30 seconds.

If the moon is so far from the earth at the time of a solar eclipse that it is not large enough to hide the face of the sun, a *ring of light* will be left around the edge of the moon. This comes from the part of the sun which is not covered up. An eclipse of this nature, which is more frequent than a total eclipse, is known as an annular, or ring-shaped, eclipse. The eclipse of November 22, 1919, was an annular one. For an observer near the equator an annular eclipse may last for 12 minutes and 24 seconds. The duration of the annular eclipse of November 22 was almost up to the maximum.

The cross-section of the moon's shadow at the place where it strikes the earth is generally less than 150 miles in diameter. As has already been stated, everybody within the narrow strip where this shadow traverses the face of the earth will see the moon pass across the face of the sun. That is, they will see a total, or an annular eclipse, according as the diameter of the moon is or is not, large enough to cover the face of the sun. Everyone within 2,000 miles on either side of this strip will see a partial eclipse of the sun. That is, as the moon passes between them and the sun, its center will pass to one side of the center of the sun, leaving one limb of the sun visible all the time. Those observers who live near the narrow strip will see the eclipse almost total, or annular, while those 2,000 miles away will scarcely see any of the sun's disk covered up by the moon. In the case of the solar eclipse of November 22, 1919, the shadow strip began near San Antonio, Texas, and ran thru the Gulf of Mexico, along the northern boundary of South America, across the Atlantic Ocean, and ended in Africa. Everyone in this strip saw an annular eclipse. Those of us who were not fortunate enough to live in this strip saw the eclipse as partial, provided we were not living so far west that the eclipse ended before sunrise.

Altho it is possible for a year to pass without a single eclipse of the moon, the orbits of the earth and moon are so constructed that there must be as many as two solar eclipses every year and there may be

as many as five. A year with five solar eclipses must have two lunar eclipses. Consequently there may be as many as seven eclipses per year. This will happen next in 1935. In the year 1917 there were seven eclipses, four of the sun and three of the moon. The most unusual number of eclipses per year is four and, as we have seen, the least possible number is two, both of the sun, and the largest possible number is seven, five solar and two lunar, or four solar and three lunar. In the year 1920 there will be four eclipses, two of the sun and two of the moon.

If the whole earth be taken into account there are more eclipses of the sun than of the moon. That is, the shadow, or the shadow produced, of the moon traverses some part of the earth more often than the moon goes into the shadow of the earth. The ratio is approximately three to two. However, if any given place on the earth be considered, the result is entirely different. The reason for this will be perfectly obvious after a little reflection. Let us remember that the full moon is visible from half the surface of the earth. Then everyone on one side of the earth will see it go into the shadow and since the earth is rotating rapidly on its axis many other observers who did not see it go in, will see it come out. Thus every lunar eclipse is visible from more than half the surface of the earth.

On the other hand, a solar eclipse is total, or annular, only for those who live in the narrow strip mentioned above. Suppose some inhabitant of Mars should reach his arm across the intervening space, and with a brush 150 miles wide, paint a streak at random across the face of the earth as it spins rapidly on its axis. What is the probability that your house would be painted? And you would not see the eclipse as total, or annular, unless your house was painted. In fact, unless you were close enough to smell the paint you would not even see a partial eclipse. That is, you could not tell by looking at the sun that anything was happening.

It is obvious that an eclipse of the sun can occur only when the moon is between the earth and the sun; that is, at the time of new moon. The solar eclipses in 1920 will occur at the new moons (May 17 and November 10) following the full moons (May 2 and October 27) at which the lunar eclipses occur.

The eclipses in any year always take place at two opposite seasons, which are called the eclipse months of the year. The eclipse seasons for the year 1920 are May and October-November. After the eclipse of November 10 there cannot be another for about six months.

Eclipses are periodic; that is, they occur at regular intervals. The period is 18 years and 11 1/3 days. This period, which was known to the ancient Chaldeans, is called the Saros. All that has been said with reference to eclipses applies not only to us but also to the inhabitants of other heavenly bodies. It is rather unfortunate for those of us who are interested in eclipses that we do not live on Jupiter or Saturn. Each of these planets has nine moons which furnish a great variety of eclipses. These moons move around their primaries (worlds) so rapidly that eclipses of the sun occur every day or so and undoubtedly interfere with business if any business is transacted on these worlds.

Let us suppose that we live on the moon. Then when the moon goes into the shadow of the earth we would see an eclipse of the sun. Why? Because the earth would be between us and the sun. This eclipse would be very interesting since it might last as

(Continued on page 526)

12 WAYS to Earn Bigger Pay

Look over the twelve wonderful home-study sets listed below. One of the twelve is YOUR BIG OPPORTUNITY FOR SUCCESS! Each set was prepared by the country's foremost authorities, written especially for you in the kind of language that you best understand. The first idea in the minds of the men who prepared these books was to help you make MORE MONEY. So they put into them everything that would help you,

photographs, diagrams, complete descriptions; all the knowledge that you need to give you surest success.

The books are handsomely bound, some in half Morocco, library style; others in American Morocco, flexible handy style. All stamped in gold. Pick out the set that is meant for you; examine it FREE. If you are satisfied pay the special bargain price, on terms of 10c a day. If not satisfied, return the books.

Invest 10c a Day in Your Brain

Jump at this big opportunity. You will never miss the 10c a day, (less than cigar money). These volumes bring you the greatest opportunity to invest in your brain—in knowledge that will double or triple your earning power. If you expect to make bigger money, you must feed your brain, give it a chance to grow. These great volumes are brain food for you. Pick your set now and examine it free.

Don't send any money. Examine the books first. If satisfied pay for them on terms so easy that you will never miss the money. You take no risk. The books must show you that they will work for you, train you for a better, bigger-pay job. Fill out the coupon now. Pay only the very small shipping charges when the books arrive. If you mail the coupon at once we will give you FREE a year's Consulting Membership in the American Technical Society. This allows you to consult our corps of experts on any problem you may have. Ordinarily this membership costs \$12. It is yours free if you act promptly. Mail the coupon before you turn the pages—before you can forget.

Send No Money

show you that they will work for you, train you for a better, bigger-pay job. Fill out the coupon now. Pay only the very small shipping charges when the books arrive. If you mail the coupon at once we will give you FREE a year's Consulting Membership in the American Technical Society. This allows you to consult our corps of experts on any problem you may have. Ordinarily this membership costs \$12. It is yours free if you act promptly. Mail the coupon before you turn the pages—before you can forget.

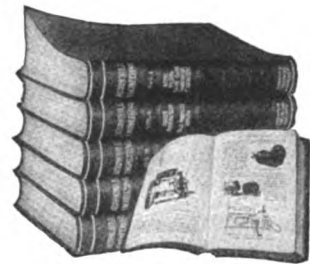

American Technical Society

Dept. X256
Chicago, U. S. A.

Carpentry and Contracting

Five volumes, 2138 pages and more than 400 illustrations. Prepares for Contractor, Building Superintendent and Carpenter Foreman. Regular price, \$37.50. Special price, \$24.80.

Civil Engineering

Nine volumes, 3600 pages and 3000 illustrations, plates and diagrams. Prepares for Civil or Structural Engineer, Transitman, Estimator, Designer or Chief Draftsman. Regular price, \$67.50. Special price, \$39.80.

Telephony and Telegraphy

Four volumes, 1738 pages and 2000 illustrations, plates and diagrams. Prepares for Telephone Engineer, Wire Chief, Exchange Manager, Trouble Man or Telegrapher. Regular price, \$30.00. Special price, \$19.80.

Mechanical and Architectural Drawing

Four volumes, 1578 pages and more than one thousand illustrations. Prepares for Architectural or Mechanical Draftsman. Regular price, \$30.00. Special price, only \$19.80.

Electrical Engineering

Eight volumes, 3000 pages and 2600 illustrations, plates and diagrams. Prepares for Electrical Engineer, Power Plant Superintendent, Substation Operator or Electrician. Regular price, \$60.00. Special price, \$34.80.

Fire Prevention and Insurance

Four volumes, 1500 pages and 600 illustrations, diagrams, forms, etc. Prepares for Counterman, Rate Clerk, Inspector or Agent. Regular price, \$30.00. Special price, \$19.80.

Automobile Engineering

Five volumes, 2400 pages and 2000 illustrations. Prepares for Garage Foreman, Automobile Mechanic or Chauffeur. Invaluable to car owners. Regular price, \$45.00. Special price, \$29.80.

Machine Shop Practice

Six volumes, 2300 pages and 2500 illustrations. Prepares for Machine Shop Superintendent or Foreman, Foundryman, Pattern Maker, Tool Designer or Tool Maker. Regular price, \$45.00. Special price, \$29.80.

Sanitary, Heating and Ventilating Engineering

Four volumes, 1454 pages and more than 1400 illustrations, etc. Prepares for Sanitary Engineer, Heating and Ventilating Engineer, Master Plumber or Plumber. Regular price, \$30.00. Special price, \$18.80.

Steam and Gas Engineering

Seven volumes, 3300 pages and 2500 illustrations, plates, diagrams, etc. Prepares for Stationary, Marine or Locomotive Engineer or Fireman. Regular price, \$52.50. Special price, \$29.80.

Law and Practice

(with Reading Course in 25 bound pamphlets). Thirteen volumes, 6000 pages and 24 illustrations. Prepares for all Bar Examinations. A wonderful aid to business men. Regular price, \$90.00. Special price, \$49.80.

Accountancy and Business Management

Seven volumes, 2700 pages and 2000 illustrations, forms, etc. Prepares for Certified Public Accountant, Auditor, Office Manager, Accountant, Credit Man or Bookkeeper. Regular price, \$52.50. Special price, \$29.80.

American Technical Society,
Dept. X256, Chicago, U. S. A.

Please send me set of.....
for 7 days' examination, shipping charges collect. I will examine the books thoroughly and, if satisfied, will send \$2.80 within 7 days and \$3.00 each month, until I have paid the special price of \$.....
If I decide not to keep the books, I will return them by express at your expense. Title not to pass to me until the set is fully paid for.

NAME
ADDRESS
REFERENCE

BE AN EXPERT IN Automotive Electricity

Every auto repair shop, today, needs expert electricians to care for and repair the complex and important starting, lighting and ignition systems, as well as batteries. For the electric repairs on autos, trucks, etc., constitute 75% of all service work today.

BIG PAY

There are twice as many jobs as men. This insures steady work and big wages to trained men. They are the aristocrats of the auto field.

8 WEEKS COURSE

A course of 8 weeks of 44 hours each, at this Institute—the only school teaching automotive electricity exclusively—you learn all the theory and actual practice of the complex electric systems of autos, etc.

In class room, laboratory and shop experience, electrical engineers train you in every detail.

LIMITED CLASSES

To insure individual instruction classes are limited to 20 men each. A new class starts every two weeks, and they are filling weeks in advance.

ENROLL NOW

Get started early—the demand for trained men is tremendous.

Let us be disappointed in getting into the class you want. We urge you to get your reservation in at once. Write to Administrative offices for terms and dates of classes open.

AMBU ENGINEERING INSTITUTE

C. J. BUCKWALTER, President

R901-1603 S. Michigan Ave. CHICAGO



Shoot Without Noise

Avoid disturbances, also flinching. Enjoy quiet shooting, anywhere, anytime. Use a

MAXIM SILENCER.

Price, .22 cal. \$7.00. Send 6c in stamps for catalog and booklet of astonishing experiences of Silencer users.

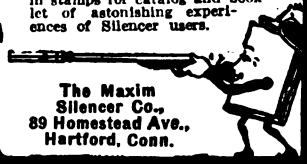

The Maxim
Silencer Co.,
89 Homestead Ave.,
Hartford, Conn.

Discover Your Talents!

Why is it that some men make a success of everything they touch while others work their lives out, and remain failures?

Why is it that some climb to the heights with little effort while others plod along for a lifetime in the same old rut?

It's not luck, nor pull—it's knowing how to direct your energies most effectively. It's discovering where your talents lie, and putting all your efforts along the lines where you can succeed.

Don't struggle along any longer, against your own personality.

Let Dr. S. S. George, the eminent psychologist and former U. S. Army expert, help you discover your talents. Dr. George has made his lifework the analysis of men's abilities.

His mental and vocational analysis course with 1,500 vocations classified, will be mailed to you on approval. Don't wait a single day. Get in touch with your abilities. This service may be worth thousands of dollars and invaluable happiness to you. Send only \$3.00 for complete course and lists.

MONEY REFUNDED IF NOT SATISFIED

At the end of 5 days, if you are not completely satisfied, we will refund your money in full.

Vocational Guidance Institute, 2255 Broadway, N. Y.

FREE TO PHOTOPLAY WRITERS

A wonderful book, illustrated with 100 photographs, of stars, directors, producers, scenes in the filming, studio interiors and exteriors. Literally takes you on tour of the great Motion Picture Studios.

It tells how Adrian Johnson, author of 300 produced photoplays by formulating a simple, practical, followable system of screen writing, has brought this fascinating profitable profession to your very door.

It is a system for persons of average intelligence. You need not be a "genius" to master it. Send no money. Get this beautiful souvenir book today, for the asking.

The Adrian Johnson Photoplay System
111 American Theatre Building, New York, N. Y.

Eclipses—How Caused

(Continued from page 524)

long as two hours. Suppose, on the other hand, that the moon's shadow traverses the earth. Then we would see an eclipse of part of the earth. That is, we would see the moon's shadow pass across the earth at the enormous speed of 1000 miles per hour.

It may be of interest to mention some of the eclipses which have occurred since the dawn of history and to see how they were regarded by man and how they influenced his conduct.

One of the earliest eclipses of which we have any record is mentioned in the Old Testament. Joel (ii, 30, 31) makes the Lord say, "I will shew wonders in heaven and earth, blood and fire and columns of smoke; the sun shall be turned into darkness and the moon into blood." The reddish color which the moon assumes during a total eclipse seems to give rise to the expression "to turn the moon into blood." The prophet Amos (VIII, 9) says, "And it shall come to pass in that day, saith the Lord God, that I will cause the sun to go down at noon, and I will spread darkness over the earth in the clear day."

Again, Job (V, 8) says, "Seek Him that maketh the seven stars and Orion, and turneth the shadow of death into the morning, and maketh the day dark with the night."

Schiaparelli, in his interesting book *Astronomy in the Old Testament*, calls attention to the fact that total eclipses of the sun were visible in Palestine on the following dates: August 15, 831 B. C., April 2, 824 B. C., and June 15, 736 B. C. He also mentions the fact that both the eclipse of 831 B. C. and that of 824 B. C. occurred during the lifetime of Joel and Amos, and that the moment of greatest darkness in 831 B. C. occurred in southern Judaea at noon. The two prophets seem to have written of a phenomenon which both of them had witnessed.

Several of the later prophets referred to eclipses of the sun. However, in view of the fact that there were no eclipses of the sun visible in Palestine between 763

B. C. and 586 B. C., it is very probable that they obtained their ideas from the earlier prophets. We quote three references.

Micah III-6: "And the sun shall go down over the prophets, and the day shall be dark over them."

Jeremiah XV-9: "Her sun is gone down while it was yet day."

Isaiah XIII-10: "The sun shall be darkened in his going forth, and the moon shall not cause her light to shine."

There are several other references to eclipses of the sun and the moon in the Old and New Testament. For example, Job V-14: "They meet with darkness in the daytime and grope in the noonday as in the night." Matthew XXIV-29: "Immediately after the tribulation in those days shall the sun be darkened, and the moon shall not give her light."

Herodotus tells us that during the sixth year of the war between the Medes and the Lydians, while the armies were in the midst of the combat, the day suddenly changed into night; whereupon the combatants stopt fighting and established peace. Astronomers tell us that this eclipse occurred on May 28, 585 B. C. This eclipse was predicted by Thales of Miletus, one of the Seven Sages, who had obtained his knowledge of astronomy from the Egyptians.

Pericles understood the nature of eclipses and, when an eclipse of the sun threatened to interfere with one of his expeditions, he managed to convince his soldiers that they had nothing to fear.

Christopher Columbus used his knowledge of eclipses to free himself and his companions from the American Indians, who held him prisoner and had reduced him almost to starvation. He happened to remember that an eclipse of the moon was due to occur on March 1, 1504, and he told the Indians that he would cause the moon to go out if they did not bring him food. They paid very little attention at first but when the moon disappeared they brought him plenty of food and worshipped him as a "God."

What's Wrong with the Motor Car

By H. WINFIELD SECOR

(Continued from page 479)

fact that you are wont to tear along the road at a speed of from 30 to 50 miles an hour, which is the common one with fast Flivver drivers, you must pay for the fuel and burn the energy and enough gasoline to develop 20 to 25 horse-power!

"And what else can I do?", you will ask. Here is what can be done, and just exactly what is being done, in many European countries which are yet smarting under the terrible lash of the World War and its aftermath. In Germany and several other countries, particularly in England, there have been developed several very interesting and thoroly practicable types of *light-weight*, low powered vehicles.

WHY 15 TO 20 MANEUVERS TO DRIVE YOUR MOTOR?

Another important principle and fact which is apparent even to the casual observer if he stops to look at an up-to-date motor car, is the very *complicated procedure* required in handling the vehicle. We do not see many women drivers—only now and then. Why is this, do you suppose? Not necessarily because the gentler sex is afraid of the noise or anything else, but simply because women like to have things (especially machinery of any kind) operate as *safely* and as *simply* as possible; and

they have a perfect right to expect this!

The accompanying illustrations show some of the almost unbelievable maneuvers and movements which the modern motor car driver often has to go thru in order to properly drive an automobile of the average type. This is not exaggerated or especially gotten up for the purpose of making a story, either. The writer checked up this matter carefully by referring to standard automobile text-books, and some of the well-known makes of cars in which the devices to be operated by the chauffeur or driver, vary from 10 to as high as 20 and more different parts, such as the Cadillac, the Packard, and several others; but you don't have to pick out any particular car; simply walk up to the first one you see on the street and look it over.

One of the latest inventions of present interest and demonstrated at the last New York Auto Show, was a fluid turbine drive or transmission which eliminates all gears and gear shifts, permitting all speeds and any variety of them to be obtained by the manipulation of a *single lever*! It can be fitted on any car and relegates the gear box and 4 or 5 position lever quadrant to the scrap pile, where it belongs. All you need is a speed control lever, steering wheel and one foot pedal for the brakes.

Westinghouse

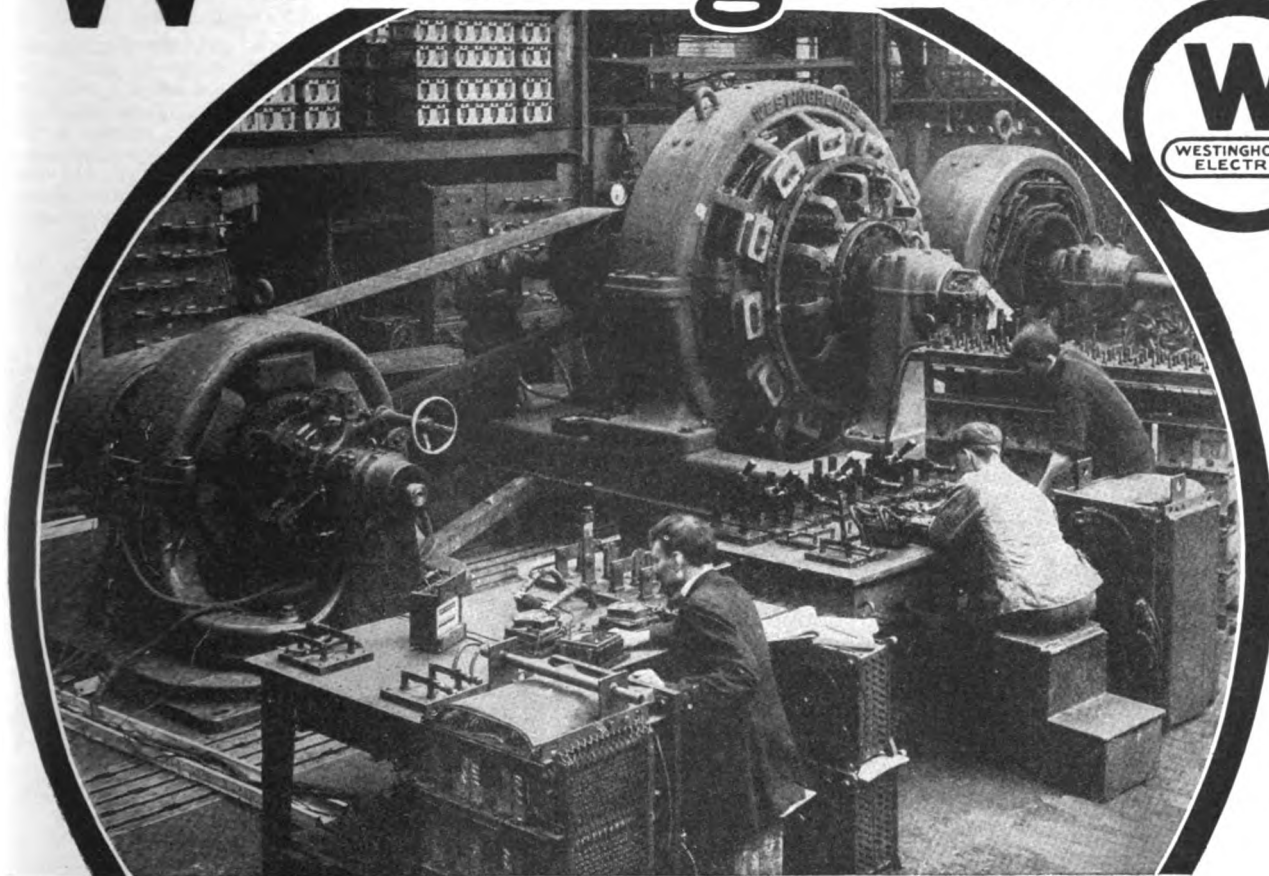

An Unusual Opportunity For An Electrical Career

Earn While You Learn

To the electrically or mechanically inclined high-school graduate, The Westinghouse Company offers NOW—

An opportunity to secure technical training in the atmosphere of industry, under the guidance and instruction of experienced electrical engineers.

Instruction in the construction and application of electrical apparatus, generators, motors, transformers, electric railway equipment or instruments.

An opportunity to earn while you are learning. To choose that phase of work, engineering or commercial, to which you are naturally inclined and fitted. To qualify for a responsible position in the field of engineering with the Westinghouse organization.

A class of thirty selected men will begin September 1. If you are interested in electricity and have not been able to go to college, this is your opportunity.

Apply in your own handwriting for further information to

THE EDUCATIONAL DEPARTMENT

Westinghouse Electric & Mfg. Company

East Pittsburgh, Pa.

"Liquid Air"

By PROF. T. O'CONNOR SLOANE, PH. D.
(Continued from page 474)

liquefaction of air has led to the discovery of the rare gases of the air, neon, cription, xenon and niton.

EATING LIQUID AIR

When liquid air is poured out into the atmosphere, as over the hand, it produces a sort of smoky vapor. This is due to the condensation of the moisture of the atmosphere and it may be of carbon dioxide, producing quite a striking effect. It may be taken into the mouth, when the cloud of condensed water vapor is still more pronounced. It is said that it has even been swallowed without permanent ill effects. It must have been rather inflating to say the least.

If placed in unsilvered vacuum receivers, a considerable ebullition will first be observed, and the outer vessel will soon become clouded with water from the air which eventually freezes, giving a coat of hoar to the glass.

It may be placed in a vessel which is then tightly corked. In a short time the air will blow the cork out with any degree of violence, according to how tightly it was forced in.

A test tube full of mercury freezes solid after a short immersion in liquid air and can be taken in a wooden test tube holder and made to drive a nail. The old trick done in the arctic regions by natural cold may be done here by freezing a bullet of mercury in a mould and firing it thru a board.

A soft lead wire is wound into a spiral. When cooled to liquid air temperature it is highly elastic and supports a weight as if it were brass or steel. But if warmed by standing in the air or by blowing upon it, the elasticity disappears and the wire straightens out.

Iron becomes brittle. An iron flask which has been chilled by it can be broken by a hammer as if it were glass.

A kettle of liquid air will boil slowly in the air; to make it boil violently it may be placed on a lump of ice.

Liquid air makes india rubber brittle. A piece immersed in it becomes like glass and can be fractured by a blow. A piece of beefsteak can be treated in the same way and will break into fragments.

If an iron or other ball of metal is dipt into liquid air and kept in it until it attains the temperature of the air and is then placed in a Bunsen burner gas flame it will precipitate a cloud of carbon dioxide and of water vapor from the products of combustion of the gas notwithstanding the heat of the flame.

Oxygen is strongly magnetic; the liquid can be attracted like iron filings by a powerful magnet; air will act in the same way when liquefied, on account of its oxygen constituent. If the temperature of the air is reduced so as to freeze the nitrogen, a magnet will draw the liquid oxygen out of the partly frozen mass.

Electrical Machinist

By H. WINFIELD SECOR.

(Continued from page 508)

noise. A very important thing to watch in this connection and a problem which should be checked whenever possible by means of an angle gage calibrated in degrees, is the *pitch* of the blades.

"What to do when the armature strikes the field poles,"—is often a serious question. There is one correct remedy for this trouble, and that is to rebush the bearings or else replace the old worn bearings with new ones, so that the armature will rotate in its exact central axis, between the field pole.

Figure 3-A shows an armature placed in the lathe and driven by a dog in connection with the face plate tooling off a fine cut with a diamond point steel tool.

One of the simplest remedies resorted to when the bearing plates seem to lock the armature, preventing its free rotation, when they are clamped into place on the field frame, is to use two or more metal *shims* placed behind one side or the other of the bearing plate or plates, as occasion may demand, so as to get the bearings into alinement in order that the armature shaft can rotate freely. This is simply a case of "cut and try" until you can make the shaft rotate with the minimum degree of friction.



A Big Raise in Salary

Is Very Easy to Get, if You Go About It in the Right Way

You have often heard of others who doubled and trebled their salaries in a year's time. You wondered how they did it. Was it a pull? Don't you think it. When a man is hired he gets paid for exactly what he does, there is no sentiment in business. It's preparing for the future and knowing what to do at the right time that doubles and trebles salaries.

Remember When You Were a Kid

and tried to ride a bike for the very first time? You thought that you would never learn and then—all of a sudden you knew how, and said in surprise: "Why it's a cinch if you know how." It's that way with most things, and getting a job with big money is no exception to the rule, if you know how.

We Will Show You How

Without loss to you of a single working hour we can show you a sure way to success and big pay. A large number of men in each of the positions listed are enjoying their salaries because of our help—we want to help you. Make check on the coupon against the job you want and we will help you to get it. Write or print your name on the coupon and send it in today.

AMERICAN SCHOOL OF CORRESPONDENCE
Dept. G-626 CHICAGO, ILLINOIS, U. S. A.

American School of Correspondence, Dept. G, 626 Chicago, U. S. A.
I want job checked—tell me how to get it.

- | | |
|--|--|
|Architect. \$5,000 to \$15,000 |Lawyer. \$5,000 to \$15,000 |
|Building Contractor. \$5,000 to \$10,000 |Mechanical Engineer. \$4,000 to \$10,000 |
|Automobile Engineer. \$4,000 to \$10,000 |Shop Superintendent. \$3,000 to \$7,000 |
|Automobile Repairman. \$2,500 to \$4,000 |Employment Manager. \$4,000 to \$10,000 |
|Civil Engineer. \$5,000 to \$15,000 |Steam Engineer. \$2,000 to \$4,000 |
|Structural Engineer. \$4,000 to \$10,000 |Foreman's Course. \$2,000 to \$4,000 |
|Business Manager. \$5,000 to \$15,000 |Photoplay Writer. \$2,000 to \$10,000 |
|Certified Public Accountant. \$7,000 to \$15,000 |Sanitary Engineer. \$2,000 to \$5,000 |
|Accountant and Auditor. \$2,500 to \$7,000 |Telephone Engineer. \$2,500 to \$5,000 |
|Draftsman and Designer. \$2,500 to \$4,000 |Telegraph Engineer. \$2,500 to \$5,000 |
|Electrical Engineer. \$4,000 to \$10,000 |High School Graduate. In two years. |
|General Education. In one year. |Fire Insurance Expert. \$3,000 to \$10,000 |

Name..... Address.....

What to Do with Your Old Phonograph—Contest

(Continued from page 499)

We have given these examples simply to show what can be done. Of course there are thousands of other good ideas and we have no doubt that our readers will think of many good ones.

We will give three prizes as mentioned elsewhere. The first prize being for \$25.00, the second for \$15.00 and the third for \$10.00, for the best ideas submitted. Please note that the judges will take into consideration the utility of the device. In other words the chances are that the idea that is really useful, will win the first prize. Also remember that the idea must be of such a nature that it does not interfere with the operation of the phonograph.

Suppose we publish such a device or such an idea thru our columns. The chances are that if the thing is good a manufacturer of such novelties will not be slow in seeing a large financial benefit from the manufacture of the device. Our readers should always bear in mind that when a device or idea is published the originator has two years in which to patent his device.

This contest will close on September 10th and the prizes will be announced in the November issue. Address all letters to Editor Phonograph Prize Contest, c/o this publication. In the event of a tie for any prize an identical award will be given to each tying contributor.

Practical Chemical Experiments

By PROF. FLOYD L. DARROW
(Continued from page 503)

meath. Place on the table, sensitive side of a photographic plate wrapped in heavy black paper. On this plate lay a book containing a key, a coin or some other dense object. Then start your coil and allow the rays to penetrate the book and plate for several minutes. Then stop the action of the tube, remove the plate and by the light of a ruby lamp develop and fix it in the usual way. The result will be a Radio-
graph.

(Next instalment will appear in the October number.)

How We "Taste"

By JOSEPH H. KRAUS

(Continued from page 478)

been benumbed by imbibing a salt solution, such as ordinary table salt, distilled water will taste sweet. For the same reason ordinary water tastes sweet after excessive salt water swimming, a fact which everyone has noticed but hardly ever investigated perhaps.

Of course, the taste areas in the tongue are localized in certain regions. The tip reacts more easily to sweet and sour substances than the back, which is more sensitive to the bitter sensations. Even the olfactory cells will react differently. A mixture of quinine and sugar if applied to the papillae will excite a bitter taste, whereas adjacent papillae may give us chiefly a sweet sensation. If all these papillae are painted with cocaine, the first effect will be the diminution of pain sensibility, hence the application of an acid will evoke a very sour taste without the ordinary pungent or stinging sensations, normally



Plant Supt.



Plumber



Shop Supt.



Surveyor



Designer



Auto Expert



Building Supt.



Aero Expert



Contractor

Mail
this
Coupon
Today

A Bigger Job For you

The very day you are proficient in any branch of engineering, you will find scores of concerns ready to pay you the full value of your services. Never before such a demand for good technical men as now. Not nearly enough men are prepared for the

goods jobs that are waiting. And—in the hours you ordinarily waste you can soon equip yourself for a big pay job. Don't put this off—at least send for information about Chicago "Tech" training. Let us give you the facts about the branch you would like to take up. See coupon below. Mark, sign and mail it now.

Master a Paying Profession

By Home Study

No longer is it necessary to spend years at college to get a technical education. Home study under the Chicago "Tech" experts will give you the practical training which is wanted in great manufacturing concerns—in engineering and architects' offices—by railroads and contractors—it will make you proficient in the shortest practicable time. Look into this now. Get the facts. Let us tell you about our method and how we can give you the training which means largely increased earning power. Send the coupon—now.

\$60 to \$150 a Week

"We want the men—and we'll pay all they're worth" is what employers say today—and you know what engineering specialists are making. How

better could you use your leisure hours than to get in line for one of these high-class positions that are actually begging for good men?

FREE TEST LESSONS

If you select Draftsmanship or Plan Reading we send you free, a test lesson which enables you to see how simple, complete and thorough our instruction is and to test it out before you enroll. Whatever course you ask for information on, you get a complete, plainly written catalog which explains every detail. No obligation on you for asking this. Just send the coupon.

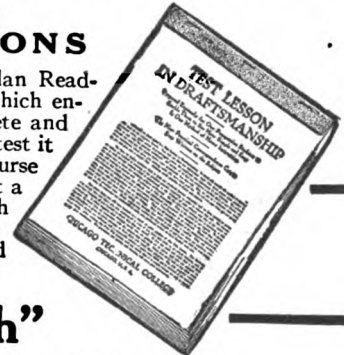

Chicago "Tech" Training Will Make You Expert

By the Chicago "Tech" method you train under practical engineers, contractors and experts—men who teach you the methods used in actual work. No time wasted on unnecessary studies. And you get the same courses by mail that you would get if you came to the College. Every lesson is taught, every exercise is read and every examination is corrected individually by members of our faculty. You are kept on the right track, steadily advanced and prepared to take your place among experienced, technically trained men.

NOW!

Learn about this home study method which has put hundreds and hundreds of ambitious men in high positions. Just put X in opposite the name of the one you want

the facts about—and sign and mail the coupon. This simple act may mean a turning point in your career—the start toward bigger things—a better job—a higher position. It costs nothing to get this information—so act now—today.

Chicago Technical College, 945 Chicago "Tech" Bldg., Chicago, Ill.

Without obligation on my part, please send free and post-paid, instructions on how I can become an expert in subject marked below:

- | | |
|---|--|
| <input type="checkbox"/> Architectural Drafting | <input type="checkbox"/> Auto. Engineering |
| <input type="checkbox"/> Machine Drafting | <input type="checkbox"/> Aero. Engineering |
| <input type="checkbox"/> Electrical Drafting | <input type="checkbox"/> Gas Engines |
| <input type="checkbox"/> Structural Drafting | <input type="checkbox"/> Plan Reading—Buildings |
| <input type="checkbox"/> Sheet Metal Drafting | <input type="checkbox"/> Estimating—Buildings |
| <input type="checkbox"/> Topographic Drafting | <input type="checkbox"/> Plan Reading—Machinery |
| <input type="checkbox"/> Surveying | <input type="checkbox"/> Plumbing—Estimating |
| <input type="checkbox"/> Designing | <input type="checkbox"/> Heating and Ventilating |
| <input type="checkbox"/> Contracting—Buildings | <input type="checkbox"/> Steam Engineering |

Name.....

Address.....

Post Office..... State.....

\$90 TO \$125 PER WEEK

Earned By Burgess-Trained Men

ELECTRICITY

TAUGHT BY A PRACTICAL MAN



BURGESS STUDENTS ARE IN DEMAND

Over 90% Now Actually Engaged in Electrical Work
BEGINNERS GET EMPLOYMENT AFTER TAKING THE BURGESS COURSE A SHORT WHILE
JUST A LITTLE OF YOUR SPARE TIME AT HOME BETWEEN YOU AND SUCCESS

BURGESS-TRAINED MEN are not only getting \$90.00 to \$125.00 per week, but they are earning it. We do NOT promise you will do it, because a good bit depends upon you alone, but the opportunity is there and it is up to you to make the best of it. The Burgess Polley is truthfulness in advertising and to give an honest and satisfactory service. Therefore we offer no free inducements, but depend rather on telling just what Burgess Men are doing. This we find is one of our strongest endorsements.

We DO say that if you have an earnest desire to succeed we know our Fifty-Fifty Plan will help you. It has helped hundreds of others who have been placed in better positions, at better salaries, by BURGESS SERVICE.

THIS IS OUR PLAN

You make moderate monthly payments for what you get, and you get what you pay for. Your payments stop any time you are not satisfied. It's up to you.

BURGESS SERVICE BRINGS SUCCESS TO MEN AND YOUNG MEN—IT IS REAL SERVICE

The Burgess Service is based on the personal experience of Yorke Burgess, for nearly a quarter of a century in practical Electrical work. Starting at the bottom, himself, and finishing at the top, he knows the needs of the very Beginner as well as the experienced man. He simplifies the principles and practice of Electricity. The electrical laws, formulas, methods of calculation and the daily problems that come up in Electrical work are made plain and clear. No frills, just simple, everyday English that anyone can understand and remember. He gives you his personal and individual attention—and he does not sign his name with a rubber stamp.

This Man Made Good—So Can You

(Mr. Engleman, now an Electrician in the Ritz Carlton Hotel, New York City, was formerly a waiter in the same hotel.)

Here are Engleman's three letters.
"Your first installment on the electrical course received, and I like the method of your instructions very well. You will find the answers to the examination questions attached to this letter. I AM OCCUPIED AS A WAITER AND WOULD BE ONLY TOO GLAD TO MOVE INTO A REAL TRADE."

From the Same Man Two Months Later

"In the book review of the Electrical Experimenter, I saw a description of the Burgess Blue Book, which I would like to possess and wish you would mail me a copy. I HAVE GIVEN UP MY POSITION AS WAITER, AND AM NOW EMPLOYED AS ELECTRICIAN in the Ritz Carlton Hotel and so far liked the work very much."

The Burgess Name Your Guarantee

"Your lessons together with your Blue Book received and I thank you very much, and I think it is like everything else that is connected with your name, really 'A No. 1.' MY WORK in the hotel CONSISTS OF WORK ON MOTORS, DUMB WAITERS AND ELEVATORS and from time to time I do repair work on small apparatus."

Hundreds of other letters like these from Beginners who have made good.

FROM CHIEF ELECTRICIAN OF A BIG COAL MINE

Dear Mr. Burgess:
I am Chief Electrician for this Company and I feel that I need the instructions in your course more today than I did when I first commenced working with electrical appliances.

If there is any electrician today who feels that he cannot gain anything by taking a BURGESS COURSE send him to me and I will soon convince him that he is wrong.

If I should live to be one hundred years old, I will continue to preach every place I go, THE BURGESS ELECTRICAL SCHOOL. I wish I could come face to face with the great number of young men of today. I believe I could convince them in a few minutes that they are missing one of the greatest opportunities by not taking this course and sticking to it.

Very sincerely yours, J. L. KNIGHT, Glen White, W. Va.
If you have any desire to learn all about this service that is helping so many make good in a big way—

Send For

"ELECTRICITY BOOK 9."

Forty-eight pages of Success in various lines of Electrical work told by Burgess Students themselves together with valuable information by Yorke Burgess. This book should be in the hands of every Beginner interested in Electricity or Experienced Men in any branch of Practical Electrical Work.
"Burgess Bulletin"—issued for the benefit of Burgess Students—contains Articles on Electricity, Problems, Diagrams, Positions Open, Electrical Information, News, Advice, etc.
Fill out coupon below and these will be sent you prepaid. They cost you nothing.

BURGESS ELECTRICAL SCHOOL

(Endorsed by Electrical Experts)

WRITE YORKE BURGESS personally—or use coupon

The Burgess Company Educational Division,
Yorke Burgess, Supt.
745 East 42nd Street, Chicago, Ill.

Please send me prepaid "ELECTRICITY BOOK 9" and the "Burgess Bulletin," without cost or obligation.

Name
Address

Burgess Electrical Hand-Book

(called THE BURGESS BLUE BOOK, originally in blue-print form)

Short Cuts and Time Savers

PREPARED in pocket size especially for practical men and those taking up the study of electricity. Contains drawings and diagrams of electrical machinery—over 200 formulas for calculation and problems worked out showing how formulas are used. From the personal note book of Yorke Burgess while on all different kinds of electrical work covering a period of nearly a quarter of a century.
Electrical laws, formulas, methods of calculation, etc. Simplified and made easy to understand and remember. Easy to apply in practical work. Many valuable stunts not to be found in any other book. Of value to any electrical man, whether Technical Graduate, Electrical Engineer, Student or Practical Man.
Electricians all over the world are sending for this book. The most complete and valuable book of its kind published. Nothing else like it. If you have never seen this book it is impossible for you to realize what you have missed.

Price \$1.00

Send dollar bill, money order or check. You take no chance—money back ANY TIME if not satisfactory.

THE BURGESS COMPANY

Consulting Electrical Engineers

Yorke Burgess, President
Engineering Division (Department 109), 750 E. 42nd St.
Chicago, Illinois, U. S. A.

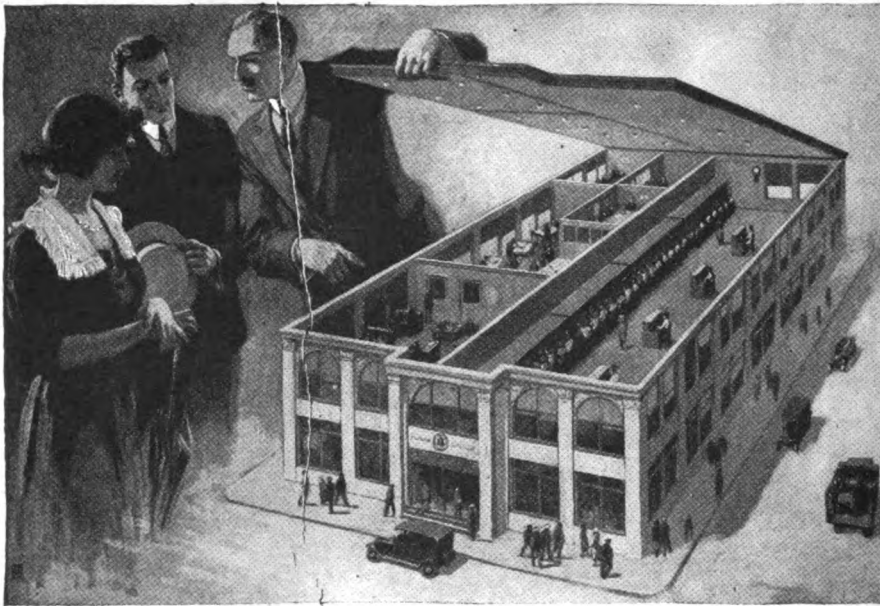

The Public Confidence

An important part of the management of the Bell System is to keep the public informed concerning all matters relating to the telephone.

We consider this an essential part of our stewardship in the operation of this public utility. It is due not only the 130,000 shareholders, but it is due the whole citizenship of the country.

We have told you of new inventions to improve service, of the growth of service, of problems involved in securing materials, employing and training workers, of financing new developments, and of rates necessary to maintain service.

You have been taken into our

confidence as to what we are doing, how we do it, why we do it. You have been told of our efforts to meet unusual conditions; of how we have bent every energy to provide service in the face of storms, floods, fires.

It is an enormous task today to provide adequate service in the face of shortage of workers, raw materials, manufacturing production and transportation.

Nevertheless the service of the Bell System has been improved and extended this year. Over 350,000 new stations have been put into operation. And the loyal workers of the Bell System are establishing new records for efficiency and will establish new records for service.



**AMERICAN TELEPHONE AND TELEGRAPH COMPANY
AND ASSOCIATED COMPANIES**

One Policy One System Universal Service

TIRE PRICES CUT

FROM OUR FACTORY TO YOU

6000 MILES GUARANTEE

Our double tread reconstructed tires save you time, energy and money and do away with tire troubles. Our tires cannot be compared with ordinary double tread or triple fabric tires of inferior make. Our reputation and success is due to the fact that we spare no time or money to make our tires excel in quality and durability. Our tires are used from Coast to Coast. Ask your banker about us. Retiner Free with every Tire. Tubes are guaranteed fresh stock.

Size	Tires	Tubes	Size	Tires	Tubes	Size	Tires	Tubes
30x3	\$6.00	\$1.75	32x4	\$8.75	\$2.60	36x4½	\$12.00	\$3.40
30x3½	7.00	2.00	33x4	9.00	2.75	35x5	13.00	3.60
31x3½	7.25	2.10	34x4	9.25	2.85	36x5	13.25	3.70
32x3½	7.50	2.25	34x4½	10.50	3.00	37x5	13.50	3.75
31x4	8.50	2.50	35x4½	11.50	3.15			

Send \$2 deposit for each tire and \$1 for each tube ordered, balance C. O. D. Tires shipped subject to your examination. State whether S. S., C. L. (Q. D.) plain or N. S. is desired. All same price.

NATIONAL GOOD-WEAR TIRE CO., 1113 Washington Blvd., Dept. 220, CHICAGO

Timing Sunlight for Plants

(Continued from page 477)

showed no tendency to blossom as late as February 12, 1920.

IMPORTANT INFLUENCE ON CROP YIELD

The influence of this discovery on crop yield is likely to be of no little importance. The length of day is proved to be the most potent factor in determining the relative proportions between the vegetative and fruiting parts of many crop plants. Indeed fruiting may be completely suppressed by day either too long or too short. The advance in agricultural practice which may be brought about largely by plant breeders and other crop specialists. For instance, will prove of material significance in the future planning of cropping systems for different regions, especially where consideration of new crops from different latitudes is necessary.

This new principle undoubtedly explains the erratic behavior which has been observed with many crops when they are shifted to different latitudes, and may also clear up the conflicting results of various tests and field tests conducted with the same crops but in different regions. The experiments have shown, for instance, that ragweed requires for flowering a stimulus that is afforded by the shortening of the days and lengthening of the nights. It does not come into flower until the period of daylight falls below 15 hours. In the latitude of Washington, that comes about July 1. But if ragweed seed should be taken to northern Maine and planted, the plants would not experience a length of day below 15 hours until about August 1. Therefore, they could not come into flower until after August 1 and, though the vegetative growth might be very rank, they could not mature seed before killing frosts intervened. The long days, therefore, make it impossible for ragweed to perpetuate itself at that latitude. On the other hand, plants that get their flowering stimulus from long day could not perpetuate themselves thru seed formation at the equator, where the day never exceeds 12 hours.

EXPLAINS LUXURIANT GROWTH IN NORTHERN LATITUDES.

This principle affords the clue to the fact that many plants grow most luxuriantly near the northern limit of their range. The long northern day allows them to attain their maximum growth before the short day intervenes to check vegetative growth and start the reproductive process.

It may be found eventually, say the biologists who worked out the principle, that the animal organism, also, is capable of responding to the stimulus of certain day lengths. They believe that the migration of birds may be an illustration. Direct response to such a stimulus, they say, is more in line with modern teachings of biology than theories which assume that birds migrate as a matter of instinct.

WIRELESS PHONE IN IRELAND

In consequence of the frequency with which telephone and telegraph wires in Ireland are being cut, the Government decided on an extensive use of wireless telephony there.

Naval signal men are being employed to start the system, and it is intimated that portable telephones with a radius of about thirty miles are being employed in transmitting messages from one police station to another, or between adjacent towns.

It is asserted that the system has proved satisfactory.

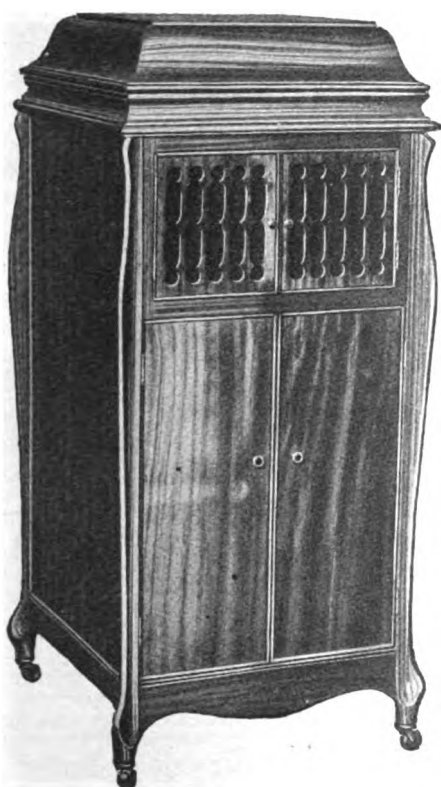

You Can Build this *Phonograph* EASILY

Tremendous Saving in Cost

A FEW hours, pleasant work—some simple tools found in any man's home—and

Our Simplified Plans

IT'S an easy and interesting job to build this fine, sweet-toned cabinet instrument by our system. We furnish blueprints, diagrams, motors, tone arms and all other metal parts together with knockdown cabinet and ready built

horn all complete. You do the assembling and finishing at a saving of more than one-half the retail cost. You can't go wrong if you follow our instructions. There's a model and price for every taste and purse. Your choice of four beautiful models.

Everybody who has built a Makafone has found it much easier than he first thought. You will find it so too.

Read What Satisfied Builders Say

"I have built my phonograph that I purchased from you and it is a dandy. I am well pleased. I had a neighbor in to look at it and he thinks it is nice. I think that he will buy one."—Crawford, East Peoria, Ill.

"I received everything O.K. and I have already built and enjoyed it for two weeks and I am very much pleased with it."—Bieschke, Chicago, Ill.

"I have the model No. 1 set up and in fine running condition and would not sell it unless I could get another one like it. It is equal to any I ever saw. I have finished it in natural wood and all that have seen it say that there is not a finer machine in any store in town."—Corbin, Vancouver, Wash.

"Have just finished the cabinet and believe me she sure does look swell. I can guarantee you several more orders very soon."—Armhein, Milwaukee, Wis.

"I am well pleased with the MAKAFONE I ordered from you some time ago and am now placing another order for a No. 4 machine."—Hysong, Covington, Ky.

"I received my MAKAFONE and have built it and find it a dandy. I will send an order for a No. 3 machine in the very near future."—Bank, Sanatobia, Miss.

Get Into the Phonograph Business for Yourself

No experience is necessary under our plan. Hundreds have gone into the business of building Makafones which they sell to their neighbors and friends at a clear profit of not less than \$50.00.

"I received the outfit in good shape. Am perfectly satisfied that the machine plays well and it was sold right away. Please send more price lists and order blanks, as I want to order a No. 5 outfit right away."—Schettling, Kansas City, Mo.

Gentlemen:

I have the phonograph finished, ordered from you some time ago. The music reproduced on this instrument is better than any I have ever heard. This machine is now sold and I soon will be able to take advantage of your discount for ordering six outfits at a time. J. A. Devenny.

Many of these people have come from clerical or other non-mechanical vocations. And they are all making good. Why not you? We shall be glad to give you full particulars so send in this coupon today.

Modern Phonograph Supply Co.

325 Springer Bldg., 313 So. Clinton St., Chicago, Ill.

Fill Out This Coupon And Mail Today

MODERN PHONOGRAPH SUPPLY CO.

325 Springer Bldg., 313 So. Clinton St., Chicago, Ill.

Gentlemen:—Please send me full particulars of your "Build Your Own Phonograph" proposition, without obligation to me.

Name

Street Address.....

City or Town.....State.....

Learn How to Write Successful Letters

THE MASTER LETTER WRITER, a 976 page Instruction Course, including 500 Successful Letters, by Ad-Man Davison, the highest paid letter writer in the world



THE most authoritative work of this kind ever written. Contains 976 pages. Part I embraces 351 pages on how to appeal to every class of reader; also Routine Correspondence: order letters, answer-to-order letters, complaints, letters of inquiry, contract and credit letters. These with the typographical arrangement of letters, including a section on Typography of Letters and Business English. A section of 100 Collection Letters for individuals, firms and collection agencies, is included.

PART II contains the 500 Master Business Letters—from the private portfolio of Ad-Man Davison, "the scribe supreme of Advertisingdom."

In this remarkable collection are endless new word-pictures to help you revivify your business story. Uncommon phrases of pith and power. Warm, winning, human arguments that compel action.

The collection includes direct merchandising letters, advertising letters, sales managers' letters, letters to dealers, to agents, letters selling service of every kind, instruction-by-mail, advertising space; order-getting letters, accountancy, insurance, investment and real estate letters; letters applying for positions as executive, salesman, correspondent, secretary, stenographer, bookkeeper, typist; soliciting and sales letters for every business.

THE MASTER LETTER WRITER is conveniently classified and indexed. Beautifully bound in rich blue extra cloth, with gold top and gold lettering. Sent postpaid on receipt of price, \$5.

If you want quicker results, larger sales, more remittances, if you want a better salary, swift promotion, Success—here are all the Success Secrets of the master writer—MAKE THEM YOUR OWN—order this great course and Collection to-day. Address Desk 74.

OPPORTUNITY PRESS, 681 Fifth Avenue, New York
48-page Booklet mailed Free.

\$25.00 FOR THIS

MADE TO YOUR MEASURE
ALL WOOL SUIT

Every suit made to individual measure from the exact fabric you select and according to your exact specifications. We ship it on approval, delivery charges prepaid, for you to try on, to inspect and examine. Unless you are well pleased your trial order will not cost you a cent.

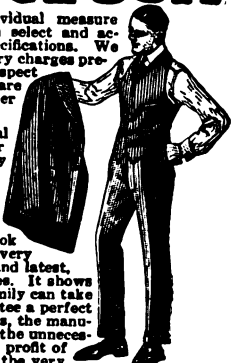

Send postal today for copy of our big catalog FREE

with 62 cloth samples of the very finest, high grade fabrics and latest, New York and Chicago styles. It shows how any member of your family can take your measures. We guarantee a perfect fit. By dealing direct with us, the manufacturers, you save the unnecessary expense and profit of agents and obtain the very highest grade of tailoring at a saving of 25% to 40%. Write today for catalog and information.

BELL TAILORS
Adams at Green Street, Dept. 911, Chicago, Illinois

Are You Flat Chested? Are Your Lungs Weak? Do You Lack Vitality? Is Your Carriage Faulty?

If any of these conditions fit your case you urgently need my book.

CORRECT BREATHING and CHEST EXPANSION

Each one of these conditions can and should be remedied. My book will teach you how. Send for it now before you forget.

PROF. ANTHONY BARKER, D. C.
127 W. 42nd St., 3562 Barker Bldg., New York

Tire Agent

We want one exclusive representative in each locality to sell the new Mellinger Extra Ply hand made tires. Guarantee Good for 6000 Miles. (No seconds). Shipped prepaid on approval. Sample sections furnished. Do not buy until you get our Special Direct Prices. Write MELLINGER TIRE & RUBBER CO., 901 Oak St., Kansas City, Mo.

Plant or Animal— which?

By WILLIAM M. BUTTERFIELD
(Continued from page 475)

whip-tail and adopt true animal movements. The bodies after a time collect in clusters, and unite into one body to form a young inert jelly-like mass.

In the end they ultimately form a creeping jelly-like mass of individuals, thus combining acts for the time as an independent organism. It often takes on the most brilliant red, yellow, purple, orange, green or similar shades, according to species. Soon it penetrates the substances of dead wood or spreads over the surface of dead leaves, bark, etc., in a network of veins, taking a somewhat fan-shaped outline. The more fluid matter in the interior of the veins streams constantly thru them, like the blood in the veins of man; the current continuing in one direction for a certain period, usually a minute and a half, when it stops—and after a moment's pause, reverses its course, flowing the opposite way for about the same length of time, but rather longer in the direction in which the jelly-mass is moving.

It is by this means that the mass creeps forward, the object being, it would appear, to obtain food—the kinds of food required for some of the species at this state of development being well known by investigators who have cultivated the varieties.

After a spell of creeping about in this fashion, which may extend over a period of weeks, months, or even in one known instance a year, the mass concentrates first compactly as shown in Fig. 8; then, in the case of *comatricha obtusata*, Fig. 9, the individuals prepare to form again into independent centers, finally dividing into thirty or forty masses. Within an hour or two these have risen to form pear-shaped bodies as seen at Fig. 10.

In six hours the black hair-like stalk has grown to its full length and bears at its summit the young ball-like spore-pod, which now consists of a white globule of viscous protoplasmic cells, with a diameter of about one-fifth of the length of the stalk.

A pink flush now begins to pervade the seed-receptacle, caused by the formation of the dark branching threads (Fig. 14) of the capillary stems. The nuclei still presents the same appearance as when observed in the streaming jelly-mass; in an hour they show the beginning of a kernel-moving division, and the cells soon become separated into masses of two spore capacity; an hour later the final division has taken place.

Now as the dark spore-walls are produced, the color of the spore-pods rapidly darkens, and about twenty hours after their first construction the groups stand in regular order on the wood.

The fungi have constructed before our very eyes a miniature forest of peculiar appearing plants with the pod of each filled with seeds. Before the seeds were formed, you remember, each fungi constructed a scaffolding of hairs joined together in meshes and forming an elastic net, lying with its strands surrounding the seeds as they finally mature. This net which is called *capillitium* serves the purpose of protection during growth, and from its peculiar construction making it writhe and twist with the least change of moisture at the time when the seeds are ripening, thus separating and loosening them; it also springs out (Fig. 14) like a jack-in-the-box when the delicate membranous covering of the spor pod burst under its strain, scattering seeds in every direction.

It would appear, in reviewing the cycle, that there really is no difference between an animal and a plant.

RICHARDSON'S POLYPHASE SLIDE RULE

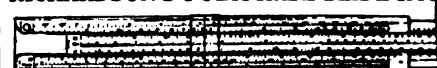

has the regular A, B, C, and D Scales; also a C1 Polyphase Scale, Logarithm, Sine and Tangent Scales. gradations are printed on white coated steel from engraved plates. These Scales are accurate and with their accuracy indefinitely. They are not affected by acids, alkalis, water or grease. Length of rule 10". A 100 page Instruction Book which teaches all there is to know about slide rules, is sent with each order.

Price of the Richardson's Polyphase Slide Rule, in case with 100 page Instruction Book \$2.00. An Ideal Slide Rule. It is low priced and an equal to any other rule in appearance, accuracy and durability. Be convinced. Your money will be promptly refunded if you are not satisfied.

Send for our 40 page catalogue of supplies. It describes rules ranging from 50c to \$10. each. Instructions for Logarithms and Trigonometry free with every catalogue.

GILSON SLIDE RULE CO. NILES, MICH.

Oh Boy! Build This Car

This nifty little car driven by gear line motor can be built in a few days. Parts furnished by us. Write for catalogue. Send 26c for building plans and price list.

SYPHER MFG. CO., 156 Sypher Bldg., Toledo, O.

Seneca Built for the Owner

Simple, Sturdy construction. Low cost of up-keep and operation. 1 CAN-CLEVER springs in rear. Comfortable. Dept. 2122

Dealers Wanted Immediate deliveries. Fifth annual year. Increased output. Lit newspaper advertising in dealers' territory. Wonderful opportunity. Write NOW.

THE SENECA MOTORCAR CO., 49 Seneca Factory, FOSTONIA, O.

Every Bicycle A Motor Cycle

by using a STEFFEY ATTACHMENT

Thoroughly PRACTICAL and SUCCESSFUL. In use over years. Fits double-bar, Arch diamond frame.

Send stamp for circular.

Dept. E STEFFEY MFG. COMPANY
5223 Brown St.

GET BIG BUSH OFFER

We do not deal through distributors but County Agents only.

Big Money Making County Agents Only

four and De Luxe six. Don't wait. Write today!

BUSH MOTOR CO., Chicago, Illinois, Dept. 15 Bush

You Can Save \$50.00

By recovering your old car make these recovery to all makes and models. Any person that drive a car can put it on Roof and quarters covered with curtain, fasteners, wells and tacks. All complete. Give us name, year and model number of your car and we will send our catalogue with same and quote you exact price.

LIBERTY TOP & TIRE CO., Dept. E4, Cincinnati, O.

ENINGER WILL SA

640. BIG MONEY SAVINGS FOR YOU

Used and rebuilt motorcycles, single and two. \$25 to \$100. Used bicycles, \$5.00 to \$25.00. All machines guaranteed in good working order. New cycles and motorcycles at 1/2 price. Motorcycles at 1/3 price. Motorcycles at 1/4 price. Write for catalogue.

Send for catalogue Eninger Cycle Co., Rockford, Ill.

YOU 25 TO 50 DOLLARS

SEX BOOKS

For Teachers, Students, Physicians, Jurists, Lawyers, Social Workers, Clergymen, Priests, Professional and Advanced Adult Readers Generally

Send for List

THE MODERN BOOK SOCIETY
5 Hanson Place, Desk 55, Brooklyn, N. Y.
"Books for Intelligent People"

ARE YOU BASHFUL?

Self Conscious, Embarrassed in Company, shy how you can overcome these defects. Poise, confidence, assurance and magnetism. Address The Veritas Science Institute, Broadway, New York, Desk 13.

153 Genuine Foreign Stamps—Made in War

Service, Guatemala, China, etc. Finest Approval Sheet 50% to 60% AG WANTED. Big 75-p. Lists Free. We Buy Stamps

Established 25 yrs.
Husman Stamp Co., Dept. 87, St. Louis, Mo.



**Automobile \$125
Engineer AWeek**



**Automobile \$50
Repairman AWeek**



**Expert \$40
Chauffeur AWeek**



**Garage \$150
Owner AWeek**

Take Your Choice of These Big Paying Jobs

THOUSANDS of men like you are wanted to fill these big-paying jobs in the automobile engineering field. Thousands of places are open, too, for chauffeurs and garage managers. It's easy to get one of these good jobs and to prepare yourself to hold it. You don't have to go to school. You don't have to serve an apprenticeship. Spare time only is needed. These great automobile books will teach you everything you need to know. Fifteen of the greatest engineers and experts in the business wrote them in simple language that anybody can understand.

Auto Books 6 Volumes Shipped Free

Just off the press—the 1920 model—an up-to-the-minute six-volume library on Automobile Engineering, covering the construction, care and repair of pleasure cars, motor trucks and motorcycles. Packed full of advance information on Lighting Systems, Garage Design and Equipment, Welding and other repair methods. Contains everything that a mechanic or an engineer or a motorcyclist or the owner or prospective owner of a motor car ought to know. Anybody can understand them. Tastefully bound in American Morocco, flexible covers, gold stamped, 2650 pages and 2300 illustrations, tables, blueprints and explanatory diagrams. A library that cost thousands of dollars to compile but that comes to you free for 7 days' examination. Over 50,000 sets of previous editions have been sold.

Only 10c a Day!

Partial Contents

Automobile Motors; Welding; Motor Construction and Repair; Carburetors and Settings; Valves, Cooling; Lubrication; Fly-Wheels; Clutch; Transmission; Final Drive; Steering Frames; Tires; Vulcanizing; Ignition; Starting and Lighting Systems; Shop Kinks; Commercial Garage; Design and Equipment; Electrics; Storage Batteries; Care and Repair of Motorcycles; Commercial Trucks; Gas Tractors.

**128 Blueprints
of Electric
Wiring Diagrams**

Not a cent to pay in advance. First you see the books in you own home or shop. Just mail coupon and pay express charges when books arrive. You can read them and study them for seven whole days before you decide whether you want to keep them or not. If you like the books, send only \$2.80 in 7 days and \$3 a month until the special introductory price of \$29.80 has been paid. (Regular Price \$45.) Along with the set goes a year's consulting membership in the American Technical Society. (Regular price \$12.) This part of our offer will be withdrawn when the membership is filled. Mail the coupon without delay.

Don't Send Money Now!

Don't take our word for it. See the books without cost. Here is a chance for you to get a real man's job with a man's size pay. Don't waste a minute in sending the coupon. Put the coupon in the mails today. Send no money—just the coupon!

American Technical Society, Dept. A-256 Chicago, Ill.

FREE Examination Coupon

American Technical Society, Dept. A-256 Chicago
Please send me the 6-volume set of Automobile Engineering for 7 days' examination, shipping charges collect. If I decide to buy, I will send \$2.80 within 7 days and the balance at \$3 a month until the \$29.80 has been paid. Then you send me a receipt showing that the \$40 set of books and the \$12 Consulting Membership are mine and fully paid for. If I think I can get along without the books after 7 days' trial, I will notify you to send for them at your expense. [Please fill out all lines.]

Name.....
Address.....
City..... State.....
Reference.....

You can make \$200 to \$350 PROFIT every month from



BATTERY CHARGING

No Expensive Renewals Easy to Operate

The Road to Big Profits Is Open Before You

No big capital is required to start this great, money-making HB Battery Charging business. A small cash payment brings you any HB Charger, and you have almost a year to pay the balance on easy monthly terms. That is an absolute guarantee of HB Chargers, because we could not sell on such terms unless every outfit absolutely made good.

Your Profits Will Easily Pay for Your HB Charger

It costs 10c to 15c each to charge batteries of any voltage. Customer pays 75c to \$2.00 each. Figure those profits! And that's NET PROFIT, too, because HB Chargers have no burn-outs, no expensive renewals, nothing fragile to wear out or break down. They are sturdy, reliable and dependable, and therefore, are permanent money-makers for all HB users. They will make BIG, STEADY PROFITS for you, right from the start.

There Is an HB Charger for Any Size Battery Business

No matter how large or how small a battery business you have, there is an HB Charger exactly suited to your needs. They charge 6-volt, 12-volt or 24-volt batteries all at the same time. That's a big advantage. Every day you wait means lost profits in battery charging. Don't delay, act NOW, and start your own business. Remember, it takes only a small payment to start you, and the profits easily pay the rest. Write at once for information on the HB Charger you want. Sizes to charge 8, 16 or 32 batteries at one time. Pick the size that suits your requirements. Write us today. Send this ad with your letter.

HOBART BROS. CO.
Successful Manufacturers Since 1893
Box 97 E Troy, Ohio

"Movie" Camera Copies Books and Legal Papers
By O. C. ROOS
(Continued from page 489)

switches, and whenever anyone was thru reading a projected exposure, for instance, a translation comparing it with the original source in a hotly contested case, he'd simply press his particular switch. *The last man to press his own switch would complete the circuit,* and the automatic projector would show the next exposure and the switches would all be reset again."

Promoter—"That's something which would be good for family study, perhaps!"

First Lawyer—"Yes, back in 1919 some people became interested in eliminating the weariness suffered by one member of a family reading to many. They knew that all the ingredients of a successful system were present in the set-up mechanisms of many inter-communicating telephones, and so they made inquiries along these lines."

Engineer—"I'll wager they found plenty of reasons urged against the system. There are just natural born vicious-minded people, you know. James might call them 'tender-minded,' but I prefer 'mulish.'"

Promoter—"Yes, I know what you're driving at. They want a 'praying' market. On its knees, as it were, for some one's pet product."

Engineer—"You can scarcely convince such people that demandor and demandee react, and irritate each other into growth. The presence of the new apparatus is like what our chemical friends call a 'catalyzer.'"

Promoter—"What's that?"

Engineer—"Why, it's the mental business minister who marries the transmitter idea to the receiver, in developing ideas. In chemistry, a third substance often unites two others, and itself comes from the process scot-free of any evidence of collusion or collision."

Promoter—"Oh! I see. Now, let's hope that the churches, colleges and schools are getting as much good out of this as the professionals, like you chaps. Why, I can see lots of ways for a business man to get into this thing."

Second Lawyer—"I've been listening attentively for some time and I've got this to say: There is more studying to be done by lawyers, doctors, engineers and in students' 'quiz' time around examination periods than you fellows even dream of. That's because a projector costs less than \$25.00 per person, for even small groups, and you saw today how cheaply we got off at the library on film expense. There's no fire risk whatever and I've watched them go back and forth by electrical means over disputed texts 400 pages long, without even touching the projector. Even in 1920 a 1000 watt lamp, I'm told, would not damage the film during the wait necessary while several persons were engaged in reading a page of script projected on the screen."

Engineer—"Let's begin. (Presses a special switch by his seat on a small panel giving main control.) Oh! There's Fig. No. 1. You see in this 60 foot room how easily the text is read. There you see 75 lines, but we could project and make out clearly 100 lines if necessary."

First Lawyer—"I've read projected small type letters 3/4 inch high easily at 100 feet with a good 1000 watt lamp. I think that a 40-foot throw and 5/8-inch letters, with a 400 watt lamp is very good. Now let's all make notes on this first page, and then everyone will press his particular series key." (They all finish in about 15 minutes and the next two pages of the patent are then suddenly flasht on the screen.)

Engineer—"I'll turn off the projection

(Continued on page 564)

1/2 SAVED GET OUR BIG BOOK



BURN LESS COAL

With an improved, all-cast pipeless furnace you can cut your coal bills in two. This efficient, basement installed heating plant heats and ventilates the entire home. It burns any grade of coal more economically than a stove. It needs no expensive piping or other equipment. Anyone can install it in a day. They are described at our wholesale prices in our Handy Man Book. Send for it.

Do Your Own Plumbing and Heating by the Cut-to-Fit Method.

By our new plan anyone can install a complete plumbing or heating plant in his own home. Send us a rough sketch with measurements. Our Engineers will draw your plans, furnish information and see that the supplies you order come CUT-TO-FIT your needs. No waste of time, labor or unused material. Only a few simple tools necessary. Send for

The Handy Man Book

It will show you how. It will tell you just what to order and what it will cost at our wholesale prices. It contains plans and useful information for every builder, property owner or contractor. It will convince you. It will increase the value of your property 50%. You can do the work yourself.

We have spared no effort or expense in the preparation of this valuable book. To keep from sending it broadcast to uninterested persons we request a temporary deposit of 25c which will be refunded with your first order. Send for it today.

The Service of HARDIN-LAVIN CO.
Is guaranteed by 40 years' business at
4510-20L Cottage Grove Avenue CHICAGO



SIGNAL ENGINEERING

Be an ELECTRICAL SIGNAL ENGINEER

FREE BOOK TELLS HOW

Big positions open now for Signal Engineers. You can qualify for this fascinating, highly-paid work in your spare time at home. Railroads everywhere need men who understand Signal Engineering and electrical safety devices.

\$2500 to \$5000 a Year

Earn a big salary right from the start—enjoy quick success and swift promotion. We train you in every branch of this great profession, including a complete course in

Practical Electricity

Write today for handsome FREE Book on Signal Engineering and details of our amazing Free Signal Engineers' Outfit. Address
DEPARTMENT OF SIGNALING, DEPT. 1796,
1924 Sunnyside Avenue, Chicago, Ill.

Be a Finger Print Detective



Earn Big Pay

Get into this fascinating new profession. Big salaries, rewards and fees are paid in this work. Finger prints needed by governments, corporations, police departments, and other institutions. Learn in spare time at home to fill one of these big jobs or go into business for yourself as a Finger Print Detective.

Book FREE Write quick for big, fully illustrated Finger Print Book. Tells all about this wonderfully interesting work and how you can easily qualify. Right now we are making an amazing special offer of a FREE COURSE in Secret Service.

UNIVERSITY OF APPLIED SCIENCE
Dept. 1796, 1920 Sunnyside Ave., Chicago, Ill.

Cleartone Phonographs

\$4.00 to \$200.00 Retail

Our Sundry Dept. offers Needles 39c per thousand. Motors \$1.35 to \$14.75 each. Tone-Arms and Reprays \$1.50 to \$5.75 per set. Main Springs 20c to 90c each. Records, Needles, Sapphire Points and Parts at reasonable prices.

Write for our 84-page catalogue, the only one of its kind in America, illustrating 33 different styles of Talking Machines and over 500 different Phonographic Parts.

LUCKY 13 PHONOGRAPH COMPANY
Export Dept. 46B East 12th Street, N. Y.



OH, YOU SKINNY!

Why stay thin as a rail? You don't have to! And you don't have to go through life with a chest that the tailor gives you; with arms of childish strength; with legs you can hardly stand on. And what about that stomach that flinches every time you try a square meal? Are you a pill-feeder? Do you expect Health and Strength in tablet form—through pills, potions and other exploited piffle?

You can't do it; it can't be done. The only way to be well is to build up your body—all of it, through nature's methods—not by pampering the stomach. It is not fate that is making you a failure; it's that poor emaciated body of yours; your half sickness shows pain in your face and the world loves healthy people. So be **HEALTHY — STRONG — VITAL.** That's living. Don't think too long; send three 2c stamps to cover mailing expenses of Special Information on Thinness and my book "Promotion and Conservation of Health, Strength and Mental Energy," written by the strongest physical instructor in the world.

STRONGFORT The Perfect Man

LIONEL STRONGFORT
Physical and Health Instructor
1415 Strongfort Institute NEWARK, N. J.
Founded 1895



Let Us Send You this Suit

Made to your measure, payable after received

Perfect fit, fine goods and tailoring, \$20 saving, all guaranteed or no pay. Samples Free. Every man wanting to dress well and save money should write at once for our beautiful free book of cloth samples and correct fashions, explaining everything. Write letter or postal, just say "Send me your samples" and get everything by return mail free. Important to every man. Write today sure.

PARK TAILORING COMPANY
Dept 214 Chicago, Ill.



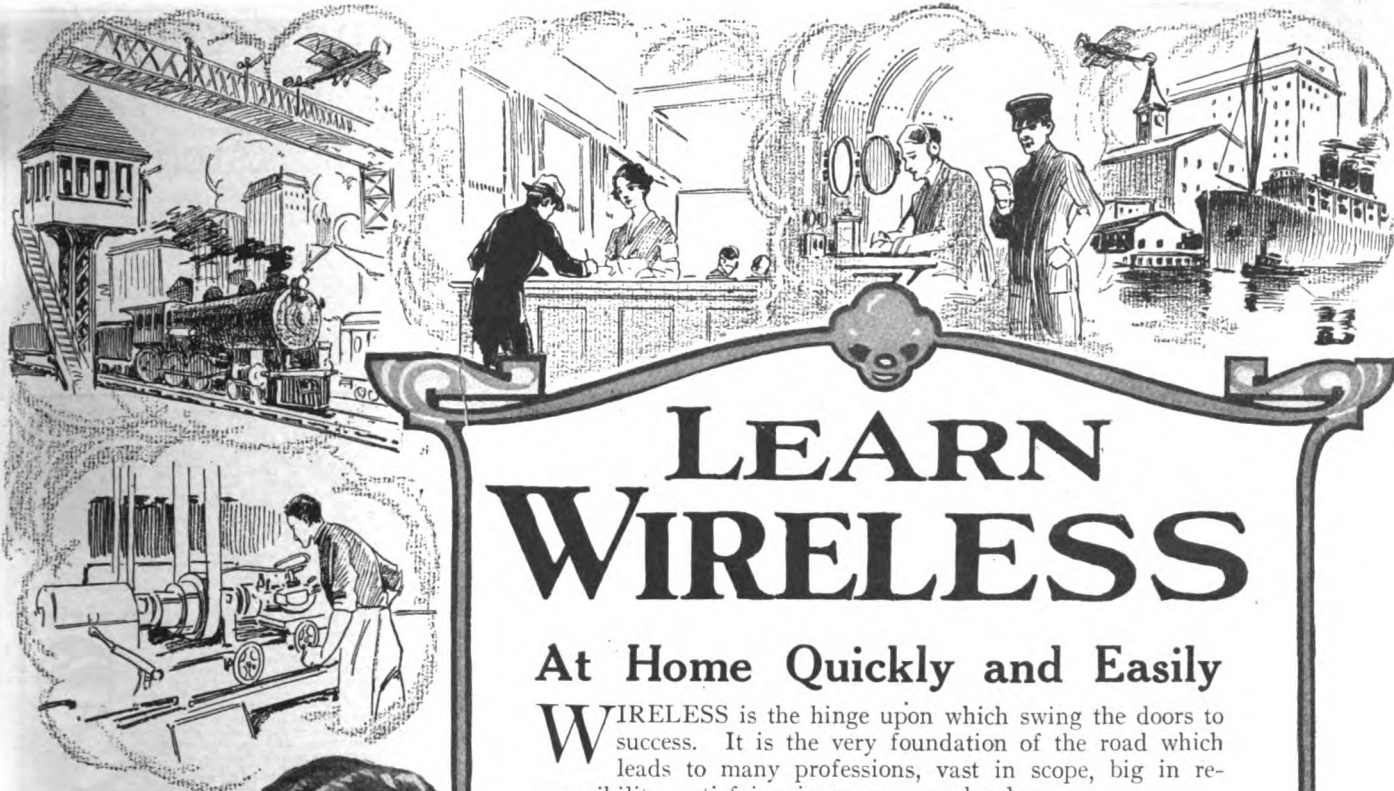

LEARN WIRELESS

At Home Quickly and Easily

WIRELESS is the hinge upon which swing the doors to success. It is the very foundation of the road which leads to many professions, vast in scope, big in responsibility, satisfying in progress and salary.

A trained Wireless Operator with initiative and ambition can easily fulfill his ideals for a successful future; one including a position filled with vital enterprise, adventure, and financial success.

Attractive Work—Alluring Salaries

Radio offers interesting work in pleasant environment, besides substantial salaries. Radio Operators' salaries start at \$125 a month with all living expenses—board, lodging, laundry, etc.—paid. When totalled and added to salary, it means \$200 or more a month, at the very start. Advancement to higher positions with bigger pay is readily accomplished.

Travel Without Expense

If you are eager to travel, anxious to visit foreign countries and increase your knowledge of world affairs, wireless offers unequalled opportunities. On shipboard you are rated as an officer, living and eating with the officers, and mingling with the passengers. All without one cent's expense to you! Land Wireless positions are just as attractive if you prefer them.

Instrument Furnished Every Student

We furnish all necessary books and equipment *with our course*. Our famous Natrometer—automatic transmitting and receiving set—is among this outfit. This instrument sends you messages at varying speeds just as you would receive them from distant wireless stations—and is operated entirely without the use of "aerials".

BOOKLET FREE—It explains how we helped hundreds of ambitious men and women, and how we can give you a thorough Wireless training in your spare time, at home, by mail, and help you secure a worth-while position.

NATIONAL RADIO INSTITUTE
Dept. 279 14th & U Sts., N. W., WASHINGTON, D. C.

.....SEND THIS COUPON TODAY.....

NATIONAL RADIO INSTITUTE
Dept. 279 14th & U Sts., N. W., WASHINGTON, D. C.

Send me your FREE book "Wireless The Opportunity of Today". Tell me about your Home Study Course in Wireless Telegraphy and Telephony—the free post-graduate course—and your Special Instrument Offer.

Name
 Age Address.....
 City State.....

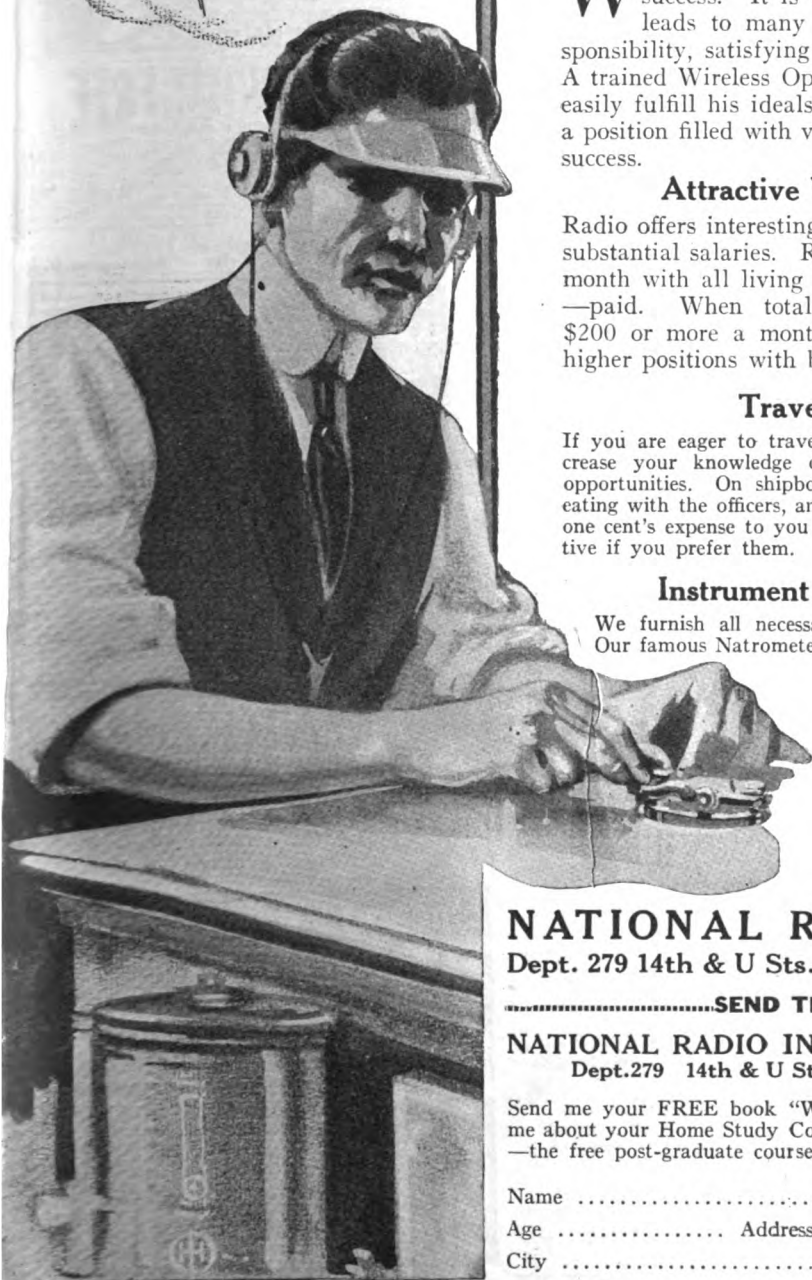



“Another \$50 Raise!”

“Why, that’s the third increase I’ve had in a year! It just shows what special training will do for a man.”

Every mail brings letters from some of the two million students of the International Correspondence Schools, telling of advancements and increased salaries won through spare time study.

How much longer are you going to wait before taking the step that is bound to bring you more money? Isn’t it better to start NOW than to wait for years and then realize what the delay has cost you?

One hour after supper each night spent with the I. C. S. in the quiet of your own home will prepare you for the position you want in the work you like best.

Yes, it will! Put it up to us to prove it. Without cost, without obligation, just mark and mail this coupon.

**INTERNATIONAL CORRESPONDENCE SCHOOLS
BOX 6249, SCRANTON, PA.**

Explain, without obligating me, how I can qualify for the position, or in the subject, before which I mark X.

- | | |
|--|--|
| <input type="checkbox"/> ELECTRICAL ENGINEER | <input type="checkbox"/> OREMINAL ENGINEER |
| <input type="checkbox"/> Electrician | <input type="checkbox"/> SALESMANSHIP |
| <input type="checkbox"/> Electric Wiring | <input type="checkbox"/> ADVERTISING MAN |
| <input type="checkbox"/> Electric Lighting | <input type="checkbox"/> Window Trimmer |
| <input type="checkbox"/> Electric Car Running | <input type="checkbox"/> Show Card Writer |
| <input type="checkbox"/> Heavy Electric Traction | <input type="checkbox"/> Outdoor Sign Painter |
| <input type="checkbox"/> Electrical Draftsman | <input type="checkbox"/> RAILROADER |
| <input type="checkbox"/> Electric Machine Designer | <input type="checkbox"/> ILLUSTRATOR |
| <input type="checkbox"/> Telegraph Expert | <input type="checkbox"/> DESIGNER |
| <input type="checkbox"/> Practical Telegraphy | <input type="checkbox"/> BUSINESS MANAGEMENT |
| <input type="checkbox"/> MECHANICAL ENGINEER | <input type="checkbox"/> Private Secretary |
| <input type="checkbox"/> Mechanical Draftsman | <input type="checkbox"/> BOOKKEEPER |
| <input type="checkbox"/> Ship Draftsman | <input type="checkbox"/> Stenographer and Typist |
| <input type="checkbox"/> Machine Shop Practice | <input type="checkbox"/> Cert. Pub. Accountant |
| <input type="checkbox"/> Toolmaker | <input type="checkbox"/> Traffic Management |
| <input type="checkbox"/> Gas Engineer | <input type="checkbox"/> Commercial Law |
| <input type="checkbox"/> CIVIL ENGINEER | <input type="checkbox"/> GOOD ENGLISH |
| <input type="checkbox"/> Surveying and Mapping | <input type="checkbox"/> STATIONARY ENGINEER |
| <input type="checkbox"/> MINE FOREMAN OR ENG’R | <input type="checkbox"/> CIVIL SERVICE |
| <input type="checkbox"/> ARCHITECT | <input type="checkbox"/> Railway Mail Clerk |
| <input type="checkbox"/> Architectural Draftsman | <input type="checkbox"/> Textile Overseer or Supt. |
| <input type="checkbox"/> PLUMBING AND HEATING | <input type="checkbox"/> AGRICULTURE <input type="checkbox"/> Spanish |
| <input type="checkbox"/> Sheet Metal Worker | <input type="checkbox"/> Poultry Raising <input type="checkbox"/> French |
| <input type="checkbox"/> Navigator | <input type="checkbox"/> Automobiles <input type="checkbox"/> Italian |

Name _____ 7-25-19
 Present Occupation _____
 Street and No. _____
 City _____ State _____

Build Your Own PHONOGRAPH

IT’S EASY WITH OUR HELP

A few hours interesting work saves many dollars and gives you a machine exactly to suit your ideals. We furnish motors, tone arms, case material, blue prints and full instructions. Plays any record. You can make fine profit building phonographs for your friends.

Write Today for Our Free Blue Print Offer

Agents wanted for our ready built phonographs

Choralcon Phonograph Co.
597 Choralcon Bldg., Elkhart, Ind.

SAVE OVER HALF

YOU NEED LOCOMA

—an interesting, inspiring, instructive MAGAZINE, dealing with the serious side of Personal Subjects — LOVE, MARRIAGE, DIVORCE, BIRTH CONTROL, EUGENICS, SEX HYGIENE, etc. 15c. a copy, \$1.50 a year, 8 months trial 50c.

100 E. E. & M. Bldg., Farmington, Michigan.

Undersea Amusement Park

By F. E. LOUDY, A.E.
(Continued from page 482)

Undersea amusement palace are multifarious and vari-colored in the extreme. Those who have seen large electrically illuminated fountains in operation at night, such as that at Willow Grove Park, near Philadelphia, will have some idea of the wonderful opportunities here presented to the illumination specialist charged with the task of working out a suitable lighting scheme for the resort. Searchlights or powerful nitrogen filled incandescent lamps, or argon filled incandescent lamps will vie with myriads of small incandescent tungsten lamps. Searchlights or else powerful flood lights of the gas filled type, will project beams of varying colors and of changing hues from the inner side of the breakwater. These lamps are maintained and supplied with current over heavily insulated wires passing down thru small vertical shafts built in the concrete wall, in the manner shown in the illustration. In the event that it is necessary to repair part of the structure or for other reasons, it may be desirable or necessary to empty the water out of the basin in which the resort is situated, suitable high powered motor driven pumps will be available to pump the water back into the sea.

When the basin is to be refilled, it is only necessary to open the sea valves and the water will then run into the basin.

STATEMENT OF THE OWNERSHIP, MANAGEMENT, CIRCULATION, etc., required by the Act of Congress of August 24, 1912; of ELECTRICAL EXPERIMENTER, published monthly, at New York, N. Y., for April 1, 1920.

State of New York, County of New York, ss. Before me, a notary public in and for the State and county aforesaid, personally appeared Hugo Gernsback, who, having been duly sworn according to law, deposes and says that he is the Editor of the ELECTRICAL EXPERIMENTER and that the following is, to the best of his knowledge and belief, a true statement of the ownership, management (and if a daily paper, the circulation), etc., of the aforesaid publication for the date shown in the above caption, required by the Act of August 24, 1912, embodied in section 443, Postal Laws and Regulations, printed on the reverse of this form, to wit:

1. That the names and addresses of the publisher, editor, managing editor, and business managers are: Publisher, Experimenter Publishing Co., 233 Fulton St., New York City; Editor, Hugo Gernsback, 233 Fulton St., New York City; Managing Editor, Harry Winfield Secor, 233 Fulton St., New York City; Business Manager, Hugo Gernsback, 233 Fulton St., New York City.

2. That the owners are: (Give names and addresses of individual owners, or, if a corporation, give its name and the names and addresses of stockholders owning or holding 1 per cent or more of the total amount of stock.) Experimenter Publishing Co., 233 Fulton St., New York City; Hugo Gernsback, 233 Fulton St., New York City; Sidney Gernsback, 233 Fulton St., New York City; Mrs. K. Hymes, 233 Fulton St., New York City; Harry Winfield Secor, 233 Fulton St., New York City.

3. That the known bondholders, mortgagees, and other security holders owning or holding 1 per cent or more of total amount of bonds, mortgages, or other securities are: (If there are none, so state.) None.

4. That the two paragraphs next above, give the names of the owners, stockholders, and security holders, if any, contain not only the list of stockholders and security holders as they appear upon the books of the company but also, in cases where the stockholder or security holder appears upon the books of the company as trustee or in any other fiduciary relation, the name of the person or corporation for whom such trustee is acting, is given; also that the said two paragraphs contain statements embracing affiant’s full knowledge and belief as to the circumstances and conditions under which stockholders and security holders who do not appear upon the books of the company as trustees, hold stock and securities in a capacity other than that of a bona fide owner; and this affiant has no reason to believe that any other person, association, or corporation has any interest direct or indirect in the said stock, bonds, or other securities than as so stated by him.

H. GERNSBACK.
Sworn to and subscribed before me this 5th day of April, 1920.
Beatrice K. Owen, Notary Public, New York County, New York; New York County No. 57; New York Register No. 1129. (My commission expires Mar. 30, 1921. (Seal.)

STUDY WIRELESS in BOSTON

The Center of Education, under former U. S. Radio Inspector for N. E. at

18 BOYLSTON STREET

Fall classes begin September 13th. Send for free literature. Enroll today.

MASSACHUSETTS RADIO AND TELEGRAPH SCHOOL

Arthur Batcheller R. F. Trop
G. R. Entwistle
Tel. Beach 7168

Learn the Sign-Show Card Business

Big field—unlimited possibilities—increasing demand for men with creative ideas. Our course develops ability and originality. Work intensely interesting.

EARN \$25. TO \$75. WEEKLY

You can do it if ambitious. Successful graduates everywhere. Our course covers every phase of work completely and thoroughly. Our graduates command big salaries. Write for catalog, samples, guarantee and Free Outfit.

DETROIT SCHOOL OF LETTERING, 688 D.S.L. Bldg. Detroit, Mich.

Learn Watch Repairing

Be a watchmaker—you can learn this profitable trade by correspondence in a few weeks in your own home by the DeSelms Chart System. After you complete the course you will know a watch from A to Z. You will know just what the matter is and how to repair one. When you graduate you will be a practical watchmaker and repairer and competent to fill any position. Positions for our graduates.

Ask for our Free Book. It explains our system and terms.

THE DESELMS WATCH SCHOOL
720 Perry St., ATTICA, IND.

ARTIST’S OUTFIT FREE

Write quick for our remarkable offer. Learn NOW at home, in spare time, by our new instruction method. Commercial Art, Caricatures, Illustrating, Drawing, Delightful, fascinating work in big demand! \$50.00 paid for one drawing. Handsome book free with everything.

SEND FOR IT TODAY.

WASHINGTON SCHOOL OF ART, Inc.
1012 H Street, N. W. Dept. 1531 Washington, D. C.

You can be an ACCOUNTANT

Get the facts about the most successful home study course ever prepared. Absolutely different in both material and method. C. P. A. instructors in personal charge of every student. Opportunity to specialize in any desired line. Moderate fees; special terms. Interesting books free. Address International Accountants Society, Inc. Dept. 922 2626 S. Michigan Ave., Chicago, Ill.

Small Steam Engines and Boilers

Gas and Gasoline Engines, 1/2 H. P. up; Tanks, Pumps, Gears, Model Maker’s Supplies. Get our Big Catalogue sent postpaid for 15c (coin preferred) or stamps. Re-funded first order. 192 Pages—over 200 Illustrations. MODERN ENGINE & SUPPLY CO. 346 Monadnock Block, CHICAGO.

MARKO STORAGE BATTERIES

ARE GOOD—TRY ONE

Paul M. Marko & Co., Inc.
1402-1412 Atlantic Ave.
Brooklyn, N. Y.

Chicago Medical School

Offers Accredited DAY AND EVENING COURSES in medicine and surgery leading to the degree of DOCTOR OF MEDICINE. Also offers through its affiliated college opportunity to complete pre-medical credits. WORK YOUR WAY PLAN.

Address REGISTRAR
3832 RHODES AVE. Dept. 7 CHICAGO

DEAFNESS IS MISERY

I know because I was Deaf and had Head Noises for over 30 years. My invisible Antiseptic Ear Drums restored my hearing and stopped Head Noises, and will do it for you. They are Tiny Mesaptones. Cannot be seen when worn. Effective when Deafness is caused by Catarrh or by Perforated, Partially or Wholly Destroyed Natural Drums. Easy to put in, easy to take out. Are “Unseen Comforts.” Inexpensive. Write for Booklet and my sworn statement of how I recovered my hearing.

A. O. LEONARD
Suite 369, 70 5th Avenue, New York City

As a matter of fact

Your first R-E-A-L cigarette pleasure will come with Camels!

YOU'LL swing into the Camel procession as easily and as delightedly as any of the thousands of smokers who have found these cigarettes an absolute revelation in quality, in refreshing flavor, in mellow mildness and in body!

Camels are unlike any cigarette you ever puffed. They are a creation—an expert blend of choice Turkish and choice Domestic tobaccos. As sure as you are a foot high you will prefer Camels blend to either kind of tobacco smoked straight!

Camels fit in with your cigarette desires just one hundred per cent! The satisfaction they impart to smokers is simply joyous.

Camels will not tire your taste! And, Camels leave no unpleasant cigaretty aftertaste nor unpleasant cigaretty odor.

You'll prove out our enthusiasm when you compare Camels with any cigarette in the world at any price!

Camels are sold everywhere in scientifically sealed packages of 20 cigarettes for 20 cents; or ten packages (200 cigarettes) in a glassine-paper-covered carton. We strongly recommend this carton for the home or office supply or when you travel.



Camel

CIGARETTES



Be an Automotive Electrical Expert

\$50 to \$100 a Week

For Specialists in Starting, Lighting Ignition and Storage Batteries

YOU can qualify quickly for a big paying position as electrical expert on automobiles, motor trucks, tractors, motorcycles, aircraft, farm lighting plants, etc. Men are needed at once to specialize in this clean, interesting work.

There are high salaried jobs open everywhere with automotive manufacturers, service stations and garages. Our Free Employment Bureau helps you to a good position just as soon as your training is completed. Or you can go into business for yourself supplying motorists with electrical repair service.

In Three Months You Can Master

all systems of starting, lighting, ignition and storage batteries. Come to America's greatest institution of electrical education and learn by practical work on actual models of automotive electrical equipment in our splendid big laboratories. Personal instruction by well-known experts.

EARN WHILE YOU LEARN

Twelve weeks' intensive, full-time training makes you a thorough master of all types of Automotive Electrical equipment. Or you can earn your own way while you are learning by devoting half time to a well-paying position which we will secure for you. Low tuition fee; dormitory and other special privileges.

Big Book Free Write today for handsome, illustrated Book telling all about the great opportunities for Automotive Electrical Experts, our quick, intensive method of training you and our Earn While You Learn plan. Do not miss this splendid chance to step into a \$50 to \$100-a-week position. Send postcard or letter today.

SCHOOL of ENGINEERING of Milwaukee

Dept. 1-AJ—373 Broadway, Milwaukee, Wis.



Be a Draftsman!

Make \$30 to \$75 a Week

Your name and address on the coupon brings this great Cyclopedic of Drawing without a penny down. Pay only net shipping charges when books arrive. With these books and a low price "school set" of drawing instruments, obtainable at any store, a man can become master of drawing and earn \$30 to \$75 weekly.

Shipped on 7 Days' FREE Trial CYCLOPEDIA OF DRAWING

4 Volumes, 1650 Pages, Thousands of Illustrations. Bound in genuine American morocco. Pages 6 1/2 x 8 1/2 inches. Covers all branches of Drafting—Architecture, Electrical, Structural Steel, Sheet Metal, etc. Teaches pen-and-ink rendering, lettering, free-hand, perspective, shades and shadows, working shop drawings, machine design, etc., etc.

75c a Week Only \$3 a month if you keep the books. Coupon explains offer, good only within borders of U. S. and Canada. Free Membership in This Society.—A Consulting Membership given free with each set—worth \$12.00.

AMERICAN TECHNICAL SOCIETY
Dept. D-256 Chicago

AMERICAN TECHNICAL SOCIETY
Dept. D-256 Chicago, U. S. A.

Please send Cyclopedic of Drawing for 7 days' examination, shipping charges collect. I will send \$2.50 within 7 days and \$3.00 a month until \$19.50 is paid, or notify you and hold books subject to your order. Title not to pass to me until fully paid.

Name
Address
Reference

The Whirling Eye

By THOMAS W. BENSON and CHARLES S. WOLFE

(Continued from page 487)

profession, and I dared not take up the defense, for if Mehlman still retained command of the faculty that had made him the terror of many a college professor, his logic would make short work of any case I might make.

For Mehlman had been my chum and room-mate at college. He had gone in for engineering, and he certainly was one of the most promising men that had ever graduated from our *alma mater*. I had lost track of him after he had gone down to South America to build railroads, and to find him in a patient's cell in an asylum was to see the impossible realized.

I dropped into the one chair in his room. "For the love of the Lord, Mehlman, what did you do that they sent you here?"

He grinned again. "Fell in love with a Venusian," he returned coolly, and the curve of his sensitive mouth was half humorous, half sad.

"A Venusian!" I echoed blankly.

"A Venusian," he replied emphatically. "An inhabitant of the planet Venus! It isn't being done in the best circles, you know!"

I turned to scrutinize him thoroly, and my slight move did not escape his keen eyes. He laughed with the greatest good nature in the world. "Now you know I'm crazy, eh?" he bantered playfully.

"Circumstances alter cases, Fred," I rejoined, slowly and gravely. "That statement, made in earnest by most anyone but Fred Mehlman, would be sufficient evidence of a positive nature for me. But you know that you have a prejudiced judge before you, old man, and I reserve judgment until I've heard more of this tale. Suppose you unburden yourself to your old pal, Fred, freely and fully, and if there is anything that I can do for you, old boy, you know that you can count on me."

Silently he held out his hand, and I wrung it until he winced. For a moment he sat lost in thought. Then he looked up and said abruptly, "There's one thing you can do, Jack, that I'll appreciate beyond words."

"And that is—?"

"Give me a smoke," he sighed wearily. "If there's one complaint I have to make against my keepers, it is that they have set an infernally long interval between smokes."

I rose and raised the window a trifle. "I'll violate the rules," I laughed, proffering my cigarette case and holding a match for him, "and join you. Now let me have the details of this horrible mess you've gotten yourself into. What's all this nonsense about the planet Venus?"

And then, sitting contentedly on the bed and swinging his feet, pausing now and then to puff deeply on his cigarette, he told his story, told it calmly and without a trace of irrationality or betraying excitement. I quote it practically verbatim in order that you may draw your own conclusions.

"It began down in South America," Mehlman said slowly. "Another chap and I were out on their God-forsaken prairies for months on end, with only the motley labor gang for company. You've no idea how tired of each other two people can get if they are thrown in each other's way every hour of the twenty-four for months that way. To keep from going mad and killing each other we had to devise something to pass our time with besides endless conversation.

"We turned to astronomy. Why? Well, for one thing, it was the easiest thing

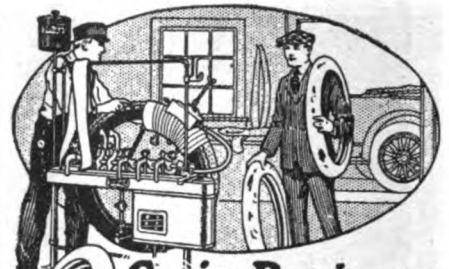

Go in Business for Yourself

Be independent—make more money—be your own boss. Open a Tire Repair Shop. Complete equipment costs less than \$100. No experience necessary. We teach you the Shaler System free.

Millions of tires need repairing. Hundreds of shops make \$25 to \$50 a day clear profit. Many make much more. Big capacity Shaler Shop Vulcanizer, all necessary tools and repair material with instructions costs less than \$100.

Write for Free Book

"How to Open a Tire Repair Shop" which gives complete information. Tells how to start—how to get work—how to make perfect repairs. Write now.

C. A. SHALER COMPANY
2208 Fourth St., Waupun, Wis.

BE AN EXPERT

Auto and Tractor Mechanic Earn \$100 to \$400 a Month

Young man, are you mechanically inclined? Come to the Sweeney School. Learn to be an expert. I teach with tools not books. Do the work yourself, that's the secret of the **SWEENEY SYSTEM** of practical training by which 5,000 soldiers were trained for U. S. Government and over 20,000 expert mechanics. Learn in a few weeks; no previous experience necessary.

FREE Write today for illustrated free catalog showing hundreds of pictures men working in new Million Dollar Trade School.

LEARN A TRADE

Sweeney

SCHOOL OF AUTO-TRACTOR-AVIATION
66 SWEENEY BLDG. KANSAS CITY, MO.

VEST POCKET \$1 BLOW TORCH

The handiest tool on the market. The most business-like little thing you ever saw. Instant intensive heat. Sootless flame. Useful for Electricians, Machinists, Automoblists, Vocational Schools, Home Tinkering.

REO SPECIALTY CO.
6381 Woodbine Avenue
Philadelphia, Pa.

Book on Law Free

Write today for our new 171-page book on "The Power of Law Training." It carries a vital and inspiring message to every ambitious man. Find out about the opportunities that await the law trained man. Find out how you can learn from masters of the law right in your own home. No obligations. The book is absolutely FREE.

Write Today now while we are making a special reduced price offer.

American Correspondence School of Law
746c Manhattan Bldg. Chicago, Illinois

You can be quickly cured, if you

STAMMER

Send 10 cents coin or stamps for 70-page book on Stammering and Stuttering, "Its Cause and Cure." It tells how I cured myself after stammering for 20 years.

Benjamin N. Boque, 720 Boque Bldg., Indianapolis

within reach. Lying on our blankets at night, we would stare up at the constellations in the Southern sky, picking out and identifying a star here and there and the groups. We began with the naked eye, and it was surprising what a lot we could locate after we got the swing of the thing. Then we followed their movements and began making calculations. Astronomy is fascinating, Jack, even here in the flesh-pots, where there are a thousand and one other things to divert you from the contemplation of the universe.

"We grew quite wrapt up in our game and began writing to the States for textbooks and literature. Most of it took months to arrive, and when it did reach us we fairly ate the stuff up.

"Quite naturally, we outgrew the limitations imposed by our eyes, and on one of my rare trips to the outside I packed in a modest three-inch refractor.

"Of course, this telescope broadened our field and opened up new wonders for our contemplation. We would be at it late into the night, and thru the day, when not actually at our posts, we'd indulge in endless discussions.

"Now, here's the funniest part of the whole business. Being engineers, you'd think that the purely mathematical side of the thing would have claimed the greatest part of our attention, wouldn't you? The calculations of orbits and transits and eclipses and things like that. Well, it didn't. Neither of us ever devoted much time to that sort of thing after the first few months. No, sir. How, didn't concern us very much. Why and what were the big questions for us.

"We fell to speculating. Were any of those twinkling little fellows that defied our lenses inhabited? If they were, what type of creatures would be on them? Did they breathe the same kind of atmosphere that we did? Maybe they lived and had their being in water like the fish, eh?

"After a few months of this kind of stuff that railroad seemed a mighty little thing to us. In fact, the whole blamed earth and what we are pleased to call its momentous affairs became trivial as we strained our gaze out into the infinite and tried to read God's riddle.

"Warped? Monomania? You begin to think I'm in the right boarding house? Well, maybe. But, man, man, it takes a supreme egoist to imagine for one little minute that out of all those millions of globes hanging out there in boundless space our own particular little fly-speck should have been singled out by the Creator as the one suitable abode for an intelligent and creating race. The man who believes that must necessarily also believe that all those stars were hung out there for adornment or for our amusement. For, unless some of them are thriving, inhabited worlds, they are the most useless things we know anything about.

"I'm crazy, according to folks who should know, but it seems to me that any one who can imagine that God Almighty hung the stars up there just for the fun of the thing will stand a little investigating himself.

"That's a trifle off the main theme of my yarn, of course, but I mention it to you to show you our viewpoint. Logically, after having reached the unanimous conclusion that many of the stars were dwelling places of animal life, we were quite frantic to get a glimpse of some of these creatures.

"In this frame of mind, we soon grew dissatisfied with our poor little three-inch refractor. We began to speculate on the possibility of getting a close enough glimpse at the face of some planet to settle the question beyond peradventure.

"We dwelt on this subject until it became an obsession. It carried us far into the theory of telescope construction. We even

LEARN WIRELESS AT HOME

The Demand for Wireless Operators Far Exceeds the Supply

The New York Wireless Institute will make you an operator—AT HOME—in your spare time—quickly, easily and thoroughly. No previous training or experience required. Our Home Study Course has been prepared by Mr. L. R. Krumm, Chief Radio Inspector, Bureau of Navigation, N. Y. Radio experts able to impart their practical and technical knowledge to YOU in an *easy to understand* way, will direct your entire Course. The graded lessons mailed you will prove so fascinating that you will be eager for the next one. The instruments furnished *free*, will make it as easy to learn the Code as it was to learn to talk. *All you will have to do*, is to listen.

Big Salaries

Wireless operators receive excellent salaries ranging from \$125 to \$200 a month and it is only a stepping stone to better positions. There is practically no limit to your earning power. Men who but yesterday were Wireless Operators are now holding positions as Radio Engineers, Radio Inspectors, Radio Salesmen at salaries up to \$5000 a year.

Travel the World Over

A Wireless Operator can visit all parts of the world and receive fine pay and maintenance at the same time. Do you prefer a steady position without travel? There are many opportunities at the numerous land stations or with the Commercial Wireless or with the Steamship Companies.

FREE Instruments and Text Books

We furnish free to all students, during the course, *the wonderful receiving and sending set exactly as produced in the illustration. This set is not loaned, but given to all students completing the Course.*

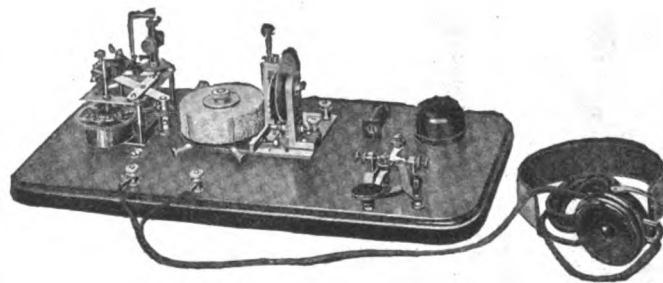

This wonderful Set for learning the Code furnished free with our Course

The Transmitter shown is the celebrated *Omnigraph* used by several Departments of the U. S. Government and by the leading Universities, Colleges, Technical and Telegraph Schools throughout the U. S. and Canada. Start the *Omnigraph*, place the phone to your ear and this remarkable invention will send you Wireless Messages, the same as though you were receiving them, through the air, from a Wireless Station hundreds of miles away. When you apply for your license, the U. S. Government will test you with the *Omnigraph*—the same model *Omnigraph* as we furnish to our students. Ask any U. S. Radio Inspector to verify this.

FREE Post-Graduate Course

A one month's Post-Graduate Course, if you so desire, at one of the largest Wireless Schools in N. Y. City. New York—the Wonder City—the largest port in the World and the Headquarters of every leading Wireless and Steamship Company.

Easy Payments

A small payment down will enroll you. We will make the payments so easy that anyone ambitious to enter the fastest growing profession—Wireless—may do so.

Send for FREE Booklet

Without obligating you in any way, send for our booklet "How to Become an Expert Wireless Operator"—it is free. Mail the coupon below, or postal or letter—but do it today.

NEW YORK WIRELESS INSTITUTE
Dept. 12, 258 Broadway
New York City

New York Wireless Institute
 Dept. 12, 258 B'way, N. Y. City
 Send me free of charge, your booklet "How to Become an Expert Wireless Operator," containing full particulars of your Course, including your *Free Instrument Offer*.
 Name
 Address
 City or Town.....State.....

What Would It Mean —To YOU—To Have Muscles Like These?

It would mean tremendous strength, putting you in a class above your fellows. It would mean that you could out-do them in feats of strength and be a leader of men. It would mean a strong personality because of your commanding appearance, thereby assuring you of success in both the business and social world. It would mean added lung power, unlimited vitality and perfect health; removing all fears of indigestion and disorders which undermine the average man and make him old long before his time.

All These Things Are Yours

I absolutely guarantee to do all this and more for you. I have found the short cut to physical perfection and applied it on my own body, proving its results. I have personally trained many of the world's strongest men by this same method. Why waste your time and money with old-time worthless methods? If you are desirous of being a real robust man, follow the path of those who have already made a success. Come now, get busy, for every day counts.

Send for My New Book, "Muscular Development" It tells the secret. Handsomely illustrated with 25 full-page photographs of myself and some of the world's best athletes whom I have trained. Also contains full particulars of my splendid offer to you. The valuable book and special offer will be sent on receipt of only 10c, stamps or coin, to cover cost of wrapping and mailing.

Don't miss this opportunity. Sit right down now and fill in the coupon. The sooner you get started on the road to health the easier it will be to reach perfect manhood. Don't drag along one day longer—mail the coupon to-day.

EARLE E. LIEDERMAN, Dept. 209, 309 Broadway, N. Y.

EARLE E. LIEDERMAN, Dept. 209, 309 Broadway New York City.

Dear Sir:—I enclose herewith 10c for which you are to send me, without any obligation on my part whatever; a copy of your latest book, "Muscular Development."

Name
Address
City State

Play the Hawaiian Guitar Just Like the Hawaiians!

Our method of teaching is so simple, plain and easy that you begin on a piece with your first lesson. In half an hour you can play it! We have reduced the necessary motions you learn to only four—and you acquire these in a few minutes. Then it is only a matter of practice to acquire the veird, fascinating tremolos, staccatos, slurs, and other effects that make this instrument so delightful.

The Hawaiian Guitar plays any kind of music, both the melody and the accompaniment. Your tuition fee includes a beautiful Hawaiian Guitar, all the necessary sticks and steel bar and 52 complete lessons and pieces of music.



**Send Coupon NOW
Get Full Particulars FREE**

First Hawaiian Conservatory of Music, Inc.
233 Broadway NEW YORK

I am interested in the HAWAIIAN GUITAR. Please send complete information, special price offer, etc., etc.

NAME
ADDRESS
TOWN
STATE E.E.
Please write name and address clearly.

REBUILT ELECTRIC MOTORS

General Electric Westinghouse Crocker-Wheeler Emerson Century Wagner etc. **All Motors Guaranteed For One Year**



Motors bought, exchanged and repaired **ELECTRICAL SUPPLIES** Wholesale Prices Sockets, wire, tape, fuses, switches, cut outs, etc. New illustrated catalogue free. Satisfaction guaranteed or money refunded. **HYRE ELECTRIC CO.** 831 S. Dearborn St. Chicago, Ill.

considered constructing one out there in that abominable scrub. Indeed, we went so far as to turn over methodically all the problems which we must solve out there in order to be successful. I believe we could have done it, too, but another and more serious problem arose, which seemed unsurmountable.

"Know anything about telescopes? Not a whole lot, eh? Well, I'll give you the pith of the matter briefly. There are two classes, the *refracting* and the *reflecting*. You look straight thru the refracting kind, like field or opera glasses somewhat, while in the reflecting you have a shallow, concave mirror, like a dish, with which you gather as much light as possible, depending mostly on the size of your mirror. Then you bring all the light rays to a focus at a point away up near the top of your tube, at which point it forms a minute image of the object from whence the light is being reflected. This image you view thru magnifying eye-pieces.

"Well, we learned that the world's biggest refractor measured some forty inches across the lens. That is, that was the diameter of the field lens. And that is about the limit, too. It won't make a whole lot of difference, so far as our problem is concerned, if they made it fifty inches. And the reason that this is the limit is a simple one. A moment's reflection will show you that, inasmuch as you look thru the glass, the thing must be supported on its edges, its weakest point. As a forty-inch lens weighs into the tons, you see that they cannot do much more in that direction.

"The world's biggest reflector, on the other hand, is at Mt. Wilson, right here in the U. S. A., and represents about the limit in that direction. That mirror weighs some thirteen tons, and the difficulty of getting a flawless piece of glass much larger than that is enormous, to say nothing of the grinding, figuring and polishing, if they do get them bigger.

"Now, the point of all this is this: With the biggest they've got they are not getting down to the surface of any of those other globes. About the best they can do is a rather vague picture of the moon's surface, showing us a few mountains and leaving all the big, vital questions unanswered.

"Well, that's where we stalled. Undoubtedly we could build a telescope out there larger than the one we had, but it was equally true that we could not hope to anywhere near equal the world's best, and these were not good enough for our purpose.

"So we contented ourselves with mapping out a campaign to be fought out when we reached civilization once more.

"Many a night we planned and discuss. We soon realized that if we would accomplish our end we must find some instrument radically different from what was in vogue.

"And once we admitted this, we were forced to admit that we had about exhausted the possibilities of glass. Some other medium we must find in order to outdo the work of the Mt. Wilson telescope.

"I can't tell you which one of us struck the idea first. I guess that we are both entitled to an equal share of whatever credit there is in our find. For the idea just grew out of our endless councils. Anyway, we had a beautiful little scheme all ready for a tryout when we could get back to the States."

Mehlman paused to gaze reflectively out into the dark night. Absently his fingers groped into his pocket, and then, remembering himself, he flushed. "Give me a cigarette, old man," he said, apologetically. In silence I proffered my case, and he continued the narration.

"Poor Jackson didn't come back to the

Delivered TO YOU FREE



Your choice of 44 styles, colors and sizes in the famous line of "RANGER" bicycles. We pay the freight from Chicago to your town. **30 Days Free Trial** allowed on the bicycle you select, actual riding test. **EASY PAYMENTS** if desired, at a small advance over our Special Factory-to-Rider cash prices. Do not buy until you get our great new trial offer and low Factory-Direct-To-Rider terms and prices. **TIRES** LAMPS, HORNS, pedals, single wheels and repair parts for all makes of bicycles at half usual prices. **SEND NO MONEY** but write today for the big new Catalog. **HEAD CYCLE COMPANY** Dept. W-107 CHICAGO



Phonograph Owners, Attention—The Ear-O-Phone when placed over the ear, collects a musical tone and brings it to the ear in an intensified form, clarifying it so that it sounds more natural with increased volume. You get a strong overtone too. Only 3 by 2 inches in size. (State for which ear it is intended.) Made in Oak, Walnut and Mahogany, price \$3.50 postpaid. Send P. O. or Exp. money order. Address **THE EAR-O-PHONE** 1413 North Broadway Los Angeles, Calif.

Handwriting Tells You Secrets

Be successful. Find out what holds you back. Send us an ink specimen of your handwriting and \$1.00. Our expert Graphologists will tell you your faults, virtues, talents, etc. Your \$1.00 back if you are not satisfied.

ROBERT R. ROSS, 110 West 40th St., N. Y.

Fun, Magic and Mystery!

56 Feats in Magic, 250 New Jokes, 21 Puzzles, 1 Fortune Telling Tablet, 52 Money-Making Secrets, 15 Card Tricks, 71 Toasts, 58 Verses in Comic Poetry, 10 Funny Readings, 41 Epitaphs, and 11 Parlor Pastimes. You get all the above-mentioned and our big illustrated Catalog of 125 Magic Tricks for only 10 cents. Write today.

DETROIT TRICK & NOVELTY CO. 454-456 Dix Avenue Detroit, Mich.

\$100 to \$350 Monthly Profit

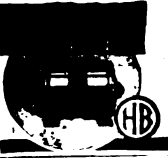

This HB charger recharges 1 to 23 6-volt batteries, or equivalent, for 10c to 15c each. Customer pays 75c to \$2.00. HB Chargers are sturdy and reliable—no repairs—no expensive renewals. Small cash payment, balance easy monthly terms. Absolute Money-Back Guarantee. Write to **Box 93-F, HOBBART BROS. CO.** Troy, Ohio

Learn to Dance!

You can learn Fox-Trot, One-Step, Two-Step, Waltz and latest "up-to-the-minute" society dances in your own home by the wonderful **Peak System of Mail Instruction**. **New Diagram Method**. Easily learned; no music needed; thousands taught successfully. **Write for Special Terms**. Send today for FREE information and surprisingly low offer. **WILLIAM CHARLES PEAK, B. S.** Room 236 - 623 Grandview Place - Chicago, Ill.

SAVE 25% to 60%



on slightly used **GRAFLEX-KODAKS** Cameras and Lenses of every description. Equal to new. Save money. Write now for **Free Bargain Book and Catalog** listing hundreds of money-saving bargains in slightly used and new cameras and supplies. All goods sold on 10 days' Free Trial. Money back not satisfied. See take no chance catalog with us. We have been in the photographic business over 18 years. Write now.

CENTRAL CAMERA CO., Dept. 119 124 S. Wabash, Chicago

CATALOG J.

Contains 24 pages of reliable apparatus, standardized parts and raw materials. Complete line switch points, knobs, switches, rod, aerial wire, etc.

Send 5c in stamps for your copy today. **Shetten Radio Mfg. Co., P. O. Box 3, Scranton, Pa.**



Send for a Complete Catalog of **MASONIC BOOKS** Jewelry and Goods **REDDING & CO.** Publishers and Manufacturers **Dept. 5 200 Fifth Avenue, N. Y.**

States. A snake bit him out there on the Pampas. They have the damndest snakes. So I arrived alone and set about constructing the thing we had worked out between us.

"Of course, I kept the thing a secret. Months of star-gazing, even, had failed to iron out of my nature that cute little trait of mankind—selfishness. Also, it just about broke me to construct the thing. I don't care—it was worth it.

"I built my five-hundred-inch reflector. How did I do it? Oh, I'll give you all the details. The selfishness thing is all out of me now. I gave the alienists the details, too, and this is where it brought me. You see, my instrument had been destroyed by fire, and I couldn't back my statements.

"I made that reflector out of mercury. Yes, that was the whole trick, that and the apparatus I had to build to handle it. I won't bore you with the mechanical details of the thing—an outline ought to do. You see, if you take a pool of mercury in a pan and whirl it, when you get sufficient speed up several natural forces act to shape the mercury into the form of a speculum.

"And there, without tedious months of casting and grinding and polishing, I had my reflecting mirror, the largest the world had ever known.

"Of course, I had many little problems to work out. To get the necessary smoothness of surface of the *whirling mercury pool*, for instance, the pan must be tremorless. The slightest tremor will ripple the whole surface, which would destroy its value as a reflector. The pivoting arrangement and the driving mechanism cost me much labor, but Jackson and I had already worked them out on paper down in South America.

"Another bothersome obstacle was the focal length of the thing. That is, the rays came to a focus so far above the surface of the mirror that the tube for the telescope would have been a discouragingly huge affair. To overcome this I resorted to an arrangement of prisms and lenses worked out by poor old Jackson, and when I got the whole thing completed the tube of my telescope was only twenty feet above the floor of my modest little observatory.

"I find it hard to tell the rest of my story calmly, Rose, and if you are going to judge me by my manner from now on to the end of the yarn, I fear that you are going to have plenty to be suspicious of.

"I ask you to put yourself in my place. After years of patient toil and waiting I was about to gaze into the most powerful tube yet devised by man. Do you wonder that my nerves gave way to the strain? And I confess to you that as evening slowly approached on that fateful day I went about my preparations gibbering to myself in a fashion about as bad as anything you have here, I guess.

"I'll pass that part. There are minutes that I don't like to think of myself, minutes full of foreboding that, after all, the thing would not work. At those times I lost control of myself altogether and just raved.

"The moment came when I trained the tube on the moon's surface. My motor was purring contentedly and my stabilizer was functioning as smoothly as a nicely balanced stop-watch. The surface of the mercury was perfect. Whirling in the thousands of revolutions a minute, that pool seemed as still as this floor.

"I trained the range-finder on our satellite, started the mechanism which follows the motion of the object observed and keeps the telescope trained and applied my eye to the Huyghenian eye-piece.

"I was looking onto the moon's surface. "For a long time I gazed, enraptured. One of our great questions had been answered to my satisfaction. Rose, the moon

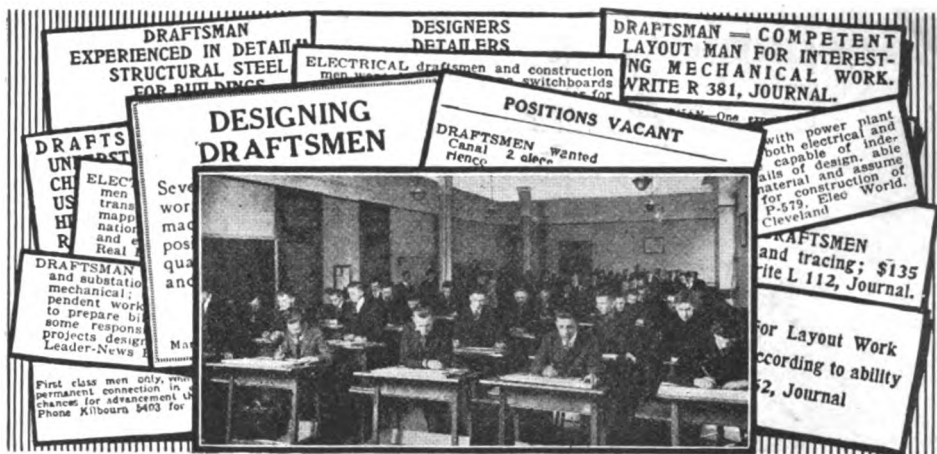

Learn Drafting!

Mechanical — Electrical — Architectural — Structural

TODAY everything is built by plan. In the factories, large and small, no new product is made, not even a change is made in an old design, but that a new sketch, worked out to the finest detail is first prepared. New buildings are constructed according to the architect's cleverly-drawn plans. Great bridges, tunnels, reclamation projects are first schemed out on paper—by draftsmen!

So we find every industry, in every land throughout the world in great need of skilled draftsmen. These men must be trained to take plans in the rough and draft them into workable, accurate graphs to guide the workmen. For this work handsome salaries are paid. But the men who earn the really big pay are the men who have been properly trained in the principles and practice of advanced draftsmanship.

Every Industry Needs Draftsmen

Railroads, steel mills, factories, ship yards, electrical concerns, contractors, construction engineers and companies, our shops, architects and hundreds of other concerns need and must have skilled draftsmen. In every industry thousands of draftsmen are daily required. The services of the man who is properly trained in this important work are always in great demand. Why don't you get into this fascinating profession?

Earn \$150 to \$400 a Month

In this fascinating profession each man is paid according to his skill and worth. Expert Draftsmen with specialized training such as School of Engineering offers can easily earn \$150 to \$400 a month. Expert Designers who have had drafting experience enjoy incomes up to \$10,000 a year and more. Salaries of over \$5,000 are often paid to Chief Draftsmen and Engineers. Train now for one of these

Become an Expert in Six Months

Practical Men Prepare You

Come to the School of Engineering of Milwaukee to learn *right* the science of *Drafting*. You will learn quickly and thoroughly here, from men who are recognized experts. No special ability or "drawing talent" is necessary. With the desire to learn and the will to win you can here quickly qualify for a responsible well-paying position in this fascinating field of work. Here you learn in large, airy, well-lighted drafting rooms. Skilled instructors, who are practical experts, train you step by step. Working models, machine parts, intricate electrical apparatus—the most thorough complete equipment for learning every phase of drafting is provided by School of Engineering. With this wonderful training you can become an expert Draftsman in six months.

Earn While You Learn

By our special system you may earn your way while learning. Our Employment Department will secure you a position to which you may devote a part of each day spending the remainder at the school. This plan both solves the students' financial problems and provides splendid experience at the same

splendid positions. With six months of special, intense instruction here, you will be started with a good work that will quickly put you into the big-pay class.

SEND FOR NEW FREE BOOK CLASSES NOW ORGANIZING

Mail the coupon now and get full information. Now is the ideal time to come to School of Engineering of Milwaukee. Here, on this breeze-swept shore of Lake Michigan, you will enjoy cool weather while you are learning. And there is every facility for recreation. The school is located in the heart of Milwaukee, a large up-to-date city with the added attraction of bathing and boating on beautiful Lake Michigan and other lakes in the surrounding country. Our students engage in baseball and other sports. You will enjoy your training at School of Engineering and your time here will pay you golden dividends all the rest of your life in increased earning power and bigger opportunities. It will mean thousands of dollars to you to mail the coupon NOW.

SCHOOL of ENGINEERING of Milwaukee
15th Successful Year Begins Sept. 1st
1-BJ-373 Broadway Milwaukee, Wis.

School of Engineering of Milwaukee
1-BJ-373 Broadway, Milwaukee, Wis.

I want full details and new catalog of the Electrical & Mechanical DRAFTING Course FREE!

Name.....
Address.....
Age..... Education.....

Mechanical Engineering

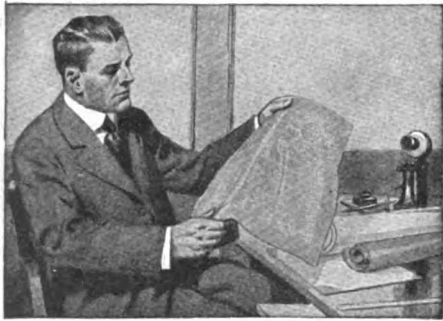

Learn at Home!

Employers everywhere are looking for men with mechanical ability. Splendid salaries and rapid advancement are offered.

There is an easy, delightful way in which you can learn right at home in spare time. For 28 years the International Correspondence Schools have been giving men and women just the training they need for success in mechanical engineering and more than 200 other subjects. Hundreds of thousands have stepped into good positions through I. C. S. help, but never were opportunities so great as now.

Let the I. C. S. help you. Choose the work you like best in the coupon below, then mark and mail it today. This doesn't obligate you in the least and it will bring you information that will start you on a successful career. This is your chance. Don't let it slip by. Mark and mail this coupon now.

TEAR OUT HERE

INTERNATIONAL CORRESPONDENCE SCHOOLS
BOX 6247 SCRANTON, PA.

Explain, without obligating me, how I can qualify for the position, or in the subject, before which I mark X.

- | | | | |
|--|---|---|--|
| <input type="checkbox"/> ELECTRICAL ENGINEER
Electrician
Electric Wiring
Electric Lighting
Electric Car Running
Heavy Electric Traction
Electrical Draftsman
Electric Machine Designer
Telegraph Expert
Practical Telephony | <input type="checkbox"/> MECHANICAL ENGINEER
Mechanical Draftsman
Ship Draftsman
Machine Shop Practice
Toolmaker
Gas Engineer
CIVIL ENGINEER
Surveying and Mapping
MINE FOREMAN OR ENG'G
ARCHITECT
Architectural Draftsman
PLUMBING AND HEATING
Sheet Metal Worker
Navigator | <input type="checkbox"/> CHEMICAL ENGINEER
SALESMANSHIP
ADVERTISING MAN
Window Trimmer
Show Card Writer
Outdoor Sign Painter
RAILROAD ENGINEER
ILLUSTRATOR
DESIGNER
BUSINESS MANAGEMENT
Private Secretary
BOOKKEEPER
Stenographer and Typist
Cert. Pub. Accountant
Traffic Management
Commercial Law
GOOD ENGLISH
STATIONARY ENGINEER
CIVIL SERVICE
Railway Mail Clerk
Textile Overseer or Supt.
AGRICULTURE
Poultry Raising
Automobiles | <input type="checkbox"/> Spanish
<input type="checkbox"/> Italian |
|--|---|---|--|

Name _____
Present Occupation _____
Street and No. _____
City _____ State _____

Electrical Engineering men with training are in demand. For more than a quarter of a century, this school has been training men of ambition and limited time, for the electrical industries. Condensed course in Electrical Engineering enables graduates to secure good positions and promotions. Theoretical and Practical Electricity, Mathematics, Steam and Gas Engines and Mechanical Drawing. Students construct dynamos, install wiring and test electrical machinery. Course with diploma complete

In One Year

Over 3000 men trained. Thoroughly equipped fireproof dormitories, dining hall, laboratories, shops.
Free catalog. 28th year opens Sept. 29, 1920
BLISS ELECTRICAL SCHOOL
260 TAKOMA AVENUE, WASHINGTON, D. C.

STAMPS 50 all diff. British Guiana, Cuba, China, India, Jamaica, Japan, Portugal, Venezuela, etc., only 10c; 100 all diff. 15c; 1000 all diff. fine collection in itself, \$5.00; 100 diff. U. S. 5c; 1000 hinges, 10c. Agents wanted, 50% commission. Lat. free. **BUY STAMPS.**
L. B. DOVER OVERLAND, MO.

is devoid of life such as we know it. A few crawling things there are and some sparse vegetation, but no race, no development, nothing like this sphere. But, man, man, there has been!

"There are ruins of cities on the moon. Next I trained the tube on Venus. This planet was poor old Jackson's favorite, and how I wished that he might have been with me at that moment.

"How shall I describe to you what lay before my eyes? The cloudy mist that astronomers notice surrounding the face of that planet will not bother the telescopes of tomorrow.

"And, Rose, those people are centuries ahead of us," his voice sank to a whisper. "Rose, night after night I watched them, night after night I followed them thru the streets of their cities, at their daily tasks, as they assembled in their big open-air auditoriums. They have mastered death up there, Rose. Physical death, I mean, of course, and if we ever come to it, I'll tell you now that the apparent problem of a teeming universe will not be hard.

"And, Rose, there's a 'girl' up there I want. I never had one down here, you know. I only hope that I'll be able to make my way up to her. And somehow, I feel that I will. And my telescope's gone, and I haven't the money to build another, nor the freedom to build it, for that matter. And—"

His voice trailed off into nothing, and he shook himself as a man does who tries to get himself awake. Finally he gained control of himself. He grinned at me sheepishly. "There! Now you know I'm crazy, don't you?" he asked, with a kind of a sob.

I regarded him soberly. "God knows, old man," I replied; "I can't tell you. I don't know what to do. I don't know what to say."

He laughed with forced cheerfulness. "Do? Why, you solemn old goose, what is there to do? Figure out a way to turn me loose, and then have your conscience working overtime for you because of it? Nothing doing. I have no desire to get loose, Rose. If I was out, I'd only try to raise funds to begin the whole business over again, and I've about figured out that the peep I got behind God's veil is about all I'm entitled to this side of Eternity. I'm content to wait until the time comes. So all I ask of you is an occasional smoke. And thanks for the patient listening to my . . ."

The sentence remained unfinished. He suddenly stiffened up as if struck by an apoplectic fit. He reeled and fell heavily over his cot just as I rushed to his assistance. I placed him tenderly upon his bed and tried to revive him. But it was useless. He had died almost instantly.

An autopsy was performed at my suggestion. The physician's report read: Frederic Mehlman, age 42. Single. Cause of death, cerebral thrombosis (blood-clot of the brain).

[THE END.]

VOICE RECORD BY RADIO.

Experiments which have been carried out in London, England, have resulted in the making of a talking machine record on wax of a voice transmitted by wireless telephone forty miles away.

While an experimenter was speaking at Chelmsford, in the county of Essex, where there is a high-power instrument capable of transmitting the voice many hundreds of miles, the equipment at the receiving plant in the Strand, London, was attached to a recorder, which engraved the messages in soft wax, following the process of manufacture of an ordinary talking machine disc.

The record when produced was perfectly audible, tho a trifle "patchy." With larger amplifiers the result, it is said, would have been louder, tho rather hoarse in its effect.



A pretty big load

—yes, but a mighty easy one for the Auto-Wheel. You may not want so many to ride, but you can be sure the Auto-Wheel will haul them safely. When the boys see the Auto-Wheel they'll want a ride. Seasoned ash, steel tires and axles, and the best of workmanship make Auto-Wheel wagons the finest in the world. We use them to haul 1000-pound loads. Get an



Auto-Wheel Coaster or an Auto-Wheel Convertible Roadster Organize an Auto-Wheel Club. "The Auto-Wheel Spokesman," a magazine for live boys, tells of our prize contests. Send names of 3 coaster dealers, telling which ones handle the wagon with the name "Auto-Wheel" on the sides. We'll put you on the mailing list for six months, FREE.

The Auto-Wheel Coaster Co., Inc. Formerly the Buffalo Sled Co. 163 Schenck Street, N. TONAWANDA, N. Y. In Canada: Preston, Ont. Export Office: 365 W. 23rd St., New York City.

Auto-Wheel

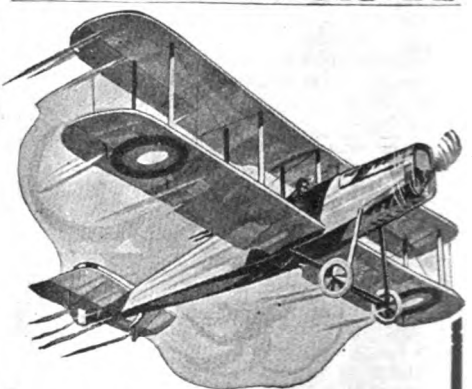

Build and Fly A Model Aeroplane This Summer!

Build a real, flying model of any of the famous Aeroplanes listed below. IDEAL Scale Drawings and Building and Flying Instructions show how you can build 3-ft. models of real 'planes. Send now for drawings and instructions for the one you want to build.

Curtiss JN4D-2 Training Plane (Just Out)	35c	Curtiss Military Tractor
NC-4 Naval Seaplane	10c	Bleriot Monoplane
DeHavilland Battle 'plane	10c	Nieuport Monoplane
		Taube Monoplane

Catalogue of IDEAL Model Aeroplanes and Supplies 5c, if you write at once; regular price 10c.
Ideal Airplane & Supply Company
Making Model Aeroplanes since 1911
159-161 Wooster St., New York City

SECRET SERVICE

Operatives, Detectives and Investigators are in big demand; earn big salaries; fascinating work. Be independent. We show you how by home study. Write American School of Criminology, Dept. B, Detroit, Mich.

Wrestling Book FREE
Be an expert wrestler. Learn at home by mail. Wonderful lessons prepared by world's champions Farmer Burns and Frank Gotch. Free book tells you how. Secret holds, blocks and tricks revealed. Don't delay. Be strong, healthy. Write for book with ease. Write for free book. Send size of Farmer Burns, 1285 Range Bldg., Omaha, Neb.

The Unknown Avenger

By HAROLD F. RICHARDS, PH. D.
(Continued from page 483)

forefinger the little notched wheel and applied the blue flame to the heap of papers. The three then warmed their hands over the flame, which leaped briskly in the cold air, while Kelly stood erect in the background, his inscrutable expression giving no indication that he had played a dangerous game—and lost.

When the fire had burned itself out, von Hernholtz motioned Kelly into the gasoline launch, whose nose touched the rock on which the party stood. The three conspirators followed, the engine chugged and soon they had reached the yacht. The launch was hoisted to its place and the great yacht steamed away due north. Kelly judged that they must be fifty miles north of Iceland, when a stop was made in mid-sea. The launch was lowered again into the water. Von Hernholtz address Kelly: "Will you be kind enough to descend into the launch?"

Kelly, still well trussed up, complied. Resistance was useless. A heavy wooden mast had been securely erected in the center of the open launch. While Lendorff covered Kelly with a revolver, von Hernholtz deftly untied his bonds. Then his left arm was tightly bound to his side, while a heavy leather thong was securely fastened to his right wrist. The thong was then passed thru a pulley fastened to the top of the mast, and Kelly's arm was steadily drawn over his head until his heels left the floor of the boat, so that he was trussed up on tiptoe. The thong was made fast to the top of the short mast, and Kelly remained in this stretched position. He uttered no word. His face bore a look of calm resignation, as of a good poker player who has risked his pile on a single deal and lost. Again von Hernholtz spoke:

"Mr. Kelly, in recognition of your devoted attention we have decided to make you a present of this launch. It is in perfect condition, as you can tell by listening to the smooth purring of the motor. There is an ample supply of fuel, and the automatic feed insures that the engine will require no attention from you. For your further convenience we have equipped the craft with one of the new gyroscopic controllers, so that the boat will follow a straight line without any hand at the wheel. I think that you had better take the course due north, as there will then be no danger of collision with any steamers. The fuel will undoubtedly last for at least fifty miles, so that your excursion will be uninterrupted. I sincerely trust that you meet no icebergs."

"My God, Hernholtz," groaned Kelly, as the full import of their plans forced itself upon his unwilling understanding. "Why can't you shoot me?"

"My dear Kelly, such an action would be extremely indelicate, and furthermore we feel that your distinguished services merit a more worthy reward. We wish you a happy voyage."

Standing on the rope ladder, von Hernholtz pushed with a long staff the clutch of the engine, and the launch darted off with its lone passenger, due north. Von Hernholtz, Lendorff and Madame Elaine Holt lighted each a gold-tipped Egyptian and puffed calmly as they watched the launch skim over the water with the figure of Kelly, stretched up at the mast, showing plainly against the horizon.

One year later a group of sinister-faced men in evening clothes were in session in a luxurious office on the twelfth floor of New York's greatest building. The directors of the Murder Syndicate were holding

A Sensational Feat

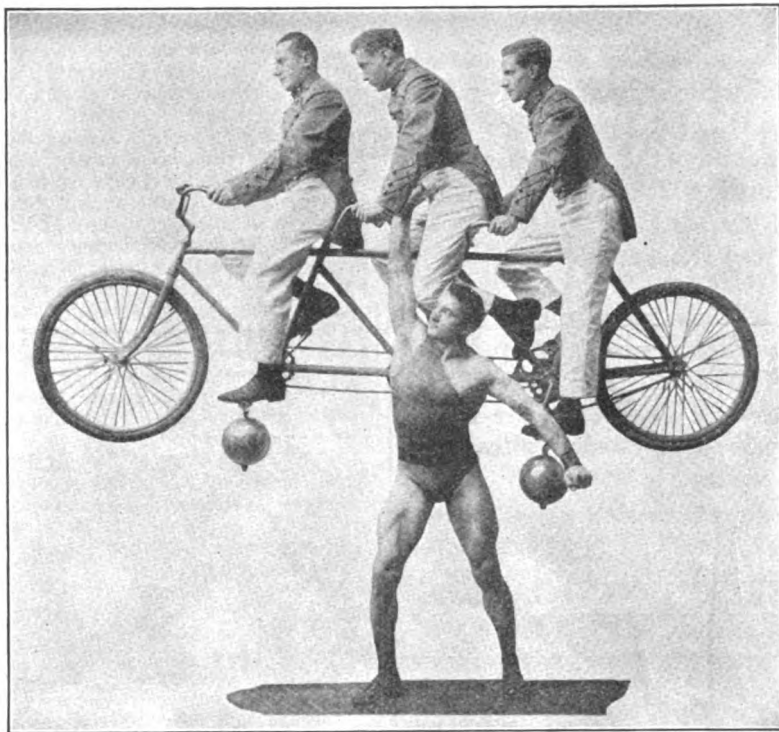

like the one shown in this picture attracts and amuses theatre goers, but the development and strength of the man who performs the feat are even more interesting than the feat itself. We remember the symmetrical development and strength of the performer long after the feat is forgotten.

Walking with a weight of 500 lbs. in the manner shown above requires strength in every part of the body. That this man has strength is shown by his broad shoulders, deep chest, and magnificently muscled arms and legs. He is one of our pupils—a man who obtained all his development through the practice of progressive bar bell exercises. Yet when he enrolled for our course of instructions he did not even have ordinary health and strength. He will give you a good idea of what you may expect to accomplish through our system of exercise.

Do You Want Strength?

You may not be particularly interested in developing enormous strength—most of our pupils exercise only for better health, with its many advantages. But like everyone else, you want to enjoy perfect health, and to have a well developed figure that will give you sufficient strength for your daily needs and a surplus of energy and vitality for emergencies. Many men have been content to be physical weaklings because they thought it impossible to better their physical condition. What about you?

Are you content to remain a man in name only? Why not give yourself a chance to succeed? You can not do it with a weak,

undeveloped body. It will be a constant handicap to you, dragging you down when you are most in need of the strength and vitality afforded by a strong constitution. Don't let them tell you it can't be done. During the past eighteen years we have handled thousands of cases just like yours, and have never had a failure!

No matter how weak or undeveloped you may be, if you are normal in other respects, we can help you. We do not merely promise results, we guarantee them. If you are going to exercise at all, why not go after results? The system of exercise which produces men such as the one shown in the picture above, can do something for you. Send for our Illustrated Catalog and Folder No. 17, describing our system of exercising. Both Free.

The Fountain of Youth

"The Fountain of Youth and How I Found It," by E. F. Dilks, in the September issue of Strength, should be read by every man and boy who is desirous of bettering his physical condition. It is the story of a boy who was a physical weakling, and who as a result was a pitiful coward—afraid of his own shadow. He did not think of trying to better his physical condition—he knew it couldn't be done.

Even at the age of thirty he was a man in name only, without sufficient courage to claim what was justly due him. There are thousands of men in a similar position who despair of bettering their physical condition. Is there any hope for them? In this article Mr. Dilks tells how the weakling developed himself into a real man. It's his own story. Don't miss it.

This is only one of the many articles in the September issue of Strength. All the others are equally good, and are handsomely illustrated with pictures of some of the strongest and best developed men in the country. An inspiration to all seekers after good health. A limited number of copies have been printed. Send in your subscription today.

SEND FOR

Our Illustrated Catalog and Folder No. 17, describing our system of exercising.

BOTH FREE

SUBSCRIPTION BLANK

Date.....

MILO BAR-BELL CO.
Diamond & Third Sts.
Dept. 8, Philadelphia, Pa.

I herewith enclose One Dollar and Fifty Cents (\$1.50) in payment for one year's subscription to "STRENGTH." (\$1.75 Canada and \$2.00 foreign countries).

The Milo Bar Bell Co.

Physical Culture Specialist and largest manufacturers and distributors of bar bells, dumbbells and kettle bells in the world. Publishers of "Strength."

Dept. 8, Diamond and Third Sts.
Philadelphia, Pa.

Name.....
Street Address.....
City or Town..... State.....

HUDSON RIVER NIGHT LINES

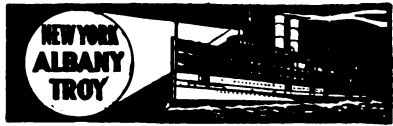

Daily Sailings from Pier 31, N. R., (at Desbrosses St.) weekdays 6 P. M. & 7 P. M., Sundays and Holidays 6 P. M. and 9 P. M.

West 132nd St., half hour later (Daylight saving time)

Due Albany 6 o'clock following morning. From Troy 8:00 P. M., from Albany 9 P. M. & 11 P. M., due New York 6 o'clock following morning.

Direct rail connections to all points. Express freight service. Autos carried.

HUDSON NAVIGATION COMPANY

Spirit Return

How Much is True? How Much False? Have You Mediumistic Power Yourself?

Read

YOUR PSYCHIC POWERS:
And How to Develop Them
By Hereward Carrington, Ph. D.

Illustrated, \$3.00. Sent on approval. Mention Science and Invention.

DODD, MEAD & COMPANY
445 Fourth Avenue New York

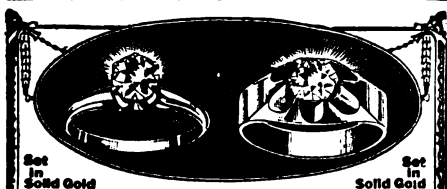

Send Your Name and We'll Send You a Lachnite

DON'T send a penny. Just send your name and say: "Send me a Lachnite mounted in a solid gold ring on 10 days' free trial." We will send it prepaid right to your home. When it comes merely deposit \$4.75 with the postman and then wear the ring for 10 full days. If you, or if any of your friends can tell it from a diamond, send it back. But if you decide to buy it—send us \$2.50 a month until \$18.75 has been paid.

Write Today Send your name now. Tell us which of the solid gold rings illustrated above you wish (ladies' or men's). Be sure to send finger size.
Harold Lachman Co., 12 N. Michigan Av. Dept. 1286 Chicago

STURDY

Bang-proof, knock-proof, thief-proof—that's what you'll say when you see this handy compact **UNION GARAGE TOOL CHEST**

Union Tool Chests are durable, handsome, of the best workmanship and finest material. There are 24 sizes and styles to choose from—an economical chest for every mechanic's needs. Sold on "Satisfaction or Money-Back" guarantee.

WRITE FOR FREE CATALOG and let us tell you more about Union Tool Chests.
UNION TOOL CHEST CO., Inc.
38 Mill Street Rochester, N. Y.



a midnight meeting. Professor Hopkins rose to address the members and took his place behind a mahogany table which was covered with a strange assortment of apparatus. Batteries, Leyden jars, electroscopes, a huge induction coil and many other pieces of apparatus strewed the table.

"Gentlemen, I feel that the experiments which I am about to perform will open a new era in the art of successful removal. As we have found in the course of our operations last year, this art has not advanced with the other sciences. Of course, electrocution and over-doses of ether are far superior to the methods of the Spanish Inquisitors, who assiduously stuck stubborn victims full of burning matches, yet the slow poison of the ancient Arabs seems still to be as effective as any of the modern methods, so far as immunity from detection is concerned. I firmly believe that the latest discoveries in radiation will furnish methods which will enable us to operate in perfect safety and give us an immense advantage over our competitors. I shall first perform for your benefit some experiments which will reveal the wonderful power of the substance contained within this tiny glass capsule.

"You will note upon the curtain the projected image of the gold leaf of this electroscope. You see that it remains stationary so long as I keep the glass capsule inside this heavy lead box. I raise the lid of the box, and you see the gold leaf collapse instantly, showing that the electrical charge has been removed from the instrument. Will somebody kindly turn off the lights? Thank you. Now note the brilliant flashes of light which this capsule causes on the screen of zinc sulfide. Now I will put this induction coil in operation and draw the spark-points apart until the spark no longer passes. I bring up the capsule and you hear the electric crash produced."

The eight listeners had followed the Professor with close attention, but their faces bore an expression of query, as if they wondered what bearing these experiments could have upon their business. But they watched eagerly as Professor Hopkins placed a guinea pig upon the table.

"You will note," the Professor continued, "that the pig starts back when I bring a lighted match near its eyes. This shows that it is not blind. I will now insert the glass capsule in a pocket in the blinder which I have prepared and place it over the right eye of the animal. In two minutes we will see the result."

The little audience waited tensely until the two minutes had past. The Professor removed the blinder and held a lighted match near the right eye of the pig. The lack of reaction showed that the right eye was blind. An excited murmur ran thru the gathering.

"If you will come to the table and examine the back of this pig you will see that the hair has been removed from a considerable portion of the back, and that in its place there is a deep, red, festering ulcer. That is caused by one day's exposure to this glass capsule."

The Professor placed on the table a glass jar, and withdrew from the alcohol which it contained a grewsome thing, resembling a bladder.

"This, gentlemen, is the stomach of a guinea pig which I caused to swallow the capsule with which I have performed these experiments. The pig died, and if you will examine this stomach you will see that its walls have been perforated by a cancerous lesion. The capsule contains twenty-five thousand dollars' worth of radium, and I think that you can readily see that with this intensely powerful agent we are now in position to proceed with many of those delicate commissions which our patrons have placed in our files. And remember, please, that this radium leaves no trace, so that foul play will never be even suspected. We can operate in perfect safety."

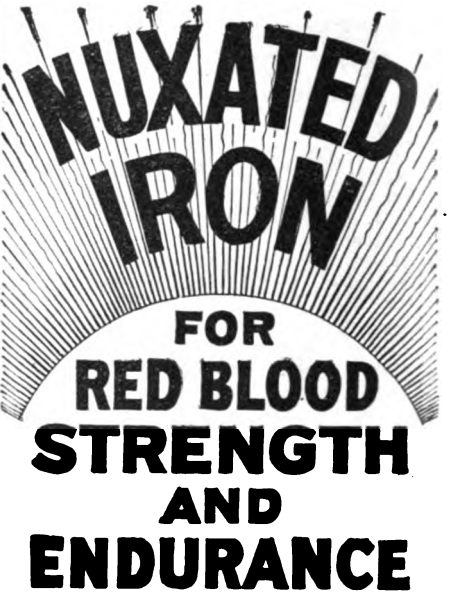

OVER 300000 PEOPLE USE IT ANNUALLY

PROSPECTIVE STUDENTS

B. C. N. will give you your N.D. degree in two years, day and night classes. This Institution teaches Electrical Therapeutics, Static, High Frequency, Violet Ray, Galvanic Current, X-Ray, Osteopathy, Orthopaedics, Chiropractic, Psychology, as embodied under the Triplet of Science known as Natureopathy. This field is unlimited right now for Natureopathic Physicians. Our experienced faculty of fourteen practical physicians will guide you surely and carefully to attain success. Earn while you learn if you so desire. Graduates of single branch schools, who are here now say that the Blumer System is the most wonderful drugless healing system in existence. Write today for our catalogue. Start right. Address Executive Secretary.

BLUMER COLLEGE OF NATUREOPATHY
97 Ann St., Dept. H., Hartford, Conn.

15 cents postage will bring to you "The Scientific Natureopath." Address Publicity Dept. of the above college.

What 15 Cents Will bring You From the Nation's Capital

The little matter of 15 cts. in stamps or coin will bring you the Pathfinder 15 weeks on trial. The Pathfinder is an illustrated weekly, published at the Nation's center, for the Nation; a paper that prints all the news of the world and tells the truth and only the truth; now in its 27th year. This paper fills the bill without emptying the purse; it costs but \$1 a year. If you will bring want to keep posted on what is going on in the world, at the least expense of time or money, this is your means. If you want a paper in your home which is sincere, reliable, entertaining, wholesome, the Pathfinder is yours. If you would appreciate a paper which puts everything clearly, briefly—here it is. Send 15c to show that you might like such a paper, and we will send the Pathfinder on probation 13 weeks. The 15c does not repay us, but we are glad to invest in new friends.
THE PATHFINDER, Box 1275 Washington, D. C.

You can be a DRUGLESS PHYSICIAN

A well-paid profession is open to you. The field beckons to both men and women. Combined home study and college course. Heal without drugs. Free catalog. International College of Drugless Physicians, Dept. EE, 4200 Grand Blvd., Chicago.



\$4 AND \$5 WILL BUY A Beautifully Reconstructed TYPEWRITER

With Every Modern Writing Convenience

WRITE TODAY FOR ILLUSTRATED CIRCULAR Explaining Try-Before-You-Buy Plan
HARRY A. SMITH, 738-218 North Wells St., Chicago, Ill.

BE AN EXPERT

Wonderful, new device, guides your hand; corrects your writing in few days. Big improvements in three hours. No failures. Complete outline FREE. Write C. J. Ozment, Dept. 44, St. Louis, Mo.

One of the auditors walked slowly to the front of the room and faced the members of the Murder Syndicate. His face was dead white and seamed with deep lines that appeared to be the tracks of an experience too harrowing to relate. He held up the handless stump of his right arm and requested attention.

"Gentlemen," he began, "one year ago I joined this syndicate. You will remember in what condition you first saw me. You have never heard how it happened. One day I was turned adrift in the ocean north of Iceland and left to starve or freeze, whichever might come first to relieve my sufferings. It does not matter now that a steamer out of its course finally rescued me from the launch in which I was prisoner with my right hand stretched up for days, lashed to a wooden post. Ever since that terrible experience my single purpose has been to take a suitable revenge upon the three who sent me to those indescribable sufferings. For a year I have watched the operations of this company, but not until hearing the revelations of Professor Hopkins this evening have I felt that the time was ripe to take my just revenge. You have often told me how greatly you value my services. Gentlemen, I ask permission to use the resources of this company to avenge my sufferings and the loss of my right hand."

As one man the strange company rose to give assent.

Kelly and Professor Hopkins were very busy for the whole of the following week. While Kelly was absent upon certain errands in which his experience in the Secret Service was of great assistance, the Professor worked diligently in his laboratory. Madame Elaine Holt was delighted with the veil which an unknown friend sent her by mail, and constantly wore it gracefully drooping from her hat, so as to cover only the upper half of her face, in the style so popular among New York's beauties. The eminent scholar Lendorff was much irritated to be unable for a whole day to find his huge, horn-rimmed spectacles, but resumed work upon his beloved manuscripts the following day, when he found the glasses in the pocket of an unused coat. Von Hernholtz continued to increase the huge fortune which he was amassing as head of a great steel factory.

Two months after Hopkins and Kelly had been so busily engaged in the laboratory, a note, signed with the peculiar mark which agents of the German government obey so implicitly, brought together in a room of a New York hotel the three valued servants of Germany. While they sat discussing what matter there was now to be attended to, the door opened and a distinguished looking man entered, accompanied by a haggard man whose right hand was missing. The three sprang to their feet as the latter quietly locked the door, but resumed their seats when Kelly covered them with an automatic. Kelly address himself to his companion:

"My dear Professor, do you remember the story of the man who was sent into the northern seas with his right hand lashed to the top of a mast? I see you do. Sit down there, Hernholtz; you seem to be troubled. What, my dear Professor, do you think should be done to the heartless criminals who could treat a man in such a manner?"

The Professor smiled and waited for Kelly to proceed.

"My dear Madame Holt, would you mind raising that heavy veil? By the way, how long have you been wearing such a heavy veil? Really, it hides your astonishing beauty. Please accommodate me by lifting it. You seem to be reluctant. I should not like to be forced to use this."

Kelly toyed with the pistol and Madame Elaine Holt, the celebrated beauty, raised the heavy veil.

LEARN DRAFTING

At Home—In Spare Time as you would in actual practice

Get into this constructive branch of industry where big salaries are paid. No previous training is necessary to become a capable draftsman with the help of the Columbia School of Drafting. You can master the practical lessons of our famous home study course, at home, in spare time. You will be personally coached and instructed, by mail, by Roy C. Claffin, president of the school, whose long experience as a draftsman and teacher, especially qualifies him to give you the training you need to become a successful Draftsman.

Become a Specialist

We not only give you thorough and practical training in Mechanical Drafting, teaching you to make actual drawings as you would in any drafting room, but the additional benefit of a post-graduate course in some special branch of drafting. A big field of opportunity is thus opened to you as a trained specialist in this profession.

Draftsmen are needed in greater numbers, and receive better salaries than ever before.



CHIEF ENGINEER \$25,000 TO \$50,000 A YEAR



CHIEF DRAFTSMAN \$50 TO \$150 A WEEK



DRAFTSMAN \$35 TO \$100 A WEEK



STUDENT

Draftsmen Get \$35 to \$100 a Week

Because of the importance of his work the draftsman is paid a big salary and is always in line for advancement. The draftsman's pay is from \$35 to \$100 a week. A knowledge of drafting is the stepping stone to big technical positions in the industrial field paying as high as \$50,000 a year.

How "Columbia" Students Succeed

Students of the Columbia School of Drafting often secure positions at \$2,000 or more a year to start before completing the course. Hundreds of men and women with "Columbia" training are now making good with big concerns all over the country. Many more are needed for splendid positions now open. Here is what "Columbia" training is doing for some of our graduates: Laurence Johnston, over \$5,000 a year; George Murray, \$45 a week to start; G. Tangorra, \$2,800 a year; A. L. Gash, \$140 a month to start; W. S. Burfoot, \$150 a month to start; T. R. Brown, \$2,860 a year; R. Fowkes, \$3,700 a year. These are only a few of a great number of similar cases.

Big Concerns Employ "Columbia" Graduates

The best concerns in America employ Columbia graduates in their drafting departments because of the thorough practical training we give which enables them to step right into important drafting positions. Our diploma is the entering wedge into big drafting rooms everywhere. As a Columbia graduate you are recognized as an experienced draftsman, not as a mere apprentice. Why be satisfied with a grinding, underpaid position when there are hundreds of promising positions open to you in the big field of Drafting. We are called upon to place trained draftsmen more rapidly than we can produce them.

Send This Coupon Today

Let us tell you the fascinating story of Drafting and how you can master this lucrative profession of big salaries and steady advancement through our help. Write today to

COLUMBIA SCHOOL OF DRAFTING

Roy C. Claffin, President
Dept. 1157, 14th & T Sts., N. W., Washington, D. C.

This Complete Drafting Equipment Furnished

to students of our school. The instruments are of standard American make of the best quality, fully guaranteed, and become your property on completion of the course. Every instrument needed for the course is included.

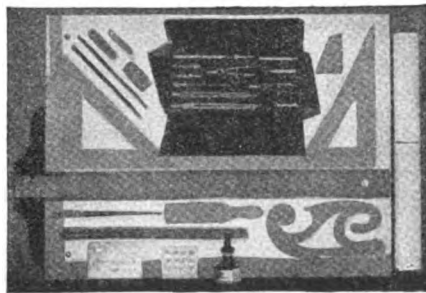

COLUMBIA SCHOOL OF DRAFTING,
Roy C. Claffin, President
Dept. 1157, 14th & T Sts., N. W.,
Washington, D. C.

I am interested in your practical training in Mechanical Drafting. Please send me Free, your illustrated book of particulars, testimonials, terms, etc. I am also interested in the special post-graduate course checked below:
(Mechanical Drafting, or Machine Drafting is the foundation course and is complete in itself.)

- Architectural Drafting.....
- Automobile Drafting.....
- Electrical Drafting.....
- Aeroplane Drafting.....
- Special Machinery Drafting.....
- Sheet Metal Drafting.....
- Structural Drafting.....
- Highway Drafting.....
- Patent Drafting.....
- Topographical Drafting.....
- Ship Drafting.....
- Statistical Drafting.....
- Radio Drafting.....
- Automotive Drafting.....
- Hydrographic Drafting.....
- Machine Design.....
- Tool Design.....
- Shop Mathematics.....
- Builders' Course.....

Name.....
Age.....
City..... State.....



LEARN
Armature Winding

Motor and Generator Repair and maintenance

In 6 Months

in the fully equipped shops and laboratories of the School of Engineering of Milwaukee.

Prepare quickly and efficiently to fill the constantly growing demands for trained men in this remunerative profession. You can

Earn While You Learn

if you like. Actual practice under wage-earning conditions will train you most successfully.

Send now for bulletin and full particulars **FREE!** Clip the coupon today.

School of Engineering of Milwaukee

1-CJ-373 Broadway Milwaukee, Wis.

CLIP HERE

School of Engineering of Milwaukee,
1-CJ-373 Broadway, Milwaukee, Wis.

Gentlemen:
Please send me full information concerning your Armature Winding and Motor Generator Course.
Name
Address
Age Education

DIAMONDS WATCHES ON CREDIT

Send for FREE Catalog

We are offering wonderful values in Diamond Rings, in all the popular mountings, plain and fancy engraved, special at \$40, \$50, \$75, \$85, \$100, \$150, and up. **EVERY ARTICLE IN OUR CATALOG is priced unusually low.** Whatever you select will be sent prepaid by us. You see and examine the article right in your own hands. If satisfied, pay one-fifth of purchase price and keep it, balance divided into eight equal amounts, payable monthly. **Watches, Guaranteed 25 years, on terms as low as \$2.50 a month. LIBERTY BONDS ACCEPTED.**

LOFTIS The National Credit Jewelers
Dept. D 224 108 N. State St.
CHICAGO, ILL. STORES IN LEADING CITIES

Navigation Taught by Mail

Be a ship officer in merchant marine—a real big money—see the world. Captain Warren Sheppard's Course on Ocean, Coast and Lakes Navigation ready. Officially adopted by the U. S. Navy. Endorsed by Merchant Marine. Merchant ship officers earn up to **\$412 per month and expenses** Whether you are on the sea or intend to go, enroll now. Send today for valuable illustrated booklet. "Your Future is on the Seven Seas." It is free.

WORLD TECHNICAL INSTITUTE
Dept. "E", Fuller Building, Jersey City, N. J.

"Truly, Madame Holt, it is too bad that your countenance is becoming so severely lined. Would you mind stepping forward, so that the Professor can examine your beauty more closely?"

With an air of haughty dignity Madame obeyed the injunction.

"Professor, do you notice that heavy red line which extends from ear to ear across cheeks and nose of the dear Madame? It seems to be a sort of cancer. It is a shame that her beauty should be thus ruined. Professor, is there any cure for such a cancer? None at all? Well, really, that is most unfortunate."

Then he continued, addressing his remarks to Madame Holt:

"My dear Madame Holt, all the time during the last two months that you have been visiting your physician regarding that strange ever-growing line across your cheeks you have been wearing that pretty veil which just covered the half of your face. I thought you would like it. It was a very valuable veil, too. Cost me twenty thousand dollars. It had a hemful of radium. Don't know where it is now, do you? I really hated to take it away, but you know we had to recover the radium. Here it is, if you want it for a souvenir. You will notice that the hem has been cut off. We needed that."

During the strange monologue of Kelly, Madame Holt had listened with an expression which gradually changed from one of defiant disinterestedness to one of amazement. As his final words brought to her a full realization of what had been done, a frightful grimace of horror and rage distorted her countenance, now so sadly disfigured with the radio-ulcer extending from ear to ear, and she shrieked an hysterical cry of rage. Suddenly she sprang at Kelly, clutching with tense fingers at his eyeballs, but he placed the muzzle of his automatic against her breast and she stopt, sinking to the floor with hysterical sobbings. Kelly smiled grimly and remarked to Professor Hopkins:

"Too bad that Madame will have to wear a heavy veil all her life. New York's gatherings will regret the loss of one of their loveliest women."

The scholar Lendorff had been strangely restless while Kelly had been talking to Madame Holt. Kelly now address his remarks to him:

"I hear that you can't read any more, Lendorff. That's too bad. It really is a great affliction to lose one's sight. By the way, did you get your glasses back? I had to take them the other day in order to recover a few thousand dollars' worth of radium, which was in the rims. You know, you really shouldn't have worn them at all after the day you thought you had lost them. Radium rays have a very harmful effect upon the optic nerve. Isn't that so, Professor?"

Lendorff said not a word, but tears rolled from his unseeing eyes. He sat humped over in his chair, a picture of abject despair.

"What are you thinking about, Lendorff?" inquired Kelly, pleasantly. "A cruise thru the northern seas on a launch with an automatic feed and a gyroscopic steering control? Well, that will be a pleasant way to pass your time, now that you can't read."

Thruout the whole conversation or rather monologue von Hersholtz had sat nervously in his chair, looking momentarily as if he would spring upon Kelly, and upon his face grew a look of horror and apprehension, as he listened to the fate which had befallen his comrades in crime and wondered what was in store for him.

"What are you so nervous about, Hersholtz? Stomach isn't bothering you, is it? What, have I hit it right? I'm afraid those pink pills that you've been taking haven't done you much good. Remember that one, a little larger than the others, that you

Ten Points

allowed our graduates toward experience, on government examination.

To Your Benefits we have

Modern Equipment, Special Short Course, Individual Instruction, Finest Staff of Teachers available.

Dormitory, Swimming Pool.

CALL OR WRITE FOR ILLUSTRATED BOOKLET

Y. M. C. A. RADIO SCHOOL

152 East 86th Street, New York, N. Y.

"Best Radio School in the East"

Take a Dollar Bill,

Pin it to the attached coupon, write your name and address plainly and mail it to the Electro Importing Company, 231 Fulton Street, New York City, and by return mail you will receive your

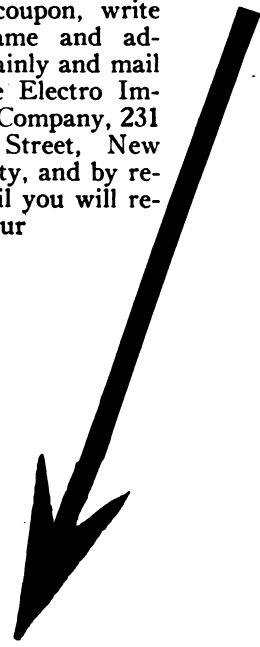

SKINDERVIKEN TRANSMITTER BUTTON

Most sensitive microphone known

Electro Importing Co.,
231 Fulton St., New York.

Gentlemen:—Enclosed please find One Dollar. Ship at once one Skinderviken Transmitter Button to

Name

Address

swallowed about two months ago?"

Von Hernholtz started and stared at his tormentor with a look of agonized apprehension. He leaned forward, as if the better to catch the words upon which he hung.

"I'll tell you how that pill was made, Hernholtz. The Professor and I took a little glass capsule, the size of a pea, and then adjusted an oxyhydrogen flame to a tiny point. With this we melted the glass in several spots, and really we manipulated the flame very cleverly, so that the melted glass, starting to run, hardened into little sharp points. The capsule became covered with short, sharp curved projections, like hooks for goldfish. Then we carefully broke off all of these hooks and fastened them back on with a cement that dissolves in forty-eight hours. You see, we really went to a great deal of trouble on your account."

Von Hernholtz groaned again, with the direct forebodings of evil. Lendorff was crumpled in his seat, sobbing softly, while Madame Holt still lay on the floor, no longer crying hysterically, but in a half-dazed manner running her delicate fingers over and over the long red line deeply engraved in the soft flesh of her once-beautiful face.

"Then," continued Kelly in the same even voice, "we covered the whole capsule with a smooth coating of gelatine that dissolves in lukewarm water in one minute. That was to allow the capsule with its hooks to slip easily down your throat."

Von Hernholtz's eyes were starting from their sockets.

"You can readily see, Hernholtz, what would happen. As soon as the outer coating of gelatine dissolved, the tiny hooks fastened the capsule securely to the nice, soft, pink lining of your stomach. There it remained until the cement holding the hooks dissolved; that is, for about two days, and then the capsule past on with the food. Oh, I nearly forgot to mention that the capsule contained about twenty thousand dollars' worth of radium. You see how deeply interested we were in your stomach. Don't you think that that was a very clever way to obtain a localized source of murderous rays? Really, the Professor and I were immensely pleased with our ingenuity. I believe that the stomach cancer with which you are now suffering will last about two months—and by a strange coincidence you will last about the same length of time. Don't you think so, Professor?"

Professor Hopkins nodded assent, but Kelly was busy covering von Hernholtz with his revolver. The latter had sprung to his feet with a roar like that of a hamstrung elephant, but half way to Kelly he had collapsed to the floor in a dead faint.

"These cancerous patients can't stand much excitement, can they, Professor?" remarked Kelly, softly.

Together the two walked to the door. As they left they turned for one last look at the suffering criminals. Von Hernholtz had immediately come out of his faint and knelt on the floor, groaning miserably. Lendorff was silent, hunched over in his chair with one hand covering his eyes. The once-beautiful Madame Elaine Holt was still lying prostrate on the floor, her fingers mechanically tracing and retracing the deep red furrow which ran unbroken across the soft pink velvet of her cheeks.

[THE END]

Are You a MAN?



WHY stay thin as a rail, a laughing stock to every man or woman who sees you? You don't have to. You don't have to go through life with arms of childish strength; with legs you can hardly stand on; with a chest and figure your tailor has to pad out to make you look anything like a real MAN. And what about that stomach of yours, which flinches every time you eat a square meal? Are you trying to make it do its work and to gain Health and Strength in tabloid form—through pills, poisons and other exploited piffle? You can't do it. IT CAN'T BE DONE.

Make a Man Out of Yourself

The ONLY way to gain Health, Strength, Energy, VITALITY, is to build up your body—all of it—through Nature's methods; NOT by pampering your stomach and giving it extra work to do trying to digest a lot of patent medicine quack "remedies." Don't be a pillfeeder. And don't make the mistake of thinking Fate is making you a failure. The chances are 99 to 100 that the real REASON why you don't succeed lies in your poor, emaciated body, in your half sickly condition, which shows in your face, in your unhealthy skin, in the way you walk and talk and do things. The world loves WELL, STRONG, HEALTHY men and women; it has no use for the weak and sickly, nobody wants to have them around.

Build Up Your Body

A man's happiness largely depends upon his Vital Power; his success in social, domestic and business life all centres around this. If he is not virile, he is not magnetic, forceful or attractive; neither is he sought after—his very strength is the axis upon which all else relating to him, revolves. Men become weak through overwork, worry, and bad habits and gradually lose their strength and manhood. When they reach the stage when they find their strength on the wane, it is the forerunner of failure and domestic happiness is then soon upset. Young men become listless and purposeless; their brain power decreases as their manhood fails. Strongfortism strengthens the internal muscles which are responsible for general health and physical strength; and the most obstinate and long standing cases give way, in a short time, to its internal action.

Strongfortism

The principles of Strongfortism are based upon my discovery—that internal muscular activity governs Health, Strength and Life itself. Most forms of disease are caused from the muscles losing their power of rapid contraction. As these muscles are responsible for holding the internal organs in position, when they are relaxed, the organs gradually fall out of their place and rest upon other organs, upsetting their functioning and causing almost every known form of disease. Strongfortism gives contractile power to these muscles and quickly makes them normal and so draws the sagging organs back to their position. I have spent my lifetime studying the action of these forces and their application to weak, sickly, anemic men and women. I built myself up through their operation until I am called today the strongest man in the world. Through my system of STRONGFORTISM I have taught pupils in every part of the globe how to free themselves from miserable ailments that were making a nightmare of their waking hours; how to build themselves up and regain their lost health, strength, elasticity, youthful vigor and the full power of enjoying life.

Let Me Help You

What I have done for thousands of other weak, ailing, discouraged men and women. I can do for YOU. There isn't the slightest doubt of it: Nature's Laws operate alike for all ages and both sexes. No matter what your present condition is; no matter if it was caused by early indiscretions



LIONEL STRONGFORT Dr. Sargent, of Harvard, declared that "Strongfort is unquestionably the finest specimen of physical development ever seen."

and excesses of your own. I GUARANTEE to improve you 100 PER CENT, if you will follow my directions for a few short months.

Remember, there's no medicine of any kind in Strongfortism; there's no expensive gymnastic apparatus required; there's no interference with your present business, work or occupation. Fifteen to twenty minutes a day in the privacy of your own bedroom, devoted to Strongfortism will work wonders for you, and you will notice your improvement within a few days after you begin the course

SEND FOR MY FREE BOOK

"Promotion and Conservation of Health, Strength and Mental Energy" will tell you all about Strongfortism and PROVE to you that it can and will do for YOU what it has done and is doing every day for other men and women who have turned to Nature for the restoration of the vitality they have lost. BE HEALTHY—STRONG—VITAL—THAT'S LIVING.

Send for the book NOW; don't put it off. IT'S FREE, but it's worth good money to any man or woman in any state of health. Fill out the coupon below and enclose it with three 2c stamps to cover packing and postage and I will mail you with the book a special letter on the subject or subjects in which you are particularly interested.

LIONEL STRONGFORT

Health and Strength Specialist

4 STRONGFORT INSTITUTE

NEWARK, N. J.

FREE CONSULTATION COUPON

Mr. Lionel Strongfort, Newark, N. J.—Please send me your book "PROMOTION AND CONSERVATION OF HEALTH, STRENGTH AND MENTAL ENERGY," for postage of which I enclose three 2-cent stamps. I have marked (X) before the subject in which I am interested.

- | | | |
|-------------------------|----------------------|--------------------------|
| .. Colds | .. Stomach Disorders | .. Despondency |
| .. Catarrh | .. Round Shoulders | .. Lung Troubles |
| .. Asthma | .. Constipation | .. Increased Height |
| .. Obesity | .. Biliousness | .. Stoop Shoulders |
| .. Headache | .. Torpid Liver | .. Muscular Development |
| .. Thinness | .. Indigestion | .. Great Strength |
| .. Rupture | .. Nervousness | .. Advanced Culture |
| .. Lumbago | .. Poor Memory | .. Weight Lifting |
| .. Neuritis | .. Rheumatism | .. Many Weight Barbell |
| .. Neuralgia | .. Bad Habits | .. Professional Training |
| .. Flat Chest | .. Weaknesses | .. Youthful Errors |
| .. Deformity (describe) | .. Impotency | .. Poor Circulation |
| .. Insomnia | .. Gastritis | .. Skin Disorders |
| .. Short Wind | .. Heartweakness | |
| .. Flat Feet | .. Poor Circulation | |

Name.....
 Age..... Occupation.....
 Street.....
 City..... State.....

AGENTS--SALESMEN SALES MANAGERS

EXCLUSIVE TERRITORY ON NEW INVENTION

Will you listen when opportunity knocks? Fortunes have been made in new automobile inventions. **Grab this one quick.** Your minutes are like dollars—don't waste them now. **Read—investigate—then act.** The Speederator for Ford cars is a new invention so good that 17 officials of the Ford Motor Company use it on their machines. **Makes any Ford run like a Packard.** Stops stalling, bucking and motor racing. Gives a smoothness to Ford driving that is wonderful. And just think—Speederator is put on **without boring holes** or special tools of any kind. Any Ford driver can put one on complete in **twenty minutes.** Never wears out—never needs attention—**operates automatically.** Sells like lightning. Old Ford drivers say best and only necessary Ford part. **Get full information.**

The
Greatest
Ford
Invention

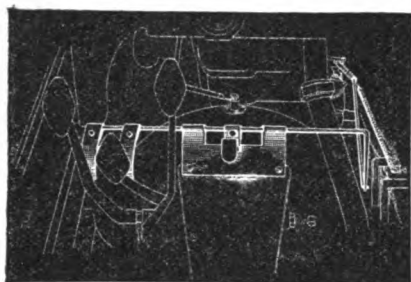

Used
By 17
Ford
Officials

LISTEN This is not a ready made fortune but it is the opportunity to secure the **exclusive sales agency** for this new invention. Don't take our word—get the proofs. Just be honest with yourself and **investigate.** Let the money you make talk from now on. Smashing records of success will show the way: **Hilton, Utah,** sold six hundred in five weeks—**profit \$1,800.00.** **Crist, N. Y.,** sold 23 first day—said would have sold more if he had had them—now averages more than 400 a month—**profit \$1,200.00.** **McAllister, Ills.,** says sold four first afternoon. He is now using 100 a week. These straight-from-the-shoulder facts point the way. **Hoover down in Ohio** sold 29 one day, **profit \$87.00.** **Benke, Mo.,** averages 200 a month. **Campbell, Tenn.,** 1000 a month. **Crandall, Iowa,** put on thirty sub-agents in one week. **Dryden, Calif.,** sold 150 in ten days. **Grace, Hawaiian Island,** 200 in two weeks. **Teeters, Mich.,** first three dozen in ten days. We say you can make

\$55.00 TO \$300.00 WEEKLY

selling the **Speederator.** Best article to advertise itself you ever saw. Once on a car the driver will never let you take it off. Sales are made fast and furious. **Boyer, Penna.,** made \$72 first day. **Cook, N. Dak.,** 150 sold first two weeks. **Cahan, Ariz.,** 72 in two weeks—\$216.00 clear. Join the ranks of successful men in this work.

NO EXPERIENCE NECESSARY

Just show us that you mean business and are ready for business and we will show you how. But first, **make us prove these facts.** We have nothing to apologize for. The **Speederator** is a **grand success**—you can make money fast if you have the territory—so get busy now. Write today for the necessary information and see for yourself. Don't delay—**plenty of good territory left**—if you are a hustler you can have money in the bank in a few weeks. **Just write—now—to**

THE PERRIN METAL PARTS CO.

1068 HAYWARD BUILDING
DETROIT, MICH.



ACHROMATIC TELESCOPE MADE UPON NEW SCIENTIFIC PRINCIPLES.

Positively such a good Telescope was never sold for this price before. Eastern Telescopes are made by one of the largest manufacturers of telescopes in America; we control entire production; measure closed 8 inches and open over 2 1/2 feet in 4 sections. They are nicely brass bound, with scientifically ground lenses. Guaranteed by the maker. Every sojourner in the country or at the seaside resorts should certainly secure one of these instruments, and no farmer should be without one. The scenery just now is beautiful. A Telescope will aid you in taking views. Objects are brought to view with astonishing clearness. Sent by mail or express, safely packed, prepaid, for only 99 cents. Our new Catalogue of Watches, etc., sent with each order. This is a grand offer and you should not miss it. We warrant each telescope just as represented or money refunded. Send 99 cents today. To dealers 6 for Four Dollars.
EASTERN NOVELTY CO., DEPT. 67, 172 E. 93d STREET, NEW YORK.

HERE IT IS

A sign for your den. Exceedingly attractive. Printed in bright red on white cardboard. No electrical bug should be without it. 7 1/4" x 11 1/4", 10c each in coin ONLY. Send stamp for postage.
LEONARD BECK, 1298 Carroll St., Brooklyn, N. Y.

STAMMER

If you stammer attend no stammering school till you get my big new **FREE** book and special rate. Largest and most successful school in the world curing all forms of defective speech by advanced natural method. Write today. **North-Western School for Stammerers, Inc., 2331 Grand Ave., Milwaukee, Wis.**

The Romance of Tungsten

By E. W. DAVIDSON

(Continued from page 492)

He was the first man to find a way to "work" this most brittle of metals. He made it ductile and thereby hangs this tale.

For about 100 years tungsten had been known before it was put to any use whatever, even as a mere alloy. Its presence was first noticed by Scheele and Bergman in 1781. They found traces of it in a metal called scheelite and coined the name "tungsten" for it from the Swedish "tung" meaning weighty and "sten" for stone. In 1783 three Spaniards discovered tungsten in the mineral Wolfram. To this day there is little tungsten taken from any other minerals. It is found in small quantities in Cumberland, England; Limoges, France; and in parts of Connecticut and North Carolina, but most of it comes from Colorado, and China.

Extracted from these minerals and pulverized, tungsten was found useful in certain steel alloys. Mixed with an adhesive it was made into lamp filaments that were efficient but exceedingly fragile. However no metallurgist was able to discover a way to work pure tungsten. This was because in pure metallic form it is *absolutely brittle!* It confounded all experts with its utter intractability. The establish processes in working other metals proved useless with tungsten.

Perhaps it was this very thing which finally brought about the harnessing of this valuable metal. Dr. Coolidge with the instinct of the true scientist pioneering in untrampled fields, tried ways that any metallurgist would have thought an idle waste of time. The result was that after long effort and many failures he finally made tungsten ductile and workable so that it could even be drawn like wire down almost to the gossamer fineness of spider's web and still be strong enough to permit its winding and curling into almost any shape. When he had done that he had conquered tungsten and made possible many devices which could never have been built without ductile tungsten.

DIFFERENCE BETWEEN TUNGSTEN AND OTHER METALS.

The radical difference in workability between tungsten and normally ductile metals the difference which nonplust the scientific world for more than a century may be explained thus:

Pure tungsten prest into bars is brittle after the very treatment which makes other metals most ductile. It differs from all other ductile metals in that when composed of grains it is extremely brittle at "room temperature," but is ductile at this temperature when fibrous.

Many an experimenter had sought to work tungsten mechanically. But none had ever succeeded in getting this intractable metal into a form suitable for mechanical working. Moissan, by an electric furnace method, obtained tungsten in a porous condition which could be slightly compressed and the pores closed up by hammering when hot. However nobody in the world suspected at that time that if tungsten could be obtained and put into suitable condition and then mechanically worked at suitable temperature, its inherently brittle nature would gradually disappear. But nobody knew how even to make a start upon the problem of working tungsten.

To make any ordinary metal soft it is heated above its annealing point and then cooled down to room temperature. *Doing this to tungsten however left it as brittle as ever!*

Violating all metallurgical rules and working for years with utmost patience, Coolidge discovered the astonishing fact that the only way to make tungsten ductile was to mash tungsten's grains out into fibrosity and thus make the metal ductile cold, and this he did by first heating it to a degree below its annealing point and then mechanically working it with infinite pains at a variety of heats, each cooler than the one before, until the metal got down to room temperature. A similar treatment, if applied to ordinary metals would destroy their ductility.

He worked out a process which, if followed without the slightest deviation, stretched the grains out, thus attaining ductility. But if the working varied from his process, failure resulted. The tungsten would smash to flinders at a stroke when it got cold.

This elaborate and delicately measured system of working tungsten is a scientific triumph. Thus was tungsten finally made ductile.

TUNGSTEN FOR LAMP FILAMENTS.

The greatest immediate use for it was in the making of electric lamp filaments. Previously the best filament was made of fine tungsten powder, mixed with a binder into a plastic mass which was squirted thru fine dies to produce fragile "wire."

This was an enormous improvement over the old-style carbon filament, thanks to the facts that tungsten, with a melting point of 3,350 degrees Centigrade will stand more heat than other metals and its vapor tension is so low that even under tremendous heats its volatile decomposition is slow. Tungsten even in this form made so good a lamp that it saved the American public a billion dollars a year on its electric light bill.

But filaments of those days could not withstand the slightest jar during the process of manufacture. They necessarily could not be strongly mounted in lamps.

Pure tungsten on the other hand drawn into filaments can stand almost anything. For one thing it is heavier than any other metal. Whereas wrought iron weighs 490 pounds per cubic foot, and lead 708 pounds, tungsten tips the beam at 1,193 pounds. Its tensile strength is startlingly high. After it has been worked down to drawn wire of about a thousandth of an inch diameter, its tensile strength is no less than 600,000 pounds per square inch of cross-section. This is greater than the best piano wire!

To use tungsten in lamp manufacture, it is dried, mixed with thorium nitrate solution and then thinned with water into a batter. This is dried and heated at 2,000 degrees Fahrenheit for an hour in a silica or fire clay crucible to agglomerate the fine particles into coarser ones. This mixture is reduced by hydrogen at 1,800 degrees Fahrenheit into tungsten metal powder.

The reduced tungsten powder is poured into a steel mold which is a slab whose face bears a groove a quarter of an inch wide and deep. Under hydraulic pressure of 16 tons per square inch this groove full of powder is pressed into an ingot 16 by 1/4 by 1/4 inches. The pressure has been exerted on the sides of this ingot not the ends. The ingot at this stage is too fragile to handle.

The slug next goes into an electric furnace where it is baked at about 2,400 degrees Fahrenheit. Now it is strong enough to handle. It is then sintered in a hydrogen atmosphere the bar being heated for 10 to 15 minutes to about 5,000° Fahrenheit by the passage of an electric current thru it.

The bar tho brittle when cold is ready to be worked. It is heated to about 2,800 degrees Fahrenheit, and past thru the revolving dies of a swaging hammer which reduce its size and produces it in rods grow-

Learn Electricity This Wonderful New Quick Way

At Home in Your Spare Time

EVERY year hundreds of young men from all over the world come to the residence school of the School of Engineering of Milwaukee to learn electricity in all its phases. Yet we know that there are thousands of ambitious men everywhere who aspire to big jobs in the great field of electricity, but who cannot conveniently leave their present work to attend a residence school. It is to train these men that this extension division has been formed.

*Just Like
Going to
School*

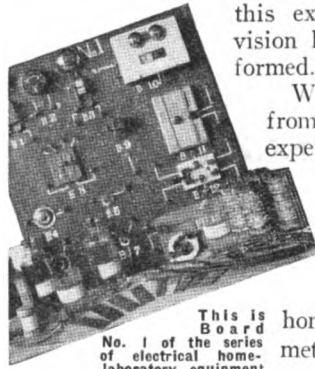

This is Board No. 1 of the series of electrical home-laboratory equipment the free use of which is given every student. (Size 24 by 24 inches.)

We know from our long experience that the ordinary plan of teaching electricity by home - study methods would not measure up to the high standards set by the School of Engineering of Milwaukee. And so, this unique, new plan of giving each student free use of a complete home-laboratory system of actual working electrical equipment was conceived. We know that it is the only practical way to learn electricity at home!

America's Greatest Electrical School Brought to Your Home!

On this plan you can now secure almost every advantage of America's Greatest Institution of Electrical Education right in your own home! In this way this famous school now gives the most thorough practical intensive home-study course in electricity ever offered! It is a specialized, graded course built up on the most advanced ideas of electrical instruction. Thorough, yet simple texts—graphically illustrated give the electrical principles which logically parallel the practical experience gained in using the instrument boards. This amazing new method of extension instruction quickly makes any ambitious man a high-salaried, electrical expert!

Free Use of This Fine Electrical Apparatus

These wonderful, cleverly constructed instrument boards—equipped with actual, practical electrical apparatus—are furnished absolutely free to each student while studying. These laboratories are not toys—but include the same instruments and devices which the elec-

trical man meets with in every day work.

You Can Fill One of These Big Pay Jobs

The field of opportunity for the well trained electrical man is practically unlimited. Billions of dollars are invested in this great industry. Thousands of men are employed in it—but the demand today is for men who are *trained specialists*. These men command handsome salaries—\$2,500 to \$6,000 and up to \$10,000 a year and more. Why don't you get into this fascinating, highly paid field of work?

Write Quick for Big FREE Book

Write quick for big free book fully describing this astonishing new plan. Tells also about Consultation Privileges with our great staff of over 90 experts. Free Employment Bureau and other special service. Don't delay! Mail the coupon Now!

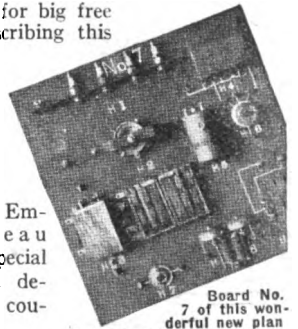

Board No. 7 of this wonderful new plan of studying electricity at home.

EXTENSION DIVISION SCHOOL of ENGINEERING of Milwaukee 19, 373 Broadway, Milwaukee, Wisconsin

Extension Division, School of Engineering of Milwaukee, 19, 373 Broadway, Milwaukee, Wisconsin.

Please send me free and without any obligation on my part full details of your special new home-study course in Practical Electricity.

Name
Address
City..... State.....
Age..... Education.....

NEW MOTORS

FACTORY GUARANTEED ALL SIZES PROMPT DELIVERY



Charging Generators
Suitable for all lighting, Battery Charging and Power Requirements.

8 v., 10 amp. \$19.50
15 v., 10 amp. \$26.50
40 v., 6 amp. \$31.50
110 v., 2 1/2 amp. \$31.50
110 v., 5 amp. \$52.50
40 v., 12 amp. \$52.50
110 v., 9 1/2 amp. \$67.50
40 v., 25 amp. \$67.50
110 v., 18 amp. \$116.50
40 v., 50 amp. \$116.50
110 v., 26 amp. \$156.50
110 v., 50 amp. \$238.50
Moving Picture Arc Generator 80 v., 35 a. \$116.50

Polyphase Motors
2 and 3 phase, A. C., 220 v., 60 c., 1750 R. P. M. Complete with base and pulley.

1/2 H. P. - \$46.50
1 H. P. - \$66.50
2 H. P. - \$86.50
3 H. P. - \$98.50
5 H. P. - \$116.50

1 H. P. Special Grinding and Belling Motor - \$106.50

Direct Current Motors
110 or 220 volts, D. C., shunt wound, 1750 R. P. M. With base pulley and starting box.

1/4 H. P. Washing Machine Motor - \$28.50
1/4 H. P., 32 v. Washing Machine Motor - \$28.50
1/2 H. P. - \$58.50
1 H. P. - \$82.50
2 H. P. - \$124.50
3 H. P. - \$142.50
5 H. P. - \$218.50

Single Phase Motors
110-220 volts, A. C., 60 cycle, 1800 R. P. M. with pulley

1/4 H. P., 110 v. grinding buffing motor - \$28.50
1/4 H. P., 220 v. induction Washing Machine Motor - \$28.50
1/2 H. P. induction, full load start - \$46.50
1/2 H. P. repulsion induction For compressor service - \$54.50
1 H. P. repulsion induction, Special Garage Motor - \$74.50
2 H. P. repulsion induction with sliding base - \$126.50
3 H. P. repulsion induction with sliding base - \$146.50
5 H. P. repulsion induction with sliding base - \$188.50

WRITE FOR CATALOG. BARGAINS IN MOTORS AND GENERATORS

1/4 SPECIAL
110 volts
S. P., 1750 R. P. M.
Complete, cord, plug and pulley

WASHING MACHINE MOTORS
Suitable for operating Small Compressors, Coffee Grinders, Bottle Washers, Etc.

\$26.50 Each

SHIPPING TERMS: 25% deposit required on all orders. Balance C. O. D. by Express. Sight draft with Bill of Lading attached by freight.

CHAS. H. JOHNSTON, Box 12, West End, Pittsburgh, Pa.

ing smaller and smaller and necessarily longer and longer as the metal goes thru one swaging after another, until it gets down to a diameter of three hundredths of an inch. It is now a metal that is ductile and its strength has increased with leaps and bounds so that at a diameter of three hundredths of an inch it can stand a pull in the proportion of 215,000 pounds per square inch of its diameter!

But it is still too large for lamp filaments tho wound on drums it appears hardly coarser than linen thread. So it starts into the process of being drawn down by successive stages thru diamond dies of smaller and smaller sizes, to any degree of fineness needed. On the drawing machines it unwinds from the feeding spool, passes thru a lubricant, runs thru a small gas furnace to attain red heat, negotiates the infinitesimal "eye" in the fragment of diamond clamped in its course, and is wound on a receiving spool ready for use.

Various of these fine sizes of tungsten wire are used for lamps over a wide range of powers, the finest of them all being used for the tiniest of lamps such as "bug-lights" on automobiles and in flashlights. The diameter of this is 0.004 of an inch. It is six times finer than human hair. The original prest ingot 16 inches long would produce more than 250 miles of such wire!

The "Vibro Whip"

By O. C. ROOS

(Continued from page 509)

It is not difficult to get proper speeds for phonographs by the use of this apparatus and by fastening the driving bands near the nodes of the fork the speed is reduced but the torque is increased and the "slip" is reduced.

Fig. 5 shows one electrical method of driving the fork. It is self-explanatory.

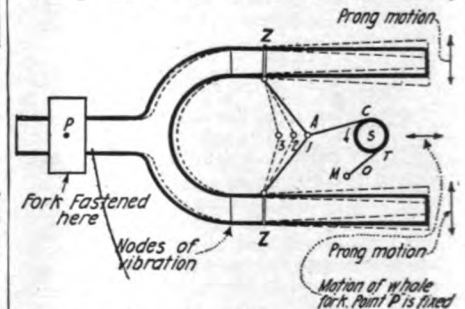

Z-Z—Movable points of attachment of driving belt which moves point A from 1-3 as fork vibrates.

Fig. 4

Fig. 4—This Shows One of the Developments of the Vibro Whip Motor Principle—the Belt Around the Shaft "S" Being Given Alternating Pulls of the Desired Magnitude by the Two Prongs of a Tuning Fork, the Fork Being Electrically Driven.

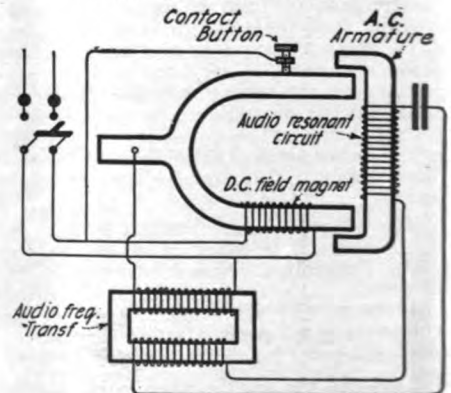
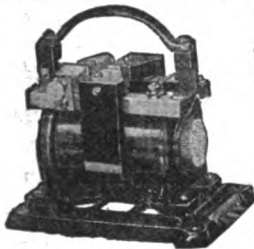

Fig. 5

Fig. 5—This Shows an Electrical Scheme For Driving the Tuning Fork of a Vibro Whip Motor, Which is Self-Explanatory.

CHARGE YOUR OWN BATTERY AT HOME 10c.

Few new auto purchasers realize to what extent the satisfactory performance of their cars depends on the storage battery, but experienced motorists know that if a car is to perform at 100% efficiency, its starting and lighting system must have a 100% energized storage battery.



F-F BATTERY BOOSTER

Bantam type 6-6 amp. 6 v. battery... \$15
Type 16-8 amp. 6 v. battery... 24
Type 166-12 amp. 6 v. battery... 32
Type 1626-12 or 7 amperes in combination for both 6 and 12 volt batteries... 48

Shipping weight complete with Ammeter and Battery Clips. 11 to 15 pounds. All outfits do the same work except as to time to complete a charge.

Include postage and insurance with remittance for parcel post shipment. Ask for bulletin No. 12 describing these and other F-F charging apparatus of larger capacities and of other voltages and cycles; also Boosters that operate on Farm Lighting Plants and Direct Current.

Write for Bulletin No. 12

THE FRANCE MANUFACTURING CO., Cleveland, Ohio

WIRELESS TELEPHONE COURSE

Covering Theory and Practice of Electricity—Radio—Blue Print Reading and Wireless Telephony. 4 in 1 Course. Our easy payment plan places this course within reach of anyone who wishes to better themselves. Immediate action will assure you of a good future. Don't delay.

FREE Audion tube, experimental electrical outfit, and other apparatus furnished each student, **FREE**. Write TODAY to

CHICAGO ELECTRICAL ENGINEERING CO.

Dept. W.

1000 Diversey Parkway

Chicago, Ill.

8 State St., New York, N. Y.

Phone Bowling Green 8079

Complete instruction in radio operating in all branches for Merchant Marine, Ocean Steamships, Telegram Service. Special course in Vacuum Tubes and Radio Telegraphy. Preparing for Government Examinations.

Elementary and Advanced Classes
Day and Evening Classes

Write for Circular.

SUCCESS OPPORTUNITY

UTTMARK'S NAUTICAL ACADEMY RADIO SCHOOL

10¢ OR 25¢

Anti-kammia TABLETS



Ask For A-K Tabs

"Lighting Fixtures"

Ready to Hang

(Direct from Manufacturers)
Completely wired, including glass-ware. New designs.

Send for catalogue No. 18
ERIE FIXTURE SUPPLY CO.
Sta. C Erie, Pa.



The ROGERS
Violet Ray, High Frequency Generator
Does not burn out. No sparking—therefore all shocks are eliminated. An ideal outfit, fully guaranteed as to material and workmanship.

PRICE COMPLETE \$25.00
With One Surface Applicator

Send for free descriptive Booklet
The Rogers Electric Laboratories Co.
Dept. B, 2056 E. 4th St., Cleveland, Ohio

Synthetic Ammonia

By LUCIEN FOURNIER

(Continued from page 493)

Upon the pressure and temperature depends the *speed of reaction*. Also from the speed of reaction depends equally the product of ammonia. By operating, at a temperature of 600 deg. C., uniformly maintained, it is possible at the cost of 100 cubic meters of gas mixture for each quart of catalyzer in one hour, to obtain the combination of 40% of gaseous mixture. This figure corresponds to the production of 6 kilograms of ammonia per hour and per kilogram of catalyzer. On the other hand the *Badische Anilin* process obtains but 500 grams of ammonia under similar conditions with a pressure of 200 atmospheres. These 500 grams correspond to the liquefaction of 10% to 12% of the mixture sent to the catalyzer. From this it is evident that in order to secure the combination of a total mixture of nitrogen and hydrogen, it is essential to return the remainder of the 88% or 90% gas thru the circulating system or to install from 8 to 10 catalyzer elements in series one after the other. On the other hand Georges Claude with his arrangement, states that 40% necessitates but 2 or 3 elements in order to terminate the total combination.

DETAILS OF THE PROCESS.

By studying the accompanying schematic diagram it is a simple matter to follow and understand the process which produces synthetic ammonia by the Georges Claude method. Nitrogen and hydrogen are first introduced into an initial compressor represented by A, from which it is led to a second compressor, B, where the mixture is directed to the super-compressor C, which further sends it to a purifier D, placed at the bottom of a specially prepared well or pit and next to the tanks containing the catalyzers. The purifier cleans the mixture of all trace of oxygen and then passes it on to the catalyzer where is effected the combination that we have already explained under the double action of the pressure of 1000 atmospheres and a temperature of 600 degrees.

The ammonia vapors are then past thru the serpentine coils of a refrigerator and thus cooled by a simple circulation of cold water. (In the *Badische Anilin* process the temperature necessary for this cooling process must be 40 degrees below zero). After this point the liquid ammonia passes thru a closed gage and thence to a distributing system where it is bottled in large stone jugs.

The remaining 60% of uncombined gas is taken up at a certain section of the gage and directed into a second catalyzer element I, where 40% of this quantity is again transformed into ammonia and condensed thru a second condenser K. As previously mentioned the ammonia escapes to L, and the remaining 20% of the mixture can be returned to the compressor A or be forced to pass thru the cycle of a third catalyzer element.

Thus we have the general explanation of the system entailing the actual problem concerning the synthesis of ammonia as it is accomplished by Georges Claude and by the *Badische Anilin Werke*.

In conclusion we may add that French science has considerably increased the transformation of ammonia not thru the form of sulfate of ammonia, but thru that of *chlorhydrate of ammonia*, which can be obtained in a much more economical manner than the former by the simple process of utilizing the chlorine lost in the soda industry by the Solvay process.

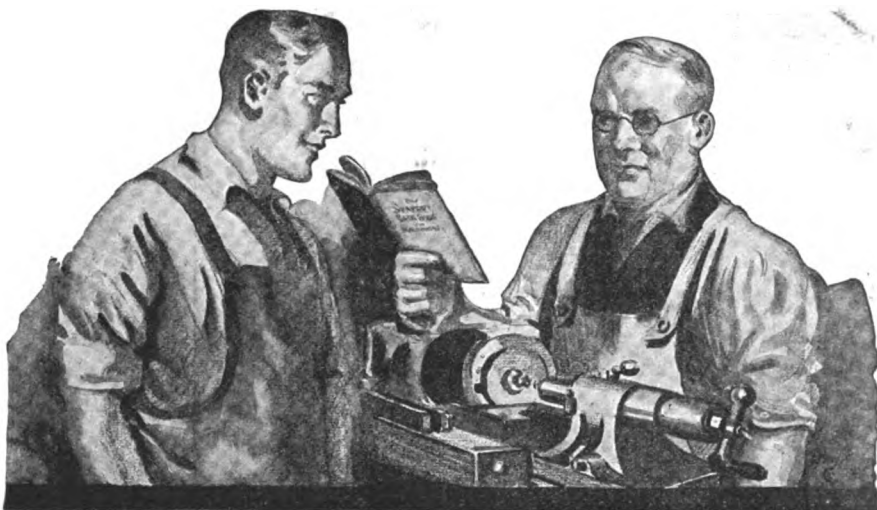

Starrett Books - Vol. II

75¢

"What you want to know is right here"



That's why machinists are buying the Starrett Data Book. It's practical. Just the things you want to know—and *only* those things—ready for use *when* you want them. Information about cutting speeds, change gears, drill and tap sizes. Screw and gear cutting, decimal equivalents, etc.—all in a handy book that you can keep in your kit or carry in your pocket, ready for constant reference.

Bound in red Atholeather, 180 pages. Size 4 3/4 x 7. Price 75c at your hardware dealer's or direct from us. Ask for Catalog 21 "LE" too, it's free.

THE L. S. STARRETT COMPANY

The World's Greatest Toolmakers
Manufacturers of Hack Saws Unexcelled
ATHOL, 42-70 MASS.

Use Starrett Tools



Motors, Electrical Toys and Specialties Are Best

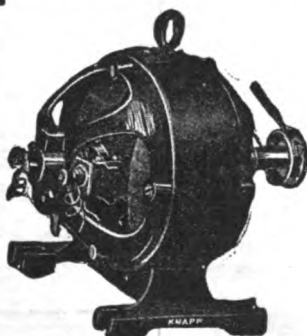

KNAPP DYNAMO MOTOR

Will electroplate, charge storage batteries, run lamps, motors, train of cars, induction coils.—In fact, the number of experiments it can be used for is unlimited. Runs on 4 to 6 Volts or can be connected to run on 110 Volts through a transformer.

Price, Complete, \$9.00

Order to-day. Or your dealer can secure them for you. **DESCRIPTIVE CIRCULAR and CATALOG** of celebrated **KNAPP MOTORS** and **Electrical Specialties** from 10c up mailed **FREE** on request.

KNAPP ELECTRIC & NOVELTY CO., 523 West 51st Street, New York City

Knapp Goods have stood the test for 29 years. No detail in construction has been spared to make them the best that money can buy. The complete Knapp line includes Toy and Power Motors, Generators and Dynamos. Specialties and Novelties that amuse and instruct. Fans, Rheostats, Compasses, etc. And Knapp prices are always lowest. Always insist on Knapp Goods.

KNAPP "LEADER"

An efficient and reliable motor that greatly resembles the big motors of real power plants. Drives from either pulley. Two speeds and reverse. A motor that you will be proud to own and one that will give you unlimited service.

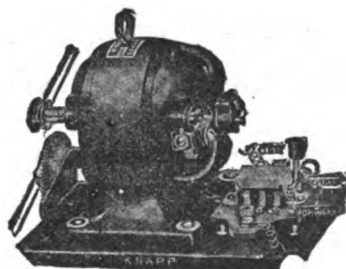

Price, Complete, \$5.00

SPECIAL VACATION PREMIUM OFFER

With a Year's Subscription to Science and Invention (Electrical Experimenter) or Radio News

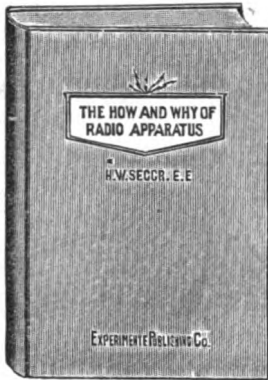

Offer A
Science and Invention
 (Electrical Experimenter)
 for one (1) year with
The How and Why
 of Radio Apparatus

REG. PRICE	\$3.00
	\$1.75
	<u>\$4.75</u>

Offer C
Science and Invention
 (Electrical Experimenter)
 for one (1) year with
A Thousand and
One Formulas

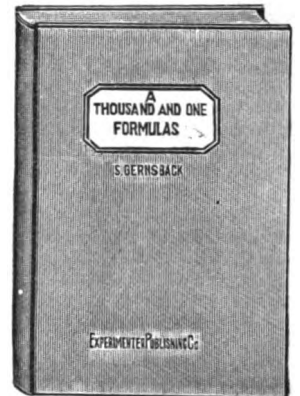

SPECIAL PRICE OFFER, A or C, \$3.75

Offer B
Radio News
 for one (1) year with
The How and Why
 of Radio Apparatus

REG. PRICE	\$2.00
	\$1.75
	<u>\$3.75</u>

Offer D
Radio News
 for one (1) year with
A Thousand and
One Formulas

A Laboratory Handbook
 for the Experimenter.
 Bound in flexible velum.
 160 pages. Size 6 x 9
 inches.

SPECIAL PRICE OFFER, B or D, \$2.75

This newest of Radio
 works, bound in flexible
 velum and hand sewed,
 has 160 pages. Size of
 book 6 x 9 inches.

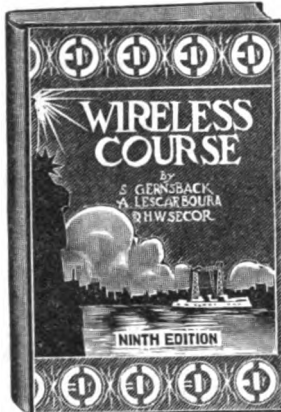

Offer E
Science and Invention
 (Electrical Experimenter)
 for one (1) year with
Wireless Course in 20
Lessons

REG. PRICE	\$3.00
	\$1.25
	<u>\$4.25</u>

Offer G
Science and Invention
 (Electrical Experimenter)
 for one (1) year with
Experimental
Electricity Course

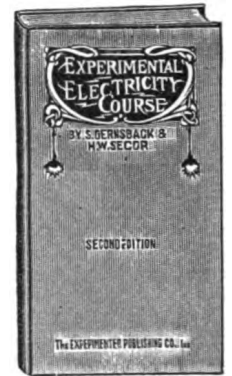

SPECIAL PRICE OFFER, E or G, \$3.50

Offer F
Radio News
 for one (1) year with
Wireless Course in 20
Lessons

REG. PRICE	\$2.00
	\$1.25
	<u>\$3.25</u>

Offer H
Radio News
 for one (1) year with
Experimental
Electricity Course

Book is bound in flexible
 Velum; has 160 pp. Size
 7x12 inches.

SPECIAL PRICE OFFER, F or H, \$2.50

Book is bound in
 flexible Velum; has
 160 pp. Size 5x9 in.

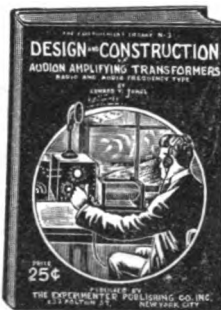

Offer K
Science and Invention
 (Electrical Experimenter)
 for one (1) year with
Design and Construction of
Audion Amplifying - Trans-
formers.
How to Make Wireless Send-
ing Apparatus.
How to Make Wireless Re-
ceiving Apparatus.

Reg. Price	\$3.00	Special Price to you
		\$3.25
	.95	
	<u>\$3.95</u>	

Printed on heavy
 paper, paper bound.
 Size 5 x 7 inches.
 Fully illustrated.
 The latest book out.

Book has 100 pages.
 Size 5 x 7 inches.
 88 illustrations.
 Paper cover printed
 in two colors.

Book has 100 pages.
 Size 5 x 7 inches.
 90 illustrations.
 Paper bound, in two
 colors.

Offer L
Radio News
 for one (1) year with
Same Books as Offer (K)

Reg. Price	\$2.00	Special Price to you
		\$2.25
	.95	
	<u>\$2.95</u>	

EXPERIMENTER PUBLISHING COMPANY, Inc.,
 233 Fulton Street,
 New York City, N. Y.

Dear Sir:

I accept your offer Enclosed find \$.....

in payment of premium and one year subscription.

Name.....

Address..... Town..... State.....

Archimedes— The World's First Great Inventor

(Continued from page 480)

Astronomy. Compared to the present knowledge of the heavenly bodies, but precious little was known in those days. However, it redounds to the credit of this master genius and inventor of antiquity that he at least produced several instruments for demonstrating and measuring a number of astronomical quantities, such as the angle of the sun and other heavenly bodies with relation to the earth; the apparent diameter of the sun, etc., and the angles subtended by them at the eye, and he also produced a marvelous instrument in the form of a sphere, or rather several spheres, operated by water power, which was so constructed as to duplicate the motions of the sun, the earth, the moon and five planets then known of the heavens.

Cicero actually saw this contrivance and has provided a brief description of it, stating that it demonstrated the motion of the moon and the apparent motion of the sun with such accuracy that it would show the eclipse of both the sun and moon. It was said by Macrobius that Archimedes discovered the distance of the planets, and in the sand-reckoner apparatus Archimedes himself describes the apparatus by which he measured the apparent diameter of the sun, or the angle subtended by it at the eye.

DEATH OF ARCHIMEDES.

Finally, after leading a life of the highest scientific endeavor and having contributed some of the first and most important mathematical and scientific literature in the history of the world, he came to a sudden end. History tells us that the life of the world's first inventor ended when the Romans captured Syracuse; and that he died as he had lived—intensely absorbed in mathematical contemplation. It is stated by Livy that, following the capture of Syracuse, Archimedes was found intent on some figures which he had drawn in the sand, and when he did not answer his questions he was instantly killed by a Roman soldier, who did not know who the master was.

According to history, it is said that Archimedes had requested his friends and relatives to place upon his tomb a monument in the form of a cylinder circumscribing a sphere within it, and bearing the inscription giving the ratio which the cylinder bore to the sphere. From this we may infer that Archimedes himself probably regarded the discovery of this ratio as his single greatest achievement.

When Cicero was quaestor in Sicily (in the year 75 B. C.), he found the tomb of Archimedes near the Agrigentine Gate overgrown with thorns and briars. "Thus," says Cicero, "would this most famous and once learned city of Greece have remained a stranger to the tomb of one of its most ingenious citizens had it not been discovered by a man of Arpinum."

It is to be regretted that we do not have a better and more complete history of the life and of the works and inventions of the Great Archimedes, but, altho some of his useful and important works may have perished, it is quite probable that these cover mostly details of his various mathematical and practical devices; and it is thought that all of his most valuable mechanical discoveries have been preserved down thru the ages.



"Good Bye, Boys!"

"Today I dropped in for a last word with the boys at the office. And as I saw Tom and Dave there at the same old desk it came to me suddenly that they had been there just so the day I came with the firm four years ago.

"When I started here I was put at a desk and given certain routine things to do. It was my first job and I took it as a matter of course. But after a few months I began to realize that I was nothing but a human machine—doing things that anyone could do and that I couldn't expect to advance that way.

"So I had a talk with the manager and I'll never forget what he said. 'If you want to get ahead, put in some of your spare time getting special training along the line of your work. We want men who care enough about their future not only to do their work well but to devote part of their spare time to preparation for advancement.'

"That very night I wrote to Scranton and a few days later had started studying evenings at home. Why, do you know, it gave me a whole new interest in our business? In a few months I was given more important work and more money. Since then I've had three increases, six months ago I was put in charge of my department, and now my big chance has come—I'm to be manager of our Western branch at \$5,000 a year!

"Tom and Dave could never see any sense in my studying nights—they said eight hours a day was enough for any man to be bothered with business. They had the same chance I had—they could have been big men in the firm today. But they stood still while I went up to one of the best jobs in our business. It just shows what spare time training will do."

Every day men who have let the International Correspondence Schools help them are moving up to more responsible positions and bigger salaries. Clerks have become advertising, sales and business managers; mechanics have become foremen, superintendents and engineers; carpenters have become architects and contractors; men and boys have risen from nothing at all to splendid positions of responsibility—because in spare hours at noon and night they have learned to do some one thing well.

If you want to make more money, show your employer you're trying to be worth more money. If you want a bigger job, show him you're willing to prepare for it.

There's a simple easy way to do it. For 29 years the International Correspondence Schools have been training men and women right in their own homes whenever they had a little time to spare. More than two million have stepped up in just this way. More than 100,000 are studying now. Ten thousand are starting every month.

Can you afford to let another priceless hour pass without finding out what the I. C. S. can do for you? Here is all we ask—without cost, without obligating yourself in any way, mark and mail this coupon.

INTERNATIONAL CORRESPONDENCE SCHOOLS Box 6246, SCRANTON, PA.

Explain, without obligating me, how I can qualify for the position, or in the subject, before which I mark X.

- | | |
|--|--|
| <input type="checkbox"/> ELECTRICAL ENGINEER | <input type="checkbox"/> CHEMICAL ENGINEER |
| <input type="checkbox"/> Electrician | <input type="checkbox"/> SALESMANSHIP |
| <input type="checkbox"/> Electric Wiring | <input type="checkbox"/> ADVERTISING MAN |
| <input type="checkbox"/> Electric Lighting | <input type="checkbox"/> Show Card Writer |
| <input type="checkbox"/> Electric Car Running | <input type="checkbox"/> Outdoor Sign Painter |
| <input type="checkbox"/> Heavy Electric Traction | <input type="checkbox"/> RAILROADER |
| <input type="checkbox"/> Electrical Draftsman | <input type="checkbox"/> ILLUSTRATOR |
| <input type="checkbox"/> Electric Machine Designer | <input type="checkbox"/> DESIGNER |
| <input type="checkbox"/> Telegraph Expert | <input type="checkbox"/> BUSINESS MANAGEMENT |
| <input type="checkbox"/> Practical Telephony | <input type="checkbox"/> Private Secretary |
| <input type="checkbox"/> MECHANICAL ENGINEER | <input type="checkbox"/> BOOKKEEPER |
| <input type="checkbox"/> Mechanical Draftsman | <input type="checkbox"/> Stenographer and Typist |
| <input type="checkbox"/> Toolmaker | <input type="checkbox"/> Cert. Pub. Accountant |
| <input type="checkbox"/> Ship Draftsman | <input type="checkbox"/> Traffic Management |
| <input type="checkbox"/> Machine Shop Practice | <input type="checkbox"/> Commercial Law |
| <input type="checkbox"/> Gas Engineer | <input type="checkbox"/> GOOD ENGLISH |
| <input type="checkbox"/> CIVIL ENGINEER | <input type="checkbox"/> Common School Subjects |
| <input type="checkbox"/> Surveying and Mapping | <input type="checkbox"/> CIVIL SERVICE |
| <input type="checkbox"/> MINE FOREMAN OR ENGR. | <input type="checkbox"/> Railway Mail Clerk |
| <input type="checkbox"/> ARCHITECT | <input type="checkbox"/> STATIONARY ENGINEER |
| <input type="checkbox"/> Architectural Draftsman | <input type="checkbox"/> Textile Overseer or Supt. |
| <input type="checkbox"/> PLUMBING AND HEATING | <input type="checkbox"/> AGRICULTURE <input type="checkbox"/> Spanish |
| <input type="checkbox"/> Sheet Metal Worker | <input type="checkbox"/> Poultry Raising <input type="checkbox"/> French |
| <input type="checkbox"/> Navigator | <input type="checkbox"/> Automobiles <input type="checkbox"/> Italian |

Name _____ 7-26-19
 Present Occupation _____
 Street and No. _____
 City _____ State _____

MODEL AIRPLANE SUPPLIES

Build and fly Model Airplanes

Send 5¢ for catalog of complete and knocked-down scale models of new machines, parts, fittings, and supplies.

Wading River Mfg. Co. 672 Broadway, Brooklyn, N.Y.



\$100.00 EARNED BY YOUNG ARTIST IN 2 DAYS

Conscientious, careful training by members of our Faculty made this possible. You, too, should succeed.

Earn \$50, \$75, \$100 a week and more

The business world pays big prices for good designs and illustrations. Learn to draw during your spare time by the "Federal" home-study method—endorsed by high authorities. Easy to learn, easy to apply. Send 5¢ in stamps today for "Your Future," a beautiful new 56-page book which explains every step. State age and occupation. Federal School of Commercial Designing, 528 Warner Bldg., Minneapolis, Minn.



No Money Down

Elgin Watch

14-kt. Gold-Filled Case 20-year Guarantee

On 10-Day Trial

New, thin model Elgin watch, warranted movement in 14-kt. gold-filled case, 20-year guarantee.

Chain and Knife FREE

A 14-kt. gold-filled knife and chain absolutely free with this offer. State if you wish a Waldemar, (shown in cut), Dickens, or vest chain.

Less Than 7c a Day

If you are pleased when the watch comes send only \$5.00 as first payment. Then wear the watch for ten full days. If you do not consider it the greatest value in America, return it at our expense and your deposit will be refunded immediately. If you decide to buy, send \$2.00 a month until \$22.50 is paid.

Order Today - On Trial

tape or annoyance. State which chain you wish. This offer limited. Act now. Send your name to Dept. 38-G.

Our 128-page catalog shows more than 2000 bargains in Diamonds, Watches and Jewelry. Write for it NOW.

J.M. LYON & CO., 1 Maiden Lane, New York, N. Y.

I Would Not Part with it for \$10,000

So writes an enthusiastic, grateful customer. In like manner testify over 30,000 people who have worn it. Conserve your body and life first.

The Natural Body Brace

Overcomes WEAKNESS and ORGANIC AILMENTS of WOMEN AND MEN. Develops erect, graceful figure. Brings restful relief, comfort, ability to do things, health and strength.

Wear It 30 Days Free at Our Expense

oes away with the strain and pain of standing and talking; replaces and supports misplaced internal organs; reduces enlarged abdomen; straightens and rengthens the back; corrects stooping shoulders; envelops lungs, chest and bust; relieves backache, irvatures, nervousness, ruptures, constipation, uncomfortable and easy to wear.

Keep Yourself Fit Write today for illustrated booklet, measurement ank, etc., and read our very liberal proposition. **OWARD C. RASH, Pres. Natural Body Brace Co.** 36 Rash Building SALINA, KANSAS



The Electric Safety Razor makes shaving a pleasure. Blade vibrating 7,200 times a minute cuts the beard smoothly and without slightest pull or irritation—feels like a gentle massage. Can be used with or without electric current.

All users of the Lek-Tro Shav speak well of it

A barber says—"Have shaved for years and have never used any shaving device near its equal." A home user says—"The most pleasing shave I've ever had in my life. Shaves my face closer than I used to shave, but there is no after irritation or ill effects as I usually get from another razor."

No. 1 Made for use from Light Socket. No. 2 Made for use from Dry Battery. Write for illustrated circular describing Lek-Tro-Shav Safety Razor fully.

VIBRATING ELECTRIC RAZOR CO. Dept. 122, Council Bluffs, Iowa

"Movie" Camera Copies Books and Legal Papers

(Continued from page 540)

lamp while we compare notes. There are miniature spotlights at your elbows on each chair for note reading during the projection of the exposures. If you want the first two pages again we can have them instantly. In this way we can study all the work simultaneously, instead of successively, and save valuable time." (The four work for an hour, doing everything that two men, with craned heads and cricks in their necks, not to mention a mounting irritation in their hearts, would have done at 10 per cent efficiency, at the public library in one-half day. They are all relaxed bodily, but alert mentally and away from the maddening and unwashed crowd.)

The above is not pure imagination, but is based on actual apparatus on the market, in 1920, which, with a little modification and a real service system, combined with a wide-awake propoganda, can be made into a revenue-producing service bureau. Such a bureau would supply homes and societies with direct copies of sketches, views, colored or uncolored, of rare or out-of-print objects, documents, clippings, etc., in the first place. Second, a resumé service would furnish valuable material accumulated during a business deal by technical men, or in the case of students, during the college term. In the latter case at least 25 per cent of the students disarrange or lose their notes. For "quizz" and "cram" work, or for just plain review lecture, its advantages need not be dwelt upon further.

Third, prevent the rush in libraries for really important patent evidence by putting on the market at 48 hours' notice any out-of-print patents.

Fourth, would flatter authors of rare and privately circulated books by multiplying their circulation tenfold. It is necessary today to take the Touriscope, Movette, Pathoscope, Aminatograph, or other apparatus using film instead of glass slides and adapt it in a special manner for rapid step-by-step photo and projecting work with small clichés, 20 by 16 millimeters. The large size has no particular advantages for this kind of work, at least on documentary comparisons.

When one witnesses the fact that six seconds, and this is A1 service today, are necessary for a single photostat copy, costing 20 cents to 40 cents a page, and mentally compares it with the above outlined possibilities, it brings a picture of very attractive future developments to the mind in the way of improvements inevitably on their way to accomplishment.

Who will reap the intellectual, cultural and financial harvest from this seed?

AIRMEN TEST FIREPROOF AIR-PLANE.

Turning themselves into a flaming comet, Aviators Kerwood and Campbell gave delegates attending the Third Pan-American Aeronautic Congress at Atlantic City a thrill in testing a new preparation for fire-proofing airplanes.

The two flyers donned special suits painted with the preparation, and then permitted mechanics to spray them with gasoline. They climbed aboard and then the airplane, similarly "drest," was touched off with matches at the same time flame was applied to the aviators.

The plane was then sent careening into the air and for five minutes anxious spectators watched the blazing ship shooting like a star until the flames had burned themselves out. When the descent was made neither the aviators nor the machine had sustained any damage except for the soot.

Banner Storage Batteries

Mean less initial expense and real guaranteed service. It is essentially important to dealers as well as automobile owners to select a dependable battery. Our batteries are positively new and guaranteed in writing for 18 months, which means that you get that much service or we will repair same free of charge. We offer you economy and service. Compare our prices with others and be convinced of a saving of 50%.

- 6 volt, 9 plate 60 amps. **\$18.00**
- 6 volt, 11 plate 80 amps. **\$22.00**
- 6 volt, 13 plate 100 amps. **\$26.00**
- 12 volt, 7 plate **\$30.00**
- 12 volt, 9 plate **\$35.00**

Shipments made within three hours of the receipt of order. Deposit required to defray shipping expenses. 2% discount if remittance in full accompanies order.

Battery Supplies and Equipment. Write for Catalog. Discount to Dealers.

BANNER BATTERY CO., INC. 1219 So. Wabash Ave. CHICAGO, ILLINOIS

Packard

Put the proper power and pressure back of your wireless outfit by installing the PACKARD. Built and designed like our large power transformers to give continuous service. Distances of 450 to 900 miles are common among PACKARD owners.



High voltage is one of the reasons for PACKARD performance. Make it work for you. Write us about your wireless problems and for illustrated Transformer Bulletin.

The Packard Electric Company WARREN OHIO

Wireless Transformer

LEARN ENGINEERING

Regular Year Term Starts September 15th Expert electrical engineers are being paid fabulous salaries—thousands needed today. We give you personal and thorough training—practical, technical courses 3 months to 2 years under expert engineers in electricity, steam, gas, auto, armature winding, drafting, etc. Extensive laboratory and shop equipment. Not a trade school. Training is condensed—if your time is limited, come to the Finlay Engineering College—only one of its kind in the West. Day and night sessions—enroll anytime. Write for FREE catalog, a post card will do.

FINLAY ENGINEERING COLLEGE 1003 Indiana Ave. Kansas City, Mo.

Learn Autos and Tractors



Wonderful opportunities constantly offered trained men; we train you thoroughly to start your own business or make good money as motor expert, driver, shop foreman, etc.

5000 Graduates making good. Catalog Free.

Cleveland Automobile School, 1807 E. 24th St., Cleveland, O.

VIOLINISTS!

NEW DISCOVERY STARTLES WORLD. Learn easily how to make a violin actually talk. Greatest opportunities, for this is absolutely new. Travel and teach others. Results positively guaranteed. Price of complete instructions, "How to Make a Violin Actually Talk," reduced, for a very limited time only, to \$1.00. Send your order now—today, before our regular price (\$5.00) goes into effect again. Act now!

LEO J. AWAD, SHENANDOAH, PA.

PIGEONS PAY



They build their own nests and work for you 11 months in the year. A few good pair of pigeons now will bring you a good sized, profitable squab farm next season.

Write today for circular.

PIGEON SUPPLY HOUSE, P.O. Box 251, Hanover, Pa.

SELENIUM CELLS

Made by entirely new process. Highly sensitive and quick-acting. Suitable for all experiments. From \$5 up.

Write for Catalog

Selenium Laboratories Good Ground, Long Island, N. Y.

TELEGRAPHY

(Both Morse and Wireless) and RAILWAY ACCOUNTING taught thoroughly and quickly. Big salaries now paid. Great opportunities for advancement. Oldest and largest school; established 46 years. Endorsed by Telegraph, Railway, Radio, and Government officials. Expenses low—opportunities to earn large portion. Catalog free.

DOEGE'S INSTITUTE A Street, Valparaiso, Chile



Edited by
H. Gernsback

In this Department we publish such matter as is of interest to inventors and particularly to those who are in doubt as to certain Patent Phases. Regular inquiries address to "Patent Advice" cannot be answered by mail free of charge. Such inquiries are published here for the benefit of all readers. If the idea is thought to be of importance, we make it a rule not to divulge all details, in order to protect the inventor as far as it is possible to do so.

Should advice be desired by mail a nominal charge of \$1.00 is made for each question. Sketches and descriptions must be clear and explicit. Only one side of sheet should be written on.

IMPORTANT NOTE TO CORRESPONDENTS

We receive from thirty to fifty letters requesting advice on patents every month. Due to lack of space, even the condensing this department into the smallest type, we can only publish from eight to ten letters, with their answers, monthly. Obviously we are falling back further and further, and it looks as tho we will never be able to publish all the requests.

For this reason we would urge correspondents to avail themselves of our special service, as outlined above. In that case an immediate answer will be assured.

EDITOR.

PHONOGRAPH.

(405) Roy M. Weaver, Ashtabula, Ohio, says: Enclosed is a diagram of an idea which came into my mind when trying to regulate the volume of the sound on our phonograph which now has no way of doing it.

The idea is to have a sort of damper, such as you would find in a stove pipe. E is that part of the arm which fastens to the sounding box. D is the movable arm.

B is the damper or shut off. A is a small knob for turning the shut off. C is the shaft which has on that end a washer and lock nuts. F is a spring used for holding the shut off from jarring. When the shut off is open it will set as shown in the drawing. When closed it will be flat side up and thus shut off the sound.

A. There are four or five phonographs on the market at the present day incorporating the same idea which you suggest. One phonograph having practically the same identical thing suggested in your letter.

Another company, the Aeolian Co., making one having a flexible cable leading to the damper, by means of which the intensity of the sound can be regulated eight to ten feet away from the instrument itself.

The device itself is by no means new, and we do not believe that you could obtain the patent on the same.

DRAWING PAPER.

(406) Lewis H. Phillips, Highlands, N. J., writes:

I am greatly interested in the department, "Patent Advice," and below describe a new kind of drawing paper on which I would like to have your advice as to its patentability.

The average drawing paper has a plain edge. If a draftsman wishes to draw a straight line down the centre, he must first measure in from the edges. Now, with a busy draftsman, time is quite valuable. My suggestion is—have the ends and edges divided into inches and fractions of inches. Now, for instance, a draftsman wishes to draw a parallel line three inches from the edge. Instead of measuring from the edge all he has to do is to set his T square on the 3 inches and draw. Therefore you can readily see that if this idea is patentable it would be a great timesaver.

A. Your idea is a good one and really practical. Whether or not a patent would be granted on the same is hard to say, as ruled paper of all kinds have been patented and patents on the same have long expired.

Thus, square paper marked off in inches at both ends and ruled with light yellow rulings needs but to have a plain ruler in order to get squares and other lines either at right angles to each other or on the oblique of 45 degrees. We believe it would pay, however, to have a search conducted.

BILLIARD CHALK.

(407) H. A. Griffin, Akron, Ohio, says: In poolrooms and clubs, etc., where billiard and pool tables are, I have noticed that chalk can never be found readily and when it is finally

found oftentimes it is on the floor in a crushed condition. My idea is to have a little chalker to be either placed on the ceiling or it can be placed on the wall at about a 30° angle with same. Now, the shaft or plunger which turns the chalk is simply the same thing as you see in these screwdrivers that turn upon being pushed; the spring pushes the chalk down again after it has reached the extent of its travel. The chalk which is to be used must be round and the little clips that hold the chalk work eccentric, and the edges that bear in the chalk are sharp. All the dust that falls off the chalk drops to the bottom and this can be removed when new chalk is put in. This is a feature that makes for cleanliness of both the floor and your self and would be appreciated in the private home.

A. Altho your idea seems very feasible and practical, we do not believe that the exploitation of the same would net a material income for the simple reason that the cost of manufacture would be greatly prohibitive when other similar devices now on the market are taken into consideration.

One device which we refer to consists of a little holder into which the chalk is inserted. This holder is suspended from the ceiling by a little reel-like mechanism so that when the chalk is released the reel rolls up again replacing the chalk to its former suspended position. The advantage of this device is that the individual can move about the table still holding on to the chalk, which obviously in your case he could not do.

In addition, a pool player likes to wiggle the chalk around on the end of the cue, another feature which your device would not permit. In this manner perfect chalking of the edge at the end of the cue is insured in the regular way presently in use, whereas your device would not permit this.

Thirdly, we do not see how your device would prevent the chalk from falling to the floor if the same were screwed into a low ceiling, as all cues are not the same size, and the opening in funnel end would have to be large enough to accommodate the thickest cue and when a thin cue was placed into the opening the chalk would nevertheless fall to the floor.

The inserting of the chalk is likewise quite bothersome, making it impractical for poolroom use as invariably something is desired which is instantaneous in its action. Because of these reasons we would not advise a patent on this device.

STAIR MOTOR.

(408) Ernest M. Fletcher, Montreal P. O., writes:

I have always thought that it was almost impossible to get something for nothing; today I read three articles in one of the ELECTRICAL EXPERIMENTERS on that old gag, "perpetual motion"; a thought came to me. Why not make use of the stairs that are climbed by so many people—make

U.S. PATENTS



SEND FOR THIS FORM

Don't Lose Your Rights

Before disclosing your invention to anyone send for blank form "Evidence of Conception" to be signed and witnessed. A sample form together with printed instructions will show you just how to work up your evidence and establish your rights before filing application for patent. As registered patent attorneys we represent hundreds of inventors all over the U. S. and Canada in the advancement of inventions. Our schedule of fees will be found reasonable. The form "Evidence of Conception" sample, instructions relating to obtaining of patent and schedule of fees sent upon request. Ask for them,—a post card will do.



255 OURAY BLDG., WASHINGTON, D. C.

"Originators of form Evidence of Conception"

PATENTS

TO THE MAN WITH AN IDEA

I offer a comprehensive, experienced, efficient service for his prompt, legal protection and the development of his proposition.

Send sketch, or model and description, for advice as to cost, search through prior United States patents, etc. Preliminary advice gladly furnished without charge.

My experience and familiarity with various arts frequently enable me to accurately advise clients as to probable patentability before they go to any expense.

Booklet of valuable information and form for properly disclosing your idea, free on request. Write today.

RICHARD B. OWEN, Patent Lawyer
164 Owen Building, Washington, D. C.
2276-8 Woolworth Bldg., New York City

PATENTS TRADE-MARKS AND COPYRIGHTS

Before disclosing an invention, the inventor should write for our blank form "EVIDENCE OF CONCEPTION." This should be signed and witnessed and if returned to us together with model or sketch and description of the invention we will give our opinion as to its patentable nature. Electrical cases a specialty.

Our illustrated Guide Book, "HOW TO OBTAIN A PATENT," sent Free on request. Highest References Prompt Attention Reasonable Terms

FREE COUPON

VICTOR J. EVANS & CO., Patent Attorneys

Chicago Offices: 1114 Tacoma Bldg. Pittsburgh Offices: 514 Empire Bldg. Philadelphia Offices: 135 S. Broad St. San Francisco Offices: Hobart Bldg.
New York Offices: 1001 Woolworth Bldg.

MAIN OFFICES: 779 NINTH, WASHINGTON, D. C.

Name..... Address.....

CAN YOU

think of a simple, practical idea that will fill one of the many requests we have on file for new inventions? It may mean a fortune for you. Thousands of things are needed RIGHT NOW. Your brains can help. Send today for our great new book—"Inventions and Trade Marks, Their Protection and Exploitation" and learn more about making money from ideas than you ever knew before. It tells many things that are wanted, too. A postal will do—it is free.

PATENTS ADVERTISED For SALE FREE
In INVENTION And MANUFACTURING SUPPLEMENT.

Published for the man with an idea. Send for free sample copy. One year's subscription 50c.

We help our clients, without charge, to get the dollars out of their ideas—having facilities none others possess.

Advice free. Don't delay—get the book at once.

AMERICAN INDUSTRIES, INC.
225 Patent Dept., WASHINGTON, D. C.

them do a little useful work besides getting to the top or bottom. Get something out of them for nothing.

Enclosed is a rough sketch which will give you my idea.

Take four steps for an example. Each step can sink one inch but is returned to its original position by springs supporting it after the weight is released. As the step No. 1 sings it pushes on a lever. This works a ratchet which turns a shaft geared to a motor which supplies the battery with current. Likewise the same on the other steps.

So we have, if a person of 144 pounds weight ascends

$$\begin{aligned} \text{Step 1} &= \frac{144}{12} \times 8 = 96 \text{ ft. lbs.} \\ \text{Step 2} &= \frac{144}{12} \times 6 = 72 \text{ ft. lbs.} \\ \text{Step 3} &= \frac{144}{12} \times 4 = 48 \text{ ft. lbs.} \\ \text{Step 4} &= \frac{144}{12} \times 2 = 24 \text{ ft. lbs.} \\ &= 240 \text{ ft. lbs.} \end{aligned}$$

If 500 people went up the steps in a day, making the return trip, that would make $240 \times 500 \times 2 = 240,000$ ft. lbs, representing practically 8 H. P.

If more steps were connected up to other levels, say, only 20 steps in all, that would mean 40 H. P. 40 H. P. for nothing on a small scale all gone into the batteries. Could be used to advantage. What do you think?

A. In the December (1916) issue this magazine issued a "phony patent" on the self-same device which you have just described. The idea is quite clever, but we would ask you whether you would like to travel up 40 steps ten times a day, making 400 steps. Then again, each of these steps would carry your weight downward two inches, making you climb a total of 800 inches more than necessary. If each step were 8 inches high, you have climbed 100 more steps than you would otherwise, and if you knew that someone also were deriving power by you having expended 100 steps more per day, like the old treadmills, we are quite sure you and everyone would object. Outside of this, the up-and-down motion while climbing such stairs would be very fatiguing and extremely annoying.

Here is another scheme similar to yours. In the large department stores we have moving stairways. Why not just put a governor on this stairway and have it on very good rollers so that a person standing upon it would carry the stairway down with his own weight. Of course, it could not run more rapidly than the governor would allow. This device could be coupled to a generator. All this energy could be put into storage batteries to operate other electric motors about the store.



FALL TERM

BEGINS SEPTEMBER 13.

Registration now open for complete standardized course, preparing you for first grade commercial license and best paying positions. Individual instruction in classes of limited size.

Not merely a school, but a real home for the out-of-town student. Comfortable dormitory rooms, modern gymnasium and swimming pool.

Write for descriptive booklet A

Y. M. C. A. RADIO SCHOOL

Marcy Avenue Near Broadway
Brooklyn, N. Y.

Tel. Williamsburg 3800

The Book for Inventors and Manufacturers

SIXTH EDITION.

By return mail FREE. Write LACEY & LACEY Dept K, Washington, DC

Get This Book!

Contains first hand, practical advice by an experienced inventor. NOT on how to get your inventions patented, but how to dispose of them after patented with the greatest advantage to you; what kind of agreements protect you; contracts and offers to avoid. Full of valuable pointers; every page one of interest and advice.

\$1.50 will bring you a copy of THE INVENTOR'S MANUAL OF VALUABLE INFORMATION

G. E. Perry Company, Publishers
1328 Broadway New York
Dept. 20

PATENTS & TRADE-MARKS

—FREE BOOKLET ON REQUEST—

MY CLIENTS ARE INFORMED OF EVERY STEP TAKEN IN THE PROSECUTION OF THEIR CASES —

WARNER I. CUBBERLEY, PATENT ATTORNEY
22 NATIONAL UNION BUILDING
WASHINGTON, D. C.

PATENTS

If you have an invention and desire to secure a patent, send for our Free Guide Book, HOW TO GET YOUR PATENT. Tells our Terms, Methods, etc. Send model or sketch and description for our opinion of its patentable nature.

RANDOLPH & CO.
Dept. 172 Washington, D. C.

Free Book on PATENTS

Contains valuable information and advice to inventors on securing Patents. Send model or sketch of your invention for Free Opinion of its patentable nature. Prompt service. 20 years experience. Write today.

TALBERT & TALBERT 4287 TALBERT BLDG., Washington, D. C.

PATENTS

Send sketch or model for preliminary examination. Booklet free. Highest references. Best results. Promptness assured. Watson E. Coleman, Patent Lawyer, 624 F St., Washington, D. C.

STREET CAR INDICATOR.

(409) L. J. Klink, Valparaiso, Ind., says:

In your opinion would a device that indicates the next stopping place of a street car be worth developing and patenting?

What I have in mind is a sign placed in a conspicuous place in the front of the car telling the block number, street or important establishment (like Union Station) that the car will stop at next. For instance, if you were going south on a Broadway car in St. Louis and wanted to get off at Pine St., after the car started from Olive (the first street north) the sign would indicate "Pine St." You would have a whole block to ring and get to the door.

While living in St. Louis I have noticed much uneasiness among the passengers to know just where they were and when to get off. In fact, I have been "carried by" very often myself. The conductors are supposed to call the name of the street but they seldom do and are not always understood when they do.

Such a device can readily be developed that will always indicate the correct place regardless of the irregularity in the length of the blocks or distances between stops or whether the car passes stops or stops at every corner.

I do not know whether a device of this character was ever placed on the market or not. How could I find out.

Kindly give your opinion as to the commercial aspect of such a device.

A. Your idea is a very old one and several hundred patents have been issued on such devices. If you can overcome the following objections which have been placed upon similar appliances of this nature by the traction car companies, you will have a valuable invention.

The device must not be manually operated, but must be entirely automatic. It must not have a trip on the streets or something similar hung beside the overhead conductor or the underground conductor. No changes must be made in present rail installations. It obviously will not work if geared to the wheels, as many times in starting the wheels slip considerably. Rain, snow or sleet must not interfere with the operation of the device.

If your device can live up to the objections just given, we do not see why the same could not be patented and be accepted immediately.

INVENTORS HAVEN'T YOU SOME IDEA

that you can't just work out? Give us the idea—we will develop it for you. Mechanical and electrical ideas developed. Experts in model and experimental work and in perfecting inventions. Designing and building labor-saving machinery a specialty. Get in touch with us—we can save you money.

ELK MFG. CO., INC.
1926 Broadway, New York

WILLIAM C. LINTON
Consulting Engineer and Patent Attorney

"Inventor's Adviser" mailed free on request. Gives full information as to Patents, Trade Marks and their Cost.

OFFICES

364 University St. Montreal, Canada 919 F St., N. W. Washington, D. C.

PATENTS

C. L. PARKER
Formerly Member Examining Corps. U. S. Patent Office.
PATENT LAWYER
McGill Bldg.
Washington, D. C.

Patents, Trade Marks, Copyrights, Patent Litigation

Handbook for Inventors, "Protecting, Exploiting and Selling Inventions," sent upon request.

PATENTS

Hand Books on Patents, Trade Marks, etc., sent free. Our 70 years of experience, efficient service, and fair dealing, assure fullest value and protection to the applicant. The Scientific American should be read by all inventors.

MUN & CO., 622 Woolworth Bldg., N. Y.
Tower Bldg, Chicago, Ill. 622 F St, Washington, D. C.
Hobart Bldg., 582 Market St. San Francisco, Cal.

MEN

Intensely interesting booklet free.
Wonderful results.

Winslow H. Chase, Washington, D. C.

A Giant Radio Central Station

(Continued from page 511)

supported on self-supporting steel towers, each 400 feet in height, with the wires suspended at the top between 150-foot cross arms. Each of the six antennæ will have twelve towers, forming, so to speak, the spokes of a giant wheel fashioned out of seventy-two miniature replicas of the famous Eiffel Tower in France. Five of these antennæ spokes will be used for regular service, while the sixth is reserved for emergency operation.

Far more impressive than physical appearance, however, will be the things the eye cannot encompass. Appreciate, that in the wires forming each spoke of the gigantic wheel there will be generated a power equal to the greatest of present day trans-oceanic wireless stations; then comprehend, if you can, the fact that all five of these powers can, if desired, be combined into one, for signaling. A telegraphic signal created out of such tremendous electromagnetic energy could encircle the entire globe!

RADIO TELEPHONE AS WELL AS TELEGRAPH.

But that is not all. The apparatus and system which will be installed for each of the five units will be the same as that at present in the New Brunswick (N. J.) station, from which the voice of Secretary of the Navy Daniels was carried to President Wilson when he was at sea aboard the U. S. S. *George Washington*. In a number of experimental tests the voice has been carried by this radio telephone over distances of 2,500 miles from complete success. This leads us to state very definitely that before long a direct wireless telephone service will be established with foreign countries.

The generation of the energy required to span thousands of miles will be effected by Alexanderson alternators, which have made it possible to carry the radio signals thru space by continuous wave trains, instead of by the interrupted or discontinuous waves, generated by systems using the old-time "spark discharge" apparatus. So efficient and reliable has the Alexanderson 200-kilowatt alternator installed at New Brunswick proven itself that leading radio experts of Europe have made special trips of investigation to the United States to view its performance.

TEN 200 KILOWATT ALTERNATORS TO BE USED.

Now this already famous single machine is to be duplicated and installed in the New York Radio Central Station; but this time there will be two 200-kilowatt machines for each transmitting station—ten in all. The achievement, from a radio engineering standpoint, has nothing approaching a parallel; ten alternators, 2000 kilowatts, 3000 horse power—an astounding force to concentrate in realization of a dream to transmit messages over the world to all points of the compass from a single source!

Mr. Nally emphasized another forward step in engineering which will be incorporated in the super station. "We will utilize what is termed a multiple tuned antenna, which," he explained, "materially reduces the wasteful electrical resistance of the long, low, flat-top aerials formerly used. A great saving in power is thus effected; in fact, for the same power input formerly used for a single station, six times the effectiveness at a distance is obtained. In other words, we obtain with this antenna the same effect at a distance with 200 kilowatts input, as would be obtained from the old type of antenna with 1200 kilowatts.

CONNECTICUT RADIO



Strong Signals

Signal strength and selectivity are outstanding advantages of the CONNECTICUT Variable Condenser, because of the low effective resistance of this Condenser.

Laboratory tests have shown the efficient resistance of the CONNECTICUT Condenser to be only a few tenths of an ohm, as against from two to fifteen ohms resistance in the ordinary commercial Condenser (rotary type).

This difference would result in a signal strength from the CONNECTICUT Condenser fully ten times as strong as from the ordinary types.

These and many other advantages of the instrument are described fully in our new booklet. Send for a copy.

Mention Your Dealer's Name

CONNECTICUT TELEPHONE & ELECTRIC COMPANY
Meriden Connecticut

RADIO CLUBS TAKE NOTICE

Buy Where You Can Get A Discount and Get What You Want—
A Most Complete Line of Radio Apparatus and Parts

We have all the Radio Books & Magazines. Get your "Hookups" from them.
Add the list below to the ones given in previous issues.

Hotshot Batteries, 6 Volt, \$2.70. Storage Batteries, 6 V-60A, \$16.00, (Marko), \$19.00. Eveready "B" Batteries, \$3.25. Cyclone, \$2.20. Standard Variable, 3.25—these batteries have 14 amp. Small "B" Batteries, 22 Volt, \$1.00. Special Pittsfield Spark Coils, without vibrator, \$2.00; postage 23c. Special Shocking Coils, 50c; worth double. We have about 200 going at that price. Motors, the kind for your rotary gap, \$10.00. Monicoll Motors, 49c, work on dry cell. Hoyt Volt Meters, 0-3 & 0-5 volts, \$6.50. Pocket type Volt & Amp. meters, \$1. Roller-Smith Ammeters, Special, D. C. 0-1 & 0-2, \$6.90. Westinghouse Ammeters, Navy Type, D. C. 0-3 & 0-5, \$10.00. Large type, \$6.00. Small Sterling Type Volt Meters, projecting or flush, Special Price \$4.00. Small Sterling Type Ammeters to match the above, 0-35, Special Price \$4.00. Variometers, \$4.50. Grebe Type, \$6.50. Variometer Coupler, \$4.50. Primary Switch, Wilcox type, 75c. Rotary Switches, \$20c, 30c, 35c, 40c, 50c, \$1.00. Spark Gap Stands without the electrodes, 2 to a set, 40c. White Metal Dial, 3" dia. with navy type knob, 70c. Brass scales, 45 degrees, 10c. Hook-Ups, the kind that will make any set work, 14 of them for 75c. We have all the parts for the amateur to build his set as he likes. De Forest and our own Catalog sent upon request and 10c.

AMERICAN ELECTRO TECHNICAL APPLIANCE COMPANY

238 FULTON STREET, DEPT. E.

NEW YORK CITY



MIGNON UNDAMPED AND REGENERATIVE RADIO APPARATUS

(MIGNON AND ARMSTRONG PATENTS)

Endorsed by Radio Department of D., L. & W. R. R. Co.

Write for Literature

MIGNON MFG. EXPORT CORP., NEWARK, N. J.

AUTHORIZED AGENTS (The Northern Radio Laboratory, Clyde, Ohio
(Canadian Radio Mfg. Co., Beville, Quebec, Canada)

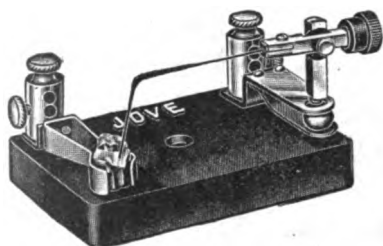

(GHEGAN PATENT)

Bunnell INSTRUMENTS Always Reliable

JOVE DETECTOR

Handiest, Handsomest, Best
Sample by Mail — \$2.00
Tested Galena Crystal—25c

Distributors of Standard Electric Novelty
Company Type B "Cyclone" Audion Batteries.
Also De Forest, and all other makes of High
Class Wireless Apparatus.

Send stamp for new edition 42E Catalog.

J. H. BUNNELL & CO., 32 Park Place, New York

"THERE'S MONEY IN IT" LEARN TELEGRAPHY MORSE AND WIRELESS

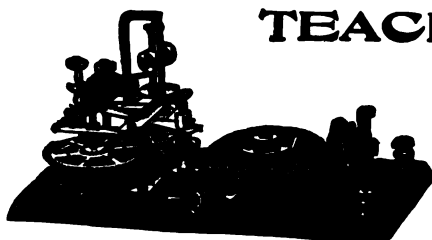

TEACH YOURSELF

In half the usual time, at trifling cost, with the wonderful Automatic Transmitter, THE OMNIGRAPH. Sends unlimited Morse or Continental messages, at any speed, just as an expert operator would.

Adopted by U. S. Gov't. 4 styles. Catalogue free.

OMNIGRAPH MFG. CO.
26 L Cortlandt St. New York

UTOMATIC FIBRE LIMBS
y Payments—Do Nature's Work. AGENTS WANTED
wear leg. Good Pay. FREE Fibre Sample.
Describe Stamp to
ORMAN CO., 252-D HENNEPIN, Minneapolis, Minn.

Learn Watchwork, Jewelrywork and Engraving
A fine trade commanding a good salary, and your services are always in demand. Address HOROLOGICAL Department, Bradley Institute, Peoria, Ill., for our latest catalog.

input! This new type of antenna is the equivalent of six independent radiators, all operating in unison at the same wave length, and for the complete station with its five antennæ units, the power required will be less than 20 per cent of that formerly necessary. The project, however, contemplates additional possibilities. To illustrate: We may, in many cases, utilize but one-half of a single spoke of the antenna system for communication service to a certain point. On this basis, the Long Island Station will ultimately permit simultaneous transmissions to a maximum number of ten points in the world, thus doubling the communication facilities originally planned."

STATIC ELIMINATION.

"The receiving aerials are of a new type, too; they have been designed for operation with the Weagant system of "static" elimination, which, by a combination of opposed electrical circuits, nullifies the long-dreaded effects of atmospheric electricity and makes possible uninterrupted reception from foreign countries under all weather conditions. We break away from precedent once again, in locating our receiving units only eighteen miles from the multiplex transmitting equipment, instead of following the former practise of establishing one transmitter and one receiver in one locality and restricting the service of the circuit to one overseas destination."

Electrical Meals

By JACQUES BOYER

(Continued from page 476)

ner. Thus, persons who live a sedentary life, and who consequently accumulate flesh reserves which are not used up, will be made to perform *ergotherapeutic exercises*. On the other hand, those whose organisms spend more energy than they are able to produce will likewise resort to the diathermic treatment which will electrically furnish them without any effort on their part whatever the required additional energy in the form of heat. To effect a reducing cure according to the Bergonié method is therefore as easy as partaking of his "electricity meal."

JAPAN ERECTING RADIO STATION AT FUKUSHIMA.

The Japanese Government is erecting a powerful wireless station in the prefecture of Fukushima for the purpose of relieving congested communications between that country and the United States. The Emperor has conferred upon John R. Geary, general manager for the General Electric Company at Tokio, the Order of the Rising Sun, Fourth Class, in recognition of his services for the development of Japan's electrical industries.

NEW YORK SUBWAY ASKS FOR ONE-MAN TRAINS.

The Interborough Rapid Transit Company has applied to the Public Service Commission for permission to install the multiple unit door control which the company has been testing for several months. The device, if installed, will make it possible for one man to operate all of the doors on a subway train, thus greatly reducing the cost of operation. It was described in the April issue of the ELECTRICAL EXPERIMENTER—Science and Invention. The commission will hold a public hearing on the application next Tuesday. In the meantime the commission's engineers are investigating the device.

AUDIOTRON

The Original Tubular Vacuum Detector, Amplifier, Oscillator
NOW FREE FROM ALL RESTRICTIONS

AUDIOTRONS, recognized as the most sensitive detectors ever produced, are now licensed under Fleming Patent No. 803684 to be used only for amateur and experimental uses in radio communication. They are no longer limited to audio frequency and can now be used as detectors and oscillators as well as amplifiers.

All patent questions have been definitely settled. Vacuum tube patents are basic and have been sustained by the Federal Courts. Be sure to get genuine AUDIOTRONS. They outclass any other form of detector and are absolutely free from all legal restrictions or difficulties. These new uses make it even more necessary to insist on the genuine. You can always tell a real AUDIOTRON by the name stamped plainly on the glass.

Insist on the name AUDIOTRON on every tube you purchase. Fully guaranteed by the AUDIOTRON Mfg. Co. (Read the guaranty).

Your Last Chance To Get An
AUDIOTRON ^{double filament} DETECTOR

Manufacturing reasons make it impossible to continue the present hand made AUDIOTRON.

This type has a double filament of special thorium tungsten and the operating life is over 2,000 hours. No special socket is required. The electrical and mechanical dimensions result in a heavy plate current and corresponding signal strength. Plate voltage under 40.

The few thousand that will still be produced will be of the same

standard of excellence that has characterized every AUDIOTRON. Already recognized as the most sensitive detector on the market, these few that still remain, with all restrictions on amateur use lifted, are undoubtedly the greatest opportunity ever offered to amateur radio operators. See your dealer at once or order direct. Be sure to benefit by this last opportunity to secure a hand made super-sensitive double filament AUDIOTRON Detector, Amplifier, Oscillator.

\$6.00 each (no increase in price)

The AUDIOTRON exclusive guarantee

Each and every AUDIOTRON is guaranteed to arrive in good condition and to prove fully satisfactory. Replacement of unsatisfactory tubes will be made free of charge. The only tube satisfactory enough to stand a guarantee.

Dealers: Get in touch with the AudioTron Mfg. Co. at once. We will give you full information about settlement of all patent difficulties. You will also be interested in our new proposition for wide awake dealers. Write us today for full details.

AUDIOTRON MFG. COMPANY (Successors to the AudioTron Sales Co.) Dept. A, Lick Bldg., San Francisco, Cal.

Be a Movie King

OH BOY. SOME SPORT

Surprise the Bunch—Have a Barrel O' Fun!

OWN A GENUINE MOVING PICTURE MACHINE

Here's what you've always wanted—a Genuine Moving Picture Machine—a machine that uses **STANDARD FILM**—like the **BIG** theatres show—at a price you can easily afford to pay. This is the **BIG** opportunity—don't **MISS** it. Read very word—then act quick. Several swell models to select from. Each the best of its kind. **ALL REAL** moving picture machines—not toys or magic lanterns—but **REAL MOVIE** Machines, that throw a big, broad, brilliant circle of light on the screen many feet away, and show a picture three to seven feet in width. One or more reels of **REAL FILM** come with each machine **FREE**, and the minute you get your machine you can start right in and give a "bully" exhibition. The "fellers" and girls and the grown ups, too, will sit spellbound, or roar with laughter, at the wonderful, lifelike, real movies you can show them.



Charlie Chaplin Films—25c each

Keystone Moviegraph

This is our largest and finest machine. A regular beauty and all complete, ready for you to use the minute it arrives. Hang up a sheet, put on a reel, turn the crank, and you're off—that's all there is to it. Nothing to get out of order. Made of metal throughout with heavy base casting. Finely adjusted mechanism, easily operated. Equipped to show slides as well as Real Moving Pictures—just like the big machines. 12x9½x6. Made to operate with electric light **ONLY**. Simply screw in the plug and you are all ready for an exhibit. Comes with 3 **EXTRA LONG**



Show Real Moving Pictures Like the Big Theatres The New Model

This is a beautiful, high-class Moving Picture Machine. Made of sheet iron with wood base. Finished in black or battleship grey with handsome red stripe trimmings. Solid and substantial construction. Size, 12x7½x5½. Uses **STANDARD FILM** same as the big machines, and throws a **BIG** picture many feet in diameter. **TWO TYPES**—Electric and Gas. The electric machine is equipped with plug and cord, complete. Gas machine has its own generator and makes its own light. The gas machines can be used anywhere and will be sent unless Electric type machine is specially ordered. Remember this and be sure to specify "electric" if you desire this type. Sent **STANDARD FILM FREE**, by express, for

\$7.50; or by Parcel Post, to any address in the world, for \$8.00.



New Model

STANDARD SIZED FILMS, 3 FINE SLIDES, and admission tickets—all **FREE**. Here is a machine you will be proud of. You can have endless fun and amusement, and **MAKE MONEY** with it. Sent by express, with full instructions and extra long cord and plug, securely packed, for \$12.00; or by Parcel Post, to any address in the world, for 75c extra.

SPECIAL. Order from this Ad. Our machines are absolutely as described and thoroly inspected before they are shipped. We guarantee them perfect and complete and all ready to use when they arrive. Make sure of getting the machine you want—order now—from this Ad. We can make immediate delivery now—so order at once, and avoid disappointment. Prices are going up all the time and you may never have a chance like this again to buy a Genuine Moving Picture Machine at the very low prices quoted here. You've always wanted a real Moving Picture Machine. Make sure to get it **NOW**.

FILMS All the films you want. Splendid subjects—15c each; Doz., \$1.50 (postpaid). Extra long films, 3 for \$1.00; Charlie Chaplin films—slide-splitters—famous favorites, 25c each. Lantern Slides (least sold)—6 for 75c.

JOHNSON SMITH & CO. Dept., P.M. 25, 3220-3224 N. Halsted St. CHICAGO, ILL.



Latest Model Cinematograph

BIG BARGAIN OFFER

3 Reels Free Here is an astonishing bargain. Our latest Model Cinematograph is a whirlwind value. At the price it has everything beat you ever heard of. Here is a genuine Moving Picture Machine—made of metal—solidly constructed—and put together by expert workmen—that you can buy at a price that will simply astound you—knock you plumb off your feet. This machine throws a brilliant beam many feet. Comes equipped with a **SAFETY** Carbide Gas Generator, and can be used to show moving pictures anywhere. The mechanism is scientific and simple and can be operated by anyone. This is the greatest value in a Genuine moving picture machine ever offered at the price. Think of it! A genuine moving picture machine—that uses **STANDARD FILM**—by express, charges collect—with 3 **REELS FREE**—for only \$3.00; or by Parcel Post to any address in the world for only \$3.25!

ROTARY GAP

Cat. No. YM1

A new development in the rotary line has been made expressly for Young & McCombs. Improvements on the well known saw tooth rotary wheel, make this gap the equal in tone and efficiency to any selling for twice the money. It is the only gap on the market which will run smoothly and reliably in either a horizontal or vertical position. Can be run in a vertical position while screwed to the wall. Rotor is machined cast aluminum with formica center. Has liberal sparking space and is drilled for either 1-4 or 3-16 shaft. Variable motor speed switch in base.

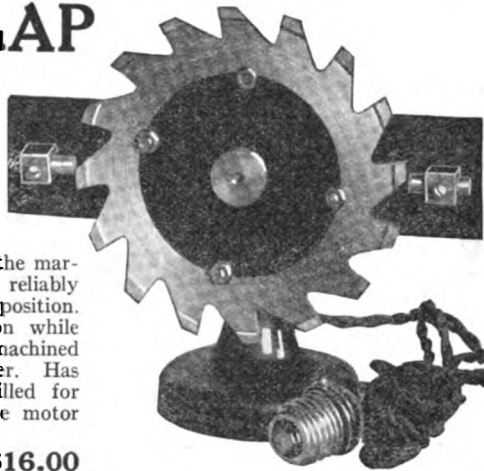

Price, complete - \$16.00

ROTORS ONLY

YM1a—Rotor and standards only.....\$7.00
 YM1b—Standards with base and binding posts 2.50

ROTORS AND STANDARDS

YM2—Plain rotor, as illustrated.....\$4.50
 YM3—Saw-tooth rotor, designed for Harmonic Chord tone..... 4.75

Send 4c in stamps for 50-page Catalog

Young & McCombs

L. P. BEST PRES.
 ROCK ISLAND, ILL.

Address Orders to Dept. 67

Collision of Earth with Heavenly Bodies

By ISABEL M. LEWIS, M.A.
 (Continued from page 501)

fraction minutes), or a total of ten thousand tons per square mile, during the period of encounter.

A fall of five pounds of meteoric matter per second entering the atmosphere with a velocity of twenty miles per second over each square mile of the earth's surface would supply a quantity of heat equal to that received from the sun over the same surface in the same time. So for a brief period of forty minutes one hemisphere of the earth would receive about eighteen hundred times as much heat from the collision as from the sun!

To get some faint idea of the effects of such an encounter consider the effect of an actual fall of about one-third of a ton of meteoric stone at Estherville, Iowa, which occurred May 10, 1879, at 5 P. M. The meteorite, according to the account, was plainly visible in daylight and the sounds produced were louder than those of the largest artillery and were recorded as "terrible and indescribable, terrifying people and scaring cattle over an area of many square miles." There were two explosions attending the fall, one at great height scattering several large fragments over an area of four square miles, and a second close to the ground scattering many small stones. The largest fragment of the fall weighed over four hundred pounds and embedded itself eight feet in stiff clay. In all about 740 pounds of meteoric stone were collected,—mostly in the form of small stones, fragments of a larger mass shattered by explosions.

Needless to say, the effects of a head-on collision of the earth with the head of a comet possessing one hundredth millionth part of the mass of the earth would produce most disastrous results to all life upon the surface of one-half of our planet earth. Instead of a fall of a third of a ton producing such effects as we have mentioned above, there would be a fall of ten thousand tons per square mile in about forty minutes.

Imagine the cannonading of the Great War spread over every square mile of half the earth's surface at maximum intensity for one hour, to form an idea of the effects of such a collision!

If the quantity of matter in the nucleus and head of the average comet approaches any such value as one hundred millionth part of the mass of the earth, and if the individual particles average hundreds of pounds in weight, we have reason to be pleased at the thought that the chances of a head-on collision of the earth with the head of a comet is, according to Babine, about once in fifteen million years!

The earth has frequently past directly thru the tail of a comet. At its last apparition we past thru the tail of Halley's comet and no one was any wiser for the fact, yet the difference in density between the nucleus and tail of a comet may be, and probably is, very great.

As a whole, the earth would go on undisturbed by its head-on collision with the head of a comet which has a mass equal to only one hundred millionth part of its own, owing partly to the briefness of the encounter (the effect of the great heat would hardly be felt before it would be over) and partly due to the fact that the mass of the comet, tho imposing enough in tons, would be so insignificant compared to the earth's mass that it could no more retard the motion of the earth than the firing of a few rifle shots could slow down the speed of a locomotive.

ALL TUBES ARE NOT ALIKE

For successful amplification the impedance of the windings of an *Amplifying Transformer* should equal that of the tube circuits.



Our A-5 type of *Amplifying Transformer* has several ratios of impedance and transformation allowing the operator to use the correct values irrespective of the tube used.

Your dealer can supply you

ACME APPARATUS COMPANY 28 Windsor Street
 Cambridge 39, Mass.
 TRANSFORMER AND RADIO ENGINEERS AND MANUFACTURERS

ANNOUNCEMENT—BINDING POSTS FREE!

To care for our business in the eastern section of the country we are opening a branch at 20 N. Ninth St., Philadelphia, Pa. We are placing a complete stock of radio equipment in this office and will be ready to care for the local and mail order trade with even more dispatch than formerly.

As a special introductory offer with each order of \$5.00 or over bearing the postmark of any date in July, we shall give one dozen of binding posts free of charge. These binding posts ordinarily sell for 6c each and are one of our best values.

Our 64-page catalogue is now on sale at 15c which amount will be deducted on your first order for \$1.50 or more.

ELECTRICAL SPECIALTY CO., Dept. E. 48-50 SO. FRONT STREET
 COLUMBUS, OHIO

Dependable Radio Apparatus

A new Tuner and a new Short Wave Set have joined the **DEPENDABLE FAMILY**

Catalogue Mailed for 10 Cents in Stamps

DORON BROTHERS ELECTRICAL COMPANY
 Hamilton, Ohio

Insure your copy reaching you promptly each month.
 Subscribe to **SCIENCE AND INVENTION—\$3.00 a Year.**

DE FOREST

Announcing The DeForest Portable Buzzer "Radiophone".

Type O. T.—5



DeForest Portable "Radiophone"
Transmitter Buzzer Type O. T.-5
"Radiophone" Name Copyrighted.

THE latest development of the famous DeForest Oscillation Transmitter (Wireless Telephone). For Automobiles, Motor and Sail Boats, Camps, Surveying and Exploring Parties, Forest Patrol, Farms, and all isolated places, this new "Radiophone" Set offers sure, quick, practical word-of-mouth communication. Operates on two 6-volt storage batteries; no "B" battery or other outside source of high potential is required. Can be easily transported; entire Transmitter, including batteries, weighs less than 60 pounds. Range on ordinary Amateur aerial is 5 to 10 miles, and can be materially exceeded under proper conditions. Operates with any suitable type of Receiver and Audion Detector; with or without an Audion Amplifier, depending on the range to be covered and loudness of reception desired.

Price Without Storage Batteries \$135.00
Including Vacuum Tubes

F. O. B. New York

Investigate this new DeForest production now. Order at once to insure early delivery; either thru your regular dealer or direct from us.

DE FOREST RADIO TELEPHONE AND TELEGRAPH COMPANY

Inventors and Manufacturers of High Grade Radio Apparatus
1415 Sedgwick Avenue New York, N. Y.
Lee DeForest, Inc., 451 Third St., San Francisco, Western Distributors

DE FOREST

THIS VT AMPLIFIER - OSCILLATOR

OF ALL VACUUM TUBES

HAS THE HIGHEST

AMPLIFICATION CONSTANT

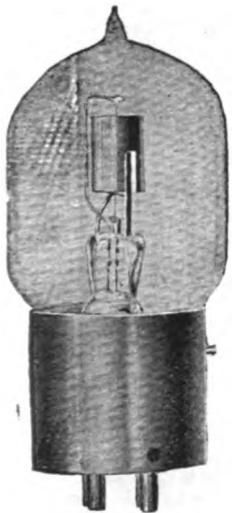

The A-P Amplifier-Oscillator is the Navy type SE 1444 "hard" tube, designed and manufactured expressly for amplification and oscillation purposes. Because of its exceptionally high vacuum and correct electrical and mechanical design this tube has the highest amplification constant of any tube known to the radio art. Recent tests by the United States Navy have established this fact. (See April, 1920, Prec. I. R. E.)

Used in conjunction with the A-P VT Amplifier-Oscillator is our A-P Electron Relay, the original tubular vacuum valve brought out by our Laboratories in 1915, but now supplied with the SHAW standard four-prong base for convenience. Of all vacuum tubes the A-P

Electron relay is the most efficient spark receptor. A combination of two or more VT tubes as amplifiers or long wave reception. In ordering ask for—

THE A-P PERFECT VACUUM TUBE COMBINATION

DEALERS <i>Write for prices and particulars</i>	The A-P Electron Relay — price \$6.00 each	The A-P VT Amplifier Oscillator — price \$7.00 each.	AMATEURS <i>Write for descriptive literature</i>
	Immediate deliveries. Order from your dealer or write direct.	Immediate deliveries. Order from your dealer or direct.	

These tubes were manufactured under the DeForest Audion and Fleming Patents

ATLANTIC RADIO SUPPLIES CO., KIRK PLACE, NEWARK, N. J., Phone, Market 1575
PACIFIC RADIO SUPPLIES CO., 638 MISSION STREET, SAN FRANCISCO, CAL.

SOLE DISTRIBUTORS FOR MOOREHEAD LABORATORIES, Inc.

Reference—The American National Bank—San Francisco

MURDOCK No. 55



2000 OHM SET.....\$4.50
3000 OHM SET..... 5.50

That these Murdock No. 55 Sets have earned a nationwide reputation for value, is due, not so much to the fact that they are, without question, the best low priced receivers obtainable anywhere, as it is to the recognized fact that they closely approximate in operation the sensitive performance of the most expensive sets.

The customary assurance of "Satisfaction or Money Back" affords the opportunity of proving the exceptional value of these 'phones at no risk to you.

Other instruments — MURDOCK MADE—of recognized merit at equally reasonable prices are illustrated in Bulletin 19B, a copy of which will be mailed on request.

WM. J. MURDOCK CO.

55 Carter St.

CHELSEA (BOSTON 50) MASS.

509 Mission St. San Francisco, Calif.

NEW DIAL INDICATOR

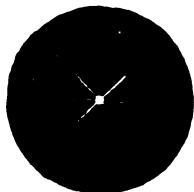

Fits standard 1/4" Shaft. Made of same quality as our smaller dial. Black composition. White filled engraving. Beveled edge.

3" Dial.....\$0.75. With Knob.....\$1.30 Postpaid
3 1/2" Dial..... 1.00. With Knob..... 1.70 Postpaid
Moorhead Electron Relay New Style.....\$6.00
Moorhead V.T. Amplifier..... 7.00
Moorhead Extra Hard V.T..... 7.50
Shipping weight 1 pound. Guaranteed. Licensed under Fleming and De Forest Patents.

Our new Catalog now ready, send 10c for it.
For sale at all RADISCO Agencies and by

A. H. CORWIN & CO.

4 West Park St., Dept.E-1, Newark, N. J.

Building "Your Own" Phonograph

(Continued from page 506)

ELECTRIC MOTOR DRIVES.

Fig. 4 shows two ways in which electric motor drives for phonographs can be used. The first method involves the connection of the electric motor to the gear train directly, with the use of the usual speed governor and regulator. The second method is a pure friction drive and this has been used to some extent commercially with very good success. The periferies of the friction pulleys may be covered with leather or they may be fiber pulleys, etc. Needless to say, the three-ball governor should be linked up with the driving train at some point, so as to keep the speed even and also to regulate the speed to the desired value.

Fig. 5 shows several stages in making your own turn-table. The standard turn-table is formed of prest steel about 3/64th inch thick, the edge being rolled over about 7/16th"; and the top of the turn-table is covered with a piece of green or other colored felt glued to the metal, and at the exact center a brass or iron hub is riveted or screwed to the steel table. The hub is usually turned up from a piece of iron or brass in a lathe, so as to contain the pin at the center which passes thru the center of the record, while the hole at the bottom of the hub accommodates the driving shaft.

In standard phonographs no set screw is required as this hole in the base of the hub is tapered to accommodate the tapered shank on the upper end of the shaft. In home-made turn-tables, a set screw is invariably threaded thru the side of the hub so as to secure the turn-table rigidly to the shaft. The turn-table can be very well made of wood about one half inch thick and a standard diameter for turn-tables is 12 inches, altho if you have a small motor which will not rotate such a large turn-table a small one, say about 10 inches in diameter, may be used. Some makes of machines employ a cast iron or brass turn-table as shown at Fig. 5, the flat part of the table being cast with a large number of holes over its entire surface to reduce the weight.

For best results and in all first-class machines, the turn-table is *balanced*. This is performed very simply by mounting the table on a shaft which projects thru about four inches on the outer side. Two straight edges, preferably steel knife edges, are leveled up by means of a spirit level in *both directions*, and the turn-table with its shaft then placed on the knife edges. Holes are drilled in the turn-table or else solder placed on the rim, etc., until the table will rest in any position you place it without manifesting any turning effort. In other words, it must stand at any point you turn it to, without moving.

BUILDING THE SOUND CHAMBER.

When it comes to sound chambers there are many varieties of them, but as Prof. Dayton C. Miller, one of the foremost experts in the physics of musical sound in America, recently pointed out to the writer, —what we desire in a phonograph sound chamber (just now we mean the main amplifying sound chamber extending from the base of the tone arm, out to the grill), is an air-tight, solidly built chamber of standard size, so that the column of air within this chamber can be vibrated at any frequency desired, such as by musical vibrations impinging upon it by the phonograph reproducer or sound box.

Looking at Fig. 6, we have the simplest imaginable form of phonograph sound chamber which is not a very remarkable af-

Super-Sensitive Microphone ONLY \$8.00



This instrument is offered at an extremely low price. It is excellent for building your own amplifier. Can also be used in many experiments where a sensitive microphone is required.

Detectagraph, \$18.00

This detecting instrument of marvelous sensitivity can be used for detecting secret conversations. Outfit consists of Sensitive Transmitter, 25-ft. Black Cord, Receiver, Headband, Case and Battery.



Send for One To-day and Convince Yourself

Detectagraph \$18.00

THE \$18.00 MICROPHONE DEAF-PHONE



is a super-sensitive instrument which has been developed to meet the demands for a practical and efficient hearing device at an extremely low price. It is equal to any \$35 instrument made and superior to most of them. The outfit consists of One Super-Sensitive Transmitter with cord connector; One Super-Sensitive Ear Piece with small black cord; One Black Single Headband; Black Case and Two Batteries.

Adjusted Model "B" Horn, with No. 20 High Grade Loud Talking Receiver, Cord Plugs and Desk Stand Base. Price, \$12.00 Complete.

Write To-day for Free Booklet

G. BOISSONNAULT CO.

26 Cortlandt St. New York

Makers of Super-Sensitive Microphone Apparatus



RADIO APPARATUS

Distributors of Reliable Radio Apparatus for Experimenters in Every Branch of the Radio Field.



"Pittsco" the Sign of service.

All we ask is a trial!

HONEY-COMB COILS

LITZENDRAHT WIRE. (While they last.)		
LL-75	330-1030 meters.....	\$1.60
LL-100	450-1460 ".....	1.70
LL-150	660-2200 ".....	2.00
LL-200	930-2850 ".....	2.10
LL-250	1300-4000 ".....	2.30
LL-300	1550-4800 ".....	2.50
LL-400	2050-6300 ".....	2.80
LL-600	4000-12000 ".....	3.00
LL-750	5000-15000 ".....	3.20
LL-1000	6200-19000 ".....	3.50
LL-1250	7000-21000 ".....	3.90

Note—These are the genuine De Forest litz coils. Send 6 cents in stamps for new catalog.

F. D. PITTS CO., Inc.

Dept. D

12 Park Square, Boston 11, Mass.

"The Livest Catalog in America"

Our big, new electrical cyclopedia No. 22 is waiting for you. Positively the most complete Wireless and electrical catalog in print today. 80 Big Pages, 300 illustrations, 200 instruments and apparatus, etc. Big "Treatise on Wireless Telegraphy." 20 FREE coupons for our 160 - page F R E E Wireless Cyclopedic No. 22. Weight 1/2 lb. Beautiful stiff covers.

Send 6 cents in stamps or coin for which we will send our latest Cyclopedic Catalog No. 22 as described.

ELECTRO IMPORTING COMPANY
231 Fulton St., New York City

"ASK ANYONE WHO HAS USED IT"
USERS ARE PROVERS

"My Brandes sets brought in Coast stations louder and clearer than the other phones with which the station was supplied." (Name on Request.)

BRANDES WIRELESS HEADSETS



"Superior" Set, 2,000 ohms, \$7

TRIAL OFFER Buy a Brandes Superior Headset and use it critically for ten days. Then, if it doesn't come up to our claims or your expectations, return it and your money will be cheerfully refunded. Test it—compare with others—for sensitiveness, clearness, distance. Prove for yourself the fine quality, the "matched tone." The two diaphragms toned exactly alike, strengthen the signals and prevent blurring. Used by many U. S. Government experts, and experts abroad; by colleges and technical schools; and by professionals and amateurs everywhere.

SEND 4c FOR CATALOGUE E

C. BRANDES, Inc.
32 Union Square, Room 814
New York City, U. S. A.
WIRELESS RECEIVER SPECIALISTS

Charge Storage Batteries

For Convenience or Profit

From any alternating current lamp socket with the Cambridge Rectifier. For home or garage use. As simple as turning on a lamp and fully guaranteed.

Quickly saves its cost and doubles the life of your battery. Always ready when you want it. Rectifier Bulletin R sent on request.

Bulletin Y of Wireless Telegraph Apparatus sent for 3c stamp.

Clapp-Eastham Co.

131 Main St. Cambridge, Mass. The Cambridge Battery Charger, Price

\$25

Arnold Loose Couplers

Combination Loose Coupler Parts and accessories.

Send 3c stamp for literature which is sure to interest you.

J. F. ARNOLD

2082 Lexington Av. N.Y. Established 1910

Vacuum Tube Control Cabinets

Beautiful mahogany finished case with handsome grained bakelite panel on which is mounted a standard socket, rheostat, grid leak, condenser and switch for arc and spark reception.

Price \$15.00. Send for our free catalogue of other "Modern" apparatus.

MODERN RADIO EQUIPMENT CO.
Elizabeth, New Jersey

LEARN WIRELESS

At the OLDEST, LARGEST and BEST EQUIPPED school of its kind in New England. Thousands of satisfied graduates all over the world. Splendid opportunities now in the Merchant Marine. Day and Evening classes. Summer Session. Start any Monday.

EASTERN RADIO INSTITUTE
899 Boylston St. Boston, Mass.

fair it is true, but at least, the writer had the pleasure of building one just like this, out of four wide shingles. And it has served its purpose very well indeed, and in fact is still doing duty in his laboratory phonograph and other tests. The reader will see at a glance just how this horn is built—the bottom is a flat shingle cut so as to taper toward the back; the two side shingles were cut straight along the bottom and taper from the outer top end down to within about 2½" at the back, where they run out so as to form a base by which they can be nailed with brads to the lower sides of the wooden throat member. The top shingle is cut tapered on both sides so as to just cover the top of the chamber tightly and rest firmly against the front of the throat chamber. The down-coming throat chamber is built of ¾" wood (oak in the author's case).

All joints are planed smooth with a carpenter's plane and then glued and nailed with a few small brads. Do not be afraid to use a few brads in building the horn, although many people will tell you there should not be a brad in it.

The main thing to be observed in building any sound chamber is as aforementioned, that it should be as nearly air-tight as possible from end to end, as Prof. Miller pointed out, since if there are any bad leaks or air holes in the chamber, there will be set up false notes or vibrations, or else a weakening of certain harmonics in the vibrations, at the points corresponding to the wave-length location of those air holes or leaks along the chamber.

Be careful therefore in drilling holes in the side of the chamber for the purpose of fitting sound valves and mufflers, etc. If you must do this, make the joint absolutely tight by using brass bushings tightly mounted in the woodwork and a tight-fitting shaft thru these bushings.

Fig. 7 shows a wooden sound chamber of the type illustrated at Fig. 6, mounted in a cabinet of the table type.

When it comes to building a first-class wooden sound chamber, Fig. 8 shows the "Daddy" of them all. All of the best phonographs have a chamber shaped something after this fashion and of course, it is evident at a glance, that this is an ideal form. The air waves can expand and amplify in this chamber, without having to break around any sharp corners, as the curve is a steady and smooth one. The amateur cabinet maker may find it quite difficult to build a chamber of this form, but it can be built by a cabinet maker or else you have one made by a carpenter for a nominal sum. The wood used may be mahogany or some other fairly hard wood, about ¾" to ½" thick, although many commercial phonographs have sound chambers of this shape built of wood ¼" thick or less. Prof. Miller states that the horn should be built of sufficiently heavy wood, so as not to vibrate but to keep the column of air "rigid," so to speak, in order that only this column of air should be vibrated by the sound waves impress upon it at its base, by the reproducer.

LARGE SOUND CHAMBERS.

When it comes to large sound chambers there are often cases where the reader will like to experiment with this, or one somewhat like it that will produce an extra large volume of sound. Figs. 9 and 10 show two examples of ultra-large sound or amplifier chambers which can be made of metal or wood—the writer prefers wood. The arrangement shown at Fig. 9 is a very clever one and it shows how one phonograph manufacturer has designed his cabinet so as to accommodate an amplifying chamber over four feet long.

(Part II will appear in the October number.)

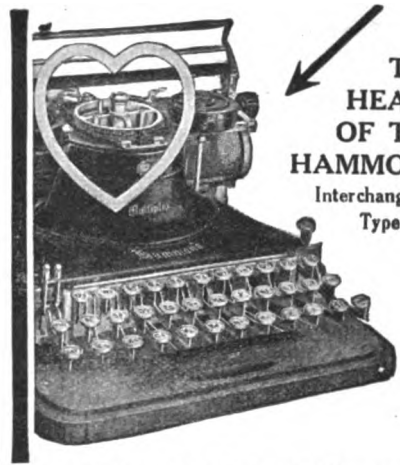

THE HEART OF THE HAMMOND
Interchangeable Type

One of the Greatest Achievements of Science and Invention.

Hammond
MULTIPLEX

"Many Typewriters In One"

For the Mathematician, Engineer, Chemist, Astronomer, Surveyor, Navigator—there is no typewriter like the Multiplex Hammond! The Multiplex does many things that no other typewriter can do!

The Mathematical Multiplex contains the characters and signs used for writing in higher and lower mathematics, and for engineering, mechanics, etc., as well as for all the ordinary work that can be done on any typewriter. Just note these fine styles of Multiplex type—

TWO STYLES OF TYPE, or two to five different languages, carried on the machine AT ONCE. "JUST TURN THE KNOB" and change instantly from Roman Type, to Italics, or Miniature Roman, or our Beautiful Script Type, or from English to Greek, Russian, German, French, etc. Any other type or language can be substituted in a few seconds.

The above gives a slight idea of the versatility of the Multiplex which has literally revolutionized typewriting—has changed it from monotonous commercial work to the beauty of fine printing and engraving.

SEND FOR FREE BOOKLET showing the many languages and type sets of the Multiplex—Chinese Phonetic and Japanese Kata Kana—the latest in languages to be added to the many already available on the Multiplex.

Fill out the Coupon and mail to us now—before you turn this page and possibly forget. You incur no obligation.



Also—an Aluminum PORTABLE Model

For Traveling—for home. Weighs about 11 lbs. Full capacity. Ask for special folder.

THE HAMMOND TYPEWRITER CO.
589 East 69th Street New York City

Name

Address

Please write your occupation below.

Pedigrees

Have you ever traced your pedigree? If you have, you probably discovered that you are the lineal descendant of some great family or individual whose achievements have stood out in history.

How you swelled with pride when you traced the red blood in your veins, the blood of these wonderfully aristocratic men and women.

Just as you take pride in your pedigree, we take pride in ours, going back to the very beginning of the business world, we find that our pedigree runs to the most royal of all royalty.

The House of Service

From the very start we have devoted our time to "Service". We have breathed it, lived it, talked it and as we grow our ideal grows with us—we uphold our pedigree, our one doctrine to all who will let us.

Not only have we traced our pedigree, but the pedigree of our apparatus.

Pedigreed apparatus is the best you can buy, no better can be had, old established, tried and true, instruments of quality, that will give you service at all times.

Why not come to us for the next instrument you need and we will show you—just what we mean by pedigree.

We list one of the most complete stocks of radio apparatus; which includes every manufacturer of responsibility.

Our special department of small parts, just installed, is unique in the fact that we cater to accessories in radio, every necessary part including contact points, switch points, knobs, switches, bushings, etc.; you should not fail to see our special display of these parts, in the first showcase on the right as you enter our showrooms.

You can secure a more comprehensive idea of our service: individual and mail order, by paying us a visit or sending twenty-five cents for catalog, the cost of which will be refunded upon the first order of five dollars.

If you are looking for something in electrical apparatus, we have it, including a most complete line of heating appliances.

Watch this space next month for startling announcement of big importance to all radio men.

Our word of honor to you is our guarantee. Let us prove it.

CONTINENTAL RADIO AND ELECTRIC CORP.

J. DI BLASI, Secretary

J. STANTLEY, Treasurer

Dept. A.1

6 WARREN STREET

NEW YORK

Skinderviken Transmitter Button

for telephone companies, wireless men and experimenters. Over 30,000 sold within last two years. Supersensitive for detectiphones, piano, violin and phonograph; music and speech transmission. \$1.00 each. Circular with instructions free.

Skinderviken Mechanical Stethoscope

detects knocks or defections in running machinery, sensitive as a detectiphone; picks up the sound of your watch; the only instrument for testing the motor of your automobile.

\$5.00 each without battery. You can buy flashlight battery at any dealer.

Switchboard key with 20 springs, \$1.25; Watchcase receiver, 75 Ohm, \$1.25; 5-Ohm, \$1.50; Single headband, \$1.00; Condensers, 1/4 to 2 mf, 60c; Induction coils, 75c; 1000 Ohm ringers, \$1.25; Powerful magnets, 35c; Transmitter complete, \$2.00 to \$2.50. My advertisements in the last two issues of Electrical Experimenter carried a more complete list of electrical supplies; look them up again.

Orders filled same day they arrive. In remitting send enough to cover postage. Ask for price list.

We want representatives in every city in the United States, Canada and Foreign Countries. Interested parties write for details.

J. SKINDERVIKEN

Inventor and sole Manufacturer

414 BROADWAY

NEW YORK

Audion Control Unit only \$13.75

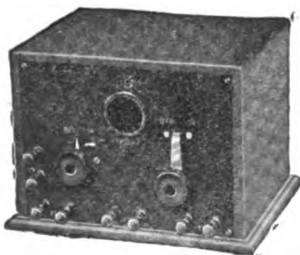

The K. & G. Wireless Supply Co., in its efforts to place technically correct and reliable wireless apparatus well within the price reach of critical amateurs, announces its new Audion Control Unit, Type A1. This new unit is absolutely reliable and can be used with every known circuit. It is designed and built for exacting service. It combines the very latest ideas in design with the best of material and workmanship. The cabinet, 8 1/2 x 6 1/2 x 6 1/2, has a highly polished mahogany finish and with its well mounted panel will add much to the attractiveness of your station. The unit contains these instruments: vacuum tube socket (for standard 4-prong tube) filament rheostat (10 ohms), grid condenser, grid leak, and filament switch. Panel has binding posts, suitably marked in white, for secondary, tickler, phones, and filament battery. Whole back of cabinet swings open on hinges and thus permits easy insertion of tube and batteries and complete inspection of the interior. Efficiency guaranteed, or money refunded.

Price \$13.75, without tube or batteries. If your dealer can't supply you, order direct. Dealers: Write for proposition.

K. & G. WIRELESS SUPPLY CO.

Dept. 15A, 152 Chambers Street

New York City

READ THE CLASSIFIED ADVERTISEMENTS ON PAGES 580-582, YOU'LL FIND MANY GOOD THINGS THERE.

Audion Poem Award

(Concluded)

(Continued from page 513)

And glittering like an opal rare,
As dainty as a butterfly,
You'll be the fairest of the fair,
A blazoned jewel in the sky.
And from old "Sparks" a tear will fall
While treading o'er the pearly path,
For one true pal—a crystal ball,
Ever faithful unto death.

Composed by

CLIFFORD P. MORRISON.

7TH HONORABLE MENTION.

Fighter since he learnt to toddle,
Soldier since he got his growth,
Knows the lightning and the static,
For he's fought and licked 'em both.
Not much figure in a dark room,
Not much hand at winning hearts,
Rotten ringer for old Mazda, but
Right there when something starts.
Just a bunch of wire and vacuum,
But you always feel a bit
That he'll get what he goes after
When he starts to hum and spit.

Jupiter found out all about him,
Set a price upon his head,
Then old Neptune's crafty warriors
Nearly kicked him out of bed.
Ocean waves and ocean currents
Tried to cut off his career,
But since first de Forest made him
It has never slept a gear.

And the souls of all the Amateurs
Give one, big, heart-felt throb
At news that our fragile Audion
Never once threw up the job!

Composed by M. H. CREAGER.

8TH HONORABLE MENTION. THE SONG OF THE AUDION.

'Oft-times when long I sit watching
That tube with its strange little light,
I fall in a fanciful musing,
Strange visions and dreams meet my
sight.

The high-pitched sounds lose their meaning,
I know not what they say.
My eyes grow dim; my senses swim,
And I'm wafted far away.

The sounds change into music.
They sing me a wondrous lay,
And the tiny light before me
Seems the flame of a starry way.

Exultant the song is that's chanted,
Boastful its tone and its key.
Its theme is victory, conquest,
Success and triumphant glee.

It tells of the wonders of Persia,
Of splendors strange and grotesque.
It tells of Scheherezade's stories
And wondrous tales arabesque.

It tells me of strange old inventions,
Of long past glorious ages.
It tells of phenomenal wonders,
The deeds of great men and sages.

And here the song becomes louder,
Pride thrills in the notes of the lay.
For it tells of a far greater triumph
Of our own most glorious day.

Then at last the music grows fainter,
Stilled its victorious glee,
And in proof of the song that was sung me
I hear voices across the sea.

Composed by NASON KENNEY.

Radio Diagrams and Formulae in Loose Leaf Form

The publishers of the CONSOLIDATED RADIO CALL BOOK have completed the preparation of diagrams and instructions on:—

- Measurement of Capacity of a Condenser. (Substitution Method.) Calibration of a Variable Condenser. Two Diagrams and Curve.....No. 1
- Measurement of Inductance of a Coil or Circuit. Two Methods—Two Diagrams.....No. 2
- Measurement of Distributed Capacity of an Inductance. Diagram and Curve.....No. 3
- Measurement of Fundamental Wavelength of an Antenna. Three Methods. Three Diagrams.....No. 4
- Measurement of Wavelength of Distant Transmitting Station. Two Methods. Calibration of a Receiving Set. Two Diagrams.....No. 5
- Measurement of Effective Antenna Capacity. Two Methods. Two Diagrams.....No. 6
- Measurement of Inductance of Antenna and a Third Method of Measuring Effective Capacity of Antenna. One Diagram.....No. 7
- Measurement of Antenna Resistance. Substitution Method.....No. 8
- Schematic Wiring Diagram of Regenerative Audion Receiving Set Suitable for Receiving High Power Undamped Wave Stations. Connections shown are those used in most Navy and Commercial Receivers.....No. 50
- Table giving the value of LC (Product of Inductance and Capacity) for wavelengths from 300 to 20,000 meters. Inductance in Microhenrys.....No. 100
- Table same as above but with Inductance in centimeters.....No. 101
- Schematic Wiring Diagram of Signal Corps Type SCR-68 Radio Telephone Transmitting and Receiving Set.....No. 51
- Schematic Wiring Diagram of Type CW-936 (Navy Submarine Chaser) Radio Telephone and Telegraph Transmitter and Receiver.....No. 52
- Schematic Diagram of Type S.E. 1100 (Navy Flying Boat) Radio Telephone and Telegraph Transmitter.....No. 53

These diagrams and instructions are the most CLEAR, CONCISE, COMPREHENSIVE and CONVENIENT form of instruction that has ever been presented. They are printed on pages size 8½ x 11.

Complete Set of 14 Sheets as described, sent postpaid **75c**

CONSOLIDATED RADIO CALL BOOK CO., Inc.
41 Park Row, New York, N. Y.

NEW VIBRATONE Jr. RADIO TRANSMITTING SET



This Set Illustrated Above Operates on 110 VOLTS, D. C. or A. C. It is absolutely complete as shown. Needs no helix, spark gap, condensers, etc., etc. Simply connect to aerial, ground and electric circuit, and send.

NO BATTERY EXPENSE
Runs all day for 2 cents.
Sends three to five miles.

PRICE \$18.00 COMPLETE
With Key, Plug and 8-foot Cord
Send for descriptive circular 148C—To-day
WIRELESS EQUIPMENT CO., Inc.
168 Greenwich St. New York, N. Y.

9TH HONORABLE MENTION. AVE, AUDION!

Trill on; trill on,
Sweet Warbler of the air!
From your vibrant, happy throat,
You bring to me Celestial Note,
On Waves Ethereal.
You sing of Verities Eternal;
Beyond the Dreams of Myth and Creed—
Back to the Dawn of Life's Young Day!
Trill on; trill on,
Sweet Warbler of the air,
At Morn, at Noon—thru dusky Night,
Sing, Sing to me;
And one, anew,
Thy Tomes of Truth and Light.

Shine on; shine on,
Oh, Thou Eternal Sun
Didst Thou not Shine ere Time begun,
Beguiling Sun?
No palsied hand ere stayed Thy course!
What puny hand would dare rob Thee
Of Thy Eternal Glories?
None, none! But hordes have worshipt
Thee.
Thy Warmth, Thy Light—Effulgent Rays—
Have been the Glory of Unending Days!
Yea, ever and anon
Didst Thou Shine on,
And Sing—Thy Antiphon!
Hast Thou not been the Light
Which drove the darkness into Day?
Didst Thou not Light the Way,
And burn Thy Rays into the nighted brain
Of him whose goods were sterile after-
thought?
Shine on; shine on,
Oh, Thou Eternal Sun!
And let this Music thru Thy Radiant Em-
bers run;
Till Men and Minds shall know
That gods were not
Ere Thou didst Sing,
Thy Antiphon!

Flow on; flow on,
Sweet Rivulets and Babbling Brooks!
Flow on, thru your Sequestered Nooks.
Yea, there I fain would steal,
Into your Sodalties Eternal.
Yea, there to be your Seneschal,
That I might lend a list'ning ear,
To catch the strains purloined by you
From primal maid and happy swain.
Sang you not there
The Antiphon—
Romancing with the Audion—
As Sun, and Moon, and Stars looked on—
Sweet Rivulets and Babbling Brooks?
Pray, let me be your Seneschal
For one fleet moment.
Ah! Now I catch your Honest Laugh?
You bid me quaff? Enough!
So, Ripple on,
Sweet Rivulets and Babbling Brooks,
As Perfumed Sepal, bending low,
Catches the Breath of your onward flow.
Envy? No!
But, Hope that in your After-glow,
Your Ripples and your Dulcet Tones,
May e'er Inspire the Human Lyre,
Adown the Vistas of the Years to come,
As you roll on;
And sing, with Audion,
Your Antiphon!
Composed by S. TYSON KINSELL.

SEAPLANE FLIES BY RADIO COMPASS.

Guided entirely by radio compass signals, the naval seaplane F-5-L recently left Norfolk and flew 95 miles on a "bee line" to pick up the battleship Ohio at sea, with no knowledge at the time of taking the air of the vessel's location. The seaplane then navigated its return to Norfolk entirely by radio compass. Navy Department officials, to whom the flight was reported, said it was the first time radio compass apparatus had been used to direct aircraft to a ship.



HIGH SCHOOL COURSE IN TWO YEARS

You Want to Earn Big Money!

And you will not be satisfied unless you earn steady promotion. But are you prepared for the job ahead of you? Do you measure up to the standard that insures success? For a more responsible position a fairly good education is necessary. To write a sensible business letter, to prepare estimates, to figure cost and to compute interest, you must have a certain amount of preparation. All this you must be able to do before you will earn promotion.

Many business houses hire no men whose general knowledge is not equal to a high school course. Why? Because big business refuses to burden itself with men who are barred from promotion by the lack of elementary education.

Can You Qualify for a Better Position?

We have a plan whereby you can. We can give you a complete but simplified high school course in two years, giving you all the essentials that form the foundation of practical business. It will prepare you to hold your own where competition is keen and exacting. Do not doubt your ability, but make up your mind to it and you will soon have the requirements that will bring you success and big money. YOU CAN DO IT.

Let us show you how to get on the road to success. It will not cost you a single working hour. We are so sure of being able to help you that we will cheerfully return to you, at the end of ten lessons, every cent you sent us if you are not absolutely satisfied. What fairer offer can we make you? Write today. It costs you nothing but a stamp.

American School of Correspondence
Dept. H-625 Chicago, U. S. A.

American School of Correspondence,
Dept. H-620, Chicago, Ill.

I want job checked — tell me how to get it.

.....Architect	\$5,000 to \$15,000Lawyer	\$5,000 to \$15,000
.....Building Contractor	\$5,000 to \$10,000Mechanical Engineer	\$4,000 to \$10,000
.....Automobile Engineer	\$4,000 to \$10,000Shop Superintendent	\$3,000 to \$7,000
.....Automobile Repairman	\$2,500 to \$4,000Employment Manager	\$4,000 to \$10,000
.....Civil Engineer	\$5,000 to \$15,000Steam Engineer	\$2,000 to \$4,000
.....Structural Engineer	\$4,000 to \$10,000Foreman's Course	\$2,000 to \$4,000
.....Business Manager	\$5,000 to \$15,000Photoplay Writer	\$2,000 to \$10,000
.....Certified Public Accountant	\$7,000 to \$15,000Sanitary Engineer	\$2,000 to \$5,000
.....Accountant & Auditor	\$2,500 to \$7,000Telephone Engineer	\$2,500 to \$5,000
.....Draftsman & Designer	\$2,500 to \$4,000Telegraph Engineer	\$2,500 to \$5,000
.....Electrical Engineer	\$4,000 to \$10,000High School Graduate	In two years
.....General Education	In one yearFire Insurance Expert	\$3,000 to \$10,000

Name.....
Address.....

Here's How To Get This Great Wireless Book FREE



MANHATTAN ELECTRICAL SUPPLY CO., INC.

Follow instructions below and get our new 1920 Wireless Manual. Describes how messages travel, putting up equipment, and all other points. Gives the codes, too. A handy text book and catalog combined — the finest ever published.

Sent for only 25 cents. Ask for Wireless Manual W-12. We credit the 25 cents on first order. Thus, you get this splendid book FREE.

Address nearest office.

Manhattan Electrical Supply Co., Inc.
New York Chicago St. Louis San Francisco

No Seals-No Secrets —But Service!

Inspection of the interior of any Radio apparatus bearing the mark:



reveals design and workmanship fully in keeping with its outward appearance.

GREBE RADIO apparatus is licensed under the original Armstrong and Marconi patents.

Our guarantee is absolute and unconditional. Each instrument must give satisfactory service. Our interest in the purchaser does not terminate with the sale.

Ask your dealer to show you our line of super-grade apparatus. If he doesn't carry it, write us—mentioning his name—for catalogue.

A. H. GREBE & CO., Inc.,
70 Van Wyck Blvd., Richmond Hill, N. Y.

LET'S FINISH THAT SONG

A C E

(Continuation of last month's storm)
(Tune—Battle Hymn of the Republic)
First you write a little letter,
It's addressed to Doctor Ace.
You will never find one better
For he always sets the pace.
He will give you all the data
So you may get in the "race".
Then you'll get the signals too.

EXPERIMENTERS. Ask your dealer about our high grade goods including latest C-W Apparatus. DEALERS. You are missing the ACE line if you fail to have our goods in stock. Ace Apparatus sells itself. —REMEMBER—"You may pay more. But you can't buy better."

THE PRECISION EQUIPMENT CO.
CINCINNATI, OHIO
Dept. E 2437 Gilbert Avenue

YOU Can Double Your Ability to Earn Money! Hold Friends! Win Love and Happiness! Our System of Personal Efficiency tells you how! Success Studygram and Personality Sketch for 10c and birth date. Thomson-Heywood Company. Dept. 350, Chronicle Building, San Francisco.

The Airplane of the Future

By H. GERNSBACK

(Continued from page 485)

York in the morning and return to London on the same day.

As will be noted, the new machine offers hardly any resistance to the air whatsoever and not even a landing gear is exposed. The landing gear in this instance will imitate our birds in flight, which pull in their feet as they fly; this they do simply to cut down air resistance. One of our illustrations shows how the landing gear is pushed thru the bottom of the airplane when a landing is to be made. Otherwise the chassis is drawn within the shell of the airplane and is not at all exposed. A side view of the machine is given in one of our illustrations, as is another view of the machine as it appears in flight when looking toward it. From this view it will be seen that a rib-like bulge runs from nose to end of the machine, the under surface of both sides of the wings being curved, with the curve toward the ground, which is necessary in order to "catch" the air. If the under side of the machine was absolutely flat, there would be considerable air "slippage" and the air would not be caught anywhere as well. In the bottom view of the machine we also see a number of holes thru which the chassis or landing gear is lowered when the machine wishes to alight. Furthermore, on each side of the machine are a number of landing skids, on which the plane rests or slides when making a landing. These skids also retract within the wings of the airplane and are not visible while the machine is in flight, therefore they do not show in our illustration. The small circular holes in this illustration are glass portholes.

The entire envelope of this machine is made of magnesium, a metal 30% as light as aluminum. Indeed, this is the very metal that was used in Mr. Stout's machine. Magnesium is a brilliant white metal and is quite strong as compared to aluminum. The entire machine as a matter of fact can be readily built of this metal, which would give the giant airplane an extraordinary light weight considering its huge bulk. The thousand-foot machine which we show in our illustration can easily transport 1,000 to 1,500 people in addition to a large amount of freight.

The speed of the machine as aforesaid may be 500 miles or more. As a matter of fact, there is nothing to hinder us from making the speed even greater, and we will surely see in the future machines that fly at a speed of 1,000 miles or more. The only drawback to such speeds will be the difficulty in retarding the speed sufficiently in order to make a landing.

Take a machine that flies at the rate of 500 miles an hour; that means over 8 miles a minute! From this it will be seen that when the machine wishes to land it cannot do so instantaneously, but the pilot or captain must start to slow down from five to ten minutes before the landing is made. If this is the case, naturally a good deal of the speed or rather the distance covered by the machine will be sacrificed. Of course, the huge 100-foot propellers can and will be reversed in most cases, and this will be about the only way that the speed of the machine can be checked rapidly. Naturally this causes great strains not only upon the propellers but upon the airplane itself and is the one thing that must be contended with when we reach such high speeds.

The next thing is the actual landing of such an aerial monster weighing perhaps 5,000 tons or more. Even a tyro will understand that this task becomes a problem of vast magnitude.

MEMORIZE CONTINENTAL CODE ALMOST INSTANTLY

This method THE short cut to success

Get Wise. Ask for latest reports from Successful, Satisfied, Grateful, Grateful Users, Maine to California—Texas to Canada. Free on request or

COMPLETE CHART
and full instructions 50 CENTS

C. K. DODGE
Box 300 Mamaroneck, N. Y.

Binding Post and Switch Points Commercial—Standard

SPECIAL—
Binding post made of brass, nickel-plated and polished.

No. 1—size, 1/4 in. diam. 1/2 in. high, per doz.	\$.75
No. 2—size, 3/8 in. diam. 3/4 in. high, per doz.	1.05
No. 3—size, 7/16 in. diam. 15/16 in. high, per doz.	1.10
No. 4—size, 1/2 in. diam. 1 in. high, Bunnell Pattern, per doz.	1.75
No. 5—Double Post, 1 1/2 in. high, three for65
No. 6—Triple Post, 1 1/2 in. high, three for65
No. 7—Contact Points, 7/32 x 7/32 in. head, with 4-36 screw, Brass, 3 dozen for80
No. 8—Contact Points, nickel-plated, with threaded shank and nut, same size head as above, 3 dozen for 1.05

Our new price list of raw materials and parts now ready, sent to any address on receipt of 5 cents in stamps, which will be refunded on first order to the amount of \$1 or over.

KEYSTONE RADIO COMPANY
Drawer 307, Greenville, Penn.

Prompt Service

We pay special attention to all mail orders and will send apparatus post-paid anywhere.

.0005 Condensers Grid	Each
.0013 Condensers Stopping	} \$.35
2,000 Ohm Phones 4.50
3,000 Ohm Phones 5.50
Adams-Morgan Rheostats 1.75

For a more complete list of instruments send 10c for catalog, cost will be deducted from first \$1.00 order.

RADISCO AGENTS

Open Evenings until 9:30 P. M.
KELLY & PHILLIPS
312 Flatbush Avenue, Brooklyn, N. Y.

Radio Men

The Mutual Purchasers Association will save you money on all

Wireless Apparatus

Write Dept. E.E. for details.

MUTUAL PURCHASERS ASS'N,
2-4 Stone Street, New York

ARLINGTON TESTED CRYSTALS



Why buy minerals on a guess? Be SURE when you buy a crystal in your detector or that it is EXQUISITELY SENSITIVE. Buy Arlington Individually tested Minerals, Galena or Silicon, post paid on receipt of price.

THE NEWMAN-STERN CO.
Dept. E. E. Cleveland, O.

Radio Handbook & Catalogue



Contains much valuable radio information, tables and data. Describes a remarkable line of wireless instruments including "Kitted Head" Phones, Arlington Tested Minerals, DeForest, Murdoch and Signal Apparatus. Write for this book today. The Newman-Stern Co. Dept. E. E. Cleveland, O.

Red Head Radio Phone



The accepted standard in wireless receivers. If they are not BETTER than anything you've ever seen return them for full cash refund. Our Radio Handy Book and Catalogue, free on request, describes them, and many other instruments. The Newman-Stern Co. Dept. E. E. Cleveland, O.

**For Homes, Offices,
Factories, Farms**

**Complete Wall Set
Magneto Telephone**

Western Electric Type



This is a complete commercial telephone station. They were bought from telephone exchanges who put in Central battery types. Slightly used but guaranteed to be in A1 working order. The cabinet is of polished oak, piano finish, within which is con-

tained the powerful magneto, the 300 Ohm polarized ringer, an induction coil. The magneto is exceptionally efficient, being of the two bar type with brass gear transmission. The extra sensitive microphone, mouthpiece and two gongs are mounted on the front of the cabinet, giving the entire instrument that desirable appearance of compactness and efficiency. Guaranteed to work over 20 miles. The telephone receiver is a double poled one, and has a hard rubber case. Seven binding posts are provided for connections.

The instrument is one which we can offer with pride to our patrons at a ridiculously low price. It is unobtainable anywhere else at less than \$15.00 and is an instrument unequalled in value for the price we ask. Size over all 11x10x3 in.

Long Distance Telephone Set—
One station.....\$7.00
Shipping weight, 15 lbs.
Two stations
Shipping weight, 25 lbs.....\$13.00

Send 6c in stamps for our big 80 page Wireless and Electrical Catalog No. 22.

The Electro Importing Co.
231 Fulton Street, New York

**Make Your Own
ELECTRICAL APPARATUS**
with the help of our
RELIABLE BOOKS
Send for price list No. 138
COLE & MORGAN, INC.
Publishers
188-190 Greenwich St. New York

For example. A locomotive is always upon the ground and can easily retard its speed by slipping over the rails; the tremendous friction set up soon stops the train. A steamship is never out of the water, and being in so dense a medium can easily retard its speed by reversing its propellers. But the airplane on the other hand has two entirely different things to contend with. In the first place, it not only must reduce its speed from a high speed to practically nothing before it can make a landing, but it also must make the transition from one medium to another, namely, from the air, a very thin medium, to the ground, a very dense medium. When we come to do this with a 5,000-ton weight, it will be readily seen that this becomes a ticklish problem. Off-hand it would seem to be almost impossible to bring so huge a weight safely down to earth without special contrivances not yet invented. Luckily there is one element in landing such a huge machine which has perhaps occurred to few people, and the writer herewith desires to advance it with diffidence.

Due to the very large surface of the machine this makes the landing rather easy for the very simple reason that the machine acts as a parachute, unlike a dead weight that does not displace much air. If the machine is designed right, and if the center of gravity of the machine is correctly calculated, and if the curvatures of both of the undersides are correct, it should be possible to stop the propellers just before the machine reaches the ground. Then by quickly reversing the propellers the huge airplane would then descend not unlike a parachute. In other words, the air between the machine and the ground cannot get away fast enough without acting as a buffer on the airplane, which would therefore descend at a slow speed similar to a parachute.

Therefore, the bigger and larger we make such a flying machine the more safely will it be possible to land it. Of course, it goes without saying that the weight of the machine in proportion to its surface must not reach beyond a certain figure, for if the weight becomes too great gravitation will overcome the parachute effect and the huge craft will come down too quickly. This, however, is a problem for the engineer to work out.

Should it not be possible to land these huge air monsters as advanced above, then perhaps it may be found that it will be safer to "land" them on a sheet of water specially prepared for "landing" purposes. If the airplane of the future is equip with retractable pontoons, then it would be a simple matter to make a landing on a small natural or artificial lake, which would thus constitute the "Air Port." Perhaps such a landing would be safer and preferable to a ground landing.

IF you should be called upon to - night to resent an improper remark about someone you love, could you play a man's part?

SUPPOSE a ruffian insults you, or worse still, passes a stinging remark about your mother or sweetheart. What will you do? The bully probably knows enough about boxing to give you a good beating. Prudence would tempt you to swallow the insult and slink away. But your pride won't let you do that—you're too much of a man—so to save yourself from disgrace you fight. And if you are like most men who know nothing about boxing, your opponent will give you a sound thrashing.

Or suppose you are waylaid on a deserted street. Unless you know how to overcome your opponent and escape, it is likely that your friends will find you lying unconscious.

Now how much longer are you going to take chances with your helplessness? The excuse that you are too old or too young to learn boxing, that you haven't the time or the money, doesn't hold good. We are teaching boxing to over 7,000 students—some of them old men, some of them boys, and we know from experience that after studying the Marshall Stillman System of Self Defense the majority of them are able to outbox stronger and heavier opponents.

It won't cost you a cent to try this course. We send it on 10-day approval. Practice some of the lessons. If at the end of ten days you feel that we can't teach you boxing and self-defense, return the course. Should you decide to keep it, simply mail \$5 in complete payment.

This course is based on the methods used by Professor Mike Donovan, who for years taught boxing at the New York Athletic Club. The lessons take place in front of your mirror. You start with things you already know, such as the breast stroke in swimming, stretching out your hand for a coin, etc. Step by step you are led from these movements to similar movements in boxing and before you know it you find yourself striking powerful blows, ducking, feinting, guarding, side stepping, etc., just as if you had a real opponent in front of you.

When you've mastered the fundamentals—the hit, guarding, ducking, feinting and foot work—you take up shadow boxing, in which we describe and illustrate such blows as the Fitzsimmons Shift, the Jack Dempsey Triple Blow, the Mike Donovan Double Blow, etc.

But the course does not stop with boxing. To properly defend yourself under all circumstances you must also know something of Jiu-jitsu and bone-breaking holds and releases. After you have mastered these lessons, you will know such valuable stunts as disarming an opponent who holds a pistol, dagger or club, releasing his hold on your throat, freeing yourself from an opponent who has locked his arms around your neck or waist, guarding against a kick for your stomach, etc.

There's also a complete set of daily muscle-building exercises to keep you fit. And to every student we send a copy of "Boxing Blows and Guards" which shows every good blow and guard known to the ring. There are 175 illustrations in the entire course.

Hundreds who read this advertisement will send for the course; they will practice a few of the lessons and see immediately that the course is practical, and will go on with it. When they are through they will know how to defend themselves like real men. If you want to be one of them, mail the coupon below to the Marshall Stillman Association, 461 Fourth Avenue, Suite E-108, New York City.

FREE TRIAL COUPON
MARSHALL STILLMAN ASSOCIATION
Suite E-108, 461 Fourth Avenue, New York
You may send me on approval your complete course in Boxing and Self Defense as described above. I have always been faithful in paying my obligations and I give you my pledge that you may feel safe in trusting me as agreed and that I will either return the course, or remit \$5 (Canada \$6, foreign countries \$7) in 10 days.

Name
Address

ORIGINAL MECANEL TELEPHONES

A highly developed telephone that stands favorable comparison with high-priced commercial telephones. Only two wires are required for the installation, there being no other phone on the market that will operate on less than three wires, due to the fact that an entirely new feature is embodied in the MECANEL TELEPHONES. They are ideal time-savers for house, farm, field or office use. By simply lifting the telephone off hook, a REAL BELL will ring at the other end until someone answers. They will operate at a distance of 200 ft. with four batteries and greater distances with additional batteries. Simple diagrams and instructions with each set.
Price \$5.00 Postpaid Money Back Guarantee
INLAND SPECIALTY COMPANY, 1562 N. Robey St. Chicago, Ill.

Check the Job You Want!
Thousands Men—Boys Wanted

.. Railway Mail Clerk \$16 0 to \$2800 .. Customs Positions \$1200 to \$1800
.. Postoffice Clerk \$1400 to \$1800 .. Internal Revenue \$1800 to \$2000
.. Postoffice Carrier \$1400 to \$1800 .. Stenographer \$1340 to \$2000
.. Rural Mail Carrier \$900 to \$2360 .. Clerk at Washington \$1340 to \$2000

Name
Address

Sign your name and address and send us this coupon immediately. We will immediately send you (1) a full description of the position checked, (2) a list of many U. S. Gov't Jobs now open and directions telling how to get free coaching for the position checked.
Franklin Institute, Dept. B161 Rochester, N. Y.

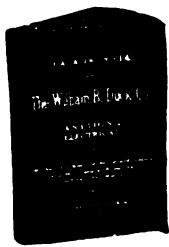

DUCK'S

New Big 200-Page No. 14
Wireless Catalog and 100
Page Electrical Catalog

The wireless catalog mailed for 12c and the electrical catalog for 6c. either in stamps or coin, which amount you are privileged to deduct on your first order of \$1.00. Catalog positively not sent otherwise.

This edition of our wireless catalog is the most complete and elaborate we have ever put out. It embraces everything in wireless worth while. As an encyclopedia of information it is invaluable. It is printed on excellent paper and with a beautiful cover. Your amateur friend will tell you that there never has been any wireless catalog to take the place in this catalog. In a word it is all worth while catalogs in one.

of Duck's, and above all that you can absolutely rely on the quality of every instrument listed in this catalog.

Audio Tron bulbs prepaid \$6.00

We discontinued selling Audio Tron bulbs and accessories for a short time but we have again resumed their sale and also panel sets, and can guarantee immediate delivery.

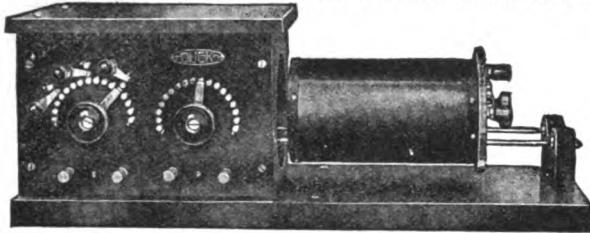

NEW MODEL 5BB. NAVY TYPE RECEIVING TRANSFORMER

A big improvement over our former model. Primary divided into four sections, with three dead end switches, greatly improving selectivity. Secondary divided into three sections, with two dead end switches, eliminating harmonics. The change in the construction of the guide rod support makes it possible to obtain a looser coupling. It is a wonderful improvement over our old model both in performance and appearance. Only \$27.50.

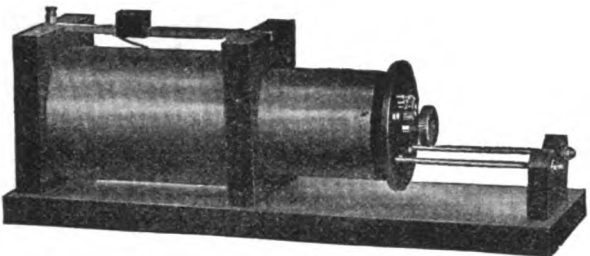

OUR IMPROVED ARLINGTON RECEIVING TRANSFORMER

The secondary on our new type Arlington is divided into three sections with two dead end switches, eliminating dead end effect and harmonics and giving greater selectivity. The end support is similar to that on our Navy type, permitting a looser coupling. It is a beautifully finished instrument.

Price only \$15.00

THE WILLIAM B. DUCK CO., 230-232 Superior St., Toledo, Ohio

How to Become a Professional Radio Man

By PIERRE H. BOUCHERON
(Continued from page 515)

tors and it is hoped that few of this type are at large today. The new element of radio men who go to sea, nowadays, is for the most part above this sort of petty childishness and ill-breeding.

An operator should never fail to remember that altho he may be paid by the radio and not the steamship company, nevertheless, as soon as he has signed the ship's articles, he is as much a member of the crew as any sailor or fireman.

Moreover, if an operator is going to conduct his business on the theory that the ship's officers have nothing to say or do with him, it is very likely that he is not going to find the business of going to sea very agreeable. There are any amount of shell-backs who will do their level best to make things miserable for "Sparks".

Of course, as in all other walks of life, one will encounter small, mean, narrow-minded seafaring men who have little faith in humanity and still less in radio operators; who are ever-ready to find fault and to make it as uncomfortable as possible for everyone about them. Here I have nothing new or enlightening to offer on the subject of dealing with such persons, but in the long run one will find that even these monsters may be brought around quite nicely by the use of a little tact and patience; otherwise known as "kidding them along". This may even be accomplished without the slightest loss of personal pride and self-respect, if one is willing to use a little common sense and give in to trifles.

The Second Edition of the

Consolidated Radio Call Book

is the only book in print officially listing all the radio calls as issued by the Bureau of Commerce. Every vessel and land station in the world is represented and listed alphabetically, according to names of vessels or land stations, and according to call letters; Revision of American coastal stations under U. S. Naval control, and their new calls.

ALL AMATEUR CALLS ALSO LISTED

SPECIAL

Given Free With Each Copy

A Wireless Map of the World in colors is given absolutely free with each copy. This map shows the locations of all the high powered RADIO stations in the world, including the time signal stations. In addition it tells at a glance how far away any of these stations are. Of greater interest are the time zones, which enable the amateur to compute instantly the correct time for the zone in which he is located from any time signal station.

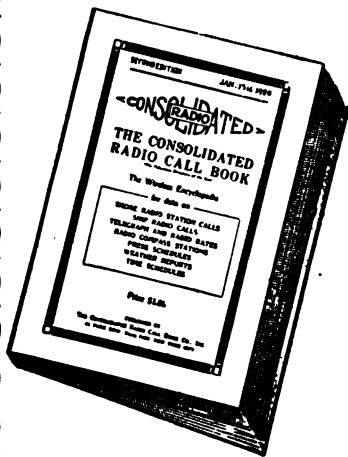

Price \$1.25 Prepaid Either Direct from us or for sale by the following responsible dealers:

- | | | |
|---|--|--|
| American Electro Technical Appliance Co., 235 Fulton St., New York, N. Y. | McCarthy Bros. & Ford, 75 W. Mohawk St., Buffalo, N. Y. | Reuter Electric Co., 34 East 6th St., Cincinnati, Ohio |
| Atlantic Radio Co., 34 Batterymarch St., Boston, Mass. | A. C. McClurg & Co., 218 So. Wabash Ave., Chicago, Ill. | Rudolph Schmidt & Co., Inc., 51 Main St., E., Rochester, N. Y. |
| L. Bamberger & Co., Newark, N. J. | Mohawk Electrical Supply Co., 325 So. Warren St., Syracuse, N. Y. | Shaffer's, 107 Granby St., Norfolk, Va. |
| J. H. Bunnell & Co., 32 Park Place, New York City | Newman-Stern Co., 1874 E. Sixth St., Cleveland, Ohio | Shotton Radio Mfg. Co., 20 West 5th Street, Charlotte, N. C. |
| California Electrical Supply Co., 648 Mission St., San Francisco, Cal. | Nola Radio Co., 134 Chartres St., New Orleans, La. | Smith Norvotoy Electric, Inc., Third and E Sts., San Diego, Cal. |
| L. W. Cleveland Co., 441 Congress St., Portland, Me. | E. P. Noll & Co., 21 No. 7th St., Philadelphia, Pa. | Southern Electric Co., 316 Union St., Seattle, Wash. |
| Cutting & Washington Co., 6 West 48th St., New York City | Pioneer Electric Co., 137 East 5th St., St. Paul, Minn. | H. E. Williamson Electric Co., 715 South Hope Street, Los Angeles, Cal. |
| De Forest Telephone & Tel. Co., 1391 Sedgwick Ave., New York City | F. D. Pitts Co., 12 Park Square, Boston, Mass. | Jos. M. Zamolski Co., Baltimore, Md. |
| Dewey Sporting Goods Co., 288 West Water St., Milwaukee, Wis. | Precision Equipment Co., 2437 Gilbert Ave., Cincinnati, Ohio | Young & McCombs, Rock Island, Ill. |
| Doubleday Hill Electric Co., 719 Liberty Ave., Pittsburgh, Pa. | Radio Corporation of America (Marconi Co.), Gay and Pratt Sts., Baltimore, Md. | Geo. S. Saunders, 168 Washington St., Boston, Mass. |
| A. T. Hovey, 61 Belvidere St., Boston, Mass. | Radio Distributing Co., 4 West Park St., Newark, N. J. | Wireless Shop, 511 W. Washington St., Los Angeles, Cal. |
| Lester I. Jenkins, 923 Purchase St., New Bedford, Mass. | Radio Engineering Co., 827 Madison Ave., Baltimore, Md. | Post Office News, 33 W. Monroe St., Chicago, Ill. |
| Klaus Radio Apparatus, Eureka, Ill. | Radio Equipment Co., 630 Washington St., Boston, Mass. | Meter Electrical Construction Co., 11 Otter St., Oshkosh, Wis. |
| Arno A. Kluge, 638 So. Figueroa St., Los Angeles, Cal. | | United Radio Telegraphers' Association, 505 E. Baltimore St., Baltimore, Md. |
| Manhattan Electrical Supply Co., 17 Park Place, New York City | | American Hardware Stores, Bridgeport, Conn. |
| Manhattan Electrical Supply Co., 114 S. Wells St., Chicago, Ill. | | |
| Pine St., St. Louis, Mo.; 604 Mission St., San Francisco, Cal. | | |

Published by

Consolidated Radio Call Book Co., Inc. 41 PARK ROW, NEW YORK CITY

Many operators step aboard a ship for the first time with the belief that unless they show "some class" they will be made light of. This is wrong; there is never any need of bull-dozing or braggadocio when one would seek to accomplish their means. Rather give in to the little things than dispute anyone's word, particularly with the word of a man who has spent a lifetime at sea and ought to know what he is talking about. Wait until something of vital importance to your welfare or integrity is at stake; then it will be time enough to dispute the rights of an operator. After all, the big things are the ones that count.

THE CAPTAIN.

Too much stress cannot be laid upon the importance of respecting and obeying this important personage. Have ever before you the fact that once the ship is outside the three mile limit, the captain is King—he is the law; he is Emperor; he has the last word to say, in fact he is Lord of all he surveys. That little tub splashing about on that mighty expanse of water is under the supreme command of the Captain. Upon him rests the safety and sometimes the destiny of the several handfuls of men as well as women who chance to be on board. *What he says goes.* Usually he is a well-seasoned, conscientious and experienced sea-dog and he will not abuse the authority rested upon him by international mercantile marine laws. There is some sort of an unwritten rule of the sea that in a shipwreck the captain and the wireless operator are the last to leave the ship,—providing they are fortunate enough to reach that point. For that reason as well as many others which the prospective wireless operator will soon learn, it behooves you to keep on the right side of him. In fact the success of your work, the amount of pleasure you are able to secure on various voyages, as well as your personal comfort on board ship depends primarily upon how you impress the captain. Some skippers are often attacked with a reckless desire to curtail many most desirable privileges and liberties.

In a smaller measure the same may be said concerning other high officers of a ship such as the Chief Engineer, the Chief Mate, the Chief Purser, the Chief Steward (your stomach is concerned here) and their various assistants. The real radio operator will do his utmost to please these men and assist them in every way possible, whether it be the securing of the time signals, daily news, baseball scores, weather reports, positions of other vessels, et cetera. *A word of warning:* don't resort to the time-honored practise of blaming it on "static" when you are unable or have failed to copy "press."

It is the boast of several radio operator friends of mine that they have made the New York to Havana, New York to Galveston, New York to Mexico, New York to Liverpool runs for several solid years without ever once missing the "daily press" texts transmitted by the high power stations nightly and which both crew and passengers so eagerly gobble-up the next morning. It is true that there are nights when "static" interference is very severe and it is sometimes very difficult to copy two straight words in succession without missing the next three. Long practise in copying thru all manner of interference and their ability "to patch up" and make sense in broken-up sentences where many words have been "lost", no doubt comes to them in good stead. There is, therefore, no reason why you cannot do the same, once you have gotten into the "swing of it."

(Part II—will appear in the October number.)

ADAMS ^{GREAT} _{SECRET} MANUAL

1920 EDITION

ADAMS SECRET MANUAL

HOW TO MAKE ELECTRICAL CHEMICAL & WIRELESS APPARATUS, DEVICES ETC. WRITTEN AND PUBLISHED FOR THE NONTECH. EXPERIMENTER

PRICE \$ 2.95

The GREATEST BOOK Ever Issued for Making Electrical, Chemical Wireless Apparatus, Supplies, etc., at little cost

TELLS HOW TO MAKE

- Print-O-Graph for 50c** prints circulars, letterheads, signs, etc., in one or more colors. Print labels, stickers and envelopes at 25c a thousand.
- Wireless Telephone** without aerials, easy to make. Materials required are receiver, transmitter, battery and wire. Transmits clearly at any distance.
- Burglar Alarm**, closed circuit for \$1.00. Bell rings automatically when wire or tin-foil is broken. Without relays, electro magnets, buttons, springs, etc.
- New Electric Battery for 50c.** Charge it at home. Without electricity, wet or dry batteries. This battery produces 12 volts.
- Wireless Set for \$1.00.** Not Will not send 1,000 miles, but is an efficient wireless apparatus that will operate anywhere if instruments are carefully made.
- Aeroplane Photography**—photograph your town, and make the picture look as if photographed from an aeroplane; tell them you were up and made a snapshot.
- Liquid Pocket Flashlight for 25c** gives steady light for six weeks with one charge without matches, oil, wicks, batteries, etc., handy and safe as a flashlight.
- Hypnotism made easy** with this chemical method—anyone can easily be hypnotized; results guaranteed. No high brow language, but plain, simple instructions.
- Telegraph electricity free.** You can get 7 volts of earth electricity free, anywhere, anytime; never runs down; this electricity operates lines up to 2 1/4 miles.
- New Electric Telephone**—With only one ordinary receiver at each end of the line you can receive and also transmit with it at any distance.
- Catch Fish Quickly**—By hundreds or dozens; when this chemical is placed in the water all fish will come to the top intoxicated ready to pick up.
- Old coins made visible.** Unreadable impressions on any old coins can be made readable again without cost. This secret is indeed valuable.
- Midget Ice Plant for 50c.** Freezes a daily supply of pure cold ice for a few cents in any season and in any part of the world.
- Self Lighting Gas**, an inexpensive chemical. Once applied to any gas mantle or burner. Lights the gas instantly, when turned on.
- 400-Mile Condenser for 25c.** Will operate satisfactorily up to that distance. This variable condenser is very simple and easy to make.
- Wireless Set without Aerials**—How to send and receive messages anywhere, anytime, without aerials, wires, coils, etc.
- New Process Embossing**, or raised colored letters on stationery, post cards, etc., for 25c a hundred, without presses, dies, etc.
- Mysterious Ball.** With this homemade ball you can pitch the most peculiar curves, such as no ballplayer can catch.

Actually Tells:

- How to Make any phone receive wireless calls.
- How to Make genuine stamp photos at 2c a doz.
- How to Make an electric walking stick.
- How to Make a small hand camera for 25c.
- How to Make A. C. Transformers for 10c.
- How to Make a small motion picture camera.
- How to Make a vest pocket wireless telegraph.
- How to Make practical storage battery for 25c.
- How to Make unbreakable flexible mirrors.
- How to Make 16 x 20-inch photos for 10c.
- How to Make rubber bands for 50c a thousand.
- How to Make duplicates of old stamps at 2c a doz.
- How to Make a simple, sensitive radio amplifier.
- How to Make a good battery recharger for 5c.
- How to Make an electric gas lighter for 10c.
- How to Make an invisible aerial.
- How to Make any clock run 2 yrs. with winding.
- How to Make or buy moving pictures at 1/4 c a ft.
- How to Make dry batteries last 3 times as long.
- How to Make an experimental battery for 5c.

MAKE A REAL SPEEDY MOTORCYCLE from any old bicycle in a few hours with ordinary home tools. Materials and parts are very cheap. You simply attach them to your bicycle and presto—your motorcycle is ready. The price of Adams Secret Manual is \$2.00, but because it is impossible to completely describe it in the limited space available, we are willing to send it anywhere prepaid for only a \$1.00 deposit, and as a special offer we will also send along material to make a simple, unique

SENDING AND RECEIVING SET FREE

with key sounder, switches, detector, etc., absolutely FREE. And still more, you can return the book and material if anything is misrepresented, and your deposit will come back as quick as Uncle Sam can carry it. Otherwise remit the \$1.00 balance. Can anything be airer? Experimenters, take advantage of this remarkable offer now—you may never see it again. SEND THAT \$1.00 TODAY. You'll be sorry if you don't—you'll be glad if you do.

ADAMS A. F. ADAMS ELECTRIC COMPANY, CHICAGO **ADAMS**
ADDRESS—1305 PEORIA STREET
10 Per Cent Discount for Cash in Full With Order and Money Back as Guaranteed

POWER!
O! Boy! but my car runs fine with the ALSOP ALL-SPARK. I have no more spark-plug troubles

The Alsop-All-Spark Will Keep Your Cylinders Free From Carbon, Too

This Test Proves It

During the war, government officers made comprehensive tests with the Alsop-All-Spark. Several automobile motors were filled with oil and run until the cylinders were so heavily coated with carbon that the motors refused to explode. The Alsop-All-Spark was then attached and the cars started at once. At the end of ten minutes, the spark plugs and cylinders were found to be absolutely free from carbon.

An Alsop-All-Spark on your car will do likewise. It will also save gasoline and make new spark plugs unnecessary.

Why don't you try an Alsop-All-Spark Intensifier on our risk? If you find it unsatisfactory from any reason whatever, you may return it and the full amount of your remittance will be refunded.

The four cylinder type sells for \$7.50. Decide at once to at least give the Alsop-All-Spark Intensifier an adequate trial. We take all the risk. Or, ask us to send you a complete report of the government tests mentioned above. Mail the coupon today.

ALL-SPARK IGNITION COMPANY, Inc.
13-X Water Street New York, N. Y.

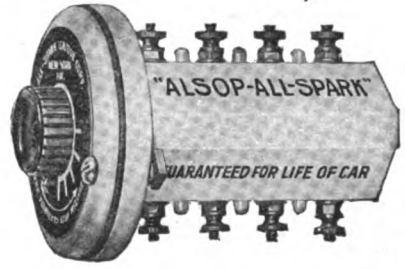

ALL-SPARK IGNITION COMPANY
13-X Water Street, New York, N. Y.

Gentlemen:

Enclosed please find remittance for \$7.50 for which please send me one Alsop-All-Spark Intensifier for a four cylinder engine.

Please send me circular describing the Alsop-All-Spark Intensifier and full report of Government tests, at once.

Name

Address

City..... State.....

Opportunity Ad-lets

YOU will find many remarkable opportunities and real bargains in these columns. It will pay you to read and investigate the offerings made every month by reliable firms, dealers and amateurs from all over the country. No matter what you may be seeking, whether supplies, automobile accessories, the opportunity to make money, or anything else, you will find listed here the best and most attractive specials of the month.

Advertisements in this section ten cents a word for each insertion. Name and address must be included at the above rate. Cash should accompany all classified advertisements unless placed by an accredited advertising agency.

Ten per cent discount for 6 issues, 20 per cent discount for 12 issues. Objectionable or misleading advertisements not accepted. Advertisements for the November issue must reach us not later than September 22.

The Circulation of Science and Invention is over 150,000 and climbing every month

EXPERIMENTER PUBLISHING CO., INC., 236 Fulton Street, New York, N. Y.

Agents Wanted.

\$10 Daily refinishing chandeliers, brass beds, automobiles by new method, without capital or experience. Free particulars and proofs. Write today. Gunmetal Co., Avenue D, Decatur, Ill.

Big money and fast sales. Every owner buys gold initials for his auto. You charge \$1.50; make \$1.35. Ten orders daily easy. Write for particulars and free samples. American Monogram Co., Dept. 71, Glen Ridge, N. J.

Agents—"Stick-On" Locks render open windows absolutely burglar-proof. Sale season now on, act quick. Sample 25 cents. Transo Co., Greenville, Ohio.

Make \$30.00 next Saturday. Speederator for Fords selling like wildfire. Used by Ford Motor officials. Makes any Ford run like a Packard. Stops stalling and bucking. Put on quick—instant satisfaction. No holes to bore. Sell ten to twelve a day easy. Splendid profits and exclusive territory. Write quick for information. Address Perrin Co., 1047 Hayward Bldg., Detroit, Michigan.

Agents. Big returns, fast office seller; particulars and samples free. One Dip Pen Co., 12 Daily Record Bldg., Baltimore, Md.

Would year-round quick seller interest you? Dept. 9, Martinek Company, 405 Lexington Avenue, New York.

Mexican Diamonds flash like genuine, fool experts, stand tests, yet sell for 1-50th the price. Few live Agents wanted to sell from handsome sample case; big profits; pleasant work. Write today. Mexican Diamond Imp'tg. Co., Box F1, Las Cruces, N. Mex.

Agents—\$40-\$100 week; free samples; gold sign letters; anyone can put on store windows; big demand; liberal offer to general agents. Metallic Letter Co., 433-Z, N. Clark, Chicago.

Signs for store and offices. Entirely new. \$50 week easily made. Chicago Sign System, G-326 River St., Chicago.

\$3.30 hourly, selling electromagnetic plates at 25c. Decker sold 742 in 5 days; made \$163.42. Send 2c. stamp for extraordinary sales-plan and free sample. A. F. W. Bowbeer, 947 Fedora, Los Angeles, Cal.

Insyde Tyres, inner armor for automobile tires double mileage and prevent punctures and blow-outs; quickly applied; cost little; demand tremendous; profits unlimited. Details free. American Automobile Accessories Co., Dept. 54, Cincinnati, Ohio.

Agents Wanted. To sell automobile accessories for four-cylinder cars; quick seller and big profits. No investments required. All-Spark Ignition, 13 Water St., New York City.

Make and Sell Your Own Goods. Formulas by expert chemists. Manufacturing processes and trade secrets. Write for formula catalog. Chapin Mystic Company, Washington, D. C.

\$100.00 a Week. For general agents handling our Instant Carbon-Remover for Automobiles. Guaranteed harmless. A rapid seller. Makes permanent customers. Write for particulars and protected territory. Buckeye Product Co., P. O. Box 991, Columbus, Ohio.

Salesmen Wanted.

Salesmen—City or traveling. Experience unnecessary. Send for list of lines and full particulars. Prepare in spare time to earn the big salaries—\$2,500 to \$10,000 a year. Employment services rendered members. National Salesmen's Training Association. Dept. 158M, Chicago, Ill.

Salesmen—Side or main line, to sell low-priced 6,000-mile guaranteed automobile tires, 30x3½ non-skid sells for \$13.95; other sizes in proportion. Good money making proposition for live wires. Master Tire Co., 1414 So. Michigan, Chicago.

Motor Engines and Dynamos.

Small motors and generators; ¼ hp. AC \$26.50; ½ hp. \$38.50; ¾ hp. AC \$67.50. Battery charging sets; charging lighting and moving picture arc generators; motors for all phases of current. Prompt delivery; wholesale prices. Write for late catalog. Address Motor Sales Dept. (12), West End, Pittsburgh, Pa.

Motors, 2, 5 and 10 hp. Special prices. Write me. William Hobart, Troy, Ohio.

Help Wanted.

Young men prepare as brakemen, firemen, \$180-\$250 monthly. Write, Trainmen's Service Bureau, Dept. 2, Jersey City, N. J.

Salaried employees unusual opportunity—Employment Manager will personally post deserving persons, all localities, how to secure better position, more salary, real future in employment qualified and desired. Co-operation nationally known concerns. E. Quinn, 2448 Leland Ave., Chicago.

Earn \$25 Weekly, spare time, writing for newspapers, magazines. Experience unnecessary; details free. Press Syndicate, 5665 St. Louis, Mo.

Detectives Make Big Money. Travel, be your own boss. Either sex. We instruct, small cost. Write Johnson's Detective School, 232 Sheldon Ave., Grand Rapids, Michigan, Dept. A.

Be a Mirror Expert. \$3-10 a day; spare time home at first; no capital; we train, start you making and silvering mirrors French method. Free Prospectus. W. R. Derr, Pres., 579 Decatur Street, Brooklyn, N. Y.

Men-Boys. Become Automobile experts. \$45 week. Learn while earning. Write Franklin Institute, Dept. B 806, Rochester, N. Y.

Detectives Earn Big Money. Excellent opportunity. Particulars free. American Detective System, 1968 Broadway, New York.

Hundreds Men-Women, over 17, wanted immediately as Government Railway Mail Clerks. \$150 month. Common education sufficient. List positions free. Franklin Institute, Dept. B-26, Rochester, N. Y.

Money in Mirrors. Tells how to cash in big. All or spare time making and silvering mirrors. Our formula best on market. Booklet free. Wear Mirror Works, Excelsior Springs, Missouri.

Detectives and Investigators are in demand. Travel and earn big money. Learn this fascinating profession by home study. Particulars free. American School of Criminology, Dept. E, Detroit, Mich.

Firemen, Brakemen, Baggage-men, \$140-\$200, Colored Porters by railroads everywhere. Experience unnecessary. 897 Ry. Bureau, East St. Louis, Ill.

Auto Accessories.

Blueprints. Automobile Armatures. See ad under "Electrical." Charles Chittenden.

Old Tires made like new. Insures double the wear. Satisfaction guaranteed, 25c. Bargain catalog free. Science Institute, E6435 N. Clark, Chicago.

Tires—Direct to you prices. Exclusive representatives wanted each locality to use and sell Mellinger Extra Ply Tires. Guarantee Bond 8,000 Miles. Sample Sections furnished. Mellinger Tire Company, 980 Oak, Kansas City, Mo.

Auto Motor Supplies—Buick, Michigan, Stoddard-Dayton, Cadillac-Overland, E. M. F. Continental and Buda Motors, all types, \$50 each and up. Special high-tension, 2 and 4 cylinder magnetos \$9.50 each. Electric and gas head lamps, coils, carburetors, air compressors, generators, starters, etc. Write for catalog. Address Motor Sales Dept. (12), West End, Pittsburgh, Pa.

Battery Charging Profits \$100 to \$250 clear monthly with HB equipment. Your lighting current or engine operates. No expense to you. Easy payment plan lets outfit earn own way. Satisfaction guaranteed. Write Hoberts, Troy, Ohio.

Fords run 34 miles per gallon with our 1920 carburetors. Use cheapest gasoline or half kerosene. Start easy any weather. Increased power. Styles for all Motors. Runs slow in high gear. Attach yourself. Big profits for agents. Money back guarantee. 30 days' trial. Air-Friction Carburetor Co., 70 Madison Ave., Dayton, Ohio.

Agencies Wanted.

James Orton—Desires sole representations for South America, Casilla 366, Buenos Aires.

Stammering.

St-Stu-t-t-ering and Stammering cured at home. Instructive booklet free. Walter McDonnell, 105 Potomac Bank Bldg., Washington, D. C.

Business Opportunities.

Start business of your own. 24 plans, \$1.00. Joel Tillberg, Proctor, Vermont.

Enter a new business. Earn \$3,000 to \$6,000 yearly in professional fees making and fitting a foot specialty, openings everywhere with all the trade you can attend to; easily learned by anyone at home in a few weeks at small expense; no further capital required; no goods to buy; job hunting, soliciting or agency. Address Stephenson Laboratory, 18 Back Bay, Boston, Mass.

Be Independent—We teach by mail how to manufacture unexcelled toilet goods. Particulars free. School of Cosmetics, Box C, Omaha, Neb.

I Made \$30 a Week evenings with a small Mail Order Business Home. Free Booklet tells how. 2c postage. Alex Scott, Cohoes, N. Y.

Patents for sale. To sell, buy or obtain patents write Patent News-309, Washington, D. C.

Any vulcanizer can save \$100.00 a week through studying "Vulcanizing Improved and Simplified." Trebles production and saves material. 20 section repairs done by students in one day. Send \$5.00 for copy and save two men's wages. Special courses for beginners. Prehn Vulcanizing College, 1554 S. Wabash Ave., Chicago, Ill.

New Auto-Knitter. Half-price. Earn at home. I. D. Matteson, Swansea, Mass.

"Money-Talks." The Business magazine published for progressive people. Send for sample copy. P. O., Box 236-B, Newark, New Jersey.

Dollars Yearly in Your Back Yard. No ginseng, mushroom dope. New ideas. Investigate. Particulars free. Metz, 313 East 89, New York.

Turn Your Spare Time Into Money for that apparatus you want. Start a profitable, permanent home business. Steady weekly income. No investment but your brains and spare time. Positively no soliciting, agency proposition. Write today. Address Opportunity, Box 175, Fredonia, N. Y.

Wanted—Advertising managers everywhere. \$50 to \$150 weekly. Experience unnecessary; learn in spare time. Details free. Koehler, Dept. 25, 1961 S. Hoover, Los Angeles.

3,384 Money-making Plans. Formulas. Trade Secrets. "Encyclopedia Business Opportunities." 3 volumes \$1. Ideal Book Shop, 5501-EV North Robey, Chicago.

New discovery! Establish a good, steady, profitable business of your own. Whole or spare time. No canvassing or mail order proposition. Everything necessary furnished. Write immediately. Ferber Company, 26-C Broadway, New York.

Substantial manufacturing corporation wants capable men to establish branch and manage salesmen. \$300 to \$2,000 necessary. Will allow expenses to Baltimore as explained. Address, Mr. Clemmer, 603 N. Eutaw St., Baltimore, Md.

Shawnee, Oklahoma, center of a great farming country. Write for free agricultural booklet. Board of Commerce, Shawnee, Oklahoma.

Breed Canaries. Profitable pastime. Particulars free. Bird Farm, Lynnhaven, Virginia.

Stamping Names.

Make \$19 a hundred stamping names on key-checks. Send 25c. for sample and particulars. Ex Keytag Co., Cohoes, N. Y.

Aeronautics.

Aviators make big money. Twenty to forty minutes daily instruction. You can learn in three weeks. Send stamp for illustrated booklet. Tells how. Philadelphia Aero-Service Corporation, Real Estate Trust Building, Philadelphia.

Propellers for aeroplane propulsion. Small propellers for motorcycle driven snow and ice sleds. Road speedsters and hydroplanes, five feet diameter, \$12, others in proportion. Can supply hub mountings, bearings, counter shafting and sprockets. Complete pamphlets free. Crawford Motor and Aeroplane Migr., 142 S. Rampart St., New Orleans.

Automobiles.

Build your own speedster or racing body. Write today for money-saving pamphlet showing different styles. Floege's System of Body-Building, North Chicago, Ill.