

# OFFICIAL PROGRAM

Pacific Radio Exposition

Aug. 16<sup>th</sup> to 21<sup>st</sup> - 1924

price  
10¢



BOOTH 'B'  
**MAGNAVOX**  
RADIO

Everything Necessary



for Radio Enjoyment



Quality  
plus  
Service  
since  
1915

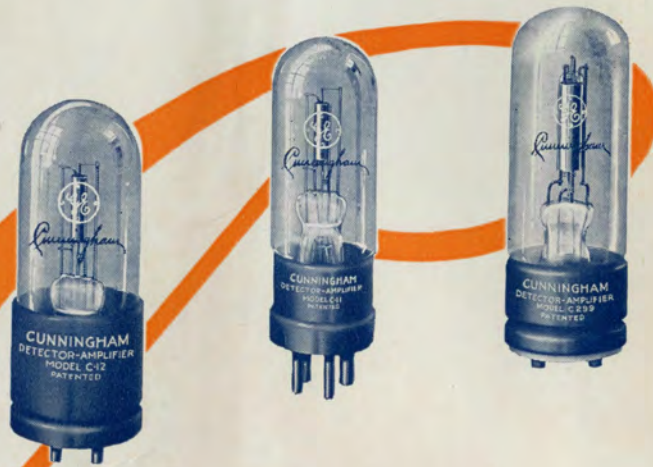

# Cunningham RADIO TUBES

*For Clear Radio Reception*

To perfection in design are added the productive resources and scientific skill of the great General Electric laboratories. The result—a series of Radio Tubes that give peak satisfaction in detection, amplification—and rugged long life.

**See the Cunningham Exhibit  
Come to Booth No. 63**

Note the amazing accuracy which governs every step in Cunningham manufacture. Then you will understand the why and wherefore of Cunningham preference.

**PATENT NOTICE.**—Cunningham tubes are covered by patents dated 2-18-08, 2-18-12, 12-30-13, 10-23-17, 10-23-17, and others licensed and pending. Licensed only for amateur experimental and entertainment use in radio communication. Any other use will be an infringement.

PRICE THE SAME  
ON ALL FIVE  
TYPES

C-301 A, C-299,  
C-300, C-11, C-12

*E. J. Cunningham, Inc.*

HOME OFFICE

182 Second St., San Francisco

Branch  
Chicago

Branch  
New York

# Radio Conquers the Fog!

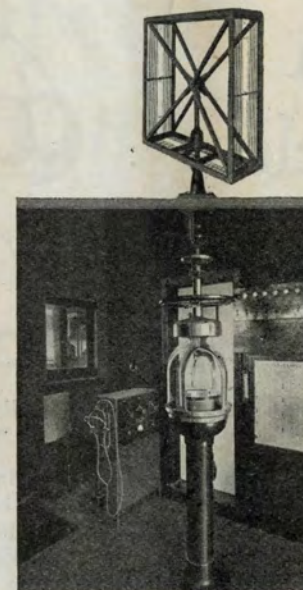

The Kolster Radio Compass on board ship insures against the loss of life and property by PREVENTING accidents in foggy or thick weather

KOLSTER RADIO COMPASS

"Federal" operates a super-telegraph service by Radio between San Francisco, Los Angeles, San Diego, Portland, Seattle and Tacoma. Connections with points in Alaska and on the C., M. & St. P. Railway and all ships on the Pacific.

Manufacturers and Distributors of

High Power C. W. Equipment

Marine C. W. and Spark Transmitters

30 to 1000 K. W.

1 to 5 K. W.

Kolster Radio Compass

Kolster Decremeter

# FEDERAL TELEGRAPH CO.

*(Pioneers in C. W. Radio)*

General Offices: 812 Hobart Bldg.

SAN FRANCISCO, CALIFORNIA



Tested and Listed as Standard by Underwriters' Laboratories

# A noiseless bulbless battery charger for the Pacific Coast



The Balkite Battery Charger is today universally known and accepted as one of the most efficient and trouble-free methods of charging radio batteries

1. It is entirely noiseless.
2. It cannot deteriorate through use or disuse.
3. It has no contact points or moving parts.
4. It has nothing to adjust, break or get out of order.
5. It cannot discharge or short-circuit the battery.
6. It requires no attention other than an occasional filling with distilled water.
7. It delivers a taper charge, and cannot damage the battery by overcharging.
8. It cannot fail to operate when properly connected to the battery and line current.
9. It is unaffected by temperature or fluctuations in line current.
10. It will charge a completely discharged battery.
11. It is simple, efficient and indestructible except through abuse.
12. Designed primarily for charging "A" batteries, it will also charge "B" batteries of the lead type without added attachments.
13. It can be used while set is in operation without disturbing noises.

The Balkite Battery Charger will charge the ordinary 6-volt radio "A" or automobile battery at 3 amperes, from 110-120 AC, 60 cycle current. Special model for 50 cycle. Sold by leading radio dealers everywhere.

**FANSTEEL**  
**Balkite Battery**  
Price, \$20 **Charger**

Manufactured by FANSTEEL PRODUCTS

Distributors: San Francisco: A. S. Lindstrom  
111 New Montgomery Street  
Los Angeles: Lombard J. Smith  
451 East Third Street

## Special Announcement

The first public showing  
of a model of our new

# Balkite "B"

a plate current supply for detector and amplifier tubes which operates from the lighting circuit and eliminates the "B" battery will take place at the Pacific Radio Exposition, Civic Auditorium, San Francisco, August 16-21.

Our Factory Representatives

**E. H. WILDER** Vice-President and Western Sales  
Manager, Fansteel Products Company

and  
**E. W. ENGLE** Development Engineer Balkite Products

will demonstrate it at our booth.

There will also be an exhibit of the rare metals Tantalum, Molybdenum and Tungsten, all used extensively in tube construction.

Booth 74

COMPANY, Inc., North Chicago, Illinois

Seattle: GEORGE H. MAIRE  
95 Connecticut Street

Portland: H. A. KILLAM  
312 McKay Building

# A Super-Heterodyne World's Record

*Will Be Established at Our Booth  
No. 16*

**S**HARP at 7:30 p. m. on Thursday, August 21, L. C. Rayment, our radio construction expert, will begin work on a complete set of parts for a **Remler-Best Super-Heterodyne**. The panel won't even be drilled when he starts! In less than three hours you will hear music coming from this same set. It will be built completely, right before your eyes. When completed, the set will be sold to the highest bidder.

We will have on display—  
An A. C. Attachment for Replacing "B" Batteries  
The Complete Line of Crosley Radio Sets  
The Gilfillan Neutrodyne

## E. M. SARGENT CO.

*Oakland's Leading Radio Dealer*

1200 FRANKLIN STREET 5661 SHAFTER AVENUE

### OAKLAND, CALIFORNIA

## OFFICIAL PROGRAM *of the* PACIFIC RADIO EXPOSITION

*Conducted, Financed and Operated by the Pacific Radio Trade Association*

EXPOSITION  
AUDITORIUM



SAN FRANCISCO  
CALIFORNIA

**AUGUST 16th to 21st, 1924**

## WELCOME—THE RADIO SHOW

**Y**OU ARE welcome to the Pacific Radio Exposition. The earnest desire of its officials and exhibitors is that you enjoy and profit from the great display of radio equipment. Most of the exhibits are educational in nature and are designed to give the visitor a clearer understanding of the details of this modern marvel of communication.

This exposition is unique in several respects. It is the largest and most comprehensive radio show ever held, not alone in San Francisco but elsewhere in the United States. It is the first public display of 1925 models, as manufacturers this year for the first time have decided to announce their new developments between the first of July and the first of September.

But aside from its size and its timeliness, the Pacific Radio Exposition is unique in that it represents the efforts of a united trade organization, a local association that for three years has been working to

stabilize, popularize and standardize radio.

The Pacific Radio Trade Association, through its show committee, thus takes pride in presenting tangible evidence of what co-operation accomplishes. Without the aid of an outside promoter and at less than half the usual expense to the visitor and the exhibitor, this association has put on a show that surpasses anything of its kind yet undertaken.

The purpose of the exposition is service to the radio buyer. Never before has such an opportunity been offered for comparison and selection. At one time and at one place you can see for yourself and judge as to the relative suitability of various kinds of equipment.

You will find this Official Show Program of great assistance in locating any particular equipment that you desire to see and in determining when it will be best worth your time to come again. For one visit will not exhaust the list of things you will want to see and hear. A

study of the list of exhibitors and the floor plan will greatly aid in an intelligent understanding of what is on display. The daily program of events should guide the time of your next visit.

Not least in value are the announcements appearing in the advertising pages. Careful perusal will disclose many items that you will want to inspect that might otherwise be overlooked.

The several editorial features of this booklet have been chosen with the idea of making the program of permanent value. You will find in it the answers to many questions that will come up during the year. So keep it for future reference.

This cordial welcome and intro-

duction to the Pacific Radio Exposition can well be concluded with a word of practical advice. Many people are postponing the purchase of a radio set in anticipation of some revolutionary discovery that will scrap all existing sets in a year or so. This is a fallacy. Improvements are being made constantly in the radio as in the auto industry. But this year's models will give you every service that you want. You can hear the concerts, the lectures and the news that is now on the air, you can have an added home enjoyment with the equipment that is now available, and there is no innovation of sufficient value to make worth while the deprivation of pleasures that you can have now.



This attractive poster in three colors was extensively used for show window display by hundreds of business houses in and around San Francisco as well as by the Southern Pacific Company for display in railway and ferry stations.

The Pacific Radio Exposition was heavily advertised for a period of more than five months. Broadcast stations, newspapers, programs, motion picture films, national magazines, street cars, etc., were used to promote the gigantic affair.

THE OFFICIAL SHOW POSTER  
Designed by W. H. Andrews

## The Leaders of the Radio Exposition



H. E. METCALF

H. E. Metcalf, president of the Pacific Radio Trade Association, is a pioneer in radio engineering development. In addition to his work as general sales manager of the Magnavox Company, he is a well-known lecturer on radio topics under the direction of the Extension Division of the University of California. He was the original "H. M. announcing" at KPO.



A. S. LINDSTROM

A. S. Lindstrom, chairman of the Pacific Radio Exposition Committee, gained much of the knowledge applied to making this show a success as assistant director of Machinery Hall at the Panama-Pacific International Exposition in 1915. From his regular business as Pacific Coast representative of a number of eastern manufacturers of radio accessories he has given most unselfishly of his time and energy in the service of this exposition.

# The Executive Show Committee

Here are the men behind the Pacific Radio Exposition. Under the direction of A. S. Lindstrom, general chairman of the executive show committee, these executives have successfully accomplished the seemingly inevitable. Five months of their time was devoted to the work of the show. Don Lippincott, whose likeness appears in the upper illustration, directed the reception and technical committee in addition to his duties of providing recreation for visitors to the show. In the radio business world he is one of the prominent Magnavox radio engineers.

Directly under the illustration of Don Lippincott is F. J. Cram, director of finances for the show. To him was assigned the important duties of budget work, supervision of booth payments, gate receipts, etc. He is vice-president of the Electric Appliance Company in San Francisco.



In the lower left-hand illustration is pictured C. C. Langevin, director of professional and special entertainment. He originated an unusual, spectacular method of entertainment. Many civic affairs were also in his charge. He is secretary of the Atlantic-Pacific Agencies Corporation, San Francisco.

Major W. P. Bear, lower center illustration, was selected as business manager of the exposition. All important business transactions with exhibitors, entertainers, publishers, etc., were under his direction. His office in the Monadnock Building remained open until midnight to take care of the show business.

In the lower right-hand corner appears an illustration of H. W. Dickow, director of rules and regulations, official program and sale of booth space. He is the business manager of the Pacific Radio Publishing Company, Incorporated.



# The Pacific Radio Trade Association

THE Pacific Radio Trade Association has been the moving force behind the marvelous spread of interest in radio in Central California during the past three years. Ever since its organization in 1921 it has been the active factor in making for better radio.

When radio broadcasting was started three years ago a few of the far-sighted men in the industry realized the necessity for a strong guiding hand in the industry, a stabilizer of trade conditions and a popularizer of the wonders of radio reception. So they organized the Pacific Radio Trade Association, the first of its kind, by the way, in the United States.

The first president was Arthur H. Halloran, editor of RADIO and the BROADCAST PROGRAM. The policies initiated at that time have gradually come to fruition under succeeding administrations, until at present it is the strongest and most influential association of its kind in the country.

Its membership comprises manufacturers, jobbers, dealers and others interested in radio trade advancement. Its important committees are concerned respectively with improvement in broadcasting, the promotion of better service to buyers of radio equipment, and the conduct of an annual radio exposition at San Francisco.

The members of its broadcast committee have assisted the United States Radio Supervisor in the allocation of

THE BOARD OF DIRECTORS



A. S. LINDSTROM



E. M. SARGENT



C. C. LANGEVIN



A. H. HALLORAN  
Chairman Broadcasting Committee

H. E. METCALF  
President

LIEUT. E. W. STONE  
Vice-President

hours and wave lengths among the various broadcast stations, advised the managements thereof as to desirable program features and initiated the publication of the BROADCAST PROGRAM. Through its advice the various members of the association have contributed to a fund from which substantial payments have been made monthly toward the program expenses of several of the local broadcasting stations.

Better service to the users of radio equipment has been given through a series of educational lectures on radio, articles in the newspapers and education of radio salesmen in better merchandizing methods. In the past the lectures on radio have been given both at the Engineers Club in San Francisco and "over the air." Some of the leading radio engineers in the country have thus tried to help newcomers in radio.

### Official Service List for the Pacific Radio Exposition

**PHOTOGRAPHER**—Bryant Photo Service, San Francisco.  
**DECORATOR**—Sadler Manufacturing Company, San Francisco.  
**ELECTRICIANS**—California Electrical Construction Company, San Francisco.  
**PROGRAM**—Pacific Radio Publishing Company, Incorporated, San Francisco.  
**TAXICABS**—Checker Cab Company, San Francisco.  
**FURNITURE**—Kaplan Furniture Company, San Francisco.  
**DETECTIVES**—Pinkerton National Detective Agency, San Francisco.  
**BROADCAST STATION**—Hale Brothers, Incorporated, San Francisco.  
**DRAYAGE**—New Sunset Moving Company, San Francisco.



CIVIC AUDITORIUM, SAN FRANCISCO, WHERE THE SHOW IS HELD

If the demand warrants, similar lectures will be continued.

Last year the show committee assisted in putting on the radio and electrical exposition at the Civic Auditorium and this year it assumed full charge. It is unique in that it is entirely co-operative and profit-sharing among the exhibitors.

The association holds monthly meetings at which technical and business problems are discussed. Although originally planned to function throughout the Pacific Coast, its useful activities thus far have been confined to Central California. It is recognized as a great constructive force continuously at work for the good of the industry and as an organization ready to act in any emergency. It has the welfare of the radio user at heart and affords an able means for correcting any abuses brought to its attention.



COL. J. F. DILLON

Col. J. F. Dillon, Radio Supervisor, and D. B. McGown, Edwin W. Lovejoy and B. Linden, are Uncle Sam's radio police for the Sixth District. Through their recommendation to the United States Department of Commerce, licenses are granted to the broadcast stations, as well as to ship, commercial and amateur operators. They are responsible for the harmonious working of the thousands of radio transmitters throughout California, Nevada, Utah and Arizona. Their service is ever courteous and unselfish, their work well and efficiently done, and above all men are they honored and respected by the radio fraternity whose affairs they regulate.



D. B. MCGOWN

B. LINDEN

EDWIN W. LOVEJOY

# Exposition Floor Plan—Showing Location of Booths

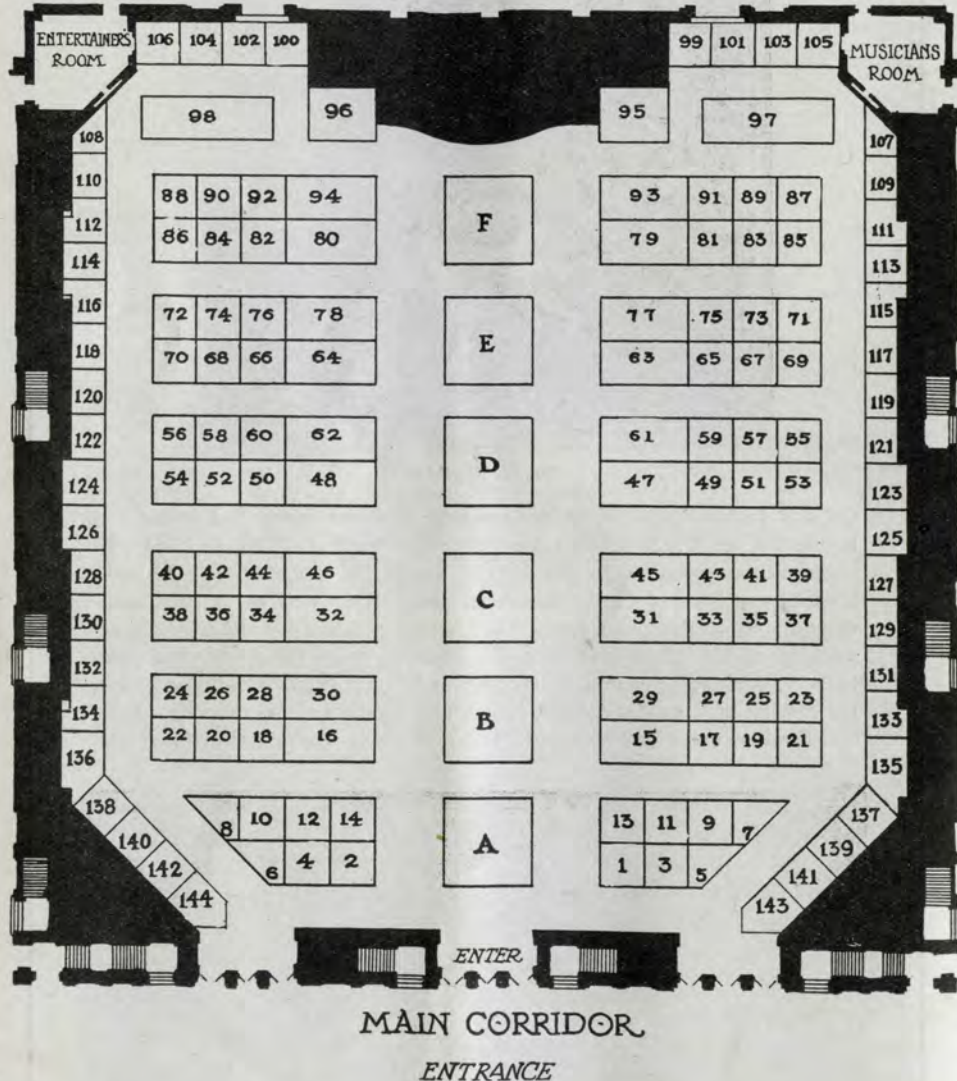

# The List of Exhibitors and Their Location

These exhibitors will either have an exclusive booth or be represented by their local factory agents:

Exhibitor—	Booth No.
A-C Electrical Manufacturing Company, Dayton, Ohio.....	61
Aerovox Wireless Corporation.....	24
American Art Mache Company, Chicago....	61
Auburn Button Works, Auburn, N. Y.....	61
Auto Indicator Company, Grand Rapids, Mich.	1
Andrea, Inc., F. A. D., New York City.....	A
Alpha Radio Supply Company.....	17
Acme Apparatus Company, Cambridge....	62
Alden Manufacturing Company, Springfield..	62
Atlantic Pacific Agencies Corporation, San Francisco .....	D
American Radio & Research Corporation....	8
Alexander & Lavenson Electrical Supply Company, San Francisco.....	126
Amsco Products, Inc., New York-San Francisco .....	86
Atwater Kent Manufacturing Company, Philadelphia .....	97
Automatic Electrical Devices Company.....	24
Automotive Service Agency, San Francisco..	97
Baker Smith Company, Inc.....	20-22
Best Manufacturing Company.....	D
B-Metal Refining Company, Detroit, Mich...	137
Brooklyn Metal Stamping Company, New York City .....	61
Bell Manufacturing Company, Boston.....	17
Brandes, Inc., C., New York City.....	48
Bosserman Radio Laboratories, San Francisco	21
Braun Corporation, The, San Francisco-Los Angeles .....	78
Baldwin Pacific & Co., San Francisco.....	1
Bristol Company, The, Waterbury, Conn....	37
BROADCAST PROGRAM, San Francisco....	2
Brunton & Sons, Julius, San Francisco....	87
California Electrical Supply Company, San Francisco .....	139
California Phonograph Company, San Francisco	98
Carter Radio Company, Chicago.....	D
Christian Science Monitor.....	143
Columbia Radio Corporation.....	24
Clapp Eastham Company, Cambridge, Mass..	15
Como Apparatus Company, Boston, Mass...	62
Connecticut Instrument Company, Stamford, Conn.....	15
Colburn Radio Laboratories, San Leandro, Calif. ....	53
City of Paris, San Francisco.....	84 90
Cunningham, Inc., E. T., San Francisco....	63
Call and Post, San Francisco.....	Stage
Chronicle, San Francisco.....	117
De Forest Radio Telegraph and Telephone Company, New Jersey .....	42 44
Day Radio Laboratory, San Francisco.....	41
Durkee-Thomas Products Company, San Francisco.....	55
Dudlo Manufacturing Company, Fort Wayne, Indiana.....	66
Dayton Fan and Motor Company, Dayton, Ohio .....	D
Dixie Supply Company, New York.....	61
Dodson and Dodson, Oakland, Calif.....	32
Diamond State Fibre Company, Pennsylvania	92
Department of Commerce, United States Radio Service .....	101
Department of Electricity, City of San Francisco .....	110
Dubilier Condenser and Radio Corporation, New York City.....	93
Dunham, Carrigan & Hayden Company, San Francisco.....	81 83
Durham & Co.....	24
Eagle Radio Company, Newark.....	129 131
Eby Company, H. H., Philadelphia.....	D
Eisemann Magneto Corporation, New York...	C
Electrad, Incorporated, New York City.....	127
Electric Appliance Company, San Francisco..	125
Examiner, San Francisco.....	6
Electric Storage Battery Company.....	47
Electrical Supply Company, Oakland.....	52
Electric Sales Corporation, Los Angeles....	49 51
Experimenter Publishing Company, Incorporated, New York City.....	140
Electrical Products Company, Providence...	61
Electrose Manufacturing Company, Brooklyn, New York .....	17
Electric Research Laboratories, Chicago....	29
Eastman Company, T. White, San Francisco..	38 40
Fansteel Products, Incorporated, North Chicago	74
Freshman, Charles H., New York City.....	17
Federal Telegraph Company, San Francisco..	34 36
Federal Telegraph and Telephone Company, Buffalo, N. Y.....	33
Frost, Herbert H., Chicago.....	65
Gallagher and Eiferle, Oakland.....	46
Garnett-Young & Co., San Francisco.....	67
Great Western Radio Corporation, San Francisco .....	D
Gibson and Glamze, New York City.....	61
General Radio Company, Cambridge .....	D
Gardiner and Hepburn, Philadelphia.....	1
Grove Company, Olin S., Oakland, Calif....	8 10
Globe Commercial Company, San Francisco..	15
Giffilan Brothers, Incorporated, Los Angeles	85
Golden Gate Brass Company.....	35
Goodyear Rubber Company, San Francisco..	144
Hart & Hegeman.....	67
Hartsell Sales Company.....	D
Heath Radio & Electric Company.....	D
Heintz and Kohlmoos, San Francisco.....	D
Hartford Instrument Company, Hartford, Connecticut .....	61
Hammarlund Manufacturing Company, New York City .....	D
Hale Brothers, Incorporated, San Francisco..	Stage
Haverkamp, H. F., San Francisco.....	112
Jackson Company, E. O., Chicago.....	61
Jackson, W. E. and W. H., San Francisco..	25
Jefferson Electric and Manufacturing Company, Chicago .....	80
Jewell Electrical Instrument Company.....	82
Jones, Howard B.....	68
Kellogg Switchboard and Supply Company, Chicago .....	75
Keeler-White Company, San Francisco.....	98
Kingston Radio and Electric Company, San Francisco .....	141
Kennon Radio Laboratory, San Francisco...	105
Kilbourne and Clark Manufacturing Company, Seattle .....	54
Kardon Products Company.....	24
Kodel Manufacturing Company, Cincinnati..	24
Klosner Improved Apparatus Company, New York City .....	17
Lagbein and Kaufman, New Haven, Conn...	62
Liberty Transformer Company.....	D
Lee Electric and Manufacturing Company, San Francisco.....	120
Magnavox Company, The, Oakland, Calif...	B
Marion Electrical Company.....	68
Muter Company, Leslie F., New York City..	15
Modern Electric Manufacturing Company, Toledo .....	61
Multiple Electric Products Company, Newark.	1
Morrison Laboratories, Incorporated, Detroit	62
Meyberg Company, Leo J., San Francisco...	60



Exhibitor—	Booth No.
Martin-Copeland Company, Providence....	138
Mitchell Company, R., Boston.....	15
Marshall & Co., Los Angeles.....	93
Marathon Radio Company, San Francisco....	136
Niagara Sales Corporation, New York City....	61
National Carbon Company, Incorporated, San Francisco.....	45
Norris-Allister-Ball Company.....	73
Offenbach Electric Company, San Francisco....	111 132
Pathe Phonograph & Radio Corporation....	24
Pacific Radio Trade Association.....	Corridor
Parkin Manufacturing Company, San Rafael, Calif.....	3
Pacific Radio Publishing Company, Incorporated, San Francisco.....	2-4
Patton-MacGuey Company, Providence....	61
Pacific-SH Super-Heterodynes, San Francisco	1
Puritan Distributors, Chicago.....	15
Philadelphia Storage Battery Company, Philadelphia.....	19
Prest-O-Lite Company, San Francisco.....	11
Precise Manufacturing Company, Rochester-San Francisco.....	71
Portal Company, E. A., San Francisco.....	31
Peerless Radio Company, San Francisco....	69
Practical Electrics, New York City.....	142
Quality Radio Shop, San Francisco.....	12-14
Radio Manufacturers Agents Association of Southern California.....	99
Radio Corporation of America.....	E
RADIO, San Francisco.....	2
Radio Headquarters, Portland, Oregon....	124
Radio Pioneers, San Francisco.....	103
Radio Club of San Francisco, Incorporated, San Francisco.....	109
Radio Inspector of Sixth District, San Francisco.....	101
Radiall Company, New York City.....	61
Radio Equipment Company, Boston.....	61
Radio Products Manufacturing Company, Chicago.....	61
Radiogram Corporation, New York City....	61
Radio Units, Incorporated, Chicago.....	61
Reliable Parts Manufacturing Company, Cleveland.....	61
Reliable Radio Service, San Francisco....	123
Ritter Radio Corporation.....	24
Ross Braid Company, Providence.....	61
Rubold, P. C., Tonawanda, N. Y.....	61
Radio Receptor Company, New York City....	127
Richter, Conrad, San Francisco.....	116
Radio News, New York City.....	142
Radio Art Studio, San Francisco.....	95
Radio Shop, The, Sunnyvale, Calif.....	77
Rice-Hitt Company, San Francisco.....	24
Roach, M. and S., Philadelphia.....	115
Remler Radio Manufacturing Company, San Francisco.....	63
Sadler Manufacturing Company, San Francisco	13
Samson Electric Company, Canton, Mass....	76
Simplex Radio Company, Philadelphia.....	61
Sargent Company, E. M., Oakland.....	16
Stevens & Co., New York-San Francisco....	23
Schicklerling Products Company.....	50
Stentofore Company, Los Angeles.....	58
Stone Company, Carl A., San Francisco and Los Angeles.....	93
Schwabacher-Frey Stationery Company, San Francisco.....	129 131
Springfield Wire and Tinsel Company, Springfield.....	61
Signal Electric Manufacturing Company, Menominee.....	17
Sleeper Radio Corporation, New York City..	70 72
Spartan Electric Corporation, New York City	0
Smith, Frank E., San Francisco.....	88

Science and Invention, New York City....	140
Stromberg-Carlson Telephone Manufacturing Company.....	67
Thornton and Everest, Los Angeles.....	61
Transtrom Manufacturing Company, Glendale, Calif.....	61
Thompson Company, Frederick H., San Francisco.....	7-9
Thompson Manufacturing Company, R. E., New York City.....	39
Thor Radio Company San Francisco.....	35
Tomlinson Company, Frederic L., San Francisco.....	61
Tribune, Oakland, Calif.....	5
Tuska Company, C. D., Hartford, Conn.....	49 51
United Radio Supplies Company, San Francisco.....	56
United Scientific Laboratories.....	24
Universal Agencies, San Francisco.....	127
U. C. Battery and Electric Company, Berkeley, Calif.....	30
United Manufacturing and Distributing Company, Chicago.....	29
U. S. L. Battery Company.....	97
United States Navy.....	104 106
Vetter, W. A., San Francisco.....	122
Van-Le Corporation, New Jersey.....	61
Walbert Manufacturing Company, Chicago..	61
Walker Company, G. E., St. Louis, Mo....	61
Western Electric Company, San Francisco..	F
White House, The, San Francisco.....	64
Wholesale Electric Company, San Francisco	39
Warner Brothers, San Francisco-Oakland...	79
Willard Storage Battery Company.....	87 89
Wurlitzer-Rudolph Company, San Francisco..	91
Wright Company, H. Earle, San Francisco..	94
Weaver Company, Chester N., San Francisco	119 121
Work-Rite Manufacturing Company, Cleveland	128 130
Weston Electrical Instrument Company, New York City.....	88
Zenith Radio Corporation, Chicago.....	81 83

The following eastern manufacturers maintain their own offices in San Francisco:

Amsco Products, Incorporated.
The Bristol Company.
Diamond State Fibre Company.
Eisemann Magneto Corporation.
Electric Storage Battery Company.
Federal Telephone & Telegraph Company.
Gould Storage Battery Company.
Kellogg Switchboard & Supply Company.
Martin Copeland Company.
Philadelphia Storage Battery Company.
Precise Manufacturing Corporation.
Radio Corporation of America.
Stevens & Co.
Weston Electric Instrument Company.

## San Francisco Representatives of Manufacturers of Radio Supplies

List of Factories Represented by Frederic L. Tomlinson Company, Pacific Building, San Francisco; 1113 Wall street, Los Angeles; 116 Thirteenth avenue, Seattle:

A-C Electrical Manufacturing Company, Dayton, Ohio.

American Art Mache Company, Chicago.

Auburn Button Works, Auburn, N. Y.

Brooklyn Metal Stamping Company, 718 Atlantic avenue, Brooklyn, N. Y.

Cannon & Miller Company, Inc., Springwater, N. Y.
Chelsea Radio Company, Chelsea, Mass.
Coburn Tool Company, Boston, Mass.
Consolidated Instrument Company, 41 East Forty-second street, New York City.
Dixie Supply Company, 91 Seventh avenue, New York City.
Electrical Products Manufacturing Company, Providence, R. I.
Gibson & Glamzo, 50 Park Place, New York City.
Hartford Instrument Company, Hartford, Conn.
E. O. Jackson Company, 500 South State street, Chicago.
Modern Electric Manufacturing Company, Toledo, O.
Niagara Sales Corporation, 3 Waverly Place, New York City.
Nash Company, Los Angeles, Calif.
Patton-MacGuey Company, Providence, R. I.
Radiall Company, 320 West Forty-second street, New York City.
Radio Equipment Company, Boston, N. Y.
Radiogem Corporation, New York City.
Radio Products Manufacturing Company, 501 South Jefferson street, Chicago.
Radio Units, Inc., Maywood, Ill.
Reliable Parts Manufacturing Company, Cleveland, O.
Ross Braid Company, Providence, R. I.
P. C. Runbold, Tonawanda, N. Y.
Simplex Radio Company, 1013 Ridge avenue, Philadelphia.
Springfield Wire & Tinsel Company, Springfield, Mass.
Thornton & Everest, Los Angeles, Calif.
Transtrom Manufacturing Company, Glendale, Calif.
Walbert Manufacturing Company, 925 Wrightwood avenue, Chicago.
G. E. Walker Company, 1926 Chestnut street, St. Louis, Mo.
Van-Le Corporation, Jersey City, N. J.

Factories Represented by Baldwin-Pacific & Co., Pacific Building, San Francisco:

Multiple Electric Products Company, Inc., Newark, N. J.

Gardner & Hepburn, Philadelphia, Pa.

Pacific S-H Super Het Kits, San Francisco.

Auto Indicator Company, Grand Rapids, Mich.

Moss-Schury Company, Detroit.

Factories Represented by Gute & Co., 150 Post street, San Francisco:

Th. Goldschmidt Corporation.

Pal Radio Corporation.

Clearstone Radio Company.

Factories Represented by Garland-Affolter Company, Rialto Building, San Francisco:

Allen-Bradley Company, Milwaukee, Wis.

Factories Represented by A. S. Lindstrom, 111 New Montgomery street, San Francisco:

Fansteel Products, Inc., North Chicago, Ill.

Sleeper Radio Corporation, New York City.

Dudlo Manufacturing Company, Fort Wayne, Ind.

Samson Electric Company, Canton, Mass.

Marion Electrical Company, Jersey City, N. J.

Howard B. Jones, Chicago, Ill.

Factories Represented by Atlantic-Pacific Agencies Corporation, Rialto Building, San Francisco:

Great Western Radio Corporation, San Francisco.

Carter Radio Company, Chicago, Ill.

General Radio Company, Cambridge.

Dayton Fan & Motor Company, Dayton, O.

Hammarlund Manufacturing Company, New York City.

Spartan Electric Corporation, New York City.

H. H. Eby Manufacturing Company, Philadelphia, Pa.

Heath Radio & Electric Company.

Hartsell Sales Company.

Liberty Transformer Company.

Interstate Electric Company.

Factories Represented by Globe Commercial Company, 709 Mission street, San Francisco:

F. A. D. Andrea, Inc., New York City.

R. Mitchell Company, Boston, Mass.

Electrical Research Laboratories, Chicago.

Signal Electrical Manufacturing Company, Menominee, Wis.

United Manufacturing & Distributing Company, Chicago.

Connecticut Instrument Company, Stamford.

Puritan Distributors, Chicago.

Leslie F. Muter Company.

Klosner Improved Apparatus Company, New York City.

Bell Manufacturing Company, Boston, Mass.

Clapp-Eastham Company, Cambridge, Mass.

Electroose Manufacturing Company, Brooklyn.

Charles Freshman Company, New York City.

A. E. Hill Manufacturing Company.

Alpha Radio Supply Company.

Factories Represented by The Spector Company, Rialto Building, San Francisco:

Acme Apparatus Company, Cambridge.

C. Brandes, Inc., New York City.

Alden Manufacturing Company, Springfield, Mass.

Como Apparatus Company, Boston.

Morrison Laboratories, Detroit.

Langbein & Kaufman, Providence.

Factories Represented by Carl A. Stone Company, New Call Building, San Francisco:

Charles A. Branton, Incorporated, Buffalo.

Bremer-Tully Manufacturing Company, Chicago.

Chelton Electric Company, Philadelphia.

King Manufacturing Corporation, Buffalo.

Philmore Manufacturing Company, New York City.

Rauland Manufacturing Company, Chicago.

Radio Condenser Company, Camden, N. J.

Shamrock Manufacturing Company, Newark, N. J.

Trimm Radio Manufacturing Company, Chicago.

R-U-F Products Company, Brooklyn, N. Y.

M. M. Fleron & Son, Trenton, N. J.

Factories Represented by C. F. Henderson, New Call Building, San Francisco:

Jewell Electrical Instrument Company, Chicago.

Factories Represented by Rice-Hitt Company, 623 Larkin street, San Francisco:

Aerovox Wireless Corporation, New York City.

Automatic Electrical Devices Company, Cincinnati, Ohio.

Columbia Radio Corporation, Chicago.

Durham Company, Philadelphia.

Charles Freshman Company, New York City.

## Daily Program Broadcast by KPO Direct From the Exposition

SATURDAY, AUGUST 16

**Evening**

8:00 p. m.—  
Talk: "Greetings to the Radio World"—  
Arthur Halloran.  
Addresses.  
Soprano solos—Mme. Dorothy R. Talbot.  
Bass solos—H. Victor Vogel.

MONDAY, AUGUST 18

**Matinee**

12:00 noon—  
Scripture reading in Russian and English—  
The Very Rev. Archpriest V. Sakovich of  
the Russian Orthodox Trinity Church.  
2:30 p. m.—  
Marimba Band.  
Contralto solos—Edna Fisher Hall, accom-  
panied by Irma Harris Vogt.  
Mezzo-soprano solos—Norma Garrett, ac-  
companied by Mary Carr Moore.  
5:30 p. m.—  
Big Brother.  
Piano accordion solos—Walter Gamba.

**Evening**

8:00 to 9:00 p. m.—  
Organ recital by Theodore J. Irwin.  
9:00 to 10:00 p. m.—  
Mezzo-soprano solos—Jean Center, accom-  
panied by Lola Gwin Smale.  
Soprano and tenor solos—Hana Shimozumi  
Iki and Harrison Coles, accompanied by  
Mabel Jones.  
Aloha Troup Hawaiians; S. Alama, director.  
Cornet solos—J. L. Conrich, accompanied  
by Mrs. Conrich.  
10:00 to 10:30 p. m.—  
Carey Quartette.  
11:15 p. m.—  
Special program. Organ recital for "DX"  
reception—Theodore J. Irwin.

TUESDAY, AUGUST 19

**Matinee**

2:30 p. m.—  
Soprano solos—May Clarke Burns, accom-  
panied by Master J. Burns.  
Gary Fisher's Amphians of Cabiria Cafe.  
5:30 p. m.—  
Big Brother.  
Recitations—Donald Gibson.  
Violin solos—Ruth Hammerburg.

**Evening**

8:00 to 10:00 p. m.—  
Dons of Peralta.  
Saxophone solos—Mrs. George Empy.  
Baritone solos—C. R. Marston, accompanied  
by Susan Passmore Brooks.

Piano solos—Susan Passmore Brooks.  
Baritone solos—Norman Simon, accom-  
panied by Walter Frank Wenzel.  
Tenor solos—Erwin Holton.  
Mezzo-soprano solos—Pearl Hossack Whit-  
comb, accompanied by Lincoln Batchelder.  
Violin solos—Agnes Poyner.  
Tenor and baritone duets—Irwin Holton  
and Norman Simon, accompanied by Walter  
Frank Wenzel.

WEDNESDAY, AUGUST 20

**Matinee**

2:30 p. m.—  
Popular songs—Baron Keyes, singing and  
playing his own compositions.  
Banjo solos—Joe Zuccharello.  
Popular songs—Mort Harris, accompanied  
by Peggie McDonald.  
Radio christening of the infant son of Mr.  
and Mrs. McGrath Perrin.  
5:30 p. m.—  
Big Brother.

**Evening**

8:00 to 10:00 p. m.—  
Scotch program: Bagpipe selections—James  
Lemon. Scotch songs—Alick Sherriffs, bass.  
Opening of French course: Address—Pat-  
rick Copinger, Gerant du Consulat-General  
de France.  
Soprano solos—Lelah Gordon Saling, ac-  
companied by B. R. Solois.  
Radio wedding.  
Baritone solos—Harold Dana. Violin obli-  
gato by Harriet French, accompanied by  
Agnes Herzer.

THURSDAY, AUGUST 21

**Matinee**

2:30 p. m.—  
Trio Artistique.  
Whistling duets—Shirley Irvine and Miss  
Buckland, accompanied by Jean S. Sands.  
5:30 p. m.—  
Big Brother.

**Evening**

8:00 to 9:00 p. m.—  
Organ.  
9:00 to 10:00 p. m.—  
Soprano solos—Augusta Hayden. Violin obli-  
gato by Rudy Seiger, accompanied by  
Molly Pratt.  
Harp solos—Marie Hughes Macquarrie.  
Contralto solos—Annae K. Blotcky, accom-  
panied by Walter Frank Wenzel.

## Insist on getting— Eby Quality Binding Posts "with Tops that Don't Come Off"

**Tip Top Plug**

This new plug is novel in design. It is easy to grip with the fingers. It takes four pair of phones in series or multiple. It lists for only \$1.00.

**Tip Top Post**

Our new TIP TOP POST is similar to our new PLUG in design. It also takes four pair of phones in series or multiple. List price 50c each.



New hook-ups mean new marked posts. No matter what the hook-up you use we make a post for it. EBY POSTS give that *quality look* to your set.

**There is only ONE GENUINE EBY POST**

*Our name on each post is your guarantee against substitutes*

**H. H. Eby Mfg. Co. — Philadelphia, Pa.**

**K P O**

**The Official Broad-  
casting Station of the  
Pacific Radio  
Exposition**

Visitors to the Pacific Radio Ex-  
position will have the opportunity of  
meeting the KPO staff in person. All  
KPO programs during show week will  
be broadcast direct from the Auditor-  
ium. Clair E. Morrison, director and  
announcer in charge of KPO, is pic-  
tured in upper center; to right of him  
is Ada Morgan O'Brien, program man-  
ager. In the upper left-hand corner is  
Dora Williams, program secretary and  
assistant hostess. In left-hand column  
appear Theodore John Irwin, official  
organist; A. Deckelman, announcer; L.  
R. Tucker, "Big Brother." To the  
right we have Harold Percy, extra an-  
nouncer. Below him is Earl J.  
Thomas, operator and announcer of  
remote control stations. The operating  
room, studio and view of KPO towers  
on Hale's Department Store are il-  
lustrated in the lower strip.

KING OF THE AIR

# The Eagle

BALANCED

## RADIO RECEIVER

*Quality*

Skill, experience and choice of  
materials are responsible for the  
marked superiority of the  
*Eagle Neutrodyne Receiver*  
*Comparison invited*

Guaranteed without reservation

**Schwabacher-Frey  
Stationery Co.**  
609 MARKET STREET SAN FRANCISCO

PACIFIC COAST DISTRIBUTORS



View of the Tribune tower, from which is suspended the antenna of KLX. The Oakland Bank Building supports the far end of the aerial.

\* \* \*

Seth T. Bailey is the program director and chief announcer at Radio KLX. Lawrence L. Taylor announces the results of baseball and sporting events and also reads news bulletins.



SETH T. BAILEY

LAWRENCE L. TAYLOR

## KLX

**"The Tribune"**  
Oakland, California

The Tribune operates a standard 500 watt Western Electric transmitter, operating on a wave length of 509 meters. The popular KLX Hawaiians, American Theatre broadcast, University of California events, and many other important programs are regularly broadcasted from this Oakland station.

Radio

Sets

*Pacific Coast Headquarters for Radiolas*

*(Radiola Super-Heterodyne with 6 Radiotrons UV-199 and Radiola Loudspeaker, complete except batteries .....\$286)*

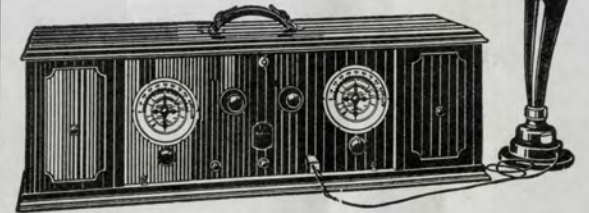

**Radioart Service**

**Means Satisfied Customers**

We concentrate on complete Radiola Sets. This allows a specialized follow-up service which insures to every customer complete satisfaction. Radio as a sideline, as a mere department of a large selling organization, can not prove as successful as when it commands the individual attention of skilled technical experts.

*See our display at the Pacific Radio Exposition  
Booth No. 95*

# Radioart Studio

492 SUTTER STREET SAN FRANCISCO

Telephone Sutter 52

JAMES B. THRELKELD, Jr.  
THOMAS R. CATTON, Jr.

Open Evenings

Service

Accuracy

**KGO**  
General Electric Co.  
Oakland, Calif.

Upper left—Studio for concerts.  
Upper center—J. A. Cranston, Pacific Coast manager of the General Electric Company.  
Upper right—Control room.  
Center left—The KGO towers.  
Center right—600 meter transmitter.  
Lower left—Carl Anderson, KGO announcer.  
Lower center—Howard I. Millholland, studio manager and announcer.  
Lower right—Jennings Pierce, KGO announcer.

# Welcome! Everyone!

to the

## *Second Annual San Francisco Radio Show*

While viewing the various and varied exhibits and stunts of this great exposition, we extend a cordial invitation to make

### Booth 105 Your Headquarters

And after the show, remember our exhibit of wonderful cabinets, efficient wiring, our promises of service and courtesy.

## KENNON RADIO LABORATORIES

THOMAS L. KENNON

CHARLES E. THOMPSON

*Radio Research Engineers*

805 Loew's Warfield Building  
Fone Franklin 73

988 Market Street  
San Francisco, California

Cable Address, "Kennon"

## Daily Program of Events

**SATURDAY, AUGUST 16**  
San Francisco Day

- 2:00 p. m.—Radio street parade on Market street.  
6:00 p. m.—Auditorium doors open to the public.  
8:30 p. m.—(a) Official opening of the exposition by H. E. Metcalf, president of the Pacific Radio Trade Association. (b) Address by A. S. Lindstrom, the chairman of the exposition executive committee. (c) Address by Col. J. F. Dillon, United States Radio Supervisor for the Sixth District. (d) Words of welcome by Hon. James Rolph, Jr., mayor of San Francisco.  
8:45 p. m.—Special broadcast program by KPO from the Auditorium stage.  
10:00 p. m.—Free raffle of one radio set by Pacific Radio Trade Association.  
11:00 p. m.—Exposition closes for the night.

**SUNDAY, AUGUST 17**  
East Bay District Day

- 2:30 p. m.—Doors open to the public.  
3:00 to 5:00 p. m.—Special KPO broadcast program and novel radio entertainment from the stage.  
8:00 p. m.—Radio entertainment and broadcast from the stage.  
10:00 p. m.—Free raffle of one radio set by Pacific Radio Trade Association.  
11:00 p. m.—Exposition closes for the night.

**MONDAY, AUGUST 18**  
The Great Valley Day

- 10:00 a. m. till 12:00 m.—Special hours for dealers only.  
12:00 m.—Radio luncheon of the Electrical Development League, Palace Hotel. Proceedings will be broadcast by KPO.  
2:30 p. m.—Exposition doors open to the public.  
3:00 p. m. to 5:00 p. m.—Radio entertainment and broadcast from the stage.  
8:00 p. m.—Special KPO broadcast from Auditorium.  
10:00 p. m.—Raffle of complete radio set by Pacific Radio Trade Association.  
11:00 p. m.—Exposition closes for the night.

**TUESDAY, AUGUST 19**  
Santa Clara and Peninsula Day

- 10:00 a. m. till 12:00 m.—Special hours for dealers only.  
2:30 p. m.—Exposition doors open to the public.  
3:00 to 5:00 p. m.—KPO program from Auditorium.  
8:00 to 10:00 p. m.—Special radio stunt exhibit and KPO broadcast from stage.  
10:00 p. m.—Raffle of one radio set by the Pacific Radio Trade Association.  
11:00 p. m.—Exposition closes for the night.

(Continued on page 70)



# KFI

Los Angeles, Calif.

This is the station of Earle C. Anthony, Inc. Illustrations show Paul Reese, KFI program director and announcer. The antenna system and a view of the studio are also shown. KFI will shortly be on the air with a new transmitter of five kilowatts capacity.

# [BMS] [PRODUCTS]

These products are leaders  
in their respective lines.

\* \* \*

TRI-JACK is a super compact, all bakelite jack, dustproof and solderless. Can be used as single or double circuit jack, without any change other than in wiring. Lists at 90c

\* \* \*

TRI-PLUG is absolutely automatic in action—no levers to push, either to grip or release the phone cords. Solid bakelite moulded to a shape that is convenient to handle. Lists at 75c

\* \* \*

TRI-COIL is famous for getting both distance and volume on one tube. Lists at \$2.00

\* \* \*

The TRI-COIL Reflex Circuit is easy to build. Write for FREE hook-ups.

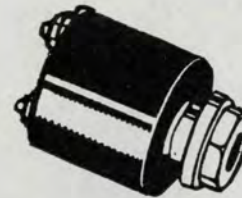

**TRI-JACK**



**TRI-PLUG**



**TRI-COIL**

This set of four HET-TRI-FORMERS and one OSCIL-LATOR COUPLER makes super-heterodynes deliver the last ounce of energy to you. \$25.00 per set  
Booth No. 61 at Radio Show.

**BROOKLYN METAL STAMPING Corp**  
718 Atlantic Ave. Brooklyn N.Y.

Pacific Coast Representative:  
**FREDERIC L. TOMLINSON CO.**  
447 Pacific Building, San Francisco  
1113 Wall Street, Los Angeles, Cal.  
116 Thirteenth Avenue, Seattle, Wash.

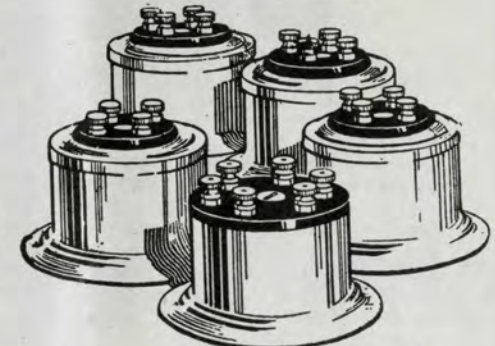

The complete set of  
**HET-TRI-FORMERS**

## K G W The Morning Oregonian Portland, Oregon



In the center illustration is shown the Degree team of the Keep-Growing-Wiser Order of Hoot Owls, midnight revelers who are heard every Friday. In the foreground is Alex F. Reilly, "grand piano." Standing are Dick Haller, director of KGW, who holds the title of "holder of the grand goat." Second from the left, next microphone, is Henry Metzger, "grand slam;" to left of microphone is Charles F. Berg, "grand screech," head of the order; seated at the owl-organ is Rt. Rev. Walter T. Sumner, Episcopal bishop of Oregon Diocese, whose title is "grand sermon" and who plays the owl-organ. Next to the bishop is Barnett H. Goldstein, "grand schmoss," and beside him is Frank J. Sardam, "grand scream" and head of the educational department, in which capacity he is lovingly known as "Uncle Sid" (Dr. Sedative P. Seidlits). Last in the line but not least, is Tige Reynolds, "grand sketch."



Upper illustration shows towers at KGW, Portland, Oregon. Towers are 290 feet above the ground. Lower photo is that of Richard V. Haller, known to the radio public as "Dick," director and chief announcer of The Oregonian station, a 500 watt standard Western Electric equipment.

The New

# MAGNAVOX

TUBES, SETS AND REPRODUCERS WILL BE ON DISPLAY AT THE SHOW

DON'T MISS THIS EXHIBIT

For full information regarding this new line  
— see us at Booth 46



[ We are Authorized  
Magnavox Dealers ]

SERVICE—SATISFACTION

# Gallagher & Eiferle

409 14th Street · OAKLAND · Phone Lakeside 9731  
"Everything for Radio Equipment"

Broadcast Station Directory

Call Letters	Meters	Location	Owned by	Power in Watts
CFAC	430	Calgary, Alberta, Canada	The Calgary Herald	650
CFCN	440	Calgary, Alberta, Canada	W. W. Grant, Radio	1500
CHBC	410	Victoria, British Columbia	Albertan Publishing Company	1000
CJCA	450	Edmonton, Alberta, Canada	Edmonton Journal	500
CKCD	410	Vancouver, British Columbia	The Daily Province	1000
CKCK	420	Regina, Saskatchewan, Canada	Leader Publishing Company	500
CYL	500	Mexico City, Mexico	El Universal	500
CYR	490	Mazatlan, Mexico	Rosseter y Cia	250
KDKA	326	East Pittsburgh, Pennsylvania	Westinghouse Electric & Mfg. Company	1000
KDPT	244	San Diego, Third and E streets	Southern Electric Company	50
KDYL	360	Salt Lake City, Utah	Newhouse Hotel	100
KDYM	280	San Diego, 236 C street	Savoy Theatre	100
KDZB	360	Bakersfield, California	The Rhodes Company	100
KDZE	270	Seattle, 1321 Second avenue	Washington State College	100
KFAE	330	Pullman, Washington	Western Radio Corporation	50
KFAF	360	Denver, 737 Lincoln street	Boise Public Schools	100
KFAU	270	Boise, Idaho	The Radio Den	10
KFAW	280	Santa Ana, California	W. K. Azbill	20
KFBC	278	San Diego, 5038 Cliff Place	Kline Brothers	10
KFBE	242	San Luis Obispo, California	Kimball-Upson	100
KFBK	283	Sacramento, California	Meier & Frank	50
KFEC	248	Portland, Oregon	Sparks High School	100
KFFR	226	Reno, Nevada	Fallon & Co.	100
KFHJ	360	Santa Barbara, 23 West Figueroa	Star Electric Company	50
KFHR	283	Seattle, Washington	Earle C. Anthony, Inc.	500
KFI	469	Los Angeles, California	Post-Intelligencer	100
KFJC	270	Seattle, Washington	Westinghouse Electric & Mfg. Company	1000
KFKX	341	Hastings, Nebraska	Drake Radio	5
KFNV	234	Santa Rosa, California	The Rhodes Company	500
KFOA	455	Seattle, 1321 Second avenue	Echophone Radio	250
KFON	234	Long Beach, California	Angelus Temple	500
KFSG	278	Los Angeles, California	Hallock & Watson Radio Service	50
GGG	360	Portland, 192 Park street	Northwestern Radio Company	100
KGN	360	Portland, 1556 East Taylor street	General Electric Company	1000
KGO	312	Oakland, California	Oregonian	500
KGW	492	Portland, Sixth and Alder streets	St. Martin's College	10
KGY	258	Lacey, Washington	Times	500
KHJ	395	Los Angeles, California	L. Wasmer	250
KHQ	360	Seattle, 419 Thirteenth avenue	Gould, The Light Man	5
KJQ	273	Stockton, California	Northwest Radio Service Company	100
KJR	283	Seattle, 6838 Nineteenth avenue	Bible Institute	750
KJS	360	Los Angeles, 536 South Hope street	Warner Brothers	250
KLS	360	Oakland, 2201 Telegraph avenue	Tribune	500
KLX	509	Oakland, Thirteenth and Franklin	Reynolds Radio Company	500
KLZ	283	Denver, Colorado	San Joaquin Light & Power Company	50
KMJ	248	Fresno, H and Tulare streets	Love Electric Company	10
KMO	360	Tacoma, 732 Pacific avenue	Electric Light Supply	100
KNX	360	Los Angeles, California	Hale Brothers, Inc.	500
KPO	425	San Francisco, Fifth and Market	Berkeley, Gazette	50
KRE	275	Berkeley, Hotel Claremont	Post-Dispatch	500
KSD	546	St. Louis, Missouri	First Presbyterian Church	750
KTW	360	Seattle, Seventh and Spring	Examiner	150
KUO	360	San Francisco, Third and Market	Portable Wireless Telephone Company	50
KWG	360	Stockton, 530 East Market street	Westinghouse Electric & Mfg. Company	500
KYW	536	Chicago, Illinois	Hotel Oakland	50
KZM	360	Oakland, Thirteenth and Harrison	The Deseret News	500
KZN	360	Salt Lake City, Utah	International Telegraph & Telephone Co.	500
PWX	400	Havana, Cuba	Star-Telegram	500
WBAP	476	Fort Worth, Texas (462m)	Detroit Free Press	500
WCX	517	Detroit, Michigan	Kansas City Star	500
WDAF	411	Kansas City, Missouri	Board of Trade	500
WDAP	360	Chicago, Illinois	Dallas News	500
WFAA	476	Dallas, Texas	Chicago Tribune	500
WGN	370	Chicago, Illinois	Sweeney Auto School	500
WHB	411	Kansas City, Missouri	Cutting & Washington Company	500
WLAG	417	Minneapolis, Minnesota	Crosley Manufacturing Company	500
WLW	309	Cincinnati, Ohio	Daily News	500
WHAQ	448	Chicago, Illinois	Woodmen of the World	500
WOAW	526	Omaha, Nebraska	Palmer School of Chiropractic	500
WOC	484	Davenport, Iowa	L. Bamberger & Co.	500
WOR	405	Newark, New Jersey	Atlanta Journal	500
WSB	429	Atlanta, Georgia	Willard Storage Battery Company	1000
WTAM	390	Cleveland, Ohio	Evening News	500
WWJ	517	Detroit, Michigan	State Government	1000
XICE	520	Chihuahua, Mexico		



# De Forest D-12 Reflex Radiophone

As exclusive distributors of the new models of DeForest Radio Receiving Sets in Northern California, we are now arranging agencies, which will be very valuable to those who are fortunate enough to get one.

Write us for particulars.

## ELECTRIC APPLIANCE COMPANY

807-809 MISSION STREET, SAN FRANCISCO

Jobbers of

RADYNE five tube, long distance Radio Receivers. "E A CO." JR. two tube sets, giving one stage of tuned radio frequency amplification, a tuned detector circuit and two stages of audio frequency amplification.

We are also exclusive distributors of the new

### 2 in 1 A. P. TUBES

With two filaments, two grids and two plates, especially adapted for radio frequency amplification and reflex circuits. Write us for full particulars.

The above items will be on display in our Booth No. 125 at the Pacific Radio Exposition.

Our Radio Accessory Catalogue No. 61R is very complete and if any dealer is not supplied let us know and it will be forwarded.

No goods at retail. We solicit only the dealers' business.

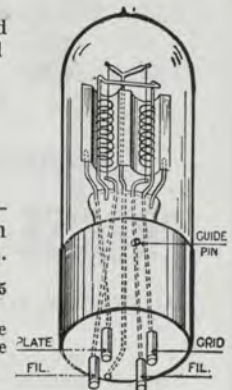



DO YOU EVER EXPERIMENT WITH NEW CIRCUITS?

Have you ever considered this — that the transformers you have been using in experimental hook-ups may have been designed a year, maybe two years, ago? And that radio moves very fast, and that perhaps you are not getting up-to-the-minute efficiency, and are holding the circuit at fault?



Ratio  
4 1/2 to 1

Crystal Finish  
Model 285B—\$5.00

PRECISE, the most advanced of all Audio Transformers, is your logical solution. Thousands of Precise have not varied a hair in their uniformity, their absolute dependability and their super-quality throughout. Built to take the highest plate voltages, the heaviest current and severest usage you can give them without a suggestion of a complaining murmur, are points that have put them foremost in experimental work throughout the world. And the remarkable quality of the amplification secured in this work has given Precise its pre-eminent position among Audio Transformers in all fields today.

*Today's factor is not price, but performance. This is guaranteed you in Precise Audio Transformers at five dollars.*

**"A Laboratory Instrument at a Commercial Price"**

**PRECISE MANUFACTURING CORPORATION**

Pacific Coast Branch

821 MARKET STREET

SAN FRANCISCO, CALIF.

SAN FRANCISCO DISTRIBUTORS

Alexander and Lavenson Electrical Supply Company

Electric Appliance Company

Frederick H. Thompson Company

AN EXCEPTIONALLY EFFICIENT REFLEX

Circuit Number Two

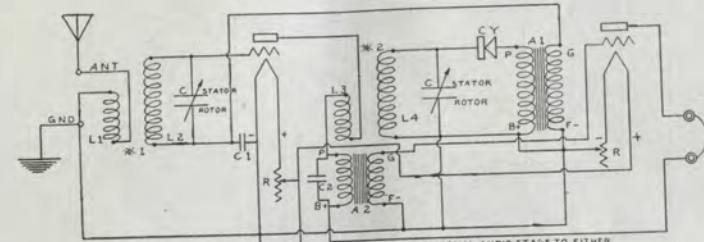

- No. 1 Antenna Tuning Coils
- L1 Primary of No. 1
- L2 Secondary of No. 1
- No. 2 R. F. Transformer
- L3 Primary of No. 2
- L4 Secondary of No. 2
- C 11 to 13 Plate Condenser .00025 to .0003
- C1 .00025 Mica Condenser
- C2 .001 to .005 Mica Condenser .005 in most cases
- CY Fixed or Semi-fixed Crystal
- R 6 to 30 Ohm Rheostat

- A1 Precise Audio Transformer 4 1/2 to 1
- A2 Precise Audio Transformer 4 1/2 to 1

*Two Tube Super-flex*

The parts in the two tube Super-flex are just the same as in our one tube circuit (circular on request) with the addition of another Audio Frequency Transformer, Socket and Rheostat. An additional stage of Audio Frequency Amplification may be added to either the one tube or the two tube, as shown in Circuit No. 2 the primary of the transformer for the extra stage is connected at the phone output of either set to which it is added. Circuit No. 2 has a long range of reception and produces immense volume on loud speakers.

**"A Laboratory Instrument at a Commercial Price"**

**PRECISE MANUFACTURING CORPORATION**

Pacific Coast Branch

821 MARKET STREET

SAN FRANCISCO, CALIF.

SOLD BY

Radio Dealers Everywhere

Ask for the New One Tube Super-Flex Circuit Diagrams

**RADIO LOG**

CALL	CITY	DATE	TIME	MILES	REMARKS

**Thompson**  
**NEUTRODYNE RADIO**  
 MODEL 5A  
LICENSED UNDER HAZELTINE PATENTS  
 \$125  
 \$28  
**The Thompson MAGNAPHONE**  
Reg. U.S. Pat. Off.

Be sure it's a THOMPSON. Then you will be sure of getting features that are possible only to an organization which has been making wireless and radio apparatus exclusively for fourteen years.

# Thompson Neutrodyne

Hear and compare the Thompson with any radio set. Even in Neutrodynes there is a big difference. Thompson sales prove this. \$125 without tubes and batteries.

## Thompson Speaker

Unusual tonal qualities and a practically unbreakable horn are just two of the features that have made the Thompson Speaker such a phenomenal success. Compare the tone at good radio dealers—\$28.

# Wholesale Electric Company

(WHOLESALE ONLY)

817 MISSION STREET

SAN FRANCISCO

## Local Radio Clubs

### Radio Pioneers

San Francisco boasts of an unusual radio association—the Society of Radio Pioneers. This organization is composed of members who have been actively engaged in the radio field prior to 1913. Its membership incorporates many leaders of the local radio trade—men who have been instrumental in the development and perfection of countless radio inventions.

Fifty-three prominent local radio men constitute the membership of this popular body. Meetings are held weekly at the club rooms, 1380 Bush street, San Francisco.

The organization was founded by H. W. Dickow, who acted as secretary for the first administrative term. Present officers include the presiding pioneer, J. Edward Jones; vice-presiding pioneer, Ralph Heintz; secretary-treasurer, T. L. Kennon; sergeant-at-arms, Henry Free. A board of directors includes an amateur pioneer, commercial pioneer, governmental pioneer, experimental pioneer and industrial pioneer. The honorary member of the organization is Col. J. F. Dillon, supervisor of the Sixth Radio District.

Regular technical and non-technical lectures are given monthly. One business meeting, one social meeting and another meeting for open discussion of radio problems constitute the monthly routine of the organization. Radio men of the bay district who have been actively engaged in the art since and prior to 1913 are eligible for membership. Communications should be addressed to the secretary, T. L. Kennon, 1380 Bush street, San Francisco.

### San Francisco Radio Club, Inc.

The radio amateurs of San Francisco have long been banded together in an organization known as the San Francisco Radio Club, Inc. The club is one of the oldest and largest of its kind in America, having been founded in 1911. It has a membership of almost one hun-

dred prominent local amateur operators. Meetings are held on Thursday evenings at 1380 Bush street, San Francisco. The president of the club is Harry Tattenham; the secretary, A. V. Bray.

The purpose of the organization is to preserve law and order "on the air" and to co-operate with the local radio supervisor in the regulation of amateur traffic on the Pacific Coast. A traffic officer and chief operator, A. Snell, has this duty assigned to him. Many of the club members have powerful transmitting stations in operation. Their signals have been heard not only in every part of the United States but also in foreign countries. The club is the father of the Pacific Plan for traffic regulation in the West. This plan was long recognized by even the large broadcasting stations.

Yearly conventions have been held in San Francisco under the direction of the club. The first radio show held in San Francisco, a number of years ago, was entirely conducted by the San Francisco Radio Club.

By attending one of the regular meetings of the club every local amateur will become convinced that he should be a member.

### San Francisco Representatives for Eastern Factories

(Continued from page 15)

Kardon Products Company, New York City.  
Kodel Manufacturing Company, Cincinnati.  
Pathe Phonograph & Radio Corporation,  
Brooklyn, N. Y.  
Ritter Radio Corporation, New York City.

**Factories Represented by Universal Agencies, 693 Mission Street, San Francisco:**  
Radio Receptor Company, New York City.  
Electrad, Incorporated, New York City.  
Durham & Co., Philadelphia.  
Peerless Radio Corporation.  
A. H. Miller Radio Company, Detroit.  
J. Thomas Rhamstine, Detroit.  
Radio Guild, Incorporated, New York City.  
Preel Radio Manufacturing Company.  
American Radiophone Manufacturing Company.  
Perfection Machine Manufacturing Company, Newark.  
Firth Radio Corporation, New York City.

**Factories Represented by Universal Agencies, Marine Building, San Francisco:**  
Radio Receptor Company, New York City.  
Electrad, Incorporated, New York City.

Dealers, See—

## FREDERICK H. THOMPSON CO.

(Wholesale Exclusively)

At the Radio Show Booths 7 and 9—or at our offices at 210 Drumm Street, San Francisco

*Best Lines*

*Best Service*

On such products as

*R-212 Radio Service Neutrodyne Set*

*Burgess Batteries*

*Dictograph Products*

*Kellogg Products*

*General Radio Products*

*Federal Products*

*Kilbourne & Clark Products*

*Erla Products*

*Carter Products*

*Shamrock Products*

*Na-ald Products*

*All-American Transformers*

*Precise Transformers*

*Cardwell Condensers*

*Hammarlund Condensers*

*Signal Condensers*

*Accuratune Dials*

*Eby Binding Posts*

*Cannon Ball Headsets*

*and many other popular lines*

*The*  
*Freed-Eisemann*  
*NEUTRODYNE RECEIVER*  
NR-5 \$150<sup>00</sup>

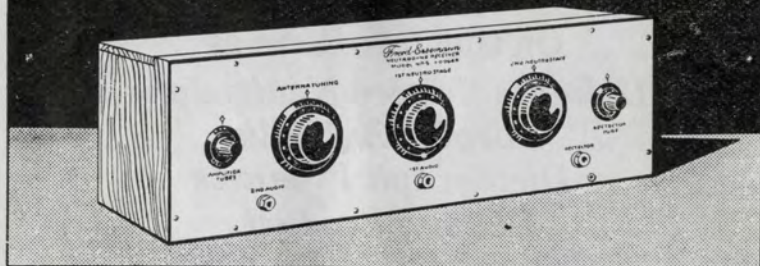

THE STANDARD  
OF COMPARISON

The world has learned to measure radio receivers by comparison with the FREED-EISEMANN.

For distance and for clarity;  
for selectivity and simplicity;  
for perfection of workmanship and dependability of performance, the FREED-EISEMANN has justly earned its recognition as

*The Last Word in the Radio Art.*

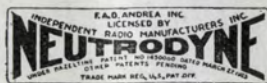

*Freed-Eisemann*

LEADERSHIP  
THROUGH  
EXCELLENCE

That the FREED-EISEMANN Receiver is the last word in the Radio Art, is a compliment paid not only by thousands of enthusiastic amateurs, but by critical radio engineers, radio editors, and experimenters whose experience covers the whole field of modern radio.

Naturally, the supply is limited. No sacrifice of quality will ever be made in this institution to gain quantity production. *Trained men* build this receiver—not mere assemblers; each of the three hundred men employed in its construction are proud of it—just as they are proud of having been selected as the builders of new receivers for the United States Government. This pride extends itself to every satisfied owner. One man tells another and therein is the secret of the reputation which the FREED-EISEMANN enjoys.

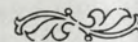

Freed-Eisemann Radio Corporation

Sperry Bldg., Manhattan Bridge Plaza  
BROOKLYN, N. Y.

BRAUN CORPORATION

Los Angeles and Oakland

Wholesale Distributors for California

## The Neutrodyne Circuit

ONE of the most recently developed circuits which has justifiably created a big sensation is the neutrodyne as developed by Prof. L. A. Hazeltine. This development is without doubt a distinct improvement in the art of radio reception in that it completely overcomes one of the most annoying causes of failure in tuned radio frequency amplification, namely it eliminates tendency of tuned amplifiers to oscillate. In order to thoroughly understand what the neutrodyne accomplishes it is necessary to examine the

trouble in radio frequency circuits is the existence of small stray or distributed capacity between different parts of the circuits. Such small capacities are especially harmful at the low wave lengths of high frequencies. For at the high frequencies the reactance of this small stray capacity becomes very small and so passes high frequency currents when it is not intended that current should pass.

Thus suppose we have, as in Fig. 1, two radio frequency circuits which are

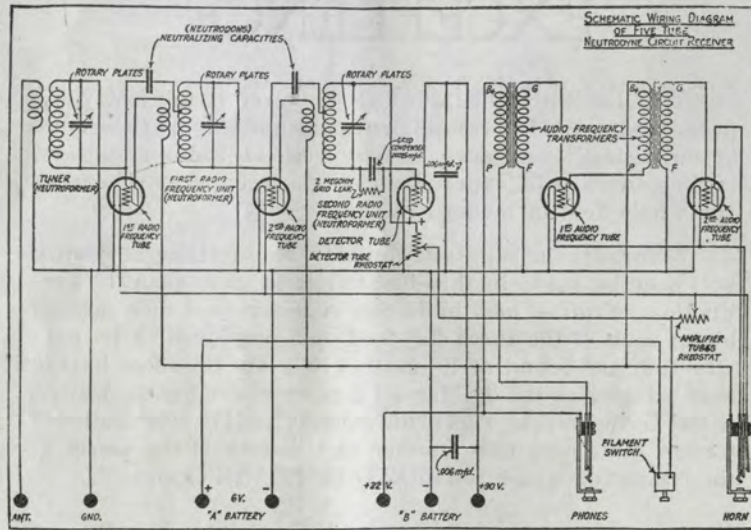

Circuit Showing Complete Neutrodyne Wiring System

conditions which led to its development.

One of the principal sources of

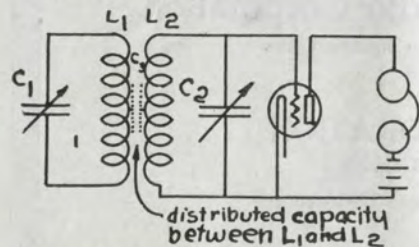

Fig. 1—Capacity Effect Between Inductively Coupled Coils

magnetically coupled to each other by the coils L1 and L2. Energy then passes from circuit 1 to circuit 2 by way of magnetic induction. But since both coils are conductors and are separated by an insulating medium they constitute a small condenser, or, in other words, there is distributed capacity between them. This distributed capacity behaves like any other condenser and will therefore let radio frequency currents flow through it. Thus high frequency currents would flow from circuit 1 to circuit 2 by way of the small stray capacity rather than by way of the transformer coils and induction,

# Stromberg-Carlson Radio Receivers

This radio receiver has all the essentials for the most gratifying reception of broadcast programs. It carries the trademark of a firm with over thirty years' manufacturing experience, and with a worldwide reputation as the builder of fine telephone and radio apparatus.

*Sensitive, Selective, Simple, Stable, Sonorous*

*Stromberg-Carlson Loud Speakers*

*Stromberg-Carlson Transformers*

*Stromberg-Carlson Head Sets*

*Stromberg-Carlson Plugs and Jacks*

# Hart and Hegeman Radio Accessories

*Dials, Sockets, Variable Condensers, Rheostats*

*Switch Levers, Points, Binding Posts,*

*Insulators*

BOOTH NO. 67

# Garnett Young and Company

Pacific Coast Sales Agents

612 Howard Street, San Francisco

Seattle

Los Angeles

Portland

thus defeating the purpose of the transformer.

Also these capacity currents, called parasitic currents, represent a loss of energy, and are therefore an undesirable feature of any circuit. Not only does this small stray capacity introduce harmful effects by by-passing from their legitimate paths currents to which the circuits are tuned, but it also creates trouble by introducing into the circuits undesirable extraneous currents to which the circuits are not tuned.

Consider again Fig. 1 which represents two radio frequency circuits inductively coupled, the secondary of which feeds the grid of a detector tube, and suppose C3 represents the small distributed capacity existing between the two coils. Let us furthermore assume that the circuits represent primary and secondary of a receiver which is supposed to receive over a band of wave lengths from 200 to 600 meters. In the first place we would have present the harmful effects described above, namely at the low wave lengths around 200 meters the distributed capacity will by-pass some of the received current, preventing the coupling coils from performing their proper function. In the second place when reception is taking place at the higher wave lengths, interference from low wave signals will be introduced by the distributed capacity. For any low wave signal which may get into the primary circuit in any way, as for example via the aerial, will be transmitted to the secondary through the capacity which exists between the

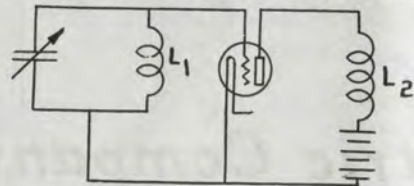

Fig. 2—Conventional Amplifier Circuit

primary and secondary, and thus will get on the grid of the detector tube and produce an interfering signal. This occurs irrespective of the tuning of the circuits, since capacity parasitic currents do not depend on the tuning of circuits but simply flow through the capacity coupling.

When we consider the vacuum tube

we are again confronted with very small capacities which influence the action of the tube considerably. Thus the plate and grid together form the two plates of a tiny condenser. In the average tube this capacity is of the order of 3 to 5 micro-microfarads. This is, of course, very minute but is capable of doing untold harm if not properly controlled.

Fig. 2 represents a conventional type of circuit frequently employed in radio reception, as for example one stage of transformer coupled radio frequency amplifier with one tuned circuit. L2 is not coupled to L1 and it might therefore be thought that such an amplifier would be stable. However, this is not necessarily the case as will be seen when we simplify this circuit as in Fig. 3 where we have inserted Cp in place of the tube. Cp represents the capacity between plate and grid. This small capacity is in reality a coupling condenser, for one plate is in the grid or input circuit while the other is in the plate or

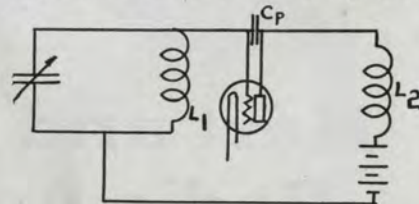

Fig. 3—Tube Capacity Effect in Circuit of Fig. 2

output circuit. As a result, even if there is zero coupling between coils L1 and L2, it will be seen that there is capacity coupling through Cp between the output and input. Any current flowing in the plate circuit of the tube will therefore feed back into the input circuit thus rendering the circuit unstable. This explains the reason for regeneration in circuits where there is no apparent feed-back coupling between input and output. The higher the frequency the greater is this capacitive feed-back, for the reactance of the small coupling condenser decreases and makes feed-back all the easier. It is for this reason that radio frequency amplification at the low waves—600 meters and under—was very unsuccessful for a long time, for the capacity coupling and feed-back was so great that cir-

(Continued on page 70)

BOOTH  
No. 76



The Helical Wound  
Coil

BOOTH  
No. 76



AUDIO  
HW-A2-6 to 1.....\$5.00  
HW-A2-3 to 1..... 5.00



PUSH PULL  
HW-A2-I—Input...\$5.00  
HW-A2-T—Output.. 5.00

The world's exclusive manufacturer of Helical wound coils announce their new line of

Samson  
Transformers

"Air Core"

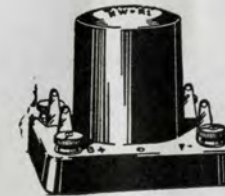

Intermediate  
Frequency

RADIO  
HW-R1—3000 meters.....\$4.50  
HW-R1—5000 meters..... 4.50  
HW-R1—10,000 meters..... 4.50

Manufactured by

Samson Electric Company  
CANTON, MASS.

REPRESENTATIVES:

SAN FRANCISCO  
A. S. Lindstrom  
111 New Montgomery St.

LOS ANGELES  
Lombard J. Smith  
451 East Third St.

PORTLAND  
H. A. Killam  
312 McKay Bldg.

SEATTLE  
G. H. Maire  
95 Connecticut St.

## The Reflex Circuit

THE last of the really original and important circuits which we have to consider is the reflex circuit, of which there are fifty-seven varieties with fancy names. The idea of the reflex circuit originated with a French engineer of international prominence, Marius Latour, who is, therefore, entitled to whatever credit is given for the circuit. It is true that his circuit was more fully developed by Americans but the original idea was his. A great many unnecessary frills and furbelows have been added to this circuit by self-styled radio experts, and as a result we have "plex" and "fref" circuits which are nothing more, generally, than the original reflex circuit in disguise.

The big idea underlying the reflex circuit, and which gives it its chief virtue, is tube economy. The importance of tube economy is, of course, well appreciated by all radio fans. Modern receivers are tending more and more towards

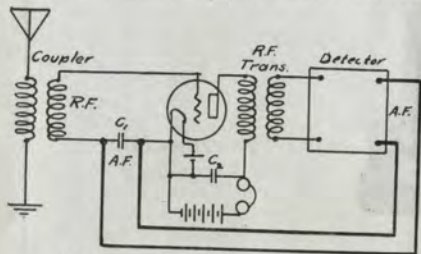

Fig. 1—Diagram Illustrating Reflex Principle

the use of radio frequency amplification before the detector. As a result, if separate tubes are used for radio frequency, detector and audio frequency, the number of tubes in the set begins to get excessive.

Five, six, seven and eight tube sets are not at all unusual. Since each tube costs \$4, the initial cost of the set and tube renewals are great. Not only this, but battery wear and expense mounts, for six tubes use up twice as much filament current as three, and also drain the "B" battery twice as fast. Hence, if some means could be provided for making four tubes, say, do the work of six an immediate four-fold saving would ensue: First, initial cost of set; second, smaller number of tube renewals; third,

"A" battery power saving; and fourth, "B" battery power saving. Such an arrangement involves incidental savings such as fewer tube sockets, rheostats, etc., and simplifies operation if we consider each tube filament has a separate rheostat to be controlled.

The reflex circuit is the first big step in this direction. Its main reason for existence is its economy. The engineering idea underlying the reflex circuit is the simultaneous use of a single tube for both audio and radio frequency amplification. This is possible to the extent that any given tube is able to amplify at both radio and audio frequencies. The efficiency of reflexing is therefore proportional to its amplifying properties at radio and audio frequencies. If the tube amplifies poorly at radio frequencies and very well at audio frequencies the reflex action will be inefficient. The same statement holds if the tube is a poor audio frequency amplifier but a good radio frequency amplifier. Good reflexing is made possible by virtue of the fact that the standard tubes as made in America are both good radio and audio frequency amplifiers. Thus the UV-201A and C-301A are uniformly good on both radio frequency and audio frequency.

Fig. 1 illustrates the action of the reflex circuit. Here is represented a single tube detector of some sort. The radio frequency from the antenna is impressed on the grid of the tube through the medium of the coupler. The radio frequency transformer in the plate circuit amplifies this signal, which is then impressed on the detector. The output of the detector is an audio frequency signal (marked AF) which is carried back to the grid of the tube as shown. An audio frequency voltage is thus impressed on the first tube which amplifies the audio signal. The telephones or loud speaker are in the plate circuit of the first tube.

Thus the tube has impressed on its grid a radio frequency signal and an audio frequency signal, and in its plate circuit appear both an amplified radio signal and audio signal, from Fig. 1, and this explanation the reader will be able to appreciate the statement as to the efficiency of the reflex. For it will be seen that if the tube is a poor audio

# STOP!!

You have missed the greatest and most sensational exhibit in this show if you have failed to visit

## BOOTH 21

where you may see and examine positively the last word in present-day radio sets and circuits, and receive a credit certificate worth

### \$5.00

## Absolutely Free

to apply on the purchase of any model of this remarkable modern development, the

### SUPER-FLEX

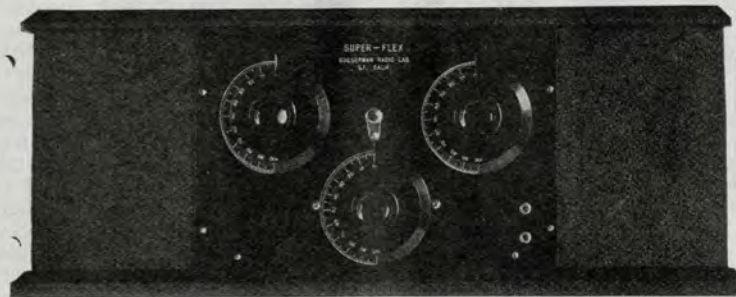

**DESCRIPTION:** Cabinet—African mahogany, beautifully hand rubbed; size, 7x8x21 (all batteries contained), therefore easily portable. **Panel**—Genuine Bakelite, handsomely engraved. **Batteries**—All dry cells, A, B and C; average battery cost to operate, 50c per month. **Circuit**—A development of engineers in our own laboratories and used only in our own sets. **Selectivity**—Positively tunes out any unwanted station, no matter how powerful or close you may be.

**GUARANTEE:** Every part of set (except tubes and crystal) fully guaranteed for a life-time, which means that any parts which might prove defective at any future date will be repaired or replaced absolutely free of charge or any service given. This insures you against repair bills and future expense, and alone is worth the whole price.

**PRICE:** With tubes, batteries and speaker complete, \$69.50.

**TERMS:** Small payment down, then take six months to pay.

## Bosserman RADIO Laboratories

New Address: 766 Post St., San Francisco

Open Tuesday and Thursday evenings till 10 p. m. Closed other evenings at 6.

frequency amplifier there will not be much advantage or gain in reflexing, for the audio signal after reflexing may not be much louder than it is in the output of the detector. In order to fully understand the action of reflex circuits and the precautions to observe, it will be best to consider some of the standard circuits.

There are two types of detectors which may be used in reflex circuits, a non-amplifying detector such as the crystal, and an amplifying detector such as the vacuum tube. Both may be used satisfactorily, though the crystal gives more stable operation. Fig. 2 illustrates a simple one-tube reflex set employing a crystal detector.

The action is identical with that de-

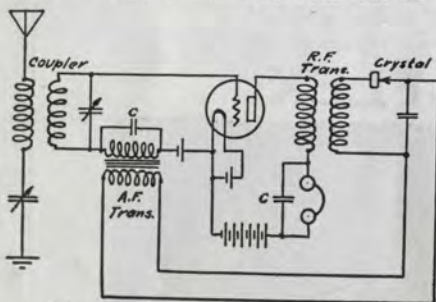

Fig. 2—Simple One-tube Reflex Circuit

scribed in the previous paragraph. It will be observed that a condenser C shunts the secondary of the audio frequency transformer, the telephones and the primary of the audio frequency transformer. These condensers are necessary for the efficient performance of the set and are essential on all reflex sets. They serve the purpose of by-passing the radio frequency currents efficiently.

Thus consider the secondary of the audio frequency transformer. If no condenser were used across the secondary the radio frequency currents in the grid circuit would have to flow through the secondary of the audio frequency transformer. This, as is well known, would introduce so much loss and voltage drop that very little radio frequency voltage would ultimately reach the grid and low signal intensity would result. To avoid this, a condenser is shunted around the transformer sec-

ondary which efficiently by-passes the radio frequency.

For the same reason the telephones or loud speaker must be shunted with a condenser. For the amplified radio frequency currents in the plate circuit of the tube will flow through them unless so shunted, and, consequently, introduces further loss.

In the case of the crystal detector and primary of the audio frequency transformer we have the case of a detector which is not perfect, that is, which does not rectify all of the radio frequency which is not rectified must be by-passed by a condenser C. These by-passing condensers must have a relatively low reactance to radio frequency currents, but at the same time must have an extremely high reactance to audio frequency currents. For, unless they do, they will by-pass or shunt the higher speech frequencies which would otherwise flow through the audio frequency transformer or telephones. In this way distortion is produced.

These two requirements for the by-passing condensers, namely low reactance to radio frequency currents and high reactance to speech frequency currents, are not incompatible. A small condenser has a low reactance to radio frequency currents, but has a high reactance to audio frequency currents. Suitable values for C are values between .0005 microfarads and .002 microfarads.

It will be observed in Fig. 2 that a C battery is employed. This is strictly necessary if good quality of speech and music is to be had. The value of the bias depends upon the plate voltage, but for voltage up to 90 volts a good value for bias potential is 3 to 4½ volts negative on all standard tubes such as the UV-201A, C-301A, UV-199 and so on. For the crystal detector it is recommended that a fixed contact crystal be used. Good ones are now available and are advertised in the various periodicals. They avoid the trouble of having to fuss with the contact. In place of the crystal detector a tube detector may be used.

Fig. 2 illustrates how, with one tube, radio frequency and audio frequency amplification may be secured. With a one tube set of this description loud speaker operation may be had if not too

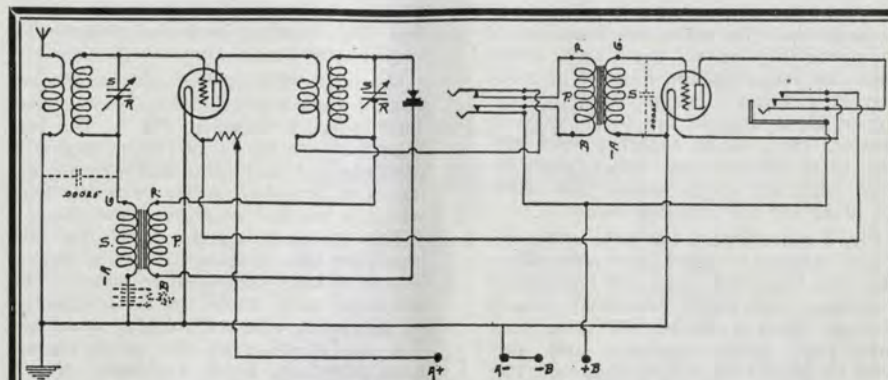

## TWO TUBE REFLEX

*The most popular circuit of the hour*

Kilbourne and Clark's complete reflex kit, containing all parts necessary for assembling the Harkness 2-tube circuit, including drilled and engraved panel and Kilbourne and Clarke's exceptionally successful spider-web type radio frequency transformers.

**List Price \$34.00**

*Kilbourne and Clark's Reflex Coils only  
\$2.50 per pair*

Also other makes of accessories, including  
Diode Tubes, Erla and R. C.  
Fixed Crystals

**United Radio Supplies Co.**

"RADIO EXCLUSIVELY"

693 MISSION STREET

Wholesale Only

SAN FRANCISCO



far from the transmitter. It will readily be seen that the reflex set lends itself to portability more than any other, since, by reflexing, the number of tubes may be reduced to almost half that required by a straight set for any given results. This, taken together with the fact that present-day tubes may be used with dry cells, makes the reflex set ideal for the portable receiver.

Fig. 3 represents a two-tube reflex receiver which is ideal for portability. The two tubes are used for both radio frequency and audio frequency amplification. Such a circuit will give very good loud speaker results, and may even be used with a loop antenna. The two tubes perform the same duties that

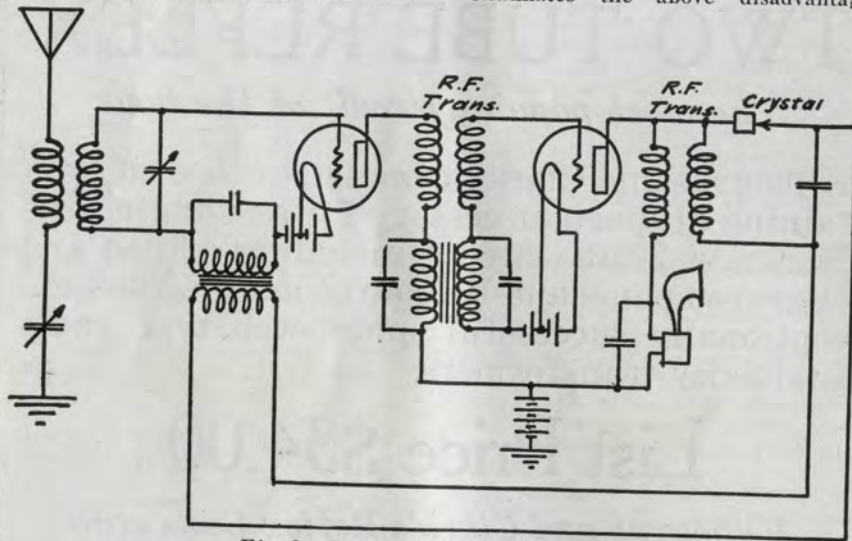

Fig. 3—Two-tube Reflex Receiver

four tubes do in the ordinary set, namely, there are two radio frequency stages and two audio frequency stages.

The circuit of Fig. 3 is what is called a straight reflex circuit, that is, the radio frequency progresses from the first tube to the last, and then the audio frequency likewise progresses from the first tube to the last. This system of reflexing is subject to a number of disadvantages. The system is subject to instability—especially when a tube detector is used—oscillations being easily set up. For, if any radio frequency passes through the detector, it is fed back to the first radio fre-

quency tube and progressively amplified. This feeding back and progressive amplification may cause oscillations.

Secondly, this system of straight reflexing causes overloading very easily. This is easily shown in Fig. 3. The last tube carries very large radio frequency currents and very large audio frequency currents, in brief, carries twice the load which a normal amplifier tube carries. Where three tubes are used the last amplifier tube carries still more power. The first tube carries little power. The last tube may, therefore, be overloaded to the point where distortion occurs.

A modification of the reflex circuit has, therefore, been developed which eliminates the above disadvantages.

This modification is called the "inverse" system and is due to D. Grimes. In the inverse system the radio frequency progresses from the first to the last tube, but the audio frequency progresses in the opposite direction, namely from the last to the first tube. The net result is that overloading is avoided, each tube carries approximately the same amount of power, and instability causing oscillations is avoided. How this is accomplished is shown in Fig. 4.

In Fig. 4 is shown an inverse reflex set employing two tubes and a crystal detector. The radio frequency in-put

**LEMCO**  
EQUIPMENT

## DON'T MISS No. 50 Two Tube Neutroflex

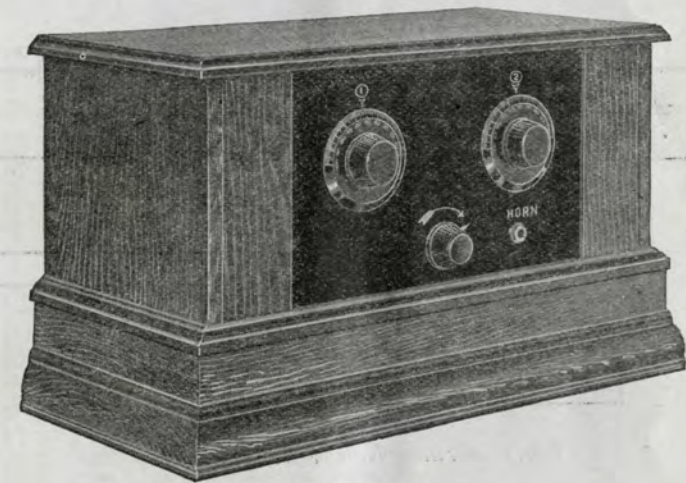

PRICE \$50.00

Booth No. 120

Pacific Radio Exposition

Demand Lemco parts for your reflex set

Lee Electric & Manufacturing Co.

220 Eighth Street

San Francisco

progresses from the first tube to the detector in the usual manner. The audio frequency output of the detector is now fed backward in the direction from the second tube to the first, that is, the second tube, which is the second radio frequency tube, is the first audio frequency tube. The audio frequency output of this tube is then fed into the first tube.

Thus the first tube, which is the first radio frequency amplifier tube, is

Finally, instability is decreased owing to the fact that progressive amplification of any radio frequency which gets through the detector is eliminated. For, if any radio frequency does get through the detector capacitively, it is applied first to the last radio frequency tube and can, therefore, be amplified only by this tube, whereas in the straight reflex it is amplified by the first and second tubes.

For these reasons the inverse system

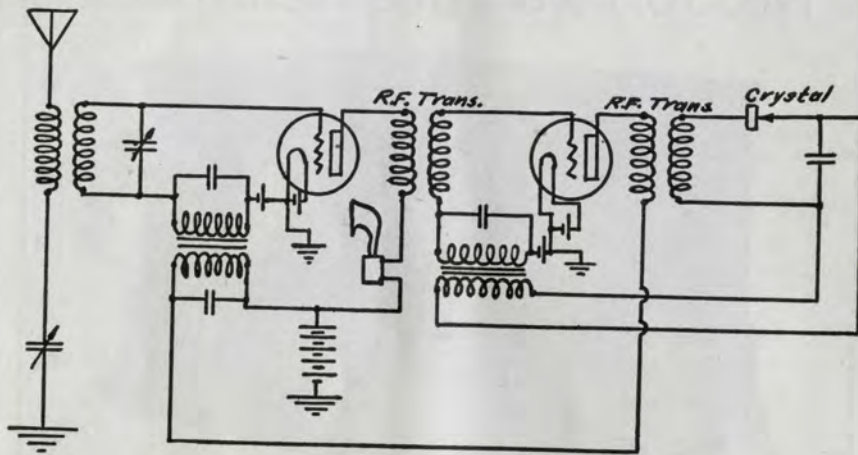
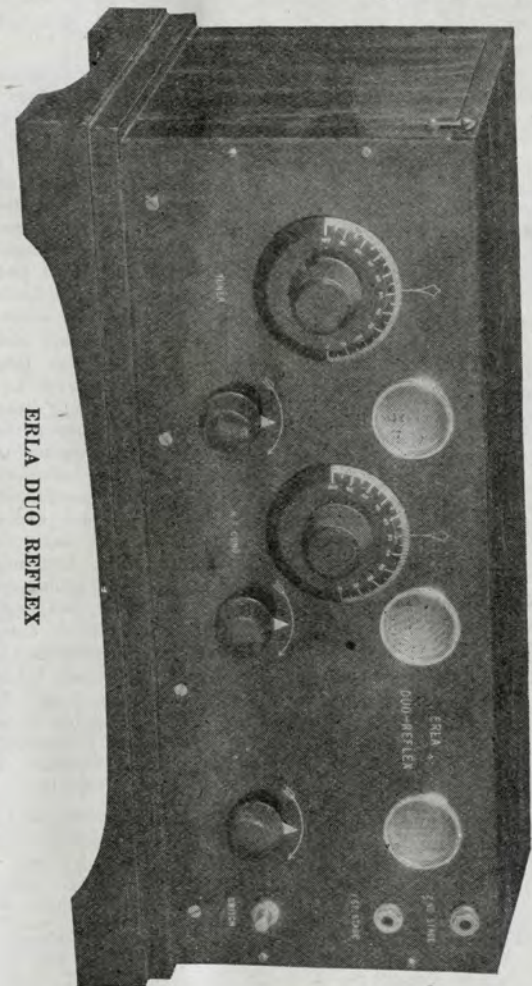

Fig. 4—Grimes Inverse Reflex Circuit

the second audio frequency stage which operates the loud speaker. As a result, it will be observed that each tube is equally loaded; if one tube carries small radio frequency currents it also carries large audio frequency currents, while if it carries small audio frequency currents it will also carry large radio frequency currents. Thus the load is equally balanced in all tubes. Secondly no tube is overloaded or worked too hard, for it never carries the full radio frequency and audio frequency load at the same time, as happens in the straight reflex system. Thus overloading and distortion are avoided.

has proved itself the best where a number of tubes are used, say three or more. Obviously, where only one tube is used the inverse system is not applicable. For two tubes it is. Whether there is any advantage in a two tube inverse reflex depends to a considerable extent on the capabilities of the tubes. Thus for UV-199 tubes the inverse system is preferable, for these tubes are easily overloaded. On the other hand, the UV-201A is capable of handling considerable power and to that extent that the straight system may be employed, provided the system is built so that there is not much capacity feed-back.

The Three Best  
Radio Receivers  
SUPERFLEX  
ERLA REFLEX  
SUPER-HETER-  
ODYNE



ERLA DUO REFLEX

SENSATIONAL EXHIBIT IN BOOTH 32

**DODDSON & DODDSON**

The most up-to-date radio retail store in the West  
1507 Washington Street Oakland, California

PHONE LAKESIDE 8983

ALSO OSGOODS DRUG STORE

CORNER TWELFTH AND WASHINGTON STS.

OAKLAND, CALIF.

## What You Will See at the Show

### New Apparatus Shown for First Time at Pacific Radio Exposition

True to their promises a large number of important radio manufacturers are showing their 1925 radio styles for the first time at the Pacific Radio Exposition. The Magnavox Company has a line of complete sets and vacuum tubes. You will find this new equipment in Booth B. The Magnavox tube uses no grid. The receiving sets employ the tuned radio frequency principle, using five tubes. One tuning control takes care of the wave length adjustment.

F. A. D. Andrea, Inc., will show their new line of FADA neutrodyne. Console and various types of cabinet models will be on display. Many important improvements have been made. F. A. D. Andrea, president; Kimball H. Stark, advertising manager and several other officials of the Andrea Company will be at the show in person.

The new Radyne portable and the standard cabinet type of Radyne sets will be shown in Booth D. J. Edward Jones, president of the Great Western Radio Corporation, manufacturers of Radyne, will personally show his apparatus. The Atlantic-Pacific Agencies Corporation, sales agents for the Radyne, will also be in Booth D. Various other lines of equipment handled by the Atlantic-Pacific Agencies will be shown in this booth.

The Eisemann Magneto Corporation of New York City will use Booth C for presenting their 1925 line of receivers and parts. Their exhibit at the 1923 San Francisco show was one of the main centers of attraction.

The Radiola line in its entirety will be shown in Booth E. Radio Corporation officials and sales managers will be in charge of the exhibit.

All kinds of broadcast equipment, public address systems, apartment house receiving systems, commercial radio telephone apparatus, loud speaking equipment, power line carrier telephone systems and miscellaneous supplies will be featured in Booth F by the Western Electric Company.

The new line of Pacific S-H Super-Heterodyne kits and accessories will be shown in Booth No. 1 by the Baldwin Pacific Company. The Atlas loud speaker line will also

be featured in this booth. A novel reproducer and table lamp will be shown by the Sadler Manufacturing Company in Booth 13. The Quality Radio Shop of San Francisco will display several new lines of complete receivers in Booths 12 and 14. Broadcast Program and Radio will occupy Booths 2 and 4. Other publications, including Radio News, Science and Invention, Practical Electrics, Motor Camper and Tourist, Christian Science Monitor, San Francisco Examiner and San Francisco Chronicle will all have displays at the show.

Gilfillan Brothers, Incorporated, of Los Angeles, manufacturers of the new Gilfillan Neutrodyne and a complete line of radio parts, will occupy Booth 85. Other Los Angeles exhibitors include The S'entofone Company, Radio Manufacturers Agents Association of Southern California, Marshall & Co., Carl A. Stone Company, Frederic L. Tomlinson Company and the Work-Rite Manufacturing Company. Marshall & Co. will show the Dubilier line. Carl A. Stone represents a number of large eastern factories and will show the Rauland, Trimm, Bremer-Tully, Branston and King products. Frederic L. Tomlinson will exhibit the following lines: A. C., American Art Mache, Auburn Button Works, Brooklyn Metal Stamping Company, Cannon Miller Company, Incorporated; Chelsea Radio Company, Consolidated Instrument Company, Dixie Supply Company, Electrical Products Manufacturing Company, Gibson & Glamzo, Hartford Instrument Company, Modern Electric Manufacturing Company, Nash Company, Niagara Sales Corporation, Patton MacGuyer Company, Radiall Company, Radio Equipment Company, Radio Units, Incorporated; Reliable Parts Manufacturing Company; Ross Braid Company, P. C. Rumgold, Simplex Radio Company, Thornton & Everest, Incorporated; Springfield Wire & Tinsel Company, Van-Le Corporation, and the Walbert line.

In Booths 15, 17, 27 and 29 the Globe Commercial Company of San Francisco, Los Angeles and Seattle will show the Erla, Signal, Andrea, Bell, Hill, Mu'er, Mitchell, Alpha, Klosner, Marinette, Puritan, United Clapp Eastham, Hubbard, Connecticut, Freshman, Feri and Williams Radio. They will show for the first time a large number of new accessories just placed on the market by eastern manufacturers.

(Continued on page 52)

“the superior tone quality of Erla Duo-Reflex circuits, as well as their unmatched range and volume, stamp them as the most advanced types yet developed”



Erla reflex transformers alone amplify at maximum both received and reflexed radio frequency currents, without distortion. List, \$5



Unique ability to amplify three stages without trace of distortion proves conclusively the superiority of Erla audios. List price, \$5

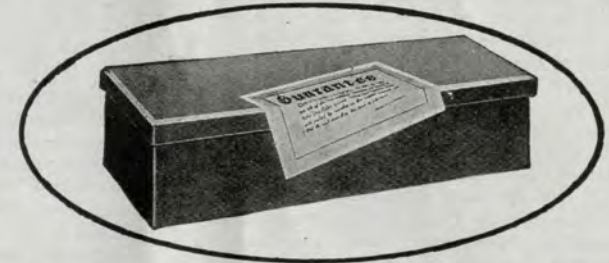

### Complete Factory Sealed Parts for Famous Erla Circuits

FACTORY sealed cartons of complete parts now make child's play of assembling Erla Duo-Reflex circuits, tube for tube, the most powerful built.

Synchronizing reflex and audio transformers, tested capacity condensers, balanced crystals, these and other factory packaged units remove all doubt as to selection of proper materials, while correct construction is made equally certain through a stenciled baseboard, drilled and lettered panel, and full-size blueprints giving the exact location of every nut, screw and wire. Soldering is eliminated by Erla solderless connectors.

Examine a complete Erla demonstrating receiver at your nearest dealer's. See how easy it is to build.

Coast Representative  
Globe Commercial Co.  
Los Angeles · Seattle  
San Francisco

# ERLA

NEW APPARATUS SHOWN

(Continued from page 50)

The Parkin Manufacturing Company of San Rafael has Booth No. 3 for showing the new Parkin receiving sets. The Oakland Tribune will be in Booth No. 5. Frederick H. Thompson Company of San Francisco, jobbers for a number of prominent lines, have Booths 7 and 9. Booths 8 and 10 will be used by the Olin S. Grove Company of Oakland for showing the new Amrad products.

Most of the well-known storage battery manufacturers have taken space. Prest-O-Lite will feature a new radio "A" and "B" storage battery. The National Carbon Company, Incorporated, will have an elaborate test panel in operation. A demonstrator will be at the booth every day to lecture to the radio audience. The Willard Storage Battery Company will show the full line of Willard batteries. Julius Brunton & Sons of San Francisco, Willard jobbers, will share the Willard booth. The Brunton people will show the complete 6RY amateur station at the show. W. Riley, operator of 6RY, will be there in person. The Electric Storage Battery Company will feature the complete Exide radio line and Durkee Thomas Products Company will show a number of types of radio "A" and "B" batteries. The Philco batteries will be on display in the Philadelphia Storage Battery booth. The Automotive Service Agency will display the USL batteries. The Kennon Radio Laboratories will share their booth with the Gould Storage Battery Company.

The new Atwater Kent sets and loud speakers will be shown in Booth 97 by the Automotive Service Agency. Radio tools, Spintie wrenches, etc., will be featured by Stevens & Co. in Booth 23. The Bosserman Radio Laboratories have taken Booth 21 for showing the Superflex line. E. M. Sargent Company of Oakland will feature the construction of the Best Super-Heterodyne receiver in Booth 16. A complete receiver will be assembled, wired and operated at the show.

A large number of local radio dealers are also in the show. They include the E. A. Portal Company, T. White Eastman Company, White House, City of Paris, Dodson & Dodson, Gallagher & Eiferle, Peerless Radio Company, Warner Brothers, Radioart Studio, California Phonograph Company, Rudolph Wurlitzer Company, Offenhach Electric Company, Conrad Richter and the U. C. Battery & Electric Company.

The R. E. Thompson neotrodyne and magnaphone will be shown by the Wholesale Electric Company in Booth 39. Bristol products will be featured in Booth 37. A radio compass, receiving equipment and a number of commercial radio devices will be shown by the Federal Telegraph Company of San Francisco in Booths 34 and 36.

Rice-Hitt & Co. of San Francisco will use Booth 24 for showing the Automatic Electrical Devices line and equipment manufactured by the Kodak Company, Aerovox Wireless Corporation, Columbia Radio Corporation, Durham & Co., Kardon Products Company, Charles Freshman Company, Pa'he Phonograph & Radio Corporation, Ritter Radio Corporation and the United Scientific Laboratories. The Day Radio Laboratory will use Booth 41 for the display of samples of radio construction work, including aerial and ground systems and the re-wiring of receiving apparatus.

The DeForest Radio Telegraph and Telephone Company of New Jersey has taken Booths 42 and 44. A sales manager of the DeForest Company will be in charge of the booths and will show the complete DeForest line. The Spector Company, representatives for Acme Apparatus Company, C. Brandes, Incorporated; Alden Manufacturing Company, Langbein & Kaufman, Como Apparatus Company and the Morrison Laboratories will show all of the lines in Booths 48 and 62. C. D. Tuska, through their Los Angeles agents, will feature the Tuska line in Booths 49 and 51. The new Schickerling tube will be shown in Booth 50 by local sales manager of the Schickerling Products, Incorporated. The Colburn Radio Laboratories of San Leandro will be in Booth 53. They will show a novel line of radio sets for every purpose. Kilburne & Clark Manufacturing Company of Seattle will show the KC line of receiving and transmitting equipment in Booth 54.

E. T. Cunningham, Incorporated, in Booth 63, will feature the line of Cunningham tubes and Remler radio parts. Local radio jobbers will also have a number of interesting displays. The Leo J. Meyberg Company, United Radio Supplies Company, W. E. and W. H. Jackson, California Electrical Supply Company, H. Earle Wright Company, Electric Appliance Company, Alexander & Lavenson Electrical Supply Company, Dunham, Carrigan & Hayden Company and the Automotive Service Agency will all have booths.

Herbert H. Frost, Incorporated, of Chicago, through the Los Angeles office, will display the entire Frost line. Garnett Young & Co. of San Francisco will exhibit

(Continued on page 58)

# How the San Francisco Examiner features radio!

The San Francisco Examiner was among the first newspapers to adopt radio and radio news as a feature. As soon as this phenomenon of the air was perfected as a means of entertainment for the masses The Examiner began treating it as a special department—and that is why TODAY The Examiner provides its readers with the best radio news available on the Pacific Coast—devoting many columns of space both daily and Sunday to the technical and amusement phases of this popular and fascinating invention.

To get the best radio news—read San Francisco's One Big Newspaper.

AN AMERICAN PAPER FOR THE AMERICAN PEOPLE  
**San Francisco Examiner**  
 Monarch of the Dailies

*Authorized Dealers in*

# K E N N E D Y

*The Royalty*  *of Radio*

*Are Reliable*

It is the earnest purpose of the Colin B. Kennedy Company to keep the Kennedy out of all stores where you must buy at your own risk.

So you will not find the Kennedy in *every* radio store. Those dealers who secure the right to sell the Kennedy are, in our judgment, trustworthy business houses of high character. You can place confidence in their recommendations.

Kennedy radio receivers, being fine musical instruments, appeal particularly to people who appreciate purity of tone in their radio entertainment.



## KIERULFF & RAVENSCROFT

RADIO EQUIPMENT



*Distributors*

SAN FRANCISCO  
654 Howard Street  
Garfield 5453

LOS ANGELES  
1630 South Los Angeles Street  
AT-lantic 3125

*We invite the public to inspect Kennedy Radio at  
California Phonograph Company's Booth No. 89*

## Here We Are!

### With the Latest in Radio



A Kellogg New Low Loss Condenser.

A Kellogg Trans-B-Former—furnished plate voltages from 110 A. C.—60 cycle current.

A New Kellogg Radio Frequency Transformer.

Also many other new items and many new improvements in our present line of high-grade radio parts.

H. A. Arth, manager of San Francisco Branch, is in charge of the Kellogg exhibit and invites you to visit Booth No. 75 and inspect our complete line of radio equipment.

E. F. Potter, manager of the Kellogg radio department, will be glad to meet the Pacific Coast radio fans, and offers to assist you with your radio problems.

Tune in with K. R. E. (Kellogg Radio Equipment) for best reception and satisfaction.

**KELLOGG SWITCHBOARD & SUPPLY COMPANY**

# YAXLEY

## APPROVED RADIO PRODUCTS

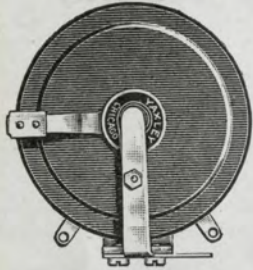

YAXLEY approved Radio products are not an experiment. They have been on the market for two years under another name.

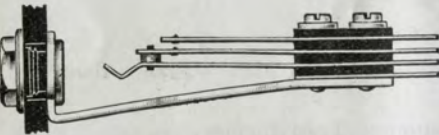
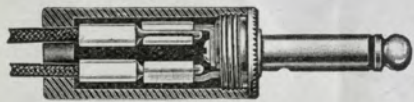

*HOWEVER*, they have always been designed and made by the Yaxley Mfg. Co. and now they carry the "Yaxley" trademark with the complete backing of the manufacturer direct.

Complete stocks carried for Pacific Coast jobbers on an air-tight jobber-to-dealer policy.

*Specify "YAXLEY" and get the best*

DIRECT FACTORY REPRESENTATIVES

## HENGER-SELTZER COMPANY

443 PACIFIC BLDG.  
SAN FRANCISCO

1125 WALL ST.  
LOS ANGELES

116 13th AVE. N.  
SEATTLE, WASH.

# ATWATER KENT



**E**VEN though you think you have heard the best, don't decide until you have heard one of the new Atwater Kent sets. Let it speak for itself.



Distributed by  
Automotive Service Agency  
Automotive Building, San Francisco 950 Van Ness Avenue

# — 1925 ATWATER KENT SETS —

—new Cabinet Sets in 5 and 6 Tube Models—new open sets for 5 and 6 tubes  
two new loud speakers—new Spinets and Consoles—a complete line ready

The most comprehensive radio line offered today. One can only appreciate its beauty by seeing it and can only realize what the sets and speakers can accomplish by hearing them. At the radio show you will find a display of the kind of sets people want and that they have purchased in ever-increasing numbers. We are extremely gratified in being able so early in the season to show Atwater Kent's new productions.

SAN FRANCISCO and its marvelous tributary territory has set a national record on Atwater Kent sales! To the dealers who have contributed to this remarkable attainment we extend hearty and sincere thanks and pledge anew an interested and painstaking service. The record established marks the definite acceptance on the part of the public of the "Wonder Set;" the man who owns one has spoken in terms that none can mistake.

When you speak of your Atwater Kent set it will please you to know that Northern California has more of these sets in use, based on population, than any other part of the United States.

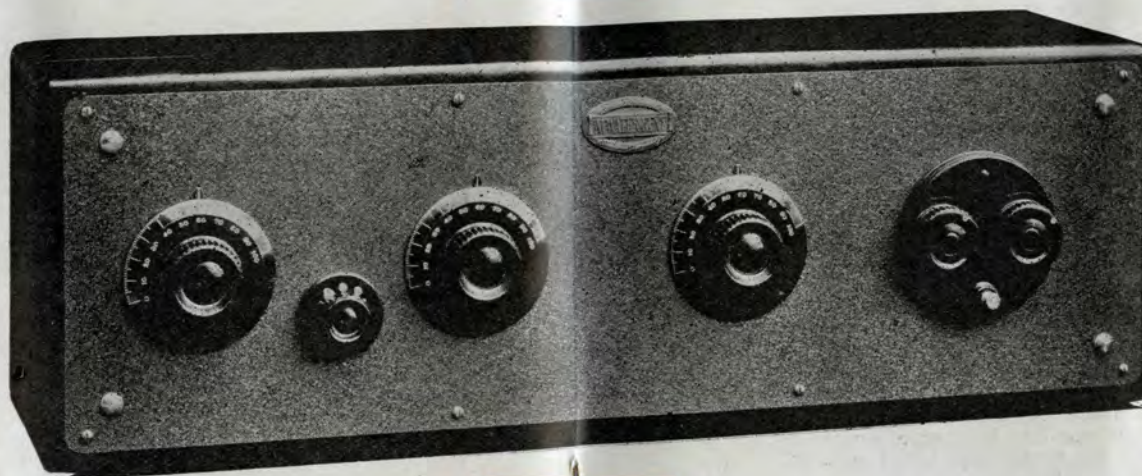

THE newer models are extremely selective, of rare tonal quality, quiet, with abundant volume and as usual in Atwater Kent products, extremely fine in workmanship. When we say that these sets on actual test have proven vastly better than any Atwater Kent model heretofore known, we are making a very strong statement, but one that the facts warrant.

The new set will enable Atwater Kent to maintain its lead as the greatest single seller in Northern California.

## USL 'A' and 'B' Batteries

THE "A" battery with the heavy navy plates—a battery that affords extremely quiet operation and that gives perfect reception until completely discharged. The glass jar rechargeable "B" battery is a new product having 4500 milli-ampere hour capacity. These batteries make any good set better.

## An Invitation to All Radio Dealers

We want you to see this line and some of the many accessories which are mentioned in part here. Irrespective of whether you are an authorized Atwater Kent dealer or not, you are invited to use our plant as your headquarters during the show. Here you may answer your mail and hold your appointments. Telephone and stenographic service are yours for the asking. We want to know you and we hope you feel the same way about us. As a matter of good business we should be acquainted.

Eveready "B" Batteries—a complete line  
Briggs & Stratton and Eisemann Headphones  
Atwater Kent Radio Parts and  
Phonograph Attachments  
Wire, Cable, Clips, Tungar Chargers

Distributed by  
Automotive Service Agency  
Automotive Building 950 Van Ness Avenue  
San Francisco

## Transcontinental Ribbon Aerial

THE genuine weather-proofed flat copper with nickel added for strength. Give it a twist—it gives superior results on reception by 25 to 50 per cent. In various lengths, boxed; complete with clips. Dealers will find this a ready seller and when used it gives results.

# ATWATER KENT

## Spinnet and Console Sets



THESE are correct reproductions of authentic furniture, encasing the sets and accessories. In various designs and finishes they constitute a worth-while addition to the furnishings of any home. Many new pieces.



ATWATER KENT'S three speakers are unusual reproducers, having full tonal value down to the faintest whisper. The standard speaker, a junior model, and the "little boy" excel anything in their price class.

AUTOMOTIVE SERVICE AGENCY  
SAN FRANCISCO



## Dependable Radio Products

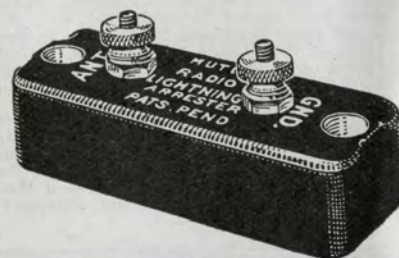

Lightning Arresters

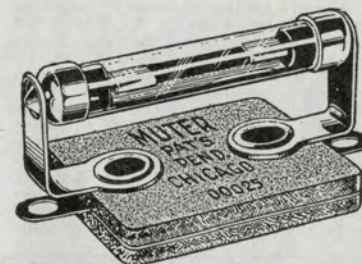

Fixed Grid Leaks

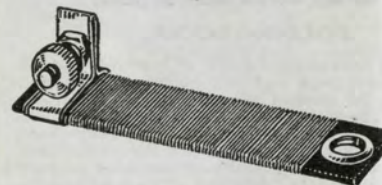

Resistance Units



Fixed Condensers

PACIFIC COAST REPRESENTATIVES

**GLOBE COMMERCIAL COMPANY**

709 MISSION STREET - SAN FRANCISCO

1113 Wall Street, Los Angeles

405 Pioneer Building, Seattle



## NEW APPARATUS SHOWN

(Continued from page 52)

the products of the Stromberg Carlson Telephone Manufacturing Company and the Hart and Hegemann line.

All of the factories represented by A. S. Lindstrom will exhibit either through Mr. Lindstrom and his staff or direct by the manufacturers. The Fansteel Products, Incorporated, of North Chicago will show the new Balkite "B," the Balkite charger and a display of rare metals used for making chargers, etc. The Samson, helical-wound transformers of various types, the line of Dudlo wire and coils, parts made by the Howard B. Jones Company of Chicago, the new line of Sleeper radio sets and other lines represented by A. S. Lindstrom will all be seen at the show. This group of Lindstrom's factories will use Booths 66, 68, 70, 72, 74 and 76.

Precise transformers will be shown in Booth 71 by the San Francisco office of the Precise Manufacturing Company. Kellogg equipment will be in Booth 75. The Echo-phone line, manufactured by the Radio Shop of Sunnyvale, will be in Booth 77. Booth 78 has been taken by the Braun Corporation for displaying the Freed-Eise-mann line and other accessories handled by Braun. Jefferson transformers are in Booth 80. The western sales department of the Zenith set's are in Booths 81 and 83, under the direction of Dunham, Carrigan & Hayden Company, Pacific Coast distributors.

Melco Supreme receivers and the com-

plete Amsco line will be shown in Booth 86 by the San Francisco office of the Amsco Products, Incorporated. Weston meters, shown by the Frank E. Smith Company, are in Booth 88. Celoron panels, tubes and rods are being shown by the Diamond State Fibre Company in Booth 92. Keeler-White Company, Booth 98, will display the Murdock line. Custom-built sets of various types will be in the Kennon Radio Laboratory booth, No. 105.

Lectures on the construction of antenna systems will be given by electricians of the City of San Francisco in Booth 110. The United States Radio Supervisor and his staff of inspectors will be in Booth 101.

Miniature and novel radio receiving sets made by the Reliable Radio Service of San Francisco will be shown in Booth 123. Radio laboratory testing devices are in Booth 124, used by the Radio Headquarters of Portland, Oregon.

Panel engraving, drilling and decorating by W. A. Vetter will be featured in Booth 122. The Work-Rite Neutrodyne and Work-Rite parts are in Booths 128 and 130. The Eagle Manufacturing Company, through their local agents—Schwabacher, Frey & Co.—will show the Eagle Neutrodyne in Booths 129 and 131. Heintz & Kohlmoos, manufacturers of scientific apparatus, radio equipment, C. W. transmitters, etc., have Booth 135. Marathon products of all kinds are in Booth 136. Marc products will be featured by the local office of the Martin Copeland Company in Booth 138. B-Metal products have taken Booth 137. The Good-year Rubber Company will have a line of radio panels and insulating material in Booth 144.

# Prest-O-Lite

## Radio Batteries for Every Purpose Designed to give you Better Results

Those who appreciate better results in reception are adopting the new Prest-O-Lite Radio Storage Batteries—there is one for every radio use. Exclusive features make them the finest radio batteries on the market. See what a difference they will make in *your* set.



### Super-Service "B" Batteries

Prest-O-Lite wet "B" Batteries in appearance and performance are the outstanding batteries of their type. Their cost is surprisingly low.

### Prest-O-Lite "A" Batteries

There are three improved models to select from—"The Extra Capacity Super-Service"—"The De Luxe" and "The Standard Prest-O-Lite." Also batteries specially designed for Peanut Tubes.

The PREST-O-LITE COMPANY, Inc.

599 EIGHTH STREET  
SAN FRANCISCO

Aisle No. 2 Booth No. 11



Price  
\$8.50

## DUO-SPIRAL

FOLDING LOOP

The highest development in a portable aerial. Compact, convenient and self contained. No outside antenna or ground wire necessary. Increases selectivity. Reduces static. Brings in stations from coast to coast. Can be used anywhere. Swivel base graduated in degrees for calibration. A convenient handle permits adjustment without body capacity effects. Adopted as standard equipment by leading manufacturers. Its handsome silver and mahogany finish harmonizes with the finest furniture. The folding feature makes it easily portable.

## TINY-TURN

A superior vernier control which makes perfect tuning easy. Has a gear ratio of 30 to 1. Rotates in same direction as dials. Fits any standard panel. Easily attached in few minutes. Handsome nickel and ebony black finish. Write us direct, if your dealer can not supply you.



## RADIO UNITS INC

1311 FIRST AVENUE

MAYWOOD, ILL.

75 Cents

AUTHORIZED  
**MAGNAVOX**  
 .DEALER.

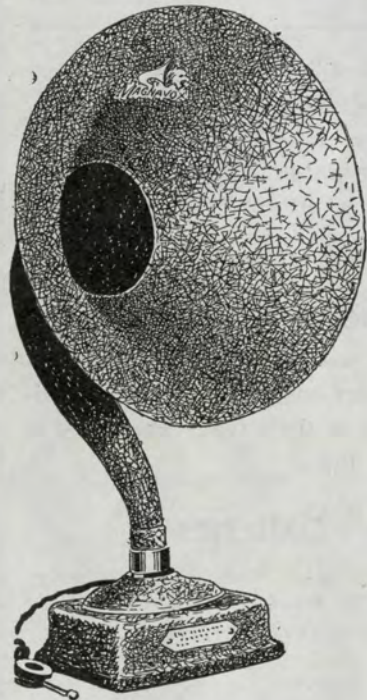

==== See ====  
 the complete new  
 line of Magnavox  
 equipment at the  
 ==== Show ====  
 Magnavox Tubes  
 Loud Speakers  
 Complete Sets

**WARNER BROS.**

428 Market St.  
 San Francisco

2201 Telegraph Ave.

350 Market St.  
 San Francisco

Oakland, California

—When you get Calgary on your radio  
 and want to see what it looks like, there's  
 one sure way to go there comfortably—just  
 hop in a—

*Studebaker*

—the standard of transportation in America  
 for more than 73 years.

—More than 200,000 *Studebaker Light  
 Sixes* in use, not one has ever worn out.

\* \* \*

*See Studebaker at the Exposition*

\* \* \*

*Chester N. Weaver Co.*

BETTER

SERVICE

1355 Van Ness Ave.  
 Weaver-Wells Co., Oakland



San Francisco, Calif.  
 Benson-Weaver Co., San Jose

## The Romance of the Sea---

Read the thrilling tales by Volney G. Mathison—deep-sea wireless operator, who has sailed the seven seas on great ocean liners. His latest book is full of humor. You will enjoy it.

## "The Radiobuster"

*One hundred and twelve pages of humor, life and reality. The only book of its kind on the market.*

**\$1.00** Per Copy  
Postpaid Anywhere!

THE COUPON  
AND \$1 BRINGS  
YOU A COPY OF  
THIS BOOK

For Sale by

**Pacific Radio Publishing Co., Inc.**  
PACIFIC BUILDING - SAN FRANCISCO

PACIFIC RADIO PUBLISHING CO., INC.,  
Pacific Building, San Francisco.

Send me "THE RADIOBUSTER" prepaid. I enclose \$1.00.

Name .....

Address .....

BOOTH No. 66



BOOTH No. 66

## DUDLO MAGNET WIRE AND COIL WINDINGS

We can guarantee greater exposed surface for less money with our new antenna wire consisting of four strands of enamel insulated and three strands of bare tinned wire alternately stranded.

Our other antenna wire consists of:

No. 14 solid copper wire, bare.	7 strands of No. 22 wire, bare.
No. 14 solid copper wire, tinned.	7 strands of No. 22 wire, tinned.
No. 14 solid copper wire, enameled.	7 strands of No. 22 wire, enameled.

We also carry a complete line of bare and tinned copper wire, cotton, silk, cotton enameled and silk enameled magnet wire in bulk and ¼, ½ and 1-lb. packages.

**DUDLO MANUFACTURING CORP.**  
Fort Wayne, Indiana

REPRESENTATIVES:

SAN FRANCISCO  
A. S. Lindstrom  
111 New Montgomery St.

LOS ANGELES  
Lombard J. Smith  
451 East Third St.

PORTLAND  
H. A. Killam  
212 McKay Bldg.

SEATTLE  
G. H. Maire  
45 Connecticut St.

# SIGNAL

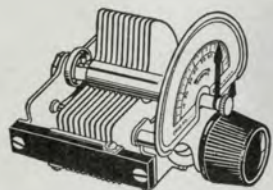

## Vernier Variable Condenser

See this condenser at the San Francisco Radio Show, August 16-21, Booth 17. Examine the pigtail connection—soldered rotor plates—method of mounting stator plates—adjustable bearings and many other new features.

Other Signal radio products including Radio Tables, Rheostats, Sockets, Cabinets—each the best in its class, will be on exhibition.

**Booth 17      August 16-21      Booth 17**

Western Offices

**Signal Electric Mfg. Co.**  
Menominee, Michigan

## The Use of "C" Batteries

While "C" batteries are employed to prevent distortion, they can also create distortion. It is only by an understanding of their operation that such distortion may be prevented.

A "C" battery is usually made up of several cells of flashlight battery connected in series so that the total voltage of the battery will be the sum of the voltages of the cells. Thus a three-cell battery gives  $4\frac{1}{2}$  volts. Such batteries are placed in a circuit so that the negative pole is connected with the grid and consequently their function is to place a negative charge of electricity upon the grid. The positive pole of the "C" battery finds its way to the filament and the negative pole of the "B" battery.

This method of connecting can easily be remembered by keeping in mind that it is connected just the reverse of the "B" battery. The positive pole of the "B" battery is always connected to the plate while the negative pole of the "C" battery is always connected to the grid. It is to be remembered that this arrangement is not to be employed with detector tubes, but only with amplifiers.

The object is to place enough negative potential upon the grid so that its maximum positive point will still remain below zero. Since a negative grid can not draw a current, no distortion will be produced.

A "C" battery of the wrong voltage, either too high or too low, will be worse than nothing. The voltage must be controlled within rather narrow limits. If it were carried beyond a critical point and the grid were made highly negative, the plate current would be distorted, and, as a result, badly distorted music, because we can not distort a current with sound superimposed upon it without at the same time distorting the sound. Indeed if we insist upon carrying the negative potential of the grid to a point where it is abnormally high, we shall cut off the plate current entirely. We should choose a "C" battery of such voltage that when the grid is at its most positive point it will still have an appreciable negative potential. This will prevent the plate current from being distorted and also keep the music sweet and melodious. A potentiometer shunted across the "C"

battery so that its potential could be varied from practically zero to full value is one extreme means of getting the correct voltage. It will be found that the voltage should be somewhere between 3 and 9.

The amount of "C" battery on the first stage is not nearly as critical as that on the second stage. This is easy to understand if we know that the voltage of the incoming radio wave is weaker and therefore can be more readily accommodated to the straight part of the characteristic curve. Since the voltage is boosted in each stage of amplification, in the second stage it has been built up to a higher point and the radio user will, therefore, find it harder to reach just the proper "C" battery potential.

Remember that a well-soldered joint can be obtained only if all the surfaces to be soldered and the iron are absolutely clean. Brush off the hot iron with a rag before touching the solder to it. Brush quickly and lightly so that the rag does not catch fire. Rub all dust and dirt off the surface to be soldered. Be sure to wipe the soldered joint well with a rag dipped in alcohol as soon as the solder is cold. This removes the soldering flux and prevents possible corrosion. But keep fire away from the soldering operation.

Batteries are generally rated at their ampere hour capacity. That is, a sixty-ampere-hour battery is rated as being able to deliver one ampere an hour over a period of sixty hours. Generally the actual delivery of current falls below this rating, but it is sufficiently accurate to enable figuring out how long a fully charged battery will last, providing the ampere consumption of the vacuum tubes is known.

## The Vario-Transformer Circuit

The circuit shown herewith employs tuned radio frequency amplification as a means of building up the strength of the signal received. This system also gives greater selectivity than is ordinarily obtained.

The antenna circuit is tuned by means of a novel form of variometer. This tuning device is made by winding a double D coil on each of six closely spaced plates mounted on a frame. Three alternate plates connected in series serve as the stator. The other three plates are mounted on a shaft, which with its bearing is a part of the frame, and are capable of being rotated through 180 degrees. The three rotating plates are joined in series, and this combination is joined in series with the stator plates. The whole combination gives a very efficient variometer whose magnetic field is closed. This feature permits very close spacing of apparatus in the receiving set.

Tuning between stages is accom-

plished with a vario transformer, which is the same as the variometer except that two additional fixed plates are used. One of the additional plates is part of the tube plate circuit, and the other is known as a compensating winding, being used in conjunction with a compensating condenser to prevent local oscillations from being set up.

The vario transformer provides for a change of coupling which maintains the uniform amplification and selectivity of the set over the entire range of wave length.

The variable compensating condenser is a three-electrode device, capacitatively shielded from the operator's hand. It is arranged so that the vario transformers are not detuned when setting the compensator or feedback eliminator. This feature makes adjustments easy.

The compensator for the last stage may be offset to allow some feedback, which results in sharper tuning characteristics and greater sensitivity.

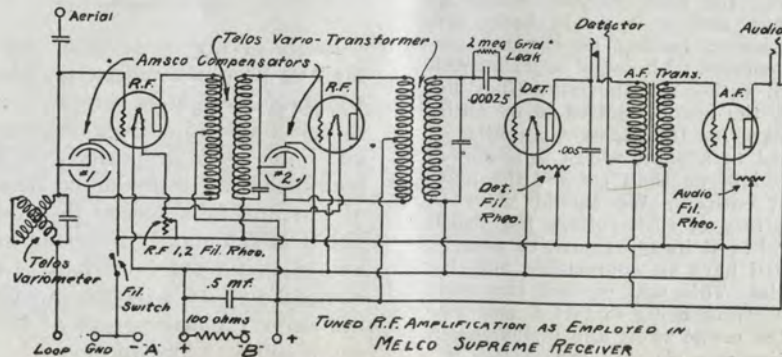

# MELCO-SUPREME RECEIVER

## Tuned Radio-Frequency

*Satisfies Every Radio Wish*

SKY-SCRAPERS and thousands of tons of steel may rear themselves to the skies, yet the Melco Supreme, nestled deep among these recognized radio barriers, still retains its marvelous long-distance reception.



- Volume
- Clarity
- Beauty
- Distance
- Simplicity
- Selectivity

Pre-Tuned  
Pre-Logged

**AMSCO PRODUCTS INC.**

FAIRBANKS BUILDING

Broome & Lafayette Sts. New York  
47 Pacific Building, San Francisco



## The Super-Heterodyne

The super-heterodyne circuit is universally recognized as the closest approximation to perfection in radio receivers yet developed commercially. It has extreme selectivity and sensitivity combined with simplicity of operation.

But unlike many forms of detector and audio-frequency circuits which give stable operation and good quality of reproduction, the super-heterodyne requires careful attention to engineering details in the selection of parts and in the circuit layout.

Great sensitiveness or range of a receiver is dependent upon the use of radio-frequency amplification. At relatively long wave lengths this is comparatively simple, but at the short broadcast wave lengths there is a tendency to oscillate due to internal capacity and circuit coupling. To overcome this tendency most radio frequency circuits use a "stabilizer," which has very properly been called a "losser." Such a stabilizer takes either the form of a resistance in the tuning circuit, introducing a loss to overcome oscillation and thereby decreasing signal strength as well as broadening the tuning, or a potentiometer to apply a positive voltage to the grid of the radio-frequency amplifier tubes. This not only increases the drain on the plate battery but also cuts down the gain from the tubes and results in distortion. The stabilizer not only introduces an extra unnecessary control but is a makeshift to compensate for errors in engineering design.

Some of the popular descriptions of

super-heterodyne circuits specify a stabilizer, with all its advantages, to compensate for errors in layout, in transformer design or in the selection of the intermediate frequency. This loss in efficiency is then partially offset by the use of high mutual conductance tubes such as C-301A or UV-201A. In multi-tube sets the dry battery tube C-299 or UV-199 gives more than sufficient amplification when operated at full efficiency.

The super-heterodyne circuit overcomes the difficulties of radio-frequency amplification at broadcast wave lengths by heterodyning or transferring the voice modulation from the incoming carrier wave to a new carrier wave of a frequency at which the effect of inter-electrode and wiring capacities disappears. The proper selection of this intermediate frequency is important. A careful analysis shows 45,000 cycles to be the best frequency. If a frequency higher than 50,000 to 60,000 is selected, internal capacity effects will tend to shunt the energy being amplified, reducing the overall gain as well as introducing instability. If the intermediate frequency is below 40,000 cycles the two settings on the oscillator condenser scale will be too close together, especially at the lower wave lengths, and poor musical quality may result.

In the super-heterodyne all radio-frequency amplification is obtained at a fixed frequency, irrespective of the incoming wave length. This eliminates all controls on the radio frequency amplifiers and thus reduces the actual number of controls to two.

Maximum amplification, however, is obtained only when the intermediate frequency transformers are designed to

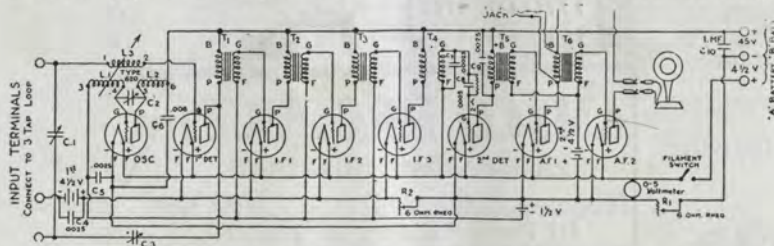

The Eight-tube Super-heterodyne

## For Better Radio Reception

Use STORAGE BATTERIES

There is no adequate substitute for the storage battery where a dependable, economical source of power for radio reception is desired.

The storage battery is noiseless in operation and maintains a constant voltage until nearly exhausted, without frequent readjustments of the rheostat. It can be re-charged again and again at trifling cost—wherein lies its great economy.

Exide Radio Batteries—A and B—are made by the world's largest manufacturer of storage batteries for every purpose. Regardless of the type of tubes you may be using, there is an Exide specially designed to meet their requirements. Ask your radio dealer or any Exide Service Station about the complete line of Exide Radio Batteries; or write us direct.

The Electric Storage Battery Co.

Factory branch: 1536-56 Bush Street

# Exide

## RADIO BATTERIES

operate at the selected frequency and whose input impedances match the output impedance of the tube.

Another advantage of this set is that it employs dry battery tubes, C-299 or UV-199, thus being extremely economical in current consumption, the filament current being less than  $\frac{1}{2}$  ampere for the eight tubes. Due to the use of three "C" batteries the plate current drain on the "B" batteries is only 10 to 12 milliamperes.

### Ground Wire

The ground connection is a necessary and important part of every receiving set that uses an outdoor antenna. The ground wire should be connected as directly as possible to the house water pipes by means of the ground clamp. If a ground clamp is not available the connection can be made by scraping a clean surface on the pipe and tightly wrapping the ground wire around this surface. After the wire has been wrapped and fastened it is advisable to wrap tinfoil over the joint to prevent it from corroding. Do not paint over this connection, because the paint will run in between the turns of wire and will act as an insulator and the connection will be destroyed.

Long wave-lengths are used in long distance radio communication because the absorption of energy is much less than where short wave-lengths, such as are used in radiophone broadcasting. The greatest distance for a given amount of power is obtained over water. Forests, mineral deposits and steel buildings in cities absorb much energy from radio signals.

### Daily Program of Events

(Continued from page 24)

#### WEDNESDAY, AUGUST 20 Los Angeles Day

- 10:00 a. m. till 12:00 m.—Special hours for dealers only.
- 2:30 p. m.—Exposition doors open to the public.
- 3:00 to 5:00 p. m.—KPO program from Auditorium stage.
- 8:00 to 9:00 p. m.—Special KPO broadcast.
- 9:00 p. m.—Radio wedding. Mischa Lhevinne, noted Russian pianist, will wed Maybelle Gartrill, daughter of Mr. and Mrs. R. F. Gartrill, formerly of Sydney, Australia. E. Harold Dana, San Francisco's famous baritone, will sing. Harriet French will play a violin obligato. The ceremony will be performed on the Auditorium stage.
- 9:00 to 10:00 p. m.—Continuation of KPO broadcast from the Auditorium.
- 10:30 p. m.—Raffle of one radio set by the Pacific Radio Trade Association.
- 11:00 p. m.—Exposition closes for the night.

#### THURSDAY, AUGUST 21 Pacific Northwest Day

- 10:00 a. m. till 12:00 m.—Special hours for dealers only.
- 2:30 p. m.—Exposition doors open to the public.
- 3:00 to 5:00 p. m.—KPO program from Auditorium stage.
- 8:00 to 10:00 p. m.—KPO broadcast from stage.
- 10:00 p. m.—Raffle of one radio set by the Pacific Radio Trade Association.
- 11:00 p. m.—Formal closing of Pacific Radio Exposition.

### The Neutrodyne Circuit

(Continued from page 40)

uits were rendered unstable at slightest provocation and would oscillate, thus ruining any amplification.

A number of methods have been advanced for mitigating this undesirable capacity effect, as for example, the well known device of a stabilizer potentiometer. This does not eliminate the regenerating effect of the tube capacity, but simply introduces such losses into the grid circuit that the amount of regeneration is reduced.



# See Booths

# 12 = 14

# NUF SED

## Up-to-date Radio Dictionary

By L. H. La Montagne

**"A" BATTERY**—The part of a radio set that takes your money and makes light of it.

**AERIAL**—That which is used to catch messages; and our chins when cutting across lots late at night.

**AMATEUR**—One far advanced with the disease "radiomaniatis." Sometimes called interference and other pet names.

**ARC**—A method of transmission invented by Noah.

**"B" BATTERY**—That which supplies the necessary high-voltage kick to a radio set.

**BROADCASTING**—The gentle art of saying or doing what you want, out of reach of your audience.

**CAGE AERIAL**—A place for the parrot, hams and other vegetables.

**CAT-WHISKER**—Another slam on Felix. Compare cat-gut.

**COPPER**—A good conductor, but collects no fares.

**CRYSTAL SET**—A piece of glass in platinum.

**DISTANCE**—Something that will make prevaricators of us all.

**GROUND WIRE**—A wire used to anchor one's set firmly to terra firma. Compare ground-hog.

**GRID LEAK**—The common cause for sloppy reception and appearance of some radio sets.

**JACK**—That substance used to buy and run a radio set.

**LOUD SPEAKER**—Any apparatus that speaks out loudly. Also loud squaker. Commonly referred to as an abomination by the neighbors.

**MUSIC**—That which is supposed to emanate from a broadcasting station.

**RADIOMANIATIS**—A disease fatal to pocketbook and time. Symptoms: The first indications are the desire to visit all radio stores and ask endless ques-

tions. Also a strong desire to gather up all homeless wire, insulators, etc., accompanied by a wish to put them into a "set." In the advanced stage, the victim is usually sleepy, and tired. Has a confirmed desire to talk nothing else but radio.

### "Blooping!"

By Earle Ennis

Day by day, in every way, the air is getting "bloopier" and "bloopier!" If there is a motto which should be learned, it is, "Bloop not, lest ye be blooped!" And thereby hangs an oscillation.

The "blooper," in the words of the cynic, is "one who bleeps." To "bloop," one turns up the lamp of one's receiving set until it glows like a lighthouse off the coast of England and starts hunting for a distant radiophone. The action is accompanied by a violent wiggling of the tickler. The result, for everybody else in the neighborhood, is a series of wild whoops and yells. These are "bleeps." When the neighbor quits, he has been "bleeped."

Any evening, for instance. Listen in. "Bloop! Bloop! Bloop!" In all directions. Duets, trios, sextettes and whole choruses of them. Sometimes they vary a bit. "Yeow-bloop!" Caterwauls, back-fence dissonances, chromatic colics, banshee yodelings. "Bleeps"—all of them! The whole radio game is being "bleeped" to death.

What can be done about them? Change the circuits? All right. Let's. It will be of common benefit. Many a good concert is "bleeped" out of existence because an ambitious listener who took the sky for a limit, tried to hear a man playing a cornet behind a fence in Stavanger, Norway, while the rest of the world was tuning for Salt Lake.

England has put the crusher on "bleeping" at the very outset of the game. Government regulations there provide that receiving sets must not oscillate, radiate or irritate. In the shadow of Buckingham Palace they are leading a peaceful and "bleepless" life while we in America are rushing toward national insanity.

Alas, the "blooper" who plucks the strings of the night and twangs an ode to misery on his damnable "bleep-ischord!"



# Satisfaction-Giving Equipment and Service

## RADIO SETS, ACCESSORIES, REPAIRING

CONVENIENTLY situated on the Sixth Floor is our Radio Department. It is conducted by men who are experts. You will find on display—

*Radiolas  
Super-Heterodynes and Reflex Sets  
Thompson Neutrodyne  
Cutting and Washington Teledyne  
and others*

*as well as a standard line of Radio Accessories*

OF PARTICULAR interest to you are the exceptional service, and the credit accommodations extended to those who are eligible to a charge account.

We do *Wiring, Installing and Repairing*  
Feel free to ask for advice and terms  
(Sixth Floor)

121 Post St.

43 Kearny St.

SAN FRANCISCO



### Care of Vacuum Tubes, Sockets and Contact Points

The vacuum tube is the heart of a radio set. Like the human heart it must perform a heavy, constant duty. Vacuum tubes require attention and care. Here are a few suggestions for lengthening the life of the tube:

1. Use a filament fuse to protect the tube against burn-outs. These fuses cost but a few cents; a new tube costs several dollars. Place the fuse in series with the filament lead. Your radio dealer will tell you what size fuse to use for your tube.

2. When connecting a fully-charged battery to your set, turn down the tube rheostats as a further precaution against burn-outs. Gradually bring the filament to full brilliancy with the rheostat.

3. For quiet operation of your set, mount the tube sockets on a cork or rubber base. This eliminates jarring and tube howling.

4. Regularly inspect contact points of the tube sockets. Clean all tube and socket contact points from time to time. Also inspect the tension spring clips on the socket. A poor contact point will always give trouble.

5. A voltmeter, connected in parallel with the filament leads, will at all times indicate the condition of the storage battery voltage. A number of the latest sets have a voltmeter mounted on the panel. An ammeter can be connected in series with the tube and battery to give ampere readings.

6. When the voltage drops below normal, immediately put your battery on charge or replace batteries if dry cells are used.

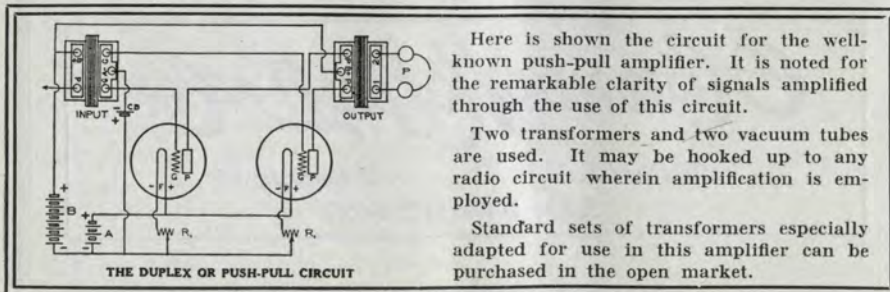

Here is shown the circuit for the well-known push-pull amplifier. It is noted for the remarkable clarity of signals amplified through the use of this circuit.

Two transformers and two vacuum tubes are used. It may be hooked up to any radio circuit wherein amplification is employed.

Standard sets of transformers especially adapted for use in this amplifier can be purchased in the open market.

### How to Become a Radio Fan

The modest expenditure of \$5 will bring the romance of radio into your home. An efficient receiving set, capable of receiving the programs from the local stations, can be purchased from local radio dealers for a few dollars. Crystal sets are the most inexpensive receivers on the market today. Any of the powerful local broadcast stations can be heard loud and clear on one of these little instruments.

It's really a very simple matter to install a small radio set. One length of wire, a hundred feet long, suspended along the roof of a house and insulated at both ends; a piece of wire running to your set from this aerial; a wire connected to a nearby water pipe; the turning of a dial—and the radio program is there for you. All the music you want, all the worth-while lectures, dramas, news reports, sporting events, etc., for \$5. Where can you duplicate such a service at so low a cost?

There are thousands of homes in every city of the Pacific Coast without a radio set simply because many people have not yet realized that a radio set can be purchased so cheaply and installed so easily. If your capital is limited it is not necessary for you to purchase an elaborate receiver. Get into the radio game with a small set. A larger and more elaborate set will be yours in due time. Once a radio bug—always a radio bug. Many of the exhibitors at the show have these inexpensive sets on display. Purchase one of them. It will be the best investment that you ever made.

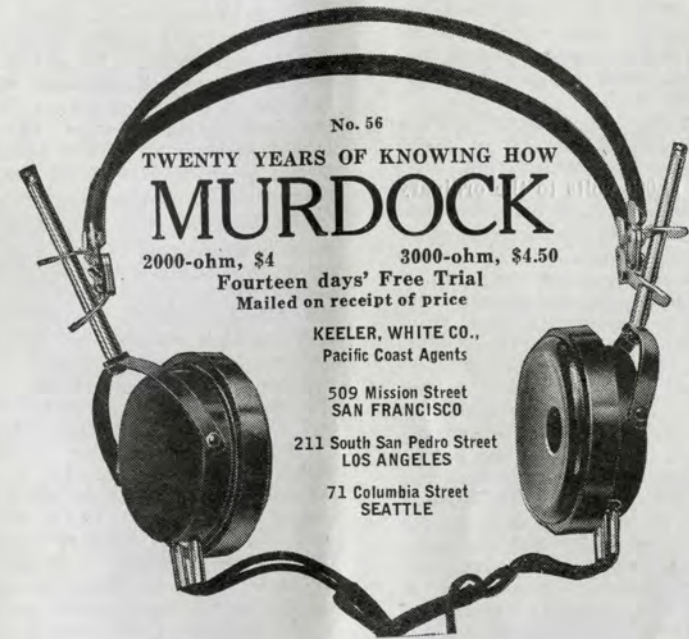

### The Solderless Jack

Connections are made to neat binding posts. Bakelite frame. Short springs of special phosphor bronze. Sterling silver contact points. Scientifically perfect in every detail.



A Radio Plug of tried design and principle. Two sets of headphones or a combination of loud speaker and one set of phones may be connected simultaneously. When so desired either phones or loud speaker may be used singly. Fits all Standard Jacks. Takes all types of tips. Perfect contact, no tools of any nature are required to connect.

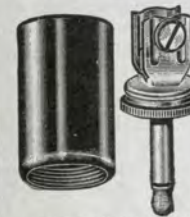

CICO DOUBLE PLUG Type A

Seattle

MANUFACTURED BY  
**CONSOLIDATED INSTRUMENT COMPANY**  
OF AMERICA, INC.

41 EAST FORTY-SECOND STREET  
**FREDERIC L. TOMLINSON COMPANY**  
Factory Representative  
San Francisco  
(BOOTH NO. 61 AT THE SHOW)

NEW YORK CITY  
Los Angeles

## Cause and Cure of Radio Noises

By G. M. BEST, Technical Adviser of "Radio"

**I**NTERFERENCE, in radio parlance, may be either that which has its source in radio transmitters or that which emanates from causes entirely remote to radio itself.

In practically every community there exists a complicated network of power lines, the voltages of which range anywhere from 11,000 volts to the ordinary 110 volts for house-to-house consumption. These lines are the cause of more extraneous disturbances in the ether than any other source and the worst of it is that without the assistance of the power companies themselves it is practically impossible to remedy the trouble. Most of you have heard at one time or another a loud buzzing or hissing sound, rough in the extreme, that seems to come in equally well on whatever wave you are tuning to, and which can not be eliminated except by disconnecting the antenna and ground leads. This noise is caused by faulty insulators in the higher voltage power lines, and the only way to cure the trouble is by either replacing the insulator, in case it is actually defective, or by the arrival of a good hard rain, which washes off the accumulated dirt and other material which often acts as a conductor to the high voltage. Do not confuse this noise with the ordinary alternating current hum, which is caused by the low voltage wires in your own home, and which is usually increased rather than lessened, when the antenna is disconnected from the set.

Another source of noise coming from without is the street lighting system with a series of direct current arc lights. Occasionally one of these lights becomes defective, and arcing occurs between parts of the automatic carbon-feeding mechanism, with the result that high frequency oscillations over a broad band of wave lengths are generated and a sharp hissing sound in the receiving set is the result. Often the use of a ground connection to a water pipe common to neighboring power apparatus will introduce serious difficulties in the way of noise, in a sensitive receiving set.

Another source of trouble, which is very intermittent, however, is the charging of the lightning arresters at large power sub-stations. This will produce

a harsh, grating sound that lasts for a few seconds and usually occurs twice a day. It is caused by a large, high voltage arc at the switch contacts, when the sub-station attendant breaks the charging circuit to the arresters. This trouble is not serious, as a rule, but is mentioned to aid in identifying the various noises you may hear.

The last, but the most troublesome noise is alternating current hum, as it is often called, distinguished from other noises by its steadiness and musical tone. Unless your set is directly underneath a high voltage line, the noise is coming from your house wiring, and the easiest way to rid yourself of the trouble is to thoroughly shield the cabinet of your set, and ground this shield to the negative of your "B" battery, which in turn is connected to a good ground connection. Thin sheet copper makes a good shield, as tin foil is too easily damaged. If you have transmitting as well as receiving apparatus, this shield is almost essential, as the presence of power transformers and wiring in the vicinity of the vacuum tube apparatus will surely introduce noise into the receiving system if care is not taken to shield the latter.

If you have a great amount of trouble of this nature, particularly from nearby power apparatus, such as motors, elevator machinery and the like, the installation of a small counterpoise, as near under the antenna as possible, will without doubt be a great aid in eliminating the disturbances. Many regard the counterpoise as useful only in transmitting, but on the contrary, a counterpoise is as good if not better, than the ordinary water pipe ground, both for general reception and noise elimination.

A good receiving counterpoise can be made of eight wires insulated if desired, about forty feet long, with about two feet separation, and six to ten feet above the ground. The wires may be insulated from the ground by porcelain cleats or antenna insulators. If it is impossible to erect the counterpoise outside of the house, a network of wires in the cellar, provided that they are not too close to the house lighting system, will answer the purpose.

— The DYMAC Line —

## Quality Merchandise at Attractive Prices



Type E Audio Frequency Amplifying  
Transformer

Enclosed core type. Forty-two pure iron laminations, moisture proof coil. Ratio three to one. Leads four-ply, silk covered and varnished, to provide adequate insulation.

List Price \$2.50

Type A Loud Speaker Unit

An exceptional loud speaker unit. Finished in black enamel with polished nickel trimmings. Ample volume for home or small hall. Standard for Victor, Columbia, Sonora and Jewett.

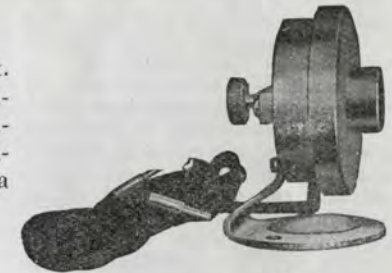

List Price \$4.00



Type A Audio Frequency Amplifying  
Transformer

Shell core type. Ratio four to one. Flux leakage very low. Amplifiers may be placed adjacent to each other without howling or other ill effects. Gives full, soft, well rounded tones.

List Price \$3.50

ELECTRICAL PRODUCTS MANUFACTURING COMPANY

Providence, R. I.

(BOOTH NO. 61 AT RADIO SHOW)

Western Representatives

**Frederic L. Tomlinson Co.**

1113 Wall Street  
LOS ANGELES

SAN FRANCISCO  
447 Pacific Building

116 13th Ave. No.  
SEATTLE

## Practical Suggestions and Trouble Shooting

When putting up your antenna, don't run your lead-in for a long distance through the house, but make it as short as possible from the window. If the lead-in is long inside the house the walls and ceilings will absorb most of the radio frequency current that should go direct to your receiver. Run your ground lead to a cold water pipe.

After a tube has been used for some time it usually becomes gasey and takes less plate voltage. Be certain your amplifying tubes are "hard" tubes and use at least 45 volts "B" battery.

In wiring your set use a heavy wire such as No. 18 tinned copper, and don't paint the leads but leave them dry. Rubber tubing can be used if desired.

Do you know that the grid leak and grid condenser are two of the most important parts of your receiver? Be certain you buy a good grid leak whose resistance does not vary and also use a good mica condenser of the correct capacity for your grid condenser.

Many accidents have occurred by erecting antenna wires over high power lines. This is dangerous, as you don't know when your antenna may fall and cause serious damage to your receiving set and endanger the life of the operator. Also aerials in the immediate vicinity of high power transmission lines often take up induction that is very annoying for the efficient operation of a receiver.

Don't endanger the filaments of your tubes by charging your "A" battery while it is still connected to your set, as this may blow out the line fuses. Voltage may be raised to such an extent as to burn out the filaments of your tubes. Also one side of the power line in your house is usually grounded, and as your receiver usually has a ground connection this may cause fireworks.

If you wish to insure good connections on the variable taps, or other sliding contacts on your receiver, coat them with a light film of vaseline. In addition to preventing corrosion, this will also insure a good electrical contact.

Don't expect to hear a station 1000 miles distant by using a crystal detector on a loop aerial. A regenerative circuit will only give fair results with a loop. Radio frequency amplification is neces-

sary for efficient operation when using a loop antenna.

If you have direct current in your home and wish to use it to charge your "A" battery, take six 32 candlepower carbon lamps and connect them in parallel. Run the positive lead from the power line to one side of the bank of lamps and run the opposite lead of the "A" battery to the other side of this bank of lamps. Connect the negative lead from the power line to the negative binding posts on your "A" battery. This will give your battery a fair charge overnight, providing it is not run down too far.

To determine the polarity of the direct current, insert the two leads in a glass of water, being careful not to short the leads and blow out the fuse. Bubbles will appear on the negative lead. It is customary to tie a knot in the positive lead and then you need have no fear of reversing the polarity when charging your "A" battery.

When building a receiver be certain to solder all connections, as corrosion will eventually make the connections poor and cause noises in your receiver. Do not use acid flux, but purchase resin core solder. A small quantity of solder will go a long way when used properly. To make a good connection, be certain that both contacts are well heated and hold these connections together with a pair of pliers after removing soldering iron, for a period of approximately 30 seconds. When connecting potentiometer across your "A" battery to maintain a negative bias on the grid of your radio frequency amplifying tube, be careful not to advance the potentiometer too far in one direction, as this will cause the tube to oscillate and the voice or music will disappear.

An easy way to sharpen up the tuning in your receiver is to string another wire, the same length as the original antenna wire and running parallel with it. This wire should not be closer than four feet to the first wire. This will increase the capacity of the antenna system and will allow the use of a smaller coil in the antenna circuit, which will decrease the resistance and also permit looser coupling.

Buy a new "B" battery when the voltage falls below 60 per cent of its orig-

Introducing ~ BOOTH 13

## "The Queen of Reproducers"

*Veltex Shade. Trimmed with silk and bullion fringe. Finished in two colors—brown and blue.*



*Furnished in two colors to harmonize with any surroundings.*

### This Elegant Instrument

Will not rattle—  
Will not vibrate—  
Will not burn out—  
It requires no battery to operate  
Needs no adjusting  
Has long portable cord  
Can be used on:  
Table  
Piano  
Phonograph

It is truly an ideal instrument in which practicability and beauty are combined.

*Your home deserves one!*

Patent applied for

**\$47.50**  
**Shipped**  
**Anywhere**  
**Prepaid**

### The Master of Tone

The latest TRUTONE Reproducer is famed for its remarkable tone qualities, faithfully and naturally reproducing all sound values with an utter lack of distortion and reverberation. The unique design of its horn makes possible an even and mellow distribution of sound in every direction. There is no bulky or uncanny horn to mar the beauty of your home. No chatter or rattle to take the joy out of music.

*"A pleasure to look at; a delight to listen to."*

*This remarkable reproducer and electric lamp will grace the most elegant home. A demonstration will convince you of its superiority.*

## Sadler Manufacturing Co.

86 Fourth Street

Booth 13

San Francisco

inal value. A "B" battery in this condition will reduce your signal strength as well as cause howling and scratching noises.

When building your receiving set, make your grid leads as short as possible and keep them as far away as you can from the other wiring.

If it is necessary to fasten a loose wire more firmly to the tube that the coil is wound on, use a small piece of sealing wax. Never use shellac on the windings.

If you contemplate building a receiver don't try to make a super-heterodyne right off the bat, but confine your activities to a crystal set or a single-tube receiver. This way you will learn more about how to build a receiver and will be qualified to build your next set.

The question is often asked, "What kind of insulators shall I use on my receiving antenna?" Purchase some ordinary glazed porcelain cleats, which do not cost very much, and will give you efficient insulation on your receiving antenna.

Often that static you hear is nothing more or less than a dead "B" battery. A small portable voltmeter will come in handy to test your batteries.

Be careful of your telephone cords, as these consist of finely-braided wire, and if you kink them they will cause noises in your head telephones. If the cords twist, get the habit of untwisting them as soon as you notice it.

When building a receiver use tools that are designed for that purpose. Don't buy a pick axe and sledge hammer and think that you are going to build an efficient set. Several sizes of screwdrivers are usually necessary, and purchase a pair of long-nosed pliers to use when working around the corners in your wiring. If you purchase a soldering iron, don't buy a big heavy, cumbersome iron, but purchase one that is thin, which will enable you to reach into the corners to solder your connections. Handle your receiver with care when putting it together, as it is a delicate piece of apparatus and its satisfactory performance depends a great deal upon you.

If you live near a high-tension line with high voltage, run your antenna at right angles, to avoid induction and noises in your receiver. Locating noises in your set may be somewhat of a tedi-

ous job; however, it is worth the while.

Many peculiar noises appear at different times. There are several places where they might originate. If it comes from the outside, it may be due to the antenna being parallel to a leaky light or power line. It may be induction from elevator motors. You can determine whether the noises originate on the outside very easily. Disconnect your antenna and ground and if the noise is in your receiver, it is not coming from the outside, but is in the receiver itself.

Then start looking and see if all wired connections are tight. See if your "A" battery is fully charged. Low "A" batteries cause noises in the tubes. Check up the voltage of your "B" batteries. Switch them around, leaving one out at a time. If the wires in your telephone cord have been broken, you can quickly detect this by moving the wire around while you are listening. Locating noises in your receiver is a job requiring quite a bit of patience, but it is worth that patience to make your receiver work properly.

Neutrodyne sets may not give good results on first placing of tubes. Try switching the tubes around until you get the best results. One bad tube in a neutrodyne set will throw it all out of whack. If you are a newcomer in the game buy a good beginner's book on radio circuits and the fundamentals of the game. Your receiver is a wonderful piece of apparatus, but don't "just turn the dials." Understand what happens when you turn the dials. You will like the game better and get more pleasure if you know what you are doing and not only improve the quality of your reception but also the range of your set. The best distance records are not obtained on the most sensitive receivers. A three-tube set in the hands of a person with a limited knowledge of radio will get more "stuff" than an eleven-tube set in the hands of a person that does not understand its operation.

It is a well-known fact that you receive longer distances at night than in the daytime. Don't blame your set if you can't hear all over the world in daytime. A single wire aerial is the best all-around aerial for broadcast reception and minimizes the static. If some nearby station is causing you trouble ask some neighbor to show you how to put a small wave trap on your set.

**PORTAL**

**RADIO EQUIPMENT  
OF QUALITY**  
EXCLUSIVELY

featuring —  
RADIOLAS  
ATWATER KENT  
EAGLE NEUTRODYNE

*"Interested Service  
After Installation"*

*Very Convenient Terms*

**E·A·PORTAL  
COMPANY**

**463 GEARY STREET**  
*(Adjoining Curran Theatre)*  
**SAN FRANCISCO, CALIF.**

*Prosper 10328*

### Loop Reception

Every radio circuit is made up of inductance, capacitance and resistance. Inductance may be obtained by winding several turns of wire on a cylindrical form or on a spool, the value of this inductance depending upon the size of the wire, the number of turns and the size and shape of the form upon which the wire is wound. Capacitance is obtained by alternately opposing metallic surfaces, one set of these surfaces being insulated from the opposing set. Such a device is called a condenser and the value of its capacitance is determined by the area of the opposing surfaces, the number of such surfaces and the distance by which they are separated.

Inductance and capacitance are the important and necessary elements of all radio circuits. Resistance, however, is inherent and should in general be reduced to a minimum.

An electrical circuit containing inductance, capacity and resistance is analogous to the mechanical system which has inertia, elasticity and friction, and we may say that an inductance coil has electrical inertia, a condenser has electrical elasticity and resistance corresponds to friction. Both are vibratory systems which may be attuned to any given period of vibration; in the one case we have vibrations or oscillations of electric current and in the other mechanical vibrations or periodic motion.

In the ordinary antenna circuit, as used in present-day radio communication, we find, in general, that the inductance of the circuit is concentrated in the form of a coil, to be found inside of the receiving cabinet, and that the

capacity of the circuit is formed by a wire or group of wires elevated above ground, these wires forming one surface of a condenser, and the earth forming the opposing surface.

It may be said, therefore, that energy is received in the radio antenna circuit by virtue of the fact that its condenser is exposed to the incoming radio wave, or in other words, that the wave enters the system by way of its condenser, thereafter to be transferred to its inductance coil.

In the receiving loop we have what may be considered as the reverse of the antenna system. In loop reception, energy is received by virtue of the fact that the inductance of the circuit is exposed to the incoming radio wave, or, in other words, the radio wave enters the receiving system by way of its inductance coil, thereafter to be transferred to its condenser.

The use of the rotatable receiving loop or inductance coil is recommended because of its directional properties. It gives greater freedom from interference and is not affected by static or atmospheric disturbances to as great an extent as is the antenna.

Fundamentally the receiving efficiency of a loop depends upon the area enclosed by the windings, the number of turns of wire with which it is wound and the resistance of the circuit to which it is connected.

To obtain full advantage of the very desirable features of the receiving loop, it is important that all of the laws which govern the efficiency of the receiving loop system throughout be faithfully obeyed.

## Four Cents a Week

One dollar brings the weekly thirty-two page **BROADCAST PROGRAM** right to your home for twenty-six weeks. Complete programs for KPO, KLX, KGO and other stations published weekly in advance. Free sample copy sent for the asking. See us at Booth No. 2 at the Pacific Radio Exposition.

Mail Subscriptions  
Solicited

**BROADCAST  
PROGRAM**

433 Pacific Building  
San Francisco



**Al. Esco**  
SAYS

See Us at  
**Booth 126**  
or  
**926 Howard Street**

Representing

**Fada—F. A. D. Andrea, Inc.**  
**Radyne—Great Western Radio Corp.**  
**Teledyne—Cutting and Washington  
Radio Corp.**  
**Balkite—Fansteel Products Co., Inc.**  
**Remler—Remler Radio Mfg. Co.**  
**Formica—Formica Insulation Co.**  
**K-C—Kilbourne and Clark Mfg. Co.**  
**Dictogrand—Dictogrand Products Co.**  
**Brandes—C. Brandes, Inc.**  
**Resistors—Daven Radio Co.**  
**Transformers—Jefferson, All-American,  
Precise**  
**Binding Posts—Eby Manufacturing Co.**  
**Jacks, Plugs—Carter Mfg. Co.**  
**Sockets—Na-ald, Benjamin, Hoosick**  
**General Radio Products**  
**Cunningham Tubes—E. T. Cunningham**  
**Mesco Speakers—Manhattan Electric Co.**  
*and scores of other recognized leaders*

**Alexander and Lavenson Electrical Supply Co.**

926 HOWARD STREET

Garfield 3940

SAN FRANCISCO

## How to Design an Aerial

Although the receiving sets that are in use among the majority of broadcasting listeners today will function fairly on even poorly constructed aeriels it will surely improve matters if the antenna is well-designed and the factors which constitute the design are known. The aerial is a source of energy which directly operates the receiver, and it is obvious that if we can increase the amount of energy collected by the antenna, through judicious design, we can thereby also increase the over-all efficiency of the receiver.

There are more factors entering into the problem of constructing a good aerial than one would imagine from a superficial glance at the subject. These factors include height, length, insulation, grounding, material, proximity to other objects, etc., on the requirements of which a brief resume will be given.

**Height.** It is a well-known fact that the higher above the earth's surface one is the greater is the degree of electrification of the atmosphere, varying with local conditions. By way of an example, an insulated antenna 400 feet high will soon become charged to a potential in the neighborhood of 10,000 volts. This charge has to leak off in some way and will jump small gaps, such as the separation between the plates of the series of antenna condenser, in order to get to ground. This produces X's, otherwise known as strays, static and atmospherics. Hence, as a rule, it is advisable to keep the receiving antenna low, of course, within limits. It has been found that a height of about forty feet is most suitable for good reception. It must be pointed out, however, that strays which come from a distance are not cut down, relative to signals, by using a low aerial. Such discharges are highly damped wave trains and affect the aerial in the manner of an ordinary signal.

**Ground.** Since the whole aerial circuit should have a low resistance the ground selected should have as great a surface as possible exposed to the earth. In city districts the best ground is the cold water pipe, it being sometimes desirable to connect both gas and water pipes together for the ground. In country districts several metal plates about two or three feet in area, should be

imbedded in the ground, surrounded by some charcoal. The plates should be connected to each other by rubber covered wire, soldering the connection. In dry weather the place may be watered, the charcoal retaining the moisture for some time. A type of ground such as this also would be of use as a transmitting ground. The ground wire would be at least of the same size as the lead-in wire and should be short—the shorter the better. The aerial itself should not be more than seventy-five feet in length.

**Insulation.** It is of the utmost importance that the insulation of the aerial wires should be nothing but the best if any pretense of efficiency is made. Thoroughly glazed porcelain insulators are the accepted standard for insulation quality, though other materials, such as rubber, bakelite and mica compositions have their adherents. Instead of using one single long insulator it is better to use two or three small ones strung out one after another, as this offers less chance of leakage taking place. The lead-in should be given special attention where it enters the house. Most of the energy losses occur at this point and it does not pay to use the best insulation at the aerial only to lose the carefully hoarded energy by installing a poor lead-in insulator.

**Material.** For receiving purposes a single wire is all that need be used. Four wires do not bring in a station better than one. It is a common error to suppose that four wires can pick up four times as much energy as one in receiving. It is true, however, that in transmitting, four wires can and do carry a great deal more energy than one. The use of iron wire is not recommended in any form. Instead, use aluminum, copper or phosphor bronze. The lead-in can be made of the same wire, keeping it well away from the side of the building—six feet not being too great a distance by any means. A rather large size of wire should be chosen for the aerial, the thought to increase the surface being the reason for the heavier wire. A small wire is a poor investment for the reason that it corrodes very

(Continued on page 88)

# Conrad Richter

## EXCLUSIVE RADIO SUPPLY HOUSE

1284 Market Street, San Francisco

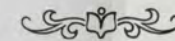

Headquarters for—

*Freed Eisemann Neutrodyne  
Harkness Reflex  
Atwater Kent  
All Standard Sets*

Largest Assorted Stock  
of Radio Parts on  
the Pacific Coast

## CONRAD RICHTER

Established 1905

1284 Market St., San Francisco

Next to Civic Auditorium

Phone Park 308

*Write or Call for Our Latest  
Price List No. 17*

# SIMPLEX

DEPENDABLE EQUIPMENT

Famed for Efficiency,  
Performance, Quality



Simplex  
Lightning  
Arrester

Approved  
Air-Gap  
type.  
Sealed  
in fine  
brown glazed  
porcelain.  
No fuse  
or vacuum

SIMPLEX  
D-X  
TUNER

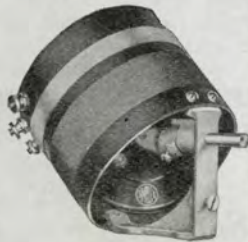

With  
Spiral wound  
Moulded Rotor  
Specially  
Designed for  
Three Circuit  
Untuned Primary  
Circuit.  
Distance, volume  
and selectivity



SIMPLEX  
180 Degree  
VARIO  
COUPLER

With  
Spiral Wound  
Moulded Rotor  
Covers all  
Broadcast  
Wavelengths.  
Neat and  
Efficient

Descriptive Folder on Request

SEE OUR EXHIBIT AT  
BOOTH NO. 61

**SIMPLEX RADIO COMPANY**

Manufacturers, Philadelphia

Western Representative  
FREDERIC L. TOMLINSON CO

Seattle                      San Francisco  
Los Angeles

## What You Should Know About Storage Batteries

Just because a storage battery looks like a piece of unbreakable equipment is no reason why you should abuse it and then afterwards demand a new battery for the one you aided on its way to the scrap heap. Storage batteries require care. They will last for years if given the proper attention. Charge them regularly; don't let them run down to the last ampere before recharging. Make it a practice to have a hydrometer handy at all times. When your battery drops below normal gravity, put it on charge. Voltmeter readings will not give the true internal condition of the battery. The hydrometer reading is the only satisfactory method to use. When fully charged the gravity of the average battery is between 1.275 and 1.300. When the gravity falls below 1.200 it is time to charge the cells. Don't overcharge the battery. Let it gas freely for a few hours. Overcharging may cause the plates to buckle. Cover the positive and negative connection posts with a light film of vasoline. This will prevent corrosion of the terminals and result in better electrical contact between the terminal and connecting wires to the set. Place the battery on a rubber mat if you want to preserve your flooring. Clean top and sides of container when you have completed charging process. This will remove the battery "sweat." Consult your battery service dealer when serious trouble arises. Most good batteries are covered by a liberal manufacturer's guarantee.

# Why Buy Radio Batteries More Than Once?

When you buy Willard Rechargeable B Batteries you're through going down into your pocket for B Batteries every little while.

For unlike the ordinary battery which lasts only a few months, Willard Rechargeable B's are good for years—with average care at least five, and probably more.

Just figure up how much you'll save if you don't have to spend a cent for new B batteries in the next five years.

The real value of Willard Rechargeable B Batteries, however, is to be measured not in dollars and cents, but in improved results.



Don't fail to see  
our exhibit at  
the RADIO show

JULIUS BRUNTON & SONS COMPANY  
1380 Bush Street, San Francisco

San Francisco  
August 16-21  
Civic Auditorium

"ASK YOUR RADIO DEALER"

STORAGE  
BATTERIES  
**Willard**

## What Causes Fading?

By Roger Bryant, Radio Engineer,  
Westinghouse Electric & Manufacturing  
Company

Many of us have experienced a feeling of great disgust when listening to a good concert from a broadcasting station to have the music gradually die out. This usually happens at the most interesting part, for instance, when a distant station is just about to sign off. Frequently the regularity with which the signals die out at the crucial point leads one to think that something has control of this phenomenon and is using this control with diabolical intent.

The periodical dying out of radio signals is known as fading. There have been many attempts to make measurements on radio transmissions to determine the exact cause of fading but few of these measurements have produced any worthwhile data. The best explanation of fading seems to be a theoretical one. It is believed that at a height of thirty or forty miles above the surface of the earth that the air becomes so rarefied that it becomes a conductor of electricity. As such it acts like a reflector of the electro-magnetic waves by which radio communication is effected. The result is that the waves reach the receiving antenna not by one definite path but by a number of paths of different length.

A radio transmitting station sends out electro-magnetic waves which radiate in all directions. Some of them go directly to the receiving station while others go by an indirect route up to the conducting layer and then down again. If the difference in length of these two paths is right, that is, a multiple of the wave length, the waves will add and the effect produced will be greater than by the direct transmission alone. But the difference in length may also be such that the waves do not add and thus the effect may be less than it would be by direct transmission. The reflecting layer is constantly shifting so that the reflection varies momentarily between the limits described resulting in varying intensity

of the signal received. Thus the fading.

This simple explanation of fading leads to several interesting things. The reflecting layer is very indefinite during the day. Hence there is less fading during the day and this seems to be the case. On account of the lack of reflection, the range of a station is much less during the day than at night and this we all know to be the case. It would also appear that it is impossible to send radio signals away from the earth.

## HOW TO DESIGN AN AERIAL

(Continued from page 84)

soon, leaving but a thin core of metal, surrounded by a coating of oxidized matter. This corrosion causes the wire to lose its original strength and further, the electrical resistance is greatly increased. The latter is the most serious of these two disadvantages. With a heavy wire, or one that is composed of a number of smaller strands, these difficulties are offset for a longer period of time, although they too will not give everlasting service.

Proximity to Other Objects. If possible the antenna should be stretched over a clear space, free from buildings and trees. It should not be strung in between two tall structures, as then these objects will cut off and screen the passing radio waves. If one end is supported by a tree allow the insulator at that end to extend at least ten feet from the branches. The tie rope or wire only needs to be lengthened to do this. The position of the lead-in has already been touched upon. Keep all wires tightly stretched.

Do not run the aerial parallel to any electric lighting or power line, nor the telephone lines. It is not advisable to get too near any other neighboring antenna either. When in such a position too much interference is apt to result, being caused by the phenomenon of induction.

It will repay you to go over your present aerial installation, keeping the above facts in mind. You will be surprised at the difference that a few changes can make if carried out in all earnestness.—New York Tribune.

# SPELL BOUND!

That is the first Radyne  
sensation

But to the Happy Family  
wherein a

*Radyne*

**PLAYS REGULARLY**

IT IS THE JOY OF QUIET  
MOMENTS.

THE PEACE AFTER A BUSY DAY.  
THE PERFECT ENTERTAINMENT  
FOR FRIENDS.

A NURSE TO THE SICK.

A FRIEND TO THE LONELY.

A MARK OF DISTINCTION  
TO THOSE WHO KNOW.

*See It*

*Hear It*

*Compare It*

*Distributed by*

**ELECTRIC APPLIANCE COMPANY**

807 Mission Street, San Francisco

**ALEXANDER & LAVENSON ELEC. SUPPLY CO.**

926 Howard Street, San Francisco

*A Product of the Great Western Radio Corporation*

ATLANTIC PACIFIC AGENCIES CORPORATION, SOLE AGENTS



## Testing "B" Batteries

The only test of a "B" battery which is worth anything is the voltage test. While battery users and dealers are in the habit of testing dry batteries with an ammeter, this test is worthless on a "B" battery. The amperage indicates, to a certain extent, the internal resistance of a battery, but since the resistance of a 22.5-volt battery is about 5 ohms, and the resistance of a vacuum tube is from 10,000 to 30,000 ohms, it is apparent that an increase of say 5 ohms, in the battery resistance will have no appreciable effect on the combined "B" battery and tube circuit. In other words, a drop in the amperage of a "B" battery, so long as the voltage is still satisfactory, means little regarding the usefulness of the battery.

The important thing to know is the voltage which the battery will deliver to the plate, and the voltage test is of real value only when made with a high-grade, accurate voltmeter. The reason for this is that the ordinary pocket voltmeter has a much lower resistance than the vacuum tube. Because of this the volt-

age shown on this type of voltmeter will be lower than that actually delivered to a tube with its high resistance. Furthermore, these voltmeters are often inaccurate. On the other hand, a high-grade, accurate instrument has approximately the same resistance as the vacuum tube and in some cases even a greater resistance. Therefore, it is certain that when a "B" battery indicates a given voltage on a voltmeter of the latter type it will deliver at least as much voltage to the tube.

The minimum working voltage of a detector tube is about 17 volts. Therefore, a "B" battery should give results till its voltage drops to this figure. Even then it need not be discarded. It can be connected in series with other batteries and used on the amplifier tube. Here it should be serviceable until its voltage has dropped to about one-half. In this connection, however, one thing should be watched. Some "B" batteries become noisy when their voltage drops, and if this is the case the battery should not be used. This is especially true of "B" batteries of ordinary construction, where no special pains are taken to eliminate the noise feature.

## The Romance of the Sea

Read the thrilling adventures of a sea-going radio operator in "THE RADIOBUSTER," the only book of its kind on the market. It is full of thrills. 112 pages; bound in cloth.

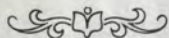

For sale by

PACIFIC RADIO PUBLISHING COMPANY, INCORPORATED

Pacific Building  
San Francisco, California

Only \$1.00 per  
copy postpaid

## Eveready Reduces 'B' Battery Prices

- Growing popularity of radio
  - Greater demand for "B" Batteries
  - Installation of improved manufacturing equipment
  - Increased and more economical production
- Enabled us to greatly reduce Eveready "B" Battery prices August 1st

### Here's Where You Profit

Better quality, longer-lasting Eveready "B" Batteries—much lower operating cost than ever before. NOW repower your radio set with fresh Eveready "B" Batteries.



No. 767

No. 767  
Horizontal 45-volt large size "B" Battery. Formerly \$5.00  
Now \$3.75



No. 772

No. 772  
Vertical 45-volt large-size "B" Battery. Formerly \$5.00  
Now \$3.75



No. 766

No. 766  
Horizontal 22½-volt large size "B" Battery. Formerly \$2.50  
Now \$2.00



No. 764

No. 764  
Vertical 22½-volt medium size "B" Battery. Formerly \$1.90.  
Now \$1.75

**EVEREADY**  
Radio Batteries  
—they last longer.

Manufactured and guaranteed by  
NATIONAL CARBON COMPANY, INC.

## Making Ground Connections

Poor grounds and poor ground connections probably cause more trouble to the operators of radio sets than any other factor. A large radio service company recently made an investigation and found that more than nine-tenths of all the cases in which trouble was experienced were due to a poor ground. A careful study of grounds was made in connection with electrical power transmission and it was found that the average depth to obtain a good ground was 90 feet.

To insure proper operation, the radio set must first be grounded to an object of proper type; and second, the ground connection must be made in the proper manner. In city installations, perhaps the best object to use for a ground is a water pipe. Make your connection, however, as near as possible to the point where the water piping enters the building. If the water meter is located in the building, make the connection on the far side of the water meter. A steam or water heating system is usually connected to the water supply, and in this case may serve as a ground. However, it is better to go direct to the water system as just mentioned. The gas piping may also be used for a ground. In this case make your connection as near as possible to the point where the pipe enters the building. If several systems are available try out one after another and use the one giving the best results.

Where a piping system is not available, a ground may be obtained by dropping a copper plate to the bottom of a well, letting the plate rest on the clay bottom. Do not attempt to use a cistern for in ordinary cases the water is too free from salt to make a good conductor. A rod may be driven into moist soil, or a plate buried in moist earth. A ground of this type is usually very unsatisfactory, because you do not penetrate the earth far enough and sufficient contact is not made with the water. Very frequently such grounds become absolutely worthless in dry weather. Do not attempt to use a lightning rod ground or the telephone

ground. In practically all cases, such grounds will be found practically worthless.

After a proper ground has been obtained be sure that a proper connection is made to the wire running to the radio set. If the ground is a pipe, the pipe must be scraped absolutely clean. If possible, empty the water from the pipe and solder to it. If this can not be done, use a ground clamp and fasten it tightly to the brightened metal. If a plate is dropped into a well, solder the wire to the plate first. If a counterpoise or fence is used, the connection may be soldered very easily, or in the case of the counterpoise a continuous wire may be run into the house without break.—Crosley Radio Bulletin.

## Washington Radio Conference

Secretary of Commerce Hoover will call a general radio conference in Washington soon after the adjournment of Congress in an effort to secure cooperation of all radio interests in clearing up the ether and solving the problem of distributing wave lengths. A conference will be called whether or not new legislation is enacted.

The conference will be similar to those in the springs of 1922 and 1923, at which representatives of the manufacturers, broadcasters, engineers, amateurs, commercial operators and broadcast listeners aided in drawing up voluntary regulations under which radio has been supervised ever since. It was in this manner that the distribution of wave lengths for broadcasters and other interests was developed.

Present indications are that broadcast stations will continue to increase although wave lengths available for this use are practically exhausted and stations are doubling up. Even time allotments in congested sections are becoming difficult to make.

Secretary Hoover believes congested conditions and interference are getting worse. If present conditions continue, he is unable to see how we could operate five years from now, and as a consequence he intends taking advantage of such suggestions from representatives of the allied radio art and industry as may be made.



# A Powerful Medium

In more than fourteen thousand homes in Central California, radio fans refer nightly to BROADCAST PROGRAM, published under the auspices of the Pacific Radio Trade Association. Advertisers are using this powerful medium to a profitable advantage. Every advertising page is a preferred position—every advertisement faces a page of programs or schedules. Every advertisement *must* be seen by the reader of the PROGRAM. And the advertising message holds good for an entire week—*not for only a day.*

Issued weekly by the publishers of "RADIO." Edited by Arthur H. Haloran. It will carry your advertising message on a preferred page to a 100 per cent select list of 14,000 radio users who *buy* the PROGRAM because they cannot afford to be without it. The cost for advertising in this popular weekly is surprisingly low. Our advertisers will tell you that BROADCAST PROGRAM is their best advertising medium. It is the outstanding advertising buy in the San Francisco and Bay District radio field.

Let us send you a specimen copy of BROADCAST PROGRAM and you will be convinced that you should use it.

## BROADCAST PROGRAM

*"The Authority of the Broadcasting West"*

PACIFIC BUILDING - SAN FRANCISCO

## The Superflex

Due to the wide publicity given to the new superflex circuit we are publishing the diagram, showing how this receiver is wired. It is a remarkably simple receiver to operate. The tuning inductance controls and filament rheostat knob complete the movable adjusting parts of this set. Loud speaker volume on this simple equipment is accomplished through the unique method of amplification employed. It is an economical set to operate.

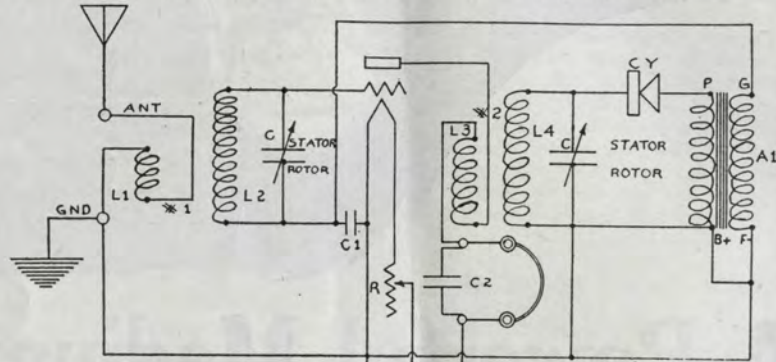

One tube Super-flex

- # 1 Antenna Tuning Coils
- # 2 R. F. Transformer
- L 1 Primary of #1
- L 2 Secondary of #1
- L 3 Primary of #2
- L 4 Secondary of #2

### Some Points to Remember

A fully charged cell should read from 2 to 2.5 volts.

Never discharge a cell below 1.8 volts.

Never let a battery stand idle without being fully charged.

When a battery is idle, charge up to boiling once a week.

Do not habitually over-charge the battery.

Bubbles of gas are given off freely when the battery is fully charged.

Positive plates vary from light brown to a chocolate color when fully charged, and to nearly black when over-charged.

Negative plates vary from pale to dark slate color.

Do not discharge too rapidly.

Storage batteries depreciate about 10 per cent of their cost per year.

By greasing the terminals the battery can be kept clean enough to keep indoors.

The Department of Agriculture has forty-one stations throughout the United States for broadcasting weather, crop and market reports.

**AMPERITE**  
The "SELF-ADJUSTING" Rheostat

PERFECT for every CIRCUIT  
Simplifies wiring  
Eliminates  
hand rheostats  
RADIALL COMPANY  
320 W. 42nd St., N. Y.



Write Dept. RS  
for free Hook-ups

\$1 10

From  
Your  
Dealer

# No matter what the circuit

An ACME Audio Transformer makes it better

WHETHER you have a neutrodyne, superheterodyne, regenerative or reflex, the addition of the ACME A-2 Audio Frequency Transformer makes it better.

Send 10 cents for 36-page book, "Amplification without Distortion," which tells how to get it. It also shows you how to get the distant stations loud and clear with "Reflex," the circuit which gives more, tube for tube, than any other.

ACME APPARATUS COMPANY  
Transformer and Radio Engineers and Manufacturers  
Cambridge, Mass.

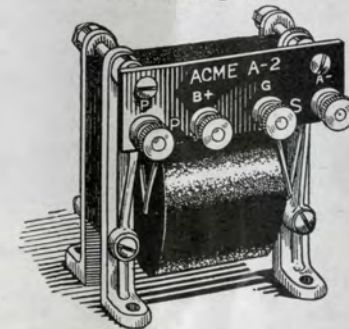

ACME A-2  
--for volume

**ACME ~for amplification**

Recommended "A" and "B" Battery Voltages for Various Tubes

Different Types Radio Tubes	Manufacturer	Type of Vacuum Tube		Terminal Voltage	Filament Current Amperes	"B" Plate Voltage Detector	"A" Filament Voltage	"C" Amplifier	"C" Battery Volts
		"A"	"A"						
UV-201A	Radio Corp. of America; General Electric Co.	5	.25	48	48	48-96	0-6	0-6	0-6
C-301A	Cunningham; General Electric Co.	5	.25	48	48	48-96	0-6	0-6	0-6
UV-201	Radio Corp. of America; General Electric Co.	5	1	48	48	48-96	0-4	0-4	0-4
C-301	Radio Corp. of America; General Electric Co.	5	1	48	48	48-96	0-4	0-4	0-4
UV-200	Radio Corp. of America; General Electric Co.	5	1	18-24	18-24	...	...	...	...
C-300	Cunningham; General Electric Co.	5	1	18-24	18-24	...	...	...	...
Sod. D-1	Connecticut Telephone & Electric Co.	5	.25	24	24	...	...	...	...
UV-190	Radio Corp. of America; General Electric Co.	3	.06	40	40	48-80	0-6	0-6	0-6
C-299	Cunningham; General Electric Co.	3	.06	40	40	48-80	0-6	0-6	0-6
WD-11	Radio Corp. of America; Westinghouse Co.	1.1	.25	40-48	40-48	48-72	0-4	0-4	0-4
WD-12	Radio Corp. of America; Westinghouse Co.	1.1	.25	40-48	40-48	48-72	0-4	0-4	0-4
DV-6A	DeForest	2.7	.30	24-48	24-48	48-200	0-6	0-6	0-6
216-A	Western Electric Co.	6	1.35	48	48	96-120	6-10	6-10	6-10

When vacuum tubes are used as amplifiers, they perform essentially as valves. Small changes in the voltage of the grid with respect to the filament cause large changes in the plate current. The changes in grid voltage are caused by the incoming signal; the resulting variations in plate current are used either to vary the grid voltage of the succeeding tube by means of an amplifying transformer, or to operate the telephone receivers or loud speaker.

It is characteristic of amplifying tubes that under many conditions distortion occurs whenever the grid voltage becomes positive. If the grid circuit of a tube is completed by connecting the grid return to the negative end of the filament, the normal steady value of grid potential is zero, and the effect of the incoming signal is to cause the grid to become alternately positive and negative. To prevent the grid from ever becoming positive, it is necessary to make the grid permanently negative. Thus if the maximum grid signal has a strength of 9 volts, the grid will never swing positive if a negative bias of 4½ volts is applied to the grid.

By connecting the grid return to the negative side of the "A" battery rather than to the negative terminal of the filament, the normal steady value of the grid potential is not zero, but is negative to the extent of the voltage drop in the filament rheostat, which should be connected in the negative lead. The amount of negative biasing which can be applied to the grid in this manner is always equal to the difference between the "A" battery voltage and the normal operating voltage of the tube. This biasing voltage is maximum when the "A" battery is fresh and gradually diminishes as the "A" battery voltage drops, until finally it disappears altogether when the "A" battery becomes nearly discharged.

# How to Choose a Radio Set

Is the title of the pamphlet we have prepared especially for visitors to the Pacific Radio Exposition.

Ask for one of these pamphlets at our Booth Number Three, and see the Parkin Super-Reflex Radio Set.



Parkin Super-Reflex

A set combining sensitivity, selectivity and volume in a handsome cabinet, the loud speaker and batteries being contained within.

Parkin Manufacturing Co.  
San Rafael, California

# 10 BIG ATTRACTIONS

## At the Show

DON'T MISS THEM!

SEE THEM ALL!

### BOOTH 127

- Radio Receptor Co. ....The RECEPTRAD Super-Heterodyne.
- Electrad, Inc. ....CERTIFIED Grid Leaks, Diode Tube, Resistance Coupled Amplifier Kits, Etc.
- Durham & Co. ....DURHAM Variable Resistance, Etc.
- Firth Radio Corp. ....Loud Speakers and L. S. Units.
- Perfection Machinery & Mfg. Co..PERFECTION Variable Condensers.
- J. Thos. Rhamstine .....NEEDEPHONE Phonograph Loud Speaker.
- American Radiophone Mfg Co...Headset and Loud Speaker.
- A. H. Miller Radio Co. ....B-Metal Crystals and Fixed Detectors.
- Peerless Radio Corp. ....Peerless Twin-Aud Transformer and Kondenser Kits.
- Precel Radio Mfg. Co. ....SUPERFIVE Tuned R. F. Receiver.

We will appreciate your visit and are confident our display will be of interest

All of the above factories represented by

# UNIVERSAL AGENCIES

JOHN H. SHAW, Mgr.

693 Mission Street  
SAN FRANCISCO

537-8 San Fernando Bldg.  
Los Angeles



## BEFORE LEAVING THE RADIO SHOW

visit our Booths  
Nos. 38 and 40

Then visit our Store

*Radio Sets*  
*Radio Parts*  
*Radio Sets Repaired*  
*Aerials Installed*  
*Radiolas*

ESTABLISHED 1883  
**T. WHITE  
FASTMAN CO.**  
2744 MISSION STREET  
PHONE VALENCIA 300  
Between Twenty-third and Twenty-fourth Streets

### New Testing Devices Cause Sensation

One of the big features of the Pacific Radio Exposition is the first showing of a line of new and novel testing equipment for recording data on many types of radio apparatus. The Radio Headquarters of Portland has brought this unique equipment with them to the show and they invite the public to bring their apparatus to the exposition for testing. The new radio testing devices are the invention of Sidney Goodwin and Arthur L. Smith. A machine has been devised to show at once if a tube is capable of oscillation. An instrument such as this can be used by radio dealers to prove to their customers that vacuum tubes leave their store in perfect working order.

The new testing apparatus is also capable of giving important data on variable condensers and variocouplers, as well as fixed condensers and other types of inductances and capacities. A half dozen types of shop laboratory test sets are being shown at the exposition. One of these instruments is called a "portable trouble-shooter." Goodwin states the test set is capable of detecting all kinds of receiving set trouble, including the location of loose or broken wires, defective tubes, improper inductances or capacities, etc.

Officials of the Radio Headquarters believe their new marvel of science will be of great assistance to manufacturer, dealer, laboratorian and experimenter alike.

## At Booth 124 We Will Test Your Parts —FREE—

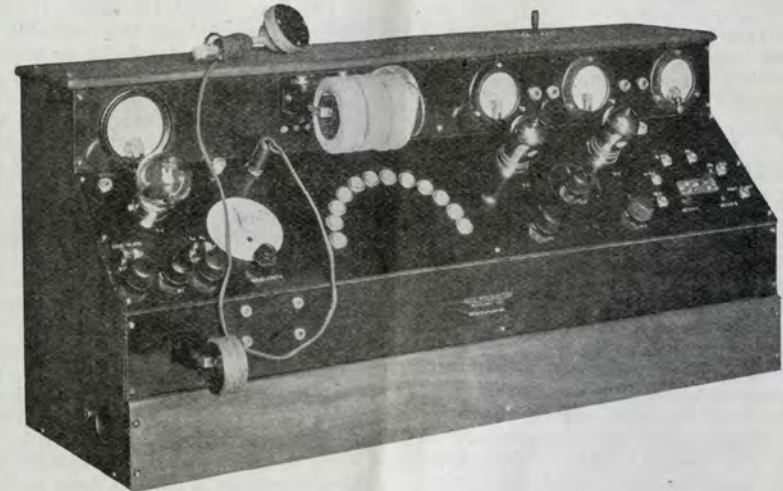

### To the Public:—

THE INSTRUMENT shown above is at your disposal during the show. We will test your tubes, transformers any kind, variable or fixed condensers in fact all parts you use in making sets absolutely free.

There are good and bad parts being manufactured that you are daily putting into your sets. No one before had any means of telling if certain parts were the right capacity or if the part would give the satisfaction claimed by the manufacturer. Our object is to show exactly how each part will function in your set.

### To the Trade:—

WE ARE manufacturing many different types of shop laboratory equipment including tube oscillators, trouble shooters, devices for measuring capacities of fixed and variable condensers. This is entirely new, there being nothing in existence which will do the work of the instrument shown above. Let us show you.

**Radio Headquarters Laboratories**  
Broadway and Ankeny Street  
Portland, Oregon

## A Simple Explanation of Radio

By Dr. F. A. Kolster

THE development and perfection of the radio telephone has resulted in popularizing radio to such an extent that, from a comparatively obscure and mysterious science, it has at once become one of the most popular and fascinating innovations the world has ever known.

As many of you know, radio communication is carried through space by means of electro-magnetic waves, traveling at a speed of approximately 186,000 miles, or 300,000,000 meters, per second. The length of these waves ranges in present practice from 150 meters to 20,000 meters or more, depending upon the nature of the transmission. While it has been the custom in radio practice to speak of the length of the wave, it has been recently recommended, for engineering reasons, that the frequency of the wave be used rather than the wave length. The wave frequency is merely the number of waves which pass a given point in one second, and therefore is a function of their speed and length. The frequency of a wave is expressed in cycles or kilocycles. A wave length of 300 meters, for example, means a wave frequency of 1,000,000 cycles or 1000 kilocycles, per second, and is obtained merely by dividing the speed by the length of the wave.

For broadcasting stations, waves up to nearly 600 meters in length have been allocated by the Government, depending upon the class and location of the station. The wave at KPO, for example, is 423 meters in length. It has a frequency of about 709,000 cycles per second; that is to say, 709,000 radio waves, each 423 meters long, passing your receiving antenna every second.

Good broadcast reception and immunity from interference depend upon utilizing selective receiving means. By selectivity we mean that property of a receiving device which, by virtue of electrical tuning permits the reception of a given wave to the exclusion of others differing but slightly in length.

One of the primary laws of electricity is that an electric current will seek the path of least resistance. Now, the radio wave is very conscientious in obeying this law, and as it travels over

the earth's surface it is continually seeking paths of least resistance. Every receiving antenna offers such a path if it has been tuned to receive this wave. When you adjust the variable condenser or the tuning inductance of your receiving set, what you are really doing is making a path of least resistance for some particular wave; in other words, you are offering an inducement to this wave to come into your home to entertain you.

Now, unfortunately, some other passing wave whose length or frequency is but slightly longer or shorter than that which you have coaxed in may find easy entrance into your receiving set because of its non-discriminating or, to be more technical, because of its non-selective character. This, of course, results in interference of a most annoying kind and I think you will agree with me that it does not pay to be too hospitable with these radio waves. Your receiving station should be a path of least resistance for one and only one wave at a time, even at the expense of having to make more than a single adjustment. When receiving over moderate distances, the use of the rotatable coil or loop in place of the ordinary antenna will materially help in reducing interference by virtue of its selective and directive properties. It is through the combination of selectivity and directivity accomplished by simple adjustments that broadcast reception will eventually be materially improved.

In the development and design of broadcast receiving equipment, the radio engineer is confronted with very severe requirements, somewhat as follows:

First, maximum sensitivity for long-distance reception.

Second, maximum selectivity and immunity from interference.

Third, extreme simplicity of adjustment.

Fourth, reasonable cost.

It is a comparatively simple matter to meet any one of these requirements by itself, but to successfully accomplish all of them in a single device is a task which presents some difficulty.

## Rabjohn Mfg. Co.

390 Ninth St., Douglas 6922 San Francisco



See our Cabinets Displayed in Booth 105

## As Usual---

This RADIO SHOW was wired complete for  
light and power by

California Electrical Construction Co.

687 MISSION STREET

PHONE SUTTER 2740

SAN FRANCISCO

See us for Complete Line of Radio and Electrical Supplies

# A NOISE

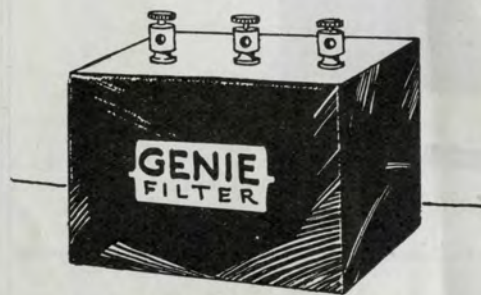

This little device eliminates radio noises. If you are bothered with telephone hums, induction noises or power leaks, the Induction Filter will solve your problem.

*Diagram shows simplicity of connection to your set. No tuning controls to bother with. Can be installed in a few moments.*

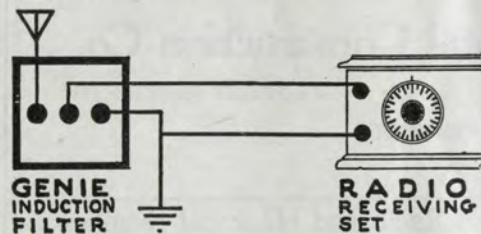

FREE—The new Genie Induction Filter for eliminating induction noises from telephone and power lines, etc. Send us your subscription to "RADIO" for one year, \$2.50, and the filter is yours. Not another cent to pay. This special offer is made by popular demand. Almost 1000 filters were given free to our subscribers during the last two months. This is your last chance to get one of these practical and useful instruments. Every radio receiving set should be equipped with this device. Don't be bothered with induction noises in your receiving set. Install a filter. This device was designed by Don Lippincott, radio engineer. It is manufactured by the Aerovox Corporation of San Francisco. Send your \$2.50 to us right now and you will get a filter by return mail and receive "RADIO" every month for a full year.

**"RADIO" Is the  
World's Best  
Practical Radio  
—Magazine—**

# KILLER FREE!

Get one of these useful devices free by subscribing to "RADIO" for only one year. Full price is \$2.50!

*Here is a great offer that should appeal to every radio fan. You get twelve issues of the big "RADIO" and one Induction Filter for only \$2.50. "RADIO" contains only the best radio articles that money can buy. It is written in simple language—contains many useful diagrams and a wealth of radio information that you don't find elsewhere.*

**MAIL THE  
COUPON!**

"RADIO," Pacific Building, San Francisco.

Send me "RADIO" for twelve months and immediately mail to my address one Induction Filter. I enclose \$2.50 in full payment.

Name .....

Address .....

## Telephone Headsets

By D. B. McGown

A telephone receiver is a device that makes audible the alternating current supplied from a transmitter. It changes electrical energy to sound energy. In the broadest sense it might be defined as a motor transforming energy from one form to another.

The common telephone receiver consists of a horseshoe magnet, with small coils wound on the two ends, and a small diaphragm of thin sheet iron, all mounted in a suitably arranged housing. The diaphragm is constantly in a state of strain, being pulled down to the magnets but not touching them, the amount depending on the strength of the magnet, the size and stiffness of the diaphragm, and the tightness with which its edges are held. When a direct current of small magnitude is permitted to flow through the coils, it either increases or decreases the effective strength of the magnet, and thus the pull on the diaphragm. The consequent vibration of the diaphragm is taken up by the air as sound.

As the magnet is thoroughly saturated with magnetism, a very slight current in the coils is applied almost entirely to moving the diaphragm. Thus the use of a permanent magnet which absorbs little or no magnetism from the coils enables small current variations to be made audible.

The resistance of the telephones used in wire telephone service is approximately 80 ohms, direct current, which gives an alternating current impedance of about 300 ohms, on 800 cycles. The receivers used in radio work average 1000 ohms resistance, direct current, and an alternating current impedance of from 10,000 to 15,000 ohms, depending on the characteristics of the phones. It would be advantageous to rate the phones in their impedance, but generally the user has no idea of the constants of the circuits of his apparatus, and therefore, even if the impedance of the phones were known, it would mean but little to him.

As receivers contain permanent magnets, care should be taken that they are not jarred, as every jar decreases the strength of the magnets. Even in spite

of good care, it will be found that telephones gradually lose their magnetism, and when this occurs they give weaker and weaker signals. In such a case the remedy is to return the phones to the manufacturer and have them re-magnetized, which usually places the phones in a condition nearly equal to new.

The diaphragms should be examined from time to time, and if they show signs of bending or rusting they should be replaced at once.

One of the commonest causes of trouble in telephone receivers is in the flexible connecting cords. These cords are made of thin copper tinsel wound on threads, and are liable to damage, through corrosion, or even continued bending. Many unknown and unexplainable noises in a receiving set can be located and eliminated by the use of new cords. A simple test for poor cords is to connect the phones across a new single dry cell. There should be a loud click when the terminals are touched, and a similar one when they are withdrawn. If the cord is worked back and forth, with the current on, a rubbing or scraping noise will be heard if the cord is defective, and it should be replaced. Usually it does not pay to try to repair cords, for if they are bad in one spot they would not be much better elsewhere and would only last a short time. Often poor cords can be located by working them back and forth while in use without bothering to connect them to a battery.

Loud speaking telephones are specially made telephone receivers, so constructed that they will handle relatively large amounts of power, without injury or distortion. Although basically they are similar to the more common types, their larger power handling ability requires that they be more ruggedly built, and that many changes of design be made.

The proper resistance or ampere turns ratio of phones must be carefully considered, as well as the shape of the magnetic circuit, the air-gap between the pole-pieces and the diaphragm, etc., all of which must be given consideration, and sometimes worked out empirically.



## To our many good friends on the Pacific Coast

YOU are cordially invited to inspect the complete line of **FROST-RADIO** on display in our booth at the Pacific Radio Exposition, San Francisco, August 16-21. Make our exhibit your headquarters while at the Show.

### **FROST-RADIO** includes the following items:

Frost-Fones	C-299 Sockets
Plugs	Shock-Absorber Single Sockets
Jacks	Shock-Absorber Gang Sockets
Jac-Boxes	Potentiometer Switches
Extension Cords	Series-Parallel Switches
Receiving Transformers	Resistance Units
Tuning Coils	Inductance Units
Metal Frame Rheostats	Bakelite Rheostats
Metal Frame Potentiometers	Bakelite Potentiometers
Tube Control Units	Protectors
Adapters	

*"Be sure to see when at the Show,  
The world's best line, **FROST-RADIO**"*

**HERBERT H. FROST, Inc.**  
154 WEST LAKE STREET. CHICAGO, ILLINOIS  
NEW YORK CITY CLEVELAND KANSAS CITY LOS ANGELES



## The Radio Compass

WHILE public interest in radio lies chiefly and most naturally in broadcast reception, radio finds its most important and its most essential application as a means of communication with ships at sea. Here, it serves to safeguard life and property. More recently, radio, through the development of the radio compass, has become of still greater importance in navigation, and particularly in promoting safety of life and property at sea.

The Government Lighthouse Service operates and maintains an extensive system of navigational aids, including lighthouses and light vessels, which are equipped with powerful lights and sound signaling devices, and everyone who has sailed upon the seas is familiar with the welcome sight of the flashing light or with the assuring sound of the fog horn.

Unfortunately, however, during fog or thick weather, these navigational aids do not serve their purpose adequately because light does not penetrate fog and sound signals are extremely unreliable and can not be depended upon to indicate direction or distance. Even under favorable weather conditions, the most modern devices for visual or sound signaling are limited to comparatively short distances.

Radio waves are unaffected by fog or thick weather and they can be transmitted over much greater distances than either light or sound waves. Any lighthouse or light vessel equipped with a radio transmitter, therefore, becomes an effective radio fog signaling station whose characteristic signal may be readily received by all ships within range, irrespective of weather conditions.

The radio compass is a nautical instrument which not only receives the radio fog signaling wave sent out by the lighthouse or lightship, but enables the navigator to determine immediately the direction or bearing of this signaling station. In other words, the radio compass is a device which is used to take the bearing of invisible radio beacons whose locations are shown on navigational charts. From such bearings the navigator is immediately informed as to his position.

One can fully appreciate this new

and simple aid to navigation unless he is somewhat familiar with the science of navigation. Since the days of the earliest mariners, navigation has depended upon astronomical observations, that is to say, upon observations of the sun and stars. When it is most important for the navigator to know his bearings, such as in foggy and stormy weather, the sun and stars are obscured and invisible, so that he is temporarily lost and must resort to dead reckoning and await clear weather before his position can be checked. The science of navigation has depended, since its earliest days, upon visibility, but now for the first time, through the aid of radio and the radio compass, it is possible for the navigator to know his position at all times regardless of weather conditions.

The equipment used for fog signaling consists of a simple radio transmitter automatically operated. The wave length used for this purpose is 1000 meters and each light vessel or lighthouse has its own characteristic signal by which it is identified.

The radio compass is generally installed over the chart room or pilot house of the ship, where it is convenient for use by the navigator. The device consists of a rotatable coil directly exposed to the radio wave and acted upon by the wave with varying degrees of intensity as the coil is rotated about its vertical axis. When the plane of the coil is at right angles to the direction in which the transmitting source lies, the signal intensity becomes zero. This position of silence is critical or sharply defined, and therefore indicates with great accuracy the direction or bearing of the signaling station. The bearing is read directly from the ship's magnetic or gyro compass to which the radio compass is attached, and therefore immediately gives the bearing with respect to magnetic north, or true north, depending upon whether a magnetic or gyro compass is used.

Personal experience in the development and practical application of the radio compass will assuredly have a revolutionary effect upon navigation. Every important lighthouse and every light vessel will, in the near future, become a radio beacon.

Keep Posted  
Through the—

## Leading Radio Paper of the Bay District

Every day The Chronicle publishes *complete* broadcasting programs and current radio news.

Every Sunday The Chronicle publishes a complete radio department consisting of special feature articles and news, giving you the constantly unfolding story of radio from both the technical and human viewpoints in a most fascinating manner.

The Chronicle prints *exclusively* The World's Radio Service—reliable and tested information on sets, hook-ups, loop aerials, and all new and proven equipment of all kinds.

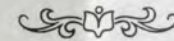

Be sure  
to visit  
The  
Chronicle  
Booth  
at the  
Radio  
Exposition

# Chronicle

Subscriptions received  
at Booth No. 117  
at the Show.  
Subscribe Now.

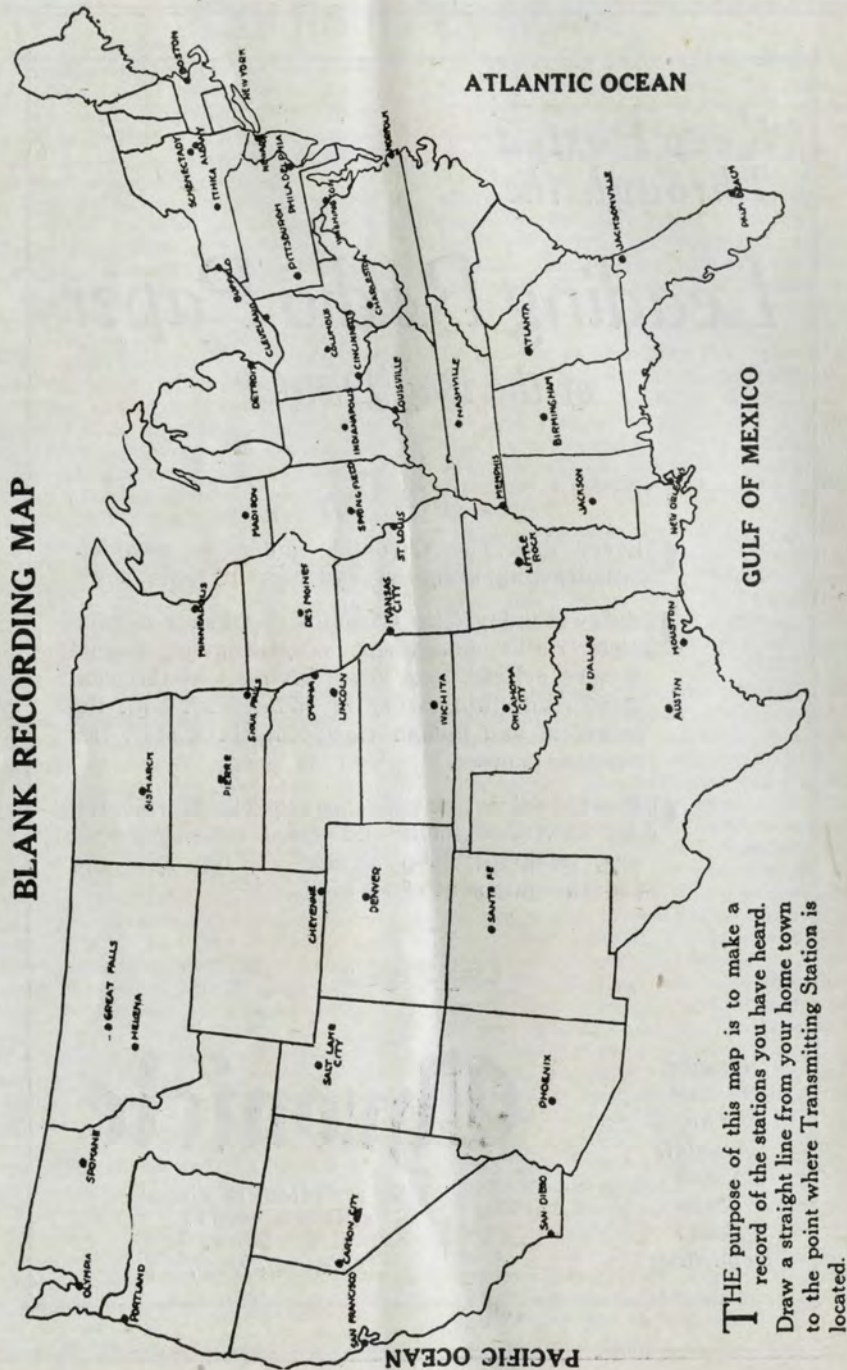

THE purpose of this map is to make a record of the stations you have heard. Draw a straight line from your home town to the point where Transmitting Station is located.

BOOTH NUMBER 92

# CELORON

(Bakelite Radio Panels - Sheets - Tubes)

CELORON is a particularly high type, high test material (approved by the Navy Department Bureau of Engineering and the United States Signal Corps). Qualifies as the leader of radio insulations because of (1) its high surface and volume resistivity; (2) its high dielectric strength; and (3) its low dielectric losses.

## The Panel Is the 'Front Door' of Your Radio Set

The appearance of **your** radio set depends on how it looks from the front. How it looks from the front depends upon what radio panel you use.

A CELORON radio panel gives your set classy appearance and maximum receptivity. You can have your CELORON panel in Lustrous Black, in Oak or in Mahogany.

Your CELORON panel is exceedingly

tough and durable. It retains its high finish. If you prefer the dull to the glossy finish, you can rub your CELORON panel down with fine sandpaper and give it a dull finish with oil. Because of its fine texture you can give it a dull finish without making it rough. You can drill clean holes in your CELORON panel. Also, it engraves cleanly, without feathering.

## CELORON

Panels come in eleven standard sizes. Celoron panels are easy to get. The leading dealers and jobbers in your neighborhood carry a full line of standard sizes and finishes.



## CELORON

(Bakelite)

Standard radio panels are for sale by all leading jobbers and dealers.

# Diamond State Fibre Company

BRIDGEPORT (near Philadelphia) PENNSYLVANIA

C. N. Wolf, Pacific Coast Manager

## Kilocycles and Meters

The Department of Commerce specifies radio station assignments in both kilocycles and meters. The tendency of radio engineering practice is to use and express frequency in kilocycles rather than wave length in meters. "Kilo" means a thousand, and "cycle" means one complete alternation. The number of kilocycles indicates the number of thousands of times that the rapidly alternating current in the antenna repeats in either direction in one second. The smaller the wave length in meters, the larger is the frequency in kilocycles. The numerical relation between the two is very simple. For approximate calculation, to obtain kilo-

cycles, divide 300,000 by the number of meters; to obtain meters divide 300,000 by the number of kilocycles. For example, 100 meters equals approximately 3000 kilocycles, 300 meters equals 1000 kilocycles, 1000 meters equals 300 kilocycles.

For highly accurate conversion the factor 299,820 should be used instead of 300,000. The table below gives accurate values of kilocycles corresponding to number of meters and vice versa. The table is based on the factor 299,820, and gives values for every 10 kilocycles or meters. It should be particularly noticed that the table is entirely reversible; that is, for example, 50 kilocycles is 5996 meters, and also 50 meters is 5996 kilocycles.

### Kilocycle-Meter Conversion Table

Kilocycles to meters, or meters to kilocycles; columns are interchangeable:

30...9994	40...7496	50...5996	510...587.9	520...576.6	530...565.7
60...4997	70...4283	80...3748	540...555.2	550...545.1	560...535.4
90...331		100...2998	570...526.0	580...516.9	590...508.2
110...2726	120...2499	130...2306	600...499.7	610...491.5	620...483.6
140...2142	150...1999	160...1874	630...475.9	640...468.5	650...461.3
170...1764	180...1666	190...1578	660...454.3	670...447.5	680...440.9
	200...1499		690...434.5		700...428.3
210...1428	220...1363	230...1304	710...422.3	720...416.4	730...410.7
240...1249	250...1199	260...1110	740...405.2	750...399.8	760...394.5
270...1110	280...1071	290...1034	770...389.4	780...384.4	790...379.5
	300...999.4		800...374.8	810...370.2	820...365.6
310...967.2	320...936.9	330...908.6	830...361.2	840...356.9	850...352.7
340...881.8	350...856.6	360...832.8	860...348.6	870...344.6	880...340.7
370...810.3	380...789.0	390...768.8	890...336.9		900...333.1
	400...749.6			910...329.5	920...325.9
410...731.3	420...713.9	430...697.3	930...322.4	940...319.0	950...315.6
440...681.4	450...666.3	460...651.8	960...312.3	970...309.1	980...303.9
470...637.9	480...624.6	490...611.9	990...302.8	1000...299.8	

## SCREWS

Large Counter Assortments  
Constructor's Packets

## BINDING POSTS

Engraved—Plain—Strips

On Display at Booth No. 61

**DIXIE SUPPLY COMPANY**

REPRESENTED BY FREDERIC L. THOMLINSON COMPANY

447 Pacific Building, San Francisco

1113 Wall Street, Los Angeles

116 Thirteenth Avenue, Seattle

# Announcing



## WRIGHT RADIO RECEIVERS



### Model 5-A Grand

A self-contained, solid mahogany, five-tube receiving set—pure of tone, powerful in encompassing distance, and extremely selective. The leading number of a line of modern receivers *par excellence* for the enjoyment of radio in the home. Sold through leading radio dealers.

**Price, \$197.50 complete**  
with dry cells, tubes and built-in loud speaker

## The H·EARLE WRIGHT CO.

131 EIGHTH STREET

SAN FRANCISCO

415 EAST EIGHTH STREET

LOS ANGELES

Sole Distributors



# Booth 94 <sup>at</sup> the Show

THE achievements of De Forest's Company since the early days in 1900 have been in harmony with the pioneering inventions of the man whose name they bear. The first indoor loop—the famous Reflex Radiophones—cross-continent reception on the loop—the practical elimination of summer static—the first simple portable long distance receiver—dry cell tubes and power tubes—laboratory tested parts and a reputation in the forefront of radio—all De Forest.

**DE FOREST RADIO**  
**TEL. & TEL. CO.**  
 Jersey City, New Jersey

# WURLITZER RADIOS



Wurlitzer Radios are without doubt the most efficient Receiving Sets on the market.

They are so simple a child can tune them.

The tone quality is unsurpassed.

They are extremely selective.

They are non-regenerative.

Will not oscillate or re-radiate on the air.

Long distance may be had clearer and stronger.

They may be had in five models, in separate cabinets, or combined with phonographs or Victrolas.

Wurlitzer experts will completely install the Radio in your home.

All accessories and installations are included in the prices of Wurlitzer Radios.

*Take One  
 Year to Pay*

The three tube Wurlitzer Portable model is the last word in Radio efficiency.

**The RUDOLPH WURLITZER Co.**

THE WORLD'S LARGEST MUSIC HOUSE—STORES IN ALL PRINCIPAL CITIES

250 Stockton St.,  
 San Francisco

2325 Mission St.  
 San Francisco

575 Fourteenth St.,  
 Oakland

607 W. Seventh St.,  
 Los Angeles



# RADIO CORPORATION of AMERICA

*invites you to inspect  
its display in Section E*

**RADIO EXPOSITION**  
CIVIC AUDITORIUM, AUG. 16-21

## **Radiolas**

*— speak for themselves*

## **Radiotrons**

*— for best reception*



*San Francisco Distributors*

Fobes Supply Company, 260 Fifth Street  
Leo-J. Meyberg Co., 973 Mission Street  
Pacific States Electric Co., 575 Mission St.

*“There’s a **Radiola** for every purse”*

