



*A Publication for the
Radio Amateur Worldwide*

*Especially Covering VHF,
UHF and Microwaves*

VHF COMMUNICATIONS

Volume No.27 . Autumn . 3/1995 . £4.00

**200mW Amplifier
for 24 GHz**



**Michael Kuhne
DB6NT**



VHF COMMUNICATIONS

A Publication for the Radio Amateur Worldwide

Especially Covering VHF, UHF and Microwaves

Volume No. 27 . Autumn . Edition 3/1995

Publishers

KM PUBLICATIONS,
5 Ware Orchard, Barby, Nr.Rugby,
CV23 8UF, United Kingdom
Tel: 01788 890365
Fax: 01788 891883

Internet:
vhf-comm@g6iqm.demon.co.uk

CompuServe: 100441,377

Editor

Mike Wooding G6IQM

Advertising Manager

Mike Wooding G6IQM

VHF COMMUNICATIONS

The international edition of the German publication UKW-Berichte is a quarterly amateur radio magazine, especially catering for the VHF/UHF/SHF technology. It is owned and published in the United Kingdom in Spring, Summer, Autumn and Winter by KM PUBLICATIONS.

The 1995 subscription price is £15.00, or national equivalent. Individual copies are available at £4.00, or national equivalent each. Subscriptions and orders of individual copies of the magazine should be addressed to the national representative shown in the next column, or - if not possible - directly to the publishers. All other enquiries should be addressed directly to the publishers.

Back issues, kits, as well as the blue plastic binders are obtainable from the national representative, or direct from KM Publications.

© KM PUBLICATIONS

All rights reserved. Reprints, translations, or extracts only with the written approval of the publishers

Translated by: Inter-Ling Services,
62 Caldecott Street, Rugby,
CV21 3TH, UK

Printed in the United Kingdom by:
Cramphorn Colour Printers Ltd.,
15c Paynes Lane, Rugby

If there is no representative shown in the adjacent column for your country please contact the publishers direct.

AUSTRIA - Verlag UKW-BERICHTe, Terry D. Bittan, POB 80,
D-91081 BAIERSDORF, Germany. Tel: (0133) 47 0
Fax: 09733 4747 Telex: 629 887. Postgiro Nbg. 30445 858.

AUSTRALIA - W.I.A., P.O. Box 300, SOUTH CAULFIELD,
3162 VIC, Australia. Tel: 528 5962

BELGIUM - UKW-BERICHTe, POB 80, D-91081 BAIERSDORF,
Germany. Tel: (0133) 47-0. Fax: 09733 4747 Telex: 629 887.
Postgiro Nbg. 30445 858.

DENMARK - KM PUBLICATIONS, 5 Ware Orchard, Barby,
Nr.RUGBY, CV23 8UF, UK. Tel: +44 788 890365.
Fax: +44 788 891883. Email: vhf-comm@g6iqm.demon.co.uk

FRANCE - Christianne Michel F5SM, SM ELECTRONIC, 20bis
Avenue des Clairons, F-89000 AUXERRE, France
Tel: (86) 46 96 59

FINLAND - KM PUBLICATIONS, 5 Ware Orchard, Barby,
Nr.RUGBY, CV23 8UF, UK. Tel: +44 788 890365.
Fax: +44 788 891883. Email: vhf-comm@g6iqm.demon.co.uk

GERMANY - UKW-BERICHTe, POB 80, D-91081
BAIERSDORF, Germany. Tel: 09133 7798 0.
Fax: 09133 779833, Postgiro Nbg. 30445 858.

GREECE - C+A ELECTRONIC, P.O. Box 25070, ATHENS
100 26, Greece. Tel: 01 52 42 867. Fax: 01 52 42 537

HOLLAND - KM PUBLICATIONS, 5 Ware Orchard, Barby,
Nr.RUGBY, CV23 8UF, UK. Tel: +44 788 890365.
Fax: +44 788 891883. Email: vhf-comm@g6iqm.demon.co.uk

ITALY - ADB ELETTRONICA di Luchesi Fabrizio IWSADB,
Via Vecchia Romana 266, 55100 ANTRACCOLI, (LUCCA), Italy.
Tel: 0583 952612. Fax: 0583 91109

NEW ZEALAND - Vaughan Henderson, AUCKLAND VHF
GROUP Inc., P.O. Box 10 138, AUCKLAND 1030, New Zealand.
Tel: 0 9 480 1556

NORWAY - HENNING THEG RADIO COMMUNICATION
LA4YG, Kjolaveien 30, 1370 ASKER, Norway.
Postgirokonto: 3 16 00 09

SOUTH AFRICA - HI-TECH BOOKS, P.O. Box 1142,
RANDBURG, Transvaal 2125, South Africa. Tel: (011) 465 3385

SPAIN & PORTUGAL - JULIO A. PRIETO ALONSO EA4CJ,
Donoso Cortes 58 5º B, MADRID 15, Spain. Tel: 543 83 84

SWEDEN - WAVELINE AB, Box 60224, S-210911 MALMÖ,
Sweden. Tel: 40 16 42 66. Fax: 40 15 05 07. GSM: 0705 16 42 66
Postgiro: 13 78 93 - 4

SWITZERLAND - KM PUBLICATIONS, 5 Ware Orchard, Barby,
Nr.RUGBY, CV23 8UF, UK. Tel: +44 788 890365.
Fax: +44 788 891883. Email: vhf-comm@g6iqm.demon.co.uk

UNITED KINGDOM - KM PUBLICATIONS, 5 Ware Orchard,
Barby, Nr.RUGBY, CV23 8UF, UK. Tel: +44 788 890365.
Fax: +44 788 891883. Email: vhf-comm@g6iqm.demon.co.uk

U.S.A. - WYMAN RESEARCH Inc., RR#1 Box 95, WALDRON,
Indiana 46182, U.S.A. Tel: (317) 525 6452

Henry Ruh, ATVQ MAGAZINE, 3 North Court Street,
Crown Point, Indiana 46307, U.S.A. Tel: (219) 662 6395.
Fax: (219) 662 6991

ELSEWHERE - KM PUBLICATIONS, address as for the U.K.

ISSN 0177-7505



Contents

Luis Cupido CT1DMK	Frequency Counter with Harmonic Mixing for the UHF/SHF Amateur	130 - 146
Michael Kuhne DB6NT	200mW GaAsFET Amplifier for 24 GHz	147 - 152
Matjaz Vidmar S53MV	A DIY Receiver for GPS and GLONASS Satellites Part-6	153 - 167
Dipl.-Ing Detlef Burchard	Linear Signal Rectification Part-1	168 - 179
Rainer Schmülling DK6ZK	Expansion and Assembly of the DB1NV Spectrum Analyser	180 - 188



KM Publications, 5 Ware Orchard, Barby, Rugby, CV23 8UF, UK

Telephone: (0)1788 890365; INT: +44 1788 890 365; FAX: (0)1788 891883

INTERNET: vhf-comm@g6iqm.demon.co.uk

COMPUSERVE: 100441,377

Luis Cupido, CT1DMK

Frequency Counter with Harmonic Mixing for the UHF/SHF Amateur

Taken from an address given to the VHF/UHF/SHF Technical Congress '94 in Munich

Amateurs building their own radio-frequency assemblies and equipment always need at least a minimum amount of measurement and testing equipment. This is particularly true for SHF operators, where there is not much measurement equipment available and prices are high. The frequency meter described below can measure up to 26.5 GHz (or even 33 GHz) with a resolution of 100 Hz, and with a constant sensitivity of - 10 dBm.

1. INTRODUCTION

It is well-known that there are reasonably-priced, ready-to-operate frequency counters which operate at up to 1.3 GHz. However, additional measurement

equipment is required for the increasing levels of activity above 1.3 GHz.

A number of different procedures are available for frequency determination - e.g., using wave meters, cavity resonators and downwards converters with a known local oscillator frequency. These techniques can provide results which can certainly be of use. But because of the poor resolution, in particular for the downwards conversion procedure, they are not very practical for a receiver.

1.1. Brief Description of Frequency Measurement Procedure

Several procedures can be used to measure frequencies (only the essentials are dealt with here).

- Low frequencies (anything below 10 MHz) can be measured by counting the number of periods over a fixed time (1 second for a resolution of 1 Hz). This procedure is described as the direct counting procedure (TTL-LS and CMOS technologies can be used).

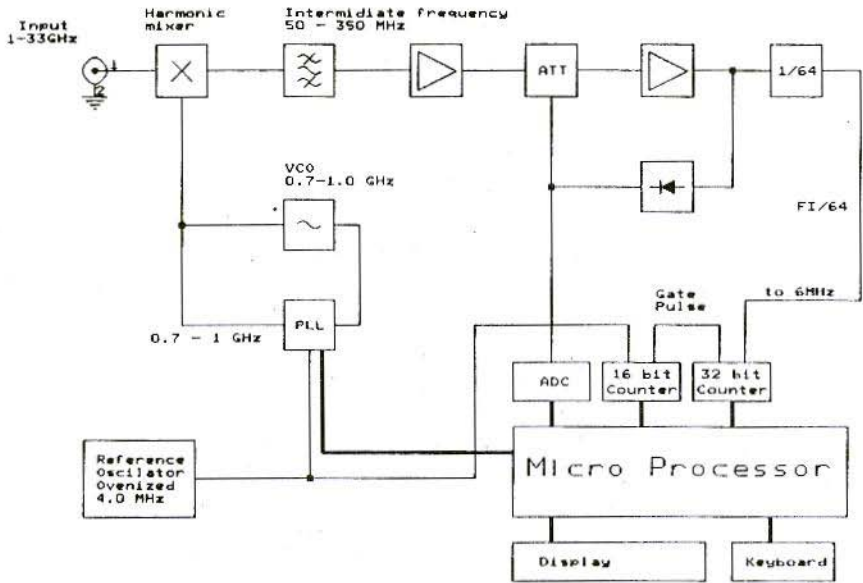

Fig.1: Block Diagram of a Frequency Counter with Harmonic Mixing

- For measurements at high frequencies, the range of direct-counting frequency counters can be expanded through the use of a pre-divider using ECL technology, with which the input frequency is divided by a factor, in general, of 10, 100, 64, 128 or 256. This procedure can be used only up to the maximum operating frequency of the divider used. Although 14-GHz pre-dividers are available on the market, they are very expensive and are beyond the reach of amateurs. Cheap pre-dividers do exist, with which division can be carried out at up to 2.5 GHz. However, most of them are for dynamic operation only - i.e. laid out as from a minimum operating frequency, so that they can be used for only a few bands.

- Frequency measurements on micro-waves can be carried out with the help of wave meters and cavity resonators at low resolution.

Measurements using the counting procedure are possible only if the signal is converted to a lower intermediate frequency, which can then be measured by direct counting. This can be done using the following procedure:

1. Interference method using a simple superheterodyne receiver to measure the precise oscillator frequency and the intermediate frequencies.
2. Transfer oscillator procedures using a simple superheterodyne receiver with an oscillator linked to the intermediate frequency signal which is in a constant relationship with the frequency of the first oscillator, which is then measured.

AMP02/03/04/07

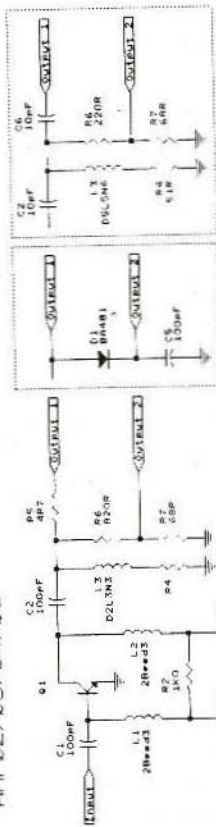

ATT01

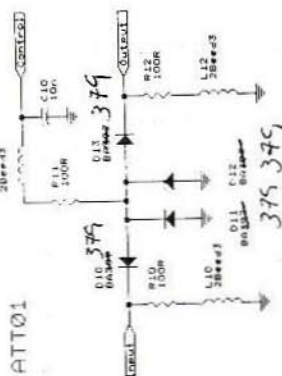

AMP02	AMP3	AMP4	AMP5
01	BFR90A	BFR91C	BFR91C
03	690	690	73P
04	15P	15P	41P
06	820P	---	20P
07	690	---	48P
08	470R	470R	770R
13	D2L3X3	D2L3X3	D2L3X3

NOTE: COILS ARE ALL WOUND WITH 20 TURNS. L1, L2, L3, L4, L5, L6, L7, L8, L9, L10, L11, L12, L13, L14, L15, L16, L17, L18, L19, L20, L21, L22, L23, L24, L25, L26, L27, L28, L29, L30, L31, L32, L33, L34, L35, L36, L37, L38, L39, L40, L41, L42, L43, L44, L45, L46, L47, L48, L49, L50, L51, L52, L53, L54, L55, L56, L57, L58, L59, L60, L61, L62, L63, L64, L65, L66, L67, L68, L69, L70, L71, L72, L73, L74, L75, L76, L77, L78, L79, L80, L81, L82, L83, L84, L85, L86, L87, L88, L89, L90, L91, L92, L93, L94, L95, L96, L97, L98, L99, L100, L101, L102, L103, L104, L105, L106, L107, L108, L109, L110, L111, L112, L113, L114, L115, L116, L117, L118, L119, L120, L121, L122, L123, L124, L125, L126, L127, L128, L129, L130, L131, L132, L133, L134, L135, L136, L137, L138, L139, L140, L141, L142, L143, L144, L145, L146, L147, L148, L149, L150, L151, L152, L153, L154, L155, L156, L157, L158, L159, L160, L161, L162, L163, L164, L165, L166, L167, L168, L169, L170, L171, L172, L173, L174, L175, L176, L177, L178, L179, L180, L181, L182, L183, L184, L185, L186, L187, L188, L189, L190, L191, L192, L193, L194, L195, L196, L197, L198, L199, L200, L201, L202, L203, L204, L205, L206, L207, L208, L209, L210, L211, L212, L213, L214, L215, L216, L217, L218, L219, L220, L221, L222, L223, L224, L225, L226, L227, L228, L229, L230, L231, L232, L233, L234, L235, L236, L237, L238, L239, L240, L241, L242, L243, L244, L245, L246, L247, L248, L249, L250, L251, L252, L253, L254, L255, L256, L257, L258, L259, L260, L261, L262, L263, L264, L265, L266, L267, L268, L269, L270, L271, L272, L273, L274, L275, L276, L277, L278, L279, L280, L281, L282, L283, L284, L285, L286, L287, L288, L289, L290, L291, L292, L293, L294, L295, L296, L297, L298, L299, L300, L301, L302, L303, L304, L305, L306, L307, L308, L309, L310, L311, L312, L313, L314, L315, L316, L317, L318, L319, L320, L321, L322, L323, L324, L325, L326, L327, L328, L329, L330, L331, L332, L333, L334, L335, L336, L337, L338, L339, L340, L341, L342, L343, L344, L345, L346, L347, L348, L349, L350, L351, L352, L353, L354, L355, L356, L357, L358, L359, L360, L361, L362, L363, L364, L365, L366, L367, L368, L369, L370, L371, L372, L373, L374, L375, L376, L377, L378, L379, L380, L381, L382, L383, L384, L385, L386, L387, L388, L389, L390, L391, L392, L393, L394, L395, L396, L397, L398, L399, L400, L401, L402, L403, L404, L405, L406, L407, L408, L409, L410, L411, L412, L413, L414, L415, L416, L417, L418, L419, L420, L421, L422, L423, L424, L425, L426, L427, L428, L429, L430, L431, L432, L433, L434, L435, L436, L437, L438, L439, L440, L441, L442, L443, L444, L445, L446, L447, L448, L449, L450, L451, L452, L453, L454, L455, L456, L457, L458, L459, L460, L461, L462, L463, L464, L465, L466, L467, L468, L469, L470, L471, L472, L473, L474, L475, L476, L477, L478, L479, L480, L481, L482, L483, L484, L485, L486, L487, L488, L489, L490, L491, L492, L493, L494, L495, L496, L497, L498, L499, L500, L501, L502, L503, L504, L505, L506, L507, L508, L509, L510, L511, L512, L513, L514, L515, L516, L517, L518, L519, L520, L521, L522, L523, L524, L525, L526, L527, L528, L529, L530, L531, L532, L533, L534, L535, L536, L537, L538, L539, L540, L541, L542, L543, L544, L545, L546, L547, L548, L549, L550, L551, L552, L553, L554, L555, L556, L557, L558, L559, L560, L561, L562, L563, L564, L565, L566, L567, L568, L569, L570, L571, L572, L573, L574, L575, L576, L577, L578, L579, L580, L581, L582, L583, L584, L585, L586, L587, L588, L589, L590, L591, L592, L593, L594, L595, L596, L597, L598, L599, L600, L601, L602, L603, L604, L605, L606, L607, L608, L609, L610, L611, L612, L613, L614, L615, L616, L617, L618, L619, L620, L621, L622, L623, L624, L625, L626, L627, L628, L629, L630, L631, L632, L633, L634, L635, L636, L637, L638, L639, L640, L641, L642, L643, L644, L645, L646, L647, L648, L649, L650, L651, L652, L653, L654, L655, L656, L657, L658, L659, L660, L661, L662, L663, L664, L665, L666, L667, L668, L669, L670, L671, L672, L673, L674, L675, L676, L677, L678, L679, L680, L681, L682, L683, L684, L685, L686, L687, L688, L689, L690, L691, L692, L693, L694, L695, L696, L697, L698, L699, L700, L701, L702, L703, L704, L705, L706, L707, L708, L709, L710, L711, L712, L713, L714, L715, L716, L717, L718, L719, L720, L721, L722, L723, L724, L725, L726, L727, L728, L729, L730, L731, L732, L733, L734, L735, L736, L737, L738, L739, L740, L741, L742, L743, L744, L745, L746, L747, L748, L749, L750, L751, L752, L753, L754, L755, L756, L757, L758, L759, L760, L761, L762, L763, L764, L765, L766, L767, L768, L769, L770, L771, L772, L773, L774, L775, L776, L777, L778, L779, L780, L781, L782, L783, L784, L785, L786, L787, L788, L789, L790, L791, L792, L793, L794, L795, L796, L797, L798, L799, L800, L801, L802, L803, L804, L805, L806, L807, L808, L809, L810, L811, L812, L813, L814, L815, L816, L817, L818, L819, L820, L821, L822, L823, L824, L825, L826, L827, L828, L829, L830, L831, L832, L833, L834, L835, L836, L837, L838, L839, L840, L841, L842, L843, L844, L845, L846, L847, L848, L849, L850, L851, L852, L853, L854, L855, L856, L857, L858, L859, L860, L861, L862, L863, L864, L865, L866, L867, L868, L869, L870, L871, L872, L873, L874, L875, L876, L877, L878, L879, L880, L881, L882, L883, L884, L885, L886, L887, L888, L889, L890, L891, L892, L893, L894, L895, L896, L897, L898, L899, L900, L901, L902, L903, L904, L905, L906, L907, L908, L909, L910, L911, L912, L913, L914, L915, L916, L917, L918, L919, L920, L921, L922, L923, L924, L925, L926, L927, L928, L929, L930, L931, L932, L933, L934, L935, L936, L937, L938, L939, L940, L941, L942, L943, L944, L945, L946, L947, L948, L949, L950, L951, L952, L953, L954, L955, L956, L957, L958, L959, L960, L961, L962, L963, L964, L965, L966, L967, L968, L969, L970, L971, L972, L973, L974, L975, L976, L977, L978, L979, L980, L981, L982, L983, L984, L985, L986, L987, L988, L989, L990, L991, L992, L993, L994, L995, L996, L997, L998, L999, L1000.

Fig.2: Assemblies 02, 03, 04 and ATT01



3. Harmonics procedure using a super-heterodyne receiver with a harmonic mixer being used as a first mixer, so that very high frequencies can be converted to an intermediate frequency. The number of harmonics then also has to be calculated to determine the frequency of the measured signal.

1.2. Frequency Meter as per Harmonic Mixing Principle

This principle was selected for the microwave frequency counter, in particular, because it is the only principle which can be used to measure high frequencies using cheap components and local (first) oscillators (1. LO) below 1 GHz, which can easily be assembled by any experienced amateur.

The radio-frequency section of the counter consists of a harmonic mixer and the intermediate frequency section (see block diagram, Fig.1). To carry out the measurement, the first oscillator is swept through until a strong intermediate-frequency signal appears. The first oscillator is then locked and the intermediate frequency is measured and stored. The first oscillator is then stepped up by a small amount (e.g. 1 kHz) and the intermediate frequency is measured again to calculate the intermediate frequency shift and the direction of deviation. The ordinal number of the harmonic can then be determined by dividing the LO shift by the intermediate frequency shift (e.g. if the shift is 12 kHz then $n = 12/1 = 12$).

The conversion side band can be determined by examining the direction of

the intermediate-frequency deviation (if downwards: USB, if upwards: LSB).

Finally, the measured frequency, f , amounts to:

$$f = LO \pm f_{IF}$$

The procedure described presupposes that a computer-controlled frequency counter is available. However, nowadays micro-controllers are simple to use and are sufficiently powerful to carry out the calculations for our applications.

2. CIRCUIT DESCRIPTION

The circuits are certainly extensive. But they are not difficult to construct. Nor do they pose any special calibration problems. The equipment is built up from several existing assemblies - OSC2's, AMP02/03/04's and ATT01's.

2.1. The Harmonic Mixer

The harmonic mixer uses a BAT14 mixing diode (26-GHz version, with no leads) in a single-cycle circuit. This GaAs diode is controlled by a 17-dBm signal from the first oscillator in the 700 - 1,000 MHz range.

The rapid switching characteristics of the BAT14 make it possible to convert up to the 33rd harmonic of the oscillator with a mixing loss of app. 50 dB. The maximum efficiency of the harmonic mixer is essentially dependent on its structure. The maximum operating fre-

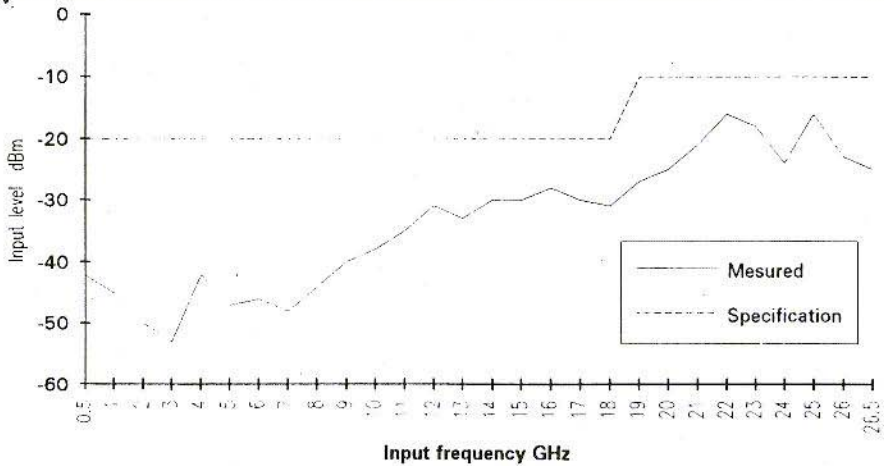

Fig.3: Characteristics of a BAT14 Diode: Comparison of Specification and Measured Values

Freq.	Sens.	Spec.
0.5	-42	-20
1	-45	-20
2	-50	-20
3	-53	-20
4	-42	-20
5	-47	-20
6	-46	-20
7	-48	-20
8	-44	-20
9	-40	-20
10	-38	-20
11	-35	-20
12	-31	-20
13	-33	-20
14	-30	-20
15	-30	-20
16	-28	-20
17	-30	-20
18	-30	-20
19	-27	-10
20	-25	-10
21	-21	-10
22	-16	-10
23	-18	-10
24	-24	-10
25	-16	-10
26	-23	-10
26.5	-25	-10

Frequency Meter I/P Sensitivity using a BAT14 diode as harmonic mixer

quency of the equipment is also determined by the upper operating frequency of the harmonic mixer. The structure of the harmonic mixer is described later.

2.2. The Intermediate-Frequency Pre-Amplifier

In the preamplifier, the main emphasis has been laid on a low noise factor within the intermediate frequency range and on maximum suppression of the LO frequency, which is extremely undesirable in the intermediate-frequency circuits. This assembly comprises a Chebycheff bandpass filter, followed by two AMP02 amplifiers, with an amplification of more than 25 dB in the intermediate-frequency range of 50 - 350 MHz. The amplifier assemblies use BFR90A transistors. At the output of the second amplifier, a signal weakened by - 10 dB is decoupled to an external intermediate-frequency output, which can be very useful.

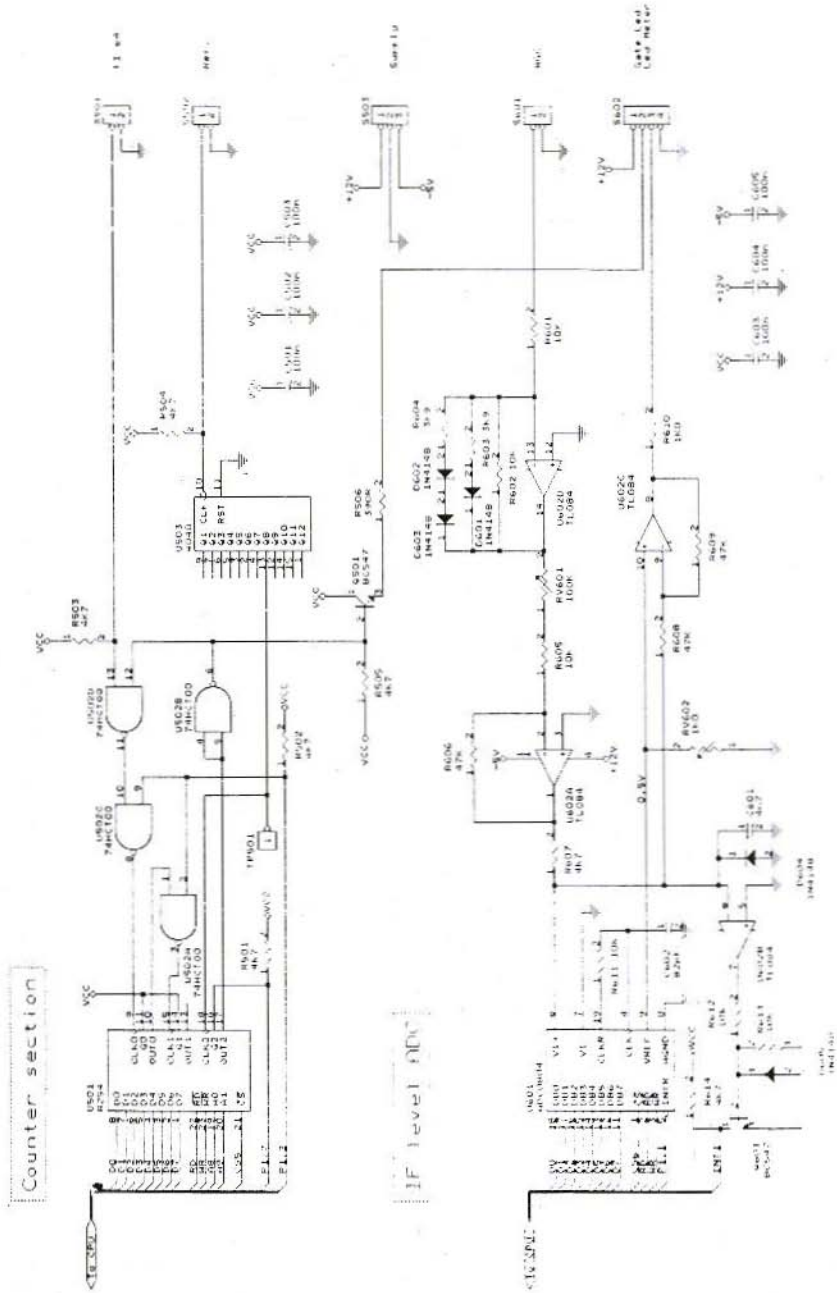

Fig.5: Circuit of Counter Section and IF Analogue/Digital Converter



2.3. The Intermediate-Frequency Amplifier And AGC

In this stage, the signal supplied by the preamplifier is amplified to the level of 0 dBm required for the processing in the subsequent digital circuits. The intermediate-frequency amplifier is 4-stage, built for a total amplification of more than 45 dB. To maintain a constant output level, the final stage contains an AGC detector to control the AGC circuits. This amplifier must have a flat frequency response in the 50 - 350 MHz range and should have as little noise as possible, so as to improve the operating threshold of the subsequent digital circuits.

The dynamic range of this intermediate frequency naturally has to be greater than the dynamic range which would be desirable for any kind of input frequency. The reason for this lies in the fact that the mixed attenuation of the harmonic mixer changes from 7 dB to 50 dB for the higher harmonics.

The best operating results for the frequency counter could be achieved if the intermediate-frequency amplifier had so much total amplification that a noise signal would be supplied at its output which was so high that it could be processed directly by the digital circuits. This happens at a level of approximately -10 to 0 dBm, at the input of the next stage.

Signals above the noise are counted, although the dynamic range of the ECL input to the next stage is narrow. So it is desirable to have a constant-level signal available at the output of the intermediate-frequency section for every signal at a level which is consid-

erably higher than the noise level. This is brought about by an automatic gain control (AGC), which operates over a wide range and makes good level compensation possible.

Signal limiters or limiter amplifiers are not desirable here, as to a large extent they generate harmonics which can impair the digital circuit functions. Remember, that with an intermediate-frequency signal of 50 MHz the harmonics are in the 50 - 350 MHz measurement range. The AGC's wide dynamic range is obtained through the control of a PIN-diode attenuating element with which over 70 dB of attenuation can be attained.

The AGC circuit is very simple and effective. Here the intermediate-frequency level is compensated using a DC current (adjusted at RV301), so that the comparator (also used as an integrator) closes the control loop through the attenuating element. The AGC's response time is in the order of 10 ms.

The AGC signal is fed into the microprocessor for the intermediate-frequency level to be evaluated. An LED column display provides an indication of the signal level, derived from the AGC signal.

2.4. The Pre-Divider

This part of the circuit serves only to bring the intermediate frequency to a level which lies within the operating range of digital CMOS circuits. Only an ECL divider from Telefunken is used in the circuit (others could have been used as well). The pre-divider is supplied with a 0 dBm signal and

Local Oscillator + PLL

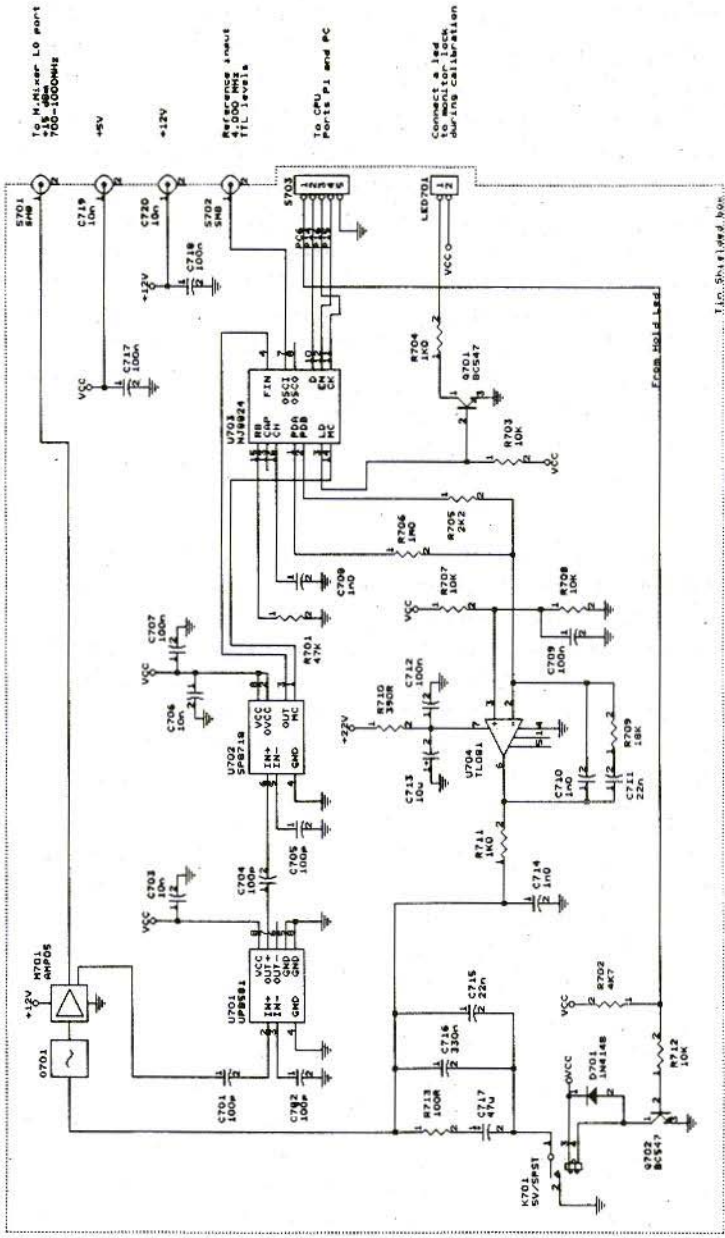

Fig.6: Circuit of LO and PLL assemblies



divides by 64. A TTT-LS inverter converts the signal to the TTL level.

2.5. The Counter Section

Here the intermediate-frequency signal, already divided, is fed to an Intel 8254 (3x16 bit counter), which is directly controlled by the micro-processor. Counters 0 and 1 are cascaded to make a 32-bit counter resolution possible, whilst counter 2 is used as a one-shot for the input gate control. The micro-processor controls all 3 counters directly.

The reference frequency for controlling the highly precise trigger signal is generated by dividing a 4-MHz signal which is supplied by a thermostatically-stabilised crystal oscillator, which is not mounted on the printed circuit board.

2.6. Analogue/Digital Conversion of Intermediate-Frequency Level

The AGC signal is initially processed in an analogue circuit to improve the real range of the AD converter (remember that the attenuating element in the intermediate frequency/AGC branch displays a very strongly non-linear attenuation gradient). Additional components are needed to send a signal to the micro-processor in case of saturation.

2.7. The First (Local) Oscillator

The first oscillator has to supply a high-level high-frequency signal (+ 17 dBm) to control the harmonic mixer.

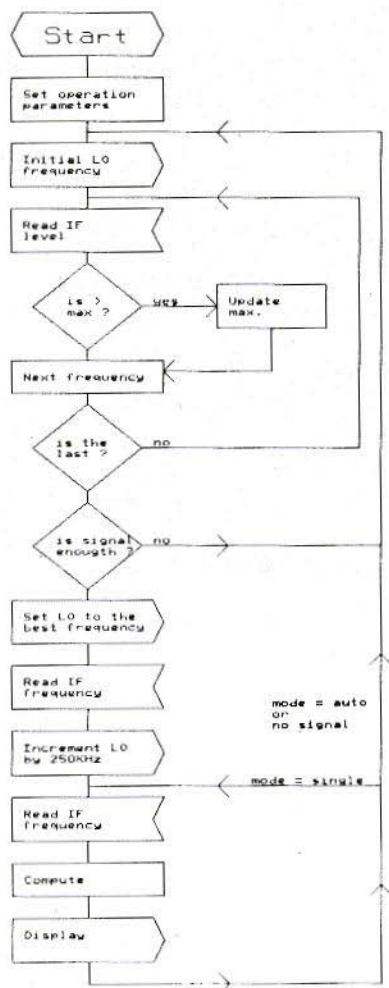

Fig.7: Flow Diagram of Software needed for Freq. Counter

The oscillator, the frequency of which can be varied over a wide range, uses a micro-strip transmission circuit. It is followed by an amplifier which supplies the output level required.

One part of the oscillator signal, attenuated by 20 dB by a PB581C pre-

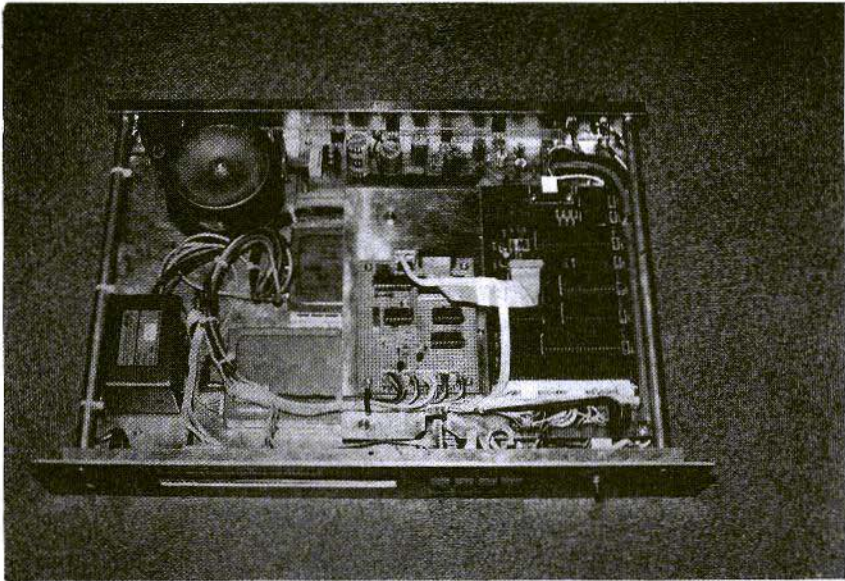

Fig.8: The Prototype unit with the easily identifiable CPU Board

divider, is fed to a dual-mode SP8727 pre-divider, which is controlled by a PLL-IC NS8242.

The NS8242 PLL module (Plessey) is a dual-mode PLL-IC with serial control inputs and two phase detectors. Motorola modules can also be used, but software changes are required.

The PLL-IC uses the same external reference signal of 4 MHz as the counter section. In the loop filter, an OP amplifier is used in the classic way. In addition, a considerably narrower filter can be wired up, if the user selects the count dwell period to obtain a considerably purer LO spectrum. Because of this characteristic, the frequency counter can be used as a reception converter.

An LED is provided to light up when

the PLL is engaged. But this is needed only for the testing and calibration procedures.

2.8. The Micro-Controller

Control and frequency counting require this equipment to have functions involving the making of decisions and fixed point calculations with 32-bit resolution. This makes it absolutely necessary to use a micro-controller.

A programmable 8032 board generally obtainable from component suppliers, R.S, etc., is used as micro-controller. This board has an 8031 with an RS232 interface, an 8255 PPI, an 8-k RAM and a 16-k ROM. 100% compatible boards can be set up how you like, provided the following addressing data are included:

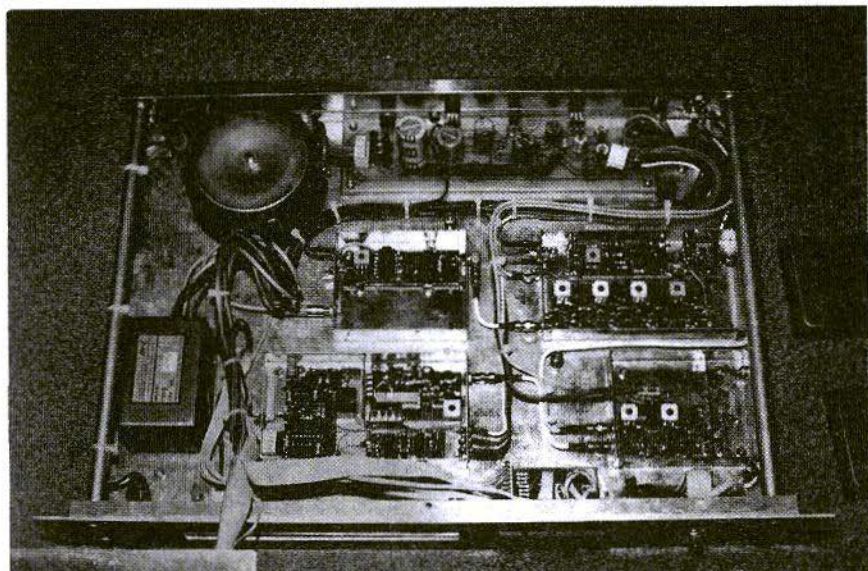

Fig.9: The Lower Assemblies are mounted in tin-plate housings on the base

ROM address:	000H...400H
RAM address:	800H...A000H
8255-PPI address:	E000/E100/E200 and E300H
CS5:	A000H
CS6:	B000H

CS5 and CS6 are used in the intermediate-frequency level and counting assemblies.

In the switching documents, you will find the descriptions P1.0 to P1.7, corresponding to port P1 of the 8031, whilst ports PA0 to PA7 and PB0 to PB7 (reserved for the "reference source connection" option) and PC0 to PC7 correspond to ports A, B and C of the 8255 interface module (this is all you need to know). Commercially obtainable boards can be used.

2.9. The Software

The software required for controlling this frequency meter must include the sequences laid down in the flow chart (Fig.7). As well as a computer core, it must also have interfaces to the user, so that mode and resolution can be selected.

In this context, the requirement for simple operation has controlled the development of the software, but without this leading to too great a loss of flexibility. It goes beyond the scope of this article to describe or illustrate the various software development options, or to provide the software listings, which are over 10 pages long. The software was developed using C language and takes up less than 8 kB of a ROM in its compiled form.

Important note: the software imposes no limit on the highest frequency available or on the number of harmonics, but only on the number of (display) characters displayed to the user - i.e., if anyone finds a harmonic mixer which, for example, displays a reasonable mixing loss at 76 GHz, then the counter will function well (I myself have tested it at 48 GHz).

3. ASSEMBLY

Assembly should not pose too many problems for an experienced amateur, as the most critical section operates on UHF frequencies using techniques with which most amateurs are familiar. The harmonic mixer, preamplifier, intermediate-frequency section, PLL and pre-divider should be individually screened. Coaxial plugs (SMB, SMC or SMA) should be used to connect up the assemblies. Power leads should always run through feedthrough capacitors. All this is normal practice for radio-frequency assembly.

3.1. The Harmonic Mixer

As this is the most critical assembly, it was built directly onto the back of a gold-plated SMA jack with a rectangular flange. The components are soldered to one another without feed wires, all within an area of 2 x 2 mm. on the earth side of the flanged bush. All components are in SMD format and the capacitors should display low losses at

microwave frequencies. ATC types are recommended. The input inductors consist of 1.5 turns of 0.2 mm. gold wire, on a 1-mm. diameter core. If a good diode and a small format are chosen, results can be obtained up to 40 GHz.

3.2. The Pre-Amplifier

Two AMP02 amplifier blocks with BFR90A transistors are used in the preamplifier. The filter has to attenuate the oscillator frequency by more than 70 dB, so it should be carefully assembled. Good screening is just as important as the filter itself here.

3.3. The IF/AGC Assembly

The attenuating element and the 4 amplifier stages of the intermediate-frequency amplifier are simply assembled one behind another in a shielded box, together with a specimen printed circuit board (2 x 5 cm.) for the AGC circuit. Normal radio-frequency assembly techniques should be used.

3.4. The Pre-Divider

A specimen printed circuit board can be used. The levels applied are 0 dBm in the 50 - 350 MHz range. Normal radio-frequency assembly techniques should be used.

3.5. The First Oscillator and the PLL

The first oscillator, consisting of an OSC2 stage, uses a BFR91A. It is directly followed by an amplifier stage

with the BFR96S. Good SMD capacitors should be used here. The pre-divider, the PLL-IC and the OP amplifier OPAMP are assembled on the surface of a standard board to produce a good earth connection. A shielding plate should be provided between the oscillator, the amplifier and the digital circuits.

3.6. The Counter and IF Level/AD Converter Assembly

Only high-level low-frequency signals are used in this assembly, so that it can be constructed using normal printed circuit boards or wire-wrap technology.

3.7. The Keyboard and Display Assembly

This can be built up however you like on the front panel. No critical circuits are used (Fig.10).

3.8. The Master Oscillator

Various oscillator circuits can be found in the literature. However, for optimal operation a thermostat-stabilised oscillator is recommended. Surplus units can also be very suitable.

3.9. The Power Supply

The requirements for operating this frequency counter are simple: + 12 V/0.35 A, + 5 V/0.6 A, - 5 V/25 mA, + 24 V/5 mA. This article does not describe the power supply.

4. TESTING AND CALIBRATION

Once the equipment has been assembled and the power supply voltages have been checked, the equipment can be powered up. It should be apparent that the software has started to operate immediately, and a start message should appear on the display unit. Any malfunctions occurring at this stage may be due to wrong connections on the micro-processor or interface module side or to damaged modules, for example in the ROM or the RAM. At all events, no further help can be given here. In the next stage, the PLL/first oscillator function is checked, as it is independent of the other radio-frequency sections. Equipment for measuring the power and frequency in the range between 0.5 and 1.5 GHz is needed here.

4.1. PLL/First Oscillator Test

The tuning voltage should be isolated from the oscillator and checked by means of an external power source or a variable resistance. During tuning between 1 and 20 V, a minimum tuning range of 650 - 1.050 MHz should be attained, and the output level should be at least 0 dBm. This level can be set with the help of the trimming resistor in the bias voltage circuit of the AMP05 amplifier. Monitor the temperature of the BFR96S during this test. The tuning voltage is then re-connected to the original circuit. As the program is running, the counter is in search



mode - i.e. the control voltage should sweep the oscillator through. A saw-tooth signal should be observed at pin-6 of the TL081.

4.2. Pre-Amplifier Testing

A preamplification of more than 25 dB and a 50 - 350 MHz band width should be measured in this assembly. No special test procedure is called for. The preamplifier can be optimised by setting the trimming resistor at any stage.

4.3. IF/AGC Testing

A spectrum analyser is of great use in the calibration of the intermediate frequency/AGC stage. The assembly is connected to a spectrum analyser. The RV301 trimming resistor should be turned up to maximum (in the direction of the R306 resistance). This causes the attenuating element to display the lowest level of attenuation. The total amplification for all stages should then be app. 48 dB. Calibrating each individual stage then improves the amplification and phase behaviour. Make sure that the gain slope and the output noise are constant over the 50 - 350 MHz range. The coils in each stage should be re-adjusted to obtain a flat gradient.

The input of the intermediate-frequency section is then connected to a radio-frequency generator at 150 MHz and at an output level of - 60 dBm. The signal level is then raised until a 0 dBm signal appears at the output. The RV301 trimming resistor is then slowly adjusted until the AGC responds. Monitor the AGC voltage gradient while the

input level is being raised, with the output level remaining constant at 0 dBm. It should then be possible to observe a dynamic range of more than 60 dB. This testing can be repeated in the 50 - 350 MHz range for confirmation purposes.

4.4. Pre-Divider

Connect the pre-divider to the intermediate-frequency section and use the radio-frequency generator in the same way as when testing the intermediate-frequency section in AGC mode. The pre-divider output should always supply a clean square-wave signal.

4.5. The Counter Assembly

This assembly does not need calibrating. Only the gate pulse should be observed. When not in search mode, it should display steep flanks if the equipment is functioning correctly.

4.6. IF Level/AD Converter

This stage should be set in such a way that it supplies 0 - 1 V at the AD converter input. This is obtained by adjusting RV601 over the full AGC range. I recommend that the radio-frequency generator should be left connected to the intermediate-frequency section and the radio-frequency output should be switched on and off. When no radio-frequency signal is applied, a voltage of 1.050 V should be observed at pin-6 of the IC U601. For the adjustment of RV602, the reference voltage of the AD converter should be set to 0.5 V.

4.7. Final Test

Assuming that nothing has gone wrong, the frequency counter should now be capable of operating. The sensitivity of the equipment can now be checked with the help of a calibrated meter. If something is wrong:-

If the frequency counter does not operate satisfactorily, you should be in a position to identify the problem.

If the unit searches for a signal but never locks on, the most probable reasons are:

Non-functioning of AGC, no binary output signals on AD converter or no intermediate-frequency signal (harmonic mixer not working).

If the unit searches for a signal and locks on, but the display data varies between wide margins, the wiring in the counter section or the CPU section is incorrect, or something is wrong with the reference signal.

If the unit's functions collapse and are no longer available for operation, the wiring of the digital section should be checked.

5. OPERATION

Only 4 keys are used to operate the frequency counter. In the format described, the frequency counter is laid out for fully automatic operation and the user has only to select the resolution and the mode.

The keys > and < are provided for

converting the resolution from 100 Hz to 1 MHz.

The "Search" key switches between automatic search per measurement and one search cycle per measurement. In the automatic search mode, the frequency counter goes into the search mode after each counting procedure. In the individual mode, the frequency counter searches and, if it finds something, it continues to count until the signal disappears.

The "Hold" key holds the display and the narrow-band lock mode of the PLL is set. In this mode, the equipment can be used as a receiver input stage.

6. CONCLUSIONS

Several improvements are being worked on at the moment and if relevant they will be made public at a later date. The prototype has now been working for a year, retaining the original specifications. Most components are wired up on specimen printed circuit boards or are in a wire-wrap format. Any co-operation or any joint effort to simplify the reproducibility would be interesting. I am also interested in hearing any observations concerning this project.

My special thanks go to DJ1CR, Max Munich, who was responsible for the selection of BAT14, which made it possible for me to obtain the optimum characteristics from this equipment.



Michael Kuhne, DB6NT

200 mW GaAsFET Amplifier for 24 GHz

Many stations have been constructed for the 24-GHz band in recent years which can generate transmit power levels ranging from a few 100 μ W to a maximum of 100 mW. These values could be obtained using low-cost transistors (selected MGF 1303 parallel). The power gain thus obtained for a 100 mW PA with MGF 1303 was approximately 13 dB.

1. INTRODUCTION

In this article, a 200 mW amplifier will be described with an amplification of 20 dB. FLR016FH and FLR026FH K-Band Power FET's are used here, from the Fujitsu company.

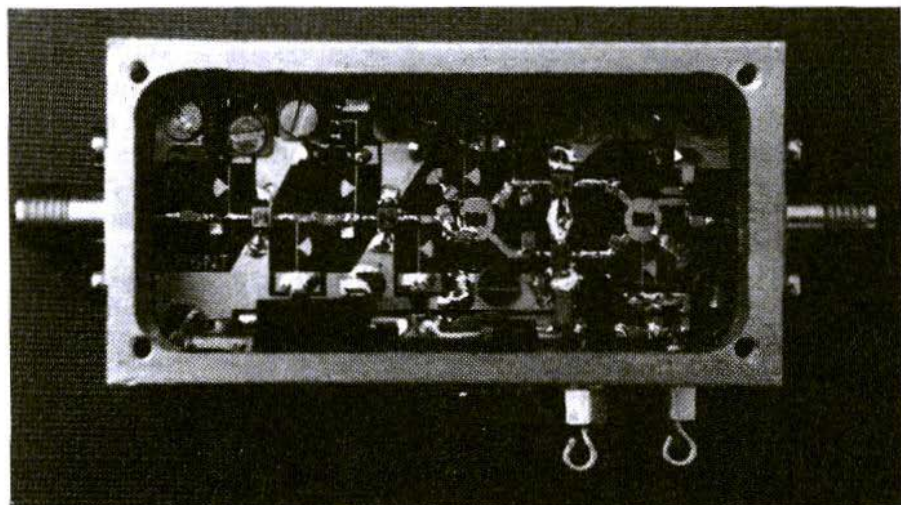

Inside the 24 GHz Amplifier

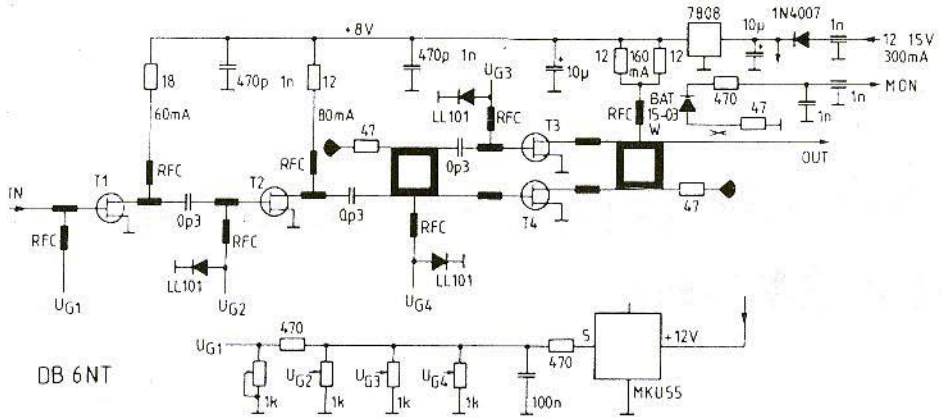

Fig.1: Circuit Diagram of the 24 GHz Amplifier

Building 24-GHz amplifiers calls for great experience in the SHF range and for a lot of patience. You have to work for every dB or mW when you're calibrating, using "little flags" and putting MOS foam and copper strips into the housing!

2.

THE AMPLIFIER CIRCUIT

Fig.1 shows the 24-GHz amplifier circuit. The amplifier is built on a 0.25 mm. thick Teflon printed circuit board made from RT/duroid 5870. Stages T1 and T2 are connected to one another through 50Ω striplines and coupling capacitors, and are capacitively tuned by means of soldered-on "little flags".

The parallel high-level stages with T3 and T4 are connected to one another through four $\lambda/4$ couplers. This circuit option makes it possible to obtain good decoupling without feedback between

the two end transistors, and makes a considerable contribution to the stability of the circuit. Should any asymmetry arise in the power stages, the radio frequency output this generates is absorbed in the resistor connected to port-4. These 47 - 50Ω resistors on the couplers are small SHF types - 1.4 x 1.4 mm. format. Di-Cap capacitors are used as coupling capacitors between the stages.

The negative voltage for the FET's is generated through an MKU 55 hybrid module. This is laterally fastened to the internal wall of the tinplate housing. At the output, the circuit has a directional coupler with a BAT 15-03W SMD Schottky diode from Siemens. The power delivered can be monitored at any time at this test output using a moving coil instrument.

The LL 101 diodes are SMD Schottky diodes and help to delay a breakdown of the FET's in the event of any short-circuiting of the coupling capacitors. SMA 3.5 mm. microstrip connectors should be used as coaxial jacks.

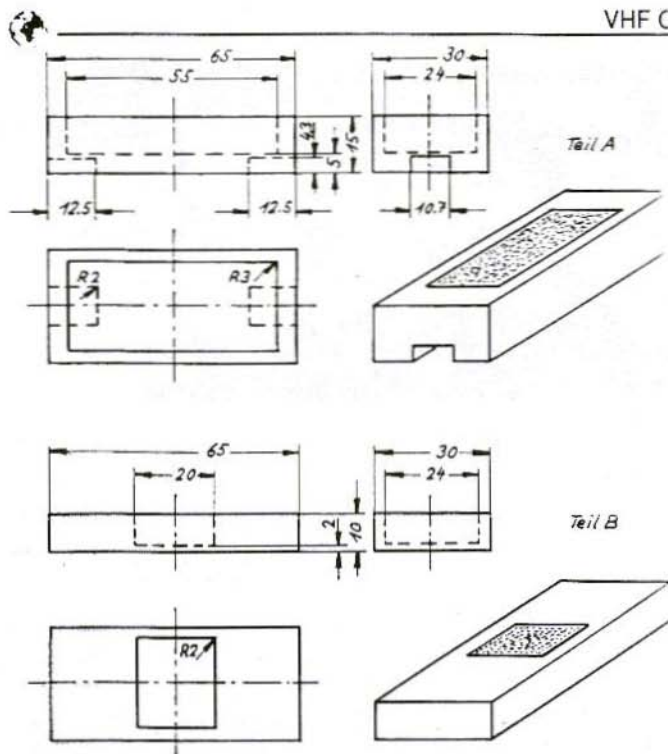

Fig.3:
Examples of Milled
Aluminium Housings

The BAT 15-03W diode is soldered "overhead" to obtain lower housing inductivity levels.

Before being put into the housing, the printed board assembly should be washed down with spirit and then aligned straight to guarantee that it is installed flat. The underside of the board is coated with heat conducting paste in the centre to improve the heat dissipation from the FET's. The coupling and decoupling side of the printed circuit board is coated with a second adhesive from below. Optimum mounting is obtained by pressing on the printed circuit board while the adhesive dries. This operating procedure must be quick and precise, as the adhesive dries very quickly and no changes can be made to the printed circuit board's position thereafter. The printed circuit

board is now fastened using 5 x M2 screws.

As an example, Fig.3 shows a milled two-part aluminium housing.

4. CALIBRATION

A power supply with fine control current limit should be used for calibration. A 24-GHz signal source with an adjustable output and a suitable power meter are required for calibration. The 1k trimmer is used to set UG1, UG2, UG3 and UG4 individually in such a way that the drain currents given in the circuit diagram flow.



FLR026FH

K-Band Power GaAs FETs
ABSOLUTE MAXIMUM RATINGS (Ambient Temperature $T_a = 25^\circ\text{C}$)

Item	Symbol	Condition	Rating	Unit
Drain-Source Voltage	V_{DS}		12	V
Gate-Source Voltage	V_{GS}		-3	V
Total Power Dissipation	P_T	$T_c = 25^\circ\text{C}$	1.88	W
Storage Temperature	T_{stg}		-65 to +175	$^\circ\text{C}$
Channel Temperature	T_{ch}		175	$^\circ\text{C}$

Fujitsu recommends the following conditions for the reliable operation of GaAs FETs:

1. The drain - source operating voltage (V_{DS}) should not exceed 10 volts.
2. The forward and reverse gate currents should not exceed 0.5 and -0.1 mA respectively with gate resistance of 2000 Ω .

ELECTRICAL CHARACTERISTICS (Ambient Temperature $T_a = 25^\circ\text{C}$.)

Item	Symbol	Test Conditions	Limit			Unit
			Min.	Typ.	Max.	
Saturated Drain Current	I_{DSS}	$V_{GS} = 3V, V_{DS} = 0V$	-	120	180	mA
Transconductance	g_m	$V_{GS} = 3V, I_{DS} = 65mA$	-	50	-	mS
Pinch-off Voltage	V_P	$V_{DS} = 3V, I_{DS} = 5mA$	-1.0	-2.0	-3.5	V
Gate -Source Breakdown Voltage	V_{GSO}	$I_{GS} = -5\mu A$	-3	-	-	V
Output Power at 1dB G.C.P.	P_{1dB}	$V_{DS} = 8V,$ $I_{DS} = 0.6 I_{DSS} (Typ.)$	22	23	-	dBm
Power Gain at 1dB G.C.P.	G_{1dB}	$f = 18\text{ GHz}$	7.0	8.0	-	dB
Power added Efficiency	η_{add}		-	29	-	%
Thermal Resistance	R_{th}	Channel to Case	-	100	120	$^\circ\text{C/W}$

CASE STYLE: FH

G.C.P.: Gain Compression Point

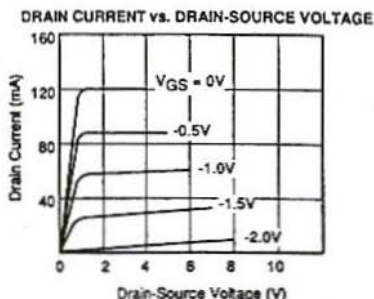
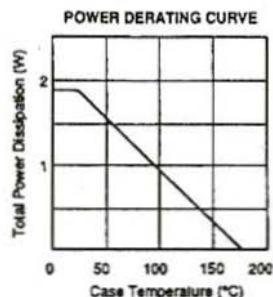
Readings for Specimen Assemblies:

P in:	P out:	P out:	P out:
	Set. 1	Set. 2	Set. 3
	coax	WG	coax
0.2 mW	21 mW	-----	20 mW
1 mW	105 mW	-----	100 mW
2 mW	195 mW	-----	190 mW
5 mW	275 mW	-----	255 mW
10 mW	300 mW	230 mW	255 mW
20 mW	310 mW	230 mW	255 mW

The measurements were carried out at various times, using the ratings which can be read off from the table.

It can be seen from the table that the saturated drain current to be expected can vary. To a large extent, this can be traced back to dispersion effects from the transistors.

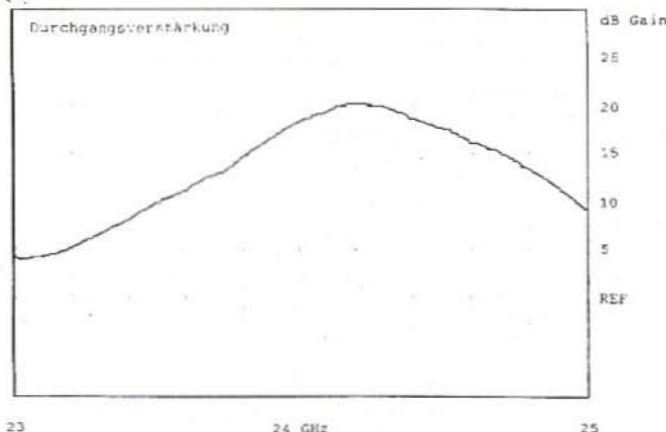

Fig.4:
Measurement Curve
for a prototype

An initial output of 200 mW was reliably obtained from all the rigs tested. Fig.4 shows the amplification curve of a prototype.

Measuring equipment:

HP 435 Power Meter with HP 8485A Power Sensor, together with Midwest 550-20 damping unit and Rosenberger R 220-3.5 mm. wave guide transmission.

- 1 x 18W SMD
- 1 x 10 μ F tantalum SMD
- 1 x 1 nF SMD
- 1 x 100 nF SMD
- 3 x Di-Cap 0.2 - 0.5 pF
- 2 x 1 μ F-DF, threaded

Printed circuit boards for coaxial or semi-conductor assemblies, together with MKU55 hybrids for generating negative voltage, can be obtained from the author.

5. PARTS LIST

- T1 FLR 016 Fujitsu
- T2 FLR 026 Fujitsu
- T3 FLR 026 Fujitsu
- T4 FLR 026 Fujitsu
- D1 BAT 15-03W Siemens
- 3 x LL 101 SMD Schottky diode
- 1 x 7808
- 1 x 1N4001
- 1 x MKU 55
- 4 x 1k Ω Minitrimmer
- 3 x 47 Ω SHF type, Rohrer, Munich
- 2 x 470 Ω 0204
- 3 x 12 Ω SMD

6. LITERATURE

- (1) DCODA: Assembly and Calibration of 24 GHz Amplifier Modules using Wave Guide Technology as per DB6NT Congress Volume, GHz Congress Dorsten, 5. 2. '94
- (2) Assemblies for 24 GHz Dubus, no. 4/1993
- (3) HB9MIN: 200 mW GaAs FET High-Level Stage VHF-UHF Congress Volume Munich, 12.-13. 3. 94



Matjaz Vidmar, S53MV

A DIY Receiver for GPS and GLONASS Satellites

Part-6

This part of the series continues with the construction details for the GPS/GLONASS Portable Receiver CPU, the 8-key Keyboard, the LCD Display Module and the Power Supply and Reset circuitry. Suggested mounting arrangements for the various modules are also discussed.

4.11 GPS/GLONASS Portable Receiver CPU

The GPS or GLONASS receiver described in this series can be built as an interface for the DSP computer [1] and [2], or as a stand-alone portable receiver. In the latter case the receiver needs its own microcomputer with a keyboard and an LCD display. After considering several possible alternatives, the simplest solution resulted in using a suitably modified CPU board as described in [1] and [2] as the microcomputer.

The circuit diagram of the modified CPU board is shown in Figs.46 and 47. Since a GPS or GLONASS receiver is a

portable unit, the power consumption is an important factor and consequently 74HCxx logic devices should be used everywhere. This allows for the omission of three 3.3 k Ω pull-up resistors. The original DSP computer CPU board requires the following modifications:

- 1 The pads below the EPROM socket should be connected so that pin-27 receives the A14 signal required by the 27C256 EPROM. Originally this pin is connected to +5V when using the 27128 EPROM.
- 2 The RAM should be increased from 64 kbytes up to 128 kbytes. This is achieved by piggy-back soldering two additional 43256 RAM chips on top of the existing two RAM chips on the CPU board. All pins of the additional RAM chips are connected in parallel with the existing RAM chip pins, except for pin-20 (chip select). The two chip-select pins of the additional RAM chips are then wired to pin-11 (Q4) of the middle 74HC138 address decoder.

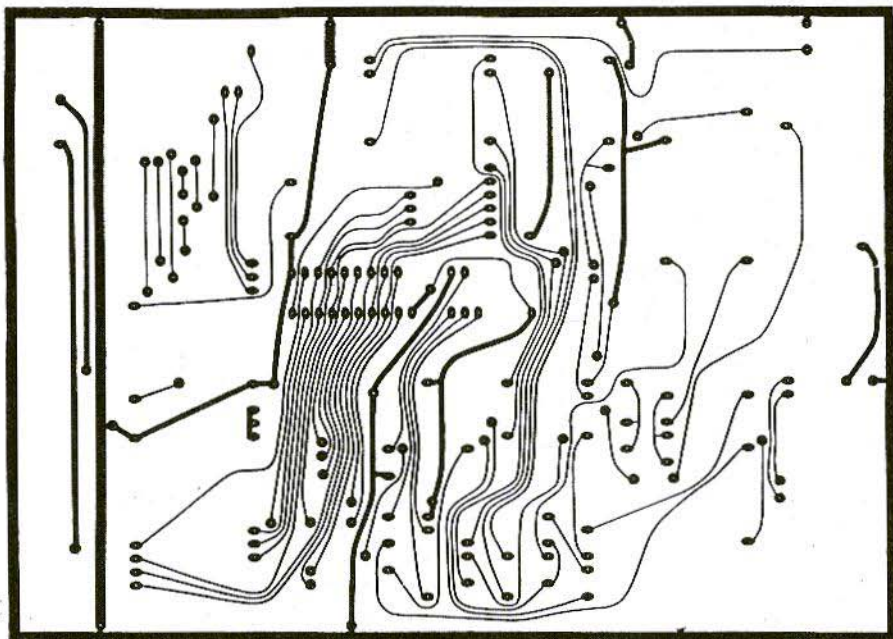

Fig.48: GPS/GLONASS CPU, upper side (top view)

3 An HSCH1001 Schottky diode should be connected between pin-11 (Q4) of the top 74HC138 address decoder and the DTACK signal (pin-12 of the 74HC05), to acknowledge the additional RAM chips to the CPU.

The keyboard connection remains unchanged. The total/partial reset switch has a new function with the GPS or GLONASS software. In the case of a stand-alone portable receiver this input should always be left open (+5V)!

The parallel output port (PD71055 channel-B) is now used to command the HD44780 LCD controller. Since there are only 8 output bits available, the HD44780 is driven in the 4-bit mode - write only. The real-time clock chip PD4990 is required by the GPS or

GLONASS software and must remain in place. The INT7 jumper must remain in place for keyboard interrupt requests while the INT1 jumper is no longer needed, although it may left in place.

The printed circuit board is not modified, as shown in Figs.48 and 49, the additions and modifications are fully visible on the component location plan in Fig.50. The connections of the 8-key keyboard and the LCD controller are also shown in Fig.50.

It is recommended that the CPU board is tested first, if possible, in a DSP computer, and then modified as described above only when it is fully tested and working 100%. In particular, the CPU board should be tested at higher clock frequencies to find any defective components. A 10 MHz ver-

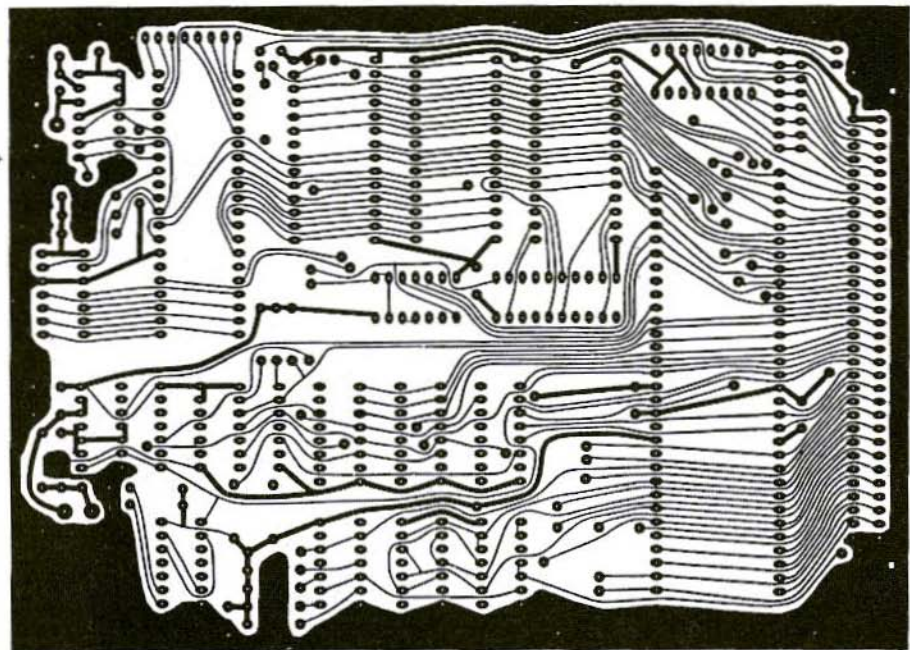

Fig.49: GPS/GLONASS CPU, lower side (bottom view)

sion of the MC68010 will usually work up to a clock frequency of 15 MHz at room temperature, so a 12 MHz clock crystal is a safe choice. The GPS or GLONASS software does not require such a high clock frequency, but the accuracy of some measurements is higher and the updating of the display is faster at higher clock rates.

4.12 8-key Keyboard

A portable GPS/GLONASS receiver requires a small keyboard to issue commands to the computer. Since a full ASCII keyboard is impractical for a portable piece of equipment, a small 8-key keyboard was developed for portable receivers.

The circuit diagram of the 8-key key-

board is shown in Fig.51. The 8 keys close towards ground, otherwise the input lines are held high by pull-up resistors. A priority encoder (74HC148) is used to encode the 8 keys into 3 bits. A double monostable (74HC4538) is used to generate the strobe pulse after a key is depressed.

The 8-key keyboard is assembled on a small single-sided printed circuit board as shown in Fig.52. This printed circuit board was designed to fit on the front panel of the receiver and carry eight square (12 x 12.7mm) push-buttons. The location of the components is shown in Fig.53. Due to the space constraints all of the components should have a low profile and small dimensions. The capacitors have a 2.5mm pin spacing and the resistors are

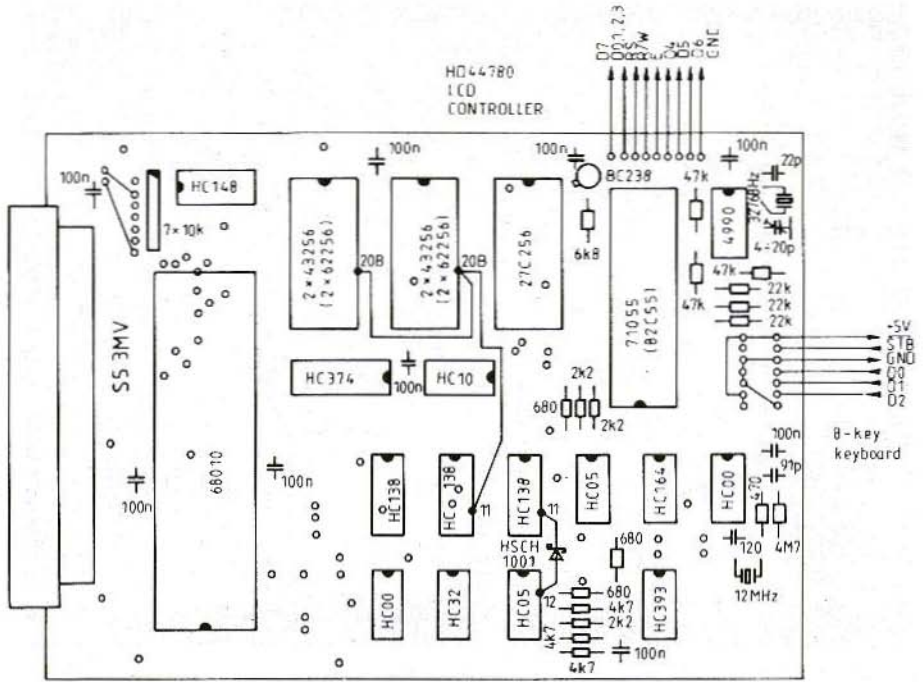

Fig.50: GPS/GLONASS CPU, Component Overlay

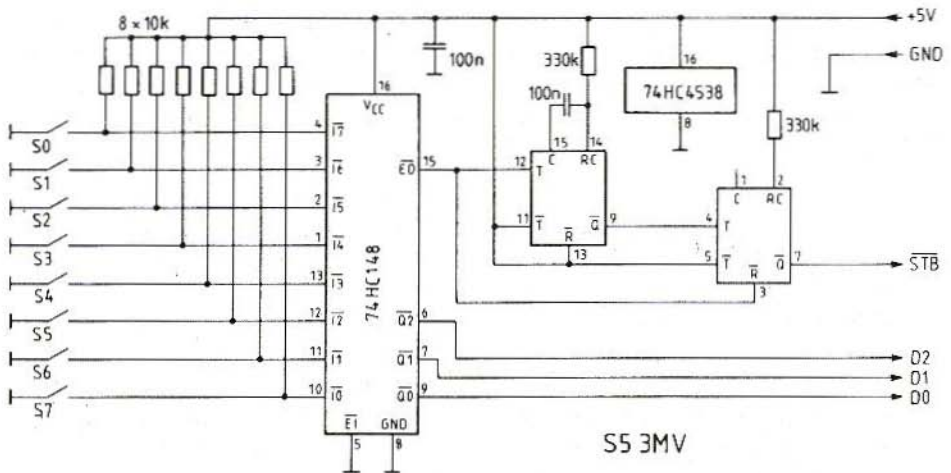

Fig.51: Circuit of the 8-key Keyboard

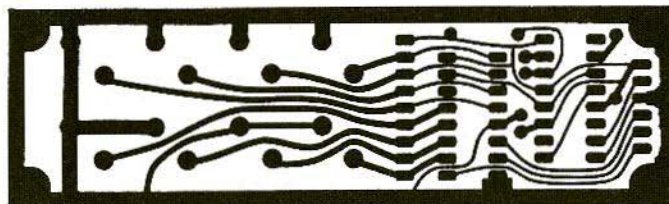

Fig.52:
8-key Keyboard
PCB (bottom view)

installed horizontally. The 8 x 10 k Ω resistor network in a SIL package should be first soldered in place and then bent towards the circuit board..The 6-pin connector is installed on the back - solder side of the board!

The GPS/GLONASS receiver software only accepts ASCII characters from \$30 to \$37 as commands, corresponding to numerals 0 to 7. These can be generated by a standard ASCII keyboard with a parallel output, or by suitably wiring the 8-key keyboard described. In particular, to obtain the codes between \$30 and \$37, the outputs D0, D1 and D2 should be wired to the corresponding inputs on the CPU board. In addition, D3, D6 and D7 should be connected to ground and D4 and D5 to +5V. All these connections, including the supply rails and the strobe signal, were already shown in Fig.50.

4.13 LCD Display Module

The only practical for a portable GPS/GLONASS receiver is an LCD module with built-in drivers. Such modules are available in many different shapes and

sizes, and may or may not be equipped with a display controller. LCD modules with a built-in controller are easy to use, since the interfacing to any micro-processor is very simple, it is identical to a parallel I/O port.

Most small dot-matrix alphanumeric LCD modules use the Hitachi HD44780 LCD controller. This integrated circuit has an on-board, extended ASCII character generator, a display area RAM including up to two rows of 40 characters each and all of the timing circuits required to drive the LCD. Modules using the HD44780 controller may have a different number of characters per row, or rows displayed, the total number of characters is, however, limited by the internal RAM to 80. Since the HD44780 SMD flat package has only 80 pins, additional LCD driver chips (HD44100) are used in most LCD modules.

AN LCD module with two lines of 40 ASCII characters each was selected for this project. Such an LCD module includes the liquid crystal display itself, one HD44780 LCD controller and four HD44100 LCD drivers. Further, the

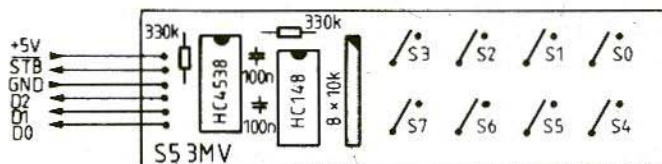

Fig.53:
8-key Keyboard
Component
Overlay

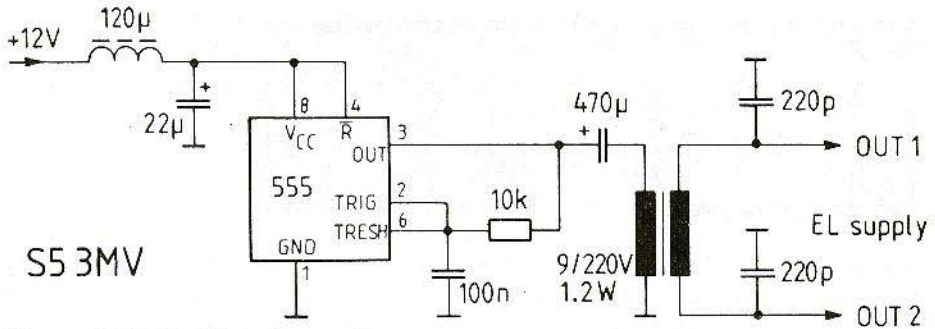

Fig.54: LCD Backlight Power Supply

display module may include some form of illuminating the LCD, either EL foil or LED. The latter is recommended if the GPS/GLONASS receiver is to be used at night as well.

Although such display modules are available from several different manufacturers, the printed circuit boards on which they are mounted all have the same dimensions: 182mm wide x 33.5 high x 13mm thick and all have the same 14-pin electrical connector. The pin numbers are usually marked on the printed circuit board and the pin allocations are as follows:

Pin-1	Vss	Ground
Pin-2	Vdd	+5V supply
Pin-3	Vo	LCD voltage, wiper of the contrast pot
Pin-4	RS	Register Select, 0 = instruction, 1 = data
Pin-5	R/W	Read/Write, 0 = write, 1 = read
Pin-6	E	Enable, 0 = inactive, 1 = active
Pin-7	DB0	LSB data, 8-bit bus
Pin-8	DB1	
Pin-9	DB2	
Pin-10	DB3	
Pin-11	DB4	LSB data, 4-bit bus
Pin-12	DB5	
Pin-13	DB6	
Pin-14	DB7	MSB data

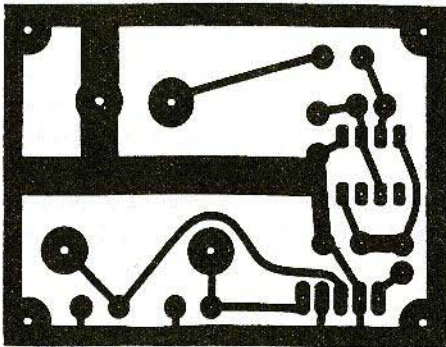

Fig.55: LCD Backlight Power Supply PCB (bottom view)

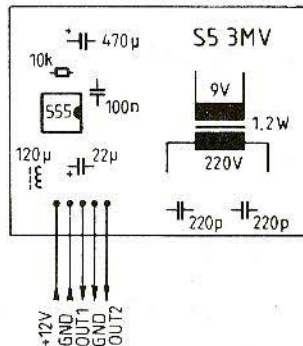

Fig.56: LCD Backlight Power Supply Component Overlay

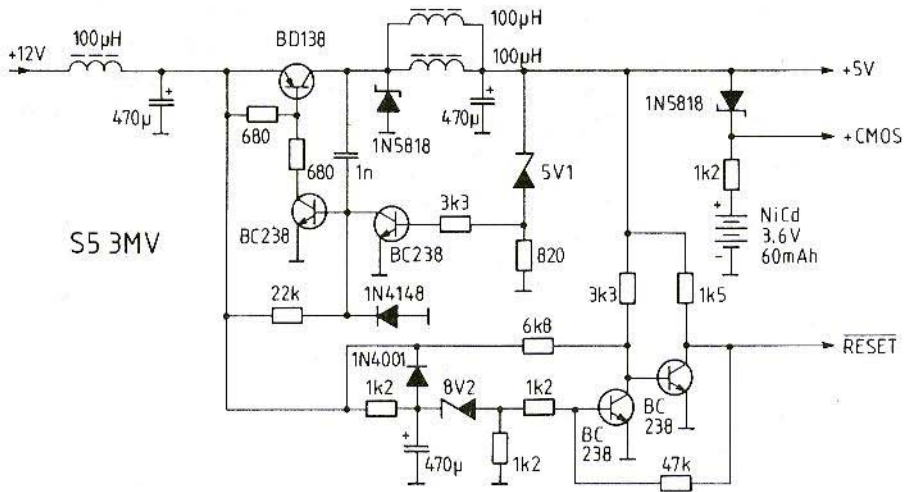

Fig.57: Power Supply and Reset Circuit

The EL or LED back-light may have two additional pins on the connector or solder pads on the printed circuit board.

When LCDs are driven in time multiplex the adjustment of the voltage applied to the LCD is critical to obtain a good contrast. A contrast control potentiometer is usually provided to adjust the best available contrast for a given viewing angle. This potentiometer provides the V_o voltage to the LCD module. Modern LCD modules require operating voltages of less than 5V, so the resistor terminals can be conveniently connected to ground and to +5V, whilst the wiper is connected to the V_o input.

Due to the internal circuits of the LCD controller and driver chips, the internal LCD ground is V_{dd} (+5V). The voltage across the LCD equals the potential difference between V_{dd} and V_o . The current through the V_o terminal is very small, so a 10 k Ω linear potentiometer

is sufficient for the LCD contrast control.

If using an LCD module with an EL foil back-light, a suitable power supply needs to be built. The EL foil usually requires a supply voltage of approximately 110V at around 500 Hz. The EL foil behaves electrically as a lossy capacitor. The voltage across its terminals affects the amount of light produced, whilst the frequency affects the colour of the light.

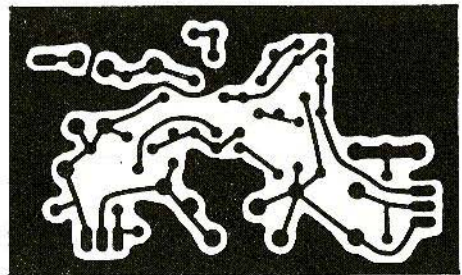

Fig.58: Power Supply and Reset PCB (bottom view)



A suitable power supply is shown in Fig.54 and includes a power oscillator (555), a step-up transformer and a few EMI filtering components. For 500 Hz operation a conventional mains transformer with a laminated core can be used, either 220V/9V or 220V/6V, of course with the primary and secondary windings interchanged. A 1.2W or

1.5W transformer is usually the smallest available, although it is still quite large for this application.

The printed circuit board for the EL foil supply is shown in Fig.55 and the component overlay in Fig.56. The power drain of the whole circuit is about 50mA from a 12V DC power supply, when the output is connected to

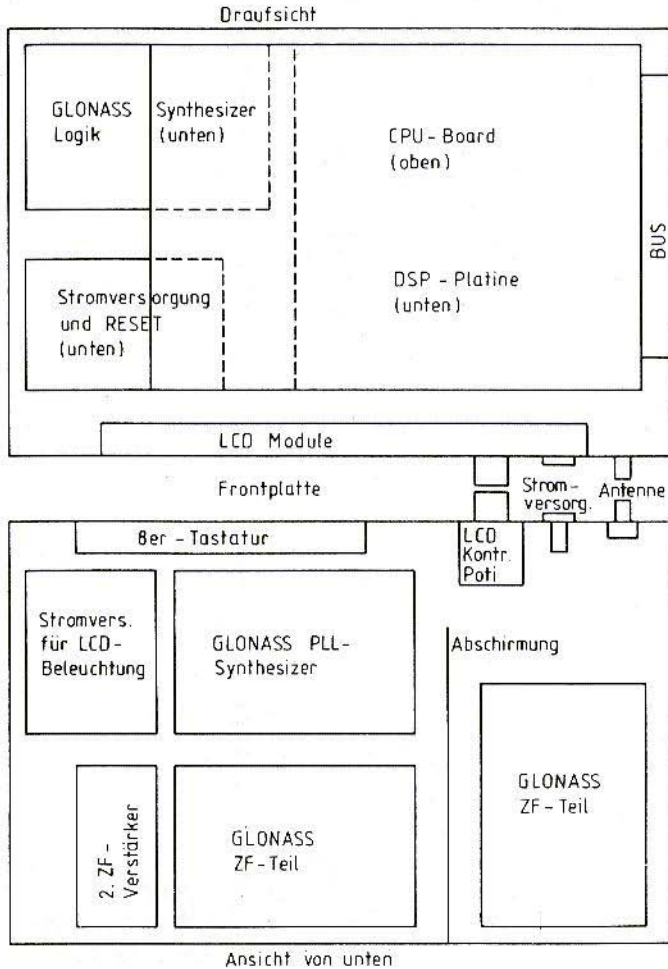

Fig.61:
Portable GLONASS
Receiver Module
Location

the load. Since the oscillator feedback is taken from the output (pin-3 of the 555), some 555 ICs may not operate in a stable way in this circuit. In the latter case the solution is to increase the oscillator frequency by decreasing the 100nF capacitor.

Of course, an LED back-light is much easier to use and usually only requires a 5C DC supply.

4.14 Power Supply and Reset Circuit

The GPS/GLONASS receiver is intended to be operated from a 12V battery, with the negative grounded. This supply voltage is common to all portable and mobile equipment.

The analogue circuits of the receiver are already designed to operate from a

MENU KEYS - DISPLAY FUNCTION					
		KEY # 4 (CODE \$ 34)	KEY # 5 (CODE \$ 35)	KEY # 6 (CODE \$ 36)	KEY # 7 (CODE \$ 37)
MENU		SHOW RX CHANNEL DATA	SHOW IMMEDIATE NAV DATA	SHOW AVERAGED NAV DATA	SHOW STATUS/ALMANAC
ACTION AFTER FIRST PRESSING		SHOW RX CHANNEL # 1 DATA	SHOW IMMEDIATE NAV DATA	SHOW AVERAGED NAV DATA	SHOW GENERAL STATUS
ACTION AFTER REPEATED PRESSING		INCREMENT RX CHANNEL NUMBER (2,3,4 1,2,)	NO ACTION	NO ACTION	SHOW VISIBLE SATELLITES (ALMANAC)
PARAMETER KEYS	KEY # 0 (CODE \$ 30)	DECREMENT CHANNEL PRN#/CHN#	NO ACTION	CLEAR AVERAGED DATA	SET ALL RX CHANNELS (PRN#/CHN# AND IF) FROM ALMANAC
	KEY # 1 (CODE \$ 31)	INCREMENT CHANNEL PRN#/CHN#	SET LON/LAT DEGREES/MINUTES/SECONDS DISPLAY FORMAT		TOTAL RESET (CLEAR ALL CWDs RAM DATA) PRESS 9 TIMES!
	KEY # 2 (CODE \$ 32)	DECREMENT CHANNEL IF (1 kHz STEPS)	SET LON/LAT DEGREES/DECIMAL FRACTION DISPLAY FORMAT		SET MAN SATELLITE SELECT MODE
	KEY # 3 (CODE \$ 33)	INCREMENT CHANNEL IF (1 kHz STEPS)	SET X/Y GAUSS - KRÜGER DISPLAY FORMAT		SET AUTO SATELLITE SELECT MODE

WARNING: THIS MAY CHANGE!

Fig.62:
GPS/GLONASS
Receiver Status



+12VC supply rail, since this voltage represents a convenient choice.

Of course, digital circuits require a +5V supply voltage, but besides the +5V there are other requirements. A GPS or GLONASS receiver should include a real-time clock that operates even when the receiver is powered down. Similarly, the almanac data including information about the available satellite orbits should be stored in the computer memory when the receiver is powered down.

Finally, since the +5V power drain amounts to about one half of the total power drain of a GPS or GLONASS receiver, the +5V supply regulator should also have a good efficiency, especially in a portable receiver.

The requirements for the microcomputer power supply are therefore the same as for the DSP computer published in [1] and [2]. The original DSP computer power supply is however about 10 times too large for this application, so a scaled-down version is shown in Fig.57. The latter includes a switching regulator from 12V to 5V, a memory (clock) backup battery and a very reliable RESET circuit.

The microcomputer power supply is built on a single-sided printed circuit board as shown in Fig.58. The corresponding component location overlay is shown in Fig.59. All of the resistors, diodes and chokes are installed horizontally. All of the capacitors have a 5mm pin lead spacing.

Several mounting holes and related pads are provided for different style NiCad batteries.

The power supply is designed for a 400mA to 500mA load on the +5V output. For this load the BD138 power transistor does not require a heatsink and easily obtained moulded chokes can be used in the switching regulator.

In particular, a 100uH choke with the external dimensions of a 1/2W resistor will withstand a current of up to 200mA to 300mA, so two such chokes are used in parallel in the switching regulator.

The total power drain when using the described power supply and including the analogue section amounts to about 4W for a portable GPS receiver and approximately 6W for a GLONASS unit, both with the LCD backlight off.

4.15 GPS/GLONASS receiver Module Location

A GPS or GLONASS receiver includes both low-level RF signal amplification and processing and very noisy digital circuits, so the module location has to be selected carefully and some shielding is required in any case.

In the case of a GPS or GLONASS receiver operating as a peripheral for the DSP computer, the RF part of the receiver should be built in its own enclosure, while the dedicated DSP hardware module is plugged into the computer bus. Of course, it is assumed that the computer already has its own shielded enclosure.

The GPS receiver RF unit needs no additional internal shields among the three modules: RF, IF converter and IF amplifier. The GLONASS receiver RF

unit is more complicated and requires some shielding. In particular, the GLONASS PLL synthesiser logic needs to be well shielded from the remaining modules: RF, IF converter, IF amplifier and PLL converter.

In the case of a stand-alone portable GPS or GLONASS receiver it is of course desirable to have the complete receiver packaged in one single enclosure. It is suggested that this enclosure is fabricated from unpainted aluminium sheet to have a good electrical contact among the various parts. Such a container is made of a rectangular frame and two covers installed with self-locking screws.

The frame has an additional internal plate that divides the internal volume into two sections, shielded both from the outside and each other. One of the sections is used for the noisy digital circuits and the other for the low-level RF stages.

Non-interfering modules, such as the keyboard and the power supplies, may be installed in either section.

The suggested module location for a portable GPS receiver is shown in Fig.60. The suggested dimensions are 200mm wide x 160mm deep x 80mm high.

The internal plate is installed at a height of 30mm, so that the digital section has a volume of 200mm x 160mm x 50mm (top) and the analogue section a volume of 200mm x 160mm x 30mm (bottom). The internal plate is screwed onto the frame on all four sides with many screws to ensure a good electrical shielding.

The two modules with 64-pin Eurocard connectors are installed on a short bus motherboard with just two female connectors with the corresponding pins tied together. The bus can be made by cutting a piece of the DSP computer bus board, or by simply installing two connectors on a piece of a universal board with holes in a uniform 0.1 pitch.

The connections between the analogue and digital units do not require feedthrough capacitors if they are routed carefully, away from the sensitive or very noisy components. Sometimes it is also of benefit to additionally ground the coaxial cable shields when crossing the internal screen.

The suggested module location for a portable GLONASS receiver is shown in Fig.61. The suggested dimensions are 240mm wide x 160mm deep x 80mm high.

The internal plate is installed at a height of 30mm, so that the digital section has a volume of 240mm x 160mm x 50mm (top) and the analogue section 240mm x 160mm x 30mm (bottom). As with the GPS receiver the internal screening plate is screwed onto the frame on all four sides.

In addition, there is a small shield between the RF module and the remaining modules in the analogue section. On the other hand, in the GLONASS receiver the computer power supply is installed in the digital section, together with the PLL synthesiser logic.

A list of PCBs and kits for this project can be found on page-191 of this issue

(References for this project can be found overleaf)



7.

REFERENCES

- [1] Matjaz Vidmar: "Digital Signal Processing Techniques for Radio Amateurs, Part-2: Design of a DSP Computer for Radio Amateur Applications"; VHF Communications 1/91, pp 2-24
- [2] Matjaz Vidmar: "Digital Signal Processing Techniques for Radio Amateurs, Part-3: Construction and use of the DSP Computer"; VHF Communications 2/89, pp 74-94
- [3] Jonathan S. Abel, James W. Chaffee: "Existence and Uniqueness of GPS Solutions"; pages 952-956/6-91, Vol.27 IEEE Trans. on Aerospace and Electronic Systems
- [4] "Interface Control Document MHO8-00002-400, rev-E", (84 pages), August 7th, 1975, Rockwell International Corporation, Space Division, 12214 Lakewood Boulevard, Downey, California 90241, USA
- [5] "Interface Control Document GPS-200", (102 pages), August 7th, 1975, Rockwell International Corporation, Space Operations and Satellite Systems Division, 12214 Lakewood Boulevard, Downey, California 90241, USA
- [6] "Global Satellite Navigation System GLONASS Interface Control Document" (46 pages), 1988, Research-and-Production Association of Applied mechanics, Institute of Space Device Engineering, Glavkosmos, Russia
- [7] Robert C. Dixon: "Spread Spectrum Systems", (422 pages), 1984, Second Edition, John Wiley & Sons, New York, USA
- [8] Matjaz Vidmar: "Digital Signal Processing Techniques for Radio Amateurs, Theoretical Part"; VHF Communications 2/88 pp 76-97
- [9] P. Mattos: "Global Positioning by Satellite", (16 pages), Inmos, Technical note 65, July 1989
- [10] J. B. Thomas: "Functional Description of Signal Processing in the Rogue GPS Receiver", (49 pages), June 1, 1988, Jet Propulsion Laboratory, California Institute of Technology, Pasadena, California, USA
- [11] Charles C. Kilgus: "Shaped Conical Radiation Pattern of the Backfire Quadrifilar Helix", (pages 392-397), IEEE Transactions on Antennas and Propagation, May 75
- [12] Matjaz Vidmar: "A Very Low Noise Amplifier for the L-Band"; VHF Communications 2/92 pp 90-96
- [13] Matjaz Vidmar: "Radio Amateur Applications of GPS/GLONASS Satellites: Using GPS/GLONASS Satellites as an Accurate Frequency/Time Standard"; (pages 186-190), Scriptum der Vortraege, 37 Weinheimer UKW Tagung, 19/20 September 1992

Dipl.-Ing. Detlef Burchard, Box 14426, Nairobi, Kenya

Linear Signal Rectification

Part-1

Linear rectification is present if the DC output signal from a circuit (instantaneous or mean value) is proportional to the AC input signal for the same circuit (instantaneous, peak, RMS, or mean value). In technically realised systems, we must assume an error in the proportionality, i.e. a departure from ideal conversion. Should this lie in the order of approximately 1%, then that is sufficient for pointer type instruments, strip chart recorders or oscilloscopes. For digital displays and further processing, a higher degree of accuracy is required - 0.1% is desirable, and even greater precision would be better.

FOREWORD

The simplest signal rectifier is the semi-conductor diode. Part I will be concerned with its characteristics and with those of rectifier circuits which, apart from diodes, contain only passive components.

Some improvement in the characteristics can be obtained by using active components. It is sometimes even possible to manage entirely without diodes, as Part-2 will show.

Finally, Part III will deal with externally-controlled rectifiers which, by their very natures, are linear even in the vicinity of the zero point. No attempt is made to deal with any of these topics in a comprehensive fashion. The idea is more to illustrate the kinds of circuits which have proved themselves in day-to-day practice without the need for explaining long mathematical derivation processes to clarify how they function. An oscillogram will make things clearer where necessary.

I. INTRODUCTION

Signal rectification comprises the measurement of AC voltage and demodulation of AM and FM, the latter with a reference tuned amplifier circuit being



needed. So a modulation measuring device comprises two rectifiers, one for demodulation and a second one to measure modulation. The frequency ranges of radio-frequency carriers and modulations intersect. 10 kHz can be either the carrier frequency in a VLF system or else a modulation audio-frequency, 4 MHz a data stream cycle or else the carrier for a short wave transmitter.

So rectifiers may therefore be involved with frequencies from 10 Hz to 10 GHz. It could scarcely be expected that this wide frequency range could be handled by a single type of rectifier or demodulator.

Rectifiers which work with charging capacitors, i.e. which weight mean, RMS or peak values, are suitable for demodulation only if there is a frequency gap between the carrier frequency and the highest modulation frequency. Those which convert instantaneous values do not require these gaps.

For the sake of completeness, it should be pointed out that digital signal processing does not need a frequency gap either. But it is not the subject of this article.

The mathematical treatment of rectifiers leads to non-linear equations and is

difficult. So I will attempt to get by without using any mathematics at all.

2. PRECISION

Only a low degree of precision is required for the acoustic reproduction of a modulation. Slope deviations of $\pm 10\%$ produce no audible differences, and even small non-linearities remain inaudible.

PAM-demodulation is even less critical. Everything above the noise level is "mark", the rest is "space". Greater precision is needed for measurements. For historical reasons, and because pointer meters used to have friction, an error is given as a percentage of the full scale deflection.

This makes sense, even with digital displays. So 1 digit is still a specific percentage of the final value displayed. The display can be no more precise than this percentage, and the rectifier need be no more precise than this.

An accuracy of 1% is reasonable for the analogue pointer instrument. For the usual 3 1/3 character digital display, an error of $\pm 0.1\%$ is better than the accuracy for most commercially manufactured products.

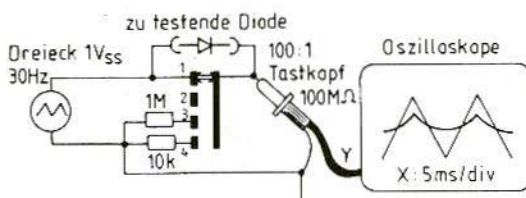

Fig.1:
Measurement Circuit for testing Diodes using various Load Resistors. Dreieck = Δ ; zu testende Diode = Diode under test; Tastkopf = probe

3. INFLUENCE OF TEMPERATURE

Like all semi-conductors, the diode is temperature-dependent. The TC of the forward drop voltage amounts to 2mV/K, irrespective of the voltage, and that of the off-state current doubles every 11 K. In the quadratic range, the conversion error is $0.3\%2/K$ and becomes rapidly smaller in the linear range.

Exact measurements, or very precise measurements, can not be taken directly in a snowstorm, or at midday with the sun vertically overhead, in the open air. If we take into account the comfort and the ability to think of the person making the measurement, an ambient temperature range of 18 to 28° C is fully adequate for measurement equipment. Within this temperature range, the quadratic diode rectifier already reaches precision properties, all the more the linear rectifier does.

Equipment which is subject to considerable self-heating must have somewhat better rectifiers. It is also true here that the accuracy of measurement increases the closer you remain to an average temperature of 23° C.

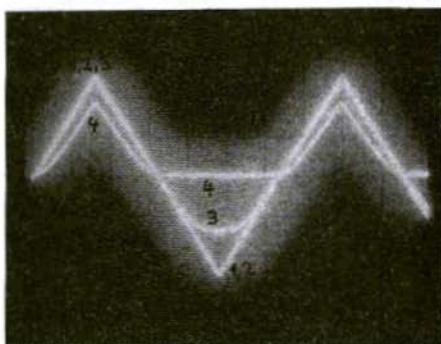
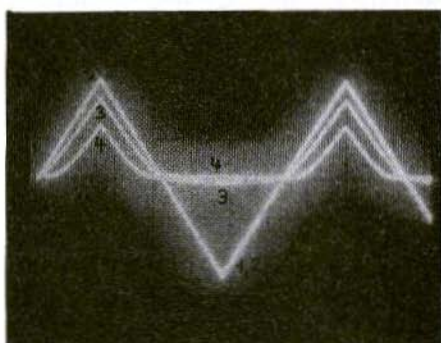
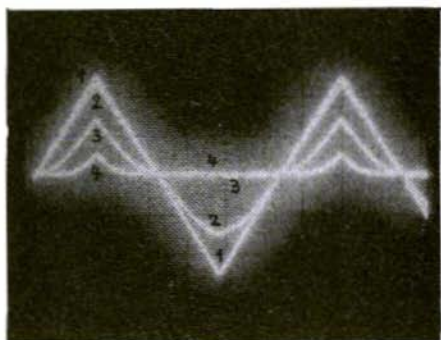

4. FREQUENCY COVERAGE

It is in no way advantageous if an instrument has a wider frequency range than it needs to have to suit the

Fig.2: Screen Images for Testing of 1N4148 (a), BA481 (b) and AAZ18 (c)
Y: 0.2V/div X: 5ms/div
The figures on the lines refer to the numbered switch positions in Fig.1

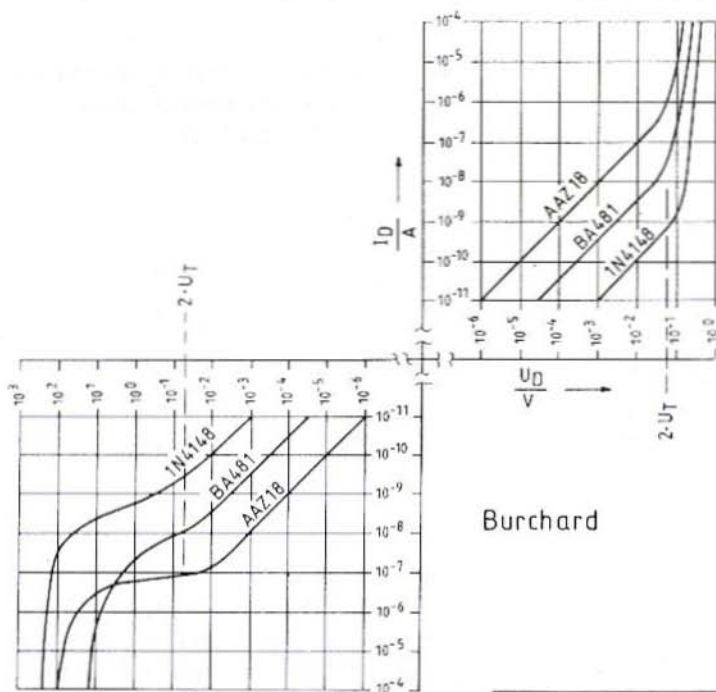

Fig.3:
Voltage-Current
Characteristics
for Diodes tested,
using a Log Scale

Burchard

requirements. The wise limitation of "no more than necessary" prevents the low-frequency voltmeter from continuously measuring the nearby medium-wave transmitter as well, or the power monitor circuit from being influenced by the signals from a ripple control system. It is admittedly not always simple to design the useful frequency range without damping and everything else with as high a damping as possible. Depending on the frequency range, active, LC or coaxial filters may be necessary. However, one thing is always possible and should never be forgotten - the capacitor at the rectifier input, which prevents DC signals from being inadvertently included in the measurements. Many multimeters do not have one, which often makes nonsense of the user's measurements.

5. DIODES

Three types were selected from the multitude of commercially available diodes - a germanium point diode, a silicon Schottky and a silicon junction diode. They can process approximately the same current levels and have similar depletion junction capacitances. If we investigate their rectifier characteristics in a circuit as per Fig.1, then we obtain very different results, as shown in Fig.2. There should be 4 curves on each individual illustration. There are usually only 3, except for the conducting state region in illustration (a). Depending on the load resistor, the voltage drop there goes from minimal to considerable (40 to 400mV). The

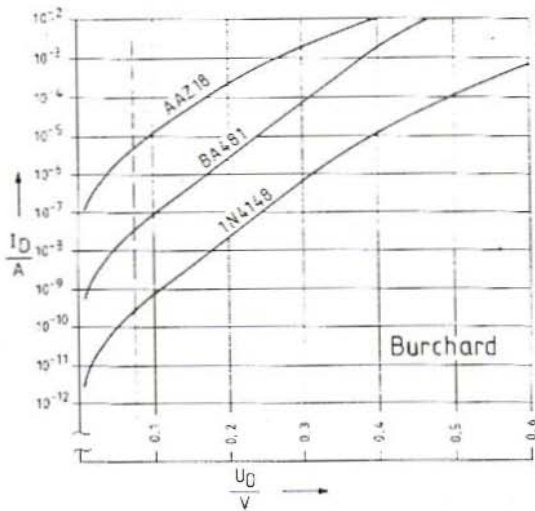

Fig. 4:
Semi-Logarithmic representation
of Forward Characteristics
displays more detail

reverse current is not low enough for the highest load resistor. For the highest load resistor in illustration (b), it is no longer possible to detect any rectifier effect at all. With a load of 1 Mohm or 10 k Ω , the voltage drop is 100 or 250mV. Finally, in illustration c, we are dealing with a directivity which is

adequate only for the smallest load resistor - the voltage drop is 120mV. None of the three diodes comes anywhere near being an ideal rectifier. They are not ideal conductors in the conducting state region and they do not provide an ideal block in the reverse state.

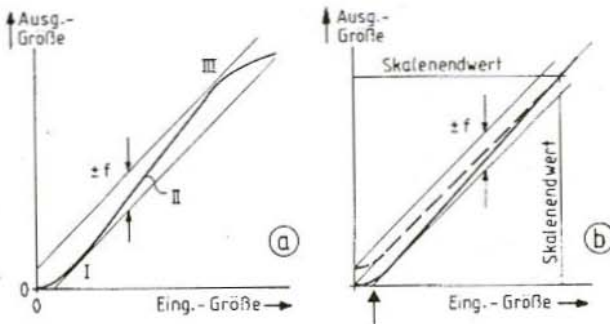

Fig. 5: General Conversion Characteristic of a Rectifier (a), and then after Scaling and avoidance of Breakdown Region (b). Further clarification in text.

Ausg.-Größe = Output value

Skalenendwert = Full-scale value

Eing.-Größe = Input value

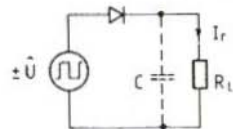

Fig. 6: Simple Rectifier Model for considering Dimensioning



If we plot the voltage-current characteristics of the diodes, then we may obtain a picture something like Fig.3. Here a wide linear range is clearly apparent in the vicinity of the zero point. The diode is best described as an ohmic resistance: 100 k Ω for the AAZ18, 3 M Ω for the BA481 and 100 M Ω for the 1N4148. However, in reality a slight bend in the curves is present. This relates to the quadratic range between $-2 \cdot U_T$ and $+2 \cdot U_T$, about which you can read more in Burchard (1). With the coarse scale used here, this can not be seen. In the reverse region this is followed by a more or less pronounced plateau where the reverse current is largely constant. In the vicinity of the specified breakdown voltage, the reverse current then rises sharply. It is this area of rapid change which displays the biggest variations between individual diodes of the same type and also between diode types produced by the same technology.

In the conducting region, the gradients very quickly become sharper above $2 \cdot U_T$. You have to use a semi-logarithmic

representation, as in Fig.4, to recognise the differences more easily. Here the curves initially run parallel at intervals of 2 current decades each, to bend round into the horizontal above various individual current levels. The bulk resistance becomes noticeable here. It is clearly at its lowest for BA841 and at its highest for 1N4148. Apart from this, any one curve can be obtained from the others by a horizontal shift of approximately 150 mV.

In the zero point region, the curve intervals were 1.5 current decades and the plateaus for the reverse currents were only about 1 current decade from each other. It can be concluded from this that the rectifier quality - the ratio of the conducting current to the blocking current - is 10 times greater in the exponential characteristic range for germanium than for the Schottky diode and 100 times greater than for the Si diode. This observation applies to the individual diodes measured here. With the multitude of types on offer, and if we take into account that, for example, Schottky diodes are manufactured for a



Fig.7:

Various types of Noise which can be correctly measured using the Quasi-RMS Value Rectifier

- Y1: White Noise with Normal Distribution**
- Y2: Band Pass Noise, Q=10 Rayleigh Distribution**
- Y3: Band Pass Noise, Q=1 Mixed Distribution**

X: 5ms/div

Centre Frequency of Band Passes 1 kHz

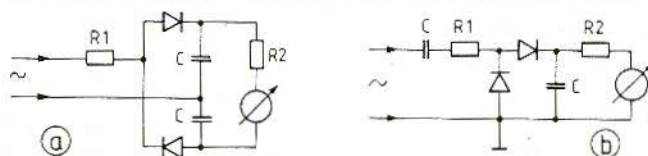

Fig.8: General Rectifier Circuit for all four types of evaluation with Floating Load (a), and a Common Line from Input and Output (b), which may also be earthed

very wide I_0 range, in an individual case a Si diode can also chance to have a higher rectifier quality than a Ge diode. In addition to this, attention should also be paid to the capacity, reverse recovery time and series inductance if you are dealing with higher frequencies.

6. CONVERSION CHARACTERISTICS

It is very common for a rectifier to display a relationship between inputs and outputs like that shown in Fig.5a. Range I can be explained by the area with quadratic rectification, and Range III by the influence of the blocking current as a breakdown approaches. Because of the high manufacturing tolerances in the blocking state region,

a sufficient margin must be preserved so that there is no breakdown - i.e. the readings must stay within linear range II. If we now scale in such a way that the desired output values (e.g. 100mA) are set for the desired input values (e.g. 5V), then we obtain a curve line like (b). Only half of the original error band $\pm f$ is now in use. The solid curve applies if it is desired to retain the zero point simultaneously - the conversion error is always negative. The dotted curve is present if the zero point is moved forward, which can be done with a pointer instrument by using the zero adjusting screw, or else can be brought about by giving the diode a bias voltage. With skillful design, the conversion error above $2 \cdot U_T$ can be brought down close to zero. The procedure is described in greater detail in Burchard (1).

Rectification	R1	R2	C
Peak Rectification	0	2.8 M Ω	§
Quasi-Peak	5 k Ω	2.5 M Ω	0.2 μ F
Quasi-RMS	250 k Ω	1.8 M Ω	§
Mean Value	630 k Ω	0	§

§ depending on Low Frequency cut-off required

Table-1



7.

ERROR ESTIMATION

The biggest conversion errors (both relative and absolute) occur in the area indicated by the arrow in Fig.5b. This is where we find the input value $f \times \text{end scale value}$ present. The output value must already be above zero - it is estimated to be 0.2 to $0.5 \times f \times \text{full scale value}$. Fig.4 provides information as to the input values at which this current flows. These values, multiplied by $1/f$, give the smallest possible measurement range with the error f .

A conceptual model, as shown in Fig.6, helps in dimensioning. Let the initial input value be a symmetrical square wave voltage and the charging capacitor, C , not be present. Then conducting-state current flows through RL for a half-wave, and blocking current flows through for the other half-wave. The difference between the two is the continuous average forward current, I_r . The blocking current must remain well below $f \times I_r$. This determines RL , for \hat{U} has already been determined by the considerations referred to in the previous paragraph. So we already have the dimensioning for an instantaneous or mean value rectifier. To give some figures here - a rectifier with a precision of 1%, wired in front of a 100mA meter, needs at least 4V with a Ge diode, at least 15V with a Schottky diode, and at least 30V with a silicon diode for the end scale value.

Peak value rectification is considered in the model in Fig.6 in that the charging capacitor is provided and the mark-

to-space ratio of the square wave generator is set low. Depending on the requirements imposed for the charging time, positive voltage will be provided for 1 to 5% of the total time. The charging capacitor is charged approximately to this voltage. The blocking voltage at the diode becomes twice as high and is applied for twice as long. The blocking current becomes rather higher and its effect lasts longer. The conducting-state current becomes 100 to $20 \times I_r$, with the mark-to-space ratio percentages referred to above. It results from all this that the smallest possible measurement range using a Ge diode will be 7V (5% case) or 13V (1% case). Much higher voltages are needed for the other diodes, especially if even greater precision is aimed for.

8.

FOUR TYPES OF RECTIFICATION

If the level of an AC current is given, this always refers to the RMS value, unless explicitly stated otherwise. If sinusoidal or slightly deformed curves are involved, it is immaterial whether the rectifier is measuring the mean value or the peak value, because the two are linked by a constant factor. This alters if the form of the curve departs significantly from the sine. Fortunately, this does not happen all that often to radio amateurs. A saturated radio-frequency or low-frequency amplifier rarely occurs in operation. To reduce the electromagnetic environmental pollution or the suffering of our

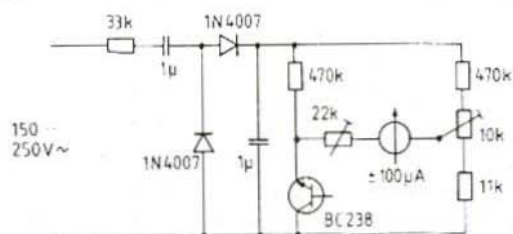

Fig.9:
Mains Voltage Monitor Circuit

cars, the level control should be reduced to a convenient level. If it really becomes necessary, a genuine RMS responsive meter can rapidly be constructed using diodes which operate in the quadratic range. Further reading on this can be found in Burchard (2). But there is a trick circuit which combines the mean and the peak value in a somewhat linear manner to get very close to the RMS value. It operates both with noise (Fig.7), as has been demonstrated by Pöhlmann (3), and with mains voltage, where the RMS value is decisive, for historical reasons (incandescent lamp light, tube heating). And then, as well as this quasi-RMS value measurement, there is also quasi-peak value measurement, which is

required for measuring external voltages and noises in accordance with standards.

The circuit in Fig.8 is suitable for all 4 types of evaluation. Without any further clarification, it is believable that $R1 = 0$ leads to peak value rectification and that $R2 = 0$ leads to mean value rectification. Quasi-RMS value rectification lies between the two, but closer to mean value rectification, whereas quasi-peak value rectification is closer to point rectification. The capacitors keep DC current away and store the reading without any significant drop over at least one period of the lowest frequency arising. Charging and discharging time constants of 1 and 250ms are standardised for quasi-peak value

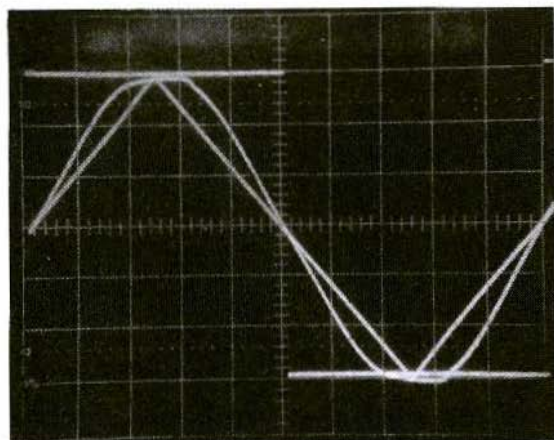

Fig.10:
The Mains Waveform is
between a Δ and a Square
Wave



measurement. All this then gives us Table 1 for dimensioning, with a 100V full scale value and 100mA full deflection meter.

Part circuit b, in Fig.8, is advantageous if there also has to be a common line from the input and the output.

It can easily be recognised that significant AC currents are present through the resistor, R1. The self-capacitance and self-inductance of this resistor lead to the display's being dependent on the frequency.

Only the peak value rectifier with $R1 = 0$ is free from this in principle. It is therefore preferred for radio frequency measurements. A small series resistance, R1, is often necessary to dampen resonances from diode capacitance and inductance. But you need no more than 100 to 200 Ω for this.

9. POWER MONITOR CIRCUIT

One application of the relationships set out above is the circuit in Fig.9. The $\pm 100\text{mA}$ measuring instrument shows the effective value of the supply voltage on an extended scale in the 150 to 250V range (this is unfortunately the normal range in which fluctuations occur in Nairobi, where the rated voltage is 240V). The rectifier corresponds to measurement for quasi-effective evaluation. It supplies sufficient output power to generate a reference voltage of about 8V with the low-frequency transistor wired up as a temperature-compensated Z-diode. Against this, the variable output voltage of the rectifier is displayed by the meter using a bridge circuit. The 10k Ω trimmer adjusts the mid-scale voltage and the 22k Ω trimmer the rate of rise.

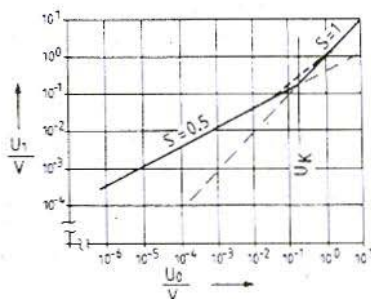
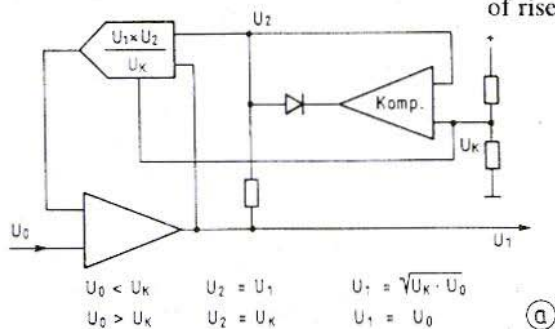

Fig.11:
Equalisation of
Quadratic Range
using a small
Analogue
Computer (a) and
Function δ
obtained (b)

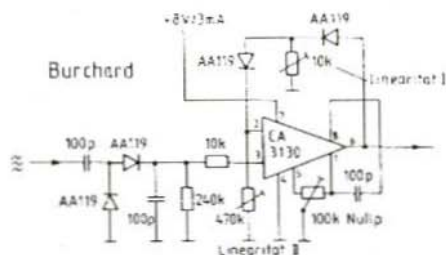

Fig.12: Equalisation of Quadratic Range using Non-Linear Feedback

A function generator is all you need to test a quasi-RMS rectifier. In this context, let us examine Fig.10. Here the central line shows the supply voltage curve from which, in spite of many phase-angle controls and peak rectifiers, is still rather sinusoidal in almost all mains supply circuits. Even with far greater degrees of deformation, it will always lie between delta and square wave forms, which are both displayed at the same time. A rectifier which gives meter readings of $1:1/\sqrt{2}:1/\sqrt{3}$ for square waves, sine waves and delta waves from a function generator has an output value which is sufficiently precisely proportional to the RMS value. With the Fig.8 circuit, this is the case if $R1:R2$ is approximately 1:7.

10. LINEARISATION OF QUADRATIC RANGE

Even for an accuracy of only 1%, a linear rectifier for all types of evaluation needs rather a high input voltage. With the introduction of semi-conductors into amplifier technology, the sig-

nal levels have fallen drastically - in the same ratio as the operating voltages, from several hundred Volts to only a few. It is thus frequently not at all possible to make sufficient input voltage available to the rectifier. Assistance can be provided by active rectifiers (see Part II) and by correcting the distortion of the quadratic range.

Fig.11a shows the relevant circuit. It consists of an analogue computing module for multiplication and division, a comparator and an operational amplifier. They are wired together in such a way that the roots of input voltages below U_k are calculated, but those above U_k are reproduced linearly. So the transfer function is as shown by Fig.11b. Naturally, the kink in the function creates a problem, because it is not available from the rectifier. To remedy this, the comparator must be replaced by a differential amplifier of appropriate amplification, the S-form transfer function of which then gives the dotted line in Fig.11b. The author will be happy to give details of this relatively complex circuit. But there is a still simpler way, as shown by Fig.12.

Here the feedback which determines the amplification is made non-linear, using the same diodes which are located on the left in the radio frequency rectifier. For very small rectified voltages, the amplification is initially great. It decreases continually as the rectified voltage increases. The decrease in the amplification is in no way hyperbolic, as it really should have been, but is rather an exponential function. Nevertheless, quite good linearisation is obtained down to a radio frequency



voltage of 10 mV. To avoid latch-up, an amplifier is used which can work right down to the negative rail, and this rail is then set to zero. The circuit is rapid enough for wobbling and delivers a voltage which is equal to the peak-to-peak of the radio-frequency voltage.

11. SUMMARY

Rectifiers with semi-conductor diodes are linear at sufficiently high signal voltages. They are distinguished by a high frequency coverage, which is restricted only by the characteristics of the diodes. Accuracy levels above 1% are difficult to obtain. At such levels of accuracy, the quadratic range can be by a simple circuit at low signal voltages, but this still means a measurement of the RMS value.

12. LITERATURE

- (1) D.Burchard (1991):
Basics of Rectifying small AC Voltages with Semiconductor Diodes
VHF Communications 3/1991, pp. 168-174
- (2) D.Burchard (1991):
Absolute Calibration of a Noise Source
VHF Communications 2/1992, pp. 76-89
- (3) W.Pöhlmann (1964):
Rauschgeneratoren und ihre Anwendung in der HF- und NF-Technik. Handbuch für Hochfrequenz- und Elektro-Techniker Bd. VII, S.254
Verlag Radio-Foto-Kinotechnik, Berlin

The Parabolic 24cm Preamplifier

A fully weather-proofed very high-quality preamplifier covering 1200 MHz to 1360 MHz. Mounted in a sealed diecast enclosure with weatherproof N-type sockets for input and output. DC powered via the output socket for remote mast-head mounting.

GAIN >40dB across the band **NOISE FIGURE** <1.6dB

£125 + £7.50 post & packing

**KM Publications, 5 Ware Orchard, Barby, Nr.Rugby, CV23 8UF,
Tel: (0)1788 890 365 Fax: (0)1788 891 883**



Rainer Schmülling, DK6ZK

Expansion and Assembly of the DB1NV Spectrum Analyser

It is now some time since I finished work on my version of the spectrum analyser from DB1NV. Constructing it inspired me to come up with some additional features, which are described below.

1. INTRODUCTION

For the most part, the expansion features have been borrowed from data sheets and other publications, so only a general description of their operation is given here. They were all assembled together on breadboards or demonstration boards; so there are no complete wiring diagrams or boards. This report is intended to stimulate interested parties to do some development work of their own.

2. BASIC PRINCIPLES

In the prototype, all DB1NV assemblies for the spectrum analyser were built on original boards. They function satisfactorily, but there are two main characteristics which seem to require improvement. These are:

1. Frequency stability of second LO
2. Precision of frequency display

Each of these problems has been eliminated by an additional assembly:

1. A frequency control unit with monoflop stabilisation.
2. A frequency counter triggered by "Sweep", with a resolution of 100 kHz for "Span" and 10 kHz for "Zero'Span".

The following additions have also

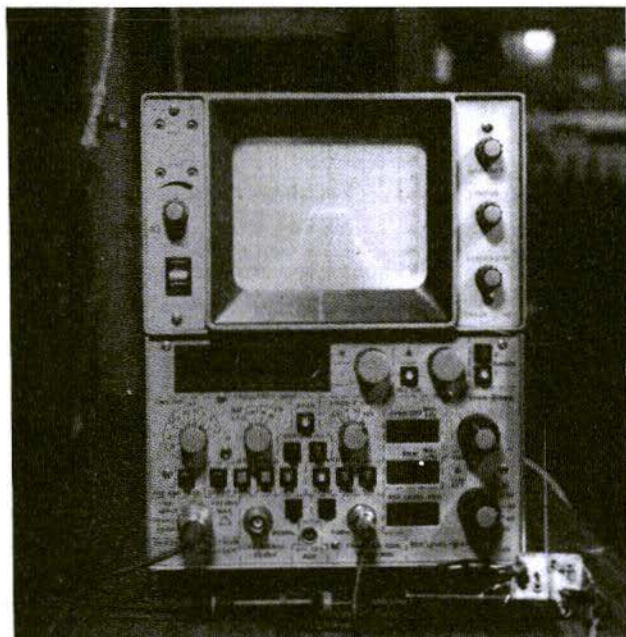

Fig.1:
Prototype of the
DB1NV Spectrum
Analyser with the
DK6ZK Additional
features, showing
the transmission
curve of an XF9A in
test mode

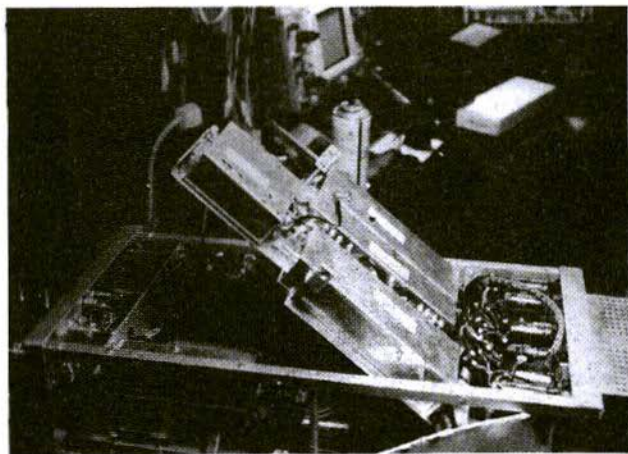

Fig.2:
Access to the
assemblies below
can be obtained
through an
installation plate
which swings out

been made and are useful in practical operation:

3. A 50dB intermediate frequency amplifier, adjustable in 1dB steps, so that even weaker signals can be shifted right up to the REF line (top) or to the nearest 10dB line. In conjunction with the REF-LEVEL display, this makes it considerably easier to read off the level. This amplifier is also necessary for the 2dB and linear displays (points 4 and 5), as these are based on the REF line!
4. An additional circuit for 2dB/DIV display.
5. Antilog amplifier for LINEAR display.
6. Demodulators for AM, narrow-band and broad-band FM, for monitoring a signal in ZERO SPAN mode.
7. 10dB pre-amplifier with MMIC (MAR-7) which can be switched on to improve sensitivity.

Finally, we should mention the logic board, on which were mounted the components for the control button system (bi-stable relays), the electronics for three displays (SPAN; RBW and REF-LEVEL) and the digital control of the 50 dB amplifier. The tasks performed by this board could certainly be carried out more elegantly by a micro-controller.

A lot of wiring and some expensive multi-level switches could be done without if keys and pulse generators were used. But I took the conventional route here.

3. DESCRIPTION OF ADDITIONAL ASSEMBLIES

3.1. Frequency stabilisation of Second LO

Although a ceramic resonator is used in the second LO, the stability is extremely unsatisfactory. This is noticeable, particularly at low display widths, in that a signal leaves the screen after a short time or, in narrow-band monitoring in ZERO SPAN mode, the transmitter hurries through the filter stage.

A remedy can be provided here by a frequency regulation loop with monoflop stabilisation, which can be inserted into the original DB1NV 006 assembly without alterations (!).

A circuit which can be used with practically no changes can be found in [1]. You just have to connect a pre-amplifier (NE 5502) and a divider by 4 ($2 \times U 862$ in the prototype unit) to the first mixer. Two 10-turn trimmers accessible from outside make it possible to match the incoming tuning voltage to the value supplied by the monoflop integrator in relation to position and amplitude. The double mixing was carried out to land up in the frequency range which was correct for the monoflop using cheap standard crystals. The circuit is simply "looped into" the tuning voltage circuit. After a warm-up period of about 1 hour (drift app. 20 kHz), the LO is still running at only a few hundred Hz an hour. Moreover, it was possible to expand the display range as far as 500 Hz/DIV in four stages. True, tuning becomes somewhat

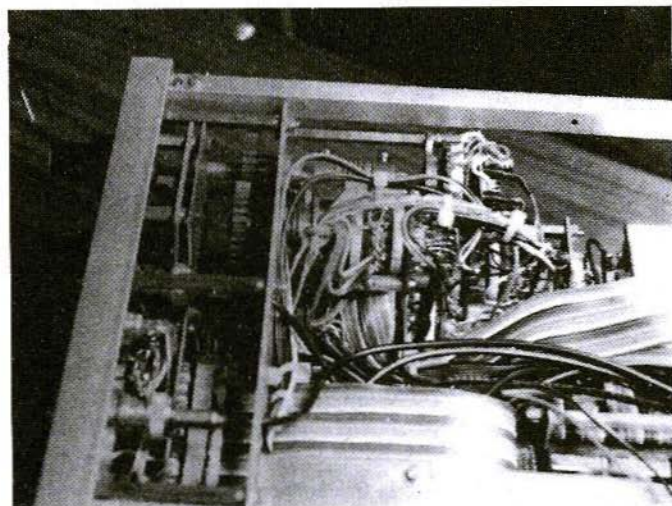

Fig.3:
The multi-level switches and coupling gears of the operational controls are clearly visible

problematic here, but can still be done reasonable well. Using the tracking generator as well, it now becomes possible to carry out even narrow-band sweeps (e.g. SSB and CW filters).

3.2. The Sweep-triggered Frequency Counter

Even in the initial tests of the "original version", displaying the frequency by measuring the tuning voltage of the first LO with a digital voltmeter seemed rather unreliable. The higher the frequency rose, the more the display value was out. Moreover, the variation in the second LO (always exactly 3 MHz) was not taken into account, so that allowances always had to be made for display errors of a few MHz due to the hunting of the last digit and the amount of deviation of the second LO. So it was only at spans greater than 500 kHz/DIV that one could be reasonably certain that the

frequency displayed was actually within the display range.

For the narrow-band displaying of a signal in an approximately known frequency range, it was necessary to key down to it, coming down from the top through the large span. When relatively narrow filters are scanned (e.g. short-wave band passes), an external mark generator would undoubtedly be required. The counter described here (resolution 100 kHz in SPAN mode and 10 kHz in ZERO SPAN) allows the frequency to be set rapidly, even in low ranges, using an indexed first LO, as the frequency displayed is now certainly within the display range (from 20 kHz/DIV upwards). The equipment is assembled using 74HCxx modules, with seven 74HC190's forming the actual counter chain. The signals from the two LO's, divided by 64, are incremented or decremented, depending on the tuning area (normal or mirror), the second intermediate frequency being pre-pro-

grammed as either positive or negative. Through the ceramic resonator used in the prototype, the second LO oscillates above the first intermediate frequency, giving the following calculations for the two tuning areas:

Displayed freq. = $1.LO - 2.LO + 10.7$
for "normal" and

Displayed freq = $1.LO + 2.LO - 10.7$
for "mirror"

If flea market filter crystals are used, the actual average frequency of the intermediate frequency naturally has to be determined and programmed (in the prototype unit this amounts to 10.68 MHz). The frequency for the first LO has already been divided. For the second LO, there is a second SDA4212 or U664 in the counter module.

Now, in order to obtain a usable result from the counter and a steady display (if the last digit is directly displayed, it always hunts through a few digits, due

to repeated metering), the final digit is certainly counted, but is not displayed. For the 100 kHz display, this requires a 10 kHz digit, and for the 10 kHz display a 1 kHz digit. Due to the 64-fold division, the gate times are 6.4 or 64ms. It can be seen here that with this simple design a 10 kHz display in SPAN mode is not possible, since the gate time is too long for fast sweep times. Triggering takes place through the horizontal deflection voltage - approximately 2 DIV left of the mid-perpendicular, through an OP wired as a Schmitt trigger. A counting sequence needs three sweep passes:

1. First LO count
2. Second LO count
3. Display Latch and SET

At ZERO SPAN, the seventh digit and a 10-fold divider are switched on during the sweep. Moreover, the dimmer circuit of the sixth display is

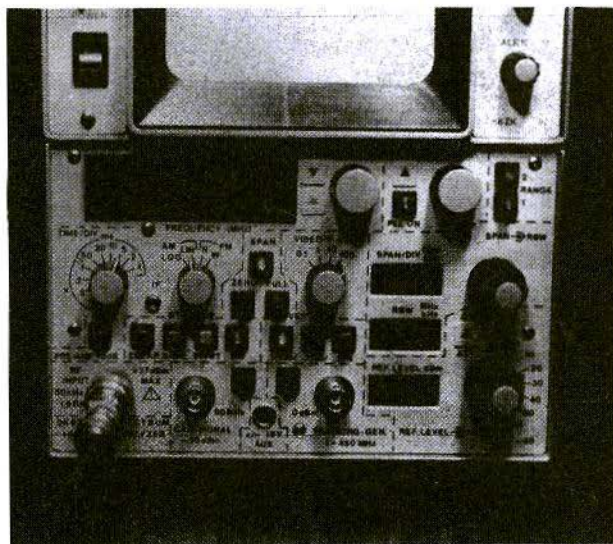

Fig.4:
Displays and
Operational controls
on the front panel

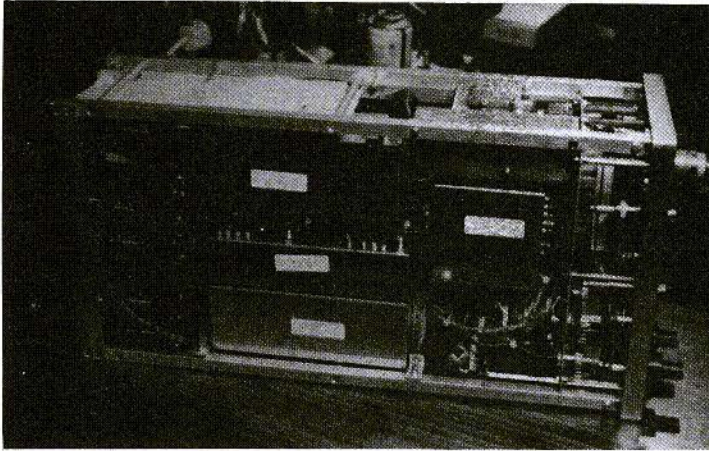

Fig.5: The external tinplate housing for the mains transformer can be seen on the left - near to it is the Power Supply board in the Spectrum Analyser

eliminated. The counter is now operating independently of the sweep and gives a six-digit display of the average frequency set.

The displays used had integrated latches and decoders, so as to save a further 6 integrated circuits (for reasons of space). Naturally, you can also use low-cost 7-segment displays with decoders (e.g. 74HC4511) if there is enough room available, or you can add a "second storey" inside the tinplate housing.

3.3. The 50 dB Amplifier at 10.7 MHz

With this amplifier, signals of up to -80dBm can be shifted individually right up to the reference line in 1dB steps,

and signals at weaker levels can be shifted to the nearest 10dB line. The level of a signal on the reference line can now be read off directly on the display. Signals on other 10dB lines can be calculated only in steps of 10.

The amplifier consists of five identical stages from [2], which can be adjusted using PIN diodes. Four of them are responsible for the 10 dB steps and one for steps from 0 to 9 (i.e. 49dB in all). Due to the feedback which arises, the two groups are de-coupled through an attenuator. The diode currents are set by means of resistances. These are controlled by decimal decoders (7442), the data for which are supplied by an incremental/decremental counter, controlled by a pulse generator on the logic board. In addition, the REF-LEVEL display also takes into account the

input attenuator, so that the level is always displayed on the top line (REF-LEVEL). An AGC-ZF-IC (e.g. SL1612) can also be successfully used to construct this amplifier.

3.4. 2dB/div Display

This circuit consists of two operational amplifiers. OP 1 inverts the Y signal supplied by TDA 1576. OP2 inverts and amplifies by a factor of five. Both OP's work as adders, so as to be able to feed in the offset voltages required in each case, which can be set through trimmers. A diode to earth at the output of the second OP limits the signal to -0.7V. Thus negative values too high for further processing in analogue switches and in the video filter are not reached, and the base line reliably disappears from the visual range again.

3.5. Linear Display by means of an Antilog Amplifier

There are certainly special integrated circuits for this purpose, but these would have been difficult for me to obtain and would have been very expensive. So I just copied the insides of the ICL8049 using two OPs and a double transistor. Since the antilog amplifier operates negatively, it can be directly controlled using the inverted signal from the 2dB/DIV stages. Following the somewhat tiresome calibration, the visual display unit now gives a voltage-linear display, i.e. half the level displayed corresponds to -6dB.

It should again be pointed out that both 2 dB mode and linear mode start from

the REF level. Signals which lie 16dB (2 dB/DIV) or app. 24dB (LIN) respectively below this level can not be displayed.

3.6. The Demodulators

With the analyser, we have a receiver operating continuously from almost zero up to 1,900 MHz. So why shouldn't we also be able just to "monitor" the signals displayed? Four demodulators are available to do this:

1. AM LOG: Here the alternating component which corresponds to the modulation is simply cut off. The incoming signal from the TDA 1576 is fed in through a capacitor to a simple Antilog circuit (transistor at input of an OP).
2. AM LIN: AM fraction of a TDA 1220 at 10.7 MHz
3. FM wide: FM fraction of a TDA1220 at 10.7 MHz
4. FM narrow: narrow-band FM circuit with conversion to 455 kHz (MC 3357)

The low frequency is released only at ZERO SPAN and fed into an amplifier in the visual display unit, where there is also a small loudspeaker. For better quality an external speaker can be connected up and the internal one can be switched off. All video and low-frequency paths (even the video filter selection) are carried by analogue switches and multiplexers, so that only DC voltages are switched by the operational controls, and so a host of screened lines can be dispensed with.

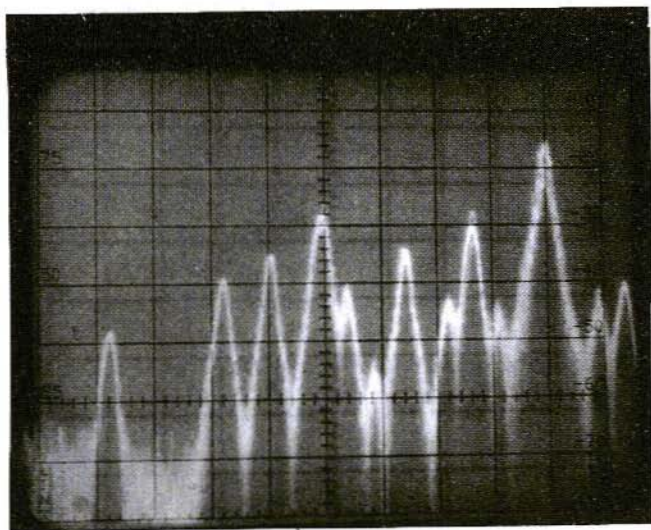

Fig.6:
Screen photo:
Longwave image; on
the left DCF77, in
the centre DLF153
Span: 20 kHz/div

3.7. Pre-Amplifier

Before the input signal reaches the DB1NV006 assembly, it passes through a 50dB attenuator, which can be switched in 10dB steps, a pre-selector (ready-made filter), and can be made app. 10dB higher if necessary. This can be done through an MAR-7, the amplification of which varies by only app. 3dB over the entire frequency range. Switching the pre-amplifier on is not taken into account in the REF-LEVEL display.

4. MECHANICAL ASSEMBLY

It is desirable to house the analyser together with the tracking generator and the visual display unit, i.e. independent of a separate oscilloscope, as a compact, portable measuring instrument. The starting point was provided by an

existing TEK type 528 visual display unit, such as are always available from flea markets, and a plug-in unit housing which matches it. Two of these housings placed one on top of the other should be sufficient for the assembly of the analyser plug-in unit.

A plug-in unit with a double front plate and three installation levels (as there were several tinplate housings) was constructed from aluminium profiles. An additional carrier plate which swings out makes it possible to reach the middle "storey" at any time, even during operation.

Corresponding to the size of the housing, the front plate has dimensions of 210mm. x 125mm. Two corresponding rotary switch pairs (SPAN/RBW and REF-LEVEL/ATT) are constructed to be controlled concentrically by means of gears and hollow shafts. The two I.O.'s, together with the sweep, video filter and demodulators, are operated by

means of control knobs. All other functions are carried out through illuminated keys or switches. The front plate also holds the sockets for input (N-type), the calibration generator and the tracking generator (both BNC type), as well as four digital displays (average frequency 6-digit; SPAN, RBW and REF-LEVEL, each 2-digit, with auxiliary LED for kHz/MHz or minus sign). An external voltage socket and an aperture for calibrating the intermediate-frequency amplification are also provided.

During the initial assembly, the transformers (normal shell-type stampings) were mounted inside the plug-in unit. But this led to considerable ripple voltages. Now toroidal core transformers are used which, together with the rectifiers, are externally mounted in a tinplate housing on the back wall of the plug-in unit. This measure means there are no longer any components carrying mains voltage within the unit. The various photographs give an impression of the mechanical assembly and show the component density, which is decidedly very high.

The individual assemblies are divided as follows:

On the "top storey" we have the image storage, the operational control, the

counter, the first I.O and the PLL assembly. The tracking generator, the calibrator (60 MHz, - 30dBm), the frequency stabilisation for the second LO, and the logic board are housed in the centre. On the swing-out frame plate below are the high frequency/intermediate frequency, the REF-level amplifier, the crystal filter and the demodulator unit. The voltage supply board is connected with the back wall through an aluminium elbow for heat extraction.

5. LITERATURE

- [1] Dr.Ing.Jochen Jirmann, DB1NV, A Spectrum Analyser for the Radio Amateur, Part3: Construction and PCBs
VHF Communications 2/1989, pp. 108-119
- [2] Dr.Ing.Jochen Jirmann, DB1NV, A Spectrum Analyser for the Radio Amateur, Part3a: Construction and PCBs
VHF Communications 3/1989, pp. 163-171

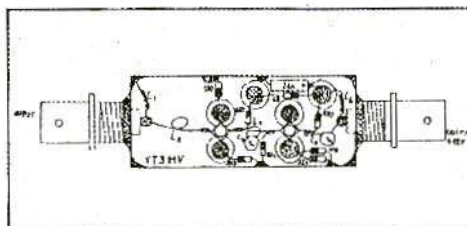

Very low noise aerial amplifier for the L-band as per the YT3MV article on page 90 of VHF Communications 2/92. Kit complete with housing Art No. 6358 £38.55. Orders to KM Publications at the address shown on the inside cover, or to UKW-Berichte direct. Price includes p&p



ERRATA

Yes I am afraid that it does sometimes happen and errors creep into articles. Often as not by my trying to be too clever!

In Carl Lodström's article in issue 2/95 entitled 'A Sweep Tuner for the VCO' all references to the bias currents in the amplifiers on page 66 and 67 should be in fA and not pA.

Also, on page 29 of issue 1/95 in Jira Otyпка's article entitled 'Calculating the Focal Point of an Offset Dish Antenna', the program listing has a few (!) errors, caused by problems with my scanner it appears. If anyone would like a copy of the correct program listing please contact us.

Apologies again - but it is rare after all!

The British Amateur Television Club

The foremost association on the world, for anyone, anywhere in the world,
who is interested in Amateur Television.

CQ-TV the quarterly journal of the BATC is recognised as the most
professionally produced amateur publication of its kind.

Join the BATC and receive *YOUR* copy of CQ-TV

Membership is *only* £9.00 per year.

BATC, Grenehurst, Pinewood Road, High Wycombe, HP12 4DD

COMPLETE KITS

for projects featured in VHF Communications

KIT	DESCRIPTION	ISSUE	ART No	PRICE
DB1NV-006	Spectrum Analyser IF Amplifier	2/89	06370	£142.00
DB1NV-007	Spectrum Analyser Lo-PLL	2/89	06371	£ 62.00
DB1NV-008	Spectrum Analyser Crystal Filter	3/89	06372	£108.00
DB1NV-009	Spectrum Analyser Sweep Gen	3/89	06373	£ 48.00
DB1NV-010	Spectrum Analyser Digital Store	3&4/91	06378	£132.00
DB1NV-011	Spectrum Analyser Tracking Gen	2/92	06474	£143.00
DB1NV-012	Spectrum Analyser VCO 1450 MHz	4/92	06483	£ 39.00
DB1NV-013	Spectrum Analyser VCO 1900 MHz	4/92	06484	£ 41.00
DB6NT-001	Measuring Amp up to 2.5 GHz	4/93	06382	£ 60.00
DB6NT-002	Frequency Divider to 5.5 GHz	4/93	06383	£100.00
DJ8ES-001	23cm FM ATV Converter	1/91	06347	£ 93.00
DJ8ES-002	Digital Frequency Indicator	1/91	06352	£ 53.00
DJ8ES-003	IF Amplifier	1/91	06355	£ 55.00
DJ8ES-004	Demodulator	1/91	06362	£ 72.00
DJ8ES-019	Transverter 144/28 MHz	4/93	06385	£143.00
DJ8ES-019mod	Transverter 50/28 MHz	2/95	06392	£143.00
DJ8ES-020	Hybrid Amplifier for 144 MHz	1/94	06387	£179.00
DJ8ES-021	13cm FM ATV Exciter	2/94	06388	£ 67.00
DJ8ES-022	28/432 MHz Transverter Oscillator	2/95	06395	£ 59.00
DJ8ES-023	28/432 MHz Transverter Converter	2/95	06396	£114.00
DC8UG-007	5W PA for 13cm	3/94	06938	£286.00

Minimum postage and packing charge is £6.75

KM Publications, 5 Ware Orchard, Barby, Nr.Rugby, CV23 8UF, U.K.

Tel: (0)1788 890365

Fax: (0)1788 891883



KITS and PRINTED CIRCUIT BOARDS

for the Matjaz Vidmar GPS/GLONASS Receiver project

KITS

Name	Issue	Description	Art.No	Price
S53MV001	1/95	GPS RF Module	06491	£ 24.35
S53MV002/003	1/95	GPS Converter, Multiplier & Mixer	06493	£ 62.95
S53MV004	1/95	GLONASS RF Module	06494	£ 29.65
S53MV005	1/95	GLONASS IF Converter	06496	£ 43.95
S53MV006	1/95	GLONASS PLL Synth. Converter	06498	£ 19.15
S53MV007	2/95	GLONASS Synthesiser	06500	£ 22.95
S53MV008	2/95	GPS/GLONASS Second IF	06502	£ 14.40
S53MV009	2/95	GPS/GLONASS DSP Module	06504	£ 75.40
S53MV010	3/95	GPS/GLONASS CPU Board	06547	£ 194.55
S53MV011	3/95	GPS/GLONASS 8-key Keyboard	06549	£ 34.90
S53MV013	3/95	GPS/GLONASS PSU and Reset	06553	£ 20.60
BSGPS		Complete GPS Kit	06555	£ 410.00
BSGLONASS		Complete GLONASS Kit	06556	£ 425.00

PC BOARDS

Name	Issue	Description	Art.No	Price
S53MV001	1/95	GPS RF Module	06490	£ 9.60
S53MV002/003	1/95	GPS Converter, Multiplier & Mixer	06492	£ 10.05
S53MV004	1/95	GLONASS RF Module	06495	£ 9.60
S53MV005	1/95	GLONASS IF Converter	06497	£ 10.05
S53MV006	1/95	GLONASS PLL Synth. Converter	06499	£ 19.15
S53MV007	2/95	GLONASS Synthesiser	06501	£ 22.95
S53MV008	2/95	GPS/GLONASS Second IF	06503	£ 6.25
S53MV009	2/95	GPS/GLONASS DSP Module	06505	£ 25.80
S53MV010	3/95	GPS/GLONASS CPU Board	06548	£ 25.80
S53MV011	3/95	GPS/GLONASS 8-key Keyboard	06550	£ 6.75
S53MV013	3/95	GPS/GLONASS PSU and Reset	06554	£ 8.65
LPGPS		Complete set of GPS Boards	06557	£ 83.10
LPGLONASS		Complete set of GLONASS Boards	06558	£ 124.75

Minimum postage and packing charge is £6.75

KM Publications, 5 Ware Orchard, Barby, Nr.Rugby, CV23 8UF, U.K.

Tel: (0)1788 890365

Fax: (0)1788 891883

PRINTED CIRCUIT BOARDS

for projects featured in VHF Communications

DB1NV	Spectrum Analyser			Art No.
PCB	DB1NV-006	IF Amplifier	Ed.2/89 06997	£ 17.25
PCB	DB1NV-007	Lo-PLL	Ed.2/89 06995	£ 17.25
PCB	DB1NV-008	Crystal Filter	Ed.3/89 06998	£ 17.25
PCB	DB1NV-009	Sweep Generator	Ed.3/89 06996	£ 17.25
PCB	DB1NV-010	Digital Store	Ed.3&4/91 06477	£ 21.15
PCB	DB1NV-011	Tracking Generator	Ed.2/92 06479	£ 15.50
PCB	DB1NV-012	VCO 1450 MHz	Ed.4/92 06480	£ 16.35
PCB	DB1NV-013	VCO 1900 MHz	Ed.4/92 06481	£ 16.35
DB6NT	Measuring Aids for UHF Amateurs			Art No. ED. 4/93
PCB	DB6NT-001	Measuring Amp up to 2.5 GHz	06379	£ 17.75
PCB	DB6NT-002	Frequency Divider to 5.5 GHz	06381	£ 17.75
DJ8ES	23cm FM-ATV Receiver			Art No. ED. 1/91
PCB	DJ8ES-001	Converter	06347	£ 10.75
PCB	DJ8ES-002	Digital Frequency Indicator	06350	£ 9.65
PCB	DJ8ES-003	IF Amplifier	06353	£ 7.95
PCB	DJ8ES-004	Demodulator	06356	£ 10.30
DJ8ES	28/144 MHz Transverter			Art No. ED. 4/93
PCB	DJ8ES-019	Transverter 144/28 MHz	06384	£ 17.75
PCB	DJ8ES-020	Hybrid Amplifier 144 MHz	06386	£ 17.25
DF9PL	High Stability Low Noise PSU			Art No. ED. 1/93
PCB	DF9PL-001	30 Volt PSU	06378	£ 9.80
PCB	DF9PL-002	Pre-Stabiliser	06376	£ 10.20
PCB	DF9PL-003	Precision Stabiliser	06377	£ 11.20
F6IWF	10 GHz FM ATV Transmitter			Art No. ED. 2/92
PCB	F6IWF-001	DRO Oscillator - PTFE	06485	£ 16.20
PCB	F6IWF-002	Modulator and Stabiliser	06486	£ 12.00
DC8UG	13cm GaAsFET PA			Art No. ED. 3/94
PCB	DC8UG-PA	5W PA for 13cm	06936	£ 19.25
PCB	DC8UG-NT	Power Supply for the PA	06937	£ 7.75

Minimum postage and packing charge is £6.75

KM Publications, 5 Ware Orchard, Barby, Nr.Rugby. CV23 8UF, U.K.

Tel: (0)1788 890365

Fax: (0)1788 891883

DESIGN OSCILLATORS & FILTERS

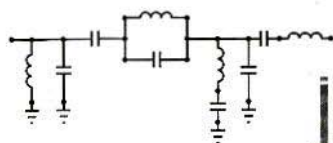

HF FILTER DESIGN AND COMPUTER SIMULATION

This book is packed with invaluable information on the practical design of L-C and distributed (both printed and machined) filters.

- ✓ Great collection of lumped and line models
- ✓ Simple, narrow and special bandpass
- ✓ Zig-zag and other elliptic types
- ✓ Equivalent circuit transformations
- ✓ End, edge and direct coupled
- ✓ Hairpin, combline and interdigital
- ✓ Group delay equalization
- ✓ Computer aided techniques
- ✓ Photographs and measured responses



428 Pages
180 Figures
62 Tables
301 Equations

\$59

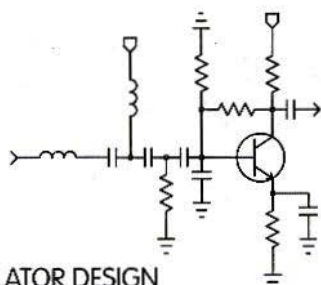

OSCILLATOR DESIGN AND COMPUTER SIMULATION

Contains easy-to-understand oscillator theory and practical tips and techniques for L-C, transmission line, SAW and crystal oscillators. Some of the topics are:

- ✓ Easy-to-understand design goals
- ✓ L-C, t-line, crystal and SAW resonators
- ✓ Bipolar and JFET amplifiers
- ✓ Starting characteristics
- ✓ Noise performance
- ✓ VCOs
- ✓ Pulling crystal oscillators
- ✓ Linear and non-linear computer analysis
- ✓ Lots of examples



300 Pages
136 Figures
27 Tables
275 Equations

\$64

Name _____
Company _____
Address _____
City _____ State _____
ZIP _____ Country _____
Phone _____ FAX _____
Card # _____ Exp _____
Signature _____

Please send the following products

- Oscillator Design \$64
 HF Filter Design \$59
 Both Books \$99

Shipping & Handling
United States \$ 5
International Air \$20

Payment Method

- VISA or MASTERCARD
 EuroCheck
 Bank Check (Must have the name of a US bank on the check)

 NOBLE PUBLISHING

2245 Dillard Street
Tucker, GA 30084 USA. TEL (404)908-2320
FAX (404)939-0157

RAPID, ACCURATE ELECTRONICS CAD

Schematic and PCB CAD

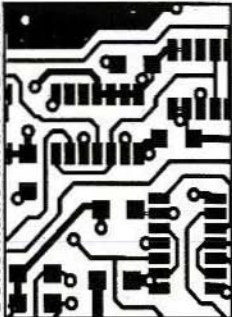

EASY-PC Professional

Electro-magnetic Simulation

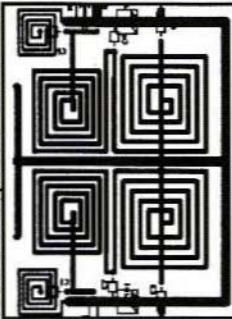

LAYAN

Smith Chart R.F. CAD

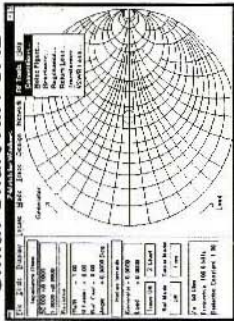

Z-MATCH

Filter Design

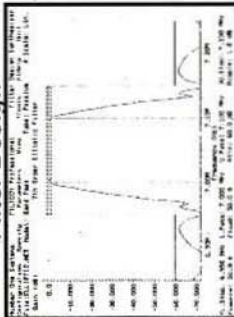

FILTECH

Logic Simulation

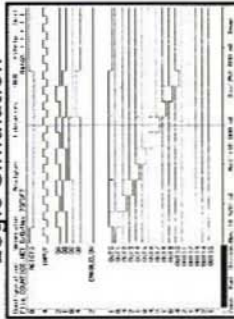

PULSAR

Analogue Simulation

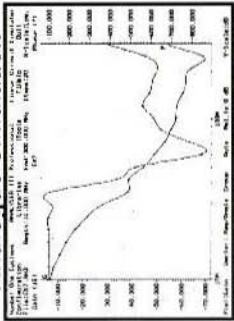

ANALYSER III

Number One Systems

Europe: Ref: VHFCOM, Harding Way, St.Ives,
Cambs, PE17 4WR, UK

USA:
Ref: VHFCOM, 126 Smith Creek Drive,
Los Gatos, CA 95030 USA

Tel: +44 (0) 1480 461778

Fax: +44 (0) 1480 494042

Tel/Fax: (408) 395-0249

From £98.00